



# R&D PROPOSAL FOR THE NATIONAL MUON ACCELERATOR PROGRAM

Revision 6d; August 23, 2010

## Abstract

This document contains a description of a multi-year national R&D program aimed at completing a Design Feasibility Study (DFS) for a Muon Collider and, with international participation, a Reference Design Report (RDR) for a muon-based Neutrino Factory. It also includes the supporting component development and experimental efforts that will inform the design studies and permit an initial down-selection of candidate technologies for the ionization cooling and acceleration systems. We intend to carry out this plan with participants from the host national laboratory (Fermilab), those from collaborating U.S. national laboratories (ANL, BNL, Jlab, LBNL, and SLAC), and those from a number of other U.S. laboratories, universities, and SBIR companies. The R&D program that we propose will provide the HEP community with detailed information on future facilities based on intense beams of muons—the Muon Collider and the Neutrino Factory. We believe that these facilities offer the promise of extraordinary physics capabilities. The Muon Collider presents a powerful option to explore the energy frontier and the Neutrino Factory gives the opportunity to perform the most sensitive neutrino oscillation experiments possible, while also opening expanded avenues for the study of new physics in the neutrino sector. The synergy between the two facilities presents the opportunity for an extremely broad physics program and a unique pathway in accelerator facilities. Our work will give clear answers to the questions of expected capabilities and performance of these muon-based facilities, and will provide defensible ranges for their cost. This information, together with the physics insights gained from the next-generation neutrino and LHC experiments, will allow the HEP community to make well-informed decisions regarding the optimal choice of new facilities. We believe that this work is a critical part of any broad strategic program in accelerator R&D and, as the P5 panel has recently indicated, is essential for the long-term health of high-energy physics.

Executive Summary.....	ii
Introduction.....	1
Present Status.....	3
Muon Collider DFS Plans.....	5
Accelerator Design and Simulations.....	6
Cost Estimation.....	25
Neutrino Factory RDR.....	25
Technology Development.....	34
RF Systems.....	34
Magnets.....	37
Summary of Technology R&D Goals.....	43
System Tests .....	43
MICE Experiment.....	44
Cooling Section Tests and Experiments.....	47
University, International, and SBIR Company Participation.....	49
Summary.....	50
References.....	51
Appendix 1: MAP Organization.....	A-1
Appendix 2: Funding Request.....	A-5
Appendix 3: Complementary Physics and Detector Studies.....	A-8

## Executive Summary

The physics program that could be pursued at a high-energy lepton collider has captured the imagination of the world high energy physics community. A lepton collider with sufficient energy and luminosity would facilitate:

- understanding the mechanism behind mass generation and electroweak symmetry breaking
- searching for, and perhaps discovering, supersymmetric particles and confirming their nature
- hunting for signs of extra space-time dimensions and quantum gravity.

Past studies have motivated lepton colliders with multi-TeV center-of-mass energies and luminosities of the order of  $10^{34} \text{ cm}^{-2}\text{s}^{-1}$ . Physics results obtained from CERN's Large Hadron Collider on the time scale of  $\sim 2014$  are expected to establish the desired energy for the next lepton collider and refine our knowledge of the required luminosity. The Particle Physics Project Prioritization Panel (P5) has recommended<sup>a</sup> “...R&D for alternative accelerator technologies, to permit an informed choice when the lepton collider energy is established.” At present, the alternatives for a multi-TeV collider are: *a*) a  $\mu^+\mu^-$  collider (MC); *b*) a normal-conducting rf  $e^+e^-$  linear accelerator (X-band NLC-type or two-beam CLIC-type); or *c*) a plasma wakefield  $e^+e^-$  linear accelerator driven either by lasers or by short electron bunches. Since muons—being much heavier particles than electrons—emit negligible synchrotron radiation, the MC promises superior attributes in a number of areas compared with either  $e^+e^-$  scheme. The absence of synchrotron radiation allows high-energy muon bunches to be stored in a compact collider ring, so a MC complex would fit conveniently on the site of an existing laboratory, e.g., Fermilab. Moreover, the radiation of particles in the collision of muon bunches (beamstrahlung) is orders of magnitude lower than in  $e^+e^-$  collisions, and hence the  $\mu^+\mu^-$  collisions would be more monochromatic. These attributes could well prove decisive in selecting the technology of the lepton collider to follow LHC.

To achieve the desired luminosity, a MC will need a muon source capable of delivering  $O(10^{21})$  muons per year within the acceptance of an accelerator. In addition to facilitating a MC, a muon source with this capability<sup>b</sup> would also enable a new type of neutrino facility in which muons decaying in a storage ring with long straight sections produce a neutrino beam with unique properties. It has been shown that the resulting Neutrino Factory (NF) would deliver unparalleled performance in studying neutrino mixing and provide tremendous sensitivity to new physics in the neutrino sector. Both the MC and NF require similar—perhaps identical—front ends, and hence much of their associated R&D is in common.

Muon Collider and Neutrino Factory R&D has been supported in the U.S. for more than a decade. The main R&D accomplishments include: *a*) the construction and successful completion of an international proof-of-principle MC/NF high-power target experiment

---

<sup>a</sup> See [http://www.science.doe.gov/hep/files/pdfs/P5\\_Report%2006022008.pdf](http://www.science.doe.gov/hep/files/pdfs/P5_Report%2006022008.pdf)

<sup>b</sup>Prospects for a MC and/or a NF in the U.S. have recently improved due to the possibility of launching Project-X at Fermilab, since the upgraded complex could ultimately serve as the required proton driver.

(MERIT); *b*) the launching of an international muon ionization cooling experiment (MICE); and *c*) a series of NF design and simulation studies that have progressively improved the performance and cost-effectiveness of the simulated NF design and prepared the way for a corresponding MC end-to-end design. Neutrino Factory R&D is now being pursued by an international community that has launched the “International Design Study of a Neutrino Factory (IDS-NF),” and aspires to deliver a Reference Design Report (NF-RDR) for a baseline design by 2013. The U.S. MC and NF R&D community is making key contributions to many aspects of the IDS-NF, with an emphasis on those common to both MC and NF designs. Since a MC requires a much more ambitious muon cooling scheme, MC R&D is less advanced. Present MC cooling channel designs employ components with assumed performance that, in some cases, has not yet been achieved.

The long-term MC development plan presented to P5 comprises three important steps toward bringing the high-energy physics frontier back to the U.S.: *i*) a study to demonstrate MC feasibility by 2014; *ii*) a subsequent program of muon beam demonstration experiments, component tests, and prototyping over the following 7–10 years; and *iii*) the start of MC construction in the early-to-mid 2020s. In parallel with this MC effort, the medium-term Neutrino Factory development plan presented to P5 comprises: *i*) completing the MICE experiment and participating in the IDS-NF to deliver a NF-RDR by 2013; and (assuming the community wishes to proceed) *ii*) pre-construction R&D for the next few years with an option to begin construction in the late 2010s. This document describes a proposal for a unified, national Muon Accelerator Program for the coming 7 years (2010–2016)—the first step in the plan presented to P5.

The main R&D deliverables of the national Muon Accelerator Program will be:

1. A Design Feasibility Study Report (DFSR) for a multi-TeV MC<sup>c</sup> including an end-to-end simulation of the MC accelerator complex using demonstrated, or likely soon-to-be-demonstrated, technologies, an indicative cost range, and an identification of further technology R&D that should be pursued to improve the performance and/or the cost effectiveness of the design.
2. Technology development and system tests that are needed to inform the MC-DFSR studies, and enable an initial down-selection of candidate technologies for the required ionization cooling and acceleration systems.
3. Contributions to the International Neutrino Factory Design Study (IDS-NF) to produce a Reference Design Report (RDR) for a NF by 2013. The emphasis of the proposed U.S. participation is on: *a*) design, simulation and cost estimates for those parts of the NF front-end that are (or could be) in common with a MC; *b*) studying how the evolving Fermilab proton source can be used for the Neutrino Factory RDR design; and *c*) studying how the resulting NF would fit on the Fermilab site.

---

<sup>c</sup> A companion physics and detector study that refines our understanding of the required performance and documents the associated physics reach will also be available at this time. This information will be developed during a complementary study coordinated with, but not part of, the MAP (see Appendix 3).

The high-level schedule for the MAP deliverables is summarized in the table below, based on two different assumptions for the funding profile—a “nominal” profile that reaches \$15M (FY10 dollars) per year and an “augmented” profile that reaches \$19M (FY10 dollars) per year in the out-years and would shorten the schedule by one year.

MAP deliverables.		
Deliverable	Nominal schedule	Augmented schedule
MC DFS		
Interim	FY14	—
Final + cost range	FY16	FY15
MICE hardware completion	FY13	
RF studies (down-select)	FY12	
IDS-NF RDR	FY14	
6D cooling definition	FY12	
6D cooling section component	FY16	FY15
bench test		
6D demonstration proposal	FY16	FY15

The present annual level of DOE support for all MC- and NF-related R&D in the U.S. is about \$10M. Thus, the requested funding (see tables below) for the R&D program proposed here corresponds to a 50% increase in annual funding for the “nominal” profile, or up to a 90% increase for an “augmented” program that would deliver the results in less time. With this increased support,<sup>d</sup> we expect to demonstrate feasibility of the MC based on a credible design, an end-to-end simulation of the full accelerator complex, and an initial cost range. We will also accomplish sufficient hardware R&D (rf, magnets, and cooling section prototyping) to guide, and give confidence in, our simulation studies.

Current-year (FY10, denoted as Y1) support for NF and MC R&D, and requested level of support for the “nominal” unified national R&D plan of the Muon Accelerator Program (see Appendix 2). Rows 2–4 give costs in FY10 dollars; totals including escalation (“then-year” dollars) are indicated in row 5.

	Y1	Y2	Y3	Y4	Y5	Y6	Y7
Effort (FTE)	31	40	44	48	47	49	47
SWF (\$M) <sup>a)</sup>	8.3	11.2	12.2	13.2	12.9	13.0	13.4
M&S (\$M) <sup>a)</sup>	2.0	4.2	3.3	2.3	2.6	2.5	1.5
Total (\$M) <sup>a)</sup>	10.3	15.4	15.5	15.5	15.5	15.5	14.9
Total (\$M) <sup>b)</sup>	10.3	16.1	16.9	17.5	18.2	19.0	19.0

<sup>a)</sup> FY10 dollars.

<sup>b)</sup> Then-year dollars, assuming 4% annual escalation.

<sup>d)</sup>The present level of support will only suffice to enable us to meet our existing commitments to the international R&D program, namely MICE and the IDS-NF, and to pursue a reduced-scope version of the rf R&D program described in our proposal.

Current-year (FY10, denoted as Y1) support for NF and MC R&D, and requested level of support for the “augmented” unified national R&D plan of the Muon Accelerator Program (see Appendix 2). Rows 2–4 give costs in FY10 dollars; totals including escalation (“then-year” dollars) are indicated in row 5.

	Y1	Y2	Y3	Y4	Y5	Y6
Effort (FTE)	31	40	51	58	61	64
SWF (\$M) <sup>a)</sup>	8.3	11.2	14.4	16.0	16.2	17.4
M&S (\$M) <sup>a)</sup>	2.0	4.2	3.5	3.2	3.3	2.0
Total (\$M) <sup>a)</sup>	10.3	15.4	17.9	19.2	19.5	19.4
Total (\$M) <sup>b)</sup>	10.3	16.1	19.5	21.7	22.9	23.7

<sup>a)</sup> FY10 dollars.

<sup>b)</sup> Then-year dollars, assuming 4% annual escalation.

The program is foreseen to comprise participants from the host U.S. laboratory (FNAL), from a number of other U.S. laboratories (ANL, BNL, Jlab, LBNL, SLAC), from universities and from SBIR companies.<sup>e</sup> Significant international collaboration with the UK, and with other countries, to understand, develop and exploit the accelerator science and technology of muon accelerators is also anticipated. Support is envisioned to come from the DOE-OHEP budget, with small additional contributions from the DOE SBIR/STTR and university grants. Our plan also assumes continued NSF support for MICE and certain other muon-related R&D activities.

By ~2014 we expect that new physics results from the LHC and from the next generation of neutrino experiments (Double Chooz, Daya Bay, T2K, and NOvA) will be available. These will provide the worldwide HEP community with the knowledge it needs to identify which types of facilities are best suited to fully exploit the exciting new physics opportunities that will undoubtedly arise. In particular, we expect that the physics cases for both a multi-TeV lepton collider and a Neutrino Factory will be more fully understood in this time frame. Our proposed work will give clear answers to the questions of expected capabilities and performance of muon-based facilities, and will provide defensible ranges for their cost. This information will allow the HEP community to make well-informed decisions regarding the optimal choice of new facilities. We believe that this work is an absolutely critical part of any broad strategic program in accelerator R&D and, as the P5 panel has recently indicated, is essential for the long-term health of high-energy physics.

The MAP proposal is organized along three separate, but interrelated, lines:

1. Design and Simulations
2. Technology Development
3. System Tests

<sup>e</sup> The organization created to carry out the MAP is described in Appendix 1.

In each area, we identify the key questions to address and estimate the resources needed. Given limited resources and limited time to accomplish our work, *our choice of topics is based on their importance to understanding the critical issues most relevant to the technical feasibility and cost of future muon-based facilities*. A brief overview of the required tasks is presented here to guide the readers through the proposal that follows.

For the Design and Simulations program, we require a self-consistent end-to-end scheme to produce a high luminosity, multi-TeV collider. A portion of what is needed is already available through previous and ongoing efforts for a NF design under IDS-NF auspices, much of which is, in turn, based on earlier NFMCC feasibility studies. The MAP work focuses on bringing the design and simulations of the MC-specific subsystems to the same level of technical maturity. Most challenging in this regard are the 6D cooling, the final 4D cooling to low emittance, the high-energy portions of the acceleration chain, and, of course, the collider ring itself. Because the designs we arrive at provide the performance specifications for technical components (magnets, rf systems, absorbers) and provide parts counts, this work must be integrated—and iterated—with the findings of the Technology Development and System Tests efforts.

Beam cooling of short-lived muons requires high rf gradients from cavities immersed in strong magnetic fields, which has proven to be difficult. To help with this issue, we are carrying out simulations of the rf breakdown process to guide the Technology Development group in ways to avoid, or at least ameliorate, the loss in gradient. In addition, we are evaluating the performance of possible alternative rf approaches as input to the eventual selection of the most favorable one. Once the Technology Development group has identified the most favorable technical option via the down-selection process described in the proposal, our simulation effort will focus on that approach. The final cooling system requires very high field solenoids; we are presently simulating channels based on solenoids in the 40–50 T range. Guidance from the Technology Development group on what is a realistic upper limit to the field of the final cooling solenoids will permit us to evaluate the collider luminosity. Finally, we need to develop a proton source scenario that builds upon the Project X design to best leverage existing facilities at Fermilab.

As already mentioned, in terms of Technology Development, the most critical issue to address—one discovered as a consequence of our earlier R&D efforts—is that of the degradation in maximum rf gradient experienced by cavities immersed in a strong axial magnetic field. Because of its strong influence on the cooling channel design, this issue has been given our highest priority. As a consequence, we are testing several different options in parallel, including surface preparation techniques, alternative cavity materials, cavities designed such that the magnetic field lines are parallel to the cavity wall surfaces (“magnetic insulation”), cavities filled with high-pressure hydrogen gas, and Atomic Layer Deposition (ALD) coating techniques, with the goal of choosing (via our specified down-selection criteria) the best approach by the end of FY2012. In this effort, we make extensive use of our Fermilab test facility, the MuCool Test Area (MTA). Another high-priority task is to investigate the limits on fabricating very high-field solenoids for the final cooling channel. Up to about 40–50 T, the ultimate luminosity of the collider scales

with the field in these magnets, so there is a premium in going to the highest practical field. Fabrication of specialized magnets for a helical cooling channel, already under study, may become more critical if the gas-filled rf cavity becomes the preferred option. Finally, the mid-plane heat load in the collider ring due to the decay electrons from the muon beam poses thermal and radiation challenges for a collider. We are examining two approaches, one using magnet coils with an open mid-plane section, and the other a more conventional design with a room-temperature inner shield.

In the System Test area, our primary ongoing task is to provide additional hardware for the MICE experiment. Operating MICE and demonstrating the muon cooling process in 4D will go a long way toward a proof-of-concept for the ionization cooling technique. Vetting the simulation tools used to describe the process will permit the Design and Simulations group to proceed with confidence toward more optimized subsystem designs. Finally, the System Test group will evaluate the need for a full 6D cooling channel test. Because of its cost and complexity, we envision an initial phase where a candidate 6D cooling system unit is bench tested to make sure the components function together according to specifications. This test will also provide confirmation that the rf cavities will perform as expected in a realistic magnetic field configuration, and will enable us to identify any other critical engineering issues that might affect cooling channel performance. We will subsequently assess the need for a beam test and, if needed, will begin preparations toward such a test by writing a proposal for an experiment.

Details on all of these tasks are provided in the proposal itself, in Sections 3–6.





## 1. INTRODUCTION

The physics potential of a high-energy lepton collider has captured the imagination of the world high energy physics community. Understanding the mechanism behind mass generation and electroweak symmetry breaking, searching for and perhaps discovering supersymmetric particles and confirming their nature, and hunting for signs of extra space-time dimensions and quantum gravity constitute some of the major physics goals of a new lepton collider. In addition, making precision measurements of standard model processes will open windows on physics at energy scales beyond our direct reach. The unexpected is our fondest hope. The Muon Collider (MC) provides a possible approach to a multi-TeV lepton collider, and hence a way to explore new territory beyond the reach of present colliders. In addition, the Neutrino Factory (NF) has been shown [1] to deliver unparalleled performance in studying neutrino mixing and has tremendous sensitivity to new physics in the neutrino sector.

We request support to continue muon accelerator R&D at an enhanced level, sufficient to enable us to deliver, within 6–7 years, (a) a Muon Collider Design Feasibility Study Report (MC-DFSR), (b) a NF Reference Design Report (NF-RDR), and (c) results from component development and proof-of-principle demonstrations sufficient to inform the design choices associated with the MC-DFSR and NF-RDR studies. The organization to carry out this R&D program, the national Muon Accelerator Program (MAP) is described in Appendix 1. The M&S and SWF support needed to conduct our proposed R&D program and the associated funding profile are presented in Appendix 2. We provide two possible funding profiles, a nominal profile with a peak funding request of  $\sim$ \$15M/yr (FY10 dollars) that will require 7 years to carry out the proposed R&D and an augmented program with peak funding of  $\sim$ \$19M/yr (FY10 dollars) that could be completed one year earlier.

Muon Collider [2,3,4,5] and Neutrino Factory [6,7,8,9,10,11,12] accelerator complexes are shown schematically in Fig. 1. At the front-end, both the NF and MC require similar, perhaps identical, intense muon sources, and hence there is significant overlap in NF and MC R&D. The muon source is designed to deliver  $O(10^{21})$  low energy muons per year within the acceptance of an accelerator, and consists of (i) a multi-MW proton source delivering a multi-GeV proton beam onto a pion production target, (ii) a high-field target solenoid that radially confines the secondary charged pions, (iii) a long solenoidal channel in which the pions decay to produce positive and negative muons, (iv) a system of rf cavities that capture the muons in bunches and reduce their energy spread (phase rotation), and (v) a muon ionization cooling channel that reduces the transverse phase space occupied by the beam by a factor of a few in each transverse direction. At this point the beam will fit within the acceptance of an accelerator for a NF. However, to obtain sufficient luminosity, a MC requires further muon cooling. In particular, the 6D phase-space must be reduced by  $O(10^6)$ , which requires a longer and more ambitious cooling channel. Finally, in both NF and MC schemes, after the cooling channel the muons are accelerated to the desired energy and injected into a storage ring. In a NF the ring has

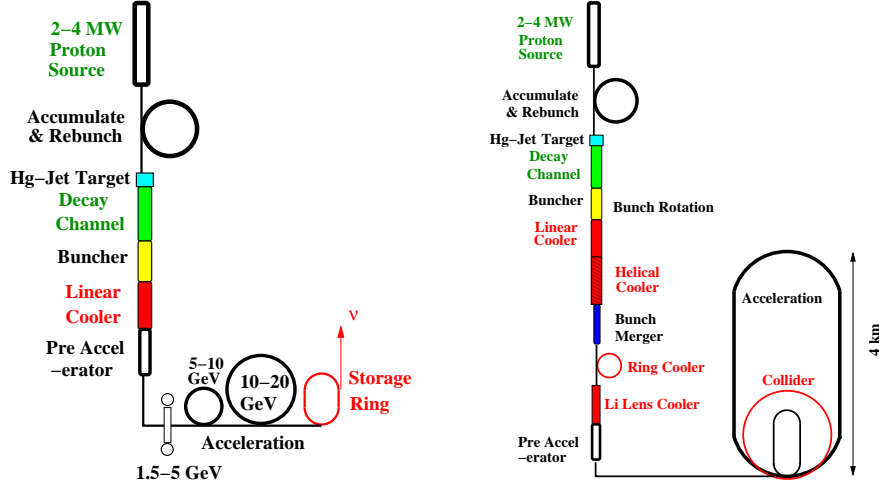

Fig. 1. (left) Schematic of 20 GeV NF; (right) schematic of 1.5 TeV MC.

long straight sections in which the neutrino beam is formed by the decaying muons. In a MC, positive and negative muons are injected in opposite directions and collide for about 1000 turns before the muons decay.

The Neutrino Factory and Muon Collider Collaboration (NFMCC [13]) has been pursuing muon accelerator R&D since 1996. The initial work on the overall Muon Collider concept resulted in the “Muon Collider Feasibility Study Report” in June 1996 [4]. The Neutrino Factory concept emerged in 1997 [6]. Since 1997 the NFMCC has pursued both NF and MC design and simulation studies [5,7,10,11], together with component development and proof-of-principle demonstration experiments. In late 2006, the Muon Collider R&D effort was complemented by the addition of the Muon Collider Task Force (MCTF [14]) centered at Fermilab, but including participation from some NFMCC institutions and from the SBIR funded company Muons, Inc. [15]. The MCTF produced an initial R&D plan [16] in 2006, and a report [17] summarizing the first year of activities in January 2008. The focus of the MCTF studies has been on exploring designs and technologies for the 6D muon cooling channel needed (beyond the NF front-end) for a MC, and the design of the MC ring.

In recent years, the NFMCC and MCTF programs have been coordinated by the Muon Collider Coordinating Committee, which comprises the leadership of the two groups. Both muon accelerator R&D programs (NFMCC and MCTF) have been reviewed annually by the Muon Technical Advisory Committee (MUTAC), which reports to the Muon Collaboration Oversight Group (MCOG). To date, MCOG has included members from the directorates of the three NFMCC sponsoring laboratories (BNL, FNAL, and LBNL). Given the status of the R&D, following the 2008 MUTAC review, both MUTAC and MCOG encouraged [18] the NFMCC and MCTF to produce a joint R&D plan aimed at delivering a Muon Collider DFSR, together with an appropriate contribution to the IDS-NF effort to produce an RDR. The resulting joint R&D plan was submitted to the DOE in December 2008. In response, the DOE requested that the NFMCC and MCTF organizations be merged into a new national organization, MAP.

The MAP organization is shown in Appendix 1. We anticipate that MCOG membership will be expanded to include representatives from the other participating national laboratories along with one or more university representatives. Fermilab has been charged with the task of serving as host laboratory for MAP. The Fermilab director has designated interim Co-Directors for MAP, and an interim organization has been put in place to plan and manage the initial execution of the R&D. DOE-OHEP has requested that the MAP organization submit an updated R&D proposal that takes into account organizational and funding guidance. This document is the resulting updated proposal for the MAP R&D in the coming 6–7 years.

The need for an enhanced muon accelerator R&D activity recommended by MUTAC and MCOG has been reinforced by the HEPAP P5 report (May 2008) : “...besides ILC, other lepton collider options with the potential for greater energy reach and reduced cost need to be developed. ...Additional R&D is also needed on longer-term concepts including the muon collider and laser- and plasma-based linear colliders. Each has potential for greater energy reach and significant cost savings, but all still require feasibility demonstrations...

*Recommendations :*

*The panel recommends a broad strategic program in accelerator R&D, including work on ILC technologies, superconducting rf, high-gradient normal-conducting accelerators, neutrino factories and muon colliders, plasma and laser acceleration, and other enabling technologies, along with support of basic accelerator science.”*

The Report also emphasizes that : “...a muon collider may be an effective means to reach multi-TeV energies. A muon collider would be free of the beam effects that can limit an  $e^+e^-$  collider at very high energies and would have the potential for highly efficient conversion of site power to useful collision energy. Using muons instead of electrons also has the advantage that recirculating linacs could use the accelerating structures multiple times to provide energy to both particle beams simultaneously. The challenge for a muon collider is to produce, collect, cool and accelerate enough muons to provide the luminosity required to study new phenomena in detail. Recent studies using a jet of mercury in a strong magnetic field have demonstrated that such a target is capable of surviving a four-megawatt proton beam. This first step toward providing muons is very encouraging. The next step is the demonstration of cooling using a combination of ionization energy loss and dispersion in a low-energy, low-frequency, acceleration system. Support for R&D for this program has been very limited. Demonstrating its feasibility or understanding its limitations will require a higher level of support.”

## **2. PRESENT STATUS**

We believe that NF R&D is now ready for an international effort to produce an RDR by 2013, and MC R&D is ready for a concerted effort to produce a DFSR on a 2014–2016 timescale.

The Neutrino Factory design studies that have prepared the way for an RDR include (i) Feasibility Study 1 [7,8], which was hosted by FNAL in 1999 and resulted in an end-to-end design and simulation for a NF together with a first cost estimate, (ii) Feasibility Study 2 [10], which was hosted by BNL in 2001 and resulted in an improved design that increased the performance of the NF to meet the requirements established by the earlier physics study [8], (iii) Feasibility Study 2a [11,12], which, based on work in the period 2002–2005, updated the Study 2 design to improve its cost effectiveness, reducing the estimated cost by about one-third while maintaining performance, (iv) the International Scoping Study (ISS) [1,19,20], which was an international NF study hosted by RAL in 2006 that established a baseline design (similar to the Study 2a design). Following the internationalization of NF R&D and the successful outcome of the ISS, the International Design Study of a Neutrino Factory (IDS-NF) is now under way. Participants of the IDS-NF [21] aspire to deliver a NF RDR by 2013.

In addition to the design and simulation studies, the NFMCC has pursued component development and proof-of-principle experiments that inform the design studies and establish the viability of the proposed accelerator subsystems. NF Feasibility Studies 1 and 2 identified the systems requiring critical hardware R&D as:

1. a target that can be operated within a high-field solenoid with a 4 MW primary proton beam, and
2. an ionization cooling channel in which rf cavities operate along with energy absorbers within a lattice of multi-Tesla solenoids.

The proof-of-principle MERcury Intense Target (MERIT) experiment [22], designed and constructed by the NFMCC with its international partners, ran successfully at CERN at the end of 2007. MERIT has established the viability of using a liquid-mercury jet injected into a high field solenoid with a 4 MW proton beam suitable for a NF and/or MC. The Muon Ionization Cooling Experiment (MICE) [23] is an international multi-phase proof-of-principle experiment that is hosted by RAL. The MICE muon beam line is commissioned and operating, and the cooling channel components have been designed and are under construction. MICE is expected to embark on Step VI in 2013.

Complementing the MICE cooling channel demonstration, the NFMCC MuCool program has been developing and testing cooling channel components. In particular, a good understanding of the performance of rf cavities operating within multi-Tesla solenoidal fields is critical if we are to have confidence in the design of muon ionization cooling channels. MuCool measurements [24] have shown that normal conducting rf (NCRF) copper vacuum cavities break down at lower gradients in multi-Tesla magnetic fields. The measurements also indicate that surface preparation is important, and that, although not yet tested with beam, the breakdown effect may be mitigated by using high-pressure gas within the cavity. In addition, new ideas for “magnetically insulated” cavities and for using advanced surface treatments (i.e., atomic layer deposition, ALD) are promising. An important part of our proposed MAP technology development plan is to vigorously pursue the rf R&D program to establish the viable options for high-gradient NCRF operating within magnetic lattices, and to measure the associated operational parameters.

Complementing the NFMCC studies, the MCTF has made progress in the design and simulation of a multi-TeV MC<sup>1</sup> and this work will be continued under the MAP. In particular,

- a novel Interaction Region (IR) optics scheme has been proposed that allows significantly larger energy spread in the colliding beams than previously considered possible;
- muon beam dynamics in ILC-type 1.3 GHz superconducting rf cavities has been numerically studied;
- detailed modeling and particle tracking have been initiated for the three most promising ionization cooling channel approaches—the Helical Cooling Channel (HCC), the “Guggenheim” channel, and the “FOFO Snake” channel composed of tilted superconducting solenoids.

In addition, the MCTF group has designed and installed a 400 MeV proton beam line from the FNAL linac to the MuCool Test Area (MTA). That beam line, which is currently completed and being commissioned, will enable a series of new experiments with high intensity beams in the MTA hall. Altogether, this progress has led to a vision of Fermilab’s long-term future in which the Muon Collider becomes the next U.S.-based energy frontier facility. As a first step in developing this vision, an effort has begun to explore the upgrade parameters of the Fermilab “Project X” facility, which is an appropriate candidate for a high-intensity proton source for the MC and/or NF complex.

Anticipating success of the MICE and NCRF R&D programs, by 2013–2014 the proof-of-principle tests for a NF front-end will be complete. In parallel, we propose to pursue within the MAP the basic hardware R&D needed to inform the technical choices that must be made in designing a MC 6D cooling channel. This, together with a vigorous design and simulation activity, will enable a MC DFSR along with an initial cost range. Hence, depending on funding level, by the end of 2015 or 2016 we will have both a NF RDR and a MC DFSR.

### **3. MUON COLLIDER DFS PLAN**

The MAP R&D plan is detailed in Sections 3–6. High-level deliverables are summarized in Table 1. These guide the plans and timelines for the activities covered in this proposal.

---

<sup>1</sup> To date, most of the design work has focused on a collider having 1.5 TeV center-of-mass energy, though we expect to examine a 3–4 TeV collider to compare in terms of technical issues, cost, and layout. The final choice of collider energy will likely not be settled until the LHC has completed its initial survey of the TeV energy regime, but by then we will have enough information to accommodate any energy in the 1–4 TeV range.

Table 1. MAP high-level deliverables.

Deliverable	Nominal schedule	Augmented schedule
MC DFS		
Interim	FY14	—
Final + cost range	FY16	FY15
MICE hardware completion	FY13	
RF studies (down-select)	FY12	
IDS-NF RDR	FY14	
6D cooling definition	FY12	
6D cooling section component bench test	FY16	FY15
6D demonstration proposal	FY16	FY15

### 3.1. Accelerator Design and Simulations

#### 3.1.1 *Overview*

A major focus of NFMCC-MCTF activities has been the design and simulation of the accelerator subsystems required by a multi-TeV MC; the MAP will continue that emphasis. In this section, we describe the accelerator design and simulation tasks that must be accomplished in order to complete a Muon Collider DFSR by 2014–2016.

The possibility of building a Muon Collider was first seriously considered by Budker, Skrinsky and their colleagues at Novosibirsk around 1970 [25]. Practical methods for implementing such a collider were studied by the U.S. Muon Collaboration<sup>2</sup> in the late 1990s [4,5]. The recent burst of activity in collider design studies was spurred by the creation of the MCTF at Fermilab in 2006 [26].

At the current time there are two overall scenarios for the MC accelerator systems that are under active investigation. These involve different choices for the desired collider parameters and for the design of the accelerator subsystems. These scenarios have come to be identified by their requirements for the transverse emittance in the collider ring as the low (LEMC) and high (HEMC) emittance MC. Main parameters for these scenarios are listed in Table 2.

There are a number of reasons why multiple designs are being considered. Muons have well-known features that complicate the accelerator design. Foremost among these are their short lifetime and their diffuse production in pion decay. As a result, muon beams are generated with emittances and energy spreads that are enormous by conventional accelerator standards. Some of the differences in the collider scenarios reflect different assessments of the optimal choice of collider parameters, for example the number of muons per bunch or the pulse repetition rate. An important goal of the R&D program outlined here is to characterize both the performance and relative cost of the various alternatives in order to select the most promising one for further exploration and

<sup>2</sup> This is the original name for what later became the NFMCC.

Table 2. Example parameters for a 1.5 TeV (c.m.) muon collider [26].

	LEMC	HEMC
Avg. luminosity ( $10^{34} \text{ cm}^{-2} \text{ s}^{-1}$ )	2.7	1
Avg. bending field (T)	10	8
Proton driver repetition rate (Hz)	65	15
$\beta^*$ (cm)	0.5	1
Muons per bunch ( $10^{11}$ )	1	20
Muon bunches in collider (each sign)	10	1
Norm. Transv. Emittance ( $\mu\text{m}$ )	2.1	25
Norm. Long. Emittance (m)	0.35	0.07
Energy spread (%)	1	0.1

optimization. Note that the various NF feasibility studies have provided the muon accelerator R&D community with experience in the process of exploring several options for various subsystems, then down-selecting to a single choice for each, and finally conducting an end-to-end study of the chosen configuration. We have modeled our down-selection plan, described in Section 3.1.4, on this experience.

### 3.1.2 Goals

As already noted, one of the major goals of the current R&D program is to choose among the accelerator alternatives and select a single initial collider configuration by 2013 (see Table 3). To accomplish this, we anticipate the following steps:

- (i) Develop an initial end-to-end design for a multi-TeV MC that is based on demonstrated technologies and/or technologies that can be demonstrated after a specified R&D program. Identify and document the key R&D tasks.
- (ii) By means of preliminary end-to-end simulations (including beam-beam simulations to give luminosity estimates), demonstrate that the design will meet the required machine performance parameters. The subsystems simulated will be based on sufficient engineering input to ensure that the assumed design includes a reasonable level of realism (i.e., realistic gradients, magnetic fields, alignment tolerances, safety windows, spatial constraints, etc.). Simulations will cover proton driver, target, and all downstream systems up to and including the collider ring; beam transfers between systems will be included as part of the simulation.
- (iii) Document the initial machine configuration, including required technologies, description of subsystems, performance estimates (luminosity, cooling performance, backgrounds), and, if possible, fabrication and installation approaches (sufficient for initial costing purposes).

Table 3. Design and Simulation task milestones and deliverables.

Date	Milestone	Designation	Deliverables <sup>a)</sup>
FY10	Specify target initial configuration	DS10.1	MR, DR
FY11	Specify front end initial configuration	DS11.1	MR, DR
	Specify NF $\mu$ acceleration initial configuration	DS11.2	MR, DR
FY12	Specify collider ring initial configuration	DS12.1	ER, DR
	Specify initial cooling configuration	DS12.2	MR, DR
FY13	Specify proton driver initial configuration	DS13.1	ER, DR
	Specify MC $\mu$ acceleration initial configuration	DS13.2	MR, DR
FY14	Finish D&S portion of Interim MC DFS report	DS14.1	FR
	Finish IDS-NF RDR report	DS14.2	FR
FY15	Provide specifications & parts count for costing	DS15.1	DR
FY16	Provide description of remaining MC R&D items	DS16.1	DR
	Finish D&S portion of Final MC DFS report	DS16.2	FR

<sup>a)</sup>DR: design report (MAP technical note); ER: external review; FR: formal report; MR: MAP (internal) review

### 3.1.3 Milestones and Deliverables

Design and simulation milestones and deliverables based on the overall MAP R&D plan (see Table 1) are shown in Table 3. The estimated amount of effort required for these tasks is included in Appendix 2.

### 3.1.4 Configuration Control

For many of the subsystems that comprise a Muon Collider, there is more than one technical implementation that might be acceptable. Given limited resources, we must, to the extent possible, restrict the options being considered without precluding the possibility that better ideas will be developed later. The concept we utilize is to identify for most subsystems an “initial design configuration,” along with a formal procedure for modifying the initial option as new information becomes available.

Because there remain initial configuration choices to be made in several areas, most notably the choice of rf technology and the choice of 6D cooling technology, we have already taken care to specify a procedure to follow in order to converge on an initial configuration for these areas. Responsibility for ensuring that this is done rests with the management group comprising the Program Director and Level 1 task leaders. In brief, the steps will include:

1. In consultation with the management group, the cognizant Level 1 leader will define a set of technical criteria against which to judge the alternative approaches.
2. After formal approval by the Program Director, these criteria will be made available to the proponents of the approaches under consideration and posted for all MAP participants to see.



3. At a time compatible with the milestones in Table 1, the Program Director will appoint an internal review group to evaluate the alternatives against the agreed-upon criteria and make a recommendation.
4. The Program Director will make the final decision on which approach to accept.
5. Such decisions will be communicated formally to MCOG. At MCOG's option, the decision can be reviewed by an external review committee, either MUTAC or an *ad hoc* group selected for this task.

The above procedure will subsequently be used to formalize the baseline design for the MC that will be described in the DFS report.

To aid the reader, in Table 4 we provide a brief summary of the present choices for an initial MC design configuration. As can be seen, the choice of 6D cooling configuration has not yet been made. Mainly, this decision awaits clarification on the choice of rf technology for this portion of the facility. Experiments planned over the next several years should clarify the options and permit a choice to be made using the procedure outlined in this section.

### 3.1.5 Proton driver design activities

Our plan for the proton driver is to design facilities that will use beam from the Project X complex being proposed for Fermilab [27]. We assume here that a reference design for the baseline version of Project X will be prepared independently of our effort. Thus, we consider here only the additional effort needed to determine the modifications that must be made and the facilities that must be added to accommodate the requirements of a Muon Collider and/or a Neutrino Factory.<sup>3</sup>

Table 4. Initial MC design configuration choices.

Subsystem	Initial configuration
Proton driver	Enhanced Project X (4 MW)
Target	Liquid-Hg jet
Decay and capture	FS2 solenoid channel
Bunching and phase rotation	Neuffer 12-bunch channel
Linear 4D cooling channel	FS2a channel
Initial 6D cooling	tbd
Bunch merging	tbd
Final 6D cooling	tbd
Final 4D cooling	~50 T linear channel
Low-energy acceleration	IDS-NF scheme (linac+RLAs+FFAG)
High-energy acceleration	Fast-cycling synchrotrons
Collider ring	2.5 km quadrupole-first HEMC lattice

<sup>3</sup> It is our explicit intention to produce a flexible design for a proton complex that can meet the needs of whatever MC and/or NF designs may emerge from the activities described in this plan. Accordingly, proton facilities for both MC and NF will be discussed in this section.

The MC and NF as presently conceived share common design concepts for the so-called front-end facilities just downstream of the pion production target, where the collection and decay of the pions and the capture of muons into bunches occur. These designs impose identical requirements on the rms length of the proton bunches ( $\sim 1\text{--}3$  ns). The pion/muon collection scheme depends upon the specified short proton bunch lengths, so that requirement is not likely to be relaxed.

Recent MC and NF designs also impose similar requirements on proton beam power ( $\sim 4$  MW). In particular, the two MC parameter sets and the ISS NF design all call for about this power level. The required beam power is unlikely to be a strong function of the center-of-mass energy of an energy-frontier MC. Of course, if the MC parameter sets turn out to be somewhat optimistic, the ability to upgrade beyond 4 MW would be a desirable feature of the proton facilities.

The baseline parameters for Project X currently call for a proton beam power of about 1 MW at an energy of a few GeV. Thus, the intensity capability of Project X must be enhanced to deliver 4 MW for the muon facilities considered here. The Project X baseline design will attempt to preserve the possibility of increasing the power delivered (as an upgrade path). As mentioned above, aiming for an even higher beam power than 4 MW would seem prudent. In cooperation with the Project X design team, we will explore upgrade options beyond the baseline parameters for the complex.

There is considerable variation among the designs in the rate of delivery of proton bunches to the target ( $\sim 10\text{--}100$  per second for the MC and  $150\text{--}250$  per second for the IDS baseline NF in bursts of three or five bunches from a basic 50-Hz cycle). It is obvious that the requirements on beam power, bunch length, and repetition rate, taken together, imply bunch intensities and peak bunch currents that will be difficult to achieve. Meeting those requirements, while also providing flexibility in the number and pattern of bunches per second delivered to the production target, is the major design challenge for the proton complex. We envision that two storage rings, an accumulator and a compressor, will be needed to provide the required flexibility.

In the following subsections, the major proposed subsystems downstream of the linac will be described briefly. The first step in the design effort for each subsystem will be to develop first-order design concepts: major parameters, layouts, beam optics designs and lattices, apertures and acceptances, rf requirements, and so forth. The next step will be to evaluate intensity-dependent effects such as space charge, electron cloud, and coherent instabilities via analytic calculations and computer simulations. Undoubtedly, the third step will be to develop strategies to mitigate intensity-dependent effects, iterating if necessary on the designs. Finally, tracking studies including realistic errors will be carried out.

Accumulator. The first storage ring will accumulate many turns of linac beam via charge-stripping of the  $H^-$  beam. The incoming beam from the linac will be chopped to allow clean injection into pre-existing rf buckets to form the desired number of bunches.

Painting will be necessary in the 4D transverse phase space and possibly also in longitudinal phase space. Very large transverse emittances must be prepared in order to control space-charge forces.

Compressor. The second storage ring will be used to accept one or more bunches at a time from the Accumulator. Then, a  $90^\circ$  bunch rotation in longitudinal phase space will be performed to shorten the bunches just prior to extraction. Of course, during this operation, the momentum spread will become large, of order 5%, so the ring must have a large momentum acceptance. Also, the space-charge tune shift will be large when the beam is short.

The existing 8-GeV Fermilab Accumulator and Debuncher rings in the Antiproton Source are high-quality storage rings having the right energy and roughly the right circumferences. Furthermore, their apertures are large. They are, however, in a shallow tunnel, which probably obviates using them in their current location. Nonetheless, they might serve the purposes described here if they were relocated to a deeper tunnel.

Combiner. The combiner is a set of transfer lines and kickers downstream of the rings that can allow more than one bunch to arrive simultaneously at the pion production target. The first major subsystem, the “trombone,” sends bunches on paths of different lengths. The second subsystem, the “funnel,” nestles the bunches side-by-side on convergent paths to the pion production target. The schematic diagram in Fig. 2 illustrates the concept.

### 3.1.6 Target design activities

Much of the design work for the target facility was done as part of NF Studies 1 [7] and 2 [10] and remains valid. These studies were for a free Hg jet injected into a high-field solenoid, and included the conceptual design of the target and solenoid systems, the shielding, and the remote handling system, along with radiation studies to estimate the survival time of the solenoid in such a high-radiation environment. Following the successful proof-of-principle demonstration of a Hg-jet target system by the MERIT experiment [28], this approach was adopted as the initial design configuration for the MC

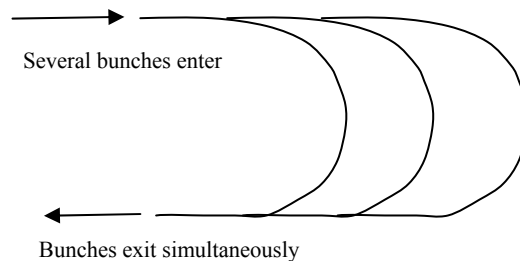

Fig. 2. A possible combiner concept to increase the intensity of proton bunches on the production target.

target system. The next steps in developing the target design are to study further the physics issues associated with the Hg-jet target and the detailed facility design issues. The second topic is covered in Section 4.3.

Simulations. In the next few years we will need to continue benchmarking the results of the MERIT experiment against detailed simulations of what was expected. Understanding the production rates, the disruption of the jet, and the magnetic field effects will be the key areas of concentration. This work will also need to be extended to the configuration anticipated for an actual NF or MC, which differs somewhat from the setup used in MERIT for logistical reasons. Simulation studies of nozzle performance will be carried out.

One aspect of the target system not covered in the MERIT experiment is that of interaction of the Hg jet and/or the proton beam with the Hg pool that serves as the beam dump. The target is about two interaction lengths long, such that about 10% of the beam power (i.e., 400 kW) will be deposited in the target system 1–2 m downstream of the target. Further, secondaries from the interaction will deposit energy around the target. The superconducting solenoids of the capture system must be protected and the heat load must be managed. These are significant issues that must be addressed by a program of magneto-hydrodynamic simulations. Another aspect of the Hg target system we intend to consider is defining and evaluating the efficacy of (and the need for) schemes to distill the mercury to reduce its radiation levels.

### 3.1.7 *Front end and cooling design activities*

Much of the current effort on the collider design is devoted to the “front end” subsystems downstream of the target. These start with a pion decay channel. A bunching and phase rotation channel then captures the daughter muons into a bunch train and reduces the energy spread of the bunches. The last part of the low-energy portion of the facility comprises an ionization cooling channel to reduce the emittance of the muon beam. The cooling starts with a pre-cooler to reduce the transverse emittance. Positive and negative muons are then typically separated and sent through dispersive 6D cooling lattices to simultaneously reduce the transverse and longitudinal emittances.

The two collider scenarios we are presently investigating differ mainly in the details of how the cooling is carried out. The HEMC scenario uses a large-pitch helical channel known as the “Guggenheim” to do the 6D cooling.<sup>4</sup> After sufficient longitudinal cooling, the beams are recombined and sent through a final cooling channel containing 50-T HTS solenoids that reduces the normalized transverse emittance to the level required by the collider. The LEMC scenario emphasizes additional cooling and a reduced number of muons per bunch. It uses a tighter-pitch helical cooling channel for 6D cooling and

---

<sup>4</sup> Another possible implementation for the initial cooling configuration is the so-called “FOFO snake,” which offers the potential advantage of avoiding the need to separate and recombine the two muon charges. As the initial configuration for this portion of the facility is not yet settled, the procedure outlined in Section 3.1.4 will ultimately be employed to designate an initial design configuration.

Parametric-Resonance Ionization Cooling (PIC) and Reverse Emittance Exchange (REMEX) for the final cooling. The muon bunch trains are recombined at higher energy.

Decay, bunching, and phase rotation. The front end captures the pions produced at the target, allows them to decay into muons, bunches the muon beam and reduces its energy spread. Two new alternatives need to be compared with Study 2a—the Neuffer 12-bunch scheme and the LEMC approach using high-pressure hydrogen-gas-filled rf cavities. The former scheme is suitable for either a NF or a MC, and has been designated as the initial design configuration for this portion of the facility. To assess its performance, and ultimately its cost, it must be studied under more realistic assumptions that correspond to a practical implementation. There are several steps needed for this:

- replace continuous magnetic fields with an actual coil geometry
- use “families” of rf cavity frequencies rather than continuously decreasing frequencies where each cavity is different
- include absorbers and rf windows in the simulation
- examine an alternative magnetic lattice having partially bucked fields to reduce the field on the rf cavities
- check the sensitivity to errors (rf gradient and phase; magnet strength, magnet alignment) of the final configuration

Precooling. A first stage of transverse cooling is useful before separating the muon charges and sending the muon beams into the 6D cooling channels. Two main alternatives are being studied as a possible replacement for the Study 2a cooling channel, which is our initial design configuration. These are:

- a Study 2a channel with hydrogen gas absorbers in place of (or in addition to<sup>5</sup>) the LiH rf windows
- a LEMC configuration<sup>6</sup>, which uses liquid hydrogen and no rf in a momentum-dependent helical cooling channel

6D cooling. The bulk of the muon cooling is done in the 6D cooling channels. As mentioned earlier, there are several 6D cooling schemes being considered for the collider; the initial design configuration will be selected during FY12. Additional subsystems for charge separation and charge recombination are required, and low-energy bunch merging may also be needed. The schemes under active consideration [29] include the Guggenheim channel, the helical cooling channel (HCC), and the FOFO-snake channel.

Each of the schemes under consideration has its advantages and challenges. The Guggenheim is based on high-gradient vacuum rf cavities with performance specifications similar to those for the pre-cooling section, about 15 MV/m at 201 MHz.<sup>7</sup> The need for magnetic shielding between “turns” is a complication to be resolved. Magnetic field effects on the rf cavities could be eliminated, or at least mitigated, with a

---

<sup>5</sup> This option is referred to as a “hybrid” channel.

<sup>6</sup> Our SBIR partner, Muons, Inc., is studying this design.

<sup>7</sup> This channel could also adopt a hybrid scheme with gas-filled rf cavities if that option proves advantageous.

shielded lattice having little or no magnetic field at the rf cavity locations. While changing the cooling lattice to achieve this is conceptually straightforward, it remains to be ascertained whether such an implementation gives adequate performance in terms of cooling and transmission. Magnetically insulated cavities that make use of a cavity shape and coil geometry such that the field is everywhere parallel to the cavity surface are an option being examined. The required cavity shapes are quite unusual, and it is unclear whether a cavity with a reasonable shunt impedance can be designed. For the HCC, there are two rf-related issues. First, we need to verify that high-pressure gas-filled cavities can work when subjected to an intense beam of ionizing radiation. Second, we need to develop a mechanical and thermal solution in a very constrained geometry. Progress on the second issue is being made, based on the concept of a dielectric-loaded cavity [30].

Because of the issues that remain to be resolved, we anticipate the need for several more years of R&D before determining an initial design configuration in this area. Although making this choice will not be easy, our colleagues have made such difficult choices in all of our past feasibility studies, and we are confident we will be able to reach closure in a time consistent with the milestone listed in Table 3.

Below, we detail the Guggenheim channel as an example design to illustrate the issues under consideration. Its components, rf cavities, solenoids, and absorbers, are similar—perhaps identical—to those being fabricated for the MICE experiment (see Section 6.2). The Guggenheim channel has been under study for a number of years, though work remains to be done. Code must be developed and comparisons must be made between alternative ways of modeling the fields in ICOOL, either using 3D field maps or a multipole expansion.

The design of the Guggenheim channel is based closely on that of the RFOFO cooling ring [31]. This ring used 12 cooling cells, each 2.75 m long. Each cell contained a wedge-shaped liquid-hydrogen absorber to provide the ionization energy loss and six 201-MHz rf cavities to restore the longitudinal component of the momentum. A pair of 2.8 T alternating polarity solenoids surrounding the rf cavities provided the necessary transverse focusing. A dipole field for bending the  $\sim 200$  MeV/c muons and for introducing dispersion was provided by tipping the axis of the solenoids by about 50 mrad. The value of the beta function at the hydrogen absorbers was 40 cm and the value of the dispersion function was 8 cm. The combination of the dispersion and the wedge shape of the absorber provided the necessary emittance exchange to reduce the longitudinal emittance of the beam. Simulations that included Al windows on the absorber and Be windows on the pillbox rf cavities showed that the number of muons in a fixed transverse and longitudinal acceptance was increased by a factor  $\sim 5$  after 15 turns in the ring.

Unfortunately, it was clear that using such a ring for doing 6D cooling presented a number of practical problems:

1. It is very difficult to design kickers to inject a large emittance muon beam into the ring and then extract it.

2. Multiple passes of the intense muon bunches would cause severe heating problems in the liquid-hydrogen absorbers.
3. It is not possible to “taper”<sup>8</sup> the channel parameters for optimal cooling as the emittance is reduced.

All of these problems can be avoided by transforming the ring geometry into the single-pass Guggenheim helix shown in Fig. 3. In particular, the Guggenheim topology lends itself to performance improvements resulting from adjusting the lattice parameters along the channel.

The benefits of such a “tapered” channel must be assessed. To do so, matching sections must be designed and realistic parameters for absorbers and windows must be determined and then used in the simulations. Preliminary simulations [32] using lattices of this type have shown that the muon emittance could be reduced from the values presented by a NF front end to those required to start a MC final cooling channel by using five Guggenheim sections. The evolution of the 6D emittance and transmission for an initial Gaussian bunch in one of these sections is shown in Fig. 4. Most of the initial loss of particles is due to scraping of the Gaussian tails and would be improved by designing a proper matching section.

We have found that a useful way of characterizing cooling channel performance is to use the variable  $Q(s)$ :

$$Q(s) = \frac{\frac{1}{\mathcal{E}_{6,n}} \left( \frac{d\mathcal{E}_{6,n}}{ds} \right)}{\frac{1}{N_\mu} \left( \frac{dN_\mu}{ds} \right)}.$$

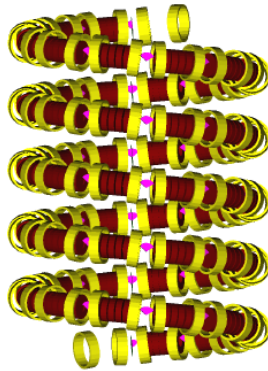

Fig. 3. Layout of the 201 MHz Guggenheim channel. The helical pitch between layers of the structure was chosen to be 3 m.

---

<sup>8</sup> By “tapering” we refer to changes in lattice parameters along the cooling section that reduce the equilibrium emittance of the downstream portions compared with the early part of the channel. This enables the beam emittance always to remain well above the equilibrium emittance—a condition that results in optimal cooling efficiency. Such an approach, used to advantage in Study 2, is only possible in a single-pass channel.

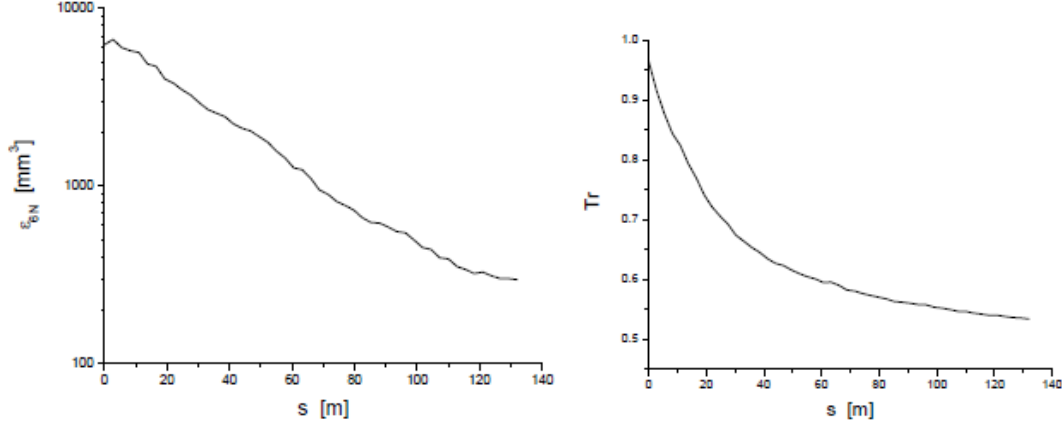

Fig. 4. Transmission and 6D emittance as a function of distance for a 201-MHz Guggenheim channel.

This quantity compares the local reduction in 6D emittance to the reduction in the number of particles. Simply reducing the emittance by throwing out particles would produce  $Q \sim 1$ , while efficient cooling produces a much larger value. The variation of  $Q(s)$  for the example described here is shown in Fig. 5. The low values of  $Q$  at small  $s$  are due to beam losses from scraping the tails from the initial Gaussian distribution. The fall-off of  $Q$  at large  $s$  is due to the fact that the emittance in the channel is approaching its equilibrium value. The peak value  $\sim 15$  shows the true cooling efficiency of a properly designed Guggenheim channel.

Obtaining the required reduction in 6D cooling with minimal muon losses will be one of the central challenges for building a high-luminosity MC. For the Guggenheim cooling concept we believe this can be done by replacing the five separate channels in the preliminary design with two *tapered* channels. The lattice parameters and rf frequencies would be modified to correspond to the reduced emittance in the channel. In that way, we believe that the  $Q$ -factor could be maintained at a high value throughout the channel. One tapered channel would encompass the 201-MHz and 402-MHz channels that preceded bunch merging in the preliminary design. The second channel would replace the 201-, 402-, and 805-MHz channels after bunch merging. Realistic parameters for the absorbers and rf windows must be used in these simulations.

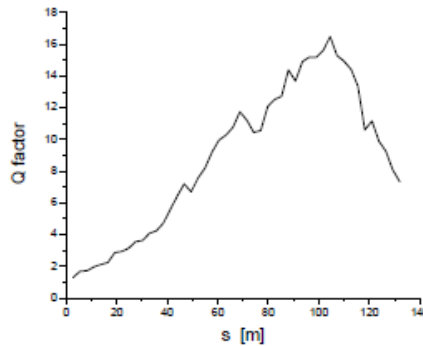

Fig. 5. Variation of local  $Q$  factor for the 201 MHz Guggenheim channel.



Performance will be checked using our two independent simulation codes, ICOOL and G4beamline. If magnetic shielding is needed between “turns” in the lattice, its effect must be evaluated. Also, an evaluation of a configuration with magnetically insulated and/or gas-filled cavities will be made. To make sure collective effects are benign, we will model space-charge effects at the end of the channel. Finally, an exploration of error sensitivity will be carried out.

The Helical Cooling Channel (HCC), another approach to 6D muon cooling, is also under active investigation under SBIR-STTR grants to Muons, Inc. [15] and its national laboratory and university partners. The initial cooling would be done in an HCC comprising solenoidal, helical dipole, and helical quadrupole magnetic fields superimposed on high-pressure hydrogen-gas-filled rf cavities. G4beamline [33] simulations of this HCC have indicated almost six orders of magnitude cooling in a 300-m-long channel, with 40% beam loss (including decays) [34], in agreement with theoretical predictions [35]. The implementation of such a channel with embedded rf cavities is challenging, but progress is being made. HCC component development now under way includes:

- a helical solenoid solution to the HCC field requirements [36];
- Nb-Ti magnets for the initial HCC helical solenoid section [37];
- YBCO magnets for the final (and most demanding) helical solenoid section [38];
- phase- and frequency-locked magnetrons [39]; and
- pressurized rf cavities [40]

The last item will undergo beam tests in the MTA at Fermilab during 2010.

Another potentially attractive option, the helical FOFO-snake channel, consists of a series of tilted solenoids oriented azimuthally in a helical manner around a straight path [41]. It has the great advantage<sup>9</sup> that both muon charges can be cooled in the same channel. There are several possible implementations of this design to study, including a gas-filled cavity version, a vacuum cavity version, and a magnetically insulated version. The other activities required to assess this approach are the same as those for the other cooling channel options, namely, studies of matching sections, space-charge effects, and error sensitivity.

The HEMC scenario combines each muon bunch train produced in the decay and phase rotation section into a single bunch in the collider partway through the 6D cooling section. Therefore, various alternatives for low-energy bunch merging must be explored, including the use of planar wigglers and helical wigglers. A lattice based on magnetically insulated and/or gas-filled cavities will also be examined. All comparisons will consider error sensitivity.

Final cooling. One of the most challenging goals in the collider design is to get a final normalized transverse emittance on the order of 2–25  $\mu\text{m-rad}$ . The strategy used in the

---

<sup>9</sup> Other helical cooling channels (HCC and Guggenheim) can only transmit muons of a given charge. In these scenarios, the muons must first be separated and then recombined after the 6D cooling is finished. Various approaches, including dipole splitters and bent solenoid versions, must be designed and compared.

cooling channel design is to end the 6D cooling section when the longitudinal emittance is well below the value needed by the collider. Then, either “brute force” transverse cooling or reverse emittance exchange can be used to obtain the required transverse emittance.

Our initial design configuration is based on a 50-T channel that uses a straight lattice of very high field HTS solenoids to do the final cooling [42]. Development of this channel requires an optimization of the lattice parameters for various assumed maximum values of the solenoid strength. Lattices must also be matched on both ends and these sections need to be designed and simulated. Collective effects, especially space charge, will be examined, as will magnetically insulated cavities. Finally, the design will be subjected to an error sensitivity study to validate its performance.

Three alternative approaches are also being considered for the final stage of cooling. Muons, Inc. is studying an extension of the HCC concept based on having two superimposed helical magnet periods and beryllium wedge absorbers to produce a very low emittance beam. This channel would provide another two orders of magnitude in 4D cooling by means of Epicyclic Parametric-Resonance Ionization Cooling (EPIC) [43] and would permit exchange of longitudinal and transverse emittances (so-called Reverse Emittance Exchange, or REMEX [44]) to provide more optimal collider luminosity. There remains much work to be done. Matching sections between the HCC and the rest of the front end need to be designed and simulated. Overall optimization of the entire system must be carried out. Here too, we will model space-charge effects at the end of the channel to make sure collective effects are benign, and we will explore error sensitivity. As this system is pressurized with  $H_2$  gas, a structural analysis of the isolation windows and a detailed safety analysis are called for.

A second alternative for final cooling uses a solenoid lattice operating in a parameter regime where the minimum of the beta function lies at the center of the focusing solenoids. This configuration can produce very small beta functions and naturally allows the addition of bucking coils to minimize the magnetic field present at the rf cavities. We will design and simulate cooling in a straight lattice, and investigate alternative designs that incorporate dispersion. We will also design the required matching sections, and look at space-charge effects and the effects of errors.

Lastly, the idea of using a lithium lens channel for the final cooling has been considered since the first MC designs. This is currently being studied by both the UCLA and Fermilab groups. A straight cooling lattice incorporating lithium lenses must be designed and simulated. Designs for the necessary matching sections must be developed. Space-charge effects and the effects of errors need to be investigated.

In the LEMC scenario, all cooling is done on a muon bunch train. This train is accelerated to high energy before being merged to a single bunch. The bunch recombination ring must be designed and simulated [45]. Injection and extraction systems and transfer lines must be designed and simulated, as must the rf gymnastics to accomplish the bunch merging. Finally, the sensitivity to errors must be examined.

End-to-end simulation. We do not plan to pursue studies of all of the cooling channel options to a deep level. As soon as at least one attractive option for rf operating in a magnetic field has been established, the initial design configuration for the MC-DFS cooling channel will be selected, and we will then focus on that configuration for detailed studies. At this stage, we will be ready to carry out an end-to-end simulation of the whole front end of the collider. This will require that we join all the initial subsystem configurations into a single model in ICOOL as well as in G4beamline. Then we will make high statistics runs through the full channel. The results from ICOOL and G4beamline will be compared and any discrepancies resolved. We will study the sensitivity of the results to the physics models used in the simulations. We will also study the sensitivity of the performance to the hardware parameters. Muon polarization that is produced in the channel will be assessed, since that may have an impact on the physics produced by the collider. The effects of space charge will be studied at critical locations using a dedicated space-charge code.

Code development. The codes ICOOL [46] and G4beamline [33] are the major tools for designing the front-end and cooling systems. We will continue to maintain and make minor improvements in these codes. More major changes in the codes will be made as necessary to investigate the performance of the subsystems discussed previously.

RF system. Presently, the major uncertainties in the front-end and cooling system designs are the breakdown characteristics of normal conducting rf cavities in strong magnetic fields, and the possibility of beam-induced breakdown of gas-filled rf cavities. We plan to study both of these subjects experimentally (see Section 5.2.1), although definitive results may not be available until 2012. Prior to specifying an initial rf design configuration, we will investigate methods to interpret the experimental results and propose ways to ameliorate problems if they do occur. To understand the experimental results we need to simulate beam breakdown in gas-filled cavities and develop a model of breakdown in vacuum cavities. Understanding breakdown may require detailed space-charge simulations. To mitigate the possible effects, we are investigating:

- the application of SCRF processing techniques to copper cavities
- using atomic layer deposition or Be walls to prevent cavity breakdown
- designing bucked coil lattices that minimize magnetic fields on the cavities
- designing a magnetically insulated cavity where  $\vec{B}$  is perpendicular to  $\vec{E}$ .

### 3.1.8 Acceleration design activities

After cooling, the muon acceleration systems must increase the muon kinetic energy from 140 MeV to, say, 750 GeV at the collider.

Low-energy acceleration. The low-energy portion of the acceleration chain (possibly up to 50–100 GeV) could be accomplished with techniques similar to those in a Neutrino Factory (and perhaps even using the systems from an existing NF). To design this portion of the MC facility we will

- study to what extent the NF acceleration system is suitable for the MC
- make any necessary modifications to the NF acceleration scenario
- include additional similar stages to the NF acceleration scenario where that would be advantageous

Acceleration to high energy. A choice must be made regarding the scenario for acceleration. As noted above, we assume, as a starting point, a beam accelerated by some variant of the acceleration scenario for a NF, possibly with an additional stage or stages added. The power in the final muon beam is substantial, and thus the efficiency of the acceleration system is an important consideration.

The advantage of a synchrotron for acceleration is that it allows a large number of passes through the rf cavities, reducing both the capital and operating costs of the machine. For this reason, we choose this approach for our initial design configuration. The challenge is that this acceleration approach requires rapid variation of the magnetic fields [47]. A short ramping time requires magnets with very thin laminations in order to manage eddy currents. Such “synchrotron” designs are often a variant of a true synchrotron design, in the sense that the fields do not increase uniformly with momentum. A mixture of fixed-field superconducting and ramped normal-conducting magnets has been suggested. It must be verified that the rapid changes in the conventional magnets do not induce quenches in the adjacent superconducting devices. It may be necessary to modify the way the magnets ramp to ensure that the beam remains synchronized with the rf. Studying this acceleration scenario will include:

- producing complete lattice designs that accelerate to the desired final energy
- performing engineering studies on the magnets to determine their feasibility and cost (see Section 5.4)
- studying the requirements for the rf systems

A recirculating linear accelerator (RLA) is potentially a straightforward option for accelerating to high energies [48]. Its primary disadvantage is the practical limitation on the number of passes the beam can make through the linac due to the complexity of the switchyard. The study of this acceleration scenario will involve:

- creating lattices that will accelerate to the final energy, including the spreader and recombiner sections
- studying the requirements for the rf systems

Although it is likely to be a “cost driver” for the facility, acceleration for a MC has had only limited study to date. In addition to the two scenarios described above, a number of alternative scenarios could be considered. One is to combine the above two options, creating an RLA that uses fast-ramping magnets, allowing for a greater number of passes. Using FFAGs, as has been proposed for a NF, is another possibility. This choice is potentially advantageous, since FFAGs generally become more efficient at higher energy.

Simulation studies will be used to indicate which alternative has the potential to be most cost effective.

Transfer line designs. The MC acceleration system requires transfer lines between acceleration stages and between the final acceleration stage and the collider ring. These transfer lines will each be designed to optimize the phase-space distribution for injection into the next system in the chain.

Single-particle simulations. The beam must be tracked through the entire acceleration system, from cooling up to the collider ring. It is likely that some code development will be needed to achieve this.

Collective effects. Because the intensity of a coalesced bunch for the collider will be quite high, collective effects constitute a potential operational limitation. There are several such effects to consider, and these must be simulated to assess their impact on performance.

Although the muon beam spends only a short time in the accelerator complex, its individual bunches have a substantial charge, and impedance-driven collective effects are likely to be important. For acceleration, the major contribution to the impedance will be the rf cavities. For the MC parameter regime, the charge in a single bunch is large enough to extract a substantial fraction of the stored energy from one of these cavities. As this is a nonstandard operating regime, we must study its beam dynamics implications. We will study the effect of short-range wakes, probably the most important effect, as well as long-range wakes.<sup>10</sup>

We will also consider the effects of having both signs of muons in the various acceleration stages simultaneously, as most acceleration scenarios envisage this. The bunches will thus collide parasitically many times during acceleration. The large bunch charge means that the crossings could substantially perturb the beam, so the importance of this must be quantified.

There is often a question of whether two-stream instabilities (electron cloud, fast-ion) are important in these machines. They are not expected to be so, due primarily to the large amount of time between bunch passages (since there are only a small number of bunches), but this must be verified.

### 3.1.9 Collider ring design activities

The final part of the MC facility is the collider ring, where the muon beams collide at low-beta interaction points. The proper design of this ring is a prerequisite for the success of the whole project. The design of the interaction region is strongly tied to the design of the detector. Close collaboration between the accelerator and detector groups will be necessary to achieve an acceptable outcome. Responsibility for this task in the MAP rests

---

<sup>10</sup> These will primarily concern fundamental-mode beam loading, but could be affected by cavity higher-order modes as well, so both aspects need investigation.

with the Machine-Detector Interface (MDI) group. There are currently several ring designs under consideration. Two of these assume high normalized transverse emittance ( $\sim 25 \mu\text{m-rad}$ ) in the collider [49]. They differ in the location of the closest dipole to the interaction point (IP) and the arrangement of the sextupole families. The quadrupole-first variant gives the better dynamic aperture and is our choice for initial design configuration. A ring design for the LEMC scenario based on a low normalized transverse emittance of  $\sim 2 \mu\text{m-rad}$  will also be needed if its corresponding cooling channel design emerges as a leading candidate for the initial design configuration.

Compared with most collider rings, the Muon Collider has some challenges, but also some simplifications. The detector background from muon decay is clearly a dominant issue and complicates both the IR design and that of the detector. On the other hand, the fact that the muons survive for only  $\sim 1000$  turns means that the beam dynamics is rather forgiving in many respects. A dynamic aperture of only  $3-4\sigma$  will suffice to store the beam for this number of turns. Thus, within reason, magnet imperfections, chromatic effects, and beam-beam effects will have relatively little impact on performance.

The goal of our efforts is to develop a lattice design that provides:

- parameters necessary to achieve the design peak luminosity specified by MC physics studies (presently taken as  $\sim 1 \times 10^{34} \text{ cm}^{-2}\text{s}^{-1}$  at  $0.75+0.75 \text{ TeV}$ ), including
  - $\beta^* < 1 \text{ cm}$  in the case of 2 IPs
  - low momentum compaction,  $|\alpha_c| < 1 \times 10^{-4}$ , in order to obtain an rms bunch length below  $1 \text{ cm}$  (i.e.,  $\sigma_\ell < \beta^* < 1 \text{ cm}$ ) with moderate rf voltage
  - small circumference  $C \sim 3 \text{ km}$  (since luminosity scales as  $1/C$ )
- momentum acceptance ( $0.5-1\%$ ) and dynamic aperture sufficient to accommodate a muon beam with the emittance expected from the upstream channel
- reasonable tolerances on field strength, field quality, and alignment errors
- stability of coherent motion of bunches containing up to  $1-2 \times 10^{12}$  muons
- compatibility with the detector and with protecting the magnets from secondary particles

Work on collider lattices must go hand-in-hand with the magnet, superconducting rf, and detector studies. It includes the steps indicated below:

Analysis of basic solutions. We need to carry out basic lattice design studies of the interaction region (IR), taking into account the constraints due to quadrupole gradients and practical magnet apertures. We need to examine various chromatic correction schemes, such as special correction sections versus local correction within the IR. We need to study the trade-offs of using FODO cells versus achromats for the arcs. We will also examine the performance trade-offs of having one versus two IRs.

Lattice composition and matching. Complete ring lattices need to be designed including special matching sections, injection, collimation, and beam abort.

Design of chromaticity and nonlinear detuning correction circuits. The chromaticity needs to be studied in higher order and the design of the correction schemes needs to be optimized.

Dynamic aperture. The muon beams must circulate in the collider ring for  $\sim 1000$  turns. Tracking studies will be made, taking into account the effects of magnet imperfections (strength, field quality, and alignment errors) and beam-beam interactions.

Simulation of secondary particle fluxes and detector backgrounds. Placing dipoles and quadrupoles near the IR has a significant effect on the backgrounds in the detector. Conversely, the design of the detector constrains the location and size of the IR magnets. In order to find a mutually acceptable solution, we will iterate on the IR and detector designs.

RF system. We need to design, analyze, and simulate the rf system. We will optimize the design of the accelerating structure, including a higher-order-mode (HOM) analysis. We will then perform wakefield and impedance simulations to evaluate the requirements for HOM damping and/or feedback systems.

Auxiliary systems. We will develop detailed scenarios for closed-orbit correction and explore other tuning algorithms suitable for these short-lived beams. We will examine the suitability for muon beams of the injection, beam abort, and collimation systems. We will also assess the efficacy of various beam instrumentation devices in the harsh collider environment.

Coherent effects. We need to calculate the impedance budget and do a stability analysis of the coherent motion of the muon beams.

Present status. The IR layout and optics functions for the latest design are shown in Fig. 6. A distinctive feature of this design is a three-sextupole local chromaticity correction scheme. Dipoles (shown as orange rectangles in Fig. 6) are placed immediately after the final-focus doublet and generate a sufficiently large dispersion function at the location of the sextupole nearest to the IP to compensate the vertical chromaticity (see bottom plot in Fig. 6). Horizontal chromaticity is compensated next, with a sextupole pair separated by a  $-I$  transformation block. Momentum acceptance achieved with this design is  $\pm 1.2\%$ . Figure 7 shows the momentum dependence of the tunes (top) and the momentum compaction factor (bottom). The results of tracking for 1024 turns in the ideal lattice are presented in Fig. 8. The dynamic aperture is  $4.7\sigma$  for a normalized emittance  $\epsilon_{\perp N} = 25 \mu\text{m}$ . In the presence of errors it will certainly be smaller. The basic parameters of the “three-sextupoles” MC lattice design are summarized in Table 5.

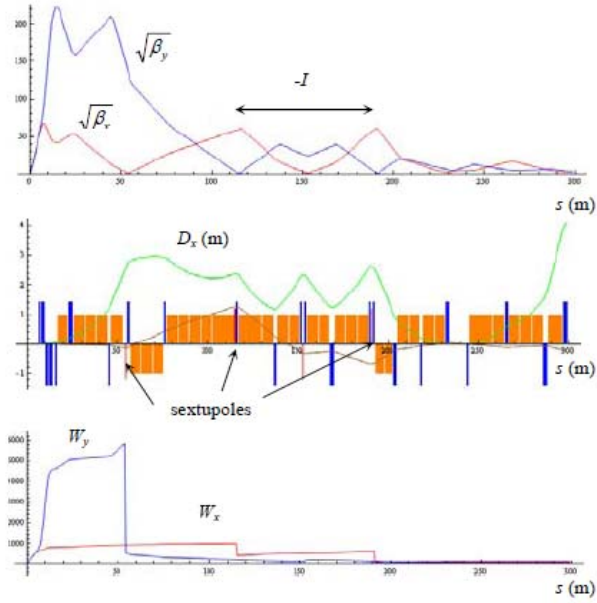

Fig. 6. (top) MC interaction region optical functions; (middle) magnet layout and dispersion function; (bottom) chromatic functions.

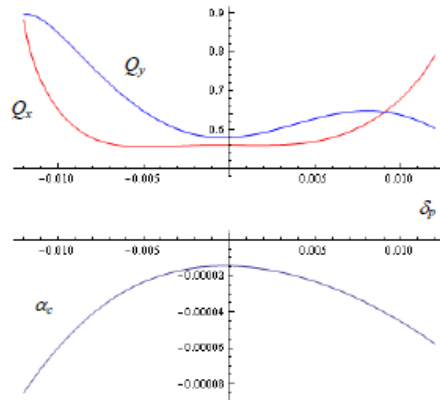

Fig. 7. Fractional tunes (top) and momentum compaction factor (bottom) vs. momentum deviation.

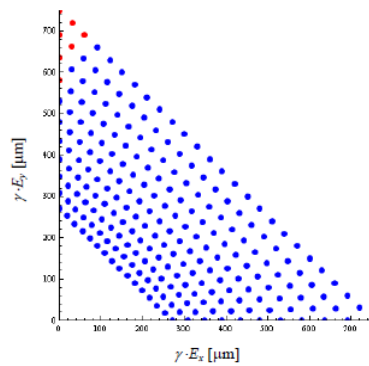

Fig. 8. Survival plot for 1024 turns. Initial conditions for lost particles are shown in red.



Table 5. Main parameters of current MC lattice.

Parameter	Value
Beam energy (TeV)	0.75
Max. dipole field (T)	10
No. of IPs	2
Circumference (km)	2.5
$\beta^*$ (cm)	1
$\beta_{\max}$ (km)	48.9
Betatron tunes, $x/y$	18.56/16.58
Momentum compaction $\alpha_c$	$-1.45 \cdot 10^{-5}$
Momentum acceptance	$\pm 1.2\%$
DA for $\varepsilon_{\perp N} = 25 \mu\text{m}$	$4.7\sigma$

### 3.2 Cost Estimation

One of the required tasks in preparing for the MC DFSR is to obtain an initial cost range for the facility. At the stage of development reached by 2015–2016, it is expected that the cost model will use a “component-level” approach as opposed to a more detailed “bottom-up” approach. As the first step in this process, a Work Breakdown Structure (WBS) must be set up. Table 6 shows a preliminary WBS scheme that will be used to begin the design and cost-estimating process.

To assess the resources required to obtain the cost estimate we make several assumptions:

- The WBS will be organized by accelerator system, as indicated in Table 6
- The cost exercise will primarily occur in 2016 (or 2015 in the augmented schedule), after the machine design is frozen
- There will be 1–2 engineers “consulting” part time throughout the design effort

The estimated engineering effort level is summarized in Table 7. The total effort required is approximately 9 FTE integrated over the period from 2010–2016.

## 4. NEUTRINO FACTORY RDR PLAN

The Neutrino Factory facility study is at a much more advanced stage than that for the Muon Collider. To date there have been four studies of the Neutrino Factory: Study 1 [7] (sponsored by FNAL), Study 2 [10] (sponsored by BNL), Study 2a [11] (organized as part of the APS Neutrino Physics Study) and the International Scoping Study (ISS) [19] (sponsored by CCLRC<sup>11</sup> in the UK). Among the strengths of the ISS were an integrated,

<sup>11</sup> CCLRC has now been merged into a new UK funding organization, the Science and Technology Facilities Council (STFC).

Table 6. Initial MC WBS scheme.

WBS	Title	WBS	Title
1	Muon Collider Accelerator Complex		
1.1	Proton Driver	1.4	Acceleration System
1.1.1	Ion Source	1.4.1	Linac
1.1.2	Beam Transport	1.4.2	RLAs
1.1.2.1	LEBT	1.4.3	Final Acceleration
1.1.2.2	MEBT	1.4.4	Ring Injection Line
1.1.2.3	Linac to Accumulator		
1.1.2.4	Accumulator to Compressor	1.5	Collider Ring
1.1.2.5	Compressor to Target	1.5.1	Magnets
1.1.3	Linac	1.5.2	Vacuum
1.1.3.1	Cryomodules	1.5.3	Instrumentation
1.1.3.2	RF source		
1.1.3.3	Instrumentation	1.6	RF Systems
1.1.4	Rings	1.6.1	NCRF
1.1.4.1	Accumulator	1.6.2	SCRf
1.1.4.2	Compressor	1.6.3	Power Source
1.2	Target Station	1.7	Control System
1.2.1	Hg jet system		
1.2.2	Capture and Decay Channel	1.8	Conventional Facilities
		1.8.1	Tunnels
1.3	Front End	1.8.2	Above-ground Support Buildings
1.3.1	Bunching		
1.3.2	Phase Rotation	1.9	Project Management
1.3.3	Initial Cooling Section		
1.3.4	6D Cooling Section		
1.3.5	6D to 4D Matching Section		
1.3.6	Final Transverse Cooling		
1.3.7	Matching to Linac		

Table 7. Engineering effort required to support the MC DFSR costing activity. Ongoing contributions will be involved in the project for 7 years with the nominal profile; the remaining persons are assumed to participate only during Y7, to provide a cost estimate for the collider facility.

Specialty	FTE	Ongoing?	Total (FTE-yr)
Sr. Mech. Eng.	0.2	Y	1.4
Sr. Electr. Eng.	0.2	Y	1.4
Proj. Eng.	1.0	N	1.0
Vacuum Eng.	0.5	N	0.5
PS and Diagnostics Eng.	0.5	N	0.5
Plant Eng.	1.5	N	1.5
RF Eng.	1.0	N	1.0
Cryogenics Eng.	0.5	N	0.5
Controls Eng.	0.5	N	0.5
Magnet Eng.	0.5	N	0.5
Survey and Alignment Eng.	0.2	N	0.2
ES&H specialist	0.2	N	<u>0.2</u>
<b>TOTAL</b>			<b>9.2</b>

international collaboration and an integrated approach to the study of the accelerator complex, the neutrino detectors, and the physics performance of the facility. These elements are being continued in the International Design Study for the Neutrino Factory (IDS-NF), which brings together the various national and regional Neutrino Factory design teams. The IDS-NF will develop the NF into a realistic option for the field, continuing the energetic R&D program and delivering a Reference Design Report in a 2013 time frame.

The primary goals of the IDS-NF are to:

- deliver a Reference Design Report (RDR) for the NF accelerator complex and its neutrino detectors in 2013
- estimate the cost of the facility at the +50–75% uncertainty level
- identify possible staging scenarios, including the possibility of a low-energy NF (4–5 GeV)
- consider possible sites for the accelerator complex and neutrino detectors, taking into account, where appropriate, the existence of suitable infrastructure

Specifications for the accelerator systems developed by the Accelerator Working Group of the ISS are described in [19]. A schematic of the ISS baseline is shown in Fig. 9 and the main parameters of the various subsystems are defined in Table 8. The baseline specification for the stored muon energy is 25 GeV and the facility will deliver a total of  $10^{21}$  useful muon decays per year. The baseline specification for the storage rings is that both signs of muon can be stored simultaneously.

The detector for the NF is optimized for the search for leptonic CP violation, the determination of the mass hierarchy, and the measurement of  $\theta_{13}$  through the detection of the “golden channel” ( $\nu_e \rightarrow \nu_\mu$ ). In order to accomplish this, two detectors located at different baselines are employed. A detector with a fiducial mass of 50 kton is located at an intermediate baseline (3000–5000 km) and a second detector of fiducial mass 50 kton is located at a long baseline (7000–8000 km). The longer baseline presents some challenging underground engineering issues for the muon storage ring that points in this direction. These issues will be discussed below.

The U.S. will contribute to the IDS-NF in the following areas:

- Proton driver
- Targetry and target stations
- Pion capture and muon phase rotation
- Ionization cooling
- Accelerator systems
- Site-specific (FNAL) underground engineering issues for the muon storage rings
- Overall coordination of effort for the low-energy NF option

The first four items are expected to be identical (or very similar) to the corresponding

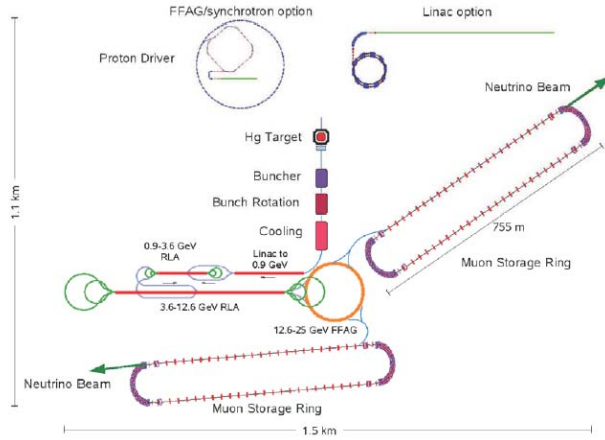

Fig. 9. Diagram of the IDS-NF baseline NF configuration.

Table 8. Baseline parameters for the subsystems that make up the NF accelerator complex. The principal interface parameters are shown in bold face.

Baseline specification for the Neutrino Factory accelerator complex			Version
Sub-system	Parameter	Value	2007/1.0
Proton driver	Average beam power (MW)	4	
	Pulse repetition frequency (Hz)	50	
	Proton kinetic energy (GeV)	$10 \pm 5$	
	Proton rms bunch length (ns)	$2 \pm 1$	
	Number of proton bunches per pulse	3	
	Sequential extraction delay ( $\mu$ s)	$\geq 17$	
	Pulse duration, liquid-Hg target ( $\mu$ s)	$\leq 40$	
Target: liquid-mercury jet	Jet diameter (cm)	1	
	Jet velocity (m/s)	20	
	Solenoidal field at interaction point (T)	20	
Pion collection <i>Tapered solenoidal channel</i>	Length (m)	12	
	Field at target (T)	20	
	Diameter at target (cm)	15	
	Field at exit (T)	1.75	
	Diameter at exit (cm)	50	
Decay channel	Length (m)	100	
Adiabatic buncher	Length (m)	50	
Phase rotator	Length (m)	50	
	Energy spread at exit (%)	10.5	
Ionisation cooling channel	Length (m)	80	
	RF frequency (MHz)	201.25	
	Absorber material	LiH	
	Absorber thickness (cm)	1	
	Input emittance (mm rad)	17	
	Output emittance (mm rad)	7.4	
	Central momentum (MeV/c)	220	
	Solenoidal focussing field (T)	2.8	
Acceleration system	Total energy at input (MeV)	244	
	Total energy at end of acceleration (GeV)	25	
	Input transverse acceptance (mm rad)	30	
	Input longitudinal acceptance (mm rad)	150	
	Final total energy (GeV)	0.9	
	Final total energy (GeV)	3.8	
	Final total energy (GeV)	12.8	
Final total energy (GeV)	25		
Decay rings	Ring type	Race track	
	Straight-section length (m)	600.2	
	Race-track circumference (m)	1,608.80	
	Number of rings (number of baselines)	2	
	Stored muon energy (total energy, GeV)	25	
	Beam divergence in production straight ( $\gamma^{-1}$ )	0.1	
	Bunch spacing (ns)	$\geq 100$	
	Number of $\mu^{\pm}$ decays per year per baseline	$5 \times 10^{20}$	

facilities needed for the MC complex and are covered in more detail in Section 3 of this document. Of course, since we are developing a Reference Design Report for the NF, our work on these topics must meet the needs of the NF RDR with respect to specifics and will thus go into more depth than would be required for a DFSR.<sup>12</sup>

#### 4.1. Milestones and Deliverables

Neutrino Factory RDR milestones and deliverables based on the overall MAP R&D plan (see Table 1) are shown in Table 9. The estimated amount of effort required for these tasks is included in Appendix 2.

#### 4.2 Proton Driver

U.S. participants in the IDS-NF will explore a NF proton driver based on the Project X linac design being developed at Fermilab. As noted earlier, the incremental effort required for the U.S. contribution to the IDS-NF proton driver design will be to coordinate with the Project X design team to determine possible modifications to the facility that would be needed to meet the requirements of the NF (while also meeting the specifications demanded by the MC). It is expected that small rings for bunch manipulation will be necessary for the NF and their design and specifications (compatible with the Project X design) will be included in the NF RDR. Because the main design effort will be driven by the MC requirements, and is therefore covered in the MC portion of this proposal (see Section 3.1.5), we consider here only the small effort needed to contribute NF-specific design information for the NF-RDR.

#### 4.3 Targetry and Target Station

As was mentioned earlier, the MERIT experiment was a great success and sets the foundation for the high-power target for the facilities that we are studying. The design of the target station itself is already at a relatively advanced stage from the work done in NF

Table 9. Neutrino Factory RDR task milestones and deliverables.

Date	Milestone	Designation	Deliverables <sup>a)</sup>
FY10	Deliver interim RDR	NF10.1	FR
FY11	Preliminary design of upgraded Project X facility	NF11.1	DR
FY12	Complete front-end engineering design	NF12.1	DR
	Specify performance of low-energy NF	NF12.2	MR
FY13	Complete costing of front-end and target systems	NF13.1	MR
FY14	Finish IDS-NF RDR report	NF14.1	FR

<sup>a)</sup>DR: design report (MAP technical note); ER: external review; FR: formal report; MR: MAP (internal) review

<sup>12</sup> Only the costs for this “incremental” effort are counted here.

Studies 1 and 2. With the input from the MERIT experiment, the U.S. contribution to the IDS-NF in this area will be on more advanced simulations to set definitive benchmarks for the NF/MC target system.<sup>13</sup> We will also explore the consequences of abnormally large or small muon pulses, such as could occur due to a missed proton pulse or an interruption of the mercury jet. Because of the high repetition rate, however, we do not envision a pulse-to-pulse stability limit *per se*.

The second aspect of this task will be to make the next iteration on the facility design (following the ORNL/TM-2001/124 technical report) and to develop engineering details of component parts of the system such as the target solenoid. There are particular aspects of the facility design that bear further examination. These include assessing designs for the upstream and downstream containment windows through which the beam must pass, developing a concept for dumping up to 4 MW of proton beam within the bore of the superconducting magnet near the target, defining a workable remote-handling scheme for changing components in this highly radioactive area, and revisiting the design of the water-cooled tungsten carbide inner shielding area. Based on the concepts being developed for other parts of the accelerator complex, it will be worthwhile to consider the implications for the target facility of utilizing HTS conductor for some portion of the hybrid target solenoid. The HTS material tends to be very radiation resistant—a potential advantage in the target environment.

The present concept for the beam dump is to use a mercury pool that is part of the overall Hg target circulation system. We will carry out engineering studies of the dump layout, look into splash mitigation, and examine the engineering issues associated with cooling and radiation hardness.

#### 4.4 Pion Capture and Muon Phase Rotation

After the target station, the front end of the NF must capture the pions and, after they decay into muons, bunch the muons and then reduce the muon bunch energy spread. At our present level of understanding of the NF and the MC, we believe that a single design of the capture, bunching and phase rotation systems can accommodate the requirements of both facilities. For the NF-RDR, we will deliver an engineering design for the entire front end (including cooling channel) that will include magnet designs, a discrete (stepped-frequency) rf system, and a realistic representation of all absorbers and windows utilized in the system.

#### 4.5 Ionization Cooling Channel

The baseline muon ionization cooling system for the NF is the Study 2a cooling channel. Compared with the earlier Study 2 design, the baseline channel takes advantage of design improvements in the downstream acceleration systems that permit a larger emittance beam to be transported. The main difference between the present baseline and the Study 2 version is that we now employ a simpler LiH absorber design instead of LH<sub>2</sub> absorbers.

---

<sup>13</sup> At present, we believe that the NF and MC target station designs are identical.

MICE is testing the Study 2 cooling channel, which uses LH<sub>2</sub> absorbers and provides more cooling, but at higher cost. MICE will also investigate LiH absorbers, which will be of great value to the IDS-NF effort. Indeed, input from the MICE experiment will also play an important role in defining the engineering specification for the pre-cooling channel in the MC DFS.

In addition to our baseline configuration, we intend to study briefly (on paper) the alternatives of using hydrogen gas absorbers in place of (or in addition to) LiH, and of using either a HPRF or magnetic insulation configuration. If, in the early stages of our design study, either of these concepts shows promise of giving advantages in either performance or cost over the baseline, we will investigate it more thoroughly for the NF RDR and would switch our technology choice if appropriate. Ideally, any such decision should be finalized by 2012.

#### 4.6 Accelerator Systems

The design of the NF acceleration systems is already at a relatively advanced stage. A detail of the acceleration scenario is given in Fig. 10 and consists of:

- a pre-accelerator linac (0.14 to 0.9 GeV)
- a 4.5-pass, 0.6 GeV per pass RLA (0.9 to 3.6 GeV)
- a 4.5-pass, 2 GeV per pass RLA (3.6 to 12.6 GeV)
- a non-scaling FFAG (12.6 to 25 GeV)

Within the IDS-NF, the main U.S. contribution will be to prepare an engineering design foundation including the following aspects:

- Definition and design of beam lines or lattices for
  - Linac
  - RLAs
  - FFAG
- Development of full component lists and detailed specifications for each system
- Studies of beam loading in FFAGs
- Resolution of physical interferences, e.g., beam line crossings, by developing floor coordinates for major components

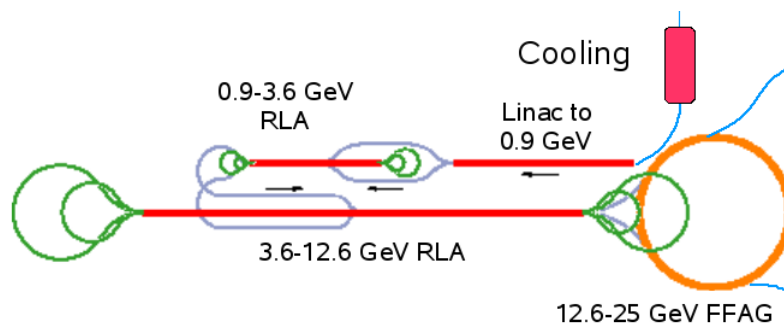

Fig. 10. IDS-NF Baseline acceleration scenario.

#### 4.6.1 201 MHz rf cryomodules

The acceleration system makes use of 201-MHz superconducting cavities. Studies of suitable manufacturing and processing techniques will be carried out, initially using 500 MHz model cavities, which can easily be tested at Cornell or Jlab. Initial tests of atomic layer deposition (ALD) techniques<sup>14</sup> to reduce dark current emission have been encouraging and these will be pursued. Because of their large size, fabricating 201-MHz superconducting cavities from bulk Nb is very unattractive. Explosion-bonded Nb on copper looks like an attractive possibility and is already under study at Cornell.<sup>15</sup>

R&D on cryomodule design will also be pursued as resources permit. Quantifying the impact of fringe fields on cavity operation is an area where we hope to make progress, as it has a big impact on component spacing, and hence acceleration system costs.

#### 4.7 Site-Specific Underground Engineering for the Decay Ring

Due the size (755 m) of the muon decay ring and the steep angle ( $\sim 30^\circ$ ) at which it must point to aim at the long-baseline (7000–8000 km) detector, the underground engineering aspects of such a design are formidable. One component of the U.S. contribution to the IDS-NF will be to study the siting of such a facility at Fermilab.

##### 4.7.1 Construction scope and definition of underground engineering

Assumptions to be used for defining the construction project scope include:

- All underground structures (tunnels, caverns, and intersections) will be of “modest span” (between 2 and 4 m in width).
- At least some of these underground facilities will be aligned on steep gradients, at depths up to 0.5 km below grade.
- A design brief can be generated in-house at Fermilab, with support from the MAP and laboratory ES&H, and accomplished in a six-month period. The brief will be relatively simple, consisting of an initial set of single-line drawings showing the underground space envelopes and a list of key as-built requirements consistent with the technical needs and conventional infrastructure.
- In-house supervision<sup>16</sup> will be utilized for the duration of field work.

To fully develop the underground engineering R&D plan, we will convene an expert panel comprising two senior representatives, one a design contractor and one a construction contractor, along with an independent technical consultant.

Although the Fermilab site has some very positive attributes, there are also some significant issues that will need to be addressed in the NF RDR. These include:

- isolating the facilities from the regional aquifers

---

<sup>14</sup> Developed at ANL and tested at Jlab.

<sup>15</sup> Historically supported by NSF funding, which is assumed to continue during the MAP.

<sup>16</sup> 1 FTE for one year.



- limitations due to rock fall occurrence
- enhancing the tunnel floor stability
- identification of “best existing” or development of improved methods to mine rock on steep slopes

Carrying out the engineering effort outlined here during the early years of concept development of the project will not only help reduce the construction cost, duration and contingency, but will also help limit the number of design iterations.

The twelve tasks identified in Table 10 will accomplish the following:

- define the *in situ* ground conditions to the full project depth (Tasks 1–6)
- identify adverse ground behaviors, and provide a rationale for selecting design and construction options (Tasks 7–8)
- support the development of a basis-of-estimate and perform a first-order cost, schedule, and risk analysis (Tasks 9–11)
- Provide expert recommendations for further study and design work (Task 12)

#### 4.8 Low-Energy Neutrino Factory Option

In case  $\theta_{13}$  is measured before the final technical case for the IDS-NF facility can be made, we are involved in the study of an alternative scenario being considered [50] within the IDS-NF—a Low-Energy Neutrino Factory (LENF). At a baseline of the order of 1300 km, a LENF utilizing stored muons with an energy of  $\sim 4$  GeV produces a neutrino oscillation pattern that is very rich and, with an appropriate detector, the  $\theta_{13}$  reach can extend down to approximately  $\sin^2 2\theta_{13} = 10^{-4}$ . A detector with low neutrino event energy threshold and excellent event energy resolution is required. A concept that uses a totally active scintillator detector (TASD) in an air-core solenoid [50] shows very interesting possibilities. For a source-to-detector baseline corresponding to that of Fermilab to DUSEL, studies of the LENF can be synergistic with ongoing work studying a wide-band superbeam to DUSEL [51].

Table 10. Tasks for underground engineering effort.

Task	Description
1	Preparation of design brief
2	Best-value procurement of geo-engineer and expert contractors
3	Geological desk studies
4	External review to support scoping of follow-up work
5	Best-value procurement of a geotechnical engineering and drilling contractor
6	Geotechnical field and laboratory studies
7	Ground characterization
8	Constructability/optimization review
9	Basis-of-estimate review
10	Best-value procurement of an underground estimating contractor
11	Independent cost and schedule development
12	Summary of findings and recommendations

## 5. TECHNOLOGY DEVELOPMENT

The goal of our proposed technology development R&D program is to:

- establish the viability of the concepts and components used for the MC-DFSR and NF-RDR designs,
- establish the engineering performance parameters to be assumed in the design studies, and
- provide a good basis for cost estimates.

The component R&D will also provide a basis for the post-DFSR R&D tests and experiments (not part of this proposal) that will be needed before a MC can be built.

### 5.1 Milestones and Deliverables

Technology development milestones and deliverables based on the overall MAP R&D plan (see Table 1) are shown in Table 11. The estimated amount of effort required for these tasks is included in Appendix 2.

### 5.2 RF Systems

#### 5.2.1 *Cooling channel rf*

As already discussed, cooling channels typically rely on rf cavities operating in high

Table 11. Technology development task milestones and deliverables.

Date	Milestone	Designation	Deliverables <sup>a)</sup>
FY10	Complete engineering design for Be-wall rf cavity	TD10.1	DR, MR
	Complete initial HPRF cavity beam test	TD10.2	DR, MR
	Test magnetically insulated “box” cavity	TD10.3	DR, MR
FY11	Fabricate Be-wall rf cavity	TD11.1	DR
FY12	Test new HPRF cavity	TD12.1	DR
	Complete Be-wall rf cavity tests	TD12.2	FR
	Test 201-MHz cavity with coupling coil in MTA	TD12.3	DR
FY13	Fabricate small HTS test magnet	TD13.1	DR
	Begin conceptual design of collider magnet	TD13.2	DR
FY14	Prepare rf test cavity with ALD coating	TD14.1	DR
	Begin conceptual design of >30-T solenoid	TD14.2	DR
	Complete component designs for 6D cooling bench test	TD14.3	FR
FY15	Fabricate components for 6D cooling bench test	TD15.1	MR
FY16	Complete components for 6D cooling bench test	TD16.1	DR
	Assemble components for 6D cooling bench test	TD16.2	MR
	Complete conceptual design of >30-T solenoid	TD16.3	DR,ER
	Finish technology section of Final MC DFS report	TD16.4	FR

<sup>a)</sup>DR: design report (MAP technical note); ER: external review; FR: formal report; MR: MAP (internal) review

magnetic fields, so it is crucial to demonstrate that the technology is feasible and reliable. There are currently four potential paths to achieving the required high gradients in multi-tesla magnetic fields for normal conducting rf cavities:

- It has been demonstrated that a cavity pressurized with ~100 bar of hydrogen gas (high-pressure rf, HPRF) has suppressed breakdown up to gradients approaching 60 MV/m, and that this performance is not affected by magnetic fields. However, such a cavity has never been tested with beam. In pure hydrogen, ionization electrons will remain in the gas for a significant portion of the rf pulse, being accelerated back and forth by the rf fields, and transferring the electromagnetic energy stored in the cavity to the gas through collisions. Depending on the intensity of the incident beam, the  $Q$  of the cavity could be reduced by several orders of magnitude. It is likely that introducing another gas species may capture these free electrons. However, a good candidate gas has not yet been found. ( $\text{SF}_6$  is frozen at  $\text{LN}_2$  temperature, and also may form hydrofluoric acid.) In addition, it must be demonstrated that the large numbers of ions created do not present a problem. A beam test of a HPRF test cavity is presently being prepared at the MTA. If successful, this initial test would be followed by the design, construction and testing of a prototype 805-MHz HPRF cavity having entrance and exit windows more suitable for beam passage.
- “Magnetic insulation” is a recently considered approach for reducing cavity breakdown. By arranging the magnetic field to be parallel to the high-gradient surfaces, it is expected that the emitted electrons can either be inhibited from leaving the surface or be guided to surfaces in regions of low gradient, thereby suppressing breakdown. A study of cavity breakdown in a magnetic field as a function of field direction, using a rotatable cavity, will be carried out to provide a test of this concept and to determine the accuracy with which the magnetic field must be aligned parallel to the cavity surface. If successful, this initial test would be followed by the design, construction and testing of an 805-MHz cavity incorporating magnetic insulation.
- Treating cavities with superconducting rf cleaning techniques has shown positive results. A 201-MHz MuCool cavity was processed with electro-polishing and high pressure rinsing and tested in the MuCool Test Area (MTA) at Fermilab. The cavity reached its design gradient with essentially no conditioning. Tests are expected in the coming two years to establish whether this cavity (or one like it but using different materials) can be operated with sufficiently high gradient while immersed in a multi-tesla magnetic field. If the results prove promising, further testing on an 805-MHz model of the 201-MHz cavity is planned, as well as testing of a 201-MHz prototype cavity for a 6D-cooling channel.
- Previous experiments have indicated that field emission and rf breakdown sites are very small, on the order of a few nm. If the electric field is inversely proportional to the radius, then even a small increase in the radii of cavity asperities would significantly reduce both the tensile stress exerted by the electric

field and the ohmic heating due to field-emitted currents. Atomic layer deposition (ALD) is a procedure that can apply conformal conductive coatings at the atomic level, increasing the radii of asperities and decreasing the electric field, and thus reducing the electric-field-induced stress and ohmic heating that can contribute to breakdown triggers. This rounding is always practiced at the macroscopic level and ALD extends the approach to the microscopic scale. ALD has been tested on superconducting cavities at surface fields up to  $\sim 70$  MV/m and has increased the  $E_{\max}$  or  $Q$  of three 1.3-GHz structures. The next step will be to test a similarly treated normal conducting cavity in a magnetic field to evaluate its performance. To this end, we anticipate developing the apparatus and the required chemistry to coat a room-temperature copper cavity and thereafter building an 805-MHz cavity for ALD coating and testing in the 5-T solenoid at the MTA. Due to funding limitations, this work will likely extend beyond the initial rf decision point in FY12. Still, we anticipate that initial results will be available in time to provide some guidance prior to completing the DFSR. If the results are positive, a prototype 201-MHz cavity for a 6D-cooling channel will be ALD processed and retested. The durability of ALD must also be determined.

In addition to investigating these specific paths, most of which will be done in the first two years of the proposed program, the exploration of alternative cavity materials and surface coatings using replaceable buttons in a dedicated test cavity will continue. Striking qualitative differences in materials have already been observed, although initial attempts to quantify the resistance of alternative materials to breakdown damage in the presence of high magnetic fields have been compromised by continued breakdown elsewhere in the copper test cavity. In particular, the beryllium components in the cavities are remarkably undamaged even after heavy arcing, and other high-strength, high-melting point materials appear to be similarly resistant. New test cavities capable of exploring the conditioning limit with higher surface fields and more stored energy may provide quantitative differences and reveal which physical properties best correlate with breakdown resistance in vacuum cavities. To this end, we will examine the practicality of operating our present 201-MHz cavity with buttons, in a similar manner to that employed for the existing 805-MHz cavity. Surface damage will be examined to obtain clues about breakdown mechanisms and to quantify the response of different materials.

Assuming adequate access to the required resources, we expect to complete enough work in the first 2–3 years to permit an initial selection of the most promising rf technology, that is, to identify an initial design configuration. Thereafter, work will focus mainly on that initial design configuration, along with perhaps one alternative that offers the potential for improved performance and/or lower cost.

Ideally, we would like to achieve an rf gradient at 201 MHz of 15 MV/m or more. It is important to note, however, that there is no “cliff edge” for this parameter—if a gradient of, say, only half this value were achievable, a Neutrino Factory or Muon Collider could still be built. There would be some loss in transmission at a lower gradient but this could likely be compensated by somewhat increased beam power from the proton driver together with incremental improvements in capture, cooling, and acceleration. Thus, the

aim of the rf R&D is not to reach a particular value of the gradient but rather to determine, for each approach studied, the realistic maximum operating gradient. This information is needed to select a practical cooling channel design.

### 5.2.2 Superconducting rf

Once the muon beams are cooled sufficiently to fit into the acceptance of a “conventional” accelerator, SRF technology is an attractive choice for rapid acceleration at high gradients. These acceleration stages are a significant cost driver in a Neutrino Factory or Muon Collider. Studies to date have assumed gradients and  $Q$  values demonstrated using sputtered coatings of niobium on copper, as was used successfully at LEP and elsewhere. Recent promising results using ALD showed improved performance of SRF structures. These developments should lead to higher available gradients with better efficiency (higher  $Q_0$ ), improving overall muon yield and reducing rf power and structure costs. To realize these gains, the MAP plan will include tasks to evaluate and optimize these promising coating technologies on small samples, test cavities and, finally, full-featured low frequency cavities with realistically large surface area. As noted earlier, our plan also assumes that NSF-sponsored work on developing 201-MHz SRF cavities will continue at Cornell, as this is a key aspect of our program.

In the final stages of MC acceleration, the beams may fit inside conventional high-frequency accelerating structures. However, the high bunch intensity, especially if bunches are merged, will place extreme demands on the superconducting rf technology. Structures optimized for this application will be needed, including such features as increased stored energy, low wakes, and high power handling capability. Given the long gestation time of new superconducting rf structures and ancillary systems, the development of these optimized structures must begin now.

## 5.3 Magnets

NF and MC accelerator complexes require magnets with quite challenging parameters. In particular, the cooling channel cost and performance will be determined in part by magnet costs and by the fields that can be reasonably delivered in the high-field solenoids at the end of the cooling channel. The magnet R&D that we propose carrying out to inform the MC-DFSR consists of:

- (i) HTS solenoid R&D to assess the parameters that are likely to be achieved
- (ii) HCC magnet R&D to assess the feasibility of this type of cooling channel and possibly to build a demonstration magnet for an HCC test section (see Section 6.3.2)
- (iii) open mid-plane dipole magnet R&D to assess the viability of this magnet type for the collider ring
- (iv) very fast ramping normal-conducting magnets for the later stages of acceleration

- (v) other magnet studies to inform choices, parameters and cost estimates for the target-station solenoid and accelerator magnets.

### 5.3.1 High-field cooling channel solenoids

Very high field solenoids with on-axis fields in excess of 30 T and apertures on the order of 50 mm are part of the initial design configuration for the MC final cooling channel. HTS technology for such magnets has been demonstrated in the 20 T regime, but it needs to be extended to higher fields with good field quality, and with reliable construction at a reasonable cost. Thus, the goals for our proposed HTS magnet R&D are:

- (i) based on initial HTS conductor and magnet R&D, establish the R&D issues that must be addressed before high-field ( $B > 30$  T) HTS solenoids can be built that are suitable for the low-emittance sections of a muon cooling channel, and hence
- (ii) assess the likelihood that suitable high-field HTS solenoids will be available within a few years and, if so, their likely cost and performance.

More specifically, we will

1. Develop with accelerator designers a set of functional specifications for a high-field solenoid, including aperture, length, body and end field quality, alignment, field strength range, power requirements (conventional and hybrid), and cost.
2. Summarize the evolving development status of conductor properties (HTS, A15, Nb-Ti, normal strands, and cables), including maximum current density *vs.* field (and field direction for tapes) and temperature; longitudinal, bending, and transverse stress/strain tolerances; quench protection and cooling requirements; cabling capabilities and performance; and conductor insulation materials. Also, as needed and not otherwise supported by existing data, evaluate new conductors and insulation materials.
3. Investigate magnetic, mechanical, magnet cooling, power, and quench protection issues of HTS and hybrid designs. As part of this, we will build and test representative HTS and hybrid-insert models to develop and demonstrate HTS coil technology and performance, and to study magnetic, mechanical, thermal, and quench properties.
4. Develop conceptual designs for magnets that meet our specifications from task 1 and conductor properties from task 2.
5. Based on the results of tasks 1–4, in 2013–2015 present a plan (conceptual design, time, effort, cost) to build a 1-m-long  $>30$  T solenoid.

The MAP magnet program will work closely with the DOE funded Very High Field Superconducting Magnet Collaboration (VHFSMC) [52] program, which shares a complementary goal of developing HTS material suitable for high-field accelerator magnets. The present focus of VHFSMC is BSCCO-2212 conductor, which has several attractive features for high-field solenoids. Subject to availability, VHFSMC- developed strand and cable will be made into insert coils for test and analysis. Data from

VHFSMC-funded conductor, cable, and coil studies will be directly incorporated into the MAP 1-m-long high-field solenoid conceptual design. Thus, we will benefit directly from the VHFSMC studies, and will maintain close contact with that program as we proceed.

### 5.3.2 Helical cooling channel magnets

The helical cooling channel requires a solenoid with superimposed helical dipole, quadrupole, and sextupole fields. A novel approach is to use a helical solenoid (HS) to generate the required field components. The basic concept (see Fig. 11) is to use short circular coils, equally spaced along the  $z$  axis, with the center of each coil shifted in the transverse plane so as to follow the helical beam orbit. Because the orbit is tilted relative to the coils, they simultaneously generate longitudinal and transverse field components. In contrast to an earlier concept using a large bore magnet, where the longitudinal and transverse field components were controlled by independent windings, this small bore system has a fixed relation among all components for a given geometry. Thus, to obtain the necessary cooling effect, the coil must be optimized together with the beam parameters.

In order to produce a practical helical cooling channel, several technical issues need to be addressed, including:

- magnetic matching sections for downstream and upstream of the HCC
- a complete set of functional and interface specifications covering field quality and tunability, the interface with rf structures, and heat load limits (requiring knowledge of the power lead requirements)

To prepare the way for an HCC test section we will:

- Develop, with accelerator designers, functional specifications for the magnet systems of a helical cooling channel, including magnet apertures to accommodate the required rf systems, section lengths, helical periods, field components, field quality, alignment tolerances, and cryogenic and power requirements. The specification will also consider the needs of any required matching sections.
- Perform conceptual design studies of helical solenoids that meet our specifications, including a joint rf and magnet study to decide how to incorporate rf into the helical solenoid bore, how to include corrector coils, how to provide matching sections, etc.
- Fabricate and test a series of four-coil helical solenoid models to develop and demonstrate the coil winding technology, pre-load and stress management, cooling, and quench protection for low-field sections based on Nb-Ti and/or Nb<sub>3</sub>Sn cable. The proposed timeline for these studies is to fabricate Nb-Ti models using easy-bend winding and indirect coil cooling in 2010. In addition, a set of hybrid Nb<sub>3</sub>Sn-HTS superconductor coils may be developed for the high-field sections. This work would be supported by SBIR funding.

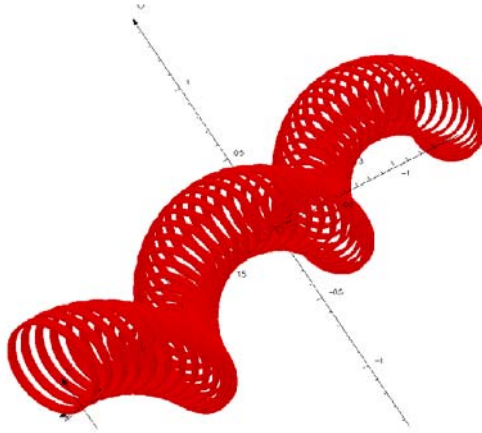

Fig. 11. Geometry of displaced solenoids that form a helical cooling channel.

### 5.3.3 Collider ring magnets

The collider ring will consist of arc dipoles, quadrupoles, correctors, and interaction region dipoles and quadrupoles. The arc dipoles should operate at high field in order to keep the ring circumference small, providing a larger number of crossings for a given number of stored muons. These magnets must also operate in a high radiation and high heat load environment resulting from the muon decay electrons, which are preferentially swept into the magnet mid-plane. In order to avoid quenches, limit the cooling-power requirements, and maintain an acceptable magnet lifetime, the superconducting coils must be protected from excessive energy deposition due to these decay electrons. Similar considerations apply to the arc and IR quadrupoles.

Despite the unique operating conditions of the MC, many of the basic magnet R&D issues are similar to those presented by other high-energy accelerators. In particular, high operating field and accommodating large energy deposition are required for the LHC energy and luminosity upgrades. Therefore, the MC R&D effort in this area will be coordinated with ongoing development of high-field dipoles and quadrupoles for the LHC. In addition, some of the fundamental materials issues (high-field superconductors, radiation hardness, thermal margins, structural materials, electrical insulation, etc.) are common to different types of magnets, such as dipoles for the collider and solenoids for muon cooling. Therefore, materials R&D can and should be effectively organized through an integrated effort supporting various magnet R&D areas for the MC as well as other accelerator projects.

Two approaches have been considered in previous dipole designs:

- use of a thick absorber surrounding, or internal to, the vacuum chamber and protecting the coils
- a magnet design that moves the superconducting coils away from the mid-plane



The former approach requires a large magnet aperture, while the latter presents considerable challenges in terms of efficiency of field generation, mechanical support, and field quality.

The R&D effort for the collider magnets will include design analysis, technology development, and modest model fabrication. Its main sub-tasks will be to:

1. Compare design options for the arc dipoles, and identify an initial magnetic, mechanical, and thermal configuration. This activity will benefit from previous studies of conventional and open mid-plane designs carried out for the NF as well as the LHC “dipole-first” IR upgrade scheme.
2. Compare design options for arc and interaction region quadrupoles to select an initial configuration. Similar to the dipole case, options previously considered include large bore designs with thick liners and designs where the conductor is removed from the mid-plane. Conventional quadrupoles have also been considered, as most of the decay energy can be absorbed by a cooled absorber outside the quadrupole.
3. Provide consistent sets of magnet parameters (aperture, length, integrated strength, tolerances on field errors) taking into account the radiation deposition issues; these will be used as input for machine optimization.
4. Define and implement technology tests in support of magnet design and prototyping. These may include mechanical models, sub-scale coil tests, experiments to determine thermal margin and radiation lifetime, materials characterization, etc. This effort will also take advantage of collaborations with other ongoing R&D efforts (such as LHC upgrades) to carry out larger scale tests.
5. Design the main magnetic elements (arc dipoles and quadrupoles, and IR quadrupoles) to a level sufficient to support preliminary cost estimates.
6. Provide cost estimates for further R&D and prototyping, and preliminary cost envelopes for magnet production.<sup>17</sup>

#### 5.3.4 *Cost models*

Magnets will be one of the significant cost drivers for the MC. We have identified above those magnets that will require R&D in order to demonstrate that they will be ready in the MC time frame. Many of the other magnet designs can be borrowed or extrapolated from existing designs or from general magnet experience.

Our plan is to develop a cost-model algorithm to apply to those magnets whose designs can be based on previous or ongoing accelerator design studies, and then use it for the MC. In addition, we will develop a catalog for all magnet elements, including categorizing magnets of like function to facilitate cost studies.

---

<sup>17</sup> More accurate estimates of production costs will be provided after prototype fabrication and testing.

## 5.4 Fast-ramping Magnets

In one of the schemes for final acceleration, a pair of fast-ramping synchrotrons are employed. These require non-standard normal-conducting magnets made from grain-oriented silicon steel laminations. As discussed below, we plan to design and fabricate several such magnets to test the principle and to verify field quality. Two 6 mm gap prototype dipoles (see Fig. 12) will be built, the first 30 cm long and the second 6.3 m long. We note that a 1250-Hz, fast excitation wiggler has been built at Brookhaven [53] using similar technology. Thin grain-oriented silicon steel laminations are used in an EI transformer layout to minimize eddy current and hysteresis losses. At 1.8 T, grain oriented silicon steel has a  $\mu$  of  $3000\mu_0$  parallel ( $\parallel$ ) to the grain direction [54]. Very little  $B^2/2\mu$  energy has to be stored in the steel. Magnetic properties perpendicular to the grain direction are not as good, e.g., at 1.5 T  $\mu_{\parallel} = 30,000\mu_0$  while  $\mu_{\perp} = 1000\mu_0$ . OPERA-3D will be used to simulate eddy current and hysteresis losses of the EI layout, optimize magnet end shapes, and calculate sextupole fields from eddy currents. Laminations will be slit and sheared and then finished using wire electrical discharge machining (EDM).

Coils will be wound with transposed copper strands to ameliorate eddy currents. Eddy current losses increase as the square of magnetic field and wire diameter. The coils are located in low magnetic field regions (at the cost of extra steel). To minimize power supply voltage ( $V = 2\pi BfNwl$ ,  $I = Bh/\mu_0N$ ), the number of coil turns ( $N$ ) should be small. Here,  $f$  is the frequency (Hz) and  $I$  is current (A). The magnet bore height, width, and length are given by  $h$ ,  $w$ , and  $l$ , respectively. The power supply will comprise a capacitor bank, IGBT switch, power return choke/diode, and a high-voltage source for topping off losses [55]. It is basically an  $LC$  circuit with the energy residing in the capacitor bank most of the time.

A 400-Hz, 1.8-T test dipole with a 46 mm  $\times$  20 mm pole face and a 1.5 mm gap is currently being assembled. It uses 3-phase EI transformer laminations made of 0.28-mm-thick grain-oriented silicon steel. The 1.5 mm gap in the laminations has been successfully fabricated with wire EDM. Twelve-gauge copper magnet coils are being wound. Power will be stored in a 33- $\mu$ F, 1400-V, 64-A polypropylene capacitor. A Hall probe, good to 2% at up to 3000 Hz, will be used to measure the magnetic field. A 30-cm-long prototype dipole will be built in 2010, and a 6.3 m long prototype dipole will be built in 2011–2012.

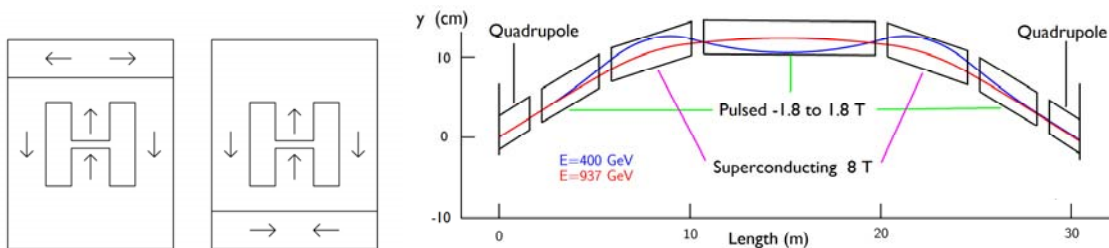

Fig. 12. Left: Alternating dipole laminations; arrows show  $B$  field and grain direction. Right: Half-cell with interleaved fixed superconducting and fast-ramping dipoles.

## 5.5 Summary of Component R&D Goals

Recognizing that there is a considerable amount of material covered in the descriptions of the Technology Development R&D program presented in Section 5, we provide in Table 12 a brief—and hopefully easily digestible—summary of the goals of this effort. As can be seen, we expect to develop specifications and conceptual designs for all of the components studied, but will only carry out an engineering design of the items deemed most critical to developing the feasibility and cost assessments. In some cases, we plan to prototype sub-assemblies to ensure a full understanding of the technical issues. Full prototypes are beyond the scope of the present MAP plan, and are envisioned to be part of the 6D cooling experiment (see Section 6.3) that, with support from the community, will come later.

## 6. SYSTEM TESTS

With the successful completion of the MERIT target experiment, the main outstanding technical challenge that is common to both NF and MC front-ends is to demonstrate the viability and performance of the technologies needed for a transverse ionization cooling channel. The MICE experiment at RAL will provide the key demonstration of the operation of a short cooling channel section, and we consider it a high priority to complete this experiment in time to inform both the NF-RDR and the MC-DFSR.

The main additional challenge that must be met for a successful MC-DFSR is to arrive at a design of an appropriate 6D cooling channel that is based on technologies and parameters in which we have confidence. At present, there are several candidate cooling channel designs that are being studied. All these designs rely on rf cavities operating in strong magnetic fields that confine the muons within the channel and provide radial focusing. Our MuCool R&D program has demonstrated that the maximum gradients achievable in normal conducting vacuum rf cavities made of copper are reduced when the cavity is operated in axial magnetic fields of a few tesla. Hence, before a cooling channel technology can be selected for the MC-DFSR design (or for the NF-RDR design) it is

Table 12. Goals of component R&D effort at the end of the MAP plan. Developing full prototypes will await the next phase of MAP. The rf effort is not included here as its goal is not component R&D but a full proof-of-principle system.

	Specifications	Conceptual Design	Engineering Design	Sub-assembly prototype	Full-assembly prototype
High field HTS solenoid	●	●	●		
HCC magnets	●	●	●	●	
Fast-ramping magnets	●	●	●	●	
Collider ring magnets	●	●			
Target design	●	●	●	●	
Guggenheim channel <sup>a)</sup>	●	●	●	●	
Helical cooling channel <sup>a)</sup>	●	●	●	●	
FOFO snake channel <sup>a)</sup>	●	●	●	●	
6D cooling experiment	●	●			

<sup>a)</sup> We anticipate that only one channel will be studied in detail, with the choice determined during year 4.

important to provide a proof-of-principle demonstration of the operation of the rf cavity in the particular magnetic field configuration for the assumed cooling channel, and to establish its maximum achievable rf gradient. Once we have demonstrated one or more rf solutions, the next step will be to build and bench-test a short cooling section. This will inform the DFSR cooling channel simulations by ensuring that the practical engineering constraints that affect performance are understood, by establishing viable cooling channel parameters, and by providing a good basis for cooling channel cost estimates. The bench-test experiment will also prepare the way for an eventual (post-DFSR) 6D cooling channel demonstration experiment.

## 6.1 Milestones and Deliverables

System test milestones and deliverables based on the overall MAP R&D plan (see Table 1) are shown in Table 13. The estimated amount of effort required for these tasks is included in Appendix 2.

## 6.2 MICE

The Muon Ionization Cooling Experiment (MICE) [56], which is hosted at Rutherford Appleton Laboratory in the UK, has been designed and is being constructed, commissioned, and operated by an international collaboration in which MAP institutions play a crucial role, contributing to every aspect of the experiment.

### 6.2.1 The MICE Program

The goals of MICE are to:

- engineer and build a section of cooling channel (of a design that can give the desired performance for a Neutrino Factory) that is long enough to provide a measurable ( $\approx 10\%$ ) cooling effect, but short enough to be moderate in cost;
- use particle detectors to measure the cooling effect with an absolute accuracy of 0.1% or better;

Table 13. System test task milestones and deliverables.

Date	Milestone	Designation	Deliverables <sup>a)</sup>
FY10	Study possible minor extensions to MICE	ST10.1	DR
FY11	Deliver Spectrometer Solenoids to RAL	ST11.1	DR
FY12	Deliver first RFCC module to RAL	ST12.1	DR, MR
FY13	Initial specification of 6D cooling bench test	ST13.1	DR, MR
FY14	Finalize 6D cooling bench test specification	ST14.1	DR, MR
FY15	Initial component specifications for 6D cooling experiment	ST15.1	MR
FY16	Install 6D cooling bench test section in MTA	ST16.1	MR
	Prepare proposal for 6D cooling experiment	ST16.2	FR, ER

<sup>a)</sup>DR: design report (MAP technical note); ER: external review; FR: formal report; MR: MAP (internal) review.

- perform measurements in a muon beam having momentum in the range 140–240 MeV/c, in which particles can be tracked individually, one particle every 100 ns or more.

The MICE apparatus is shown schematically in Fig. 13. It consists of an upstream instrumentation section to precisely measure incoming muons, a short cooling channel section consisting of absorbers and rf cavities in a solenoid lattice, and a downstream instrumentation section to precisely measure the outgoing muons. The MICE apparatus can be viewed as a quite general test-bed for ionization cooling ideas. The ionization-cooling lattice cell comprises eight superconducting coils that can be variously powered to create “super-FOFO” [10] (field direction alternating each half-cell) or solenoid-type (field direction constant) optics, and the currents can be tuned to characterize cooling performance with a variety of beta functions. The MICE goals require that this be done in order to validate the Monte Carlo simulations that are used to design such cooling channels.

MICE is located in a new purpose-built muon beam at the ISIS synchrotron. Preparing for MICE has required the development and installation of a tunable pion/muon beam line as well as a target that can be dipped into the ISIS beam as needed. These are now in place, and the process of installing and commissioning the beam and particle-identification instrumentation is well under way. The MICE cooling channel will be gradually built up and commissioned over the next several years as indicated schematically in Fig. 14. This stepwise approach has the virtue of allowing the measurement systematics to be thoroughly evaluated and optimized. We anticipate that MICE will be completed in 2013–2014. At this time, a transverse cooling channel

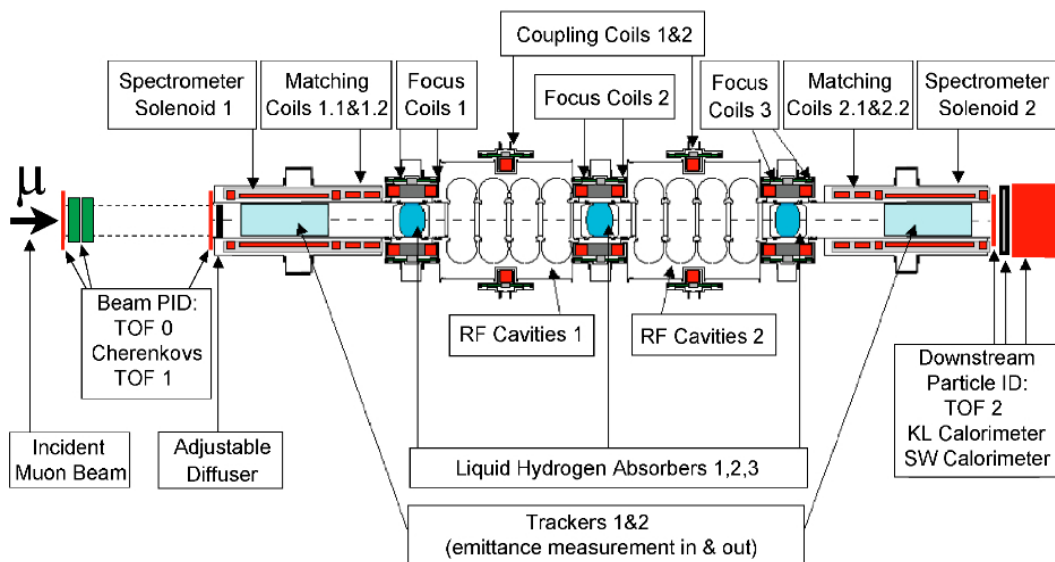

Fig. 13. Schematic drawing of MICE apparatus, comprising a muon beam line at left (not shown), particle-identification systems, and input and output spectrometers surrounding a single ionization-cooling lattice cell.

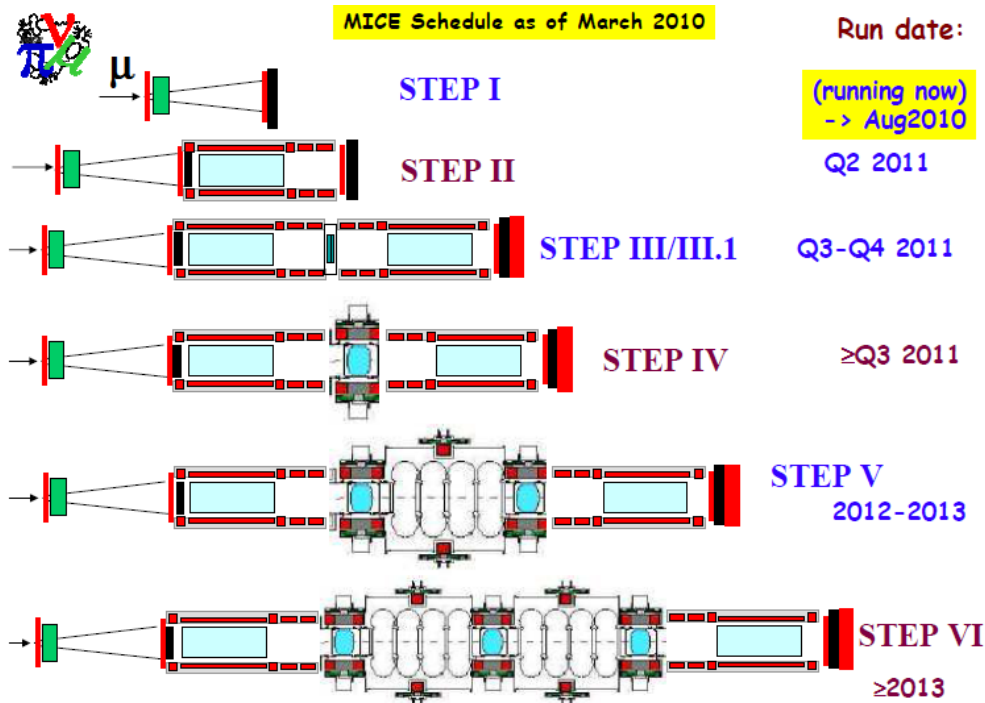

Fig. 14. Projected schedule of MICE experiment at RAL, showing stepwise execution of the experiment.

suitable for a NF or MC would have been demonstrated, and MICE results available then will be used to inform the NF-RDR. Beyond this initial MICE program, there is the possibility of using the MICE apparatus to begin to explore some aspects of 6D cooling that are relevant to the design of MC cooling channels, and that can inform the MC-DFSR studies.

A simple test of the six-dimensional ionization-cooling concept can be made by inserting a wedge absorber (composed, e.g., of LiH) into a beam having suitable dispersion, and measuring the effect on the beam. This may be possible in MICE either by tuning the incoming beam so as to produce the desired dispersion or by selecting out of the distribution of incoming muons an ensemble that has dispersion matched to the configuration of the wedge absorber. This concept needs further study to evaluate both its feasibility and the degree to which it could constitute an incisive demonstration of six-dimensional cooling.

The official MICE US deliverables are:

- Spectrometer solenoids (2), including engineering, fabrication, testing, and field-mapping
- Assembly of scintillating-fiber planes (15) for fiber-tracking spectrometers (**completed**)
- AFE-II readout boards, VLPCs, and VLDS interface modules for fiber-tracking readout (**completed**)

- Design, fabrication, and commissioning of VLPC cryostats (4) for fiber-tracking spectrometers (**completed**)
- Fiber-tracking readout system integration and commissioning (**completed**)
- Fabrication, installation, and commissioning of two Cherenkov counters (**completed**)
- RFCC modules (2), each comprising 4 rf cavities and 1 coupling coil
- Scintillating-fiber beam position/profile monitors (4 planes) (**completed**)
- Design and fabrication of LiH absorbers
- Beam line optimization (**completed**)
- Participation in MICE operations and analysis

### 6.3 Cooling Section Tests and Experiments

By the end of 2012, we anticipate making a choice of which cooling channel scheme to adopt for the baseline design, end-to-end simulation, and costing. The various candidate cooling schemes will become more or less attractive as viable options depending on the results of the rf tests described in Section 5.2. We anticipate critical results from the rf tests in the first 2–3 years of our R&D program, and thereafter expect to build a short cooling section of our selected cooling scheme.<sup>18</sup> When completed, that cooling section will be tested in the MTA to determine its viability and operating parameters, and to pave the way for the post-DFS R&D program. The cooling channel configuration choice for the MC-DFS will define which 6D cooling section will be built and tested—either a Guggenheim channel, a FOFO-Snake channel or a Helical Cooling Channel. To illustrate the R&D path leading to the construction and test of the chosen cooling channel, we consider two of the candidate choices, the Guggenheim channel and the HCC, in Sections 6.3.1 and 6.3.2, respectively. The design and construction phase for the test section will inform the MC-DFS.

#### 6.3.1 *Guggenheim test section*

The R&D path that would lead to a test of a Guggenheim section with magnetically insulated normal conducting rf cavities, cavities using superconducting cavity treatment techniques plus ALD, or HPRF cavities, is as follows:

Years 1–2: Successful 805-MHz cavity tests separately demonstrating the effects of superconducting cavity treatment, cavity material choice, and magnetic field direction on maximum achievable gradient. Also, successful end-to-end simulation of a Guggenheim cooling channel based on the established rf parameters and technologies.

---

<sup>18</sup> For the purposes of estimating the cost of this task, we separately estimated the cost of a section comprising one helix period of the HCC (with three rf cavities mounted inside) and one cell of a Guggenheim channel. Each gave a similar result, albeit with a different mixture of M&S and SWF. The HCC estimate was assumed in the cost estimate outlined in Appendix 2.

Years 3–4: Designing the test section. The outcome of the design work will inform the MC-DFSR baseline decision. ALD results will be taken into account to improve the design and/or performance.

Years 5–7: Build and test a Guggenheim test section in the MTA. Test results would validate the engineering performance at the end of the MC-DFSR study and prepare the way for the post-DFS R&D.

### 6.3.2 *Helical cooling channel test section*

The R&D path that would lead to a test of a HCC section with HPRF is:

Year 1: Successful beam test of the existing 805-MHz HPRF test cavity in the MTA, and successful HCC few-coil model tests to validate the winding technology and magnet concept.

Years 2–3: Successful beam test of a realistic 805-MHz HPRF cavity in the MTA and successful end-to-end simulation of a MC HCC cooling channel section. Thereafter, begin HCC test section design.

Year 4: Complete design of test section. The outcome of the design work will inform the MC-DFSR baseline decision.

Years 5–7: Build and test the HPRF test section in the MTA. Test results will validate the engineering performance at the end of the MC-DFSR and prepare the way for the post-DFS R&D.

### 6.3.3 *Preparations for a 6D cooling demonstration experiment*

The basic physics of transverse cooling will be demonstrated by MICE, and the basic physics of 6D cooling may well be demonstrated by using a wedge-shaped absorber in the MICE channel, selecting tracks to create a “virtual” beam with dispersion at that wedge, and measuring the 6D emittances before and after using the MICE detectors. A more ambitious six-dimensional ionization-cooling test could be considered in which the MICE beam and detectors were used to evaluate and study an actual prototype of a six-dimensional cooling channel. Thus, the MICE hall has been discussed as a possible site for the proposed MANX experiment [57], as well as for testing other six-dimensional cooling lattices that might be considered. For example, a section of an RFOFO ring or “Guggenheim” cooler could be built and inserted into MICE, or such a lattice could perhaps be approximated using components already being built for MICE.

A full 6D demonstration experiment would clearly be a major undertaking, and could not be finished in the next 6–7 years. We therefore do not plan to commit to one until after the basic technology choices have been made and the goals of the experiment are better defined, i.e., towards the end of the DFRS process. Nevertheless, conceptual studies of the options will be undertaken, with the aim of developing a proposal by the end of year 7



of the MAP plan. To prepare for the proposal, the sensitivity of the MC-DFS cooling channel configuration to its parameters, errors and misalignments, etc., and to any simulation uncertainties must be assessed, and the goals and requirements of the experiment studied. In addition, conceptual designs and cost estimates are required for:

- beam and detector technologies that will measure the cooling at the different stages
- integration of the cooling channel components for each potential experiment.

## **7. UNIVERSITY, INTERNATIONAL, AND SBIR COMPANY PARTICIPATION**

Accelerator R&D projects provide an excellent training ground for accelerator physics students and post-doctoral research associates. Both the NFMCC and MCTF activities are built around close and productive collaborations between laboratory and university groups. In recent years, the muon accelerator R&D program has provided three Ph.D. projects, all brought successfully to completion on topics ranging from rf studies to beam dynamics. The proposed R&D program for the coming 7 years provides an opportunity for many more thesis topics, and a continued and enhanced opportunity for university group involvement. Based on our experience to date, a university group consisting of one faculty member, one post-doctoral research associate, and one or more graduate students, can make a valuable and valued contribution to the overall R&D program. Although the majority of the resources we are requesting for muon accelerator R&D would be utilized by the national laboratories, the proposed program would also support significant university involvement. The present U.S. university groups that are playing an integral role in the muon accelerator R&D program are Cornell, IIT, University of Mississippi, Princeton, Stony Brook, UCLA, and UC-Riverside. Other groups have been more active in the past, but lack resources for active involvement at present. We anticipate that with increased muon accelerator R&D support the university involvement would grow, with perhaps 8–10 groups making significant contributions. Some funds to provide “seed money” to new university groups seeking to contribute to muon accelerator R&D will be set aside each year from the MAP budget.

Several Small Business Innovative Research (SBIR) and Small Business Technology Transfer (STTR) companies already contribute very actively to muon accelerator R&D projects. The most notable examples are Muons, Inc., Tech-X Corporation, and Particle Beam Lasers, Inc., all of which have initiated and carried out a number of very important studies on the physics and technologies of the MC and NF. The proposed R&D plan will provide guidance and permit closer coordination between the SBIR/STTR companies and the research at the national laboratories and universities. It is anticipated that the companies will continue to contribute to the R&D on HTS magnets, high-pressure gas-filled rf cavities, 6D cooling channel design, prototyping, and experiments, and in the design and end-to-end simulations of the MC and NF.

At present, activities of both the NFMCC and MCTF involve significant international participation. This plan calls for strengthened international cooperation. The most

important international activities will be MICE and the Neutrino Factory RDR work. As we carry out the MAP R&D plan, we will seek additional international participation in developing the advanced muon accelerator physics and technology concepts needed for a Muon Collider.

## **8. SUMMARY**

By ~2014 we expect that new physics results from the LHC and from the next generation of neutrino experiments (Double Chooz, Daya Bay, T2K, and NOvA) will be available. These will provide the worldwide HEP community with the knowledge it needs to identify which types of facilities are best suited to fully exploit the exciting new physics opportunities that will undoubtedly arise. In particular, we expect that the physics cases for both a multi-TeV lepton collider and a Neutrino Factory will be more completely understood at this time.

The R&D program that we have outlined in this proposal will provide the HEP community with detailed information on future facilities based on intense beams of muons—the Muon Collider and the Neutrino Factory. We believe that these facilities, which could be considered separately or as part of a staged approach to a world-class scientific program, offer the promise of extraordinary physics capabilities. The Muon Collider presents a powerful option to explore the energy frontier and the Neutrino Factory gives the opportunity to perform the most sensitive neutrino oscillation experiments possible, while also opening expanded avenues for study of new physics in the neutrino sector. The synergy between the two facilities presents the opportunity for an extremely broad physics program and a unique pathway in accelerator facilities.

Facilities based on short-lived muons present many challenges, both for the accelerator builder and for the detector builder. It is addressing these challenges in a timely way that motivates this proposal. Specifically, the program presented here, if funded at the nominal level, will deliver (with our international partners) an RDR for the Neutrino Factory by 2013 and a DFSR for a Muon Collider by 2016. With the augmented funding profile, we would expect to complete the program one year earlier.

Our work will give clear answers to the questions of expected capabilities and performance of these muon-based facilities, and will provide a defensible cost range for them. This information, together with the physics insights gained from the next-generation neutrino and LHC experiments, will allow the HEP community to make well-informed decisions regarding the optimal choice of new facilities. We believe that this work is an absolutely critical part of any broad strategic program in accelerator R&D and, as the P5 panel has recently indicated, is essential for the long-term health of high-energy physics.

## REFERENCES

- [1] S. F. King, K. Long, Y. Nagashima, B.L. Roberts, O. Yasuda (Eds.), “Physics at a future Neutrino Factory and super-beam facility,” RAL-TR-2007-019, December 2007; Reports on Prog. in Physics 72, 10621, 2009; [http://www.iop.org/EJ/article/0034-4885/72/10/106201/rpp9\\_10\\_106201.pdf](http://www.iop.org/EJ/article/0034-4885/72/10/106201/rpp9_10_106201.pdf).
- [2] E.A. Perevedentsev and A.N. Skrinsky, Proc. 12<sup>th</sup> Int. Conf. on High Energy Accelerators, F.T. Cole and R. Donaldson, Eds., (1983) p. 485; A.N. Skrinsky and V.V. Parkhomchuk, Sov. J. of Nucl. Physics 12, 3 (1981).
- [3] D. Neuffer, “Colliding Muon Beams at 90 GeV,” Fermilab Physics Note FN-319 (1979); D. Neuffer, Part. Accel. 14, 75 (1983).
- [4] R. Palmer, A. Tollestrup and A. Sessler (Eds.), “Muon Muon Collider: Feasibility Study,” BNL-52503, FERMILAB-CONF-96/092, LBNL-38946.
- [5] C. Ankenbrandt *et al.* (Muon Collider Collaboration), “Status of muon collider research and development and future plans,” Phys. Rev. ST Accel. Beams 2 081001 (1999); M. Alsharo’*a et al.* (Muon Collider Collaboration), “Recent progress in neutrino factory and muon collider research within the Muon Collaboration,” Phys. Rev. ST Accel. Beams, 6 081001 (2003).
- [6] S. Geer, “Neutrino beams from muon storage rings: Characteristics and physics potential,” Phys. Rev. D 57, 6989 (1998).
- [7] N. Holtkamp and D. Finley (Eds.), “A Feasibility Study of a Neutrino Source Based on a Muon Storage Ring,” Fermilab-Pub-00/108-E.
- [8] S. Geer and H. Schellman (Eds.), “Physics at a Neutrino Factory,” FERMILAB-FN-692, hep-ex/0008064.
- [9] A. DeRujula, M.B. Gavela, P. Hernandez, Nucl. Phys. B 547, 21 (1999).
- [10] S. Osaki, R. Palmer, M. Zisman, and J. Gallardo (Eds.), “Feasibility Study II of a Muon-Based Neutrino Source,” BNL-52623.
- [11] S. Geer and M. Zisman (Eds.), “The neutrino factory and beta beam experiments and development,” APS Neutrino Study, BNL-72369-2004, FERMILAB-TM-2259, Nov 2004. 115pp. , e-Print: physics/0411123.
- [12] S. Geer and M. S. Zisman, “Neutrino Factories: Realization and physics potential,” Prog. in Part. and Nucl. Physics 59, 631 (2007).
- [13] NFMCC web page: <http://www.cap.bnl.gov/mumu/>.
- [14] MCTF web page: <http://apc.fnal.gov/groups2/muon.shtml>.
- [15] Muons, Inc. web page: <http://www.muonsinc.com/>.
- [16] Muon Collider advanced accelerator R&D proposal: [https://mctf.fnal.gov/muoncollider\\_aard\\_proposal\\_v3.doc](https://mctf.fnal.gov/muoncollider_aard_proposal_v3.doc).

- [17] Muon Collider Task Force Report, FERMILAB-TM-2399-APC, December 2007, [https://mctf.fnal.gov/annual-reports/mctf-report-2007\\_v9.doc/view](https://mctf.fnal.gov/annual-reports/mctf-report-2007_v9.doc/view).
- [18] MUTAC reports: <http://www.cap.bnl.gov/mumu/MUTAC/>.
- [19] M. Apollonio *et al.* (ISS Accelerator Working Group), “International scoping study of a future Neutrino Factory and super-beam facility: Accelerator design concept for future neutrino factories, (ed. M. Zisman), RAL-TR-2007-23, December 2007; arXiv:0802.4023v1 [physics.acc-ph], 27 February 2008; JINST 4, P07001, 2009; [http://www.iop.org/EJ/article/-search=67573990.1/1748-0221/4/07/P07001/jinst9\\_07\\_p07001.pdf](http://www.iop.org/EJ/article/-search=67573990.1/1748-0221/4/07/P07001/jinst9_07_p07001.pdf)
- [20] T. Abe *et al.* (ISS Detector Working Group), “International scoping study of a future Neutrino Factory and super-beam facility: Detectors and flux instrumentation for future neutrino facilities,,” RAL-TR-024, December 2007; JINST 4, T05001, 2009; [http://www.iop.org/EJ/article/1748-0221/4/05/T05001/jinst9\\_05\\_t05001.pdf](http://www.iop.org/EJ/article/1748-0221/4/05/T05001/jinst9_05_t05001.pdf).
- [21] IDS Web page: <https://www.ids-nf.org/wiki/FrontPage>.
- [22] H. G. Kirk *et al.*, “A high-power target experiment at the CERN PS,” in Proc. 2007 Particle Accelerator Conf., Albuquerque, June 25–29, 2007, pp. 646–648.
- [23] P. Drumm (ed.), “MICE: an international muon ionization cooling experiment, Technical design report,” see: [http://www.isis.rl.ac.uk/accelerator/MICE/TR/MICE\\_Tech\\_ref.html](http://www.isis.rl.ac.uk/accelerator/MICE/TR/MICE_Tech_ref.html).
- [24] J. Norem, *et al.*, “Recent Results from the MuCool Test Area,” in Proc. 2007 Particle Accelerator Conf., Albuquerque, June 25–29, 2007, pp. 2239–2241.
- [25] The early history of the idea for muon colliders can be found in D. Cline (ed.), Physics Potential and Development of  $\mu^+\mu^-$  Colliders, AIP Conf. Proc. 352, 1994, pp. 3–15.
- [26] C. Ankenbrandt *et al.*, “Muon collider task force report,” Fermilab-TM-2399-APC, 2007.
- [27] See <http://projectx.fnal.gov>.
- [28] H. G. Kirk *et al.*, “The MERIT high power target experiment at CERN,” in Proc. EPAC 2008, p. 2886.
- [29] R. B. Palmer *et al.*, “A complete scheme of ionization cooling for a muon collider,” in Proc. PAC 2007, p. 3193, see also <http://www.cap.bnl.gov/mumu/polit/palmer-p5.pdf>; R. P. Johnson and Y. Derbenev, “Low Emittance Muon Colliders,” in Proc. PAC 2007, p. 706.
- [30] M. Popovic, *et al.*, “RF Cavities Loaded with Dielectric for Muon Facilities,” in Proc. PAC09, Vancouver, BC, paper TU5PFP017, to be published.
- [31] R. Palmer *et al.*, “Ionization cooling ring for muons,” Phys. Rev. ST-AB 8, 061003 (2005).

- [32] R. Palmer *et al.*, “Scheme for ionization cooling for a muon collider,” Proc. Science PoS (Nufact08) 019.
- [33] T. J. Roberts, *et al.*, “G4beamline Particle Tracking in Matter-Dominated Beam Lines”, in Proc. EPAC 2008, p. 2776.
- [34] K. Yonehara *et al.*: 2009 MCDW, BNL,  
<http://www.cap.bnl.gov/mumu/conf/collider-091201/talks/KYonehara1-091201.ppt>
- [35] Y. Derbenev and R. P. Johnson, Phys. Rev. Spec. Topics Accel. and Beams **8**, 041002 (2005).
- [36] V. Kashikhin, *et al.*, “Design Studies of Magnet Systems for Muon Helical Cooling Channels”, in Proc. EPAC 2008, p. 2437.
- [37] M. Lamm, *et al.*, “4-Coil Superconducting Helical Solenoid Model for MANX”, in Proc. PAC 2009, paper MO6PFP059, to be published.
- [38] M. Lopes, *et al.*, in Proc. PAC 2009, paper MO6PFP060, to be published.
- [39] M. Neubauer, R. Johnson, A. Moretti, and M. Popovic, “Phase and Frequency Locked Magnetrons for SRF Sources,” in Proc. PAC 2009, paper TU5PFP019, to be published.
- [40] K. Yonehara, *et al.*, “Doped H<sub>2</sub>-Filled RF Cavities for Muon Beam Cooling”, in Proc. PAC 2009, paper TU5PFP020, to be published.
- [41] Y. Alexahin *et al.*, “6D ionization cooling channel with resonant dispersion generation,” in Proc. 2007 Particle Accelerator Conf., Albuquerque, June 25–29, 2007, p. 3477.
- [42] S. A. Kahn *et al.*, “A high field HTS solenoid for muon cooling,” in Proc. 2007 Particle Accelerator Conf., Albuquerque, June 25–29, 2007, p. 446.
- [43] V. Morozov *et al.*, 2009 Muon Collider Design Workshop, BNL, December 1–3, 2009; see <http://www.cap.bnl.gov/mumu/conf/collider-091201/talks/Morozov.ppt>
- [44] Y. Derbenev and R. Johnson, “Parametric Resonance Ionization Cooling and Reverse Emittance Exchange for Muon Collider,” in Proc. COOL 2005; see [http://www.muonsinc.com/reports/COOL05\\_PIC\\_and\\_REMEX\\_for\\_MC.pdf](http://www.muonsinc.com/reports/COOL05_PIC_and_REMEX_for_MC.pdf).
- [45] R. P. Johnson *et al.*, “Muon bunch coalescing,” in Proc. 2007 Particle Accelerator Conf., Albuquerque, June 25–29, 2007, p. 2930.
- [46] R.C. Fernow, “Recent Developments on the Muon-Facility Design Code ICOOL,” in Proc. PAC 2005, Knoxville, TN, 2005, p. 2651.
- [47] D. Summers *et al.*, “Muon acceleration to 750 GeV in the Tevatron tunnel for a 1.5 TeV  $\mu^+\mu^-$  collider,” in Proc. 2007 Particle Accelerator Conf., Albuquerque, June 25–29, 2007, p. 3178.
- [48] S. Bogacz *et al.*, “Recirculating linac muon accelerator with ramped quadrupoles,” in Proc. EPAC 2008, p. 2629.

- [49] P. Snopok *et al.*, “A new lattice design for a 1.5 TeV CoM muon collider consistent with the Tevatron tunnel,” in Proc. 2007 Particle Accelerator Conf., Albuquerque, June 25–29, 2007, p. 3483; Y. Alexahin, see <http://www.cap.bnl.gov/mumu/conf/collider-091201/talks/YAlexahin2-091201.ppt>.
- [50] S. Geer, O. Mena, and S. Pascoli, Phys. Rev. D 75, 093001 (2007); A. Bross, *et al.*, Phys. Rev. D 77, 093012 (2008); C. Ankenbrandt *et al.*, Phys. Rev. ST-AB 12, 070101 (2009).
- [51] N. Saoulidou, J. Phys. 136, 022021 (2008).
- [52] See <https://mctf.fnal.gov/links/vhfsmc-final-september-30.pdf/view>.
- [53] J. Gallardo *et al.*, IEEE Trans. Magnetics 30 (1994) 2539.
- [54] H. Sasaki, “Magnets for Fast Ramping Synchrotrons,” KEK Report 91-216.
- [55] K. Bourkland *et al.*, “Power Supply for Neutrino Horns,” Fermilab-Conf-02-122-E.
- [56] See <http://mice.iit.edu/> and references therein.
- [57] MANX Collaboration, see e.g., “MANX: A 6D Ionization-Cooling Experiment,” D. M. Kaplan for the MANX Collaboration, in Proc. Ninth Intl. Workshop on Neutrino Factories, Superbeams, and Betabeams (NuFact07), AIP Conf. Proc. 981, 296 (2008); K. Yonehara *et al.*, “Status of the MANX Muon Cooling Experiment,” in Proc. EPAC 2008, p. 2844.

## **APPENDIX 1: MUON ACCELERATOR PROGRAM ORGANIZATION**

### A1-1. Introduction

Here we describe the organization being set up by Fermilab in response to the request it received from DOE/OHEP asking that it serve as the host laboratory for an integrated national muon accelerator R&D program. The intent is to execute a multi-year program aimed at completing a Muon Collider Design Feasibility Study (DFS), participating in the ongoing International Design Study for a Neutrino Factory (IDS-NF), and providing a supporting muon accelerator technology R&D program.

The current muon accelerator R&D organization consists of two closely coordinated efforts—the U.S. Neutrino Factory and Muon Collider Collaboration (NFMCC) and the Fermilab-sponsored Muon Collider Task Force (MCTF). Responding to the charge from DOE requires integrating these two organizations into a single national Muon Accelerator Program (MAP) organization that enables an appropriate level of oversight and direction by the host laboratory (Fermilab). An interim MAP organization has now been formed, and is charged initially with revising the original proposal, submitted in December 2008, and then preparing for a DOE review of the revised proposal. Assuming a successful review, the final version of the new organization will assume responsibility for executing the plan under a permanent Program Director.

### A1-2. Muon Accelerator Program Organization

The goal of MAP is to carry out the multi-year R&D program outlined in Section A1-1. To do so, we have created an organization that is:

- a coherent, national R&D program
- a multi-laboratory and multi-university program
- a streamlined organization with clear reporting lines

The organizing principles of MAP (see Fig. A-1) established by the Fermilab management are listed below:

- Fermilab will provide overall leadership of the national Muon Accelerator Program (MAP).
- The MAP will be a collaborative effort, integrating participants from the existing NFMCC and MCTF.
- Existing commitments of NFMCC, such as to the Muon Ionization Cooling Experiment (MICE) and the International Design Study for a Neutrino Factory (IDS-NF), will be supported.
- The MAP organization will maintain the U.S. portion of the MICE organization in its current form.
- The MAP will have a dedicated management team, led by a Program Director reporting to the Fermilab Director. The Program Director provides the primary point of management contact to DOE/OHEP.

- The MAP Program Director will control the allocation of funds to the collaborating institutions.
- DOE-OHEP will establish a Muon Program Manager who will oversee the MAP program from within the agency.
- The MAP will be organized and managed utilizing project management tools.
- An oversight group will be formed with representation drawn from the participating institutions.
- Activities undertaken by the MAP and the associated resource support will be agreed upon with DOE, with a mutually understood ~7-year time horizon for development of the MC-DFS, the NF-RDR (under the auspices of the IDS-NF), MICE, and carrying out a supporting technology development program.
- An advisory committee will monitor progress of the program and report to the oversight group and/or the Fermilab Director.
- The organization will provide a mechanism for interacting with international organizations that have common interests, such as the IDS-NF and the MICE collaboration.

Proposed organization

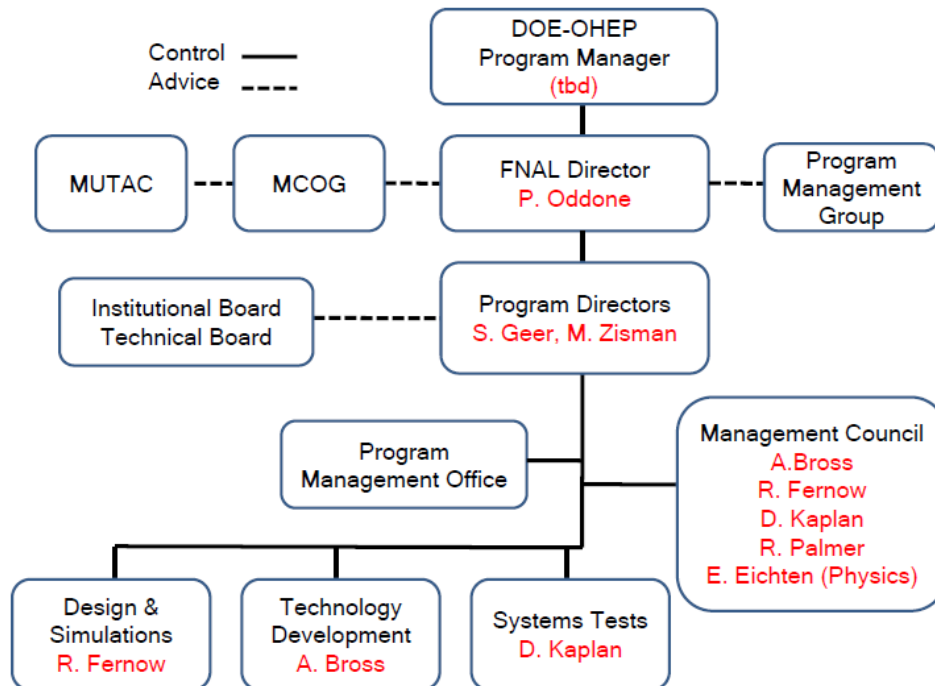

Fig. A-1. Interim MAP organization.



- The Fermilab Director has appointed the MAP Program interim Co-Directors, and will later appoint the Program Director. The Program Director will be generally charged to:
  - Update, as necessary, and maintain a multi-year plan for MAP activities including
    - Definition of major goals and objectives: technical, cost, and schedule
    - Identification of required resources
    - Definition of responsibilities within the collaboration
  - Establish an organization to execute the MAP program
  - Define and execute the supporting R&D program
  - Provide periodic technical, cost, schedule reports at a frequency agreed to with the Fermilab Director and DOE/OHEP
- A Muon Collaboration Oversight Group (MCOG) will provide oversight by the participating institutions
  - MCOG will be constituted from one representative from each participating laboratory plus some representatives from the university community
  - MCOG will advise the Fermilab Director
- A Muon Technical Advisory Committee (MUTAC) will be appointed by MCOG as the primary body for technical advice and for review of the MAP activities.
- Distribution of funds to the collaborating institutions will be based upon the direction of the MAP Program Director.
- Various committees designated by the Program Director will aid in the following functions: development of the technical strategy, management of the program, and coordination of the participating institutions. These are represented schematically by the Technical Board, the Management Council, and the Institutional Board in Fig. A-1. The detailed structure and accompanying responsibilities and authorities will be defined by the Program Director, subject to some guidance from MCOG.
- It is assumed that university collaborators will participate in the MAP. They will participate in planning and coordination via membership on the Institutional Board, and representation on MCOG.
- It is assumed that a complementary Muon Collider Physics and Detector Collaboration will be formed, supported by a separate funding stream from the DOE. In order to provide close coordination between this Collaboration and the MAP it is proposed that the MCP&D Collaboration Spokesperson (or designee) be an *ex officio* member of the MAP Management Council. In addition a Machine-Detector Interface task has been created within the MAP to serve as the primary technical contact point between the two organizations.
- The interim Level-2 structure for the MAP organization is shown in Fig. A-2. The details of this organization have been determined jointly by the interim Project Co-Directors and the interim Level-1 managers.

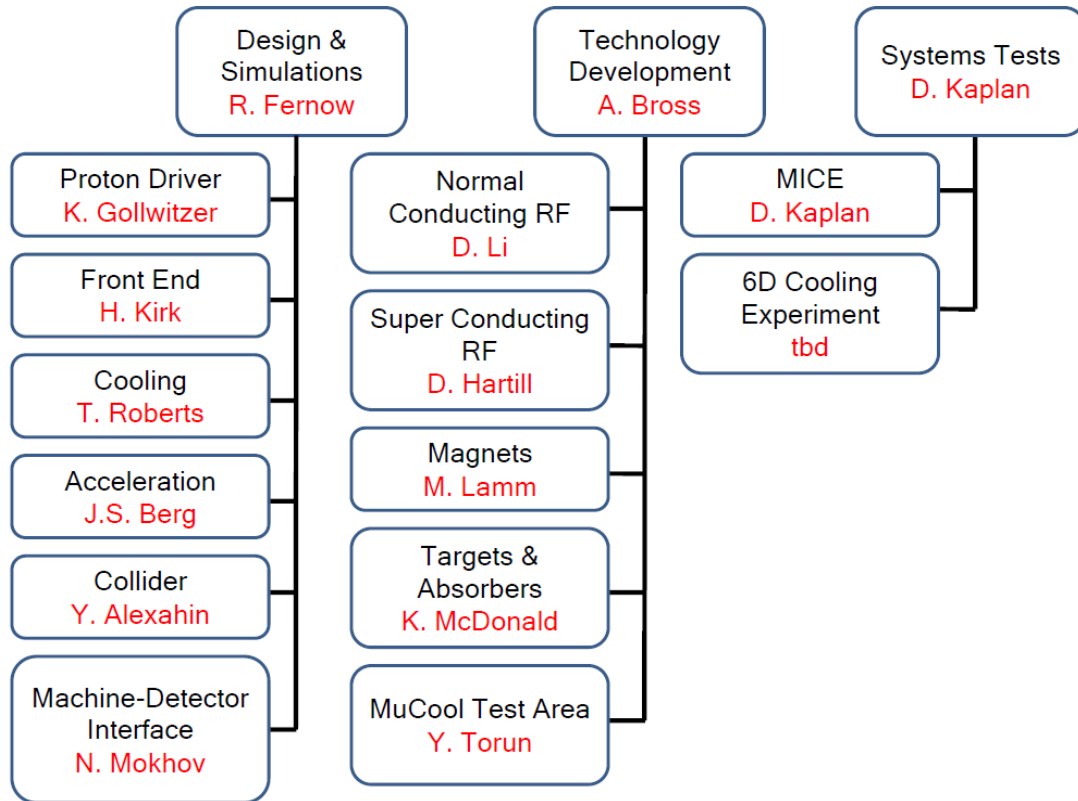

Fig. A-2. Interim MAP Level-2 organization.

### 3. Transition Plan

- Because the new organization is just being formed, the funding distribution for FY10 (Y1 of the MAP plan) among the NFMCC institutions will be organized as in the past, i.e., via the NFMCC Project Manager and the MCTF leaders, and approved by MCOG.
- The Fermilab Director designated two members of the current Muon Collaboration Coordinating Committee as interim Co-Directors, with responsibility for coordinating editing of the revised multi-year proposal, submitting it to DOE, and preparing for the DOE review. During this period the NFMCC and MCTF will formally exist but will closely coordinate activities via the existing MCCC.
- The Fermilab Director will form a search committee for a permanent Program Director.
- MCOG, in consultation with the interim Co-Directors, will draw up relevant governing documents and MOUs to establish the new organization. These will be approved by the DOE and the Fermilab Director.
- Once the new organization is in place, NFMCC and MCTF will cease to exist as independent entities.

## APPENDIX 2: FUNDING REQUEST

Here we summarize the funding and effort requirements for the activities proposed for the Muon Accelerator Program. Table A-1 indicates the proposed effort levels for Y1–Y7 for the nominal funding profile, along with the associated costs. Table A-2 shows the equivalent information for the augmented funding profile. The values shown in Tables A-1 and A-2 are “burdened” with appropriate overhead rates both for effort and for M&S, and, in row 5, the costs are escalated by 4% annually to obtain “then-year” total dollars. As can be seen, mounting the proposed program requires approximately a 50% increase in annual funding for muon-related R&D. Figures A-3 and A-4 show the cost information from Tables A-1 and A-2 in graphical form, respectively. The effort profiles from Tables A-1 and A-2 are plotted in Figs A-5 and A-6, respectively. Integrated funding required for the nominal MAP plan is \$117M; that for the enhanced plan is slightly less, \$114M.

Assuming we are successful—and have the support of the high-energy physics community—we anticipate that the next stage of this program would ramp up for a follow-on activity that would include, for example, mounting a full 6D cooling experiment based on the technologies we have developed, the development of a Conceptual Design Report for a proposed facility, and hopefully the start of pre-construction R&D.

Table A-1. Current-year (FY10, denoted as Y1) support for NF and MC R&D, and requested level of support for the “nominal” unified national R&D plan of the Muon Accelerator Program. Rows 2–4 give costs in FY10 dollars; totals including escalation (“then-year” dollars) are indicated in row 5.

	Y1	Y2	Y3	Y4	Y5	Y6	Y7
Effort (FTE)	31	40	44	48	47	49	47
SWF (\$M) <sup>a)</sup>	8.3	11.2	12.2	13.2	12.9	13.0	13.4
M&S (\$M) <sup>a)</sup>	2.0	4.2	3.3	2.3	2.6	2.5	1.5
Total (\$M) <sup>a)</sup>	10.3	15.4	15.5	15.5	15.5	15.5	14.9
Total (\$M) <sup>b)</sup>	10.3	16.1	16.9	17.5	18.2	19.0	19.0

<sup>a)</sup> FY10 dollars.

<sup>b)</sup> Then-year dollars, assuming 4% annual escalation.

Table A-2. Current-year (FY10, denoted as Y1) support for NF and MC R&D, and requested level of support for the “augmented” unified national R&D plan of the Muon Accelerator Program. Rows 2–4 give costs in FY10 dollars; totals including escalation (“then-year” dollars) are indicated in row 5.

	Y1	Y2	Y3	Y4	Y5	Y6
Effort (FTE)	31	40	51	58	61	64
SWF (\$M) <sup>a)</sup>	8.3	11.2	14.4	16.0	16.2	17.4
M&S (\$M) <sup>a)</sup>	2.0	4.2	3.5	3.2	3.3	2.0
Total (\$M) <sup>a)</sup>	10.3	15.4	17.9	19.2	19.5	19.4
Total (\$M) <sup>b)</sup>	10.3	16.1	19.5	21.7	22.9	23.7

<sup>a)</sup> FY10 dollars.

<sup>b)</sup> Then-year dollars, assuming 4% annual escalation.

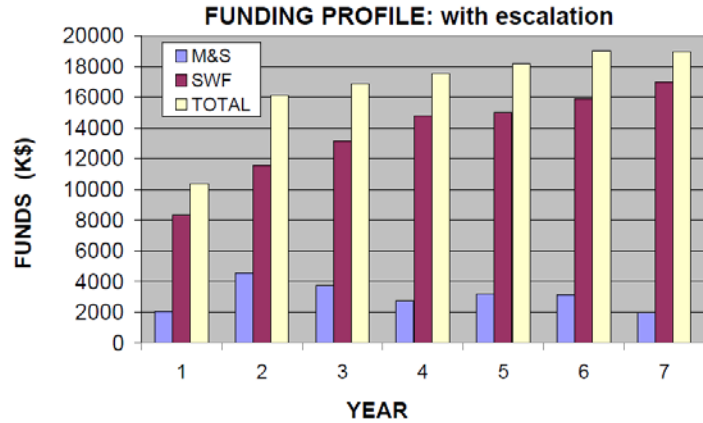

Fig. A-3. Graphical representation of the nominal cost profile from Table A-1.

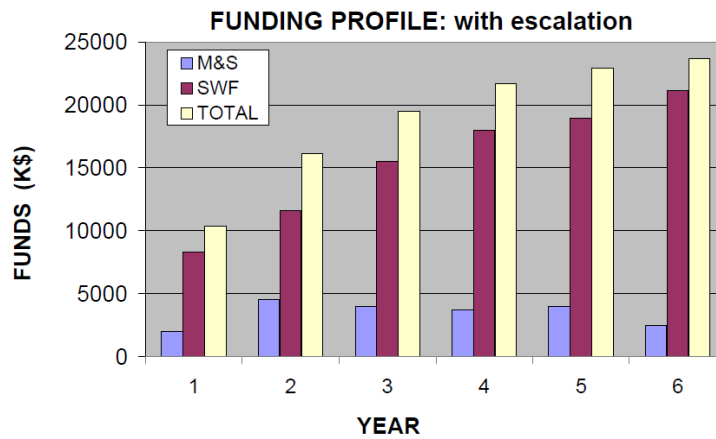

Fig. A-4. Graphical representation of the augmented cost profile from Table A-2.

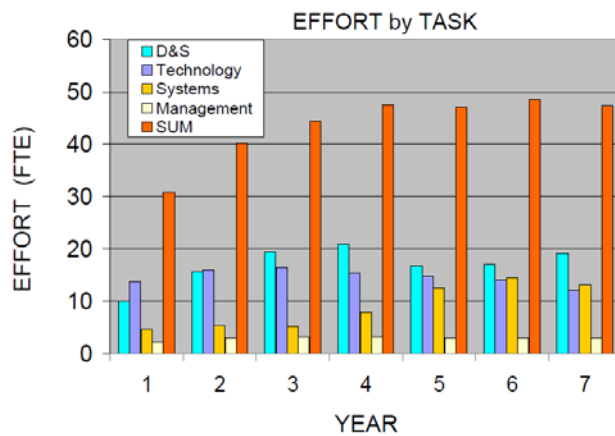

Fig. A-5. Effort profile for the nominal MAP R&D activities. Integrated levels for each system are: Design and Simulation, 119 FTE-yr; Technology Development, 103 FTE-yr; System Tests, 63 FTE-yr; and Management, 21 FTE-yr. The full program requires 306 FTE-yr.

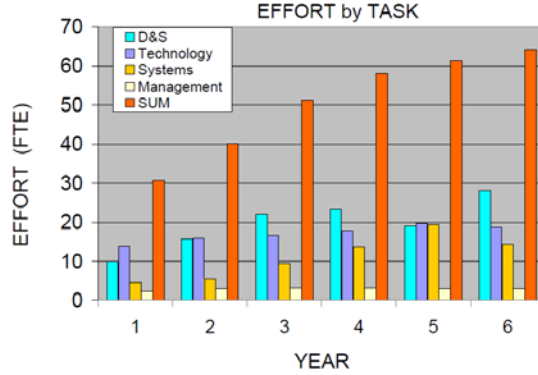

Fig. A-6. Effort profile for the augmented MAP R&D activities. Integrated levels for each system are: Design and Simulation, 118 FTE-yr; Technology Development, 103 FTE-yr; System Tests, 67 FTE-yr; and Management, 18 FTE-yr. The full program requires 306 FTE-yr.

Table A-3 shows the projected\* distribution of effort among the main national laboratories (BNL, FNAL, and LBNL) and that projected for other institutions, universities, and SBIR companies for the nominal funding plan. Equivalent information for the augmented funding plan is contained in Table A-4.\* As can be seen, the anticipated laboratory commitments only partially fulfill the program requirements, especially in the augmented case. We anticipate that the remaining effort will be provided by other laboratories, universities and SBIR companies.

Table A-3. Effort profile by institution for nominal funding plan.

	Y1 (FTE)	Y2 (FTE)	Y3 (FTE)	Y4 (FTE)	Y5 (FTE)	Y6 (FTE)	Y7 (FTE)
BNL	5	7	8	8	8	8	6
FNAL	20	23	25	28	31	33	30
LBNL	3	4	5	5	4	3	5
Other <sup>a)</sup>	3	6	6	7	4	5	6
<b>TOTAL</b>	<b>31</b>	<b>40</b>	<b>44</b>	<b>48</b>	<b>47</b>	<b>49</b>	<b>47</b>

<sup>a)</sup> Includes SBIR companies, universities, other laboratories, additional engineering from the main laboratories and/or external vendor contracts.

Table A-4. Effort profile by institution for augmented funding plan.

	Y1 (FTE)	Y2 (FTE)	Y3 (FTE)	Y4 (FTE)	Y5 (FTE)	Y6 (FTE)
BNL	5	7	8	9	9	10
FNAL	20	23	30	34	37	37
LBNL	3	4	5	6	6	6
Other <sup>a)</sup>	3	6	8	9	9	11
<b>TOTAL</b>	<b>31</b>	<b>40</b>	<b>51</b>	<b>58</b>	<b>61</b>	<b>64</b>

<sup>a)</sup> Includes SBIR companies, universities, other laboratories, additional engineering from the main laboratories and/or external vendor contracts.

\* We anticipate some flexibility in allocating effort among the participating institutions as the program evolves and new institutions join.

## APPENDIX 3: COMPLEMENTARY PHYSICS AND DETECTOR STUDIES

### A3.1 Physics Study

In the next decade the physics of the Terascale will be explored at the LHC. Furthermore, planned experiments studying neutrino oscillations, quark/lepton flavor physics, and rare processes may also provide insight into new physics at the Terascale and beyond. This new physics might be new gauge bosons, additional fermion generations or fundamental scalars. It might be SUSY or new dynamics or even extra dimensions. In any case, it is hard to imagine a scenario in which a multi-TeV lepton collider would not be required to fully explore the new physics.

A multi-TeV Muon Collider provides a very attractive possibility for studying the details of Terascale physics after the initial running of the LHC. To give a sense of the overall MC study program envisioned, we describe here the anticipated physics and detector studies that will complement the MAP. The goal of these studies is to understand the required MC parameters (in particular luminosity and energy) and map out, as a function of these parameters, the associated physics potential. The physics studies will set benchmarks for various new physics scenarios (e.g., SUSY, Extra Dimensions, New Strong Dynamics) as well as Standard Model processes. The development of the physics case will be coordinated with the studies of detector performance, the design of the interaction region, and studies of the background environment. This coordination will be required to determine the signal efficiencies and background rates. These efforts will not be formally part of MAP, but we anticipate a strong coupling among them. In particular, there will be a Machine-Detector Interface (MDI) activity within the MAP that will support, and coordinate with, the Physics and Detector study.

During the first 2–3 years the physics case will be refined and the physics reach as a function of energy and luminosity of the collider will be documented. This will enable the specification of the initial configuration parameters for the collider before the completion of MC design studies. It will be important to establish a software platform for the physics studies as early as possible and dedicated resources, both manpower and equipment, are needed. The physics case needs to have broad laboratory theory group involvement and support. The larger theory community also needs to be included in this effort. A series of workshops will be held<sup>†</sup> to stimulate interest and ideas from the larger theory community. An initial report on the physics case should be completed in this period.

The last 3–4 years will be devoted to detailed physics studies, including a more complete detector simulation. In this period, comparisons with other possible facilities, e.g., CLIC and SLHC, will be made. Any new information from LHC experiments on the physics at the Terascale will be incorporated and the physics case updated.

---

<sup>†</sup> The first of these has already taken place at Fermilab, on November 10–12, 2009.

### A3.2 Collider Detector Studies

The detectors that will record and measure the charged and neutral particles produced in collisions at a Muon Collider are quite challenging. They must operate in an environment that is very different from that of the ILC or CLIC. Compared with hadronic interactions, lepton collisions generate events essentially free from backgrounds from underlying events and multiple interactions. They provide accurate knowledge of the center-of-mass energy, initial state helicity and charge, and produce all particle species democratically. Muon Collider detectors need not contend with extreme data rates. Indeed, most likely they can record events without the need for electronic pre-selection and thus without the biases such selection may introduce.

The challenges for the detectors lie in the areas of precision, radiation hardness and background rejection due to the copious background from muon decays. To define the physics reach of the detector, a realistic simulation is needed, one that includes beamstrahlung, background from muon decays in flight, and a realistic evaluation of the bunch structure of the beams with time stamping. This would allow for realistic pattern recognition and track fitting of charged tracks. We foresee that setting up the simulation will take most of the effort in the first year. The simulation studies will be further refined and tools will be developed in the subsequent years to establish the physics reach.

As for vertex detectors and trackers, there is sufficient overlap of the requirements for the LHC upgrade experiments and the ILC experiments that we do not see any additional effort needed for the DFSR for the MC detector. We do, however, see a significant effort in establishing the required calorimetry for a Muon Collider detector. To mitigate detector backgrounds, previous MC final focus shielding designs resulted in an uninstrumented cone in the forward direction of  $20^\circ$  opening angle. Possibilities for limiting the opening angle or partly instrumenting this cone need to be explored.

Many of the interesting physics processes at a lepton collider appear in multi-jet final states, often accompanied by charged leptons or missing energy. The reconstruction of the invariant mass of two or more jets will provide an essential tool for identifying and distinguishing  $W$ ,  $Z$ ,  $H$ , and top particles, and for discovering new states or decay modes. Ideally, the di-jet mass resolution should be comparable to the natural decay widths of the parent particles, around a few GeV or less. Improving the jet energy resolution to 3–4% of the total jet energy, which is about a factor of two better than that achieved at LEP, will provide such di-jet mass resolution. Achieving such resolution represents a considerable technical challenge. The ILC and CLIC detectors emphasize “Particle Flow” to improve the jet energy resolution. Simulation studies indicate that, up to center-of-mass energies of 1 TeV, jet energy resolution of 3.5% can be retained in an  $e^+e^-$  environment. How the Particle Flow analysis performance evolves with increasing center-of-mass energy, the importance of different detector technologies, and the sensitivity to backgrounds are all unknown at this point. We anticipate that R&D on calorimetry suitable for a 3-TeV Muon Collider will be at the center of the detector R&D program. The evolution of the performance of Particle-Flow-based technologies with

center-of-mass energy will need to be compared with the performance of alternative technologies, such as total absorption dual-readout calorimetry.

Our detector study plan is:

Year 1: Establish a realistic simulation of the Muon Collider background environment, and study the final-focus shielding design.

Years 2–3: Define detector requirements based on physics studies and expected backgrounds, and hence identify and plan the detector R&D that will best inform the DFSR studies, and then begin this R&D.

Years 4–5: Carry out detector R&D and further simulation studies, establishing the likely detector performance.

Year 5: Write the detector section of the interim DFSR.

Years 6–7: Continue refining detector design in response to changes in collider design and/or changes in the physics landscape, and develop a cost range for the proposed baseline system. Complete the updates needed for the final DFSR.

### A3.3 Magnetization Concepts for Neutrino Detectors

All detector concepts for the Neutrino Factory require a magnetic field in order to determine the sign of the muon (or possibly the electron) produced in a neutrino interaction. For the baseline detector, this is done with magnetized iron. Technically, this is very straightforward, although for the 50 kton baseline detectors it does present challenges because of their size. The cost of this magnetic solution is believed to be manageable.

Magnetic solutions for other NF detectors will be much more challenging. We have considered magnetizing volumes as large as 60,000 m<sup>3</sup> for a liquid-argon detector or a totally-active scintillator detector (TASD). For the cases of the TASD and the LAr approach currently being studied by U.S. and Canadian groups, providing the required magnetic volume with 10 solenoids of roughly 15 m diameter × 15 m length has been considered, with the solenoids configured into a magnetic cavern as shown in Fig. A-7. After considering a number of field strengths, we adopted 0.5 T as our baseline.

The problem with building very large conventional superconducting solenoids is that 90% of the cost goes into the cryostat, which must withstand enormous vacuum loading forces. We avoid this problem in our design by using the superconducting transmission line (STL) concept that was developed for the Very Large Hadron Collider superferric magnets [20]. The solenoid windings thus consist of a superconducting cable that is confined in its own cryostat. Each solenoid comprises 150 turns and requires about 7500 m of cable. There is no large vacuum vessel and, since the STL does not need to be close-packed in order to reach an acceptable field level, access to the detectors can be



made through the winding support cylinder. As part of the IDS-NF RDR we will include work on this magnet concept. The scope will include:

- redesign of a superconducting transmission line for this application
- conceptual design of a full-scale (15 m diameter) 3-turn prototype
- engineering design and procurement for a prototype STL device
- assembly and commissioning of the prototype
- prototype test and evaluation

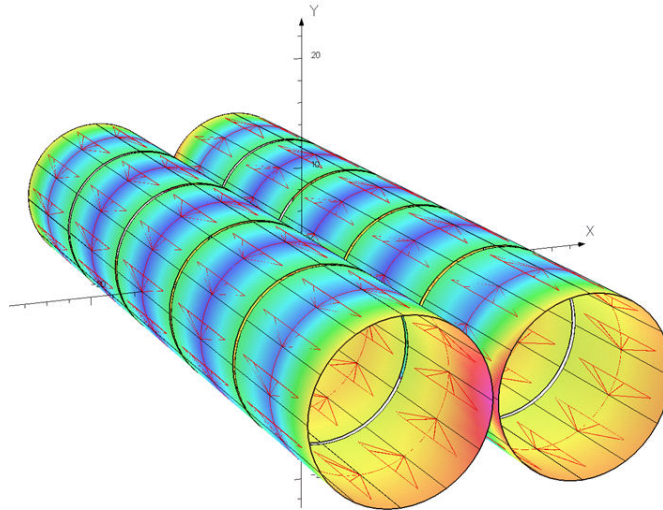

Fig. A-7. Magnetic cavern configuration.