

NOAA NESDIS CENTER for SATELLITE APPLICATIONS and RESEARCH

DOCUMENT GUIDELINE DG-7.1.A

PRELIMINARY DESIGN DOCUMENT GUIDELINE - APPENDIX Version 3.0



**TITLE: DG-7.1.A: PRELIMINARY DESIGN
DOCUMENT GUIDELINE APPENDIX VERSION 3.0**

AUTHORS:

Ken Jensen (Raytheon Information Solutions)

DATE: October 1, 2009

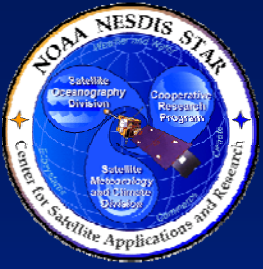

<Project and/or Product Name>

Preliminary Design Review

<Date>

Prepared By: <Preparer 1>¹, <Preparer 2>², ..., and <Preparer N>^N

¹ <Organization for Preparer 1>

² <Organization for Preparer 2> ...

^N <Organization for Preparer N>



Review Agenda

Introduction	<Start Time> - <End Time>	<Presenter(s)>
PRR Report	<Start Time> - <End Time>	<Presenter(s)>
Operations Concept	<Start Time> - <End Time>	<Presenter(s)>
Requirements	<Start Time> - <End Time>	<Presenter(s)>
Break	<Start Time> - <End Time>	
Algorithm Theoretical Basis	<Start Time> - <End Time>	<Presenter(s)>
Software Architecture & Interfaces	<Start Time> - <End Time>	<Presenter(s)>
Lunch	<Start Time> - <End Time>	
Quality Assurance	<Start Time> - <End Time>	<Presenter(s)>
Requirements Allocation	<Start Time> - <End Time>	<Presenter(s)>
Break	<Start Time> - <End Time>	
Risks and Actions	<Start Time> - <End Time>	<Presenter(s)>
Summary and Conclusions	<Start Time> - <End Time>	<Presenter(s)>

Review Agenda Slide



Review Agenda - Day 1

Introduction	<Start Time> - <End Time>	<Presenter(s)>
PRR Report	<Start Time> - <End Time>	<Presenter(s)>
Break	<Start Time> - <End Time>	
Operations Concept	<Start Time> - <End Time>	<Presenter(s)>
Requirements	<Start Time> - <End Time>	<Presenter(s)>
Lunch	<Start Time> - <End Time>	
Algorithm Theoretical Basis	<Start Time> - <End Time>	<Presenter(s)>
Break	<Start Time> - <End Time>	
Algorithm Theoretical Basis (continued)	<Start Time> - <End Time>	<Presenter(s)>

**Review Agenda Slide
Alternative – Day 1**



Review Agenda - Day 2

Software Architecture & Interfaces	<Start Time> - <End Time>	<Presenter(s)>
Break	<Start Time> - <End Time>	
Requirements Allocation	<Start Time> - <End Time>	<Presenter(s)>
Lunch	<Start Time> - <End Time>	
Quality Assurance	<Start Time> - <End Time>	<Presenter(s)>
Break	<Start Time> - <End Time>	
Risks and Actions	<Start Time> - <End Time>	<Presenter(s)>
Summary and Conclusions	<Start Time> - <End Time>	<Presenter(s)>
Open Discussion	<Start Time> - <End Time>	

**Review Agenda Slide
Alternative – Day 2**

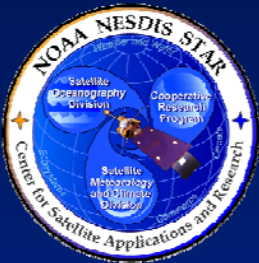

- **INTRODUCTION**
- PRR REPORT
- OPERATIONS CONCEPT
- REQUIREMENTS
- ALGORITHM THEORETICAL BASIS
- SOFTWARE ARCHITECTURE
- QUALITY ASSURANCE
- REQUIREMENTS ALLOCATION
- RISKS AND ACTIONS
- SUMMARY AND CONCLUSIONS

Section 1 Setup Slide



Section 1 - Introduction

Presented by

<Presenter's Name>
<Presenter's Title/Role>
<Presenter's Organization>

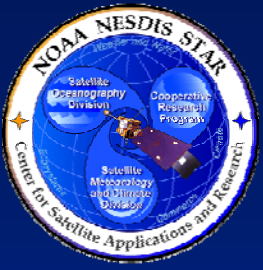

<Project Name> - Development Project Plan

- The Development Project Plan (DPP) is a standard artifact of the STAR EPL process.
 - » The DPP identifies project objectives, stakeholder roles and tasks, resources, milestones and schedule
 - » PDR reviewers can access this document at <pointer to the DPP>
- Guidelines for the DPP are found in STAR EPL process asset DG-5.1
 - » PDR reviewers can access this document at <pointer to DG-5.1>



Project Objectives

- **Objective 1**
 - » Sub-bullet 1
 - »
 - » Sub-bullet N
- **Objective 2**
 - » Sub-bullet 1
 - »
 - » Sub-bullet N
-
- **Objective M**
 - » Sub-bullet 1
 - »
 - » Sub-bullet N

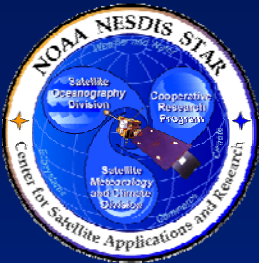

Project Stakeholders

- **<Stakeholder Role 1> - <Named Stakeholder(s) or TBD>**
 - » Sub-bullet 1 (Description of stakeholder tasks)
 - »
 - » Sub-bullet M (Description of stakeholder tasks)
- **<Stakeholder Role 2> - <Named Stakeholder(s) or TBD>**
 - » Sub-bullet 1 (Description of stakeholder tasks)
 - »
 - » Sub-bullet M (Description of stakeholder tasks)
-
- **<Stakeholder Role N> - <Named Stakeholder(s) or TBD>**
 - » Sub-bullet 1 (Description of stakeholder tasks)
 - »
 - » Sub-bullet M (Description of stakeholder tasks)

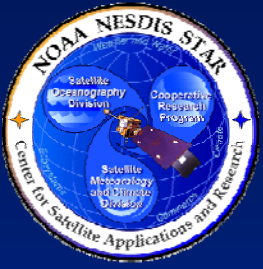

Project Stakeholders

Stakeholder	Names	Description
<Role 1>	<Names or TBD>	<Description>
<Role 2>	<Names or TBD>	<Description>
.....	<Names or TBD>	<Description>
<Role N>	<Names or TBD>	<Description>

**Section 1.3 –
Table Alternative**

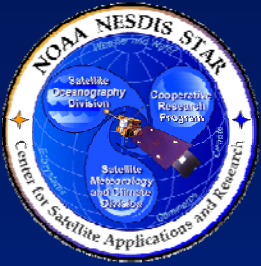

<Project Name> Organization Chart

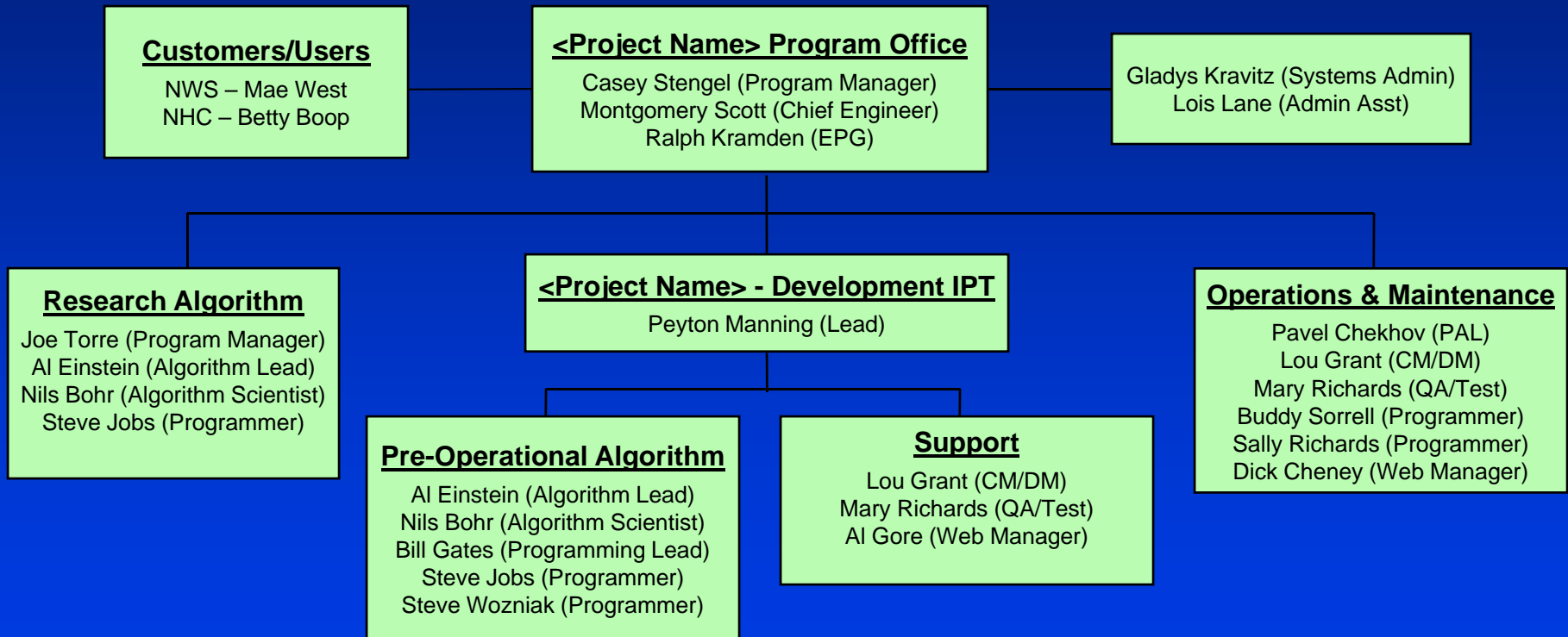

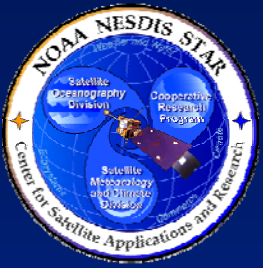

Project Milestones

- Gate 3 Review - <Date>
- Project Requirements Review - <Date>
- **Preliminary Design Review - <Date>**
- Critical Design Review - <Date>
- Gate 4 Review - <Date>
- Test Readiness Review - <Date>
- Code Test Review - <Date>
- System Readiness Review - <Date>
- Gate 5 Review - <Date>
- Delivery to Operations - <Date>

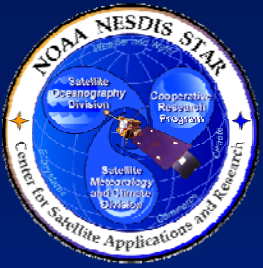

Project Timeline

- PDR**
09/29/04
- L1C Products CDR**
01/12/06
- L1C Code**
04/05/06
- L2 Code**
07/31/06
- ATBD 1st draft**
11/10/06
- L2 Products CDR**
11/14/06

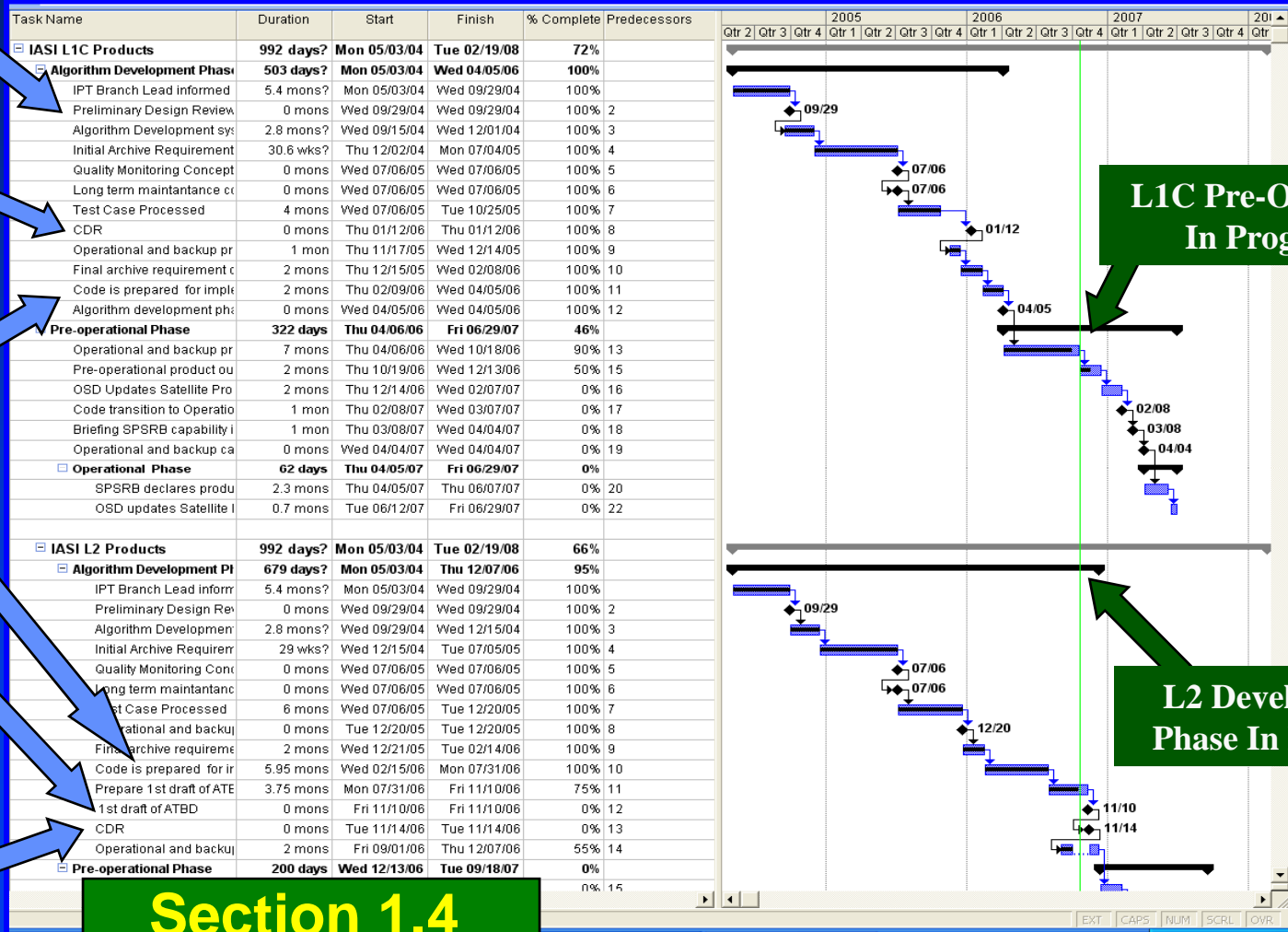

Section 1.4

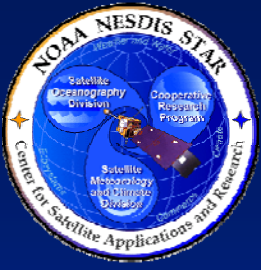

Project Timeline - Design Phase

- PDR**
09/29/04
- L1C Products CDR**
01/12/06
- L1C Code**
04/05/06
- L2 Code**
07/31/06
- ATBD 1st draft**
11/10/06
- L2 Products CDR**
11/14/06

Task Name	Duration	Start	Finish	% Complete	Predecessors
IASI L1C Products	992 days?	Mon 05/03/04	Tue 02/19/08	72%	
Algorithm Development Phase	503 days?	Mon 05/03/04	Wed 04/05/06	100%	
IPT Branch Lead informed	5.4 mons?	Mon 05/03/04	Wed 09/29/04	100%	
Preliminary Design Review	0 mons	Wed 09/29/04	Wed 09/29/04	100%	2
Algorithm Development sys	2.8 mons?	Wed 09/29/04	Wed 12/01/04	100%	3
Initial Archive Requirement	30.6 wks?	Thu 12/02/04	Mon 07/04/05	100%	4
Quality Monitoring Concept	0 mons	Wed 07/06/05	Wed 07/06/05	100%	5
Long term maintanance c	0 mons	Wed 07/06/05	Wed 07/06/05	100%	6
Test Case Processed	4 mons	Wed 07/06/05	Tue 10/25/05	100%	7
CDR	0 mons	Thu 01/12/06	Thu 01/12/06	100%	8
Operational and backup pr	1 mon	Thu 11/17/05	Wed 12/14/05	100%	9
Final archive requirement c	2 mons	Thu 12/15/05	Wed 02/08/06	100%	10
Code is prepared for imple	2 mons	Thu 02/09/06	Wed 04/05/06	100%	11
Algorithm development pha	0 mons	Wed 04/05/06	Wed 04/05/06	100%	12
Pre-operational Phase	322 days	Thu 04/06/06	Fri 06/29/07	46%	
Operational and backup pr	7 mons	Thu 04/06/06	Wed 10/18/06	90%	13
Pre-operational product ou	2 mons	Thu 10/19/06	Wed 12/13/06	50%	15
OSD Updates Satellite Pro	2 mons	Thu 12/14/06	Wed 02/07/07	0%	16
Code transition to Operatio	1 mon	Thu 02/08/07	Wed 03/07/07	0%	17
Briefing SPSRB capability i	1 mon	Thu 03/08/07	Wed 04/04/07	0%	18
Operational and backup ca	0 mons	Wed 04/04/07	Wed 04/04/07	0%	19
Operational Phase	62 days	Thu 04/05/07	Fri 06/29/07	0%	
SPSRB declares produ	2.3 mons	Thu 04/05/07	Thu 06/07/07	0%	20
OSD updates Satellite I	0.7 mons	Tue 06/12/07	Fri 06/29/07	0%	22
IASI L2 Products	992 days?	Mon 05/03/04	Tue 02/19/08	66%	
Algorithm Development PI	679 days?	Mon 05/03/04	Thu 12/07/06	95%	
IPT Branch Lead inform	5.4 mons?	Mon 05/03/04	Wed 09/29/04	100%	
Preliminary Design Rev	0 mons	Wed 09/29/04	Wed 09/29/04	100%	2
Algorithm Development	2.8 mons?	Wed 09/29/04	Wed 12/15/04	100%	3
Initial Archive Requirem	29 wks?	Wed 12/15/04	Tue 07/05/05	100%	4
Quality Monitoring Conc	0 mons	Wed 07/06/05	Wed 07/06/05	100%	5
Long term maintananc	0 mons	Wed 07/06/05	Wed 07/06/05	100%	6
Test Case Processed	6 mons	Wed 07/06/05	Tue 12/20/05	100%	7
Operational and backu	0 mons	Tue 12/20/05	Tue 12/20/05	100%	8
Final archive requireme	2 mons	Wed 12/21/05	Tue 02/14/06	100%	9
Code is prepared for ir	5.95 mons	Wed 02/15/06	Mon 07/31/06	100%	10
Prepare 1st draft of ATE	3.75 mons	Mon 07/31/06	Fri 11/10/06	75%	11
1st draft of ATBD	0 mons	Fri 11/10/06	Fri 11/10/06	0%	12
CDR	0 mons	Tue 11/14/06	Tue 11/14/06	0%	13
Operational and backu	2 mons	Fri 09/01/06	Thu 12/07/06	55%	14
Pre-operational Phase	200 days	Wed 12/13/06	Tue 09/18/07	0%	

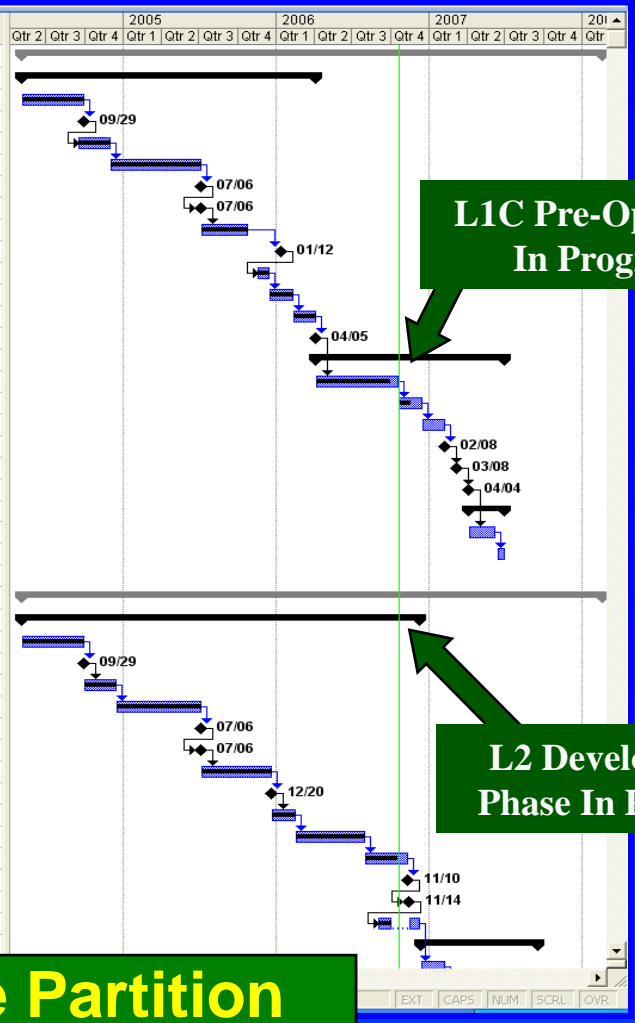

Section 1.4 - Timeline Partition

Project Plan - Changes Since Project Requirements Review

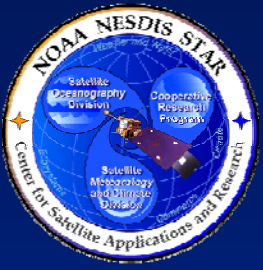

<Describe any changes to the project plan – objectives, stakeholders, tasks, schedule and milestones – that have occurred since the Project Requirements Review. Use multiple slides as necessary for clarity.>

<OR, if there have been no changes, state the following:>

- There have been no changes to the project plan since the Project Requirements Review

Project Plan

Stakeholder Involvement (1)

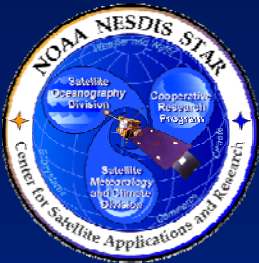

- **<Describe the involvement of stakeholders in the project, noting compliance or deviation from the project plan. Use multiple slides as necessary for clarity. Follow the format shown on this slide and the next slide.>**
- **Development Lead**
 - » Sub-bullet 1 (Description of involvement related to the Project Plan)
 - »
 - » Sub-bullet M (Description of involvement related to the Project Plan)
- **Development Scientists**
 - » Sub-bullet 1 (Description of involvement related to the Project Plan)
 - »
 - » Sub-bullet M (Description of involvement related to the Project Plan)
- **Development Testers**
 - » Sub-bullet 1 (Description of involvement related to the Project Plan)
 - »
 - » Sub-bullet M (Description of involvement related to the Project Plan)

Project Plan

Stakeholder Involvement (2)

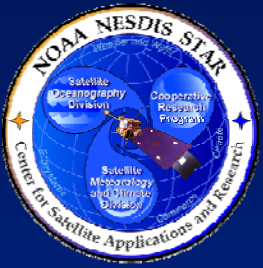

- **Development Programmers**
 - » Sub-bullet 1 (Description of involvement related to the Project Plan)
 - »
 - » Sub-bullet M (Description of involvement related to the Project Plan)
- **QA**
 - » Sub-bullet 1 (Description of involvement related to the Project Plan)
 - »
 - » Sub-bullet M (Description of involvement related to the Project Plan)
- **CM/DM**
 - » Sub-bullet 1 (Description of involvement related to the Project Plan)
 - »
 - » Sub-bullet M (Description of involvement related to the Project Plan)
- **Customers / Users**
 - » Sub-bullet 1 (Description of involvement related to the Project Plan)
 - »
 - » Sub-bullet M (Description of involvement related to the Project Plan)

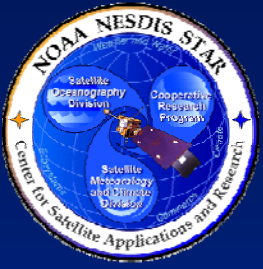

PDR Guidelines and Check List

- Guidelines for the PDR reviewers are in STAR EPL process asset PRG-7
 - » Reviewers can access this document at <pointer to PRG-7>
- The PDR Review Check List is STAR EPL process asset CL-7
 - » Reviewers can access this document at <pointer to CL-7>

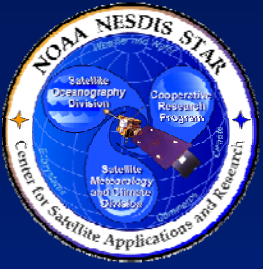

PDR Guidelines and Check List

- Guidelines for the PDR reviewers are in STAR EPL process asset PRG-7
 - » Reviewers can access this document at <pointer(s) to PRG-7>
- The PDR Review Check List is in the Development Project Plan (DPP) Appendix C
 - » Reviewers can access this document at <pointer(s) to DPP Appendix C>

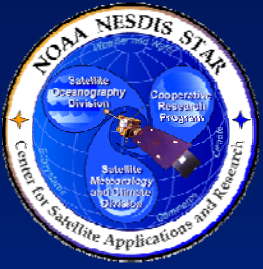

PDR Report

- The PDR Report (PDRR) is a standard artifact of the STAR EPL process.
 - » The PDR reviewers should produce this report after conducting the PDR.
 - » The report will be an artifact for the Critical Design Review.
- Guidelines for the PDRR are found in STAR EPL process asset DG-7.2
 - » PDR reviewers can access this document at <pointer to DG-7.2>



Review Objectives (1)

- Review the Project Requirements Review (PRR) report
 - » Focus on actions
- Review the operations concept
 - » Operations Concept Document (OCD)
- Review the requirements (basic and derived)
 - » Focus on changes since PRR
 - » Requirements Allocation Document (RAD)
- Review the algorithm theoretical basis
 - » Algorithm Theoretical Basis Document (ATBD)



Review Objectives (2)

- Review the software system architecture
 - » Software Architecture Document (SWA)
- Review the plans for quality assurance
 - » Verification and Validation Plan (VVP)
- Review the requirements allocation
 - » Requirements Allocation Document (RAD)
- Identify risks and actions

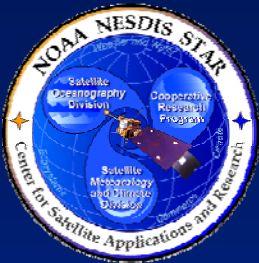

Review Objectives (3)

- <Project-Unique Objective 1>
 - » Sub-bullets
- <Project-Unique Objective 2>
 - » Sub-bullets
-
 - »
- <Project-Unique Objective N>
 - » Sub-bullets
- Review the status of actions
 - » Sub-bullets



- INTRODUCTION
- **PRR REPORT**
- OPERATIONS CONCEPT
- REQUIREMENTS
- ALGORITHM THEORETICAL BASIS
- SOFTWARE ARCHITECTURE
- QUALITY ASSURANCE
- REQUIREMENTS ALLOCATION
- RISKS AND ACTIONS
- SUMMARY AND CONCLUSIONS

Section 2 Setup Slide

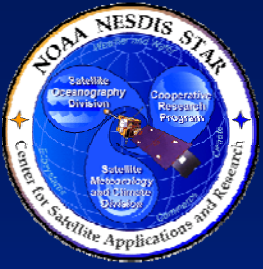

Section 2 - Project Requirements Review Report

Presented by

<Presenter's Name>
<Presenter's Title/Role>
<Presenter's Organization>

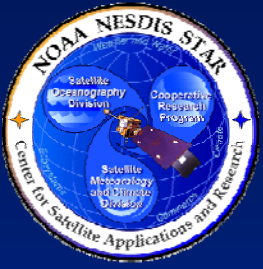

Project Requirements Review Report (PRRR)

- <Pointer to the PRRR>
- PRRR is the approved report of the PRR reviewers
- PRRR includes approval status for each PRR requirement
 - » Status should be Pass, Conditional Pass, Waive, or Defer
 - » Items with “Conditional Pass” status must have associated actions that should be closed prior to PDR
 - » Items with “Defer” status must have associated actions
 - Actions deferred to the PDR must be addressed prior to PDR approval
 - » Agreement of relevant stakeholders should be documented
- PRRR should include an assessment of risk items, with recommendations for risk mitigation
 - » Status of the risk items should be addressed at PDR

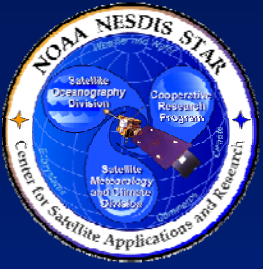

<Project Name> PDR - Entry Criteria

Raytheon

- <List the entry criteria for this PDR. Present as bullets. Use multiple slides as necessary for clarity. The following three slides should be used if the standard PDR entry criteria, documented in STAR EPL Check List CL-7, are used.>
- <If the entry criteria for a particular project have been tailored, revise these slides as necessary to capture the set of entry criteria documented in the PRRR.>

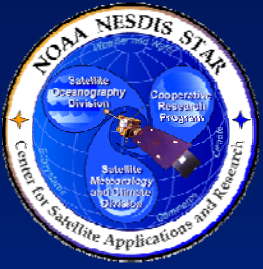

<Project Name> PDR - Entry Criteria # 1 - 3

- **Entry # 1** - A Project Requirements Review Report (PRRR) has been written. The PDR reviewers have access to the approved version of the PRRR.
- **Entry # 2** - A Development Project Plan (DPP) has been written. The PDR reviewers have access to the approved version of the DPP.
- **Entry # 3** - An Operations Concept Document (OCD) has been written. The PDR reviewers have access to the approved version of the OCD



<Project Name> PRR - Entry Criteria # 4 - 6

- **Entry # 4** - A Requirements Allocation Document revision (RAD) has been written. The PDR reviewers have access to the approved version of the RAD.
- **Entry # 5** - An Algorithm Theoretical Basis Document (ATBD) has been written. The PDR reviewers have access to the approved version of the ATBD.
- **Entry # 6** - A Software Architecture Document (SWA) has been written. The PDR reviewers have access to the approved version of the SWA.



<Project Name> PDR - Entry Criteria # 7 - 9

- **Entry # 7** - A Verification and Validation Plan (VVP) has been written. The PDR reviewers have access to the approved version of the VVP.
- **Entry # 8** - A Preliminary Design Document (PDD) has been written. PDR review objectives are clearly stated in the PDD.
- **Entry # 9** - A Project Baseline Report (PBR) has been written. The PDR reviewers have access to the approved version of the PBR.

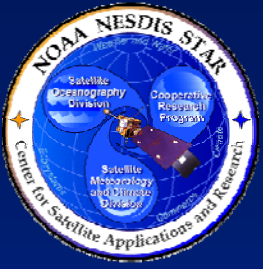

<Project Name> - Tailored PDR Entry Criteria

- <List PDR entry criteria that are non-standard (added or revised from the standard set of entry criteria in STAR EPL Check List CL-7), explain the deviation, provide a rationale, and assess the risk, usually by reference to a risk # to be discussed in Section 9>
- <If there are no tailored entry criteria, omit this slide>

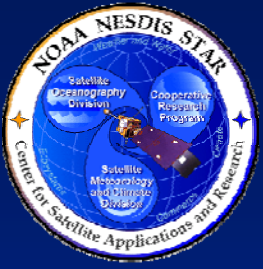

<Project Name> - Waived PDR Entry Criteria

- <List any standard entry criteria that have been waived for this PDR. Provide a rationale, based on the PRRR, and assess the risk, usually by reference to a risk # to be discussed in Section 9. Use multiple slides as necessary for clarity.>
- <If there are no waived entry criteria, omit this slide>

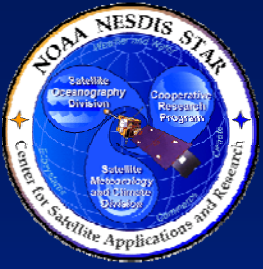

<Project Name> PDR - Exit Criteria

- <List the exit criteria for this PDR. Present as bullets. Use multiple slides as necessary for clarity. The following slides should be used if the standard PDR exit criteria, documented in STAR EPL Check List CL-7, are used.>
- <If the exit criteria for a particular project have been tailored, revise these slides as necessary to capture the set of exit criteria documented in the PRRR.>

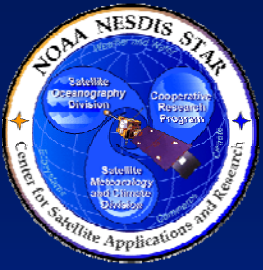

<Project Name> PDR - Exit Criteria # 1 - 4

- **Exit # 1** - PRR "Conditional Pass" items have been satisfactorily disposed of
- **Exit # 2** - PRR "Defer" items have been satisfactorily disposed of
- **Exit # 3** – Project plan and DPP are satisfactory
- **Exit # 4** - Operations concept and OCD are satisfactory

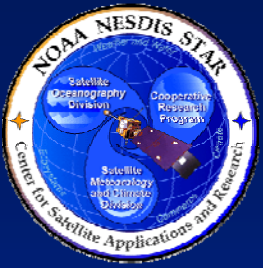

<Project Name> PDR - Exit Criteria # 5 - 8

- **Exit # 5** - Requirements changes since PRR are approved.
- **Exit # 6** - Algorithm theoretical basis and ATBD are satisfactory.
- **Exit # 7** - Software architecture and SWA are satisfactory
- **Exit # 8** - Verification and validation plan and VVP are satisfactory.

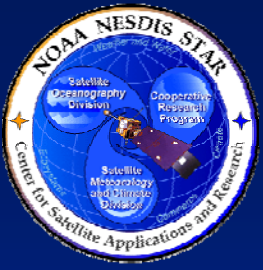

<Project Name> PDR - Exit Criteria # 9 - 11

- **Exit # 9** - Requirements allocation and RAD are satisfactory
- **Exit # 10** – Project baseline and PBR are satisfactory
- **Exit # 11** - A selected solution has been consistently identified in the project artifacts.

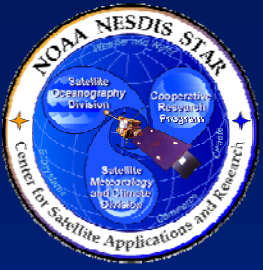

<Project Name> PDR - Exit Criteria # 12 - 14

- **Exit # 12** – The selected solution is approved
- **Exit # 13** - The PDR reviewers' assessment of outstanding risks and actions is documented in the PDR Report
- **Exit # 14** – Project risks and actions are acceptable



<Project Name> - Tailored PDR Exit Criteria

- <List PDR exit criteria that are non-standard (added or revised from the standard set of exit criteria in STAR EPL Check List CL-7), explain the deviation, provide a rationale, and assess the risk, usually by reference to a risk # to be discussed in Section 9>
- <If there are no tailored exit criteria, omit this slide>

<Project Name> - Waived PDR Exit Criteria



- <List any standard exit criteria that have been waived for this PDR. Provide a rationale and assess the risk, usually by reference to a risk # to be discussed in Section 9. Use multiple slides as necessary for clarity.>
- <If there are no waived exit criteria, omit this slide>



- INTRODUCTION
- PRR REPORT
- **OPERATIONS CONCEPT**
- REQUIREMENTS
- ALGORITHM THEORETICAL BASIS
- SOFTWARE ARCHITECTURE
- QUALITY ASSURANCE
- REQUIREMENTS ALLOCATION
- RISKS AND ACTIONS
- SUMMARY AND CONCLUSIONS

Section 3 Setup Slide

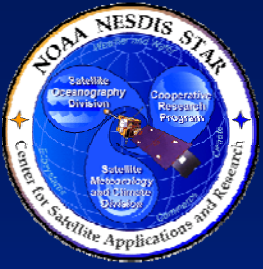

Section 3 – Operations Concept

Presented by

<Presenter's Name>
<Presenter's Title/Role>
<Presenter's Organization>

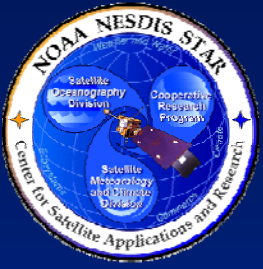

Operations Concept - Overview

- Before requirements can be developed for a product and product system, the developers must know the intentions of the customers and/or users of the product. They must have the answers to the following questions:
 - » Why is this product being produced?
 - » How will this product be used?
 - » How should this product be produced?
- The answers to the preceding questions should be derived from customer/user needs and expectations and production constraints
- Given the required input from customers/users, the development team should develop and document timeline scenarios for product operation and user interaction, at a level of detail and maturity appropriate for each step in the Design Development Phase
- The operations concept is typically refined by the development team, in consultation with customers/users, as the product solutions and

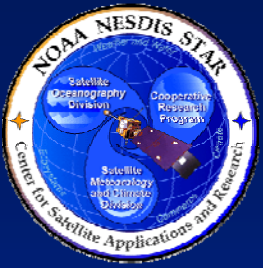

Operations Concept Document

- Operations Concept Document (OCD)
 - » Describes how the users' vision can be realized in an operational environment. Guidelines in STAR EPL process asset DG-6.1 <Pointer to DG-6.1>
- OCD v1r0 (PRR artifact), the initial version, should capture customer needs and expectations
- **OCD v1r1 (PDR artifact), the first planned revision, is available at <pointer to OCD v1r1>**
 - » **Adds to v1r0 by providing operational scenarios for product operation and user interaction for each alternative solution under consideration at PDR.**
- OCD v1r2, a CDR artifact, adds to v1r1 by providing a refinement of the operations concept that may occur as a result of detailed design development

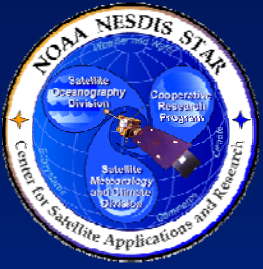

Why Are The Products Being Produced?

- <Itemize customer/user needs>
 - » <Refer to a customer ConOps, if one exists>
 - » <Explain how this question was answered, if a ConOPs does not exist>
 - » <This should be documented in the OCD, consistently with the DPP. Use text, figures, tables from the OCD>
 - » <Use multiple slides as necessary for clarity>
 - » <Most of this material should be obtainable from the Project Requirements Document (PRD) Section 3 slides, but there may be additional material obtainable
- Section 3.2** CD v1r1 update.>



How Will The Products Be Used?

- <Itemize customer/user expectations>
 - » <Refer to a customer ConOps, if one exists>
 - » <Explain how this question was answered, if a ConOPs does not exist>
 - » <This should be documented in the OCD, consistently with the DPP. Use text, figures, tables from the OCD>
 - » <Use multiple slides as necessary for clarity>
 - » <Most of this material should be obtainable from the Project Requirements Document (PRD) Section 3 slides, but there may be additional material obtainable from the OCD v1r1 update.>

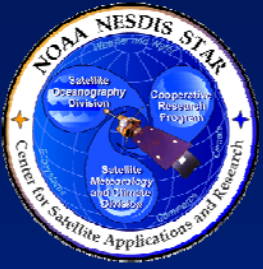

How Should The Products Be Produced? (1)

- Available production environments
 - » <Describe the production environments that are available for the product lifecycle, including development, transition, operations and delivery>
 - <Itemize the hardware, software and personnel resources that can be available for each environment>
 - <Describe how the environments can be integrated. Include boundaries and constraints>
 - » <Describe the production environments that are available for the product lifecycle, including development, transition, operations and delivery>
 - » <This should be documented in the OCD. Use text, figures, tables from the OCD. Use multiple slides as necessary for clarity>
 - » <Some of this material should be obtainable from the Project Requirements Document (PRD) Section 3 slides, but there will typically be additional material obtainable from the OCD v1r1



How Should The Products Be Produced? (2)

- Production and Delivery scenarios
 - » < Describe production and delivery scenarios, consistent with the level of detail in the customer's concept of operations, the production environment constraints, and operator needs and expectations.>
 - <A scenario is a sequence of events that might occur in the production and use of the product, which is used to make explicit the needs of the stakeholders>
 - » <This should be documented in the OCD. Use text, figures, tables from the OCD. Use multiple slides as necessary for clarity>
 - » <Some of this material should be obtainable from the Project Requirements Document (PRD) Section 3 slides, but there will typically be additional material obtainable from the OCD v1r1 update.>



- INTRODUCTION
- PRR REPORT
- OPERATIONS CONCEPT
- **REQUIREMENTS**
- ALGORITHM THEORETICAL BASIS
- SOFTWARE ARCHITECTURE
- QUALITY ASSURANCE
- REQUIREMENTS ALLOCATION
- RISKS AND ACTIONS
- SUMMARY AND CONCLUSIONS

Section 4 Setup Slide

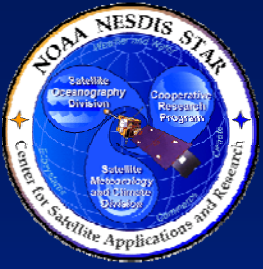

Section 4 - Requirements

Presented by

<Presenter's Name>
<Presenter's Title/Role>
<Presenter's Organization>

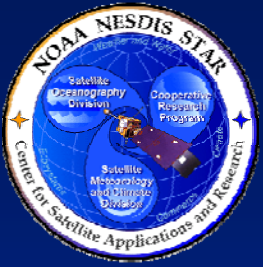

Requirements Development Process

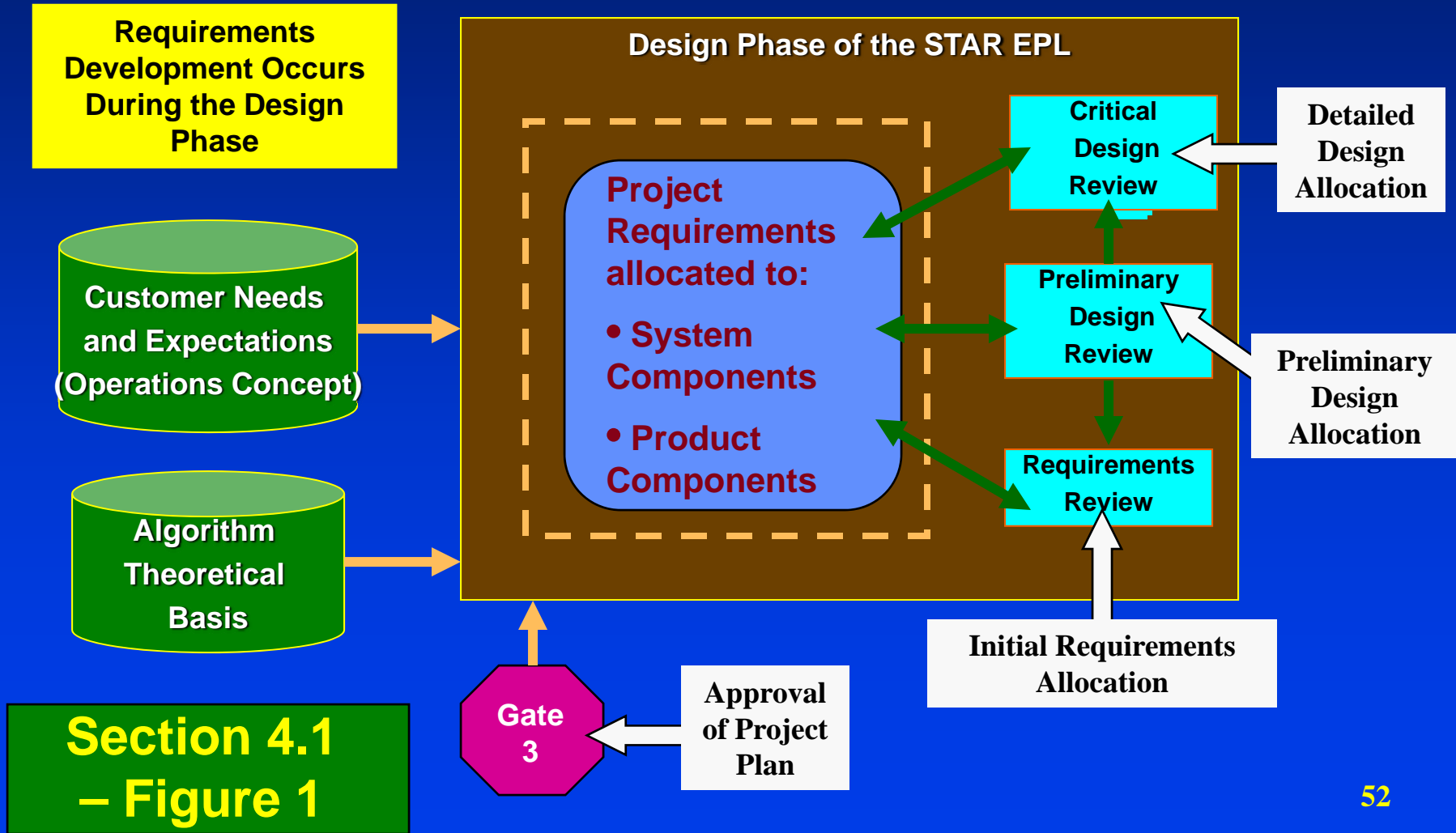

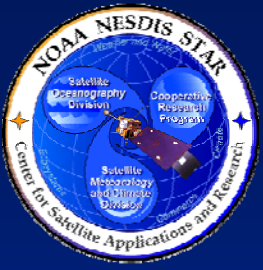

Iterative (Spiral) Development of Requirements

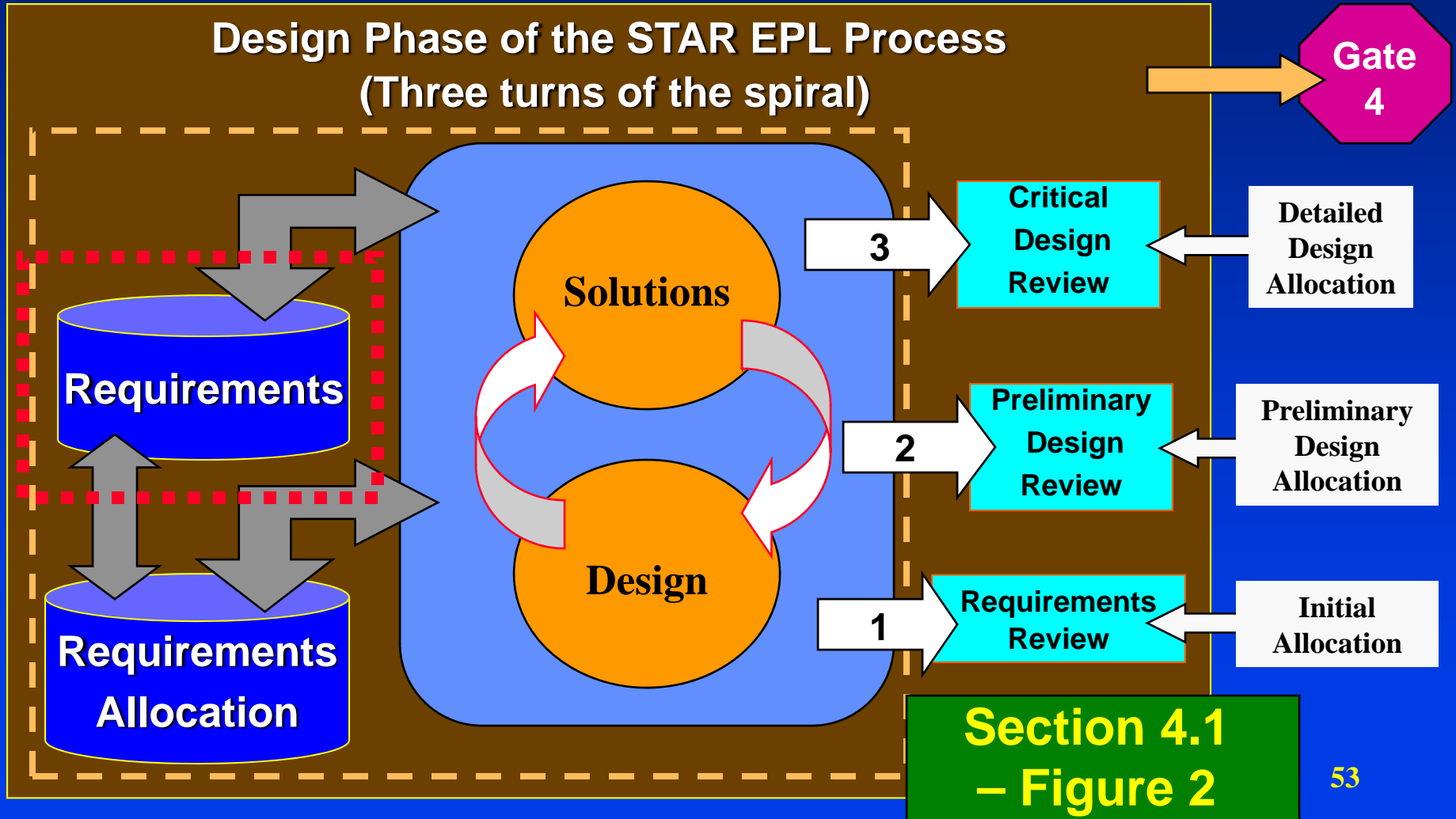

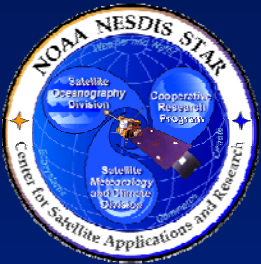

Project Requirements Have Been Established and Refined

- **Established at Project Requirements Review (PRR)**
 - » Requirements Allocation Document (RAD) v1r0
 - » Project Requirements Document (PRD)
 - » Project Requirements Review Report (PRRR)
- **Refined for Preliminary Design Review (PDR)**
 - » Preliminary Design Document (PDD – this presentation)
 - » **Requirements Allocation Document (RAD) v1r1**



Requirements Allocation Document

Raytheon

- Requirements Allocation Document (RAD)
 - » RAD v1r1, a PDR artifact, can be obtained at <Pointer to RAD v1r1>
 - » RAD Document Guidelines in STAR EPL process asset DG-6.2 <Pointer to DG-6.2>
- The RAD contains the basic and derived requirements for the work products.
 - » **RAD v1r1 notes updates to requirements after PRR**
- RAD v1r1 includes the allocation of the requirements to system components and product components, at a preliminary design level of detail
 - » **Requirements allocation will be addressed in Section 8 of this PDD**

Section 4.2

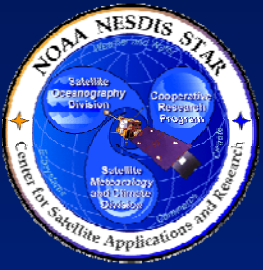

New Requirements Since PRR

- <List each new requirement>
 - » <If a derived requirement, list higher-level driving requirements>
 - » <If a basic requirement, list new derived requirements>
 - » <Note whether the new requirement has been approved at a delta Requirements Review>
 - » <If the new requirement has not been approved:>
 - <Explain rationale for the new requirement (e.g., revealed by detailed design issue, new customer request, etc.)>
 - <Note potential effects on the project plan>
 - <Document the agreement of affected stakeholders>
 - <Note new or modified risks that result from the new requirement>
 - <Note any recommended actions that result from the new requirement>

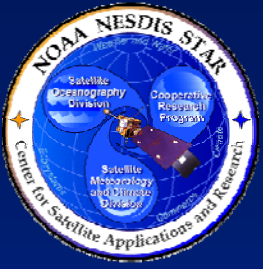

Requirements Changes Since PRR

- <List each requirement change>
 - » <If a derived requirement, list higher-level driving requirements>
 - » <If a basic requirement, list derived requirements that are affected>
 - » <Note whether the change has been approved at a delta Requirements Review>
 - » <If the change has not been approved:>
 - <Explain rationale for the change (e.g., revealed by detailed design issue, operational constraint)>
 - <Note potential effects on the project plan>
 - <Document the agreement of affected stakeholders>
 - <Note new or modified risks that result from the change>
 - <Note any recommended actions that result from the change>



- INTRODUCTION
- PRR REPORT
- OPERATIONS CONCEPT
- REQUIREMENTS
- **ALGORITHM THEORETICAL BASIS**
- SOFTWARE ARCHITECTURE
- QUALITY ASSURANCE
- REQUIREMENTS ALLOCATION
- RISKS AND ACTIONS
- SUMMARY AND CONCLUSIONS

Section 5 Setup Slide

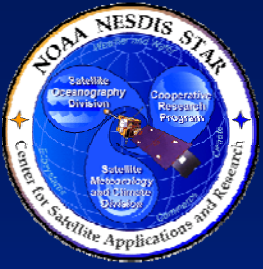

Section 5 – Algorithm Theoretical Basis

Presented by

<Presenter's Name>
<Presenter's Title/Role>
<Presenter's Organization>

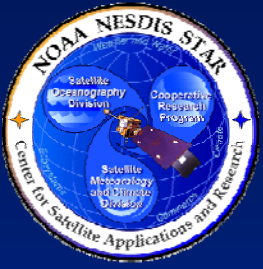

Algorithm Theoretical Basis

- Purpose: Provide product developers, reviewers and users with a theoretical description (scientific and mathematical) of the algorithm that is used to create a product that meets user requirements.
- Documented in the Algorithm Theoretical Basis Document (ATBD)
 - » ATBD Guidelines in DG-1.1 <pointer to DG-1.1>
 - » The ATBD is developed throughout the STAR EPL, beginning with Basic Research (v1r0) and continuing through the Build phase (v2r2)
 - » The version of the ATBD developed for PDR is v2r0
 - » ATBD v2r0, a PDR artifact, is available at <Pointer to ATBD v2r0>

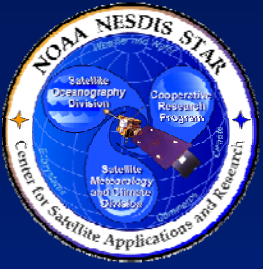

PDR Algorithm

- At PDR, there are $\langle X \rangle$ alternative solutions under consideration
 - » \langle Description of basic approach for Solution 1. Note algorithm heritage. Use multiple slides as necessary for clarity. \rangle
 - » \langle Description of Solution 2. Note algorithm heritage. Use multiple slides as necessary for clarity. \rangle
 - » \langle etc. \rangle
 - » \langle If there is only one solution under consideration, a rationale should be provided for the rejection of any alternatives. \rangle

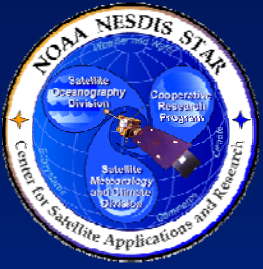

Algorithm Objectives

- <Describe the objectives of the algorithm, including the intended output data products and their intended use>
- <Show how the algorithm objectives are derived from the operations concept>



Sensor Inputs

- <Describe the attributes of the sensing system(s) used to supply data for the retrieval algorithm. Provide references to the appropriate Sensor Specifications if available.
- Use slides from sensor reviews if available. Use multiple slides as necessary for clarity.>



Ancillary Inputs

- < Describe the attributes of all input data used by the algorithm for Alternative Solution # 1, including ancillary data, forward models and look-up tables. Use multiple slides as necessary for clarity.>
- < Describe the attributes of all input data used by the algorithm for Alternative Solution # 2, including ancillary data, forward models and look-up tables. Use multiple slides as necessary for clarity.>
- <etc.>

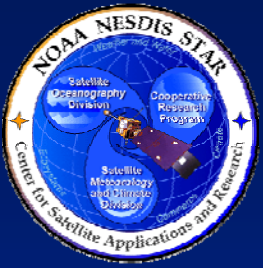

Retrieval Strategy

- <For Alternative Solution # 1, describe the fundamental approach for retrieval at a level of detail sufficient for reviewers to determine that the algorithm theoretical description is adequate.>
- <For Alternative Solution # 2, describe the fundamental approach for retrieval at a level of detail sufficient for reviewers to determine that the algorithm theoretical description is adequate.>
- <etc.>



Processing Outline

- < For Alternative Solution # 1, describe the processing outline of the retrieval algorithm at a preliminary design level of detail. A process flow chart is recommended.>
- < For Alternative Solution # 2, describe the processing outline of the retrieval algorithm at a preliminary design level of detail. A process flow chart is recommended.>
- <etc.>

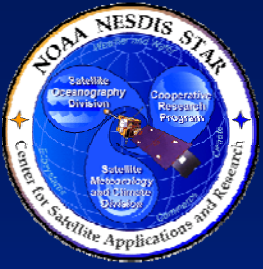

Physical Description

- <For Alternative Solution # 1, describe the physics and associated phenomenology key to the retrieval>
 - » <Refer to the relevant section of the ATBD>
 - » <Note whether any part of the physical description is not based on proven algorithm heritage – in that case, evaluate the risk of new algorithm physics.>
- <For Alternative Solution # 2, describe the physics and associated phenomenology key to the retrieval>
 - » <Refer to the relevant section of the ATBD>
 - » <Note whether any part of the physical description is not based on proven algorithm heritage – in that case, evaluate the risk of new algorithm physics.>
- <etc.>

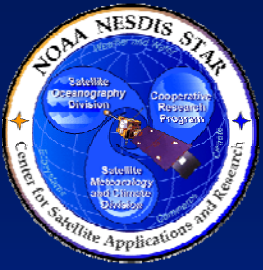

Mathematical Description

- < For Alternative Solution # 1, describe the mathematics used by the retrieval, including all simplifications, approximations, and numerical methods. Refer to the relevant section of the ATBD.>
- < For Alternative Solution # 2, describe the mathematics used by the retrieval, including all simplifications, approximations, and numerical methods. Refer to the relevant section of the ATBD.>
- <etc>

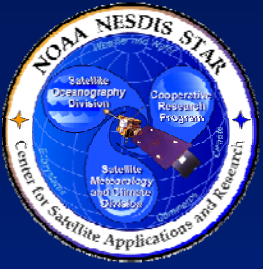

Algorithm Output

- <Describe the algorithm output, mapping output characteristics to product requirements. Refer to the relevant section of the ATBD.>

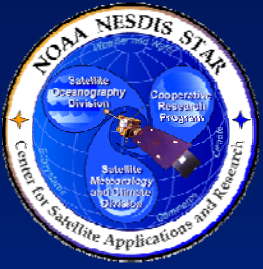

Performance Estimates

- <For each alternative solution, describe the predicted algorithm performance and quality of the products derived from analysis and tests with simulated and/or proxy test data. Use multiple slides as necessary for clarity.>
 - » <Refer to the relevant sections of the ATBD>
 - » <Note verification methods and assumptions>
 - <Identify error sources to be tested (e.g. calibration, sensor noise, etc.)>
 - <Identify and justify stratifications to be tested, including typical and stressing conditions>
 - <Identify test data sets that span the stratifications>
 - <Describe all assumptions that have been made concerning the performance estimates. To the extent possible, the potential for degraded performance should be explored, along with mitigating strategies.>
 - » <Use text, figures etc. from the ATBD>
 - » <Include error budgets if available>
 - » <Compare performance estimates with product requirements. Identify performance risks.>
- <You may separate the alternative solutions, if there is enough difference in methods, test data, and results. Alternatively, you can compare and contrast the alternative solutions in a common presentation (e.g. a unified scatter plot of results with different colors for the data points of each solution).>



Practical Considerations

- <For each alternative solution, describe how the algorithm is numerically implemented, including any possible issues with computationally intensive operations (e.g., large matrix inversions).>
- <For each alternative solution, describe any important programming and procedural aspects related to implementing the numerical model into operating code.>
- <Refer to the relevant ATBD section>

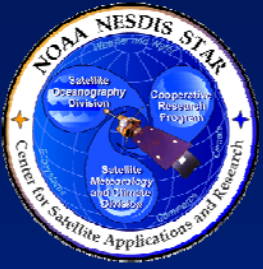

- INTRODUCTION
- PRR REPORT
- OPERATIONS CONCEPT
- REQUIREMENTS
- ALGORITHM THEORETICAL BASIS
- **SOFTWARE ARCHITECTURE**
- QUALITY ASSURANCE
- REQUIREMENTS ALLOCATION
- RISKS AND ACTIONS
- SUMMARY AND CONCLUSIONS

Section 6 Setup Slide

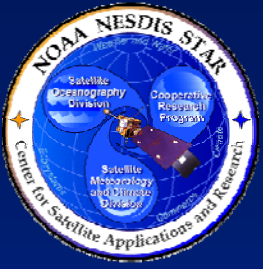

Section 6 – Software Architecture and Interfaces

Presented by

<Presenter's Name>
<Presenter's Title/Role>
<Presenter's Organization>

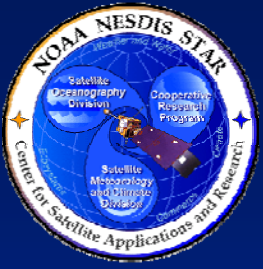

Software Architecture (1)

- The software system is an integrated collection of software elements, or code, that implements a solution, producing well-defined output products from a well-defined set of input data.
- The software architecture describes the structure of the system software elements and the external and internal data flows between software elements.

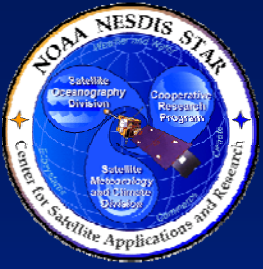

Software Architecture (2)

- Requirements are allocated to elements of the software architecture
 - » This allocation will be discussed in Section 8 of this PDD
- The software architecture provides the framework for the detailed design that will be developed after the PDR.
 - » The bridge between the detailed design and the requirements allocation

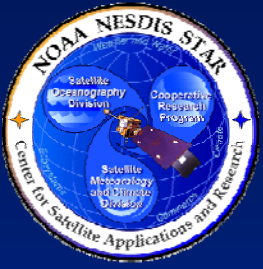

Software Architecture Layers

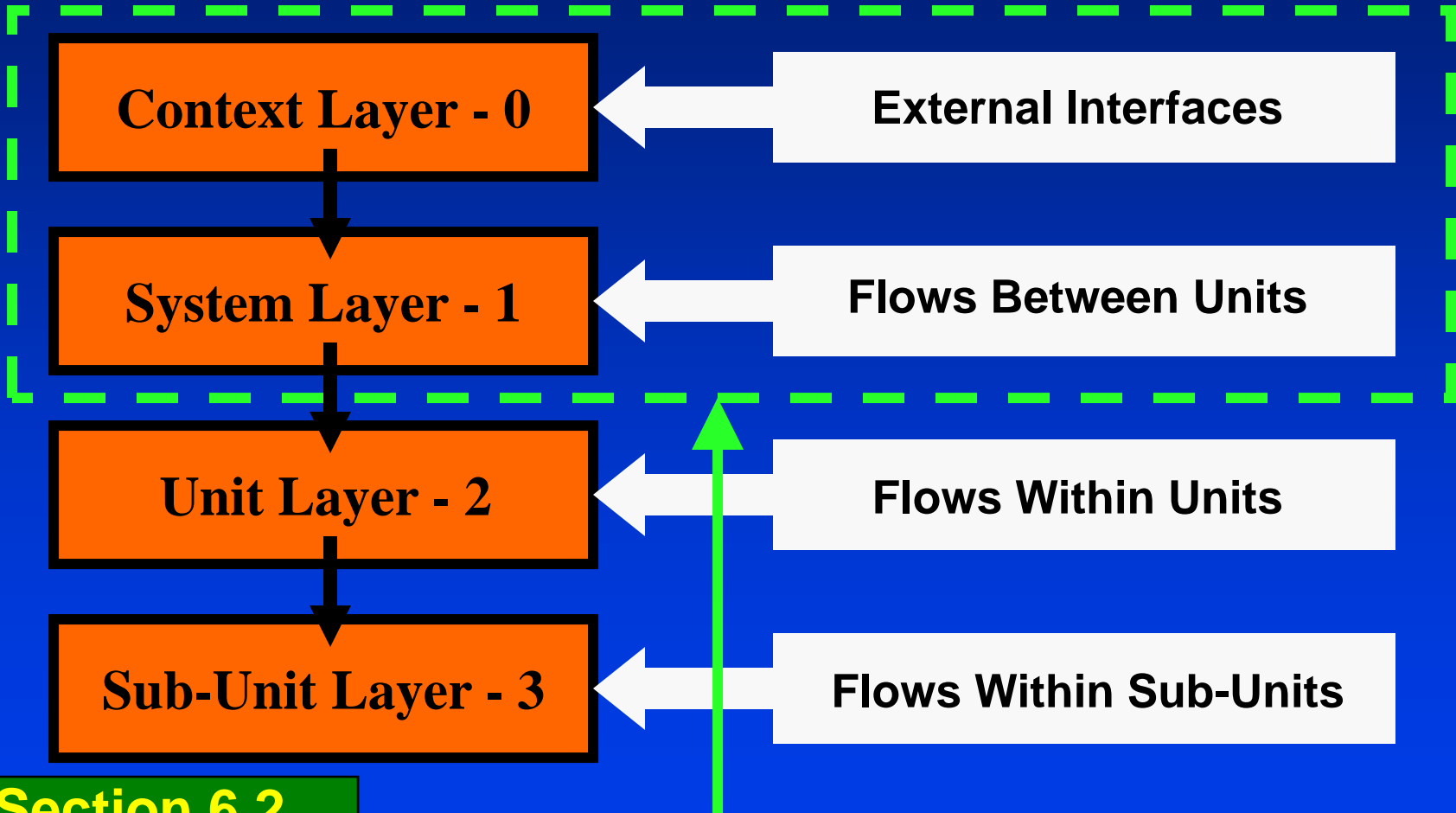

**Section 6.2
– Figure 1**

Preliminary Design Layers

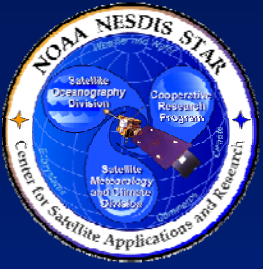

The Context-Layer

- The Context-Layer describes the flows between the system and its external interfaces
- An external input is defined as a data source needed by the system that is produced or made available by a process external to the system
- An external output is defined as a data sink that is produced by the system for an external user
- External interfaces must meet standard criteria to be included in the system architecture

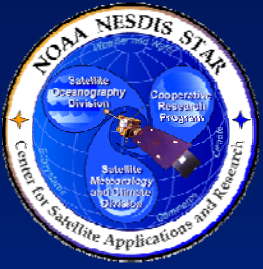

External Interfaces - Criteria

- <State the criteria for the design of interfaces (e.g. security, acceptance testing, etc. Use multiple slides as necessary for clarity.>
 - » <Note any deviations from the STAR standard criteria>
 - <Explain any deviations>



The System-Layer

- The System-Layer data flow expands upon the Context-Layer data flow, showing the first layer of decomposition.
 - » In addition to the System-Layer inputs and outputs, the major processing units are shown along with their inputs and outputs.
 - » Each unit is designed as a stand-alone program for ease of testing and integration into a System-Layer scheduler.



Software Architecture Documentation

- At PDR, there are <X> alternative solutions under consideration, each with its own software architecture
- Documented in the Software Architecture Document (SWA)
 - » SWA Guidelines in STAR EPL process asset DG-1.2 <pointer to DG-1.2>
 - » The SWA is developed throughout the STAR EPL, beginning with Basic Research (v1r0) and continuing through the Build phase (v2r2)
 - » The version of the SWA developed for PDR is v2r0
 - » SWA v2r0, a PDR artifact, is available at <Pointer to SWA v2r0>
 - » Purpose: Demonstrate that the algorithm process flow provides for an implementation that is consistent with the theoretical basis and requirements.

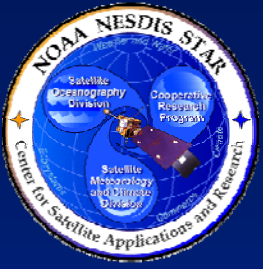

Solution 1 - PDR Software Architecture

- <Present the PDR software architecture for Alternative Solution # 1, following the examples in the following slides.>

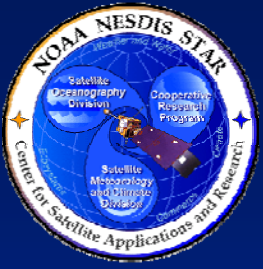

Solution 1 - External Interfaces

- <For Alternative Solution # 1, show all external inputs and outputs to and from the software system>
 - » <Start with a context diagram (see next slide for an example).>

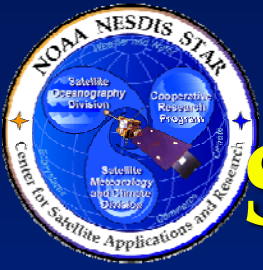

System External Interfaces

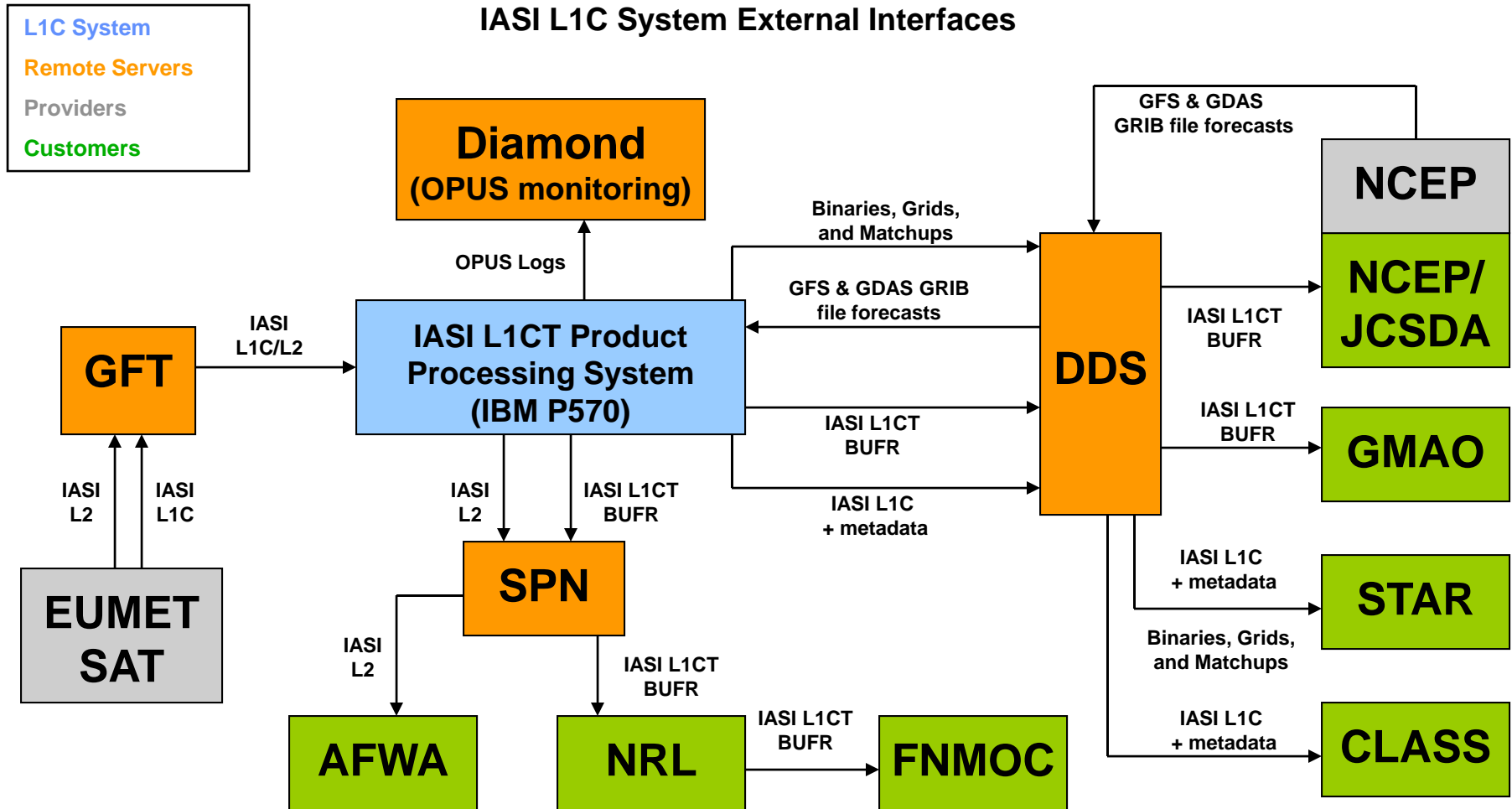

Section 6.4 – Figure 1

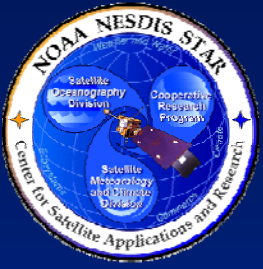

Solution 1 - External Interface Design

- <For Alternative Solution # 1, discuss each interface item at a level of detail that is warranted for the item. Include a table if that adds clarity (see next slide for an example).>

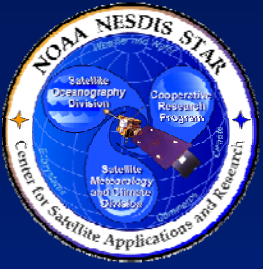

Solution 1 - External Interfaces

Input and Output Context-Layer Data Flows

Interface Item	Interface Type	Source	Description
Total Column Ozone	Input	NCEP	NCEP total column ozone, re-gridded to the moderate resolution VIIRS swath
Calibrated Radiance	Input	VIIRS	VIIRS calibrated radiance in bands I1, I2, and I3, at the imagery resolution VIIRS swath
VIIRS Snow Binary Map	Output	VIIRS Snow/Ice System	Snow binary map, at the imagery resolution VIIRS swath, with associated metadata, Earth location, and quality flags

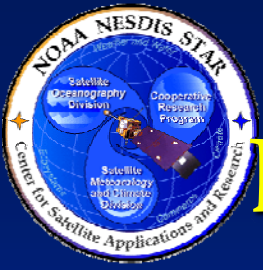

Solution 1 - External Interface Acceptance

- <Demonstrate that each external interface for Alternative Solution # 1 satisfies acceptance criteria>
- <This demonstration can include analysis, simulation, security certification, and past practices>
- <Use figures and tables as warranted. Use multiple slides as needed for clarity.>



Solution 1 - System-Layer Data Flows (1)

- <For Alternative Solution # 1, show the System-Layer data flows as a data flow diagram (see next slide for an example)>



Solution 1 - System-Layer Data Flows (2)

IASI System Flow Diagram

L1C System Units
Remote Servers
IASI System

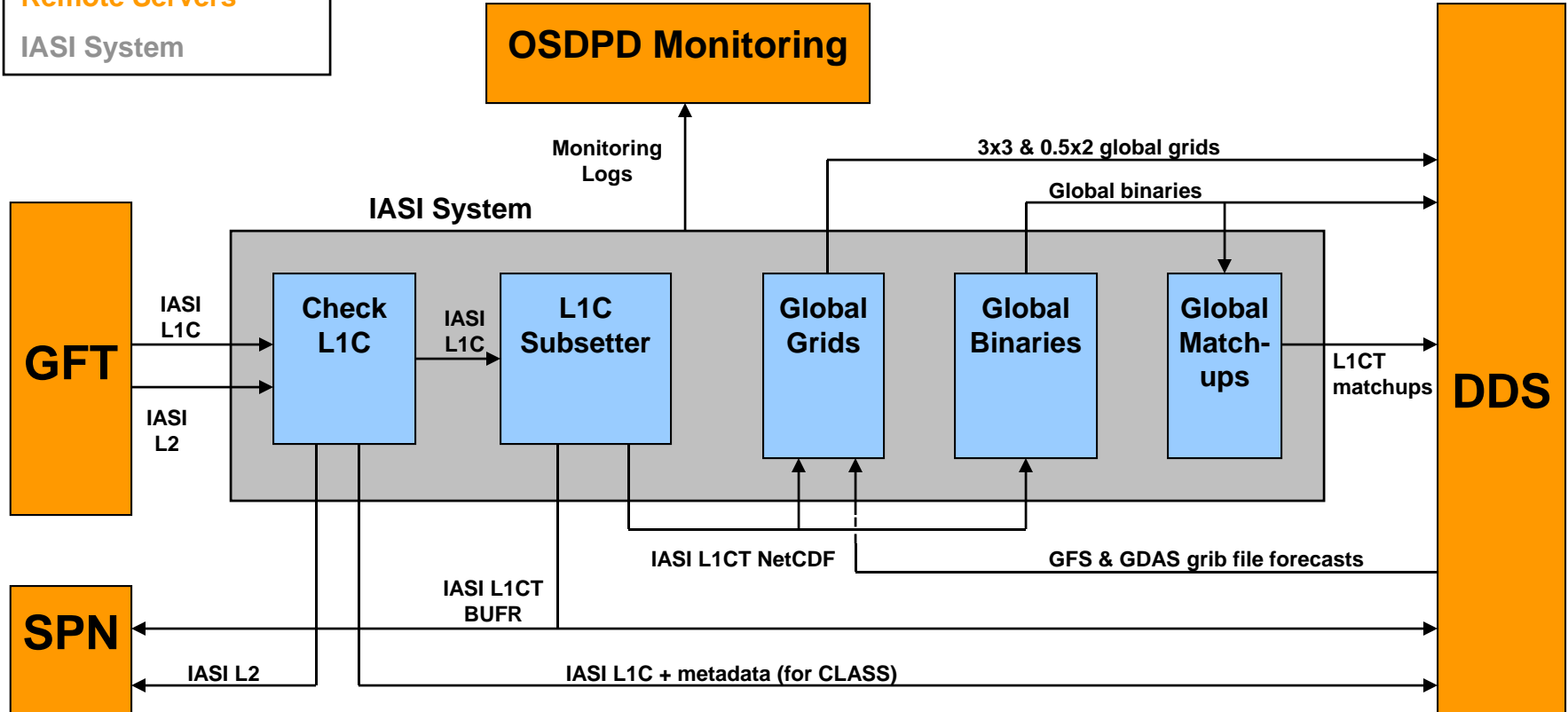

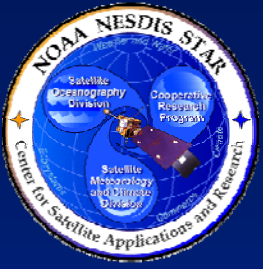

Solution 1 - System-Layer Data Flows (3)

- <For Alternative Solution # 1, show the System-Layer data flows as a table if that adds clarity (see next slide for an example).>

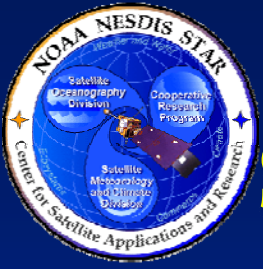

Solution 1 - System-Layer Data Flows (4)

Input, Internal, and Output System-Layer Data Flows

System Element	Interface Type	Source	Description
Total Column Ozone	Input	NCEP	NCEP total column ozone, re-gridded to the moderate resolution VIIRS swath
Ice Concentration IP	Internal	VIIRS Snow/Ice System	Ice concentration and associated weights on the VIIRS imagery swath
VIIRS Sea Ice Characterization EDR	Output	VIIRS Snow/Ice System	Sea ice concentration, on the VIIRS imagery swath, with associated metadata, Earth location, weights, and quality flags. Sea ice age classification, at HCS resolution (3 x 3 imagery pixels), with associated metadata, Earth location, weights, and quality flags

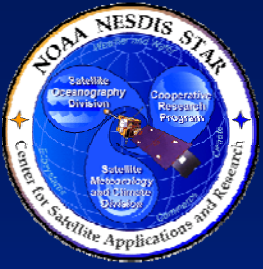

Solution 2 - PDR Software Architecture

- <Repeat slides 81 – 89 for Alternative Solution # 2.>
- <Repeat again for each additional alternative solution.>

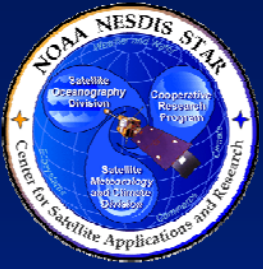

- INTRODUCTION
- PRR REPORT
- OPERATIONS CONCEPT
- REQUIREMENTS
- ALGORITHM THEORETICAL BASIS
- SOFTWARE ARCHITECTURE
- **QUALITY ASSURANCE**
- REQUIREMENTS ALLOCATION
- RISKS AND ACTIONS
- SUMMARY AND CONCLUSIONS

Section 7 Setup Slide

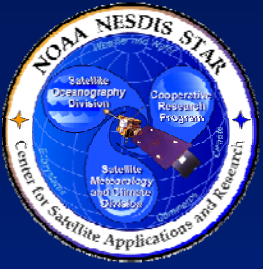

Section 7 - Quality Assurance

Presented by

<Presenter's Name>
<Presenter's Title/Role>
<Presenter's Organization>

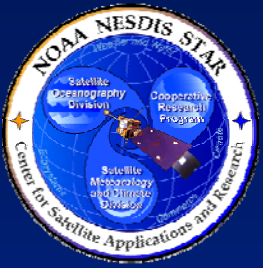

Quality Assurance

- Quality assurance consists of PROCESS QA and PRODUCT QA
- PROCESS QA is concerned with assuring that the STAR EPL process standards are met during the planning, development, operations, and distribution phases of the project.
 - » Process QA is achieved through the standard reviews of the STAR EPL process. Each review check list and entry/exit criteria are designed to ensure that the relevant process standards are met by the implementation of standard practices during the steps leading up to the review.
- PRODUCT QA is concerned with assuring that the work products created during the project's lifecycle meet their requirements
 - » Product QA is achieved by verification of the project's work products and validation of the products, operator needs, and user needs



Configuration Management Stakeholders

Raytheon

- <Identify the CM/DM stakeholders for the project. Verify their commitment to the Project Plan.>



Configuration Management Tools

- <Describe the CM/DM tools that are in use for the project. Use multiple slides as necessary for clarity.>

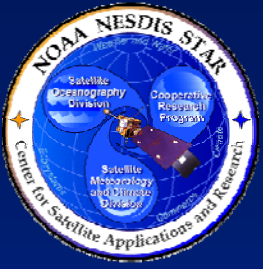

Project Baseline Report

- The project's baseline and change history is maintained in a Project Baseline Report (PBR).
 - » Document guidelines are in STAR EPL process asset DG-5.4.
 - <Pointer to DG-5.4>
 - » The PBR includes the change history, approval status, and location of every Configuration Item in the project's baseline.
 - » PBR v2r2, a PDR artifact, can be accessed at <pointer to PBR v2r2>

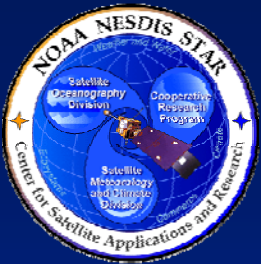

Verification and Validation

- Verification is the formal process of confirming that the requirements specified for a specific product or system are satisfied by the completed product or system.
- Validation is a process of evaluation, integration, and test activities conducted to ensure that the final developed system will satisfy the needs and expectations of customers, users, and operators
- In a well-designed system, needs and expectations are completely captured by the requirements allocation (see Section 8 of this PDD) – in that case, there is no meaningful distinction between verification and validation
- The methods and planned activities for verification and validation of the project's process and products constitutes the project verification and validation plan

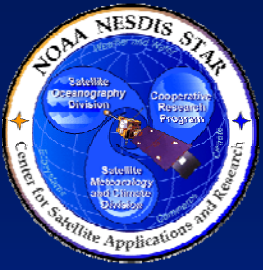

Verification and Validation Documentation

- The plan for verification and validation is documented in a Verification and Validation Plan (VVP)
- VVP v1r0 (PRR artifact), the initial version, provided an initial plan for verification and validation of the requirements identified in RAD v1r0
- **VVP v1r1 (PDR artifact), the first planned revision, is available at <pointer to VVP v1r1>**
- VVP v1r1 adds to v1r0 by updating the listing and description of verification and validation items and plans, based on the maturing of the requirements allocation, solutions and design since PRR, as documented in the RAD and SWA.

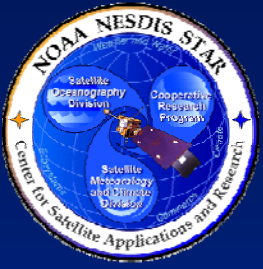

Verification Items

- <Identify the work products to be verified. These should be traceable to the software architecture. Note that this will be documented in the project's VVP.>
- <Identify the requirements to be satisfied by each work product selected for verification. Note that these are documented in the RAD, to be discussed in the next section.>

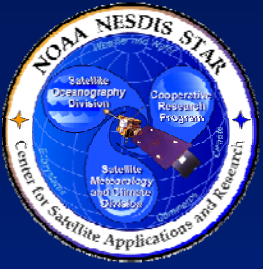

Verification Methods

- <Describe the verification methods that will be used, as described in the VVP>
 - » The verification methods should be described in as much detail as possible and a rationale for their selection should be provided.>
 - » Use figures, graphs, examples as warranted. Use multiple slides as necessary for clarity and completeness.>
- <Note which verification items will be verified with each method or combination of methods. If available, show a matrix obtained from the VVP.>

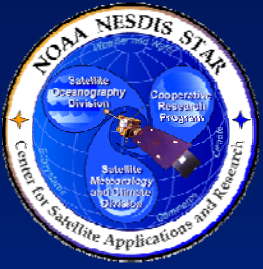

Verification in the Project Plan

- <Show the project plan with verification tasks highlighted>
- <Extract (as bullets) the verification task name, start date, end date, predecessor tasks, and successor tasks from the project plan>
- <Note any adjustments in the DPP (usually, schedule and resources) that are needed to accommodate the updated verification plan. For example, new verification tasks or a revised time interval for one or more verification tasks, with consequent impact on successor tasks. Most important: note any risk to milestone dates and impact on successor milestones.>
- These risks will be addressed in a later section (“Risks”) of this presentation



Validation of Products

- <Identify user-driven requirements on the product or products to be validated. These are typically found in the project's basic requirements, should be documented in the RAD, and should have been discussed in Section 4 ("Requirements") of this presentation.>
- <For each product component, describe the scope of the validation (e.g., product quality attributes, validation environments, validation campaigns). Distinguish between pre-launch and post-launch plans.>



Validation of Operator Needs

- <Identify operator needs (operations and maintenance, or O&M) to be validated. The product or product component must be maintainable and supportable in its intended operational environment. Operator needs are typically found in the project's derived requirements, should be documented in the RAD, and should have been discussed in Section 4 ("Requirements") of this presentation. Most operator needs will be generic. Note which needs are specific to the project.>
- <Identify the tools and training available for O&M (e.g. Operations Manual, System Maintenance Manual, Process Assets)>
- <For each operator need, describe the scope of the validation. Usually, this will consist of simulations in the operational environment by the intended O&M personnel with the actual O&M tools and training in place.>

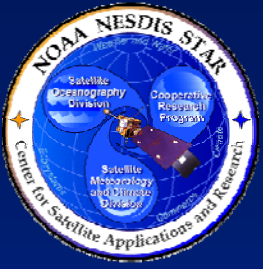

Validation of User Needs

- <Identify user needs (training, support, use of products) to be validated. These are typically found in the project's derived requirements, should be documented in the RAD, and should have been discussed in Section 4 ("Requirements") of this presentation. Many user needs will be generic. Note which needs are specific to the project.>
- <Identify the tools, training, and support services available to the user (e.g. External Users Manual) and the procedure for delivering these to the intended users>
- <For each user need, describe the scope of the validation. Usually, this will consist of simulations in a user environment by the intended users and/or beta testers with the actual User tools and training in place.>



- INTRODUCTION
- PRR REPORT
- OPERATIONS CONCEPT
- REQUIREMENTS
- ALGORITHM THEORETICAL BASIS
- SOFTWARE ARCHITECTURE
- QUALITY ASSURANCE
- **REQUIREMENTS ALLOCATION**
- RISKS AND ACTIONS
- SUMMARY AND CONCLUSIONS

Section 8 Setup Slide

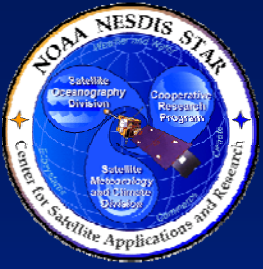

Section 8 - Requirements Allocation

Presented by

<Presenter's Name>
<Presenter's Title/Role>
<Presenter's Organization>

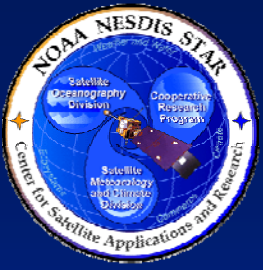

Iterative (Spiral) Development of Requirements Allocation

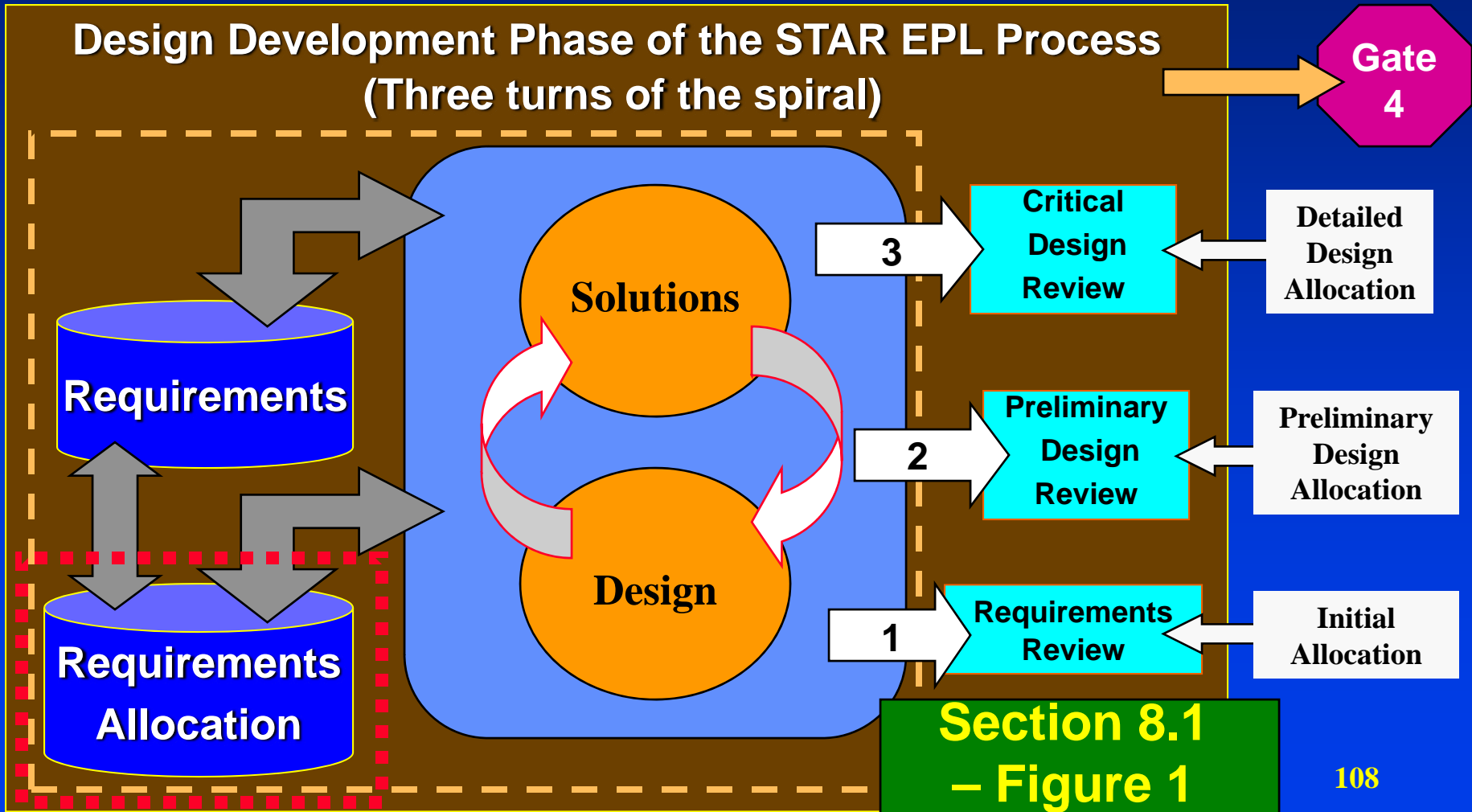

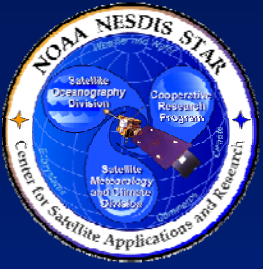

Requirements Allocation – Changes Since PRR

- **<List each requirements allocation change. Use multiple slides as needed for clarity.>**
 - » <If a derived requirement, list higher-level driving requirements>
 - » <If a basic requirement, list derived requirements that are affected>
 - » <Note whether the change is due to a new requirement, a changed requirement, or a design change>
 - If due to a new or changed requirement, specify the requirement and trace it to the requirements presentation in this PDD
 - If due to a design change, specify the change and trace it to the design presentation in this PDD
 - » <Note whether the change has been approved at a delta Requirements Review>
 - » <If the change has not been approved:>
 - <Explain rationale for the change (e.g., revealed by detailed design issue, operational constraint)>
 - <Note potential effects on the project plan>
 - <Document the agreement of affected stakeholders>
 - <Note new or modified risks that result from the change, to be summarized in Section 9 of this PDD>
 - <Note any recommended actions that result from the change, to be summarized in Section 9 of this PDD >



- INTRODUCTION
- PRR REPORT
- OPERATIONS CONCEPT
- REQUIREMENTS
- ALGORITHM THEORETICAL BASIS
- SOFTWARE ARCHITECTURE
- QUALITY ASSURANCE
- REQUIREMENTS ALLOCATION
- **RISKS AND ACTIONS**
- SUMMARY AND CONCLUSIONS

Section 9 Setup Slide



Section 9 - Risks and Actions

Presented by

<Presenter's Name>
<Presenter's Title/Role>
<Presenter's Organization>

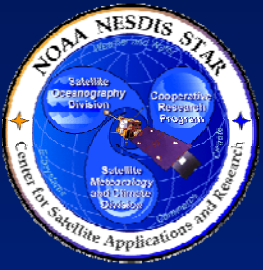

<Project Name> - Risks at PDR

- There are <fill in the correct number> risks to be reviewed at the PDR
 - » <fill in the correct number> risks were identified at the PRR and documented in the PRRR
 - » <fill in the correct number> risks were identified after the PRR
- The following slides contain, for each risk item:
 - » A risk statement
 - » Risk assessment (Severity and Likelihood)
 - » Risk mitigation recommendation
 - » Status of actions identified to mitigate the risk

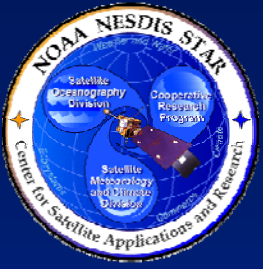

Risks from the PRR - Risk # 1

Raytheon

- **RISK # 1 - <Risk statement>**
- **Risk Assessment: <TBS>** (Severity = <TBS>, Likelihood = <TBS>).
<TBS = HIGH, MEDIUM, or LOW>
- **Risk Mitigation: <Describe the risk mitigation plan, as stated in the CUTR report. Use sub-bullets as warranted for clarity. Note actions associated with each item (sub-bullet) of the plan.>**
- **Status: <Present the development team's current assessment of the risk (HIGH, MEDIUM, LOW, or NONE). Explain the rationale for the assessment (e.g. list actions that are completed).**
- **<Present status of actions associated with Risk # 1 in subsequent slides. Present completed actions, then open actions. Use separate slides for each action (see next 2 slides).>**

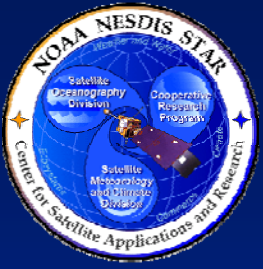

Completed Actions - <Action number>

- ACTION: <Number> - <Action statement>
- CLOSURE CRITERIA: <Closure criteria statement>
- STATUS: Completed. <Demonstrate that the closure criteria have been met. Use multiple slides as necessary.>
- <Repeat for each completed action associated with Risk # 1>

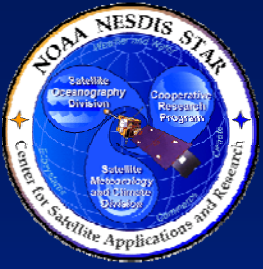

Open Actions - <Action number>

- ACTION: <Number> - <Action statement>
- CLOSURE CRITERIA: <Closure criteria statement>
- CLOSURE PLAN: <Closure plan>
- STATUS: Open. <Explain what parts of the closure plan have been completed and what remains to be done. Use multiple slides as necessary.>
- <Repeat for each open action associated with Risk # 1>

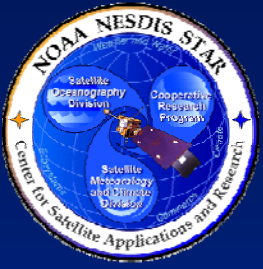

Risks from the PRR - Risk # 2

- <Present Risk # 2 status, using the same format as for Risk # 1>
- <On separate slides, present status of all actions associated with Risk # 2. Present completed actions, then open actions. Use the same format as for Risk # 1 actions.>
- <Repeat for each risk>
- <Then, present any new risks identified after the PRR (see next slide)>

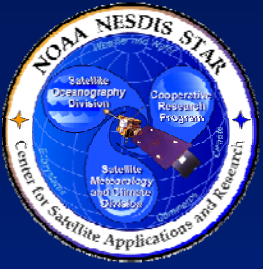

New Risks - Risk # <N>

- **RISK # <N>** - <Risk statement>
- **Risk Assessment:** <TBS> (Severity = <TBS>, Likelihood = <TBS>). <TBS = HIGH, MEDIUM, or LOW>
- Risk Mitigation: <Describe the risk mitigation plan. Use sub-bullets as warranted for clarity. Note actions associated with each item (sub-bullet) of the plan.>
- <Present status of actions associated with Risk # N in subsequent slides. Present completed actions, then open actions. Use separate slides for each action (see next 2 slides).>

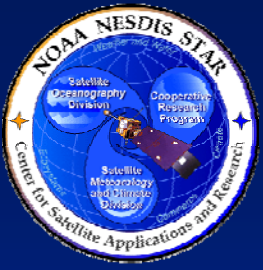

Completed Actions - <Action number>

- ACTION: <Number> - <Action statement>
- CLOSURE CRITERIA: <Closure criteria statement>
- STATUS: Completed. <Demonstrate that the closure criteria have been met. Use multiple slides as necessary.>
- <Repeat for each completed action associated with Risk # N>



Open Actions - <Action number>

- ACTION: <Number> - <Action statement>
- CLOSURE CRITERIA: <Closure criteria statement>
- CLOSURE PLAN: <Closure plan>
- STATUS: Open. <Explain what parts of the closure plan have been completed and what remains to be done. Use multiple slides as necessary.>
- <Repeat for each open action associated with Risk # N>



New Risks - Risk # <N + 1>

- **RISK # <N + 1> - <Risk statement>**
- **Risk Assessment: <TBS>** (Severity = <TBS>, Likelihood = <TBS>). <TBS = HIGH, MEDIUM, or LOW>
- Risk Mitigation: <Describe the risk mitigation plan. Use sub-bullets as warranted for clarity. Note actions associated with each item (sub-bullet) of the plan.>
- <Present status of actions associated with Risk # N + 1 in subsequent slides, following the same format used for the Risk # N actions. Present completed actions, then open actions. Use separate slides for each action.>

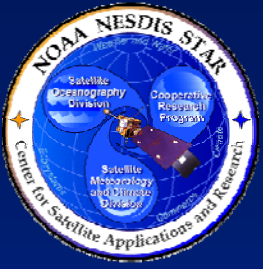

Risk Summary - <N> Risks Can Be Closed

- <Present a bulleted list of risk statements for the risks that can be closed>
 - » <For each risk, list the associated actions that can be closed. Each of these should have been presented in Sections 9.1 or 9.2 as a completed action.>
 - » <Use multiple slides as necessary for clarity>

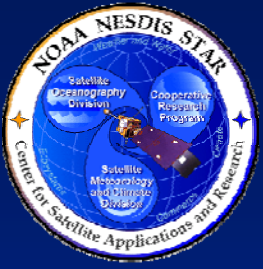

Risk Summary - <N> Risks Remain Open

- <Present a bulleted list of risk statements for the risks that are still open. Present HIGH risks first, followed by MEDIUM risks, then LOW risks.>
 - » <For each risk, list the actions that must be closed to reduce the risk to an acceptable level, with closure plans and estimated closure dates>

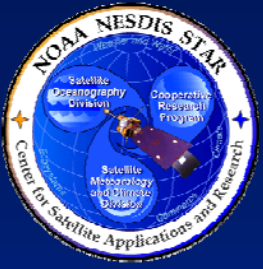

- INTRODUCTION
- PRR REPORT
- OPERATIONS CONCEPT
- REQUIREMENTS
- ALGORITHM THEORETICAL BASIS
- SOFTWARE ARCHITECTURE
- QUALITY ASSURANCE
- REQUIREMENTS ALLOCATION
- RISKS AND ACTIONS
- **SUMMARY AND CONCLUSIONS**

Section 10 Setup Slide

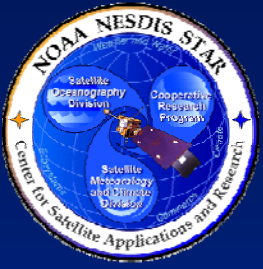

Section 10 – Summary and Conclusions

Presented by

<Presenter's Name>
<Presenter's Title/Role>
<Presenter's Organization>

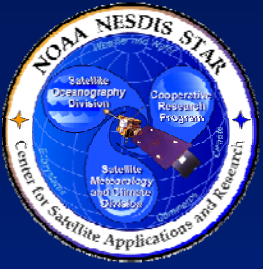

Review Objectives Have Been Addressed

- <Explain how each review objective has been addressed>
- Project Requirements Review Report and actions have been reviewed
 - » <Notable conclusions from this section>
 - Operations concept has been reviewed
 - » <Notable conclusions from this section>
 - Requirements changes have been reviewed
 - » <Notable conclusions from this section>
 - Algorithm theoretical basis has been reviewed
 - » <Notable conclusions from this section>

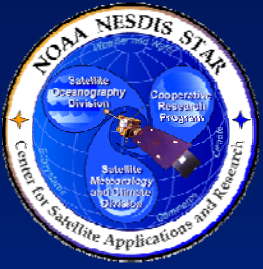

Review Objectives Have Been Addressed

<Explain how each review objective has been addressed>

- Software system architecture and interfaces have been reviewed
 - » <Notable conclusions from this section>
- Plans for quality assurance have been reviewed
 - » <Notable conclusions from this section>
- Requirements allocation has been reviewed
 - » <Notable conclusions from this section>
- Risks and Actions have been reviewed
 - » <Notable conclusions from this section>

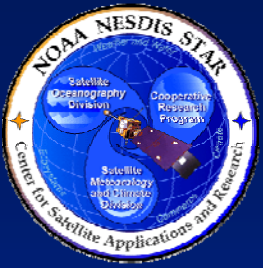

Issues, Actions And Risks

<List important issues, actions and risks that require attention. Use multiple slides as necessary for clarity.>

- <Item 1>
 - » <Conclusions about item 1>
-
 - »
- <Item N>
 - » <Conclusions about item N>

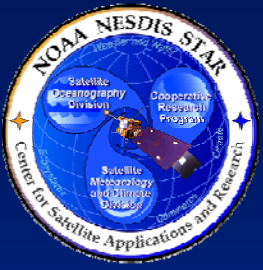

Next Step - Detailed Design

<List recommendations for next steps after the PDR>

- Detailed Design Development
 - » <Recommendations for Detailed Design step>
 - » <Recommendations for open actions>
 - » <Preparation of Critical Design Review artifacts>

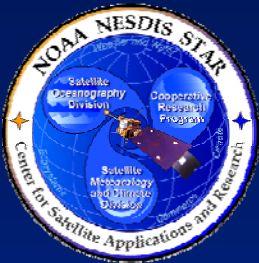

Open Discussion

- The review is now open for free discussion