



U.S. System of Oversight of Genetic Testing: A Response to the Charge of the Secretary of Health and Human Services

**Report of the Secretary's Advisory Committee
on Genetics, Health, and Society**

April 2008

A pdf version of this report is available at
http://www4.od.nih.gov/oba/sacghs/reports/SACGHS_oversight_report.pdf



U.S. System of Oversight of Genetic Testing: A Response to the Charge of the Secretary of Health and Human Services

**Report of the Secretary's Advisory Committee
on Genetics, Health, and Society**

April 2008



Secretary's Advisory Committee on
Genetics, Health, and Society
6705 Rockledge Drive
Suite 750, MSC 7985
Bethesda, MD 20892-7985
301-496-9838
301-496-9839 Fax
<http://www4.od.nih.gov/oba/sacghs.htm>

April 30, 2008

The Honorable Michael O. Leavitt
Secretary of Health and Human Services
200 Independence Avenue, S.W.
Washington, D.C. 20201

Dear Secretary Leavitt:

In March 2007, you charged the Secretary's Advisory Committee on Genetics, Health, and Society (SACGHS) with investigating specific questions related to the adequacy and transparency of the current oversight system for genetic testing. In answer to this charge, we are pleased to submit our report on the *U.S. System of Oversight of Genetic Testing: A Response to the Charge of the Secretary of Health and Human Services*. The report, which is the culmination of nearly a year of extensive factfinding, analysis, expert consultation, outreach to the public, and deliberation by the Committee, highlights gaps in the oversight system for genetic testing and provides recommendations to maximize the benefits of genetic testing and minimize harms.

In carrying out its work, the Committee used a broad interpretation of oversight to include not only Federal and State governments and agencies, but also standard-setting organizations, knowledge-generating organizations, public and private sector health care payers, professional societies, health providers, patients, and consumers. The recommendations focus primarily on actions that the Committee strongly believes should be taken by the Department of Health and Human Services (HHS) and its agencies but also speak to the critical role of the private sector and the value of public-private partnerships in enhancing oversight.

The Committee identified gaps in five main areas: the regulations governing clinical laboratory quality; the oversight of the clinical validity of genetic tests; the transparency of genetic testing; the level of current knowledge about the clinical usefulness of genetic tests; and meeting the educational needs of health professionals, the public health community, patients, and consumers, along with providing tools to assist these groups with the interpretation and communication of genetic test results. We would like to highlight critical action steps identified in the report to address gaps in these five areas.

- To improve clinical laboratory quality, the Centers for Medicare & Medicaid Services should require proficiency testing (PT) of all nonwaived laboratory tests for which PT products are available, HHS should support innovations in the way PT is performed, and the Department should also ensure funding for the development of reference materials and methods for assay, analyte, and platform validation; quality control; performance assessment; and standardization.
- To help close the gaps in oversight related to clinical validity, which would help assure the appropriate use of laboratory tests, the Food and Drug Administration (FDA) should address all laboratory tests, regardless of how they are produced (i.e., as a commercial test kit or laboratory-developed test), in a manner that takes advantage of its current experience.

- To enhance the transparency of genetic testing and assist efforts in reviewing the clinical validity of laboratory tests, HHS should appoint and fund a lead agency to develop and maintain a mandatory, publicly available, Web-based registry for laboratory tests.
- To better understand the usefulness of genetic tests, HHS should create and fund a public-private partnership to evaluate the clinical utility of genetic tests, develop a research agenda to address gaps in knowledge, conduct public health surveillance to assess the health impact of genetic testing, and help advance the appropriate use of electronic health records as a resource for assessing clinical utility and quality of health care.
- To meet the educational needs of health professionals, public health workers, patients, and consumers, HHS should support efforts to identify education or training deficiencies in each of these groups and support research and development of effective clinical decision support systems. In addition, FDA should prepare a guidance document articulating the scope of its regulation of clinical decision support systems.

Although SACGHS was tasked to look at the oversight of genetic tests specifically, we concluded that the concerns associated with genetic testing generally do not differ from other complex laboratory tests. For this reason, and because it will be increasingly difficult to distinguish between genetic and other complex laboratory tests, we chose to apply a number of our recommendations to laboratory tests generally. Nonetheless, we recognize that implementing an expansion of Federal oversight of laboratory tests will require incremental steps and that, in this context, genetic tests should have the highest priority.

The Committee's recommendations identify very important steps that HHS can take to enhance the oversight of genetic tests, which are critical to the public health and the advancement of personalized health care. The Committee also highlights the complexity of the oversight system and urges enhanced interagency coordination of the activities associated with the oversight of genetic testing, including policy and resource development, education, regulation, and knowledge generation. Although challenging, we believe that implementation of these recommendations will help the Department fulfill its mission to improve the health and well-being of Americans.

We appreciated the opportunity to address this important topic and hope that our input will prove helpful to you and the Department. We stand ready and would welcome the opportunity to provide further advice on the implementation of these important and challenging initiatives.

Sincerely,



Steven Teutch, M.D., M.P.H.
Current Chair, SACGHS



Reed V. Tuckson, M.D.
Former Chair, SACGHS

About SACGHS

The Secretary’s Advisory Committee on Genetics, Health, and Society (SACGHS) was first chartered in 2002 by the Secretary of the U.S. Department of Health and Human Services (HHS) as a public forum for deliberation on the broad range of policy issues raised by the development and use of genetic tests and, as warranted, to provide advice on these issues. Its mandate includes the following areas of study:

- Integration of genetic and genomic technologies into health care and public health
- Clinical, public health, ethical, economic, legal, and societal implications of genetic and genomic technologies and applications
- Opportunities and gaps in research and data collection and analysis efforts
- Impact of current patent policy and licensing practices on access to genetic and genomic technologies
- Uses of genetic information in education, employment, insurance, and law

SACGHS consists of up to 17 individuals from around the Nation who have expertise in disciplines relevant to genetics and genetic technologies. These disciplines include biomedical sciences, human genetics, health care delivery, evidence-based practice, public health, behavioral sciences, social sciences, health services research, health policy, health disparities, ethics, economics, law, health care financing, consumer issues, and other relevant fields. At least two of the members are specifically selected for their knowledge of consumer issues and concerns and of the views and perspectives of the general public.

Representatives of at least 19 Federal departments or agencies also sit on SACGHS in an ex officio (nonvoting) capacity. The departments and agencies are the Department of Commerce, Department of Defense, Department of Education, Department of Energy, Administration for Children and Families (HHS), Agency for Healthcare Research and Quality (HHS), Centers for Disease Control and Prevention (HHS), Centers for Medicare & Medicaid Services (HHS), Food and Drug Administration (HHS), Health Resources and Services Administration (HHS), National Institutes of Health (HHS), Office for Civil Rights (HHS), Office for Human Research Protections (HHS), Office of Public Health and Science (HHS), Department of Justice, Department of Labor, Department of Veterans Affairs, Equal Employment Opportunity Commission, and Federal Trade Commission.

Committee Roster

Chair

Steven Teutsch, M.D., M.P.H. (*Current Chair*)
Executive Director
Outcomes Research & Management
Merck & Co., Inc.
West Point, PA

Reed V. Tuckson, M.D. (*Former Chair*)
Executive Vice President
Chief of Medical Affairs
UnitedHealth Group
Minnetonka, MN

Members

Mara Aspinall, M.B.A.
Senior Advisor
Genzyme Genetics
Genzyme Corporation
Westborough, MA

Sylvia Mann Au, M.S., CGC
Hawaii State Genetics Coordinator
Genetics Program
Hawaii Department of Health
Honolulu, HI

Paul Billings, M.D., Ph.D., FACP, FACMG.*
President and Chief Executive Officer
Cellpoint Diagnostics
Mountain View, CA
Chairman
Signature Genomics Laboratories, LLC
Spokane, WA

Rochelle Dreyfuss, M.A., J.D.
Pauline Newman Professor of Law
New York University School of Law
New York, NY

James P. Evans, M.D., Ph.D.
Associate Professor of Genetics and Medicine
Director of Clinical Cancer Genetics and the
Bryson Program in Human Genetics
Departments of Medicine and Genetics
The University of North Carolina at Chapel Hill
Chapel Hill, NC

Andrea Ferreira-Gonzalez, Ph.D.
Professor of Pathology
Director of Molecular Diagnostics Laboratory
Virginia Commonwealth University
Richmond, VA

Kevin T. FitzGerald, S.J., Ph.D., Ph.D.
Dr. David P. Lauler Chair in Catholic Health Care Ethics
Research Associate Professor
Department of Oncology
Georgetown University Medical Center
Washington, DC

Julio Licinio, M.D.
Professor and Chairman
Department of Psychiatry and Behavioral Sciences
Miller School of Medicine
University of Miami
Miami, FL

Barbara Burns McGrath, R.N., Ph.D.
Research Associate Professor
University of Washington School of Nursing
Seattle, WA

Paul Steven Miller, J.D.*
Director
UW Disability Studies Program
Henry M. Jackson Professor of Law
University of Washington School of Law
Seattle, WA

Joseph Telfair, Dr.P.H., M.P.H., M.S.W.
Professor, Public Health Research and Practice
Department of Public Health Education
The University of North Carolina at Greensboro
Greensboro, NC

Marc S. Williams, M.D., FAAP, FACMG
Director
Clinical Genetics Institute
Intermountain Healthcare
Salt Lake City, UT

* Appointment Pending

Paul Wise, M.D., M.P.H.*
Richard E. Behrman Professor of Child Health and Society
Center for Health Policy
Center for Primary Care and Outcomes Research
Stanford University School of Medicine
Stanford, CA

Ex Officio Members

Michael Amos, Ph.D.
Department of Commerce

Col. Scott D. McLean, MC, USA
Department of Defense

Daniel Drell, Ph.D.
Department of Energy

Department of Health and Human Services

Martin Dannenfelser
Administration for Children and Families

Gurvaneet Randhawa, M.D., M.P.H.
Agency for Healthcare Research and Quality

Muin J. Khoury, M.D., Ph.D.
Centers for Disease Control and Prevention

Barry M. Straube, M.D.
Centers for Medicare & Medicaid Services

Steven I. Gutman, M.D., M.B.A.
Food and Drug Administration

Denise Geolot, Ph.D., R.N.
Health Resources and Services Administration

Francis S. Collins, M.D., Ph.D.
National Institutes of Health

Robinsue Frohboese, J.D., Ph.D.
Office for Civil Rights

Michael Carome, M.D.
Office for Human Research Protections

Inyang Isong, M.D., M.P.H.
Office of Public Health and Science

Thomas Alexander, J.D.
Department of Labor

Ellen Fox, M.D.
Department of Veterans Affairs

Naomi Earp, J.D.
Equal Employment Opportunity Commission

Matthew Daynard, J.D.
Federal Trade Commission

* Appointment Pending

Acknowledgments

The Committee wishes to thank the members of the Secretary’s Advisory Committee on Genetics, Health, and Society (SACGHS) Task Force on Oversight of Genetic Testing for their pivotal role in guiding the development of this report. The Task Force was chaired by Andrea Ferreira-Gonzalez and composed of the following SACGHS members: Sylvia Mann Au, Kevin FitzGerald, Paul Steven Miller, Steven Teutsch, and Marc Williams.

The Committee is indebted to the following Task Force members for sharing their knowledge and expertise on the issues surrounding the oversight of genetics testing:

- Amy Brower (Third Wave Technologies), Barbara Evans (University of Houston Law Center), Mark Hoffman (Cerner Corporation), Kathy Hudson (The Genetics and Public Policy Center), Richard Naples (Becton, Dickinson and Company), Glenn Palomaki (Women & Infants Hospital), Victoria Pratt (Quest Diagnostics), Carolyn Sue Richards (Oregon Health and Science University), James Robb, Gail Habegger Vance (Indiana University Medical School), Ann Willey (New York State Department of Health)
- Gurvaneet Randhawa (Agency for Healthcare Research and Quality); Linda Bradley, Joe Boone, Marie Earley, Scott Grosse, Lisa Kalman, Muin Khoury, Ira Lubin, Joanne Mei (Centers for Disease Control and Prevention); Judy Yost (Centers for Medicare & Medicaid Services); Steven Gutman, Elizabeth Mansfield (Food and Drug Administration); Marie Mann (Health Resources and Services Administration); Tim O’Leary (Department of Veterans Affairs); Phyllis Frosst (National Institutes of Health (NIH)); Michael Amos (National Institute of Standards and Technology)

The Committee thanks all the individuals and organizations who responded to the Committee’s requests for public comments during the development of this report (see Appendix B). The Committee gave careful consideration to each of the comments, and together they greatly enhanced the accuracy and comprehensiveness of the report and relevance of the recommendations.

The Committee wishes to thank The Lewin Group, particularly Clifford Goodman, Christel Villarivera, Laura Peterson, and Lindsey Wu, for their contributions to the report’s comprehensive map, and Sandra Howard of the Office of the Assistant Secretary for Planning and Evaluation for supporting The Lewin Group’s work on the report. The Committee is also grateful to Capital Consulting Corporation, particularly Donna Cay Tharpe, Linda Stark, Rachel Ratel, Char Glendening, and Barbara Singer, for copyediting services and final production of the report.

The Committee wishes to recognize the work of SACGHS staff. Cathy Fomous served as lead staff on the project and was responsible for organizing the deliberations of the Task Force and full Committee and for managing the development of the report. Suzanne Goodwin worked on several sections of the report, and Tara Hurd provided administrative support. Consultant Betsy Earp provided writing and editing support and consultant Sara Maddox prepared a summary of the public comments. Sarah Carr provided overall guidance to staff and consultants.

The Committee thanks the NIH Office of Biotechnology Activities, under the direction of Amy Patterson, and the NIH Office of Science Policy, under the direction of Lana Skirboll, for its ongoing support and operational management of SACGHS.

Contents

Executive Summary	1
Current Trends in the Oversight of Genetic Testing	2
Challenges and Key Considerations	5
Recommendations	6
Overarching Recommendation	6
Analytical Validity, Proficiency Testing, and Clinical Validity	6
Clinical Utility	10
Communication and Decision Support	11
Chapter I—Background and Scope	13
Introduction	13
Methodology	16
Are Genetic Tests Different from Other Laboratory Tests?	17
Overview of the Report	21
Chapter II—Systems of Oversight for Genetic Testing	23
Elements of Oversight	23
Information Development and Synthesis	23
Setting Standards	24
Compliance Mechanisms	24
Integration of Oversight Elements	26
Overview: Governmental and Nongovernmental Oversight Bodies	27
Oversight Roles of Federal and State Regulatory Agencies	29
Regulatory Status of Currently Available Genetic Tests	39
Reimbursement Policies and Genetic Testing	41
Roles of Federal Agencies in R&D and Evidence Synthesis	43
Professional and Industry Organizations	46
Public Policy and Consumer Advocacy Organizations	48
A Comprehensive Map of Oversight	49
Overarching Recommendation	52

Chapter III—Genetic Testing Technologies and Responsibilities of Laboratory Personnel.....	53
Overview and History of Types of Genetic Tests	53
Biochemical Tests.....	53
Cytogenetic Tests.....	54
Molecular Tests.....	55
Combined Technologies	57
Requirements for Laboratory Personnel.....	58
Future Trends	59
Chapter IV—Analytical Validity, Proficiency Testing, and Clinical Validity	63
Background	63
Pathways for Bringing Genetic Tests to Clinical Practice	65
Analytical Validity	67
Key Terms and Concepts.....	68
Challenges Related to Analytical Validity.....	70
Proficiency Testing.....	73
Value of Proficiency Testing	73
Current Proficiency Testing Programs and Related Activities	76
Organized Alternative Assessment Programs.....	80
PT Performance and Alternative Assessment.....	80
Newborn Screening Quality Assurance Program	81
Genetic Testing Reference Materials Coordination Program.....	82
Challenges Related to Proficiency Testing.....	83
Clinical Validity	85
Key Terms and Concepts.....	85
Types of Genetic Tests	86
Evaluating Clinical Validity	87
Clinical Validity: A Case Study.....	88
Challenges Related to Clinical Validity.....	90
Current Oversight Systems for Ensuring the Validity of Genetic Tests and the Quality of Laboratories	91
Federal Regulatory Agencies.....	91
State Regulatory Agencies.....	98

Standards Development Organizations.....	100
Knowledge Generation Agencies	102
Professional Societies	103
Gaps in the Oversight of Analytical and Clinical Validity	106
Evidence of Harms and Potential Harms	108
Inadequate Knowledge of the Analytical Validity of Genetic Tests	108
Inadequate or Misapplied Knowledge of the Clinical Validity of Genetic Tests.....	109
Recommendations	111
Chapter V—Development and Evaluation of Evidence for the Clinical Utility of Genetic Tests.....	115
Definition of Clinical Utility	115
Clinical Utility and Value.....	117
Development of Evidence of Clinical Utility	120
Assessment of Evidence of Clinical Utility	123
The Clinical Utility Spectrum	127
Tests with Proven Clinical Utility	127
Mandated Tests and Uncertain Clinical Utility	128
Rare Disease Testing and Emerging Evidence of Utility	128
Controlled Research Environment vs. Routine Clinical Use.....	129
Pharmacogenomics and Incomplete Evidence of Clinical Utility	129
Tests for Which Information Alone Has Utility	131
Consequences of Inadequate Clinical Utility Evidence	131
Gaps and Challenges Concerning the Clinical Utility of Genetic Testing	132
Lack of Evidence, Assessment Tools, and Evidentiary Standards	132
Diverse Uses of Genetic Tests	134
Evidence of Harms and Potential Harms	137
Recommendations	138
Chapter VI—Effective Communication and Decision Support	141
Key Terms and Concepts	143
Current Systems for Communication of Genetic Test Information	144
Roles and Responsibilities in Genetic Testing.....	151

Health Care Professionals Without Specialty Training in Genetics	151
Genetics Professionals	156
Role of Laboratories in Providing Genetic Expertise	160
Genetic Specialty Laboratories	160
Nongenetic Laboratories	163
Point-of-Care Genetic Testing	163
Impact of Direct-to-Consumer Advertising	164
Patient Access to Expertise	166
Role of Professional Societies	167
Role of Third-Party Payers	169
Communication of Test Results	170
Role of Electronic Health Records	171
Representation of Genetic and Genomic Test Results	172
Communication To Support Genetic Testing in the EHR	173
Role of the Personalized Health Record	173
Risk Stratification and Clinical Decision Support	174
Passive Decision Support	175
Active Decision Support	177
Communicating Genetic Test Results: Implications for the Consumer	180
Gaps in Communication and Decision Support	185
Evidence of Harms and Potential Harms	187
Recommendations	188
Chapter VII—Conclusion	191
Appendix A: Twelfth Meeting of the SACGHSHealth, and Society—Summary of	A-1
March 26, 2007, Oversight Session	
Appendix B: List of Public Commenters	B-1
Appendix C: Detailed Maps of the U.S. Oversight System for Genetic Testing	C-1
Appendix D: Genetic Technology Resources	D-1
Appendix E: College of American Pathologists Proficiency Testing Program	E-1
Appendix F: Guidelines and Standards for Molecular Diagnostics Testing	F-1
Appendix G: Acronyms and Abbreviations	G-1

Executive Summary

Since the launch of the Human Genome Project, genetic testing has been adopted increasingly into standard practice for diagnosing and managing disease, predicting the risk of future disease, and informing decisions about life planning and behavior change. Today, genetic tests use combinations of biochemical, cytogenetic, and molecular methods to analyze deoxyribonucleic acid (DNA), ribonucleic acid (RNA), chromosomes, proteins, and selected metabolites. Advances in genetics research are enabling improved prevention, treatment, and disease management for common chronic conditions such as cancer, heart disease, and diabetes.

As genetic testing technology is integrated into health care, increasingly detailed information about individual and population genetic variations becomes available to patients and providers. More and more, health professionals are turning to genetic testing to assess the risk of and specifically diagnose disease in individuals, families, and populations and then using this information to guide health care decisions. However, availability of this information requires significant support for efforts to understand its validity, interpretation, and utility in clinical and personal decisionmaking. Scientific and technological advances in genetic testing present certain challenges to existing frameworks for regulation and oversight. It is critical to anticipate and adapt to the impacts of these advances on individual health care and public health.

The significance of the information from genetic tests, the expanded use of genetic testing in clinical practice and public health, and the pace and extent of technological change in the ways testing is performed have prompted efforts to examine the current systems of oversight and regulation of genetic tests and test results. The Secretary's Advisory Committee for Genetics, Health, and Society (SACGHS) first identified the oversight of genetic testing as a priority area in 2004. After monitoring the issue for a couple of years, SACGHS began a concentrated effort in 2006 to assess the various systems of oversight that play a role in genetic testing. Like its predecessor—the Secretary's Advisory Committee on Genetic Testing—the overarching concern of SACGHS was the adequacy of the oversight system and whether there were gaps that could lead to harms in public health.

In March 2007, the Department of Health and Human Services (HHS) launched the Personalized Health Care Initiative to advance the integration of genomic technologies that are capable of tailoring treatment and prevention strategies to each patient's unique genetic characteristics and individual needs into general health care.¹ The Initiative recognizes that the accuracy, clinical validity, and clinical utility of genetic tests are central to the realization of personalized health care. Because this effort dovetailed with the work under way by SACGHS, the HHS Secretary charged the Committee with investigating specific issues related to the adequacy and transparency of current oversight systems for genetic testing. The charge complements related efforts under way at the Federal level and encompasses all sectors of the health care system concerning oversight, including the Federal Government, State Governments, and the private sector. Refined during Committee discussion, the charge was to:

¹ Department of Health and Human Services Web site: "Personalized Health Care: Goals." See <http://www.hhs.gov/myhealthcare/goals/index.html#Goal3>. Accessed on March 14, 2008.

Undertake the development of a comprehensive map of the steps needed for evidence development and oversight for genetic and genomic tests, with improvement of health quality as the primary goal. Consider and address the following questions:

- What evidence of harm exists regarding genetic tests? Is that harm attributable to analytical validity, clinical validity, or clinical utility of the tests? If evidence does not exist, what threats are not currently being addressed? What public health benefits are not accruing as quickly as they might?
- What distinguishes genetic tests from other laboratory tests for oversight purposes?
- What are the existing pathways that examine the analytical validity, clinical validity, and clinical utility of genetic tests? Consider the use of case studies.
- What organizations are currently involved with each of these aspects, and what are they doing to address these issues? Who should be responsible for each of these aspects?
- What resources (e.g., standards reagents/materials) are needed to develop proficiency testing (PT) kits or protocols for genetic tests? What is currently available in terms of PT kits or protocols for genetic tests? What information is provided by PT? Is the current level of PT for genetic tests adequate, and are the results of such laboratory performance assessments sufficiently transparent?
- What are the potential pathways to communicate clear information to guide test and treatment selection by the provider?
- What new approaches or models should be considered for private and public-private sector engagement in demonstrating clinical validity and clinical utility for developing effectiveness measures of genetic tests in clinical practice?
- Would additional or revised Government oversight add value for patients, and, if so, how and where?

Given the charge, this report focuses on the oversight of genetic testing and the application of genetic information in patient care and management. In developing the report, the Committee came to appreciate that many of the issues subject to its review of genetic tests were similar to those of other complex laboratory tests. As such, the discussions and recommendations on the analytical validity, clinical validity, and clinical utility of genetic testing; possible gaps in testing oversight that may lead to harms; evidence development for oversight of genetic and genomic tests; and new approaches to demonstrate the clinical validity and clinical utility of genetic testing in clinical practice could well be applied more broadly to improve the quality of all laboratory tests.

Current Trends in the Oversight of Genetic Testing

Advances in the technology and application of genetic testing have confirmed and widened some gaps and ambiguities that exist in current systems of oversight. The prevalence of genetic testing in health care today has highlighted the need to examine the regulatory framework governing a variety of test uses and testing procedures. The responsibilities for the oversight of genetic testing are shared by multiple governmental and nongovernmental bodies. Systems of oversight address activities related to genetic testing that range from the research and development of tests to the delivery and interpretation of tests results to guide health and lifestyle decisions. Depending on the aspect of testing, oversight is provided by Government agencies, health care payers, professional associations, or other groups; voluntarily by certain sectors; or not at all. Some aspects of oversight are quite specific to genetic testing, whereas others are of broader scope, applying to medical devices or other products or professional activities in general.

At the Federal level, oversight of genetic tests includes activities carried out by the Food and Drug Administration (FDA) and the Centers for Medicare & Medicaid Services (CMS). Currently, there are two main pathways for bringing genetic tests into clinical practice. Some tests are developed by *in vitro* diagnostic (IVD) test manufacturers for distribution in interstate commerce to multiple laboratories. Other tests, known as laboratory-developed tests (LDTs), are developed for use solely in the test developer's laboratory.

FDA regulates genetic tests that qualify as devices, which includes test kits and analyte-specific reagents (ASRs). ASRs can be antibodies, receptor proteins, nucleic acid sequences, or other biological or chemical reagents used to identify or quantify substances in biological specimens.² Until recently, FDA has not exercised its regulatory authority over LDTs; the Clinical Laboratory Improvement Amendments of 1988 (CLIA) are used to regulate the laboratories that develop LDTs.³

CLIA, which is overseen by CMS, requires all clinical laboratories, including genetic testing laboratories, to undergo inspections to assess their compliance with established standards. This process includes inspections for personnel qualification and responsibilities, quality control standards, PT, quality assurance, and recordkeeping. CLIA requires a laboratory to verify and establish the analytical performance characteristics of tests offered by that laboratory. Although CMS provides guidance and resources to help laboratories achieve compliance, current regulations do not specify particular procedures or protocols. Rather, they require laboratories to ensure that their test results are accurate, reliable, timely, and confidential and do not present the risk of harm to patients. Many have called for a closer examination and coordination of the dual regulations of FDA and CLIA. In addition, bills were introduced in the 110th Congress that addressed the oversight of genetic testing.^{4,5}

At the State level, many agencies use CLIA requirements to regulate genetic testing laboratories. The States of New York and Washington, however, independently operate laboratory certification programs, both of which are exempt from CLIA because CMS has deemed them equal to or more stringent than CLIA requirements. The New York State Department of Health has one of the most stringent State-level oversight systems, requiring preapproval prior to offering a genetic test in a clinical setting. As all laboratories that solicit and receive specimens from New York are subject to these clinical laboratory requirements,⁶ an estimated 75 percent of all cytogenetic and genetic specimens tested in the United States are subject to this oversight.⁷

² Gutman, S.I. *FDA's Role in the Regulation of In Vitro Diagnostic*. Presentation May 10, 2003. Food and Drug Administration, Center for Devices and Radiological Health, Office of In Vitro Device Evaluation and Safety. See <http://www.fda.gov/cdrh/oivd/presentations/051003-gutman-1.html>. Accessed on March 19, 2008.

³ Centers for Medicare & Medicaid Services Web site. "Clinical Laboratory Improvement Amendments (CLIA)". See <http://www.cms.hhs.gov/clia>. Accessed on March 19, 2008.

⁴ S.976: Genomics and Personalized Medicine Act of 2007. See http://frwebgate.access.gpo.gov/cgi-bin/getdoc.cgi?dbname=110_cong_bills&docid=f:s976is.txt.pdf. Accessed on March 20, 2008.

⁵ S. 736: Laboratory Test Improvement Act. See http://frwebgate.access.gpo.gov/cgi-bin/getdoc.cgi?dbname=110_cong_bills&docid=f:s736is.txt.pdf. Accessed on March 20, 2008.

⁶ Wadsworth Center, New York State Department of Health Web site. "Clinical Laboratory Evaluation Program." See <http://www.wadsworth.org/labcert/lep/lep.html>. Accessed on March 20, 2008.

⁷ Willey, A.W. *New York State Laboratory Specific Assay Validation Review and Approval as Applied to Genetic Testing*. Presentation to SACGHS meeting March 26, 2007. See <http://www4.od.nih.gov/oba/sacghs/meetings/Mar2007/Mon%20pm%20-%20Willey.pdf>. Accessed on March 20, 2008.

Ensuring the analytical and clinical validity of genetic testing is paramount. Analytical validity refers to a test's ability to measure the analyte or genotype of interest accurately and reliably; clinical validity refers to a test's ability to detect or predict the associated disorder (phenotype). Only analytical validity is fully enforced under CLIA, as CMS does not have authority under CLIA to enforce clinical validity.⁸ FDA plays a role in assessing the clinical validity of genetic tests insofar as it is charged with assessing "safety and effectiveness." Its evaluation of clinical performance depends on the nature of the test, its intended use, and the amount of existing information about the associations of genetic markers and clinical diagnosis. Prospective data of a test's clinical validity, however, are often unavailable or incomplete for years after a test is developed, especially for predictive or presymptomatic tests. As such, numerous challenges remain for the demonstration of clinical validity, such as the collection of postmarket data and the sharing of information among laboratories.

There are also questions about the sufficiency of CLIA's requirements for assessing the performance of genetic testing laboratories. While CLIA requires laboratories to have quality assurance programs in place, most genetic testing laboratories are not required by CLIA to perform PT unless they are testing a small subset of established analytes regulated under CLIA,⁹ none of which are genetic tests *per se*. PT serves as an assessment of laboratory competence by comparing a laboratory's test performance and results to an established external standard,¹⁰ and it is considered to be the most rigorous form of performance assessment currently available. In principle, all genetic tests and other high-complexity tests should be required to undergo PT. Thus, gaps in oversight still exist regarding the regulation, breadth, costs, and availability of testing materials for existing PT programs.

Clinical utility, which refers to the net balance of risks and benefits associated with using a test in routine practice, is another critical element for translating genetic testing into clinical practice. With the establishment of analytical and clinical validity as prerequisites, information and data illustrating the potential health benefits and harms of a genetic test are necessary for the effective management of patients, the development of professional guidelines, and coverage decisions. The current evidence base for the clinical utility of genetic testing is limited, and public and private health care payers are increasingly calling for such evidence in order to make coverage decisions. Although Federal initiatives by the Agency for Healthcare Research and Quality (AHRQ), Centers for Disease Control and Prevention (CDC), Health Resources and Services Administration, and National Institutes of Health (NIH) have led to great strides in evidence development for genetic testing, a more coordinated approach for effectively translating genetic applications into clinical practice and health policy is needed.

Technical advances in genetic testing must be accompanied by accurate interpretation and communication of genetic test results. Professional recommendations, including those from such groups as the American College of Medical Genetics, U.S. Preventive Services Task Force, and others, provide information to

⁸ Centers for Medicare & Medicaid Services Web site. "Clinical Laboratory Improvement Amendments (CLIA)." Op. cit.

⁹ Centers for Disease Control and Prevention Web site. "Clinical Laboratory Improvement Amendments (CLIA), Subpart I – Proficiency Testing Program for Nonwaived Testing." See http://wwwn.cdc.gov/clia/reggs/subpart_i.aspx. Accessed on March 20, 2008.

¹⁰ Tholen, D.W., Berte, L.M., Boone, D.J., Cooper, W.G., Gun-Munro, J., Noble, M.A., Sarewitz, S.J., and Williams, M.L. Using Proficiency Testing to Improve the Clinical Laboratory; Approved Guideline – 2nd Edition. GP27-A2, Vol. 27(8). Wayne, PA: Clinical and Laboratory Standards Institute. See <http://www.clsi.org/source/orders/free/gp27-a2.pdf>. Accessed on March 20, 2008.

¹¹ American College of Medical Genetics Website. "American College of Medical Genetics Practice Guidelines." See http://www.acmg.net/AM/Template.cfm?Section=Practice_Guidelines&Template=/CM/HTMLDisplay.cfm&ContentID=2257. Accessed on March 20, 2008

practitioners about the ordering of genetic tests and reporting of results.¹¹ Organizations such as the National Coalition for Health Professional Education in Genetics have engaged in efforts to enhance clinician understanding of genetic testing and its appropriate use.¹² Yet there are insufficient data about how well practitioners order, conduct, and interpret genetic tests and the extent to which genetic test results are used appropriately to support clinical decisionmaking. Most practitioners are unfamiliar with guidelines for the appropriate use of genetic tests, and few processes have been implemented, evaluated, or enforced to support practitioners in this regard.

Along with efforts to guide health care professionals, it is necessary to improve the education of patients and other consumers. The increasing prevalence of genetic testing has led to a rise in direct-to-consumer (DTC) advertising of genetic tests. In 2006 the Federal Trade Commission (FTC), in conjunction with FDA and CDC, issued an alert warning consumers to be wary of claims made by at-home genetic tests.¹³ There also appears to be a lack of patient guidance for interpreting information from all forms of genetic testing, not just DTC tests. With the possible exception of State-based newborn screening programs, few patients have access to genetics expertise, as there are only a small number of formally trained genetic service providers in the country. Thus, there have been calls for more genetics professionals to help patients understand the health impact of their genetic information.^{14,15,16}

Challenges and Key Considerations

There are many challenges to effective oversight of genetic testing. Analytical and clinical validity must be established for the increasing number of new technologies to be of practical use to clinicians and patients, highlighting the need for information exchange, premarket and postmarket data, and reference materials to verify newly developed assays. Clarification and improved coordination of FDA, CLIA, and State-based regulations over quality assurance and PT will be necessary to reduce ambiguity and increase consistency over standards for laboratory compliance. The small body of existing research on clinical utility of genetic testing highlights a critical lack of information on how genetic test information is used to influence clinical decisionmaking and how it affects health outcomes. A related shortcoming is the dearth of educational programs for clinicians, practitioners, and health care professionals on how to deliver and interpret genetic information for patients. The translation of genetic tests into clinical practice will rely heavily on preanalytical and postanalytical clinical decision support and research into the impact of genetic information on health care delivery, outcomes, and costs.

¹² National Coalition for Health Professional Education in Genetics Web site. “Contracts and Grants.” See <http://www.nchpeg.org/content.asp?dbsection=contracts#1>. Accessed on March 20, 2008.

¹³ Federal Trade Commission Web site. “At-Home Genetic Tests: A Healthy Dose of Skepticism May Be the Best Prescription.” See <http://www.ftc.gov/bcp/edu/pubs/consumer/health/hea02.shtm>. Accessed on March 20, 2008.

¹⁴ Cooksey, J.A., Forte, G., Benkendorf, J., and Blitzer, M.G. (2005). The state of the medical geneticist workforce: findings of the 2003 survey of American Board of Medical Genetics certified geneticists. *Genetics in Medicine*. 7(6):439-443.

¹⁵ Cooksey, J.A., Forte, G., Flanagan, P.A., Benkendorf, J., and Blitzer, M.G. (2006). The medical genetics workforce: an analysis of clinical geneticist subgroups. *Genetics in Medicine*. 8(10):603-614.

¹⁶ Benkendorf, J. *The Medical Genetics Workforce: Getting to Where We Need to Be From Here*. Presentation to SACGHS meeting November 20, 2007. See <http://www4.od.nih.gov/oba/SACGHS/meetings/Nov2007/benkendorf.pdf>. Accessed on March 20, 2008.

Key considerations for the oversight of genetic testing include the following:

- **Analytical and clinical validity** must be established for emerging genetic testing technologies, including through the development of assay validation tools, improved data sharing among researchers, and establishment of evidentiary standards. This effort requires clear provisions for authority and resources for oversight.
- **Proficiency testing and quality assurance** are essential for continuous quality management and the maintenance of process standards for laboratories performing genetic testing. Emerging technologies continue to pose a significant challenge with regard to the availability of materials for PT and quality assurance.
- **Demonstration of clinical utility**, using data from a variety of prospective and retrospective studies, can help establish how genetic testing affects health outcomes. The development of evidentiary standards, data sources, and evidence-based methods applicable to genetic testing can help establish clinical utility and guide the effective translation of genetic research into practice.
- **Education and guidance** for clinicians, laboratory personnel, and other health care professionals are essential to ensure the accurate use and interpretation of genetic tests. Training on the effective use of electronic health records and clinical decision support in the preanalytical and postanalytical phases of genetic testing is also needed.
- **Ongoing public health surveillance** such as surveys of patients, providers, and the general population are needed to monitor the uptake and use of genetic tests and the determinants of care.
- **Coordination of public and private sector activities** has the potential to strengthen oversight of genetic testing through complementary and consistent State and Federal requirements for establishing analytical validity, quality assurance, clinical validity, clinical utility, and education and guidance.

Recommendations

Overarching Recommendation

In keeping with his responsibility and commitment to protect and improve public health and as part of an effort to support the advancement of personalized health care, the HHS Secretary charged SACGHS to assess the adequacy of the U.S. system of oversight of genetic testing. After extensive factfinding, consultation, and analysis, the Committee found significant gaps in the U.S. system of oversight of genetic testing that can lead to harms. The Committee also identified novel opportunities that would enhance oversight. The Committee formulated recommendations that, if implemented and sufficiently supported, will close major gaps, enhance future oversight, help ensure public safety and health, and facilitate the realization of personalized health care. These steps are extraordinarily challenging, and they will require both swift action and sustained leadership by the HHS Secretary and coordinated efforts at the highest level within the administration of HHS.

Analytical Validity, Proficiency Testing, and Clinical Validity

1. **For a number of years, CMS had been planning to address gaps in the oversight of laboratories that conduct genetic tests by adding a genetic testing specialty under CLIA. Recently, CMS changed direction and is now addressing these gaps with a multifaceted action plan. SACGHS considered the CMS rationale and reviewed the CMS action plan. SACGHS also carefully considered the recommendations of prior groups as well as the perspectives of stakeholders that support the specialty. In the end, the Committee concluded that identified gaps can be addressed without the creation of a genetic testing specialty. SACGHS proposes the following recommendations to support and/or augment the CMS action plan:**

- A. Currently, CLIA requires all nonwaived tests to undergo some form of performance assessment, but only 83 specific analytes, none of which are genetic tests *per se*, are required to undergo the type of assessment called PT. PT is currently considered to be the most rigorous form of performance assessment. In principle, genetic tests and all other nonwaived laboratory tests should be required to undergo PT. However, such a goal cannot be achieved immediately. Consequently, the following actions should be taken:
- CMS should require PT of all nonwaived laboratory tests for which PT products are available. For tests without PT products, laboratories must use alternative assessment methods, as required under current CLIA regulations.
 - To promote the development of new PT products and facilitate performance assessment efforts, HHS should fund studies of the effectiveness of other types of performance assessment methods to determine whether they are as robust as PT and should support innovations in the way PT is performed, such as through methodology-based processes.
- B. CMS should consult or contract with experts in the field to train inspectors of genetic testing laboratories. Training by such experts will enhance inspectors' understanding of the technologies, processes, and procedures utilized by genetic testing laboratories and equip them to assess compliance with CLIA requirements. In addition, CMS should identify and evaluate innovative, alternative mechanisms to inspect genetic testing laboratories.
- C. As recommended in a 2006 Government Accountability Office report on clinical laboratory quality, CMS should use revenues generated by the CLIA program to hire sufficient staff to fulfill CLIA's statutory responsibilities, and the program should be exempt from any hiring constraints imposed by or on CMS.
- 2. Currently, there are gaps in the extent to which analytical validity and clinical validity data can be generated and evaluated for genetic tests. To address these gaps, SACGHS recommends devoting public resources for genetic testing through the following actions:**
- A. In consultation with relevant agencies, HHS should ensure funding for the development and characterization of reference materials, methods, and samples (e.g., positive and negative controls and samples from different ethnic/geographic populations) for assay, analyte, and platform validation; for quality control and performance assessment; and for standardization.
- B. HHS should ensure funding for the development of a mechanism to establish and support a laboratory-oriented consortium to provide a forum for sharing information regarding method validation, quality control, and performance issues.
- C. HHS agencies, including NIH and CDC, should continue to work with public and private partners to support, develop, and enhance public reference databases to enable more effective and efficient collection of mutation and polymorphism data, expand clinical reference sequence databases, and provide summary data on gene-disease associations to inform clinical validity assessments (e.g., RefSeqGene, HuGENet). Such initiatives should be structured to encourage robust participation; for example, there is a need to consider mechanisms for anonymous reporting and/or protections from liability to encourage information sharing among members.
- D. HHS should provide the necessary support for professional organizations to develop and disseminate additional standards and guidelines for applying genetic tests in clinical practice. CMS should work

with professional organizations to develop interpretative guidelines to enhance inspector training and laboratory compliance.

3. The Committee is concerned by the gap in oversight related to clinical validity and believes that it is imperative to close this gap as expeditiously as possible. To this end, the Committee makes the following recommendations:

- A. FDA should address all laboratory tests in a manner that takes advantage of its current experience in evaluating laboratory tests.
- B. This step by FDA will require the commitment of significance resources to optimize the time and cost of review without compromising the quality of assessment.
- C. The Committee recommends that HHS convene a multistakeholder public and private sector group to determine the criteria for risk stratification and a process for systematically applying these criteria. This group should consider new and existing regulatory models and data sources (e.g., New York State Department of Health Clinical Laboratory Evaluation Program). The multistakeholder group should also explicitly address and eliminate duplicative oversight procedures.
- D. To expedite and facilitate the review process, the Committee recommends the establishment of a mandatory test registry as noted in the following recommendation.

4. There are considerable information gaps about the number and identity of laboratories performing genetic tests and the specific genetic tests being performed. To gain a better understanding of the genetic tests being offered as laboratory-developed tests and to enhance the transparency in this field, SACGHS reviewed proposals for a voluntary or mandatory test registry and considered the benefits and burdens of each type of system. The Committee decided that a mandatory, publicly available, Web-based registry that is well staffed to maintain an accurate and current database would offer the best approach to addressing these information gaps in the availability of tests and their analytical and clinical validity. Since genetic tests are not different from other laboratory tests for oversight purposes, the registry should include all laboratory tests. The Committee also discussed whether such a database should reside at CDC, CMS, or FDA, but recognized that unresolved issues, including practical and legal questions, require further analysis before a final decision can be made about how and where to implement the registry. In concluding that a mandatory registry should be established, SACGHS recommends the following course of action:

- A. HHS should appoint and fund a lead agency to develop and maintain the mandatory registry for laboratory tests. The lead agency should work collaboratively with its sister agencies to create a comprehensive registry and minimize duplicative collection of registry information. For this purpose, the lead agency should be staffed with qualified personnel who are experienced in developing and updating large databases in a timely and accurate manner.
- B. The lead agency, in collaboration with its sister agencies, should convene a stakeholders meeting by September 2008 to determine the data elements associated with analytical validity, clinical validity, clinical utility, and accessibility that should be included in the test registry. The lead agency should cast a wide net for broad stakeholder representation, including individuals from the private sector who can represent a role for public-private partnerships in developing a registry. The lead agency, through this stakeholder effort, should assess the level of effort, as well as the burden on the laboratory and the impact on other key stakeholders such as patients, physicians, and payers, necessary to obtain each data element, including linking to reliable sources of existing information.

C. While awaiting completion of the above processes, HHS should use short-term voluntary approaches such as incentivizing laboratories to register with GeneTests and encouraging laboratories to make their test menus and analytical and clinical validity data for these tests publicly available on laboratory Web sites.

5. Factfinding by SACGHS also identified gaps in the enforcement of existing regulations. For example, the CLIA program has an array of enforcement actions available, but those actions cannot be directly imposed on uncertified laboratories. Instead, CMS must report the laboratory to the HHS Inspector General for action. Neither Medicare nor Medicaid can reimburse laboratories without CLIA certificates, but this restriction has no consequence for laboratories that perform direct-to-consumer testing. To address enforcement gaps, SACGHS recommends the following actions:

- A. To prevent laboratories from performing tests without appropriate CLIA certification, CMS should establish and exercise its regulatory authority to take direct enforcement actions against laboratories that perform tests for clinical purposes without proper CLIA certification. CMS should step up its efforts to make publicly available a list of laboratories that have been cited by CLIA for condition-level deficiencies.
- B. Appropriate Federal agencies, including CDC, CMS, FDA, and FTC, should strengthen monitoring and enforcement efforts against laboratories and companies that make false and misleading claims about laboratory tests, including direct-to-consumer tests.

6. SACGHS is concerned about certain types of health-related tests that are marketed directly to consumers and apparently fall outside the scope of CLIA. Some nutrigenomic tests (e.g., a test for caffeine metabolism) and tests that determine the gender of a fetus are examples of health-related tests that skirt the boundaries of CLIA’s authority. There is insufficient oversight of laboratories offering such tests, and their potential impact on the public health is an increasing concern. Direct-to-consumer marketing of laboratory tests and consumer-initiated testing have the potential for adverse patient outcomes, social stigmatization, privacy concerns, and cost implications for the health care system. SACGHS recommends that:

CLIA regulations and, if necessary, CLIA’s statutory authority, along with FDA’s risk-based regulatory authority and regulatory processes, should be expanded to encompass the full range of health-related tests, including those offered directly to consumers. Relevant Federal agencies (e.g., CMS, CDC, FDA, and FTC) should collaborate to develop an appropriate definition of health-related tests that FDA and CMS could use as a basis for expanding their scope. Additionally, these Federal agencies, including the HHS Office for Civil Rights, along with other State agencies and consumer groups should propose strategies to protect consumers from potential harm and from unanticipated and unwanted compromises in privacy that may lead to harm. Additional oversight strategies that might be established should be balanced against the benefits that consumers may gain from wider access to genetic tests and potential cost savings.

Clinical Utility

- 1. Information on clinical utility is critical for managing patients, developing professional guidelines, and making coverage decisions. SACGHS found a paucity of information on the clinical utility of genetic testing. There are inadequate data on which to base utility assessments, and only a few studies have been done of the clinical utility of specific genetic tests. More fundamentally, there has been insufficient analysis of the standard of evidence on which the clinical utility of genetic tests should be evaluated and on which evidence-based methods applicable to genetic testing should be developed. Further policy analysis is also needed to define the process by which clinical utility assessments will be applied. To fill these needs SACGHS recommends the following:**
 - A. HHS should create and fund a sustainable public/private entity of stakeholders to assess the clinical utility of genetic tests (e.g., building on CDC's Evaluation of Genomic Applications in Practice and Prevention [EGAPP] initiative). This entity would:
 - Identify major evidentiary needs
 - Establish evidentiary standards and level of certainty required for different situations such as coverage, reimbursement, quality improvement, and clinical management
 - Establish priorities for research and development
 - Augment existing methods for assessing clinical utility as well as analytical and clinical validity, such as those used by EGAPP and the U.S. Preventive Services Task Force, with relevant modeling tools
 - Identify sources of data and mechanisms for making them usable for research, including the use of data from electronic medical records
 - Recommend additional studies to assess clinical effectiveness
 - Achieve consensus on minimal evidence criteria to facilitate the conduct of focused, quick-turnaround systematic reviews
 - Increase the number of systematic evidence reviews and make recommendations based on their results
 - Facilitate the development and dissemination of evidence-based clinical practice guidelines and clinical decision support tools for genetic/genomic tests
 - Establish priorities for implementation in routine clinical practice
 - Publish the results of these assessments or otherwise make them available to the public via a designated HHS or other publicly supported Web site (e.g., GeneTests)
 - B. To fill gaps in the knowledge of the analytical validity, clinical validity, clinical utility, utilization, economic value, and population health impact of genetic tests, a Federal or public/private initiative should:
 - Develop and fund a research agenda to fill those gaps, including the initial development and thorough evaluation of genetic tests and the development of evidence-based clinical practice guidelines for the use of those tests
 - Disseminate these findings to the public via a designated HHS or other publicly supported Web site (e.g., GeneTests)
- 2. Health care payers are increasingly requiring evidence of clinical utility before they will pay for genetic tests. Therefore, coverage and reimbursement decisions play a critical role in stimulating innovation and facilitating access to genetic testing. In February 2006, SACGHS issued a report that made recommendations for developing evidence of clinical utility and addressing other barriers to the coverage and reimbursement of genetic tests and services in the public and private**

sectors. SACGHS offers the following recommendation concerning the development of clinical utility evidence:

Because the issues identified by SACGHS in the *Coverage and Reimbursement of Genetic Tests and Services* report are still current, the Committee urges HHS to act on the report's recommendations. In addition, public and private health care payers, in collaboration with relevant groups such as test developers and clinical laboratorians, should develop mechanisms, such as coverage with evidence development or phased reimbursement, to facilitate the collection of clinical utility evidence for high-priority tests and applications. Implementation of innovative approaches should be accompanied by careful evaluation to assess whether they enhance or hinder innovation, the understanding of effectiveness, and appropriate utilization.

- 3. The value of genetic tests to patients is realized only when they are used appropriately. Quality improvement processes are needed to ensure that genetic tests are delivered consistently to appropriate patients. Furthermore, an ongoing process is needed to identify opportunities for improving the use of genetic testing, including the collection of postmarket outcome data. SACGHS, therefore, makes the following recommendation:**

HHS should conduct public health surveillance to assess health outcomes (or appropriate surrogate outcomes), practice measures (including appropriate utilization), and the public health impact of genetic testing. Information should be linked to quality improvement practices that affect patient outcomes and the provision of health care services. Data on specific genetic testing results would be required to permit understanding of the significance of genetic variants and new detection methods to improve the utility of genetic testing.

- 4. The clinical utility and value of genetic testing is inextricably linked to methods to improve health care processes and decision support. Interoperable electronic health records will play a central role in the translation of guidelines into health care practices through their decision support and educational functions. These records will serve as a critical resource for assessing clinical utility and quality of health care. SACGHS therefore makes the following recommendation:**

HHS should ensure the coordination and implementation of efforts—including the deliberations of SACGHS; the American Health Information Community (AHIC) and/or its successors; and other work groups addressing personalized health care, population health and clinical care connections, and confidentiality, privacy, and security—to advance the appropriate use of interoperable patient-level data for research and enhance the quality of decisionmaking.

Communication and Decision Support

- 1. There are documented deficiencies in genetic knowledge in all relevant stakeholder groups. In addition to the creation of the SACGHS education task force, SACGHS recommends the following strategies to address these deficiencies:**

- A. HHS should work with all relevant government agencies and interested private parties to identify and address deficiencies in knowledge about appropriate genetic and genomic test applications in practice and to educate key groups such as health care practitioners, public health workers, public and private payers, and consumers of health care. These educational efforts should take into account differences in language, culture, ethnicity, and perspectives on health and disability as well as issues of medical literacy, access to electronic information sources such as the Internet, and deficiencies in public infrastructures (e.g., libraries) that can affect the use and understanding of genetic information.

B. Based on increased research regarding analytical validity, clinical validity, and clinical utility, sufficient resources should be provided to translate this knowledge into evidence-based clinical practice guidelines that enhance the quality of clinical health care and public health care outcomes.

- 2. Although FDA has asserted its authority over clinical decision support systems, the extent to which the Agency intends to regulate such systems is not clear. Given that clinical decision support systems will be necessary to communicate information appropriately in the preanalytical and postanalytical periods and given that these systems contain elements that involve the practice of medicine, clarification of the nature and scope of FDA oversight of such support systems is critical. SACGHS recommends that:**

FDA should engage with other relevant Federal agencies, advisory committees to the HHS Secretary (e.g., AHIC and the Advisory Committee on Heritable Disorders and Genetic Diseases in Newborns and Children), and stakeholders to gather perspectives on the appropriate regulatory framework for clinical decision support systems in light of changing health care delivery and health care data collection systems. As part of this process, FDA should prepare a guidance document articulating the basis of its authority to regulate clinical decision support systems as well as its rationale for and approach to such regulation, explaining in particular which features of the system constitute a device.

- 3. The need for genetic expertise to support best genetic testing practices has been identified as an essential element for the provision and interpretation of appropriate genetic tests. Access to genetic expertise could be addressed in part by solving problems in the reimbursement of genetic tests and services. SACGHS recommends that:**

HHS act on the recommendations in the 2006 SACGHS *Coverage and Reimbursement of Genetic Tests and Services* report.

- 4. There are extensive gaps in knowledge about genetic tests and their impact on patient care. Prioritizing activities under the authority of HHS would help close these gaps and enhance the quality of patient care. SACGHS recommends that:**

HHS allocate resources to AHRQ, CDC, NIH, and the Health Resources and Services Administration to design and support programmatic and research efforts to encourage the development and assist in the evaluation and dissemination of tools, particularly computerized tools, for clinical decision support in the ordering, interpretation, and application of genetic tests. HHS also should address current inadequacies in the clinical information needed for test interpretation. These efforts will require engaging health care providers and payers as well as providing incentives and protections to ensure their participation in the design and dissemination of tools, the implementation of clinical decision support, and the contribution of necessary data.

I. Background and Scope

Introduction

The science and clinical applications of genetic testing have undergone great advances since inherited diseases were first linked to chromosomal abnormalities more than a century ago. Historically, genetic testing has been used to evaluate a person's risk of developing or passing on single-gene disorders, enable early detection of genetic diseases or conditions, and diagnose diseases or conditions of genetic origin. Today, genetic testing is increasingly used in targeted treatment selection, identification and quantification of treatment risks, monitoring of treatment effectiveness and prognosis, and personalized disease management.

Advances in genetics research are enabling improved prevention, treatment, and disease management for common chronic conditions such as cancer, heart disease, and diabetes. Drawing from some of these advances, pharmacogenomic testing is a relatively new form of genetic testing that is attracting great attention. Pharmacogenomics attempts to uncover the genetic basis for individual differences in drug toxicity and efficacy to optimize drug design and drug therapy. Customized treatment choices and regimens can mean better responsiveness, reduced side effects, and more cost-effective drug development and use of drugs.¹⁷

As health care professionals increasingly turn to genetic testing to assess disease risks and use the information to guide clinical practice and public health decisions, it will be necessary to anticipate and adapt to the impacts of these advances on individual health care and public health. The Secretary's Advisory Committee on Genetics, Health, and Society (SACGHS, or the Committee) has prepared this report with the goal of further integrating genetic testing into clinical and public health practice in a responsible manner, so as to minimize possible harms and maximize the benefits of innovative existing and emerging testing technologies.

Over the past decade, in parallel with advances in science and the growth of health uses of genetic tests, various groups have called for increased Federal oversight of genetic testing and testing laboratories. In 1997, the Task Force on Genetic Testing, convened jointly by the National Institutes of Health (NIH) and the U.S. Department of Energy (DOE), issued *Promoting Safe and Effective Genetic Testing in the United States*, which made several recommendations regarding the oversight of genetic tests and testing laboratories.¹⁸ The Task Force also called for the formation of a standing committee to provide advice to the Secretary of the U.S. Department of Health and Human Services (HHS) about the level of scrutiny needed for genetic tests. This recommendation led to the chartering in 1998 of the Secretary's Advisory Committee on Genetic Testing (SACGT), which operated until 2002, when it was succeeded by SACGHS.

¹⁷ World Health Organization Web site. "Ethical, Legal, and Social Implications (ELSI) of Human Genomics: Pharmacogenomics." See <http://www.who.int/genomics/elsi/pharmacogenomics/en/>. Accessed on March 20, 2008.

¹⁸ National Human Genome Research Institute (1997). *Promoting Safe and Effective Genetic Testing in the United States*. See <http://www.genome.gov/10001733>. Accessed on March 20, 2008.

Between 1998 and 2000, the Clinical Laboratory Improvement Advisory Committee (CLIAC) recommended the augmentation of regulations governing the quality of clinical laboratories generally and genetic testing laboratories specifically.¹⁹ In May 2000, the Centers for Disease Control and Prevention published a Notice of Intent soliciting public comments on plans to add a genetic testing specialty under regulations of the Clinical Laboratory Improvement Act Amendments of 1988 (CLIA).²⁰ Later that year, SACGT issued *Enhancing the Oversight of Genetic Tests*, which concluded that additional oversight of genetic tests was warranted and should be achieved through new multifaceted and innovative oversight mechanisms.²¹ SACGT also agreed with CLIAC that a genetics specialty should be added to CLIA. In 2003, the CLIA regulations were amended in several general ways (e.g., to enhance confidentiality of laboratory practices and expand requirements for result reporting).²²

SACGHS first identified the oversight of genetic tests as a priority area in 2004 based on the expanded use of genetic testing in clinical practice and public health and on the pace and extent of technological change in the ways tests were performed. In addition, like SACGT, the Committee was concerned about the adequacy and transparency of the oversight system and whether there were gaps in it that could lead to harms in public health. In 2006, after several years of monitoring developments, SACGHS received public testimony expressing concern about the delay in augmenting CLIA and then learned that the Centers for Medicare & Medicaid Services had decided not to proceed with adding a genetics specialty to CLIA. In March 2007, SACGHS began gathering more extensive information about the oversight roles of Federal, State, and private sector entities concerning the analytical and clinical validity of genetic tests, private sector responsibilities for clinical laboratory accreditation, standard setting, and the development of clinical practice guidelines for genetic testing. A summary of these presentations is found in Appendix A.

These efforts converged with the goals of HHS Secretary Michael Leavitt, when he identified personalized health care as a top national priority. The Personalized Health Care (PHC) Initiative, coordinated by the Office of the Secretary, aims to improve health care in the United States by using genomics to help tailor health care to individual genetic characteristics. One of the main goals of the PHC Initiative is to ensure the analytical validity, clinical validity, and clinical utility of genetic tests used in clinical practice.²³

To synchronize the work of SACGHS with the Secretary's priorities, the Office of the Secretary charged the Committee on March 26, 2007, with investigating specific issues related to the adequacy of current oversight systems for genetic testing. The charge, designed to complement related efforts under way at the Federal level, also encompassed all sectors of the health care system concerning oversight, including the

¹⁹ Centers for Disease Control and Prevention. Summary of Clinical Laboratory Improvement Advisory Committee (CLIAC) meeting, September 16-17, 1998. See <http://www.phppo.cdc.gov/CLIAAC/cliac0998.aspx>. Accessed on March 20, 2008.

²⁰ Federal Register. May 4, 2000. 65: 25928-25934. Notice of Intent: Genetic Testing Under the Clinical Laboratory Improvement Amendments. See http://frwebgate.access.gpo.gov/cgi-bin/getdoc.cgi?dbname=2000_register&docid=00-11093-filed.pdf. Accessed on March 20, 2008.

²¹ Secretary's Advisory Committee on Genetic Testing (2000). *Enhancing the Oversight of Genetic Tests: Recommendations of SACGT*. See http://www4.od.nih.gov/oba/sacgt/reports/oversight_report.pdf. Accessed November 5, 2007.

²² Federal Register. January 24, 2003. 68: 3640-3714. Medicare, Medicaid, and CLIA Programs: Laboratory Requirements Relating to Quality Systems and Certain Personnel Qualifications: Final Rule. See <http://a257.g.akamaitech.net/7/257/2422/14mar20010800/edocket.access.gpo.gov/2003/pdf/03-1230.pdf>. Accessed on March 20, 2008.

²³ Department of Health and Human Services Web site. "Personalized Health Care: Goals." See <http://www.dhhs.gov/myhealthcare/goals/index.html#Goal3>. Accessed on March 20, 2008.

Federal Government, State Governments, and the private sector. Refined during Committee discussion, the charge was to:

Undertake the development of a comprehensive map of the steps needed for evidence development and oversight for genetic and genomic tests, with improvement of health quality as the primary goal. Consider and address the following questions:

- What evidence of harm exists regarding genetic tests? Is that harm attributable to analytic validity, clinical validity, or clinical utility of the tests? If evidence does not exist, what threats are not currently being addressed? What public health benefits are not accruing as quickly as they might?
- What distinguishes genetic tests from other laboratory tests for oversight purposes?
- What are the existing pathways that examine the analytic validity, clinical validity, and clinical utility of genetic tests? Consider the use of case studies.
- What organizations are currently involved with each of these aspects, and what are they doing to address these issues? Who should be responsible for each of these aspects?
- What resources (e.g., standard reagents/materials) are needed to develop proficiency testing (PT) kits or protocols for genetic tests? What is currently available in terms of PT kits or protocols for genetic tests? What information is provided by PT? Is the current level of PT for genetic tests adequate and are the results of such laboratory performance assessments sufficiently transparent?
- What are the potential pathways to communicate clear information to guide test and treatment selection by the provider?
- What new approaches or models should be considered for private and public-private sector engagement in demonstrating clinical validity and clinical utility for developing effectiveness measures of genetic tests in clinical practice?
- Would additional or revised Government oversight add value for patients, and if so, how and where?

Pursuant to these questions, this report focuses on the oversight of genetic testing and the application of genetic information in patient care and management. The recommendations presented in this report call for new models for private and public-private partnerships; additional efforts in research, public health surveillance, data sharing, information exchange, and clinical decision support; and enhanced Government oversight of genetic testing. Although SACGHS was tasked to look at the oversight of laboratory testing through the lens of genetic tests, in general the issues associated with genetic tests do not differ from other complex laboratory tests. Therefore, the recommendations in this report could be applied more broadly to improve the quality of all laboratory tests.

SACGHS is well aware of concerns that stigmatization and psychological harms may increase as more people learn about their risks for late-onset diseases, particularly those for which there are no effective treatments.²⁴ These broader societal implications and potential harms of genetic testing, which are being explored by the Committee through other avenues, are not the subject of this report. To respond directly to the charge from the Secretary, this report focuses primarily on harms that might occur in the course of the testing process, including the preanalytical, analytical, and postanalytical phases, and from deficiencies

²⁴ Council for Responsible Genetics (2001). *Genetic Discrimination: Position Paper* (update of 1997 Position Paper on Genetic Discrimination). See http://www.gene-watch.org/educational/genetic_discrimination.pdf. Accessed on March 20, 2008.

in knowledge and understanding about the validity and utility of genetic tests and their appropriate use, interpretation, and communication.

Methodology

To develop a report that responded adequately to the Secretary's charge, SACGHS formed an Oversight Task Force, which was composed of six SACGHS members and many *ad hoc* experts from the public and private sectors with knowledge of genetics, clinical laboratory practice and accreditation, test evaluation, diagnostic manufacturing, health information technology, law and public policy, and consumer perspectives. The resulting 33-member Task Force worked intensively from June 2007 through October 2007. After developing the scope of the report, defining key terms and concepts, and drafting an outline that would fully respond to the charge from the Secretary, the Task Force divided into smaller working groups that were charged with developing each chapter of the report. Led by the Task Force Chair, the six SACGHS members (the Steering Group) coordinated the work of each team and oversaw report progress. The chapter teams conducted extensive reviews of the literature related to their topics, analyzed prior policy recommendations in these areas, and reviewed the current policies and relevant activities of Federal and State agencies and private sector organizations. Key topics for discussion included definitions of the scope of the study (see Box 1–1), the identification of gaps in the system, existing and potential harms related to these gaps, and the development of recommendations.

Two full-day, face-to-face meetings of the Task Force were held in Washington, DC, to review the progress of the report and find common ground on the challenging issues. The first meeting focused on policy options in each chapter and examined whether the report content was fully responsive to the charge from the Secretary. During the second meeting the Task Force deliberated and reached agreement on draft recommendations. Throughout this process, participants purposefully considered the perspectives and solutions of various stakeholders with a range of views pertaining to the oversight of genetic testing. Task Force members endeavored to strike a balance among public, private, and collaborative solutions and carefully examined the potential impact of increased oversight on innovation and access to care.

Following the second meeting, the report and recommendations were further developed, and after review and discussion by SACGHS in an October 2007 conference call, the draft report was revised and released for public comment on November 5, 2007. Targeted announcements to more than 2,000 groups or individuals encouraged them to provide comments. These groups included health care professionals, laboratory companies, pharmaceutical companies, health insurance companies, professional organizations, standard-setting organizations, academic institutions with health advocacy programs, Federal agencies and their advisory groups, consumer advocacy groups, and the public. Those contacted were asked to disseminate the request for comment to their colleagues. In addition to written comments, all interested parties had an opportunity to provide input on the draft report directly to SACGHS members at the Committee's November 19–20, 2007, meeting during an extended public comment period. A total of 64 sets of written comments were received by the December 21, 2007, closure of the public comment period (see Appendix B for a list of commenters), and all were carefully considered. Key themes that emerged in the comments were discussed by the Steering Group in conference calls in January 2008. The revised draft recommendations were then discussed with the entire Oversight Task Force via teleconference. After the Task Force's comments were incorporated, the recommendations underwent final review and were approved by SACGHS at its February 12–13, 2008, meeting. The final recommendations and a penultimate draft report were provided to the HHS Secretary at the end of February 2008. After editorial changes were completed, the final report was transmitted to the Secretary in April 2008.

Box 1–1. Definition of a Genetic/Genomic Test and Intended Use

As defined in this report, a genetic or genomic test involves an analysis of human chromosomes, deoxyribonucleic acid, ribonucleic acid, genes, and/or gene products (e.g., enzymes and other types of proteins), which is predominately used to detect heritable or somatic mutations, genotypes, or phenotypes related to disease and health. The purpose of genetic tests includes predicting risk of disease, screening newborns, directing clinical management, identifying carriers, and establishing prenatal or clinical diagnoses or prognoses in individuals, families, or populations. Excluded from the definition are tests conducted exclusively for forensic and identity purposes as well as tests conducted purely for research. Also excluded are tests that are used primarily for other purposes but that may contribute to diagnosing a genetic disease or disorder (e.g., blood smears, certain serum chemistries). For example, cholesterol screening in the general population is not considered a genetic test, but it may reveal a genetic disorder such as an inherited form of hypercholesterolemia.

Are Genetic Tests Different from Other Laboratory Tests?

One of the questions in the Secretary’s charge was whether genetic tests should be treated differently from other laboratory tests for oversight purposes. The idea that genetic information should be treated differently is known as “genetic exceptionalism,” a term adapted from the previously coined term “HIV exceptionalism.” The term was first used during deliberations of the Task Force on Genetic Information and Insurance, formed in 1991 by the Joint NIH-DOE Working Group on the Ethical, Legal, and Social Implications of Human Genome Research. There is extensive scholarship on the subject of genetic exceptionalism and the question of whether genetic information should be considered special or unique from a public policy perspective (see Box 1–2).

The scholarly and policy literature suggests that views on this issue are evolving. While genetic information may be different in some respects from other health information, the differences are not significant enough to warrant special treatment in every case or situation. Moreover, given the significant role of genetic variation in health and disease, it may be neither wise nor possible to render genetic information distinct from other health information. These views suggest that, although it may be appropriate and necessary for certain areas of public policy to address genetic information in a specific way (e.g., Federal protection against genetic discrimination in health insurance and employment), it is not necessary for every public policy to take such an approach. Genetic tests and the laboratories performing them should be expected to meet the same high standards of accuracy, validity, and utility to which other medical information is subject.

In considering how genetic tests and the information they provide might be different from other laboratory tests, it is helpful to think about whether other medical information shares some of the characteristics of genetics. Genetic test results for germline mutations do not change over a person’s lifetime; they can provide predictive information about the risks of developing disease in the future; they have implications for family members; and the information can be stigmatizing. Some medical tests that are not considered genetic tests, such as those for cholesterol levels or infectious disease, can also provide information about factors that affect the risk of developing disease and may have implications for family members. Other nongenetic medical information, such as a diagnosis of a mental illness or a sexually transmitted disease, can be stigmatizing.

Another potential difference between genetic tests and other laboratory tests is an incomplete understanding of the clinical validity and clinical utility of many genetic tests. Health professionals may also lack sufficient knowledge of genetics and may not be prepared to use genetic tests appropriately. Although the extent may differ, incomplete understanding and provider knowledge can also be true of other medical tests when they are introduced. Thus genetic tests can be treated similarly to other complex laboratory tests that are expected to meet high standards of accuracy, validity, and utility.

Box 1–2. Evolving Perspectives on Genetic Exceptionalism

When considering whether genetic testing is different from other laboratory tests, it is important to understand the viewpoint known as “genetic exceptionalism,” the perspective that genetic information is unique among health-related information and therefore deserves special considerations and protections.²⁵ Proponents of this perspective usually point to the following features of genetic information as being distinct from other types of health information:

- It can be used to make predictions about an individual’s health future.
- It does not change throughout a person’s lifetime.²⁶
- It has the potential to reveal information about family members.
- There are instances in which it has been used to discriminate against individuals or selected populations.²⁷

Genetic tests can provide diagnostic and predictive information about disorders that have no treatment or preventive measures.²⁸ This aspect raises questions about the clinical utility of such tests and their benefit to patients, as well as concerns about patients’ psychological well-being.²⁹ Genetic information can be used to identify individuals based solely on their genetic sequence.³⁰

Concerns about the stigmatizing potential of genetic information can be greater than for other types of medical information due to the legacy of the eugenics movement of the early 20th century,³¹ which sought to improve the fitness of the human race by eliminating perceived undesirable genes from the population.³²

Continues on next page.

²⁵ Murray, T.H. (1997). Genetic Exceptionalism and “Future Diaries”: Is Genetic Information Different From Other Medical Information? In *Genetic Secrets: Protecting Privacy and Confidentiality in the Genetic Era*. Ed. Rothstein, M.A. New Haven: Yale University Press. pg. 60-73.

²⁶ Hodge, J.G. Jr. (2004). Ethical issues concerning genetic testing and screening in public health. *American Journal of Medical Genetics Part C, Seminars in Medical Genetics*. 125(1):66-70.

²⁷ Annas, G., Glantz, L., and Roch, A. (1995). Drafting the Genetic Privacy Act: science, policy, and practical considerations. *The Journal of Law, Medicine, and Ethics*. 23(4):360-366.

²⁸ Murray, T.H. (1997). Genetic Exceptionalism and “Future Diaries”: Is Genetic Information Different From Other Medical Information? In *Genetic Secrets: Protecting Privacy and Confidentiality in the Genetic Era*. Ed. Rothstein, M.A. New Haven: Yale University Press. pg. 60-73.

²⁹ Annas, G. (1995). Genetic prophecy and genetic privacy – can we prevent the dream from becoming a nightmare? *American Journal of Public Health*. 85(9):1196-1197.

³⁰ Murray, T.H. (1997). Genetic Exceptionalism and “Future Diaries”: Is Genetic Information Different From Other Medical Information? In *Genetic Secrets: Protecting Privacy and Confidentiality in the Genetic Era*. Ed. Rothstein, M.A. New Haven: Yale University Press. pg. 60-73.

³¹ Micklos, D. and Carlson, E. (2000). Engineering American society: the lesson of eugenics. *Nature Review Genetics*. 1(2):153-158.

³² Wickler, D. (1999). Can we learn from eugenics? *Journal of Medical Ethics*. 25(2):183-194.

Concerns persist today among minority and disability communities and others that technologies such as preimplantation genetic diagnosis and prenatal genetic testing can be applied beyond ethical norms, putting vulnerable groups at increased risk for discrimination.³³ These concerns have highlighted how the concepts of health and risk may lead some to consider genetic testing in a special light.

Contrasting perspectives note that other tests are also used for risk assessment and prediction of later onset diseases. High cholesterol and HIV-positive status can, to a certain extent, predict an individual's health future.³⁴ Moreover, a genetic test's predictive value can be affected by limited knowledge of the penetrance of disease-causing genes, gene-gene and gene-environment interactions, and difficulty in distinguishing between genetic and nongenetic causes of disease.^{35,36} The potential to reveal information about family members, affect their health status, and invite discrimination and social stigma also exist with tuberculosis, HIV, and sexually transmitted diseases.³⁷ In today's information-rich, electronic environment, the risk of individual identification extends beyond genetic testing; many databases contain sufficient information, health-related or not, to identify individuals.³⁸

Public fear of genetic discrimination has been cited as an argument in favor of genetic exceptionalism and as justification for legislators to adopt an exceptionalist approach to genetics policy. A 2007 survey conducted by the Genetics and Public Policy Center found that 92 percent of people are concerned that the results of genetic tests could be misused to harm the individual tested and that less than a quarter of those surveyed would trust an insurance company or employer to have access to their genetic information.³⁹ A study of genetic counselors' experiences found that 38 percent of patients seeking genetic testing were fearful of discrimination, a figure that does not include patients who opted out of genetic testing altogether due to fears of discrimination.⁴⁰ Public concerns about misuse of personal genetic information indicates a need for protections sufficient to allay individuals' reluctance to seek potentially beneficial genetic tests.^{41,42} A majority of State legislatures have

Continues on next page.

³³ Parens, E. and Asch, A. (1999). The disability rights critique of prenatal genetic testing: reflections and recommendations. *Hastings Center Report*. 29(5):S1-22. See http://geneticsandsociety.org/downloads/1999_parensasch_hastings.pdf. Accessed on March 20, 2008.

³⁴ Green, M.J. and Botkin, J.R. (2003). "Genetic exceptionalism" in medicine: clarifying the differences between genetic and nongenetic tests. *Annals of Internal Medicine*. 138(7):571-575.

³⁵ Murray, T.H. (1997). Genetic Exceptionalism and "Future Diaries": Is Genetic Information Different From Other Medical Information? In *Genetic Secrets: Protecting Privacy and Confidentiality in the Genetic Era*. Ed. Rothstein, M.A. New Haven: Yale University Press. pg. 60-73.

³⁶ Hodge, J.G. Jr. (2004). Ethical issues concerning genetic testing and screening in public health. *American Journal of Medical Genetics Part C, Seminars in Medical Genetics*. 125(1):66-70.

³⁷ Green, M.J. and Botkin, J.R. (2003). "Genetic exceptionalism" in medicine: clarifying the differences between genetic and nongenetic tests. *Annals of Internal Medicine*. 138(7):571-575.

³⁸ Murray, T.H. (1997). Genetic Exceptionalism and "Future Diaries": Is Genetic Information Different From Other Medical Information? In *Genetic Secrets: Protecting Privacy and Confidentiality in the Genetic Era*. Ed. Rothstein, M.A. New Haven: Yale University Press. pg. 60-73.

³⁹ Genetics and Public Policy Center (2007). *U.S. Public Opinion on Uses of Genetic Information and Genetic Discrimination*. See http://www.dnapolicy.org/resources/GINAPublic_Opinion_Genetic_Information_Discrimination.pdf. Accessed on March 20, 2008.

⁴⁰ Hall, M.A. and Rich, S.S. (2000). Genetic privacy laws and patients' fear of discrimination by health insurers: the view from genetic counselors. *The Journal of Law, Medicine, and Ethics*. 28(3):245-257.

⁴¹ Nuffield Council on Bioethics (2003). *Pharmacogenetics: Ethical Issues*. See http://www.nuffieldbioethics.org/go/ourwork/pharmacogenetics/publication_314.html. Accessed on March 20, 2008.

⁴² Glaser, J. and Henley, D.E. Letter to the American Health Information Community from the Personalized Health Care Working Group, July 31, 2007. See http://www.hhs.gov/healthit/ahic/materials/08_07/phc/recs.doc. Accessed on March 20, 2008.

adopted additional protections for genetic information.⁴³ State policies include protections against discrimination in insurance and employment decisions as well as penalties for violating genetic privacy.⁴⁴ Pending Federal legislation, the Genetic Information Nondiscrimination Act of 2007, would prohibit discrimination based on genetic information in health insurance and employment.⁴⁵

Recent research suggests that the public's views may be evolving about the nature of genetic information. A 2007 study involving focus groups of members of a health maintenance organization suggested that they did not view genetic information as fundamentally different from nongenetic medical information. They did express strong opinions about the privacy and protection of their medical records but did not limit their concerns to genetic information or indicate that genetic information deserved additional protections. Given the homogeneous composition of the focus groups, however, further research is needed to ensure the generalizability of the findings.⁴⁶

Likewise, a nonexceptionalist approach has been taken with respect to Federal health privacy protections. The Federal Health Information Portability and Accountability Act Privacy Rule, which became effective in 2003, treats genetic information as equally sensitive as other medical information and provides the same level of protection to genetic and other types of personal health information.⁴⁷ Recent policy recommendations encourage movement away from genetic exceptionalism. Some States, including Michigan, Nebraska, South Dakota, and Washington, have enacted legislation that does not follow an exceptionalist approach.⁴⁸ Washington explicitly includes genetic information under the definition of health care information.⁴⁹ Michigan prohibits certain genetic discrimination practices but considers genetic information to be no more or less confidential than other health information.⁵⁰ International policy recommendations also discourage adopting genetic exceptionalism in developing policy. The Nuffield Council on Bioethics in the United Kingdom rejects genetic exceptionalism, but recognizes that specific policies may need to be adopted in response to patient beliefs and fears regarding genetic information. Consideration of special protections for genetic information could reveal areas where the protection provided for other personal health information is insufficient.⁵¹

Continues on next page.

⁴³ National Conference of State Legislatures Web site. "Genetic Technologies Project." See <http://www.ncsl.org/programs/health/genetics.htm>. Accessed on March 20, 2008.

⁴⁴ French, M.E. and Moore, J.B. (2003). *Harnessing Genomics To Prevent Disease & Improve Health: A State Policy Guide*. Partnership for Prevention. See <http://genes-r-us.uthscsa.edu/resources/genetics/geneticsguide.pdf>. Accessed on March 20, 2008.

⁴⁵ H.R. 493: Genetic Information Nondiscrimination Act of 2007. See http://frwebgate.access.gpo.gov/cgi-bin/getdoc.cgi?dbname=110_cong_bills&docid=f:h493ih.txt.pdf. Accessed on March 20, 2008.

⁴⁶ Diergaarde, B., Bowen, D.J., Ludman, E.J., Culver, J.O., Press, N., and Burke, W. (2007). Genetic information: special or not? Responses from focus groups with members of a health maintenance organization. *American Journal of Medical Genetics Part A*. 143A(6):564-569.

⁴⁷ Health Privacy Project, Institute for Health Care Research and Quality, Georgetown University (2002). *Genetics and Privacy: A Patchwork of Protections*. Prepared for the California Health care Foundation. See <http://www.chcf.org/documents/ihealth/GeneticsAndPrivacy.pdf>. Accessed on March 20, 2008.

⁴⁸ French, M.E. and Moore, J.B. (2003). *Harnessing Genomics To Prevent Disease & Improve Health: A State Policy Guide*. Partnership for Prevention. See <http://genes-r-us.uthscsa.edu/resources/genetics/geneticsguide.pdf>. Accessed on March 20, 2008.

⁴⁹ National Conference of State Legislatures Web site. "Genetic Technologies Project." See <http://www.ncsl.org/programs/health/genetics.htm>. Accessed on March 20, 2008.

⁵⁰ French, M.E. and Moore, J.B. (2003). *Harnessing Genomics To Prevent Disease & Improve Health: A State Policy Guide*. Partnership for Prevention. See <http://genes-r-us.uthscsa.edu/resources/genetics/geneticsguide.pdf>. Accessed on March 20, 2008.

⁵¹ Nuffield Council on Bioethics (2003). *Pharmacogenetics: Ethical Issues*. See http://www.nuffieldbioethics.org/go/ourwork/pharmacogenetics/publication_314.html. Accessed on March 20, 2008.

More recently, the Personalized Health Care Workgroup of the HHS American Health Information Community (AHIC) has been considering whether genetic information should be treated differently in electronic health records (EHRs) and the characteristics of genetic test information that should be considered in determining protections that should be in place for accessing data. The fluidity of knowledge and understanding of genetic tests and the evolving nature of societal perspectives about genetic information are key points that suggest the need for flexible policies that can also evolve over time. A paper reviewed by the PHC Workgroup in October 2007 states that “Genetic test information in the near term should be treated as other sensitive information in the EHR, and the same policies regarding confidentiality, privacy and security should apply.”⁵²

Overview of the Report

In response to the HHS Secretary’s considerable charge, five working groups within the Oversight Task Force were each assigned a specific chapter to develop and write for the report. Led by SACGHS members responsible for overseeing the process, the working groups developed the chapters outlined below, which address various aspects of the Secretary’s charge.

Chapter II provides an overview of the current landscape of systems of oversight that play a role in ensuring the appropriate use and interpretation of genetic tests, including the key Federal and State agencies and the public and private sector entities that play roles in these systems. Oversight of genetic tests and the information they provide relies on systems of multiple, interrelated activities that focus on specific aspects related to the delivery and use of genetics tests, such as test manufacturing, or on specific participants, such as physicians and clinical laboratories. These systems help ensure that the risk of harms that may result from genetic tests is reduced. Federal and State statutes governing the oversight and regulation of genetic tests are described, as well as the roles of public sector groups in ensuring and influencing the quality of genetic tests.

Chapter III provides a brief history of the development of genetic testing technologies, from early biochemical analysis (e.g., PKU) and chromosome analysis to analysis of single nucleotide polymorphisms. The chapter describes how the intended use of analysis determines whether a technology is considered genetic testing. A broad overview is provided of key technologies used for genetic testing and future trends. A brief description of laboratory personnel is also provided.

In accordance with the charge from the Office of the Secretary, Chapters IV, V, and VI identify harms and gaps associated with the current systems of oversight and develop recommendations to address them. Chapter IV describes the current oversight framework for analytical validity, PT (an important component of analytical validity), and clinical validity and defines key terms related to these concepts. The chapter describes the two most widely used models for providing genetic testing: commercial development of products (test kits) by *in vitro* diagnostics manufacturers for distribution to multiple laboratories after clearance or approval by the U.S. Food and Drug Administration and laboratory-developed tests that are used solely by the developing laboratory. The chapter also discusses the reference and quality control materials essential for validating the performance characteristics of a test, monitoring test performance,

⁵² Confidentiality, Privacy, and Security Subgroup of the American Health Information Community Personalized Health Care Work Group (2007). *Confidentiality, Privacy, and Security Issues As They Pertain to Genetic Test Information in Electronic Health Records*. See http://www.hhs.gov/healthit/ahic/materials/10_07/phc/issues.html. Accessed on March 20, 2008.

and detecting problems in the testing process. Activities and programs related to PT as well as challenges related to meeting PT requirements are discussed. Case studies are presented that illustrate the complex issues surrounding analytical validity and clinical validity, which is influenced by multiple factors. These factors include the purpose of the test, the prevalence of the disease or condition for which the test is being conducted, and the adequacy of the information available to determine test accuracy in detecting or predicting risk for a health condition or phenotype.

Chapter V discusses the meaning of clinical utility and the processes for generating information about it, including clinical trials and observational studies using registries and other longitudinal datasets. The chapter addresses current mechanisms for collecting and synthesizing information, such as systematic evidence reviews, decision models, and expert opinion, as well as determination of appropriate health care through clinical guidelines. Clinical utility relies heavily on effective translation of research into practice, which may necessitate a variety of incentives (e.g., insurance contracts, pay-for-performance) to promote quality improvement and adherence to clinical guidelines. While economic issues and their relation to clinical utility are beyond the scope of this report, Chapter V broadly discusses the challenges associated with identifying how genetic information can make a difference in health outcomes.

Chapter VI addresses the need for clinical guidance on the use of genetic tests. Once confined to specialty settings and primarily applied to those affected by or at risk for rare diseases, genetic testing is now used in a variety of settings, including primary care. With the recent accelerated use of genetic tests, it is critical to provide clinicians with appropriate decision support as they consider the use and interpretation of genetic tests. Health care providers need to be able to identify which patients might benefit from genetic testing, determine the appropriate test, provide pretest and posttest information to the patient, and interpret test results accurately. Laboratories must also accurately interpret and effectively communicate test results to the ordering physicians. Professional societies play an important role in defining standards of practice. Effective use of EHRs will play a great role in improving the quality and consistency of patient care. Several workgroups within AHIC, such as the PHC Workgroup, are advancing the use of health information technology to integrate genetic and genomic test information into EHRs.⁵³ Clinical decision support is also a large part of PHC, making efforts to increase clinicians' effectiveness by providing resources to improve the quality of care, avoid adverse events, provide actionable guidelines, and help integrate newly discovered information into clinical practice. Chapter VI addresses these issues and offers recommendations on effective communication and clinical decision support in the preanalytical and postanalytical phases of genetic testing.

Chapter VII sums up the Committee's findings, conclusions, and recommendations.

⁵³ American Health Information Community (2007). *Personalized Health Care Work Group Update: Vision and Priorities*. See www.hhs.gov/healthit/documents/m20070424/phcslides_files/outline/index.html. Accessed on March 20, 2008.

II. Systems of Oversight for Genetic Testing

The purpose of oversight for laboratory testing, including genetic testing, is to reduce the risk of harms that may accompany testing and test results and to promote appropriate uses of testing that will maximize health benefits. The delivery and use of genetic testing rely on a range of activities spanning the research and development (R&D) of test technologies, the performance of clinical laboratory testing procedures, and the use of test results to guide health and lifestyle decisions. The oversight system has various elements that pertain to particular activities, such as test development and commercialization, or to specific participants such as physicians and laboratory personnel. Many elements of oversight apply generally to medical devices or other products and professional activities, but some are specific to genetic testing. Depending on the aspect of testing, oversight may be mandatory or voluntary, and it is provided by Government agencies, health care payers, professional associations, and/or other groups.

This chapter describes the basic elements required for an oversight system and then focuses specifically on those elements that address genetic testing. It also provides an overview of the public, professional, and private sector agencies and organizations that have roles in the oversight of genetic testing, including the Federal and State agencies that oversee the regulation of genetic tests and their use in clinical practice.

Elements of Oversight

This report distinguishes three main elements of oversight that are necessary in virtually any context: information development and synthesis, standard-setting, and compliance mechanisms (i.e., mandatory, incentive-driven, and voluntary or informal compliance mechanisms).

Information Development and Synthesis

Information development and synthesis refers to data collection, scientific studies, and reporting requirements aimed at identifying and measuring potential benefits and harms. Spanning premarket and postmarket activities, it involves, for example, conducting studies of the performance characteristics and potential uses of new tests, gathering data on adverse events associated with tests already on the market, developing evidence-based guidelines for appropriate clinical use of tests, inspecting manufacturing facilities and clinical laboratories, and collecting clinical and population data on patterns of use and reimbursement of tests. It also involves identifying and assessing strategies to improve the balance of benefits and harms and monitoring the effectiveness of measures to implement those strategies. Furthermore, it entails creation, maintenance, and dissemination of evidence and other information to guide providers, payers, patients, policymakers, and other decisionmakers participating in the delivery and use of genetic testing.

Setting Standards

Standards arise from identifying and describing the characteristics that a product or service should have in order to be regarded as offering an acceptable level of benefits and risks. Standard-setting activities are carried out by governmental bodies, such as regulatory agencies, or by professional organizations, and the requirements for implementing these activities range from compulsory to voluntary. Examples include establishing standards for:

- Analytical or clinical performance for genetic tests
- Safety and effectiveness that genetic testing products must meet before they can be marketed in interstate commerce
- Quality systems for clinical laboratories that offer testing services to the public
- Training and credentialing for medical professionals, counselors, and others involved in delivering genetic testing to the public
- Physicians' professional care (e.g., appropriateness of offering genetic testing to a patient and responses to specific test results)
- Clinical care, best practices, and guidelines on appropriate application of testing in specific clinical contexts
- Liability in State product-liability lawsuits against manufacturers and negligence suits against physicians and other providers of health-related services
- Reimbursement by governmental payers and private health insurers (e.g., whether genetic testing should be covered and the payment amounts for testing)

Compliance Mechanisms

Oversight frameworks vary widely in terms of compliance with the standards they establish. At one end of the spectrum is a traditional “command-and-control” regulatory approach, by which an oversight body establishes mandatory standards, monitors compliance, and requires a response or applies legal sanctions in the event of noncompliance. This approach is often associated with formal, governmental regulatory bodies that have been granted statutory authority to set and enforce standards. Nongovernmental oversight bodies, however, may achieve effective enforcement of standards through nonlegal sanctions, such as professional censure or expulsion of members who refuse to comply.

At the opposite end of this spectrum is an approach sometimes referred to as a “regulatory triangle,” consisting of an oversight body, the industry or activity that is being overseen, and the public.⁵⁴ In this model, the governmental or nongovernmental oversight body plays an information management role, such as gathering information about the safety of various providers of a service and disseminating it to the public and decisionmakers, who can then factor it into their private decisions. In this model, the oversight body does not necessarily set standards and may rely on the public to draw its own conclusions about acceptable standards of performance. This approach can help promote good standards of behavior, but there is a risk that information development and standard-setting may have little impact if the oversight body lacks effective mechanisms for promoting compliance.

This report distinguishes three categories of compliance mechanisms: mandatory compliance that is legally enforceable under Federal and/or State statutes and regulations, incentive-driven compliance that is not

⁵⁴ World Bank (1999). *Greening Industry: New Roles for Communities, Markets, and Governments*. New York: Oxford University Press.

legally mandatory but that is supported by concrete financial or liability-related incentives, and informal or voluntary compliance.

Mandatory compliance mechanisms include empowering a governmental regulatory agency to deny market access to testing products that fail to meet an established standard of safety and effectiveness or requiring certification or licensing by a governmental body that verifies compliance with a defined standard. Mandatory compliance requires a statutory or regulatory framework that applies a penalty or withholds a benefit in the event that the standard is not being met. Examples of penalties could include seizure of noncompliant products, removal of a license or certification that is required to conduct business, civil penalties such as fines, or criminal sanctions. Withholding of benefits could include denying a noncompliant party a commercial advantage, such as the ability to market its goods or to carry on its business or profession.

Incentive-driven compliance mechanisms provide financial incentives to comply with a standard that is otherwise voluntary in nature. These incentives can be in the form of a financial benefit or reward, such as a tax break or eligibility for third-party payment, or an opportunity to avoid costs, such as by reducing lawsuit risks (tort liability). Incentives for compliance may be created via laws and regulations, even when compliance itself is not required by law. Incentive-based mechanisms have also been linked to health care quality improvement through pay-for-performance programs (sometimes known as P4P) or “value-based purchasing.” One example is the Hospital Quality Incentive Demonstration, a pay-for-performance project led by the Centers for Medicare & Medicaid Services (CMS) and Premier Inc., which aims to determine if financial incentives can effectively improve clinical quality by rewarding bonuses to hospitals that demonstrate high-quality care in several areas of acute care.⁵⁵ Congress has also shown some support for financial incentives by calling on CMS to develop a plan for hospital value-based purchasing by 2009. Despite these trends, researchers are still exploring the potential benefits of pay-for-performance mechanisms.⁵⁶

Another example of an incentive-driven compliance mechanism is CMS’s policy of granting “deemed” eligibility status for Medicare reimbursements to health care facilities that voluntarily undergo certification by the Joint Commission (formerly the Joint Commission for the Accreditation of Health Care Organizations).^{57,58} While accreditation is not legally mandatory, the advantages of deemed eligibility status create a strong incentive for hospitals to participate in this voluntary accreditation program. By analogy, CMS reimbursement policies have the potential to play an important role in promoting incentive-driven compliance with voluntary standards established in the area of genetic testing. Because CMS’s policies often influence the coverage policies of private insurers, incentive-driven compliance mechanisms developed through the Medicare and Medicaid reimbursement framework have significant potential to extend to broader beneficiary populations through emulation by private insurers.

⁵⁵ Premier Inc. (2006). *Centers for Medicare & Medicaid Services (CMS)/Premier Hospital Quality Incentive Demonstration (HQID) Project: Findings from Year Two*. See <http://www.premierinc.com/quality-safety/tools-services/p4p/hqi/resources/hqi-whitepaper-year2.pdf>. Accessed on March 22, 2008.

⁵⁶ Lindenauer, P.K., Remus, D., Roman, S., Benjamin, E. M., Ma, A., Bratzler, D.W., and Rothberg, M.B. (2007). Public reporting and pay for performance in hospital quality improvement. *New England Journal of Medicine*. 356(5):486-496.

⁵⁷ 42 USC 1395bb §1865. Social Security Act, Part E—Miscellaneous Provisions, Effect of Accreditation. See http://www.ssa.gov/OP_Home/ssact/title18/1865.htm#act-1865-a. Accessed on March 22, 2008.

⁵⁸ 42 USC 1395x §1861(e). Social Security Act, Part E—Miscellaneous Provisions, Definition of Services, Institutions, Etc. See http://www.ssa.gov/OP_Home/ssact/title18/1861.htm#act-1861-v-1. Accessed on March 22, 2008.

There are numerous examples of compliance incentives that flow from parties' desire to reduce their tort liabilities. In the United States, tort lawsuits are primarily matters of State law and include product liability suits against manufacturers and negligence suits against physicians, clinical laboratories, and other providers of health-related services. Liability rules vary considerably among States, but in the aggregate they play a crucial role in establishing incentives for compliance with standards for safe, effective use of genetic testing. For example, some States allow clinical practice guidelines to be introduced as evidence in malpractice suits. A physician who complied with a guideline could use this compliance as a defense in a malpractice claim,⁵⁹ which provides an incentive for physicians to follow guidelines even when compliance is voluntary. The strength of this incentive differs among States, however, as they vary regarding whether and when they allow clinical practice guidelines to be introduced into evidence and how much weight these are given.⁶⁰

While legal incentives are a potential method for increasing compliance, it is also important to maintain high evidentiary standards when evaluating new therapies and how they will be utilized or covered by insurers. The use of high-dose chemotherapy with autologous bone marrow transplant (HDC-ABMT) for breast cancer patients a decade ago is one example of political pressures heavily influencing coverage decisions outside of the clinical trial setting. In the face of heavy lobbying and litigation, insurers were forced to provide coverage for HDC-ABMT before a sufficient body of rigorous research on its safety and effectiveness was prepared;⁶¹ data, as they became available, did not bear out this decision. Coverage policies pertaining to tests and other procedures for detecting prostate cancer, breast cancer, low bone density, and other conditions have been redefined as payers apply greater scrutiny to available evidence.

Informal or voluntary compliance mechanisms may help promote implementation of voluntary standards even when those standards are not legally enforceable and are not supported by clear financial or liability-related incentives. Voluntary certification and self-regulation programs developed by professional bodies and industry groups sometimes can be highly effective, for example, if these bodies are able to mobilize their members via application of informal sanctions (e.g., censure of members who operate outside accepted standards). “Watchdog” activities by consumer advocacy organizations and fear of adverse publicity can promote compliance with good practices. Industry self-regulatory activities also can play a constructive role in oversight by drawing attention to potential issues within the industry and by mobilizing industry participants to adopt voluntary standards for addressing those issues. In some cases, self-regulatory schemes may include some form of intra-industry peer review (self-policing) to monitor whether members of the industry are complying with the adopted standards. Self-regulatory arrangements are subject to limitations inherent in their voluntary nature and to possible conflicts of interest between the industry and public interests. While they can play a constructive role in oversight, they should not be regarded as a substitute for more formal regulation in the public interest.

Integration of Oversight Elements

Although informal compliance mechanisms can be effective in certain circumstances, they frequently prove inadequate. Over-reliance on informal compliance mechanisms can negate the efforts that oversight bodies invest in information development and standard-setting activities. An effective oversight framework must integrate all three elements: information development, standard-setting, and appropriate compliance

⁵⁹ Curran, W.J., Hall, M.A., Bobinski, M.A., and Orentlicher, D. (1998). *Health Care Law and Ethics*, 5th ed. New York: Aspen Law & Business, 365-367.

⁶⁰ Hall, M.A. (1991). The defensive effect of medical practice policies in malpractice litigation. *Law and Contemporary Problems*. 54(1-2):119-145.

⁶¹ Mello, M.M. and Brennan, T.A. (2001). The controversy over high-dose chemotherapy with autologous bone marrow transplant for breast cancer. *Health Affairs (Millwood)*. 20(5):101-117.

mechanisms. This last element need not be a “command-and-control” mandatory compliance framework, but it does need to provide effective incentives for parties to act on available information and adopt the standards that the oversight framework has developed.

Overview: Governmental and Nongovernmental Oversight Bodies

Numerous governmental and nongovernmental bodies share responsibilities for the oversight of genetic testing. These include Federal and State legislatures, Federal and State regulatory agencies, State and Federal courts, and professional and industry oversight bodies. Table 2–1 summarizes the key elements of jurisdiction and corresponding systems of oversight for genetic testing.

The U.S. Congress and State legislatures are directly involved in the oversight of genetic testing through statutes that establish regulatory standards, such as the “safety and effectiveness” standard that the Federal Food, Drug, and Cosmetic Act (FFDCA) requires for genetic tests that are regulated as medical devices and the “reasonable and necessary” standard for Medicare coverage. At the Federal and State levels, legislatures can delegate authority to governmental regulatory bodies to interpret, apply, and enforce the statutory standards in particular cases and address particular uses and misuses of genetic information (e.g., State^{62,63} and proposed Federal⁶⁴ legislation prohibiting genetic discrimination in employment and insurance enrollment, as well as legislation addressing data privacy and information security⁶⁵).

Federal and State regulatory agencies have powers delegated by Federal or State legislatures to oversee particular aspects of genetic testing. Regulatory agencies have a statutorily defined “jurisdiction”—that is, specific sets of delegated powers and controls corresponding to specific issues, aspects of industry activity, and/or industry participants. These delegated powers may include the power to engage in information development and standard-setting activities; a quasi-legislative power to issue rules that are legally binding in character (i.e., “regulations,” which in the case of Federal agencies are recorded in the Code of Federal Regulations); quasi-executive powers to inspect, monitor, and enforce their standards; and quasi-judicial powers to adjudicate specific cases in which the regulations are applied to particular regulated parties. In addition to regulatory agencies for laboratories, in general many States have advisory committees with oversight of their newborn screening programs. Key Federal and State regulatory agencies involved in the oversight of genetic testing are described later in this chapter.

State and Federal courts play a key role in resolving disputes about standards of conduct and the scope of regulatory authority. State courts are the primary venue for tort lawsuits (product liability and negligence suits) in the United States and therefore play a crucial role in defining the standards of conduct to which manufacturers, clinical laboratories, physicians, counselors, and other parties will be held. State liability rules establish incentives for such parties to comply with regulatory standards (e.g., warnings in product labeling or evidence-based practice guidelines developed by a Federal agency) and informal standards (e.g., voluntary clinical practice guidelines). Federal courts are generally less involved in tort lawsuits.

⁶² Williams, E.D., Sarata, A.K., and Redhead, C.S. (2007). *Genetic Discrimination: Overview of the Issue and Proposed Legislation*. Congressional Research Service, Cornell University. See <http://digitalcommons.ilr.cornell.edu/cgi/viewcontent.cgi?article=1028&context=crs>. Accessed on March 23, 2008.

⁶³ Clayton, E.W. (2003). Ethical, legal, and social implications of genomic medicine. *New England Journal of Medicine*. 349(6):562-569.

⁶⁴ H.R. 493 §358. Genetic Information Nondiscrimination Act of 2007. See http://frwebgate.access.gpo.gov/cgi-bin/getdoc.cgi?dbname=110_cong_bills&docid=f:h493ih.txt.pdf. Accessed on March 23, 2008.

⁶⁵ Public Law 104-191. Health Insurance Portability and Accountability Act of 1996 (HIPAA). See <http://aspe.hhs.gov/admsimp/pl104191.htm>. Accessed on March 23, 2008.

The statutes that authorize Federal regulatory oversight activities typically provide for Federal courts to hear appeals of regulatory decisions. In this capacity these courts may resolve disputes about the scope of a regulator’s authority and handle appeals of disputed decisions by Federal regulators. Thus, State courts have continuous, ongoing involvement in oversight, via thousands of lawsuits in which aggrieved parties seek redress for alleged breaches of appropriate standards of conduct. The Federal courts’ role in oversight is infrequent but has the potential for great impact when it does occur.

<i>Area of Jurisdiction</i>	<i>Systems of Oversight</i>
Regulation of clinical laboratories and testing services	Federal: CMS Clinical Laboratory Improvement Amendments of 1988 (CLIA), with involvement of other federal agencies (e.g., the Food and Drug Administration (FDA) in categorization of tests and the Federal Trade Commission (FTC) in oversight of marketing) Some States: e.g., New York, Washington, California
Medical product regulation	Federal: FDA regulation of genetic tests and therapies used in conjunction with genetic tests, with oversight of marketing shared between FDA and FTC
Regulations affecting reimbursement and access to genetic testing	Federal: CMS Medicare State: State health programs and insurance regulations affecting private insurers Informal/private sector: Medical necessity and utilization review practices, contracts
Clinical practice regulation (e.g., when, whom to test; physicians’ claims and disclosures about tests)	State law: Medical practice and pharmacy regulations, consent laws, genetic privacy acts, tort law Informal regulation: Voluntary guidelines and professional standards
Regulation of specific uses and misuses of test results (e.g., privacy and data security; discrimination in employment and insurance; torts involving inappropriate or mistaken uses of genetic information)	Federal: Health Insurance Portability and Accountability Act (HIPAA), ⁶⁶ Americans with Disabilities Act, ⁶⁷ Employee Retirement Income Security Act ⁶⁸ State: Statutes and tort law
Standards of patient responsibility	State tort law: Delineates when patients are responsible for protecting themselves as opposed to when they are entitled to rely on protection by other parties (e.g., manufacturers, physicians)

⁶⁶ Health Insurance Portability and Accountability Act of 1996 (HIPAA), Pub. L. No. 104-191, 110 Stat. 1936 (1996) (codified at scattered sections of the U.S. Code). See also HIPAA privacy regulations at 45 C.F.R. Parts 160, 164, which set forth medical privacy rules affecting use and disclosure of genetic information by HIPAA-covered entities.

⁶⁷ Americans With Disabilities Act of 1990 (ADA), Pub. L. No. 101-336, 104 Stat. 327 (1990) (codified at 42 U.S.C. §§ 12101-12213. See Equal Employment Opportunity Commission (EEOC) Compliance Manual, Vol. 2 (2 EEOC Compl. Man. (BNA) § 902:0045 (Mar. 1995)) interpreting ADA as potentially applying to presymptomatic individuals with a genetic predisposition for a disabling condition.

⁶⁸ Employee Retirement Income Security Act of 1974 (ERISA), Pub. L. No. 93-406, 88 Stat. 829 (1974) (codified at 29 U.S.C. § 1001 *et seq.*) § 514(a), (b)(2)(A), and (b)(2)(B) at 29 U.S.C. §§ See, e.g., ERISA §/1/A, and (b)(2)(b)144(a), (b)(2)(B), which can have the effect of preempting State tort lawsuits against ERISA health insurance plans for alleged misuses of genetic information in medical necessity determinations.

Professional and private sector oversight bodies. Professional societies, industry trade groups, and private-sector accreditation and oversight bodies play important roles in the oversight of genetic testing. The terms “informal regulation” and “informal regulatory bodies” are sometimes used to refer to these activities. In this report, the terms “regulatory” and “regulation” are reserved for formal, governmental regulatory activities unless the term “informal” is expressly stated. Activities of key professional and private-sector oversight bodies in the area of genetic testing are described later in this chapter.

Oversight Roles of Federal and State Regulatory Agencies

The United States has a bifurcated policy that requires prior regulatory review of the safety and effectiveness for some, but not all, genetic and diagnostic tests. This situation reflects longstanding differences in the regulation of test products and testing services. At the Federal level, FDA and CMS have prominent oversight roles. In large part, their respective regulatory authorities derive from dual yet sometimes overlapping systems of regulating tests as medical devices as opposed to regulating testing services. Genetic testing products are medical devices subject to regulation under FFDCAs,⁶⁹ implemented by FDA. Under FFDCAs, the agency is mandated to ensure that medical devices are safe and effective.

Federal regulation of testing products. Genetic testing products, with limited exceptions, must pass through FDA’s medical device premarket clearance or approval processes. As just noted, FDA’s statutory mandate under the FFDCAs is to ensure that medical devices are safe and effective.⁷⁰ FDA has interpreted this mandate as requiring a prior assessment of analytical and clinical performance of the device. This requirement is claims-driven, meaning the manufacturer must provide data supporting any analytical and clinical claims related to the use and/or effectiveness of a product. These claims are distinct from the payment claims used to seek reimbursement. Other chapters of this report discuss the specific requirements in terms of proof of analytical validity, clinical validity, and clinical utility. FDA and FTC both play roles in the regulation of the marketing and promotion of testing products (i.e., protecting consumers from misleading or inaccurate information about the risks and benefits of genetic testing products).

Federal regulation of testing services. CMS has regulatory responsibilities for laboratory testing, including genetic testing, under the Clinical Laboratory Improvement Amendments of 1988 (CLIA).⁷¹ CMS oversees the administration of the many functions of CLIA, including the two main requirements for testing services: registration with the CLIA program and certification by an approved accreditation body or CMS. Certification is intended to ensure that a clinical laboratory meets CLIA established standards for quality assurance (QA), records maintenance, proficiency testing (PT), personnel qualifications and responsibilities, and quality control (QC). CLIA requirements for laboratory certification depend on the complexity of the tests performed; the more complex the test, the more stringent the requirements. FDA has been involved with

⁶⁹ Public Law 75-717, 52 Stat. 1040 (1938), as amended. Codified at 21 USC §301-399. Federal Food, Drug, and Cosmetic Act. See http://www.ssa.gov/OP_Home/comp2/F075-717.html. Accessed on March 23, 2008.

⁷⁰ In evidence-based medicine and related fields, the term “efficacy” refers to how well a technology works under ideal or well-controlled conditions of use, whereas “effectiveness” refers to how well a technology works under routine or general conditions. Although FFDCAs uses the term “effective,” the evidence required by FDA to support premarket clearance or approval of new technologies is typically generated under conditions that would demonstrate efficacy rather than effectiveness.

⁷¹ Centers for Medicare & Medicaid Services Web site. “Clinical Laboratory Improvement Amendments (CLIA).” See <http://www.cms.hhs.gov/clia/>. Accessed on March 23, 2008.

CLIA since 2000, when it took over the responsibility of categorizing the complexity of certain diagnostic tests.⁷² These tests are also subject to relevant FTC regulations for marketing.

CLIA gives CMS the authority to regulate laboratories that use laboratory-developed tests (LDTs), as well as FDA-approved or -cleared tests. Although a laboratory can use its LDTs to provide testing services to the public, it cannot sell its LDTs for use by others. CLIA requirements for LDTs and the FDA requirements of the 510(k) and premarket approval (PMA) review processes serve different purposes and use essentially different information sets—that is, FDA for safety and efficacy and CLIA for accurate testing. Protocols instituted by each agency to meet their statutory responsibilities continue to be streamlined to reduce burdens without compromising the integrity of each program’s goals.

CLIA takes a process-oriented approach that focuses on factors such as credentials of laboratory personnel and laboratory testing procedures rather than on data-driven regulatory clearance or approval for specific LDTs before they can enter clinical use. Thus, LDTs are not required to pass through an external regulatory review process to substantiate their claimed performance characteristics, although they generally do receive internal analytical validation by the laboratories that made them. CLIA surveyors review analytical data (on QC, PT, and QA) for a sample of tests from all areas for which the laboratory is certified and the clients they serve. The emphasis of this review is on new tests or on instruments and tests/requirements with which the laboratory has had problems in the past. Laboratories under CLIA are not discouraged from establishing clinical performance and validation of a new test. Even though it is not currently a regulatory requirement under this program, CLIA expects the laboratory director to ensure that all tests offered by the laboratory are clinically relevant for the patient population being tested.

CMS has also established specific requirements for CLIA specialty areas such as microbiology and cytogenetics (the study of chromosomes and the diseases caused by numerical and structural chromosomal abnormalities), although genetic testing is not recognized as a CLIA specialty area.⁷³ In 1997, a joint National Institutes of Health (NIH)–U.S. Department of Energy (DOE) Task Force recommended that the Clinical Laboratory Improvement Advisory Committee (CLIAC) consider the creation of a genetic testing specialty for CLIA. The Task Force determined that, in the absence of a genetic testing specialty, “there is no assurance that every laboratory performing genetic tests for clinical purposes meets high standards.” CLIAC made recommendations to strengthen genetic testing under CLIA pertaining to matters of informed consent, reuse of tested specimens, confidentiality, QC, specimen integrity, PT, and personnel qualifications and responsibilities.⁷⁴ In the final rule promulgating CLIA in 2003, CMS addressed CLIAC’s recommendations pertaining to enhanced confidentiality, expanded requirements for test result reporting and unidirectional workflow in its quality systems regulations, and QC procedures for tests based on polymerase chain reaction, though not pertaining to PT.⁷⁵

⁷² Centers for Medicare & Medicaid Services Web site. “Clinical Laboratory Improvement Amendments (CLIA), Categorization of Tests.” See http://www.cms.hhs.gov/CLIA/10_Categorization_of_Tests.asp#TopOfPage. Accessed on March 23, 2008.

⁷³ Centers for Medicare & Medicaid Services Web site. “Clinical Laboratory Improvement Amendments (CLIA).” See <http://www.cms.hhs.gov/clia/>. Accessed on March 23, 2008.

⁷⁴ Centers for Disease Control and Prevention. Summary of Clinical Laboratory Improvement Advisory Committee (CLIAC) meeting, September 16-17, 1998. See <http://www.phppo.cdc.gov/CLIAC/cliac0998.aspx>. Accessed on March 23, 2008.

⁷⁵ Federal Register. January 24, 2003. 68: 3640-3714. Medicare, Medicaid, and CLIA Programs: Laboratory Requirements Relating to Quality Systems and Certain Personnel Qualifications: Final Rule. See <http://a257.g.akamaitech.net/7/257/2422/14mar20010800/edocket.access.gpo.gov/2003/pdf/03-1230.pdf>. Accessed on March 23, 2008.

Although CMS had indicated that it would issue a Notice of Proposed Rulemaking (NPRM) that would establish a genetic testing specialty under CLIA, the agency announced in September 2006 that it would no longer pursue this path.⁷⁶ In explaining this decision, CMS stated that CLIA already certifies genetic testing laboratories under requirements for existing specialties, and since the field is so dynamic, prescriptive standards for genetic testing likely would be outdated before they were published. CMS also expressed the view that a genetic testing specialty would not solve the lack of clinical validation of genetic LDTs or address concerns about the lack of PT for genetic testing laboratories. CMS said there were not sufficient data indicating that genetic testing laboratories experience more problems than laboratories performing other types of tests and noted also that there was no widely accepted definition of a “genetic test.” Furthermore, the agency expressed its belief that additional CLIA regulations would not address the ethical, legal, and social issues associated with genetic testing. In lieu of a CLIA genetic testing specialty, CMS made plans, and in some cases has already begun implementing efforts, to pursue the following options:

- Provide CMS surveyors with guidance on assessing genetic testing laboratories for compliance and technical training from genetic testing experts
- Develop educational materials for and provide education to genetic testing laboratories
- Maximize the expertise of CMS-approved accreditation organizations, some of which already have molecular diagnostic standards
- Explore creative surveying alternatives
- Develop alternative PT mechanisms (e.g., inter-laboratory comparisons) with the assistance of the Centers for Disease Control and Prevention (CDC) and FDA and encourage laboratories to participate in them
- Seek assistance from FDA and CDC on the review of complex analytical test validations
- Collect data on genetic testing laboratory performance
- Work with CLIAC and the Clinical Laboratory Standards Institute on oversight concepts/issues
- Collaborate with CDC and FDA on ongoing oversight activities

CLIAC accepted the CMS decision not to publish the NPRM yet acknowledged the need to examine the regulatory framework further, with the goal of attaining enhanced oversight for genetic testing. CLIAC concluded that CMS and CDC should work with experts to clarify the critical issues.

In 2006, the Government Accountability Office (GAO) published a report on CMS’s implementation of CLIA requirements and the related activities of several survey organizations, including the Joint Commission, the College of American Pathologists (CAP), and COLA (formerly the Commission on Office Laboratory Accreditation). The study was not specific to genetic testing but rather examined the quality of laboratory testing; the effectiveness of surveys, complaint investigations, enforcement actions in detecting and addressing laboratory problems, and the adequacy of CMS’s CLIA oversight. GAO recommended that CMS improve CLIA oversight by standardizing the reporting of survey deficiencies to permit meaningful comparisons across survey organizations by working with survey organizations to ensure that educating laboratory workers does not preclude appropriate regulation, such as identifying and reporting deficiencies that affect laboratory testing quality, and by allowing the CLIA program to fully use revenues generated by the program to hire sufficient staff to fulfill its statutory responsibilities.⁷⁷ CMS and the affected accrediting

⁷⁶ Centers for Disease Control and Prevention. Summary of Clinical Laboratory Improvement Advisory Committee (CLIAC) meeting, September 20-21, 2006. See <http://wwwn.cdc.gov/cliac/cliac0906.aspx>. Accessed on March 23, 2008.

⁷⁷ Government Accountability Office (2006). *Clinical Lab Quality: CMS and Survey Organization Oversight Should Be Strengthened*. See <http://www.gao.gov/new.items/d06416.pdf>. Accessed on March 23, 2008.

organizations responded by stating that many of the report's recommendations were already in place or were in the process of being implemented.

Premarket and postmarket Federal regulation of testing products and services. In addition to having no authority or mechanism for external review of the clinical validity and clinical utility of tests, CMS has no authority to perform postmarket review or adverse event reporting, which are safeguards provided in FDA's medical device regulations.⁷⁸ To date, there have been few documented cases in which patients experienced harm because of errors in a CLIA-regulated genetic test.^{79,80,81} The lack of reports, however, may reflect the absence of a reporting requirement. CLIA provides for biennial inspections of laboratories, but these do not focus on the clinical performance records of the LDTs themselves. The FFDCFA provides FDA with recall authority with respect to medical devices (including genetic tests). This authority allows the agency to take action to protect the public if, based on adverse event reports or other data, a test or device proves injurious in clinical use. If there are substantiated concerns about analytical accuracy and the laboratory does not correct them, CLIA does provide for sanctions. These sanctions include requiring the laboratory to cease testing or removing its certificate and Medicare payment when there is risk of harm to patients arising from a potentially faulty test result or in a problem testing area.

FDA has statutory authority to require data demonstrating the safety and effectiveness of LDTs, although this authority has been under debate. Within its enforcement discretion, FDA has declined in recent years to exercise this authority.^{82,83,84,85} The agency issued two draft guidances in September 2006, however, that are likely to place these tests under the greater scrutiny of premarket review via the 510(k) or PMA processes.

The first guidance clarifies FDA's oversight of analyte-specific reagents (ASRs), which are the building blocks used by clinical laboratories to develop LDTs. ASRs include antibodies, receptor proteins, nucleic acid sequences, and other biological or chemical reagents that are used to identify or quantify substances in biological specimens.⁸⁶ The guidance, which was made final in September 2007, clarifies that a single ASR that is combined or promoted for use with another product such as other ASRs, general purpose reagents, controls, laboratory equipment, or software or that is promoted with specific analytical or clinical performance claims, instructions for use in a particular test, or instructions for validation of a particular test using the ASR is not

⁷⁸ Food and Drug Administration. Medical Device Reporting. [21CFR 806]. See <http://www.accessdata.fda.gov/scripts/cdrh/cfdocs/cfcfr/CFRSearch.cfm?CFRPart=803>. Accessed on March 23, 2008.

⁷⁹ Libby, E.N., Booker, J.K., Gulley, M.L., Garcia, D., and Moll, S. (2006). False-negative factor V Leiden genetic testing in a patient with recurrent deep venous thrombosis. *American Journal of Hematology*. 81(4):284-289.

⁸⁰ Klein, R.D. and Mahoney, M.J. (2007). Medical legal issues in prenatal diagnosis. *Clinics in Perinatology*. 34(2):287-297, vi.

⁸¹ Genetics and Public Policy Center. *Overview of Court Decisions Involving Reproductive Genetics*. See http://www.dnapolicy.org/resources/Overviewofcourtdecisions_Crockin.pdf. Accessed on March 23, 2008.

⁸² Gutman, S. (1999). The role of Food and Drug Administration regulation of in vitro diagnostic devices – applications to genetics testing. *Clinical Chemistry*. 45(5):746-749.

⁸³ Federal Register. November 21, 1997. 62: 62243, 62249. Final Rule: Medical Devices; Classification/Reclassification; Restricted Devices; Analyte Specific Reagents. See http://frwebgate.access.gpo.gov/cgi-bin/getpage.cgi?dbname=1997_register&position=all&page=62243. Accessed on March 25, 2008.

⁸⁴ Johnson, R.M. Presentation to the Association of Microbiological Diagnostics Manufacturers, October 28, 1992.

⁸⁵ Schifreen, R.S. and Louth, C. (1996). Industry view on the regulation of ancillary reagents. *Food and Drug Law Journal*. 51(1):155-159.

⁸⁶ Gutman, S.I. *FDA's Role in the Regulation of In Vitro Diagnostic*. Presentation May 10, 2003. Food and Drug Administration, Center for Devices and Radiological Health, Office of In Vitro Device Evaluation and Safety. See <http://www.fda.gov/cdrh/oivd/presentations/051003-gutman-1.html>. Accessed on March 19, 2008.

considered by FDA to be an ASR and thus is not exempt from premarket notification requirements.⁸⁷ The draft guidance addresses industry efforts to market more complex combinations of ASR-based products under the less demanding requirements of single ASRs.^{88,89}

The second guidance—first issued in September 2006 and revised in July 2007—explains FDA’s proposed oversight for a subset of LDTs known as *in vitro* diagnostic multivariate index assays (IVDMIA).^{90,91,92} These must meet premarket and postmarket device requirements under FFDCAs and FDA regulations, including, when applicable, premarket review requirements for class II and III devices. IVDMIA typically use complex mathematical algorithms, often with the aid of computer software, to interpret large amounts of genetic or protein data to yield results that can be used to guide medical decisionmaking.⁹³ These tests include some of the complex genetic and proteomic tests, such as gene expression profiles that might predict cancer prognosis and guide the use of chemotherapy. In February 2007, FDA cleared the first IVDMIA, MammaPrint[®]. Marketed in The Netherlands since 2005, MammaPrint[®] is a gene expression profiling test for predicting whether an existing cancer will metastasize in women with early-stage breast cancer.⁹⁴ This guidance does not affect the many genetic LDTs that do not fall within the multivariate index assays.

There have been various calls over the past decade to require a more rigorous external prior regulatory review process for LDTs. In 1997, the NIH-DOE Task Force recommended systematic, well-designed studies to assess the safety and effectiveness of genetic tests before they become routinely available and after they undergo significant modifications.⁹⁵ Three years later, the Secretary’s Advisory Committee on Genetic Testing (SACGT) called for FDA to assume responsibility for premarket review, approval, and labeling of all new genetic tests that have moved beyond the basic research stage.⁹⁶ SACGT envisioned

⁸⁷ Food and Drug Administration, Center for Devices and Radiological Health, Office of In Vitro Diagnostic Device Evaluation and Safety (2007). *Guidance for Industry and FDA Staff: Commercially Distributed Analyte Specific Reagents (ASRs): Frequently Asked Questions*. See <http://www.fda.gov/cdrh/oivd/guidance/1590.pdf>. Accessed on March 25, 2008.

⁸⁸ Genetics and Public Policy Center News Release, “Center Sees ‘New Era in Oversight’ of Genetic Tests in Two New FDA Draft Guidances.” See http://www.dnapolicy.org/news.release.php?action=detail&pressrelease_id=56. Accessed on March 25, 2008.

⁸⁹ Gibbs, J.N. (2003). Regulations & standards: the past, present, and future of ASRs. *Medical Device Link*. See <http://www.devicelink.com/ivdt/archive/03/11/012.html>. Accessed on March 25, 2008.

⁹⁰ Department of Health and Human Services (2006). *Draft Guidance for Industry, Clinical Laboratories, and FDA Staff on In Vitro Diagnostic Multivariate Index Assays* [Docket No. 2006D-0347]. See <http://www.fda.gov/OHRMS/DOCKETS/98fr/ch0641.pdf>. Accessed on March 25, 2008.

⁹¹ Food and Drug Administration, Center for Devices and Radiological Health, Office of In Vitro Diagnostic Device Evaluation and Safety (2006). *Draft Guidance for Industry and Food and Drug Administration Staff; In Vitro Diagnostic Multivariate Index Assays*. See <http://www.fda.gov/cdrh/oivd/guidance/1610.pdf>. Accessed on March 25, 2008.

⁹² Federal Register. July 26, 2007. 72(143): 41081-41083. Draft Guidance for Industry, Clinical Laboratories, and FDA Staff: In Vitro Diagnostic Multivariate Index Assays. See <http://a257.g.akamaitech.net/7/257/2422/01jan20071800/edocket.access.gpo.gov/2007/pdf/07-3660.pdf>. Accessed on March 25, 2008.

⁹³ Food and Drug Administration News Release, “FDA Drafts Regulatory Guidance to Industry and Labs for Group of Medical Tests.” See <http://www.fda.gov/bbs/topics/NEWS/2006/NEW01445.html>. Accessed on March 25, 2008.

⁹⁴ Food and Drug Administration News Release, “FDA Clears Breast Cancer Specific Molecular Prognostic Test.” See <http://www.fda.gov/bbs/topics/NEWS/2007/NEW01555.html>. Accessed on March 25, 2008.

⁹⁵ National Human Genome Research Institute Web site. “Task Force on Genetic Testing: Joint NIH-DOE Ethical, Legal and Social Implications Working Group of the Human Genome Project.” See <http://www.genome.gov/10001808>. Accessed on March 25, 2008.

⁹⁶ Secretary’s Advisory Committee on Genetic Testing (2001). *Development of a Classification Methodology for Genetic Tests: Conclusions and Recommendations of the Secretary’s Advisory Committee on Genetic Testing*. See http://www4.od.nih.gov/oba/sacgt/reports/Addendum_final.pdf. Accessed on March 25, 2008.

data-driven reviews focusing on the analytical and clinical validity of genetic tests, as well as on any claims the developer plans to make about a test's clinical utility. As described below, most genetic tests that are newly available to U.S. consumers are entering the market by the CLIA pathway rather than through the FDA clearance/approval process. For example, commercial test kits—which are approved or cleared by FDA—generally are not available for rare genetic disorders.

FDA review also results in public posting of the final review memorandum in template form. This practice ensures transparency in the nature of analytical and clinical testing performed and gives health care providers information that may be of value in selecting conventional and off-label uses of a new test. Statutory regulation is a potential vehicle for providing changes in oversight, such as standardizing the reporting and labeling of information about genetic tests, which might help provide more information to interested stakeholders than is now available, particularly for tests brought to market without FDA review.

Legislative actions. The Food and Drug Administration Amendments Act of 2007 became Public Law 110-85⁹⁷ on September 27, 2007. Section 1103 of this law states that the Secretary of the U.S. Department of Health and Human Services (HHS) shall commission the Institute of Medicine of the National Academy of Sciences to assess and make recommendations on how Federal oversight and regulation of genetic tests can be improved if SACGHS does not submit its report to the HHS Secretary by July 2008.

Two bipartisan bills introduced in the 110th Congress, but not yet passed, would place greater requirements on LDTs and renew a call for CMS to establish a genetic testing specialty under CLIA. The Genomics and Personalized Medicine Act of 2007 (S.976),⁹⁸ introduced by Senators Barack Obama (D-IL) and Richard Burr (R-NC), would call for the HHS Secretary to:

- Undertake a comparative analysis of CLIA and FDA review requirements and mandate a CLIA specialty in genetic testing
- Develop a decision matrix for determining which genetic tests, including LDTs, should require review and determine the appropriate agency to oversee this review
- Conduct postmarket public health surveillance of genetic tests with a focus on direct-to-consumer tests
- Establish a national biobanking database, biobank initiatives grant program, and mechanism for management and submission of pharmacogenomic data developed by FDA in collaboration with NIH and CDC

The Laboratory Test Improvement Act (S.736),^{99,100} introduced by Senators Edward Kennedy (D-MA) and Gordon Smith (R-OR), would put into place a comprehensive system of oversight for all LDTs, including genetic tests. In particular, it would:

⁹⁷ H.R. 3580: Food and Drug Administration Amendments Act of 2007. See http://frwebgate.access.gpo.gov/cgi-bin/getdoc.cgi?dbname=110_cong_bills&docid=f:h3580enr.txt.pdf. Accessed on March 25, 2008.

⁹⁸ S.976: Genomics and Personalized Medicine Act of 2007. See <http://www.govtrack.us/congress/billtext.xpd?bill=s110-976>. Accessed on March 25, 2008.

⁹⁹ S. 376: Laboratory Test Improvement Act - Amends the Federal Food, Drug, and Cosmetic Act (FFDCA) to deem a laboratory-developed test that is a direct-to-consumer test to be a prescription test if it satisfies the requirements of this Act. See <http://www.thomas.gov/cgi-bin/bdquery/z?d110:SN00736:@@D&summ2=m&>. Accessed on March 25, 2008.

¹⁰⁰ Genetics and Public Policy Center ENews, “Senator Kennedy introduces the Laboratory Test Improvement Act.” See http://www.dnapolicy.org/news.enevs.article.nocategory.php?action=detail&newsletter_id=20&article_id=78. Accessed on March 25, 2008.

- Grant explicit authority to FDA to regulate LDTs as medical devices
- Require all laboratories using LDTs to register with FDA as medical device manufacturers and to submit a list of tests offered by the laboratory, the intended uses of the tests, information on the tests' analytical validity, and information on the tests' clinical validity if they are intended for clinical use
- Require laboratories offering direct-to-consumer tests to submit their tests for FDA review
- Make laboratories using LDTs subject to other requirements applicable to medical device manufacturers, such as reporting of adverse events resulting from the use of LDTs
- Provide that compliance with CLIA regulations would satisfy FDA's Quality System Regulation requirements unless and until CLIA's requirements are found to be inadequate for protecting the public's health
- Create a genetic testing specialty under CLIA

Critics of this bill argue that these submission requirements would present a burden for both laboratories and FDA and could threaten the development and use of potentially beneficial tests.

In addition to these two pieces of legislation regarding LDTs, the Newborn Screening Saves Lives Act of 2007 (S.1858),¹⁰¹ introduced by Senators Christopher Dodd (D-CT) and Orrin Hatch (R-UT), addresses regulation and QC issues specific to newborn screening. This bill:

- Requires annual funding for CDC's newborn screening QA program
- Directs the HHS Secretary to produce a contingency plan for newborn screening operations
- Mandates the creation of a Web-based interactive clearinghouse of educational information on newborn screening through CDC and NIH
- Establishes QA standards for laboratories involved in newborn screening

Passed in the Senate, its companion bill, H.R.3825,¹⁰² has been introduced in the U.S. House of Representatives by Congresswoman Lucille Roybal-Allard (D-CA) and Congressman Mike Simpson (R-ID) and awaits action in the House Committee on Energy and Commerce.

State regulation of testing services.¹⁰³ At the State level, statutory regulation plays an important role in genetic testing. Twenty-six States have some degree of statutory authority for oversight of the practice of clinical laboratory medicine. New York and Washington are the only States that have CLIA-exempt status because their standards have been reviewed by CMS and approved to be at least equivalent to or more stringent than CLIA in accordance with the CLIA statute and regulations. New York State has specific standards for genetic testing, but Washington State does not—although it does review the clinical validity of certain tests. Through its Genetics Disease Branch and newborn screening and prenatal screening program, California has rigorous review of those types of assays, but its oversight does not generally extend to other genetic testing. New Jersey applies some personnel standards of the American Board of Medical Genetics to laboratories that perform genetic testing. With the exception of New York, no State requires review of validation data for individual assays, other than in the context of a physical onsite inspection, which for

¹⁰¹ S. 1858: Newborn Screening Saves Lives Act of 2007. See http://frwebgate.access.gpo.gov/cgi-bin/getdoc.cgi?dbname=110_cong_bills&docid=f:s1858rfh.txt.pdf. Accessed on March 25, 2008.

¹⁰² H.R. 3825: Newborn Screening Saves Lives Act of 2007. See http://frwebgate.access.gpo.gov/cgi-bin/getdoc.cgi?dbname=110_cong_bills&docid=f:h3825ih.txt.pdf. Accessed on March 25, 2008.

¹⁰³ Willey, A.W. *New York State Laboratory Specific Assay Validation Review and Approval as Applied to Genetic Testing*. Presentation to SACGHS meeting, March 26, 2007. See <http://www4.od.nih.gov/oba/sacghs/meetings/Mar2007/Mon%20pm%20-%20Willey.pdf>. Accessed on March 25, 2008.

most State programs does not involve peer review. The Washington State program, however, does evaluate the clinical validity of tests.

New York is generally recognized as having the most stringent State laboratory standards in the country. Because New York is CLIA-exempt, laboratories having a New York license must only meet the State requirements in order to be in compliance with CLIA. A 1964 New York State statute, which predated CLIA, requires that the State oversee the practice of laboratory medicine for the testing of all specimens derived from the human body for all purposes. The statute holds that “A laboratory shall perform only those assays that have been validated or verified at the site where the assay will be performed.” It applies primarily to large, multisite commercial entities that want to validate an assay at one site and then transfer it to other sites. They must reproduce the validation data at any site at which they intend to offer the test or ship all the specimens for that assay to one site. A laboratory must hold the appropriate permit category for the test.

New York has 26 specialties, with 70 different categories in which it issues permits. Every test falls into one or more of those categories. The laboratories must meet all other requirements related to personnel, PT, and onsite inspection. New York State review of the validation of LDTs or assays using certain commercial reagents is part of an integrated program. Every category must have an assistant director or director holding specified credentials. They must be doctoral-degreed individuals with a minimum of 4 years of postdoctoral clinical laboratory experience and a minimum of 2 years in the specialty. All other personnel must meet relevant training experience. The laboratories are physically inspected every 2 years for their QA program, QC, reagents, equipment, and physical location. They are required to participate in New York’s PT program and are encouraged to participate in other relevant proficiency tests.

Under the New York program, there are two types of tests: FDA-approved/cleared and all other tests. The latter category includes tests for research or investigative purposes only and for LDTs. A number of LDTs are manufactured using ASRs.¹⁰⁴ The laboratory program must approve non-FDA-approved tests before they can be offered. New York has conducted approximately 450 reviews of genetic and nongenetic tests, which include both analytical and clinical validity. They also provide laboratory guidance on the materials needed for review. All reference laboratories in the country are likely to have a site in New York State, because any testing on a New York resident, regardless of where it takes place, is covered under New York State law and the tests must be submitted there for approval. It is estimated that 75 percent of the genetic testing in the United States is subject to New York State oversight.¹⁰⁵

The program in New York is divided into two segments: cytogenetics (since 1972) and genetics (since 1990). Cytogenetics includes clinical information about test selection and interpretation, patient consent, confidentiality, specimen retention times, and turnaround time. There are requirements that reports be signed by a cytogeneticist, that there be an interpretation suitable for a nongeneticist, and that there be prenatal and preimplantation outcome verification. Laboratories are subject to the New York State PT program.

There are similar requirements for other types of genetic testing, including clinical information about test selection and interpretation, patient consent, confidentiality, specimen retention times, and very detailed QC

¹⁰⁴ Food and Drug Administration. Specimen Preparation Reagents. [21 CFR 864, Subpart E]. See <http://www.accessdata.fda.gov/scripts/cdrh/cfdocs/cfcfr/CFRSearch.cfm?FR=864.4020>. Accessed on March 25, 2008.

¹⁰⁵ Willey, A.W. *New York State Laboratory Specific Assay Validation Review and Approval as Applied to Genetic Testing*. Presentation to SACGHS meeting, March 26, 2007. See <http://www4.od.nih.gov/oba/sacghs/meetings/Mar2007/Mon%20pm%20-%20Willey.pdf>. Accessed on March 25, 2008.

procedures, with method documentation and retention of records. The reports must be signed by a geneticist. There must be an interpretation suitable for a nongeneticist physician and prenatal and preimplantation outcome verification. In this case, however, PT requirements are the same as those under CLIA. When PT material is not available, particularly for rare diseases, the laboratory is subject to alternative PT, if available, or review twice per year.

The New York process for validation review of non-FDA-cleared tests is not unique to genetics; it applies to any laboratory test, whether clinical chemistry, microbiology, or virology. The standards require that the laboratory submit validation data and clinical validity data. For genetic testing, only a very small number of cases are required to be tested to establish validation. There must be a known clinical association with the genetic marker. All LDTs using ASRs require departmental approval, whether for genetics or microbiology. LDTs that do not use ASRs also require departmental approval because they are developed in-house and are not currently regulated by FDA.¹⁰⁶

State regulation of clinical use of genetic testing. The clinical use of genetic tests is primarily regulated at the State level. A complex web of State statutes, regulations, and liability rules influence the extent to which patients benefit from genetic testing and are protected from harms. This web includes State medical practice acts, informed consent statutes, pharmacy regulations, State genetic testing statutes and privacy acts, and State tort liability rules that serve to define the physician's standard of care. State laws affect whom to test, when to test, which test to use, and what actions should be taken in response to specific test results.

In addition to the regulation of genetic tests in general, States have specific oversight of newborn screening. Since their inception, newborn screening systems have increased in complexity, which influences the policy issues that shape program outcomes. While all programs have statutory requirements, there is considerable variation among newborn screening services across the country, and statutes, rules, regulations, protocols, and financing strategies vary from State to State. Contributing to this variation is the absence of a national newborn screening law or financing scheme.¹⁰⁷

Federal efforts to improve information development and standard-setting for genetic tests may have very little impact on day-to-day clinical practice unless States adopt regulations and liability rules that supply incentives to follow these standards. An example of this problem arises with physician compliance with safety warnings stated in FDA-approved product labeling. Under FDCA, FDA decides whether medical products can lawfully be sold and reviews their labeling but does not require physicians to comply with the use standards (i.e., instructions and warnings) implicit in product labeling. Congress did not intend, when it passed FDCA in 1938, to authorize broad FDA regulation of the practice of medicine.^{108,109} Courts have not subsequently found constitutional limits on FDA's power to regulate physicians, but FDA, as a matter

¹⁰⁶ Wadsworth Center, New York State Department of Health Web site. "Clinical Laboratory Evaluation Program." See <http://www.wadsworth.org/labcert/TestApproval/submitguide.htm>. Accessed on March 25, 2008.

¹⁰⁷ Therrell, B.L., Johnson, A., and Williams, D. (2006). Status of newborn screening programs in the United States. *Pediatrics*. 117(5 Pt 2): S212-252.

¹⁰⁸ Federal Register. 37: 16503-16505. 1972. FDA, Legal Status of Approved Labeling for Prescription Drugs; Prescribing for Uses Unapproved by the Food and Drug Administration (Notice of Proposed Rulemaking).

¹⁰⁹ Hoffman, J.E. (1999). Administrative Procedures of the Food and Drug Administration. In Fundamentals of Law and Regulation. Ed. Adams, D.G., Cooper, R.M., and Kahan, J.S. Washington, DC: Food and Drug Law Institute. pg. 17-24.

of policy, has sought to avoid direct regulation of their activities.^{110,111,112} States were left to develop their own approaches for promoting physician compliance with warnings and instructions in labeling. States have not embraced a direct regulatory approach to this problem, and tort lawsuits are the main *de facto* compliance mechanism at the State level.¹¹³ The result is a very weak set of incentives for physicians to heed warnings in product labeling,¹¹⁴ since only some States treat compliance with labeling as the standard of care, and many States treat it as merely one factor to consider.^{115,116}

Even if FDA's oversight duties were expanded to include all genetic tests (including LDTs), this would not necessarily ensure that patients would gain the public health benefits of genetic tests and be protected from potential harms. Sound State policies are crucial to these latter goals. In the case of genetic tests, FDA arguably has statutory authority to restrict how tests are used in clinical settings. The 1976 Medical Device Amendments¹¹⁷ to FFDCAs authorized FDA to characterize a medical device as "restricted" and impose stringent limitations on its sale, distribution, or use.¹¹⁸ To date, however, FDA has not exercised this authority for the purpose of restricting the clinical uses of genetic tests. Physicians are generally free to use an FDA-approved genetic test either in or out of compliance with its labeling, subject only to State tort liability for uses that prove positively injurious. Therefore, Federal efforts to improve prior review and labeling of genetic tests and genetically targeted drugs are almost entirely dependent on the States to supply clinical compliance mechanisms for use of tests.

HHS cannot influence State laws, regulations, and liability rules directly, but the Agency can play a valuable role in information development, for example, by funding surveys and data-gathering efforts to assess whether existing State policies encourage or discourage sound clinical application of genetic tests. These data would inform State policymakers and courts as they modernize outdated State liability rules and could help stimulate multi-State efforts to develop uniform model laws that promote appropriate clinical application of genetic testing. These data also could inform Congress regarding whether certain aspects of genetic testing merit statutory preemption of State laws, for the purpose of ensuring uniform national standards to protect all Americans.

Specific uses and misuses of genetic tests. Federal and State laws apply to specific uses and misuses of genetic tests and genetic information. The Federal Health Insurance Portability and Accountability Act, the associated HIPAA privacy regulations, and many State statutes affect storage and disclosure of genetic test

¹¹⁰ Adams, D.G. (1999). The Food and Drug Administration's Regulation of Health Care Professionals. In *Fundamentals of Law and Regulation*. Ed. Adams, D.G., Cooper, R.M., and Kahan, J.S. Washington, DC: Food and Drug Law Institute. pg. 423, 425-426.

¹¹¹ Federal Register. 37: 16503-16505. 1972. FDA, Legal Status of Approved Labeling for Prescription Drugs; Prescribing for Uses Unapproved by the Food and Drug Administration (Notice of Proposed Rulemaking).

¹¹² Christopher, W.L. (1993). Off-label drug prescription: filling the regulatory vacuum. *Food and Drug Law Journal*. 48:247 at n. 6.

¹¹³ Brennan, T.A. and Rosenthal, M. (1995). Medical malpractice reform: the current proposals. *Journal of General Internal Medicine*. 10(4):211-280.

¹¹⁴ Evans, B.J. and Flockhart, D.A. (2006). The unfinished business of U.S. drug safety regulation. *Food and Drug Law Journal*. 61(1):45-63.

¹¹⁵ Sharp, L.A. Annotation, Malpractice: Physician's Liability for Injury or Death Resulting From Side Effects of Drugs Intentionally Administered to or Prescribed for a Patient. 57 A.L.R. 5th 433 (1997, updated through 2004), §§ 2[a], 7.

¹¹⁶ Minneman, D.C. Annotation, Medical Malpractice: Drug Manufacturer's Package Insert Recommendations as Evidence of the Standard of Care, 82 A.L.R. 4th 166 (1990, updated through 2004), §§ 2-6.

¹¹⁷ Public Law 94-295, 90 Stat. 539. (1976). Codified at 15 U.S.C. § 55 and 21 U.S.C. *passim*.

¹¹⁸ FFDCAs §520(e), codified at 21 U.S.C. § 360j(e). FDA's authority to restrict use of a device to certain categories of practitioners, however, is limited.

results. State insurance regulations and the Federal Employee Retirement Income Security Act of 1974¹¹⁹ may affect the use of test results by insurers. The Genetic Information Nondiscrimination Act of 2007,¹²⁰ which was passed by the House in April 2007 but is pending in the Senate at this writing, would limit the use of genetic test results in insurance enrollment, premium-setting, and employment decisions.

Regulatory Status of Currently Available Genetic Tests

Data on genetic tests of all types. According to data submitted voluntarily to an online directory of genetic tests and the laboratories that offer them, tests for more than 1,500 genetic diseases are offered currently in 1,254 clinical laboratories.¹²¹ FDA has cleared or approved several dozen genetic tests to date (e.g., tests for factor V Leiden/factor II, cystic fibrosis, *UGT1A1*, cytochrome P450 (CYP450) genes *CYP2D6* and *CYP2C19*, breast cancer prognosis gene expression test, bladder cancer fluorescence *in situ* hybridization (FISH), prenatal aneuploidy FISH, and *HER2* FISH.)¹²² This figure refers to molecular genetic tests; when biochemical assays for genetic conditions (mainly for newborn screening) are added, the total approaches 100. Most genetic tests in use today are LDTs and have not been reviewed by FDA. For example, although BRCA tests are widely used to predict patients' future risk of breast and ovarian cancer, no BRCA test has been approved by FDA.¹²³ A 2003 survey of U.S. molecular diagnostics laboratories found that genetic testing for inherited diseases was the second-largest diagnostic testing activity, representing 15 percent of the total volume of tests performed. Among the laboratories surveyed, 85 percent reported using at least one LDT.¹²⁴

Data on pharmacogenomic and other tests used to guide drug-prescribing decisions. Pharmacogenomics attempts to reveal the genetic basis for individual differences in drug toxicity and efficacy to optimize design and drug therapy. Customized treatments can result in better responsiveness, reduced side effects, and more cost-effective drug development and use of drugs.¹²⁵ In 1998, FDA approved the first molecular diagnostic test for use in detecting the HER2 protein, which is the target for the breast cancer biologic therapy trastuzumab (Herceptin®). The agency subsequently approved a test for genetic alterations of the *HER2*-encoding gene based on FISH technology. FDA also has cleared a test for genetic variations in HIV virus, for use in selecting appropriate therapies. It was not until December 2004 that FDA cleared a drug-metabolizing enzyme genotyping system, which is designed to detect a patient's genotype at certain *CYP450* loci.¹²⁶ In August 2005, FDA cleared a second test of this type, for use in detecting variations in the *UGT1A1* gene that encodes the enzyme UDP-glucuronosyltransferase, which affects metabolism of the cancer drug irinotecan.

¹¹⁹ 29 U.S.C. §1001-1461.

¹²⁰ H.R. 493: Genetic Information Nondiscrimination Act of 2007. See http://frwebgate.access.gpo.gov/cgi-bin/getdoc.cgi?dbname=110_cong_bills&docid=f:h493ih.txt.pdf. Accessed on March 25, 2008.

¹²¹ GeneTests Web site. See www.genetests.org. Accessed on March 25, 2008.

¹²² Food and Drug Administration Web site. "Product Code Classification Database." See <http://www.fda.gov/cdrh/prodcode.html>. Accessed on March 25, 2008.

¹²³ Committee on New Approaches to Early Detection and Diagnosis of Breast Cancer, National Cancer Policy Board (2005). *Saving Women's Lives: Strategies for Improving Breast Cancer Detection and Diagnosis*. Ed. Joy, J.E., Penhoet, E.E., and Petitti, D.B. Washington, DC: The National Academies Press. pg. 225. See http://www.nap.edu/catalog.php?record_id=11016#toc. Accessed on March 25, 2008.

¹²⁴ Enterprise Analysis Corporation (2003). *Molecular Diagnostics—An In-depth Survey of the U.S. Molecular Diagnostic Laboratories*.

¹²⁵ World Health Organization Web site. "Ethical, Legal, and Social Implications (ELSI) of Human Genomics: Pharmacogenomics." See <http://www.who.int/genomics/elsi/pharmacogenomics/en/>. Accessed on March 25, 2008.

¹²⁶ Food and Drug Administration News Release, "FDA Clears First of Kind Genetic Lab Test" See <http://www.fda.gov/bbs/topics/news/2004/new01149.html>. Accessed on March 25, 2008.

Federal regulation of drug labeling that includes genetic testing information. In addition to its roles of clearing and approving genetic testing products, FDA oversees the labeling of drug and biologic therapies (together, “drugs”) that include pharmacogenomic information. Labeling information explains genetic factors that may affect individual drug response or provides instructions for using genetic tests to guide prescribing decisions. Recent FDA activities indicate that the agency has identified pharmacogenomics as an area of oversight priority. These activities involve the FDA Center for Drug Evaluation and Research in conjunction with the Office of In Vitro Diagnostic Device Evaluation and Safety, the Office of Combination Products, and the Interdisciplinary Pharmacogenomics Review Group.

In August 2007, FDA approved an updated prescription label that includes information describing the role of genetics in warfarin dosing. The new label will reflect that “lower initiation doses should be considered for patients with certain genetic variations in *CYP2C9* and *VKORC1* enzymes.”¹²⁷ The Secretary’s Advisory Committee on Genetics, Health, and Society (SACGHS) has just published a report that explores the opportunities for pharmacogenomics to advance the development of diagnostic, therapeutic, and preventive strategies to improve health and that identifies challenges to the integration and application of pharmacogenomics to clinical practice and public health.¹²⁸ The report makes recommendations to the HHS Secretary in areas such as basic and translational research, the development process for pharmacogenomic products, clinical validity and clinical utility of pharmacogenomic technologies, use of pharmacogenomic technologies in clinical practice, and research on ethical, legal, and social issues.

At present, an estimated 120 drugs include some form of pharmacogenomic information in their labels.¹²⁹ There are several examples in which a drug and a test are expressly cross-labeled for use together, so that the drug’s label identifies specific tests and gives information on how to prescribe in response to test results.¹³⁰ In other cases, labeling notes that patient response may vary based on genetic factors, but it lacks specific recommendations for testing and interpretation of test results.¹³¹ Some labeling for drugs that are known to exhibit genetic variability of response do not yet provide such specific recommendations. Scientists and physicians have called for more information about genetic variability of drug response to be included in drug labeling.¹³² Even if FDA had the authority to compel drug and test manufacturers to cross-label their products, cross-labeling presents other legal and practical issues that are unresolved at present. It is unknown how many of the existing LDTs that have not received external, prior review of their analytical and performance characteristics would meet FDA’s evidentiary standards for inclusion in drug labeling. Currently, even if a drug label includes pharmacogenomic information, this information does not indicate or guarantee that an FDA-cleared or -approved genetic test is commercially available.

¹²⁷ Bristol-Myers Squibb Company. Coumadin label. See <http://www.fda.gov/cder/foi/label/2007/009218s1051blv2.pdf>. Accessed on March 25, 2008.

¹²⁸ Secretary’s Advisory Committee on Genetics, Health, and Society (2008). *Realizing the Potential of Pharmacogenomics: Opportunities and Challenges*. See: http://www4.od.nih.gov/oba/sacghs/reports/SACGHS_PGX_report.pdf. Available May 2008.

¹²⁹ Rudman, A. *Pharmacogenomics: Update and Practical Regulatory Outset*. Regulatory Affairs Professionals Society 2006 Annual Conference and Exhibition, October 18, 2006.

¹³⁰ For example, approved package insert for trastuzumab (Herceptin™). See <http://www.gene.com/gene/products/information/oncology/herceptin/insert.jsp>. Accessed on March 25, 2008.

¹³¹ For example, approved package insert for Atomoxetine HCl (Strattera™).

¹³² For example, Andersson, T., Flockhart, D.A., Goldstein, D.B., Huang, S.M., Kroetz, D.L., Milos, P.M., Ratain, M.J., and Thummel, K. (2005). Drug-metabolizing enzymes: evidence for clinical utility of pharmacogenomic tests. *Clinical Pharmacology and Therapeutics*. 78(6):559-581.

Reimbursement Policies and Genetic Testing

Reimbursement policies play an essential role in determining whether and how genetic tests will be used. They affect whether patients will be covered for, and therefore will be more likely to have access to, genetic testing. Given that the revenue stream for test makers is largely determined by the volume of covered tests and the payment levels per test, reimbursement influences willingness to invest in the development of new tests.¹³³ While it would be desirable for payment levels to reflect such factors as the incremental innovation, the effort required to conduct the test, and the value to the patient (e.g., of the test itself or the effectiveness of treatment informed by test results), laboratory fee schedules and related payment mechanisms for tests are less discerning of those factors.

Reimbursement policies also affect whether appropriate courses of action will be taken in response to genetic test results when results are used to guide clinical decisions. Medical necessity determinations are a key point of control for ensuring that appropriate inferences are drawn in response to specific test results.¹³⁴ An example is the use of pharmacogenomic test results in medical necessity determinations, which may decide whether a patient will receive reimbursement for a particular drug. Before authorizing reimbursement for the drug, payers may require documentation that a pharmacogenomic test has been conducted and that there is a particular test result. A concern is that, given differences among analytical validity, clinical validity, and clinical utility of tests, some patients who are predicted by a pharmacogenomic test to respond favorably to a drug will not, whereas some patients who are predicted not to respond favorably to the drug may, in fact, respond well to it. Thus, patients who might have been good candidates for treatment with a given drug could be denied reimbursement for it. This risk can be minimized through appropriate oversight of tests and through information development and synthesis activities to strengthen the evidentiary base for reimbursement decisionmaking.

Medicare reimbursement. Current Medicare reimbursement provisions may have implications for genetic tests due to the limitations placed on the coverage of diagnostic tests. The Medicare statute restricts payment to items or services that are “reasonable and necessary for the diagnosis or treatment of illness or injury or to improve the functioning of a malformed body member.”¹³⁵ Laboratory tests used only for screening purposes are not covered under Medicare unless Congress authorizes coverage for specific tests.¹³⁶ Thus, most genetic tests will not be eligible for coverage unless they are performed on symptomatic patients or used to identify treatment-responsive subpopulations.

Establishing genetic tests as “reasonable and necessary” for diagnosis or treatment is often difficult. While determining analytical validity of genetic tests is usually straightforward, direct evidence of clinical utility and related health care outcomes as required by Medicare’s core provisions can be more challenging. Studies on diagnostic genetic tests often focus on test specificity, sensitivity, and/or ability to detect the

¹³³ Goodman, C., Faulkner, E., Gould, C., Karnes, E., Smith, A., Aguiar, C., Nelson, C., Grover, A., Berlin, A., Phillips, R., and Horan, A. (2005). *The Value of Diagnostics: Innovation, Adoption, and Diffusion into Health Care*. The Lewin Group, Inc. See <http://www.advamed.org/NR/rdonlyres/61EB858F-EC9E-4FAB-9547-09DABF7D2A72/0/thevalueofdiagnostics.pdf>. Accessed on March 25, 2008.

¹³⁴ Evans, B.J. (2007). Finding a liability-free space in which personalized medicine can bloom. *Clinical Pharmacology and Therapeutics*. 82(4):461-465.

¹³⁵ 42 U.S.C. §1395y(a)(1)(A).

¹³⁶ Goodman, C., Faulkner, E., Gould, C., Karnes, E., Smith, A., Aguiar, C., Nelson, C., Grover, A., Berlin, A., Phillips, R., and Horan, A. (2005). *The Value of Diagnostics: Innovation, Adoption, and Diffusion into Health Care*. The Lewin Group, Inc. See <http://www.advamed.org/NR/rdonlyres/61EB858F-EC9E-4FAB-9547-09DABF7D2A72/0/thevalueofdiagnostics.pdf>. Accessed on March 25, 2008.

presence of disease rather than on the impact of testing on clinical decisions, let alone on downstream health outcomes.¹³⁷ Many genetic tests provide information that may not be necessary for, or even relevant to, informing treatment decisions.

In recent years, Congress has sought to expand Medicare coverage to screening and other prevention-related services through amendments, including the Medicare Prescription Drug, Improvement, and Modernization Act of 2003.¹³⁸ These provisions, however, may have limited applicability to genetic tests. For example, pharmacogenomic tests aim to detect genetic variations that may affect drug metabolism or susceptibility to adverse drug reactions. Coverage decisions for this class of genetic tests may rest on the ability to demonstrate that test results will provide information that is considered medically necessary. It also remains uncertain how specific genetic tests that target biomarkers that are known to be associated with treatment response will fare under Medicare's coverage criteria.¹³⁹

Reimbursement by private insurers. A special concern relates to the clinical validity and clinical utility of genetic tests whose results are used to inform medical necessity determinations by private insurers. Current State^{140,141} and proposed Federal¹⁴² laws on genetic discrimination in insurance prohibit the use of genetic information in insurance enrollment, underwriting, and premium-setting decisions. It is permissible, however, for insurers to condition reimbursement for specific medical treatments and procedures on genetic test results to the extent that those results reveal whether the person has a condition that makes the treatment medically necessary.¹⁴³ Thus, for example, it is permissible for an insurer to condition reimbursement for trastuzumab on documentation of a HER2 test showing that the patient would be a suitable candidate for this therapy. The Congressional Research Service, however, has suggested that there is uncertainty regarding insurers' uses of pharmacogenomic tests. Using pharmacogenomics to guide treatment of a manifested illness, while legally permissible, still may be controversial (e.g., when only one treatment is available and the patient is deemed not to be a candidate for that drug).¹⁴⁴ Harms to public health and to public confidence in the payment system may result if medical necessity determinations rely on tests with dubious clinical validity and clinical utility.

¹³⁷ Medicare Coverage Advisory Committee, Operations and Methodology Subcommittee (2006). *Process for Evaluation of Effectiveness and Committee Operations*. See <http://www.cms.hhs.gov/FACA/Downloads/recommendations.pdf>. Accessed on March 25, 2008.

¹³⁸ Public Law 108-173. Medicare Prescription Drug, Improvement, and Modernization Act of 2003. See http://frwebgate.access.gpo.gov/cgi-bin/getdoc.cgi?dbname=108_cong_public_laws&docid=f:publ173.108. Accessed on March 25, 2008.

¹³⁹ Goodman, C., Faulkner, E., Gould, C., Kames, E., Smith, A., Aguiar, C., Nelson, C., Grover, A., Berlin, A., Phillips, R., and Horan, A. (2005). *The Value of Diagnostics: Innovation, Adoption, and Diffusion into Health Care*. The Lewin Group, Inc. See <http://www.advamed.org/NR/rdonlyres/61EB858F-EC9E-4FAB-9547-09DABF7D2A72/0/thevalueofdiagnostics.pdf>. Accessed on March 25, 2008.

¹⁴⁰ Williams, E.D., Sarata, A.K., and Redhead, C.S. (2007). *Genetic Discrimination: Overview of the Issue and Proposed Legislation (RL33903)*, at CRS-1. Congressional Research Service. See <http://openocrs.cdt.org/document/RL33903>. Accessed on March 25, 2008.

¹⁴¹ Clayton, E.W. (2003). Ethical, legal, and social implications of genomic medicine. *New England Journal of Medicine*. 349(6):562-569.

¹⁴² H.R. 493: Genetic Information Nondiscrimination Act of 2007. See http://frwebgate.access.gpo.gov/cgi-bin/getdoc.cgi?dbname=110_cong_bills&docid=f:h493ih.txt.pdf. Accessed on March 25, 2008.

¹⁴³ Senate Report 110-48: Genetic Information Nondiscrimination Act of 2007: Report (to accompany S. 358). pg. 21. See http://frwebgate.access.gpo.gov/cgi-bin/getdoc.cgi?dbname=110_cong_reports&docid=f:sr048.110.pdf. Accessed on March 25, 2008.

¹⁴⁴ Williams, E.D., Sarata, A.K., and Redhead, C.S. (2007). *Genetic Discrimination: Overview of the Issue and Proposed Legislation (RL33903)*, at CRS-1. Congressional Research Service. See <http://openocrs.cdt.org/document/RL33903>. Accessed on March 25, 2008.

This issue presents a significant regulatory challenge. As applied by private payers, the term “medical necessity” is largely a matter of contract law subject to the terms of the specific insurance policies. No Federal regulation defines medical necessity for private insurers; only about a third of the States have any regulatory definition of the term¹⁴⁵ and those that do rarely focus specifically on the use of genetic testing in medical necessity determinations. While accepting that medical necessity determinations are largely a matter of private contract law, HHS could play a valuable role in information development by supporting efforts to create an information base to inform the public and insurers about which tests have sufficient evidence to guide specific types of medical management decisions, by monitoring the use of genetic tests in medical necessity determinations, and by examining whether these uses are consistent with what is currently known about the tests’ clinical validity and clinical utility. Thus, evidence-based assessments of clinical utility and evidence-based guidelines should inform coverage and reimbursement as well as clinical management.

Roles of Federal Agencies in R&D and Evidence Synthesis

The success of the Human Genome Project has accelerated the translation of genomic information into clinical applications. The increasing number of genetic tests and other anticipated applications of genomic technologies for screening and prevention have the potential for broad public health impact.

Federal leadership by NIH, the Agency for Healthcare Research and Quality (AHRQ), CDC, and the Health Resources and Services Administration (HRSA) is contributing to the initial part of the translational pathway, which begins with research on the genetic role in disease and ultimately leads to improved health outcomes. Several key Federal initiatives are advancing the translation of genetic tests and services into clinical and public health practice, some of which are described below. Although these Federal initiatives have made great strides in genetic testing, a more coordinated approach for effectively translating genomic applications into clinical practice and health policy is still needed.

The *ACCE Project* was a CDC-sponsored initiative carried out between 2000 and 2004 that generated a model process for evaluating data on emerging genetic tests. Taking its name from the four components of evaluation—analytical validity, clinical validity, clinical utility, and associated ethical, legal, and social implications—the process included collecting, evaluating, interpreting, and reporting data about deoxyribonucleic acid (DNA) and related testing for disorders with a genetic component in a format that provides current and reliable information for decisionmaking.¹⁴⁶

Evaluation of Genomic Applications in Practice and Prevention (EGAPP), another CDC initiative, integrates knowledge and experience gained through ACCE and other processes, such as those of the U.S. Preventive Services Task Force (USPSTF). Launched in 2004, its goal is to establish and evaluate a systematic, evidence-based process for assessing genetic tests and other applications of genomic technology in transition from research to clinical practice and public health. EGAPP is an independent, non-Federal, multidisciplinary working group that selects genomic applications for evaluation, establishes methods and process, monitors expert and peer review of commissioned evidence reports, and develops conclusions

¹⁴⁵ Substance Abuse and Mental Health Services Administration (2003). *Special Report: Medical Necessity in Private Health Plans*. See <http://mentalhealth.samhsa.gov/publications/allpubs/SMA03-3790/default.asp>. Accessed on March 25, 2008.

¹⁴⁶ Federal Register. December 7, 2000. 65(236):76643-76645. Department of Health and Human Services, Secretary’s Advisory Committee on Genetic Testing. Request for public comment on a proposed classification methodology for determining level of review for genetic tests. See <http://frwebgate1.access.gpo.gov/cgi-bin/waisgate.cgi?WAISdocID=298311134234+2+0+0&WAIAction=retrieve>. Accessed on March 25, 2008.

and recommendations based on the evidence. The initiative is supported by evidence reviews prepared by the Evidence-based Practice Centers program of AHRQ. To date, evidence reviews have been prepared on testing hereditary nonpolyposis colorectal cancer, on genomics tests for ovarian cancer detection and management, and on testing for cytochrome P450 polymorphisms in the treatment of depression.^{147,148}

The **CDC Division of Laboratory Systems** (DLS) has a mission to improve the quality of laboratory testing in the Nation's clinical and public health laboratories by enhancing the use of evidence-based laboratory practices through policy development and laboratory health services research.¹⁴⁹ For example, DLS manages and receives advice from CLIAC, which is charged with advising HHS on matters related to CLIA and laboratory practices relevant to health care.¹⁵⁰ Currently, DLS is working with CLIAC and private and public partners to develop national guidance for laboratory practices associated with genetic testing.¹⁵¹ This guidance will aid laboratories and CLIA surveyors to ensure quality and promote good laboratory practices in the area of genetic testing under the current CLIA framework; however, all recommendations made by the guidelines will be voluntary and nonenforceable. DLS has also organized several pivotal conferences to address challenges faced by laboratories, including the need for laboratory control materials,¹⁵² rare disease testing,¹⁵³ and biochemical genetic testing.¹⁵⁴ Based on recommendations from these conferences, several efforts are under way, including establishment of the Genetic Testing Reference Materials Coordination Program, the Collaboration, Education, and Test Translation (CETT) Program, and the National Laboratory Network.¹⁵⁵ DLS is also involved in promoting voluntary professional competency in laboratory and clinical settings.¹⁵⁶

The **CETT Program**, which is overseen by the NIH Office of Rare Diseases, promotes the translation of tests for rare genetic diseases into clinical settings and works to encourage clinical laboratory and research collaborations. The program has active partnerships with Federal entities, including CDC, HRSA, and CMS. Collaborations also include many non-Federal groups, such as the Genetic Alliance, the American

¹⁴⁷ Evaluation of Genomic Applications in Practice and Prevention (EGAPP) Web site. See <http://www.egappreviews.org>. Accessed on March 25, 2008.

¹⁴⁸ Centers for Disease Control and Prevention Web site. "Genetic Testing." See <http://www.cdc.gov/genomics/gtesting.htm>. Accessed on March 25, 2008.

¹⁴⁹ Centers for Disease Control and Prevention Web site. "Division of Laboratory Systems." See <http://www.cdc.gov/dls/default.aspx>. Accessed on March 25, 2008.

¹⁵⁰ Centers for Disease Control and Prevention Web site. "Clinical Laboratory Improvement Advisory Committee (CLIAC)." See <http://www.cdc.gov/cliac/default.aspx>. Accessed on March 25, 2008.

¹⁵¹ Clinical Laboratory Improvement Advisory Committee (2007). Minutes of Full Committee Meeting, February 14-15, 2007. See <http://www.cdc.gov/cliac/cliac0207.aspx>. Accessed on March 25, 2008.

¹⁵² Chen, B., O'Connell, C., Boone, D.J., Amos, J.A., Beck, J.C., Chan, M.M., Farkas, D.H., Lebo, R.V., Richards, C.S., Roa, B.B., Silverman, L.M., Barton, D.E., Bejjani, B.A., Belloni, D.R., Bernacki, S.H., Caggana, M., Charache, P., Dequeker, E., Ferreira-Gonzalez, A., Friedman, K.J., Greene, C.L., Grody, W.W., Highsmith, W.E. Jr., Hinkel, C.S., Kalman, L.V., Lubin, I.M., Lyon, E., Payne, D.A., Pratt, V.M., Rohlf, E., Rundell, C.A., Schneider, E., Willey, A.M., Williams, L.O., Willey, J.C., Winn-Deen, E.S., and Wolff, D.J. (2005). Developing a sustainable process to provide quality control materials for genetic testing. *Genetics in Medicine*. 7(8):534-549.

¹⁵³ Access to Quality Testing for Rare Diseases: A National Conference Web site. See <http://rarediseases.info.nih.gov/QTRD/>. Accessed on March 25, 2008.

¹⁵⁴ Centers for Disease Control and Prevention (2006). *Quality, Access, and Sustainability of Biochemical Genetic Testing*, October 6-7, 2006. See <http://www.cdc.gov/dls/genetics/qualityaccess/default.aspx>. Accessed on March 25, 2008.

¹⁵⁵ National Laboratory Network for Rare Disease Genetic Testing Web site. See <http://www.rarediseasetesting.org/index.php>. Accessed on March 25, 2008.

¹⁵⁶ Funding Opportunity Announcement: Genetics in Clinical Practice: A Team Approach (Funding Opportunity Number: CDC-RFA-CI07-707, Catalog of Federal Domestic Assistance Number: 93.064). See <http://www.cdc.gov/od/pgo/funding/CI07-707.htm>. Accessed on March 25, 2008.

College of Medical Genetics (ACMG), and the Association for Molecular Pathology (AMP). Several tests have been approved for translation through CETT by various laboratories and commercial organizations using multiple methodologies. Recently, CETT addressed the issue of biochemical genetic testing and recommended improved training of laboratory and clinical personnel; guideline development to ensure the quality of testing, result interpretation, and diagnosis for inherited metabolic disorders and other genetic diseases; enhancement of QA measures for various laboratory tests; and international collaboration in research.¹⁵⁷

AHRQ's Evidence-based Practice Centers Program generates evidence reports in support of the EGAPP initiative, among others. In conjunction with the CDC, AHRQ has commissioned a study on monitoring use and outcomes of gene-based applications in the U.S. health care system. AHRQ also administers the USPSTF, an independent panel of experts in primary care and prevention that systematically reviews evidence of effectiveness and develops recommendations for clinical preventive services. USPSTF has conducted reviews of relevant genetics topics, including BRCA testing and hereditary hemochromatosis.¹⁵⁸

The **Secretary's Advisory Committee on Heritable Disorders and Genetic Diseases in Newborns and Children** (ACHDGDNC), staffed by HRSA's Maternal and Child Health Bureau, provides advice and recommendations to the HHS Secretary for the development of grant administration policies and priorities and to enhance the Secretary's ability to reduce mortality or morbidity from heritable disorders. In 2004, ACHDGDNC began to advise and guide the HHS Secretary on the most appropriate application of universal newborn screening tests, technologies, policies, guidelines, and programs for reducing negative outcomes of heritable disorders.

Evaluation of Screening Conditions Appropriate for Screening Infants and Children, an activity of ACHDGDNC, commenced in 2007 with the establishment of an evidence review working group (ERW) that will examine and evaluate the evidence for screening conditions for newborn and other childhood screening programs. This activity is unique in that it is developing a process to evaluate relatively rare conditions for screening in population-based programs. Similar to the Advisory Committee on Immunization Practices, ACHDGDNC will evaluate ERW's evidence review and make recommendations to the Secretary.

The **National Institute of Standards and Technology** (NIST), a nonregulatory Federal agency within the U.S. Department of Commerce, supports measurement procedures and reference materials for traditional biomarkers, such as cholesterol and calcium in serum, and new protein-based markers, such as troponin, homocysteine, and folate, as well as DNA-based standards for *HER2* testing standards and fragile X syndrome diagnosis. Recent efforts have addressed the development of reference measurement procedures and reference materials for new health status markers for *in vitro* medical devices.¹⁵⁹ NIST also advances health information technology (IT) standards that are complete and testable by providing the necessary conformance tests and interoperability tools and techniques. These activities, when integrated into standards, software, and certification processes, raise the quality of clinical outcomes and lower the costs of health IT implementation.

¹⁵⁷ Collaboration Education and Test Translation (CETT) Program Web site. "CETT Program – A New Paradigm." See <http://www.cettprogram.org/paradigm.aspx>. Accessed on March 25, 2008.

¹⁵⁸ Agency for Healthcare Research and Quality Web site. "U.S. Preventive Services Task Force (USPSTF)." See <http://www.ahrq.gov/clinic/uspstfix.htm>. Accessed on March 25, 2008.

¹⁵⁹ National Institute of Standards and Technology Web site. See <http://www.nist.gov/>. Accessed on March 25, 2008.

The *U.S. Department of Veterans Affairs* (VA) has launched a major research and care initiative related to genomic medicine. As VA has more than 7.7 million enrolled veterans and sees 5.5 million of them yearly in a system of 156 hospitals and more than 900 outpatient clinics, the potential impact is fairly substantial. The program receives guidance from a Genomic Medicine Program Advisory Committee that advises the Department on both research and care. The research effort includes large-scale genomic association studies and implementation research among its program areas.

Professional and Industry Organizations

Professional societies, industry organizations, and other groups can mobilize attention to highlight the importance of genetics issues for their members, including laboratory oversight. Many diverse organizations are involved in improving the quality of laboratory practices and in developing clinical practice guidelines to ensure appropriate genetic testing. Private sector accreditation organizations can apply for “deemed status” under CLIA and thus they can survey laboratories for CMS, as long as their standards are at least equivalent to those under CLIA. The following professional organizations are among those involved in accreditation of laboratories, guideline and standards development, advancement of best practices, PT programs, promotion of health professional education in human genetics, and other efforts that improve health care through laboratory medicine.

ACMG develops clinical practice guidelines; establishes uniform laboratory standards, QA, and PT; and serves as a voice for the medical genetics profession. ACMG’s voluntary standards and guidelines are educational resources to help medical geneticists provide accurate and reliable diagnostic genetic laboratory testing consistent with current technologies in clinical cytogenetics, biochemical genetics, and molecular diagnostics.¹⁶⁰

AMP is dedicated to the advancement, practice, and science of clinical molecular laboratory medicine and basic and translational research based on the applications of genomics and proteomics. AMP supports the development of new technologies in molecular biology to be used in laboratory medicine, including diagnosis, treatment, and prognosis of genetic disorders. AMP aims to inform and educate its members about advances in DNA-, ribonucleic acid-, and protein-based diagnostics and their applications.¹⁶¹

The **American Association for Clinical Chemistry** (AACC) is a professional society dedicated to improving health care through laboratory medicine. Its nearly 10,000 members are clinical laboratory professionals, physicians, research scientists, and others involved in developing tests and directing laboratory operations. AACC publishes the scientific journal *Clinical Chemistry*, maintains the patient-centered Web site Lab Tests Online, and hosts the world’s largest conference on laboratory medicine and technology.¹⁶²

The **American Society of Human Genetics** provides venues for investigators to share their research findings in human genetics; informs health professionals, legislators, health policymakers, and the general public about all aspects of human genetics; and facilitates interactions between geneticists and other communities, including policymakers, industry, educators, and patient and public advocacy groups. Its membership of

¹⁶⁰ American College of Medical Genetics Web site. “Mission Statement.” See http://www.acmg.net/AM/Template.cfm?Section=Mission_Statement&Template=/CM/HTMLDisplay.cfm&ContentID=2103. Accessed on March 25, 2008.

¹⁶¹ Association for Molecular Pathology Web site. “Mission” and “Vision.” See <http://www.amp.org/AboutAMP/mission.htm>. Accessed on March 25, 2008.

¹⁶² American Association for Clinical Chemistry Web site. See <http://www.aacc.org/AACC/>. Accessed on March 25, 2008.

nearly 8,000 professionals includes researchers, academicians, clinicians, laboratory practice professionals, genetic counselors, and nurses.¹⁶³

The *Association of Public Health Laboratories* works to strengthen public health laboratories in the United States and abroad. It advances laboratory systems and practices and promotes policies that support healthy communities, such as State newborn screening programs and the oversight of genetic tests. Membership includes State and local public health laboratories, environmental laboratories, and others that conduct testing of public health significance.¹⁶⁴

The *Clinical and Laboratory Standards Institute* (CLSI, formerly NCCLS) develops voluntary standards and guidelines in clinical and laboratory testing and promotes their use using a consensus-driven process that balances the viewpoints of industry, government, and the health care professions.¹⁶⁵ CLSI has approximately 2,000 member organizations and 2,000 volunteers that collaborate to develop CLSI consensus documents.

The *College of American Pathologists* is the world's largest association composed exclusively of pathologists and is widely considered the leader in laboratory QA. Approximately 6,500 U.S. laboratories are accredited by CAP and approximately 23,000 laboratories are enrolled in its PT programs.¹⁶⁶ The goals of the CAP accreditation program are to ensure that tests are analytically and clinically valid, that there is patient safety and patient access to testing, and that there is innovation and improvement of LDTs.

The *International Society of Nurses in Genetics* (ISONG) is dedicated to fostering the scientific and professional growth of nurses in human genetics and genomics worldwide. ISONG promotes caring for people's genetic and genomic health.¹⁶⁷

The *National Coalition for Health Professional Education in Genetics* (NCHPEG) is an "organization of organizations" committed to a national effort to promote health professional education and access to information about advances in human genetics. NCHPEG members are an interdisciplinary group of leaders from more than 140 diverse health professional organizations, consumer and volunteer groups, Government agencies, private industry, managed care organizations, and genetics professional societies. NCHPEG is not a policy, standard-setting, or regulatory organization. Its goals are to integrate genetics content into the knowledge base of health professionals and students of the health professions, to develop educational tools and information resources to facilitate the integration of genetics into health professional practice, and to strengthen and expand its interdisciplinary community of organizations and individuals.¹⁶⁸

The *National Society of Genetic Counselors* (NSGC) promotes the recognition of the genetic counseling profession as an integral part of health care delivery, education, research, and public policy. It promotes the professional interests of genetic counselors and provides a network for professional communications.

¹⁶³ American Society of Human Genetics Web site. See <http://www.ashg.org>. Accessed on March 25, 2008.

¹⁶⁴ Association of Public Health Laboratories Web site. "About APHL." See http://www.aphl.org/about_aphl/Pages/default.aspx. Accessed on March 25, 2008.

¹⁶⁵ Clinical and Laboratory Standards Institute Web site. See <http://www.clsi.org/>. Accessed on March 25, 2008.

¹⁶⁶ College of American Pathologists Web site. See <http://www.cap.org>. Accessed on March 25, 2008.

¹⁶⁷ International Society of Nurses in Genetics Web site. "Vision Statement" and "Mission Statement." See <http://www.isong.org/about/Statements.cfm>. Accessed on March 25, 2008.

¹⁶⁸ National Coalition for Health Professional Education in Genetics Web site. See <http://www.nchpeg.org>. Accessed on March 25, 2008.

NSGC encourages local and national continuing education opportunities and the discussion of all issues relevant to human genetics and the genetic counseling profession.¹⁶⁹

Public Policy and Consumer Advocacy Organizations

Through the involvement of advocacy groups, organizations, and individuals, the public is engaged in issues pertaining to genetic testing. Patient advocacy groups, as well as individuals and families affected by genetic conditions, play an important role in setting standards and in developing guidelines through advocacy and the monitoring of health care practices. Other organizations monitor and analyze developments in genetics that affect health care and serve as sources of information for the public, the media, and policymakers. Examples of such organizations are described briefly below.

The *Genetic Alliance* is a coalition of more than 600 advocacy organizations serving 25 million people affected by some 1,000 conditions. The organization works to transform leadership in the genetics community to build capacity in advocacy organizations and to educate policymakers by leveraging the voices of individuals and families. The interactions of its member groups are intended to accelerate translational research, improve the climate for technology development, encourage cohorts for clinical trials, increase the availability of linked, annotated biological resources, and ultimately lead to improved human health.¹⁷⁰

The *Genetics and Public Policy Center* helps policy leaders, decisionmakers, and the public better understand the rapidly evolving field of human genetics and its application to health care. New diagnostic tools and treatments raise a host of ethical, legal, and social concerns. The Center surveys public attitudes about genetics issues, analyses the existing regulatory landscape, monitors the transition of genetic applications into clinical practice, and presents options and likely outcomes of key genetics policies.¹⁷¹

The *Marti Nelson Cancer Foundation/CancerActionNow* (CAN) works to make effective and safe cancer treatments available to cancer patients. Because the drug development timeline is lengthy, CAN supports compassionate use or expanded access to programs that provide experimental treatments to patients once a treatment is shown to be relatively safe and effective.¹⁷²

The *National Breast Cancer Coalition* is the country's largest breast cancer advocacy group. Its trained advocates have lobbied at the national, State, and local levels for public policies that affect breast cancer research, diagnosis, and treatment. This grassroots advocacy effort has hundreds of member organizations and tens of thousands of individual members working toward increased Federal funding of breast cancer research and collaboration with the scientific community to implement new models of research, improve access to high-quality health care and breast cancer clinical trials for all women, and expand the influence of breast cancer advocates.¹⁷³

The *Ovarian Cancer National Alliance* comprises seven ovarian cancer groups that joined together in 1997. Their primary goal is to establish a coordinated national effort to place ovarian cancer education,

¹⁶⁹ National Society of Genetic Counselors Web site. "Our Society's Vision and Mission Statements." See <http://www.nsgc.org/about/visionMission.cfm>. Accessed on March 25, 2008.

¹⁷⁰ Genetic Alliance Web site. "About Us." See http://www.geneticalliance.org/ws_display.asp?filter=about. Accessed on March 25, 2008.

¹⁷¹ Genetics and Public Policy Center Web site. See <http://www.dnapolicy.org/>. Accessed on March 25, 2008.

¹⁷² CancerActionNow.org Web site. See <http://www.canceractionnow.org/>. Accessed on March 25, 2008.

¹⁷³ National Breast Cancer Coalition Web site. See <http://www.natlbcc.org/>. Accessed on March 25, 2008.

policy, and research issues prominently on the agendas of national policymakers and women's health care leaders.¹⁷⁴

A Comprehensive Map of Oversight

Figure 2–1 provides a comprehensive map of the current U.S. oversight system for genetic testing. The oversight system has evolved over several decades in response to many factors such as the extraordinary range of laboratory tests and services and a patchwork history of legislation and regulations. Figure 2–1 weaves together five main components that are important for the oversight of laboratory tests: R&D, FDA approval and clearance of tests, CLIA regulation of laboratories, CLIA-exempt State regulation of laboratories, and clinical availability and guidance in the use of genetic tests. Appendix C provides individual diagrams and explanations for each of these five components. Figure 2–1 also includes gaps in the oversight system, which are briefly summarized in Table 2–2. These gaps are discussed in more detail in subsequent chapters of this report.

¹⁷⁴ Ovarian Cancer National Alliance Web site. See <http://www.ovariancancer.org/>. Accessed on March 25, 2008.

Figure 2–1. Map of the U.S. Oversight System for Genetic Testing

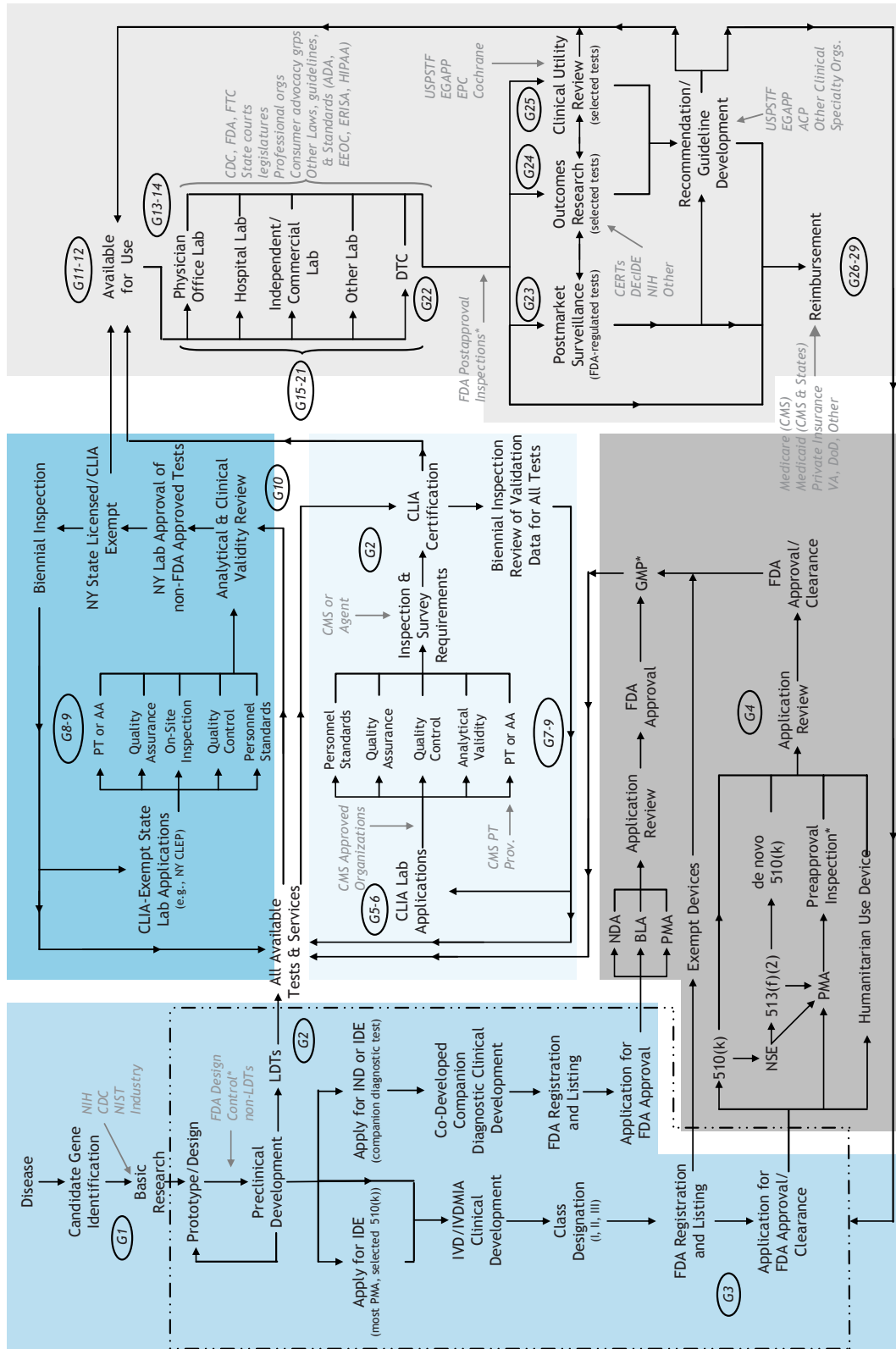

Table 2–2. Gaps in Genetic Testing Oversight

1.	Need for reference materials for assay, analyte, and platform validation
2.	No premarket review of many LDTs as FDA does not have sufficient resources to carry out such reviews for all tests if existing mechanisms are used
3.	No national mechanism for reporting faulty manufacture of in-house reagents if manufacturers are not required to be registered or list these products with FDA
4.	Inadequate resources for review of analytical validity and clinical validity for many tests; clinical validity data may not be available at the time tests are offered clinically
5.	Additional training needed for CLIA laboratory inspectors for genetic LDTs
6.	Analytical validity of laboratory tests is reviewed after tests are on the market, not before
7.	Inadequate PT requirements, as most analytes for genetic testing are not among the 83 CLIA-regulated analytes that require PT
8.	Insufficient resources, funding, and means to develop PT for all genetic tests
9.	No data exist on the effectiveness of PT versus alternative assessment
10.	Insufficient oversight of laboratories that offer certain types of tests such as lifestyle tests (e.g., testing for caffeine metabolism), which skirt the boundaries of CLIA regulations
11.	Federal research agency agendas are not tied directly to translation of genetic tests into clinical practice
12.	Inadequate information and transparency on the number and type of genetic tests used in clinical and public health practice
13.	Limited information about how practitioners order genetic tests
14.	Limited information on how practitioners interpret test results in context of related patient and family information
15.	Insufficient monitoring and enforcement of laws pertaining to false and misleading claims about genetic tests
16.	Deficiencies in knowledge of genetics among practitioners, public health workers, and consumers
17.	Lack of access to and insufficient number of providers with genetic expertise
18.	Lack of guidance for interpreting complex genomic tests
19.	Suboptimal means to communicate and implement testing guidelines at time of test ordering
20.	Lack of educational materials and other guidance to help patients and consumers use test results
21.	Ambiguity regarding regulation of clinical decision support systems, given changes in health care delivery and information technology
22.	Gaps in knowledge about the potential for direct-to-consumer (DTC) advertising and consumer-initiated testing to lead to adverse patient outcomes and costs
23.	Most LDTs are not subject to postmarket review or adverse event reporting
24.	Insufficient evidence on the impact of genetic testing on patient care and public health
25.	Insufficient evidence of clinical utility for most tests
26.	Insufficient cost-effectiveness and economic impact data for most tests
27.	Inadequate, outdated systems for coding, coverage, and payment for genetic tests and services
28.	Laboratory tests used only for screening purposes are not covered under Medicare unless Congress authorizes coverage for a specific test
29.	Potential for misuse of genetic information in insurance enrollment, premium-setting, and employment decisions

Overarching Recommendation

In keeping with his responsibility and commitment to protect and improve public health and as part of an effort to support the advancement of personalized health care, the HHS Secretary charged SACGHS to assess the adequacy of the U.S. system of oversight of genetic testing. After extensive factfinding, consultation, and analysis, the Committee found significant gaps in the U.S. system of oversight of genetic testing that can lead to harms. The Committee also identified novel opportunities that would enhance oversight. The Committee formulated recommendations that, if implemented and sufficiently supported, will close major gaps, enhance future oversight, help ensure public safety and health, and facilitate the realization of personalized health care. These steps are extraordinarily challenging, and they will require both swift action and sustained leadership by the Secretary and coordinated efforts at the highest level within HHS.

III. Genetic Testing Technologies and Responsibilities of Laboratory Personnel

As defined in this report, a genetic or genomic test involves an analysis of human chromosomes, deoxyribonucleic acid (DNA), ribonucleic acid (RNA), genes, and/or gene products (e.g., enzymes and other types of proteins) that is primarily used to detect heritable or somatic mutations, genotypes, or phenotypes related to disease and health. The purpose of genetic tests includes predicting risk of disease, screening newborns, directing clinical management, identifying carriers, and establishing prenatal or clinical diagnoses or prognoses in individuals, families, or populations. Excluded from the definition are tests conducted exclusively for forensic and identity purposes, and tests conducted purely for research. Also excluded are tests that are used primarily for other purposes but that may contribute to diagnosing a genetic disease or disorder (e.g., blood smears, certain serum chemistries). For example, cholesterol screening in the general population is not considered a genetic test, but it may reveal a genetic disorder such as an inherited form of hypercholesterolemia. Another example is immunohistochemistry staining of tissue for the purpose of identifying the p53 tumor suppressor protein with an increased half-life due to gene mutations, which is considered a genetic test. The same technique for detection of cytomegalovirus (CMV) antigens in tissue in order to diagnose CMV disease in transplant patients, however, is not regarded as a genetic test. Hemoglobin analysis to diagnose sickle cell disease or carrier status is a genetic test, but it is not regarded as genetic testing when used to detect modified hemoglobin that is associated with diabetes. Considering intended use helps define the types of laboratory techniques and procedures that are considered genetic tests.

Overview and History of Types of Genetic Tests

Genetic tests use biochemical, cytogenetic, and molecular methods or a combination of these methods to analyze DNA, RNA, chromosomes, proteins, and certain metabolites. The history of analyzing the genetic basis of health conditions spans more than a century. This history demonstrates that genetic tests evolve and expand with available technologies and advancing knowledge. Emerging technologies are providing increasingly detailed information about genetic variations, but interpretation of this information is becoming more complex and its significance in health is not always clear. (See Appendix D for additional resources related to genetic testing.)

Biochemical Tests

Biochemical tests do not directly evaluate DNA, but they measure products of genes such as enzymes and hormones. The history of the biochemical characterization of inherited disease begins with Archibald Garrod's 1901 description of "black urine disease" (alkaptonuria) and his 1908 lecture explaining its chemistry.¹⁷⁵ The clinical use of biochemical genetics was firmly established, in the form of newborn screening, in

¹⁷⁵ Watts, R.W. and Watts, R.A. (2006). Alkaptonuria: a 60-yr follow-up. *Rheumatology (Oxford)*. 46(2):358-359.

the 1960s with the introduction of the Guthrie test to detect phenylketonuria in newborns. In the ensuing decades, several assays that screened for hormone and enzyme deficiencies and hemoglobinopathies were added to the Guthrie test. Following the introduction of tandem mass spectrometry (MS/MS) technology in the late 1990s, newborn screening rapidly expanded. MS/MS enables screening for 30 or more metabolic disorders in a single analysis from one small disk of dried blood.¹⁷⁶ Biochemical tests are used after the newborn period for screening and diagnosis of inherited disorders, and they are also applied prenatally for the screening and diagnosis of metabolic disorders using specimens of amniotic fluid, maternal serum, or chorionic villi.¹⁷⁷

Cytogenetic Tests

Cytogenetic tests evaluate changes in the number or structure of chromosomes. The clinical cytogenetic era began with pioneers such as Theodore Boveri, who described polyploidy in human tumors in 1914.¹⁷⁸ Although several investigators studied human chromosomes in the first half of the last century, the medical use of cytogenetics did not begin to flourish until 1956, when the human chromosome count in diploid cells was established as 46. Prior to this period, the human chromosome number was thought to be 48. Technical improvements such as colchicine treatment to arrest cells during division and use of hypotonic solutions to swell cells and spread out their contents made it easier to visualize and count chromosomes. These improvements, along with the development of photomicroscopy to document chromosome content accurately, stimulated the use of cytogenetics in a clinical setting.

By the end of the 1950s, numerical chromosome abnormalities had been reported in patients with Down,¹⁷⁹ Turner,¹⁸⁰ and Klinefelter¹⁸¹ syndromes and in XXX females.¹⁸² In 1960, Nowell and Hungerford described the Philadelphia chromosome in patients with chronic granulocytic leukemia,¹⁸³ the first report of a structural chromosomal change associated with human cancer (although at the time it was reported as a chromosomal deletion instead of a translocation¹⁸⁴). In 1966, Steele and Breg reported a method, still widely used today, to analyze the chromosome content of fetal cells cultured from amniotic fluid.¹⁸⁵ The field of medical cytogenetics was greatly advanced in the early 1970s with the introduction of chromosome banding,¹⁸⁶ a

¹⁷⁶ Chace, D.H., Kalas, T.A., and Naylor, E.W. (2003). Use of tandem mass spectrometry for multianalyte screening of dried blood specimens from newborns. *Clinical Chemistry*. 49(11):1797-1817.

¹⁷⁷ Cavicchi, C., Donati, M.A., Funghini, S., la Marca, G., Malvagia, S., Ciani, F., Poggi, G.M., Pasquini, E., Zammarchi, E., and Morrone, A. (2006). Genetic and biochemical approach to early prenatal diagnosis in a family with mut methylmalonic aciduria. *Clinical Genetics*. 69(1):72-76.

¹⁷⁸ Pearson, P.L. (2006). Historical development of analysing large-scale changes in the human genome. *Cytogenetic and Genome Research*. 115(3-4):198-204.

¹⁷⁹ Lejeune, J., Gautier, M., and Turpin, R. (1959). Etude des chromosomes somatiques de neuf enfant mongoliens. *Comptes Rendus Hebdomadaires des Séances de l'Académie des Sciences*. 248(11):1721-1722.

¹⁸⁰ Ford, C.E., Jones, K.W., Polani, P.E., De Almeida, J.C., and Briggs, J.H. (1959). A sex-chromosome anomaly in a case of gonadal dysgenesis (Turner's syndrome). *Lancet*. 1(7075):711-713.

¹⁸¹ Jacobs, P.A. and Strong, J.A. (1959). A case of human intersexuality having a possible XXY sex-determining mechanism. *Nature*. 183(4657):302-303.

¹⁸² Jacobs, P.A., Baikie, A.G., Brown, W.M., MacGregor, T.N., MacLean, N., and Harnden, D.G. (1959). Evidence for the existence of the human "super female." *Lancet*. 2(7100):423-425.

¹⁸³ Nowell, P. and Hungerford, D. (1960). A minute chromosome in human chronic granulocytic leukemia. *Science*. 132:1497-1501.

¹⁸⁴ Gartler, S.M. (2006). The chromosome number in humans: a brief history. *Nature Reviews Genetics*. 7(8):655-660.

¹⁸⁵ Steele, M.W. and Breg, W.R., Jr. (1966). Chromosome analysis of human amniotic-fluid cells. *Lancet*. 1(7434):383-385.

¹⁸⁶ Caspersson, T., Zech, L., and Johansson, C. (1970). Differential banding of alkylating fluorochromes in human chromosomes. *Experimental Cell Research*. 60(3):315-319.

chemical treatment that produces differentially stained regions on chromosomes. Banding provided a means to identify individual chromosomes and their subregions and to describe chromosome rearrangements, inversions, duplications, and/or deletions as etiologies for numerous syndromes. By the mid-1970s high-resolution banding techniques emerged that improved the resolution from 500 bands to more than 1,000 bands per karyotype.¹⁸⁷ High-resolution banding facilitated the detection of subtle duplications and deletions and the identification of contiguous gene syndromes, such as Prader-Willi syndrome and velocardiofacial syndrome.

Today, even with numerous technological advances, cytogenetics is often the first tier of genetic testing for assessment of a child with multiple congenital abnormalities and/or developmental delay, prenatal detection of chromosome anomalies, detection of mosaicism, or evaluation of a cancerous tumor.¹⁸⁸

Molecular Tests

Molecular genetic tests evaluate DNA or RNA for alterations such as nucleotide substitutions, deletions, or insertions or for changes in the amount of DNA. Quantitative measurements of DNA began in the 1930s with Caspersson's pioneering work using ultraviolet absorption methods. In the 1960s, techniques emerged that quantified DNA by measuring fluorescence of a DNA-specific stain instead of stain absorbance. In the late 1970s, quantification by fluorescence was integrated into flow cytometry methodologies. For flow cytometry, nuclei in suspension are stained with a DNA-specific fluorochrome, and their fluorescence is measured against a known standard by passing the stained nuclei through the path of a laser of a specific wavelength.¹⁸⁹ Flow cytometry is useful for detecting abnormal DNA content, particularly in tumor cells.¹⁹⁰ In the 1990s, image analysis densitometry technology began to emerge and has been shown to be particularly useful for DNA quantification for cancer diagnosis and prognosis.^{191, 192}

The 1970s brought two pioneering discoveries that have become ubiquitous tools in molecular genetic testing—restriction enzyme digestion and hybridization. Restriction enzymes cut DNA at sequence-specific sites, called restriction sites, which generates specific and reproducible DNA fragments (restriction fragments). In 1970, Smith and Wilcox demonstrated that the restriction enzyme endonuclease R cleaved the bacteriophage T7 to produce specific fragments of DNA,¹⁹³ and Kelly and Smith determined the restriction site recognized by this enzyme.¹⁹⁴ A year later, Danna and Nathans reported that endonuclease R cleaved simian virus 40 to produce specific fragments of DNA that could be separated from one another by

¹⁸⁷ Yunis, J.J. (1976). High resolution of human chromosomes. *Science*. 191(4233):1268-1270.

¹⁸⁸ Constantin, C.M., Faucett, A., and Lubin, I.M. (2005). A primer on genetic testing. *Journal of Midwifery and Women's Health*. 50(3):197-204.

¹⁸⁹ Hardie, D.C., Gregory, T.R., and Hebert, P.D. (2002). From pixels to picograms: a beginners' guide to genome quantification by Feulgen image analysis densitometry. *Journal of Histochemistry and Cytochemistry*. 50(6):735-749.

¹⁹⁰ Pearson, P.L. (2006). Historical development of analysing large-scale changes in the human genome. *Cytogenetic and Genome Research*. 115(3-4):198-204.

¹⁹¹ Bertino, B., Knape, W.A., Pylinska, M., Strauss, K., and Hammou, J.C. (1994). A comparative study of DNA content as measured by flow cytometry and image analysis in 1864 specimens. *Analytic Cellular Pathology*. 6(4):377-394.

¹⁹² Borgiani, L., Cogorno, P., Toso, F., Gallo, L. Buccaran, G., Rovida, S., and Canepa, M. (1994). Comparative DNA analysis of breast cancer by flow cytometry and image analysis. *Pathologica*. 86(4):356-359.

¹⁹³ Smith, H.O. and Wilcox, K.W. (1970). A restriction enzyme from *Hemophilus influenzae*. I. Purification and general properties. *Journal of Molecular Biology*. 51(2):379-391.

¹⁹⁴ Kelly, T.J., Jr. and Smith, H.O. (1970). A restriction enzyme from *Hemophilus influenzae*. II. *Journal of Molecular Biology*. 51(2):393-409.

electrophoresis.¹⁹⁵ Danna and Nathans foresaw several potential applications of restriction enzymes, such as mapping genes, DNA sequencing, detection of mutations, and DNA fingerprinting for forensic purposes.¹⁹⁶ By the mid-1970s restriction enzymes were an integral element in recombinant DNA technology. The use of restriction enzymes can be applied clinically to detect certain disease-related mutations, such as the genetic variation that causes sickle cell anemia, as these mutations alter a restriction site and the pattern of restriction fragments when separated by electrophoresis.

As predicted by Danna and Nathans, restriction enzymes also became important reagents in DNA sequencing. In 1977, reports of two different methods of DNA sequencing were published, although both methods used restriction enzymes to generate fragments of DNA for sequencing. The Maxam and Gilbert method¹⁹⁷ used restriction fragments labeled at one end with a radioisotope (³²P) and particular chemicals that broke the DNA chain at adenine-, guanine-, cytosine-, or thymine-specific sites. This base-specific cleavage produced a set of radioactive fragments that were separated by electrophoresis, and the sequence could be read from the pattern of bands. The Sanger method¹⁹⁸ used restriction fragments as primers for newly synthesized DNA. The restriction fragments were mixed with DNA polymerase, radiolabeled deoxyribonucleoside triphosphate (e.g., ³²PdATP), and inhibitors (dideoxy bases) that terminated the newly synthesized DNA chain at specific residues (i.e., adenine, guanine, cytosine, or thymine). This method produced DNA chains of varying lengths that were separated by electrophoresis, and the sequence could be determined from the pattern of bands. The Sanger method is the basis of current automated sequencing techniques. DNA sequencing is used to identify gene mutations in numerous disorders.

Hybridization was in its infancy in the early 1970s but had matured by the 1980s and was integrated into clinical use by the 1990s. Hybridization involves the interaction of complementary nucleic acid strands, which can occur between two strands of DNA or between DNA and RNA strands. The sequence of one strand is labeled, usually with a fluorescent tag, and is called the probe. The complementary strand is called the target. Hybridization is the basis of many molecular techniques, such as Southern blot, a technique that separates DNA fragments by electrophoresis and transfers the fragments to a nylon or nitrocellulose membrane for enhanced visualization. Used clinically, target DNA from a patient is hybridized to a matching probe to detect point mutations, microdeletions, or other types of genetic changes such as inversions. For example, hybridization can be used to detect an inversion in the *F8* gene, which causes hemophilia A.¹⁹⁹

Molecular testing was further revolutionized in the 1980s by the advent of DNA amplification. This involves repeated cycles of copying a DNA sequence of interest through a technique called polymerase chain reaction (PCR) to generate millions of copies of that particular sequence. In a short time, PCR became a fundamental tool with many applications, such as detecting the presence or absence of a sequence or to measure its size. For example, using PCR for DNA sequences specific to the Y chromosome can confirm or rule out the presence of XY cells in females with Turner syndrome, as such cells in the gonads can become

¹⁹⁵ Danna, K. and Nathans, D. (1971). Specific cleavage of simian virus 40 DNA by restriction endonuclease of *Hemophilus influenzae*. *Proceedings of the National Academy of Sciences of the United States of America*. 68(12):2913-2917.

¹⁹⁶ Roberts, R.J. (2005). How restriction enzymes became the workhorses of molecular biology. *Proceedings of the National Academy of Sciences of the United States of America*. 102(17):5905-5908.

¹⁹⁷ Maxam, A.M. and Gilbert, W. (1977). A new method for sequencing DNA. *Proceedings of the National Academy of Sciences of the United States of America*. 74(2):560-564.

¹⁹⁸ Sanger, F., Nicklen, S., and Coulson, A.R. (1977). DNA sequencing with chain-terminating inhibitors. *Proceedings of the National Academy of Sciences of the United States of America*. 74(12):5463-5467.

¹⁹⁹ Goodeve, A.C., Preston, F.E., and Peake, I.R. (1994). Factor VIII gene rearrangements in patients with severe haemophilia A. *Lancet*. 343(8893):329-330.

malignant.²⁰⁰ Quantitative fluorescence PCR allows detection of common aneuploidies—such as trisomy 13, 18, and 21, and those involving the sex chromosomes—within 1 or 2 days. This short timeframe for analysis is especially attractive for prenatal diagnosis.²⁰¹

Numerous methods for amplifying targets to detect nucleic acids are now available, and all have advantages and disadvantages. A unified approach to amplification and detection is emerging. A large number of commercial and laboratory-developed tests combine amplification with detection in the form of real-time PCR technology utilizing hybridization or hydrolysis probe approaches. These technologies allow not only the detection and quantitation of nucleic acids with exquisite sensitivity and specificity but also the identification of specific nucleic acid sequences for the purpose of genotyping.

Completion of the Human Genome Project (HGP) in 2003²⁰² shifted molecular analysis from single-gene alterations to a simultaneous examination of large numbers of DNA and RNA sequences. In the post-HGP era, many laboratory methods rely on the essential technologies of amplification and hybridization discussed above.

A large number of hybridization tests performed simultaneously forms the basis of microarray technology. Microarrays, which were first introduced in the 1990s, consist of hundreds to thousands of different DNA probes anchored to a solid support such as glass slides, silicon chips, nylon membranes, or beads. Genomic microarrays are gradually being applied to clinical genetics. One type of microarray uses sequence variations known as single nucleotide polymorphisms (SNPs). Polymorphisms are natural DNA sequence variations that occur in more than 1 percent of a population. SNPs are estimated to affect 1 in 300 nucleotides in the human genome²⁰³ and serve as fingerprints of our genome. SNP microarrays show great promise in identifying individuals with variations that affect drug efficacy. For example, a microarray known as the AmpliChip[®] P450 can identify 29 polymorphisms in the *CYP2D6* gene and two polymorphisms in the *CYP2C19* gene. These genes play a role in the metabolism of approximately 25 percent of prescription drugs.²⁰⁴ This type of testing could potentially help physicians select appropriate drugs for their patients and adjust dosage based on test outcomes.

Combined Technologies

With the development of new technologies, combined methodologies such as molecular cytogenetics have emerged. Molecular cytogenetics is a type of genetic test in which molecular techniques are combined with classical cytogenetics. For example, a technique called fluorescence *in situ* hybridization (FISH) uses fluorescently labeled DNA probes applied to chromosome preparations.²⁰⁵ By the mid-1990s FISH was providing an accurate means for detecting microdeletions and microduplications, cryptic rearrangements,

²⁰⁰ Brant, W.O., Rajimwale, A., Lovell, M.A., Travers, S.H., Furness, P.D., 3rd, Sorensen, M., Oottamasathien, S. and Koyle, M.A. (2006). Gonadoblastoma and Turner syndrome. *Journal of Urology*. 175(5):1858-1860.

²⁰¹ Shaffer, L.G. and Bui, T.H. (2007). Molecular cytogenetic and rapid aneuploidy detection methods in prenatal diagnosis. *American Journal of Medical Genetics Part C (Seminars in Medical Genetics)*. 145(1):87-98.

²⁰² Collins, F.S., Green, E.D., Guttmacher, A.E., and Guyer, M.S. (2003). A vision for the future of genomics research. *Nature*. 422(6934):835-847.

²⁰³ Anderson, J.E., Hansen, L.L., Mooren, F.C., Post, M., Hug, H., Zuse, A., and Los, M. (2006). Methods and biomarkers for the diagnosis and prognosis of cancer and other diseases: Towards personalized medicine. *Drug Resistance Updates*. 9(4-5):198-210.

²⁰⁴ Ragoussis, J. and Elvidge, G. (2006). Affymetrix GeneChip[®] system: moving from research to the clinic. *Expert Review of Molecular Diagnostics*. 6(2):145-152.

²⁰⁵ Constantin, C.M., Faucett, A., and Lubin, I.M. (2005). A primer on genetic testing. *Journal of Midwifery and Women's Health*. 50(3):197-204.

and marker chromosomes.²⁰⁶ Improved resolution is an important advancement in the development of FISH assays. Resolution improved from about 5 megabases (Mb) for whole chromosomes in metaphase spreads to 50 kilobases (kb)–2 Mb for interphase nuclei and was later refined to 5 kb–500 kb for chromatin strands using fiber FISH. Labeling strategies that allowed the simultaneous visualization of all 24 human chromosomes, each in a different color, was another advancement. Specific technologies that use these strategies are multiplex-FISH, spectral karyotyping, and combined binary ratio labeling.²⁰⁷

Comparative genome hybridization (CGH) is another means to evaluate chromosome abnormalities. CGH is particularly useful for characterizing tumors with complex rearrangements, and it is also used to identify the loss or gain of critical genetic regions involved in microdeletion/microduplication syndromes as well as subtelomeric regions associated with developmental delay.²⁰⁸ CGH is not well suited, however, for balanced genetic alterations such as inversions or balanced translocations or for the detection of low-level mosaicism. Array CGH emerged in the late 1990s.^{209, 210} Instead of hybridizing a labeled probe to metaphase chromosomes, thousands of well-characterized probes, representing entire chromosomes or genomes, are affixed in an ordered manner onto a solid surface such as a glass slide to form a genetic array. DNA from a patient is fragmented, labeled in a certain color, mixed with the same amount of reference DNA (labeled in a different color), and hybridized to the DNA probes on the array.²¹¹ DNA that does not hybridize is washed off, and the ratio of patient to reference DNA is analyzed to detect gains or losses of DNA sequences.²¹²

Requirements for Laboratory Personnel

Most genetic testing is performed in a laboratory that does high-complexity testing and as such must meet Federal regulations for laboratory personnel.²¹³ (Several States also have State laboratory licensure laws.) For example, Federal regulations require that the laboratory director for high-complexity testing must be a doctor of medicine (M.D.), doctor of osteopathy (D.O.), or doctor of podiatry (D.P.M.) currently licensed to practice in the State in which the laboratory is located or must have a doctoral degree (Ph.D.) in a chemical, physical, biological, or clinical laboratory science. All Ph.D. laboratory directors must also be board-certified (e.g., certified in clinical molecular genetics by the American Board of Medical Genetics). Laboratory directors may also be pathologists who are certified in clinical or anatomic pathology by the American Board of Pathology, and all directors must have experience and training in a high-complexity

²⁰⁶ Pearson, P.L. (2006). Historical development of analysing large-scale changes in the human genome. *Cytogenetic and Genome Research*. 115(3-4):198-204.

²⁰⁷ Speicher, M.R. and Carter, N.P. (2005). The new cytogenetics: blurring the boundaries with molecular biology. *Nature Reviews Genetics*. 6(10):782-792.

²⁰⁸ Dave, B.J. and Sanger, W.G. (2007). Role of cytogenetics and molecular cytogenetics in the diagnosis of genetic imbalances. *Seminars in Pediatric Neurology*. 14(1):2-6.

²⁰⁹ Solinas-Toldo, S., Lampel, S., Stilgenbauer, S., Nickolenko, J, Benner, A., Döhner, H., Cremer, T., and Lichter, P. (1997). Matrix-based comparative genomic hybridization: biochips to screen for genomic imbalances. *Genes Chromosomes Cancer*. 20(4):399-407.

²¹⁰ Pinkel, D., Seagraves, R., Sudar, D., Clark, S., Poole, I., Kowbel, D., Collins, C., Kuo, W.L., Chen, C., Zhai, Y., Dairkee, S.H., Ljung, B.M., Gray, J.W., and Albertson, D.G. (1998). High resolution analysis of DNA copy number variation using comparative genomic hybridization to microarrays. *Nature Genetics*. 20(2):207-211.

²¹¹ Smeets, D.F.C.M. (2004). Historical prospective of human cytogenetics: from microscope to microarray. *Clinical Biochemistry*. 37(6):439-446.

²¹² Speicher, M.R. and Carter, N.P. (2005). The new cytogenetics: blurring the boundaries with molecular biology. *Nature Reviews Genetics*. 6(10):782-792.

²¹³ Centers for Disease Control and Prevention Web site. “Clinical Laboratory Improvement Amendments (CLIA), Subpart M—Personnel for Nonwaived Testing.” See http://wwwn.cdc.gov/clia/regs/subpart_m.aspx. Accessed on March 28, 2008.

testing laboratory. The laboratory director is responsible for the overall operation and administration of the laboratory, including employing personnel who are competent to perform test procedures; recording and reporting test results promptly, accurately, and proficiently; and ensuring compliance with all applicable regulations. The regulations for laboratory personnel provide a detailed explanation of the qualification and responsibilities for the laboratory director.²¹⁴

Laboratories that perform high-complexity testing also have a technical supervisor, clinical consultant, general supervisor, and testing personnel. If qualified, the laboratory director may also perform the duties required by these positions. The qualifications of the technical supervisor are similar to the laboratory director; the technical supervisor must be a currently licensed doctor or have a doctoral degree in a biological science and must have proper training and relevant experience to provide technical services. The technical supervisor's duties include selecting the test methodology that is appropriate for the clinical use of the test results; establishing a quality control program appropriate for the testing performed, including enrollment and participation in proficiency testing; resolving technical problems; and evaluating the competency of the laboratory staff. Federal regulations provide a detailed list of the technical supervisor's qualifications and responsibilities.²¹⁵

Laboratories that perform high-complexity testing must also have a clinical consultant who can discuss with the laboratory's clients the appropriateness of the test(s) ordered, the interpretation of the test results, and the diagnosis, treatment, and management of patient care. The clinical consultant must be qualified as a laboratory director or be an M.D., D.O., or D.P.M. currently licensed to practice in the State in which the laboratory is located. Laboratories performing high-complexity testing must also have one or more general supervisors who provide day-to-day supervision of testing personnel and reporting of test results. Testing personnel for high-complexity testing are responsible for specimen processing, test performance, and reporting test results. Each individual performs only those high-complexity tests that are authorized by the laboratory director and are commensurate with the individual's education, training or experience, and technical abilities. Federal regulations provide a detailed list of qualifications and responsibilities for the clinical consultant,²¹⁶ general supervisor,²¹⁷ and testing personnel.²¹⁸

²¹⁴ Centers for Disease Control and Prevention Web site. "Clinical Laboratory Improvement Amendments (CLIA), Subpart M—Personnel for Nonwaived Testing: Standard, Laboratories performing high complexity testing; laboratory director." See http://wwwn.cdc.gov/clia/regs/subpart_m.aspx#493.1441. Accessed on March 28, 2008.

²¹⁵ Centers for Disease Control and Prevention Web site. "Clinical Laboratory Improvement Amendments (CLIA), Subpart M—Personnel for Nonwaived Testing: Standard, Laboratories performing high complexity testing; technical supervisor." See http://wwwn.cdc.gov/clia/regs/subpart_m.aspx#493.1447. Accessed on March 28, 2008.

²¹⁶ Centers for Disease Control and Prevention Web site. "Clinical Laboratory Improvement Amendments (CLIA), Subpart M—Personnel for Nonwaived Testing: Standard, Laboratories performing high complexity testing; clinical consultant." See http://wwwn.cdc.gov/clia/regs/subpart_m.aspx#493.1453. Accessed on March 28, 2008.

²¹⁷ Centers for Disease Control and Prevention Web site. "Clinical Laboratory Improvement Amendments (CLIA), Subpart M—Personnel for Nonwaived Testing: Standard, Laboratories performing high complexity testing; general supervisor." See http://wwwn.cdc.gov/clia/regs/subpart_m.aspx#493.1459. Accessed on March 28, 2008.

²¹⁸ Centers for Disease Control and Prevention Web site. "Clinical Laboratory Improvement Amendments (CLIA), Subpart M—Personnel for Nonwaived Testing: Standard, Laboratories performing high complexity testing; testing personnel." See http://wwwn.cdc.gov/clia/regs/subpart_m.aspx#493.1487. Accessed on March 28, 2008.

Future Trends

New genetic testing technologies are rapidly emerging. While current genetic tests may be applicable to about 2 percent of the general population, genetic testing in development promises future applicability to more than 60 percent of the population.²¹⁹ Advancing knowledge of the human genome, coupled with rapidly evolving technologies, is leading to new opportunities to assess common, multifactorial disorders such as heart disease, diabetes, asthma, and mental illness, which likely involve multiple genes and environmental factors. One such opportunity is genome-wide association studies, which analyze a large set of SNPs across the genome (in some studies, 500,000 to 1 million SNPs) to identify genetic variants that influence health and disease. Additionally, emerging technologies will help decipher complex phenomena such as gene-gene interactions; epigenetic effects, which are heritable changes in gene function that do not alter the DNA sequence (e.g., DNA methylation); copy number variations that involve the gain or loss of large segments of DNA (ranging in size from thousands to millions of DNA bases); and the influence of environmental factors such as diet and exposure to exogenous substances (e.g., allergens, toxic chemicals) on gene expression.

Protein and antibody microarrays, which allow the simultaneous evaluation of multiple sets of proteins, show potential for improving diagnosis, prognosis, and management of a variety of diseases including cancer, cardiovascular disease, vision disorders, and neurological disease.²²⁰ Recently developed array technologies allow multiplex protein analyses using a planar or bead-based approach. Planar microarrays involve a two-dimensional surface such as a glass slide or microchip that has defined reaction loci for individual analyses. For example, an antibody microarray test, which measures the expression levels of three proteins associated with angiogenesis, invasion, and metastasis of tumors, has been developed for the diagnosis of breast cancer.²²¹ Multiplex bead-based microarrays, also called liquid arrays, employ suspensions of microsphere sets in which each set represents an individual analytical test. This approach has been used to identify disease-specific profiles for vitreoretinal disorders based on the analysis of cellular mediators such as cytokines, chemokines, and growth factors.²²²

Another application of protein microarrays is to characterize the effect of gene alterations on the function of the resulting protein. For example, microarray technology can be used to quantify the effect of cancer-associated mutations and polymorphisms in the *TP53* gene on the DNA-binding function of the p53 oncoprotein.²²³ Microarrays that use small nucleic acid molecules called aptamers, which specifically bind proteins, have been developed for protein detection. Aptamers, due to their stability and binding specificity, hold great promise for the development of new classes of protein arrays for the combined detection of protein and nucleic acids.²²⁴

²¹⁹ Tsongalis, G.J. (2006). Genetic testing: current and future trends. *Medical Laboratory Observer*. 38(10):42, 44.

²²⁰ Ling, M.M., Ricks, C., and Lea, P. (2007). Multiplexing molecular diagnostics and immunoassays using emerging microarray technologies. *Expert Review of Molecular Diagnostics*. 7(1):87-98.

²²¹ Weissenstein, U., Schneider, M.J., Pawlak, M., Cicenias, J., Eppenberger-Castori, S., Oroszlan, P., Ehret, S., Geurts-Moespot, A., Sweep, F.C., and Eppenberger, U. (2006). Protein chip based miniaturized assay for the simultaneous quantitative monitoring of cancer biomarkers in tissue extracts. *Proteomics*. 6(5):1427-1436.

²²² Banerjee, A., Savant, V., Scott, R.A., Curnow, S.J., Wallace, G.R., and Murray, P.I. (2007). Multiplex bead analysis of vitreous humor of patients with vitreoretinal disorders. *Investigative Ophthalmology and Visual Science*. 48(5):2203-2207.

²²³ Boutell, J.M., Hart, D.J., Godber, B.L., Kozlowski, R.Z., and Blackburn, J.M. (2004). Functional protein microarrays for parallel characterisation of p53 mutants. *Proteomics*. 4(7):1950-1958.

²²⁴ Angenendt, P. (2005). Progress in protein and antibody microarray technology. *Drug Discovery Today*. 10(7):503-511.

Small RNA molecules, known as microRNAs, are also likely to play a role in genetic testing, particularly as a tool to classify cancers²²⁵ and provide information about cancer progression and response to treatment.²²⁶ MicroRNAs are short segments of RNA (about 20 nucleotides) that do not encode proteins but instead play a role in regulating gene expression. MicroRNAs attach to certain sites on messenger RNA, which blocks the production of proteins. It is estimated that one-third of human protein-encoding genes are regulated by microRNAs.²²⁷ MicroRNAs also play a role in controlling the replication and latency of viruses such as HIV.^{228, 229}

Research studies have shown that levels of particular microRNAs can be used to differentiate between normal and cancerous tissues and also to help determine the stage of the cancer. For example, Bloomston et al.²³⁰ compared expression patterns of microRNAs in pancreatic cancer to those of normal pancreas and chronic pancreatitis. They found that pancreatic cancer may have a distinct microRNA expression pattern. Their findings also suggested that microRNAs expression patterns may be able to distinguish between long- and short-term survivors. Research by Shell et al.²³¹ indicates that levels of the microRNA let-7 could be used as a predictor of cancer progression. In the cells they studied, let-7 reduced the expression of the *HMGA2* gene, which is typically overexpressed in cancer cells. Cells from benign ovarian tumors had high levels of let-7 and low levels of *HMGA2* expression compared with tumor cells from advanced ovarian cancers. Levels of let-7 and *HMGA2* were better predictors of ovarian cancer prognosis than established markers such as vimentin and E-cadherin. Research evidence indicates that let-7 also acts as a tumor suppressor in other types of cancer such as lung cancer.²³² A test for let-7 levels is not available for clinical use, but the technology is rapidly advancing.²³³

Important advances have also been made in the area of instrument automation. High throughput, accuracy, speed, and flexibility are the main reasons for the interest in these automated instruments. The introduction of fully automated platforms will allow more laboratories to implement genetic testing because the need for specialized technical training will be minimized. Until recently, the clinical application of nucleic acid-based technology has been restricted to high-complexity laboratories with specialized staff trained to design

²²⁵ Lu, J., Getz, G., Miska, E.A., Alvarez-Saavedra, E., Lamb, J., Peck, D., Sweet-Cordero, A., Ebert, B.L., Mak, R.H., Ferrando, A.A., Downing, J.R., Jacks, T., Horvitz, H.R., and Golub, T.R. (2005). MicroRNA expression profiles classify human cancers. *Nature*. 435(7043):834-838.

²²⁶ Calin, G.A. and Croce, C.M. (2006). MicroRNA signatures in human cancers. *Nature Reviews Cancer*. 6(11):857-866.

²²⁷ Mattick, J.S. and Makunin, I.V. (2006). Non-coding RNA. *Human Molecular Genetics*. 15 Spec No 1:R17-R29.

²²⁸ Huang, J., Wang, F., Argyris, E., Chen, K., Liang, Z., Tian, H., Huang, W., Squires, K., Verlinghieri, G., and Zhang, H. (2007). Cellular microRNAs contribute to HIV-1 latency in resting primary CD4+ T lymphocytes. *Nature Medicine*. 13(10):1241-1247.

²²⁹ Triboulet, R., Mari, B., Lin, Y.L., Chable-Bessia, C., Bennasser, Y., Lebrigand, K., Cardinaud, B., Maurin, T., Barbry, P., Baillat, V., Reynes, J., Corbeau, P., Jeang, K.T, and Benkirane, M. (2007). Suppression of microRNA-silencing pathway by HIV-1 during virus replication. *Science*. 315(5818):1579-1582.

²³⁰ Bloomston, M., Frankel, W.L., Petrocca, F., Volinia, S., Alder, H., Hagan, J.P., Liu, C.G., Bhatt, D., Taccioli, C., and Croce, C.M. (2007). MicroRNA expression patterns to differentiate pancreatic adenocarcinoma from normal pancreas and chronic pancreatitis. *Journal of the American Medical Association*. 297(17):1901-1908.

²³¹ Shell, S., Park, S.M., Radjabi, A.R., Schickel, R., Kistner, E.O., Jewell, D.A., Feig, C., Lengyel, E., and Peter, M.E. (2007). Let-7 expression defines two differentiation stages of cancer. *Proceedings of the National Academy of Sciences*. 104(27):11400-11405.

²³² Yanaihara, N., Caplen, N., Bowman, E., Seike, M., Kumamoto, K., Yi, M., Stephens, R.M., Okamoto, A., Yokota, J., Tanaka, T., Calin, G.A., Liu, C.G., Croce, C.M., and Harris, C.C. (2006). Unique microRNA profiles in lung cancer diagnosis and prognosis. *Cancer Cell*. 9(3):189-198.

²³³ The University of Chicago Medical Center Press Release, "New Genetic Marker Characterizes Aggressiveness of Cancer Cells." See <http://www.uchospitals.edu/news/2007/20070625-let-7.html>. Accessed on March 28, 2008.

and run these assays. In 2006, however, self-contained, fully automated products were developed,²³⁴ which could make nucleic acid analysis available to moderate-complexity laboratories in physician offices and clinical settings.

In addition to automation, the future of genetic testing will likely embrace improvements in nanotechnology, the science of building devices that uses small particles such as individual atoms, molecules, viruses, or cells and that merges biology with information technology. Nanotechnology promises to affect the clinical laboratory industry through the development of miniaturized components and devices for chemical processing and measuring sensors along with devices that use extremely small amounts of expensive materials. This technology could prove to be extremely useful in the movement toward small, versatile, reasonably priced point-of-care tests.²³⁵

As current advances in sequencing become more widely available, with increased speed and decreased cost, it is likely that sequence-based approaches for the analysis of chromosome arrangements will become more important and widely used. Genome-wide analysis of DNA methylation and histone acetylation, in addition to copy number changes, will become an integral part of genetics.²³⁶

Continued refinement in the application of existing technologies and the introduction of novel methodologies, along with an advanced understanding of the human genome, will expand the genetic diagnostic toolbox available to health care providers, patients, and in some cases the general U.S. population seeking better health care choices. Genetic testing is also a key element in personalized medicine. If wisely developed and used, genetic testing has the potential to shift the U.S. health care paradigm from reactive to proactive or preventive. This shift will pose significant challenges, such as ensuring valid testing procedures and educating the lay public, health care providers, third-party payers, and policymakers about the optimal use of genetic technologies.

²³⁴ Jobbagy, Z., van Atta, R., Murphy, K.M., Eshleman, J.R., and Gocke, C.D. (2007). Evaluation of Cepheid GeneXpert BCR-ABL assay. *Journal of Molecular Diagnostics*. 9(2):220-227.

²³⁵ Gau, V. and Wong, D. (2007). Oral fluid nanosensor test (OFNASET) with advanced electrochemical-based molecular analysis platform. *Annals of the New York Academy of Sciences*. 1098:401-410.

²³⁶ Speicher, M.R. and Carter, N.P. (2005). The new cytogenetics: blurring the boundaries with molecular biology. *Nature Reviews Genetics*. 6(10): 782-792.

IV. Analytical Validity, Proficiency Testing, and Clinical Validity

This chapter describes key elements of genetic tests—analytical validity and clinical validity, as well as proficiency testing (PT), which is an important component of quality assurance (QA) programs. In addition, it explains various elements in the current oversight framework designed to ensure that genetic tests are analytically and clinically validated prior to use in patient health care. The chapter concludes with a discussion of the gaps in this framework and makes recommendations that might help close those gaps. The following questions in the charge of the Secretary of the U.S. Department of Health and Human Services (HHS) are addressed in this chapter:

- What evidence of harm exists regarding genetic tests? Is that harm attributable to the analytical validity or clinical validity of the tests? If evidence does not exist, what threats are not currently being addressed?
- What are the existing pathways that examine the analytical validity and clinical validity of genetic tests?
- What organizations are currently involved with each of these aspects, and what are they doing to address these issues? Who should be responsible for each of these aspects?
- What resources (e.g., standard reagents/materials) are needed to develop PT kits or protocols for genetic tests? What is currently available in terms of PT kits or protocols for genetic tests? What information is provided by PT? Is the current level of PT for genetic tests adequate and are the results of laboratory performance assessments sufficiently transparent?
- What new approaches or models should be considered for private and public-private sector engagement in demonstrating clinical validity for developing effectiveness measures of genetic tests in clinical practice?
- Would additional or revised Government oversight add value for patients, and if so, how and where?

Ensuring analytical and clinical validity is paramount for genetic testing because predictive and susceptibility genetic testing is often performed on asymptomatic persons and the interpretation of results may not be supported by other findings. Moreover, genetic testing for a particular heritable condition or disorder is typically performed once and not repeated or confirmed.

Background²³⁷

Like all other laboratories that test human specimens for the purpose of assessing health, diagnosis, and treatment, genetic testing laboratories are regulated by the 1988 Clinical Laboratory Improvement Amendments (CLIA).²³⁸ The implementation of CLIA requirements is overseen by the Centers for Medicare

²³⁷ The 2006 U.S. Government Accountability Office report, *Clinical Lab Quality: CMS and Survey Organization Oversight Should be Strengthened*, provides an excellent overview of how clinical laboratories are regulated. See <http://www.gao.gov/new.items/d06416.pdf>. Accessed on March 29, 2008.

²³⁸ Centers for Medicare & Medicaid Services Web site, “Clinical Laboratory Improvement Amendments (CLIA).” See <http://www.cms.gov/clia/>. Accessed on March 29, 2008.

& Medicaid Services (CMS). Genetic testing laboratories must undergo inspections (also called surveys) every 2 years to assess their compliance with CLIA quality requirements such as personnel qualifications and responsibilities, quality control (QC) standards, PT, QA, and record keeping. Laboratories have a choice of becoming CLIA certified by an agency in their State department of health that is under contract with CMS to conduct inspections or by one of six private accrediting organizations²³⁹ approved by CMS as having standards equivalent to CLIA. Forty-eight State agencies use CLIA requirements for their surveys; New York and Washington operate State laboratory certification programs that have CLIA-exempt status because they are considered by CMS to be equal to or more stringent than CLIA requirements. Therefore, New York and Washington States and the six private accrediting organizations use their own requirements, which have been approved by CMS, to survey laboratories. In addition to the biennial surveys, laboratories must participate in PT three times a year. If PT is unavailable, laboratories must perform a different type of assessment called an alternative assessment (AA).²⁴⁰ (PT and AA are discussed in more detail later in this chapter.)

Under CLIA, deficiencies that are identified during CMS surveys are classified as “standard-level” or “condition-level.” Generally, standard-level deficiencies occur in relation to stand-alone, unique requirements that may not be serious, while condition-level deficiencies indicate serious and/or comprehensive problems and consist of standard-level requirements. A serious problem is one that adversely affects (or has the potential to adversely affect) the health and safety of patients. When deficiencies are found, laboratories are required to submit a plan detailing how they will address the deficiencies, and they are given an opportunity to correct the deficiencies before sanctions are imposed. CMS can impose an armamentarium of sanctions that fall into two categories—alternative or principal. Alternative sanctions are less severe and usually include severe monetary penalties or onsite monitoring. Principal sanctions include revocation of a CLIA certification, cancellation of Medicare payments, or imposition of limitations on testing. Sanctions are selected based on the history of the laboratory’s performance and the severity and pervasiveness of the problem’s impact on patient health and safety.

The Food and Drug Administration (FDA), under authority transferred to it from the Centers for Disease Control and Prevention (CDC) by interagency agreement, categorizes laboratory tests by the complexity of the assay. The two categories are waived tests and nonwaived tests (which can be of moderate or high complexity). Waived tests are examinations or procedures that are simple to perform and have little likelihood of erroneous results, including those approved for home use. Facilities performing only waived tests are not subject to routine surveys or the quality standards under CLIA, but they must follow the manufacturer’s instructions for test performance. Laboratories that perform nonwaived tests must meet more stringent requirements under CLIA (such as routine surveys, personnel qualifications, QA, QC, and PT). Currently, most genetic tests are categorized as high-complexity tests, and laboratories performing these tests are subject to the most stringent standards.

Like any other laboratory test, the process of performing a genetic test can be divided into three different phases: preanalytical, analytical, and postanalytical. The preanalytical phase includes activities such as appropriate test selection and ordering tests for the clinical condition being evaluated, provision of appropriate clinical and demographic information, and specimen collection, handling, and processing. The analytical phase encompasses the steps necessary to perform the test itself, QC, and collection of analytical

²³⁹ The six private CLIA-accrediting organizations are the American Association of Blood Banks (AABB), American Osteopathic Association (AOA), the American Society of Histocompatibility and Immunogenetics (ASHI), the College of American Pathologists (CAP), COLA, and the Joint Commission.

²⁴⁰ 42 CFR 493.801(a)(2)(ii) and 42 CFR 493.1236(c)(1).

test results. The postanalytical phase includes the following necessary evaluation steps to analyze and interpret results obtained during the analytical phase and then reporting the test results to the person who ordered the test or will use those results.

Pathways for Bringing Genetic Tests to Clinical Practice

Currently, there are two pathways for bringing genetic tests into clinical practice: commercial product development and tests developed within a laboratory. These pathways are subject to distinct regulatory requirements. Commercial products are developed by *in vitro* diagnostic device (IVD) manufacturers for distribution to multiple laboratories. In the other pathway, laboratories provide genetic tests by developing and validating tests for use solely in that laboratory. These tests are called laboratory-developed tests (LDTs). (Such tests have also been known as in-house tests or home-brew tests, but these terms are no longer in favor.)

Analyte-specific reagents (ASRs) are used in the development of many genetic tests, and FDA regulates ASRs that are sold to laboratories.²⁴¹ ASRs are specific substances such as antibodies, receptor proteins, ligands, or nucleic acid sequences that are used as active ingredients in tests that identify or quantify a particular chemical entity in patient specimens. All manufacturers and suppliers of commercially distributed ASRs are required to register with FDA, provide a list of the ASRs they supply to laboratories for use in developing LDTs, meet current good manufacturing practices, comply with medical device report requirements, and report adverse events related to ASRs,²⁴² as well as comply with a number of other requirements included in FDA's definition of general controls.

Most ASRs are regulated by FDA as class I exempt devices, subject to general controls but exempt from premarket review. A small number of ASRs are classified as class II devices, which are subject to general and special controls, or class III devices, which are subject to premarket approval (PMA). Only laboratories certified by CLIA to perform high-complexity tests can provide tests using ASRs, and only physicians or other health care practitioners authorized by applicable State law are permitted to order LDTs that use ASRs. In addition, the labels on commercially distributed ASRs must indicate that the analytical and performance characteristics of the ASR are not established.

Test kits contain quality-controlled reagents for the performance of the test for a particular clinical condition. For example, a kit might include the reagents necessary for nucleic acid isolation, amplification, and detection/quantitation. FDA regulates test kits as *in vitro* diagnostic devices, and if the classification of the test indicates that premarket review is required, then they must be cleared or approved before they can be marketed and commercially distributed. There are numerous class I–exempt test kits that are exempt from premarket review, but none of these are genetic tests. FDA premarket review of test kits focuses on their analytical validity and effectiveness. FDA reviews the performance data supporting the claims made and the labeling provided for the kit, and test manufacturers are subject to registration, listing, and adverse event reporting requirements, among others.

Manufacturers may market similar product designs that have not undergone FDA review with a label indicating that the products are for research use only (RUO), not for use in diagnostic procedures. These

²⁴¹ Food and Drug Administration. Analyte Specific Reagents. [21CFR 809.10(e), 809.30, and 864.4020]. See <http://www.accessdata.fda.gov/scripts/cdrh/cfdocs/cfCFR/CFRSearch.cfm>. Accessed on March 29, 2008.

²⁴² Food and Drug Administration. Analyte Specific Reagents. [21CFR 864.4020]. See <http://www.accessdata.fda.gov/scripts/cdrh/cfdocs/cfCFR/CFRSearch.cfm?fr=864.4020&SearchTerm=asr>. Accessed on March 29, 2008.

products are not intended for clinical laboratory use in diagnostic testing. Devices for which the design phase is complete but for which performance data are not established may be offered with appropriate labeling and other controls for investigational use only (IUO).

A laboratory verifies that the system performs as claimed when used by the persons who routinely perform patient testing. It also verifies that the established performance specifications (e.g., accuracy, precision) are achieved. Specific activities required for assay verification may be outlined in CLIA regulations or in standards governing laboratories, such as the College of American Pathologists (CAP) Checklist for Molecular Pathology: 2006.²⁴³ If a laboratory chooses to modify elements of an FDA-approved or -cleared IVD for off-label use, then it must perform an analytical validation for the modification prior to patient testing to establish performance specifications.

LDTs are developed using reagents that are entirely produced within the laboratory and/or use ASRs and general purpose reagents purchased from a variety of manufacturers. FDA considers LDTs to be medical devices and, as such, these are products subject to FDA regulatory oversight. There is some opposition, however, to this position in a number of quarters.^{244, 245, 246, 247} With a few exceptions, FDA has not exercised its regulatory authority in this area, a decision based on the limited resources it has available and the understanding that laboratories developing LDTs for clinical use are regulated by CLIA.²⁴⁸

In a departure from previous years, when FDA decided not to exercise regulatory authority over most LDTs, the agency recently published a draft guidance for *in vitro* diagnostic multivariate index assays (IVDMIAAs).²⁴⁹ The draft guidance addresses FDA's regulatory approach to IVDMIAAs as a discrete category of devices, even those offered as LDTs. As defined in this guidance, an IVDMIA is a device that combines the values of multiple variables using an interpretation function to yield a single, patient-specific result (e.g., a classification, score, or index). These devices are intended for use in the diagnosis of disease and other conditions or in the cure, mitigation, treatment, or prevention of disease, providing a result whose derivation is nontransparent and cannot be independently derived or verified by the end user. IVDMIAAs raise concerns about safety and effectiveness because they are based on observed correlations between multivariate data and clinical outcome, and the clinical validity of the claims is not transparent to patients, laboratorians, and clinicians who order these tests. The draft guidance clarifies that IVDMIAAs must meet premarket and postmarket device requirements appropriate to their level of risk, including premarket review requirements for class II and III devices.

²⁴³ College of American Pathologists (2006). Checklist for Molecular Pathology. See http://www.cap.org/apps/docs/laboratory_accreditation/checklists/molecular_pathology_december2006.pdf. Accessed on March 29, 2008.

²⁴⁴ Washington Legal Foundation News Release, "WLF Criticizes FDA Efforts to Regulate Clinical Laboratories, ASRs." See <http://www.wlf.org/upload/030907RS.pdf>. Accessed on March 29, 2008.

²⁴⁵ American Clinical Laboratory Association. Letter to HHS Secretary Tommy Thomson, September 12, 2002. Comments on the Secretary's Advisory Committee on Genetic Testing (SACGT) Report, *Enhancing the Oversight of Genetic Tests: Recommendations of the SACGT*.

²⁴⁶ Washington Legal Foundation. Citizen Petition Regarding FDA Regulation of Laboratory Developed Tests, September 28, 2006. See <http://www.wlf.org/upload/Clinical%20Labs-%20FDA%20Citizen%20Petition.pdf>. Accessed on March 29, 2008.

²⁴⁷ Food and Drug Administration Web site. "Docket 2006D-0347: Guidance for Industry, Clinical Laboratories, and FDA Staff on In Vitro Diagnostic Multivariate Index Assays." See <http://www.fda.gov/ohrms/dockets/dockets/06d0347/06d0347.htm>. Accessed on March 2008.

²⁴⁸ Food and Drug Administration Web site. "CLIA - Clinical Laboratory Improvement Amendments". See <http://www.fda.gov/cdrh/cliia/>. Accessed on March 2008.

²⁴⁹ Food and Drug Administration (2007). *Draft Guidance for Industry, Clinical Laboratories, and FDA Staff—In Vitro Diagnostic Multivariate Index Assays*. See <http://www.fda.gov/cdrh/oivd/guidance/1610.html>. Accessed on March 29, 2008.

The breadth involved in analytically validating an LDT is similar, but more involved, than verification of a commercial IVD. Verification of an FDA-approved or -cleared test under CLIA means that the laboratory must confirm that it is within the manufacturer's specifications for accuracy, precision, reference range, and reportable range (i.e., the test works appropriately in the laboratory). If a test is modified by the laboratory (any change that affects the test's performance specifications), if the test is not FDA-cleared or -approved (including LDTs), or if the performance specifications are not provided by the manufacturer, the laboratory must validate the test. Validation means that the laboratory must "establish" the specifications for their laboratory for the above four parameters, as well as for specificity and sensitivity. The validation plan for an LDT considers analytical performance characteristics as well as regulatory requirements such as those put forth by CLIA. In addition, some laboratories voluntarily address international standards such as ISO 13485:2003, a comprehensive quality management system for the design and manufacture of medical devices published in 2003 by the International Organization for Standardization (ISO). The validation of an LDT often will also need to meet requirements of other regulatory and guidance frameworks (e.g., CLIA²⁵⁰ ISO 17025:2005,²⁵¹ ISO 15189:2007,²⁵² and Clinical and Laboratory Standards Institute (CLSI) MM01-A2,²⁵³ and CLSI MM07-A²⁵⁴).

Analytical Validity

When a laboratory test is performed, the manufacturer, regulatory agencies, credentialing organizations, laboratory, ordering physician, and patient all need to have a high level of confidence that reported results are accurate and reliable.

In 2005, the National Physical Laboratory and the Laboratory of the Government Chemist in the United Kingdom issued six principles of valid analytical measurement²⁵⁵ that describe the important aspects of making reliable analytical measurements. Although U.S. laboratories are not required to abide by these principles, they serve as a useful tool to highlight important aspects of analytical validity:

- Analytical measurements should be made to satisfy an agreed requirement.
- Analytical measurements should be made using methods and equipment that have been tested to ensure they are fit for purpose.
- Staff members making analytical measurements should be both qualified and competent to undertake the task.
- There should be a regular independent assessment of the technical performance of the laboratory.
- Analytical measurements made in one location should be consistent with those made elsewhere.
- Organizations making analytical measurements should have well-prepared QC and QA procedures.

²⁵⁰ Centers for Medicare & Medicaid Services Web site. "Interpretive Guidelines for Laboratories." See http://www.cms.hhs.gov/CLIA/03_Interpretive_Guidelines_for_Laboratories.asp. Accessed on March 29, 2008.

²⁵¹ International Organization for Standardization Web site. "General Requirements for the Competence of Testing and Calibration Laboratories (ISO 17025:2005)." See <http://www.iso.org/iso/en/CatalogueDetailPage.CatalogueDetail?CSNUMBER=39883>. Accessed on March 29, 2008.

²⁵² International Organization for Standardization Web site. "Medical Laboratories—Particular Requirements for Quality and Competence (ISO 15189:2007)." See <http://www.iso.org/iso/en/CatalogueDetailPage.CatalogueDetail?CSNUMBER=42641>. Accessed on March 28, 2008.

²⁵³ Clinical and Laboratory Standards Institute (2006). *Molecular Diagnostic Methods for Genetic Diseases; Approved Guideline—Second Edition*. CLSI document MM01-A2. 2006.

²⁵⁴ Clinical and Laboratory Standards Institute (2004). *Fluorescence In Situ Hybridization (FISH) Methods; Approved Guideline—First Edition*. CLSI document MM07-A. 2004.

²⁵⁵ National Measurement System Chemical and Biological Metrology Web site. "Valid Analytic Measurement Principles." See <http://www.nmschembio.org.uk/GenericListing.aspx?m=108>. Accessed on March 31, 2008.

One aspect of assay reliability is the validity of the analytical method itself. In laboratory medicine, the medical device used to perform the measurement needs to meet an accepted standard of quality to ensure that the results are reliable. It is important to understand that any measurement is subject to some level of uncertainty. Measurement uncertainty is composed of two factors: random error and systematic error. Random error is an uncontrollable variation inherent to the particular measurement method employed. Systematic error is controllable in that it can often be “corrected” by application of a conversion factor.

Key Terms and Concepts

The quality of a measurement (i.e., its analytical validity) is a function of the following factors:

Accuracy: the closeness of agreement between a test result and true value of what is being measured (see Figure 4–1).

Precision: the closeness of agreement between independent results of measurements obtained under stipulated conditions²⁵⁶ (see Figure 4–1).

Reproducibility: the closeness of agreement between independent results of measurements obtained with the same assay method when as many known variables as possible (e.g., operators, instruments, reagent lots, day of the week) are tested for their effect on the assay result.

Uncertainty: a parameter associated with the result of a measurement that characterizes the dispersion of the values that could reasonably be attributed to the measurand;²⁵⁷ it is a formal quantitative statement of the confidence in the result of an assay.

Traceability: a property of the result of a measurement or the value of a standard whereby it can be related to stated references, usually national or international standards, through an unbroken chain of comparisons, all having stated uncertainties.²⁵⁸

Robustness: the ability of a method to remain unaffected by small fluctuations in assay parameters; it is often assessed through interlaboratory comparison studies or by varying parameters such as temperature and relative humidity to determine the operating range of the method.

Validation: established by assessing various assay performance parameters specific to each test. Because of the breadth of tests covered by this report, a detailed discussion is not possible regarding all aspects of analytical validation. In general, assay validation addresses quality parameters related to the:

- Analytical method (e.g., polymerase chain reaction [PCR], microarray, gene sequencing for nucleic acids, immunoassay of proteins, or analytical chemistry for metabolites)
- Measurand—the analyte (e.g., genetic sequence, protein or metabolite) being measured in a particular matrix or type of sample
- Type of result being reported, which can be either:

²⁵⁶ International Organization for Standardization (1993). *International Vocabulary of Basic and General Terms in Metrology*.

²⁵⁷ International Organization for Standardization (1993). *International Vocabulary of Basic and General Terms in Metrology*.

²⁵⁸ National Institute of Standards and Technology Traceability Web site. “Traceability – NIST Policy and Supplementary Materials.” See <http://ts.nist.gov/traceability/>. Accessed on March 29, 2008.

Figure 4–1. Reference Values

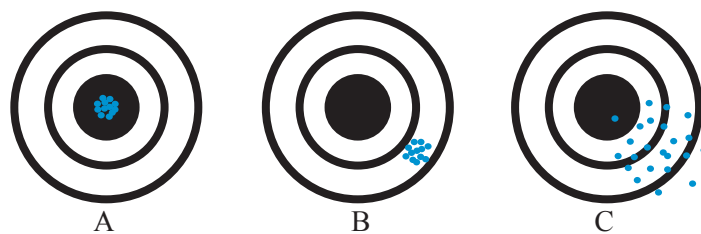

This figure shows three “targets” in which the center of the target is the true or reference value. Each of the dots indicates a repeated test measurement. Target A shows results that are both precise (all results are close together) and accurate (in the center of the target). Target B is precise, but not accurate. Target C is neither precise nor accurate. [Adapted from Med4You²⁵⁹ with permission from Dr. Wolfgang Hübl.]

- quantitative—a numerical value is reported as the result and is obtained by running the patient sample against a set of internationally accepted and traceable standards (e.g., the amount of thyroid stimulating hormone in human serum), when available
- qualitative—the result is reported as to whether the analyte is present (positive) or absent (negative) in the sample or if the test was not able to determine a result definitively (equivocal) (e.g., the presence or absence of a genetic mutation in a particular sample of the patient’s deoxyribonucleic acid [DNA])

Wherever possible, a medical laboratory measurement should be validated against a standard reference method using reference materials that are traceable to an internationally recognized certified standard reference material (SRM).²⁶⁰ Unfortunately, relatively few standard reference methods and certified SRMs are available. Overall, however, the analytical performance of genetic tests has been good when specific tests have been examined,^{261, 262} but many genetic tests have not undergone examination.

Analytical sensitivity describes how effectively a test can detect all true positive specimens, as determined by a reference method. For example, in testing samples of DNA, analytical sensitivity is how well an assay can detect certain mutations when they are present. This description is most often used for tests that yield a qualitative result. The concept can also be expressed as the test’s false negative rate (1-sensitivity), or how often a test incorrectly reports the absence of a DNA alteration when in fact that alteration is present in the sample.

²⁵⁹ Med4You Web site. See http://www.med4you.at/laborbefunde/allgemeines/lbef_qualitaet.htm#Pr. Accessed on March 29, 2008

²⁶⁰ Bureau International des Poids et Mesures Web site. “JCTLM: Joint Committee for Traceability in Laboratory Medicine.” See <http://www.bipm.org/en/committees/jc/jctlm/>. Accessed on March 29, 2008.

²⁶¹ Palomaki, G.E., Bradley, L.A., Richards, C.S., and Haddow, J.E. (2003). Analytic validity of cystic fibrosis testing: a preliminary estimate. *Genetics in Medicine*. 5(1):15-20.

²⁶² Palomaki, G.E., Haddow, J.E., Bradley, L.A., Richards, C.S., Stenzel, T.T., and Grody, W.W. (2003). Estimated analytic validity of *HFE* C282Y mutation testing in population screening: the potential value of confirmatory testing. *Genetics in Medicine*. 5(6):440-443.

Analytical sensitivity can also be defined as a change in the response of a measurement system (analyte change) divided by the corresponding change in the stimulus (analyte).²⁶³ The most critical point in this regard is usually limit of detection, which can be defined by the lowest amount of analyte that can be measured accurately (limit of quantitation) or by the lowest amount of analyte in a sample that can be detected but not quantified as an exact value.^{264, 265} This definition is most often used for tests that yield a quantitative result. Different assays will have different limits of sensitivity.

Analytical specificity is defined as the ability of a measurement procedure to measure solely the analyte of interest.²⁶⁶ Two important aspects of analytical specificity are interference by endogenous or exogenous substances other than the analyte of interest and cross-reactivity of the analytical system with substances other than the intended analyte of interest.

Interference may result from contamination, admixture, or presence of exogenous substances in samples, which can occur for a variety of reasons such as poor sampling, lack of sample stabilizer (where appropriate), cross-contamination during sample processing, inclusion of normal, non-diseased tissue with the diseased tissue of interest, tissue from a source additional to the desired sample (e.g., maternal cells obtained during fetal specimen collection), or failure to remove exogenous substances (e.g., anticoagulants used during blood collection, residual reagents used during sample processing). Laboratories and IVD manufacturers account for the effects of contamination, admixture, and interfering substances during assay validation testing. FDA requires manufacturers to assess the potential for interference by using substances that are likely to be problematic. The American College of Medical Genetics (ACMG) has published technical standards and guidelines for prenatal testing to require that an ancillary test be used to verify the absence of contributing maternal DNA to a prenatal diagnostic result;²⁶⁷ these guidelines may also apply to other mixed specimens.

Cross-reactivity of an assay with analytes other than the ones it is designed to measure should also be assessed. FDA requires manufacturers to assess the potential for cross-reactivity by using substances that are likely to be problematic. It is important to consider analytes that have a nonnegligible probability of being present in any of the target population's specimen collection site/sample type.

Challenges Related to Analytical Validity

Emerging Technologies

New technologies such as microarray and highly multiplex technology have been used to study several tumor types, most notably breast, ovary, colon, gastric, leukemias, malignant lymphoma, prostate, lung, and malignant melanoma. Almost daily, there is an announcement of a new genomic association of specific patterns of single nucleotide polymorphisms (SNPs) or gene expression patterns to different diseases

²⁶³ International Organization for Standardization (1993). *International Vocabulary of Basic and General Terms in Metrology*.

²⁶⁴ World Health Organization (1995). *Glossary of Terms for Biological Substances Used for Texts of the Requirements*. Expert Committee on Biological Standardization. World Health Organization unpublished document BS/95.1793.

²⁶⁵ Clinical and Laboratory Standards Institute (2004). *Protocols for Determination of Limits of Detection and Limits of Quantitation; Approved Guideline—First Edition*. CLSI document EP-17A.

²⁶⁶ International Organization for Standardization (1993). *International Vocabulary of Basic and General Terms in Metrology*.

²⁶⁷ American College of Medical Genetics (2006). *Laboratory Standards and Guidelines for Clinical Genetics Laboratories, 2006 Edition*. See http://www.acmg.net/Pages/ACMG_Activities/stds-2002/g.htm. Accessed on March 29, 2008.

such as cancer, cardiovascular disease, and diabetes. Analytical and accurate clinical interpretations from currently available data are a challenging task, as there are numerous inter-experimental variations that can significantly influence the interpretation of results. Proper statistical analysis with an adequate number of well-characterized patients and independent validation in a large series of patients is one way to address this dilemma. Most of the molecular signatures are based on retrospective studies but in some cases may need to be validated with prospective studies in representative populations. Technologies for gene-expression profiling for breast cancer are gradually being implemented in the clinic. Prognostic factors that have been used for over 20 years to help clinicians guide adjuvant therapy treatment for breast cancer and microarray technology for gene-expression profiling may become an important adjunct to the known prognostic factors. For breast cancer, two relevant gene-expression profiles associated with prognosis have been identified: a 70-gene classifier (MammaPrint[®]) and a 21-gene signature (OncotypeDx[®]).

In addition, emerging technologies will pose a continuous challenge in the availability of QC materials and materials available for PT. The continued development of molecular genetic tests, performed by an extensive number of different methods, challenges vendors to stay abreast of PT requirements for comprehensive and suitable testing materials that assess laboratory performance for newly discovered genetic mutations and recently introduced technologies. Vendors have partnered with others to assist in development of PT strategies. One example is the recently developed and clinically implemented microarray testing for cancer diagnosis, prognosis, and treatment planning. Federal Government agencies are actively working with physicians as well as with academic and commercial institutions to understand the complexities, PT needs, and possible regulatory changes that are needed to ensure quality laboratory testing and patient safety in this rapidly evolving area.^{268, 269}

An example of the cooperative nature of the above interactions is the MicroArray Quality Control Project, an evaluation of current gene expression profile testing. This collaborative project has shown “intra-platform consistency across test sites as well as a high level of inter-platform concordance in terms of genes identified as differentially expressed. Furthermore, the project provides a resource that represents an important first step toward establishing a framework for the use of microarrays in clinical and regulatory settings.”²⁷⁰ This project has also developed and used two batches of whole human genome ribonucleic acid (RNA) sample types that are supplied at no cost to appropriate individuals and/or institutions. These same specimen batches will be supplied by their manufacturers for the next several years. Eventually, these

²⁶⁸ Casciano, D.A. and Woodcock, J. (2006). Empowering microarrays in the regulatory setting. *Nature Biotechnology*. 24(9):1103-1104.

²⁶⁹ Frueh, F.W. (2006). Impact of Microarray Data Quality on the Genomic Data Submissions to the FDA. *Nature Biotechnology*. 24(9):1105-1107.

²⁷⁰ MAQC Consortium. (2006). The MicroArray Quality Control (MAQC) project shows inter-and intraplatform reproducibility of gene expression measurements. *Nature Biotechnology*. 24(9):1151-1161.

two extensively characterized RNA sample sets can form the basis of a reasonable PT program in this area.^{271, 272, 273}

Other newly emerging areas of clinical molecular genetics/genomics include gene dosage (comparative genomic hybridization) and SNP arrays, described in Chapter III. There are several key issues involved in these areas, as well as in the microarray area.

Regulatory Harmonization

Most genetic tests are LDTs and must be analytically validated by the laboratory according to CLIA. Laboratories that test samples from New York State patients or return results within New York State must submit their validation documentation for review and approval by the New York State Department of Health (NYSDOH). Oversight might be enhanced by greater consistency of State and Federal requirements.

In addition, due to limited test availability, not all genetic tests for U.S. citizens are performed in the United States. While there are a few CLIA-certified laboratories operating outside the United States, for the most part these laboratories have no routine U.S. oversight unless they perform testing on specimens from New York State or are accredited. For these laboratories, an internationally accepted set of mutually recognized requirements for analytical validity becomes important. CMS is evaluating various options and alternatives for the routine oversight of foreign laboratories.

Will the U.S. professional and governmental communities accept an international assessment of laboratory capability to perform genetic testing? How would the analytical validity be established for non-U.S. performed tests? However the process of oversight is achieved by blending professional, governmental, and international activities, the goal is to ensure that all genetic tests have their analytical validity established for all health assessment purposes and that the established analytical validity is considered to be sufficient for its specific intended use.

Professional Guideline Development

Although professional societies play an important role in developing clinical guidelines and standards, they cannot keep up with the pace of development of genetic tests. Thus, there are and always will be gaps in current standards until professional organizations are given the support needed to develop guidelines for every genetic test.²⁷⁴

²⁷¹ Canales, R.D., Luo, Y., Willey, J.C., Austermler, B., Barbacioru, C.C., Boysen, C., Hunkapiller, K., Jensen, R.V., Knight, C.R., Lee, K.Y., Ma, Y., Maqsoodi, B., Papallo, A., Peters, E.H., Poulter, K., Ruppel, P.L., Samaha, R.R., Shi, L., Yang, W., Zhang, L., and Goodsaid, F.M. (2006). Evaluation of DNA microarray results with quantitative gene expression platforms. *Nature Biotechnology*. 24(9):1115-1122.

²⁷² Shippy, R., Fulmer-Smentek, S., Jensen, R.V., Jones, W.D., Wolber, P.K., Johnson, C.D., Pine, P.S., Boysen, C., Guo, X., Chudin, E., Sun, Y.A., Willey, J.C., Thierry-Meig, J., Thierry-Meig, D., Setterquist, R.A., Wilson, M., Lucas, A.B., Novorodovskaya, N., Papallo, A., Turpaz, Y., Baker, S.C., Warrington, J.A., Shi, L., and Herman, D. (2006). Using RNA sample titrations to assess microarray platform performance and normalization techniques. *Nature Biotechnology*. 24(9):1123-1131.

²⁷³ Tong, W., Lucas, A.B., Shippy, R., Fan, X., Fang, H., Hong, H., Orr, M.S., Chu, T.M., Guo, X., Collins, P.J., Sun, Y.A., Wang, S.J., Bao, W., Wolfinger, R.D., Shchegrova, S., Guo, L., Warrington, J.A., and Shi, L. (2006). Evaluation of external RNA controls for the assessment of microarray performance. *Nature Biotechnology*. 24(9):1132-1139.

²⁷⁴ Richards, S. Presentation to SACGHS meeting, March 26-27, 2007. See <http://www4.od.nih.gov/oba/SACGHS/meetings/Mar2007/SACGHSMar2007meeting.htm>. Accessed on March 29, 2008.

Proficiency Testing

CLIA regulations require laboratories to maintain a level of quality and accuracy in performing tests. CLIA requires laboratories to have QA programs in place, and all of the CLIA quality standards together help facilitate test accuracy and reliability. A key component of such programs is PT.²⁷⁵ There are two approaches to this type of performance assessment: regulated PT via a CMS-approved PT program or AA. AA is a twice yearly assessment of the laboratory's testing performance when regulated or routine PT is not available.

PT is an external assessment of laboratory competence. PT performance reflects the accuracy of the laboratory's testing process and can also serve as an educational activity for the laboratory staff. It determines testing performance by comparing with an external standard the laboratory's results obtained by testing unknown challenge specimens. The external standard is generally the mean of values obtained by other laboratories using the same test method, but it may be assigned by a reference method or some other procedure. Laboratories engage in PT three times a year, and their results are graded by a CMS-approved PT program. A list of CMS-approved PT programs can be found on the CMS CLIA Web site.²⁷⁶

Examples of AA are split-sample testing between two or more laboratories that share test results with all participants, repeat testing on previously analyzed specimens whose earlier results were blinded to the laboratory technical staff, enrollment in a non-approved PT program, and testing by a different method.²⁷⁷

Most genetic testing laboratories are not required by CLIA to perform formal PT unless they are testing regulated analytes that are listed in the CLIA regulations in Subpart I,²⁷⁸ irrespective of the fact that genetic tests are high-complexity tests. CMS enforces the formal PT performance requirement only for laboratories offering any of the 83 regulated analytes. According to CLIA regulations, AA must be performed for all other tests.

Genetic testing laboratories that are accredited by a CMS-deemed organization, such as CAP, may be required by that organization to carry out PT (if available) for all tests the laboratory offers, including genetic tests. This requirement is applied regardless of whether the analyte is regulated by CLIA (an analyte for which PT is specifically required by regulation) or nonregulated. If PT is not available, then AA is required.

Value of Proficiency Testing

Congress recognized the importance of PT in 1988 when the CLIA program was authorized. According to the law's legislative history, Congress wanted PT to "be the central element of determining a laboratory's competence since it purports to measure actual test outcomes rather than merely gauging the potential for accurate outcomes."²⁷⁹

²⁷⁵ External Quality Assessment (EQA) is a term equivalent with PT but more commonly used in Europe.

²⁷⁶ Centers for Medicare & Medicaid Services Web site. "Clinical Laboratory Improvement Amendments (CLIA): Overview." See <http://www.cms.hhs.gov/cliia>. Accessed on March 28, 2008.

²⁷⁷ Clinical and Laboratory Standards Institute (2002). *Assessment of Laboratory Tests When Proficiency Testing is Not Available; Approved Guideline—First Edition*. CLSI document GP29-A.

²⁷⁸ Centers for Disease Control and Prevention Web site. "Clinical Laboratory Improvement Amendments, Subpart I—Proficiency Testing Programs for Nonwaived Testing." See http://wwwn.cdc.gov/cliia/regs/subpart_i.aspx. Accessed on March 29, 2008.

²⁷⁹ H.R. 100-899 [legislative history]: Clinical Laboratory Improvement Amendments of 1988.

Since the earliest days of PT, its contribution to the improvement of laboratory practice has been substantiated. Laboratories utilize PT as a tool for quality management through comparison of a laboratory's test result and interpretation to that of a larger group or reference method, as education of laboratory personnel, as a way to monitor internal processes and way to evaluate summary data to compare method performance, and as a source of continuing laboratory education.²⁸⁰ In addition, such data could be pooled to assess the type and frequency of preanalytical and postanalytical errors to provide "real-world" estimates of analytical sensitivity and specificity that would be obtained from method comparison.

A satisfactory PT result, however, is only one of many different measures of laboratory performance. Initial validation of a method, periodic recalibration of instruments, contemporaneous QC testing, a well-functioning QA plan, and onsite inspection by external organizations all supplement the assurance provided by a record of satisfactory PT performance. Nevertheless, ongoing monitoring of PT allows the laboratory to assess and monitor the quality of its test results and identify testing problems that may not surface with other control activities. Such information enables the laboratory to take preventative action and avoid future unacceptable results or inaccuracies in patient testing.²⁸¹ Likewise, the investigation of unacceptable results can identify clerical errors, methodological problems, equipment problems, technical problems, problems with the PT material, and problems with test interpretation.

For genetic testing, PT materials also provide a source of continuing education to the laboratory. More specifically, PT materials include commentaries that accompany the participant summary reports, evaluations of educational or ungraded specimens, and recommendations for improvement of test method and utilization of proper nomenclature.^{282, 283}

The case example below examines laboratory tests for the overexpression of human epidermal growth factor receptor 2 (*ERBB2*, also known as HER2) and illustrates the value of PT (see Box 4–1). Amplification of the *ERBB2* gene causes overexpression of the HER2 protein receptor in 25 percent to 30 percent of breast tumors. Compared with breast cancer with normal HER2 expression, HER2-positive breast cancer has a significantly worse prognosis with an aggressive disease course and increased risk of recurrence.²⁸⁴ Herceptin® (trastuzumab) is a cancer drug that specifically targets the HER2 receptor, is a proven treatment for HER2-positive metastatic breast cancer,²⁸⁵ and improves disease-free survival in the adjuvant

²⁸⁰ Tholen, D.W., Berte, L.M., Boone, D.J., Cooper, W.G., Gun-Munro, J., Noble, M.A., Sarewitz, S.J., and Williams, M.L. Using Proficiency Testing to Improve the Clinical and Laboratory; Approved Guideline – Second Edition. Clinical and Laboratory Standards Institute GP27-A2, Vol. 27(8).

²⁸¹ Tholen, D.W., Berte, L.M., Boone, D.J., Cooper, W.G., Gun-Munro, J., Noble, M.A., Sarewitz, S.J., and Williams, M.L. Using Proficiency Testing to Improve the Clinical and Laboratory; Approved Guideline – Second Edition. Clinical and Laboratory Standards Institute GP27-A2, Vol. 27(8).

²⁸² Mascarello, J.T., Cooley, L.D., Davison, K., Dewald, G.W., Brothman, A.R., Herrman, M., Park, J.P., Persons, D.L., Rao, K.W., Schneider, N.R., and Vance, G.H. (2003). Problems with ISCN FISH Nomenclature make it not practical for use in clinical test reports or cytogenetic databases [corrected]. *Genetics in Medicine*. 5(5):370-377.

²⁸³ Gulley, M.L., Brazier, R.M., Halling, K.C., Hsi, E.D., Kant, J.A., Nikiforova, M.N., Nowak, J.A., Ogino, S., Oliveira, A., Polesky, H.F., Silverman, L., Tubbs, R.R., Van Deerlin, V.M., Vance, G.H., and Versalovic, J. (2007). Clinical laboratory reports in molecular pathology. *Archives of Pathology and Laboratory Medicine*. 131(6):852-863.

²⁸⁴ Slamon, D.J., Clark, G.M., Wong, S.G., Levin, W.J., Ullrich, A., and McGuire, W.L. (1987). Human breast cancer: correlation of relapse and survival with amplification of the HER-2/neu oncogene. *Science*. 235(4785):177-182.

²⁸⁵ Cobleigh, M.A., Vogel, C.L., Tripathy, D., Robert, N.J., Scholl, S., Fehrenbacher, L., Wolter, J.M., Paton, V., Shak, S., Lieberman, G., and Slamon, D.J. (1999). Multinational study of the efficacy and safety of humanized anti-HER2 monoclonal antibody in women who have HER2-overexpressing metastatic breast cancer that has progressed after chemotherapy for metastatic disease. *Journal of Clinical Oncology*. 17(9):2639-2648.

setting.²⁸⁶ Therefore, accurate genetic testing for HER2 status of invasive breast cancer is essential for clinical decisionmaking in the treatment of breast cancer.

Box 4–1. Case Example: HER2 Testing

Two methods are commonly used to determine HER2 status: immunohistochemistry (IHC), which measures HER2 protein levels on the cell surface of breast cancer tumor cells, and fluorescence *in situ* hybridization (FISH), which measures the copy number of the *ERBB2* gene. Perez et al.²⁸⁷ explain how results are assessed in each of these methods. IHC scoring is performed on a subjective basis by a pathologist, who assigns a score of 0, 1+, 2+, or 3+ based on the percentage of malignant cells stained and the degree of membrane staining present in these malignant cells. FISH testing results are semiquantitative, based on the average ratio of *ERBB2* signals to *CEP17* signals in nonoverlapping interphase nuclei of invasive tumor cells.

Two recent studies have examined the accuracy and reproducibility of HER2 diagnostic testing by analyzing the concordance of HER2 testing results obtained from local, central, or reference laboratories.^{288,289} One study—which retested all tumor specimens from a prospective, community-based, Phase IV study by HER2 IHC and FISH at a high-volume, experienced laboratory—found that concordance between local and central laboratory IHC testing was highest for local IHC 3+ samples (77 percent) and lowest for IHC 2+ samples (26 percent).²⁹⁰ Furthermore, the investigators found that 33 percent of samples testing IHC 2+ at a local laboratory tested HER2-positive by FISH analysis at the central laboratory. Another study evaluated concordance between local and central laboratory HER2 test results in patients from the North Central Cancer Treatment Group, a randomized, Phase III clinical trial comparing three drug regimens for women with HER2-positive resected breast cancer.²⁹¹ Concordance was 88.1 percent for results obtained by FISH and 81.6 percent for IHC results. Accurate HER2 test results are critical for identifying appropriate candidates for trastuzumab therapy. The discordance revealed in these studies indicates that therapy is misdirected in a significant number of cases.

Continues on next page.

²⁸⁶ Piccart-Gebhart, M.J., Proctor, M., Leyland-Jones, B., Goldhirsch, A., Untch, M., Smith, I., Gianni, L., Baselga, J., Bell, R., Jackisch, C., Cameron, D., Dowsett, M., Barrios, C.H., Stegr, G., Huang, C., Andersson, M., Inbar, M., Lichinitser, M., Láng, I., Nitz, U., Iwata, H., Thomssen, C., Lohrisch, C., Suter, T.M., Rüschoff, J., Sütő, T., Gøtzsche, V., Ward, C., Strachle, C., McFadden, E., Dolci, S., Gelber, R.D., for the Herceptin Adjuvant (HERA) Trial Study Team. (2005). Trastuzumab after adjuvant chemotherapy in HER2-positive breast cancer. *New England Journal of Medicine*. 353(16):1659-1672.

²⁸⁷ Perez, E.A., Suman, V.J., Davidson, N.E., Martino, S., Kaufman, P.A., Lingle, W.L., Flynn, P.J., Ingle, J.N., Visscher, D., and Jenkins, R.B. (2006). HER2 testing by local, central, and reference laboratories in specimens from the North Central Treatment Group N9831 intergroup adjuvant trial. *Journal of Clinical Oncology*. 24(19):3032-3038.

²⁸⁸ Reddy, J.C., Reimann, J.D., Anderson, S.M., and Klein, P.M. (2006). Concordance between central and local laboratory HER2 testing from a community-based clinical study. *Clinical Breast Cancer*. 7(2):153-157.

²⁸⁹ Perez, E.A., Suman, V.J., Davidson, N.E., Martino, S., Kaufman, P.A., Lingle, W.L., Flynn, P.J., Ingle, J.N., Visscher, D., and Jenkins, R.B. (2006). HER2 testing by local, central, and reference laboratories in specimens from the North Central Treatment Group N9831 intergroup adjuvant trial. *Journal of Clinical Oncology*. 24(19):3032-3038.

²⁹⁰ Reddy, J.C., Reimann, J.D., Anderson, S.M., and Klein, P.M. (2006). Concordance between central and local laboratory HER2 testing from a community-based clinical study. *Clinical Breast Cancer*. 7(2):153-157.

²⁹¹ Perez, E.A., Suman, V.J., Davidson, N.E., Martino, S., Kaufman, P.A., Lingle, W.L., Flynn, P.J., Ingle, J.N., Visscher, D., and Jenkins, R.B. (2006). HER2 testing by local, central, and reference laboratories in specimens from the North Central Treatment Group N9831 intergroup adjuvant trial. *Journal of Clinical Oncology*. 24(19):3032-3038.

The findings of these studies, as well as others,^{292,293} support the recommendations by the American Society of Clinical Oncology/CAP²⁹⁴ and the National Comprehensive Cancer Network task force²⁹⁵ to improve the accuracy of HER2 testing in invasive breast cancer. Among the recommendations, these organizations call for PT along with other actions such as formal validation of assays, use of standardized operating procedures, stringent laboratory accreditation standards, competency assessment, and concordance testing by laboratories performing HER2 testing for clinical purposes.

Current Proficiency Testing Programs and Related Activities

CAP PT Program

CAP is a professional organization of board-certified pathologists. Shortly after its inception in 1947, the CAP Board of Governors issued a directive to institute national PT. In 1949, the CAP Chemistry Survey enrolled 515 participant laboratories. By 1963, 1,400 laboratories were participating in 6 surveys including microbiology, immunohematology, toxicology, hematology, urinalysis, and nuclear medicine. In 2007, the College enrolled 23,000 national and international laboratories in 1 or more of 530 PT products. PT surveys for genetic testing are produced for cytogenetics, molecular and biochemical genetics, and molecular pathology. A complete list of these products can be found in Appendix E (Table 1: CAP Products for PT). Approximately 700 laboratories are enrolled in the molecular pathology PT products and 250 laboratories in the cytogenetic PT products. New CAP products for 2007–2008 include analytical, interpretative, and patient management components of pharmacogenetic markers in five genes; a stand-alone module for cystic fibrosis (CF) testing; and a comparative genomic hybridization array format for detecting copy number variants. Additionally, a coordinated system has evolved through which laboratories performing tests for rare disorders are able to develop interlaboratory programs within the CAP-ACMG program.

CAP provides individual laboratories with unknown “challenge” specimens for testing. Most typically, five challenge specimens are sent to PT subscribers in a single mailing, and three mailings are sent per year. CAP offers challenges for approximately 20 genetic disorders.

Each PT survey is developed within one or more CAP scientific resource committees of the College’s Council on Scientific Affairs. The College partners with other medical specialty organizations in producing PT programs. For example, the Cytogenetic and Molecular/Biochemical Genetic Resource Committees are jointly sponsored with the ACMG. These resource committees are also responsible for PT grading.

²⁹² Roche, P.C., Suman, V.J., Jenkins, R.B., Davidson, N.E., Martino, S., Kaufman, P.A., Addo, F.K., Murphy, B., Ingle, J.N., and Perez, E.A. (2002). Concordance between local and central laboratory HER2 testing in the breast intergroup trial N9831. *Journal of the National Cancer Institute*. 94(11):855-857.

²⁹³ Paik, S., Bryant, J., Tan-Chiu, E., Romond, E., Hiller, W., Park, K., Brown, A., Yothers, G., Anderson, S., Smith, R., Wikerham, D.L., and Wolmark, N. (2002). Real-world performance of HER2 testing—National Surgical Adjuvant Breast and Bowel Project experience. *Journal of the National Cancer Institute*. 94(11):852-854.

²⁹⁴ Wolff, A.C., Hammond, M.E., Schwartz, J.N., Hagerty, K.L., Allred, D.C., Cote, R.J., Dowsett, M., Fitzgibbons, P.L., Hanna, W.M., Langer, A., McShane, L.M., Paik, S., Pegram, M.D., Perez, E.A., Press, M.F., Rhodes, A., Sturgeon, C., Taube, S.E., Tubbs, R., Vance, G.H., van de Vijver, M., Wheeler, T.M., Hayes, D.F., (2007). American Society of Clinical Oncology/College of American Pathologists guideline recommendations for human epidermal growth factor receptor 2 testing in breast cancer. *Journal of Clinical Oncology*. 25(1):118-145.

²⁹⁵ Carlson, R.W., Moench, S.J., Hammond, M.E., Perez, E.A., Burstein, H.J., Allred, D.C., Vogel, C.L., Goldstein, L.J., Somlo, G., Gradishar, W.J., Hudis, C.A., Jahanzeb, M., Stark, A., Wolff, A.C., Press, M.F., Winer, E.P., Paik, S., Ljung, B.M. (2006). HER2 testing in breast cancer: NCCN Task Force report and recommendations. *Journal of the National Comprehensive Cancer Network*. 4 Suppl 3: S1-S22.

As previously discussed, grading PT challenges is generally with reference to the mean of values obtained by other laboratories using the same test method, but it may also be assigned by a reference method or some other procedure. Quantitative tests are expected to perform within two standard deviations of the mean or within a specified percentage deviation from the mean to be considered acceptable. For qualitative tests, agreement with the response provided by 80 percent of peer laboratories or 80 percent of referee laboratories is required for acceptable performance.

Performance on a mailing is considered “satisfactory” when at least 80 percent of a laboratory’s responses to challenges in a single mailing (sometimes called an “event” or a “cycle”) are acceptable. For certain high-risk analytes, such as those used in ABO blood-type testing, satisfactory performance requires that all responses (100 percent) be acceptable. Some challenge specimens are sent for educational value and are not designed to be graded. When laboratory responses to a challenge cannot be graded because of technical considerations or lack of either referee or participant consensus, the challenge is also considered educational and not factored into the determination of a laboratory’s acceptable performance. When a PT survey is developed for a new analyte or new testing method/technology, the entire survey may be considered educational and not graded for one or more years, ensuring field validation. At a minimum, CLIA requires laboratories to review and evaluate the results obtained on PT. For any unsatisfactory testing event, CLIA also requires laboratories to document and retain their remedial actions for 2 years.

Periodically, supplementary questionnaires are sent to laboratories enrolled in PT surveys. These questionnaires solicit information about a variety of laboratory procedures and practices, including laboratory accession methods and reporting formats and preanalytical and postanalytical variables. Compilation of responses provides insight into preanalytical and postanalytical laboratory practices being used by clinical laboratories. Summaries of PT challenges and supplementary evaluations prepared by the scientific resource committees are found in the literature.^{296, 297, 298}

PT Monitoring of CAP-Accredited Laboratories

Laboratories performing moderate- and high-complexity testing (nonwaived) must hold either a certificate of compliance or a certificate of accreditation if surveyed by a CMS-deemed accrediting agency. (CMS issues all certificates; however, the deemed agencies may also issue an accreditation to laboratories.) Accreditation is granted by a nonprofit organization, such as CAP, that has been approved (“deemed”) by CMS to have requirements that are equal to or more stringent than key (condition-level) CLIA requirements.²⁹⁹

CAP’s Laboratory Accreditation Program (LAP) is responsible for monitoring PT performance in CAP-accredited laboratories. This oversight occurs in two venues. The Continuous Compliance Committee

²⁹⁶ Cell Markers and Cytogenetics Committees, College of American Pathologists (2002). Clinical laboratory assays for HER-2/neu amplification and overexpression. *Archives of Pathology and Laboratory Medicine*. 126:803-808. See [http://arpa.allenpress.com/pdfserv/10.1043%2F0003-9985\(2002\)126%3C0803:CLAFHN%3E2.0.CO%3B2](http://arpa.allenpress.com/pdfserv/10.1043%2F0003-9985(2002)126%3C0803:CLAFHN%3E2.0.CO%3B2). Accessed on March 29, 2008.

²⁹⁷ Mascarello, J.T., Brothman, A.R., Davison, K., Dewald, G.W., Herrman, M., McCandless, D., Park, J.P., Persons, D.L., Rao, K.W., Schneider, N.R., Vance, G.H., and Cooley, L.D. (2002). Proficiency testing for laboratories performing fluorescence in situ hybridization with chromosome-specific DNA probes. *Archives of Pathology and Laboratory Medicine*. 126(12):1458-1462.

²⁹⁸ Nikiforova, M.N., Hsi, E.D., Braziel, R.M., Gulley, M.L., Leonard, D.G., Nowak, J.A., Tubbs, R.R., Vance, G.H., Van Deerlin, and V.M. (2007). Detection of clonal IGH gene rearrangements: summary of molecular oncology surveys of the College of American Pathologists. *Archives of Pathology and Laboratory Medicine*. 131(2):185-189.

²⁹⁹ Valenstein, P. (Editor). (2005). Quality Management in Clinical Laboratories-Promoting Patient Safety Through Risk Reduction and Continuous Improvement. College of American Pathologists. pg. 56.

(CCC) of CAP's Commission on Laboratory Accreditation monitors laboratory PT performance and intervenes when a laboratory does not enroll in PT, enrolls in a PT survey but does not submit PT results, or demonstrates unsatisfactory PT performance. When performance is unacceptable, an escalating series of responses is initiated (see Appendix E, Figure 1). If a laboratory has two unacceptable testing events within three successive PT cycles, then it must either cease testing for that analyte with failed PT or submit to CAP a credible plan of corrective action for testing. If the laboratory chooses to provide a plan of corrective action and that plan is acceptable to CCC, then the laboratory is permitted to continue testing until the next PT event. If the laboratory's result on the next event is unsatisfactory, the laboratory must cease testing for that analyte. If the laboratory performs satisfactorily on the next two PT events, the laboratory can continue testing for the analyte. The opportunity to submit a credible plan of correction is allowed only on the first unsuccessful performance. A subsequent unsuccessful performance would require an immediate cessation of testing.

Laboratory PT performance for CAP-accredited laboratories is also assessed during the onsite laboratory inspection performed by a team of external inspectors once every 2 years. During the inspection process, the inspector reviews enrollment, PT performance, documentation, and laboratory review of PT. The laboratory must retain documentation of its corrective action for each unacceptable PT result. If documentation is absent or the laboratory has not engaged in corrective action, the laboratory is cited for a deficiency. All PT deficiencies are set as phase II, which means that the laboratory must respond to CAP within 30 days of the inspection with a corrective plan of action. The technical and professional staff review that plan, and a decision is rendered as to whether the plan is acceptable. If the plan is not acceptable, the laboratory accreditation may be withheld or revoked. Laboratories are normally subjected to external inspection every 2 years, but laboratories with a history of poor PT performance, inspection deficiencies, or other problems may be inspected more frequently. Results of failed PT and inspection decisions from an out-of-cycle inspection, if conducted, are included in the inspector's packet for the next inspection.

All CAP-accredited laboratories must participate in PT for analytes designated by CAP.³⁰⁰ This requirement is applied regardless of whether the analyte is regulated by CLIA (an analyte for which PT is specifically required by regulation) or nonregulated. For analytes not on the CAP list, the laboratory must engage in an alternative method of PT, and the laboratory must document this activity. The documentation is reviewed during the on-site laboratory inspection. If the laboratory has failed to perform, to document results, or to review results for AA, then the laboratory is cited with a deficiency as described above.

CAP Reporting of PT Results

The CAP Surveys Department, as an approved CMS PT provider, sends laboratory PT performance data to CMS for all enrolled laboratories (referenced by CLIA ID) for the 83 regulated analytes. These results are available to the public upon request to CMS. AA results are not required to be reported to CMS but are assessed during onsite inspections and cited as appropriate. Anyone can request and obtain a laboratory's inspection report from CMS and evaluate AA performance based on a deficiency citation.

³⁰⁰ CAP Laboratory Accreditation Program (2007). *PT Enrollment Guide 2007*. See http://www.cap.org/apps/docs/laboratory_accreditation/2007_pt_enrollment_guide.pdf. Accessed on March 29, 2008.

PT Monitoring of Non-CAP-Accredited Laboratories

Authority for ensuring compliance with CLIA is vested in CMS. In addition to CAP, CMS has delegated (deemed) authority to several other nonprofit accrediting organizations to inspect laboratories on its behalf, although CAP inspects the large majority of laboratories with genetic testing capabilities. As explained above, CMS monitors laboratory PT regularly for enrollment and satisfactory performance and during routine biennial surveys. AA performance is assessed during routine biennial onsite laboratory inspections that are conducted by the State agencies with which CMS contracts. Each approved accrediting organization is expected to do the same for the laboratories it evaluates.

PT Monitoring of New York State–Certified Laboratories

The New York clinical laboratory reference system has operated PT programs in clinical laboratory disciplines since its inception in 1964. Cytogenetics PT was added in 1972. This program currently sends test challenges to more than 70 cytogenetics laboratories nationwide that perform cytogenetic testing on New York State specimens. This testing program is largely method based, examining laboratories' ability to reach the correct cytogenetic diagnosis from a variety of tissue types collected from patients with varied reasons for clinical referral. In addition to the correct test result as specified by the International System of Cytogenetic Nomenclature, the program also reviews the actual karyotypes prepared in support of the diagnosis, and the test report that must be written with an interpretation suitable for the nongeneticist physician. On a similar basis, the New York State program also conducts PT in molecular oncology for somatic genetic changes associated with cancers.

Laboratories performing constitutional genetic testing are required to design and execute alternative proficiency assessments for each of their analytes at least two times per year. They may use other external proficiency tests to meet this requirement partially. The greatest challenge to PT for genetic tests is that external PT relies on grading of performance based on a correct response established by a peer group of laboratories performing the particular analysis. To date the New York State program has not identified a critical mass of laboratories performing any one assay using common methods that would warrant distribution of a test-specific PT challenge. This finding would suggest the use of method-based PT, which entails sending a specimen and asking the laboratory to test it for any gene mutation or genetic marker that the laboratory has on its test menu. Correct response would be determined by peer grading. Similar issues arise in molecular oncology as new markers are added and in cytogenetics, where no panel of test specimens will evaluate the performance of all FISH probes used by each laboratory. Therefore, the use of AA with careful review of the results and evaluation of this performance evaluation tool at the time of laboratory inspection remains vitally important.

New York State PT results are available preferably from the individual laboratories. Results, however, are also available from the program under the Freedom of Information Law. The status of the laboratories permit is publicly posted, which would imply overall successful proficiency performance in all permitted categories.

CDC's PT Workgroup

In 2006, CDC formed a workgroup to assess the effectiveness of clinical laboratory PT for regulatory, educational, and quality improvement purposes. Membership in this workgroup was constituted to provide a balance among PT users, PT providers, and accrediting organizations. Recommendations in its report were generally developed to be applicable to the broad area of clinical laboratory testing. For genetic testing,

the report recognizes the rapid growth of molecular diagnostics and rare disease testing and suggests that alternatives to traditional PT need to be explored in certain instances, such as when only a few laboratories offer a particular test. The report also suggests that an independent advisory body be formed and charged with considering innovative approaches to PT in such situations. The workgroup recommended that one approach to explore was the development of a PT program based on the process of testing (i.e., a platform-based approach) rather than measurement of specific analytes. The final report of the workgroup is expected to be available by May 2008.

Organized Alternative Assessment Programs

In summer 2007, CAP initiated an Internet-based registry service designed to connect genetic testing laboratories performing low-volume genetic tests.³⁰¹ The need for this service arose in the context of the nonavailability of PT for new genetic tests together with the importance of supporting quality practices. Laboratories enroll online, and when three laboratories are identified as testing for the same genetic disorder, CAP facilitates contact among them so that the exchange may be negotiated.

The CAP/ACMG Biochemical and Molecular Genetics Committee provides scientific support to the CAP registry through provision of tools as well as through supplementary educational materials. This information is also included in the Molecular Genetics Survey's Participant Summary Report as a benefit to subscribers.

The Association of Molecular Pathology (AMP) facilitates sample exchange between laboratories through its listserv, CHAMP. Laboratories seeking others to test performance on specific analytes contact one another via the listserv. The laboratories are responsible for establishing testing parameters and facilitating exchange of specimens and test results.

PT Performance and Alternative Assessment

Laboratories participating in CAP PT for genetic testing have performed well. Aggregate data for 2006 molecular genetics PT demonstrates that on a cumulative basis for the two PT events (MGL 2006 A & B), 99 percent of laboratory responses to challenges were acceptable (see Appendix E, Table 2). Analytes in these two surveys included the highest volume genetic tests: factor V Leiden, prothrombin, methylenetetrahydrofolate reductase, fragile X mental retardation, CF, Prader Willi/Angelman syndromes, hemochromatosis, Duchenne muscular dystrophy, and hemoglobin S/C genes. Interpretation of the analytical result was also evaluated, and 98 percent of participant laboratory responses were acceptable. Additionally, cumulative PT result data for 2002–2006 for cytogenetics (four components) and molecular pathology and genetics demonstrate improving trends of performance (see Appendix E, Table 3). In surveys and continuous reviews conducted by CMS of 27,558 U.S. laboratories between January 2004 and September 2006, 1.5 percent of these laboratories were cited for unsuccessful PT at the condition level, and 3.6 percent were cited for nonenrollment in PT for regulated analytes.³⁰²

For genetic tests without available PT survey material, laboratories are required to perform an AA. The laboratory AA program must be documented. Results must be recorded and reviewed by the laboratory. Corrective action taken for unsuccessful performance must be documented and available for review during the laboratory's external biennial inspection performed by CMS or a CMS-deemed accrediting agency.

³⁰¹ College of American Pathologists Web site. See <http://www.cap.org>. Accessed on March 29, 2008.

³⁰² Judy Yost, CMS, personal communication.

Failure to perform AA or document its results, review results, or take corrective action for an unacceptable performance will lead to a deficiency citation upon laboratory inspection. In 20,722 CMS surveys (2004–2006), 7.1 percent of laboratories were not in compliance with this requirement. Deficiency citations are reported to CMS and available to the public upon request to CMS.

In a 2006 survey of 190 genetic testing laboratories, Hudson et al.³⁰³ found wide variations in laboratory performance, as measured by the number of deficiencies in formal PT and the number of incorrect test results reported by a laboratory. The survey further found that these quality measures were related to the extent of the laboratory’s participation in PT. The authors reported that when a formal PT program was not available, 23 percent of laboratories did not always perform an AA (which the survey referred to as “informal PT”). Overall, the survey found that about one-third of laboratories offered some genetic tests for which they performed no formal PT or AA. Moreover, PT deficiencies decreased significantly with increasing use of PT and AA, and the number of PT deficiencies experienced by a laboratory correlated positively with the number of incorrect test results reported by the laboratory.

Bonini et al.³⁰⁴ reviewed seven studies of general clinical laboratory practice and found that most laboratory errors occurred in the preanalytical phase (31–75 percent), followed by the analytical (4–40 percent) and postanalytical phases (9–31 percent). The 2006 survey by Hudson et al. went beyond these studies and found that laboratories whose most common error was an analytical one were more likely to perform genetic tests without either formal PT or AA.

Newborn Screening Quality Assurance Program

Newborn screening is the largest genetic testing effort in the Nation and is primarily performed by State public health laboratories. State laboratories, their associated laboratories, or private laboratories routinely screen dried-blood-spot (DBS) specimens for inborn errors of metabolism and other disorders that require intervention. For more than 28 years, CDC and its co-sponsor, the Association of Public Health Laboratories, has conducted research on materials development and assisted laboratories with QA for these DBS screening tests. The annual summary report as well as the quarterly reports for most of the PT programs can be found online at <http://www.cdc.gov/labstandards/nsqap.htm>.

The Newborn Screening Quality Assurance Program (NSQAP) at CDC is the most comprehensive QA program worldwide for newborn screening of analytes in the DBS matrix. It provides certified DBS QC materials, PT for more than 35 disorders, training and consultations for problem-solving, and filter paper QA. The QC program enables laboratories to achieve high levels of technical proficiency and continuity that transcend changes in commercial assay reagents while maintaining the high-volume specimen throughput that is required. The PT program provides laboratories with quarterly panels of blind-coded DBS specimens and gives each laboratory an independent external assessment of its performance. All laboratories in the United States that test DBS specimens participate voluntarily in NSQAP, free of charge.³⁰⁵ Since it is a voluntary program, there is no requirement to participate other than possibly satisfying CLIA or State requirements. CLIA requires AA,³⁰⁶ and laboratories can utilize NSQAP to meet this standard.

³⁰³ Hudson, K.L., Murphy, J.A., Kaufman, D.J., Javitt, G.H., Katsanis, S.H., and Scott, J. (2006). Oversight of US genetic testing laboratories. *Nature Biotechnology*. 24(9):1083-1090.

³⁰⁴ Bonini, P., Plebani, M., Ceriotti, F., and Rubboli, F. (2002). Errors in laboratory medicine. *Clinical Chemistry*. 48(5):691-698.

³⁰⁵ Centers for Disease Control and Prevention Web site. “Newborn Screening Quality Assurance Program.” See <http://www.cdc.gov/labstandards/nsqap.htm>. Accessed on March 29, 2008.

³⁰⁶ 42 CFR 493.1236.

Newborn screening analytes and the DBS matrix are not regulated by CLIA. Therefore, no process exists to obtain CLIA-approved PT provider status for NSQAP. NSQAP, however, exceeds most of the operation requirements of a CLIA-approved PT provider in terms of the number of challenges distributed per year.

NSQAP prepares and distributes more than 500,000 DBS materials per year to national laboratories. DBS materials for QC and PT are certified for homogeneity, accuracy, stability, and suitability for all assays from different commercial sources. The program also serves as a central repository of critical QA data, as an unbiased point of coordination and communication, and as a reference resource for the Nation's screening laboratories. False-positive and false-negative reports are received and processed each quarter. CDC provides immediate notification and consultation to laboratories that misclassify a specimen so that corrective actions may be taken to maintain high-quality test results.

Genetic Testing Reference Materials Coordination Program

CDC, in partnership with the genetics community, has established the Genetic Testing Reference Materials (GeT-RM) Coordination Program.³⁰⁷ Its goal is to improve the supply of publicly available and well-characterized genomic DNA that can be used as reference materials for PT, QC test development/validation, and research studies.

Well-characterized reference materials are fundamental to laboratory QA programs, including both external assessment by PT and internal QA activities such as QC and test development/validation. Several types of reference materials exist, and the selection of appropriate material is based on the needs of the assay, test methodology, and availability. For example, human genomic DNA provides the closest approximation of an actual patient sample, but scientists can typically control for only a few genotypes at a time. Other sample types such as synthetic DNA controls—short fragments of DNA synthesized in a laboratory—are useful when human DNA is not available or when multiple alleles or genotypes need to be monitored simultaneously. Synthetic DNA samples, however, will not test the laboratory's preanalytical processes for extraction and purification of DNA, which are additional sources of error.

Currently, characterized reference or QC materials are not available for the vast majority of clinical genetic tests. PT program vendors usually solicit large hospital centers or commercial vendors to obtain blood and tissue specimens from affected patients to support the PT programs. These materials must be validated prior to use. For some genetic tests, including many disorders in the CAP PT surveys, sufficient and appropriate material is not publicly available. For example, until very recently, genomic DNA materials for allele repeat lengths representing important phenotypic classes and diagnostic cutoffs for fragile X were not publicly available. The absence of such materials for routine QC, PT, and test development may have accounted for the differences in laboratory performance in some recent CAP PT fragile X surveys.

The GeT-RM program has recently characterized 57 cell lines to be utilized as reference materials for disorders such as fragile X syndrome, Huntington disease, and disorders on the Ashkenazi Jewish panel (i.e., Bloom syndrome, Canavan disease, Fanconi anemia, familial dysautonomia, Gaucher disease, mucopolysaccharidosis IV, Neimann Pick disease, and Tay-Sachs disease). These materials are (or soon will be) publicly available from Coriell Cell Repositories, which houses several National Institutes of Health (NIH)-funded collections of essential research reagents. A characterization study of 14 DNA materials with important mutations causing CF is currently under way in six collaborating clinical laboratories.

³⁰⁷ Centers for Disease Control and Prevention Web site. "Genetic Testing Reference Materials Coordination Program (GeT-RM) - Home." See <http://wwwn.cdc.gov/dls/genetics/qcmaterials/default.aspx>. Accessed on March 29, 2008.

Additionally, the GeT-RM program is characterizing a panel of DNA specimens with identifiable gene mutations for confirmatory testing in disorders included in State newborn screening panels. This includes disorders such as congenital adrenal hyperplasia, medium-chain acyl-CoA dehydrogenase deficiency, maple syrup urine disease, CF, and galactosemia. Additional materials are in development for gene mutations found in Gaucher's disease, Tay-Sachs disease, and Canavan disorders. Development of materials will soon be initiated for other disorders, including inherited breast cancer (caused by *BRCA1* or *BRCA2* mutations), alpha-1 antitrypsin deficiency, and type 2 multiple endocrine neoplasia.

To date, the GeT-RM program has focused its efforts on DNA-based testing for inherited genetic disorders. Other areas of genetics, including molecular oncology, molecular infectious disease testing, and biochemical genetic testing, however, are also facing a paucity of reference and PT materials. To address these needs, the GeT-RM program, together with the genetics community, professional organizations, and other governmental agencies outside of CDC, is trying to assess what reference materials are currently available for laboratory QA programs and is beginning to formulate plans for collecting and characterizing materials where shortages exist.

Challenges Related to Proficiency Testing

Education vs. Regulation

How can PT best detect laboratory error in the short term in order to improve testing quality in the long term? When performance problems are identified, the PT provider should be able to give technical assistance to the laboratory in developing the remediation plan. As new categories or new analytes are tested, it is generally advisable to offer ungraded but thoroughly evaluated proficiency challenges to make certain the tested laboratories know what is expected and to make sure the PT provider understands the potential issues to be identified. What is the balance of education vs. punitive action for PT? Punitive regulatory action may result in adverse actions, including a decrease in the number of laboratories subscribing for non-required PT and pressure to lessen the difficulty of PT challenges to ensure a satisfactory passing percentage.

Breadth of PT

Whenever possible, PT should include a formal assessment of the laboratory's pre-analytical analysis of real specimens and its post-analytical analysis based on the laboratory report and supporting materials. In this way, laboratories are scored for performance on accession data and interpretation of the test result. The Molecular Oncology and Molecular Genetic surveys produced by CAP include scoring of interpretive responses. Additionally, periodic summary evaluations are included with PT materials that inquire about laboratory accession and result reporting.

Sufficient Specimens

There must be a sufficient volume of uniform testing specimens so that laboratories are testing the same reagent/tissue/analyte. With the new HER2 guidelines published in 2007,³⁰⁸ there has been an increase in

³⁰⁸ Wolff, A.C., Hammond, M.E., Schwartz, J.N., Hagerty, K.L., Allred, D.C., Cote, R.J., Dowsett, M., Fitzgibbons, P.L., Hanna, W.M., Langer, A., McShane, L.M., Paik, S., Pegram, M.D., Perez, E.A., Press, M.F., Rhodes, A., Sturgeon, C., Taube, S.E., Tubbs, R., Vance, G.H., van de Vijver, M., Wheeler, T.M., Hayes, D.F., (2007). American Society of Clinical Oncology/College of American Pathologists guideline recommendations for human epidermal growth factor receptor 2 testing in breast cancer. *Journal of Clinical Oncology*. 25(1):118-145.

PT participation for the CAP IHC and FISH surveys. Laboratory enrollment in HER2 PT has increased by 153 percent for IHC and 10 percent for FISH. Providing sufficient uniform material to be utilized in these surveys required CAP to seek assistance from the National Cancer Institute and from private and commercial anatomic pathology laboratories to supply sufficient tissue specimens.

The lack of test kits and standards for many genetic tests means each laboratory has its own LDTs, so methods may be different between laboratories and the outcome of PT may be different as well. Therefore, clinical interpretation of the result is as important as the analytical interpretation with regard to limitations of each test and the sensitivity/specificity for the disease in question.

The CAP PT program usually sends out cell lines (or extracted DNA or RNA) for nearly all of its genetic PT surveys but may use residual clinical specimens when available. Access to abundant, high-quality patient specimens is limited and, in part, is being addressed by the GeT-RM program. Funding is needed to expand the scope of this type of work so that additional cell lines and tissues are developed, obtained, and characterized for use in PT for genetics, oncology, and pharmacogenetic testing.

Cost of PT Programs

There is little financial motivation for vendors to produce PT materials for genetics because of the relatively low volume of subscribers compared with the high cost of producing the PT challenges. Vendors must supply not only materials for PT but the supporting infrastructure as well, including marketing, staff assistance, scientific and statistical expertise, and communication formats. Professional organizations such as CAP see it as a longer-term investment in promoting laboratory quality and patient safety.

Vendors also witness declining participation in existing PT products due to gene patents and exclusive licensing agreements, such as with *BRCA1* and *BRCA2*. As a result, the ACMG/CAP PT program for exclusively licensed genetic tests may become extinct due to prohibitive cost. Additionally, vendors see increasing costs of materials from cell banks and repositories such as the American Type Culture Collection.

Increased costs to the vendor are passed on to the laboratory. As the cost of PT increases, the number of laboratory participants (especially low-volume laboratories) may decrease due to declining reimbursement for laboratory tests. Most reimbursement is drifting downward to Medicare or sub-Medicare levels, and there is insufficient Medicare reimbursement for many molecular current procedural terminology codes.

Transportation of Biological Material

Transportation restrictions imposed on shipping biological material across State lines raise problems for access to PT specimens for PT products. Because of FDA requirements for blood collection applicable to interstate commerce, there may be difficulties with access to blood samples for use in PT panels for rare genetic disorders. The Secretary's Advisory Committee on Genetics, Health, and Society (SACGHS) encourages FDA to work with industry to facilitate the availability of blood from persons with genetic disorders for use solely in proficiency panels.

Clinical Validity

The clinical validity of a genetic test refers to the test's accuracy in detecting the presence of, or predicting the risk for, a health condition or phenotype.³⁰⁹ When a test is used diagnostically, clinical validity measures the association of the test result with the disorder. When a test is used to identify genetic susceptibility, clinical validity measures the accuracy with which it predicts a future clinical outcome. This property corresponds to the gene-disease associations measured in epidemiological studies.

Key Terms and Concepts

Along with the elements of analytical validity, six elements are relevant to assessing clinical validity:^{310, 311}

Clinical sensitivity (or the clinical detection rate) measures the proportion of individuals for whom the test result correctly identifies or predicts the presence of a well-defined disorder. In genetic tests, this is often seen as the relationship between genotype and phenotype. The clinical sensitivity of some genetic tests depends on the number of mutations that the test is able to identify (e.g., a test for only the p.F508 mutation in the CFTR protein will identify fewer individuals with CF compared with a test that detects the entire ACMG recommended panel of 23 CFTR mutations).

Clinical specificity measures the proportion of individuals for whom the test result correctly detects or predicts the absence of a well-defined clinical disorder.

Positive and negative predictive values are the probabilities that people (within a defined population) with positive test results will get the disease (positive predictive value) and that people (within a defined population) with negative results will not get the disease (negative predictive value). These values are useful ways to present clinical validity data to clinicians.

Prevalence measures the proportion of individuals in the selected setting or population who have the phenotype.

Penetrance defines the relationship between genotype and phenotype. It is the probability or likelihood that the condition (or phenotype) will be expressed when a particular genotype is present.³¹² Penetrance is expressed numerically (e.g., if 100 individuals all have a particular gene mutation but only 80 of them have the condition associated with that mutation, then the mutation is said to be 80 percent penetrant). For example, Duchene muscular dystrophy is considered 100 percent penetrant, as virtually 100 percent of individuals with disease-causing mutations in the *DMD* gene will develop Duchene muscular dystrophy, whereas hereditary nonpolyposis colorectal cancer (HNPCC) is considered 75 percent penetrant as about 75 percent of people with HNPCC-causing mutations develop this cancer.

³⁰⁹ Adapted from the 1997 NIH/DOE Task Force report, *Promoting Safe and Effective Genetic Testing in the United States*. See <http://www.genome.gov/10001733>. Accessed on March 29, 2008.

³¹⁰ Centers for Disease Control and Prevention Web site. "ACCE: A CDC-Sponsored Project Carried Out by the Foundation of Blood Research." See <http://www.cdc.gov/genomics/gtesting/ACCE.htm>. Accessed on March 29, 2008.

³¹¹ Centers for Disease Control and Prevention Web site. "About EGAPP." See <http://www.cdc.gov/genomics/gtesting/EGAPP/about.htm>. Accessed on March 29, 2008.

³¹² Constantin, C.M., Faucett, A., and Lubin, I.M. (2005). A primer on genetic testing. *Journal of Midwifery and Women's Health*. 50(3):197-204.

Modifiers include other genetic or environmental factors that may interact with the genetic alteration being studied and the outcome of interest. Modifiers can affect expressivity, which refers to the variability of signs or symptoms that occur with a phenotype.

Types of Genetic Tests

Genetic tests may have a number of purposes, and some tests are used for more than one purpose (see Table 4–1).

Table 4–1. Types of Genetic Tests	
Test Type	Description
<i>Tests for gene mutations with high penetrance</i>	
Diagnosis of genetic disease	Testing patient with indicative clinical findings of a specific disease to establish the diagnosis
Newborn screening	Testing newborns to identify the presence of condition(s) that require immediate initiation of treatment to prevent death or disability
Carrier tests	Testing performed in an asymptomatic adult to identify whether the individual is a carrier for an autosomal or X-linked recessive condition(s)
Prenatal tests	Testing to identify a fetus with a genetic disease or condition. Testing is usually initiated due to family history or maternal factors. Some prenatal tests are routinely offered, such as for Down syndrome
Presymptomatic tests for adult onset of a genetic condition or disease	Testing adults to identify a genetic condition that will occur later in life such as Huntington disease
<i>Tests for gene variants that are associated with genetic susceptibility</i>	
Test to predict drug response	Testing to identify individuals likely to have a reduced or increased response to a particular drug, or reduced or increased risk of adverse drug reaction
Assess genetic risk for common complex disease/disorder	Testing to identify individuals at future risk for developing a disease or disorder with multigenic and environmental causes, such as heart disease or diabetes
Test to evaluate prognosis	Testing to evaluate the likely outcome or course of a disease, particularly cancers

A test’s clinical validity is influenced by a number of factors, including the purpose of the test, the prevalence of the disease or condition for which the test is being conducted, and the adequacy of the information available to determine how accurate the test is in detecting or predicting risk for a health condition or phenotype.

The acceptable levels for clinical sensitivity and specificity may vary, depending on the purpose for which the test is used. For example, tests that diagnose a condition in clinically symptomatic individuals may place more emphasis on sensitivity and less emphasis on high specificity because of the high *a priori* likelihood

(high prevalence). For example, testing for three *HFE* mutations in individuals with clinical and biochemical evidence of hereditary hemochromatosis may be warranted, even though two of the three mutations are of low penetrance. Although the identification of two *HFE* mutations can be useful for diagnosis, treatment is likely to be based on biochemical measurements such as serum ferritin. Alternatively, tests that are used in the general population often stress specificity over sensitivity, especially if the disorder of interest is relatively uncommon (low prevalence). According to recommendations from ACMG, identifying carrier couples as part of the prenatal diagnosis of CF via *CFTR* testing should be limited to 23 mutations that are known to cause classic CF. Although such a panel will have lower clinical sensitivity than a much larger panel, higher clinical specificity will be achieved, as the possibility of false positive results due to nondeleterious polymorphisms being interpreted as classic mutations will be reduced.

Evaluating Clinical Validity

Evaluation of the clinical validity of the genetic test is a complex process that might be incomplete at the time of offering the service. The evaluation that led to the recommendations for CF screening provides a useful example. In April 2001, ACMG's Cystic Fibrosis Carrier Screening Working Group issued recommendations for a population screening program to determine carrier status within the *CFTR* gene using a panel of 25 mutations and variants that were known to have an allele frequency of greater than 0.1 percent among North American patients with CF. This recommendation was the result of an NIH Cystic Fibrosis Consensus Conference that CF carrier screening be offered to all couples before conception or prenatally. At that time, the Working Group recognized limitations in understanding the population frequencies of several *CFTR* alleles but still recommended population screening to determine CF carrier status for couples before conception or prenatally. In light of this understanding, the Working Group proposed to review mutation distribution data after the first 2 years of the program. In 2004, this mutation panel was ultimately revised by the ACMG Cystic Fibrosis Carrier Screening Working Group based on 2-year laboratory data derived from general population screening.^{313, 314, 315, 316, 317}

Existing programs—such as the Collaboration, Education, and Test Translation (CETT) program,³¹⁸ which focuses on rare diseases—or new models of private or public-private partnerships could spur evaluation of the clinical validity of genetic tests without adversely affecting innovation. For example, an experienced group of genetic experts could be tasked to review preliminary data submitted by a laboratory and to provide specific recommendations to strengthen the scientific claims. Similar approaches for review and

³¹³ National Institutes of Health Consensus Development Program (1997). *Genetic Testing for Cystic Fibrosis: National Institutes of Health Consensus Development Conference Statement*. See <http://consensus.nih.gov/1997/1997GeneticTestCysticFibrosis106html.htm>. Accessed on March 30, 2008.

³¹⁴ American College of Obstetricians and Gynecologists Committee Opinion. (2005). Number 325, December 2005. Update on carrier screening for cystic fibrosis. *Obstetrics and Gynecology*. 106(6):1465-1468.

³¹⁵ Grody, W.W., Cutting, G.R., Klinger, K.W., Richards, C.S., Watson, M.S., Desnick, R.J., Subcommittee on Cystic Fibrosis Screening, Accreditation of Genetic Services Committee, American College of Medical Genetics. (2001). Laboratory standards and guidelines for population-based cystic fibrosis carrier screening. *Genetics in Medicine*. 3(2):149-154.

³¹⁶ American College of Obstetricians and Gynecologists and American College of Medical Genetics. (2001). *Preconception and Prenatal Carrier Screening for Cystic Fibrosis: Clinical and Laboratory Guidelines*. Washington, D.C.: ACOG.

³¹⁷ Watson, M.S., Cutting, G.R., Desnick, R.J., Driscoll, D.A., Klinger, K., Mennuti, M., Palomaki, G.E., Popovich, B.W., Pratt, V.M., Rohlf, E.M., Strom, C.M., Richards, C.S., Witt, D.R., and Grody, W.W. (2004). Cystic fibrosis population carrier screening: 2004 revision of American College of Medical Genetics mutation panel. *Genetics in Medicine*. 6(5):387-391.

³¹⁸ Collaboration, Education, and Test Translation Program Web site. See <http://www.cettprogram.org/>. Accessed on March 30, 2008.

certification have been successfully implemented in other areas of medicine. For example, in an effort to promote the adoption of electronic health records (EHRs) while ensuring minimal levels of interoperability, functionality, and security, HHS contracted with a consortium of private-sector entities, the Certification Commission for Health Information Technology (CCHIT), to develop and implement a voluntary, transparent certification process for EHRs. Through a collaborative, multistakeholder process, certification standards were adopted, and currently approximately 40 percent of companies with ambulatory EHR products have had their products certified by CCHIT. Potential purchasers of EHR products can now buy such products with greater certainty of their effectiveness, and EHR companies remain free to innovate.

A voluntary certification process could also be considered for genetic tests as an incremental, market-oriented mechanism for enhanced oversight that would complement the existing regulatory framework. HHS could contract with a private consortium representing multiple stakeholders (e.g., a “Genetic Test Certification Commission”) to adopt consensus standards for the effectiveness of specific genetic tests and to establish a transparent certification process. Companies offering genetic tests could voluntarily submit their tests for certification, and once certified such tests could be performed as “certified laboratory-developed genetic tests.” As such, companies with noncertified genetic LDTs could continue to perform their tests and innovate, but they would have an incentive to meet the consensus standards represented by certification. Such a certification process could potentially enhance public confidence in the clinical validity of genetic tests.

Clinical Validity: A Case Study

Clinical validity is certainly an issue of great complexity and importance in the case of genetic testing. The issue becomes increasingly problematic for genetic tests that are rapidly being marketed to a broad segment of the population through direct-to-consumer advertising, despite the fact that clinical validity has not been adequately established for many of these tests.² in all population groups. Box 4–2, on breast cancer caused by mutations in the *BRCA1* or *BRCA2* gene, helps illustrate the nuances involved in this topic.

Box 4–2. Case Example: *BRCA1* and *BRCA2*

Mutations in two genes, *BRCA1* and *BRCA2*, are implicated in 5 percent to 10 percent of all breast cancers. Mutations in these genes also predispose patients to ovarian and prostate cancers (*BRCA1*) or pancreatic cancer (*BRCA2*). The *BRCA1* gene was identified in 1990 and sequenced in 1994,³¹⁹ the same year that the *BRCA2* gene was located.³²⁰ *BRCA1* and *BRCA2* mutations have been estimated to induce approximately 45 percent of breast cancer susceptibility syndromes that are transmitted as an

Continues on next page.

³¹⁹ Miki, Y., Swensen, J., Shattuck-Eidens, D., Futreal, P.A., Harshman, K., Tavtigian, S., Liu, Q., Cochran, C., Bennett, L.M., Ding, W., Bell, R., Rosenthal, J., Hussey, C., Tran, T., McClure, M., Frye, C., Hattier, T., Phelps, R., Haugen-Strano, A., Katcher, H., Yakumo, K., Gholami, Z., Shaffer, D., Stone, S., Bayer, S., Wray, C., Bogden, R., Dayananth, P., Ward, J., Tonin, P., Narod, S., Bristow, P.K., Noriss, F. H., Helvering, L., Morrison, P., Rosteck, P., Lai, M., Barrett, J.C., Lewis, C., Neuhausen, S., Cannon-Albright, L., Goldgar, D., Wiseman, R., Kamb, A., and Skolnick, M.H. (1994). A strong candidate for the breast and ovarian cancer susceptibility gene BRCA1. *Science*. 266(5182):66-71.

³²⁰ Wooster, R., Neuhausen, S.L., Mangion, J., Quirk, Y., Ford, D., Collins, N., Nguyen, K., Seal, S., Tran, T., Averill, D., Fields, P., Marshall, G., Narod, S., Lenoir, G.M., Lynch, H., Feunteun, J., Devilee, P., Cornelisse, C.J., Menko, F.H., Daly, P.A., Ormiston, W., McManus, R., Pye, C., Lewis, C.M., Cannon-Albright, L.A., Peto, J., Ponder, B.A.J., Skolnick, M.H., Easton, D.F., Goldgar, D.E., and Stratton, M.R. (1994). Localization of a breast cancer susceptibility gene, BRCA2, to chromosome 13q12-13. *Science*. 265(5181):2088-2090.

autosomal dominant trait and are usually associated with a younger age of onset. These discoveries were important, as they led to tests for women with a strong family history of breast cancer that could determine whether they have mutations in these genes. Even though genetic testing was available, there were a significant number of uncertainties on how to proceed in the management of patients and family members of patients with breast cancer. There were also ethical issues that arose regarding who should be tested.

There was a lack of consensus for BRCA testing, partly due to the considerable uncertainty about the penetrance of *BRCA1* and *BRCA2* mutations. First, studies have estimated the lifetime risk of breast cancer associated with *BRCA1* and *BRCA2* mutations that range from 36 percent to 85 percent, while the variation in cancer phenotype (i.e., breast cancer, ovarian cancer, both, or neither) remains unexplained.^{321, 322, 323, 324} Second, the efficacy of the interventions offered to *BRCA1* and *BRCA2* mutation carriers—early mammography, ovarian cancer screening, prophylactic surgery—was uncertain and based largely on expert opinion.³²⁵ Furthermore, the intervention with the most efficacy data, prophylactic mastectomy,³²⁶ was accepted by only a minority of eligible women.³²⁷ As a result, there were uncertainties about key parameters, clinical validity, and clinical utility.

Today, we know that inheritance of the mutation does not necessarily convey a certainty of developing cancer, nor does it indicate the type of cancer or the age of onset. The average cumulative risk of breast cancer mutations in either the *BRCA1* gene or *BRCA2* gene is about 27 percent to age 50 and 64 percent to age 70. Both environmental and other genetic factors play roles in the development of breast or other cancers in the mutation-positive patients, as does the type of DNA mutation in *BRCA1* or *BRCA2*. Mutations in these genes are heterogeneous and located throughout each gene, with more than 1,600 different mutations identified to date. Interestingly, the range of mutations varies greatly

Continues on next page.

³²¹ Easton, D.F., Ford, D., and Bishop, D.T. (1995). Breast and ovarian cancer incidence in BRCA1-mutation carriers. Breast Cancer Linkage Consortium. *American Journal of Human Genetics*. 56(1):265-271.

³²² Struwing, J.P., Abeliovich, D., Peretz, T., Avishai, N., Kaback, M.M., Collins, F.S., and Brody, L.C. (1995). The carrier frequency of the BRCA1 185delAG mutation is approximately 1 percent in Ashkenazi Jewish individuals. *Nature Genetics*. 11(2):198-200.

³²³ Ford, D., Easton, D.F., Stratton, M., Narod, S., Goldgar, D., Devilee, P., Bishop, D.T., Weber, B., Lenoir, G., Chang-Claude, J., Sobol, H., Teare, M.D., Struwing, J., Arason, A., Scherneck, S., Peto, J., Rebbeck, T.R., Tonin, P., Neuhausen, S., Barkardottir, R., Eyfjord, J., Lynch, H., Ponder, B.A., Gayther, S.A., Zelada-Hedman, M., Birch, J.M., Lindblom, A., Stoppa-Lyonnet, D., Bignon, Y., Borg, A., Hamann, U., Haites, N., Scott, R.J., Maugard, C.M., Vasen, H., Seitz, S., Cannon-Albright, L.A., and Scholfield, A. (1998). Genetic heterogeneity and penetrance analysis of the BRCA1 and BRCA2 genes in breast cancer families. The Breast Cancer Linkage Consortium. *American Journal of Human Genetics*. 62(3):676-689.

³²⁴ Thorlacius, S., Struwing, J.P., Hartge, P., Olafsdottir, G.H., Sigvaldason, H., Tryggvadottir, L., Wacholder, S., Tulinius, H., and Eyfjord, J.E. (1998). Population-based study of risk of breast cancer in carriers of BRCA2 mutation. *Lancet*. 352(9137):1339-1339.

³²⁵ Burke, W., Daly, M., Garber, J., Botkin, J., Kahn, M.J., Lynch, P., McTiernan, A., Offit, K., Perlman, J., Petersen, G., Thomson, E., and Varricchio, C. (1997). Recommendation for follow-up care of individuals with an inherited predisposition to cancer. II. BRCA1 and BRCA2. Cancer Genetics Studies Consortium. *Journal of the American Medical Association*. 277(12):997-1003.

³²⁶ Hartmann, L.C., Schaid, D.J., Woods, J.E., Crotty, T.P., Myers, J.L., Arnold, P.G., Petty, P.M., Sellers, T.A., Johnson, J.L., McDonnell, S.K., Frost, M.H., and Jenkins, R.B. (1999). Efficacy of bilateral prophylactic mastectomy in women with a family history of breast cancer. *New England Journal of Medicine*. 340(2):77-84.

³²⁷ Lerman, C., Hughes, C., Croyle, R.T., Main, D., Durham, C., Snyder, C., Bonney, A., Lynch, J.F., Narod, S.A., and Lynch, H.T. (2000). Prophylactic surgery decisions and surveillance practices one year following BRCA1/2 testing. *Preventive Medicine*. 31(1):75-80.

among different populations, with founder mutations observed in many ethnic groups. Testing for disease-associated mutations is made difficult by the heterogeneity of the disease-causing mutations and the complexity of the *BRCA1* and *BRCA2* genes. Moreover, the clinical significance of some observed variants is unknown, and in some cases observed variants may be benign. The issue of possible differences in the clinical outcome of the *BRCA*-mutation carriers compared with that of woman with sporadic breast cancer has been addressed by a number of different studies but results have been conflicting, with some reports of worse prognosis related to *BRCA1* mutational status and others highlighting no substantial differences.³²⁸

Continuing uncertainties regarding *BRCA1* and *BRCA2* genetic testing prompted the development of practice guidelines and recommendations by professional societies and the Federal Government. Guidelines for assessment, counseling, and testing for genetic susceptibility for breast and ovarian cancer have been developed by ACMG and the New York Department of Health.³²⁹ The U.S. Preventive Services Task Force developed a set of recommendations titled *Genetic Risk Assessment and BRCA Mutation Testing for Breast and Ovarian Cancer Susceptibility*³³⁰ that provided recommendations for screening for *BRCA1* mutation carriers and mutations.

Challenges Related to Clinical Validity

For many genetic tests, particularly those that are predictive or presymptomatic, prospective knowledge of the test's clinical validity may be incomplete for many years after the test is developed, although the probable clinical validity may be estimated in some cases using retrospective data. When information that may affect clinical validity is incomplete, the potential harms of the test may increase and must be considered more carefully.³³¹ Even with incomplete data, however, there may be sufficient information to warrant offering the test in addition to the fact that even greater harm may be caused by denying testing. Nonetheless, to minimize harms, it is important to collect data over time. Because the data for clinical validity are often incomplete, innovative approaches involving many organizations and disciplines working together to collect and share data and analyses may be needed. Such approaches may require new policy and programmatic constructs and resources. CDC's Evaluation of Genomic Applications in Practice and Prevention (EGAPP) initiative³³² (discussed in Chapter II) and the CETT program³³³ are examples of current activities that successfully evaluate clinical validity. Long-term followup is also needed to ensure that the test has clinical utility, which is discussed in Chapter V.

³²⁸ Begg, C.B., Haile, R.W., Borg, A., Malone, K.E., Concannon, P., Thomas, D.C., Langholz, B., Bernstein, L., Olsen, J.H., Lynch, C.F., Anton-Culver, H., Capanu, M., Liang, X., Hummer, A.J., Sima, C., and Bernstein, J.L. (2008). Variation of breast cancer risk among BRCA 1/2 carriers. *Journal of the American Medical Association*. 299(2):194-201.

³²⁹ American College of Medical Genetics Foundation with support from New York State Department of Health. (1999). *Genetic Susceptibility to Breast and Ovarian Cancer: Assessment, Counseling and Testing Guidelines*. See <http://www.health.state.ny.us/nysdoh/cancer/obcancer/contents.htm>. Accessed on March 30, 2008.

³³⁰ U.S. Preventive Services Task Force (2005). Genetic risk assessment and BRCA mutation testing for breast and ovarian cancer susceptibility: recommendation statement. *Annals of Internal Medicine*. 143(5):355-361.

³³¹ Secretary's Advisory Committee on Genetic Testing (2000). *Enhancing the Oversight of Genetic Tests: Recommendations of the SACGT*. See http://www4.od.nih.gov/oba/sacgt/reports/oversight_report.pdf. Accessed on March 30, 2008.

³³² Evaluation of Genomic Applications in Practice and Prevention (EGAPP) Web site. See <http://www.egappreviews.org/>. Accessed on March 30, 2008.

³³³ Collaboration, Education, and Test Translation Program Web site. See <http://www.cettprogram.org/>. Accessed on March 30, 2008.

Numerous challenges exist to collecting postmarket data. Multisite research projects and longitudinal followup studies are often necessary. There is also the need to link laboratory results with clinical data, which is particularly challenging with regard to issues of privacy and confidentiality. Additionally, it is important to have broad access to data for secondary analysis and dissemination. Possible models include the CETT program, the Human Variome Project,³³⁴ and dbGaP (in which genotype-phenotype information is accessible in an up-to-date database).³³⁵

Assessing clinical validity may be particularly challenging in the case of tests for ultrarare diseases. As relatively few people have these diseases, gathering statistically significant data can be extremely challenging. Thus prevalence is a factor in determining how much data on test performance should be available before a test is offered to patients.³³⁶

Many different organizations provide clinical practice guidelines using different processes and methodologies, but their approaches are not always transparent. Evidence may be lacking when the guidelines are issued, and as new data emerge, revisions are necessary. In the field of genetics, technology is evolving rapidly, and the quality of evidence builds over time.³³⁷ Increasingly, multidisciplinary approaches to guideline development (e.g., by professional organizations with a clinical and/or laboratory focus) may have advantages.

Current Oversight Systems for Ensuring the Validity of Genetic Tests and the Quality of Laboratories

Genetic testing laboratories must comply with regulations set forth by Federal and State (if applicable) agencies as they apply to LDTs and manufacturers of commercially distributed test kits. Agencies and organizations involved in standards development also provide a critical element in oversight by providing QC and reference materials that are essential for validating performance characteristics of laboratory tests. Knowledge generation and synthesis agencies play a crucial role in oversight by collecting data and analyzing research findings to determine the appropriate use of genetic tests. Several professional societies are actively involved in improving the quality of laboratory practices and developing clinical guidelines to ensure the appropriate use of genetic testing.

Federal Regulatory Agencies

Oversight at the Federal level includes activities carried out by both FDA and CMS (under CLIA). A broad discussion of oversight is provided in Chapter II.

CMS and CLIA

CLIA regulations are designed to ensure the quality of laboratory testing. These regulations require laboratories to verify/establish the test's analytical performance characteristics before laboratories can

³³⁴ The Human Variome Project Web site. See <http://www.variome.org/>. Accessed on March 30, 2008.

³³⁵ National Center for Biotechnology Information dbGAP Web site. See <http://www.ncbi.nlm.nih.gov/sites/entrez?db=gap>. Accessed on March 30, 2008.

³³⁶ Secretary's Advisory Committee on Genetic Testing (2000). *Enhancing the Oversight of Genetic Tests: Recommendations of the SACGT*. See http://www4.od.nih.gov/oba/sacgt/reports/oversight_report.pdf. Accessed on March 30, 2008.

³³⁷ Burke, W. Presentation to SACGHS meeting, March 26-27, 2007. See <http://www4.od.nih.gov/oba/SACGHS/meetings/Mar2007/SACGHSMar2007meeting.htm>. Accessed on March 30, 2008.

offer a new test and report patient results. The regulations do not require that a laboratory follow specific procedures or protocols as long as it can ensure that its test results are accurate, reliable, timely, and confidential and that there is little risk of harm to patients.³³⁸ CMS, however, does provide guidance and resources in its Interpretive Guidelines for Laboratories³³⁹ to help laboratories achieve compliance.

Analytical Validity

CLIA regulations for analytical validity apply to FDA-cleared and -approved products, modified tests that use cleared or approved products, and LDTs. The CLIA survey process does not evaluate every test in the laboratory every 2 years but instead evaluates the laboratory operation as whole, using a sample of tests for all of the laboratory's systems and processes. For recertification, surveyors examine samples of validation procedures and data for LDTs, other noncleared or nonapproved tests, and FDA cleared or approved tests. They also review new tests and specialties instituted since the previous inspection process and any that were previously problematic. CLIA requires that all nonwaived tests introduced into the laboratory after April 24, 2003 (previously this requirement applied only to high-complexity tests), have performance specifications or analytical validity verified or established prior to reporting patient test results.³⁴⁰

As discussed earlier in this chapter, there are two different sets of requirements—for verification or validation—dependent on whether the test is FDA cleared, approved, or neither. CLIA also requires that the laboratory determine calibration and control procedures based on the performance specifications it verified or validated. In this determination, the laboratory must consider test system stability, test frequency, the method's technique dependence, QC failure frequency, and the training, experience, and competence of testing personnel. All performance specification verification or validation efforts must be documented. CLIA does not specify how the laboratory must meet this requirement or a required number of specimens due to the variations in laboratory operations, patient populations, and test volume, but CMS does offer interpretations, clarifications of terms (which are not always compatible with CLSI and ISO terminology), and suggestions to facilitate compliance in its Interpretive Guidelines and brochures.³⁴¹ CMS State surveyors will look to determine whether the test is providing accurate and reliable results in that laboratory as a result of the laboratory's evaluation of analytical validity.

Proficiency Testing

All nonwaived laboratories must enroll annually in PT with a CMS-approved PT provider for the regulated analytes, specialties, and subspecialties in which the laboratory performs testing. The testing disciplines

³³⁸ Centers for Medicare & Medicaid Services Web site. "Clinical Laboratory Improvement Amendments (CLIA). Appendix C: Survey Procedures and Interpretive Guidelines for Laboratories and Laboratory Services." See <http://www.cms.hhs.gov/CLIA/downloads/apcpolicy.pdf>. Accessed on April 9, 2008.

³³⁹ Centers for Medicare & Medicaid Services Web site. "Clinical Laboratory Improvement Amendments (CLIA). Interpretive Guidelines for Laboratories." See http://www.cms.hhs.gov/CLIA/03_Interpretive_Guidelines_for_Laboratories.asp. Accessed on March 30, 2008.

³⁴⁰ Center for Disease Control and Prevention. Laboratory Standards: Establishment and verification of performance specifications [45 CFR 1253]. See http://wwwn.cdc.gov/cliaregs/subpart_k.aspx#493.1253. Accessed on March 30, 2008.

³⁴¹ Centers for Medicare & Medicaid Services Web site. "Clinical Laboratory Improvement Amendments (CLIA). Interpretive Guidelines for Laboratories." See http://www.cms.hhs.gov/CLIA/03_Interpretive_Guidelines_for_Laboratories.asp. Accessed on March 30, 2008.

and 83 regulated analytes are listed in the CLIA regulations at subpart I.³⁴² None of the 83 analytes are DNA or RNA but are instead other materials such as proteins. For laboratories with multiple testing sites, each site with a separate CLIA certificate must enroll in its own PT survey and must demonstrate successful performance. When a laboratory measures an analyte by more than one test method, PT is required only for the primary test method in use. In addition, the laboratory must also:

- Notify HHS which PT program(s) it has selected
- Participate in those program(s) at least 1 year prior to changing PT providers
- Establish and revalidate accuracy at least twice a year (using either an external PT program or an AA procedure) for tests that a laboratory performs that are not listed in subpart I
- Authorize the release of laboratory PT data to HHS to:
 - Enable ongoing monitoring of laboratory performance
 - Make laboratory PT results for the 83 regulated analytes available to the public upon request

A laboratory must test PT samples in the same manner as its patient specimens along with routine patient workload by personnel who regularly test these patients, using the laboratory's standard methods. The laboratory must not engage in interlaboratory communications regarding PT results until after they are reported back by the PT program. The laboratory must not send PT samples to another laboratory for testing or its certificate will be revoked for 1 year. Laboratories receiving PT samples for testing from another laboratory must notify HHS. Intentional referral of PT to another laboratory or communication with another laboratory about PT results during a PT event automatically results in certificate revocation for 1 year, and the laboratory director (owner/operator) is unable to direct any laboratory for 2 years.

Each laboratory performing any of the nonwaived tests listed in subpart I of the CLIA regulations must successfully participate in PT, which requires three PT test events with five challenges/events each year. Unsuccessful PT performance is defined as failure to attain the minimal satisfactory score (usually 80 percent) for the same analyte, specialty, or subspecialty for any two of three consecutive testing events evaluated in a rolling timeframe. Clerical errors will also result in failed PT.

Enforcement action is taken by CMS when a laboratory fails to pass PT. For the initial failure, CMS may direct the laboratory to undertake training and technical assistance and ensure that the root of the problem is corrected. If, however, there is risk of harm to patients or a history of repeated failure, or if the laboratory does not correct the root cause of the failure, then CMS will impose severe penalties. For subsequent failures, the laboratory's certificate will be revoked or limited and its Medicare payments suspended or cancelled. The laboratory must cease testing in the area of failure for 6 months and demonstrate sustained satisfactory performance for two consecutive PT events before resuming clinical testing. Failure to enroll in PT for any required test is considered a condition-level deficiency that will be cited on a deficiency statement, and appropriate enforcement actions will be imposed. In addition, laboratories that fail to perform or return PT results will automatically receive a zero score. CMS is in the process of enhancing the CLIA Web site so that information on laboratory performance is easily accessible to the public.

Laboratories must review and evaluate PT results received from PT programs and must verify the accuracy of testing for the following circumstances:

³⁴² Centers for Disease Control and Prevention Web site. "Clinical Laboratory Improvement Amendments (CLIA), Subpart I—Proficiency Testing Programs for Nonwaived Testing." See http://wwwn.cdc.gov/clia/regs/subpart_i.aspx. Accessed on March 30, 2008.

- Analytes in subpart I that have not been scored by the PT program
- Analytes for which the laboratory receives a zero score for nonparticipation or late result return
- Analytes that are not included in subpart I and must have their accuracy verified twice per year, at a minimum

Laboratories must take effective corrective actions for any unacceptable PT test results.

PT evaluation and verification activities must be documented, and records must be maintained for 2 years. A laboratory's PT enrollment and results are regularly monitored by CLIA surveyors and during routine biennial onsite inspections by CMS or other deemed-status accreditation organization to verify PT enrollment or AA activity and testing results.

Additional information and guidance about PT performance and surveyor compliance assessment can be found on the CMS CLIA Web site at www.cms.hhs.gov/clia under Interpretive Guidelines.

Clinical Validity

The CLIA program is not designed to assess the clinical validity of laboratory tests. CLIA regulations under 42 CFR § 493.1445(e)(3)(i), however, require the laboratory director and technical supervisor to ensure that selected test methodologies are capable of providing the quality of results required for patient care. Implicit in this regulation is the responsibility of the laboratory director to use medically relevant test methodologies that have an effective clinical purpose—otherwise those methodologies cannot be said to be “required for patient care.” For example, CLIA requires the laboratory to have a clinical consultant, who “must be qualified to consult with and render opinions to the laboratory’s clients concerning the diagnosis, treatment and management of patient care.”³⁴³ The responsibilities of the clinical consultant include providing information “regarding the appropriateness of the testing ordered and interpretation of the test results.”³⁴⁴ This requirement may be loosely translated in practice, however, and does not ensure that a test will be offered to the appropriate patients or that the test has clinical significance. Also, because there is no CLIA specialty for genetic testing, there are no specific personnel requirements in place for genetic testing laboratories.

Notwithstanding these requirements, analytical validity is the only performance measure that CLIA fully enforces or has ever enforced. CLIA does not assess laboratory performance in clinical validity or utility, and CMS is not required to enforce any requirements except those related to analytical validity per the CLIA statute. According to CMS, moreover, Congress intended the CLIA regulations to ensure the “accuracy of testing” and therefore did not expect CLIA to ensure the clinical validity of the tests. Adding clinical validity requirements to the CLIA regulations would have created duplicative roles for FDA and CLIA³⁴⁵ where FDA has implemented its authority for the oversight of clinical validity or safety and effectiveness.

³⁴³ Centers for Disease Control and Prevention Web site. “Clinical Laboratory Improvement Amendments (CLIA), Subpart M—Personnel for Nonwaived Testing.” See http://wwwn.cdc.gov/clia/regs/subpart_m.aspx#493.1455. Accessed on March 30, 2008.

³⁴⁴ Centers for Disease Control and Prevention Web site. “Clinical Laboratory Improvement Amendments (CLIA), Subpart M—Personnel for Nonwaived Testing.” See http://wwwn.cdc.gov/clia/regs/subpart_m.aspx#493.1457. Accessed on March 30, 2008.

³⁴⁵ Judy Yost, CMS, personal communication.

Assessment by the U.S. Government Accountability Office

The U.S. Government Accountability Office (GAO) examined clinical laboratory quality and issued a report (GAO-06-416), *Clinical Lab Quality: CMS and Survey Organization Oversight Should Be Strengthened*,³⁴⁶ in June 2006, along with accompanying testimony before Congress (GAO-06-879T).³⁴⁷ GAO made several recommendations to improve the oversight of laboratory tests. It was asked to examine the quality of laboratory testing; the effectiveness of surveys, complaint investigations, and enforcement actions in detecting and addressing laboratory problems; and the adequacy of CMS's CLIA oversight. GAO's recommendations to CMS to improve CLIA oversight included standardizing the reporting of survey deficiencies to permit meaningful comparisons across survey organizations; working with survey organizations to ensure that educating laboratory workers does not preclude appropriate regulation, such as identifying and reporting deficiencies that affect laboratory testing quality; and allowing the CLIA program to use fully the revenues generated by the program to hire sufficient staff members to fulfill its statutory responsibilities. CMS concurred with most of GAO's recommendations and noted that the report provided insights into areas where it can improve, augment, and reinforce oversight. Since the report was issued, CMS has made significant inroads in accomplishing these recommendations.

CMS has considered adding a genetic testing specialty under CLIA that would identify standards for laboratories performing genetic testing but decided that mechanisms other than adding a specialty could be used more effectively to address gaps in oversight.³⁴⁸ Additionally, the genetic testing specialty would not address issues such as the PT sample paucity and lack of clinical validity assessment. CMS's decision has received mixed reactions from the laboratory community. For example, ACMG released a position statement³⁴⁹ in July 2007 supporting the specialty, whereas the American Clinical Laboratory Association issued a letter³⁵⁰ in September 2007 supporting CMS's decision not to establish a new genetic testing specialty. SACGHS agrees with CMS that a genetic testing specialty under CLIA may not be the best approach to improve the oversight of genetic testing. The recommendations in this report suggest enhancements of current regulatory mechanisms and propose new approaches to strengthen the oversight of genetic testing.

³⁴⁶ Government Accountability Office (2006). Report to Congressional Requesters. *Clinical Lab Quality: CMS and Survey Organization Oversight Should Be Strengthened*. See <http://www.gao.gov/new.items/d06416.pdf>. Accessed on March 30, 2008.

³⁴⁷ Government Accountability Office (2006). Testimony Before the Subcommittee on Criminal Justice, Drug Policy, and Human Resources, Committee on Government Reform, House of Representatives. *Clinical Labs: CMS and Survey Organization is Not Sufficient to Ensure Lab Quality*. See <http://www.gao.gov/new.items/d06879t.pdf>. Accessed on March 30, 2008.

³⁴⁸ Hamilton, T. and Yost, J. Presentation to SACHGS meeting, November 13, 2006. See <http://www4.od.nih.gov/oba/SACGHS/meetings/Nov2006/SACGHSNov2006meeting.htm>. Accessed on March 30, 2008.

³⁴⁹ American College of Medical Genetics (2007). *Position Statement of the American College of Medical Genetics on the Regulatory Oversight of Genetic and Genomic Tests*. July 29, 2007. See http://www.acmg.net/AM/Template.cfm?Section=ACMG_Newsletter_The_ACMG_Medical_Geneticist&Template=/CM/ContentDisplay.cfm&ContentID=2112. Accessed on March 30, 2008.

³⁵⁰ American Clinical Laboratory Association (2007). *ACLA Supports CMS Response on Genetic Specialty*. September 5, 2007. See <http://www.clinical-labs.org/documents/PressreleaseSeptember52007onGeneticSpecialty.pdf>. Accessed on March 30, 2008.

Food and Drug Administration

The Federal Food, Drug, and Cosmetic Act,³⁵¹ as amended, authorizes FDA to regulate medical devices, such as reagents, test kits, and instruments used by clinical laboratories to conduct testing.

Analytical Validity

FDA reviews analytical validation prior to approval or clearance of commercially marketed reagents, test kits, and/or instruments. For an unmodified FDA-approved or -cleared IVD, in which FDA has reviewed validation data and cleared or approved the test, the laboratory must verify only that the established performance specifications (e.g., accuracy, precision) are achieved when the IVD is used by persons who routinely perform patient testing. If a laboratory chooses to modify elements of an FDA-approved or -cleared IVD for off-label use, the laboratory must perform full validation of the modification prior to patient testing. For example, if a test product is cleared for CF carrier screening but is used to diagnose CF, then the diagnostic test must be validated. The laboratory takes full responsibility for performance, which must be disclosed in test reports.

FDA seeks specific analytical performance information for tests kits (including genetic tests) as outlined in the 510(k) decision summaries posted on the Office of *In Vitro* Diagnostics (OIVD) Web site.³⁵² When applicable, FDA recommends the following six distinct types of information be provided to establish analytical performance for a new test:

- Precision/reproducibility—information on total variability for each specimen type, including information on sites (if applicable), lots, users, instruments, and other sources of variation
- Linearity/reportable range—information on the linearity of quantitative tests and the reportable range over which reliable results can be expected
- Traceability, stability, expected values (controls, calibrators, or methods)—information on source, value assignment, and credentials of materials and methods used to control and calibrate the test system
- Detection limit—information describing minimal sample requirements and limits of detection for measurement
- Analytical specificity—studies to evaluate both interference and cross reactivity of relevant substances or samples, including carryover studies when appropriate
- Assay cutoff—information to demonstrate how the assay cutoff was chosen and whether an equivocal zone may be warranted

FDA also requires method comparisons to establish accuracy (trueness) or bias of the test compared with a reference or standard working method. The comparative method can vary depending on the nature of the test being studied, but for classic genetic tests, bi-directional sequencing is usually the most appropriate comparative method. For other kinds of tests, alternative methods may be appropriate, and for some tests (e.g., complex genetic signatures) there may be no reference method. If no reference method is available, test performance stability and clinical performance comparison to some measure of clinical truth serve as mechanisms for establishing the performance of a new analytical system.

³⁵¹ Food and Drug Administration Web site. “Federal Food, Drug, and Cosmetic Act.” See <http://www.fda.gov/opacom/laws/fdcact/fdctoc.htm>. Accessed on March 30, 2008.

³⁵² Food and Drug Administration, Office of In Vitro Diagnostic Device (OVID) Evaluation and Safety Web site. “OIVD Decision Summaries for Products Cleared or Approved Since November 2003.” See <http://www.fda.gov/cdrh/oivd/decisionsummaries.html>. Accessed on March 30, 2008.

FDA analytical performance evaluation is usually assessed in the context of information on the device design and description and includes an analysis of software and hardware performance. While FDA prefers analytical studies be carried out on natural patient samples, the agency recognizes that for rare alleles or substances, meeting this requirement may not be possible. In these cases, contrived or spiked samples may sometimes be used to supplement or replace actual specimens. These samples should be matrix-specific and as close to real-life samples as possible.

FDA review of analytical performance data is conducted by one or more scientific reviewers. If appropriate, consultation is sought from medical officers, statisticians, and/or engineers to ensure comprehensive evaluation of the test's performance and labeling. Following the review, design, analytical, and clinical information about the test is posted in a standardized summary on the OIVD Web site. This procedure allows health care providers and other interested stakeholders to assess what studies were done to support claims made in product labeling and to review the thoroughness and rigor of the data being used to establish analytical performance.

FDA also regulates ASRs that are commercially distributed for use by laboratories or by IVD manufacturers for development of tests or kits. Because these products are ingredients and not tests, they have no defined performance characteristics in isolation. Thus, there is no requirement to validate class I ASRs. When an ASR is used in a laboratory test, the test must be validated under the appropriate oversight framework (i.e., CLIA), and labeling for the test must comply with the requirements of the appropriate Federal regulations.

Clinical Validity

As noted earlier, FDA has exercised enforcement discretion over genetic tests that are developed as LDTs. Most genetic tests are currently offered as LDTs, which means that FDA does not currently assess the clinical validity of most genetic tests. Thus, FDA's current role in assessing clinical validity applies primarily to test kits.

Although "clinical validity" is a term defined in this report and often used in discussing test performance, the law and regulations do not define clinical validity as a parameter to be reviewed by FDA. Instead, FDA is charged with assessing the safety and effectiveness³⁵³ of the device or test. These parameters are generally tied to assessment of analytical and clinical performance of the test or device. FDA may assess clinical performance of genetic tests in several different ways, depending on the nature of the test, its intended use, and the amount of existing information about the association of the genetic marker(s) being tested with a clinical diagnosis.

For tests that are subject to premarket clearance or approval, the information that FDA seeks to support clinical performance of a genetic test is claims-driven and is based on the intended use and the indications for use of the diagnostic device being reviewed. In order for a test manufacturer to meet regulatory requirements to demonstrate safety and efficacy, there must be information on clinical performance in relation to what the manufacturer claims as the intended use. Ideally, this information provides a description of test sensitivity and specificity in clinical specimens compared with known clinical status, or "clinical truth." In instances

³⁵³ For FDA, the term "effectiveness" means that based on information provided, "it can fairly and responsibly be concluded by qualified experts that the device will have the effect it purports or is represented to have under the conditions of use prescribed, recommended, or suggested in the labeling of the device" (FDCA, section 513(a)(3)(A)). This is informally interpreted as "do the performance data provided adequately support the intended use claimed by the sponsor?" Elsewhere in this report, the term effectiveness is used as a measure of how well the test performs in "real-world" clinical settings and "efficacy" is used for outcomes seen in controlled research settings.

where clear clinical truth cannot be measured, FDA may accept a clear description of surrogate endpoints for truth. In any case, for genetic tests it is important for the manufacturer to account for prevalence of the marker in different populations, the penetrance of the marker, and other elements of variability that might affect the applicability or value of the test result.

FDA will often accept analytical testing on specimens from enriched populations of patients with the genetic variation or condition in question, together with a listing of the relevant literature, as the basis for an assertion of clinical validity or a likelihood of acceptable clinical performance. In these cases, an analytical signal for a genetic marker is well established and easily understandable in terms of clinical use, and the published literature provides evidence that the marker is well associated with a particular phenotype.

If the genetic marker is new, not amenable to direct interpretation in clinical use, or has unknown clinical performance parameters, FDA may request clinical data from one or more clinical studies to demonstrate that the marker is predictive of the disease or condition in the populations for which the test is intended. These data may need to be collected in a prospective study in some cases, but often an analysis of well-credentialed stored samples (i.e., specimens with well-documented, agreed-upon clinical status) may be sufficient.

For tests with sufficient performance data, FDA generates a letter authorizing marketing and establishes a classification for the test that includes a general classification number and a product code. This letter, along with the registration and listing information, allows devices to be tracked postmarket to ensure that analytical performance is maintained consistently over time, that problems can be identified and remedied (through notifications to customers or through recalls), and that appropriate medical device reports of adverse events can be made.

State Regulatory Agencies

Oversight of analytical validity at the State level varies. New York State has one of the most stringent State-level oversight systems. NYSDOH requires pre-approval prior to offering clinical testing. Other States have little to no oversight of analytical validation and rely on oversight provided by Federal authorities and guidelines provided by professional societies.

NYSDOH oversees the analytical validity of testing performed on all patient samples. It uses a licensing process prior to making a test available. Subsection 58-1.10 of Part 58 of Title 10 (Health) of the Official Compilation of Codes, Rules and Regulations of the State of New York states that all technical procedures used in a laboratory shall be of proven reliability and generally accepted by leading authorities in the specialties of laboratory medicine and/or approved by the Department.³⁵⁴ The laboratory must submit an application along with the validation summary and raw data to NYSDOH for all modified FDA-approved assays, IUO and RUO assays, and LDTs with or without ASRs for genetic assays. Once the analytical validation is approved, laboratories are licensed to perform testing on New York State patient samples.

The NYSDOH review process starts with the basic scientific premise of the assay, generally based on the published literature establishing an association of the marker to be tested (e.g., a deletion detected by FISH, gene mutation, or enzyme level) and the disease of interest. This process also forms the basis of the clinical validity for most of the assays submitted. The procedural method is reviewed for clarity of the instructions

³⁵⁴ Wadsworth Center, New York State Department of Health Web site. "Clinical Laboratory Evaluation Program." <http://www.wadsworth.org/labcert/TestApproval/submitguide.htm>. Accessed on March 30, 2008.

to the analyst, correct concentrations of reagents, and complete materials and equipment list. The analytical validity data for the selected normal and abnormal case materials are reviewed. A critical component of this review is determining how the specimen is characterized as to the expected result. This determination could be by comparison to a gold standard method or by clinical characterization of the patient source that is independent of the result of the assay being studied. Reproducibility and robustness of the assay as well as interrun and intrarun or lot variation must be submitted. All educational materials for the patient and ordering physician are submitted and reviewed, along with sample normal and abnormal reports. As New York State Civil Rights Law requires, explicit written informed consent for genetic testing and the consent documents are also submitted for review. The majority of submissions are not approved on first submission, and some have required as many as six resubmissions for missing data.

In New York State, tests that must be reviewed prior to being offered include commercially distributed assays labeled for research use only, those using ASRs, FDA-approved assays or IUO assays that have been modified from their intended use or investigational device exemption approval from FDA, and any LDT. A change in the specimen type, type of analysis (e.g., qualitative or quantitative), purpose of the assay (e.g., screening, diagnosis, prognosis, monitoring, confirmation), or target population outlined in the FDA-cleared or -approved package insert is considered a change in an intended use. The materials submitted for validation review must include:

- The target population(s)
- The purpose (e.g., diagnostic, prognostic, screening, predictive)
- Whether the result is qualitative or quantitative
- The performance evaluation method (e.g., comparability to an established method or correlation of results to clinical status of test subjects)
- Practitioner/patient information, including limitations of the test
- Indication of clinical validity (generally, as reported in the literature)
- For germline genetic tests, policy and compliance documents relevant to informed consent
- Sample reports for both normal and abnormal samples, including all necessary disclaimers
- Scientific references
- Performance characteristics of the assay (e.g., accuracy, precision, reportable ranges, sensitivity, and specificity)

In cases where performance evaluation is based on the clinical outcome of test subject status, additional information is needed on protocols to establish clinical status, protocols to blind specimen evaluation from clinical status, how discrepant results are resolved, and how predictive value calculation is done. New York State standards also require that cytogenetics and genetics laboratories report, with an interpretation suitable for a nongeneticist physician, reference ranges (e.g., for germline genetics of single-gene disorders, the heterozygote and homozygote results) and whether the assay predicts disease state.

All laboratories that solicit and receive specimens from New York State are subject to New York State clinical laboratory permit requirements, including approval of LDTs. The program currently certifies more than 70 cytogenetics laboratories, including 6 preimplantation genetic testing laboratories that are not subject to CLIA requirements. More than 200 biochemical and DNA-based genetic testing laboratories, 100 molecular oncology laboratories, and 30 paternity identity or forensic DNA laboratories are included in the program. All large commercial reference laboratories do business in New York State and thus must have New York State laboratory permits. This list includes Quest Diagnostics, Laboratory Corporation of America, Genzyme, Mayo, and ARUP laboratories. While there are many other laboratories performing rare genetic tests, the vast majority of them perform cytogenetic, common biochemical genetic (e.g., Tay

Sachs carrier testing), and DNA-based mutation tests (e.g., *CFTR* mutations, triplet repeats in the *FMRI* gene). Therefore, although as few as 30 percent of the genetic testing laboratories are regulated by New York State, it has been estimated that as much as 75 percent of all cytogenetic and genetic testing performed in the United States (numbers of specimens tested, not number of laboratories) is subject to New York State oversight.

For rare genetic tests not available from any New York State–permitted laboratory, the program issues a letter authorizing the New York State provider, physician, or referring permitted laboratory to send the particular specimen on the particular patient to that nonpermitted laboratory. This letter includes caveats for the ordering physician and the patient regarding the lack of any review of the validity of the promised test. The program also sends communication to the reference laboratory to inform them of the New York State permit process and requirements. If the program receives over 50 requests for a single test to be sent to one laboratory, that laboratory is informed that it will no longer be authorized to accept New York State specimens; continued acceptance can result in fines. If a provider, specifically a New York State–permitted laboratory, continues to submit specimens to a laboratory without a New York State permit or that has not validated the assay, NYSDOH will send that referring laboratory a cease and desist letter and a warning that they will be fined \$2,000 per specimen for continued operation.

Although about half of the 50 States have some degree of statutory authority for oversight of the practice of clinical laboratory medicine, only two other States besides New York require some review of clinical validity data for individual assays. California reviews genetic tests used in newborn and prenatal screening. This evaluation is based largely on the published literature establishing an association of the marker to be tested (e.g., deletions detected by FISH, gene mutations, or enzyme levels) and the disease of interest. Washington State also has a program that evaluates the clinical validity on an as needed basis when there is doubt about a specific test.³⁵⁵

Standards Development Organizations

QC and reference materials are essential for validating the performance characteristics of a laboratory test, monitoring test performance, and detecting problems in the testing process. Unlike other areas of the clinical laboratory testing for which these materials are readily available, well-characterized cell lines, DNA materials, or residual clinical specimens with mutations or polymorphisms that should be detected by the intended genetic test are not always readily obtainable. FDA has cleared QC materials for only two genetic tests: CF testing and cytochrome CYP450. Not all alleles commonly included in these tests are represented in the FDA-cleared QC materials, however. Laboratories must obtain and verify QC and reference materials for all alleles included in their test panels. To do this, they often utilize residual patient samples, cell lines, or synthetic DNA materials.

The National Institute of Standards and Technology (NIST) and the CDC, through the GeT-RM Coordination Program, are working to address these QC and reference materials needs. Commercial companies are also developing these materials.

NIST, a nonregulatory agency of the U.S. Department of Commerce, develops and certifies physical and chemical standards in support of national commerce, manufacturing, and science. In its role supporting U.S. science and industry, NIST responds to specific standards needs, most recently for medically and biologically

³⁵⁵ Washington State Legislature Web site. “Washington Administrative Code, Chapter 246-338, Medical test site rules.” See <http://apps.leg.wa.gov/WAC/default.aspx?cite=246-338>. Accessed on March 30, 2008.

important analytes. Broad-based consensus, developed through interdisciplinary NIST workshops, initiated the development of the NIST-certified DNA standards. SRMs are highly characterized, high-order reference materials that are produced in small quantities. Such materials serve the diagnostic community and help manufacturers benchmark a variety of DNA diagnostic testing platforms.

One of NIST's first efforts in the clinical genetics area was the development of an SRM for fragile X testing (SRM 2399). This SRM contains nine different PCR products or amplicons with varying CGG repeat sizes along the normal to premutation range for the *FMR1* gene. Due to the difficulty in manufacturing and the cost, this SRM is intended for use during assay validation or for assay calibration but not for daily use as a QC material. Until recently, SRM 2399 was the only SRM available for molecular genetic testing, although a few others are in development. There is a critical need for additional materials for use as calibrators and for analytical validation of new genetic tests.

The CDC GeT-RM program, AMP, and nine laboratories from the molecular genetics community have engaged in an effort to obtain and characterize reference materials for fragile X syndrome testing. This effort entailed the evaluation of 16 cell lines deposited at Coriell containing clinically relevant *FMR1* alleles in the normal and premutation range. DNA from the 16 fragile X cell lines, as well as five control samples, were characterized by nine clinical genetic laboratories using both laboratory-developed assays and a RUO platform to determine the allele size of the different cell lines.³⁵⁶ This project was coordinated by the GeT-RM program, infrastructure and logistics were provided by AMP, and the nine laboratories volunteered reagents and personnel for the evaluation. Similar characterization projects were also completed to create 14 Huntington reference materials³⁵⁷ and 31 Ashkenazi Jewish Panel reference materials, and studies are currently under way for other disorders such as CF. These studies have been extremely well received by the genetic community but have only provided a limited amount of validated materials. There is still a significant need for additional reference materials, but limited funding for participating laboratories have hampered these efforts.

Commercial vendors of QC materials provide cell lines that can be used for both assay validation/verification and daily QC. Many of these vendors are listed on the GeT-RM Web site.³⁵⁸ FDA regulates commercial QC vendors.³⁵⁹ The cost of FDA-cleared QC materials can be significant to both the manufacturer during development and to the laboratory during use, which may impede both the development and use of these materials.

³⁵⁶ Amos, W.J., Pratt, V.M., Phansalkar, A., Muralidharan, K., Highsmith, W.E., Jr., Beck, J.C., Bridgeman, S., Courtney, E.M., Epp, L., Ferreira-Gonzalez, A., Hjelm, N.L., Holtegaard, L.M., Jama, M.A., Jakupciak, J.P., Johnson, M.A., Labrousse, P., Lyon, E., Prior, T.W., Richards, C.S., Richie, K.L., Roa, B.B., Rohlf, E.M., Sellers, T., Sherman, S.L., Siegrist, K.A., Silverman, L.M., Wiszniewska, J., and Kalman, L.V. Fragile Xperts Working Group of the Association for Molecular Pathology Clinical Practice Committee (2008). Consensus characterization of 16 *FMR1* reference materials: a consortium study. *Journal of Molecular Diagnostics*. 10(1):2-12.

³⁵⁷ Kalman, L., Johnson, M.A., Beck, J., Berry-Kravis, E., Buller, A., Casey, B., Feldman, G.L., Handsfield, J., Jakupciak, J.P., Maragh, S., Matteson, K., Muralidharan, K., Richie, K.L., Rohlf, E.M., Schaefer, F., Sellers, T., Spector, E., and Richards, C.S. (2007). Development of genomic reference materials for Huntington disease genetic testing. *Genetics in Medicine*. 9(10):719-723.

³⁵⁸ Centers for Disease Control and Prevention Web site. "Genetic Testing Reference Materials Coordination Program (Ge T-RM) – Home." See <http://wwwn.cdc.gov/dls/genetics/rmmaterials/default.aspx>. Accessed on March 30, 2008.

³⁵⁹ Food and Drug Administration (2007). *Guidance for Industry and FDA Staff—Assayed and Unassayed Quality Control Material*. See: <http://www.fda.gov/cdrh/oivd/guidance/2231.html>. Accessed on March 30, 2008.

Knowledge Generation Agencies

Federal research agencies such as the Agency for Healthcare Research and Quality (AHRQ), CDC, the Health Resources and Services Administration (HRSA), and NIH play a critical role in determining the genetic contribution to disease and in collecting data and generating, analyzing, and summarizing knowledge to support the appropriate use of genetic tests. Such work advances the understanding of the clinical validity of genetic tests and is an essential part of determining their safety and effectiveness. The initiatives of AHRQ, CDC, HRSA, and NIH that relate to genetic testing are discussed in Chapter II.

Additional activities include an NIH focus on studying small differences (at the level of individual bases) in individual genomes and investing in whole-genome association research that attempts to correlate genetic variations with specific disease. The application of this knowledge will contribute to the clinical validity of genetic tests. To this end, the Human Genome Epidemiology Network (HuGENet),³⁶⁰ an international collaborative effort established at CDC, promotes the synthesis, interpretation, and dissemination of population-based data on human genetic variation in health and disease, providing summary data to inform clinical validity assessments.

While the efforts of these agencies are significant, most Federal resources in genetics and genomics are focused on basic research. Fewer resources are applied to translation research and surveillance activities for genetic tests and other genetic discoveries entering clinical practice and public health, nor are there requirements for this type of research to be performed prior to a test being offered clinically. Current programs that explicitly target clinical validity in the context of LDT translation are CETT,³⁶¹ EGAPP,³⁶² and the Secretary's Advisory Committee on Heritable Disorders and Genetic Diseases in Newborns and Children (ACHDGDNC).³⁶³

In 2001, SACGHS's predecessor, the Secretary's Advisory Committee on Genetic Testing (SACGT),³⁶⁴ began an assessment of HHS efforts to increase knowledge of clinical validity and utility of genetic tests both before and after a test is marketed. As part of its fact-finding, SACGT gathered data from AHRQ, CDC, FDA, HRSA, and NIH about their roles and activities in supporting primary and secondary data collection efforts from fiscal year 1996 to fiscal year 2000. The activities were categorized as primary research, secondary data analysis, summary information development, and information dissemination.³⁶⁵

³⁶⁰ Centers for Disease Control and Prevention Web site. "Human Genome Epidemiology Network." See <http://www.cdc.gov/genomics/hugenet/default.htm>. Accessed on March 30, 2008.

³⁶¹ Collaboration, Education, and Test Translation Program Web site. See <http://www.cettprogram.org/>. Accessed on March 30, 2008.

³⁶² Evaluation of Genomic Applications in Practice and Prevention (EGAPP) Web site. See <http://www.egappreviews.org/>. Accessed on March 30, 2008.

³⁶³ Green, N.S., Rinaldo, P., Brower, A., Boyle, C., Dougherty, D., Lloyd-Puryear, M., Mann, M.Y., and Howell, R.R. (2007). Committee Report: advancing the current recommended panel of conditions for newborn screening. *Genetics in Medicine*. 9(11):792-796.

³⁶⁴ Archive of the Secretary's Advisory Committee on Genetic Testing. See <http://www4.od.nih.gov/oba/sacgt.htm>. Accessed on March 30, 2008.

³⁶⁵ The categories were defined as follows: Primary research – the generation of original data to increase knowledge of the analytic validity, clinical validity, and clinical utility of genetic tests; Secondary data analysis – systematic reviews and meta-analyses combining data from a number of studies in order to increase knowledge of the analytic validity, clinical validity, or clinical utility of genetic tests; Summary information development – the development or updating of information summaries on the analytic validity, clinical validity, or clinical utility of genetic tests for clinicians, laboratory personnel, policy-makers, patients/consumers, and the general public; Information dissemination – dissemination of information about the analytic validity, clinical validity, or clinical utility of genetic tests to professionals and the public.

Over the 5-year period, the agencies supported 1,068 projects and activities spanning the range of genetic test development and application, from the identification of a genetic component in a disease or condition to the education of health professionals. Seventy-two percent of the projects (766) focused on one of 184 diseases/conditions; the most common diseases/conditions to be funded were cancer-related, with breast cancer as the most common (89 projects). Some of the nondisease topics included education, technology development, and QA. NIH supported 94 percent of the reported projects, totaling more than \$1.03 billion. Eighty-eight percent of the projects were categorized as primary research, with NIH supporting more than 98 percent. Among the agencies, NIH also supported most of the secondary data analysis, summary information development, and information dissemination.

Professional Societies

Several professional societies contribute to the oversight system by developing standards, position statements, and practice guidelines. For example, CAP develops standards for its membership under LAP and operates PT programs. CLSI, formerly the National Committee on Clinical Laboratory Standards, develops consensus recommendations for standardization of test methodologies. Other organizations, such as ACMG, the American Academy of Pediatrics, American College of Obstetrics and Gynecology, American Gastroenterological Association (AGA), AMP, American Society of Clinical Oncology (ASCO), American Society of Human Genetics (ASHG), and National Society of Genetic Counselors are also involved in the development of guidelines and recommendations regarding the appropriate use of genetic tests. These guidelines may be evidence based, best practices, or based on expert opinion.

For example, ACMG and ASHG published practice guidelines for the appropriate clinical use of genetic testing for colon cancer.³⁶⁶ ACMG has also developed ACT sheets that describe actions health professionals should take in the followup of infants with positive newborn screening results.³⁶⁷ Among its many practice guidelines and technology assessments, ASCO provides recommendations on the use of tumor marker tests (some of which are genetic tests) in the prevention, screening, treatment, and surveillance of breast cancer.³⁶⁸ AGA provides a position statement on the use of genetic testing for hereditary colorectal cancer.³⁶⁹

Clinical guidelines help make sense of thousands of articles on a given clinical topic. They help clinicians deal with complex decisions, improve the quality of decisionmaking, and provide justifications to patients, payers, and the legal system about why decisions are made. Guidelines are useful for transmitting medical knowledge, assisting with patient and physician decisions, setting clinical norms, and contributing to quality improvement projects in hospitals and group practices. They can also be used for privileging

³⁶⁶ Genetic testing for colon cancer: joint statement of the American College of Medical Genetics and American Society of Human Genetics. (2000). Joint Test and Technology Transfer Committee Working Group. *Genetics in Medicine*. 2(6):362-366.

³⁶⁷ American College of Medical Genetics Web site. "Newborn Screening ACT Sheets and Confirmatory Algorithms." See <http://www.acmg.net/resources/policies/ACT/condition-analyte-links.htm>. Accessed on March 30, 2008.

³⁶⁸ American Society of Clinical Oncology Web site. "American Society of Clinical Oncology 2007 Update of Recommendations for the Use of Tumor Markers in Breast Cancer." See <http://www.asco.org/ASCO/Quality+Care+%26+Guidelines/Practice+Guidelines/Clinical+Practice+Guidelines/Assays+and+Predictive+Markers/American+Society+of+Clinical+Oncology+2007+Update+of+Recommendations+for+the+Use+of+Tumor+Markers+in+Breast+Cancer>. Accessed on March 30, 2008.

³⁶⁹ American Gastroenterological Association (2001). American Gastroenterological Association medical position statement: hereditary colorectal cancer and genetic testing. *Gastroenterology*. 121(1):195-197. See http://www.gastro.org/user-assets/Documents/02_Clinical_Practice/medical_position_statments/colorectal_cancer_genetic_mps.pdf. Accessed on March 30, 2008.

and credentialing, payment, cost control, and medicolegal evaluation. Chapter VI discusses their role in communication and appropriate use of tests.

Some professional societies work in partnership with CMS and CDC. CMS is willing to work with developers of guidances to place references to these documents in Surveyor Interpretive Guidelines and/or to include all or parts of these documents. In doing so, laboratories might accept them more readily, but the guidances still would not have the force of regulations. Most of the oversight provided by professional societies is offered as recommendations for laboratories. With the exception of CAP's LAP program of accreditation, these recommendations are not enforced. Appendix F summarizes available guidelines and standards for molecular diagnostics testing.

ACMG develops clinical practice guidelines focusing on medical practice as well as technical standards and guidelines on laboratory practice for clinical laboratories.³⁷⁰ The ACMG guidelines include tests performed with FDA-cleared or -approved kits, as well as LDTs. ACMG recommends that validation with well-characterized samples is critical.

A section on test validation is included in the technical standards and guidelines that relates to clinical validity.³⁷¹ The document recommends, in accordance with CLIA 1988, that each laboratory be responsible for validating each new test before its introduction into clinical use, including tests performed with FDA-cleared or -approved kits, as well as LDTs (reagents homemade or purchased under analyte-specific reagent rules). First, it is necessary to define the clinical disorder being tested for as well as the intended use or clinical setting of the test (e.g., diagnostic testing, screening) because clinical validity can vary based on the clinical setting.

Validation of each test in a specific clinical setting is focused on the collection of data to establish analytical validity, clinical validity, and clinical utility. The process involves reviewing professional guidelines and relevant literature; performing and evaluating analytical and clinical correlation studies within the laboratory to establish validity; defining the limitations of the test; determining the variables that must be monitored to maintain a high level of performance; identifying and addressing relevant ethical, legal, and social issues; and collecting information about the clinical utility of the test in order to inform patients and providers about appropriate test usage. ACMG also notes that for some test applications, gaps in knowledge may exist, and these should be identified. They recommend that the laboratory provide justification for offering the test in a clinical setting based on the information and data currently available.

ACMG is also developing a Quality Watch program that will facilitate communication when laboratories have problems with products such as reagents, tests kits, or equipment. Quality Watch will be a new feature on the ACMG Web site³⁷² and is expected soon. Laboratorians who encounter a problem will fill out and submit an online form describing the problem. Submissions will be monitored and, when appropriate, e-mails will be sent out through listservs asking other laboratories that have encountered the same problem to fill out a Quality Watch form. The responses will be reviewed to determine whether a single product is likely causing the problem. If so, laboratorians will be encouraged to contact the manufacturer. This program is based on an incident in which a company making syringes changed the coating. Cell cultures

³⁷⁰ American College of Medical Genetics (2006). *Laboratory Standards and Guidelines for Clinical Genetics Laboratories, 2006 Edition*. See http://www.acmg.net/Pages/ACMG_Activities/stds-2002/g.htm. Accessed on March 30, 2008.

³⁷¹ ACMG Technical S&G for Clinical Genetics Labs, Section C8.1 Test validation overview, 2006.

³⁷² American College of Medical Genetics Web site. See <http://www.acmg.net>. Accessed on March 30, 2008.

from amniocentesis samples failed when samples were sent to the laboratory in these syringes. Using a cytogenetics listserv, the problem was pinpointed within a week. The problem was discussed with the manufacturer and resolved.

AMP provides published recommendations for in-house development and operation of molecular diagnostic tests, including genetic testing.³⁷³ In addition, AMP continuously provides workshops at its annual meeting regarding assay standardization, analytical and clinical validation of genetic tests, development of QC materials, and other related topics. AMP has provided significant support for the CDC-sponsored Fragile Xperts working group, to analytically validate a number of different cells lines that can be used for QC of fragile X syndrome testing. Furthermore, AMP has undertaken three sample exchanges for real-time PCR assessment for *BCR/ABL* involving 36 laboratories across North America. A manuscript describing results from the sample exchanges and proposed test standardization and reporting guidelines is currently being drafted.

CAP provides guidelines on the analytical performance of each assay in accordance with CLIA 1988. CAP evaluates the analytical validity of an assay by using checklists and a laboratory inspection process after the assay has been made available. The analytical validation must include an evaluation of the performance characteristics such as analytical sensitivity, analytical specificity, precision, linearity (for quantitative tests), reportable range of patient test results, reference range (normal values), and any other applicable performance characteristic.³⁷⁴

The CAP LAP also provides mechanisms for ensuring the clinical validity of genetic tests. For example, CAP expects laboratories to demonstrate how the tests they offer have been clinically validated. CAP looks for whether there is documentation that validation studies have been performed to establish the performance characteristics of the LDT. It determines whether clinical performance characteristics of each assay are documented, using either literature citations or a summary of internal study results, and whether final reports include an appropriate summary of the methods, the loci or mutations tested, the analytical interpretation, the clinical interpretation (if appropriate), and a summary statement, signed by the laboratory director or designee, that documents the review of validation studies and approval of the test for clinical use.³⁷⁵

CLSI provides voluntary consensus standards and guidelines for the health care community (see Appendix F). These standards and guidelines, which are neither mandatory nor enforced, are often used by laboratories during the validation process, and many are recognized by FDA as standards suitable for use in assessing performance of IVD tests. CLSI recommends identifying and characterizing the critical analytical performance properties relevant to ensuring consistent and reliable results. At a minimum, the analytical sensitivity, analytical specificity, robustness, and precision/reproducibility of the assay should be evaluated. The test should be validated for all specimen types (e.g., blood, chorionic villus sample, fibroblasts) that will be tested. The analytical performance should first be characterized using known, well-characterized specimens. Then the assay should be reassessed using clinical samples or control materials to optimize the procedure. It is recommended that the laboratory identify any limitations and contraindications for use of the test, including factors that have an adverse impact on accuracy of test interpretation (e.g., allelic

³⁷³ Association for Molecular Pathology statement (1999). Recommendations for in-house development and operation of molecular diagnostic tests. *American Journal of Clinical Pathology*. 111(4):449-463.

³⁷⁴ College of American Pathologists (2006). *Molecular Pathology Checklist*. See http://www.cap.org/apps/docs/laboratory_accreditation/checklists/molecular_pathology_december2006.pdf. Accessed on March 30, 2008.

³⁷⁵ Vance, G. Presentation to SACGHS meeting, March 26-27, 2007. See <http://www4.od.nih.gov/oba/SACGHS/meetings/Mar2007/SACGHSMar2007meeting.htm>. Accessed on March 30, 2008.

mutations that cannot be detected by the test, less than optimal analytical performance) and any technical limitations of the assay, such as interferences or inhibitors.³⁷⁶

The term “clinical validity” is not used in the CLSI MM01-A2 document,³⁷⁷ a guideline that specifically addresses diagnostic methods for genetic diseases. Instead, for global harmonization purposes, CLSI uses the ISO definition for diagnostic performance, which is “the ability of the test to correctly measure or predict the diagnostic endpoint of interest (e.g., clinical outcome, phenotype, and genetic status, genotype).” For the purposes of this discussion, these definitions of diagnostic performance and clinical validity are viewed as having the same components (i.e., diagnostic sensitivity and specificity, or clinical sensitivity and specificity, and positive- and negative-predictive values). The CLSI document is technical and describes how to assess diagnostic performance, referring readers to the ACMG Standards and Guidelines for Clinical Genetics Laboratories for a more indepth discussion of what is required of genetic laboratories. Certain CLSI documents are accepted by FDA as “special controls” and as recognized standards, and, as such, they may also have a limited regulatory role.

Gaps in the Oversight of Analytical and Clinical Validity

- It is estimated that tests for more than 1,100 genetic diseases are currently offered in clinical laboratories. This estimate is based on data submitted voluntarily to Gene Tests, an online directory of genetic tests and the laboratories that offer them.³⁷⁸ AMP also maintains a voluntary registry.³⁷⁹ There is, however, no complete or official source of information on the number and types of genetic tests that are clinically available in the United States. No Federal agency or national organization maintains a complete list, although FDA maintains a database for FDA-cleared and -approved products, which includes those used for genetic testing.³⁸⁰
- For the vast majority of these tests, no publicly available validated QC materials are available. Therefore, laboratories must improvise to obtain these reagents and, in some cases, develop and run assays without adequate controls. Samples are often derived from residual patient specimens, synthetic samples, or cell lines. The laboratory must validate these materials prior to use as QC or SRMs. Most of the common mutations in the common genetic disorders have SRMs available for analytical validation.

In addition, some laboratories use reagents that are manufactured in-house and/or reagents marketed as RUO to develop genetic LDTs. There is no national mechanism for reporting these reagents when they are faulty because manufacturers are not required to be registered or to list these products with FDA. ACMG’s soon-to-be-launched Quality Watch program for reporting problems associated with reagents/assays could serve as a model, however. CAP’s Council on Scientific Affairs has developed a process designed around patient safety issues detected from summary PT data. Similarly, if an LDT is faulty due to design or validation failures, there is no mechanism to report the faulty test.

³⁷⁶ Clinical and Laboratory Standards Institute (2006). *Molecular Diagnostic Methods for Genetic Diseases; Approved Guideline—Second Edition*. CLSI document MM01-A2. 2006.

³⁷⁷ Clinical and Laboratory Standards Institute (2006). *Molecular Diagnostic Methods for Genetic Diseases; Approved Guideline—Second Edition*. CLSI document MM01-A2. 2006.

³⁷⁸ Gene Tests Web site. See <http://www.genetests.org>. Accessed March 30, 2008.

³⁷⁹ Association for Molecular Pathology Web site. See <http://www.amp.org>. Accessed March 30, 2008.

³⁸⁰ Food and Drug Administration, Center for Devices and Radiological Health Web site. See <http://www.accessdata.fda.gov/scripts/cdrh/cfdocs/cfPMN/pmn.cfm?IVDproducts=0n>. Accessed on March 30, 2008.

- For some genes (e.g., *HFE*), variation in allele and polymorphism frequencies in the general population and for some population groups have been well described in the literature, while other population groups have much less information available.^{381, 382} Some of these allelic variances or polymorphisms could have an impact on the ability to detect or classify clinically significant genetic variants in the process of providing genetic testing services.
- Laboratories offering tests whose purpose is solely to assess or guide lifestyle-related matters (e.g., nutrigenomic tests) or to determine the gender of a fetus are not covered by CLIA. Questions also exist about whether SNP profiles, currently offered by a few laboratories and provided to patients' clinicians on a CD, are covered by CLIA. These tests are being marketed with claims that physicians will be able to interpret the data and predict medical needs. CLIA regulations cover only the testing of a human specimen for the purpose of assessing health, diagnosis, and treatment. Since such tests can have health-related implications, ensuring their accuracy and validity is important. Concerns have been raised among health professionals, Federal agencies, Congress, and the public about whether consumers may be harmed by these unregulated tests.
- Currently, there are no Federal requirements that laboratories establish or verify the clinical validity of each test offered. Laboratories are not required by CLIA to document the performance characteristics, including clinical sensitivity, specificity, and predictive values, in relevant patient groups and populations. While at present clinical validity for the more common genetic tests can in fact be estimated by use of published literature, there will be some tests that are proprietary for which published literature addressing clinical validity is lacking.

CLIA does not address clinical validity, in part because Congress recognized that adding clinical validity requirements to CLIA would be duplicative of FDA regulations. Very few LDTs, however, are reviewed by FDA, and the agency does not currently have sufficient resources to carry out such reviews for all tests if existing review mechanisms are used.

- CLIA inspectors may not be sufficiently trained to evaluate genetic LDTs, a problem that CMS is addressing through training of CMS inspectors and contracting with specially trained personnel. CAP provides trained inspectors for genetics specialty laboratories upon director request.
- Establishing the analytical and clinical validity of an ever-increasing number of genetic tests with greater complexity may require a different framework from the processes in place today. Elements of the CETT, EGAPP, and ACHDGDNC initiatives might be adapted for such a framework.
- Most of the analytes that pertain to genetic testing (and the thousands of other clinical tests that are in use in U.S. laboratories) are not among the 83 analytes regulated by CLIA. Therefore, prescriptive PT enrollment is not required for genetic testing analytes, although all laboratories must at least perform AA for all analytes on their testing menu. Congress intended HHS to require PT of all laboratories for each type of clinical test they performed, unless the HHS Secretary determined that was not feasible.

³⁸¹ Le Gac, G. and Ferec, C. (2002). The molecular genetics of haemochromatosis. *European Journal of Human Genetics*. 13(11):1172-85.

³⁸² Worwood M. (2002). HFE Mutations as risk factors in disease. *Best Practice and Research. Clinical Haematology*. 15(2):295-314.

While CDC is willing to assist in developing alternative means to achieve PT for genetic tests, the resources, funding, and means to develop formal PT for all genetic tests are lacking. CMS currently has a system to compile regulated PT scores for surveyor review and will make these available to the public upon request. Information regarding laboratory deficiencies in PT for the 83 regulated analytes and deficiencies in AA is also publicly available upon request. The certification status of a laboratory is available to the public, and CMS is in the process of making that information more readily available on the CLIA Web site so that it is possible to know whether a laboratory has been certified to comply with CLIA requirements.

- No data exist on the effectiveness of PT vs. AA.
- PT based on test methodologies such as sequencing, which exists in European laboratories, has not been developed in the United States. CAP offers method-based PT for conventional and molecular cytogenetics, biochemical, and molecular testing. It is not known at this point if PT based on test methodology can be of benefit.
- In general, the research agendas of Federal research agencies are not directly tied to translation of genetic tests into clinical practice. The CETT program supported by CDC and NIH is an exception.

Evidence of Harms and Potential Harms

Inadequate Knowledge of the Analytical Validity of Genetic Tests

- Avoidable false-positive or false-negative results may occur due to the use of a test that has not been subjected to appropriate analytical validation. This problem arises from a lack of knowledge regarding the different sequence variations or the lack of postmarket surveillance data for new sequence variations, which have not been clinically validated but which might affect the analytical validity of the test. For some genes (e.g., *HFE*), variation in allele and polymorphism frequencies in the general population and for some population groups have been well described in the literature, while other population groups have much less information available.^{383,384,385,386,387} Some of these allelic variances or polymorphisms could affect the ability to detect or classify clinically significant genetic variants in the process of providing genetic testing services. Laboratories should make efforts to report allelic frequencies as well

³⁸³ In 1999, Jeffrey et al. reported that a previously described HFE polymorphism, 5569A, was associated with misdiagnosis of C282Y/5569A heterozygotes as C282Y homozygotes. The reason for the misdiagnosis was due to the presence of a single base pair polymorphism located in the primer binding site for the C282Y wild type allele in exon 4. Since only the mutant allele would then be amplified, this could result in the appearance of a C282Y homozygote, and a false positive result. Subsequently, two other laboratories reported misclassification of C282Y heterozygotes as homozygotes. Because this polymorphism is relatively common (allele frequencies as high as 13 percent), this report raised immediate concern about C282Y results in genotyping studies worldwide and led some laboratories to re-analyze previous results.

³⁸⁴ Jeffrey, G.P., Chakrabarti, S., Hegele, R.A., and Adams, P.C. (1999). Polymorphism in intron 4 of HFE may cause overestimation of C282Y homozygote prevalence in haemochromatosis. *Nature Genetics*. 22(4):325-326.

³⁸⁵ Totaro, A., Grifa, A., Carella, M., D'Ambrosio, L., Valentino, M., Roth, M.P., Borot, N., Coppin, H., Roetto, A., Camaschella, C., and Gasparini, P. (1997). Hereditary hemochromatosis: a HpaI polymorphism within the HLA-H gene. *Molecular and Cellular Probes*. 11(3):229-230.

³⁸⁶ Gomez, P.S., Parks, S., Ries, R., Tran, T.C., Gomez, P.F., and Press, R.D. (1999). Polymorphism in intron 4 of HFE does not compromise haemochromatosis mutation results. *Nature Genetics*. 23(3):272.

³⁸⁷ Somerville, M.J., Sprysak, K.A., Hicks, M., Elyas, B.G., and Vicens-Wyhony, L. (1999). An HFE intronic variant promotes misdiagnosis of hereditary hemochromatosis. *American Journal of Human Genetics*. 65(3):924-926.

as polymorphisms that could interfere with test analysis. Even though this is important information for the health care community, there is no formal mechanism for its collection and dissemination.

- Avoidable false-positive or false-negative results can occur due to lack of method optimization and standardization. Even though false negative results for factor V Leiden mutations are unusual, a study³⁸⁸ has reported false negative results in one patient with a history of deep venous thrombosis. Although clerical errors and sample mishandling cannot be ruled out, it is possible that the incorrect results were due to testing methodology, which could highlight the need for standardization of optimized factor V Leiden genetic testing methods.
- Avoidable false-positive or false-negative results may occur when an assay is not analytically validated due to the lack of appropriate reference materials.³⁸⁹
- As with any laboratory test, inaccurate test results may occur due to faulty reagents or instruments.
- Reduced analytical and clinical sensitivity can lead to excessive assay failure rates, inconclusive results, and increased costs. For example, a recent evidence review on *CYP2C9* and *VKORC1* testing to inform warfarin dosing found that 1 percent to 10 percent of samples, depending on the method used, can experience repeated assay failures resulting in inconclusive test results.^{390,391}

Inadequate or Misapplied Knowledge of the Clinical Validity of Genetic Tests

- As with any clinical laboratory test, the potential risks of positive test results include possible social, psychological, and economic harms, including altered self-image, impact on family relationships, stigmatization, exclusion from health insurance and employment, and identification of risk status in other family members (although this may also be a potential benefit). In the event of false-positive test results, individuals may be exposed to an unnecessary battery of testing or treatment. A false-negative test result could give false reassurance regarding risk due to nongenetic causes or induce psychological effects such as survivor guilt. False-negative test results may delay diagnosis, screening, and treatment.
- In some cases, genetic test results that are correct and valid could be misapplied, for example by a poorly trained health care provider, and lead to adverse actions such as inappropriate medical management, denied insurance, or denied employment.
- Significant harms (real or potential) can occur if a genetic test is used before its clinical validity is understood. For many genetic tests, particularly those that are predictive or presymptomatic, knowledge

³⁸⁸ Libby, E.N., Booker, J.K., Gulley, M.L., Garcia, D., and Moll, S. (2006). False-negative factor V Leiden genetic testing in a patient with recurrent deep venous thrombosis. *American Journal of Hematology*. 81(4):284-289.

³⁸⁹ Baum, M. (2005). New NIST reference material reinforces fragile-x screens. *National Institute of Standards and Technology Tech Beat*. See http://www.nist.gov/public_affairs/techbeat/tb2005_0224.htm#new. Accessed March 30, 2008.

³⁹⁰ McClain, M.R., Palomaki, G.E., Piper, M., and Haddow, J.E. (2008). A rapid ACCE review of *CYP2C9* and *VKORC1* allele testing to inform warfarin dosing in adults at elevated risk for thrombotic events to avoid serious bleeding. *Genetics in Medicine*. 10(2):89-98. See <http://www.acmg.net/AM/template.cfm?section=Home3&Template=/CM/ContentDisplay.cfm&ContentID=2263>. Accessed on March 30, 2008.

³⁹¹ Flockhart, D.A., O’Kane, D., Williams, M.S., Watson, M.S., Gage, B., Gandolfi, R., King, R., Lyon, E., Nussbaum, R., Schulman, K., and Veenstra, D. (2008). Pharmacogenetic testing of *CYP2C9* and *VKORC1* alleles for warfarin. *Genetics in Medicine*. 10(2):139-150.

of the test's clinical validity may be incomplete for many years after the test is developed. When information that may affect clinical validity is incomplete, the potential harms of the test may increase and must be considered more carefully. The following examples illustrate real harms that can be attributed to applying a genetic test without proper documentation that the clinical validity is adequate for the test's intended use.

- Applying a test with established clinical validity for one condition to an unrelated condition for which clinical validity had never been established. Burlington Northern Santa Fe Rail Company applied a genetic test that is clinically valid for a peripheral nerve condition called hereditary neuropathy with liability to pressure palsies to identify workers with carpal tunnel syndrome. The clinical validity of this test for carpal tunnel syndrome has not been established. Harm resulted when employees were threatened with dismissal from the company if they did not have the test. (They were not informed that a genetic test was being done.) Presumably, if the test came back positive the employees would have been denied coverage for treatment of carpal tunnel syndrome based on a “pre-existing condition.”^{392,393,394, 395}
- HLA-B27 can be useful in diagnosing the genetic disorder axial spondyloarthritis. Available data from the literature were used to develop a diagnostic algorithm for the use of HLA-B27 in the subset of patients with low back pain who also had inflammatory back pain. In the clinical setting of inflammatory back pain, the HLA-B27 test had very good positive predictive value for axial spondyloarthritis. However, when the HLA-B27 test was applied to all patients with low back pain, regardless of inflammation, the positive predictive value was significantly lower (i.e., the test has less clinical validity). Several harms resulted, including increased use of resources relating to testing (by testing all rather than a subset), exposure of patients without axial spondyloarthritis to anti-inflammatory therapies with less benefit and an increased harm from adverse drug events, and exposure to additional diagnostic tests.³⁹⁶
- Ordering a test in an inappropriate clinical setting is another potential harm. For example, thrombophilia assessments are being done in individuals with arterial disease, which is not indicated, since the impact of thrombophilic factors is in venous disease, not arterial.³⁹⁷ Assessing protein C and S levels during acute thrombotic events can result in abnormal results in patients with arterial disease. In a recent study,³⁹⁸ 62 percent of tests were ordered at an inappropriate time. At least 40 tests had abnormal values of protein C and/or S, all of which proved to be secondary to the illness or treatment as opposed to an intrinsic deficiency. Harms included inappropriate classification as deficient (with attendant medical and insurance implications), inappropriately aggressive treatment

³⁹² Schafer, S. (2001). Railroad agrees to stop gene-testing workers. *Washington Post*. April 19, 2001. See <http://www.washingtonpost.com/ac2/wp-dyn/A34877-2001Apr18?language=printer>. Accessed on March 30, 2008.

³⁹³ PBS Online NewsHour Web site. “A NewsHour with Jim Lehrer Transcript, Genetic Testing, June 7, 2001.” See http://www.pbs.org/newshour/bb/health/jan-june01/genetest_06-07.html. Accessed on March 30, 2008.

³⁹⁴ Clayton, E.W. (2003). Ethical, legal, and social implications in genomic medicine. *New England Journal of Medicine*. 349(6):562-569.

³⁹⁵ Schulte, P.A. and Lomax, G. (2003). Assessment of the scientific basis for genetic testing of railroad workers with carpal tunnel syndrome. *Journal of Occupational and Environmental Medicine*. 45(6):592-600.

³⁹⁶ Rudwaleit, M., van der Heijde, D., Khan, M.A., Braun, J., and Sieper, J. (2004). How to diagnose axial spondyloarthritis early. *Annals of the Rheumatic Diseases*. 63(5):535-543.

³⁹⁷ de Moerloose, P. and Boehlen, F. (2007). Inherited thrombophilia in arterial disease: a selective review. *Seminars in Hematology*. 44(2):106-113.

³⁹⁸ Somma, J., Sussman, II., and Rand, J.H. (2006). An evaluation of thrombophilia screening in an urban tertiary care medical center: A “real world” experience. *American Journal of Clinical Pathology*. 126(1):120-7.

based on perception of increased risk, diagnostic odyssey, and the wasted cost of doing a test at an inappropriate time.

Recommendations

1. For a number of years, CMS had been planning to address gaps in the oversight of laboratories that conduct genetic tests by adding a genetic testing specialty under CLIA. Recently, CMS changed direction and is now addressing these gaps with a multifaceted action plan. SACGHS considered the CMS rationale and reviewed the CMS action plan. SACGHS carefully considered the recommendations of prior groups as well as the perspectives of stakeholders who support the specialty. In the end, the Committee concluded that identified gaps can be addressed without the creation of a genetic testing specialty. SACGHS proposes the following recommendations to support and/or augment the CMS action plan:

- A. Currently, CLIA requires all nonwaived tests to undergo some form of performance assessment, but only 83 specific analytes, none of which are genetic tests *per se*, are required to undergo the type of assessment called PT. PT is currently considered to be the most rigorous form of performance assessment. In principle, genetic tests and all other nonwaived laboratory tests should be required to undergo PT. However, such a goal cannot be achieved immediately. Consequently, the following actions should be taken:
 - CMS should require PT of all nonwaived laboratory tests for which PT products are available. For tests without PT products, laboratories must use alternative assessment methods, as required under current CLIA regulations.
 - To promote the development of new PT products and facilitate performance assessment efforts, HHS should fund studies of the effectiveness of other types of performance assessment methods to determine whether they are as robust as PT and should support innovations in the way PT is performed, such as through methodology-based processes.
- B. CMS should consult or contract with experts in the field to train inspectors of genetic testing laboratories. Training by such experts will enhance inspectors' understanding of the technologies, processes, and procedures utilized by genetic testing laboratories and equip them to assess compliance with CLIA requirements. In addition, CMS should identify and evaluate innovative, alternative mechanisms to inspect genetic testing laboratories.
- C. As recommended in a 2006 Government Accountability Office report on clinical laboratory quality, CMS should use revenues generated by the CLIA program to hire sufficient staff to fulfill CLIA's statutory responsibilities, and the program should be exempt from any hiring constraints imposed by or on CMS.

2. Currently, there are gaps in the extent to which analytical validity and clinical validity data can be generated and evaluated for genetic tests. To address these gaps, SACGHS recommends devoting public resources for genetic testing through the following actions:

- A. In consultation with relevant agencies, HHS should ensure funding for the development and characterization of reference materials, methods, and samples (e.g., positive and negative controls and samples from different ethnic/geographic populations) for assay, analyte, and platform validation, for quality control, for performance assessment, and for standardization.

- B. HHS should ensure funding for the development of a mechanism to establish and support a laboratory-oriented consortium to provide a forum for sharing information regarding method validation, quality control, and performance issues.
 - C. HHS agencies, including NIH and CDC, should continue to work with public and private partners to support, develop, and enhance public reference databases to enable more effective and efficient collection of mutation and polymorphism data, expand clinical reference sequence databases, and provide summary data on gene-disease associations to inform clinical validity assessments (e.g., RefSeqGene, HuGENet). Such initiatives should be structured to encourage robust participation; for example, there is a need to consider mechanisms for anonymous reporting and/or protections from liability to encourage information sharing among members.
 - D. HHS should provide the necessary support for professional organizations to develop and disseminate additional standards and guidelines for applying genetic tests in clinical practice. CMS should work with professional organizations to develop interpretative guidelines to enhance inspector training and laboratory compliance.
- 3. The Committee is concerned about the gap in oversight related to clinical validity and believes that it is imperative to close this gap as expeditiously as possible. To this end, the Committee makes the following recommendations:**
- A. FDA should address all laboratory tests in a manner that takes advantage of its current experience in evaluating laboratory tests.
 - B. This step by FDA will require the commitment of significance resources to optimize the time and cost of review without compromising the quality of assessment.
 - C. The Committee recommends that HHS convene a multistakeholder public and private sector group to determine the criteria for risk stratification and a process for systematically applying these criteria. This group should consider new and existing regulatory models and data sources (e.g., New York State Department of Health Clinical Laboratory Evaluation Program). The multistakeholder group should also explicitly address and eliminate duplicative oversight procedures.
 - D. To expedite and facilitate the review process, the Committee recommends the establishment of a mandatory test registry as noted in recommendation 4.
- 4. There are considerable information gaps about the number and identity of laboratories performing genetic tests and the specific genetic tests being performed. To gain a better understanding of the genetic tests being offered as laboratory-developed tests and to enhance transparency in this field, SACGHS reviewed proposals for a voluntary or mandatory test registry and considered the benefits and burdens of each type of system. The Committee decided that a mandatory, publicly available, Web-based registry that is well staffed to maintain an accurate and current database would offer the best approach to address these information gaps in the availability of tests and their analytical and clinical validity. Since genetic tests are not different from other laboratory tests for oversight purposes, the registry should include all laboratory tests. The Committee also discussed whether such a database should reside at CDC, CMS, or FDA, but recognized that unresolved issues, including practical and legal questions, require further analysis before a final decision can be made about how and where to implement the registry. In concluding that a mandatory registry should be established, SACGHS recommends the following course of action:**

- A. HHS should appoint and fund a lead agency to develop and maintain the mandatory registry for laboratory tests. The lead agency should work collaboratively with its sister agencies to create a comprehensive registry and minimize duplicative collection of registry information. For this purpose, the lead agency should be staffed with qualified personnel who are experienced in developing and updating large databases in a timely and accurate manner.
 - B. The lead agency, in collaboration with its sister agencies, should convene a stakeholders meeting by September 2008 to determine the data elements associated with analytical validity, clinical validity, clinical utility, and accessibility that should be included in the test registry. The lead agency should cast a wide net for broad stakeholder representation, including representatives from the private sector who can represent a role for public-private partnerships in developing a registry. The lead agency, through this stakeholder effort, should assess the level of effort, as well as the burden on the laboratory and the impact on other key stakeholders such as patients, physicians, and payers, necessary to obtain each data element, including linking to reliable sources of existing information.
 - C. While awaiting completion of the above processes, HHS should use short-term voluntary approaches such as incentivizing laboratories to register with GeneTests and encouraging laboratories to make their test menus and analytical and clinical validity data for these tests publicly available on laboratory Web sites.
- 5. Factfinding by SACGHS also identified gaps in the enforcement of existing regulations. For example, the CLIA program has an array of enforcement actions available, but those actions cannot be directly imposed on uncertified laboratories. Instead, CMS must report the laboratory to the HHS Inspector General for action. Neither Medicare nor Medicaid can reimburse laboratories without CLIA certificates, but this restriction has no consequence for laboratories that perform direct-to-consumer testing. To address enforcement gaps, SACGHS recommends the following actions:**
- A. To prevent laboratories from performing tests without appropriate CLIA certification, CMS should establish and exercise its regulatory authority to take direct enforcement actions against laboratories that perform tests for clinical purposes without proper CLIA certification. CMS should step up its efforts to make publicly available a list of laboratories that have been cited by CLIA for condition-level deficiencies.
 - B. Appropriate Federal agencies, including CDC, CMS, FDA, and the Federal Trade Commission (FTC), should strengthen monitoring and enforcement efforts against laboratories and companies that make false and misleading claims about laboratory tests, including direct-to-consumer tests.
- 6. SACGHS is concerned about certain types of health-related tests that are marketed directly to consumers and apparently fall outside the scope of CLIA. Some nutrigenomic tests (e.g., a test for caffeine metabolism) and tests that determine the gender of a fetus are examples of health-related tests that skirt the boundaries of CLIA's authority. There is insufficient oversight of laboratories offering such tests, and their potential impact on the public health is an increasing concern. Direct-to-consumer marketing of laboratory tests and consumer-initiated testing have the potential for adverse patient outcomes, social stigmatization, privacy concerns, and cost implications for the health care system. SACGHS recommends that:**

CLIA regulations and, if necessary, CLIA's statutory authority, along with FDA's risk-based regulatory authority and regulatory processes, should be expanded to encompass the full range of health-related

tests, including those offered directly to consumers. Relevant Federal agencies (e.g., CMS, CDC, FDA, and FTC) should collaborate to develop an appropriate definition of health-related tests that FDA and CMS could use as a basis for expanding their scope. Additionally, these Federal agencies, including the HHS Office for Civil Rights, along with other State agencies and consumer groups, should propose strategies to protect consumers from potential harm and from unanticipated and unwanted compromises in privacy that may lead to harm. Additional oversight strategies that might be established should be balanced against the benefits that consumers may gain from wider access to genetic tests and potential cost savings.

V. Development and Evaluation of Evidence for the Clinical Utility of Genetic Tests

The potential value of a genetic test is realized only when it provides a meaningful benefit to patients, families, or society. This chapter discusses the meaning of clinical utility and the processes for generating information about clinical utility, including clinical trials and observational studies using registries, epidemiological studies, and other longitudinal data sets. Current mechanisms for synthesizing information, such as systematic evidence reviews, decision models, and expert opinion, also are discussed, as well as the determination of appropriate care through clinical guidelines. This chapter addresses the following questions in the charge of the Secretary of the U.S. Department of Health and Human Services (HHS):

- What evidence of harm exists regarding genetic tests? Is there harm attributable to issues concerning the clinical utility of the tests? If evidence does not exist, what threats are not currently being addressed?
- What are the existing pathways that examine the clinical utility of genetic tests?
- What organizations are currently involved with each of these aspects, and what are they doing to address these issues? Who should be responsible for each of these aspects?
- What new approaches or models should be considered for private and public-private sector engagement in demonstrating clinical utility for developing effectiveness measures of genetic tests in clinical practice?
- Would additional or revised Government oversight of clinical utility add value for patients, and if so, how and where?

In response to these questions, specific recommendations are presented for reducing harms. The application of clinical utility to decision support systems is discussed in Chapter VI. However, the application of clinical utility to quality improvement and coverage decisions is beyond the scope of this report. Yet it should be recognized that clinical utility and an understanding of the magnitude of impact is critical to priority setting and efforts to improve clinical care and disease prevention processes. Similarly, economic evaluation, which combines clinical utility with measures of economic cost, is outside the scope of this report, but it plays an important role in priority setting, selection of alternative uses of resources, and enhancing the efficiency of the U.S. public health and clinical care system.³⁹⁹

Definition of Clinical Utility

Within the field of genetics, clinical utility represents a balance between health-related benefits and the harms that can ensue from a genetic test. In other settings, clinical utility is usually referred to as “clinical effectiveness.” In general, the benefits and harms of genetic testing should be compared with the best

³⁹⁹ Secretary’s Advisory Committee on Genetics, Health, and Society (2006). *Coverage and Reimbursement of Genetic Tests and Services*. See http://www4.od.nih.gov/oba/sacghs/reports/CR_report.pdf. Accessed on March 31, 2008.

alternative to genetic testing. The additional net benefit or net harm that would be achieved by using the genetic test is called the incremental benefit or incremental harm. Those benefits and harms should be considered at the individual, family, and societal levels.

The analytical validity and clinical validity of tests are important prerequisites for assessing clinical utility. Until the clinical utility and value are known, however, the use of a test is at best conjectural. Some laboratory testing has achieved extraordinary levels of precision, and tests frequently have high analytical sensitivity and specificity. The clinical utility, however, is often inadequately documented, which leads to a poor understanding of which tests should be ordered and how results can be applied.

Since there is harm associated with almost every clinical intervention, it is important to understand the health-related benefits that can result from appropriate clinical diagnosis and intervention and to evaluate whether the expected benefits are likely to exceed the harms and for whom. Harms, at a minimum, will include the time and cost incurred as a result of the intervention. The challenge is to have sufficient information to determine the magnitudes of expected benefits and harms. Ideally, findings from well-designed and suitably conducted research that addresses important clinical and public health issues are used in evidence-based processes to determine the most appropriate clinical and preventive practices.

The United States currently spends only 0.05 percent of health care expenditures and 1 percent of research and development dollars on technology assessment. The lack of investment in health care technology assessment is an important contributor to overuse and misuse of health care resources.⁴⁰⁰ Much of current clinical practice is not based on high-quality evidence or evidence-based assessments, and even the promulgation of evidence-based guidelines is often limited in scope and speed of implementation. For single-gene disorders, high-quality clinical studies and evidence-based guidelines are even less common, although the HHS Secretary's Advisory Committee on Heritable Disorders and Genetic Diseases in Newborns and Children (ACHDGDNC) is developing evidence-based processes and working with professional organizations to provide practical clinical guidance.

The most rigorous evidence-based assessments reflect both the magnitude of effect and certainty of the evidence. These assessments are conducted by organizations such as the U.S. Preventive Services Task Force (USPSTF) and are generally restricted to common disorders and interventions. As a result, achieving that level of rigor is a challenge for many clinical decisions, particularly in genetics. The Evaluation of Genomic Applications in Practice and Prevention (EGAPP) process is an attempt to bring that level of rigor to genetic testing in a timely way.

Assessment of scientific evidence and the development of evidence-based clinical guidelines have been used to inform not only clinical management but also insurance coverage decisions, quality improvement initiatives, and policy decisions. Guidelines provide general recommendations that need to be integrated with specific patient needs and preferences. Since providers and patients are not always comfortable with guidelines, they may disregard them if the guidelines fail to endorse popular practices. In many cases, insurance coverage decisions may be influenced more by employers' willingness to pay for services, provider/consumer demand, and what is considered "standard of care" than by evidence-based clinical guidelines or evidence reviews.

⁴⁰⁰ Emanuel, E.J., Fuchs, V.R., and Garber, A.M. (2007). Essential elements of a technology and outcomes assessment initiative. *Journal of the American Medical Association*. 298(11):1323-1325.

Clinical Utility and Value

Many genetic tests in use today identify germline mutations associated with specific diseases. In the future, however, genetic tests will be used in the diagnosis, prognosis, and risk prediction for chronic conditions. In this report, clinical utility for clinical decisionmaking is defined as the balance between the benefits and harms of testing and the ensuing follow-up evaluation, treatment, or prevention. It must be evaluated within a specific context, including the clinical variables, availability of resources, acceptability and values, and patient preference.⁴⁰¹ Moreover, the same genetic test can be used in very different ways (e.g., for population or family screening, risk assessment, diagnosis, or prognosis), and its utility may vary, depending on available alternatives. While the test may have adequate utility in one situation, it may not in another. For example, the clinical utility of BRCA testing is established for women with a family history of breast or ovarian cancer that includes a relative with a known deleterious mutation in the *BRCA1* or *BRCA2* gene.^{402,403} BRCA testing in the general population, however, is not recommended because of the low risk for developing breast or ovarian cancer associated with *BRCA1* or *BRCA2* mutations in the absence of a family history of these cancers.

Once clinical utility has been assessed, the critical issue becomes how to translate the certainty and net benefit of the test into specific decisions. Decisionmakers such as regulators, payers, patients, and health care providers place different emphasis on various factors.⁴⁰⁴ Table 5–1 illustrates some of the factors these decisionmakers may consider.

The assessment of clinical utility presumes that a minimal threshold of analytical and clinical validity has been established. Without an analytically valid test that accurately predicts disease or treatment outcomes, it is unlikely that clinical utility can be established. Nonetheless, important clinical and reimbursement decisions often are made on the basis of analytical and clinical validity before evidence regarding clinical utility is established. By the same token, it is easy to imagine that the evidence required to bring a product to market may differ substantially from what is needed to include that test in clinical guidelines, and it may further differ from evidence needed for reimbursement decisions. Therefore, it is important to consider where to “set the bar” in terms of net benefit and certainty of that net benefit for each situation. A taxonomy of decisions is lacking, however, along with agreement on the level of evidence needed for net benefit and certainty and on the types of study designs that would suffice for each decision.⁴⁰⁵ Such a taxonomy could provide guidance on the types of studies that are best suited for each situation, help shape research priorities, and provide guidance as to their appropriate use given the state of knowledge.

⁴⁰¹ Lomas, J., Culyer, T., McCutcheon, C., McAuley, L., and Law, S. (2005). *Conceptualizing and Combining Evidence for Health System Guidance*. See http://www.chsrf.ca/other_documents/pdf/evidence_e.pdf. Accessed on March 31, 2008.

⁴⁰² Genetic risk assessment and BRCA mutation testing for breast and ovarian cancer susceptibility: recommendation statement. (2005). *Annals of Internal Medicine*. 143(5): 355-361.

⁴⁰³ U.S. Preventive Services Task Force (2005). *Genetic Risk Assessment and BRCA Mutation Testing for Breast and Ovarian Cancer Susceptibility: Recommendation Statement*. See <http://www.ahrq.gov/clinic/uspstf05/brcagen/brcagenrs.htm>. Accessed on March 31, 2008.

⁴⁰⁴ Teutsch, S. *Issues in Adjusting the Evidence Framework to Decision Needs*. Presentation at Institute of Medicine Workshop, “Judging the Evidence: Standards for Determining Clinical Effectiveness,” February 5, 2007. See <http://www.iom.edu/Object.File/Master/40/367/Steve%20Teutsch.pdf>. Accessed on March 31, 2008.

⁴⁰⁵ Teutsch, S.M., Berger, M.L., and Weinstein, M.C. (2005). Comparative effectiveness: asking the right questions, choosing the right method. *Health Affairs (Millwood)* 24(1):128-132.

Decisionmakers	Factors Considered
Public Health	Effectiveness Safety Comparative effectiveness Cost and cost-effectiveness Population characteristics Legal and ethical considerations Social preferences Feasibility
Payers	Effectiveness Comparative effectiveness Cost and cost-effectiveness Clinical situation (e.g., population tested, stage of illness, natural history of condition, test purpose [e.g., prediction/predisposition, prevention, diagnosis, treatment, monitoring]) Legal and ethical considerations (e.g., precedent, malpractice, Federal and State laws and regulations) <i>To a lesser extent:</i> Patient values and preferences Feasibility (e.g., infrastructure requirements) Stakeholder interests
Clinical Guideline Developers	Safety Efficacy Effectiveness Comparative effectiveness Clinical situation <i>To a lesser extent:</i> Legal and ethical considerations Feasibility
Quality Improvement Organizations	Effectiveness Clinical situation Administrative options (e.g., tools for targeting or limiting use to those most likely to benefit) Feasibility
Patients, Families, and Providers	Effectiveness Cost and cost-effectiveness Clinical situation Values and preferences

⁴⁰⁶ Evaluation of Genomic Applications in Practice and Prevention (EGAPP) Web site. See <http://www.egapprovals.org/>. Accessed on March 31, 2008.

In general, the systems and considerations for assessing the clinical utility of genetic tests do not differ substantially from other technologies. They are, however, a harbinger of issues that the health care system will be facing. Hence, confronting these challenges can help address other medical issues. Though not unique to genetic testing, the issues that these technologies raise include the following:

An information explosion. The number of genetic variants and their penetrance, genetic pleiotropy, polygenic interactions, and interactions with individual behaviors and environmental exposures pose enormous challenges to understanding all of the information and integrating it so that clinical utility is realized at the population as well as the individual level. Because these challenges could be overwhelming, they need to be managed intelligently.

Medicalization. As more genetic risk characteristics are identified, there is likely to be increased medicalization of previously unknown conditions and risk factors linked to important health conditions. In hyperlipidemia, for example, low-density lipoprotein cholesterol thresholds for high-risk individuals have been decreased to a target as low as 70 mg/dL, well below what was previously considered “normal.” The consequence is that many more individuals now have a medical condition (hyperlipidemia) that will lead to clinical management.

Timeliness. Capitalizing on all the information and making new knowledge available in a timely manner will continue to be challenging. The more time that passes between the clinical availability of a test and evidence of clinical utility, the more likely practice patterns of use will be established and hard to modify. For example, routine chest x-ray and Venereal Disease Research Laboratory syphilis screening were in widespread use before evidence showed little or no benefit; it took many additional years for clinicians to change what had become engrained practice.

Rare conditions. Single-gene high-penetrance conditions are typically rare, and the challenges associated with them have been discussed in other reports.⁴⁰⁷ The need for personalized health care is likely to expand with improved knowledge of population subgroups that are at risk for genetic conditions, respond differentially to therapy, or require tailored followup. Subgroups that are large enough can be studied with traditional clinical epidemiologic methods. On the other hand, such studies for rare conditions may be impractical. Systems for managing those conditions will also be needed.

Need for methods development. Clinical utility is generally established by clinical trials and observational studies conducted specifically for that purpose. The large number of *de novo* studies and evidence syntheses that would be required to provide comparable evidence for the burgeoning number of gene-based technologies and clinical issues may not be practical. It may be necessary to prioritize such evaluations. Other methods to assess the utility of laboratory tests using postmarketing strategies are also needed, such as making inferences on the basis of pathophysiologic mechanisms and using vast databases that may emerge from electronic health records or other information systems.

⁴⁰⁷ Sanderson, S., Zimmern, R., Kroese, M., Higgins, J., Patch, C., and Emery, J. (2005). How can the evaluation of genetic tests be enhanced? Lessons learned from the ACCE framework and evaluating genetic tests in the United Kingdom. *Genetics in Medicine*. 7(7):495-500.

Family, community, and social consequences. Although not unique to genetic testing, the clinical utility of genetic tests for families, communities, and society has ethical and social consequences that cannot be ignored. For example, there is potential for stigmatization among population subgroups that are targeted for screening of genetic disorders or genetic variants that occur with a higher frequency within these subgroups compared with the general population. These issues will need to be systematically addressed as part of clinical utility.

Development of Evidence of Clinical Utility

There are several existing processes to generate evidence of clinical utility. The first step in evaluating the impact of a genetic test is to understand the natural history of the underlying disease or condition and the clinical validity of the test in predicting or diagnosing that disease or condition. This evaluation is typically done through longitudinal epidemiology studies typified by cohort studies funded by the National Institutes of Health (NIH), case-control studies, and global integration efforts, such as the Human Genome Epidemiology Network,⁴⁰⁸ which is sponsored by the Centers for Disease Control and Prevention (CDC). The next step is to evaluate the impact of interventions that occur as a consequence of genetic testing.

Although individual studies assess efficacy or effectiveness to varying degrees, clinical utility is primarily concerned with effectiveness. Efficacy outcomes (often short-term surrogate outcomes) are measured in an ideal-world setting, whereas effectiveness outcomes (often long-term health outcomes) are measured in a real-world setting in which variations in provider training, education, and skills affect appropriate choice and delivery of an intervention. Other factors, such as the affected individual's age and gender, access to intervention, adherence to an intervention, presence of comorbidities and other treatments, dietary and behavioral activities, and cost of the intervention, also may have a large impact on the outcomes. The use of the term "effectiveness" by the U.S. Food and Drug Administration (FDA), as in the phrase "drugs are safe and effective," corresponds more closely to this report's use of the word "efficacy."

Data on therapies are typically generated by pharmaceutical and biotechnology companies to gain FDA approval, though some interventions could be lifestyle modifications to improve diet, decrease tobacco use, and increase physical activity. Typically, these studies are randomized controlled trials (RCTs) that focus on surrogate, short-term outcomes in select patient populations, making it difficult to understand the applicability of these results in the general population. Thus, these studies often have good internal validity but poor external validity or applicability. Additionally, these studies are not designed to evaluate rare or long-term outcomes. These deficiencies have lent support for conducting practical clinical trials (also called large sample trials) with large sample sizes, broad inclusion criteria, and modest data collection leading to estimates of effectiveness in typical care settings.^{409, 410} Practical clinical trials in the fields of behavioral

⁴⁰⁸ Centers for Disease Control and Prevention Web site. "Human Genome Epidemiology Network (HuGENet™)." See <http://www.cdc.gov/genomics/hugenet/default.htm>. Accessed on March 31, 2008.

⁴⁰⁹ Glasgow, R.E., Magid, D.J., Beck, A., Ritzwoller, D., and Estabrooks, P.A. (2005). Practical clinical trials for translating research to practice: design and measurement recommendations. *Medical Care*. 43(6):551-557.

⁴¹⁰ Tunis, S.R., Stryer, D.B., and Clancy, C.M. (2003). Practical clinical trials: increasing the value of clinical research for decision making in clinical and health policy. *Journal of the American Medical Association*. 290(12):1624-1632.

disorders,^{411,412} cardiovascular disease,⁴¹³ and mental illness have been conducted.^{414,415,416} Practical clinical trials are typically funded by NIH, but some are supported by private funding.⁴¹⁷

As relatively few practical clinical trials have been conducted, the relevant data are often collected through observational studies using existing data sources, such as insurance claims or electronic medical records. These studies are necessarily performed after the test or intervention has been released into clinical practice. Such studies can be funded by Federal agencies, such as the Agency for Healthcare Research and Quality (AHRQ), the U.S. Department of Veterans Affairs, CDC, the Health Resources and Services Administration (HRSA), and NIH, or by private sources, such as pharmaceutical companies or health plans. While this method is less costly, it has some drawbacks, since there are limited study design options to control for bias with data that have already been collected.⁴¹⁸ Another approach is exemplified by the Oncotype DX^{®419} test, which entered the clinical market based on data from a study that used a prospectively defined 21-gene assay and recurrence-score algorithm to quantify the likelihood of distant recurrence in patients from a previous RCT who had node-negative, estrogen receptor-positive breast cancer who had been treated with tamoxifen.⁴²⁰ Kaiser of Northern California is still conducting a 5-year prospective study of this test.

Most studies measuring the clinical utility of genetic tests are conducted in the premarket approval phase, and there is often less evidence generated in the postmarket phase. Lack of postmarket evidence constrains the ability to understand the impact of tests and therapies after they enter clinical and public health practice. Even beyond the area of genetic testing, there is a recognized need for more postmarket research and surveillance, particularly in the area of safety, where there have been high-profile examples of product recalls and changes to labeling.⁴²¹ In addition to harms to patients, harms may be incurred by practitioners, industry, and society through lawsuits, withdrawal of medication, resources spent on medications, treatment of complications, and the resultant impact on families and businesses.

⁴¹¹ Weiss, M.D., Gadow, K., and Wasdell, M.B. (2006). Effectiveness outcomes in attention-deficit/hyperactivity disorder. *Journal of Clinical Psychiatry*. 67 Suppl 8:38-45.

⁴¹² Glasgow, E., Davidson, K.W., Dobkin, P.L., Ockene, J., and Spring, B. (2006). Practical behavioral trails to advance evidence-based behavioral medicine. *Annals of Behavioral Medicine*. 31(1):5-13.

⁴¹³ Strandberg, T.E., Pitkala, K.H., Berglund, S., Nieminen, M.S., and Tilvis, R.S. (2006). Multifactorial intervention to prevent recurrent cardiovascular events in patients 75 years or older: the Drugs and Evidence-Based Medicine in the Elderly (DEBATE) study: a randomized, controlled trial. *American Heart Journal*. 152(3):585-592.

⁴¹⁴ Perkins, D.O. (2006). Clinical trials in schizophrenia with results for the real world. *CNS Spectrums*. 11(7 Suppl 7):9-13.

⁴¹⁵ March, J.S., Silva, S.G., Compton, S., Shapiro, M., Califf, R., and Krishnan, R. (2005). The case for practical trials in psychiatry. *American Journal of Psychiatry*. 162(5):836-846.

⁴¹⁶ March, J.S., Silva, S.G., Compton, S., Anthony, G., DeVeaugh-Geiss, J., Califf, R., and Krishnan, R. (2004). The Child and Adolescent Psychiatry Trials Network (CAPTN). *Journal of the American Academy of Child and Adolescent Psychiatry*. 43(5):515-518.

⁴¹⁷ Hahn, D.L. and Plane, M.B. (2004). Feasibility of a practical clinical trial for asthma conducted in primary care. *The Journal of the American Board of Family Practice*. 17(3):190-195.

⁴¹⁸ Manolio, T.A., Bailey-Wilson, J.E., and Collins, F.S. (2006). Genes, environment and the value of prospective cohort studies. *Nature Reviews Genetics*. 7(10):812-820.

⁴¹⁹ Genomic Health: Oncotype DX Breast Cancer Assay Web site. See <http://www.genomichealth.com/oncotype/default.aspx>. Accessed on March 31, 2008.

⁴²⁰ Paik, S., Shak, S., Tang, G., Kim, C., Baker, J., Cronin, M., Baehner, F.L., Walker, M.G., Watson, D., Park, T., Hiller, W., Fisher, E.R., Wickerham, D.L., Bryant, J., and Wolmark, N. (2004). A multigene assay to predict recurrence of tamoxifen-treated, node-negative breast cancer. *New England Journal of Medicine*. 351(27):2817-2826.

⁴²¹ Committee on the Assessment of the U.S. Drug Safety System (2007). *The Future of Drug Safety: Promoting and Protecting the Health of the Public*. Eds. Baciu, A., Stratton, K., and Burke, S.P. Washington, D.C.: The National Academies Press, 2007.

From a practical standpoint, understanding the clinical utility of an intervention requires an assessment of the balance of benefits and harms in outcomes in order to guide decisions on its use. The outcomes of interest are determined by the disease or condition as well as by the clinical intervention, setting, perspective, and purpose. The outcomes of interest may be categorized as: health, surrogate (or intermediate), process, efficiency, and quality. This report will focus on many of the health-related outcomes described in Table 5–2, which summarizes an outcomes lexicon developed by the EGAPP Working Group. Some of these outcomes, however, are outside the scope of this report. The appropriate choice of an outcome depends on the perspective and context of the decisionmaker. Table 5–3 provides examples of surrogate and health outcomes for some common and rare conditions. For the purposes of this report, however, the focus is on outcomes related to the clinical management of individuals.

Table 5–2. Examples of Types of Health-Related Outcomes⁴²²

Potential Outcomes	Examples
Diagnostic Thinking/ Health Information Impact	Ending diagnostic odyssey Knowledge of prognosis/disease course Long-term planning Distress (increased or decreased) Satisfaction with testing services Increased/decreased sense of control Stigmatization or discrimination Incidental information (unwanted information) Changes in family dynamics Cultural, ethnic identity
Therapeutic Choice	Changes in preventive or therapeutic strategies Adherence to therapeutic regimen Satisfaction with treatment choice Health behavior (test recipients)
Patient Outcome Impact	Mortality Morbidity Change in response to therapy Incidence of adverse outcome(s) following testing Severity of adverse outcome(s) following testing Health-related quality of life Pregnancy termination decisions Prenatal interventions
Familial and Societal Impact	Impact on health disparities Health care utilization by family members Disabilities perspective Fostering genetic determinism in society Eugenics attitudes in society Technology innovation Population health interventions

⁴²² Botkin, J.R., Teutsch, S., Kaye, C.I., Hayes, M., Bradley, L.A., Szegda, K., and Dotson, W.D. on behalf of the EGAPP Outcomes Working Group. *Outcomes of Interest in Evidenced-Based Evaluations of Genetic Tests*. Manuscript in preparation.

Table 5–3. Examples of Surrogate and Health Outcomes for Specific Conditions

Indication for Testing	Gene/Marker	Surrogate Outcomes	Health Outcomes
Familial adenomatous polyposis	<i>APC</i>	Colorectal polyps	Colorectal cancer mortality Quality of life
Alpha 1-antitrypsin (AAT) deficiency	<i>SERPINA1</i>	Serum AAT levels Loss of lung tissue measured by computed tomography scan	Shortness of breath Morbidity and mortality from cirrhosis
Chronic myelogenous leukemia	<i>BCR, ABL</i>	BCR-ABL level White blood cell level	Mortality Morbidity from suppressed immunity
Warfarin treatment	<i>VKORC1, CYP2C9</i>	International normalized ratio level	Mortality and morbidity from insufficient anticoagulation (stroke and pulmonary embolism) or overanticoagulation (hemorrhage)

To support evidence development, AHRQ and CDC are jointly conducting a needs assessment of existing systems and databases for monitoring the utilization and outcomes of gene-based applications, including tests and related interventions in the U.S. health care system.⁴²³ This assessment, expected in May 2008, will identify characteristics of an optimal database or linkages between databases that would enable assessment of utilization and outcomes of gene-based applications, would inventory existing databases and assess their strengths and limitations in identifying outcomes, and would provide options for ascertaining outcomes of gene-based applications.

Assessment of Evidence of Clinical Utility

An important premise of clinical utility is that each intervention has predictable and unpredictable consequences that can either be beneficial or have the potential to cause harm. Therefore an assessment of benefits and harms is necessary prior to recommending use of an intervention in order to ensure that effective interventions are provided and that harmful or ineffective ones are not.

Evaluation of the evidence and decisionmaking involves two separate steps. Recognizing that there are tradeoffs between timeliness and rigor, the first step is a systematic, explicit, transparent, rigorous, and reproducible evidence assessment, accomplished through a systematic evidence review (SER) as part of a technology assessment (TA). SERs are useful for clarifying the variety of evidence sources and quality of data and identifying gaps in the evidence in order to prioritize research. They provide information about clinical and/or economic benefits and harms of interest to stakeholders. In addition, TAs often examine the

⁴²³ Agency for Healthcare Research and Quality Web site. “Needs Assessment to Establish an Infrastructure for Monitoring the Utilization and Outcomes of Gene-Based Applications in the United States Health Care System (Research Abstract).” See <http://effectivehealthcare.ahrq.gov/healthInfo.cfm?infotype=nr&ProcessID=46>. Accessed on March 31, 2008.

social, ethical, and economic implications of the development, diffusion, and use of technologies. Table 5–4 provides examples of organizations conducting SERs and TAs.

Groups Performing SERs/TAs	Supporters	Purpose
Evidence-Based Practice Centers ⁴²⁴	AHRQ	Reviews all relevant scientific literature on clinical, behavioral, organizational, and financial topics to produce SERs and TAs. These reports are used to inform and develop coverage decisions, quality measures, educational materials and tools, guidelines, and research agendas.
The Cochrane Collaboration ⁴²⁵	International independent not-for-profit organizations	Investigates effects of interventions for prevention, treatment, and rehabilitation in a health care setting. Most Cochrane reviews are based on RCTs, but other types of evidence may also be taken into account if appropriate.
TA Organizations associated with or used by third-party payers	Blue Cross Blue Shield Technology Evaluation Center, ⁴²⁶ ECRI, ⁴²⁷ Hayes, ⁴²⁸ Drug Effectiveness Review Project ⁴²⁹	Provides health care decisionmakers with timely, rigorous, and credible assessments that synthesize the available evidence on the diagnosis, treatment, management, and prevention of disease.

The second step in assessing clinical utility is an evidence-based decisionmaking process. Ideally, the evidence assessment is done by a team of independent decisionmakers, such as clinical guideline development panels or advisory committees. Although the two steps are closely linked, they are usually independent. The outcomes of interest and scope of review are clarified by the decisionmakers, the evidence assessment is done by the evidence review team, and the balance of benefits and harms is determined by the decisionmakers.⁴³⁰ EGAPP and USPSTF are existing processes that incorporate these steps into the assessment of clinical utility. For example, the EGAPP Working Group commissions evidence reports to independent review teams or evidence-based practice centers, specifying outcomes of interest and providing input through participation in technical expert panels. The subsequent EGAPP Working Group recommendation statements are developed independently of the evidence review team but with direct linkage to the evidence. Realistically, this separation frequently does not occur, particularly in the realm of

⁴²⁴ Agency for Healthcare Research and Quality Web site. “Evidence-based Practice Centers (EPC).” See <http://www.ahrq.gov/clinic/epc/>. Accessed on March 31, 2008.

⁴²⁵ The Cochrane Collaboration Web site. See <http://www.cochrane.org/index.htm>. Accessed on March 31, 2008.

⁴²⁶ BlueCross BlueShield Association Web site. “Technology Evaluation Center.” See <http://www.bcbs.com/betterknowledge/tec/>. Accessed on March 31, 2008.

⁴²⁷ ECRI Institute Web site. See <http://www.ecri.org/>. Accessed on March 31, 2008.

⁴²⁸ Hayes Web site. See <http://www.hayesinc.com/>. Accessed on March 31, 2008.

⁴²⁹ Oregon Health & Science University Web site. “Drug Effectiveness Review Project.” See <http://www.ohsu.edu/drugeffectiveness/>. Accessed on March 31, 2008.

⁴³⁰ Teutsch, S.M. and Berger, M.L. (2005). Evidence synthesis and evidence-based decision making: related but distinct processes. *Medical Decision Making*. 25(5):487-489.

genetic testing for rare disorders. Table 5–5 gives examples of several existing guideline developers that create clinical guidelines based on an evaluation of clinical utility.

<i>Table 5–5. Examples of Groups That Develop Guidelines</i>			
Guideline Developers	Supporter	Purpose	Process for Development
Consensus development panels ⁴³¹	NIH	<ul style="list-style-type: none"> • Evaluates available scientific information on a biomedical issue • Develops a statement that advances understanding • Useful to health professionals and the public 	<ul style="list-style-type: none"> • Broad-based, independent panel of experts considers information provided by experts and the public • Composes a statement to address a set of predetermined questions
USPSTF ⁴³²	AHRQ	<ul style="list-style-type: none"> • Evaluates benefits of individual services based on age, gender, and risk factors for disease • Makes recommendations about which preventive services should be incorporated into primary medical care and for which populations 	<ul style="list-style-type: none"> • Systematically assembles and reviews the evidence and estimates the magnitude of benefits and harms for each preventive service • Determines net benefit for each preventive service and secures external reviews • Issues a recommendation
EGAPP Working Group ⁴³³	CDC	<ul style="list-style-type: none"> • Seeks to develop a sustainable process for evaluating genetic tests and other genomic applications using an evidence-based approach • Only group with a focus exclusively on the evaluation of genetic tests 	<ul style="list-style-type: none"> • Establishes methods and processes • Prioritizes and selects topics for review based on systematic evidence reviews • Develops and publishes conclusions or recommendations • Provides guidance and feedback on other project activities

⁴³¹ NIH Consensus Development Program. See <http://consensus.nih.gov/>. Accessed on March 31, 2008.

⁴³² Agency for Healthcare Research and Quality Web site. “U.S. Preventive Services Task Force (USPSTF).” See <http://www.ahrq.gov/clinic/uspstfix.htm>. Accessed on March 31, 2008.

⁴³³ Evaluation of Genomic Applications in Practice and Prevention (EGAPP) Web site. See <http://www.egapreviews.org/>. Accessed on March 31, 2008.

Guideline Developers	Supporter	Purpose	Process for Development
Clinical Efficacy Assessment Project ⁴³⁴	American College of Physicians	<ul style="list-style-type: none"> • Reviews clinical literature on a specified topic • Presents information so that practitioners can readily determine the usefulness of diagnostic tests, procedures, or treatments 	<ul style="list-style-type: none"> • Systematically reviews the literature • Seeks critical review • Develops a manuscript and guideline
Guideline Panels	Professional specialty societies	<ul style="list-style-type: none"> • Most common mechanism for creating practice guidelines • Groups consist primarily of “decisionmakers” • Can potentially reflect practitioner bias 	<ul style="list-style-type: none"> • Make recommendations based on varying levels of literature review and expert opinion.

When ascertaining the strength of evidence for a key question or domain, the evidence assessment should take into account the quality, quantity, and consistency of studies and attempt to determine the magnitude of benefits and harms. Attention should also be paid to whether the intervention or test was studied in conditions or situations that are the same as or similar to the proposed clinical application. Studies can be ranked on these characteristics based on the study design and methodology. RCTs are usually placed at the top of the hierarchy, since they have the least potential for bias and confounding variables, minimizing the potential for making erroneous conclusions. Case reports and expert opinions are typically placed at the bottom of the hierarchy since they have the greatest potential for making an erroneous conclusion. Observational studies, such as cohort and case-control studies, are somewhere in the middle of the hierarchy.

The study population, clinical setting, duration, primary outcomes evaluated, and conduct of a study also influence the conclusions drawn from study findings and thus are important in determining the strength of evidence. A well-designed and well-executed nested, case-control study can provide more definitive results than a poorly designed RCT. Additionally, a study that more accurately models the application of the test or intervention in a real-world delivery system might provide more relevant information about the effectiveness of the test or intervention than a highly controlled RCT. The gap between theoretical efficacy and practical effectiveness can be large, with concomitantly smaller net benefit in real-world practice.

Guidelines developers examine the strength of evidence and magnitude of benefits and harms to assess the magnitude of net benefit and its degree of certainty. Focus is placed on evidence of the intervention’s impact on clinically relevant health outcomes, such as mortality, morbidity, and quality of life. These developers typically consider the impact of an intervention on surrogate markers, such as biochemical or metabolic changes, only when the link between the surrogate marker and a health outcome is well established. Formulation of guidelines for a broad population often requires extrapolation and generalization of the evidence.

⁴³⁴ American College of Physicians Web site. “Clinical Efficacy Assessment Subcommittee.” See <http://news.acponline.org/clinical/guidelines/intro.htm>. Accessed on March 31, 2008.

While the principles of evidence-based guidelines are well established, they have only recently been adapted specifically to genetic testing by USPSTF,⁴³⁵ EGAPP,⁴³⁶ ACHDGDNC,⁴³⁷ and the ACCE Project (which takes its name from the four components of evaluation—Analytical validity, Clinical validity, Clinical utility, and associated Ethical, legal, and social implications).^{438, 439} For example, evidence-based reviews usually contain a description of the condition’s natural history, as well as current management options. The EGAPP and ACCE processes have adapted these concepts to apply to genetic tests, and ACHDGDNC is adapting them for rare genetic conditions. Additionally, virtually no laboratory test is perfectly predictive of a condition or an outcome. In genetics, even a test that perfectly predicts a genotype may not predict the phenotype, which is what is clinically important, because of variable penetrance and expressivity.

Scarcity of evidence can have extraordinary consequences for the health care system. For example, autologous bone marrow transplantation for advanced breast cancer came into widespread use following a massive legal settlement despite the lack of evidence of effectiveness. Ultimately, the procedure was found to be ineffective and rapidly fell into disfavor, but countless women suffered needlessly, and the cost to the health care system was massive.⁴⁴⁰

The Clinical Utility Spectrum

Currently, the degree to which clinical utility is established for different genetic tests varies widely. The widespread use and regulation of these tests often varies according to the type of test and the populations or conditions with which they are associated. The following examples illustrate a spectrum of evidence for clinical utility and associated challenges when evidence of utility is incomplete.

Tests with Proven Clinical Utility

The test for HER2, or human epidermal growth factor receptor 2, is an example of a necessary test linked to a treatment with proven clinical utility. The HER2 receptor, which is produced from the *ERBB2* gene, is involved in cell growth. Herceptin® (trastuzumab) is a cancer drug that specifically targets the HER2 to inhibit its signaling pathway. The genetic test is used to identify HER2-positive patients who would receive benefit from the drug and to predict response to therapies such as hormone therapy and chemotherapy.^{441, 442}

⁴³⁵ Agency for Healthcare Research and Quality Web site. “U.S. Preventive Services Task Force (USPSTF).” See <http://www.ahrq.gov/clinic/uspstfix.htm>. Accessed on March 31, 2008.

⁴³⁶ Centers for Disease Control and Prevention Web site. “Evaluation of Genomic Applications in Practice and Prevention (EGAPP): Implementation and Evaluation of a Model Approach.” See <http://www.cdc.gov/genomics/gtesting.htm>. Accessed on March 31, 2008.

⁴³⁷ Health Resources and Services Administration Web site. “Advisory Committee on Heritable Disorders and Genetic Diseases in Newborns and Children.” See <http://www.hrsa.gov/heritabledisorderscommittee/>. Accessed on March 31, 2008.

⁴³⁸ Gudgeon, J.M., McClain, M.R., Palomaki, G.E., and Williams, M.S. (2007). Rapid ACCE: experience with a rapid and structured approach for evaluating gene-based testing. *Genetics in Medicine*. 9(7):473-478.

⁴³⁹ Centers for Disease Control and Prevention Web site. “ACCE Model System for Collecting, Analyzing and Disseminating Information on Genetic Tests.” See <http://www.cdc.gov/genomics/gtesting/ACCE/fbr.htm>. Accessed on March 31, 2008.

⁴⁴⁰ Rettig, R.A., Jacobson, P.D., Farquhar, C.M., and Aubry, W.M. (2007). *False Hope: Bone Marrow Transplantation for Breast Cancer*. New York: Oxford University Press.

⁴⁴¹ Lab Tests Online Web site. “A Public Resource on Clinical Lab Testing From the Laboratory Professionals Who Do the Testing.” See <http://www.labtestsonline.org/understanding/analytes/her2neu/test.html>. Accessed on March 31, 2008.

⁴⁴² Colozza, M., de Azambuja, E., Cardoso, F., Bernard, C., and Piccart, M.J. (2006). Breast cancer: achievements in adjuvant systemic therapies in the pre-genomic era. *Oncologist*. 11(2):111-125.

In this case, the benefits of this test for the HER2-positive subset of patients far outweigh the harms; the survival benefit has been quantified, and studies have demonstrated cost-effectiveness.^{443,444,445} Postmarket studies continue to refine this application.

Mandated Tests and Uncertain Clinical Utility

Newborn screening, which is mandated in all States, is conducted for a panel of genetic disorders. The best known example is the test for phenylketonuria (PKU). Early detection and treatment of PKU prevent the mental retardation associated with this disorder. Although the panel for newborn screening is determined at the State level, many States screen for the 29 disorders recommended in the American College of Medical Genetics (ACMG) report to HRSA.⁴⁴⁶ To be included in the panel recommended by ACMG, there must be “demonstrated benefits of early detection, timely intervention and efficacious treatment of the condition being tested,”⁴⁴⁷ although there is considerable disagreement about the standard of clinical utility and value of information that should be used.^{448, 449} Furthermore, cost-effectiveness for several disorders included in newborn screening panels has not been demonstrated.⁴⁵⁰

Rare Disease Testing and Emerging Evidence of Utility

People affected by rare inherited diseases may want information that is provided by genetic testing. The small market for these tests, however, limits their translation from research laboratories to clinical practice. When genetic tests for rare diseases are offered in research settings, regulations under the 1988 Clinical Laboratory Improvement Amendments (CLIA) prohibit the return of results to patients unless the laboratory is CLIA certified. In clinical settings, most clinical laboratories performing rare genetic disease testing have limited monetary and personnel resources for the development of new tests and lack resources for data collection and development of educational materials, although many laboratories see this as the role of the clinician, not the laboratory. There also are issues with proficiency testing and quality assurance, as discussed in Chapter IV. Finally, the ability to conduct clinical trials to assess the impact of testing on medical outcomes is limited by small numbers of patients and tests. For almost all rare genetic disorders, randomized trials of effectiveness are not conducted for practical reasons. All these factors contribute to decreased access to potentially useful tests. Identification of individuals with rare disorders through genetic testing could facilitate earlier diagnosis and referral to experts.

⁴⁴³ Kurian, A.W., Thompson, R.N., Gaw, A.F., Arai, S., Ortiz, R., and Garber, A.M. (2007). A cost-effectiveness analysis of adjuvant trastuzumab regimens in early HER2/neu-positive breast cancer. *Journal of Clinical Oncology*. 25(6):634-641.

⁴⁴⁴ Liberato, N.L., Marchetti, M., and Barosi, G. (2007). Cost effectiveness of adjuvant trastuzumab in human epidermal growth factor receptor 2-positive breast cancer. *Journal of Clinical Oncology*. 25(6):625-633.

⁴⁴⁵ Millar, J.A. and Millward, M.J. (2007). Cost effectiveness of trastuzumab in the adjuvant treatment of early breast cancer: a lifetime model. *Pharmacoeconomics*. 25(5):429-442.

⁴⁴⁶ Health Resources and Services Administration Web site. “Newborn Screening: Toward a Uniform Screening Panel and System.” See <http://mchb.hrsa.gov/screening/>. Accessed on March 31, 2008.

⁴⁴⁷ Health Resources and Services Administration (2005). *Newborn Screening: Toward a Uniform Screening Panel and System, Executive Summary*. pg. 6. See <ftp://ftp.hrsa.gov/mchb/genetics/screeningdraftsummary.pdf>. Accessed on March 31, 2008.

⁴⁴⁸ Botkin, J.R., Clayton, E.W., Fost, N.C., Burke W., Murray, T.H., Baily, M.A., Wilfond, B., Berg, A., and Ross, L.F. (2006). Newborn screening technology: proceed with caution. *Pediatrics*. 117(5):1793-1799.

⁴⁴⁹ Grosse, S.D., Boyle, C.A., Kenneson, A., Khoury, M.J., and Wilfond, B.S. (2006). From public health emergency to public health service: the implications of evolving criteria for newborn screening panels. *Pediatrics*. 117(3):923-929.

⁴⁵⁰ Grosse, S.D., Teutsch, S.M., and Haddix, A.C. (2007). Lessons from cost-effectiveness research for United States public health policy. *Annual Review of Public Health*. 28:365-391.

The NIH Office of Rare Diseases and CDC established a pilot program to address these issues. As mentioned in Chapter IV, the Collaboration, Education, and Test Translation (CETT) program is a partnership among clinicians, laboratorians, researchers, and advocacy groups. Applicants provide information on the performance of the test (analytical validity); the clinical setting for which the test is appropriate, with data supporting the test's use (clinical validity); and evidence on how the results of the test will affect the clinical management of the patient or family (clinical utility). In addition, it requires development of patient education materials; provider education materials in the form of a GeneReview;⁴⁵¹ template reports for positive, negative, and variants of unknown significance test results; ongoing collection of clinical data; analysis of these clinical data in the context of the genetic test result (genotype-phenotype correlation); storage of the data in a public database for a minimum of 5 years; and submission of progress reports to the CETT program staff at regular intervals. In return, the CETT program provides funding to help develop a test in a clinical laboratory. While the impact of this type of program is unknown at present, the process may increase the understanding of the clinical utility of rare disease testing and provide solutions that may increase the benefits and reduce the harms.

Controlled Research Environment vs. Routine Clinical Use

Many tests or interventions, including genetic tests, that show a measurable improvement in the outcome of interest in a strictly controlled research environment do not show the same magnitude of effect when translated into general clinical use. The reasons for this difference include less rigorous patient selection, expansion of the clinical setting, and variation from the ideal treatment protocol. Adenomatosis polyposis coli testing for conditions such as familial colorectal cancer can provide definitive information regarding risk for disease development in some patients and families if the test is appropriately interpreted. There are significant problems with misinterpretation of laboratory reports by nongenetics professionals, however.⁴⁵² Misinterpretation of results significantly alters the balance between benefits and harms of the test when compared with a setting in which the test is assured of accurate interpretation. So-called natural setting trials have been proposed as a possible way to address this issue.⁴⁵³

Pharmacogenomics and Incomplete Evidence of Clinical Utility

Pharmacogenomics addresses the influence of genetic variation on drug response, which can affect drug dosing decisions, effectiveness, and adverse drug reactions (ADRs).^{454, 455} In theory, knowing how genetic variations affect pharmacokinetics and pharmacodynamics should allow clinicians to choose the most effective drug with the lowest risk of an ADR. In practice, this can be complicated.

For example, a particular polymorphism in the UDP-glucuronosyltransferase 1A1 (*UGT1A1*) gene predisposes patients to severe toxic reaction to the chemotherapeutic drug irinotecan.⁴⁵⁶ Advanced colorectal

⁴⁵¹ GeneTests Web site. See <http://www.geneclinics.org/>. Accessed on March 31, 2008.

⁴⁵² Giardiello, F.M. (1997). Genetic testing in hereditary colorectal cancer. *Journal of the American Medical Association*. 278(15):1278-1281.

⁴⁵³ Freund, C.L., Clayton, E.W., and Wilfond, B.S. (2004). Natural settings trials- improving the introduction of clinical genetic tests. *The Journal of Law, Medicine, and Ethics*. 32(1):106-10.

⁴⁵⁴ National Institute of General Medical Sciences Web site. "Frequently Asked Questions About Pharmacogenetics." See http://www.nigms.nih.gov/Initiatives/PGRN/Background/pgm_faq.htm. Accessed on March 31, 2008.

⁴⁵⁵ National Center for Biotechnology Information Web site. "One Size Does Not Fit All: The Promise of Pharmacogenomics." See <http://www.ncbi.nlm.nih.gov/About/primer/pharm.html>. Accessed on March 31, 2008.

⁴⁵⁶ Innocenti, F. and Ratain, M.J. (2004). "Irinogenetics" and UGT1A: from genotypes to haplotypes. *Clinical Pharmacology and Therapeutics*. 75(6):495-500.

cancer patients with this polymorphism appear to be more responsive to chemotherapy but are at increased risk of an abnormally low level of a type of white blood cell (a disorder known as neutropenia), especially when they receive a high-dose regimen of irinotecan. Since June 2005 the label for this drug warns that homozygosity for this particular polymorphism is a risk factor for severe neutropenia, and patients with this genotype should be treated with a reduced dose of irinotecan.⁴⁵⁷ Even if consideration of harms and benefits is restricted to patients undergoing chemotherapy, the situation is very complex. Identification of those at risk can lead to reduced dosage and less effective treatment or avoidance of the drug altogether. Had they received standard dosing, at-risk patients might sustain the risk of neutropenia but also the potential for better tumor response. Would an alternative strategy of more frequent monitoring of the white blood count with dosage adjustment or treatment regimens that do not include irinotecan provide more utility than the genetic test? Other permutations of this discussion can be found in an upcoming EGAPP evidence report on this issue.⁴⁵⁸

Another topical example is *CYP2C9* and *VKORC1* testing for dosing of warfarin. In the United States, as many as 1 million individuals per year start taking this drug, but according to the FDA Adverse Event Reporting System, warfarin is among the 10 drugs with the largest number of serious adverse event reports submitted since 1990.⁴⁵⁹ Three polymorphisms seem to account for most of the genetic variability; however, these genetic factors account for at most 40 percent of the attributable risk for an adverse event. Other factors, such as weight, gender, renal function, and use of other drugs, account for another 30 percent of the risk. Even if all the known genetic and clinical factors are combined, 30 percent to 40 percent of the variation in dosing response cannot be predicted.

It is also noteworthy that current information focuses on the surrogate outcome, prediction of final dose. While it is reasonable to assume that arriving at the final dose faster should lead to a concomitant reduction in ADRs, this effect has not been demonstrated in clinical trials. Also, if trials do show efficacy, it is important to determine the impact of the turnaround time of the test result. Pharmacogenomic testing may not be feasible in certain clinical settings if test results are needed for the initial dosing decision. Since the cost-effectiveness of this intervention depends on the avoidance of both ADRs and incorrect dosing, prevention of even a few ADRs may be difficult to justify, even if the cost of the test is modest. It should be noted that despite these gaps in evidence,^{460,461} *CYP2C9* and *VKORC1* testing is offered clinically in this country, and the test is included in the FDA-approved warfarin label. A discussion of the ethical issues relating to pharmacogenomic testing can be found in Freund and Wilfond.⁴⁶² The issue is currently being studied in clinical trials sponsored by AHRQ and NIH.⁴⁶³

⁴⁵⁷ Innocenti, F. and Ratain M.J. (2006). Pharmacogenetics of irinotecan: clinical perspectives on the utility of genotyping. *Pharmacogenomics*. 7(8):1211-1221.

⁴⁵⁸ EGAPP UGT1A1 Evidence Review (in development).

⁴⁵⁹ Wysowski, D.K., Nourjah, P., and Swartz, L. (2007). Bleeding complications with warfarin use: a prevalent adverse effect resulting in regulatory action. *Archives of Internal Medicine*. 167(13):1414-1419.

⁴⁶⁰ McClain, M.R., Palomaki, G., Piper, M., and Haddow, J.E. (2008). A rapid-ACCE review of *CYP2C9* and *VKORC1* alleles in testing to inform warfarin dosing in adults at elevated risk for thrombotic events to avoid serious bleeding. *Genetics in Medicine*. 10(2):89-98.

⁴⁶¹ Flockhart, D.A., O’Kane, D., Williams, M.S., Watson, M.S., Gage, B., Gandolfi, R., King, R., Lyon, E., Nussbaum, R., Schulman, K., and Veenstra, D. (2008). Pharmacogenetic testing of *CYP2C9* and *VKORC1* alleles for warfarin. *Genetics in Medicine*. 10(2):139-150.

⁴⁶² Freund, C.L. and Wilfond, B.S. (2002). Emerging ethical issues in pharmacogenomics: from research to clinical practice. *American Journal of Pharmacogenomics*. 2(4):273-281.

⁴⁶³ Computer Retrieval of Information on Scientific Projects (CRISP) Web site. See <http://crisp.cit.nih.gov/>. Accessed March 31, 2008.

Tests for Which Information Alone Has Utility

Utility of a test need not be exclusively linked to a medical treatment or intervention. For example, despite the lack of a treatment, genetic testing for Huntington disease, when performed in conjunction with genetic counseling and patient consent, may result in decreased anxiety, opportunities for life-planning, and improved quality of life, compared with the situation for individuals who choose not to be tested, irrespective of whether the test result is positive or negative.^{464, 465, 466} The true utility of information alone is difficult to quantify, since many patients do not want to know their test result.⁴⁶⁷

Consequences of Inadequate Clinical Utility Evidence

Incomplete knowledge of clinical utility can lead to wasted resources and jeopardize patient care. For example, clinical management could be diverted from effective strategies to those that are uncertain or even harmful. These situations can be characterized as “opportunity costs”—that is, the overall cost of decreasing or eliminating something of proven effectiveness (even if it may not be perfectly effective) to do something for which utility is still questionable.

Tests with incomplete evidence of clinical utility can lead to false expectations or the fallacy of determinism. For example, some individuals with *BRCA* mutations who are not from known high-risk kindreds believe it is inevitable that they will develop cancer, even though the risk is far less than 100 percent. Conversely, women from a family with a history of *BRCA* mutations who do not have *BRCA* mutations themselves may believe they will never develop breast cancer and hence not follow routine surveillance recommendations, even though they still have a one in eight risk of developing cancer (based on data on women born in the United States).⁴⁶⁸

Available genomic test panels can detect dozens to hundreds or thousands of genetic variations, many of which have no known clinical consequence. Detection of multiple abnormal and unexpected genomic findings is similar to “incidentalomas” that are discovered in radiological studies (when imaging modes⁴⁶⁹ report on the area of clinical concern and, incidentally, on other organs in the field of view). These real but

⁴⁶⁴ Duncan, R.E., Gillam, L., Savulescu, J., Williamson, R., Rogers, J.G., and Delatycki, M.B. (2007). “Holding your breath”: interviews with young people who have undergone predictive genetic testing for Huntington disease. *American Journal of Medical Genetics Part A*. 143(17):1984-1989.

⁴⁶⁵ Cutler, S.J. and Hodgson, L.G. (2003). To test or not to test: interest in genetic testing for Alzheimer’s disease among middle-aged adults. *American Journal of Alzheimer’s Disease and Other Dementias*. 18(1):9-20.

⁴⁶⁶ Bookman, E.B., Langehorne, A.A., Eckfeldt, J.H., Glass, K.C., Jarvik, G.P., Klag, M., Koski, G., Motulsky, A., Wilfond, B., Manolio, T.A., Fabsitz, R.R., and Leupker, R.V. (2006). Reporting genetic results in research studies: summary and recommendations of an NHLBI working group. *American Journal of Medical Genetics Part A*. 140(10):1033-1040.

⁴⁶⁷ Hepburn, E.R. (1996). Genetic testing and early diagnosis and intervention: boon or burden? *Journal of Medical Ethics*. 22(2):105-10.

⁴⁶⁸ Ries, L.A.G., Melbert, D., Krapcho, M., Mariotto, A., Miller, B.A., Feuer, E.J., Clegg, L., Horner, M.J., Howlander, N., Eisner, M.P., Reichman, M., and Edwards, B.K. (Editors). *SEER Cancer Statistics Review, 1975-2004*. National Cancer Institute. See http://seer.cancer.gov/csr/1975_2004/. Accessed on March 31, 2008.

⁴⁶⁹ Gigerenzer, G. (2007). Helping physicians understand screening tests will improve health care. *Association for Psychological Science Observer*. 20(10). See <http://www.psychologicalscience.org/observer/getArticle.cfm?id=2253>. Accessed on March 31, 2008.

incidental findings can lead to aggressive diagnostic procedures and therapies in otherwise healthy people. The cost of genomic medicine can also increase substantially with little benefit to patients.⁴⁷⁰

Emerging genetics knowledge, such as data from genome-wide association studies, has the potential to alter the currently large reactive medical paradigm to a proactive one that may optimize health and prevent or minimize medical problems through personalized health care and disease prevention. The medical and public health communities will need to determine and understand the clinical utility of genetic information that is probabilistic, or the era of personalized medicine may never come to pass. Family history is somewhat analogous in that the risk stratification provides probabilistic information of a future event. Studies have shown that this risk information can be conveyed to patients in an understandable fashion and that health behaviors change in response to this information, at least in some patients,^{471,472} although most people—including clinicians—are notoriously poor at understanding risks and probabilities.⁴⁷³

Gaps and Challenges Concerning the Clinical Utility of Genetic Testing

Lack of Evidence, Assessment Tools, and Evidentiary Standards

As is unfortunately common in medicine, the widespread lack of high-quality evidence of benefit from prevention or treatment interventions is the primary gap in identifying the net benefit for individuals who undergo genetic testing.

Clinical validity (discussed in Chapter IV) is an important component in an evidence base. A growing number of genetic tests, however, are inappropriately offered based on genetic association studies that have not been adequately validated. If a genotype does not predict disease phenotypes as depicted by test developers and marketers, the test will not support appropriate management decisions. For example, studies of the gene responsible for classic hemochromatosis (HFE) have cast doubt on claims that HFE mutations associated with hereditary hemochromatosis are associated with elevated risk of serious morbidity and mortality from diseases such as arthritis, diabetes, and heart disease; instead, evidence has focused more narrowly on the elevated risk of liver disease and associated mortality.⁴⁷⁴ Consequently, there is doubt about the clinical utility of population screening for HFE mutations or iron overload phenotypes, even though phlebotomy is an effective and inexpensive treatment for established disease. To respond to this gap in knowledge, independent funding of large-scale studies of genotype-phenotype associations is essential.

Assuming that analytical and clinical validity are established, another gap in knowledge is a comparison of outcomes with and without intervention. RCTs are rarely available, and even when they are they may not include all relevant populations, be underpowered or too short in duration to assess important outcomes, or raise questions about external validity. Although considered the gold standard, RCTs are not immune to the perceived weaknesses of other types of trials. Observational studies of treatment effectiveness are prone to

⁴⁷⁰ Kohane, I.S., Masys, D.R., and Altman, R.B. (2006). The incidentalome: a threat to genomic medicine. *Journal of the American Medical Association*. 296(2):212-215.

⁴⁷¹ Katapodi, M.C., Lee, K.A., Facione, N.C., and Dodd, M.J. (2004). Predictors of perceived breast cancer risk and the relation between risk and breast cancer screening: a meta-analytic review. *Preventive Medicine*. 38(4):388-402.

⁴⁷² Siddiqui, A.A., Patel, A., and Huerta, S. (2006). Determinants of compliance with colonoscopy in patients with adenomatous colon polyps in a veteran population. *Alimentary Pharmacology and Therapeutics*. 24(11-12):1623-1630.

⁴⁷³ Viscusi, W.K. (1998). *Rational Risk Policy*. Oxford: Clarendon Press.

⁴⁷⁴ Whitlock, E.P., Garlitz, B.A., Harris, E.L., Beil, T.L., and Smith, P.R. (2006). Screening for hereditary hemochromatosis: a systematic review for the U.S. Preventive Services Task Force. *Annals of Internal Medicine*. 145(3):209-223.

various types of bias, depending on the type of application, such as differential ascertainment and access to care in population screening. Nonetheless, they are often the best source of information for many questions. It can be costly, however, to collect data, especially for rare diseases. Pilot studies in which testing is provided in one geographic area and not in another, with the same level of clinical care, can be useful if data on outcomes are rigorously collected and estimates are adjusted for potential ascertainment bias. A good example is a recent study of outcomes of medium-chain acyl-CoA dehydrogenase deficiency in Australian States with and without newborn screening using tandem mass spectrometry.⁴⁷⁵

Another challenge is when a condition has multiple adverse outcomes for which there is uneven evidence of effectiveness of interventions. Assessment of clinical utility requires not only evaluating the quality of conflicting evidence but also weighting the relative importance of different types of outcomes. For example, newborn screening for cystic fibrosis has been controversial because early identification has not been shown to reverse or even slow the primary pulmonary manifestations of the disease. A CDC review examined the risks and benefits of screening newborns for cystic fibrosis and concluded that there was evidence of moderate net benefit sufficient to endorse screening but cautioned that screening should be conducted with adequate safeguards to minimize risks of harms.^{476, 477}

Another situation in which assessment of clinical utility can be problematic is where there is a continuum of risk and where testing identifies individuals at risk for whom there is little evidence of the effectiveness of interventions to improve outcomes. For example, screening for hemoglobin disorders for the primary purpose of detecting sickle cell anemia has been shown to yield substantial clinical benefits for the primary target group. It is unclear to what extent individuals with other hemoglobin variants benefit from identification and treatment, however. Such issues have largely been ignored in assessments of hemoglobinopathy screening. Because the number of individuals with other variants greatly exceeds the number identified with sickle cell anemia, this is not a minor issue.⁴⁷⁸

As more tests become available for common clinical conditions such as diabetes, cardiovascular disease, and asthma, the incremental clinical validity will need to be established. For some, such as predictive tests currently available for diabetes, the predictive value is too small, particularly when considered with established risk factors such as body mass and family history.

Some tests that have been approved by FDA have sparse information on clinical utility. A recent example is the use of cytochrome P450 (CYP450) testing in patients with depression. Among the clinically available tests to detect CYP450 variation is the FDA-cleared AmpliChip[®] CYP450 test marketed by Roche Diagnostics, which detects variations in the *CYP2D6* and *CYP2C19* genes. EGAPP, through an AHRQ-

⁴⁷⁵ Wilcken, B., Haas, M., Joy, P., Wiley, V., Chaplin, M., Black, C., Fletcher, J., McGill, J., and Boneh, A. (2007). Outcome of neonatal screening for medium-chain acyl-CoA dehydrogenase deficiency in Australia: a cohort study. *Lancet* 369(9555):37-42.

⁴⁷⁶ Grosse, S.D., Boyle, C.A., Botkin, J.R., Comeau, A.M., Kharrazi, M., Rosenfeld, M., and Wilfond, B.S. (2004). Newborn screening for cystic fibrosis: evaluation of benefits and risks and recommendations for state newborn screening programs. *Morbidity and Mortality Weekly Report. Recommendations and Reports/Centers for Disease Control*. 53(RR-13):1-36.

⁴⁷⁷ National Guideline Clearinghouse Web site. "Newborn screening for cystic fibrosis: evaluation of benefits and risks and recommendations for state newborn screening programs." See http://www.guideline.gov/summary/summary.aspx?ss=15&doc_id=5950&nbr=3919. Accessed on March 31, 2008.

⁴⁷⁸ Pass, K.A., Lane, P.A., Fernhoff, P.M., Hinton, C.F., Panny, S.R., Parks, J.S., Pelias, M.Z., Rhead, W.J., Ross, S.I., Wethers, D.L., and Elsas, L.J., 2nd. (2000). U.S. newborn screening system guidelines II: follow-up of children, diagnosis, management, and evaluation: Statement of the Council of Regional Networks for Genetic Services. *Journal of Pediatrics*. 137(4 Suppl):S1-S46.

sponsored evidence-based practice center, conducted a review to determine whether testing for CYP450 polymorphisms in adults with nonpsychotic depression prior to treatment with selective serotonin reuptake inhibitors (SSRIs) led to improved outcomes. The researchers found no supporting evidence that results of CYP450 testing influenced SSRI choice or dose or improved patient outcomes or that they were useful in medical, personal, or public health decisionmaking.^{479,480,481} As new genetic testing technologies are made available for clinical use, it is important to emphasize that FDA clearance or approval is based on test accuracy and evidence of an established link between a particular test result and prediction of clinical phenotype, rather than on demonstration of improved clinical outcomes, except where test labeling claims to improve clinical outcomes.⁴⁸² The chosen examples reflect DNA-based tests that have been reasonably well studied; however, the same issues may apply to any genetic test as defined in this report.

Additionally, as discussed in Chapter IV, many genetic tests are laboratory-developed tests that have not undergone FDA review and approval prior to availability for clinical use. Thus, it is not uncommon for tests to be covered and reimbursed by insurers without having undergone FDA review, which hampers development of evidence of clinical utility, even though FDA approval generally only requires demonstration of potential clinical utility. Moreover, tests in wide clinical use, such as genetic testing for thrombophilia, frequently lack evidence of clear utility. The most recently published guidelines on antithrombotic therapy for venous thromboembolic disease makes recommendations on how to respond to patients presenting with thromboembolism who have one or more thrombophilic factors, despite sparse evidence.⁴⁸³ It is likely, as part of value-based purchasing, that diagnostics, procedures, and devices will move to a tiered system similar to drugs, increasing pressure to generate evidence that demonstrates value and potentially lowers costs.

Diverse Uses of Genetic Tests

Genetic tests are used for several different purposes, such as diagnosing disease, determining carrier status, helping predict the risk of developing a particular disorder, providing prognostic information, and guiding therapeutic interventions. The prevalence of the genetic disorder and the varied levels of evidence for genotype-phenotype associations add to the complexity of genetic testing. The diverse uses of genetic tests applied to a range of genetic conditions present different risks, benefits, and oversight challenges, which may require substantially different regulatory approaches and oversight mechanisms. A “one-size-fits-all” oversight framework for all genetic tests may not be appropriate. The United States should continue to move toward a framework of “tailored oversight” that applies variable regulatory requirements and oversight mechanisms to different subclasses of genetic tests.

⁴⁷⁹ Agency for Healthcare Research and Quality (2007). *Testing for Cytochrome P450 Polymorphisms (CYP450) in Adults with Non-Psychotic Depression Prior to Treatment with Selective Serotonin Reuptake Inhibitors (SSRIs)*. See <http://www.ahrq.gov/clinic/tp/cyp450tp.htm>. Accessed on March 31, 2008.

⁴⁸⁰ Recommendations from the EGAPP Working Group: testing for cytochrome P450 polymorphisms in adults with nonpsychotic depression treated with selective serotonin reuptake inhibitors. (2007). *Genetics in Medicine*. 9(12):819-825.

⁴⁸¹ Thakur, M., Grossman, I., McCrory, D.C., Orlando, L.A., Steffens, D.C., Cline, K.E., Gray, R.N., Farmer, J., DeJesus, G., O'Brien, C., Samsa, G., Goldstein, D.B., and Matchar, D.B. (2007). Review of evidence for genetic testing for CYP450 polymorphisms in management of patients with nonpsychotic depression with selective serotonin reuptake inhibitors. *Genetics in Medicine*. 9(12):826-835.

⁴⁸² Matchar, D.B. and Thakur, M. (2007). Is genetic testing for cytochrome P450 polymorphisms ready for implementation? *American Family Physician*. 76(3) 348, 351.

⁴⁸³ Caro, J.J. and Albers, G.W. (2004). Optimizing oral anticoagulation in managed care. *The American Journal of Managed Care*. 10(14 Suppl):S474-S477.

FDA does not require evidence of clinical utility for clearance or approval of a laboratory test unless the test manufacturer makes a clinical utility claim, and CLIA does not require demonstration of clinical validity or clinical utility. Tests with unproven clinical utility—for example, tests for rare genetic disorders—may need a special framework that lets them be used clinically, subject to ongoing postmarket research requirements and informed consent provisions that require disclosure of the lingering uncertainties.

Assessing the clinical utility of pharmacogenomic tests and other tests that are designed for use in conjunction with another medical product (e.g., with a drug or biologic) can be challenging. As noted by Evans,⁴⁸⁴ it may be difficult to characterize the clinical utility of a test as distinguished from the utility of the drug itself or the drug/test combination. Inconsistent assessments of clinical benefit can create confusion about the appropriate use of pharmacogenomic tests. For example, physicians and their patients face tough dilemmas if FDA has approved a particular test but insurers and Medicare decline to reimburse it. This situation is further complicated if there are several competing tests, particularly if scientific evidence suggests that a newer, non-FDA-regulated test may be more reliable than an older, FDA-approved test. There is a critical need for appropriate, consensus-based methodologies to evaluate the incremental safety and the therapeutic and economic benefits of using genetic tests to target drug and biologic therapies.

Labeling is an important clinical decisionmaking tool in determining the appropriate use of medical products. Genetic tests used in conjunction with drug interventions also raise issues of how to label companion products to promote appropriate joint use of the test and the therapeutic product. A current example is HER2 testing to assess whether patients would benefit from treatment with the cancer drug Herceptin[®]. Genetic tests that are used alone, in the sense of not directing the use of another therapeutic product, do not raise the same labeling issues. An analysis by Evans raises several concerns.⁴⁸⁵ Because these genetic tests can be used to direct treatment decisions, they are inevitably linked to the clinical practice of medicine and raise issues of how to draw the line between the regulation of medical products and regulation of medical practice. A key concern is to protect patients from unreliable tests and misleading claims about what the tests can do. Product labeling has been FDA's first-line of communication for indicated uses, instructions, and warnings. Traditional labeling may not be able to fulfill this role in the case of genetic tests that are used in conjunction with drugs or other biologic therapies. Clinicians need clear and timely instructions on how to target drugs, but there has been wide variation in this information in the drug/test products that FDA has approved. For example, the HER2 test and Herceptin[®] are expressly cross-labeled for use together; the drug label identifies specific tests and provides information on how to vary prescribing based on test results.⁴⁸⁶

⁴⁸⁴ Evans, B.J. (2006). What will it take to reap the clinical benefits of pharmacogenomics? *Food and Drug Law Journal*. 61(4):753-794.

⁴⁸⁵ Evans, B.J. (2007). Distinguishing product and practice regulation in personalized medicine. *Clinical Pharmacology and Therapeutics*. 81(2):288-293.

⁴⁸⁶ Package insert for trastuzumab (Herceptin[®]), sections on "Clinical Studies: HER-2 Detection" and "Precautions," which cross-reference package inserts for the HercepTest[®] IHC assay and the Pathvysion[®] HER-2 DNA Probe Kit. See <http://www.gene.com/gene/products/information/oncology/herceptin/insert.jsp>. Accessed on March 31, 2008.

For other drugs, labeling merely notes that patient response may vary based on genetic factors but provides no specific information about testing and interpretation of results.⁴⁸⁷

Off-label use of drug/test products also presents another complex set of issues. Off-label use may pertain to the drug, the genetic test, or both. FDA has traditionally declined to restrict off-label uses of the products it approves. Some off-label uses of drug/test combinations could be left to the physician's discretion but made subject to informed consent, so that risks and benefits are disclosed to patients. Other uses, however, may need to be banned or discouraged by FDA or through other mechanisms, such as denial of insurance reimbursements, State medical practice regulations and malpractice standards, or practice guidelines developed within the medical profession. Protecting the public from faulty targeting of medicines, while preserving the line between product and practice regulation, may require a careful coordination among FDA, State regulators, and the medical profession.

Implementing a tailored approach to the oversight of genetic testing implies the need for a risk-stratification classification algorithm to determine which tests require which type of oversight. This classification algorithm would consider the following elements:

- The degree of risks and harms that could occur when clinical utility is uncertain
- The potential benefits of allowing the test to be used and whether there are any currently available alternative ways to achieve those same benefits
- Other characteristics of the test, such as whether it is for a rare disorder
- The seriousness of the condition that the test diagnoses or predicts
- How the test will be delivered to patients (e.g., over-the-counter vs. a high-proficiency laboratory)
- How soon test results become available after a test is ordered
- Other characteristics that bear on the risks and benefits of allowing the test into widespread clinical use

It will be a major challenge to develop an algorithm that will have a compact set of sorting criteria yet also yield consistent results, so that similarly situated tests receive consistent approaches to regulation and oversight. Another key challenge will be the design of a flexible oversight framework that acknowledges the health information technologies of today but that can adapt as new technologies emerge. This framework must strike a balance that lets potentially beneficial new tests move into clinical use while managing uncertainties until their clinical utility is resolved. The following goals should be considered in designing such a framework:

- Adopt a stratified approach that identifies the tests in which uncertainties about clinical utility pose the most serious threat of harm and limit access to these tests until the uncertainties are further resolved.
- For tests where uncertainty about clinical utility poses less serious harms or threats or for tests for rare genetic disorders, where resolution of uncertainty is infeasible without wider clinical use of the test, allow the tests to go into clinical use subject to requirements to confirm clinical utility through postmarket followup.
- Press forward with efforts to resolve uncertainties about the clinical utility of genetic tests at their source by putting in place the health information systems and adaptive, postmarket regulatory and data

⁴⁸⁷ Package insert for Atomoxetine HCL (Strattera®), sections on “Human Pharmacokinetics: Metabolism and Elimination,” “Drug-Drug Interactions,” and “Precautions,” noting that the drug is metabolized primarily through the CYP2D6 enzymatic pathway and commenting on the possible need for dosage adjustment when the drug is co-administered with certain CYP2D6 inhibitors.

collection frameworks that ultimately are going to be required to support timely assessment of clinical utility in an adaptive manner as tests move into clinical use.

Evidence of Harms and Potential Harms

This section focuses on harms due to the lack of information about clinical utility. These harms are in addition to those due to insufficient analytical and clinical validity and separate from those due to inadequate clinical decision support systems. Nonetheless, issues in analytical and clinical validity directly affect clinical utility. For instance, high false-positive and false-negative rates reduce the clinical utility of laboratory tests, and poor clinical validity or attributable fraction leads to tests that provide little additional information. Tests for which clinical utility is known but where harms exceed benefits should not generally be used and are not discussed further. The following potential harms are the consequences of inadequate information about clinical utility.

- Genetic tests without proven clinical utility could divert clinical management away from effective strategies to those that are uncertain (or even harmful). For example, screening for lung cancer with computerized tomography may detect many lesions requiring potentially harmful evaluation and management with no evidence that the procedure leads to improved outcomes for lung cancer.⁴⁸⁸ The cost of pursuing an action of questionable utility instead of providing an intervention of proven effectiveness is characterized as an opportunity cost.
- There is an economic cost and the cost of provider and patient time associated with laboratory tests and interventions of uncertain value.
- Genome-scale screening tests may lead to a phenomenon in which multiple abnormal genomic findings are discovered, many of which have unknown clinical significance. Patients could be subjected to unnecessary followup tests, causing additional morbidity, and the cost of genomic medicine will increase substantially, with little benefit to patients or physicians.⁴⁸⁹ Extensive evaluations performed for some patients with incidental findings may reflect the unwillingness of many physicians to accept uncertainty, even in the case of an extremely unlikely diagnosis. This unwillingness may be driven, in part, by fear of potential malpractice liability, a failure to appreciate the influence of prevalence data on the interpretation of diagnostic testing, or other factors. The major justification for further evaluation of these patients is not so much to avoid morbidity and mortality for the rare patient who truly is at increased risk but rather to reassure the physician and patients in whom further testing is negative.⁴⁹⁰
- Inadequate information for the clinical utility of particular genetic tests, particularly those offered directly to consumers (such as an analysis of variants in the *TCF7L2* gene associated with diabetes), coupled with the nuanced interpretation of these tests can be confusing and may lead to uninformed decisions that are harmful. For example, people who test negative for *TCF7L2* variants may falsely believe that they are not at risk for diabetes rather than having at least the same risk as the general population. This false sense of security could lead to poor health decisions related to diet and weight control.

⁴⁸⁸ Humphrey, L.L., Teutsch, S., and Johnson, M.S. (2004). Lung cancer screening with sputum cytologic examination, chest radiography, and computed tomography: an update for the U.S. Preventive Services Task Force. *Annals of Internal Medicine*. 140(9):740-753.

⁴⁸⁹ Kohane, I.S., Masys, D.R., and Altman, R.B. (2006). The incidentalome: a threat to genomic medicine. *Journal of the American Medical Association*. 296(2):212-215.

⁴⁹⁰ Aron, D.C. and Howlett, T.A. (2000). Pituitary incidentalomas. *Endocrinology and Metabolism Clinics of North America*. 29(1):205-221.

Recommendations

1. Information on clinical utility is critical for managing patients, developing professional guidelines, and making coverage decisions. The Secretary's Advisory Committee on Genetics, Health, and Society (SACGHS) found a paucity of information on the clinical utility of genetic testing. There are inadequate data on which to base utility assessments and only a few studies have been done of the clinical utility of specific genetic tests. More fundamentally, there has been insufficient analysis of the standard of evidence on which the clinical utility of genetic tests should be evaluated and on which evidence-based methods applicable to genetic testing should be developed. Further policy analysis is also needed to define the process by which clinical utility assessments will be applied. To fill these needs SACGHS recommends the following:

- A. HHS should create and fund a sustainable public/private entity of stakeholders to assess the clinical utility of genetic tests (e.g., building on CDC's Evaluation of Genomic Applications in Practice and Prevention initiative). This entity would:
- Identify major evidentiary needs
 - Establish evidentiary standards and level of certainty required for different situations, such as coverage, reimbursement, quality improvement, and clinical management
 - Establish priorities for research and development
 - Augment existing methods for assessing clinical utility as well as analytical and clinical validity, such as those used by EGAPP and the U.S. Preventive Services Task Force, with relevant modeling tools
 - Identify sources of data and mechanisms for making them usable for research, including the use of data from electronic medical records
 - Recommend additional studies to assess clinical effectiveness
 - Achieve consensus on minimal evidence criteria to facilitate the conduct of focused, quick-turnaround systematic reviews
 - Increase the number of systematic evidence reviews and make recommendations based on their results
 - Facilitate the development and dissemination of evidence-based clinical practice guidelines and clinical decision support tools for genetic/genomic tests
 - Establish priorities for implementation in routine clinical practice
 - Publish the results of these assessments or otherwise make them available to the public via a designated HHS or other publicly supported Web site (e.g., GeneTests)
- B. To fill gaps in the knowledge of the analytical validity, clinical validity, clinical utility, utilization, economic value, and population health impact of genetic tests, a Federal or public/private initiative should:
- Develop and fund a research agenda to fill knowledge gaps, including the initial development and thorough evaluation of genetic tests and the development of evidence-based clinical practice guidelines for the use of those tests
 - Disseminate these findings to the public via a designated HHS or other publicly supported Web site (e.g., GeneTests).

- 2. Health care payers are increasingly requiring evidence of clinical utility before they will pay for genetic tests. Therefore, coverage and reimbursement decisions play a critical role in stimulating innovation and facilitating access to genetic testing. In February 2006, SACGHS issued a report that made recommendations for developing evidence of clinical utility and addressing other barriers to the coverage and reimbursement of genetic tests and services in the public and private sectors. SACGHS offers the following recommendation concerning the development of clinical utility evidence:**

Because the issues identified by SACGHS in the *Coverage and Reimbursement of Genetic Tests and Services* report are still current, the Committee urges HHS to act on the report's recommendations. In addition, public and private health care payers, in collaboration with relevant groups such as test developers and clinical laboratorians, should develop mechanisms, such as coverage with evidence development or phased reimbursement, to facilitate the collection of clinical utility evidence for high-priority tests and applications. Implementation of innovative approaches should be accompanied by careful evaluation to assess whether these enhance or hinder innovation, the understanding of effectiveness, and appropriate utilization.

- 3. The value of genetic tests to patients is realized only when the tests are used appropriately. Quality improvement processes are needed to ensure that genetic tests are delivered consistently to appropriate patients. Furthermore, an ongoing process is needed to identify opportunities for improving the use of genetic testing, including the collection of postmarket outcome data. SACGHS therefore makes the following recommendation:**

HHS should conduct public health surveillance to assess health outcomes (or appropriate surrogate outcomes), practice measures (including appropriate utilization), and the public health impact of genetic testing. Information should be linked to quality improvement practices that affect patient outcomes and the provision of health care services. Data on specific genetic testing results would be required to allow an understanding of the significance of genetic variants and new detection methods to improve the utility of genetic testing.

- 4. The clinical utility and value of genetic testing are inextricably linked to methods to improve health care processes and decision support. Interoperable electronic health records will play a central role in the translation of guidelines into health care practices through their decision support and educational functions. These records will serve as a critical resource for assessing clinical utility and quality of health care. SACGHS therefore makes the following recommendation:**

HHS should ensure the coordination and implementation of efforts—including the deliberations of SACGHS, of the American Health Information Community and/or its successors, and of other work groups addressing personalized health care, population health and clinical care connections, and confidentiality, privacy, and security—to advance the appropriate use of interoperable patient-level data for research and enhance the quality of decisionmaking.

VI. Effective Communication and Decision Support

This chapter addresses issues relating to effective communication and clinical decision support in the pre- and postanalytical phases of genetic testing, discusses what is known about harms due to deficiencies in communication and interpretation, and identifies knowledge gaps that should be addressed to reduce these harms. It was developed in response to the following question from the Secretary's charge:

- What are the potential pathways to communicate clear information to guide test and treatment selection by the provider?

The responsibility for the interpretation of laboratory tests has typically rested with the ordering clinician. While the laboratory clearly has a role in interpretation, as evidenced by inclusion of reference ranges in laboratory reports, there has been little study of the impact of communication of laboratory results on patient care.

As early as 1985, Zinder⁴⁹¹ noted that the increasing complexity of medical care necessitated a change in communication practice between the laboratory and the clinician, stating that the clinician's "lack of knowledge of the laboratory... led (and still does lead) to erroneous, and sometimes life-threatening, decisions on his part, for which the laboratory is soundly denounced.... The laboratory, on the other hand, has been content to give results which are usually accurate, precise and rapid...irrespective of the circumstances involved in obtaining and delivering it." The subject was raised again by Zinder in 1998.⁴⁹² Arguably, the nature and complexity of genetic testing require a different degree of communication between the clinician and the laboratory both at the point of test ordering and when the result is reported.⁴⁹³

In addition, involvement of patients in shared medical decisionmaking is an increasingly important component of medical care. Zinder explicitly defined an important role for the patient in the communication and interpretation process for laboratory results.⁴⁹⁴ This role is of particular relevance in genetic testing, given the complexity of the indications for testing as well as the interpretation. It is important to recognize that consumers can directly order laboratory tests in 27 States, with another 10 allowing consumer-ordered tests under defined circumstances.⁴⁹⁵ The ability to self-order tests has led to direct-to-consumer (DTC) advertising campaigns for genetic testing, as described in previous chapters. While the impact of these campaigns is difficult to define at present, the increasing availability of a variety of genetic profile tests that claim to answer questions regarding cardiovascular risk, drug metabolism, and deoxyribonucleic acid

⁴⁹¹ Zinder, O. (1985). Laboratory-clinician interaction and the interpretation of test results. *Contemporary Issues in Clinical Biochemistry*. 2:52-62.

⁴⁹² Zinder, O. (1998). New directions in laboratory-clinician communications. *Clinical Chemica Acta*. 278(2):83-94.

⁴⁹³ Struse, H.M. and Montoya, I.D. (2001). Health services implications of DNA testing. *Clinical Laboratory Science*. 14(4):247-251.

⁴⁹⁴ Zinder, O. (1985). Laboratory-clinician interaction and the interpretation of test results. *Contemporary Issues in Clinical Biochemistry*. 2:52-62.

⁴⁹⁵ Genetics and Public Policy Center (2007). *Survey of Direct-to-Consumer Testing Statutes and Regulations*. See <http://www.dnapolicy.org/resources/DTCStateLawChart.pdf>. Accessed on April 1, 2008.

(DNA)-informed diet suggests that patients will assume increasing responsibility in the interpretation and utilization of these tests results.^{496,497} This trend has raised significant ethical concerns,^{498,499} as well as prompting discussion of the role of both genetics professionals and clinicians who are not trained in genetics with patients who request interpretation of results.^{500,501,502} The issue is now well enough accepted that it has begun to appear in professional societies' policies.^{503,504,505,506,507}

The topics discussed in this chapter should be interpreted in the context of general concerns about the translation of any new technology into medical care. The benefits of effective technologies are realized only when they are delivered to patients. "Translation into practice" is the phrase used to describe the processes for assessing technologies for their clinical utility and ensuring their appropriate delivery into clinical management. Chapter V reviews the assessment of clinical utility, which is generally seen as the first step in the translational process from research into practice. Based on assessments of clinical utility, evidence-based clinical guidelines are usually developed that form a foundation for defining the appropriate clinical application of technologies. The recommendations for practice in guidelines however, must be tailored to the needs and preferences of individual patients.

The translational process requires that all parts of the health care system take an active role in ensuring the delivery of needed services, while minimizing misuse, overuse, or inappropriate use (i.e., getting the right service to the right patient at the right time). Some 40 years ago, Donabedian framed the quality

⁴⁹⁶ Genetic testing for breast and ovarian cancer susceptibility: evaluating direct-to-consumer marketing--Atlanta, Denver, Raleigh-Durham, and Seattle, 2003. (2004). *MMWR Morbidity and Mortality Weekly Report*. 53(27):603-606.

⁴⁹⁷ Mouchawar, J., Hensley-Alford, S., Laurion, S., Ellis J., Kulchak-Rahm, A., Finucane, M.L., Meenan, R., Axell, L., Pollack, R., and Ritzwoller, D. (2005). Impact of direct-to-consumer advertising for hereditary breast cancer testing on genetic services at a managed care organization: a naturally-occurring experiment. *Genetics in Medicine*. 7(3):191-197.

⁴⁹⁸ Wasson, K., Cook, E.D., and Helzlsouer, K. (2006) Direct-to-consumer online genetic testing and the four principles: an analysis of the ethical issues. *Ethics in Medicine*. 22(2):83-91.

⁴⁹⁹ Wolfberg, A.J. (2006). Genes on the Web--direct-to-consumer marketing of genetic testing. *New England Journal of Medicine*. 355(6):543-545.

⁵⁰⁰ Mouchawar, J., Hensley-Alford, S., Laurion, S., Ellis J., Kulchak-Rahm, A., Finucane, M.L., Meenan, R., Axell, L., Pollack, R., and Ritzwoller, D. (2005). Impact of direct-to-consumer advertising for hereditary breast cancer testing on genetic services at a managed care organization: a naturally-occurring experiment. *Genetics in Medicine*. 7(3):191-197.

⁵⁰¹ Myers, M.F., Chang, M.H., Jorgensen, C., Whitworth, W., Kassim, S., Litch, J.A., Armstrong, L., Bernhardt, B., Faucett, W.A., Irwin, D., Mouchawar, J., and Bradley, L.A. (2006). Genetic testing for susceptibility to breast and ovarian cancer: evaluating the impact of a direct-to-consumer marketing campaign on physicians' knowledge and practices. *Genetics in Medicine*. 8(6):361-370.

⁵⁰² Wade, C.H. and Wilfond, B.S. (2006). Ethical and clinical practice considerations for genetic counselors related to direct-to-consumer marketing of genetic tests. *American Journal of Medical Genetics Part C Seminars in Medical Genetics*. 142(4):284-292, discussion 293.

⁵⁰³ American Society of Clinical Oncology policy statement update: genetic testing for cancer susceptibility. (2003). *Journal of Clinical Oncology*. 21(12):2397-2406.

⁵⁰⁴ American College of Medical Genetics (2006). *Standards and Guidelines for Clinical Genetics Laboratories, 2006 Edition*. See http://www.acmg.net/Pages/ACMG_Activities/stds-2002/b.htm. Accessed on April 1, 2008.

⁵⁰⁵ American College of Medical Genetics. (2008). ACMG Statement on Direct-to-Consumer Genetic Testing. See http://www.acmg.net/AM/Template.cfm?Section=Policy_Statements&Template=/CM/ContentDisplay.cfm&ContentID=2975. Accessed on April 11, 2008.

⁵⁰⁶ Hudson, K., Javitt, G., Burke, W., and Byers, P., with the ASHG Social Issues Committee (2007). ASHG Statement on direct-to-consumer genetic testing in the United States. *American Journal of Human Genetics*. 81: 636-637. See <http://download.ajhg.org/AJHG/pdf/PIIS0002929707613627.pdf>. Accessed on April 1, 2008.

⁵⁰⁷ American Medical Association. (2007). House of Delegates Resolution 522(A-07).

improvement process based on structure, process, and outcome—a framework that serves us well today.⁵⁰⁸ Recent literature describes the translation process⁵⁰⁹ (and for genomics in particular⁵¹⁰), providing models for understanding the components necessary for quality improvement. Translation requires a systems approach to quality improvement so that information, incentives, and systems are aligned to deliver recommended health care. This process involves all participants in health care delivery, and the perspectives of each will be discussed in this chapter.

Evaluation is needed to monitor the effectiveness of the translation process. This evaluation often takes the form of public health surveillance to monitor the delivery of services and, more important, to establish whether the anticipated health outcomes are being realized.

Key Terms and Concepts

For the purposes of this chapter, “effective communication” is defined as “a process by which test results are communicated by the laboratory in a format and with supportive information, when applicable, that promotes their appropriate use by the clinician and/or patient in making informed healthcare decisions.”⁵¹¹ Although not explicitly included in this definition, it is well known that, in many cases, proper interpretation of genetic tests requires the clinician to supply the laboratory with information that places the test in the proper clinical context.⁵¹²

Another major concern is the appropriate use of genetic test results. “Appropriate use” within the context of health care can be defined as “application of the test result consistent with an established evidence base or, when this does not exist, in concert with expert opinion and/or experience.”⁵¹³ Appropriate use has been recognized as a problem with laboratory tests in general for more than 20 years,⁵¹⁴ and the complexity and probabilistic nature of genetic test results are likely to exacerbate this problem.⁵¹⁵ One proposed solution is to use clinical decision support systems within electronic medical records to facilitate communication from the clinician to the laboratory in the preanalytical phase and from the laboratory to the clinician once the test result is available.⁵¹⁶ “Clinical decision support” refers broadly to providing clinicians and/or patients with clinical knowledge and patient-related information, intelligently filtered or presented at appropriate times, to enhance patient care.⁵¹⁷ This approach has been demonstrated to improve appropriate test ordering and interpretation of results, with concomitant improvement in patient care and decreases in

⁵⁰⁸ Donabedian, A. (1966). Evaluating the quality of medical care. *Milbank Memorial Fund Quarterly*. 44(3 Suppl):166–206.

⁵⁰⁹ Westfall, J.M., Mold, J., and Fagnan, L. (2007). Practice-based research—“Blue Highways” on the NIH roadmap. *Journal of the American Medical Association*. 297(4):403-406.

⁵¹⁰ Khoury, M.J., Gwinn, M., Yoon, P.A., Dowling, N., Moore, C.A., and Bradley, L. (2007). The continuum of translation research in genomic medicine: How can we accelerate the appropriate integration of human genome discoveries into health care and disease prevention? *Genetics in Medicine*. 9(10):665-674.

⁵¹¹ Lubin, I.M. (2007). SACGHS Workgroup on Effective Communication.

⁵¹² Lyon, E. and Miller, C. (2003). Current challenges in cystic fibrosis screening. *Archives of Pathology and Laboratory Medicine*. 127(9):1133-1139.

⁵¹³ Lubin, I.M. (2007). SACGHS Workgroup on Effective Communication.

⁵¹⁴ Zinder, O. (1985). Laboratory-clinician interaction and the interpretation of test results. *Contemporary Issues in Clinical Biochemistry*. 2:52-62.

⁵¹⁵ Petersen, G.M. (2000). Genetic testing. *Hematology/Oncology Clinics of North America*. 14(4):939-952.

⁵¹⁶ McNeely, M.D. (2002). The use of expert systems for improving test use and enhancing the accuracy of diagnosis. *Clinics in Laboratory Medicine*. 22(2):515-528.

⁵¹⁷ Adapted from Teich, J.M., Osherooff, J.A., Pifer, E.A., Sittig, D.F., and Jenders R.A. (2005). Clinical decision support in electronic prescribing: recommendations and an action plan: report of the joint clinical decision support workgroup. *Journal of the American Medical Informatics Association*. 12(4):365-376.

cost, particularly when evidence-based guidelines are embedded into clinical decision support tools that support best practice.⁵¹⁸

Current Systems for Communication of Genetic Test Information

The science of genetics and genomics is providing important knowledge and tools that promise to advance health care in the United States and the rest of the world. Genetic tests, like other medical tests, are used to assist clinicians and patients in making informed decisions about patient health. A broad range of testing is encompassed that addresses heritable and somatic conditions and markers of drug metabolism. Genetic testing, once relegated to specialty settings and primarily applied to those affected by or at risk for very rare diseases, is now used in a variety of settings, including that of primary care. In 2000, Acheson et al. reported that, nationwide, family physicians are addressing a variety of genetics issues with patients, particularly with respect to perinatal conditions and family cancers.⁵¹⁹ With the exception of population-based newborn screening (NBS) tests, limited data are available about practices associated with the ordering and reporting of genetic tests and results.

As described previously in this report, laboratories are regulated under the Clinical Laboratory Improvement Amendments (CLIA), which provide minimal standards for quality assurance.⁵²⁰ Genetic testing is currently regulated under the general CLIA requirements, and a set of criteria mandates what information is to be requested when a test is ordered and what is to be reported when a result is determined. Some States, such as New York, through their Clinical Laboratory Evaluation Program, have additional requirements.⁵²¹ Professional recommendations, such as those from the American College of Medical Genetics (ACMG) and the Clinical and Laboratory Standards Institute, provide more detailed recommendations pertaining to the ordering of genetic tests and reporting of results.⁵²² For laboratories choosing accreditation through the College of American Pathologists (CAP), specific practices must be in place for approval. In 2007, Gulley et al. published guidelines on behalf of CAP, providing guidance for molecular pathology reports.⁵²³ Studies have not yet been published that describe the implementation of these guidelines and their usefulness to the laboratory and end-user.

There are also no published studies that summarize clinicians' ordering practices for genetic tests. In 2001, the American College of Obstetricians and Gynecologists (ACOG), together with ACMG, published recommendations on testing all couples who are pregnant or contemplating pregnancy for carrier status for

⁵¹⁸ McNeely, M.D. (2002). The use of expert systems for improving test use and enhancing the accuracy of diagnosis. *Clinics in Laboratory Medicine*. 22(2):515-528.

⁵¹⁹ Acheson, L.S., Wiesner, G.L., Zyzanski, S.J., Goodwin, M.A., and Stange, K.C. (2000). Family history-taking in community family practice: implications for genetic screening. *Genetics in Medicine*. 2(3):180-185.

⁵²⁰ Food and Drug Administration Web site. "CLIA - Clinical Laboratory Improvement Amendments." See <http://www.fda.gov/cdrh/cliia/>. Accessed on April 1, 2008.

⁵²¹ Wadsworth Center, New York State Department of Health Web site. "Clinical Laboratory Evaluation Program." See <http://www.wadsworth.org/labcert/clep/clep.html>. Accessed on April 1, 2008.

⁵²² Clinical and Laboratory Standards Institute (2006). *Molecular Diagnostic Methods for Genetic Diseases: Approved Guideline—Second Edition*. CLSI document MM1-A2 [ISBN 1-56238-615-8].

⁵²³ Gulley, M.L., Brazier, R.M., Halling, K.C., Hsi, E.D., Kant, J.A., Nikiforova, M.N., Nowak, J.A., Ogino, S., Oliveira, A., Polesky, H.F., Silverman, L., Tubbs, R.R., Van Deerlin, V.M., Vance, G.H., and Versalovic, J. (2007). Clinical laboratory reports in molecular pathology. *Archives of Pathology & Laboratory Medicine*. 131(6):852-863.

cystic fibrosis (CF).⁵²⁴ As a consequence, some laboratories reported significant increases in test volume, with one particular laboratory reporting an increase from 1,000 test samples per month in 2001 to over 14,000 samples a month in 2003.⁵²⁵ In 2005, Morgan et al. investigated the self-reported familiarity of genetic testing guidelines among practicing obstetricians and gynecologists.⁵²⁶ Approximately 90 percent of respondents to the survey saw the guideline as an important document, but only about 20 percent reported that they reviewed it thoroughly. Eighty-two percent knew for whom screening should be offered, but only 22 percent could answer specific questions about genetic risk when integrating information about the sensitivity of the screening test. These limitations in knowledge have also been reflected in other studies.⁵²⁷

These findings suggest that a significant percentage of clinicians may not be sufficiently familiar with guidelines for genetic testing to appropriately refer patients in some settings. Some experts have proposed that efforts are needed to make guidelines and other knowledge about testing available to clinicians in a useful format to promote appropriate use of tests.⁵²⁸ In addition to a number of professional societies, the National Coalition for Health Professional Education in Genetics (NCHPEG), established in 1996 by the American Medical Association (AMA), the American Nurses Association, and the National Human Genome Research Institute, is an “organization of organizations” whose prime mission is to develop and promote professional education. As such, NCHPEG is engaged in several projects to enhance clinician understanding and appropriate use of genetic testing, and information resources for clinicians have also been developed.

GeneTests,⁵²⁹ funded by the National Library of Medicine, was developed to provide a laboratory directory and expert peer-reviewed articles for a large number of molecular genetic tests. Studies of the utilization of this resource are limited by restrictions that prevent the tracking of who is accessing the site, how the site is being used to find information, and frequency of access. A voluntary survey was developed in 2005 to try to assess some of this information, but the data obtained were inadequate for analysis due to very low response rates.⁵³⁰ Many clinical laboratories also provide Web-based and written resources to clinicians, as well as consultation. With funding from the Health Resources and Services Administration (HRSA), ACMG has developed Action (ACT) sheets to provide guidance to health care providers who have patients with a positive newborn screening test.⁵³¹ What has not been studied is the extent to which clinicians, especially those less familiar with genetics, are aware of these resources, use them, and find them useful in informing clinical decisionmaking.

⁵²⁴ Grody, W.W., Cutting, G.R., Klinger, K.W., Richards, C.S., Watson, M.S., and Desnick, R.J. (2001). Laboratory standards and guidelines for population-based cystic fibrosis carrier screening. *Genetics in Medicine*. 3(2):149-154. See http://www.acmg.net/AM/Template.cfm?Section=Policy_Statements&Template=/CM/ContentDisplay.cfm&ContentID=2480. Accessed on April 1, 2008.

⁵²⁵ Vastag, B. (2003). Cystic fibrosis gene testing a challenge: experts say widespread use is creating unnecessary risks. *Journal of the American Medical Association*. 289(2):2923-2924.

⁵²⁶ Morgan, M.A., Driscoll, D.A., Zinberg, S., Schulkin, J., and Mennuti, M.T. (2005). Impact of self-reported familiarity with guidelines for cystic fibrosis carrier screening. *Obstetrics and Gynecology*. 105(6):1355-1361.

⁵²⁷ Hayflick, S.J., Eiff, M.P., Carpenter, L., and Steinberger, J. (1998). Primary care physicians' utilization and perception of genetics services. *Genetics in Medicine*. 1(1):13-21.

⁵²⁸ Guttmacher, A.E., Porteous, M.E., and McInerney, J.D. (2007). Educating health-care professionals about genetics and genomics. *Nature Reviews Genetics* 8(2):151-157.

⁵²⁹ GeneTests. See <http://www.genetests.org>. Accessed on April 9, 2008.

⁵³⁰ Roberta Pagon, personal communication.

⁵³¹ American College of Medical Genetics Web site. “Newborn Screening ACT Sheets and Confirmatory Algorithms.” See <http://www.acmg.net/resources/policies/ACT/condition-analyte-links.htm>. Accessed on April 1, 2008.

A recent study by Levy et al.⁵³² assessed the availability, completeness, and accuracy of answers provided by online databases to clinical questions for five genetic conditions commonly dealt with by primary care physicians. The study examined nine online databases, including two genetic and seven nongenetic resources. Out of a total of 180 questions, these databases cumulatively provided complete answers only 33 percent of the time. Furthermore, wrong answers were given for these questions up to 15 percent of the time. Even among the most efficient databases in the study sample, the time required to find relevant information was twice as long as the time that providers are reportedly willing to spend looking for information. These findings suggest that current resources are not adequate to meet the needs of providers looking for information to assist with the interpretation of genetic tests.

The interpretation of genetic test results almost always requires information beyond the genotype, enzymatic activity, or cytogenetic result. While this is true for most medical tests, genetic test interpretation often requires information that is uniquely available from the laboratory, which the clinician is unlikely to have or be able to understand. For instance, laboratories performing DNA-based CF testing will report varying numbers of mutations depending on the methodology offered, which may result in differing detection rates.⁵³³ This variation is particularly problematic when no mutation is found, and a patient's residual risk for having an undetected mutation must ultimately be determined and communicated. Other factors that can affect detection rates include race/ethnicity, family history, and clinical information.

The case of Tay-Sachs disease is another example from the field of biochemical genetics. While this disease is most closely associated with those of Ashkenazi Jewish descent, it does occur outside this ethnic/racial group. While Jewish Tay-Sachs carriers do exist, some non-Jewish individuals have experienced false positive results due to an unrelated mutation that reacts with certain assay types, interfering with the accuracy of the test.⁵³⁴ Therefore, it is important for laboratories to know the race/ethnicity of the patient when selecting the test to run in order to interpret the results appropriately. It is conceivable that the absence of such information might lead to harm through misinterpretation. A limited number of studies have been published describing the extent to which laboratories request or collect such information to inform the development of the test result report.

Similarly, little work has been done to describe what is useful to clinicians in a genetic test report. In 2002, Andersson et al. assessed the adequacy of information content provided on test reports based on a cross-section of laboratories offering DNA-based testing for CF and factor V Leiden.⁵³⁵ Findings showed that many reports failed to include information deemed essential by professional guidelines and recommendations. This study led to followup work by Krousel-Wood et al., which found that clinicians prefer reports that are sufficiently comprehensive to provide guidance for clinical decisionmaking.⁵³⁶ The extent to which current reporting practices have led to adverse outcomes has not been documented.

⁵³² Levy, H.P., LoPresti, L., and Seibert, D.C. (2008). 20 questions in genetic medicine—an assessment of World Wide Web databases for genetics information at the point of care. *Genetics in Medicine*. Submitted.

⁵³³ Grody, W.W., Desnick, R.J., Carpenter, N.J., and Noll, W.W. (1998). Diversity of cystic fibrosis mutation-screening practices. *American Journal of Human Genetics* 62(5):1252–1254.

⁵³⁴ Triggs-Raine, B.L., Mules, E.H., Kaback, M.M., Lim-Steele, J.S., Dowling, C.E., Akerman, B.R., Natowicz, M.R., Grebner, E.E., Navon, R., and Welch, J.P. (1992). A pseudodeficiency allele common in non-Jewish Tay-Sachs carriers: implications for carrier screening. *American Journal of Human Genetics*. 51(4):793-801.

⁵³⁵ Andersson, H.C., Krousel-Wood, M.A., Jackson, K.E., Rice, J., and Lubin, I.M. (2002). Medical genetic test reporting for cystic fibrosis (deltaF508) and factor V Leiden in North American laboratories. *Genetics in Medicine* 4(5):324-327.

⁵³⁶ Krousel-Wood, M.A., Andersson, H.C., Rice, J., Jackson, K.E., Rosner, E.R., and Lubin, I.M. (2003). Physicians' perceived usefulness of and satisfaction with test reports for cystic fibrosis (deltaF508) and factor V Leiden. *Genetics in Medicine*. 5(3):166-171.

Studies suggest that clinicians may not be well prepared to understand genetic testing and, in particular, results that are realistic, such as those relevant to genetic risk. In 1997, Giardiello et al. reported a study that described patients who underwent genetic tests for familial adenomatous polyposis (FAP). They found that these patients received inadequate counseling as a consequence of incorrect interpretation of the test results by physicians.⁵³⁷ Another study by Sandhaus et al., in 2001, found that many physicians are unprepared to interpret genetic risk information relevant to results reported for *BRCA* mutations.⁵³⁸ Similarly, McGovern et al. published results from a nationwide survey of genetic counselors in 2003, in which 83 percent of respondents indicated the need to contact the laboratory regarding clarification of the report interpretation.⁵³⁹ These observations suggest the potential for harm due to miscommunication and/or misunderstanding of the meaning of a test result relevant to patient risk for disease. Currently, however, there is a paucity of data documenting actual harms related to the miscommunication of test results.

Another area of concern is in the interpretation of DNA-sequence data. With existing technology, laboratories can detect sequence variations, but laboratories and clinicians must still collaborate to understand the relationship between sequence variations and health conditions. ACMG developed a guideline that places findings from sequence analysis on a continuum, ranging from sequence variations known to have a strong correlation with a health condition to those that are benign. The guideline also identifies sequence variations for which no data are available to support the presence or absence of an association.⁵⁴⁰ In the absence of such data, other criteria are sometimes applied to communicate a likelihood that a sequence variation may interfere with protein structure.^{541,542} The challenge for the clinician is in understanding such inferences and appropriately applying them to clinical decisionmaking. Inappropriate recommendations have the potential to harm patients. Formal studies and guidance are lacking in this area, although one study is currently addressing an aspect of this question.⁵⁴³

Communication of results from highly complex tests is also of concern. Tests that fall in this category analyze multiple parameters, including sequence variations, gene or protein expression levels, or a serum protein. Often, an algorithm is necessary to convert the data into clinically useful information. A number of

⁵³⁷ Giardiello, F.M., Brensinger, J.D., Petersen, G.M., Luce, M.C., Hyland, L.M., Bacon, J.A., Booker, S.V., Parker, R.D., and Hamilton, S.R. (1997). The use and interpretation of commercial APC gene testing for familial adenomatous polyposis. *New England Journal of Medicine*. 336(12):823-827.

⁵³⁸ Sandhaus, L.M., Singer, M.E., Dawson, N.V., and Wiesner, G.L. (2001). Reporting BRCA test results to primary care physicians. *Genetics in Medicine* 3(5):327-334.

⁵³⁹ McGovern, M.M., Benach, M., and Zinberg, R. (2003). Interaction of genetic counselors with molecular genetic testing laboratories: implications for non-geneticist health care providers. *American Journal of Medical Genetics Part A*. 119(3):297-301.

⁵⁴⁰ Haig, H., Boehm, C.D., and Seltzer, W.K. (2000). ACMG recommendations for standards for interpretation of sequence variations. *Genetics in Medicine*. 2(5):302-303. See <http://www.acmg.net/resources/policies/pol-027.pdf>. Accessed on April 3, 2008.

⁵⁴¹ Osorio, A., Milne, R.L., Honrado, E., Barroso, A., Diez, O., Salazar, R., de la Hoya, M., Vega, A., and Benitez, J. (2007). Classification of missense variants of unknown significance in BRCA1 based on clinical and tumor information. *Human Mutation*. 28(5):477-485.

⁵⁴² Gedge, F., McDonald, J., Phansalkar, A., Chou, L. S., Calderon, F., Mao, R., Lyon, E., and Bayrak-Toydemir, P. (2007). Clinical and analytic sensitivities in hereditary hemorrhagic telangiectasia testing and a report of de novo mutations. *Journal of Molecular Diagnostics* 9(2):258-265.

⁵⁴³ NIH Grant No.: 1R01HG004064-01A1. *Do Physicians Understand Uncertain Variants and Other Genetic Test Results?* Plon, S.E.

platforms have been developed, many of which are still in development in research settings, although a few have been transitioned to clinical settings (see Chapter III).^{544,545}

These tests can be divided into two categories: those in which a number of individual tests have been combined into a single platform and those in which a combination of measurements is submitted to an algorithm that provides clinically relevant information. An example of the former is the use of pharmacogenomic assays to establish a patient's metabolizer status for particular drugs. An example of the latter is testing for ribonucleic acid (RNA) expression levels to inform decisions about a patient's risk for recurrence of cancer. Some of these assays fall under the Food and Drug Administration (FDA) definition of an *in vitro* diagnostic multivariate index assay (IVDMIA). Although some of these assays have transitioned to clinical settings and a few are FDA-cleared or FDA-approved, there is significant debate concerning their utility compared with traditional regimens. Studies have yet to be published that would resolve such questions. As such, it is critical that the clinician using such tests has accurate information concerning what is known and not known about the result returned.

In some instances, pharmacogenetic testing could be considered of even higher complexity due to the multitude of factors considered when applying test results and determining how a particular patient will metabolize a specific drug.^{546,547} In 2004, the Roche AmpliChip[®] cytochrome P450 (CYP450) test received FDA clearance.⁵⁴⁸ The product is marketed to provide data on variants in the genes *CYP2D6* and *CYP2C19*, and it provides patient classification of metabolizer status.⁵⁴⁹ As an FDA-cleared kit, the user is provided with specific instructions for setting up the assay and evaluating the results to determine how a patient is likely to metabolize certain drugs. There can be patient-specific issues, however, that are important to recognize, and additional interpretation is needed to inform clinical decisionmaking.

The National Academy of Clinical Biochemistry has prepared draft guidelines to address these issues.⁵⁵⁰ The guidelines emphasize that decisions made as a consequence of the test results should be based on evidence in the scientific literature. They also raise the issue of drug-drug and drug-gene interactions. For example, Kirchheiner and Seeringer have shown that persons possessing the *CYP2C9* *2/*2 or *3/*3 genotype are typically labeled as poor metabolizers, but there are classes of drugs that do not fit into this category.⁵⁵¹ Since many patients are on multiple drug regimens, drug-gene interactions sometimes need to be factored into the interpretation. For example, certain selective serotonin reuptake inhibitors can inhibit

⁵⁴⁴ Hadd, A.G., Brown, J.T., Andruss, B.F., Ye, F., and WalkerPeach, C.R. (2005). Adoption of array technologies into the clinical laboratory. *Expert Review of Molecular Diagnostics*. 5(3):409-420.

⁵⁴⁵ Anderson, J.E., Hansen, L.L., Mooren, F.C., Post, M., Hug, H., Zuse, A., and Los, M. (2006). Methods and biomarkers for the diagnosis and prognosis of cancer and other diseases: towards personalized medicine. *Drug Resistance Updates*. 9(4-5):198-210.

⁵⁴⁶ Eichelbaum, M., Ingelman-Sundberg, M., and Evans, W.E. (2006). Pharmacogenomics and individualized drug therapy. *Annual Review of Medicine* 57:119-137.

⁵⁴⁷ Kirchheiner, J. and Seeringer, A. (2007). Clinical implications of pharmacogenetics of cytochrome P450 drug metabolizing enzymes. *Biochimica et Biophysica Acta*. 1770(3):489-494.

⁵⁴⁸ Food and Drug Administration (2005). *Guidance for Industry and FDA Staff. Class II Special Controls Guidance Document: Drug Metabolizing Enzyme Genotyping System*. See <http://www.fda.gov/cdrh/oivd/guidance/1551.html>. Accessed on April 8, 2008.

⁵⁴⁹ Jain, K.K. (2005). Applications of AmpliChip CYP450. *Molecular Diagnosis*. 9(3):119-127.

⁵⁵⁰ The National Academy of Clinical Biochemistry (2007). *Draft Guidelines and Recommendations for Laboratory Analysis and Application of Pharmacogenetics to Clinical Practice*. See http://www.aacc.org/NR/rdonlyres/0D5A26E2-21D4-473B-BBE8-D91941F72FEA/0/complete_PGx_LMPG_Dec_2007.pdf. Accessed on April 3, 2008.

⁵⁵¹ Kirchheiner, J. and Seeringer, A. (2007). Clinical implications of pharmacogenetics of cytochrome P450 drug metabolizing enzymes. *Biochimica et Biophysica Acta*. 1770(3):489-494.

some forms of CYP450 enzymes, altering the metabolizer status determined from genotyping.⁵⁵² Thus, a question is raised concerning whose role it is to integrate this information into the interpretation of the test result. Furthermore, the laboratory's role must be determined.

To date, no studies have documented the use of pharmacogenetic/pharmacogenomic testing in clinical settings. Such studies are essential for identifying gaps in information exchange, benefits achieved, and harms. This research would provide a firm grounding for identifying areas that might benefit from additional professional guidance and oversight.

Another type of highly complex test measures RNA expression levels from multiple genes.^{553,554} In the past few years, two platforms have become available for prognosis in breast cancer: MammaPrint® (which is FDA-cleared for assessing patients' risk of distant metastasis) and OncotypeDX® (which is not FDA-approved or FDA-cleared). These tests provide prognostic information for women who have stage I or stage II node-negative breast cancer. The tests analyze RNA expression levels from a panel of 70 and 21 genes, respectively. Algorithms are used to analyze the data and provide a score that classifies the patient as having high, intermediate, or low likelihood of recurrence for breast cancer. Some physicians use these tests to identify patients who will benefit from chemotherapy to avoid recurrence and overtreatment of patients who otherwise would not have a remission. Although physicians may use these tests to guide therapy, MammaPrint® was not FDA-cleared for this intended use. The studies provided to FDA to support MammaPrint's® intended use were not designed to identify women who would benefit from therapy.⁵⁵⁵ Additionally, the studies that determined the effectiveness of these platforms used retrospective tumor specimens, coupled with known treatment and clinical outcomes in a specific subset of breast cancer patients.^{556,557,558} Prospective trials are planned or are currently under way using different platforms (the North American TAILORx study will use the OncotypeDX® assay, and the European Union MINDACT study will use the MammaPrint® assay).⁵⁵⁹

Despite the lack of prospective trial data, these tests are enjoying wide clinical use based on the retrospective analysis, even among women for whom the incremental predictive value is lacking. There is significant debate as to whether these and similar protocols, in their present format and with our current knowledge, do indeed influence patient outcomes. Studies have not yet been performed that report the impact of testing on

⁵⁵² Spina, E., Scordo, M.G., and D'Arrigo, C. (2003). Metabolic drug interactions with new psychotropic agents. *Fundamental & Clinical Pharmacology* 17(5):517-538.

⁵⁵³ Hadd, A.G., Brown, J.T., Andruss, B.F., Ye, F., and WalkerPeach, C.R. (2005). Adoption of array technologies into the clinical laboratory. *Expert Review of Molecular Diagnostics*. 5(3):409-420.

⁵⁵⁴ Modlich, O., Prissack, H.B., and Bojar, H. (2006). Breast cancer expression profiling: the impact of microarray testing on clinical decision making. *Expert Opinion on Pharmacotherapy* 7(15):2069-2078.

⁵⁵⁵ Food and Drug Administration Web site. "510(k) Premarket Review Notification, MammaPrint." See <http://www.accessdata.fda.gov/scripts/cdrh/cfdocs/cfPMN/pmn.cfm?ID=22721>. Accessed on April 3, 2008.

⁵⁵⁶ Paik, S., Shak, S., Tang, G., Kim, C., Baker, J., Cronin, M., Baehner, F.L., Walker, M.G., Watson, D., Park, T., Hiller, W., Fisher, E.R., Wickerham, D.L., Bryant, J., and Wolmark, N. (2004). A multigene assay to predict recurrence of tamoxifen-treated, node-negative breast cancer. *New England Journal of Medicine*. 351(27):2817-2826.

⁵⁵⁷ Lacal, J.C. (2007). How molecular biology can improve clinical management: the MammaPrint experience. *Clinical & Translational Oncology* 9(4):203.

⁵⁵⁸ Glas, A.M., Floore, A., Delahaye, L.J., Wittenveen, A.T., Pover, R.C., Bakx, N., Lahti-Domenici, J.S., Bruinsma, T.J., Wamoes, M.O., Bernards, R., Wessels, L.F., and Van't Veer L.J. (2006). Converting a breast cancer microarray signature into a high-throughput diagnostic test. *BMC Genomics*. 7:278.

⁵⁵⁹ Paik, S. (2006). Molecular profiling of breast cancer. *Current Opinion in Obstetrics and Gynecology*. 18(1):59-63.

patient outcomes or how clinicians integrate results into their decisionmaking process.⁵⁶⁰ Another question raised is how these tests and similar ones compare in categorizing patients. It is also important to know whether differences exist across populations. Clearly, if the application of these tests based on current information proves to be inaccurate or incomplete, there is a potential for patient harm. In an evidence report prepared for the Agency for Healthcare Research and Quality (AHRQ) about genomic tests for ovarian cancer detection and management, the authors arrived at similar conclusions about available tests.⁵⁶¹ Other tests are emerging rapidly into clinical practice.⁵⁶²

The tests described above provide probabilistic risks, but other tests under development are designed to provide a likely diagnosis. In 2002, Petricoin et al. published a paper describing the use of mass spectrometry as a diagnostic tool for detecting early-stage ovarian cancer.⁵⁶³ The test reportedly detected all patients with ovarian cancers in a set of 50 samples, while falsely identifying only three patients as being affected. This diagnostic method was a significant improvement over the use of CA125, a biomarker that is FDA-cleared for use in monitoring after a diagnosis of ovarian cancer but is not cleared for use in screening. Methods using CA125 in screening are reported to miss about half of the patients in the earliest stages of the disease.⁵⁶⁴

Upon reanalysis of the data by biostatisticians at the University of Maryland, concerns were raised about the reproducibility of the data, particularly in reference to the interpretation of the mass spectroscopy data. It was concluded that since the technology was so new, the data collected were insufficient to document the potential benefits and limitations in clinical settings. For instance, it is possible that the proteomic profile could vary based on the patient's stress or drug regimen.⁵⁶⁵ Clinicians having access to such tests are not likely to review the methodological issues and will focus on the test result, which in this case would be indicative of whether a patient had cancer. Without standards for ensuring that such tests are providing meaningful information to the clinician from such complex tests, potential harm can result from misidentifying patients as being affected or unaffected.

More complete data on current practices regarding how results are reported and their impact on health outcomes are lacking. As such, surveillance of practices and their links to patient outcomes is necessary to develop the evidence base necessary for understanding where resources should be allocated and where additional oversight and guidance would be useful.

⁵⁶⁰ Oratz, R. Impact of OncoType DX recurrence score on decisionmaking in early-stage breast cancer. *Journal of Clinical Oncology*. In press.

⁵⁶¹ Agency for Healthcare Research and Quality (2006). Duke University Evidence-based Practice Center. *Genomic Tests for Ovarian Cancer Detection and Management*. See <http://www.ahrq.gov/downloads/pub/evidence/pdf/genomicovc/genovc.pdf>. Accessed on April 3, 2008.

⁵⁶² Pusztai, L., Cristofanilli, M., and Paik, S. (2007). New generation of molecular prognostic and predictive tests for breast cancer. *Seminars in Oncology*. 34(2 Suppl 3):S10-S16.

⁵⁶³ Petricoin, E.F., Ardekani, A.M., Hitt, B.A., Levine, P.J., Fusaro, V.A., Steinberg, S.M., Mills, G.B., Simone, C., Fishman, D.A., Kohn, E.C., and Liotta, L.A. (2002). Use of proteomic patterns in serum to identify ovarian cancer. *Lancet* 359(9306):572-577.

⁵⁶⁴ Check, E. (2004). Proteomics and cancer: running before we can walk? *Nature* 429(6991):496-497.

⁵⁶⁵ Check, E. (2004). Proteomics and cancer: running before we can walk? *Nature* 429(6991):496-497.

Roles and Responsibilities in Genetic Testing

Health Care Professionals Without Specialty Training in Genetics

In order to take advantage of the advances in genetics described above, nongenetics health care providers need to develop the skills to identify which patients may benefit from genetic testing, determine the appropriate test, provide pretest and posttest information to the patient, and interpret the test result accurately. Hayflick et al. proposed specific roles of primary care professionals in the provision of genetics services in a 1998 publication (see Box 6–1).⁵⁶⁶ Interestingly, none of the proposed roles extend beyond identification of patients and the provision of basic information. Instead, the authors recommended that primary care providers work with genetics professionals to provide appropriate genetic services to their patients.

Box 6–1. Role of Primary Care Professionals in the Provision of Genetic Services

- Identification of individuals who may benefit from genetic services
- Recognition of historical and physical features of common genetic conditions and susceptibilities that suggest a genetic disorder
- Monitoring of individual’s health, in conjunction with genetics professionals
- Provision of basic genetic information to patients and families in a culturally competent manner using nondirective counseling approach
- Coordination of care for individuals and families with complex genetic service needs
- Recognition of special psychosocial issues for a family with members affected with genetic disorder or at risk
- Knowledge of available genetic services from which patient may benefit
- Referral of patients with additional genetic services needs
- Facilitation of use of genetic services

Although all health care professionals are likely to be involved in providing some level of genetic services, most of the current studies have focused on primary care providers and oncologists. The extent of involvement of primary care professionals in ordering genetic tests will vary depending on physician knowledge, public awareness, uptake of tests, type and prevalence of the disorder, precision of the test, and availability of therapy.⁵⁶⁷ Two studies from the United Kingdom estimated that a general practitioner may have one to two patients per month who would require genetic services.⁵⁶⁸ The prevalence of genetic testing, however, is projected to increase as testing for pharmacogenomics and more genetic tests for common chronic disorders are incorporated into primary practice.

A survey conducted by the AMA reported that more than 70 percent of respondents stated that their primary care doctor would be their first choice for information on a genetic disorder. About 80 percent said that they were very confident or somewhat confident that their primary care provider could advise them regarding a

⁵⁶⁶ Hayflick, S.J., Eiff, M.P., Carpenter, L., and Steinberger, J. (1998). Primary care physicians’ utilization and perceptions of genetics services. *Genetics in Medicine*. 1(1):13-21.

⁵⁶⁷ Kinmonth, A.L., Reinhard, J., Bobrow, M., and Pauker, S. (1998). The new genetics. Implications for clinical services in Britain and the United States. *British Medical Journal*. 316(7133):767-770.

⁵⁶⁸ Emery, J., Watson, E., Rose, P., and Andermann, A. (1999). A systematic review of the literature exploring the role of primary care in genetic services. *Family Practice*. 16(4):426-445.

family member's risk of developing an inherited cancer, inform them about the availability of genetic testing for the cancer, and interpret the results from a genetic test.⁵⁶⁹ During a medical errors study conducted by Baldwin et al., patients reported that they expected to be notified about their test results by someone who is knowledgeable enough to answer their questions.⁵⁷⁰

The National Cancer Institute, however, conducted a more recent study on a random sample of 1,251 physicians from eight specialties, which found that only 40 percent of primary care physicians and 57 percent of tertiary care physicians felt qualified to recommend genetic testing for cancer susceptibility to their patients. Additionally, almost 25 percent of all the physicians surveyed perceived that genetic testing for cancer susceptibility had too many inaccurate or ambiguous results, and nearly 75 percent thought that clear management guidelines were not available when a patient had a positive test result.⁵⁷¹ Other studies reveal that the willingness of the physician to offer genetic services, including a genetic test, is correlated with the genetics knowledge of the primary care provider.^{572,573,574,575,576}

The HHS Secretary's Advisory Committee on Genetics, Health, and Society (SACGHS) draft report on pharmacogenomics states that the uptake of pharmacogenomics testing and therapies will depend on acceptance by physicians, who are faced with complex concerns regarding their benefits, risks, and costs.⁵⁷⁷ Also, providers are challenged with maintaining current knowledge of what tests are available; their accuracy, predictive validity, and cost; which patients are most appropriate for testing; and how test results should inform therapeutic decisions.⁵⁷⁸ Further studies have revealed that many nongenetics health care providers have little training in genetics and do not feel knowledgeable enough to determine genetic risks and communicate the information to their patients. Wilkins-Haug et al. found that their nongenetics health

⁵⁶⁹ American Medical Association (1998). *Genetic Testing. A Study of Consumer Attitudes*. Chicago: Survey Center.

⁵⁷⁰ Baldwin, D.M., Quintela, J., Duclos, C., Staton, E.W., and Pace, W.D. (2005). Patient preferences for notification of normal laboratory test results: a report from the ASIPS Collaborative. *Biomedical Central Family Practice*. 6(1):11. See <http://www.biomedcentral.com/1471-2296/6/11>. Accessed on April 3, 2008.

⁵⁷¹ Freedman, A.N., Wideroff, L., Olson, L., Davis, W., Klabunde, C., Srinath, K.P., Reeve, B.B., Croyle, R.T., and Ballard-Barbash, R. (2003). US physicians' attitudes toward genetic testing for cancer susceptibility. *American Journal of Medical Genetics A*. 120(1):63-71.

⁵⁷² Weitz, R. (1981). Medical norms and medical innovations: adoption of new drugs and genetic counseling among primary care physicians. *Sociology of Health and Illness*. 3:207-219.

⁵⁷³ Geller, G., Tambor, E.S., Bernhardt, B.A., Chase, G.A., Hofman, K. J., Faden, R.R., and Holtzman, N.A. (1993). Physicians' attitudes toward disclosure of genetic information to third parties. *Journal of Law, Medicine, and Ethics*. 21(2):238-240.

⁵⁷⁴ Hofman, K.J., Tambor, E.S., Chase, G.A., Geller, G., Faden R.R., and Holtzman, N.A. (1993). Physicians' knowledge of genetics and genetic tests. *Academic Medicine*. 68(8):625-632.

⁵⁷⁵ Modell, M., Wonke, B., Anionwu, E., Khan, M., Tai, S.S., Lloyd, M., and Modell, B. (1998). A multidisciplinary approach for improving services in primary care: randomised controlled trial of screening for haemoglobin disorders. *British Medical Journal*. 317(7161):788-791.

⁵⁷⁶ Suther, S. and Goodson, P. (2003). Barriers to the provision of genetic services by primary care physicians: a systematic review of the literature. *Genetics in Medicine*. 5(2):70-76.

⁵⁷⁷ Secretary's Advisory Committee on Genetics, Health, and Society (2008). *Realizing the Potential of Pharmacogenomics: Opportunities and Challenges*. See: http://www4.od.nih.gov/oba/sacghs/reports/SACGHS_PGX_report.pdf. Available May 2008.

⁵⁷⁸ McCann, S., MacAuley, D., Barnett, Y., Bunting, B., Bradley, A., Jeffers, L., and Morrison, P.J. (2007). Cancer genetics: consultants' perception of their roles, confidence and satisfaction with knowledge. *Journal of Evaluation in Clinical Practice*. 13(2):276-286.

care providers cite the rapidly changing knowledge about genetics as the greatest obstacle to providing information to their patients.^{579,580,581,582,583}

The ability of health care professionals to interpret genetic test results accurately and communicate this information effectively to families and other health care providers is as important as determining and communicating information about the appropriate genetic testing. Studies such as the one by Giardiello et al. have found that only 68.4 percent of FAP genetic testing results were correctly interpreted by nongenetics medical professionals.⁵⁸⁴

Even when the test result is interpreted correctly, many primary care physicians report an inability to discuss the details of the condition or management of the condition with their patients. This finding is true even for relatively routine testing, such as NBS.⁵⁸⁵ Families also report that they do not receive educational materials to support their knowledge of genetic conditions in their families. A recent study found that 64 percent of 5,915 respondents reported receiving no genetics education materials from the provider responsible for managing the genetic condition in their family.⁵⁸⁶

Merely using the term “genetic test” may lower the rate of adoption of a test by primary care physicians. One study of 1,120 physicians found that calling a proposed test “genetic” vs. a “serum protein test” lowered the likelihood that the physician would offer it to their patients by 11 percent.⁵⁸⁷ Even for genetic testing that has been part of a mandatory public health activity for over 30 years, such as NBS, physicians have difficulty communicating information about false positive results or positive carrier status results to

⁵⁷⁹ Hofman, K.J., Tambor, E.S., Chase, G.A., Geller, G., Faden R.R., and Holtzman, N.A. (1993). Physicians’ knowledge of genetics and genetic tests. *Academic Medicine*. 68(8):625-632.

⁵⁸⁰ Christianson, C.A., McWalter, K.M., and Warren, N.S. (2005). Assessment of allied health graduates’ preparation to integrate genetic knowledge and skills into clinical practice. *Journal of Allied Health*. 34(3):138-144.

⁵⁸¹ Freedman, A.N., Wideroff, L., Olson, L., Davis, W., Klabunde, C., Srinath, K.P., Reeve, B.B., Croyle, R.T., and Ballard-Barbash, R. (2003). US physicians’ attitudes toward genetic testing for cancer susceptibility. *American Journal of Medical Genetics A*. 120(1):63-71.

⁵⁸² Menasha, J.D., Schechter, C., and Willner, J. (2000). Genetic testing: a physician’s perspective. *Mount Sinai Journal of Medicine*. 67(2):144-151.

⁵⁸³ Wilkins-Haug, L., Hill, L., Schmidt, L., Holzman, G.B., and Schulkin, J. (1999). Genetics in obstetricians’ offices: a survey study. *Obstetrics and Gynecology*. 93(5 Pt 1):642-647.

⁵⁸⁴ Giardiello, F.M., Brensinger, J.D., Petersen, G.M., Luce, M.C., Hyland, L.M., Bacon, J.A., Booker, S.V., Parker, R.D., and Hamilton, S.R. (1997). The use and interpretation of commercial APC gene testing for familial adenomatous polyposis. *New England Journal of Medicine*. 336(12):823-827.

⁵⁸⁵ Kemper, A.R., Uren, R.L., Moseley, K.L., and Clark, S.J. (2006). Primary care physicians’ attitudes regarding follow-up care for children with positive newborn screening results. *Pediatrics*. 118(5):1836-1841.

⁵⁸⁶ Harvey, E.K., Fogel, C.E., Peyrot, M., Christensen, K.D., Terry, S.F., and McInerney, J.D. (2007). Providers’ knowledge of genetics: a survey of 5915 individuals and families with genetic conditions. *Genetics in Medicine*. 9(5):259-267.

⁵⁸⁷ Shields, A., Blumenthal, D., Weiss, K.B., Comstock, C.B., Currivan, D., and Lerman, C. (2005). Barriers to translating emerging genetic research on smoking into clinical practice. Perspectives of primary care physicians. *Journal of General Internal Medicine*. 20(2):131-138.

parents. This difficulty can cause confusion about the disease state, medical complications associated with carrier status, and reproductive decisions.^{588,589,590,591}

Studies of other allied health care professionals report experiences similar to those of physicians in terms of genetics knowledge, skills, and abilities surrounding genetic testing for their patients.^{592,593,594} For example, studies of nurses have revealed a lack of genetics education in this profession. Bankhead et al. found that over 96 percent of the 600 nurses surveyed collected a family history on their patients. The nurses reported, however, that they were unsure how to proceed when a family had a medical history of a disorder and would defer to a general practitioner.⁵⁹⁵ Additionally, in a survey of individuals graduating from six allied health care training programs, 78 percent reported that the genetics knowledge and skills covered in their training programs were marginal to none. Despite the lack of genetics education, these professionals reported that they were still responsible for providing genetics-related clinical services, such as taking family histories and discussing the genetic basis and impact of the disorder with the patients.⁵⁹⁶

Generally, there is an expectation among patients and families that their primary health care provider is able to identify their risk for a genetic disorder and provide appropriate testing. Most patients are simply seeking an assessment and reassurance.⁵⁹⁷ As such, it is important to equip primary care providers with the skills necessary to assess the genetic risk of disease and determine whether any genetic testing is required. Ultimately, genetics education needs to be incorporated routinely in all health care provider training programs. The Association of American Medical Colleges (AAMC) recognizes the emerging importance of clinical training in genetics. As part of its Medical School Objectives Project, AAMC outlines specific recommendations on the attitudes, knowledge, and core skills that graduating medical students should achieve in genetics. AAMC also provides recommendations for future genetics-focused educational needs in residency and practice. The Accreditation Council for Graduate Medical Education, which is responsible for accrediting post-M.D. medical training programs, outlines common requirements for graduate programs in molecular genetics, including curriculum requirements and core competencies. Additionally, genetics continuing education for practicing primary care providers needs to be offered using traditional methods

⁵⁸⁸ Markel, H. (1998) Scientific Advances and Social Risks: Historical Perspectives of Genetic Screening Programs for Sickle Cell Disease, Tay-Sachs Disease, Neural Tube Defects, and Down Syndrome, 1970-1997. In *Promoting Safe and Effective Genetic Testing*. Ed. Holtzman, N.A. and Watson, M.S. Baltimore: The Johns Hopkins University Press. pg. 161-176.

⁵⁸⁹ Kwon, C. and Farrell, P.M. (2000). The magnitude and challenge of false-positive newborn screening test results. *Archives of Pediatric and Adolescent Medicine*. 154(7):714-718.

⁵⁹⁰ Farrell, M.H., La Pean, A., and Ladouceur, L. (2005). Content of communication by pediatric residents after newborn genetic screening. *Pediatrics*. 116(6):1492-1498.

⁵⁹¹ Ciske, D.J, Haavisto, A., Laxova, A., Rock, L.Z., and Farrell, P.M. (2001). Genetic counseling and neonatal screening for cystic fibrosis: an assessment of the communication process. *Pediatrics*. 107(4):699-705.

⁵⁹² Lapham, E.V., Kozma, C., Weiss, J.O., Benkendorf, J.L. and Wilson, M.A. (2000). The gap between practice and genetics education of health professionals: HuGEM survey results. *Genetics in Medicine*. 2(4):226-231.

⁵⁹³ Bankhead, C., Emery, J., Qureshi, N., Campbell, H., Austoker, J., and Watson, E. (2001). New developments in genetics – knowledge, attitudes and information needs of practice nurses. *Family Practice*. 18(5):475-486.

⁵⁹⁴ Christianson, C.A., McWalter, K.M., and Warren, N.S. (2005). Assessment of allied health graduates' preparation to integrate genetic knowledge and skills into clinical practice. *Journal of Allied Health*. 34(3):138-44.

⁵⁹⁵ Bankhead, C., Emery, J., Qureshi, N., Campbell, H., Austoker, J., and Watson, E. (2001). New developments in genetics – knowledge, attitudes and information needs of practice nurses. *Family Practice*. 18(5):475-486.

⁵⁹⁶ Christianson, C.A., McWalter, K.M., and Warren, N.S. (2005). Assessment of allied health graduates' preparation to integrate genetic knowledge and skills into clinical practice. *Journal of Allied Health*. 34(3):138-44.

⁵⁹⁷ Thomas, S.M. (1999). Genomics: the implications for ethics and education. *British Medical Bulletin*. 55(2):429-445.

(e.g., grand rounds, journal articles) and new technologies, such as distance learning.⁵⁹⁸ Fortunately, efforts are under way to develop core competencies in genetics and incorporate genetics into allied health training programs.^{599,600,601} Additional efforts are needed, however, for continuing education for practicing health care providers. In recognition of these issues, SACGHS has established an education task force to revisit this topic since its last report in 2004.⁶⁰²

As far back as the 1976 American Academy of Pediatrics Genetic Screening Task Force report, many publications have emphasized a team approach to identifying patients at risk for genetic disorders, offering appropriate testing, and providing posttest information.^{603,604,605,606,607} This team approach to providing genetic services should use a model of primary care access to geneticists, genetic counselors, and nurse specialists that can provide accurate information to guide the appropriate use of tests. Further discussion of the role of genetics professionals in genetic testing is provided in the following section. The genetics professions can also develop guidelines to aid the primary care provider in identifying patients who may benefit from a genetic test, choosing an appropriate test, and providing pretest and posttest information and resources for referral to genetics professionals. Several studies have indicated that primary care providers want such guidelines to be developed.^{608,609,610}

Nongenetics health care professionals need resources to identify at-risk patients, determine appropriate genetic tests, and provide pretest and posttest information to families. Genetics education in training programs, continuing genetics education in practice, development of clear guidelines, and development of a working relationship with a team of genetics professionals are the components required to provide adequate support for nongenetics health care providers so that they can provide optimal genetic testing and followup for their patients.

⁵⁹⁸ Emery, J., Watson, E., Rose, P., and Andermann, A. (1999). A systematic review of the literature exploring the role of primary care in genetic services. *Family Practice*. 16(4):426-445.

⁵⁹⁹ Jenkins, J., Blitzer, M., Boehm, K., Feetham, S., Gettig, E., Johnson, A., Lapham, E.V., Patenaude, A.F., Reynolds, P., and Guttmacher, A.E. (2001). Recommendations of core competencies in genetics essential for all health professionals. *Genetics in Medicine*. 3(2):155-159.

⁶⁰⁰ National Association of Social Workers (2003). *NASW Standards for Integrating Genetics into Social Work Practice*. Report from the NASW Genetics and Social Work Practice Standards Working Group.

⁶⁰¹ National Coalition for Professional Education in Genetics Web site. See www.nchpeg.org. Accessed on April 3, 2008.

⁶⁰² Secretary's Advisory Committee on Genetics, Health, and Society (2004). *Resolution of the Secretary's Advisory Committee on Genetics, Health, and Society on Genetics Education and Training of Health Professionals*. See <http://www4.od.nih.gov/oba/sacghs/reports/EducationResolutionJune04.pdf>. Accessed on April 3, 2008.

⁶⁰³ American Academy of Pediatrics. (1976). The Task Force on Genetic Screening: The pediatrician and genetic screening (every pediatrician a geneticist). *Pediatrics*. 58(5):757-764.

⁶⁰⁴ Weitzel, J. (1999). Genetic cancer risk assessment. Putting it all together. *Cancer*. 86(11 Suppl):2483-2492.

⁶⁰⁵ Fry, A., Campbell, H., Gudmundsdottir, H., Rush, R., Porteous, M., Gorman, D., and Cull, A. (1999). GPs' views on their role in cancer genetics services and current practice. *Family Practice*. 16(5):468-474.

⁶⁰⁶ Emery, J. and Hayflick, S. (2001). The challenge of integrating genetic medicine into primary care. *British Medical Journal*. 322(7293):1027-1030.

⁶⁰⁷ Knottnerus, J.A. (2003). Community genetics and community medicine. *Family Practice*. 20(5):601-606.

⁶⁰⁸ Fry, A., Campbell, H., Gudmundsdottir, H., Rush, R., Porteous, M., Gorman, D., and Cull, A. (1999). GPs' views on their role in cancer genetics services and current practice. *Family Practice*. 16(5):468-474.

⁶⁰⁹ Emery, J. and Hayflick, S. (2001). The challenge of integrating genetic medicine into primary care. *British Medical Journal*. 322(7293):1027-1030.

⁶¹⁰ Freedman, A.N., Wideroff, L., Olson, L., Davis, W., Klabunde, C., Srinath, K.P., Reeve, B.B., Croyle, R.T., and Ballard-Barbash, R. (2003). US physicians' attitudes toward genetic testing for cancer susceptibility. *American Journal of Medical Genetics A*. 120(1):63-71.

Genetics Professionals

The importance of access to formally trained genetics professionals has been an overarching concern and/or recommendation in each report developed by SACGHS for the HHS Secretary. It is not surprising that many studies have revealed that genetics professionals are better equipped than primary care providers and other specialists to order appropriate genetic tests and provide genetic counseling before and after testing.^{611,612,613,614,615} Massachusetts State law requires that all genetic testing be accompanied by a statement that the person was informed about the availability of genetic counseling and was provided with written information identifying a genetic counselor or a clinical or medical geneticist from whom the person might obtain counseling.⁶¹⁶

The SACGHS report *Coverage and Reimbursement of Genetic Tests and Services* recognized that there are a wide range of providers of genetic counseling services, including M.D. geneticists, Ph.D. geneticists, masters-level genetic counselors, genetics nurses, and other health care providers. It noted that “certain providers of genetic counseling services will be more appropriate than others, depending on the nature of the test and the condition for which the test is performed, the indications for testing, the complexity of the issues being discussed, and the education and qualifications of the provider.”⁶¹⁷

The Coverage and Reimbursement report also states that, “genetic counseling services can be provided prior to testing to collect and interpret family, genetic, medical, and psychosocial information, as well as to inform the patient of the various ethical, legal, and psychosocial issues raised by genetic testing.”⁶¹⁸ It is important to add that information obtained during genetics evaluation and counseling is essential in helping the genetics professional determine the appropriate genetic tests to offer and the sequence of testing that may need to occur. The Coverage and Reimbursement report emphasizes that “after a test is administered, genetic counseling services may be provided to discuss test results and the options of the patient based on those results.”⁶¹⁹

The Coverage and Reimbursement report also presents information on the training, qualifications, and credentialing of genetic services professionals, including the number of formally trained genetics professionals. At the end of 2007, there were 1,253 M.D. clinical geneticists who were board-certified by

⁶¹¹ Rubin, S.P., Malin, J., and Maidman, J. (1983). Genetic counseling before prenatal diagnosis for advanced maternal age: an important medical safeguard. *Obstetrics and Gynecology*. 62(2):155-159.

⁶¹² Gordis, L., Childs, B., and Roseman, M.G. (1977). Obstetricians’ attitudes toward genetic screening. *American Journal of Public Health*. 67(5):496-471.

⁶¹³ Koscica, K.L., Canterino, J.C., Harrigan, J.T., Dalaya, T., Ananth, C.V., and Vintzileos, A.M. (2001). Assessing genetic risk: comparison between the referring obstetrician and genetic counselor. *American Journal of Obstetrics and Gynecology*. 185(5):1032-1034.

⁶¹⁴ Wilkins-Haug, L., Erickson, K., Hill, L., Power, M., Holzman, G.B., and Schulkin, J. (2000). Obstetrician-gynecologists’ opinions and attitudes on the role of genetics in women’s health. *Journal of Women’s Health and Gender-Based Medicine*. 9(8):873-879.

⁶¹⁵ Kemper, A.R., Uren, R.L., Moseley, K.L., and Clark, S.J. (2006). Primary care physicians’ attitudes regarding follow-up care for children with positive newborn screening results. *Pediatrics*. 118(5):1836-1841.

⁶¹⁶ Massachusetts 2000 Session Laws, Chapter 254: An Act Relative to Insurance and Genetic Testing and Privacy Protection. See www.mass.gov/legis/laws/seslaw00/sl000254.htm. Accessed on April 3, 2008.

⁶¹⁷ Secretary’s Advisory Committee on Genetics, Health, and Society (2006). *Coverage and Reimbursement of Genetic Tests and Services*. See http://www4.od.nih.gov/oba/sacghs/reports/CR_report.pdf. Accessed on April 3, 2008.

⁶¹⁸ Secretary’s Advisory Committee on Genetics, Health, and Society (2006). *Coverage and Reimbursement of Genetic Tests and Services*. See http://www4.od.nih.gov/oba/sacghs/reports/CR_report.pdf. Accessed on April 3, 2008.

⁶¹⁹ Secretary’s Advisory Committee on Genetics, Health, and Society (2006). *Coverage and Reimbursement of Genetic Tests and Services*. See http://www4.od.nih.gov/oba/sacghs/reports/CR_report.pdf. Accessed on April 3, 2008.

the American Board of Medical Genetics (ABMG), 155 ABMG board-certified Ph.D. medical geneticists, and approximately 2,760 certificates issued for clinical laboratory disciplines (i.e., biochemical genetics, cytogenetics, and molecular genetics).⁶²⁰ By the end of 2007, the American Board of Genetic Counseling (ABGC) reported 2,448 ABMG/ABGC board-certified genetic counselors.⁶²¹ In addition, 39 individuals were credentialed as either advanced practice nurses in genetics or genetic clinical nurses. Thirty nurses who are members of the International Society of Nurses in Genetics (ISONG) are also board-certified in genetic counseling.⁶²²

Genetics professionals are uniquely qualified by their training and board certification or credentialing to determine the appropriate genetic testing and communicate options to the family or health care provider prior to genetic testing. Their training also allows them to interpret the genetic test results accurately and provide information to the families and health care providers tailored to the recipient. All genetics specialties include competencies to determine appropriate testing, interpret test results accurately, and convey information appropriately to the intended recipient. Genetics professionals are also trained to continually update their knowledge base, since genetics continues to be a rapidly expanding field of knowledge. Box 6–2 provides the specific requirements for genetics professionals.

Box 6–2. Qualifications of Genetics Professionals

M.D. Geneticists^a

In order to be eligible for ABMG board certification, a M.D. geneticist must have:

- (1) 24 months of satisfactorily completed full-time training in an Accreditation Council for Graduate Medical Education (ACGME)-accredited residency program in a specialty (other than clinical genetics) that is recognized by the American Board of Medical Specialties and an additional 24 months of satisfactorily completed full-time training in an ACGME-accredited clinical genetics residency program; or
- (2) 48 months of satisfactorily completed full-time training in an ACGME-accredited 4-year clinical genetics residency. (Note: In this instance the 48 months of training satisfy both the graduate medical training requirement and the medical genetics training requirement); or
- (3) 60 months of satisfactorily completed full-time training in an ACGME-accredited combined pediatrics/medical genetics or internal medicine/medical genetics residency. Upon successful completion of all requirements of the combined residency, a trainee is qualified to apply for certification by either or both the American Board of Pediatrics and ABMG OR either or both the American Board of Internal Medicine and ABMG. Applicants must satisfactorily complete the specific credentialing requirements of each Board to be eligible to sit for the examination of that Board. Certification in one specialty is not contingent upon certification in the other.

Continues on next page.

⁶²⁰ American Board of Medical Genetics Web site. “Number of Certified Specialists in Genetics.” See http://www.abmg.org/pages/resources_certspecial.shtml. Accessed on April 3, 2008.

⁶²¹ American Board of Genetic Counseling Web site. See <http://abgc.iamonline.com/english/View.asp?x=1418>. Accessed on April 3, 2008.

⁶²² American Board of Genetic Counseling Web site. See <http://abgc.iamonline.com/english/View.asp?x=1418>. Accessed on April 3, 2008.

Ph.D. Medical Geneticists^b

An individual who holds an earned Ph.D. from a training program that also has an ABMG-accredited Ph.D. medical genetics training program may, at the discretion of the program director of the individual's ABMG-accredited medical genetics training program, apply for certification in the Ph.D. medical genetics specialty and one laboratory specialty after 2 years of combined medical genetics training in these two specialties in an ABMG-accredited program, if and only if:

- (1) The earned Ph.D. is from a degree-granting program that is documented to be integrated with a postdoctoral program that is ABMG-accredited for at least Ph.D. medical genetics and one laboratory specialty; and
- (2) During the Ph.D. degree program, the individual has taken graduate course work including formal medical genetics and mathematical genetics, and the individual documents significant participation in clinical genetics: communicating with patients, communicating with referring physicians, and regularly attending clinical conferences. These activities must be documented and described in detail by the director of the ABMG-accredited medical genetics program and by the institution's director of the Ph.D. program granting the doctoral degree; and
- (3) The applicant submits two logbooks, one of 150 cases for the laboratory specialty collected during the medical genetics fellowship training and one of 75 additional cases for the specialty of Ph.D. medical genetics (unrelated to the laboratory specialty) also collected during the medical genetics fellowship training.

Certified Genetic Counselors^c

A genetic counselor must demonstrate competencies in the following areas to graduate from an ABGC-accredited master's level genetic counseling program: (1) principles of human, medical, and clinical genetics; (2) psychosocial theory and techniques; (3) social, ethical, and legal issues; (4) health care delivery systems and principles of public health; and (5) teaching techniques and research methods. Additionally, to qualify to be board certified by ABGC, a genetic counselor must have:

- (1) Graduation from an ABGC-accredited master's level genetic counseling program
- (2) A logbook of 50 distinct genetic counseling cases demonstrating a broad clinical training experience obtained after July 1, 1999, at approved genetic counseling training settings
- (3) Letters of reference from two board-certified genetics professionals and the program director of the ABGC-accredited genetic counseling program

Advanced Practice Nurse in Genetics^d

Nurse genetics professionals can receive credentialing as an Advanced Practice Nurse in Genetics (APNG) or as a Genetics Clinical Nurse (GCN). In order to qualify for APNG credentialing, a nurse must be a master's level nurse and complete credentialing through successful completion of a professional portfolio review process. The credentialing requirements are:

- (1) Proof of R.N. license in good standing and
- (2) 300 hours of genetic practicum experiences as a clinical genetic nurse with a genetic practice component greater than 50 percent

Continues on next page.

- (3) Completion of log of 50 cases within 5 years of the application
- (4) Four written case studies reflecting International Society of Nurses in Genetics standards of clinical genetics nursing practice
- (5) Graduation from an accredited graduate program in nursing
- (6) 50 hours of genetic content in the past 5 years through academic courses or continuing education
- (7) Evidence of patient/family and/or client teaching

Genetics Clinical Nurse^e

In order to qualify as a GCN, credentialing is also obtained through successful completion of a professional portfolio review process. The credentialing requirements are:

- (1) Proof of R.N. license in good standing
- (2) 5 years of experience as a GCN with a genetic practice component greater than 50 percent
- (3) Log of 50 cases within 5 years of the application
- (4) Written case studies reflecting ISONG standards
- (5) Graduation from an accredited baccalaureate program in nursing
- (6) 45 contact hours of genetic content within 3 calendar years of application through academic courses or continuing education
- (7) Evidence of patient/family and/or client teaching and evidence of genetics-related in-service education

^a American Board of Medical Genetics. Training Requirements for Certification. See http://www.abmg.org/pages/cert_trainingreq.shtml. Accessed on January 26, 2008.

^b American Board of Medical Genetics. Specialties of Genetics. See http://www.abmg.org/pages/training_specialties.shtml. Accessed on January 26, 2008.

^c American Board of Genetic Counseling Web site. See <http://abgc.iamonline.com/english/View.asp?x=1667&mp=1664>. Accessed on June 9, 2007.

^d Genetic Nursing Credentialing Commission Web site. See <http://www.geneticnurse.org/advancedpracticeapng.html>. Accessed on June 9, 2007.

^e Genetic Nursing Credentialing Commission Web site. See <http://www.geneticnurse.org/geneticnurse.org/geneticnurse.org/geneticsnursegcn.html>. Accessed on June 9, 2007.

One of the primary tools for a genetics professional in determining appropriate testing for an individual or family is a three-generation family history. Many nongenetics health care professionals, however, do not take such a family history. Additionally, studies have revealed that in genetic counseling sessions conducted with a three-generation pedigree, up to 50 percent of the patients were found to have additional genetic risk factors that were not identified by the referring obstetrician.^{623,624,625} Genetics professionals have the skills and current knowledge to identify accurately the genetic risks of the individual or family and determine appropriate genetic testing and options, but they may not be using all the tools available to provide complete and accurate guidance to patients.

⁶²³ Frezzo, T.M., Rubinstein, W.S., Dunham, D., and Ormond, K.E. (2003). The genetic family history as a risk assessment tool in internal medicine. *Genetics in Medicine*. 5(2):84-91.

⁶²⁴ Cohn, G.M., Cimaroli, T., Macri, C.J., Habecker-Green, J., and Miller R.C. (1996). The usefulness of a prenatal genetic questionnaire in genetic risk assessment. *Obstetrics and Gynecology*. 88(5):806-810.

⁶²⁵ Koscica, K.L., Canterino, J.C., Harrigan, J.T., Dalaya, T., Ananth, C.V., and Vintzileos, A.M. (2001). Assessing genetic risk: comparison between the referring obstetrician and genetic counselor. *American Journal of Obstetrics and Gynecology*. 185(5):1032-1034.

Furthermore, some studies have even revealed that a patient's perception of a test result is influenced by whether the results are given by a geneticist or a nongenetics health care professional. Johnson et al. found that genetic counseling by a genetics professional and subsequent testing increased overall patient adherence with recommended colon screening, especially for those with positive genetic test results.^{626,627} A study by Michie et al.⁶²⁸ found that 103 unaffected at-risk adults who received a negative predictive DNA test result for FAP attended bowel screening at a much higher rate when the results were received from a nongenetics professional, compared with patients given results by a genetics professional. Michie et al. attributed the difference to factors such as methods used to convey information about the accuracy of the test result, seriousness of the disease, and attitudes toward bowel screening.

The training, skills, and knowledge of a genetics professional allows for the accurate interpretation and appropriate genetic counseling for the person or family receiving the test result. Genetic professionals can also provide the link between the primary care provider, who may not be knowledgeable about genetics, and the family in using the results to determine the options for treatment and management of a genetic disorder or risk for a genetic disorder.

Role of Laboratories in Providing Genetic Expertise

As noted above, given the complexity of genetic testing, the laboratory must play a role in interpreting and effectively communicating the test result to the ordering physician. This section reviews the role of the laboratory in providing genetic expertise in the genetic specialty laboratory and the nongenetic specialty laboratory. While the issues are the same for both, there are differences in practice that must be addressed in order to understand existing gaps and harms.

Genetic Specialty Laboratories

The preanalytical and postanalytical communication issues discussed above have led many genetic specialty laboratories to employ or contract with clinical genetics professionals to provide clinical consultation with ordering clinicians and patients. A clinical consultant is required by CLIA regulations for all laboratories.⁶²⁹ This amendment provides the following definition of a clinical consultant:

42 CFR § 493.1455 Standard; Clinical consultant qualifications.

The clinical consultant must be qualified to consult with and render opinions to the laboratory's clients concerning the diagnosis, treatment, and management of patient care. The clinical consultant must:

- (a) Be qualified as a laboratory director under § 493.1443(b) (1), (2), or (3)(i); or
- (b) Be a doctor of medicine, doctor of osteopathy, or doctor of podiatric medicine and possess a license to practice medicine, osteopathy, or podiatry in the State in which the laboratory is located.

⁶²⁶ Johnson, K.A., Trimbath, J.D., Petersen, G.M., Griffin, C.A., and Giardiello, F.M. (2002). Impact of genetic counseling and testing on colorectal cancer screening behavior. *Genetic Testing*. 6(4):303-306.

⁶²⁷ Hadley, D.W., Jenkins, J.F., Dimond, E., de Carvalho, M., Kirsch, I., and Palmer, C.G. (2004). Colon cancer screening practices after genetic counseling and testing for hereditary nonpolyposis colorectal cancer. *Journal of Clinical Oncology*. 22(1):39-44.

⁶²⁸ Michie, S., Collins, V., Halliday, J., and Marteau, T.M. (2002). Likelihood of attending bowel screening after a negative genetic test result: the possible influence of health professionals. *Genetic Testing*. 6(4):307-311.

⁶²⁹ Food and Drug Administration Web site. "CLIA – Clinical Laboratory Improvement Amendments." See <http://www.fda.gov/cdrh/cliia/> Accessed April 3, 2008.

While that standard states that the consultant “must be qualified,” it does not specify the qualifications for any clinical consultant in general or clinical consultants in genetic laboratories in particular. The Standards and Guidelines for Clinical Genetic Laboratories (ed. 2006) of ACMG state, “The clinical consultant must be an American Board of Medical Genetics certified clinical geneticist, Ph.D. medical geneticist, or clinical laboratory geneticist. The laboratory director can fulfill this role. The clinical consultant is required to provide consultation but not counseling to the patient.”⁶³⁰

McGovern et al. published a survey on molecular genetic testing laboratories.⁶³¹ Of the 245 molecular laboratory directors who responded, 83 percent reported an affiliation with one or more doctoral-level genetics professionals. Approximately half of these affiliated geneticists provided clinical consultation to referring physicians while the rest provided consultation to patients. Additionally, 70 percent of the directors reported either employing (27 percent) or affiliating (43 percent) with clinical genetic counselors who provided similar consultative services to physicians and patients. A similar survey of biochemical genetics laboratories showed that of the 133 directors who responded, only 23 percent reported an affiliation with one or more doctoral-level genetics professionals. Of these affiliated geneticists, 89 percent provided clinical consultation to referring physicians and 72 percent to patients.⁶³² This study did not address the use of genetic counselors in the biochemical setting. Neither of these surveys specifically addressed how many laboratory directors fulfilled the clinical consultant role, which would meet the criteria of the ACMG statement.⁶³³ Nonetheless, the discrepancy between practices in the molecular and biochemical laboratories is notable.

It is a measure of the perceived importance of these services that most genetic testing laboratories employ or contract with clinical genetics professionals, despite the inability to be directly reimbursed for their services. In theory, these costs could be distributed across the tests offered as an indirect overhead expense reflected in the charge for the service. In practice, given that many laboratories contract to accept payment at a discounted rate and that third-party payers such as Medicare set maximum allowable charges that do not cover the laboratory’s costs for testing, it is unlikely that this indirect approach results in coverage of this expense, although there are no published data to support this conclusion.

Furthermore, there are few data indicating whether the clinical genetic consultant improves appropriate testing, interpretation, and use of the test result. McGovern et al. tried to indirectly answer this question by surveying genetic counselors regarding their interaction with molecular genetic testing laboratories.⁶³⁴ Of the 758 counselors who responded to this survey, more than 80 percent indicated that they contacted a laboratory after receiving the results of a test for a variety of reasons, including clarification of report interpretation (83 percent), information about methodology used (82 percent), interpretation of results (81 percent), and revised risk based on a negative test result (69 percent). A total of 57 percent of the respondents indicated that they contacted a genetic counselor employed by the laboratory. Other contacts

⁶³⁰ American College of Medical Genetics (2006). *Standards and Guidelines for Clinical Genetics Laboratories*. See http://www.acmg.net/Pages/ACMG_Activities/stds-2002/b.htm. Accessed on April 3, 2008.

⁶³¹ McGovern, M.M., Benach, M.O., Wallenstein, S., Desnick, R.J., and Keenlyside, R. (1999). Quality assurance in molecular genetic testing laboratories. *Journal of the American Medical Association*. 281(9):835-840.

⁶³² McGovern, M.M., Benach, M., Wallenstein, S., Boone, J., and Lubin, I.M. (2003). Personnel standards and quality assurance practices of biochemical genetic testing laboratories in the United States. *Archives of Pathology and Laboratory Medicine*. 127(1):71-76.

⁶³³ American College of Medical Genetics (2006). *Standards and Guidelines for Clinical Genetics Laboratories*. See http://www.acmg.net/Pages/ACMG_Activities/stds-2002/b.htm. Accessed on April 3, 2008.

⁶³⁴ McGovern, M.M., Benach, M., and Zinberg, R. (2003). Interaction of genetic counselors with molecular genetic testing laboratories: implications for non-geneticist health care providers. *American Journal of Medical Genetics Part A*. 119(3):297-301.

included the client services employee (19 percent), laboratory director (16 percent), clinical consultant (12 percent), and laboratory supervisor (7 percent). Of the 758 genetic counselors, 21 percent indicated that the laboratories were not always able to answer a question, and 28 percent reported a “frequent need” to clarify reports prior to providing information to a patient.

The authors specifically raised the concern that despite the high level of training of the genetic counselors and the fact that more than 90 percent worked with a doctoral-level clinical geneticist, only 72 percent felt that the reports contained enough information to explain test results. A total of 76 percent of respondents indicated receiving a test report that did not have an interpretation, despite the ACMG requirement that genetic test reports contain a statement interpreting the data and that the interpretation should be understandable to a nongeneticist professional.⁶³⁵ The authors conclude that, “It could be reasonably expected that the perceived deficiencies in laboratory reports articulated by these trained genetics professionals may pose an even greater challenge to primary care physicians.” It may be expected that consumers who have ordered their own genetic tests would experience similar challenges. This concern was echoed by Malinowski and Blatt.⁶³⁶ The only published test highlighting this concern was in a study by Giardiello et al., which reported that 17 percent of patients had “inappropriate” indications for testing and more than 31 percent of physicians misinterpreted the results of an *APC* gene test.⁶³⁷ Some research has also indicated that a number of identified genetic testing laboratories are not in compliance with the recommendation that a clinical consultant be available.^{638,639} If these findings represent a decrease in the quality of patient care, there is potential for harm.

An approach that was developed to address similar problems in anatomic pathology reporting is synoptic reporting.⁶⁴⁰ Focused on the reporting of tumor pathology, this approach has had a dramatic impact on improving the quality of patient care. The Cancer Committee of CAP developed a series of cancer protocols that culminated on January 1, 2004, with mandatory compliance to Standard 4.6 of the American College of Surgeons Commission on Cancer (COC). This standard requires that pathologists at COC-approved cancer programs include all scientifically validated or regularly used data elements of the CAP checklists in their pathology reports for each site and specimen.⁶⁴¹ The Centers for Disease Control and Prevention (CDC) is currently exploring whether synoptic reporting of genetic and genomic test results could result in similar improvements in patient care.⁶⁴²

⁶³⁵ American College of Medical Genetics (2006). *Standards and Guidelines for Clinical Genetics Laboratories*. See http://www.acmg.net/Pages/ACMG_Activities/stds-2002/b.htm. Accessed on April 3, 2008.

⁶³⁶ Malinowski, M.J. and Blatt, R.J. (1997). Commercialization of genetic testing services: the FDA, market forces, and biological tarot cards. *Tulane Law Review*. 71(4):1211-1312.

⁶³⁷ Giardiello, F.M., Brensinger, J.D., Petersen, G.M., Luce, M.C., Hyland, L.M., Bacon, J.A., Booker, S.V., Parker, R.D., and Hamilton, S.R. (1997). The use and interpretation of commercial APC gene testing for familial adenomatous polyposis. *New England Journal of Medicine*. 336(12):823-827.

⁶³⁸ McGovern, M.M., Benach, M.O., Wallenstein, S., Desnick, R.J., and Keenlyside, R. (1999). Quality assurance in molecular genetic testing laboratories. *Journal of the American Medical Association*. 281(9):835-840.

⁶³⁹ McGovern, M.M., Benach, M., Wallenstein, S., Boone, J., and Lubin, I.M. (2003). Personnel standards and quality assurance practices of biochemical genetic testing laboratories in the United States. *Archives of Pathology and Laboratory Medicine*. 127(1):71-76.

⁶⁴⁰ Leslie, K.O. and Rosai, J. (1994). Standardization of the surgical pathology report: formats, templates, and synoptic reports. *Seminars in Diagnostic Pathology*. 11(4):253-257.

⁶⁴¹ Amin, M.B. (2006). Key issues in reporting common cancer specimen findings using the College of American Pathologists cancer protocols. *Archives of Pathology and Laboratory Medicine*. 130(3):284-286.

⁶⁴² Funding Opportunity: Reporting DNA-Based Genetic Test Results Applicable to Heritable Conditions and/or Markers of Drug Metabolism: The Clinical Laboratory Report as a Decision-Support Tool (Funding Opportunity Number: CDC-RFA-CI07-709). See <http://www.cdc.gov/od/pgo/funding/CI07-709.htm>. Accessed on April 3, 2008.

Nongenetic Laboratories

As the volume of genetic and genomic tests grows, it is anticipated that many of these tests may move into the general clinical laboratory. This trend is already evident with the rapid detection of infectious agents using DNA-based technology. While not quantified, some molecular genetic tests for human mutations (e.g., factor V Leiden and other thrombophilic polymorphisms, hemochromatosis due to the *HFE C282Y* mutation) are being performed in general clinical laboratories. Emerging pharmacogenomic tests that will be used to choose the most appropriate medications and doses for patients may require a turnaround time that is unachievable by a reference laboratory, thus promulgating testing at or near the point of care. Finally, an increasing number of commercial test kits have been FDA cleared/approved, making these tests financially attractive to nongenetic laboratories because there would be no costs associated with test development. Some authors have raised concerns about the impact on the quality of testing. While this concern has primarily been focused on analytical validity,⁶⁴³ it could be argued that if there is a lack of clinical genetic expertise to inform interpretation and reporting, this will have a tremendous clinical impact even if the testing is analytically valid. Currently, there are no published data that allow assessment of the magnitude of this problem.

Point-of-Care Genetic Testing

At the present time, molecular genetic testing is not being performed at the point of care with the exception of some DNA-based tests that are used in studying the epidemiology of infectious diseases. Several authors, however, have noted that point-of-care testing may well emerge in the near future.^{644,645} This type of testing may be required in situations such as pharmacogenomic testing, where dosing decisions may not be able to wait for the sample to be sent to a referral laboratory with its attendant turnaround time. In the setting of a clinical trial, genotyping of the common variants of *CYP2C9* and *VKORC1* was completed with a median turnaround time of 48 minutes, which allowed this information to be used to inform the initial dose of coumadin in patients initiating anticoagulation.⁶⁴⁶ All the problems noted in this report regarding validity and utility will likely be amplified if point-of-care testing becomes commonplace.⁶⁴⁷

⁶⁴³ Strom, C.M. (2005). Mutation detection, interpretation, and applications in the clinical laboratory setting. *Mutation Research*. 573(1-2):160-167.

⁶⁴⁴ Fortina, P., Surrey, S., and Kricka, L.J. (2002). Molecular diagnostics: hurdles for clinical implementation. *Trends in Molecular Medicine*. 8(6):264-266.

⁶⁴⁵ Trent, R.J., Yu, B., and Caramins, M. (2004). Challenges for clinical genetic DNA testing. *Expert Review of Molecular Diagnostics*. 4(2):201-208.

⁶⁴⁶ Clinical Trials.gov Web site. "A Pharmacogenetic Study of Warfarin Dosing, 'The COUMA-GEN Study.'" See <http://clinicaltrials.gov/ct/show/NCT00334464;jsessionid=1B6C6035A24A8C808FCAF2C58E9952B1?order=39>. Accessed on April 3, 2008.

⁶⁴⁷ Fortina, P., Surrey, S., and Kricka, L.J. (2002). Molecular diagnostics: hurdles for clinical implementation. *Trends in Molecular Medicine*. 8(6):264-266.

Impact of Direct-to-Consumer Advertising

Increasingly, laboratories are marketing directly to the consumer to encourage testing. While the impact of these campaigns is difficult to define at present,^{648, 649} this practice has attracted the attention of both the Government and organized medicine. SACGHS has encouraged collaboration of Federal agencies on the regulation of advertisements for genetic tests marketed directly to consumers and the impact of DTC marketing of these tests.⁶⁵⁰ An investigation of companies offering nutrigenetic testing directly to consumers by the U. S. Government Accountability Office concluded that the information provided by these companies “misleads consumers by making predictions that are medically unproven and so ambiguous that they do not provide meaningful information to consumers.”⁶⁵¹ The Federal Trade Commission (FTC), FDA, and CDC also issued a consumer alert warning consumers to be “wary of claims about the benefits these products supposedly offer.”⁶⁵² This concern led ACOG, represented by the Massachusetts delegation to the AMA’s House of Delegates, to submit a resolution on the subject of DTC genetic testing. This resolution took the form of a directive to take action that stated “that our American Medical Association study the issue of direct to consumer advertising of genetics tests and the provision of genetics testing to patients on the Internet or other vehicles not directly involving the patient’s physician, taking into consideration appropriate mechanisms to regulate this practice.”⁶⁵³

Currently, there is no requirement that providers of non-FDA-cleared or -approved tests disclose information to support claims about the accuracy and validity of testing, and there is no central or uniform mechanism for providing this information in an accessible format to patients and providers. IVDMA kits, however, are subject to FDA regulations for labeling, and data to support performance claims are publicly available.

While attention has focused primarily on the utility of DTC tests, significant privacy concerns may also arise. Currently, many disease-specific patient mailing lists are available through list sellers and represent a strong profit center for these businesses. A keyword search on “genetic” at List Brokers, Inc., does not currently produce a consumer list, but concerns exist that this information may become available in the near future.⁶⁵⁴ Most health information that is collected, compiled, used, and sold for marketing purposes does not come from the health care system, due to protections provided by the Federal Health Insurance

⁶⁴⁸ Genetic testing for breast and ovarian cancer susceptibility: evaluating direct-to-consumer marketing--Atlanta, Denver, Raleigh-Durham, and Seattle, 2003. (2004). *MMWR Morbidity and Mortality Weekly Report*. 53(27):603-606.

⁶⁴⁹ Mouchawar, J., Hensley-Alford, S., Laurion, S., Ellis, J., Kulchak-Rahm, A., Finucane, M.L., Meenan, R., Axell, L., Pollack, R., and Ritzwoller D. (2005). Impact of direct-to-consumer advertising for hereditary breast cancer testing on genetic services at a managed care organization: a naturally-occurring experiment. *Genetics in Medicine*. 7(3):191-197.

⁶⁵⁰ Secretary’s Advisory Committee on Genetics, Health, and Society. Letter to HHS Secretary Tommy Thompson from SACGHS Chair, Reed Tuckson, December 8, 2004. See <http://www4.od.nih.gov/oba/sacghs/reports/DTCletter.pdf>. Accessed on April 3, 2008.

⁶⁵¹ Kutz, G. Testimony Before the Special Committee on Aging, U.S. Senate (2006). *Nutrigenetic Testing Tests Purchased from Four Web Sites Mislead Consumers*. See <http://www.gao.gov/new.items/d06977t.pdf>. Accessed on April 3, 2008.

⁶⁵² Federal Trade Commission Web site. See <http://www.ftc.gov/bcp/edu/pubs/consumer/health/hea02.shtm>. Accessed on April 3, 2008.

⁶⁵³ American Medical Association. (2007). House of Delegates Resolution: 522(A-07).

⁶⁵⁴ World Privacy Forum. Public Comment: Secretary’s Advisory Committee on Genetics, Health, and Society meeting, February 12, 2008. See <http://www4.od.nih.gov/oba/SACGHS/meetings/2008Feb/SACGHSFeb2008meeting.htm>. Accessed on April 3, 2008.

Portability and Accountability Act (HIPAA).⁶⁵⁵ Given the current lack of regulation of DTC advertising and testing, it is likely that these may become sources of genetic information for marketing or other purposes. Even if genetic test results are kept strictly confidential, it is possible that the results could be inferred by analyzing an individual's Internet usage.⁶⁵⁶ Concerns of this type in the United Kingdom resulted in a call for regulation in October 2007.⁶⁵⁷ In the United States, FTC, FDA, and CDC issued the joint consumer alert *At Home Genetic Tests: A Healthy Dose of Skepticism May Be the Best Prescription*,⁶⁵⁸ in response to a letter generated by SACGHS in 2006.⁶⁵⁹ Despite these significant concerns, it is difficult to put forward initiatives to address these issues, as there is no one agency that has oversight responsibility for all of them. It is very important that all public and private entities referenced in this report explicitly identify and address privacy concerns that are within their purview.

An information management technique that is showing promise in complex medical conditions is known as shared decisionmaking. Shared medical decisionmaking is an attempt to balance the tension between evidence-based guidance and a respect for patient choice. The principles involved in shared decisionmaking are:⁶⁶⁰

- At least two (often many more) participants, with as a minimum the doctor and the patient
- Both parties take steps to participate in the process of decisionmaking
- Information sharing is a prerequisite to sharing decisionmaking
- A decision is made and both parties agree to it

An extensive review of existing decision aids by The Cochrane Collaboration demonstrated that decision aids are consistently superior to usual care in increasing knowledge and patient satisfaction while decreasing decisional conflict.⁶⁶¹ Elwyn et al. note that genetic counseling already embraces many of the concepts of shared decisionmaking.⁶⁶² Applications of shared decisionmaking in genetic care were published by the Nijmegen group, involving decisions about breast surgery or cancer surveillance in known *BRCA1* and

⁶⁵⁵ Wolfberg, A.J. (2006). Genes on the Web—direct-to-consumer marketing of genetic testing. *New England Journal of Medicine*. 355(6):543-544.

⁶⁵⁶ Federal Trade Commission Web site. "Behavioral Advertising: Tracking, Targeting, & Technology." See <http://www.ftc.gov/bcp/workshops/behavioral/index.shtml>. Accessed on April 3, 2008.

⁶⁵⁷ GeneWatch Web site. "GeneWatch Press Release: Regulation Needed to Prevent Human Genome From Becoming Massive Marketing Scam." See [http://www.genewatch.org/article.shtml?als\[cid\]=396520&als\[itemid\]=558234](http://www.genewatch.org/article.shtml?als[cid]=396520&als[itemid]=558234). Accessed on April 3, 2008.

⁶⁵⁸ Federal Trade Commission (2006). *FTC Facts for Consumers. At Home Genetic Tests: A Healthy Dose of Skepticism May Be the Best Prescription*. See <http://www.ftc.gov/bcp/edu/pubs/consumer/health/hea02.pdf>. Accessed on April 3, 2008.

⁶⁵⁹ Secretary's Advisory Committee on Genetics, Health, and Society. Letter to HHS Secretary Tommy Thompson from SACGHS Chair, Reed Tuckson, December 8, 2004. See <http://www4.od.nih.gov/oba/sacghs/reports/DTCletter.pdf>. Accessed on April 3, 2008.

⁶⁶⁰ Elwyn, G., Gray, J., and Clarke A. (2000). Shared decision making and non-directiveness in genetic counseling. *Journal of Medical Genetics* 37(2):135-138.

⁶⁶¹ O'Connor, A.M., Stacey, D., Rovner, D., Holmes-Rovner, M., Tetroe, J., Llewellyn-Thomas, H., Entwistle, V., Rostom, A., Fiset, V., Barry, M., and Jones, J. (2003). Decision aids for people facing health treatment or screening decisions. *Cochrane Database of Systematic Reviews*. (2):CD001431.

⁶⁶² Elwyn, G., Gray, J., and Clarke A. (2000). Shared decision making and non-directiveness in genetic counseling. *Journal of Medical Genetics*. 37(2):135-138.

BRCA2 carriers.^{663,664} There are no published reports of this approach being used in the decision to undergo genetic testing.

Given the growing role of consumers in shared decisionmaking and the ability of consumers to assess some genetic tests without health care provider intervention, there is a greater need to ensure that information about tests is complete and reliable; otherwise, appropriate use and interpretation of the tests cannot be assured.

Patient Access to Expertise

The only area of genetic testing where there may be consistent patient access to genetics expertise is in the State-based newborn screening programs. Most NBS programs have been mandated by State law for more than 30 years and are funded by user fees.^{665,666} The user fees allow the programs to pay for consultations with genetics providers or other subspecialists when a newborn receives a positive NBS test result.⁶⁶⁷ This type of guaranteed payment model gives patients access to genetics expertise at least up to the diagnosis of the disorder. Some NBS programs go farther by subsidizing treatment and followup services, such as nutritional and clinical consultations.⁶⁶⁸ One of the reasons that NBS has been successful is that the Federal Government has been active in providing funding and technical assistance to the NBS programs, community-based support services, and primary care provider communities. For example, HRSA's Maternal and Child Health Bureau (MCHB) funds many technical assistance, education, and followup activities related to NBS, such as the National Newborn Screening & Genetics Resource Center,⁶⁶⁹ the National Coordinating Center for the Genetics and Newborn Screening Regional Collaborative Groups,⁶⁷⁰ Sickle Cell Disease Community-Based Projects,⁶⁷¹ and partnerships with the American Academy of Pediatrics (AAP) and National Conference of State Legislatures. In 2000, Congress authorized and in 2003 the HHS Secretary chartered the Advisory Committee on Heritable Disorders and Genetic Diseases in Newborns and Children (ACHDGDNC).⁶⁷² ACHDGDNC assists the HHS Secretary by providing:

⁶⁶³ Stalmeier, P.F., Unic, I.J., Verhoef, L.C., and Van Daal, W.A. (1999). Evaluation of a shared decision making program for women suspected to have a genetic predisposition to breast cancer: preliminary results. *Medical Decision Making*. 19(3):230-241.

⁶⁶⁴ Unic, I.J., Stalmeier, P.F., Verhoef, L.C., Van Daal, W.A. (1998). Assessment of the time-tradeoff values for prophylactic mastectomy of women with a suspected genetic predisposition to breast cancer. *Medical Decision Making*. 18(3):268-277.

⁶⁶⁵ National Newborn Screening and Genetics Resource Center (2008). *National Newborn Screening Status Report*. See <http://genes-r-us.uthscsa.edu/nbsdisorders.pdf>. Accessed on April 4, 2008.

⁶⁶⁶ National Newborn Screening and Genetics Resource Center (2007). *Summation of Fees Charged for Newborn Screening in the U.S. in 2007*. See <http://www2.uthscsa.edu/nnsis/>. Accessed on April 4, 2008.

⁶⁶⁷ Johnson, K., Lloyd-Puryear, M.A., Mann, M.Y., Ramos, L.R., and Therrell, B.L. (2006). Financing State newborn screening programs: sources and uses of funds. *Pediatrics*. 117(5 Pt 2):S270-S279.

⁶⁶⁸ Johnson, K., Lloyd-Puryear, M.A., Mann, M.Y., Ramos, L.R., and Therrell, B.L. (2006). Financing State newborn screening programs: sources and uses of funds. *Pediatrics*. 117(5 Pt 2):S270-S279.

⁶⁶⁹ National Newborn Screening & Genetics Resource Center Web site. See <http://genes-r-us.uthscsa.edu/>. Accessed on April 4, 2008.

⁶⁷⁰ National Coordinating Center for the Genetics and Newborn Screening Regional Collaborative Groups Web site. See <http://www.nccrcg.org/>. Accessed on April 4, 2008.

⁶⁷¹ Sickle Cell Disease Association of America Web site. "Sickle Cell Disease and Newborn Screening Program." See <http://www.sicklecelldisease.net/index.html>. Accessed on April 4, 2008.

⁶⁷² Health Resources and Services Administration Web site. "Advisory Committee on Heritable Disorders and Genetic Diseases in Newborns and Children." See <http://www.hrsa.gov/heritabledisorderscommittee/>. Accessed on April 4, 2008.

- Advice and recommendations concerning the grants and projects authorized under the Heritable Disorders Program
- Technical information to develop policies and priorities for this program that will enhance the ability of State and local health agencies to provide for newborn and child screening, counseling, and health care services for newborns and children having or at risk for heritable disorders
- Recommendations, advice, or information that may be necessary to enhance, expand, or improve the ability of the HHS Secretary to reduce the mortality or morbidity in newborns and children with heritable disorders

Unfortunately, other areas of genetics do not share the same broad access to services as NBS. As described earlier in this section, there are only a small number of formally trained genetic service providers in the country. Most health care is provided by primary care providers who have little, if any, training in genetics. In addition to the shortage of genetic service providers, the SACGHS Coverage and Reimbursement report concluded that patients' access to genetic services may be limited by their health insurer or a genetics providers' lack of reimbursement for services. The report also noted that families in rural areas may not have access to genetics professionals or may have to travel long distances for an appointment.⁶⁷³

The SACGHS draft report *Realizing the Potential of Pharmacogenomics: Opportunities and Challenges*⁶⁷⁴ states that the role of genetics professionals is important to help interpret pharmacogenomics testing information, since many doctors do not possess the training to interpret it correctly. The report also notes, however, that many other support systems besides the availability of genetics professionals must be put in place to help primary care providers understand the criteria for testing, the information to be discussed with the patient, interpretation of the test result, and use of the results for patient care. To date, no research has been done to determine whether the proposed support systems would result in appropriate use of pharmacogenomic tests. Some initial studies using telephonic access to genetic expertise (telegenetics) established that this is technically feasible and may be equivalent to face-to-face counseling in some circumstances.^{675,676,677} Additional studies are needed to determine whether this is a viable solution to rural access, although this approach will not address the genetic provider shortage.

Role of Professional Societies

Professional societies have played and will continue to play an important role in defining standards of practice. In addition to defining training to become eligible for specialty status and (where appropriate) board certification, professional societies are increasingly engaged in the production of professional practice guidelines to improve and standardize clinical care. "Practice guidelines" are systematically developed

⁶⁷³ Secretary's Advisory Committee on Genetics, Health, and Society (2006). *Coverage and Reimbursement of Genetic Tests and Services*. See http://www4.od.nih.gov/oba/sacghs/reports/CR_report.pdf. Accessed on April 4, 2008.

⁶⁷⁴ Secretary's Advisory Committee on Genetics, Health, and Society (2008). *Realizing the Potential of Pharmacogenomics: Opportunities and Challenges*. See: http://www4.od.nih.gov/oba/sacghs/reports/SACGHS_PGX_report.pdf. Available May 2008.

⁶⁷⁵ Gattas, M.R., MacMillan, J.C., Meinecke, I., Loane, M., and Wootton, R. (2001). Telemedicine and clinical genetics: establishing a successful service. *Journal of Telemedicine and Telecare*. 7 Suppl 2:68-70.

⁶⁷⁶ Lea, D.H., Johnson, J.L., Ellingwood, S., Allan, W., Patel, A., and Smith, R. (2005). Telegenetics in Maine: successful clinical and educational service delivery model developed from a 3-year pilot project. *Genetics in Medicine*. 7(1):21-27.

⁶⁷⁷ Stalker, H.J., Wilson, R., McCune, H., Gonzalez, J., Moffett, M., and Zori, R.T. (2006). Telegenetic medicine: improved access to services in an underserved area. *Journal of Telemedicine and Telecare*. 12(4):182-185.

statements to assist practitioner and patient decisions about appropriate health care for specific clinical circumstances.⁶⁷⁸

Professional societies, including ACMG, ACOG, the American Society of Clinical Oncologists, the Association of Public Health Laboratories, and the National Society of Genetic Counselors have actively developed and promoted guidelines regarding a variety of genetic tests. Dissemination of these guidelines has occurred through the societies' journals, Web sites, and a variety of other educational venues. It is anticipated that the number of guidelines will continue to increase.

While important, guidelines in and of themselves are not sufficient to optimize medical practice,⁶⁷⁹ as evidenced by studies that show that only 50 percent of patients receive recommended preventive care.⁶⁸⁰ In acute care situations, only 70 percent of patients receive recommended care, while 30 percent receive treatments that are contraindicated.⁶⁸¹ Even worse, among patients with chronic illness, only 60 percent receive recommended treatments, and 20 percent receive contraindicated treatments.⁶⁸² The reasons for these findings are many and will not be recapitulated here. There is no reason to believe that this situation will be any different with regard to genetic tests. As noted by Giardiello et al., 20 percent of the *APC* gene tests in their study cohort were ordered inappropriately.⁶⁸³ Grover et al. reported that of 75 patients who met the Bethesda criteria for familial risk of colorectal cancer, only 13 (17 percent) were subsequently referred by gastroenterologists for genetic counseling, despite guidelines that recommended this action.⁶⁸⁴ One study by Rohlfs et al. that measured compliance with recommended testing for the IVS-8 poly(T) variant in the *CFTR* gene showed no difference in testing behavior before and after the guideline was issued.⁶⁸⁵ While it is tempting to dismiss this finding as a problem of practitioners who have inadequate training in genetics, a study by Andersson et al. demonstrates significant deficiencies in compliance with guidelines for genetic test reporting in *CFTR* and factor V Leiden.⁶⁸⁶

Another issue is that guidelines are not in and of themselves subject to any type of enforcement. As noted in Chapter II of this report, the U.S. tort system may use compliance or noncompliance with guidelines to

⁶⁷⁸ Beghi, E., Citterio, A., Cornelio, F., Filippini, G., Grilli, R., and Liberati, A. (1998) Practice guidelines: a more rational approach to diagnosis and treatment and a more effective use of health care resources. *Italian Journal of Neurologic Science*. 19(2):120-123.

⁶⁷⁹ Lomas, J., Anderson, G.M., Domnick-Pierre, K., Vayda, E., Enkin, M.W., and Hannah, W.J. (1989). Do practice guidelines guide practice? The effect of a consensus statement on the practice of physicians. *New England Journal of Medicine*. 321(19):1306-1311.

⁶⁸⁰ Schuster, M.A., McGlynn, E.A., and Brook, R.H. (1998). How good is the quality of health care in the United States? *Milbank Quarterly*. 76(4):517-563, 509.

⁶⁸¹ Schuster, M.A., McGlynn, E.A., and Brook, R.H. (1998). How good is the quality of health care in the United States? *Milbank Quarterly*. 76(4):517-563, 509.

⁶⁸² Schuster, M.A., McGlynn, E.A., and Brook, R.H. (1998). How good is the quality of health care in the United States? *Milbank Quarterly*. 76(4):517-563, 509.

⁶⁸³ Giardiello, F.M., Brensinger, J.D., Petersen, G.M., Luce, M.C., Hyland, L.M., Bacon, J.A., Booker, S.V., Parker, R.D., and Hamilton S.R. (1997). The use and interpretation of commercial APC gene testing for familial adenomatous polyposis. *New England Journal of Medicine*. 336(12):823-827.

⁶⁸⁴ Grover, S., Stoffel, E.M., Bussone, L., Tschöegl, E., and Syngal, S. (2004). Physician assessment of family cancer history and referral for genetic evaluation in colorectal cancer patients. *Clinical Gastroenterology and Hepatology*. 2(9):813-819.

⁶⁸⁵ Rohlfs, E.M., Weinblatt, V.J., Treat, K.J., and Sugarman, E.A. (2004). Analysis of 3208 cystic fibrosis prenatal diagnoses: impact of carrier screening guidelines on distribution of indications for CFTR mutation and IVS-8 poly(T) analyses. *Genetics in Medicine*. 6(5):400-404.

⁶⁸⁶ Andersson, H.C., Krousel-Wood, M.A., Jackson, K.E., Rice, J., and Lubin, I.M. (2002). Medical genetic test reporting for cystic fibrosis (deltaF508) and factor V Leiden in North American laboratories. *Genetics in Medicine* 4(5):324-327.

bolster a malpractice claim or defense. The tort system, however, may have less to do with breaching an appropriate standard of medical practice and more to do with disruption of the provider-patient relationship. In short, doctors with fewer medical errors but who have a poor bedside manner are more likely to be sued than doctors who maintain good provider-patient relationships but do not provide high-quality health care.^{687,688} Some authors even contend that the focus on malpractice may have a negative effect on efforts to reduce error and enhance safety.⁶⁸⁹

Another way that compliance to guidelines might be encouraged is through reimbursement mechanisms. The role of third-party payers will be explored in more detail below, but the emergence of “pay for performance” initiatives that tie reimbursement to compliance with evidence-based medical practice may elevate the role that guidelines could play in directing medical practice. Conceptually, this makes sense, but there is little empirical evidence at present to allow conclusions to be drawn regarding the impact of pay-for-performance on improvements in medical care.⁶⁹⁰ There are no studies in the literature that examine pay-for-performance in the context of genetic or genomic testing guidelines.

In conclusion, professional societies will continue to play a critical role in the development and maintenance of guidelines for appropriate use of genetic tests, but publication of these guidelines is insufficient to affect the use of tests in the clinical setting. Potential solutions to this dilemma are discussed below.

Role of Third-Party Payers

While payers are not traditionally considered to have a role in oversight, access to tests and interventions in the United States depends in part on whether insurers will pay for the test or intervention. Insurers make determinations regarding medical necessity (i.e., Will the test or intervention lead to benefit for the patient) and experimental/investigational status (i.e., Is there sufficient evidence in the literature to support a test or intervention as being a standard of care, or at least well-accepted in clinical practice). In addition, the definition of benefits explicitly states what the insurer will and will not cover. If a benefit excludes coverage of genetic tests (a situation that is encountered not infrequently), it does not matter whether the test is medically necessary and no longer investigational—it is not covered by the insurer. A full discussion of the implications of third-party reimbursement for genetic and genomic tests is outside the scope of this document and has been addressed in a separate report.⁶⁹¹

There is, however, one specific aspect that is relevant to address in this report. In order for third parties to make determinations of medical necessity and experimental/investigational status, it is necessary for them to perform technology assessments. Most of these groups lack specific genetic expertise. As a result,

⁶⁸⁷ Studdert, D.M., Thomas, E.J., Burstin, H.R., Zbar, B.I., Orav, E.J., and Brennan, T.A. (2000). Negligent care and malpractice claiming behavior in Utah and Colorado. *Medical Care*. 38(3):250-260.

⁶⁸⁸ Localio, A.R., Lawthers, A.G., Brennan, T.A., Laird, N.M., Hebert, L.E., Peterson, L.M., Newhouse, J.P., Weiler, P.C., and Hiatt, H.H. (1991). Relation between malpractice claims and adverse events due to negligence. Results of the Harvard Medical Practice Study III. *New England Journal of Medicine*. 325(4):245-251.

⁶⁸⁹ Pawlson, L.G. and O’Kane, M.E. (2004). Malpractice prevention, patient safety, and quality of care: a critical linkage. *American Journal of Managed Care*. 10(4):281-284.

⁶⁹⁰ Petersen, L.A., Woodard, L.D., Urech, T., Daw, C., and Sookanan, S. (2006). Does pay-for-performance improve the quality of health care? *Annals of Internal Medicine*. 145(4):265-272.

⁶⁹¹ Secretary’s Advisory Committee on Genetics, Health, and Society (2006). *Coverage and Reimbursement of Genetic Tests and Services*. See http://www4.od.nih.gov/oba/sacghs/reports/CR_report.pdf. Accessed on April 4, 2008.

assessment of new genetic tests is challenging.^{692,693} This is a critical issue, as it has been shown in this report that there is no current independent oversight of most genetic and genomic tests. This lack of expertise can potentially lead to harms, both from the denial of reimbursement for a test of proven clinical benefit and from access to a test of dubious utility. Ramsey et al. have proposed an evidence-based approach for payers to use when evaluating new tests.⁶⁹⁴ Gudgeon et al. have adapted CDC's ACCE model (from the four components of evaluation—Analytical validity, Clinical validity, Clinical utility, and associated Ethical, legal, and social implications) for use as a standardized way for payers and others to perform a rapid technology assessment of emerging genetic tests.^{695,696}

The barriers to gaining access to genetics professionals will most likely increase as genetic testing becomes more readily available for diagnosis, predictive testing, and pharmacogenomics. Strategies using the development of practice guidelines, new technology to provide services, and the training of primary care providers will be needed to increase access for families to accurate information before and after genetic testing.

Communication of Test Results

Electronic health records (EHRs) are increasingly promoted as a tool to improve the quality and consistency of patient care for two primary reasons:⁶⁹⁷ the dramatic increase in the amount and complexity of medical information and the recognition that a team approach to patient care results in better outcomes.⁶⁹⁸ Use of EHRs has been shown to be directly related to prevention of errors and improved care.^{699,700} It has also been shown that patients who understand their conditions and partner with their clinical practitioners in making health care decisions are better able to manage these illnesses. Use of a patient-centered health information system, sometimes referred to as a Personalized Health Record (PHR), has been shown to have a positive impact.⁷⁰¹ While much has been promised by the use of EHRs and PHRs, some authors debate how well the current evidence base supports the implementation of electronic records systems.⁷⁰² Moreover, implementation of EHR systems in the United States is slow. As of 2005, only 24 percent of physicians had

⁶⁹² Logue, L.J. (2003). Genetic testing coverage and reimbursement: a provider's dilemma. *Clinical Leadership & Management Review*. 17(6):346-350.

⁶⁹³ Gudgeon, J.M., McClain, M.R., Palomaki, G.E., and Williams, M.S. (2007). Rapid-ACCE: experience with a rapid and structured approach for evaluating gene-based testing. *Genetics in Medicine*. 9(7):473-478.

⁶⁹⁴ Ramsey, S.D., Veenstra, D.L., Garrison, L.P., Jr., Carlson, R., Billings, P., Carlson, J., and Sullivan, S.D. (2006). Toward evidence-based assessment for coverage and reimbursement of laboratory-based diagnostic and genetic tests. *American Journal of Managed Care*. 12(4):197-202.

⁶⁹⁵ Gudgeon, J.M., McClain, M.R., Palomaki, G.E., and Williams, M.S. (2007). Rapid-ACCE: experience with a rapid and structured approach for evaluating gene-based testing. *Genetics in Medicine*. 9(7):473-478.

⁶⁹⁶ Centers for Disease Control and Prevention Web site. "ACCE Model System for Collecting, Analyzing and Disseminating Information on Genetic Tests." See: <http://www.cdc.gov/genomics/gtesting/ACCE/fbr.htm>. Accessed on April 4, 2008.

⁶⁹⁷ Shortliffe, E.H. (1999). The evolution of electronic medical records. *Academic Medicine*. 74((4):414-419.

⁶⁹⁸ Dove, J.T. (2005). The electronic health record--the time is now. *American Heart Hospital Journal*. 3(3):193-200.

⁶⁹⁹ Balas, E.A. (2001). Information systems can prevent errors and improve quality. *Journal of the American Medical Informatics Association*. 8(4):398-399.

⁷⁰⁰ Miller, R.H. and Sim, I. (2004). Physicians' use of electronic medical records: barriers and solutions. *Health Affairs*. 23(2):116-126.

⁷⁰¹ Gustafson, D.H., Hawkins, R., Boberg, E., Pingree, S., Serlin, R.E., Graziano, F., and Chan, C.L. (1999). Impact of a patient-centered, computer-based health information/support system. *American Journal of Preventive Medicine*. 16(1):1-9.

⁷⁰² Clamp, S. and Keen, J. (2007). Electronic health records: is the evidence base any use? *Medical Informatics and the Internet in Medicine*. 32(1):5-10.

an EHR in the ambulatory setting and only 5 percent of hospitals were using computerized provider order entry (CPOE) systems.⁷⁰³

Role of Electronic Health Records

Recognition of the need for EHRs has led to a number of initiatives to promote their use. One of the four “leaps” in hospital quality and safety is implementation of CPOE systems.⁷⁰⁴ The Institute of Medicine of the National Academy of Sciences has identified information technology, including medical informatics, as a priority area of study to improve the quality of the U.S. health care system.⁷⁰⁵ Research in medical informatics is being sponsored by AHRQ.⁷⁰⁶ Other countries are also exploring national, integrated EHRs.⁷⁰⁷

The mounting evidence is enough so that in the United States, the HHS Secretary launched the American Health Information Community (AHIC).⁷⁰⁸ AHIC is a Federal advisory body, chartered in 2005, to make recommendations to the HHS Secretary on how to accelerate the development and adoption of health information technology (HIT) and help achieve President Bush’s goal for most Americans to have access to secure EHRs by 2014. There are 10 workgroups of AHIC, including the Personalized Medicine Workgroup (PMW) formed in October 2006. PMW is charged with determining how HIT can be used for the development of standards for interoperable integration of genomic test information into personal EHRs.

Personalized health care begins with HIT and the EHR. As the HHS Secretary stated at an AHIC meeting on September 12, 2006, “genomics will play an increasingly larger role in medicine, and now is the time to figure out how best to incorporate genetic information into e-health records, before multiple nonstandard approaches take hold.” Part of the proposed charge of PMW aims to “encourage the incorporation of interoperable, clinically useful genetic laboratory test data and analytical tools into electronic health records to support clinical decisionmaking for the health care provider and patient.” This charge has been broadened by the workgroup to include family history, given its importance in the ordering and interpretation of genetic and genomic tests.⁷⁰⁹ It seems clear that EHRs and informatic applications will be critical in realizing the maximal benefit from genetic and genomic tests. More recently, workgroups on clinical decision support and NBS have been added to PMW. PMW has identified numerous issues that affect these areas, including significant deficiencies in current disease (phenotype) and laboratory coding systems (particularly for molecular tests), lack of standardization of family history data, and identification of important elements related to screening.

⁷⁰³ Jha, A.K., Ferris, T.G., Donelan, K., DesRoches, C., Shields, A., Rosenbaum, S., and Blumenthal, D. (2006). How common are electronic health records in the United States? A summary of the evidence. *Health Affairs (Millwood)*. 25(6):w496-507.

⁷⁰⁴ The Leapfrog Group Web site. “The Leapfrog Group Fact Sheet.” See http://www.leapfroggroup.org/about_us/leapfrog-factsheet. Accessed on April 4, 2008.

⁷⁰⁵ Chassin, M., Galvin, R., and National Roundtable on Health Care Quality (1998). *Statement on Quality of Care—The Urgent Need to Improve Health Care Quality*. Institute of Medicine.

⁷⁰⁶ Agency for Healthcare Research and Quality (2002). *Medical Informatics for Better and Safer Health Care*. See <http://www.ahrq.gov/data/informatics/informatria.htm>. Accessed on April 4, 2008.

⁷⁰⁷ Alvarez, R. (2004). The electronic health record: a leap forward in patient safety. *Healthcare Papers*. 5(3):33-36.

⁷⁰⁸ Department of Health and Human Services, Health Information Technology Web site. “American Health Information Community.” See <http://www.hhs.gov/healthit/community/background/>. Accessed on April 4, 2008.

⁷⁰⁹ Department of Health and Human Services, Health Information Technology Web site. “Personalized Health Care Workgroup.” See http://www.hhs.gov/healthit/ahic/health_care/. Accessed on April 4, 2008.

Representation of Genetic and Genomic Test Results

Computerized systems that capture and deliver genetic test results to the provider can help detect procedural errors in the laboratory and reduce communication errors between the laboratory and provider. Eventually, the adoption of EHR systems can also help ensure that genetic test results are appropriately, consistently, and continuously utilized in the delivery of patient care. The EHR is significantly more than an electronic replacement for patient charts and printed reports. It is an interactive system in which transactions, such as medication orders, can be evaluated using context-specific algorithms to assess whether a decision is appropriate for a particular patient. Inappropriate decisions can be intercepted before a patient is harmed. EHR systems can also automatically identify and address gaps in patient data and enact activities that address these gaps. In the context of genetic testing, for example, an abnormal clotting result might trigger an automated order for a panel of genetic tests related to inherited clotting disorders, but it could also prevent the practitioner from ordering clotting protein levels, as these results are not informative in the context of an acute clotting event.⁷¹⁰

Three components of the EHR are particularly relevant for this discussion: the laboratory information system (LIS), the electronic chart, and the CPOE system. The LIS is utilized within the diagnostic laboratory to manage workflow, document results, and support the reporting (electronic or manual) of the results to the ordering provider. Much information captured in the LIS is not provided to the ordering clinician, such as details related to the extraction of nucleic acid from the patient specimen. Currently, most genetic test findings are stored in long textual reports and are thus of limited value to both clinical decision support systems and for queries.

Among the most common approaches to documenting genetic test findings is the use of off-the-shelf database systems or of an anatomic pathology reporting system. Some high-volume, low-complexity genetic test findings are captured using clinical pathology systems such as factor V Leiden results. Anatomic pathology and clinical pathology systems are generally capable of electronically transmitting the genetic test report to an electronic chart or generating a printed or faxed report. Some LIS suppliers now offer modules designed specifically to support the capture of discrete genetic test findings, optimized to support genetic testing workflow. At the present time, the challenge of representing genomic test results from multiplex platforms is unsolved for the most part. The impact on patient management of these deficiencies is unknown at present.

Results review has also been identified as a key issue in adoption of the EHR.⁷¹¹ Most EHR systems offer an electronic chart that provides a computer-viewable summary of clinically significant information about the patient. Electronic charts may present a variety of views to the clinician and combine the ability to view discrete results with the ability to open online versions of a clinical report. LIS systems and electronic charts can either be fully integrated, if developed by the same supplier, or be interfaced, generally using Health Language 7 (HL7) messages.⁷¹²

Electronic integration (whether direct or via an interface) is important, as it provides the means to synchronize updates or corrections in real time between the laboratory and the provider, a key safety

⁷¹⁰ Hoffman, M.A. (2007). The genome-enabled electronic medical record. *Journal of Biomedical Informatics*. 40(1):44-46.

⁷¹¹ Wilbright, W.A., Marier, R., Abrams, A., Smith, L., Tran, D., Thriffley, A., Jr., Butler, M.K., Rigamer, E., Williams, C., and Post, R. (2005). Building a results review system: a critical first step in transitioning from paper medical records. *American Medical Informatics Association Annual Symposium Proceedings*. 819-823.

⁷¹² Health Level Seven Web site. "HL7." See <http://www.hl7.org>. Accessed on April 4, 2008.

advantage over paper-based reporting methodologies. The degree to which current EHR systems are able to integrate genetic test results is unknown. It has been indicated, however, that this degree of functionality is absent from most commercial EHRs, which limits the ability to perform the safety functions inherent in supporting the highest quality of patient care. While some high-volume genetic referral laboratories with fully functional LISs that are HL7-enabled have been unable to integrate results into their own EHRs,⁷¹³ some other commercial products are able to present discrete genetic findings in an electronic chart, sending these test results from the LIS to the EHR.⁷¹⁴

In a CPOE system, discrete results integrated into an EHR allow for electronically captured clinical decisions to be evaluated. For example, medication orders may be evaluated using “if-then” logic based on a patient’s age, gender, known allergies, or genetic test results. A patient with a known variant of the *CYP2C9* gene may, by default, be treated with a different dose of warfarin than a patient with a “wild-type” *CYP2C9* genotype. The CPOE system can also be configured to prompt the ordering practitioner to provide pre-analytical information that is necessary for interpretation of the test result. Additionally, a CPOE system could prevent a practitioner from reordering a genetic test that had been performed previously, given that the result will not change over time. An internal survey at Intermountain Health Care (unpublished data) revealed a large number of duplicate tests for factor V Leiden were not necessary. The impact of CPOE systems to improve ordering of genetic tests has not been studied. It can also be seen that practitioners in different health systems will not have access to results, given the lack of interoperability of systems. This problem is certainly not limited to genetic test ordering and is one of several factors that led to the creation of AHIC.

Communication To Support Genetic Testing in the EHR

In its most basic iteration, the EHR can simply represent an electronic version of the paper medical record. While this approach has some advantages (e.g., access to appropriate health care workers without transporting a paper chart, improved ability to find information, lower risk of losing information), it does not support most of the goals outlined above. Representation of genetic and genomic test results as scanned images or free text does not address the critical issue of how to communicate these results effectively. Perhaps more important, an EHR that does not support transactions, such as the CPOE for laboratory tests, misses the opportunity to collect patient-specific information in the preanalytical phase, which is crucial for proper interpretation of the test result. Realizing the full potential of genetic and genomic tests requires the use of clinical decision support.

Role of the Personalized Health Record

PHRs are consumer-viewable versions of EHRs.⁷¹⁵ Generally utilized through either Web-based access or kiosks, the PHR allows consumers (patients) to conduct activities such as managing appointments, updating prescription refills, and viewing laboratory results. With respect to genetic test result findings, the last activity raises a number of process concerns:

⁷¹³ Mollie Ullman-Cullere, personal communication.

⁷¹⁴ Mark Hoffman, personal communication.

⁷¹⁵ Haux, R. (2006). Health information systems - past, present, future. *International Journal of Medical Informatics*. 75(3-4):268-281.

- PHR systems should be configurable to limit whether certain laboratory results, including genetic test results, can be viewed by the consumer until required transactions, such as a genetic counseling consultation, have occurred.
- PHR systems often integrate with general Web search capabilities. With respect to genetic testing, tools that promote the use of clinically appropriate requisitioning of genetic tests should be promoted.
- PHR systems are often based on groups determined by insurance coverage. Parents can often access laboratory results for their minor children. When a genetic test result is provided and that test has been performed for multiple family members, informed consumers may be able to draw conclusions about the paternity of their children.

There has been no systematic study of genetic test reporting in the PHR environment.

Another issue is the development of commercially operated, advertiser-supported PHRs. A consumer who consents to the compilation of his or her health information in a PHR not covered by HIPAA may not be protected against release of this information to other parties without permission. The Confidentiality, Privacy, and Security⁷¹⁶ and the PMW⁷¹⁷ Workgroups of AHIC are assessing privacy and genetic information issues related to PHRs, although the Consumer Empowerment Workgroup⁷¹⁸ is ultimately charged with the responsibility for PHRs.

Risk Stratification and Clinical Decision Support

As suggested above, a key part of the value of electronic capture and communication of genetic test results is the opportunity to apply automated algorithms to discrete data in order to evaluate the appropriateness of clinical processes for a patient. Discretely stored genetic test results can also be applied to algorithms that perform automatic risk stratification. For example, CF screening results can be combined with discrete documentation capturing patient response to questions about family history, ethnicity, and other information necessary to make a complete assessment of residual risk. These computations can be performed by the system, limiting the risk of human error or inconsistency in determining the risk assessment.

Clinical decision support provides value both within the care delivery setting (e.g., through recommending useful orders) or in the laboratory setting. The LIS can be configured to intercept and flag values that fall above or below expected reference ranges. For genetic testing, these automated capabilities can be very useful in flagging cases that require further review before delivering the results to the ordering physician, as discussed in more detail below.

As noted at the beginning of this chapter, clinical decision support refers broadly to providing clinicians and/or patients with clinical knowledge and patient-related information, intelligently filtered or presented at appropriate times, to enhance patient care.⁷¹⁹ Clinical decision support can be passive or active. Passive decision support occurs when a system facilitates access to relevant patient data or clinical knowledge

⁷¹⁶ Department of Health and Human Services, Health Information Technology Web site. “Confidentiality, Privacy & Security Workgroup.” See <http://www.hhs.gov/healthit/ahic/confidentiality/>. Accessed on April 4, 2008.

⁷¹⁷ Department of Health and Human Services, Health Information Technology Web site. “Personalized Health Care Workgroup.” See http://www.hhs.gov/healthit/ahic/health_care/. Accessed on April 4, 2008.

⁷¹⁸ Department of Health and Human Services, Health Information Technology Web site. “Consumer Empowerment Workgroup.” See <http://www.hhs.gov/healthit/ahic/consumer/>. Accessed on April 4, 2008.

⁷¹⁹ Adapted from Teich, J.M., Osheroff, J.A., Pifer, E.A., Sittig, D.F., and Jenders R.A. (2005). Clinical decision support in electronic prescribing: recommendations and an action plan: report of the joint clinical decision support workgroup. *Journal of the American Medical Informatics Association*. 12(4):365-376.

for interpretation by the physician, while active decision support implies a higher level of information processing or inference.⁷²⁰ In the traditional laboratory setting, a reference to the normal value ranges that accompany a laboratory report can be considered passive decision support, whereas calling the physician with a critical value on a result is active decision support (at its most simplistic).

To illustrate the difference, consider a patient presenting with an acute asthma attack. The patient is experiencing air hunger and has a respiratory rate of 50 breaths per minute with retractions and decreased air movement. A blood gas is obtained and the PaCO₂ is 40 mm Hg. Passive decision support provides a reference range for PaCO₂ of 35–45 mm Hg. The passive information tells the physician that the result is in the normal range. An experienced physician knows that even though the result is in the normal range, it is not normal for the clinical presentation. This patient is experiencing incipient respiratory failure. If this result were assumed to be normal by the physician, the gravity of the situation could be missed and the patient could suffer injury and death. In contrast, an active decision support system built for this scenario would use rules to capture relevant data about the diagnosis and patient parameters, so that when the result returned, it would generate an urgent message to the health care team indicating that the patient was at risk for respiratory failure and, depending on its sophistication, could suggest possible interventions.

Passive Decision Support

Preanalytical phase. An example of a passive decision support tool is an order sheet, whether paper or electronic, that requires the ordering practitioner to fill in certain data elements necessary to interpret the test. In the case of maternal serum screening, information would need to be provided about gestational age, diabetic status, single vs. multiple gestation, and maternal weight, so that the analyte values can be compared against the appropriate reference ranges. The quality of the information provided has a measurable impact on the performance of the test.⁷²¹ Patient-specific factors, such as ethnicity, have such a large impact on test interpretation that they are referenced in professional society guidelines for genetic testing of CF⁷²² and breast and ovarian cancer.⁷²³ The problem with this type of system is that if the practitioner does not have access to the form, does not complete all the information, or enters erroneous information, the test interpretation will be either delayed or inaccurate. Human intervention is required to catch and remedy the error. For example, if inaccurate data entry led to an interpretation of an increased risk for Down syndrome and the error were not caught, the patient would be offered an invasive diagnostic procedure (amniocentesis) with risk for pregnancy loss secondary to the procedure. To date, the degree to which the lack of collection of data in the pre-analytical phase affects interpretation of genetic test results has not been studied.

Postanalytical phase. One approach to improving the interpretation of the test result is to embed educational resources with the result. This approach gives practitioners access to relevant material with a single click without navigating away from the patient record. This “just-in-time” educational approach facilitates

⁷²⁰ Elson, R.B. and Connelly, D.P. (1995). Computerized decision support systems in primary care. *Primary Care*. 22(2):365-384.

⁷²¹ Benn, P.A., Borgida, A., Horne, D., Briganti, S., Collins, R., and Rodis, J.F. (1997). Down syndrome and neural tube defect screening: the value of using gestational age by ultrasonography. *American Journal of Obstetrics and Gynecology*. 176(5):1056-1061.

⁷²² Grody, W.W., Cutting, G.R., Klinger, K.W., Richards, C.S., Watson, M.S., and Desnick, R.J. (2001). Laboratory standards and guidelines for population-based cystic fibrosis carrier screening. *Genetics in Medicine*. 3(2):149-154. See http://www.acmg.net/AM/Template.cfm?Section=Policy_Statements&Template=/CM/ContentDisplay.cfm&ContentID=2480. Accessed on April 1, 2008.

⁷²³ American College of Medical Genetics (1996). *Statement on Population Screening for BRCA-1 Mutation in Ashkenazi Jewish Women*. See <http://www.acmg.net/StaticContent/StaticPages/Ashkenazi.pdf>. Accessed on April 4, 2008.

rapid access to context-specific material that can answer questions that arise. State NBS programs have used just-in-time education (through the use of information sheets and contact with professionals to aid in management) for primary care providers for decades with great success.⁷²⁴ Since most of the disorders detected are very rare, primary care providers appreciate the information when they have a patient who potentially has the disorder. With HRSA funding, ACMG and AAP have jointly developed “ACT sheets” for primary care providers to provide this type of just-in-time information for NBS.⁷²⁵ The ACT sheets were designed to be relatively easy to incorporate into EHR clinical decision support, and some initial work on this effort is under way. In addition, the AAP Newborn Screening Authoring Committee, in its recent publication on expanded NBS, has published recommendations in the form of algorithms that have the potential to be translated into a computerizable form that would facilitate incorporation into clinical decision support systems.⁷²⁶ There is some evidence to suggest that embedded educational resources may be the most effective way to promote the practice of evidence-based medicine.⁷²⁷ Just-in-time patient education has also been shown to be effective even for patients with low literacy facing complex medical issues.⁷²⁸

For State NBS programs, just-in-time patient education has been used quite successfully. HRSA has funded several projects over the past several decades to develop just-in-time patient education that is culturally competent and community-based.^{729,730,731} Sickle cell disease/trait is an example of an area that has extensive patient educational materials.⁷³² Just-in-time education has been used to deliver information on genetics and genomics at the point of care for practitioners and patients^{733,734,735} including one project specifically focused

⁷²⁴ For example, California Newborn Screening Program. GeneHelp Resource Center. See <http://www.dhs.ca.gov/pcfh/gdb/html/NBS/GeneHelpResCenter.htm>. Accessed on April 4, 2008.

⁷²⁵ American College of Medical Genetics Web site. “Newborn Screening ACT Sheets and Confirmatory Algorithms.” See <http://www.acmg.net/resources/policies/ACT/condition-analyte-links.htm>. Accessed on April 4, 2008.

⁷²⁶ Newborn screening expands: recommendations for pediatricians and medical homes—implications for the system. (2008). *Pediatrics*. 121(1):192-217.

⁷²⁷ Slawson, D.C. and Shaughnessy, A.F. (2005). Teaching evidence-based medicine: should we be teaching information management instead? *Academic Medicine*. 80(7):685-689.

⁷²⁸ Jibaja-Weiss, M.L., Volk, R.J., Friedman, L.C., Granchi, T.S., Neff, N.E., Spann, S.J., Robinson, E.K., Aoki, N., Robert Beck, J. (2006). Preliminary testing of a just-in-time, user-defined values clarification exercise to aid lower literate women in making informed breast cancer treatment decisions. *Health Expectations*. 9(3):218-231.

⁷²⁹ Department of Health and Human Services News Brief, “HRSA Awards \$1.9 Million to Improve Treatment of Sickle Cell Disease.” See <http://newsroom.hrsa.gov/NewsBriefs/2006/sickle-cell-treatment.htm>. Accessed on April 4, 2008.

⁷³⁰ Department of Health and Human Services News Brief, “HRSA Awards More Than \$4.4 Million in Grants to Enhance Services for Newborns with Sickle Cell Disease and Improve Women’s Health.” See <http://newsroom.hrsa.gov/releases/2002releases/sicklecell.htm>. Accessed on April 4, 2008.

⁷³¹ Department of Health and Human Services News Brief, “HRSA Awards \$3.6 Million to Improve State Sickle Cell Disease and Newborn Screening Programs.” See <http://newsroom.hrsa.gov/releases/2003/sicklecell.htm>. Accessed on April 4, 2008.

⁷³² For example, American College of Medical Genetics, *Newborn Screening ACT Sheet: Sickle Cell Anemia*. See http://www.acmg.net/resources/policies/ACT/ACT-sheet_HBSC_FSC_4-18-06.pdf. Accessed on April 4, 2008.

⁷³³ Green, M.J., Peterson, S.K., Baker, M.W., Harper, G.R., Friedman, L.C., Rubinstein, W.S., and Mauger, D.T. (2004). Effect of a computer-based decision aid on knowledge, perceptions, and intentions about genetic testing for breast cancer susceptibility: a randomized controlled trial. *Journal of the American Medical Association*. 292(4):442-452.

⁷³⁴ Kaihoi, B., Petersen, C., and Bolander, M.E. (2005). Providing “just-in-time” medical genomics information for patient care. *American Medical Informatics Association Annual Symposium Proceedings*. 1003.

⁷³⁵ Del Fiol, G., Williams, M.S., Maram, N., Rocha, R.A., Wood, G.M., and Mitchell, J.A. (2006). Integrating genetic information resources with an EHR. *American Medical Informatics Association Annual Symposium Proceedings*. 904.

on education relevant to genetic test results.⁷³⁶ The latter study found that nearly half of the respondents were unfamiliar with some aspect of the result report. They confirmed the usefulness of the program as an educational tool at the point of care. At present, most EHRs do not support this capability, which could lead to suboptimal care.

Active Decision Support

Preanalytical phase. The concept of active decision support in the laboratory to support collection of preanalytical information and assist in test interpretation dates to the late 1970s, with extant examples presented in the literature as early as 1982.⁷³⁷ Even then, the main limitation identified was the lack of key clinical information.⁷³⁸ This limitation not only hindered interpretation of the ordered test result, it missed the opportunity to suggest a more appropriate test to answer the clinical question for which the test was actually ordered. This problem has been recognized even with tests for common disorders.⁷³⁹ This variability seems to be related to individual physician characteristics.⁷⁴⁰ These results led to the conclusion that if electronic knowledge support could be applied during the ordering phase of testing, one could influence use, optimize test ordering, and gain the critical clinical information needed to enhance test interpretation.⁷⁴¹

While the development of expert systems is complex, it has been demonstrated that even with common clinical conditions and tests, implementation of a system can decrease the cost of testing while improving the diagnostic accuracy.^{742,743} The complexity and frequent requirement for patient information in the preanalytical phase in order to interpret the results of a genetic test have led to calls for closer relationships among clinicians, patients, and laboratories.⁷⁴⁴ Despite the demonstration of the role that active decision support can play to solve this issue, there are no published examples of active clinical decision support being implemented in the preanalytical phase, although an operating example of a CPOE system that supports genomic testing for neuropsychiatric medications at Cincinnati Children's Hospital was presented at the 2007 NCHPEG meeting.⁷⁴⁵ This gap has been noted by the Collaboration, Education, and Test Translation (CETT) program. A 2007 presentation by Lisa Forman outlined the challenges of collecting patient data and

⁷³⁶ Goos, L.M., Silverman, I., Steele, L., Stockley, T., and Ray, P.N. (2004). Providing information at the point of care: educational diagnostic reports from a genetic testing service provider. *Clinical Leadership & Management Review*. 18(1):11-24.

⁷³⁷ McNeely, M.D. (2002). The use of expert systems for improving test use and enhancing the accuracy of diagnosis. *Clinics in Laboratory Medicine*. 22:515-528.

⁷³⁸ McNeely, M.D. (2002). The use of expert systems for improving test use and enhancing the accuracy of diagnosis. *Clinics in Laboratory Medicine*. 22(2):515-528.

⁷³⁹ van Walraven, C. and Naylor, C.D. (1998). Do we know what inappropriate laboratory utilization is? A systematic review of laboratory clinical audits. *Journal of the American Medical Association*. 280(6):550-558.

⁷⁴⁰ Malcolm, L., Wright, L., Seers, M., Davies, L., and Guthrie, J. (2000). Laboratory expenditure in Pegasus Medical Group: a comparison of high and low users of laboratory tests with academics. *New Zealand Medical Journal*. 113(1105):79-81.

⁷⁴¹ McNeely, M.D. (2002). The use of expert systems for improving test use and enhancing the accuracy of diagnosis. *Clinics in Laboratory Medicine*. 22(2):515-528.

⁷⁴² Smith, B.J. and McNeely, M.D. (1999). The influence of an expert system for test ordering and interpretation on laboratory investigations. *Clinical Chemistry*. 45(8 Pt 1):1168-1175.

⁷⁴³ van Wijk, M.A., van der Lei, J., Mosseveld, M., Bohnen, A.M., and van Bommel, J.H. (2001). Assessment of decision support for blood test ordering in primary care. A randomized trial. *Annals of Internal Medicine*. 134(4):274-281.

⁷⁴⁴ Quillin, J.M., Jackson-Cook, C., and Bodurtha, J. (2003). The link between providers and patients: how laboratories can ensure quality results with genetic testing. *Clinical Leadership & Management Review*. 17(6):351-357.

⁷⁴⁵ Glauser, T. (2007). See http://www.nchpeg.org/downloads/annual_mtg_2007_agenda.doc. Accessed on April 4, 2008.

linking these data with the test sample and result,⁷⁴⁶ which could harm patient well-being and waste scarce medical resources on inappropriate or duplicate tests. McPherson presents several genetic testing scenarios that illustrate these concepts.⁷⁴⁷ This problem, however, has not been systematically studied at present.

Postanalytical phase. As noted above, there is ample documentation of the challenges faced by practitioners who attempt to interpret the results of genetic tests with resultant negative impacts on patient care. As with the preanalytical phase, the proposed solution at the present time is to produce clearer written reports, supplemented by having genetics professionals associated with the laboratory available for consultation.^{748,749} In the laboratory setting, there is evidence that active decision support can facilitate appropriate interpretation of results.^{750,751,752} Again, there are no published examples of such a system being used to facilitate the interpretation by the clinician of genetic or genomic tests. The Couma-Gen trial used an algorithm to combine patient characteristics such as age, gender, weight, and medications with genomic data to determine the starting dose of coumadin for patients initiating anticoagulation.⁷⁵³ While the results of the trial are still being analyzed, the active decision support algorithm that supplied the dose to the doctor of pharmacy performed well and was well accepted by the practitioners. The necessary components of a system, including whether it should reside in the EHR or the LIS, as well as factors that are necessary to maximize acceptance and use by clinicians, remain to be elucidated. The role, and indeed the question of whether there should be a role, for the PHR in active decision support for interpretation of test results is unknown.

One additional point with regard to the EHR needs to be addressed. This issue involves how the capture of outcomes data can improve knowledge and ultimately improve the care of patients. In a study by van Wijk et al.,⁷⁵⁴ the authors noted that 61 percent of practitioners were not in compliance with the expert system's recommendation. In nearly two-thirds of these cases, there were deficiencies in the underlying guidelines. Capture of the noncompliant orders led to improvement in construction of the guideline. This issue is critically important in the case of genetic and genomic tests, where complete knowledge is rarely present at the time of test introduction. The CETT program's data collection process is designed to capture

⁷⁴⁶ Collaboration Education and Test Translation Program (2007). See http://www.cettprogram.org/documents/CETT_Meeting_Database_NCBI_March_2007.pdf. Accessed on April 4, 2008.

⁷⁴⁷ McPherson, E. (2006). Genetic diagnosis and testing in clinical practice. *Clinical Medicine & Research*. 4(2):123-129.

⁷⁴⁸ McGovern, M.M., Benach, M., and Zinberg, R. (2003). Interaction of genetic counselors with molecular genetic testing laboratories: implications for non-geneticist health care providers. *American Journal of Medical Genetics Part A*. 119(3):297-301.

⁷⁴⁹ Quillin, J.M., Jackson-Cook, C., and Bodurtha, J. (2003). The link between providers and patients: how laboratories can ensure quality results with genetic testing. *Clinical Leadership & Management Review*. 17(6):351-357.

⁷⁵⁰ Van Lente, F., Castellani, W., Chou, D., Matzen, R.N., and Galen, R.S. (1986). Application of the EXPERT consultation system to accelerated laboratory testing and interpretation. *Clinical Chemistry*. 32(9):1719-1725.

⁷⁵¹ Trendelenburg, C., Colhoun, O., Wormek, A., and Massey, K.L. (1998). Knowledge-based test result in interpretation in laboratory medicine. *Clinica Chimica Acta*. 278(2):229-242.

⁷⁵² Smith, B.J. and McNeely, M.D. (1999). The influence of an expert system for test ordering and interpretation on laboratory investigations. *Clinical Chemistry*. 45(8 Pt 1):1168-1175.

⁷⁵³ ClinicalTrials.gov Web site. "A Pharmacogenetic Study of Warfarin Dosing, 'The COUMA-GEN Study'." See <http://clinicaltrials.gov/ct/show/NCT00334464;jsessionid=1B6C6035A24A8C808FCAF2C58E9952B1?order=39>. Accessed on April 3, 2008.

⁷⁵⁴ van Wijk, M.A., van der Lei, J., Mosseveld, M., Bohnen, A.M., and van Bommel, J.H. (2001). Assessment of decision support for blood test ordering in primary care. A randomized trial. *Annals of Internal Medicine*. 134(4):274-281.

information that can be used to increase knowledge about ultra rare genetic disorders.⁷⁵⁵ Several genetic referral laboratories routinely store variants of unknown significance and periodically reevaluate these in light of new knowledge and increased experience.⁷⁵⁶

HRSA is currently funding the development of model data structures and electronic systems to collect long-term followup data on children who have disorders detected via newborn screening.⁷⁵⁷ This type of research would not be possible without electronic systems. How to implement such a system, where the data should be kept, who should access to the data, and under what circumstances it should be used are problems that await a solution. The lack of such systems could delay integration of new knowledge into clinical care, resulting in harm to patients. Recognition of these problems has led to the establishment of two programs within the AHRQ: Centers for Education and Research on Therapeutics⁷⁵⁸ and Developing Evidence to Inform Decision on Effectiveness.⁷⁵⁹ For a more complete discussion of the potential value of this type of system in health care (although not specific to genetic applications), see Detmer 2003 or Etheredge 2007.^{760,761}

Finally, FDA's revised draft guidance on IVDMIAs has implications for regulation and oversight of clinical decision support.⁷⁶² The guidance defines an IVDMIA as a device that:

- Combines the values of multiple variables using an interpretation function to yield a single, patient-specific result (e.g., “classification,” “score,” “index,”), that is intended for use in the diagnosis of disease or other conditions, or in the cure, mitigation, treatment, or prevention of disease
- Provides a result whose derivation is nontransparent and cannot be independently derived or verified by the end user

Specific examples are used to illustrate what FDA considers to be within and outside the scope of its definition. As discussed in Chapter IV, FDA considers “a device that integrates a patient’s age, gender, and genotype of multiple genes to predict risk of or diagnose a disease or condition” as an IVDMIA subject to its regulation. The pharmacogenomic dosing of warfarin could fall under this regulation if FDA interprets this method as predicting risk or diagnosing a condition. To further complicate the issue, however, FDA

⁷⁵⁵ Collaboration Education and Test Translation Program (2007). See http://www.cettprogram.org/documents/CETT_Meeting_Database_NCBI_March_2007.pdf. Accessed on April 4, 2008.

⁷⁵⁶ Chenevix-Trench, G., Healey, S., Lakhani, S., Waring, P., Cummings, M., Brinkworth, R., Deffenbaugh, A.M., Burbidge, L.A., Pruss, D., Judkins, T., Scholl, T., Bekessy, A., Marsh, A., Lovelock, P., Wong, M., Tesoriero, A., Renard, H., Southey, M., Hopper, J.L., Yannoukakos, K., Brown, M., Easton, D., Tavtigian, S.V., Goldgar, D., and Spurdle, A.B. (2006). Genetic and histopathologic evaluation of BRCA1 and BRCA2 DNA sequence variants of unknown clinical significance. *Cancer Research*. 66(4):2019-27.

⁷⁵⁷ Health Resources and Services Administration, Maternal and Child Health Bureau. Minutes of Meeting of the Advisory Committee on Heritable Disorders and Genetic Diseases in Newborns and Children, May 17-18, 2007. See http://mchb.hrsa.gov/programs/genetics/committee/final-10th-minutes.htm#_Toc168809630. Accessed on April 4, 2008.

⁷⁵⁸ Agency for Healthcare Research and Quality Web site. “Centers for Education and Research on Therapeutics.” See <http://www.ahrq.gov/clinic/certsovr.htm>. Accessed on April 4, 2008.

⁷⁵⁹ Agency for Healthcare Research and Quality Web site. “Developing Evidence to Inform Decision on Effectiveness.” See <http://effectivehealthcare.ahrq.gov/aboutUs/index.cfm>. Accessed on April 4, 2008.

⁷⁶⁰ Detmer, D.E. (2003). Building the national health information infrastructure for personal health, health care services, public health, and research. *BMC Medical Informatics and Decisionmaking*. 3:1.

⁷⁶¹ Etheredge, L.M. (2007). A rapid-learning health system. *Health Affairs (Millwood)*. 26(2):w107-118.

⁷⁶² Food and Drug Administration. *Draft Guidance for Industry, Clinical Laboratories, and FDA Staff - In Vitro Diagnostic Multivariate Index Assays*. See <http://www.fda.gov/cdrh/oivd/guidance/1610.html>. Accessed on April 4, 2008.

outlines that clinical decision support tools that analyze stored clinical information to create disease registries, summarize patient-specific information in an integrated report, and/or track a patient's treatment or disease outcome “[do] not represent a unique interpretation function but rather summarizes standard interpretation of individual variables that clinicians could do themselves.”

In the case of warfarin dosing, if a clinician uses an available dosing algorithm that incorporates the results of the *CYP2C9* and *VKORC1* tests done by a referral laboratory with clinical information supplied by the clinician, it is unclear whether it would be considered an IVDMIA and subject to regulation as a device. Presumably, if all these functions were integrated within the testing laboratory and a warfarin dose were returned to the clinician as a result, this would clearly meet the definition of an IVDMIA. At what point, however, does the assembly of disparate information within an EHR, independent of the testing laboratory, constitute an IVDMIA? Harm could potentially result from overzealous application of regulation, by inhibiting the development and implementation of clinical decision support needed to empower clinicians to use the results of genetic tests. On the other hand, potential harm could also result from insufficient scrutiny of devices whose safety, effectiveness, and clinical utility are not well understood, leading to inappropriate application of the test in a clinical setting.

The prevailing standard is the use of Arden syntax,⁷⁶³ a formalized representation of clinical decision support logic modules. Often, clinical decision support logic is deployed as a local configuration within the EHR system and is not generally considered to be new software development. An analogy is the use of macros within a commercial spreadsheet system—all users of the system are free to implement local macros that satisfy their particular goals. Often provider organizations that implement local clinical decision support logic create a local review committee that approves the clinical logic and confirms that appropriate validation of the clinical decision support system has been performed. While FDA provides general guidance on the validation of clinical software,⁷⁶⁴ there are no known guidelines describing a formal process for the adoption and validation of local clinical decision support configurations.

Communicating Genetic Test Results: Implications for the Consumer

Patients and families need accurate, accessible, and complete information about genetic tests in order to make informed health care decisions. (For purposes of readability, all subsequent references to “patient” include the concept of “relevant family members.”) Three factors make the availability of high-quality information about testing particularly important. First, patients are taking a greater interest in and responsibility for managing their health care. Second, as discussed above, primary care providers may not have sufficient training or expertise to offer high-quality genetic testing information and services. Third, the increasing marketing and sale of genetic tests directly to consumers mean that testing services can be contacted by patients themselves without the involvement of a health care provider.

There is a rich and extensive history of social science research on the public's attitudes toward genetic research, the clinical application of genetics and genetic testing, and the social and policy issues emerging from advances in our understanding of the human genome. Numerous studies have also detailed patient understanding, patient preferences, and the information and support needs of specific patient populations. These studies have been undertaken to inform the design of research studies and clinical practices. For

⁷⁶³ Arden Syntax Web site. “Mission” and “Charter.” See <http://www.hl7.org/Special/committees/Arden/index.cfm#Mission>. Accessed on April 4, 2008.

⁷⁶⁴ Food and Drug Administration (2002). *General Principles of Software Validation; Final Guidance for Industry and FDA Staff*. See <http://www.fda.gov/cdrh/comp/guidance/938.html>. Accessed on April 4, 2008.

example, researchers have sought to understand attitudes toward genetic testing, factors that affect perceptions of risk, decisionmaking of at-risk and healthy individuals about whether to obtain a specific genetic test,^{765,766,767,768,769,770,771,772,773} models of informed consent,^{774,775,776,777} modes of education and communication,⁷⁷⁸ the psychological impact of testing,^{779,780,781,782,783} and the like. Some of these studies

⁷⁶⁵ Metcalfe, K., Liede, A., Hoodfar, E., Scott, A., Foulkes, W.D., and Narod, S.A. (2000). An evaluation of needs of female BRCA1 and BRCA2 carriers undergoing genetic counseling. *Journal of Medical Genetics*. 37(1):866-874.

⁷⁶⁶ Eccles, D.M., Evans, D.G., and Mackay, J. (2000). Guidelines for a genetic risk-based approach to advising women with a family history of breast cancer. UK Cancer Family Study Group (UKCFSG). *Journal of Medical Genetics*. 37(3):203-209.

⁷⁶⁷ Vernon, S.W., Gritz, E.R., Peterson, S.K., Perz, C.A., Marani, S., Amos, C.I., and Baile, W.F. (1999). Intention to learn results of genetic testing for hereditary colon cancer. *Cancer Epidemiology, Biomarkers, and Prevention*. 8(4 Pt 2):353-360.

⁷⁶⁸ Codori, A.M., Petersen, G.M., Miglioretti, D.L., Larkin, E.K., Bushey, M.T., Young, C., Brensinger, J.D., Johnson, K., Bacon, J.A., and Booker, S.V. (1999). Attitudes toward colon cancer gene testing: factors predicting test uptake. *Cancer Epidemiology, Biomarkers, and Prevention*. 8(4 Pt 2):345-351.

⁷⁶⁹ Lerman, C., Seay, J., Balshem, A., and Audrain, J. (1995). Interest in genetic testing among first-degree relatives of breast cancer patients. *American Journal of Medical Genetics*. 57(3):385-392.

⁷⁷⁰ Holloway, S.M., Porteous, M.E., Fitzpatrick, D.R., Crosbie, A.E., Cetnarskyj, R., Warner, J., and Barron, L. (1998). Presymptomatic testing for Huntington's disease by linkage and by direct mutation analysis: comparison of uptake of testing and characteristics of test applicants. *Genetic Counseling*. 9(2):103-111.

⁷⁷¹ Trippitelli, C.L., Jamison, K.R., Folstein, M.F., Bartko, J.J., and DePaulo, J.R. (1998). Pilot study on patients' and spouses' attitudes toward potential genetic testing for bipolar disorder. *American Journal of Psychiatry*. 155(7):899-904.

⁷⁷² Tambor, E.S., Rimer, B.K., and Strigo, T.S. (1997). Genetic testing for breast cancer susceptibility: awareness and interest among women in the general population. *American Journal of Medical Genetics*. 68(1):43-49.

⁷⁷³ Quaid, K.A. and Morris, M. (1993). Reluctance to undergo predictive testing: the case of Huntington disease. *American Journal of Medical Genetics*. 45(1):41-45.

⁷⁷⁴ Bernhardt, B.A., Geller, G., Strauss, M., Helzlsouer, K.J., Stefanek, M., Wilcox, P.M., and Holtzman, N.A. (1997). Toward a model informed consent process for BRCA1 testing: a qualitative assessment of women's attitudes. *Journal of Genetic Counseling*. 6(2):207-222.

⁷⁷⁵ Geller, G., Botkin, J.R., Green, M.J., Press, N., Biesecker, B.B., Wilfond, B., Grana, G., Daly, M.B., Schneider, K., and Kahn, M.J. (1997). Genetic testing for susceptibility to adult-onset cancer. The process and content of informed consent. *Journal of the American Medical Association*. 277(18):1467-1474.

⁷⁷⁶ Geller, G., Strauss, M., Bernhardt, B.A., and Holtzman, N.A. (1997). "Decoding" informed consent. Insights from women regarding breast cancer susceptibility testing. *Hastings Center Report*. 27(2):28-33.

⁷⁷⁷ Andrews, L.B. (1997). Compromised consent: deficiencies in the consent process for genetic testing. *Journal of the American Medical Women's Association*. 52(1):39-42, 44.

⁷⁷⁸ Green, M.J. and Fost, N. (1997). An interactive computer program for educating and counseling patients about genetic susceptibility to breast cancer. *Journal of Cancer Education*. 12(4):204-208.

⁷⁷⁹ Lerman, C., Hughes, C., Lemon, S.J., Main, D., Snyder, C., Durham, C., Narod, S., and Lynch, H.T. (1998). What you don't know can hurt you: adverse psychologic effects in members of BRCA1-linked and BRCA2-linked families who decline genetic testing. *Journal of Clinical Oncology*. 16(5):1650-1654.

⁷⁸⁰ Audrain, J., Schwartz, M.D., Lerman, C., Hughes, C., Peshkin, B.N., and Biesecker, B. (1997). Psychological distress in women seeking genetic counseling for breast-ovarian cancer risk: the contributions of personality and appraisal. *Annals of Behavioral Medicine*. 19(4):370-377.

⁷⁸¹ Croyle, R.T. and Lerman, C. (1993). Interest in genetic testing for colon cancer susceptibility: cognitive and emotional correlates. *Prevention Medicine*. 22(2):284-292.

⁷⁸² Codori, A.M. (1997). Psychological opportunities and hazards in predictive genetic testing for cancer risk. *Gastroenterology Clinics of North America*. 26(1):19-39.

⁷⁸³ Codori, A.M., Slavney, P.R., Young, C., Miglioretti, D.L., and Brandt, J. (1997). Predictors of psychological adjustment to genetic testing for Huntington's disease. *Health Psychology*. 16(1):36-50.

focused on racial and ethnic differences in attitudes toward uptake and impacts of genetic testing or participation in genetics research.^{784,785,786,787,788,789,790}

There are a number of publicly available sources of information and support about genetic conditions and genetic testing,^{791,792,793,794,795} as well as informational materials provided by individual clinics, State programs, disease-specific support groups, and laboratories. Not all of these resources are designed to provide information at the patient level. In addition, a motivated patient would encounter difficulties in accessing and understanding relevant articles in the medical literature because many are available only with a subscription and the articles themselves use highly technical language and complex statistical analyses. Some patient and professional groups are now advocating open access to these resources. As an example, the Genetic Alliance has established The National Consumer Center for Genetics Resources and Services funded by a cooperative agreement with the HRSA MCHB Genetic Services Branch.⁷⁹⁶ The major purpose of this 5-year, \$500,000 annual special project is to mitigate the substantial information and resource deficit for consumers of genetic services. Even if there were appropriate materials developed, not all consumers would have access to them, as many households do not have Internet access, and publicly accessible locations, such as public libraries, may not have adequate resources to support the demand for information, particularly in disadvantaged areas.

Various studies have assessed the accuracy, completeness, and readability of patient information about genetic tests. For example, a study of materials on the genetic risk of breast cancer found that the images and text were not sufficiently clear.⁷⁹⁷ Another study of educational materials about genetic testing found

⁷⁸⁴ Mittman, I.S. and Secundy, M.G. (1998). A national dialogue on genetics and minority issues. *Community Genetics*. 1(3):190-200.

⁷⁸⁵ Duran, D.G. (1998). Lack of Hispanics' involvement in research—is it Hispanics or scientists? *Community Genetics*. 1(3):183-189.

⁷⁸⁶ Jaeger, A.S., Goode, E.L., and Boyle, J.M. (1997). Attitudes and opinions towards genetic testing among US Hispanics. *American Journal of Human Genetics*. 61(4):A221.

⁷⁸⁷ Durfy, S.J., Bowen, D.J., McTiernan, A., Sporleder, J., and Burke, W. (1999). Attitudes and interest in genetic testing for breast and ovarian cancer susceptibility in diverse groups of women in western Washington. *Cancer Epidemiology, Biomarkers, and Prevention*. 8(4 Pt 2):369-375.

⁷⁸⁸ Lerman, C., Hughes, C., Benkendorf, J.L., Biesecker, B., Kerner, J., Willison, J., Eads, N., Hadley, D., and Lynch, J. (1999). Racial differences in testing motivation and psychological distress following pretest education for BRCA1 gene testing. *Cancer Epidemiology, Biomarkers, and Prevention*. 8(4 Pt 2):361-367.

⁷⁸⁹ Glanz, K., Grove, J., Lerman, C., Gotay, C., and Le Marchand, L. (1999). Correlates of intentions to obtain genetic counseling and colorectal cancer gene testing among at-risk relatives from three ethnic groups. *Cancer Epidemiology, Biomarkers, and Prevention*. 8(4 Pt 2):329-336.

⁷⁹⁰ Hughes, C., Gomez-Camirero, A., Benkendorf, J., Kerner, J., Isaacs, C., Barter, J., and Lerman, C. (1997). Ethnic differences in knowledge and attitudes about BRCA1 testing in women at increased risk. *Patient Education and Counseling*. 32(1-2):51-62.

⁷⁹¹ National Center for Biotechnology Information Web site. "OMIM - Online Mendelian Inheritance in Man." See <http://www.ncbi.nlm.nih.gov/sites/entrez?db=OMIM>. Accessed on April 4, 2008.

⁷⁹² GeneTests Web site. See <http://www.genetests.org/>. Accessed on April 4, 2008.

⁷⁹³ Genetics Home Reference. See <http://ghr.nlm.nih.gov/>. Accessed on June 25, 2007.

⁷⁹⁴ Genetic Alliance Web site. See <http://www.geneticalliance.org/>. Accessed on April 4, 2008.

⁷⁹⁵ National Organization of Rare Disorders (NORD) Web site. See <http://www.rarediseases.org/>. Accessed on April 4, 2008.

⁷⁹⁶ Genetic Alliance Web site. "Genetic Alliance Establishes the National Consumer Center for Genetics Resources and Services." See http://geneticalliance.org/ws_display.asp?filter=national.consumer.center.press.release. Accessed on April 4, 2008.

⁷⁹⁷ Thompson, H.S., Wahl, E., Fatone, A., Brown, K., Kwate, N.O., and Valdimarsdottir, H. (2004). Enhancing the readability of materials describing genetic risk for breast cancer. *Cancer Control*. 11(4):245-253.

that most materials did not contain essential information about the purpose or accuracy of the test.⁷⁹⁸ In addition, materials frequently fail to discuss the social and psychological implications of testing.

Several efforts to develop and assess genetic testing information materials have identified key issues about testing that should be included in patient materials.⁷⁹⁹ A study in Europe⁸⁰⁰ used the following key issues in evaluating informational materials about genetic testing and found substantial omissions in the materials reviewed:

- Background and effect of condition
- Treatment and management
- Heredity and risk
- Patient rights
- Type of test
- Accuracy of test
- What happens after the test
- Shared decisionmaking
- Psychosocial consequences
- Consequences for family members
- Benefits and risks
- Date and sources
- Additional support and information

An earlier study in the United States concluded that most materials did not contain basic information about the purpose or accuracy of the test.

When discussing the role of the consumer in genetic testing, the focus has generally been on either patients/families/disease-specific support groups or the general public. If these two “communities” are considered as the ends of a spectrum, it is clear that there may be other self-identified communities that reside between these two ends. These could include racial/ethnic communities, culturally defined groups, and those with disabilities. Some work has been done to define some of these communities and explore their attitudes and beliefs about genetics.

Ethnic, racial, and cultural minorities, many of whom are new immigrants, face the greatest barriers to understanding pregenetic and postgenetic testing information. Many studies already document the language, cultural, and socioeconomic barriers that prevent these minority populations from getting access to and

⁷⁹⁸ Cho, M.K., Arruda, M., and Hotlzman, N.A. (1997). Education material about genetic tests: does it provide key information for patients and practitioners? *American Journal of Medical Genetics*. 73(3):314-320.

⁷⁹⁹ Shepperd, S., Farndon, P., Grainge, V., Oliver, S., Parker, M., Perera, R., Bedford, H., Elliman, D., Kent, A., and Rose, P. (2006). DISCERN-Genetics: quality criteria for information on genetic testing. *European Journal of Human Genetics*. 14(11):1179-1188.

⁸⁰⁰ Lewis, C., Mehta, P., Kent, A., Skirton, H., and Coviello, D. (2007). An assessment of written patient information provided at the genetic clinic and relating to genetic testing in seven European countries. *European Journal of Human Genetics*. 15(10):1012-1022.

using health care information and services.^{801,802,803,804,805,806,807,808,809,810,811} The greatest barrier for minority populations has been universally identified as the lack of English proficiency. According to the 2000 U.S. Census data, over 50 percent of Hispanics, Chinese, and Vietnamese do not speak English.⁸¹² The lack of English proficiency and the other documented barriers to gaining access to and understanding basic health care information does not bode well for minority populations' ability to take advantage of the complexities of genetic test results to improve health outcomes.

Qureshi and Kai reviewed the literature to assess the use of genomic medicine for minority populations. They found that effective communication with appropriate translations and interpretations in the context of the ethnic, racial, or cultural groups was the biggest challenge facing the introduction of genomic medicine to minority groups.⁸¹³ The importance of appropriate translation of health information was also reported by Ngo-Metzger et al.⁸¹⁴ The Ngo-Metzger group conducted focus groups in Boston with Chinese and Vietnamese patients with limited English skills to assess their general health care information needs. The patients reported that the use of professional interpreters who are gender-concordant, rather than family members, was very important to them. Given that genetic information may affect the family member who is translating the information, Qureshi and Kai also found that the use of professional interpreters to help non-English-speaking minority patients should be the preferred practice by health care providers if the provider cannot communicate in the patient's language.⁸¹⁵

⁸⁰¹ Yu, S.M., Huang, Z.J., Schwalberg, R.H., and Nyman, R.M. (2006). Parental English proficiency and children's health services access. *American Journal of Public Health*. 96(8):1449-1455.

⁸⁰² Davidson, J.A., Moreno, P.R., Badimon, J.J., Lopez-Candales, A., Maisonet Giachello, A.L., Ovalle, F., Rodriguez, C.J., Rosenson, R.S., Rodbard, H.W., and Kannel, W.B. (2007). Cardiovascular disease prevention and care in Latino and Hispanic subjects. *Endocrine Practice*. 13(1):77-85.

⁸⁰³ Ngo-Metzger, Q., Massagli, M.P., Clarridge, B.R., Manocchia, M., Davis, R.B., Iezzoni, L.I., and Phillips, R.S. (2003). Linguistic and cultural barriers to care. *Journal of General Internal Medicine*. 18(1):44-52.

⁸⁰⁴ Kelly, P.A. and Haidet, P. (2007). Physician overestimation of patient literacy: a potential source of health care disparities. *Patient Education and Counseling*. 66(1):119-122.

⁸⁰⁵ Safeer, R.S., Cooke, C.E., and Keenan, J. (2006). The impact of health literacy on cardiovascular disease. *Vascular Health and Risk Management*. 2(4):457-464.

⁸⁰⁶ Health literacy: report of the Council on Scientific Affairs. Ad Hoc Committee on Health Literacy for the Council on Scientific Affairs, American Medical Association. (1999). *Journal of the American Medical Association*. 281(6):552-557.

⁸⁰⁷ Sanders, T.V., Cavazos-Rehg, P., Jupka, K., Caito, N., Gratzke, J., Tate, K., Deshpande, A., and Kreuter, M. (2008). Evidential preferences: cultural appropriateness strategies in health communications. *Health Education Research*. Epub ahead of print.

⁸⁰⁸ Torke, A.M., Corbie-Smith, G.M., and Branch, W.T., Jr. (2004). African American patients' perspectives on medical decision making. *Archives of Internal Medicine*. 164(5):525-530.

⁸⁰⁹ Ray-Mazumder, S. (2001). Role of gender, insurance status and culture in attitudes and health behaviors in a US Chinese student population. *Ethnicity and Health*. 6(3-4):197-209.

⁸¹⁰ Nguyen, G.T. and Bowman, M.A. (2007). Culture, language, and health literacy: communicating about health with Asians and Pacific Islanders. *Family Medicine*. 39(3):208-210.

⁸¹¹ Ka'opua, L.S., Mitschke, D., and Lono, J. (2004). Increasing participation in cancer research: insights from Native Hawaiian women in medically underserved communities. *Pacific Health Dialog*. 11(2):170-175.

⁸¹² Shin, H.B. and Bruno, R. (2002). Language use and English-speaking ability, CK2BR-29, U.S. Census Bureau.

⁸¹³ Qureshi, N. and Kai, J. (2005). Genomic medicine for underserved minority populations in family medicine. *American Family Physician*. 72(3):386-387.

⁸¹⁴ Ngo-Metzger, Q., Massagli, M.P., Clarridge, B.R., Manocchia, M., Davis, R.B., Iezzoni, L.I., and Phillips, R.S. (2003). Linguistic and cultural barriers to care. *Journal of General Internal Medicine*. 18(1):44-52.

⁸¹⁵ Qureshi, N. and Kai, J. (2005). Genomic medicine for underserved minority populations in family medicine. *American Family Physician*. 72(3):386-387.

Most studies about genetic testing in minority populations has centered on genetic testing for cancer risk assessment. Several studies have shown that the uptake of cancer susceptibility genetic tests is lower in African American, Hispanic, Asian, and Native American populations than in the Caucasian population.^{816,817,818} The African American and Native American populations expressed more anxiety about the use of genetic information for adverse actions, such as discrimination.^{819,820,821} Interestingly, Catz et al. found that Hispanic and Asian patients reported more difficulty getting access to the services because of language and cultural barriers rather than any fear of adverse actions.⁸²² For Asian Americans, one major identified cultural barrier was the inability of Western doctors to respect and incorporate the patients' beliefs about traditional Asian medicine and practices into their care.⁸²³ Given the difficulties that minority groups face in obtaining, understanding, and using genetic tests and information, it is important that preeducational and posteducational materials also be made available in languages other than English. It is not enough to just translate the English information directly; an effort must be made to translate the information within the context of the culture of the minority group to optimize the use of the information by the patient. It is also important to ensure that professional translators are available, especially if the genetic test or information may affect a family member who had come with the patient to translate.

Whatever strategy is developed to provide pregenetic and postgenetic testing information to patients must include additional effort and funding to make the information and materials culturally, ethnically, and racially appropriate. These efforts would help ensure that minority groups will have some hope in overcoming the barriers to access and will use appropriate genetic tests and information to improve their health outcomes. In addition, health care providers must receive further training to help them provide the genetic information within their patients' cultural and lifestyle beliefs to optimize the use of the genetic information.

Gaps in Communication and Decision Support

There are significant gaps in the communication of information required for interpretation of test results. During the preanalytical phase, gaps include limited information about how practitioners order genetic tests, an inability of laboratories to collect the clinical information necessary for test interpretation, and insufficient data concerning how family information is obtained and used to support clinical decisionmaking about ordering tests and reporting results.

⁸¹⁶ Armstrong, K., Micco, E., Carney, A., Stopfer, J., and Putt, M. (2005). Racial differences in the use of BRCA1/2 testing among women with a family history of breast or ovarian cancer. *Journal of the American Medical Association*. 293(14):1729-1736.

⁸¹⁷ Hall, M.J. and Olopade, O.I. (2006). Disparities in genetic testing: thinking outside the BRCA box. *Journal of Clinical Oncology*. 24(14): 2197-2203.

⁸¹⁸ Peters, N., Rose, A., and Armstrong, K. (2004). The association between race and attitudes about predictive genetic testing. *Cancer Epidemiology, Biomarkers, and Prevention*. 13(3):361-365.

⁸¹⁹ Peters, N., Rose, A., and Armstrong, K. (2004). The association between race and attitudes about predictive genetic testing. *Cancer Epidemiology, Biomarkers, and Prevention*. 13(3):361-365.

⁸²⁰ Armstrong, K., Micco, E., Carney, A., Stopfer, J., and Putt, M. (2005). Racial differences in the use of BRCA1/2 testing among women with a family history of breast or ovarian cancer. *Journal of the American Medical Association*. 293(14):1729-1736.

⁸²¹ Catz, D.S., Green, N.S., Tobin, J.N., Lloyd-Puryear, M.A., Kyler, P., Umemoto, A., Cernoch, J., Brown, R., and Wolman, F. (2005). Attitudes about genetics in underserved, culturally diverse populations. *Community Genetics*. 8(3):161-172.

⁸²² Catz, D.S., Green, N.S., Tobin, J.N., Lloyd-Puryear, M.A., Kyler, P., Umemoto, A., Cernoch, J., Brown, R., and Wolman, F. (2005). Attitudes about genetics in underserved, culturally diverse populations. *Community Genetics*. 8(3):161-172.

⁸²³ Ngo-Metzger, Q., Massagli, M.P., Clarridge, B.R., Manocchia, M., Davis, R.B., Iezzoni, L.I., and Phillips, R.S. (2003). Linguistic and cultural barriers to care. *Journal of General Internal Medicine*. 18(1):44-52.

Concerning test results, there is limited information about how practitioners interpret them and about the collection and use of patient and family information to support them, a lack of guidance for interpreting complex genomic tests, an inconsistent approach to clinically validating and communicating information about variants of unknown significance, insufficient data on how practitioners account for variations in laboratory methodologies in applying results to decisionmaking, how practitioners are using genomic information to inform care or how genomic information is combined with other information in clinical decisionmaking, and logistical issues that create barriers to the transfer of information to and from laboratories.

There are no studies on the incorporation of guideline recommendations into laboratory practice or the impact of implementation on the laboratory and end-user. Practitioners are unfamiliar with guidelines for appropriate use of genetic tests, and there is a lack of appropriate mechanisms to communicate guidelines for testing at the time of test ordering. Processes have not been implemented and evaluated to support practitioners in the use of genetic /genomic test information. Publication of care guidelines is insufficient to alter patterns of care delivery, and guidelines are not enforceable. There are no data on the role that active clinical decision support can play in driving appropriate utilization of genetic/genomic tests and results, on practitioner use and acceptance of active clinical decision support for genetic/genomic tests, or on the role of active clinical decision support in the personal health record.

There is inadequate didactic and practical genetics education in practitioner training programs, resulting in an inadequately educated provider system. Other deficiencies include a lack of resources on genetic/genomic tests, a lack of educational materials designed to help patients use genetic/genomic test results, and a lack of knowledge concerning how practitioners use available resources to answer questions about genetic/genomic tests and the role of just-in-time education to support best practice. Data are needed on electronic information resources, including the number of practitioners using available online genetic resources and the accuracy and accessibility of genetic information in commonly used electronic resources.

There is a lack of reimbursement for the laboratory-employed or contracted genetics professionals who provide support to patients and practitioners regarding genetic tests and a lack of data on whether these genetics professionals improve the ordering and interpretation of genetic tests. Conversely, there are no data on whether the lack of these professionals adversely affects the ordering and interpretation of genetic tests. There is a lack of access to providers with genetic expertise and a lack of genetic expertise in groups that perform technology assessment of emerging genetic/genomic tests.

In the area of research and translation, there is a lack of on ongoing data collection to refine knowledge after a test is clinically available and a lack of integration of new knowledge into decision support to improve care.

There is a lack of studies that compare multiplex genomic assays to other approaches to stratify risk and that determine the impact of point-of-care testing.

There are gaps in CLIA and gaps in the oversight of clinical validation.

Numerous gaps exist related to EHRs and PHRs. There is limited deployment, utilization, and functionality of EHR systems in general. The representation of genetic test results and multiplex genomic results in EHRs is now in development, but current coding systems are inadequate for this purpose. The impact of this deficiency on patient care is unknown. There are no data on representing genetic/genomic test results in the PHR and no data on the role of the CPOE in ensuring appropriate utilization of genetic/genomic

tests. There is a lack of interoperability between systems and barriers to data sharing. For example, widely used versions of HL-7 (versions 2.7 and lower) require updating to support transmission of genetic and genomic test findings. There is also a lack of communication between public and private data repositories, a lack of an accepted and consistent process for local review and approval of clinical decision support logic by affected providers, and a lack of clarity concerning how FDA will choose to regulate clinical decision support systems that are not integrated within the testing laboratory for genetic and genomic tests.

A consumer who consents to the compilation of his or her health information in a PHR not covered by HIPAA may not be protected against release of this information to other parties without permission.

Evidence of Harms and Potential Harms

There is a lack of studies that quantify actual harms to patients, families, practitioners, and the health care system. But the following harms have at least some documentation in the literature:

- Practitioners unfamiliar with guidelines about the indications for conducting a genetic test may order tests inappropriately. Practitioners are less likely to order a test if it is labeled as a genetic test.
- There is misinterpretation of tests based on limited or inaccurate clinical information and because of inadequate or confusing reports.
- Practitioners are not adequately prepared to use test information to treat patients appropriately, and practice guidelines are insufficient to ensure appropriate care.
- There is a lack of patient access to expertise.
- The lack of adequate EHRs affects patient safety, although the genetic contribution is unknown.
- Duplicate genetic and genomic testing wastes limited resources.
- DTC advertising misleads consumers with claims that are unproven and ambiguous.

The following harms are not documented in the literature, but are nonetheless plausible:

- Tests could be misinterpreted because of limited or inaccurate clinical information, because the patient ordered the test, or because of an inadequate or confusing report. Inappropriate attribution of causality could lead to diagnostic and therapeutic interventions that are not indicated. Conversely, incorrect assignment of a variant as “benign” could lead to beneficial interventions not being offered. It could be incorrectly inferred that data obtained from retrospective studies will define the appropriate application in clinical settings in the absence of prospective trials.
- There is a lack of available educational materials designed to help patients use genetic/genomic test results, and harms could also result if patients do not understand their conditions. In addition, a lack of discussion about psychological and social implications of testing could result in harms.
- The lack of adequate EHRs creates an inability to collect data and integrate new knowledge to improve patient care in a timely fashion, which could result in suboptimal patient care. Text-based reports limit the ability to implement practice guidelines to support active clinical decision support.
- The lack of specific codes for genetic and genomic tests also hinders electronic support for appropriate care, as could an inability to communicate critical between LIS and EHRs.
- Uncertainty about FDA’s role in regulating clinical decision support systems for genetic/genomic tests that are not integrated within the testing laboratory could result in harms.
- The use of systems that do not support current regulatory requirements (e.g., HIPAA) risks release of personal health information.

- The privacy of health information could be breached if a patient’s PHR is not covered by HIPAA and information is released to other parties without permission.
- Given the current lack of regulation of DTC advertising and testing, it is likely that DTC advertising and testing may become sources of genetic information for marketing or other purposes. Even if genetic test results are kept strictly confidential, it is possible that the results could be inferred by analyzing an individual’s Internet usage.

Recommendations

1. There are documented deficiencies in genetics knowledge in all relevant stakeholder groups. In addition to the creation of the SACGHS education task force, SACGHS recommends the following strategies to address these deficiencies:

- A. HHS should work with all relevant government agencies and interested private parties to identify and address deficiencies in knowledge about appropriate genetic and genomic test applications in practice and to educate key groups such as health care practitioners, public health workers, public and private payers, and consumers of health care. These educational efforts should take into account differences in language, culture, ethnicity, and perspectives on health and disability as well as issues of medical literacy, access to electronic information sources such as the Internet, and deficiencies in public infrastructures (e.g., libraries) that can affect the use and understanding of genetics information.
- B. Based on increased research regarding analytical validity, clinical validity, and clinical utility, sufficient resources should be provided to translate this knowledge into evidence-based clinical practice guidelines that enhance the quality of clinical health care and public health care outcomes.

2. Although FDA has asserted its authority over clinical decision support systems, the extent to which the Agency intends to regulate such systems is not clear. Given that clinical decision support systems will be necessary to communicate information appropriately in the preanalytical and postanalytical periods and because these systems contain elements that involve the practice of medicine, clarification of the nature and scope of FDA oversight of such support systems is critical. SACGHS recommends that:

FDA should engage with other relevant Federal agencies, advisory committees to the HHS Secretary (e.g., AHIC and the Advisory Committee on Heritable Disorders and Genetic Diseases in Newborns and Children), and stakeholders to gather perspectives on the appropriate regulatory framework for clinical decision support systems in light of changing health care delivery and health care data collection systems. As part of this process, FDA should prepare a guidance document articulating the basis of its authority to regulate clinical decision support systems as well as its rationale for and approach to such regulation, explaining in particular which features of the system constitute a device.

- 3. The need for genetics expertise to support best genetic testing practices has been identified as an essential element for the provision and interpretation of appropriate genetic tests. Access to genetics expertise could be addressed in part by solving problems in the reimbursement of genetic tests and services. SACGHS recommends that:**

HHS act on the recommendations in the 2006 SACGHS report *Coverage and Reimbursement of Genetic Tests and Services*.

- 4. There are extensive gaps in knowledge about genetic tests and their impact on patient care. Prioritizing activities under the authority of HHS would help close these gaps and enhance the quality of patient care. SACGHS recommends that:**

HHS allocate resources to AHRQ, CDC, the National Institutes of Health, and HRSA to design and support programmatic and research efforts to encourage the development and assist in the evaluation and dissemination of tools, particularly computerized tools, for clinical decision support in the ordering, interpretation, and application of genetic tests. HHS also should address current inadequacies in the clinical information needed for test interpretation. These efforts will require engaging health care providers and health care payers as well as providing incentives and protections to ensure their participation in the design and dissemination of tools, implementation of clinical decision support, and contribution of necessary data.

VII. Conclusion

The Secretary of the U.S. Department of Health and Human Services (HHS) charged the Secretary's Advisory Committee on Genetics, Health, and Society (SACGHS) with investigating specific issues related to the adequacy and transparency of the current oversight systems for genetic testing, particularly gaps in the analytical validity, clinical validity, and clinical utility of genetic tests. In response, the Committee examined the roles of public and private entities that have responsibility for oversight, the resources available to them, and, where relevant, the regulations that govern them. Through an extensive review of the literature, input from expert consultants, outreach to the public, and analysis and deliberation, SACGHS identified gaps in the following areas: the regulations governing clinical laboratory quality; the oversight of the clinical validity of genetic tests; the level of current knowledge about the clinical utility of genetic tests; and meeting the educational needs of health professionals, the public health community, patients, and consumers, along with providing tools to assist these groups with the interpretation and communication of genetic test results.

To address these gaps, the Committee's recommendations emphasize the importance of enforcing existing regulations more than the need for additional regulation. The Committee also recognizes the complexity of the oversight system and calls for enhanced interagency coordination of the activities associated with the oversight of genetic testing, including policy and resource development, education, regulation, and knowledge generation. The following are among the recommended actions:

- To address gaps in laboratory quality assurance, the Committee recommends that the Centers for Medicare & Medicaid Services (CMS) require proficiency testing (PT) of all nonwaived laboratory tests for which PT products are available. To promote the development of new PT products and facilitate performance assessment efforts, HHS should fund studies of the effectiveness of other types of performance assessment methods to determine whether they are as robust as PT. SACGHS also found that there is a need for additional training of Clinical Laboratory Improvement Amendments (CLIA) laboratory inspectors and recommends that experts be used to train them in the practical application of CLIA requirements.
- To prevent laboratories from performing genetic tests without appropriate CLIA certification, the Committee recommends that HHS explore mechanisms for developing new authorities and resources that will enable CMS to strengthen its enforcement efforts against laboratories that perform genetic tests for clinical purposes without proper CLIA certification. In addition, appropriate Federal agencies should strengthen monitoring and enforcement efforts against laboratories and companies that make false and misleading claims about genetic tests, especially those offered directly to consumers.
- To help close the gaps in oversight related to clinical validity, which would help ensure the appropriate use of laboratory tests, the U.S. Food and Drug Administration (FDA) should address all laboratory tests, regardless of how they are produced (i.e., as a commercial test kit or laboratory-developed test), in a manner that takes advantage of its current experience.
- To gain a better understanding of the types of genetic tests currently being offered and to facilitate the oversight of laboratory tests, HHS should appoint and fund a lead agency to develop and maintain

a mandatory, publicly available, Web-based registry for laboratory tests. The Committee discussed whether such a registry should reside at the Centers of Disease Control and Prevention (CDC), CMS, or FDA but recognized that unresolved issues, including practical and legal questions, require further analysis before a final decision can be made about how and where to implement the registry. While awaiting implementation of a mandatory registry, HHS should use short-term voluntary approaches such as incentivizing laboratories to register with GeneTests and encouraging laboratories to make their test menus and analytical and clinical validity data for these tests publicly available.

- To close the extensive gaps that exist in knowledge regarding the clinical utility of genetic tests and their impact on patient care, research and programmatic efforts are recommended. Funding for the Agency for Healthcare Research and Quality, CDC, the Health Resources and Services Administration, and the National Institutes of Health is needed to support the development of evidence and the dissemination of guidelines on evidence-based practice for genetic/genomic tests, to assist in the evaluation and dissemination of computerized tools for clinical decision support related to genetic tests, and to address inadequacies in the clinical information needed for test interpretation.
- To meet the education needs of health professionals, public health workers, patients, and consumers, HHS should support efforts to identify education or training deficiencies in each of these groups and support research and development of effective clinical decision support systems. Because of the importance of clinical decision support systems in the preanalytical and postanalytical periods, clarification of the nature and scope of FDA oversight of these systems is critical. FDA should engage with other relevant Federal agencies, advisory groups, and stakeholders to gather perspectives on the appropriate regulatory framework for clinical decision support systems in light of the changing health care delivery and health care data collection systems. FDA should then prepare a guidance document articulating the scope of its regulation of clinical decision support systems.

SACGHS hopes that this report and these recommendations will be useful to the HHS Secretary in leading HHS efforts to maximize the benefits of genetic testing in the United States and the important role these tests will play in achieving personalized health care.

Appendix A

Twelfth Meeting of the SACGHS Summary of March 26, 2007, Oversight Session

Update on the Secretary's Personalized Health Care Initiative

Sheila Walcoff, J.D.
Counselor for Science and Public Health
Office of the Secretary
U.S. Department of Health and Human Services

Ms. Walcoff presented an update on the work of the Department of Health and Human Services (HHS) in accelerating personalized health care (PHC). She stated that Secretary Leavitt outlined the PHC Initiative to the Personalized Medicine Coalition the previous week and she recapped his remarks, stating that PHC is one of the Secretary's top 10 priorities. He believes that advances in medicine, biomedical science, and technology present opportunities for health care practices to become increasingly patient-specific. The desired outcome is the effectiveness and safety of medical practices and increased value and transparency for patients using modern tools, technologies, and information. The PHC Initiative emphasizes a health care strategy that incorporates new methods of genetic analyses to better manage a patient's disease or predisposition to a disease and facilitates the discovery and clinical testing of new products.

Some of the long-term goals for the next 5 to 10 years are to promote connectivity through a national system of health care information networks; assess the need for new policies, technologies, and oversight approaches; develop incentives across the health care system to use genetic information; foster new business models for the pharmaceutical and diagnostic industries; encourage consumer participation in medical decisionmaking, health care management, and prevention through new information-based tools; increase consulting support and incentives; and provide real-time decision support for disease management strategies using health information technology systems.

Some of the short-term goals are to present the American Health Information Community (AHIC) with recommendations for genomic medical testing and family medical history data adoption in electronic health records (EHRs). The Initiative is also developing policies and programs to strengthen consumer and health care provider trust in parallel with infrastructure and technical capacity development, encouraging development of validated clinical genomic testing capabilities, and establishing networks of interactive data sources.

Ms. Walcoff displayed a pyramid-shaped diagram of the overall vision. Health information technology and knowledge development (expansion of the science) form the base of the pyramid. These elements include electronic systems, clinical databases, and knowledge repositories that are based on a common set of definitions and standards. The next level of the pyramid is intervention development and review.

Ms. Walcoff said there is an increasing need for and value placed on integrated data sets and high-quality information about efficacy and safety outcomes. The ability to assimilate and relate experiences using integrated databases is enabling incredible predictive power for outcomes in disease management. As technological capabilities develop across the health care system, better information, based on individual differences, will aid in future medical product evaluation and postmarket assessments of safety and efficacy. An expanded set of health measurement tools will foster research and development for conditions for which there are currently few successful health interventions or preventive approaches. The top of the pyramid represents translation into clinical practice. Ms. Walcoff stated that the key players in this transformation are health care providers and she said that better bridges are needed between research and health care delivery. Currently, the field lacks the infrastructure and analytical strategies for data management and knowledge development across biomedical research and health delivery enterprises. There are barriers to standardized formats that would allow information exchange among willing partners in health care. The PHC Initiative is attempting to create a health care system with a continuum of transformation that builds on knowledge management to support the integration of discovery, development, and delivery in the health care enterprise and paves the way for a modern doctor-patient relationship in which value for the patient is the ultimate objective. Ms. Walcoff said the Secretary's role in the Initiative is to facilitate technology development and the formulation of policies to support the appropriate use of genetic information.

Technology goals include the establishment of an interoperable public/private data partnership of networks that facilitate the appropriate use of research and clinical data. The President's Fiscal Year (FY) 2008 budget included \$15 million for the Initiative to begin building this network, which will ultimately link genomic and clinical data to add efficiencies to therapy development, identify clinical best practices, and provide better methods for tracking adverse events. Ms. Walcoff said this effort was just starting and would be based at the Agency for Healthcare Research and Quality (AHRQ). The technology track also includes the establishment of standards for the incorporation of genomic health information and personal family history into EHRs.

The goal of appropriate use of genetic information includes protecting individuals from genetic discrimination through legislation, providing oversight of genetic testing to assure analytical and clinical validity through regulation of testing platforms and systems and proficiency in practices for performing tests and data interpretation, and standardizing access policies to federally funded databases of genetic information. Current policies for accessing these genomic databases are not entirely consistent.

Ms. Walcoff noted that AHIC established a PHC work group to advise on these issues. The group is composed of a broad cross-section of stakeholders from Federal agencies; industry; health plans; laboratories; consumer organizations; and experts on ethical, legal, and social issues. The specific charge to the work group is to make recommendations to AHIC on establishing standards for reporting and incorporation of common medical genomic tests and family medical history data into EHRs and to provide incentives for adoption across the country, including Federal agencies. If such standards are not widely accepted, a patchwork of different systems of EHRs will impede interoperability and the exchange of useful health information. It is also important that primary care physician acceptance and understanding of this new medical technology catches up with the rapid pace of genetic research.

Secretary's Charge to the Secretary's Advisory Committee on Genetics, Health, and Society (SACGHS) on the Oversight of Genetic Testing. Ms. Walcoff noted that the Secretary's office was aware of the deliberations of SACGHS on the oversight issues and had recently reviewed the July 2000 report, *Enhancing the Oversight of Genetic Tests*, prepared by the Committee's predecessor, the Secretary's Advisory Committee on Genetic Testing (SACGT). The Office of the Secretary (OS) was also closely

following the information-gathering efforts of a broad cross-section of stakeholders in other forums to better understand the issues and to discuss internally how the Department should coordinate oversight in this complex area.

Ms. Walcoff indicated that because the oversight issues are critical to the Secretary's PHC goals, the Secretary wanted SACGHS to extend its efforts on the topic. Ms. Walcoff then presented the Committee with a specific charge involving the development of a comprehensive map of steps needed for evidence development and oversight for genetic and genomic tests, with improvement of health quality as the primary goal. The map would consider and address the following questions:

Generally, what are the existing pathways that examine the analytical validity, clinical validity, and clinical utility of genomic tests? What organizations are currently responsible for each of these aspects and what are they doing to address the issues? What are the potential pathways to communicate clear information to guide test and treatment selection by providers? OS also wanted input on the analytical validity and clinical validity of genetic tests, including: What evidence of human harm exists regarding genetic tests? Is that harm attributable to analytical validity of the tests, clinical validity, and/or clinical utility? If evidence does not exist, what threats exist that currently are not being addressed by regulatory oversight? What distinguishes genetic tests from other laboratory tests for oversight purposes? What resources, such as standard reagents or materials, are needed to develop proficiency testing (PT) requirements? What is currently available in terms of PT kits for genetic tests and what information is provided by PT? What new approaches or models for private and/or public/private sector engagement could demonstrate clinical validity and utility for developing effectiveness measures for use of genetic tests? What should be considered and why? Where and how would additional revised Government oversight add value for patients?

Dr. Tuckson thanked her for conveying the charge and noted that the public's anxiety concerning privacy and confidentiality is the sister issue to oversight. He said the PHC movement would not go far if the public does not have trust in the regulatory process. He recognized that the Secretary was interested in seeing results in a timely manner and asked the Committee to think about what product could be delivered in a short time frame. Dr. Tuckson said the Committee would return to a discussion of the charge later in the meeting.

Dr. Andrea Ferreira-Gonzalez asked Ms. Walcoff if the Secretary wanted SACGHS to look at the roles of the Federal Government, the States, and the private sector in the oversight of genetic testing. Ms. Walcoff said the charge was purposefully crafted to be broad so that the information SACGHS gathers will reflect input from the variety of stakeholders that SACGHS represents. She indicated that the charge is focused primarily on the Federal side since OS can make an impact primarily in that area, and the intersection of Federal efforts with the private sector, including public/private partnerships. She stated that OS would continue to work with the Committee as the charge was refined and asked the group to work on an accelerated timeline.

Discussion of the Secretary's Oversight Charge

SACGHS members engaged in further discussion of the charge with Gregory J. Downing, D.O., Ph.D., Project Director, PHC Initiative, who accompanied Ms. Walcoff. In response to a question from Dr. Ferreira-Gonzalez about organizations referenced in the charge, Dr. Downing replied that it included organizations involved in the systems being examined, e.g., Federal regulatory agencies, regulated industries and

providers, research organizations, and professional organizations. He said there are conduits of information aggregation and analysis that could be useful and that the Secretary would like to see a categorization of the types of information needed at various steps.

Dr. Teutsch noted that the charge seemed focused on clinical issues. He asked whether it also included public health and population health utility of laboratory tests. Some genetic information used for population health may be related to toxic exposures in the environment or recommendations for nutrition policy and some tests might have a population health impact for specific ethnic or geographic groups. Dr. Downing clarified that both clinical individual patient use and tests used in population-based environments are part of the Committee's charge.

Dr. Tuckson referred to Dr. Khoury's statement that the effort would primarily be a fact-finding activity, since much work had already been done. All the domains of organizations that might be relevant should be included, whether in the academy, private sector initiatives, or Government regulatory agencies. The charge was to lay out a road map that indicates all the relevant organizations and entities involved in the oversight of genetic tests.

Dr. Ferreira-Gonzalez asked how SACGHS should focus its efforts, in light of work already under way in the Secretary's Office to review the oversight issues within Federal agencies. She asked whether the Committee should focus on the private sector. Dr. Downing said HHS internal efforts were exploring the different authorities of each agency and their intersections to determine where they do or do not align in order to identify gaps and overlaps of policies and regulations. This effort would help agency communications, interactions, and deployment of policies. Dr. Downing added that many different types of technologies had evolved since previous reports on genetic testing were developed in 2000 and 2001. He suggested that SACGHS look at specific requirements for different types of genetic tests, whether polymerase chain reaction (PCR) or multigene array analyses, to see whether the information developed has differences in terms of clinical and analytical validity. The interpretation and defining of genetic tests should take into consideration the methodologies and types of information that are developed, processed, and presented as data to be utilized for clinical applications or in population-based health.

Refinements to the charge were made to reflect Dr. Downing's statements and the Committee's discussion. One of the changes emphasized the point about a legitimate role for public/private partnerships as a solution to problems with oversight.

Dr. Downing said OS was interested in the key analytical questions that must be framed and answered in order to develop the information necessary to use tests in a way that allows transparency about the implications of their results. He said a number of models and discussions had been recently published about what would be needed in terms of organization and science, medical, and health systems input to deploy these technologies and the information necessary to create a process in which information continues to accrue. He spoke about the refinement of those tools and their applications. He said OS did not have a specific concept in mind, but thought that the path forward would require more than just the Federal Government's role. He said SACGHS work should be focused on the public/private partnership role for clinical validity and utility and the use of tests in clinical practice. The Committee should address the question: Where do those responsibilities currently fall and what are some better ways to accrue information moving forward?

Dr. FitzGerald noted that the pharmacogenomics report identifies clinical outcomes as an important part of the formula and asked if they should be included in the oversight report. Dr. Downing said they would be useful if the Committee had the insight and expertise to address the issue. If not, the evidence OS was

looking for in the short term related to analytical validity in the oversight of the test kits themselves and the performance of those tests. Those issues were the prominent concerns of SACGHS and had been discussed in previous meetings. OS was interested in more clarity on those concerns.

Dr. Tuckson summarized by stating that the Committee was being asked to describe the pathways that exist now for analytical and clinical validity and clinical utility and define the organizations with responsibility and accountability for those pathways. They would also need to look at the appropriate role for public/private efforts. He stated that once the road map was laid out, the Committee could look at whether roles should change to include not only Government oversight, but public/private partnerships.

Dr. Randhawa asked for clarification on “developing effectiveness measures.” He asked whether this meant developing new measures or collecting known measures and synthesizing them appropriately. In response, Dr. Downing said the term “evidence development” could be substituted—i.e., how do we know that a test is providing information that clinicians, health care providers, and consumers want, need, and can reliably use, and under what parameters is it useful? He said that if the Committee was already thinking about new ways to develop that information, it would be useful to include it in the report.

Dr. Randhawa asked whether the Committee should consider efficacy as part of effectiveness or focus only on effectiveness. Dr. Downing said he would combine the two approaches, although he wanted to give the Committee latitude in framing the issues. Dr. Tuckson said Dr. Randhawa raised an important question. In addition to the actual oversight of tests, the idea of measures of effectiveness was being introduced. The Committee needed to think about whether to address that issue.

Dr. Tuckson opened discussion on the aspect of the charge that addressed “potential pathways to communicate clear information to guide tests and treatment selection by the provider.” Dr. Ferreira-Gonzalez asked Dr. Downing if this meant SACGHS should look not only at how testing is differentiated, but how different technologies are viewed and information is relayed to physicians and how that information is interpreted and leads to testing. Dr. Downing said OS was not looking for a complete inventory of every test that could be categorized as a genetic test, but for a framework for understanding those cases in which the result is not just a positive or a negative, but instead required interpretive skills and analysis. How will those results be interpreted and what information is passed on to those making decisions with it? He said the earlier reports focused predominantly on test performance and that was still an important issue. However, the field is moving into more complex areas, and OS wants to know what is new in cases where interpretation is required. How is information gauged? What is the level of evidence that the test results are benchmarked against? And if that includes utilizing other data sets, how is that process performed and what are the cognitive capabilities needed to make accurate determinations? Dr. Downing suggested that expertise might be needed on an *ad hoc* basis from outside SACGHS.

With regard to the question in the charge about the evidence of harm related to genetic testing, Dr. Tuckson noted that it would be important to identify real or potential harms through the development of case scenarios. Dr. Downing agreed and suggested that case studies might provide transparency on how information is gathered and used, which would inform processes to deal with new information as it unfolds.

Dr. Downing noted that in the context of legislation, “genetic information” has a very broad definition and it should be left to the Committee to decide how to define this concept for the report. Regardless of the definition, information with a genetic origin is used for many different types of decisionmaking processes. The levels of risk in play when making decisions about test results have bearing on the level of oversight needed and the kinds of questions and evidence necessary. He said “harm” does not necessarily mean that

someone has to be harmed; it includes analytical work not being done or being done incorrectly. How are genetic technologies and tests different from other types of medical tests? What is unique and definable about genetic tests that causes concern?

Dr. Collins said the Committee should not only look for evidence of harms or potential threats, but for instances in which public benefit has been slowed or limited, so that benefits are not accruing as rapidly as they might. Dr. Downing agreed that “harm” should be broadly defined, but still apply specifically to genetic tests.

Dr. Tuckson asked Dr. Downing to explain the aspect of the charge concerning resources needed for PT. Dr. Downing replied that OS was looking for answers to questions such as: What are the models for PT with well-characterized specimens and processes for splitting or sharing samples? Are there unique and common reagents or things that are used to test and provide common results from different laboratories performing those tests, particularly as new tests evolve and roll out? Are those things commonly available, and what are the implications of that on the laboratory for everything from costs to availability? He said that a “perfect” framework would not work in the real world if the necessary reagents to conduct testing are not available. If there is a menu of commonly available materials necessary to provide analytical validity requirements in a framework that addresses different types of genetic tests, it would be helpful to know what they are.

In response to a question from Dr. Tuckson about the part of the charge that includes guidance to Government, Dr. Downing said that OS was asking SACGHS to be creative and think outside the box in terms of methods and approaches.

Dr. Downing was also asked whether a literal map or diagram of pathways and communications was being requested or whether the Committee should simply address each question in a logical fashion. Dr. Downing clarified that OS wanted a tool that would help a layperson visually and graphically understand the oversight process, the technologies that are developed and performed, and the information flow that enables the physician and clinical providers to obtain the right information. Dr. Tuckson said the map should lay out what exists today and what does not exist and indicate where the gaps lie. It should show where the responsibility lies for the Food and Drug Administration (FDA) and the Center for Medicare & Medicaid Services (CMS), and where no one has responsibility.

Dr. Scott McLean asked how the Committee should conceptualize treatment (e.g., management, genetic counseling, pharmacologic interventions). Dr. Downing said treatment in this context should be defined broadly, in terms of either wellness decisionmaking processes or others. He said the context was that of someone taking a test and making a decision that will alter a process or health function.

Dr. Williams said that much of what was being discussed related to decision support algorithms. He said the Committee would need to be explicit concerning oversight in this area because there had already been talk in other venues of clinical support algorithms that were being scrutinized under the rubric of a device. He suggested that advice for the Government might mean elimination of some functions, not necessarily the addition of something.

Dr. Tuckson closed the discussion by stating that the group would subpopulate the outline for responding to the charge in the afternoon session. The Committee was not limited by what the Secretary’s office asked for. Dr. Tuckson thanked Dr. Downing for guiding SACGHS so that the Committee’s efforts fit in with HHS’s overall efforts. Dr. Downing said they were agnostic about the manner in which the response was prepared, but he emphasized that time was of the essence.

Session on Oversight of Genetic Tests

Framing the Session

Reed Tuckson, M.D.

Andrea Ferreira-Gonzalez, Ph.D.

Dr. Tuckson recapped the activities of the November 2006 SACGHS meeting relating to oversight. He stated that Judy Yost and Tom Hamilton of CMS reported that a Notice of Proposed Rulemaking (NPRM) on a genetic testing specialty would not go forward as planned. CMS had decided to explore other avenues for strengthening genetic testing oversight that would be faster to implement and, in their view, equally effective—i.e., improving the CMS Web site, providing technical training to surveyors on genetic testing, and collaborating with the Centers for Disease Control and Prevention (CDC) to publish educational materials. Dr. Ann Willey, Director of Laboratory Policy at Wadsworth Center, New York State Department of Health, described the New York State program and conveyed some concerns about gaps in the oversight system. Steve Gutman of FDA described two new draft guidances relating to oversight of certain types of genetic tests. The first clarified that when analyte-specific reagents (ASRs), the active ingredients in genetic tests, are marketed in combination with other products or with instructions for use in a specific test, they are considered test systems and are not exempt from pre-market notification requirements. The second draft guidance targeted the class of devices known as *in vitro* diagnostic multivariate index assays (IVDMIA), which use an algorithm to calculate a patient-specific result. The IVDMIA guidance clarifies that these tests must meet premarket and postmarket device requirements appropriate to their level of risk.

Dr. Tuckson further recalled that at the November 2006 meeting, the Committee heard conflicting perspectives from presenters about gaps in the oversight of genetic testing and concluded that it was not clear where the gaps were or who was responsible for addressing them. The Committee decided to probe these issues more fully, and Andrea Ferreira-Gonzalez agreed to chair a task force to organize a fact-finding session and to discuss preparation of a letter to the Secretary expressing concerns about oversight.

Dr. Ferreira-Gonzalez provided an overview of the day's sessions, which were designed to address the oversight roles of Federal, State, and private sector entities in the analytic and clinical validity of genetic tests, followed by presentations on New York and other State laboratory systems. The final presentations would focus on private sector responsibilities for clinical laboratory accreditation, standard setting, and the development of clinical practice guidelines for genetic testing. Dr. Ferreira-Gonzalez introduced Dr. Wylie Burke, who presented via videocast.

Primer on the Oversight of Genetic Testing

Wylie Burke, M.D., Ph.D.

*Chair, Department of Medical History and Ethics
University of Washington School of Ethics*

Dr. Burke said the reasons for concern about the oversight of genetic testing have been discussed for a decade. Some stem from the fact that many new genetic tests are resulting from the Human Genome Project. They involve many different technologies, complexities in determining who to test, and difficulties in interpreting test results. In addition, many clinicians have a limited knowledge of genetics and are uneasy about using genetic tests. Dr. Burke emphasized four areas in which action can be taken on oversight: statutory regulation, public leadership, decisions about health care funding, and professional leadership.

Statutory regulation of genetic testing at the Federal level comes primarily from Clinical Laboratory Improvement Amendments of 1988 (CLIA) certification of laboratories and the role of FDA in premarket review. The CLIA system provides certification for laboratories that provide test results for clinical use. It provides oversight regarding laboratory procedures and documentation, standards for training laboratory personnel, and the credentials needed for test interpretation. At issue was whether a genetic testing specialty was needed under CLIA.

Dr. Burke discussed the work of the National Institutes of Health (NIH) and Department of Energy Task Force, which published a report on genetic testing in 1997 that found that genetic tests need more attention to ensure a sufficient evidence base before entering clinical practice and called for evidence-based entry of new genetic tests into clinical practice. The Task Force also called for criteria to identify the tests for which special measures should be taken to require validation and clinical utility data before entering the marketplace. The Task Force envisioned that the process would involve an independent review of tests prior to market entry and that professional organizations as well as FDA might play important roles. The Task Force also recommended the establishment of a Secretarial level advisory committee to study this issue further.

As a result, SACGT was established in 1998. In a 2000 report, SACGT recommended that all genetic tests, including laboratory-developed tests, should be subject to FDA oversight. The committee also developed a tool, a data template, to help streamline the review process for what is known and not known about each test in terms of analytic validity, clinical validity (which is often limited when a test comes to market), and clinical utility (information is extremely limited). The HHS Secretary accepted the Committee's report, which made several other pertinent recommendations, and asked FDA to consider what would be involved in its implementation. SACGHS also tried to develop a simple formula for determining when a test should receive higher scrutiny but decided in the end that there was no simple way to categorize genetic tests because most genetic tests have multiple uses, there are different definitions for terms such as "predictive" and "diagnostic," and test manufacturers would likely seek review under the least problematic test category.

Ultimately, Dr. Burke stated that recent activities of FDA related to oversight indicated that they had identified two areas of priority: pharmacogenomics and test complexity. She stated that test complexity is a more functional way to think about tests that need higher scrutiny than the diagnostic/predictive categorization used by SACGT. She said that FDA had recently issued several draft guidance statements related to this, focusing on the voluntary collection and submission of data and creating a "safe harbor" in which to explore interesting data that could inform manufacturers and the public about appropriate development and use of drugs. FDA also made a statement about its intent to change the clinical pharmacology section of the drug label to include pharmacogenomic information when it is relevant to the use of the test. In the past several years, FDA approved several genetic test kits—e.g., Roche AmpliChip, Invader UGT1A1, and HER2 molecular assays. The agency issued a draft guidance proposing the extension of oversight to IVDMIAs, tests that utilize both laboratory data and analytic tools to generate results, such as gene expression profiles that might predict cancer prognosis and guide the use of chemotherapy.

Dr. Burke said it was an open question whether different kinds of statutory regulation were needed for direct-to-consumer (DTC) tests. She noted that a Government Accounting Office report on nutrigenetic testing raised questions about whether Web sites offering nutrigenetic tests were misleading consumers.

On the topic of genetic discrimination, Dr. Burke said that the role of the Americans with Disabilities Act (ADA) in providing protection against genetic discrimination was unclear. Based on the courts'

interpretation of ADA claims in nongenetic cases, it seemed that ADA would provide protection only when people's lives are actively interrupted. Genetic susceptibility is not likely to meet that standard. The other opportunity for oversight concerning genetic discrimination was legislation at the Federal level.

At the State level, statutory regulation plays an important role in genetic testing. Some States have more stringent laboratory oversight than is called for by CLIA. Many States enacted genetic nondiscrimination legislation, although it had not yet been tested in the courts. Newborn screening is also under the oversight of the States.

Dr. Burke said the role of statutory regulation in the oversight of genetic tests was not clear. However, at FDA, there was an ongoing concern about whether there should be more regulation concerning performance of genetic tests in laboratories and uncertainty about measures that should be taken to protect consumers from DTC tests. Statutory regulation was a potential vehicle for standardized reporting and labeling of information about genetic tests, but, in her opinion, not a route for establishing a standard of practice around the use of genetic tests. Dr. Burke felt that other mechanisms were more likely to be effective, as described below.

She said Federal agencies, in addition to regulatory responsibilities, have the opportunity to provide public leadership in a variety of ways. These include promoting best practices and supporting education and training, practice guidelines, and research. Dr. Burke cited the example of the Division of Laboratory Sciences at CDC. The Laboratory Practice Evaluation and Genomics Branch within this Division is providing leadership for quality control and quality assessment in the development of technology and practice improvement. Other activities include education and training, research activities, and policy development (e.g., interaction with CLIA on standard setting).

Dr. Burke stated that public leadership extends to such areas as guideline development, stating that the Evaluation of Genomic Applications in Practice and Prevention project (EGAPP) is an important initiative of CDC and AHRQ. In addition to providing guidance on the use of some genetic tests, EGAPP was working on establishing methodologies for evaluating genetic tests and addressing the level of evidence sufficient for claiming that a particular genetic test is ready for clinical use. The U.S. Preventive Services Task Force had also provided some important guidelines, notably around BRCA testing. The Secretary's Advisory Committee on Heritable Disorders and Genetic Diseases in Newborns and Children was very active in the area of newborn screening.

Dr. Burke noted that public leadership could contribute to the translational pathway, which begins with research on the genetic contribution to disease and ultimately leads to improved health outcomes. Federal research support is critical in the early part of that pathway, such as that provided by NIH, AHRQ, CDC, and the Health Resources and Services Administration. There is great potential for enhancing oversight through Federal research support for educational research and interventions (helping providers and patients use genetic testing appropriately), for a focus on clinical utility (starting with clarifying the term and determining what kind of evidence would be needed to support clinical utility for different kinds of tests), and for research into ethical, legal, and social implications and policy options. Dr. Burke said it was an open question whether more Federal support should be provided in specific areas.

Dr. Burke said that future decisions about health care funding will have a powerful impact on whether a test is used, even when it is available for clinical use. Challenges include determining when genetic counseling is essential and who should provide it, inflexible reimbursement rules, and inequitable access to genetic services because they are underfunded or because people lack insurance.

Professional leadership and collaborations by organizations could play a powerful role in creating standards of practice. Professional organizations could help identify the importance of genetics issues for their members, whether in national meetings or stand-alone educational programs. They can also play an important role in laboratory oversight, working within the context of CLIA to set standards and create PT programs. They develop practice guidelines, which are a trusted source of information for doctors. Dr. Burke said the problem with practice guidelines is that they are “all over the map.” Many different bodies provide guidelines using different processes, some of which are more transparent and evidence-based than others. Professional, personal, or financial interests sometimes affect the process, and methodologies vary and are not always disclosed. Even if the processes used are good ones, the evidence may be lacking. Public and professional leadership is important in ensuring that research is being conducted to gather evidence and that practice guidelines follow rigorous procedures so they can provide legitimate guidance. Dr. Burke said it is necessary to acknowledge that “standard of practice” is an evolving concept. As new data emerge, guidelines must be revised. In the field of genetics, technology is evolving rapidly and the quality of evidence is increasing over time. Case law also influences what is meant by standard of practice.

Dr. Burke stated that health professional education has the potential to enhance other efforts by enabling health care providers to make good judgments in gray areas. However, there are many challenges. Traditional methods of holding conferences and lectures do not have much impact on physician practice. Many genetics curricula are collecting dust. Dr. Burke said it would be important to talk to individuals in need of genetics education to determine what would be most relevant to them.

Dr. Burke closed by stating that different approaches to the oversight of genetic testing have the potential to be complementary. She said it would be a challenge to think through what should be expected through statutory regulation, public and professional leadership, the research agenda, better practice guidelines processes, and education.

Dr. Ferreira-Gonzalez opened up the floor for questions. Dr. Marc Williams asked Dr. Burke to address postmarket data collection and surveillance. Dr. Burke stated that if there is not much evidence available when a test enters the clinical arena, even more evidence will be needed postmarket. Some questions, such as the clinical validity of a test, can only be answered over time. Dr. Burke raised the idea of a premarket review that has requirements for certain kinds of postmarket data collection. She also asked what kind of partnerships should be put in place to maximize the quality of the information obtained postmarket, such as the laboratories offering the tests, large health care systems that have a stake in the proper use of these tests, and appropriate public participation through funding. These partnerships might create systems in which there is prospective planning for gathering data on the uptake, outcome, and ultimate clinical effects of new tests.

Dr. Williams asked if Dr. Burke felt the Collaboration, Education, and Test Translation (CETT) model of translation for rare diseases could be applied for common disease-based genetic tests. The model has incentives built in to translate knowledge into the clinical arena and it requires transparency, educational materials for patients and providers, and data collection for five years after a test is in clinical practice. Dr. Burke said that the questions would be the same, but pointed out that some of the logistics issues would be more complex, such as the need to collect data more broadly and to collect comparative data.

Dr. Ferreira-Gonzalez asked Dr. Burke for her view on genetic exceptionalism. Dr. Burke replied that genetic tests have extraordinarily high predictive value compared with other medical tests. The idea that genetic tests require a different approach to oversight is based on that fact. In addition, genetic tests raise questions about family members that are not raised by other tests. There is greater cost effectiveness if family members

at risk are identified, but this leads to unique issues concerning confidentiality and privacy. Dr. Burke stated that since our society accords tremendous power to genetic information, people are concerned about discrimination. However, she cautioned against pushing the concept of genetic exceptionalism too far.

Dr. Julio Licinio asked whether there should be special protections when the genetic contribution to disease is very small (e.g., 3 percent in the case of a common, complex disease). He pointed out that a specific variant associated with depression, diabetes, or arthritis does not mean that an individual will have the disease. Dr. Burke said this was a tremendously important issue and she worried that a variant that predicts a small increased risk of type II diabetes would be viewed as having the same power as a test for a Mendelian disease. She suggested that public and professional leadership and those involved in health professional education craft the right kind of messages about multifactorial disorders.

New York State’s Clinical Laboratory Evaluation Program

Ann M. Willey, Ph.D., J.D.
Director of Laboratory Policy and Planning
Wadsworth Center
New York State Department of Health

Dr. Willey said that New York State has had statutory regulatory authority concerning clinical laboratory oversight since 1964, which predates CLIA. The 1964 statute was passed to limit the practice of laboratory medicine to laboratories physically in the State of New York, which infringed on interstate commerce. The statute was challenged in the Federal courts and overturned in its ability to restrict business to laboratories in New York. However, the same court said that the State could apply its standards to any laboratory doing business in New York. Thus, the New York State regulations now apply to other States as well as laboratories around the world, including Iceland, the United Kingdom, and Hong Kong. If a specimen is drawn in New York State and shipped to a laboratory anywhere in the world, the laboratory is subject to New York licensure requirements. Dr. Willey clarified that New York does not regulate manufacturers of kits, devices, or reagents—only laboratories.

The New York statute says that “a laboratory shall perform only those assays that have been validated or verified at the site where the assay will be performed.” This statute applies primarily to multisite, large commercial entities that want to validate an assay at one site and then transfer it to other sites. They must reproduce the validation data at any site at which they intend to offer the test or ship all the specimens for that assay to one site. A laboratory must hold the appropriate permit category for the test. New York State has 26 specialties, with 70 different categories in which they issue permits. Every test falls into one or more of those categories. The laboratories must meet all other requirements related to personnel, PT, and onsite inspection. New York State review of the validation of a laboratory-developed assay or an assay using certain commercial reagents is part of an integrated program, and inspectors are familiar with the types of personnel required in the laboratories. Every category must have an Assistant Director or Director holding specified credentials. They must be doctoral-degreed individuals with a minimum of four years postdoctoral clinical laboratory experience and a minimum of two years in the specialty. All other personnel must meet relevant training experience. The laboratories are physically inspected every two years for their quality assurance program, quality control, reagents, equipment, and physical location. They are required to participate in New York State’s PT program and encouraged to participate in any other relevant proficiency tests.

Dr. Willey listed assays that require specific validation review for approval prior to offering the test. These include commercially distributed assays labeled for research use only (RUO) and those using ASRs. Other assays that require validation review include FDA-approved assays or investigational use only assays that have been modified from their intended use or investigational device exemption approval from the FDA, and any in-house developed assays. Dr. Willey stated that a change in an intended use is a change in the specimen type, the type of analysis (e.g., qualitative or quantitative), the purpose of the assay (e.g., screening, diagnosis, prognosis, monitoring, confirmation), or the target population, as specified by the FDA or outlined in the package insert.

The materials submitted for validation review must include the assay name; the manufacturer of any reagents other than those they make themselves (the majority of laboratories obtain reagents from manufacturers); if using manufactured components, the commercial designation (e.g., RUO, ASR); the method or scientific principle behind the assay; the New York State permit category; the specimen type (e.g., blood, tissue, bone marrow); the target population(s); the purpose (e.g., diagnostic, prognostic, screening, predictive); whether it is qualitative or quantitative in intent; the performance evaluation method (e.g., comparability to an established method or correlation of results to clinical status of test subjects); assay description and complete standard operating procedures; practitioner/patient information, including limitations of the test; specimen collection instructions; the principle of the assay and indication of clinical validity (usually as reported in the literature); equipment list; reagents and their sources; controls; means of calculating or interpreting the result; interferences and limitations; copy of test requisition; for germline genetic tests, policy and compliance documents relevant to informed consent; sample reports for both normals and abnormal, including all necessary disclaimers; scientific references; analytical validation data; analyte and specimen matrix stability; reagent source and quality, particularly for RUOs; and performance characteristics of the assay (e.g., accuracy, precision, reportable ranges, sensitivity, and specificity).

In cases where performance evaluation is based on the clinical outcome of test subject status, additional information is needed on protocols to establish clinical status, protocols to blind specimen evaluation from clinical status, how discrepant results are resolved, and how predictive value calculation is done. New York State standards also require that cytogenetics and genetics laboratories report with an interpretation suitable for a nongeneticist physician, reference ranges (e.g., the heterozygote and homozygote results for germline genetics of single gene disorders), and whether the assay predicts disease state. Also required are the assay data for representative runs, the quality assurance plan, and the internal PT design. New York State has its own cytogenetics proficiency test and occasionally tests the ability of a laboratory to perform fluorescence *in situ* hybridization (FISH). All laboratories must have some form of proficiency assessment twice a year for every analyte. They must develop their own blinded proficiency assessment, usually using materials derived from previous specimens. When surveyors visit, they ask to see the data and the design of the assay.

Dr. Willey provided some statistics on the program's workload since 1995. During that year, they looked at eight assays, all of which were for genetics. In 2006, they looked at 586 assays. The majority was for genetics and included genetic testing, biochemical genetic testing, deoxyribonucleic acid (DNA)-based genetic testing, cytogenetics, preimplantation genetic diagnosis, forensic DNA technologies, paternity identity, histocompatibility, and oncology molecular markers.

Dr. Willey said they are often asked about the impact of the New York State program on testing in this country. She said they have 70 cytogenetics laboratories in the country, 5 of which are preimplantation genetic diagnosis laboratories. There are 32 laboratories that perform biochemical genetic assays and 71 molecular genetics laboratories, including 4 that perform preimplantation genetic diagnosis. The impact

of the New York State validation review program is that all major reference laboratories solicit and receive specimens from New York and are subject to New York clinical laboratory permit requirements, including approval of in-house developed assays. It has been estimated by others that as much as 75 percent of all cytogenetic and genetic testing performed in the United States (numbers of specimens tested, not number of laboratories) is subject to New York State oversight. GeneTests estimates that more than 300 laboratories are subject to New York State requirements. Dr. Willey stated that tort law medical malpractice cases have not looked favorably on laboratories subject to New York State standards that apply less stringent standards to the testing of specimens from other jurisdictions.

Concerning other States, Dr. Willey said that 26 have some degree of statutory authority for oversight of the practice of clinical laboratory medicine. Washington is the only other State that has CLIA-exempt status, and they do not have specific standards for genetic testing. California, through its Genetics Disease Branch and newborn screening and prenatal screening program, has rigorous review of those types of assays. That oversight does not generally extend to other genetic testing. New Jersey applies some personnel standards of the American Board of Medical Genetics to laboratories that perform genetic testing. Dr. Willey said she knew of no State that requires review of validation data for individual assays, other than in the context of a physical onsite inspection which, for most State programs, does not involve peer review.

Dr. Willey explained how the New York State program addresses harms. She stated that if specimens are sent from New York to a laboratory that offers unvalidated assays or assays that the State believes are problematic, New York is aggressive in sending the laboratory a cease-and-desist letter, warning that they can be fined \$2,000 a day for continued operation or \$2,000 a specimen. She gave the example of a laboratory in New England that offered to predict the gender of fetuses at 5 weeks but had never submitted validation materials to the State to indicate analytical validity. Other laboratories have offered to conduct single nucleotide polymorphism (SNP) profiles and provide them to patients' clinicians on a compact disc, claiming that the physicians will be able to interpret the data and predict medical needs. The laboratories have not been able to document clinical validity for the vast majority of those SNPs. There have also been serious challenges from laboratories that wish to perform nutrigenomics (i.e., profiling SNPs that they claim are linked to genes that may predict responses to nutritional products). These laboratories have not proven clinical validity. Some entities offer profiling for ancestry and paternity. In New York State, consumers cannot legally order laboratory tests other than those that have been approved by the FDA for over-the-counter self-testing. The laboratories cannot accept any of those tests without the written consent of the person being tested. Laboratories in violation are told they must cease and desist.

Dr. Willey said the greatest challenge of the New York State program is its expense. The costs for personnel and expertise to conduct the reviews are significant. The cost to the laboratories is also high, and there is a lawsuit pending because some laboratories did not want to pay for that part of the program. It is time-consuming for laboratories to prepare documentation for these validations in a format that can be readily reviewed by State staff. The major criticism of the New York State program is turnaround time. The program tries to complete reviews within 45 days, but some packages wait for a year or more. Often, the packages go back to the laboratories more than once for more information before being approved. The largest contributing problem is that laboratories frequently ignore previous critiques and their submissions are poorly organized. Dr. Willey noted that the State also has an active program for investigating complaints.

In New York, if a physician wants to order a test that is not offered in an approved laboratory or is offered only in a laboratory whose documentation is awaiting review, a specific request can be made for a non-permitted laboratory approval based on medical necessity. The permit granted is for a one-time test for a specific patient in a specific laboratory. A letter is sent to the doctor stating that the laboratory is not

approved for the test and that the State cannot guarantee the results. There is a 24-hour turnaround time for those requests.

Dr. Ferreira-Gonzalez asked if the program examines clinical utility. Dr. Willey replied that it does not and clarified that when she used the term “clinical outcome” she meant whether the patient is symptomatic of the disease for which the test is being established (i.e., clinical validity). Dr. Ferreira-Gonzalez also asked how they identified DTC laboratories. Dr. Willey said this occurs through the Internet, general health care, pharmaceuticals, and laboratory entities soliciting the submission of specimens. She said several companies have established themselves as test facilitators. They market to consumers at high costs, often 10 times what a laboratory would charge and they do not perform the tests themselves. Sometimes they use legitimate laboratories for legitimate validated assays. Dr. Willey noted that New York State requires the laboratory to bill patients directly.

Dr. Williams asked if the program had begun to develop standards concerning what information laboratories should be reporting back on variance of unknown significance for DNA. Dr. Willey said the laboratories have to be able to describe how are they going to resolve the issue—Are they going to sequence the gene? Are they going to send it to another laboratory? How are they going to report it?

Dr. Tuckson thanked Dr. Willey and asked her to help the Oversight Task Force as they move forward with the Secretary’s charge. Dr. Ferreira-Gonzalez introduced Dr. Gail Vance.

Accreditation of Genetic Testing Laboratories

Gail Habegger Vance, M.D., FCAP
College of American Pathologists

Dr. Gail Vance said she would be speaking on the College of American Pathologists (CAP) accreditation program as it pertains to molecular pathology, cytogenetics, and PT. The goals of the CAP accreditation program are to assure that tests are analytically and clinically valid and that there is patient safety, patient access to testing, and innovation and improvement of laboratory-developed tests. The accreditation program is designed to assure that high-complexity laboratory tests are provided by high-quality laboratories that assure analytic and clinical validity of their tests, have patient safety plans in place, and have incremental improvement and innovation in testing and that testing is not impeded.

CAP is a professional organization composed of approximately 16,000 board-certified pathologists. The accreditation program is CMS-approved and, like New York, holds to a higher standard than the CLIA regulations require. There are specialized inspector requirements for genetics laboratories, many of which are developed through scientists on the Scientific Resource Committees. Approximately 24 of these committees develop specialty accreditation requirements. In the field of genetics, there are hybrid committees composed of both College members who are pathologists and laboratory scientists who are members of the American College of Medical Genetics (ACMG). Laboratories enrolled in the accreditation program are required to report and update their testing menu continuously. This effort allows CAP to know what the laboratories are testing for and provide the required PT.

The CAP accreditation program began in 1961, predating CLIA, and was initially voluntary. The first Cytogenetics Checklist and inspections were offered in 1976 and a Molecular Pathology Checklist was created in 1993. Laboratory members of the accreditation program are required to undergo inspections by a team of external reviewers every two years. The team is usually composed of peer inspectors who are

actively practicing scientists in the specialty they inspect. The inspection tool used is the checklist, which allows laboratories to understand the standards to which they are being held. CAP offers approximately 18 checklists consisting of about 3,500 discipline-specific laboratory requirements. Over half of these requirements, approximately 1,700 questions, are in addition to CLIA minimal standards. Some of the special disciplines not covered by CLIA include forensic testing, autopsy, histology processing, embryology, and molecular pathology. Sections within traditional disciplines that go beyond the CLIA standards include PT for nonregulated analytes, laboratory computer systems, laboratory safety and hygiene, prenatal screening, and sweat chloride testing.

CAP inspectors are actively practicing molecular scientists familiar with the checklist to be utilized and possessing the technical and interpretive skills necessary to evaluate the quality of the laboratories' performance. Inspector training includes live training seminars or online interactive training modules. There are also audio conferences for discipline-specific areas. As of July 2006, every Team Leader must have completed mandatory training and must renew that training every two years. Regulations were being put in place for a requirement for retraining of team members every two years.

Standards that apply to genetics and exceed CLIA requirements include clinical validation, use of universal and proper nomenclature, correlation with clinical information and other studies, recommendations for genetic counseling and further studies, and turnaround time requirements. Examples of how CAP standards exceed CLIA are found in two of the questions from the Molecular Pathology Checklist: "Are the clinical performance characteristics of each assay documented, using either literature citations or a summary of internal study results? Does the final report include an appropriate summary of the methods, the loci or mutations tested, the analytical interpretation, and clinical interpretation, if appropriate?"

The CAP Molecular Pathology Checklist covers most aspects of clinical molecular testing, including not only inherited genetic testing, but also acquired genetic testing. It includes oncology, hematology, infectious disease, inherited disease, histocompatibility typing, forensics, and parentage applications. Any testing that involves DNA, ribonucleic acid, or nucleic acid probe hybridization or amplification constitutes molecular testing. Techniques covered by this checklist include requirements for extraction and purification, amplification, restriction endonucleases, sequencing, detection, real-time PCR, arrays, and *in situ* hybridization, all of which exceed CLIA requirements. CAP is piloting a test for comparative genomic hybridization arrays in the Cytogenetics Resource Committees and hopes to offer that as a proficiency test in the future.

The CAP Cytogenetics Checklist covers cytogenetic testing, including both standard G-banding and molecular cytogenetics. It covers chromosome analysis of amniotic fluid and chorionic villi, non-neoplastic blood and fibroblasts, and neoplastic blood and bone marrow. Techniques with specific compliance requirements include the establishment and maintenance of cultures, cells counted, karyotypes, band levels of resolution, and FISH.

Dr. Vance described how the accreditation process is conducted. She said that if a deficiency is cited during an inspection, the laboratory must respond to CAP with a corrective action plan within 30 days. A two-tier review process by a CAP technical staff analyst and a practicing pathologist designated as a regional commissioner to CAP determines the adequacy of the action plan and the laboratory's ability to maintain sustained compliance. However, the ultimate decisionmaking resides with the Accreditation Committee of the Council on Accreditation, which is composed of laboratory experts. On alternate years, when the laboratories are not being externally inspected, they are required to complete a self-inspection and submit the results. These results go into the inspector packet for the next cycle of external inspection.

CAP accredits approximately 6,500 national and international laboratories, including approximately 250 laboratories in the cytogenetics discipline and approximately 700 laboratories with a molecular pathology discipline. CAP accreditation includes 98 of the top 100 hospitals and the majority of large commercial reference laboratories, including LabCorp and Quest.

Some of the most common deficiencies cited in molecular pathology are in response to the following questions: 1) In cases where there is no commercially or externally available PT, does the laboratory at least semiannually (in compliance with CLIA) participate in external PT or exercise an alternate performance assessment system for determining the reliability of analytic testing? 2) Are temperatures checked and recorded appropriately for equipment in which the temperature is critical? 3) Is there a summary statement signed by the laboratory director or designee documenting review of validation studies and approval of the test for clinical use?

Some of the most common deficiencies cited for cytogenetics are in response to the following questions: 1) Are the final reports for tests requiring rapid reporting results available within seven days of specimen receipt in at least 90 percent of cases? 2) Are the final reports for neoplastic bloods and bone marrow analysis provided within 21 calendar days of specimen receipt in at least 90 percent of cases? 3) Are reagents and solutions properly labeled as applicable and appropriate? Dr. Vance explained that there are four or five criteria that must be labeled on the reagent and if only one of those is missing, the laboratory is cited for a deficiency.

CAP offers external PT for genetic laboratories, allowing them to evaluate their performance regularly and improve the accuracy of their results. Each laboratory is provided with unknown specimens for testing. They are told the category, but not the specimen. The participants analyze the specimens and return the results to CAP for evaluation. The results are evaluated by the Scientific Resource Committees or their peer groups from a comprehensive database of laboratories. CAP's proficiency tests in genetics are among the few in existence. Some of the products available include chromosomal abnormality identification, FISH using chromosome-specific DNA probes, biochemical genetics for metabolic diseases, and molecular analysis of lymphoma and leukemia. Dr. Vance displayed an algorithm that indicated what it looks like when there is a PT failure in a laboratory. If a laboratory receives an unsatisfactory PT evaluation on one PT event, it is issued a warning for testing for that analyte. They are also provided with educational materials on how to improve. The laboratory is monitored and if there is one unsatisfactory report for the next two PT events, the laboratory is given a choice: cease testing for that analyte or document a plan for corrective action. If a corrective action plan is submitted and considered acceptable, the laboratory is allowed to continue testing for that analyte until the next PT event, although at maximum for six months. If the next PT is satisfactory, the laboratory is monitored for another PT cycle. If their results are good, they are allowed to continue testing. If, on the following PT event for that analyte, they again receive an unacceptable response, they are required to cease testing for that analyte. The laboratory must sign a cease testing form and document a plan of action for that analyte. The earliest that the laboratory could test for that analyte again is six months.

Dr. Vance displayed a summary of the PT performance results for 2006. The analytes tested included factor V Leiden, prothrombin, prothrombin interpretation, methylene tetrahydrofolate reductase, fragile X mental retardation, Prader-Willi syndrome, hemochromatosis, Duchenne muscular dystrophy, and hemoglobins S and C. Laboratory performance on these analytes was generally good in 2006.

Dr. Vance said the CAP laboratory accreditation program can serve as a model for improving the quality of laboratory-developed tests. The CAP accreditation process improves patient care and protects the public's health, but does not stifle or impede test development, innovation, and improvement. CAP's recommendation

to SACGHS was that private organizations, including CAP and laboratories, should build on the work of CLIA that has been successful over the previous 15 years. CAP believes that the goal of assuring analytic and clinical validity for all high-complexity laboratory tests could best be achieved through the CLIA inspection process. Dr. Vance concluded by stating that, to achieve this goal, statutory changes to CLIA may be needed.

Dr. Ferreira-Gonzalez thanked Dr. Vance and introduced Dr. Carolyn Sue Richards.

Clinical Laboratory Standard Setting

Carolyn Sue Richards, Ph.D.

Professor of Molecular and Medical Genetics

Director of the DNA Diagnostic Laboratory

Oregon Health and Science University

Dr. Richards said she is involved in standards development with a number of groups but was speaking primarily as a representative of ACMG. Through ACMG, there are multiple mechanisms for setting professional guidelines, including the Laboratory Quality Assurance Committee, the Professional Practice and Guidelines Committee, and ACMG special projects for commissioned guidelines.

There are three types of ACMG statements that can be viewed as standards: policy statements, which are often responses to a single issue that must be addressed immediately; a practice guideline, which is a clinical guideline on the testing that should be done in specific settings but often does not specify how testing should be performed; and laboratory standards and guidelines, which address how laboratories should perform particular tests. The purpose of ACMG standards and guidelines, which are voluntary, is to provide an educational resource to assist medical geneticists in providing accurate and reliable diagnostic genetic laboratory testing consistent with current technologies in clinical cytogenetics, biochemical genetics, and molecular diagnostics.

The ACMG Laboratory Quality Assurance Committee is dedicated to evaluating new technologies, monitoring accreditation requirements, and, through CAP, monitoring laboratory PT. Committee representatives attend meetings of the CAP Resource Committee to monitor laboratory performance. They use this information as a trigger for developing new standards and guidelines. For example, if there is an analyte for which laboratories are performing poorly, the Committee addresses the problem with a guideline. The guidelines therefore change continually over time. They also include model laboratory reports. Since 2000, ACMG has issued disease-specific guidelines.

The Laboratory Quality Assurance Committee functions as a resource for education, including for the nongenetics communities. When new guidelines are developed, ACMG reaches out to different professional groups and organizations and conducts workshops. They believe all health professionals will have a role in the genetic testing process and, as such, need to be conversant with test quality issues and the communication of test results interpretation. Three working subcommittees, composed of clinical laboratory geneticists certified by the American Board of Medical Genetics, address molecular, cytogenetic, and biochemical genetics. A biostatistician helps with validation questions and statistical work. Outside experts are frequently used for selected topics.

Some Laboratory Quality Assurance Committee representatives are involved in the Clinical and Laboratory Standards Institute (CLSI) and some work with EGAPP projects. ACMG has a pulse on activities in genetic

testing and tries to address new issues as they arise. Dr. Richards said that standards ensure the quality of genetic testing by setting a standard of practice in the field. They are used to develop laboratory inspection checklists for CAP as a regulatory requirement for accreditation. They are also used to develop PT challenges and test interpretations through the CAP process and as an educational resource.

Dr. Richards provided an example of how ACMG professional guidelines have intersected with Government projects. The CDC and NIH sponsored meetings about promoting quality laboratory testing for rare disease in 2004 and 2005 to address quality, availability, and accessibility of genetic testing for rare disorders. The CETT project, a laboratory guideline developed by ACMG on technical standards, and guidelines for molecular genetic testing for ultra-rare disorders resulted from this work.

Dr. Richards said there is a need for guidelines and standards to ensure quality assurance for genetic testing, and ACMG believes they can play a major role in their development and they were interested in working with SACGHS to answer questions about technologies, personnel, test validation, quality control, quality assurance, and test interpretation. They address preanalytical, analytical, and postanalytical test issues and pitfalls that could be involved in genetic testing. A number of guidelines were in development through the various ACMG working groups. “Quality Watch” is a program for reporting and following up on adverse events that might be caused by laboratory products or reagents that impede accuracy in genetic testing. Quality Watch was to be launched on the new ACMG Web site in May 2007.

Dr. Richards described how standard development is supported. Committees are composed of unpaid volunteers and are supported from public and private sources, including industry. Costs can range from \$100,000 (e.g., the pharmacogenetics standard and guideline) to \$1 million (newborn screening documents). Costs include meeting costs, evidence-based reviews, and administrative costs.

Standard development begins when a need is identified. Approval is sought from the Laboratory Quality Assurance Committee, and a leader and working group of five to six members are appointed. They develop documents through conference calls and e-mails. They hold two face-to-face meetings a year and the remaining work is done behind the scenes with no funding. If a guideline is fast-tracked, it can reach draft form within six months. Many guidelines take much longer. There is a thorough review process that is similar to the CLSI consensus document review process. Several rounds of revisions include comments from the full Laboratory Quality Assurance Committee, the Board of Directors, experts in the field, and others who review the document online on the ACMG Web site. After all comments are addressed, the draft is sent to the Board of Directors for approval. If approved, the document is posted on the Web site and published in *Genetics in Medicine*. There is an ongoing renewal and revision process that ensures that the document keeps pace with advances in knowledge in technology. Although adherence is voluntary, the standards are used for developing accreditation standards and PT models and are therefore indirectly enforced through CAP.

The ACMG standards exceed CLIA requirements, have incorporated some of New York State’s requirements, and are attentive to their European and Australasian counterparts. ACMG has a strong focus on nomenclature standards and reporting standards.

Dr. Richards said standard-setting organizations interact with and involve the Government in various ways. They respond to the Government on guidance statements and legislative proposals and include Government representatives in the committee work that develops the standards and guidelines. She acknowledged that there are, and always will be, gaps in current standards because professional organizations cannot keep pace with test development.

Dr. Richards closed by suggesting that SACGHS address issues related to gene patents and licensing that are affecting test validation. She said that exclusive licensure of testing to a single entity will not allow for the expertise needed to develop standards or support PT. She concluded her remarks by stating that the ACMG guidelines are available on the Web site www.acmg.net.

Dr. Ferreira-Gonzalez thanked Dr. Richards and introduced Dr. Alfred Berg, who presented via teleconference.

Development of Clinical Practice Guidelines

Alfred Berg, M.D., M.P.H.
Professor and Chair
Department of Family Medicine
University of Washington

Dr. Berg described clinical practice guidelines as recommendations issued for the purpose of influencing a decision about a health intervention. They have been in existence as long as medicine has been practiced. In the past, many guidelines were well intentioned but were proved incorrect in practice. Dr. Berg noted that there is renewed attention to guidelines because medical literature is increasingly complex, which makes it difficult for an individual clinician to understand a given clinical topic. Patients are increasingly interested in participation in medical decisions, including guidelines. There is also legal pressure to define standards in medicine. He said there are now better methods to generate guidelines than there were in the past.

Clinical guidelines are needed because clinicians cannot keep up with the large volume of emerging medical literature. Guidelines help make sense of thousands of articles on a given clinical topic. They help clinicians deal with complex decisions, improve the quality of decisionmaking, and provide justifications to patients, payers, and the legal system about why decisions are made. Guidelines are useful for transmitting medical knowledge, assisting with patient and physician decisions, setting clinical norms, contributing to quality improvement projects in hospitals and group practices, and privileging and credentialing, and they can be used for payment, cost control, and medicolegal evaluation.

Dr. Berg stated that in the past, most guidelines were constructed using “global subjective judgment.” This technique had clinicians meet together to develop guidelines based on their own judgment. The process was not transparent. Now guidelines are increasingly explicit and evidence-based. The hallmarks of evidence-based guidelines are that they are clearly laid out, transparent, and publicly accountable. Dr. Berg listed the characteristics the Institute of Medicine specifies as important to clinical guideline development: the guideline should be extremely clear about the clinical condition addressed; the health practice or intervention proposed; the target population; the health care setting (e.g., whether a specialist setting or primary care setting); the type of clinician (e.g., nurse, physician, nurse practitioner, or physician assistant); the purpose (e.g., to improve clinical care); and the source of the guideline and sponsorship (e.g., who is funding guideline development).

AHRQ has also specified a number of process characteristics for clinical practice guidelines. These include: How was the panel selected and what were the screens for potential conflicts of interest? How was the problem specified? How was the literature search strategy devised, how was the analysis conducted, and how was the evidence summarized? How does the evidence link to the recommendations made? What are the clinical outcomes? Dr. Berg said the process should be sensitive to cost and practicality. AHRQ’s attributes of a guideline are that it be valid, reliable, practically applicable, flexible, clear, multidisciplinary,

peer-reviewed before publication, and well documented. AHRQ's specific characteristics of validity include clear projected health outcomes, projected costs, and any policy rationale. It should be evidence-based, including a rigorous literature review and literature evaluation.

Dr. Berg stated that there is growing availability and promotion of genetic tests and that clinicians need authoritative advice. Although evidence-based processes for clinical guidelines have evolved, there are challenges in using these methods for genetic tests. Many conditions in genetic testing are uncommon or exceedingly rare, and the interventions and clinical outcomes are not well defined. The technologies for interventions and test characteristics are changing so rapidly that there is not enough time to thoroughly examine the clinical outcomes. Many genetic tests have inadequate sensitivity and specificity in the general population. Many tests are proposed and marketed based on descriptive evidence and pathophysiological reasoning, not evidence from clinical trials. A number of advocacy groups from industry and patient special interests are concerned about these challenges.

Dr. Berg focused specifically on EGAPP, for which he is a panel member. EGAPP has a nonregulatory, multidisciplinary panel composed of independent, non-Federal employees. The panel underwent an exhaustive conflict of interest review to ensure that no participants had biases about genetic testing or had financial interests at stake. The panel's process is evidence-based, transparent, and publicly accountable. The goal is to establish and evaluate a systematic and sustainable mechanism for premarket and postmarket assessment of genomic applications in the United States. The first two years focused on the methodology, which includes topic selection, an analytic framework for literature search strategies and assessment of the evidence, attention to analytic and clinical validity, and a way to specify clinical outcomes. Many of the clinical outcomes in genetic testing are different from clinical outcomes in other domains of medicine. The project made significant progress in advancing the field of clinical outcomes and was developing a manuscript for publication that outlines four general categories: health information impact, therapeutic choice, impact on patient outcomes, and impact on the family and society.

The work plan steps are to select topics, define relevant clinical outcomes, conduct reviews and make recommendations, and test methods. The first topics examined were CYP450, HNPCC, and ovarian cancer screening. EGAPP is experimenting with brief reviews when the data are limited. Since they may not be able to cover all the components in a full clinical practice guideline, the scope is narrow. The first review was a UGT1A1. Dr. Berg said they were midway through the third year of a three-year project that was extended to four years and might be extended to five years. They hope to conduct three to five major reviews and two to three brief reviews, to publish their methods, and to conduct a rigorous evaluation.

Dr. Berg walked through the clinical scenario for the EGAPP topic of CYP450 testing, which was fairly advanced, to give the Committee a sense of how the panel works. The question asked was: Does testing for CYP450 polymorphisms in adults entering selective serotonin reuptake inhibitors treatment for nonpsychotic depression lead to improved outcomes or are testing results useful in medical, personal, or public health decisionmaking? It was hoped that the results would provide useful advice to clinicians and patients. They started by developing an analytic framework. Out of that framework, they extracted a series of key questions and conducted an explicit search using a standard abstract, full text, and two reviewers. They assessed the quality of evidence, and when there was enough information to put into a table (which was not often), they created evidence tables.

The overarching question was: Does testing improve outcomes? Derivative questions were: What are the test characteristics? What are the correlations of the tests with efficacy and adverse effects? Are there any known effects on management, clinical outcomes, or decisionmaking? Are there harms associated with

testing? The preliminary observations for CYP450 testing found that there are some data on sensitivity and specificity, but no studies directly linking testing to clinical outcomes. The studies they found were small, poor-quality cohort studies. No studies directly compared alternative testing strategies, and many of the studies failed to account for the relevant genotypes, making it difficult to combine the studies and develop a single clinical recommendation.

Dr. Berg summarized the apparent gaps in genetic testing evidence, including gaps in knowledge about the prevalence of these abnormalities in the general population, a gap in evidence regarding the penetrance of the abnormalities into something that is clinically recognizable, an absence of clinical trials that compare testing and intervention strategies, an absence of studies that fully assess all relevant outcomes, a lack of attention to harms, and very little literature on the cost and feasibility of these technologies. His personal observations were that a large and growing number of tests are marketed to clinicians and consumers in the United States, and the national attitude seems to be that “more is always better” and “technology is always good.” This environment is relatively hostile toward regulation. There is potential to use these technologies for both benefits and harms, but unfortunately there is limited evidence. Dr. Berg stated that he was surprised that the EGAPP topics had so little evidence because they were chosen based on the belief that they had the most data.

Roundtable Discussion

Dr. Tuckson reviewed the charge given to SACGHS earlier in the day. Dr. Ferreira-Gonzalez asked Dr. Vance if she could account for the apparent discrepancy between the public comments from the Genetics and Public Policy Center (GPPC), which stated that two-thirds of laboratories are involved in PT testing and a third are not, and Dr. Vance’s data indicating that in 700 molecular pathology laboratories, the most frequent deficiency on the PT program accounted for 3.9 percent of laboratories. Dr. Vance replied that not all laboratories adhere to CAP standards, as it is a voluntary program. She added that the numbers are dynamic because small laboratories are often bought by larger laboratories and new laboratories open frequently. She said it is very difficult to track the laboratories and make sure that they are involved in a CLIA or CAP inspection process.

Dr. Berg stated that a number of tests are promoted as single-source tests, which presents a problem because the data relevant to their usefulness in practice are proprietary. In addition, there is very little information in the peer-reviewed literature on these tests. They are also not subject to PT mechanisms that are in place for other kinds of tests.

Dr. Tuckson asked Dr. Berg to help the Task Force develop some case studies that show the continuum of activities from analytic and clinical validity and clinical utility all the way through to the point where tests are chosen for use by a clinician. He said Dr. Berg’s description of CYP450 might be one example and he asked him to think of others.

Dr. Ferreira-Gonzalez asked Dr. Vance whether CAP reports the results of its PT to CMS. Dr. Vance said yes, but she could not address what CMS does with that information. Dr. Ferreira-Gonzalez also asked who is responsible for checking on laboratories that fail the PT program to make sure they follow the required steps. Dr. Vance replied that CAP has become more involved and recently spent \$9 million to bolster its accreditation program, particularly with regard to monitoring, and they created a new council called the Council on Accreditation. One of its subcommittees is called the Continuous Compliance Committee, which has responsibility for monitoring PT results and sending cease-testing letters. There is a two-pronged

review: monitoring the laboratory testing menus to ensure that laboratories are enrolled in required PT and making sure they are performing PT successfully. The inspectors look at PT results and plans of action if the laboratories have been previously unsuccessful.

Dr. Steve Teutsch asked Dr. Berg about the complexity of getting guidelines translated into practice. Dr. Berg said that those who work in primary care have been happy to see the NIH Roadmap leading toward T2 translation (bedside to the community). He hoped that more groups will address that process.

Dr. James Rollins asked the EGAPP panel members present how the EGAPP initiative will result in positive outcomes at the population level, decreased cost, or better management of patients. Dr. Berg emphasized that EGAPP is committed to issues of clinical utility.

After concluding the question-and-answer session and with input provided by Clinical Laboratory Improvement Advisory Committee (CLIA) chair Dr. Lou Turner and Joe Boone, Associate Director for Science in the Division of Public Health Partnership of CDC, Dr. Ferreira-Gonzalez reported on the February 2007 CLIA meeting's discussion of CMS's decision not to go forward with the NPRM for a genetic testing specialty under CLIA. CLIA heard from CMS about its plans for strengthening genetic testing oversight, and CLIA members generally expressed support for these efforts. However, several members of the committee expressed concerns about CMS's decision not to go forward with a genetic testing specialty and questioned the agency's rationale. They pointed to concerns in the genetic testing community about laboratory quality, particularly regarding the qualifications of laboratory personnel and the interpretation of genetic test results. They said these two important measures of quality are not being captured in CMS survey data because CMS surveys do not routinely inspect genetic testing laboratories.

In summarizing the session, Dr. Tuckson said he was concerned about the testimony from the GPPC regarding the relationship between the specialty designation and PT. The GPPC representative stated that one-fourth of laboratories are not doing PT as they should be. Dr. Williams pointed out that because participation in CAP and other accreditation programs is voluntary; laboratories have the choice to opt out. Dr. Tuckson stated if the CLIA committee did not explicitly deal with the frequency of PT, the issue should be added to the SACGHS charge. He also said that SACGHS should determine whether the results of PT performance are being made available to the public.

Dr. Ferreira-Gonzalez led the Committee in a discussion of the questions in the oversight charge from HHS OS. The Oversight Task Force had also developed a list of questions prior to the meeting, and Dr. Ferreira-Gonzalez asked the group to compare the two lists and determine whether any issues should be added to the charge. She felt that the Task Force's question 5 should be added to the charge from the Secretary. It read: "What would be the impact of these solutions on the accuracy and quality of genetic testing, investment and innovation, availability and cost of genetic tests, and patient/consumer health and health care decision-making? How might these effects vary for different categories of genetic tests, for example, direct-to-consumer, predictive, diagnostic, pharmacogenomics? What would be the effects of leaving the system as it is?"

Dr. Joseph Telfair pointed out that the oversight charge from OS contained a number of compound questions that should be rewritten to be more discrete. He also suggested looking at existing information, such as the work of CDC, to draw upon the efforts that are already under way.

Dr. Ferreira-Gonzalez noted that public comments from Gentrif Corporation addressed the use by some entities of reference controls that are not FDA-cleared. She suggested adding this issue to the discussion of

PT materials. Dr. Williams said this issue had come up frequently in the CETT process. He asked whether, if all controls were required to be FDA-cleared, there would be a system for controls for all tests—even ultra-rare disorders that rely on patient samples—or whether there would be certain exemptions. He felt this was a relatively narrow view of the control issue. Dr. Ferreira-Gonzalez agreed, stating that not only are there a limited number of FDA-cleared controls, but there is a cost associated with running the controls, complicated by a lack of reimbursement. She added that there might be exceptions allowing the use of already characterized specimens from patients that have been run with FDA-cleared testing. She said this was an issue for further examination.

Dr. Tuckson ended the day by thanking the Task Force for arranging the sessions on Oversight.

Appendix B

List of Public Commenters

The following organizations and individuals responded to a November 5, 2007, request for public comments on an earlier version of this report.

American Association for Clinical Chemistry
Advisory Committee on Heritable Disorders and Genetic Diseases in Newborns and Children
AdvaMed
Affymetrix
Agency for Healthcare Research and Quality
America's Health Insurance Plans
American Association of Clinical Endocrinologists
American Clinical Laboratory Association
American Clinical Laboratory Association Testimony to SACGHS
American Dietetic Association
American College of Medical Genetics
American Heart Association
American Nurses Association
American Proficiency Institute
American Society for Clinical Pathology
American Society of Clinical Oncology
American Society of Human Genetics
Association for Molecular Pathology
Association of Pathology Chairs
AstraZeneca
Benkendorf, Judith, MS, CGC
Biotechnology Industry Association
Blue Cross and Blue Shield Association
Centers for Medicare & Medicaid Services
Charache, Patricia, Johns Hopkins Medical Institutions
Coalition for 21st Century Medicine
College of American Pathologists
College of American Pathologists Testimony to SACGHS
Cooley, James, and Judy Devore
DNA Direct

Donlon, Timothy A., Ph.D., FACMG
European Molecular Genetics Quality Network
Food and Drug Administration
Genetic Alliance
Genetics and Public Policy Center
Genzyme
Helicos BioSciences Corporation
Health Resources and Services Administration, Advisory Committee on Heritable Disorders and Genetic Diseases in Newborns and Children
International Society of Nurses in Genetics, Inc.
International Society of Nurses in Genetics, Inc. Testimony to SACGHS
Kaput, Jim, FDA Division of Personalized Nutrition and Medicine
Klein, Roger D., M.D., J.D., University of South Florida College of Medicine
Leininger, Anna, MS
Maves, Michael D., MD, MBA
Merck
National Business Group on Health
National Cancer Institute
National Institute of Diabetes and Digestive and Kidney Diseases
National Institutes of Health (NHLBI, NIMH, NINDS, NCRR, NIAAA, NHGRI)
National Society of Genetic Counselors and the American Board of Genetic Counseling
ParagonDx
Personalized Medicine Coalition
Pfizer
PHG Foundation (UK)
Public Citizen's Health Research Group and Neil A. Holtzman
Roche Diagnostics Corporation and F. Hoffmann-La Roche AG
Stanley, Donald E., Associates in Pathology
University of Michigan Center for Public Health and Community Genomics
Veripath Laboratories
Wideroff, Louise, NCI
World Privacy Forum

Appendix C

Detailed Maps of the U.S. Oversight System for Genetic Testing

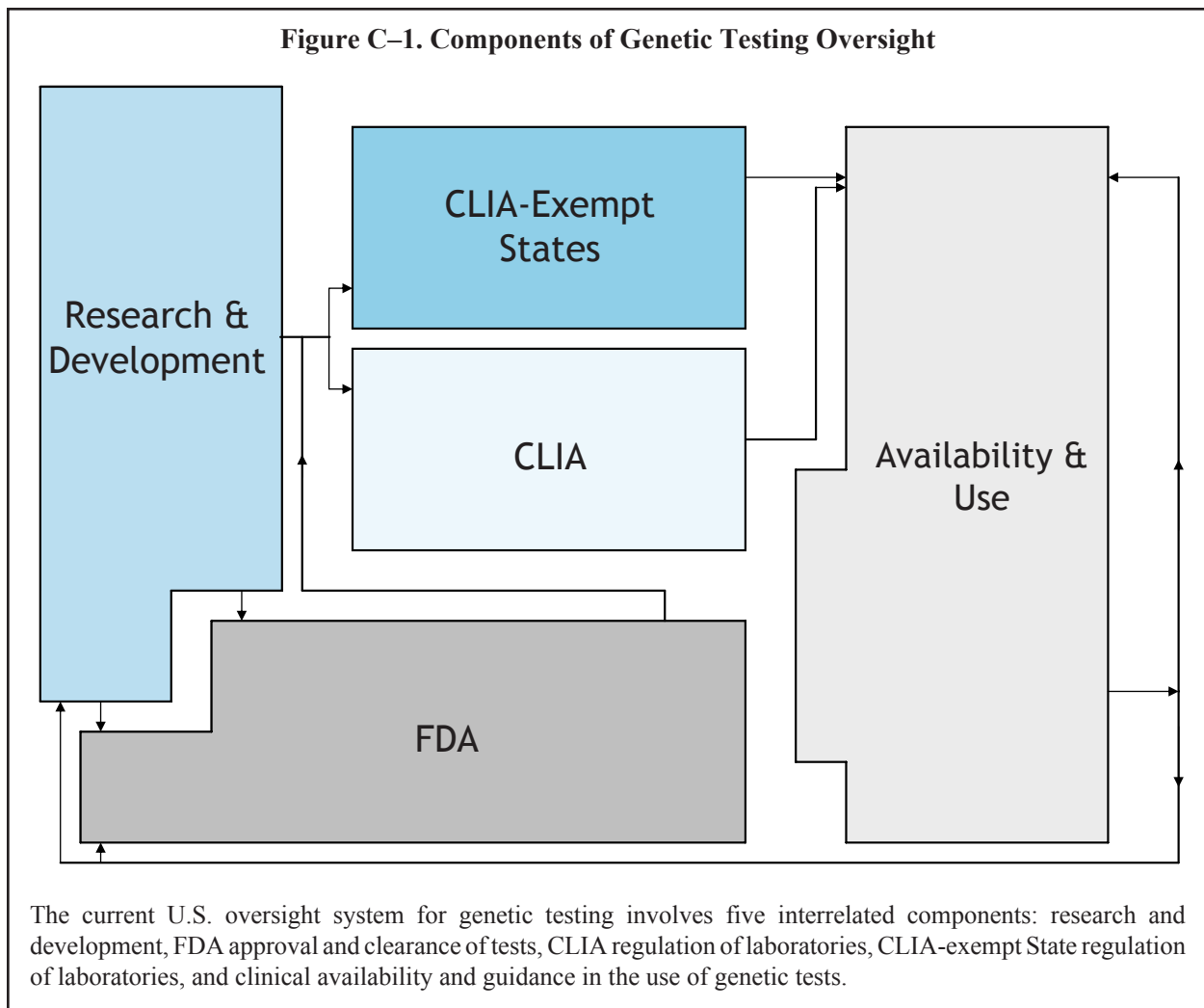
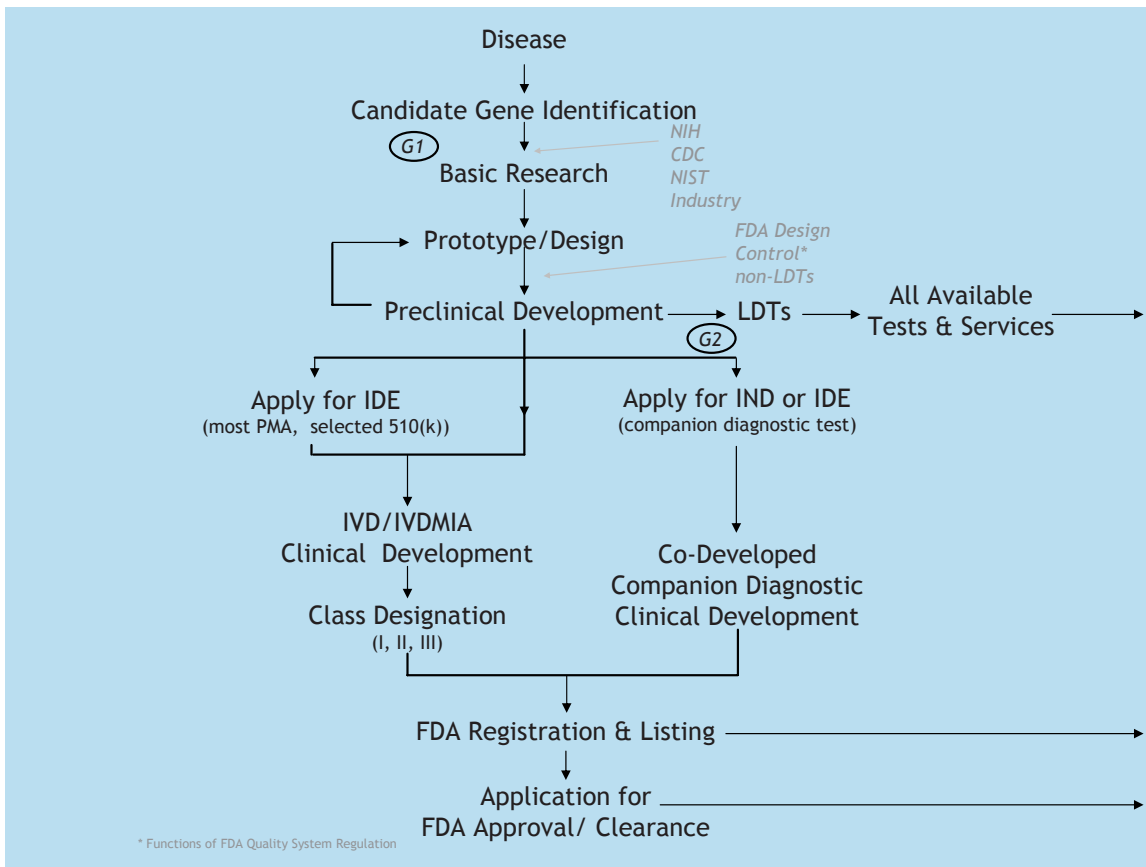

Figure C–2. Research and Development



Research sponsored by government (e.g., the National Institutes of Health [NIH], Centers for Disease Control and Prevention [CDC], and the National Institute of Standards and Technology [NIST]), industry, and other sources identifies candidate genes that may play a role in particular disorders and health conditions. Further basic research leads to the design and development of genetic test prototypes. All devices are classified by risk as class I, II, or III, and most medical devices must comply with Food and Drug Administration (FDA) design control requirements. For devices with significant risk, device manufacturers must apply for and receive an investigational device exemption (IDE) before use of the device on human subjects during clinical development. Most class I and some class II devices are exempt from the FDA approval and clearance process. Most class II and class III devices are required to submit a 510(k) application for FDA premarket notification or PMA application for premarket approval, respectively, and receive FDA clearance or approval prior to marketing the device. Manufacturers are required to register and list new devices with FDA within 30 days of placing a device on the market. Co-developed companion diagnostics may follow the aforementioned IDE route for device development, or they may follow the investigational new drug (IND) route. Co-developed diagnostic devices are subject to the same general controls as other devices, such as registration and listing with FDA.

Two important gaps are found in the R&D component: (G1) the need for reference materials for assay, analyte, and platform validation to establish that new tests are accurate and (G2) no review of many laboratory-developed tests (LDTs) as they move from the research setting to the clinical setting due to FDA enforcement discretion.

Figure C-3. FDA Approval or Clearance of Tests

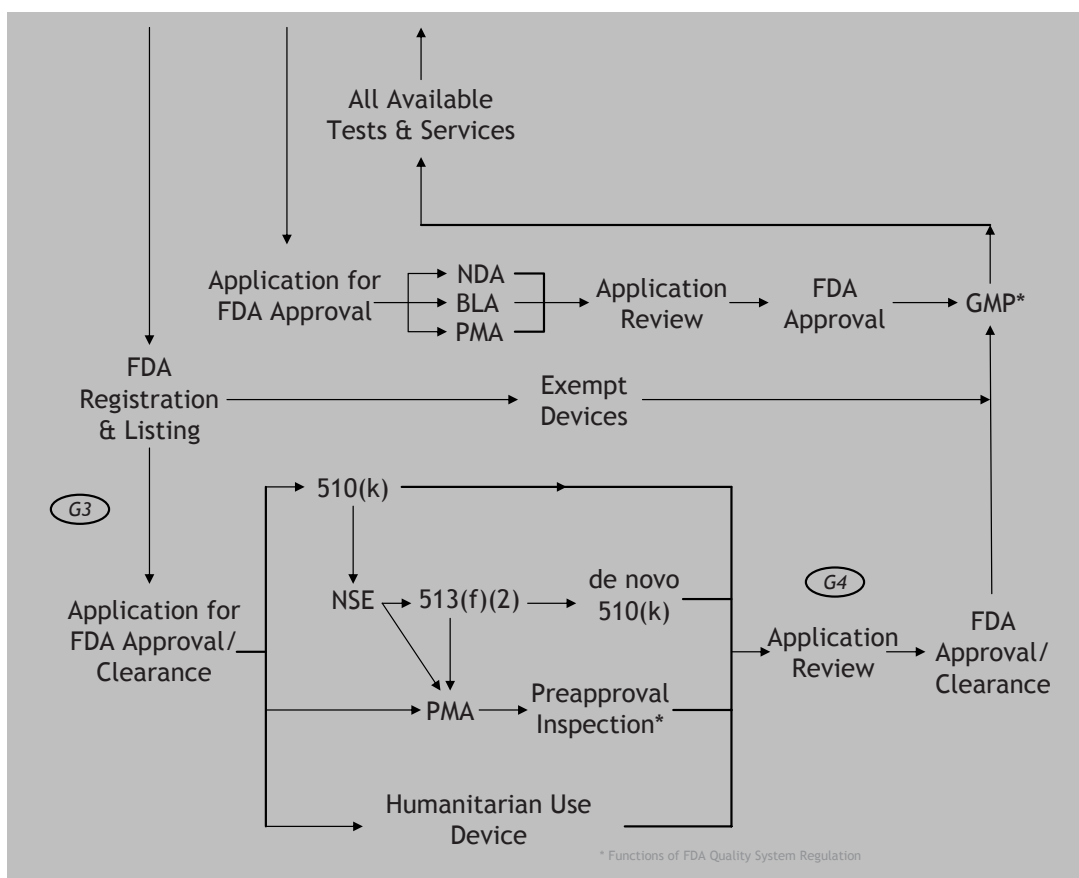

There are several routes that the sponsor of a device can take to achieve FDA approval or clearance, if required (i.e., if the device is not exempt). Some class I, most class II, and a very small number of class III devices are subject to 510(k) premarket notification. Manufacturers of these devices must demonstrate that the new device is substantially equivalent to a device that is legally marketed. Upon premarket notification review, new devices with no legally marketed predicate receive a decision of “not substantially equivalent (NSE)” and are classified by statute as class III. For new devices that are not high risk and for which identification and application of special controls is sufficient to establish a reasonable assurance of safety and effectiveness, downclassification to class II may be sought. For new devices that are determined to be low risk and for which general controls (e.g., good manufacturing practices [GMPs]) are sufficient to establish a reasonable assurance of safety and effectiveness, downclassification to class I may be sought. Downclassification is usually obtained through a mechanism (known as the de novo process) provided in section 513(f)(2) of the Federal Food, Drug, and Cosmetic Act (although there are other less commonly used mechanisms). New devices that cannot be downclassified remain as class III devices, and sponsors of such devices must use the PMA process and are subject to FDA preapproval inspections to establish compliance with the Quality System regulation. Co-developed companion diagnostics may undergo FDA approval through the new drug application (NDA), biologic license application (BLA), or PMA process.

Gaps in this component of oversight include: (G3) lack of a national mechanism for reporting faulty manufacture of in-house reagents if manufacturers are not required to be registered or list these products with FDA and (G4) inadequate resources for review of analytical validity and clinical validity for many laboratory tests; clinical validity data may not be available at the time of approval/clearance for some tests.

Figure C-4. Certification and Inspection of Laboratories

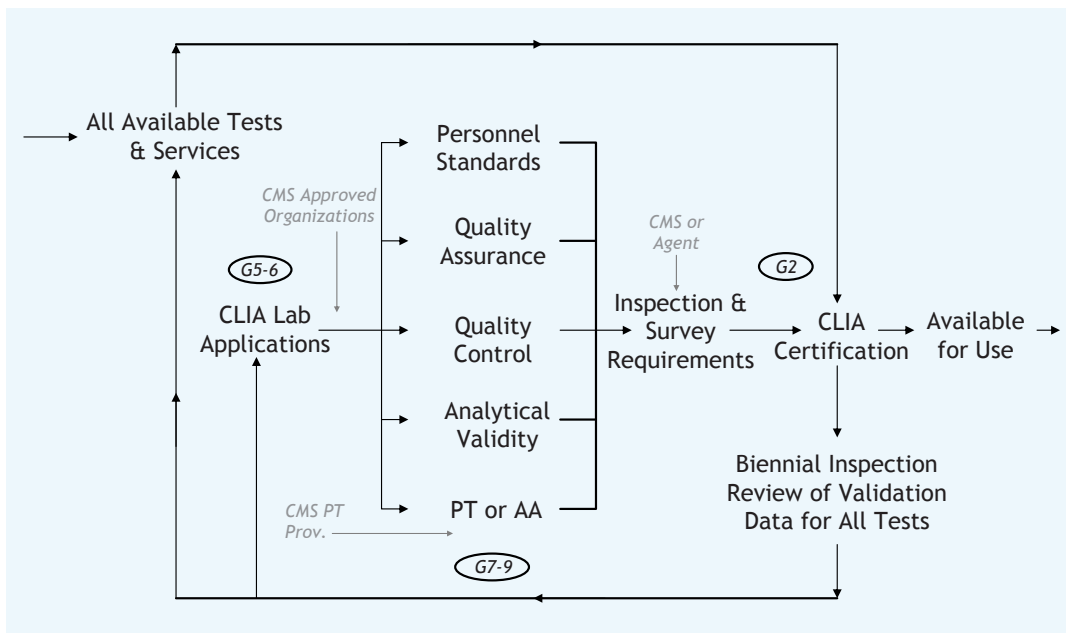

All laboratories that test human specimens for the purpose of assessing health, diagnosis, or treatment are regulated by the 1988 Clinical Laboratory Improvement Amendments (CLIA), which are implemented by the Centers for Medicare & Medicaid Services (CMS). CLIA regulation begins with a laboratory’s application for CLIA certification. Laboratories can then choose by whom they will be surveyed—through a CMS-approved accrediting organization (e.g., College of American Pathologists, Joint Commission, or COLA) or by CMS, which contracts with State Departments of Health. Through biennial onsite inspections, laboratories must demonstrate compliance with CLIA standards for personnel qualifications and responsibilities, quality assurance, quality control, proficiency testing (PT), and record keeping (which includes the analytical validity of tests). Laboratories that do not meet CLIA requirements may be required to stop providing one or more tests or may lose their CLIA certification, depending on the severity of their failure to comply with CLIA regulations and other key factors.

Several gaps arise in this component of oversight. G5 highlights the need for additional training of CLIA laboratory inspectors to improve their understanding of rapidly advancing genetic technologies. G6 points out that the analytical validity of laboratory tests is reviewed after tests are on the market, not before. G7-9 are gaps in PT such as inadequate PT requirements, as most analytes for genetic testing are not among the 83 CLIA-regulated analytes that require PT. Other gaps arise because of insufficient resources and means to develop PT products for genetic tests and lack of data on the effectiveness of PT versus alternative methods of assessment.

Figure C-5. Laboratory Certification in CLIA-Exempt States

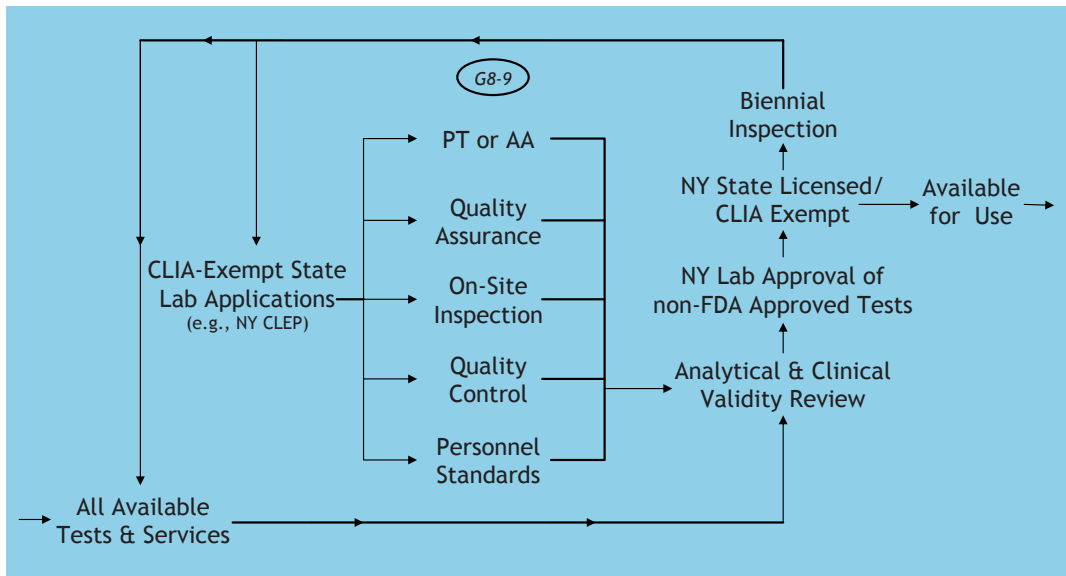

Two States—New York and Washington—have CLIA-exempt status because their laboratory standards have been reviewed by CMS and determined to be at least as rigorous as CLIA. New York State’s Clinical Laboratory Evaluation Program (CLEP) has been cited as having particularly stringent laboratory standards. The New York program requires evidence of analytical and clinical validity for all tests offered, and, unlike the CLIA program, CLEP must also approve tests that are not reviewed by FDA before they can be offered. After a laboratory obtains a New York State laboratory permit, it is subject to biennial inspections. Laboratories that do not pass these inspections may be required to stop providing one or more tests or may lose their New York State permit, depending on the severity of failure to comply with CLEP regulations.

Gaps (G8-9) in CLIA-exempt State regulations are related to PT.

Figure C-6. Availability and Use of Genetic Tests

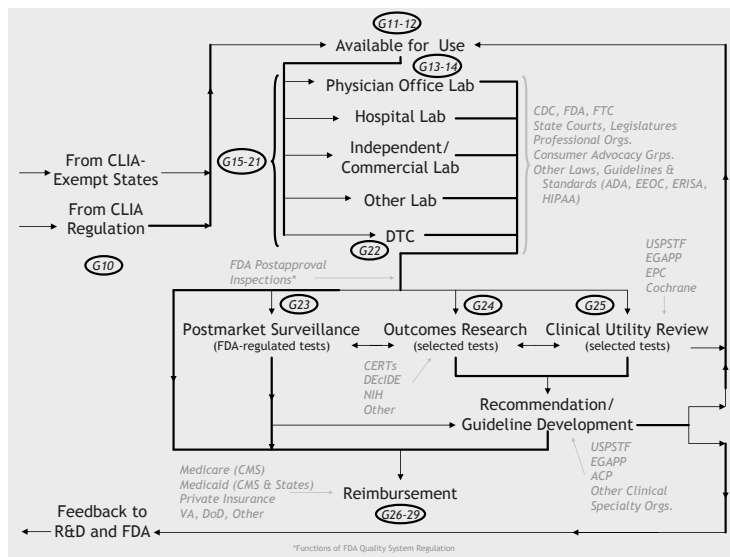

Some genetic tests are devices that have also been approved or cleared by FDA; others are devices called LDTs that have not been subject to FDA oversight. In addition to FDA and CMS, other agencies and organizations contribute to oversight regarding the availability and use of genetic tests, including CDC, the Federal Trade Commission (FTC), State courts and legislatures, professional organizations, consumer advocacy groups, and laws such as the Americans with Disabilities Act (ADA), Health Insurance Portability and Accountability Act (HIPAA), and the Employee Retirement Income Security Act (ERISA), as well as an order issued from the Equal Opportunity Employment Commission (EEOC). After tests are on the market, they can be subject to various types of oversight and evaluation such as CLIA laboratory inspections and FDA surveillance. For example, devices that have been approved or cleared by FDA are subject to postmarket surveillance for adverse events attributed to the tests and to FDA post-approval inspections to establish compliance with FDA’s Quality System regulation. Certain types of tests are subject to other forms of nonregulatory reviews, usually based on available evidence of analytical validity, clinical validity, and clinical utility. Such reviews are conducted, although not on a comprehensive or systemic basis, by the Evaluation of Genomic Applications in Practice and Prevention (EGAPP) program, the U.S. Preventive Services Task Force (USPSTF), and evidence-based practice centers (EPCs). Health professional organizations and other groups incorporate findings from available reviews, outcomes research, and postmarket surveillance into evidence-based practice guidelines on selected topics. Payers from the public and private sectors may use these same findings and practice guidelines to inform their health benefits and coverage policies.

The following gaps have been identified in the availability and use of genetic tests: (G10) insufficient oversight of laboratories that offer certain types of lifestyle tests that skirt the boundaries of CLIA regulations; (G11) research agendas that do not support translation of genetic tests into clinical practice; (G12) inadequate transparency on the number and types of available tests; (G13-14) limited information on how practitioners order genetic tests and interpret the results; (G15) insufficient monitoring and enforcement of laws pertaining to false and misleading claims about genetic tests; (G16-21) deficiencies in knowledge of genetics among practitioners, public health workers, and consumers, coupled with an insufficient number of providers with genetic expertise and suboptimal resources to communicate guidelines for ordering and interpreting genetic tests; (G22-26) little knowledge about the impact of genetic testing on patient care and public health, including direct-to-consumer (DTC) advertising and testing; insufficient data to assess clinical utility, cost-effectiveness, and economic impact of most genetic tests; and lack of postmarket review for most LDTs; and (G27-29) inadequate systems of coding and coverage for genetic tests and services and the potential for misuse of genetic information in insurance enrollment, premium-setting, and employment decisions.

Figure C-7. Map of the U.S. Oversight System for Genetic Testing

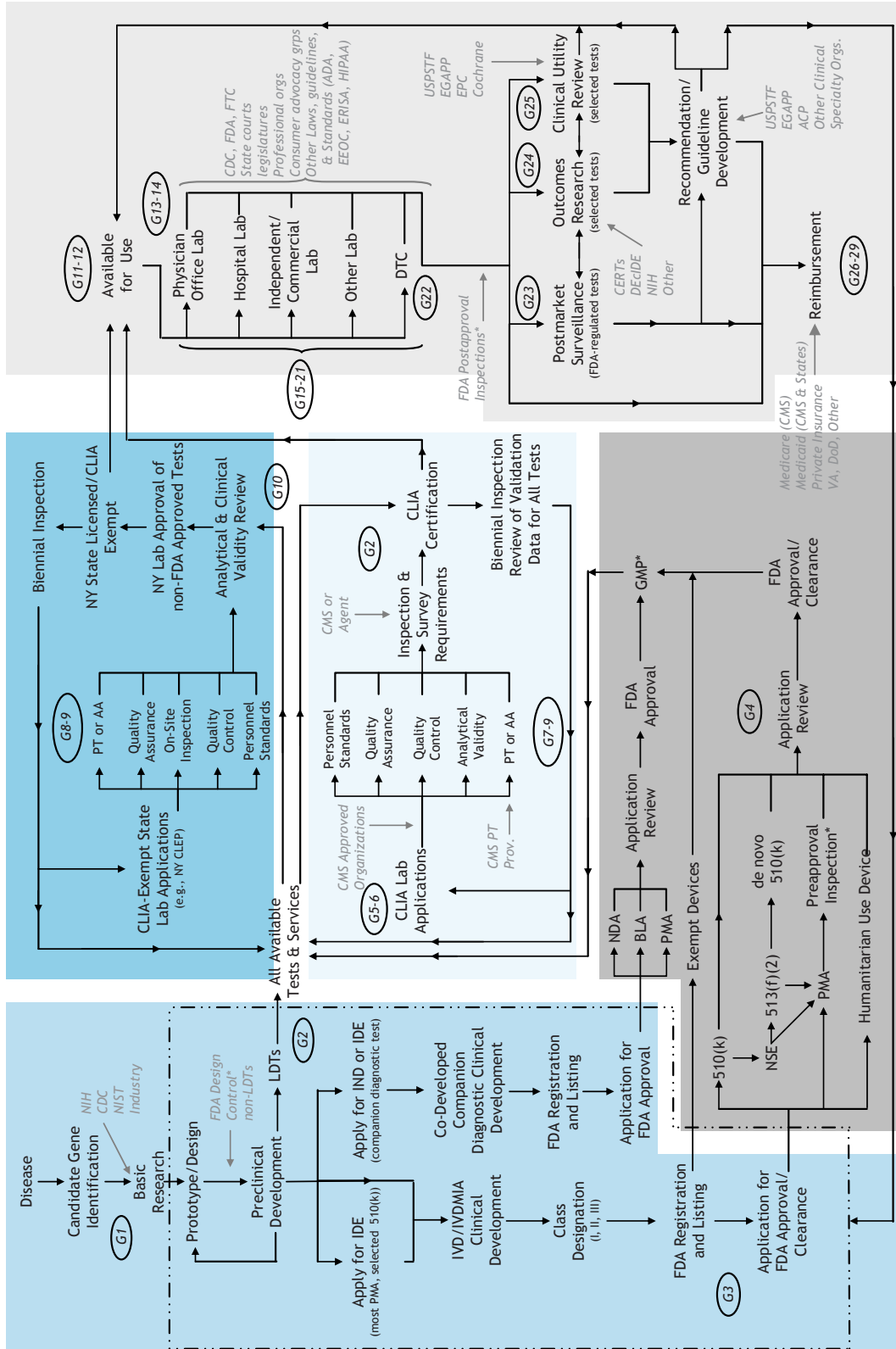

Appendix D

Genetic Technology Resources

Regulation and Guidance

Centers for Medicare & Medicaid Services (CMS), Clinical Laboratory Improvement Amendments (CLIA): http://www.cms.hhs.gov/clia/01_overview.asp.

CMS regulates all laboratory testing (except research) performed on humans in the United States through the Clinical Laboratory Improvement Amendments.

Clinical and Laboratory Standards Institute: Molecular Diagnostic Methods for Genetic Diseases; Approved Guideline—Second Edition (2006): <http://www.clsi.org/source/orders/index.cfm?section-SALES&SKU-MM01A2E>.

This document provides guidance for the use of molecular biological techniques for clinical detection of heritable mutations associated with genetic disease.

Food and Drug Administration (FDA) Office of In Vitro Diagnostics Web Information Page: www.fda.gov/cdrh/oivd.

This site contains a guidance database, a database with cleared or approved FDA submissions, and up-to-date news on FDA regulatory activities.

Chromosome Databases

Database of Chromosomal Imbalance and Phenotype in Humans using Ensembl Resources (DECIPHER): <http://www.sanger.ac.uk/PostGenomics/decipher>.

The DECIPHER database of submicroscopic chromosomal imbalance collects clinical information about chromosomal microdeletions/duplications/insertions, translocations, and inversions.

European Cytogenetics Association Register of Unbalanced Chromosome Aberrations: <http://www.ECARUCA.net>.

This database provides cytogenetic and clinical information on rare chromosomal disorders, including microdeletions and microduplications.

National Center for Biotechnology Information (NCBI), Cancer Chromosomes database: <http://www.ncbi.nlm.nih.gov/sites/entrez?db=cancerchromosomes>.

This resource combines three databases: the National Cancer Institute (NCI)/NCBI SKY/M-FISH and CGH Database, the NCI Mitelman Database of Chromosome Aberrations in Cancer, and the NCI Recurrent Aberrations in Cancer.

Sequence Variation Databases

Catalog of Somatic Mutations in Cancer (COSMIC): <http://www.sanger.ac.uk/genetics/CGP/cosmic>. Mutation data and associated information is extracted from the primary literature and entered into the COSMIC database, which can be queried by tissue, histology, or gene.

Database of Genomic Variants: <http://projects.tcag.ca/variation/>. This database provides a curated catalogue of structural variation in the human genome.

Human Gene Mutation Database (HGMD): <http://www.hgmd.cf.ac.uk/ac/index.php>. HGMD collates known (published) gene lesions responsible for human inherited disease. The database includes mutations within the coding regions, splicing, and regulatory regions of human nuclear genes; somatic mutations and mutations in the mitochondrial genome are not included.

International HapMap Project: <http://www.hapmap.org/index.html.en>. HapMap is an international partnership to develop a public resource that will help researchers find genes associated with human disease and response to pharmaceuticals.

National Center for Biotechnology Information, Database of Single Nucleotide Polymorphisms (dbSNP): <http://www.ncbi.nlm.nih.gov/projects/SNP/>. dbSNP is a central repository for both single-base nucleotide substitutions and short deletion and insertion polymorphisms.

The Pharmacogenetics and Pharmacogenomics Knowledge Base (PharmGKB): <http://www.pharmgkb.org/>. PharmGKB curates information that establishes knowledge about the relationships among drugs, diseases, and genes, including their variations and gene products.

Sorting Intolerant from Tolerant (SIFT): <http://blocks.fhcrc.org/sift/SIFT.html>. SIFT predicts whether an amino acid substitution affects protein function based on sequence homology and the physical properties of amino acids. SIFT can be applied to naturally occurring nonsynonymous polymorphisms and laboratory-induced missense mutations. Given a protein sequence, SIFT will return predictions for what amino acid substitutions will affect protein function.

University of California Santa Cruz Genome Browser: <http://genome.ucsc.edu/cgi-bin/hgGateway>. This resource provides a rapid and reliable display of any requested portion of genomes at any scale, together with dozens of aligned annotation tracks (e.g., known genes, predicted genes, expressed sequence tags, messenger ribonucleic acid, CpG islands, assembly gaps and coverage, and chromosomal bands).

WayStation—locus-specific databases: <http://www.centralmutations.org/Lsdb.php>. This resource provides a central point for the submission and collection of human genetic variation data.

Gene Expression Databases

miRBase: <http://microrna.sanger.ac.uk>.

This database contains all published microRNA (miRNA) sequences, genomic locations, and associated annotation and predicted miRNA targets genes. It also provides a service for assigning official names for novel miRNA genes prior to publication of their discovery.

Oncomine database: <http://www.oncomine.org>.

This product for online cancer gene expression analysis is dedicated to the academic and nonprofit research community.

Disease-Related Genetic Databases

GeneTests: <http://www.genetests.org/>.

This resource provides current, authoritative information on genetic testing and its use in diagnosis, management, and genetic counseling.

Genetic Association Database (GAD): <http://geneticassociationdb.nih.gov/>.

GAD is an archive of human genetic association studies of complex diseases and disorders that allow users to identify medically relevant polymorphisms from the large volume of polymorphisms and mutational data, in the context of standardized nomenclature.

Genomics and Disease Prevention Information System (GDPInfo): <http://apps.nccd.cdc.gov/Genomics/GDPQueryTool/default.asp>.

GDPInfo provides access to information and resources for guiding public health research, policy, and practice on using genetic information to improve health and prevent disease.

Human Genome Epidemiology Network (HuGENet™): <http://www.cdc.gov/genomics/hugenet/default.htm>.

Human Genome Epidemiology Network, or HuGENet,™ is a global collaboration of individuals and organizations committed to the assessment of the impact of human genome variation on population health and how genetic information can be used to improve health & prevent disease.

National Center for Biotechnology Information, Database of Genotype and Phenotype (dbGAP): <http://www.ncbi.nlm.nih.gov/sites/entrez?db=gap>.

dbGAP archives results from studies that have investigated the interaction of genotype and phenotype, such as genome-wide association studies, medical sequencing, and molecular diagnostic assays, as well as association between genotype and nonclinical traits.

Online Mendelian Inheritance in Man (OMIM): <http://www.ncbi.nlm.nih.gov/sites/entrez?db=OMIM>.

OMIM is a curated catalog of human genes and genetic disorders.

Genetic Test Review Programs

Collaboration, Education, and Test Translation (CETT) Program: <http://www.cettprogram.cettprogram.org/>. The CETT Program facilitates the translation of genetic tests from the research setting to CLIA-certified laboratories through collaborations among clinicians, laboratories, researchers, and disease-specific advocacy groups.

Evaluation of Genomic Applications in Practice and Prevention (EGAPP): <http://www.cdc.gov/genomics/gtesting/EGAPP/about.htm>.

EGAPP is a pilot project initiated by the Centers for Disease Control and Prevention National Office of Public Health Genomics, in fall 2004. The project's goal is to establish and evaluate a systematic, evidence-based process for assessing genetic tests and other applications of genomic technology in transition from research to clinical and public health practice.

U.S. Preventive Services Task Force (USPSTF): <http://www.ahrq.gov/clinic/uspstfix.htm>.

The USPSTF conducts rigorous, impartial assessments of the scientific evidence for the effectiveness of a broad range of clinical preventive services, including screening, counseling, and preventive medications. It makes recommendations about which preventive services should be incorporated routinely into primary medical care and for which populations, and it identifies a research agenda for clinical preventive care.

Appendix E

College of American Pathologists Proficiency Testing Program

Table 1. CAP Products for Proficiency Testing

ACMG/CAP Cytogenetics CY CY

product_u	mail_c	enrollment	Domestic	International
CY	A	314	231	83
CY	B	319	236	83
CY	C	319	236	83

ACMG/CAP Fluorescence In Situ Hybridization – Constitutional and Hematologic Disorders CYF

product_u	mail_c	enrollment	Domestic	International
CYF	A	*344	219	125
CYF	B	264	225	39

ACMG/CAP Fluorescence In Situ Hybridization – Breast Cancer (HER2 Gene Amplification) CYH

product_u	mail_c	enrollment	Domestic	International
CYH	A	253	218	35
CYH	B	257	222	35

ACMG/CAP Fluorescence In Situ Hybridization – Urothelial Carcinoma CYI

product_u	mail_c	enrollment	Domestic	International
CYI	A	108	108	0

ACMG/CAP FISH for Paraffin Embedded Tissue

product_u	mail_c	enrollment	Domestic	International
CYP	A	93	82	11
CYJ	A	59	54	5
CYK	A	38	36	2
CYKX	A	5	4	1
CYL	A	58	53	5
CYLX	A	14	10	4

* Labs that were enrolled in CYG and CYF in 2006 were autoconverted to 2 CYF modules for 2007.

ACMG/CAP Biochemical Genetics BGL

product_u	mail_c	enrollment	Domestic	International
BGL	A	110	85	25
BGL	B	113	88	25

ACMG/CAP Molecular Genetics MGL1, MGL2, MGL3, MGL4

product_u	mail_c	enrollment	Domestic	International
MGL1	A	370	350	20
MGL1	B	379	359	20
MGL2	A	212	192	20
MGL2	B	214	194	20
MGL3	A	39	33	6
MGL3	B	41	35	6
MGL4	A	31	27	4
MGL4	B	32	28	4

Molecular Oncology MO, MO2, MO3

product_u	mail_c	enrollment	Domestic	International
MO	A	78	63	15
MO	B	76	61	15
MO2	A	80	69	11
MO2	B	80	69	11
MO3	A	102	87	15
MO3	B	103	88	15

In Situ Hybridization ISH

product_u	mail_c	enrollment	Domestic	International
ISH	A	105	94	11
ISH	B	111	98	13

Minimal Residual Disease MRD

product_u	mail_c	enrollment	Domestic	International
MRD	A	90	65	25
MRD	B	95	69	26

Figure E-1. Proficiency Testing Monitoring by the CAP Laboratory Accreditation Program

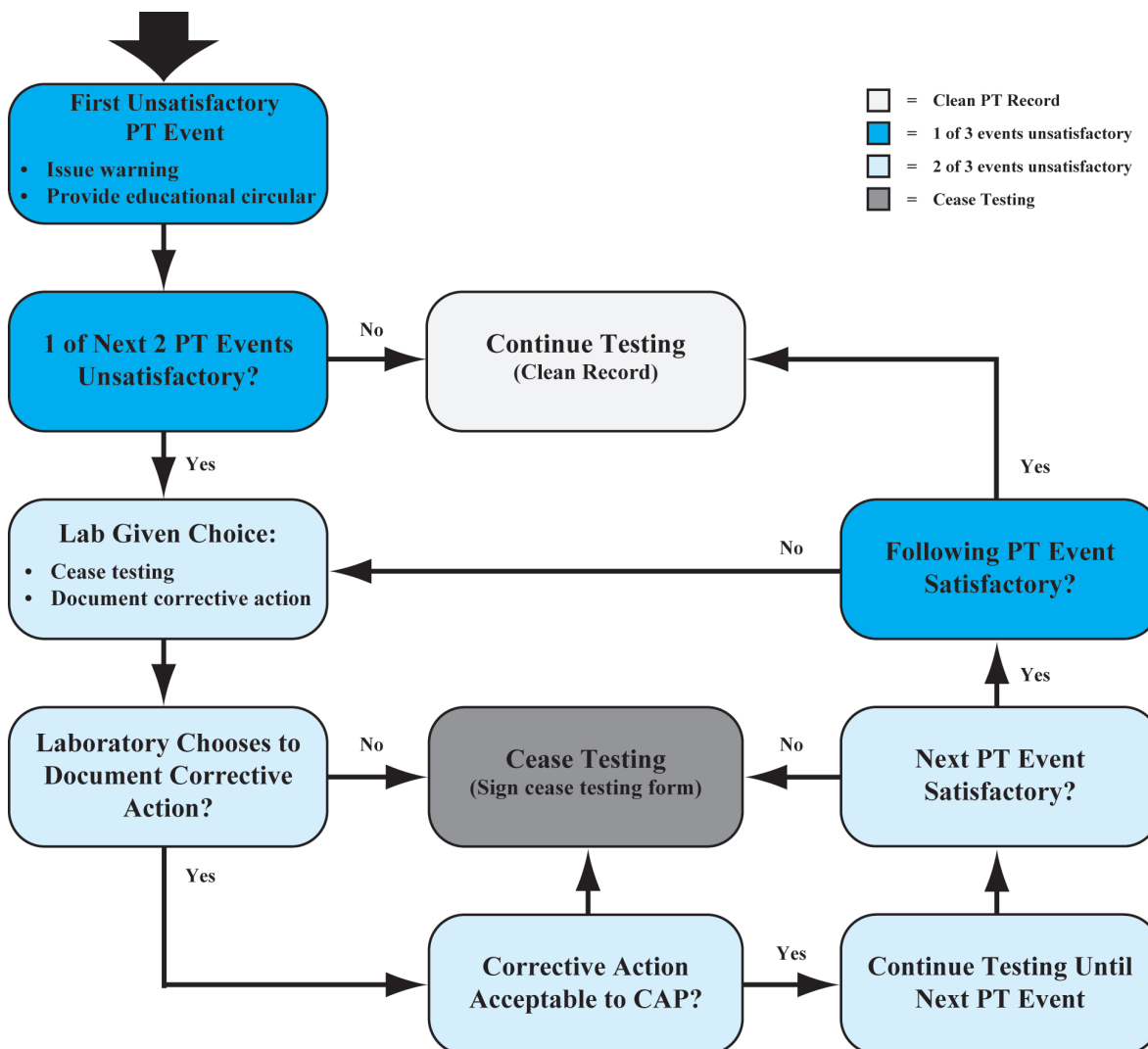

<i>Table 2. 2006 MGL PT Performance</i>							
Analyte	2006 A	2006 A	2006 A	2006 B	2006 B	2006 B	2006 A+B
	correct	total	correct	total	correct	total	correct
FVL	778	784	0.992	831	834	0.996	0.994
FVL interp	782	786	0.995	833	835	0.998	0.996
PT	758	764	0.992	789	798	0.989	0.990
PT interp	756	765	0.988	799	808	0.989	0.989
MTHFR	454	458	0.991	476	482	0.988	0.989
MTHFR interp	424	457	0.928	472	491	0.961	0.945
FMR1	223	229	0.974	256	260	0.985	0.980
FMR1 status	245	246	0.996	261	265	0.985	0.990
FMR interp	247	247	1.000	262	267	0.981	0.990
PW interp	169	170	0.994	178	180	0.989	0.991
HH	337	339	0.994	348	348	1.000	0.997
HH interp	319	338	0.944	341	343	0.994	0.969
DMD	21	21	1.000	21	24	0.875	0.933
HB S/C	72	72	1.000	72	75	0.960	0.980
HB S/C interp	72	72	1.000	72	75	0.960	0.980

<i>Table 3. CAP PT Performance (2002-2006)</i>				
CY Analytes	Reporting Year	No. Acceptable*	Cumulative**	Percent
Karyotype Nomenclature	2002	692	865	80.00%
Karyotype Nomenclature	2003	281	402	69.90%
Karyotype Nomenclature	2004	2067	2200	92.69%
Karyotype Nomenclature	2005	3186	3300	96.55%
Karyotype Nomenclature	2006	2991	3407	87.79%
Modal Chromosome Number	2002	47	48	97.92%
Modal Chromosome Number	2003	49	56	87.50%
Modal Chromosome Number	2004	2126	2148	98.98%
Modal Chromosome Number	2005	3270	3300	99.09%
Modal Chromosome Number	2006	3179	3407	93.31%
Molecular Pathology & Genetics	2004	8526	8847	96.37%
Molecular Pathology & Genetics	2005	12311	12929	95.22%
Molecular Pathology & Genetics	2006	8207	8815	93.10%
Recognition of Abnormalities	2002	211	241	87.55%
Recognition of Abnormalities	2003	145	187	77.54%
Recognition of Abnormalities	2004	2041	2178	93.71%
Recognition of Abnormalities	2005	3229	3300	97.85%
Recognition of Abnormalities	2006	3056	3407	89.70%
Sex Chromosome Designation	2002	37	38	97.37%
Sex Chromosome Designation	2003	25	32	78.13%
Sex Chromosome Designation	2004	2126	2148	98.98%
Sex Chromosome Designation	2005	3270	3300	99.09%
Sex Chromosome Designation	2006	3184	3407	93.45%

Appendix F

Guidelines and Standards for Molecular Diagnostics Testing

Organization	Guideline or Standard	Address
Clinical and Laboratory Standards Institute	<p>MM01-A2 Molecular Diagnostic Methods for Genetic Diseases</p> <p>MM02-A2 Immunoglobulin and T-Cell Receptor Gene Rearrangement Assays</p> <p>MM04-A Quality Assurance for Immunocytochemistry</p> <p>MM05-A Nucleic Acid Amplification Assays for Molecular Hematology</p> <p>MM07-A Fluorescence <i>In Situ</i> Hybridization Methods for Medical Genetics</p> <p>MM09-A Nucleic Acid Sequencing Methods in Diagnostic Laboratory Medicine</p> <p>MM12-A Diagnostic Nucleic Acid Microarrays</p> <p>MM13-A Collection, Transport, Preparation, and Storage of Specimens for Molecular Methods</p> <p>MM14-A Proficiency Testing for Molecular Methods</p> <p>MM16-A Use of External RNA Controls in Gene Expression Arrays</p> <p>MM17-P Validation and Verification of Multiplex Nucleic Acid Assays</p> <p>C50-A Mass Spectrometry in the Clinical Laboratory</p> <p>EP05-A2 Evaluation of Precision Performance of Quantitative Measurement Methods</p> <p>GP27-A2 Using Proficiency Testing to Improve the Clinical Laboratory</p> <p>GP29-A Assessment of Laboratory Tests When Proficiency Testing is Not Available</p> <p>ILA23-A Radioimmunoassays and Enzyme, Fluorescence, and Luminescence Immunoassays</p> <p>ILA24-A Fluorescence Calibration and Quantitative Measurement of Fluorescence Intensity</p>	<p>Wayne, PA</p> <p>http://www.clsi.org/Source/Custom/Currentdocs.cfm?Section=CurrentVersions_of_CLSI_Documents</p>

Organization	Guideline or Standard	Address
ACMG	<p>Standards and guidelines for clinical genetic laboratories: Policy Statements</p> <p>Prenatal Interphase Fluorescence <i>In Situ</i> Hybridization</p> <p>ACMG Position Statement on Multiple Marker Screening in Women 35 and Older</p> <p>Fragile X Syndrome: Diagnostic and Carrier Testing</p> <p>Technical standards and guidelines for Fragile X: The first in a series of disease-specific supplements to the standards and guidelines for clinical genetics laboratories of the American College of Medical Genetics</p> <p>Statement on Storage and Use of Genetic Materials</p> <p>Statement on Multiple Marker Screening in Pregnant Women</p> <p>Statement on Use of Apolipoprotein E Testing for Alzheimer Disease</p> <p>Diagnostic Testing for Prader-Willi and Angelman Syndromes:</p> <p>Statement on Population Screening for BRCA-1 Mutation in Ashkenazi Jewish Women</p> <p>Genetic Susceptibility to Breast and Ovarian Cancer: Assessment, Counseling and Testing Guidelines</p> <p>Principles of Screening: Report of The Subcommittee on Screening of the American College of Medical Genetics Clinical Practice Committee</p> <p>Position Statement on Carrier Testing for Canavan Disease</p> <p>Cystic fibrosis carrier screening, laboratory standards and guidelines for population based Cystic Fibrosis Carrier Screening</p> <p>Genetic testing for colon cancer: a joint statement of the American College of Medical Genetics and the American Society of Human Genetics</p> <p>Consensus Statement on Factor V Leiden Mutation Testing</p>	<p>ABMG/ABGC/ACMG, Administrative office, 9650 Rockville Pike, Bethesda. MD 20814-3998</p> <p>www.acmg.net</p>

Organization	Guideline or Standard	Address
ACMG (continued)	<p>Technical and clinical assessment in fluorescence <i>in situ</i> hybridization: an ACMG/ASHG position statement. Technical considerations</p> <p>ACMG recommendations for standard interpretation of sequence variations</p> <p>American College of Medical Genetics statement on diagnostic testing for uniparental disomy</p>	
ASHI	Standards for Molecular Histocompatibility and Immunogenetic Testing	<p>ASHI PO Box 15804 Lenexa, KS 66285-5804</p>
NIH-DOE	Task Force on Genetic Testing—Promoting Safe and Effective Genetic Testing in the United States	<p>www.nhgri.nih.gov/Policyandpublicaffairs/Elsi/tfgentest</p>
FDA	<p>Guidance for industry in the manufacture and clinical evaluation of <i>in vitro</i> tests to detect <i>in vitro</i> nucleic acid sequences of HIV-1-Draft</p> <p>Guidance for industry and/or FDA reviewers staff-Premarket approval applications for assays pertaining to Hepatitis C virus (HCV) that are indicated for diagnosis or monitoring of HCV infection or associated disease-Draft Guidance</p> <p>Guidance for Industry and FDA Staff—Assayed and Unassayed Quality Control Material</p> <p>Guidance for Industry and FDA Staff Commercially Distributed Analyte Specific Reagents (ASRs): Frequently Asked Questions</p> <p>Draft Guidance for Industry, Clinical Laboratories, and FDA Staff—<i>In Vitro</i> Diagnostic Multivariate Index Assays</p> <p>Guidance for Industry and FDA Staff—Pharmacogenetic Tests and Genetic Tests for Heritable Markers</p> <p>Guidance for Industry and FDA Staff—Class II Special Controls Guidance Document: Drug Metabolizing Enzyme Genotyping System</p> <p>Guidance for Industry and FDA Staff—Class II Special Controls Guidance Document: Gene Expression Profiling Test System for Breast Cancer Prognosis</p>	<p>www.fda.gov/cber/gdlns/nashiv.pdf</p> <p>www.fda.gov/cdrh/ode/1353pdf</p> <p>http://www.fda.gov/cdrh/oivd/guidance/2231.html</p> <p>http://www.fda.gov/cdrh/oivd/guidance/1590.html</p> <p>http://www.fda.gov/cdrh/oivd/guidance/1610.html</p> <p>http://www.fda.gov/cdrh/oivd/guidance/1549.html</p> <p>http://www.fda.gov/cdrh/oivd/guidance/1551.html</p> <p>http://www.fda.gov/cdrh/oivd/guidance/1627.html</p>

Organization	Guideline or Standard	Address
FDA (continued)	<p>Guidance for Industry and FDA Staff—Class II Special Controls Guidance Document: Quality Control Material for Cystic Fibrosis Nucleic Acid Assays</p> <p>Guidance for Industry and FDA Staff—Class II Special Controls Guidance Document: CFTR Gene Mutation Detection Systems</p> <p>Class II Special Controls Guidance Document: RNA Preanalytic Systems (RNA Collection, Stabilization and Purification Systems for RT-PCR used in Molecular Diagnostic Testing)</p> <p>Guidance for Industry and FDA Staff—Class II Special Controls Guidance Document: Automated Fluorescence <i>In Situ</i> Hybridization (FISH) Enumeration Systems</p> <p>Guidance for Industry and FDA Staff—Class II Special Controls Guidance Document: Factor V Leiden DNA Mutation Detection Systems</p>	<p>http://www.fda.gov/cdrh/oivd/guidance/1614.html</p> <p>http://www.fda.gov/cdrh/oivd/guidance/1564.html</p> <p>http://www.fda.gov/cdrh/oivd/guidance/1563.html</p> <p>http://www.fda.gov/cdrh/oivd/guidance/1550.html</p> <p>http://www.fda.gov/cdrh/oivd/guidance/1236.html</p>
AMP	Recommendations for in-house development and operation of molecular diagnostic tests	www.ampweb.org
Technical Working Group on DNA Analysis Methods	Guidelines for a Quality Assurance Program for DNA Analysis	Crime Laboratory Digest (1991) 18:44-75
International Organization for Standardization (ISO)	<p>Clinical laboratory testing and <i>in vitro</i> diagnostic test systems—<i>in vitro</i> diagnostic medical devices for professional use—summary of regulatory requirements for information supplied by the manufacturer. ISO/TR 18112:2006.</p> <p>Clinical laboratory medicine—<i>in vitro</i> diagnostic medical devices—validation of user quality control procedures by the manufacturer. ISO 15198:2004.</p> <p>Medical laboratories—particular requirements for quality and competence. ISO 15189:2007.</p> <p>Medical laboratories—requirements for safety. ISO 15190:2003</p> <p>Laboratory medicine—requirements for reference measurement laboratories. ISO 15195:2003.</p>	http://www.iso.org/iso/home.htm

Appendix G

Acronyms and Abbreviations

AA	alternative assessment
AACC	American Association for Clinical Chemistry
AAMC	Association of American Medical Colleges
AAP	American Academy of Pediatrics
ABGC	American Board of Genetic Counseling
ABMG	American Board of Medical Genetics
ACGME	Accreditation Council for Graduate Medical Education
ACHDGDNC	Advisory Committee on Heritable Disorders and Genetic Diseases in Newborns and Children
ACMG	American College of Medical Genetics
ACOG	American College of Obstetricians and Gynecologists
ACT	action sheets
ADR	adverse drug reaction
AHIC	American Health Information Community
AHRQ	Agency for Healthcare Research and Quality
AGA	American Gastroenterological Association
AMA	American Medical Association
AMP	Association for Molecular Pathology
APNG	Advanced Practice Nurse in Genetics
ASCO	American Society of Clinical Oncology
ASHG	American Society of Human Genetics
ASR	analyte-specific reagent
CAN	CancerActionNow
CAP	College of American Pathologists
CCC	Continuous Compliance Committee (of CAP)

CCHIT	Certification Commission for Healthcare Information Technology
CDC	Centers for Disease Control and Prevention (HHS)
CETT	Collaboration, Education, and Test Translation Program
CF	cystic fibrosis
CGH	comparative genome hybridization
CLIA	Clinical Laboratory Improvement Amendments of 1988 (CMS)
CLIAC	Clinical Laboratory Improvement Advisory Committee
CLSI	Clinical and Laboratory Standards Institute
CMS	Centers for Medicare & Medicaid Services
CMV	cytomegalovirus
COC	Commission on Cancer (of American Council of Surgeons)
COLA	Commission on Office Laboratory Accreditation
CPOE	computerized provider order entry
DBS	dried blood spot
DLS	Division of Laboratory Systems (of CDC)
DNA	deoxyribonucleic acid
D.O.	doctor of osteopathy
DOE	Department of Energy
D.P.M.	doctor of podiatry
DTC	direct to consumer
EGAPP	Evaluation of Genomic Applications in Practice and Prevention
EHR	electronic health record
ERW	evidence review working group
FAP	familial adenomatous polyposis
FDA	Food and Drug Administration
FFDCA	Federal Food, Drug, and Cosmetic Act
FISH	fluorescence in situ hybridization
FTC	Federal Trade Commission
GAO	Government Accountability Office

GCN	Genetics Clinical Nurse
GET-RM	Genetic Testing Reference Materials
HDC-ABMT	high-dose chemotherapy with autologous bone marrow transplant
HER2	human epidermal growth factor receptor 2
HFE	hemochromatosis
HGP	Human Genome Project
HHS	Department of Health and Human Services
HIPAA	Health Insurance Portability and Accountability Act of 1996
HIT	health information technology
HL7	Health Language 7
HRSA	Health Resources and Services Administration
HuGENet	Human Genome Epidemiology Network
IHC	immunohistochemistry
ISO	International Organization for Standardization
ISONG	International Society of Nurses in Genetics
IT	information technology
IUO	investigational use only
IVD	in vitro diagnostic device
IVDMIA	in vitro diagnostic multivariate index assay
LAP	Laboratory Accreditation Program (of CAP)
LDT	laboratory-developed test
LIS	laboratory information system
MCHB	Maternal and Child Health Bureau
M.D.	doctor of medicine
MS/MS	tandem mass spectrometry
NBS	newborn screening
NCHPEG	National Coalition for Health Professional Education in Genetics
NIH	National Institutes of Health
NIST	National Institute of Standards and Technology

NPRM	Notice of Proposed Rulemaking
NSGC	National Society of Genetic Counselors
NSQAP	Newborn Screening Quality Assurance Program
NYSDOH	New York State Department of Health
OIVD	Office of In Vitro Diagnostic Device Evaluation and Safety (CDRH)
PCR	polymerase chain reaction
PHR	personalized health record
PKU	phenylketonuria
PMA	premarket approval
PMW	Personalized Medicine Workgroup (of AHIC)
PT	proficiency testing
QA	quality assurance
QC	quality control
R&D	research and development
RCT	randomized controlled trial
RNA	ribonucleic acid
RUO	research use only
SACGHS	Secretary's Advisory Committee on Genetics, Health, and Society
SACGT	Secretary's Advisory Committee on Genetic Testing
SER	systematic evidence review
SNP	single nucleotide polymorphisms
SRM	Standard Reference Materials
SSRI	serotonin reuptake inhibitors
TA	technology assessment
UKNEQAS	U.K. National External Quality Assessment Service
USPSTF	U.S. Preventive Services Task Force
VA	Department of Veterans Affairs

