



U.S. ARMY
USAG-YONGSAN
INSTALLATION MANAGEMENT COMMAND

RSO
RELIGIOUS SUPPORT OFFICE



USAG-Yongsan Religious Support Office Garrison Chaplain Welcome Brief

CH (MAJ) Marsi

Unit Ministry Teams . . . Here For You!



U.S. ARMY
USAG-YONGSAN
INSTALLATION MANAGEMENT COMMAND

RSO
RELIGIOUS SUPPORT OFFICE



Welcome !
To The Army's
Most Vibrant Garrison
Religious Support Program

God, The Corps, & Yongsan
Want & Need YOUR Giftedness!

Unit Ministry Teams . . . Here For You!



**How
We
Can
Help !**

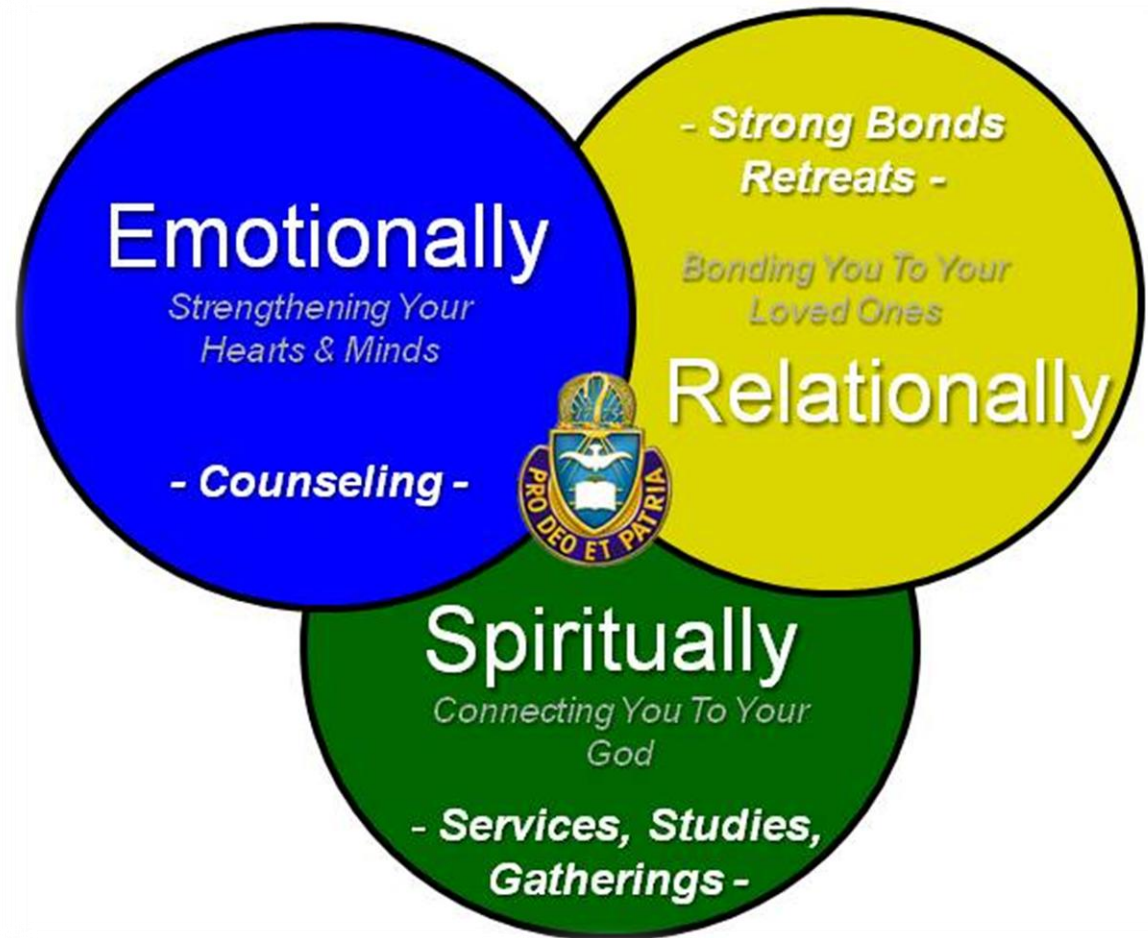

Unit Ministry Teams . . . Here For You!



How Chaplains & Chaplain Assistants Can Serve You . . .

How We Can Help

1. Emotionally

Much of what a chaplain does is **COUNSELING** . . . Strengthening Hearts & Minds. Unit Chaplains counsel daily, and here at Yongsan, you have the added advantage of the clinically trained Chaplain Family Life Center for professional pastoral care. Any venue with a chaplain offers you complete confidentiality — what you say with us stays with us. Your communication is privileged.

2. Relationally

Another area in which Unit Ministry Teams add value to you is **RETREATS** . . . Bonding You To Your Loved Ones. The Strong Bonds Retreat Program is the premier relational resiliency tool for the Army. Designed for Singles, Couples, Families, and even Spouses of Deployed Soldiers, this program provides fun, relevant relational tools at 5-Star venues intended to honor you and inspire you!

3. Spiritually

Of course, chaplains are ministers in uniform. We are completely comfortable discussing and leveraging the benefits of your Faith to help you. The main venues for you are **RELIGIOUS SERVICES, STUDIES, & GATHERINGS**. We're also comfortable serving those who don't identify religiously but simply need care and concern — we're here to help you!

Yongsan At A Glance

The Most Vibrant Spiritual Community In The United States Military!

- 6 Chapels in Area II**
- All Faiths Served**
- 20 Distinct Services Weekly**
- 7 Post-Wide Gatherings Weekly**
- 80+ Diverse Ministries**
- 100,000+ Served Annually**



Opportunities For You

6 Chapels

- **Brian Allgood Hospital Chapel**
Traditional Protestant, Seventh Day Adventist, & Episcopal Services
- **Memorial Chapel**
Multiple Catholic Masses and CCD Classes, Liturgical and Classic Protestant Services, English Speaking Pentecostal Service

• South Post Chapel

Contemporary Service, Non-Denominational Service, Gospel Service, and Jewish Service

- **Hannam Village Chapel**
Family Friendly Blended Service and Hispanic Pentecostal Service

• K-16

Contemporary Protestant Service

- **Religious Retreat Center Chapel**
As scheduled during Retreats/Activities

3 Centers

- Family Life Counseling Center
- Mustard Seed Christian Pre-School
- Religious Retreat Center

7 Post-Wide Men's, Women's & Youth Programs

Helping You Get From Where You Are To Where You Want To Be !

Unit Ministry Teams . . . Here For You!



U.S. ARMY
USAG-YONGSAN
INSTALLATION MANAGEMENT COMMAND

RSO
RELIGIOUS SUPPORT OFFICE



RSO TEAM VISION

Best Ministry

Doing the Right Ministry

Best Methods

Doing the Ministry Right

Best Model

An Inspiring Example Of Excellence

Unit Ministry Teams . . . Here For You!



TEAM VALUES

Caring

We demonstrate goodness

Courteous

We demonstrate kindness

Competent

We demonstrate skill

Excellent

*We demonstrate superior mission
accomplishment*

Unit Ministry Teams . . . Here For You!



U.S. ARMY
USAG-YONGSAN
INSTALLATION MANAGEMENT COMMAND

RSO
RELIGIOUS SUPPORT OFFICE



Your Religious Support Plan (RSP) Overview For USAG-Y

Unit Ministry Teams . . . Here For You!



U.S. ARMY
USAG-YONGSAN
INSTALLATION MANAGEMENT COMMAND

RSO
RELIGIOUS SUPPORT OFFICE



DID YOU KNOW?

Yongsan is recognized as the most vibrant spiritual community in the U.S. Army!

- ***6 Chapels In Area II***
- ***20 Distinct Services Weekly***
- ***80-Plus Diverse Ministries***
- ***7 Post-Wide Gatherings Weekly***
 - ***3 Professional Centers***
 - ***100,000 Served Annually***

Unit Ministry Teams . . . Here For You!



U.S. ARMY
USAG-YONGSAN
INSTALLATION MANAGEMENT COMMAND

RSO
RELIGIOUS SUPPORT OFFICE



6 CHAPELS

Unit Ministry Teams . . . Here For You!



South Post Chapel

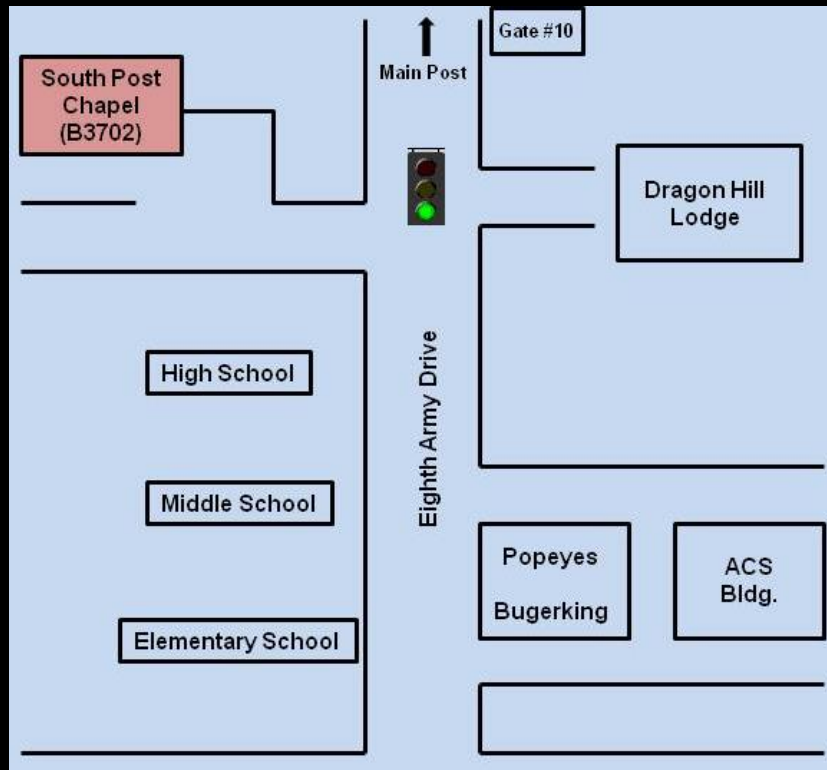

Unit Ministry Teams . . . Here For You!



U.S. ARMY
USAG-YONGSAN
INSTALLATION MANAGEMENT COMMAND

RSO
RELIGIOUS SUPPORT OFFICE



Memorial Chapel

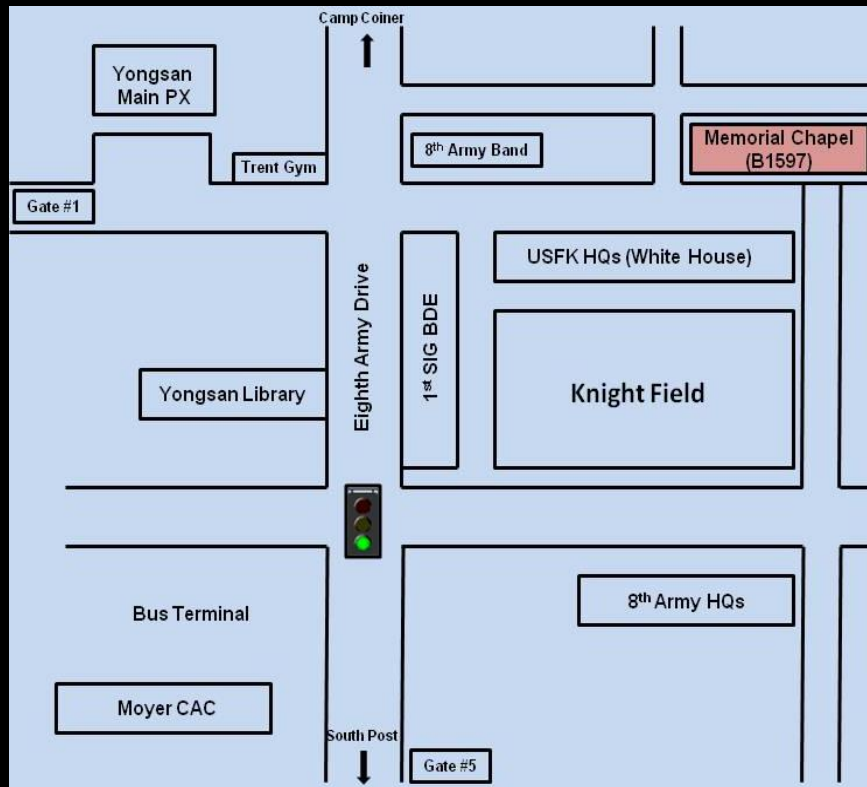

Unit Ministry Teams . . . Here For You!



U.S. ARMY
USAG-YONGSAN
INSTALLATION MANAGEMENT COMMAND

RSO
RELIGIOUS SUPPORT OFFICE



Hannam Village Chapel

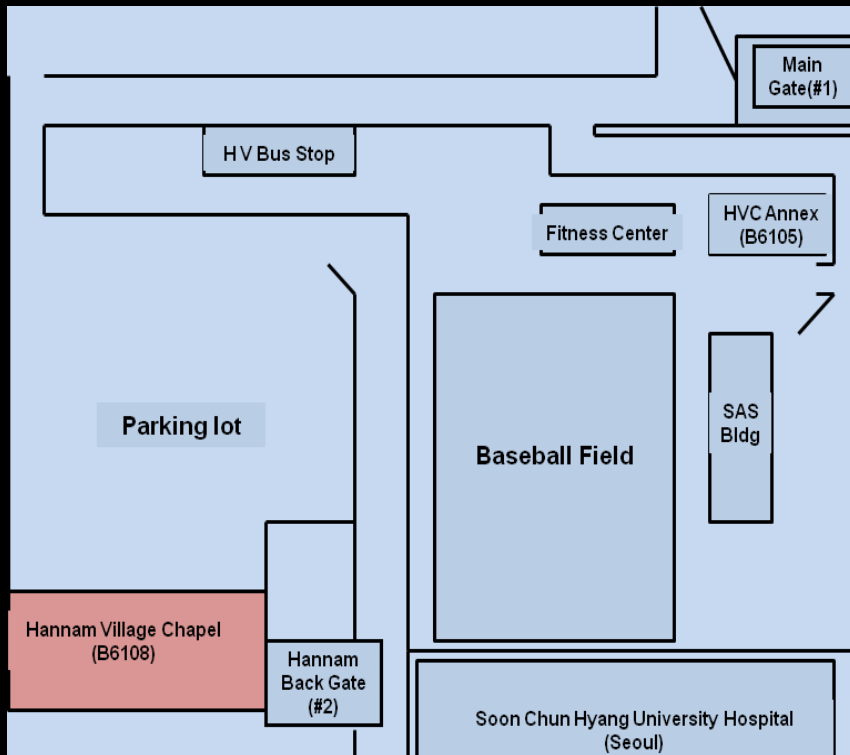

Unit Ministry Teams . . . Here For You!



U.S. ARMY
USAG-YONGSAN
INSTALLATION MANAGEMENT COMMAND

RSO
RELIGIOUS SUPPORT OFFICE



Brian Allgood Hospital Chapel

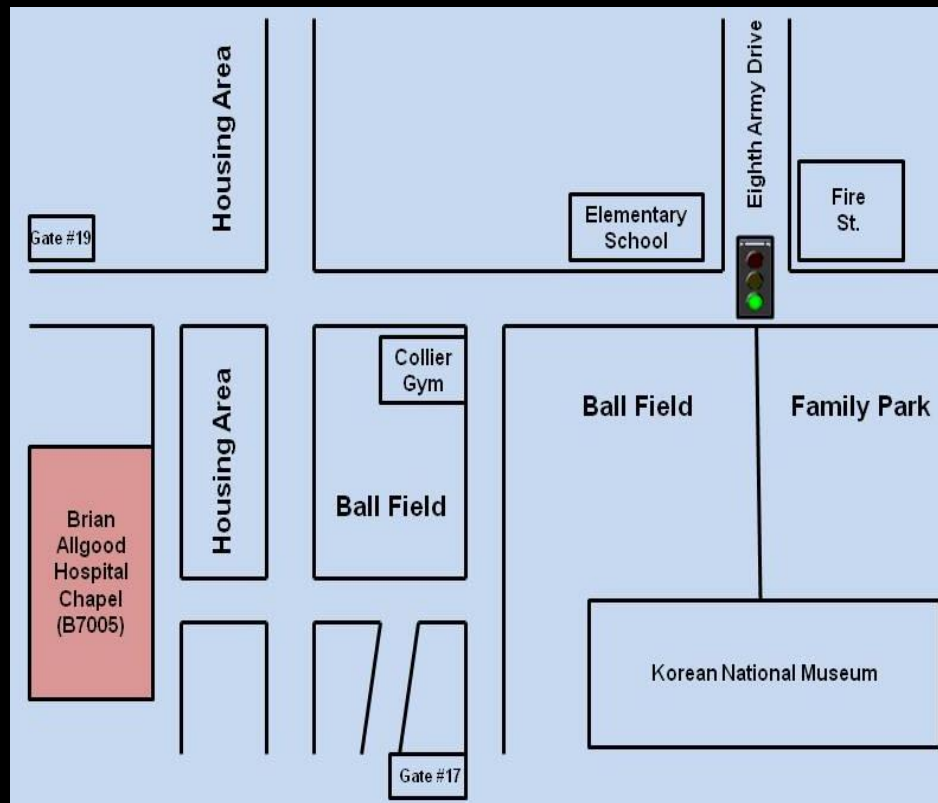

Unit Ministry Teams . . . Here For You!



K-16 Community Chapel

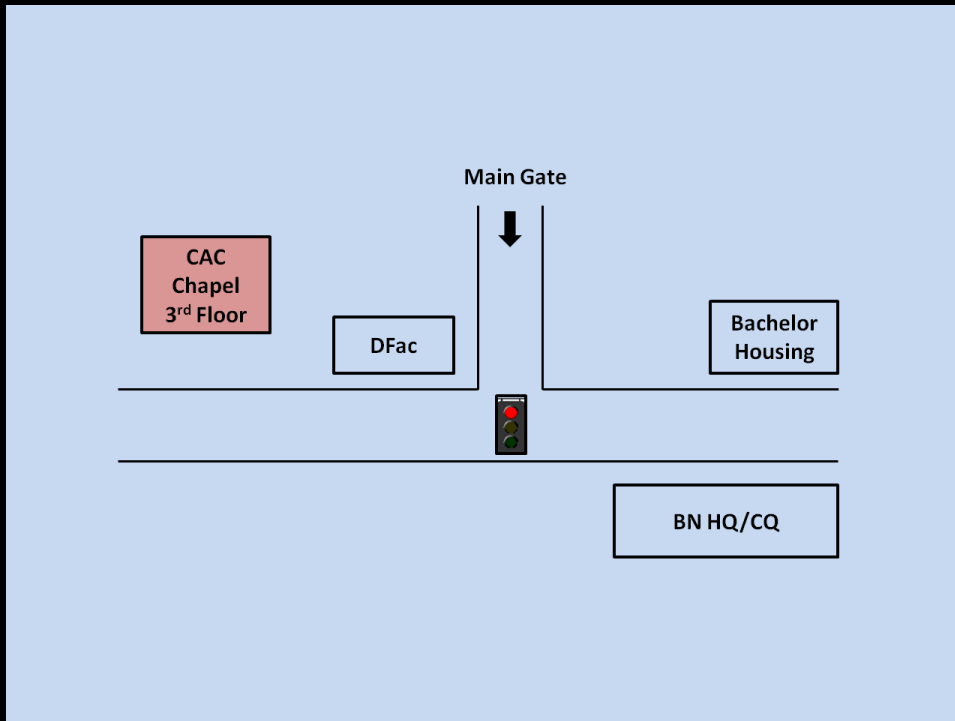

Unit Ministry Teams . . . Here For You!



U.S. ARMY
USAG-YONGSAN
INSTALLATION MANAGEMENT COMMAND

RSO
RELIGIOUS SUPPORT OFFICE



RRC Chapel and Complex

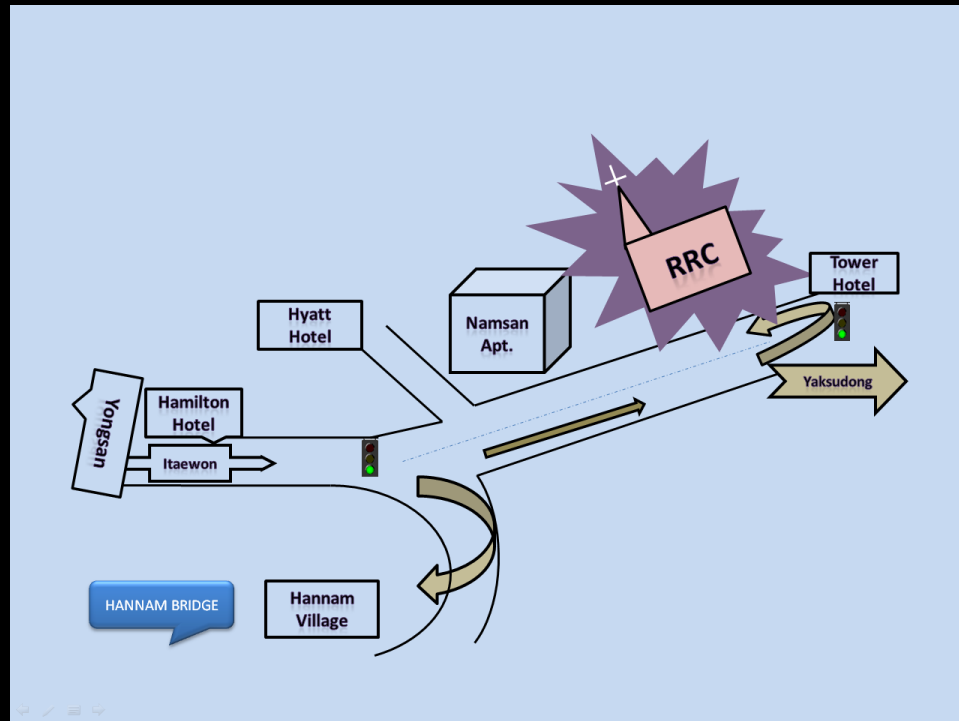

Unit Ministry Teams . . . Here For You!



U.S. ARMY
USAG-YONGSAN
INSTALLATION MANAGEMENT COMMAND

RSO
RELIGIOUS SUPPORT OFFICE



6 Chapels . . .

- **Brian Allgood Hospital Chapel**

Traditional Protestant, Seventh Day Adventist, & Episcopal Services

- **Memorial Chapel**

Multiple Catholic Masses and CCD Classes, Liturgical Service, and English Speaking Pentecostal Service

Unit Ministry Teams . . . Here For You!



U.S. ARMY
USAG-YONGSAN
INSTALLATION MANAGEMENT COMMAND

RSO
RELIGIOUS SUPPORT OFFICE



6 Chapels . . .

- **South Post Chapel**

*Contemporary Service, Sunday School,
Non-Denominational Service, Gospel Service,
Jewish Service*

- **Hannam Village Chapel**

*Family Friendly Blended Service
Hispanic Pentecostal Service*

Unit Ministry Teams . . . Here For You!



U.S. ARMY
USAG-YONGSAN
INSTALLATION MANAGEMENT COMMAND

RSO
RELIGIOUS SUPPORT OFFICE



6 Chapels . . .

- **K-16 Chapel**

Contemporary Protestant Service

- **Religious Retreat Center (RRC)**

As scheduled during Retreats / Activities

Unit Ministry Teams . . . Here For You!



21 SERVICES WEEKLY

SOUTH POST CHAPEL

"CONTEMPORARY"	SUN	0900
"NONDENOMINATIONAL"	SUN	1100
"GOSPEL"	SUN	1300
JEWISH	FRI	1900

MEMORIAL CHAPEL

CATHOLIC MASS	SUN	0800
"LITURGICAL"	SUN	0930
CATHOLIC MASS	SUN	1130
PENTECOSTAL	SUN	1300
CATHOLIC MASS	SAT	1700
CATHOLIC DAILY MASS	M/W/T/F	1145
KATUSA WORSHIP	TUE	1830
CATHOLIC MASS (BLESSED VIRGIN)	1 ST SAT	0900
KOREAN CHRISTIAN FELLOWSHIP	3 RD TUE	1145
ROK CATHOLIC MASS	3 RD THU	1800

HANNAM VILLAGE CHAPEL

PROTESTANT "CONTEMPORARY"	SUN	1100
HISPANIC PENTECOSTAL	SUN	1430

ALLGOOD HOSP. CHAPEL

PROTESTANT "TRADITIONAL"	SUN	0930
EPISCOPAL	SUN	1100
SEVENTH DAY ADVENTIST (SDA)	SAT	0930

K-16 CHAPEL

PROTESTANT "CONTEMPORARY"	SUN	1030
---------------------------	-----	------

3 Sources Of Chaplains For Your Chapels:

1. **"OWNED"**
 RSO CHs (4)
2. **"LOANED"**
 Tenant CHs (16)
 (8th Army / USFK)
3. **"HIRED"**
 Contracted (2-3)
 (Catholic & Episcopal)

Unit Ministry Teams . . . Here For You!



Worship Services

South Post Chapel (738-6054) (South Post Bldg 3702)

Protestant "Contemporary"	Sunday	0900
Protestant "Nondenominational"	Sunday	1100
Protestant "Gospel"	Sunday	1300
Jewish	Friday	1900

Hannam Village Chapel (723-4524) (Hannam Village Bldg 6108)

Protestant "Contemporary"	Sunday	1100
Mision Pentecostal Hispana Monte Sion	Sunday	1430

Brian Allgood Hospital Chapel (737-5000/4335) (South Post Bldg 7005)

Protestant "Traditional"	Sunday	0930
Episcopal	Sunday	1100
Seventh Day Adventist (SDA)	Saturday	0930

Unit Ministry Teams . . . Here For You!



Worship Services

Memorial Chapel (725-4076/8182) (Main Post Bldg 1597)

Catholic Mass	Sunday	0800
Protestant "Liturgical"	Sunday	0930
Catholic Mass	Sunday	1130
United Pentecostal Church International (UPCI)	Sunday	1300
Catholic Mass	Saturday	1700
Catholic Daily Mass	M/W/Th/F	1145
KATUSA Worship	Tuesday	1830
Catholic Mass in Honor of the Blessed Virgin Mary	1 st Saturday	0900
Korean Christian Fellowship Association (KFCA)	3 rd Tuesday	1145
ROK Catholic Mass	3 rd Thursday	1800

K-16 Chapel (741-6280/6448) (K-16 Bldg S-302)

Protestant "Contemporary"	Sunday	1030
---------------------------	--------	------

Unit Ministry Teams . . . Here For You!



Religious Programs

South Post Chapel (738-6054)

Children's Church	(0900 Svc)	Sunday	0900
Sunday School	(1100 Svc)	Sunday	0945
Sunday Adult Bible Study	(1100 Svc)	Sunday	0950
Children's Church	(1100 Svc)	Sunday	1100
Sunday School	(1300 Svc)	Sunday	1200
Children's Church	(1300 Svc)	Sunday	1300
Club Beyond: Middle & High School Bible Study		Sunday	1630
AWANA	(Age 3-8 th Grade)	Monday	1830
MOTMC Bible Study		Tuesday	0600
Moms In Touch		Tuesday	0830
Prayer Ministry		Tuesday	0930
Hangul Women Bible Study		Tuesday	1000
Bilingual Tres Dias		Tuesday	1500

Unit Ministry Teams . . . Here For You!



Religious Programs

South Post Chapel (738-6054)

Praise & Worship Choir Rehearsal	(1300 Svc)	Tuesday	1700
Men's Tres Dias	(1100 Svc)	Tuesday	1730
Club Beyond: Middle School	(Grade 6-8)	Tuesday	1600
Club Beyond: High School	(Grade 9-12)	Tuesday	1830
Protestant Women Of The Chapel		Wednesday	0900
Handbell Choir Rehearsal	(1100 Svc)	Wednesday	1730
Family Dinner/Bible Study	(1300 Svc)	Wednesday	1800
Praise & Worship Rehearsal	(0900 Svc)	Wednesday	1800
Sanctuary Choir Rehearsal	(1100 Svc)	Wednesday	1900
MOTMC Bible Study	(Green Street)	Thursday	0600
MCCW Bible Study	(Catholic)	Thursday	0930
MOTMC Promise Keepers	(1100 Svc)	Thursday	1800
Mime Ministry	(1300 Svc)	Thursday	1800

Unit Ministry Teams . . . Here For You!



Religious Programs

South Post Chapel (738-6054)

PWOC Evening Bible Study		Thursday	1800
Hospitality Committee	(1300 Svc)	Thursday	1815
Catholic Choir Practice		Thursday	1830
Men Of Valor	(1300 Svc)	Thursday	1830
Singles Ministry	(1300 Svc)	Thursday	1900
Women's Friday Fellowship	(1300 Svc)	Friday	1100
Catholic Altar Service Meeting		Friday	1500
Tres Dias Secretariat		Friday	1730
Vida Nueva		Saturday	1800
MOTMC Monthly Prayer Breakfast		1st Saturday	0800

Unit Ministry Teams . . . Here For You!



Religious Programs

Memorial Chapel (725-4076)

LDS Leadership Meeting		Sunday	0700
Children's Church	(Catholic)	Sunday	0800
Children's Church	(0930 Svc)	Sunday	0945
Fellowship	(0930 Svc)	Sunday	1030
Catholic Continued Adult Edu Program (SAHS)		Sunday	0940
Catholic Children's Church		Sunday	1130
Catholic Teen Youth Ministry		Sunday	1800
Rosary Making Class		Monday	1300
KATUSA Worship Service Leaders Meeting		Monday	1730
West Core Team & Team		Monday	1730
Knights of Columbus Meeting		Tuesday	1800
LDS Branch President Interviews		Tuesday	1830
Miraculous Medal Novena		Tuesday	1900
KATUSA Fellowship		Tuesday	2000

Unit Ministry Teams . . . Here For You!



Religious Programs

Memorial Chapel (725-4076)

Community Rosary (Blessed Sacrament Chapel)	Wednesday	0800
Music Rehearsal (UPCI)	Wednesday	1130
Men Of Ezekiel Bible Study	Wednesday	1130
Catholic Adult Education	Wednesday	1700
UPCI Bible Study	Wednesday	1900
Catholic Korean Ladies Bible Study	Thursday	1000
Collective Protestant Choir Rehearsal	Thursday	1800
Altar Server Training	Friday	1500
Catholic Adult Education	Friday	1700
Catholic Confessions	Saturday	1600
Family Ministry Program Coordination	2 nd Monday	1030
Catholic Knights Of Columbus Roundtable (Annex)	2 nd Saturday	1000

Unit Ministry Teams . . . Here For You!



U.S. ARMY
USAG-YONGSAN
 INSTALLATION MANAGEMENT COMMAND

RSO
 RELIGIOUS SUPPORT OFFICE



Religious Programs

Hannam Village Chapel & Annex Bldg 6105 (723-8893)

Sunday School	Sunday	0930
Choir Rehearsal	Sunday	1330
Women' Bible Study "Lioness Arising"	Tuesday	1000
Mision Pentecostal Hispana Bible Study	Thursday	1900
Intercessory Prayer Meeting	Friday	0900
Family Night	Friday	1800
Men's Prayer Breakfast	2 nd Saturday	0730

Brian Allgood Community Hospital Chapel (737-5000)

Prayer And Meditation	Everyday	24hrs
Church of Christ Meeting	Wednesday	1800

K-16 Chapel (741-6280/6448)

Praise Band Rehearsal	Sunday	0930
Bible Study	Wednesday	1830

Unit Ministry Teams . . . Here For You!



U.S. ARMY
USAG-YONGSAN
INSTALLATION MANAGEMENT COMMAND

RSO
RELIGIOUS SUPPORT OFFICE



7 POST-WIDE MINISTRIES

Unit Ministry Teams . . . Here For You!



U.S. ARMY
USAG-YONGSAN
INSTALLATION MANAGEMENT COMMAND

RSO
RELIGIOUS SUPPORT OFFICE



AWANAS . . .

*Weekly fun and
biblically based spiritual
growth and character
development program
just for kids!*

*Mondays, 1830,
South Post Chapel*



Unit Ministry Teams . . . Here For You!



U.S. ARMY
USAG-YONGSAN
INSTALLATION MANAGEMENT COMMAND

RSO
RELIGIOUS SUPPORT OFFICE



Club Beyond

Fun and meaningful weekly ministry to teenagers. Sessions for both Middle and High Schoolers.

*Tuesdays at 1600 (MS)
& 1830 (HS) and
Sundays at 1630,
South Post Chapel*

Unit Ministry Teams . . . Here For You!



U.S. ARMY
USAG-YONGSAN
INSTALLATION MANAGEMENT COMMAND

RSO
RELIGIOUS SUPPORT OFFICE



MCCW . . .

*Catholic women's
gathering for service &
support.*

*Thursdays, 0930
South Post Chapel*



Unit Ministry Teams . . . Here For You!



U.S. ARMY
USAG-YONGSAN
INSTALLATION MANAGEMENT COMMAND

RSO
RELIGIOUS SUPPORT OFFICE



Knights Of Columbus

*Catholic men's
gathering for service
and spiritual depth. 2nd
Saturday Monthly, 1000,
Memorial Chapel*

Unit Ministry Teams . . . Here For You!



U.S. ARMY
USAG-YONGSAN
INSTALLATION MANAGEMENT COMMAND

RSO
RELIGIOUS SUPPORT OFFICE



Men Of The Morning Calm

Active men's gathering designed to develop strong men, strong homes, and strong churches. 1st Saturday Monthly, 0800, South Post Chapel



Unit Ministry Teams . . . Here For You!



U.S. ARMY
USAG-YONGSAN
INSTALLATION MANAGEMENT COMMAND

RSO
RELIGIOUS SUPPORT OFFICE



PWOC

A weekly Christian women's gathering designed to encourage and inspire through rich relationships.

*Wednesdays, 0900,
South Post Chapel*



Unit Ministry Teams . . . Here For You!



U.S. ARMY
USAG-YONGSAN
INSTALLATION MANAGEMENT COMMAND

RSO
RELIGIOUS SUPPORT OFFICE



Tres Dias & Vida Nueva

*Transformational retreat
program with
opportunity for weekly
follow up. Adults (Tres
Dias) and Teens (Vida
Nueva) separately. Call
for retreat info.*



Unit Ministry Teams . . . Here For You!



U.S. ARMY
USAG-YONGSAN
INSTALLATION MANAGEMENT COMMAND

RSO
RELIGIOUS SUPPORT OFFICE



3 PROFESSIONAL CENTERS

Unit Ministry Teams . . . Here For You!



U.S. ARMY
USAG-YONGSAN
INSTALLATION MANAGEMENT COMMAND

RSO
RELIGIOUS SUPPORT OFFICE



3 Professional Centers

- **Family Life Counseling Center**
Caring, Competent, Confidential Clinical Pastoral Counseling. Individual, Group, and Family counseling and care

Unit Ministry Teams . . . Here For You!



U.S. ARMY
USAG-YONGSAN
INSTALLATION MANAGEMENT COMMAND

RSO
RELIGIOUS SUPPORT OFFICE



3 Professional Centers

- **Mustard Seed**

Christian Pre-School

*100+ children nurtured in pre-school excellence
at South Post Chapel*

- **Religious Retreat Center**

*The Army's only Religious Retreat Center with
specially tailored unit and organizational
retreats*

Unit Ministry Teams . . . Here For You!



U.S. ARMY
USAG-YONGSAN
INSTALLATION MANAGEMENT COMMAND

RSO
RELIGIOUS SUPPORT OFFICE



STRONG BONDS

*The Army's Premier Relational
Resiliency Program*

**Unit-Based, 5-Star Get-A-Ways To
Honor & Inspire While Providing
Practical Tools For
Relational Success**

Unit Ministry Teams . . . Here For You!



U.S. ARMY
USAG-YONGSAN
INSTALLATION MANAGEMENT COMMAND

RSO
RELIGIOUS SUPPORT OFFICE



Strong Bonds Programs

Get a free weekend for two



And a stronger marriage.

The Couples Program.

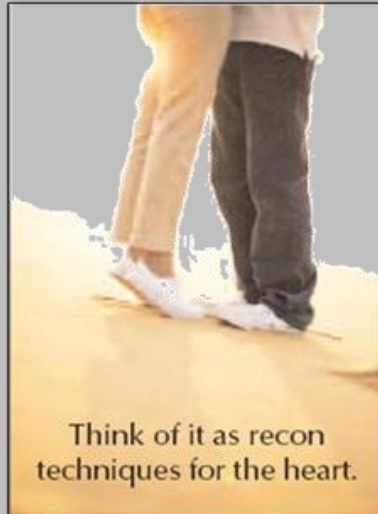

Think of it as recon techniques for the heart.

The Single Soldier Program.



We're better together.

The Family Program.



The Spouse Program.



Unit Ministry Teams . . . Here For You!



U.S. ARMY
USAG-YONGSAN
 INSTALLATION MANAGEMENT COMMAND

RSO
 RELIGIOUS SUPPORT OFFICE



Strong Bonds Programs



Your Invited!
 To JSOC's RST
 Strong Bonds

Spiritual Adventure Training
 (Whitewater Rafting)

Labor Day Weekend
 Friday, 29 August – Sunday, 1 September

The Amazing New River
 Lansing, West Virginia

Great For Anyone
On The JSOC Team:

- * Singles &
- * Marrieds

FREE Transportation !
FREE Class III-IV Rapids !
FREE Lodging & Meals !
FREE Tips & Tools

Reserve Your Spot
 Windia Mitchell
 At 243-2515

This Weekend!



Sign Up For . . .
 JSOC's RST
 Strong Bonds

Married Couples
"R & R" Event
 Building Relationships & Readiness

Winston-Salem, North Carolina
 Friday, 5 September – Sunday, 7 September

Colonial "Old Salem"
 Just Around The Corner!

Great For Any Married Couple
On The JSOC Team !

\$490 Value For Only \$20 Donation

FUN, ROMANTIC Get-Away!
FREE Childcare!
FREE Lodging & Meals !
GREAT Tips & Tools On "Building An Unshakable, Unbreakable Love"

**** Reserve Your Spot NLT 3 SEP With: Windia Mitchell In The Chaplain's Office At 243-2515 or mitchellwb@soc.smil.mil**



Unit Ministry Teams . . . Here For You!



U.S. ARMY
USAG-YONGSAN
INSTALLATION MANAGEMENT COMMAND

RSO
RELIGIOUS SUPPORT OFFICE



ANNUAL POST-WIDE EVENTS

Spirit Warrior- MOMC Pen-Wide Conf. (250)	JAN
National Prayer Breakfast (550)	FEB
Easter Sunrise Service (300)	MAR / APR
Faithlift - PWOC Pen-Wide Conference (250)	MAR / APR
USAG-Y Garrison Strong Bonds Retreat (60)	MAY
RSO Volunteer Recognition Gala	JUN
Vacation Bible School (350)	Summer
Volunteer Recognition / Fall Festival	OCT
USAG-Y Strong Bonds Resiliency Retreat	NOV
Christmas Candlelight Concert (500)	DEC

Unit Ministry Teams . . . Here For You!



**How
We
Can
Help !**

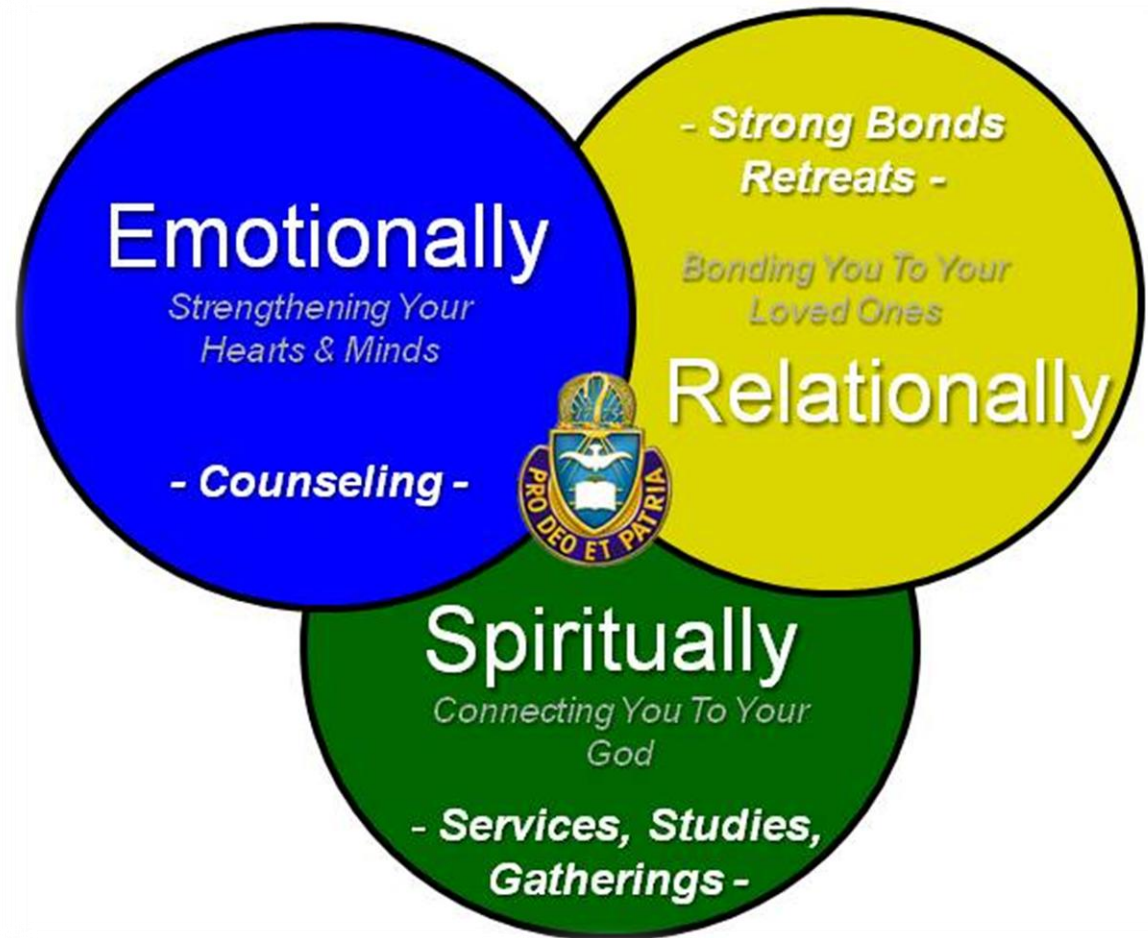

Unit Ministry Teams . . . Here For You!



How Chaplains & Chaplain Assistants Can Serve You . . .

How We Can Help

1. Emotionally

Much of what a chaplain does is **COUNSELING** . . . Strengthening Hearts & Minds. Unit Chaplains counsel daily, and here at Yongsan, you have the added advantage of the clinically trained Chaplain Family Life Center for professional pastoral care. Any venue with a chaplain offers you complete confidentiality — what you say with us stays with us. Your communication is privileged.

2. Relationally

Another area in which Unit Ministry Teams add value to you is **RETREATS** . . . Bonding You To Your Loved Ones. The Strong Bonds Retreat Program is the premier relational resiliency tool for the Army. Designed for Singles, Couples, Families, and even Spouses of Deployed Soldiers, this program provides fun, relevant relational tools at 5-Star venues intended to honor you and inspire you!

3. Spiritually

Of course, chaplains are ministers in uniform. We are completely comfortable discussing and leveraging the benefits of your Faith to help you. The main venues for you are **RELIGIOUS SERVICES, STUDIES, & GATHERINGS**. We're also comfortable serving those who don't identify religiously but simply need care and concern — we're here to help you!

Yongsan At A Glance

*The Most Vibrant Spiritual Community In
The United States Military!*

- 6 Chapels in Area II**
- All Faiths Served**
- 20 Distinct Services Weekly**
- 7 Post-Wide Gatherings Weekly**
- 80+ Diverse Ministries**
- 100,000+ Served Annually**



Opportunities For You

6 Chapels

- **Brian Allgood Hospital Chapel**
Traditional Protestant, Seventh Day Adventist, & Episcopal Services
- **Memorial Chapel**
Multiple Catholic Masses and CCD Classes, Liturgical and Classic Protestant Services, English Speaking Pentecostal Service

• **South Post Chapel**
Contemporary Service, Non-Denominational Service, Gospel Service, and Jewish Service

- **Hannam Village Chapel**
Family Friendly Blended Service and Hispanic Pentecostal Service

• **K-16**
Contemporary Protestant Service

- **Religious Retreat Center Chapel**
As scheduled during Retreats/Activities

3 Centers

- Family Life Counseling Center
- Mustard Seed Christian Pre-School
- Religious Retreat Center

7 Post-Wide Men's, Women's & Youth Programs

Helping You Get From Where You Are To Where You Want To Be !

Unit Ministry Teams . . . Here For You!



U.S. ARMY
USAG-YONGSAN
INSTALLATION MANAGEMENT COMMAND

RSO
RELIGIOUS SUPPORT OFFICE



Always Within Reach !

24 / 7

On Call Duty Chaplain

738-7404 / 7405

Unit Ministry Teams . . . Here For You!



U.S. ARMY
USAG-YONGSAN
INSTALLATION MANAGEMENT COMMAND

RSO
RELIGIOUS SUPPORT OFFICE



**Helping You Get
From Where You Are
To Where You Want To Be !**

**USAG-Y Religious Support Office
Chaplain (MAJ) Bob Marsi
738-3011**

Unit Ministry Teams . . . Here For You!