

W1-1L

W1-1R
TURN

See page 6-2 for symbol design.

A	B	C	D	E	F	G	H	J	K	L	M	N
450	10	15	175	50	60	141	89	50	29	25	60	40
600	10	15	219	63	75	175	112	60	37	30	76	50
C 750	13	20	291	84	100	233	149	80	109	40	101	50
900	15	25	365	104	125	292	186	100	136	50	126	60
1200	20	30	513	146	175	410	262	140	192	70	178	70

WARNING SIGN COLORS:
LEGEND — BLACK
BACKGROUND— YELLOW (RETROREFLECTIVE)

TTC SIGN COLORS:
LEGEND — BLACK
BACKGROUND— ORANGE (RETROREFLECTIVE)

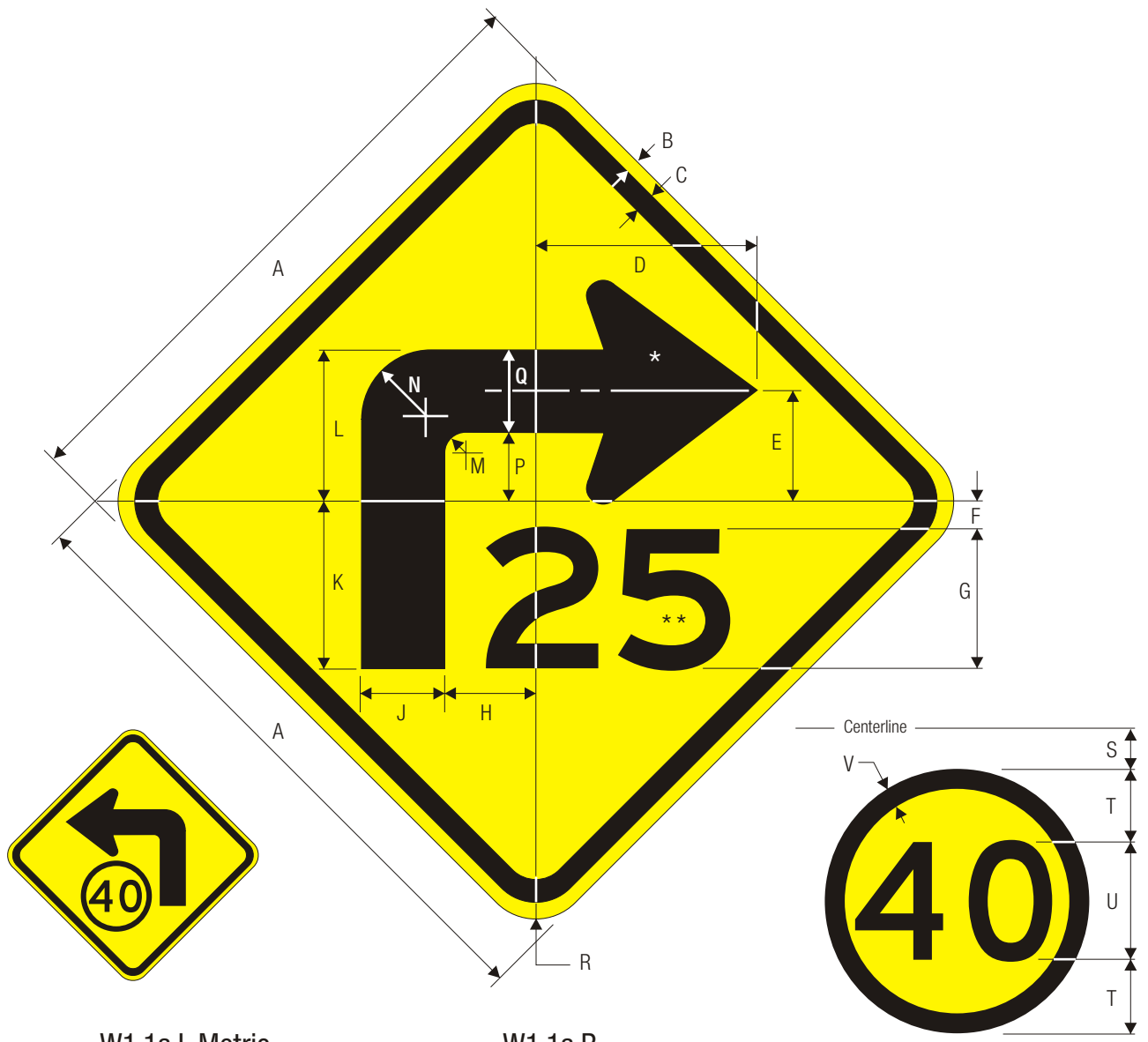

W1-1a L Metric

W1-1a R
TURN (ENGLISH)

*See page 6-2 for symbol design.
**Optically locate numerals.

A	B	C	D	E	F	G	H	J	K	L	M
750	13	20	266	132	50	150 E	109	100	200	182	25
900	15	25	333	166	73	175 E	136	125	248	228	33
1200	20	30	466	233	126	225 E	190	175	351	321	45

N	P	Q	R	S	T	U	V
80	82	100	50	24	87.5	125 D	20
100	103	125	60	29	105	150 D	25
140	146	175	70	39	140	200 D	30

COLORS: LEGEND — BLACK
BACKGROUND— YELLOW (RETROREFLECTIVE)

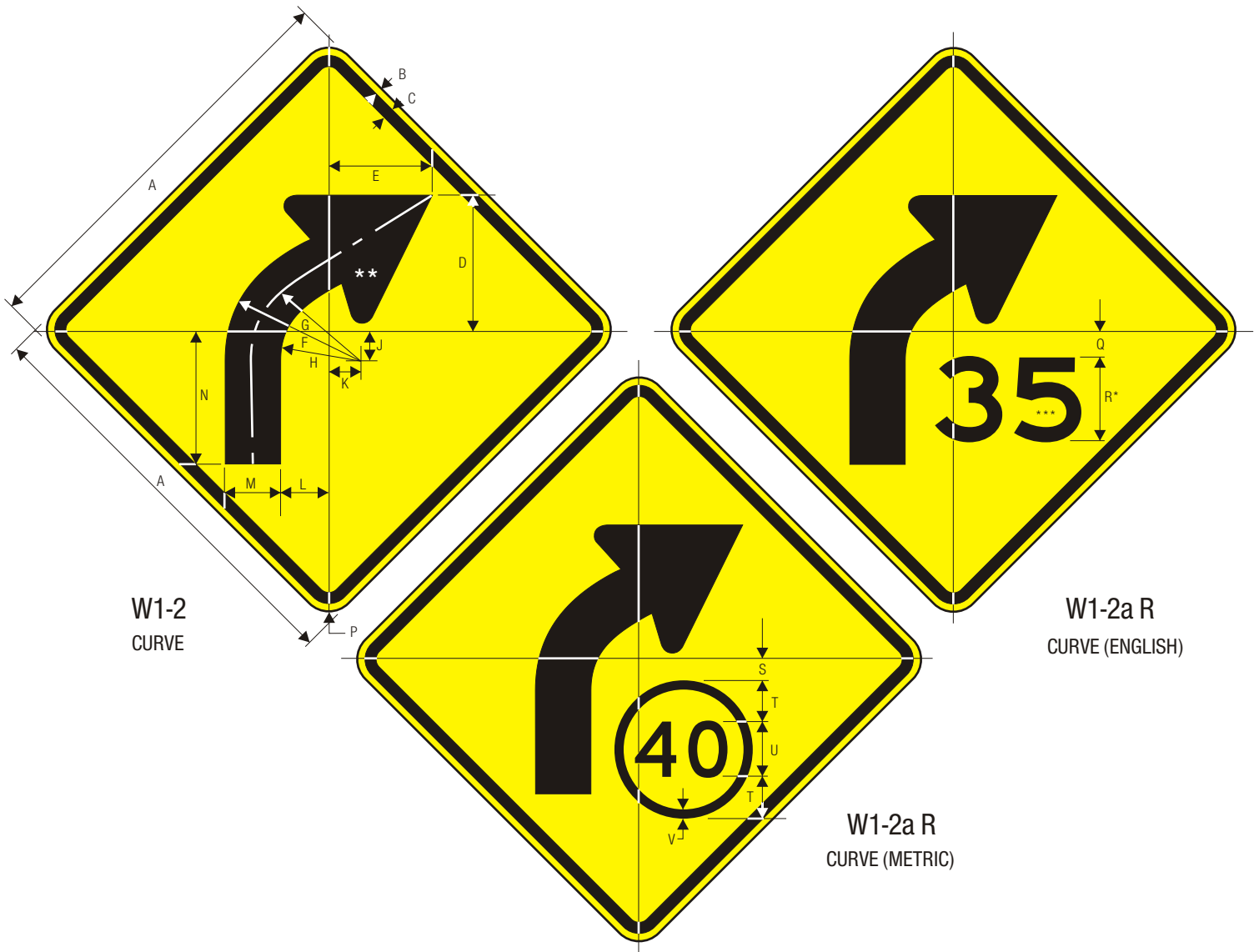

W1-2
CURVE

W1-2a R
CURVE (ENGLISH)

W1-2a R
CURVE (METRIC)

A	B	C	D	E	F	G	H	J	K	L	M
450	10	15	135	129	150	117	84	44	33	51	66
600	10	15	177	181	200	156	112	58.5	44	69	87
750	13	20	243	188	245	195	145	56	58	87	100
900	15	25	304	234	305	242.5	180	71	73	109	125
1200	20	30	425	328	425	337.5	250	99	102	152	175

C

N	P	Q	R	S	T	U	V
155	40	37	100 E	25	44	50 D	10
206	50	62	125 E	37	62	75 D	12
243	50	50	150 E	38	75	100 D	15
304	60	73	175 E	45	87.5	125 D	20
425	70	126	225 E	75	125	150 D	30

*See page 6-2 for symbol design.
**Optically position numerals.

WARNING SIGN COLORS:
LEGEND — BLACK
BACKGROUND— YELLOW (RETROREFLECTIVE)

TTC SIGN COLORS:
LEGEND — BLACK
BACKGROUND— ORANGE (RETROREFLECTIVE)

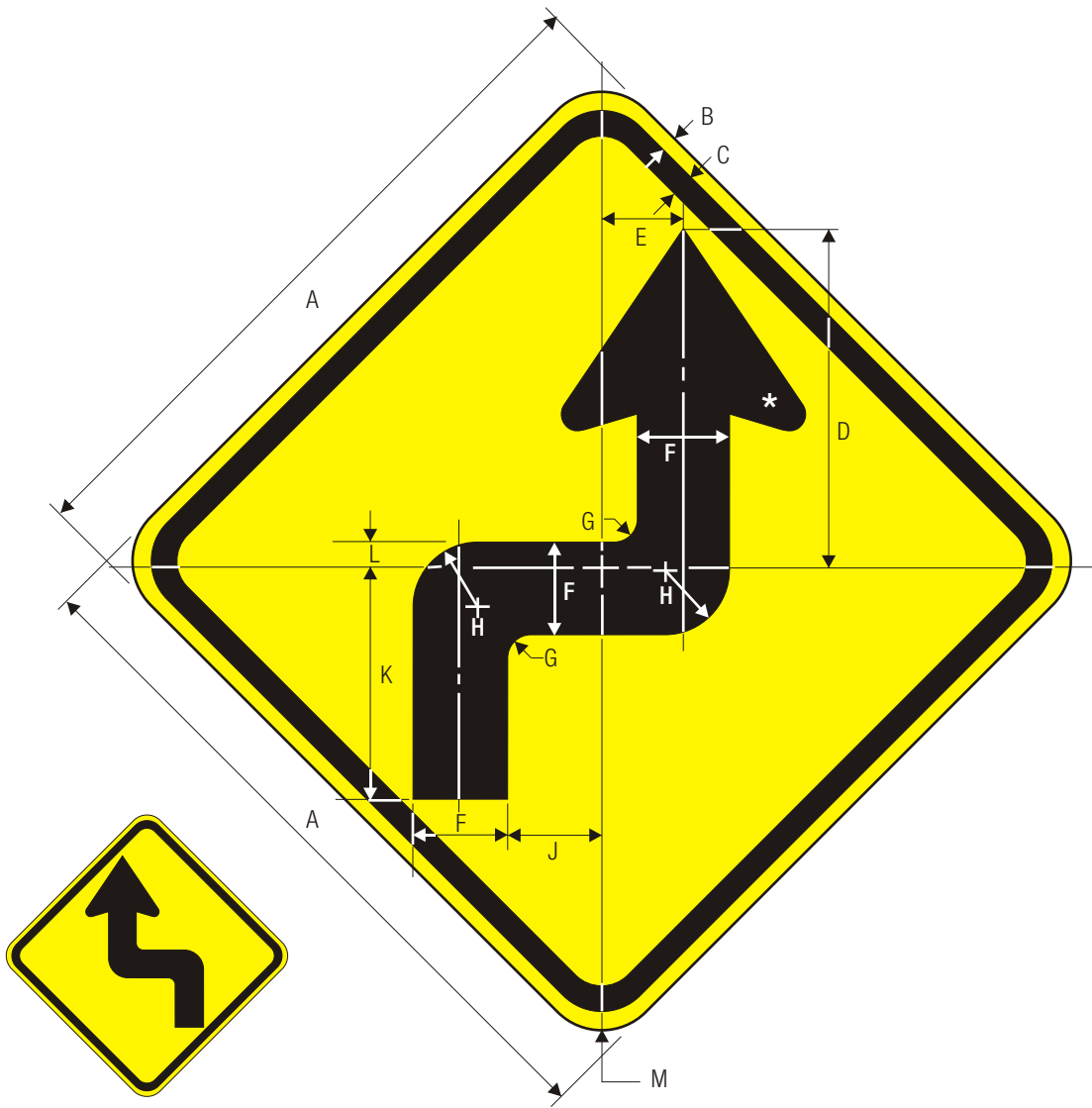

W1-3L

W1-3R
REVERSE TURN

*See page 6-2 for symbol design.

A	B	C	D	E	F	G	H	J	K	L	M
450	10	15	213	54	63	16	45	58	149	9	40
600	10	15	296	74	88	22	62	80	206	13	50
C 750	13	20	370	93	110	28	78	100	258	16	50
900	15	25	444	112	132	34	94	120	310	19	60
1200	20	30	592	148	175	44	123	159	412	25	70

WARNING SIGN COLORS:
 SYMBOL — BLACK
 BACKGROUND— YELLOW (RETROREFLECTIVE)

TTC SIGN COLORS:
 SYMBOL — BLACK
 BACKGROUND— ORANGE (RETROREFLECTIVE)

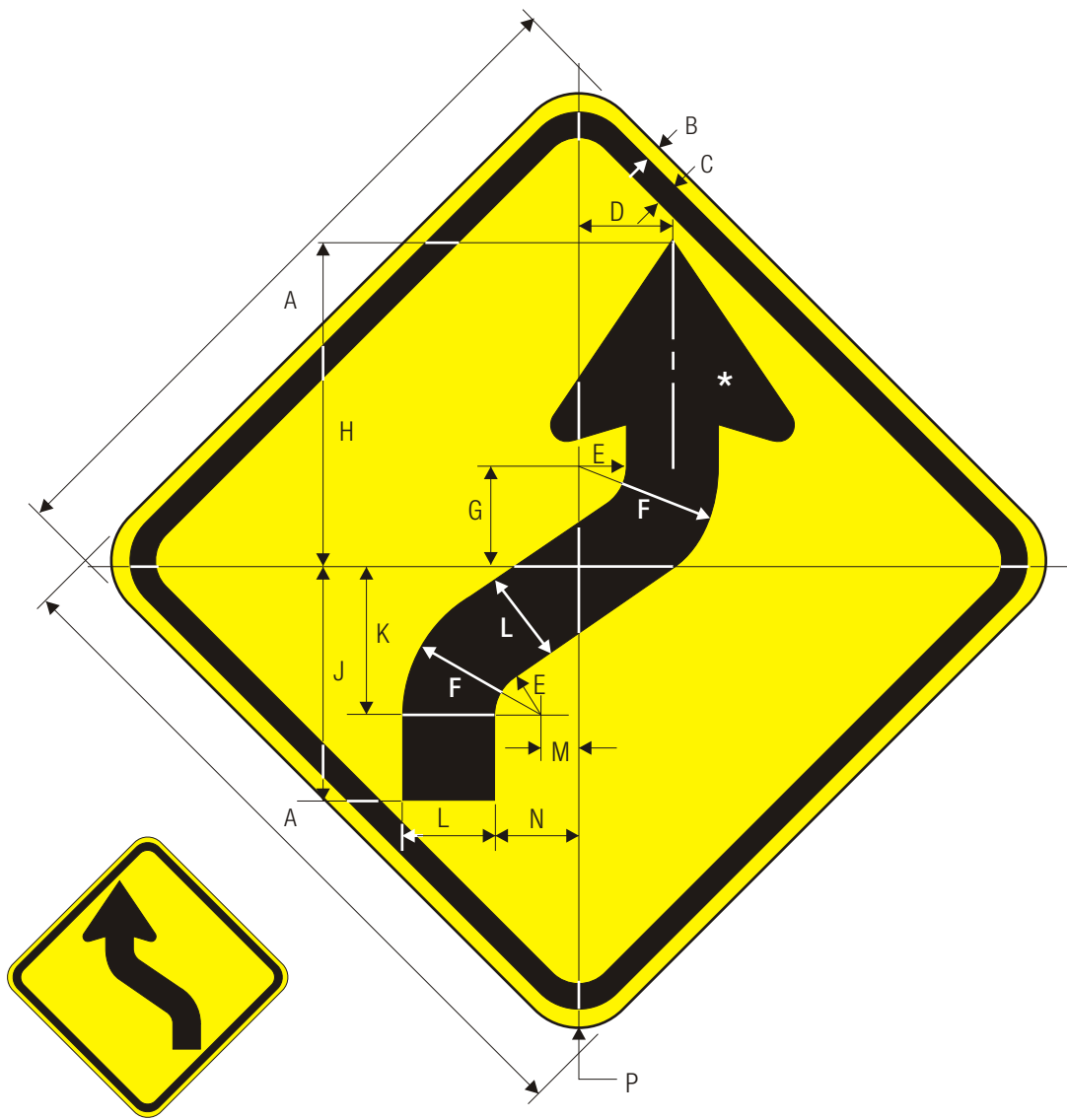

W1-4L

W1-4R

REVERSE CURVE

*See page 6-2 for symbol design.

A	B	C	D	E	F	G	H	J	K	L	M
450	10	15	60	30	90	62	210	156	101	60	26
600	10	15	75	38	113	76	260	196	127	75	32
750	13	20	100	50	150	101	348	262	169	100	43
900	15	25	125	63	188	126	437	325	210	125	54
1200	20	30	175	88	263	148	579	419	326	175	75

G

N	P
56	40
71	50
94	50
118	60
165	70

WARNING SIGN COLORS:
 SYMBOL — BLACK
 BACKGROUND— YELLOW (RETROREFLECTIVE)

TTC SIGN COLORS:
 SYMBOL — BLACK
 BACKGROUND— ORANGE (RETROREFLECTIVE)

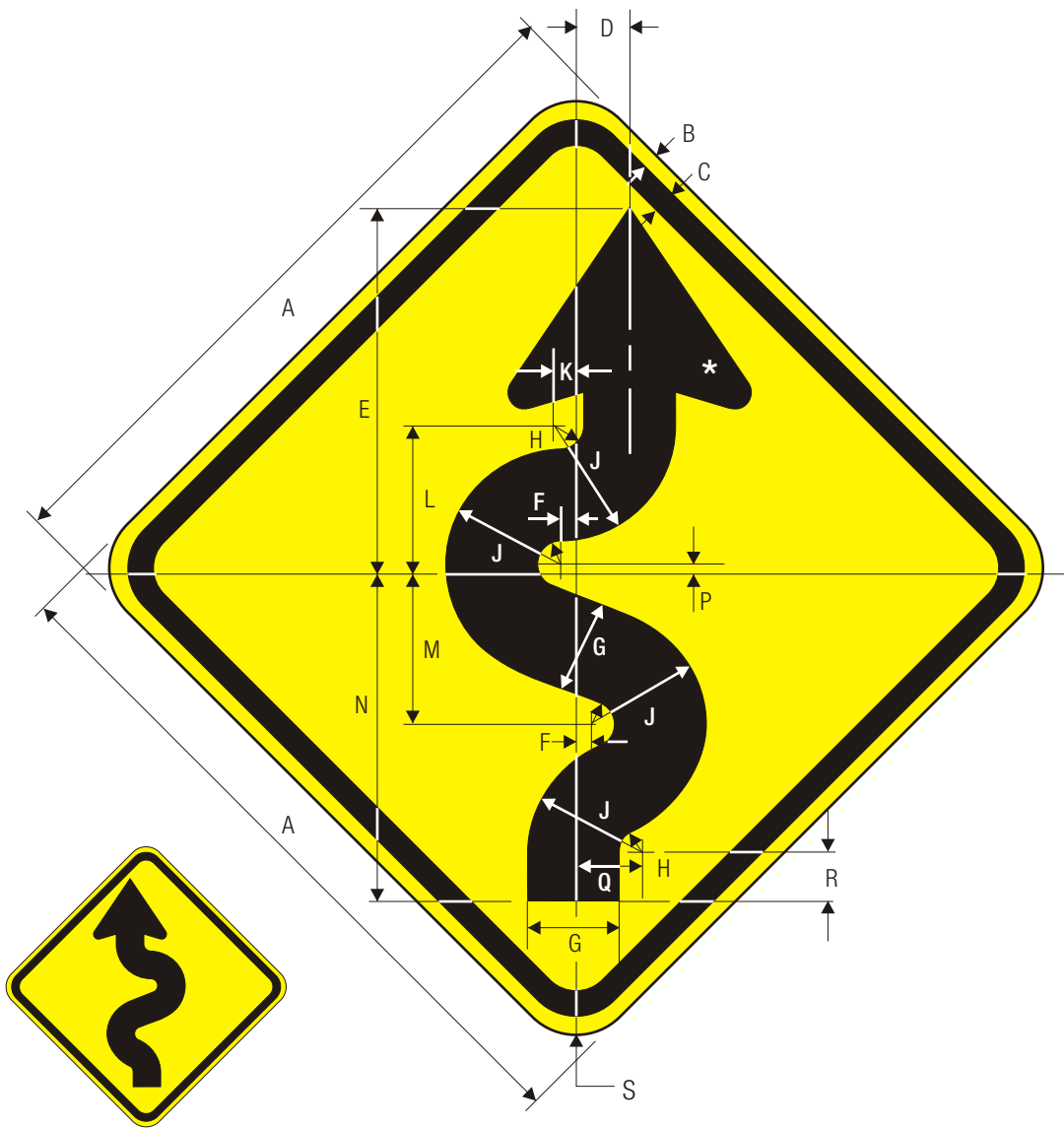

W1-5L

W1-5R
WINDING ROAD

*See page 6-2 for symbol design.

A	B	C	D	E	F	G	H	J	K	L	M
450	10	15	35	237	10	60	15	75	10	94	111
600	10	15	44	301	13	75	19	94	13	123	121
750	13	20	58	395	16	100	25	125	16	157	157
900	15	25	73	489	21	125	31	156	21	192	214
1200	20	30	102	647	30	175	44	219	30	276	292

C

N	P	Q	R	S
216	4	44	32	40
265	10	54	40	50
360	7	72	53	50
454	4	90	66	60
628	13	127	92	70

COLORS: LEGEND — BLACK
BACKGROUND— YELLOW (RETROREFLECTIVE)

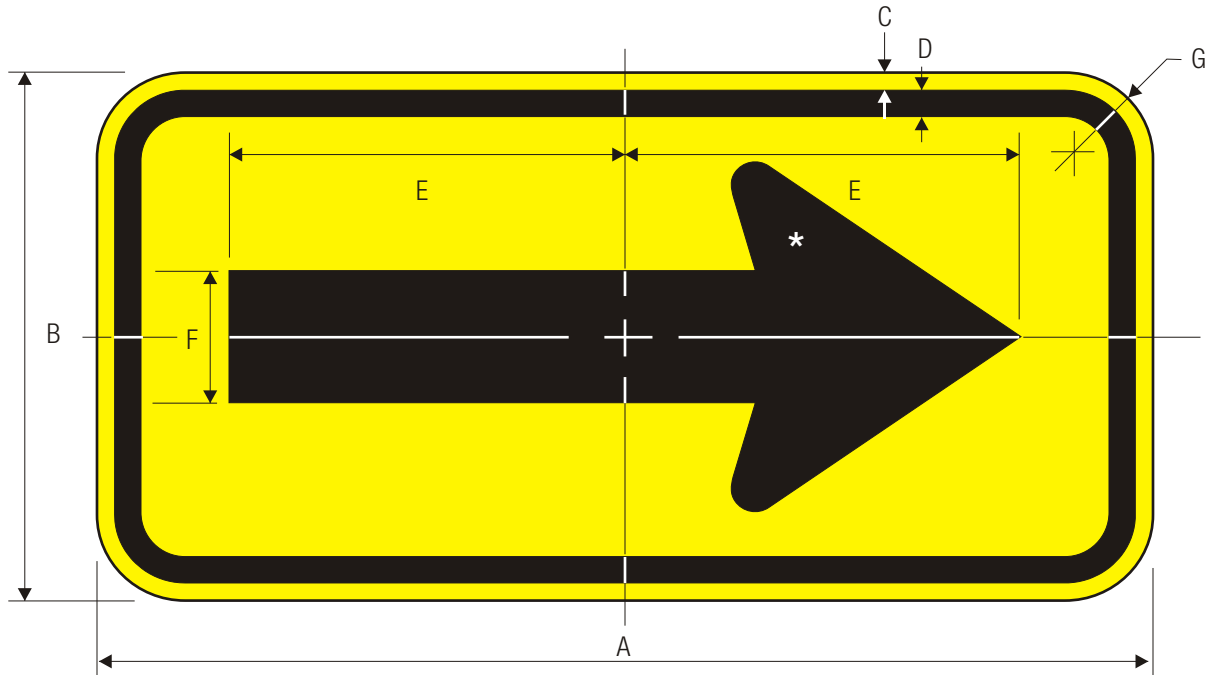

W1-6R

ONE DIRECTION LARGE ARROW



W1-6L

*See page 6-2 for symbol design.

	A	B	C	D	E	F	G
	600	300	10	15	225	75	50
	900	450	15	25	350	125	60
C	1200	600	20	30	475	150	70
	1500	750	20	30	600	200	70

WARNING SIGN COLORS:
 SYMBOL — BLACK
 BACKGROUND— YELLOW (RETROREFLECTIVE)

TTC SIGN COLORS:
 SYMBOL — BLACK
 BACKGROUND— ORANGE (RETROREFLECTIVE)

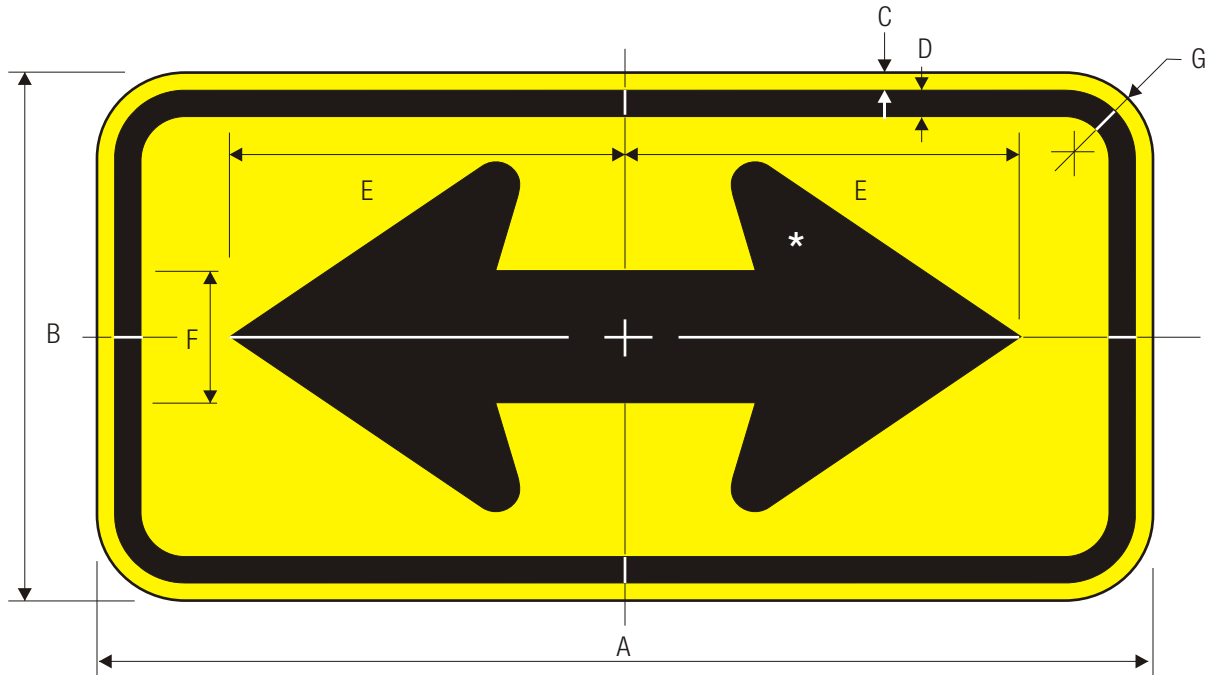

W1-7
TWO DIRECTION LARGE ARROW

*See page 6-2 for symbol design.

	A	B	C	D	E	F	G
	600	300	10	15	225	75	50
	900	450	15	25	350	125	60
C	1200	600	20	30	475	150	70
	1500	750	20	30	600	200	70

WARNING SIGN COLORS:
LEGEND — BLACK
BACKGROUND— YELLOW (RETROREFLECTIVE)

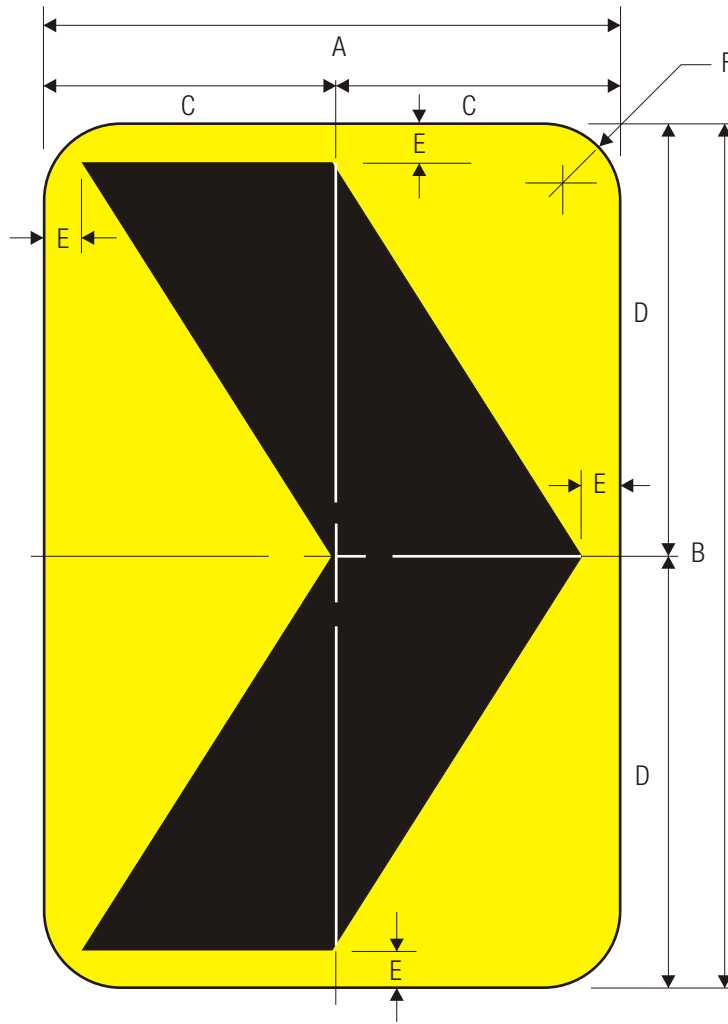

W1-8L

W1-8R
CHEVRON ALIGNMENT

	A	B	C	D	E	F
	300	450	150	225	20	40
C	450	600	225	300	20	40
	600	750	300	375	25	50
	750	900	375	450	25	50
	900	1200	450	600	30	60

WARNING SIGN COLORS:
LEGEND — BLACK
BACKGROUND— YELLOW (RETROREFLECTIVE)

TTC SIGN COLORS:
LEGEND — BLACK
BACKGROUND— ORANGE (RETROREFLECTIVE)

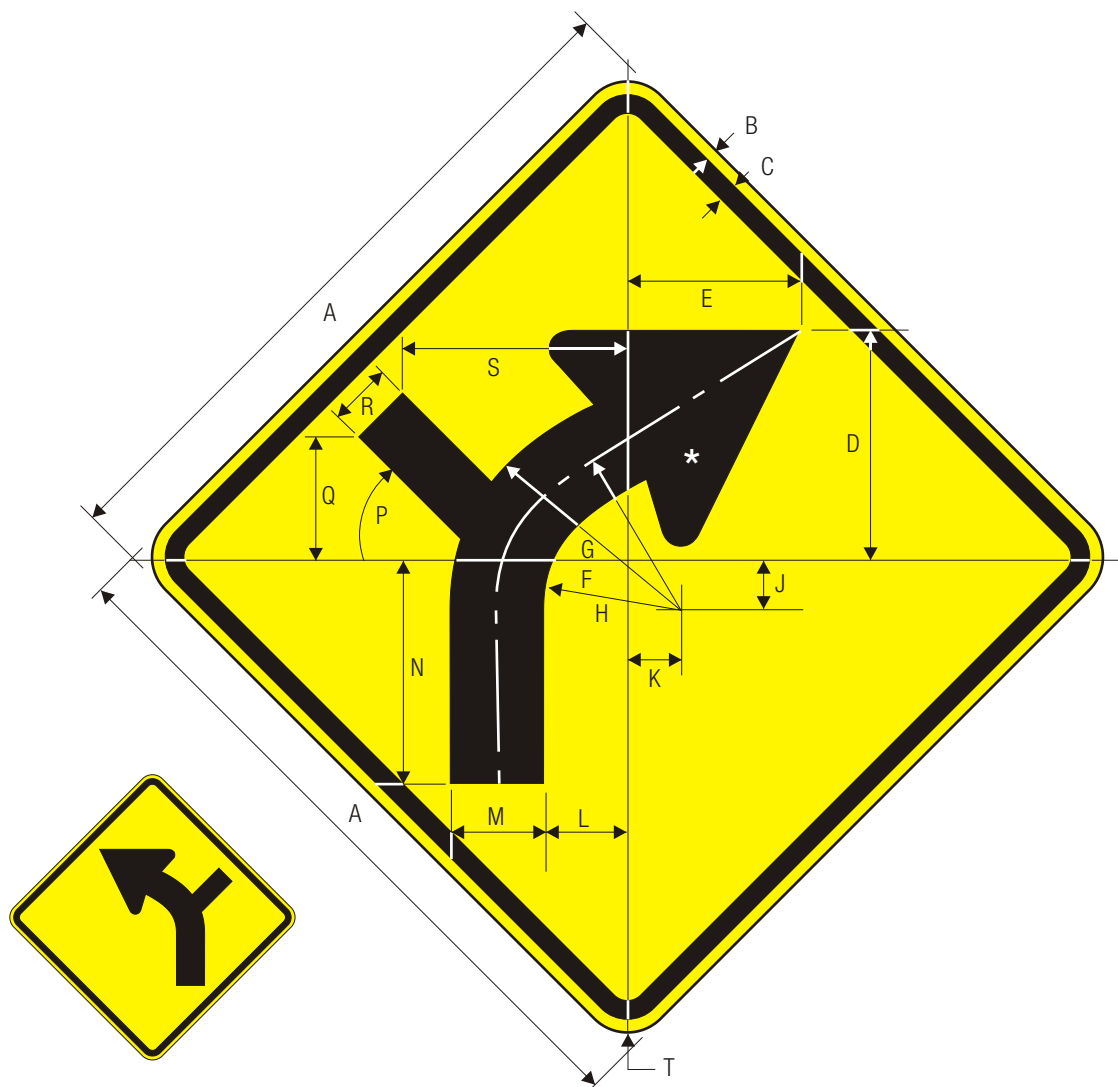

W1-10L

W1-10R

HORIZONTAL ALIGNMENT

See page 6-2 for symbol design.

A	B	C	D	E	F	G	H	J	K	L	M
450	10	15	146	113	146	116	86	34	35	53	60
600	10	15	182	140	182	144.5	107	43	44	65	75
750	13	20	243	188	245	195	145	56	58	87	100
900	15	25	304	234	305	242.5	180	71	73	109	125
1200	20	30	425	328	425	337.5	250	99	102	152	175

C

N	P	Q	R	S	T
146	45°	77	40	144	40
182	45°	103	50	192	50
243	45°	129	65	240	50
304	45°	155	75	288	60
425	45°	207	100	384	70

COLORS: LEGEND — BLACK
BACKGROUND— YELLOW (RETROREFLECTIVE)

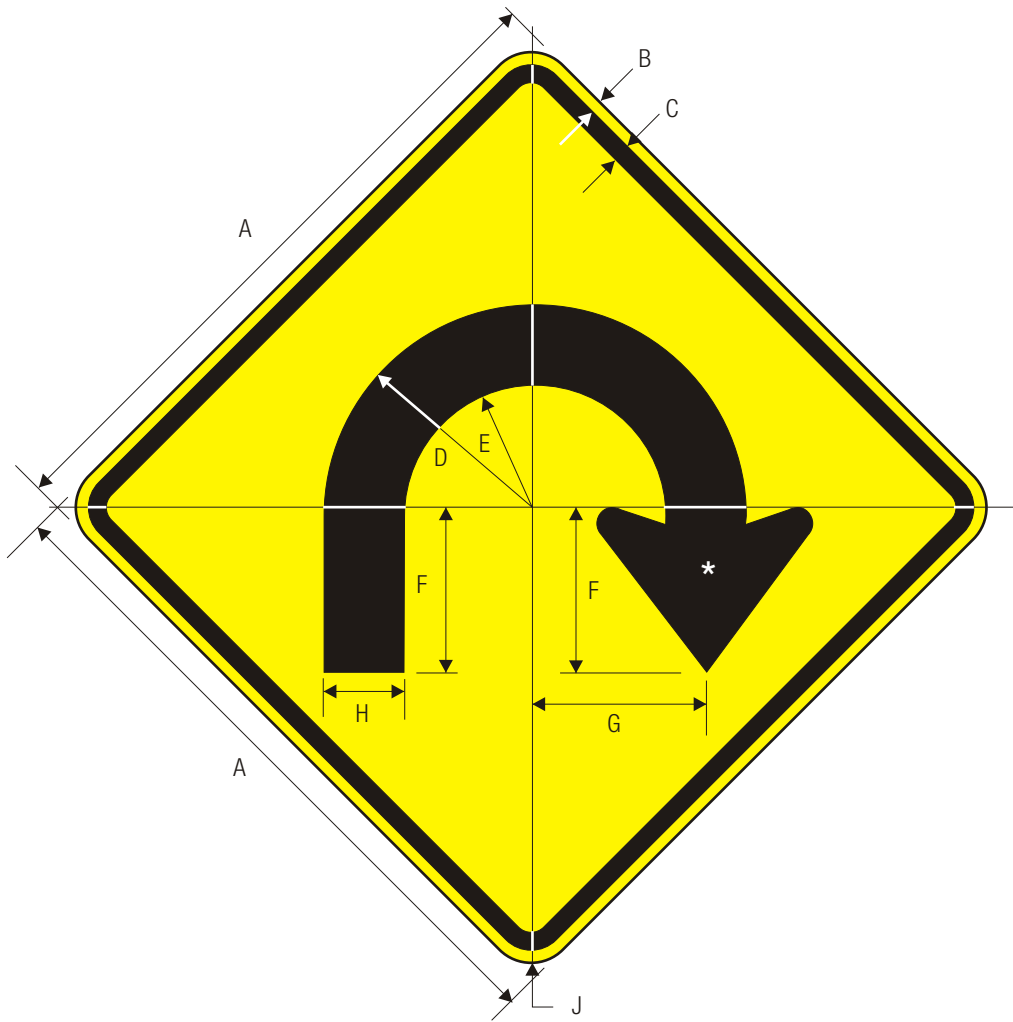

W1-11
HAIRPIN CURVE

*See page 6-2 for symbol design.
**Optically position numerals.

	A	B	C	D	E	F	G	H	J
C	750	13	20	235	145	184	196	90	50
	900	15	25	282	174	221	235	108	60
	1200	20	30	376	232	294	314	144	70

COLORS: LEGEND — BLACK
BACKGROUND— YELLOW (RETROREFLECTIVE)

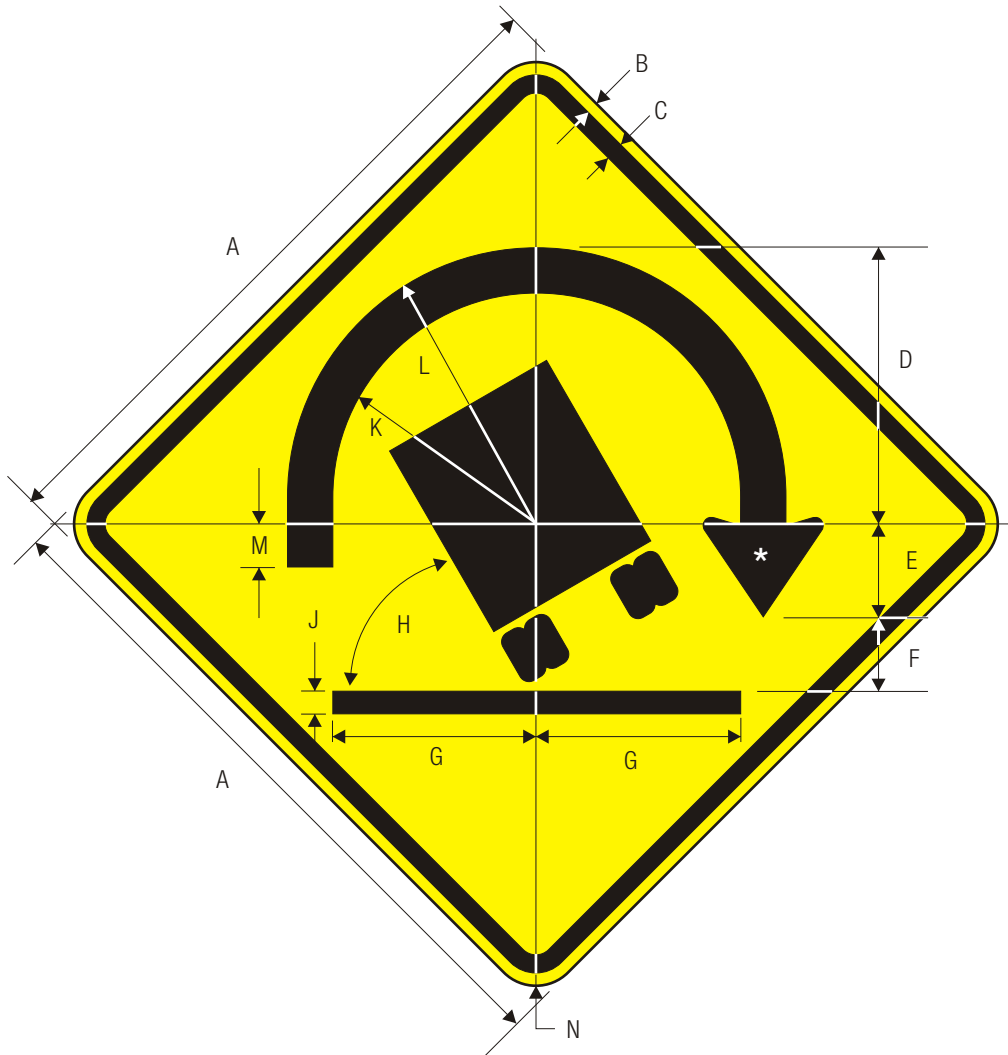

W1-13
TRUCK ROLLOVER

*See page 6-2 and 6-62 for symbol design.

	A	B	C	D	E	F	G	H	J	K	L	M	N
C	750	13	20	305	103	83	226	60°	24	255	305	48	50
	900	15	25	366	124	100	271	60°	29	306	366	58	60
	1200	20	30	488	165	133	362	60°	38	408	488	77	70

COLORS: SYMBOL — BLACK
BACKGROUND— YELLOW (RETROREFLECTIVE)

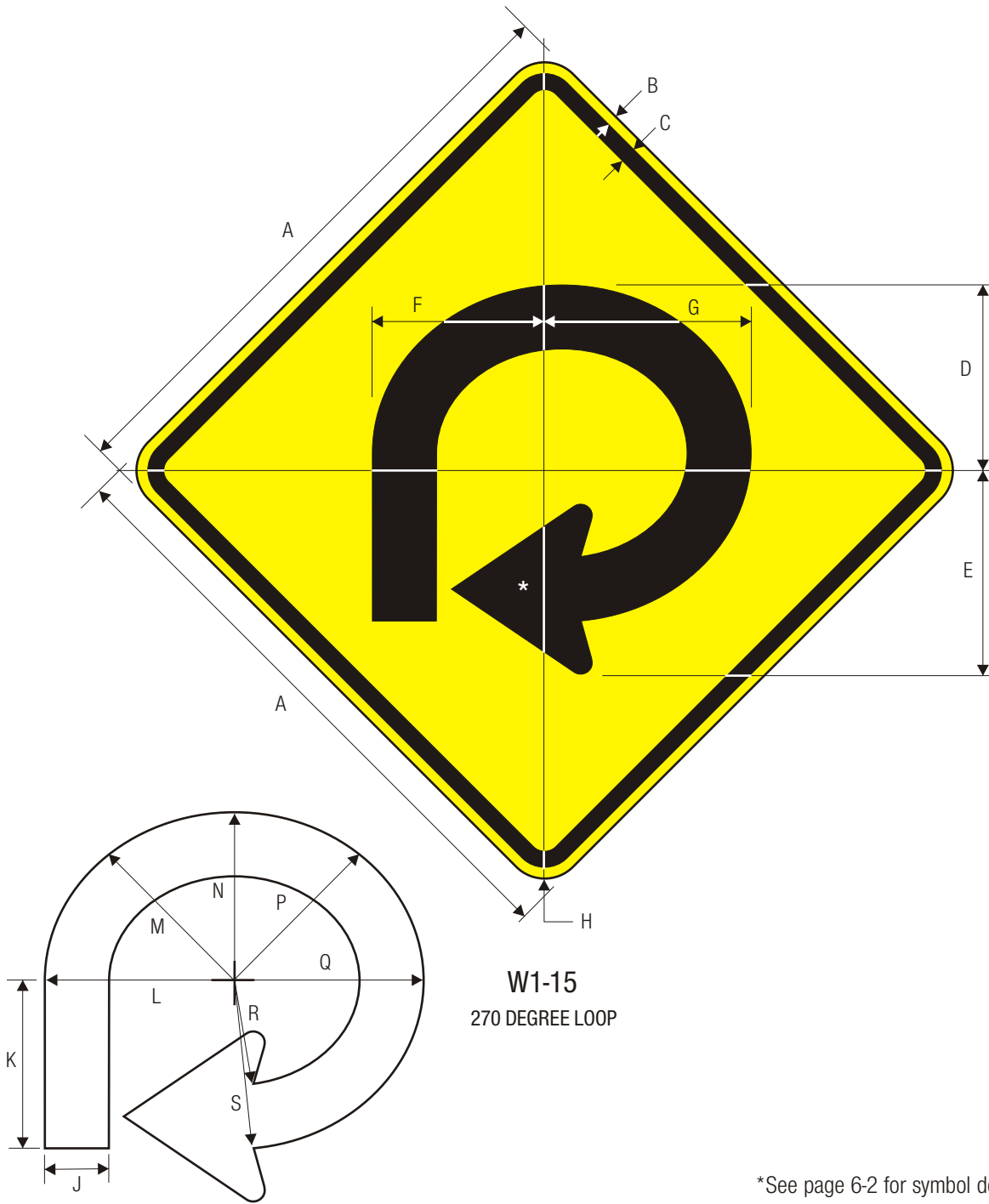

*See page 6-2 for symbol design.

C

A	B	C	D	E	F	G	H	J	K	L	M
750	13	20	232	254	215	258	50	80	210	236	224
900	15	25	278	305	258	310	60	96	252	283	269
1200	20	30	371	406	344	413	70	128	336	378	358

N	P	Q	R	S
209	224	236	132	212
251	269	283	158	254
334	358	378	211	339

COLORS: LEGEND — BLACK
BACKGROUND— YELLOW (RETROREFLECTIVE)

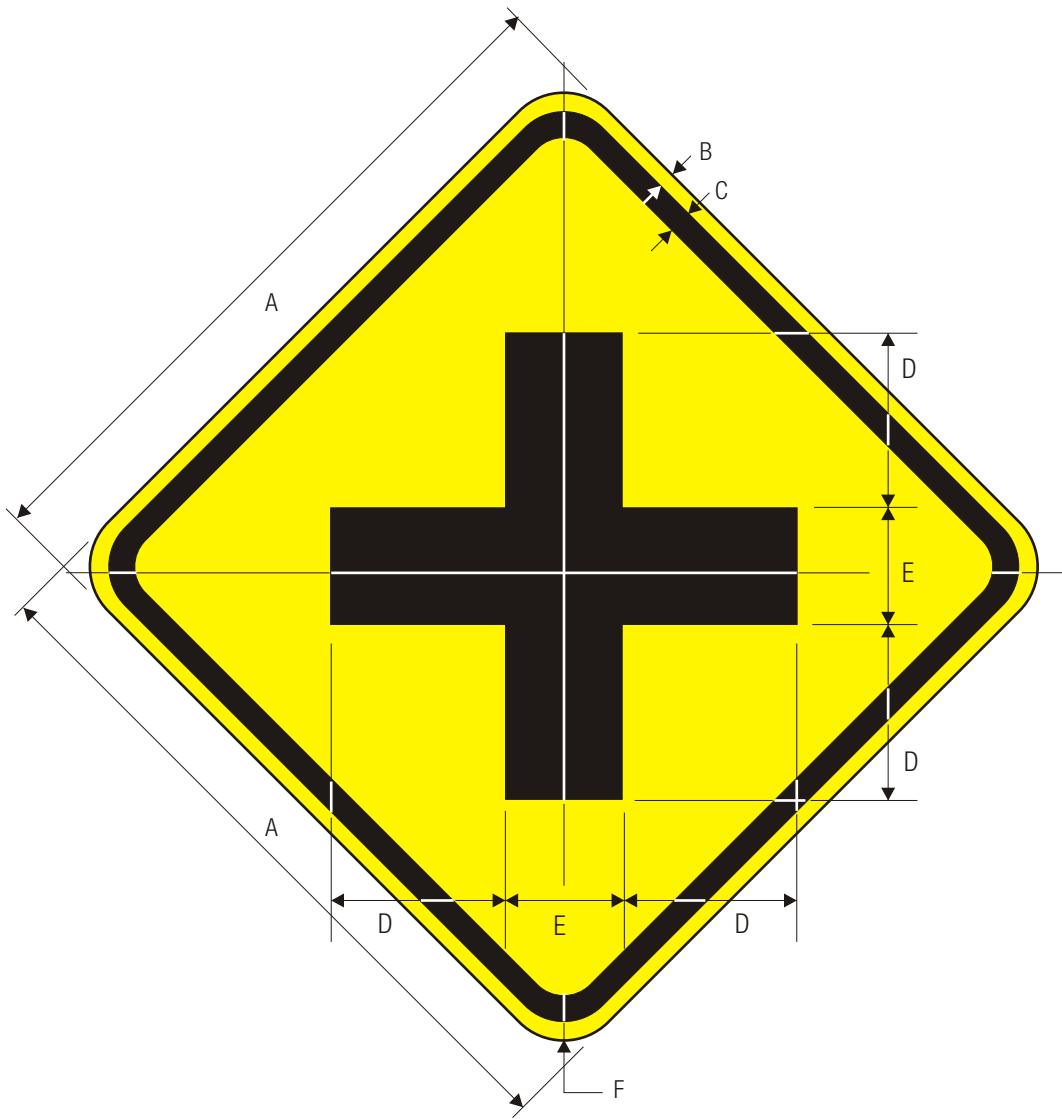

W2-1
CROSS ROAD

	A	B	C	D	E	F
	450	10	15	150	75	40
	600	10	15	200	100	50
C	750	13	20	250	125	50
	900	15	25	300	150	60
	1200	20	30	400	200	70

COLORS: LEGEND — BLACK
BACKGROUND— YELLOW (RETROREFLECTIVE)

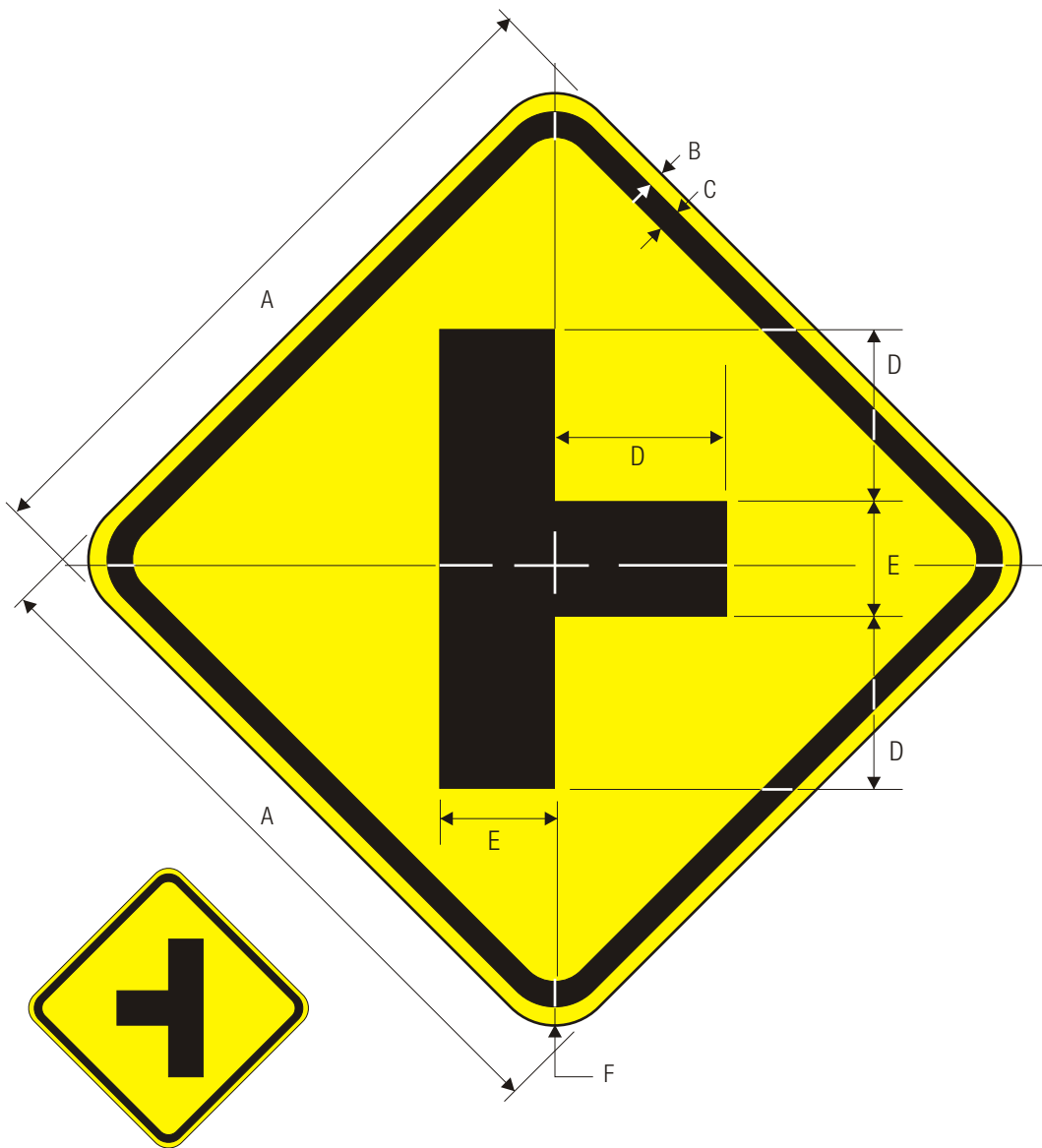

W2-2L

W2-2R
CROSS ROAD

C

A	B	C	D	E	F
450	10	15	150	75	40
600	10	15	200	100	50
750	13	20	250	125	50
900	15	25	300	150	60
1200	20	30	400	200	70

COLORS: LEGEND — BLACK
BACKGROUND— YELLOW (RETROREFLECTIVE)

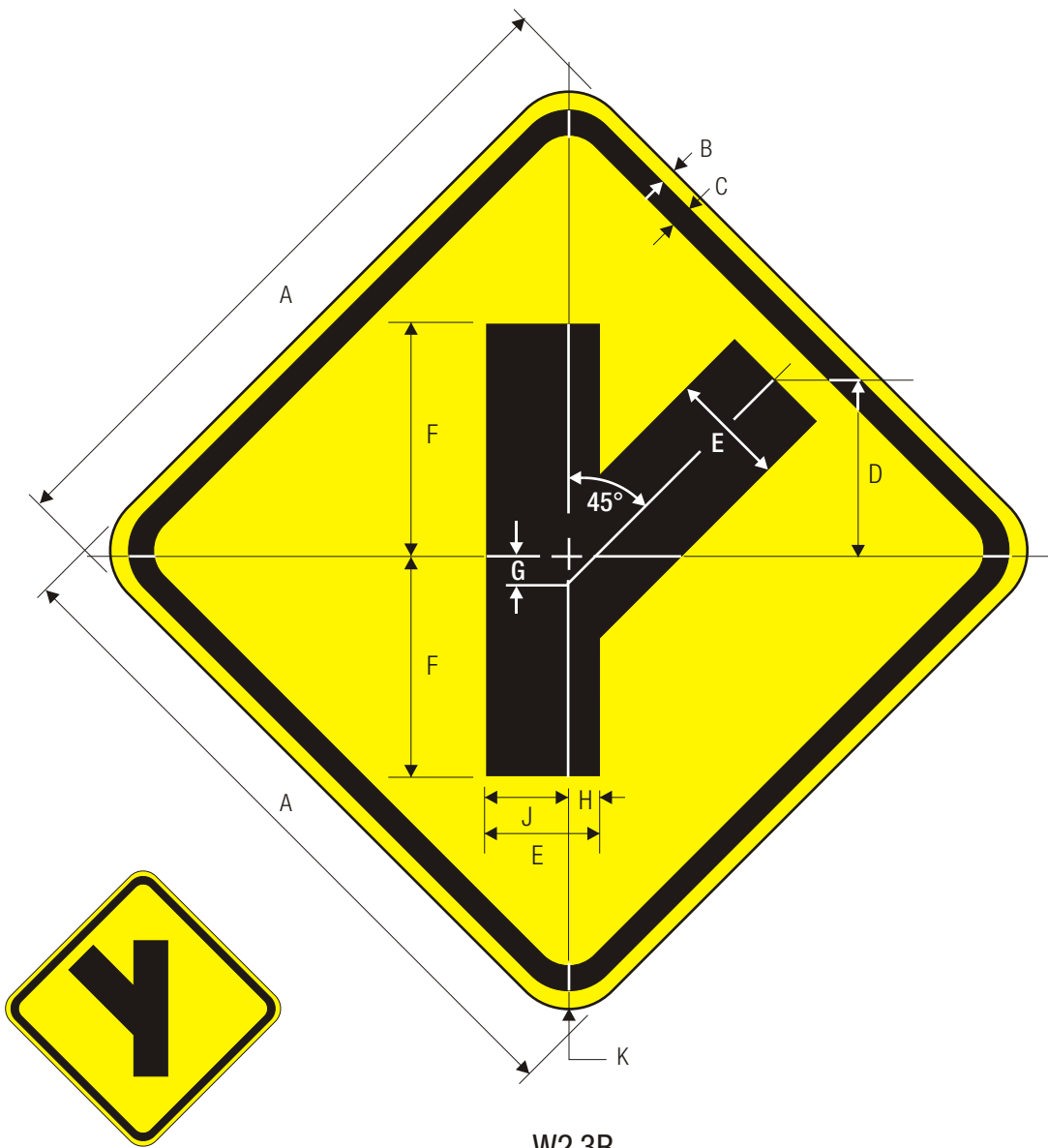

W2-3L

W2-3R
SIDE ROAD

C

A	B	C	D	E	F	G	H	J	K
450	10	15	125	75	187.5	37.5	20	55	40
600	10	15	150	100	250	50	25	75	50
750	13	20	200	125	312.5	62.5	30	95	50
900	15	25	250	150	375	75	40	110	60
1200	20	30	325	200	500	100	50	150	70

COLORS: LEGEND — BLACK
BACKGROUND— YELLOW (RETROREFLECTIVE)

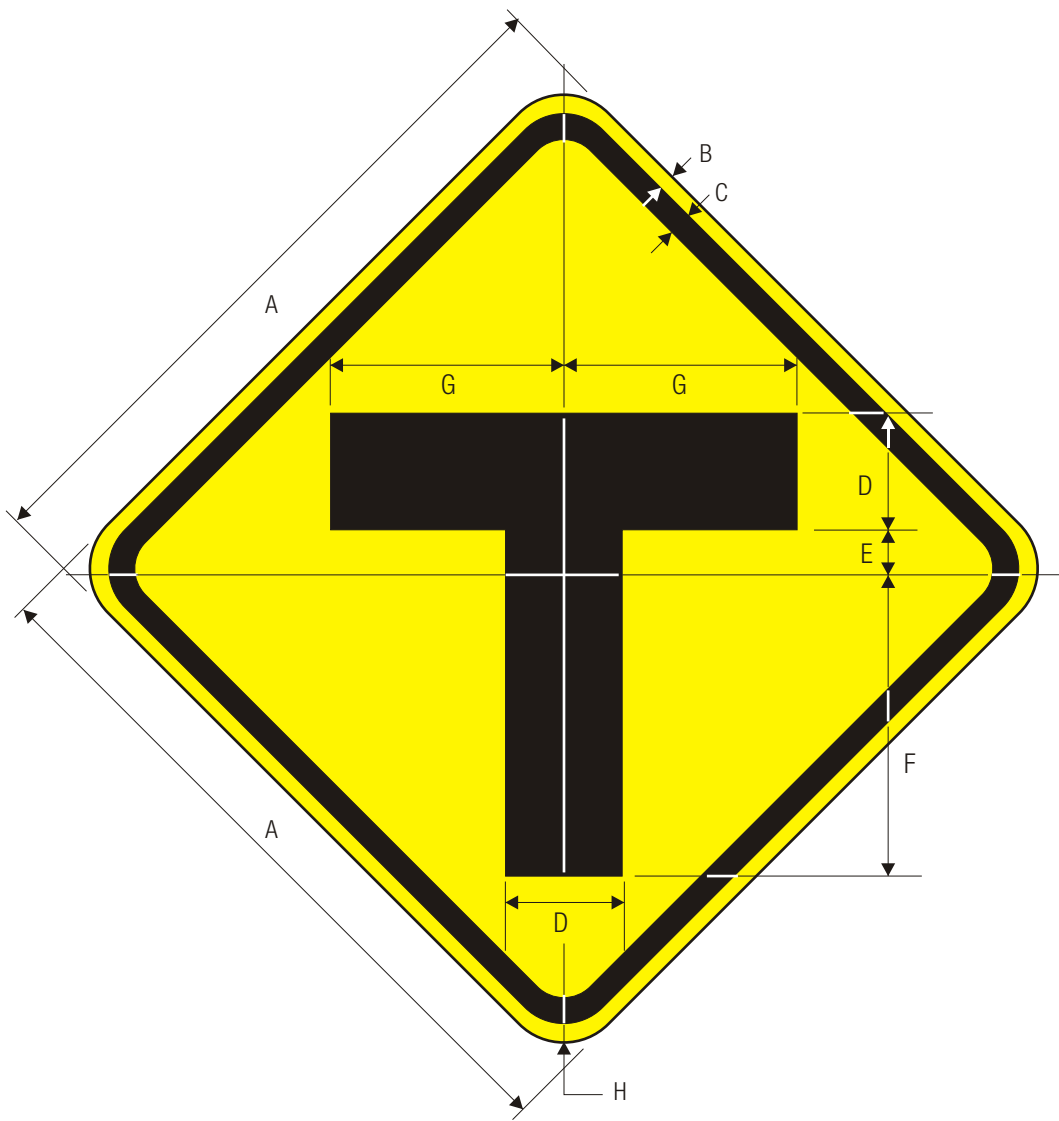

W2-4
T-SYMBOL

	A	B	C	D	E	F	G	H
	450	10	15	75	20	200	150	40
	600	10	15	100	30	275	200	50
C	750	13	20	125	40	350	250	50
	900	15	25	150	50	400	300	60
	1200	20	30	200	60	550	400	70

COLORS: LEGEND — BLACK
BACKGROUND— YELLOW (RETROREFLECTIVE)

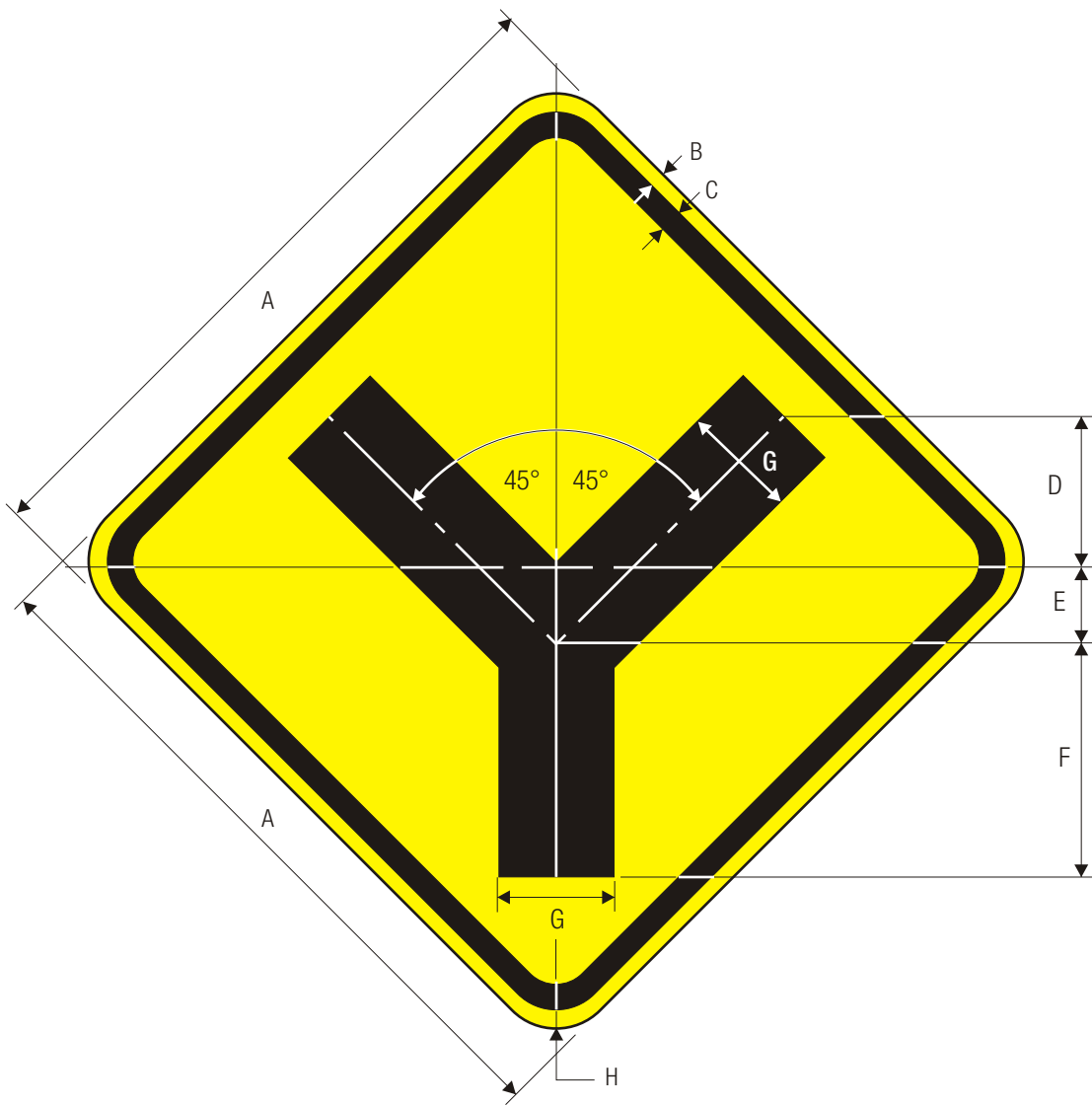

W2-5
Y-SYMBOL

	A	B	C	D	E	F	G	H
	450	10	15	94	55	152	75	40
	600	10	15	125	73	202	100	50
C	750	13	20	156	91	253	125	50
	900	15	25	188	110	303	150	60
	1200	20	30	250	146	404	200	70

COLORS: LEGEND — BLACK
BACKGROUND— YELLOW (RETROREFLECTIVE)

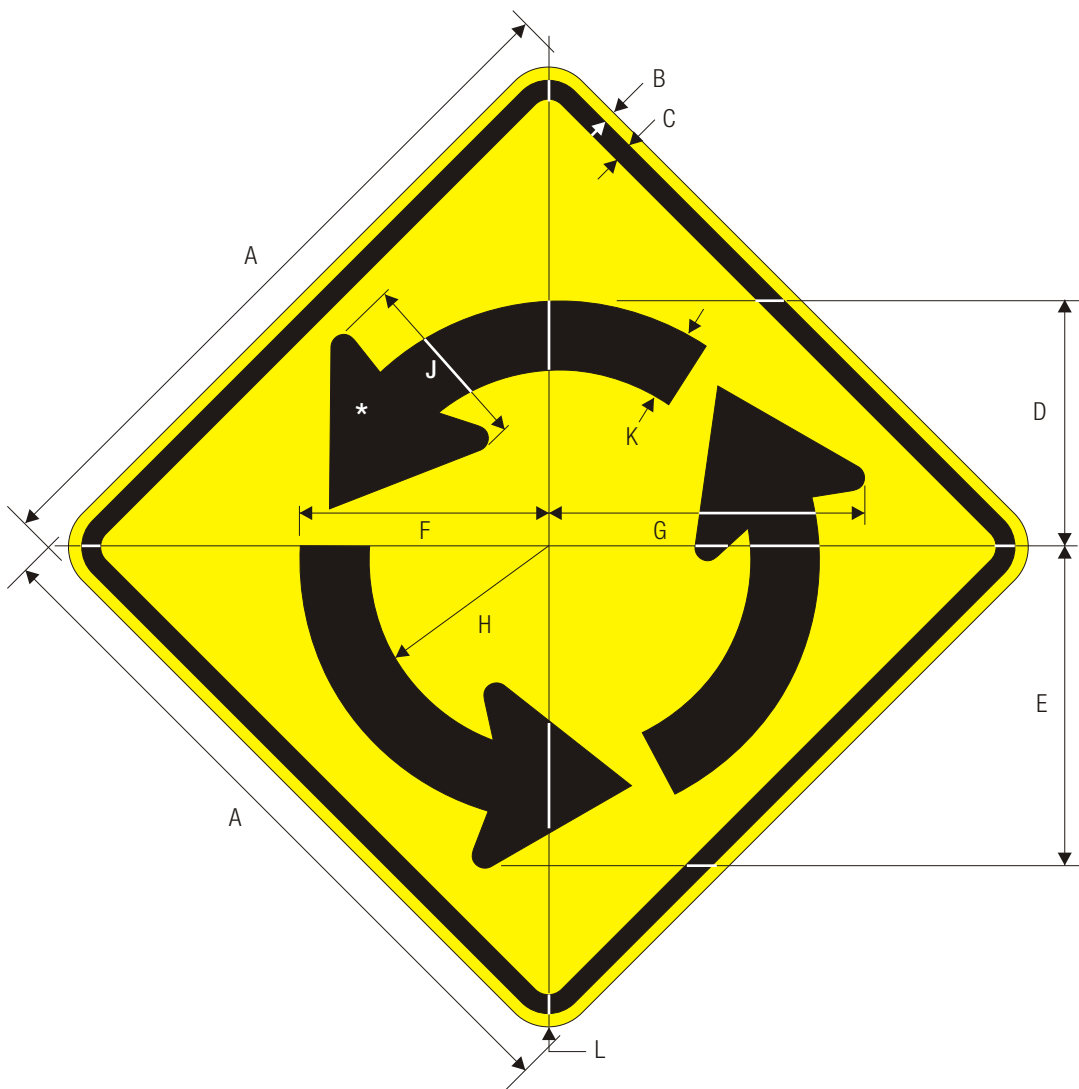

W2-6
CIRCULAR INTERSECTION

*See page 6-36 for symbol design.

A	B	C	D	E	F	G	H	J	K	L
600	10	15	210	270	210	271	151	154	159	50
750	13	20	262	337	262	339	188	192	74	50
900	15	25	314	404	314	407	225	230	89	60
1200	20	30	420	540	420	542	302	308	118	70

COLORS: SYMBOL — BLACK
BACKGROUND— YELLOW (RETROREFLECTIVE)

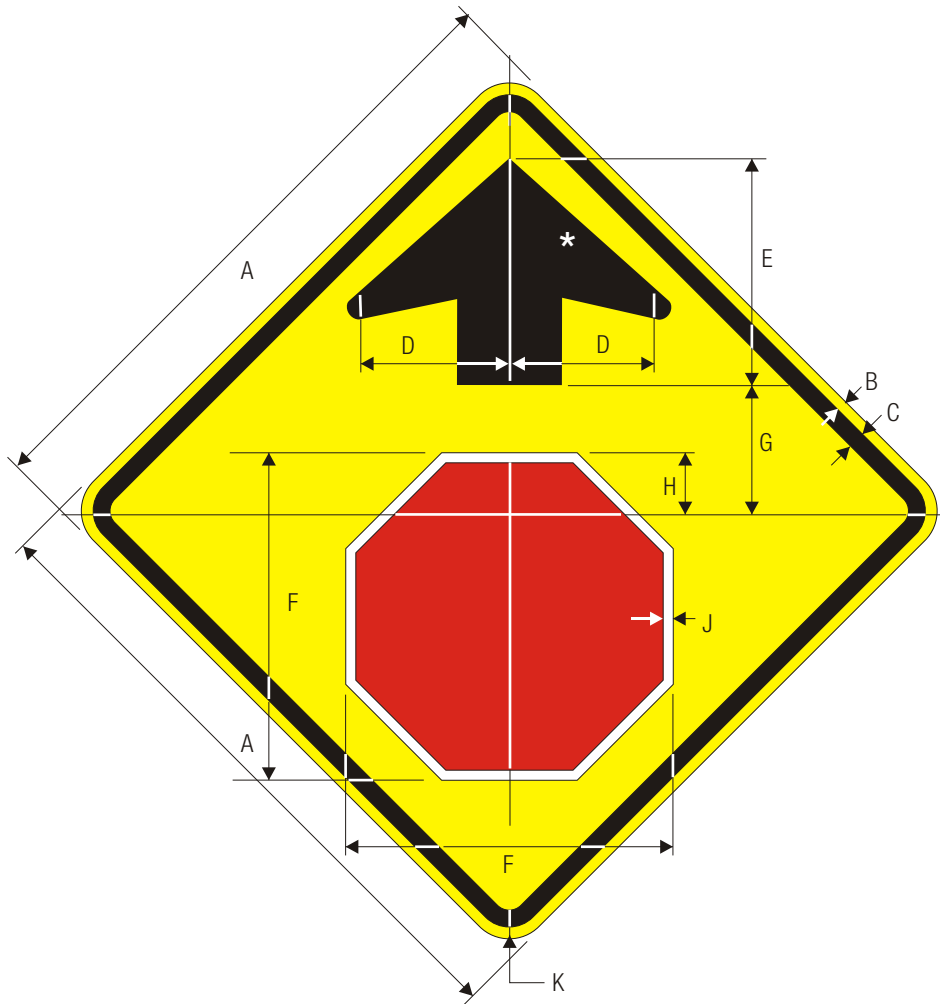

W3-1

STOP AHEAD

*See page 6-3 for symbol design.

A	B	C	D	E	F	G	H	J	K
450	10	15	108	162	238	90	42	8	40
600	10	15	144	216	313	120	56	10	50
750	13	20	180	270	400	150	70	10	50
900	15	25	216	324	475	180	84	15	60
1200	20	30	288	432	625	240	112	20	70

WARNING SIGN COLORS:

BORDER & ARROW – BLACK

SYMBOL – WHITE BORDER / RED BACKGROUND (RETROREFLECTIVE)

BACKGROUND – YELLOW (RETROREFLECTIVE)

TTC COLORS:

BORDER & ARROW – BLACK

SYMBOL – WHITE BORDER / RED BACKGROUND (RETROREFLECTIVE)

BACKGROUND – ORANGE (RETROREFLECTIVE)

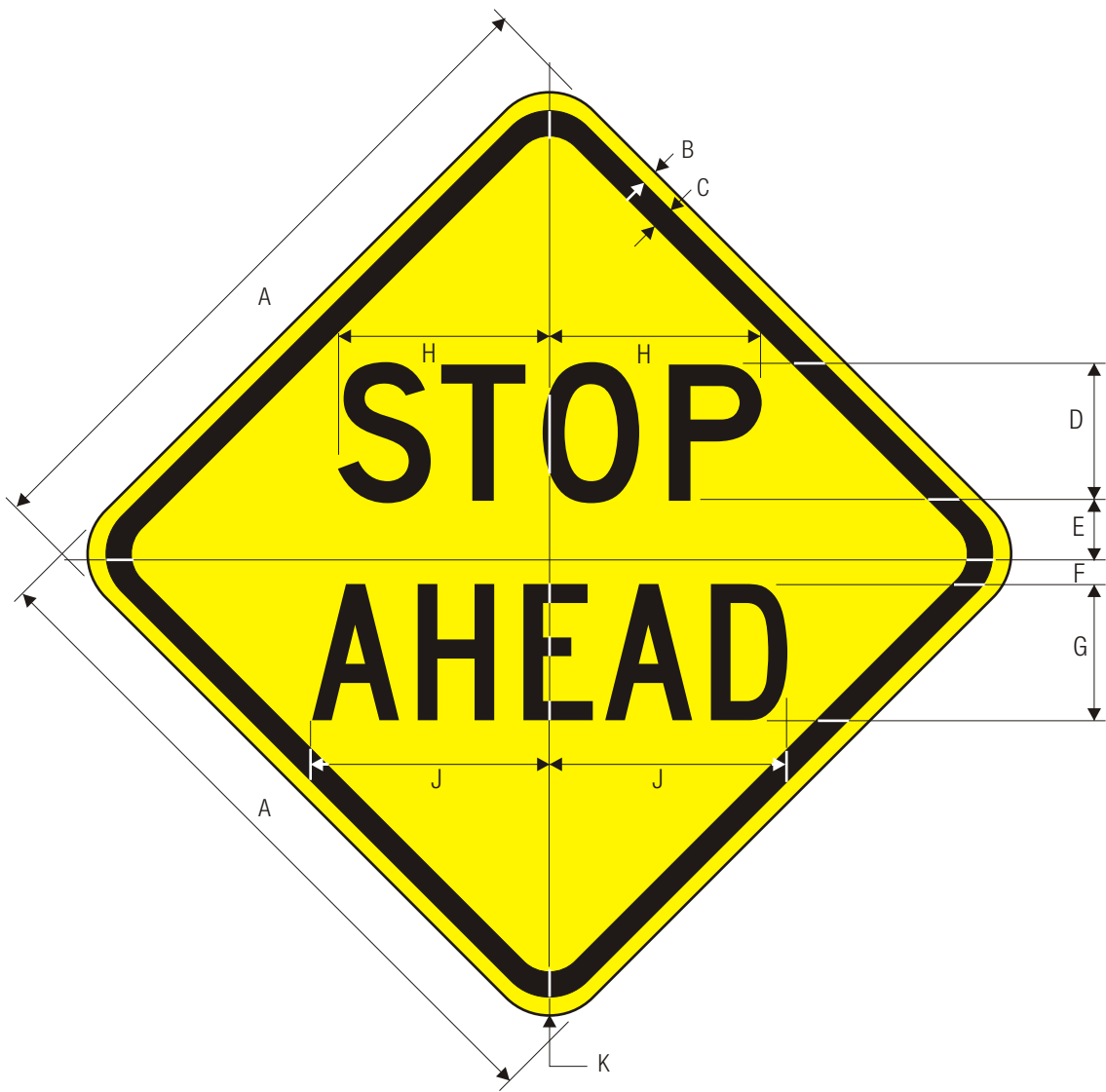

W3-1a

STOP AHEAD

A	B	C	D	E	F	G	H	J	K
450	10	15	75 D	45	20	75 C	116.5	130.5	40
600	10	15	125 D	50	25	125 C	194	218	50
750	13	20	150 D	60	30	150 C	233	261.5	50
C 900	15	25	175 D	75	40	175 C	272	305	60
1200	20	30	225 D	100	50	225 C	349.5	392	70

COLORS: LEGEND — BLACK
 BACKGROUND— YELLOW (RETROREFLECTIVE)

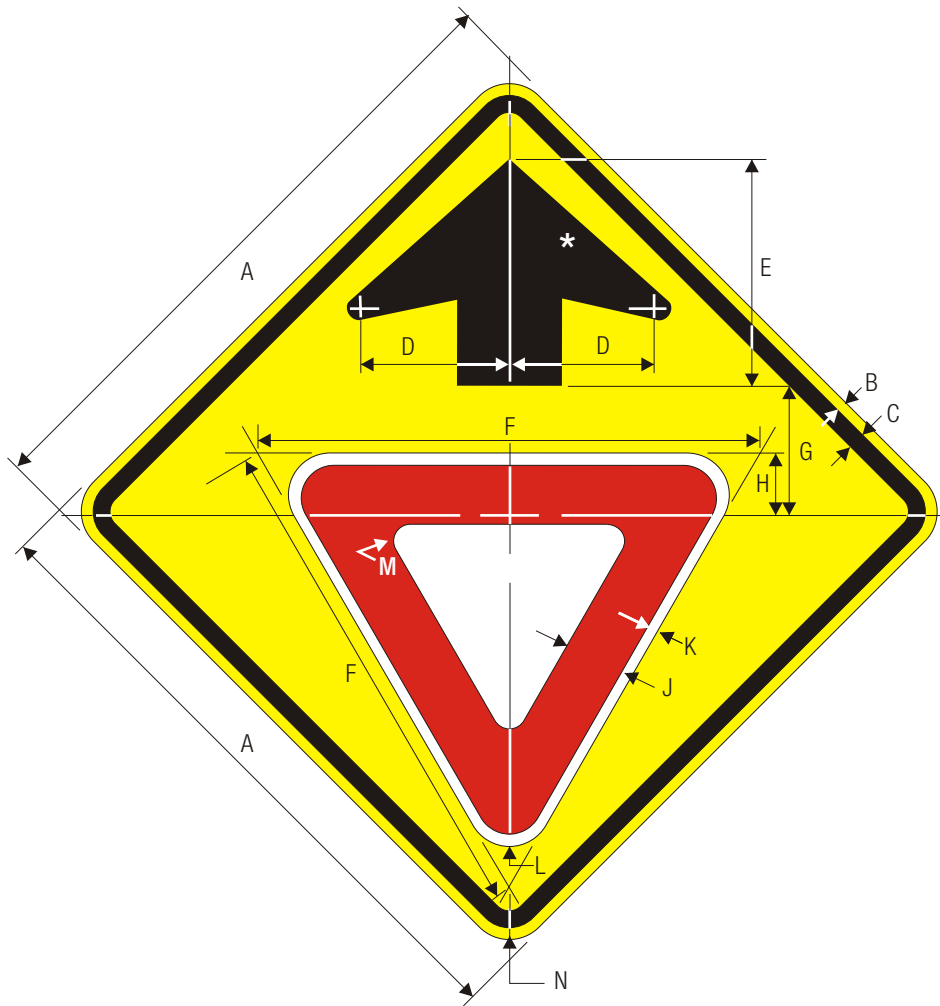

W3-2

YIELD AHEAD

*See page 6-3 for symbol design.

A	B	C	D	E	F	G	H	J	K	L	M	N
450	10	15	108	162	363	90	42	43	8	30	24	40
600	10	15	144	216	475	120	56	58	10	40	32	50
750	13	20	180	270	600	150	75	70	10	50	40	50
900	15	25	216	324	725	180	84	85	15	60	48	60
1200	20	30	288	432	950	240	112	115	20	80	64	70

C

WARNING SIGN COLORS:

BORDER & ARROW – BLACK

SYMBOL – WHITE BORDER / RED BACKGROUND (RETROREFLECTIVE)

BACKGROUND – YELLOW (RETROREFLECTIVE)

TTC COLORS:

BORDER & ARROW – BLACK

SYMBOL – WHITE BORDER / RED BACKGROUND (RETROREFLECTIVE)

BACKGROUND – ORANGE (RETROREFLECTIVE)

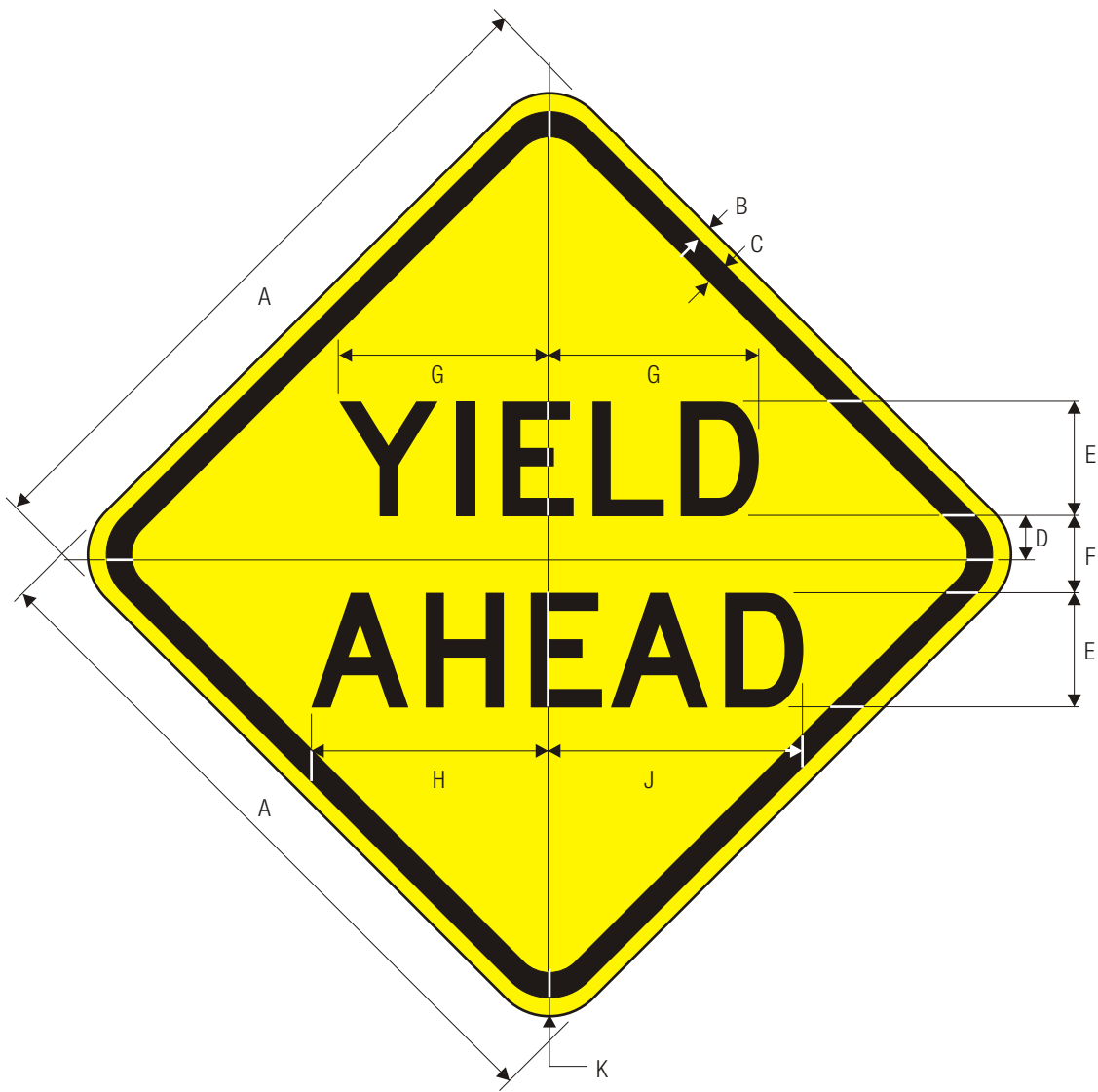

W3-2a

YIELD AHEAD

	A	B	C	D	E	F	G	H	J	K
	450	10	15	25	75 D	50	137	156	165	40
	600	10	15	34	100 D	67	182.5	208.5	220.5	50
	750	13	20	42	125 D	84	228.5	260	279	50
C	900	15	25	50	150 D	100	274	312	330	60
	1200	20	30	67	200 D	134	365.5	416	441	70

COLORS: LEGEND — BLACK
 BACKGROUND — YELLOW (RETROREFLECTIVE)

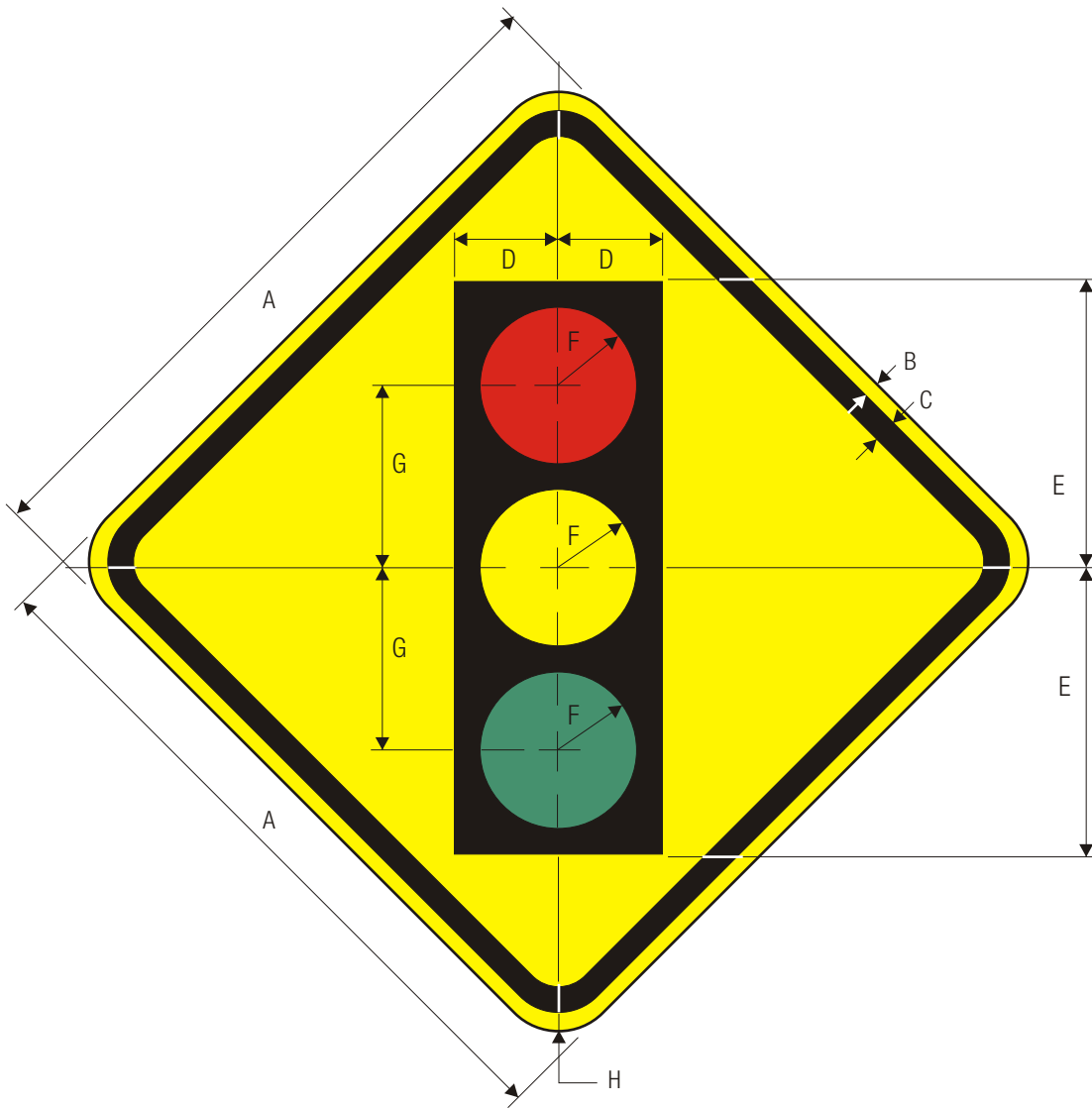

W3-3
SIGNAL AHEAD

	A	B	C	D	E	F	G	H
	450	10	15	75	200	56	125	40
	750	13	20	125	335	94	219	50
C	900	15	25	150	400	112	250	60
	1200	20	30	200	535	150	325	70

WARNING SIGN COLORS:
 TOP CIRCLE — RED (RETROREFLECTIVE)
 BOTTOM CIRCLE — GREEN (RETROREFLECTIVE)
 BACKGROUND — YELLOW (RETROREFLECTIVE)

TTC SIGN COLORS:
 TOP CIRCLE — RED (RETROREFLECTIVE)
 BOTTOM CIRCLE — GREEN (RETROREFLECTIVE)
 BACKGROUND — ORANGE (RETROREFLECTIVE)

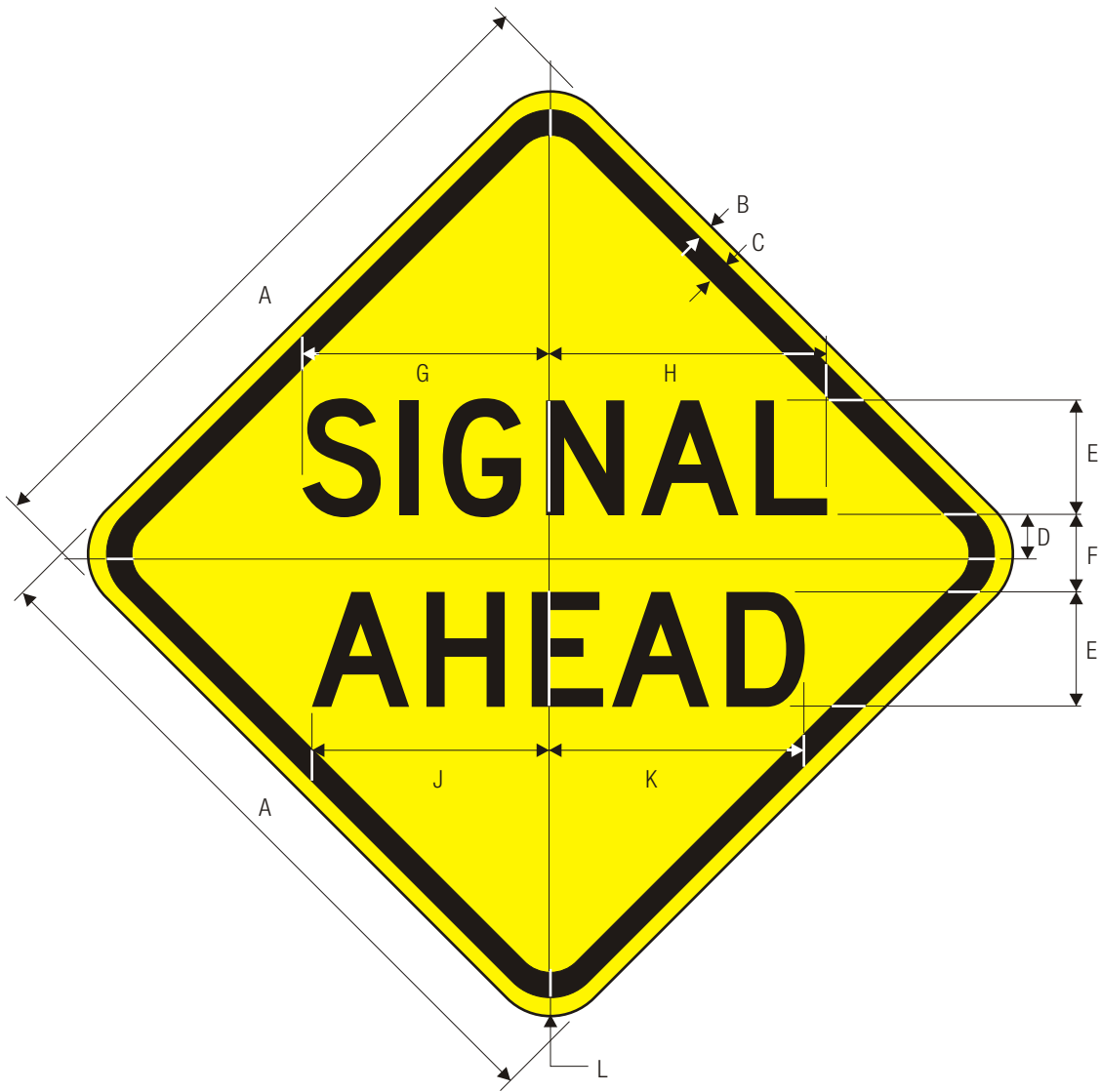

W3-3a
SIGNAL AHEAD

A	B	C	D	E	F	G	H	J	K	L
450	10	15	25	75 D	50	162	180	156	165	40
750	13	20	42	125 D	84	270	300	260	279	50
900	15	25	50	150 D	100	324	360	312	330	60
1200	20	30	67	200 D	134	432	480	416	441	70

C

COLORS: LEGEND — BLACK
BACKGROUND — YELLOW (RETROREFLECTIVE)



W3-4

BE PREPARED TO STOP

*Series 2000 Standard Alphabets.

C

A	B	C	D	E	F	G	H	J	K	L
750	13	20	125 C	68	18	77	341	271	290	50
900	15	25	150 C	90	23	92.5	409.5	327	346	60
1200	20	30	200 C	120	30	123.5	546	435	462	70
1500	20	30	225 C	135	35	139	614	486	504.5	70

WARNING SIGN COLORS:

LEGEND — BLACK
BACKGROUND — YELLOW (RETROREFLECTIVE)

TTC SIGN COLORS:

LEGEND — BLACK
BACKGROUND — ORANGE (RETROREFLECTIVE)

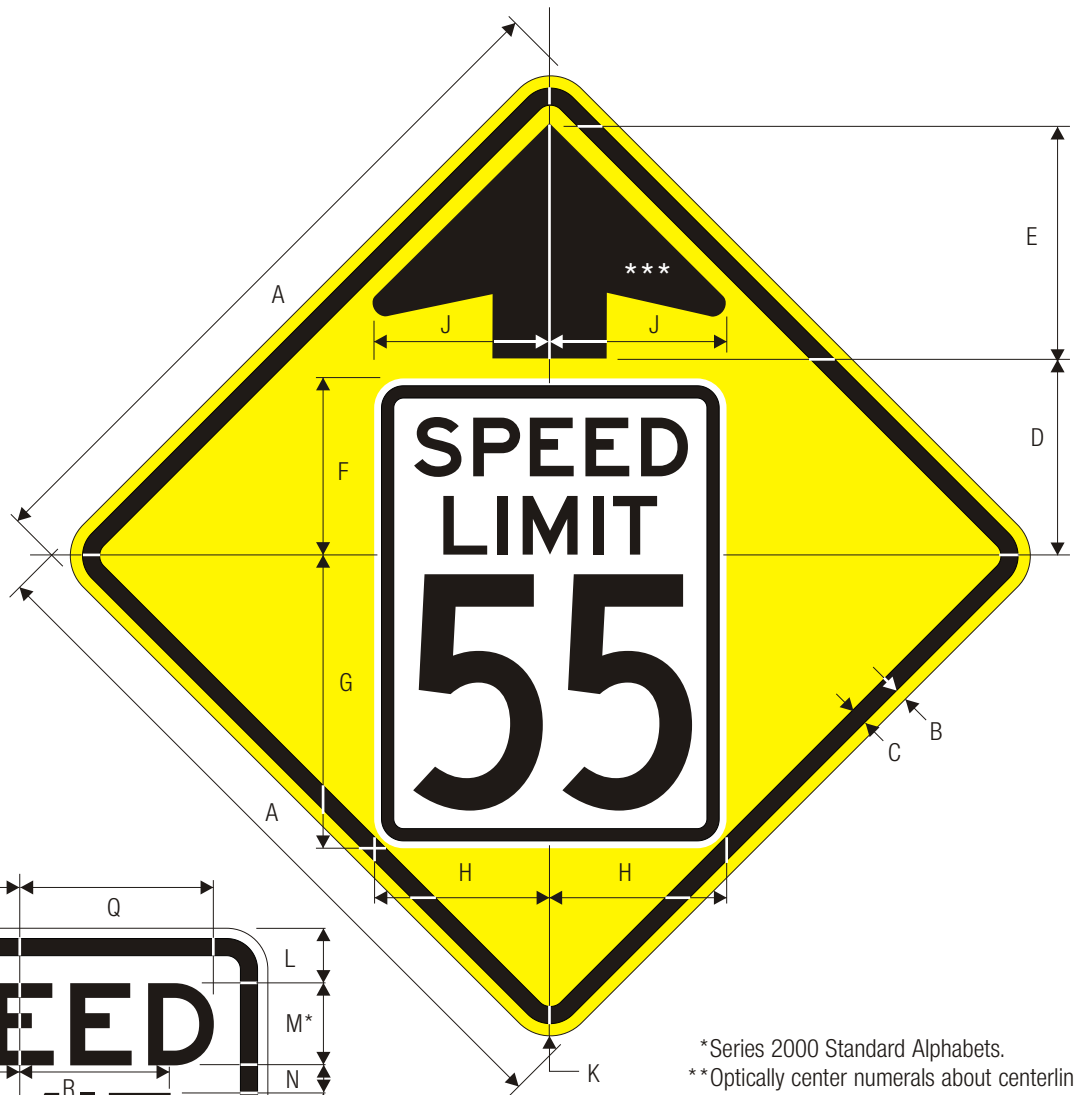

W3-5
SPEED REDUCTION

*Series 2000 Standard Alphabets.
 **Optically center numerals about centerline.
 ***See page 6-3 for symbol design.

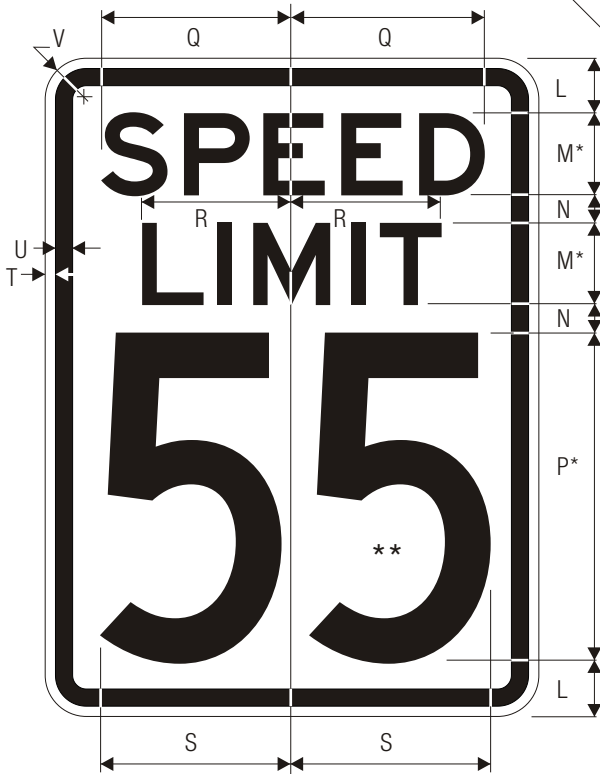

A	B	C	D	E	F	G
900	15	25	250	300	225	375
1200	20	30	294	450	269	481

H	J	K	L	M	N	P
225	225	60	50	75 E	25	300 C
300	300	70	57.5	100 E	30	375 C

Q	R	S	T	U	V
175	136.5	178	10	15	40
233	182	231	10	15	50

WARNING SIGN COLORS:

- BORDER & ARROW – BLACK
- SYMBOL – SEE R2-1
- BACKGROUND – YELLOW (RETROREFLECTIVE)

TTC COLORS:

- BORDER & ARROW – BLACK
- SYMBOL – SEE R2-1
- BACKGROUND – ORANGE (RETROREFLECTIVE)

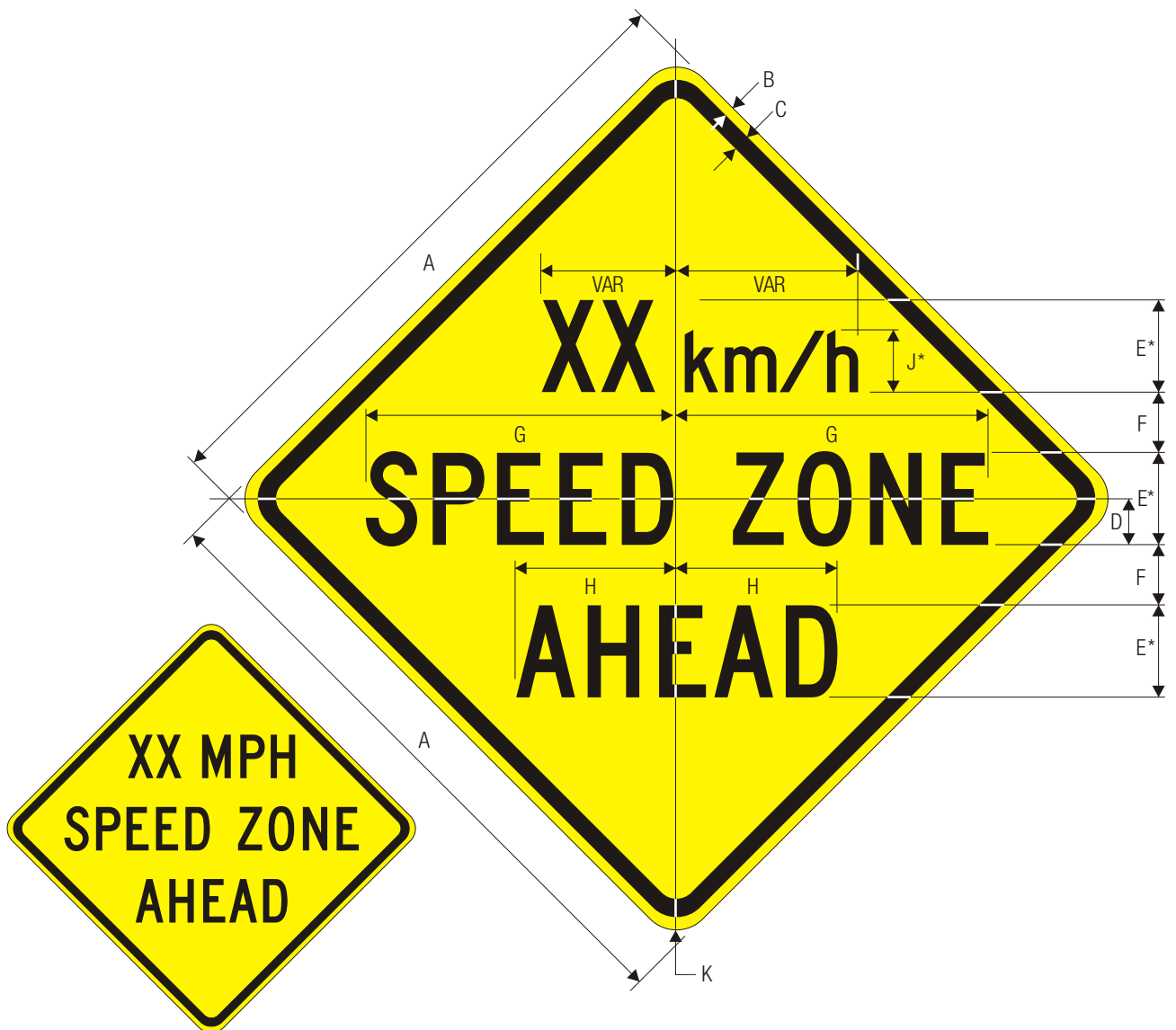

W3-5a
SPEED REDUCTION (ENGLISH)

W3-5a
SPEED REDUCTION (METRIC)

	A	B	C	D	E	F	G	H	J	K
	750	13	20	50	100 C	75	337.5	174.5	68 C	50
C	900	15	25	63	125 C	90	422	218	85 C	60
	1200	20	30	88	175 C	115	591	305	119 C	70
	1500	20	30	100	200 C	150	675.5	348.5	136 C	70

WARNING SIGN COLORS:
LEGEND — BLACK
BACKGROUND— YELLOW (RETROREFLECTIVE)

TTC SIGN COLORS:
LEGEND — BLACK
BACKGROUND— ORANGE (RETROREFLECTIVE)

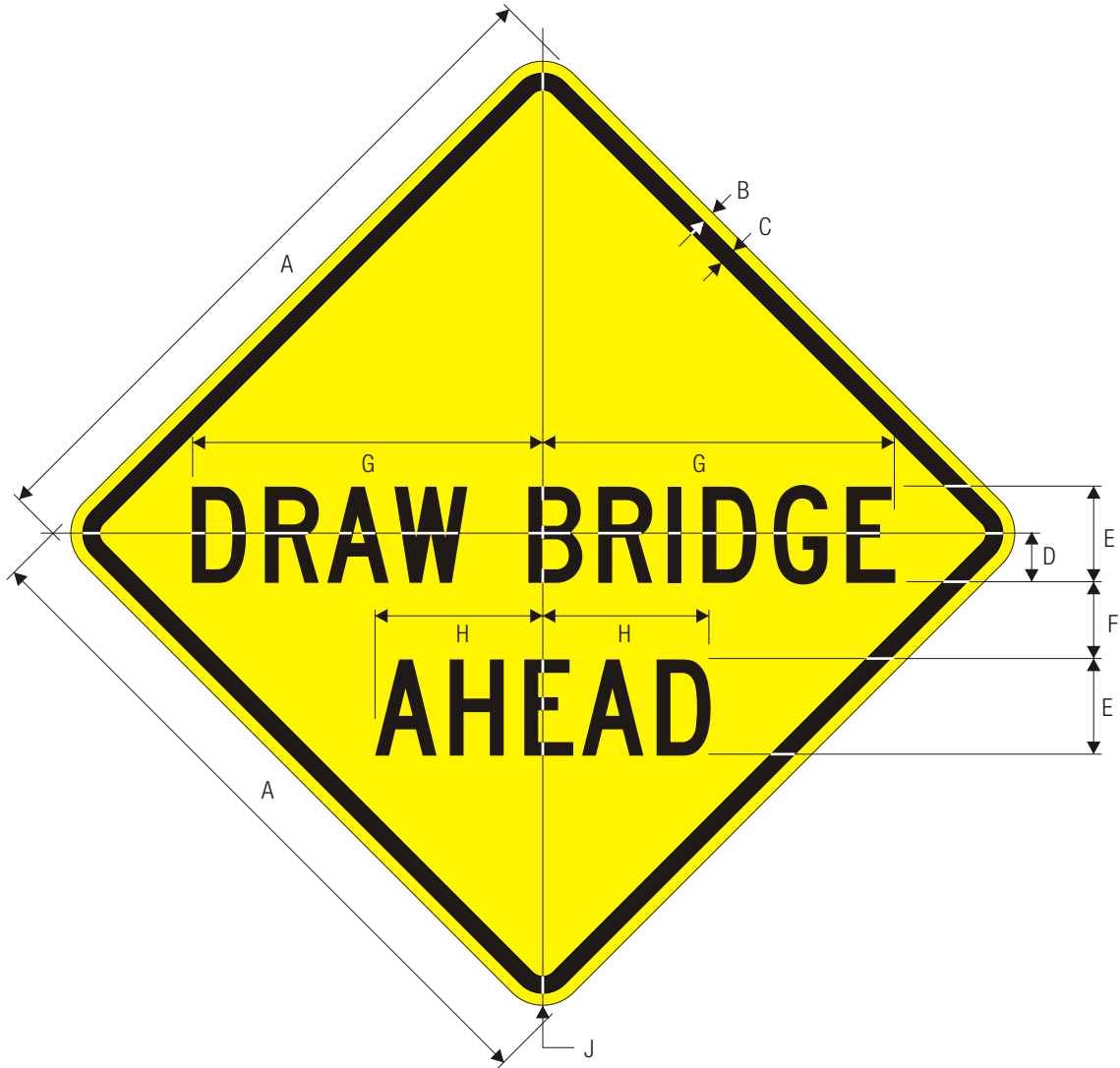

W3-6
DRAW BRIDGE AHEAD

	A	B	C	D	E	F	G	H	J
C	900	15	25	63	125 C	100	457	218	60
	1200	20	30	88	175 C	150	639.5	305	70
	1500	20	30	113	225 C	200	822	392	70

COLORS: LEGEND — BLACK
BACKGROUND — YELLOW (RETROREFLECTIVE)

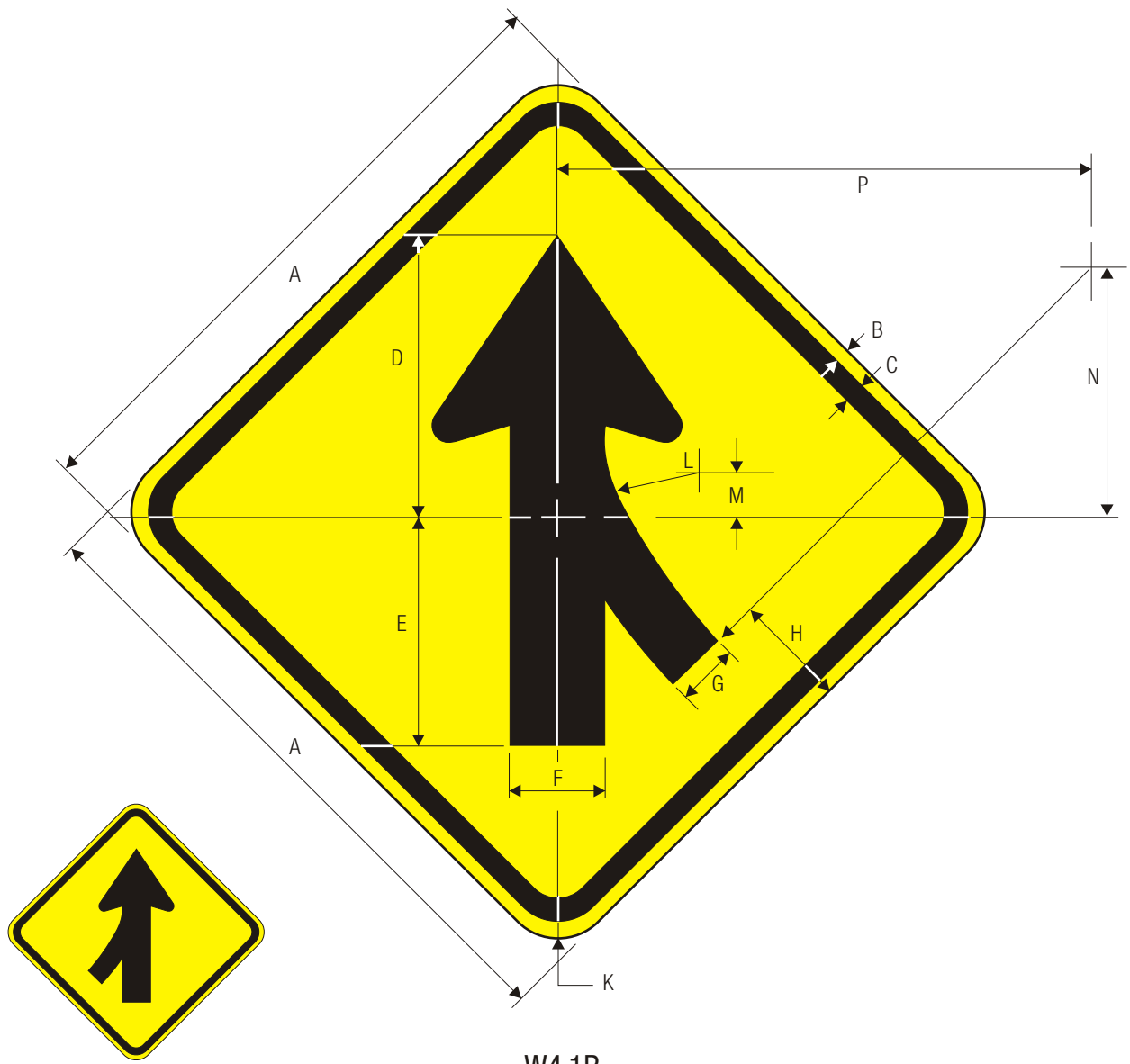

W4-1L

W4-1R
MERGE

A	B	C	D	E	F	G	H	J	K	L	M	N	P
600	10	15	260	222	90	60	106	565	50	118	67	264	564
750	13	20	328	280	113	76	134	712	50	149	84	333	711
900	15	25	397	339	137	92	162	862	60	180	102	403	860
1200	20	30	520	444	179	120	212	1129	70	236	134	528	1127

C

WARNING SIGN COLORS:
SYMBOL – BLACK
BACKGROUND– YELLOW (RETROREFLECTIVE)

TTC SIGN COLORS:
SYMBOL – BLACK
BACKGROUND– ORANGE (RETROREFLECTIVE)

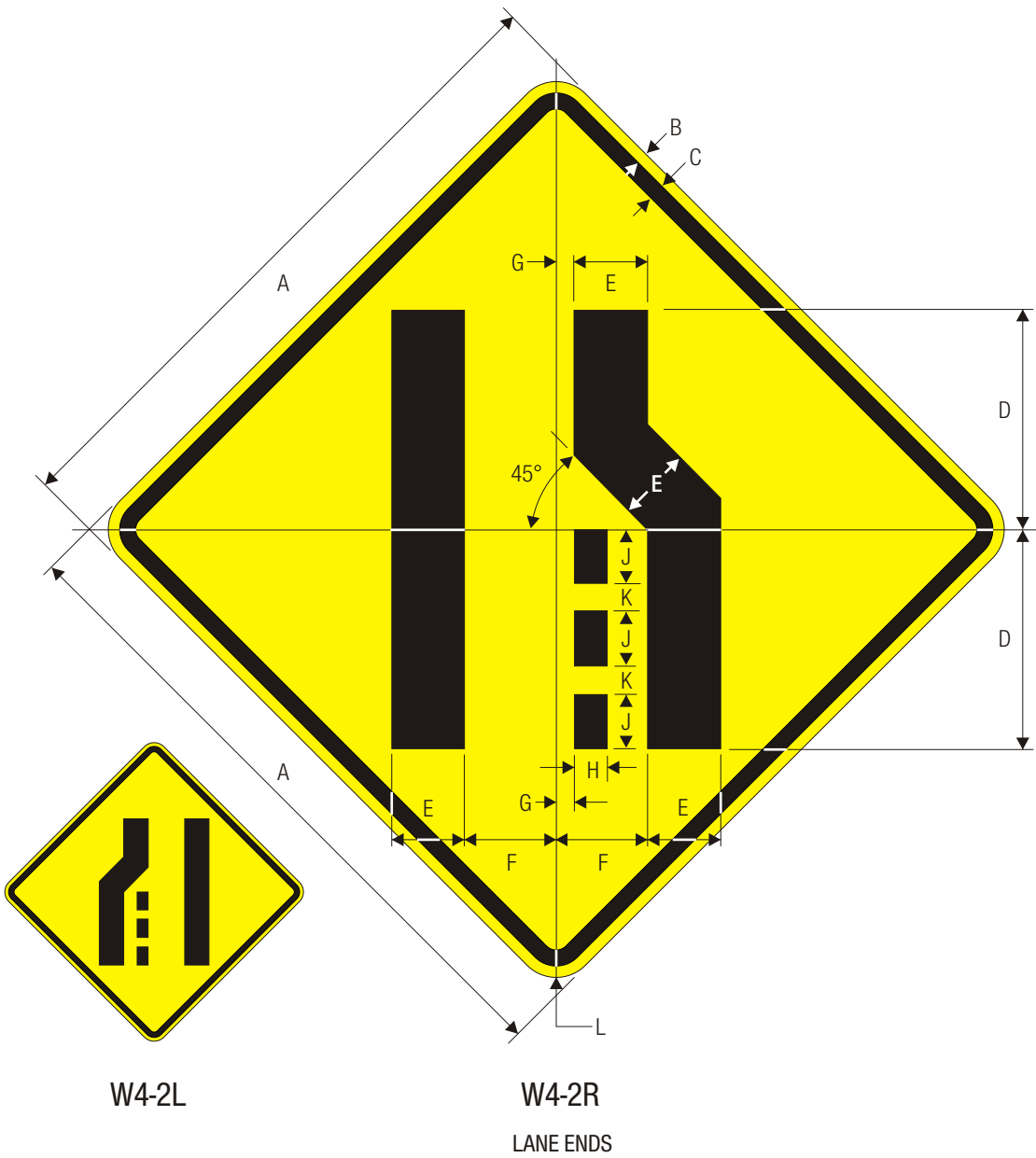

C	A	B	C	D	E	F	G	H	J	K	L
	750	13	20	250	83	104	21	29	62	32	50
	900	15	25	300	100	125	25	35	75	37.5	60
	1200	20	30	400	133	167	33	47	100	50	70

WARNING SIGN COLORS:

SYMBOL — BLACK
BACKGROUND — YELLOW (RETROREFLECTIVE)

CONSTRUCTION SIGN COLORS:

SYMBOL — BLACK
BACKGROUND — ORANGE (RETROREFLECTIVE)

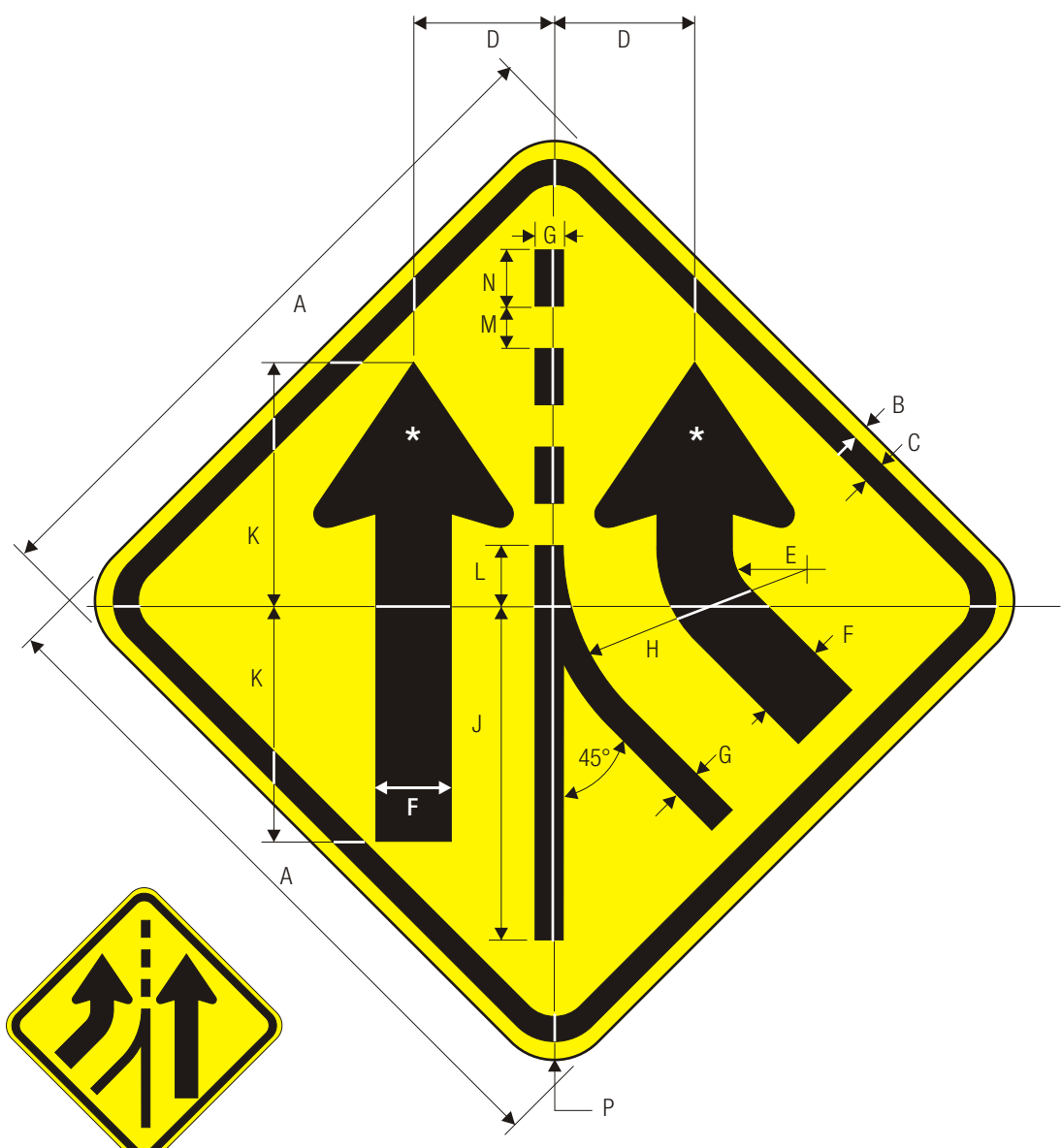

W4-3L

W4-3R

ADDED LANE

*See page 6-2 for symbol design.

A	B	C	D	E	F	G	H	J	K	L	M
750	13	20	157	62	84	32	250	375	266	62	47
900	15	25	188	75	101	38	300	450	319	75	56
1200	20	30	250	100	134	50	400	600	425	100	75

C

N	P
62	50
75	60
100	70

WARNING SIGN COLORS:
 SYMBOL – BLACK
 BACKGROUND– YELLOW (RETROREFLECTIVE)

TTC SIGN COLORS:
 SYMBOL – BLACK
 BACKGROUND– ORANGE (RETROREFLECTIVE)



W4-4

TRAFFIC DOES NOT STOP



W4-4a



W4-4b

FOR USE WITH R1-1 STOP SIGN

	A	B	C	D	E	F	G	H	J	K	L	M	N
C	600	300	10	15	65	60 C	50	248.5	248.5	50	260	261	60 B
	750	375	13	20	80	75 C	65	310.5	310.5	50	327	328	75 B
	900	450	15	25	100	88 C	74	376.5	364.5	60	395	382.5	88 B
	1200	600	20	30	138	112 C	100	463.5	479.5	70	503	487	112 B

COLORS: LEGEND — BLACK
BACKGROUND — YELLOW (RETROREFLECTIVE)

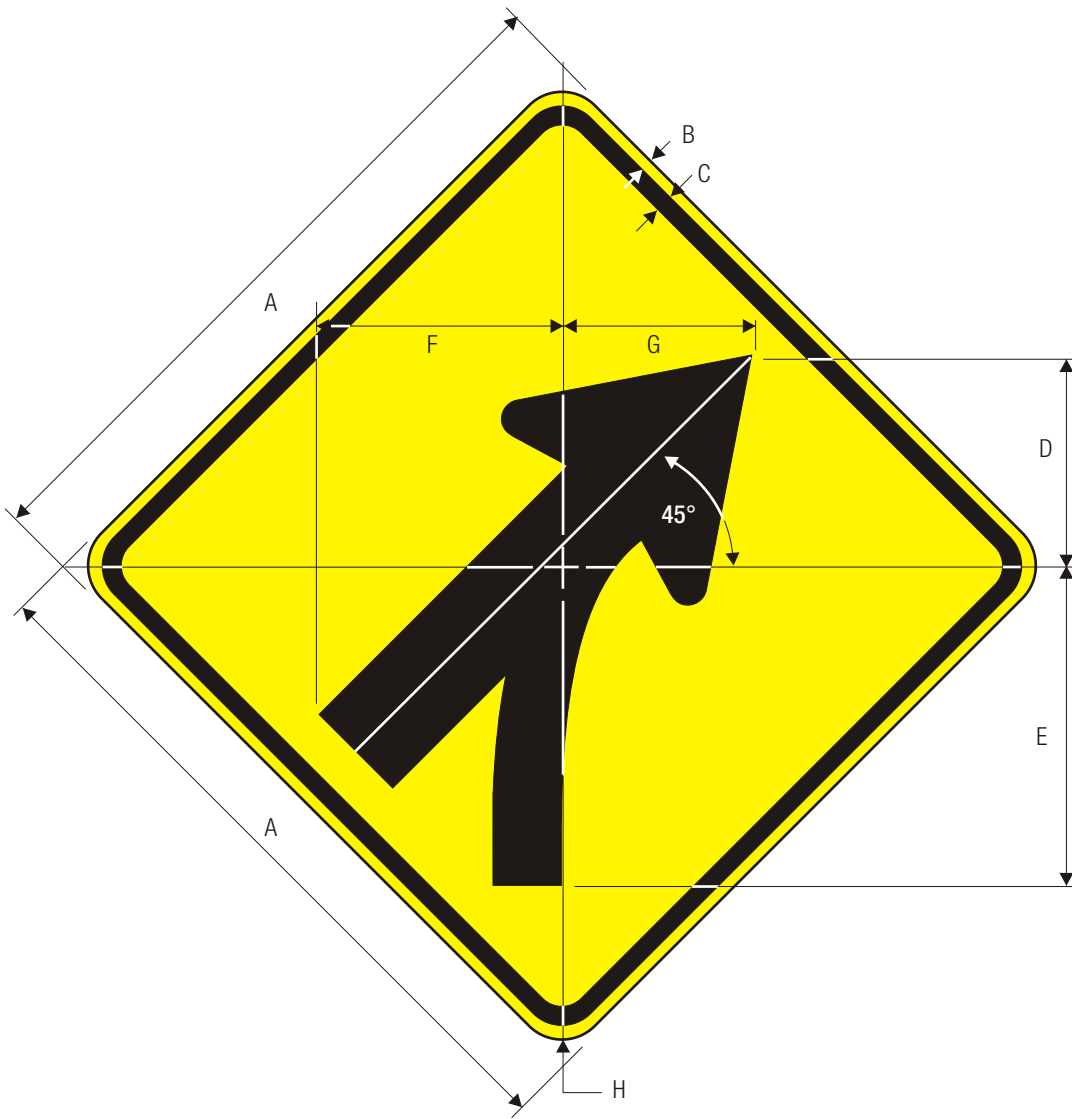

W4-5

ENTERING ROADWAY MERGE

*Scale and rotate W4-1 to fit dimensions.

	A	B	C	D	E	F	G	H
	600	10	15	182	275	209	163	50
	750	13	20	228	344	261	204	50
C	900	15	25	273	413	314	245	60
	1200	20	30	364	550	418	326	70

WARNING SIGN COLORS:

SYMBOL — BLACK
BACKGROUND — YELLOW (RETROREFLECTIVE)

TTC SIGN COLORS:

SYMBOL — BLACK
BACKGROUND — ORANGE (RETROREFLECTIVE)

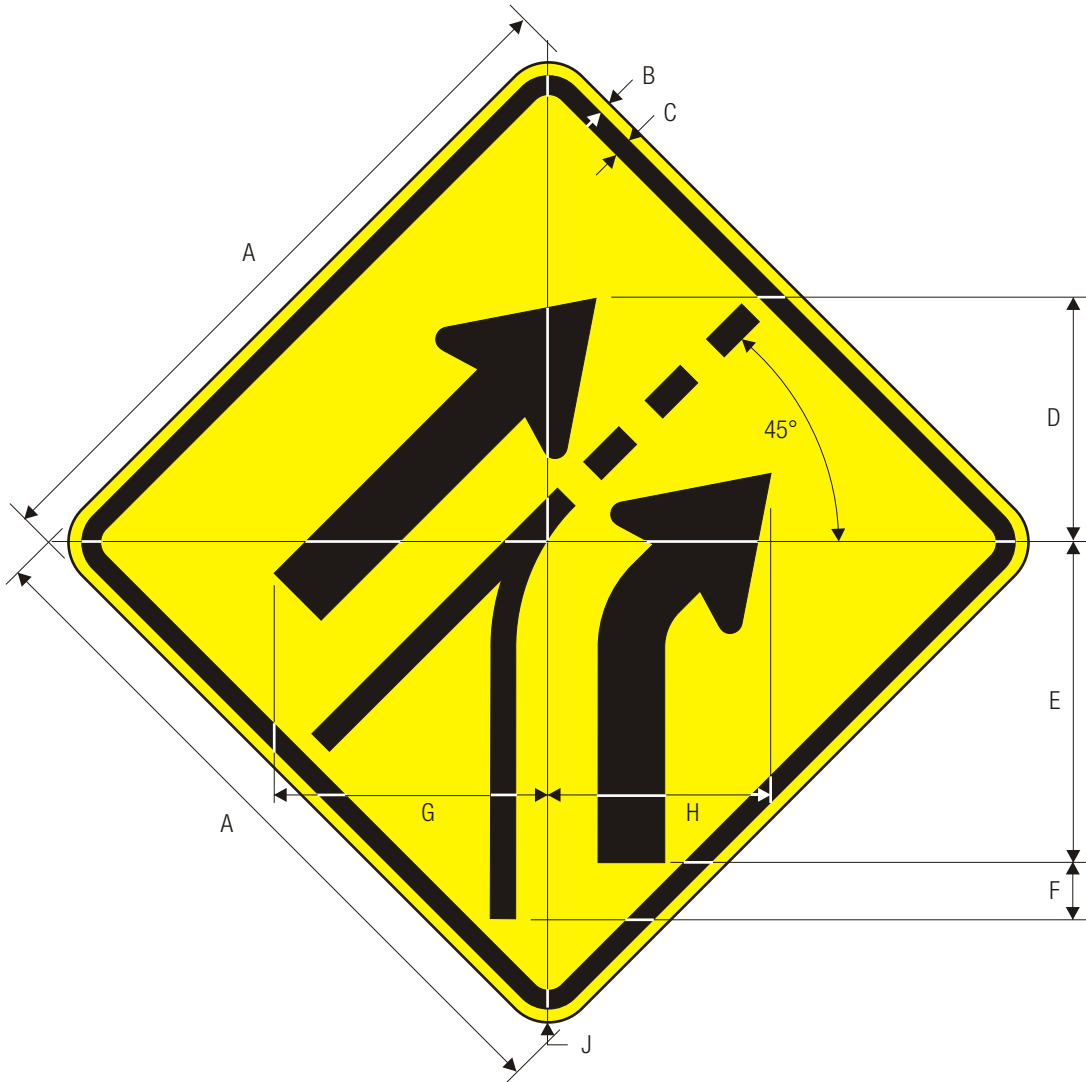

W4-6

ENTERING ROADWAY ADDED LANE

*Scale and rotate W4-3 to fit dimensions.

A	B	C	D	E	F	G	H	J
600	10	15	259	268	314	291	224	50
750	13	20	324	335	392	364	280	50
900	15	25	389	402	470	437	336	60
1200	20	30	518	536	628	582	448	70

C

WARNING SIGN COLORS:

LEGEND — BLACK
BACKGROUND — YELLOW (RETROREFLECTIVE)

TTC SIGN COLORS:

LEGEND — BLACK
BACKGROUND — ORANGE (RETROREFLECTIVE)



W5-1
ROAD NARROWS

	A	B	C	D	E	F	G	H	J
	750	13	20	125D	75	44	208.5	373.5	50
C	900	15	25	150D	89	50	250.5	448	60
	1200	20	30	200D	100	75	334	597.5	70

WARNING SIGN COLORS:
LEGEND — BLACK
BACKGROUND— YELLOW (RETROREFLECTIVE)

TTC SIGN COLORS:
LEGEND — BLACK
BACKGROUND— ORANGE (RETROREFLECTIVE)



W5-2
NARROW BRIDGE

	A	B	C	D	E	F	G	H	J
	600	10	15	100D	6	50	261	224	50
	750	13	20	125D	12	64	326	280	50
C	900	15	25	150D	19	75	391.5	336	60
	1200	20	30	200D	23	90	522	448	70

WARNING SIGN COLORS:
LEGEND — BLACK
BACKGROUND— YELLOW (RETROREFLECTIVE)

TTC SIGN COLORS:
LEGEND — BLACK
BACKGROUND— ORANGE (RETROREFLECTIVE)

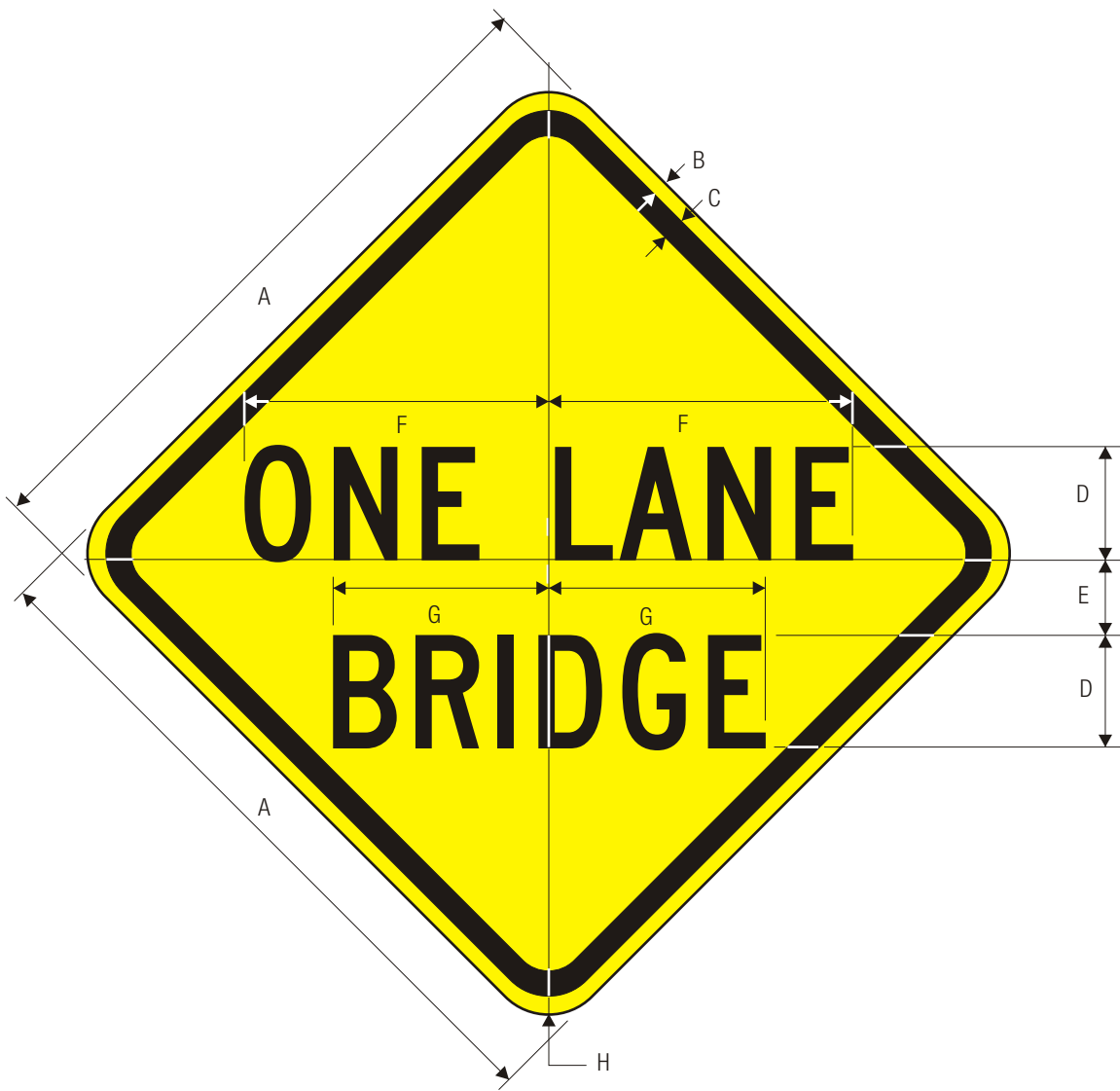

W5-3

ONE LANE BRIDGE

A	B	C	D	E	F	G	H
600	10	15	100 C	63	268	190.5	50
750	13	20	125 C	82	335	238	50
900	15	25	150 C	100	402	286	60
1200	20	30	200 C	125	536	381	70

C

WARNING SIGN COLORS:
 LEGEND — BLACK
 BACKGROUND— YELLOW (RETROREFLECTIVE)

TTC SIGN COLORS:
 LEGEND — BLACK
 BACKGROUND— ORANGE (RETROREFLECTIVE)

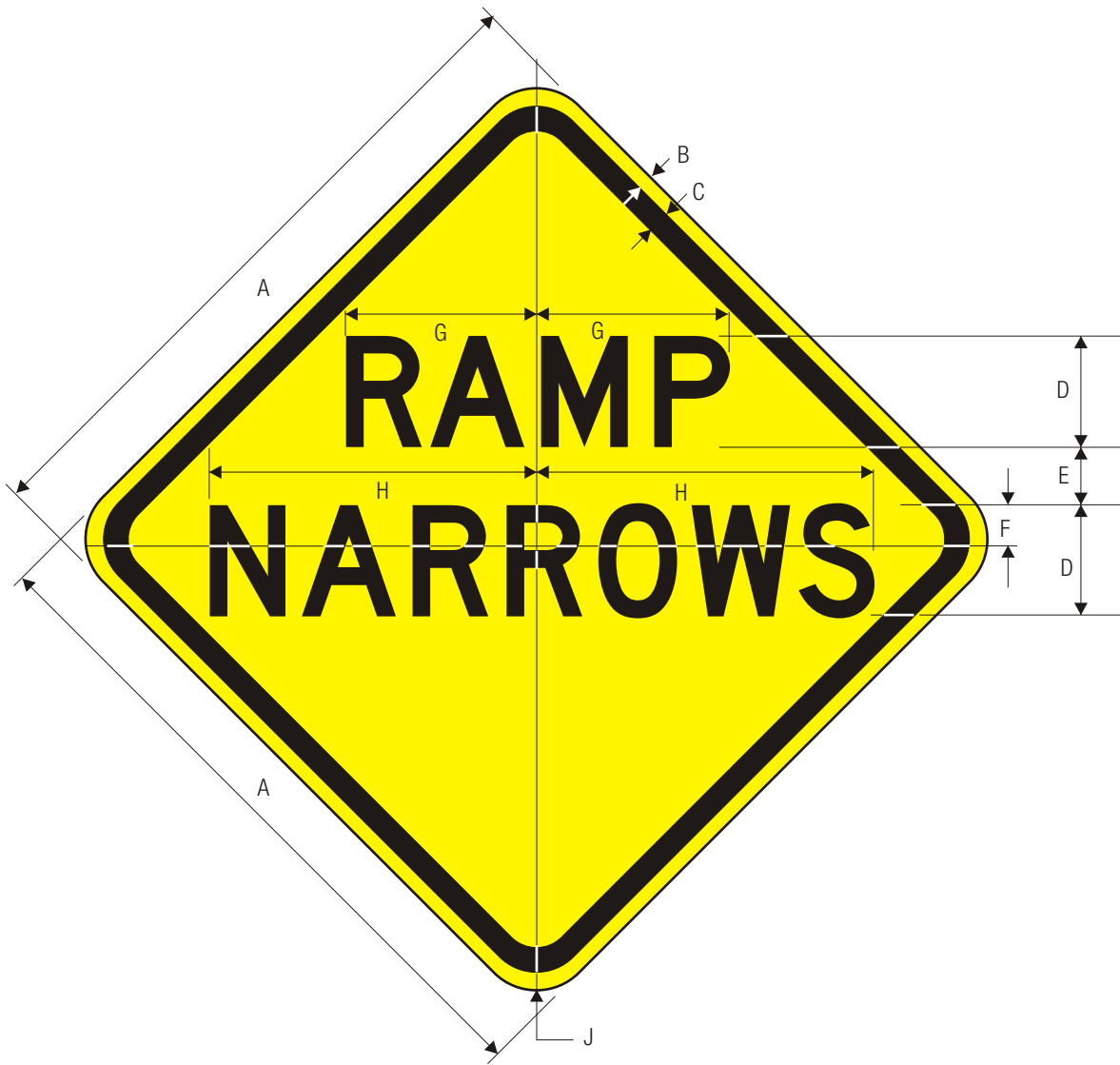

W5-4

RAMP NARROWS

	A	B	C	D	E	F	G	H	J
	750	13	20	125 D	68	27	215.5	373.5	50
C	900	15	25	150 D	78	32	259	448	60
	1200	20	30	200 D	147	42	347	601	70

WARNING SIGN COLORS:

LEGEND — BLACK
 BACKGROUND — YELLOW (RETROREFLECTIVE)

TTC SIGN COLORS:

LEGEND — BLACK
 BACKGROUND — ORANGE (RETROREFLECTIVE)



W5-4a

BIKEWAY NARROWS

A	B	C	D	E	F	G	H	J
450	10	15	16	75 C	25	171	188	40
750	13	20	25	125 C	45	285	313.5	50

COLORS: LEGEND — BLACK
 BACKGROUND — YELLOW (RETROREFLECTIVE)

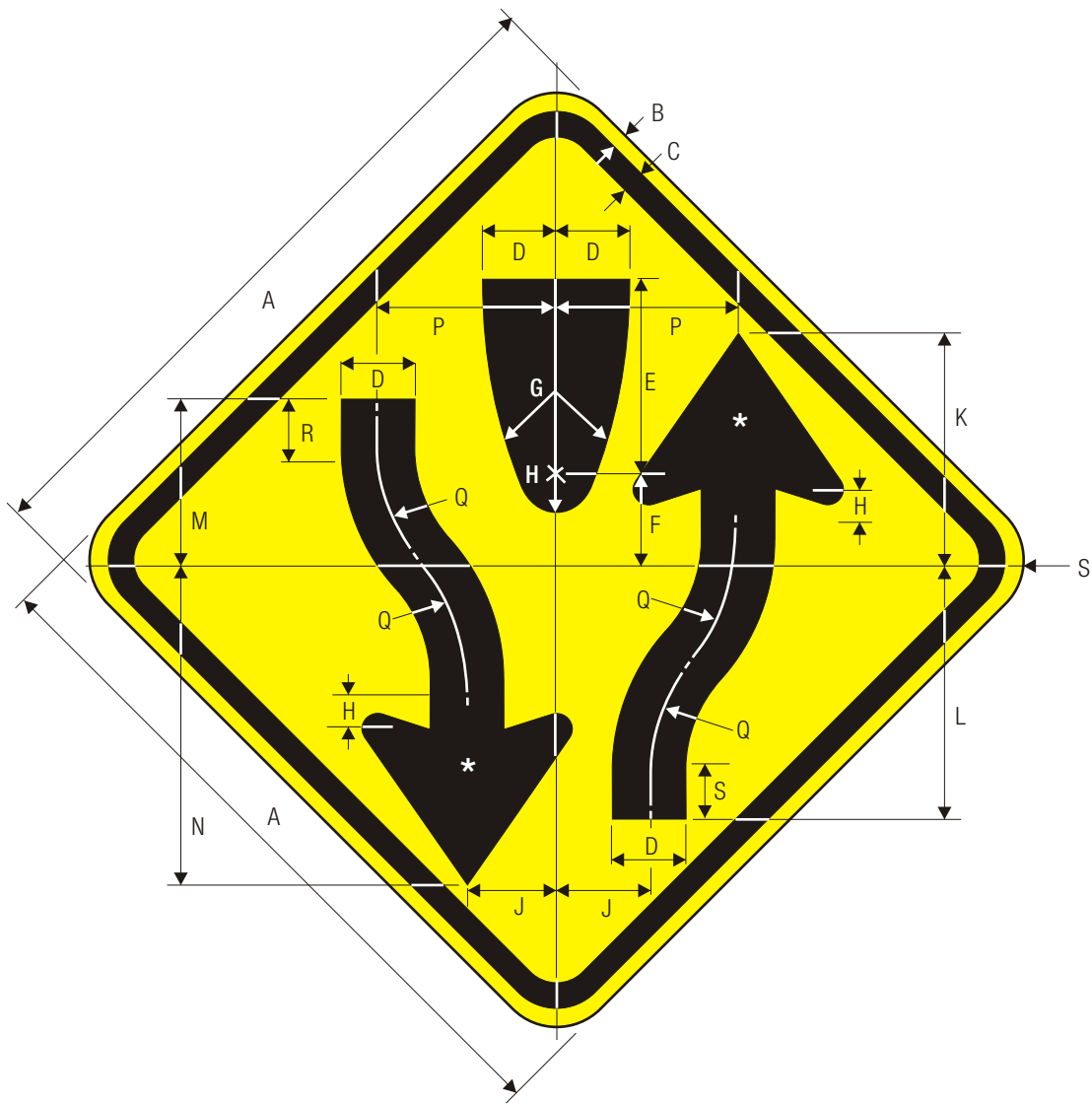

W6-1

DIVIDED HIGHWAY

*See page 6-2 for arrow design.

A	B	C	D	E	F	G	H	J	K	L	M
750	13	20	80	216	57	601	38	97	252	276	180
900	15	25	95	257	68	714	45	115	299	328	214
1200	20	30	125	338	89	939	59	151	393	431	281

C

N	P	Q	R	S
348	198	181	54	50
413	235	215	64	60
543	309	283	84	70

WARNING SIGN COLORS:
 SYMBOL — BLACK
 BACKGROUND— YELLOW (RETROREFLECTIVE)

TTC SIGN COLORS:
 SYMBOL — BLACK
 BACKGROUND— ORANGE (RETROREFLECTIVE)



W6-1a

DIVIDED HIGHWAY

A	B	C	D	E	F	G	H	J
600	10	15	100 C	50	34	207	236	50
750	13	20	125 C	62	43	259	295	50
900	15	25	150 C	75	52	311	354	60
1200	20	30	200 C	100	70	414.5	472	70

C

COLORS: LEGEND — BLACK
 BACKGROUND — YELLOW (RETROREFLECTIVE)

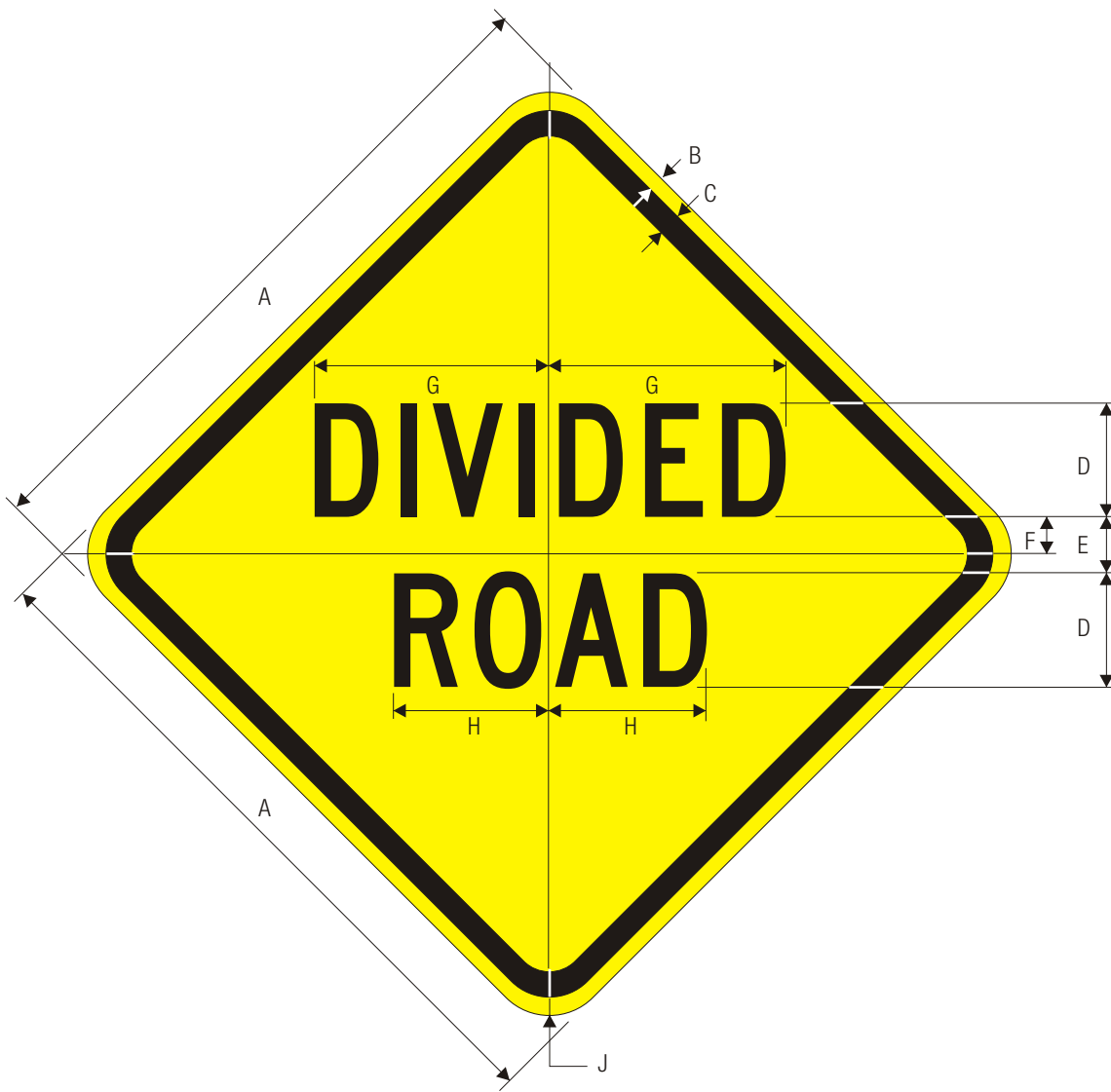

W6-1b

DIVIDED ROAD

A	B	C	D	E	F	G	H	J
600	10	15	100 C	50	34	207	137.5	50
750	13	20	125 C	62	43	259	172	50
900	15	25	150 C	75	52	311	206.5	60
1200	20	30	200 C	100	70	414.5	275.5	70

C

COLORS: LEGEND — BLACK
BACKGROUND — YELLOW (RETROREFLECTIVE)

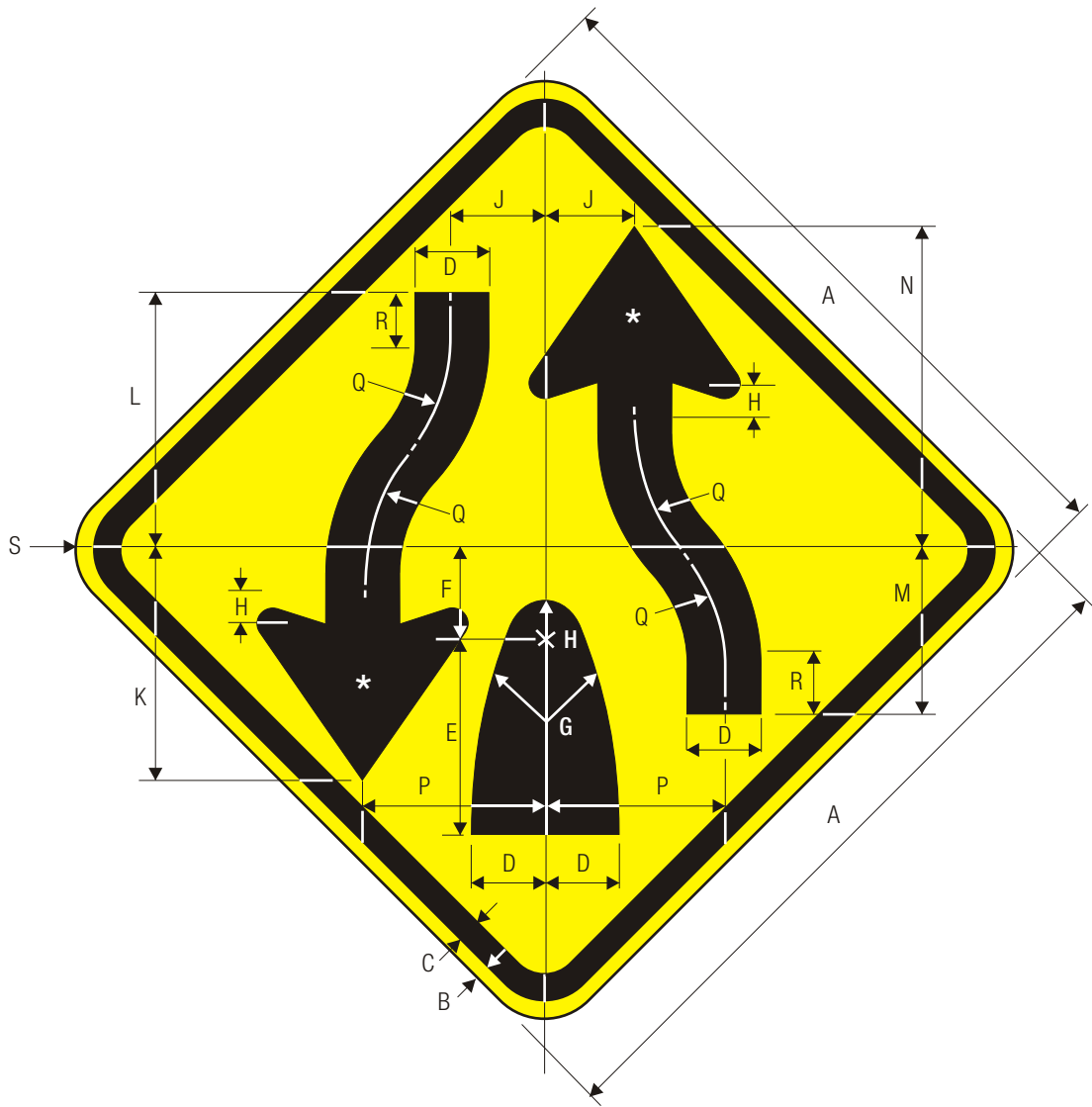

W6-2

DIVIDED HIGHWAY ENDS

*See page 6-2 for arrow design.

A	B	C	D	E	F	G	H	J	K	L	M
750	13	20	80	216	57	601	38	97	252	276	180
900	15	25	95	257	68	714	45	115	299	328	214
1200	20	30	125	338	89	939	59	151	393	431	281

C

N	P	Q	R	S
348	198	181	54	50
413	235	215	64	60
543	309	283	84	70

WARNING SIGN COLORS:

SYMBOL — BLACK
 BACKGROUND — YELLOW (RETROREFLECTIVE)

TTC SIGN COLORS:

SYMBOL — BLACK
 BACKGROUND — ORANGE (RETROREFLECTIVE)



W6-2a

DIVIDED HIGHWAY ENDS

	A	B	C	D	E	F	G	H	J	K
	750	13	20	125 C	62	19	259	295	170	50
C	900	15	25	150 C	75	22	311	354	204	60
	1200	20	30	200 C	100	24	414.5	472	272	70

WARNING SIGN COLORS:

LEGEND — BLACK
BACKGROUND — YELLOW (RETROREFLECTIVE)

TTC SIGN COLORS:

LEGEND — BLACK
BACKGROUND — ORANGE (RETROREFLECTIVE)



W6-2b

DIVIDED ROAD ENDS

	A	B	C	D	E	F	G	H	J	K
	600	10	15	100 C	50	10	207	1375	136	50
	750	13	20	125 C	62	19	259	172	170	50
C	900	15	25	150 C	75	22	311	206.5	204	60
	1200	20	30	200 C	100	24	414.5	275	272	70

WARNING SIGN COLORS:

LEGEND — BLACK
 BACKGROUND — YELLOW (RETROREFLECTIVE)

TTC SIGN COLORS:

LEGEND — BLACK
 BACKGROUND — ORANGE (RETROREFLECTIVE)

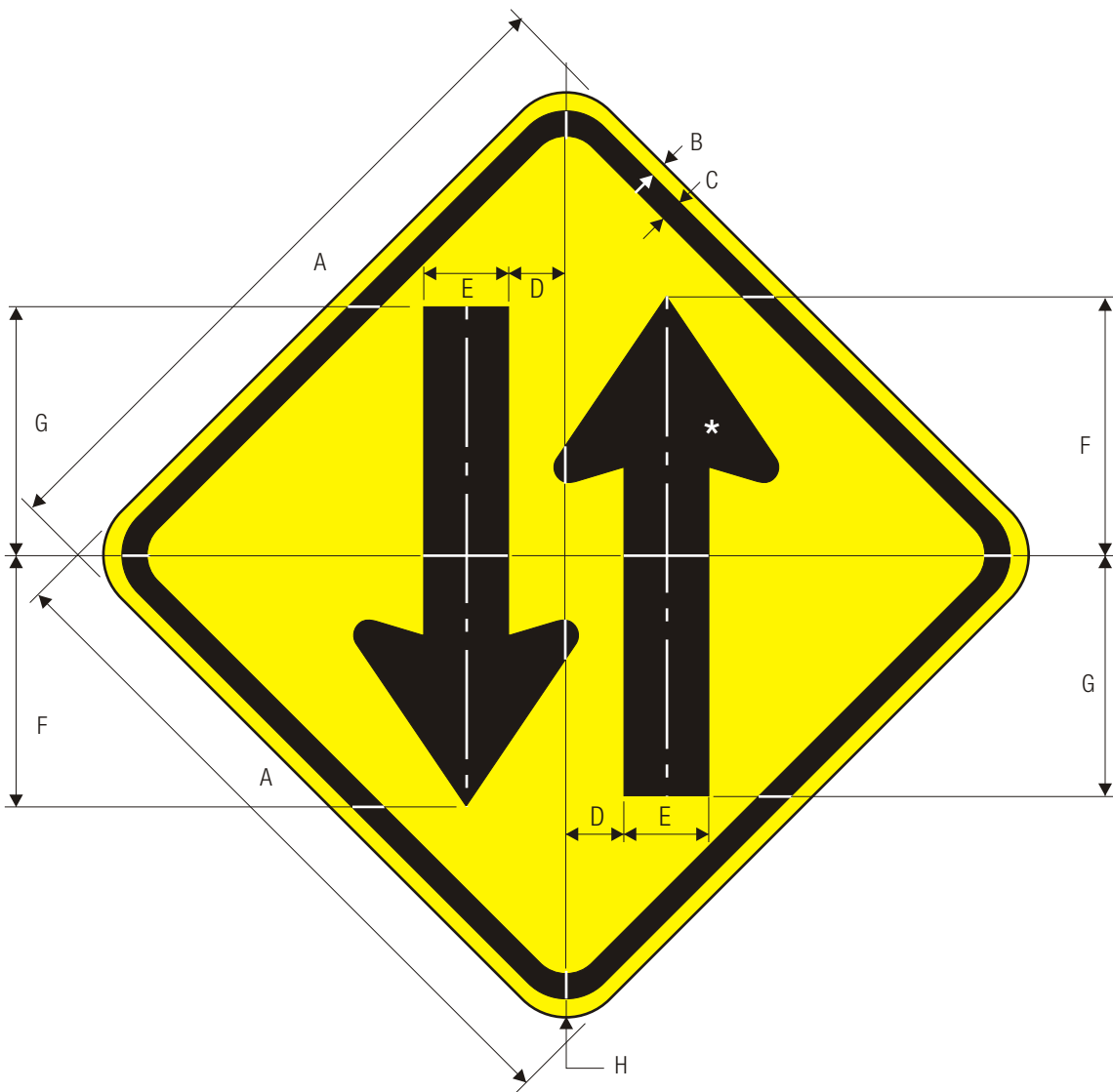

W6-3

TWO WAY TRAFFIC

*See page 6-2 for arrow design.

	A	B	C	D	E	F	G	H
	750	13	20	63	94	281	266	50
C	900	15	25	76	113	337	319	60
	1200	20	30	101	150	448	424	70

WARNING SIGN COLORS:

SYMBOL — BLACK
 BACKGROUND — YELLOW (RETROREFLECTIVE)

TTC SIGN COLORS:

SYMBOL — BLACK
 BACKGROUND — ORANGE (RETROREFLECTIVE)

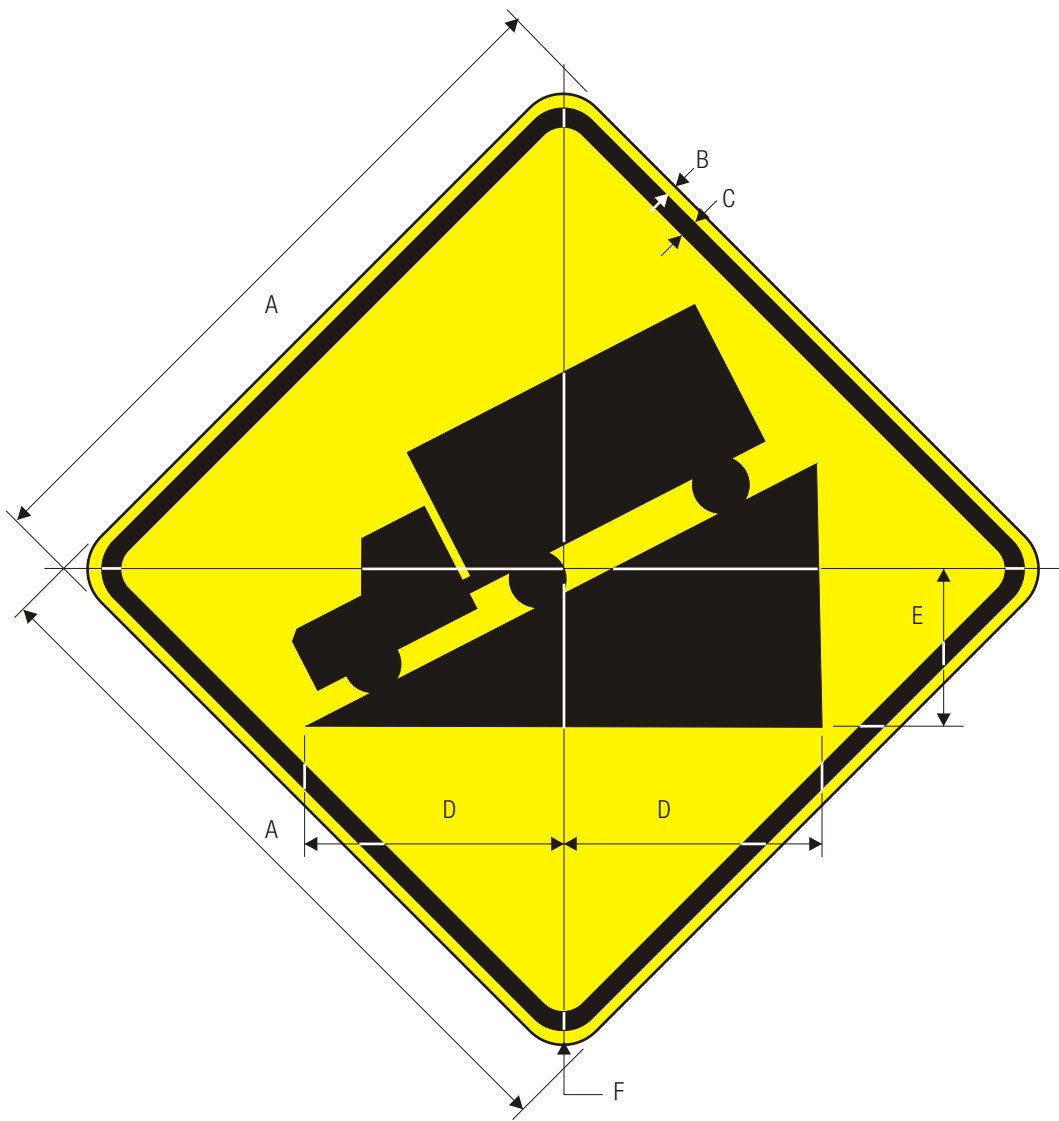

W7-1
HILL

*See page 6-5 for symbol design.

	A	B	C	D	E	F
	600	10	15	222	134	50
C	750	13	20	278	168	50
	900	15	25	334	202	60
	1200	20	30	445	269	70

WARNING SIGN COLORS:
SYMBOL — BLACK
BACKGROUND— YELLOW (RETROREFLECTIVE)

TTC SIGN COLORS:
SYMBOL — BLACK
BACKGROUND— ORANGE (RETROREFLECTIVE)

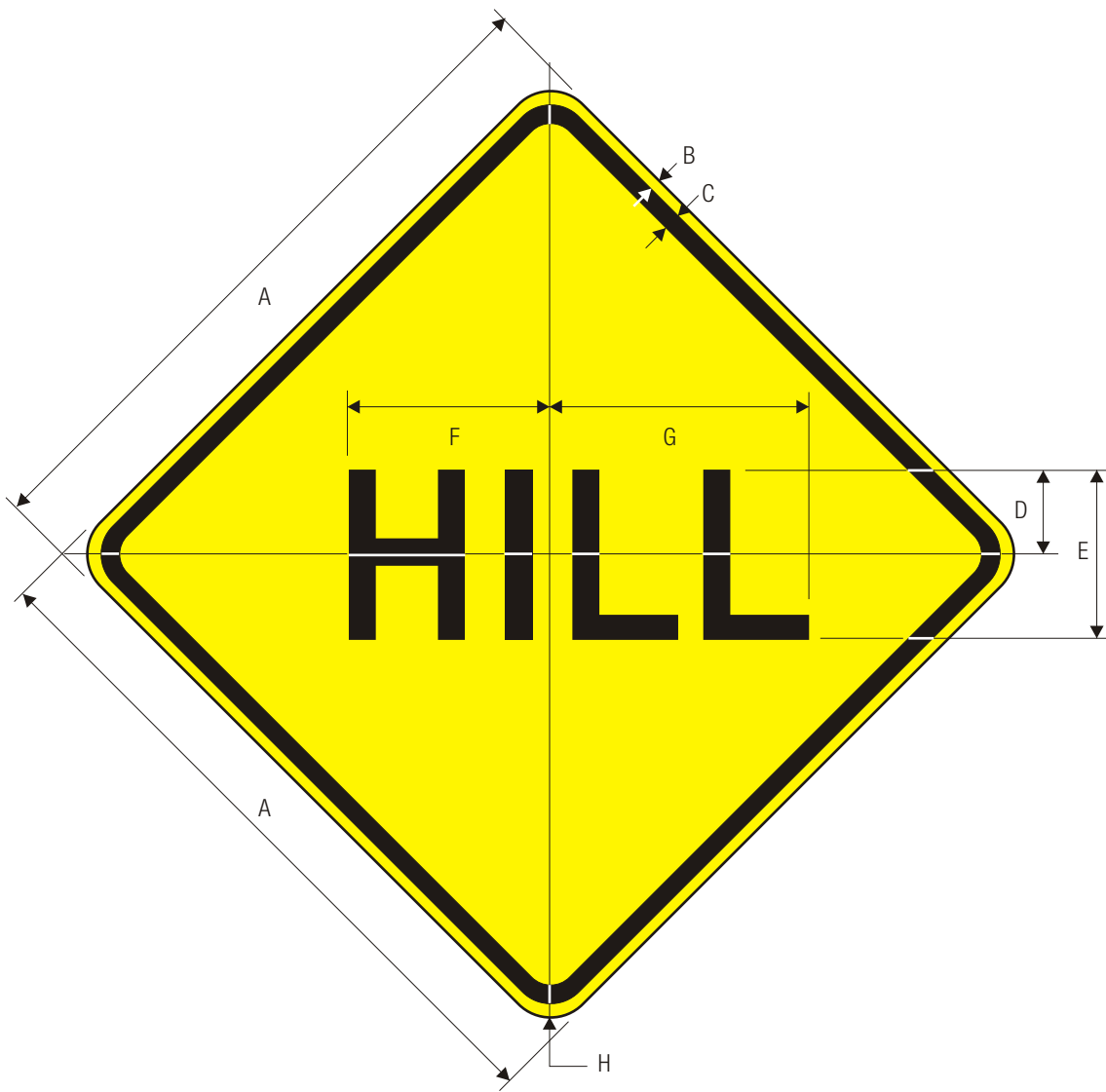

W7-1a
HILL

	A	B	C	D	E	F	G	H
	600	10	15	75	150 D	177	228	50
C	750	13	20	100	200 D	241	299	50
	900	15	25	125	250 D	304	371	60
	1200	20	30	150	300 D	363	447	70

WARNING SIGN COLORS:
 LEGEND — BLACK
 BACKGROUND— YELLOW (RETROREFLECTIVE)

TTC SIGN COLORS:
 LEGEND — BLACK
 BACKGROUND— ORANGE (RETROREFLECTIVE)

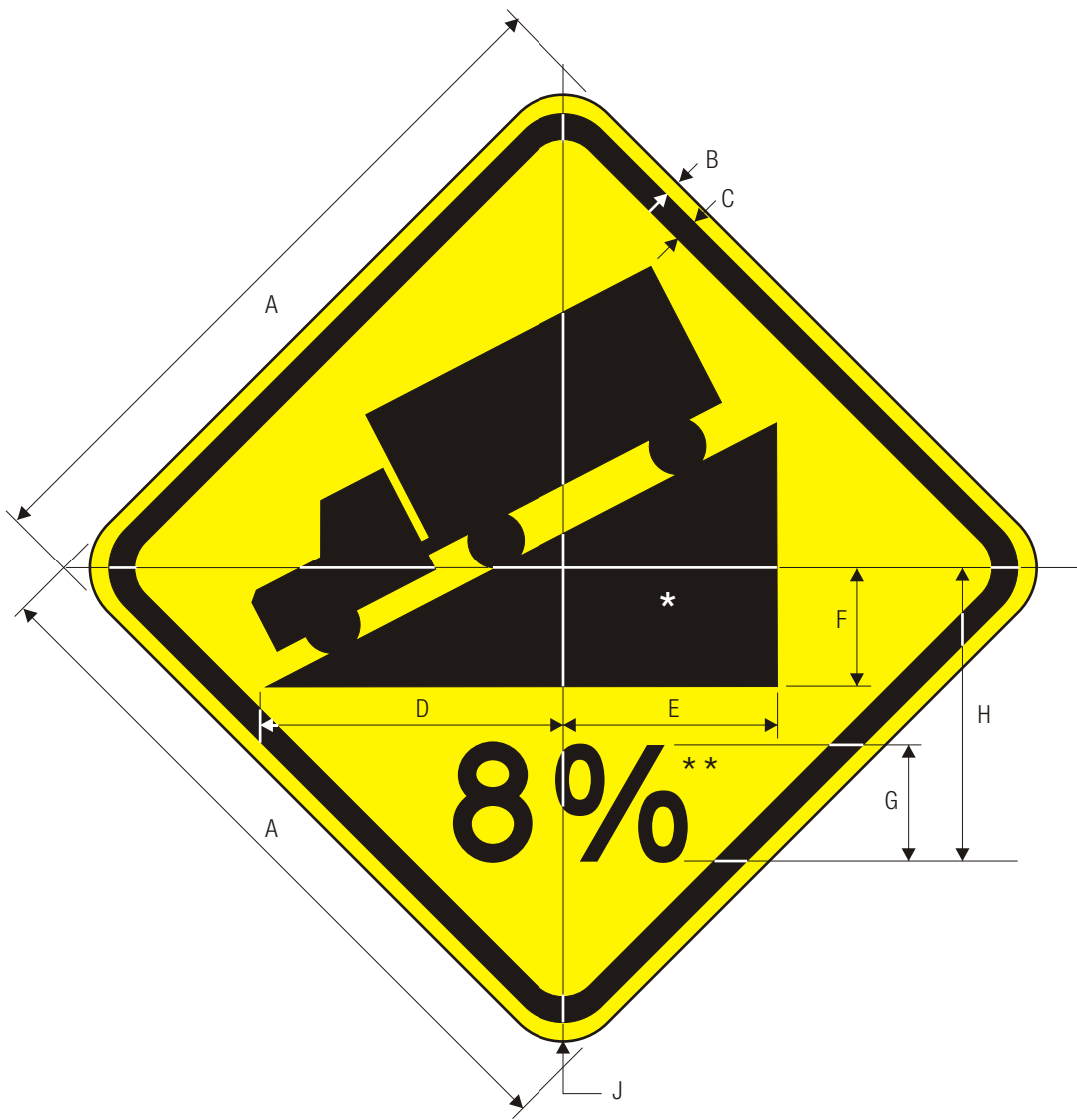

W7-1b
HILL

*See page 6-22 for symbol design.
**Optically space numeral and % about centerline.

	A	B	C	D	E	F	G	H	J
	600	10	15	256	191	100	100 D	250	50
C	750	13	20	319	231	125	125 D	312	50
	900	15	25	384	287	150	150 D	375	60
	1200	20	30	512	362	200	200 D	500	70

WARNING SIGN COLORS:
SYMBOL & LEGEND—BLACK
BACKGROUND— YELLOW (RETROREFLECTIVE)

TTC SIGN COLORS:
SYMBOL & LEGEND—BLACK
BACKGROUND— ORANGE (RETROREFLECTIVE)

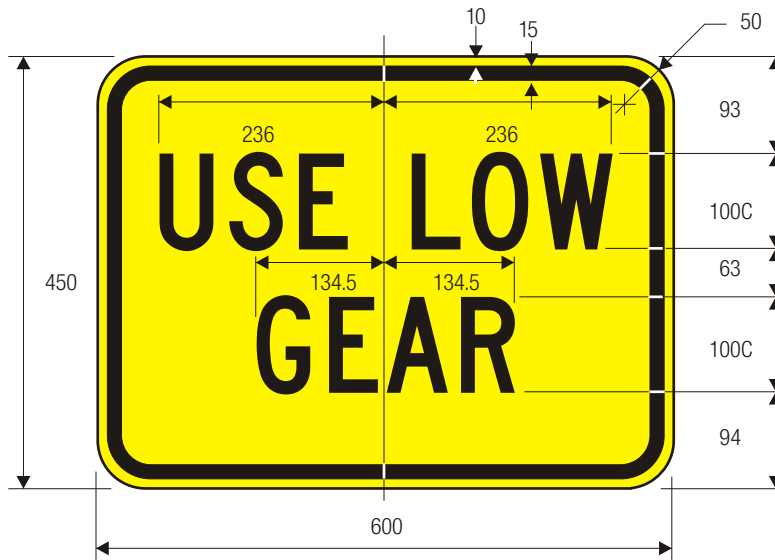

W7-2
HILL PLAQUE

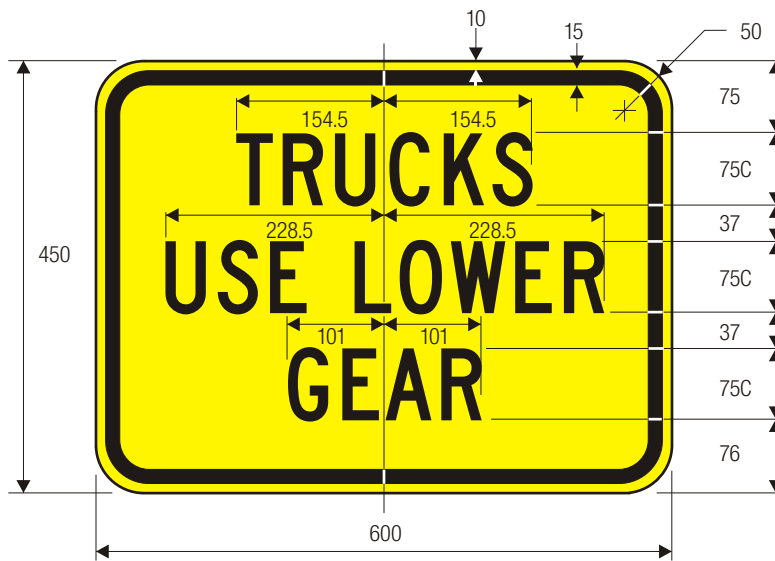

W7-2b
HILL PLAQUE

COLORS: LEGEND — BLACK
BACKGROUND — YELLOW (RETROREFLECTIVE)

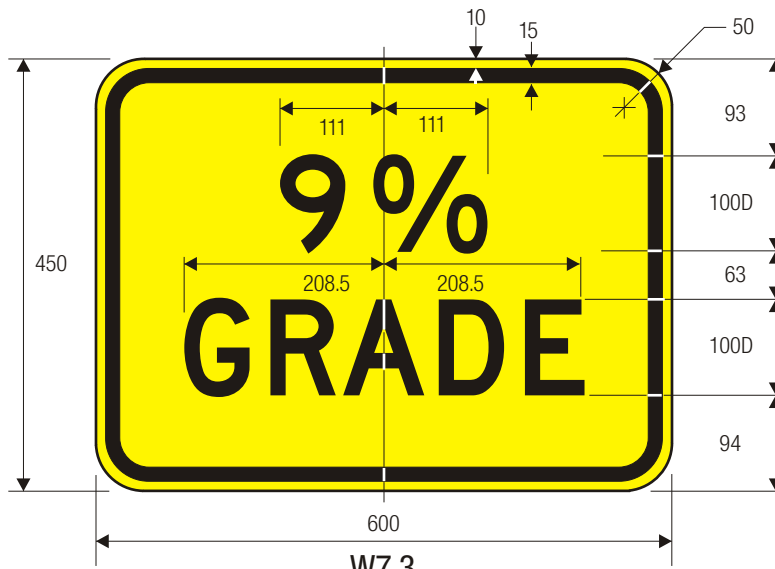

W7-3
HILL PLAQUE



W7-3a
HILL PLAQUE

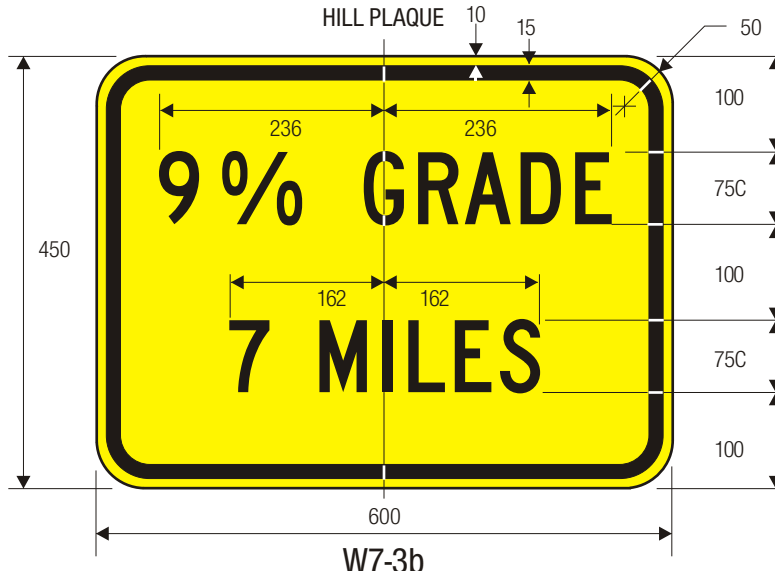

W7-3b
HILL PLAQUE

COLORS: LEGEND — BLACK
BACKGROUND — YELLOW (RETROREFLECTIVE)

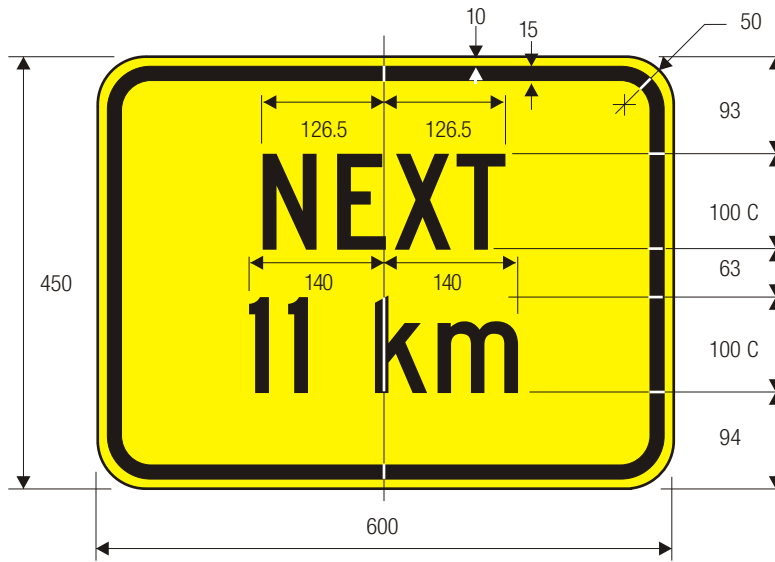

W7-3a Metric
HILL PLAQUE

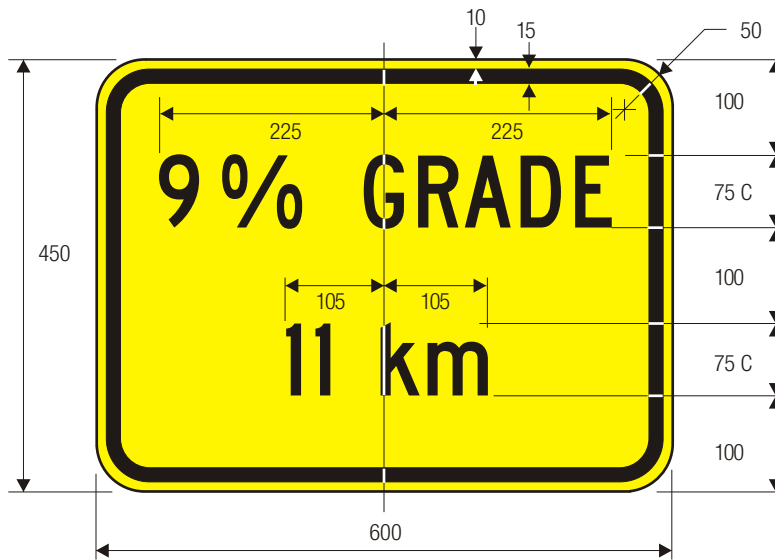

W7-3b Metric
HILL PLAQUE

COLORS: LEGEND — BLACK
BACKGROUND — YELLOW (RETROREFLECTIVE)

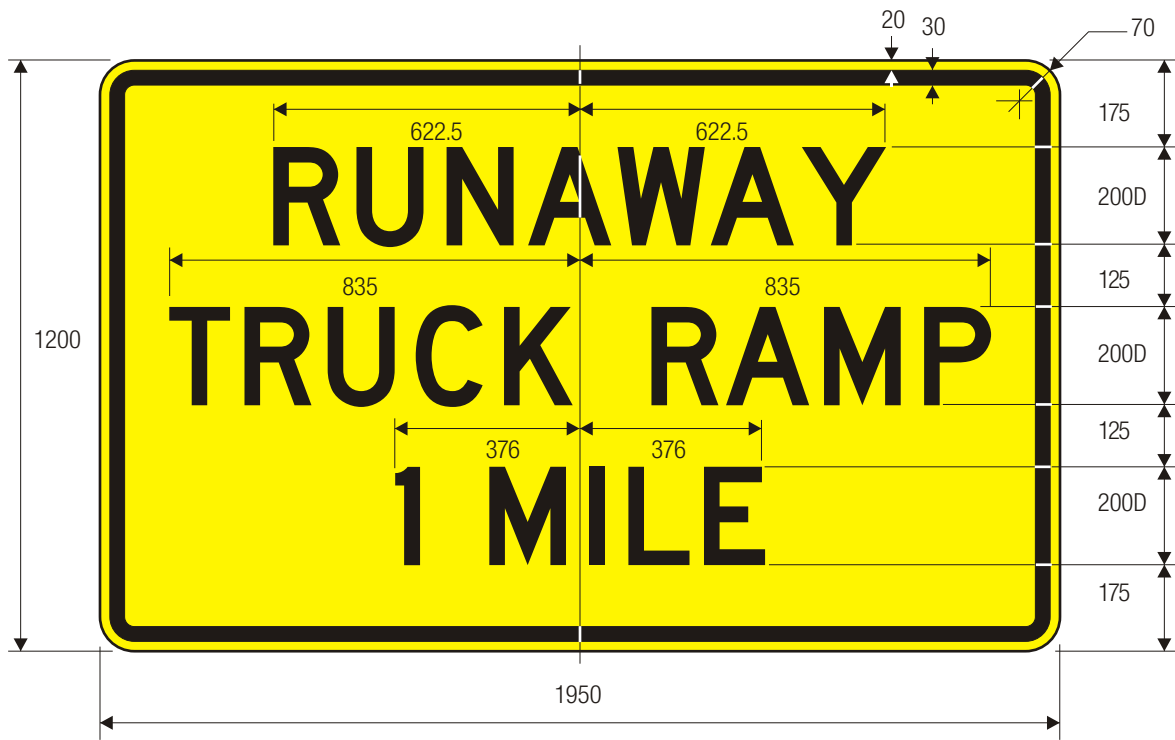

W7-4

TRUCK ESCAPE RAMP



W7-4b

TRUCK ESCAPE RAMP

*See page 6-3 for arrow design.

COLORS: LEGEND — BLACK
BACKGROUND — YELLOW (RETROREFLECTIVE)

2-54

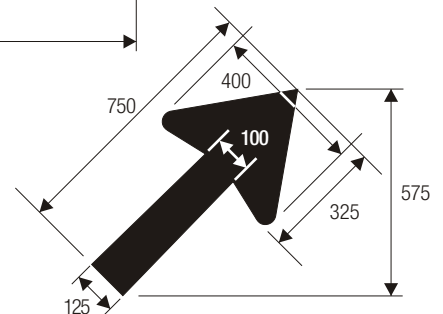



W7-4c

TRUCK ESCAPE RAMP

COLORS: LEGEND — BLACK
 BACKGROUND — YELLOW (RETROREFLECTIVE)

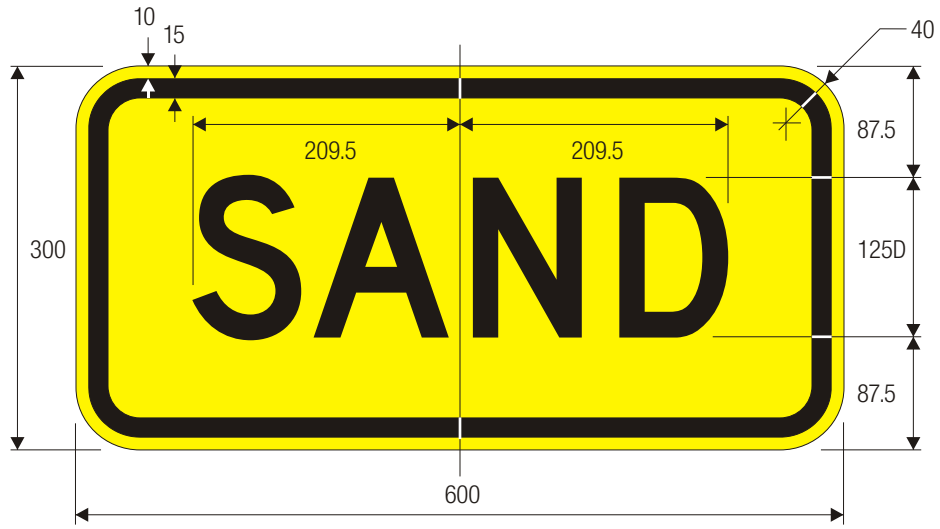

W7-4d

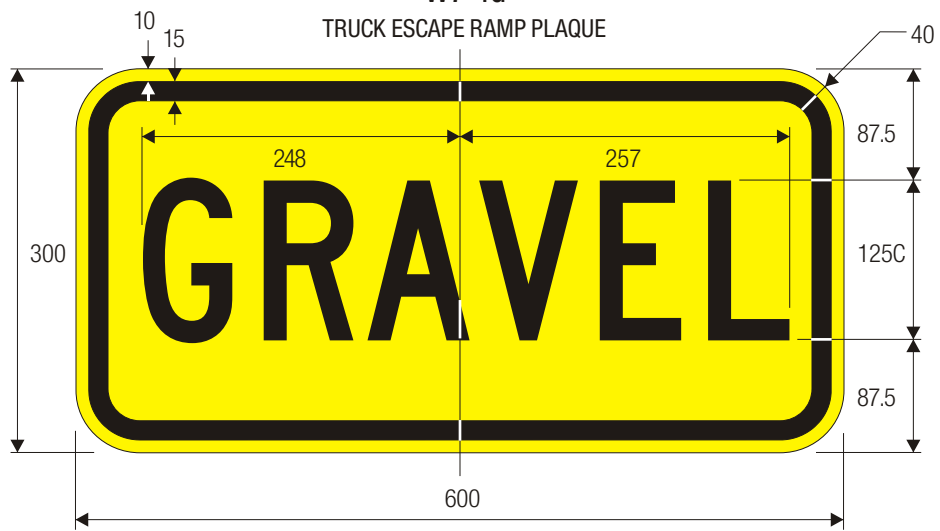

W7-4e

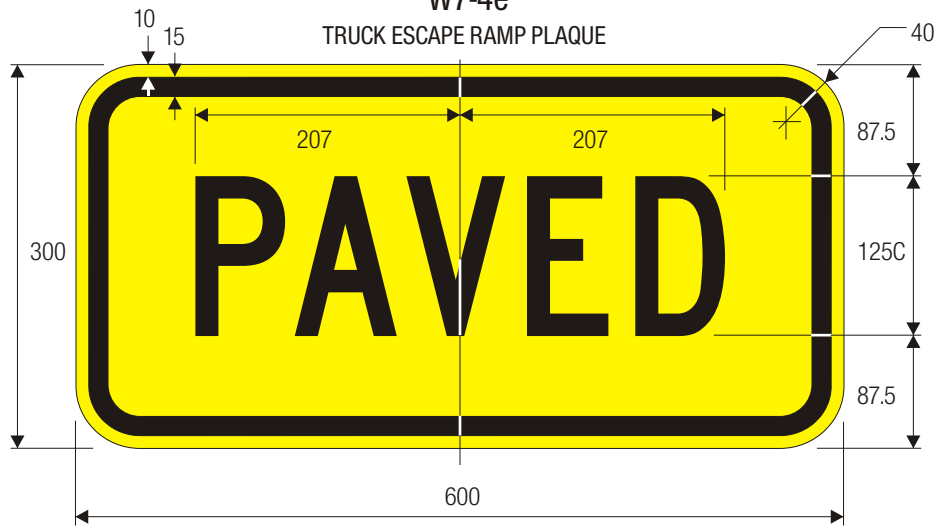

W7-4f

TRUCK ESCAPE RAMP PLAQUE

COLORS: LEGEND — BLACK
 BACKGROUND — YELLOW (RETROREFLECTIVE)

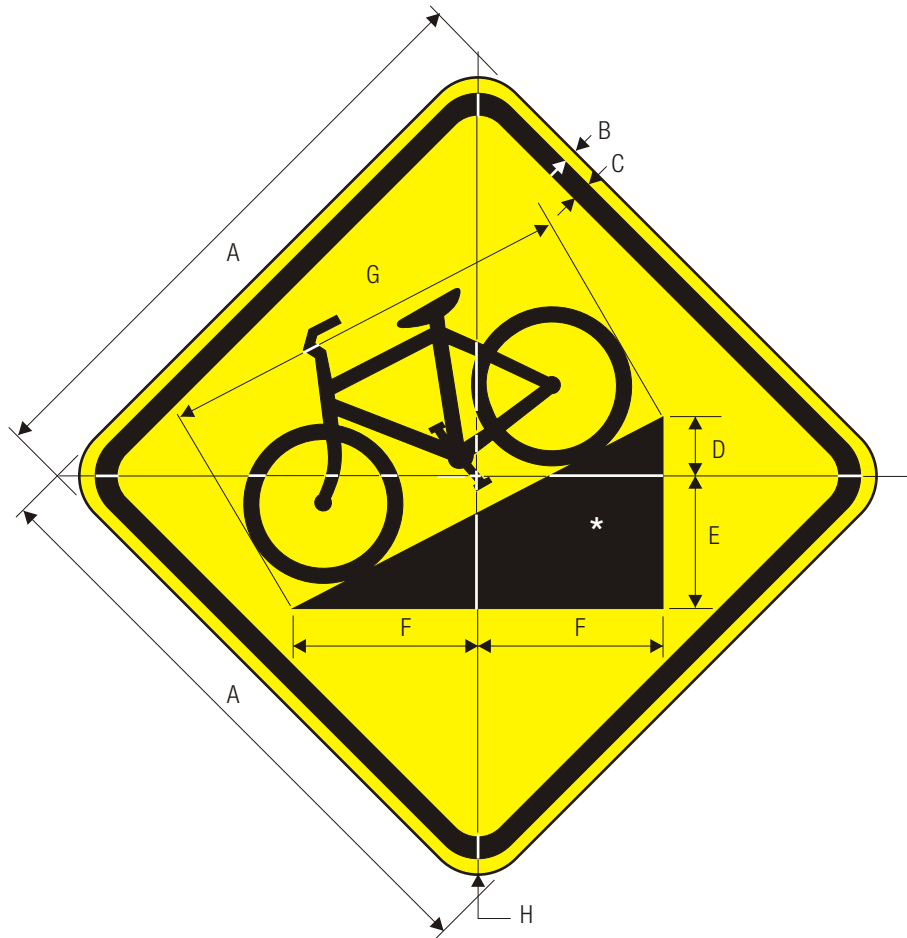

W7-5

*See page 6-7 for symbol design.

BICYCLE HILL PLAQUE

A	B	C	D	E	F	G	H
450	10	15	45	100	140	315	40
600	10	15	60	133	187	420	50

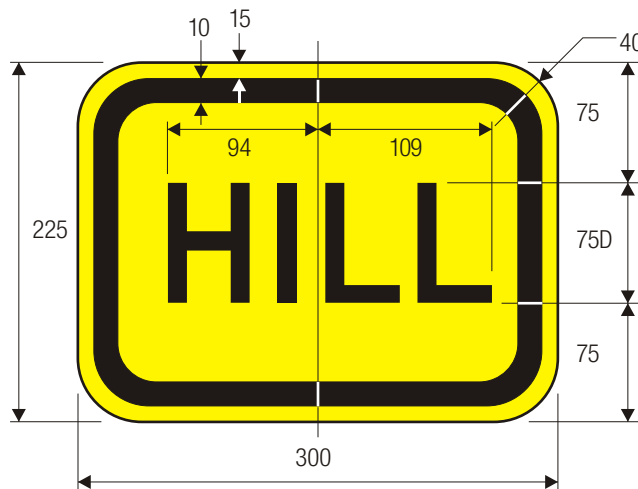

W7-5a

COLORS: LEGEND — BLACK
 BACKGROUND — YELLOW (RETROREFLECTIVE)

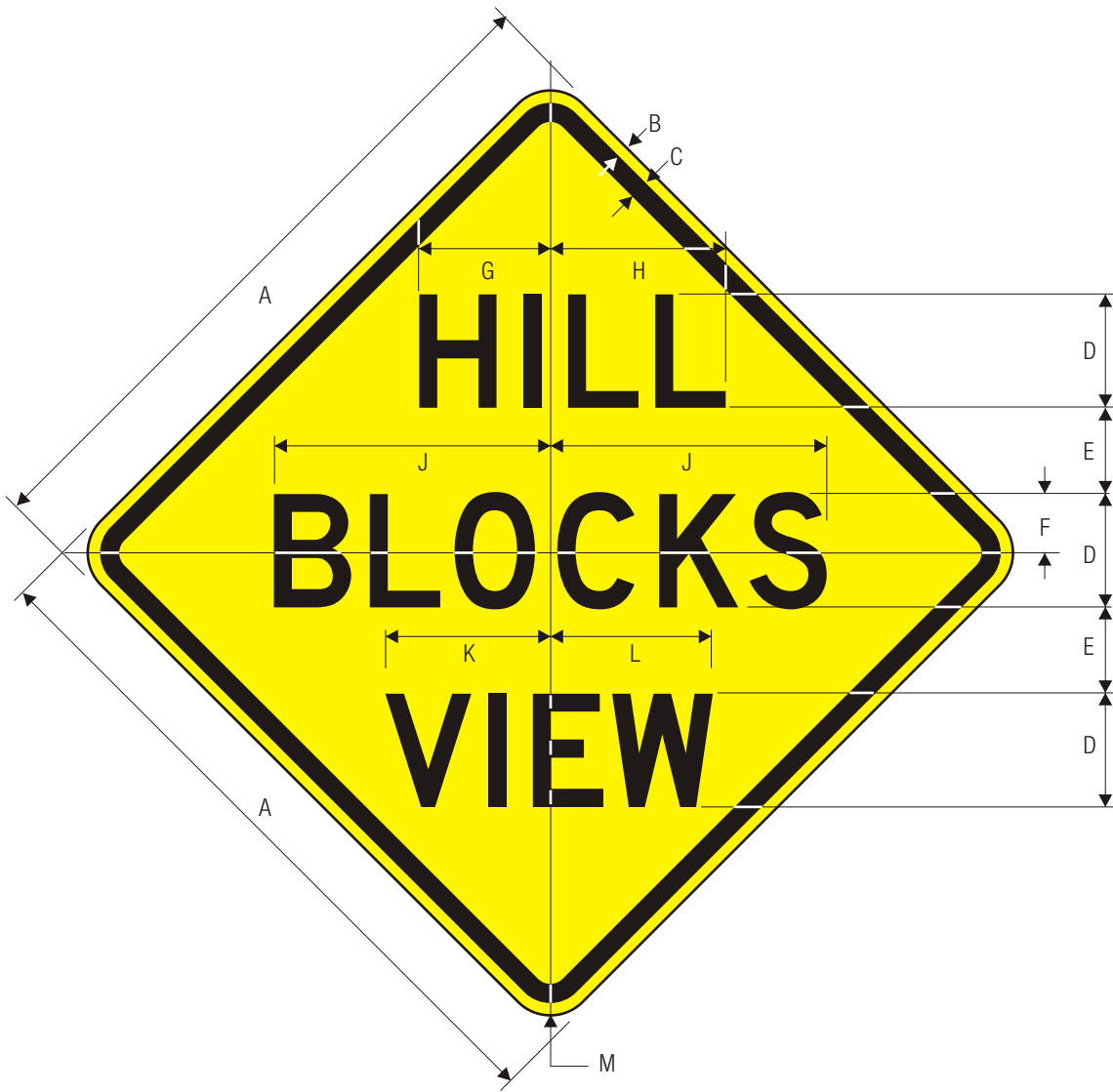

W7-6
HILL BLOCKS VIEW

C

A	B	C	D	E	F	G	H	J	K	L	M
600	10	15	100 D	75	50	120	150	243.5	146	143	50
750	13	20	125 D	95	65	144	194	304.5	182	179	50
900	15	25	150 D	112	75	171	234	365.5	222	211	60
1200	20	30	175 D	131	88	208	265	426	254	251	70

COLORS: LEGEND — BLACK
BACKGROUND — YELLOW (RETROREFLECTIVE)

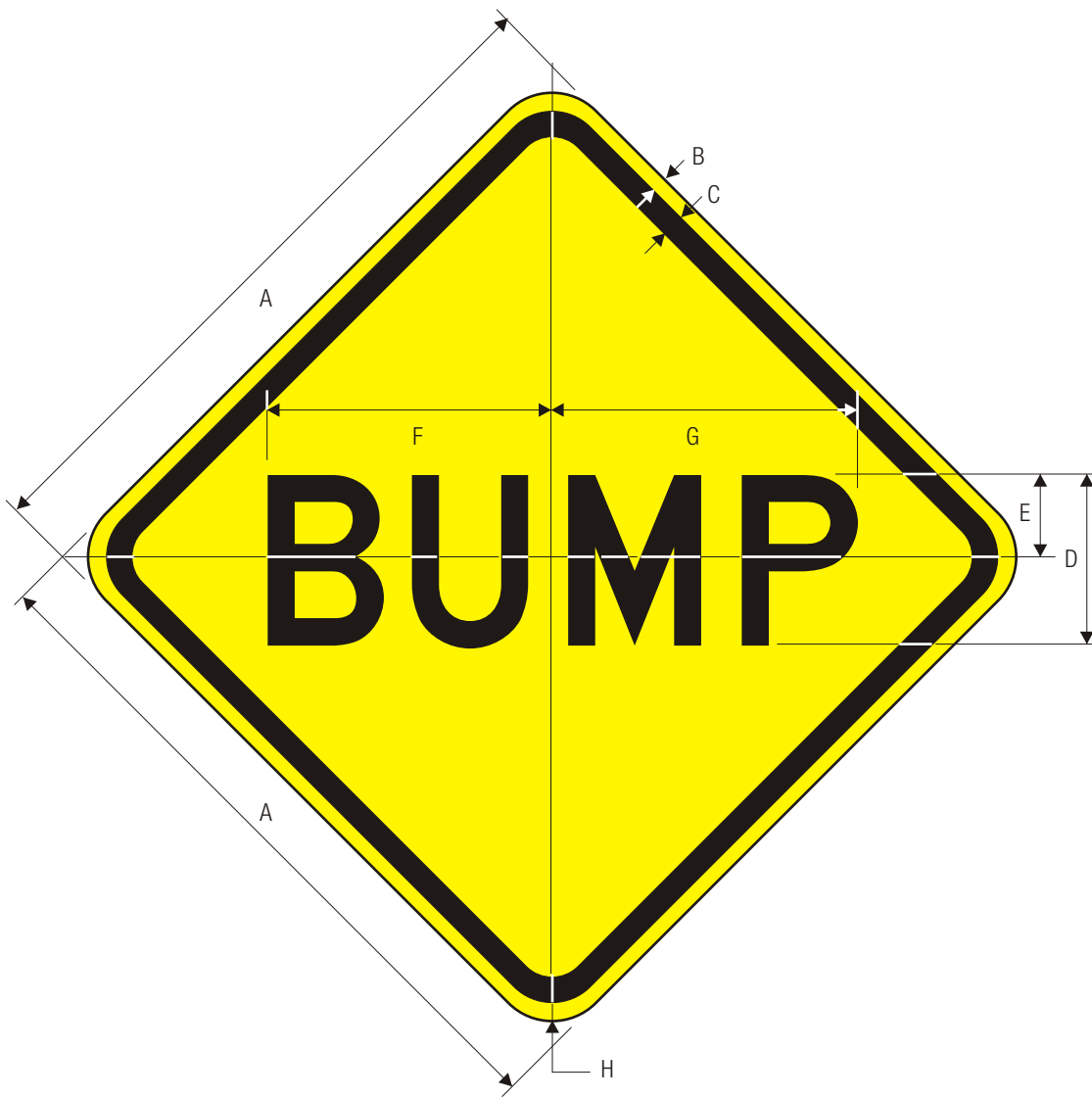

W8-1

BUMP

C

A	B	C	D	E	F	G	H
450	10	15	100 D	50	162	184	40
600	10	15	150 D	75	247	272	50
750	13	20	200 D	100	332	360	50
900	15	25	250 D	125	413	451	60
1200	20	30	300 D	150	500	537	70

WARNING SIGN COLORS:

LEGEND — BLACK

BACKGROUND— YELLOW (RETROREFLECTIVE)

TTC SIGN COLORS:

LEGEND — BLACK

BACKGROUND— ORANGE (RETROREFLECTIVE)

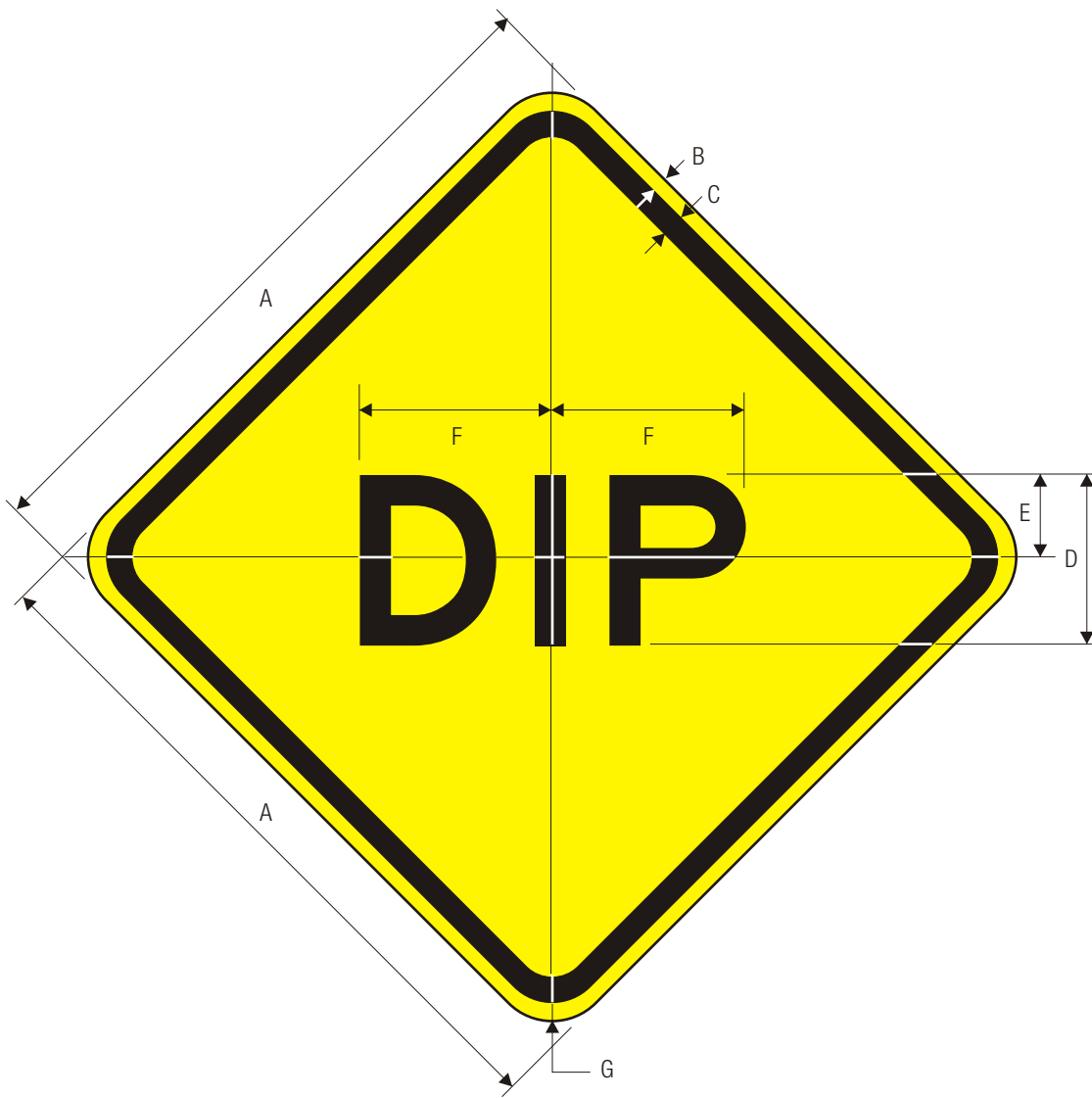

W8-2
DIP

	A	B	C	D	E	F	G
	450	10	15	125 E	63	141.5	40
	600	10	15	150 E	75	148	50
C	750	13	20	200 E	100	226	50
	900	15	25	250 E	125	282.5	60
	1200	20	30	300 E	150	339.5	70

WARNING SIGN COLORS:
 LEGEND — BLACK
 BACKGROUND— YELLOW (RETROREFLECTIVE)

TTC SIGN COLORS:
 LEGEND — BLACK
 BACKGROUND— ORANGE (RETROREFLECTIVE)



W8-3

PAVEMENT ENDS

	A	B	C	D	E	F	G	H	J
	600	10	15	100 C	75	12	275.5	136	50
C	750	13	20	125 C	94	19	344.5	170	50
	900	15	25	150 C	113	25	413	204	60
	1200	20	30	200 C	150	33	551	272	70

WARNING SIGN COLORS:

LEGEND — BLACK

BACKGROUND— YELLOW (RETROREFLECTIVE)

TTC SIGN COLORS:

LEGEND — BLACK

BACKGROUND— ORANGE (RETROREFLECTIVE)

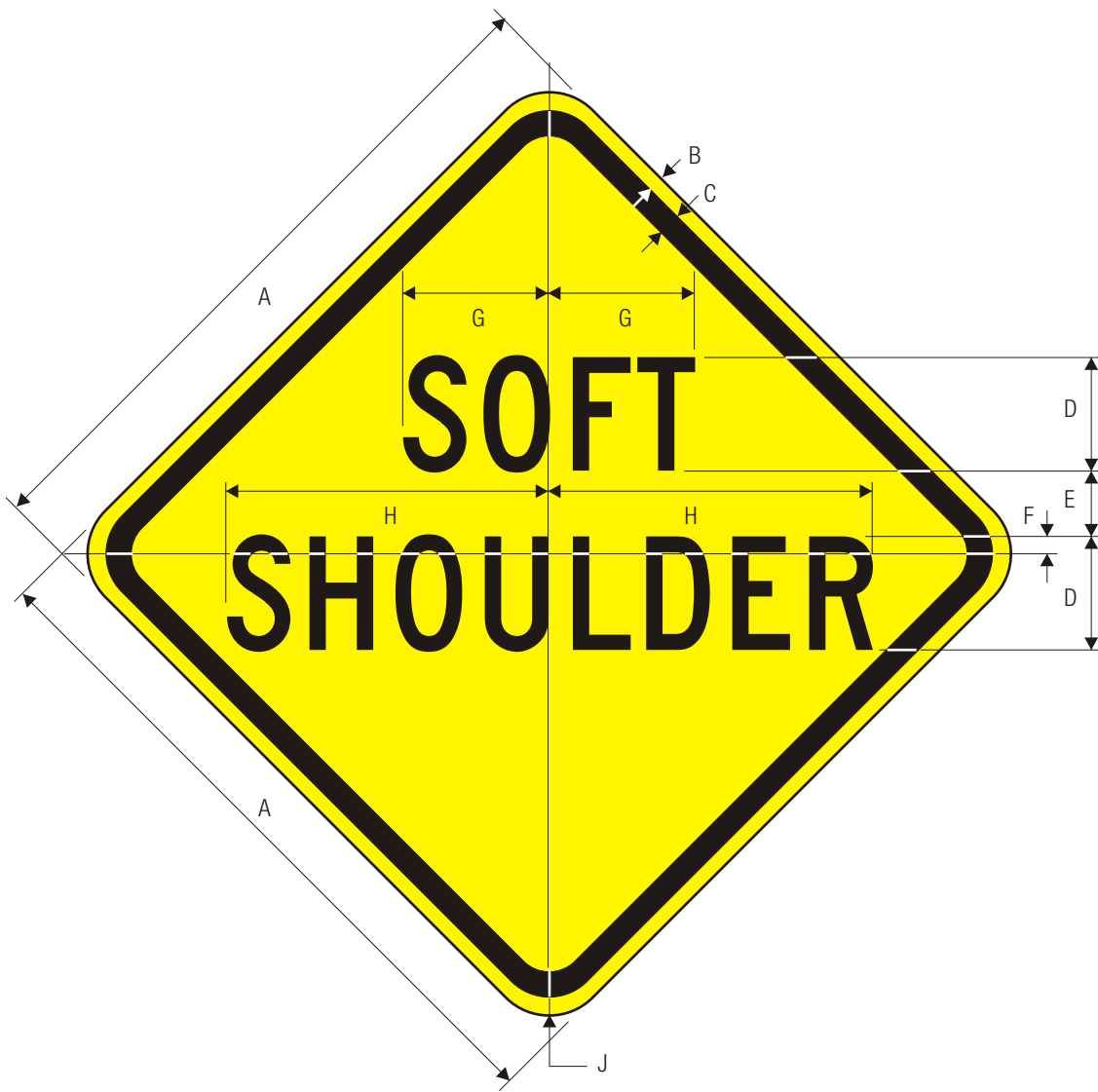

W8-4

SOFT SHOULDER

A	B	C	D	E	F	G	H	J
600	10	15	100 C	75	12	128.5	284	50
750	13	20	125 C	94	19	160.5	355.5	50
900	15	25	150 C	113	25	193	426.5	60
1200	20	30	200 C	150	30	257	568.5	70

WARNING SIGN COLORS:

LEGEND — BLACK
 BACKGROUND — YELLOW (RETROREFLECTIVE)

TTC SIGN COLORS:

LEGEND — BLACK
 BACKGROUND — ORANGE (RETROREFLECTIVE)

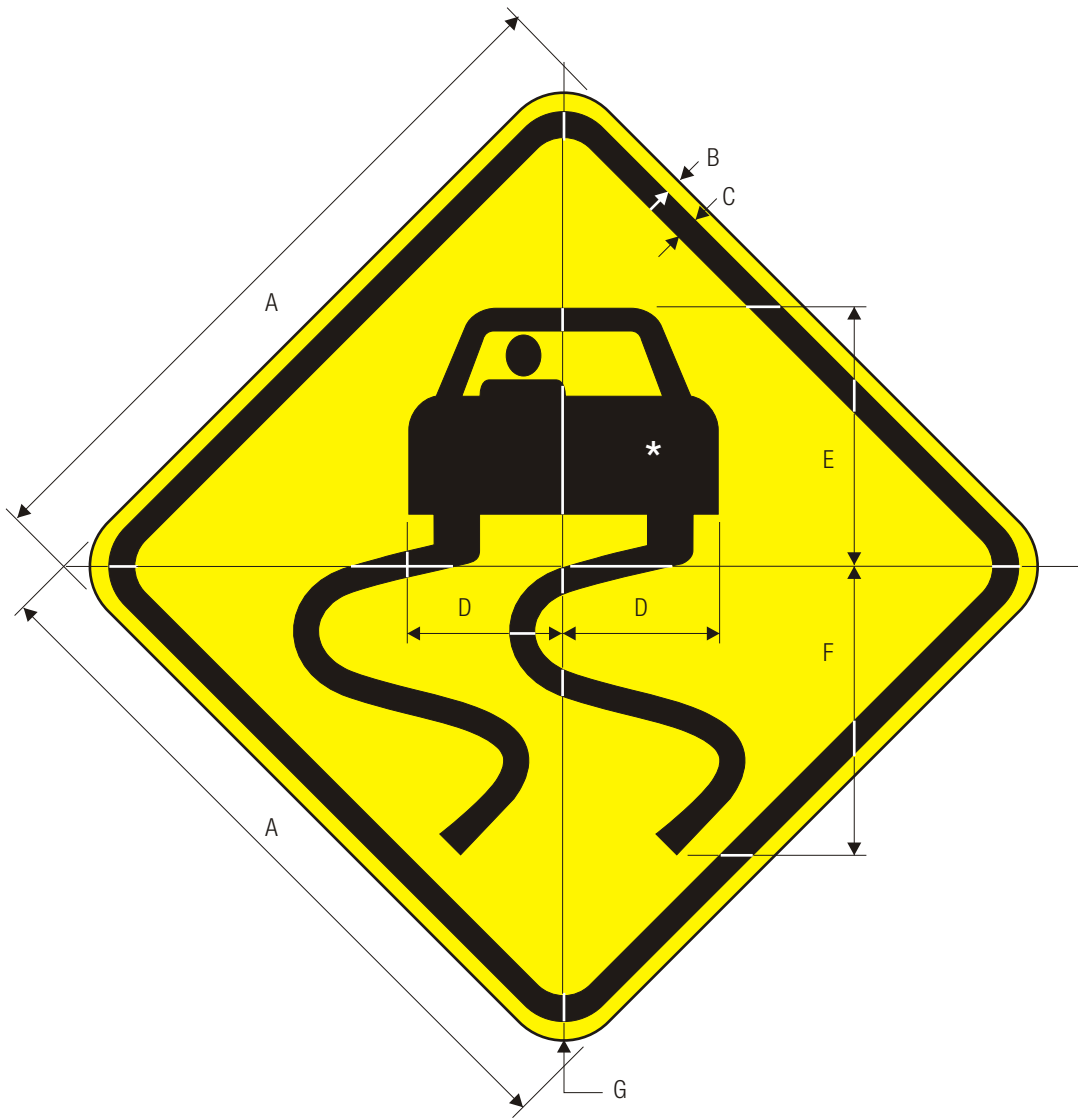

W8-5
SLIPPERY WHEN WET

*See page 6-23 for symbol design.

	A	B	C	D	E	F	G
	600	10	15	133	220	250	50
C	750	13	20	166	275	312	50
	900	15	25	207	344	390	60
	1200	20	30	259	430	488	70

WARNING SIGN COLORS:

SYMBOL — BLACK
BACKGROUND — YELLOW (RETROREFLECTIVE)

TTC SIGN COLORS:

SYMBOL — BLACK
BACKGROUND — ORANGE (RETROREFLECTIVE)

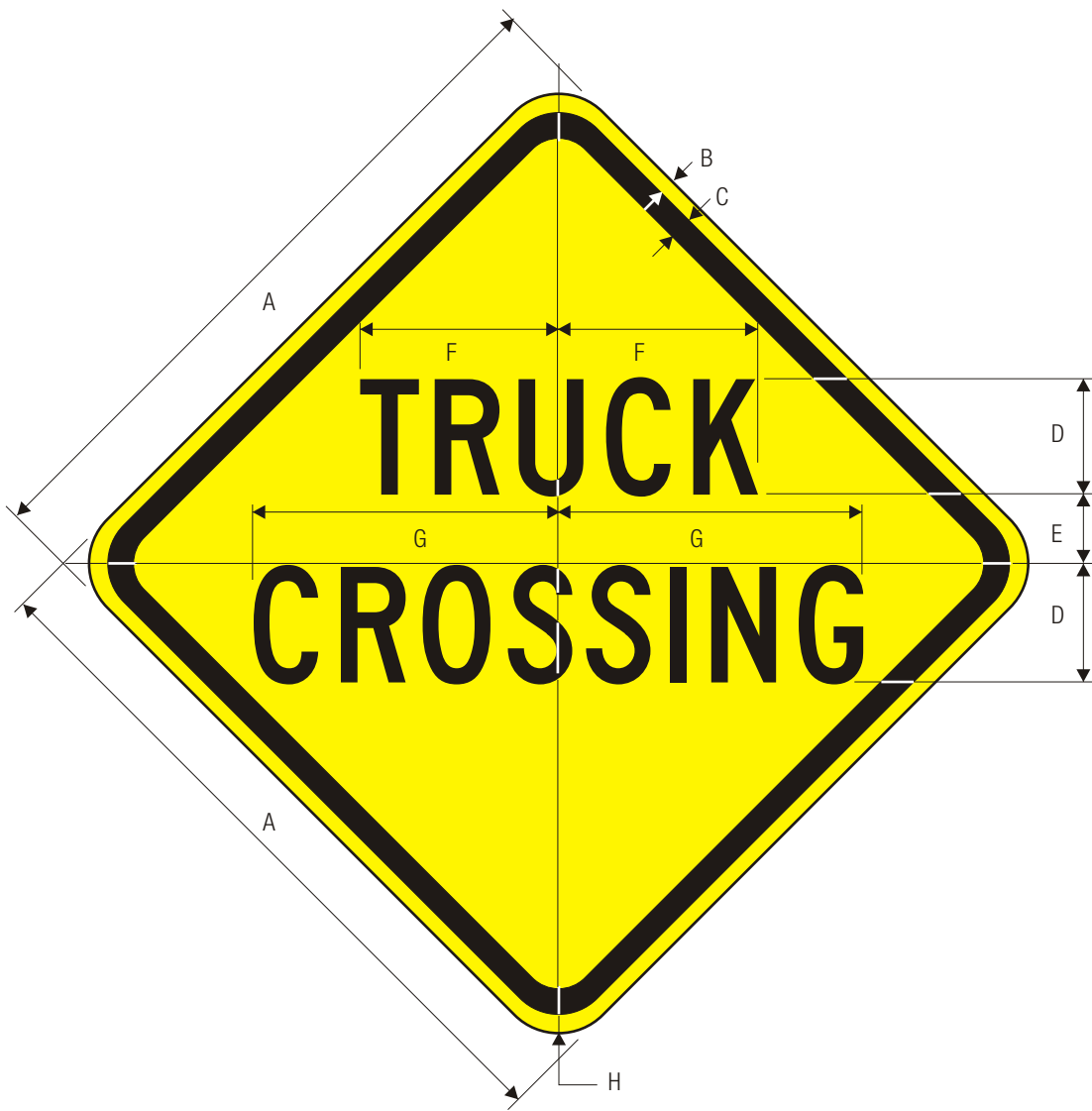

W8-6
TRUCK CROSSING

	A	B	C	D	E	F	G	H
C	600	10	15	100 C	75	172	264	50
	750	13	20	125 C	94	215	329.5	50
	900	15	25	150 C	113	258.5	395.5	60
	1200	20	30	200 C	150	344.5	527.5	70

WARNING SIGN COLORS:

LEGEND — BLACK
BACKGROUND — YELLOW (RETROREFLECTIVE)

TTC SIGN COLORS:

LEGEND — BLACK
BACKGROUND — ORANGE (RETROREFLECTIVE)

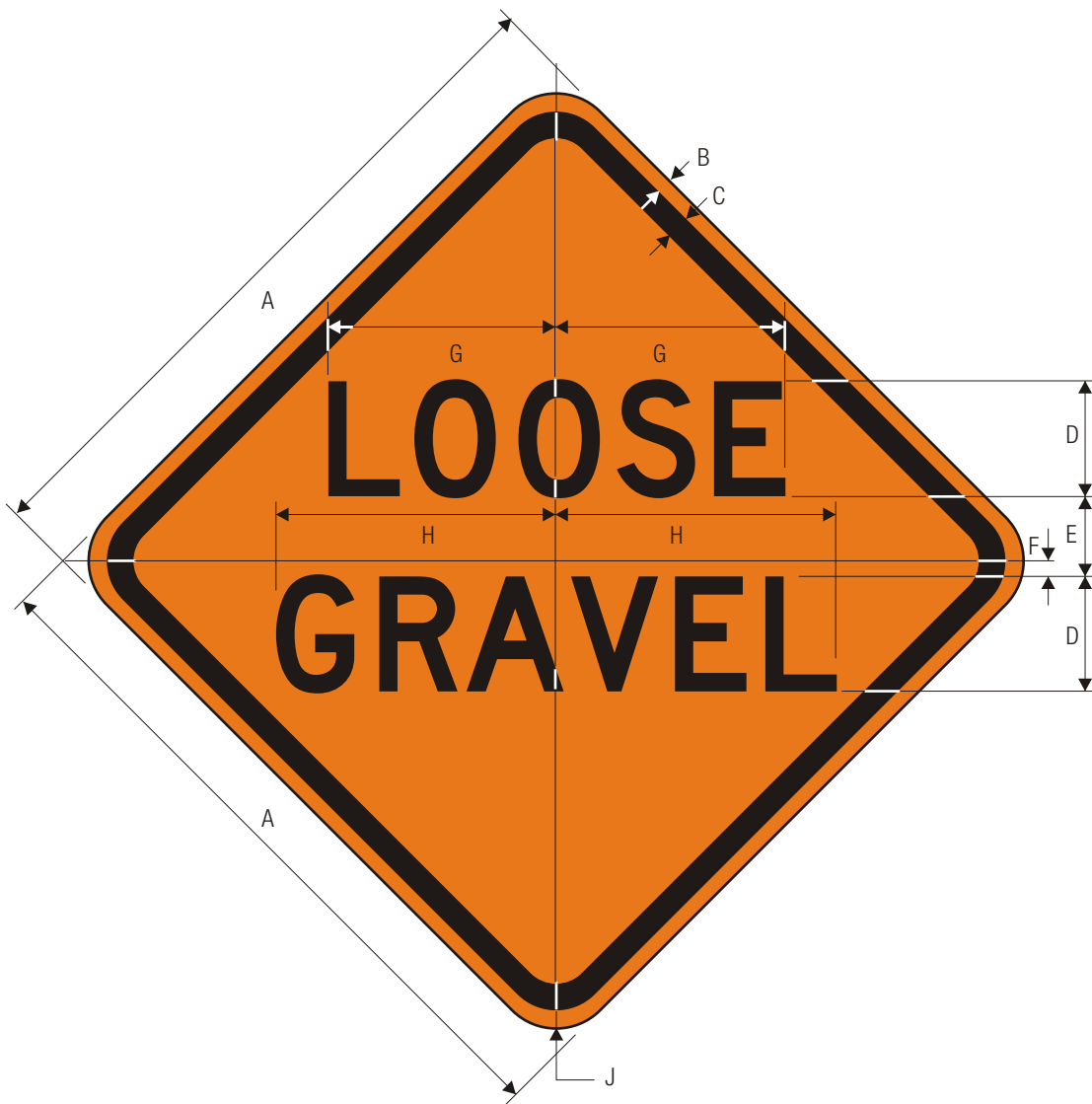

W8-7

LOOSE GRAVEL

	A	B	C	D	E	F	G	H	J
	600	10	15	100 D	75	17	198.5	243.5	50
C	750	13	20	125 D	94	22	248.5	304.5	50
	900	15	25	150 D	113	27	298	365.5	60
	1200	20	30	200 D	150	36	397.5	487.5	70

WARNING SIGN COLORS:

LEGEND — BLACK
BACKGROUND — YELLOW (RETROREFLECTIVE)

TTC SIGN COLORS:

LEGEND — BLACK
BACKGROUND — ORANGE (RETROREFLECTIVE)



W8-8

LOOSE GRAVEL

C

A	B	C	D	E	F	G	H	J
600	10	15	100 D	75	19	211	167	50
750	13	20	125 D	100	22	265.5	210	50
900	15	25	150 D	125	25	316.5	250.5	60
1200	20	30	200 D	150	37	422	334	70

WARNING SIGN COLORS:

LEGEND — BLACK
 BACKGROUND — YELLOW (RETROREFLECTIVE)

TTC SIGN COLORS:

LEGEND — BLACK
 BACKGROUND — ORANGE (RETROREFLECTIVE)

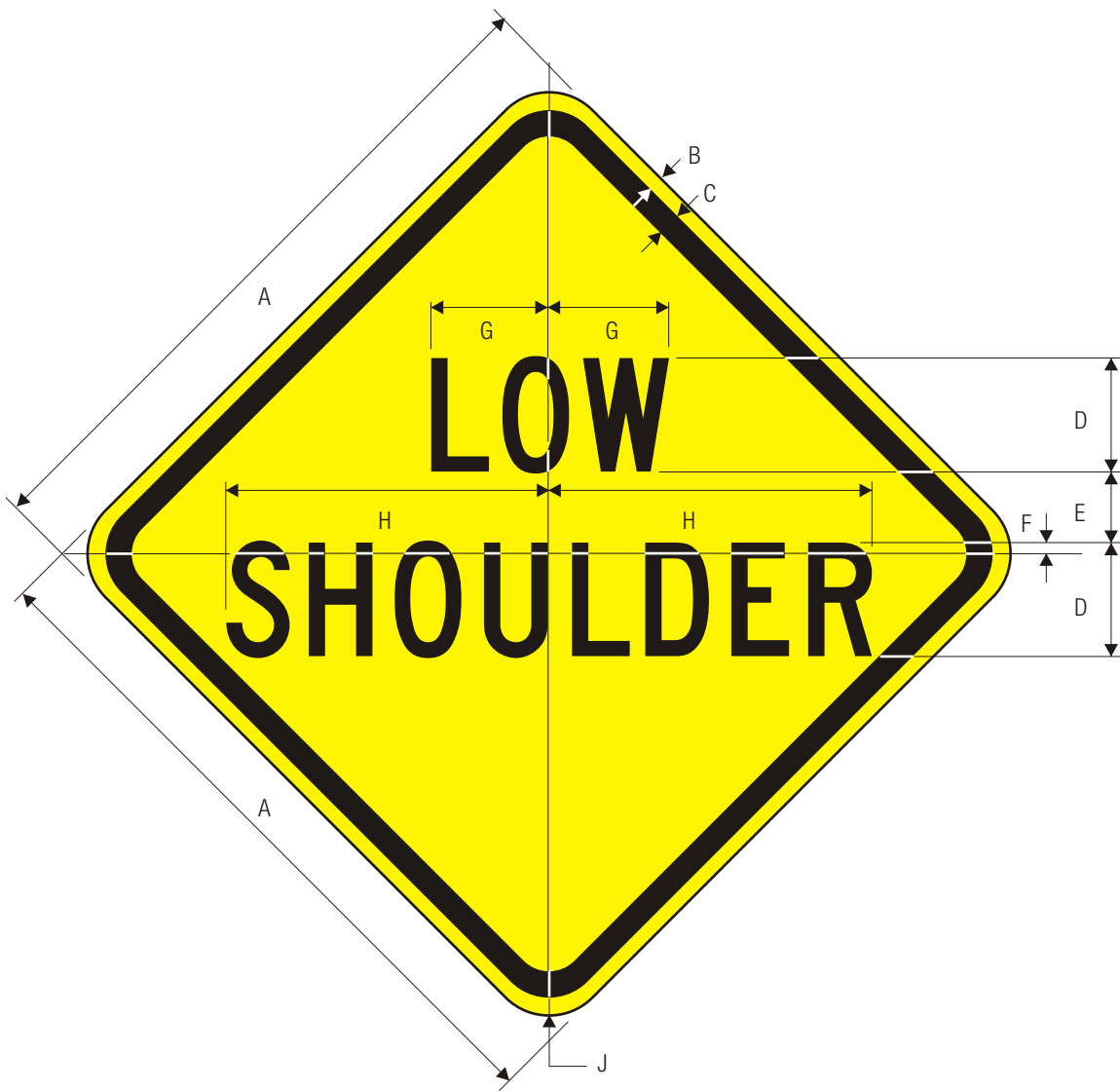

W8-9

LOW SHOULDER

	A	B	C	D	E	F	G	H	J
	600	10	15	100 C	75	12	104.5	284	50
C	750	13	20	125 C	94	19	131	355.5	50
	900	15	25	150 C	113	25	157	426.5	60
	1200	20	30	200 C	150	30	209.5	568.5	70

WARNING SIGN COLORS:

LEGEND — BLACK
BACKGROUND — YELLOW (RETROREFLECTIVE)

TTC SIGN COLORS:

LEGEND — BLACK
BACKGROUND — ORANGE (RETROREFLECTIVE)

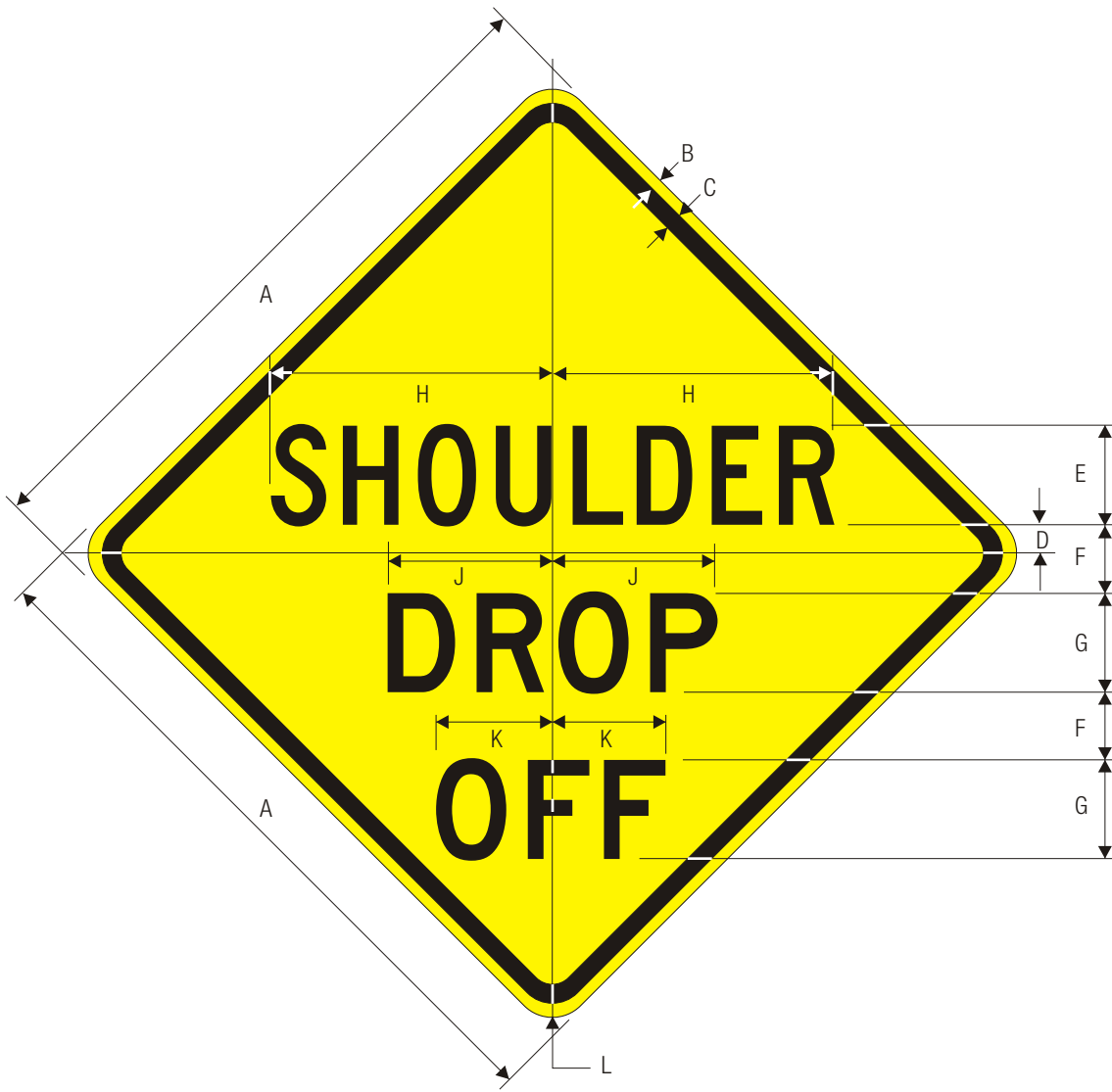

W8-9a

SHOULDER DROP OFF

C

A	B	C	D	E	F	G	H	J	K	L
600	10	15	25	75 C	50	75 D	213	125	87	50
750	13	20	35	100 C	75	100 D	284	166.5	115.5	50
900	15	25	40	125 C	100	125 D	355.5	208	144.5	60
1200	20	30	50	175 C	120	175 D	497.5	291	202.5	70

WARNING SIGN COLORS:

LEGEND — BLACK
 BACKGROUND — YELLOW (RETROREFLECTIVE)

TTC SIGN COLORS:

LEGEND — BLACK
 BACKGROUND — ORANGE (RETROREFLECTIVE)

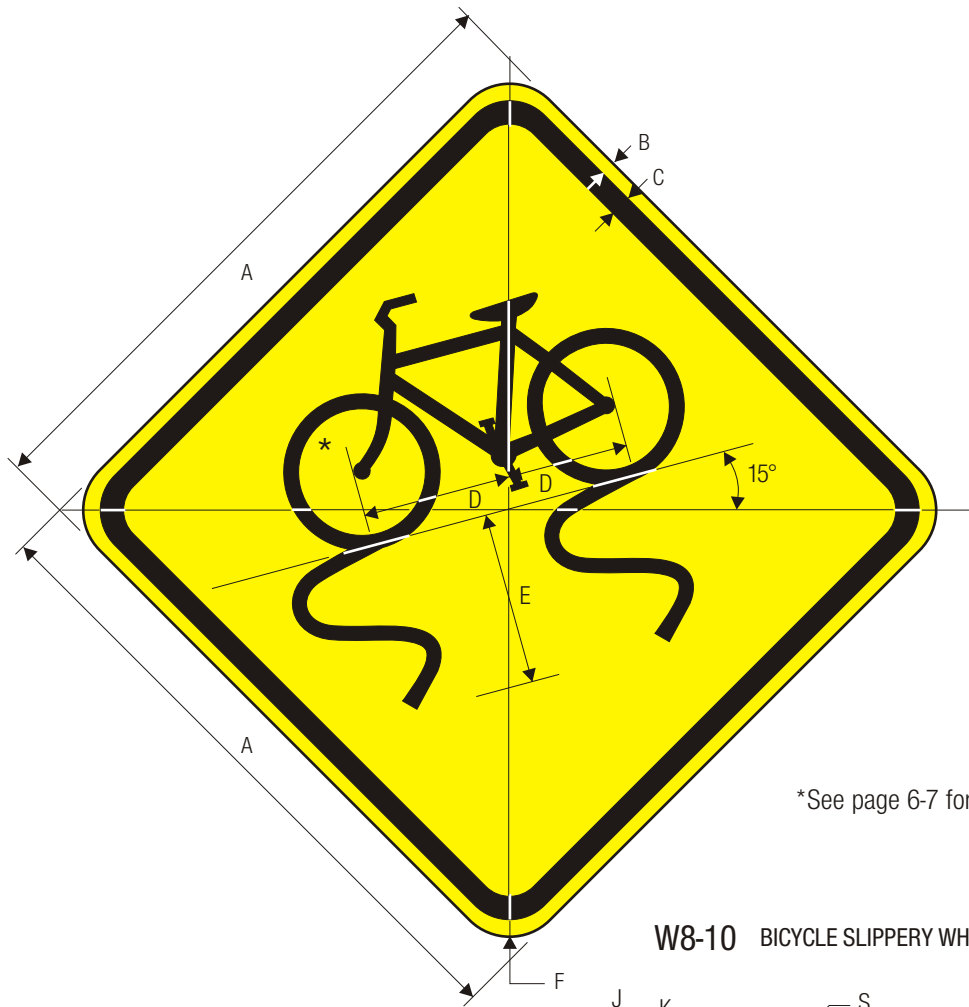

*See page 6-7 for symbol design.

W8-10 BICYCLE SLIPPERY WHEN WET



W8-10a

BICYCLE SLIPPERY WHEN WET PLAQUE

A	B	C	D	E	F	G	H	J	K	L	M
450	10	15	90	110	40	300	225	10	15	55	45 C
600	10	15	120	155	50	600	450	10	15	100	100 C

N	P	Q	R	S
35	35 C	115.5	97	40
75	75 C	254.5	208	50

COLORS: LEGEND — BLACK
 BACKGROUND — YELLOW (RETROREFLECTIVE)

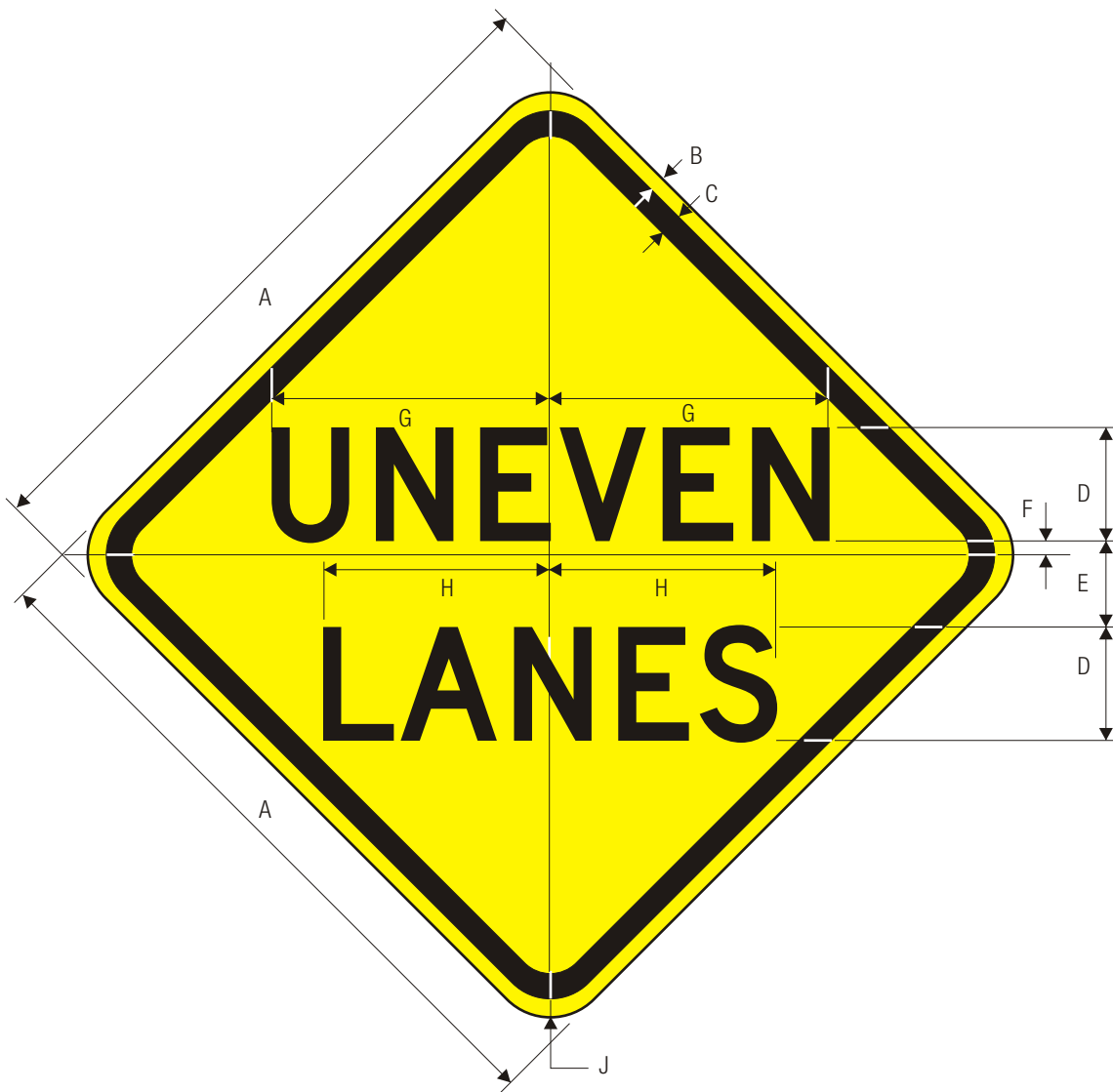

W8-11

UNEVEN LANES

	A	B	C	D	E	F	G	H	J
	600	10	15	100 D	75	16	245	199.5	50
C	750	13	20	125 D	94	20	306	249	50
	900	15	25	150 D	113	24	367.5	299	60
	1200	20	30	200 D	150	32	490	398.5	70

WARNING SIGN COLORS:

LEGEND — BLACK
BACKGROUND — YELLOW (RETROREFLECTIVE)

TTC SIGN COLORS:

LEGEND — BLACK
BACKGROUND — ORANGE (RETROREFLECTIVE)



W8-12
NO CENTER STRIPE

	A	B	C	D	E	F	G	H	J	K
	600	10	15	100 D	70	14	80	237	210.5	50
C	750	13	20	125 D	87	17	100	296.5	263	50
	900	15	25	150 D	105	20	120	355.5	316	60
	1200	20	30	200 D	114	27	160.5	474	421	70

WARNING SIGN COLORS:
LEGEND — BLACK
BACKGROUND— YELLOW (RETROREFLECTIVE)

TTC SIGN COLORS:
LEGEND — BLACK
BACKGROUND— ORANGE (RETROREFLECTIVE)



W8-13

BRIDGE ICES BEFORE ROAD

	A	B	C	D	E	F	G	H	J	K
C	750	13	20	100 C	50	50	190.5	350	1375	50
	900	15	25	125 C	62	62	238	437	172	60
	1200	20	30	150 C	75	75	286	524.5	206.5	70

WARNING SIGN COLORS:

LEGEND — BLACK
 BACKGROUND — YELLOW (RETROREFLECTIVE)

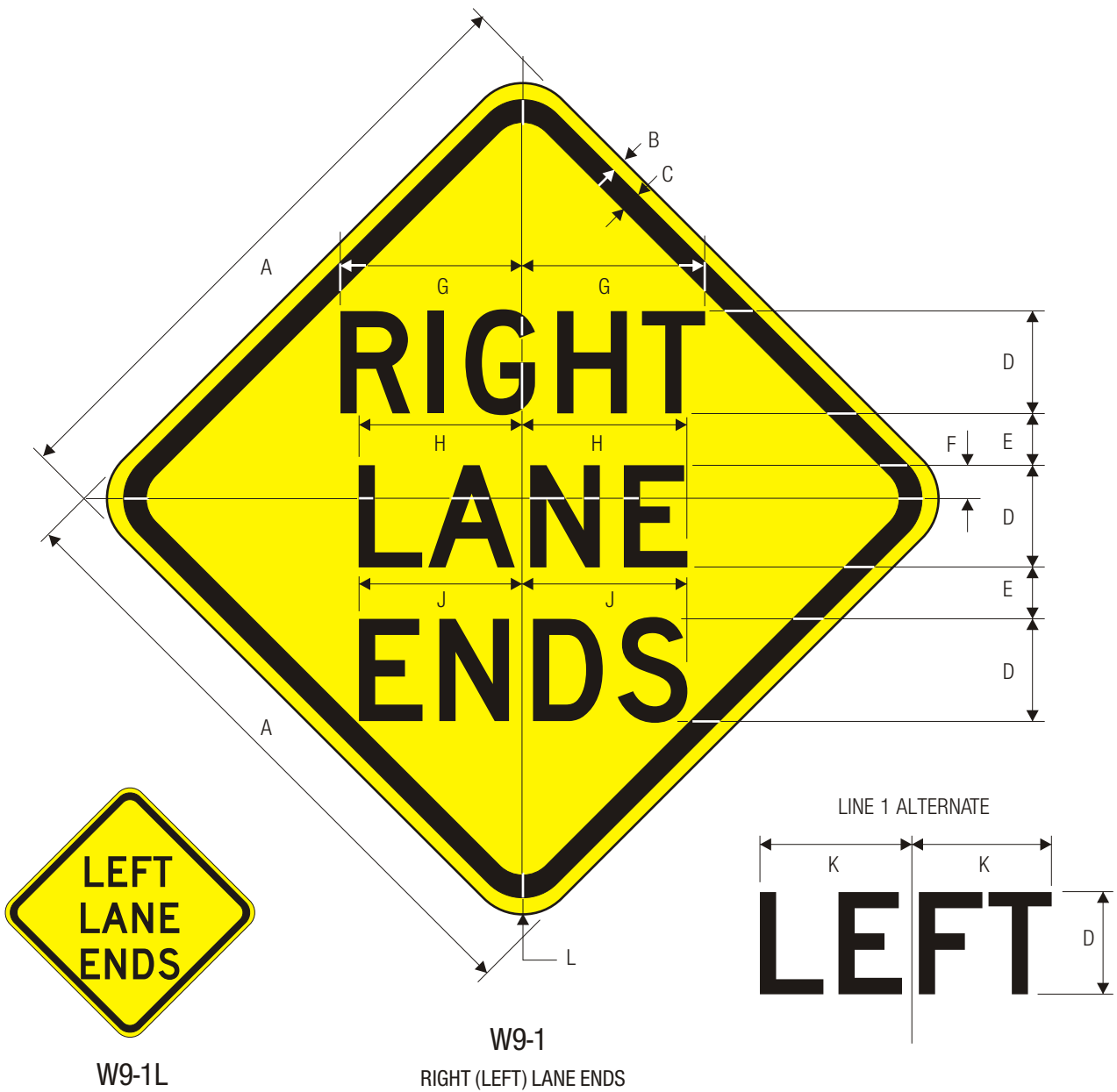

A	B	C	D	E	F	G	H	J	K	L
600	10	15	100 D	50	37	178	160.5	160.5	142.5	50
750	13	20	125 D	62	37	222.5	200.5	200.5	178	50
900	15	25	150 D	75	50	267	240.5	240.5	214	60
1200	20	30	200 D	100	75	356.5	321	321	285	70

C

WARNING SIGN COLORS:
 LEGEND — BLACK
 BACKGROUND— YELLOW (RETROREFLECTIVE)

TTC SIGN COLORS:
 LEGEND — BLACK
 BACKGROUND— ORANGE (RETROREFLECTIVE)

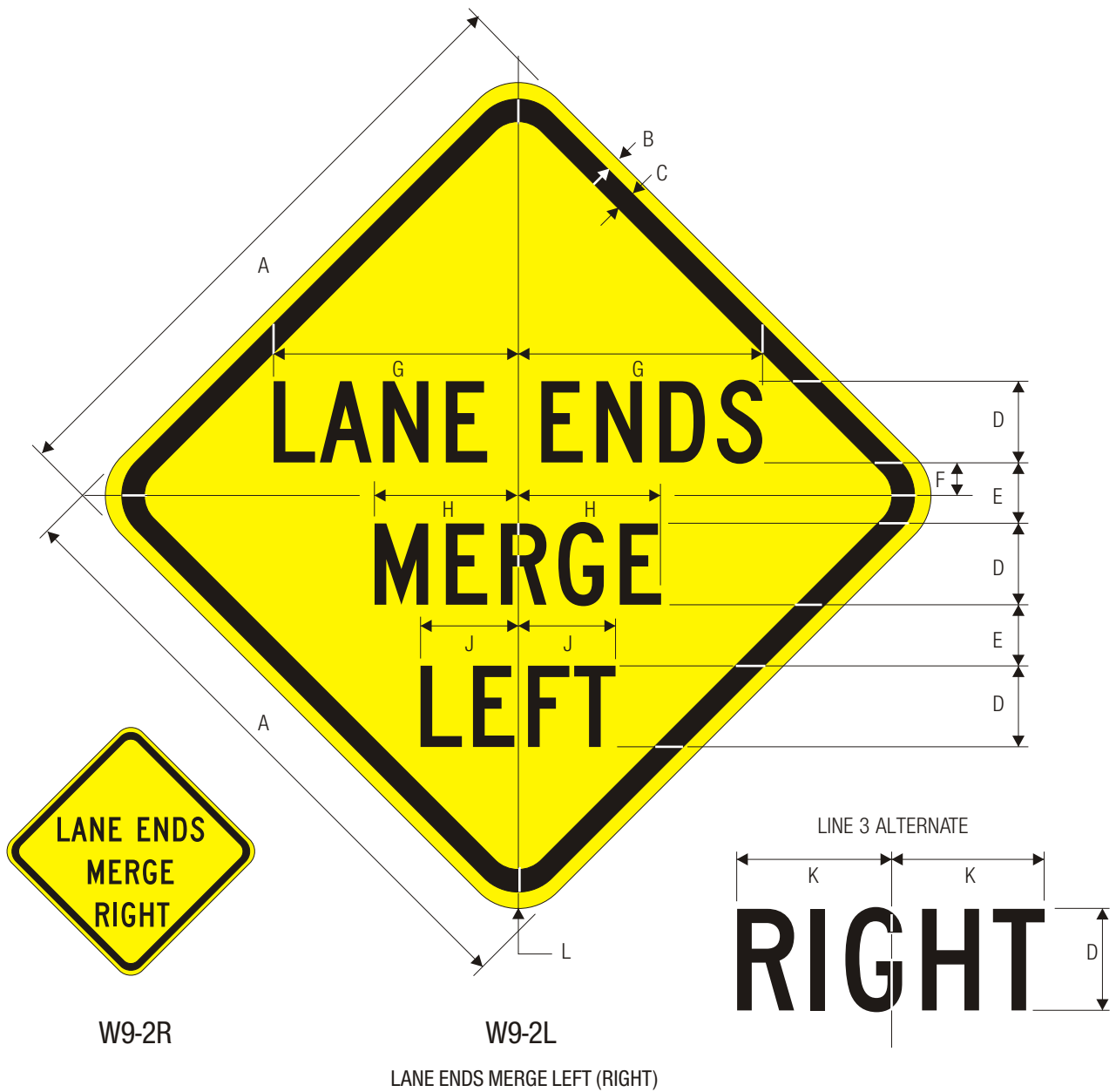

	A	B	C	D	E	F	G	H	J	K	L
C	750	13	20	100 C	75	42	300.5	176	120	151.5	50
	900	15	25	125 C	94	49	375.5	220.5	150	189	60
	1200	20	30	150 C	113	61	451	264.5	180	227	70

WARNING SIGN COLORS:
 LEGEND — BLACK
 BACKGROUND— YELLOW (RETROREFLECTIVE)

TTC SIGN COLORS:
 LEGEND — BLACK
 BACKGROUND— ORANGE (RETROREFLECTIVE)

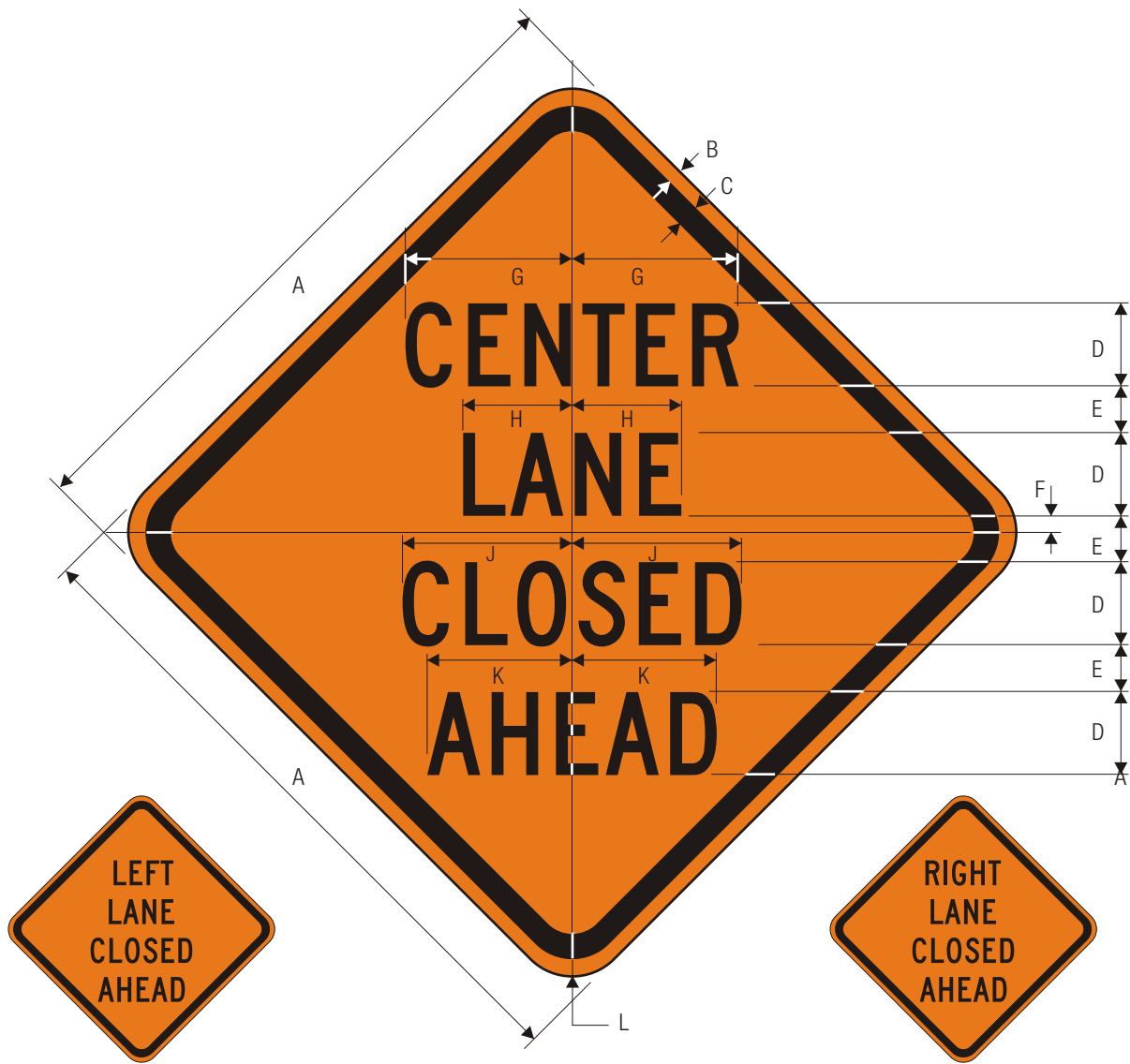

W9-3L

W9-3

W9-3R

CENTER (RIGHT) (LEFT) LANE CLOSED AHEAD

	A	B	C	D	E	F	G	H	J	K	L
	750	13	20	100 C	56	22	200.5	131.5	204	174.5	50
C	900	15	25	125 C	50	17	250.5	164	255	218	60
	1200	20	30	150 C	113	27	301	197	306	261.5	70
	1500	20	30	200 C	130	41	401	262.5	408	348.5	70

TTC SIGN COLORS:
 LEGEND — BLACK
 BACKGROUND— ORANGE (RETROREFLECTIVE)

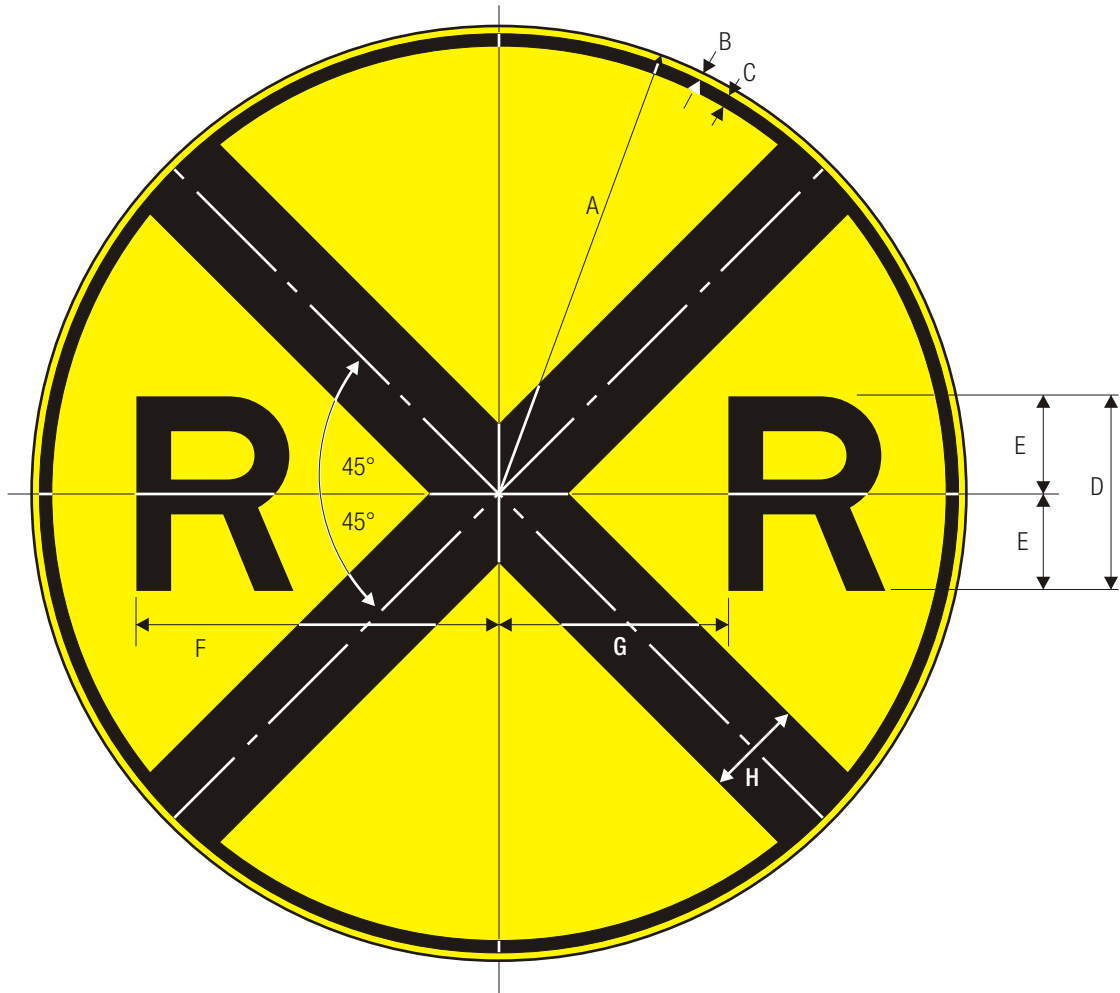

W10-1

HIGHWAY-RAIL GRADE CROSSING ADVANCE WARNING

	A	B	C	D	E	F	G	H
	225	6	10	100 E	50	183	106	50
	300	10	15	125 E	62.5	233	148	62.5
C	375	10	15	175 E	87.5	304	172	75
	450	10	15	200 E	100	365	212	100
	600	10	15	250 E	125	466	295	125
	750	13	20	300 E	150	566	362	150
	900	15	25	350 E	175	688	433	175

COLORS: LEGEND — BLACK
 BACKGROUND — YELLOW (RETROREFLECTIVE)

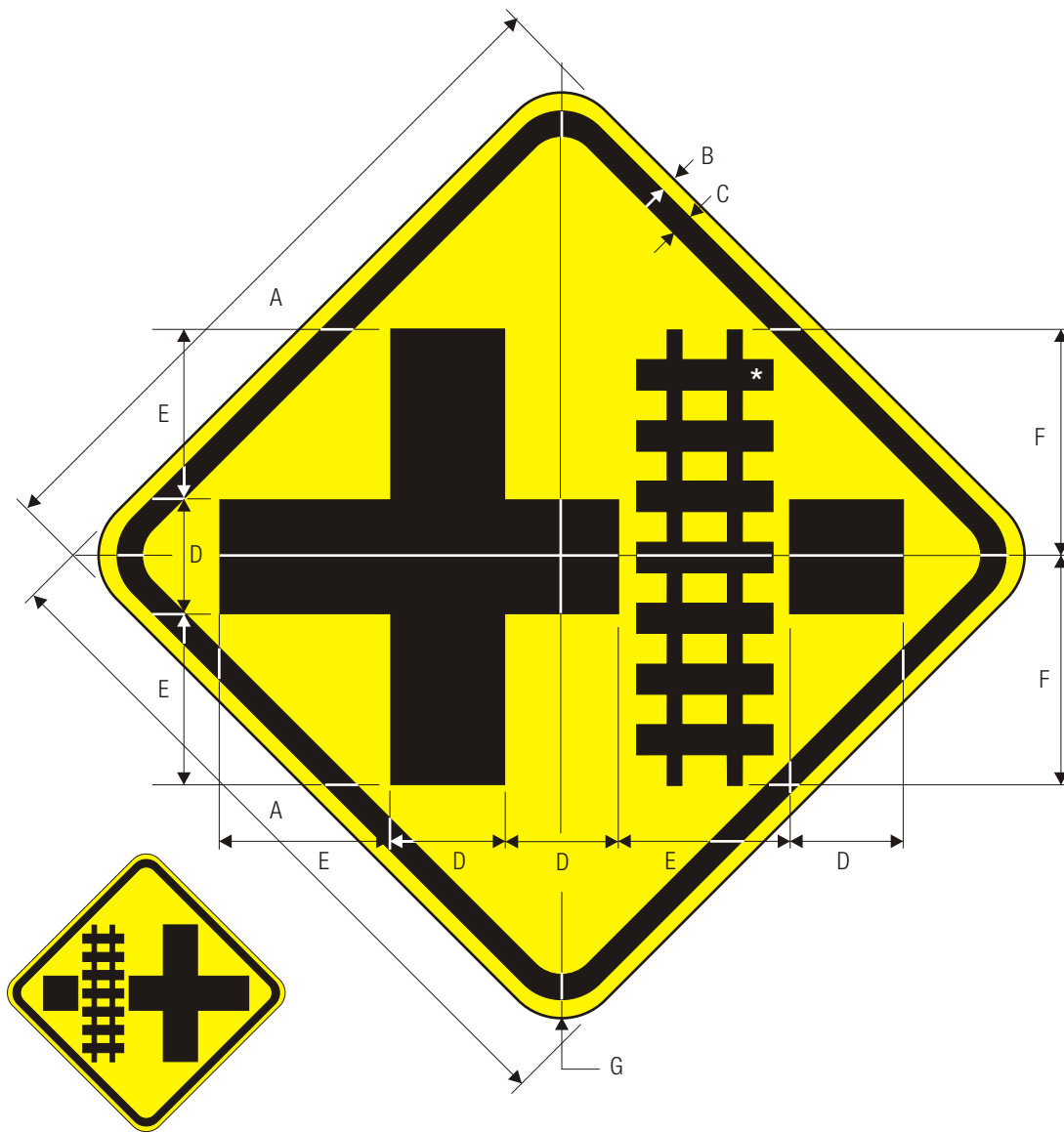

W10-2L

W10-2R

HIGHWAY-RAIL GRADE CROSSING ADVANCE WARNING

*See page 6-24 for symbol design.

	A	B	C	D	E	F	G
	450	10	15	75	112	150	40
	600	10	15	100	150	200	50
	750	13	20	125	187	250	50
C	900	15	25	150	225	300	60
	1200	20	30	200	300	400	70

COLORS: LEGEND — BLACK
 BACKGROUND — YELLOW (RETROREFLECTIVE)

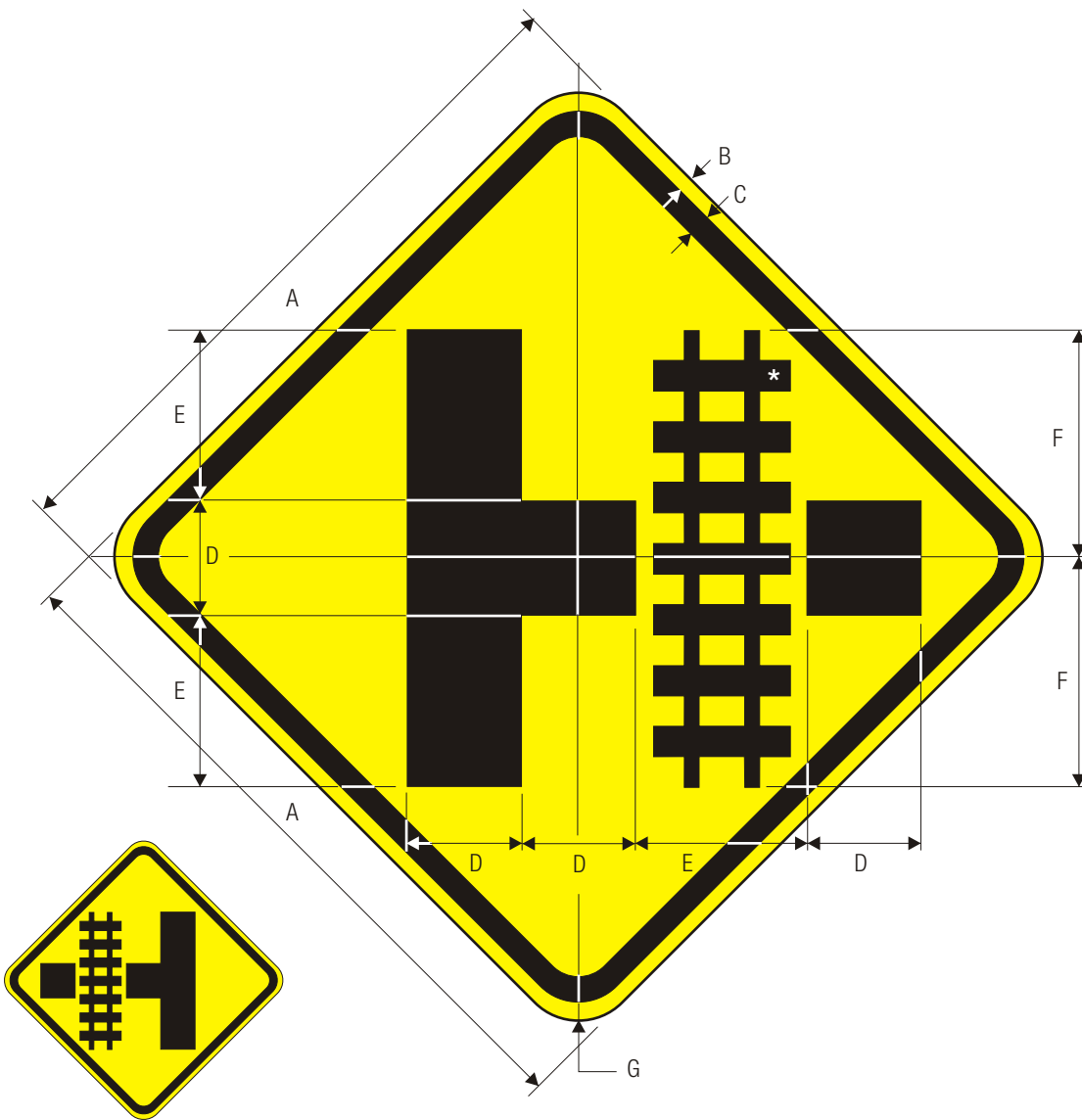

W10-3L

W10-3R

HIGHWAY-RAIL GRADE CROSSING ADVANCE WARNING

*See page 6-24 for symbol design.

	A	B	C	D	E	F	G
	450	10	15	75	112	150	40
	600	10	15	100	150	200	50
	750	13	20	125	187	250	50
C	900	15	25	150	225	300	60
	1200	20	30	200	300	400	70

COLORS: LEGEND — BLACK
BACKGROUND — YELLOW (RETROREFLECTIVE)

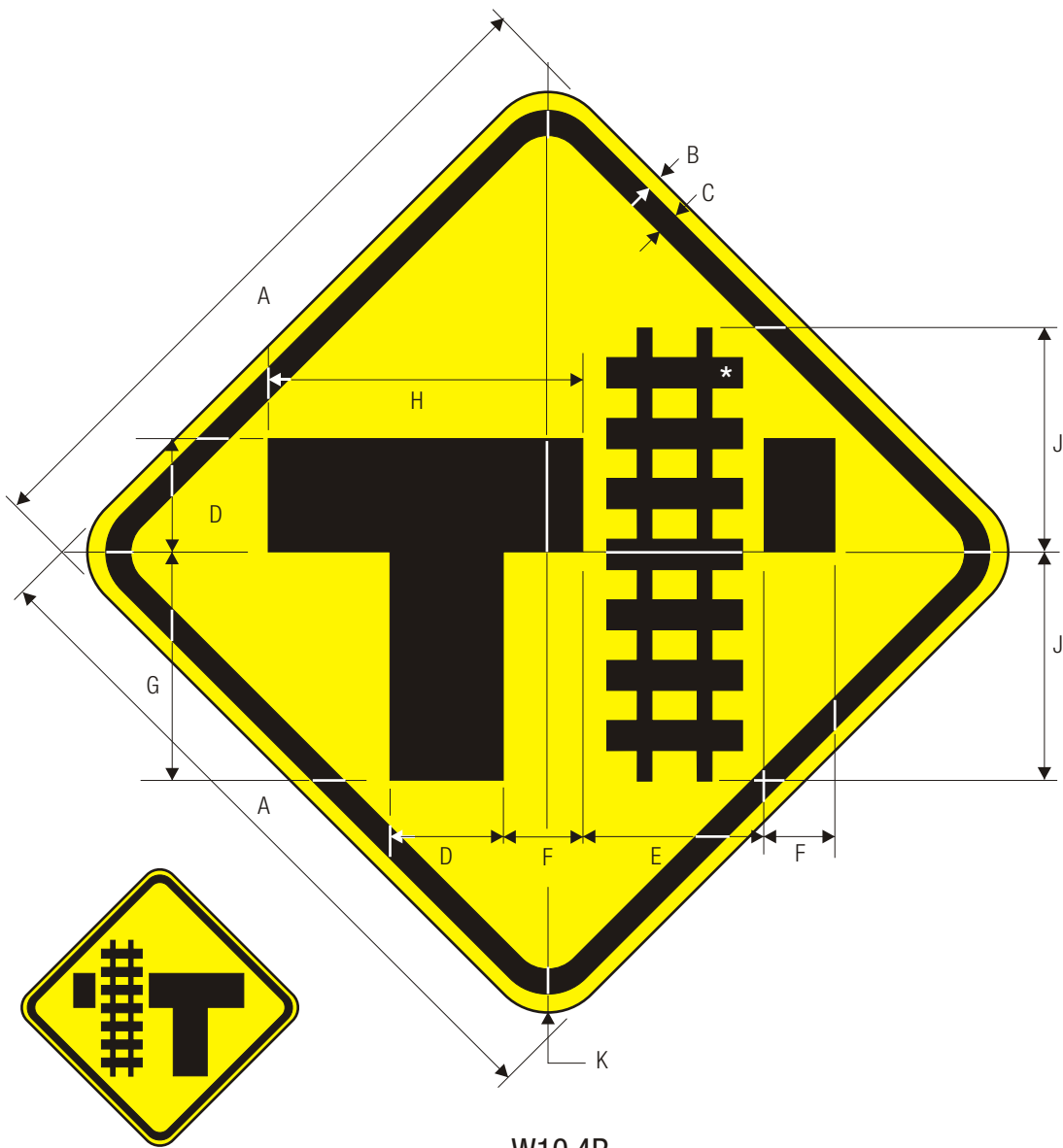

W10-4R

W10-4L

HIGHWAY-RAIL GRADE CROSSING ADVANCE WARNING

*See page 6-24 for symbol design.

	A	B	C	D	E	F	G	H	J	K
	450	10	15	75	112	50	150	212	150	40
	600	10	15	100	150	68	200	286	200	50
	750	13	20	125	187	86	250	360	250	50
C	900	15	25	150	225	100	300	425	300	60
	1200	20	30	200	300	125	400	550	400	70

COLORS: LEGEND — BLACK
 BACKGROUND — YELLOW (RETROREFLECTIVE)

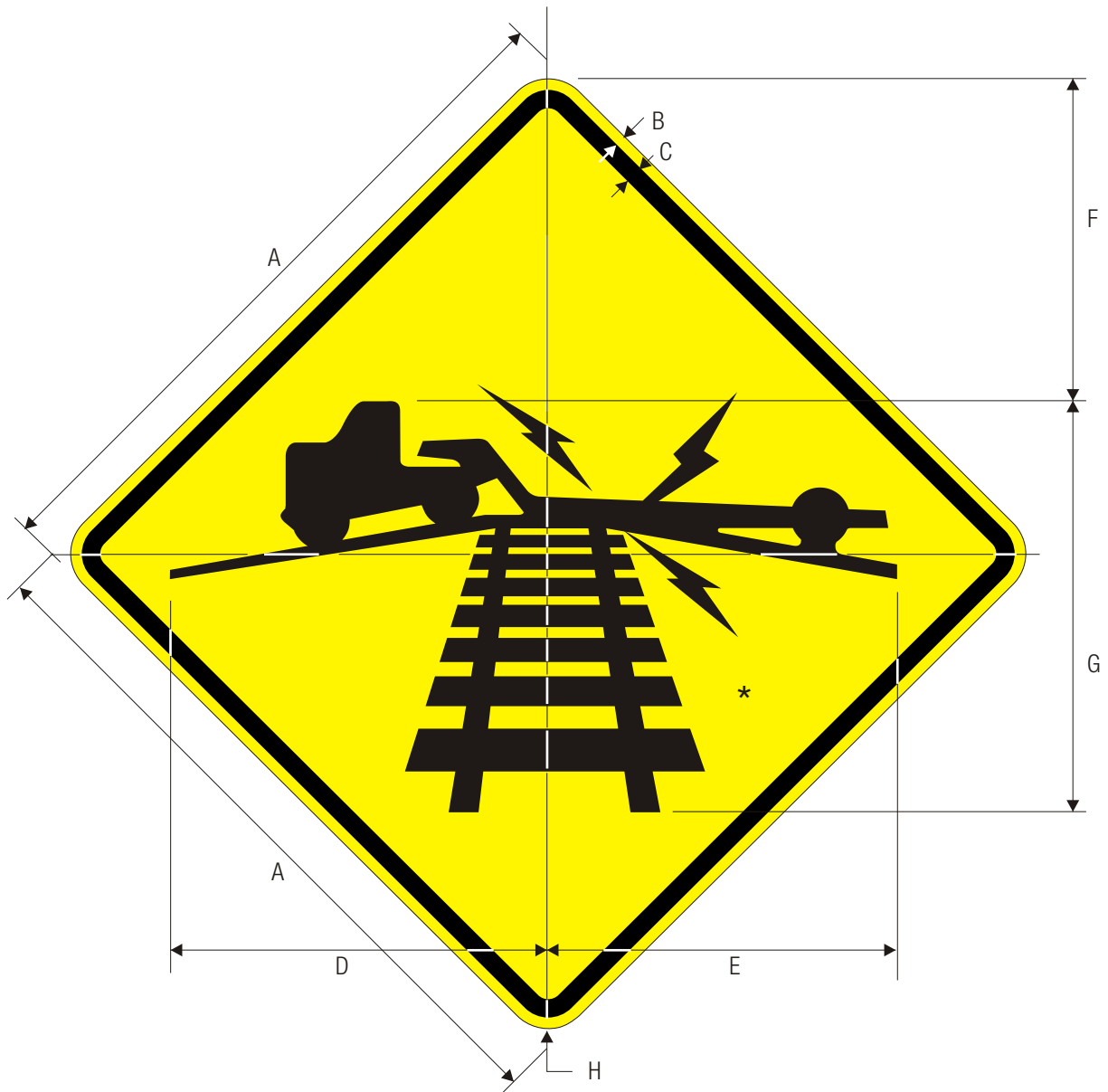

W10-5

LOW GROUND CLEARANCE HIGHWAY-RAIL GRADE CROSSING

*See page 6-15 for symbol design.

A	B	C	D	E	F	G	H
600	10	15	322	311	271	357	50
750	10	20	392	381	335	438	50
900	15	25	482	472	386	540	60
1200	20	30	621	611	515	696	70

COLORS: SYMBOL BLACK
BACKGROUND YELLOW (RETROREFLECTIVE)

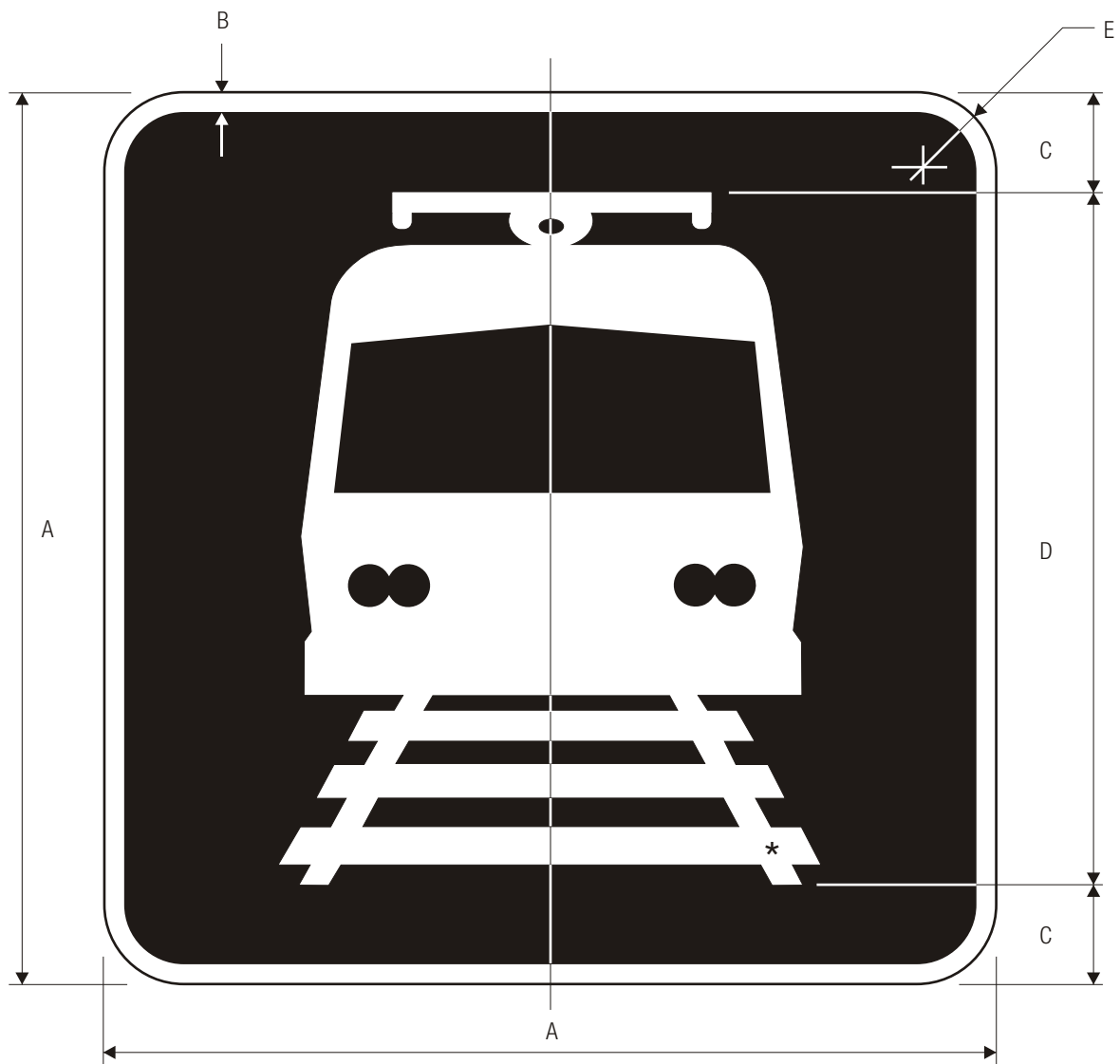

W10-7

LIGHT RAIL ACTIVATED BLANK-OUT SYMBOL

*See page 6-17 for symbol design.

	A	B	C	D	E
C	600	15	62.5	475	50
	750	20	75	600	50
	900	25	87.5	725	60

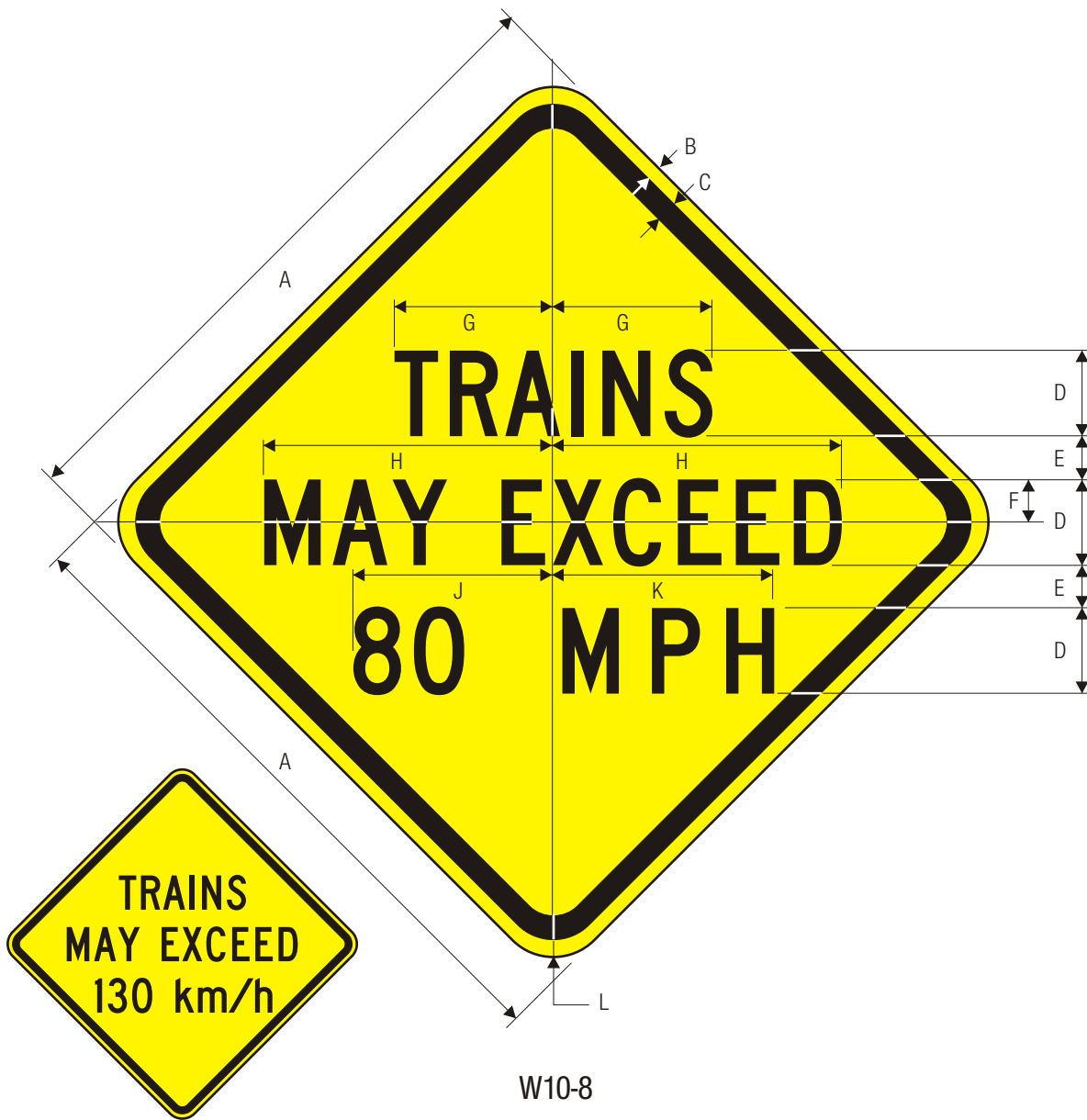

W10-8
TRAINS MAY EXCEED XX MPH

	A	B	C	D	E	F	G	H	J	K	L
	750	13	20	100 C	50	50	185.5	337	VAR	VAR	50
C	900	15	25	125 C	62	62	232	421.5	VAR	VAR	60
	1200	20	30	150 C	75	75	278.5	506	VAR	VAR	70

COLORS: LEGEND — BLACK
BACKGROUND — YELLOW (RETROREFLECTIVE)

FOR USE WITH W10-1

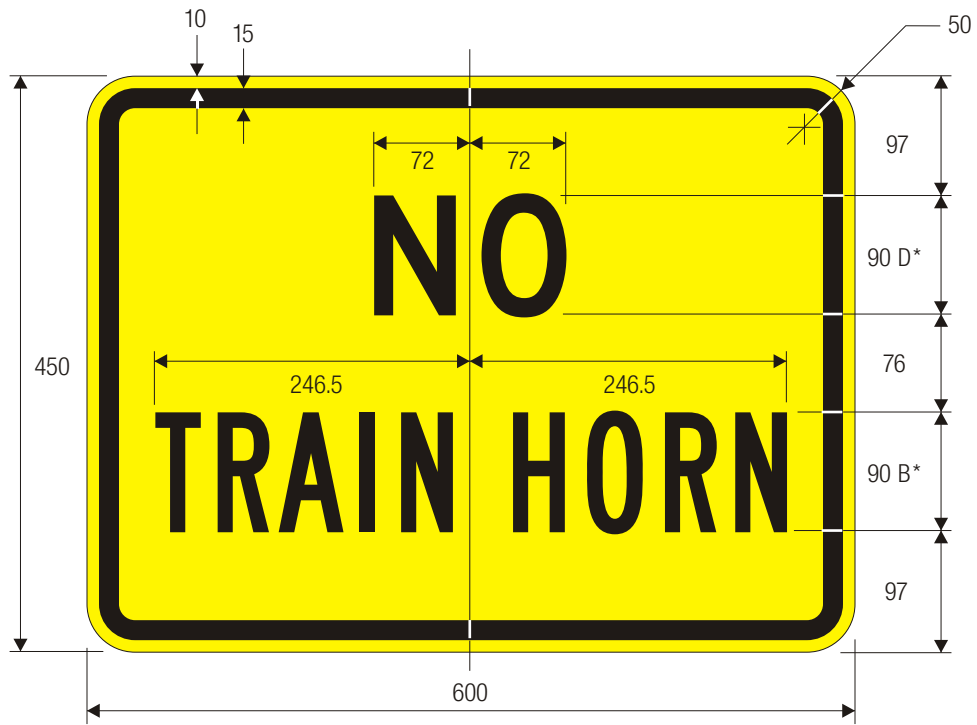

W10-9

*Series 2000 Standard Alphabets.

NO TRAIN HORN

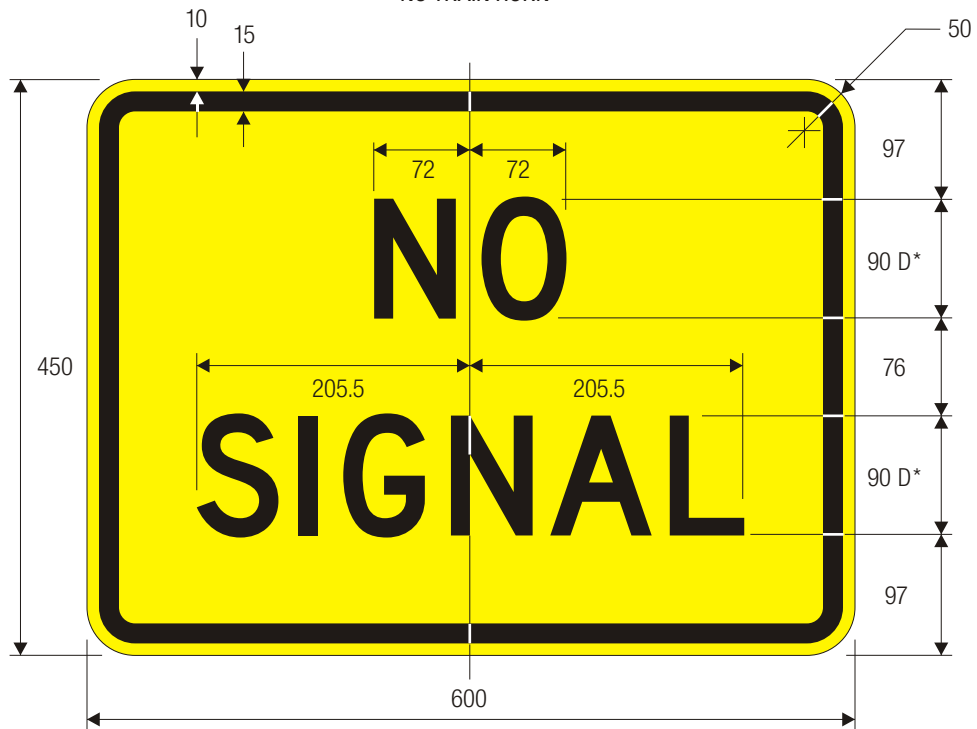

W10-10

NO SIGNAL

COLORS: LEGEND — BLACK
BACKGROUND — YELLOW (RETROREFLECTIVE)

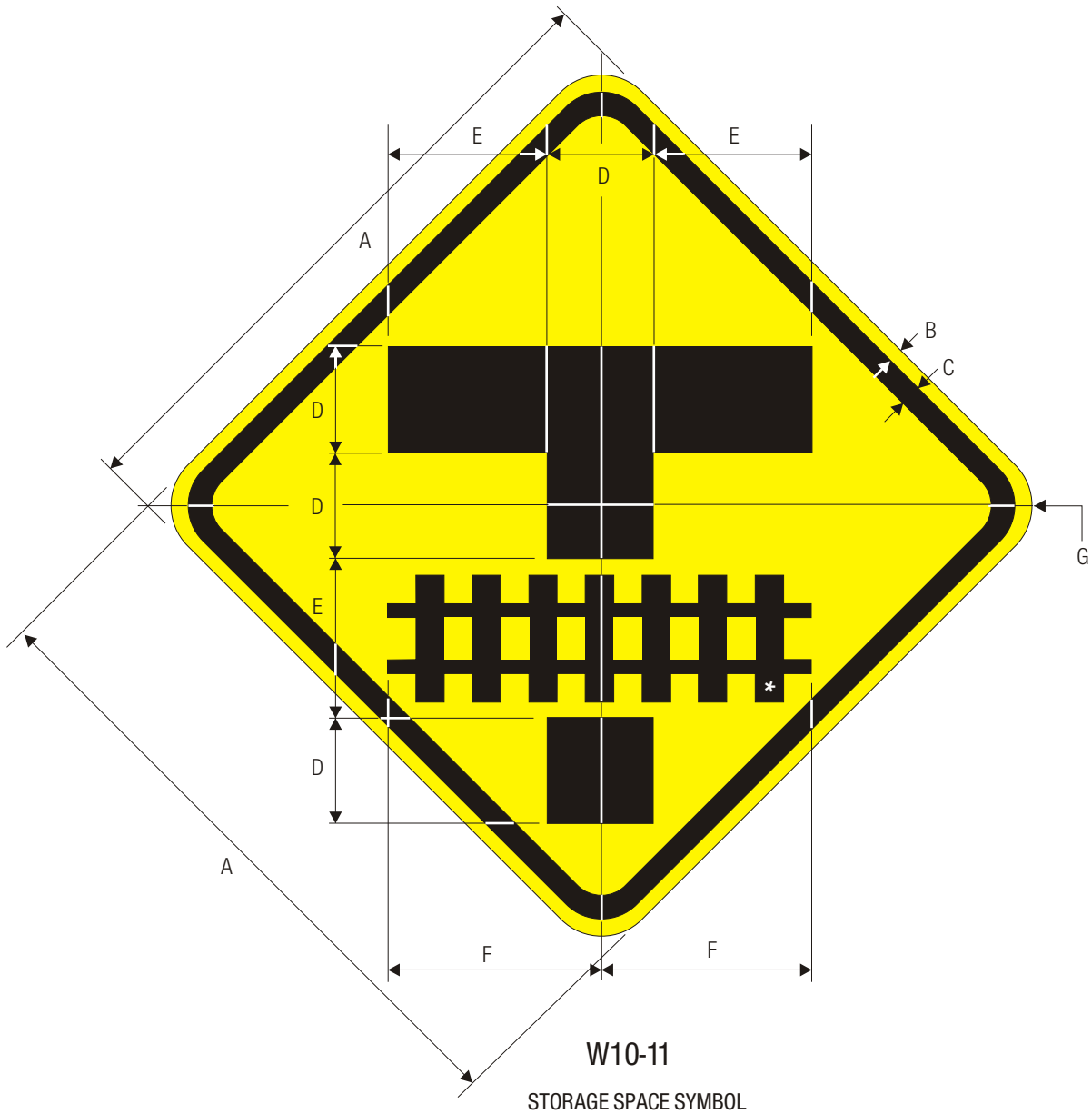

*See page 6-24 for symbol design.

	A	B	C	D	E	F	G
	450	10	15	75	112	150	40
	600	10	15	100	150	200	50
	750	13	20	125	187	250	50
C	900	15	25	150	225	300	60
	1200	20	30	200	300	400	70

COLORS: LEGEND — BLACK
BACKGROUND — YELLOW (RETROREFLECTIVE)



W10-11a

STORAGE SPACE XX FEET (ENGLISH)

COLORS: LEGEND — BLACK
 BACKGROUND — YELLOW (RETROREFLECTIVE)

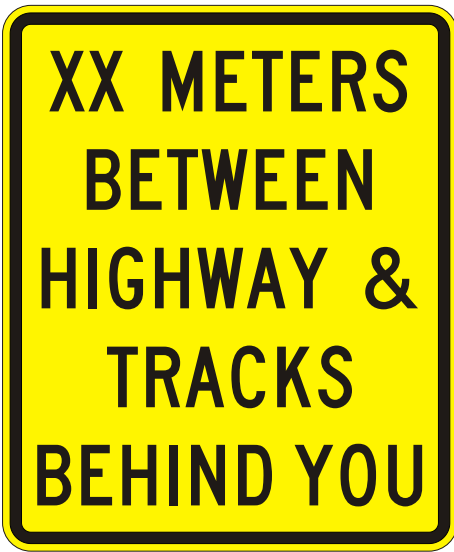

W10-11b

STORAGE SPACE XX FEET (ENGLISH)

COLORS: LEGEND — BLACK
 BACKGROUND — YELLOW (RETROREFLECTIVE)

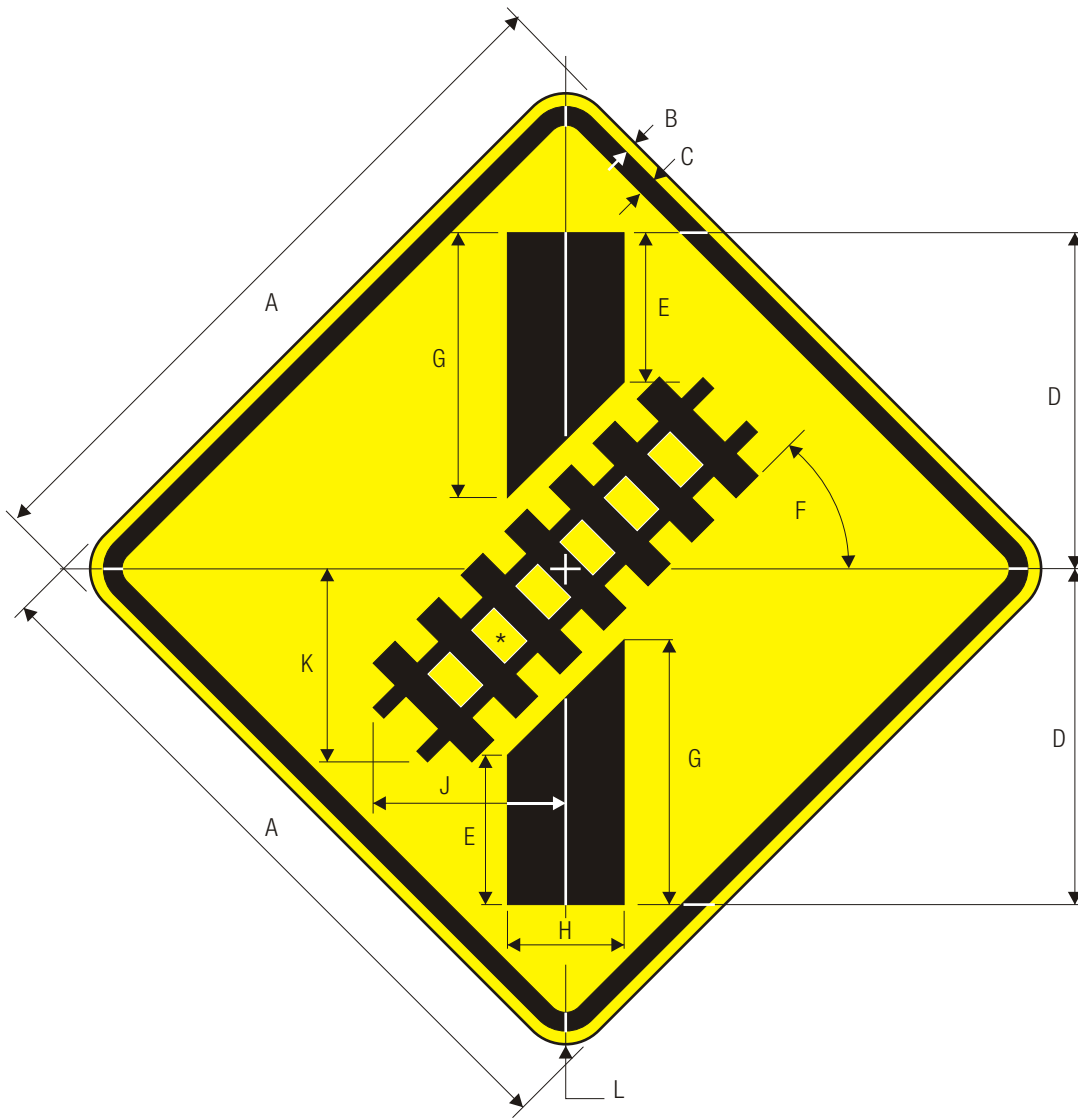

W10-12

SKEWED CROSSING

*See page 6-24 for symbol design.

A	B	C	D	E	F	G	H	J	K	L
450	10	15	216	95	45°	170	75	123	124	40
600	10	15	288	127	45°	227	100	164	166	50
750	13	20	360	159	45°	284	125	205	207	50
900	15	25	432	191	45°	341	150	246	248	60
1200	20	30	576	254	45°	454	200	328	331	70

C

COLORS: LEGEND — BLACK
 BACKGROUND — YELLOW (RETROREFLECTIVE)

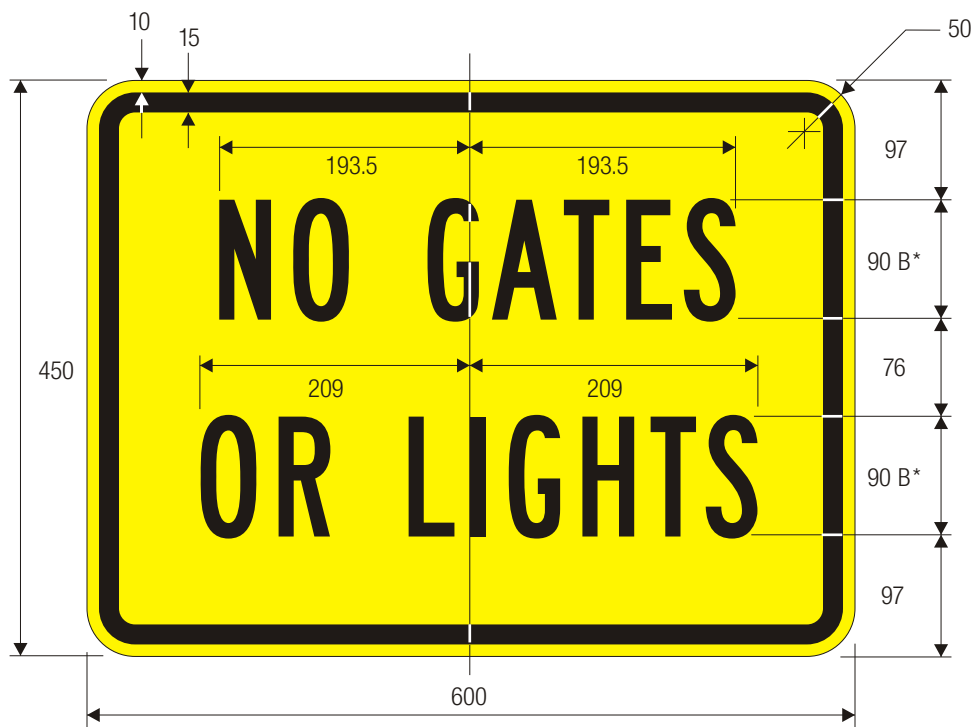

For use with W10-1

W10-13

*Series 2000 Standard Alphabets.

NO GATES OR LIGHTS

COLORS: LEGEND — BLACK
 BACKGROUND — YELLOW (RETROREFLECTIVE)

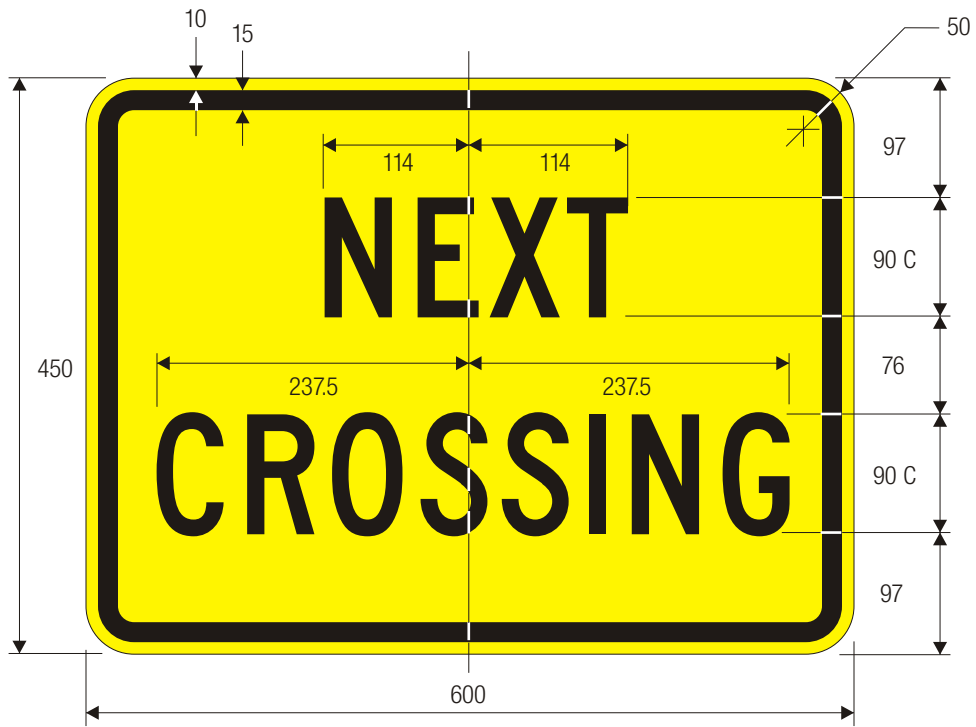

W10-14

NEXT CROSSING

For use with W10-5

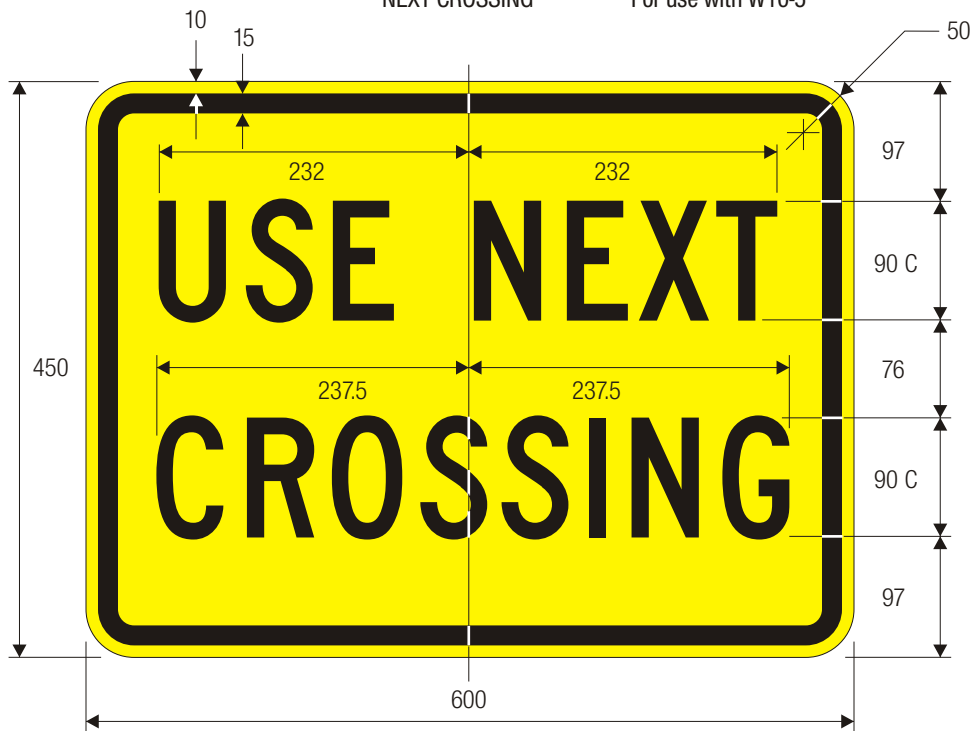

W10-14a

USE NEXT CROSSING

COLORS: LEGEND — BLACK
 BACKGROUND — YELLOW (RETROREFLECTIVE)

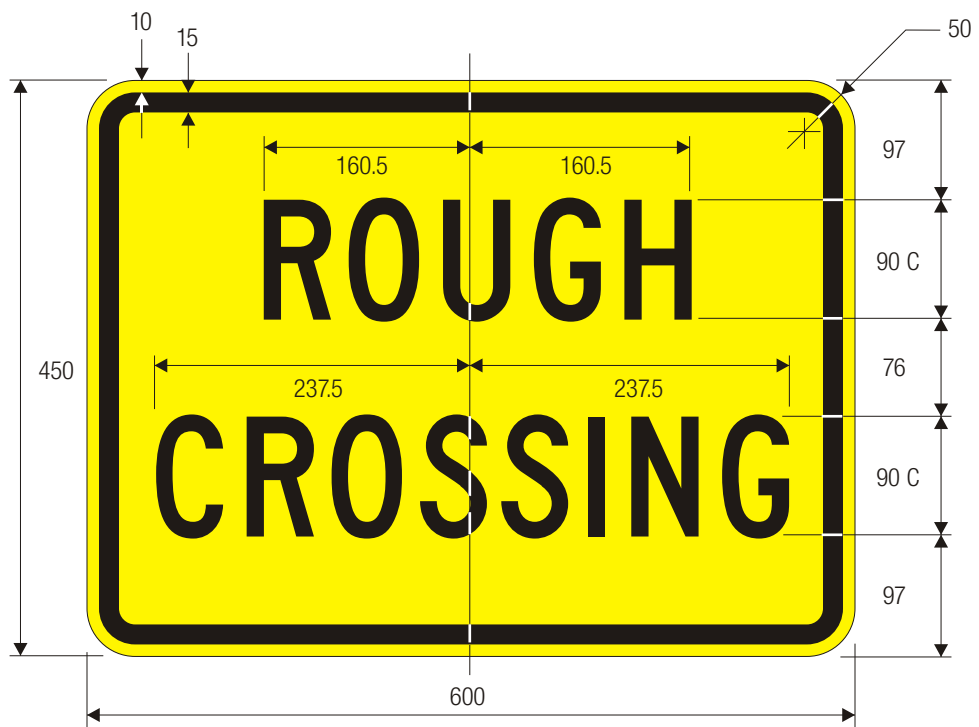

W10-15p

ROUGH CROSSING

COLORS: LEGEND — BLACK
 BACKGROUND — YELLOW (RETROREFLECTIVE)



W11-1
BICYCLE TRAFFIC

*See page 6-7 for symbol design.

	A	B	C	D	E	F
	450	10	15	125	15	40
C	600	10	15	170	20	50
	750	13	20	212	25	50
	900	15	25	250	30	60
	1200	20	30	340	40	70

COLORS: SYMBOL — BLACK
BACKGROUND — YELLOW (RETROREFLECTIVE)

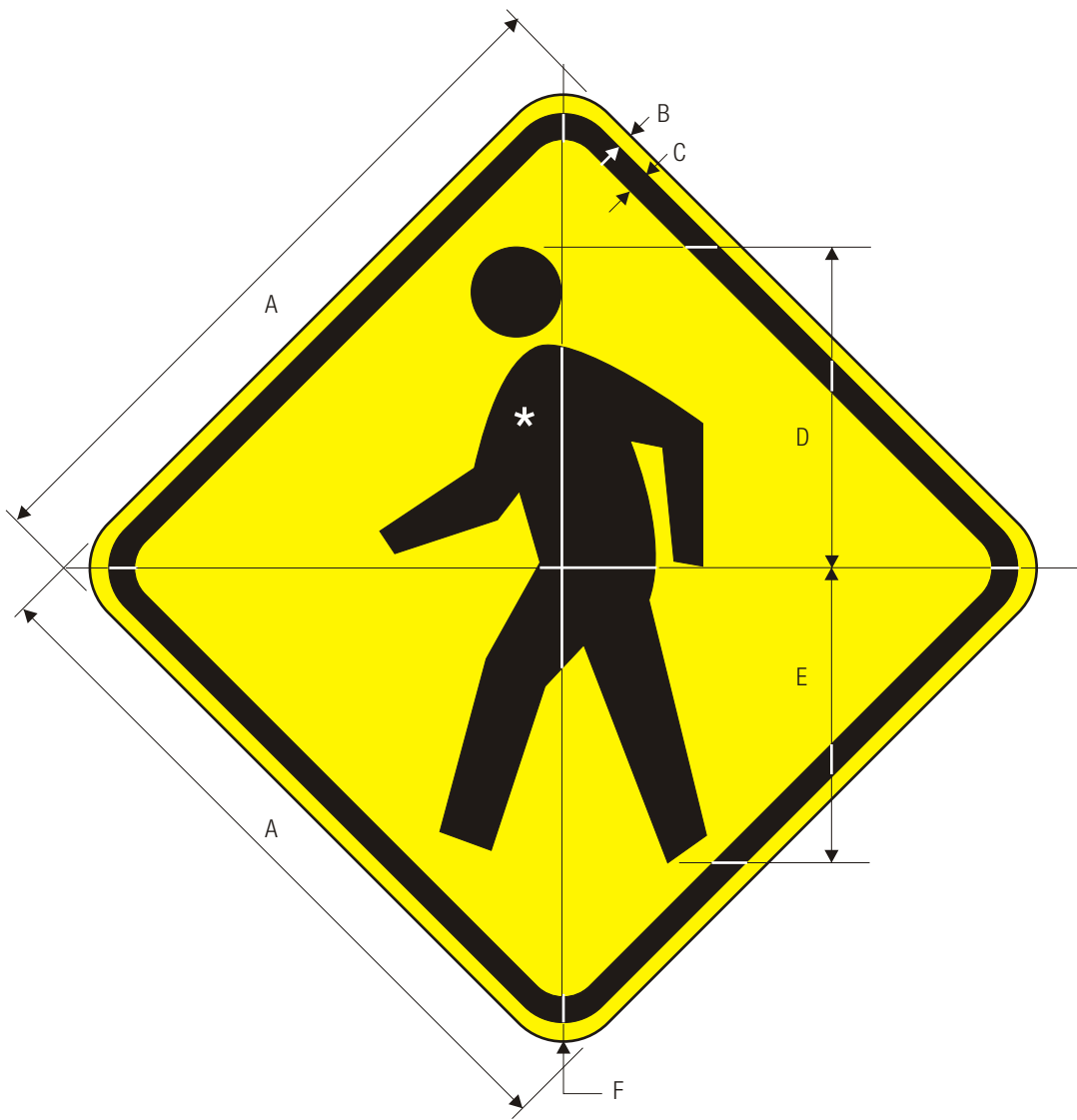

W11-2
PEDESTRIAN TRAFFIC

*See page 6-10 for symbol design.

	A	B	C	D	E	F
	450	10	15	200	186	40
	600	10	15	275	255	50
C	750	13	20	337	313	50
	900	15	25	400	372	60
	1200	20	30	550	511	70

COLORS: SYMBOL — BLACK
BACKGROUND — YELLOW (RETROREFLECTIVE)

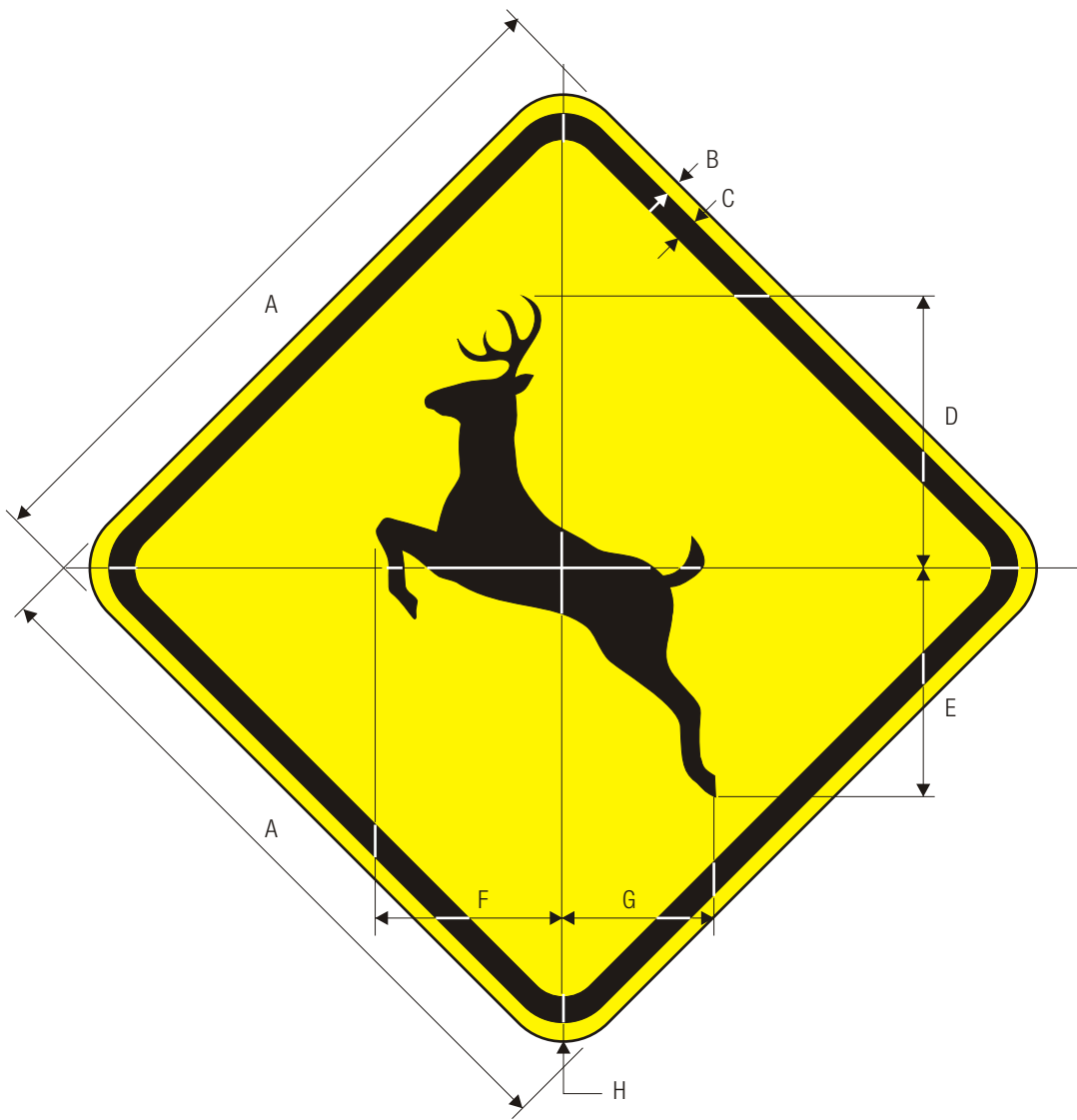

W11-3
DEER TRAFFIC

*See page 6-25 for symbol design.

	A	B	C	D	E	F	G	H
C	600	10	15	236	195	162	132	50
	750	13	20	302	250	206	169	50
	900	15	25	362	300	250	198	60
	1200	20	30	470	390	325	259	70

COLORS: SYMBOL — BLACK
BACKGROUND — YELLOW (RETROREFLECTIVE)

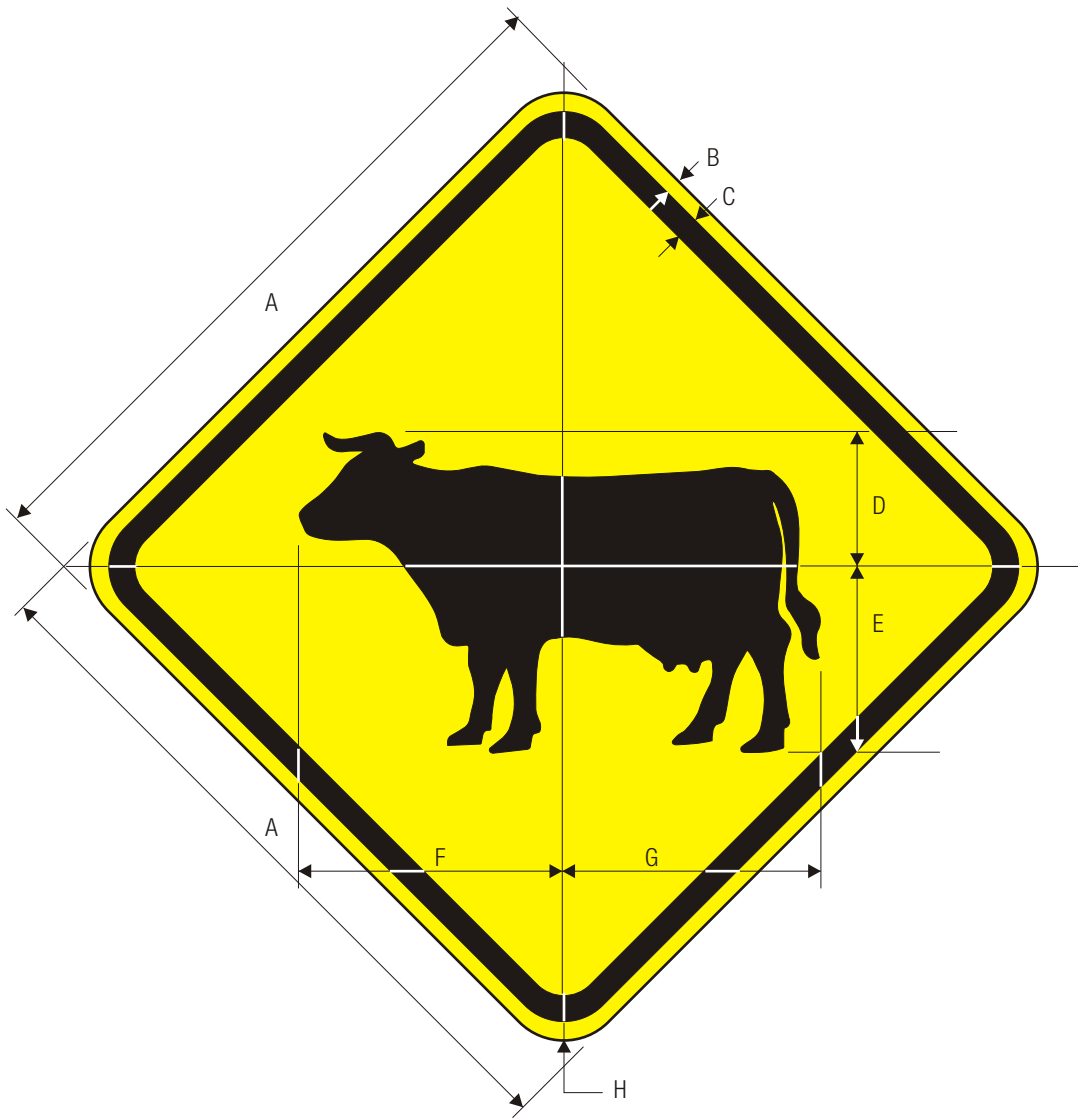

W11-4
CATTLE TRAFFIC

*See page 6-26 for symbol design.

	A	B	C	D	E	F	G	H
	600	10	15	119	158	231	221	50
C	750	13	20	150	200	291	278	50
	900	15	25	181	242	351	336	60
	1200	20	30	237	317	460	440	70

COLORS: SYMBOL — BLACK
BACKGROUND — YELLOW (RETROREFLECTIVE)

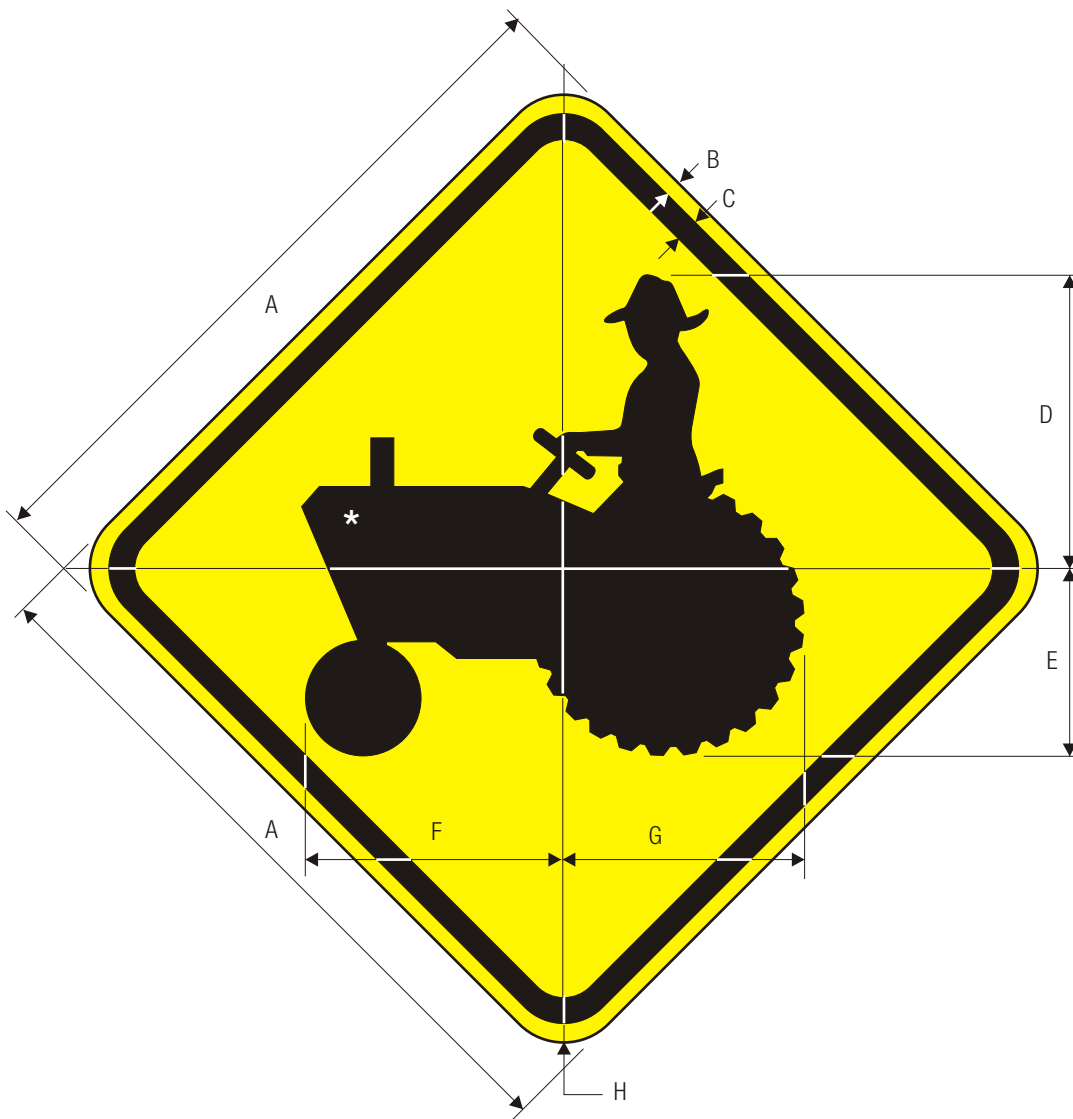

W11-5

FARM MACHINERY TRAFFIC

*See page 6-27 for symbol design.

	A	B	C	D	E	F	G	H
C	600	10	15	260	163	225	211	50
	750	13	20	325	202	282	263	50
	900	15	25	389	242	339	316	60
	1200	20	30	510	317	445	413	70

COLORS: SYMBOL — BLACK
 BACKGROUND — YELLOW (RETROREFLECTIVE)

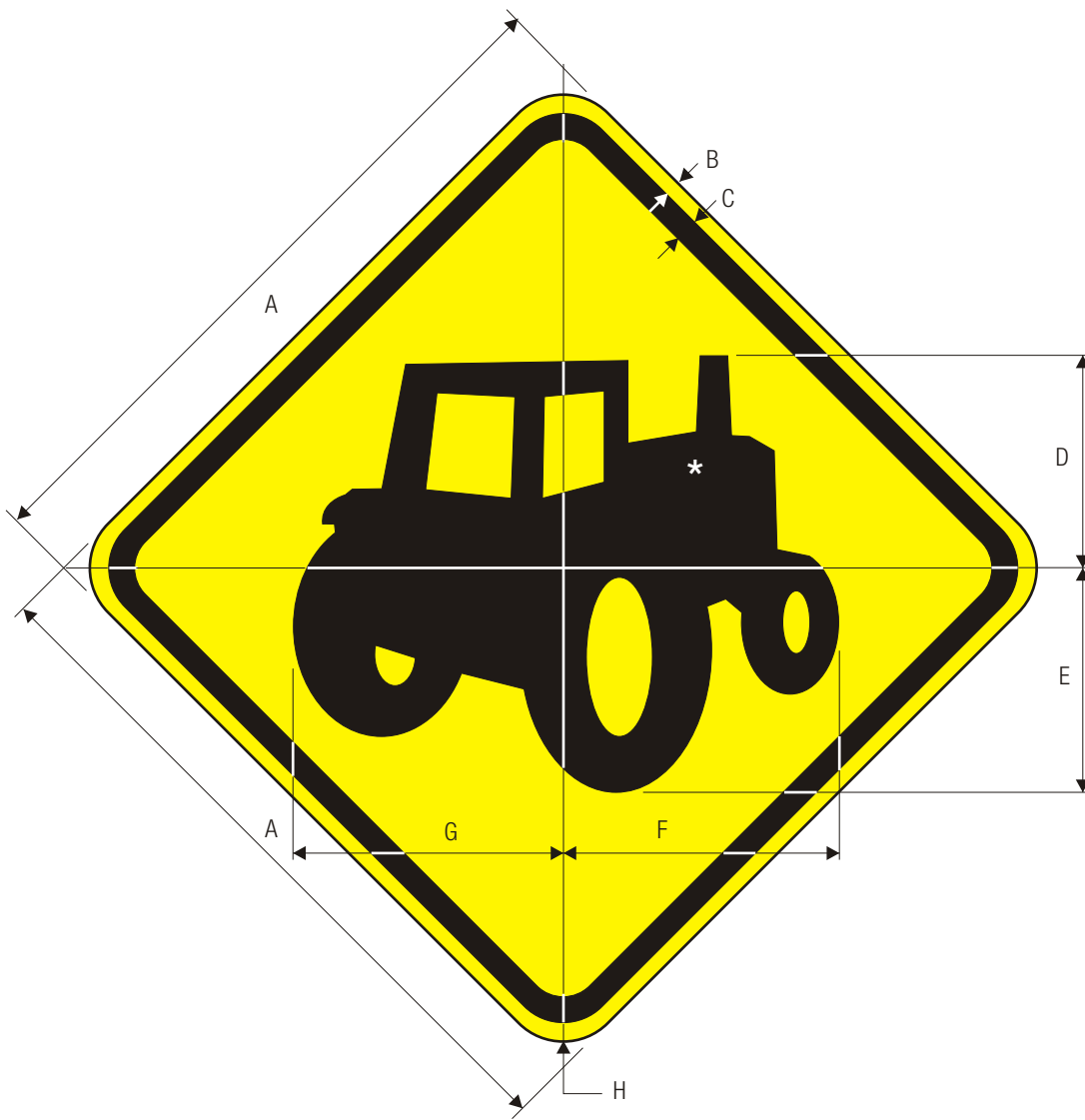

W11-5a

FARM MACHINERY TRAFFIC

*See page 6-28 for symbol design.

	A	B	C	D	E	F	G	H
	600	10	15	184	191	236	232	50
C	750	13	20	230	239	295	290	50
	900	15	25	276	287	354	348	60
	1200	20	30	368	383	472	464	70

COLORS: SYMBOL — BLACK
 BACKGROUND — YELLOW (RETROREFLECTIVE)

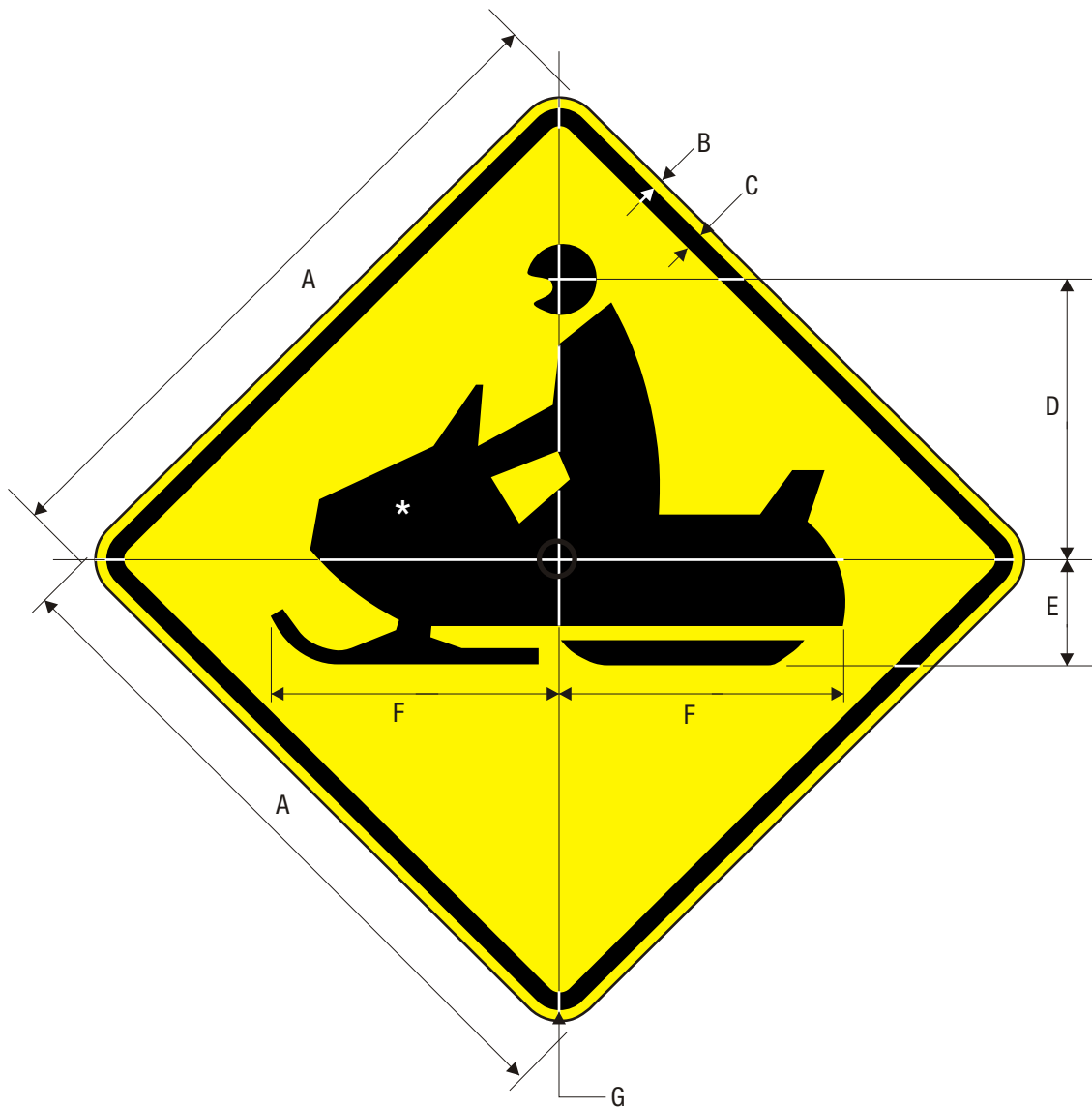

W11-6

SNOWMOBILE TRAFFIC

*See page 6-29 for symbol design.

	A	B	C	D	E	F	G
	600	10	15	182	119	225	50
C	750	13	20	228	149	281	50
	900	15	25	274	179	337	60

COLORS: SYMBOL — BLACK
BACKGROUND — YELLOW (RETROREFLECTIVE)

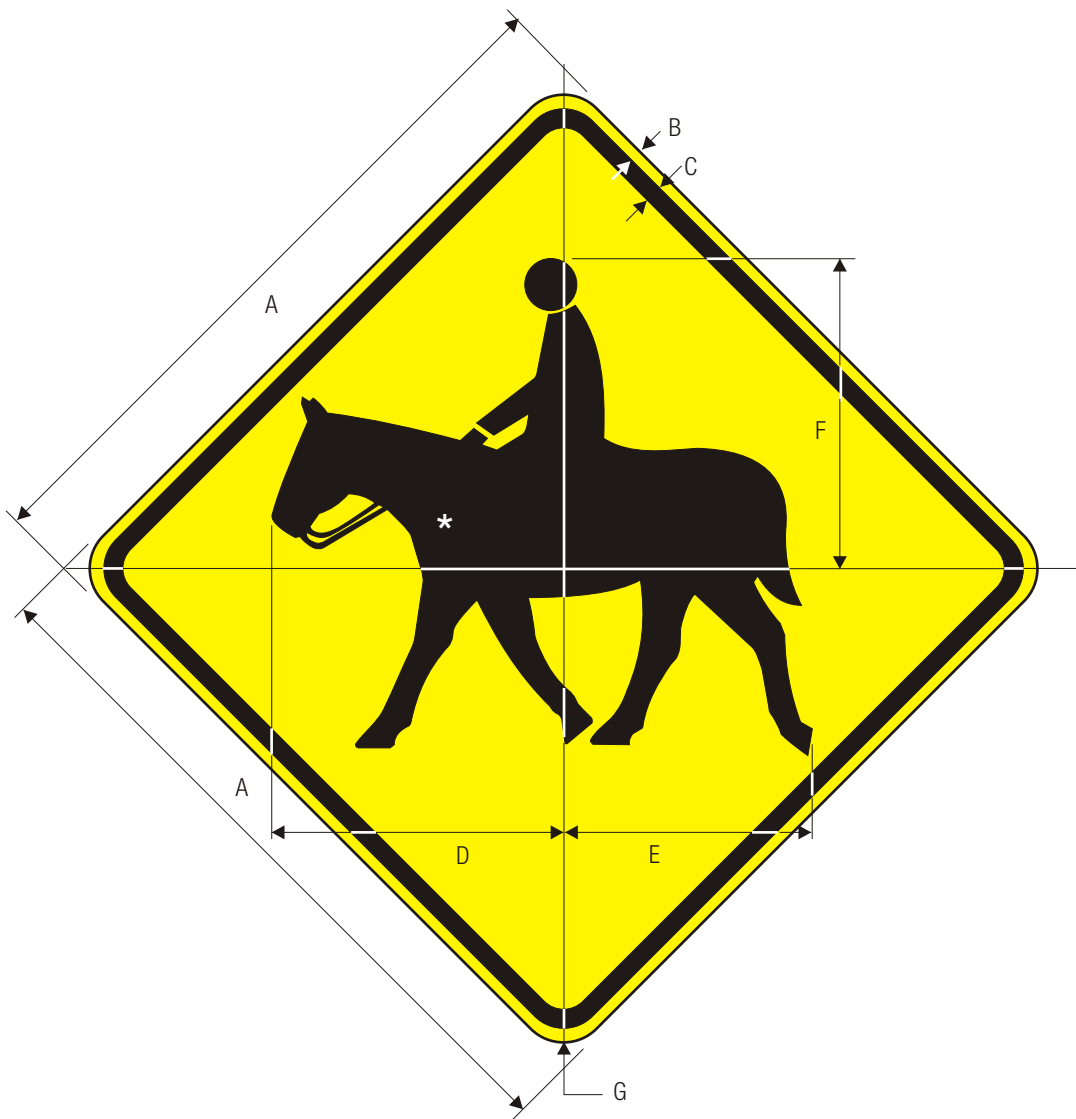

W11-7

EQUESTRIAN TRAFFIC

*See page 6-30 for symbol design.

	A	B	C	D	E	F	G
	600	10	15	250	215	267	50
C	750	13	20	313	269	334	50
	900	15	25	376	323	401	60
	1200	20	30	501	431	535	70

COLORS: SYMBOL — BLACK
 BACKGROUND — YELLOW (RETROREFLECTIVE)

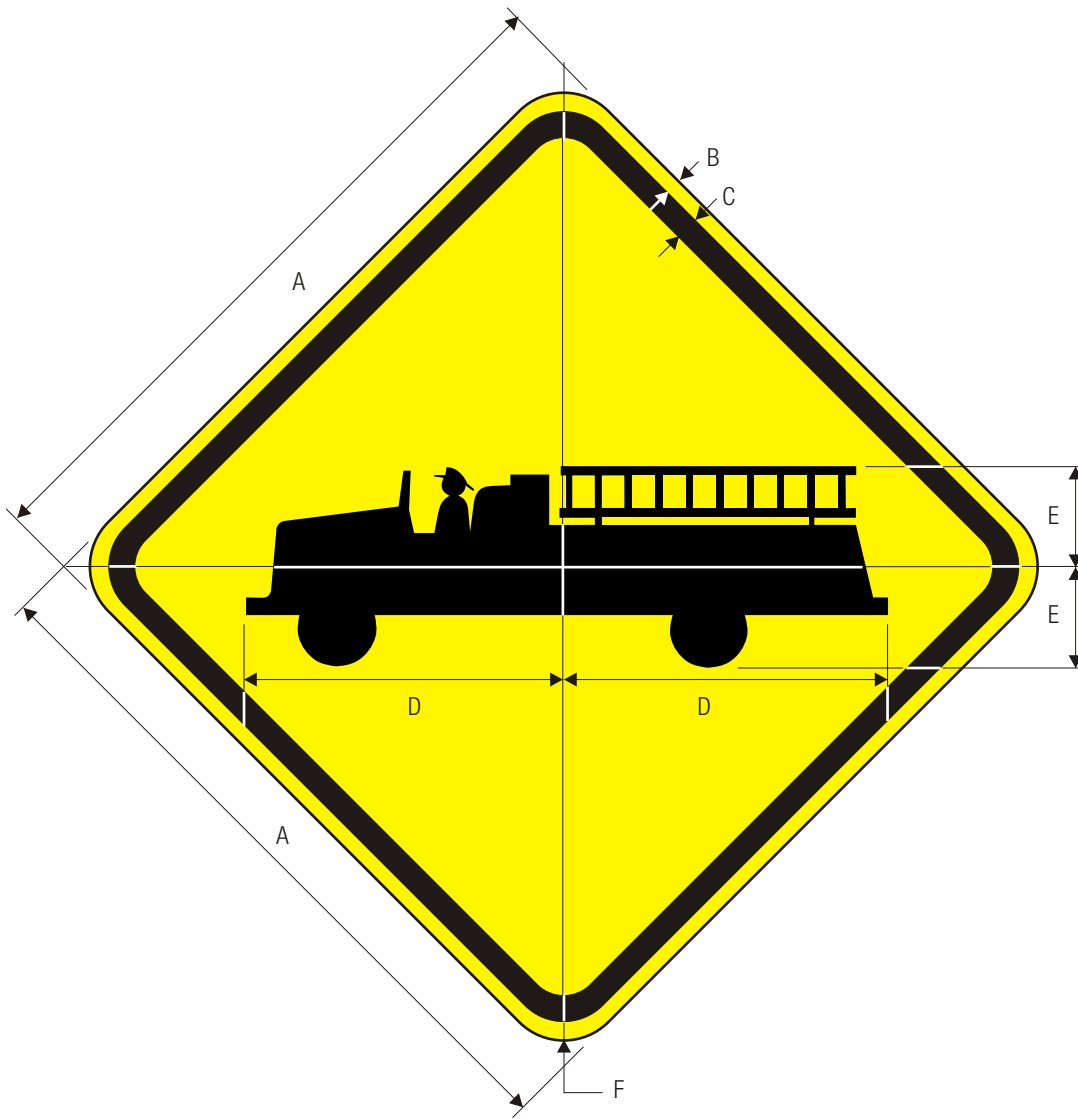

W11-8

EMERGENCY VEHICLE

*See page 6-16 for symbol design.

	A	B	C	D	E	F
	600	10	15	225	87	50
C	750	13	20	344	108	50
	900	15	25	413	130	60
	1200	20	30	550	173	70

COLORS: SYMBOL — BLACK
 BACKGROUND — YELLOW (RETROREFLECTIVE)

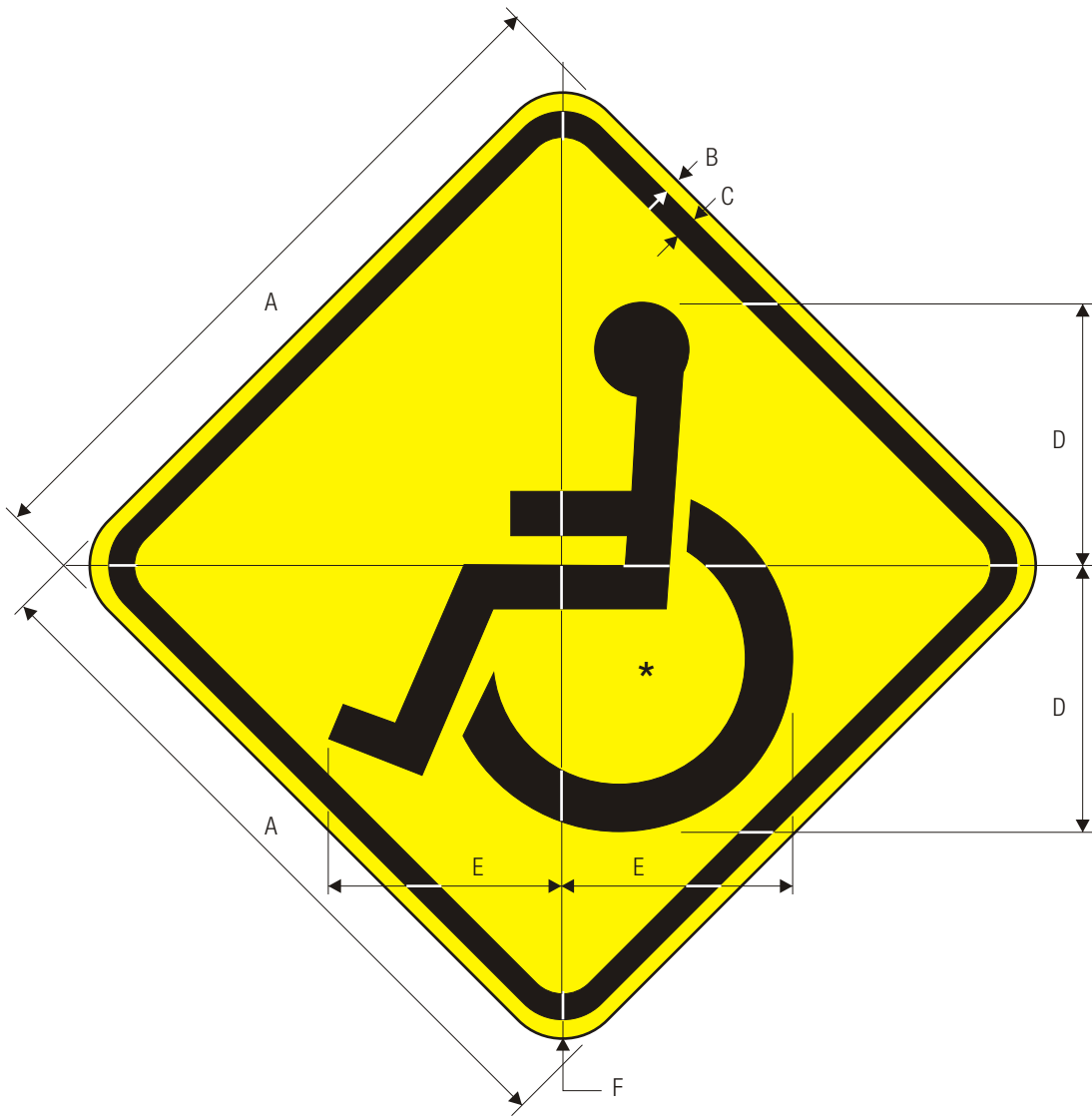

W11-9
HANDICAPPED

*See page 6-31 for symbol design.

	A	B	C	D	E	F
	600	10	15	228	200	50
C	750	13	20	286	250	50
	900	15	25	343	300	60
	1200	20	30	456	400	70

COLORS: SYMBOL — BLACK
BACKGROUND — YELLOW (RETROREFLECTIVE)

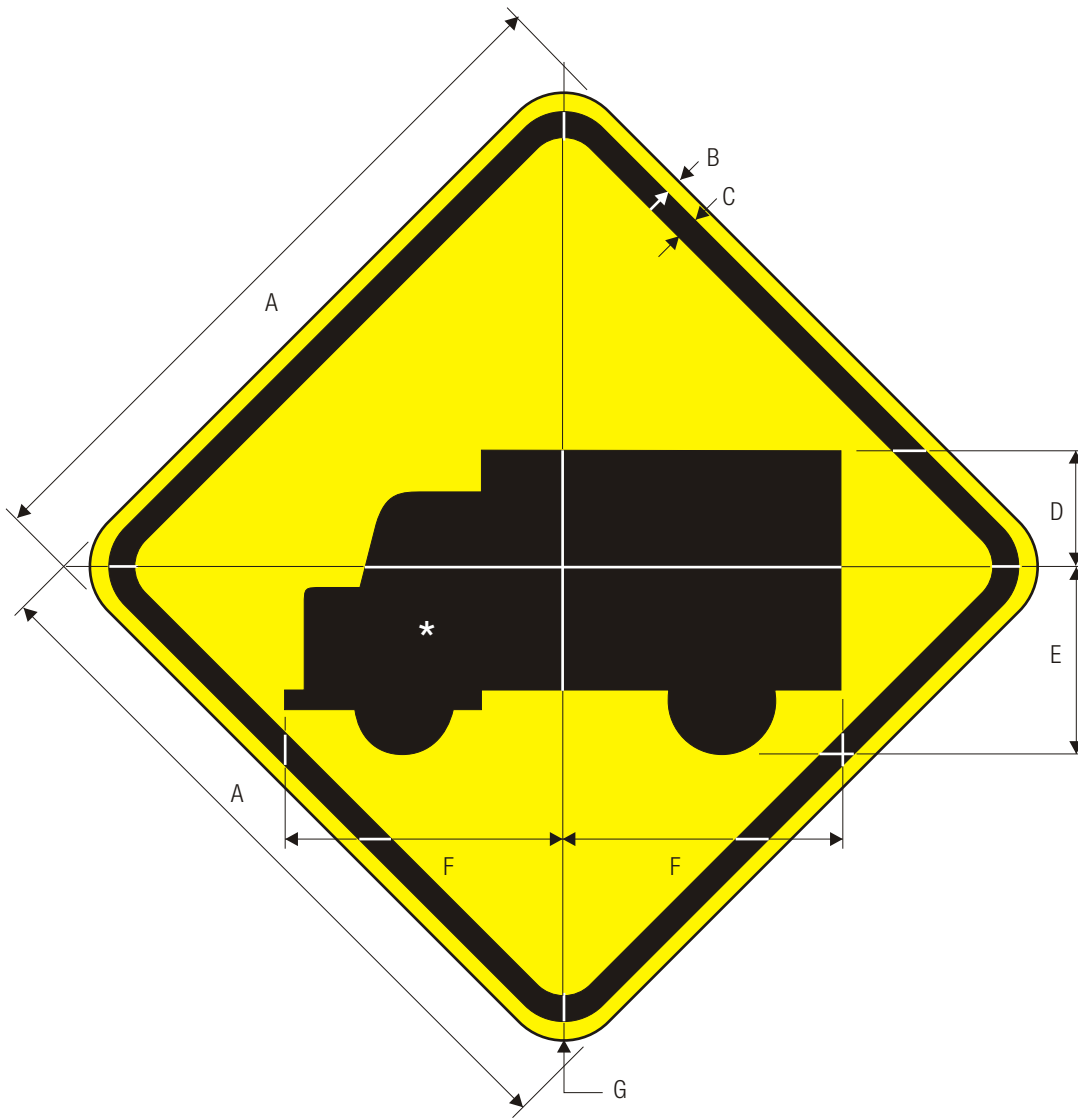

W11-10

TRUCK CROSSING

*See page 6-4 for symbol design.

	A	B	C	D	E	F	G
	600	10	15	102	160	240	50
C	750	13	20	128	200	300	50
	900	15	25	154	240	360	60
	1200	20	30	204	320	480	70

WARNING SIGN COLORS:
 SYMBOL — BLACK
 BACKGROUND— YELLOW (RETROREFLECTIVE)

TTC SIGN COLORS:
 SYMBOL — BLACK
 BACKGROUND— ORANGE (RETROREFLECTIVE)

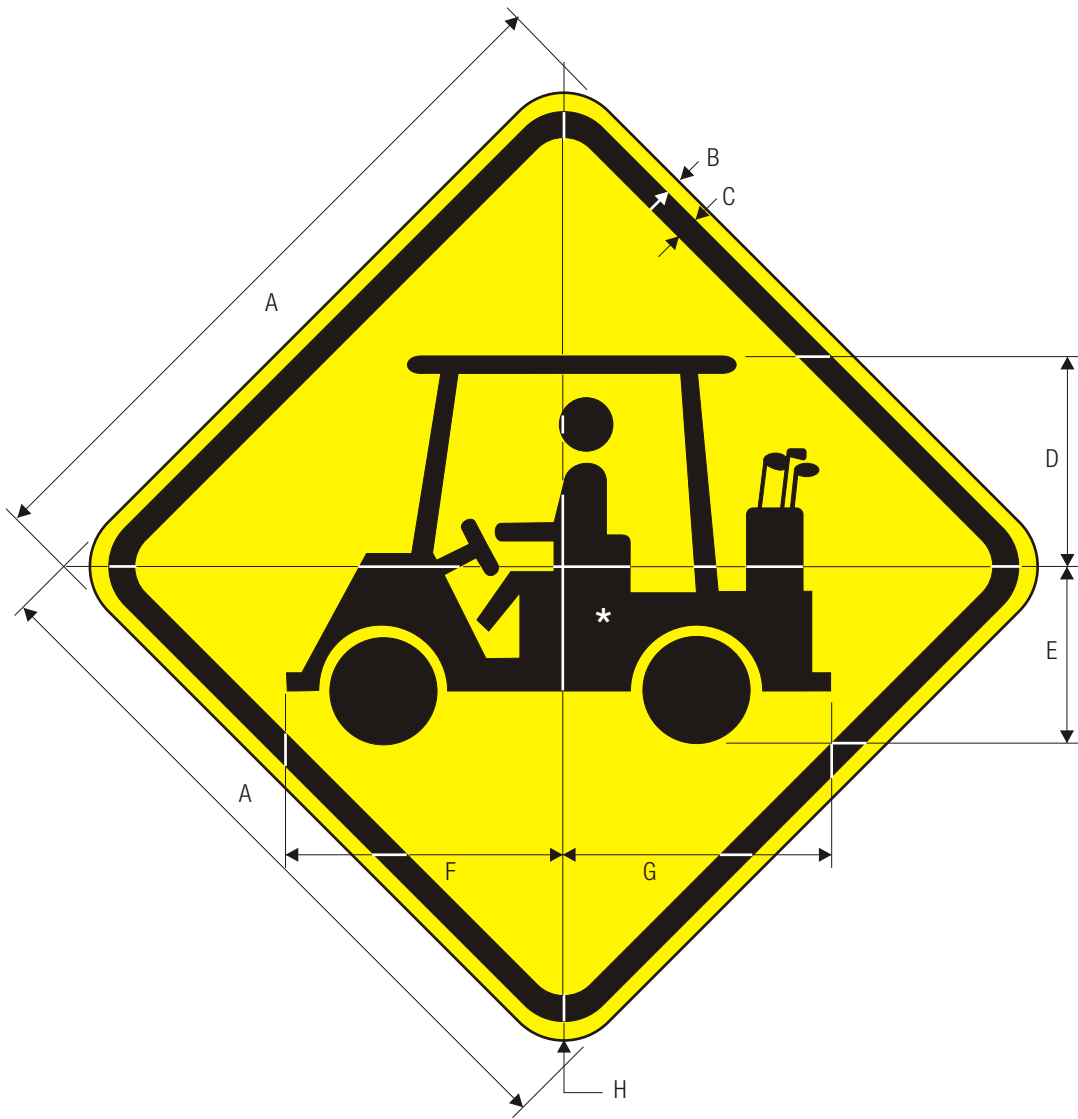

W11-11

*See page 6-32 for symbol design.

	A	B	C	D	E	F	G	H
	600	10	15	182	152	237	228	50
C	750	13	20	228	190	297	286	50
	900	15	25	273	228	356	343	60
	1200	20	30	364	303	473	456	70

COLORS: SYMBOL — BLACK
 BACKGROUND — YELLOW (RETROREFLECTIVE)



W11-12p

EMERGENCY SIGNAL AHEAD

For use with W11-8 Emergency Vehicle Design.

*Series 2000 Standard Alphabets.

C

A	B	C	D	E	F	G	H	J	K	L	M
600	450	10	15	72	75 C	40	73	241.5	142.5	130.5	40
750	600	13	20	100	100 C	50	100	322	190	174.5	50
900	750	15	25	135	110 C	75	135	354.5	209	191.5	60

COLORS: LEGEND — BLACK
 BACKGROUND— YELLOW (RETROREFLECTIVE)

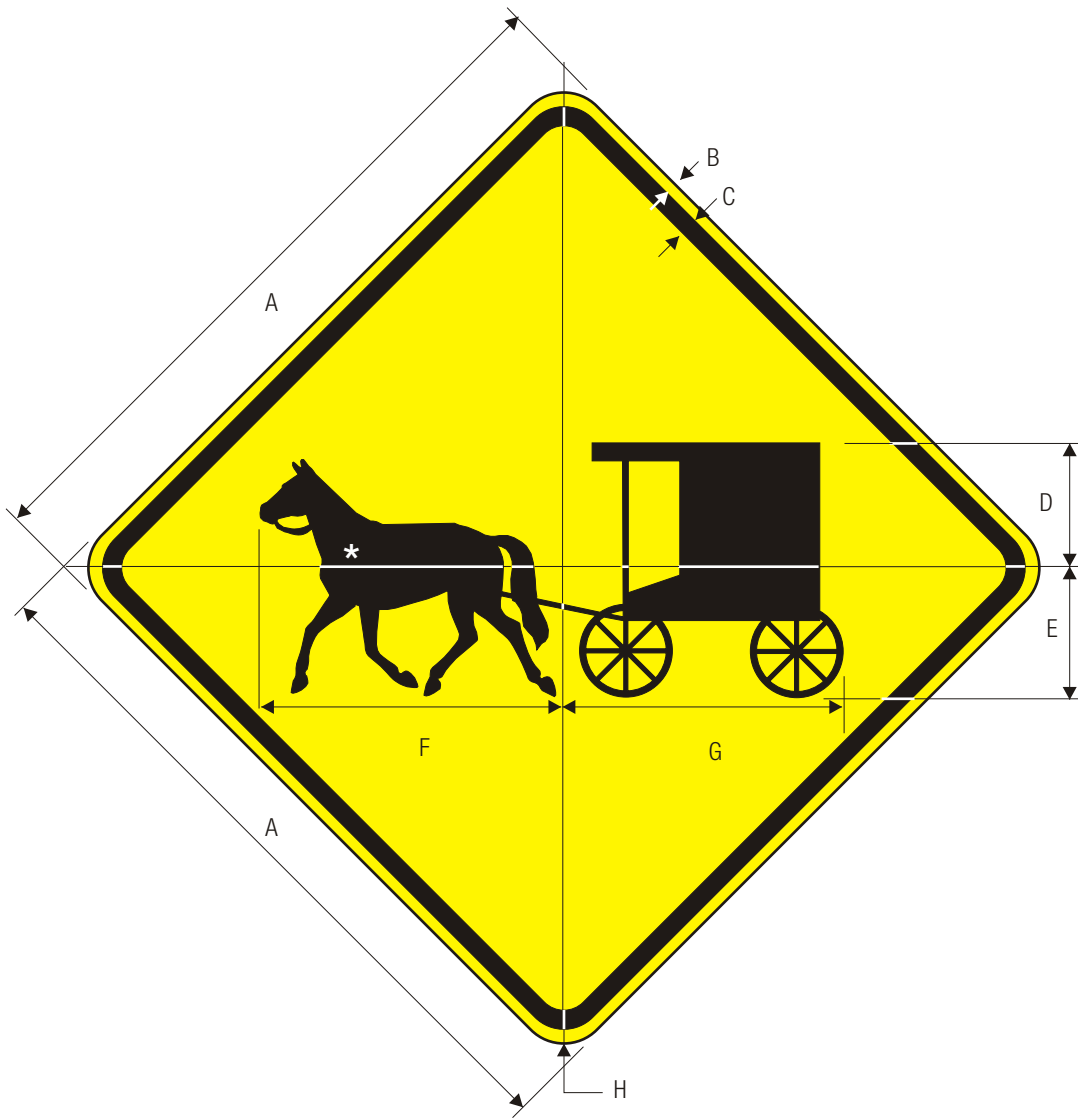

W11-14

HORSE AND BUGGY TRAFFIC

*See page 6-37 for symbol design.

	A	B	C	D	E	F	G	H
C	600	10	15	108	111	260	239	50
	750	13	20	135	139	325	299	50
	900	15	25	162	167	390	359	60
	1200	20	30	216	223	520	479	70

COLORS: LEGEND — BLACK
 BACKGROUND — YELLOW (RETROREFLECTIVE)

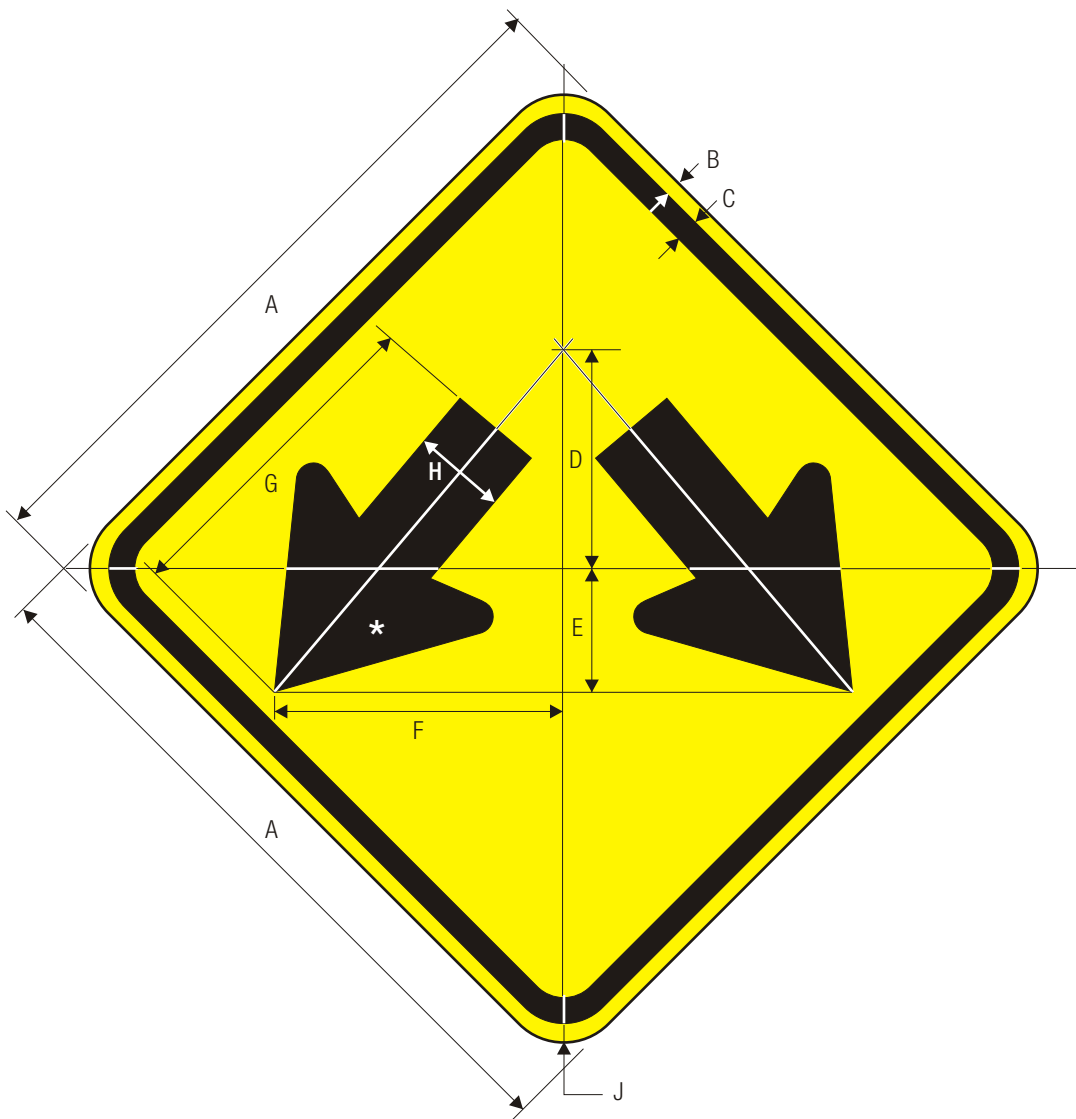

W12-1

DOUBLE ARROW

*See page 6-2 for symbol design.

	A	B	C	D	E	F	G	H	J
	600	10	15	203	105	248	295	80	50
C	750	13	20	254	131	310	369	100	50
	900	15	25	305	157	372	443	120	60
	1200	20	30	406	210	496	590	160	70

WARNING SIGN COLORS:

SYMBOL — BLACK
 BACKGROUND — YELLOW (RETROREFLECTIVE)

TTC SIGN COLORS:

SYMBOL — BLACK
 BACKGROUND — ORANGE (RETROREFLECTIVE)



LOW CLEARANCE (METRIC)

*See page 6-3 for symbol design.
**Optically space numerals about center line.

A	B	C	D	E	F	G	H	J	K	L	M	N
450	10	15	162	75	90	16.5	34.5	39.5	11.5	150 C	75	40
750	13	20	189	125	150	28	57	67	19	250 C	125	50
900	15	25	324	150	180	33	69	79	23	300 C	150	60
1200	20	30	432	200	240	44	91	108	30	400 C	200	70

C

WARNING SIGN COLORS:

SYMBOL & LEGEND—BLACK
BACKGROUND —YELLOW (RETROREFLECTIVE)

TTC SIGN COLORS:

SYMBOL & LEGEND—BLACK
BACKGROUND —ORANGE (RETROREFLECTIVE)

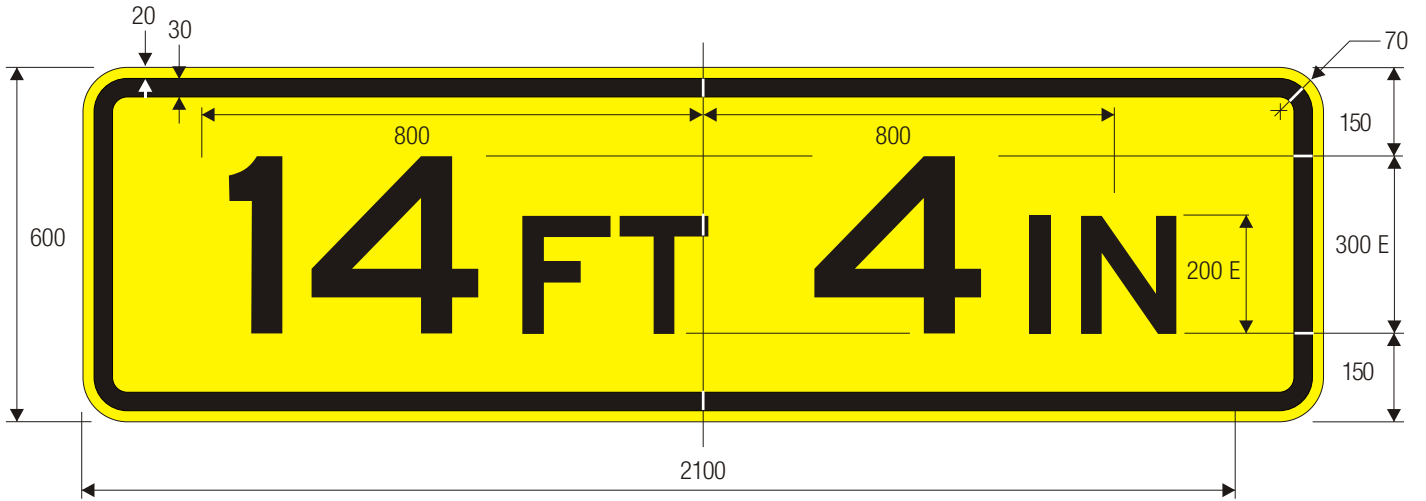

W12-2p

LOW CLEARANCE (ENGLISH)

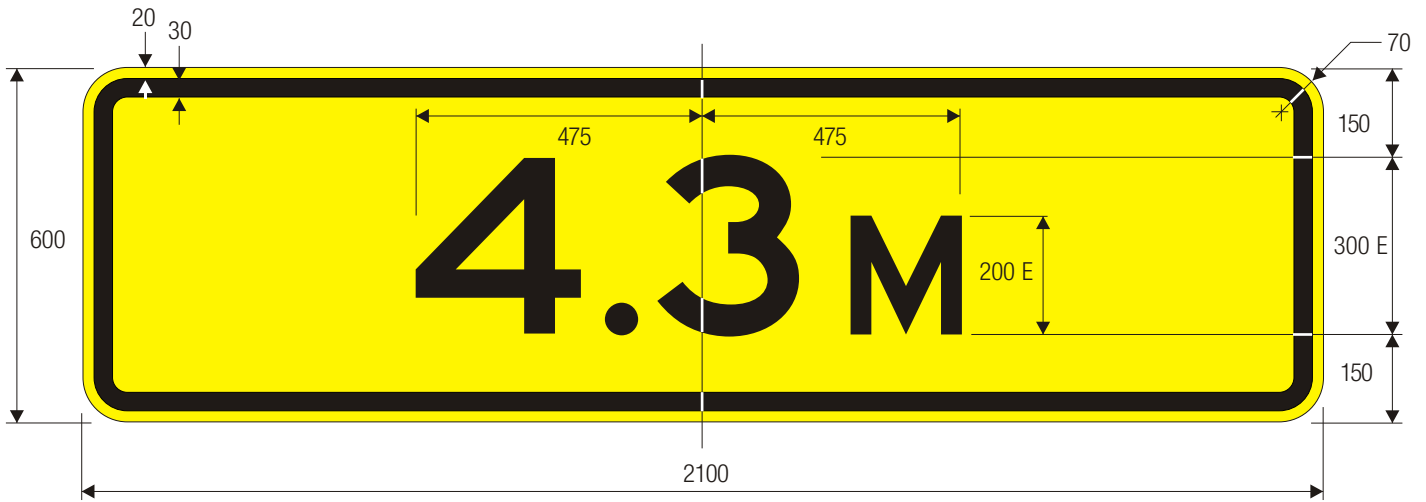

W12-2p metric

LOW CLEARANCE (METRIC)

COLORS: LEGEND — BLACK
 BACKGROUND — YELLOW (RETROREFLECTIVE)



W13-1

ADVISORY SPEED (ENGLISH)

*Optically space numerals about vertical centerline.

	A	B	C	D	E	F	G	H	J
C	450	10	15	62	200 E	51	75 E	118	40
	600	10	15	92	250 E	66	100 E	157	50
	750	13	20	113	300 E	99	125 E	185.5	50

WARNING SIGN COLORS:

LEGEND — BLACK
 BACKGROUND — YELLOW (RETROREFLECTIVE)

TTC SIGN COLORS:

LEGEND — BLACK
 BACKGROUND — ORANGE (RETROREFLECTIVE)

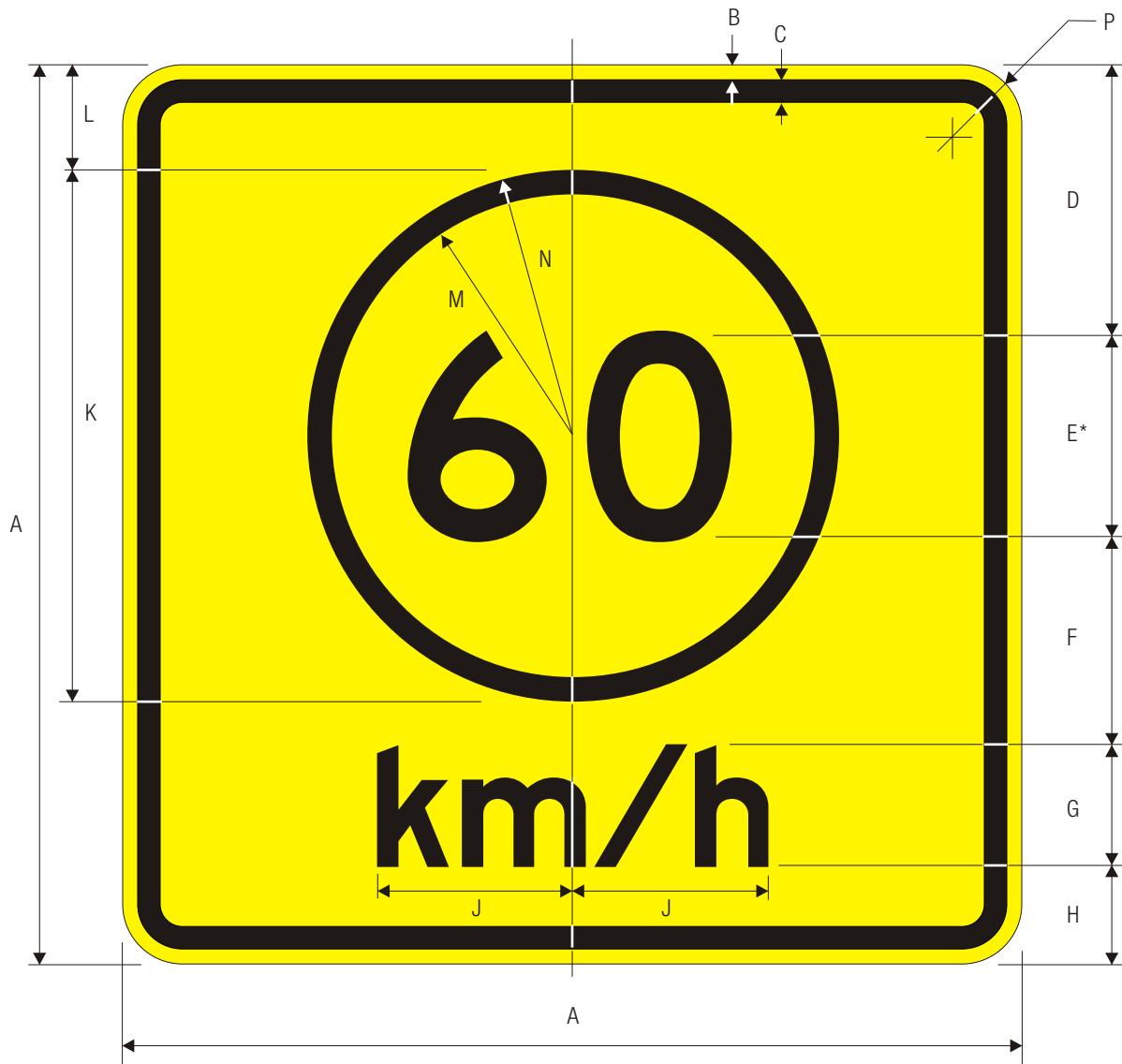

W13-1
ADVISORY SPEED (METRIC)

	A	B	C	D	E	F	G	H	J
C	450	10	15	137	100 D	105	60 E	48	95.5
	600	10	15	185	125 D	143	80 E	67	130.5
	750	13	20	231	150 D	179	100 E	90	160

K	L	M	N	P
266	53	118	133	40
355	70	163	178	50
444	88	202	222	50

*Optically space numerals about vertical centerline.

WARNING SIGN COLORS:

LEGEND — BLACK
BACKGROUND — YELLOW (RETROREFLECTIVE)

TTC SIGN COLORS:

LEGEND — BLACK
BACKGROUND — ORANGE (RETROREFLECTIVE)



W13-2

ADVISORY SPEED (ENGLISH)

*Optically space numerals about centerline.
 **Increase spacing to fit.

	A	B	C	D	E	F	G	H	J	K	L	M
C	600	750	10	15	75	100 E	50	60	200 E	100 E	65	152.5
	900	1200	15	25	110	200 E	80	125	300 E	125 E	110	304.5
	1200	1500	20	30	150	250 E	100	125	400 E	150 E	170	381

N	P
167	50
224	60
276	70

COLORS: LEGEND — BLACK
 BACKGROUND— YELLOW (RETROREFLECTIVE)

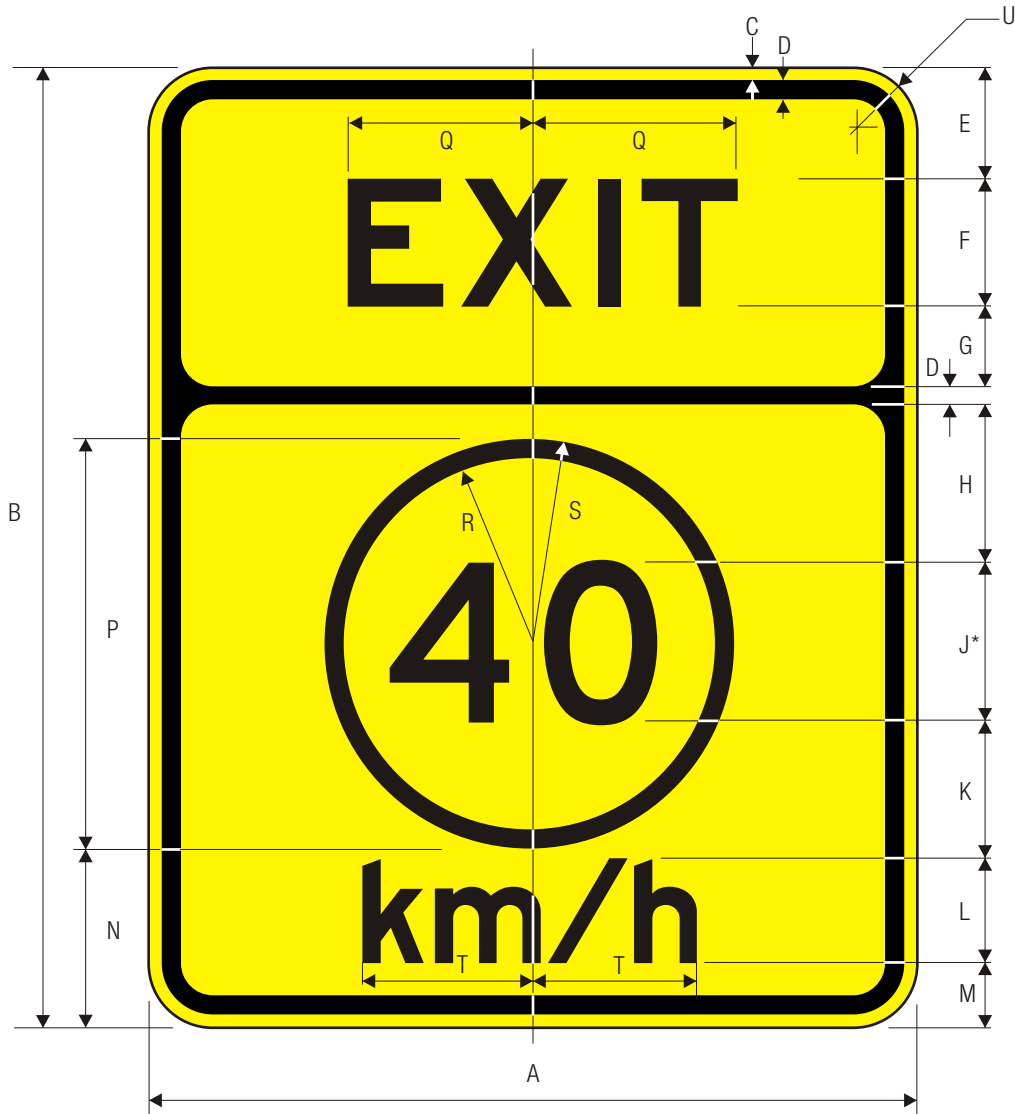

W13-2
ADVISORY EXIT SPEED (METRIC)

*Optically space numerals about centerline.

C

A	B	C	D	E	F	G	H	J	K	L	M
600	750	10	15	87	100 E	62	125	125 D	106	80 E	50
900	1200	15	25	150	150 E	100	182	200 D	174	125 E	94
1200	1500	20	30	175	200 E	125	233	250 D	217	150 E	119

N	P	Q	R	S	T	U
140	320	152.5	145	160	130.5	50
228	512	304.5	231	256	199.5	60
280	640	381	290	320	239	70

COLORS: LEGEND — BLACK
 BACKGROUND — YELLOW (RETROREFLECTIVE)
 CIRCLE — BLACK



W13-3

ADVISORY RAMP SPEED

*Optically space numerals about centerline.
 **Increase spacing to fit.

	A	B	C	D	E	F	G	H	J	K	L	M
C	600	750	10	15	87	100 E	62	60	200 E	100 E	66	205
	900	1200	15	25	150	150 E	100	120	300 E	125 E	110	307.5
	1200	1500	20	30	175	200 E	125	130	400 E	150 E	175	410

N	P
131	50
224	60
276	70

COLORS: LEGEND — BLACK
 BACKGROUND— YELLOW (RETROREFLECTIVE)

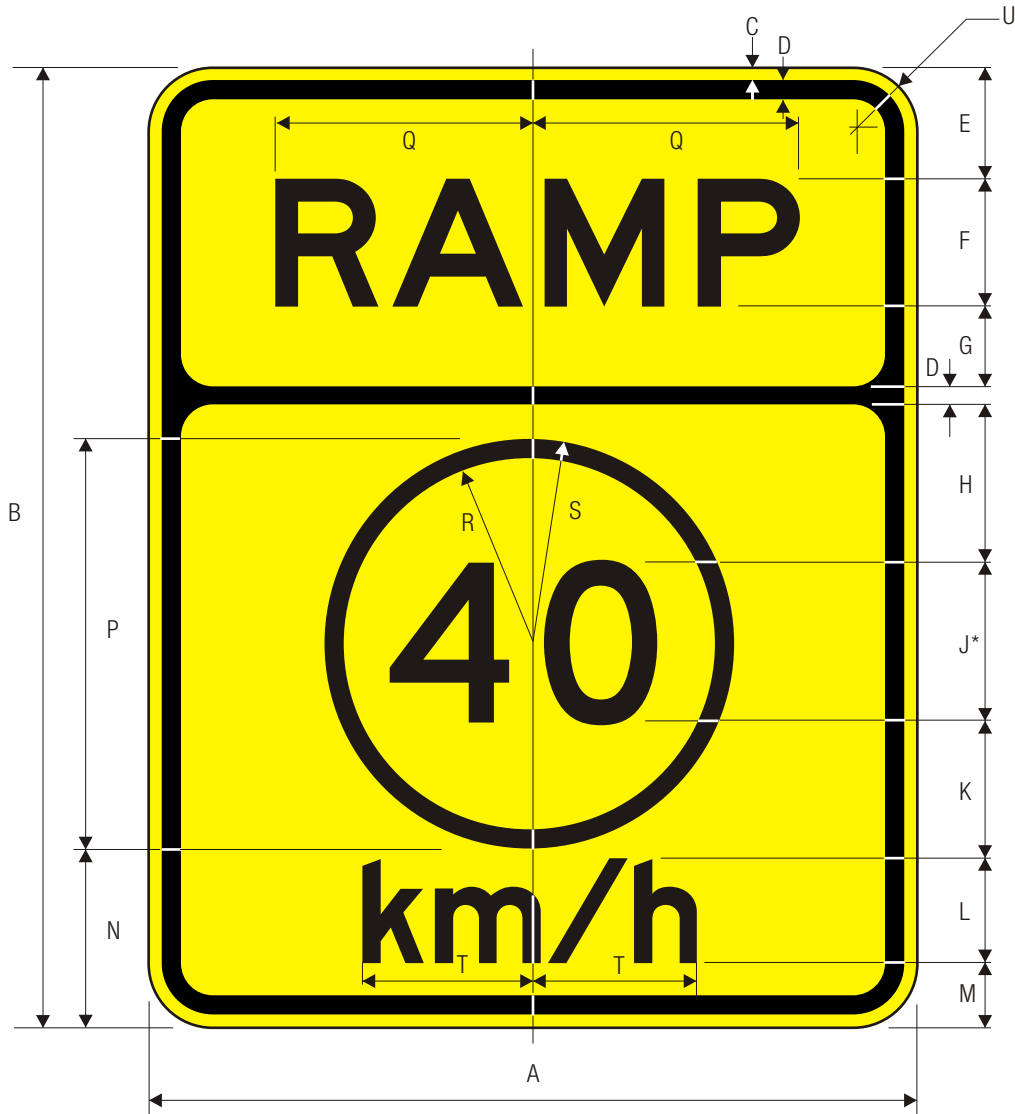

W13-3
ADVISORY RAMP SPEED

*Optically space numerals about centerline.

C

A	B	C	D	E	F	G	H	J	K	L	M
600	750	10	15	87	100 E	62	125	125 D	106	80 E	50
900	1200	15	25	150	150 E	100	182	200 D	174	125 E	94
1200	1500	20	30	175	200 E	125	233	250 D	217	150 E	119

N	P	Q	R	S	T	U
140	320	205	145	160	130.5	50
228	512	307.5	231	256	199.5	60
280	640	410	290	320	239	70

COLORS: LEGEND — BLACK
 BACKGROUND — YELLOW (RETROREFLECTIVE)
 CIRCLE — BLACK



W13-5

ADVISORY CURVE SPEED (ENGLISH)

*Optically space numerals about centerline.
 **Increase spacing to fit.

	A	B	C	D	E	F	G	H	J	K	L	M
C	600	750	10	15	87	100 E	62	60	200 E	100 E	66	243
	900	1200	15	25	150	150 E	100	120	300 E	125 E	110	365
	1200	1500	20	30	175	200 E	125	130	400 E	150 E	175	486.5

N	P
131	50
224	60
276	70

COLORS: LEGEND — BLACK
 BACKGROUND— YELLOW (RETROREFLECTIVE)

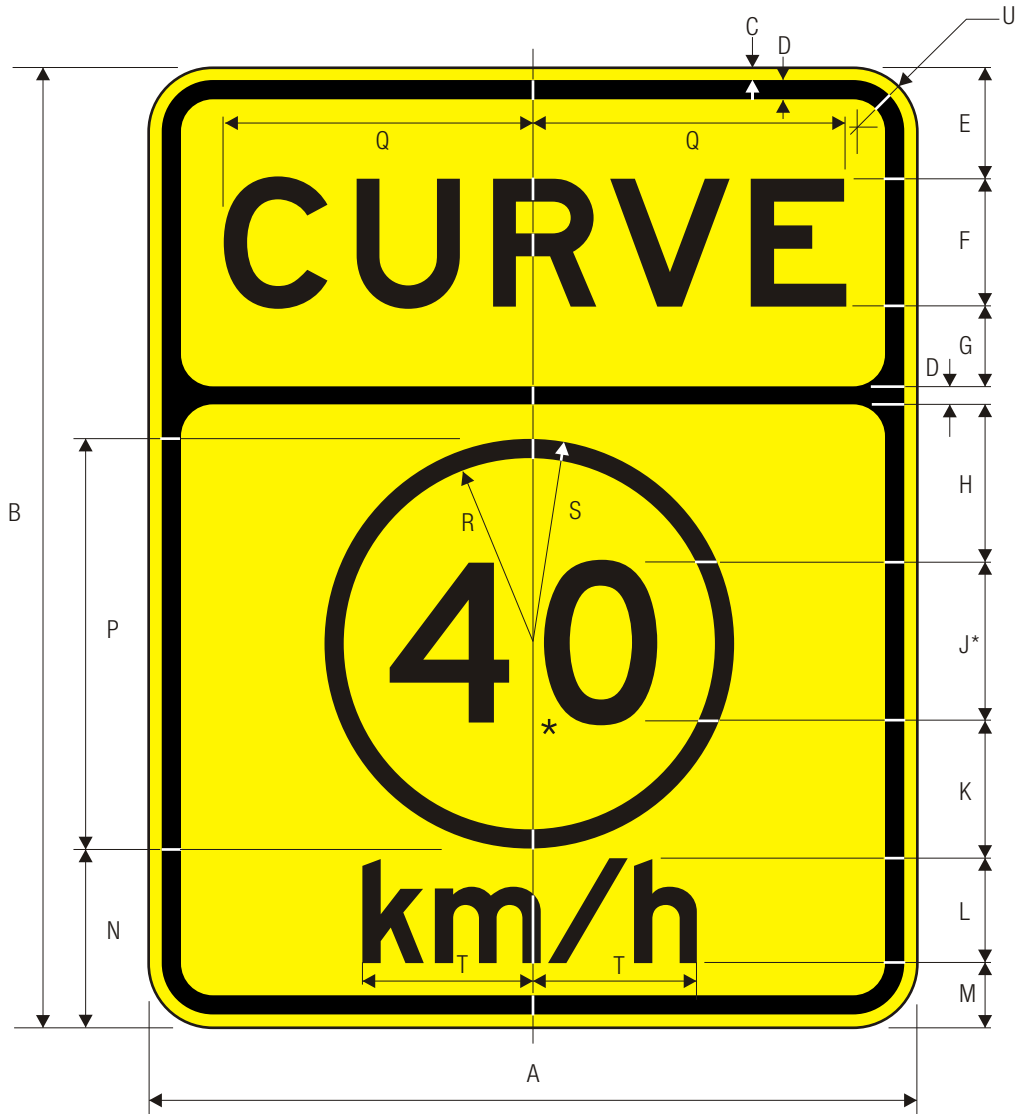

W13-5 Metric

ADVISORY CURVE SPEED (METRIC)

*Optically space numerals about centerline.

C

A	B	C	D	E	F	G	H	J	K	L	M
600	750	10	15	87	100 E	62	125	125 D	106	80 E	50
900	1200	15	25	150	150 E	100	182	200 D	174	125 E	94
1200	1500	20	30	175	200 E	125	233	250 D	217	150 E	119

N	P	Q	R	S	T	U
140	320	243	145	160	130.5	50
228	512	365	231	256	199.5	60
280	640	486.5	290	320	239	70

COLORS: LEGEND — BLACK
 BACKGROUND — YELLOW (RETROREFLECTIVE)
 CIRCLE — BLACK

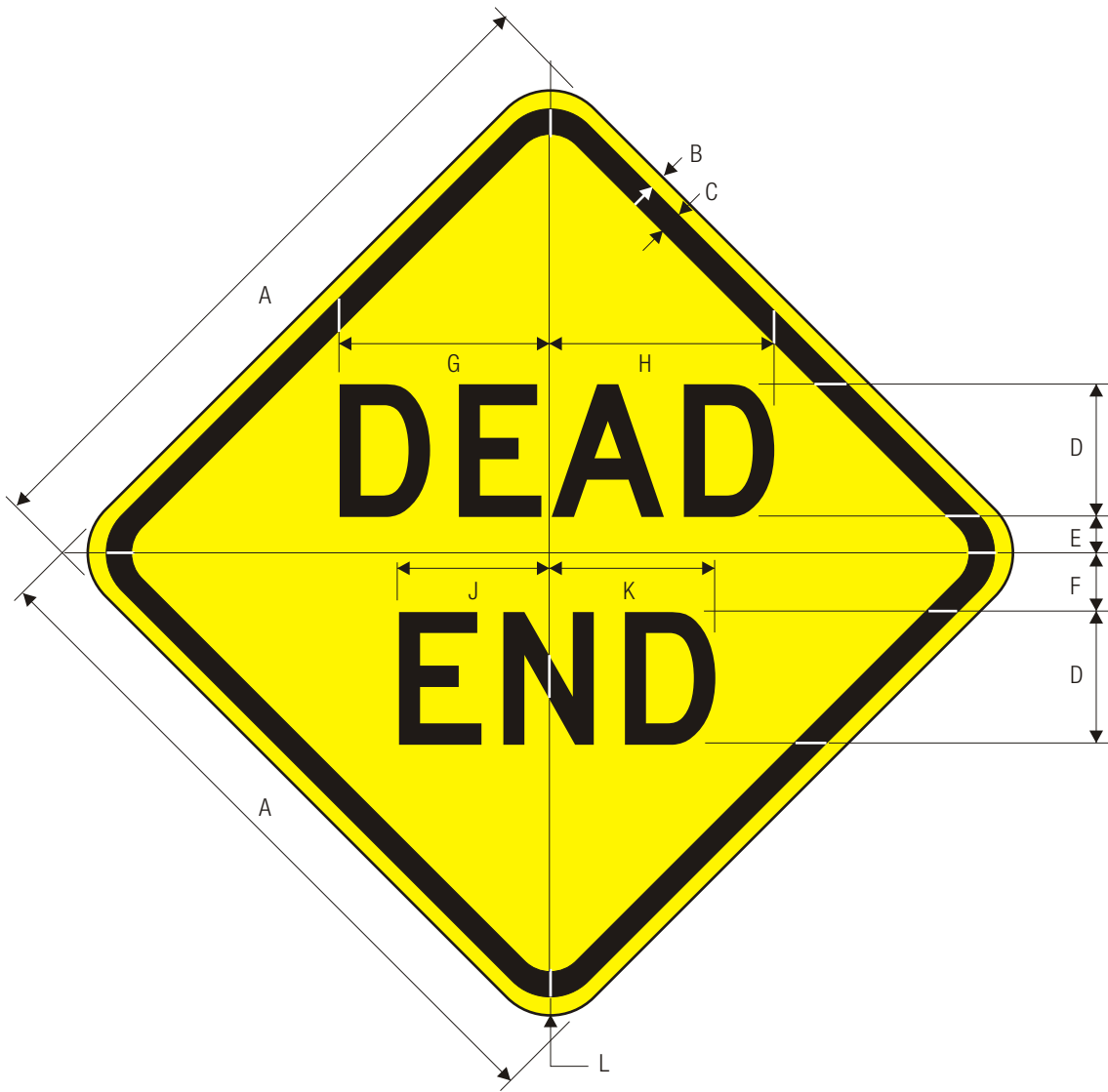

W14-1
DEAD END

	A	B	C	D	E	F	G	H	J	K	L
C	600	10	15	125 D	25	50	196	213	141	157	50
	750	13	20	150 D	37	62	231	260	166	191	50
	900	15	25	175 D	50	75	277	296	199	218	60

COLORS: LEGEND — BLACK
BACKGROUND— YELLOW (RETROREFLECTIVE)

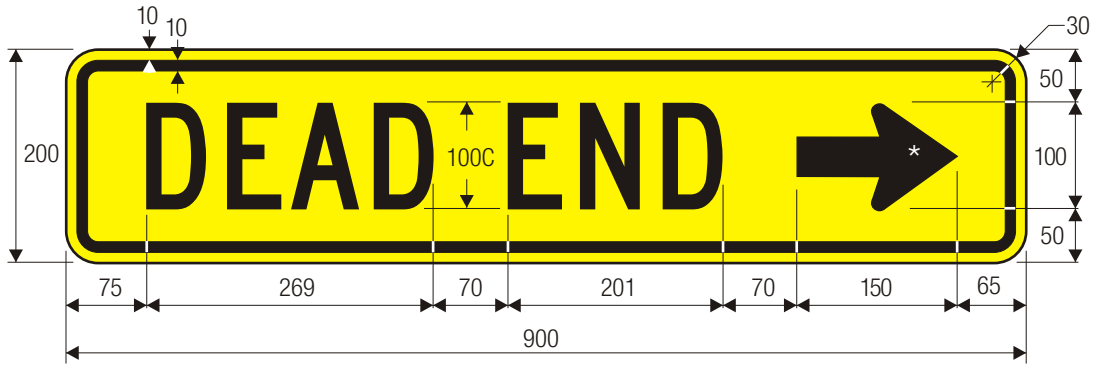

W14-1aR
DEAD END



W14-1aL
DEAD END

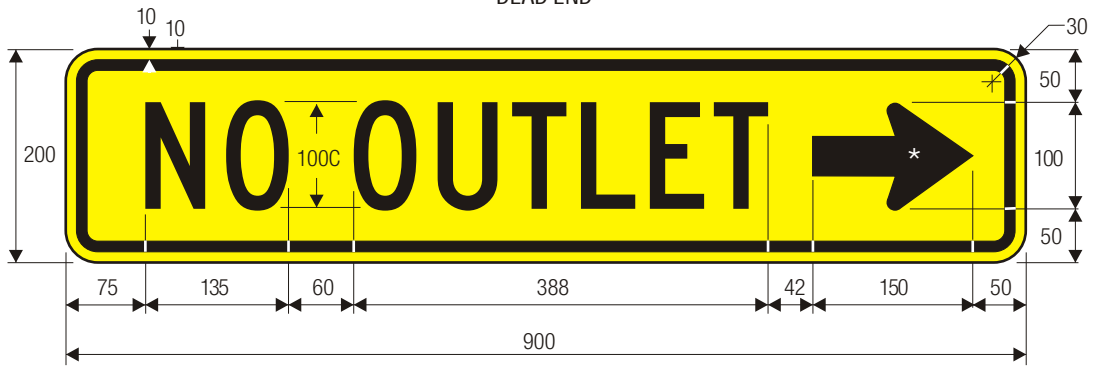

W14-2aR
NO OUTLET



W14-2aL
NO OUTLET

*See page 6-2 for symbol design.

COLORS: LEGEND — BLACK
BACKGROUND — YELLOW (RETROREFLECTIVE)



W14-2

NO OUTLET

	A	B	C	D	E	F	G	H	J	K	L
	600	10	15	125 D	75	19	97	103	279	296	50
C	750	13	20	150 D	100	24	115	125	335	355	50
	900	15	25	175 D	125	28	134	146	390	415	60

COLORS: LEGEND — BLACK
 BACKGROUND— YELLOW (RETROREFLECTIVE)



W14-3
NO PASSING ZONE

A	B	C	D	E	F	G	H	J	K	L	M
900	600	13	20	121	75 C	44	166	75	101	332	208
1000	750	13	20	152	100 C	44	187	94	134	442	277
1200	900	15	25	182	125 C	50	243	88	168	553	334
1600	1200	20	30	257	150 C	75	343	146	201	663	416

N	P
60	50
80	50
93	60
118	70

WARNING SIGN COLORS:

LEGEND — BLACK
BACKGROUND — YELLOW (RETROREFLECTIVE)

TTC SIGN COLORS:

LEGEND — BLACK
BACKGROUND — ORANGE (RETROREFLECTIVE)

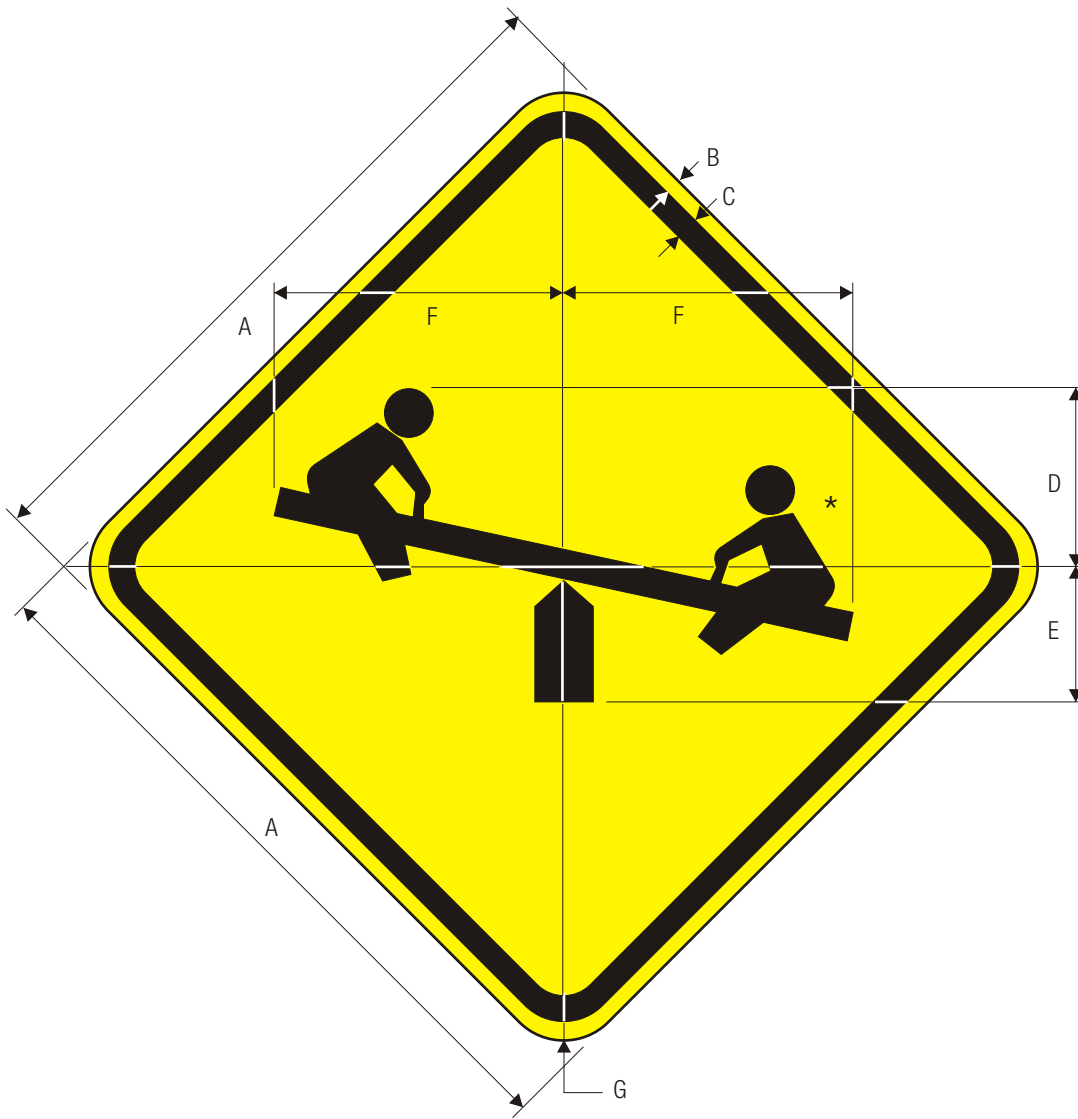

W15-1
PLAYGROUND

*See page 6-34 for symbol design.
**Option.

	A	B	C	D	E	F	G
	450	10	15	116	86	186	40
	600	10	15	155	115	248	50
C	750	13	20	192	144	310	50
	900	15	25	231	172	372.5	60

COLORS: SYMBOL — BLACK
 BACKGROUND — YELLOW (RETROREFLECTIVE)
 — FLOURESCENT YELLOW GREEN (RETROREFLECTIVE)



W16-1

Note: For use with Warning Signs for slower forms of transportation such as the Bicycle, Golf Cart, Farm Machinery, Horse Drawn Vehicle and ATV Warning Signs.

	A	B	C	D	E	F	G	H	J	K	L
C	450	600	10	15	87	100 C	63	171.5	96.5	137.5	40
	600	750	10	15	107.5	125 C	80	214.5	120.5	172	50

COLORS: LEGEND BLACK
BACKGROUND YELLOW (RETROREFLECTIVE)

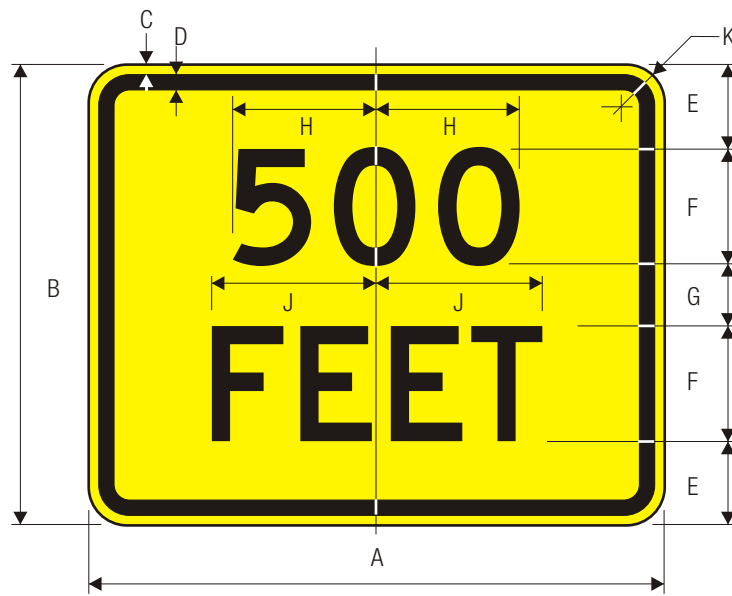

W16-2

500 FEET (2 LINE) (ENGLISH)

C

A	B	C	D	E	F	G	H	J	K
450	300	10	15	50	75 D	2	VAR		40
600	450	10	15	75	125 D	50	VAR	179.5	50
750	600	13	20	110	150 D	80	VAR	215	50

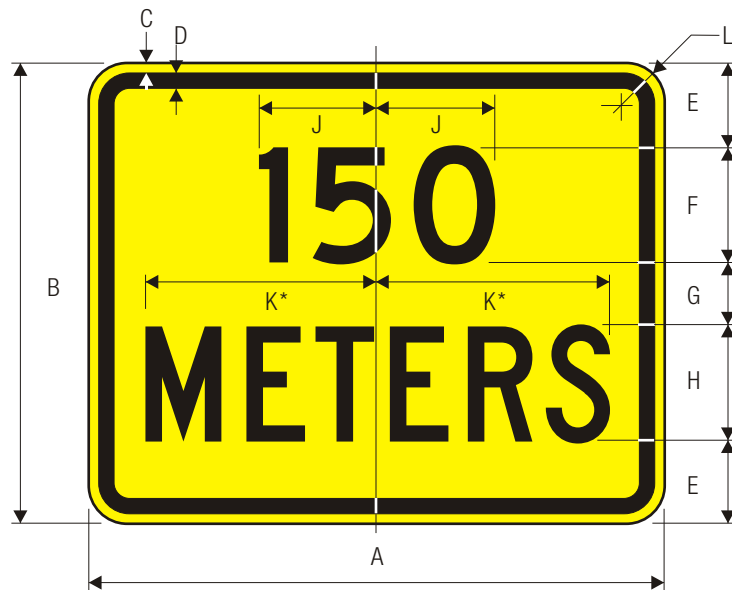

W16-2

150 METERS (2 LINE) (METRIC)

*Reduce spacing to fit on 600 mm size.

C

A	B	C	D	E	F	G	H	J	K	L
450	300	10	15	50	75 D	2	75 C	VAR		40
600	450	10	15	75	125 D	50	125 C	VAR	240.5	50
750	600	13	20	110	150 D	80	150 C	VAR	302.5	50

WARNING SIGN COLORS:
 LEGEND — BLACK
 BACKGROUND— YELLOW (RETROREFLECTIVE)

TTC SIGN COLORS:
 LEGEND — BLACK
 BACKGROUND— ORANGE (RETROREFLECTIVE)

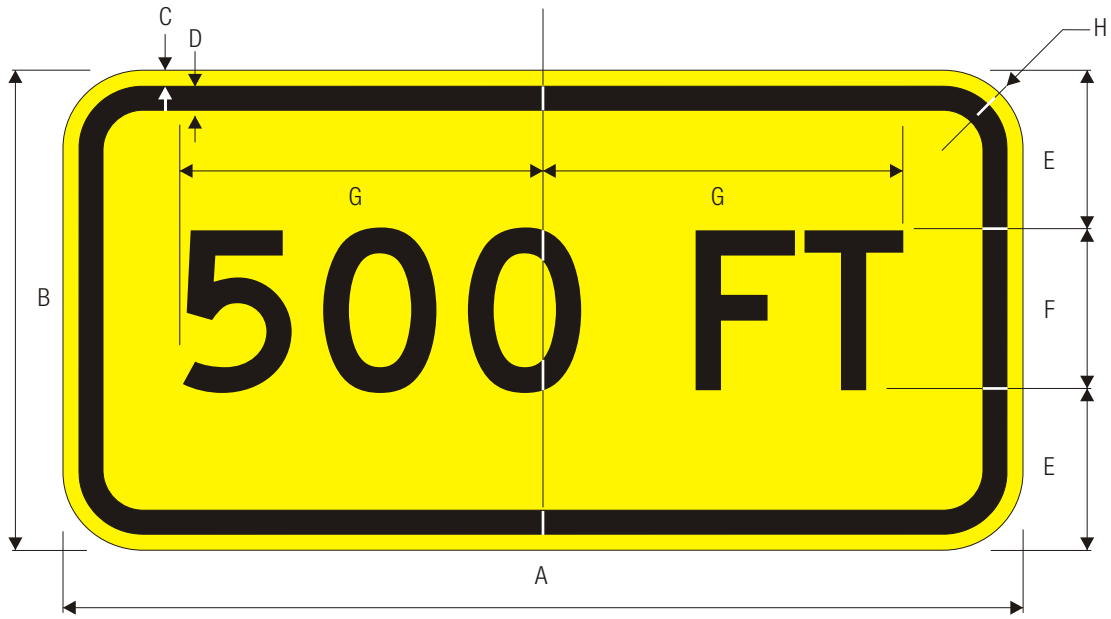

W16-2a

500 FT (1 LINE) (ENGLISH)

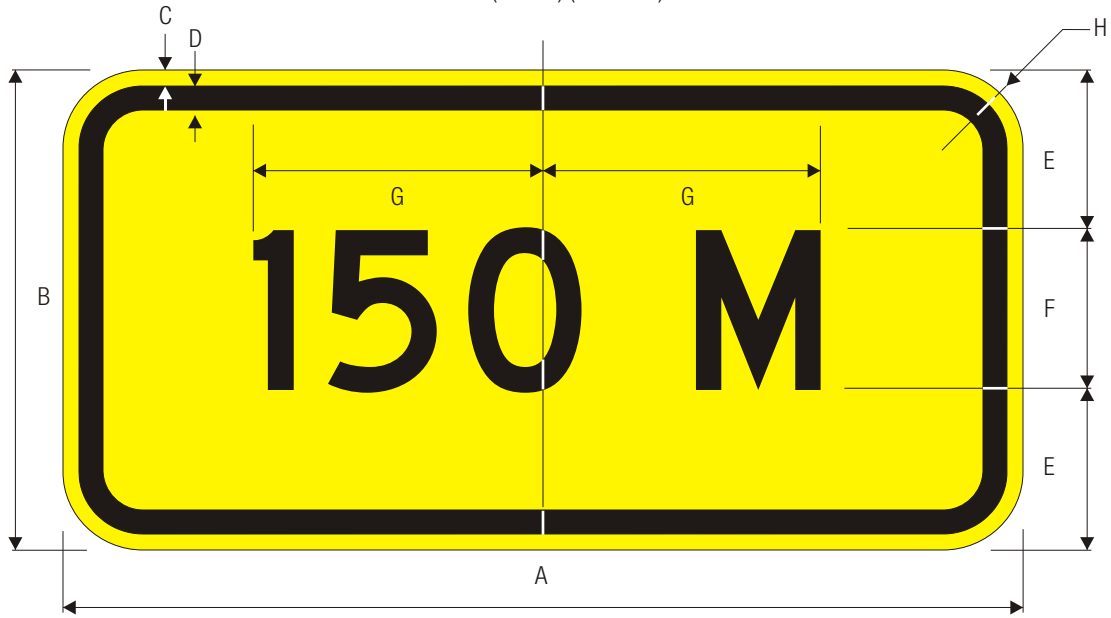

W16-2a Metric

150 M (1 LINE) (METRIC)

	A	B	C	D	E	F	G	H
C	600	300	10	15	100	100 D	VAR	50
	750	450	13	20	162.5	125 D	VAR	50

COLORS: LEGEND — BLACK
 BACKGROUND— YELLOW (RETROREFLECTIVE)

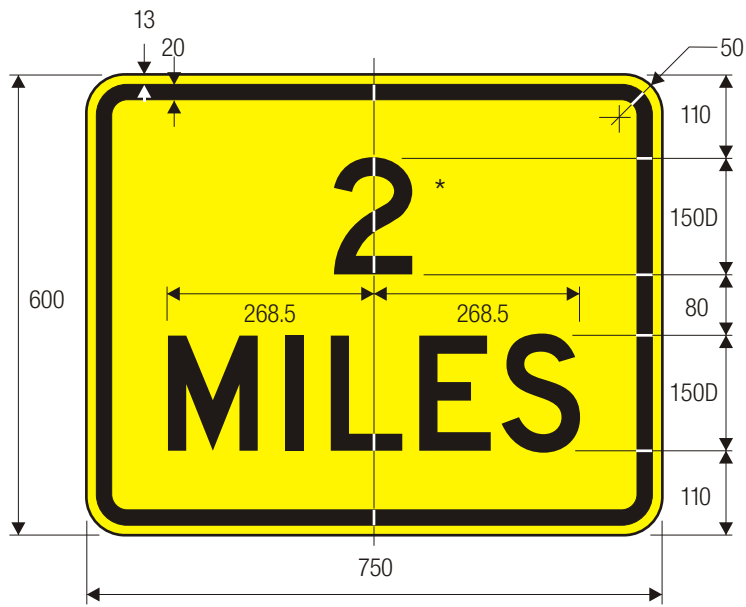

W16-3

2 MILES (2 LINE) (ENGLISH)

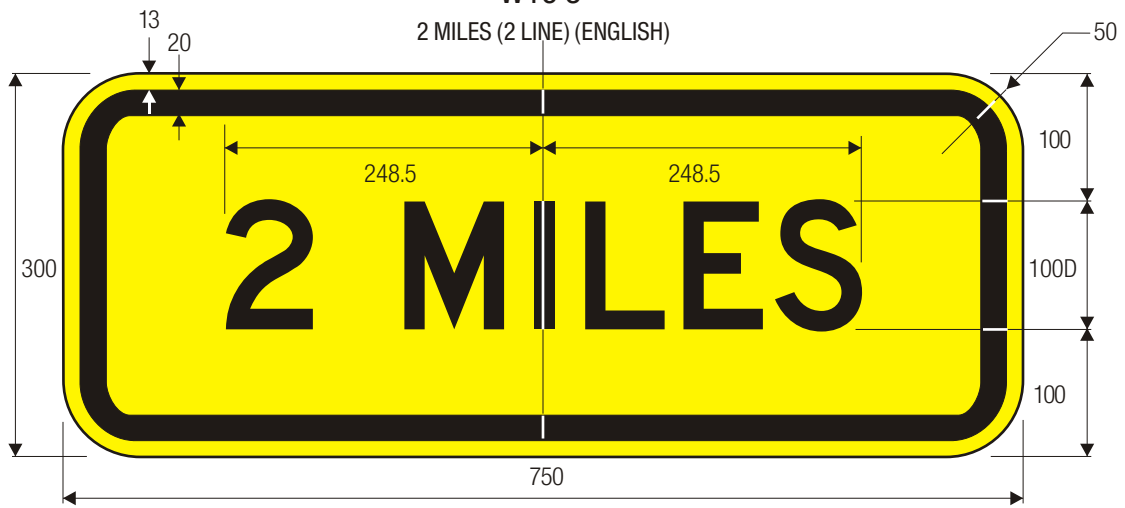

W16-3a

2 MILES (1 LINE) (ENGLISH)

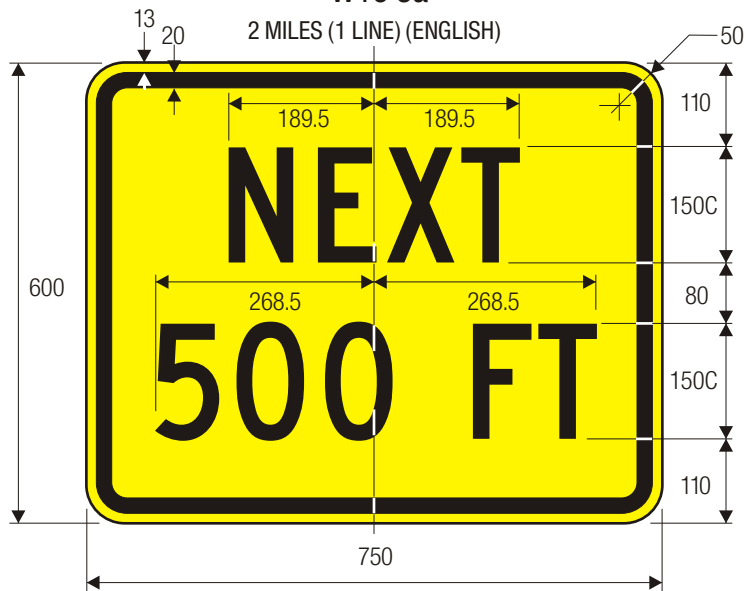

W16-4

500 FT (2 LINE) (ENGLISH)

*Optically locate numerals about centerline.

COLORS: LEGEND — BLACK
 BACKGROUND — YELLOW (RETROREFLECTIVE)



W16-5pR
ARROW PLAQUE

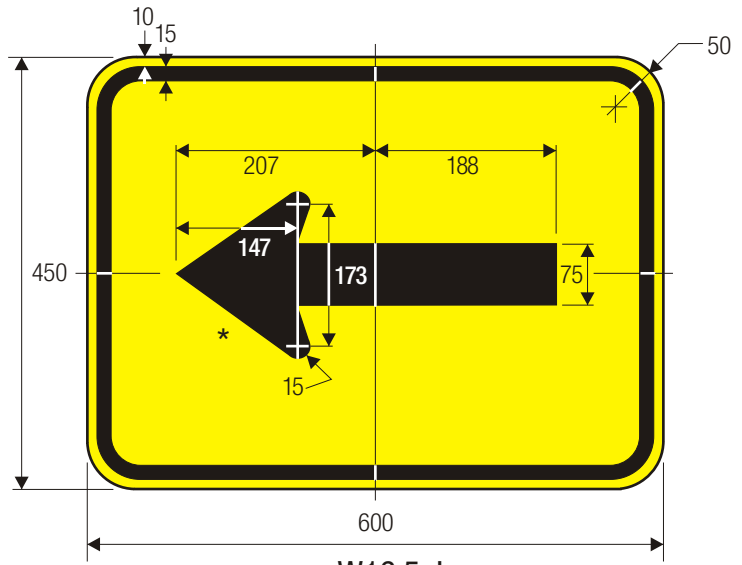

W16-5pL
ARROW PLAQUE



W16-6pR
ARROW PLAQUE

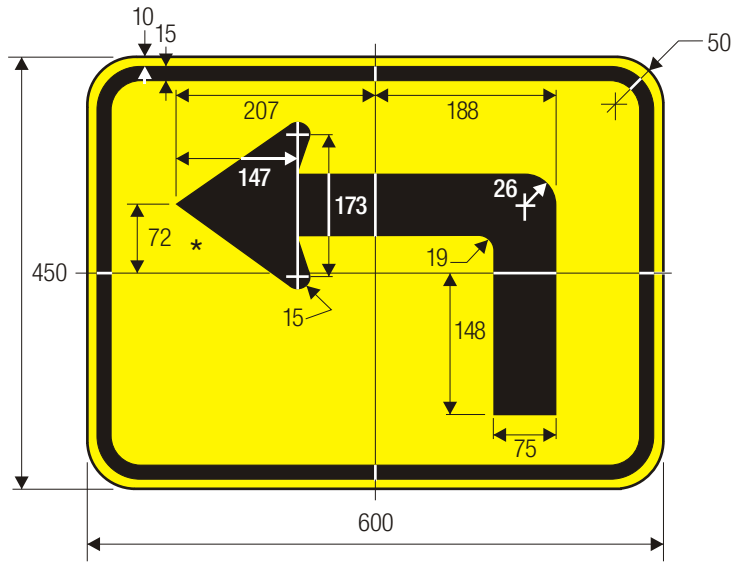

W16-6pL
ARROW PLAQUE

*See page 6-2 for arrow design.

COLORS: LEGEND — BLACK
BACKGROUND — YELLOW (RETROREFLECTIVE)

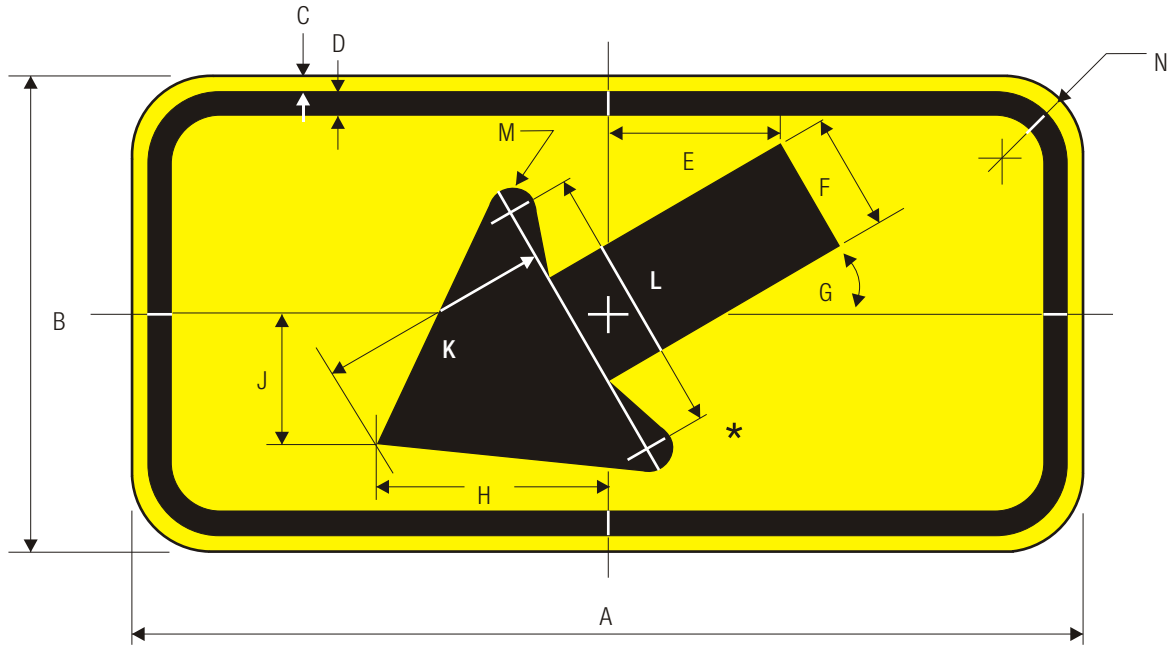

W16-7pL
LEFT DIAGONAL ARROW PLAQUE

C

A	B	C	D	E	F	G	H	J	K	L	M	N
600	300	10	15	108	75	30°	146	82	147	173	15	50
750	450	13	20	163	113	30°	219	123	221	260	23	50



W16-7pR
RIGHT DIAGONAL ARROW PLAQUE

*See page 6-2 for arrow design.

COLORS: LEGEND — BLACK
BACKGROUND— YELLOW (RETROREFLECTIVE)

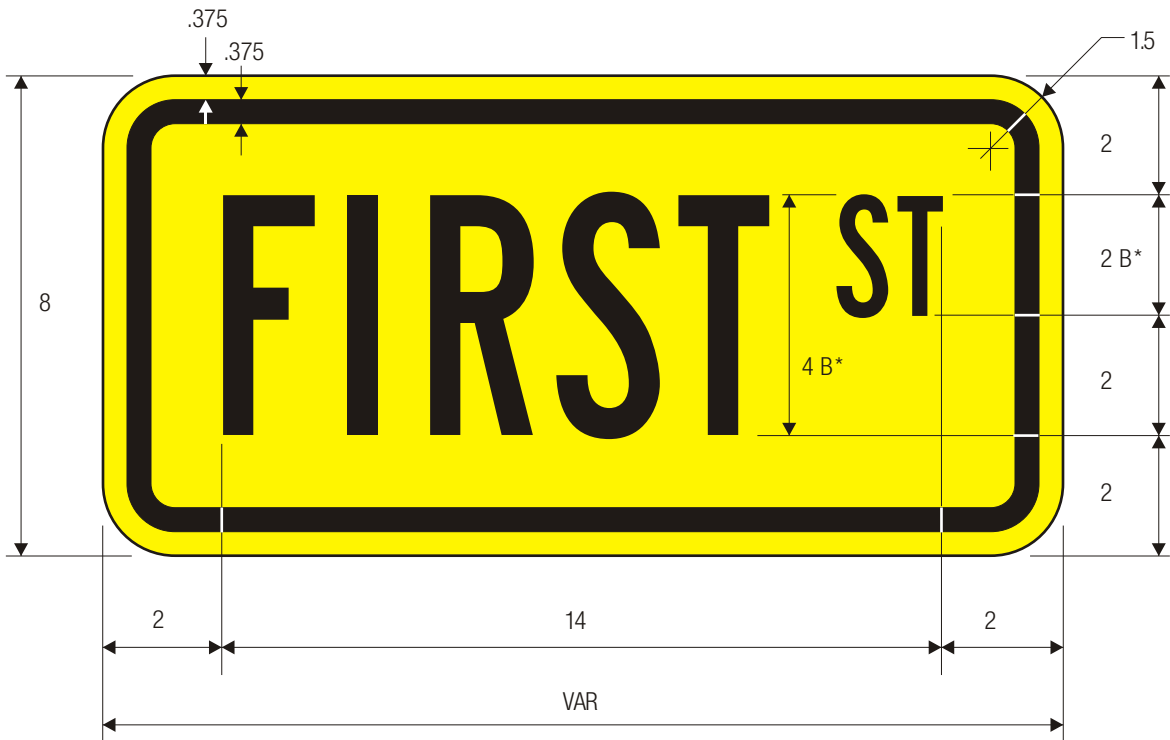

W16-8

ADVANCE STREET NAME PLAQUE

*Series 2000 Standard Alphabets.

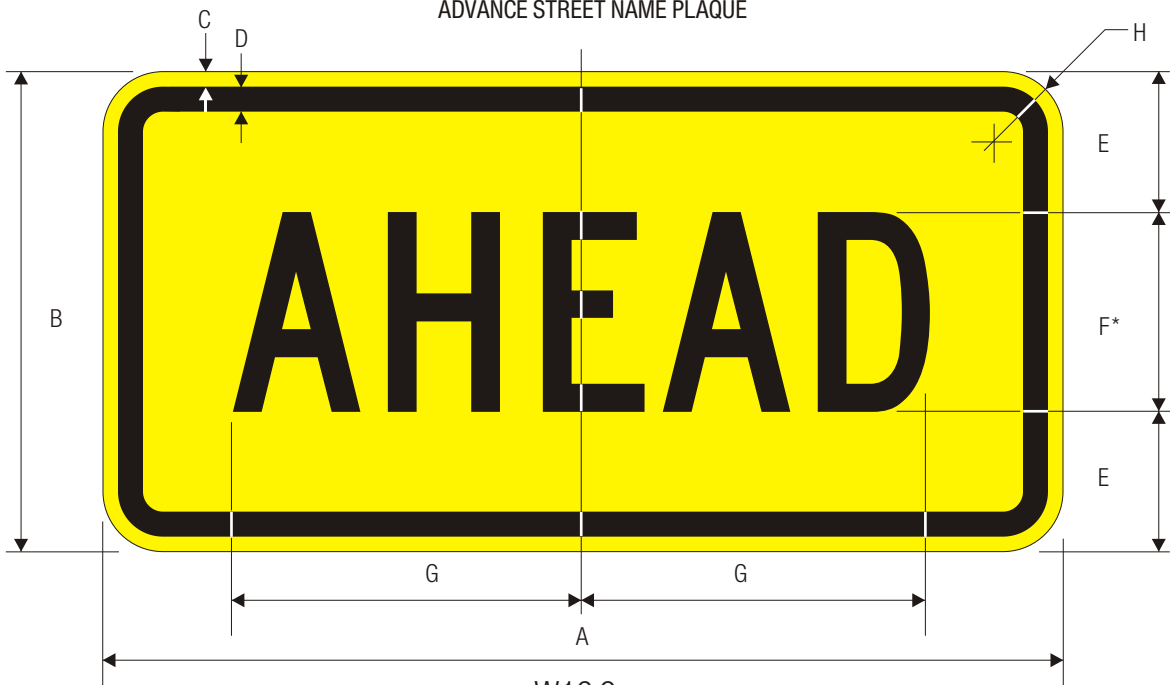

W16-9p

AHEAD PLAQUE

	A	B	C	D	E	F	G	H
C	600	300	10	15	87.5	125 C	218	50
	750	450	13	20	137.5	175 C	305	50
	900	600	15	25	200	200 C	348.5	60
	1200	900	20	30	325	250 C	435.5	70

COLORS: LEGEND — BLACK
 BACKGROUND — YELLOW (RETROREFLECTIVE)



W16-8a

ADVANCE STREET NAME PLAQUE

WARNING SIGN COLORS:
 LEGEND — BLACK
 BACKGROUND— YELLOW (RETROREFLECTIVE)

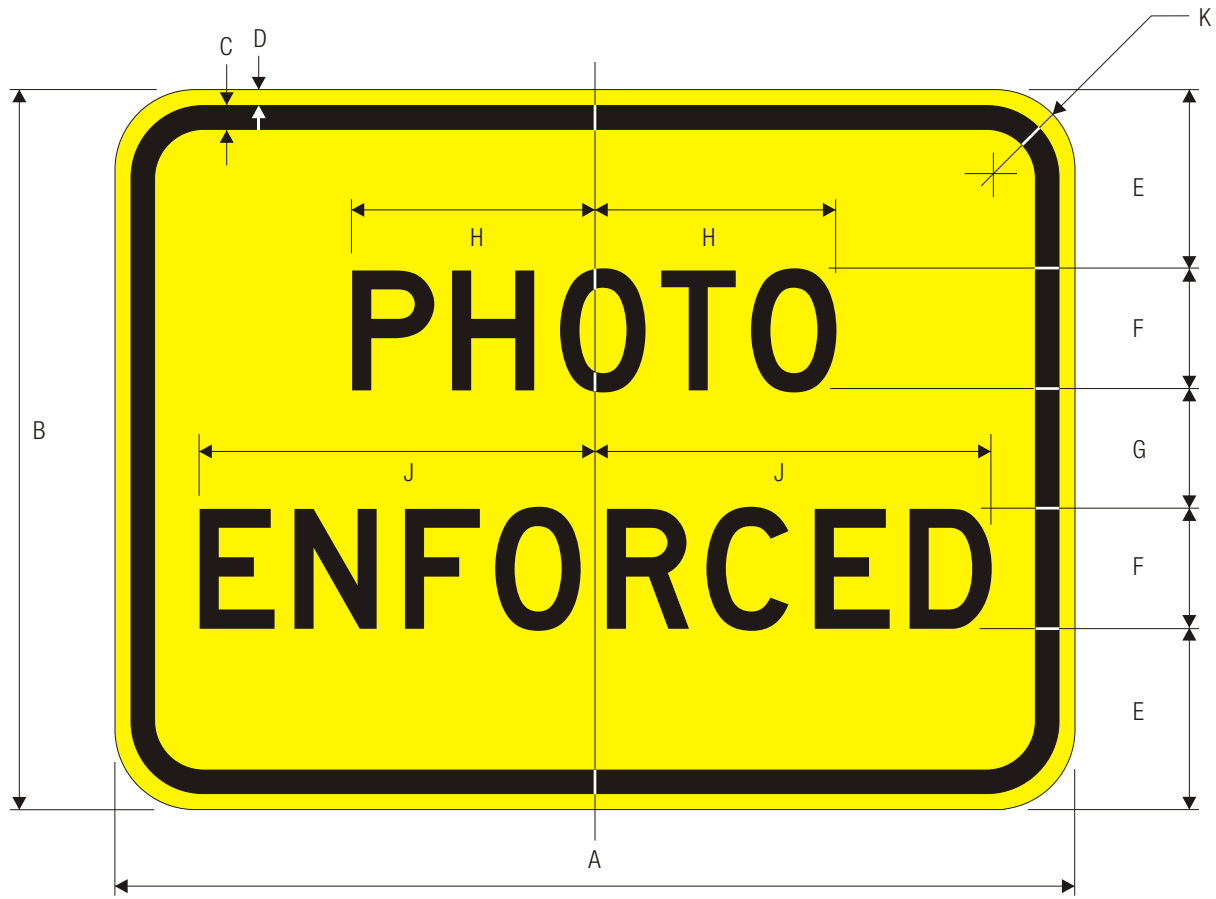

W16-10

PHOTO ENFORCED

	A	B	C	D	E	F	G	H	J	K
C	600	450	10	15	113	75 D	74	151.5	247.5	50
	900	600	15	25	150	100 D	100	200.5	328	60
	1200	900	20	30	225	150 D	150	301	492	70

COLORS: LEGEND — BLACK
 BACKGROUND— YELLOW (RETROREFLECTIVE)

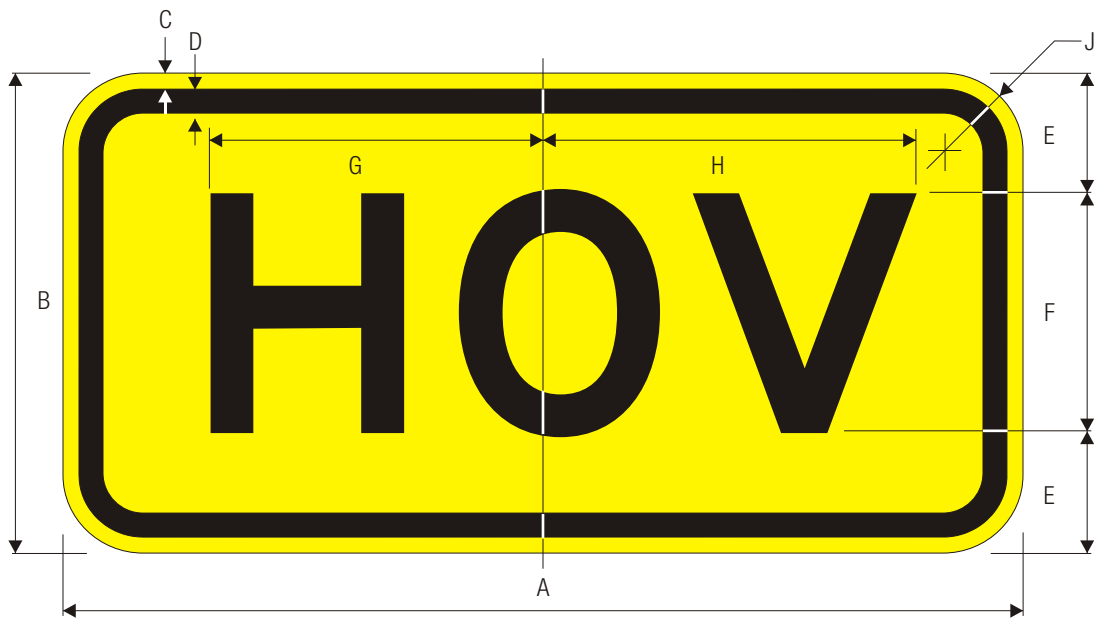

W16-11
HOV

For use with a Warning Sign that applies to the HOV Lane.

A	B	C	D	E	F	G	H	J
600	300	10	15	75	150 E	208	233	50
750	450	13	20	125	200 E	281	307	50

COLORS: LEGEND — BLACK
BACKGROUND — YELLOW (RETROREFLECTIVE)

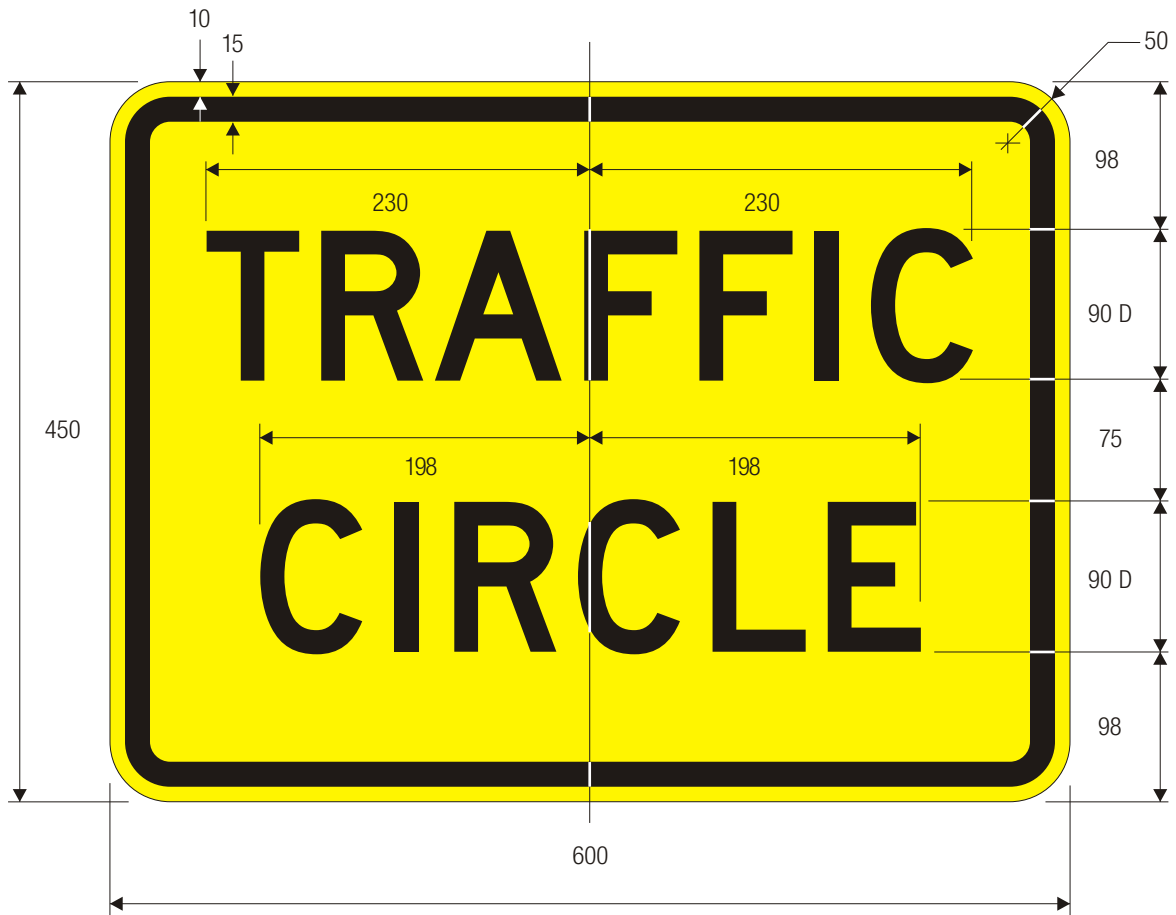

W16-12p

TRAFFIC CIRCLE PLAQUE

WARNING SIGN COLORS:

LEGEND — BLACK
 BACKGROUND — YELLOW (RETROREFLECTIVE)

TTC SIGN COLORS:

LEGEND — BLACK
 BACKGROUND — ORANGE (RETROREFLECTIVE)

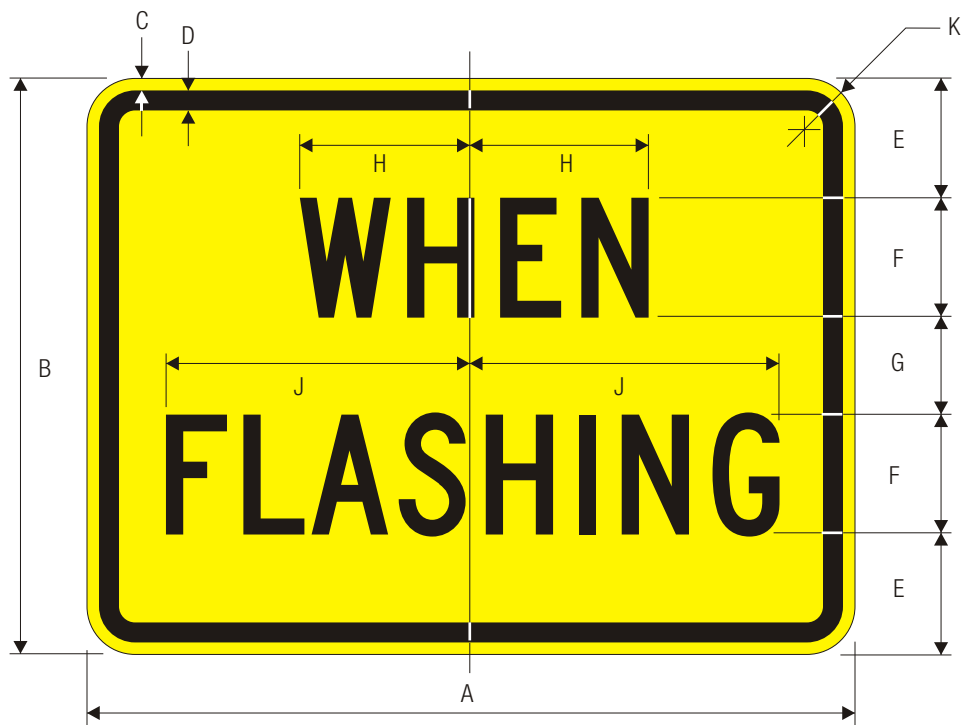

W16-13

WHEN FLASHING

For use with W3-4 BE PREPARED TO STOP sign.

A	B	C	D	E	F	G	H	J	K
600	450	10	15	97	90 C	76	131	230	50
750	600	13	20	125	125 C	100	181.5	319.2	50

COLORS: LEGEND — BLACK
 BACKGROUND — YELLOW (RETROREFLECTIVE)



W17-1
SPEED HUMP

	A	B	C	D	E	F	G	H	J
	600	10	15	100D	6	50	196	176	50
C	750	13	20	125D	12	64	245.5	220.5	50
	900	15	25	150D	19	75	294.5	264.5	60

COLORS: LEGEND — BLACK
BACKGROUND— YELLOW (RETROREFLECTIVE)



W18-1

NO TRAFFIC SIGNS

	A	B	C	D	E	F	G	H	J	K
	600	10	15	100 D	62	31	80	255.5	182	50
C	750	13	20	125 D	78	37	100	319.5	227.5	50
	900	15	25	150 D	94	45	120	383	273.5	60

COLORS: LEGEND — BLACK
 BACKGROUND— YELLOW (RETROREFLECTIVE)



W25-1

ONCOMING TRAFFIC HAS EXTENDED GREEN

COLORS: LEGEND — BLACK
 BACKGROUND — YELLOW (RETROREFLECTIVE)



W25-2

ONCOMING TRAFFIC MAY HAVE EXTENDED GREEN

COLORS: LEGEND — BLACK
 BACKGROUND — YELLOW (RETROREFLECTIVE)

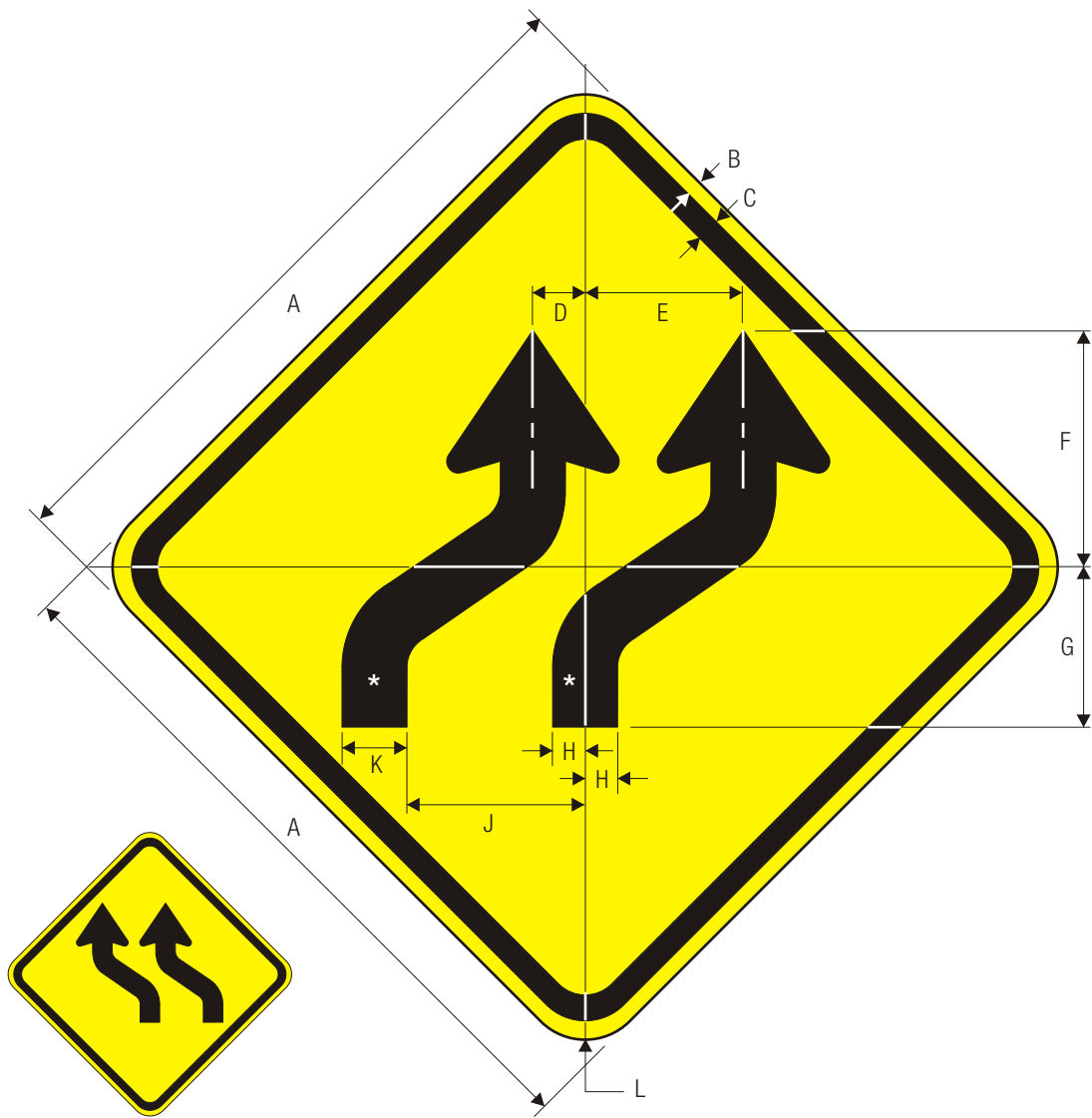

W1-4bL

W1-4bR

TWO LANE REVERSE CURVE

*Reduce W1-4 Arrow 30%.

**See page 6-2 for arrow design.

C

A	B	C	D	E	F	G	H	J	K	L
600	10	15	53	128	192	128	26	154	52	50
750	13	20	56	170	256	170	35	191	70	50
900	15	25	76	213	322	211	43.5	246	87	60
1200	20	30	106	256	384	256	52	308	104	70

TTC SIGN COLORS:

LEGEND — BLACK

BACKGROUND— ORANGE (RETROREFLECTIVE)

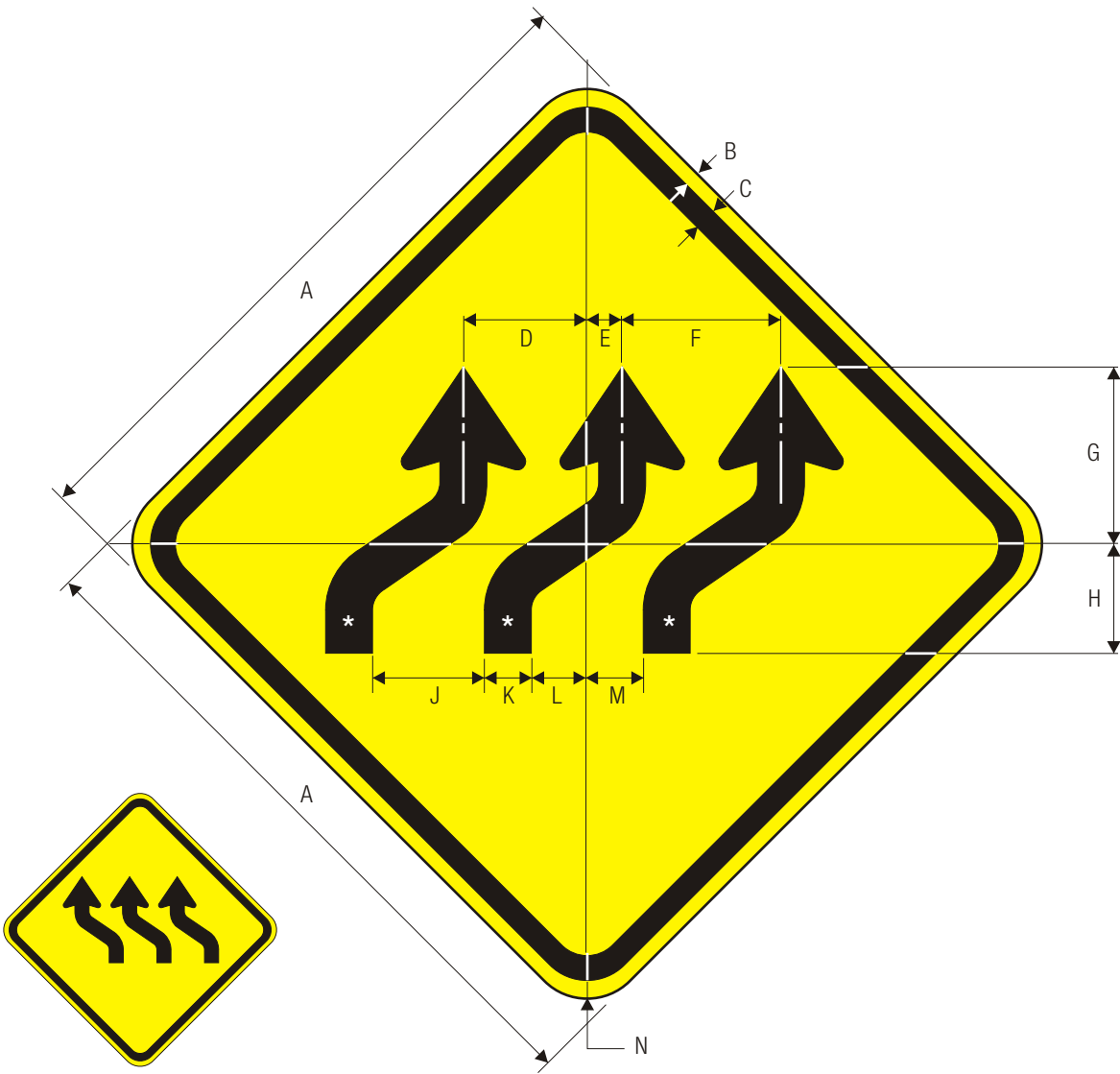

W1-4cL

W1-4cR
THREE LANE REVERSE CURVE

*Reduce W1-4bR Arrow 20%.
**See page 6-2 for arrow design.

	A	B	C	D	E	F	G	H	J	K	L	M	N
	600	10	15	111	31	142	160	96	100	42	50	50	50
	750	13	20	135	37	181	214	128	125	56	71.5	53.5	50
C	900	15	25	178	41	232	269	157	162	70	94	68	60
	1200	20	30	222	62	284	320	192	200	84	100	100	70

TTC SIGN COLORS:
LEGEND — BLACK
BACKGROUND— ORANGE (RETROREFLECTIVE)

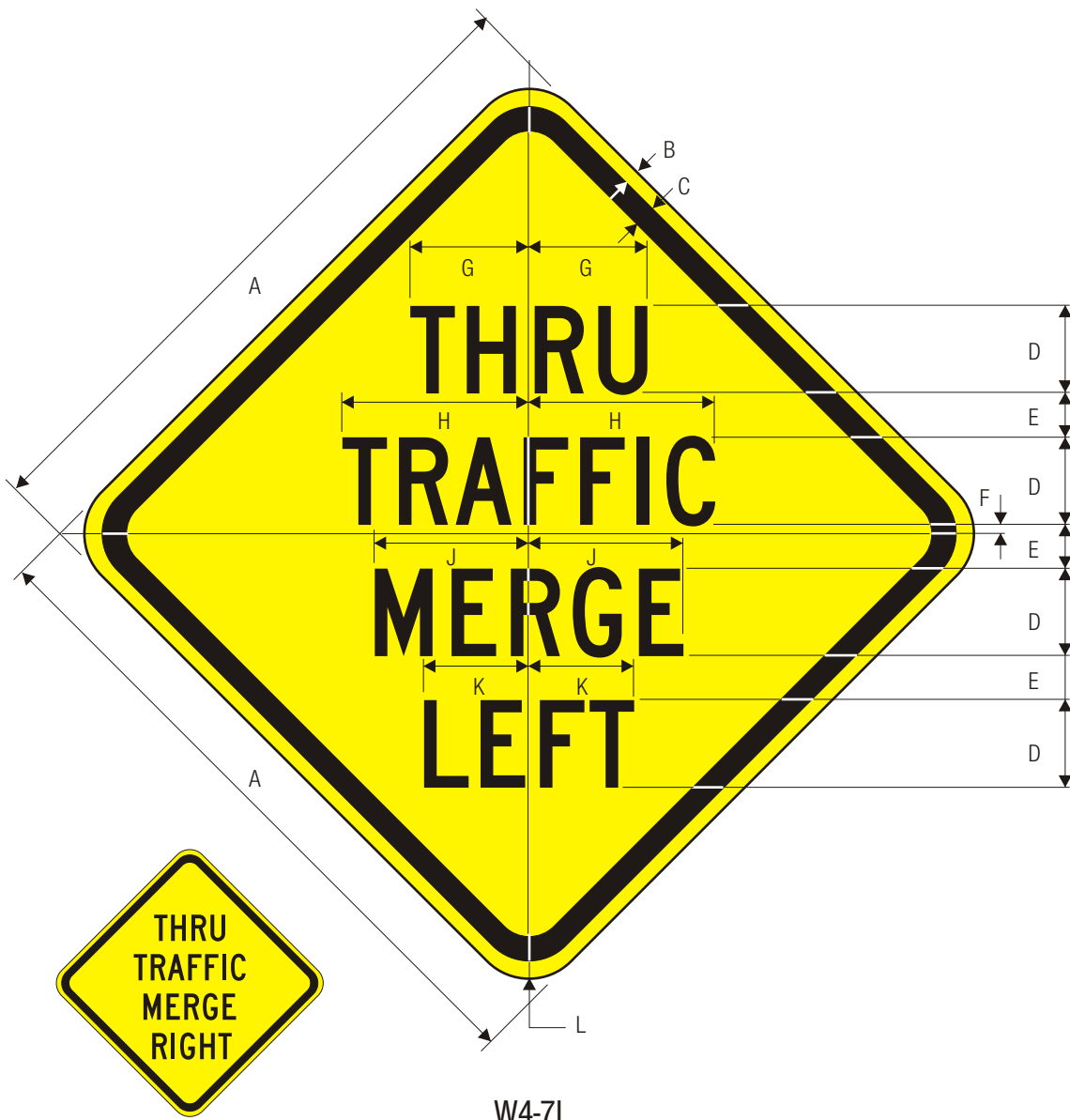

W4-7R

W4-7L

THRU TRAFFIC MERGE LEFT

A	B	C	D	E	F	G	H	J	K	L
750	13	20	100 C	50	12	135.5	213	176	120	50
900	15	25	125 C	60	14	169	266	220.5	150	60
1200	20	30	150 C	75	18	203	319.5	264.5	180	70
1500	20	30	200 C	100	24	270.5	425.5	352.5	240	70

WARNING SIGN COLORS:

LEGEND — BLACK
 BACKGROUND — YELLOW (RETROREFLECTIVE)

TTC SIGN COLORS:

LEGEND — BLACK
 BACKGROUND — ORANGE (RETROREFLECTIVE)

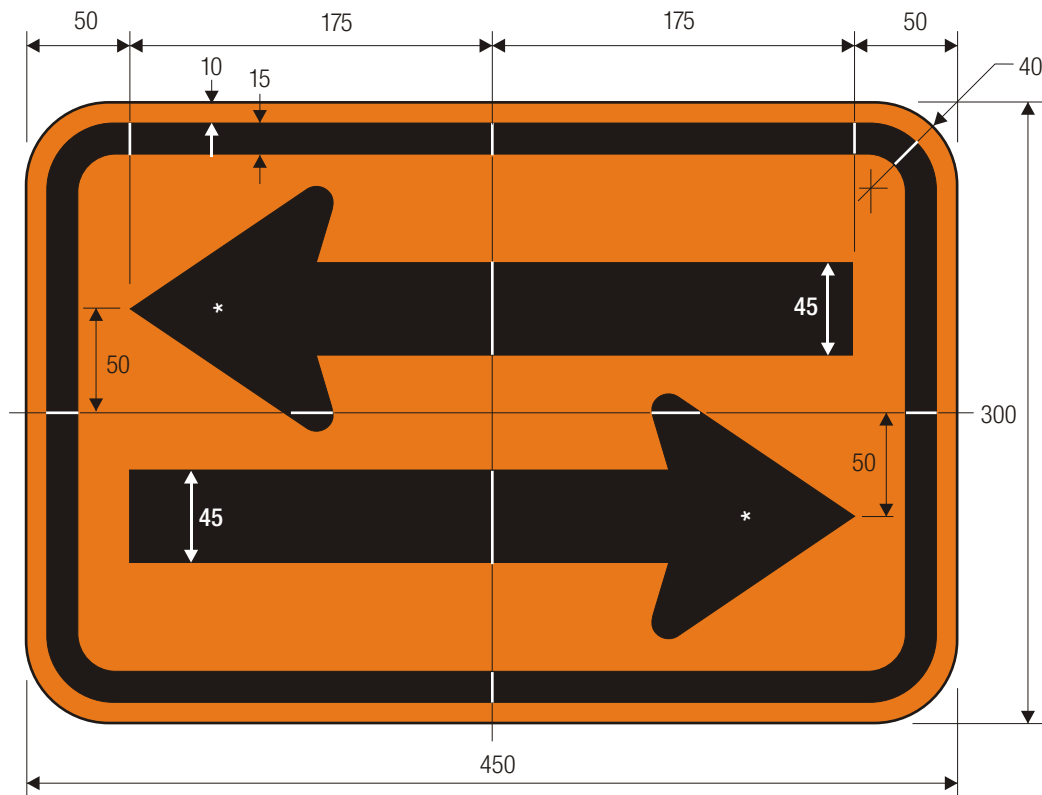

W6-4

TWO WAY TRAFFIC

*See page 6-2 for arrow design.

TTC SIGN COLORS:
 SYMBOL — BLACK
 BACKGROUND— ORANGE (RETROREFLECTIVE)

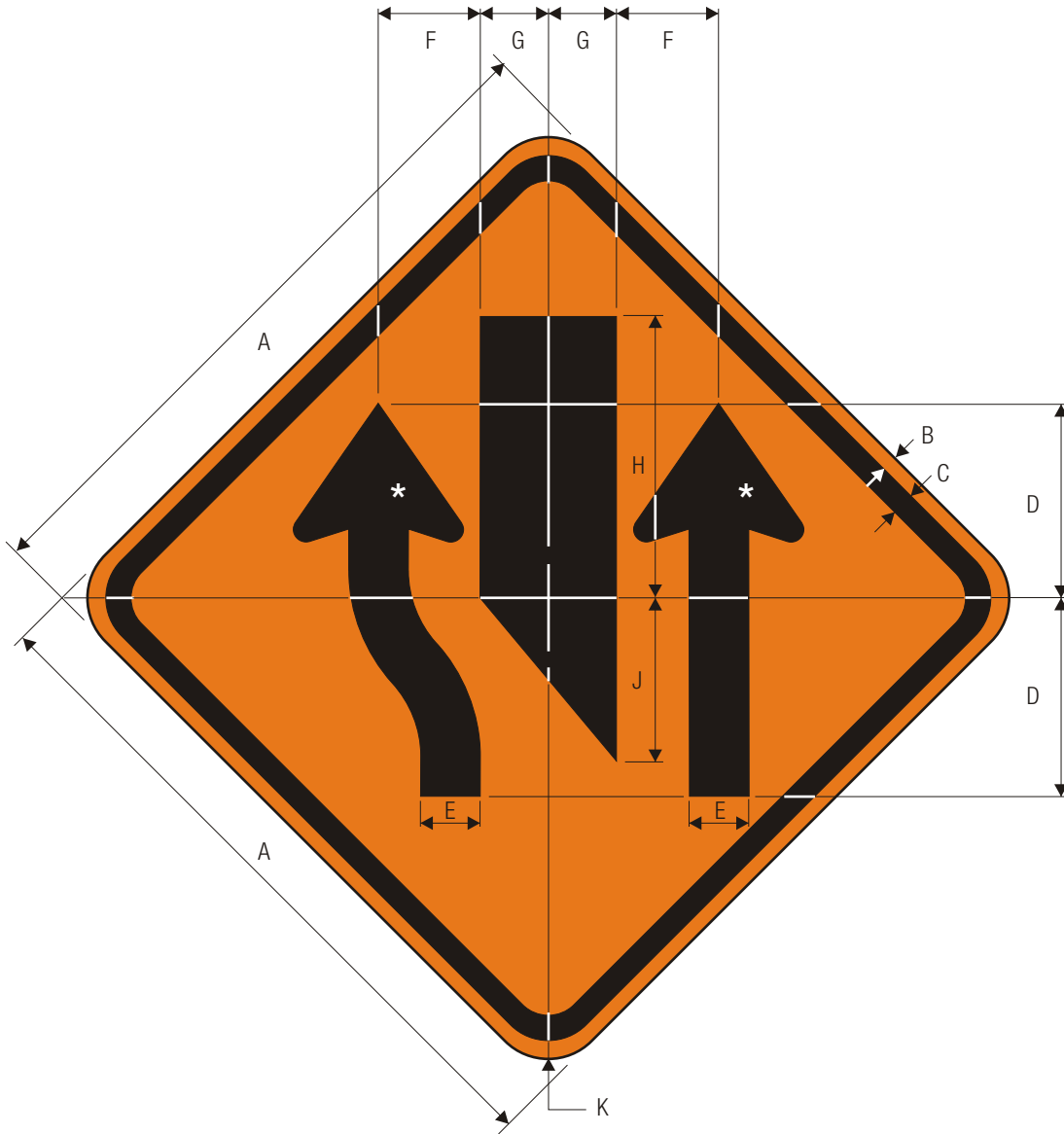

W9-3a
CENTER LANE CLOSED

*See page 6-2 for symbol design.

	A	B	C	D	E	F	G	H	J	K
	600	10	15	173	53	90	60	250	142	50
	750	13	20	216	66	113	75	313	178	50
C	900	15	25	259	79	136	90	376	214	60
	1200	20	30	345	105	181	120	501	285	70

TTC SIGN COLORS:

SYMBOL — BLACK

BACKGROUND— ORANGE (RETROREFLECTIVE)

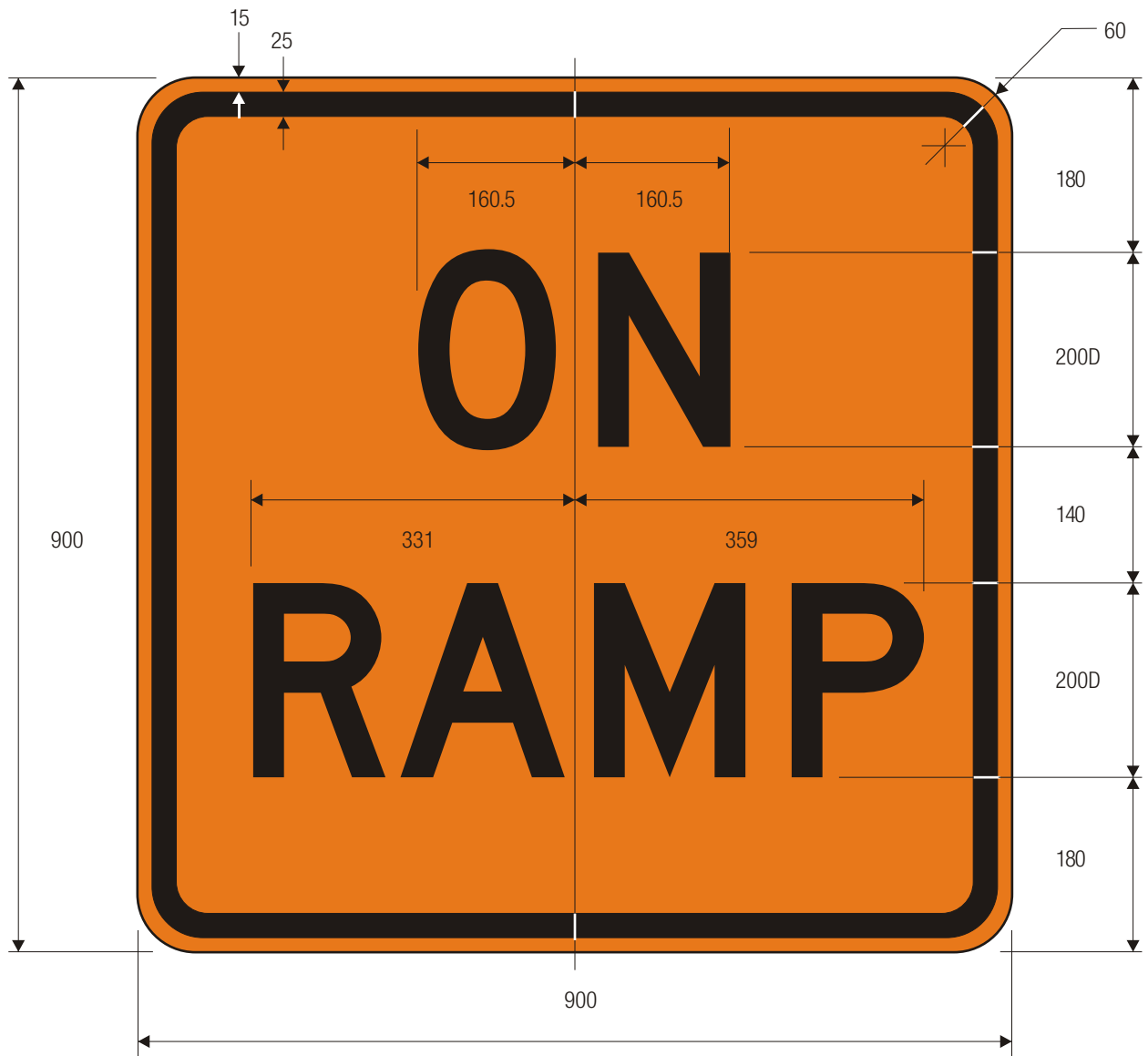

W13-4

ON RAMP

TTC SIGN COLORS:

LEGEND — BLACK

BACKGROUND— ORANGE (RETROREFLECTIVE)

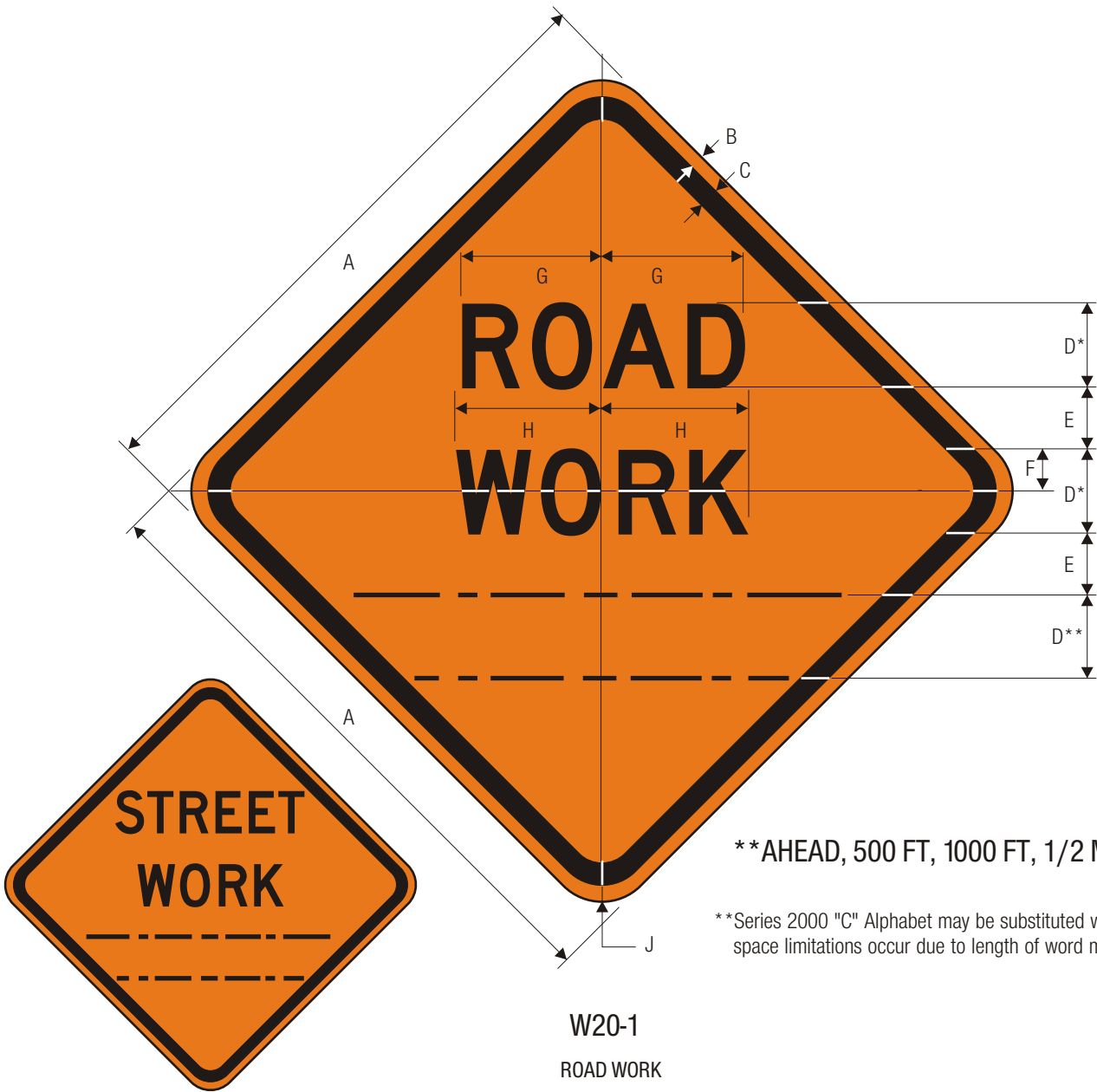

	A	B	C	D	E	F	G	H	J
	600	10	15	100 D	50	50	167	174	50
	750	13	20	100 D	69	50	167	174	50
C	900	15	25	125 D	92	62	210	216.5	60
	1200	20	30	175 D	120	87	292	294.5	70
	1500	20	30	200 D	137	100	334	348	70

TTC SIGN COLORS:
 LEGEND — BLACK
 BACKGROUND— ORANGE (RETROREFLECTIVE)

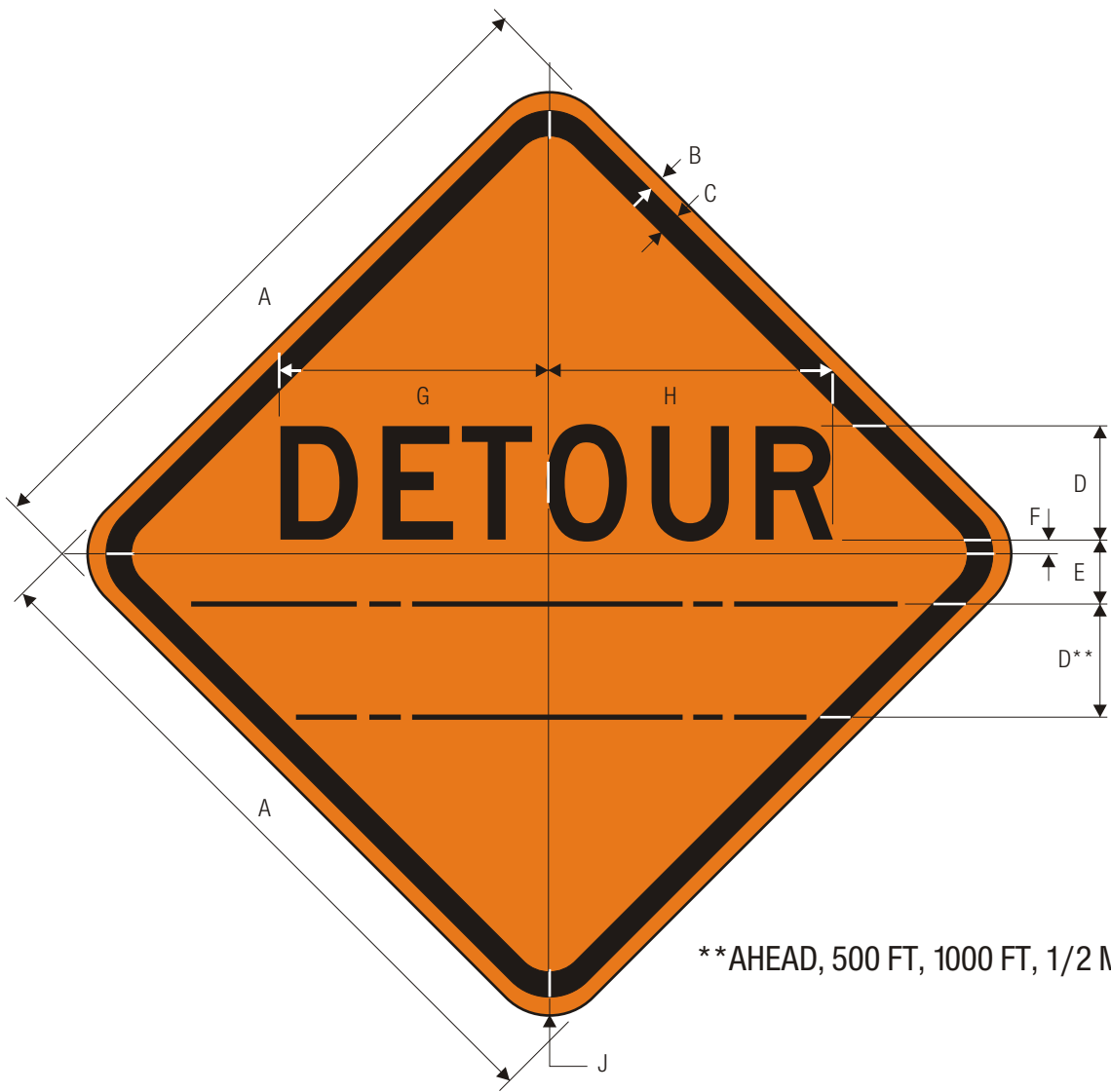

**AHEAD, 500 FT, 1000 FT, 1/2 MILE

W20-2

	A	B	C	D	E	F	G	H	J
C	900	15	25	150 D	87	22	355	374	60
	1200	20	30	200 D	118	31	471	501	70

TTC SIGN COLORS:
 LEGEND — BLACK
 BACKGROUND— ORANGE (RETROREFLECTIVE)



C

A	B	C	D	E	F	G	H	J	K	L	M
900	15	25	125 D	87	94	81	208.5	300.5	60	238	125 C
1200	20	30	175 D	119	131	112	292	421	70	333	175 C

TTC SIGN COLORS:
 LEGEND — BLACK
 BACKGROUND— ORANGE (RETROREFLECTIVE)

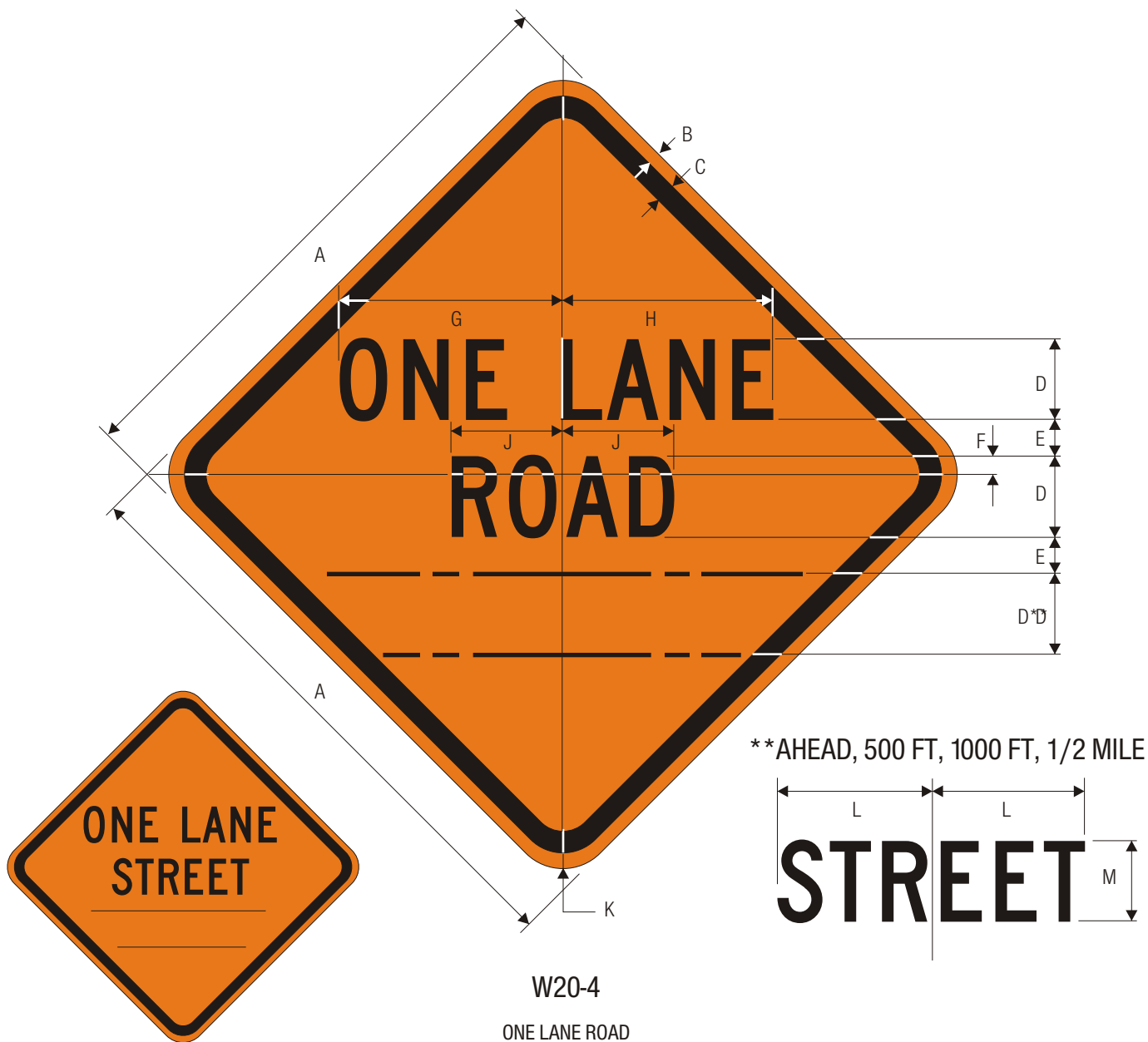

	A	B	C	D	E	F	G	H	J	K	L	M
C	900	15	25	125 C	56	31	345	325	172	60	238	125 C
	1200	20	30	175 C	78	44	480	458	241	70	333	175 C

TTC SIGN COLORS:
 LEGEND — BLACK
 BACKGROUND— ORANGE (RETROREFLECTIVE)

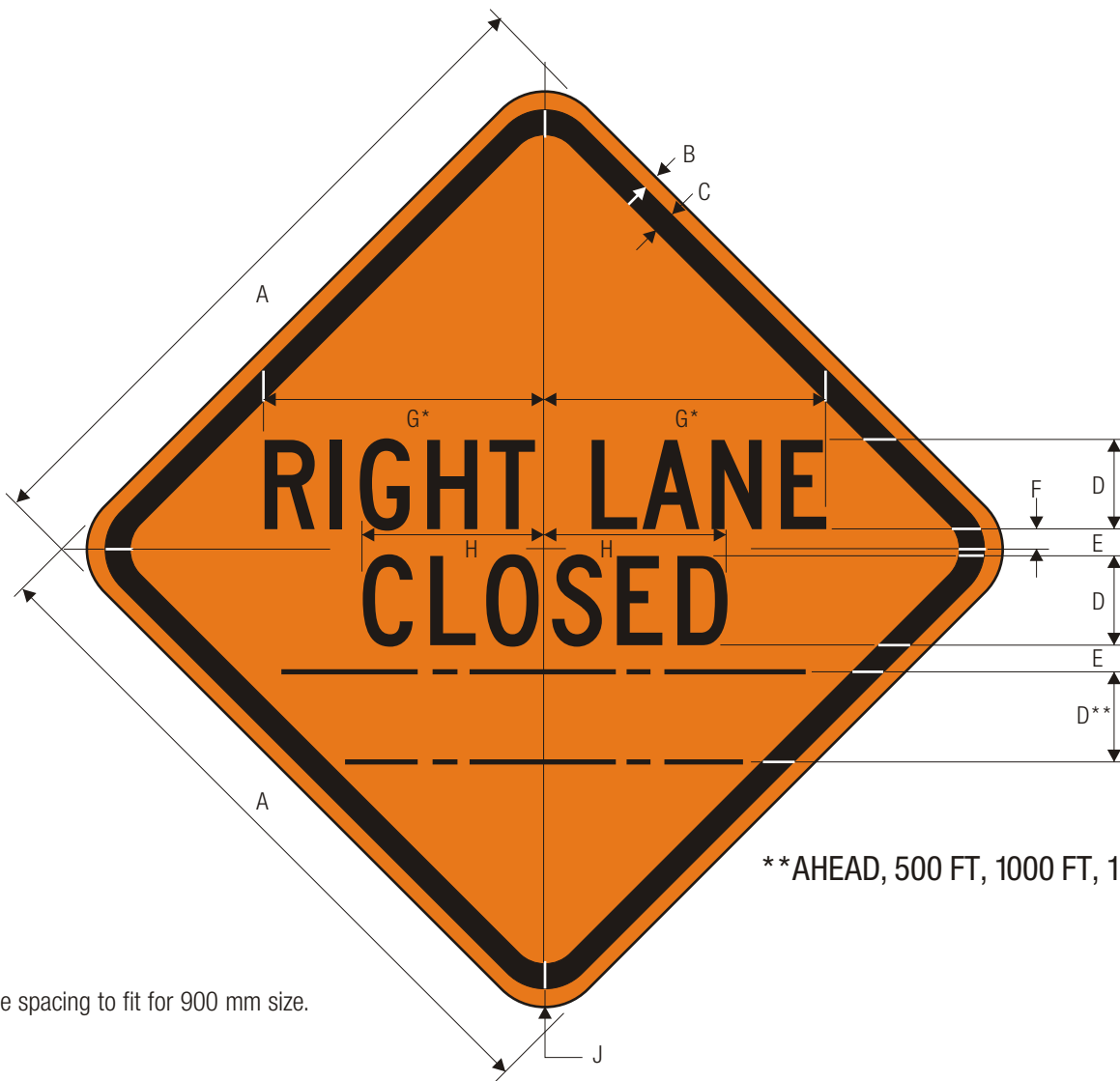

**AHEAD, 500 FT, 1000 FT, 1/2 MILE

*Reduce spacing to fit for 900 mm size.

W20-5

RIGHT (CENTER) (LEFT) LANE CLOSED



C

A	B	C	D	E	F	G	H	J	K	L	M
900	15	25	125 C	48	37	382	255	60	353.5	422	410
1200	20	30	150 C	58	44	471.5	306	70	424.5	547.5	547.5
1500	20	30	200 C	70	53	628.5	408	70	629	738	722

TTC SIGN COLORS:

LEGEND — BLACK

BACKGROUND— ORANGE (RETROREFLECTIVE)

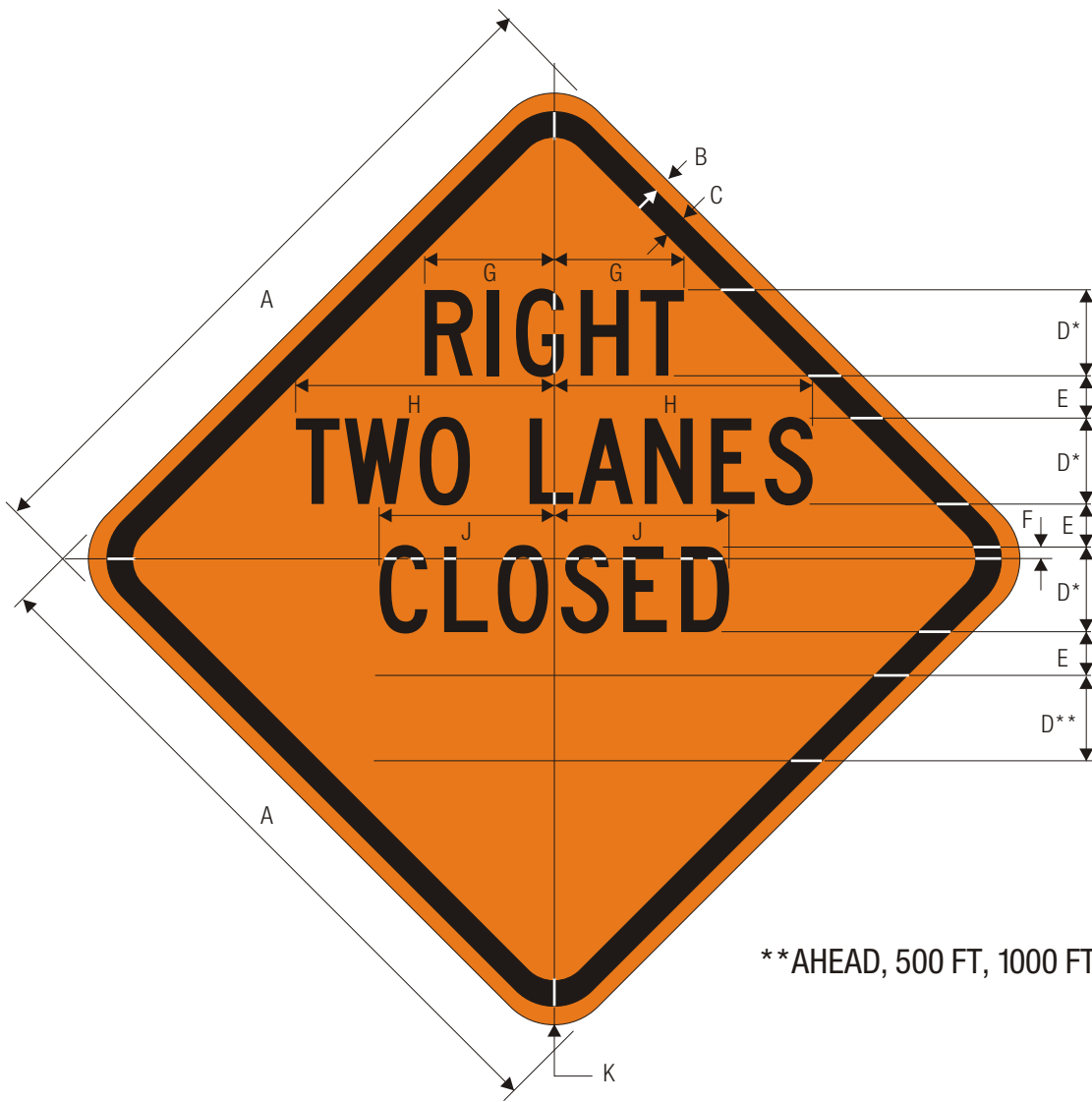

**AHEAD, 500 FT, 1000 FT, 1/2 MILE

W20-5a

RIGHT TWO LANES CLOSED

*Series 2000 Standard Alphabets.

C

A	B	C	D	E	F	G	H	J	K
750	13	20	100 C	38	14	151.5	301.5	204	50
900	15	25	125 C	50	18	189	377	255	60
1200	20	30	150 C	75	25	227	452.5	306	70

TTC SIGN COLORS:

LEGEND — BLACK

BACKGROUND— ORANGE (RETROREFLECTIVE)

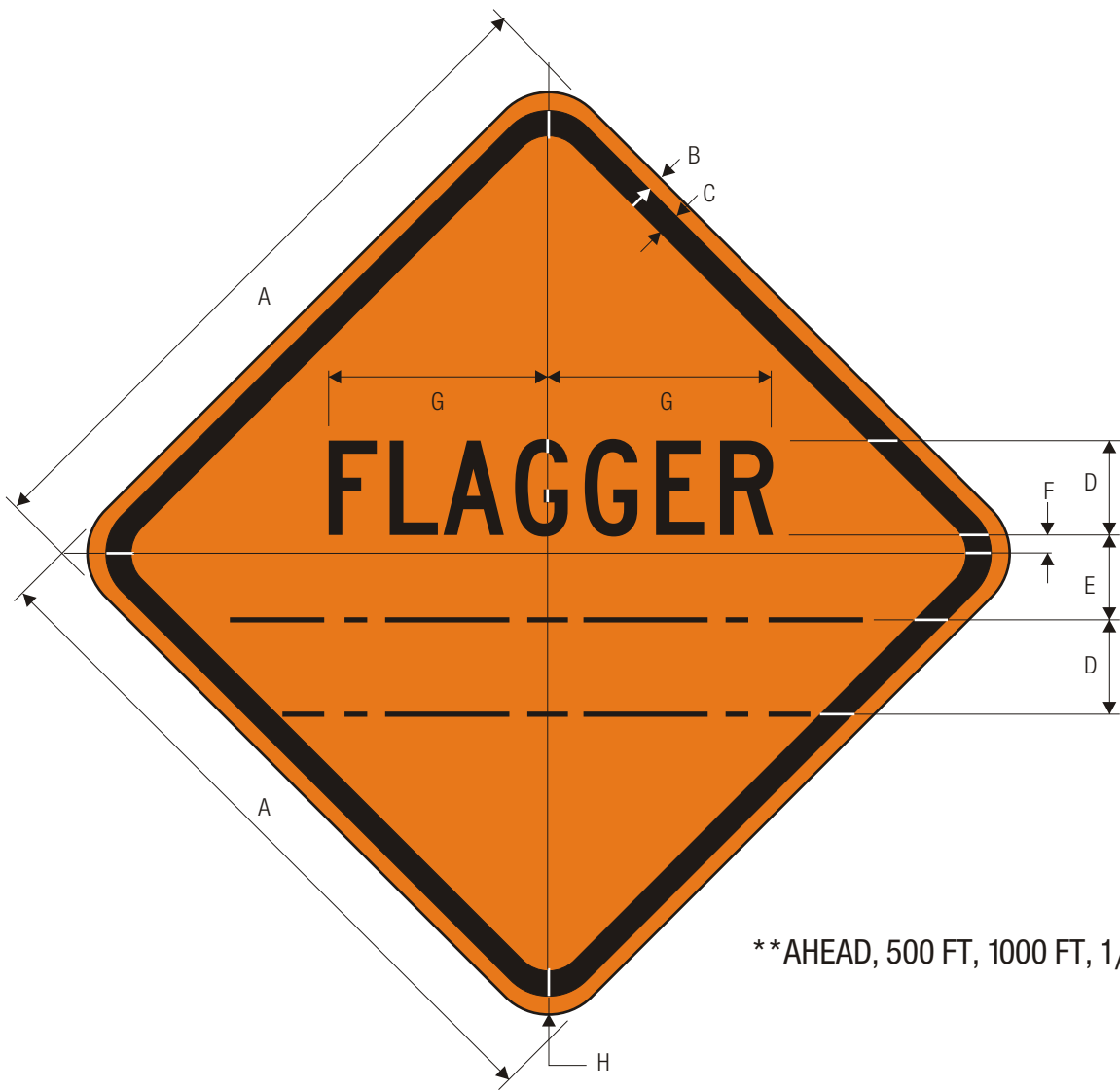

**AHEAD, 500 FT, 1000 FT, 1/2 MILE

W20-7

FLAGGER

	A	B	C	D	E	F	G	H
C	900	15	25	125 C	112	25	293.5	60
	1200	20	30	175 C	156	62	411	70

TTC SIGN COLORS:

LEGEND — BLACK

BACKGROUND— ORANGE (RETROREFLECTIVE)

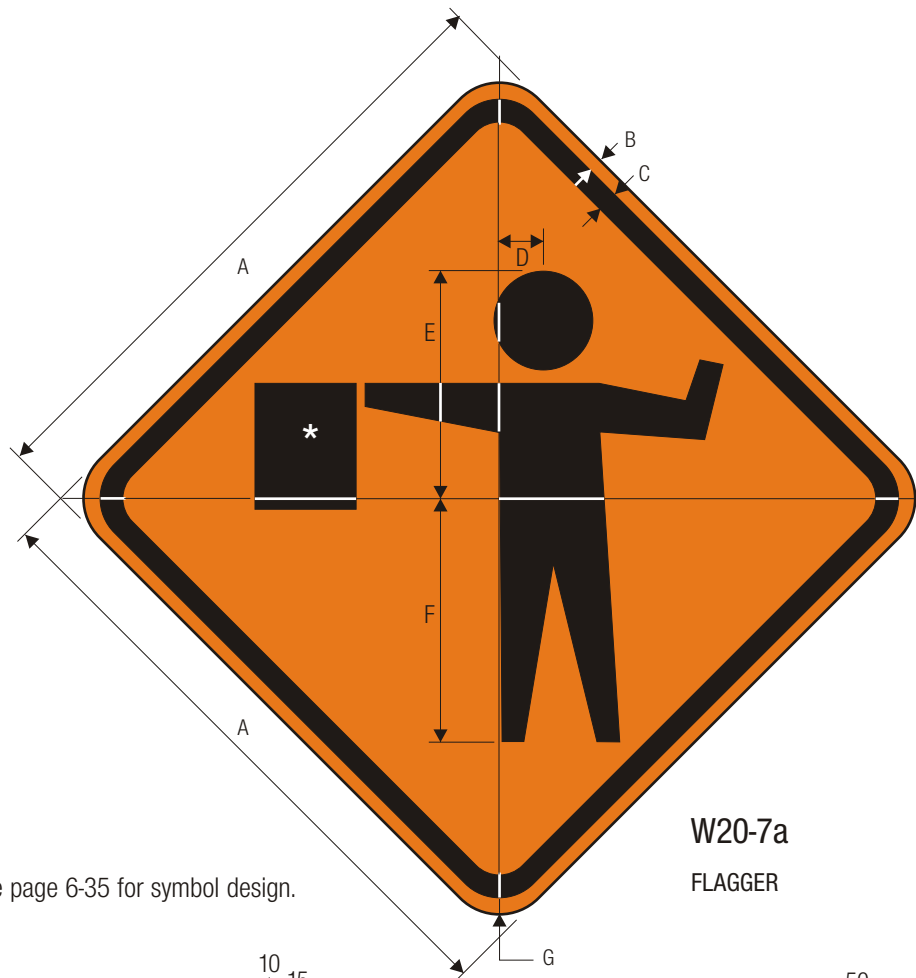

W20-7a
FLAGGER

*See page 6-35 for symbol design.

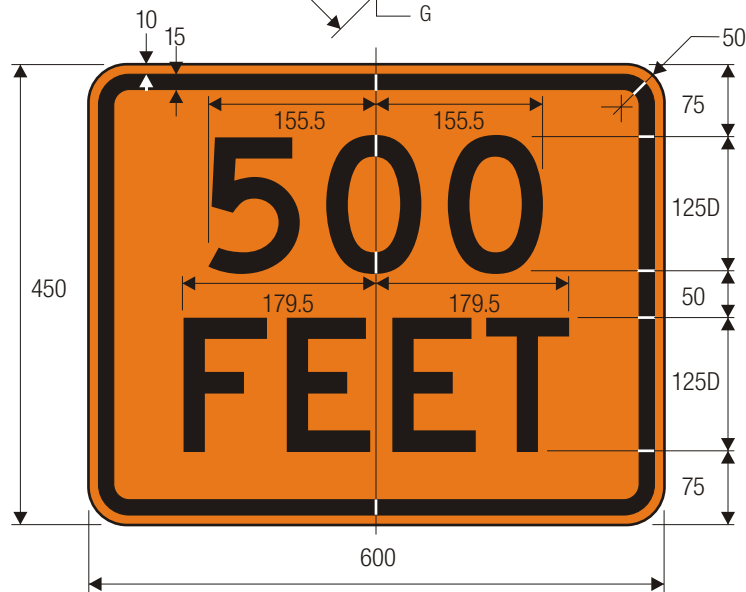

W2-16
DISTANCE (2 LINE) (ENGLISH)

	A	B	C	D	E	F	G
	600	10	15	44	225	242	50
	750	13	20	55	281	303	50
C	900	15	25	66	337	364	60
	1200	20	30	86	438	473	70

COLORS: LEGEND — BLACK
BACKGROUND — ORANGE (RETROREFLECTIVE)



W21-1
WORKERS

A	B	C	D	E	F	G
600	10	15	50	100 D	294.5	50
750	13	20	62.5	125 D	368	50
C 900	15	25	75	150 D	442	60
1200	20	30	100	200 D	589	70

TTC SIGN COLORS:
 LEGEND — BLACK
 BACKGROUND— ORANGE (RETROREFLECTIVE)



W21-1a

WORKERS

*See page 6-59 for symbol design.

	A	B	C	D	E	F	G
	750	13	20	46	350	250	50
C	900	15	25	55	420	300	60
	1200	20	30	73	559	399	70

TTC SIGN COLORS:

SYMBOL — BLACK

BACKGROUND— ORANGE (RETROREFLECTIVE)

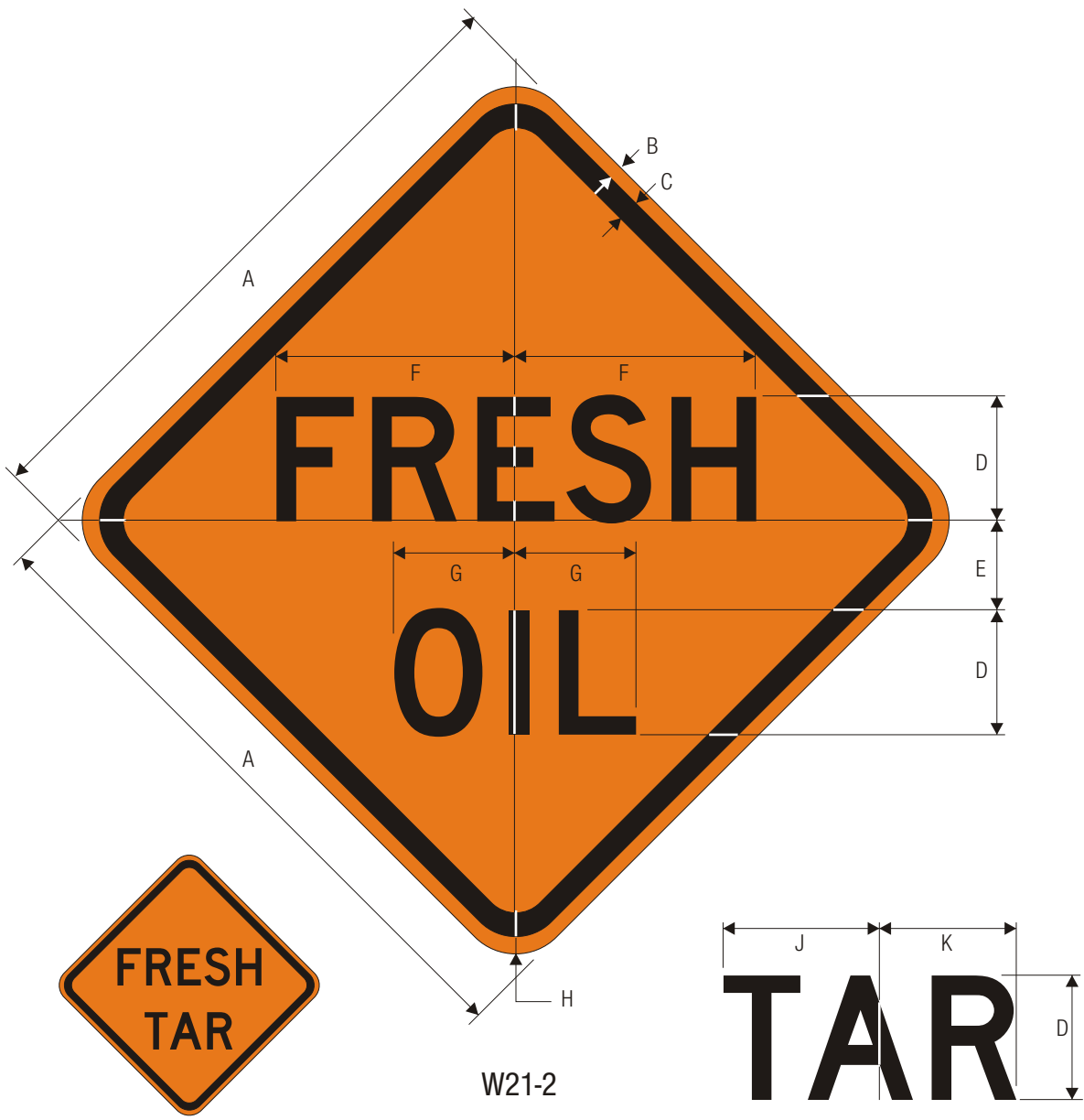

W21-2

FRESH OIL (TAR)

C

A	B	C	D	E	F	G	H	J	K
600	10	15	125 D	75	241	121.5	50	155	139
750	13	20	150 D	100	289	145.5	50	182	171
900	15	25	175 D	125	337	170	60	208	204
1200	20	30	200 D	150	385.5	194.5	70	253	218

TTC SIGN COLORS:

LEGEND — BLACK

BACKGROUND— ORANGE (RETROREFLECTIVE)

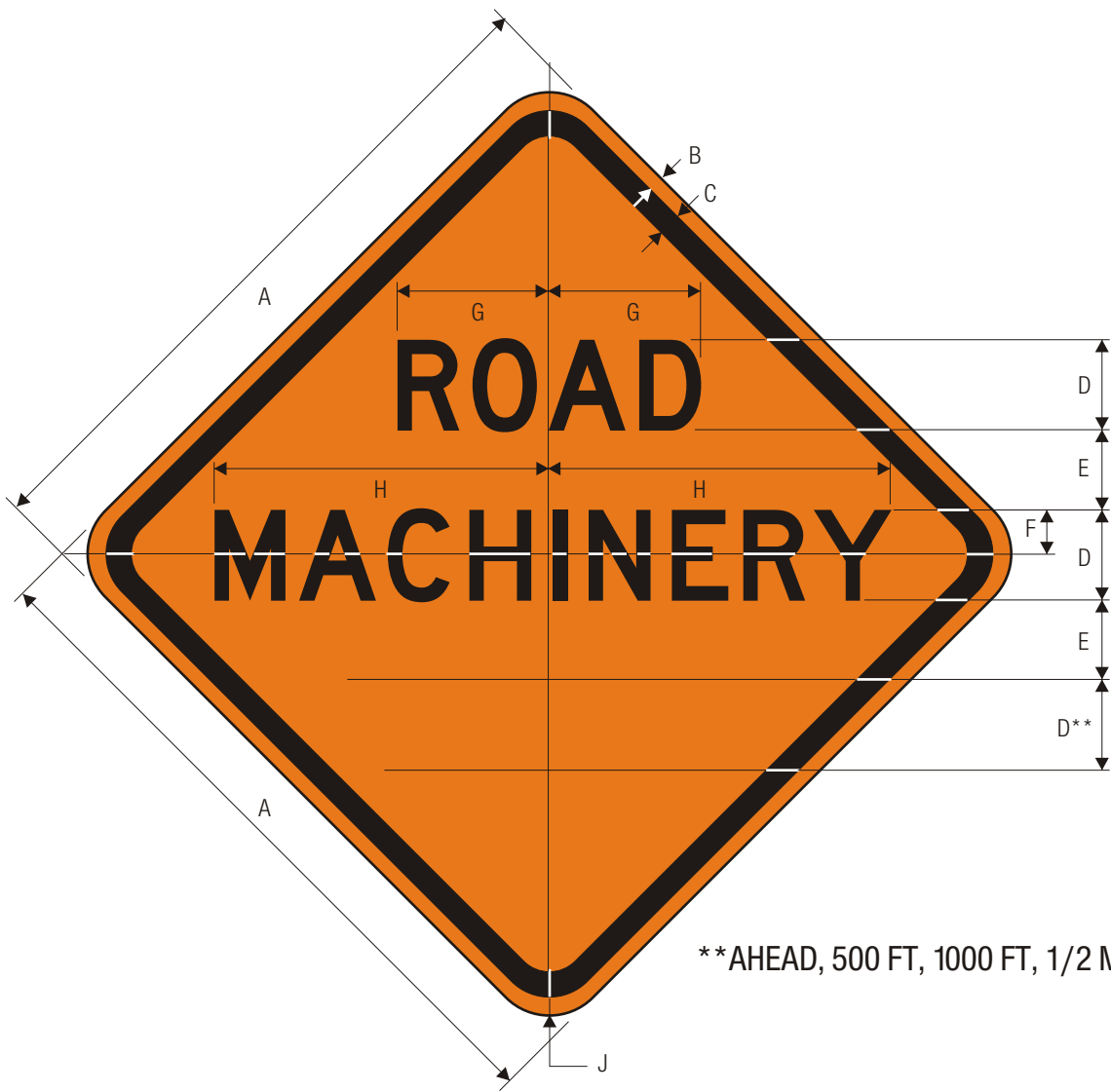

**AHEAD, 500 FT, 1000 FT, 1/2 MILE

W21-3

ROAD MACHINERY

	A	B	C	D	E	F	G	H	J
	600	10	15	75 D	63	38	125	279	50
C	750	13	20	100 D	87	50	167	372	50
	900	15	25	125 D	100	62	208.5	465.5	60
	1200	20	30	175 D	125	87	292	651.5	70

TTC SIGN COLORS:

LEGEND — BLACK

BACKGROUND— ORANGE (RETROREFLECTIVE)

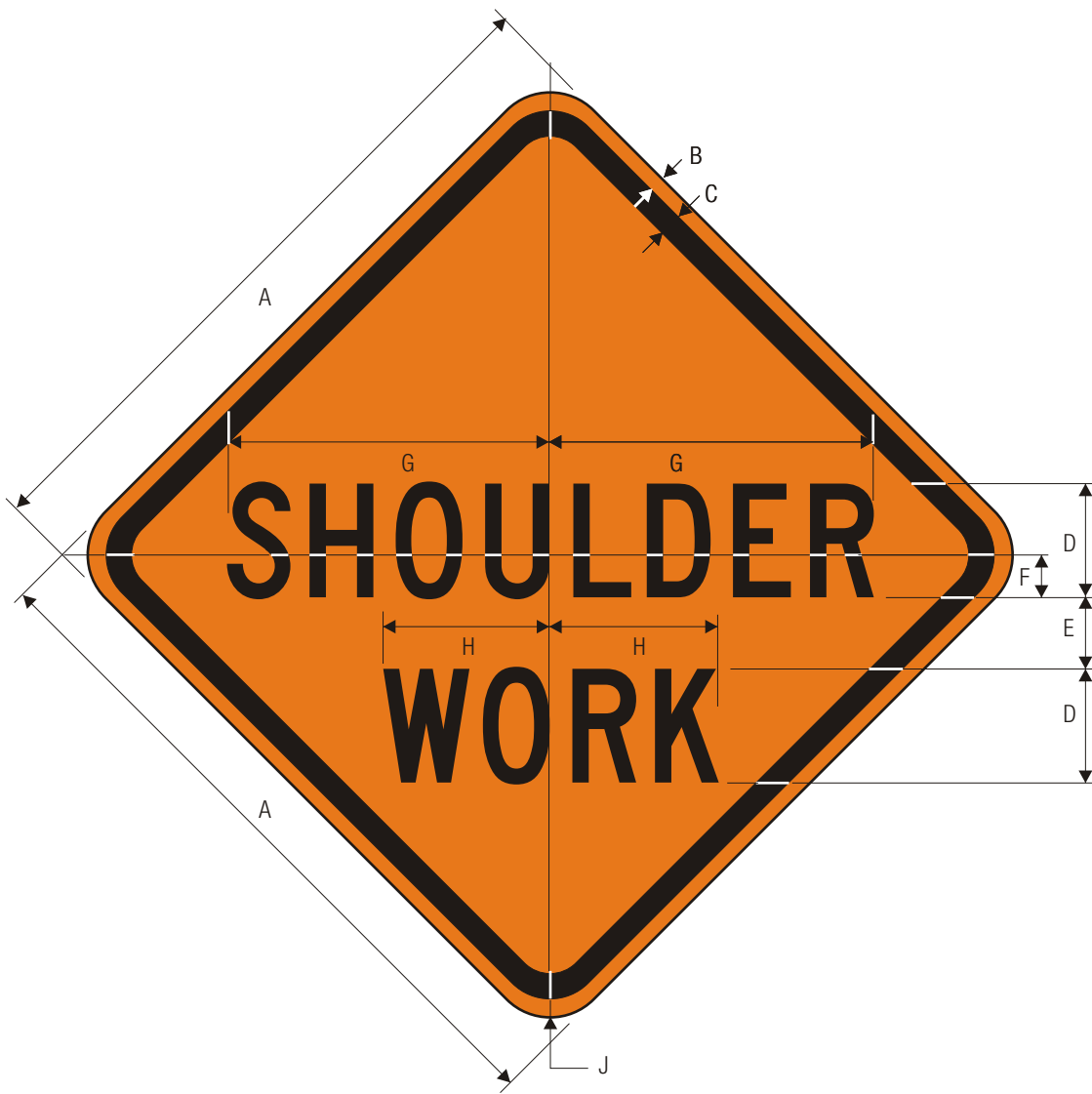

W21-5

	A	B	C	D	E	F	G	H	J
	600	10	15	100 C	62	36	284	147.5	50
C	750	13	20	125 C	75	42	355.5	184.5	50
	900	15	25	150 C	87	50	426.5	221	60
	1200	20	30	200 C	100	77	568.5	295	70

TTC SIGN COLORS:

LEGEND — BLACK

BACKGROUND— ORANGE (RETROREFLECTIVE)

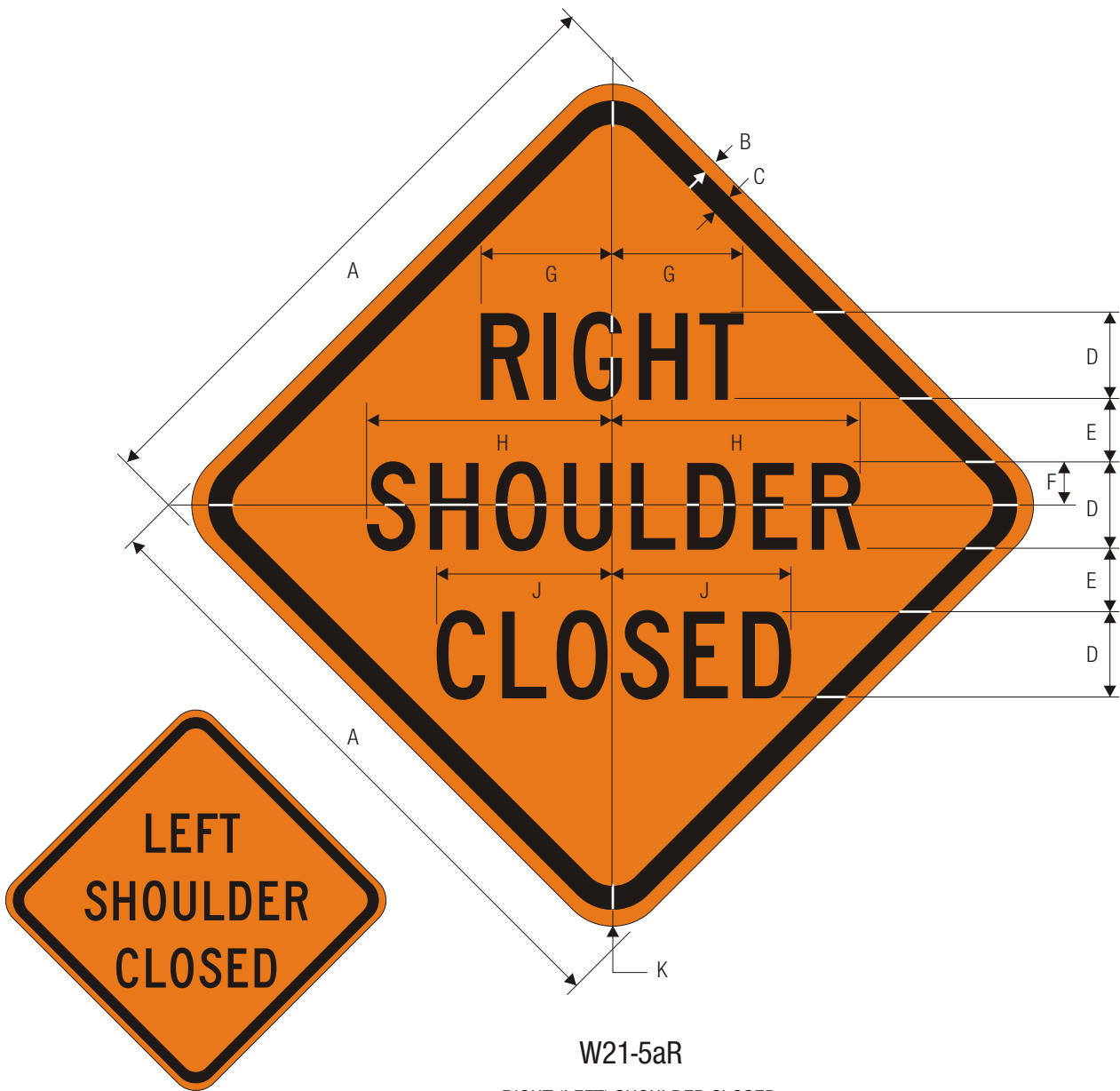

W21-5aL

W21-5aR
RIGHT (LEFT) SHOULDER CLOSED

	A	B	C	D	E	F	G	H	J	K
	750	13	20	100 C	69	50	151.5	284	204	50
C	900	15	25	125 C	92	62	189	355.5	255	60
	1200	20	30	175 C	120	87	265	479.5	344.5	70
	1500	20	30	200 C	137	100	302.5	568.5	408	70

TTC SIGN COLORS:
 LEGEND — BLACK
 BACKGROUND— ORANGE (RETROREFLECTIVE)

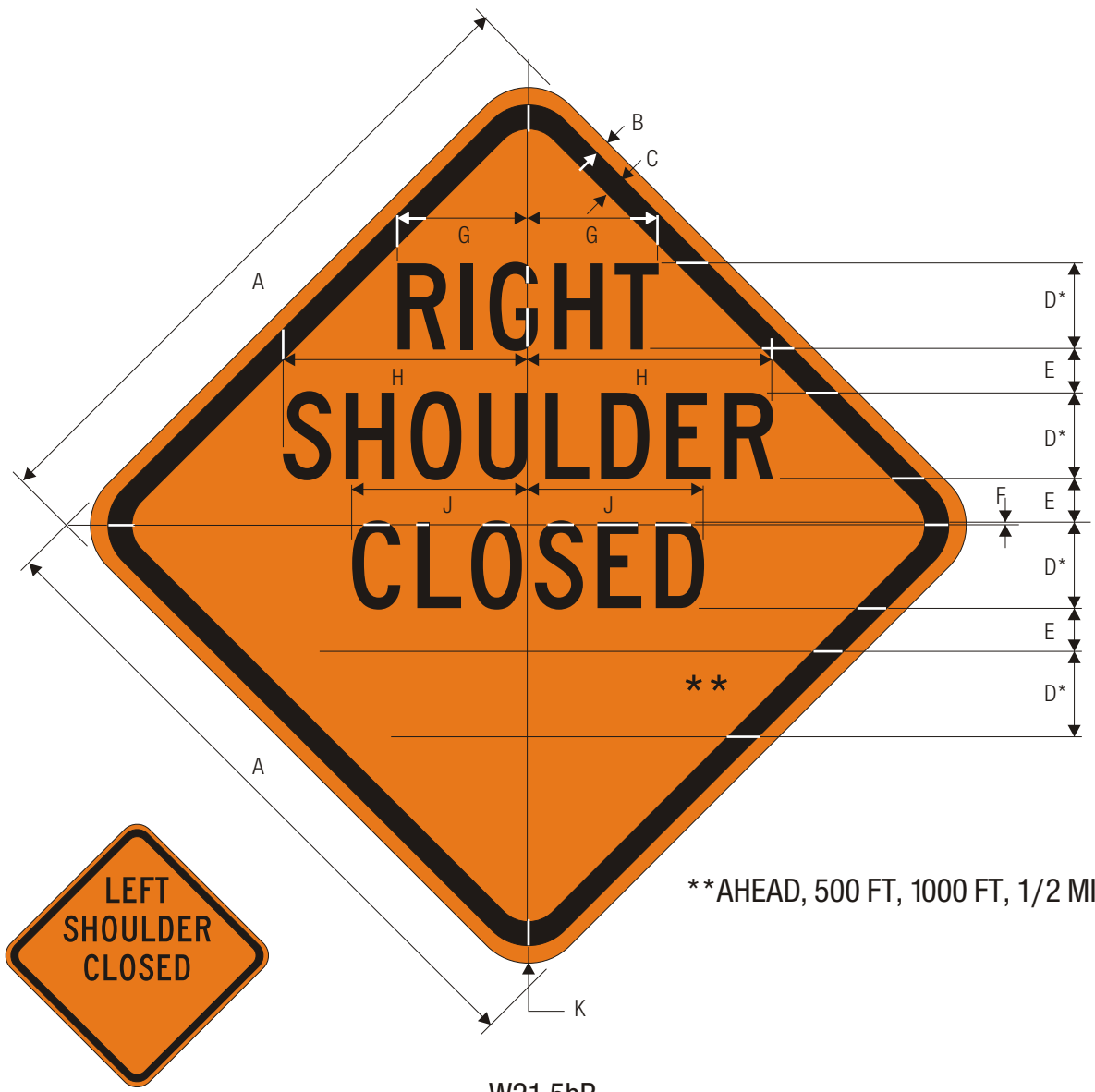

**AHEAD, 500 FT, 1000 FT, 1/2 MILE

W21-5bL
 W21-5bR
 RIGHT (LEFT) SHOULDER CLOSED

*Series 2000 Standard Alphabets.

	A	B	C	D	E	F	G	H	J	K
	750	13	20	100 C	50	4	151.5	284	204	50
C	900	15	25	125 C	60	5	189	355.5	255	60
	1200	20	30	150 C	75	6	227	426.5	306	70
	1500	20	30	200 C	100	8	302.5	568.5	408	70

TTC SIGN COLORS:
 LEGEND — BLACK
 BACKGROUND— ORANGE (RETROREFLECTIVE)

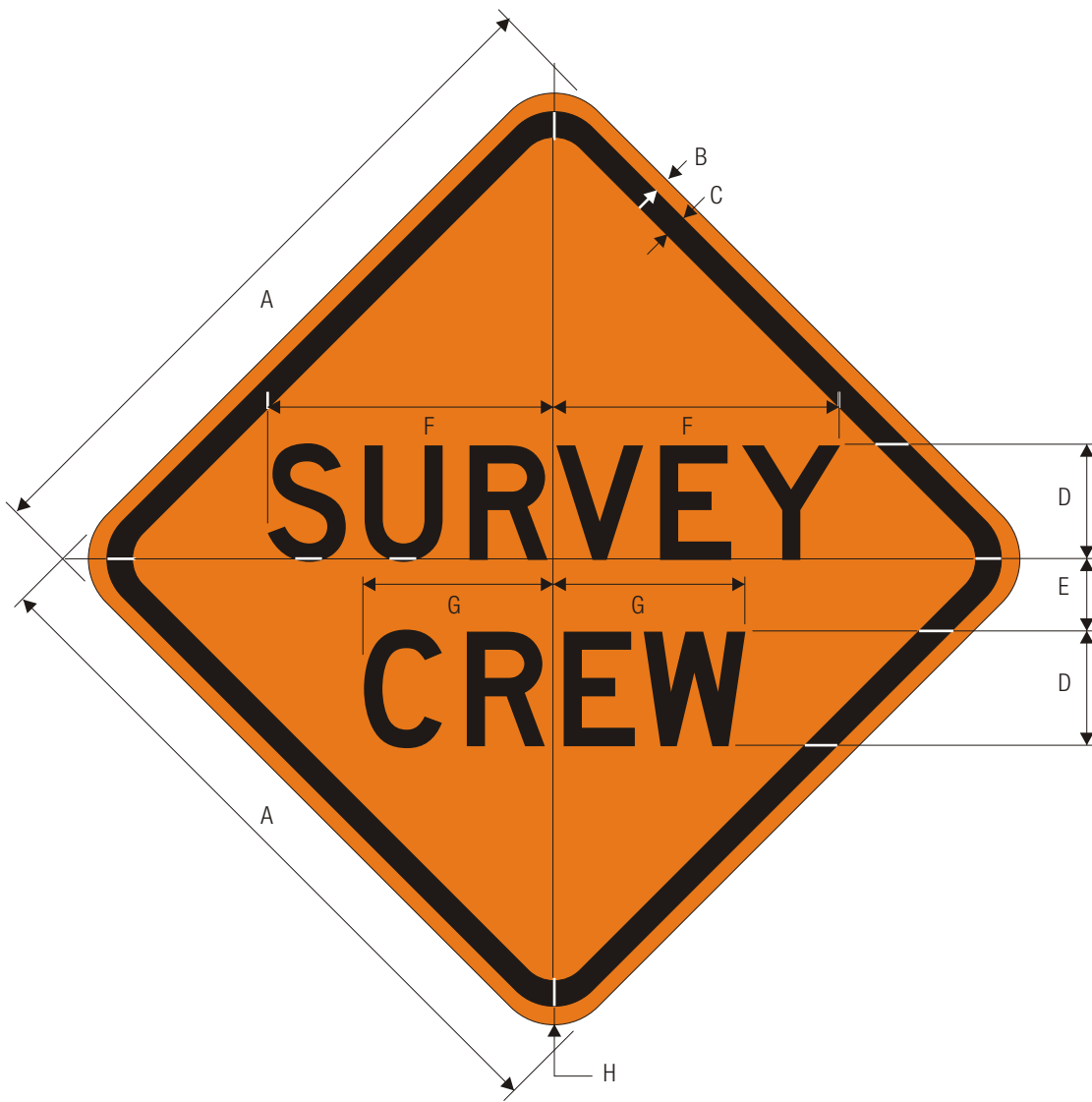

W21-6

SURVEY CREW

	A	B	C	D	E	F	G	H
	600	10	15	100 D	60	249.5	166.5	50
C	750	13	20	125 D	75	312	208	50
	900	15	25	150 D	90	374.5	249.5	60
	1200	20	30	200 D	120	499.5	333	70

TTC SIGN COLORS:

LEGEND — BLACK

BACKGROUND— ORANGE (RETROREFLECTIVE)

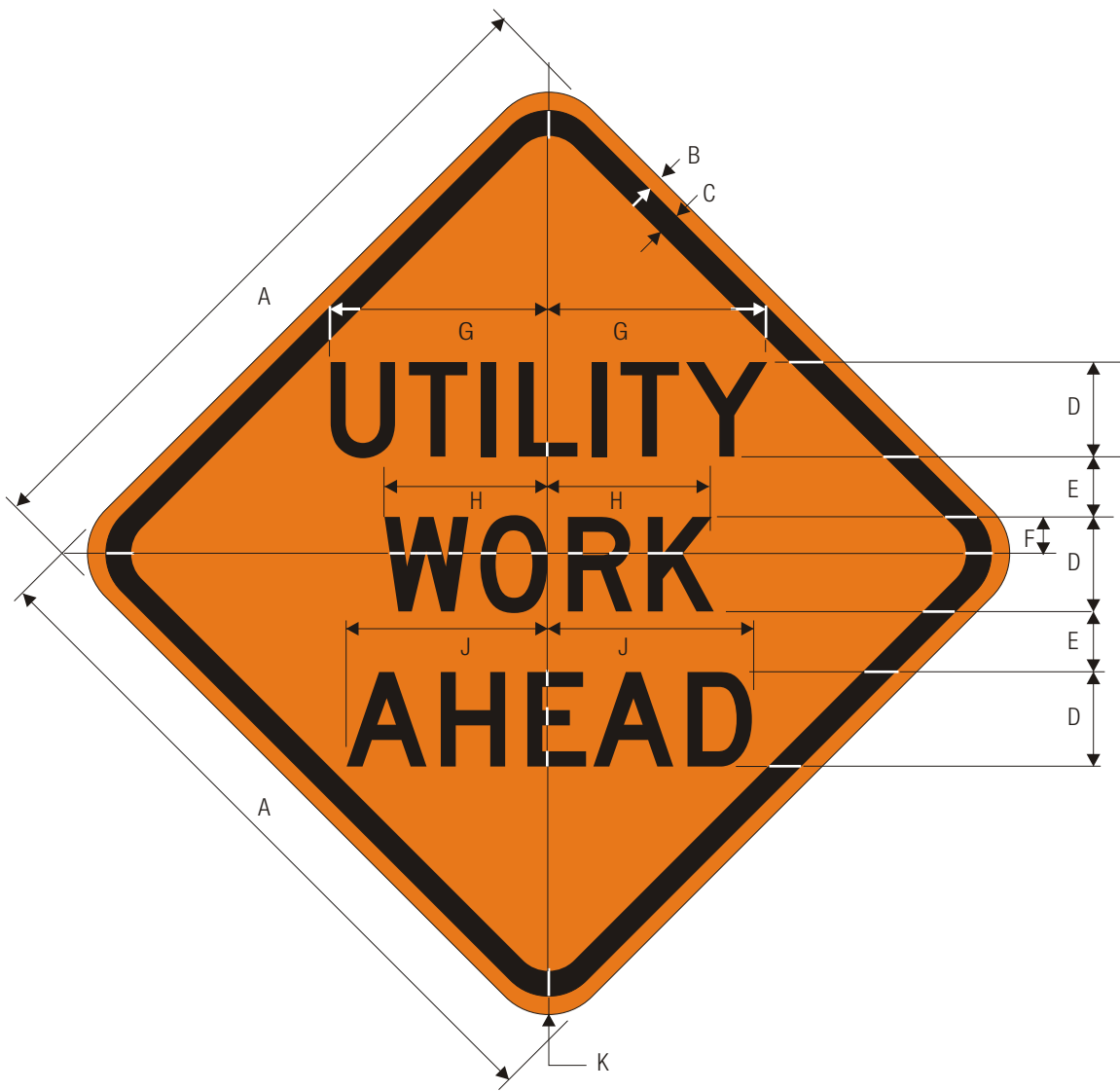

W21-7
UTILITY WORK AHEAD

	A	B	C	D	E	F	G	H	J	K
	750	13	20	100 D	70	40	230.5	174	214.5	50
C	900	15	25	125 D	80	50	288.5	217.5	268	60
	1200	20	30	175 D	90	57	404	247	365	70

TTC SIGN COLORS:
 LEGEND — BLACK
 BACKGROUND— ORANGE (RETROREFLECTIVE)

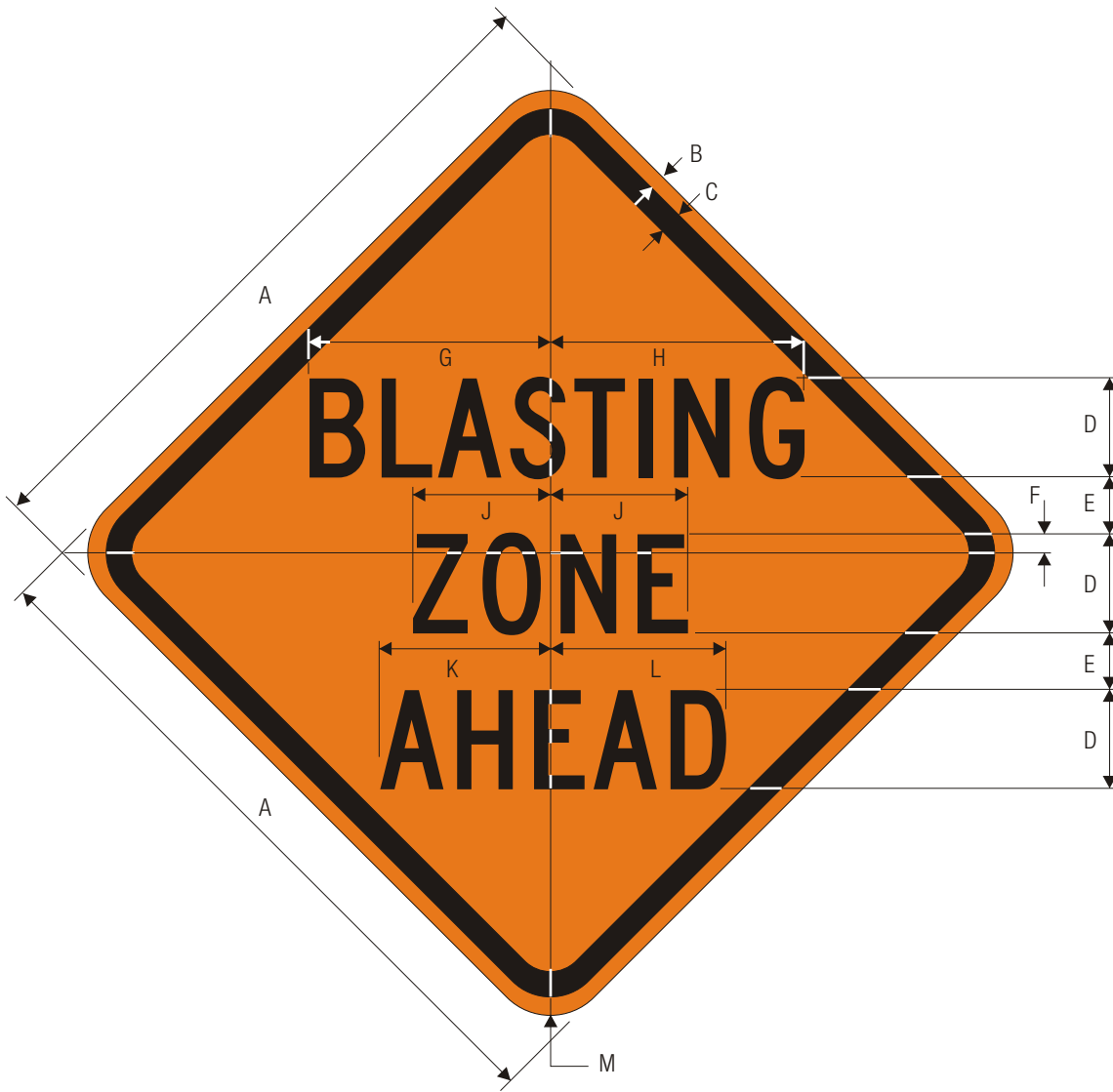

W22-1

BLASTING ZONE AHEAD

A	B	C	D	E	F	G	H	J	K	L	M
900	15	25	125 C	75	24	303	320	173	211	225	60
C 1200	20	30	175 C	100	37	425	448	242.5	294	316	70

TTC SIGN COLORS:

LEGEND — BLACK

BACKGROUND— ORANGE (RETROREFLECTIVE)



W22-2

TURN OFF 2-WAY RADIO AND CELL PHONE

	A	B	C	D	E	F	G	H	J	K	L	M
C	1050	900	20	30	125	175 C	99	100 C	38	467.5	347.5	105.5

N	P
337	70

TTC SIGN COLORS:

LEGEND — BLACK

BACKGROUND— ORANGE (RETROREFLECTIVE)



W22-3

END BLASTING ZONE

	A	B	C	D	E	F	G	H	J	K	L
C	1050	900	15	25	112	175 C	75.5	176	436.5	242.5	60

TTC SIGN COLORS:

LEGEND — BLACK

BACKGROUND— ORANGE (RETROREFLECTIVE)

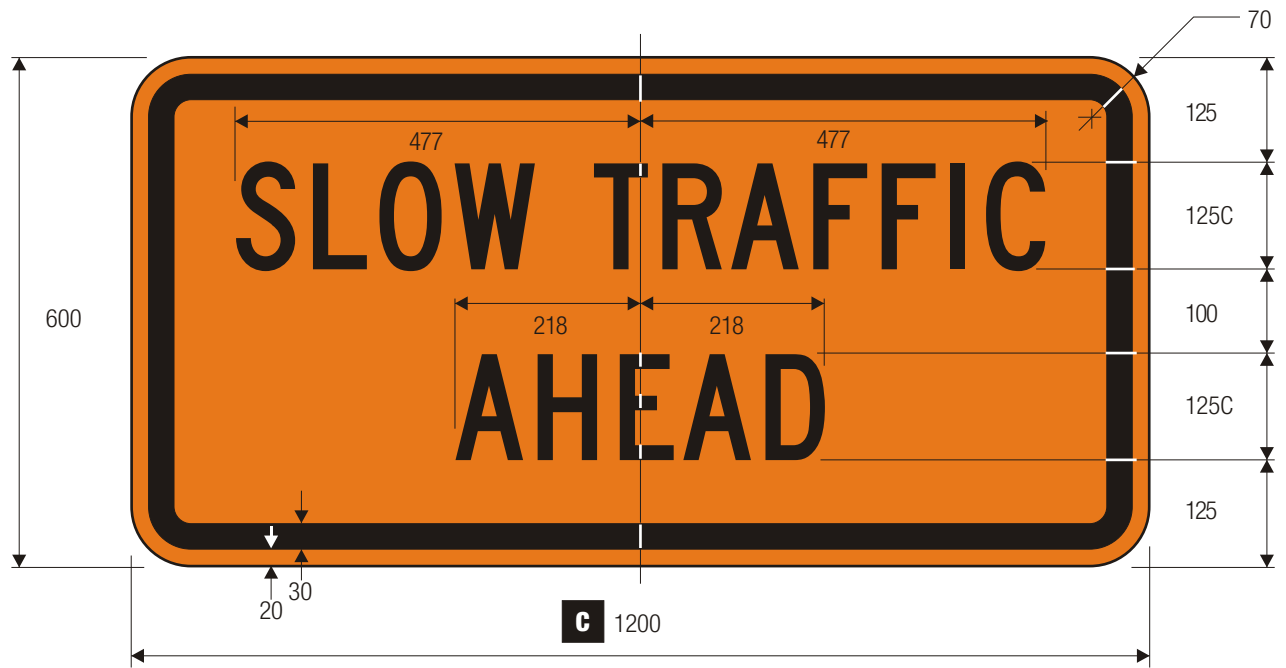

W23-1
SLOW TRAFFIC AHEAD

TTC SIGN COLORS:
 LEGEND — BLACK
 BACKGROUND— ORANGE (RETROREFLECTIVE)

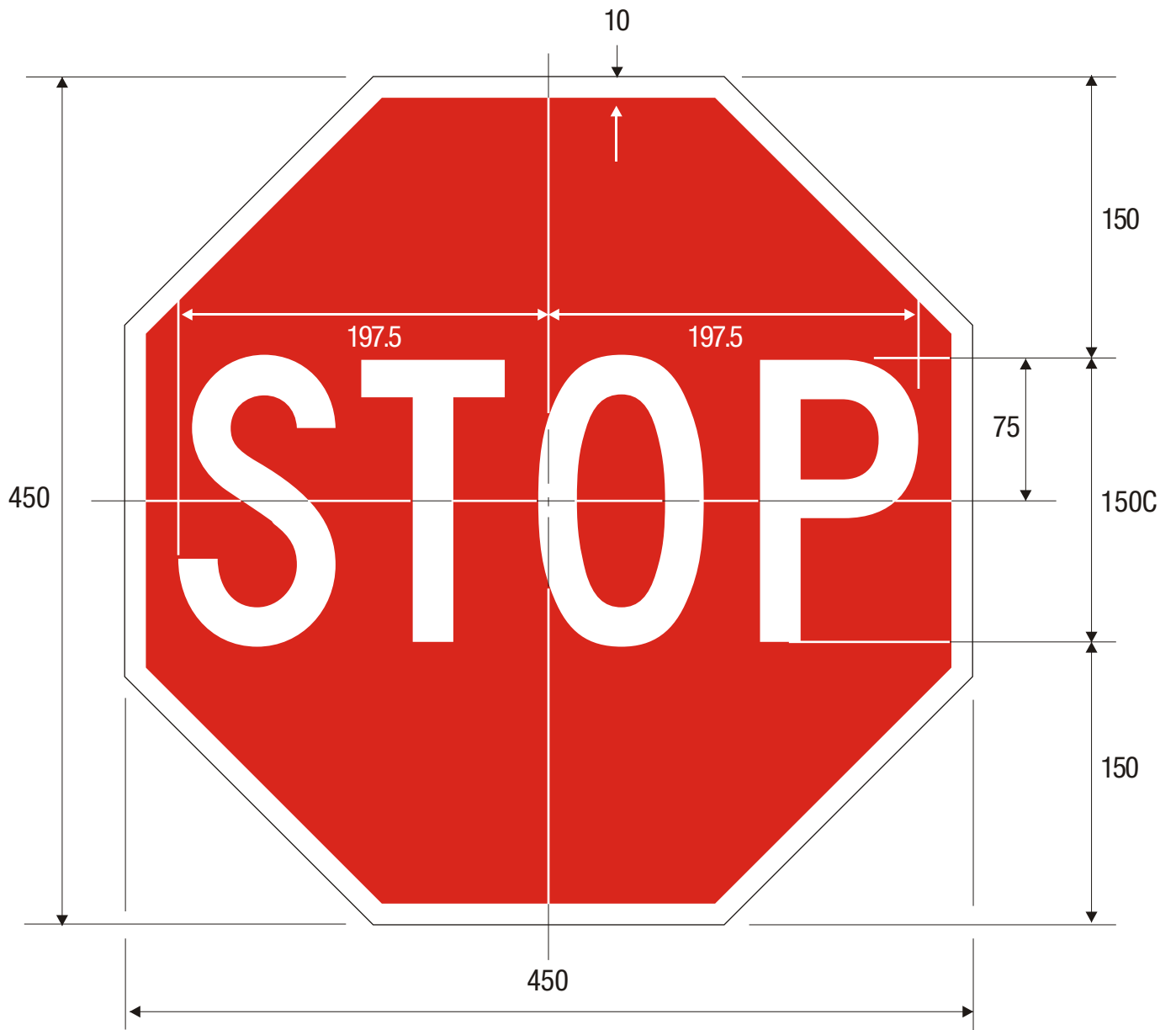

STOP - SLOW PADDLE

COLORS: LEGEND — WHITE (RETROREFLECTIVE)
 BACKGROUND — RED (RETROREFLECTIVE)

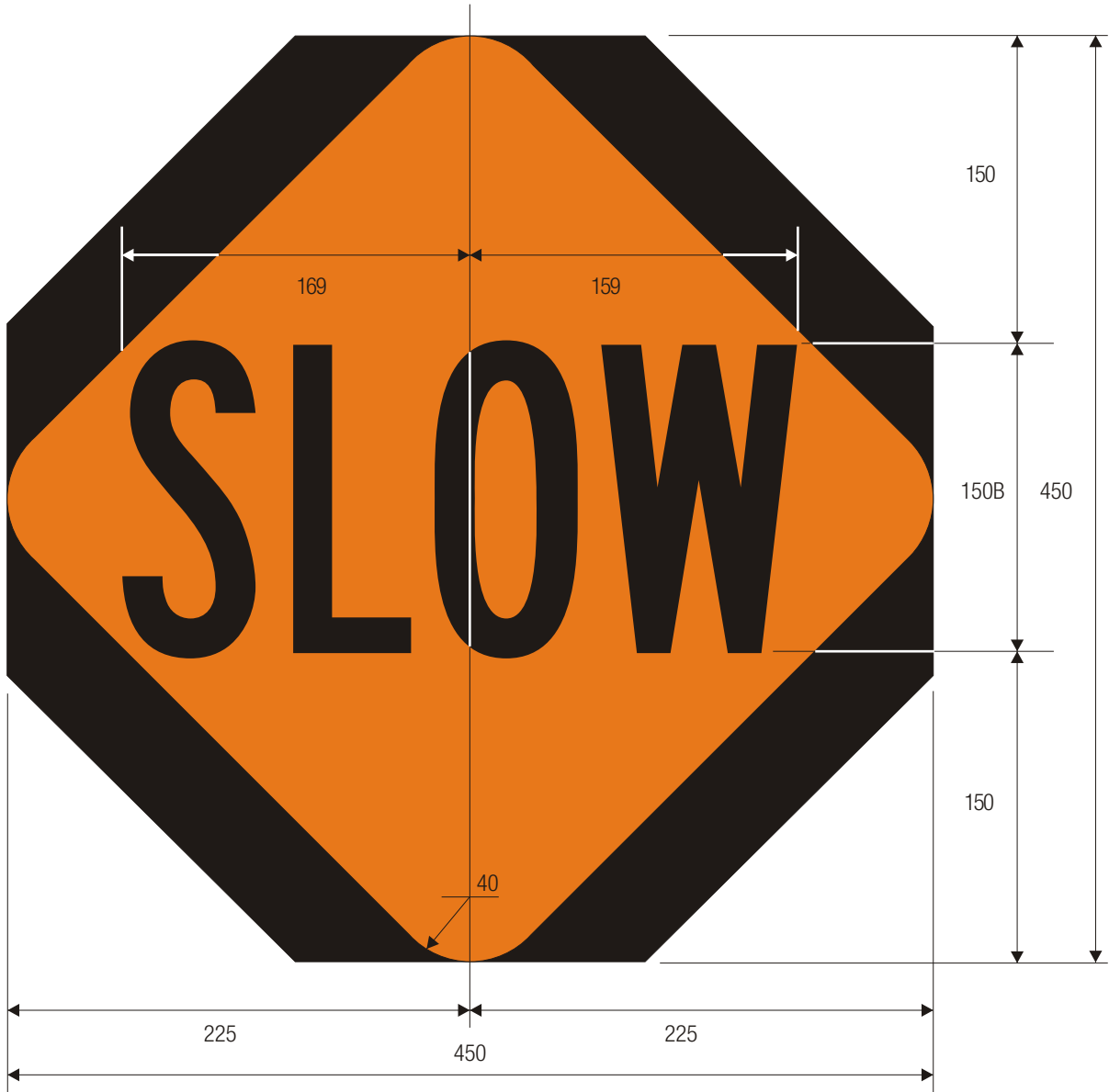

STOP - SLOW PADDLE

COLORS: LEGEND – BLACK
 BACKGROUND – ORANGE (RETROREFLECTIVE)
 AREA OUTSIDE DIAMOND – BLACK

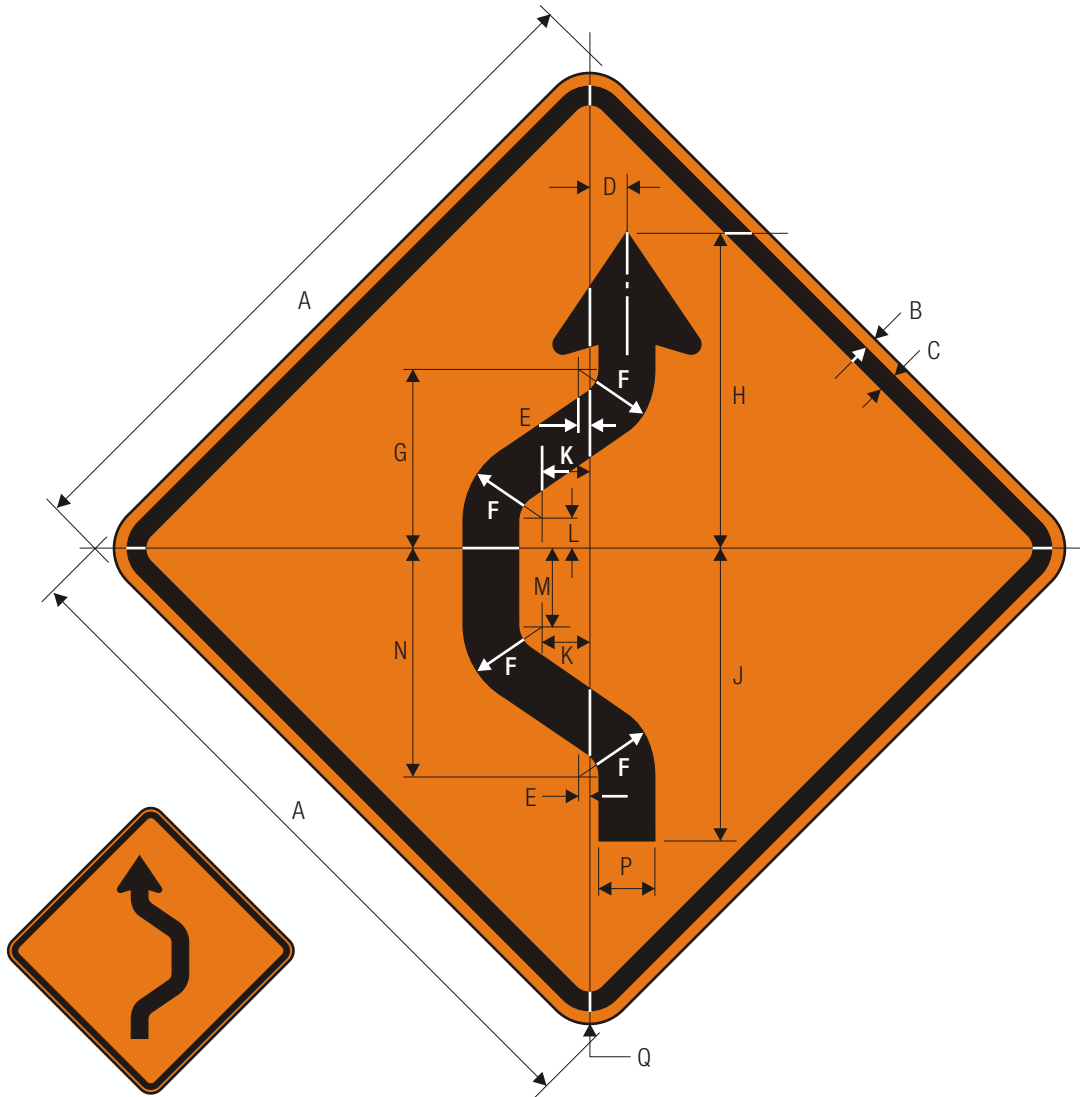

W24-1R

DOUBLE REVERSE CURVE (1 LANE)

W24-1L

DOUBLE REVERSE CURVE (1 LANE)

*See page 6-2 for symbol design.

	A	B	C	D	E	F	G	H	J	K	L	M
	750	13	20	40	7	77	185	339	314	59	37	88
C	900	15	25	48	8	92	222	407	377	71	44	106
	1200	20	30	64	11	123	296	542	502	94	59	141

N	P	Q
237	60	50
284	72	60
379	96	70

TTC SIGN COLORS:
 SYMBOL — BLACK
 BACKGROUND— ORANGE (RETROREFLECTIVE)

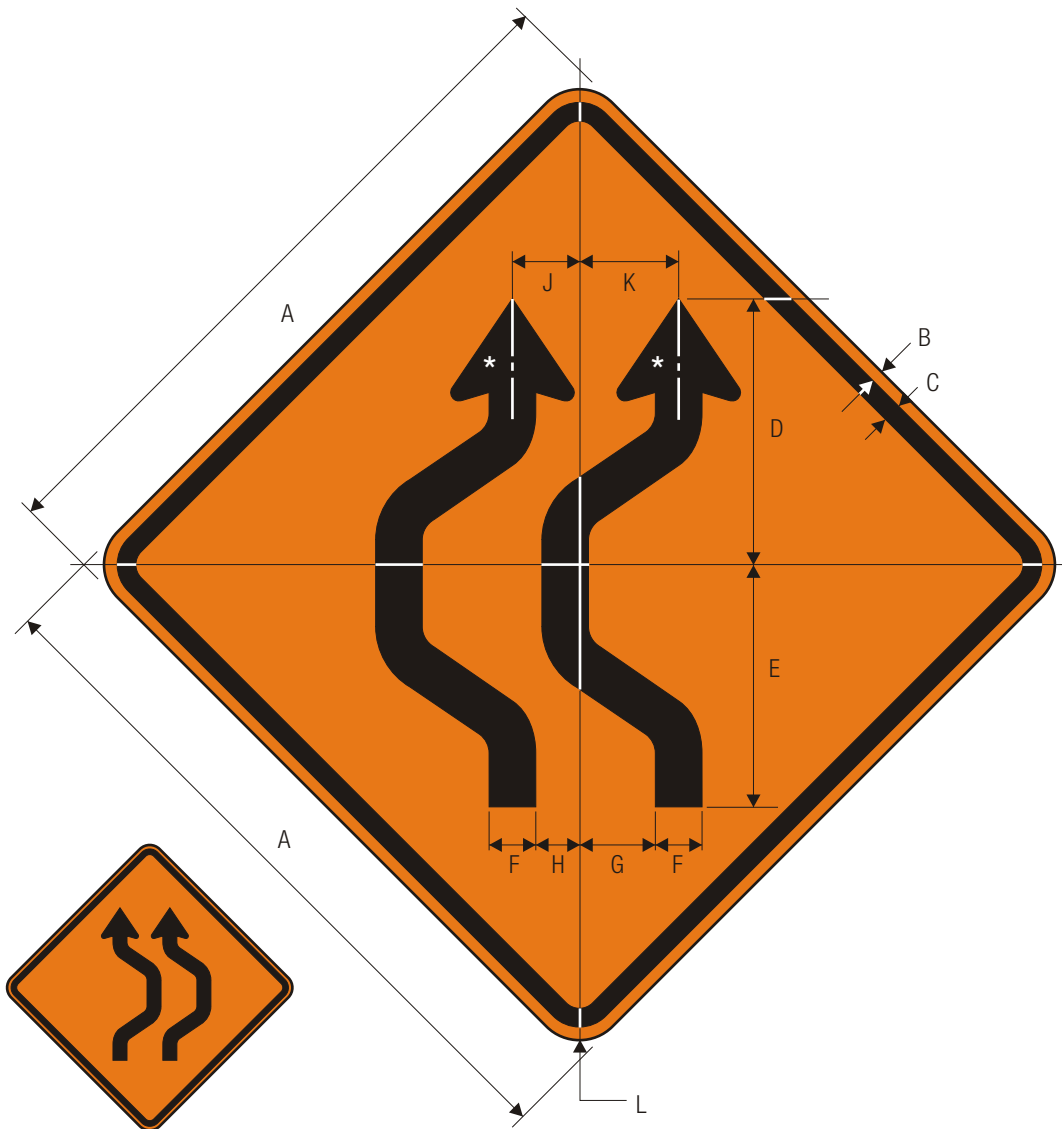

W24-1aR

DOUBLE REVERSE CURVE (2 LANES)

W24-1aL

DOUBLE REVERSE CURVE (2 LANES)

*Reduce arrow from W24-1 15%.

	A	B	C	D	E	F	G	H	J	K	L
	750	13	20	288	267	50	83	47	73	109	50
C	900	15	25	346	320	61	100	56	88	131	60
	1200	20	30	461	427	82	133	75	116	174	70

TTC SIGN COLORS:

SYMBOL – BLACK

BACKGROUND – ORANGE (RETROREFLECTIVE)

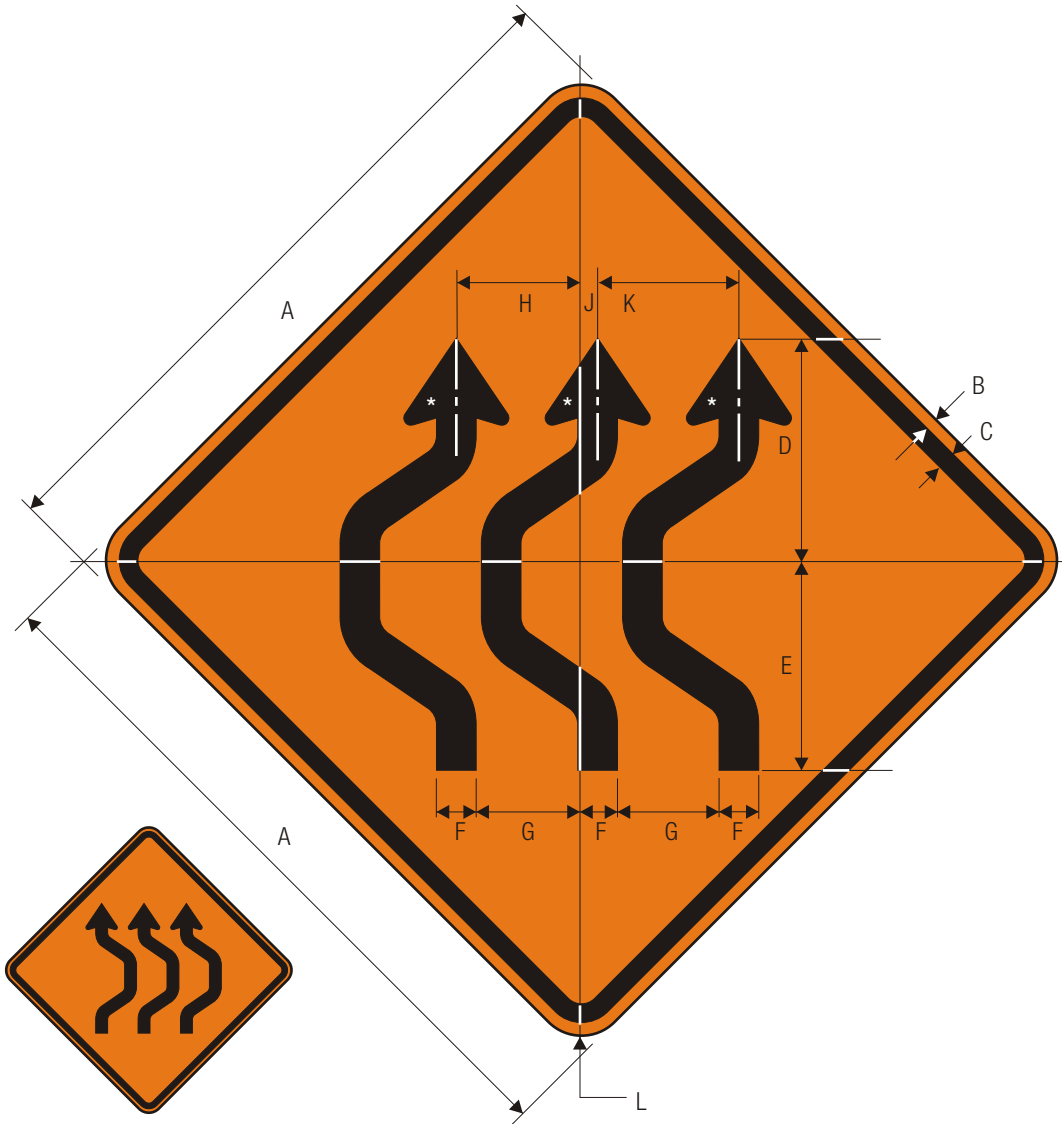

W24-1bR

DOUBLE REVERSE CURVE (3 LANES)

W24-1bL

DOUBLE REVERSE CURVE (3 LANES)

*Reduce arrow from W24-1 30%.

	A	B	C	D	E	F	G	H	J	K	L
	750	13	20	237	220	42	118	139	21	160	50
C	900	15	25	285	264	50	142	167	25	192	60
	1200	20	30	379	351	67	188	221	33	255	70

TTC SIGN COLORS:

SYMBOL — BLACK

BACKGROUND— ORANGE (RETROREFLECTIVE)



G20-1

ROAD WORK NEXT 5 MILES



G20-2

END ROAD WORK

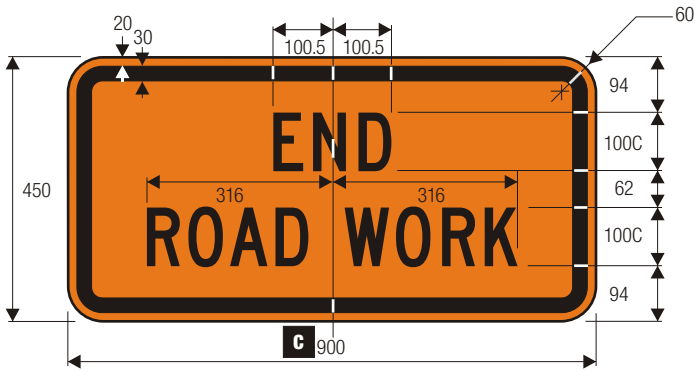

G20-2

END ROAD WORK

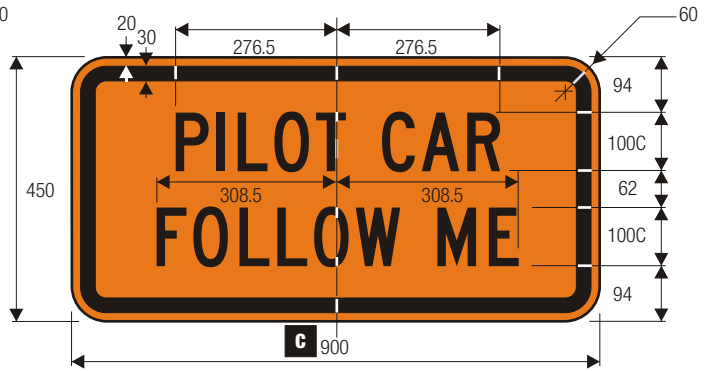

G20-4

PILOT CAR FOLLOW ME

TTC SIGN COLORS:
 LEGEND — BLACK
 BACKGROUND— ORANGE (RETROREFLECTIVE)

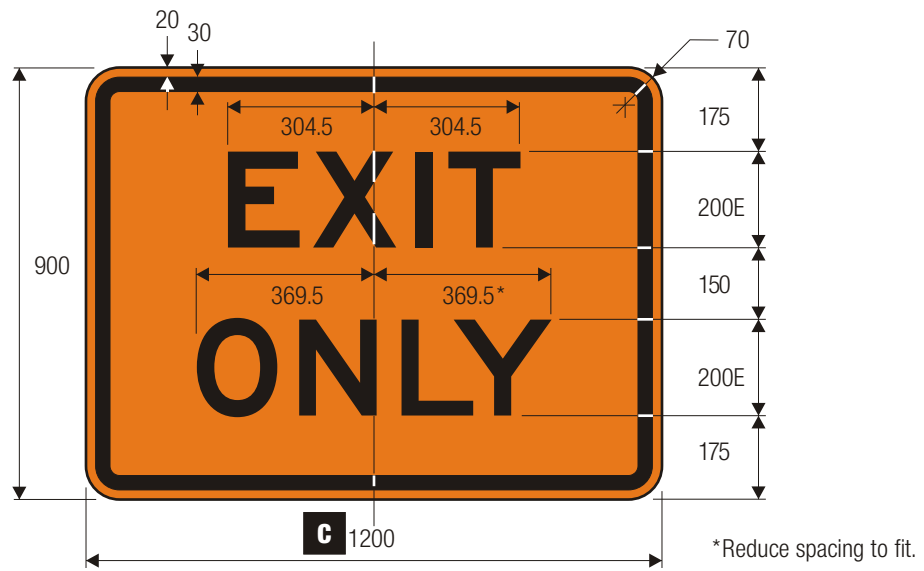

E5-3 EXIT ONLY

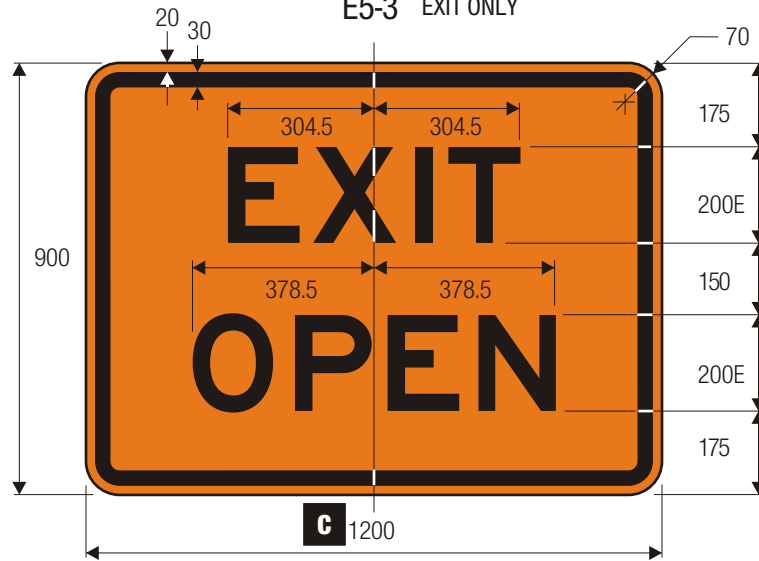

E5-2 EXIT OPEN

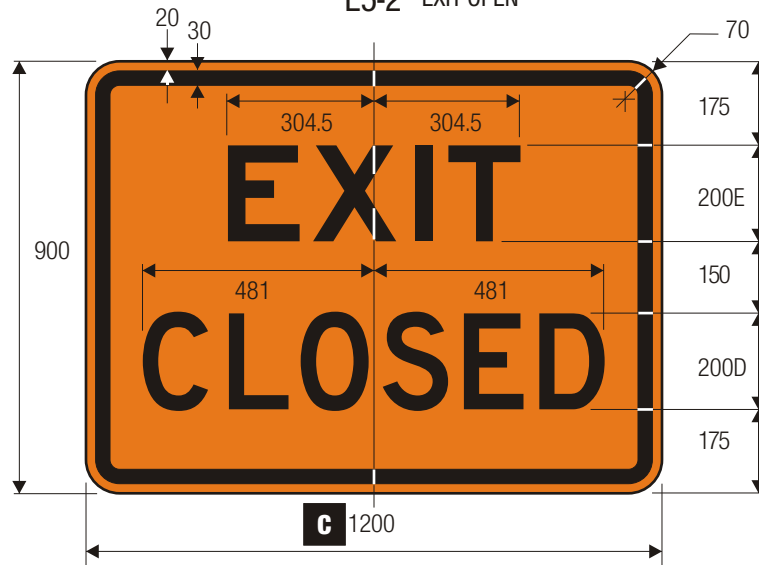

E5-2a EXIT CLOSED

TTC SIGN COLORS:

LEGEND — BLACK

BACKGROUND— ORANGE (RETROREFLECTIVE)

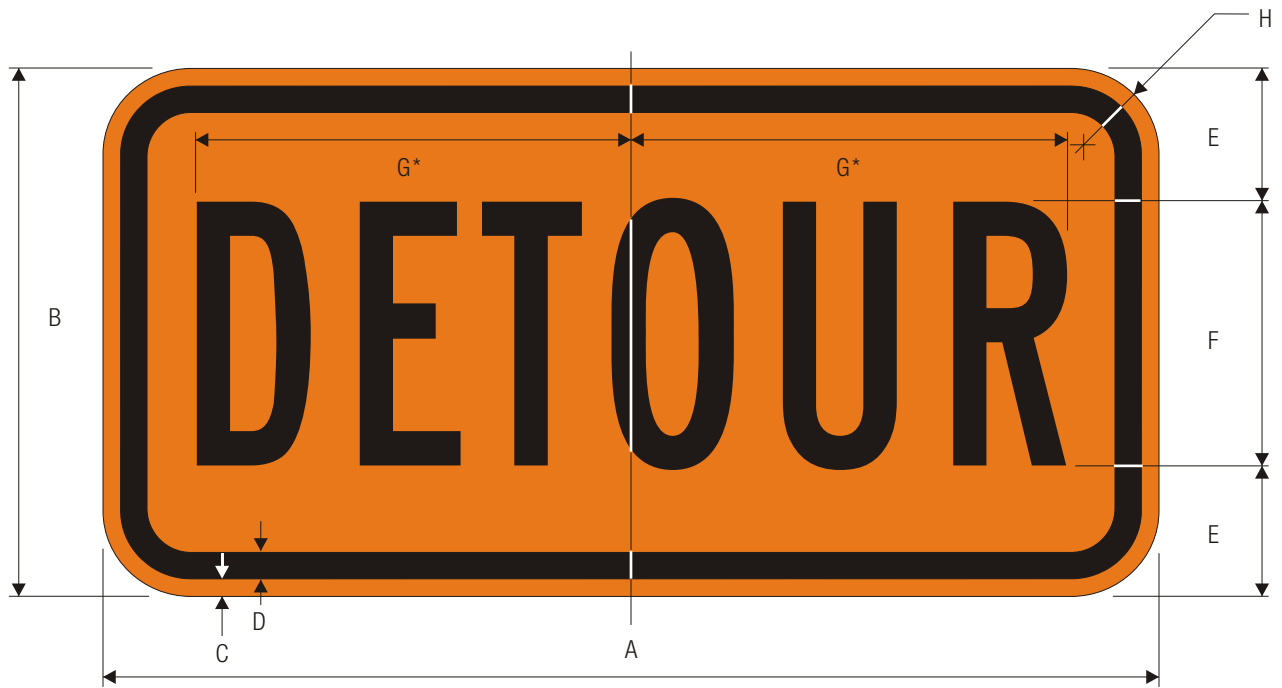

M4-8

DETOUR

*Reduce to fit for 750 mm size.

	A	B	C	D	E	F	G	H
C	600	300	10	14	75	150 B	247	50
	750	375	13	20	87.5	200 B	313.5	50

TTC SIGN COLORS:

LEGEND — BLACK

BACKGROUND— ORANGE (RETROREFLECTIVE)

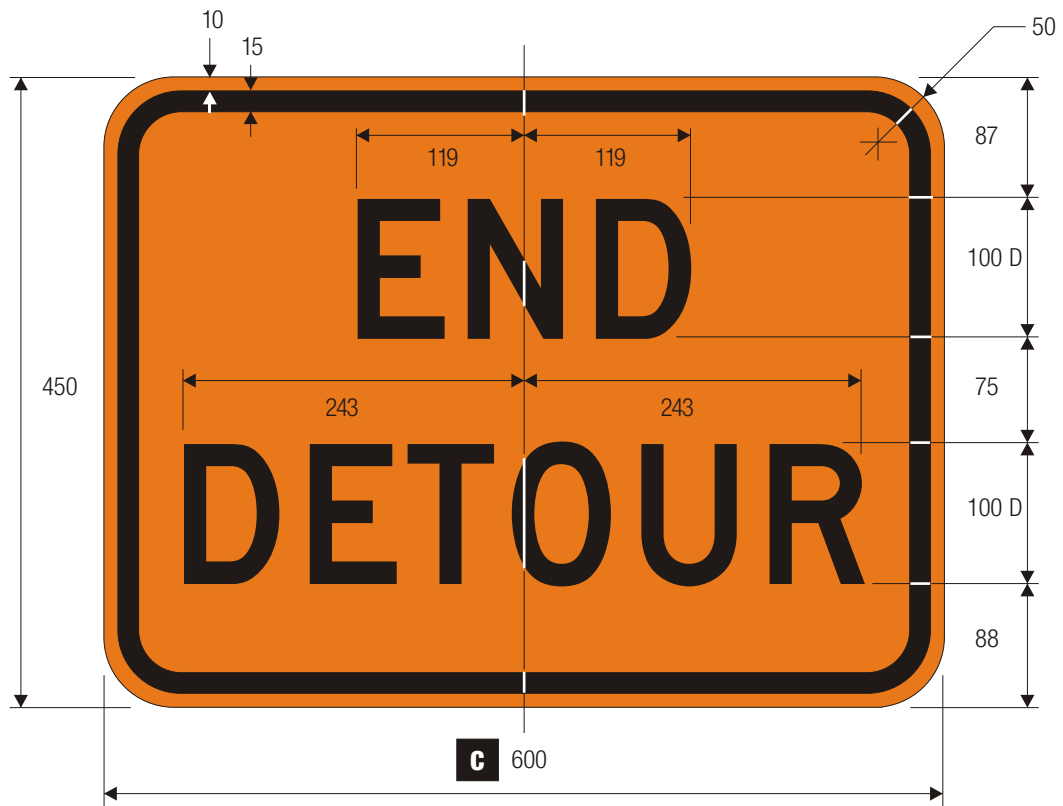

M4-8a

END DETOUR

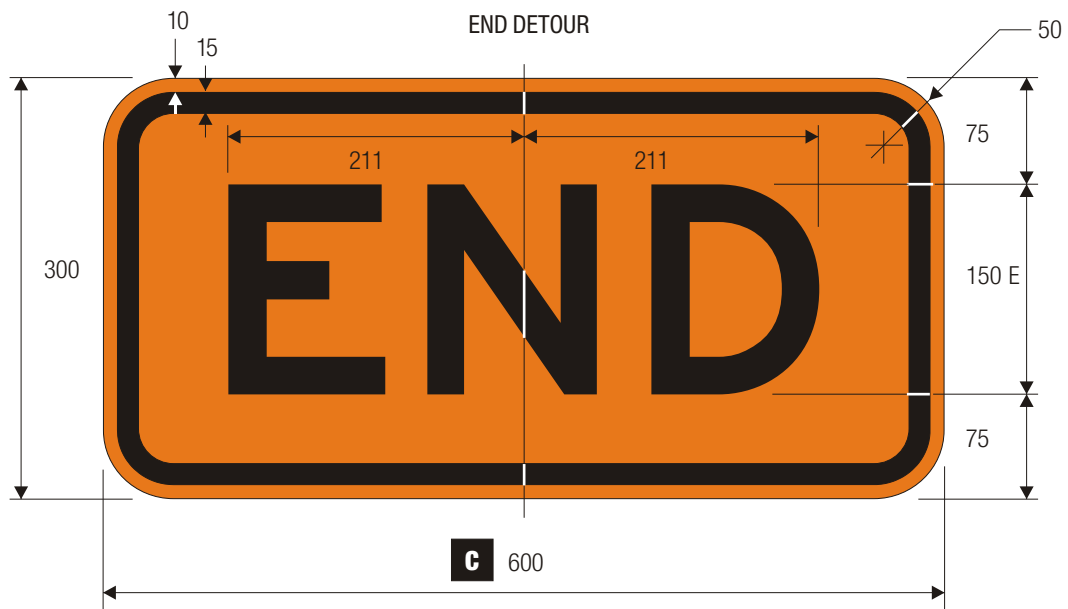

M4-8b

END

TTC SIGN COLORS:
 LEGEND — BLACK
 BACKGROUND— ORANGE (RETROREFLECTIVE)

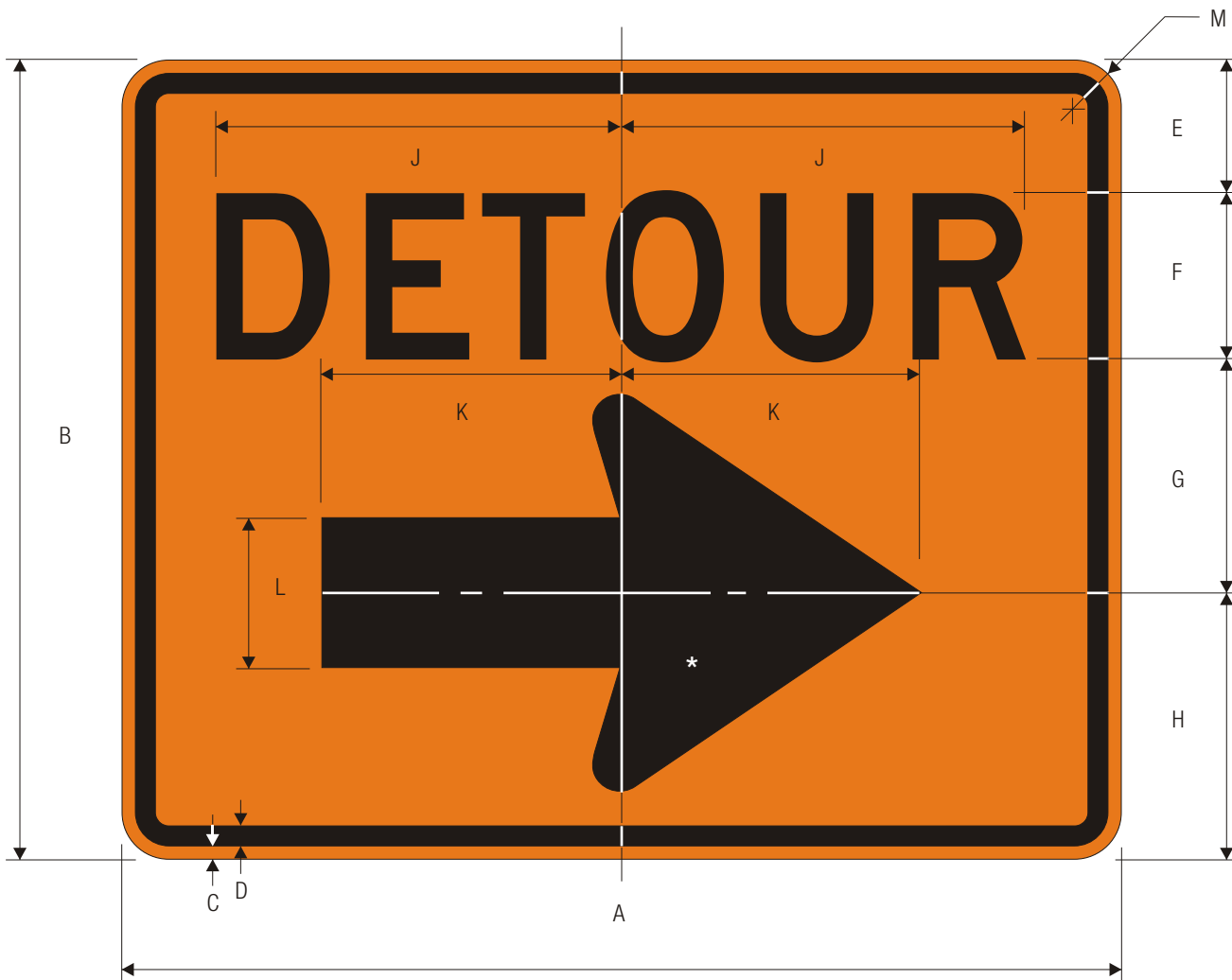

M4-9R

DETOUR



M4-9L

DETOUR

*See page 6-2 for design details.

	A	B	C	D	E	F	G	H	J	K	L	M
C	750	600	13	20	100	125 D	175	200	304	225	112	50
	1200	900	20	30	150	200 D	250	300	486	337	175	70
	1500	1200	20	30	200	250 D	350	400	607.5	450	225	70

TTC SIGN COLORS:

LEGEND — BLACK

BACKGROUND— ORANGE (RETROREFLECTIVE)



M4-9a

BICYCLE PEDESTRIAN DETOUR

*See page 6-10 for symbol design.

**See page 6-7 for symbol design.

***See page 6-2 for arrow design.

	A	B	C	D	E	F	G	H	J	K	L	M
C	750	600	13	20	50	180	25	125 D	95	125	133	78
	1200	900	20	30	75	266	41	200 D	148	170	202	110
	1500	1200	20	30	130	333	52	250 D	185	250	173	253

	N	P	Q	R	S	T
	225	213	304	175	50	50
	338	332	486	280	80	70
	420	420	607.5	350	100	70

TTC SIGN COLORS:

LEGEND — BLACK

BACKGROUND— ORANGE (RETROREFLECTIVE)



M4-9b
PEDESTRIAN DETOUR

*See page 6-10 for symbol design.
Optically center symbol about centerline.
**See page 6-2 for design details.

C

A	B	C	D	E	F	G	H	J	K	L	M
750	600	13	20	50	180	25	125 D	95	125	304	175
1200	900	20	30	75	266	41	200 D	148	170	486	280
1500	1200	20	30	130	333	52	250 D	185	250	607.5	350

N	P
50	50
80	70
100	70

TTC SIGN COLORS:
LEGEND — BLACK
BACKGROUND— ORANGE (RETROREFLECTIVE)



M4-9c
BICYCLE DETOUR

*See page 6-7 for symbol design.
Optically center symbol about centerline.
**See page 6-2 for design details.

	A	B	C	D	E	F	G	H	J	K	L	M
C	750	600	13	20	255	125 D	95	125	304	175	50	133
	1200	900	20	30	382	200 D	148	170	486	280	80	202
	1500	1200	20	30	515	250 D	185	250	607.5	350	100	173

N	P
225	50
338	70
420	70

TTC SIGN COLORS:
LEGEND — BLACK
BACKGROUND— ORANGE (RETROREFLECTIVE)

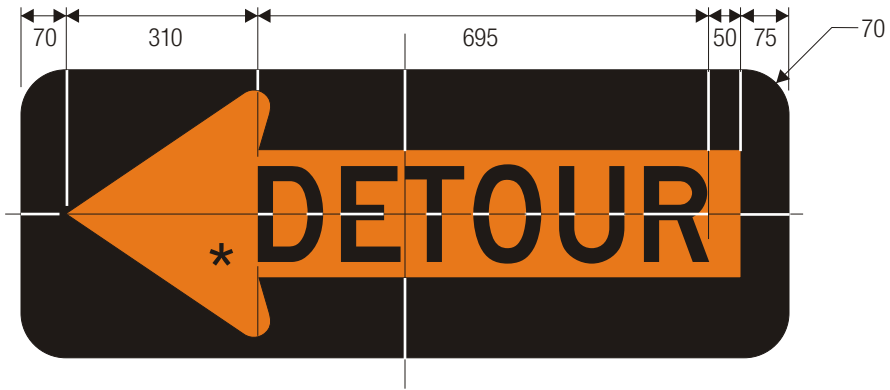

M4-10L
DETOUR (INSIDE ARROW)

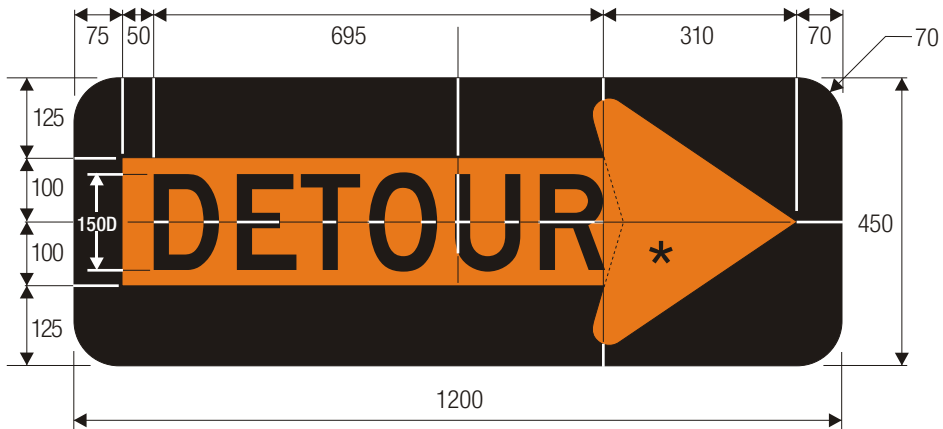

M4-10R
DETOUR (INSIDE ARROW)

*See page 6-2 for arrow design.

TTC SIGN COLORS:
 LEGEND — BLACK
 BACKGROUND— ORANGE (RETROREFLECTIVE)