

STANDARD ARROW DETAILS

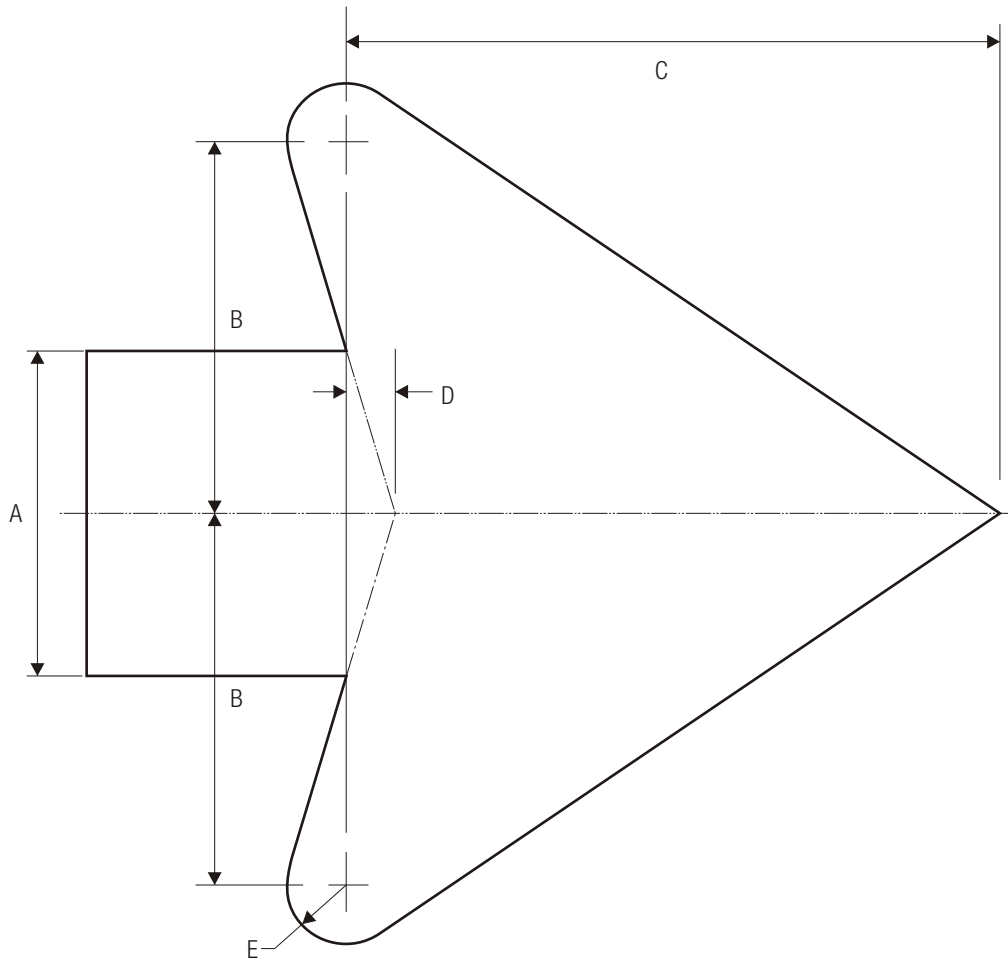

A	B	C	D	E
50	57	100.5	7.5	9
55	62.7	110.5	8.25	10
60	68.4	120.6	9	10.8
65	74.1	130.6	9.75	11.7
70	79.8	140.7	10.5	12.6
75	85.5	150.75	11.25	13.5
80	91.2	160.8	12	14.4
85	96.9	170.85	12.75	15.3
90	102.6	180.9	13.5	16.2
95	108.3	190.95	14.25	17.1
100	114	201	15	18
105	119.7	211	15.75	18.9
110	125.4	221.1	16.5	19.8
115	131.1	231.15	17.25	20.7
120	136.8	241.2	18	21.6
125	142.5	251.25	18.75	22.5

A	B	C	D	E
130	148.2	261.3	19.5	23.4
135	153.9	271.35	20.25	24.3
140	159.6	281.4	21	25.2
145	165.3	291.45	21.75	26.1
150	171	301.5	22.5	27
155	176.7	311.55	23.25	27.9
160	182.4	321.6	24	28.8
165	188.1	331.65	24.75	29.7
170	193.8	341.7	25.5	30.6
175	199.5	351.75	26.25	31.5
180	205.2	361.8	27	32.4
185	210.9	371.85	27.75	33.3
190	216.6	381.9	28.5	34.2
195	222.3	391.95	29.25	35.1
200	228	402	30	36

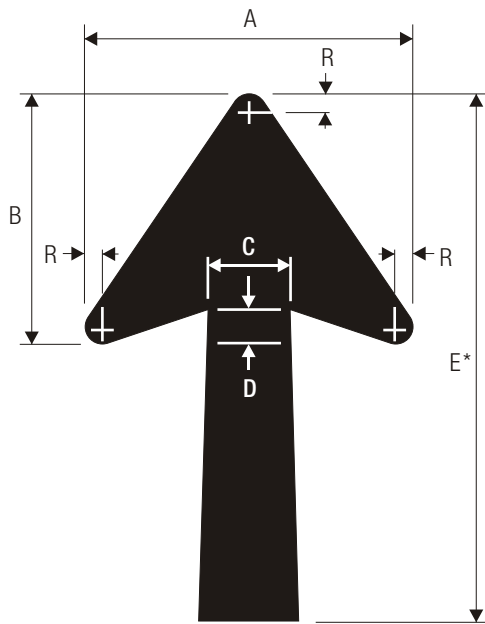

UP ARROW

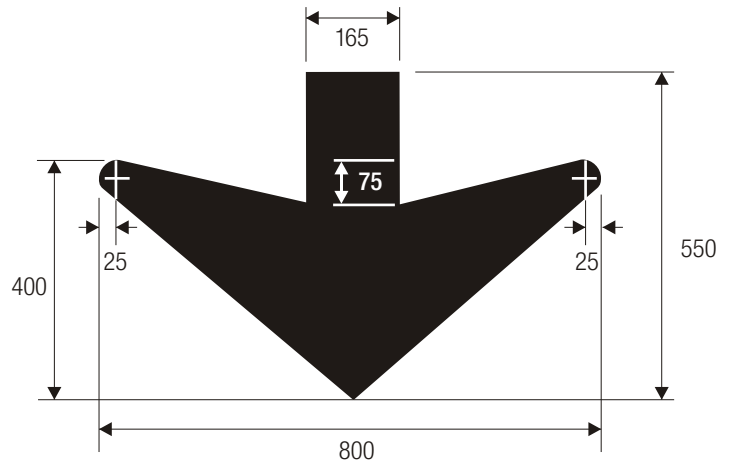

DOWN ARROW

ARROWS FOR GUIDE SIGNS

Dimensions of Arrow When Used With Various Letter Cap Heights.

Letter Size	A	B	C	D	E*	R
200	380	290	95	33	425-625	20
250-325	456	348	114	40	510-750	24
400	559	426	140	49	625-875	29

*Taper of 13 mm per 300 mm should be held constant for longer or shorter shaft lengths.

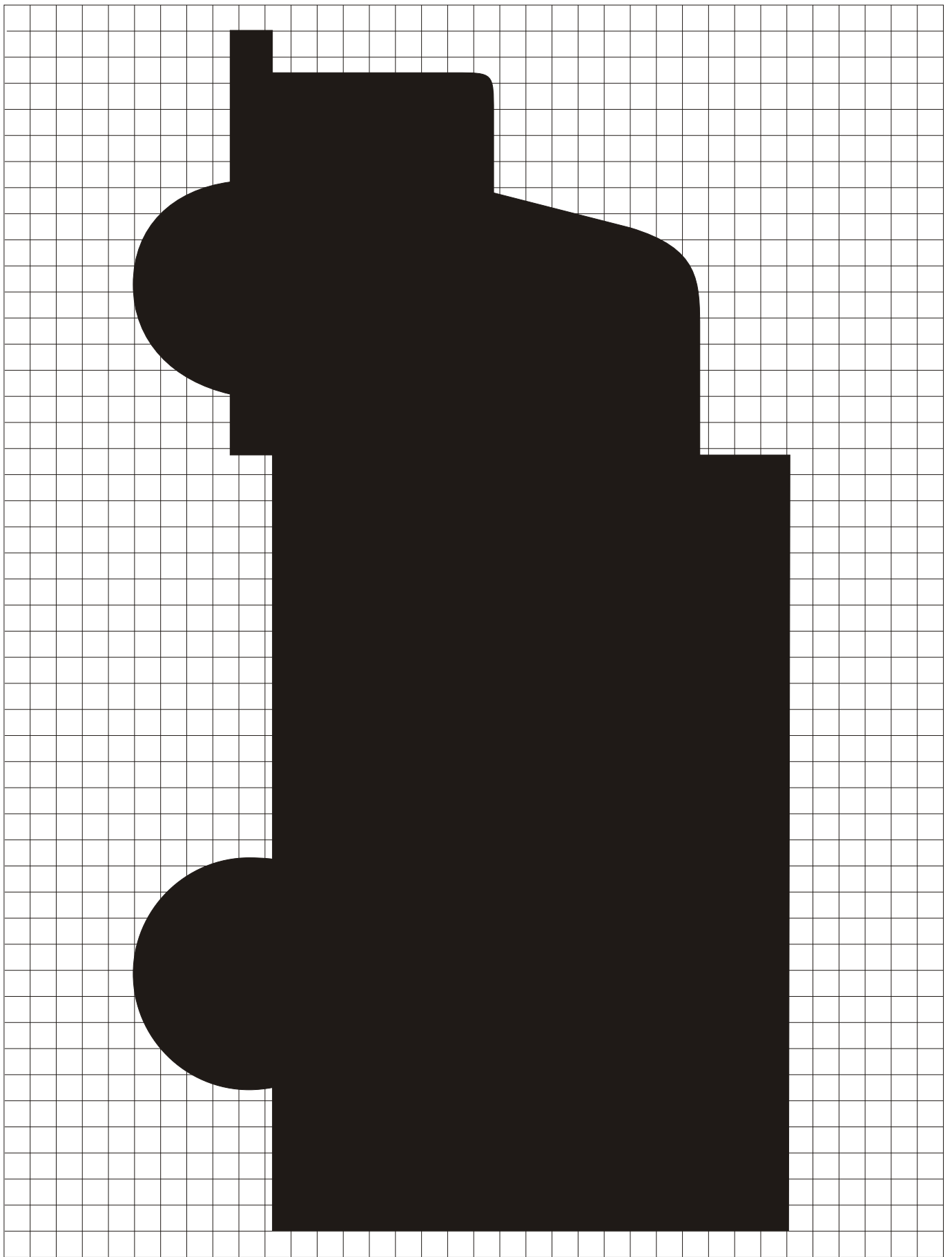

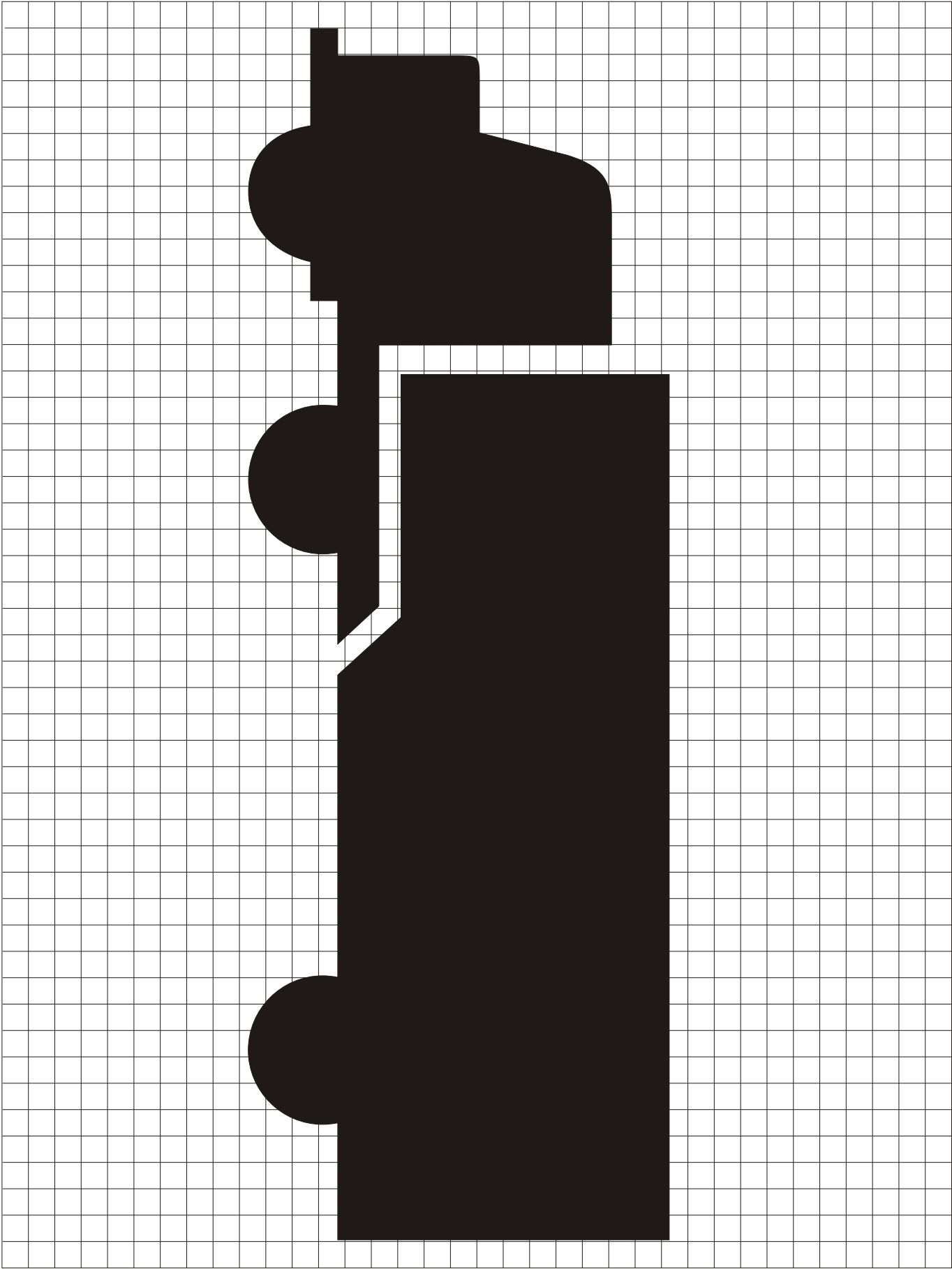

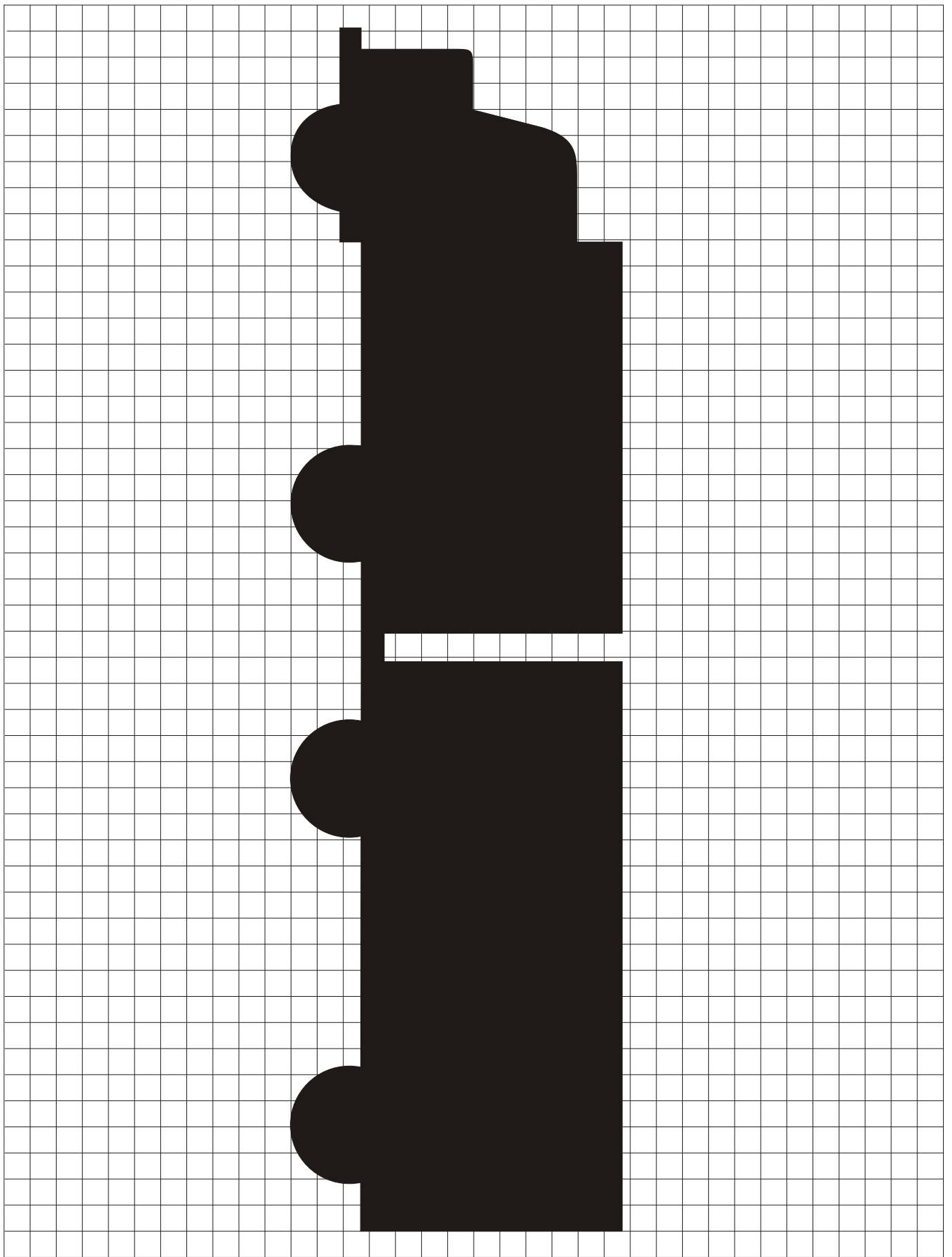

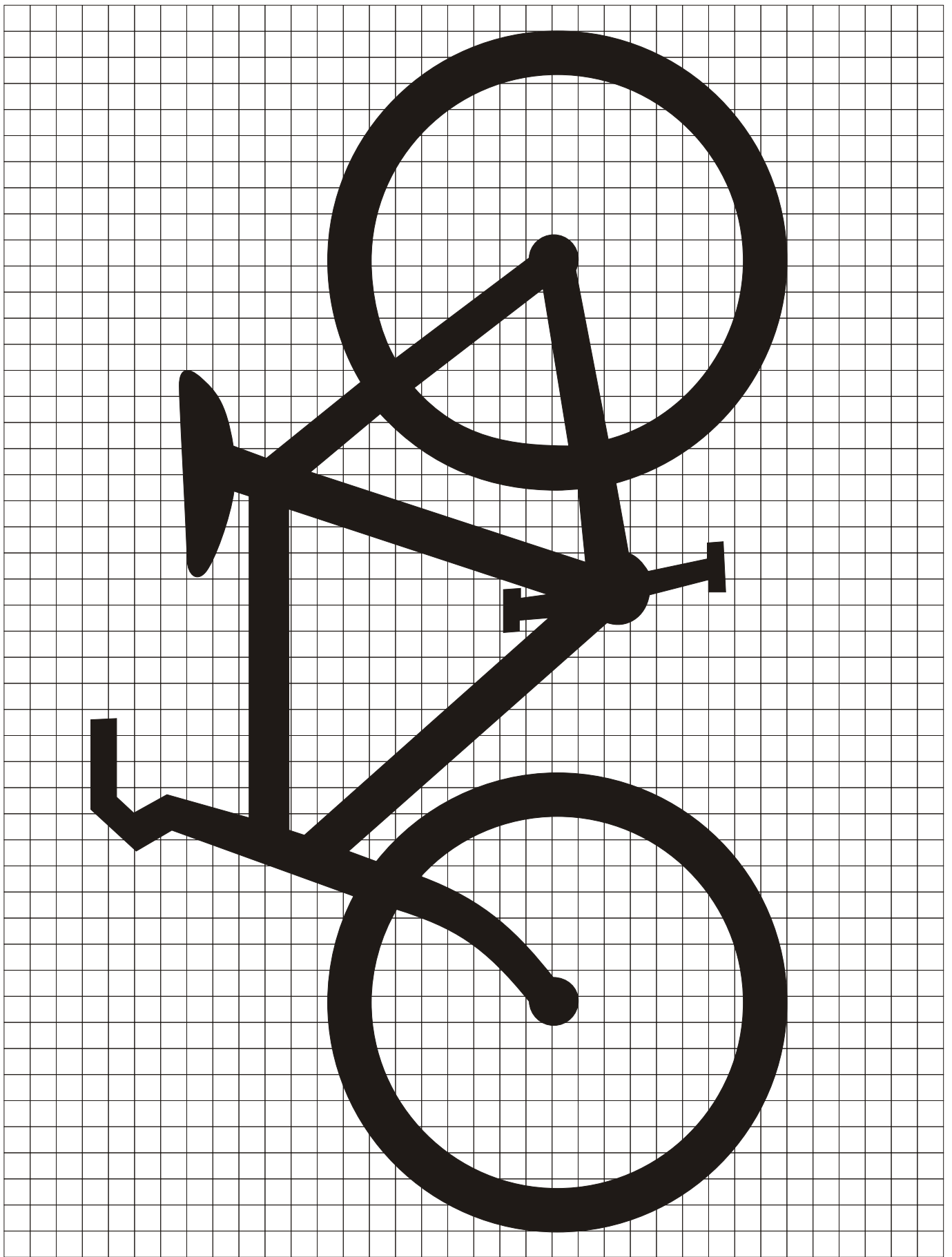

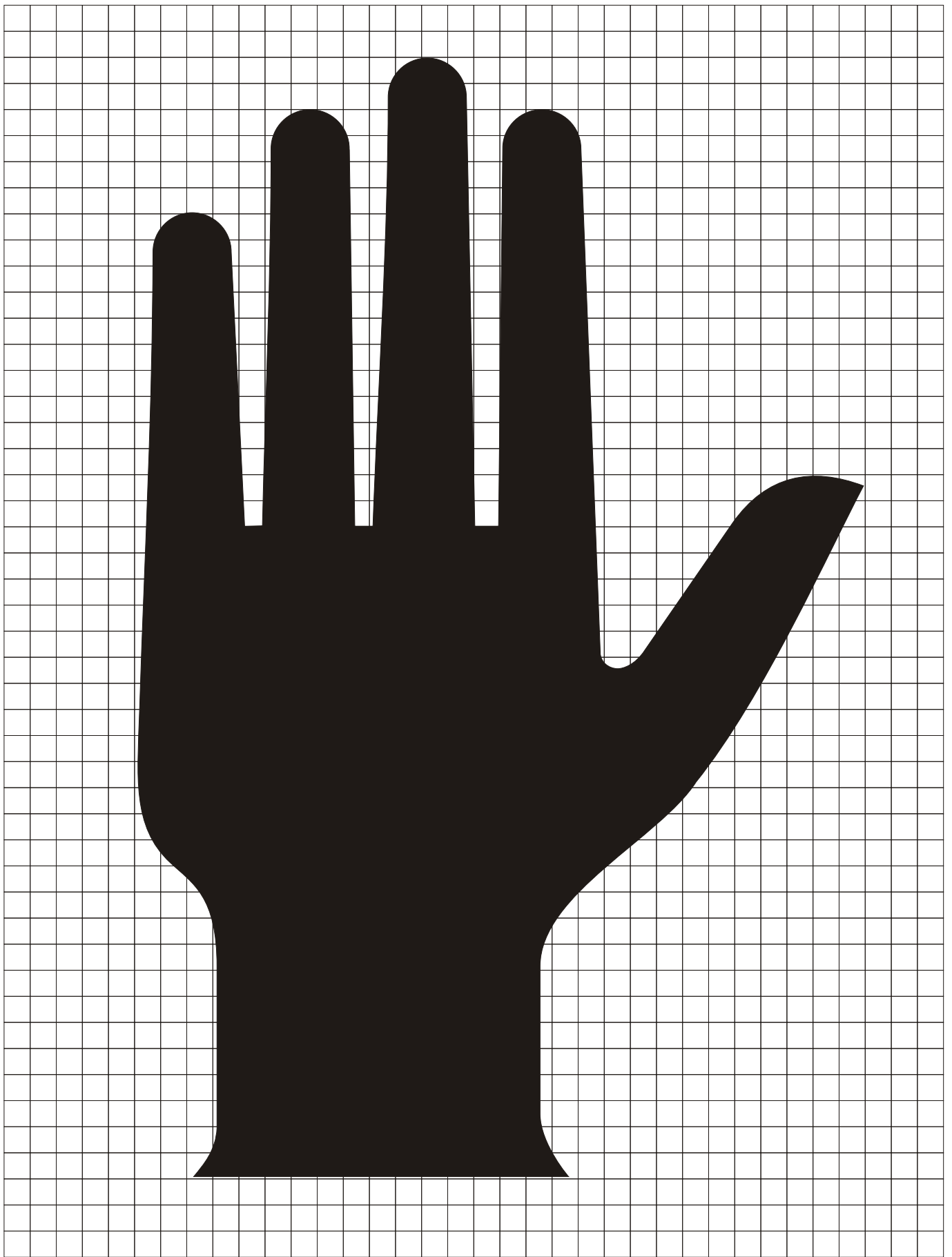

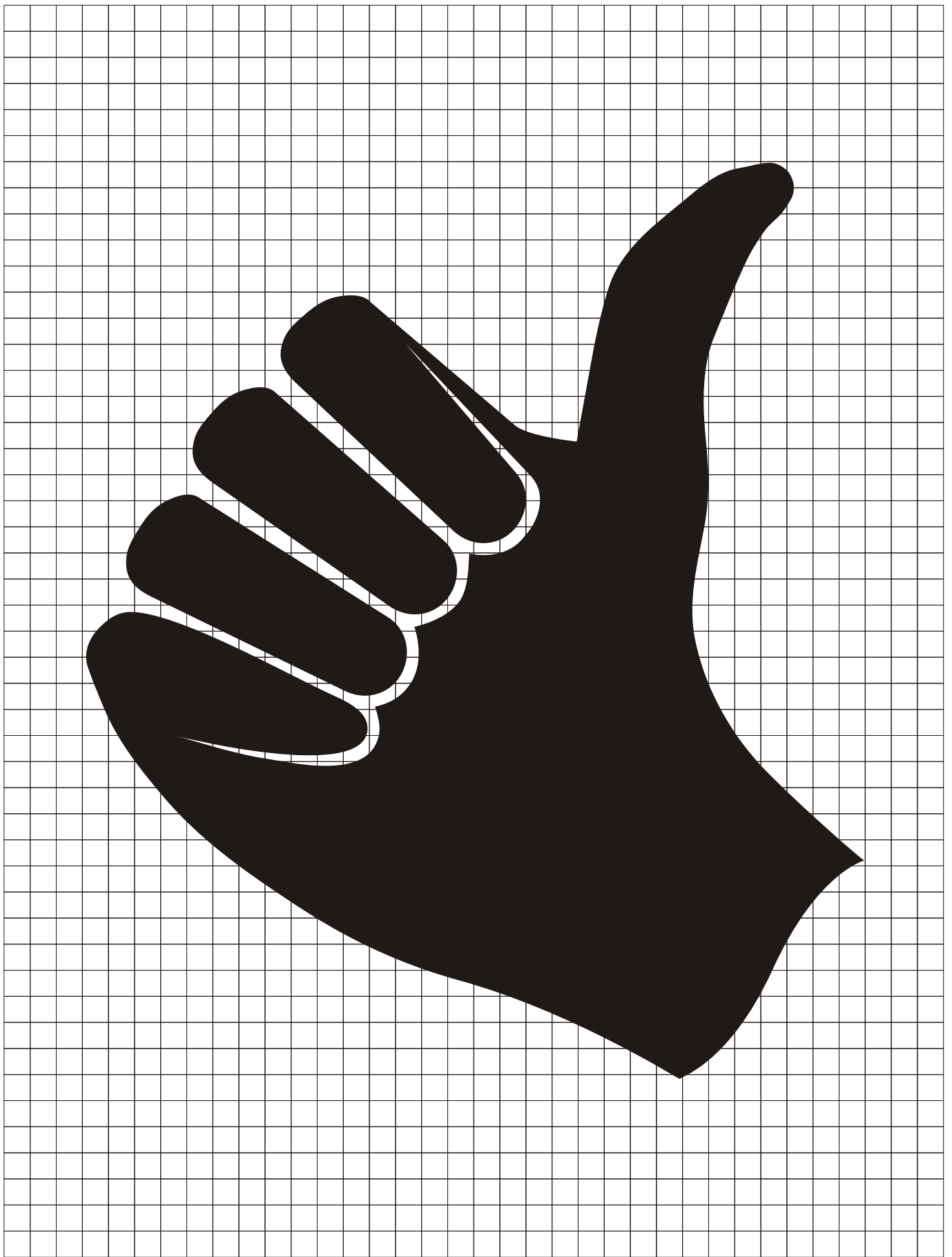

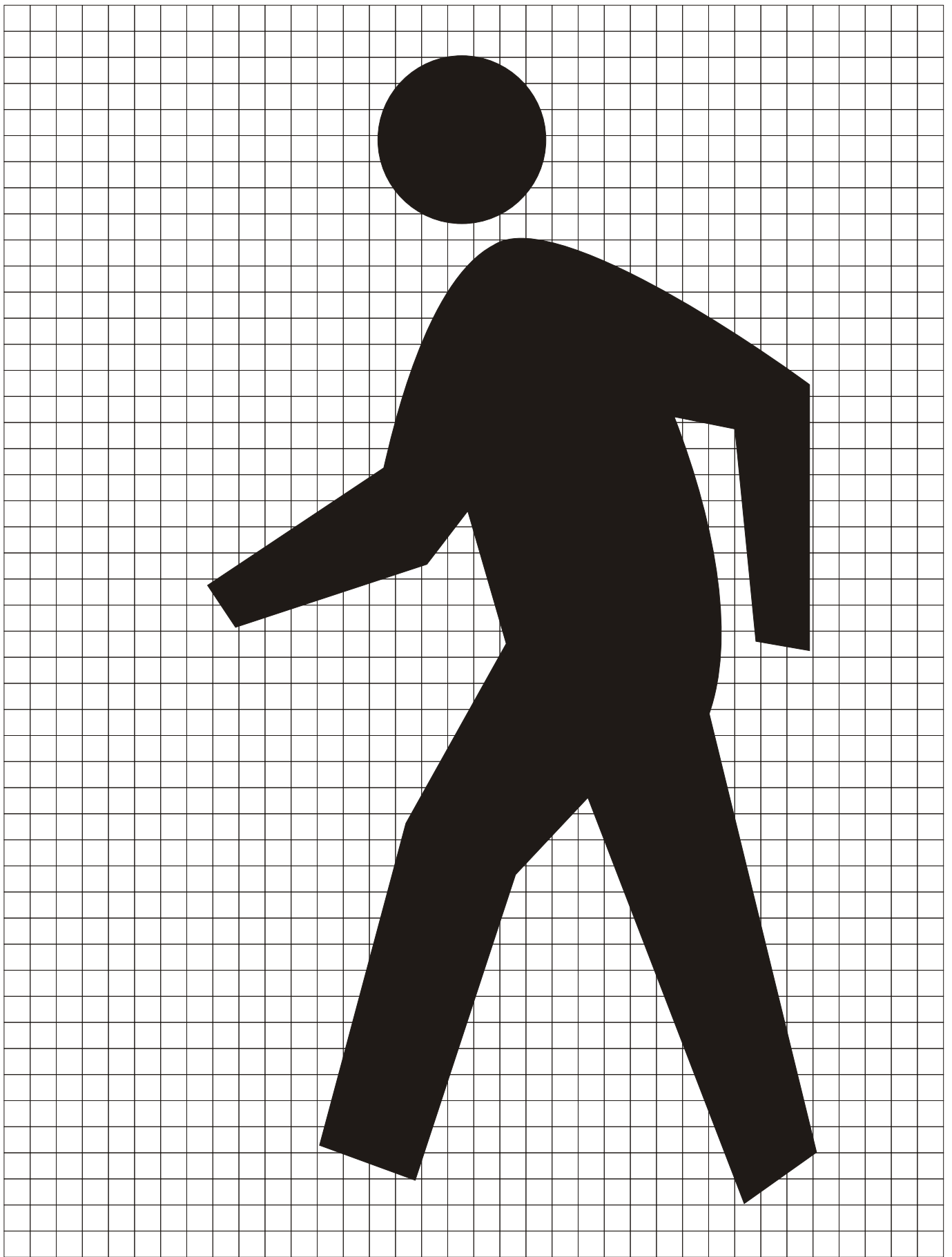

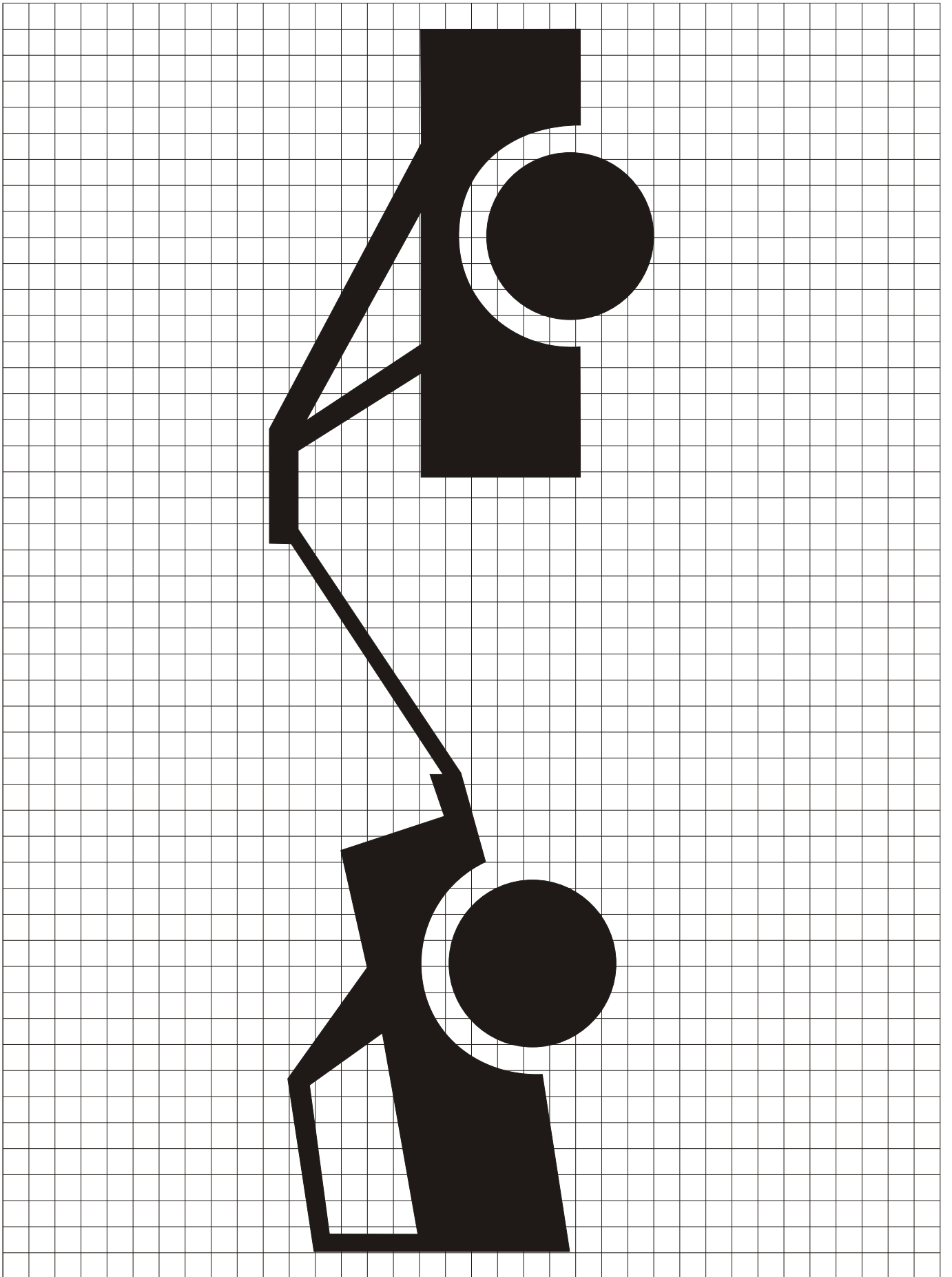

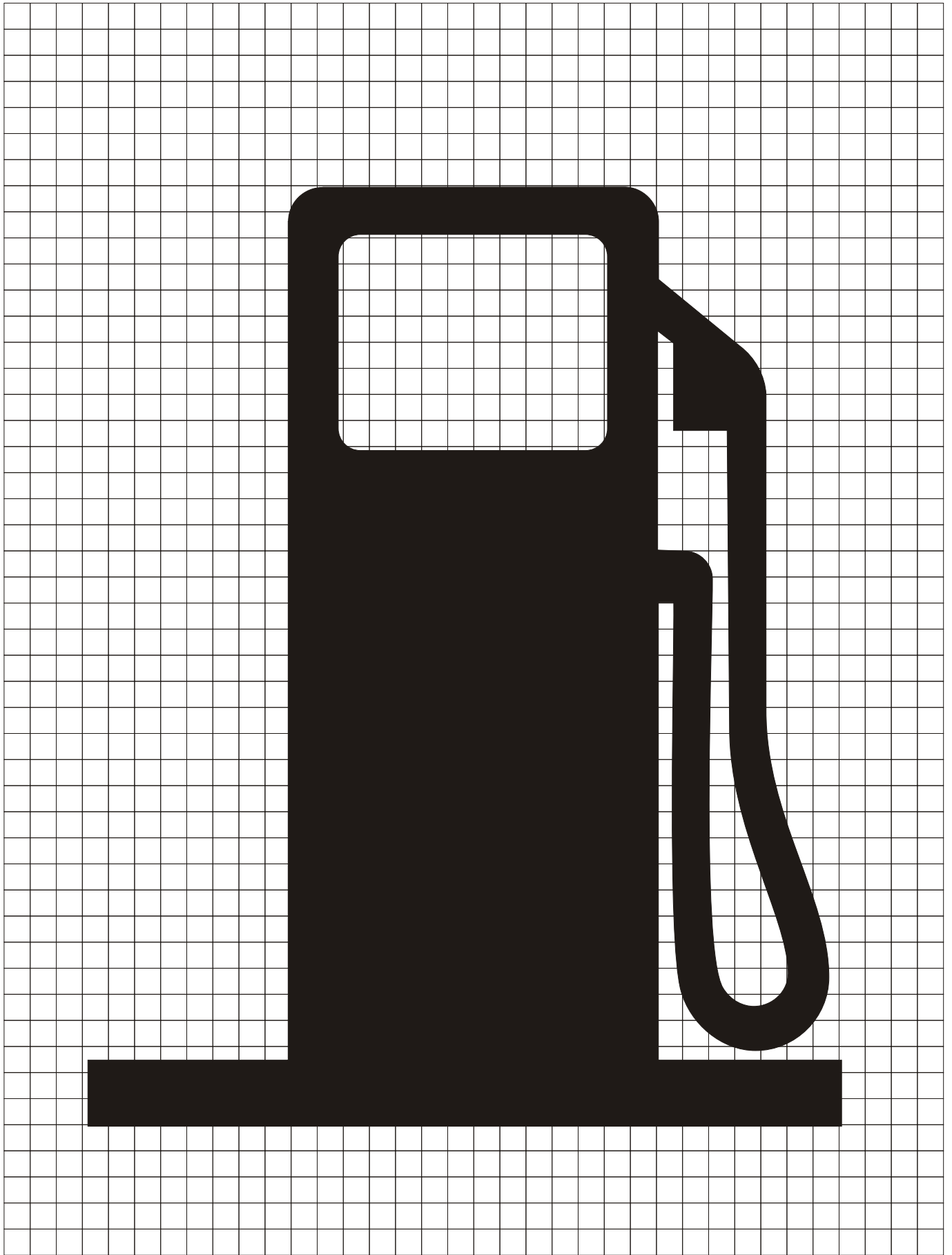

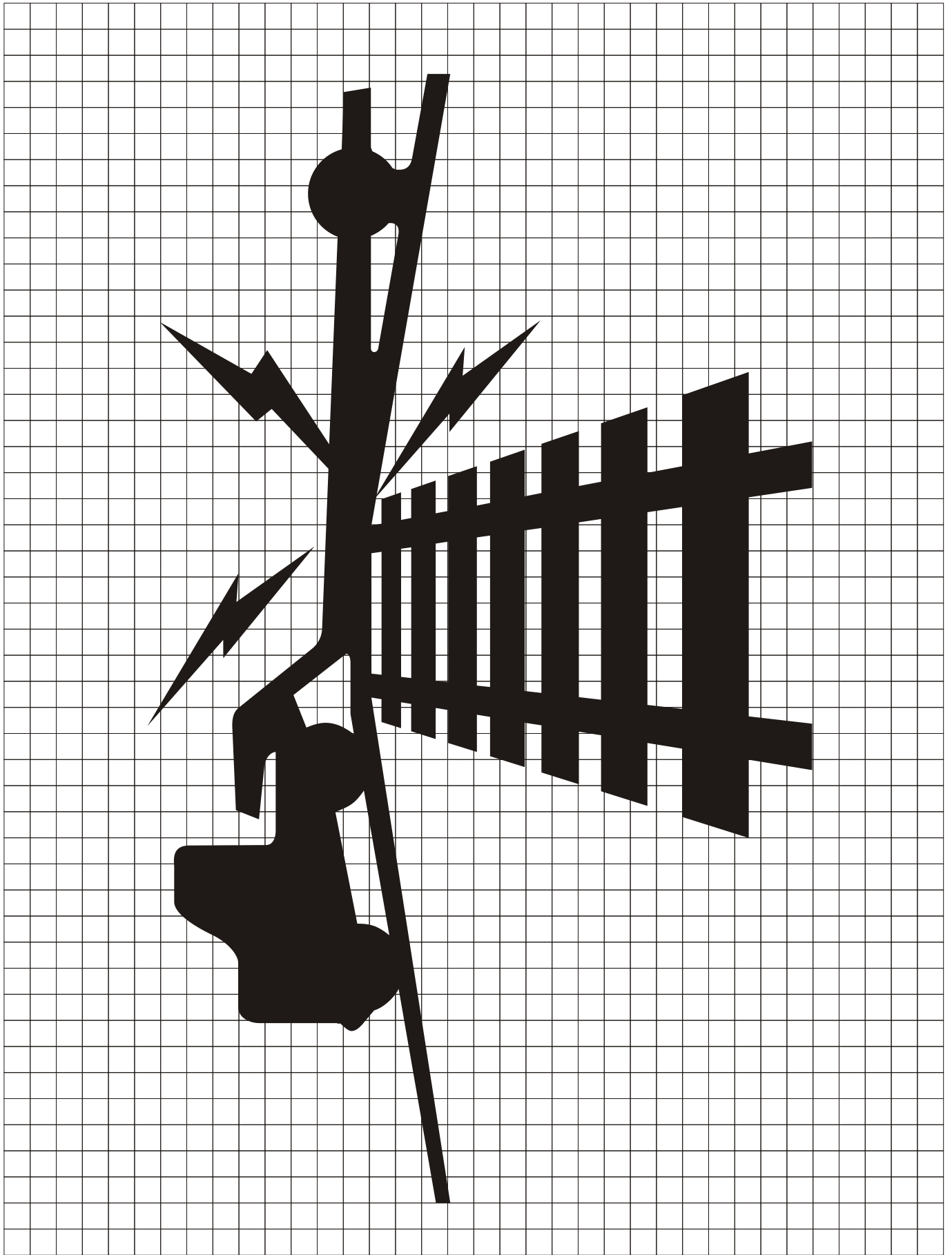

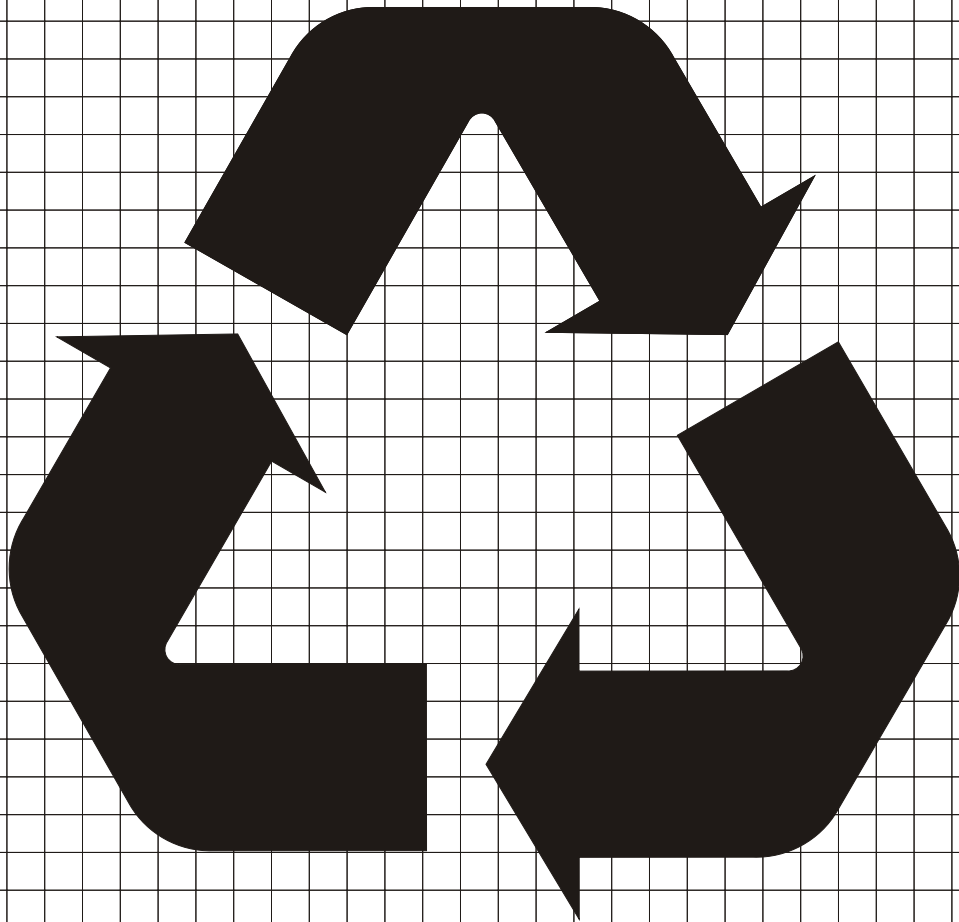



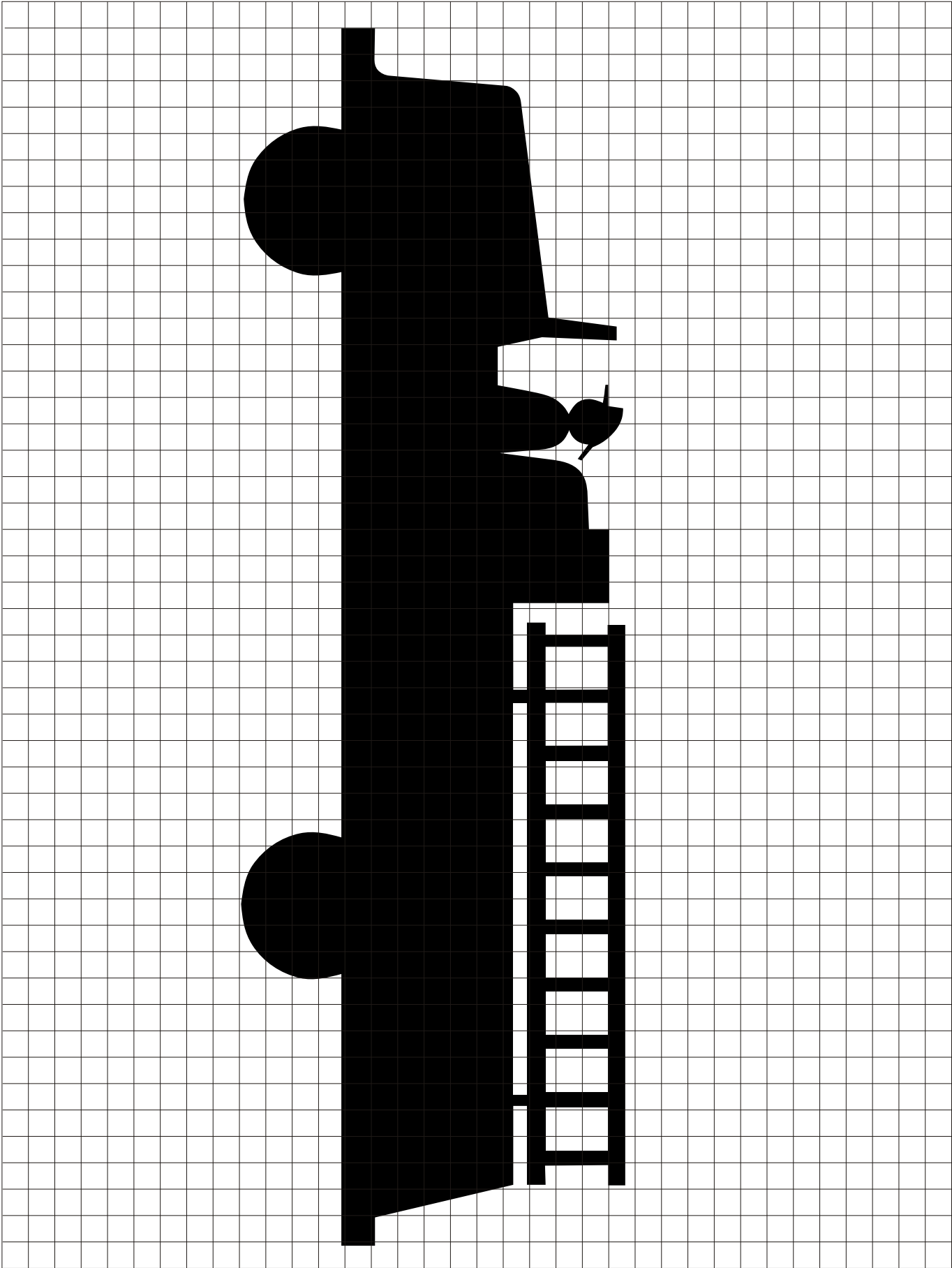

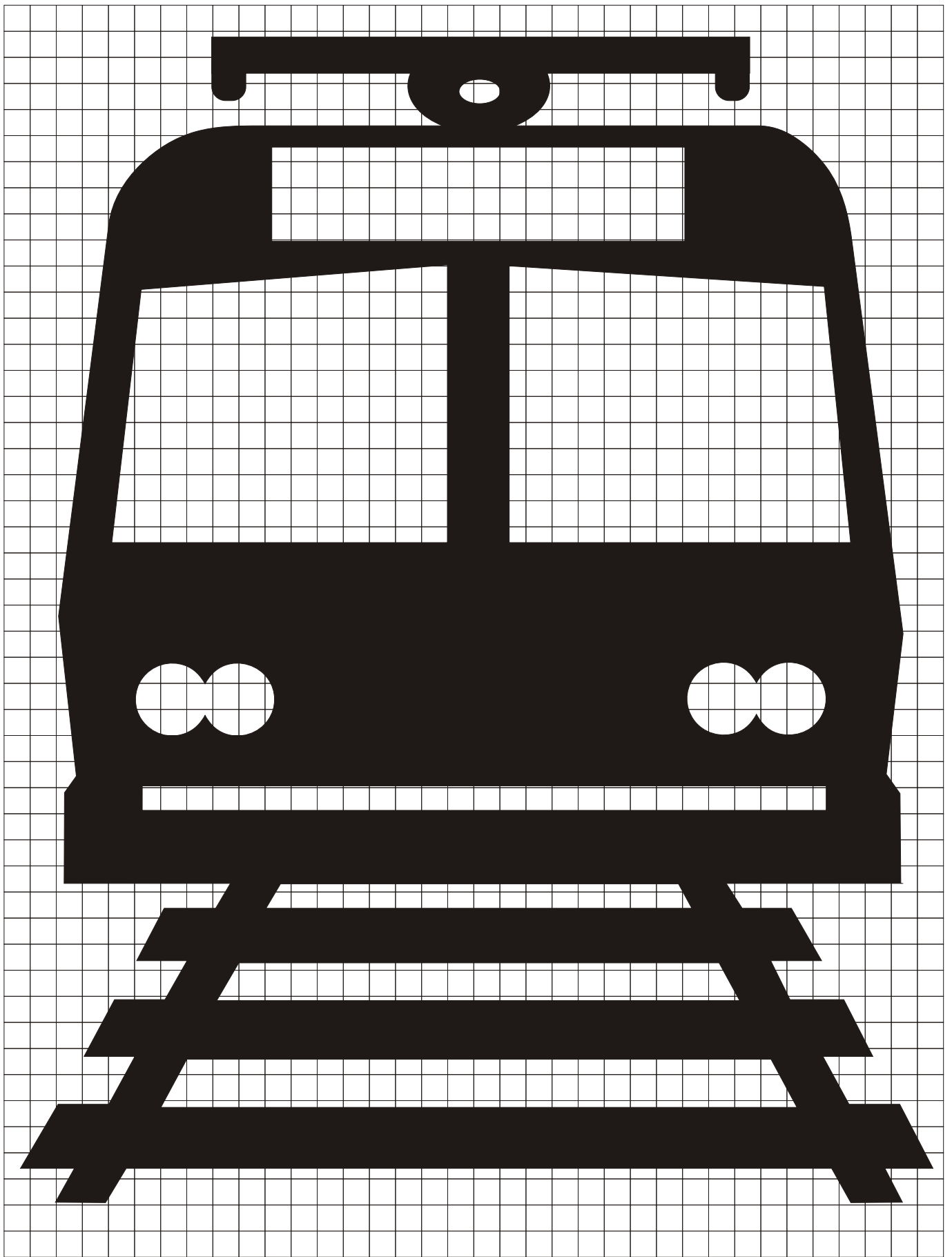

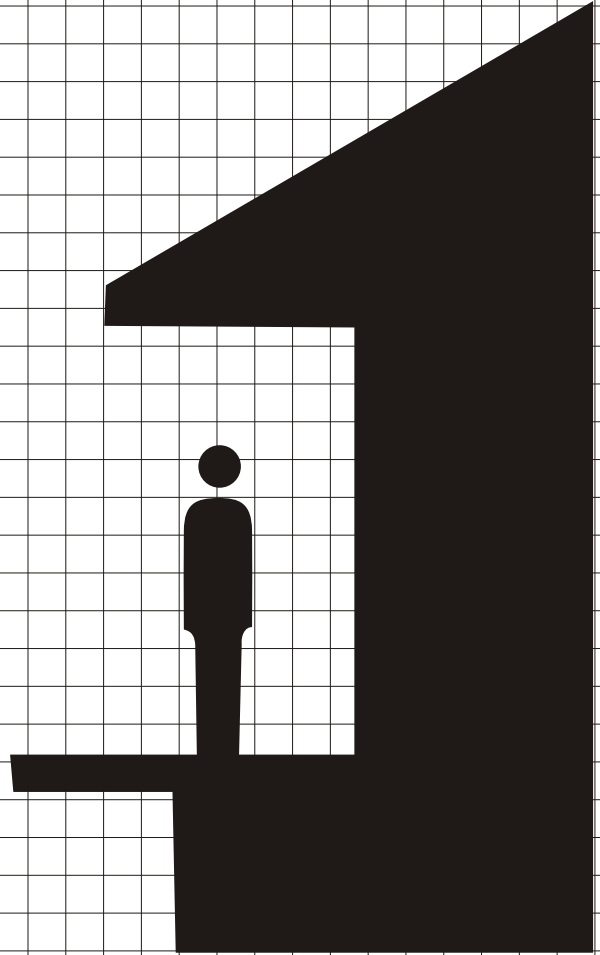
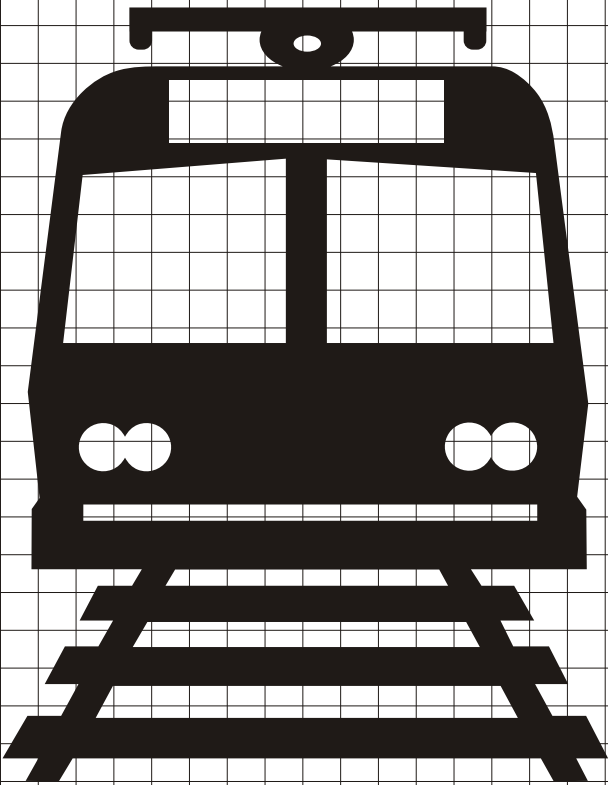

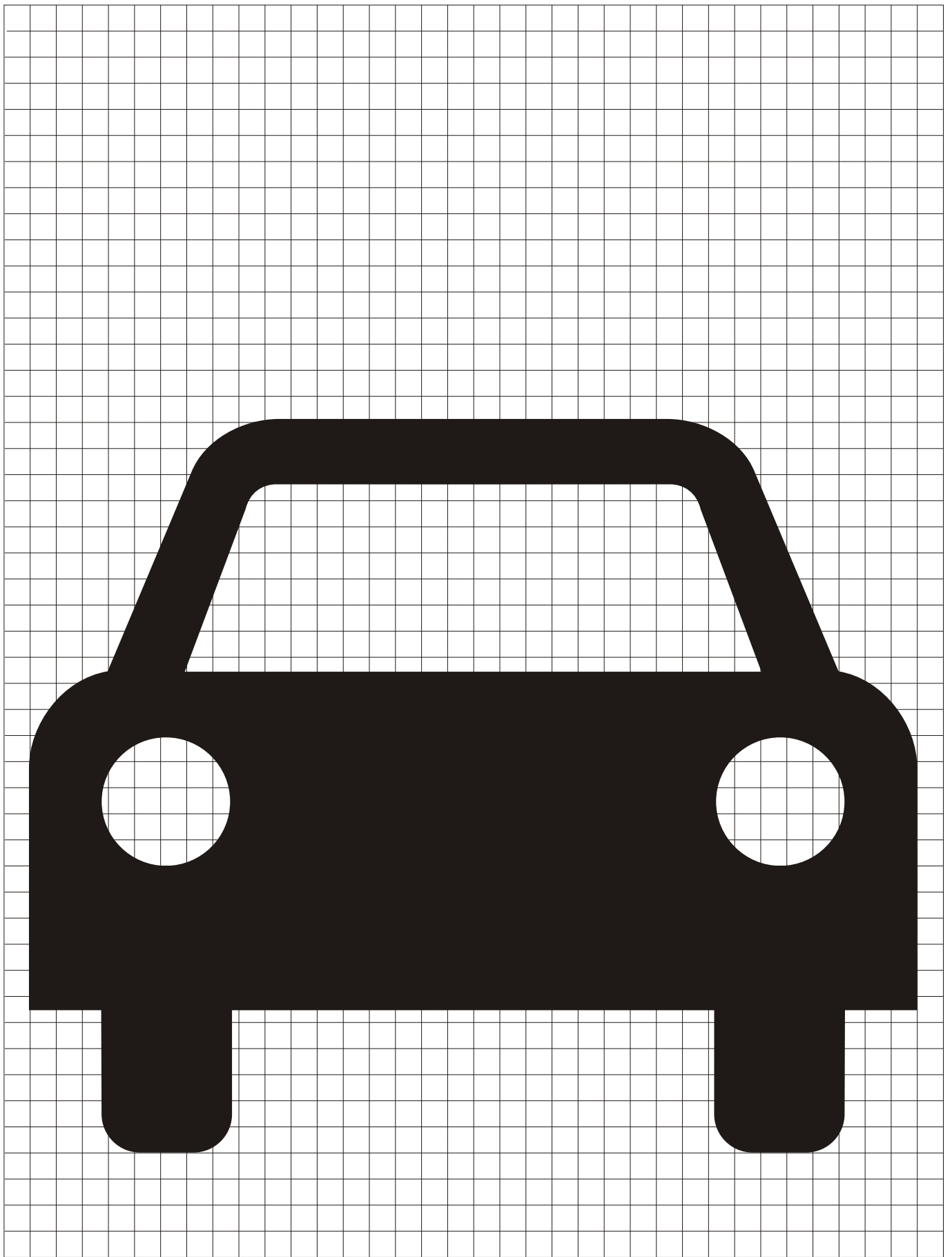

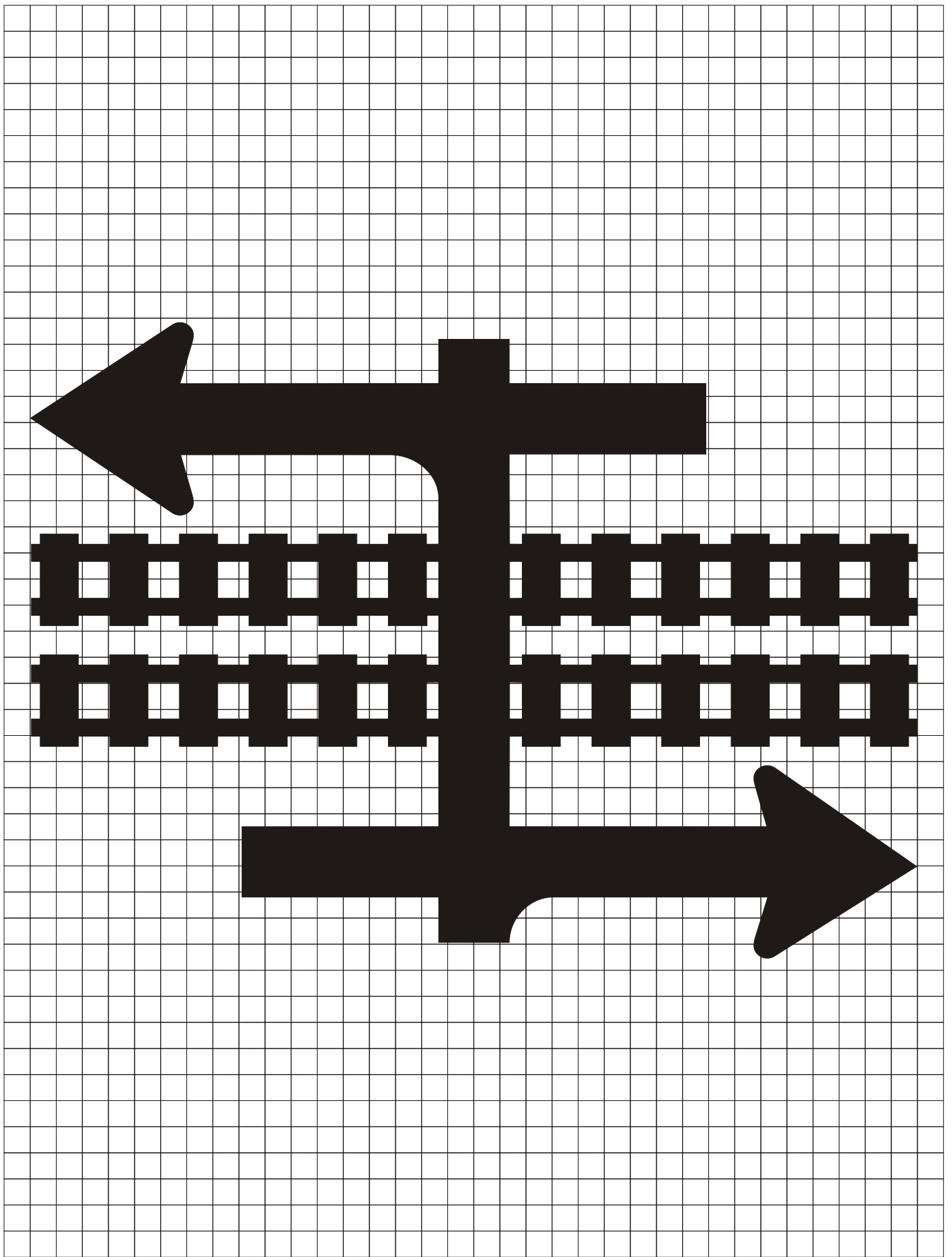

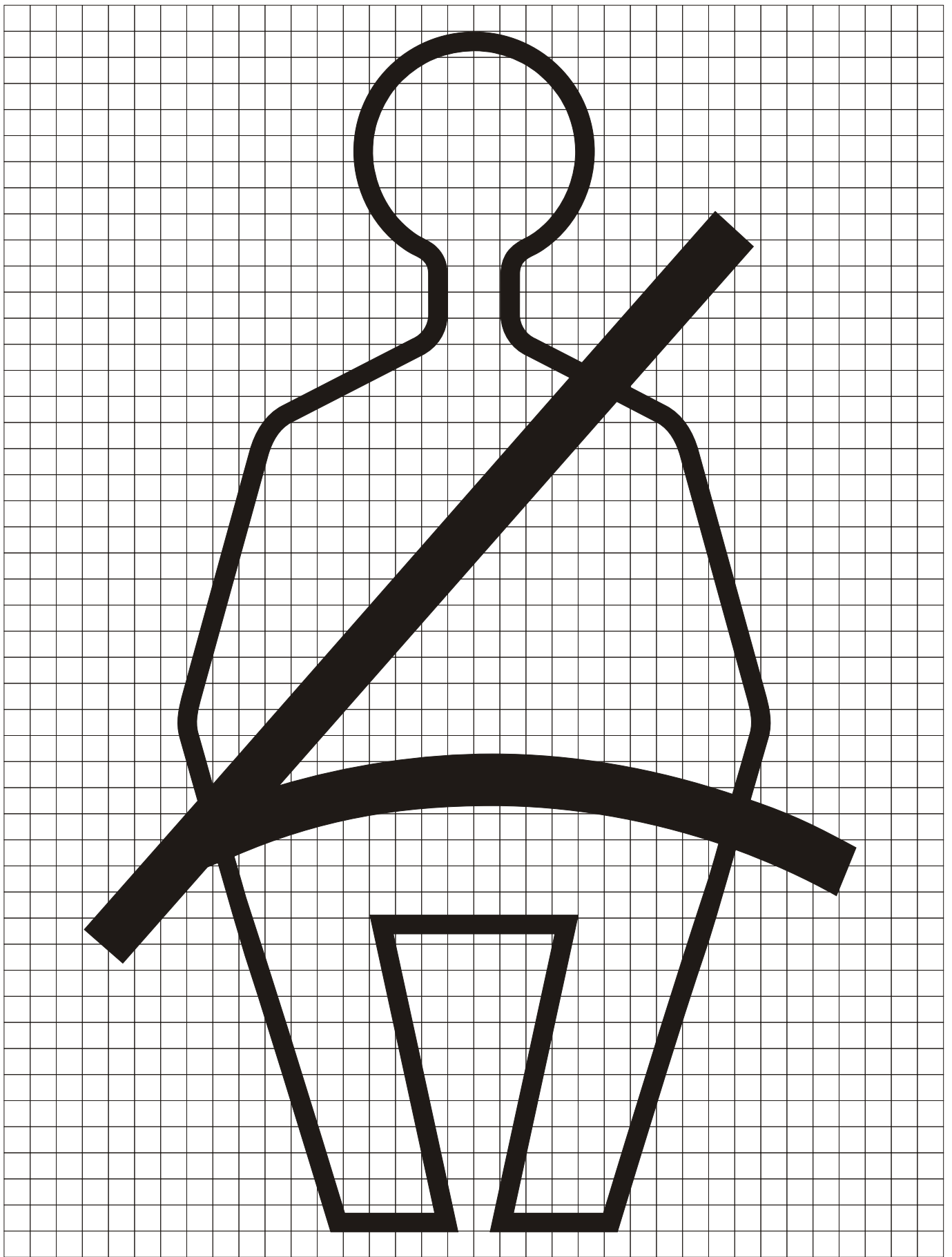

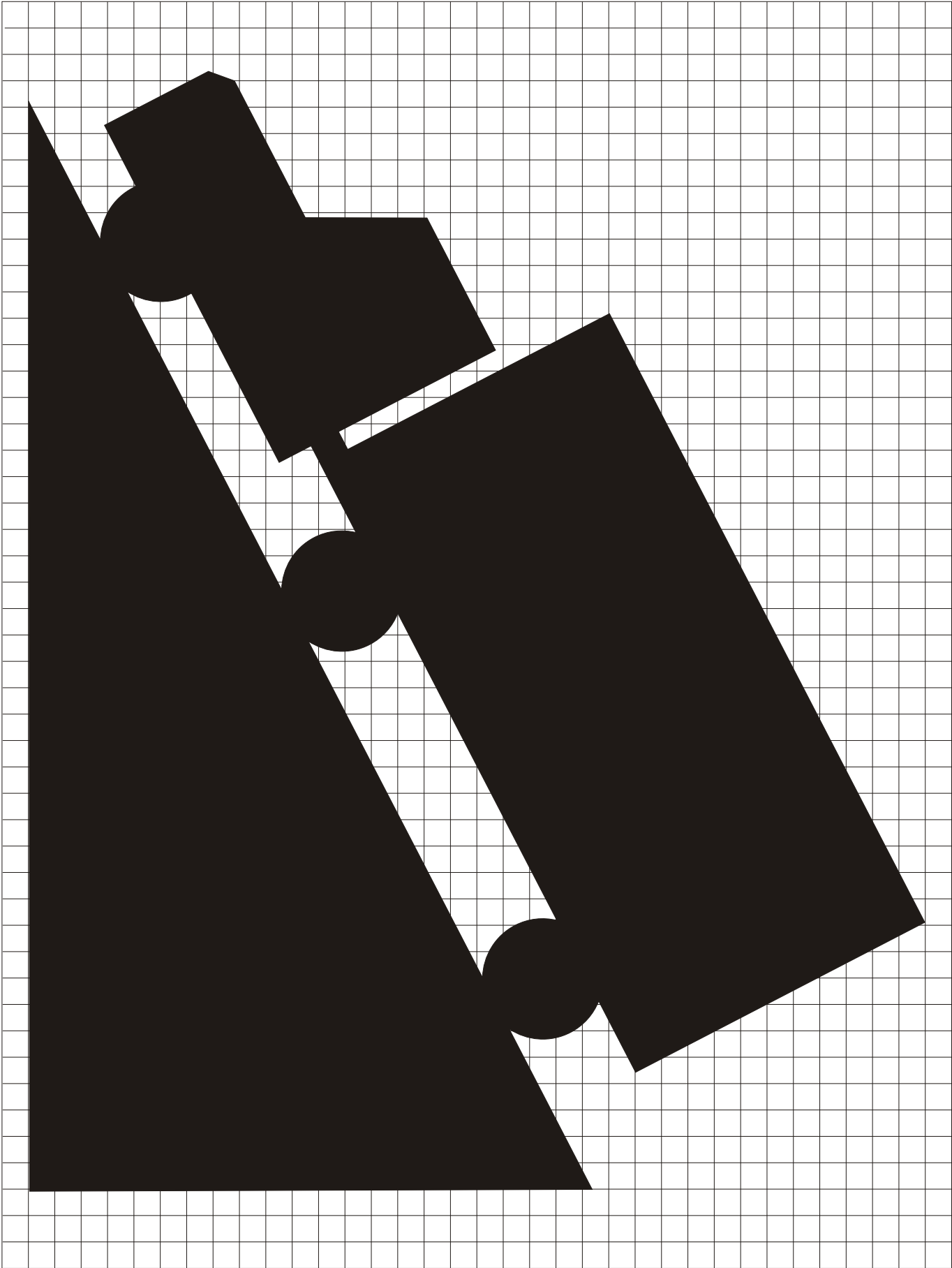

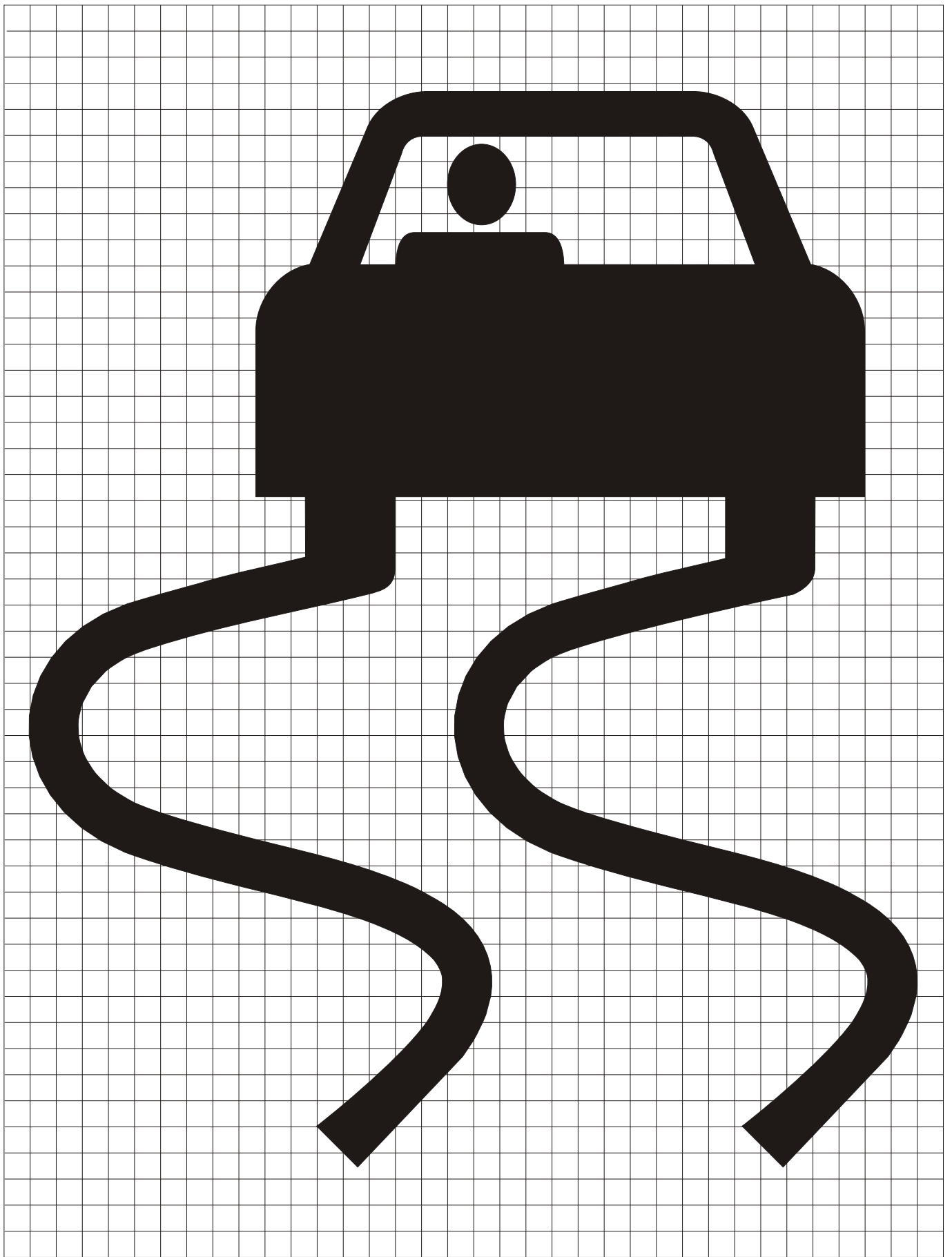

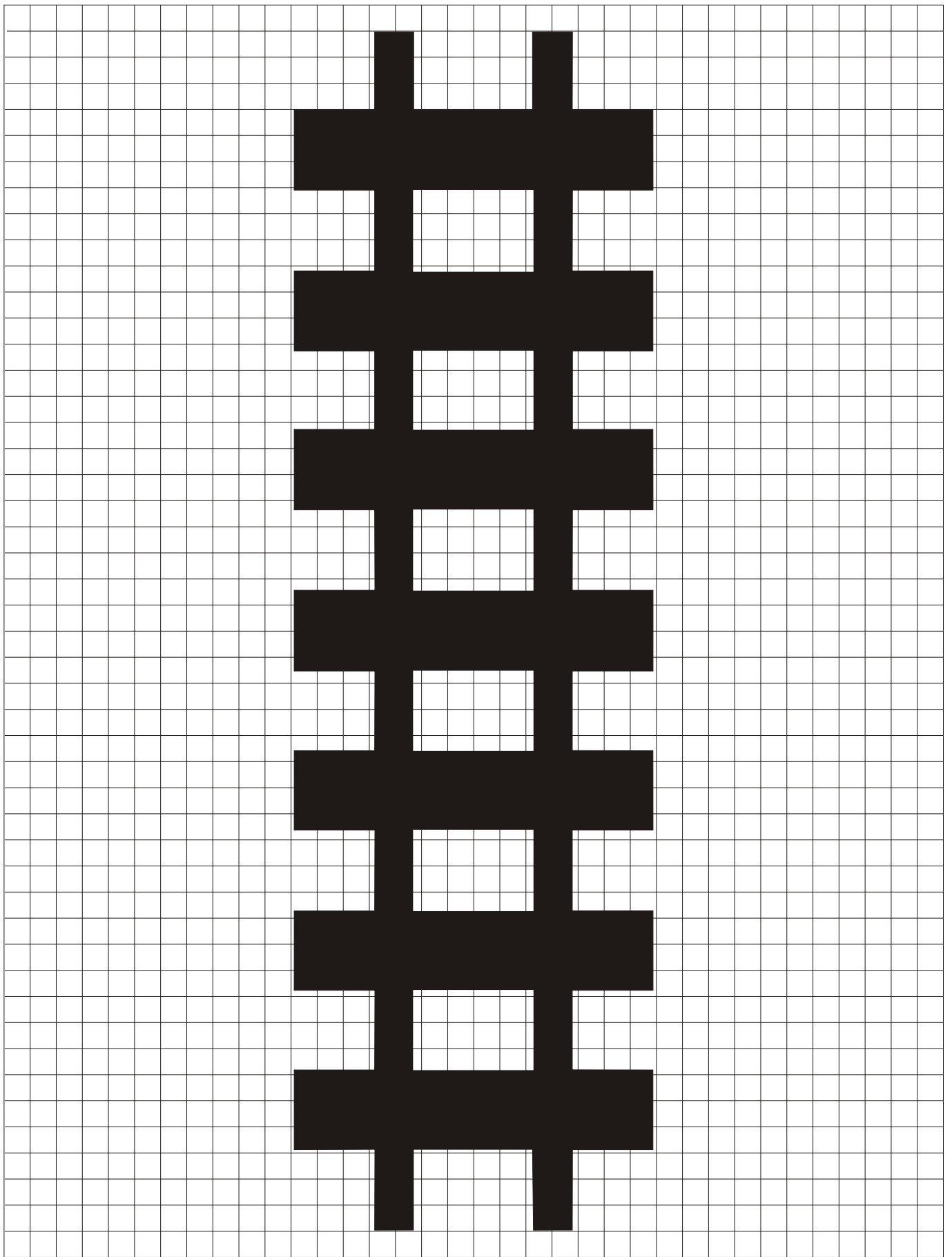

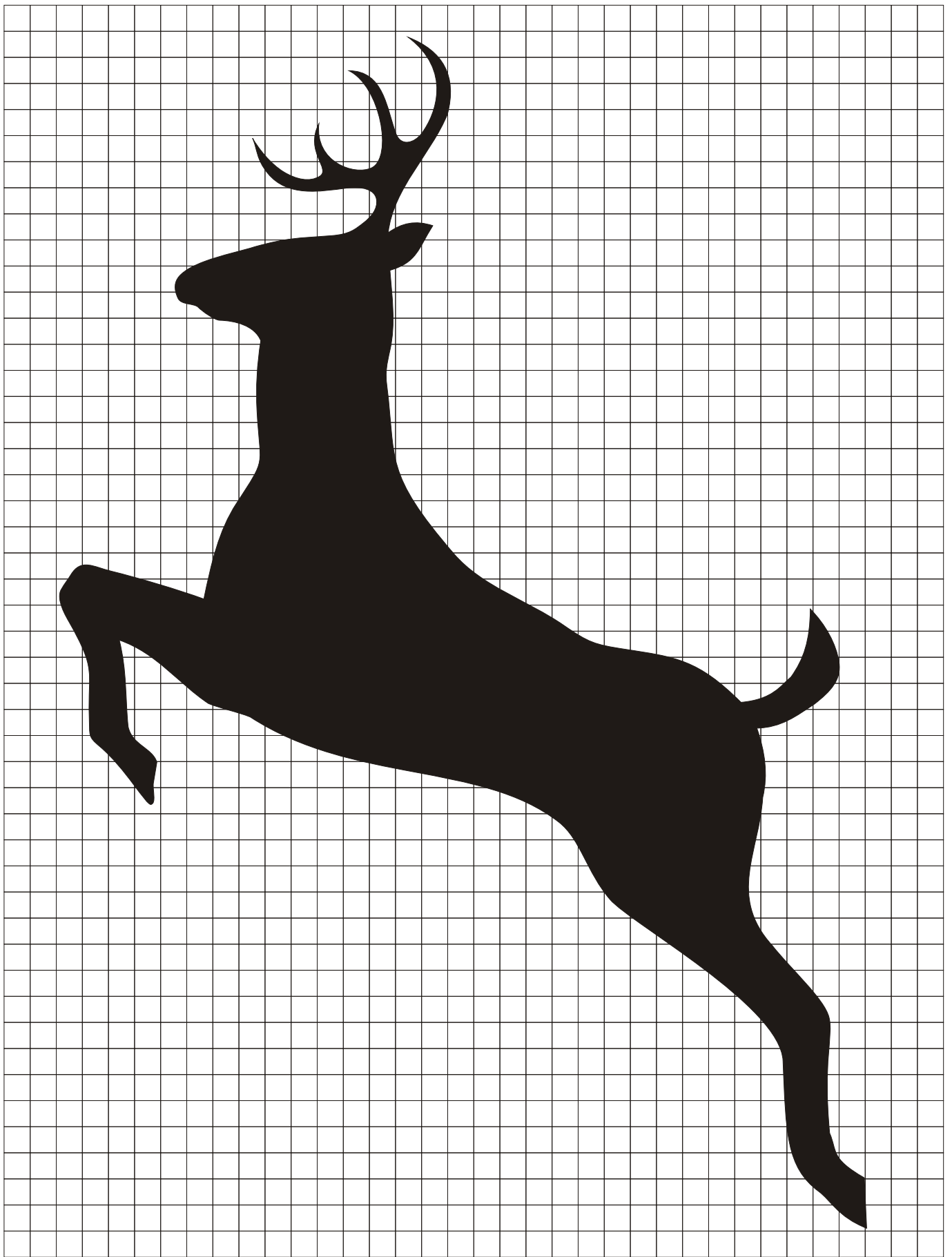

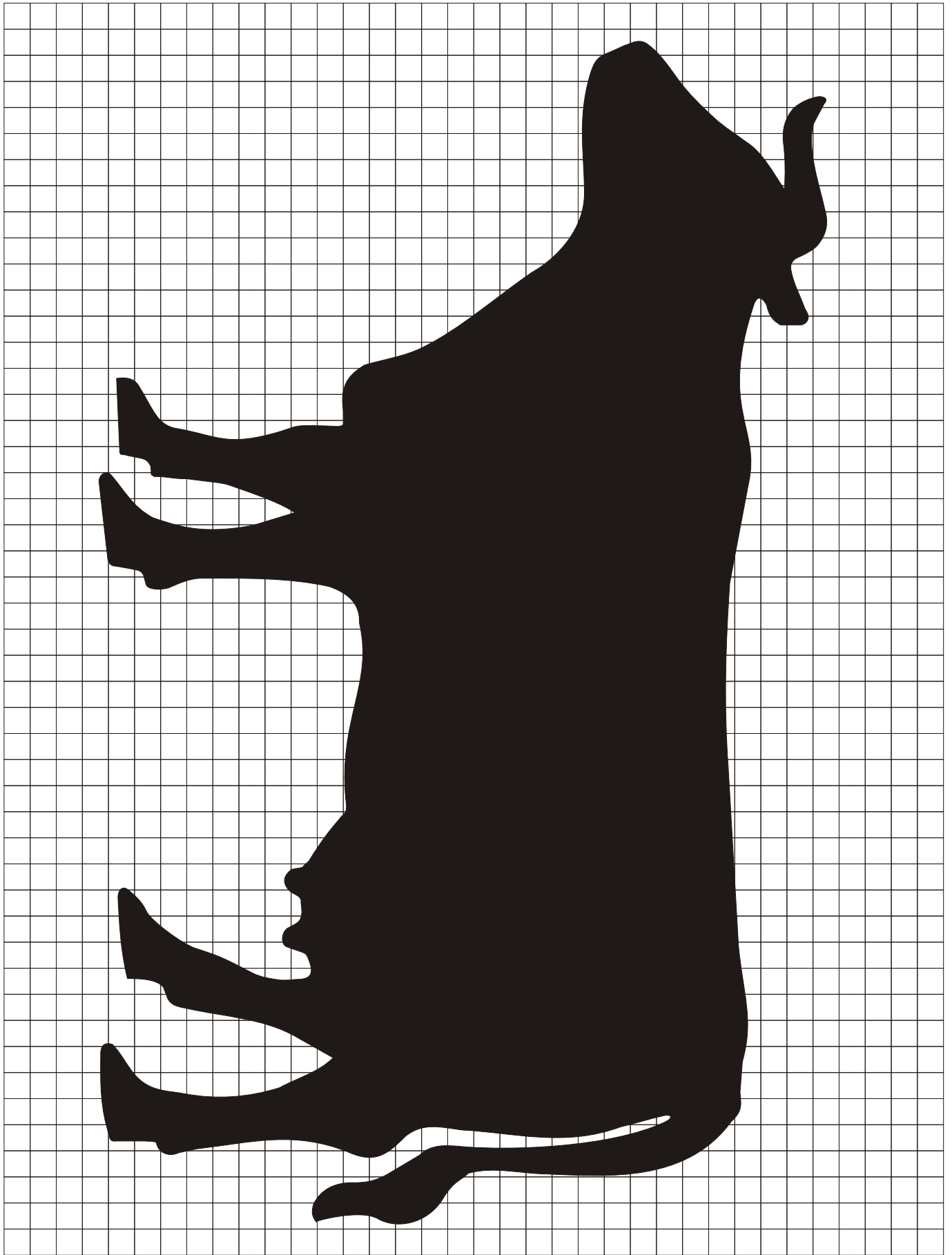

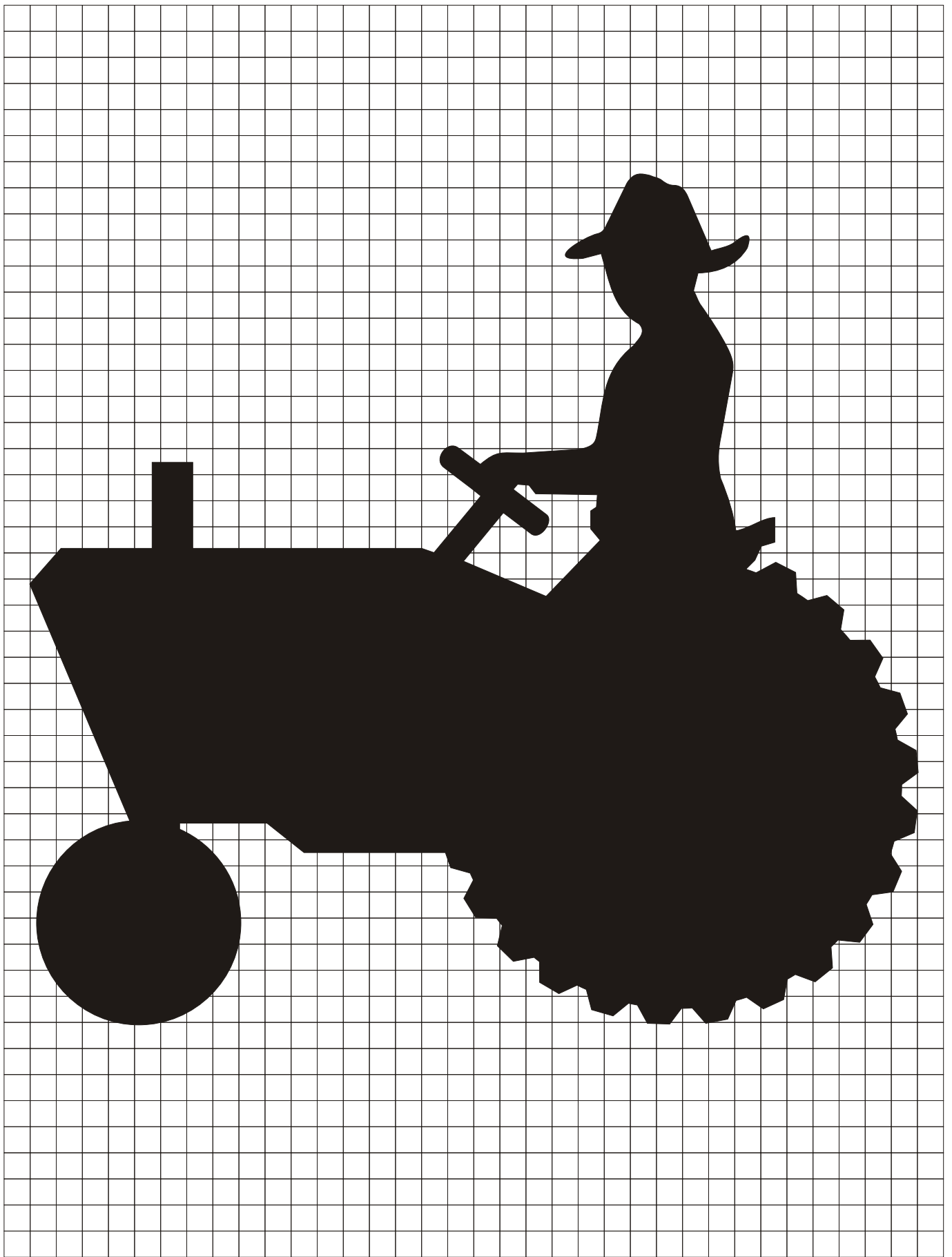

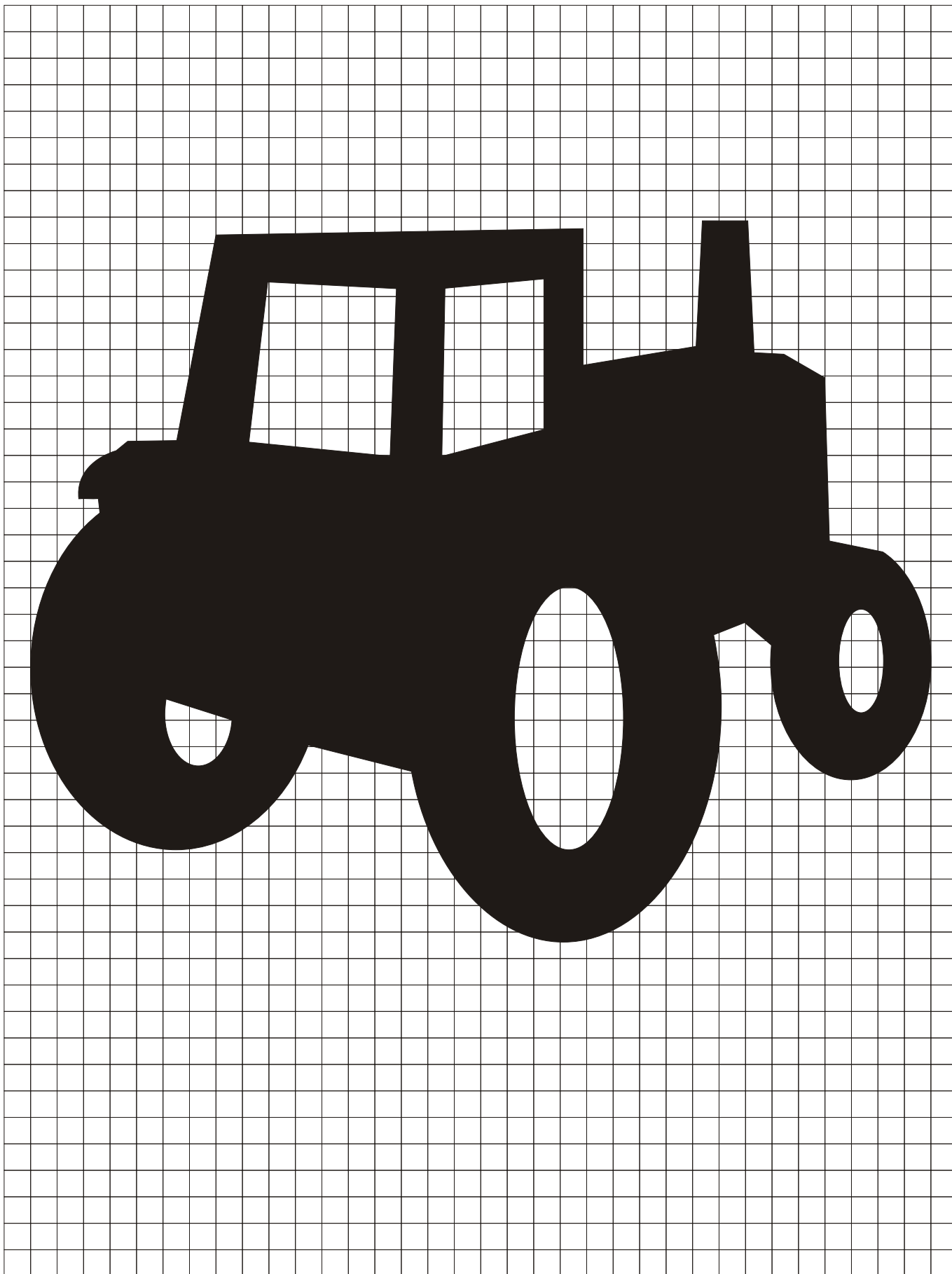

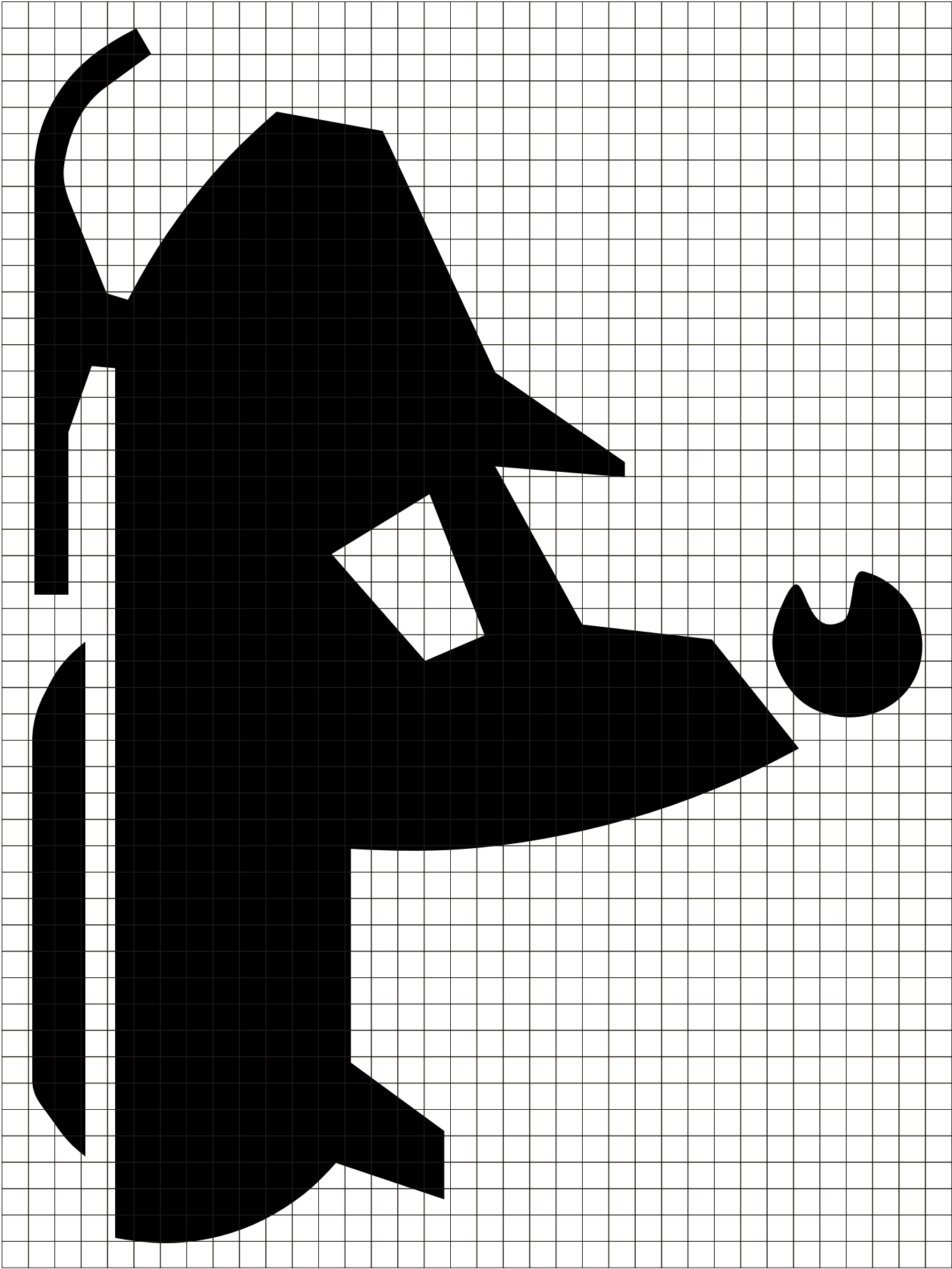

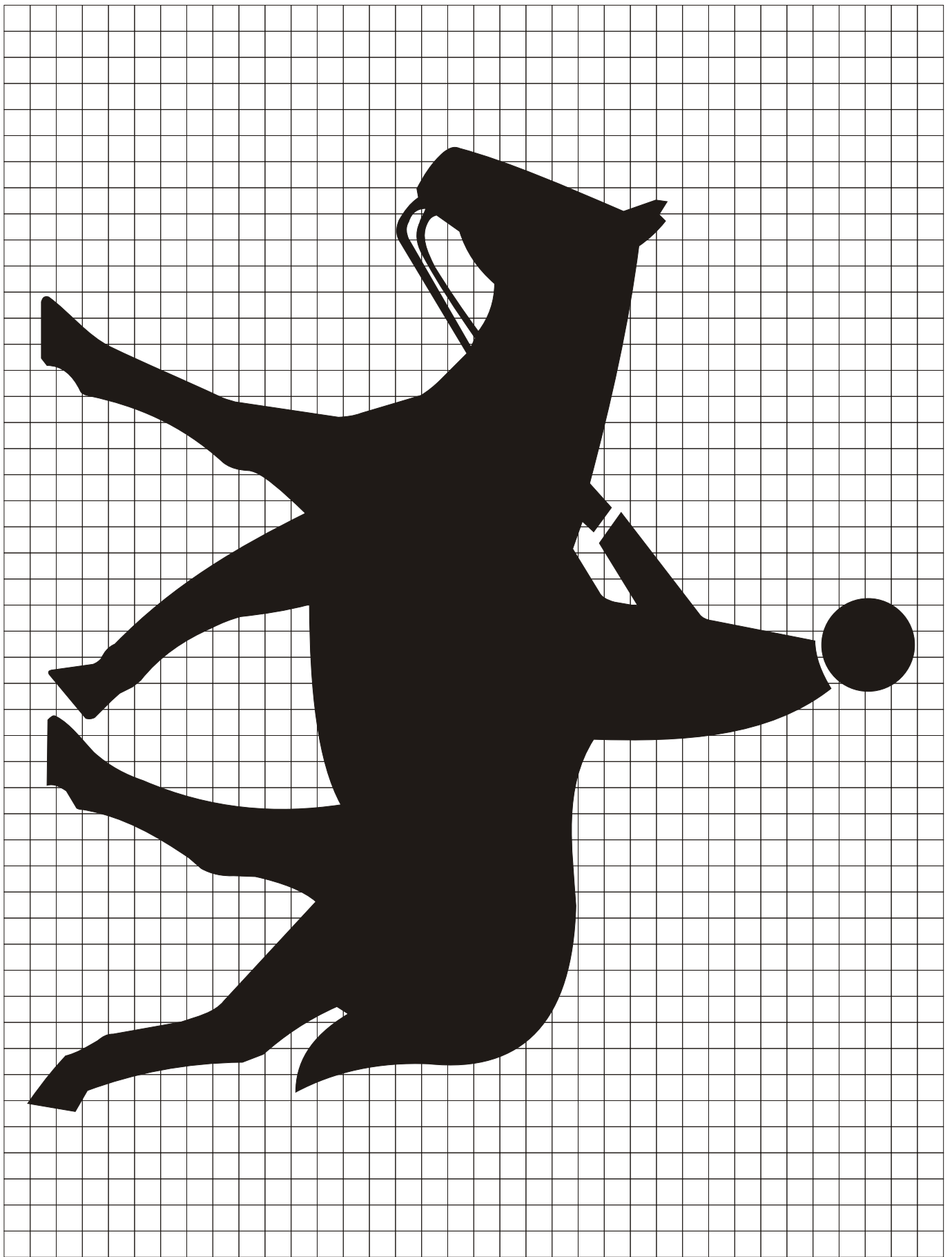

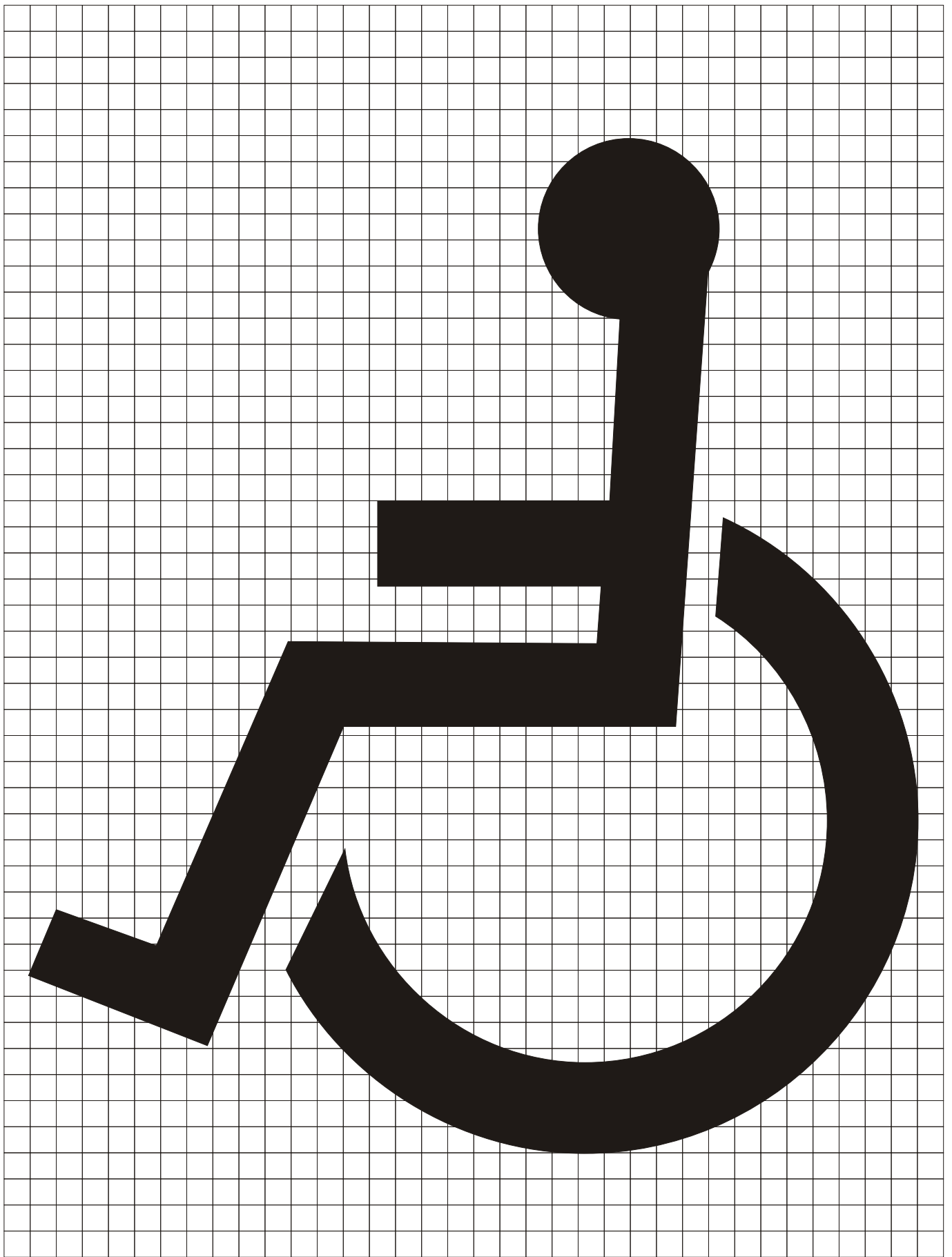

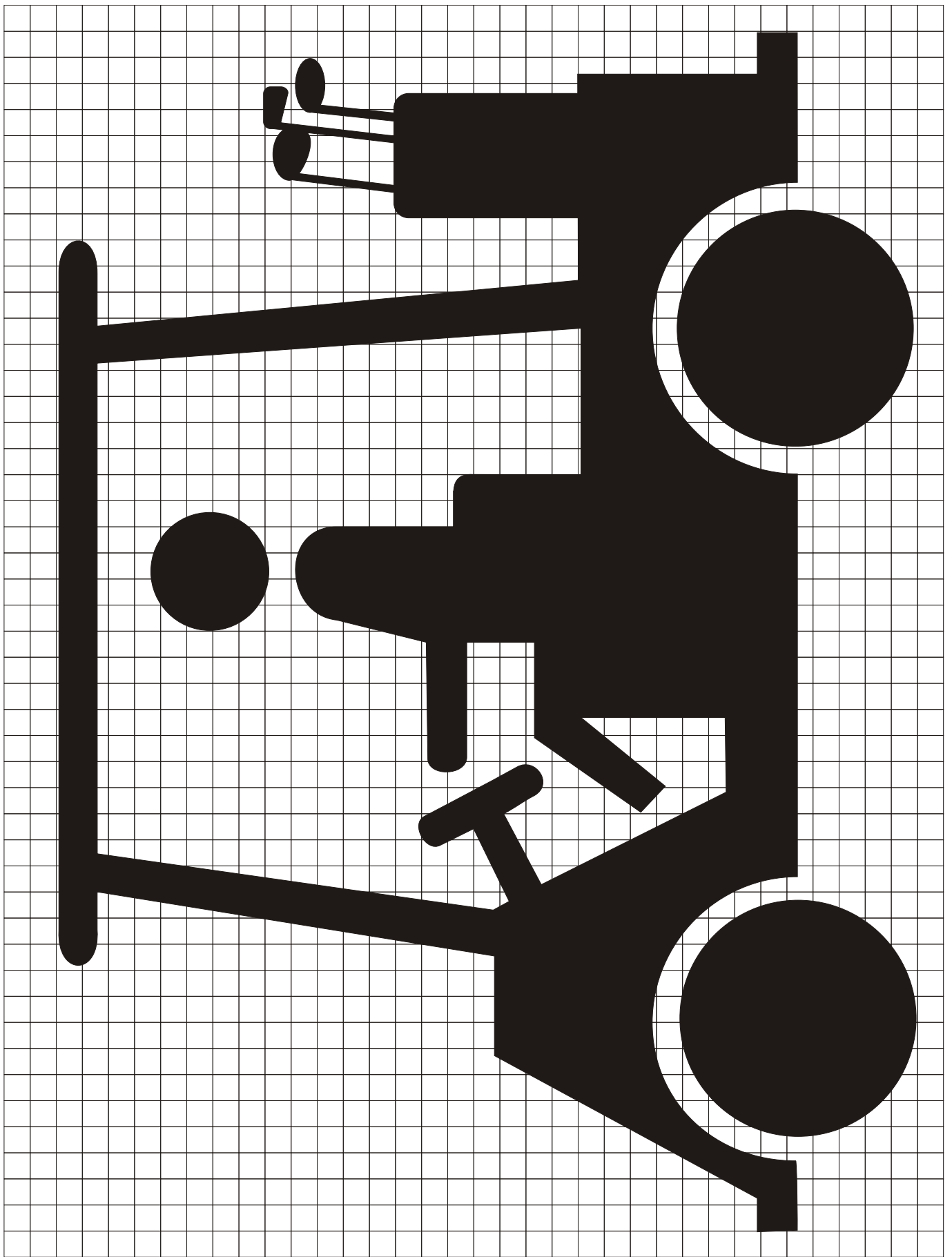

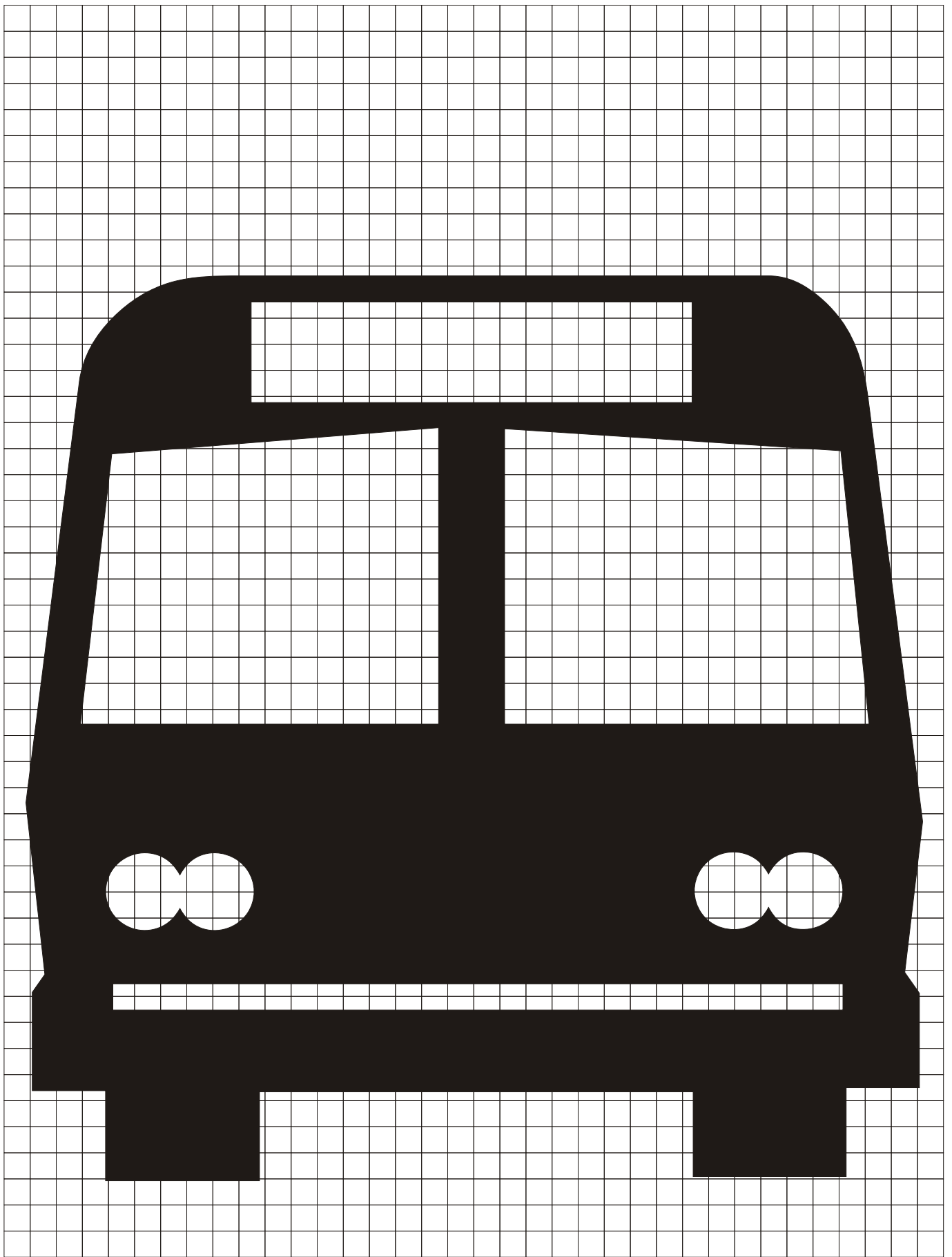

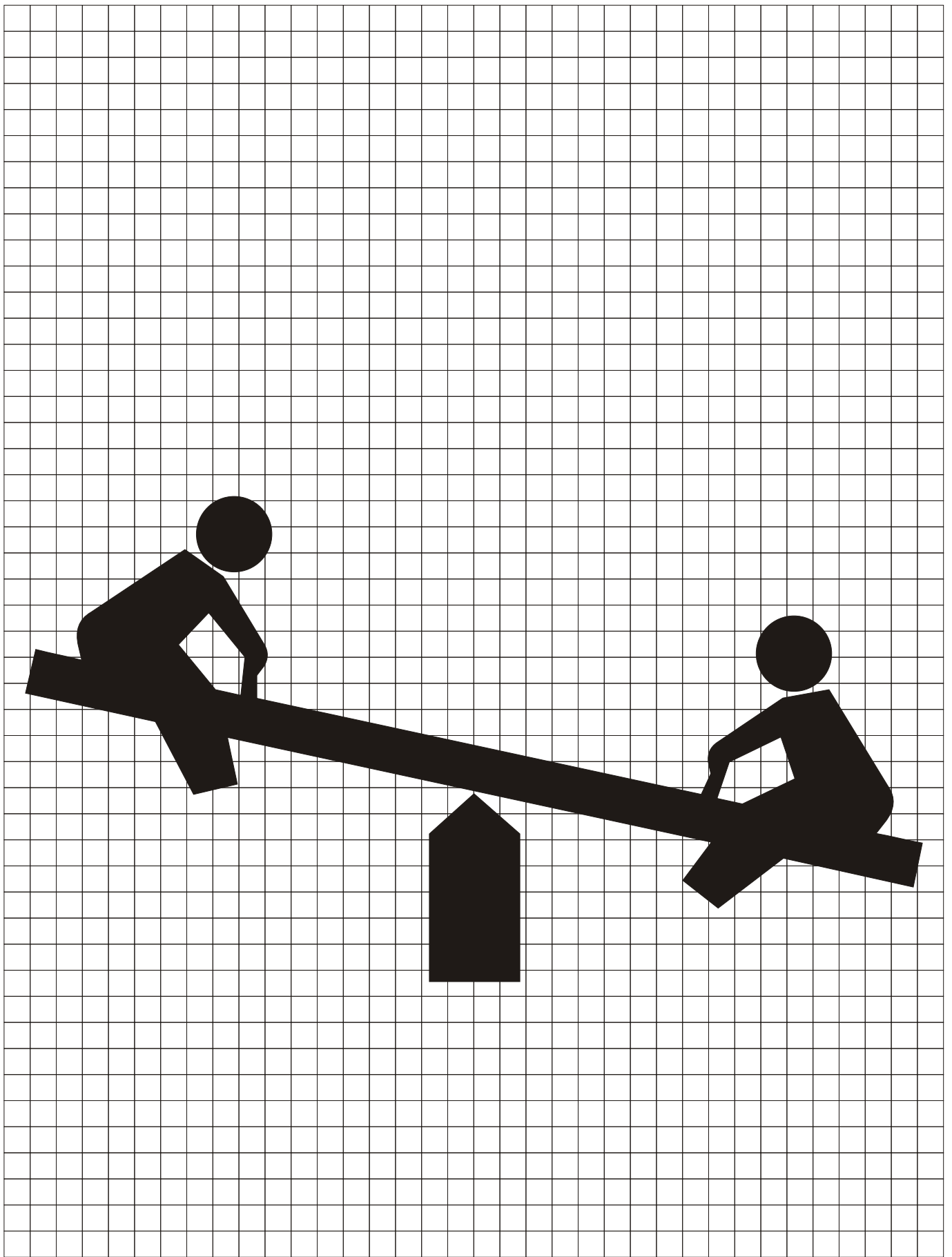

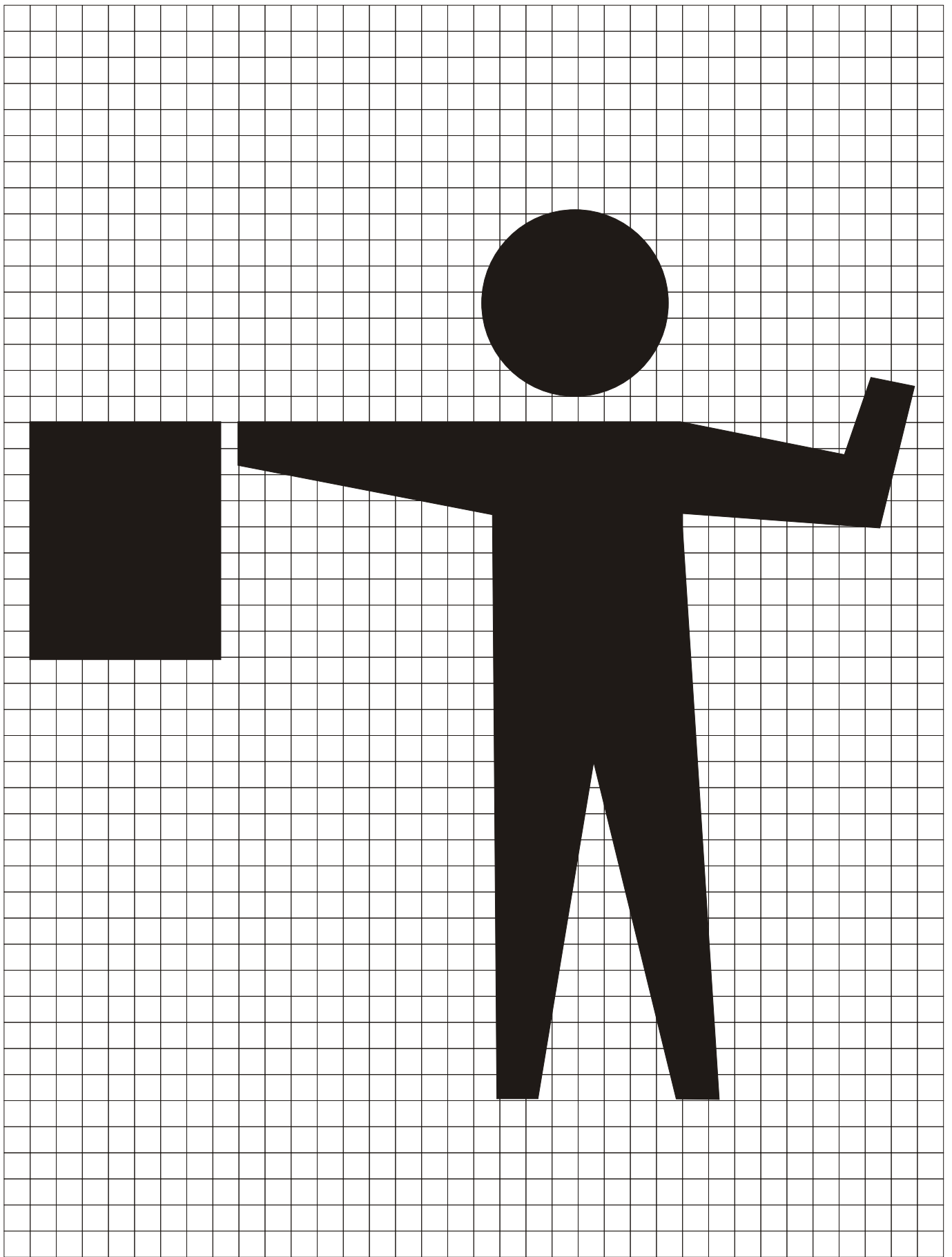

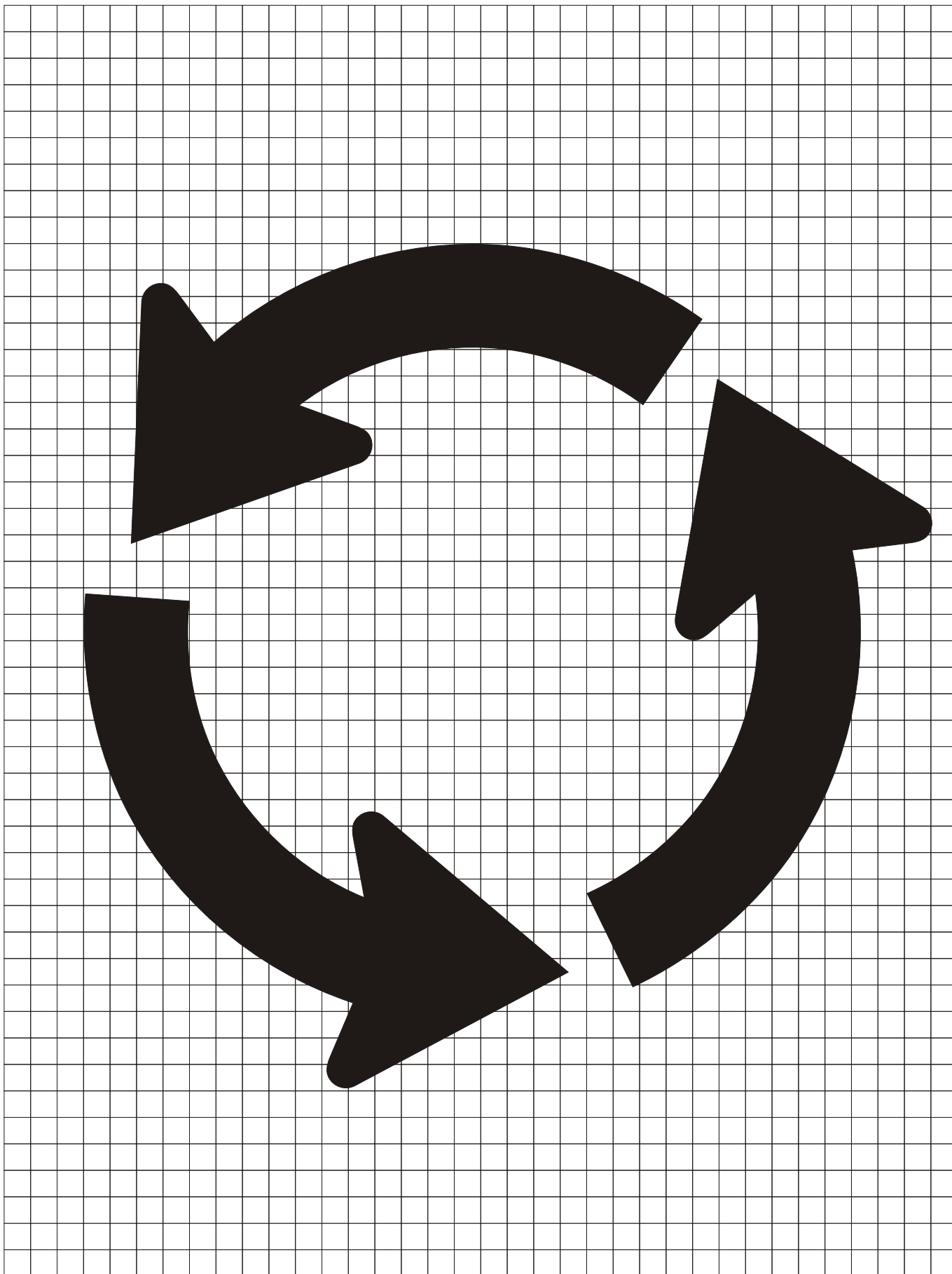

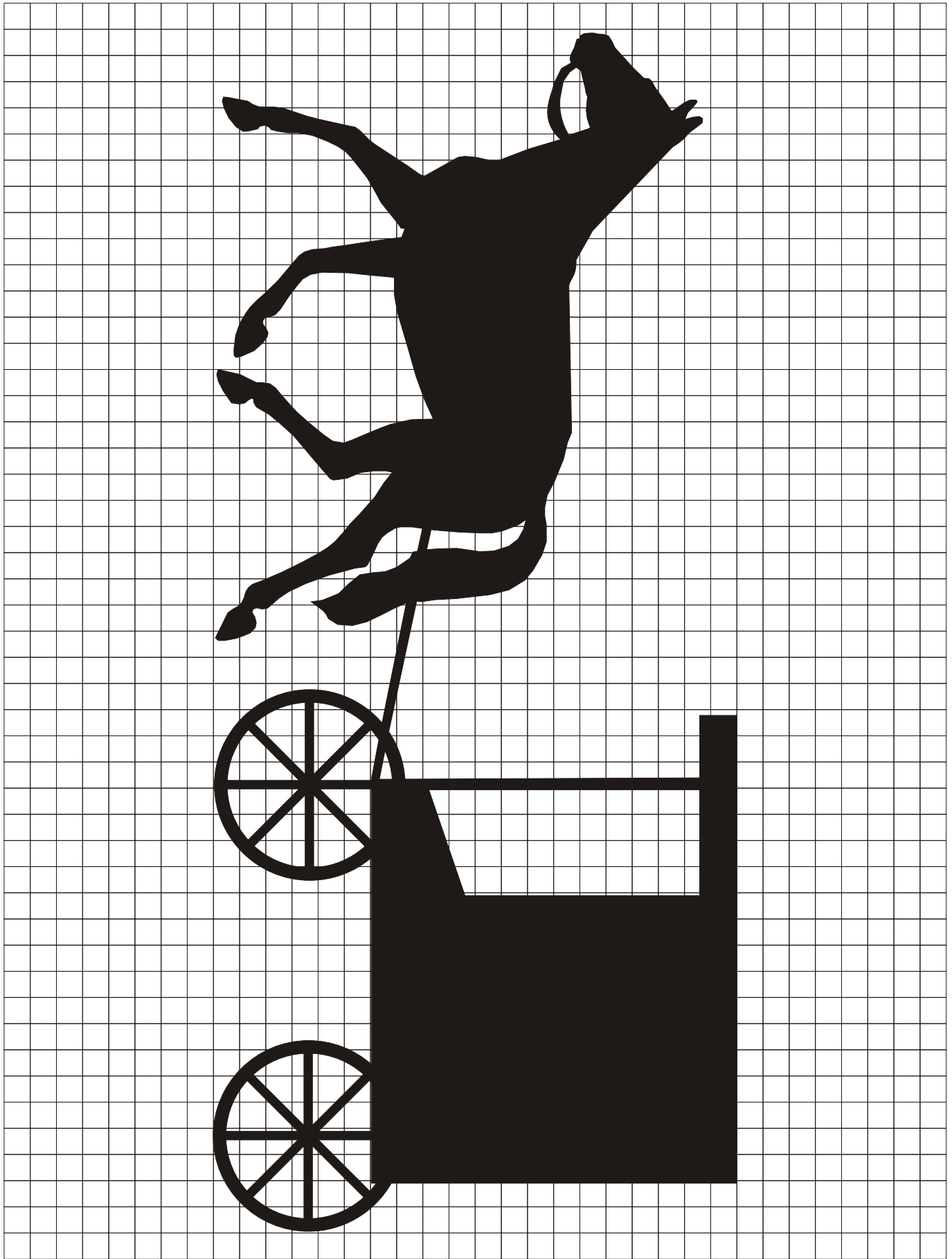

**National
Forests**

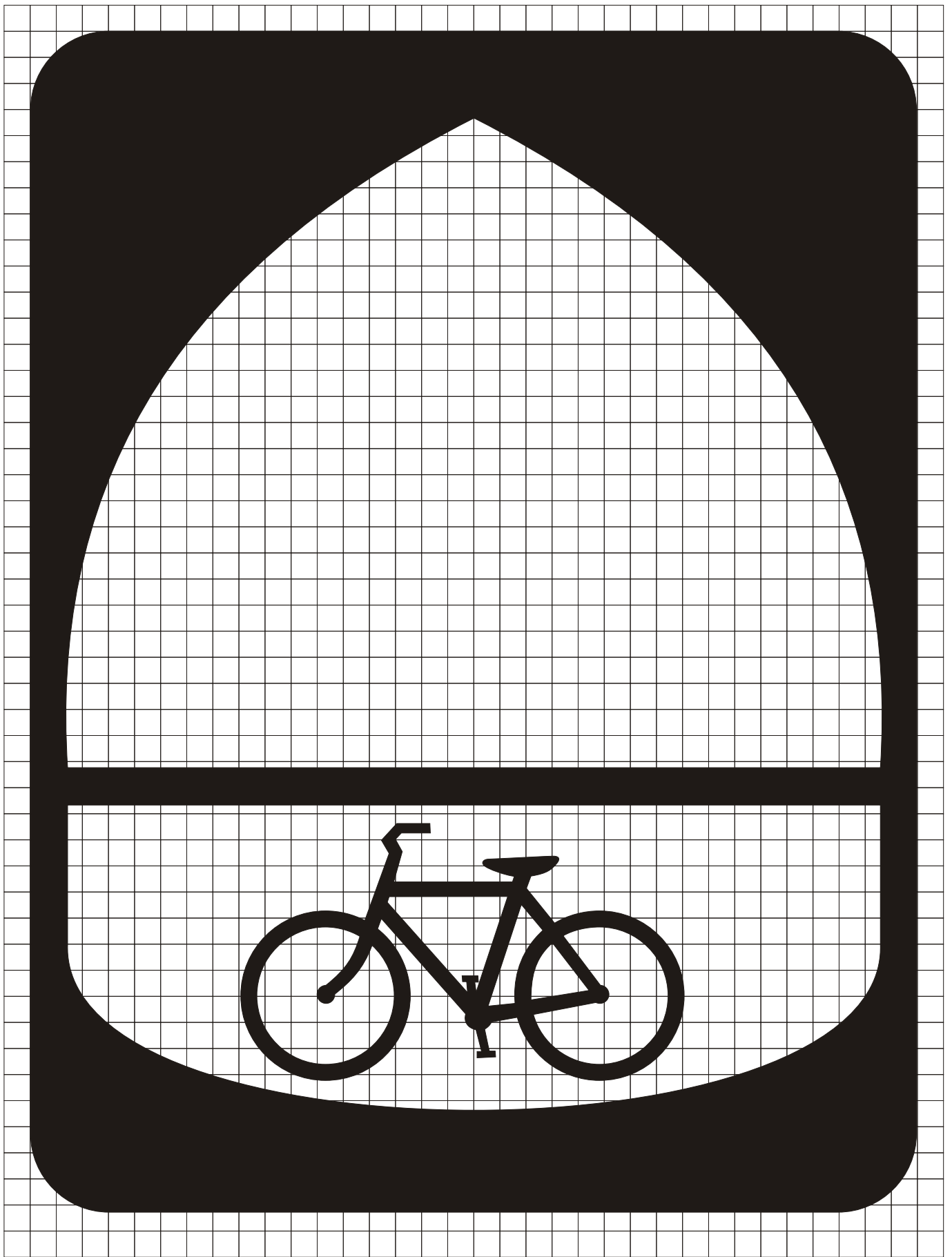

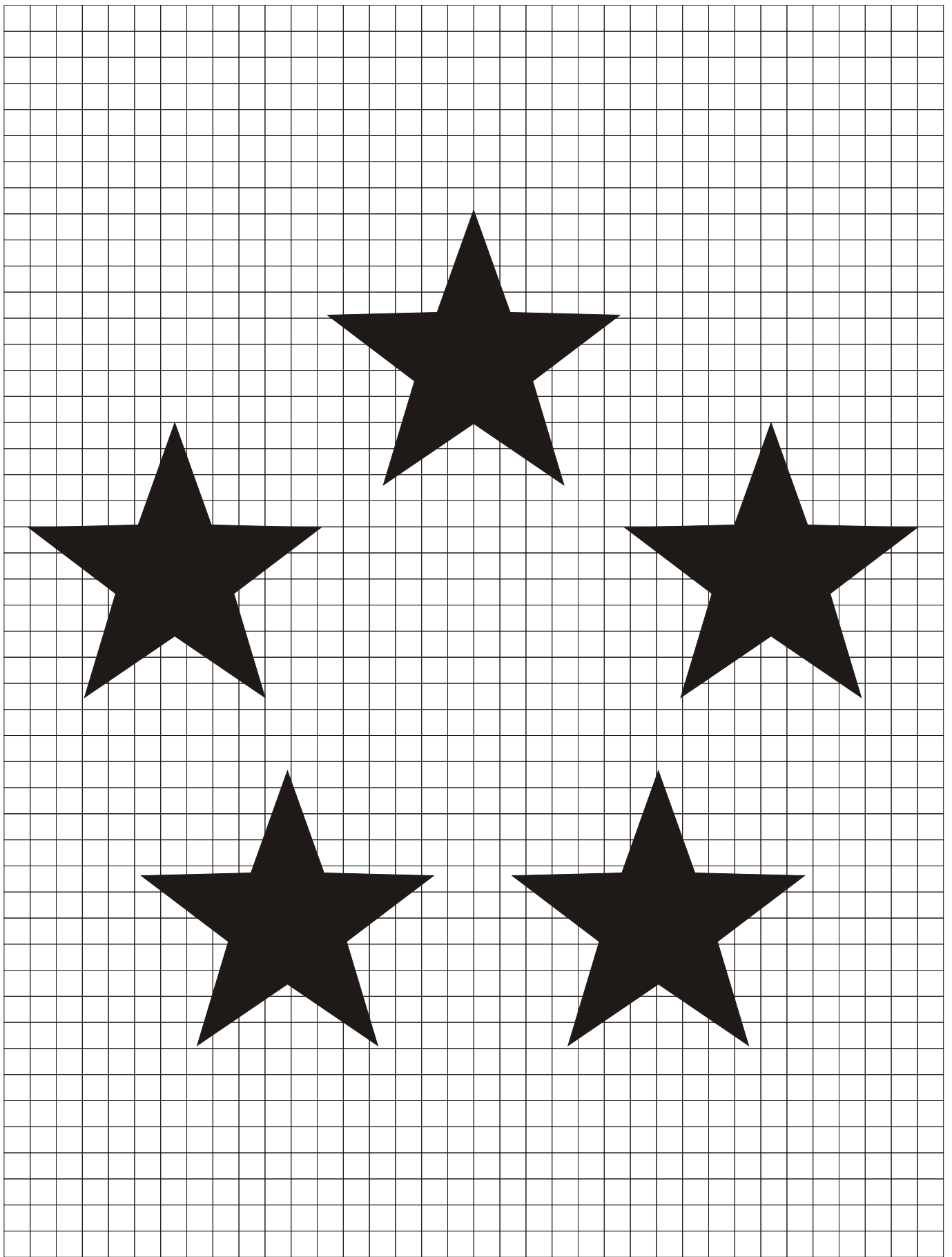

ESSENTIAL INTELLIGENCE SYSTEM

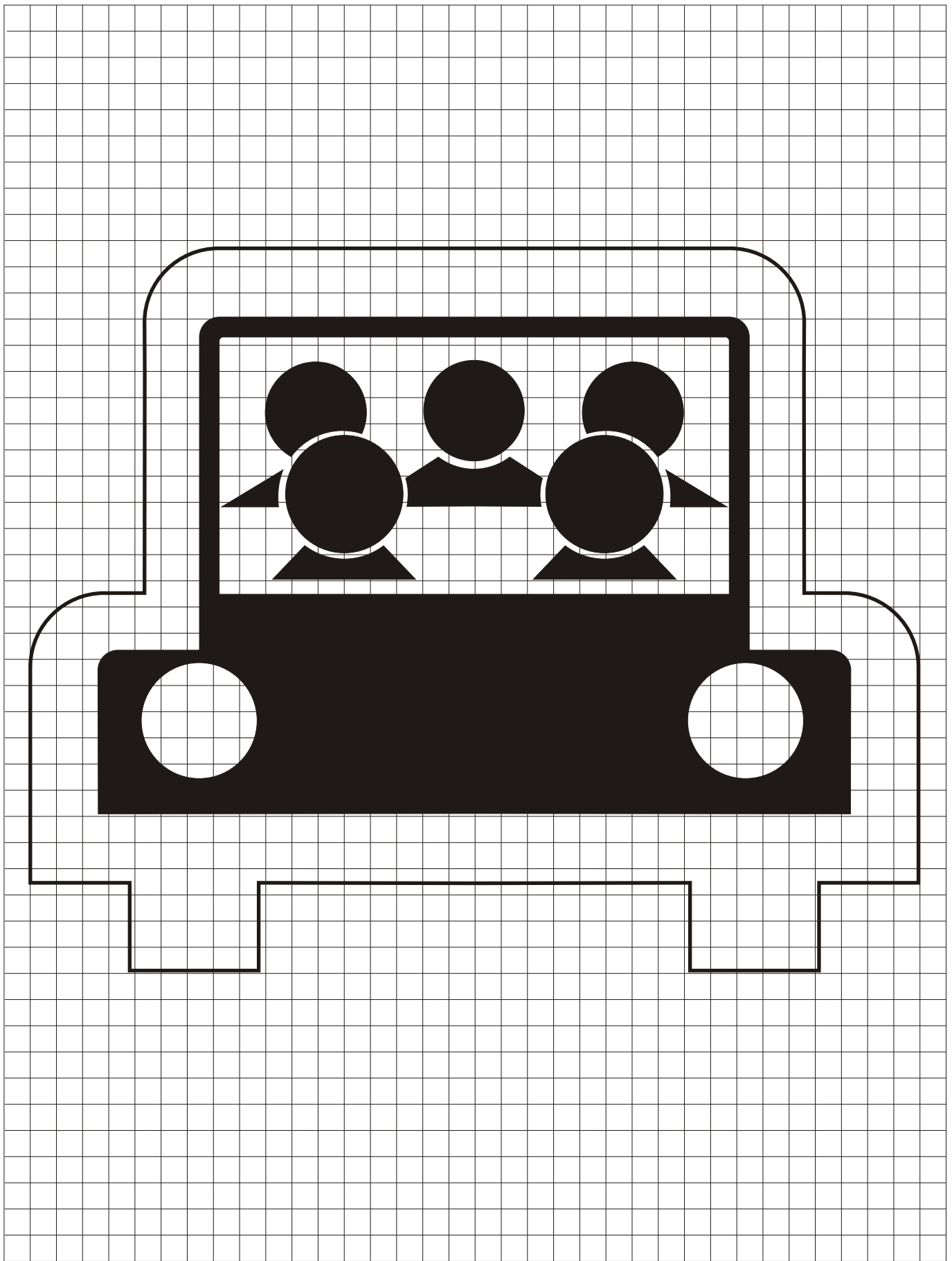

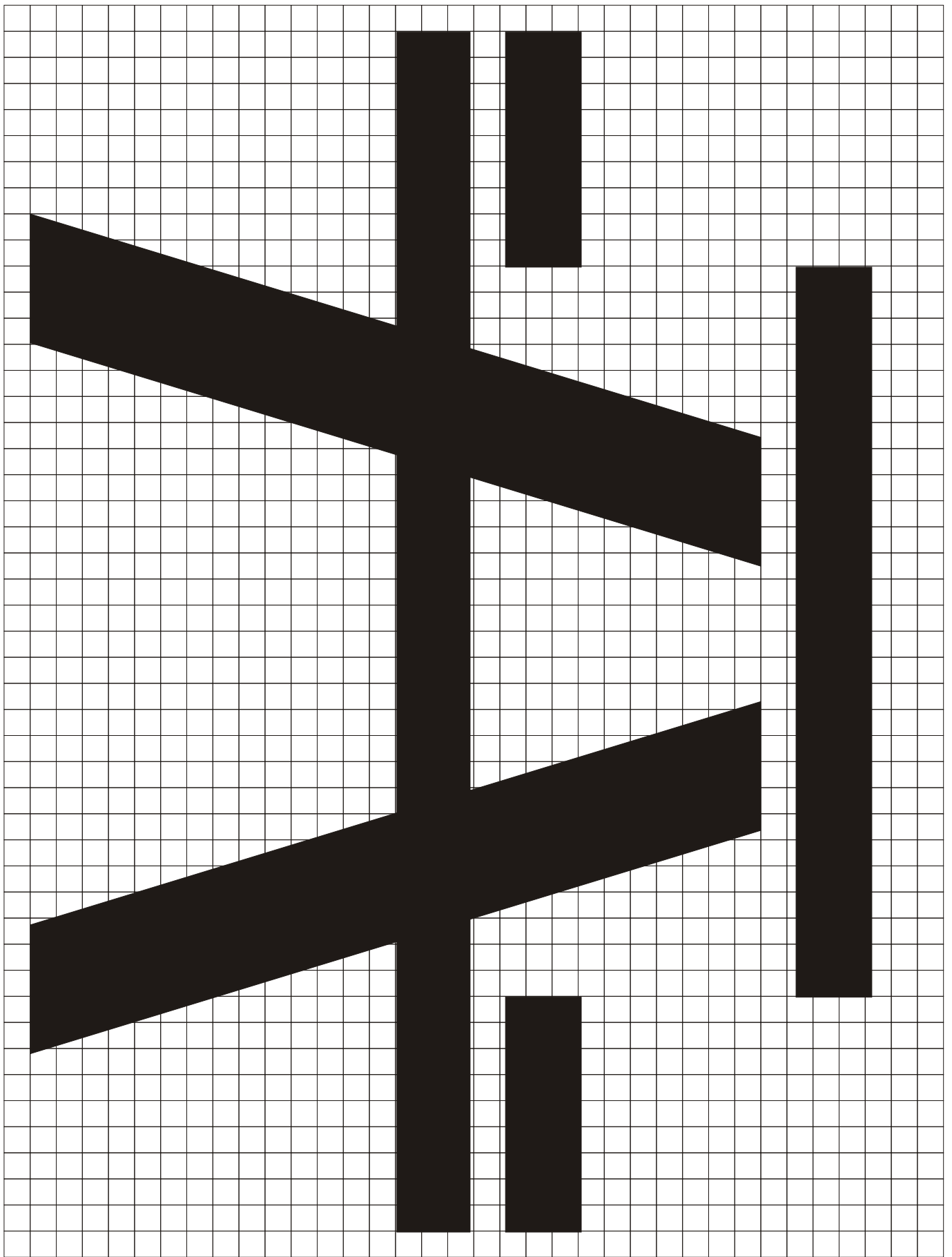

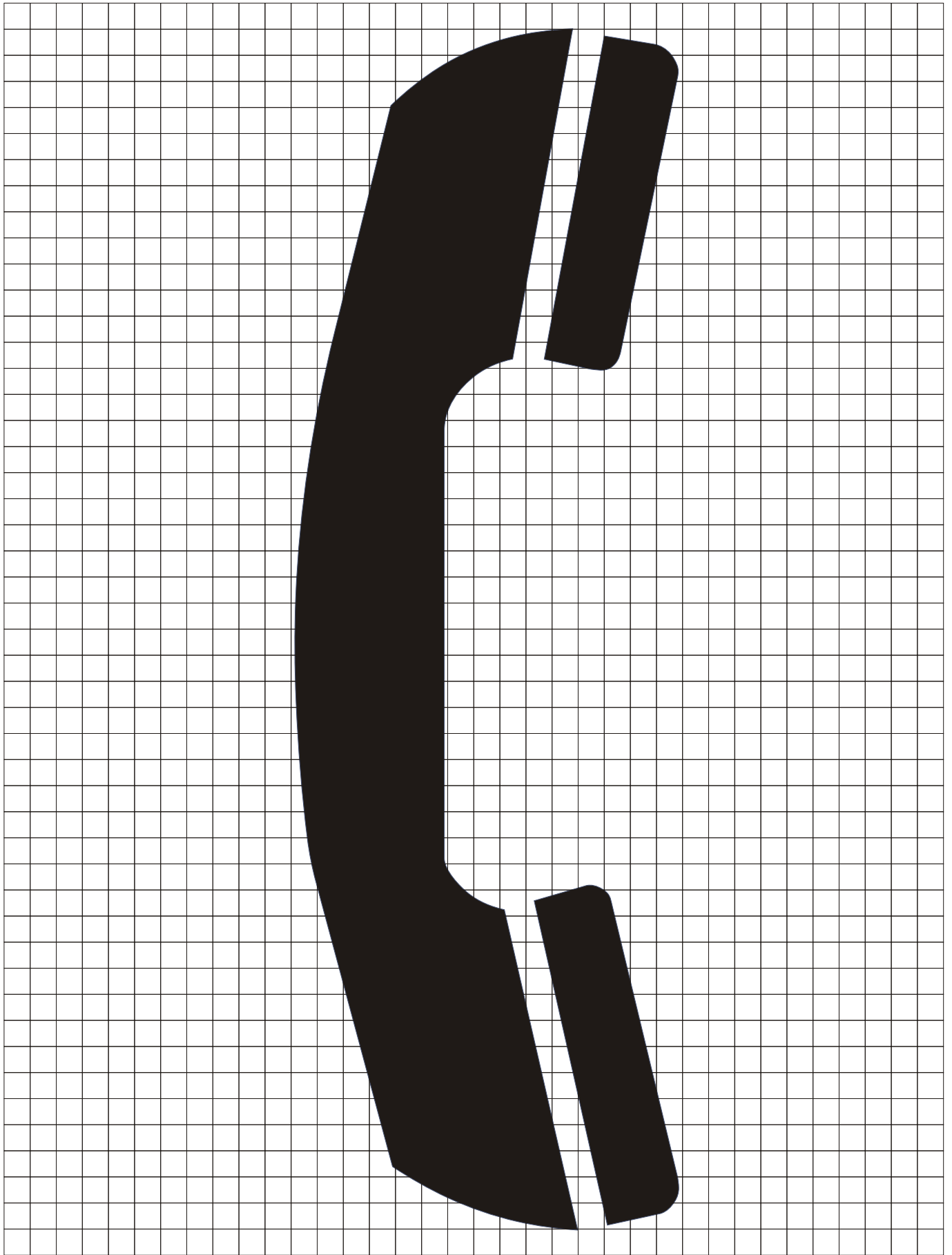

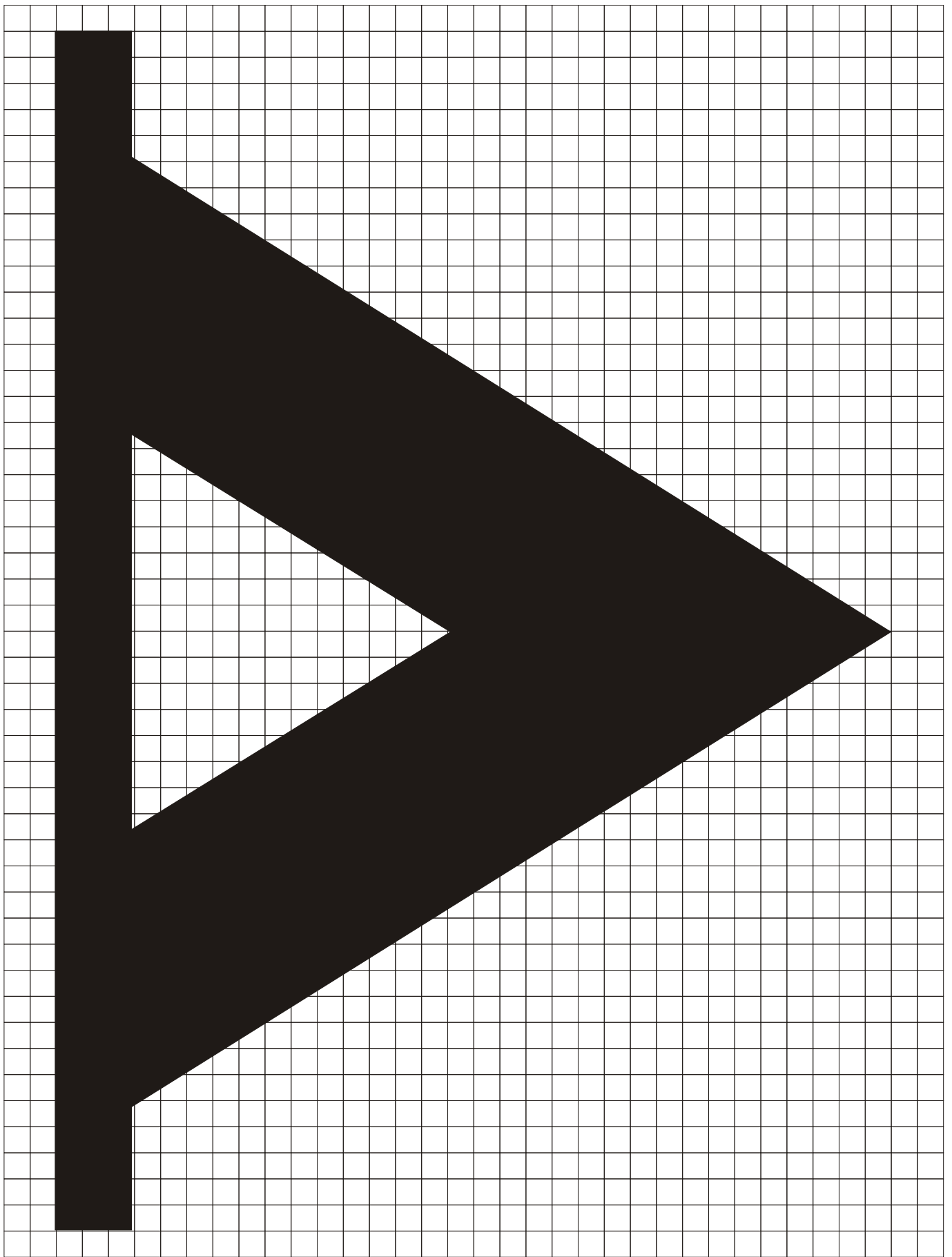

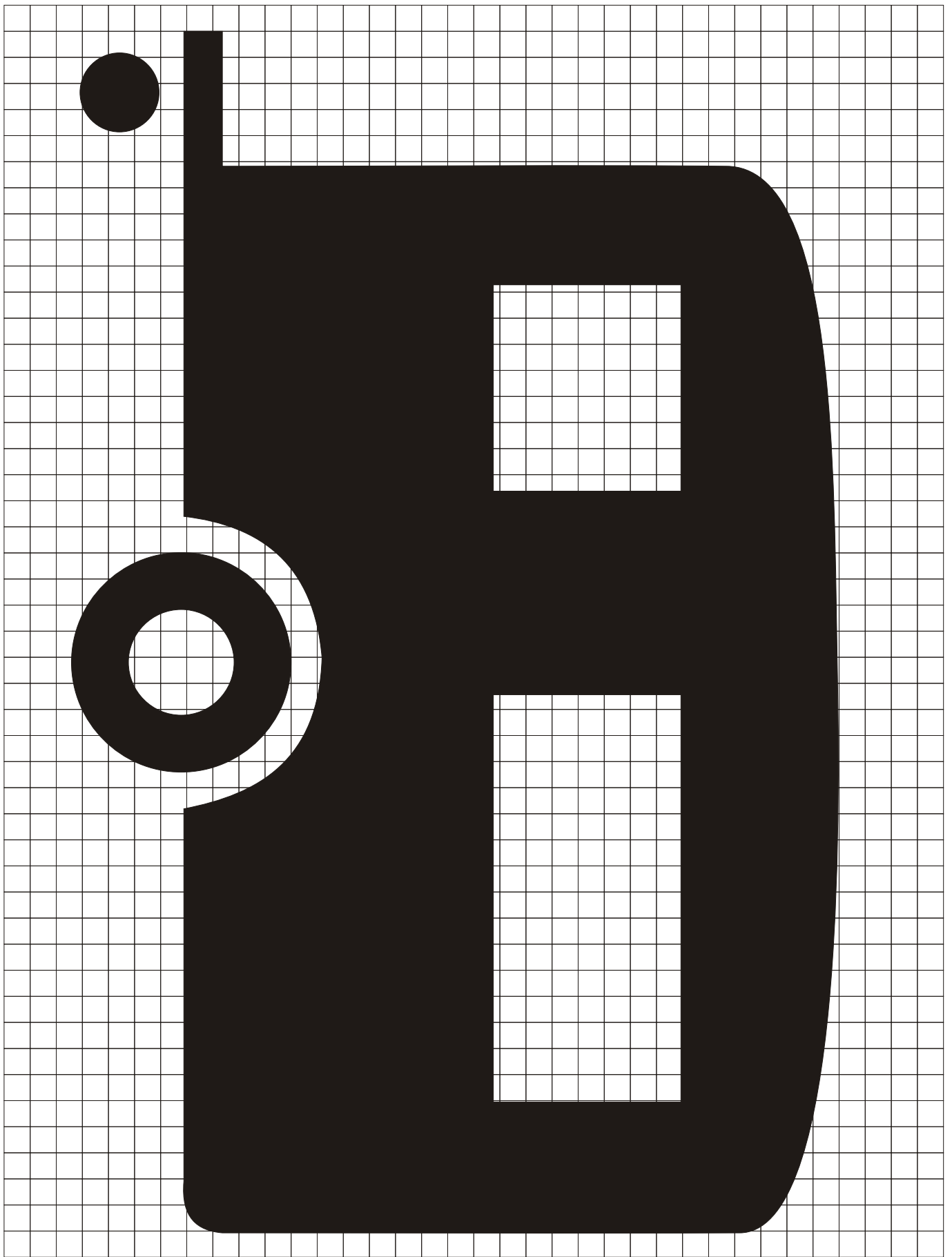

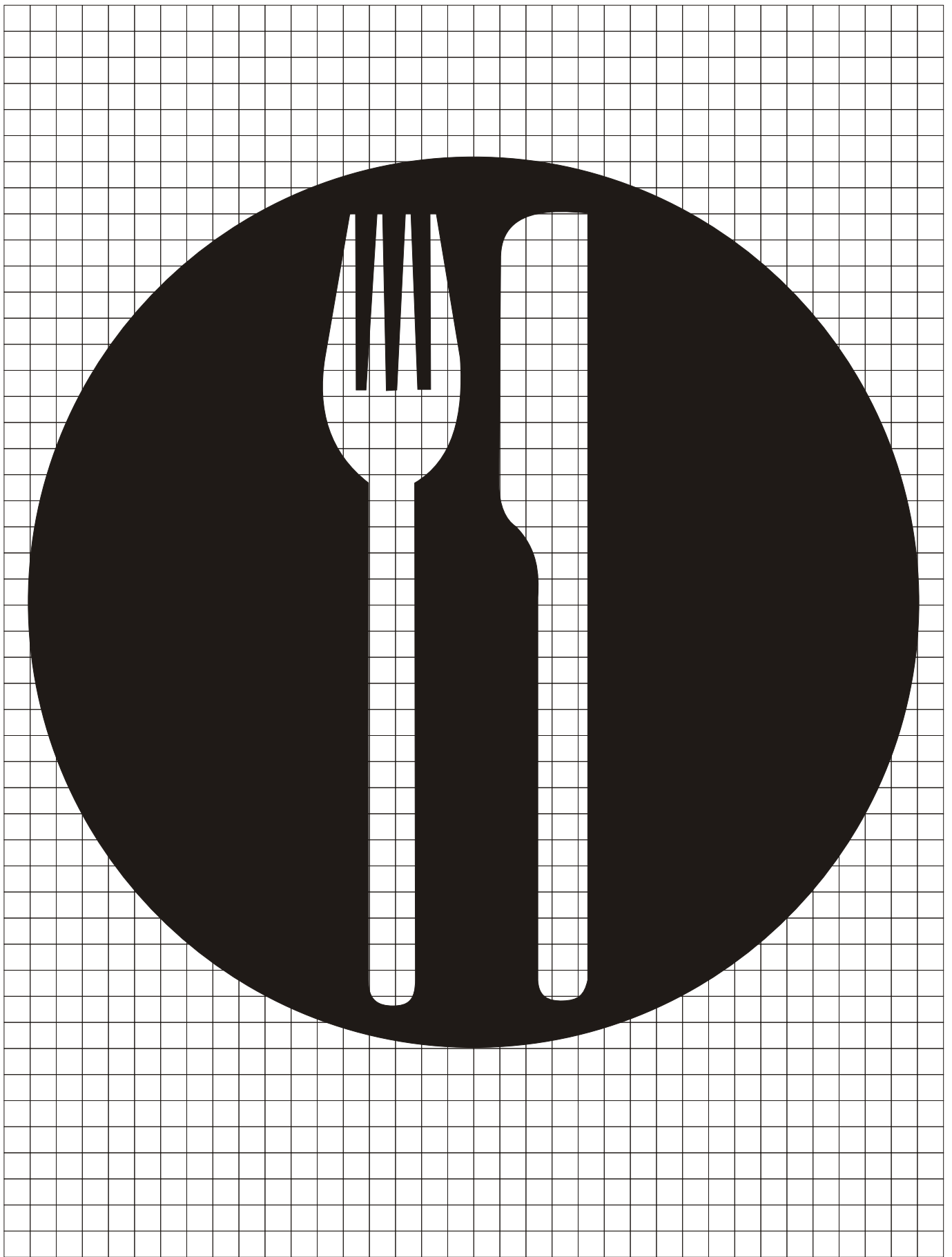

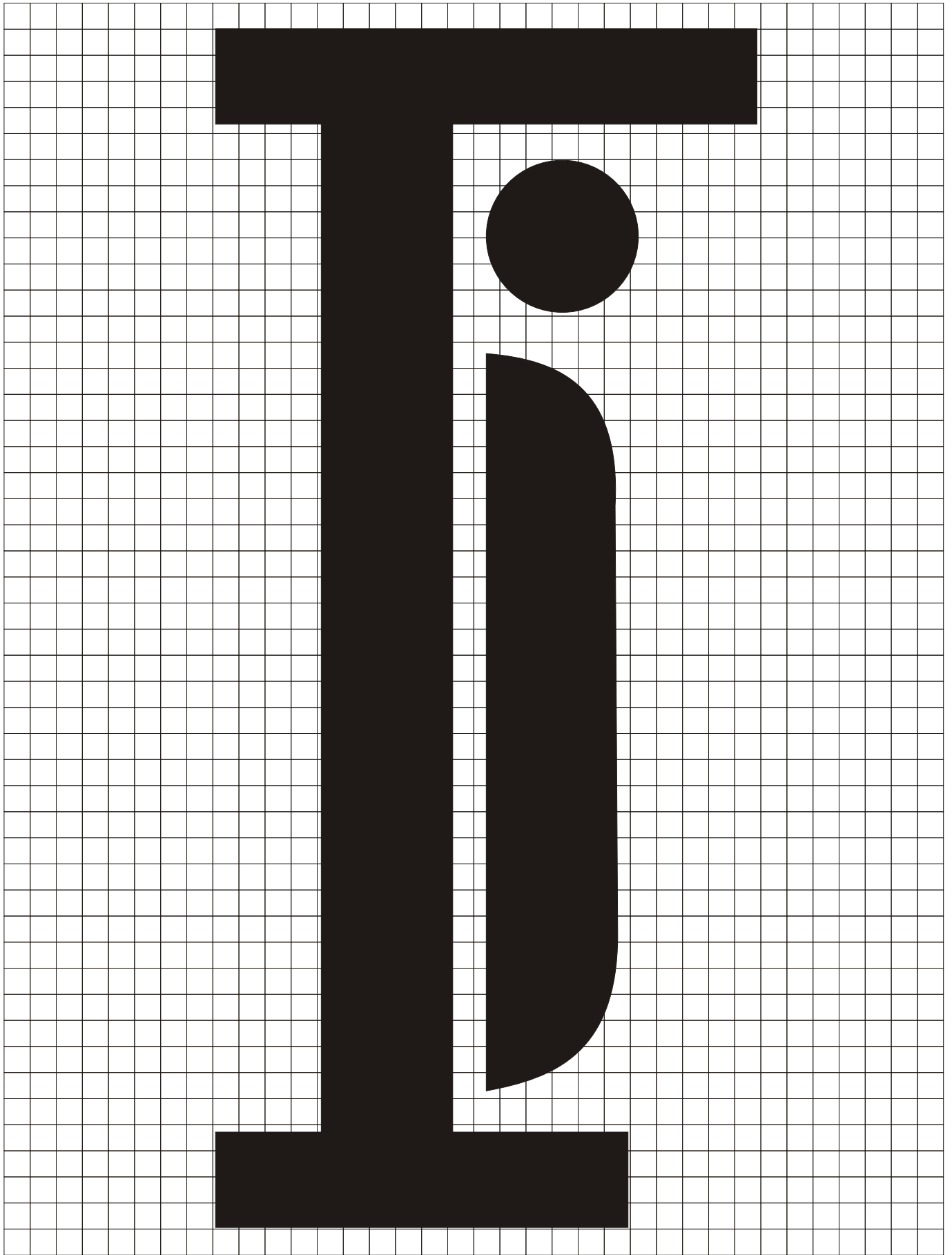

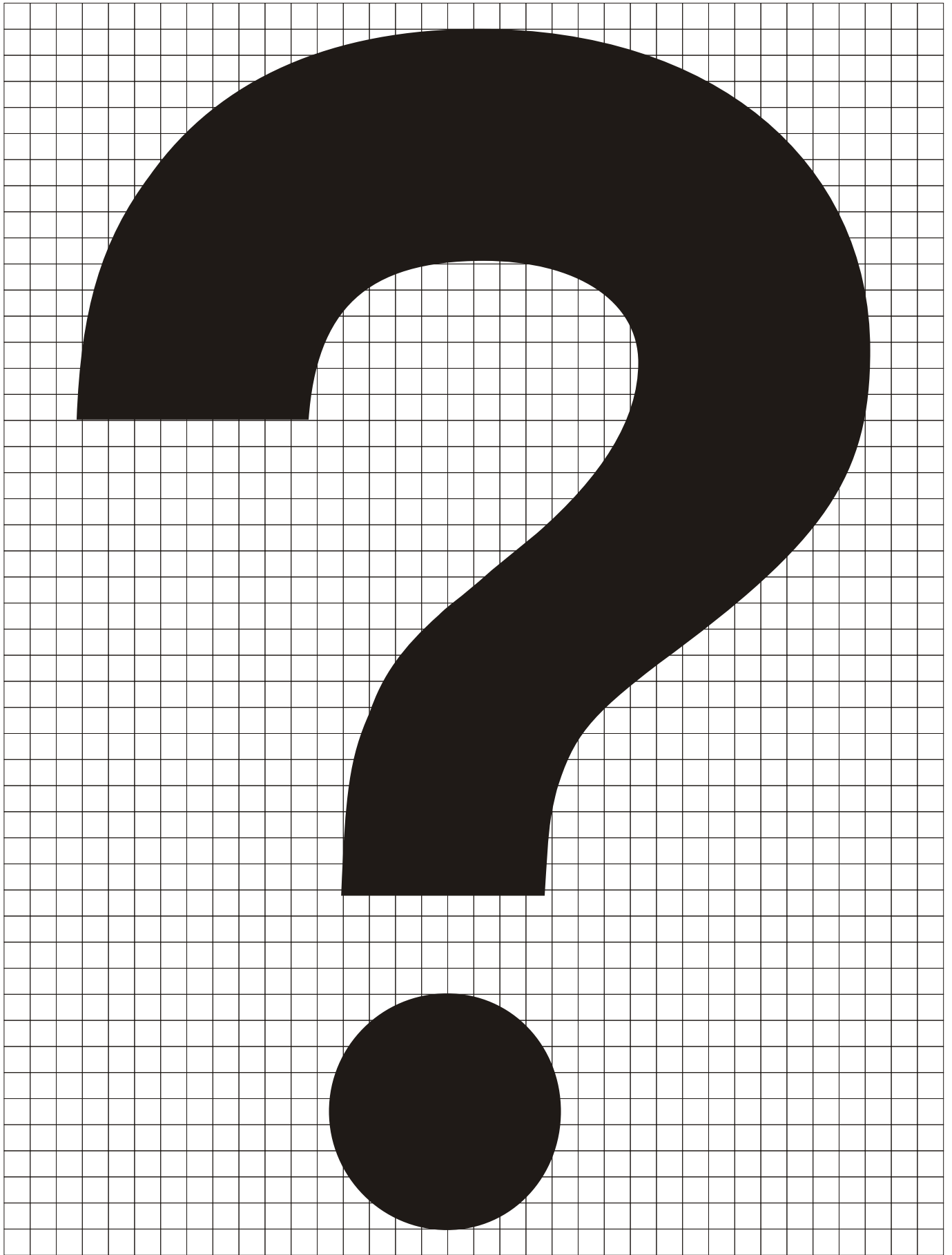

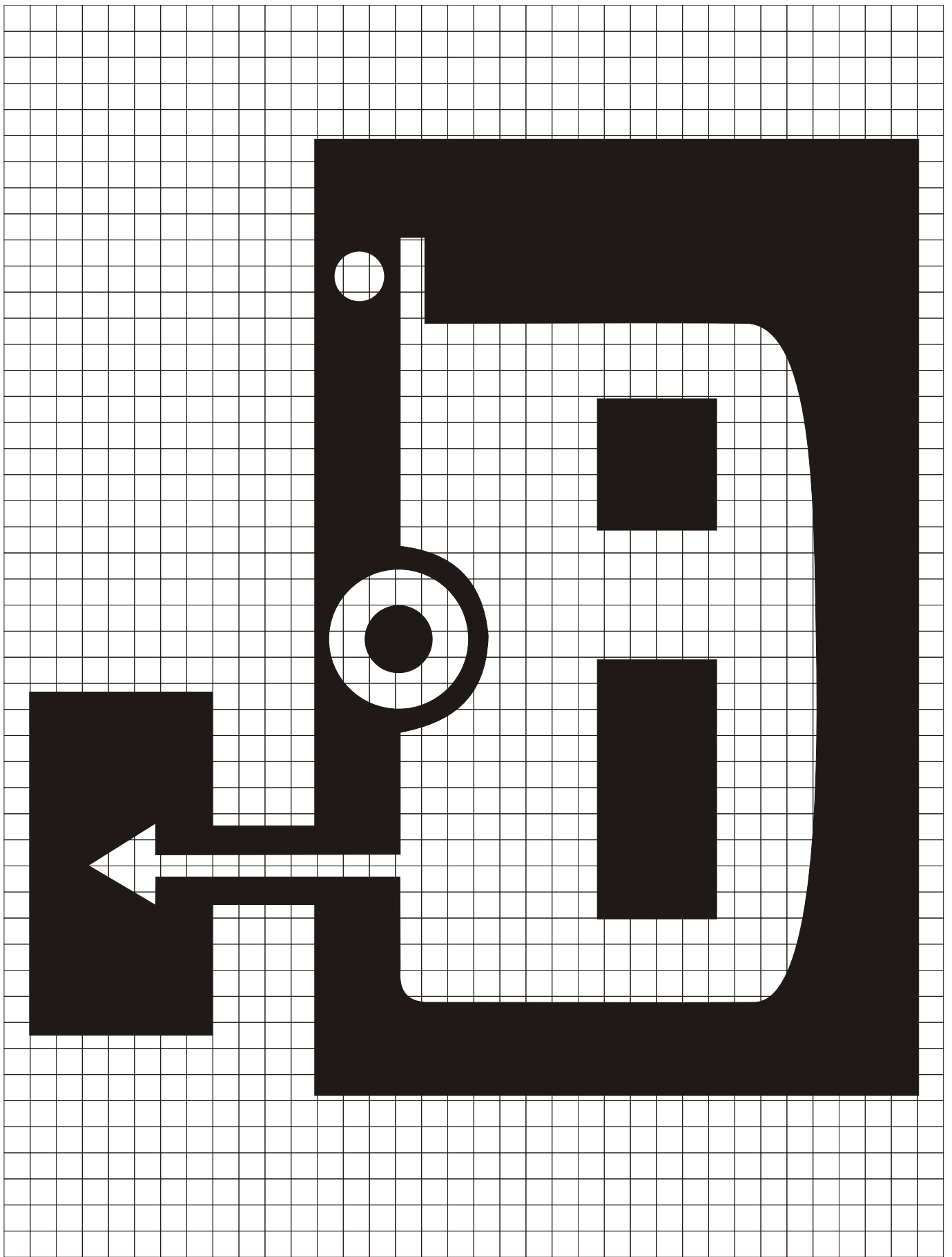

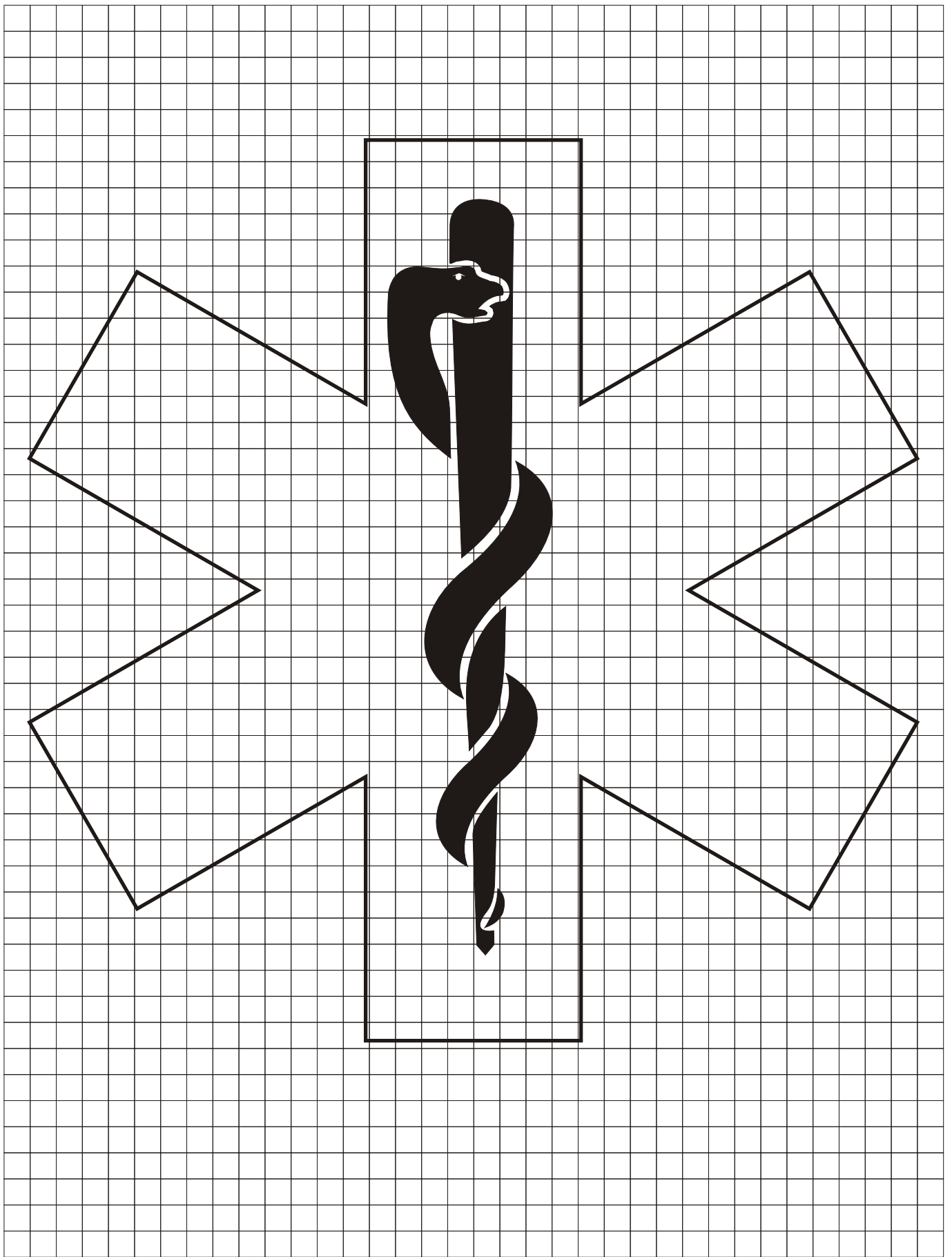

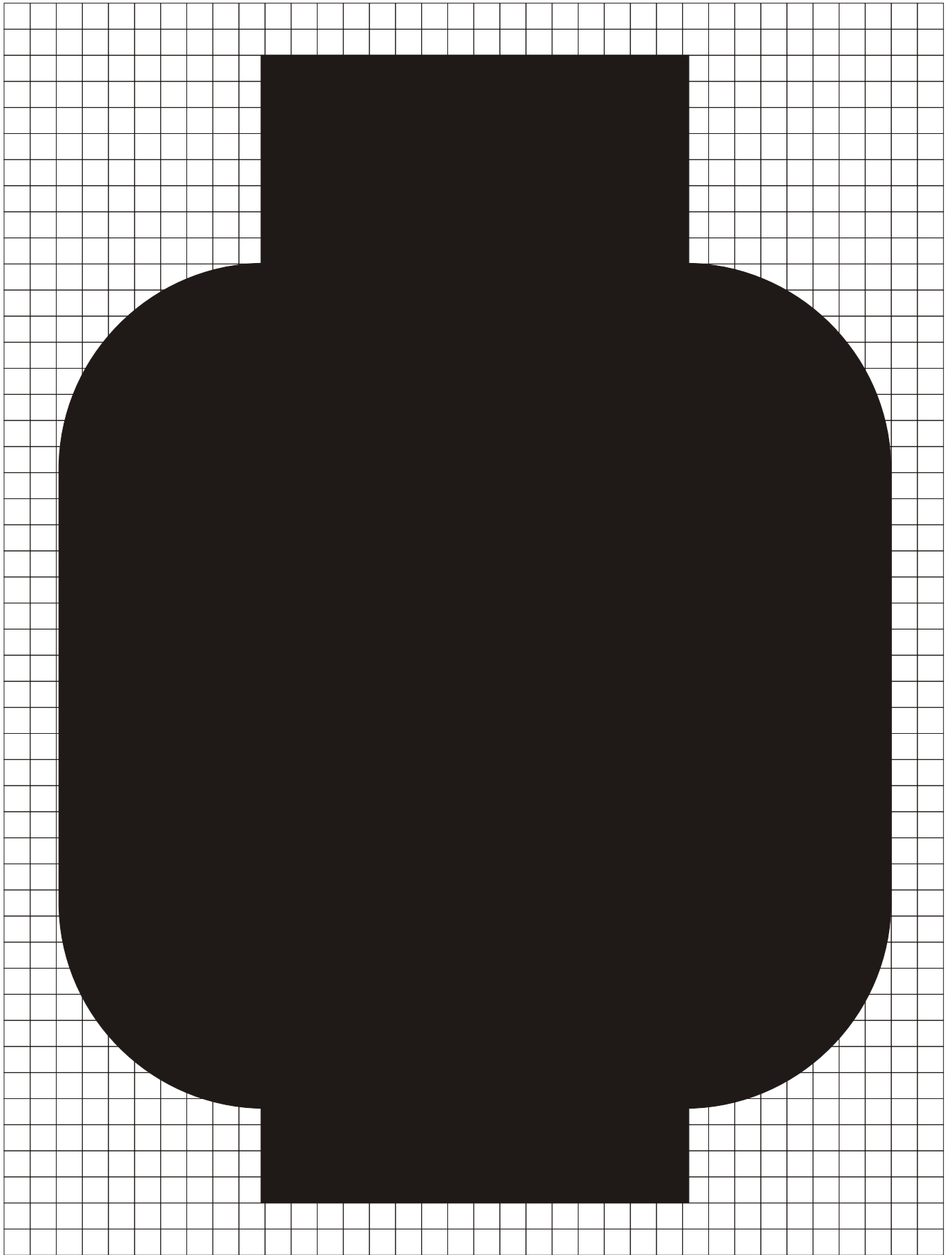

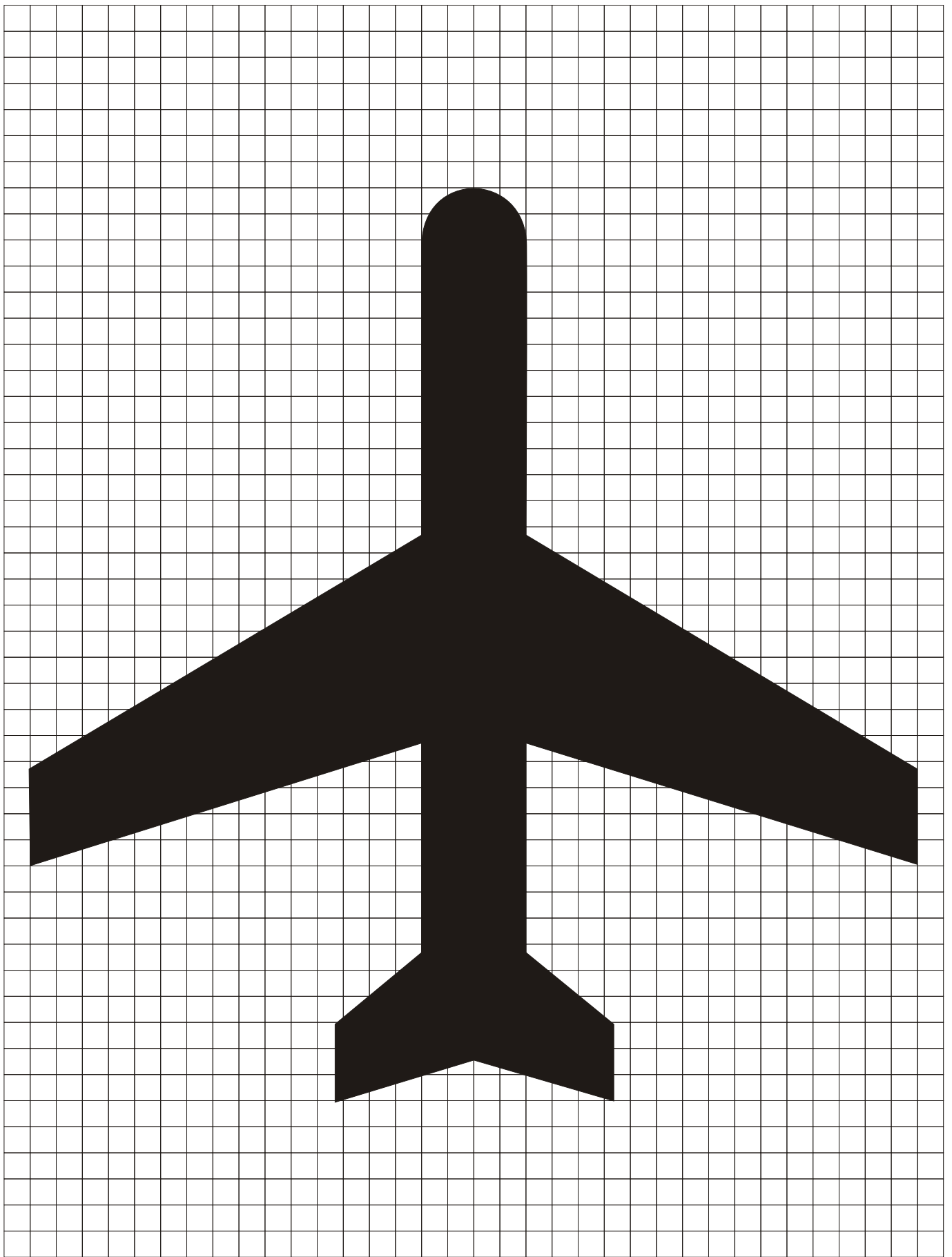

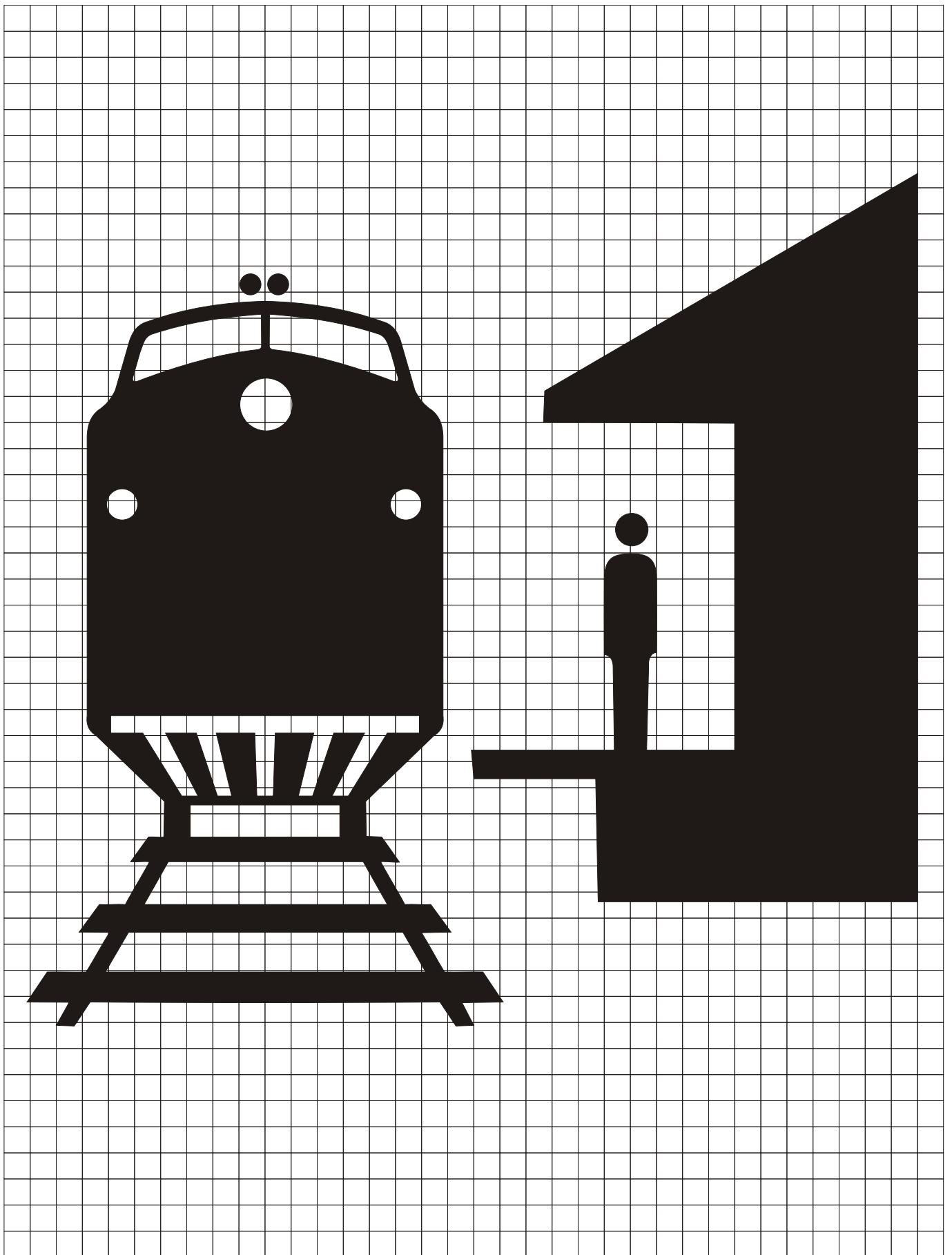

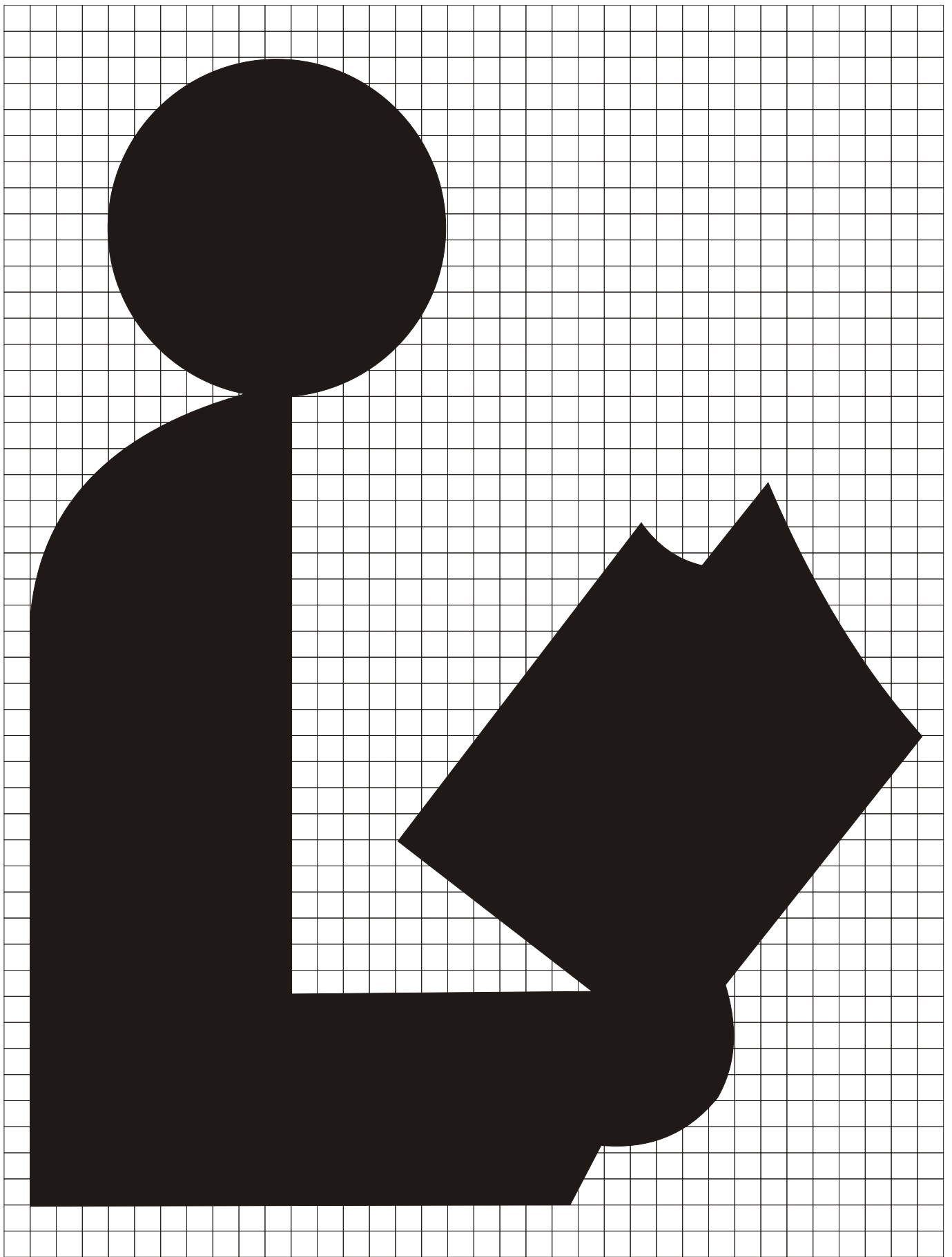

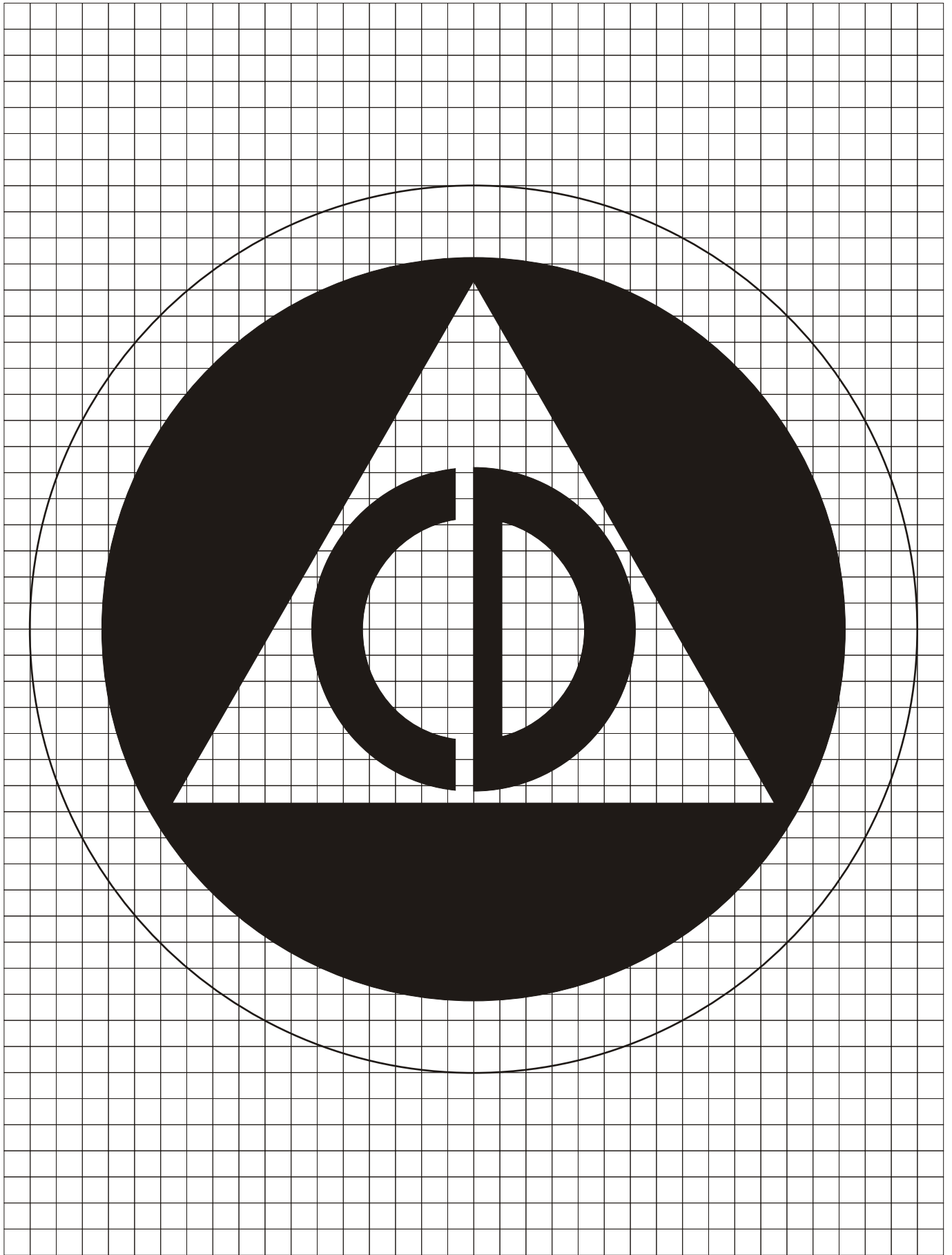

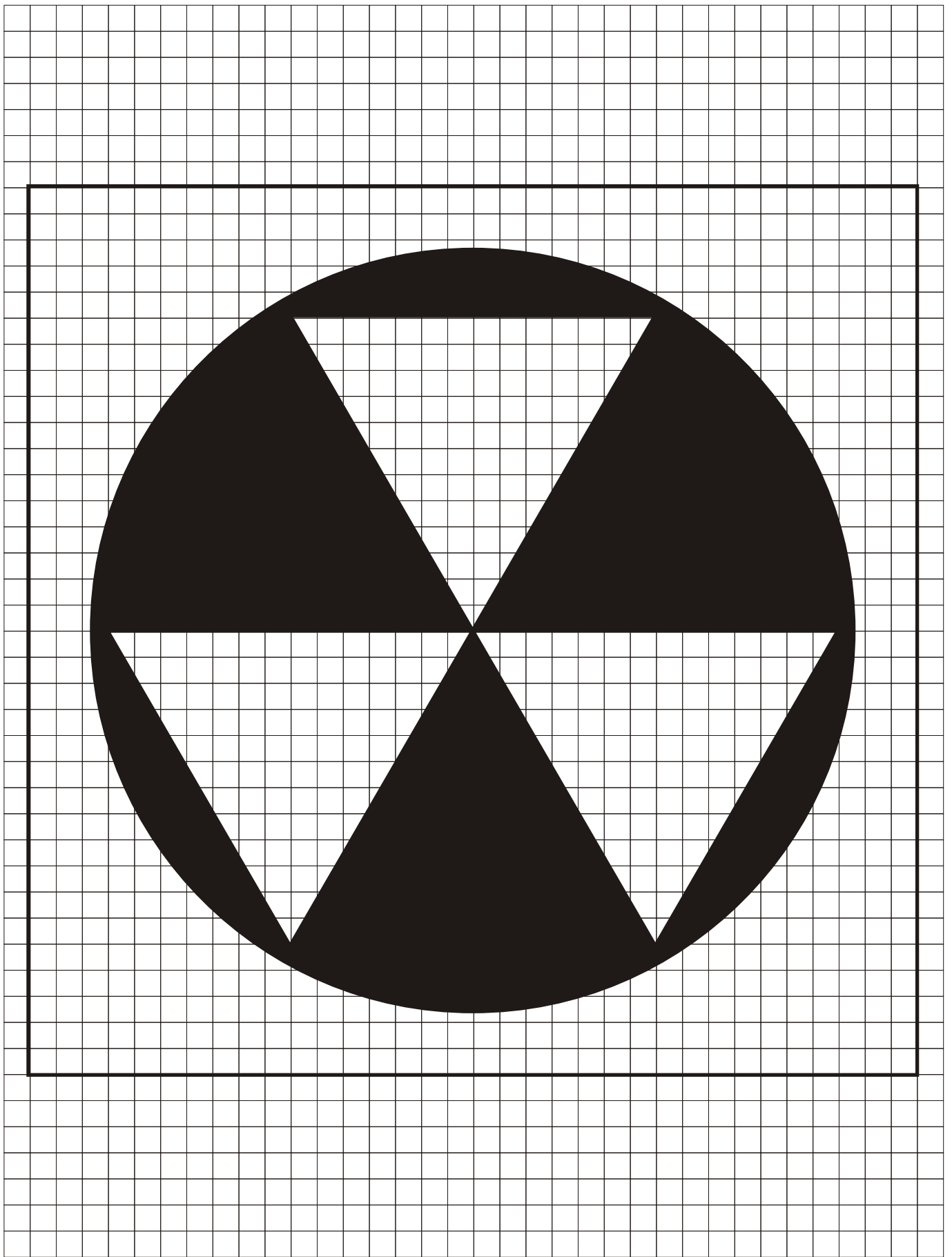

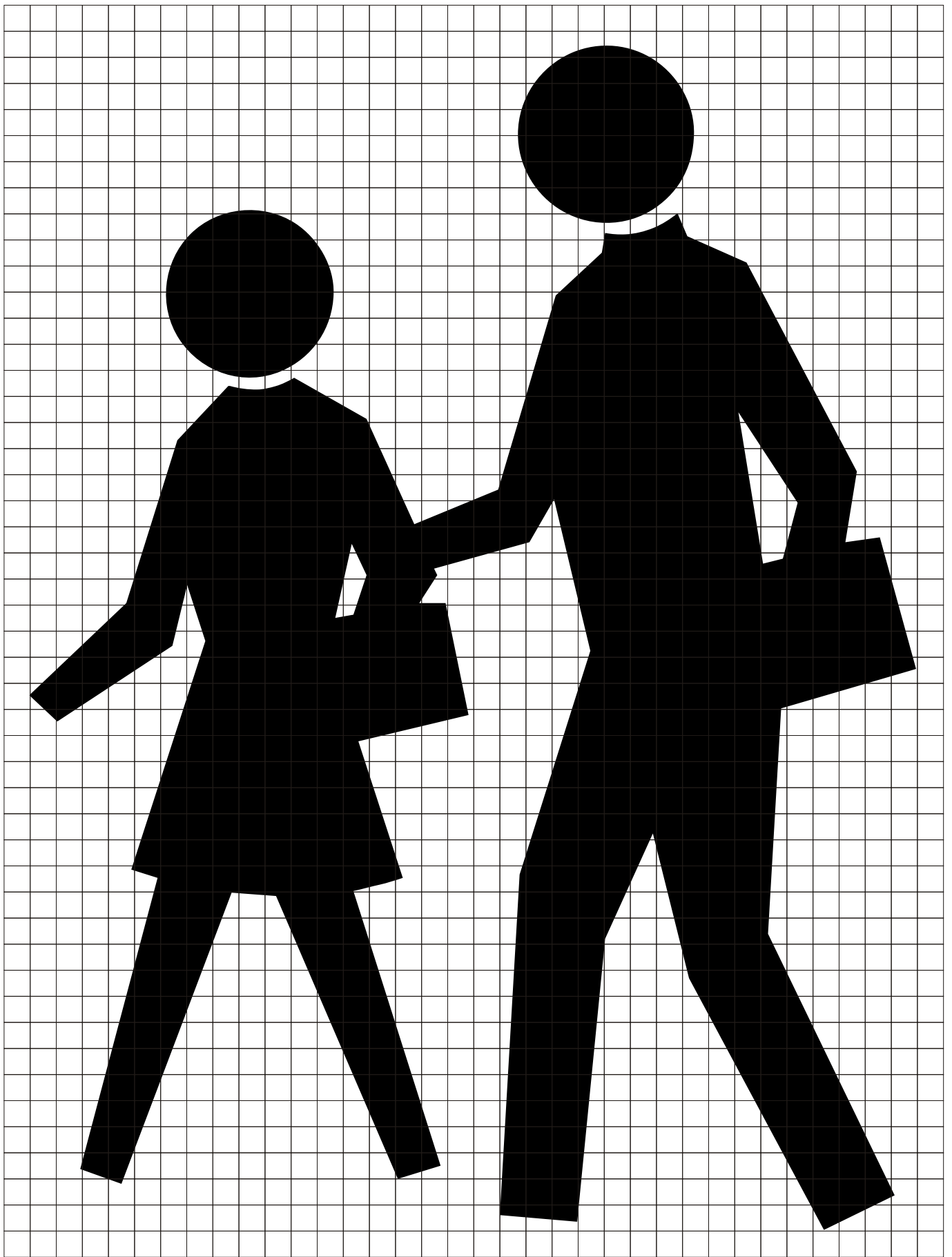

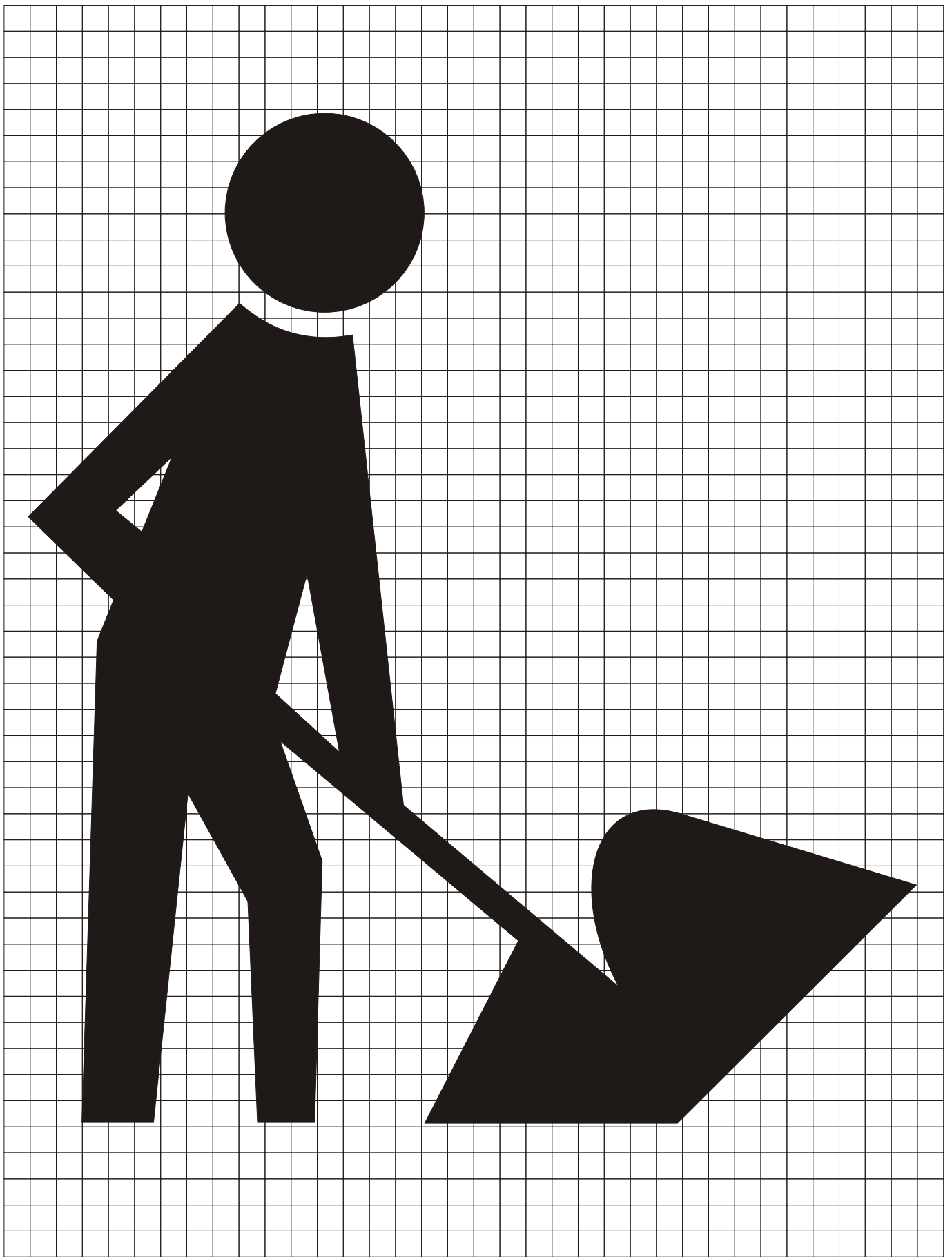

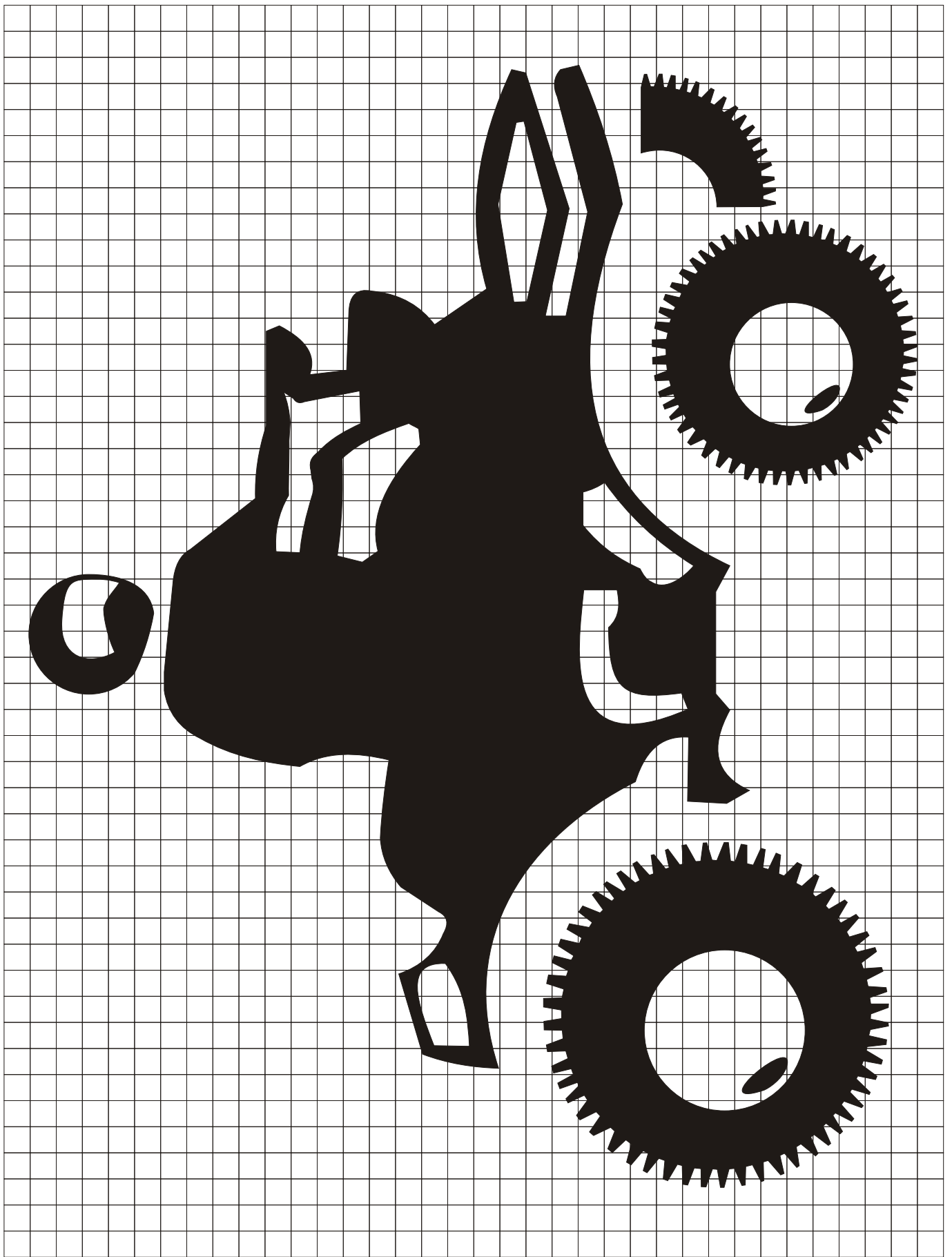

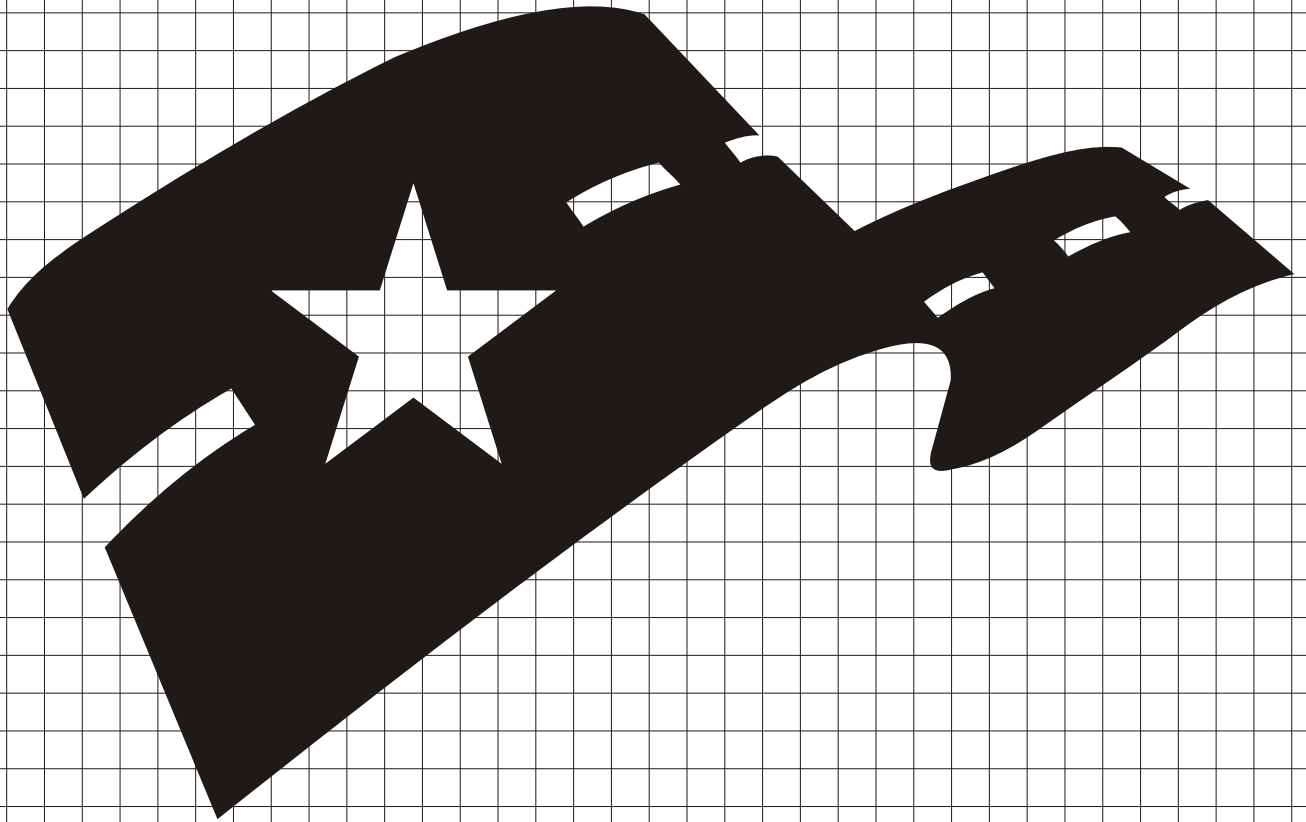

**AMERICA'S
BYWAYS**

