

UNITED NATIONS
NATIONS UNIES

**UNITED NATIONS
PEACEKEEPING
TRAINING MANUAL**



UNITED NATIONS
DEPARTMENT OF
PEACEKEEPING
OPERATIONS



**United Nations
Department of
Peace-Keeping
Operations Training**

PEACE-KEEPING TRAINING

Training Guidelines and Exercises

**GENERAL
GUIDE**



GENERAL GUIDE

INDEX

SUBJECT AREA	PAGE
PART 1 - INTRODUCTION	7
Background	7
Aim	7
Restrictions, Limitations and Use	8
Organization and Layout	10
PART 2 - BACKGROUND TO UN PEACE-KEEPING	11
Section 1 - Introduction	11
Section 2 - Peace-keeping, the Charter, Empirical Innovations and Composition of PKOs	12
Section 3 - The Development of the Military Strategy for Peace-Keeping	19
Section 4 - Geo-Political Briefings, Study of Mandate and Mission	22
Section 5 - Documentation, Medical Examination, Kit Inspection, Kit Issue, Briefing on Pay, Leave, Visits, Domestic Arrangements, etc.	24



Training Guide

GENERAL GUIDE

PART 3 - WEAPON TRAINING AND FAMILIARITY WITH THEATRE WEAPONS, VEHICLES AND EQUIPMENT	26
Section 1 - Introduction	26
Section 2 - Weapon Training	25
Section 3 - Familiarity with Theatre Weapons, Vehicles and Equipment	28
Section 4 - Night Vision Equipment (NVE), Radars, Nuclear, Biological and Chemical Warfare	30
Section 5 - Mine Awareness Training	32
Section 6 - Field Exercises including Battle Practice	33
PART 4 - GENERAL MILITARY TRAINING AREAS	35
Section 1 - Introduction	35
Section 2 - Physical Training	36
Section 3 - Map Reading	37
Section 4 - Communications, Voice Procedure	38
Section 5 - First Aid, Hygiene and Sanitation	40



Training Guide

GENERAL GUIDE

PART 5 - TRAINING IN UN OPERATING TECHNIQUES

Section 1 -	Introduction	42
-------------	--------------	----

Section 2 -	Positions and Observation Posts	43
-------------	------------------------------------	----

Section 3 -	Checkpoints, Road-blocks, Searches	46
-------------	---------------------------------------	----

Section 4 -	Patrolling	49
-------------	------------	----

Section 5 -	Investigations	53
-------------	----------------	----

Section 6 -	Negotiations/Liaison	55
-------------	----------------------	----

Section 7 -	Use of Force	56
-------------	--------------	----

Section 8 -	Leadership	59
-------------	------------	----

PART 6 - SAFETY MEASURES AND PRECAUTIONS

Section 1 -	Introduction	60
-------------	--------------	----

Section 2 -	Shelters	61
-------------	----------	----

Section 3 -	Equipment	63
-------------	-----------	----

Section 4 -	Travelling and Movement	64
-------------	-------------------------	----

Section 5 -	Non-Operational Safety Measures	66
-------------	------------------------------------	----



Training Guide

GENERAL GUIDE

PART 7 - SPECIALIZED TRAINING AREAS	68
Section 1 - Introduction	68
Section 2 - Driving (Specialist Skills)	69
Section 3 - Helicopter Training	71
Section 4 - Staff Training, UN Procedures and Reports and Language Training	72
Section 5 - Explosive Ordnance Disposal (EOD)/Explosive Ordnance Reconnaissance (EOR)	73
Section 6 - Media Reports	74
ANNEXES	74
"A" - Safety Precautions for Battle Inoculation	75
"B" - Perimeter Defence to a Standard Section Sized Compound and Internal Layout	78
"C" - Suggested Layout - Checkpoint Positions	79
"D" - Mobile Checkpoints	83



GENERAL GUIDE

GENERAL GUIDE

Aim

The aim of this document is to provide guidelines for actual or prospective troop contributing governments in the preparation and training of their personnel for assignments with United Nations peace-keeping Operations (PKOs).

Target group

The present training guidelines have been designed to assist commanders of national contingents and their training officers to prepare and conduct in-country training programmes **before** deployment in a peace-keeping Operation. Trainers dealing with the main lectures and exercises must have experience of a UN peace-keeping Operation and must have proved that they understand the fundamental concepts of UN peace-keeping. In the event that a country does not have trainers with UN peace-keeping experience, it is advised to investigate, through normal diplomatic channels, if other countries are willing to make trainers available. Trainers must be able to speak and write the common language of the PKO since troops are to receive also language training.

Content

This package contains a series of documents.

- The first, entitled “**TRAINING GUIDELINES FOR NATIONAL OR REGIONAL TRAINING PROGRAMMES**”, includes a wide range of subject areas in peace-keeping without pretending to cover all specific training requirements.
- The documents which follow, are a series of **SPECIFIC EXERCISES** which aim to assist the trainers in developing practical and standardized skills in eight subject areas of importance. Each exercise contains a “**Training Guide**” (on light-blue paper), “**Lecture Notes**” and **transparencies**. The exercises are based on the “Nordic UN Tactical Manual” with the permission from the Nordic Countries.
- The exercises could be changed or other added according to the future requirements of the peace-keeping operations.

This trainer’s manual has been prepared by the Department of Peace-Keeping Operations, United Nations, New York; the pedagogical design, the layout, illustration and printing was done by the International Training Centre of the International Labour Organization, Turin.



GENERAL GUIDE

Table of contents

■ TRAINING GUIDELINES FOR NATIONAL OR REGIONAL TRAINING PROGRAMMES

■ TRAINING EXERCISES

- **Exercise 1:** Neutrality, Reliability, Impartiality
(An Introduction to peace-keeping)

- **Exercise 2:** Guarding of HQ and Vital Objects

- **Exercise 3:** Escorting (Convoys)

- **Exercise 4:** Use of Force

- **Exercise 5:** Mine, Bomb and Booby-Trap Threats

- **Exercise 6:** Negotiation

- **Exercise 7:** Patrolling

- **Exercise 8:** Checkpoints



GENERAL GUIDE

Use and limitations

This package is not a comprehensive training manual. It contains basic guidelines which should help a trainer to prepare his training programme as well as additional specific training and information material.

The Training Guide of each Exercise sometimes suggests that case studies, role plays, simulation and other exercises be included. Such cases, roles, simulation exercises must be prepared by the trainer, drawing from his own or other people's experiences in peace-keeping operations. In other words, the Training Guide provides ample flexibility for the trainer to create and include exercises which must be very close to the reality of the area of operation.

The Guidelines and Exercises address the training needs of personnel at different levels.

An Exercise may offer the opportunity to train officers, junior officers and soldiers in carrying out their specific tasks within the same exercise. Officers' tasks will obviously concentrate more on planning and organizational aspects while soldiers should receive training in practical UN operations techniques.

The trainer should use all additional available materials such as:

- UN Charter
- Guideline Standard Operating Procedures for PKO (GSOP-PKO)
- Instructional peace-keeping Training Video Series
- Information on UN Security Council Resolutions and the mandate for the peace-keeping mission
- The task(s) for the peace-keeping Force
- Information about the mission area



GENERAL GUIDE

Training facilities

Training may take place in any military garrison which has the following facilities available:

- accommodation for student officers;
- classroom with projection facilities for transparencies and video;
- group work facilities with flipcharts;
- communications and language teaching facilities;
- access to a major exercise area where cross-country patrols, checkpoints and observation posts, mine field simulation exercises and cross-country driving can be carried out as well as exercises with live ammunition.



**United Nations
Department of
Peace-Keeping
Operations Training**

PEACE-KEEPING TRAINING

**TRAINING
GUIDELINES
For National
or Regional
Training Programmes**

UNITED NATIONS

Restricted

TRAINING GUIDELINES FOR NATIONAL OR REGIONAL TRAINING PROGRAMMES

THE INFORMATION
IN THIS DOCUMENT
IS NOT TO BE COMMUNICATED
DIRECTLY OR INDIRECTLY
TO THE PRESS
OR TO ANY PERSON
NOT AUTHORIZED
TO RECEIVE IT

PART 1 - INTRODUCTION

Background

The General Assembly on 8 December 1989 adopted Resolution 44/49 on the “Comprehensive Review of the whole question of peace-keeping operations in all their aspects”. Operative paragraph 6 of the Resolution encourages Member States to establish national training programmes for military and civilian personnel for peace-keeping operations and, in this connection, requests the Secretary-General to prepare training manuals which Member States might wish to use as guidelines for their national or regional training programmes.

The title of this document, “**Training Guidelines for National or Regional Training Programmes**”, is meant to reflect that:

- a. many of the skills required for peace-keeping are basic military ones which form part of military training in the forces of most Member States and are well covered in national military manuals;
- b. some countries and regions already have training programmes in place, specifically designed for service in peace-keeping operations (PKOs) together with manuals and other training sources.

Aim

The aim of this document is to provide guidelines for actual or prospective troop-contributing governments in the preparation and training of their personnel for assignment with United Nations peace-keeping operations (PKOs).

Restrictions, limitations and use

While the guidelines will endeavour to be as wide ranging as possible, it must be emphasized that they cannot anticipate **all** or **specific** training requirements of given PKOs. Observer Missions require different points of emphasis than peace-keeping Forces, which in turn can differ from one another in the range of skills required.

What the guidelines do is to present a range of subject areas from which specific training modules can be constructed to suit particular needs.

a. **Example 1 (Officer Observer Mission).**

This PKO may require deep geo-political briefs, mandate study, patrolling techniques, negotiation and incident investigation but not use of force, checkpoints, searches, etc.

b. **Example 2 (peace-keeping Force A).**

This PKO may not require the same level of background briefs but will certainly require practical training in checkpoints, searches, fortifications, etc.

c. **Example 3 (peace-keeping Force N).**

This PKO may need a large naval input with embarked troops. In this case it may be necessary to develop specialized training rather than the normal land-based techniques.

It is necessary to base the guidelines on the range of skills required for the normal peace-keeping force. This does not invalidate them for other more specialized PKOs. The guidelines propounded in this document are meant to be chosen as required and developed with a particular mission in mind.

Many armies today have sophisticated training and experience in techniques of low intensity aid to the civil power. For such armies only a change in emphasis is necessary, as they will already have well-honed skills which are directly applicable to peace-keeping.

It is hoped that these guidelines will be studied by the governments of all Member States which already contribute military personnel to United Nations peace-keeping operations or intend to do so. In many cases, existing troop contributors will have already prepared their own training materials, taking into account the experience of their contingents which have previously served in

the operation in question, but they may find in this document some additional points to be covered. In the case of those governments who are contributing to peace-keeping for the first time, it is important that, wherever possible, they should have already used these guidelines to design training programmes before they make any military personnel available for service with the United Nations.

When a new PKO is established, or when a Member State contributes for the first time to an existing operation, the Secretariat will endeavour to provide a checklist of any additional points which should be covered in national training programmes.

It is assumed that troop-contributing governments will provide the necessary training to their military personnel at the time that they are concentrated, processed and kitted before deployment to the mission area. It is recognized that in some cases it may not be possible, for a variety of reasons including lack of equipment used in the PKO, for the contributing government to provide all the necessary training. Where possible, any gaps in training will be filled by the PKO after the troops have been deployed with it. To this end it is important that, on joining its PKO, a contingent or unit should be able to report clearly to the Force Commander (FC) or Chief Military Observer (CMO) what training it has received and what gaps remain to be filled in. It must, however, be emphasized that, given the short period of time for which contingents usually serve in a PKO, it is essential that the bulk of the training they require be provided in their home countries before deployment to the PKO.

Organization and layout

These guidelines are organized broadly as follows:

Part 1 - Introduction

Part 2 - Background to UN peace-keeping

Part 3 - Weapon Training and Familiarity

Part 4 - General Military Training Areas

Part 5 - Training in UN Operating Techniques

Part 6 - Safety Measures and Precautions

Part 7 - Specialized Training Areas

PART 2 - BACKGROUND TO UN PEACE-KEEPING

Introduction

This Part describes the main areas which should be included in the background briefing of potential UN peace-keepers. The depth of the brief will depend on the level of those being briefed. The guideline covers the main points only and wider reading may be necessary in preparing specific lectures/talks.

This part is set out as follows:

- Section 1 -** Introduction
- Section 2 -** Peace-keeping, the Charter, Empirical Innovations and Composition of PKOs
- Section 3 -** The Development of the Military Strategy for peace-keeping
- Section 4 -** Geo-Political Briefings, Study of Mandate and Mission
- Section 5 -** Documentation, Medical Examination, Kit Inspection, Kit Issue, Briefing on Pay, Leave, Visits, Domestic Arrangements, etc.

Peace-keeping, the Charter, empirical innovations and composition of PKOs

The United Nations was established in the shadow of two major world conflicts in 25 years, in the wake of the failure of the League of Nations to avert the Second World War. As such its Charter proclaims in strong unambiguous language the views of the founders of the UN on the maintenance of international peace and security.

The Charter

The Charter, inter alia, states the following:

- a. **in the Preamble** - the resolve of the UN “to unite our strength to maintain international peace and security”;
- b. **in Chapter I, Article 1** - the purpose of the UN “to maintain international peace and security, and to that end to take effective collective measures for the prevention and removal of threats... (and) for the suppression of acts of aggression”;
- c. **in Chapter VI, Article 33** - the importance of negotiation, enquiry, mediation and conciliation as ways of settling disputes, failing which Article 37 empowers the Security Council to recommend a solution;
- d. **in Chapter VII** - action with respect to threats to peace, breaches of the peace and acts of aggression, dealing in detail with the mechanics of peace enforcement action when conciliation fails. This chapter spells out the imposition of economic sanctions and other measures to give effect to the Security Council’s decisions, including the use of the Military Staff Committee in conducting military action to this end.

The start of the Cold War meant that the peace enforcement provisions of the Charter could never be implemented because of:

- a. the lack of agreement amongst the Permanent Members on crucial issues and the risk of the use of the veto in the Security Council;
- b. the ineffectiveness of the Military Staff Committee.

As a result, peace enforcement as envisaged in Chapter VII of the Charter did not prove practicable. Instead the UN resorted, in specific situations, to an alternative method of maintaining the peace, described by Hammarskjöld as falling under “Chapter VI and a half” of the Charter. This method - peace-keeping as we know it - can be said to be based on two provisions:

- a. **Chapter VII, Article 40** provides that before resorting to enforcement the SC may “call on the parties concerned to comply with such provisional measures as it deems necessary or desirable.....without prejudice to the rights, claims or position of the parties concerned”.
- b. **Chapter V, Article 29** stipulates that “the Security Council may establish such subsidiary organs as it deems necessary for the performance of its functions”.

The experience

In practice, however, peace-keeping has developed as a pragmatic response to immediate problems requiring UN action short of the measures explicitly provided for in the Charter.

As it has developed, certain principles have become common to all peace-keeping operations:

- a. since peace-keeping does not involve peace enforcement, it is vital that the operation have the consent and co-operation of the parties to the conflict in question;
- b. it must enjoy the support of the international community as a whole, as represented in the Security Council which normally adopts the resolution setting up the operation and decides on its mandate, usually on the basis of a recommendation by the Secretary-General. Thereafter, the Council’s role remains crucial in providing political support to the Secretary-General as he carries out the mandate and in renewing or amending the mandate as necessary;

- c. the troops or military observers required for a peace-keeping operation are provided voluntarily by Member States, who are under no formal obligation in this respect (unlike the provisions in Chapter VII). The willingness of Member States to provide troops is of crucial importance;
- d. the operation is under the command of the Secretary-General who is himself responsible to the Security Council for all aspects of the operation. It is a basic principle of peace-keeping that the military personnel in a peace-keeping operation do not accept orders from their national authorities in respect of operational matters, but only from their United Nations commander, who receives his orders from the Secretary-General. Failure to respect this chain of command can lead to serious operational and political difficulties;
- e. there should be a clear mandate, or one as clear as possible, given the probable consensus nature of the decisions taken by the Security Council;
- f. the operation maintains an attitude of complete impartiality between the parties to the conflict. It must not interfere in the internal affairs of the host country and must not be used in any way to favour one party against another;
- g. in the case of peace-keeping Forces which are armed, force is used to the minimum extent possible and normally only in self-defence;
- h. the costs of a peace-keeping operation are normally considered to be the collective responsibility of the Member States of the United Nations. Each Member State is required to pay its share, which is assessed on the basis of that Member State's ability to pay.

In the current (1990) procedure, the Security Council is the authority for mandating and terminating UN PKOs. The General Assembly can also, utilizing the "uniting for peace" procedure (Resolution 377 (v) of 3 November 1950), set up an operation. This last happened in 1956 during the debates which led to the setting up of UNEF I, when France and the UK, because of their involvement in the Suez, blocked action in the Security Council. This has proved, to date, to be an exception and in the present climate of international relations is unlikely to become common practice.

Composition of PKOs

In some cases, a PKO performs tasks which are of a non-military nature and which require large civilian components, e.g. civilian police or electoral monitors. In such cases overall command in the field is normally exercised by a civilian official, usually designated Special Representative of the Secretary-General, to whom the Force Commander/Chief Military Observer reports.

Military component

The military component of a UN PKO consists of a commander, who is designated Force Commander or Chief Military Observer (Chief of Staff in the case of UNTSO), and a number of contingents provided by selected Member States of the United Nations upon the request of the Secretary-General. In all PKOs established since October 1973, the contingents are selected in consultation with the Security Council and with the parties concerned, bearing in mind the principle of equitable geographical representation. The military personnel of an operation, although remaining in their national service, are, during the period of their assignment to the operation, international personnel under the authority of the UN and subject to the instructions of the commander, through the chain of command. The functions of the operation are exclusively international, and its members are expected to discharge those functions and regulate their conduct with the interest of the UN only in view.

The Special Representative of the Secretary-General or the Force Commander/Chief Military Observer is provided by the Secretary-General with civilian advisers in political, legal and information fields and with a civilian administrative staff. As a rule, these personnel are selected from existing UN staff. They follow the rules and regulations of the UN Secretariat. Additionally, the commander may recruit such local personnel as the operation requires. The terms and conditions of employment for locally recruited personnel are prescribed by the commander and generally, to the extent possible, follow the practice prevailing in the host country.

Responsibility at UN Headquarters New York

- a. As already noted, the Security Council is almost invariably the authority for mandating and terminating United Nations peace-keeping operations;
- b. command of peace-keeping operations is vested in the Secretary-General under the authority of the Security Council;
- c. the Under-Secretary-General for Department of Peace-Keeping Operations (DPKO), is delegated by the Secretary-General with responsibility for the planning, establishment, political direction and operational guidance of peace-keeping operations;
- d. the Military Adviser provides military advice on peace-keeping to the Secretary-General and to the Under-Secretary-General for Department of peace-keeping operations;
- e. the Field Administration and Logistic Division (FALD) within the Department of peace-keeping operations is responsible for the administration and logistical aspects of peace-keeping operations.

Command in the field

Command of the operation in the field is exercised by the Special Representative of the Secretary-General, by a Force Commander, Chief Military Observer or Chief of Staff appointed by the Secretary-General with the consent of the Security Council. The commander is responsible to the Secretary-General. The commander exercises full command authority over the operation except for disciplinary questions. The commander has full authority with respect to all assignments of members and of his headquarters staff and, through the chain of command, of all members of the operation, including the deployment and movements of all contingents in it and all units assigned to it. The contingents comprising the operation are integral parts of it and take their orders exclusively from the commander. The operation has its own headquarters, whose composition must be representative of the contingents comprising the operation. The commander designates the chain of command of the operation, making use of his headquarters staff and the commanders of the national contingents made available by troop-contributing governments. He may delegate his authority through the chain of command. The operation undertakes no functions which are not consistent with the definition of its mandate as set forth in the Security Council Resolution establishing it. Any doubt about a proposed action of the operation being consistent with such definition must be submitted to the Secretary-General for decision.

Discipline

The commander has general responsibility for the good order and discipline of the operation. He may make investigations, conduct inquiries and require information, reports and consultations for the purpose of discharging this responsibility. Responsibility for disciplinary action in national contingents, however, rests with the commanders of the national contingents. Reports concerning disciplinary action are communicated to the commander who may consult with the commander of the national contingent and, if necessary, through the Secretary-General with the authorities of the troop-contributing government concerned.

Administration

The commander with his civilian Chief Administrative Officer, in accordance with the procedures prescribed by him within the limits of the budgetary provisions for the operation and the financial rules and regulations of the United Nations, arranges for: the billeting and provision of food for the military component; the establishment, maintenance and operation of service institutes providing amenities for members of the operation and other UN personnel as authorized by the commander; the transportation of personnel and equipment; the procurement, storage and issuance

of supplies and equipment which are not directly provided by the participating governments; maintenance and other services required for the operation; the establishment, operation and maintenance of telecommunication and postal services; and the provision of medical, dental and sanitary services for its personnel. The foregoing is achieved through the co-ordinated effort of the military logistics staff of the operation and the civilian staff. Formulation of provision systems and review of requirements are the responsibility of the military Chief Logistics Officer and his staff, and the responsibility for procurement and timely delivery of provisions rests with the civilian Chief Procurement Officer.

The development of the military strategy for peace-keeping

Peace-keeping is defined in “The Blue Helmets” as “an operation involving military personnel but without enforcement powers, established by the UN to help maintain or restore peace in areas of conflict”.

Early innovations were the use of military observers reporting to the Consular Commission on Indonesia and the Special Committee on the Balkans. These military officers were not under the Secretary-General’s authority and were therefore not considered as part of a UN operation. Similarly the UN operation in Korea is not considered a peace-keeping operation since it does not conform to the principles outlined in paragraph 8 above. In particular, it is directed by one Member State, the United States, rather than by the Security Council; its action is not based on the consent of the parties and it involves the use of force.

The first observer mission was the United Nations Truce Supervision Organization (UNTSO). It was initially established in Palestine in 1948 to supervise a truce between Israel and her Arab neighbours, and in 1949 was given the task of assisting in the implementation of the General Armistice Agreement of that year. The first UN peace-keeping Force was the United Nations Emergency Force I (UNEF I), deployed between Egyptian and Israeli forces from November 1956 to May 1967.

Starting with these early operations, a substantial body of practical experience has been built up which underpins and guides operations. Peace-keeping operations (PKOs) can be categorized as follows:

- a. observer missions, consisting of unarmed officer observers;
- b. peace-keeping Forces, consisting of lightly armed troops generally organized on conventional unit lines;
- c. combined observer/force missions.

Observer missions are ideal instruments for tasks such as the monitoring of a cease-fire, the policing of an agreement, the supervision of a withdrawal. They operate observation posts (OPs),

undertake patrolling and engage in investigations and negotiations. Observer missions, with the exception of the two early ones (UNTSO, UNMOGIP), work on a fixed-term mandate which can be renewed if necessary.

Peace-keeping Forces are required in some of the more volatile situations where the additional authority of an unorganized force of armed troops may be required, although they are not empowered to use their weapons in a peace-enforcing role. Peace-keeping Forces usually work on a short-term renewable mandate, though some of the existing ones have been in the field for a very long time (in UNFICYP's case, since 1964).

UN military techniques for peace-keeping have developed based on the wide experiences of past and current PKOs. The tactical considerations are dealt with in Part 5. The strategic considerations on the use of PKOs can be summarized as follows:

- a. **Separation of Forces.** A peace-keeping Force is best suited to this type of operation although Observer Missions have also been used to this end. It involves the interpositioning of a UN PKO between the warring parties, with their agreement. Separation of forces can permit the stabilization of the situation while more durable peace-keeping efforts get underway. Very often interposition leads to the development of an area of separation or buffer zone. UNEF I and II and UNFICYP are examples of this technique.
- b. **Policing of Agreements.** This occurs when a cease-fire agreement between the parties has been reached. Such agreements will probably involve some or all of the following:
 - Creation of a buffer zone/area of separation.
 - Agreement on the parties' forward defensive locations.
 - Restrictions on numbers of troops.
 - Restrictions on the number of armaments, equipments, etc.
 - Monitoring of the observance of an agreed cease-fire by the parties will very often be a necessary function at an early stage of the mission.

In policing the agreement the UN PKO will check that both parties are conforming to the terms agreed. The PKO will investigate alleged breaches, negotiate, reduce tension and mistrust. UNDOF is a good example of this process.

- c. **Supervision of a Withdrawal.** This involves the supervision of a withdrawal plan agreed by the parties. Here the PKO monitors the withdrawal and ensures that the terms of agreement are adhered to by all parties. UNTAG and UNAVEM are good examples.

While such categorizations are a useful study aid, it must be emphasized that it would be incorrect to try to force all PKOs into one strategic category or another. UNFICYP is a good example. Since 1974 it has been an interpositioning operation. A buffer zone operation has evolved from this although no agreement has been reached between the parties.

- d. The recent development of PKOs has seen another dimension of the missions, including election monitoring, human rights monitoring, verification of troop withdrawals, demobilisation, etc.

Geo-political briefings, study of mandate and mission

The subject areas of this section may not be relevant for some training modules. Certainly officer observers should cover the complete section. For peace-keeping Forces the complete section may be relevant for selected officers and senior NCOs. **Some** study of the mandate/mission will be necessary for all ranks.

Geo-political briefings

Many contributing countries are already producing geo-political studies of areas into which elements of their Defence Forces have been, or are likely to be, committed. These studies can be produced in booklet form for issue to selected personnel, or used as study aids during training. Where detailed study is not necessary they can be used as background reading by those giving lectures as part of training.

Within contributing countries there can be many sources for such studies: the universities, institutes of strategic studies, Intelligence Branch of the Defence Forces HQ, etc. The studies will cover such areas as:

- geography;
- history;
- economy;
- political system - government;
- Defence Forces and Internal Security Forces;
- internal influences including religion, militias, revolutionary movements, etc.;
- external influences;
- culture and customs.

Mandate and mission study

The mandate and mission is central to all operations of a PKO. As such it must be dealt with during pre-deployment training. How deeply one needs to go into mandate and mission study will be a selective decision by those responsible for training. In general, senior unit and staff officers should familiarize themselves thoroughly with the subject. At the other end of the scale, a simple explanation of the military mission, with discussion and a question-and-answer session, should suffice.

At the higher level the following are suggested as areas of lecture/lectures, study and discussion:

- the historical origins of the dispute;
- the major developments in the dispute;
- the involvement of the UN in the peace-making/political field and in the peace-keeping field, if the PKO has been established for some time and the trainees are being deployed there on rotation;
- the emergence of the mandate from the Security Council including a discussion on the actual document;
- if pertinent, further study should take place on subsequent Security Council Resolutions and Secretary-General's reports;
- civilian involvement in the PKO, including responsibilities and civilian/military co-ordination.

Finally, the military mission should be the subject of study discussion at **all** levels. The mandate for a PKO comes directly from the relevant Security Council Resolutions. It will normally be quite specific as to the tasks to be undertaken by the PKO and will translate readily into a military mission. If the terms of the mission are not specific enough, the SRSG/CMO will, after analysis of the mandate, state a military mission. The SRSG/CMO may also wish to expand on the concept behind the mission or emphasize certain elements of it. This he does by appending a commanders' concept to the mission. The mission and concept of operation are central to **all** military operations and peace-keeping is no different. Study and discussion of it is necessary at **all** levels.

Documentation, medical examination, kit inspection, kit issue, briefing of personnel

This section deals with administrative rather than training matters but administration should be included in all training modules. While operational training should take precedence in the concentration area, these administrative details are important and if not thoroughly completed, can impinge on the operational effectiveness of personnel.

Medical examinations, grading, inoculations, etc. should be programmed early in order to ensure that any replacements for those failing medicals do not miss operational training. Losses resulting from medical examination failure need NOT affect training if sufficient substitutes are called to concentration at the beginning. Some inoculations/injections may have a reaction and this should also be programmed.

Proper documentation is a necessity prior to deployment of a PKO. The actual type of documentation to be completed will be dictated by national requirements, but certain basic documents and documentation must be checked/initiated. Time must be programmed for this. This processing should include:

- check of personal details (Ser No, Name, Rank, physical details, blood group, etc.);
- details of next of kin and their location during tour of duty with PKO;
- completion of wills;
- pay arrangements.

It is essential operationally that all members of the PKO be properly clothed and equipped. Shortly after arrival in the national concentration area, or if possible **before** arrival the kit of all personnel must be checked and replacements issued if necessary. Items of UN kit must be issued in due course. Checks and issues of kit must be programmed.

For many individuals, and in particular for dependants, deployment overseas as a member of a PKO can be domestically traumatic. To counteract this it is essential to:

- have proper briefings for all ranks before they depart;
- put in place a support system for dependants after deployment.

The briefings could include pay, allowances, conditions, tour of duty, leave, visits, post, deployment, domestic arrangements, etc.

The support system for dependants is a matter for the contributing country. It is not considered here as it is a personnel rather than a training function. It should at least provide each dependant with a "contact address" at home and provide for visits to dependants at irregular intervals during the deployment of the PKO.

PART 3 - WEAPON TRAINING, FAMILIARITY WITH THEATRE WEAPONS, VEHICLES AND EQUIPMENT

Introduction

Pre-deployment training must always include weapon training and familiarity with weapons, vehicles and equipment in use in the theatre. Part 3 expands somewhat on these areas to include other allied subjects such as night visibility equipment, radars, mines, etc.

The areas covered will not automatically be included in all programmes of training but may be included selectively in certain modules directed at particular training needs. Part 3 is organized as follows:

- Section 1 - Introduction
- Section 2 - Weapon Training
- Section 3 - Familiarity with Theatre Weapons, Vehicles and Equipment
- Section 4 - Night Vision Equipment, Radars, Nuclear, Biological and Chemical Warfare
- Section 5 - Mine Awareness Training
- Section 6 - Field Exercise including Battle Practices

All soldiers serving in a peace-keeping Force in unit or staff appointments are expected to have attained acceptable levels of competence in weapon training before arriving in the area of operations.

Line personnel in units and in staff appointments should:

- be fully trained, tested and have completed and passed range practices in the current year in their own particular personal weapon;
- be fully trained, tested and have completed and passed range practices in the current year in other small arms weapons on issue within the sub-unit;
- have a general working knowledge and be capable of serving as a minor crew member in crew-served support weapons on issue within the unit (not necessary for those in staff appointments).

Personnel in crew-served support weapons sub-units should:

- be fully trained, tested and have completed and passed range practices in the current year in the support weapons which they man in the organization;
- be fully trained, tested and have completed and passed range practices in the current year in their personal weapon;
- have a general working knowledge of other crew served support weapons in the support sub-unit.

It is necessary during concentration time to check if all soldiers have attained the minimum standards outlined above. If they have not, this must be included in the pre-deployment training.

Very often in PKOs troops will not deploy with their own personal weapons. They will be expected to take over the personal and crew-served weapons of those rotating home. Where this happens arrangements must be made, as soon as possible after arriving in the area of operations, for each soldier to zero/test-fire the weapons.

Familiarity with theatre weapons, vehicles and equipment

All military personnel in a PKO should be familiar with the weapons, vehicles and equipment being used in the area of operation by the parties. It is also desirable that they are familiar with the weapons, vehicles and equipment being used throughout the PKO.

This area should be covered in training during the concentration period. In a new PKO this may initially require some research by those responsible for training, but as the peace-keeping mission is extended, a body of knowledge is likely to develop in this subject.

The priority requirement is that personnel are familiar with weapons, vehicles and equipment which the parties use operationally. Further knowledge is an advantage but not a necessity.

For a new PKO in a new area of operations, research will be necessary, possibly at Defence Forces HQ Intelligence level, to ascertain the weapons, vehicles and equipment in use by the parties. The next step is to get further technical details from the standard texts such as "Janes", "National Defence Review" or other similar publications covering such areas as:

- infantry weapons;
- armour;
- artillery;
- military vehicles;
- aircraft;
- weapons systems;
- naval vessels and weapon systems.

The information gleaned must be put together in a useful manner. The soldier will not require the detailed technical knowledge available in these publications. He will, however, need to know what the items look like and what their characteristics are. Many of the texts available will concentrate to a large degree on technical data and exclude the recognition factor the soldier requires. Training researchers will be required to make up for this deficiency. The PKO soldier will often have to file a report based on a quick glance or an incomplete picture due to obscuring by dis-

tance, smoke, camouflage, etc. It is important, therefore, that training in this area concentrates on elements of recognition such as:

- silhouette recognition (armour, air, naval, etc.);
- muzzle features (artillery, tank main armaments, etc.);
- turret features (armour, naval, etc.);
- track characteristics (armour, APCs, etc.);
- wheel features (vehicles, artillery, etc.);
- small arms features (magazine type, belt/box, butstock, etc.).

Night Vision Equipment (NVE), radars, nuclear, biological and chemical warfare

NVE and Radars In addition to illumination, PKOs use a wide variety of NVE and ground radars. The NVE/ Radars deployed in PKOs come from many sources:

- some are deployed to the area of operations as part of the agreed equipment which came with the initial troops;
- other equipment comes subsequently from contributing countries, normally under “letter of assist” procedures;
- other items are purchased by UN and issued to contingents/units.

This proliferation of types of equipment can create some problems in the training phase. Defence Forces providing troops to PKOs will either have:

- no NVE/radars in their home countries;
- some NVE/radars at home but NOT deployed in the UN area of operations where other types of equipment are issued;
- NVE/radars at home and have the same or similar equipment deployed in the UN Area of operations.

For those with no NVE/radars, pre-training is obviously impossible. The best that can be done is probably an introductory lecture followed by training after arrival in the Area of operations (AO). For those with NVE/radar equipment at home but about to be equipped with different items once they are deployed, training can take place at home followed by conversion training in the AO. For the final category, full training at home with some minor conversion or familiarization training in the AO should suffice.

On arrival in the AO the unit concerned must assess its NVE/radar training in the light of the equipment they find on issue. They must then organize the appropriate training programmes, either utilising their own internal expertise or by requesting PKO HQ for assistance.

Throughout training, the cost and sensitivity of NVE/radar equipment must be stressed, especially to troops who have not used such equipment before.

Finally, troops must be instructed in the effectiveness and limitations of illumination. Instructions must include its use in high wind and low-cloud ceiling situations. The use of day binoculars in association with illumination must be stressed.

Nuclear, biological and chemical warfare

UN peace-keeping Troops have NOT been subjected to the difficulties of having to work in a nuclear or biological warfare environment. They have been obliged, in the past, to work in a chemical warfare environment. It is therefore important that some elements of NBC warfare be covered in training.

If time considerations put pressure on the amount of training which can be done in the area, then concentration should be on chemical warfare.

Certainly if troops are to be deployed in a potential NBC warfare area, training in this topic must be included, as must the issue of specialist clothing and monitoring equipment.

Training should concentrate on:

- characteristics;
- symptoms;
- precautions;
- use of protective clothing and monitoring equipment.

Mine awareness training

UN PKOs have over the years suffered relatively heavy casualties if one considers that their mission is one of peace rather than belligerence. Some of these casualties have been avoidable, especially those sustained by mines and other similar items. PKOs will normally be deployed in the vicinity of former battlefields. They will therefore have to contend with old minefields and many other types of dangerous battlefield debris. PKOs can also find themselves in a situation where some elements among the parties are still engaged in low intensity operations. This can involve the laying of mines, roadside bombs and other explosive devices, directed against each other or against members of the PKO. UN will never have the resources to deal with the whole problem of mines, roadside bombs and miscellaneous battlefield debris. Their response will have to be a combination of:

- technical anti-mine/bomb activity;
- safety precautions;
- mine awareness programmes for troops.

Training before arrival in the mission area has a part to play in this. Specialist training is dealt with in part 7 below. This involves training for both reconnaissance (EOR teams) and disposal (EOD) teams. General Training in the pre-deployment phase should concentrate on:

- recognition of devices/mines in use;
- principles of use and how to recognize areas where a threat exists;
- mine awareness programmes for troops, emphasising the following principles:
 - personnel will assume that only areas specifically cleared by the UN and Checked regularly are mine-free;
 - personnel will move only in these areas, which will be clearly marked;
 - any suspect object should be reported, not touched;
 - troops should be aware of the parties' mine-marking techniques;
 - the collection of war "souvenirs" is forbidden;
 - personnel should be taught to recognize mines, roadside bombs, battlefield debris etc.

Field exercises including battle practice

While classroom training and briefings can be excellent pre-deployment activity for troops, they cannot replace the sense of realism which field exercises can create. Many of the principles covered in the classroom can be applied in a field exercise situation.

Training in UN operating techniques which is dealt with in Part 5 below is a case in point. Most of the areas covered there can be rounded off in a field exercise. It can, for instance, be beneficial to cover checkpoint operation and searches in the classroom, but they are best illustrated and perfected on the ground during field exercises.

Similarly, weapons training is best finished off by way of a battle practice. Battle practices in conventional training involve troops in fire and movement exercises usually geared towards the offensive. In UN training they are better described as battle inoculation practices.

Battle inoculation exercises must be set up with a clear objective in mind. In the case of troops about to serve in a PKO, the purpose of these exercises may be defined as:

- to accustom troops to the experience of being under fire, and to enable them to function under those conditions;
- to teach troops the sounds of the various weapons being fired, and to be able to identify them.

While under fire, troops should be given other tasks to perform in order to condition them into continuing with their main function, despite being under fire. Tasks could include:

- a. sending verbal reports of the fire giving all details (such as weapon, calibre, source, number of rounds, etc.) to a junior leader or umpire;
- b. having junior leaders commit their observations to writing or having them report it by radio to an umpire;

- c. transmitting routine prepared messages to an umpire during the exercise.

The use of sound-effect simulators, engineer demolition, thunder flashes, etc., all add to the realism of the exercise. It is desirable, however, that the sounds created by these devices should replicate, where possible, the impact of known munitions, such as mortar, artillery, tank and anti-tank gunfire.

It is unsafe to use smoke-generating devices or grenade smoke (signalling) as they may obscure the line of sight of direct fire weapons involved.

While battle inoculation training can be very useful and effective, the safety of troops under training is paramount. Defence Forces of contributing countries will have their own safety regulations to consider, but Annex "A" attached includes some suggested measures.

PART 4 - GENERAL MILITARY TRAINING AREAS

Introduction

Certain basic skills are common to all Defence Forces. These are part of basic and continuing career training and include such diverse areas as weapon training, minor tactics, fieldcraft, etc., all of which are utilized in peace-keeping. Additional basic skills which are particularly pertinent to peace-keeping include: physical training, map reading, communications/voice procedure, first aid, hygiene and sanitation.

Perspective military peace-keepers will possess these skills at various levels of competence. When concentration takes place the levels should be checked and adequate training offered to help bring all personnel up to the required levels of competence.

This part is divided into the following sections:

- Section 1 - Introduction
- Section 2 - Physical Training
- Section 3 - Map Reading
- Section 4 - Communications, Voice Procedure
- Section 5 - First Aid, Hygiene and Sanitation

Physical training

It is a basic requirement that all soldiers keep themselves physically fit. This is an important aspect of military life at home, especially for troops in operational units. In UN PKOs the demand for physical fitness can be greater than at home. This is because UN PKOs:

- can experience operations over a protracted period;
- will be operating very often in climatic and geographical conditions which are outside the experience of the troops;
- may require administrative personnel to be at a higher level of physical fitness than would normally suffice at home.

The best approach to physical fitness for troops about to embark on a UN PKO is to:

- establish an appropriate level of fitness for all ranks;
- prior to concentration for pre-deployment training, ensure that all potential UN personnel are in training towards achieving the acceptable level of physical fitness;
- once personnel arrive at the concentration area, they should be tested for physical fitness; those NOT attaining the appropriate level should be either:
 - put on a personal fitness programme, or
 - failed for acceptance and a replacement called; choice should be based on an assessment as to whether the individual is capable or not of attaining the acceptable level during the pre-deployment training phase.

The physical fitness level and training module should:

- be graded on age;
- be graded according to appointment;
- include tests/training incorporating:
 - endurance;
 - strength;
 - physical skills (e.g. obstacle course training).

In addition, a field exercise involving endurance marching on hilly terrain, including the setting up of base camps, should be included in the module. Physical training should be incorporated where possible into all training (e.g. marching to a training area instead of using transport).

Map reading

A good standard of map reading is a requirement for all NCO ranks in most Defence Forces. In PKOs private soldiers may be required to read maps, though this would usually be for reporting purposes rather than in order to determine routes, an activity in which an NCO would normally accompany them.

Map reading instruction during pre-deployment training should concentrate on:

- refresher training for all officers and NCOs;
- basic training for privates concentrating on:
 - map orientation to ground;
 - reading of co-ordinates.

An ideal culmination of training for privates would be a simple map exercise involving the giving of accurate grid references and map reading in general, using maps of the area into which personnel are to be deployed with the PKO.

Communications - voice procedure

In PKOs signals personnel will man the PKO communications network (“net”) from units to PKO HQ. Within the unit they will control the unit net. Non-signals personnel can be involved in radio communication in the following areas:

- company nets;
- battalion net - company HQ terminal;
- PKO net (certain drivers and other categories).

Battalion and company nets will normally be in the unit’s native language, so no real linguistic problem exists. It may be possible to have trained signallers operate on the unit net between company HQ and battalion comcen. There will nevertheless be a requirement for non-signals personnel to operate nets from observation posts, checkpoints, etc., to company HQ. Soldiers operating in this capacity will require some basic knowledge of voice procedure and radio operator “working knowledge” training in their native language.

Signals personnel operating from battalion HQ to PKO HQ on PKO net will require familiarity with English voice procedure. Certain drivers and other non-signal categories who will have access to PKO nets will require basic voice procedure training in English.

The best solution in meeting these requirements is a combination of:

- astute selection processes;
- basic training.

Signals personnel expected to operate on the PKO net should be fluent in the operating language. Selected other non-signals personnel (e.g. certain drivers) who are expected on PKO nets should be fluent in the operating language. Careful selection on this basis will save much training time. The only alternative is voice procedure training in the operational language for personnel who must operate on PKO nets.

Voice procedure training in the native language for non-signals personnel must be provided for and should include:

- care and daily maintenance inspection of set;
- battery or part replacement;
- basic voice procedure.

Time will be a problem but training need not cover all personnel; it can be limited if necessary to 2-3 personnel in each operational section. Other section members can pick up the skill "on the job". Training can concentrate on clear, concise and accurate reporting of operational incidents and should be completed as part of a field exercise.

First aid, hygiene and sanitation

First aid

Training in first aid should be organized largely on an individual level in order to develop self-confidence, self-reliance and resourcefulness, since statistically most first aid work will be done by the individual working alone, either on his/her own wounds or on a companion.

The object of first aid training is to train the soldier in rendering first aid to him/herself or to his/her comrades.

It is important that first aid training cover the following areas:

- principles of first aid;
- use and application of field dressings on wounds;
- slings and knots;
- haemorrhage control by use of pressure on various pressure points;
- treatment for shock, fainting, epilepsy;
- fractures:
 - types and symptoms,
 - treatment including improvised splints;
- poisons and treatment;
- artificial respiration to include mouth to mouth and cardiac massage.

Hygiene, sanitation and health awareness

PKOs will often operate in geographical areas and conditions outside the experience of many of the military participants. The pressures of peace-keeping may impose prolonged periods of strain on individuals. Other dangers to health will also be prevalent. In the circumstances, a preventive medical care programme should be implemented during the pre-deployment phase.

This programme can be implemented by a series of health awareness lectures and the provision of individual information packs. The areas covered should include:

- personal hygiene and sanitation;
- food hygiene;
- water hygiene;
- avoidance of heat injury;
- utilization of rest and recreation to combat stress;
- recognition of stress in self and others;
- alcohol and/or drug abuse;
- sexually transmitted diseases.

PART 5 - TRAINING IN UN OPERATING TECHNIQUES

Introduction

PKOs differ from one another and the operational techniques required will also differ. In designing the correct training module an assessment of the needs of the particular mission will be necessary. This is relatively easy in dealing with a PKO which has been ongoing for several years. It is more difficult when training for a new mission. In training for a new mission the training module will have to concentrate on the elements common to most, if not all, PKOs in the hope that techniques covered may be utilized once the PKO is deployed. This Part will cover some of these techniques and is laid out as follows:

- Section 1 - Introduction
- Section 2 - Positions and Observation Posts
- Section 3 - Checkpoints, Road-blocks, Searches
- Section 4 - Patrolling
- Section 5 - Investigations
- Section 6 - Negotiations/Liaison
- Section 7 - Use of Force
- Section 8 - Leadership

The level of training required will vary from one contributing country to another. Full-time professional soldiers will require less grounding than reserves. Full-time professionals with experience in aid to the civil power or internal security will have encountered the techniques before but will be required to direct them towards peace-keeping, which **may** involve a less aggressive mode.

Positions and observation posts

Definitions

- a. **Position (Posn).** A Posn is a tactically sited location permanently occupied by military members of a PKO from where they carry out various operational tasks such as check-points, road-blocks, observation, patrols. A Posn is normally occupied by armed troops.
- b. **Observation Post.** An OP is a permanently occupied location from where UN peace-keepers carry out “observe and report” missions. In locating OPs one may often have to sacrifice good tactical siting for good observation. An OP can be occupied by armed troops or unarmed observers. It is not current practice to man OPs with a mixture of armed troops and unarmed observers.
- c. **Temporary Posns/OPs.** These are manned as required on a temporary basis, for a limited period of time, for an observation or control task. They are not administratively self-contained but may be located in old permanent positions or OPs, in which case they will contain some of the features from their previous status.

Marking and protection

All Posns/OPs must be well delineated, distinctively marked and provide protection for the occupants.

- a. They should be surrounded by a protective wall (earth mound, rock construction wall, gabions, T-walls, etc.). Outside the perimeter wall should be extensive wire entanglements and the entrance gate should be zigzagged.
- b. The Posn/OP should be painted white with “UN” markings in black or blue. The Posn/OP number should also be prominently displayed. These markings should be visible from the air. The UN flag should be flown at **all** times from a prominently placed flagpole. The Posn/OP and flag should be well lit at night.

- c. The Posn/OP should incorporate a shelter capable of withstanding the type of fire which is likely in the area. With scarce resources a categorization and priority programme may be necessary.

Posns/OPs should have:

- a. line and radio communications to next higher HQ;
- b. specific written orders;
- c. a specified minimum strength.

Training aid

The ideal training aid would be an actual Posn/OP constructed in the concentration area of the contributing country, where economically feasible, or perhaps under a regional training arrangement. Other training, covered below, such as checkpoints, searches and shelters, could also be carried out in the location. If such a fully developed training aid is not possible, a less sophisticated "mock-up" may suffice. As a last resort, use can be made of detailed audiovisual training aids (e.g. diagrams, slides, VCRs, etc.). A diagrammatic plan for a position is attached as Annex "B".

The training periods should cover:

- a. daily routine;
- b. observing techniques.

Daily routine

This can be covered initially by briefing and lectures. Where a properly constructed location as described above is available, the briefing can be followed up by actually having trainees live there while doing other aspects of training, although it is recognized that this may not always be possible. The following areas should be covered:

- a. hygiene and cleaning programmes;
- b. minor maintenance tasks;
- c. generator operation and care;
- d. cooking (UNMO's).

Observing techniques

Training in observation should include:

- a. technique for searching ground;
- b. use of binoculars;
- c. use of Night Vision Equipment.

The climax to training should be a training exercise involving day and night observation where troops/observers would be tested on their ability to observe and report on some contrived incidents.

Checkpoints, road-blocks, searches

A checkpoint is a manned point used as a means of controlling movement and checking vehicles and pedestrians, in order to enforce control measures, orders and regulations. Although used widely by some PKOs, the nature and frequency of their use would depend on the mandate and concept of operation as well as the status of forces agreement, which may limit UN powers of search. Closed checkpoints are called road-blocks. They can also form the basis of blocking positions if these are required because of developments on the ground (e.g. incursions by the parties).

Checkpoints as outlined here are relevant only in a situation where the PKO's mandate requires it to maintain a high profile in circumstances of actual or potential conflict. The training will require adjustment for missions where such conditions do not exist.

Checkpoints (CHPs) can be classified as:

- a. static;
- b. mobile.

Static CHPs are deployed permanently at fixed locations. Normally a position adjoins the installation. Troops who man the CHP will live at the position. CHPs are deployed on a road or major track, normally at a crossroads or junction or at the entrance to a controlled area. Annex "C" gives suggested layouts for CHPs. All CHPs will have a method of slowing traffic (ramps and/or a "zigzag" device) and a search bay for the more thorough searches. The CHP is manned on a 7-day week/24-hour day basis, but it can be closed and converted to a road-block where movement is forbidden during given hours. The blocking of the road/track does not relieve the position of its normal security/observation mission. CHPs sometimes vary in the degree of search they are required to carry out (e.g. military vehicles only, all vehicles, random proportion of vehicle). Depending on local circumstances, searches may also include the searching of individuals or at least males.

Mobile CHPs are deployed where the PKO has difficulties covering all roads and tracks with static CHPs. Mobile CHPs will be composed of a minimum of one section in two armoured vehicles. This group will leave base, operate over a given road-track network and set up “snap CHPs” en route for short periods. Annex “D” covers the operation of mobile CHPs.

Training in the operation of CHPs, road-blocks and searches is best conducted in sequence as follows:

- a. introductory lecture/discussion;
- b. practical application;
- c. exercise.

The lecture/discussion and practical application should cover the theory, layout, siting and operation of CHPs, road-blocks and searches. While the initial part can be done in a classroom/lecture hall, the practical application can only be attempted on the ground. If a training position/OP has been constructed, it would be useful to incorporate a static CHP into the training area. This would be ideal for training in all three areas. Otherwise a simple “mock-up” should be used. For training in mobile CHPs the necessary equipment can usually be easily provided from local resources. Thereafter a training circuit can be laid out and the operation of mobile CHPs practised. Annex “D” is the operations Directive from UNIFIL on mobile CHPs. It may prove beneficial when constructing a training period in this area.

The final phase of training in this area should be an exercise involving the operation of static and mobile CHPs, the conversion of CHPs to road-blocks and the actual searching of personnel and vehicles where **some** will actually be carrying contraband goods. The normal subsidiary problems encountered at CHPs should also be included in exercises (e.g. build-up of traffic and consequent loss of tempers, truculent subjects of search, “crash through” incidents and follow-up action, etc.).

The exercise and training leading towards it should include the following areas:

- a. security and deployment of personnel;
- b. method of search;

- c. what to do when people:
 - refuse to produce ID card,
 - refuse to open the boot of the car,
 - produce a weapon;
- d. training in traffic control;
- e. training for junior leaders in:
 - isolating problems quickly,
 - preventing their escalation,
 - scaling down and defusing problems quickly.

Patrolling

Patrolling is an essential part of UN peace-keeping. It is virtually impossible to conceive of a mission in which there would be no patrolling. This activity is conducted by PKOs whether they are observer groups, peace-keeping Forces or a mixture of both. Pre-deployment training on patrolling must cover the following areas:

- a. types of patrol to be undertaken;
- b. aims of patrolling in the PKO;
- c. principles to be adhered to by patrols;
- d. conduct of the patrolling.

These training guidelines deal with the subject in broad outline. In designing its own training programme the relevant national authority will have to bear in mind the particular PKO and its likely patrolling requirements.

Types

The types of patrolling utilized by PKOs, currently and in the past, have been many and varied. Training should cover the type of patrolling to be undertaken by the PKO in question. These patrols, which can be by day or night, may be:

- a. foot patrols;
- b. vehicle patrols;
- c. air patrols;
- d. sea patrols;
- e. special (river/marsh, ski, etc.) patrols.

Aims of patrolling

Training should specify the aims of patrolling for the PKO in question. These aims may be to:

- a. confirm/supervise a cease-fire;
- b. gain information;
- c. check on areas which cannot be observed from OPs;
- d. indicate a UN presence to parties;
- e. reassure isolated communities;
- f. carry out mobile CHPs;
- g. inspect existing and empty positions of the parties;
- h. insert "ambush" parties along infiltration lanes;
- j. carry out observation from isolated and unoccupied OPs;
- k. provide a physical link between adjoining but relatively isolated UN positions;
- l. provide protection for parties or local population where travelling without the UN might provoke an incident;
- m. interpose standing patrols between parties during a period of tension.

Where patrolling is to be included in pre-deployment training the suggested sequence is:

- a. lecture/discussion including the stressing of UN patrolling procedures;
- b. practice;
- c. exercise.

In preparing a training module covering patrolling, the lecture/discussion sequence should cover the following:

- a. **Strength.** Minimum strengths for patrols should be laid down in SOPs to include use of specialist vehicles and minimum number of vehicles if necessary.
- b. **Security.** Security measures should be covered. These could include:
 - safe (mine cleared) patrol routes/paths;
 - LOs/guides/interpreters;
 - “no go” area information;
 - night patrol restrictions/special procedures;
 - where necessary, overt measures to ensure patrol recognition by parties.
- c. **Communications.** Radio report lines system, etc.
- d. **Equipment Levels.**
- e. **Reinforcement Plan.**
- f. **Tactical Formations.**
- g. **Medevac Plans.**

In the practice/exercise phase the following areas should be included:

- a. **Patrol Preparations**
 - Briefing on mission, area, time in and out, routes in and out, etc.
 - Personal preparation;
 - Preparation and testing of equipment, vehicles, communications.
- b. **Patrol Execution**
 - Maintenance of radio contact/reports;
 - Action on encounters;
 - Action on halts.

c. Debrief

Verbal to the “patrol master” (e.g. Coy Comd, Ops Offr, Info Offr, etc.), followed by a written report/marked map to next higher headquarters.

The preparation and execution of an exercise on UN patrolling techniques should be part of all pre-deployment training. The scenario should cover as many of the aims of patrolling (see page 49) as possible. Depending on available training time it may be necessary to concentrate on some areas only. The most important areas would be:

- a. information gathering patrol, including ground observation;
- b. mobile CHP patrol (peace-keeping Force members only);
- c. interposition patrols (more relevant to peace-keeping Forces than Observers);
- d. “ambush” patrols on infiltration lanes (peace-keeping Force members only).

Investigations

In the pre-deployment training of United Nations Military Observers, the whole area of operational investigations should be covered. It does not have much pertinence for non-commissioned officers or privates destined to be members of a peace-keeping Force, although officers of a Force may be involved in such investigations.

An operational investigation is one carried out by the UN into any special operational occurrence. It will normally evolve from:

- a. a particularly serious operational incident requiring further detailed appraisal;
- b. a request by one of the parties after an alleged incident involving the other party;
- c. a complaint from one of the parties about the operational behaviour/reaction of UN military personnel.

Operational investigations are normally held against the background of a serious or potentially serious incident. As such they are very important and, properly handled, can be a definite contributing factor towards keeping potentially explosive situations in check. To ensure that they are properly carried out the procedures should be covered in the training of officers.

A request for an operational investigation can be initiated at headquarters or local level. An investigation can be offered by the PKO without a request from the party/parties if it is felt that it will defuse a potentially serious situation. If one is requested at the unit level and involves a purely local incident, it may be investigated at that level but only after seeking and being granted the approval of the PKO HQ. At HQ level, depending on the seriousness of the incident an investigation can be instituted by the FC/CMO or one of his senior staff officers, most probably the Chief Operations Officer.

An operational investigation should be carried out by at least two officers who are suitably qualified. They must be properly briefed and if possible be given written terms of reference. The parties may be asked to provide LCs, documentary or material evidence and witnesses. The team will carry out the investigation with efficiency, discretion and courtesy. They will be strictly impartial and

will not accept any pressure from the parties. They will not express personal opinions, although professional opinions will be part of their report.

The investigation will be carried out at the scene of the incident or as close to it as possible. The team will take notes, make sketches, mark maps, take photographs, tag material evidence items with serial number/date-time group/map reference. The team will maintain communication with the headquarters throughout.

Report

At the conclusion of the investigation, a written report will be submitted to the convening authority. This report will form the basis of reports to the parties, UN New York, etc. The report will include:

- terms of reference;
- broad description of background to investigation;
- actions of investigation team;
- statements;
- maps, physical evidence, sketches, photographs, etc.;
- conclusions.

In many Defence Forces officers will have already been involved in operational investigations of one kind or the other. They may not, however, have experience in UN investigations. Some officers will have no experience whatsoever in this area. In assessing the type of training to be covered in this module, the experience of the potential students will have to be considered. Based on this assessment the actual training can vary from:

- a. simple lecture/discussion, to
- b. lecture/discussion followed by an exercise where students are asked to investigate a contrived incident and produce a report, with subsequent class criticism/discussion periods.

Negotiations/liaison

Liaison with the parties is an essential element of UN peace-keeping. All PKOs will have a liaison system in place to provide a structured link between the UN and the parties through which negotiation of mutual problems can take place. The liaison system will embody:

- a. a high-level link at FC/CMO levels;
- b. a medium working level link between PKO HQ and the parties on a continuing day-to-day basis;
- c. unit ground-level link, organized at unit level and designed to defuse problems at source.

In the area of liaison work, certain nominated officers at PKO HQ and unit levels may be nominated to negotiate.

Other forms of negotiation outside this formalized system exist:

- a. military observers may be called to negotiate on a problem which has arisen on the ground;
- b. junior leaders at corporal or even private level may have to negotiate a sudden problem which has arisen in their area (e.g. a CHP dispute).

The training for negotiation and liaison will of necessity be restricted. At the formal end of the scale, the selection of personnel with negotiating ability and experience is all-important. As far as informal negotiation by UNMOs and junior leaders is concerned, some general training can be carried out.

The best format is lecture/discussion followed by simple exercises:

- a. lecture/discussion should cover such areas as diplomacy, tact, firmness, fairness, friendliness and flexibility;
- b. the exercises could be at low level involving junior leaders (e.g. an imaginary CHP incident) and could be co-ordinated with other exercises (e.g. CHP searching, etc.).

Use of force

Training/discussion on the use of force within a PKO forms a very important part of the training programme. It must be included for all levels in all modules. This is necessary because:

- a. the non-enforcement nature of peace-keeping has developed to such a stage that it is now an integral part of PKOs;
- b. soldiers from many contributing countries will have been conditioned to an “automatic return of fire” philosophy;
- c. soldiers with wide experience of aid to the civil power at home will still find differences in the application of UN doctrine;
- d. soldiers with previous UN experience may find the doctrine changed slightly as part of the ongoing evolutionary process.

The whole ethos of peace-keeping is that it be achieved without the use of military force. As explained in Part 1, it is quite different from “peace enforcement” under Chapter VII of the UN Charter. UN PKOs are carried out by unarmed observers, armed forces equipped only for self-defence, or a combination of both.

Where armed troops are part of a UN PKO, the topic of “Use of Force” must be covered in pre-deployment training. It is suggested that the subject be dealt with in the following order:

- definition of force;
- when force can be used;
- principles in the application of force;
- how force is to be applied;
- authority for the use of force;
- actions after force has been applied.

Definition

Force is the use of **physical means** to impose one's will.

The Report of the Secretary-General on the establishment of UNIFIL summed up the basic principle on the use of force by PKOs when it stated inter alia that "the Force will be provided with weapons of a defensive character and shall not use force except in self-defence. Self-defence would include resistance to attempts by forceful means to prevent it from discharging its duties under the mandate of the Security Council".

Force can be used only in self-defence against direct attacks on, or threats to the lives of UN personnel or when UN security in general is under threat. This would include attempts at forceful entry into UN positions and their environs by one party for use as a fire base against the other and attempts by force to disarm UN troops.

Principles in the application of force

Once a decision to use force is taken, certain principles will be adhered to by the UN:

- a. only the minimum force consistent with achieving the aim will be employed;
- b. if possible, prevention by negotiation or persuasion should precede force. This escalatory process is, however, an ideal which it may not always be possible to realize;
- c. if a situation develops where firing for effect seems the only option, it will be preceded by warnings. These can be oral, firing of flares which are understood by the parties as being a warning, warning shots in the air, firing short, etc.;
- d. "fire for effect" will be initiated after the procedures above have been exhausted. However, if there is an immediate threat to UN lives or if UN casualties have already occurred, "fire for effect" may be initiated without delay. "Fire for effect" is firing to hit;
- e. in firing for effect there should be no escalations in type of fire. The idea should be to return like with like;
- f. fire should be controlled and should cease once the aim has been achieved;

- g. after the incident the UN Commander involved must immediately transmit a full SITREP to HQ, including the type and number of rounds fired by UN forces.

The Force Commander may wish to reserve to himself the authorization to fire heavy support weapons (120 mm mortars) with authorization for the firing of other heavy weapons being reserved to the Battalion CO. A request in clear or radio for authorization to fire such weapons can incidentally have a deterrent effect on its own. In the final analysis, however, it is the commander on the spot who must assess his situation and take what he sees as appropriate action.

During training the broad principles stated above should be expanded on, especially for the junior soldier. Consideration should be given to utilizing the medium of simple scenarios based on situations the soldier is likely to encounter.

Leadership

Peace-keeping places a large amount of responsibility on leaders, at the junior officer and non-commissioned officer levels. Unlike conventional operations where senior leaders will very often be near at hand, peace-keeping is often carried out in isolated positions, scattered checkpoints, small patrols, etc.

Leaders, senior and junior, officers and NCOs, are selected for their innate or acquired abilities in this field. They will, in most cases, have received adequate career training in leadership techniques as part of their professional education.

It is not therefore necessary, in most cases, to undertake separate instruction in leadership in the pre-deployment phase. What is required is an emphasis on the exercise of responsibility and command. To assist in the development of the leadership potential of the section and sub-section commanders, their responsibilities should be emphasized from the commencement of training and their sections should train as a team throughout. Close supervision of junior leaders should be exercised by those responsible for the training, with on-the-spot remedial action employed as required.

PART 6 - SAFETY MEASURES AND PRECAUTIONS

Introduction

No commander at any level wishes his troops to sustain casualties. It is therefore important that security measures at all levels be dealt with during pre-deployment training. This part will look at troop safety under the following headings:

- Section 1 - Introduction
- Section 2 - Shelters
- Section 3 - Equipment
- Section 4 - Travelling and Movement
- Section 5 - Non-operational Safety Measures

It must be emphasized that maintenance of the security drills learned in basic training will always be pertinent.

Shelters

All UN positions and observation posts should include a shelter or shelters large enough to accommodate the manning strength as well as some extra personnel. Each shelter should be well stocked with sufficient water and pack rations to allow personnel to survive without resupply for a given number of days, as laid down by the commander in SOPs (ten days is a suggested minimum). There will be a holdings chart and checks will be carried out regular intervals (at least once a month). Proper paper stock rotation should take place.

The construction of shelters will depend on:

- a. how immediate a threat to UN personnel is perceived;
- b. the resources available.

Where resources are not immediately available to achieve the standard laid down in the preceding paragraph, the positions most likely to be involved in observing and reporting a major outbreak of hostilities should have first priority, followed by positions in the likely area of fighting, followed by other positions. To meet relevant requirements, pre-deployment training should cover:

- a. the theory and practice of shelter construction;
- b. the development of shelters;
- c. the organization, daily routine and maintenance of established shelters.

Training is best implemented by lecture/discussions followed by practical experience.

- a. The theory and practice of shelter construction can focus on the necessity for shelters, the high priority which should be given to the shelter in the development of a position, materials used in the construction of shelters (sandbags, T walls, earth mounds, concrete blocks, gabions, Damascus shelters etc.). The practical aspect should involve familiarization with materials and some practical construction.

- b. The topic of the development of shelters should cover the addition of comfort and practical innovations in the shelter once the priority of protection has been achieved (e.g. sleeping bunks, ration storage, radio remotes, drainage, lighting, power, etc.).
- c. Established shelter training is best done in a “mock up” or real training shelter. Training can centre around the daily checks of foods, medical kit, radio, etc. which should be undertaken. If it is felt necessary, troops can experience living in a shelter while undertaking other training activities although this will be restricted by the number of personnel involved and the number of shelters in the training area.

Equipment

The security of troops engaged in peace-keeping can be enhanced by the issue and utilization of protective items of equipment.

Steel helmets

These are NOT a UN issued item but all personnel engaged in peace-keeping should be issued with them. The operational situation will dictate when they should be worn.

Fragmentation vests

These are NOT a UN issued but should be made available by the contributing country. They can be issued as a personal item of kit to all soldiers or a pre-designated quantity could be deployed with the unit to enable an adequate pool system to be set up. They should be carried or worn by all personnel when on exposed operational duty

NBC suits

There are NOT a UN issued item, nor is it normal for troops engaged in peace-keeping to have them as a personal kit item or that they be available from a unit pool. However, where the UN assesses that a nuclear, biological or chemical threat exists, contributing countries may be asked to make NBC suits available for issue to personnel on operational duty in risk areas.

From a training viewpoint, it should be sufficient just to emphasize the carrying of helmets and fragmentation vests by way of lecture. If it is felt that additional emphasis is necessary, helmets and fragmentation vest can be scheduled as dress for certain training periods (e.g. operational training). It may also be necessary to include a period of familiarization with, and wearing of, the NBC suit for all troops. Ideally all soldiers should be obliged to wear and work in the suit for at least 30 minutes. Failing this they should at least know how to don the suit and be aware how uncomfortable it can be to personnel who are not used to wearing it.

Travelling and movement

UN personnel, depending on the threat in their area of operations, can be at special risk when travelling. Pre-deployment training must cover this area with particular emphasis on convoy driving and hijack drills.

- a. United Nations Military Observers are almost always unarmed. When it is judged that there is a threat to their security, SOPs will probably require them to travel in two vehicle convoys with reliable communications. Consideration can also be given to supplying them with arms and/or an armed escort, but studies of this question in the past have almost invariably led to the conclusion that arming the observer would compromise their ability to carry out their duties and would create a potentially dangerous confusion between armed troops and unarmed military observers, whose methods of operation are quite different and must be so perceived by those with whom they deal.
- b. A United Nations Force might be in a low-risk situation. It should nevertheless employ security measures such as a minimum number of armed personnel to travel in each vehicle.
- c. In high risk situations, a UN Force should employ the convoy system with:
 - two vehicles at least in each convoy;
 - four armed personnel in each convoy;
 - radio in at least one vehicle;
 - convoy procedures employed (e.g. keeping vehicle behind always in view);
 - no predictable travel patterns;
 - limited after-dark movement (e.g. operations only, armoured vehicles only, etc.);
 - no progress reports in “clear” on radio (e.g. use report lines or brief HQ before leaving, report by telephone on arrival, use radio in emergency only).

Hijack

Where a danger of hijacking exists, SOPs will include an anti-hijack drill. This should include:

- a. an initial hijack message from vehicle under threat or OP/vehicle observing incident, giving:
 - posn (e.g. 1 Km N of Posn 6-34);
 - who (e.g. 4 armed elements);
 - in what (e.g. Blue Volvo);
 - other details (e.g. going North)

- b. hijack alert to all stations with resulting action:
 - closing of CHPs to create road-blocks;
 - alerting of mobile reserves (unit and force);
 - mobile patrol from nearest unit to location of incident;
 - helicopters on standby (if deployed with PKO);
 - dog teams on standby (if deployed with PKO);
 - liaison with local authorities and others in a position to help.

Non-operational safety measures

A high proportion of deaths and serious injuries in PKOs come not from operational causes but from so-called natural causes and accidents. These include:

- a. health reasons;
- b. traffic accidents;
- c. fire;
- d. suicide;
- e. weapon handling accidents;
- f. accidents while on leave.

Proper briefing and preventive measures prior to deployment can reduce these unnecessary casualties:

- a. The pre-UN service medical examination must be thorough and it must pay particular attention to conditions which might be adversely affected by stress, new climatic conditions etc.;
- b. Great stress must be laid on briefing drivers on the different road and track conditions they will meet (e.g. the treacherously slippery conditions which come after the first rains in some areas) and the local driving practices. Defensive driving must be emphasized;
- c. training in fire prevention, fire precaution, fire fighting and rescue is necessary. Emphasis should be placed on:
 - identification of fire hazards;
 - the exercising of personnel in the use of fire fighting equipment;
 - first aid and general rescue measures;
 - evacuation of buildings;
 - safety measures in the handling of inflammable materials.

- d. Troops must be briefed on how to recognize and deal with depression in themselves and in their companions; they must be pre-warned on the dangers of loneliness and stress and on the effect these can have in over-emphasizing reactions to such things as bad news for home;
- e. Although a normal military attribute, care in weapon handling must also be stressed during training. Troops serving in PKOs will probably handle their personal weapons much more than in the home environment. Over-familiarity and carelessness can prove a fatal combination and troops should be aware of this. There are training films and videos widely available on this subject;
- f. Leave, after a prolonged period of tension and abstinence, can often lead to over-indulgence, especially in alcohol, which in turn can create the conditions for serious accidents while on leave. Troops should be briefed on this prior to service with a PKO and again prior to taking leave in the mission area.

PART 7 - SPECIALIZED TRAINING AREAS

Introduction

Certain specialized training will be required to be completed by military personnel, ideally before commencing service with a PKO. This type of training may not always be possible during pre-deployment training due to lack of relevant equipment/facilities in the contributing country. In this situation some training will be possible after arrival in the PKO's area of operations but it is emphasized that this will be the exception rather than the rule. This part will specify whether training in the area of operations can be expected to be available or not. The list of specialized areas dealt with here is not exhaustive but one can make assumptions for other areas covered below. These are:

- a. training in specialized areas will NOT be provided after arrival in the PKO, except in the area of familiarization;
- b. training prior to deployment will have to be completed in the same areas or with similar equipment at home.

Finally specialized training should not be confused with specialist training. All specialists being deployed with a PKO are expected to be fully trained and competent in their specialist area.

The part is organized as follows:

- | | |
|-------------|----------------------------------------|
| Section 1 - | Introduction |
| Section 2 - | Driving (Specialized Skills) |
| Section 3 - | Helicopter training |
| Section 4 - | Staff Training (UN Procedures/Reports) |
| Section 5 - | EOR/EOD Training |
| Section 6 - | Media Relations |

Driving (specialist skills)

For service with PKOs the following driving skills are mandatory prior to arrival in area of operations:

- a. All UN Military Observers must be able to drive four-wheel drive, gear shift, light and medium military vehicles over rough and variable terrain as well as on roads and tracks. They must be also capable of carrying out daily maintenance checks and preventive action;
- b. All nominated non-specialist military drivers whose appointment requires them to drive must be capable of driving vehicles up to medium truck level with four wheel drive and gear shift over a variety of terrain and conditions. They must also be capable of daily maintenance checks and preventive action;
- c. All heavy specialist drivers must be able to drive and operate their own specialist vehicles (earth movers, water trucks, wreckers, heavy articulated trucks etc.) as well as other non-specialist vehicles over a variety of terrain and conditions. They must also be capable of daily maintenance checks and preventive action;
- d. All armoured vehicle drivers must be able to drive their own specialist vehicles (e.g. armoured cars, armoured personnel cars) as well as other non-specialist vehicles over a variety of terrain and conditions. They must also be capable of daily maintenance checks and preventive action.

For military observers, especially those who may not be used to driving the relevant vehicles, a short familiarization course on four-wheel drive, gear shift, light operational vehicles may be necessary. It is assumed that these officers drive regularly but have limited opportunities to drive military vehicles. The training should therefore aim at familiarization followed by practice driving over variable terrain. The ideal training circuit would be cross-country and should include dry tracks, rocky surfaces, mud, water, sand, snow. Not all of these conditions will be found together but the circuit should contain as many of them as possible. Many defence forces of contributing countries will have purpose-built training circuits but if not these can be easily surveyed and laid out.

Non-specialist military drivers, it is assumed, will have much more ongoing experience in driving military vehicles than some of the potential officer observers. As such they will require less time on training than the UNMOs but should be thoroughly tested on the training circuit in their full range of vehicles, preferably ones similar to those in the PKO.

Specialist drivers, like non-specialist, should have plenty of ongoing experience in driving their own particular specialist military vehicles. They should however be tested both on their specialist vehicles and should also do the training circuit test on other vehicles.

Armoured vehicle drivers, assuming good ongoing experience, should be tested on a training circuit before deployment to the PKO. Depending on the armoured vehicles available in the PKO, drivers may have to undergo familiarization training after arrival in the PKOs area of operations.

Helicopter training

In most PKOs, helicopters are used for:

- reconnaissance;
- logistics support;
- casualty evacuation;
- tactical lift

Most contributing countries should be able to cover the basic training elements required for units wishing to use helicopter support. In certain cases this will not be possible. These contingents should so inform the PKO on arrival in the mission area so that some helicopter familiarization training can be organized.

First priority should be given to unit medical personnel in the area of casualty evacuation by helicopter. This should include preparation of casualty for evacuation by helicopter, how to approach the helicopter with the casualty, the use of specialized evacuation equipment (mountain rescue stretchers, winching etc.). Support training for casualty evacuation by helicopter, covering such aspects as the characteristics of permanent helipads, characteristic construction and operations from temporary helipads, and emergency lighting of helipads, should also be covered.

Some training in reconnaissance procedures from helicopter should be conducted for selected officers.

From the point of view of logistics support, relevant troops should receive instruction in

- preparation of items for transportation in helicopters;
- procedures for loading and unloading helicopters

Troops likely to be tactically lifted by helicopter and others likely to be utilising helicopter transport should be briefed on:

- embarking and disembarking drills;
- safety precautions

Staff training

UN procedures and reports and language training

All rank staff will be deployed to work at PKO HQ. Unit staff will be required to work from unit HQ to PKO HQ. These staff appointments must be filled by suitably qualified personnel who have home experience (and ideally UN staff experience) in the relevant areas (e.g. personnel hoping to fill appointments in logistics at PKO HQ should ideally have filled a similar logistics appointment at home and if possible have served previously at unit level in logistics with a UN PKO). Potential staff personnel should also be competent in the main operational language of the mission.

The key to success with international staff officers is correct selection based on qualifications, competence, experience and knowledge of the working language. Lack of any of these qualities will prove a severe handicap to the aspiring staff officer. Unfortunately the time available for pre-deployment training will not allow this shortfall to be corrected. Staff training should therefore be directed towards revision of the subject area followed by familiarization with UN procedures and use of the various UN reports and returns. For aspiring UNMOs familiarisation with UN reporting formats will be essential.

Similarly, language training can only afford to concentrate on revision and practice of already achieved linguistic skills.

EOD/EOR training

Proper indoctrination training and recognition sessions during pre-deployment was covered above. The training of specialist personnel in EOD and EOR is also necessary for peace-keeping Forces.

EOD will normally be provided at PKO HQ level only; training for this is very specialized and is not covered here. Some contributing countries may however feel that they should have an EOD capacity. If this is accepted and authorized by UN HQ New York then obviously the relevant troops must be trained at home with particular emphasis on what they may encounter in the mission area.

On the other hand an EOR capability is considered a necessity for all peace-keeping Forces. Certain elements of EOR training area also pertinent for military observers. In units of a peace-keeping Force it is essential that pioneer assault platoon personnel be trained in EOR. Training can also be extended to other relevant personnel. EOR training should cover:

- a. search awareness;
- b. vehicle search drills and procedures as part of anti-car bomb/booby-trap training;
- c. anti-booby-trap training as part of building searches, patrol path clearance, approaching and recovery of dead bodies etc.;
- d. route clearance and area search techniques.

Media reports

UN PKOs have always been a media interest area. During a tour of duty it is almost inevitable that there will be a media visit to units of a peace-keeping Force. Observer Missions can similarly expect visits in the field.

It is normal that a staff officer trained in media Relations will fill an appointment as Military Press Information Officer (MPIO), or the officer concerned may have to cover press relations in addition to other duties.

At unit level it is important also to have a staff officer trained in media relations. At that level it would be unusual to have an actual appointment of press officer but the position would normally be filled by one of the four main staff officers. The usual appointee is the Information Officer (G or S 2).

It is important that officers filling media Relations appointments, whether full or part time, be carefully chosen and professionally trained. National forces who allocate units to PKOs from reserves can endeavour to select personnel who are involved in the media area in civilian life. If this is not possible then the officer should ideally undergo a media relations course run by the relevant school or unit in his own forces. If such a course is not available an outside training agency in media relations could be asked to impart these skills. Such courses are generally expensive or may not be available in some troop contributing countries. In this case briefings by media personnel from the contributing country would be an option.

In addition to officers filling media Relations appointments, officers and soldiers in the field can expect to be interviewed by the media. A general briefing during pre-deployment training should be essential as a minimum. For personnel most likely to be the focus of media attention (e.g. Commanding Officers, Operations Officers, Company Commanders, Support Commanders) every effort should be made to provide some media training.

Annex "A" **to Guidelines for National or Regional Training Programmes**

SAFETY PRECAUTIONS FOR BATTLE INOCULATION

Weapons involved

Only machine guns which are tripod mounted or AFV mounted should be involved so that they can be clamped and conditioned in such a manner that the axis of the bore does not deviate during firing.

Conditioning of weapons

Tripod mounted weapons should be conditioned so that the tripod will not collapse during firing. This is normally ensured by placing sandbags under the mount. All machine guns will have "stops" placed under the barrel so that the barrel cannot be depressed below the safety angle. Left or arc and right of arc "stops" will also have to be applied so that the cone of fire of any two guns on the firing detail will not converge. In general, barrels should be parallel, but they may also be splayed so that a long line of troops under cover may be subjected to the inoculation more effectively.

Barrels

Barrels must be free from wear and should be inspected by an armourer before the exercise commences.

Ammunition

Service ball or mixed ball and tracer ammunition only should be fired during the exercise. Short range, plastic bulletted, other "safety" ammunition, or any ammunition whose ballistics do not conform to that of service ammunition should not be used for battle inoculation. Rates of fire will be slow or normal during the exercises, with service bursts and correct intervals being applied at all times.

Safety angle

The safety angle (see Fig 1) is the angle created between the line of sight and the axis of the bore. This angle will ensure that the cone

of fire of a service burst will pass a given distance above the troops being subjected to the inoculation. The safety angle takes into consideration the trajectory of a round and the dispersion of a group of rounds in a service burst. It does not allow for inaccuracies of firing or shifting of the guns mount during firing. The rule for calculating the safety angle that has been applied here is:

- a. set the sights on the gun at 1600 metres, and lay an aim at the parapet beneath which the troops who are to receive battle inoculation will be located;
- b. without upsetting the lay of the gun, depress the rear sight fully and sight along it and the fore sight. This new line of sight will be the axis of the bore. It will also give an aiming point on the ground for the guns, beneath which rounds should not fall. (This aiming point should be expressed as a linear target, so that guns do not converge during firing).

Rules for the range

Weapon positions and emplacements where troops are to be located must be between 300 and 500 metres of each other, (at lesser distances the safety angle is considered to be too small and at greater distances the dispersion of the cone of fire is too Great)

Troop emplacements and the impact area of the fire must be constantly visible from the firing position so that fires can be stopped by an observing safety officer at any time should the need arise.

No flares, incendiary rounds, smoke generators or similar devices should be used which may initiate fires or obscure the area during the exercise.

Rules for troops

Troops entering and leaving the area of the emplacements from which they will be subjected to battle inoculation must be accompanied by an umpire and safety party who will carry out the following tasks:

- a. the umpire will exercise control of the troops, who will move into and out of the area on orders from the exercise controller. He will normally receive these instructions by radio;
- b. the safety party each with a red danger flag will position themselves at the front and rear of the troops on the move into and out of the area. This party will also delineate the extreme left of arc and right of arc of the troops;
- c. the exercise controller shall normally be the officer IC practices who shall be assisted by a Range Safety Officer.. The exercise controller shall maintain line or radio contact with the Officer IC Firing Point, the Engineering Officer IC impact simulations effects and the umpire IC the troops.

Annex "B" to Guidelines for National or Regional Training Programmes

INTERNAL LAYOUT TO A STANDARD SECTION SIZED COMPOUND

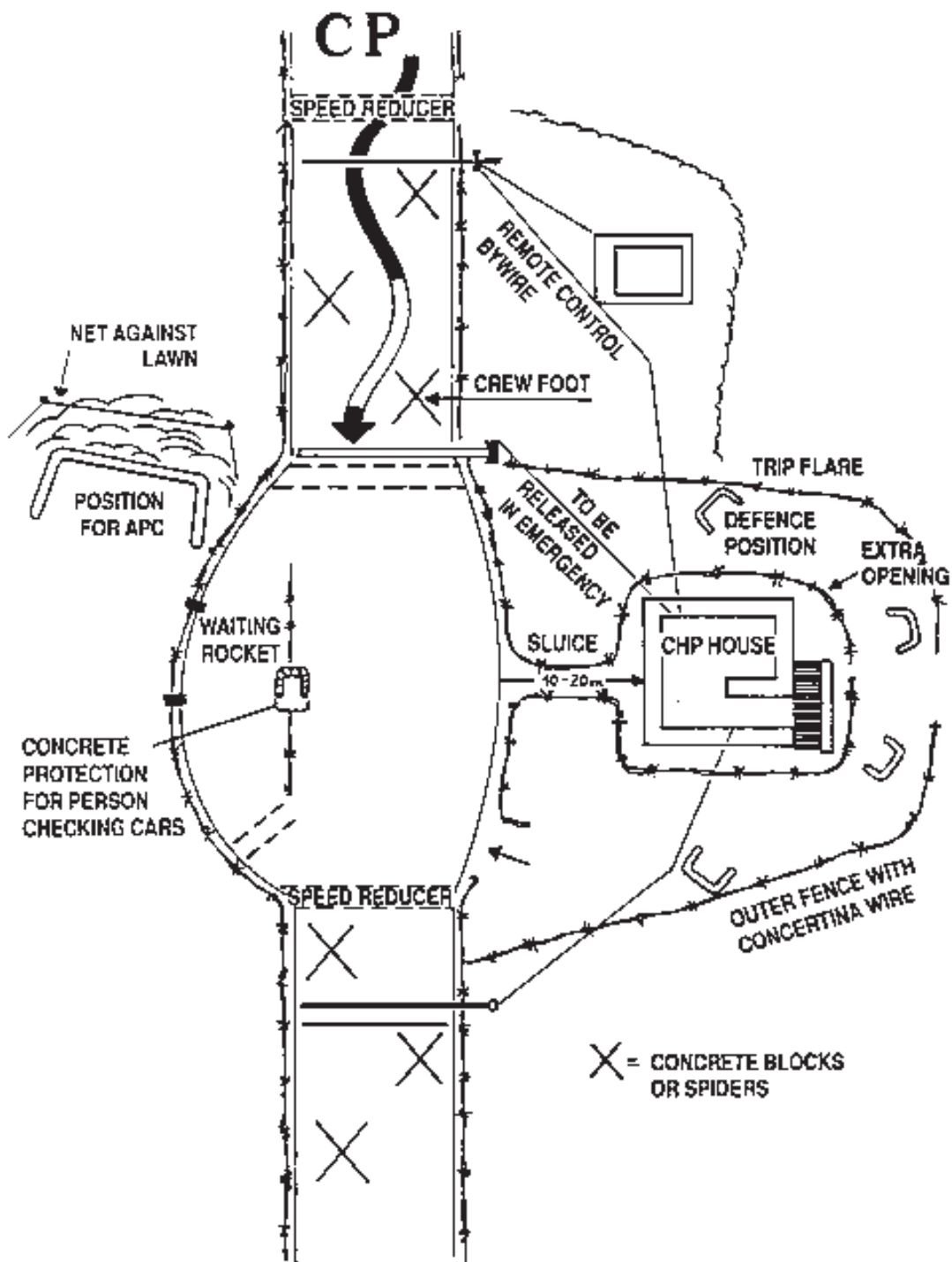

Annex "C.1." to Guidelines for National or Regional Training Programmes

PERIMETER DEFENCES TO A STANDARD SECTION SIZED COMPOUND

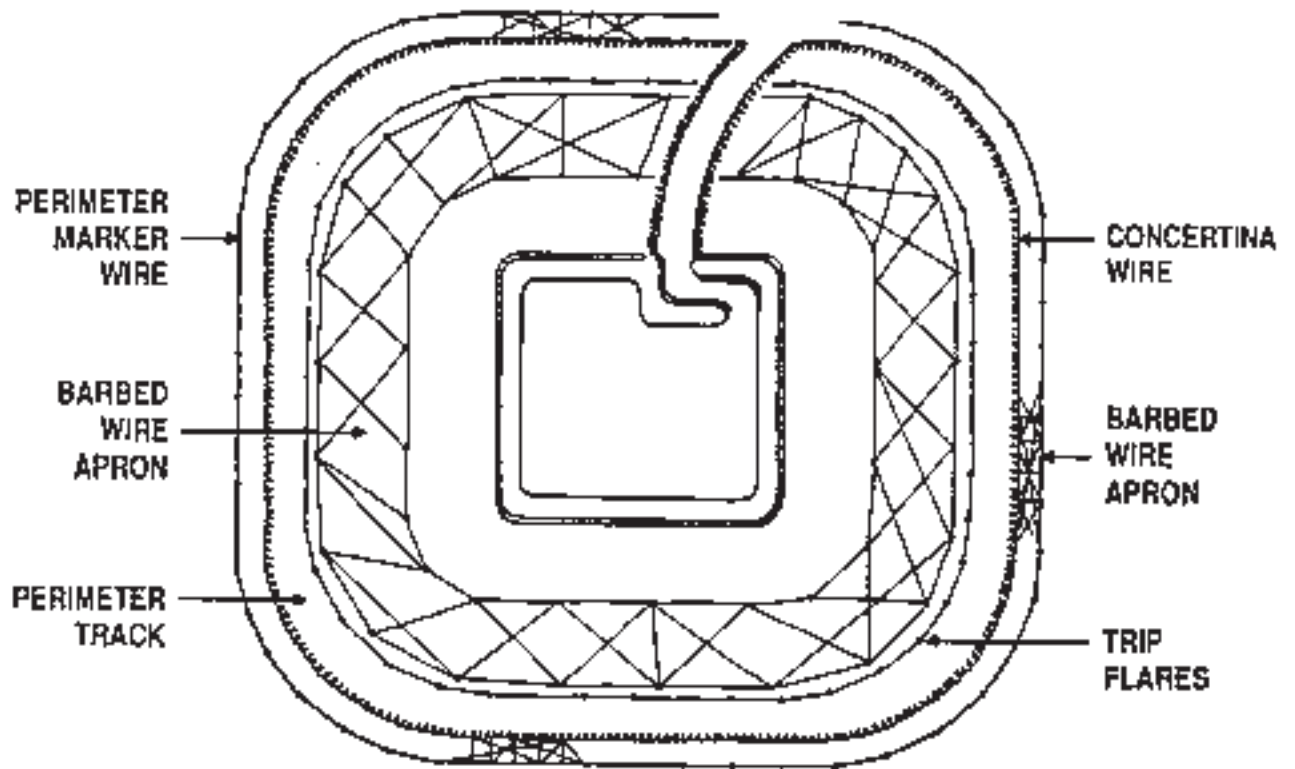

Annex "C.2." to Guidelines for National or Regional Training Programmes

SUGGESTED LAYOUT CHECKPOINT POSITION

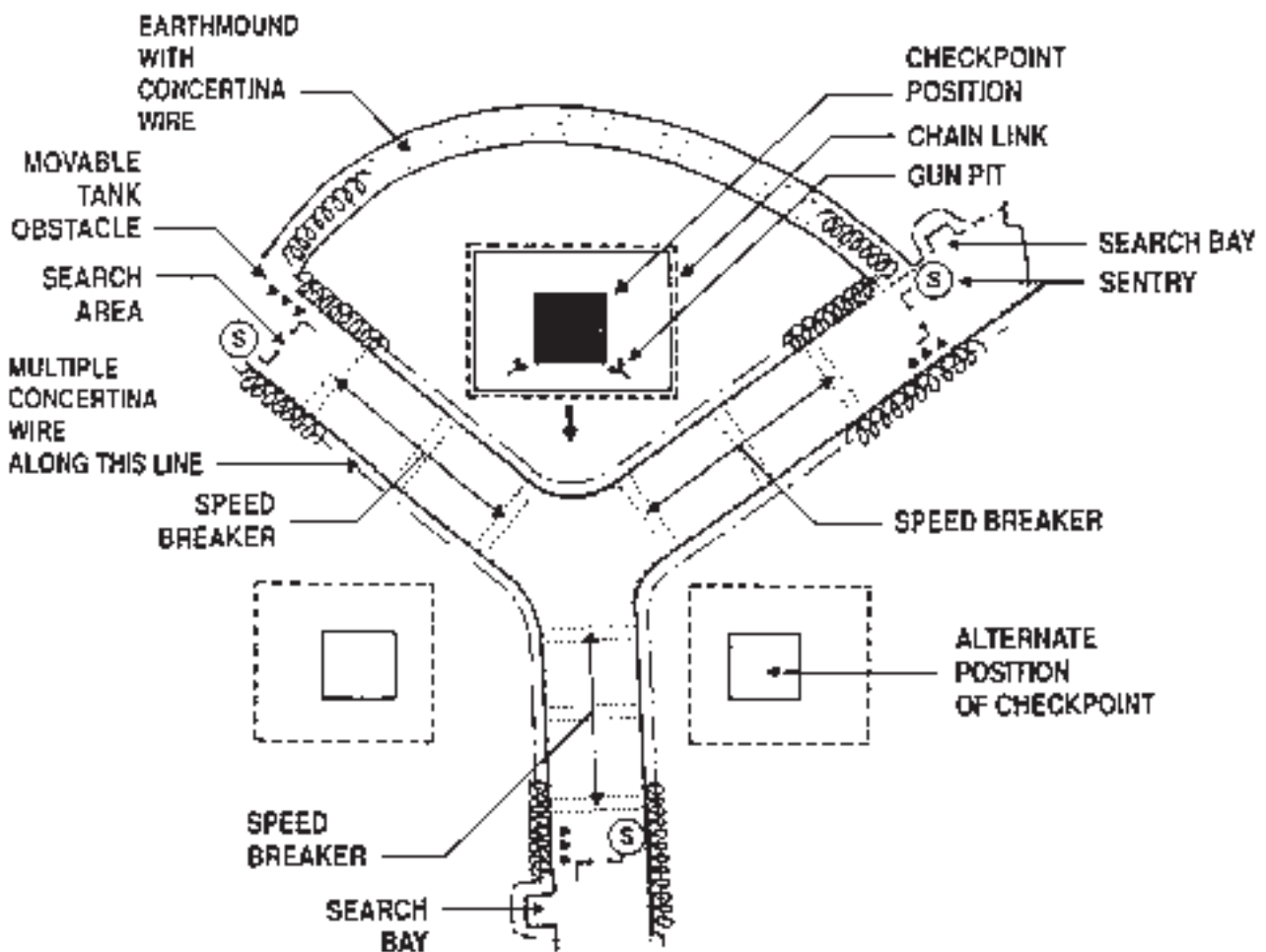

Annex "C.3." to Guidelines for National or Regional Training Programmes

SUGGESTED LAYOUT CHECKPOINT POSITION

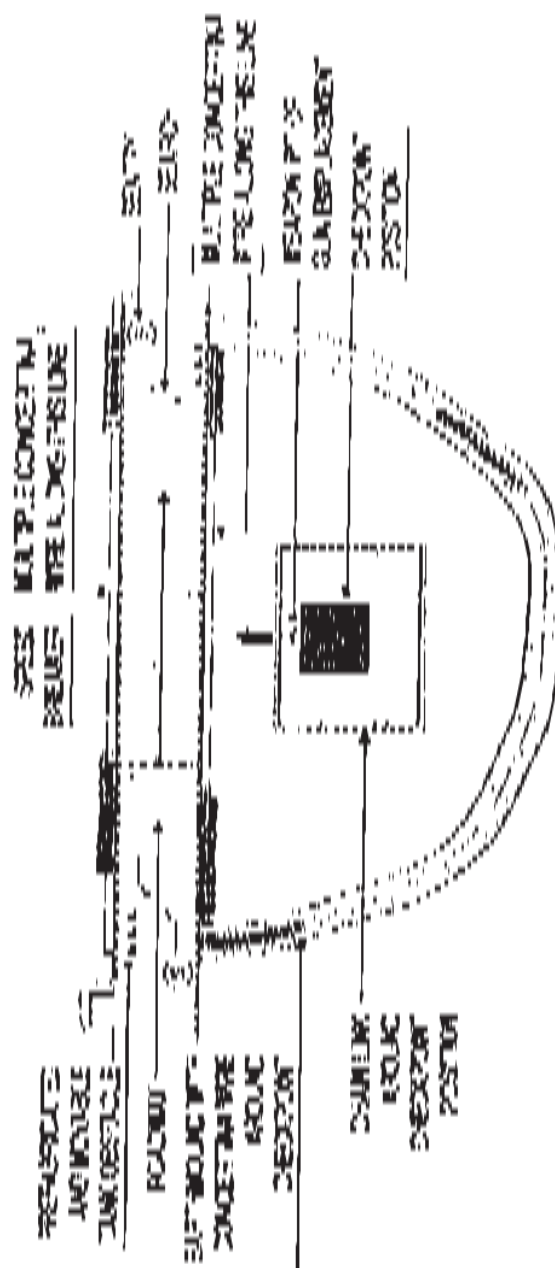

Annex "D" to Guidelines for National or Regional Training Programmes

MOBILE CHECKPOINTS

General

The increase in the road network and the improvement in navigable tracks throughout the AO poses problems for UNIFIL. The use of mobile CHPs is seen as an adequate temporary solution. Each BATT will plan for an operate mobile CHPs each day to augment permanent CHPs and to enhance the control over the area. These CHPs will consist of no less than four soldiers and will cover the many side roads within the AO. Ensure that the location and times of these CHPs are varied and do not become predictable. They will be in radio contact with than major CHP so that they can easily relieve them of pressure when the traffic is heavy. Signs reading "Mobile Checkpoint" written in Arabic and English will always be clearly displayed in the area of the vehicle.

It is stressed that mobile CHPs are not patrols showing a UNIFIL presence. They are separate operations with a definite CHP mission. they can of course be combined with patrolling, depending on the area they are deployed.

Each battalion will pursue a vigorous CHP policy in their AO ensuring that they cover tracks and lesser routes as well as new roads which do not have permanent CHPs.

Mobile CHPs should be co-ordinated by battalions OPs.

Depending on the allocation of armoured vehicles within the unit, each individual Coy could undertake such activity in their own area but it is more likely that a single element (i. e. Recce Coy) be tasked with the mission for the whole AO. This is a prerogative of the unit.

Battalion OPs will maintain a separate mobile CHP register and brief/debrief the CHP before and after each mission. For suggested layout of the Mobile Checkpoint Register see Annex B, OPS Directive 1/88. the main features are covered in paragraph 12, OPS Directive 1/88.

Mobile CHPs can be either category A, B, or C, depending on where they are deployed but it would be normal to follow a Category B policy as they cover areas not normally checked, where they may be a high level of potential infiltration of weapons and a low traffic density.

Strength and equipment. This is a unit responsibility but ideally the strength of the CHP should be at least a section and two armoured vehicles. Personal weapons and the vehicle should apply the necessary defensive potential. The vehicles should provide protection. Ancillary equipment such as signposts, wire barriers, mobile vehicle stops, etc., should be carried in the vehicles.

Method of operation

The mobile CHP/patrol should leave base after briefing by the unit ops officer. The briefing should include:

- Routes out and back. These should be varied constantly to avoid interdiction or planned attack;
- The number of CHPs required, the position of deployment and the average time in place;
- Instructions on communications, report lines, etc.;

Special instructions

The patrol then leaves base and sets up its first CHP. In choosing a CHP location, the following criteria should be applied. Though it will not be possible to ensure that all criteria are available on the ground, nevertheless the following provides a set of guiding principles:

- CHPs should be established at varying times and for irregular periods of time.
- Good communications. This is an essential element. An excellent site with poor communications is in fact not a site at all.
- Communications are necessary to:
 - maintain contact with controlling station (normally battalion OPS);
 - to call on EMR as back-up;
 - to allow the CHP to be redeployed should a particular problem arise elsewhere.

CHPs should not be visible to approaching vehicles from a long way off to avoid them taking alternative routes. CHPs should, however, be sited so that they give some short term warning to approaching vehicles and so avoid accidents. Proper use of terrain features is a necessary requirement.

If possible, the CHP should be sited on an incline which will slow down traffic.

CHP locations should be different each time specific route is given. Routes should not be specific to given days. Routes in a given area should be varied if possible.

Once a CHP has been in position for the planned period of time it should redeploy to its next location and so, until it arrives back at base for debrief.

Security of CHPs

All CHPs should provide adequate security for personnel. The nature of the mission requires some soldiers to be dismounted in order to check/search vehicles. These soldiers must be given the same protection as they would get on a permanent CHP. This security is provided by:

- the proper deployment of the CHP in order to give it a tactical advantage over the vehicle to be checked;
- use of makeshift barriers;
- use of armoured vehicle to block the road;
- use of main armament of armoured vehicle to cover troops involved in checking and searching;
- in some cases, where terrain and strength of patrol allow, a dismounted covering group could occupy a suitable position to give additional cover to the whole CHP.

Pre-recce and preparation

The implementation of this policy will require pre-recce by the units and sub-units concerned before a battalion plan can be drawn up. Consultation with local leaders may also prove beneficial before putting this policy into effect.



**United Nations
Department of
Peace-Keeping
Operations Training**

PEACE-KEEPING TRAINING

**An introduction
to peace-keeping**

**Exercise 1
NEUTRALITY,
RELIABILITY,
IMPARTIALITY**



NEUTRALITY, RELIABILITY AND IMPARTIALITY: an introduction to UN Peace-Keeping

Aim of this exercise

- Personnel at all levels will understand correctly the UN concepts and principles of Peace-Keeping.
- Their conduct and behaviour will be consistent with the UN mandate for Peace-Keeping.

General suggestions

This subject should be dealt with by a senior officer with knowledge and experience in UN Peace-Keeping.

It may be useful for the commander of the national contingent to include this subject in his initial briefing of troops to be trained for Peace-Keeping Operations.

Additional reading materials should be distributed to strengthen the fundamental understanding of UN Peace-Keeping Operations.



NEUTRALITY, RELIABILITY AND IMPARTIALITY

Suggested training strategy

Classroom Training

TRAINING CONTENT	ACTIVITY	MEDIA
<ul style="list-style-type: none"> ■ INTRODUCTION TO UN PEACE-KEEPING MANDATE <ul style="list-style-type: none"> • UN vision of collective security. • Peace-keeping different form traditional military concepts. 	Lecture and discussion with visual aids	Transparency No. 1 Video N. 2
<ul style="list-style-type: none"> ■ PRINCIPLES TO BE FOLLOWED <ul style="list-style-type: none"> • Avoidance of the use of force. • Recognition of Host Government’s Authority • Impartiality • Clarity of purpose • Firmness • Reliability • Anticipation • Integration 	Lecture and discussions with visual aids. Lecture, discussion and tests Lecture and role-play of constructed incidents Lecture and discussion Lecture illustrated with constructed incidents and examples of definitive behaviour Lecture and discussion Lecture and role-play Lecture and discussion	Transparency No. 2 Transparency No. 3 Transparency No. 4 Transparency No. 5 Transparency No. 6 Transparency No. 7 Transparency No. 8 Transparency No. 9

Note: A role-play may cover one or more of the above principles



Lecture Notes

NEUTRALITY, RELIABILITY AND IMPARTIALITY

NEUTRALITY, RELIABILITY AND IMPARTIALITY: an introduction to UN Peace-Keeping

Introduction

When the United Nations was founded at the end of the Second World War, one of its fundamental principles was the idea of “Collective Security”. The evolution of UN peace-keeping has been the effort to make the vision of collective security a reality.

The attitude and conduct of UN peace-keeping personnel at all levels must be consistent with the UN concepts of Neutrality, Reliability and Impartiality. It is in this respect that UN peace-keeping is fundamentally at variance with the traditional military attitude and conduct. Peace-keeping must adhere to principles that are different from military concepts: and it demands knowledge that is not acquired through military training.

Principles

Principles to be followed by all UN personnel are:

- Avoidance of force
- Recognition of Host Governments’ Authority
- Impartiality
- Clarity of purpose
- Firmness
- Reliability
- Anticipation
- Integration



Lecture Notes

NEUTRALITY, RELIABILITY AND IMPARTIALITY

Avoidance of the use of force

“Force will not be used to bring an end to a conflict to maintain peace” is a fundamental principle on which UN Peace-Keeping was founded in the 1950s by the Secretary-General, DAG HAMMARSKJÖLD (Chapter 6 1/2). Ever since, peace-keeping troops have never used force except in self-defence when all else failed. Peace-keeping troops are armed, but their arms are not meant to be used in a military sense. They are soldiers, but their martial skills are to be used only in exceptional circumstances.

The conditions for the use of force in self-defence are:

- prevention, as far as possible by negotiation
- if negotiation fails and a situation develops where “firing for effect” is the only option, it must be preceded by warnings and only the minimum of force must be used.

Recognition of host governments’ authority

“A Peace-Keeping Operation will take place only with the consent of the States involved” is another principle of UN Peace-Keeping. A Peace-Keeping Force deployed in a country is invited to the country by its Government. It can remain there only at the consent of the very same Government. While a Peace-Keeping Force enjoys certain privileges and immunities, its members must respect the host country’s law and customs, bearing in mind that *“UN Peace-Keeping Force is not an occupation force”*.

Impartiality

Absolute impartiality and neutrality, in word and deed, is essential in order to retain the trust and confidence of the parties to the dispute and of the host government. When and if a Peace-Keeping Force is suspected of favouring one of the parties concerned, the other party will no longer trust the Peace-Keeping Force. Once mutual trust has evaporated, the UN force will find it difficult to implement its mandate. The parties involved are usually concerned about their amour-propre, and an unwise word or act which pokes fun at one of the parties or injures its self-esteem will result in bitterness, non-cooperation, and perhaps hostility, and may jeopardize the Peace-Keeping Operation.

Clarity of purpose

It is essential that both sides are made fully aware of what the Peace-Keeping Forces are trying to achieve, and why. Failure in this respect leads to misunderstandings and distrust, that may be hard to put right.



Lecture Notes

NEUTRALITY, RELIABILITY AND IMPARTIALITY

Firmness

On matters of principle, peace-keepers must show a firmness of purpose and excellent solidity otherwise their prestige will be lowered. A party to the dispute may threaten to use force, but it is well aware that its government will have to answer to the Security Council later for the use of violence, and have to face public opinion too.

A firm adherence to principles and purpose enhances the prestige and image of a UN Peace-Keeping Force. It dissuades a party that threatens aggression. The potential aggressor may to some extent become “hostage” to the principled behaviour of a UN Peace-Keeping Force, and also to public opinion. It may be argued that terrorists, who are not very concerned about their own reputation, are not inhibited by such constraints. Nonetheless, a government which supports a terrorist group might feel embarrassed by the terrorist’s actions.

Reliability

The UN Peace-Keeping Force, relying on conduct founded on good principles, enhances its trustworthiness. Indeed in a chaotic and critical situation, the only reliable agency the desperate people can depend on is the UN Peace-Keeping Force.

Anticipation

Incidents likely to provoke violence should be anticipated as far as possible. Timely actions should be taken to prevent violence. This may also involve rapid deployment of Peace-Keeping Force between the two sides, before an incident develops into a serious situation.

Integration

A Peace-Keeping Force is composed of national contingents which are integrated into a whole to uphold common UN identity and clarity of purpose. The integration can be in two respects:

- The national contingents must all be dependent on one another. This is usually achieved by allotting, inter alia, responsibilities for logistic support, communications, and airlift to different countries so that no contributor is perceived to exercise undue influence.
- When a confrontation is likely between the Peace-Keeping Force and one or both of the parties, it is wise to interpose a small group drawn from as many national contingents as possible, or a force reserve in order to demonstrate solidarity and unity of purpose of the UN Peace-Keeping force.



United Nations
Department of
Peace-Keeping
Operations Training

PEACE-KEEPING TRAINING

**An introduction
to peace-keeping**

**Exercise 1
NEUTRALITY,
RELIABILITY,
IMPARTIALITY**

Transparencies

INTRODUCTION TO UN PEACE-KEEPING

RELIABILITY AND IMPARTIALITY

- The attitude and conduct of UN Peace-Keeping Personnel is at variance with traditional military concepts
- It requires understanding and behaviour that are not acquired through military training

AVOIDANCE OF THE USE OF FORCE

The ethos of Peace-Keeping is based on:

- KEEPING PEACE BY NEGOTIATION
- TROOPS ARE ARMED ONLY FOR SELF-DEFENCE
- FORCE CAN BE USED ONLY IN SELF-DEFENCE AGAINST DIRECT ATTACKS

RECOGNITION OF THE HOST GOVERNMENT'S AUTHORITY

- A Peace-Keeping Force is not an occupation force
- It is invited there by the Government of the country and will remain there only at the consent of the Government
- UN personnel must respect the laws and customs of the country

IMPARTIALITY

**Absolute impartiality
in word and deed
is essential
in order to retain
the trust
and confidence
of the parties
to a dispute**

CLARITY OF PURPOSE

**Parties to a dispute
should be made
fully aware of what
the PKO is trying
to achieve,
and why**

FIRMNESS

**The prestige,
power and reputation
of UN Peace-Keeping
depends heavily on:**

**“FIRM ADHERENCE
TO PRINCIPLES”**

RELIABILITY

**The image and
conduct of
UN Peace-Keeping Force
must demonstrate that
it can be relied on
and trusted**

ANTICIPATION

**Incidents likely
to provoke violence
should be anticipated
and defused**

INTEGRATION

**A Peace-Keeping Force
composed of national
contingents should be
integrated to uphold
the UN mandate**

**It should project
a common UN image**



**United Nations
Department of
Peace-Keeping
Operations Training**

PEACE-KEEPING TRAINING

Exercise 2 GUARDING of HQ and VITAL OBJECTS



GUARDING OF HEADQUARTERS AND VITAL OBJECTS

Aim of this exercise

To achieve:

- Adequate protection for personnel buildings and sensitive equipment at HQ and field posts.

In particular this guideline focusses on:

- How to protect objects such as headquarters, communication centres, weapon depots, etc.;
- How to organize the guard;
- How to make simple alarm devices.

General suggestions

Theoretical training should include principles of planning and organization for the protection of UN objects. It should also include the study of types, duties and behaviour of sentries.

The practical training exercises should include the actual planning and implementation of protection measures of existing or simulated objects in every detail. Surveillance and control duties must be practised in various types of objects and in simulating a variety of circumstances which range between normal and emergency situations during day and night time.



Training Guide

GUARDING OF HQ AND VITAL OBJECTS

Suggested training strategy

TRAINING CONTENT	ACTIVITY	MEDIA
<ul style="list-style-type: none"> ■ AIM OF THE EXERCISE <ul style="list-style-type: none"> • Protect personnel, buildings, equipment • Organize objects and guard 	<p>Explain</p>	
<ul style="list-style-type: none"> ■ THREATS <ul style="list-style-type: none"> • Attempt to steal • Direct firing, shelling or bombing • Terrorist attacks 	<p>Discuss which items are likely objects of theft</p> <p>Illustrate with examples</p>	
<ul style="list-style-type: none"> ■ PROTECTION OF THE OBJECT <ul style="list-style-type: none"> • Compounds and buildings • Location of operation and signal centre, guard room, first aid station etc. • Guard facility • Window protection • Perimeter and ground protection • Engineering (auxiliary power generator, tools, fire fighting equipment) • Shelter 	<p>Demonstrate examples</p> <p>Demonstrate layout plans of different objects</p> <p>Simulation exercise</p> <p>Practise protection of existing windows</p> <p>Illustrate and practice examples shown in T3, T4, T5, T6, T7, T8</p> <p>Practise operation of engineering equipment</p> <p>Practise setting up and using shelters</p>	<p>Transparencies Nos. 1, 2, 3</p> <p>Transparencies Nos. 3, 4, 5, 6, 7, 8</p> <p>Transparency No. 8</p>



Training Guide

GUARDING OF HQ AND VITAL OBJECTS

TRAINING CONTENT	ACTIVITY	MEDIA
<ul style="list-style-type: none"> Defence and evacuation 	<p>Exercise the planning of defence and evacuation of the object</p> <p>Exercise practical drills in emergency simulations</p>	
<p>■ MAIN TASKS OF GUARDS</p> <ul style="list-style-type: none"> Control of personnel and vehicles Admission control Patrols inside and outside the object Surveillance of areas 	<p>Lecture and discussion</p> <p>Practise of each main task</p>	
<p>■ TYPES AND DUTIES OF SENTRIES</p> <ul style="list-style-type: none"> Standing sentry Moving sentry <p>■ SURVEILLANCE SENTRIES</p> <ul style="list-style-type: none"> Positioning Surveillance techniques and tools Improve visibility 	<p>Discuss advantages and disadvantages</p> <p>Exercise the planning of positioning surveillance sentries using different objects</p> <p>Practise day and night duties of surveillance sentries</p> <p>Use example in the transparencies</p>	<p>Transparencies Nos. 3, 7, 8, 9</p> <p>Transparencies Nos. 3, 4</p>



Training Guide

GUARDING OF HQ AND VITAL OBJECTS

TRAINING CONTENT	ACTIVITY	MEDIA
<ul style="list-style-type: none"> ■ CONTROL SENTRIES <ul style="list-style-type: none"> • Admission control • Entrance protection for approaching vehicles • Control of vehicles 	<p>Discuss admission rules Practice identification of admission cards</p> <p>Practise layout of the transparencies</p> <p>Discuss control procedures practice both admission control and control of vehicles</p>	<p>Transparencies Nos. 1, 2, 3</p> <p>Transparencies Nos. 10 and 11</p>
<ul style="list-style-type: none"> ■ SIMPLE ALARM DEVICES <ul style="list-style-type: none"> • Devices which are admitted and those which are not • Fabrication of simple devices 	<p>Illustrate examples</p> <p>Practice the fabrication and positioning of devices during surveillance sentries exercises.</p>	<p>Transparency No. 12</p>



Lecture Notes

GUARDING OF HQ AND VITAL OBJECTS

GUARDING OF HEADQUARTERS AND VITAL OBJECTS

Aims

In general, how to achieve improved protection for personnel, buildings and sensitive equipment.

More specifically:

- how to protect different objects, like headquarters, communication centres, weapon depots, etc.
- how to organize the guard
- how to make simple alarm devices

Threats

The UN will often be respected by the different parties in an area. Nevertheless, serious situations might appear. The most serious threat to the UN might be:

- elements trying to steal documents, weapons/ammunition or food/fuel, direct threats/bomb threats to UN personnel or to UN key objects
- direct firing at or shelling of UN positions
- terrorist attacks



GUARDING OF HQ AND VITAL OBJECTS

Protection of the object

The OPs, CPs and UN headquarters are not concealed. As well known, the UN also paint their objects white so the objects are easily observed. Usually UN cannot use camouflage to hide and thus protect its objects.

Figure T1 illustrates a layout of a compound and Figures T2 and T3 examples of buildings.

Internal Layout of a Standard Section-Sized Compound

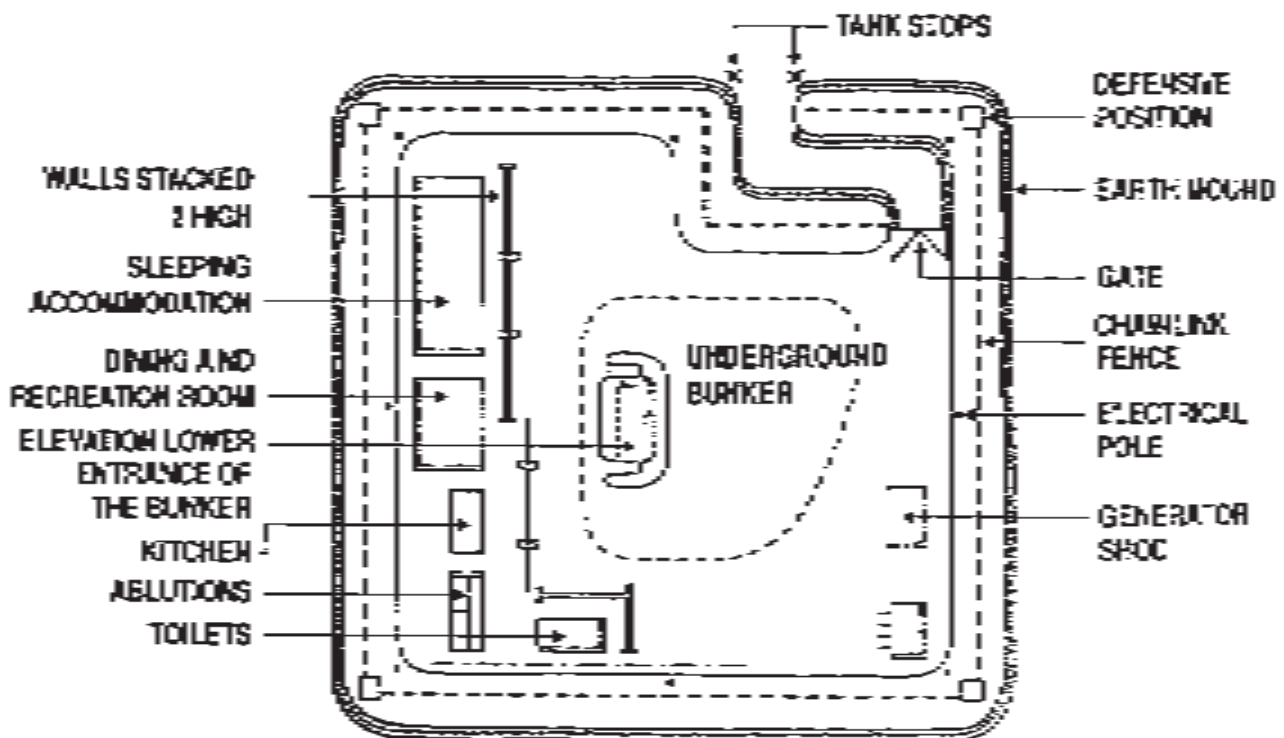



Lecture Notes

GUARDING OF HQ AND VITAL OBJECTS

Example of defence positions for building protection

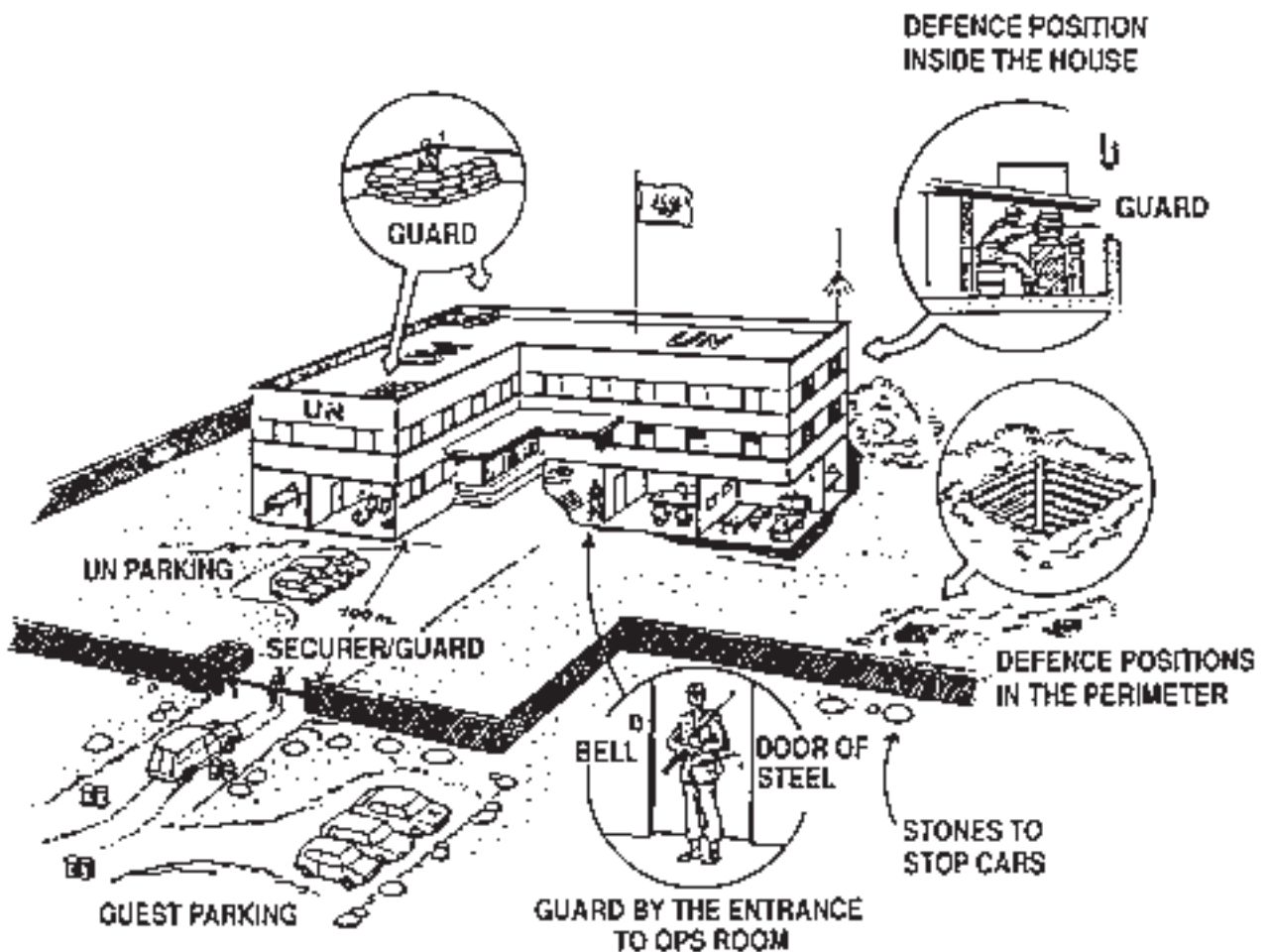

NOTE:

1. IF THERE IS A DANGER OF CAR BOMBS, A CHP IS TO BE CONSTRUCTED BY THE ENTRANCE FOR COMPLETE PROTECTION.
2. TO IMPROVE PROTECTION, EARTH WALLS AROUND LOWER PARTS OF BUILDING OR SAND BAGS.



Lecture Notes

GUARDING OF HQ AND VITAL OBJECTS

The building

The first step will be to find a suitable and well-built building. Old buildings may often offer better protection against direct firing than some buildings of modern construction, but also other facilities are needed in a modern headquarters.

Location of services

The operation centre, signals centre, guard room, first aid station, etc. should not be situated on the top floor, but are better placed on the lower floors or ground floor and in the centre of the floor itself. This is to obtain maximum protection. Normally it should be impossible to look in from the outside.

If the objects get a direct hit, these rooms have a better possibility of surviving.

Reinforcement

Furthermore, many of these rooms ought to be reinforced by girders and/or rafters or simply by the use of sandbags when possible. (Remember to take into consideration the weight of the sandbags).

Guard facility

As suitable room/flat must be picked out to serve as a guard room and quarters for soldiers off duty, with facilities for rest/sleep.

The guard room must be situated inside or on the object, and it is an advantage if the room is not visible from the outside. It should be provided with radio and land line communication to the higher unit.

Window protection

In trouble spots it is usual to block windows in the lower parts of the building. Instead of windows, small holes are to be made. On the upper floors wire fencing may be used.

Perimeter and ground protection

An object or compound requires adequate protection of the external perimeter by means of fencing and clearing of the surrounding area. Figures T3 and T4 illustrate an example in which a UN compound has been fenced off. The external surrounding of the fence have been cleared from vegetation for a width of 10 to 20 meters and covered with sand and an obstacle of dried branches instead of barbed wire.



Lecture Notes

GUARDING OF HQ AND VITAL OBJECTS

Example of building protection

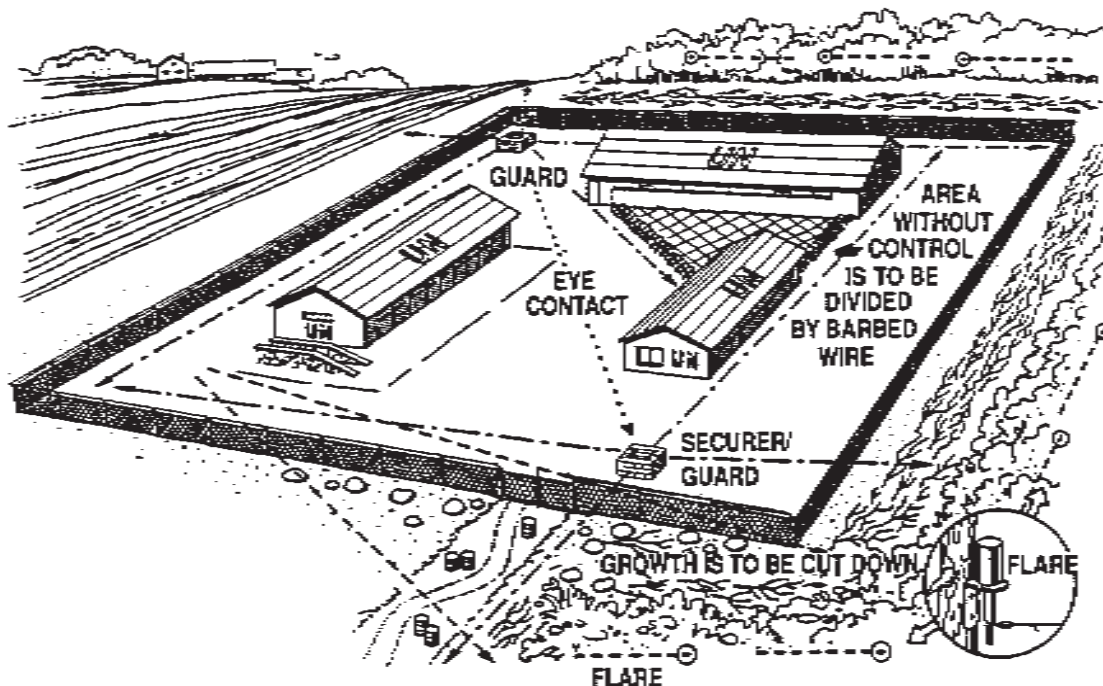

Perimeter protection of an object

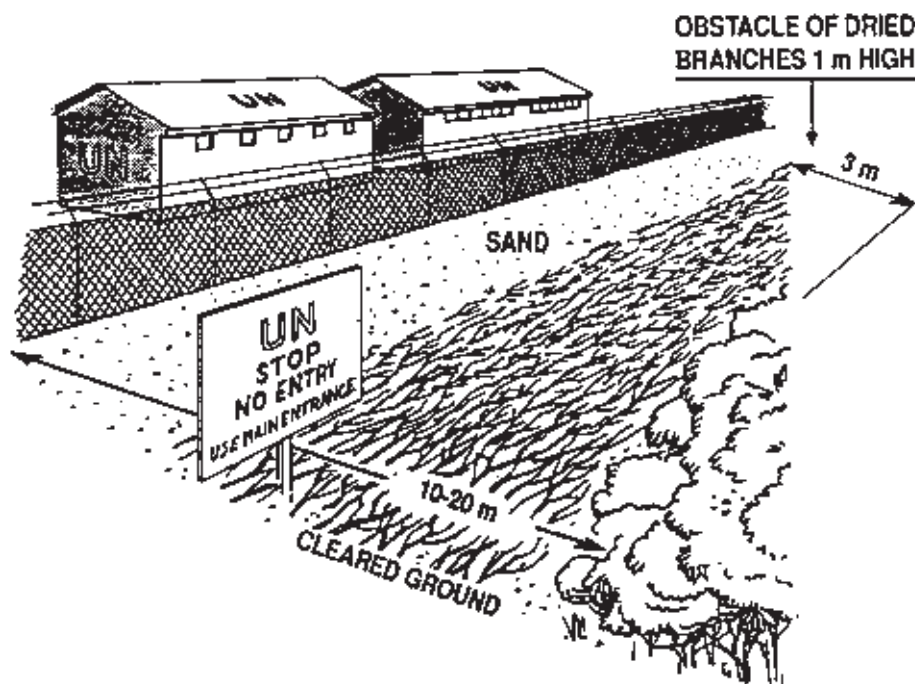

Intertwined dried branches have the advantage of signalling if they are stepped upon.



Lecture Notes

GUARDING OF HQ AND VITAL OBJECTS

Figure T5 illustrates a concrete wall protected with glass fragments, nails or concertina wire on top.

Details of perimeter wall protection

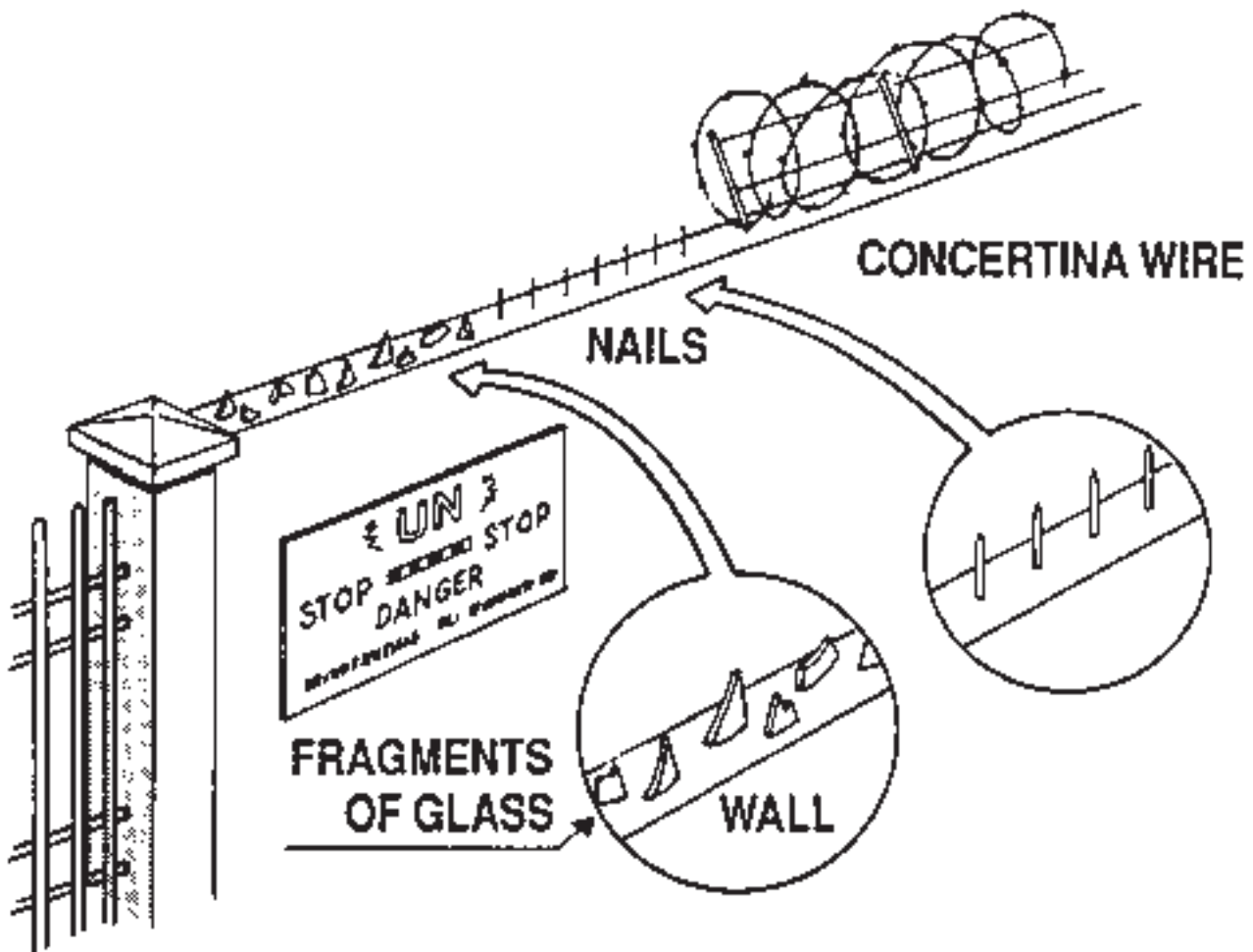

FRAGMENTS OF GLASS, NAILS AND CONCERTINA WIRE MAY BE USED ON TOP OF THE WALL, BUT DISTINCT SIGNS MUST BE SET UP AS A WARNING

Warning panels should set up in all cases.



Lecture Notes

GUARDING OF HQ AND VITAL OBJECTS

Figures T6, T7, T8 show protections with barbed wire or concertina of areas inside the compound.

Stairs protection

BARBED WIRE OR CONCERTINA WIRE ARE EFFECTIVE ON STAIRS. ALWAYS REMEMBER TO NAIL DOWN THE CONCERTINA WIRE.

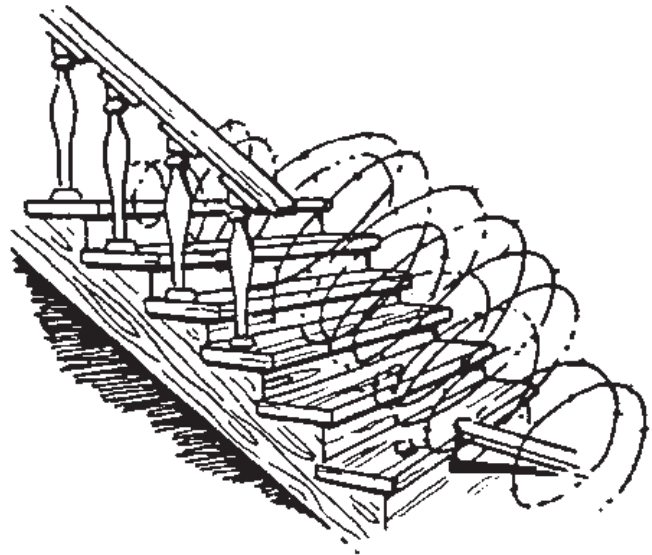

Protection of "dead-zones"

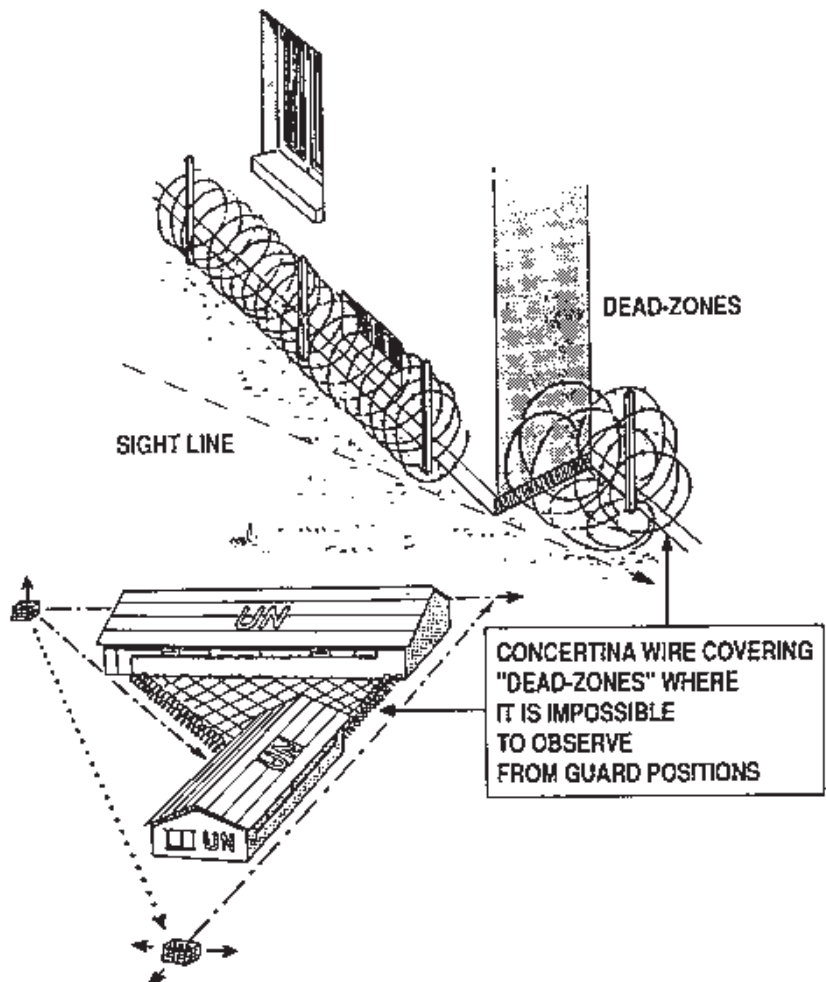



Lecture Notes

GUARDING OF HQ AND VITAL OBJECTS

Engineering

An extra electrical power plant has to be installed.

Tools for the use in collapsed buildings have to be present inside and outside the building.

Proper fire fighting equipment must be installed and proper training has to be carried out. (See chapter on engineering concerning fire fighting equipment).

First aid

First aid equipment must also be at hand in different places. Premises in critical areas may be equipped with an infirmary.

Shelter

Shelters have to be built and properly equipped. Food, water and medical equipment must be present in the shelters. A "shelter plan" must be worked out, which clearly indicates who will be in specific shelters.

Protection and evacuation

How to protect/defend the object must be well planned and frequently drilled.

A plan for evacuation of the buildings (forced or not forced) must be made, together with plans for documents, etc. that must be destroyed and what should be brought along.

Proper orders and good training/motivation will probably prevent serious losses if an accident occurs.



Lecture Notes

GUARDING OF HQ AND VITAL OBJECTS

Main tasks for guards

Main tasks for guards are:

- control of personnel and vehicles
- admission control
- patrols inside and outside of the object
- surveillance of areas with binoculars, and in the dark with search lights and night observation goggles.

Types and duties of sentries

The most important element in the guards' service is the sentry, who may be standing still or patrolling. Generally a sentry who is standing still is better than a sentry who is patrolling.

The advantages of a sentry who is standing still are:

- he can see and hear better
- he can be given protection in the position
- he is more difficult to discover, for whoever wishes to do so.

Surveillance sentries

Surveillance sentries survey an object and the surroundings.

Sentries who are going to survey an area are usually placed high up, preferably on the top floor or on the roof. Firing positions are organized by using sandbags. On the roof several positions may be built, but only a few of them are manned during normal conditions.

(See Figure T9.)



Lecture Notes

GUARDING OF HQ AND VITAL OBJECTS

Positioning sentries and guards

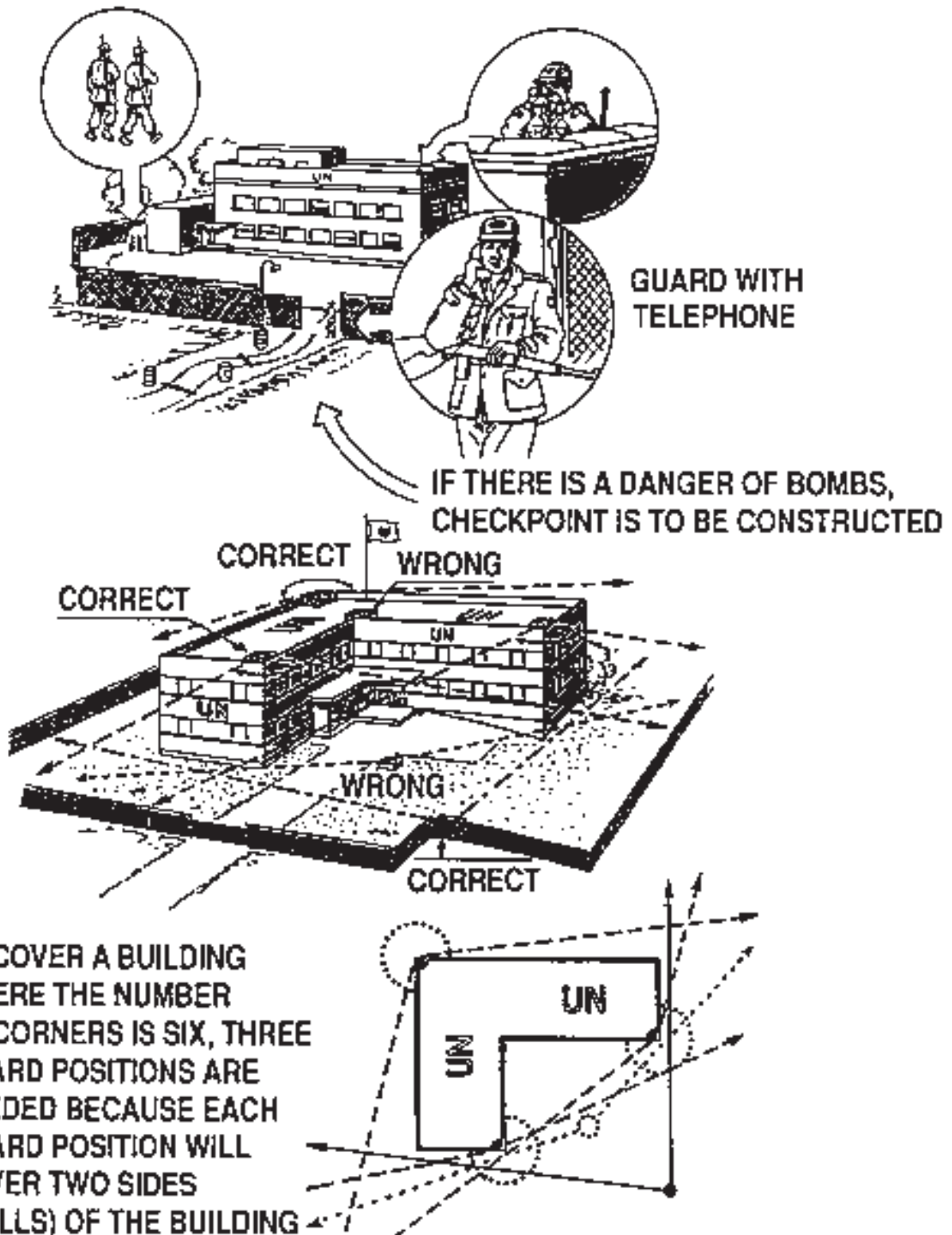



Lecture Notes

GUARDING OF HQ AND VITAL OBJECTS

Sentries surveying a building should be placed in such a manner as to enable them to survey all sides of the construction. Areas without control should be protected with barbed wire.

(See Figures T7 and T8.)

If possible, sentries position should facilitate eye contact among them.

(See Figure T3.)

It is an advantage if high vegetation is reduced to a minimum. This makes the observation and surveillance in the terrain surrounding the object easier. Growth that may throw shadows when searchlights are in use in the dark ought to be reduced to a minimum.

(See Figures T3 and T4.)

Control sentries

Control sentries control personnel, vehicles and goods. There are two types of control: admission control and the control of vehicles.

Admission control

Personnel who have permission to enter the object have to be issued with admission cards that cannot easily be copied. In a headquarters some areas may be restricted. Only a few people have admission to these areas. Such areas are usually:

- operations room,
- signals room,
- briefing room,
- guard room,
- store room for sensitive items (weapons etc.).

Extra guards may be on duty outside the doors to these rooms, and extra locks may be fitted on the doors.



Lecture Notes

GUARDING OF HQ AND VITAL OBJECTS

Control of vehicles

If there is danger of car bombs, etc., only UN vehicles may drive close up to the object. Non-UN personnel may park at a distance of 100-200 meters from the object. It is advisable to use concrete blocks, bumps in the road and other solid obstacles around the object so no type of car (not even a big truck) could force the obstacles .

(See Figures T1, T2 and T3.)

Entrance control must be established, such as a CHP. Non-UN cars have to be checked as described in the chapter on search of personnel and cars.

The illustrated example T10 shows the sequence of operations in controlling a vehicle approaching a checkpoint.

Figure T11 shows how such a checkpoint may be lit during the night.

If there is a tense situation the guard should be reinforced and the resting force kept to a high degree of alert readiness.



Lecture Notes

GUARDING OF HQ AND VITAL OBJECTS

Vehicle stopping and controls



In addition to signs about 50-100 meters before the post, CHP flashes with flashlight telling the driver to reduce speed.

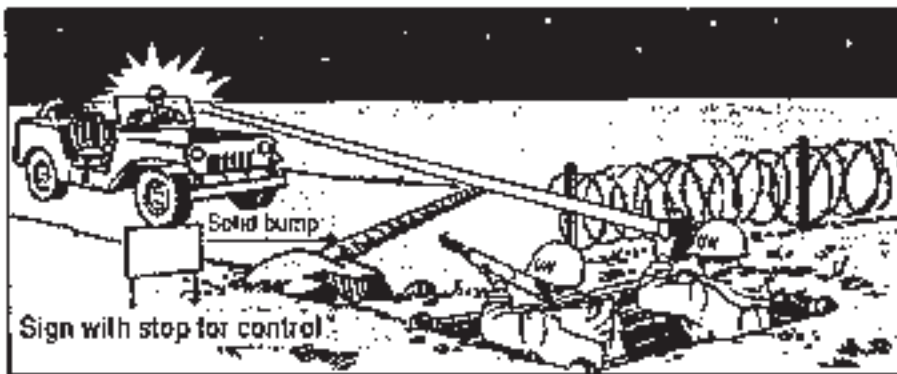

The car has to stop at least 3 m. away from the post.

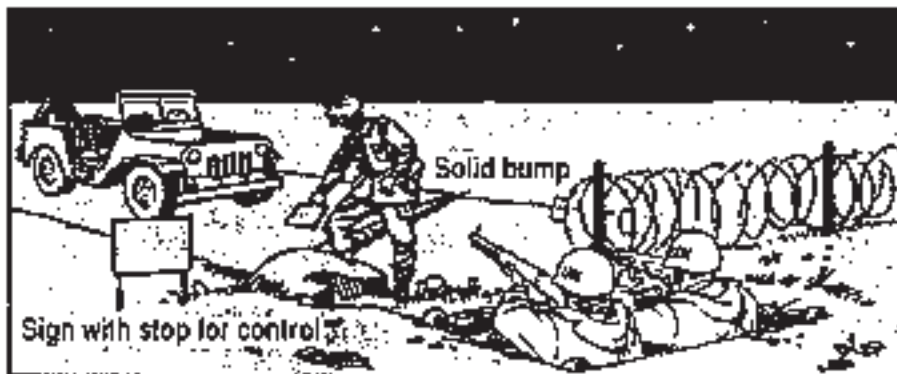

The driver of the unknown car stops the engine, turns the headlights off, gets out of the car and places his admission card/legitimation in an agreed place.

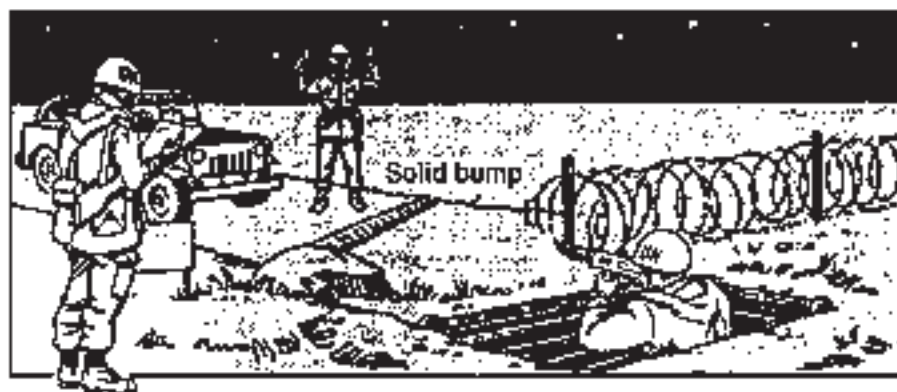

The driver walks away and waits for the results of the examination of his papers.



Lecture Notes

**GUARDING OF HQ
AND VITAL
OBJECTS**

Simple alarm devices

Usually the ears/eyes of the personnel are the most important "devices" in discovering an intruder. It is not allowed to use explosives, etc., that may hurt intruders.

Only trip flares, smoke flares/grenades are allowed. The following drawings, illustration T12, show guard systems and how simple devices are to be made.

Simple alarm devices - 1

CONCERTINA WIRE

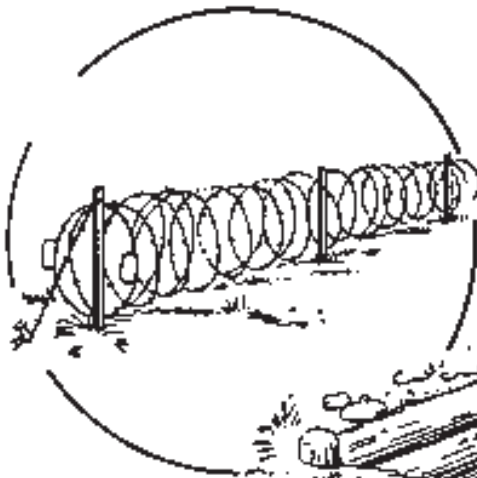

EMPTY CANS PUT TOGETHER

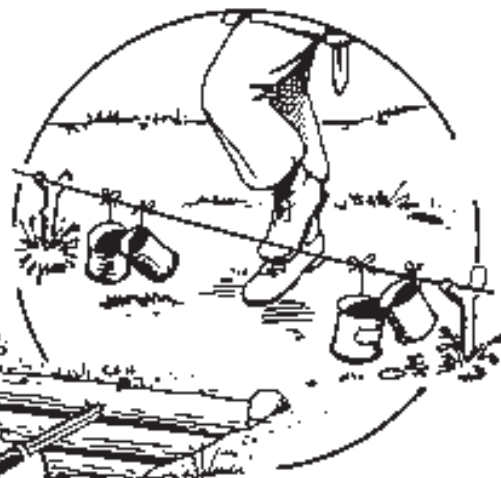

TRIP FLARE

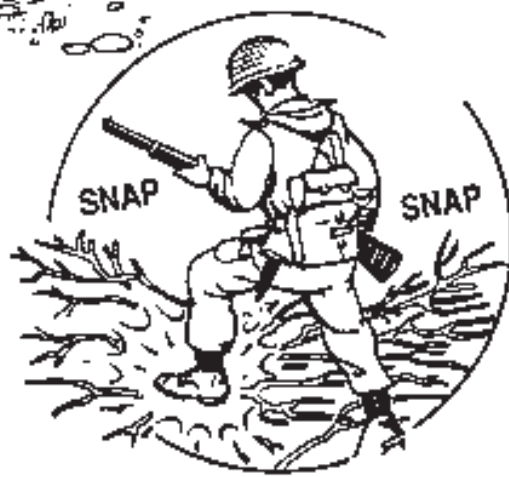

DRY BRANCHES



Lecture Notes

**GUARDING OF HQ
AND VITAL
OBJECTS**

Simple alarm devices - 2

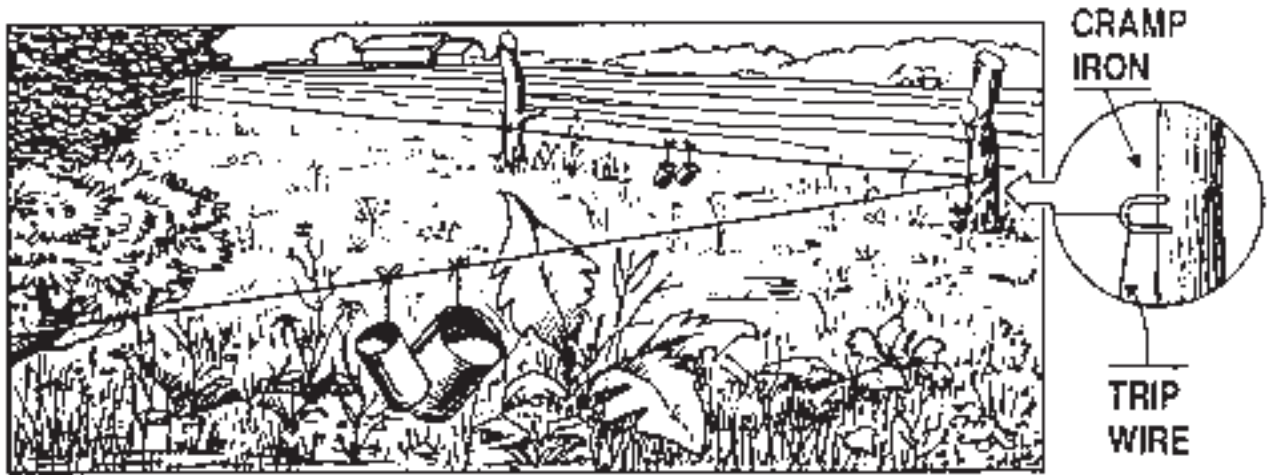

Empty cans put together as a simple warning device. Notice the use of cramp iron for the trip wire.

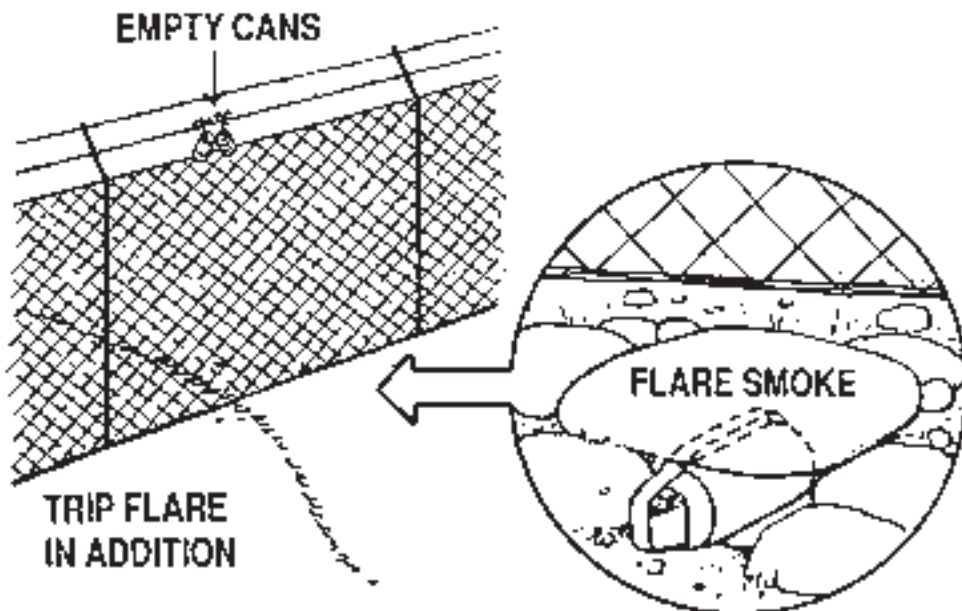

If the fences are not dug down in the ground, it is possible to enter the camp from beneath the fence. Reinforcements like this improve the protection of the object.



**United Nations
Department of
Peace-Keeping
Operations Training**

PEACE-KEEPING TRAINING

Exercise 2 GUARDING of HQ and VITAL OBJECTS

Transparencies

Internal Layout of a Standard Section-Sized Compound

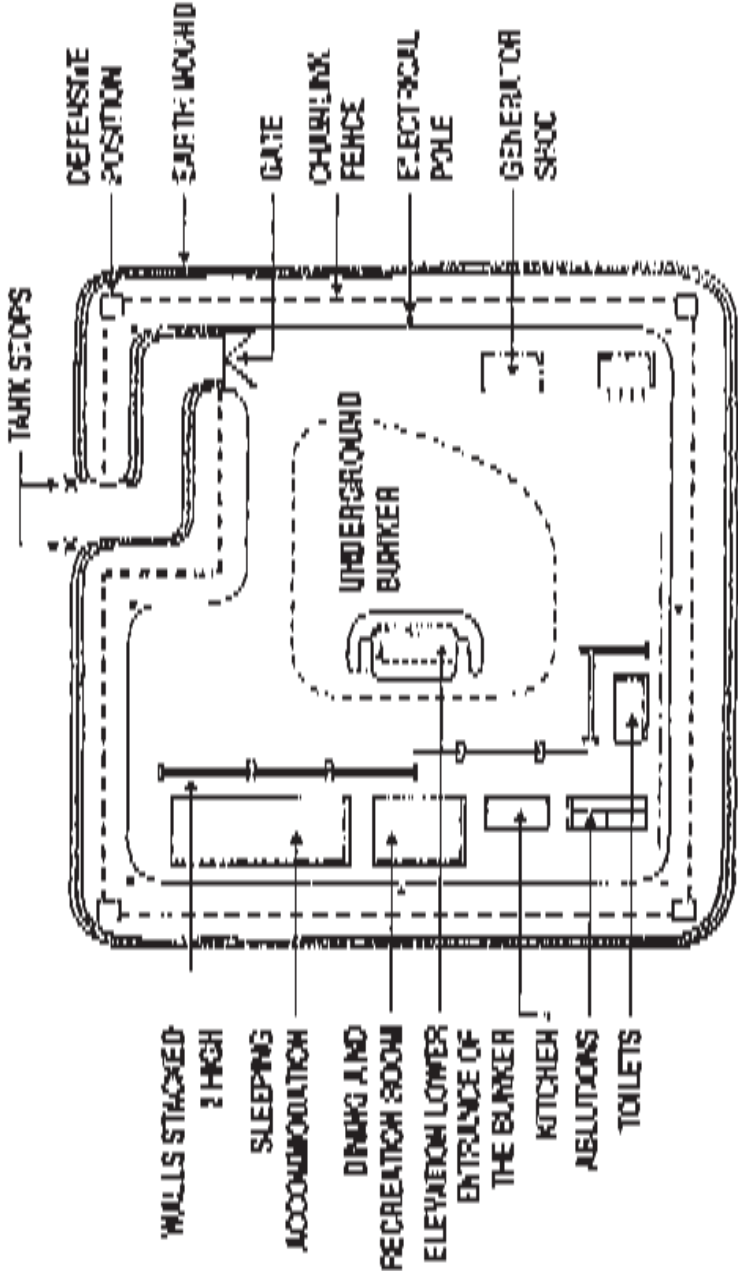

Example of defence positions for building protection

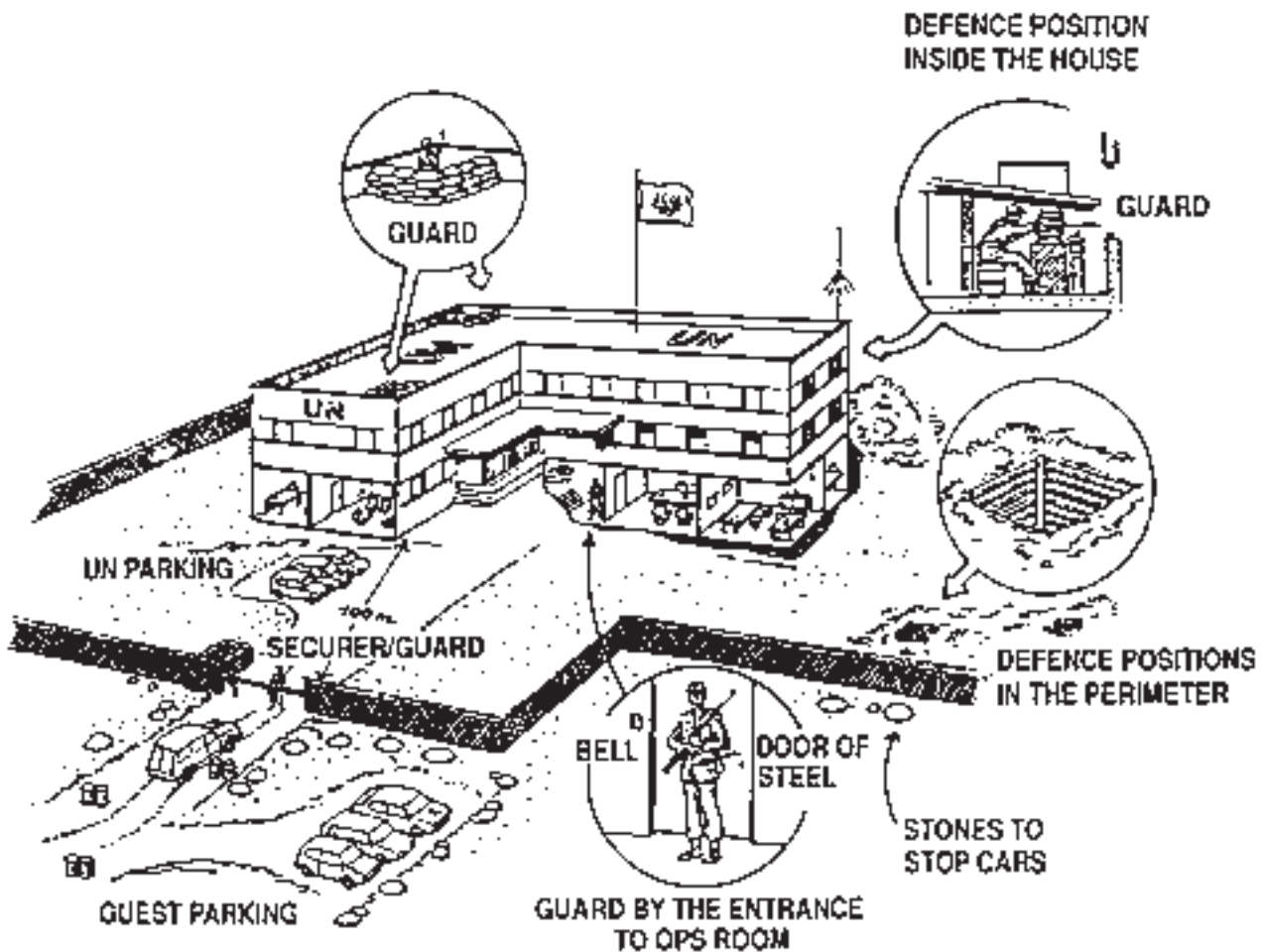

NOTE:

1. IF THERE IS A DANGER OF CAR BOMBS, A CHP IS TO BE CONSTRUCTED BY THE ENTRANCE FOR COMPLETE PROTECTION.
2. TO IMPROVE PROTECTION, EARTH WALLS AROUND LOWER PARTS OF BUILDING OR SAND BAGS.

Example of building protection

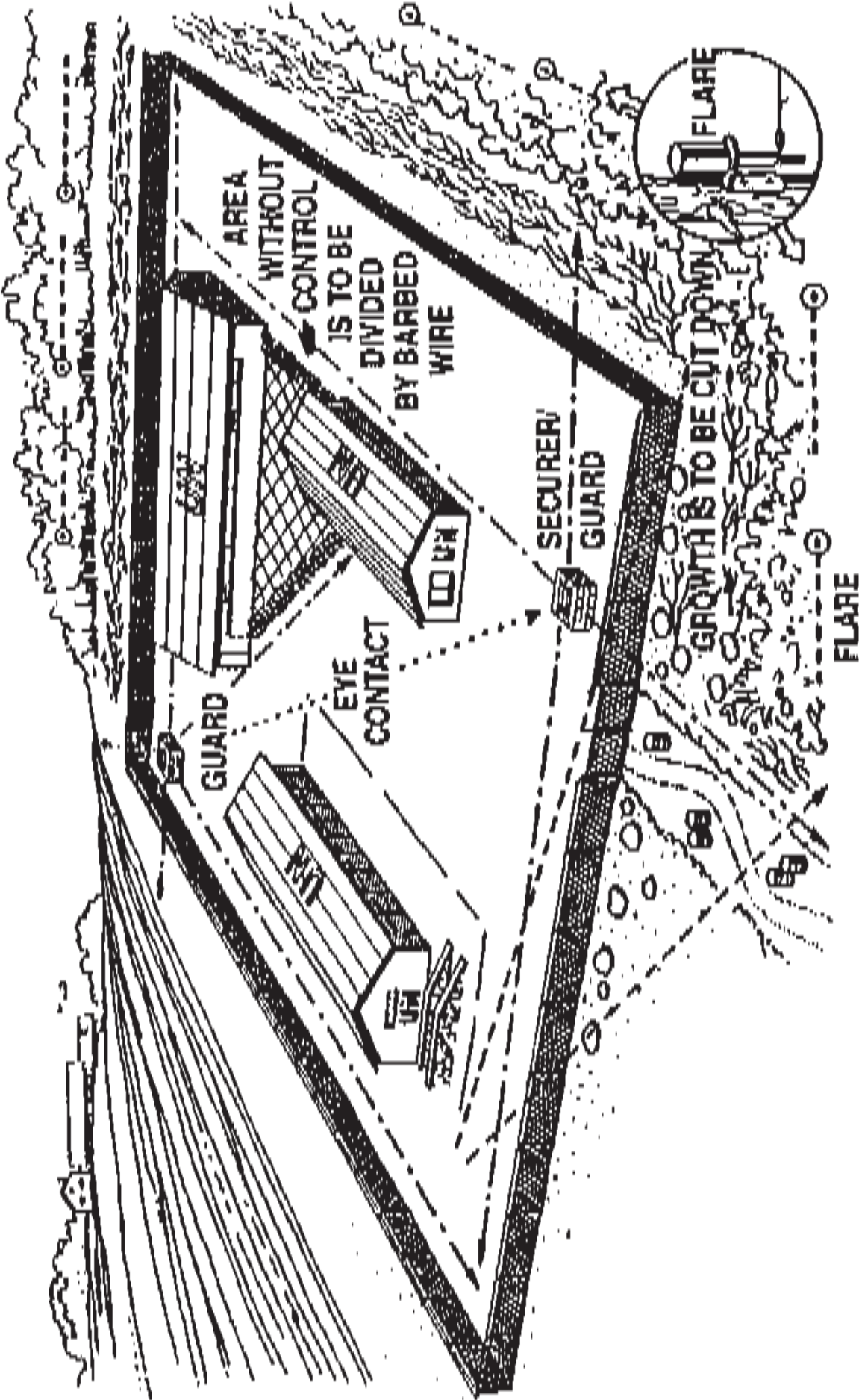

Perimeter protection of an object

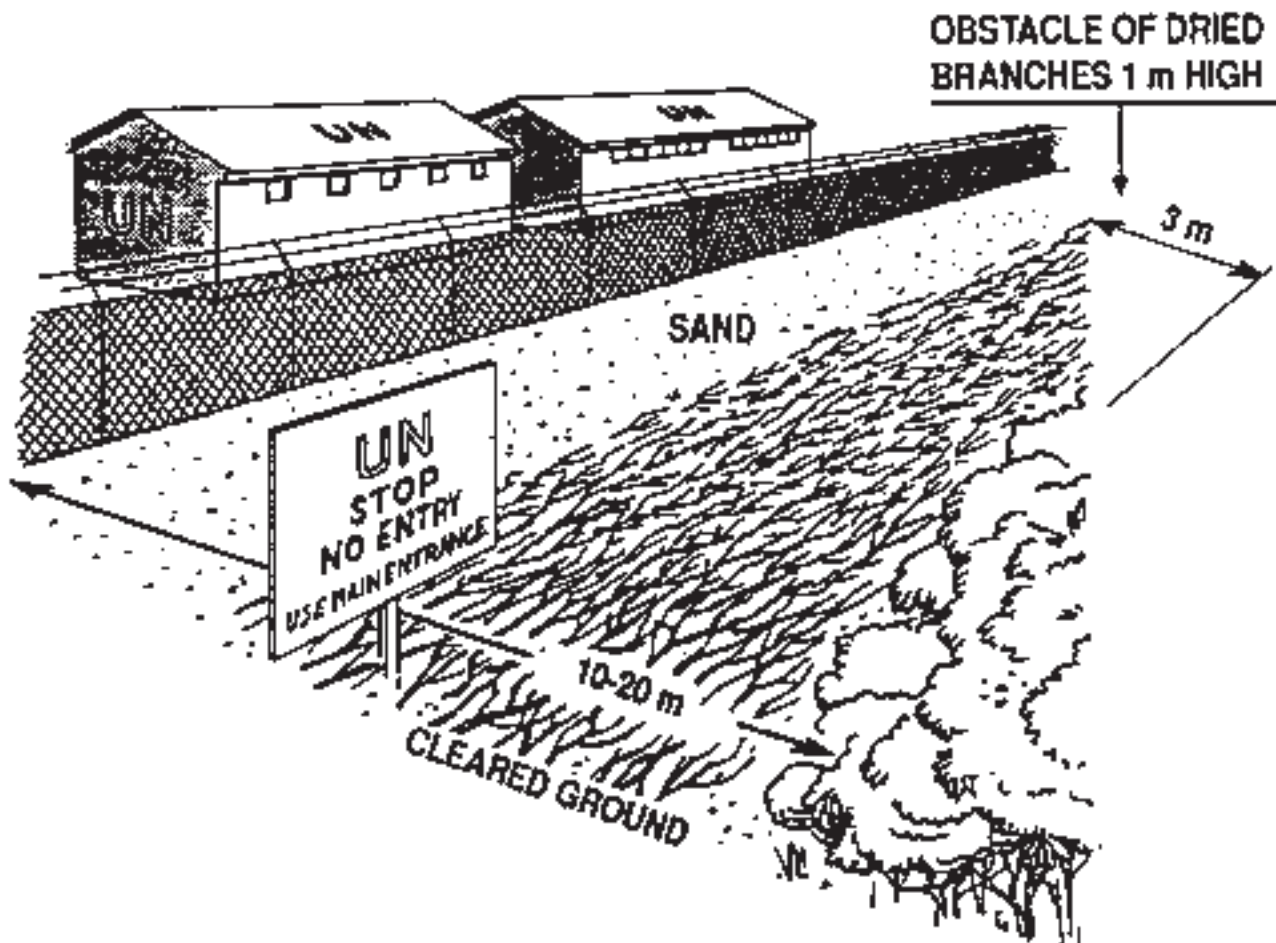

Details of perimeter wall protection

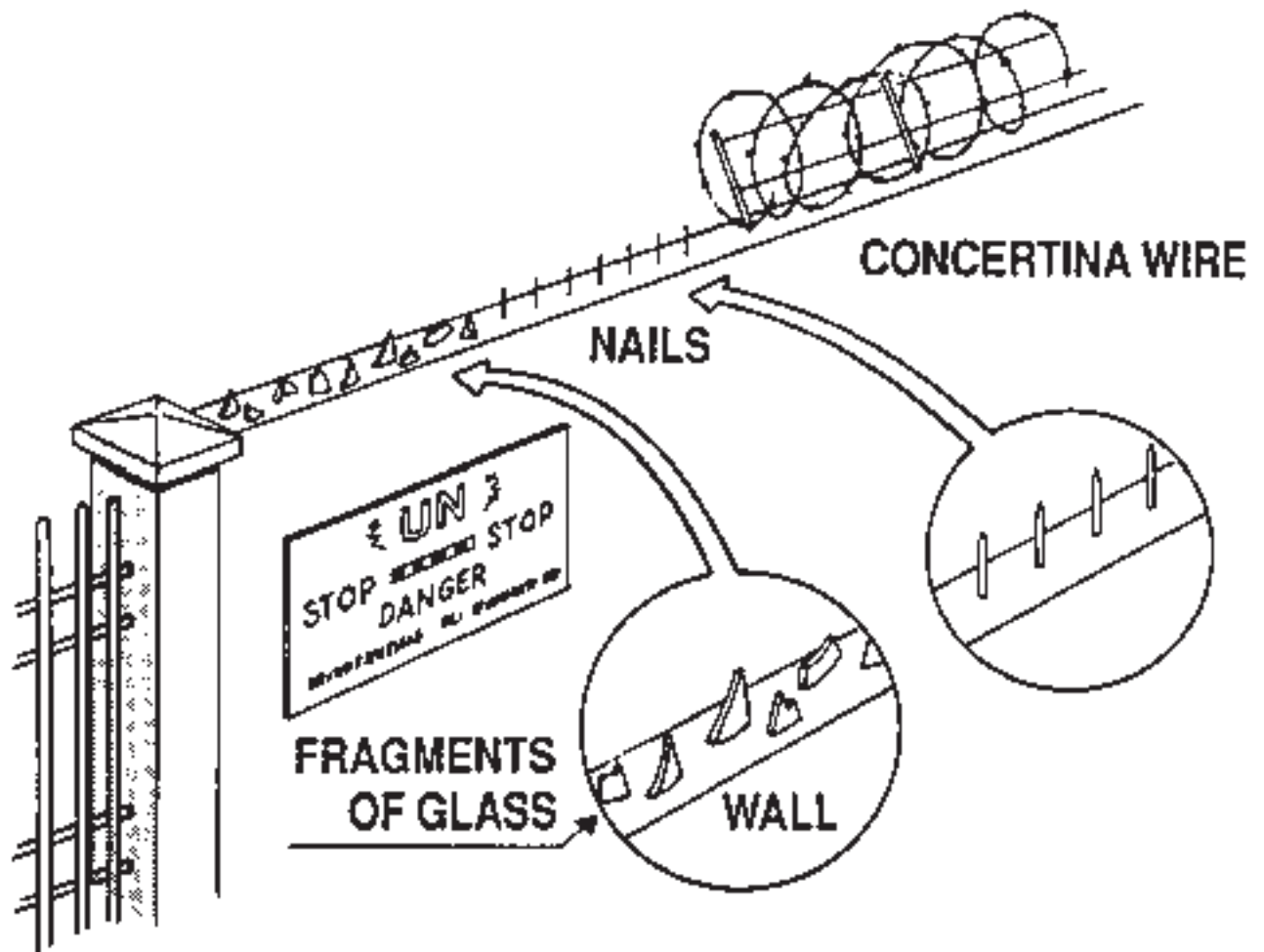

FRAGMENTS OF GLASS, NAILS AND CONCERTINA WIRE MAY BE USED ON TOP OF THE WALL, BUT DISTINCT SIGNS MUST BE SET UP AS A WARNING

Protection of stairs

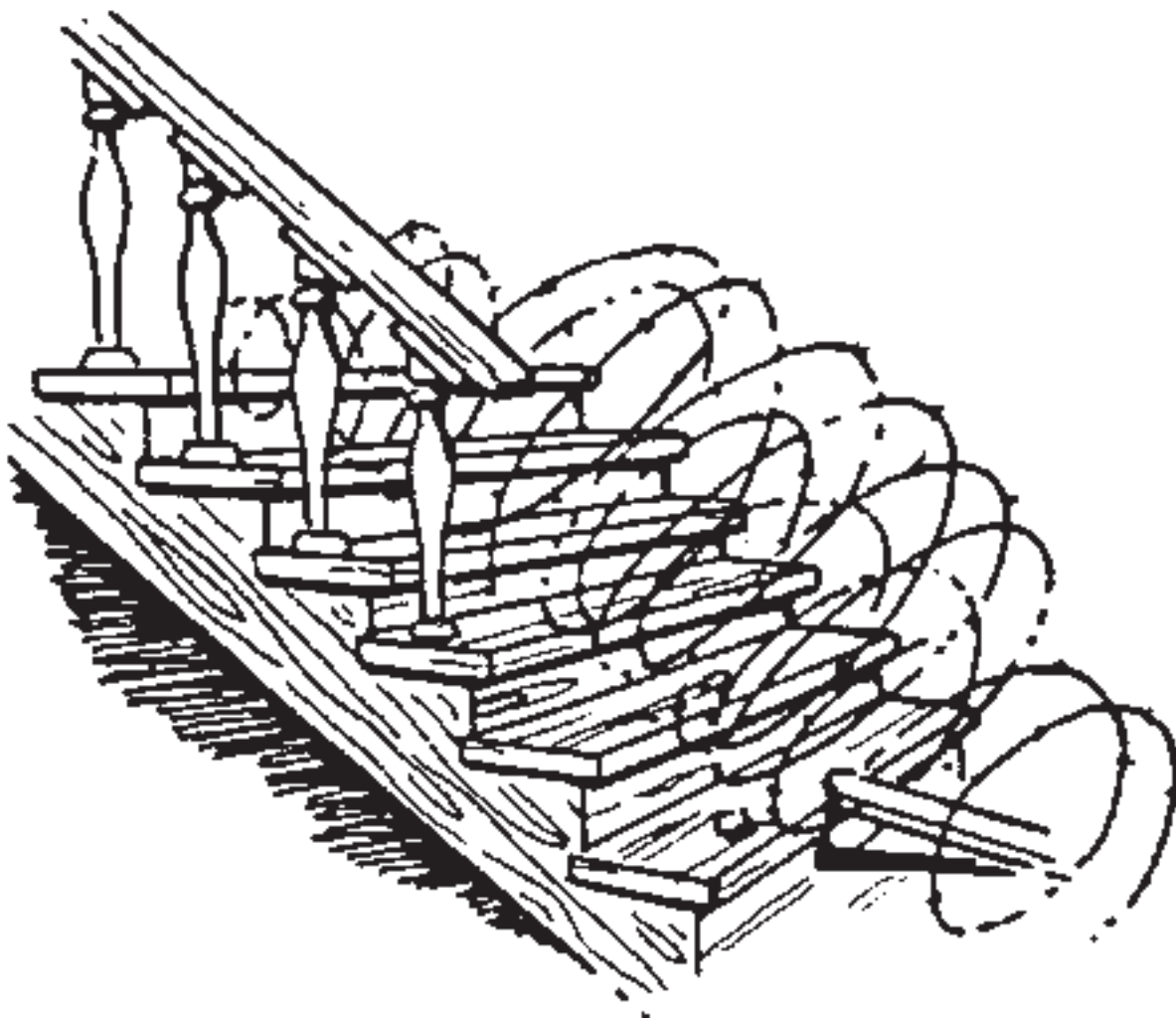

**BARBED WIRE OR CONCERTINA WIRE ARE
EFFECTIVE ON STAIRS.
ALWAYS REMEMBER TO NAIL DOWN THE
CONCERTINA WIRE.**

Protection of "dead-zones"

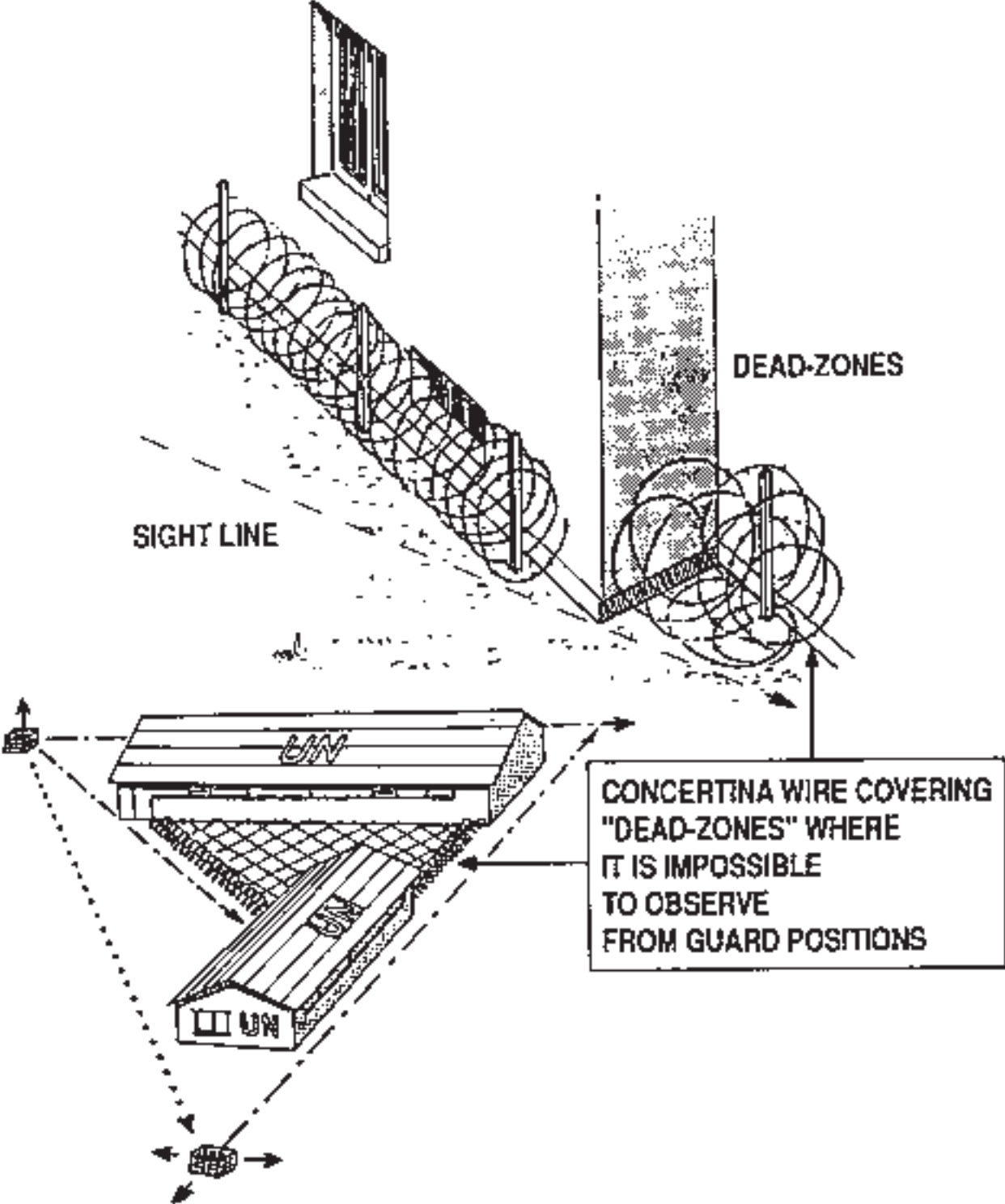

Positioning sentries and guards

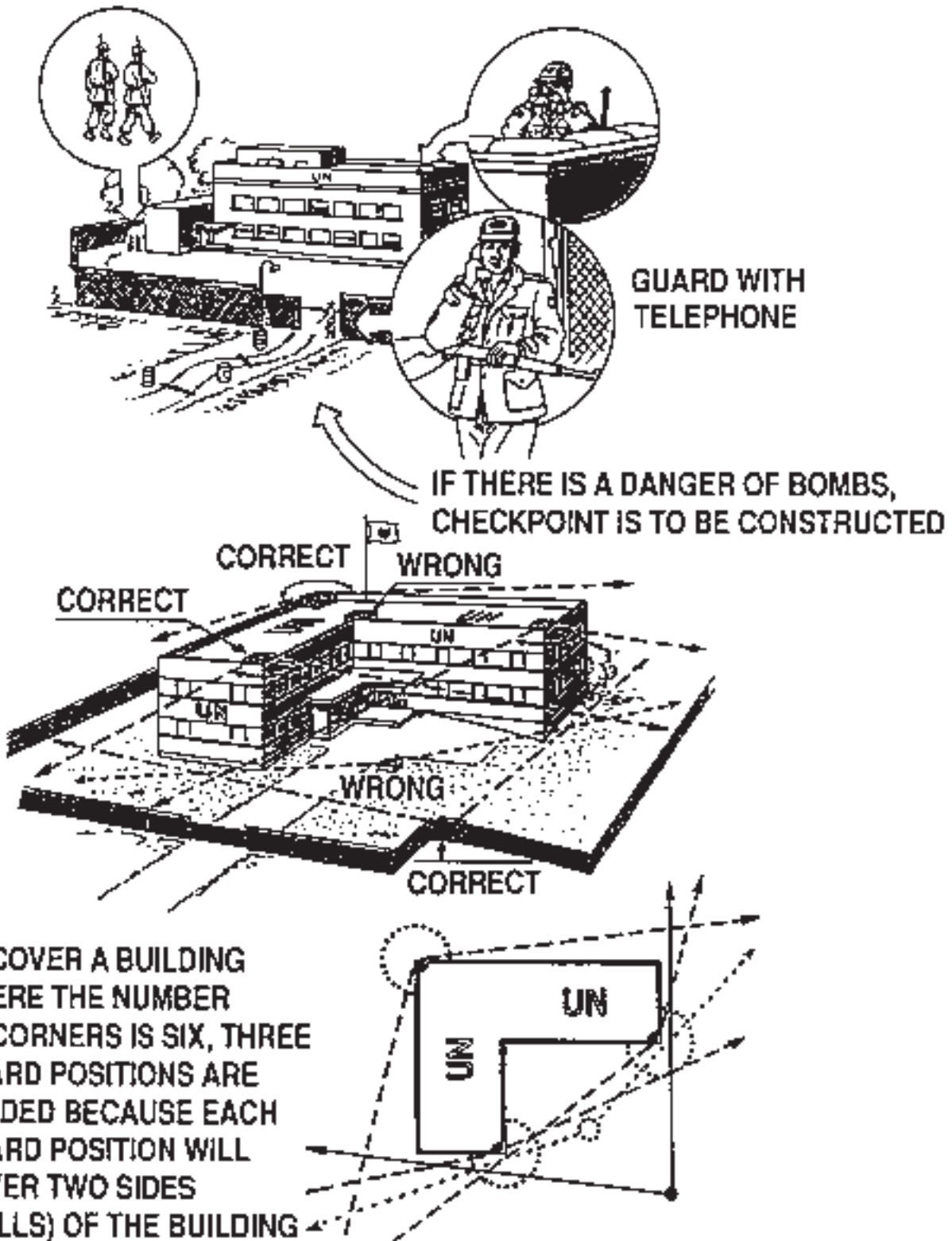

Vehicle stopping and controls

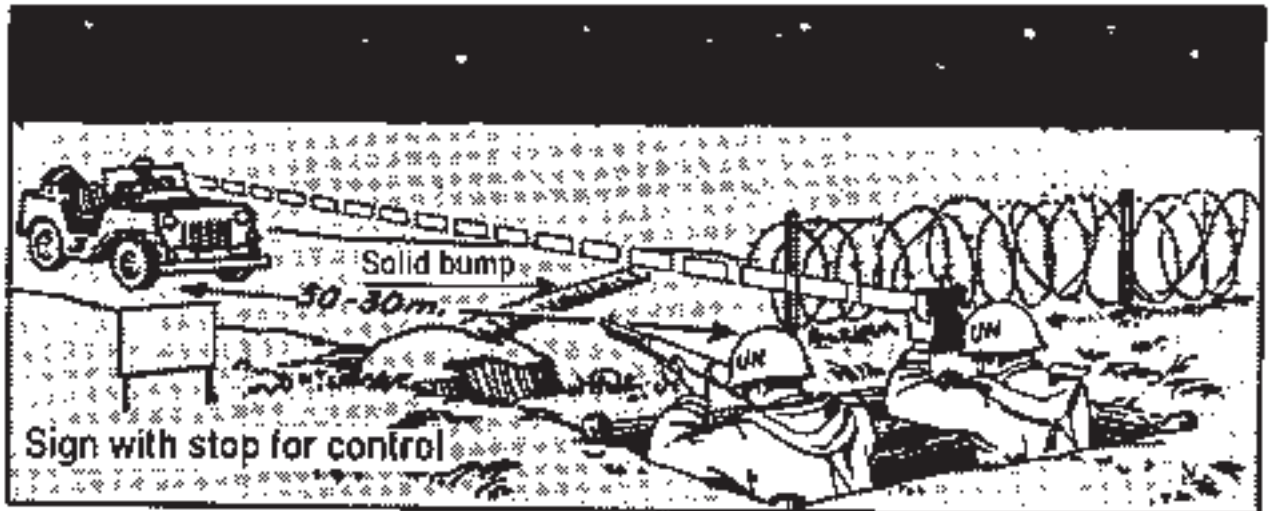

In addition to signs about 50-100 meters before the post/CHP flashes with flashlight telling the driver to reduce speed.

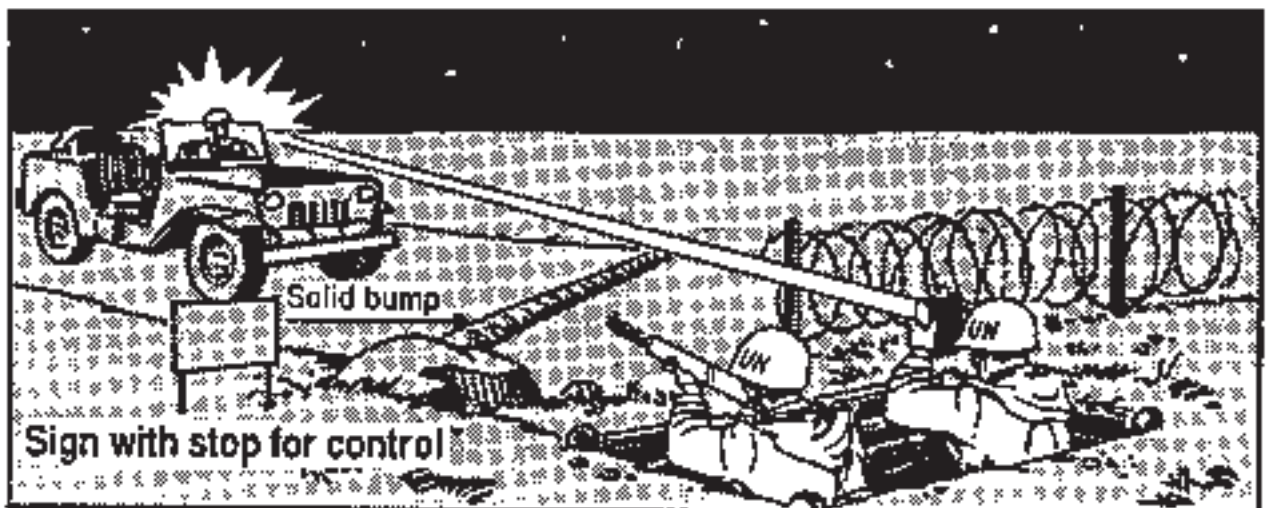

The car has to stop at least 10 m. away from the post.

Vehicle stopping and controls

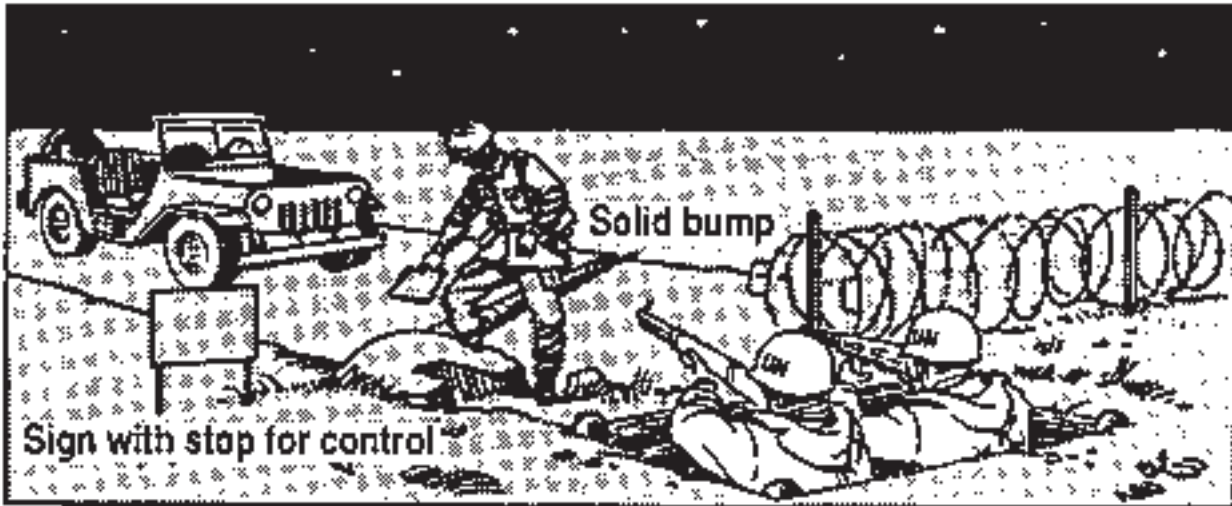

The driver of the unknown car stops the engine, turns the headlights off, gets out of the car and places his admission card/legitimation in an agreed place.

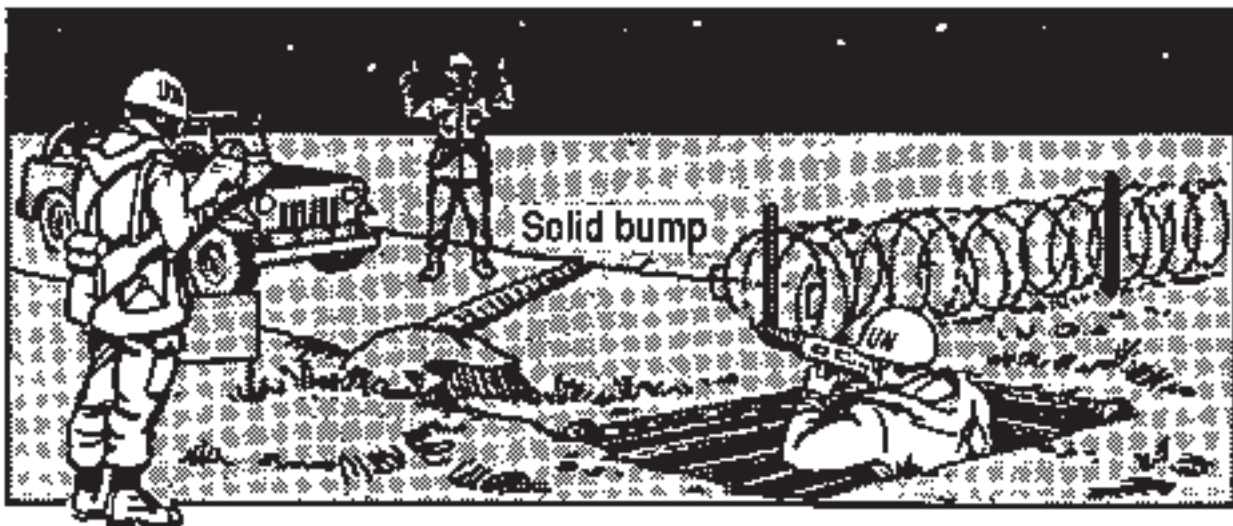

The driver walks away and waits for the results of the examination of his papers.

Lighting of checkpoints

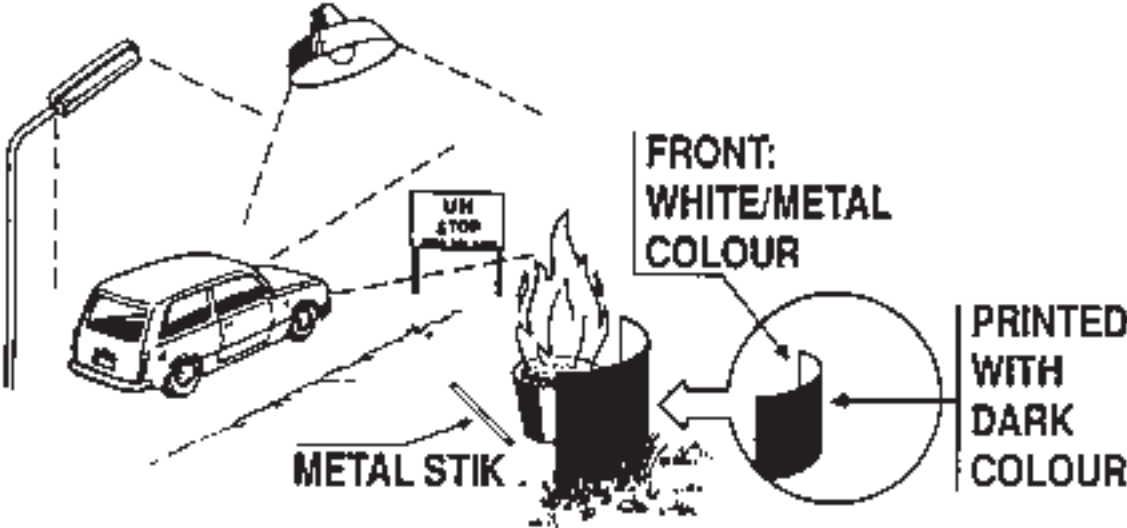

Simple alarm devices - 1

CONCERTINA WIRE

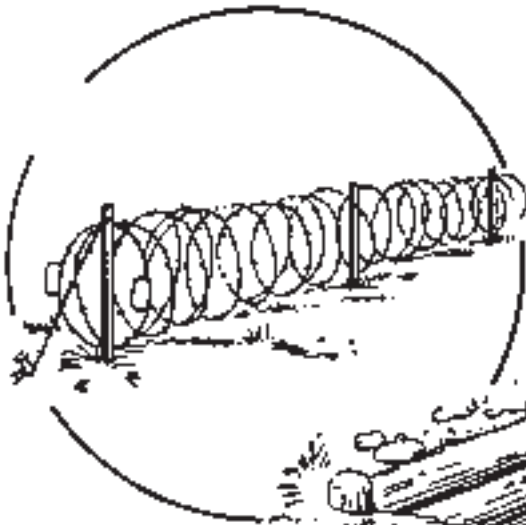

EMPTY CANS PUT TOGETHER

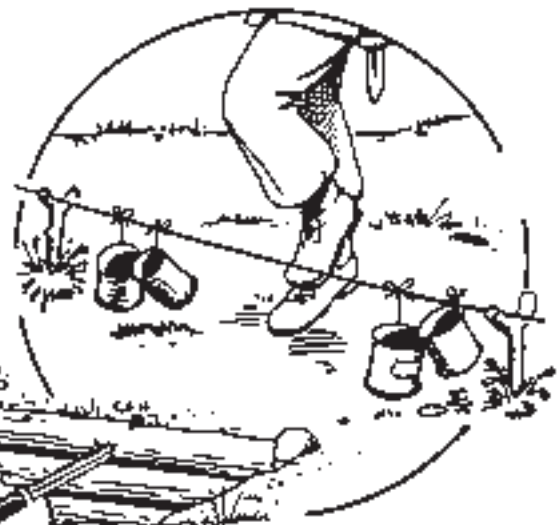

TRIP FLARE



DRY BRANCHES

Simple alarm devices - 2

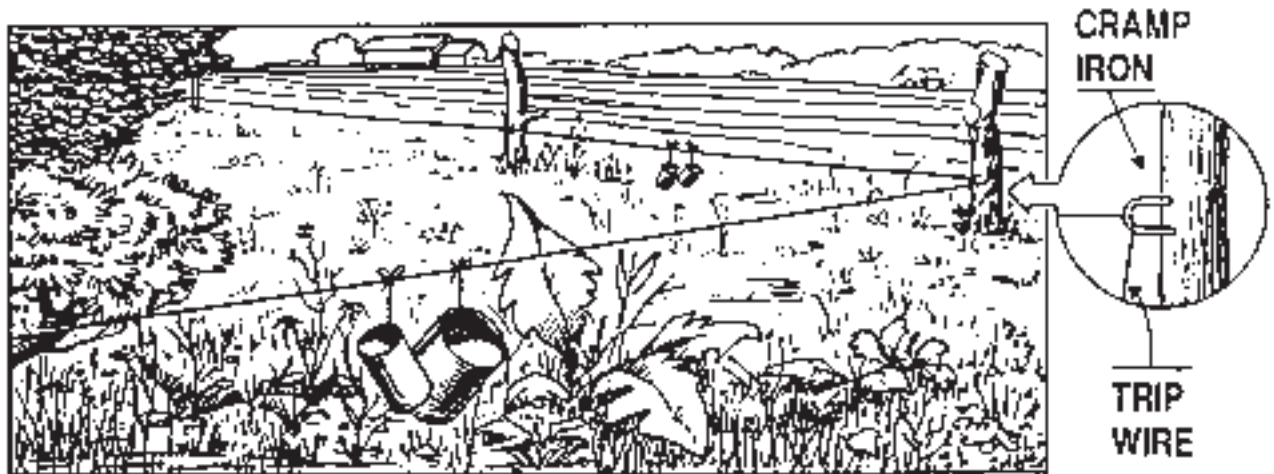

Empty cans put together as a simple warning device.
Notice the use of cramp iron for the trip wire.

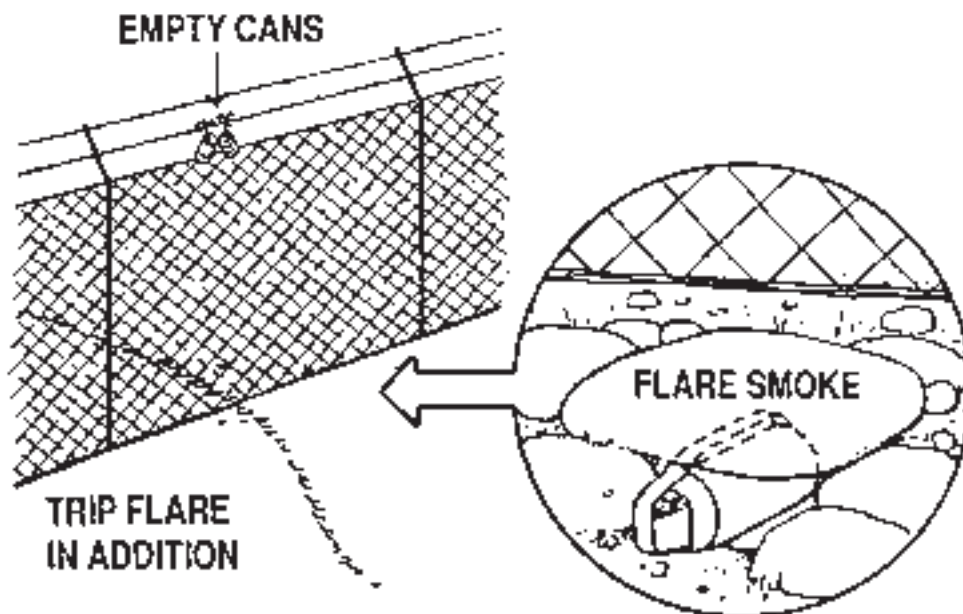

If the fences are not dug down in the ground, it is possible to enter the camp from beneath the fence. Reinforcements like this improve the protection of the object.



**United Nations
Department of
Peace-Keeping
Operations Training**

PEACE-KEEPING TRAINING

Exercise 3

ESCORTING



ESCORTING

Aim of this exercise

The general aim of this training exercise should focus on developing the skills required for the planning, organization and equipping convoys as well as in driving and operating convoys under normal and exceptional circumstances.

General suggestions

The traffic situation in a conflict area is usually very critical and often dangerous.

It is therefore essential to train all drivers in the home country, before departure to the mission operation.

The training must include orienteering and map reading and exercises in preparing convoys and in driving and reporting. Incidents such as traffic accidents, vehicle breakdown, ambush and hijack should be simulated and drivers must learn how to behave in such circumstances. You may wish to use the UN Peace-Keeping training video and show the part related to "Transport/Convoy Exercise".



Suggested training strategy

TRAINING CONTENT	ACTIVITY	MEDIA
<p>■ ORGANIZATION</p> <ul style="list-style-type: none"> • Traffic regulations in AO • Orienteering and map reading • Briefing before departure • Convoy rules and compositions • Checking vehicles and equipment 	<p>Study local regulations Test</p> <p>Map reading exercises Orienteering field exercise</p> <p>Lecture, demonstration and verbal and written exercises</p> <p>Lecture, discussion and exercises</p> <p>Lecture, discussion and practical exercises</p>	<p>Video No. 4</p> <p>Video No. 4</p> <p>Transparency No. 1</p>
<p>■ EQUIPMENT</p> <ul style="list-style-type: none"> • Personal equipment • Convoy equipment 	<p>Lecture, demonstration, familiarization</p> <p>Lecture demonstration, familiarization and practice</p>	<p>Video No. 4</p> <p>Transparency No. 2</p>



Training Guide

ESCORTING

TRAINING CONTENT	ACTIVITY	MEDIA
<p>■ OPERATION</p> <ul style="list-style-type: none"> • March discipline and driving • Reporting along route • Normal operation procedures • Traffic accident • Vehicle breakdown • Ambush, hijack 	<p>Lecture and driving practice</p> <p>Demonstration and practice</p> <p>Lecture, demonstration, practice.</p> <p>Lecture , simulation, exercise</p> <p>Lecture, simulation, exercise</p> <p>Lecture, simulation, exercise</p>	<p>Video No. 4</p> <p>Transparency No. 3</p> <p>Transparency No. 4</p> <p>Transparency No. 5</p>
<p>■ COMMAND, COMMUNICATION</p> <ul style="list-style-type: none"> • Leadership • Communication inside convoy • Communication outside convoy 	<p>Lecture, discussion</p> <p>Lecture, demonstration and practice</p> <p>Lecture, demonstration and practice</p>	<p>Video No. 4</p>



Lecture Notes

ESCORTING

ESCORTING

Aim

The general purpose of escorting is to protect the transportation of personnel, material, food, mail and money in the area of the UN mission and operation.

Organization

The convoy commander has the responsibility of ensuring that the convoy and its protection is properly organized. Before departure he has to deliver a written paper indicating the organization of the convoy, including details of each man and vehicle, and give a briefing to the escorted and convoy personnel.

Preparation includes the routing of the convoy and issuing of maps for each vehicle.

Regular convoys normally follow routine routes and only exceptionally change their routes according to orders which aim to avoid road-blocks or risky areas.

In all convoys there has to be at least two vehicles and at least two men in each. Everyone has to carry a weapon. The organization shall be in accordance with the numbers of vehicles and quality of load. If necessary, there are APC's to protect the convoy: one in front, (one in the middle) and one in the rear.



Lecture Notes

ESCORTING

Example of a convoy



Escort vehicle (APC)



Vehicle(s) to be escorted



Convoy commander



Rear escort vehicle (DCO)



Additional escort vehicle
(towing capability)



Radio with connection
to NCS



Radios in convoy net





Lecture Notes

ESCORTING

Equipment

Personal equipment

- combat uniform flak jacket
- personal weapon with three magazines
- UN beret, field cap or helmet
- food and water
- additional clothing according to the weather

Convoy equipment

- maps covering the whole route
- flare pistol or illumination rockets
- written orders for different situations (such as road-blocks, cases of hijack, alternate routes, etc.)
- radios
- a shield in English (and local language) with the text: "UN CONVOY, STAY BEHIND" on the last vehicle



Lecture Notes

ESCORTING

Operation

Normal operations

The convoy commander reports to his net control station at the time of departure, when passing certain points along the route and arrival at the destination. When reporting that the convoy is passing by the points along the route, the messages must be camouflaged.

The march-discipline including ordered speed and distances in between the vehicles must be followed. The distances can be changed according to other traffic.

**THERE MUST BE EYE CONTACT
BETWEEN THE VEHICLES**

At destination the convoy commander gives orders of further activities and divides his personnel to unload the freight. He also gives orders for the return journey, meals and accommodation if necessary. After having returned to BN HQ the convoy commander gives debriefing.

Traffic accident

If any of the vehicles in the convoy is involved in a traffic accident, the procedure is as follows:

- close the accident area
- organize warning of other traffic
- report to the next control station
- call for MP (if not done by NCS)
- if there are injured persons, give first aid and call for medical personnel



Lecture Notes

ESCORTING

Vehicle breakdown

In case of vehicle breakdown:

- move the vehicle to the side of the road, if possible (be wary of mines beside the road!)
- check the damage
- report to the next control station
- if possible, repair it yourself (e.g. change the tyre); if not, call for a towing vehicle
- move the load from the damaged vehicle to another one if there is enough space
- leave the driver and one guardsman with the vehicle to wait for the towing vehicle

Ambush or hijack

If the convoy is fired at, it has to try to:

- seek protection according to the situation
- fire back, if the task so demands (if possible, warning rounds first)
- stop the vehicles behind in order to prevent them from entering into the area of fire, or push through if safe withdrawal is not possible.

The firing must be reported immediately to the next control station, which orders reinforcements and other help to the spot. Any wounded have to be evacuated according to orders given for this kind of situation. Attempts of hijacking must be counteracted by determined action, even by firing. Such attempts must also be reported to the next control station.

**AN UNAUTHORIZED VEHICLE IN THE CONVOY
MIGHT MEAN:**

ATTEMPT AT HIJACKING

CAR BOMB

STOP THE CONVOY



Lecture Notes

ESCORTING

Command and communication

A CONVOY IS UNDER THE LEADERSHIP OF THE CONVOY COMMANDER IRRESPECTIVE OF THE RANK OF PERSONNEL TO BE ESCORTED

Communication inside the convoy

The convoy commander usually travels in the first vehicle. He should have radio contact with the last vehicle of the convoy. It is recommended that he has contact with all the vehicles in the convoy.

Communication outside the convoy

The convoy has to be in permanent contact with the net control station (usually OPS). It has to be able to communicate with the Force's operational or emergency frequency, at least with one radio set.



**United Nations
Department of
Peace-Keeping
Operations Training**

PEACE-KEEPING TRAINING

Exercise 3

ESCORTING

Transparencies

EXAMPLE CONVOY



Escort vehicle (APC)



Vehicle(s) to be escorted



Convoy commander



Rear escort vehicle (DCO)



Additional escort vehicle (towing capability)



Radio with connection to NCS



Radios in convoy net

CONVOY EQUIPMENT

- maps covering the whole route
- flare pistol or rockets
- written orders for different situations
 - road-blocks,
 - hijack,
 - alternative routes
- radios
- shield: “UN-CONVOY, STAY BEHIND”
- first aid kit in every vehicle
- water
- fuel reserve

CONVOY TRAFFIC ACCIDENT

- **CLOSE THE ACCIDENT AREA**
- **ORGANIZE WARNING OF
OTHER TRAFFIC**
- **REPORT TO NEXT
CONTROL STATION**
- **CALL FOR MP
(IF NOT DONE BY NCS)**
- **GIVE FIRST AID IF NECESSARY**

CONVOY VEHICLE BREAK DOWN

- **MOVE VEHICLE ASIDE
(BE WARY OF MINES)**
- **CHECK DAMAGE**
- **REPORT TO NEXT CONTROL
STATION**
- **IF POSSIBLE REPAIR OR CALL
FOR TOWING VEHICLE**
- **MOVE LOAD TO ANOTHER
VEHICLE IF POSSIBLE**
- **LEAVE DRIVER AND GUARDSMAN
WITH VEHICLE TO WAIT
FOR TOWING VEHICLE**

AMBUSH/HIJACK

- **SEEK PROTECTION**
- **FIRE BACK IF NECESSARY
(WARNING ROUNDS FIRST)**
- **STOP VEHICLES BEHIND
TO PROTECT THEM FROM FIRE**
- **PUSH THROUGH IF SAFE
WITHDRAWAL IS NOT POSSIBLE**
- **REPORT FIRING TO NEXT CONTROL
STATION AND REQUEST
REINFORCEMENT OR HELP**
- **GIVE FIRST AID IF NECESSARY**
- **EVACUATE CASUALTIES
ACCORDING TO ORDERS**



**United Nations
Department of
Peace-Keeping
Operations Training**

PEACE-KEEPING TRAINING

Exercise 4

USE OF FORCE



USE OF FORCE BY PKO

Aim of this exercise

The fundamental aim is:

- keeping peace without the use of force
- respecting conditions under which force may be used.

General suggestions

Training should focus on the concepts and principles of UN Peace-Keeping Operations, including practical exercises such as:

- defusing threats without the use of force
- how warnings should be given, when necessary
- how “firing for effect” should be resorted to
- when “firing for effect” should be stopped, etc.

The training should also focus on the retraining of soldiers who, because of their past training and experience are conditioned to traditional military duties, keeping in mind that attitudes and conduct of UN Peace-Keeping Operations are different from traditional military duties. Considering that “retraining is more difficult than training”, special emphasis should be given to aspects of attitudinal changes and behavioural patterns expected of the UN PKO personnel.



Training Guide

USE OF FORCE BY PKO

General suggestions

Training methods that are more conducive to learning behavioural changes should be adopted and validated for this exercise. Drills, simulation of surprise and threats, tests on desired behavioural patterns etc. should be specially constructed to achieve the required attitudes and skills.

A simple approach to changing the traditional soldiers' attitudes and behaviour may require the following steps:

- identify participants' ideas and perceptions on UN PKO
- create doubts (question) on their perceptions which need to be changed
- suggest alternative PKO norms and conduct
- ensure that participants accept PKO concepts and norms
- reinforce their new PKO attitude and behaviour through repeated drills and conditioning.



Suggested training strategy

TRAINING CONTENT	ACTIVITY	MEDIA
<ul style="list-style-type: none"> ■ AIM <ul style="list-style-type: none"> • How to keep peace without the use of force • To be able to follow conditions for the use of force 	<p>Gathering participants' norms and perception</p> <p>Presentation of PKO concepts</p>	<p>Transparency No. 1</p>
<ul style="list-style-type: none"> ■ PRINCIPLES <ul style="list-style-type: none"> • Threats should be stopped by peaceful means • Force will only be used when peaceful means have failed 	<p>Presentation followed by discussion</p>	<p>Transparency No. 2</p>
<ul style="list-style-type: none"> ■ DEFINITION OF FORCE <ul style="list-style-type: none"> • Unarmed forces • Armed forces 	<p>Presentation</p>	<p>Transparency No. 3</p>
<ul style="list-style-type: none"> ■ CONDITIONS UNDER WHICH FORCE MAY BE USED <ul style="list-style-type: none"> • Only minimum force necessary for: <ul style="list-style-type: none"> – self-defence – defence of PKO premises and vehicles under attack – when PKO is prevented forcefully 'from carrying out its duties – support of PKO troops under attack 	<p>Theory and discussion followed by simulated exercises and drills, including constructed incidents requiring discrimination</p>	<p>Transparency N. 4</p>



Training Guide

USE OF FORCE BY PKO

TRAINING CONTENT	ACTIVITY	MEDIA
<p>■ EXAMPLES</p> <ul style="list-style-type: none"> • Attempts to disarm PKO personnel • Safety of endangered PKO personnel • Forced attempts to occupy PKO positions • Attack of PKO premises • Attempts to arrest or disarm UN personnel • Other similar armed attack against PKO 	<p>Provide mixed examples requiring and not requiring the use of force. Test with multiple choice questions of constructed incidents</p>	<p>Transparency No. 5</p>
<p>■ FIRING FOR EFFECT</p> <ul style="list-style-type: none"> • Oral warning • Showing UN flag • Firing flares • Warning shots • Firing “short” • Firing for effect 	<p>Theory followed by practical exercise and repeated drills</p>	<p>Transparency No. 6</p>



Lecture Notes

USE OF FORCE BY PKO

USE OF FORCE BY UN PEACE-KEEPING FORCE

Introduction

When the United Nations was founded at the end of the Second World War, one of its fundamental principles was the idea of “collective security”. The evolution of UN Peace-Keeping has been the effort to make the vision of collective security a reality.

Chapter Six of the UN Charter authorized the use of peaceful measures, like economic sanctions, to prevent aggression. Chapter Seven authorized the use of military force, if necessary, to maintain peace. The Charter also called for a standing military force under UN authority. Nowhere in the Charter does the word “Peace-Keeping” occur.

The first UN Peace-Keeping mission consisted of a number of officers from several countries who arrived in Israel in 1948 as military observers to monitor the cease-fire which had ended the bitter fighting between Arabs and Jews. In this mission the UN created an international system for observing and reporting military activity.

In the mid-1950s, tension between the Cold War superpowers increased.

The Suez Crisis of 1956, in which Egypt’s nationalizing of the Suez Canal brought an Israeli attack, British and French military intervention, and serious threats of conflict escalation from the Soviets, prompted the search for a workable formula for authorizing UN Peace-Keeping Forces.



Lecture Notes

USE OF FORCE BY PKO

The solution was found by Secretary-General Dag Hammarskjöld in what he called "Chapter 6 1/2". Hammarskjöld introduced and promoted the idea of using a multinational force, approved by the Security Council but under the Secretary-General's direct authority, to supervise and control a negotiated cease-fire between hostile states, thereby preventing escalations of conflicts and keeping peace throughout the world.

Hammarskjöld's concept of Peace-Keeping was based on two principles:

- a) A Peace-Keeping Operation would take place only with the consent of the states involved;
- b) force would not be used to bring an end to a conflict or to maintain peace.

With this formula, the role of Peace-Keeping has broadened. The new ramifications of Peace-Keeping have become increasingly less familiar to the traditional military operations. It demands skills that are not acquired through military training, and Peace-Keeping, per se, encompasses assumptions that are fundamentally at variance with a soldier's military training.

In 1988, the Nobel Prize was awarded, for the first time ever, to a group of soldiers - the UN soldiers who for forty years had struggled bravely, enduring danger and abuse, making considerable sacrifices, bearing only light arms with instructions to use them only in self defense, to keep the peace in a warring world.

The fundamental principle of UN Peace-Keeping is the same today as it was in 1948 - that to be effective -keepers, soldiers who have been trained to win through killing and using force must be retrained to win, but by using negotiation and restraint. On this basic principle hangs the success or failure of all UN Peace-Keeping Operations of any kind, past, present and future.



Lecture Notes

USE OF FORCE BY PKO

Aim

To understand and adhere to the specified conditions under which force may be used by UN Peace- Keeping Operations.

Principles

Incidents should be prevented and stopped by negotiation and/or persuasion rather than by the use of force. Force will only be used when all peaceful means have failed and the Peace- Keeping Force is under direct threat.

Definition of force

Force is the use of physical means to impose the will of the PKO. For the purpose of this directive, force will be divided in two parts:

- a. Unarmed force is the employment of all means, other than weapons, to impose the will of the PKO. Examples are the use of vehicles and personnel to prevent passage of armed persons and vehicles or to remove military equipment.
- b. Armed force is the use of any weapon, military or non-military. Examples are clubs, batons, rifle butts, bayonets or opening fire.



Lecture Notes

USE OF FORCE BY PKO

Circumstances under which force may be used

Only the minimum force necessary is to be used. The only circumstances in which fire may be opened are:

- a. Self-defence, including defence against attempts by force to disarm PKO personnel or to prevent it by forceful means from carrying out its task;
- b. in the defence of PKO posts, premises and vehicles under armed attack; and
- c. in support of other PKO troops under armed attack.

Commanders at all levels should attempt to foresee dangerous situations and seek guidance from HQ when force is considered as an alternative action. The decision to use armed or unarmed force will always rest with the Commander on the spot.



Lecture Notes

USE OF FORCE BY PKO

Examples

Some examples of when force might be employed are as follows:

- a. self-defence, including attempts to disarm PKO personnel;
- b. when the safety of PKO personnel is endangered;
- c. when attempts are made by force to compel PKO personnel to withdraw from a position which they occupy under orders from their Commanders, or to infiltrate and envelop these positions;
- d. when attempts by force are made to prevent PKO personnel from carrying out their responsibilities as ordered by their commanders;
- e. when violation by force is made on UN premises; and
- f. when attempts are made to arrest or abduct UN civilian or military personnel.



Lecture Notes

USE OF FORCE BY PKO

Firing for effect

If a situation develops where firing for the effect is the only option, it must be preceded by warnings:

- oral warnings
- showing the United Nations flag;
- firing flares, understood by the parties as warnings;
- warning shots in the air;
- firing “short”, etc.

If there is an immediate threat to UN lives, or if casualties have already occurred, firing for effect or firing to hit may be initiated without delay.



**United Nations
Department of
Peace-Keeping
Operations Training**

PEACE-KEEPING TRAINING

Exercise 4

USE OF FORCE

Transparencies

AIM OF UN PEACE-KEEPING

**KEEP PEACE
WITHOUT
THE USE OF FORCE**

**USE OF FORCE ONLY
FOR SELF-DEFENSE
UNDER DIRECT
THREAT/ATTACK**

PRINCIPLES

**THREATS/ATTACK
SHOULD BE STOPPED
BY PEACEFUL MEANS**

**FORCE IS PERMITTED
ONLY IF
ALL OTHER ATTEMPTS
HAVE FAILED**

DEFINITION OF FORCE

UNARMED FORCE

which includes employment of all enforced means other than weapons (e.g. blocking passages by use of vehicles)

ARMED FORCE

is the use of weapons, military or non-military (examples are clubs, batons, rifle butts, bayonets or opening fire)

CONDITIONS UNDER WHICH FORCE MAY BE USED

ONLY THE MINIMUM FORCE NECESSARY FOR

- SELF-DEFENSE
- ATTEMPTS TO DISARM
PKO PERSONNEL
- FORCEFUL ATTEMPT TO PREVENT
PKO PERSONNEL FROM CARRYING
OUT ITS TASKS
- DEFENSE OF PKO PREMISES AND
PROPERTIES UNDER ATTACK
- SUPPORT TO PKO TROOPS
UNDER ATTACK

A FEW EXAMPLES

- **ATTEMPTS TO DISARM
PKO PERSONNEL**
- **SAFETY OF ENDANGERED
UN PERSONNEL**
- **FORCED ATTEMPTS
TO OCCUPY PKO PROPERTIES**
- **ATTACK OF PKO PREMISES**
- **ATTEMPT TO ARREST OR
ABDUCT UN PERSONNEL,
BOTH CIVILIAN AND MILITARY**

STEPS IN FIRING FOR EFFECT

- **ORAL WARNING**
- **SHOWING UN FLAG**
- **FIRING WARNING FLARES**
- **WARNING SHOTS INTO THE AIR**
- **FIRING “SHORT”**
- **FIRING FOR EFFECT**



**United Nations
Department of
Peace-Keeping
Operations Training**

PEACE-KEEPING TRAINING

Exercise 5 MINE, BOMB and BOOBY- TRAP THREATS



Training Guide

MINE, BOMB AND BOOBY-TRAP THREATS

MINE, BOMB AND BOOBY-TRAP THREATS

Aim of this exercise

- Personnel will be able to behave correctly when finding bombs, mines or other explosive munitions
- Personnel will be able to apply correct safety measures if they find themselves in a vehicle or on foot in a minefield or area of mine/munition contamination
- Personnel will be able to evacuate mine or munition casualties
- Personnel will be able to recognize explosive devices



Training Guide

MINE, BOMB AND BOOBY-TRAP THREATS

General suggestions

Explosive Ordnance Reconnaissance (EOR), which means that personnel should recognize mines, roadside bombs, battlefield debris, etc., is considered a necessity for all Peace-Keeping Forces.

Certain elements of EOR training are also pertinent for military observers.

Mine awareness training for troop should also concentrate on the recognition, marking, and recording of minefields as well as safety precautions when operating in mined areas.

Awareness training must also include practical training and simulations on actions to be taken when encountering mines on foot or in a vehicle.

Finally, troops require practical exercises on what they should do in the event of an accident.

Classroom training and briefings can be an excellent predeployment activity for troops, but they cannot replace the sense of realism which field exercise alone can create. Many of the principles covered in the classroom should therefore be practised/simulated in field exercises.

While EOR training is a requirement for all PKO personnel, training in Explosives Ordnance Disposal (EOD) is needed only for EOD specialists.

EOD will normally be provided at PKO HQ level only; training for this is highly specialized and is not covered here. Some contributing countries may however feel that they should have an EOD capacity. If this is accepted and authorized by UN HQ New York then obviously the relevant troops must be trained at home with particular emphasis on what they may encounter in the mission area.



MINE, BOMB AND BOOBY-TRAP THREATS

Suggested training strategy

Classroom training

TRAINING CONTENT	ACTIVITY	MEDIA
<ul style="list-style-type: none"> ■ MINEFIELD OWNERSHIP PREMISES <ul style="list-style-type: none"> • Ownership • Confidentiality obligations • Conditions of mine clearing 	<p>Lecture and discussion with visual aids</p>	<p>Transparency No. 1</p>
<ul style="list-style-type: none"> ■ MINEFIELD MARKING AND RECORDING RESPONSIBILITIES <ul style="list-style-type: none"> • Relevant Geneva Conventions • Responsibility for fences and signs • UN guidelines for minefield marking • Responsibility for marking and recording • Minefield intelligence 	<p>Lecture and discussion with visual aids</p>	<p>Transparency No. 2</p>



Training Guide

MINE, BOMB AND BOOBY-TRAP THREATS

TRAINING CONTENT	ACTIVITY	MEDIA
<ul style="list-style-type: none"> ■ WARNING OF NEW MINEFIELDS <ul style="list-style-type: none"> • Warning messages • Updating maps • Minefield reconnaissance duties • SOP's guidelines on handling mines and unexploded bombs (UXBs) • Guarding minefields 	Lecture, discussion and tests	Transparency No. 3
<ul style="list-style-type: none"> ■ HOW TO ACT IF NO MAP OR CORRECT INFORMATION IS AVAILABLE <ul style="list-style-type: none"> • What to do if in doubt • Classification of hazards: <ul style="list-style-type: none"> – Mine existence is known – Existence is suspected – No mines found – No mine risk 	Lecture and theoretical tests	Transparency No. 4



MINE, BOMB AND BOOBY-TRAP THREATS

TRAINING CONTENT	ACTIVITY	MEDIA
<ul style="list-style-type: none"> ■ WARNING SIGNS FOR MINES, BOOBY-TRAPS AND BOMBS <ul style="list-style-type: none"> • Damaged vehicles • Dead animals • Local avoidance of the area • Packing materials and suspicious objects • Trip wire • Detonating devices • Camouflage for bombs 	<p>Presentation and discussion with illustrations</p>	<p>Transparency No. 5</p>
<ul style="list-style-type: none"> ■ PRECAUTIONS IN MINED AREAS <ul style="list-style-type: none"> • Selection and use of roads • Use of mine maps 	<p>Lecture and discussion</p> <p>Practice in reading mine maps</p>	



Training Guide

MINE, BOMB AND BOOBY-TRAP THREATS

Suggested training strategy

Practical training

TRAINING CONTENT	ACTIVITY	MEDIA
<ul style="list-style-type: none"> ■ RECOGNITION OF DEVICES AND MINES 	Drill	
<ul style="list-style-type: none"> ■ MINEFIELD MARKING AND RECORDING 	Demonstration and practice	
<ul style="list-style-type: none"> ■ MINE DISCOVERY WHEN ON FOOT <ul style="list-style-type: none"> • How to move • Marking • Reporting 	Lecture, demonstration, group exercise and drill	Transparency No. 6
<ul style="list-style-type: none"> ■ MINE DISCOVERY WHEN IN VEHICLE <ul style="list-style-type: none"> • Staying in the vehicle • Leaving the vehicle • Moving the vehicle 	Lecture, demonstration, group exercise and drill	Transparencies Nos. 7, 8 and 9



Training Guide

**MINE, BOMB AND
BOOBY-TRAP
THREATS**

TRAINING CONTENT	ACTIVITY	MEDIA
<p>■ BEHAVIOUR IN ACCIDENTS</p> <ul style="list-style-type: none"> • On foot • In vehicle • Leaving vehicle • Entering vehicle • Moving casualties • Moving vehicle 	<p>Lecture, demonstration, group exercise and drill</p>	<p>Transparencies Nos. 10, 11, 12 and 13</p>



Lecture Notes

MINE, BOMB AND BOOBY-TRAP THREATS

MINE, BOMB AND BOOBY-TRAP THREATS

Introduction

UN PKOs have over the years suffered relatively heavy casualties if one considers that their mission is one of peace rather than belligerence. Some of these casualties were avoidable, especially those sustained by mines and other similar items.

PKOs will normally be deployed in the vicinity of former battlefields. They will therefore have to contend with old minefields and many other dangerous battlefield debris. PKOs can also find themselves in a situation where some elements among the parties are still engaged in low-intensity operations. This can involve the laying of mines, roadside bombs and other explosive devices, directed against each other or against members of the PKO.

The UN will never have the resources to deal with the whole problem of mines, roadside bombs and miscellaneous battlefield debris. Their response will have to be a combination of:

- a. technical anti-mine/bomb activity;
- b. safety precautions
- c. mine awareness programmes for troops.

It is vital to establish where mines are in your area. Many anti-tank and anti-personnel mines may well be left on the battlefield when the opposing parties withdraw, and it is rare that mine maps or minefield records exist, or can be made available to the Peace-Keeping Force. In some areas, mines and submunitions are scattered around at random, creating an even greater hazard.



Lecture Notes

MINE, BOMB AND BOOBY-TRAP THREATS

Aim

The aim of this chapter is:

- to recognize explosive devices/mines in use;
- to inform all personnel how to act if they find bombs, mines or other explosive munitions;
- to establish safety drills for those in vehicles or on foot who find themselves in a minefield or area of mine or munition contamination;
- to establish drills for the evacuation of mine or munition casualties.

Minefield ownership premises

Minefields in the battle zone belong to the parties that laid them. In theory the mines must remain as a part of the obstacle plan if the UN Peace-Keeping Force withdraw. The UN is obliged not to reveal the positions of one party's minefields to the other, although it can ensure such minefields are properly marked. The UN is not permitted to lift either party's minefields, except to remove those mines or munitions that present a hazard to UN operations.

Minefield marking and recording responsibilities

All minefields must be recorded and fenced off using distinctive markings. Ideally, minefields should be marked and recorded in accordance with the provisions of the Geneva Convention. If a UN Force fences off a mined area, that Force is then responsible for the maintenance of fences and signs. All members in the UN Force must be familiar with UN minefield marking systems, and the marking systems used by the opposing parties.



Lecture Notes

MINE, BOMB AND BOOBY-TRAP THREATS

It is vital to establish which areas are contaminated and which are free of mines. UN engineer troops are responsible for coordinating all minefield marking and recording, and maintain a master minefield map at the BN HQ covering the whole operational area, in cooperation with the Information Officer and Operations Officer.

It is the responsibility of unit and sub-unit Commanders to ensure that their own mine area maps are up to date, to ensure that any mine intelligence is passed to their operations room, and to establish good relationships with local town mayors, village headmen or local police who may know where mines are, and must be given all available mine information.

Warning of “new” minefields

When a new minefield or mined area is discovered, the area must be marked, and a warning sent immediately to nearby units and Force headquarters, so that minefield maps can be updated. The Force engineers will send a minefield reconnaissance team to mark and record the mined area.

Every UN Peace-Keeping Unit should have SOPs containing guidance on handling mines and unexploded bombs (UXB). These should be read with care. When mine clearing is going to last for several days, the minefields has to be guarded 24 hours a day until the work is completed and proper markings are made ready.



Lecture Notes

MINE, BOMB AND BOOBY-TRAP THREATS

How to act if no minefield maps or correct information about minefields is available

If mines are known to have been used anywhere in the theatre of operations, assume that all areas are mined until there is evidence to the contrary.

ONLY ENGINEERS OR EOD (Explosive Ordnance Disposal) OFFICERS ARE QUALIFIED TO STATE WHICH AREAS ARE MINED OR CLEAR.

IF IN DOUBT, ASSUME THAT YOU ARE IN A MINED AREA.

DO NOT TAKE UNNECESSARY RISKS.

The mine hazard can be classified as follows

- Condition 1:** Mines are known to exist; there is a high risk of mines, bombs and/or booby-traps.
- Condition 2:** Mines are suspected: there is some risk of mines, bombs and/or booby-traps.
- Condition 3:** No mines have been found; there is little risk of mines, bombs and/or booby-traps, but they could still be present.
- Condition 4:** No risk of mines.



Lecture Notes

MINE, BOMB AND BOOBY-TRAP THREATS

Warning signs indicating mines or minefields

If there are no mine marking signs or fences, and no mines can be seen, the following signs may indicate the presence of mines:

- Damaged cars or trucks
- Dead animals
- Local avoidance of the area
- The presence of mine boxes or packing materials
- Suspicious metal, plastic or rubber objects on the ground

Mines may not be the only hazard. Cluster bombs and submunitions may have been used, and could be scattered anywhere. Look out for their delivery rockets or carrier pods, and the plastic separators that hold them in place during launch. Learn to recognize them, and avoid the areas in which they are found.

Warning signs for booby-traps or bombs

The presence of trip wires is a good indication of booby-traps, and signs of electrical wires or radio receivers could indicate command-wire or radio detonated explosive devices. Artillery shells and bombs are often used as the explosive component to attack hard targets such as fortifications. Terrorist bombs are often camouflaged or planted in suitcases, boxes or plastic bags such as garbage bags. A good principle is to stack garbage well away from the roads. It is easy to place bombs in cars; they are often held in place by magnets, and put under the floor pan beneath the driver's seat, or in one of the front wheel arches. See chapter about check point duty, how to check cars for car bombs, etc.



Lecture Notes

MINE, BOMB AND BOOBY-TRAP THREATS

Simple precautions when operating in mined areas

Never move off roads or paths which are in daily use. If possible never use unpaved or dirt roads, if paved roads are available.

If off-route movement is inevitable, use roads which have been cleared by UN engineer troops. If these are not available, drive or walk on stony ground, where mines or munitions would be hard to conceal. Always carry and pay attention to your mines map, if you have one.

**FAILURE TO TAKE PRECAUTIONS COULD RESULT
IN A SERIOUS INCIDENT**

Action on discovering a mine

When on foot:

1. stop;
2. withdraw;
3. mark the mined area with whatever is at hand;
4. report to BATT OPS;
5. if possible, stay in the area and point out the place where the mine was found. If you must leave, try to mark the area so others will avoid coming into this dangerous section;
6. walk back the same way you walked into the minefield. When possible use the same tracks. Use a metal stick/bayonet for safety reasons.

DO NOT TOUCH OR MOVE THE MINE/BOMB

**DO NOT TRY TO DETONATE IT BY THROWING
STONES OR SHOOTING AT IT**

KEEP AWAY



Lecture Notes

MINE, BOMB AND BOOBY-TRAP THREATS

If in a vehicle:

1. halt;
2. report your position and the nature of the mine or bomb immediately by radio to BATT OPS. If you have detected a bomb by the roadside, be careful about using the radio, as the radio signals may set off the bomb;
3. stay with your vehicle, and wait for engineer assistance to get you out. You may already have driven through a mined area. Point out the mined area to the engineer when they arrive.

If you have to leave your vehicle:

4. do not move the steering wheel;
5. climb over the front seat and leave the car from the rear;
6. put on any protective gear you may have and walk carefully back along the vehicle tracks;
7. move all your passengers out the same way, at 20m intervals, dressed in protective clothing;

If you have to move the vehicle before help arrives:

8. use a metal prodder/bayonet to prod for mines between the wheel tracks, and about 50 cm out to each side until you are back on safe ground;
9. dismount all passengers as in (7) above;
10. wearing full protective gear, reverse the car slowly and carefully back down the area you have cleared. You may need an assistant to help with this; he should also be in full protective clothing;
11. if it is dark wait in the car until daylight, unless given instructions to the contrary;
12. report to the nearest unit available;
13. close the road, and clearly mark any diversion you have made.



Lecture Notes

MINE, BOMB AND BOOBY-TRAP THREATS

Action in event of an accident

On foot:

1. **DO NOT IMMEDIATELY RUN TO THE CASUALTY.**

Stand still, and assess the situation;

2. move to the casualty, moving in his exact footprints, and apply immediate first aid, standing as near to the point of detonation of the mine as possible. If his footsteps are not clear, do not risk another casualty, but hand-clear a path to the casualty using a prodder/bayonet before applying first aid;
3. summon medical help and CASEVAC as quickly as possible by radio;
4. do not attempt to move the casualty until help arrives, unless it is absolutely necessary;
5. using a prodder/bayonet, hand-clear an area around the casualty, and enlarge the path back from the casualty to a safe area, for use by the medical and CASEVAC teams. Remember that a stretcher party carrying a heavy load requires a wide cleared area to walk on;
6. if the patient is conscious, one member of the party should stay with him/her to give comfort and reassurance.

If in a vehicle patrol which hits a mine:

1. stop immediately;
2. if your radio is working report on the radio to BATT OPS. Call for CASEVAC and engineer assistance;
3. if your vehicle has been damaged, give immediate first aid to any casualties;



Lecture Notes

MINE, BOMB AND BOOBY-TRAP THREATS

4. if another vehicle in your patrol is damaged,

DO NOT IMMEDIATELY RUN TO THE CASUALTY - STOP AND CONSIDER

5. leave your vehicle by climbing over the front seat, and leaving from the rear. Put on all protective clothing, and walk back along your own wheel tracks. Move passengers out in the same way;
6. find an area where the damaged vehicles tracks and your own coincide, and walk to the damaged vehicle along its tracks.

DO NOT WALK ROUND THE DAMAGED VEHICLE

7. enter the damaged vehicle from the rear, and carry out immediate first aid to any casualties;
8. stay with the vehicle, and wait for medical help and engineer assistance to get you out. Point out the mined area to the engineers when they arrive.

If you have to move a casualty:

9. using a metal prodder/bayonet, clear an area round the casualty so that he can be extricated from the vehicle;
10. clear a path from the damaged vehicle back to safe ground, and carry the casualty along it. Wait for CASEVAC assistance.

If you have to move your vehicle before help arrives:

11. use a metal prodder/bayonet to prod for mines between the wheel tracks, and about 50 cm out to each side until you are back on safe ground;
12. move all passengers out;



Lecture Notes

MINE, BOMB AND BOOBY-TRAP THREATS

13. wearing full protective gear, reverse the car slowly and carefully back down the area you have cleared. You may need an assistant to help with this; he should also be in full protective clothing;
14. if it is dark wait in the car until daylight, unless given instructions to the contrary;
15. report to the nearest unit available;
16. close the road, and clearly mark any diversion you have made.



**United Nations
Department of
Peace-Keeping
Operations Training**

PEACE-KEEPING TRAINING

Exercise 5 MINE, BOMB and BOOBY- TRAP THREATS

Transparencies

MINE, BOMB AND BOOBY-TRAP THREATS

AIM

- TO RECOGNIZE MINES AND EXPLOSIVE DEVICES
- TO RECOGNIZE, RECORD, MARK MINEFIELDS AND APPLY SAFETY PRECAUTIONS
- TO TAKE CORRECT ACTION WHEN ENCOUNTERING MINES ON FOOT OR IN VEHICLES
- TO TAKE CORRECT ACTION IN THE EVENT OF AN ACCIDENT

MINEFIELD RESPONSIBILITIES

PREMISES

- Minefields belong to parties that laid them
- They must remain as obstacles if PKO withdraws
- UN is not obliged to disclose them to the other party
- UN can properly mark them
- UN can clear them only if they present a hazard to PKO

RESPONSIBILITIES

- Proper marking and recording is the responsibility of UN ENGINEERS
- Unit and Sub Unit COMMANDERS should ensure:
 - minefield maps are up to date
 - mine intelligence is passed on to operations room
 - good relations are established with local leaders who know where mines are

WARNING ON NEW MINEFIELDS

- Mark new mine areas where discovered
- Inform nearby Units and Headquarters
- Take EOR assistance
- Follow UXB guidelines
- Guard 24 hours until marking is completed

HOW TO ACT IF NO MAPS OR INFORMATION IS AVAILABLE

- If in doubt assume that you are in a mined area
- Do not take risks
- Only engineers and EOD offices are qualified to state which areas are clear of mines

WARNING SIGNS FOR BOOBY-TRAPS AND BOMBS

OBJECTS

- Trip wire
- Electrical wire or radio receivers
- Camouflaged suitcases, boxes, plastic bags and garbage bags
- Objects placed under floor pan and front wheel arch

INDICATIONS

- Booby-trap
- Command wire or radio detonated devices
- Terrorist bombs
- Car bombs

Failure to take precautions could result in a serious incident

ACTION ON DISCOVERING A MINE

WHEN ON FOOT:

- STOP
- WITHDRAW
- MARK AN AREA
- REPORT TO BATT OPS
- STAY IN THE AREA TO AVOID OTHERS FACING DANGER
- IF YOU MUST LEAVE, WALK BACK USING SAME TRACKS

ACTION ON DISCOVERING A MINE

WHEN IN A VEHICLE

- HALT
- REPORT POSITION
- BE CAREFUL IN USING RADIO
- STAY WITH VEHICLE UNTIL ASSISTANCE ARRIVES
- INDICATE MINED AREA

PRECAUTIONS IF YOU MUST LEAVE A VEHICLE

- DO NOT MOVE STEERING WHEEL
- LEAVE THE VEHICLE FROM THE REAR
- PUT ON PROTECTIVE GEAR
- MOVE ALL PASSENGERS OUT THE SAME WAY, AT 20 METRE INTERVALS

PRECAUTIONS IF YOU MUST MOVE THE VEHICLE

- **PROD FOR MINES BETWEEN WHEEL TRACKS AND 50 CM OUT TO EACH SIDE**
- **MOVE PASSENGERS OUT FROM REAR**
- **PUT ON PROTECTIVE GEAR; REVERSE VEHICLE SLOWLY DOWN THE CLEARED PATH**
- **IF IT IS DARK, WAIT IN THE VEHICLE UNTIL DAYLIGHT**

ACTION IN EVENT OF ACCIDENT

WHEN ON FOOT

- **STAND STILL AND ASSESS SITUATION**
- **MOVE TO CASUALTY FOLLOWING FOOTPRINTS**
- **APPLY FIRST AID**
- **SUMMON MEDICAL HELP**
- **DO NOT MOVE CASUALTY UNLESS IT IS ABSOLUTELY NECESSARY**
- **USE PRODDER/BAYONET TO CLEAR BACKING DOWN PATH TO SAFE AREA**
- **ONE PERSON SHOULD STAY WITH PATIENT TO GIVE COMFORT**

Do not immediately run to the patient without pondering

ACTION IN EVENT OF ACCIDENT WHEN A VEHICLE HITS A MINE - 1

- STOP IMMEDIATELY
- CALL MEDICAL ASSISTANCE BY RADIO, IF POSSIBLE
- GIVE FIRST AID TO CASUALTY
- IF ANOTHER VEHICLE IN YOUR PATROL IS HIT, DO NOT RUN TO IT; STOP AND PONDER
- LEAVE THE HIT VEHICLE FROM THE REAR

*Do not walk around the
damaged vehicle*

ACTION IN EVENT OF ACCIDENT

WHEN A VEHICLE HITS A MINE - 2

- WALK TO THE DAMAGED VEHICLE
ALONG ITS EXACT TRACKS
- ENTER THE VEHICLE
FROM THE REAR
- GIVE FIRST AID
- CALL FOR HELP AND STAY
WITH THE VEHICLE

ACTION IN EVENT OF ACCIDENT

IF YOU MUST MOVE A DAMAGED VEHICLE

- CLEAR BACK DOWN PATH WITH A PRODDER/BAYONET
- MOVE ALL PASSENGERS OUT
- WEAR PROTECTIVE GEAR
- REVERSE CAREFULLY ALONG CLEARED PATH
- IF IT IS DARK, WAIT UNTIL DAYLIGHT
- CONTACT NEAREST UNIT
- CLOSE THE ROAD AND CLEARLY MARK DIVERSION YOU MADE



**United Nations
Department of
Peace-Keeping
Operations Training**

PEACE-KEEPING TRAINING

Exercise 6

NEGOTIATION SYSTEM



NEGOTIATION SYSTEM

NEGOTIATION SYSTEM

Aim of this exercise

The basic aim of negotiations is to resolve disputes within the PKO's area of competence, without recourse to force.

Particular skills required are:

- identifying and isolating areas of dispute
- preventing their escalation
- narrowing down areas of conflict
- resolution of disputes
- follow-up and prevention of recurrence of disputes.

The negotiating skills required will vary according to hierarchical status within the PKO and the nature of disputes. However all PKO personnel is likely to encounter disputes which could be best resolved through negotiation.



General suggestions

The training for negotiation and liaison will of necessity be restricted. At the formal end of the scale, the selection of personnel with negotiating ability and experience is all important. As far as informal negotiation by UNMOs and junior leaders is concerned, some general training can be carried out.

The training on the theory and practice of negotiation should be provided using the most appropriate training techniques. Incident analysis and “role-plays” are ideal training techniques for developing negotiating skills. They should, however, be used in a situation, reflecting as far as possible real-life PKO problems and the socio-cultural and physical environment in which disputes arise. A word of caution may also be necessary against reducing a role-play to a mere “play” or a “drama”; rather than using it as an exercise for skill development and training control.

The incident-analysis proposed as a methodology, is more than mere presentation of examples/incidents. It requires the trainees involvement for:

- understanding the incident
- analysing the process of negotiation that took place
- identifying factors of success and failures of negotiation
- lessons to be learned.



NEGOTIATION SYSTEM

Suggested training strategy

TRAINING CONTENT	ACTIVITY	MEDIA
<ul style="list-style-type: none"> ■ AIM <ul style="list-style-type: none"> • Resolution of disputes • With the consent of the parties concerned • With decisive assistance of PKO • Without recourse to force 	<p>Gathering participants' perception, followed by presentation and discussion using OHT</p>	<p>Transparencies Nos. 1 and 2</p>
<ul style="list-style-type: none"> ■ PRINCIPLES OF NEGOTIATION <ul style="list-style-type: none"> • Refrain from "win-lose" conflict resolution • Avoidance of the use of force • Principled settlement of disputes • Resolution of disputes with the agreement of the parties concerned • Mediator/negotiator providing impartial and unbiased support 	<p>Presentation, discussion and incident analysis</p>	<p>Transparency No. 3</p>
<ul style="list-style-type: none"> ■ ELEMENTS OF NEGOTIATION <ul style="list-style-type: none"> • Identifying and isolating problems of disputes • Preventing their escalation • Narrowing down areas of conflict • Resolution of disputes • Prevention against recurrence of disputes 	<p>Presentation of theory and discussion, followed by practical exercises on PKO incident analysis and role-plays.</p>	<p>Transparency No. 4</p>



Training Guide

NEGOTIATION SYSTEM

TRAINING CONTENT	ACTIVITY	MEDIA
<p>■ NEGOTIATION PHASES</p> <ul style="list-style-type: none"> • Preparation • Negotiation proper • Closing • Reports and follow-up 	<p>Presentation and discussion</p>	<p>Transparency No. 5</p>
<p>■ PREPARATIONS</p> <ul style="list-style-type: none"> • Investigation: understand both parties' and PKOs' versions • List prior agreements • Understand both parties' goals, perceptions and limitations • Decide where, when and with whom negotiation is to be held 	<p>Presentation followed by practical exercises on preparation of negotiation</p> <p>Comparative analysis of preparatory exercises.</p>	<p>Transparency No. 6</p>
<p>■ NEGOTIATION PROPER</p> <ul style="list-style-type: none"> • Avoid sudden beginning; start with polite and tension-reducing gestures • Understand both parties points of view and their limits of concession • Narrow down differences • Enhance positive outcome by using "softpower" • Be correct, impartial and act within the limits of your competence • Request renewed negotiation 	<p>Theoretical presentation followed by practical exercises of incident analysis and role-plays</p>	<p>Video No. 4</p> <p>Transparency No. 7</p>



Training Guide

NEGOTIATION SYSTEM

TRAINING CONTENT	ACTIVITY	MEDIA
<p>■ CLOSING</p> <ul style="list-style-type: none"> • Repeat what has been agreed • Note key points for report • Build up confidence in negotiated settlement • Set time and place for continued negotiation • Conclude with polite expressions 	<p>(As above)</p>	<p>Transparency No. 8</p>
<p>■ REPORTS AND FOLLOW-UP</p> <ul style="list-style-type: none"> • Report important developments to your commander • Write a report • File report • Take follow-up actions 	<p>Presentation followed by practical exercises and incident analysis</p>	<p>Transparency No. 9</p>



Lecture Notes

NEGOTIATION SYSTEM

NEGOTIATION SYSTEM

Introduction

In ordinary military service, the use of arms is of primary importance. Non-use of arms, negotiations and mediations are not only rare, but is relevant only at very high levels.

In peace-keeping missions the situation is different. Concepts such as non-use of arms, negotiation and mediation are basic principles. Liaison and negotiation with the parties is an essential element of UN peace-keeping. All PKOs will have a liaison system in place to provide a structured link between the UN and the parties through which negotiation of mutual problems can take place. The liaison system will embody:

- a. a high level link at FC/CMO levels;
- b. a medium working level link between PKO HQ and the parties on a continuing day to day basis;
- c. Unit ground level link, organized at unit level and designed to defuse problems at source.

In the area of liaison work, certain nominated officers at PKO HQ and unit levels may be nominated to negotiate.

Other forms of negotiation outside this formalized system exist:

- a. military observers may be called to negotiate on a problem which has arisen on the ground:
- b. junior leaders at corporal or even private level may have to negotiate a sudden problem which has arisen in their area (e.g. a CHP dispute).



Lecture Notes

NEGOTIATION SYSTEM

Aim

The basic aim of negotiation is to resolve disputes, within the PKO's area of competence and without recourse to force . Negotiations and mediations are aimed at:

- identifying and isolating areas of dispute;
- preventing their escalation;
- narrowing down differences and areas of conflict;
- resolution of disputes; and
- follow-up and preventive actions against recurrence of disputes.

Principles of negotiation

The PKO negotiating principles are:

- refrain from "win-lose" conflict resolution
- settlement based on principles, even under duress/hostage conditions
- avoidance of the use of the force
- resolution of disputes with the agreement of parties concerned
- mediator/negotiator providing decisive but fair assistance.

Refrain from "win lose" conflict resolution

Negotiated settlements are not a short-sighted "I win, you lose" strategy for conflict resolution. Negotiations recognize that both parties to a dispute have a stake and a share in peaceful settlement of their disputes. If the thinking of a party to a dispute is clouded by other set ideas and convictions, it is the responsibility of the negotiator to help create a favourable attitude.

Peaceful settlement of disputes through negotiation is essential, because it is the least costly alternative in terms of human and material costs. In other words it is an "I win, you win" strategy of conflict resolution.



Lecture Notes

NEGOTIATION SYSTEM

Settlement based on principles

“Might is right” is not the basis for a negotiation. Settlement of disputes unless it is founded on internationally accepted norms and principles can only prove to be the root of further conflicts. Hence, no negotiation should give in to unprincipled demands under conditions of duress.

The UN peace-Keeping Force in particular has a great responsibility to uphold the UN principles and mandate, including Human Rights and Geneva Conventions.

Avoidance of the use of force

It is in this respect that the UN peace-Keeping Force is fundamentally different from a regular military force. “Force would not be used to bring an end to a conflict or to maintain peace” is a principle on which UN peace-Keeping Operations were founded, ever since UN PKO missions were deployed. Negotiated peaceful settlement of disputes has also over a time proved to be an effective strategy for conflict resolution.

Resolution of disputes with the consent of parties

Negotiated settlement can only take place with the consent of both parties to a dispute. It is the function of the negotiator to make unwilling and uncompromising parties understand that without their willingness no negotiation is possible. The alternative can be unresolved disputes or even escalation of conflicts, at a high human and material cost to both parties.

The mediator/negotiator should provide decisive, but fair assistance. In all negotiations, particularly the most sensitive and difficult ones, the role of the negotiator can be very decisive. While he has no authority to “enforce” a settlement, he can and he should use persuasion and “softpower” that helps the disputing parties to arrive at a negotiated settlement. The “soft power” includes:

- the negotiator’s information control: the correct use of the information; his depth of understanding of the conflict; his expert knowledge of any technical aspect, etc.
- the effort and time a negotiator is able to put in
- the negotiator’s integrity, fair-play, and lack of bias
- his communication skills and his use of the right words in negotiation (use of words can get you what you want; it can also lose what you have)



Lecture Notes

NEGOTIATION SYSTEM

- his perception and understanding of disputing parties' positions, which can quite often be shrouded by rhetoric and misleading perceptions.

The negotiator's integrity, fairness and lack of bias does not, however, imply that a negotiator should always be totally impartial. While the expectation of a fair deal can be met, the negotiator is also expected by both parties to give guidance and ruling on factual points and authority views which may not always support one of the parties. Indeed, confidence and trust in a negotiator will only be enhanced if he uses "softpower" to help resolve a sensitive and difficult situation, which neither party is in a position to extricate itself from.

Elements of negotiation

The basic elements in a negotiating process include:

- identification and isolation of problems and disputes
- preventing the escalation of disputes
- narrowing down the areas of conflict
- resolution of disputes
- prevention of the recurrence of disputes.

These elements in their proper sequence are dealt with in the following chapter.

Phases of negotiation

A negotiation process may be divided into four phases. They are:

- preparation for negotiation
- negotiation proper
- closing negotiation
- reports and follow-up actions



Lecture Notes

NEGOTIATION SYSTEM

Preparation for negotiation

The preparation for negotiation should broadly cover the elements of “identification and isolation of disputes” and “preventing the escalation of disputes”. During this phase an investigation, as detailed as possible, should be carried out in order to get a deep understanding of the views, motives, perceptions and expectations, as well as the strengths and weaknesses of both parties to the dispute. An attempt should also be made to isolate the real disputes from peripheral issues.

Further, action should be initiated and agreed to, to prevent further escalation of disputes. Such action may include agreement by both parties to resolve disputes by negotiation, avoidance the use of force, stipulation of disputes, prior agreement on the decision to hold negotiation, its location, authorized representatives, timing, etc.

Above all, preparation should aim to achieve a commitment by both parties to resolve a dispute through negotiation.

Negotiation proper

During this phase an attempts should be made to progressively “narrow down the areas of conflict” and “resolve disputes”. Precautions should also be taken, as far as possible, against the failure of negotiations. During the negotiation proper, the negotiator will follow these basic rules:

1. Don't start to talk directly about the object of the negotiation. Great the parties, introduce yourself, open up with polite phrases, accept refreshments, and use tension-reducing gestures. Talk about subjects of common interests and try to ascertain the mood of your counterpart (nervous, excited, calm, irritated, etc.).



Lecture Notes

NEGOTIATION SYSTEM

2. Try to let the counterpart open - don't go directly to the point. Gently lead the conversation on to your subject or, if the counterpart has asked for the negotiation, then listen and let him speak out. Don't give any admissions during his interpretation. Remember that the counterpart will present his subject as advantageously as possible for himself and using all available means. If it is quite clear that incorrect information is given, point out (with correct evidence) the actual state of things.
3. If there is confusion about the point of issue, make notes of the views of the counterpart and point out that the opposite side (even the UN) is of another opinion and that the UN will return to the matter after investigation .

Carry out an investigation, listen to the opposite party and then take up the subject in a new negotiation.

4. In some situations, the negotiating party will deliver complaints or other views to the opposite side. Be clear on all details. Make notes.

Take up the subject with the opposite side at a negotiation.

5. Make no promises or admissions, unless the situation and your negotiation authorities clearly state that you can do so. Don't give any information about the opposite side which can be of any value to the counterpart. A UN peace-keeper must always be impartial and correct.

Always be restrained if the counterpart expresses any opinion about the UN or the morale, methods, politics of the opposite side, etc. Try to get the counterpart to accept a possible solution which the UN has prepared. Use the material you have prepared, but use it tactfully. Make careful reminders about agreements, arrangement, past practice, earlier pronouncements of the counterpart, etc.



Lecture Notes

NEGOTIATION SYSTEM

Closing negotiations

Conclude the negotiation by repeating what has been agreed upon. Ask to be given the record of the meeting which has been written by the counterpart. It can be used later during further negotiations on the same subject.

Build up confidence in negotiated settlements by focussing on positive and substantial accomplishments.

Decide on agreed time and place for continuing negotiations if necessary.

Part with polite greetings and expressions of good will.

Report and follow-up actions

There are two aspects to this phase, namely:

- consolidation of accomplishments of negotiations
- prevention of recurrence of further disputes.

The consolidation aspects include:

- reporting important developments and accomplishments to your Commander
- recording and filing of reports and agreements
- taking follow-up action based on the agreements of both parties.

The aspect of preventing recurrence of further disputes is concerned with perception of the impact of the earlier negotiations on future developments.



Lecture Notes

NEGOTIATION SYSTEM

Even a very successful outcome to a negotiated settlement may not by itself represent the end to the conflict. If such an outcome is used by the parties themselves as a stepping stone to resolve future differences, the negotiator has accomplished an ideal “win-win” situation.

If there are other serious and simmering issues to be attended to, then the UN PKO should initiate necessary and relevant dialogues and actions.



United Nations
Department of
Peace-Keeping
Operations Training

PEACE-KEEPING TRAINING

Exercise 6

NEGOTIATION SYSTEM

Transparencies

GENERAL

NEGOTIATION IS AN IMPORTANT PART OF A PEACE-KEEPING OPERATION

- USED ON ALL LEVELS
- BY ROUTINE AND AT ESTABLISHED TIMES
- BEFORE STARTING A NEGOTIATION, THE AIM AND PURPOSE HAVE TO BE CLARIFIED

AIM OF NEGOTIATION

- RESOLUTION OF DISPUTES
- WITH THE CONSENT
OF PARTIES CONCERNED
- WITHOUT USE OF FORCE
- WITH DECISIVE ASSISTANCE
OF PKO

PRINCIPLES OF NEGOTIATION

- REFRAIN FROM "WIN-LOSE"
CONFLICT RESOLUTION
- AVOIDANCE OF THE USE
OF FORCE
- RESOLUTION OF DISPUTES
WITH CONSENT OF PARTIES
- NEGOTIATOR/MEDIATOR
PROVIDES DECISIVE BUT FAIR
AND UNBIASED SUPPORT

ELEMENTS OF NEGOTIATION

- IDENTIFICATION AND ISOLATION OF AREAS OF DISPUTE
- PREVENTION OF DISPUTE ESCALATION
- NARROWING DOWN AREAS OF CONFLICT
- RESOLUTION OF CONFLICT
- PREVENTION OF RECURRENCE OF DISPUTES

NEGOTIATION PHASES

1

■ *PREPARATION*

2

■ *NEGOTIATION PROPER*

3

■ *CLOSING*

4

■ *REPORTS*

1. PREPARATION

- INVESTIGATION:
FIND OUT IN DETAIL
WHAT HAPPENED, BOTH PARTIES'
VERSION AND THE UN VERSION
- LIST PRIOR AGREEMENTS
AND OTHER STIPULATIONS:
WHAT HAS BEEN SAID
AND UNDERSTOOD BEFORE
- FIND OUT BOTH PARTIES'
PERCEPTIONS AND PURPOSES
FOR NEGOTIATION
- DECIDE WHERE,
WHEN AND
WITH WHOM
NEGOTIATION IS TO BE HELD

2. NEGOTIATION PROPER

- **START WITH POLITE EXPRESSIONS AND GESTURES. AVOID ABRUPT BEGINNING**
- **UNDERSTAND BOTH PARTIES' VIEWPOINTS AND CONCESSION LIMITS**
- **NARROW DOWN DIFFERENCES; CAREFULLY REMIND OF EARLIER STATEMENT, AGREEMENTS, ETC.**
- **ENHANCE POSITIVE CONTRIBUTIONS AND OUTCOME; USE SOFT POWER (USING RIGHT WORDS YOU CAN GET WHAT YOU WANT; INAPPROPRIATE EXPRESSIONS CAN ALSO LOSE WHAT YOU ALREADY HAVE)**
- **BE CORRECT, UNBIASED AND IMPARTIAL (DON'T MAKE PROMISES BEYOND YOUR COMPETENCE)**
- **REQUEST ANOTHER ENCOUNTER FOR RENEWED NEGOTIATIONS**

3. CLOSING

- **CLOSE THE NEGOTIATION BY REPEATING WHAT HAS BEEN AGREED (BUILD UP CONFIDENCE ON NEGOTIATED SETTLEMENT)**
- **NOTE KEY POINTS FOR NEGOTIATION REPORT**
- **SET THE TIME AND PLACE FOR CONTINUING NEGOTIATIONS**
- **CONCLUDE WITH POLITE EXPRESSIONS**

REPORTS AND FOLLOW- UP

- **REPORT TO YOUR COMMANDER ABOUT IMPORTANT STEPS FORWARD OR FAILURES**

- **WRITE A NEGOTIATION REPORT**
- **FILE THE REPORT AS STIPULATED BY YOUR COMMANDER**

- **TAKE NECESSARY FOLLOW UP ACTION FOR SETTLING DISPUTES AND PREVENTING THEIR RECURRENCE**



**United Nations
Department of
Peace-Keeping
Operations Training**

PEACE-KEEPING TRAINING

Exercise 7

PATROLLING



General suggestions

These training guidelines deal with the subject in broad outline. In designing its own training programme the relevant national authority will have to bear in mind the particular PKO and its likely patrolling requirements.

Training should cover the type of patrolling to be undertaken by the PKO in question. These patrols, which can be by day or night, may be:

- foot patrols;
- vehicle patrols;
- air patrols;
- sea patrols;
- special (river/marsh, ski, etc.) patrols.

Beside theoretical training, pre-deployment training should include the preparation and execution of a field exercise on UN patrolling techniques. The scenario should cover as many of the aims of patrolling as possible.

If time for training is limited, it may be necessary to concentrate on the most important aims such as:

- information gathering, including ground observation
- mobile CHP's (Peace-Keeping Force members only)
- interposition between parties (more relevant to Peace-Keeping Forces than observers)
- "ambush" on infiltration lanes (Peace-Keeping Force members only)



Suggested training strategy

TRAINING CONTENT	ACTIVITY	MEDIA
<ul style="list-style-type: none"> ■ TYPES OF PATROLS (WHAT) 	Lecture and discussion	Transparency No. 1
<ul style="list-style-type: none"> ■ AIMS OF PATROLS (WHAT FOR) <ul style="list-style-type: none"> • Information gathering, mobile CHP's, interposition, ambush, reassure, protect, monitor cease-fire, investigate etc..... 	Describe with examples and discuss many different PKO scenarios requiring patrols	Transparency No. 2
<ul style="list-style-type: none"> ■ PLANNING OF PATROL <ul style="list-style-type: none"> • The context • Patrol routes • Schedules • Number, composition, strength of patrol • Manning of patrol • Equipment levels • Communication system • Reinforcement Plan • Tactical formations • Medevac plans 	Lecture and discussion	Transparency No. 3



Training Guide

PATROLLING

TRAINING CONTENT	ACTIVITY	MEDIA
<p>■ SECURITY OF PATROL</p> <ul style="list-style-type: none"> • Safe (mine cleared) routes • LO's/guides/interpreters • "No go" area information • Night patrol restrictions/special procedures • Measures for patrol recognition by parties 	<p>Lecture and discussion</p>	<p>Transparency No. 4</p>
<p>■ BRIEFING, REPORTING</p> <ul style="list-style-type: none"> • Briefing of a patrol before start • Verbal reporting during patrol • Written records during patrol • Debriefing after re-entry • Preparation of written report 	<p>Lecture and discussion, demonstrate examples.</p> <p>Exercises or verbal reporting should include role play on communication and reporting, Practise report writing, including sketching of maps, situations, etc.</p>	<p>Transparency No. 5</p>
<p>■ PATROLLING PROCEDURES AND TASKS</p> <ul style="list-style-type: none"> • Complying with plan • Observation and reporting • Behaviour if challenged 	<p>Lecture and discussion</p>	<p>Transparency No. 6</p>



Training Guide

PATROLLING

TRAINING CONTENT	ACTIVITY	MEDIA
<ul style="list-style-type: none"> ■ PATROLLING PRACTICE/ EXERCISE <ul style="list-style-type: none"> ● Patrol preparation: <ul style="list-style-type: none"> – briefing – personal preparation – preparation of equipment and vehicles ● Patrol execution: <ul style="list-style-type: none"> – reporting by radio – action on encounters – action on halts ● Debrief: <ul style="list-style-type: none"> – verbal debriefing to “patrol master” – writing report to HQ 	<p>This practical application should be carried out on the ground as a field exercise. If available, static CHP's or OP's should be incorporated into the training area. Otherwise simple “mock-ups” should be simulated. The exercise may cover an area involving a number of patrols and focussing on a number of different aims and tasks. The final phase of training should take place not in a simulated environment but in the area of operation of the PKO under actual conditions of danger, stress and other constraints.</p>	<p>Video No. 5</p>



Lecture Notes

PATROLLING

THE GENERAL AIM OF UN PATROLLING IS TO HAVE FULL CONTROL IN THE AO, KEEP INFILTRATORS OUT AND BRING SAFETY TO THE POPULATION

General

Patrolling is an essential part of UN Peace-Keeping. It is virtually impossible to conceive of a mission in which there would be no patrolling. This activity is conducted by PKOs whether they are observer groups, Peace-Keeping Forces or a mixture of both.

Patrolling is a key factor in most Peace-Keeping Operations, and if well planned, vigorous and intelligently executed, it can achieve important tactical advantages for the peace-keeper. To be fully effective, the patrols need complete freedom of movement and of observation. This is not necessarily always granted to UN Forces whose powers of investigating may be restricted.

Reporting is a no less important a function, for it is so often the case that Peace-Keeping successes depend on early and accurate reporting. The art of good reporting should therefore be specially studied and developed in any patrol programme concerned, and an intensive training programme should be carried out.

The most usual patrols are those which control "dead ground" not covered by OPs and CPs. Other types of patrols, such as standing patrols and mine detection patrols, are also important.

All patrols have a task either:

- to interpose or intervene
- to stop or reduce attempts at infiltration, or
- to show UN presence in the AO.

All patrolling demands highly trained and motivated personnel. To get the maximum effect from patrolling, the equipment must be up to date, the tactics flexible and modern and very well co-ordinated with other patrols, OPs and CPs.



Lecture Notes

PATROLLING

Types of patrols

Foot patrols

These remain the conventional form of patrolling and the basis on which any patrol system will be operated.

In built-up areas, it is an advantage to use foot patrols. This will give better contact with the population, which is of great importance to all UN missions. Good contact with the locals may also result in useful information. However, much of this information must be handled with care. It might be false and cause innocent people to suffer. People giving information to UN personnel may also be harassed by others.

Foot patrols can either be mobile or standing. Their limitations compared to vehicle patrols are:

- reduced flexibility in terms of tasks
- reduced operational range in terms of distance and endurance
- less reliable and shorter range radio communication capability, with lightweight portable equipment compared to vehicle mounted equipment.

Whereas a vehicle can be plainly marked to indicate its identity, a foot patrol needs to carry a distinguishing sign which is visible at an appropriate distance to avoid mistaken identity and the patrol being fired upon.

A banner, flag or placard can be carried by one member of the patrol where it is most visible. Foot patrols, however restricted in their operational manoeuvrability, have a greater access to areas which are denied to vehicular patrols for reasons of climate or terrain. For this reason alone, foot patrolling remains a fundamental requirement in the conduct of Peace-Keeping Operations.

If a foot patrol moves into an area controlled by another unit, careful co-ordination in advance is necessary.



Lecture Notes

PATROLLING

Vehicle patrols

Vehicle patrols are used in the following situations:

- lack of manpower
- huge area of responsibility
- limitation in freedom of movement
- where speed is necessary
- where it is necessary to bring along a heavy or large amount of equipment.

Vehicle patrols have obvious advantages over foot patrols, for they:

- commands greater mobility and range with its cross-country performance
- can cover patrol routes more quickly, thereby allowing a greater number of patrols to be mounted in a shorter period of time
- are more easily identifiable through vehicle markings than is possible with a foot patrol
- can carry more sophisticated radio equipment, providing longer transmission range, clearer and more secure communication links and a more reliable report system
- give more visible evidence of the Peace-Keeping presence to a larger number of people
- allow large searchlights to be installed in the vehicles for improved observation during darkness.

Vehicle patrols also have their limitations, for they are restricted to fairly smooth surfaces and cannot travel everywhere that a foot patrol can. However, the biggest limitation is perhaps a psychological rather than a physical one, deriving from the very character of the patrol method used, the temptation on the part of the patrolman to carry out all his observations and investigations from "sitting positions" inside the vehicle.

Patrolling has to be thorough in order to be productive in information gathering. At certain observation points, the patrol has to stop the vehicle, turn off the engine and conduct a thorough observation. This is particularly important during darkness. The places picked out for observation have to be changed often and the time of observation has to vary.



Lecture Notes

PATROLLING

Aerial patrols

These can be undertaken by helicopter or light aircraft. The hover capability of the former makes it particularly appropriate for observation and sight reporting of incidents taking place on the ground. Aerial patrols may also be executed by RPV (Remotely Piloted Vehicle) or UAV (Unmanned Aerial Vehicle) that may photograph the area, tape it on video or transmit from a TV camera.

Normally, all parties involved have to agree upon aerial surveillance before it is conducted.



Lecture Notes

PATROLLING

Aims of patrolling

- confirm/supervise a cease-fire;
- gain information;
- check on areas which cannot be observed from OPs and CHP's;
- indicate a UN presence to parties;
- reassure isolated communities;
- carry out mobile CHPs;
- inspect existing and empty positions of the parties;
- insert "ambush" parties along infiltration lanes;
- carry out observation from isolated and unoccupied OPs;
- provide a physical link between adjoining but relatively isolated UN positions;
- avoid static deployment and give UN forces a certain freedom of movement;
- provide protection for parties or local population where travelling without the UN might provoke an incident;
- interpose standing patrols between parties during a period of tension;
- investigate incidents.



Lecture Notes

PATROLLING

Planning of patrol

When planning the patrols, the following must be considered:

- What is the general situation in the AO?
- Which areas are dead ground to the OPs and CHPs, and what kind of information is desirable?
- Where are the possible infiltration routes, and where are the routes, seen in relation to the villages, and positions belonging to other armed forces and what is the aim of the infiltration?
- Are there people belonging to special hostile fractions in any of the villages?
- Are there religious or other events or celebrations ahead, that might lead to assassinations or bombs, etc.?
- Are there minefields to be avoided?
- Is patrolling to be conducted by day, in darkness or during special weather conditions?

These things must be carefully co-ordinated with all other patrols. The duration and task of each patrol must be carefully evaluated. Some of the patrols may meet in an area, for example where they join and keep a valley, or several villages, under surveillance. In some areas, bad weather often means a reduction in the number of infiltrators. In other areas, it means more infiltration or trouble due to worse observation possibilities for the UN.

In planning patrols, the operations officers must act unpredictably towards the opposing parties by changing often:

- the patrol routes
- timing of departure and arrival
- number of patrols
- size of patrols
- compositions of the patrols



Training Guide

PATROLLING

FREQUENTLY CHANGING THE PATROL SYSTEM IS VERY IMPORTANT

The operations officer also has to:

- be in frequent contact with the patrol leaders
- gather information
- constantly consider the general situation and his resources

A UN mission will almost never have enough resources to cover all terrain. It is therefore necessary to use the troops at hand as effectively as possible.

WHEN PLANNING ROUTES FOR PATROLLING ALWAYS BE AWARE OF MINES

Due to the danger of mine, the operations officer might leave some areas totally free of UN patrols. If no maps or information are available, mine clearing is the only possibility, perhaps combined with routes chosen on roads, or paths on stony ground. Carrying out patrolling in some UN missions might risky.

Therefore it is of utmost importance to take the safety of UN personnel into great consideration when planning the routes for patrolling.

Manning of the patrol

The normal number of men would be three, but the size of the patrol depends on the situation in the area and the duration of the patrol. As a rule, a patrol must consist of at least two men. LRPs (long range patrols) are usually a squad or more.



Equipment

Basic equipment Personal weapon, proper UN uniform with cap, etc., UN ID-card, personal first aid kit, radio including code words and frequencies and a sufficient volume of drinking water.

Patrol execution

Patrol phases There are three phases in a patrol operation, each requiring a set of procedures. The three phases are:

- before departure: planning, preparation, training and briefing
- during patrolling: execution
- after return: debriefing and reporting

Briefing of a patrol before start

In due time before departure, the patrol leader and the whole patrol must be thoroughly briefed. The patrol has to be fully updated on all events before leaving, and must be sure how to act in different kinds of situations.

EACH MEMBER OF A PATROL HAS TO BE CAREFULLY AND THOROUGHLY BRIEFED BEFORE DEPARTURE. EACH MEMBER SHOULD BE PREPARED TO TAKE OVER AS PATROL LEADER.



Training Guide

PATROLLING

Brief should comprise:

- the aim of the patrol and its specific task
- alternative task if the primary missions cannot be carried out
- the general situation in the area, special events to be aware of, reports from previous patrols. All current and up-to-date information must be obtained, including obstacles
- other UN patrols or activity to be aware of. The route of the nearest UN patrols, own night firing exercises, etc.
- local procedures in use by the other parties or by civilian authorities in the area
- the patrol route
- how flanking units and OPs are to be informed. Code words for communication and emergency
- time of departure, time of arrival at different objects, and the latest time for return to base.
- MEDEVAC procedure
- weather forecast
- debrief and patrol report, where and when
- questions

Example of brief

The example illustrates a short and precise statement of the itinerary, the task to be carried out and the time schedule:

BLUE patrol route, from base to OP 4 - 10 to position 413, to Hill 360, then ABA valley and return to base. On Hill 360, establish OP position for 3 hrs. Observe and report all activities found in the area.

- *Time of departure: 10.00 p.m*
- *Time of return: 05.00 - 05.15 a.m.*
- *Questions?*



Patrolling procedures

During patrolling, it is essential that the patrol should:

- Comply strictly with the patrol plan. Failure to do so could affect the success of the patrol;
- maintain a written record of all observation the patrol makes, noting times - do not rely on memory alone. Draw sketches where they are helpful. When possible and without risk to the patrol, use video or camera for verification.
- halt when challenged and establish the identity of the patrol. Report at once by radio to headquarters any attempt to obstruct the patrol's progress and await instructions;
- maintain continuous radio contact with the patrol base and, where appropriate, higher and flanking headquarters and keep them informed of the patrol's progress. If, due to tactical reasons, the patrol has to minimize the use of radio, the patrol will only report when reaching certain previously plotted reporting points on the route. Short code words are normally used;
- in addition to the patrol's specific tasks, observe:
 - the condition of roads and tracks
 - the nature of the terrain
 - the presence of obstacles of any kind, including minefields;
- record any changes in the dispositions of armed forces of either side, particularly if and where positions have been advanced or newly dug, or where airstrips have been constructed or extended;
- ensure the security of all maps, documents and equipment belonging to the patrol. Do not surrender these to anyone unless instructed to do so by higher headquarters authority;
- record any changes in environmental or civilian activity, why farmers are not ploughing or harvesting their fields during the appropriate season and where they have previously been doing so. Changes of any kind in civilians lifestyle can denote tensions and could predict a renewal of hostilities;



Training Guide

PATROLLING

- refrain from diverging from the original patrol plan in order to investigate unscheduled incidents or situations without first obtaining approval from Coy or BN headquarters. Diverging can interfere with the patrol's ability to complete its planned task and it is often better to check any new development discovered during the course of one patrol by another specially mounted for the purpose.

Debriefing and reporting

On its return, the patrol should:

- report immediately for debriefing;
- prepare a detailed written report with sketches, photographs and diagrams as necessary;
- check vehicles and equipment taken on patrol and report and damage and/or deficiencies;
- report any patrol member requiring medical attention.



**United Nations
Department of
Peace-Keeping
Operations Training**

PEACE-KEEPING TRAINING

Exercise 7

PATROLLING

Transparencies

PATROLLING

FOOT PATROL

ADVANTAGES

- greater access to areas denied to vehicle patrols

LIMITATIONS

- reduced flexibility and operational range
- reduced radio communication capability
- limitation of portable equipment
- limited visibility of UN presence

VEHICLE PATROL

ADVANTAGES

- greater mobility operational range
- speed, better visibility of UN presence
- can carry more equipment
- longer radio communication range

LIMITATIONS

- cannot travel everywhere
- patrolman is tempted to carry out his tasks “in sitting position”

AIMS FOR PATROLS

(WHAT FOR)

- GAIN INFORMATION
- MOBILE CHECKPOINTS
(Peace-Keeping Force members PFM)
- INTERPOSITION (more relevant for PFM than Observers)
- AMBUSH (PFM)
- CONFIRM/SUPERVISE CEASE-FIRE
- INDICATE UN PRESENCE
(REASSURE)
- INSPECT POSITIONS
- LINK UN POSITIONS
- PROTECT TRAVELLING
POPULATION
- INVESTIGATE INCIDENTS

PLANNING PATROL

- THE CONTEXT
- PATROL ROUTES
- SCHEDULES
- NUMBER, COMPOSITION,
STRENGTH
- MANNING
- EQUIPMENT
- COMMUNICATION SYSTEM
- REINFORCEMENT PLAN
- TACTICS
- MEDEVAC PLANS
- SECURITY

SECURITY OF PATROL

- mine-cleared routes
- LOs/guides/interpreters
- “no-go” area
- night patrol restrictions
- patrol recognition

BRIEFING/REPORTING

BRIEF (before departure)

- aim and specific task
- alternative task
- situation in area/weather forecast
- other UN patrols
- local procedures
- patrol routes
- schedule
- communication & codes
- MEDEVAC procedures
- debriefing instructions
- questions

PATROLLING PROCEDURES/TASKS

- **COMPLY STRICTLY WITH PLAN**
- **OBTAIN APPROVAL FOR DIVERGING**
- **OBSERVE, RECORD, SKETCH, FILM**
- **IN ADDITION TO SPECIFIC TASKS
RECORD:**
 - nature of terrain
 - condition of track
 - obstacles
 - changes in positions of armed forces
 - changes in behaviour of civilian population
- **MAINTAIN CONTINUOUS RADIO
CONTACT ACCORDING TO
INSTRUCTIONS**
- **IF CHALLENGED**
 - halt
 - provide identity
 - contact headquarters
- **ENSURE SECURITY
OF DOCUMENT/EQUIPMENT**



**United Nations
Department of
Peace-Keeping
Operations Training**

PEACE-KEEPING TRAINING

Exercise 8

CHECKPOINTS



CHECKPOINTS

Aim of this exercise

The general aim is to enforce control measures, orders and regulation in a particular location.

More specifically training should focus on:

- how to plan and organize static and mobile checkpoints
- how to control personnel and traffic
- how to registrate specific data
- how to communicate and to report

General suggestions

This training and practical application should cover the theory, layout, siting and operation of checkpoints (CHPs), road-blocks and searches. While the initial part can be done in a classroom/lecture hall, the practical application can only be attempted on the ground. If a training position/OP has been constructed, it would be useful to incorporate a static CHP into the training area. This would be ideal for training in all three areas. Otherwise a simple “mock up” should be used. For training in mobile CHPs the necessary equipment can usually be easily provided from local resources. Thereafter a training circuit can be laid out and the operation of mobile CHPs practised.



Training Guide

CHECKPOINTS

As an example

You may wish to use the Operations Directive from UNIFIL on mobile CHPs to prepare a training exercise. The UNIFIL Directive is attached.

The final phase of training should be an exercise involving the operation of static and mobile CHPs, the conversion of CHPs to road-blocks and the actual searching of personnel and vehicles where some will actually be carrying contraband. The normal subsidiary problems encountered at CHPs should also be included in exercises (e.g. build up of traffic and consequent loss of tempers, truculent subjects of search, "crash through" incident and follow up action, etc.).

The training should also include and experience of what to do when people:

- refuse to produce an identity card
- refuse to open the boot of a car
- produce a weapon

Junior leaders especially should practise their skills in:

- isolating problems quickly
- preventing their escalation
- scaling down and solving problems on the spot.



CHECKPOINTS

Suggested training strategy

TRAINING CONTENT	ACTIVITY	MEDIA
<ul style="list-style-type: none"> ■ AIM OF THE EXERCISE <ul style="list-style-type: none"> • Planning and organisation of CHPs • Personnel and traffic control • Data registration • Communication and report 	<p>Explain what you aim to achieve in this exercise explain its meaning</p>	<p>Transparency No. 1</p>
<ul style="list-style-type: none"> ■ DEFINITION OF A CHP ■ TYPES OF CHP'S <ul style="list-style-type: none"> • Static checkpoints • Mobile checkpoints 	<p>Explain main characteristics Illustrate examples of layout, "mock-ups" and real CHP's if available</p> <p>Explain main characteristics</p>	<p>Transparencies Nos. 3. 4. 5</p> <p>Video No. 4</p> <p>Transparency No. 6</p>
<ul style="list-style-type: none"> ■ PURPOSE OF CHECKPOINTS <ul style="list-style-type: none"> • Show UN presence • Survey and report activities • Check/inspect persons/traffic • Prevent infiltration • Act as OP or work with OPs • Block all or selected traffic 	<p>Lecture, discuss and illustrate examples on the basis of cases</p> <p>Practical exercises should cover each one of the listed purposes</p>	<p>Transparency No. 7</p>



Training Guide

CHECKPOINTS

TRAINING CONTENT	ACTIVITY	MEDIA
<ul style="list-style-type: none"> ■ PLANNING/ESTABLISHING CHPs <ul style="list-style-type: none"> • Planning static CHPs • Setting up static CHPs • Establishing mobile CHPs 	<p>Present cases and areas and exercise the planning of layouts and equipment</p> <p>If an exercise in setting up a static CHP is not possible, you should at least visit one</p> <p>This exercise must include cost-effective combinations with OPs</p>	Transparency No. 8
<ul style="list-style-type: none"> ■ CHP BRIEFING 	<p>Illustrate and demonstrate briefing sessions</p> <p>Practise role plays</p>	
<ul style="list-style-type: none"> ■ MANNING CHPs 	<p>Explain manning using various examples of situations and traffic</p>	
<ul style="list-style-type: none"> ■ COMMUNICATION <ul style="list-style-type: none"> • Network between OPs, CHPs units, BN OPs • Operating 	<p>Illustrate the operation of communication equipment</p>	
<ul style="list-style-type: none"> ■ EQUIPMENT <ul style="list-style-type: none"> • Personal equipment: <ul style="list-style-type: none"> – For static checkpoints – For mobile checkpoints 	<p>Practise the use</p> <p>List and familiarize troops with equipment</p> <p>List and practise the use of equipment</p>	



Training Guide

CHECKPOINTS

TRAINING CONTENT	ACTIVITY	MEDIA
<p>■ CONTROL</p> <ul style="list-style-type: none"> • Checking and searching identification of persons , body search, etc. • Checking traffic <ul style="list-style-type: none"> – admittance rules – regulating traffic – searching vehicles 	<p>Lecture, demonstrate and practise through role plays and simulation of resistance and threat</p> <p>Lecture, demonstrate and discuss various cases. Practise during day and night, peak-load: simulate crash-through , refusal to orders. Exercise cooperation with other OPs and CHPs.</p>	
<p>■ REPORTING AND REGISTRATION</p> <ul style="list-style-type: none"> • Registration • Reporting <ul style="list-style-type: none"> – orally – in writing 	<p>Demonstrate and practise registration Develop accuracy of observations</p> <p>Demonstrate and practise oral reporting to other OPs or CHPs</p> <p>First exercise report writing in class, then practise report writing during field exercise</p> <p>Develop accuracy</p>	



Lecture Notes

CHECKPOINTS

CHECKPOINTS

Aim

In general to enforce control measures, orders and regulations in a particular location.

More specifically:

- to plan and organize static and mobile CHPs
- to control persons and traffic
- to register specific data
- to communicate and report

Definition

A checkpoint is a manned point used as a means of controlling movement and checking vehicles and pedestrians in order to enforce measures, orders and regulations.

Although used widely by some PKOs, the nature and frequency of their use would depend on the mandate and concept of operation as well as the status of the force's agreement, which may limit UN powers of search.

Closed checkpoints are called road-blocks. They can also form the basis of blocking positions, if these are required because of developments on the ground (e.g. incursions by the parties).



Lecture Notes

CHECKPOINTS

Types of checkpoint

Static checkpoints

Static CHPs are deployed permanently at fixed locations. Normally a position adjoins the installation. Troops who man the CHP will live at the position. CHPs are deployed on a road or major track, normally at a crossroad or junction or at the entrance to a controlled area. T3, T4 and T5 illustrate suggested layouts for CHPs. All CHPs will have a method of slowing traffic (ramps and/or a "zig zag" device) and a search bay for the more thorough searches. The CHP is manned on a 7-day week/24-hours day basis but it can be closed and converted into a road-block where movement is forbidden during given hours. The blocking of the road/track does not relieve the position of its normal security/observation mission. CHPs sometimes vary in the degree of search they are required to carry out (e.g. military vehicles only, all vehicles, random proportion of vehicles). Depending on local circumstances, searches may also include the searching of individuals or at least males.

Mobile checkpoints

Mobile CHPs are deployed where the PKO has difficulties covering all roads and tracks with static CHPs. Mobile CHPs will be composed of a minimum of one section in two armoured vehicles. This group will leave base, operate over a given road/track network and set up "snap CHPs" en route for short periods. The annex shows an example of mobile checkpoints and covers the operation of such checkpoints.

Mobile CHPs can often be very efficient, because no one knows in advance where they are temporarily being set up. This could help to prevent smuggling of weapons and explosives. The purpose of a mobile CHP is to reinforce control and make smuggling/infiltration more difficult. A temporary mobile CHP would normally consist of a vehicle or an APC, with some concertina wire, CHPs signs and personnel.

To control a narrow path, you need 3-6 soldiers. Pick out a concealed position, so that the CHP is a surprise to the people approaching.



Lecture Notes

CHECKPOINTS

Purpose of checkpoints

- To show the presence of the UN to all parties and to the population in the area.
- To survey all activity in the terrain, along roads and in inhabited areas.
- To check/inspect and register all traffic of personnel, vehicles into and out of the UN zone.
- To prevent the smuggling of weapons, ammunition and explosives into or out of the UN zone.
- To count special traffic, such as military vehicles, tanks, APCs, artillery, etc.
- To act as an OP or CHP and work together with other OPs and CHPs.
- To report all activities to UN command.
- On specific order, to be able to close the CHP or OP and block different types of traffic.



Lecture Notes

CHECKPOINTS

Planning and establishing CHPs

New missions

OPs and CHPs are to be established at a very early stage of a new mission.

When a Commander arrives on a new and often difficult mission, he should establish mobile Operation Posts (Ops) and CHPs during the daytime and pull them back just before darkness.

This will give him more time to study the situation in the area and to plan permanent OPs and CHPs.

Establishing a mobile CHP must be coordinated with other CHPs and OPs. The mobile CHP ought to be operating within 30 to 60 min. After approximately one hour, the position of the CHPs will be known and the effect is reduced.

Combining CHPs and OPs

Combining CHPs and OPs is very cost effective.

If, for example, two roads join to form a single road, place the CHP a couple of hundred metres after the junction, thus saving one CHP. Even better, choose a place for the CHPs where there are no or very few possibilities of passing it by simply walking or driving through the terrain outside the CHP. In the case of a border CHP intended to clearly mark the UN "BORDER", it may be difficult to find the best place for the CHP.

A border CHP is therefore established on the border or cease-fire line, whenever possible. Even in a narrow valley or similar places, it may be possible to bypass the CHP. This could be prevented by building fences or obstacles outside the CHP.

To achieve the maximum effect in stopping infiltrators, the various CHPs and OPs have to work together very efficiently. The CHP could be very simple. It might consist of some barrels filled with stone or concrete, and some concertina wire.



Lecture Notes

CHECKPOINTS

If there are heavily armed elements in the area, or a risk of car bombs, the CHP itself must be built in a totally different way

(See Annex 1).

To save resources and personnel, it is often advisable to combine a CHP just outside a compound with the OP inside. The OP must be able to observe and secure the CHP.

CHP briefing

Setting up mobile CHPs or daily shift operations of a fix CHP is preceded by a briefing. The briefing may include the following types of information and instructions:

1. Location of the CHP
2. Purpose and task
3. General observation, limitations, checkpoint technique etc.
4. Nearest UN positions, HQ, and direction and distance to other UN positions
5. Nearest position(s) belonging to other factions in the area, direction, distance and strength
6. Manning of the CHP
7. Brief about the equipment (very short simple demo)
8. Communications
9. Logistics
10. Special regulations
11. Latest events

End of brief, questions?



Lecture Notes

CHECKPOINTS

Manning a CHP

There should be a minimum of two soldiers manning the CHP, depending on the traffic and the general situation. One of the soldiers checks people and vehicles. One soldier covers the area where people and vehicles are checked. The soldier covering the other area is armed and has easy access to radio and telephone. If more soldiers are manning the CHP, one of them could be ready to set up obstacles to stop vehicles trying to force their way through the CHP.

Basic rules

The first rule in the OP or CHP is that all radios, lights and equipment must work properly and that all books, maps and files are ready for use. No unnecessary pictures, etc. are to be pinned up inside the OP. Private radios, cassette players and magazines are strictly forbidden in the OP tower.

Communications

All OPs and CHP are to be connected to their unit or directly to the BN OPs by radio and telephone line. If necessary, a spare radio and batteries should be applied to the OP and CHP

OPs and CHPs of great operational value may be connected by direct landline to ensure rapid coordination in urgent situations.

**BE WARY:
YOUR RADIO TRANSMISSION MAY BE
MONITORED AND TAPED**



Lecture Notes

CHECKPOINTS

Equipment

Personal equipment

- Proper uniform with UN blue headgear
- UN ID-card
- Personal weapon
- Helmet, flak jacket
- C-equipment
- Personal first aid kit/bandage

CHP and OP equipment

There are many items that may be used to reinforce a CHP or OP. Some of the equipment in use is mentioned below:

- Knife rests, concertina wire, different types of bars and drums for reducing speed, defence positions, string with nails or similar gear to puncture the tyres of vehicles
- Heavy concrete blocks (2 tons or heavier)
- UN sign, indicating what kinds of personnel, weapons, uniforms, etc. are prohibited in the UN zone
- In case of a "Blue Line" CHP, the area around the CHP should be provided with invisible warning signs. The access road should contain signs about 100 to 150 meters from the CHP at both sides with text in English and local language:

YOU ARE NOW ENTERING (LEAVING) THE UN ZONE.

REDUCE SPEED TO - - MPH/KM/T.

PLEASE HAVE YOUR ID-CARD READY.

NO WEAPONS, KNIVES OR EXPLOSIVES ARE ALLOWED IN THE UN ZONE.



Lecture Notes

CHECKPOINTS

Control

Control of persons

Persons authorized to enter in the UN zone are regulated in the SOP.

The main reason for checking persons is for

- identification
- preventing illegal items being carried into the AO through the CHP

Personnel must identify themselves with:

- an ID-card
- a passport

Normally ID-cards are written in the local language. In some cases local inhabitants may be provided with UN ID-cards issued in English and the local language

Refusal of identity

If a person refuses to produce an ID-card you should

(MISSING INFORMATION)

Weapons

If the persons checked have weapons, ammunition or explosives, these are to be confiscated and the persons questioned by a UN MP. When weapons are discovered these must be confiscated before the persons can be allowed to enter the area of operation.



Lecture Notes

CHECKPOINTS

The control of persons effected in different ways:

Body search

Look for persons acting strangely or with bulging clothing. If you decide to carry out a body search, feel along the clothes without patting them.

Special attention must be paid to the lower parts of the back, and from the shoes up to the knees. Also armpits must be checked. Also check boots, hats, etc.

Metal detector search

The metal detector is very effective, and is moved smoothly over the whole body in contact with the clothing.

Women and clerical persons

Making a body search of women and clerical persons is often very difficult in Moslem countries, and may lead to very strong reactions against UN personnel. This must be thoroughly discussed with mayors, etc., by the UN Commander. Usually women are only checked with a metal detector.

Traffic control

Traffic controls may involve a variety of duties which range from reporting on vehicle movements to searching vehicles. If there is a danger of car bombs, pay special attention to cars containing only one person.

The CHP must be equipped with speed reducers and defence position for every man, and with spikes or bars to prevent any attempt at breaking through.

Free entrance

Usually the following vehicles are admitted:

- UN personnel
- UN observers
- Red Cross personnel (if you know them)
- Local police and authorities



Lecture Notes

CHECKPOINTS

No entrance

The following vehicles should not be admitted:

- Armed elements
- Civilians without valid ID-card
- Unauthorized persons
- During curfew, nobody has permission to pass through the CHPs

By night

All cars must be stopped for CHP checking and registration. All cars with civilians will be ordered to drive on to their destination without halting after being checked. The next CHP must be informed so that the traffic can be supervised. Normally, the CHPs are well informed concerning the time needed to driving from one CHP to the next. OPs should also be involved.



Lecture Notes

CHECKPOINTS

Reporting and registration

Reporting

Reporting is a very important function.

The art of good reporting should be specially studied and developed in all training programmes.

When preparing reports, it is crucial to make certain that:

- only accurate and checked statements of fact are included;
- unclear observations should be cross-checked;
- the report must contain precise information in terms of the kind of movements observed and of their quantity. This is the purpose the CHP personnel's register.
- the content is clear and concise, avoiding ambiguity.

Registration

When checking all traffic, register:

- time
- name of driver
- type of vehicle, licence number or kind of animal (donkey or camel)
- direction/destination

In some cases you may also include:

- number of passengers
- type of load



Lecture Notes

CHECKPOINTS

Annex 1

UNIFIL Directive for National or Regional Training Programmes

MOBILE CHECKPOINTS

General

The increase in road networks and improvement in navigable tracks throughout the AO poses problems for UNIFIL. The use of mobile CHPs is seen as an adequate temporary solution. Each BATT will plan for and operate mobile CHPs each day to augment permanent CHPs and to enhance control over the area. These CHPs will consist of no less than four soldiers and will cover the many side roads within the AO. Ensure that the location and times of these CHPs are varied and do not become predictable.

They will be in radio contact with the major CHP so that it can easily relieve them of pressure when traffic is heavy. Signs reading "Mobile Checkpoint" written in Arabic and English will always be clearly displayed in the area of the vehicle.

It is stressed that mobile CHPs are not patrols showing a UNIFIL presence. They are separate operations with a definite CHP mission. They can of course be combined with patrolling, depending on the area where they are deployed. Each battalion will pursue a vigorous CHP policy in their AO ensuring that they cover tracks and lesser routes as well as new roads which do not have permanent CHPs.

Mobile CHPs should be coordinated by battalion OPs. Depending on the allocation of armoured vehicles within the unit, each individual Coy could undertake such activity in their own area, but it is more likely that a single element (i.e. Recce Coy) be tasked with the mission for the whole AO. This is a prerogative of the unit.

Battalion OPs will maintain a separate mobile CHP register and brief/debrief the CHP before and after each mission. Mobile CHPs can be either A, B, or C, depending on where they are deployed, but it would be normal to follow a Category B policy as this covers areas not normally checked, where there may be a high level of potential infiltration of weapons and a low traffic density.



Lecture Notes

CHECKPOINTS

Strength and equipment

This is a unit responsibility but ideally the strength of the CHP should be at least a section and two armoured vehicles. Personal weapons and the vehicle should supply the necessary defensive potential. The vehicles should provide protection. Ancillary equipment such as signposts, wire barriers, mobile vehicle stops, etc., should be carried in the vehicles.

Method of operation. The mobile CHP/patrol should leave base after briefing by the unit ops officer. The briefing should include:

- routes out and back. These should be varied constantly to avoid interdiction or planned attack;
- the number of CHPs required, the position of deployment and the average time in place;
- instructions on communications, report lines, etc.;
- special instructions.

The patrol then leaves base and sets up its first CHP. In choosing a CHP location, the following criteria should be applied. Though it will not be possible to ensure that all criteria are available on the ground, nevertheless the following provides a set of guiding principles:

- CHPs should be established at varying times and for irregular periods of time.
- Good communications. This is an essential element. An excellent site with poor communications is in fact not a site at all. Communications are necessary to:
 - maintain contact with controlling station (normally battalion OPs);
 - to call on BMR as back-up;
 - to allow the CHP to be redeployed should a particular problem arise elsewhere.

CHPs should not be visible to approaching vehicles from a long way off to avoid them taking alternative routes. CHPs should, however, be sited so that they give some short-term warning to approaching vehicles and so avoid accidents. Proper use of terrain features is a necessary requirement. If possible, the CHPs should be sited on an incline which will slow down traffic.



Lecture Notes

CHECKPOINTS

CHP locations should be different each time a specific route is given. Routes should not be specific to given days. Routes in a given area should be varied if possible.

Once a CHP has been in position for the planned period of time it should redeploy to its next location and then to the next, until it arrives back at base for debriefing.

Security of CHPs

All CHPs should provide adequate security for personnel. The nature of the mission requires some soldiers to be dismounted in order to check/search vehicles.

These soldiers must be given the same protection as they would get on a permanent CHP.

This security is provided by:

- the proper deployment of the CHP in order to give it a tactical advantage over the vehicle to be checked;
- use of makeshift barriers;
- use of armoured vehicle to block the road;
- use of main armament of armoured vehicle to cover troops involved in checking and searching;
- in some cases, where terrain and strength of patrol allow, a dismounted covering group could occupy a suitable position to give additional cover to the whole CHP.

Pre-recce and preparation

The implementation of this policy will require pre-recce by the units and sub-units concerned before a battalion plan can be drawn up.

Consultation with local leaders may also prove beneficial before putting this policy into effect.



**United Nations
Department of
Peace-Keeping
Operations Training**

PEACE-KEEPING TRAINING

Exercise 8

CHECKPOINTS

Transparencies

AIM OF CHECKPOINT TRAINING

**TO ENFORCE CONTROL MEASURES,
ORDERS AND REGULATIONS
IN A PARTICULAR LOCATION**

MORE SPECIFICALLY:

- HOW TO PLAN AND ORGANISE
STATIC AND MOBILE CHECKPOINTS
- HOW TO CONTROL PERSONNEL
AND TRAFFIC
- HOW TO REGISTER SPECIFIC DATA
- HOW TO COMMUNICATE AND
REPORT

STATIC CHECKPOINT

- IS VISIBLE AND WELL PROTECTED
- IS USUALLY IN A STRATEGIC POSITION (ROAD JUNCTION, BRIDGE, NARROW VALLEY)
- HAS A DEVICE FOR SLOWING DOWN OR BLOCKING TRAFFIC
- HAS A SEARCH BAY
- HAS A SHELTER FOR PERSONNEL
- HAS GOOD TELEPHONE OR RADIO COMMUNICATION
- IS MANNED 7 DAYS A WEEK, 24 HOURS/DAY
- CAN BE CONVERTED INTO A ROAD-BLOCK
- CAN BE COMBINED WITH OP

Suggested layout for CHPs - 1

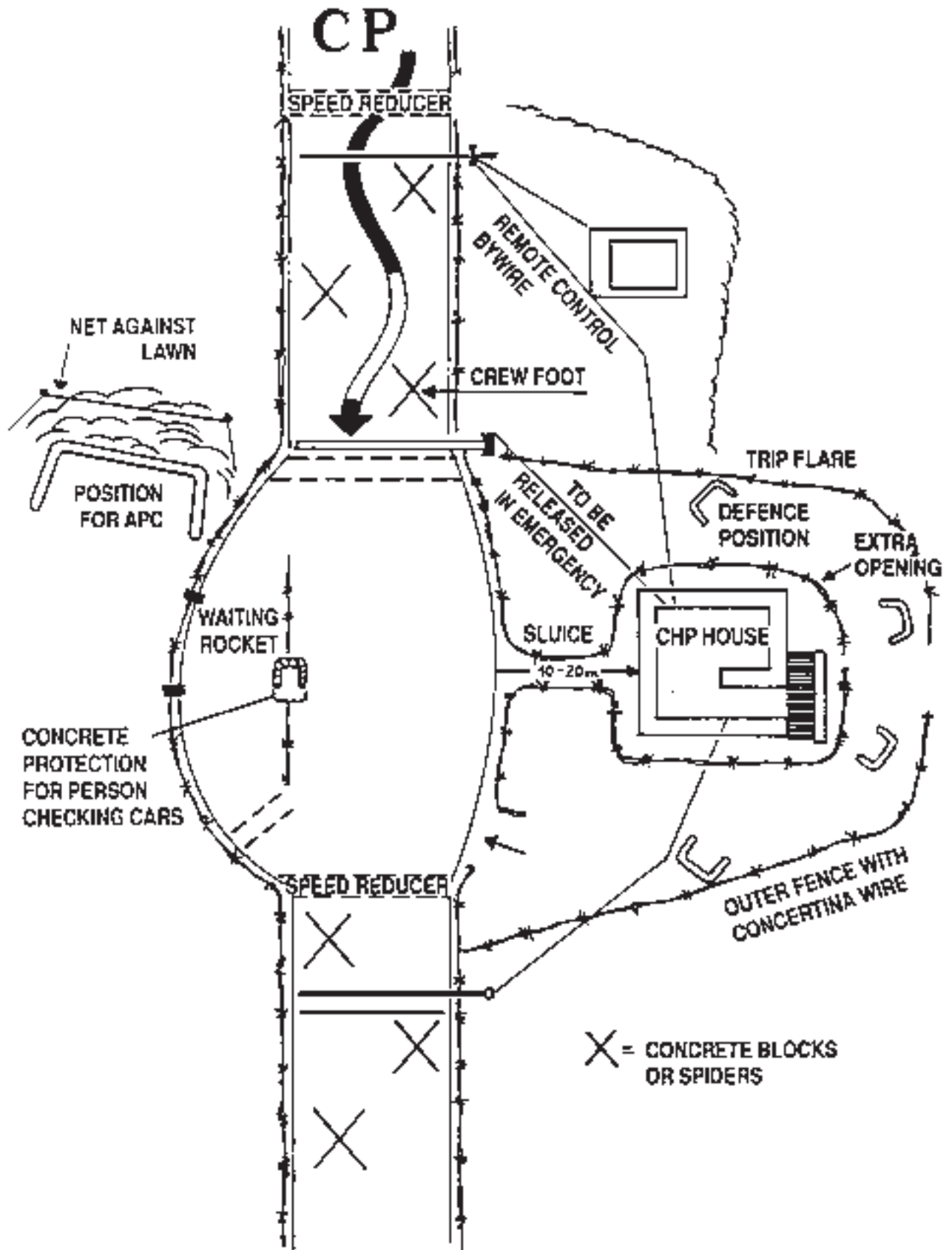

Suggested layout for CHPs - 2

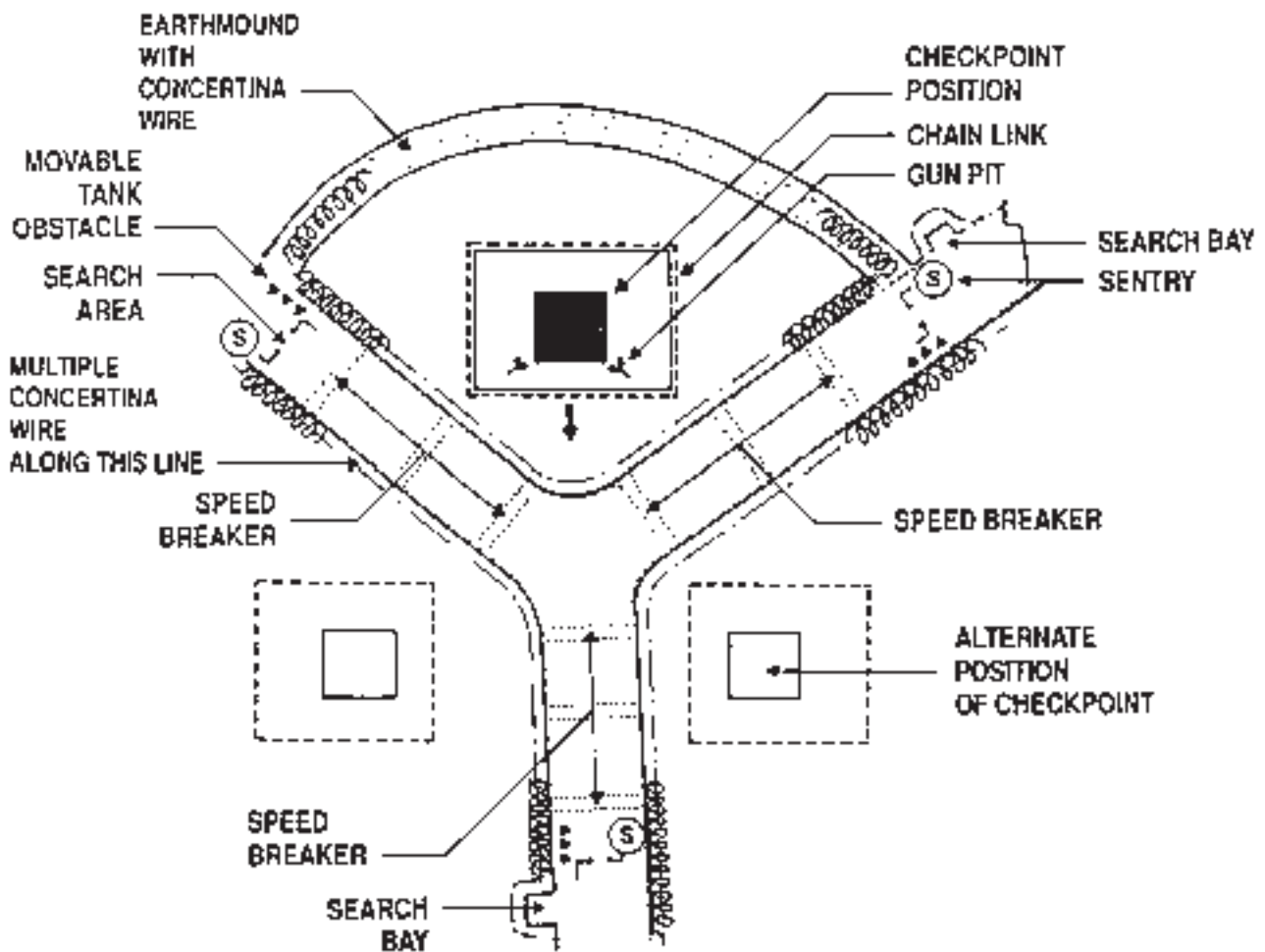

Suggested layout for CHPs - 3

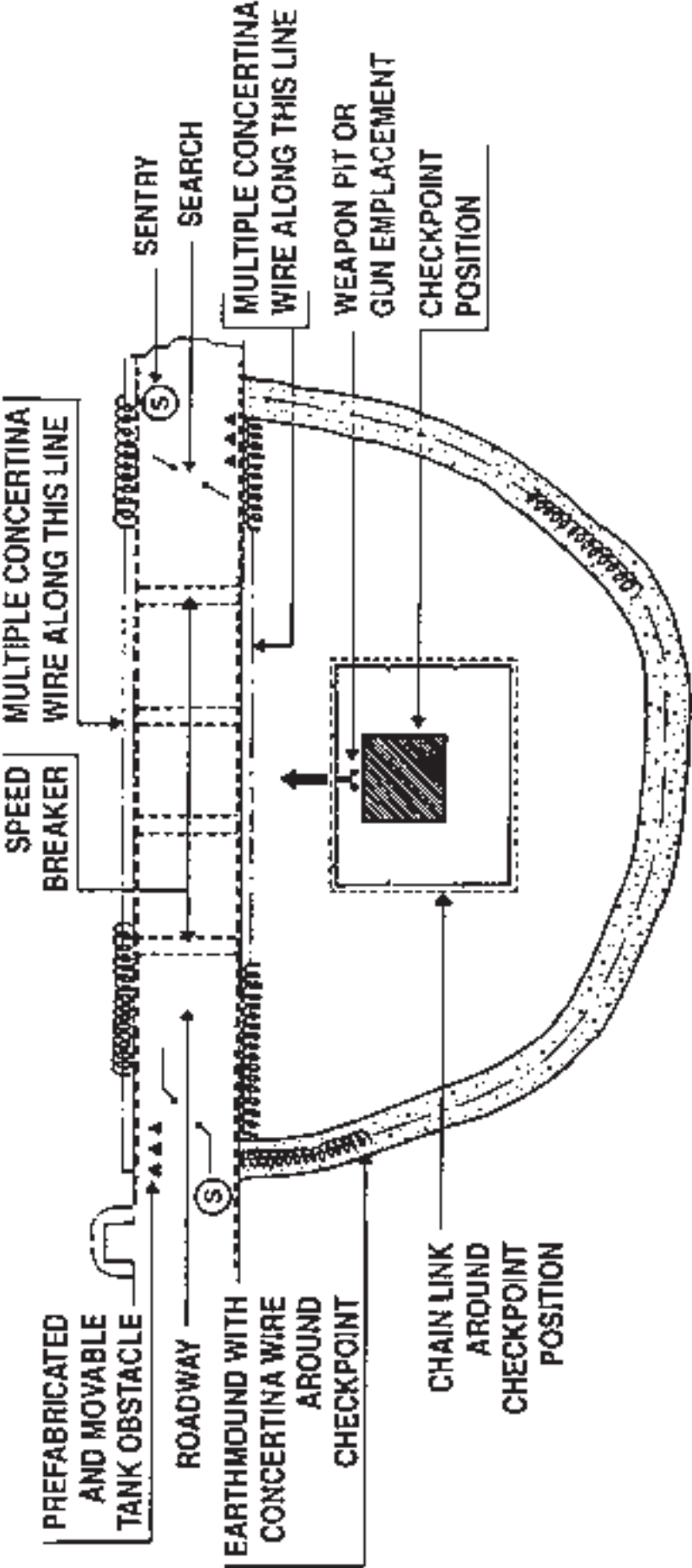

MOBILE CHECKPOINTS

- COVER ROADS/TRACKS NOT CONTROLLED BY STATIC CHP's
- MINIMUM COMPOSITION:
ONE SECTION IN
TWO ARMoured VEHICLES
- MANNED WITH 3-6 SOLDIERS
- SETS UP "SNAP" CHP's FOR SHORT PERIODS
- LOCATED IN CONCEALED POSITION
- THEIR LOCATION IS NOT PREDICTABLE
- WELL IDENTIFIED AS UN POSITION
- ALWAYS WITH GOOD COMMUNICATION LINK WITH STATIC CHP

PURPOSE OF CHECKPOINTS

- SHOW UN PRESENCE, REASSURE
- SURVEY AND REPORT ACTIVITIES
- CHECK/INSPECT PERSONS AND TRAFFIC
- PREVENT INFILTRATION
- ACT AS OP OR WORK WITH OPS
- BLOCK ALL OR SELECTED TRAFFIC

PLANNING/ESTABLISHING CHP's

- ESTABLISH CHP in STRATEGIC POSITION where it is difficult to bypass
- BUILD FENCES or OBSTACLES outside CHP TO PREVENT BYPASSING CHP
- MAP POSITIONS OF OTHER CHPs, OPs, HQ, ETC.
- ESTABLISH MOBILE CHP QUICKLY TO ENHANCE SURPRISE
- CHANGE POSITION OFTEN AND UNPREDICTABLY
- MOBILE CHECKPOINTS MUST BE COORDINATED with other CHPs and OPs
- COMBINING MOBILE CHPs WITH OPs IS VERY COST EFFECTIVE
- OPs MUST OBSERVE AND PROTECT CHP

CHP BRIEF

- LOCATION
- PURPOSE AND TASK
- GENERAL OBSERVATION,
LIMITATIONS, TECHNIQUES, ETC.
- DIRECTION, DISTANCE, STRENGTH
OF OTHER UN POSITIONS
(INCLUDING OTHER FACTIONS)
- MANNING
- EQUIPMENT (INCLUDING DEMO)
- COMMUNICATIONS
- LOGISTICS
- SPECIAL REGULATIONS
- LATEST EVENTS
- QUESTIONS?