CONTENTS **PAGE NUMBER**
PREFACE

Table of Contents	i
-------------------------	---

2.0. TECHNICAL CRITERIA	2-1
2.1. Codes and Standards	2-1
2.1.1. National Codes and References	2-1
2.1.2. Local Codes and References	2-2
2.1.3. Other Recommended Reference Standards	2-2
2.1.4. HIPAA	2-2
2.1.5. Life Safety	2-3
2.2. Site Considerations	2-4
2.2.1. Introduction	2-4
2.2.2. Planning	2-4
2.2.3. Topography	2-5
2.2.4. Zoning	2-5
2.2.5. Historic Features	2-5
2.2.6. Roadways	2-5
2.2.7. Site Signage/Wayfinding	2-6
2.2.8. Proximity to Adjoining Facilities.....	2-6
2.2.9. Shared Amenities	2-7
2.2.10. Utility Access.....	2-7
2.2.11. Services	2-8
2.2.12. Landscaping (Natural & Designed).....	2-8
2.2.13. Covered Entry.....	2-9
2.3. Perception and Interiors	2-9
2.3.1. Introduction	2-9
2.3.2. Perception.....	2-9
2.3.3. Lighting.....	2-10
2.3.4. Contrast and Glare.....	2-12
2.3.5. Physiological and Psychological Benefits.....	2-12
2.3.6. Acoustics/Noise Control.....	2-13
2.3.7. Interior Finishes	2-13
2.3.8. Characteristics of Floor Finishes	2-16
2.3.9. Color & Texture Selection	2-17
2.3.10. Wayfinding & Signage	2-17
2.4. Systems Criteria.....	2-18
2.4.1. Heating, Ventilating and Air Conditioning (HVAC).....	2-18
2.4.2. Plumbing.....	2-20
2.4.3. Electrical	2-22
2.4.4. Reference Tables	2-24
2.5. Guide Plates, Reflected Ceiling Plans and Data Sheets	2-26
2.6. Inpatient Unit	2-28
2.6.1. Patient Room Option 1 – 375 NSF [34.83 NSM]	2-28
2.6.2. Patient Room Option 2 – 290 NSF [26.94 NSM]	2-34

- 2.6.3. Nurse Station Option 1 – 100 NSF [9.29 NSM]
Floor Plan and Reflected Ceiling Plan.....2-40
- 2.6.4. Nurse Station Option 2 – 200 NSF [18.58 NSM]
Floor Plan and Reflected Ceiling Plan.....2-43
- 2.6.5. Recreation Therapy Room, Group – 1300 NSF [120.77 NSM].....2-46
- 2.6.6. Dining Room – 400 NSF [37.16 NSM]2-51
- 2.6.7. Quiet Treatment Room (PT/OT/Speech) – 120 NSF [11.15 NSM].....2-55
- 2.6.8. Family Multipurpose Room – 500 NSF [46.45 NSM].....2-59
- 2.6.9. Family Living – 500 NSF [46.45 NSM].....2-63
- 2.6.10. Rehabilitation Gym – 2000 NSF [185.80 NSM]2-68
- 2.6.11. Cognitive / TBI Therapy Exam / Treatment Room –
120 NSF [11.15 NSM] Floor Plan and Reflected Ceiling Plan2-72
- 2.6.12. Computer Activities Room – 200 NSF [11.15 NSM].....2-75
- 2.6.13. TBI / Cognitive Therapy Multipurpose Room –
150 NSF [13.93 NSM].....2-79
- 2.7. Transitional Rehabilitation Center2-83
- 2.7.1. Transitional Resident Bedroom – 215 NSF [19.97 NSM].....2-83
- 2.7.2. Apartment-type Unit – 545 NSF [50.63 NSM]2-87
- 2.7.3. Nurse Station / Check-in Station – 160 NSF [14.86 NSM]2-93
- 2.7.4. Dining Area – 300 NSF [27.86 NSM].....2-97
- 2.7.5. Recreation / Activity Room – 240 NSF [22.29 NSM]2-101
- 2.8. Outpatient2-106
- 2.8.1. Lounge Space (Home Room) – 240 NSF [22.29].....2-106
- 2.8.2. Physical/Occupational Therapy – 900 NSF [83.61 NSM].....2-110
- 2.8.3. Recreation Therapy Room, Group – 500 NSF [46. NSM].....2-114
- 2.8.4. Gait & Balance Lab – 600 NSF [55.73 NSM]2-119
- 2.8.5. Exam Room – 120 NSF [11.14 NSM]2-123

INDEX OF FIGURES AND TABLES

Figure No.	Description	Page No.
Figure 2.1	Overhead Diffuse Lighting – Low Intensity	2-11
Figure 2.2	Overhead Diffuse Lighting – Low Intensity w/ Lighted End Walls	2-11
Figure 2.3	Overhead Diffuse Lighting – High Intensity	2-11
Figure 2.4	Legend of Symbols	2-27

INDEX OF FIGURES AND TABLES (con't)

Table No.	Description	Page No.
Table 2.1	Color Classification of Light Sources	2-12
Table 2.2	Recommended Ceiling Heights	2-16
Table 2.3	Indoor Design Conditions	2-24
Table 2.4	Supply Air Requirements	2-25
Table 2.5	Outdoor Air Requirements	2-25

Table 2.6	Exhaust Air Requirements	2-25
Table 2.7	Noise Criteria	2-26
Table 2.8	Format Example	2-26

2.0. TECHNICAL CRITERIA

2.1. Codes and Standards

2.1.1. National Codes and References

The Department of Veterans Affairs requires consultants to use the latest editions of codes and standards for all projects. Among the required codes and standards are:

1. VA Directives, Design Manuals, Master Specifications and other guidance in the Technical Information Library (TIL) <http://www.va.gov/facmgt/standard>.
2. *Occupational, Safety and Health Administration (OSHA) standards.*
3. *National Fire Protection Association (NFPA) codes.*
4. *National Electrical Code (NEC).*
5. *International Building Code, 2006 Edition (IBC 2006).*
6. *National Standard Plumbing Code (NSPC).*
7. *Safety Code for Elevators and Escalators A 17.1*, published by American Society of Mechanical Engineers (ASME),
8. *Uniform Federal Accessibility Standards (UFAS)*, including Barrier Free Design Guide; A Supplement to the UFAS (DVA PG-18-13; February 1997).
9. *Building Code Requirements for Reinforced Concrete (ACI 318)*, published by the American Concrete Institute.
10. *Specifications for the Design, Fabrication, and Erection of Structural Steel for Buildings*, published by the American Institute of Steel Construction (AISC).
11. *Energy Code for New Federal Commercial and Multi-Family High Rise Residential Buildings; Final Rule*, (mandatory for new federal buildings), Department of Energy (DOE) Regulations, 10 Code of Federal Regulations (CFR) Parts 434 and 435.
12. *Provisions for Construction and Safety Signs*, stated in General Requirements Section 010000 of the VA Master Construction Specification.
13. *Greening the Government through Efficient Energy Management* – Executive Order 13123.

14. *Greening the Government through Leadership in Environmental Management* – Executive Order 13148.
15. *Ventilation for Acceptable Indoor Air Quality* – ASHRAE Standard 62.1-2007, published by the American Society of Heating, Refrigerating and Air-Conditioning Engineers, Inc.
16. *Safety Standard for Refrigeration Systems* – ASHRAE Standard 15- 2007, published by the American Society of Heating, Refrigerating and Air-Conditioning Engineers, Inc.
17. *Design Guide for Humidity Control In Commercial and Institutional Buildings*; 2001, published by the American Society of Heating, Refrigerating and Air-Conditioning Engineers, Inc.

The current profiles of VA clients indicate that a high percentage of patients require assistance in activities of daily living such as toileting and showering. The VA *Barrier Free* supplement PG-18-13 establishes requirements, which differ from those of UFAS. The more stringent requirement is to be followed. It is recommended that Polytrauma Rehabilitation Centers serving our nation's Veterans adhere to the requirements of PG-18-13, and provide accessibility in 100% of patient bedrooms and patient toilets designed to accommodate both male and female PRC veterans.

2.1.2. Local Codes and References

VA is not subject to local imposition of code enforcement procedures, such as drawing reviews, building permits, inspections, fees, etc. Therefore, VA functions as the Authority Having Jurisdiction for all VA facilities and projects.

2.1.3. Other Recommended Reference Standards

The following consensus document provides additional guidance and useful insights into the minimum functional requirements of Polytrauma Rehabilitation Center design:

1. *Guidelines for Design and Construction of Hospital and Health Care Facilities*, 2006 Edition (Guidelines 2006), published by the American Institute of Architects Academy of Architecture for Health and the Facilities Guidelines Institute, with assistance from the U.S. Department of Health and Human Services.

2.1.4. HIPAA

The Healthcare Insurance Portability and Accountability Act of 1996 (HIPAA) protects individuals rights to audible as well as visual privacy. This is especially the case with respect to protection of each individual's medical records, private information and communications. The law protects all conversations between patients and admission interviewers, caregivers, nurses, physicians and families. Serious breaches of those rights to privacy are subject to Federal litigation.

Patient unit layouts now consider the juxtaposition of rooms and spaces, which may limit sounds of private conversations from being overheard. Planning of staff stations, reception desks, conference rooms, offices, treatment and therapy rooms, where exposed private records may be seen and conversations overheard by unauthorized persons, should also consider privacy during design

2.1.5. Life Safety

Successful strategies have long been available for making a sprinkler system inconspicuous. However, in new construction, achieving “homelike” residential environments for many of the patient and family spaces remains a significant challenge when attempting to incorporate fire safety and egress provisions required for PRC occupancies under contemporary codes.

PRC life safety issues that require attention include evacuation standards and disaster planning. Among them are the following:

1. Evacuation Standards

Those who may be so afflicted can become frightened and confused if awakened by an evacuation alarm in the middle of the night. Given the limited staff that may be available to assist patients on some shifts, vertical evacuation from even one floor above grade may simply not be practical. Many people prefer to depend upon horizontal evacuation plans.

Multi-story buildings must consider planning for horizontal evacuation to a safe area of refuge. This includes:

- a. Planning the facility so that each floor is divided into at least two fire & smoke compartments separated by a rated enclosure that extends full height
- b. Openings in this enclosure are strictly limited to ducts equipped with automatic fire dampers and horizontal exits across corridors.
- c. Doors opening in opposite directions in egress corridors are recommended so that occupants in either smoke compartment may safely exit to an area of refuge on the other side of that wall.
- d. A fully sprinklered building where each smoke compartment has at least two other means of egress.
- e. An area of refuge on each side of the firewall sized to accommodate the entire adjacent zone population that could be present on the other side of the barrier.

2. Disaster Planning

Situations can arise in which it may not be feasible to evacuate patients for days, weeks, or months. In those cases, emergency power will be required to maintain food service, heating, ventilating and vertical transportation systems, and life safety systems. This is especially important to keep the patient population reasonably comfortable and safe. This Design Guide recommends that the project consider planning for this contingency in order

to care for the veteran population especially when the facility is located in an area where a high probability of threat exists from natural disasters such as hurricanes and earthquakes.

2.2. Site Considerations

2.2.1. Introduction

Site analysis and planning are influential to the success of a project. At the beginning of the design process, the design team should perform several preliminary analyses that will affect the final design of the facility. Several of the site related factors that are required for a Polytrauma Rehabilitation Center are mentioned in this section and are to be considered as essential tools for planning of a PRC. Each project designer should consider the project specifics that include, but are not limited to:

- a. Site Area
- b. Site Geometry
- c. Local Zoning
- d. Topography
- e. Regional and Climactic Factors
- f. Utilities
- g. Other Site Characteristics

2.2.2. Planning

When planning a Polytrauma Rehabilitation Center, consider the activities of the multiple users including the patients and patients, staff, visitors, maintenance personnel, service providers, emergency crews and utility workers. The completed site should include:

- a. Landscaped Features
- b. Setbacks and Buffers
- c. Ample Parking for Staff and Visitors
- d. Access for Emergency Vehicles
- e. Utility and Service Access
- f. Covered Entry
- g. Signage - Wayfinding

1. Parking

The patients of PRC Inpatient facilities do little driving; therefore, the requirements for parking are generated by staff, visitors, service technicians and deliveries.

The anticipated peak periods of parking requirement will be from 2pm to 4pm on a weekday. An average of .37 parking spaces per bed during peak hours between 2 pm and 4 pm for visitors. An average of 1.5 spaces per 1,000 sf [92.90 SM]for a PRC facility. The number of beds, the number of staff, and the size of the facility all play a role in adequately sizing a parking area for a PRC facility is to be used as a starting requirement.

2.2.3. Topography

Topographical influences may effect the orientation of access points to the facility such as entrance, service, egress, parking, perimeter road for emergency, retaining walls, berms, landscaping and general location of the structure on the site. During the planning phase of the project, consider what the impact of the topography of the site will have on the design. Walks, ramps, outcroppings and roadways are also features that are impacted by site topography. During the initial survey of the site, a physical review of the site is recommended. Large rock outcroppings could influence landscaping on site as well as the location of the facility on the site. Consider using major outcroppings as a landscaping feature on the project site.

Where possible, at-grade site access from the facility is desired. Existing on-site grading is an important consideration when planning and locating the access points of the facility.

2.2.4. Zoning

Unlike many general aspects of site design such as roadways and parking aisles, zoning is site specific. Preliminary plans should not advance without performing a zoning analysis. In the case of government-owned property, it is important to consider the zoning and adjacencies for compatibility with neighboring buildings. Factors for zoning include:

- a. Height
- b. Lot Occupancy
- c. Number of Stories
- d. Parking
- e. Green Space
- f. Historic District
- g. F.A.R.
- h. Setbacks
- i. Use Groups

2.2.5. Historic Features

Early in the design phase, there should be an analysis, which determines whether there are any historic issues. As with the zoning analysis, the historic related issues and features are site specific. The impact of historic related issues includes: finish of the exterior; window types, colors and shapes; roof types and slopes; color of façade; height of facility and location of facility. Federal, state and local jurisdictions and related agencies should be contacted to assure that the guidelines in place are followed.

2.2.6. Roadways

1. Site Access

Site access roadways may be located directly at main public roadways. The location of curb cuts and aprons should be planned in accordance with local zoning code or AHJ.

2. On-Site Roadways

Width of roads should accommodate traffic in each direction. A path from the site entrance to entry of the facility should be logical and easily identifiable.

Site roadways to and from parking areas should be capable of accommodating two-way traffic. Proper signage and direction arrows may enhance clarity of destinations and paths.

3. Emergency Roadways

Emergency access is required on the grounds of the facility. This access relates to ambulance, fire and rescue, law enforcement and other emergency related vehicles. The width of the roadway for emergency purposes should be maintained and unobstructed at all times.

A loop road or some means of complete site access is generally required in every jurisdiction. Loop road design should accommodate a fire truck, and enable emergency vehicles to access a complete revolution around the facility. At a minimum, access to every part of the site and facility for emergency vehicles must be provided.

4. Service Road

The service road may better serve the facility by having a separate access point. Should that not prove feasible due to site restrictions or other reasons, consider a separation of roadways upon entry to the site. Clearly indicate the service road and design it in such a way as to not interfere with general site access or emergency roadways. The service roadway should accommodate truck traffic in two directions unless the roadway system is designed and clearly identified as a one-way traffic pattern.

2.2.7. Site Signage/Wayfinding

Locate signage on the site for visitors, patients, staff and service accommodations. Some suggestions for site signage include:

- a. Directional Traffic (one-way)
- b. Restrictions
- c. Parking
- d. Deliveries
- e. Passenger Pick-up
- f. Entrance to Site
- g. Entrance to Facility

2.2.8. Proximity to Adjoining Facilities

The identified Polytrauma Rehabilitation Centers will be an integral part of VA medical center campuses. The foregoing topics are considered issues for site planning and

design. Site access and roadways of an adjoining existing medical center are examples where a new PRC facility may be able to utilize in-place vehicular pathways.

Adjoining or proximate facilities may influence or determine certain characteristics of the new facility. Refer to the VA's Environmental Design Manual for specific signage requirements.

2.2.9. Shared Amenities

The nature of the site with respect to location and co-existence could influence several aspects of a facility. Shared amenities, for example, could impact:

- a. Siting of facility
- b. Orientation of entrance
- c. Location of services
- d. Access to site
- e. Availability of utilities

If physically affiliated, this physical connection may require the use of a common service road or a common entrance to the site in general. Independent access to power, communications, gas, water and other utilities is preferable, thereby enabling the facility to remain on line in the event of outages on the shared campus.

Emergency power provisions for the facility should be a part of the planned program due to the needs of the patients.

The advantage of sharing campus amenities include, but are not limited to:

- a. Access to site
- b. Services and utilities
- c. Possibility for use of existing on site features
- d. Existing buildings
- e. Medical facilities
- f. Outdoor amenities

Many of these items translate into cost savings over the life of the facility. These and other shared amenities significantly affect project costs.

2.2.10. Utility Access

Site utilities are critical to successful operations. Among the utilities or utility related components requiring site accesses are:

- a. Electrical service transformers
- b. Communications services
- c. Gas lines
- d. Stormwater management
- e. Water and sewer utility
- f. Oil service (if applicable)
- g. Emergency power (including fuel)
- h. Power and communications

Where possible, dual feeds for some utilities should be provided. The most pronounced of these would be power sources. An attempt should be made to attain a feed to the facility from different substations.

2.2.11. Services

Services as referred to in this section include, but are not limited to:

- a. Loading docks
- b. Shipping/receiving areas
- c. Morgue service areas
- d. Trash areas
- e. Vehicular turnaround roadways
- f. Service ramps

The services for PRC facilities are a major component of day-to-day operations. The location of the services are not to conflict with the main entrance to the facility.

2.2.12. Landscaping (Natural & Designed)

1. Natural Features

Landscape features provide a major service to any site or campus. Natural features may include:

- a. Rock outcroppings
- b. Water features (lakes, streams, ponds, etc.)
- c. Trees
- d. Fields

Where possible, these features should be considered during the building and site design phases of the project. Just as a designer considers the topography during the planning phases, so should the natural aspects of a site be considered.

2. Designed Features

Designed features that relate to the site include:

- a. Trees
- b. Shrubs
- c. Grass
- d. Stone treatments
- e. Gardens
- f. Fountains
- g. Fences
- h. Plazas

While planning for the landscaping of the site, consider indigenous vegetation whether introduced or replaced because of the project. Additional considerations include requirements of a shared site or other site-specific covenants that may affect the design.

2.2.13. Covered Entry

As part of the building and site design, provisions for a covered entrance at the primary access point to the facility are recommended. Provide enough covered area to accommodate two vehicles, one behind the other. The width of the roadway or motor court under the covering also should be designed to accommodate an accessible van to park at the entrance while allowing a vehicle to pass. Height of covered entrance is to be designed to allow clearance for large emergency vehicles.

The covered entrance is also an area where visitors and patients may relax and sit. Ample space should be planned and provided for seating and circulation near the entrance to the facility.

2.3. Perception and Interiors

2.3.1. Introduction

The PRC facility is considered a welcoming environment. When designing interiors of the PRC, include considerations for:

- a. Interior Finishes
- b. Colors
- c. Spatial Relationships
- d. Size of Spaces
- e. Exterior View
- f. Exterior Access

These are important aspects of the environment where individuals are indoors for extended periods of time. Designers should minimize travel distances between dining, recreation, family and lounge areas. Where shortened distances are not possible, provide handrails, and rest stops with convenient seating or other physical supports along an extended travel route.

2.3.2. Perception

Individual perception differs according to the social situation. In a PRC facility, the creation of a healing environment can greatly improve the patient and family members perception of their overall well being and sense of control over their environment. For example, a dark border may be perceived as a drop-off and should be avoided or a toilet in stark contrast to the floor is perceived as a separate entity rather than a large field of a single surface.

Perception of space is based upon the use of cues that normally associates distance in our daily life. Many of these cues are developed at an early age in life and typically do not change as an individual ages. Examples of perception and relationships include:

- a. Familiar behavioral settings
- b. Lounge Area

- c. Living Room
- d. Sociopetal space and furniture
 - Clustered seating
 - Newspaper and magazine racks
- c. Get-Away Spaces
 - Outdoor Nature settings
 - Benches and pathways near water or of feature in a courtyard or garden
- d. Family Spaces
 - Room with fireplace
 - Home-like arrangements
- e. Intimate Spaces
 - Tables and chairs on a balcony
 - Benches with a view
- f. Views to Exterior
 - Large windowed walls
 - Indoor/Outdoor areas (balconies, screened porches)

2.3.3. Lighting

Lighting plays an important role in the ability to perceive and discriminate light, color, contrast and textures. An inability to accurately judge color in interior environments can result in disorientation, accidents, and reduced efficiency in completing tasks, overall discomfort or ill health. The following sub-sections relate to the natural and artificial lighting considerations for the design of a Polytrauma Rehabilitation Center facility:

3. Natural Light (Daylighting)

Daylight is the standard against which the human mind measures all things seen. Colors seen with daylight will appear real and appropriate through color constancy. The color produced by daylight will vary from dawn, to noon, to dusk. Color reflection from adjacent surfaces will vary as well. Strategies and elements of daylighting should be included in design. Daylighting is not an afterthought or a simple matter of applying some shading controls to the windows. Many factors are involved with the use of daylight in buildings:

- a. Aesthetics
- b. Psychological response
- c. Health
- d. Energy/Cost
- e. Percentage of window area
- f. Placement of window
- g. Orientation

Specific goals related to daylighting of buildings may be stated in simple terms:

- a. Design to achieve daylight in all feasible areas in significant, useful quantities.
- b. Distribute daylight reasonably uniformly, with no significant dark spots.

- c. Avoid allowing direct sunshine into the building interior in such a way that it may cause visual discomfort or visual disability. Assess the design for all possible sun penetration angles.
- d. Provide daylight sensitive controls for the electric lighting so that it will be dimmed or turned off when not needed.

4. Artificial Lighting

When measuring the effectiveness of artificial light, there are generally two scales by which this is done: the Color Rendering Index (CRI) and the Correlated Color Temperature (CCT). The CRI indicates how precisely a specific source of light can show an object in relationship to its true color. The CCT describes the degree to which a color appears warm (reddish), neutral or cool (bluish) and is measured in degrees Kelvin (K).

The following illustrations demonstrate the effects of artificial lighting on a plane of interest and the various solutions available:

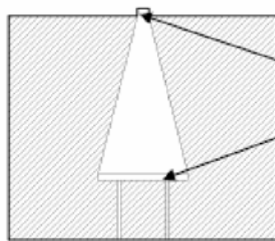

Figure 2.1
Overhead Downlighting - Low Intensity

Overhead Downlighting is effective for task-oriented activities such as those found in occupational therapy. This lighting technique will allow the individual to focus on that surface, either a table or a wall.

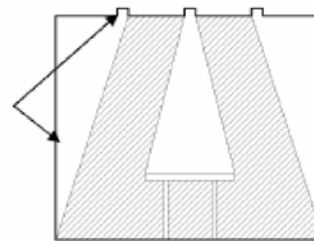

Figure 2.2
Overhead Downlighting - with Lighted End Walls

This lighting technique allows a greater amount of illumination over a greater surface area.

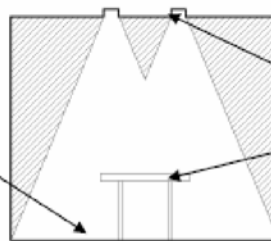

Figure 2.3
Overhead Diffuse - High Intensity

Overhead Diffuse lighting is effective in group activities such as dining and card playing.

Color Temperature	Applications
2500	Bulk industrial and security lighting
2700-3000	Low light levels (10fc); General residential lighting, hotels, fine dining and family restaurants, theme parks
2950-3500	Display lighting in retail and galleries; feature lighting
3500-4100	General lighting in offices, schools, stores, industry, medicine; display lighting; sports lighting
4100-5000	Special-application lighting where color discrimination is very important (uncommon for general lighting)
5000-7500	Special-application lighting where color discrimination is critical (uncommon for general lighting)
Minimum Lamp CRI	Applications
50	No critical industrial, storage and security lighting
50-70	Industrial and general illumination where color is important.
70-79	Most office, retail, school, healthcare and recreational spaces.
80-89	Retail, work and residential spaces where color quality is important
90-100	Retail and work spaces where color rendering is critical

Table 2.1

Color Classification of Light Sources

2.3.4. Contrast and Glare

The quality of lighting can be judged through two primary characteristics: contrast and glare. Contrast is necessary for good visual perception. It is also possible to produce excessive contrast, which impedes good visual response. Therefore, luminaires and light fixtures need some type of shielding device to prevent a direct view of the lamps.

Glare is usually associated with brightness differences or with reflected light. It is not recommended that luminaires be placed on the ceiling unless properly shielded with a lens, diffuser or shading device. Windows should generally be located to the patient's side to produce good quality task light without veiling reflections.

2.3.5. Physiological and Psychological Benefits

Interior design for PRC facilities present a wide range of color problems due to the different needs of patients, visitors, doctors, nurses and other staff and the varied nature

of specific spaces. The goal is to design a typical patient environment as a place where hospitality is the emphasis. During design, consider the following:

- a. Loss of balance
- b. Cognitive impairment
- c. Visual impairment
- d. Hearing impairment
- e. Increased sensitivity to temperature and direct sunlight

Physiological and psychological design considerations include:

- a. Avoiding excessive direct natural light
- b. Providing visual flexibility such as adjustable lighting, blinds and shades
- c. Introducing stimuli through lighting
- d. Providing natural lighting
- e. Using 20 to 30% of the exterior wall as window area
- f. Providing views with natural and synthetic elements

2.3.6. Acoustics/Noise Control

If handled improperly, acoustical design in a PRC facility can affect the patient's ability to recover. This may also cause the patients social discomfort, contributing to fear, embarrassment, depression, or isolation. Introduce sound absorption materials or compartmentalization in the plan.

Two types of noise that disrupt patients include:

- a. Sound from adjacent rooms, such as a patient reacting to pain or listening to a loud television program
- b. Sound generated from the outside, such as carts rolling down the hall

2.3.7. Interior Finishes

Consider the following few key factors in the design process. These considerations have an impact on the built environment and the life cycle costs of the facility. The factors include:

- a. Maintenance
- b. Durability
- c. Affordability
- d. Texture
- e. Therapeutic attributes
- f. Improve wayfinding
- g. Reduce confusion of patients

Additionally, designers should specify special coatings on fabrics and moisture resistant backings. Consider testing all product colors and textures for its perception and psychological impact.

Creating a 'Healing Environment' that supports health is essential to quality patient care. Factors that can assist in creating this environment include:

- a. Soft colors
- b. Warm finishes
- c. Music
- d. Healing gardens

5. Floors

To minimize the number of falls and cushion them when they do occur, consider using continuous, slip resistant and resilient flooring materials, such as sheet rubber or vinyl with welded joints, in patient toilet rooms and showers, in lieu of harder and sometimes uneven surfaces such as ceramic tiles with grouted joints. Carefully selected and appropriately specified carpeting materials used in lieu of harder surfaces may also minimize injuries due to falls in patient rooms and unit corridors, especially when recessed flush with adjacent flooring materials. Consider the following when choosing a flooring material:

- a. Readily cleanable surfaces
- b. Water resistance in food consumption and preparation areas
- c. Being physically unaffected by germicidal cleaning solutions.

Avoid or minimize slippery floor surfaces, area rugs, and abrupt changes in flooring materials without tapered thresholds or nosings. Reflective, glossy floors are to be avoided for a number of reasons. Beside the obvious fall hazard it presents, for those patients with vision degeneration diseases and depth perception issues, this finish can easily deceive the elderly population and cause unwanted behavioral and management problems. There are numerous low-luster resilient floorings available.

Consider carpet density when selecting it as a floor covering. Carpet density is the amount of pile yarn in unit volume of the carpet. This number translates into a "carpet traffic classification" which ranges from:

- a. I (light)
- b. II (Heavy)
- c. III (Extra Heavy)

The above classifications fluctuate according to use. In a PRC environment, the patient room is considered Class II, while the staff station and corridors are considered Class III. The transition of finishes must be considered.

The following are the top 10 specified materials in the healthcare industry listed in order of preference. Refer to item 2.3.8 for specific benefits:

- a. VCT
- b. Sheet vinyl
- c. Broadloom carpet
- d. Vinyl-backed carpet
- e. Ceramic tile
- f. Carpet tile
- g. Vinyl plank flooring
- h. Linoleum

- i. Rubber flooring
- j. Poured flooring

6. Walls

Walls are not seen only as a form of enclosure and privacy, but also as a form of support and guidance. Certain materials, textures, and colors should be encouraged while planning the interior design of the facility. Consider the following:

- a. Patient Rooms (wall finishes)
Water/latex-based paint, Type II vinyl wall covering, rigid vinyl sheet/corner guards, wall covering borders
- b. Public Spaces (wall finishes)
Type II vinyl wall covering, water/latex-based paint and rigid vinyl sheet and corner guards or Type I vinyl wall covering, plaster/sheet corner guards

7. Doors and Hardware

Door hardware for this building type is unique because the patients include people with varying levels of disability. PRC patients need to operate hardware with the least amount of effort.

HW 4

Butts as required
Door Pull / Push Plate
Closer C02011
Armor Plate
Holder C22511

HW 6

Butts as required
Door Pulls / Push Plates
Combination Closer / Holder
Armor Plate

HW 7

Butts as required
Latch F01 or F75
Door Pull / Push Plate

HW 23

Butts as required
Lock F04 or F81

HW 43

Butts as required
Lock F07 and F86
Closer C02051

HW 45

Butts as required
Lock F04 or F81
Closer C02011

HW 52

Butts as required
Latch F04 or F81
Closer C02011

HW 69

Butts as required
Lock F17 or E16071
Door Pull
Push/Pull plate J300
Closer C02051
Armor Plate

HW 126

Butts as required
Lock F17 or E16071
2 Flush Bolts Top / Bot
2 Push Pull Plates J300
2 Door – pulls
2 Armor Plates

8. Ceiling Material and Height

When choosing a ceiling material and height, consider the use of the space and the intended user. The materials commonly specified are gypsum wallboard (GWB) and acoustical ceiling tile (ACT).

Consider the following ceiling heights when designing for the patients of a PRC facility:

Room/Space	Recommended Minimum Heights
Patient Room	9'-0"
Corridors	9'-0"
Activity Areas	10'-0"
Dining	10'-0"
Patient Toilet/Shower	8'-0"

Table 2.2

Recommended Ceiling Heights

Note: Local or existing building conditions will determine feasibility of ceiling heights.

2.3.8. Characteristics of Floor Finishes

While aesthetics are significant, maintenance also must be taken into consideration. The finish types that follow illustrate some of the characteristics to consider when planning the interior designs and furnishings for a PRC facility.

1. Carpet

- a. Aesthetically pleasing
- b. Durable
- c. Ease of maintenance
- d. Wheelchair access
- e. Acoustics
- f. Availability of vinyl backing to provide moisture resistance

2. Sheet Vinyl Flooring

- a. Infection control
- b. Aesthetics
- c. Moisture barrier
- d. Usually complies with health department regulations

3. Vinyl Composite Tile (VCT)

- a. Low Initial cost
- b. Durability

4. Vinyl Wall covering

- a. Aesthetics

- b. Durability
 - c. Wheelchair access
 - d. Infection control
5. Water-based Paint
- a. Indoor air quality (IAQ)
 - b. Reduced off-gassing
6. Vinyl Upholstery
- a. Durability
 - b. Ease of maintenance
 - c. Infection control
 - d. Moisture-proof
 - e. Bleach-resistant

2.3.9. Color & Texture Selection

Polytrauma Rehabilitation Center design should consider colors and hues. The principal hues are composed of three distinct palettes - warm, cool and neutral.

7. Warm

Warm colors are generally associated with physical warmth and the resultant sense of contentment. Warm colors can be used where large windows symbolize sunrise and sunset as features in commons areas. Hues on the warm side of the color circle (red, orange, and yellow) and their related tints and shades are generally understood as comfortable, cozy, homelike, and pleasant. Interiors with primarily warm color schemes may prove comfortable to occupants with actual air temperatures lower than required to achieve similar comfort in identical spaces using cooler colors.

8. Neutral

Neutral colors, depicted by white, black, gray and chromatic colors are desaturated with a high content of neutrals. They fall between warm and cool colors, so they have a less psychological effect on its users – often referred to being “boring” or “bland”.

Neutral colors offer no emotional stimulation or response and should not be used in areas where activity and or group responses are desired.

9. Cool

Cool colors are not associated with calm, relaxing experiences, as the name would indicate. These colors tend to lower the sense of actual air temperature and so are often preferred in situations where excessive heat is anticipated. In terms of interior design, cool colors can often cause depressive and negative behavior.

2.3.10. Wayfinding & Signage

Orientation to and throughout any facility is important. In the case of a PRC, it tends to be of an elevated importance. Disorientation of a patient can be a traumatic experience. To mitigate this occurrence, clear, attractive signage with large contrasting notations is required.

Color coding patient rooms and common areas are also helpful tools for the patients when trying to find their way around. In addition, placing a recognizable photograph of a loved one or the patient himself or herself on the door, aids in wayfinding.

In terms of signage, designers should understand the effects of hue, saturation, and brightness on “attention getting” as they select color schemes.

Lighting can be used to identify settings as well as to provide visual acuity. Definition in rooms, adjoining spaces and corridors can be accomplished by planned placement of various types of lighting fixtures. Chandeliers, pendants, table lamps, floor lamps and sconces can all be used to identify spatial relationships, as well as to define usage within a room or area. Dining alcoves may use pendent fixtures for table placements. Corridors may combine sconces and pendants to accentuate an intersection or feature.

2.4. Systems Criteria

2.4.1. Heating, Ventilating and Air Conditioning (HVAC)

10. General

The HVAC system should comply with the most current version of Department of Veterans Affairs (VA) HVAC Design Manuals, VA Design and Construction Procedures, VA Master Construction Specifications and VA Standard Details, where applicable. Deviations from the VA guidelines may be made provided approval is obtained from the VA. Where specific VA requirements are not available or indicated in this document, design criteria from industry standards such as ASHRAE, NFPA, and DOE etc. should be submitted to the VA for review and approval.

11. Energy Economic Analysis

The HVAC system should be selected based on an economic analysis performed in compliance with Public Law 95-619 to determine the most cost effective system for the building over a 20-year life cycle.

12. Energy Conservation

Energy conservation should be emphasized in all aspects of the building design. The building should meet the requirements of the most current version of ASHRAE Standard 90.1 and the DOE regulations. These energy standards apply to HVAC systems as well as the building envelope, service water heating, lighting and energy management. Certification should be provided to the VA that the building is designed in compliance with the applicable energy conservation provisions.

13. Exterior Design Conditions

Exterior design conditions should be based on the most current edition of the 2008 HVAC Design Manual. Summer design conditions should be based on the 0.4 percent dry bulb and wet bulb temperatures indicated under “Cooling db/mwb”. Where cooling towers are applicable, select the cooling tower based on the wet bulb temperature indicated under “Evaporation wb/mdb”. Winter design conditions should be based on the 99.6 percent dry bulb temperature indicated under “Heating dry bulb”. The A/E may recommend more severe outdoor climatic conditions for review and approval by the VA.

14. Indoor Design Conditions

Indoor design conditions for each space should be maintained throughout the year. Interior design conditions for all spaces should be maintained in accordance with the 2007 ASHRAE Handbook of Applications. In addition, the conditions shown in Table 2.3 should be maintained.

15. Supply Air Requirements

The supply air volume should be established to meet the cooling load requirements of the occupied space. The supply volume should, however, be modified to meet a) minimum air change requirements, or b) maintain proper space pressurization relative to room exhaust requirements. For all air systems, the supply air minimum airflows shall be established to maintain the minimum air change rates. See Table 2.4. In addition, filtration shall be comprised of a minimum 30% efficient pre-filter [Pre-filters = VA Grade A (MERV = 8)] and 85% efficient after-filters [After-filters = VA Grade D (MERV = 15)], where filter efficiencies shall be based on the most current version of ASHRAE Standard 52.

16. Outdoor Air Requirements

The HVAC design should provide each space with not less than the minimum recommended quantity of ventilation air as indicated in the most current version of ASHRAE Standard 62.1. In addition to the ASHRAE Standard 62.1 requirements, the minimum air changes of outside air shown in Table 2.5 should be required.

17. Exhaust Air Requirements

The HVAC design should provide exhaust air to spaces to control the transfer of odors and provide proper room pressurization. At a minimum, exhaust air and pressurization should be provided as shown in Table 2.6

18. Noise Criteria

The HVAC design should provide resulting sound levels in occupied spaces not to exceed the levels shown on Table 2.7 in all octave bands.

19. Seismic Requirements

Where applicable, earthquake resistive design should comply with the most current version of VA Handbook H-18-8, Seismic Design Requirements and the Uniform Building Code. Seismic design also should conform to the most current versions of SMACNA and NUSIG guidelines.

20. Design Features

Economizer: Air conditioning systems should be designed to operate below 48 degrees F (9 degrees C) outdoor air temperature without refrigeration. **Perimeter heat:** Provide perimeter heat for bedrooms and other perimeter spaces when the outdoor winter design temperature is 9 degrees F (-12 degrees C) or lower than interior temperature.

Emergency Power: Emergency power should be provided for, but not limited to, the following equipment/systems:

- a. All heating water system components (pumps, condensate return pumps, boilers, etc.) where outdoor design conditions are below 20 degrees F (-6 degrees C)
- b. Automatic temperature control system and components
Exhaust system serving the isolation suite

21. Temperature Control Criteria

General: The automatic temperature controls should be direct digital control (DDC) with electric actuation of valves, dampers, terminal units, etc. A dedicated standalone building management system (BMS) or engineering control center (ECC) should be provided. The ECC should be capable of being connected to an existing or future ECC at the medical center, if applicable. Final selection of the control system options (electric, standalone or tied into existing ECC, etc.) should be reviewed and approved by the VA prior to proceeding with the design of the temperature control system.

Room Temperature Control: Individual room controls should be provided for, but not limited to, the following spaces: bedrooms, anterooms, conference rooms, director's office and corridors. In addition, not more than four interior rooms of similar function should be grouped to one control zone, nor should interior and exterior spaces be grouped on a common zone.

2.4.2. Plumbing

22. General

The plumbing and medical gas systems should comply with the current version of Department of Veterans Affairs (VA) Plumbing Design Manuals, VA Design and

Construction Procedures, VA Master Construction Specifications and VA Standard Details, where applicable. Deviations from the VA guidelines may be made provided approval is obtained from the VA. In addition, the design should meet the requirements of the current version of the National Standard Plumbing Code (NSPC) and the National Fire Protection Association (NFPA). Where state or local codes are more stringent than the above requirements, submit criteria to the VA for review and approval.

23. Domestic Water Systems

Water service should be extended to the building to serve the domestic and fire protection systems. Domestic water should be distributed to the plumbing fixtures and equipment. The system should maintain a maximum velocity and pressure in accordance with the National Standard Plumbing Code and provide water hammer arrestors in accordance with ASSE 1010 for sealed wall installations without access panels. Size and locate arrestors per the Plumbing Drainage Institute (PDI). Provide wall hydrants on each exterior wall, not to exceed 100 feet (30 m) apart.

A domestic booster pump system should be provided where street pressure is inadequate. Domestic booster system should include three pumps. One pump should be sized for one-third the total demand and the two remaining pumps should be sized for two-thirds of the total demand. Provide alternating control for the pumps as well as a pressurized storage tank. Emergency power should be provided for the domestic booster system.

Provide duplex shell and steam coil central water heaters with the capacity of generating the flow demand at 140 degrees F (60 degrees C) with each heater sized to supply 100% of the demand. The heater discharge temperature, however, should be set for 130 degrees F (54 degrees C). A hot water re-circulating system should be provided. The domestic heating water system also should be in accordance with the requirements of the most current version of ASHRAE Standard 90.1.

24. Plumbing Fixtures

Plumbing fixture types and flow restrictors should be in accordance with the current version of the National Standard Plumbing Code. In addition, plumbing fixtures, where required, should comply with the current version of the American with Disabilities Act (ADA) and as per state and Federal requirements.

25. Sanitary and Storm Drainage Systems

Provide an adequate number of sanitary and storm drainage connections from the building. Provide a minimum of two connections from each building with a maximum sanitary sewer size of 12-inch (300 mm). One sanitary connection may be provided if the connection size is six-inch (150 mm) or less. Maximum allowable storm drain size is 15-inch (375 mm). Sizing should be based on the most current version of the National Standard Plumbing Code.

Kitchen waste, where applicable, should be provided with a grease removal system.

26. Medical Gas and Vacuum Systems

Medical compressed air, oxygen and medical vacuum systems should be provided in accordance with the most current versions of NFPA 50 and 99 and the Compressed Gas Association Standards. Air, oxygen and vacuum requirements may range from 10 to 100% of the beds. Coordinate project specific requirements with the VA.

27. Seismic Requirements

Where applicable, earthquake resistive design should comply with the most current version of VA Handbook H-18-8, Seismic Design Requirements and the IBC. Seismic design also should conform to the most current versions of SMACNA and NUSIG guidelines.

2.4.3. Electrical

28. Electrical Closets

Provide separate electrical closets with clearances in accordance with the requirements of the National Electrical Code (NEC). In buildings having multiple floors, stack closets.

29. Public Utility Requirements

Contact servicing agencies and comply with their requirements for electric services. Make necessary submittals to utility companies for approval of equipment to be installed.

30. Seismic Restraints

Requirements should be as specified by local codes and ordinances. Work shall comply with detailed provisions made by local authorities having plan check and inspection jurisdiction.

31. Electrical System Characteristics

Contact the local electric utility company for the type and availability of service. When possible, multiple utility feeders from separate utility substations should be provided for service redundancy. Three phase, 480/277 volt or 208/120 volt secondary systems are acceptable. A utility owned, pad mounted transformer is preferred for these services. Service entrance equipment should comply with the VA Electrical Design Manual.

32. Emergency Power

An emergency generator should be provided as an electrical source for power and lighting during an interruption of the normal electric supply. Where stored fuel is required, storage capacity should permit continuous operation for at least 24 hours. The specific loads and branch circuit arrangement should comply with NEC Article 517 as well as the VA Electrical Design Manual Chapter 4.

33. Lighting

Comply with the Illuminating Engineering Society (IES) recommended lighting levels. Patient rooms should utilize natural light as much as possible. In addition, general lighting and night lighting are required. A reading light should be provided for each patient. Reading light controls should be readily accessible to patients. At least one night light fixture in each patient room should be controlled at the room entrance. All light controls in patient areas should be silent. Lighting should comply with the VA Electrical Design Manual Chapter 6.

34. Receptacles

Provide each patient room with duplex-grounded receptacles. Provide one at each side of the head of each bed and one on every other wall. Electrical receptacle cover plates or electrical supplied from the emergency system should be distinctively colored or marked for identification. Ground fault interrupters should comply with NFPA 70. Receptacles should comply with the VA Electrical Design Manual Chapter 3.

35. Conduits

Conduits should be rigid where used in damp or exposed locations, or where specifically required by the NEC. PVC conduits should be used where routed underground. Electrical metallic tubing should be used in dry concealed locations and furred ceiling spaces. Flexible conduits should be used for final connections to recessed lighting fixtures, to motor driven equipment and vibrating equipment. PVC Schedule 40 conduits should be used for concrete encased feeders. PVC Schedule 80 conduits should be used for direct buried branch circuits. Conduit should not be used as a ground path; all electrical circuits should contain a ground wire. Minimum conduit size should be 0.5 inches [13 mm].

36. Conductors

Provide copper conductors with 600-volt insulation for low voltage distribution. Conductors No. 8 and larger should be stranded, type THWN. Smaller conductors should be a solid type THHN/THWN. Aluminum conductors are not permitted. Conductors for use in high temperature locations should be insulated as required by the NEC. Minimum size of power conductors should be No. 12.

37. Nurse Call System

Provide a nurse call system. Provide each bed location with a call device. An emergency call system should be provided at each patient toilet, bath, and shower room. This system should be accessible to a patient lying on the floor. Design the emergency call system so that a call activated by a patient will initiate a signal distinct from the regular staff call system and that can be turned off only at the patient's location. The signal should activate an annunciator panel at the staff work area or other appropriate location, and either a visual signal in the corridor or at the patient's door.

Wireless technologies for staff should be studied along with hard wired or integrated systems, to meet the needs of individual facilities.

38. Fire Alarm System

Provide fire alarm and detection systems in compliance with NFPA 101 and NFPA 72 as well as VA Fire Protection Design Manual.

2.4.4. Reference Tables

Room or Area	Summer		Winter	
	db (°F)	max RH %	db (°F)	max RH %
One / Two Bed Rooms	75-77	60	70-75	30
Ante Rooms	75-77	50	70-75	30
Dining Room	75-78	50	70-72	30
Lounges	78	50	72	30
Bathrooms & Toilet Rooms	78	--	72	--
Offices / Conference Rooms	75-78	60	70-75	30
All other occupied spaces	75-78	50	70-75	30

Note:

(a) The difference between 70° and 75° is NOT the dead-band but the ability of the patient to select any temperature at any time to meet his or her needs

(b) Calculate the cooling capacity to maintain 70° inside design temperature and 60% RH and calculate the heating capacity to maintain 75° inside design temperature and 30% RH

Table 2.3

Indoor Design Conditions

Room or Area	Minimum Design Supply Air Changes per Hour
Patient Rooms	6
Ante Rooms	12
Dining	4
Corridors	4

Table 2.4

Supply Air Requirements

** See CDC criteria as higher air change rates may be required to meet the intent of the CDC requirements dependent upon HVAC distribution methodology.

Room or Area	Minimum Air Changes per Hour of Outside Air
Patient Rooms	2
Offices	1
Inpatient Isolation Rooms	10

Table 2.5

Outdoor Air Requirements

Room or Area	Room Pressure	Minimum Exhaust Air Changes per Hour
Bathing Facilities	Negative	10
Bathrooms & Toilet Rooms	Negative	10
Clean Utility	Positive	Supply air minus 15%
Inpatient Rooms	Neutral	6
Inpatient Isolation Rooms	Negative	10
Locker Rooms	Negative	Supply air plus 15%
Soiled Linen / Utility	Negative	6
Storage Rooms (soiled or dirty)	Negative	Supply air plus 15%
Transitional Patient Rooms	Neutral	6

Table 2.6

Exhaust Air Requirements

Room or Area	Maximum NC Level
Patient Rooms	35
Bathrooms & Toilet Rooms	40
Dining	40
Offices, Lobbies, Waiting Areas	35

Table 2.7
Noise Criteria

2.5. Guide Plates, Reflected Ceiling Plans and Data Sheets

Architectural Notes

Applicable Codes and Standards: See 2.1.1 Codes and Standards.

39. All new construction and all renovated areas shall be fully protected by an automatic sprinkler system.

40. The data sheets, which accompany each guide plate, list equipment in the following format:

QUANTITY	A / I	DESCRIPTION

Table 2.8
Format Example

The legend for the Equipment Tables is as follows:

QUANTITY - Quantity of equipment in room module.

A / I - Acquisition/Installation

vv – VA furnished and VA installed

vc – VA furnished and Contractor installed

cc – Contractor furnished and Contractor installed

cv – Contractor furnished and Contractor installed

Note: The above may vary from project to project

DESCRIPTION – Detailed specification of equipment.

41. When producing architectural drawings for the VA, designers should follow Standard Detail 00000-1.DWG (PG-18-4) which outlines the accepted symbols for designating equipment with regard to accountability as to procurement and installation responsibilities.

42. Provide reinforcement behind automatic door push plates.

Legend of Symbols































	GROUND FAULT INTERRUPTOR		NURSE CALL STAFF STATION
	JUNCTION BOX		NURSE CALL DOME LIGHT
	HUMIDISTAT		FIRE EXTINGUISHER
	THERMOSTAT		FIRE ALARM/MANUAL PULL STATION
	NIGHT LIGHT		FIRE ALARM/AUDIO-VISUAL DEVICE
	NURSE CALL EMERGENCY STATION		HOSPITAL RADIO TUNER/ VOLUME CONTROL
	NURSE CALL EMERGENCY STATION		VACUUM OUTLET *
	NURSE CALL DUTY STATION		TELEVISION CABLE OUTLET
	SPEAKER		DUPLEX RECEPTACLE
	INCANDESCENT LIGHT FIXTURE		QUADRAPLEX RECEPTACLE
	1 X 4 FLUORESCENT LIGHT FIXTURE		SINGLE POLE SWITCH
	2' X 4' FLUORESCENT LIGHT FIXTURE		THREE WAY SWITCH
	HVAC SUPPLY		BUILDING SECTION
	HVAC RETURN		FLOOR MOUNTED RECEPTACLE
	TELEPHONE JACK		
	EXIT LIGHT		
	SMOKE DETECTOR		

Figure 2.4

Legend of Symbols

2.6. Inpatient Unit

Twelve (12) bed unit is basis for the PRC Design Guide and Space Planning Criteria.

2.6.1. Patient Room Option 1 – 375 NSF [34.83 NSM]

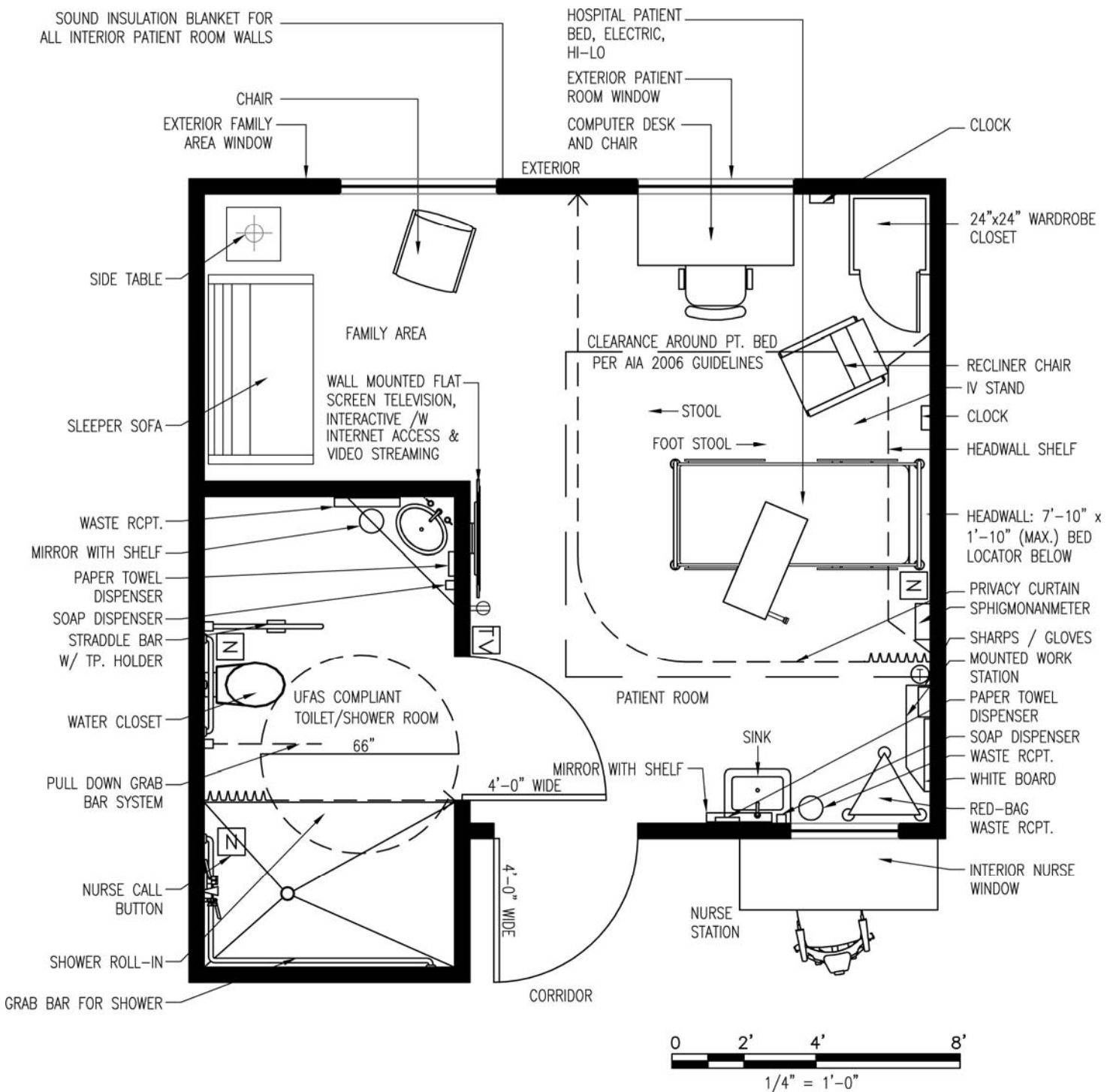

Inpatient Unit

2.6.1. Patient Room Option 1 - Reflected Ceiling Plan

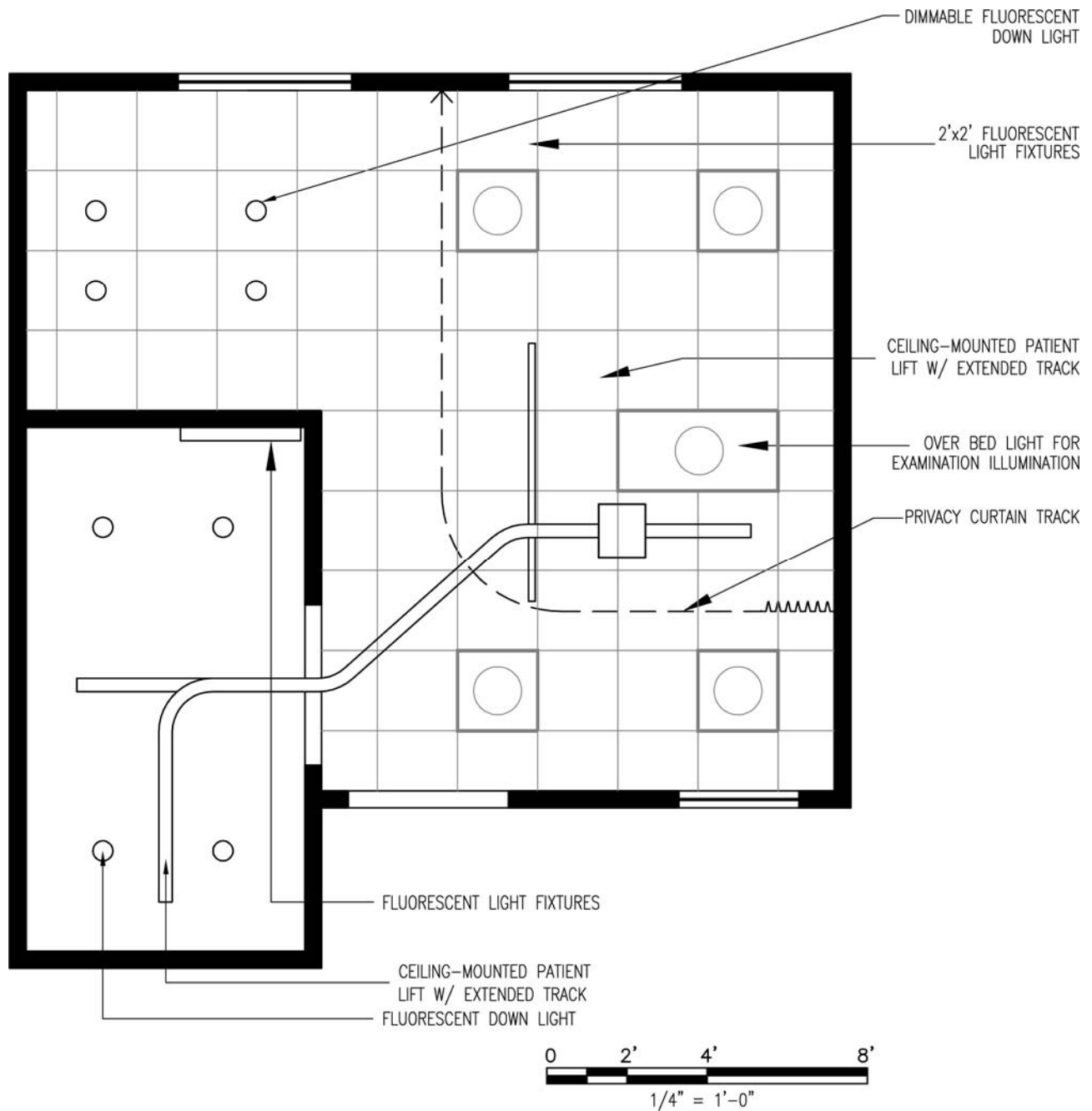

Inpatient Unit

2.6.1. Patient Room - Option 1

Function:

Patient Room - Option 1 is the core space of the Inpatient Unit. Option 1 includes both a family visiting area at bedside (near the window) and a separate family alcove for longer / overnight stays, larger family groups (including children), consultations with caregivers and patient privacy during procedures without requiring the family to leave the room. Square footage shown includes that for the Family Area and Patient Toilet / Shower Room.

Note: Where VA standard items are shown, non-institutional & sustainable options should be considered if feasible.

Space Requirement:

375 NSF [34.83 NSM]

Architectural:

Floor Finish:	Vinyl Composition Tile
Base:	RB
Wall Finish:	Gypsum Wallboard,
Ceiling:	Gypsum Wallboard, Acoustical Tile
Ceiling Height:	9'-0
Noise (STC Rating):	Sound insulation from adjacent spaces critical.
Slab Depression:	Yes – see VHA Program Guide PG-18-3
Special Construction:	Overhead patient lift system
Hardware:	7
Doors:	4'-0" x 7'-0" wood or metal, optional view glass panel.
Windows:	Required by code, operable, see PG-18-3, Topic 1, Codes and Standards.

HVAC:

Individual Room	
Temperature Control:	70° - 75° (year-round) 30% - 60% RH
Min. Air Changes/Hour:	6 AC/H
Min. % Outside Air:	33%
Pressure:	Neutral (0)
% Filtration	30%
Noise Criteria:	NC 35
Individual Room Temperature:	Required

Electrical:

Lighting Levels:	
Gen. Illum:	10 fc
Task Illum:	20 fc Dimmable fluorescent downlights; provide nighttime lighting protocol
Over Bed:	30% Integrated in casework
Emergency Egress:	
Emergency Power:	
Medical Gases:	Y
Night Lights:	Y
Vanity Light:	N/A
One Receptacle per PBPU:	Y
Nurse Call:	Y

Inpatient Unit

2.6.1. Patient Room - Option 1

Equipment Table:

SYMBOL	QUANTITY	AI	DESCRIPTION
			Note: Where VA standard items are shown, non-institutional & sustainable options should be considered if feasible.
	1	VV	BED, WITH MATTRESS, HOSPITAL PATIENT, ELECTRIC, HI-LO, 1067 mm X 2388 mm (42" X 94") WITH 76 mm (3") DIA. WHEELS
	1	CC	BUMPER GUARD, 51 mm (2") DEEP, WALL-MOUNTED OFF THE FLOOR BEHIND HEAD OF BED; OPTIONAL IF ABUSE-RESISTANT WALL PANELS USED
	1	VV	MONITOR, PHYSIOLOGICAL; PARAMETERS TO BE DETERMINED
	1	VV	TABLE, OVER-BED, ADJUSTABLE HEIGHT, 838 mm X 356 mm (33" X 14") ON CASTERS
	1	VV	CABINET, BEDSIDE, PORTABLE, 508 mm X 406 mm X 876 mm (20" X 16" X 34-1/2")
	1	VV	CHAIR, STACKING
	1	VV	CHAIR, RECLINER, PATIENT
	1	VC	LIFT, PATIENT, CEILING-MOUNTED WITH EXTENDED TRACK
	1	CC	WARDROBE LOCKER, PATIENT, WITH PUSH BUTTON SECURITY LOCK, 914 mm X 622 mm X 1981 mm (36" X 25-1/2" X 78") (TOP SHELF FOR PILLOW AND BLANKET STORAGE) WALL MOUNTED
			-OR-
	1	VV	WARDROBE LOCKER/BEDSIDE TABLE COMBINATION, MOBILE, TYPE AND SIZE AS REQUIRED
	1	CC	PREFABRICATED BEDSIDE PATIENT UNIT:
	1	CC	OUTLET, MASTER TELEVISION ANTENNA
	1	CC	BRACKET, FOR TELEVISION RECEIVER, MOUNTED AT FOOT OF BED
	1	VV	RECEIVER, TELEVISION, FLAT SCREEN, INTERACTIVE W/INTERNET ACCESS & VIDEO STREAMING; NURSE CALL OPTIONAL
	1	CC	LIGHT, BED, ON WALL, OVER BED, 2134 mm (84") ABOVE FLOOR
	1	CC	LIGHT, FLUORESCENT, FOR EXAMINATION ILLUMINATION, CEILING MOUNTED OVER EACH BED
	1	CC	LIGHT, NIGHT, INCANDESCENT, CEILING MOUNTED AT ENTRANCE TO BED ROOM WITH SWITCH AT ENTRANCE TO BED ROOM
	1	CC	VANITY, WITH SOLID SURFACE COUNTER TOP, MOLDED SELF EDGE AND BACKSPLASH; INTEGRAL LAVATORY OPTIONAL
	1	CC	LAVATORY, COUNTER MOUNTED (NOT REQUIRED IF LAVATORY INTEGRAL WITH COUNTERTOP PROVIDED)
	1	VV	DISPENSER, SOAP, LIQUID, WALL MOUNTED

SYMBOL	QUANTITY	AI	DESCRIPTION
	1	CC	MIRROR, 610 mm X 914 mm (24" X 36")
	1	CC	LIGHT, FLUORESCENT, MOUNTED ABOVE MIRROR
	1	CC	DISPENSER, PAPER TOWEL AND DISPOSAL COMBINATION UNITS
	1	CC	LIGHT, NIGHT
	1	CC	NURSE CALL, PANEL WITH CORRIDOR SIGNAL LIGHT
	AR	CC	SHELVING, WALL HUNG, 1829 mm (6 FEET) OFF FINISHED FLOOR, 610 mm (24") DEEP X LENGTH AS REQUIRED
	1	CC	HEADWALL, ON EACH SIDE OF THE BED : 3 OXYGEN, 3 VACUUM, 1 MEDICAL AIR, 1 QUAD STANDARD POWER OUTLET, 1 QUAD EMERGENCY POWER OUTLET, LOCATED SYMMETRICALLY.
			FAMILY AREA:
	1	VV	SOFA SLEEPER WITH STORAGE, 2134 mm X 762mm (84" X 30") OR SIZE AS SPACE ALLOWS
	AR	VV	TABLE, SIDE, 18" X 18"
	1	VV	CHAIR, LOUNGE, 711.2mm X 711.2mm (28" X 28"), AS SPACE ALLOWS
			UFAS COMPLIANT TOILET / SHOWER ROOM
	1	CC	WATER CLOSET, FLOOR-MOUNTED
	AR	CC	BAR, GRAB FOR WATER CLOSET
	1	CC	NURSE CALL, EMERGENCY STATION WITH CORRIDOR SIGNAL LIGHT, PROVIDE PULL CORD AT TOILET ENCLOSURE
			NOTE: THE ABOVE NURSE CALL-EMERGENCY STATION IS IN ADDITION TO THE BATH EMERGENCY SYSTEM
	1	CC	DISPENSER, TOILET TISSUE, DOUBLE ROLL
	1	CC	VANITY, WITH SOLID SURFACE COUNTER TOP, MOLDED SELF EDGE AND BACKSPLASH; INTEGRAL LAVATORY OPTIONAL
	1	CC	LAVATORY, COUNTER MOUNTED (NOT REQUIRED IF LAVATORY INTEGRAL WITH COUNTERTOP PROVIDED)
	1	CC	SHELF, STAINLESS STEEL, WALL HUNG, 152 mm X 457 mm (6" X 18") OR INTEGRATE SHELF WITH WALL TILE
	1	CC	CABINET, STORAGE, RECESSED (FOR PERSONAL TOILETRIES) OR INTEGRATE WITH WALL TILE
	1	CC	LIGHT, FLUORESCENT, MOUNTED ABOVE MIRROR
	1	VV	DISPENSER, SOAP, LIQUID, WALL MOUNTED
	1	CC	MIRROR, ADA COMPLIANT, 610 mm X 914 mm (24" X 36") MINIMUM

SYMBOL	QUANTITY	AI	DESCRIPTION
	1	VV	DISPENSER, BIFOLD PAPER TOWEL, SURFACE MOUNTED
	AR	CC	HOOK, CLOTHES
	1	CC	NURSE CALL, EMERGENCY STATION WITH CORRIDOR SIGNAL LIGHT CONNECTED TO NEAREST NURSE CONTROL STATION
	1	CC	SHOWER, ROLL-IN
	1	CC	DISH, SOAP, RECESSED
	AR	CC	BAR, GRAB FOR TUB OR SHOWER
	1	CC	BAR, TOWEL
	1	CC	ROD, CURTAIN, TUB OR SHOWER
	1	VV	CURTAIN - TUB OR SHOWER
	1	VV	RECEPTACLE, WASTE, STEP ON TYPE, APPROX., 305 mm (12") DIAMETER

Inpatient Unit

2.6.2. Patient Room Option 2 – 290 NSF [26.94 NSM]

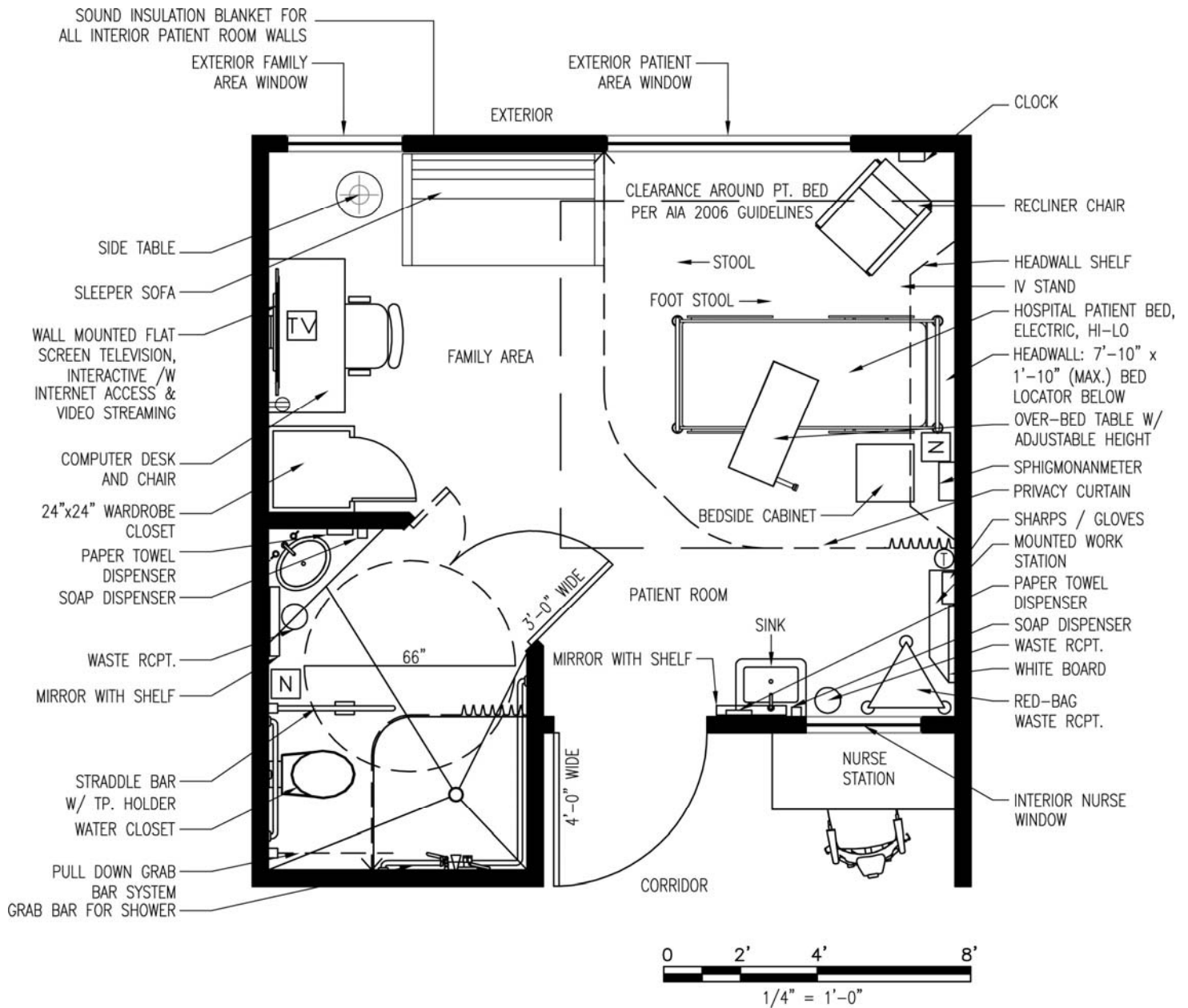

Inpatient Unit

2.6.2. Patient Room Option 2 - Reflected Ceiling Plan

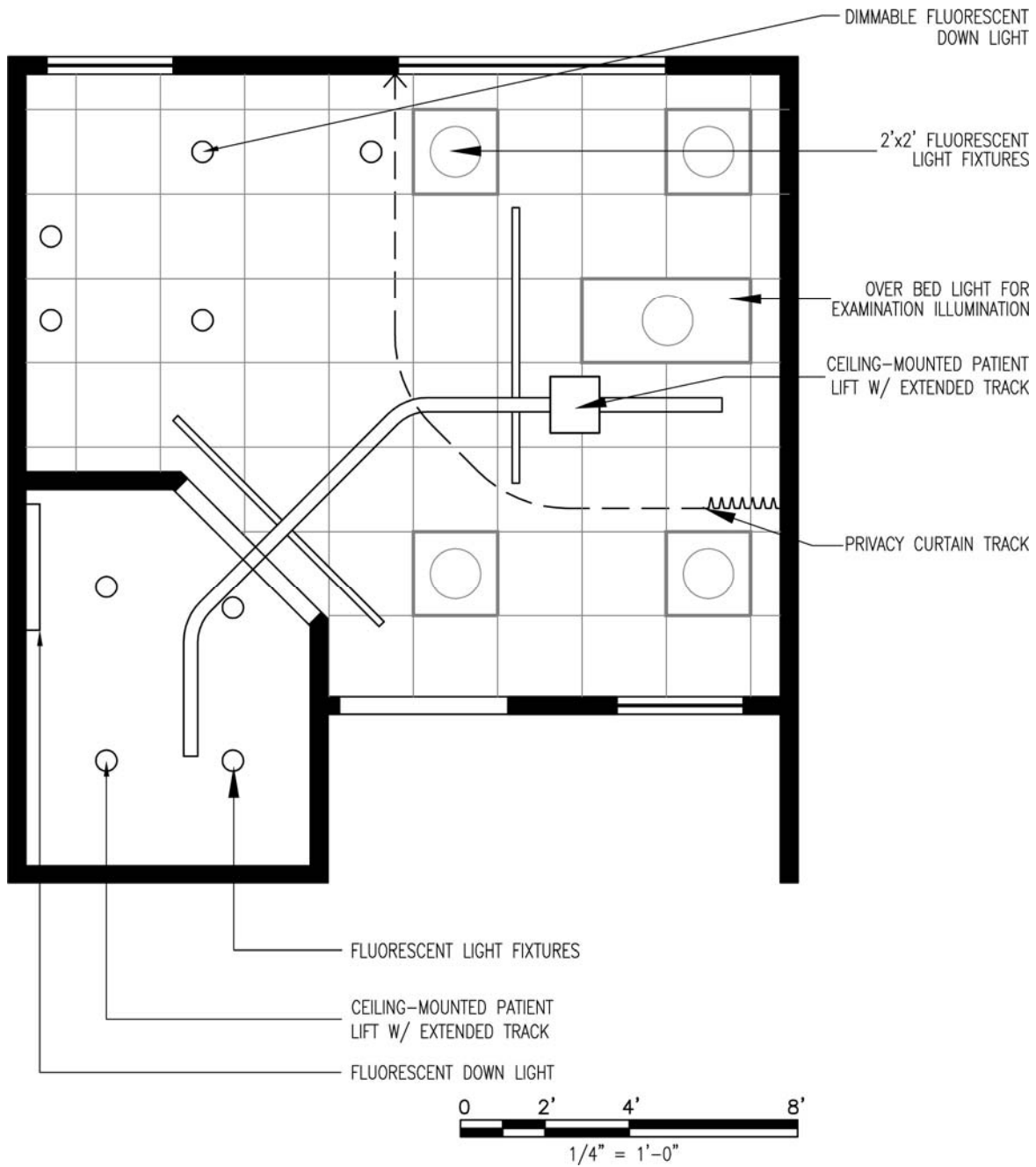

Inpatient Unit

2.6.2. Patient Room - Option 2**Function:**

Patient Room - Option 2 is the core space of the Inpatient Unit. Option 2 is a more standard size room with a family visiting area added at bedside (near the window) to accommodate large family groups and longer length of stay. Square footage shown includes that for the Alcove and Patient Toilet / Shower Room.

Note: Where VA standard items are shown, non-institutional & sustainable options should be considered if feasible.

Space Requirement:

290 NSF [26.94 NSM]

Architectural:

Floor Finish:	Vinyl Composition Tile
Base:	RB
Wall Finish:	Gypsum Wallboard
Ceiling:	Gypsum Wallboard, Acoustical Tile
Ceiling Height:	9'-6"
Noise (STC Rating):	Sound insulation from adjacent spaces critical.
Slab Depression:	Yes – See VHA Program Guide PG-18-3
Special Construction:	Overhead patient lift system
Hardware:	7
Doors:	4'-0" x 7'-0" wood or metal, optional view glass panel.
Windows:	Required by code, operable, see PG-18-3, Topic 1, Codes and Standards.

HVAC:

Individual Room	
Temperature Control:	70° - 75° (year-round) 30% - 60% RH
Min. Air Changes/Hour:	6 AC/H
Min. % Outside Air:	33%
Pressure:	Neutral (0)
% Filtration	30%
Noise Criteria:	NC 35
Individual Room Temperature:	Required

Electrical:

Lighting Levels:	
Gen. Illum:	10 fc
Task Illum:	20 fc Dimmable fluorescent downlights; provide nighttime lighting protocol
Over Bed:	30% Integrated in casework
Emergency Egress:	
Emergency Power:	
Medical Gases:	Y
Night Lights:	Y
Vanity Light:	N/A
One Receptacle per PBPU:	Y
Nurse Call:	Y

Inpatient Unit

2.6.2. Patient Room - Option 2

Equipment Table:

SYMBOL	QUANTITY	AI	DESCRIPTION
			Note: Where VA standard items are shown, non-institutional & sustainable options should be considered if feasible.
	1	VV	BED, WITH MATTRESS, HOSPITAL PATIENT, ELECTRIC, HI-LO, 1067 mm X 2388 mm (42" X 94") WITH 76 mm (3") DIA. WHEELS
	1	CC	BUMPER GUARD, 51 mm (2") DEEP, WALL-MOUNTED OFF THE FLOOR BEHIND HEAD OF BED; OPTIONAL IF ABUSE-RESISTANT WALL PANELS USED
	1	VV	MONITOR, PHYSIOLOGICAL; PARAMETERS TO BE DETERMINED
	1	VV	TABLE, OVER-BED, ADJUSTABLE HEIGHT, 838 mm X 356 mm (33" X 14") ON CASTERS
	1	VV	CABINET, BEDSIDE, PORTABLE, 508 mm X 406 mm X 876 mm (20" X 16" X 34-1/2")
	1	VV	CHAIR, STACKING
	1	VV	CHAIR, RECLINER, PATIENT
	1	VC	LIFT, PATIENT, CEILING-MOUNTED WITH EXTENDED TRACK
	1	CC	WARDROBE LOCKER, PATIENT, WITH PUSH BUTTON SECURITY LOCK, 914 mm X 622 mm X 1981 mm (36" X 25-1/2" X 78") (TOP SHELF FOR PILLOW AND BLANKET STORAGE) WALL MOUNTED
			-OR-
	1	VV	WARDROBE LOCKER/BEDSIDE TABLE COMBINATION, MOBILE, TYPE AND SIZE AS REQUIRED
	1	CC	PREFABRICATED BEDSIDE PATIENT UNIT:
	1	CC	OUTLET, MASTER TELEVISION ANTENNA
	1	CC	BRACKET, FOR TELEVISION RECEIVER, MOUNTED AT FOOT OF BED
	1	VV	RECEIVER, TELEVISION, FLAT SCREEN, INTERACTIVE W/INTERNET ACCESS & VIDEO STREAMING; NURSE CALL OPTIONAL
	1	CC	LIGHT, BED, ON WALL, OVER BED, 2134 mm (84") ABOVE FLOOR
	1	CC	LIGHT, FLUORESCENT, FOR EXAMINATION ILLUMINATION, CEILING MOUNTED OVER EACH BED
	1	CC	LIGHT, NIGHT, INCANDESCENT, CEILING MOUNTED AT ENTRANCE TO BED ROOM WITH SWITCH AT ENTRANCE TO BED ROOM
	1	CC	VANITY, WITH SOLID SURFACE COUNTER TOP, MOLDED SELF EDGE AND BACKSPLASH; INTEGRAL LAVATORY OPTIONAL
	1	CC	LAVATORY, COUNTER MOUNTED (NOT REQUIRED IF LAVATORY INTEGRAL WITH COUNTERTOP PROVIDED)
	1	VV	DISPENSER, SOAP, LIQUID, WALL MOUNTED

SYMBOL	QUANTITY	AI	DESCRIPTION
	1	CC	MIRROR, 610 mm X 914 mm (24" X 36")
	1	CC	LIGHT, FLUORESCENT, MOUNTED ABOVE MIRROR
	1	CC	DISPENSER, PAPER TOWEL AND DISPOSAL COMBINATION UNITS
	1	CC	LIGHT, NIGHT
	1	CC	NURSE CALL, PANEL WITH CORRIDOR SIGNAL LIGHT
	AR	CC	SHELVING, WALL HUNG, 1829 mm (6 FEET) OFF FINISHED FLOOR, 610 mm (24") DEEP X LENGTH AS REQUIRED
	1	CC	HEADWALL, ON EACH SIDE OF THE BED : 3 OXYGEN, 3 VACUUM, 1 MEDICAL AIR, 1 QUAD STANDARD POWER OUTLET, 1 QUAD EMERGENCY POWER OUTLET, LOCATED SYMMETRICALLY.
			FAMILY AREA:
	1	VV	SOFA SLEEPER WITH STORAGE, 2134 mm X 762mm (84" X 30") OR SIZE AS SPACE ALLOWS
	AR	VV	TABLE, SIDE, 18" X 18"
	1	VV	CHAIR, LOUNGE, 711.2mm X 711.2mm (28" X 28"), AS SPACE ALLOWS
			UFAS COMPLIANT TOILET / SHOWER ROOM:
	1	CC	WATER CLOSET, FLOOR-MOUNTED
	AR	CC	BAR, GRAB FOR WATER CLOSET
	1	CC	NURSE CALL, EMERGENCY STATION WITH CORRIDOR SIGNAL LIGHT, PROVIDE PULL CORD AT TOILET ENCLOSURE
			NOTE: THE ABOVE NURSE CALL-EMERGENCY STATION IS IN ADDITION TO THE BATH EMERGENCY SYSTEM
	1	CC	DISPENSER, TOILET TISSUE, DOUBLE ROLL
	1	CC	VANITY, WITH SOLID SURFACE COUNTER TOP, MOLDED SELF EDGE AND BACKSPLASH; INTEGRAL LAVATORY OPTIONAL
	1	CC	LAVATORY, COUNTER MOUNTED (NOT REQUIRED IF LAVATORY INTEGRAL WITH COUNTERTOP PROVIDED)
	1	CC	SHELF, STAINLESS STEEL, WALL HUNG, 152 mm X 457 mm (6" X 18") OR INTEGRATE SHELF WITH WALL TILE
	1	CC	CABINET, STORAGE, RECESSED (FOR PERSONAL TOILETRIES) OR INTEGRATE WITH WALL TILE
	1	CC	LIGHT, FLUORESCENT, MOUNTED ABOVE MIRROR
	1	VV	DISPENSER, SOAP, LIQUID, WALL MOUNTED
	1	CC	MIRROR, ADA COMPLIANT, 610 mm X 914 mm (24" X 36") MINIMUM

SYMBOL	QUANTITY	AI	DESCRIPTION
	1	VV	DISPENSER, BIFOLD PAPER TOWEL, SURFACE MOUNTED
	AR	CC	HOOK, CLOTHES
	1	CC	NURSE CALL, EMERGENCY STATION WITH CORRIDOR SIGNAL LIGHT CONNECTED TO NEAREST NURSE CONTROL STATION
	1	CC	SHOWER, ROLL-IN
	1	CC	DISH, SOAP, RECESSED
	AR	CC	BAR, GRAB FOR TUB OR SHOWER
	1	CC	BAR, TOWEL
	1	CC	ROD, CURTAIN, TUB OR SHOWER
	1	VV	CURTAIN - TUB OR SHOWER
	1	VV	RECEPTACLE, WASTE, STEP ON TYPE, APPROX., 305 mm (12") DIAMETER

Inpatient Unit

2.6.3. Nurse Station Option 1 – 100 NSF [9.29 NSM]
Floor Plan and Reflected Ceiling Plan

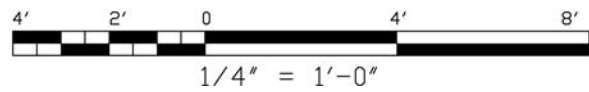
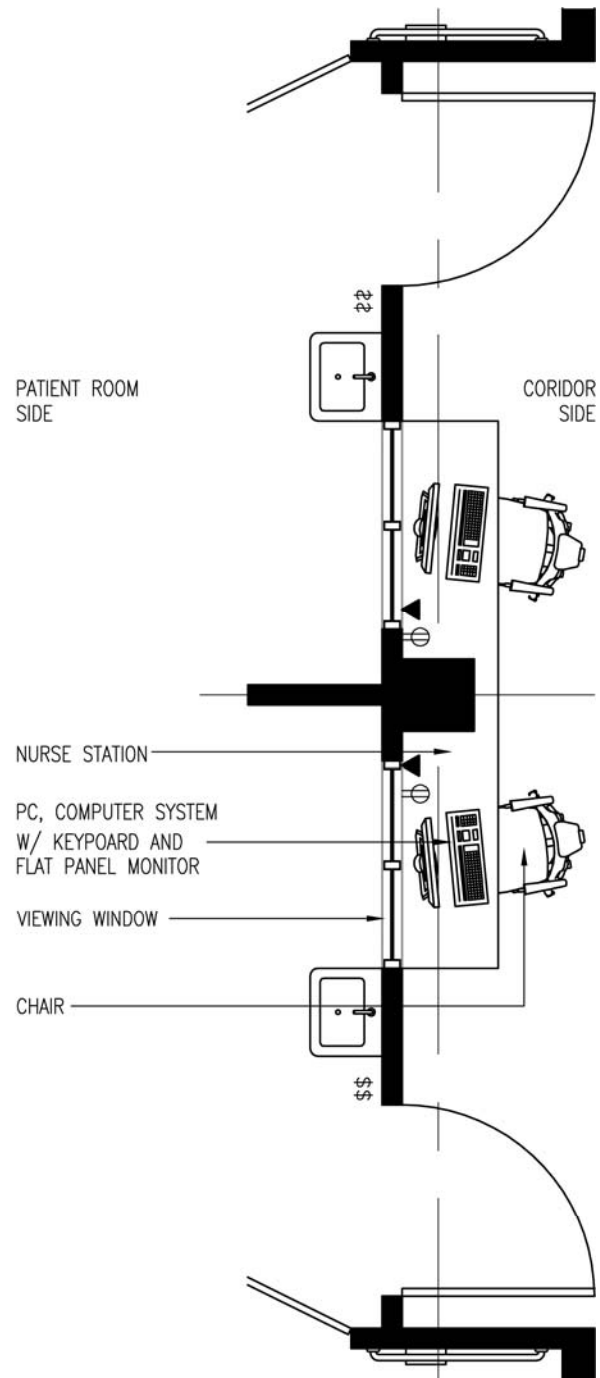
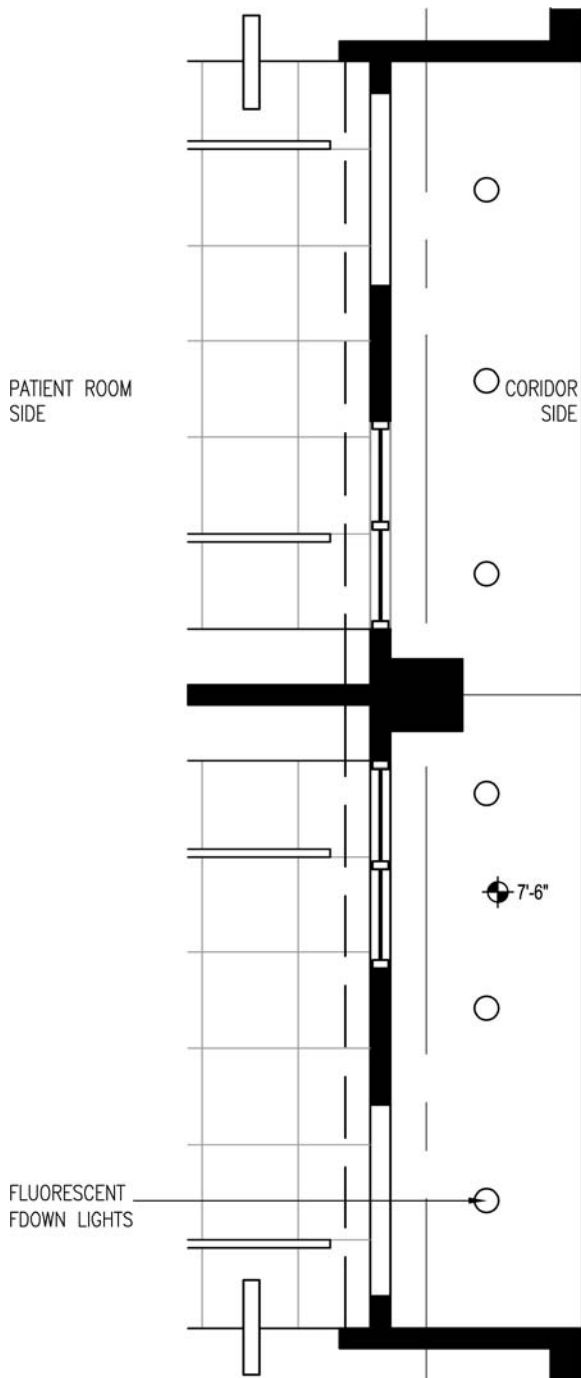

Inpatient Unit

2.6.3. Nurse Station - Option 1**Function:**

Nurse Station - Option 1 provides for a decentralized nursing model via a corridor niche with direct observation into two paired patient rooms. Shared wall is the patient headwall for both rooms. Design considerations include type of equipment (computers, etc.), charting and filing to be done at satellite stations and whether such is to be part of the niche or portable. Square footage shown is for one satellite station serving two patient rooms. For a 12 bed unit with all standard rooms this total should be multiplied by six (6). In addition, a separate staff workroom for centralized functions and patient consultations / privacy should be provided.

Note: Where VA standard items are shown, non-institutional & sustainable options should be considered if feasible.

Space Requirement:

100 NSF [9.29 NSM]

Architectural:

Floor Finish:	Vinyl Composition Tile
Base:	RB
Wall Finish:	Gypsum Wallboard
Ceiling:	Gypsum Wallboard, Acoustical Tile
Ceiling Height:	9'-0" w/ lower soffit
Noise (STC Rating):	NA
Slab Depression:	None
Special Construction:	None
Hardware:	23 (If doors are needed)
Doors:	None
Windows:	View window with integral blinds or switchable glazing

HVAC:

Individual Room	
Temperature Control:	75° in summer 70° in winter with 5° dead-band as stipulated in ASHRAE 90.1 - 2007
Min. Air Changes/Hour:	4 AC/H
Min. % Outside Air:	25%
Pressure:	N/A
Noise Criteria:	NC 40
Individual Room Temperature:	Required

Electrical:

Lighting Levels:	
Gen. Illum:	2x2 parabolic fluorescent
Task Illum:	Dimmable fluorescent downlight
Over Bed:	N/A
Emergency Egress:	1fc Ave.
Emergency Power:	
Medical Gases:	No
Night Lights:	No
Vanity Light:	N/A
One Receptacle per PBPU:	N/A
Nurse Call:	Reporting station optional

Inpatient Unit

2.6.3. Nurse Station - Option 1

Equipment Table:

SYMBOL	QUANTITY	AI	DESCRIPTION
			Note: Where VA standard items are shown, non-institutional & sustainable options should be considered if feasible.
	2	VV	PC, COMPUTER SYSTEM WITH KEYBOARD & FLAT SCREEN MONITOR
	2	VV	CHAIR, TASK, WITH ARMS
	1	VV	COUNTER TOP, SOLID SURFACE WITH KEYBOARD TRAY, 1828.8mm X 762mm X 762mm (72" X 30" X 30")

Inpatient Unit

2.6.4. Nurse Station Option 2 – 200 NSF [18.58 NSM]
Floor Plan and Reflected Ceiling Plan

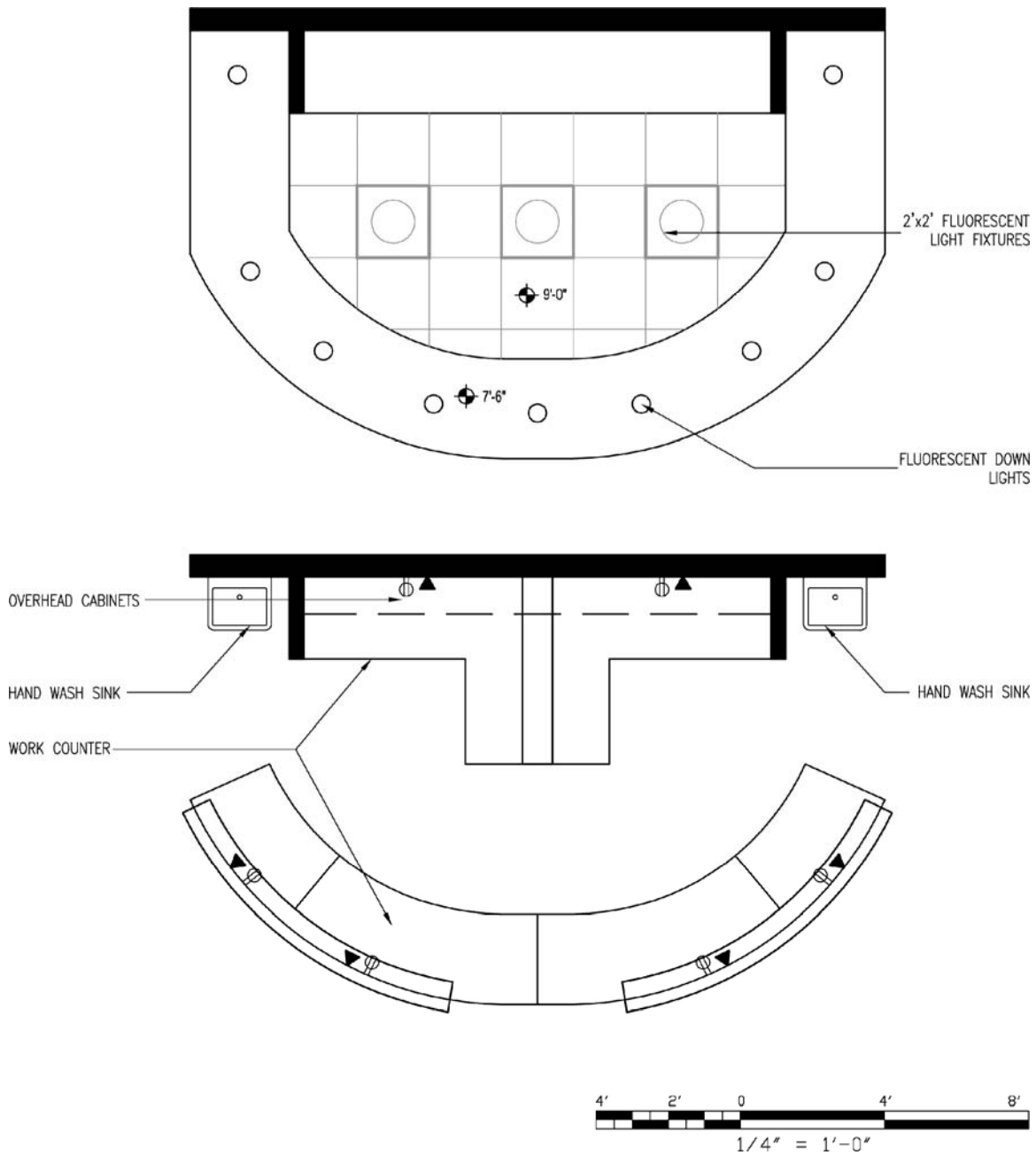

Inpatient Unit

2.6.4. Nurse Station - Option 2**Function:**

Nurse Station - Option 2 is a traditional, centralized nurse station. This option allows for more efficient use of space, staff redundancy / accountability and camaraderie. Single location for technology, systems reporting. Design considerations include maximizing patient visibility from station, increased staff walking distances to rooms and provision of sound absorptive materials to reduce noise from station.

Note: Where VA standard items are shown, non-institutional & sustainable options should be considered if feasible.

Space Requirement:

200 NSF [18.58 NSM]

Architectural:

Floor Finish:	Vinyl Composition Tile
Base:	RB
Wall Finish:	Gypsum Wallboard
Ceiling:	Gypsum Wallboard, Acoustical Tile
Ceiling Height:	9'-0" w/ lower soffit
Noise (STC Rating):	NA
Slab Depression:	None
Special Construction:	None
Hardware:	23
Doors:	Optional if nurse station is enclosed
Windows:	Optional if nurse station in enclosed. View window with integral blinds or switchable glazing

HVAC:

Individual Room	
Temperature Control:	70° - 75° (year-round) 30% - 60% RH
Min. Air Changes/Hour:	4 AC/H
Min. % Outside Air:	25%
Pressure:	N/A
Noise Criteria:	NC 40
Individual Room Temperature:	Required

Electrical:

Lighting Levels:	
Gen. Illum:	2x2 parabolic fluorescent
Task Illum:	Dimmable fluorescent downlight
Over Bed:	N/A
Emergency Egress:	1fc Ave.
Emergency Power:	
Medical Gases:	No
Night Lights:	No
Vanity Light:	N/A
One Receptacle per PBP:	N/A
Nurse Call:	Central reporting station

Inpatient Unit

2.6.4. Nurse Station - Option 2

Equipment Table:

SYMBOL	QUANTITY	AI	DESCRIPTION
			Note: Where VA standard items are shown, non-institutional & sustainable options should be considered if feasible.
	1	CC	COUNTER, CENTER, COMMUNICATION, WITH DESK, KEYBOARD TRAY, INDIVIDUAL SINGLE DRAWERS BELOW FULL LENGTH OF COUNTER AS REQUIRED, SIZE ACCORDING TO INDIVIDUAL PROJECT DESIGN
	1	CC	NURSE CALL, CONSOLE, ANNUNCIATOR, AUDIO VISUAL DESK TYPE
	AR	VV	CENTRAL STATION, PATIENT MONITORING
	AR	VV	PC, COMPUTER SYSTEM, WITH KEYBOARD & FLAT SCREEN MONITOR
	AR	VV	CHAIR, TASK, WITH ARMS
	AR	VV	CABINET, FILING, UNDERCOUNTER
	1	CC	FIRE ALARM STATION, RED SIGNAL LIGHT AND CHIME, WALL MOUNTED
	1	CC	ALARM, AIR, OXYGEN AND VACUUM FAILURE, WALL MOUNTED
	1	CC	STATION, PNEUMATIC TUBE (DETERMINED ON INDIVIDUAL BASIS)

Inpatient Unit

2.6.5. Recreation Therapy Room, Group – 1300 NSF [120.77 NSM]

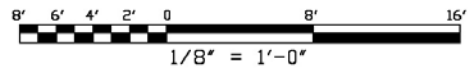
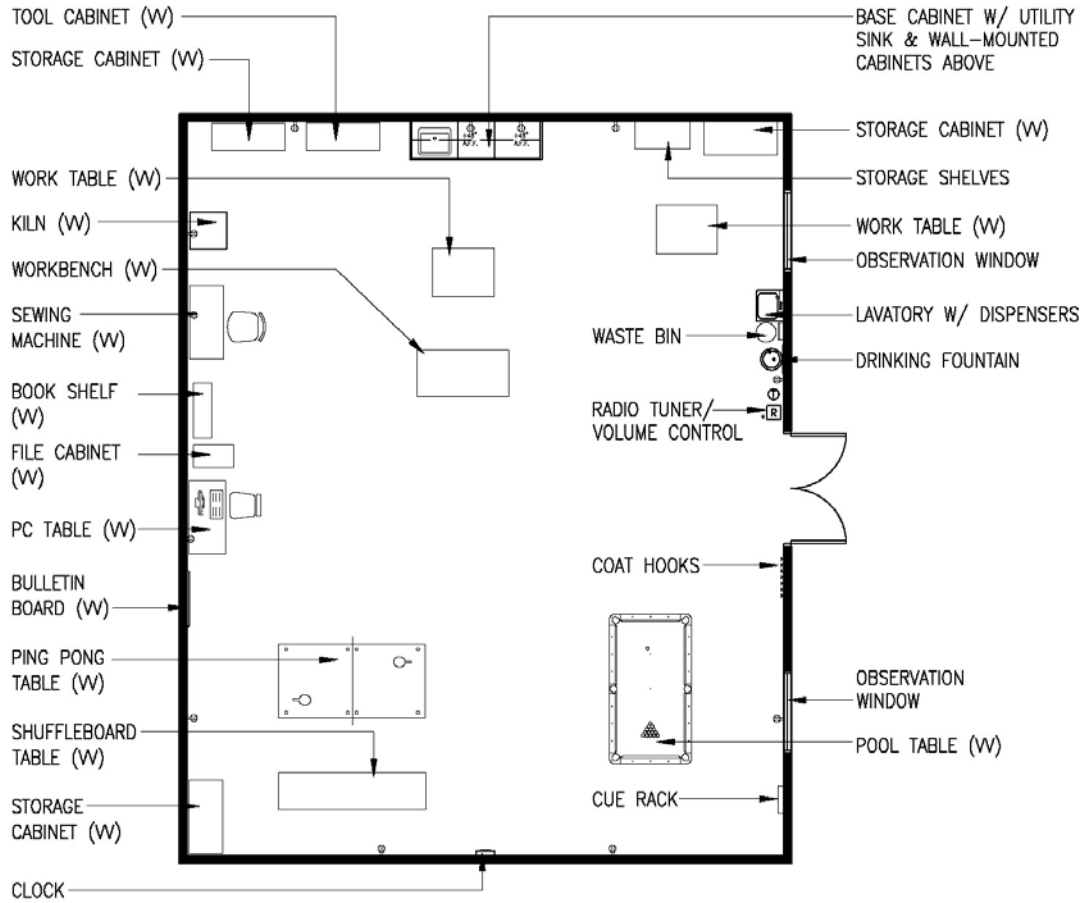

Inpatient Unit

2..6.5 Recreation Therapy Room, Group - Reflected Ceiling Plan

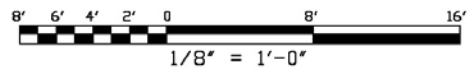
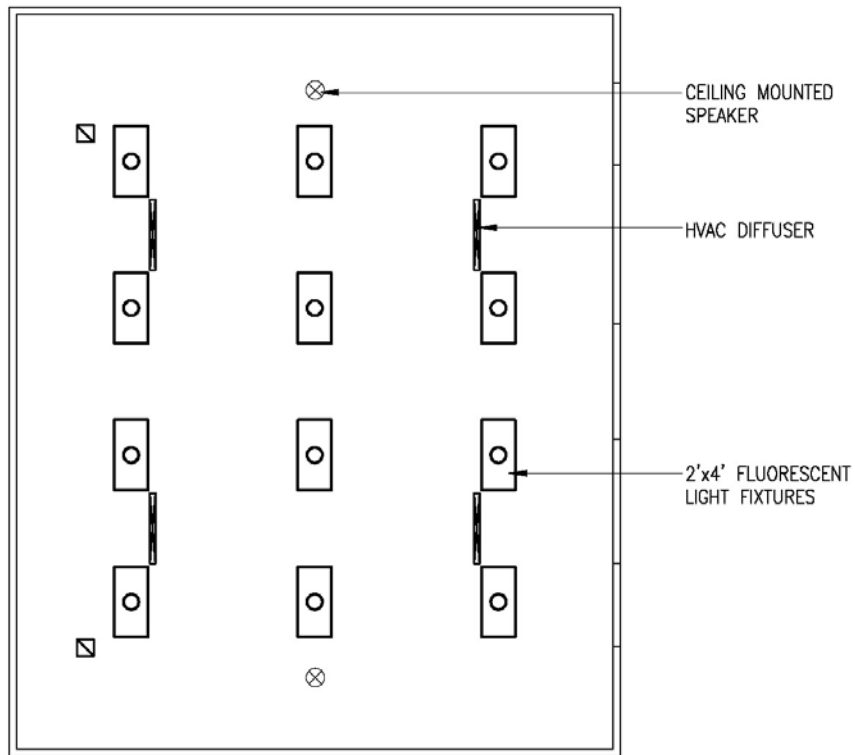

Inpatient Unit

2.6.5 Recreation Therapy Room, Group**Function:**

This space is intended to accommodate a variety of unsupervised recreational activities among patients and on occasion patients and family.

Space Requirement:

1300 NSF

Architectural:

Floor Finish:	Vinyl Composition Tile
Base:	Vinyl
Wall Finish:	Gypsum Wallboard/Paint
Ceiling:	Acoustical Tile
Ceiling Height:	10'-0"
Noise (STC Rating):	30
Slab Depression:	None
Special Construction:	-
Hardware:	69
Doors:	(2) 3'-0" X 7'-0" wood or metal with upper half laminated safety glass
Windows:	None Required but Desirable

HVAC:

Individual Room	
Temperature Control:	70° - 75° (year-round) 30% - 50% RH
Min. Air Changes/Hour:	6 AC/H
Return Air:	Permitted
Min. % Outside Air:	15%
Pressure:	Negative (-)
Noise Criteria:	NC 45
Individual Room Temperature:	Required

Electrical:

Lighting Levels:	
Gen. Illum:	30fc
Emergency Power:	
One Ceiling Light	
Nurse Call	

Inpatient Unit

2.6.5 Recreation Therapy Room, Group**Equipment Table:**

SYMBOL	QUANTITY	AI	DESCRIPTION
	2	VV	TABLE, WORK 60"W x 36"L x 36"H
	1	VV	WORKBENCH 30"W x 60"L x 32"H
	1	VV	BOOKCASE, SECTIONAL, EACH SECTION 33" x 13" x 15" WITH 10" BASE
	1	VV	CABINET, FILING (LETTER), 5-DRAWER, 15" x 25" x 60"
	1	VV	MACHINE, SEWING 20" x 40"
	1	VV	TABLE, COMPUTER (PC), 24"W x 48"L x 30"H
	1	VV	KILN, FLOOR, 208 VOLT, 30 AMP, SINGLE PHASE, TIMER SWITCH
	AR	VV	TABLE, POOL 98" x 54"
	AR	VV	RACK, CUE, WALL
	1	VV	BULLETIN BOARD, APPROX. 36" x 36"
	AR	VV	COAT HOOKS
	1	VV	CABINET, TOOLS, 2-DOOR, 3 SHADOW BOARDS, FOUR DRAWERS ALL WITH LOCKS
	2	VV	CABINET, STORAGE, METAL, 2-DOOR WITH LOCK
	1	VV	TABLE, SHUFFLE BOARD 24" x 96" x 36"
	AR	CC	RECEPTACLE, ELECTRICAL, DUPLEX, 120 VOLT, 20 AMP
	AR	VV	CART, MOBILE 18" x 30" x 36" or 24" x 48" x 36"
	1	VV	TABLE, PING PONG 48" x 96"
	1	VV	CABINET, ASSEMBLY WITH 2 UNDERCOUNTER UNITS WITH 1 DRAWER EACH, 1 HINGED DOOR AND 1 ADJ. SHELF, SINK CABINET TO HAVE 2 HINGED DOORS, WALL CABINETS TO BE WITH SLOPING TOP AND 2 GLAZED SLIDING DOORS AND 2 ADJ. SHELVES, COUNTER TOP OF CORROSION RESISTING STEEL WITH INTEGRAL BACKSPLASH AND SINK (18" x 20" x 7 1/2") WITH PLASTER TRAP, REMOVABLE STRAINER AND SWING SPOUT FAUCET.
	1	CC	DRINKING FOUNTAIN, MECHANICALLY COOLED, WHEELCHAIR
	1	VV	CLOCK, BATTERY OPERATED
	AR	VV	RECEPTACLE, WASTE, 13" DIAMETER

Inpatient Unit

2.6.5 Recreational Therapy**Equipment Table Continued:**

SYMBOL	QUANTITY	AI	DESCRIPTION
	1	CC	LAVATORY, STRAIGHT, BACK, WRIST CONTROL, GOOSENECK SPOUT, 20" x 18" & 3 ½" APRON
	1	VV	DISPENSER, SOAP, LIQUID, WALL MOUNTED
	1	VV	DISPENSER, BIFOLD PAPER TOWEL, WALL MOUNTED

Inpatient Unit

2.6.6. Dining Room – 400 NSF [37.16 NSM]

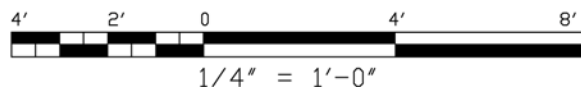
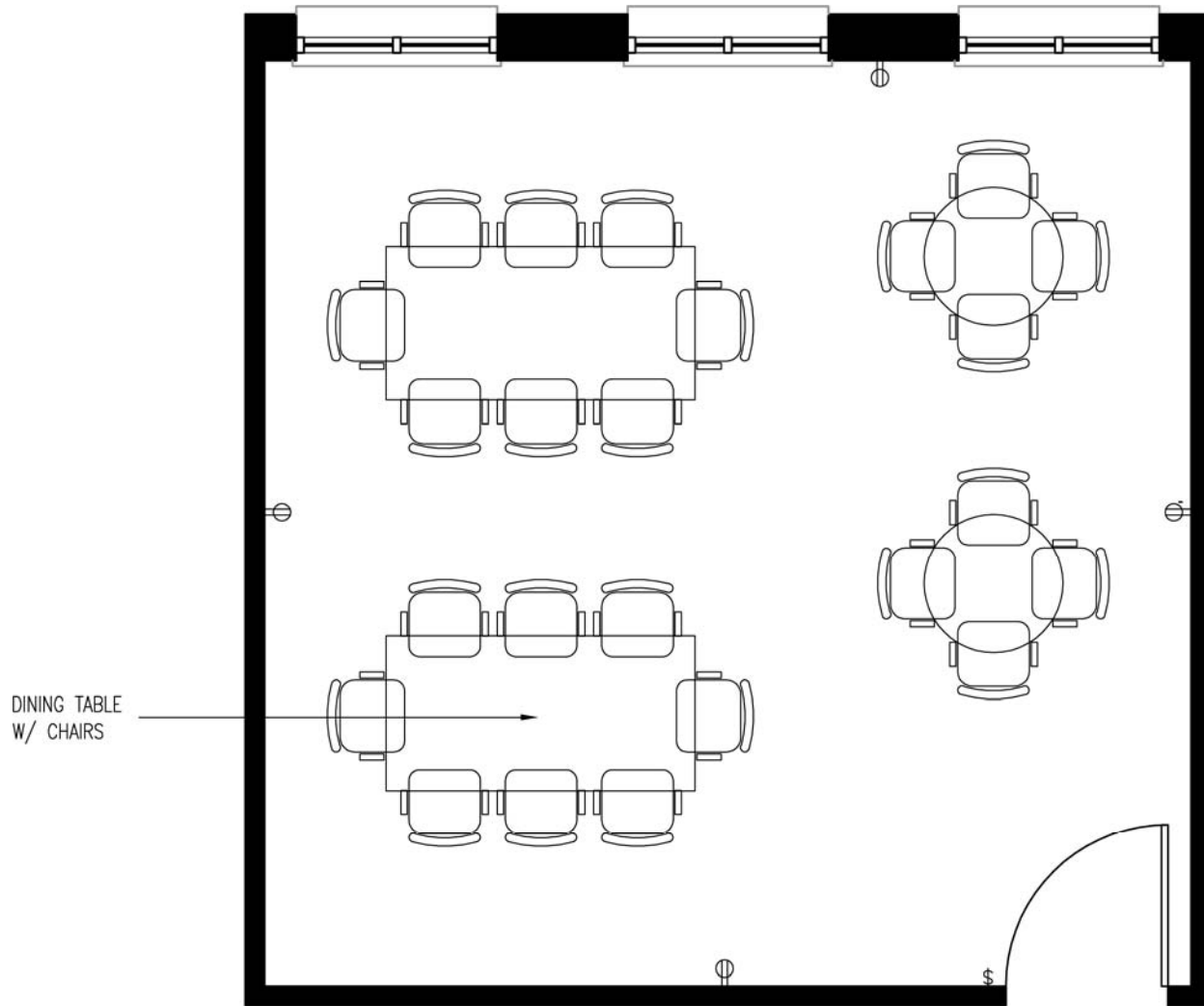

Inpatient Unit

2.6.6. Dining Room – Reflected Ceiling Plan

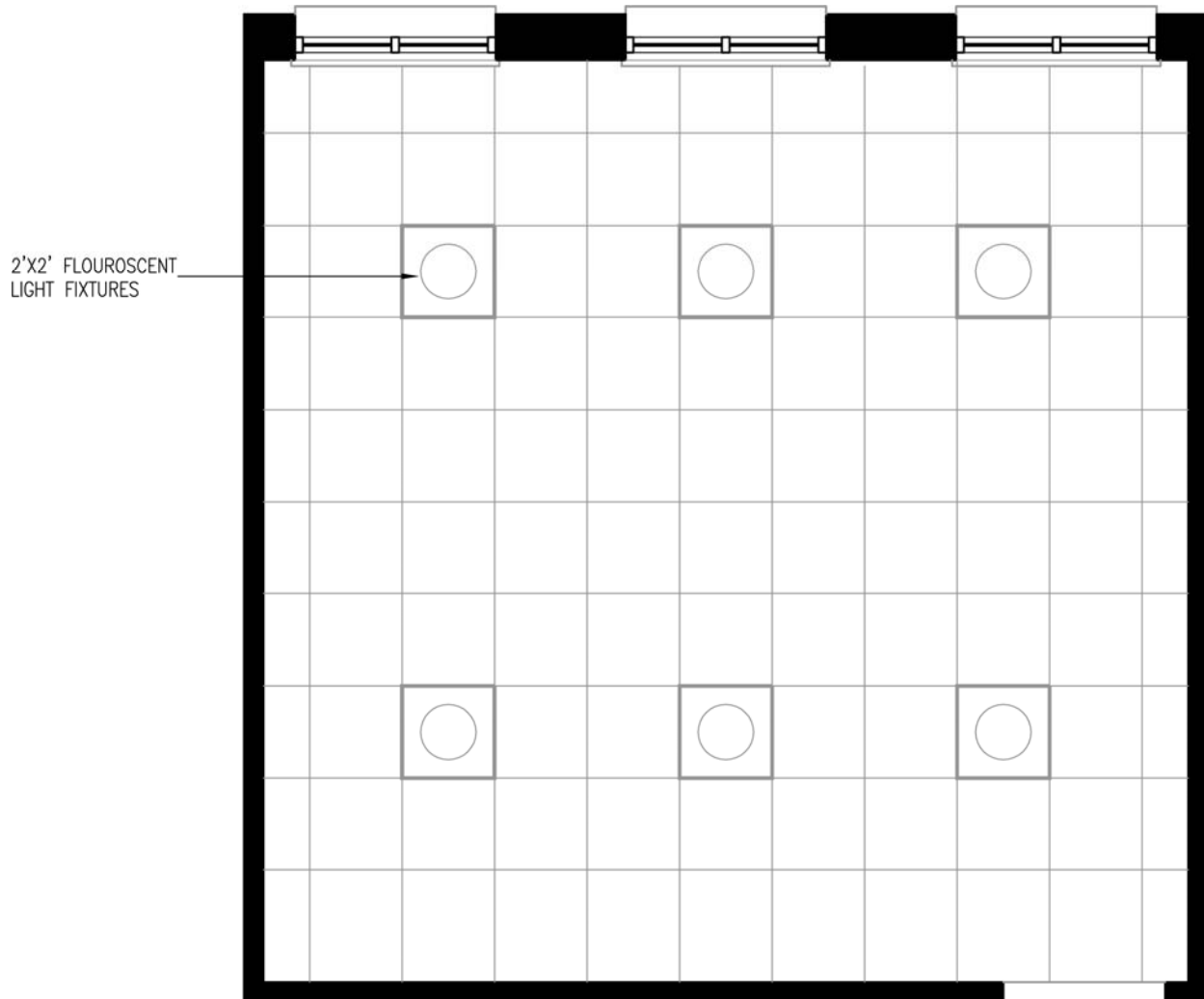

Inpatient Unit

2.6.6. Dining Room**Function:**

The Dining Room is a shared Patient & Family space. It provides for group interaction and socialization for patients. The Kitchen is used by family during 24/7 and/or long term patient stays. It allows family members to remain close to their loved ones, provides flexibility in scheduling meals and offers a lower cost alternative to restaurants or hospital food. The Dining Room & Kitchen are part of the overall Family suite of spaces which promote improved patient outcomes via an integrated model of care.

A separate Quiet Dining Room should be provided for patients who have difficulty eating, are self conscious and/or require assistance.

Note: Where VA standard items are shown, non-institutional & sustainable options should be considered if feasible.

Space Requirement:

400 NSF [37.16 NSM]

Architectural:

Floor Finish:	Sheet Vinyl
Base:	RB
Wall Finish:	Gypsum Wallboard
Ceiling:	Gypsum Wallboard Acoustical Tile
Ceiling Height:	10'-0"
Noise (STC Rating):	Sound absorptive materials
Slab Depression:	None
Special Construction:	None
Hardware:	126
Doors:	Wood or metal
Windows:	Daylight recommended. Aluminum insulated.

HVAC:

Individual Room	
Temperature Control:	70° - 75° (year-round) 30% - 50% RH
Min. Air Changes/Hour:	4 AC/H
Min. % Outside Air:	ASHRAE Standard 62.1 - 2007
Pressure:	Negative (-) Supply +15%
Noise Criteria:	NC 40
Return Air:	Permitted
Individual Room Temperature:	Required

Electrical:

Lighting Levels:	
Gen. Illum:	2x2 parabolic fluorescent
Task Illum:	Dimmable fluorescent downlight
Over Bed:	N/A
Emergency Egress:	1fc Ave.

Emergency Power:
 Medical Gases: No
 Night Lights: No
 Vanity Light: N/A
 One Receptacle
 per PBPU: N/A
 Nurse Call: Yes

2.6.6. Dining Room

Equipment Table:

SYMBOL	QUANTITY	AI	DESCRIPTION
			Note: Where VA standard items are shown, non-institutional & sustainable options should be considered if feasible.
	AR	VV	CHAIR, DINING, APPROX. 609mm X 609mm (24"X 24")
	AR	CC	TABLE, DINING, APPROX. 914mm DIAMETER (36" DIAMETER) AND / OR TABLE, DINING 914mm X 1828.8mm (36" X 72") AS SPACE ALLOWS
	1	CC	NURSE CALL, EMERGENCY STATION WITH CORRIDOR SIGNAL LIGHT CONNECTED TO NEAREST NURSE CONTROL STATION
	1	VV	CLOCK, BATTERY OPERATED

Inpatient Unit

2.6.7. Quiet Treatment Room (PT/OT/Speech) – 120 NSF [11.15 NSM]

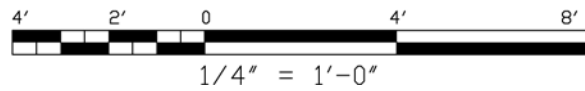
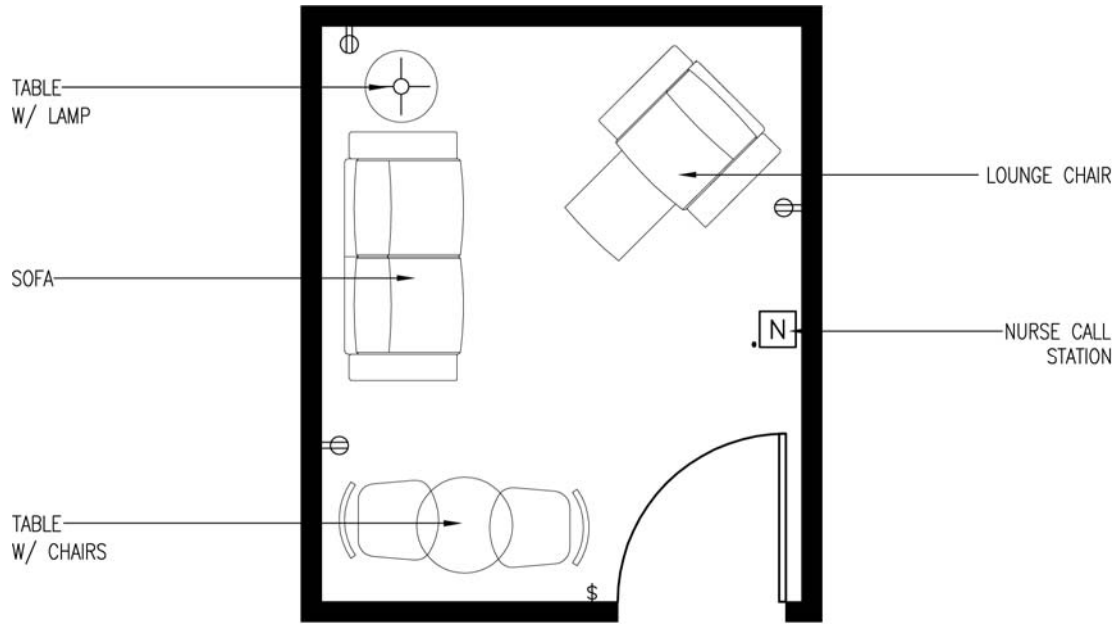

Inpatient Unit

2.6.7. Quiet Treatment Room (PT/OT/Speech) - Reflected Ceiling Plan

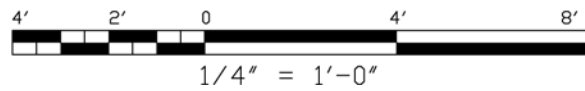
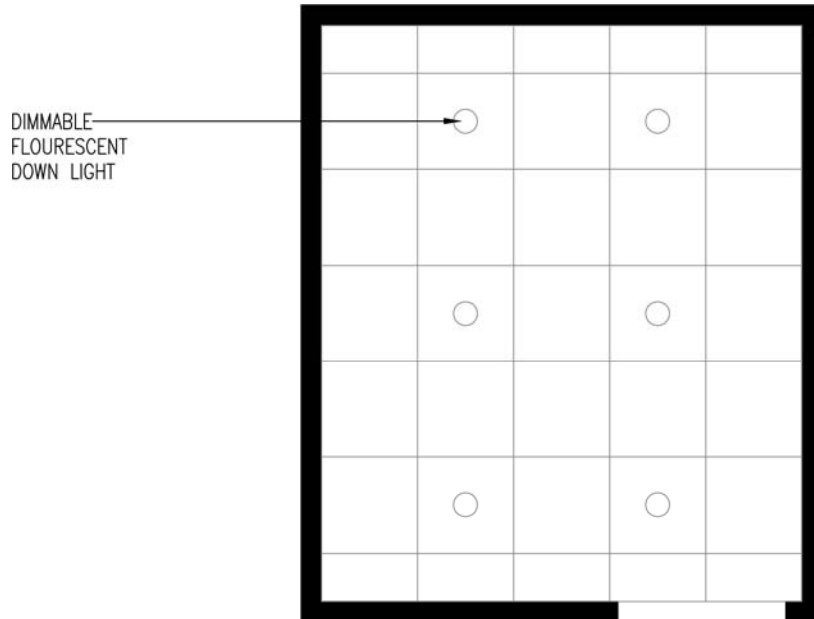

Inpatient Unit

2.6.7. Quiet Treatment Room (PT/OT/Speech)**Function:**

The Quiet Room is place for patients who require a reduced stimulation environment due to effects of TBI, PTSD, treatment or environmentally related stress. Design considerations include provision of sound insulation and architectural detailing to eliminate sound transmitted into the room from adjacent spaces, as well as sound absorptive materials within the room. Light levels (daylight and artificial) must be variable, with room darkening capability provided. Furniture and finishes should promote relaxation and passive/reflective activities such as meditation. Views to the exterior should be provided, with subject matter conducive to relaxation. Intrusive/unappealing views and/or exterior noise sources should be screened.

This room is separate from the Quiet Dining Room.

Note: Where VA standard items are shown, non-institutional & sustainable options should be considered if feasible.

Space Requirement:

120 NSF [11.15 NSM]

Architectural:

Floor Finish:	Carpet
Base:	RB
Wall Finish:	Gypsum Wallboard, Fabric Wall Covering / Wall Panels
Ceiling:	Acoustical Tile
Ceiling Height:	9'-0"
Noise (STC Rating):	Sound insulation from adjacent spaces critical, Sound absorptive materials for interior finishes
Slab Depression:	None
Special Construction:	None
Hardware:	52
Doors:	Wood or metal
Windows:	Daylight recommended with room darkening shades. Aluminum insulated.

HVAC:

Individual Room	
Temperature Control:	70° - 75° (year-round) 30% - 60% RH
Min. Air Changes/Hour:	4 AC/H
Min. % Outside Air:	2 AC/H
Return Air:	Permitted
Pressure:	Neutral (0)
Noise Criteria:	NC 30
Return Air:	Permitted
Individual Room Temperature:	Required

Electrical:

Lighting Levels:	
Gen. Illum:	Dimmable fluorescent downlights
Task Illum:	Table lamp
Over Bed:	N/A
Emergency Egress:	

Emergency Power:

Medical Gases:	No
Night Lights:	No
Vanity Light:	N/A
One Receptacle per PBPU:	N/A
Nurse Call:	Yes

2.6.7. Quiet Treatment Room (PT/OT/Speech)

Equipment Table:

SYMBOL	QUANTITY	AI	DESCRIPTION
			Note: Where VA standard items are shown, non-institutional & sustainable options should be considered if feasible.
	1	VV	TABLE, APPROX., 914 mm DIAMETER (36" DIAMETER)
	2	VV	CHAIR, STACKING
	AR	VV	SOFA, 3 SEAT, UPHOLSTERED, APPROX., 2108 mm X 838 mm X 711 mm (83" X 33" X 28")
	1	VV	CHAIR, UPHOLSTERED, RECLINING
	1	CC	NURSE CALL, EMERGENCY STATION WITH CORRIDOR SIGNAL LIGHT CONNECTED TO NEAREST NURSE CONTROL STATION
	1	VV	CLOCK, BATTERY OPERATED

Inpatient Unit

2.6.8. Family Multipurpose Room – 500 NSF [46.45 NSM]

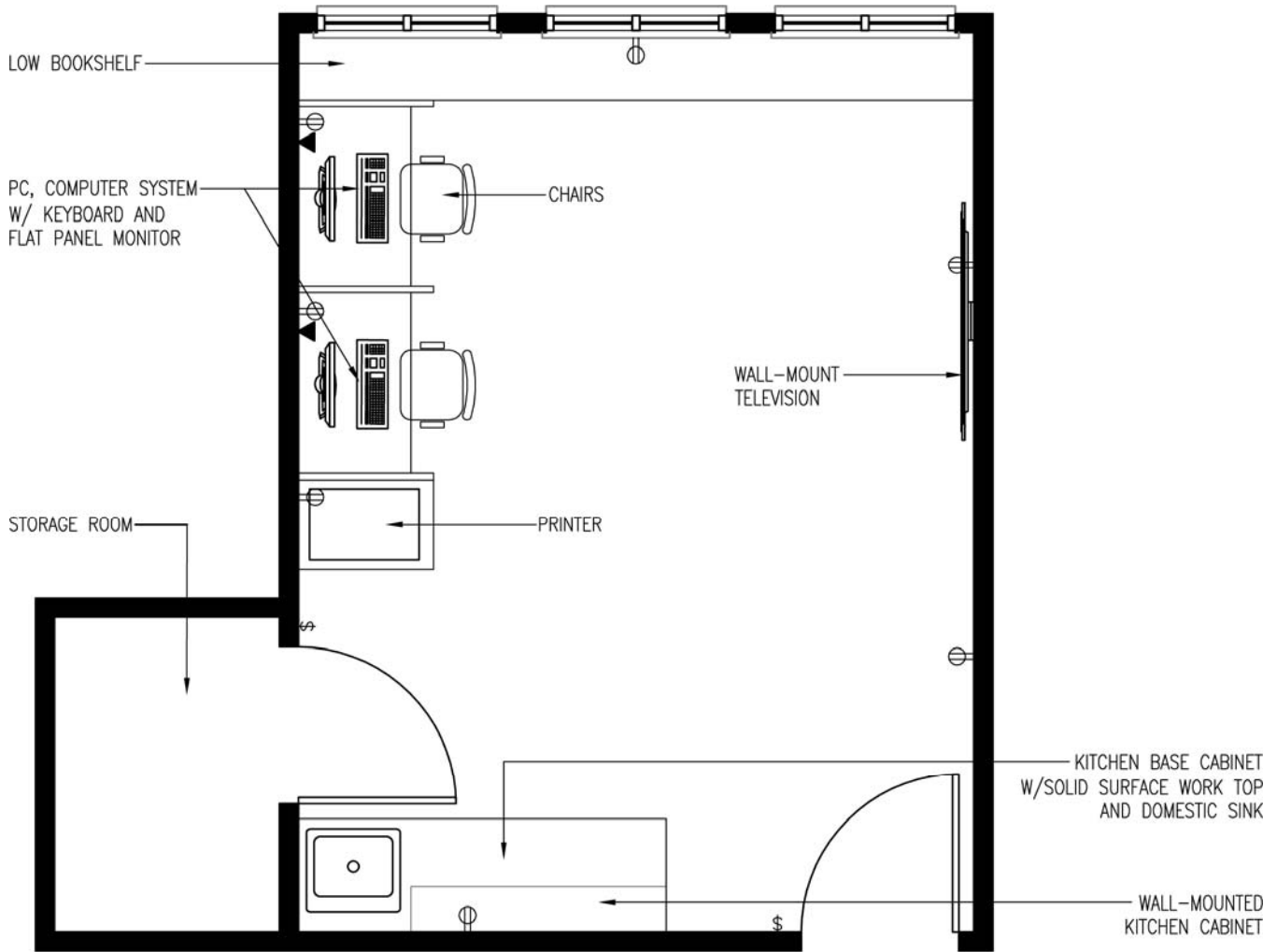

NOTE: OPTION – OMIT TV WALL AND COMBINE W/ FAMILY LIVING SPACE

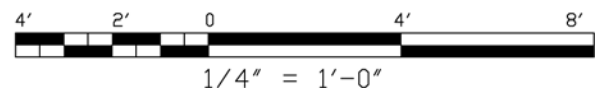

Inpatient Unit

2.6.8. Family Multipurpose Room - Reflected Ceiling Plan

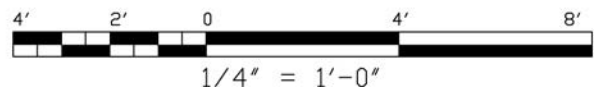
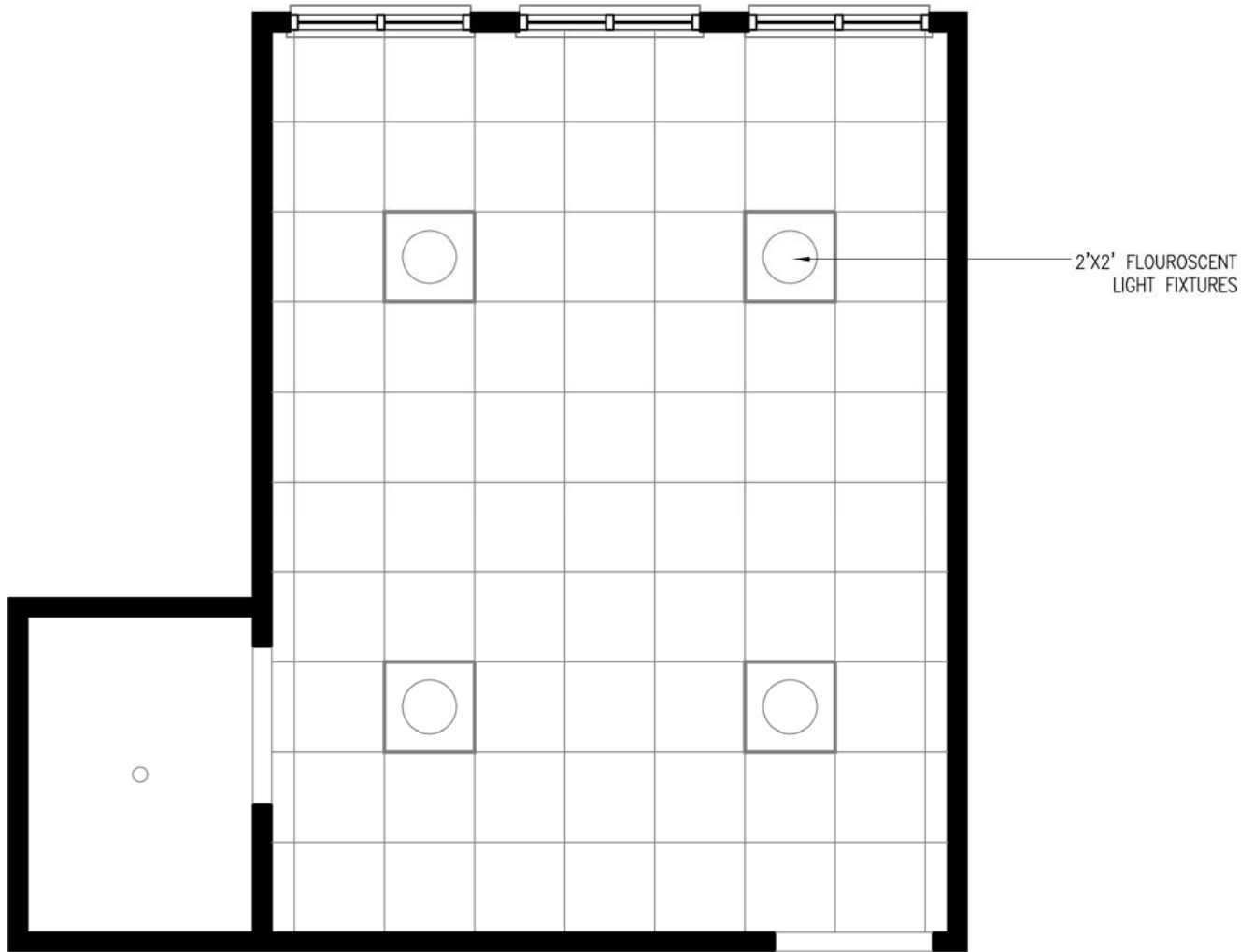

Inpatient Unit

2.6.8. Family Multipurpose Room**Function:**

The Family Multipurpose Room is a classroom-type space used for educational programs, family/staff consultations (separate from patient), and celebration of patient life events and recovery milestones. It includes a Family Resource Center comprised of two Internet terminals and printed reading / research material.

As a design option, the Multipurpose Room may be combined with Family Living to provide a more open and relaxed environment. If such an arrangement is desired, an operable partition may be included to subdivide the space when required. The Multipurpose Room is part of the overall Family suite of spaces which promote improved patient outcomes via an integrated model of care.

Note: Where VA standard items are shown, non-institutional & sustainable options should be considered if feasible.

Space Requirement:

300 NSF [27.87 NSM]

Architectural:

Floor Finish:	Carpet
Base:	RB
Wall Finish:	Gypsum Wallboard
Ceiling:	Acoustical Tile
Ceiling Height:	10'-0"
Noise (STC Rating):	Sound absorptive materials
Slab Depression:	None
Special Construction:	None
Hardware:	4
Doors:	Wood or metal
Windows:	Daylight recommended with room darkening shades. Aluminum insulated.

HVAC:

Individual Room	
Temperature Control:	70° - 75° (year-round) 30% - 50% RH
Min. Air Changes/Hour:	4 AC/H
Min. % Outside Air:	15%
Pressure:	Negative (-)
Noise Criteria:	NC 40
Return Air:	Permitted
Individual Room Temperature:	Required
Exhaust:	50 CFM [1.41 CM]

Electrical:

Lighting Levels:	
Gen. Illum:	2x2 parabolic fluorescent
Task Illum:	Dimmable fluorescent downlights
Over Bed:	N/A
Emergency Egress:	

Emergency Power:

Medical Gases: No
 Night Lights: No
 Vanity Light: N/A
 One Receptacle per PBPU: N/A
 Nurse Call: Yes

2.6.8. Family Multipurpose Room

Equipment Table:

SYMBOL	QUANTITY	AI	DESCRIPTION
			Note: Where VA standard items are shown, non-institutional & sustainable options should be considered if feasible.
	1	CC	OUTLET, MASTER TELEVISION ANTENNA
	1	VV	RECEIVER, TELEVISION, 120 VOLT, 20 AMP
	1	VV	PLAYER, DVD/VCR
	1	VV	BRACKET, TELEVISION, WALL-MOUNT
	1	CC	CABINET, KITCHEN, BASE, WITH SOLID SURFACE WORK TOP AND SINK, DOMESTIC
	1	CC	CABINET, KITCHEN, WALL MOUNTED, DOMESTIC
			FAMILY RESOURCE CENTER
	2	VV	PC, COMPUTER SYSTEM W/KEYBOARD
	AR	VV	BOOKCASE, SECTIONAL, EACH SECTION, 838 mm X 330 mm X 381 mm (33" X 13" X 15") WITH 254 mm (10") BASE

Inpatient Unit

2.6.9. Family Living – 500 NSF [46.45 NSM]

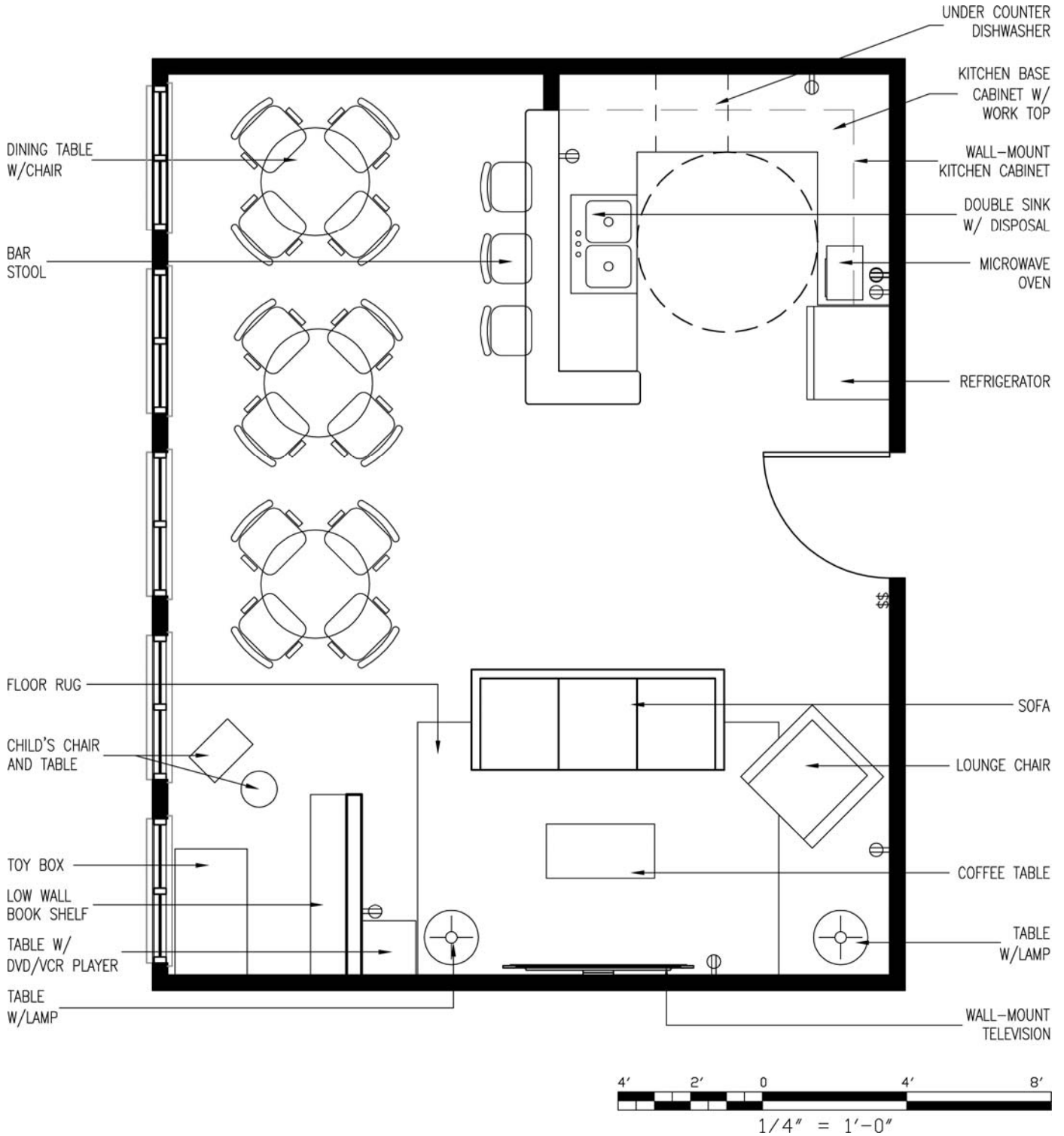

Inpatient Unit

2.6.9. Family Living - Reflected Ceiling Plan

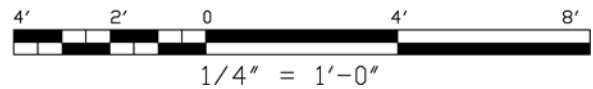
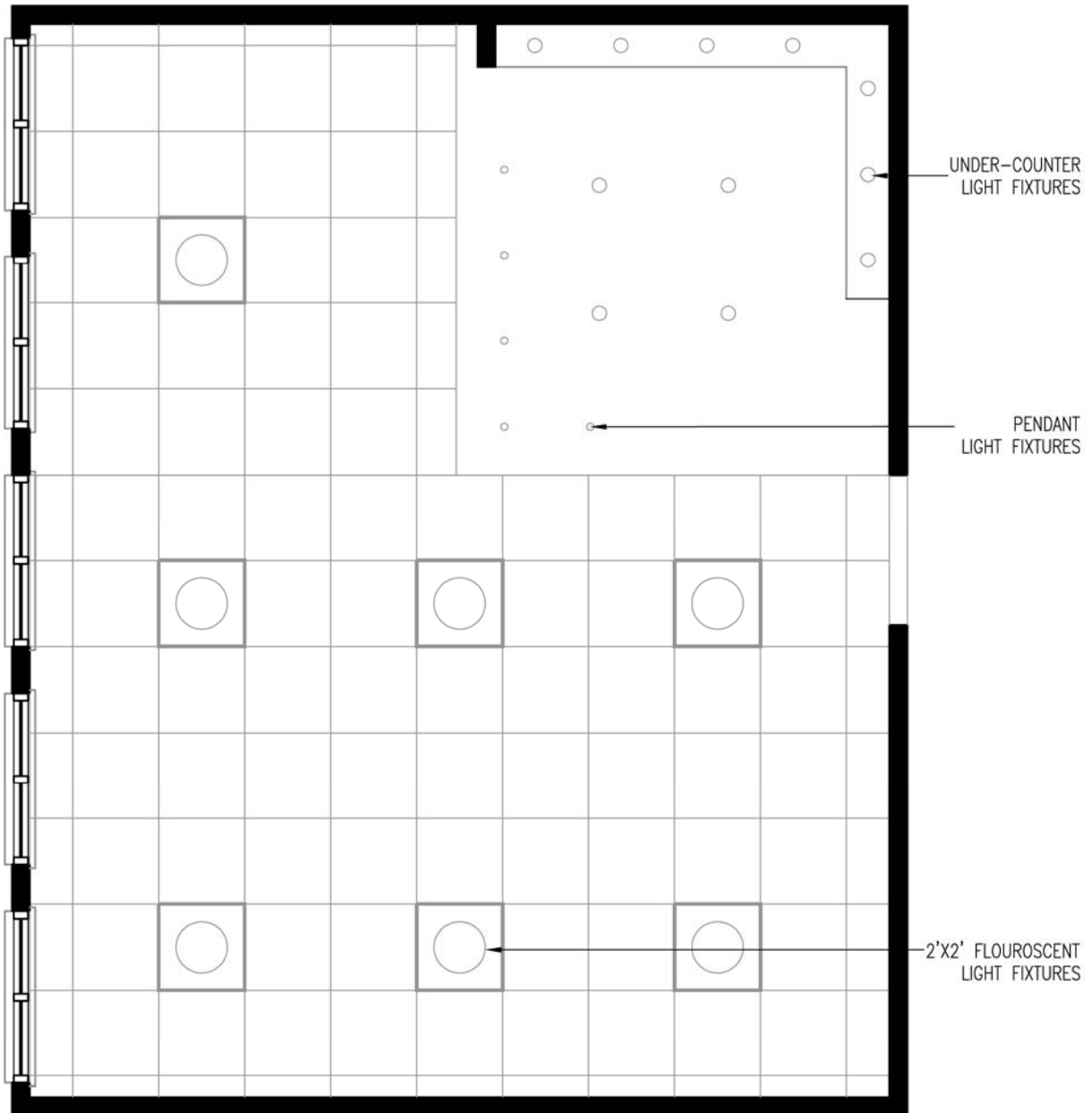

Inpatient Unit

2.6.9. Family Living**Function:**

The Family Living room is the core of the PRC Family suite of spaces. It provides a place of relaxation and socialization for patient families. The Living space includes upholstered seating, televisions, video game modules, a table for four, and children's play area. Internet access for family use and/or online gaming is optional.

As a design option, Family Living may be combined with the Dining Room / Kitchen and/or Multipurpose Room to provide a more open and relaxed environment. If such an arrangement is desired, operable partition(s) may be included to subdivide spaces when required.

Note: Where VA standard items are shown, non-institutional & sustainable options should be considered if feasible.

Space Requirement:

500 NSF [46.45 NSM]

Architectural:

Floor Finish:	Carpet
Base:	RB
Wall Finish:	Gypsum Wallboard
Ceiling:	Acoustical Tile
Ceiling Height:	9'-0"
Noise (STC Rating):	Sound absorptive materials
Slab Depression:	None
Special Construction:	None
Hardware:	4
Doors:	Wood or metal
Windows:	Daylight recommended. Aluminum insulated.

HVAC:

Individual Room	
Temperature Control:	70° - 75° (year-round) 30% - 50% RH
Min. Air Changes/Hour:	4 AC/H
Min. % Outside Air:	15%
Pressure:	Negative (-)
Noise Criteria:	NC 45
Individual Room Temperature:	Required
Exhaust:	60 CFM [1.69 CM] over the kitchen
Return Air:	Permitted

Electrical:

Lighting Levels:	
Gen. Illum:	2x2 parabolic fluorescent
Task Illum:	Dimmable fluorescent downlights, table lamps
Over Bed:	N/A
Emergency Egress:	

Emergency Power:

Medical Gases:	No
Night Lights:	No
Vanity Light:	N/A
One Receptacle per PBPU:	N/A
Nurse Call:	Yes

2.6.9. Family Living**Equipment Table:**

SYMBOL	QUANTITY	AI	DESCRIPTION
			Note: Where VA standard items are shown, non-institutional & sustainable options should be considered if feasible.
	AR	VV	SOFA, 3 SEAT, UPHOLSTERED, APPROX., 2108 mm X 838 mm X 711 mm (83" X 33" X 28")
	AR	VV	CHAIR, LOUNGE
	AR	VV	TABLE, DINING, APPROX., 914 mm X 914 mm (36" X 36")
	1	VV	RECEPTACLE, WASTE, APPROX., 406 mm X 406 mm (16" X 16")
	AR	VV	CHAIR, DINING, APPROX., 457 mm X 457 mm (18" X 18")
	1	VV	CLOCK, BATTERY OPERATED
	1	CC	OUTLET, MASTER TELEVISION ANTENNA
	1	VV	RECEIVER, TELEVISION, 120 VOLT, 20 AMP
	1	VV	PLAYER, DVD/VCR
	AR	VV	TABLE, BUMPER POOL (WHEN BILLIARD ROOM NOT PROVIDED)
	AR	VV	TABLE, GAME, PORTABLE, ELECTRONIC, 120 VOLT, 20 AMP
			CHILDREN'S PLAY AREA
	1	VV	CHAIR, PRE-SCHOOL (16" X 16")
	1	VV	TABLE, PRIMARY (30" DIAMETER)
			TABLE, ACTIVITY, MAGNETIC SAND, BUSY FINGERS OR SIMILAR
	1	VV	STORAGE UNIT, MOBILE WITH BINS (48" X 24" X 12") AND / OR BOOKCASE (48" X 24" X 12")
	1	CC	OUTLET, MASTER TELEVISION ANTENNA
	1	VV	RECEIVER, TELEVISION, 120 VOLT, 20 AMP
	1	VV	PLAYER, DVD/VCR
			KITCHENETTE

SYMBOL	QUANTITY	AI	DESCRIPTION
	1	CC	CABINET, KITCHEN, BASE, WITH WORK TOP AND SINK, DOMESTIC
	1	CC	DISPOSAL, WASTE, SINK UNIT
	1	CC	CABINET, KITCHEN, WALL MOUNTED, DOMESTIC
	1	CC	COFFEEMAKER, TWIN, AUTOMATIC, 120/208 VOLT, 33 AMP, 11 L (3 GALLONS) EACH SIDE, SINGLE SERVICE, 914 mm X 610 mm X 813 mm (36" X 24" X 32")
	1	VV	REFRIGERATOR/FREEZER, 120 VOLT, 20 AMP, DOMESTIC, APPROX., 787 mm X 711 mm X 1676 mm (31" X 28" X 66")
	1	VV	MICROWAVE OVEN, 120 VOLT, 20 AMP (SIT ON COUNTER)
	1	CC	ICE AND WATER STATION WITH AUTOMATIC ICE MAKER AND DISPENSER, FLOOR MOUNTED, 120 VOLT, 20 AMP, 113 KG (250 LBS.) PER DAY, 27 KG (60 LB.) BIN, 660 mm X 660 mm X 2134 mm (26" X 26" X 84")
	1	CC	RESIDENTIAL DISHWASHER
			NOTE: SERVICES, ELECTRICAL & PLUMBING, AS REQUIRED FOR EQUIPMENT

Inpatient Unit

2.6.10. Rehabilitation Gym – 2000 NSF [185.80 NSM]

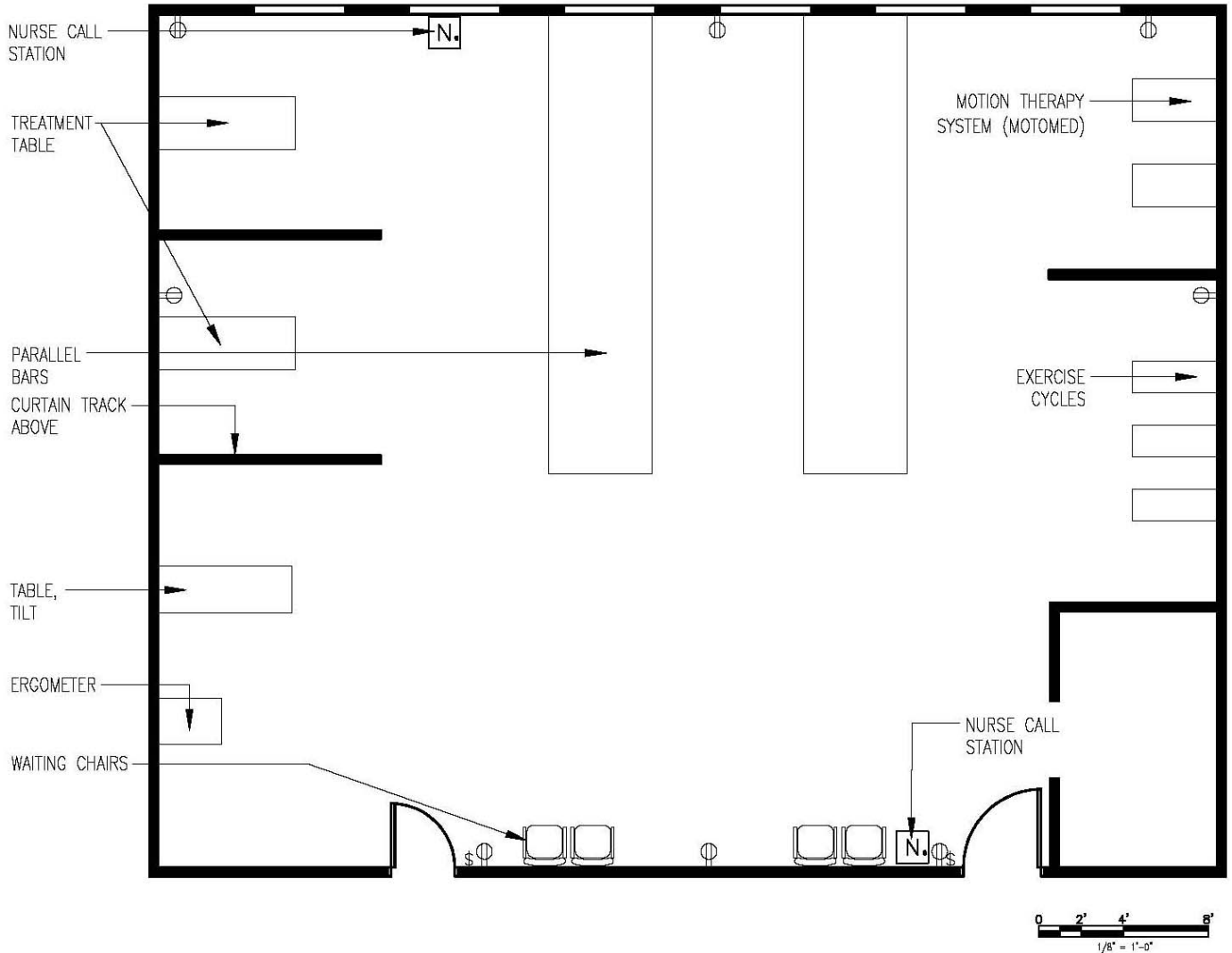

Inpatient Unit

2.6.10. Rehabilitation Gym - Reflected Ceiling Plan

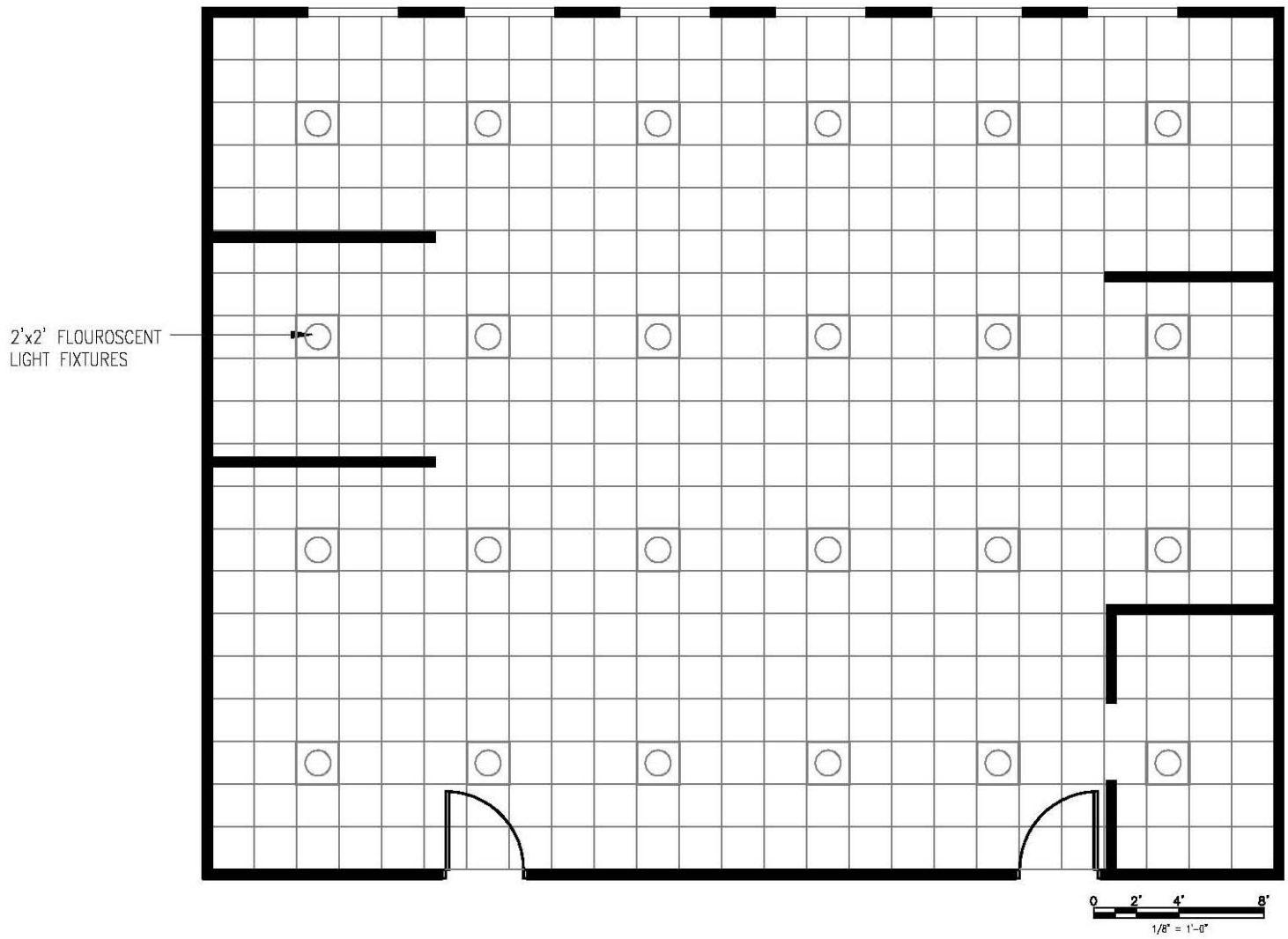

Inpatient Unit

2.6.10. Rehabilitation Gym**Function:**

The Inpatient Rehabilitation Gym provided dedicated Physical, Occupational, Recreational and Kinesiotherapy space for Polytrauma patients. This population is primarily differentiated from the main hospital census by the prevalence of Traumatic Brain Injury (TBI). These patients suffer from multiple serious injuries or conditions overlaid with the cognitive, emotional, and physical limitations due to brain injury. As such they do not respond well to typical Physical Medicine & Rehabilitation (PM&R) treatment modalities such as therapy in a large gym setting. TBI patients often require a low stimulation environment and are sensitive to noise, light, and visual “clutter”. Due to perceived (though not always actual) functional limitations, non-TBI patients do not always mix well with this group.

These specialized needs require provision of some PM&R type spaces which may seem duplicative of those in the main medical center. Only Polytrauma / TBI specific therapy spaces should be provided in the PRC. Spaces whose uses may be shared, and those which contain highly specialized or cost-intensive equipment (such as Gait Lab, Prosthetics Lab, Assistive Technology, Hydrotherapy, etc.) should not be duplicated and should reside in the main medical center. Location and layout of the PRC should provide direct access to these shared spaces for TBI patients.

Note: Where VA standard items are shown, non-institutional & sustainable options should be considered if feasible.

Space Requirement:

2000 NSF [185.80 NSM]

Architectural:

Floor Finish:	Sheet Vinyl
Base:	RB
Wall Finish:	Gypsum Wallboard
Ceiling:	Acoustical Tile
Ceiling Height:	12'-0"
Noise (STC Rating):	Sound absorptive materials
Slab Depression:	None
Special Construction:	None
Hardware:	126
Doors:	Wood or metal
Windows:	Daylight recommended with room darkening shades provided. Aluminum insulated.

HVAC:

Individual Room	
Temperature Control:	70° - 75° (year-round) 30% - 50% RH
Min. Air Changes/Hour:	6 AC/H
Min. % Outside Air:	15%
Return Air:	Permitted
Pressure:	Negative (-)
Noise Criteria:	NC 45
Individual Room Temperature:	Required

Electrical:

Lighting Levels:

Gen. Illum:	2x2 parabolic fluorescent
Task Illum:	Dimmable fluorescent downlights
Over Bed:	N/A
Emergency Egress:	
Emergency Power:	
Medical Gases:	No
Night Lights:	No
Vanity Light:	N/A
One Receptacle per PBP:	N/A
Nurse Call:	Yes

2.6.10. Rehabilitation Gym

Equipment Table:

SYMBOL	QUANTITY	AI	DESCRIPTION
			Note: Where VA standard items are shown, non-institutional & sustainable options should be considered if feasible.
	AR	VV	TABLE, TREATMENT, HI-LO, ELECTRICAL, 120 VOLT, 20 AMP, 762 mm X 1981 mm X 813 mm (30" X 78" X 32")
	AR	VV	TABLE, TILT, ELECTRICAL, 120 VOLT, 20 AMP, 711 mm X 1930 mm X 813 mm (28" X 76" X 32")
			MOTION THERAPY SYSTEM (MOTOMED)
	1	VV	CYCLE, EXERCISER (ERGOMETER) WITH READOUT CAPABILITIES, APPROX., 610 mm X 1219 mm X 1016 mm (24" X 48" X 40")
	1	VV	ERGOMETER, ARM, 660 mm X 914 mm X 914 mm (26" X 36" X 36")
	AR	VV	CYCLE, EXERCISE, RECUMBENT, APPROX., 457 mm X 1219 mm X 762 mm (18" X 48" X 30")

Inpatient Unit

2.6.11. Cognitive / TBI Therapy Exam / Treatment Room – 120 NSF [11.15 NSM]
Floor Plan and Reflected Ceiling Plan

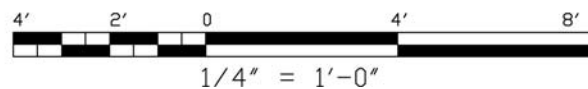
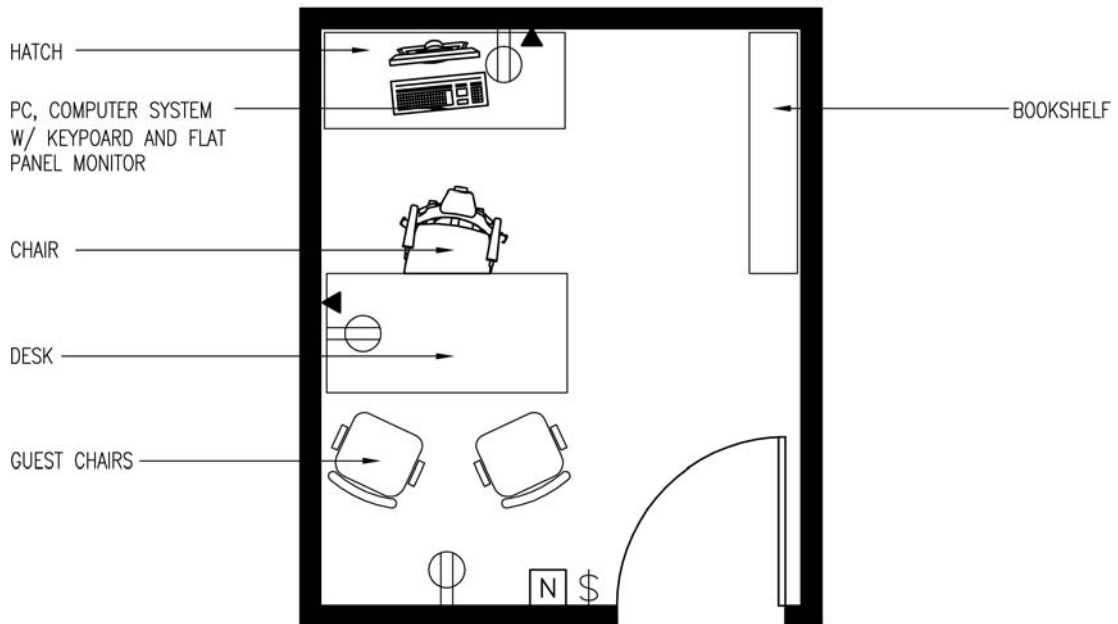
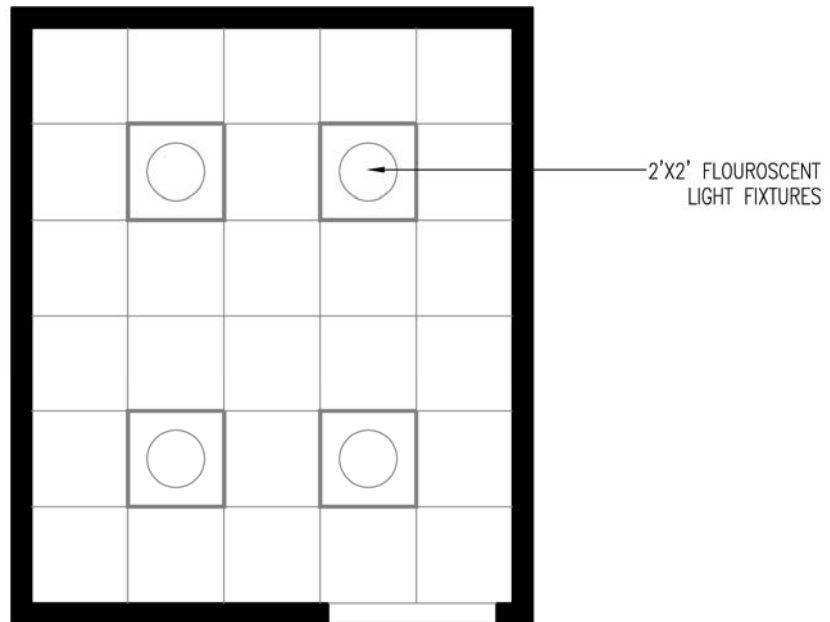

Inpatient Unit

2.6.11. Cognitive / TBI Therapy Exam / Treatment Room**Function:**

The Cognitive / TBI Therapy Exam / Treatment Room provides a quiet, intimate setting for patient-staff consultation, patient testing, evaluation and treatment.

Note: Where VA standard items are shown, non-institutional & sustainable options should be considered if feasible.

Space Requirement:

120 NSF [11.15 NSM]

Architectural:

Floor Finish:	Carpet
Base:	RB
Wall Finish:	Gypsum Wallboard
Ceiling:	Acoustical Tile
Ceiling Height:	9'-0"
Noise (STC Rating):	Sound insulation buffer from exterior spaces, Sound absorptive materials for interior finishes
Slab Depression:	None
Special Construction:	None
Hardware:	23
Doors:	Wood or metal
Windows:	Daylight recommended with room darkening shades provided. Aluminum insulated.

HVAC:

Individual Room	
Temperature Control:	70° - 75° (year-round) 30% - 50% RH
Min. Air Changes/Hour:	6 AC/H
Min. % Outside Air:	15%
Return Air:	Permitted
Pressure:	Neutral (0)
Noise Criteria:	NC 35
Individual Room Temperature:	Required

Electrical:

Lighting Levels:	
Gen. Illum:	2x2 parabolic fluorescent
Task Illum:	Desk lamp
Over Bed:	N/A
Emergency Egress:	
Emergency Power:	
Medical Gases:	No
Night Lights:	No
Vanity Light:	N/A
One Receptacle per PBP:	N/A
Nurse Call:	Yes

Inpatient Unit

2.6.11. Cognitive / TBI Therapy Exam / Treatment Room

Equipment Table:

SYMBOL	QUANTITY	AI	DESCRIPTION
			Note: Where VA standard items are shown, non-institutional & sustainable options should be considered if feasible.
	AR	VV	DESK, PEDESTAL, APPROX., 1524 mm X 762 mm X 749 mm (60" X 30" X 29-1/2")
	AR	VV	HUTCH, PEDESTAL, APPROX., 1524 mm X 762 mm X 749 mm (60" X 30" X 29-1/2")
	AR	VV	CHAIR, TASK, WITH ARMS
	AR	VV	CHAIR, STRAIGHT, WITH ARMS
	AR	VV	BOOKCASE, SECTIONAL, EACH SECTION, 838 mm X 330 mm X 381 mm (33" X 13" X 15") WITH 254 mm (10") BASE
	AR	VV	CABINET, FILING (LETTER SIZE) 5 DRAWER, APPROX., 381 mm X 635 mm X 1524 mm (15" X 25" X 60")
	1	VV	BULLETIN BOARD, APPROX., 914 mm X 914 mm (36" X 36")
	AR	VV	RECEPTACLE, WASTE, COVERED
	AR	VV	CRT, COMPUTER SYSTEM, WITH KEYBOARD
	1	VV	PRINTER, COMPUTER SYSTEM
	1	VV	CLOCK, BATTERY OPERATED

Inpatient Unit

2.6.12. Computer Activities Room – 200 NSF [11.15 NSM]

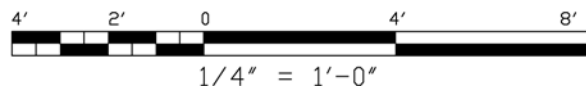
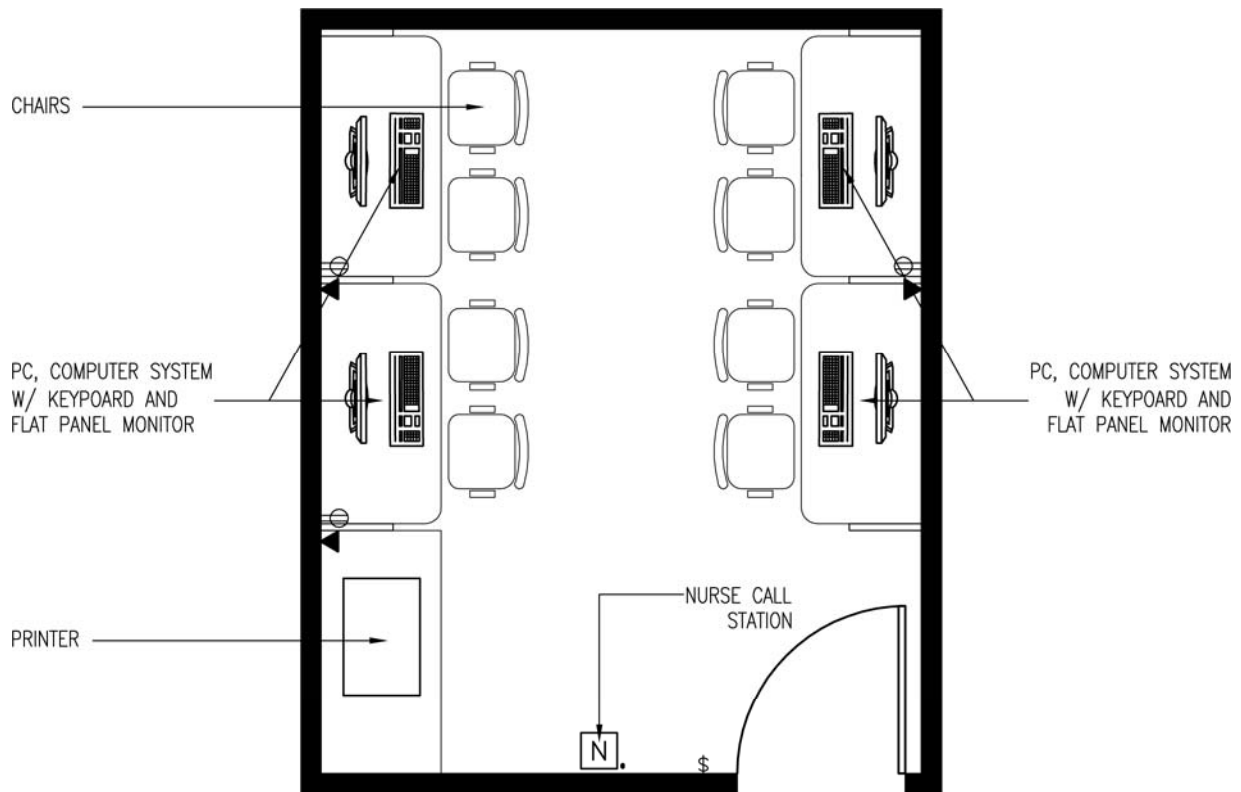

Inpatient Unit

2.6.12. Computer Activities Room - Reflected Ceiling Plan

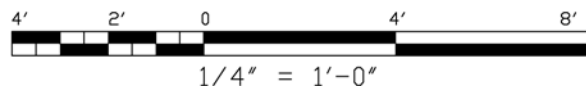
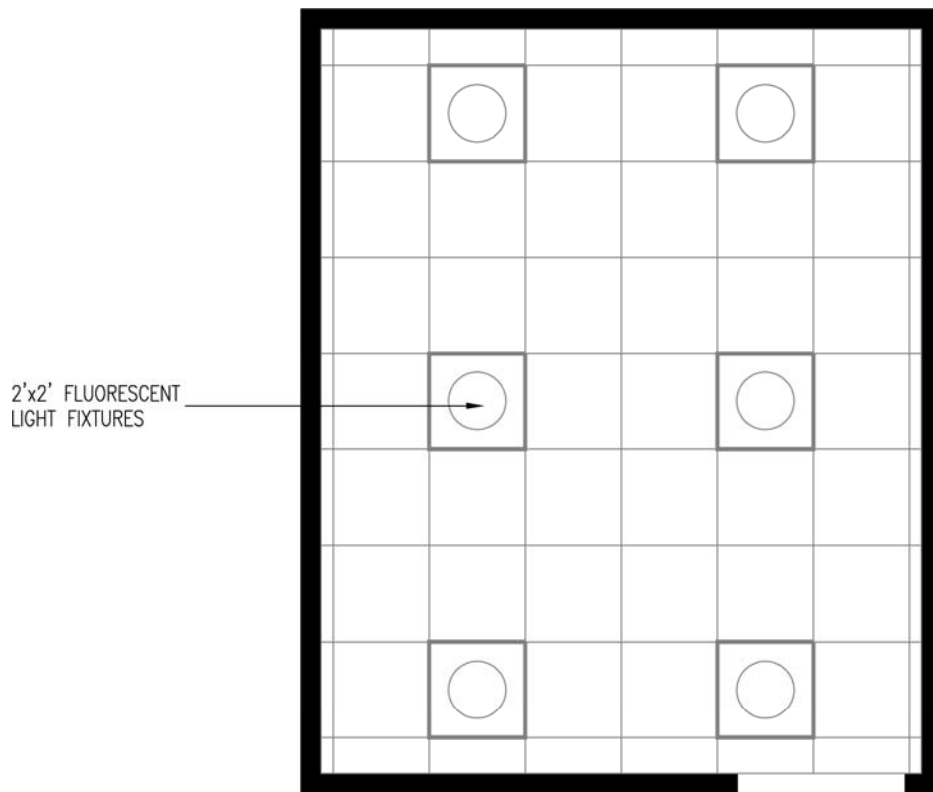

Inpatient Unit

2.6.12. Computer Activities Room**Function:**

The Recreational Computer Activities Room provides an array of cognitive, physical, occupational, vocational and life skills education activities through patient computer interaction.

Note: Where VA standard items are shown, non-institutional & sustainable options should be considered if feasible.

Space Requirement:

200 NSF [18.58 NSM]

Architectural:

Floor Finish:	Carpet
Base:	RB
Wall Finish:	Gypsum Wallboard
Ceiling:	Acoustical Tile
Ceiling Height:	9'-0"
Noise (STC Rating):	Sound insulation buffer from exterior spaces, Sound absorptive materials for interior finishes
Slab Depression:	None
Special Construction:	None
Hardware:	45
Doors:	Wood or metal
Windows:	Daylight recommended with room darkening shades provided. Aluminum insulated.

HVAC:

Individual Room	
Temperature Control:	70° - 75° (year-round) 30% - 50% RH
Min. Air Changes/Hour:	6 AC/H
Min. % Outside Air:	15%
Return Air:	Permitted
Pressure:	Neutral (0)
Noise Criteria:	NC 40

Electrical:

Lighting Levels:	
Gen. Illum:	2x2 parabolic fluorescent
Task Illum:	N/A
Over Bed:	N/A
Emergency Egress:	
Emergency Power:	
Medical Gases:	No
Night Lights:	No
Vanity Light:	N/A
One Receptacle per PBP:	N/A
Nurse Call:	Yes

Inpatient Unit

2.6.12. Computer Activities Room

Equipment Table:

SYMBOL	QUANTITY	AI	DESCRIPTION
			Note: Where VA standard items are shown, non-institutional & sustainable options should be considered if feasible.
	1	VV	CLOCK, BATTERY OPERATED
	4	VV	PC, COMPUTER SYSTEM WITH KEYBOARD AND FLAT PANEL MONITOR
	4	VV	TABLE, RECTANGULAR, COMPUTER WITH KEYBOARD TRAY, 1219 mm X 762 mm X 762 mm (48" X 30" X 30")
	4	VV	STAND, COMPUTER WITH KEYBOARD TRAY, APPROX. 762MM X 610mm X 711.2mm (30" X 24" X 28")
	8	VV	CHAIR, TASK, WITH ARMS
	1	VV	PRINTER, COMPUTER SYSTEM
	1	VV	STAND, COMPUTER PRINTER, APPROX., 610 mm X 610 mm X 660 mm (24" X 24" X 26")

Inpatient Unit

2.6.13. TBI / Cognitive Therapy Multipurpose Room – 150 NSF [13.93 NSM]

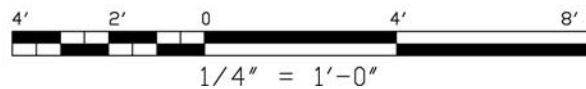
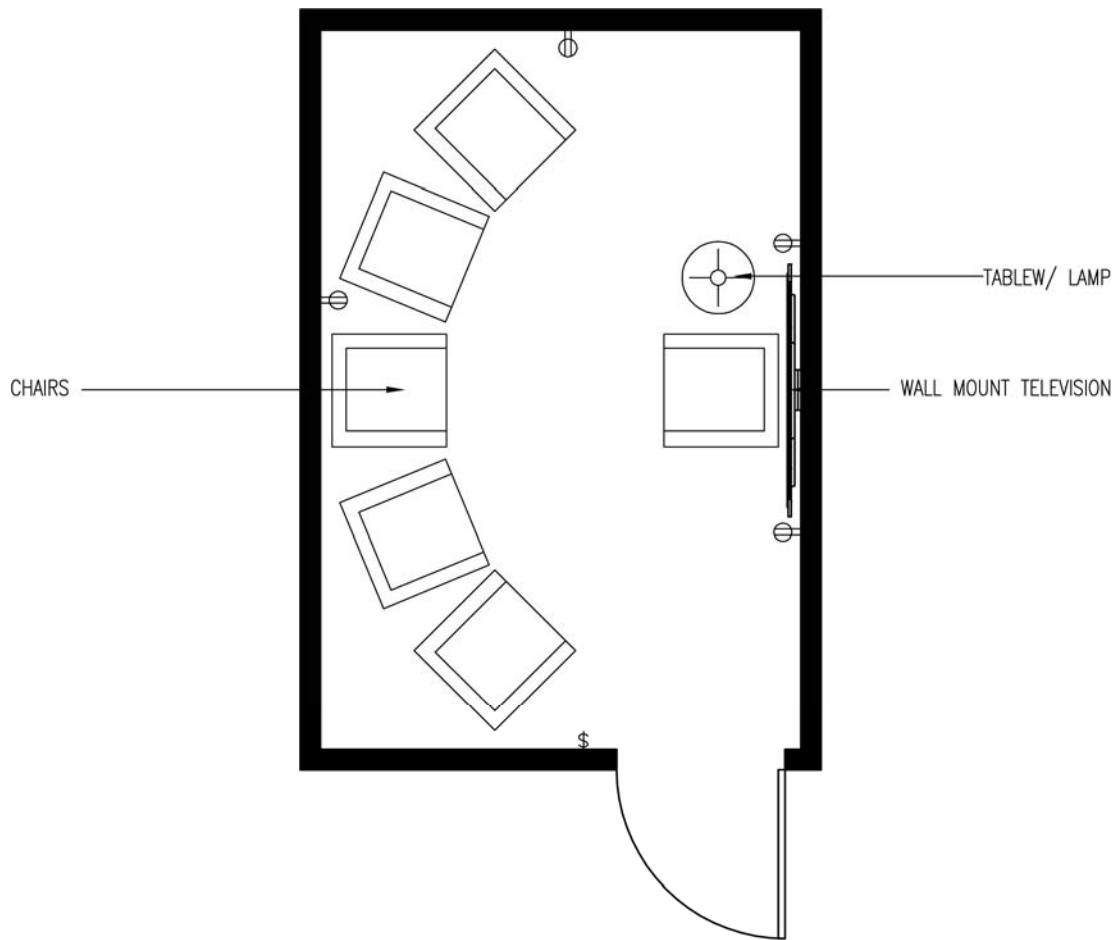

Inpatient Unit

2.6.13. TBI / Cognitive Therapy Multipurpose Room - Reflected Ceiling Plan

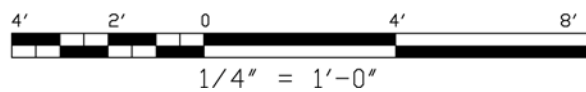
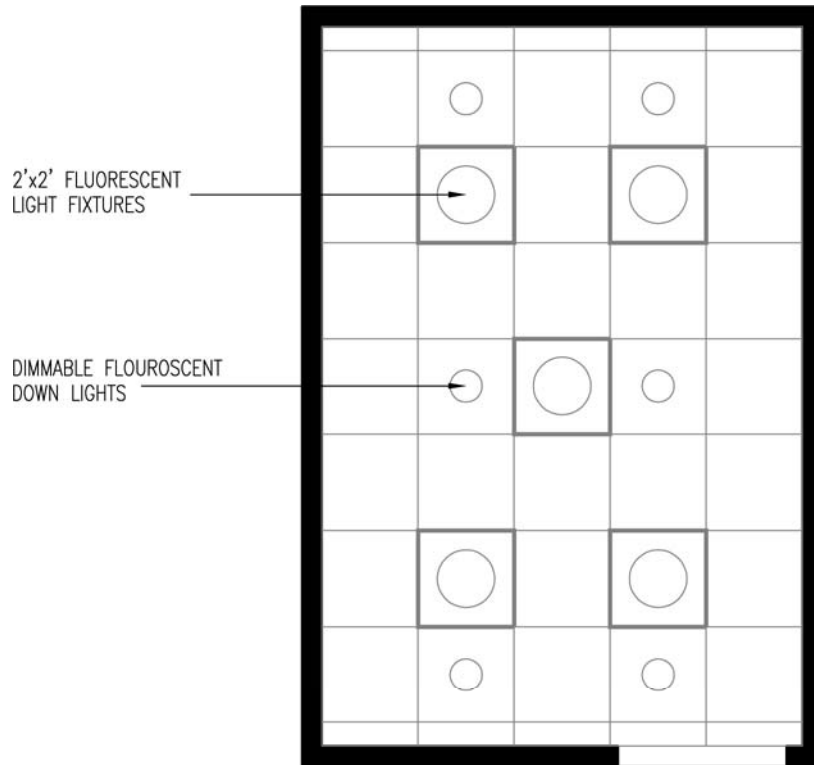

Inpatient Unit

2.6.13. TBI / Cognitive Therapy Multipurpose Room**Function:**

The TBI / Cognitive Therapy Multipurpose Room provides a space for group therapy sessions. Design considerations include the ability to control light (daylight & artificial), with room darkening available. Comfortable seating in a controlled stimulus environment. Finishes should help create a relaxed atmosphere. Sound control from adjacent spaces is important.

Note: Where VA standard items are shown, non-institutional & sustainable options should be considered if feasible.

Space Requirement:

150 NSF [13.93 NSM]

Architectural:

Floor Finish:	Carpet
Base:	RB
Wall Finish:	Gypsum Wallboard
Ceiling:	Acoustical Tile
Ceiling Height:	9'-0"
Noise (STC Rating):	Sound insulation buffer from exterior spaces, Sound absorptive materials for interior finishes
Slab Depression:	None
Special Construction:	None
Hardware:	52
Doors:	Wood or metal
Windows:	Daylight recommended with room darkening shades provided. Aluminum insulated.

HVAC:

Individual Room	
Temperature Control:	70° - 75° (year-round) 30% - 50% RH
Min. Air Changes/Hour:	4 AC/H
Min. % Outside Air:	25%
Pressure:	Neutral (0)
Noise Criteria:	NC 35
Individual Room Temperature:	Required

Electrical:

Lighting Levels:	
Gen. Illum:	2x2 parabolic fluorescent
Task Illum:	Dimmable fluorescent downlights, table lamp
Over Bed:	N/A
Emergency Egress:	
Emergency Power:	
Medical Gases:	No
Night Lights:	No
Vanity Light:	N/A
One Receptacle per PBPU:	N/A
Nurse Call:	Yes

Inpatient Unit

2.6.13. TBI / Cognitive Therapy Multipurpose Room

Equipment Table:

SYMBOL	QUANTITY	AI	DESCRIPTION
			Note: Where VA standard items are shown, non-institutional & sustainable options should be considered if feasible.
	6	VV	CHAIR, UPHOLSTERED
	1	VV	TACKBOARD, 610 mm X 914 mm (24" X 36")
	AR	VV	TABLE, CONFERENCE, FOLDING PORTABLE
	AR	VV	SIDE TABLE, 18" DIAMETER, WITH LAMP
	1	VV	RECEPTACLE, WASTE
	1	CC	SCREEN, PROJECTION, CEILING OR WALL MOUNTED, RETRACTABLE
	1	CC	OUTLET, MASTER TELEVISION ANTENNA
	1	VV	TELEVISION, WALL MOUNTED FLAT SCREEN HD, 120 VOLT, 20 AMP
	1	VV	PLAYER, DVD/VCR
	AR	VV	SHADES OR DRAPES, WINDOW, LIGHTPROOF
	1	VV	PROJECTOR, CEILING MOUNTED
	1	VV	RECORDER, VIDEO

2.7. Transitional Rehabilitation Center

2.7.1. Transitional Resident Bedroom – 215 NSF [19.97 NSM]

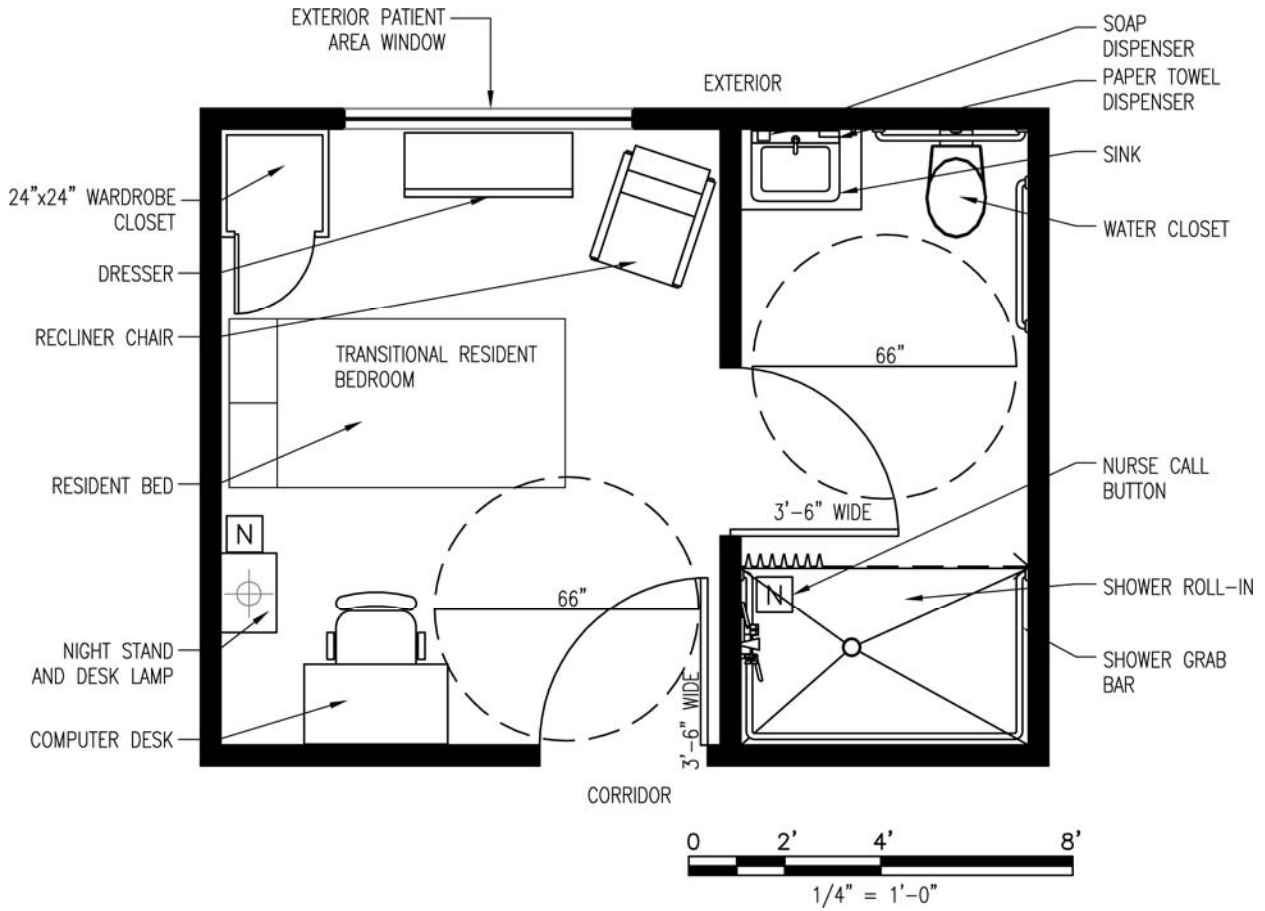

Transitional Rehabilitation Center

2.7.1 Transitional Resident Bedroom Reflected Ceiling Plan

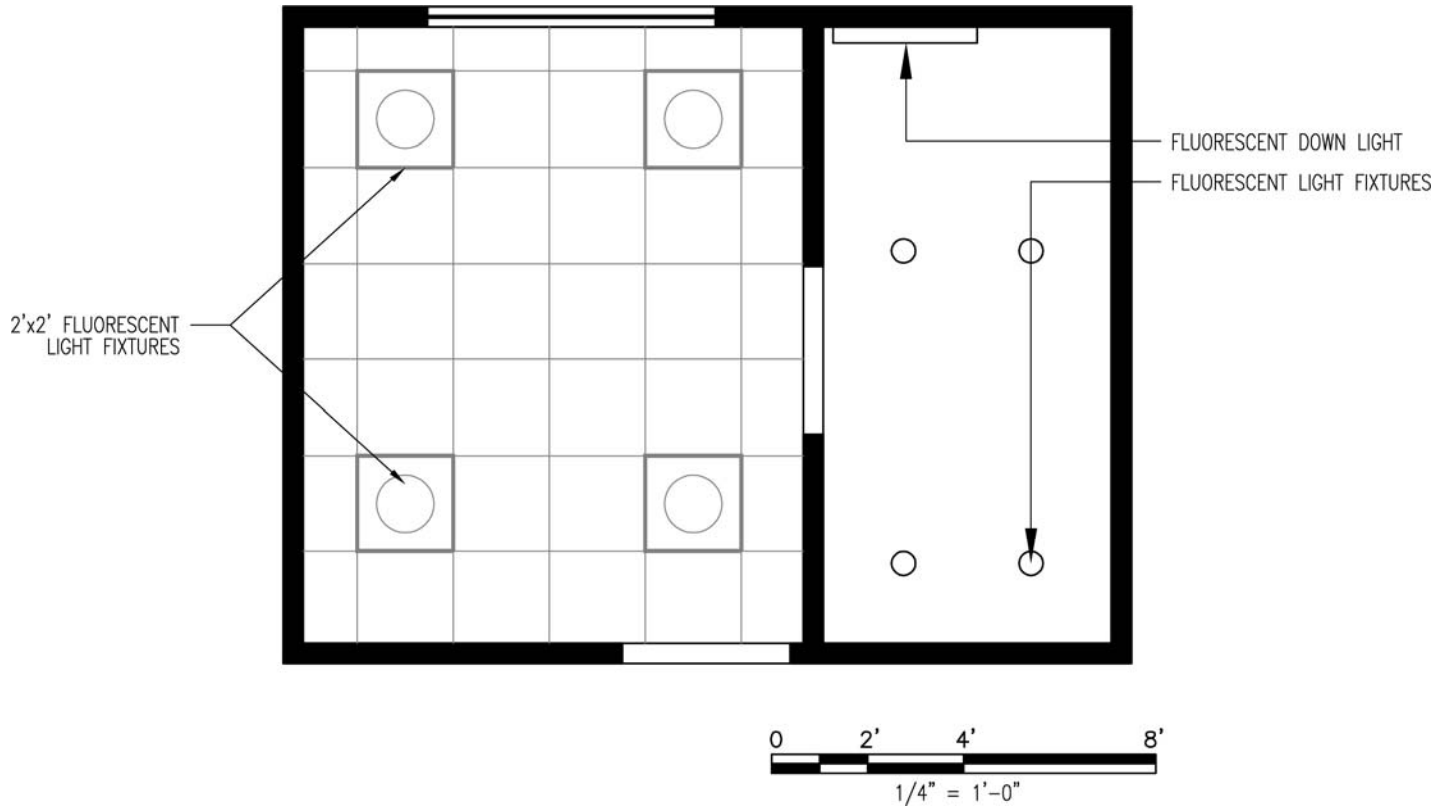

Transitional Rehabilitation Center

2.7.1 Transitional Bedroom Data Sheet**Function:**

- Common staff area
- Central filing
- Shared technology (telemetry reporting, computers, telephone, etc.)
- Efficient space utilization
- Single point of contact for visitors
- Limited patient contact & visibility
- "Institutional" imagery

Space Requirement:

215 NSF [19.97 NSM]

Architectural:

Floor Finish:	Carpet
Base:	Vinyl
Wall Finish:	GWB/ Vinyl Fabric Wallcover
Ceiling:	Acoustical Tile
Ceiling Height:	9'-0"
Noise (STC Rating):	30
Slab Depression:	NONE
Special Construction:	Yes, see VHA Program Guide PG-18-3
Hardware:	23
Door:	4'-0" x 7"-0" wood or metal
Window:	?

HVAC:

Individual Room	
Temperature Control:	70° - 75° (year-round) 30% - 60% RH
Min. Air Changes/Hour:	6 AC/H
Min. % Outside Air:	33%
Pressure:	Neutral (0)
Noise Criteria:	Max. 35 NC

Electrical:

Lighting Levels:	
Gen. Illum:	10fc
Task Illum:	20fc
Over Bed:	N/A
Emergency Egress:	N/A
Emergency Power:	
Medical Gases:	N/A
Night Lights:	Y
Vanity Light:	N/A
One Receptacle per PBP:	N/A
Nurse Call:	Y

Transitional Rehabilitation Center

2.7.1 Transitional Bedroom Equipment Table

SYMBOL	QUANTITY	AI	DESCRIPTION
	1	VV	BED, WITH HEADBOARD
	1	VV	DRESSER, WITH MIRROR, SIZE AS REQUIRED
	1	VV	CHAIR, STRAIGHT WITH ARMS
	1	VV	STAND, NIGHT, WITH DRAWER, APPROX., 457 mm X 457 mm X 610 mm (18" X 18" X 24")
	1	CC	NURSE CALL, EMERGENCY STATION WITH CORRIDOR SIGNAL LIGHT CONNECTED TO NEAREST NURSE CONTROL STATION
BATHROOM:			
	1	CC	SHOWER, ROLL-IN
	2	CC	BAR, GRAB, UPRIGHT AND ANGULAR, AROUND SHOWER
	1	CC	WATER CLOSET, FLUSH TANK TYPE
	1	CC	BAR, GRAB FOR WATER CLOSET
	1	CC	LAVATORY, COUNTER MOUNTED
	1	CC	MIRROR, HEAT TEMPERED GLASS, OVER LAVATORY
	1	CC	NURSE CALL, EMERGENCY STATION WITH CORRIDOR SIGNAL LIGHT CONNECTED TO NEAREST NURSE CONTROL STATION

Transitional Rehabilitation Center

2.7.2. Apartment-type Unit – 545 NSF [50.63 NSM]

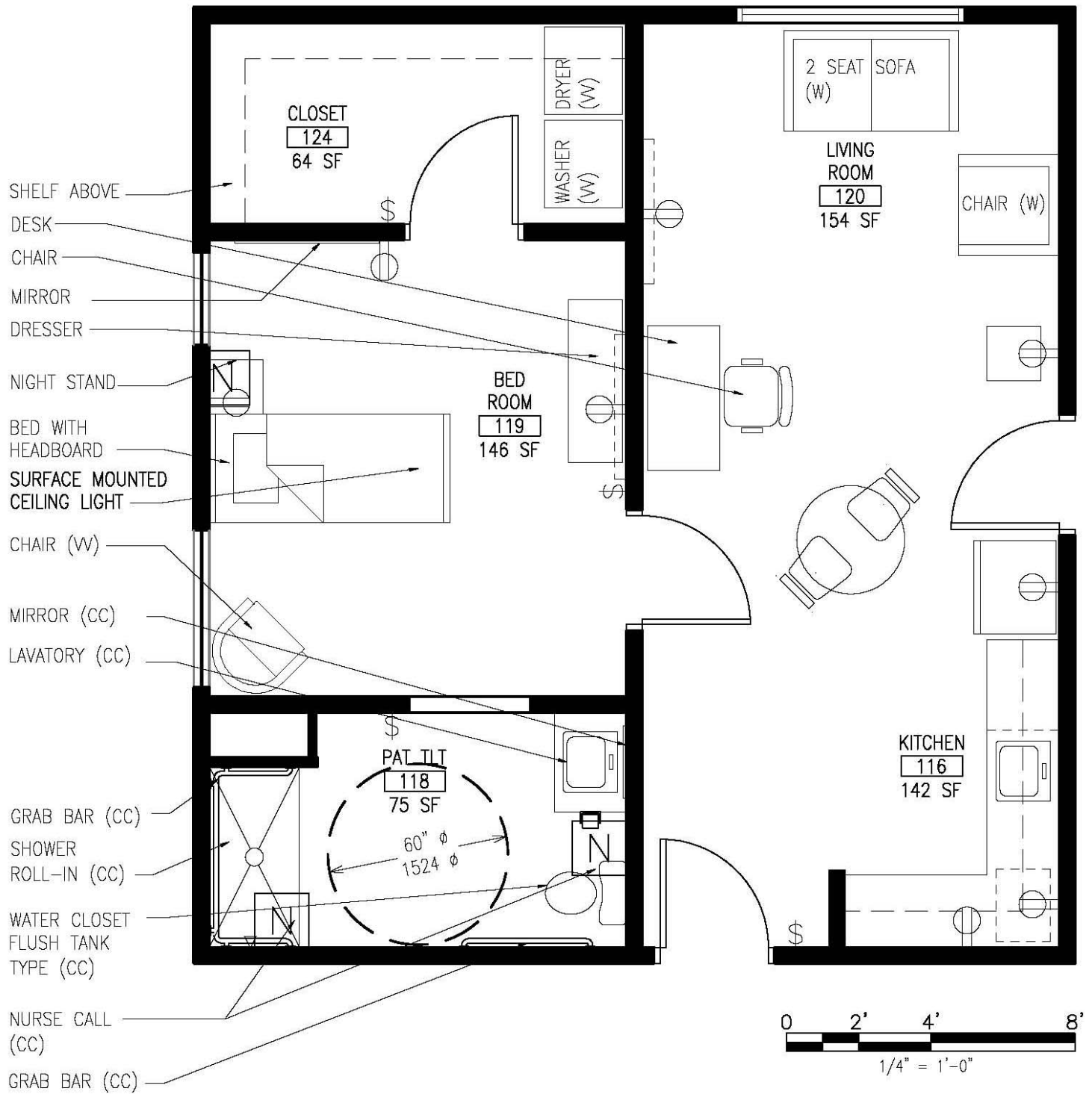

Transitional Rehabilitation Center

2.7.2 Apartment-type Unit Reflected Ceiling Plan

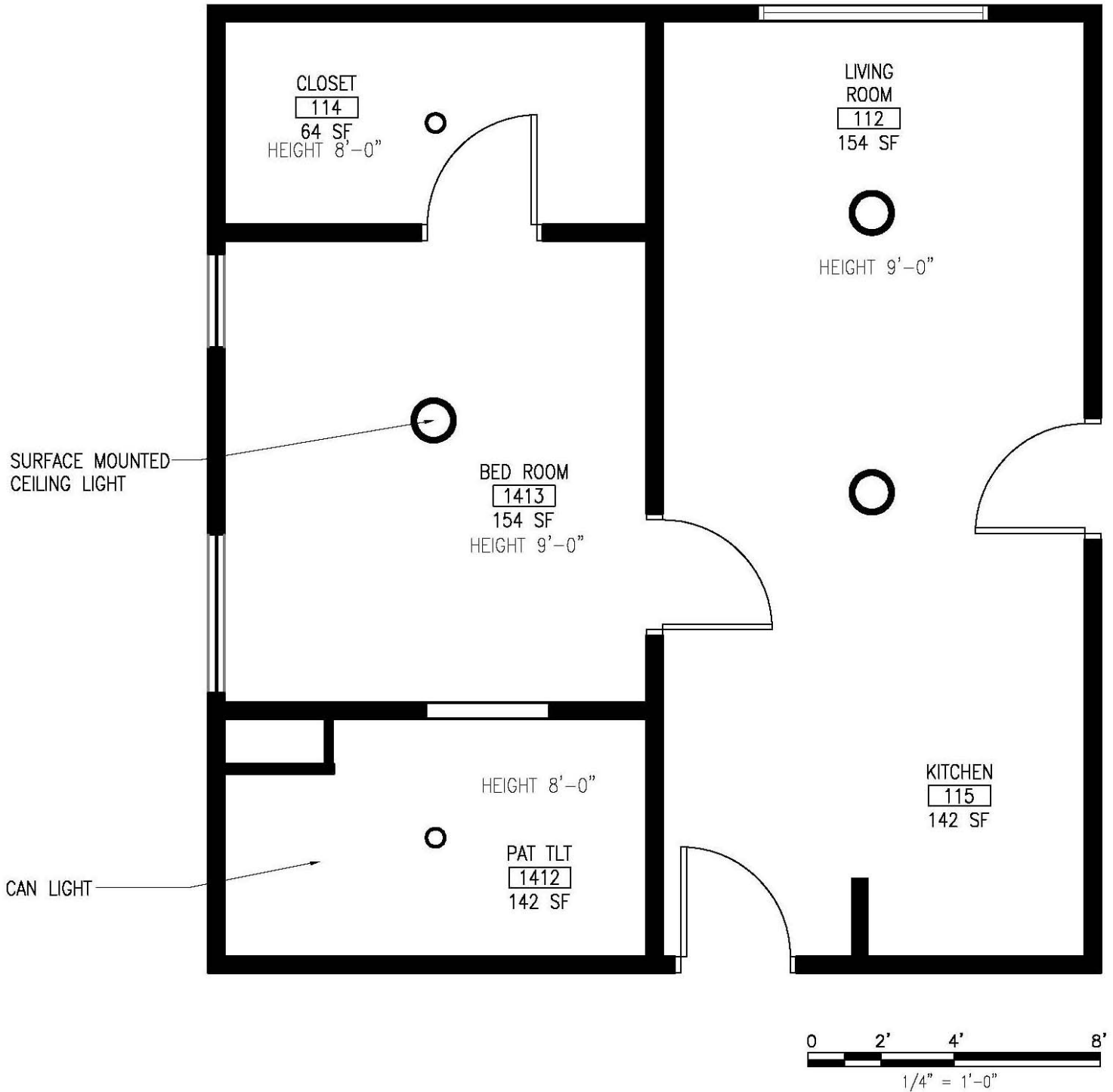

Transitional Rehabilitation Center
2.7.2 Double Apartment-type Units

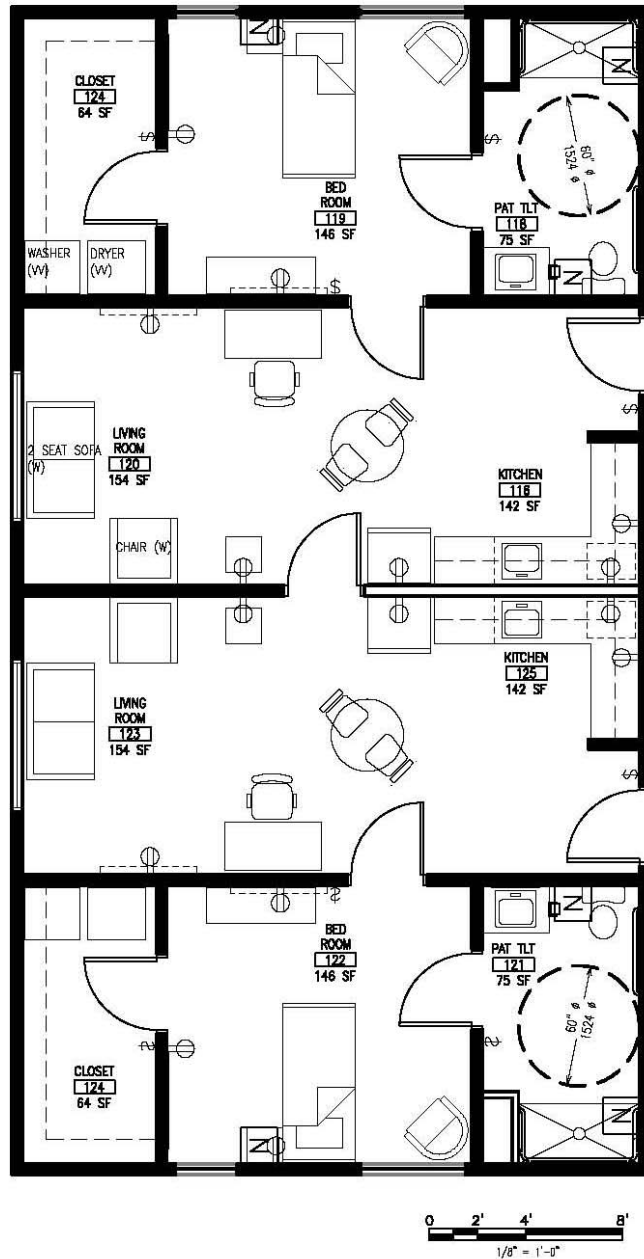

Transitional Rehabilitation Center

2.7.2 Apartment-type Unit Data Sheet**Function:**

- Patient bedroom w/ exterior windows
- In-unit kitchen w/ small dining
- In-unit laundry
- Desk area

Space Requirement:

545 NSF [50.63 NSM]

Architectural:

Floor Finish:	Carpet
Base:	Vinyl
Wall Finish:	GWB/ Vinyl Fabric Wallcover
Ceiling:	Acoustical Tile
Ceiling Height:	9'-0"
Noise (STC Rating):	30
Slab Depression:	Yes, see VHA Program Guide PG-18-3
Special Construction:	-
Door:	3'-0"x 7'-0" Wood or Metal
Window:	NONE

HVAC:

Individual Room	
Temperature Control:	70° - 75° (year-round) 30% - 50% RH
Min. Air Changes/Hour:	6 AC/H
Min. % Outside Air:	33%
Return Air:	Permitted
Pressure:	Neutral (0)
Noise Criteria:	Max. 35 NC
Individual Room Temperature:	Required

Electrical:

Lighting Levels:	
Gen. Illum:	10fc
Task Illum:	30fc
Over Bed:	N/A
Emergency Egress:	N/A
Emergency Power:	
Medical Gases:	N/A
Night Lights:	Y
Vanity Light:	N/A
One Receptacle per PBPU:	N/A
Nurse Call:	Y

Transitional Rehabilitation Center

2.7.2 Apartment-type Unit Equipment Table

SYMBOL	QUANTITY	AI	DESCRIPTION
KITCHENETTE			
	1	CC	CABINET, KITCHEN, BASE, WITH WORK TOP AND SINK, DOMESTIC
	1	CC	DISPOSAL, WASTE, SINK UNIT
	1	CC	CABINET, KITCHEN, WALL MOUNTED, DOMESTIC
	1	VV	REFRIGERATOR/FREEZER, 120 VOLT, 20 AMP, DOMESTIC, APPROX., 787 mm X 711 mm X 1676 mm (31" X 28" X 66")
	1	VV	MICROWAVE OVEN, 120 VOLT, 20 AMP (SIT ON COUNTER)
	1	CC	CONNECTIONS, PLUMBING, ELECTRICAL OR MECHANICAL AS REQUIRED
NOTE: ALL ABOVE EQUIPMENT ARE WHEELCHAIR ACCESSIBLE.			
LIVING ROOM/DINING			
	1	VV	SOFA, 2 SEAT, UPHOLSTERED
	2	VV	CHAIR, UPHOLSTERED WITH ARMS
	1	VV	TABLE, COFFEE, APPROX., 1041 mm X 508 mm X 381 mm (41" X 20" X 15")
	1	VV	TABLE, END, APPROX., 508 mm X 660 mm X 508 mm (20" X 26" X 20")
	1	VV	LAMP, TABLE TYPE
	2	CC	OUTLET, MASTER TELEVISION ANTENNA
	2	VV	RECEIVER, TELEVISION, 120 VOLT, 20 AMP
	1	VV	TABLE, DINING, APPROX., 914 mm X 914 mm (36" X 36")
	2	VV	CHAIR, DINING, APPROX., 457 mm X 457 mm (18" X 18")
	1	VV	DESK, APPROX., 610 mm X 1219 mm (24" x 28")
	1	VV	CHAIR, DESK, APPROX., 457 mm X 457 mm (18" X 18")
BEDROOM / CLOSET			
	1	VV	BED, WITH HEADBOARD
	1	VV	DRESSER, WITH MIRROR, SIZE AS REQUIRED
	1	VV	CHAIR, STRAIGHT WITH ARMS

SYMBOL	QUANTITY	AI	DESCRIPTION
	1	VV	STAND, NIGHT, WITH DRAWER, APPROX., 457 mm X 457 mm X 610 mm (18" X 18" X 24")
	1	CC	NURSE CALL, EMERGENCY STATION WITH CORRIDOR SIGNAL LIGHT CONNECTED TO NEAREST NURSE CONTROL STATION
	1	VV	WASHER, CLOTHES, FRONT LOADING AND FRONT CONTROL COMMERCIAL, 120 VOLT, 20 AMP
	1	CC	WASHING MACHINE, SUPPLY AND DRAIN UNITS
	1	VV	DRYER, CLOTHES, FRONT LOADING AND FRONT CONTROL COMMERCIAL, 208 VOLT, 30 AMP, SINGLE PHASE
BATHROOM:			
	1	CC	SHOWER, ROLL-IN
	2	CC	BAR, GRAB, UPRIGHT AND ANGULAR, AROUND SHOWER
	1	CC	WATER CLOSET, FLUSH TANK TYPE
	1	CC	BAR, GRAB FOR WATER CLOSET
	1	CC	LAVATORY, COUNTER MOUNTED
	1	CC	MIRROR, HEAT TEMPERED GLASS, OVER LAVATORY
	1	CC	NURSE CALL, EMERGENCY STATION WITH CORRIDOR SIGNAL LIGHT CONNECTED TO NEAREST NURSE CONTROL STATION

Transitional Rehabilitation Center

2.7.3. Nurse Station / Check-in Station – 160 NSF [14.86 NSM]

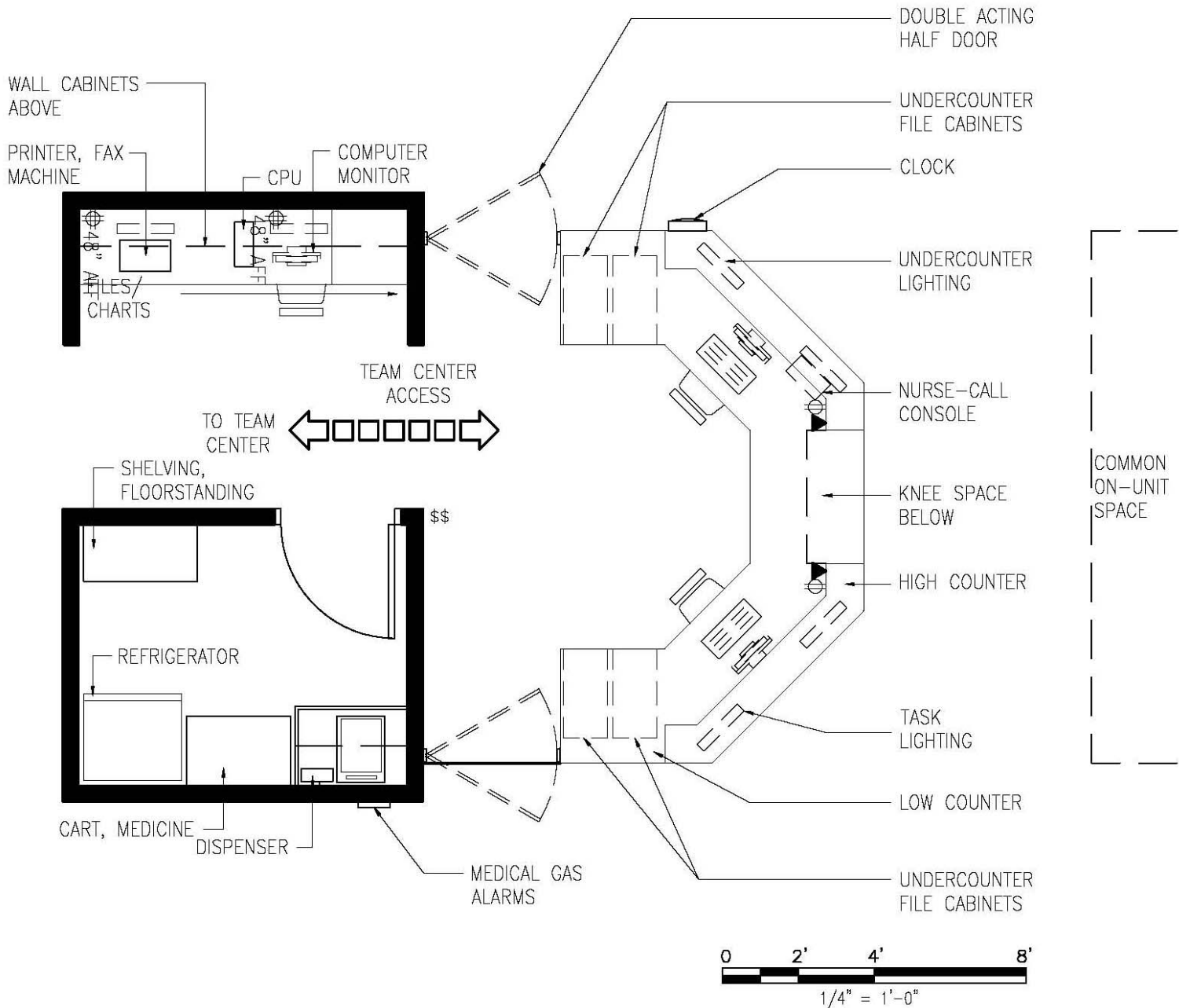

Transitional Rehabilitation Center

2.7.3 Nurse Station / Check-in Station Reflected Ceiling Plan

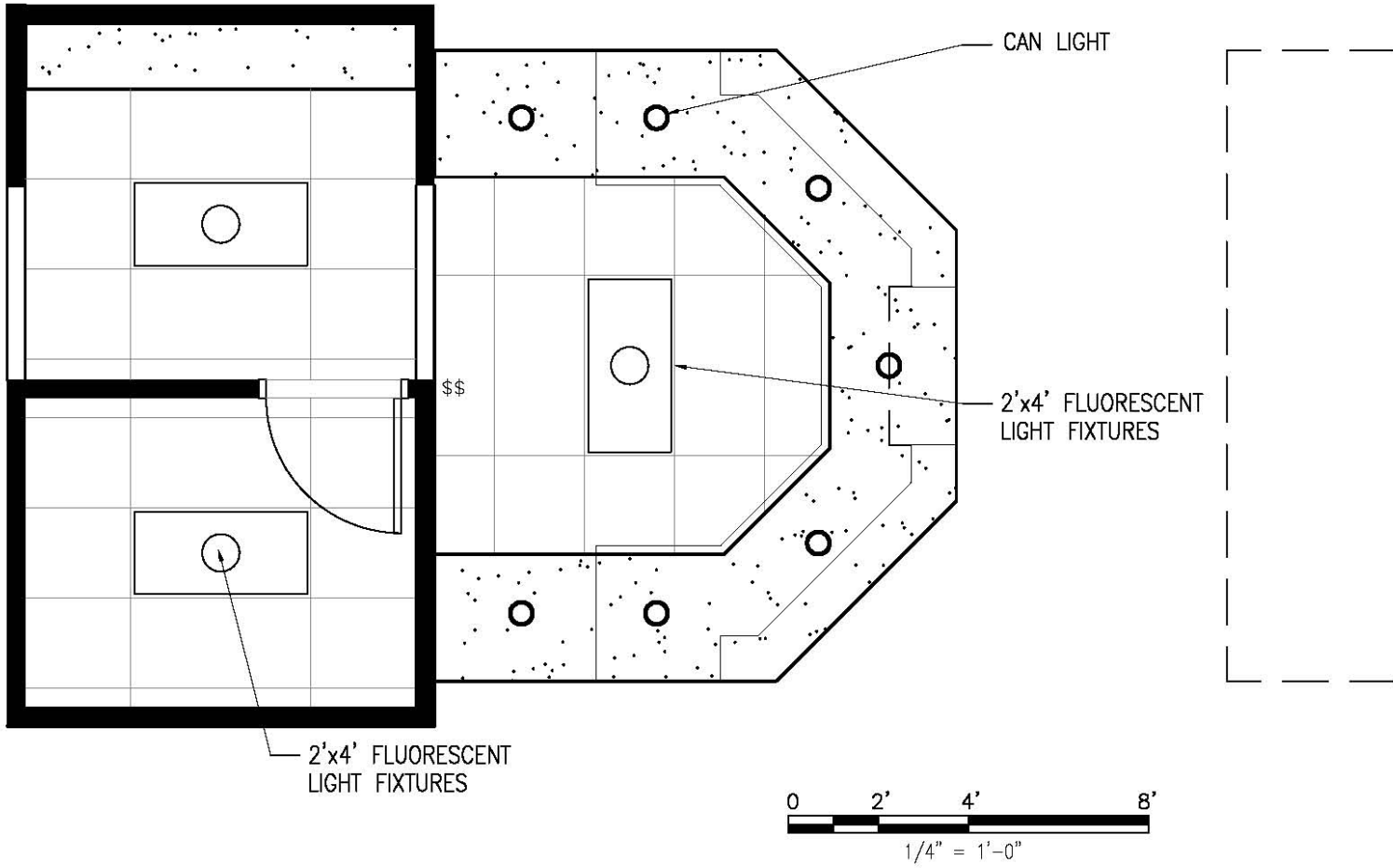

Transitional Rehabilitation Center

2.7.3 Nurse Station / Check-in Station Data Sheet**Function:**

- Common staff area
- Central filing
- Shared technology (telemetry reporting, computers, telephone, etc.)
- Efficient space utilization
- Single point of contact for visitors
- Limited patient contact & visibility
- "Institutional" imagery

Space Requirement:

160 NSF [14.86 NSM]

Architectural:

Floor Finish:	Vinyl Composition Tile
Base:	Vinyl
Wall Finish:	Veneer Plaster/ Vinyl Fabrication
Ceiling:	Acoustical Tile
Ceiling Height:	9'-0"
Noise (STC Rating):	N/A
Slab Depression:	NONE
Special Construction:	-
Door:	NONE
Window:	NONE

HVAC:

Individual Room	
Temperature Control:	70° - 75° (year-round) 30% - 50% RH
Min. Air Changes/Hour:	6 AC/H
Min. % Outside Air:	33%
Pressure:	Neutral (0)
Noise Criteria:	Max. 40 NC

Nurse Station / Medication Room:

Min. Air Changes/Hour:	4 AC/H
Min. % Outside Air:	25%
Pressure:	Positive (+)

Electrical:

Lighting Levels:	
Gen. Illum:	10fc
Task Illum:	30fc
Over Bed:	N/A
Emergency Egress:	N/A
Emergency Power:	
Medical Gases:	N/A
Night Lights:	Y
Vanity Light:	N/A
One Receptacle per PBPU:	N/A
Nurse Call:	Y

Transitional Rehabilitation Center

2.7.3 Nurse Station / Check-in Station Equipment Table

SYMBOL	QUANTITY	AI	DESCRIPTION
	1	CC	COUNTER, CENTER, COMMUNICATION, WITH DESK, KEYBOARD TRAY, INDIVIDUAL SINGLE DRAWERS BELOW FULL LENGTH OF COUNTER AS REQUIRED, SIZE ACCORDING TO INDIVIDUAL PROJECT DESIGN
	1	CC	NURSE CALL, CONSOLE, ANNUNCIATOR, AUDIO VISUAL DESK TYPE
	AR	VV	CHAIR, TASK, WITHOUT ARMS
	AR	VV	CABINET, FILING, UNDERCOUNTER
	1	CC	FIRE ALARM STATION, RED SIGNAL LIGHT AND CHIME, WALL MOUNTED
	1	VV	PRINTER, COMPUTER SYSTEM
	1	CC	RECEPTACLE, ELECTRICAL, QUADRAPLEX, FOR COMPUTER EQUIPMENT ITEMS
	1	VV	CLOCK, BATTERY OPERATED
MEDICATION ROOM:			
	1	CC	CABINET, BASE, WITH SOLID SURFACE TOP AND SINK
	1	CC	CABINET, WALL, WITH SLOPING TOP
	AR	VV	DISPENSER, MEDICATION, COMPUTERIZED
	1	VV	REFRIGERATOR, MEDICATION WITH REMOTE MANAGER – OR – REFRIGERATED MEDICATION DISPENSER UNIT
	1	CC	SHELVING, FLOORSTANDING, STEEL, WITH SLOPING TOP AND 4 OR 5 ADJUSTABLE SHELVES, 914 mm X 457 mm X 2134 mm (36" X 18" X 84")
	1	VV	CART, MEDICINE, 559 mm X 838 mm X 1118 mm (22" X 33" X 44")
	1	VV	DISPENSER, BIFOLD PAPER TOWEL, SURFACE MOUNTED

Transitional Rehabilitation Center

2.7.4. Dining Area – 300 NSF [27.86 NSM]

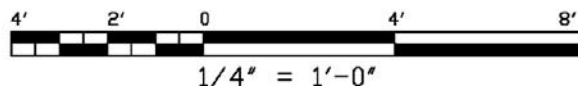
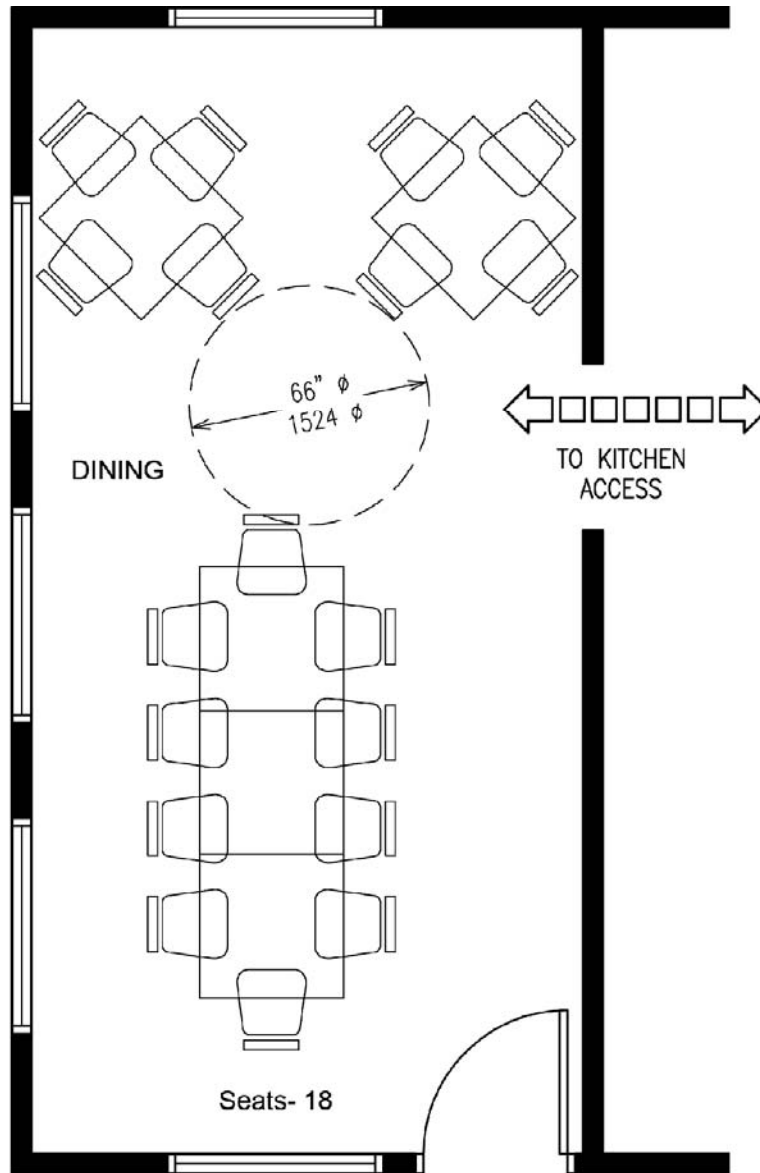

Transitional Rehabilitation Center

2.7.4 Dining Area Reflected Ceiling Plan

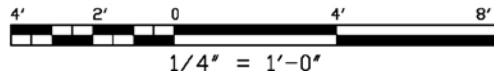
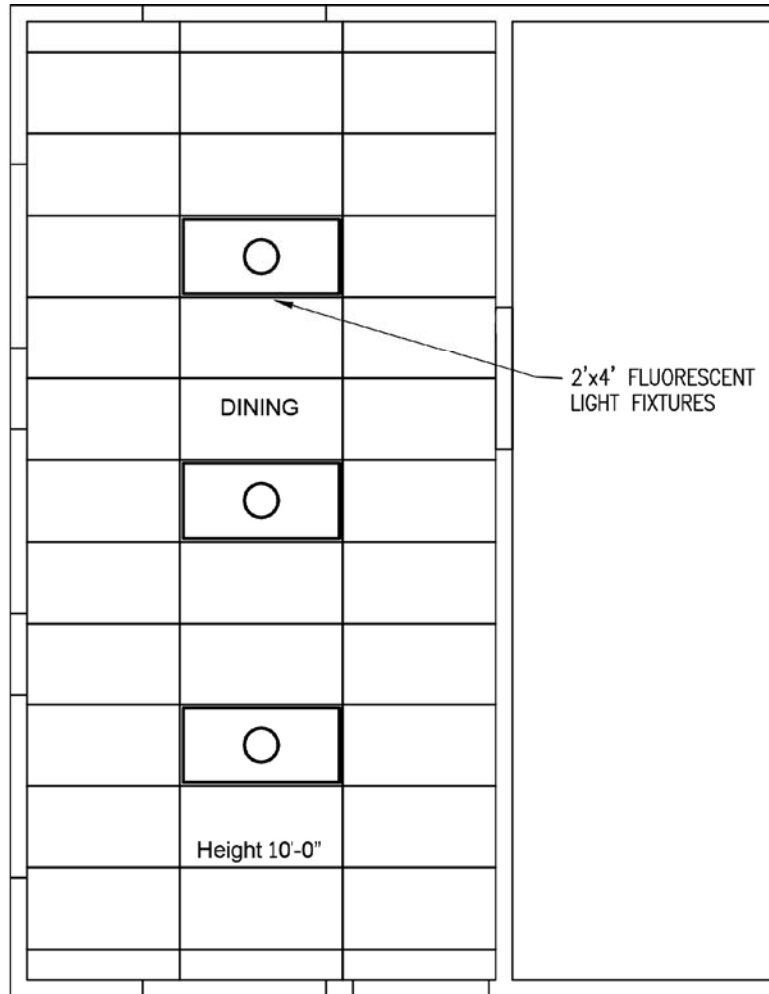

Transitional Rehabilitation Center

2.7.4 Dining Area Data Sheet**Function:**

The dining room is used by PRC Transitional Rehabilitation Patients for on-unit dining on a daily basis. The dining room may be used for other purposes such as recreation therapy during non-dining hours.

Space Requirement:

300 NSF [27.87 NSM]

Architectural:

Floor Finish:	Vinyl Composition Tile
Base:	Vinyl
Wall Finish:	GWB/ Vinyl Fabric Wallcover
Ceiling:	Acoustical Tile
Ceiling Height:	10'-0"
Noise (STC Rating):	40
Slab Depression:	NONE
Special Construction:	-
Door:	2 @ 3'-0" x 7'-0" wood or metal. Upper Half= Laminated Safety Glass
Window:	?

HVAC:

Individual Room	
Temperature Control:	70° - 75° (year-round)
	30% - 50% RH
Min. Air Changes/Hour:	4 AC/H
Return Air:	Permitted
Min. % Outside Air:	15%
Pressure:	Negative (-)
Noise Criteria:	Max. 40 NC
Individual Room Temperature:	Required

Electrical:

Lighting Levels:	
Gen. Illum:	10fc
Task Illum:	30fc
Over Bed:	N/A
Emergency Egress:	N/A
Emergency Power:	
Medical Gases:	N/A
Night Lights:	Y
Vanity Light:	N/A
One Receptacle	
per PBPU:	N/A
Nurse Call:	Y

Transitional Rehabilitation Center

2.7.4 Dining Area Equipment Table

SYMBOL	QUANTITY	AI	DESCRIPTION
	AR	VV	CHAIR, DINING, APPROX., 457 mm X 457 mm (18" X 18")
	AR	CC	TABLE, (36" x 36") SQUARE

Transitional Rehabilitation Center

2.7.5. Recreation / Activity Room – 240 NSF [22.29 NSM]

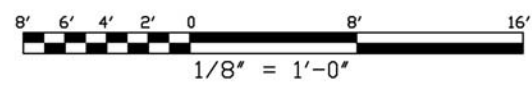
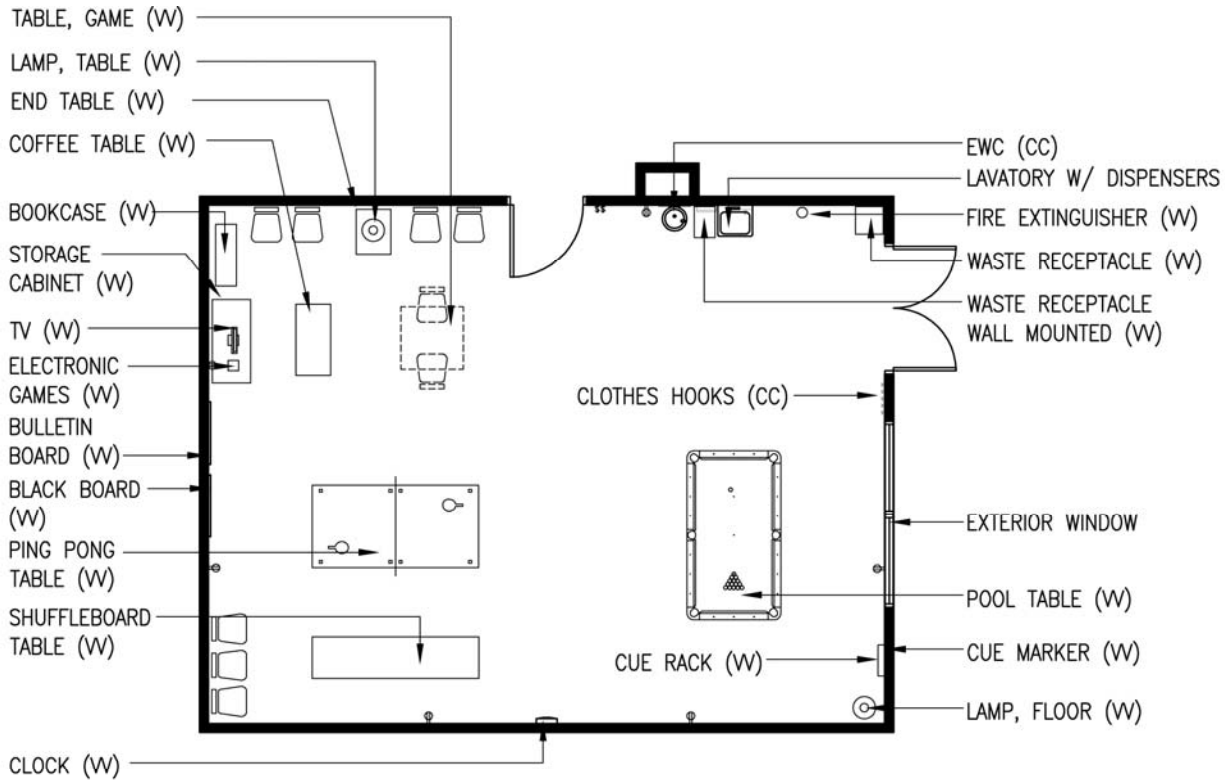

Transitional Rehabilitation Center

2.7.5 Recreation / Activity Room Reflected Ceiling Plan

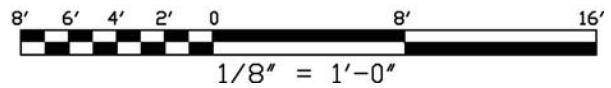
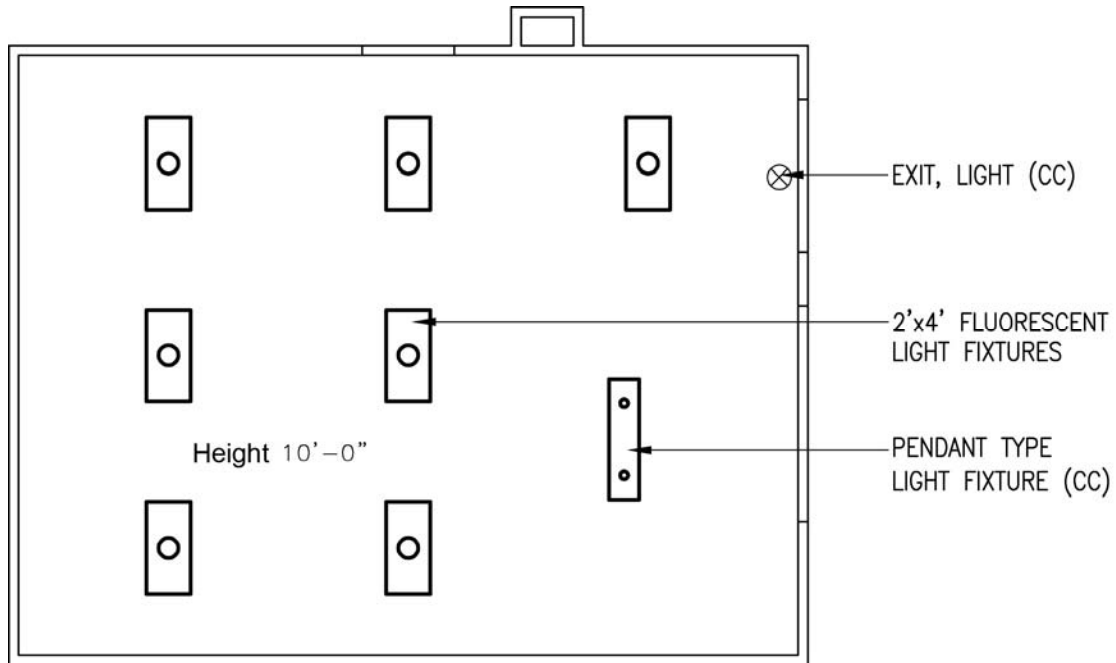

Transitional Rehabilitation Center

2.7.5 Recreation / Activity Room Data Sheet**Space Requirement:**

240 NSF [22.29 NSM]

Architectural:

Floor Finish:	Vinyl Composition Tile
Base:	Vinyl
Wall Finish:	Gypsum Wallboard/ Paint
Ceiling:	Acoustical Tile
Ceiling Height:	10'-0"
Noise (STC Rating):	40
Slab Depression:	NONE
Special Construction:	-
Door:	3 @ 3'-0" x 7'-0" wood or metal
Window:	?

HVAC:

Individual Room	
Temperature Control:	70° - 75° (year-round) 30% - 50% RH
Min. Air Changes/Hour:	6 AC/H
Min. % Outside Air:	15%
Pressure:	Negative (-)
Noise Criteria:	Max. 45 NC
Return Air:	Permitted
Individual Room Temperature:	Required

Electrical:

Lighting Levels:	
Gen. Illum:	10fc
Task Illum:	30fc
Over Bed:	N/A
Emergency Egress:	N/A
Emergency Power:	
Medical Gases:	N/A
Night Lights:	Y
Vanity Light:	N/A
One Receptacle per PBPU:	N/A
Nurse Call:	Y

Transitional Rehabilitation Center

2.7.5 Recreation / Activity Room Equipment Table

SYMBOL	QUANTITY	AI	DESCRIPTION
	AR	VV	TABLE, POOL
	AR	VV	RACK, CUE, WALL MOUNTED
	AR	VV	MARKER, CUE
	AR	VV	TABLE, BUMPER POOL (WHEN BILLIARD ROOM NOT PROVIDED)
	AR	CC	FIXTURE, LIGHTING, FLUORESCENT, DROP TYPE, OVER POOL TABLE
	AR	CC	HOOK, CLOTHES
	AR	CC	LIGHT, EXIT
	1	VV	BULLETIN BOARD, APPROX., 914 mm X 914 mm (36" X 36")
	1	VV	FIRE EXTINGUISHER, 2A:20 BC, 9 L (2-1/2 GAL.) CAPACITY, GENERAL PURPOSE, DRY CHEM. (NFPA VOL. 1-10)
	1	CC	OUTLET, MASTER TELEVISION ANTENNA
	1	VV	RECEIVER, TELEVISION, 120 VOLT, 20 AMP
	AR	VV	RECEPTACLE, WASTE, WALL MOUNTED, 457 mm X 305 mm X 914 mm (18" X 12" X 36")
	1	CC	ELECTRIC WATER COOLER, WHEELCHAIR, WALL HUNG, SELF-CONTAINED (SEE ARCHITECTURE DRAWING FOR EXACT LOCATION)
	1	VV	BLACKBOARD, 914 mm X 914 mm (36" X 36")
	AR	CC	SEATS, SPECTATOR
	1	VV	SHUFFLEBOARD TABLE, 610 mm X 2438 mm X 914 mm (24" X 96" X 36")
	AR	VV	GAMES, ELECTRONIC, INTERACTIVE (SUCH AS Wii, X-BOX, PLAYSTATION)
	1	CC	CABINET, STORAGE, WITH SLOPING TOP, 2 HINGED PANEL DOORS, LOCK AND 5 ADJUSTABLE SHELVES, 1219 mm X 559 mm X 2134 mm (48" X 22" X 84")
	1	VV	CLOCK, BATTERY OPERATED
	1	VV	TABLE, PING PONG, PORTABLE
	AR	VV	TABLE, END, APPROX., 508 mm X 660 mm X 508 mm (20" X 26" X 20")
	AR	VV	TABLE, COFFEE, APPROX., 1041 mm X 508 mm X 381 mm (41" X 20" X 15")
	1	VV	TABLE, GAME, FOUR SIDED, STANDARD (OPTIONAL)
	AR	VV	BOOKCASE, SECTIONAL, EACH SECTION, 838 mm X 330 mm X 381 mm (33" X 13" X 15") WITH 254 mm (10") BASE
	AR	VV	LAMP, FLOOR TYPE, 305 mm (12") DIAMETER BASE (OPTIONAL)

SYMBOL	QUANTITY	AI	DESCRIPTION
	AR	VV	LAMP, TABLE TYPE (OPTIONAL)
	AR	VV	RECEPTACLE, WASTE, APPROX., 406 mm X 406 mm (16" X 16")

2.8. Outpatient

2.8.1. Lounge Space (Home Room) – 240 NSF [22.29]

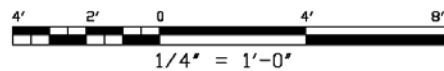
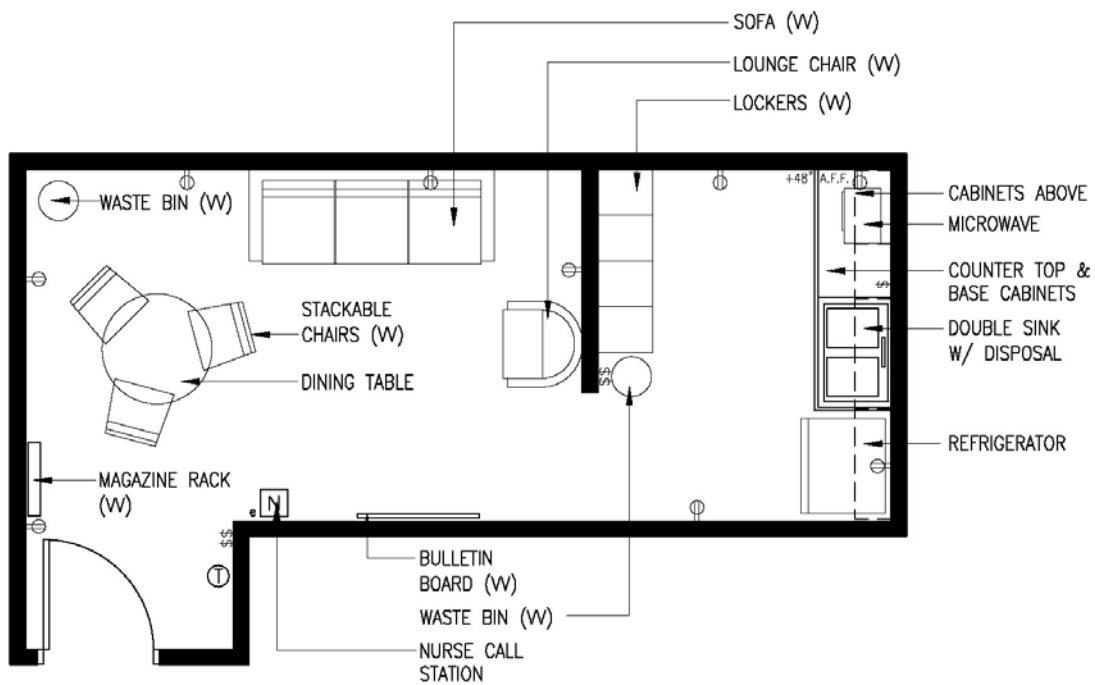

2.8.1 Lounge Space (Home Room) Reflected Ceiling Plan

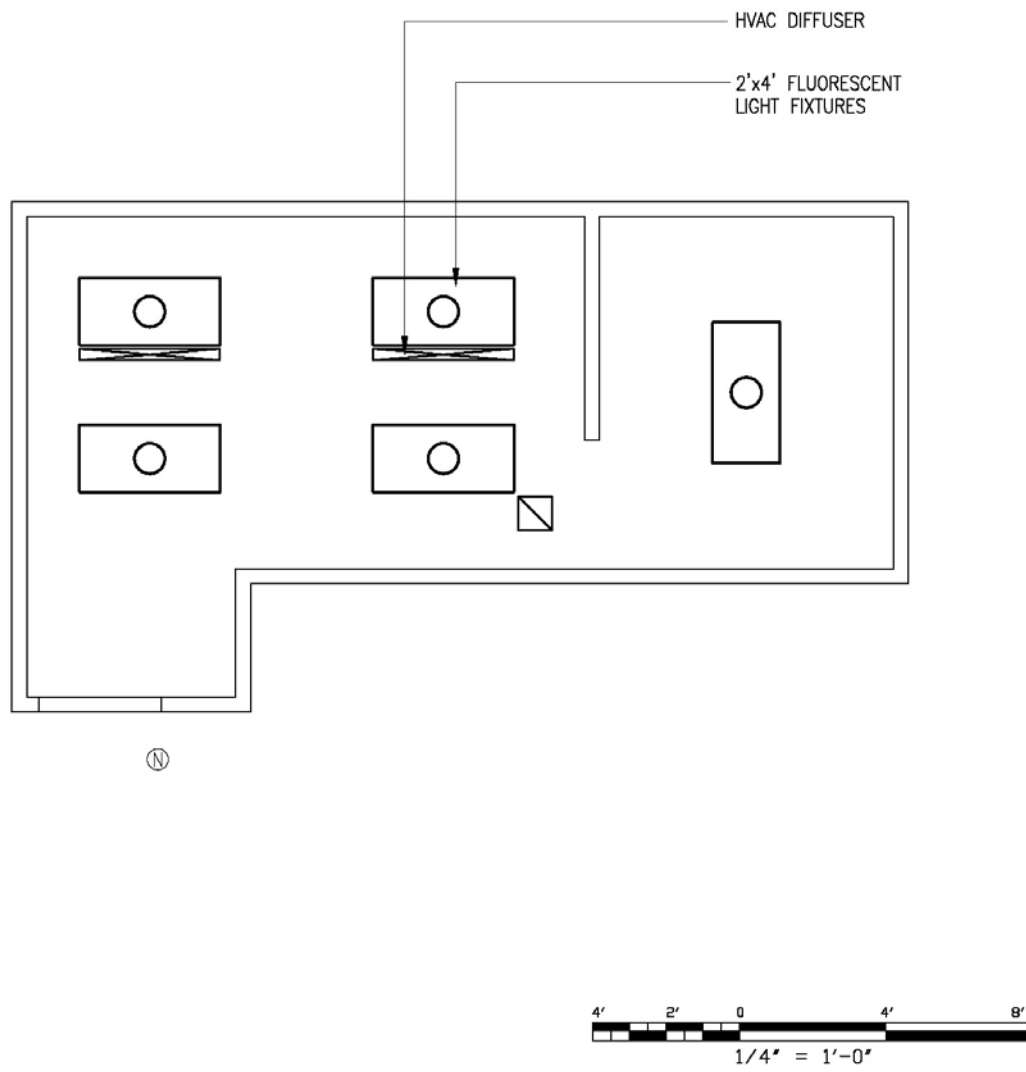

Outpatient Center

2.8.1 Lounge Space (Home Room)

Function:

This space is intended to accommodate a variety of unsupervised recreational activities among patients and on occasion patients and family.

Space Requirement:

240 NSF [22.29 NSM]

Architectural:

Floor Finish:	Vinyl Composition Tile
Base:	Vinyl
Wall Finish:	GWB / Vinyl Fabric Wall Covering
Ceiling:	Acoustical Tile
Ceiling Height:	10'-0"
Noise (STC Rating):	35
Slab Depression:	None
Special Construction:	-
Hardware:	52
Doors:	(2) 3'-0" X 7'-0" wood or metal with upper half laminated safety glass
Windows:	None Required but Desirable

HVAC:

Individual Room	
Temperature Control:	70° - 75° (year-round) 30% - 50% RH
Min. Air Changes/Hour:	6 AC/H
Return Air:	Not permitted (exhaust all air outdoors)
Min. % Outside Air:	15%
Pressure:	Negative (-)
Noise Criteria:	NC 40
Individual Room Temperature:	Required

Electrical:

Lighting Levels:	
Three-level Fluorescent:	
High:	60fc
Med:	45fc
Low:	20fc
Emergency Power:	
One Ceiling Light	
Nurse Call	

Outpatient Center

2.8.1 Lounge Space (Home Room)**Equipment Table:**

SYMBOL	QUANTITY	AI	DESCRIPTION
	AR	VV	SOFA, 3-SEAT UPHOLSTERED
	AR	VV	CHAIR, LOUNGE
	AR	VV	CHAIR, STACKABLE
	AR	VV	TABLE, DINING
	1	CC	CABINET, KITCHEN, BASE, WORK TOP AND SINK, DOMESTIC
	1	CC	DISPOSAL, WATSE, SINK UNIT
	1	CC	CABINET, KITCHEN, WALL MOUNT, DOMESTIC
	1	VV	REFRIGERATOR/FREEZER, ICE MAKER, DOMESTIC
	1	VV	MICROWAVE OVEN
	AR	VV	LOCKERS, STEEL, DOUBLE TIER, SHELVES & COMBINATION LOCK
	1	VV	MAGAZINE RACK
	1	VV	BULLETIN BOARD
	1	CC	NURSE CALL EMERGENCY STATION WITH CORRIDOR SIGNAL LIGHT CONNECTED TO NEAREST NURSE CONSTROL STATION
	AR	CC	RECEPTACLE, ELECTRICAL, DUPLEX, 120 VOLT, 20 AMP
	AR	VV	RECEPTACLE, WASTE, 13" DIAMETER

Outpatient Center

2.8.2. Physical/Occupational Therapy – 900 NSF [83.61 NSM]

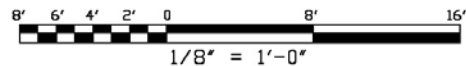
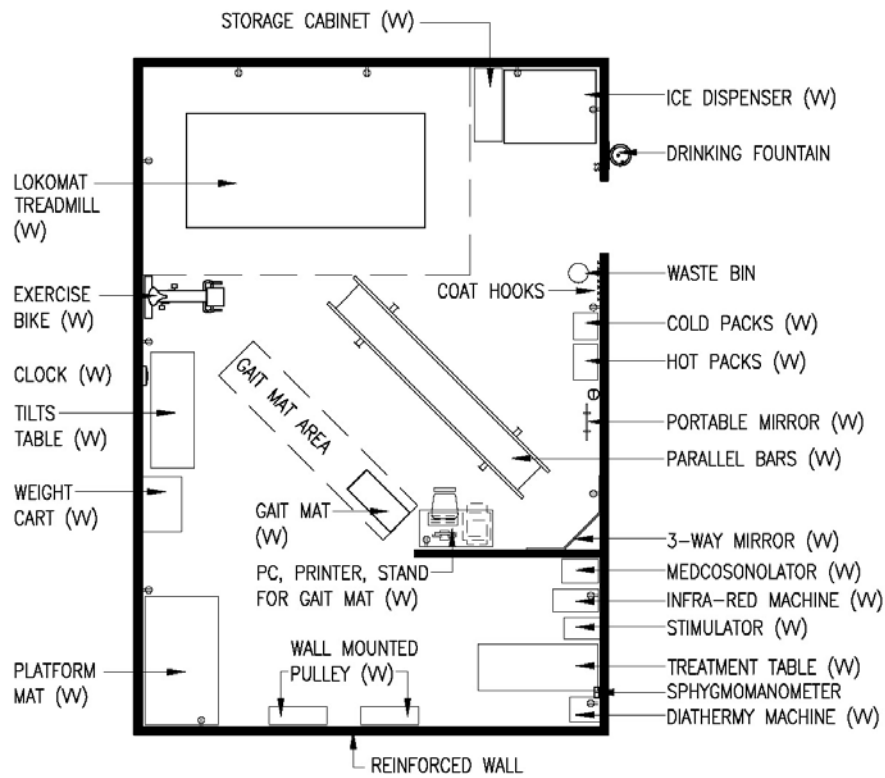

2.8.2 Physical/Occupational Therapy Reflected Ceiling Plan

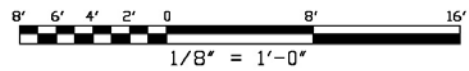
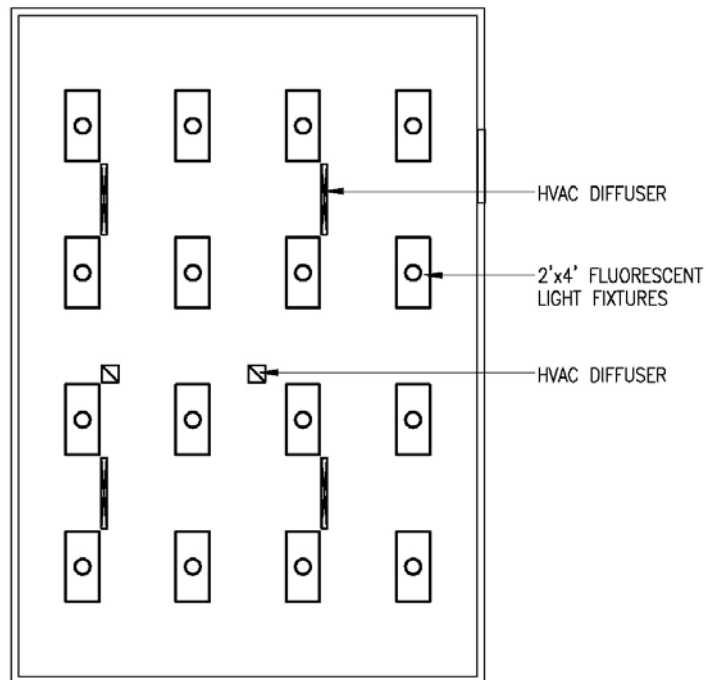

Outpatient Center

2.8.2 Physical/Occupational Therapy

Function:

This space is intended to accommodate physical, psychosocial and vocational evaluation and therapy.

Space Requirement:

900 NSF [83.61 NSM]

Architectural:

Floor Finish:	Vinyl Composition Tile
Base:	Vinyl
Wall Finish:	Gypsum Wallboard/Paint
Ceiling:	Acoustical Tile
Ceiling Height:	10'-0"
Noise (STC Rating):	30
Slab Depression:	None
Special Construction:	Wall-mounted pulleys require a reinforced wall with hardwood veneer plywood surface
Hardware:	23
Doors:	(2) 3'-0" X 7'-0" wood or metal with upper half laminated safety glass
Windows:	None Required but Desirable

HVAC:

Individual Room	
Temperature Control:	70° - 75° (year-round) 30% - 50% RH
Min. Air Changes/Hour:	6 AC/H
Return Air:	Permitted
Min. % Outside Air:	15%
Pressure:	Negative (-)
Noise Criteria:	Max. 45 NC
Individual Room Temperature:	Required

Electrical:

Lighting Levels:	
Gen. Illum:	30fc
Emergency Power:	
One Ceiling Light	
Nurse Call	

Outpatient Center

2.8.2 Physical/Occupational Therapy**Equipment Table:**

SYMBOL	QUANTITY	AI	DESCRIPTION
	1	VV	PLATFORM MAT, 72"W x 96"L x 18"H or 48"W x 84"L x 18"H
	AR	VV	TABLE, TREATMENT, HI-LO ELECTRICAL, 120 VOLT, 20 AMP, 30"W x 78"L x 32"H
	1	VV	AUTOMATED TREADMILL (LOKOMAT)
	1	VV	BARS, PARALLEL, APPROX. 26"W x 180"L x 40"H
	1	VV	TABLE, TILT, ELECTRICAL, 120 VOLT, 20 AMP, 28"W x 76"L x 32"H
	1	VV	CART, WEIGHT, APPROX. 26"W x 36"L x 54"H
	1	VV	MIRROR, FULL LENGTH, MOBILE
	1	VV	MIRROR, 3-WAY, POSTURE
	1	VV	CABINET, STORAGE, METAL, 2-DOOR WITH LOCK
	1	VV	CLOCK, BATTERY OPERATED
	AR	CC	RECEPTACLE, ELECTRICAL, DUPLEX, 120 VOLT, 20 AMP
	AR	VV	RECEPTACLE, WASTE, 13" DIAMETER
	1	VV	MACHINE, INFRA-RED
	1	VV	MACHINE, MEDCOSONOLATOR
	1	VV	HYDROCOLLATOR, COLD-PAK TYPE
	1	VV	HYDROCOLLATOR, HOT-PAK TYPE
	1	VV	DIATHERMY, MICROWAVE
	1	VV	STIMULATOR, ELECTRIC, 120 VOLT, 20 AMP
	1	VV	GAIT MAT WITH COMPUTER SOFTWARE PACKAGE
	1	CC	DRINKING FOUNTAIN, MECHANICALLY COOLED, WHEELCHAIR

Outpatient Center

2.8.3. Recreation Therapy Room, Group – 500 NSF [46. NSM]

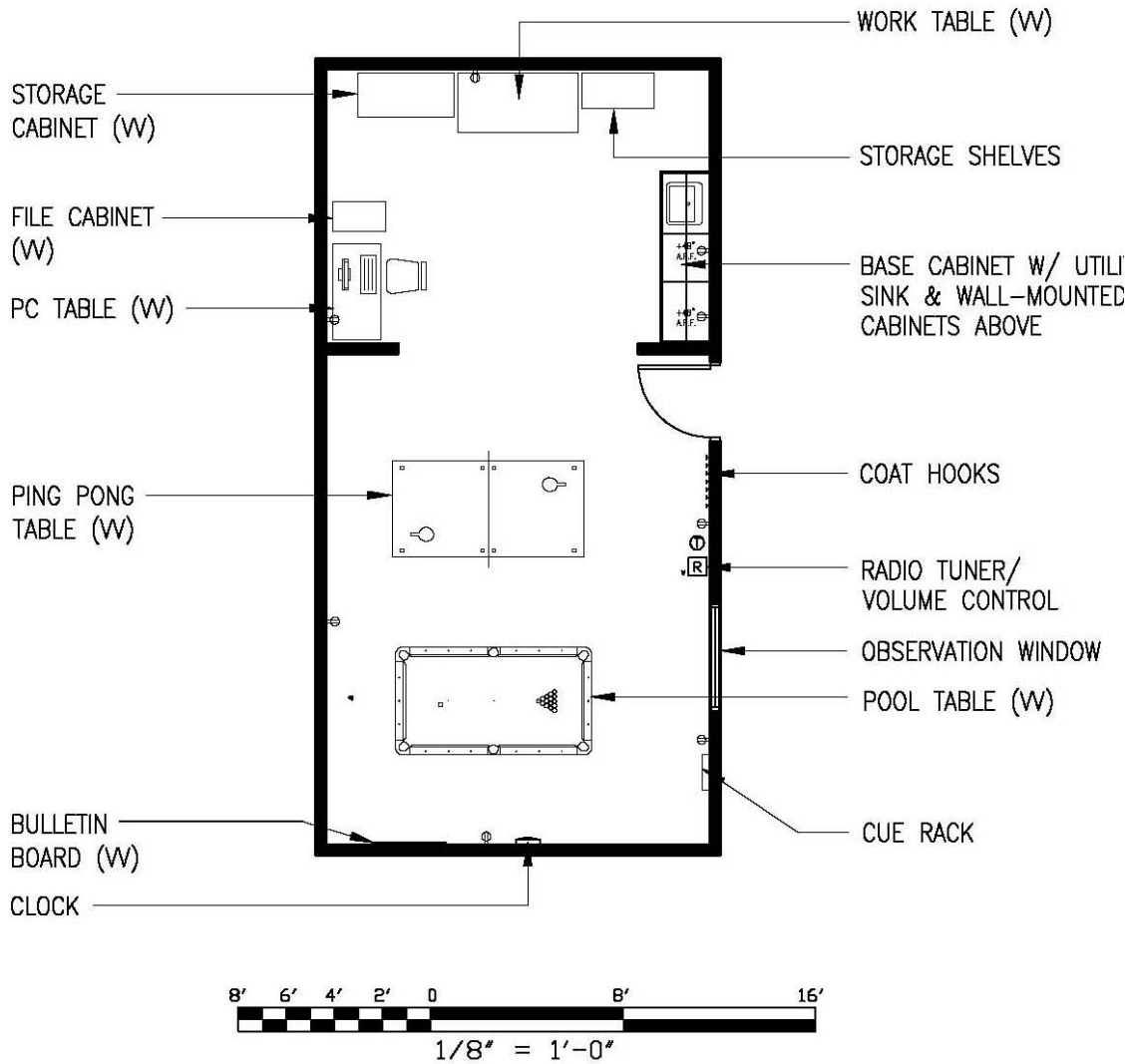

Outpatient Center

2.8.3 Recreation Therapy Room, Group - Reflected Ceiling Plan

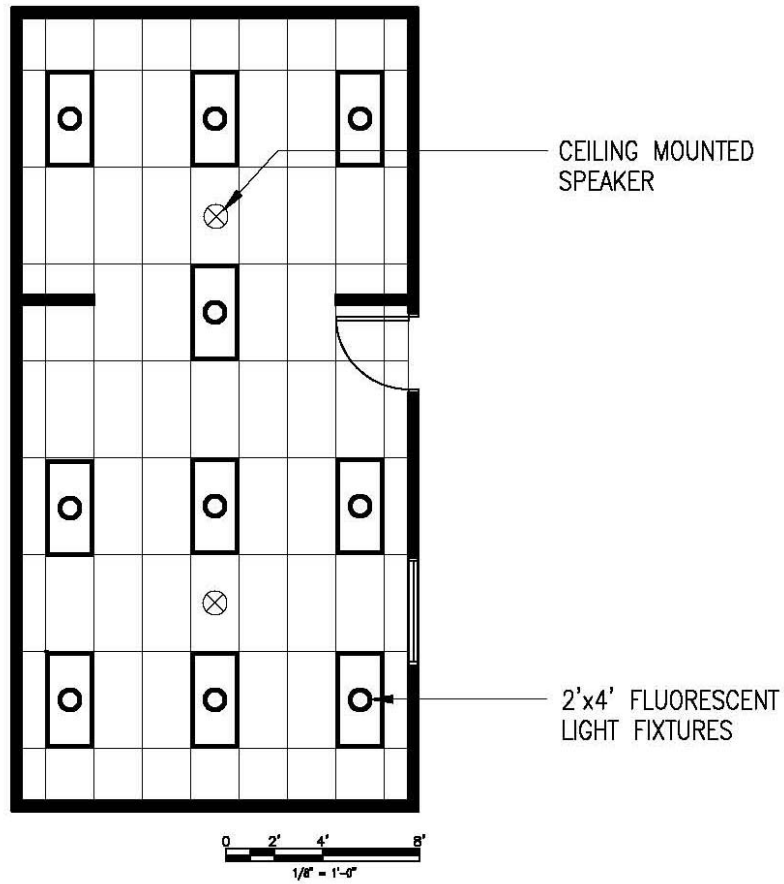

Outpatient Center

2.8.3 Recreation Therapy Room, Group

Function:

This space is intended to accommodate a variety of unsupervised recreational activities among patients and on occasion patients and family.

Space Requirement:

1300 NSF

Architectural:

Floor Finish:	Vinyl Composition Tile
Base:	Vinyl
Wall Finish:	Gypsum Wallboard/Paint
Ceiling:	Acoustical Tile
Ceiling Height:	10'-0"
Noise (STC Rating):	30
Slab Depression:	None
Special Construction:	-
Hardware:	69
Doors:	(2) 3'-0" X 7'-0" wood or metal with upper half laminated safety glass
Windows:	None Required but Desirable

HVAC:

Individual Room	
Temperature Control:	70° - 75° (year-round) 30% - 50% RH
Min. Air Changes/Hour:	6 AC/H
Return Air:	Permitted
Min. % Outside Air:	15%
Pressure:	Negative (-)
Noise Criteria:	NC 45
Individual Room Temperature:	Required

Electrical:

Lighting Levels:	
Gen. Illum:	30fc
Emergency Power:	
One Ceiling Light	
Nurse Call	

Outpatient Center

2.8.3 Recreation Therapy Room, Group**Equipment Table:**

SYMBOL	QUANTITY	AI	DESCRIPTION
	1	VV	WORKBENCH 30"W x 60"L x 32"H
	1	VV	CABINET, FILING (LETTER), 5-DRAWER, 15" x 25" x 60"
	1	VV	TABLE, COMPUTER (PC), 24"W x 48"L x 30"H
	AR	VV	TABLE, POOL 98" x 54"
	AR	VV	RACK, CUE, WALL
	1	VV	BULLETIN BOARD, APPROX. 36" x 36"
	AR	VV	COAT HOOKS
	1	VV	CABINET, TOOLS, 2-DOOR, 3 SHADOW BOARDS, FOUR DRAWERS ALL WITH LOCKS
	2	VV	CABINET, STORAGE, METAL, 2-DOOR WITH LOCK
	AR	CC	RECEPTACLE, ELECTRICAL, DUPLEX, 120 VOLT, 20 AMP
	1	VV	TABLE, PING PONG 48" x 96"
	1	VV	CABINET, ASSEMBLY WITH 2 UNDERCOUNTER UNITS WITH 1 DRAWER EACH, 1 HINGED DOOR AND 1 ADJ. SHELF, SINK CABINET TO HAVE 2 HINGED DOORS, WALL CABINETS TO BE WITH SLOPING TOP AND 2 GLAZED SLIDING DOORS AND 2 ADJ. SHELVES, COUNTER TOP OF CORROSION RESISTING STEEL WITH INTEGRAL BACKSPLASH AND SINK (18" x 20" x 7 ½") WITH PLASTER TRAP, REMOVABLE STRAINER AND SWING SPOUT FAUCET.
	1	VV	CLOCK, BATTERY OPERATED
	AR	VV	RECEPTACLE, WASTE, 13" DIAMETER

Outpatient Center

2.8.3 Recreation Therapy Room, Group**Equipment Table Continued:**

SYMBOL	QUANTITY	AI	DESCRIPTION
	1	CC	LAVATORY, STRAIGHT, BACK, WRIST CONTROL, GOOSENECK SPOUT, 20" x 18" & 3 ½" APRON
	1	VV	DISPENSER, SOAP, LIQUID, WALL MOUNTED
	1	VV	DISPENSER, BIFOLD PAPER TOWEL, WALL MOUNTED

Outpatient Center

2.8.4. Gait & Balance Lab – 600 NSF [55.73 NSM]

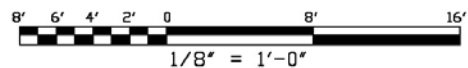
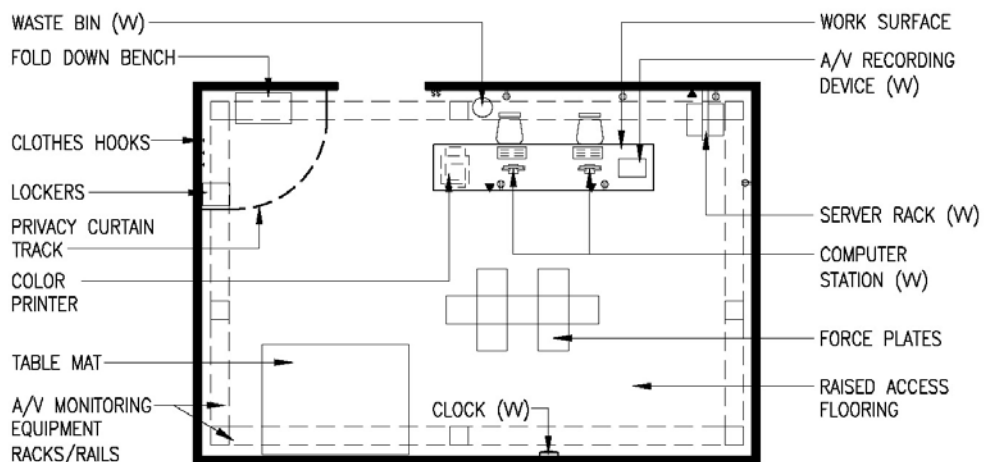

2.8.4 Gait & Balance Lab Reflected Ceiling Plan

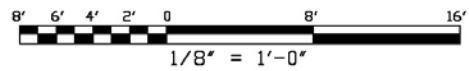
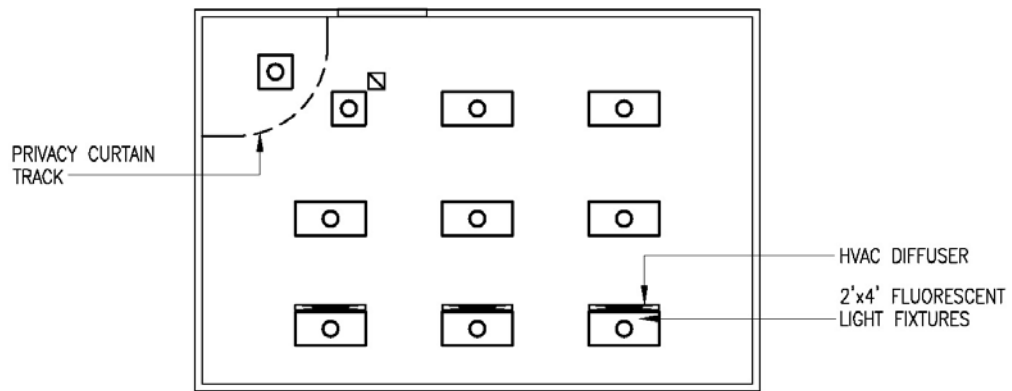

Function:

This space is intended to provide for the examination and determination of PolyTrauma Outpatients' gait performance and therapy progress..

Space Requirement:

600 NSF

Architectural:

Floor Finish:	Vinyl Composition Tile
Base:	Vinyl
Wall Finish:	Gypsum Wallboard/Paint
Ceiling:	Acoustical Tile
Ceiling Height:	10'-0"
Noise (STC Rating):	40
Slab Depression:	None
Special Construction:	-
Hardware:	69
Doors:	3'-0" x 7'-0" wood or metal
Windows:	Observation, safety glazing in metal frame

HVAC:

Individual Room	
Temperature Control:	70° - 75° (year-round) 30% - 50% RH
Min. Air Changes/Hour:	4 AC/H
Min. % Outside Air:	50%
Pressure:	Negative (-) Supply = exhaust 15%
Noise Criteria:	Max. 40 NC
Return Air:	Permitted
Individual Room Temperature:	Required

Electrical:

Lighting Levels:	
General Illum:	30fc
Emergency Power:	
One Ceiling Light	
One Receptacle	
Nurse Call	

Outpatient Center

2.8.4 Gait & Balance Lab**Equipment Table:**

SYMBOL	QUANTITY	AI	DESCRIPTION
	AR	VV	ACCESS FLOOR, RAISED
	1	VV	CLOCK, BATTERY OPERATED
	AR	VV	CLOTHES HOOKS, WALL MOUNTED
	1	VV	LOCKERS, STEEL, DOUBLE TIER, 15" x 18" x 78"
	1	VV	FOLD DOWN BENCH
	AR	CC	RECEPTACLE, ELECTRICAL, DUPLEX, 120 VOLT, 20 AMP
	1	VV	WORK SURFACE, 30" DEEP WTH GROMMETS AS REQUIRED
	AR	VV	CHAIR, TASK, WITHOUT ARMS
	AR	VV	COMPUTER / PRINTER
	AR	VV	AUDIO/VISUAL RECORDING EQUIPMENT
	AR	VV	SERVER RACK
	AR	VV	AUDIO/VISUAL MONITORING EQUIPMENT RACKS & RAILS
	1	VV	TABLE, MAT 72" x 96"
	AR	CC	FORCE PLATES
	1	VV	RECEPTACLE, WASTE, 13" DIAMETER

Outpatient Center

2.8.5. Exam Room – 120 NSF [11.14 NSM]

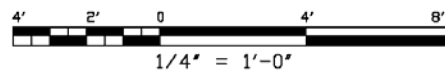
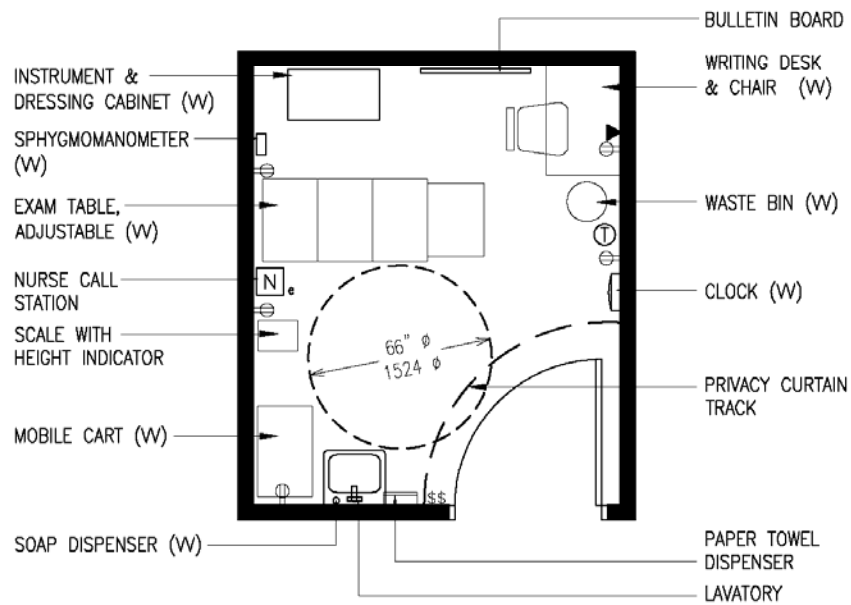

2.8.5 Exam Room Reflected Ceiling Plan

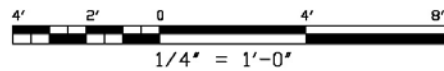
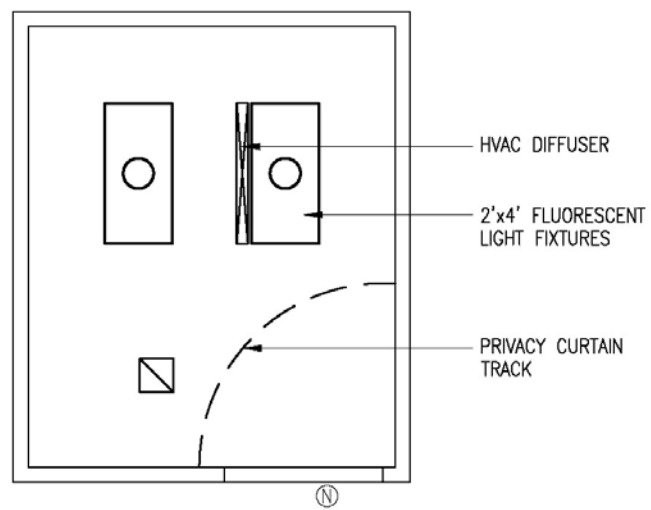

Function:

This space is intended to provide for the examination of PolyTrauma Outpatients. It should be adjacent to the Physician's Office.

Space Requirement:

120 NSF

Architectural:

Floor Finish:	Vinyl Composition Tile
Base:	Vinyl
Wall Finish:	Gypsum Wallboard/Paint
Ceiling:	Lay-in Gypsum Panels
Ceiling Height:	9'-0"
Noise (STC Rating):	40
Slab Depression:	None
Special Construction:	-
Hardware:	4
Doors:	4'-0" x 7'-0" wood or metal
Windows:	None Required

HVAC:

Individual Room	
Temperature Control:	70° - 75° (year-round) 30% - 50% RH
Min. Air Changes/Hour:	4 AC/H
Min. % Outside Air:	50%
Pressure:	Neutral (0)
Noise Criteria:	Max. 35 NC
Return Air:	Permitted
Individual Room Temperature:	See HVAC Design Manual

Electrical:

Lighting Levels:	
Two-level illumination:	
High:	100fc
Low:	50fc
Emergency Power:	
One Ceiling Light	
One Receptacle	
Nurse Call	

Outpatient Center

2.8.5 Exam Room

Equipment Table:

SYMBOL	QUANTITY	AI	DESCRIPTION
	1	VV	TABLE, EXAMINING, PADDED, ADJUSTABLE TOP
	1	CC	LAVATORY, ELECTRONIC SENSOR CONTROL FAUCET WITH RIGID GOOSENECK SPOUT, 20" x 18" & 3 1/2" APRON
	1	CC	DISPENSER, PAPER TOWEL AND DISPOSAL COMBINATION UNIT
	1	CC	DISPENSER, SOAP WITH FOOT CONTROL, WALL MOUNTED OVER SINK
	1	VV	CABINET, INSTRUMENT & DRESSING, APPROX. 30"W x 16"D x 60"H
	1	VV	CART, MOBILE, 18"W x 30"L x 36"H
	1	VV	CLOCK, BATTERY OPERATED
	1	VV	SCALE WITH HANDRAILS, PLATFORM TYPE, 500LB CAPACITY WITH HEIGHT INDICATOR
	1	VV	HAMPER, SOILED LINEN, HINGED SELF-CLOSING TOP
	1	VV	HOOK, COAT, WALL MOUNTED
	1	CC	PHONE/DATA JACK
	1	CC	NURSE CALL EMERGENCY STATION WITH CORRIDOR SIGNAL LIGHT CONNECTED TO NEAREST NURSE CONTROL STATION
	AR	CC	RECEPTACLE, ELECTRICAL, DUPLEX, 120 VOLT, 20 AMP
	1	VV	DESK, W/ DRAWERS & BOOKSHELF, APPROX. 24"D x 36"W x 29"H
	1	VV	CHAIR, TASK, WITHOUT ARMS
	1	VV	SPHYGMOMANOMETER, WALL HUNG
	1	VV	RECEPTACLE, WASTE, 13" DIAMETER