

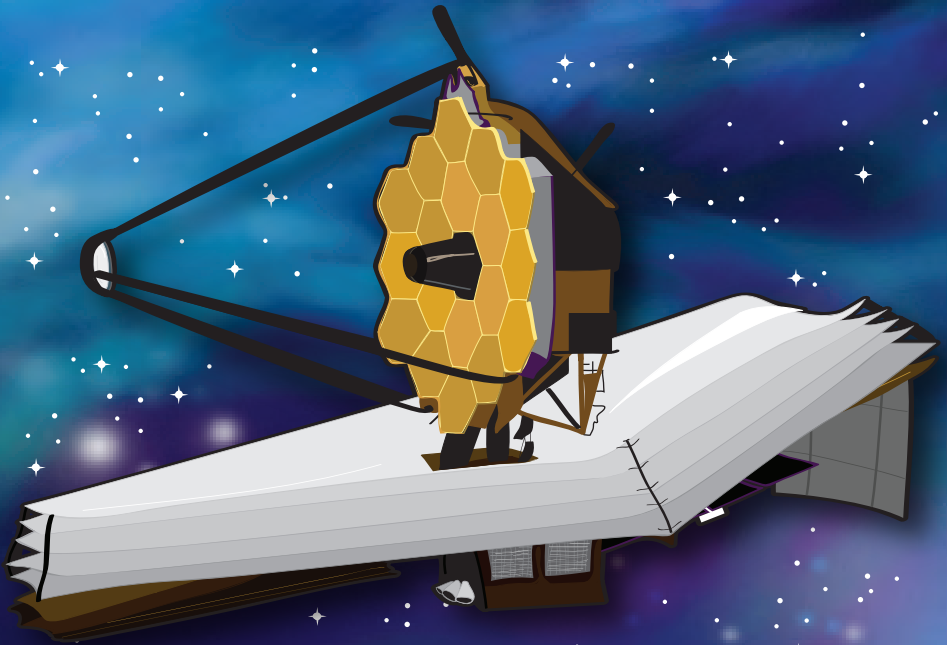

James Webb Space Telescope

Webb Telescope Fun Pad

PACKED WITH THINGS TO DO!



Note to Parents:

This Fun Pad is designed for ages 5 - 10 years old and is divided into sections.

- The front section contains general information about Webb Telescope
- The middle section contains activities for younger children
- The back section contains more challenging activities

**EXPLORE
MORE**

For more information on NASA and the Webb Telescope, visit these web sites:

<http://education.nasa.gov>

<http://nasascience.nasa.gov/>

<http://www.jwst.nasa.gov/>

<http://www.nasa.gov/hubble>

<http://www.stsci.edu/jwst/>

WEBB TELESCOPE

Mission logo



This is the Webb telescope mission patch. The National Aeronautics and Space Administration (NASA), the European Space Agency (ESA), and the Canadian Space Agency (CSA) are working together to create and build this new telescope.

JAMES WEBB

A man and his telescope



The Webb telescope was named after the person who was the head of NASA in the 1960s. Though he is most commonly linked to the Apollo Moon Program, James Webb was the one who thought NASA should be doing more science. Because he inspired NASA's successful science program, it is only fitting that the next generation space telescope bears his name.

HUBBLE IN SPACE

Connect the dots to see Hubble

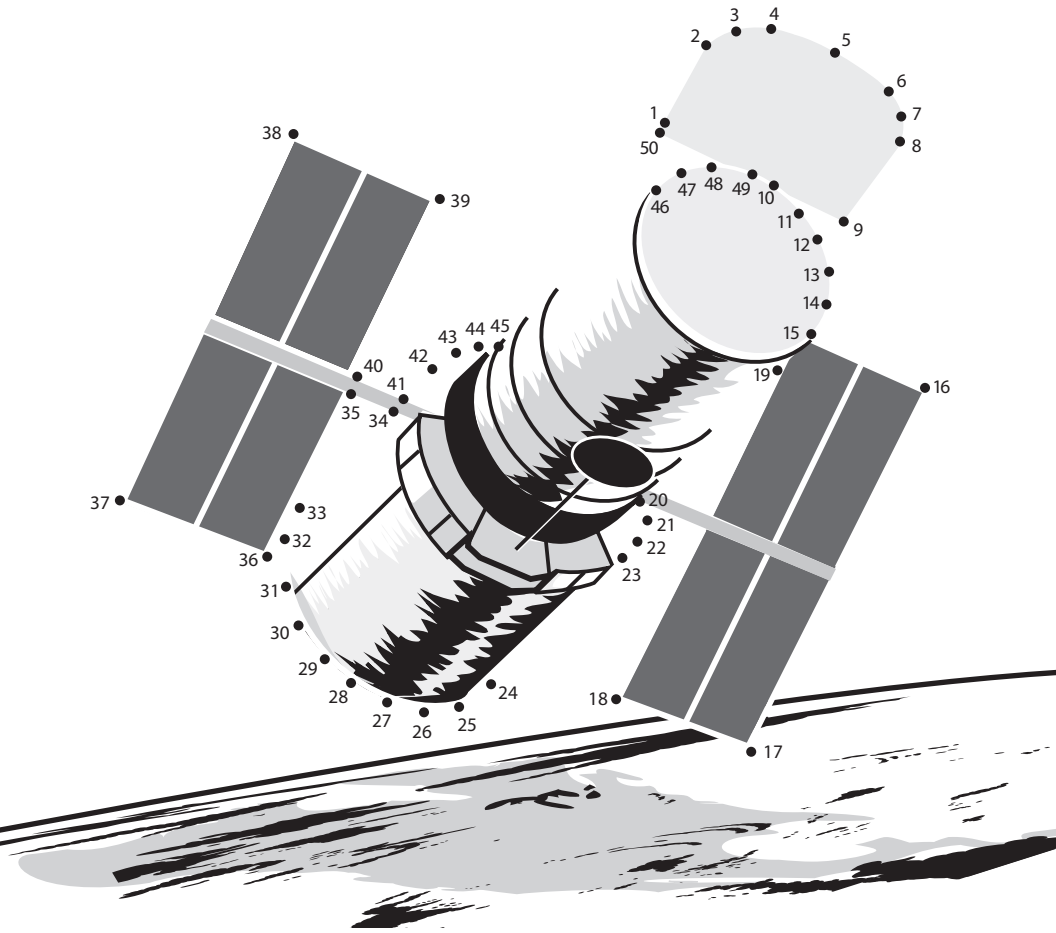

The Hubble Space Telescope was launched into space in 1990. After more than 20 years and a few upgrades, Hubble keeps sending back beautiful images and helping scientists to learn about the universe. The Webb telescope will be the “big brother” to Hubble and scientists expect great discoveries and wonderful images from the Webb telescope.

LEARN ABOUT WEBB TELESCOPE

Fun facts

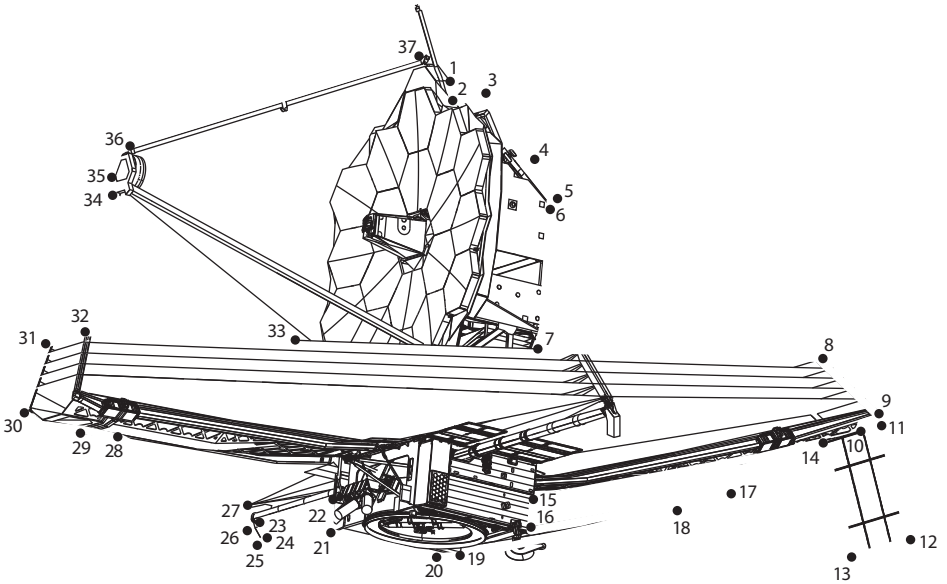

The Webb telescope will have the largest mirror ever placed in space, so large that for it to fit in the rocket, it will have to be folded like origami. The five layer sunshield, the size of a tennis court, will protect the telescope from the light and heat of the Sun, Earth, and Moon. The sunshield adds protection to the telescope that is equivalent to SPF 1,000,000. Webb will be such a powerful telescope that it will be able to see a penny from 24 miles away.

The Webb will be a giant leap forward in our quest to understand the universe and our origins. The Webb will examine every phase of cosmic history: from the bright glows after the Big Bang to the formation of galaxies, stars, and planets to the evolution of our own solar system.

MIRROR... MIRROR

Count and write in the number of segments in the Webb mirror

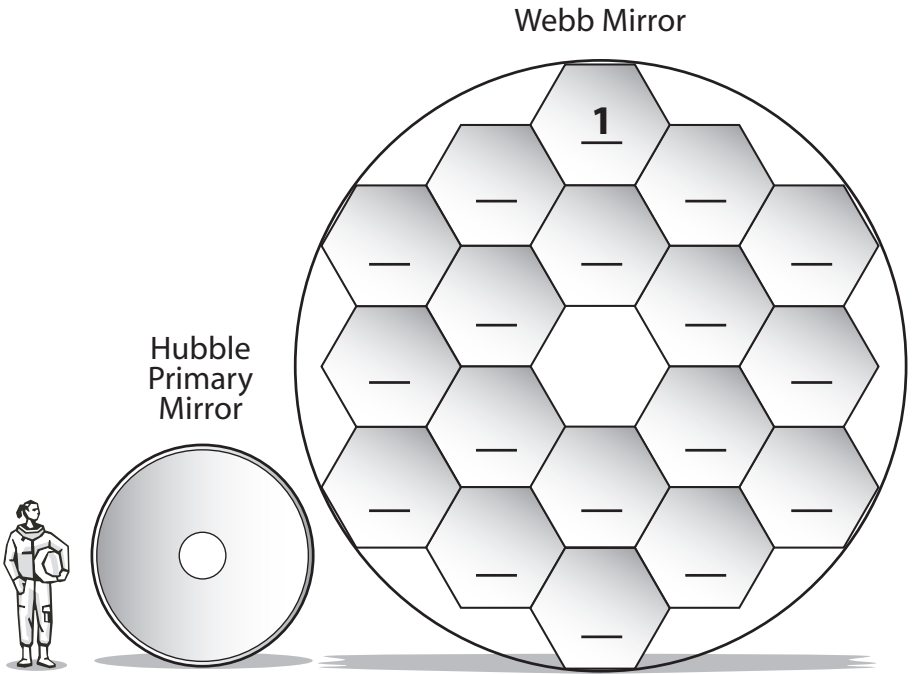

The Webb mirror is very large and will collect 7 times more light than Hubble's mirror. However, a large, solid mirror (like Hubble's) would be too heavy to launch into space, Webb's is made up of 18 mirror segments that will act as one. The mirror segments will be folded up and put inside the rocket for launch.

A NEW IDEA TO SEE BETTER

How microshutters work



One of the science instruments on the Webb telescope has a new way of looking at faint, far away galaxies. It uses something called microshutters. To get an idea of how this works, think about how you would make something far away look clearer—just squint! By squinting, your eyelashes block out the light closest to you. This is very similar to how microshutters work.

READY TO LAUNCH

Find out how Webb folds up and fits into the launch rocket nose cone

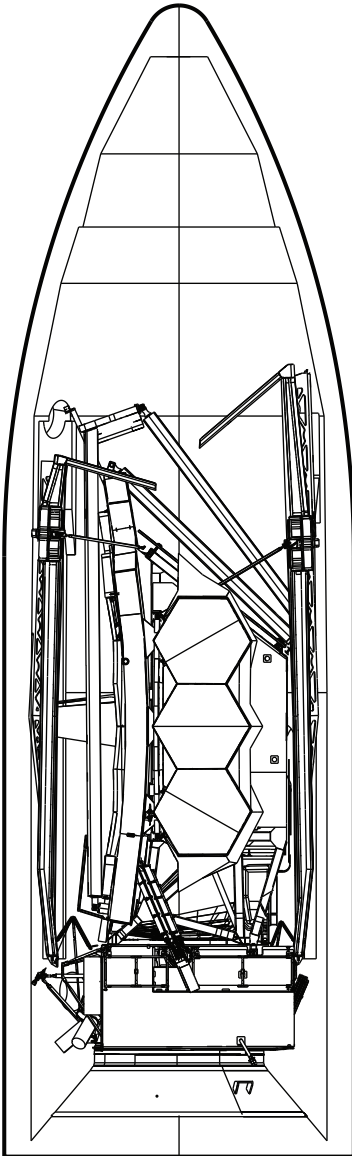

The Webb telescope is as wide as a tennis court and as tall as a 3-story building.

It is too big to fit into a rocket, so Webb will be folded up like origami and tucked inside the nose of the rocket.

Once in space, the telescope will open like a transformer.

WEBB TELESCOPE IN SPACE

How far away will it be?

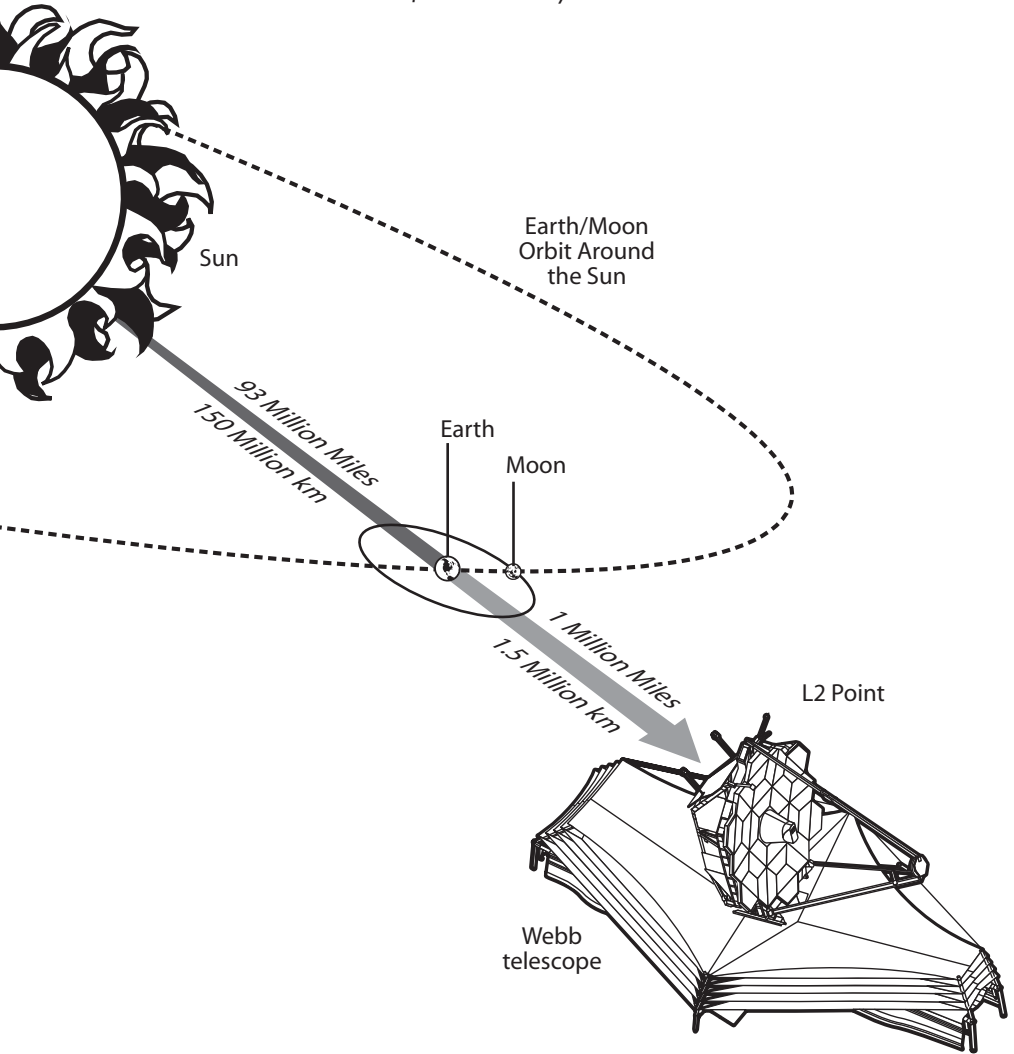

The Webb telescope will live 1 million miles from Earth. This is nearly 4 times the distance between the Earth and the Moon.

DOWNLOADING DATA

How does the information get to us?

There are three stages in getting the data from Webb to the ground:

- 1 The Webb gathers the data
- 2 The Webb sends the data down to ground stations on Earth
- 3 The data is sent to the Science Center

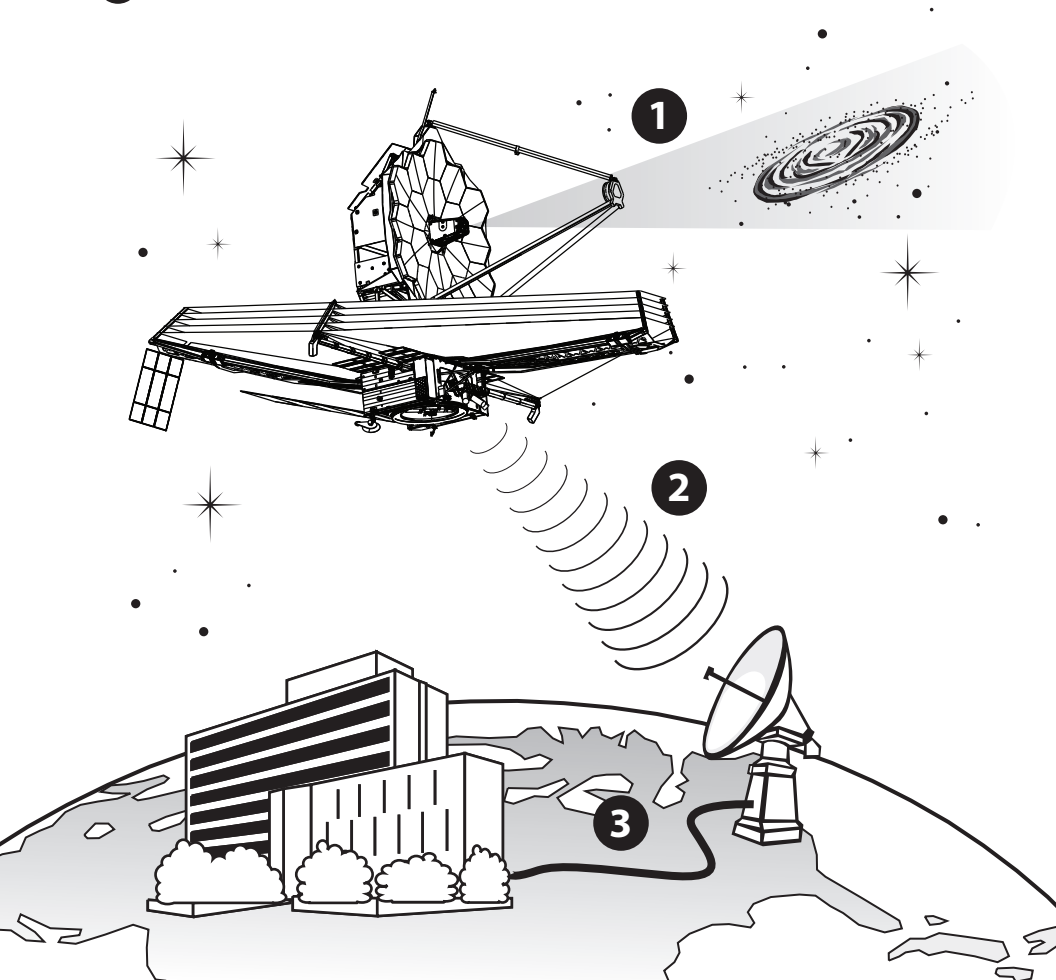

INFRARED IMAGING

How Webb will see objects in space



Infrared light can be seen through some materials that visible light cannot. Notice that in the visible light image, you cannot see the man's hand in the black bag. With an infrared camera, however, we can detect the heat from the man's arm and hand and thus "see" through the bag. Similarly, Webb can detect the infrared light from young stars hidden in clouds and dust.

SEEING IN A NEW LIGHT

Infrared facts

Can you tell what animals are in these pictures?

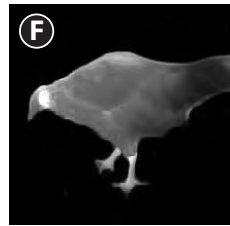
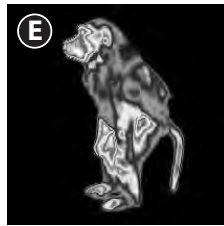
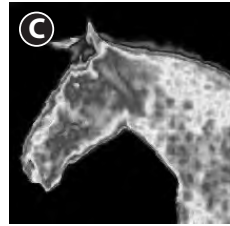
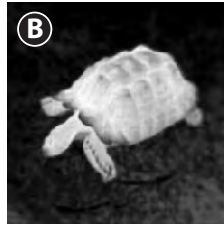
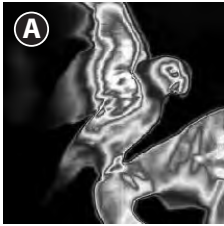

A. _____

D. _____

B. _____

E. _____

C. _____

F. _____

To make infrared pictures like the ones above, we can use special cameras that sense heat. Many things besides people and animals give off infrared light — the Earth, Sun, and far away things like stars and galaxies do also!

FILL IN THE NUMBERS

Write in the missing digits

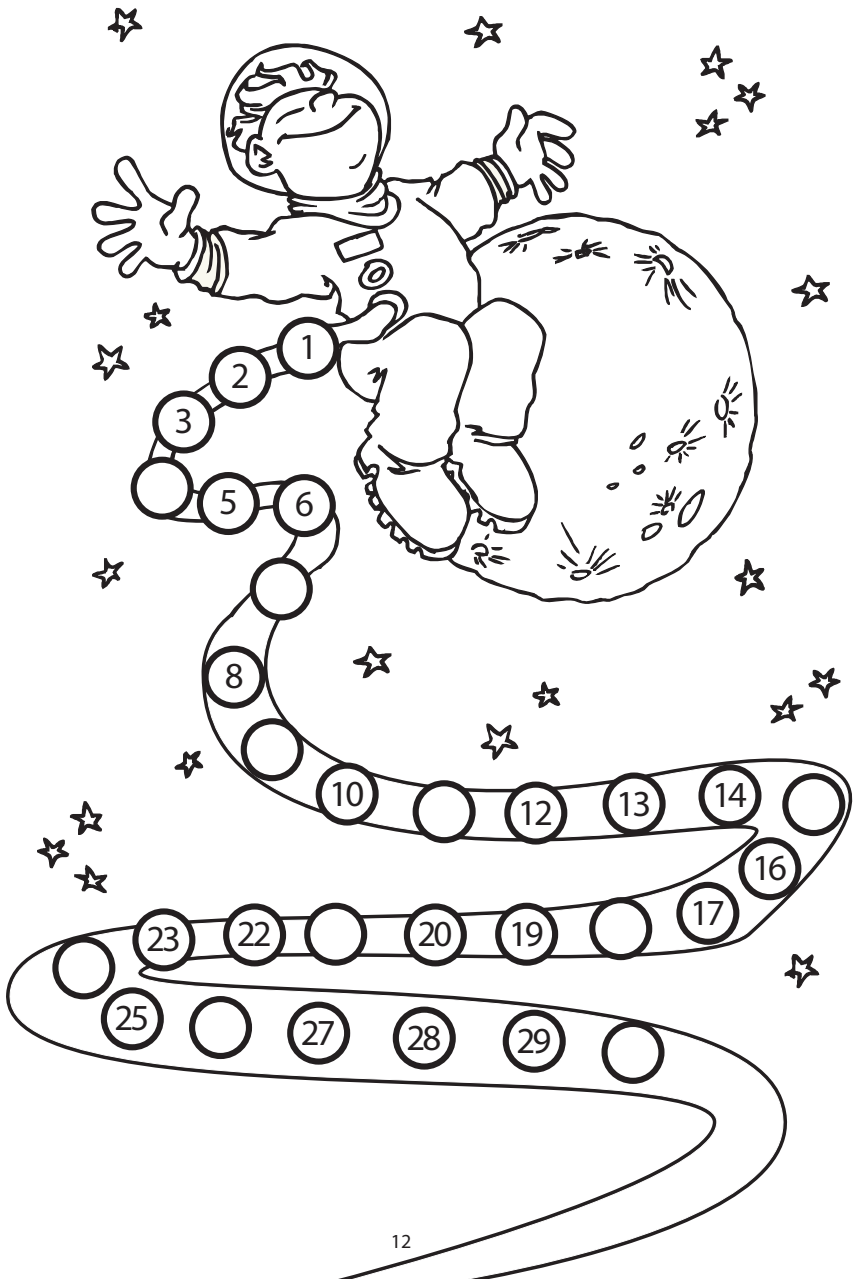

MAKE A MATCH

Draw a line between the matching pictures and words

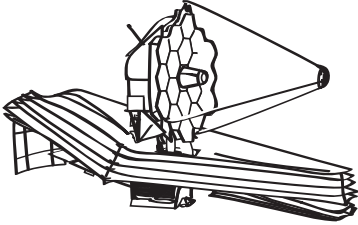

Hubble
Telescope



Galaxy

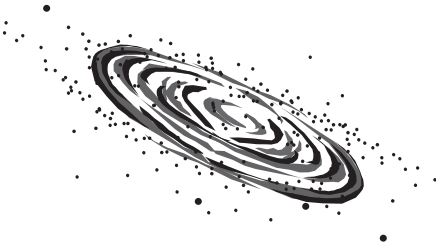

Webb
telescope

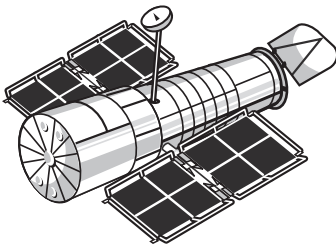

Earth

DRAW A FACE ON THE STAR

Make it sad, mad, or glad!

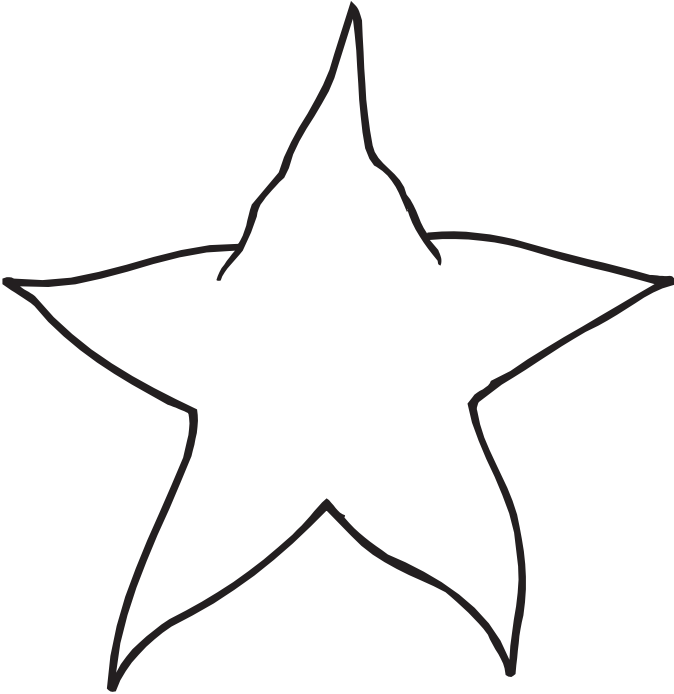

SAD



MAD



GLAD

LOOKING DIFFERENT

Circle the one that is not the same

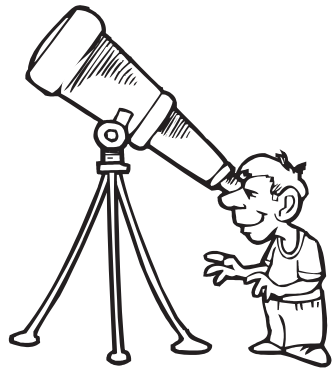
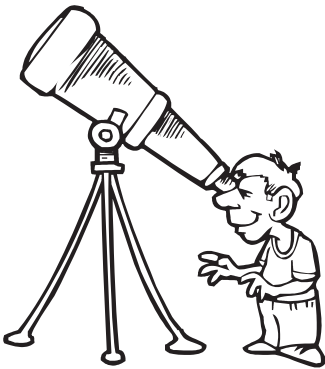
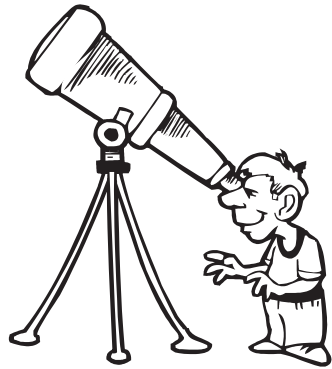
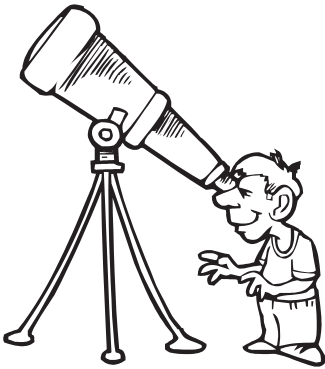
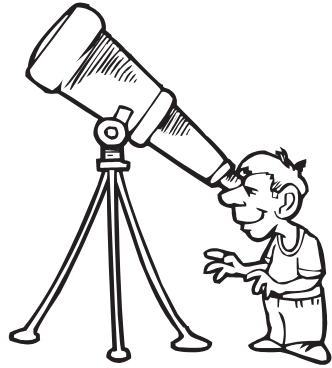
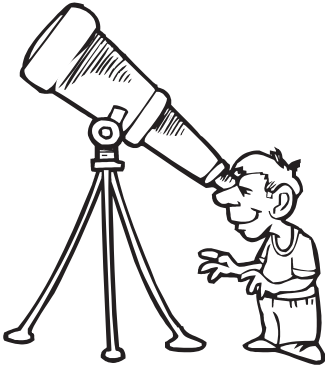

COLOR THE WEBB TELESCOPE

Make this a work of art and space

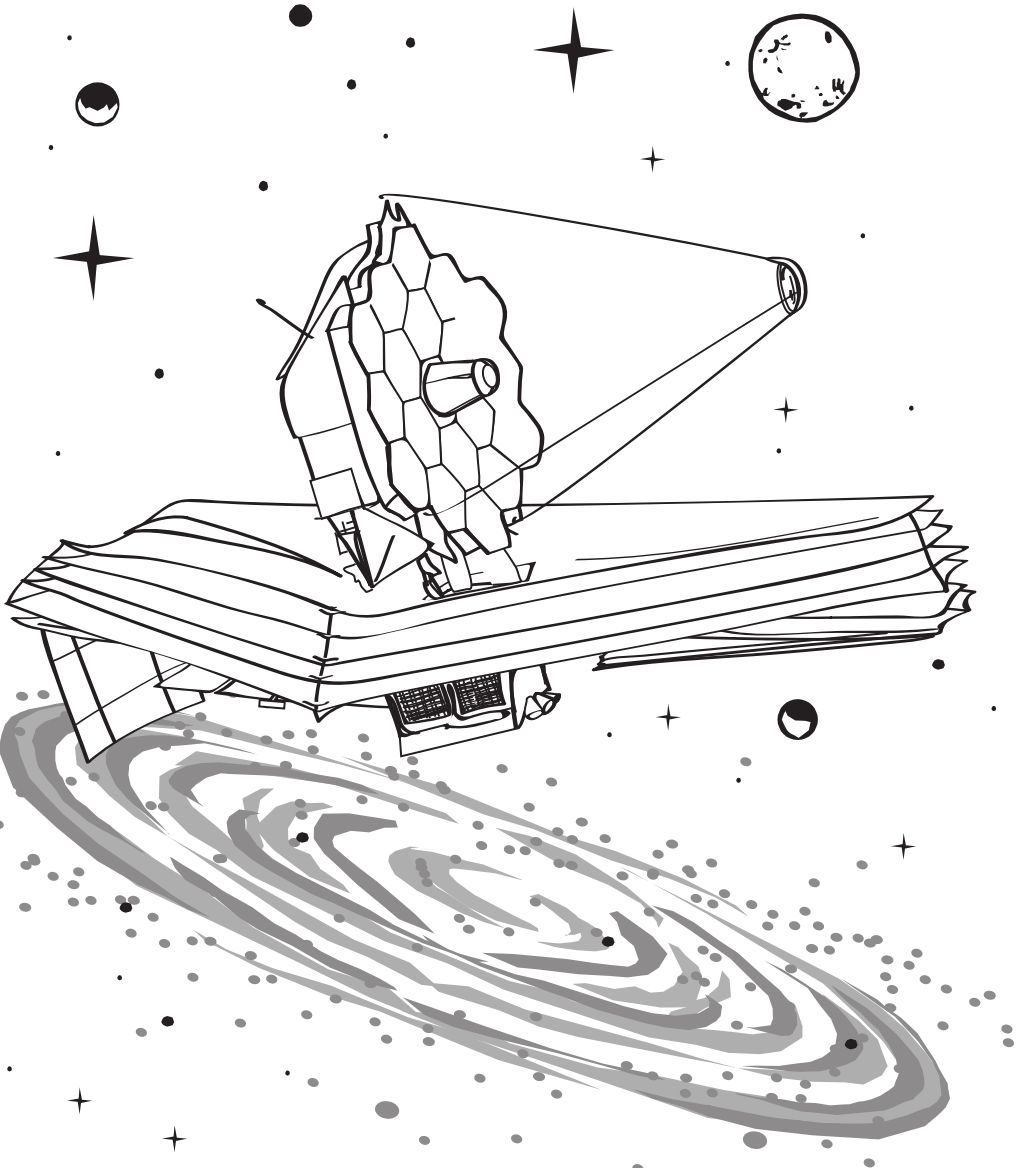

MIX AND MATCH

Draw a line from the shape to its shadow

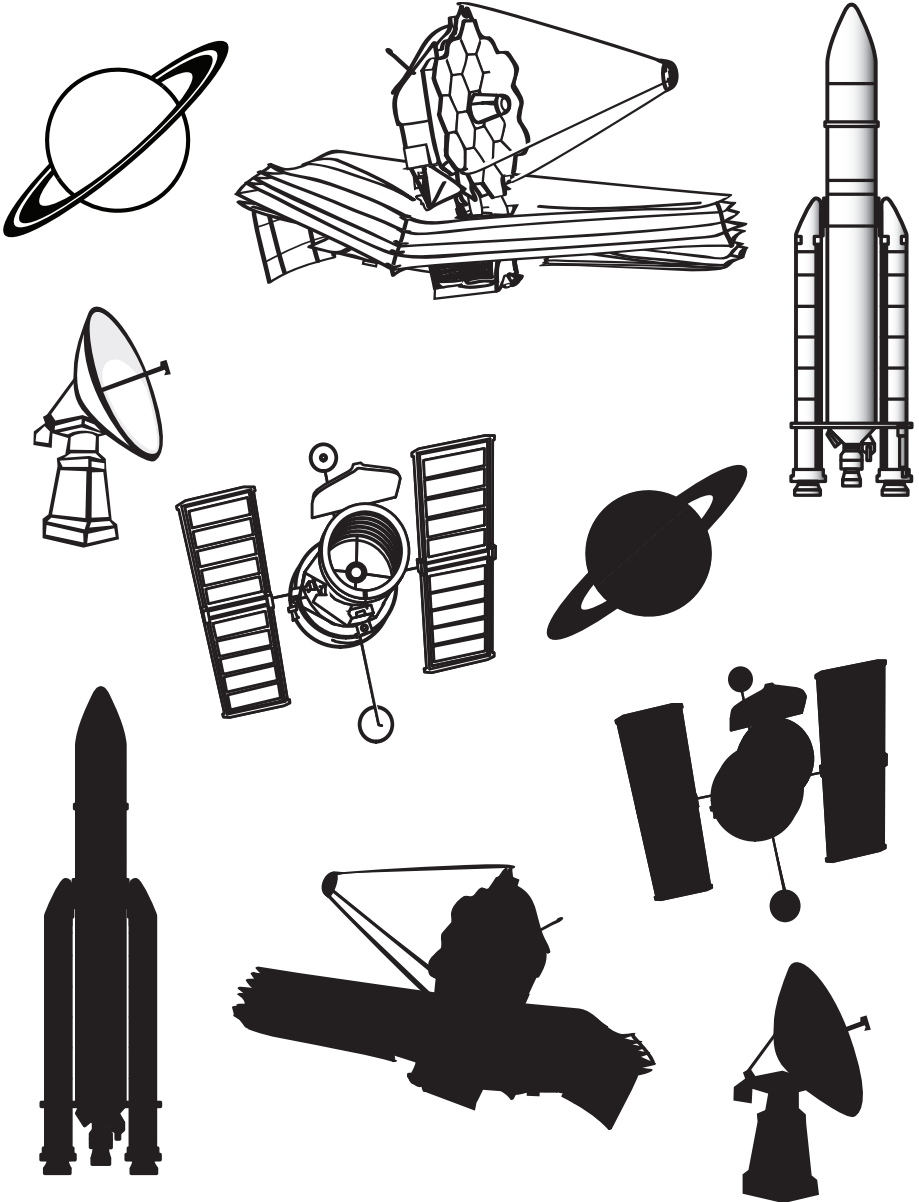

MOON DOGGIE

Color-by-number space dog

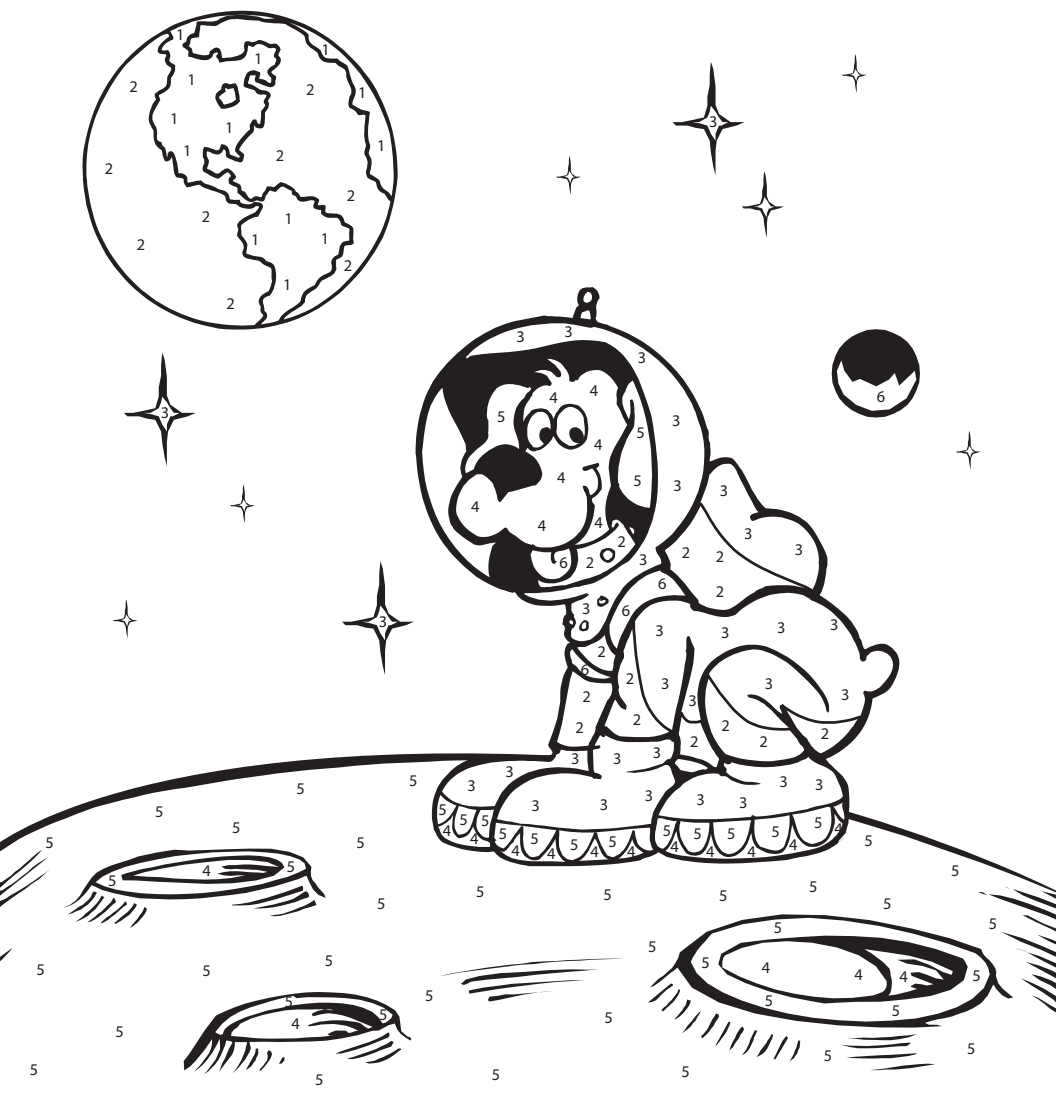

- | | |
|----------------|-----------|
| 1 - Green | 4 - Brown |
| 2 - Blue | 5 - Tan |
| 3 - Light Blue | 6 - Red |

IS IT FREEZING IN SPACE?

Connect the dots to see a cold spot



The snowman's temperature is around 27° Fahrenheit (-3° Celcius).
The Webb telescope has to stay at -400° F (-240° C) below zero.

WHAT DOES NOT BELONG?

Circle the one that doesn't belong

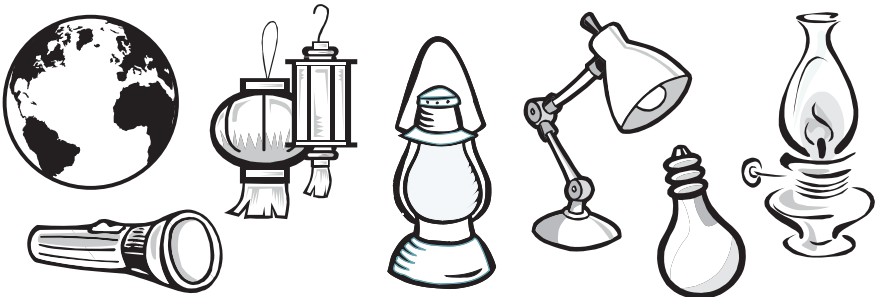
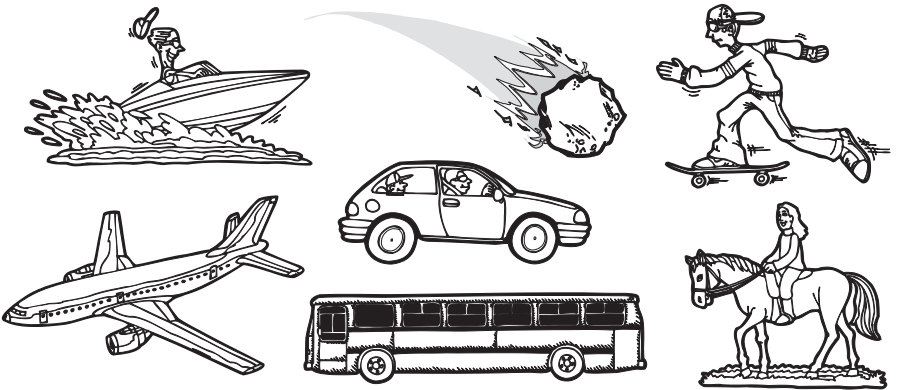
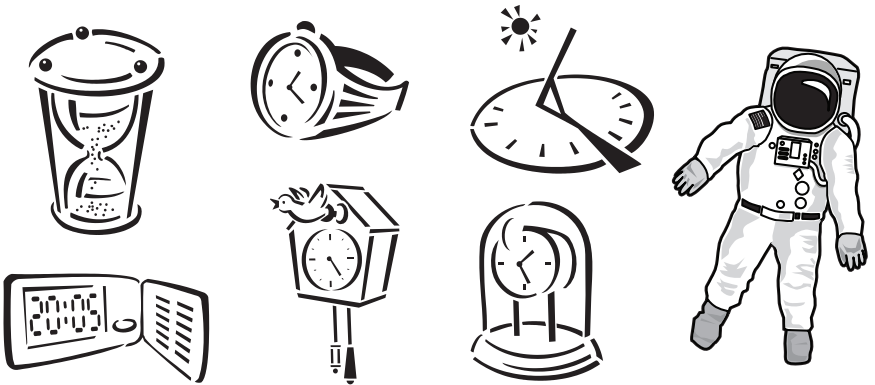

WHAT COMES NEXT?

Draw the picture that comes next in each row

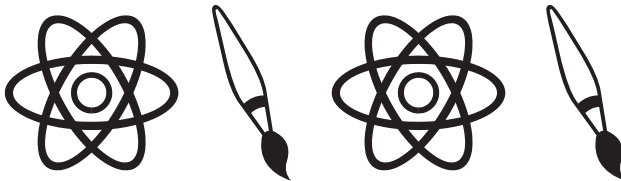
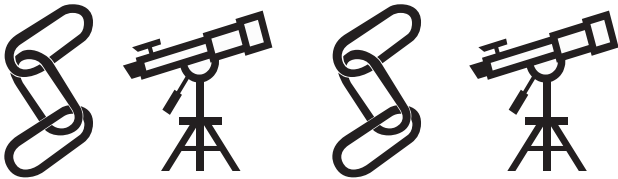

WHAT ARE ASTRONOMERS?

Find and circle these shapes



An astronomer is a scientist who studies celestial bodies such as planets, stars, and galaxies. NASA has many astronomers who will use the Webb telescope to look at new and wondrous things.

DRAWING THE LINE

Draw a line between the pictures and the words that match

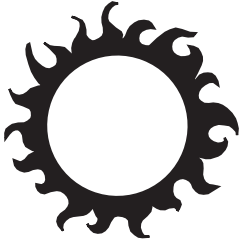

Webb
telescope

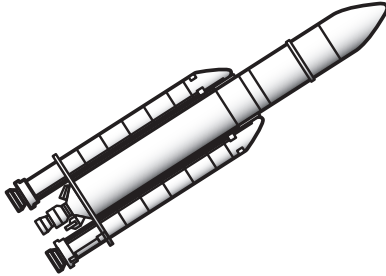

Sun



Rocket

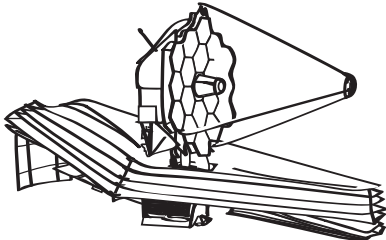

Hexagon

RHYME TIME

What other words rhyme with STAR?

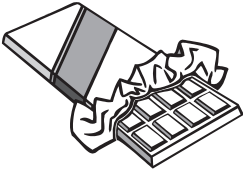

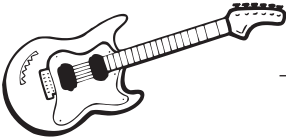





ASTRONAUT COLOR BY NUMBER

Help the astronaut place the flag

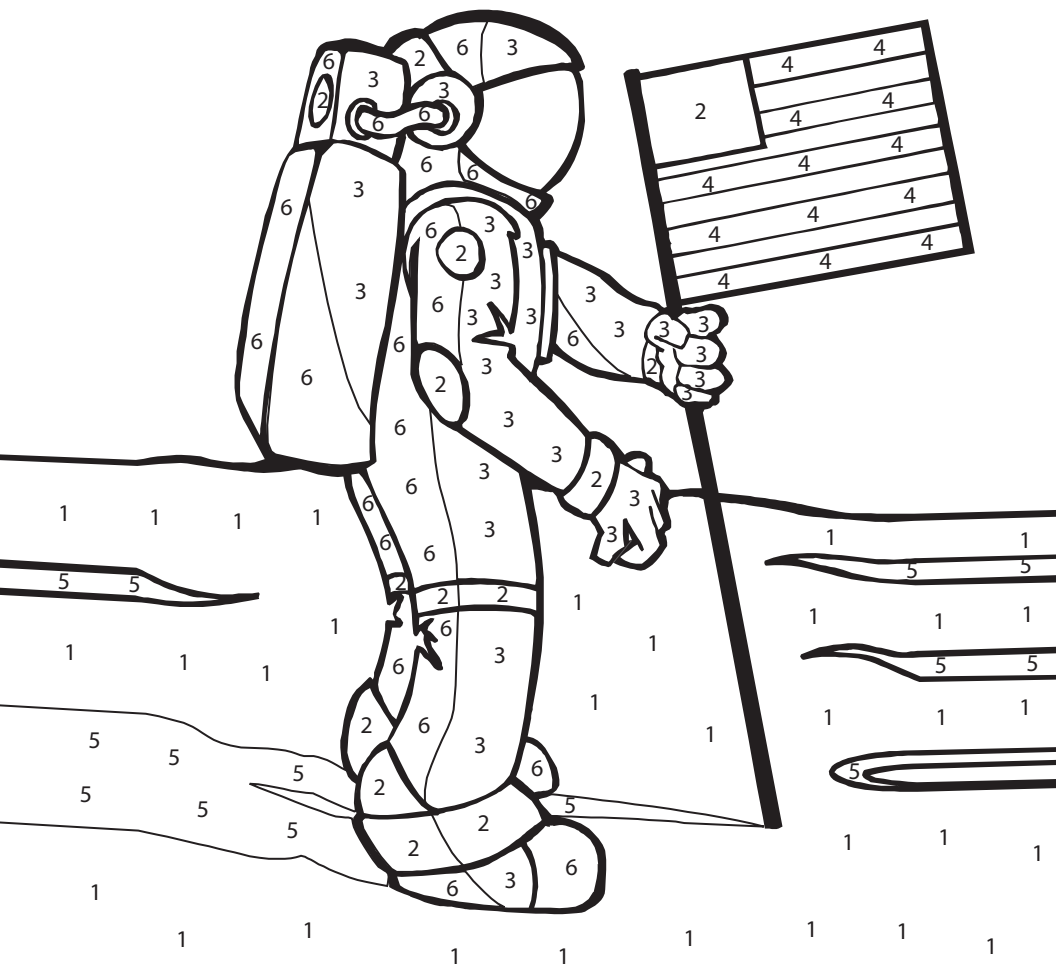

- | | | |
|----------|----------|---------------|
| 1 - Tan | 3 - Gray | 5 - Brown |
| 2 - Blue | 4 - Red | 6 - Dark Gray |

ONE MORE WORD

What word replaces the question mark?

Webb [?]

Hubble Space [?]

Ultraviolet [?]

Optical [?]

Radio [?]

X-ray [?]



DRAWING LESSON

Draw your own space telescope

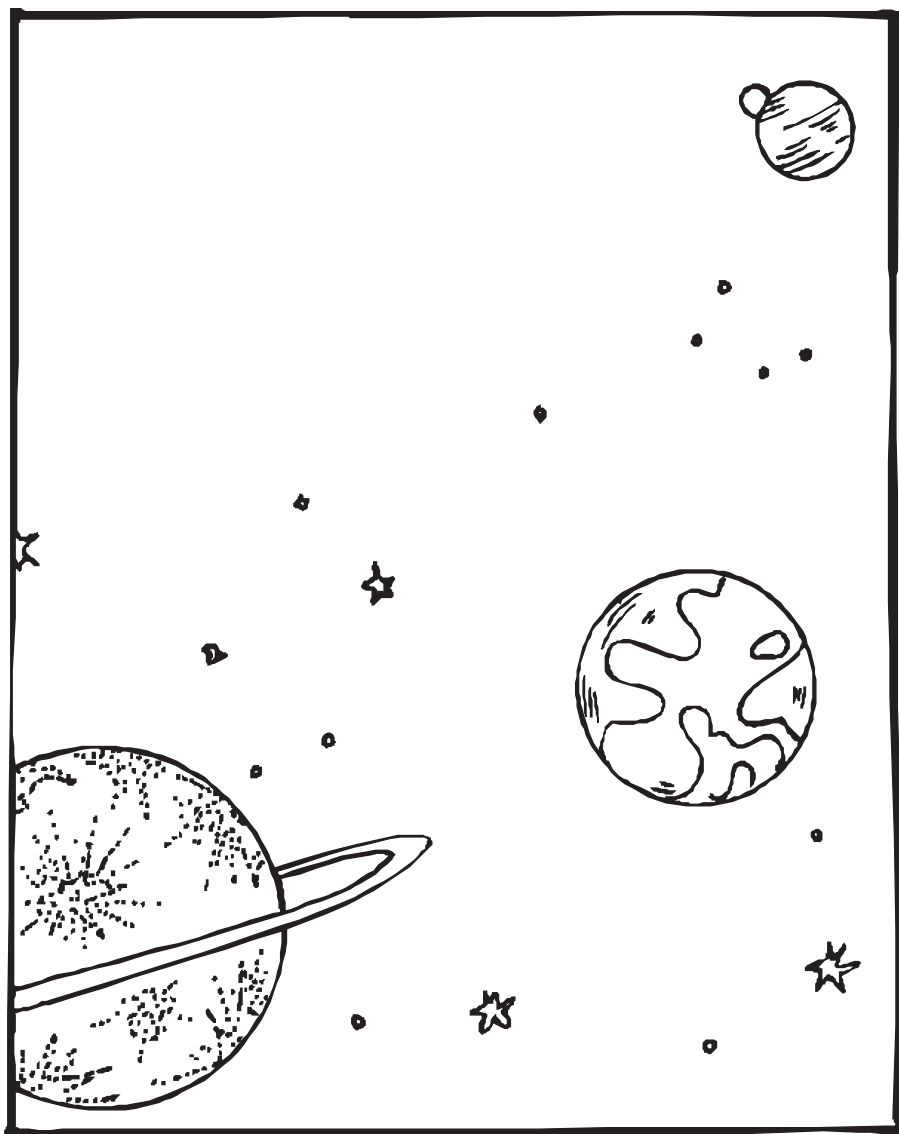

SPACE STUFF

Unscramble the letters to spell space words

XLAYGA

HRATE

NTEPAL

NUHALC

UNS

RSTA

UDLCO

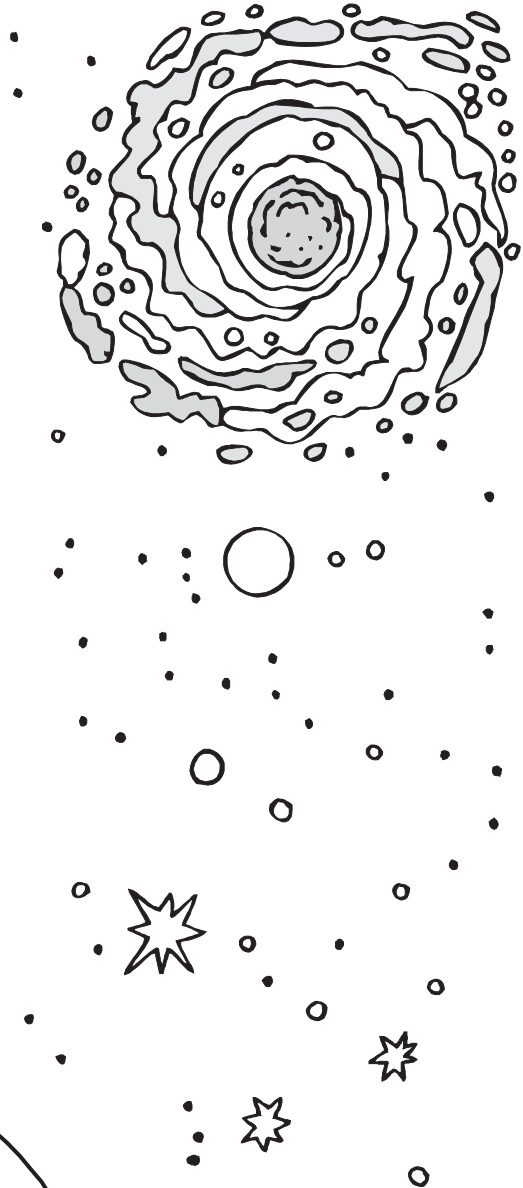

Galaxy, Earth, Planet, Launch, Sun, Star, Cloud

ORDER UP!

Alphabetize these space-related words

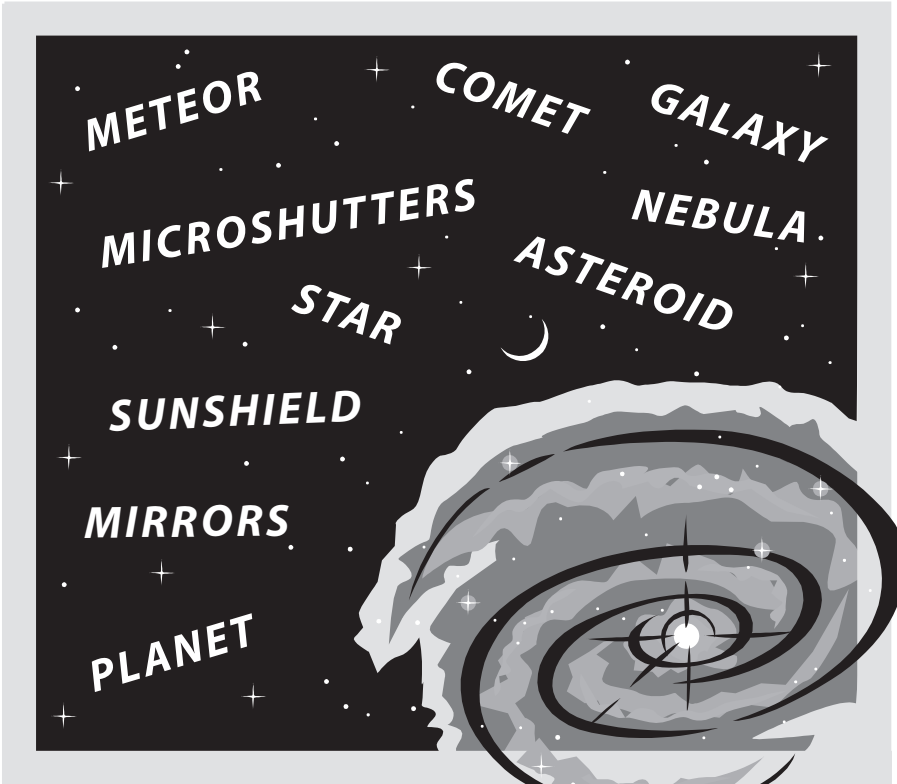

1. _____

6. _____

2. _____

7. _____

3. _____

8. _____

4. _____

9. _____

5. _____

10. _____

Asteroid, Comet, Galaxy, Meteor, Microshutters, Mirrors, Nebula, Planet, Star, Sunshield

A STRONG ELEMENT

How many words can you spell using the letters in BERYLLIUM?

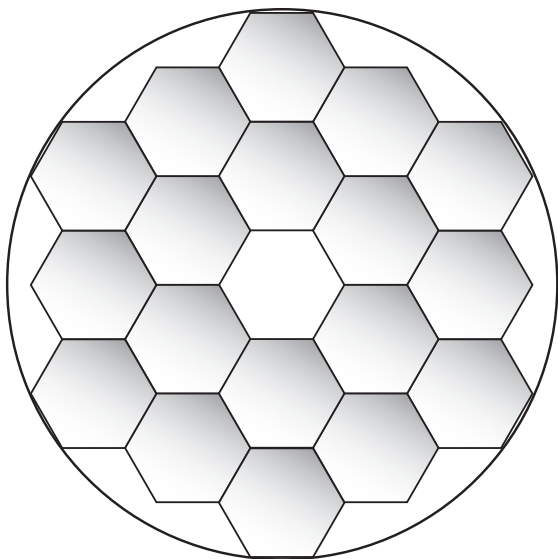

1. _____

6. _____

2. _____

7. _____

3. _____

8. _____

4. _____

9. _____

5. _____

10. _____

Beryllium is a steel grey, strong, light-weight metal that is used to make the Webb's mirrors and optics.

THE PLANETS AROUND US

Name the planets in our Solar System

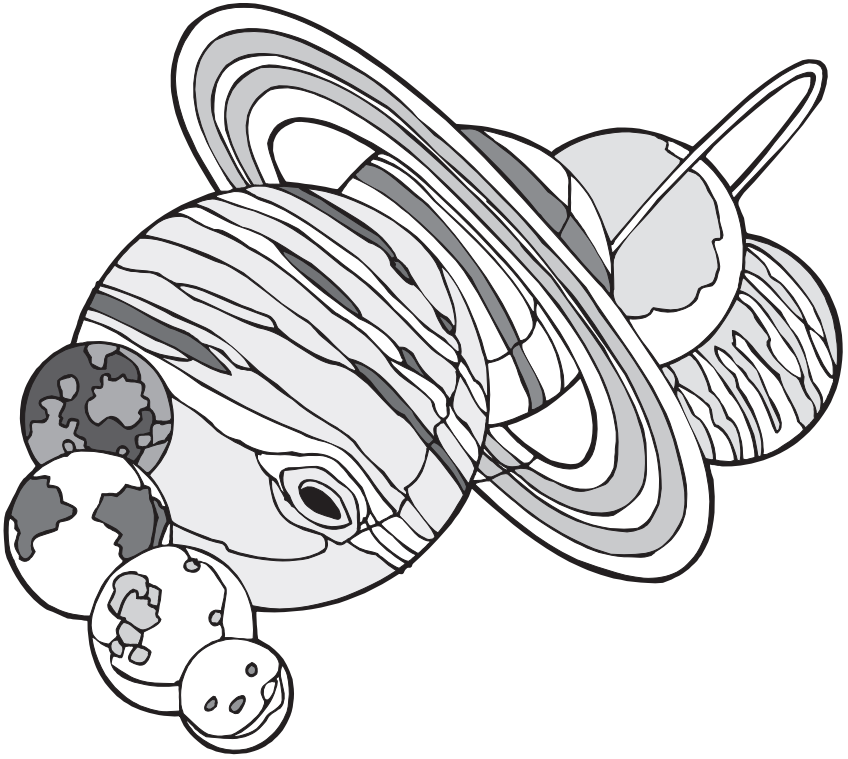

M _____

J _____

V _____

S _____

E _____

U _____

M _____

N _____

HINT: My Very Educated Mother Just Served Us Noodles

CHIP OFF THE OLD UNIVERSE

Chocolate chips and you



The universe continues to grow and the galaxies keep moving farther apart.

One way to understand this is to look at chocolate chips in the dough of unbaked cookies. As the dough bakes and rises, the chocolate chips move farther apart making more space between the chocolate chips.

FIND SOME SHADE

How many times can you find the word "sunshade"?

S	U	A	S	U	S		
U	N	H	U	E	S		
N	S	A	N	E	A		
S	U	N	S	H	A	D	E
H	N	A	H	S	N	U	S
A	S	H	A	U			
D	H	A	D	A			
E	A	A	E	H			
S	D	N	S				
U	E	A	E				
N	U	A	E				

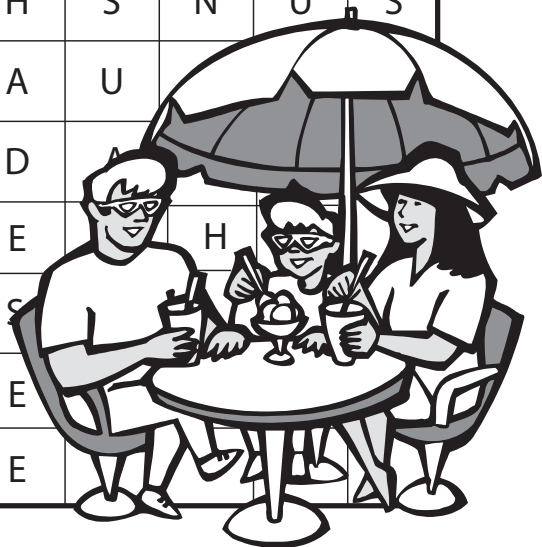
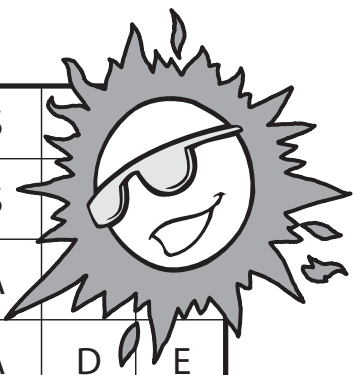

The large sunshield (sunshade) will protect the Webb telescope from getting hot by direct sunlight, allowing it to cool down to a temperature -400° below zero Fahrenheit (or -240° Celcius).

CROSSWORDS

Answer the clues to fill in the word

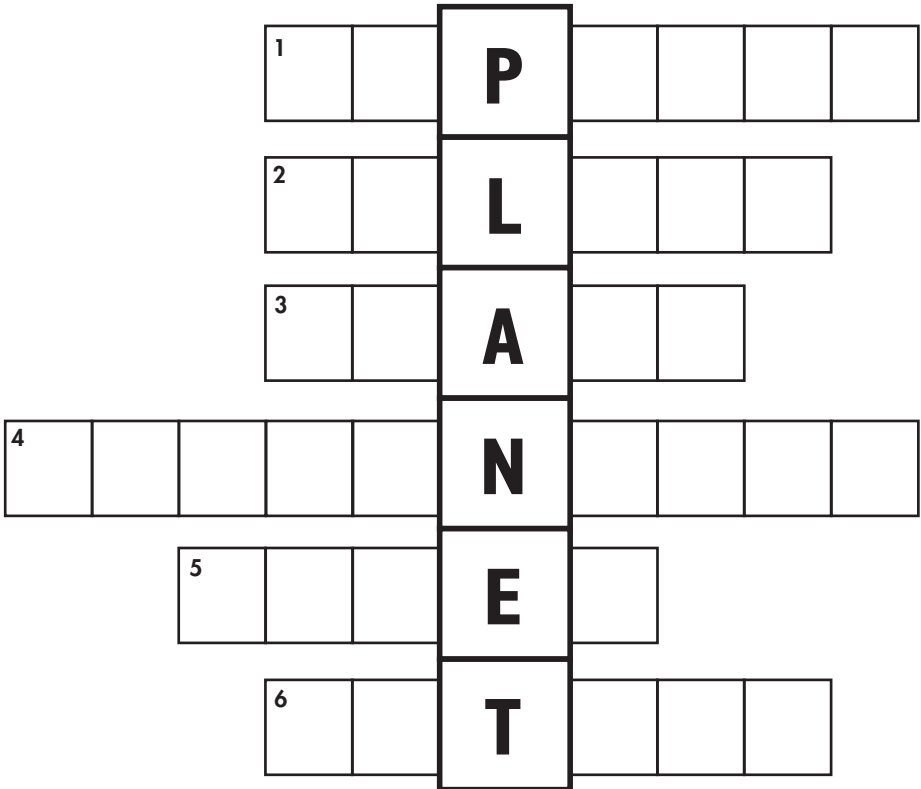

CLUES:

1. The fifth planet from the Sun, the largest and most massive in the solar system
2. Our solar system is in the Milky Way _____
3. Celestial bodies that are seen as points of light in the night sky
4. A scientist who studies planets, stars, and galaxies
5. A small extraterrestrial body that is a frozen mass that travels around the Sun
6. Any small solid extraterrestrial bodies that hits the Earth's atmosphere

LOOK FOR WEBB TELESCOPE WORDS

Search and find

D	E	R	A	R	F	N	I
D	J	D	L	E	I	H	S
O	E	W	A	V	E	T	G
B	E	T	S	K	Y	R	A
S	P	E	C	T	R	A	L
E	O	T	A	T	L	E	A
R	C	E	N	U	S	T	X
V	S	L	B	E	N	H	Y
A	U	E	N	D	E	G	H
T	N	S	C	A	F	I	C
O	O	C	T	A	M	L	N
R	D	O	L	A	P	O	U
Y	N	P	G	N	A	S	A
E	N	E	R	G	Y	E	L

EARTH
ENERGY
GALAXY
HEAT
IMAGE

INFRARED
LAUNCH
LIGHT
✓NASA

NEBULA
OBSERVATORY
SCAN
SCOPE

SENSOR
SHIELD
SKY
SPACE

SPECTRAL
SUN
TELESCOPE
WAVE

COMPARE THE SIZE

Hubble or Webb: Which is bigger?

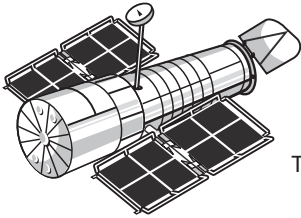

Hubble
Space
Telescope

The Hubble Space Telescope is about the size of a large tractor trailer truck.

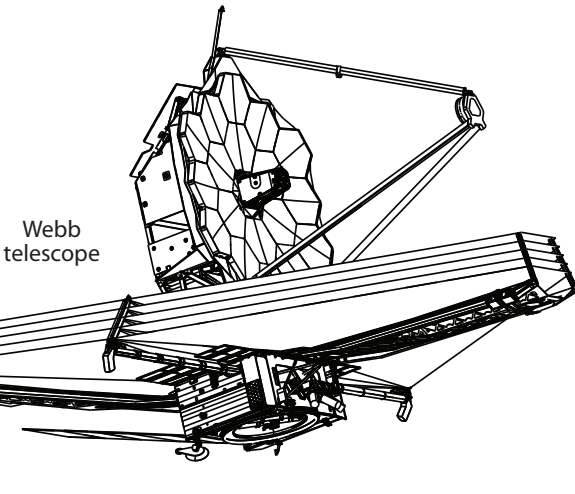
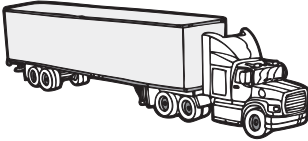

Webb
telescope

The Webb telescope's sunshield is almost as big as a Boeing 737 airplane!

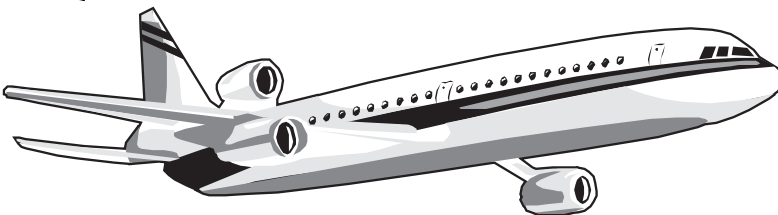

Webb Telescope

CROSSWORDS

Answer the clues to fill in the word

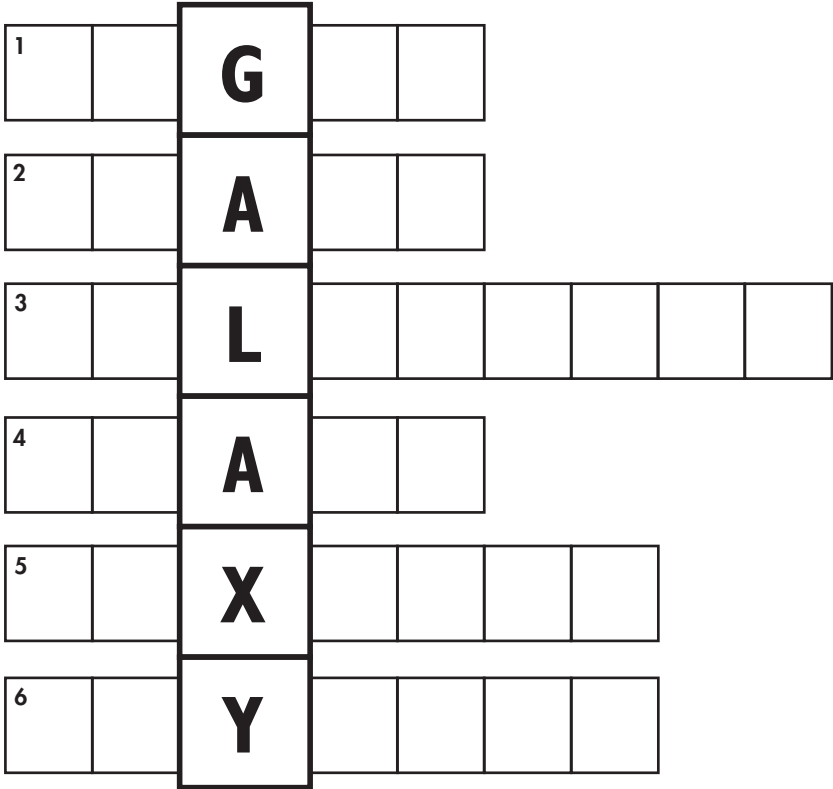

CLUES:

1. What the Sun, a lamp, or a beacon gives off
2. The Webb telescope will be launched into outer _____
3. Webb _____ or Hubble Space _____
4. Heavenly bodies that look like points of light in the sky
5. The shape of Webb's eighteen mirrors
6. Equipment that is launched on board the Shuttle or rockets for a mission in space

WAY OUT OF HERE

Get Webb to the launch pad

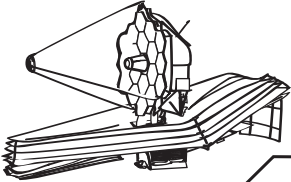

Start
Here

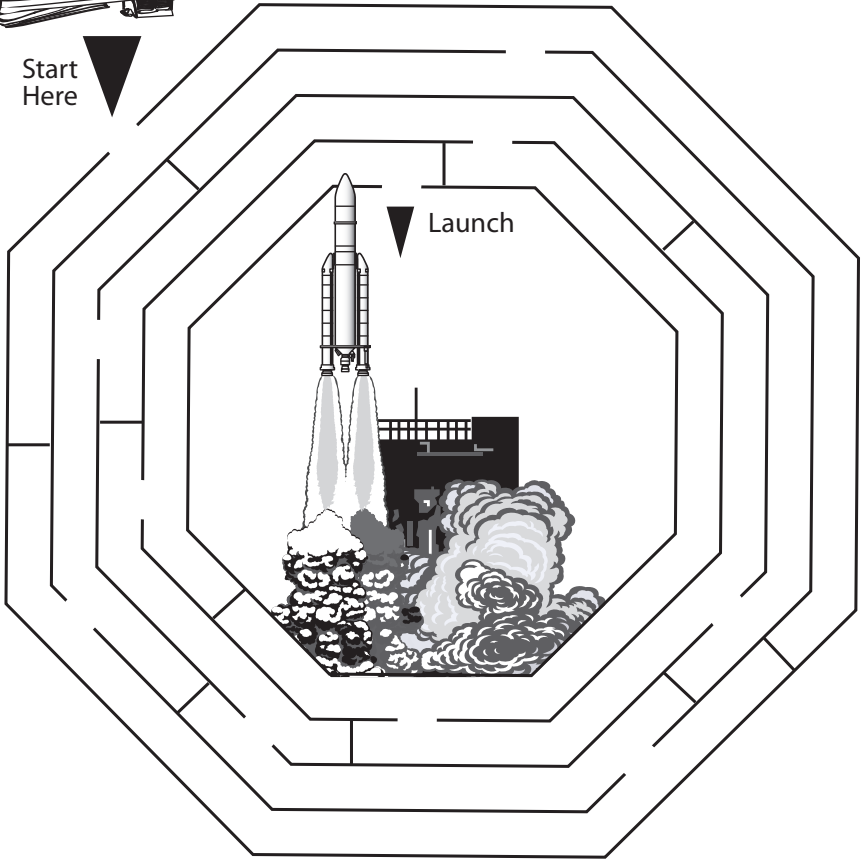

The Webb telescope will be launched on an Ariane-5 rocket in South America.

SEARCHING FOR WORDS

Circle the Webb telescope words

C	A	M	E	R	A	L	Y
P	N	I	R	O	I	K	E
A	S	C	O	R	S	N	P
Y	A	R	R	A	C	R	G
L	C	O	R	T	I	A	P
O	O	S	I	S	T	O	Y
A	S	H	M	A	P	R	M
D	M	U	D	R	O	B	O
E	O	T	N	C	R	I	N
L	S	T	K	A	L	T	O
B	B	E	W	G	S	I	R
B	T	R	A	W	N	A	T
U	E	S	J	D	E	M	S
H	T	E	N	A	L	P	A

✓ NASA
ARRAY
ASTRONOMY
CAMERA
COSMOS

DATA
GAS
HUBBLE
LENS
MICROSHUTTERS







MIRROR
ORBIT
OPTICS
PAYLOAD
PLANET

PRISM
RING
ROCKET
SKY

STAR
SUN
WEBB

WEBB HAS EIGHTEEN...

Find the answer by writing the first letter of each object in the box beside the picture

Moon, Ice Cream, Rabbit, Rocket, Ring, Saturn = MIRRORS

SPACE COUNTING

How many times can you find the word "space"?



S	P	A	C	E	C	E	S
P	P	C	A	E	S	P	C
A	E	A	S	E	A	S	S
C	S	C	C	C	P	P	E
E	C	A	E	A	A	A	C
P	P	C	A	P	A	E	A
S	E	A	P	S	E	P	P
S	P	A	C	E	C	E	S

DIFFERENT EARTHLINGS

Find and circle 8 different things

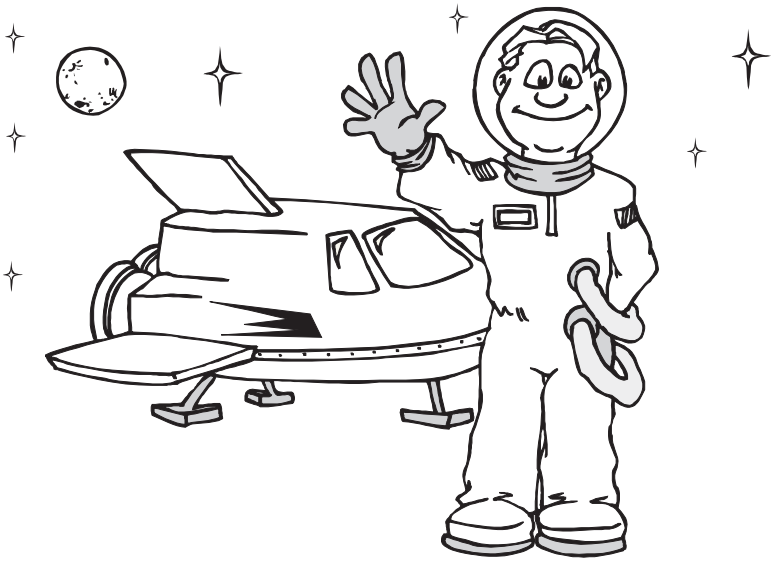

MAZE CRAZE

*Help light get from the galaxy
to the Webb telescope*

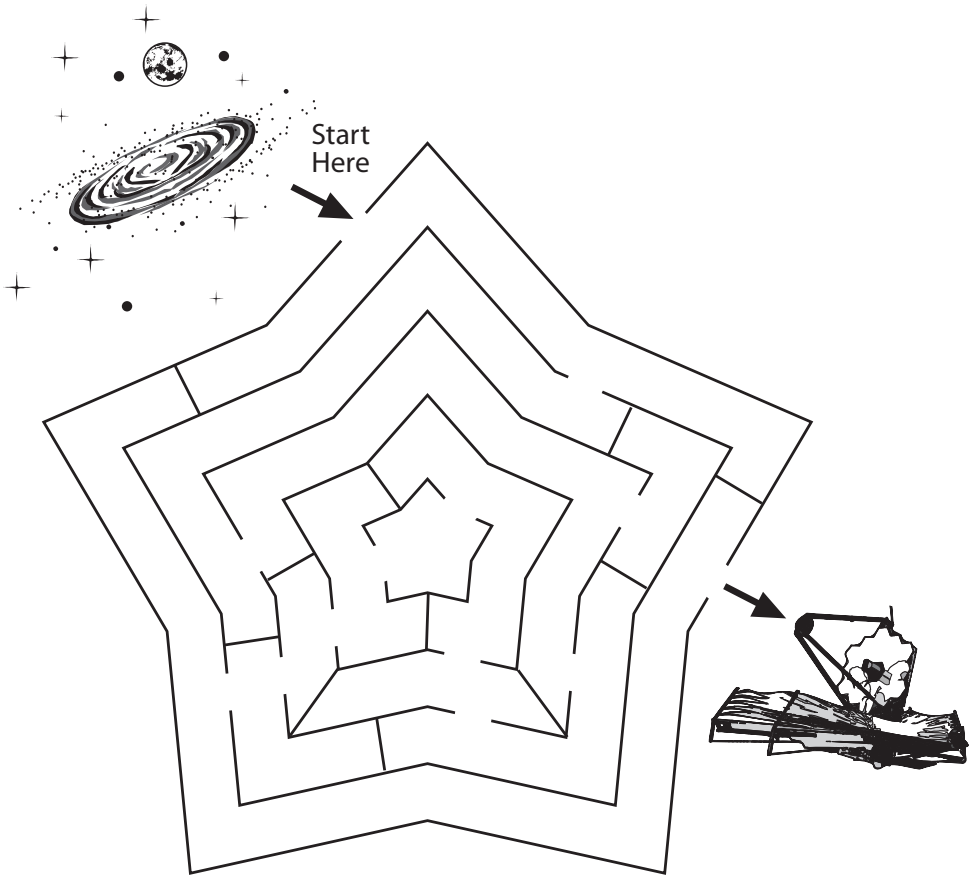

The Webb telescope will be a million miles from Earth, which means that it will be much farther away from us than the Moon! Webb needs to stay cool so it can see faint, far away galaxies. The place where Webb will be will let the telescope use its large sunshield to block out infrared light from the Sun, Earth, and Moon.

WEBB TELESCOPE PARTS

Use the code to name the parts of the spacecraft

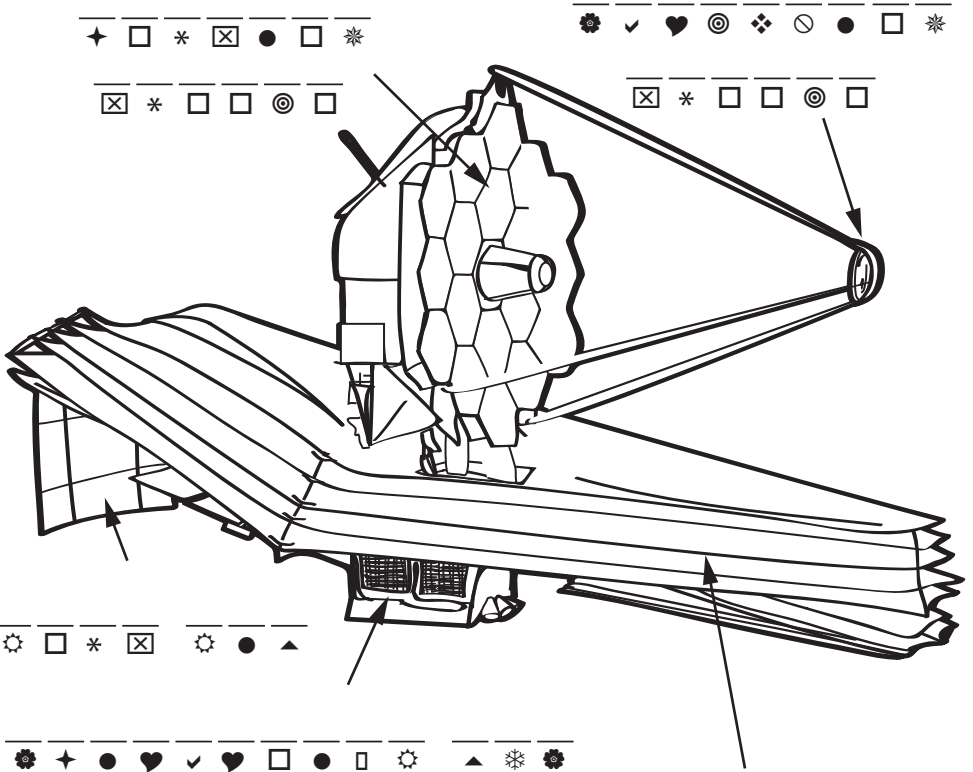

✦ □ * ☒ ● □ *

⚙️ ✓ ♥️ 🎯 ❖ 🚫 ● □ *

☒ * □ □ 🎯 □

☒ * □ □ 🎯 □

⚙️ □ * ☒ ⚙️ ● ▲

⚙️ ✦ ● ♥️ ✓ ♥️ □ ● ▭ ⚙️ ▲ ❄️ ⚙️

⚙️ ❄️ ❖ ⚙️ ▶️ * ✓ 😊 🚫

- | | | | | | |
|--------|--------|--------|-------|--------|-------|
| A = ● | F = □ | K = ☹️ | O = 🎯 | S = ⚙️ | W = 🌠 |
| B = ▲ | G = 👁️ | L = 😊 | P = ✦ | T = ⚙️ | X = 📞 |
| C = ♥️ | H = ▶️ | M = ☒ | Q = 😊 | U = ❄️ | Y = * |
| D = 🚫 | I = * | N = ❖ | R = □ | V = ○ | Z = ▼ |
| E = ✓ | J = | | | | |

Primary Mirror, Secondary Mirror, Trim Tab, Spacecraft Bus, Sunshield

COUNT THEM UP

How many objects can you find?

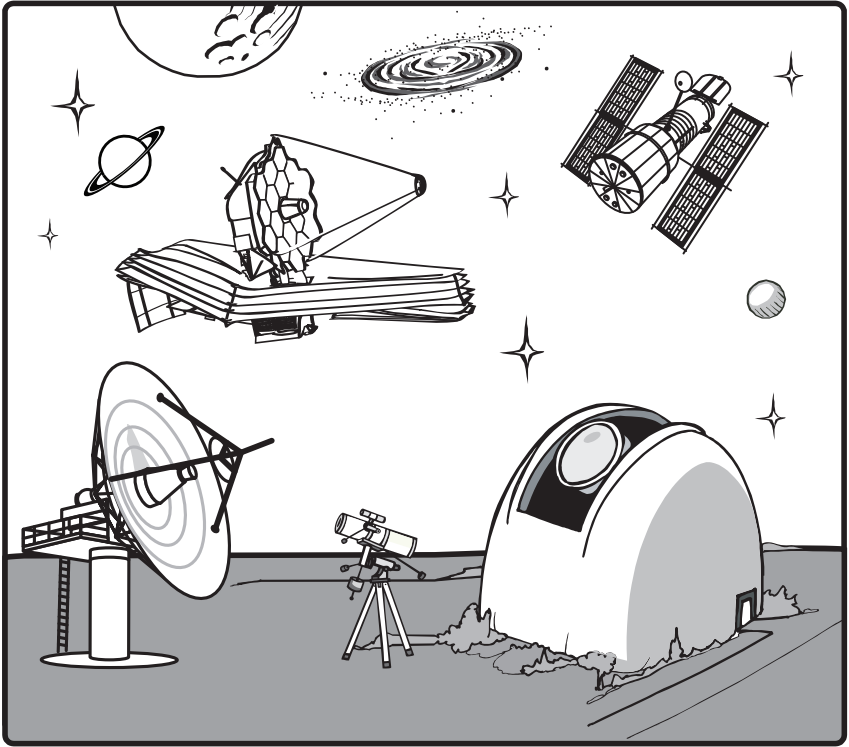

How many telescopes? _____

How many stars? _____

How many galaxies? _____

How many planets? _____

How many radar antenna? _____

4 Telescopes, 6 Stars, 1 Galaxy, 3 Planets, 1 Radar Antenna

IDENTICAL WEBB

Circle the two telescopes that are the same

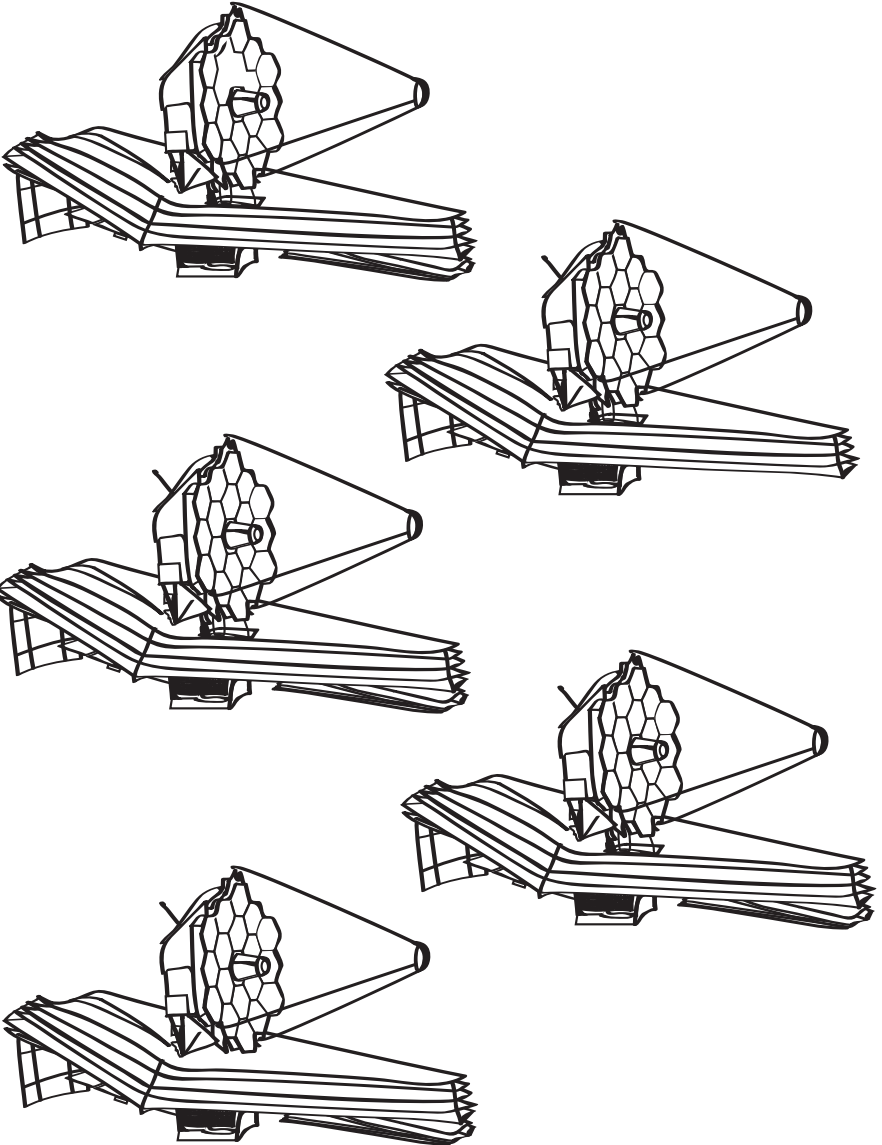

SCRAMBLE TIME

Trace over the dashed lines and unscramble the words to name the spacecraft

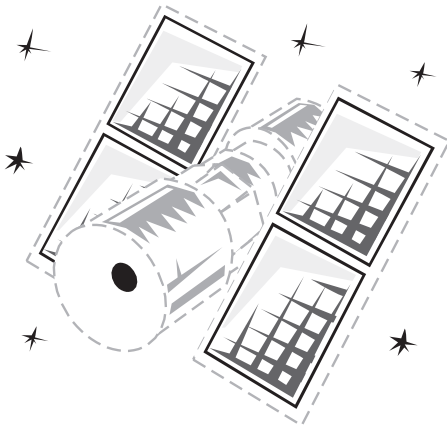

LEUBHB
CEPSA
LETPOESCE

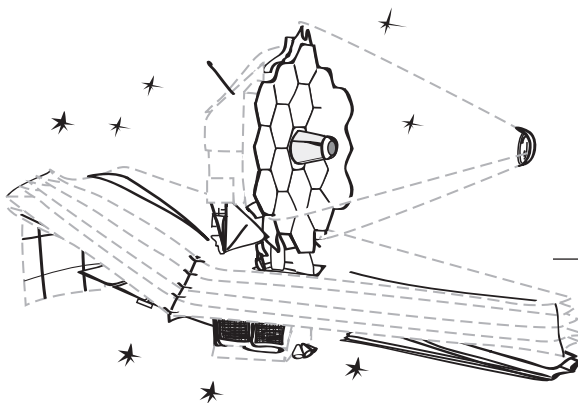

BEWB
POCLEETSE

HOW DID WE GET HERE?

From the first light in the universe to the birth of planets and the origins of life



The launch of the Webb telescope will be a giant step in the human quest to understand our place in the universe. With the largest telescope mirror ever placed in space, the Webb telescope will examine every phase of our history: from wisps of gas condensing into the first stars and galaxies after the Big Bang, to the formation of solar systems capable of supporting life on planets like Earth, and to the evolution of our own Solar System.

**EXPLORE
MORE**

For more information on NASA
and the Webb Telescope, visit
these web sites:

<http://education.nasa.gov>

<http://nasascience.nasa.gov/>

<http://www.jwst.nasa.gov/>

<http://www.nasa.gov/hubble>

<http://www.stsci.edu/jwst/>

National Aeronautics and Space Administration



James Webb Space Telescope

Webb Telescope Fun Pad

PACKED WITH THINGS TO DO!

