



**US Army Corps  
of Engineers**

Hydrologic Engineering Center

---

# **Flood Damage Analysis Package on the Microcomputer**

## **Installation and User's Guide**

**April 1994**

# REPORT DOCUMENTATION PAGE

Form Approved OMB No. 0704-0188

The public reporting burden for this collection of information is estimated to average 1 hour per response, including the time for reviewing instructions, searching existing data sources, gathering and maintaining the data needed, and completing and reviewing the collection of information. Send comments regarding this burden estimate or any other aspect of this collection of information, including suggestions for reducing this burden, to the Department of Defense, Executive Services and Communications Directorate (0704-0188). Respondents should be aware that notwithstanding any other provision of law, no person shall be subject to any penalty for failing to comply with a collection of information if it does not display a currently valid OMB control number.

**PLEASE DO NOT RETURN YOUR FORM TO THE ABOVE ORGANIZATION.**

<b>1. REPORT DATE</b> (DD-MM-YYYY) April 1994		<b>2. REPORT TYPE</b> Training Document		<b>3. DATES COVERED</b> (From - To)	
<b>4. TITLE AND SUBTITLE</b> Flood Damage Analysis Package on the Microcomputer  Installation and User's Guide				<b>5a. CONTRACT NUMBER</b>	
				<b>5b. GRANT NUMBER</b>	
				<b>5c. PROGRAM ELEMENT NUMBER</b>	
				<b>5d. PROJECT NUMBER</b>	
				<b>5e. TASK NUMBER</b>	
<b>6. AUTHOR(S)</b> Robert D. Carl				<b>5f. WORK UNIT NUMBER</b>	
<b>7. PERFORMING ORGANIZATION NAME(S) AND ADDRESS(ES)</b> US Army Corps of Engineers Institute for Water Resources Hydrologic Engineering Center (HEC) 609 Second Street Davis, CA 95616-4687				<b>8. PERFORMING ORGANIZATION REPORT NUMBER</b> TD-31	
<b>9. SPONSORING/MONITORING AGENCY NAME(S) AND ADDRESS(ES)</b>				<b>10. SPONSOR/ MONITOR'S ACRONYM(S)</b>	
				<b>11. SPONSOR/ MONITOR'S REPORT NUMBER(S)</b>	
<b>12. DISTRIBUTION / AVAILABILITY STATEMENT</b> Approved for public release; distribution is unlimited.					
<b>13. SUPPLEMENTARY NOTES</b> .					
<b>14. ABSTRACT</b> The Flood Damage Analysis Package integrates hydrologic an hydraulic information with economic calculations to evaluate existing conditions as well as project conditions using the "frequency" method to determine expected annual damage. This document details the MS-DOS personal computer system requirements and the software installation procedure. It also documents changes made to the individual computer programs subsequent to the last release of their associated users' manual.					
<b>15. SUBJECT TERMS</b> flood damage analysis, expected annual damage, structure inventory, depth-damage functions, grid cell database, HEC data storage system, MENUFDA, test data files					
<b>16. SECURITY CLASSIFICATION OF:</b>			<b>17. LIMITATION OF ABSTRACT</b> UU	<b>18. NUMBER OF PAGES</b> 112	<b>19a. NAME OF RESPONSIBLE PERSON</b>
<b>a. REPORT</b> U	<b>b. ABSTRACT</b> U	<b>c. THIS PAGE</b> U			<b>19b. TELEPHONE NUMBER</b>

# **Flood Damage Analysis Package on the Microcomputer**

Installation and User's Guide

**April 1994**

US Army Corps of Engineers  
Institute for Water Resources  
Hydrologic Engineering Center  
609 Second Street  
Davis, CA 95616

(530) 756-1104  
(530) 756-8250 FAX  
[www.hec.usace.army.mil](http://www.hec.usace.army.mil)

TD-31



## Table of Contents

INTRODUCTION .....	1
PC Package Content .....	1
Overview of Modifications Since the September 1990 Release .....	3
Introduction .....	3
HECDSS .....	3
DAMCAL .....	3
MENUFDA .....	3
EAD .....	4
SID .....	4
SIDEDT .....	4
PIP .....	4
FDA2PO .....	4
Purpose of Each Program .....	5
Flood Damage Analysis Computer Programs .....	5
Hydrologic Analysis Computer Programs .....	5
HECDSS (Data Management) Utility Programs .....	7
Program Support .....	7
Installation Procedure .....	9
Computer Equipment Requirements .....	11
Hard Disk Organization .....	12
USE OF MENUFDA .....	13
Running MENUFDA .....	13
General Menu Program Description .....	13
Function and Cursor Control Keys .....	13
MENUFDA Associated Disk Files .....	18
DESCRIPTION OF MENUS IN MENUFDA .....	19
Banner .....	19
Select Study .....	19
Edit Study .....	20
Select Program .....	20
Define Data Files .....	21
Data Directory List .....	22
Default Data File Extensions .....	23
DAMCAL .....	23
EAD .....	24
SID .....	24
SIDEDT .....	25
DSSUTL .....	25
DSPLAY .....	26
FDA2PO .....	26
PIP .....	27
HEC-1 .....	27
HEC-2 .....	28
HEC-5 .....	28
DSS5T6 .....	29
REFERENCES .....	31
APPENDIX A: SUPPLEMENTAL COMPUTER PROGRAM INSTRUCTIONS .....	35

Introduction .....	35
DAMAGE REACH STAGE-DAMAGE CALCULATION (DAMCAL) .....	36
J3 Record: Third Job Record (Required Record) .....	36
ZW Record -- Write elevation-damage function to a DSS file .....	37
DT Record --- Damage Reach Title Record .....	38
File Assignments .....	38
EXPECTED ANNUAL FLOOD DAMAGE COMPUTATION (EAD) .....	39
Grand Summary of Undiscounted EAD .....	39
Footnotes To Frequency-Damage Table .....	39
Calculation Status On the Personal Computer .....	40
Suppression of Output - Truncation Notes and Affluence .....	40
PP Record - Printout and Punch Options (Optional Record) .....	41
File Assignments .....	42
STRUCTURE INVENTORY FOR DAMAGE ANALYSIS (SID) .....	43
Observing the Maximum Limits For Floodproofing .....	43
Sampling Using the SL Record .....	43
Additional Results Written to the HECDSS Data File .....	44
Modification To J2 Record .....	44
Computing the Reference Flood Elevation .....	45
Calculation Progress On the Personal Computer .....	45
File Assignments .....	45
STRUCTURE INVENTORY FOR DAMAGE ANALYSIS EDIT PROGRAM (SIDEDT) .....	47
User Input Error Correction .....	47
Generation of Random Damage Function File .....	47
File Assignments .....	47
HEC-2 POST-PROCESSOR FOR FLOOD DAMAGE COMPUTATIONS (FDA2PO) .....	50
Program Purpose .....	50
File Assignments .....	50
Reference Flood Calculation .....	51
Discharge-Elevation Function Calculation .....	52
Example Execution of FDA2PO .....	53
APPENDIX B: REQUIRED FILE ASSIGNMENTS TO TEST SAMPLE DATA SETS FROM USER'S MANUALS .....	59
BAT File To Execute Sample Data Files .....	59
DAMCAL Sample Data Files .....	61
Test 1 .....	61
Test 2 .....	61
Test 3 .....	62
Test 4 .....	62
EAD Sample Data Files .....	63
Test 1 .....	63
Test 2 .....	63
Test 3 .....	63
Test 4 .....	64
Test 5 .....	64
SID Sample Data Files .....	65
Test 1 .....	65
Test 2 .....	65
Test 3 .....	66
Test 4 .....	66
Test 5 .....	67
Test 6A .....	67
Test 6B .....	68
Test 7 .....	68

SIDEDT Sample Data Files .....	69
Test 1 .....	69
Test 2 .....	69
Test 3 .....	70
Test 4 .....	70
Test 5 .....	71
FDA2PO Sample Data Files .....	72
Test 1 .....	72
Test 2 .....	72
Test 3 .....	73
Test 4 .....	73
APPENDIX C: REQUIRED FILE ASSIGNMENTS TO TEST TRAINING DOCUMENT 21 SAMPLE	
DATA .....	75
BAT File To Execute T.D. 21 Sample Data .....	75
HEC-1 Test Data Files .....	76
Test 1 .....	76
HEC-5 Test Data Files .....	76
Test 1 .....	76
DSSUTL Test Data Files .....	77
Test 1 .....	77
Test 2 .....	77
Test 3 .....	78
HEC-2 Test Data Files .....	79
Test 1 .....	79
Test 2 .....	79
FDA2PO Test Data Files .....	80
Test 1 .....	80
Test 2 .....	81
Test 3 .....	81
SID Test Data Files .....	82
Test 1 .....	82
Test 2 .....	82
EAD Test Data Files .....	83
Test 1 .....	83
APPENDIX D: DESCRIPTION OF SELECTED FILES .....	85
APPENDIX E: LIST OF FILES ON 3½ INCH DISKETTE .....	87
APPENDIX F: LIST OF FILES ON 3½ INCH HECDSS DISKETTE .....	93
APPENDIX G: LIST OF FILES ON 3½ INCH GSS DRIVERS DISKETTE .....	97

## List of Figures

Figure 1: Flood Damage Analysis Package .....	6
Figure 2: MENUFDA Banner .....	19
Figure 3: Select Study Menu .....	19
Figure 4: Edit Study Menu .....	20
Figure 5: Select Computer Program .....	20
Figure 6: Define Data Files Menu .....	21
Figure 7: Data Directory List .....	22
Figure 8: DAMCAL Menu .....	23
Figure 9: EAD Menu .....	24
Figure 10: SID Menu .....	24
Figure 11: SIDEDT Menu .....	25
Figure 12: DSSUTL Menu .....	25
Figure 13: DSPLAY Menu .....	26
Figure 14: FDA2PO Menu .....	26
Figure 15: PIP Menu .....	27
Figure 16: HEC-1 Menu .....	27
Figure 17: HEC-2 Menu .....	28
Figure 18: HEC-5 Menu .....	28
Figure 19: DSS5T6 Menu .....	29



## List of Tables

Table 1: Grand Summary of Undiscounted EAD .....	39
Table 2: Frequency-Damage Truncation .....	40
Table 3: DAMCAL Test 1 Files .....	61
Table 4: DAMCAL Test 2 Files .....	61
Table 5: DAMCAL Test 3 Files .....	62
Table 6: DAMCAL Test 4 Files .....	62
Table 7: EAD Test 1 Files .....	63
Table 8: EAD Test 2 Files .....	63
Table 9: EAD Test 3 Files .....	63
Table 10: EAD Test 4 Files .....	64
Table 11: EAD Test 5 Files .....	64
Table 12: SID Test 1 Files .....	65
Table 13: SID Test 2 Files .....	65
Table 14: SID Test 3 Files .....	66
Table 15: SID Test 4 Files .....	66
Table 16: SID Test 5 Files .....	67
Table 17: SID Test 6A Files .....	67
Table 18: SID Test 6B Files .....	68
Table 19: SID Test 7 Files .....	68
Table 20: SIDEDT Test 1 Files .....	69
Table 21: SIDEDT Test 2 Files .....	69
Table 22: SIDEDT Test 3 Files .....	70
Table 23: SIDEDT Test 4 Files .....	70
Table 24: SIDEDT Test 5 Files .....	71
Table 25: FDA2PO Test 1 Files .....	72
Table 26: FDA2PO Test 2 Files .....	72
Table 27: FDA2PO Test 3 Files .....	73
Table 28: FDA2PO Test 4 Files .....	73
Table 29: HEC-1 Test 1 Files .....	76
Table 30: HEC-5 Test 1 Files .....	76
Table 31: DSSUTL Test 1 Files .....	77
Table 32: DSSUTL Test 2 Files .....	77
Table 33: DSSUTL Test 3 Files .....	78
Table 34: HEC-2 Test 1 Files .....	79
Table 35: HEC-2 Test 2 Files .....	79
Table 36: FDA2PO Test 1 Files .....	80
Table 37: FDA2PO Test 2 Files .....	81
Table 38: FDA2PO Test 3 Files .....	81
Table 39: SID Test 1 Files .....	82
Table 40: SID Test 2 Files .....	82
Table 41: EAD Test 1 Files .....	83



---

# INTRODUCTION

---

## PC Package Content

This document describes the Flood Damage Analysis (FDA) Package as it is implemented for an IBM or MS-DOS compatible personal computer (PC). The Package contains several computer programs that are linked through a data base management system. Most programs are executed in a "batch" style (i.e. they read data from a fixed formatted input data file and write to an output data file). The FDA Package supplied does not contain all of the programs as documented in HEC's publication "Flood Damage Analysis Package," Training Document No. 21 (1). However, additional utility programs are included and the supplied programs facilitate storage and retrieval of all of the required parametric relationships. Specifically, this package includes the following analysis programs.

The "Flood Damage Analysis" Diskettes contain the following programs:

- Damage Reach Stage-Damage Calculation (DAMCAL).
- Expected Annual Flood Damage Computation (EAD).
- Interactive Paired-Function Input Program (PIP).
- Structure Inventory for Damage Analysis (SID).
- Structure Inventory for Damage Analysis Edit (SIDEDT).
- HEC-2 Post Processor (FDA2PO).
- Preliminary paired data editor program (EDPFDATA).
- Mathematical Manipulation of Data Stored in a DSS Data File (MATHPK).
- Menu user interface for editing and listing files, executing programs, and managing disk space (FDAMENU, MENUFDA).
- Utility to List Files on your screen (LIST).
- Utility to print output with page ejects (PROUT.EXE).
- The Corps Editor and on-line help files for programs EAD, SID, and DAMCAL (COED, COEDEAD.HPG, etc.).
- Copies of hardcopy documentation for COED, LIST, and PKWARE.

The HECDSS software diskettes contain:

- Data Storage System Utility (DSSUTL).
- Data Storage System Display, both tabular and graphical (DSPLAY).
- File conversion utility for converting DSS files of version 5 to version 6 (DSS5T6).
- Paired Function Input Program (DSSPD).
- Regular Interval Time Series Input Program (DSSIN).
- Irregular Interval Time Series Input Program (DSSITS).
- Text Data Input Program (DSSTXT).
- Regular Interval Time Series Input Program (DSSTS).
- Mathematical Computations, extended memory version (DSSMATHL).
- Mathematical Computations, 640K version (DSSMATH).
- Precipitation, NWS to DSS conversion (NWSOSS).

- Watstore to DSS conversion (WATDSS).
- SHEF to DSS conversion (SHFDSS).
- DSS to SHEF conversion (DSSSHF).
- Report Generator (REPGEN).

The GSS Device Driver diskettes contain device drivers which HECDSS DSPLAY requires in order to generate plots. If you do not need plots from DSPLAY, the graphics device drivers are not needed.

Other programs utilized in the FDA Package calculations include: HEC-1, HEC-2, and HEC-5. All three of these programs are operational on the PC and they each have their own menu program and associated utilities. The standard distribution copies of HEC-1 and HEC-5 are capable of accessing HECDSS data files. FDA2PO, the HEC-2 post-processor program, is compatible with the previous as well as the current release of the HEC-2 Package. It facilitates writing results to HECDSS data files. As a substitute to using the HEC-1, HEC-5, and FDA2PO programs directly, the user may run the PIP program to store frequency curves and discharge-elevation functions. However, this requires the user to manually enter the numbers and can require substantial effort. The FDA2PO program requires that HEC-2 either be run on the PC and the results saved from the "TAPE95" file or that the "TAPE96" file from the mainframe/minicomputer be saved and loaded on the PC.

Several utility programs are included. A menu program (FDAMENUX) is supplied. This menu program facilitates convenient study selection, program execution, and data file selection and modification. To edit and create input data files, the menu program invokes the text editor "COED" in full screen mode. It also invokes the "Help Program" mode for the DAMCAL, EAD, SID, and SIDEDT programs, and the utilities "LIST" to display output results to the monitor and "PROUT" to print output to a printer.

The FDA Package uses several software packages which have been obtained from commercial vendors. The HECDSS-DSPLAY program utilizes device driver software to generate plots on monitors, printers, and/or pen plotters. Network Computing Devices (NCD) (2) has licensed HEC to distribute these device drivers. The analysis programs EAD, SID, and DAMCAL utilize the Spindrift Library (3) of software to generate computation status messages without scrolling. The utility programs "PKUNZIP" (4) and "PKZIP" are supplied. The GSS drivers are stored on diskette in a compressed format. The utility program "PKUNZIP" decompresses the GSS drivers into a usable form on your fixed disk drive. Finally, the computer programs and example data sets are stored on diskette in a compressed format. They are unusable in this format and must be decompressed into a usable form. An installation program is supplied that performs this task automatically for the user.

The installation program used to install The Flood Damage Analysis Package, INSTALL, is licensed software provided by Knowledge Dynamics Corp, P.O. Box 780068, San Antonio, Texas 78278 (USA)(5). INSTALL is Copyright (c) 1987-1993 by Knowledge Dynamics Corp which reserves all copyright protection worldwide. INSTALL is provided to you for the exclusive purpose of installing The Flood Damage Analysis Package. The Hydrologic Engineering Center and any of its approved vendors are exclusively

responsible for the support of The Flood Damage Analysis Package, including support during the installation phase. In no event will Knowledge Dynamics Corp provide any technical support for The Flood Damage Analysis Program.

This document describes the installation process and provides documentation for using the FDA package on the PC.

## **Overview of Modifications Since the September 1990 Release**

### **Introduction**

Since the September 1990 release of the FDA Package for the MS-DOS personal computer, there have been several minor modifications and additions to the Package. The following programs have been compiled and linked for use in extended (XMS) memory: DAMCAL, EAD, FDA2PO, PIP, SID, & SIDEDT. These programs can be run from within the DOS window of Microsoft Windows 3.1. They also require very little base memory (within the first 640Kb) and can run simultaneously with your network software. The downside to these extended memory programs is that they require significantly more fixed disk drive space and take longer to load at execution time. The programs have been compiled using the Lahey Computer System Inc. 32-bit FORTRAN compiler (6) and linked using the Lahey/Phar Lap Development tools (7). The programs DSSUTL and DSPLAY still must run within the first 640Kb of memory and therefore probably can't run simultaneously with your network software. Other than the conversion to extended memory programs, the changes to these programs since the last release are summarized below.

### **HECDSS**

HEC has developed a new version of DSSUTL. DSSUTL has added capabilities for exporting and importing to and from spreadsheets using an intermediary ASCII file. The process is somewhat cumbersome and final documentation is not available.

### **DAMCAL**

HEC has made several modifications to the DAMCAL program. Subroutine RDATEBK now checks for an end-of-file in the grid cell data bank file. If the user does not define the maximum row, DAMCAL will not abort. Subroutine HECDSS was modified to write an elevation-structures function to DSS. When writing elevation-structures information to DSS, DAMCAL defines part C as "ELEVATION-STRUCTURES". HEC has modified subroutines ELDAMS and OVER to compress output tables (lines containing only the character "\*" have been eliminated). Subroutine ELDAMS was modified: calls which wrote elevation-damage data to HECDSS were moved and the starting elevation (ELEV) was computed again before calling HECDSS. Subroutine LANDUS was modified to read 64 characters for the title "TLLU".

### **MENUFDA**

HEC made several minor changes to the MENUFDA program. If the user has the Lahey "Blackbeard" editor (8), the user can invoke it by pressing "Alt-B" from the menu. Other modifications include several minor cursor movement changes.

## **EAD**

HEC made several minor changes to the EAD program. Subroutine PRNEAD was modified so that event damage comes out properly when multiple flow values are entered on the QF record. The computation and storage in DSS of incremental expected annual damage was added to subroutines EAV, CMPDMG, DAMAGE, ZWFRDA. Subroutine CMPDMG was modified to provide printout of the extended matrix when JTRACE=1. Subroutine ZWREAD was modified so that the option ZW.E would work properly in all situations. If the "ZW.E C=FREQ-DAMAGE" was not the last "ZW" record entered, the extended matrix was not written to the DSS data file.

## **SID**

The new extended memory version of SID processes 5,000 damage functions without use of a random damage function file generated by SIDEDT. The memory limits MEMAX1 and MEMAX2 are set to 10,000 and 120,000 respectively. This provides enough memory to process 100 damage reaches, 5,000 damage functions, 10 single events, 18 damage categories, and 18 ordinates in the elevation-damage function tables. HEC modified SID so that if the parameter NUBLDG is greater than 1, the average value of each structure is entered rather than the total value for all structures. The total value represented by one SL & SD record combination is NUBLDG multiplied times VIFS. Subroutines RDFOP, RDFOPO, and RDRAND were added to allow the storage of a varying number of random damage functions without code change, only dimension change. Thus, custom modifications to SID which will allow more damage functions will be compatible with existing random damage function files. At the beginning of the SID output and if the user enters "SID ?", the program will print the values for the variables MEMAX1, MEMAX2, and the maximum allowable number of damage functions.

## **SIDEDT**

The existing version of SIDEDT was modified to accept the new format of random damage function files. There is a radically new version of a replacement for SIDEDT. The new version is run within Microsoft Windows and is menu and mouse driven. It is available separately from this version of the FDA Package. Contact the Planning Analysis Division at HEC if you wish to use the new version.

## **PIP**

The PIP program remains unchanged.

## **FDA2PO**

HEC modified the FDA2PO program to increase the number of characters in pathname Part A from 14 to 32 and in Part F from 24 to 32. The FDA2PO program now reads a maximum 800 cross-sections from HEC-2 results and now prints an error message and stops if the number of sections exceeds that limit.

## Purpose of Each Program

The HEC Flood Damage Analysis Package is schematically illustrated in Figure 1. The package is comprised of the following computer programs:

### **Flood Damage Analysis Computer Programs**

Six programs are used to compute flood damage. All six are included in the distribution of the FDA Package. If flood damage computations are based on conventional structure inventories, then a structure file is constructed based on a field inventory of structures vulnerable to flood damage and the **SID** program is used. If damage computations are spatially based, then a grid cell data bank is constructed and the **DAMCAL** program is used. It is possible that both damage approaches may be used for a given study, in which case both files will exist. The flood damage analysis programs include:

- **SID, Structure Inventory For Damage Analysis (9)**; processes inventories of structures located in the flood plain; used to develop elevation-damage relationships.
- **SIDEDT, Structure Inventory For Damage Analysis Edit Program (10)**; edits structure inventory and damage function files used for the SID program.
- **DAMCAL, Damage Reach Stage-Damage Calculation (11)**; performs a similar analysis as SID based on a geographic (spatial) unit; used to develop elevation-damage relationships.
- **EAD, Expected Annual Damage Computation (12)**; computes expected (or equivalent) annual damage and inundation reduction benefits; used to compare flood damage mitigation plans.
- **FDA2PO, HEC-2 post-processor program**; computes the reference flood elevation at structures and stores discharge-elevation rating curves in a HECDSS data file.
- **PIP, Interactive Paired-Function Input Program (13)**; allows the user to directly enter paired-function relationships to a DSS data file, for example, an elevation-damage relationship derived by hand from field data.

### **Hydrologic Analysis Computer Programs**

The FDA Package also utilizes the following Hydrologic Analysis Computer Programs. They are maintained separate from the FDA Package. From the standpoint of flood damage analysis, they are used to model the rainfall-runoff processes and basin modeling for multiple plans. These programs include:

- **HEC-1 Flood Hydrograph Package (14)**; simulates rainfall-runoff, simple reservoirs, and hydrologic channel routing. It is used to develop existing and future without and with project conditions flow-frequency functions.

Figure 1: Flood Damage Analysis Package

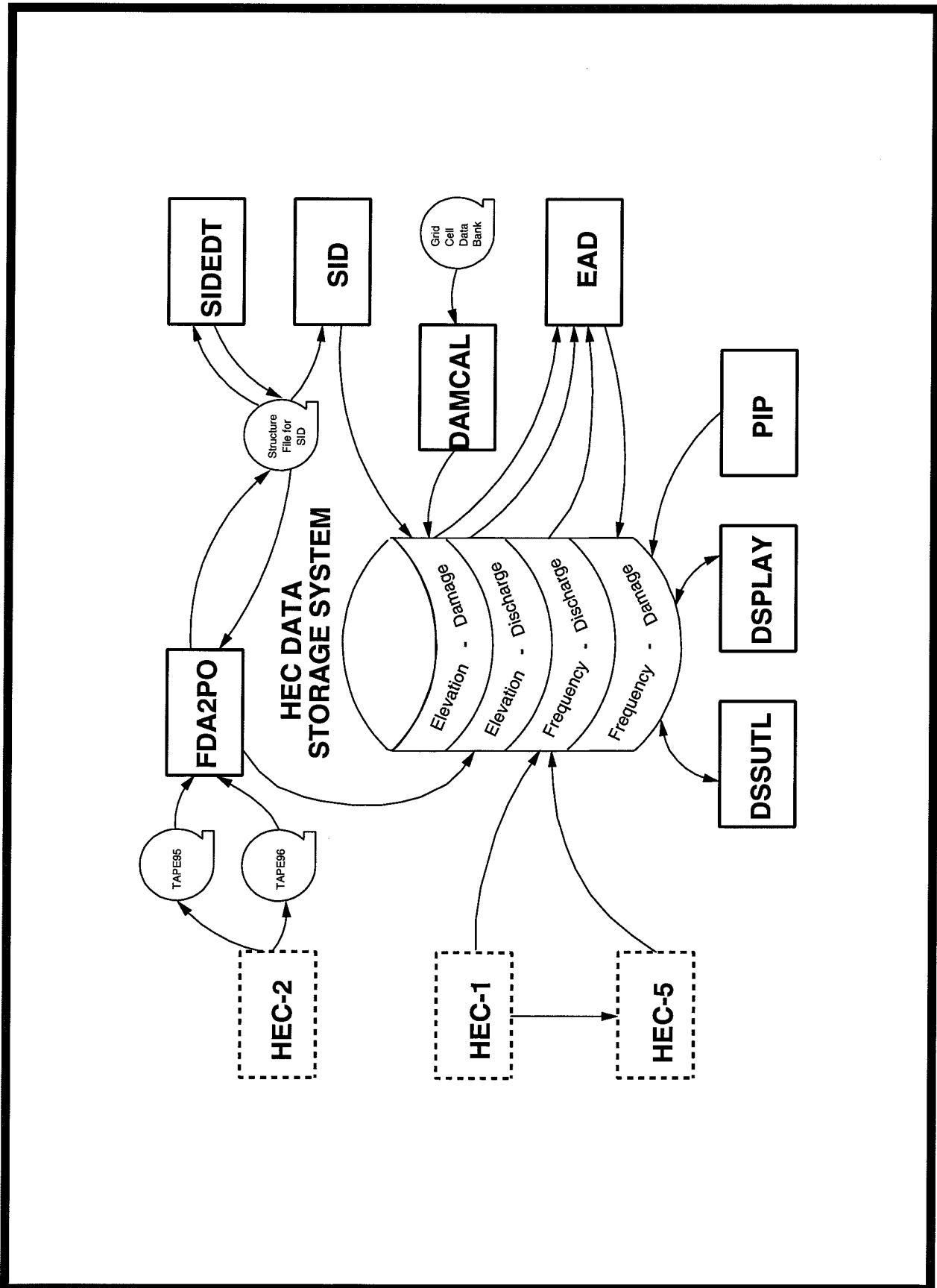



- **HEC-2 Water Surface Profiles** (15); computes steady-state, uniform flow water surface profiles. It is used to develop existing and future without and with project conditions discharge-elevation functions.
- **HEC-5 Simulation of Flood Control and Conservation Systems** (16); simulates complex reservoir systems. It is used to develop existing and future without and with project conditions flow-frequency functions.

## **HECDSS (Data Management) Utility Programs**

The FDA Package also utilizes the following HECDSS Utility Programs. They are included on the FDA Package distribution diskettes. The utilities facilitate ad-hoc data entry of flood damage related matrices, HECDSS data file management, and output displays of data stored in HECDSS data files. These programs include:

- **DSSUTL, HECDSS Utility Program** (17); provides the means of performing utility functions on data stored in the HECDSS data file, for example, cataloging, editing, and deleting data.
- **DSPLAY, HECDSS Display Program** (17); provides the means to tabulate and plot data stored in a HECDSS data file.
- **DSS5T6, HECDSS File Conversion Program**; facilitates converting HECDSS files from version 5 to version 6 format for the HECDSS software.

## **Program Support**

Several user's manuals and a training document describe most of the programs utilized in the Flood Damage Analysis (FDA) Package. The "Supplemental Computer Program Instructions" appended to this document provide additional information for those programs which have outdated or non-existent user's manuals. The HEC-2 post-processor FDA2PO has no user's manual but is documented in an appendix of this manual. HEC has modified the programs DAMCAL, EAD, SID, and SIDEDT since the last user's manuals have been released. These modifications are briefly described in an appendix. Other publications describe procedures and give application examples. Technical Papers give more generalized information on flood damage analysis (18,19,20) and floodplain management (21,22,23). Training documents give more detailed information and examples on flood damage analysis (1,24), floodplain management (25), and geographic information system methods (26,27,28).

The references on page 31 list appropriate computer manuals which describe individual computer programs or provide supplemental information related to the FDA Package. The manuals as well as other related publications may be ordered from HEC or from private vendors. A Publication Catalog contains a listing of all available publications as well as ordering information and prices. HEC also maintains a list of vendors who sell the Package and provide support. The list may be obtained by contacting:

Hydrologic Engineering Center  
Water Resources Support Center  
609 Second Street  
Davis, California 95616-4687  
(916) 756-1104

---

## Installation Procedure

---

To quickly install the April 1994 version (Version 2.1) of the Flood Damage Analysis Package, follow the instructions listed below. These instructions assume that your floppy diskette drive is drive "a:" although it could be any other valid drive (such as "b:").

- Check to make sure your computer meets the equipment requirements stated on page 11.
- Insert the diskette labeled "Flood Damage Analysis Package Disk #1, Installation" into your 3½ inch diskette drive.
- Type "a:install" (or "b:install").
- Respond to the questions that the INSTALL program asks and insert new diskettes as prompted. The Install program performs the operations listed below:
  - Creates (if necessary) the subdirectories \HECEXE and \HECEXE\SUP.
  - Extracts all executable code and ".bat" files into the \HECEXE subdirectory.
  - Extracts all supplemental files into the \HECEXE\SUP subdirectory. This includes on-line help for COED and menu screens for PIP.
  - Extracts all requested sample data sets into the user-specified subdirectories.
- If you allow it, the installation program will modify the config.sys and autoexec.bat files. The "autoexec.bat" file must contain a "path" command and contain a reference to the \hecexe subdirectory. The installation program will add a "set" command to enable the use of device drivers for graphics with the DSPLAY program. For example:

```
path c:\;c:\dos;d:\hecexe;  
SET CGIPATH=D:\GSS
```

The config.sys file must contain a "files" statement which requests that at least 30 files be available for use. For example:

```
files=30
```

If an older version of DISPLAY has been loaded on the computer, the "config.sys" file may contain "device" statements for the GSS device drivers. These statements should be removed from the "config.sys" file. An example list of statements that should be removed is:

```
device = c:\gss\ibmvgal2.sys  
device = c:\gss\hpplot.sys  
device = c:\gss\msmouse.sys /g:mice  
device = c:\gss\gsscgi.sys /t
```

- Re-boot your computer to invoke changes made to the "AUTOEXEC.BAT" and "CONFIG.SYS" files.
- To begin using the FDA Package, initiate the FDA Package Menu program by typing "MENUFDA".
- Define your study (or use the example data sets), select the desired program, define the data files for that program, and execute the program. Use the "list" option from the MENUFDA program to view the computed results.

## **Computer Equipment Requirements**

The April 1994 version (Version 2.1) of the Flood Damage Analysis Package requires a hard (or fixed) disk. The FDA Package requires the following minimum system configuration:

- 640 Kilobytes (KB) of Random Access Memory (RAM).
- 4Mb of extended (XMS) memory.
- MS DOS 3.3 or higher.
- One 3½ inch floppy diskette drive capable of reading 1.4Mb diskettes.
- A fixed (hard) disk. The FDA Package requires 10Mb storage for programs and 3.8MB for all of the sample data. Large studies may require 50 to 300 megabytes of storage for input and condensed output data.
- A math coprocessor.
- Either a 80386 or 80486 processor.
- Either a Video Graphics Adapter (VGA) or an Enhanced Color Graphics Adapter (EGA) is highly recommended but not required. A graphics adapter is required for graphical displays using the HECDSS-DSPLAY computer program.

## Hard Disk Organization

The FDA Package Installation Program facilitates installation on a hard disk. It requires that all program executable files exist in the subdirectory "\HECEXE" and that supplemental files (such as program help or menu files) exist in the subdirectory "\HECEXE\SUP". The user should create separate subdirectories for each study that is performed. For example, the sample data contains two data sets. Each should be stored in a separate subdirectory. For example:

Study	Data subdirectory
Sample Data	\DATA\FDA\TESTDATA
Silver Creek	\DATA\FDA\TD21DATA

For the Silver Creek Study, the subdirectory "\DATA\FDA\TD21DATA" would contain all data associated with this study. This includes EAD, PIP, SID, SIDEDT, and HEC-2 input data and output results. Because of the nature of the menu program, **you must store all data associated with a given study in one subdirectory. Also, each subdirectory should contain data for only one study.**

---

## USE OF MENUFDA

---

### Running MENUFDA

To use the FDA Package on a hard disk system, a menu program may be used to assist the user in applying the different programs. To begin the menu program, enter:

MENUFDA

This should load the program and begin by displaying a banner page as described below. If the banner page does not appear, then the most likely cause of failure is that either one of the following files is missing:

[drive:]\HECEXE\MENUFDA.BAT or  
[drive:]\HECEXE\FDAMENUX.EXE

### General Menu Program Description

The menu program consists of a banner page, three primary menus and two subordinate menus. The structure of the menus can be illustrated in outline format as shown below:

- Banner page.
- Select Study.
  - Enter or edit study name and associated data subdirectory.
- Select Program.
- Define Data Files.
  - List files in current directory with mask.

To successfully execute a program, the user must progress through the primary menus. The subordinate menus are used only if the user wishes and are not required for an individual execution.

### Function and Cursor Control Keys

Several keys are used to control menu selection, item selection within a menu, and operation selection (edit or list a file and execute a program). The following list summarizes the primary MENUFDA **action keys**.

<u>Key(s)</u>	<u>Description</u>
F2	Reset selection or definition. Example: in the "Define data files" menu, the F2 key resets all file names to those initially selected when this menu was last invoked.
F3	Delete the highlighted files.
F4	Edit the selected disk file with COED. Pressing the F4 function key initiates editing the currently selected disk file with COED. This is operational only from the "Define data files" menu. The MENUFDA program invokes COED in a full screen mode with "Help Program" files, if applicable. You may obtain on-line documentation for COED by pressing the F1 function key while in COED and by following subsequent instructions. A complete COED user's manual is stored in the file "COED.DOC". It may be copied to a printer. Alternatively, a pre-printed manual is available from HEC.
F5	Define the background screen color. The color is changed by repeatedly pressing the F5 key only in the "Select Study" and "Select Program" menus. You may select one of eight colors: black, blue, green, light blue, red, violet, orange, and white.
F6	Define the foreground screen color. The color is changed by repeatedly pressing the F6 key only in the "Select Study" and "Select Program" menus. You may select one of eight colors: black, blue, green, light blue, red, violet, orange, and white. The foreground color may be either normal or intense. To cycle through all possible definitions, you must press the F6 key sixteen times. Portions of the menu are displayed in reverse video. If you select an intense foreground color, sometimes you will get unexpected results. One example is using black as a foreground color. One combination that works well is a blue background and an intense white foreground.
F8	Execute the selected program. Pressing the F8 key initiates execution of the currently selected program (all necessary data files must have been defined). This is operational from the "Select Program" and "Define Data Files" menus.
F9	Return to previous menu. The F9 key allows you to exit the current selected menu and return to the previous menu. For example, if you are in the "Define data files" menu, you can go to the "Select Study" menu by pressing the F9 key twice - the first time you will access the "Select Program" menu and the second time the "Select Study" menu.



Key(s)	Description
F10	Exit to DOS. By pressing the F10 key from any menu, you will immediately terminate the MENUFDA program and return to the DOS environment.
Esc	Reset the current selection or return to the previous menu. Pressing the Esc key resets the current file, study name, data directory, etc. to that previously defined. The Esc key changes only the current selection (e.g. the currently selected file) whereas the F2 key changes all selections (e.g. all defined data files) or resets the current menu selection. The Esc key returns to the previous menu if the user is not editing a file name.
Home	Select the first option, file, study, etc. The Home key controls the item selection on the current menu and page. For example, on the "Select Study" menu, pressing the Home key selects the first study displayed on the current page of studies (the study in the upper left corner of the menu).
End	Select the last option, file, study, etc. The End key controls the item selection on the current menu and page. For example, on the "Select Study" menu, pressing the End key selects the last study displayed on the current page of studies (the study in the lower right corner of the menu).
Home,←	Move cursor to first character. Pressing the Home key, releasing it, and then pressing the left arrow key moves the cursor to the first character in a field. This is operational when you are editing study names, filenames, and directory names.
Home,→	Move cursor to last character. Pressing the Home key, releasing it, and then pressing the right arrow key moves the cursor to the last character in a field. This is operational when you are editing study names, filenames, and directory names.
←	Move cursor one character to the left. Pressing the left arrow key moves the cursor one character to the left. It is operational when you are editing study names, filenames, and directory names.
→	Move cursor one character to the right. Pressing the right arrow key moves the cursor one character to the right. It is operational when you are editing study names, filenames, and directory names.
↑	Select previous study, file, or option. Pressing the up arrow changes the current selection to the one displayed just above the current selection. It is operational in all menus.

Key(s)	Description
↓	Select next study, file, or option. Pressing the down arrow changes the current selection to the one displayed just below the current selection. It is operational in all menus.
PgUp	Change to previous page. Pressing the PgUp key moves the display from the current page to a previous page of information. This is operational in the "Select Study" and "Directory Listing" menus and only if there are more studies (or files) than can fit on one page of display.
PgDn	Change to next page. Pressing the PgDn key moves the display from the current page to the next page of information. This is operational in the "Select Study" and "Directory Listing" menus and only if there are more studies (or files) than can fit on one page of display.
Ins	Change insert character mode. Pressing the Ins key toggles the insert character mode between on and off. It is operational when you are editing study names, filenames, and directory names. When the "insert character" mode is on, any character entered will be added to those existing. If the mode is off, any character entered will replace the existing character at the cursor location.
Del	Delete character. Pressing the Del key deletes the character at the current cursor position.
Alt-D	Delete the selected disk file. Pressing the Alt key and holding it down while pressing the "D" key deletes the currently selected file from the disk.
Alt-E	Edit the selected disk file with COED. Pressing the Alt key and holding it down while pressing the "E" key initiates editing the currently selected disk file with COED. This is operational only from the "Define data files" menu. The MENUFDA program invokes COED in a full screen mode and with "Help Program" files, if applicable. You may obtain on-line documentation for COED by pressing the F1 function key while in COED and by following subsequent instructions. A complete COED user's manual is stored in the file "COED.DOC". It may be copied to a printer. Alternatively, a pre-printed manual is available from HEC.

Key(s)	Description
Alt-F1	<p>While in COED, you may get information from the "Help Program" files by pressing Alt-F1. This information should be available for the DAMCAL, EAD, SID, and SIDEDT data files which require a fixed format. It is not available for the SIDEDT user input commands. You access the help program feature by entering a valid two character record identifier (e.g. "J1") in columns one and two of an input data file and then pressing Alt-F1. You can get descriptions for each input field of the input data by positioning the cursor at the desired field using the tab key and then by pressing the Alt-F1 key. COED then displays the description for that field. It is similar or identical to the description contained in the program user's manual. The COED user's manual contains a more detailed description of the help program.</p>
Alt-L	<p>List the currently selected disk file with "LIST". Pressing the Alt key and holding it down while pressing the "L" key initiates listing the currently selected disk file. The currently selected disk file is indicated by the highlighted box. This is operational only from the "Define data files" menu. Documentation for the LIST program is located on the FDA Installation diskette labeled "Install FDA" in the file LIST.DOC. If you try to list an HECDSS file, the menu will attempt to list its associated catalog file. There is no protection against listing a binary data file.</p>
Alt-P	<p>Print the currently selected disk file using the MS-DOS PRINT command (or with "PROUT" if printing HEC-1, HEC-2, or HEC-5 output). Pressing the Alt key and holding it down while pressing the "P" key initiates printing the currently selected disk file. The currently selected disk file is indicated by the highlighted box. This is operational only from the "Define data files" menu. There is no documentation for the PROUT program. It merely converts the mainframe carriage control character into a code recognized by PC printers to assure proper pagination.</p>
Alt-X	<p>Execute the selected program. Pressing the Alt key and holding it down while pressing the "X" key initiates execution of the currently selected program (all data files must have been defined). This is operational from the "Select Program" and "Define Data Files" menus.</p>

## MENUFDA Associated Disk Files

There are several important disk files associated with the menu program. They are described as follows:

<u>File</u>	<u>Description</u>
FDAMENU.DFT	Contains the last selected screen colors, output device, and study. After the first execution of the menu program, this file should always exist in the subdirectory [drive:]\HECEXE\SUP.
FDAMENU.SDY	Contains a cross-reference of study names and associated data subdirectories where all data for each study is stored. This file should be created if you install some of the test data when the Installation Program is run. After the first execution of the menu program, this file should always exist in the subdirectory [drive:]\HECEXE\SUP.
FDAMENU.FIL	Contains a listing of last selected file names, colors, devices, etc. for each study. After the first execution of the menu program for a given study, a file should exist in the subdirectory which contains data for that study. In other words, for each study, there should be a file named "FDAMENU.FIL". If there are ten studies, there should be ten files named "FDAMENU.FIL" located in appropriate subdirectories. For example, if data for the study "Silver Creek" is stored in the subdirectory "D:\DATA\FDA\TD21DATA", then the file "D:\DATA\FDA\TD21DATA\FDAMENU.FIL" will be created when that study is selected and files are edited.

## DESCRIPTION OF MENUS IN MENUFDA

### Banner

Figure 2: MENUFDA Banner

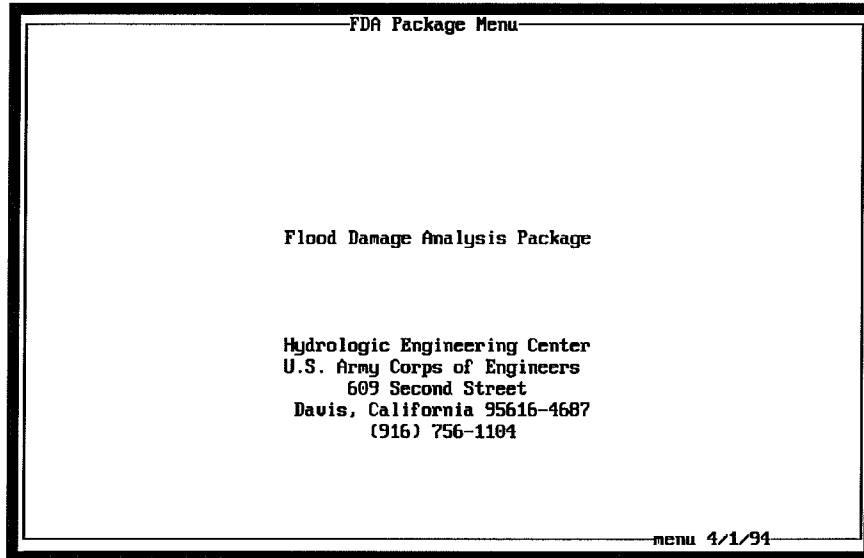

When executing the menu program, the "Banner" menu is the first information displayed. It gives HEC's address and phone number, the version date of the menu program, and the banner indicating that you are executing the MENUFDA program. This page will disappear after five to ten seconds. You can proceed to the next menu sooner by pressing any ASCII key (such as the <Enter> key or the <space bar>). The banner menu should appear as shown in Figure 2.

### Select Study

Figure 3: Select Study Menu

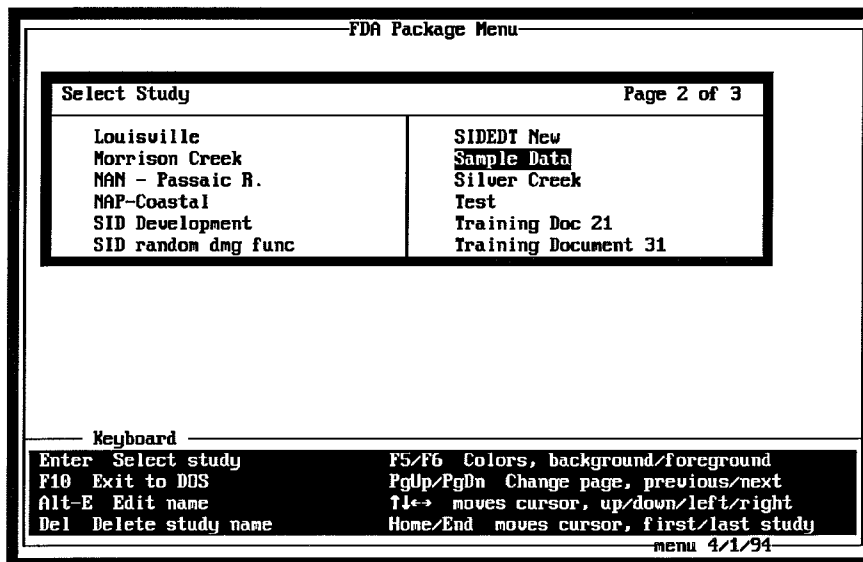

The "Select Study" menu allows you to select the study (or set of data) that you wish to analyze. You select a study by maneuvering the highlighted box over the desired study and pressing the <Enter> key. To enter a new study, position the highlighted box over the line "(specify new study)" and press the <Enter> key or begin entering a new study name. To edit an existing study, position the highlighted box over the study and press the "Alt-E" keys. The study menu should appear as shown in Figure 3.

## Edit Study

Figure 4: Edit Study Menu

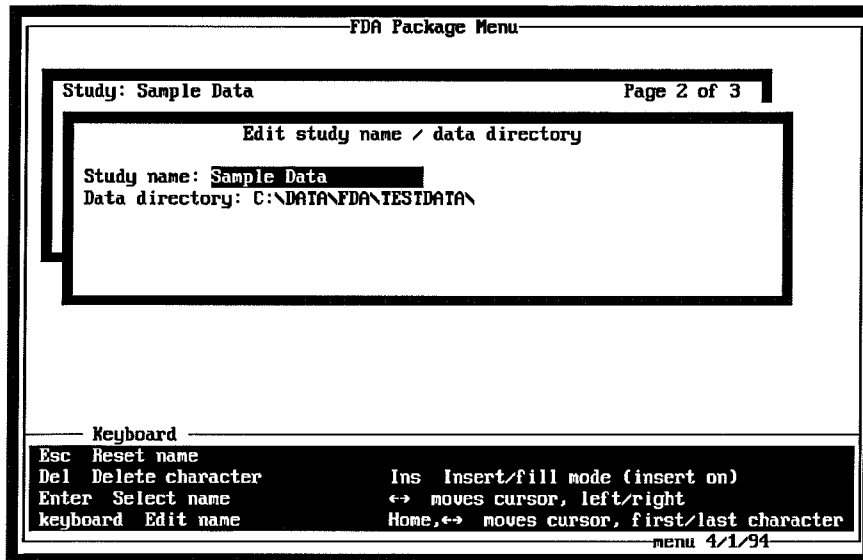

directory" menu should appear as shown in Figure 4.

For each study, there is an associated subdirectory name where the data is stored. Any time you enter a new study (or edit an existing study reference by entering "Alt-E"), you may edit the subdirectory into which the data will be entered. If data already exists in a subdirectory and you change the subdirectory, the data will not be moved to the new subdirectory. The subdirectory name is simply the location that the menu program searches to find data files for a given study. If you enter a new study or edit an existing study, the "Edit study name / data

## Select Program

Figure 5: Select Computer Program

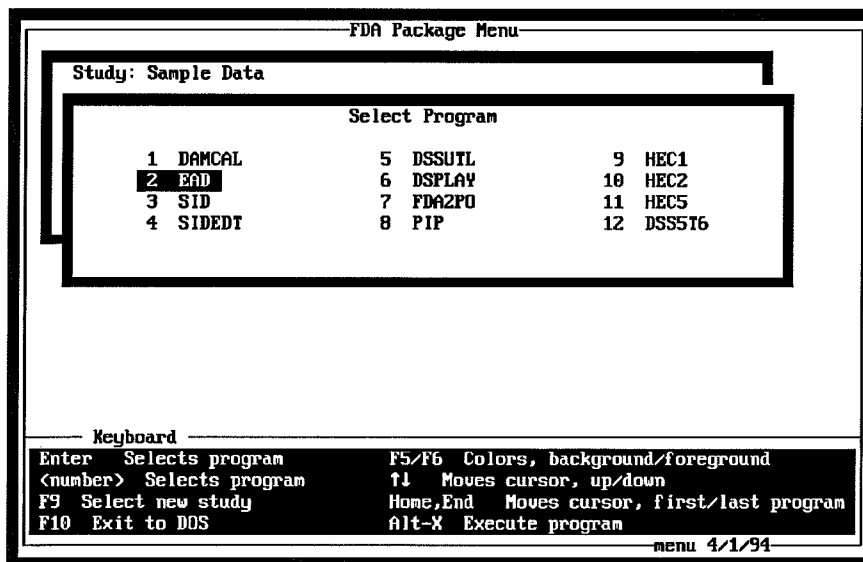

menu by pressing and holding the "Alt" key and then pressing the "X" key (or alternatively the F8 function key).

The "Select Program" menu allows you to indicate the program that you wish to execute or the program for which you wish to enter or edit data. You may select the program for which you wish to enter or edit data by either entering the appropriate integer (e.g., pressing the "2" key for the EAD program) or by maneuvering the highlighted box over the desired program and pressing the <Enter> key as shown in Figure 5. If you have already defined the appropriate data files for the desired program, you may execute the program from this

## Define Data Files

Figure 6: Define Data Files Menu

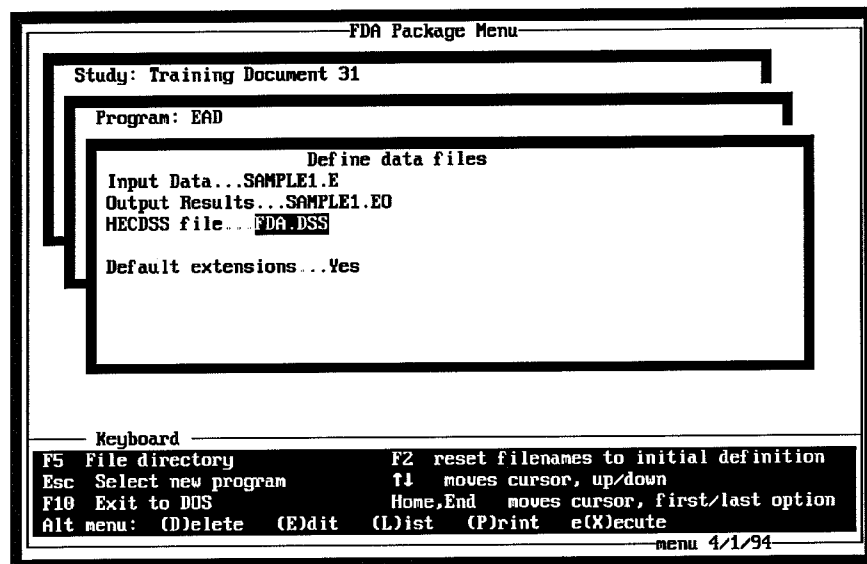

The "Define data file" menu allows you to enter the file names which contain the input data or output results for each program. To enter or edit a file name, position the highlighted box over the desired filename and then type the filename. If a filename has already been entered but you do not wish to use a file, enter the characters "NONE." (a period follows the characters "NONE") and then press the <Enter> key. The menu program will display the character string "(none)" and will not assign any file when the selected program is executed. (That FORTRAN

unit is actually assigned to the default scratch file internal to each program.) The menu program assumes certain default filename extensions as described later in the "Default Data File Extensions" section. You may override these defaults by entering a period (".") followed by your desired extension. The menu program will use your defined extension for future definitions. This selection is stored in the file "FDAMENU.FIL" which is associated with the selected study. In addition to defining the data file names, you may edit, list, delete, and print files or execute the currently selected program from this menu. The following codes invoke these operations. You must press and hold down the "Alt" key and then press the appropriate key (such as the "L" key) for each operation.

Alt Key	Function Key	Operation
Alt-D	F3	Delete currently highlighted file.
Alt-E	F4	Edit currently highlighted file using COED.
Alt-L	F6	List currently highlighted file using the "LIST" program.
Alt-P		Print currently highlighted file using the "PROUT" program.
Alt-X	F8	Execute the currently selected program using the selected files displayed on the screen.

## Data Directory List

Figure 7: Data Directory List

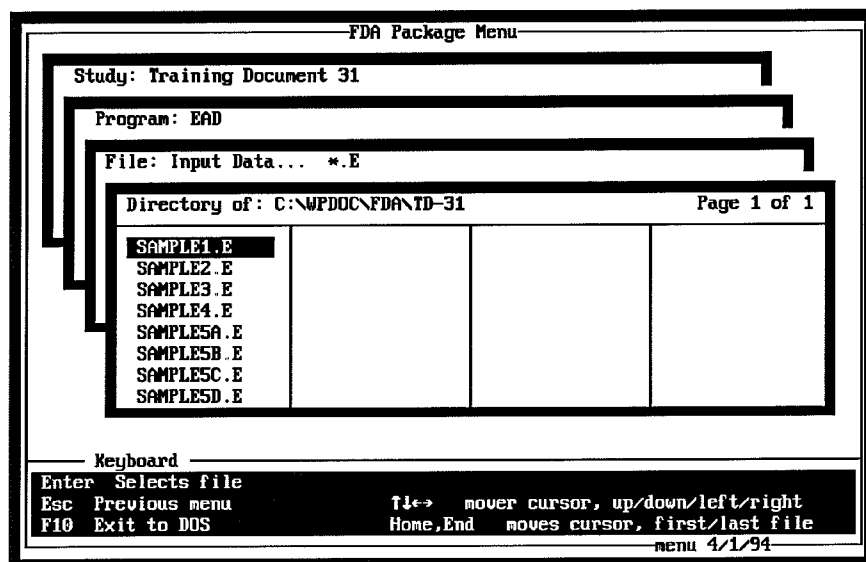

You may also define a data file by obtaining a file directory listing and selecting a file from this list. Figure 7 illustrates the Data Directory List. To get a file directory listing, you may do any one of the following:

- F5 Pressing the F5 function key lists all files which have the current default extension. For example, the EAD data input files have the default extension ".E". If the "F5" key is pressed, the menu program initiates a "DIR \*.E" DOS command, then sorts all of the files that meet that criteria, and displays them to the screen. The user may select a file by positioning the highlighted box over a file and pressing the <Enter> key. If the desired file does not exist, press the "Esc" key to return to the previous menu.

\*.\* Entering the characters "\*" lists all files (up to a maximum of 300 files) which are in the current default directory. You may select the desired file by positioning the highlighted box over the desired file and pressing the <Enter> key.

SLV01??E Entering "SLV01??E" lists any file meeting the user specified file mask "SLV01??E" (or any other file mask). You may select the desired file by positioning the highlighted box over the desired file and pressing the <Enter> key.



## Default Data File Extensions

The menu program assumes certain file extensions for each file (including no extension in some cases). The assumed default extension will be used unless you override it by changing the "Default extensions" option to "NO", entering the filename, followed by a period (".") and up to three characters. If no characters are entered after the period, then no extension is used. For example, the EAD input data files use the default extension ".E", while the EAD output data files use the default extension ".EO", and the HECDSS data files use the extension ".DSS". These default extensions used by the menu program are illustrated starting with Figure 8 and ending with Figure 19. The default extensions are displayed by using the filename "EXAMPLE" or some valid file name and showing the resulting menu for each program. **These examples show every file defined for every program for information purposes only. In general, only some of the files for each program need be defined.** For the EAD program, the input file name is "COOPER.E" and the output file name is "COOPER.EO".

## DAMCAL

Figure 8: DAMCAL Menu

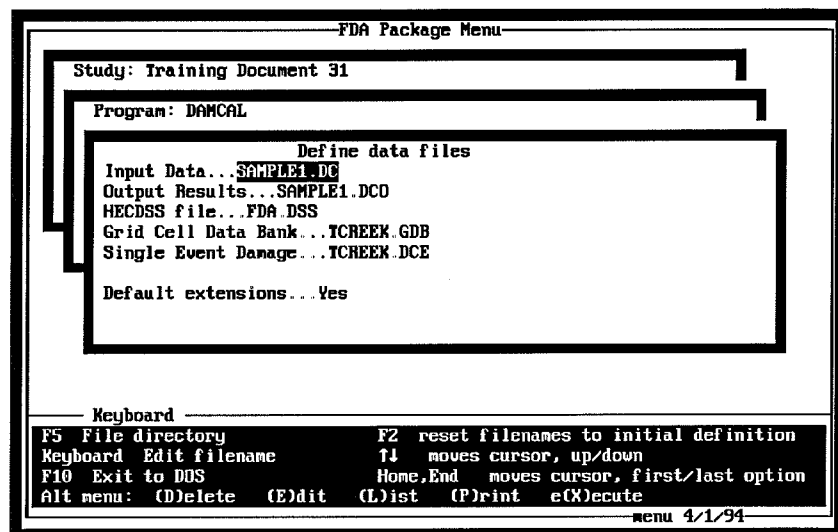

# EAD

Figure 9: EAD Menu

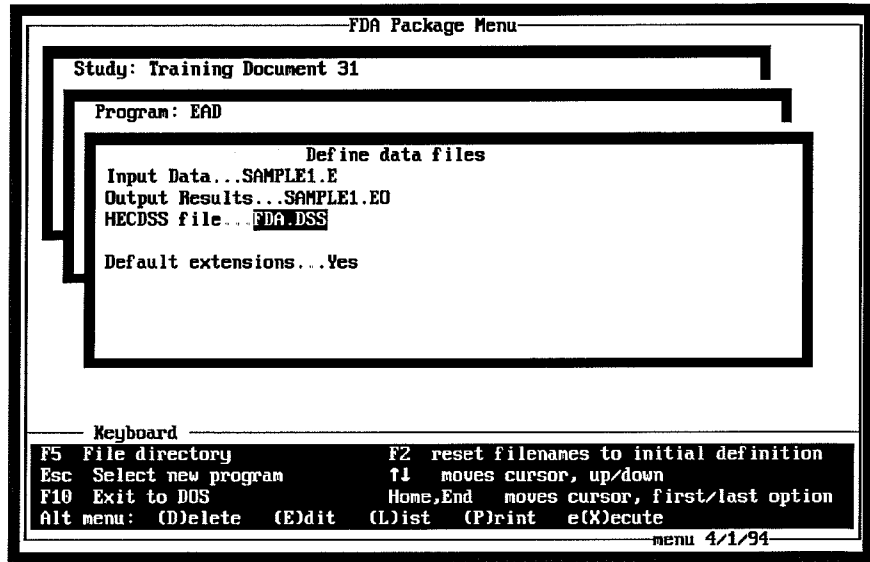

# SID

Figure 10: SID Menu

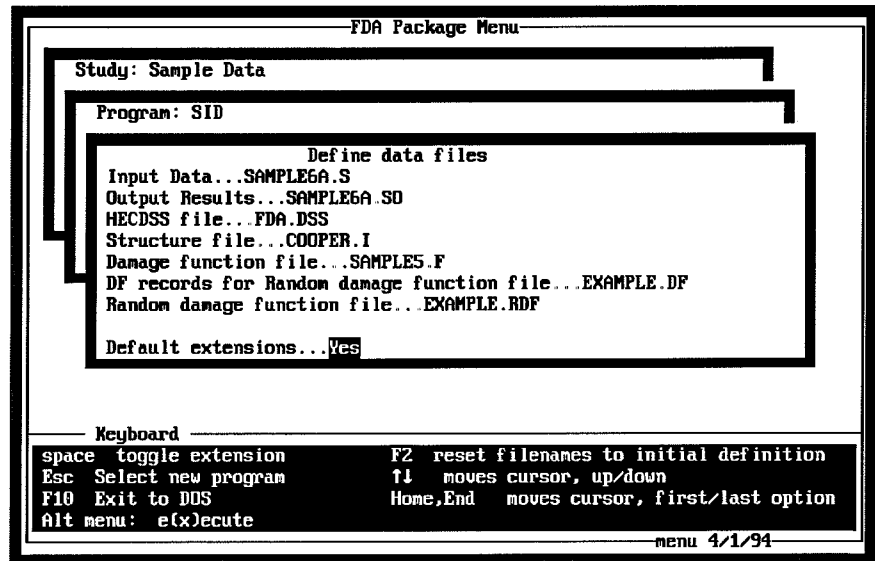

SIDEDT

Figure 11: SIDEDT Menu

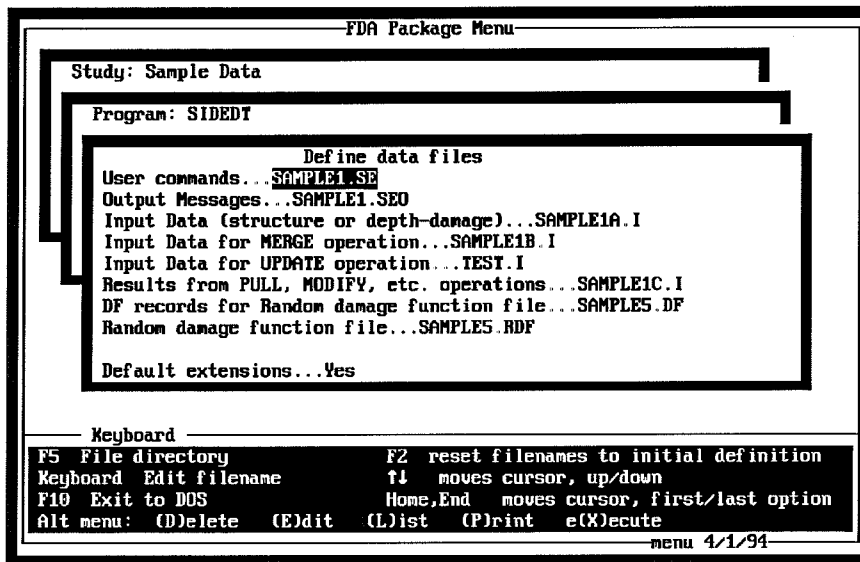

DSSUTL

Figure 12: DSSUTL Menu

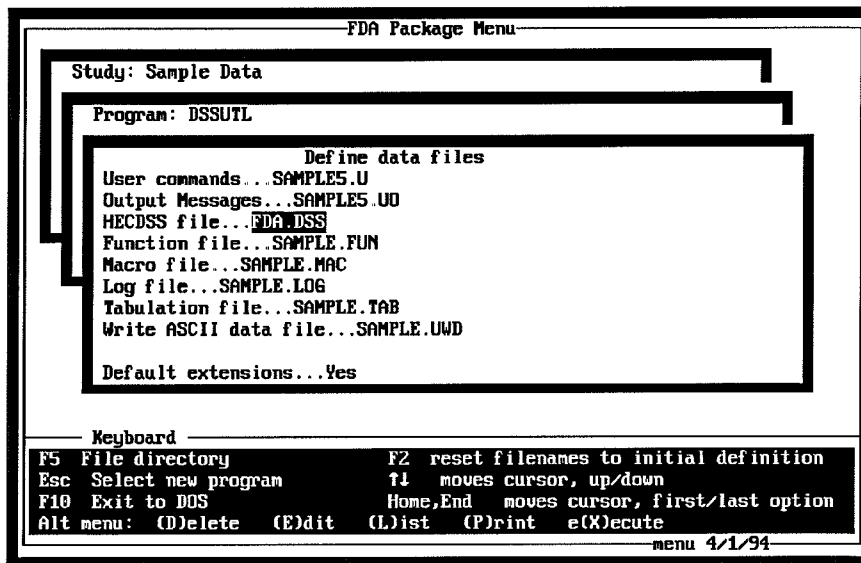

# DSPLAY

Figure 13: DSPLAY Menu

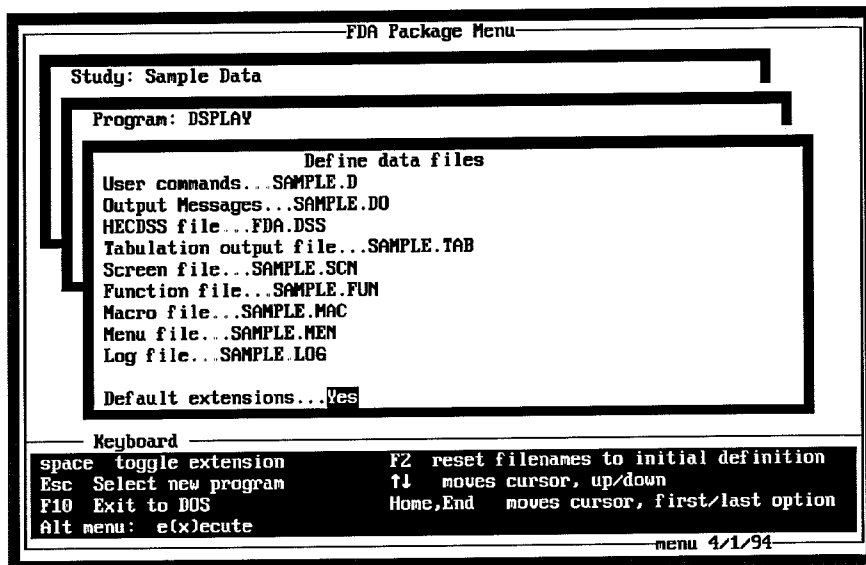

# FDA2PO

Figure 14: FDA2PO Menu

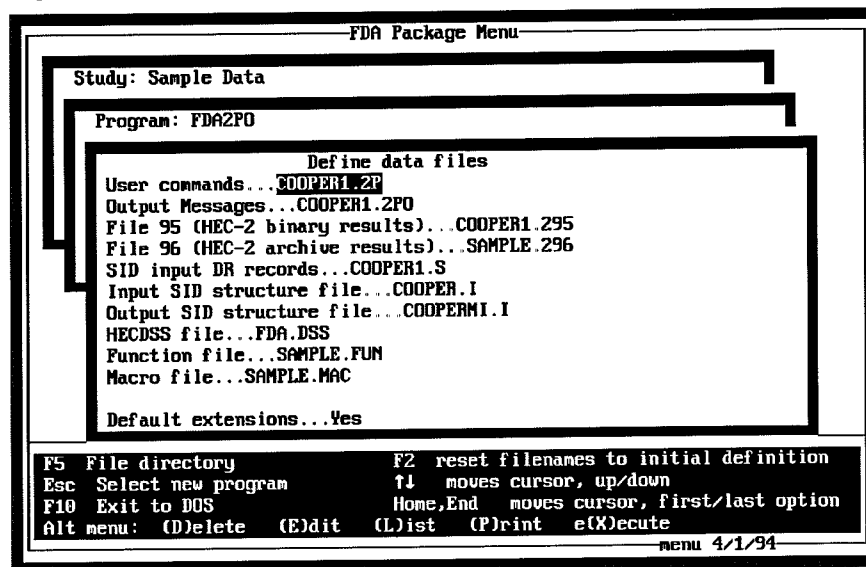

# PIP

Figure 15: PIP Menu

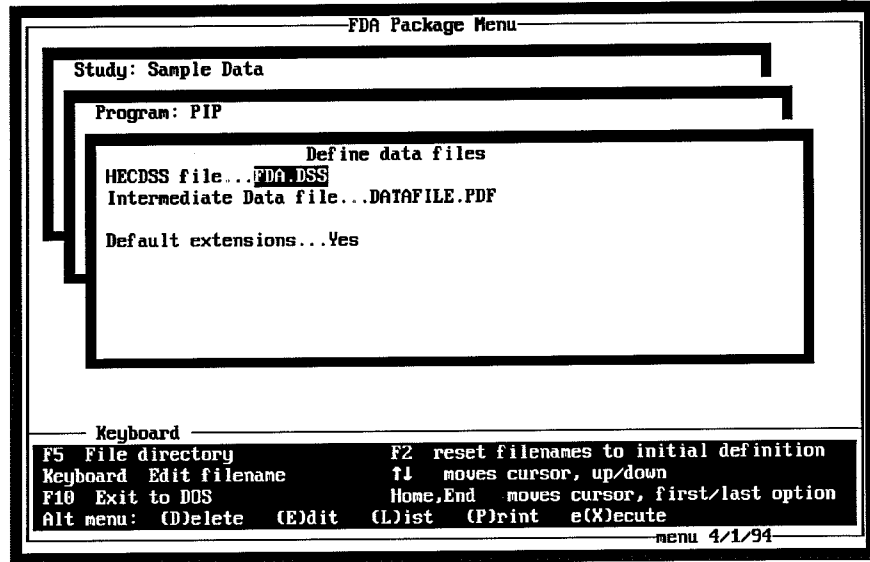

# HEC-1

Figure 16: HEC-1 Menu

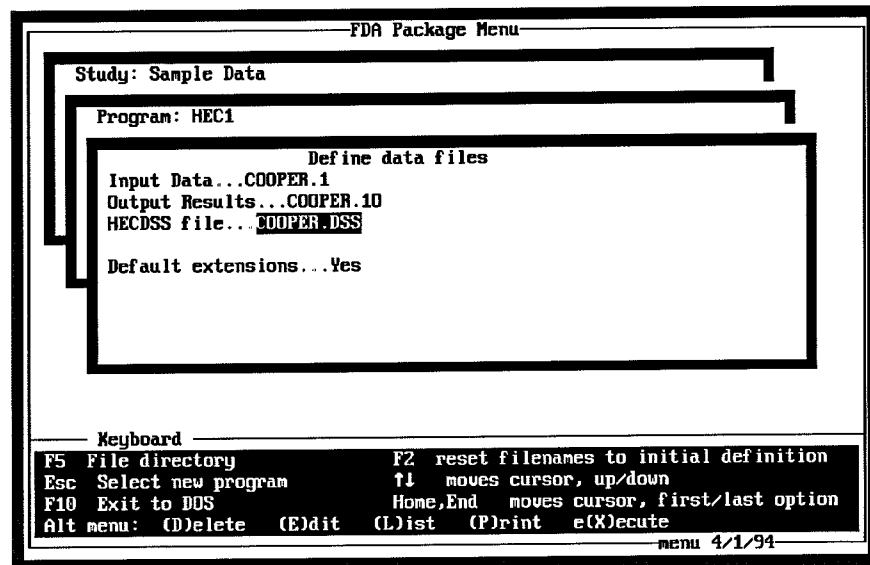

## HEC-2

Figure 17: HEC-2 Menu

```

FDA Package Menu
Study: Sample Data
Program: HEC2
Define data files
Input Data...COOPER1.2
Output Results...COOPER1.20
File 95 (HEC-2 binary results)...COOPER1.295
File 96 (HEC-2 archive results)...SAMPLE.296
HECDSS file...COOPER.DSS
Default extensions...Yes

Keyboard
space toggle extension      F2 reset filenames to initial definition
Esc Select new program      ↑↓ moves cursor, up/down
F10 Exit to DOS             Home,End moves cursor, first/last option
Alt menu: e(x)ecute

menu 4/1/94
```

## HEC-5

Figure 18: HEC-5 Menu

```

FDA Package Menu
Study: Training Doc 21
Program: HEC5
Define data files
Input Data...P1&4.5
Output Results...P1&4.50
HECDSS file...(none)
Input HECDSS file...SILVER1.DSS
Output HECDSS file...SILVERS.DSS
Menu file...SAMPLE.MEN
QLOCINC file...SAMPLE.SQL
JSF file...SAMPLE.SJS
Default extensions...Yes

Keyboard
space toggle extension      F2 reset filenames to initial definition
Esc Select new program      ↑↓ moves cursor, up/down
F10 Exit to DOS             Home,End moves cursor, first/last option
Alt menu: e(x)ecute

menu 4/1/94
```

# DSS5T6

Figure 19: DSS5T6 Menu

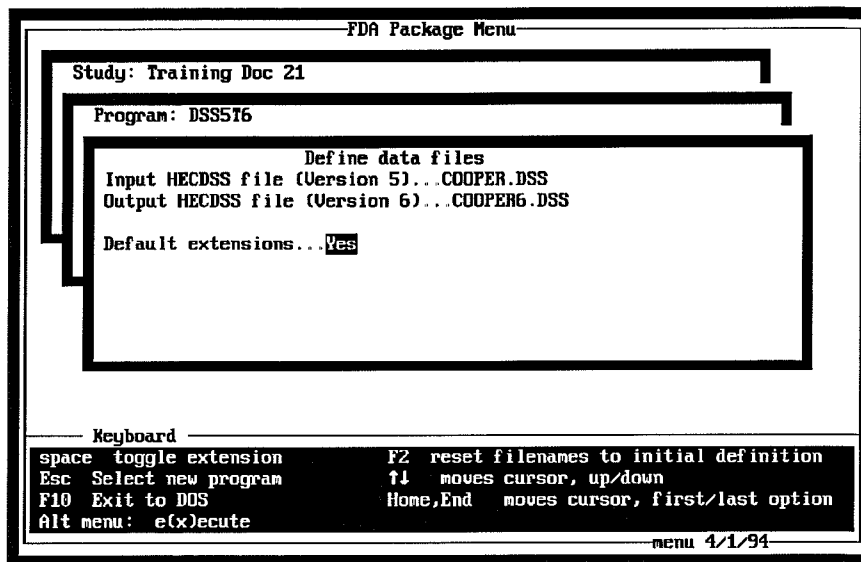





---

## REFERENCES

---

1. Corps of Engineers, U. S. Army, "Flood Damage Analysis Package User's Manual", Hydrologic Engineering Center, Davis, CA, April 1988.
2. Network Computing Devices (NCD), 9590 S.W. Gemini Drive, Beaverton, OR 97005.
3. Spindrift Laboratories, "The SPINDRIFT Library, A Subroutine Library for Use with the IBM Personal Computer and Microsoft Fortran Version 4.00", Spindrift Laboratories, 116 South Harvard Avenue, Arlington Heights, IL 60005, (708) 255-6909, June 1, 1987.
4. PKWARE, Inc., "PKWARE Version 1.0, The File Compression System Where Speed and Small Spaces Make a Big Difference", PKWARE, Inc., 7545 North Port Washington Road, Suite 205, Glendale, WI 53217, October 1989.
5. Knowledge Dynamics Corp, "Install 32. For DOS, Windows, and OS/2", Knowledge Dynamics Corp, P.O. Box 780068, San Antonio, TX 78278 (USA), June 25, 1993.
6. Lahey Computer Systems Inc., "Lahey F77L-EM/32 FORTRAN Programmer's Reference", Lahey Computer Systems Inc., P.O. Box 6091, Incline Village, NV 89450, June 1990.
7. Lahey Computer Systems Inc., "Lahey/Phar Lap DOS-Extender and Tools Reference", Lahey Computer Systems Inc., P.O. Box 6091, Incline Village, NV 89450, Revision A, January 1992.
8. Lahey Computer Systems Inc., "Lahey Blackbeard Editor Reference Manual", Lahey Computer Systems Inc., P.O. Box 6091, Incline Village, NV 89450, June 1990.
9. Corps of Engineers, U. S. Army, "Structure Inventory for Damage Analysis (SID) User's Manual", Hydrologic Engineering Center, Davis, CA, June 1989.
10. Corps of Engineers, U. S. Army, "Structure Inventory for Damage Analysis Edit Program (SIDEDT) User's Manual", Hydrologic Engineering Center, Davis, CA, 1983.
11. Corps of Engineers, U. S. Army, "Damage Reach Stage-Damage Calculation (DAMCAL) User's Manual", Hydrologic Engineering Center, Davis, CA, 1979.
12. Corps of Engineers, U. S. Army, "Expected Annual Flood Damage Computation (EAD) User's Manual", Hydrologic Engineering Center, Davis, CA, 1989.

13. Corps of Engineers, U. S. Army, "Interactive Paired-Function Input Program (PIP) User's Manual", Hydrologic Engineering Center, Davis, CA, January 1986.
14. Corps of Engineers, U. S. Army, "Flood Hydrograph Package (HEC-1) User's Manual", Hydrologic Engineering Center, Davis, CA, 1987.
15. Corps of Engineers, U. S. Army, "Water Surface Profiles (HEC-2) User's Manual", Hydrologic Engineering Center, Davis, CA, 1982.
16. Corps of Engineers, U. S. Army, "Simulation of Flood Control and Conservation Systems (HEC-5) User's Manual", Hydrologic Engineering Center, Davis, CA, April 1982.
17. Corps of Engineers, U. S. Army, "HECDSS User's Guide and Utility Program Manuals", Hydrologic Engineering Center, Davis, CA, 1990.
18. Corps of Engineers, U. S. Army, "Hydrologic and Economic Simulation of Flood Control Aspects of water Resources Systems", Technical Paper Number 43, Hydrologic Engineering Center, Davis, CA, August 1985.
19. Corps of Engineers, U. S. Army, "Flood Damage Assessments Using Spatial Data Management Techniques", Technical Paper Number 57, Hydrologic Engineering Center, Davis, CA, May 1978.
20. Corps of Engineers, U. S. Army, "Engineering and Economic Considerations in Formulating Nonstructural Plans", Technical Paper Number 103, Hydrologic Engineering Center, Davis, CA, January 1985.
21. Corps of Engineers, U. S. Army, "Comprehensive Flood Plain Studies Using Spatial Data Management Techniques", Technical Paper Number 47, Hydrologic Engineering Center, Davis, CA, October 1976.
22. Corps of Engineers, U. S. Army, "Interactive Nonstructural Flood-Control Planning", Technical Paper Number 68, Hydrologic Engineering Center, Davis, CA, June 1980.
23. Corps of Engineers, U. S. Army, "The Hydrologic Engineering Center Experience in Nonstructural Planning", Technical Paper Number 96, Hydrologic Engineering Center, Davis, CA, February 1984.
24. Corps of Engineers, U. S. Army, "Flood Control System Component Optimization HEC-1 Capability", Training Document Number 9, Hydrologic Engineering Center, Davis, CA, September 1977.
25. Corps of Engineers, U. S. Army, "Analytical Instruments for Formulating and Evaluating Nonstructural Measures", Training Document Number 16, Hydrologic Engineering Center, Davis, CA, January 1982.
26. Corps of Engineers, U. S. Army, "Application of Spatial Data Management Techniques to HEC-1 Rainfall-Runoff Studies", Training Document Number 19, Hydrologic Engineering Center, Davis, CA, October 1983.

27. Corps of Engineers, U. S. Army, "Guide Manual for the Creation of Grid Cell Data Banks", Training Document Number 2, Hydrologic Engineering Center, Davis, CA, September 1978.
28. Corps of Engineers, U. S. Army, "A Tutorial on Creating a Grid Cell Land Cover Data File from Remote Sensing Data", Training Document Number 22, Hydrologic Engineering Center, Davis, CA, June 1985.



---

## APPENDIX A: SUPPLEMENTAL COMPUTER PROGRAM INSTRUCTIONS

---

### Introduction

This Appendix contains supplemental instructions for the programs contained in the personal computer version of the FDA Package. They document either capabilities that have been added to each program subsequent to the last printing of the user's manual, capabilities that have not been included in the preliminary version of the program, or characteristics unique to the personal computer.

## DAMAGE REACH STAGE-DAMAGE CALCULATION (DAMCAL)

The computer program DAMCAL can evaluate a broad range of alternative flood damage reduction measures that will provide flood damage relief for existing and future land use conditions. It accesses a geographic information system (GIS) data base file from which it extracts information for flood damage computations. This information includes: topographic elevation, reference flood elevation, damage reach delineation, existing land use classification, and alternative future land use patterns. Each alternative analysis results in the creation of an aggregated elevation-damage function for each land use category at each damage reach index location. The aggregated elevation-damage function can then be stored in a DSS file by following the supplemental instructions listed below.

### J3 Record: Third Job Record (Required Record)

This record defines the sequence numbers of the data variables used in the analysis and the number of categories for particular data variables.

Field	Variable	Value	Description
0-8	...	...	No change. Fields defined as before.
9	GSIZE	-	Grid cell size and analysis control DAMCAL will calculate and print an elevation-structures flooded table.
		+	The grid cell size in acres. DAMCAL will develop an elevation-area table.
10	NDUR	0	No duration damage functions.
		+	The number of duration values entered for duration-damage functions. Variable INPET (field LU.2) must be less than zero. Depth and duration values are entered immediately after the LT record. If changes are made (variable CHANGE, field LC.7 is less than zero), then revised numbers are entered after the LC records.

## ZW Record -- Write elevation-damage function to a DSS file

The **optional** ZW record requests the DAMCAL program to store elevation-damage, elevation-area, and elevation-structures functions in a data storage system (DSS) data file. The functions are stored by land use for each reach. The pathname parts A, E, and F may be entered in either of two formats:

- (1) The "HEC standard" method in which the parts are entered in free format. Each part is preceded by the part identifier (A, E, or F) and an equal sign. A blank column follows each part name. The characters **ZW** must be entered in columns one and two. Columns 3 and 4 may contain the option ".A" to store the elevation-area matrix. The format for entering the parts is:

ZW A=study E=data year F=alternative or plan

An example user entry using this format is:

ZW A=SILVER CREEK E=1990 F=BASELINE

- (2) The "old" method in which the parts are entered in fixed format is documented below. Part A is entered in columns 3 through 16, part F in columns 17 through 40, and part E in columns 45 through 48.

Field	Variable	Value	Description
0	KODE	ZW	Record identification.
1-2	PROJ(1)	AN	Project pathname label (part A).
3-5	ALT	AN	Alternative pathname label (part F).
6 (45-48)	IYR	AN	Output data year (part E) to be specified in pathname label.
7	IAREA	0	Do <u>not</u> write the elevation-area matrix to the HECDSS data file.
		1	Write the elevation-area matrix to the HECDSS data file.

## DT Record --- Damage Reach Title Record

The DT record labels the damage reach and provides the unique identifier (name or location) for each reach.

Field	Variable	Value	Description
0		DT	Record Identification.
1		(AN)	Damage reach location or name (part B of the DSS pathname).
2-10		(AN)	Description of the damage reach on the preceding DR record (DR.1).

## File Assignments

The key words used to assign files when the program is executed have been changed. If you use the menu program to execute the programs, you need not worry about these key words. However, if you execute on the Harris or don't use the menu program, you need to know these key words. To determine the current definition, enter the command:

DAMCAL ?

The results from this command should look similar to the following:

```
DAMCAL - Version 2.1.00; April 1994; IBM-PC Compatible (Lahey 32bit)
UNIT      KEYWORD      *ABREV  **MAX  DEFAULT
  2      SINGLE-EVENT  S        64     SCRATCH.002
  4      FILE4        F        64     SCRATCH.003
  5      INPUT        I        64     CON
  6      OUTPUT       O        64     CON
  8      FILE8        FILE8    64     SCRATCH.004
  1      DATA BANK   D        64     SCRATCH.001
NOP      DSS FILE     DS       64     SCRATCH.031
* ABREV - SHORTEST ABBREVIATION ALLOWED FOR KEYWORD
** MAX - MAXIMUM # OF CHARACTERS FOR FILENAME (OR STRING)
```



## EXPECTED ANNUAL FLOOD DAMAGE COMPUTATION (EAD)

The EAD Computer Program User's Manual was updated in March 1989. Since this update, several changes have been made to the program including:

### Grand Summary of Undiscounted EAD

The EAD output includes a grand summary table of undiscounted expected annual damage when equivalent annual damage is calculated as shown in Table 1. One table is output for each plan. Each table summarizes the expected annual damage for all damage categories and all reaches.

Table 1: Grand Summary of Undiscounted EAD

```

* * * * *
* * * * *
TEST NO. 2 -- PERIOD OF RECORD ANALYSIS WITH PRINTOUT SUPPRESSION
BASIN DEVELOPMENT FOR 1976, 1990, AND 2020
DAMAGE VALUES IN $1000

** EXPECTED ANNUAL FLOOD DAMAGE **
** GRAND TOTAL FOR ALL DAMAGE REACHES
** PLAN 1 = WITHOUT PROJECTS
** INPUT DATA YEARS = 1976 1990 2020
** PERIOD OF ANALYSIS = 100 YEARS
** DAMAGE BASE = JUNE 1974 DOLLARS
    
```

DAMAGE CATEGORIES	STUDY YEAR 1976	BASE YEAR 1981	DECADE YEARS					END OF PERIOD 2080
			10 1990	20 2000	30 2010	40 2020	50 2030	
1 AGRIC	324.46	358.71	420.12	433.70	447.75	462.22	462.22	462.22
2 SERVICE	65.67	71.01	80.61	82.86	85.19	87.59	87.59	87.59
3 URBAN	383.98	411.62	461.86	478.91	496.30	513.95	513.95	513.95
TOTAL	774.12	841.34	962.59	995.48	1029.24	1063.76	1063.76	1063.76

```

* * * * *
* * * * *
    
```

### Footnotes To Frequency-Damage Table

Frequency-damage tables include a footnote character when interpolated results are truncated because discharge-elevation functions and/or elevation-aggregated damage matrices do not cover the desired range of exceedance frequency. Table 2 depicts a typical computed matrix in which interpolated elevations and damage have been truncated. In this example, the discharge-elevation function did not extend as high as the flow-frequency curve. The footnote "b" indicates that the elevation-damage matrix goes higher than the discharge-elevation function but that the discharge-elevation function was not higher than the frequency curve. The footnote "b" is replaced by a "c" if both the highest ordinate on the elevation-damage matrix is lower than the highest ordinate on the discharge-elevation function and the highest ordinate on the discharge-elevation function is lower than the highest point on the frequency curve.

**Table 2: Frequency-Damage Truncation**

++DAMAGE DATA, REACH RCH11 FOR PLAN 1 -- EXISTING COND. - USES BASE QF,QS,DG DATA										
	FREQ	FLOW	STAGE	RESIDENT	GAS STAT	SCHOOL	CHURCH	OTHER	TOTAL	ACC
EAD										
1	99.00	303.	617.25	.00a	.00a	.00a	.00a	.00a	.00	18.93
2	60.00	1304.	620.88	.00a	.00a	.00a	.00a	.00a	.00	18.93
3	50.00	1544.	621.44	.00	.00	.00	.00	1.80	1.80	18.90
4	40.00	1818.	622.06	.00	.00	.00	.00	13.11	13.11	18.19
5	30.00	2151.	622.44	.00	.00	.00	.00	19.13	19.13	16.55
6	20.00	2595.	622.95	.00	.00	.00	.00	21.09	21.09	14.51
7	15.00	2896.	623.21	6.23	.00	.00	.00	21.62	27.84	13.31
8	10.00	3290.	623.52	21.62	.00	.00	.00	23.63	45.26	11.54
9	7.00	3603.	623.73	37.09	.00	.00	.00	25.94	63.04	9.93
10	5.00	3893.	623.92	61.15	.00	.00	.00	28.20	89.36	8.43
11	3.00	4338.	624.19	98.63	.00	.00	.00	31.44	130.07	6.26
12	2.00	4697.	624.39	130.62	.00	.00	.00	33.99	164.62	4.81
13	1.00	5428.	624.75	190.57	.00	.00	.00	38.96	229.52	2.88
14	.50	6124.	625.06	240.20	.00	.00	.00	43.24	283.44	1.60
15	.20	6858.	625.38	284.73	.00	.00	.00	47.62	332.35	.69
16	.10	7503.	625.47a	297.05b	.00b	.00b	.00b	48.81b	345.86	.35
EXP ANNUAL DAMAGE				9.32	.00	.00	.00	9.61	18.93	
Note: (a) Truncation; (b) Rating curve truncated										

**Calculation Status On the Personal Computer**

The scrolling status printout has been replaced by a fixed screen display of the computation status. It displays a more detailed status of calculations.

**Suppression of Output - Truncation Notes and Affluence**

The user may suppress the output from the affluence calculations as well as the output of interpolation truncation footnotes.

## PP Record - Printout and Punch Options (Optional Record)

This record may be inserted at any time along with reach input data to activate or deactivate desired printout and/or punch options. The specified options remain in effect until another PP record is encountered.

Field	Variable	Value	Description
0-2	...	...	No change. Definitions remain the same.
3	JDGPR (0)	+	The sum of the following printout suppression options that are desired for expected annual damage routines. For example, a value of 15 will suppress all output for each reach and only the final job summary will be output. Some of the test data in Exhibit 4 illustrates the use of this option.
		0	No output will be suppressed.
		1	Suppress printout of input data for each damage reach.
		2	Suppress printout of computed damage for each flow or stage (usually associated with an exceedance frequency).
		4	Suppress printout of expected annual damage (EAD) as computed. Results of EAD will only appear in the summary tabulation.
		8	Suppress printout of expected annual damage by decades and equivalent annual flood damage for each plan of each reach.
		16	Suppress summary by reach for each category.
		32	Suppress grand summary by reach for total damage.
		64	Suppress all summary output.

PP Record - Printout and Punch Options (Optional Record) **continued**

Field	Variable	Value	Description
		128	Suppress footnotes in the frequency-damage tabular output.
		256	Suppress the detailed output from affluence calculations.

## File Assignments

The key words used to assign files when the program is executed remain the same. If you use the menu program to execute the programs, you need not worry about these key words. However, if you execute on the Harris or don't use the menu program, you need to know these key words. To determine the current definition, enter the command:

EAD ?

The results from this command should look similar to the following:

```
EAD - Version 2.1.00; April 1994; IBM-PC Compatible (LAHEY 32bit).
UNIT      KEYWORD      *ABREV      **MAX      DEFAULT
  5        INPUT        I           64         CON
  6        OUTPUT       O           64         CON
  7        PUNCH        P           64         SCRATCH..001
  29       TRACE        T           64         SCRATCH..002
  8        FILE8        F           64         SCRATCH..008
  9        FILE9        FILE9       64         SCRATCH..009
NOP       DSSFILE      D           64         SCRATCH..031
* ABREV - SHORTEST ABBREVIATION ALLOWED FOR KEYWORD
** MAX - MAXIMUM # OF CHARACTERS FOR FILENAME (OR STRING)
```

An example user entry to execute the program on the Harris (or on the personal computer if you are not using the menu program) may look like the following:

```
EAD I=SLV01.E O=SLV01.EO DSS=SILVER.DSS
```

## STRUCTURE INVENTORY FOR DAMAGE ANALYSIS (SID)

The **SID** Computer Program User's Manual was updated in March 1989. Since this update, several changes have been made to the program.

### Observing the Maximum Limits For Floodproofing

If the user specifies a maximum floodproofing or raise-to-target limit and that limit would be exceeded, SID will print a message and reduce the floodproofing limit to the specified maximum. This change is documented in the sample data sets of the SID manual. The limits are entered on the DC records.

### Sampling Using the SL Record

If one set of SL and SD records represents more than one structure, the number of structures may be entered in columns 76-80 of the SL record. This value is then used in the flood zone summary tables.

#### SL RECORD (Required)

Field	Variable	Value	Description
0-9	...	...	<b>Defined as before.</b>
10	NUBLDG		Allows sampling while maintaining an accounting of the number of structures in each flood zone.
		0 or 1	Entry on this set of SL, SD, etc. records represents 1 structure.
		+	Entry on this set of SL, SD, etc. records represents NUBLDG structures. The average structure value is entered on the SD records. The variable NUBLDG is used in the flood zone summaries to indicate the number of structures in each flood zone. For example, if this set of SL and SD records reflects 10 structures having an average value of \$125,000, NUBLDG is set to 10 and V1FS on the SD record is set to 125 (one hundred twenty-five thousand dollars).

## Additional Results Written to the HECDSS Data File

SID writes additional information to the HECDSS file including flood zone summary information for aggregated damage, value of structures, and number of structures. Flood zone summaries include tables for structure value based on zero damage elevations. The information written to the HECDSS data file may be suppressed using the variable IODSS, field J2.10.

## Modification To J2 Record

Field	Variable	Value	Description
0-9	...		No change in definition.
10	IODSS		Controls the output of results to the HECDSS data file. Each type of output is controlled by summing the following suppression numbers. For example, an entry of 6 would suppress the storage of flood-zone summary and event-damage information.
		0	No suppression. All of the results are written to the DSS data file.
		1	Suppress the storage of the elevation-damage matrices. These are the ones used by the EAD program.
		2	Suppress the storage of the flood-zone summaries.
		4	Suppress the storage of the event-damage results. The values used on the ST record are used as the ordinates of the first variable. If numeric values are entered, they are stored as numeric. If character values are entered, the first four characters are stored.

## Computing the Reference Flood Elevation

In the past, the user must enter the reference flood elevation for each structure in field SL.5 for every structure. Now, the user may automatically compute this elevation using the results from HEC-2 and the HEC-2 post-processor program FDA2PO. To facilitate this, the user must identify the river mile associated with each structure. The FDA2PO program uses the river mile to interpolate the computed water surface elevation from the HEC-2 calculated water surface profile and stores it in field SL.5 of the SID structure input data stream. The river mile is entered in field SO.9.

## Calculation Progress On the Personal Computer

The scrolling status printout has been replaced by a fixed screen display of the computation status. It displays a more detailed status of calculations. On the personal computer, the SID program issues a message indicating the status of calculations. Sometimes, it may seem that your computer is "hung" - nothing is being processed. To help alleviate this problem, the program issues a message at the conclusion of the elevation-damage function for every ten structures. On faster machines, this message appears frequently (once every ten seconds or less). On slower machines, this message may appear infrequently (once every minute or two).

## File Assignments

The key words used to assign files when the program is executed remain the same as the previous version. If you use the menu program to execute the programs, you need not worry about these key words. However, if you execute on the Harris or don't use the menu program, you need to know these key words. To determine the current definition, enter the command:

SID ?

The resulting output should look similar to the following:

```
SID - Version 2.1.00; April 1994; IBM-PC Compatible (LAHEY 32bit).
      (Functions= 5000 / MEMAX2=120000 / MEMAX1=10000)
UNIT  KEYWORD      *ABREV  **MAX  DEFAULT
   5   INPUT       I         64    CON
   6   OUTPUT      O         64    CON
  11   STRUCTURE   S         64    SCRATCH.001
  12   DMGFUNC     D         64    SCRATCH.002
  13   F13         F         64    SCRATCH.032
  14   F14         F14       64    SCRATCH.003
NOP    DSSFILE     DS         64    SCRATCH.031
  92   DFRECS      DF         64    SCRATCH.004
NOP    RANDMG      R         64    SCRATCH.033
* ABREV - SHORTEST ABBREVIATION ALLOWED FOR KEYWORD
** MAX - MAXIMUM # OF CHARACTERS FOR FILENAME (OR STRING)
```

The key words reflect the purpose of each unit. The most significant units are:

<u>Keyword</u>	<u>Abbrev.</u>	<u>Purpose</u>
STRUCTURE	S	Contains sequential structure records.
DMGFUNC	D	Contains sequential damage functions.
DFRECS	DF	Contains DF records associated with the damage functions contained on the random damage file.
RANDMG	R	Contains damage functions stored in a random access format.



## **STRUCTURE INVENTORY FOR DAMAGE ANALYSIS EDIT PROGRAM (SIDEDT)**

The SIDEDT program is unchanged for the most part. However, it was modified for the last release so that it is more "user friendly" to the person entering commands from the keyboard (as opposed to reading commands from a file).

### **User Input Error Correction**

The SIDEDT program will not abort if you enter an incorrect command from the keyboard. Instead, it will display a brief description of the command that it thinks you are entering. If it can not determine the command that you have entered, it will display a list of all valid commands. It will not give you a description of each command. SIDEDT sometimes accepts incomplete commands and produces no error messages. For example, if the user enters the following command:

READ TYPE

SIDEDT does not recognize that it is an incomplete command and will not issue an error message. If the user attempts other operations, they will fail because SIDEDT does not know the type of data the user wishes to process.

### **Generation of Random Damage Function File**

The user must let the SIDEDT program generate a random access damage function file. Harris versions of SID and SIDEDT cannot converse with random access damage function files created with older versions of the programs or files generated with the use of the JCL command "\$GE filename R".

### **File Assignments**

The key words used to assign files when the program is executed are the same as the previous version. If you use the menu program to execute the programs, you need not worry about these key words. However, if you execute on the Harris or don't use the menu program, you need to know these key words. To determine the current definition, enter the command:

SIDEDT ?

The resulting output should look similar to the following:

```

SIDEDT - Version 2.1.00; April 1994; IBM-PC Compatible (Lahey 32 bit).
(Function= 5000).
UNIT      KEYWORD      *ABREV      **MAX      DEFAULT
  5        IN          I           64        CON
  6        OUT          O           64        CON
  8        DIN          D           64        SCRATCH.001
  9        MERGE       M           64        SCRATCH.002
 10        UPDATE     U           64        SCRATCH.003
 11        SCRATCH    S           64        SCRATCH.004
 12        DOUT       DO          64        SCRATCH.005
 29        TRACE      T           64        SCRATCH.009
 92        DFRECS     DF          64        SCRATCH.006
NOP       RANDMG      R           64        SCRATCH.031
* ABREV - SHORTEST ABBREVIATION ALLOWED FOR KEYWORD
** MAX - MAXIMUM # OF CHARACTERS FOR FILENAME (OR STRING)

```

The key words reflect the purpose of each unit. The most significant units are:

Keyword	Abbrev.	Purpose
DIN	DI	Contains either sequential damage functions or sequential structure records. This is considered to be "FILE8" for use in the input commands.
MERGE	M	Contains either sequential damage functions or sequential structure records when they are to be merged with those contained in the "DIN" file (or unit 8). This is considered to be "FILE9" for use in the input commands.
UPDATE	U	Contains new values which will update those existing in the "DIN" file (or unit 8). This is considered to be "FILE10" for use in the input commands.
DOUT	DO	Contains the output sequential damage function or structure data after an edit command is executed. This is considered to be "FILE12" for use in the input commands.
DFRECS	DF	Contains the damage function DF records generated when a random access damage function file is created. This is considered to be "FILE92" for use in the input commands.
RANDMG	R	Contains the damage functions in a random access format. This unit may be used as either an input or output unit. This is considered to be "FILE98" for use in the input commands.

The MENUFDA program does not allow the user to define a filename for unit 11. At the conclusion of the SIDEDT execution, the scratch file associated with unit 11 is deleted. It is recommended that you perform only one SIDEDT operation before redefining your data files. However, if you are an

experienced user, you may perform multiple edit operations. However, you must never conclude editing when your desired output results have been written to unit 11 because you will lose them --- always conclude your editing with the final results stored on the "DOUT" file (or unit 12).

## **HEC-2 POST-PROCESSOR FOR FLOOD DAMAGE COMPUTATIONS (FDA2PO)**

### **Program Purpose**

The FDA2PO program post-processes computed results from HEC-2. It allows you to store discharge-elevation functions in an HECDSS data file and/or compute reference flood elevations for each structure. This method of storing discharge-elevation functions is an alternative to storing them directly with HEC-2. The FDA2PO program allows you to select the cross-sections at which you desire to store the curves rather than storing curves for all sections as is currently done by HEC-2 in the Harris version. The computation of the reference flood elevations requires that you supply a SID structure file containing "SL", "SD", and "SO" records and a SID input data file containing the reach identification records "DR".

The FDA2PO program processes results from either "TAPE95" or "TAPE96" output from a HEC-2 execution. The "TAPE95" file is a binary disk file to which HEC-2 writes computed results. It is a "binary" or "unformatted" file (not readable using the DOS "TYPE" command). It must be created with one of the more recent versions of the HEC-2 program and not older versions so that it will be compatible (and readable) by the FDA2PO program. The "TAPE96" file is the archive output file from HEC-2. It is written in an ASCII (or readable) format. This file can be created on another computer system (such as the Harris) and downloaded to the personal computer where the FDA2PO program can process it and store discharge-elevation functions and structure reference elevations in an HECDSS file on the personal computer. It is far more efficient to use the "TAPE95" file - it requires about fifty percent less processing time. However, program versions of the HEC-2 and FDA2PO must match and you can not look at the file using the DOS command "TYPE".

### **File Assignments**

If you use the menu program to execute the programs, you need not worry about these key words. However, if you execute on the Harris or don't use the menu program, you need to know these key words. To determine the current definition, enter the command:

FDA2PO ?

The resulting output should look similar to the following:

```

Post-Process HEC-2 (Lahey 32bit); Version - 2.1.00; April 1994.
UNIT      KEYWORD      *ABREV      **MAX      DEFAULT
   5      IN          I           64        CON
   6      OUT          O           64        CON
  NOP     F95          F           64        SCRATCH.032
  NOP     F96          F96        64        SCRATCH.001
  NOP     DR          D           64        SCRATCH.002
  NOP     SIN          S           64        SCRATCH.003
  NOP     SOUT         SO          64        SCRATCH.004
  NOP     DSS          DS           64        SCRATCH.031
   30     SCRATCH     SC           64        SCRATCH.005
  NOP     FUNFILE      FU           64        FDA2PO.FUN
  NOP     MACFILE      M           64        FDA2PO.MAC
* ABREV - SHORTEST ABBREVIATION ALLOWED FOR KEYWORD
** MAX - MAXIMUM # OF CHARACTERS FOR FILENAME (OR STRING)

```

The user should enter filenames for the key words as follows:

Keyword	Description
F95 or F96	File which contains the results from HEC-2.
DR	File contains input data for the SID program including the DR records.
SIN	File contains the original structure records (SL, SD, and SO) for SID.
SOUT	File will contain the same structure records as the SIN file after they are modified with the computed reference flood elevation in field SL.5 and the translated first floor elevation in field SO.10.
DSS	File is the HECDSS data file to which discharge-elevation functions are written.

## Reference Flood Calculation

To compute the reference flood elevations, you must have SID input data containing the DR reach record(s) and the structure records SL, SD, and SO. You must also have the computed results from HEC-2 written on either "TAPE95" or "TAPE96" and one of the profiles calculated by HEC-2 must be acceptable as the reference flood. The structure records and the DR records may exist in the same file but you will have to specify that same file name for both the DR file and the input structure file. Field 2 of the DR record will be over written by the calculated reference flood elevation at the index location. The structure data must contain SO records with the river mile entered in field nine. The FDA2PO program will use the reference flood water surface profile to:

- (1) calculate the structure transformed first floor elevation after conceptually moving it to the index location and writing that elevation in field ten of the SO record.
- (2) calculate the reference flood elevation at the structure by interpolating the profile at the river mile entered by the user in field nine of the SO record. The FDA2PO program assumes that the cross-section number entered in field one of the HEC-2 input data file is expressed in river miles and it uses it for interpolation of the reference flood elevation. The calculated elevation is written in field five of the SL record. The FDA2PO program writes all of the records to a new file to allow the user to compare the modified records with the original records.
- (3) calculate the reference flood elevation at the index location by interpolating the profile at the river mile associated with the cross-section that the user defines as the index location when prompted by the FDA2PO program. The FDA2PO program allows the user to redefine the river mile associated with the index location. This is desirable if none of the sections coincide with the index location. The calculated elevation is written in field two of the DR records and will overwrite any existing value.

## Discharge-Elevation Function Calculation

To store discharge-elevation function(s) in an HEC-DSS data file, you must have SID input data containing the structure records SL, SD, and SO. You must also have the computed results from HEC-2 written on either "TAPE95" or "TAPE96". The HEC-2 results must be for several profiles of increasing discharge spanning the range of desired exceedance frequencies. The FDA2PO program prompts the user to identify the damage index locations by cross-section index number. For example, if there are 50 cross-sections, the user might identify cross-section 14 as the section coinciding with the damage index location. The user may identify the cross-section using the river mile (which is defined in field one of the X1 record of the HEC-2 input) by entering the code S={river mile}. For example, if cross-section 14 is at river mile 56.78 and it is the index location, the user may identify it by entering "S=56.78". The FDA2PO program uses the structure data to determine the number of reaches for which discharge-elevation functions must be defined. If the HEC-2 results span more damage reaches than those defined in the SID structure file, the user needs to run FDA2PO several times, each time specifying a new structure file.

Before storing the discharge-elevation functions in the HEC-DSS data file, FDA2PO prompts the user to define the pathname parts A, E, and F. FDA2PO utilizes the six character reach identification from the SL records as part B of the pathname. One record will be written to the HEC-DSS data file for each reach. Each record contains one discharge-elevation function.

## Example Execution of FDA2PO

The following pages illustrate a simple execution of the FDA2PO program. The data consists of the two structures and the HEC-2 geometric data shown in Training Document 21 (Computer Program Document 59). The reference flood is the sixth profile as computed by HEC-2. The damage index location coincides with river mile 49.0 or cross-section 4. Both the discharge-elevation function and the flood reference elevations are calculated. The program output and the user input are in normal font whereas the explanatory messages are in italics.

*{Two files are shown below. The first file contains the DR record for RCH 1. The FDA2PO program modifies the DR record by calculating the reference flood elevation at the damage index location and storing it in field two (columns 9 through 16). The second file contains the SID structure records. The FDA2PO program will modify the SL records by calculating the reference flood elevations at each structure and storing it in field five (columns 33 through 40). It will also modify the SO record by calculating the structure first floor elevation after it has been transposed to the index location.}*

```

T1      SILVER CREEK
T2
T3
J1      0      0      0      0      0      0      0      0
J2      4      2      1      1      1      1      18      1      2
ZW A=SILVER CREEK      F=BASE
DC      RESDNTL      RESIDENTIAL STRUCTURE AND CONTENTS
DC      COMERCL      COMMERCIAL STRUCTURE AND CONTENTS
DR RCH 1      3462      0.5
DT      DAMAGE REACH 1 FOR RIVERTON
ES

SL RCH 1      R001      3463.8      0      1
SD RCH 1      R001 RESDNTLRS1 130RS2 -50
SO RCH 1      R001      48.965
SL RCH 1      C001      3462.4      1
SD RCH 1      C001 COMERCLCM1 60CM2 250
SO RCH 1      C001      48.988
  
```

*{The following is the output from FDA2PO as it processes HEC-2 output which has been stored on "TAPE95". Like this paragraph, explanations of the output not written by FDA2PO appear within brackets and in italics.}*

```

Number of sections from File95 header:      5.

Process profile 1.
Process profile 2.
Process profile 3.
Process profile 4.
Process profile 5.
Process profile 6.
Process profile 7.
Process profile 8.
Process profile 9.
  
```

Process profile 10.  
 Process profile 11.  
 Process profile 12.  
 Process profile 13.  
 Process profile 14.

*{The following output displays the computed water surface elevations. In this case there are 14 profiles. The water surface elevation for the tenth profile is located in the second line below the column titled "Profile 5". The "Cum dist." is simply the cumulative distance (in feet) of each cross-section from the first section. The "Section no." is simply the river mile entered in field one of the X1 record in the HEC-2 input data file.}*

There were 14 profiles, 5 sections, and 0 tributaries.

Section no.	Cum dist.	Profile 1	Profile 2	Profile 3	Profile 4	Profile 5
48.300	0.	3436.67	3439.58	3441.47	3442.85	3444.04
		3445.05	3445.86	3446.61	3447.30	3447.96
		3449.17	3451.32	3453.22	3457.32	
48.500	1056.	3442.94	3445.25	3446.76	3447.99	3449.02
		3449.88	3450.63	3451.34	3452.00	3452.64
		3453.85	3456.05	3458.04	3462.45	
48.800	2640.	3451.82	3453.73	3454.78	3455.35	3455.63
		3456.56	3457.31	3458.26	3460.15	3461.09
		3462.58	3463.65	3464.30	3466.41	
49.000	3696.	3459.69	3461.93	3463.44	3464.65	3465.65
		3466.39	3467.12	3467.76	3467.97	3468.30
		3468.82	3470.25	3471.60	3473.97	
49.500	6202.	3472.89	3474.98	3476.02	3476.60	3476.85
		3477.16	3477.29	3477.59	3478.28	3478.87
		3479.99	3481.91	3483.52	3486.76	

Do you want to store rating curves in a DSS data file?

(y/n): **Y**

*{User responds by entering "y" to indicate that discharge-elevation rating curves will be stored in an HEC DSS data file. FDA2PO recognizes either lower or upper case letters.}*

Do you want to compute reference flood elevations?

(y/n): **Y**

*{User responds by entering "y" to indicate that reference flood elevations will be computed at each structure and at the index locations.}*

Note, file SILVER.I already exists!

Do you want to overwrite it? (y/n) **Y**



*{FDA2PO displays this message whenever the file to which the modified structure data is written already exists. This allows the user to verify that existing data will be overwritten.}*

```
There are 1 reach(es) in the structure file:
  Index  I.D.  Index  I.D.  Index  I.D.  Index  I.D.  Index  I.D.
-----
      1  RCH 1
```

*{FDA2PO displays this message after it has read all of the structure data contained in the SID input structure file.}*

Eliminate any cross-sections? (y/n) **n**

*{FDA2PO allows the user to eliminate any cross-sections from the reference flood interpolation procedure. For this example, none of the sections are eliminated.}*

For each damage reach from SID, you must identify the following:

- (1) The cross-section which corresponds to the index location.
- (2) The index number of the profile which will be used for the reference flood.
- (3) An edited river mile for the index location.

To eliminate a damage reach from consideration, enter a "d" when prompted for the section number.  
To get a list of cross-sections, enter "L" when prompted for the section number.

Damage reach RCH 1,  
Identify the cross-section at the index location (1-5)> **L**

*{The user has entered the character "L" to obtain a listing of all of the HEC-2 cross-sections. Two numbers appear for each cross-section: (1) The first number is the integer index which ranges from one through the number of sections, and (2) The second number is the river mile associated with that section as defined in field one of the HEC-2 X1 record.}*

```
                    5 Cross-sections
-----
  IDX  Section  IDX  Section  IDX  Section  IDX  Section  IDX  Section
-----
```

1 48.300 2 48.500 3 48.800 4 49.000 5 49.500

Damage reach RCH 1,

Identify the cross-section at the index location (1-5) > **4**

*{The user has defined cross-section four (river mile 49.000) as the damage index location. This means that an discharge-elevation rating curve will be stored in the HECDSS data file for this location and that a DR record should exist in the SID input data file for "RCH 1".}*

Damage reach RCH 1,

Identify the profile to use as the reference flood (1-14) > **6**

*{The user has defined profile six as the reference flood water surface profile. FDA2PO prompts the user with "(1-14)" to indicate that there are fourteen possible profiles as computed by HEC-2. This profile will be used to compute reference flood elevations at all structures and at the index location for this reach.}*

Damage reach RCH 1. Redefine the index location river mile  
(or press Enter to retain the current definition).

RCH 1(49.000) > **<Enter> key pressed**

*{The user has pressed the <Enter> key to indicate that the river mile 49.000 will be used for the index point location for reach one.}*

-----DSS---ZOPEN; Existing File Opened - Unit: 71 File: SILVER.DSS

Enter one of the following:

- (1) The pathname part(s) in the format:  
A=pathname part A, E=pathname part E, F=pathname part F
- (2) The pathname part when prompted.
- (3) The command "EXIT" or press the "Enter" key to store  
the rating curves in the HECDSS data file.
- (4) A "?" go get this message.

Study name - pathname part A ( ).

Data year - pathname part E ( ).

Alternative or plan - pathname part F ( ).

Study name - part A - ( ) > **SILVER CREEK**

Study name - pathname part A (SILVER CREEK).

Data year - pathname part E ( ).

Alternative or plan - pathname part F ( ).

Data year - part E - ( ) > **<Enter> key pressed**

Study name - pathname part A (SILVER CREEK).

Data year - pathname part E ( ).

Alternative or plan - pathname part F ( ).

Alternative or plan - part F () > **BASE**

Study name - pathname part A (SILVER CREEK) .  
Data year - pathname part E ().  
Alternative or plan - pathname part F (BASE) .

Store rating curves and exit? (y/n) > **Y**

```
-----DSS---ZWRITE Unit 71; Vers. 5: /SILVER CREEK/RCH 1/ELEV-FLOW//BASE/  
-----DSS---ZCLOSE Unit: 71  
Number of Records: 12  
File Size: 9.7 Kbytes  
Percent Inactive: .00
```

*{In the above section, the FDA2PO program opens the HECDSS data file and prompts the user for the pathname parts A, E, and F. The user did not enter part E. A blank part is defined by simply pressing the <Enter> key when prompted by FDA2PO for a pathname part. The final response of "y" triggered the storage of all (in this case one) discharge-elevation rating curves in the HECDSS data file as indicated below.}*

```
-----DSS---ZWRITE Unit 71; Vers. 5: /SILVER CREEK/RCH  
1/ELEV-FLOW//BASE/  
-----DSS---ZCLOSE Unit: 71  
Number of Records: 13  
File Size: 10.5 Kbytes  
Percent Inactive: 1.22
```

*{The following is a list of the original file containing the SID DR record after FDA2PO has modified the reference flood elevation.}*

```

T1      SILVER CREEK
T2
T3
J1      0      0      0      0      0      0      0      0
J2      4      2      1      1      1      1      18      1      2
ZW SILVER CREEK BASE
DC      RESDNTL      RESIDENTIAL STRUCTURE AND CONTENTS
DC      COMERCL      COMMERCIAL STRUCTURE AND CONTENTS
DR RCH 1 3466.39      3462      0.5
DT      DAMAGE REACH 1 FOR RIVERTON
ES

```

*{The following is a list of the output SID structure file containing the modified records including the structure reference flood elevations and the transformed first floor elevations.}*

```

SL RCH 1 R001      3464.67 3463.8      0      1
SD RCH 1 R001 RESDNTLRS1 130RS2 -50
SO RCH 1 R001      48.965 3465.52
SL RCH 1 C001      3465.80 3462.4      1
SD RCH 1 C001 COMERCLCM1 60CM2 250
SO RCH 1 C001      48.988 3462.99

```

## APPENDIX B: REQUIRED FILE ASSIGNMENTS TO TEST SAMPLE DATA SETS FROM USER'S MANUALS

### BAT File To Execute Sample Data Files

The following is a list of the file "GOTEST.BAT" which is included with the sample data set for "Test Data". The individual computer program user's manuals illustrate the application of this data. The ".BAT" file "GOTEST.BAT" allows you to process all of the supplied input data without using MENUFDA.

```
ERASE FDA.DS?
ERASE SAMPLE*.20
ERASE COO*.20
ERASE SILV*.20
ERASE *.295
ERASE*.296
ERASE SAMPLE*.DCO
ERASE SAMPLE*.EO
ERASE SAMPLE*.SO
ERASE SAMPLE*.UO
ERASE SAMPLE*.SEO
ERASE COOPEM.I
ERASE SILVERM.I
ERASE SAMPLE5.RDF
ERASE SAMPLE7.RDF
rem
rem  DAMCAL Test Data
rem
-----
DAMCAL I=SAMPLE1.DC O=SAMPLE1.DCO D=TCREEK.GDB DSS=FDA.DSS
DAMCAL I=SAMPLE2.DC O=SAMPLE2.DCO D=TCREEK.GDB DSS=FDA.DSS
DAMCAL I=SAMPLE3.DC O=SAMPLE3.DCO D=TCREEK.GDB DSS=FDA.DSS
DAMCAL I=SAMPLE4.DC O=SAMPLE4.DCO D=TCREEK.GDB DSS=FDA.DSS
rem
rem  FDA2PO Test Data
rem
-----
HEC2 INPUT=COOPER1.2 OUTPUT=COOPER1.2O TAPE95=COOPER1.295 TAPE96=COOPER1.296
FDA2PO I=COOPER1.2P O=COOPER1.2PO F95=COOPER1.295 DR=COOPER1.S SI=COOPER.I SO=COOPEM.I
DS=FDA.DSS
rem
HEC2 INPUT=COOPER5.2 OUTPUT=COOPER5.2O TAPE95=COOPER5.295 TAPE96=COOPER5.296
FDA2PO I=COOPER5.2P O=COOPER5.2PO F95=COOPER5.295 DR=COOPER1.S SI=COOPER.I SO=COOPEM.I
DS=FDA.DSS
rem
HEC2 INPUT=SILVER1.2 OUTPUT=SILVER1.2O TAPE95=SILVER1.295 TAPE96=SILVER1.296
FDA2PO I=SILVER1.2P O=SILVER1.2PO F95=SILVER1.295 DR=SILVER1.S SI=SILVER.I SO=SILVERM.I
DS=FDA.DSS
rem
HEC2 INPUT=SILVER5.2 OUTPUT=SILVER5.2O TAPE95=SILVER5.295 TAPE96=SILVER5.296
FDA2PO I=SILVER5.2P O=SILVER5.2PO F95=SILVER5.295 DR=SILVER1.S SI=SILVER.I SO=SILVERM.I
DS=FDA.DSS
rem
rem  SIDEDT Test Data
rem
-----
SIDEDT I=SAMPLE1.SE O=SAMPLE1.SEO D=SAMPLE1A.I M=SAMPLE1B.I DO=SAMPLE1C.I
SIDEDT I=SAMPLE2.SE O=SAMPLE2.SEO D=SAMPLE2A.I U=SAMPLE2.SEU DO=SAMPLE2B.I
SIDEDT I=SAMPLE3.SE O=SAMPLE3.SEO D=SAMPLE3A.I DO=SAMPLE3B.I
SIDEDT I=SAMPLE4.SE O=SAMPLE4.SEO D=SAMPLE4A.F M=SAMPLE4B.F DO=SAMPLE4C.F
SIDEDT I=SAMPLE5.SE O=SAMPLE5.SEO D=SAMPLE5.F DF=SAMPLE5.DF R=SAMPLE5.RDF
rem
rem  SID Test Data
rem
-----
SID I=SAMPLE1.S O=SAMPLE1.SO
SID I=SAMPLE2.S O=SAMPLE2.SO
SID I=SAMPLE3.S O=SAMPLE3.SO
SID I=SAMPLE4.S O=SAMPLE4.SO
SID I=SAMPLE5.S O=SAMPLE5.SO DF=SAMPLE5.DF R=SAMPLE5.RDF
SID I=SAMPLE6A.S O=SAMPLE6A.SO DS=FDA.DSS
SID I=SAMPLE6B.S O=SAMPLE6B.SO DS=FDA.DSS
```

```
SIDEM I=SAMPLE7.S O=SAMPLE7.SO D=SAMPLE7.F
rem
rem EAD Test Data
rem
```

```
-----
EAD I=SAMPLE1.E O=SAMPLE1.EO
EAD I=SAMPLE2.E O=SAMPLE2.EO
EAD I=SAMPLE3.E O=SAMPLE3.EO DSS=FDA.DSS
EAD I=SAMPLE4.E O=SAMPLE4.EO
rem
rem
rem Compute event damage
rem
DSSUTL I=SAMPLE5.U O=SAMPLE5.UO DSS=FDA.DSS
rem
EAD I=SAMPLE5A.E O=SAMPLE5A.EO DSS=FDA.DSS
EAD I=SAMPLE5B.E O=SAMPLE5B.EO DSS=FDA.DSS
EAD I=SAMPLE5C.E O=SAMPLE5C.EO DSS=FDA.DSS
EAD I=SAMPLE5D.E O=SAMPLE5D.EO DSS=FDA.DSS
```

## DAMCAL Sample Data Files

### Test 1

Table 3: DAMCAL Test 1 Files

Data File Identification	Filename
Input Data...	SAMPLE1.DC
Output Results...	SAMPLE1.DCO
HECDSS file...	FDA.DSS
Grid Cell Data Bank...	TCREEK.GDB
Single Event Damage...	(none)

### Test 2

Table 4: DAMCAL Test 2 Files

Data File Identification	Filename
Input Data...	SAMPLE2.DC
Output Results...	SAMPLE2.DCO
HECDSS file...	FDA.DSS
Grid Cell Data Bank...	TCREEK.GDB
Single Event Damage...	(none)

### Test 3

Table 5: DAMCAL Test 3 Files

Data File Identification	Filename
Input Data...	SAMPLE3.DC
Output Results...	SAMPLE3.DCO
HECDSS file...	FDA.DSS
Grid Cell Data Bank...	TCREEK.GDB
Single Event Damage...	(none)

### Test 4

Table 6: DAMCAL Test 4 Files

Data File Identification	Filename
Input Data...	SAMPLE4.DC
Output Results...	SAMPLE4.DCO
HECDSS file...	FDA.DSS
Grid Cell Data Bank...	TCREEK.GDB
Single Event Damage...	(none)



## **EAD Sample Data Files**

### **Test 1**

**Table 7:** EAD Test 1 Files

Data File Identification	Filename
Input Data...	SAMPLE1.E
Output Results...	SAMPLE1.EO
HECDSS file...	(none)

### **Test 2**

**Table 8:** EAD Test 2 Files

Data File Identification	Filename
Input Data...	SAMPLE2.E
Output Results...	SAMPLE2.EO
HECDSS file...	(none)

### **Test 3**

**Table 9:** EAD Test 3 Files

Data File Identification	Filename
Input Data...	SAMPLE3.E
Output Results...	SAMPLE3.EO
HECDSS file...	FDA.DSS

Before running EAD Test 3, you must first run SID Tests 6A and 6B. These SID jobs store elevation-aggregated damage matrices in the DSS data file for two plans - base and floodproofing.

## Test 4

Table 10: EAD Test 4 Files

Data File Identification	Filename
Input Data...	SAMPLE4.E
Output Results...	SAMPLE4.EO
HECDSS file...	(none)

## Test 5

Table 11: EAD Test 5 Files

Data File Identification	Filename
Input Data...	SAMPLE5A.E
Output Results...	SAMPLE5A.EO
HECDSS file...	FDA.SSS

## **SID Sample Data Files**

### **Test 1**

**Table 12:** SID Test 1 Files

Data File Identification	Filename
Input Data...	SAMPLE1.S
Output Results...	SAMPLE1.SO
HECDSS file...	(none)
Structure file...	(none)
Damage function file...	(none)
DF records for Random damage function file...	(none)
Random damage function file...	(none)

### **Test 2**

**Table 13:** SID Test 2 Files

Data File Identification	Filename
Input Data...	SAMPLE2.S
Output Results...	SAMPLE2.SO
HECDSS file...	(none)
Structure file...	(none)
Damage function file...	(none)
DF records for Random damage function file...	(none)
Random damage function file...	(none)

### Test 3

Table 14: SID Test 3 Files

Data File Identification	Filename
Input Data...	SAMPLE3.S
Output Results...	SAMPLE3.SO
HECDSS file...	(none)
Structure file...	(none)
Damage function file...	(none)
DF records for Random damage function file...	(none)
Random damage function file...	(none)

### Test 4

Table 15: SID Test 4 Files

Data File Identification	Filename
Input Data...	SAMPLE4.S
Output Results...	SAMPLE4.SO
HECDSS file...	(none)
Structure file...	(none)
Damage function file...	(none)
DF records for Random damage function file...	(none)
Random damage function file...	(none)

## Test 5

Table 16: SID Test 5 Files

Data File Identification	Filename
Input Data...	SAMPLE5.S
Output Results...	SAMPLE5.SO
HECDSS file...	(none)
Structure file...	(none)
Damage function file...	(none)
DF records for Random damage function file...	SAMPLE5.DF
Random damage function file...	SAMPLE5.RDF

Before running SID Test 5, you must first run SIDEDT Test 5. The SIDEDT Test 5 creates the random damage function file SAMPLE5.RDF and the file which contains the "DF" records, SAMPLE5.DF.

## Test 6A

Table 17: SID Test 6A Files

Data File Identification	Filename
Input Data...	SAMPLE6A.S
Output Results...	SAMPLE6A.SO
HECDSS file...	FDA.DSS
Structure file...	(none)
Damage function file...	(none)
DF records for Random damage function file...	(none)
Random damage function file...	(none)

## Test 6B

Table 18: SID Test 6B Files

Data File Identification	Filename
Input Data...	SAMPLE6B.S
Output Results...	SAMPLE6B.SO
HECDSS file...	FDA.DSS
Structure file...	(none)
Damage function file...	(none)
DF records for Random damage function file...	(none)
Random damage function file...	(none)

## Test 7

Table 19: SID Test 7 Files

Data File Identification	Filename
Input Data...	SAMPLE7.S
Output Results...	SAMPLE7.SO
HECDSS file...	(none)
Structure file...	(none)
Damage function file...	SAMPLE7.F
DF records for Random damage function file...	(none)
Random damage function file...	(none)

## **SIDEDT Sample Data Files**

### **Test 1**

**Table 20:** SIDEDT Test 1 Files

Data File Identification	Filename
User commands...	SAMPLE1.SE
Output Messages...	SAMPLE1.SEO
Input Data (structure or depth-damage)...	SAMPLE1A.I
Input Data for MERGE operation...	SAMPLE1B.I
Input Data for UPDATE operation...	(none)
Results from PULL, MODIFY, etc. operations...	SAMPLE1C.I
DF records for Random damage function file...	(none)
Random damage function file...	(none)

### **Test 2**

**Table 21:** SIDEDT Test 2 Files

Data File Identification	Filename
User commands...	SAMPLE2.SE
Output Messages...	SAMPLE2.SEO
Input Data (structure or depth-damage)...	SAMPLE2A.I
Input Data for MERGE operation...	(none)
Input Data for UPDATE operation...	SAMPLE2.SEU
Results from PULL, MODIFY, etc. operations...	SAMPLE2B.I
DF records for Random damage function file...	(none)
Random damage function file...	(none)

### Test 3

Table 22: SIDEDT Test 3 Files

Data File Identification	Filename
User commands...	SAMPLE3.SE
Output Messages...	SAMPLE3.SEO
Input Data (structure or depth-damage)...	SAMPLE3A.I
Input Data for MERGE operation...	(none)
Input Data for UPDATE operation...	(none)
Results from PULL, MODIFY, etc. operations...	SAMPLE3B.I
DF records for Random damage function file...	(none)
Random damage function file...	(none)

### Test 4

Table 23: SIDEDT Test 4 Files

Data File Identification	Filename
User commands...	SAMPLE4.SE
Output Messages...	SAMPLE4.SEO
Input Data (structure or depth-damage)...	SAMPLE4A.F
Input Data for MERGE operation...	SAMPLE4B.F
Input Data for UPDATE operation...	(none)
Results from PULL, MODIFY, etc. operations...	SAMPLE4C.F
DF records for Random damage function file...	(none)
Random damage function file...	(none)



## Test 5

Table 24: SIDEDT Test 5 Files

Data File Identification	Filename
User commands...	SAMPLE5.SE
Output Messages...	SAMPLE5.SEO
Input Data (structure or depth-damage)...	SAMPLE5.F
Input Data for MERGE operation...	(none)
Input Data for UPDATE operation...	(none)
Results from PULL, MODIFY, etc. operations...	(none)
DF records for Random damage function file...	SAMPLE5.DF
Random damage function file...	SAMPLE5.RDF

## FDA2PO Sample Data Files

### Test 1

Table 25: FDA2PO Test 1 Files

Data File Identification	Filename
User commands...	COOPER1.2P
Output Messages	COOPER1.2PO
File 95 (HEC-2 binary results)...	COOPER1.295
File 96 (HEC-2 archive results)...	(none)
SID input DR records...	COOPER1.S
Input SID structure file...	COOPER.I
Output SID structure file...	COOPERM.I
HECDSS file...	FDA.DSS
Function file...	(none)
Macro file...	(none)

### Test 2

Table 26: FDA2PO Test 2 Files

Data File Identification	Filename
User commands...	COOPER5.2P
Output Messages	COOPER5.2PO
File 95 (HEC-2 binary results)...	COOPER5.295
File 96 (HEC-2 archive results)...	(none)
SID input DR records...	COOPER1.S
Input SID structure file...	COOPER.I
Output SID structure file...	COOPERM.I
HECDSS file...	FDA.DSS
Function file...	(none)
Macro file...	(none)

### Test 3

Table 27: FDA2PO Test 3 Files

Data File Identification	Filename
User commands...	SILVER1.2P
Output Messages	SILVER1.2PO
File 95 (HEC-2 binary results)...	SILVER1.295
File 96 (HEC-2 archive results)...	(none)
SID input DR records...	SILVER.F
Input SID structure file...	SILVER1.S
Output SID structure file...	SILVERM.I
HECDSS file...	FDA.DSS
Function file...	(none)
Macro file...	(none)

### Test 4

Table 28: FDA2PO Test 4 Files

Data File Identification	Filename
User commands...	SILVER5.2P
Output Messages	SILVER5.2PO
File 95 (HEC-2 binary results)...	SILVER5.295
File 96 (HEC-2 archive results)...	(none)
SID input DR records...	SILVER5.S
Input SID structure file...	SILVER.I
Output SID structure file...	SILVERM.I
HECDSS file...	FDA.DSS
Function file...	(none)
Macro file...	(none)



## APPENDIX C: REQUIRED FILE ASSIGNMENTS TO TEST TRAINING DOCUMENT 21 SAMPLE DATA

### BAT File To Execute T.D. 21 Sample Data

The following is a list of the file "GOTD21.BAT" which is included with the sample data set for "Silver Creek". Training Document 21 (1) illustrates the application of this data. The ".BAT" file "GOTD21.BAT" allows you to process all of the supplied input data without using MENUFDA.

```
rem   Run HEC-1
rem   -----
HEC1 I=P1&3.1 O=P1&3.1O DSS=SILVER1.DSS
rem
rem   Run HEC-5
rem   -----
H5AEM I=P1&4.5 O=P1&4.5O DSSIN=SILVER1.DSS DSSOUT=SILVER5.DSS
H5BEM DSSOUT=SILVER5.DSS
rem
rem   Run DSSUTL
rem   -----
DSSUTL I=SAMPLE1.U O=SAMPLE1.UO DSS=SILVER1.DSS WD=QF1TEST.UWD
DSSUTL I=SAMPLE2.U O=SAMPLE2.UO DSS=SILVER5.DSS WD=QF5TEST.UWD
DSSUTL I=SAMPLE3.U O=SAMPLE3.UO DSS=SILVER.DSS
rem
rem   Run HEC-2
rem   -----
HEC2 I=P1.2 O=P1.2O TAPE95=P1.295 TAPE96=P1.296
HEC2 I=P5.2 O=P5.2O TAPE95=P5.295 TAPE96=P5.296
rem
rem   Run FDA2PO
rem   -----
FDA2PO I=P1.2P O=P1.2PO F95=P1.295 DR=P1.S SIN=SILVERA.I SOUT=SILVER.I DSS=SILVER.DSS
FDA2PO I=P2.2P O=P2.2PO F95=P1.295 DR=P2.S SIN=SILVERA.I SOUT=SILVER.I
FDA2PO I=P5.2P O=P5.2PO F95=P5.295 DR=P1.S SIN=SILVERA.I DSS=SILVER.DSS
rem
rem   Run SID
rem   -----
SID I=P1.S O=P1.SO DSS=SILVER.DSS S=SILVER.I D=SILVER.F
SID I=P2.S O=P2.SO DSS=SILVER.DSS S=SILVER.I D=SILVER.F
rem
rem   Run EAD
rem   -----
EAD I=SILVER.E O=SILVER.EO DSS=SILVER.DSS
rem
```

## **HEC-1 Test Data Files**

### **Test 1**

**Table 29:** HEC-1 Test 1 Files

Data File Identification	Filename
Input Data...	P1&3.1
Output Results...	P1&3.1O
HECDSS file...	SILVER1.DSS

The Test 1 data set may be used with the PC version of HEC-1.

## **HEC-5 Test Data Files**

### **Test 1**

**Table 30:** HEC-5 Test 1 Files

Data File Identification	Filename
Input Data...	P1&4.5
Output Results...	P1&4.5O
HECDSS file...	(none)
Input HECDSS file...	SILVER1.DSS
Output HECDSS file...	SILVER5.DSS
Menu file...	(none)
QLOCINC file...	(none)
JSF file...	(none)

This data set may be used with the PC version of HEC-5. It is recommended that you use the extended memory version of HEC-5 which requires 4mb of memory.

## DSSUTL Test Data Files

### Test 1

Table 31: DSSUTL Test 1 Files

Data File Identification	Filename
User commands...	SAMPLE1.U
Output Messages...	SAMPLE1.UO
HECDSS file...	SILVER1.DSS
Function file...	(none)
Macro file...	(none)
Log file...	(none)
Tabulation file...	(none)
Write ASCII data file...	QF1TEST.UWD

This job copies frequency-flow curves written by HEC-1 from the HEC-1 DSS file to the master economics DSS file. You must run the HEC-1 test (P1&3.1) first before running this test.

### Test 2

Table 32: DSSUTL Test 2 Files

Data File Identification	Filename
User commands...	SAMPLE2.U
Output Messages...	SAMPLE2.UO
HECDSS file...	SILVER5.DSS
Function file...	(none)
Macro file...	(none)
Log file...	(none)
Tabulation file...	(none)
Write ASCII data file...	QF5TEST.UWD

This job copies frequency-flow curves written by HEC-5 from the HEC-5 DSS file to the master economics DSS file. You must run the HEC-5 test (P1&4.5) first before running this test.

### Test 3

Table 33: DSSUTL Test 3 Files

Data File Identification	Filename
User commands...	SAMPLE3.U
Output Messages...	SAMPLE3.UO
HECDSS file...	SILVER.DSS
Function file...	(none)
Macro file...	(none)
Log file...	(none)
Tabulation file...	(none)
Write ASCII data file...	(none)

This job reads frequency-flow curves from the file QFDATA and stores them in the master economics data file. They were written to that file using DSSUTL on the Harris. This job overwrites frequency curves written by the first two DSSUTL samples.



## **HEC-2 Test Data Files**

### **Test 1**

**Table 34:** HEC-2 Test 1 Files

Data File Identification	Filename
Input Data...	P1.2
Output Results...	P1.2O
File 95 (HEC-2 binary results)...	P1.295
File 96 (HEC-2 archive results)...	(none)
HECDSS file...	SILVER.DSS

Base plan. The file P1.295 is supplied. If you execute HEC-2, it will overwrite the existing results.

### **Test 2**

**Table 35:** HEC-2 Test 2 Files

Data File Identification	Filename
Input Data...	P5.2
Output Results...	P5.2O
File 95 (HEC-2 binary results)...	P5.295
File 96 (HEC-2 archive results)...	(none)
HECDSS file...	SILVER.DSS

Channel improvement plan. The file P5.295 is supplied. If you execute HEC-2, it will overwrite the existing results.

## **FDA2PO Test Data Files**

### **Test 1**

**Table 36: FDA2PO Test 1 Files**

Data File Identification	Filename
User commands...	P1.2P
Output Messages	P1.2PO
File 95 (HEC-2 binary results)...	P1.295
File 96 (HEC-2 archive results)...	(none)
SID input DR records...	P1.S
Input SID structure file...	SILVERA.I
Output SID structure file...	SILVER.I
HECDSS file...	SILVER.DSS
Function file...	(none)
Macro file...	(none)

Base plan. The file P1.295 is supplied but can be rewritten using HEC-2. This sample stores discharge-elevation functions and computes the reference flood elevations.

## Test 2

Table 37: FDA2PO Test 2 Files

Data File Identification	Filename
User commands...	P2.2P
Output Messages	P2.2PO
File 95 (HEC-2 binary results)...	P1.295
File 96 (HEC-2 archive results)...	(none)
SID input DR records...	P2.S
Input SID structure file...	SILVERA.I
Output SID structure file...	SILVER.I
HECDSS file...	(none)
Function file...	(none)
Macro file...	(none)

The file P1.295 is supplied but can be rewritten using HEC-2. This sample computes the reference flood elevations for the reach index locations. Alternatively, enter the same reference flood elevation from file P1.S in the file P2.S.

## Test 3

Table 38: FDA2PO Test 3 Files

Data File Identification	Filename
User commands...	P5.2P
Output Messages	P5.2PO
File 95 (HEC-2 binary results)...	P5.295
File 96 (HEC-2 archive results)...	(none)
SID input DR records...	P1.S
Input SID structure file...	SILVERA.I
Output SID structure file...	(none)
HECDSS file...	SILVER.DSS
Function file...	(none)
Macro file...	(none)

Channel improvement plan. This job stores the discharge-elevation functions in the DSS file for the channel improvement condition.

## **SID Test Data Files**

### **Test 1**

**Table 39:** SID Test 1 Files

Data File Identification	Filename
Input Data...	P1.S
Output Results...	P1.SO
HECDSS file...	SILVER.DSS
Structure file...	SILVER.I
Damage function file...	SILVER.F
DF records for Random damage function file...	(none)
Random damage function file...	(none)

Base condition. You must first compute reference flood elevations by running Test 1 of the FDA2PO program.

### **Test 2**

**Table 40:** SID Test 2 Files

Data File Identification	Filename
Input Data...	P2.S
Output Results...	P2.SO
HECDSS file...	SILVER.DSS
Structure file...	SILVER.I
Damage function file...	SILVER.F
DF records for Random damage function file...	(none)
Random damage function file...	(none)

Flood proofing plan. You must first compute reference flood elevations by running Tests 1 and 2 of the FDA2PO program.

## EAD Test Data Files

### Test 1

Table 41: EAD Test 1 Files

Data File Identification	Filename
Input Data...	SILVER.E
Output Results...	SILVER.EO
HECDSS file...	SILVER.DSS

Computes expected annual damage for all plans. You must first store intermediate results in the DSS file before running this test data set. This includes running:

- (1) either HEC-1 and HEC-5 with DSSUTL Tests 1 and 2;  
or DSSUTL Test 3.
- (2) HEC-2 tests 1 and 2 (optional).
- (3) FDA2PO tests 1, 2, and 3.
- (4) SID tests 1 and 2.



## APPENDIX D: DESCRIPTION OF SELECTED FILES

File Name	File Description
COED.DOC	Hard-copy documentation for COED. It corresponds to the COED user's manual.
COED.EXE	The executable code for the COED program.
COED.HLP	On-line help and documentation for the COED editor.
COED.HPG	An index of the current COED help files that are available. This file is stored in the subdirectory \HECEXE\SUP. It may be modified by MENUFDA to reflect changes in "help program" information files.
COEDANY.HPG	Generic help file that sets up data justification in HEC format (columns 1&2 for record identification, one data field of 6 columns, and 9 data fields of 8 columns).
COEDDAMC.HPG	Help program file for DAMCAL. It is accessed by the COED editor.
COEDEAD.HPG	Help program file for EAD. It is accessed by the COED editor.
COEDSID.HPG	Help program file for SID. It is accessed by the COED editor.
DAMCAL.EXE	The DAMCAL program in executable form.
DRIVERS.EXE	The GSS Device Driver management program in executable form. It loads required device drivers in memory before executing DSPLAY and removes them from memory after terminating the DSPLAY program.
DSP.BAT	".BAT" file which may be used to execute the DSPLAY program outside of the MENUFDA program.
DSPLAY.EXE	The DSPLAY program in executable form.
DSPLAY.HLP	The on-line help information for the DSPLAY program.
DSSUTL.EXE	The DSSUTL program in executable form.
DSSUTL.HLP	The on-line help information for the DSSUTL program.
EAD.EXE	The EAD program in executable form.
FDA2PO.EXE	The FDA2PO program in executable form.
FDAMENUX.EXE	The menu program for the FDA Package.
INSTALL.EXE	Installation program for the FDA Package.
LIST.COM	Utility program which provides convenient screen displays of disk files.
LIST.DOC	Documentation for the LIST.COM program.

File Name	File Description
MENUFDA.BAT	The batch file which is used to execute the menu program for the FDA Package.
PIP.EXE	The PIP program in executable form.
PIP.HLP	The on-line help information for the PIP program.
PIP.MEN	The menu screens for the PIP program.
PKUNZIP.EXE	Program to extract data from a compressed (or "zipped") file. All compressed files have the extension ".ZIP". The program "PKZIP" is used to compress files.
PKZIP.EXE	Program to store data in a compressed (or "zipped") file. All compressed files have the extension ".ZIP". The program "PKUNZIP" is used to extract data from a compressed file.
PKZIPFIX.EXE	Program which reconstructs corrupted ZIP files.
PROUT.EXE	Utility program which sends some computer program output files to the printer. It inserts DOS printer carriage control characters in files which are formatted for printing on mainframes.
SID.EXE	The SID program in executable form.
SIDEDT.EXE	The SIDEDT program in executable form.



## APPENDIX E: LIST OF FILES ON 3½ INCH DISKETTE

Disk Volume Label	Disk File Name	Uncompressed File Name	Compressed File Size	Uncompressed File Size	File Date	File Time
FDA#1-APR94						
	DISK ID	-		87	04-21-94	24:02
	FDA.001	COED EXE	90,756	211,871	11-04-87	10:48
		COED HLP	26,728	91,085	2-19-87	9:53
		COED HPG	121	468	10-17-91	24:11
		COEDANY.HPG	89	306	2-17-87	11:41
		COEDDAMC.HPG	9,374	43,670	9-05-89	16:33
		COEDEAD.HPG	13,753	58,072	3-19-90	16:47
		COEDSID.HPG	19,516	90,322	5-02-90	17:25
		COED.DOC	33,121	118,769	3-02-87	1:17
		RDAUTOEX EXE	31,158	52,946	11-19-93	14:44
		LIST.COM	6,161	8,191	3-12-92	23:35
		LIST.DOC	3,684	10,676	5-23-86	10:35
		PROUT EXE	16,358	24,553	8-02-88	20:05
		F77L3.EER	3,440	40,584	10-25-93	13:39
		DAMCAL EXE	220,940	762,305	3-25-94	14:10
		EAD EXE	273,144	747,412	3-25-94	14:23
		FDA2PO EXE	233,603	680,917	3-25-94	14:31
		FDAMENUX EXE	38,995	180,810	3-25-94	15:00
	INSTALL EXE	-		111,616	04-22-94	13:51
	INSTALL.DAT	-		33,030	04-22-94	14:12
	PKUNZIP EXE	-		29,371	01-24-93	11:04
	PKZ204E EXE	-		196,424	07-09-93	1:49
	PKZIP EXE	-		42,475	01-24-93	11:04
	PKZIPFIX EXE	-		7,682	01-24-93	11:04
FDA#2-APR94						
	DISK ID	-		87	04-22-94	14:16
	FDA.002	FDAMENUX EXE	48,153	0	3-25-94	15:00
		MENUFDA.BAT	74	95	10-26-93	16:55
		PIP EXE	200,157	485,419	3-25-94	14:35
		PIP.HLP	3,640	14,064	4-03-90	18:15

Disk Volume Label	Disk File Name	Uncompressed File Name	Compressed File Size	Uncompressed File Size	File Date	File Time
		PIP MEN	546	2,598	4-03-90	17:33
		SID EXE	272,599	2,648,827	3-25-94	14:39
		SIDEDT EXE	178,016	450,671	3-25-94	14:43
		COOPER1 S	455	1,722	3-30-94	14:34
		COOPER I	951	10,068	5-17-89	14:07
		COOPER1 2	2,123	9,059	7-05-89	14:54
		COOPER5 2	2,160	9,344	3-24-88	11:10
		SILVER1 2	518	3,252	1-07-88	24:19
		SILVER5 2	541	3,300	3-14-90	10:32
		TCREEK.GDB	43,562	416,442	9-22-89	16:50
		COOPER1 2O	9,406	57,293	10-26-93	16:47
		SAMPLE1 SO	13,855	117,647	10-28-93	9:30
		SAMPLE2 SO	16,036	137,158	10-26-93	16:47
		SAMPLE1 SEO	1,323	8,701	10-26-93	16:47
		GOTEST BAT	573	2,766	10-26-93	16:43
		GODAMCAL.BAT	76	240	3-21-90	9:06
		GOSIDEDT.BAT	139	441	6-03-93	14:47
		GOSID.BAT	246	612	6-03-93	14:48
		GOFDA2PO.BAT	198	771	5-26-93	11:13
		GOEAD.BAT	191	547	5-27-93	15:17
		SAMPLE1 DC	1,135	6,033	3-09-92	14:02
		SAMPLE2 DC	1,129	6,059	8-30-90	13:27
		SAMPLE3 DC	1,125	6,017	8-30-90	13:27
		SAMPLE4 DC	1,133	6,045	8-30-90	13:27
		SAMPLE1 E	677	1,871	8-30-90	15:42
		SAMPLE2 E	1,404	4,714	8-30-90	15:42
		SAMPLE3 E	380	872	5-21-93	13:26
		SAMPLE3 SO	13,351	117,201	10-26-93	16:47
		SAMPLE4 E	382	965	5-25-93	16:28
		SAMPLE1 S	1,328	5,560	5-26-93	11:59
		SAMPLE2 S	1,400	5,862	5-26-93	11:59
		SAMPLE3 S	1,430	5,865	5-26-93	24:00
		SAMPLE4 S	1,459	5,965	5-26-93	24:01
		SAMPLE5 S	692	2,270	5-26-93	24:00

Disk Volume Label	Disk File Name	Uncompressed File Name	Compressed File Size	Uncompressed File Size	File Date	File Time
		SAMPLE6A S	1,399	5,823	5-26-93	24:00
		SAMPLE6B S	1,479	6,001	5-26-93	24:00
		SAMPLE1 SE	108	274	12-17-87	16:48
		SAMPLE1A I	1,445	6,362	11-17-87	9:14
		SAMPLE1B I	594	2,159	11-17-87	9:14
		SAMPLE2 SE	208	467	9-27-89	10:57
		SAMPLE2A I	1,818	8,938	6-17-88	14:51
		SAMPLE2 SEU	86	156	12-18-87	9:27
		SAMPLE3 SE	194	357	11-17-87	9:15
		SAMPLE3A I	1,818	8,938	6-17-88	14:51
		SAMPLE4 SE	131	250	11-17-87	9:15
		SAMPLE4A F	441	2,516	11-17-87	9:13
		SAMPLE4B F	162	560	11-17-87	9:13
		SAMPLE5 SE	97	169	8-28-91	18:06
		SAMPLE5 F	637	3,306	3-20-90	16:46
		COOPER1 2P	56	65	5-25-93	15:22
		SILVER1 295	8,858	24,577	10-26-93	16:47
		COOPER5 2P	53	68	3-20-90	16:11
		SILVER5 295	7,742	24,577	10-26-93	16:47
		SILVER1 2P	46	46	5-25-93	15:15
		COOPER5 295	21,844	59,577	10-26-93	16:47
		SILVER1 S	186	902	10-26-93	16:47
		SILVER5 2P	54	54	3-20-90	16:17
		SILVER I	136	492	8-31-90	9:19
		COOPER1 2PO	1,879	6,710	10-26-93	16:47
		SAMPLE2 SEO	1,325	7,987	10-26-93	16:47
		SAMPLE4 SO	13,675	121,556	10-26-93	16:48
		COOPER5 2O	13,281	79,555	10-26-93	16:47
		SILVER5 2O	5,567	37,754	10-26-93	16:47
		COOPER1 295	21,857	59,577	10-26-93	16:47
		SILVER1 2O	6,193	42,124	10-26-93	16:47
		SILVER1 2PO	1,452	4,380	10-26-93	16:47
		SILVER5 2PO	1,488	4,477	10-26-93	16:47
		SAMPLE5 SO	5,746	52,574	10-26-93	16:48

Disk Volume Label	Disk File Name	Uncompressed File Name	Compressed File Size	Uncompressed File Size	File Date	File Time
		COOPER5 2PO	1,924	6,813	10-26-93	16:47
		COOPER1 296	32,843	211,796	10-26-93	16:47
		SAMPLE6A SO	14,557	122,509	10-26-93	16:48
		SAMPLE3 SEO	1,190	4,838	10-26-93	16:47
		SAMPLE1 C.I	1,818	8,938	10-26-93	16:47
		SAMPLE6B SO	14,216	124,846	10-26-93	16:48
		COOPER5 296	33,829	212,370	10-26-93	16:47
		SAMPLE1 EO	3,258	24,902	10-26-93	16:48
		SILVER1 296	11,918	92,276	10-26-93	16:47
		SAMPLE2 EO	9,396	64,925	10-26-93	16:48
		SILVERM I	134	492	10-26-93	16:47
		SILVER5 296	10,069	92,358	10-26-93	16:47
		COOPERM I	1,176	11,070	10-26-93	16:47
		SAMPLE3 EO	4,317	38,272	10-26-93	16:48
		SAMPLE4 EO	3,775	25,413	10-26-93	16:48
		SAMPLE4 SEO	731	3,618	10-26-93	16:47
		SAMPLE2B I	1,893	8,938	10-26-93	16:47
		SAMPLE1 DCO	8,692	77,385	10-26-93	16:46
		SAMPLE5 SEO	677	3,331	10-26-93	16:47
		SAMPLE2 DCO	8,218	77,440	10-26-93	16:46
		FDA DSS	11,197	67,580	11-03-93	9:55
		SAMPLE3 DCO	8,181	76,197	10-26-93	16:46
		SAMPLE4 DCO	8,252	78,256	10-26-93	16:47
		SAMPLE3B I	538	1,968	10-26-93	16:47
		SAMPLE4C F	508	3,444	10-26-93	16:47
		FDA DSC	775	4,380	11-03-93	9:55
		FDA DSD	593	6,101	11-03-93	9:55
		P1&3 1	532	1,408	9-27-89	14:34
		P1&4 5	456	1,556	9-27-89	14:47
		SAMPLE1 U	53	59	5-27-93	10:49
		SAMPLE2 U	53	59	5-27-93	10:49
		SAMPLE3 U	22	22	2-09-88	10:19
		SILVER DSC	456	1,564	11-03-93	9:55
		P1 2	518	3,252	1-07-88	24:19

Disk Volume Label	Disk File Name	Uncompressed File Name	Compressed File Size	Uncompressed File Size	File Date	File Time
		P5 2	540	3,299	1-15-88	9:30
		P1 2P	47	47	9-27-89	11:51
		P1 S	188	902	11-01-93	13:15
		SILVERA I	117	384	6-03-88	10:50
		SILVER I	136	492	11-01-93	13:15
		P2 2P	20	20	9-27-89	24:09
		P2 S	213	1,066	11-01-93	13:15
		P5 2P	46	46	9-27-89	24:16
		SILVER F	108	424	12-14-87	16:49
		SILVER E	328	875	2-03-88	17:21
		GOTD21.BAT	341	1,423	6-03-93	15:39
		P1&3 IO	4,595	27,384	11-01-93	13:14
		P1&4 5O	12,678	98,603	11-01-93	13:15
		SILVER1 DSC	544	3,479	11-03-93	9:55
		SAMPLE1 UO	880	4,836	11-01-93	13:15
		SAMPLE2 UO	610	1,932	11-01-93	13:15
		SAMPLE3 UO	534	1,422	11-01-93	13:15
		QF1TEST.UWD	355	845	11-01-93	13:15
		QF5TEST.UWD	382	647	11-01-93	13:15
		P1 2O	6,195	42,124	11-01-93	13:15
		P5 2O	5,569	37,754	11-01-93	13:15
		P1 2PO	1,479	4,464	11-01-93	13:15
		P2 2PO	1,033	3,008	11-01-93	13:15
		P5 2PO	1,375	4,140	11-01-93	13:15
		P1 SO	4,224	25,094	11-01-93	13:15
		P2 SO	4,486	27,602	11-01-93	13:15
		SILVER EO	5,101	25,650	11-01-93	13:15
		SILVER5 DSC	346	830	11-03-93	9:55
		SILVER5 DSS	1,188	17,404	11-03-93	9:55
		SILVER1 DSD	446	4,531	11-03-93	9:55
		SILVER.DSS	17,793	47,104	11-03-93	9:55
		P1 295	8,858	24,577	11-01-93	13:15
		P5 295	7,742	24,577	11-01-93	13:15
		SILVER1 DSS	5,383	66,556	11-03-93	9:55

Disk Volume Label	Disk File Name	Uncompressed File Name	Compressed File Size	Uncompressed File Size	File Date	File Time
		P1.296	11,917	92,276	11-01-93	13:15
		P5.296	4,691	92,358	11-01-93	13:15
	INSTALL.DAT	-		13,336	04-22-94	14:15
FDA#3-APR94						
	DISK.ID	-		87	04-22-94	14:18
	FDA.003	P5.296	5,380	0	11-01-93	13:15
		EDPFDATA.EXE	263,614	706,974	11-30-93	10:32
		MATHPK.EXE	429,706	1,422,757	1-18-94	15:14
	INSTALL.DAT	-		3,344	04-22-94	14:17
Total			2,971,512	12,966,442		

## APPENDIX F: LIST OF FILES ON 3½ INCH HECDSS DISKETTE

Disk Volume Label	Disk File Name	Uncompressed File Name	Compressed File Size	Uncompressed File Size	File Date	File Time
DSS_DISK1						
	ASKME.COM	-		75	02-15-91	24:00
	DISK ID	-		77	04-19-94	16:14
	DISK1 EXE	DOS4GW EXE	118,834	231,155	02-11-93	09:50
		DSP BAT	149	318	04-05-94	17:37
		DSPLAY EXE	261,946	581,349	04-12-94	11:02
		DSPLAY.HLP	16,865	60,655	05-13-93	08:53
		DSSMATH EXE	229,332	512,098	04-18-94	09:45
		DSSMATH.HLP	19,616	80,128	12-29-93	16:03
		DSSMATHL EXE	365,246	895,831	04-18-94	09:55
		DSSUTL EXE	239,443	546,807	02-16-94	13:56
		DSSUTL.HLP	40,722	169,468	02-16-94	14:01
		F77L3.EER	3,175	40,584	10-25-93	13:39
		GNUSORT EXE	25,649	42,254	01-27-94	16:11
		SAMPLE.DSS	24,614	91,132	02-16-94	15:06
	DSS.DAT	-		1,445	03-23-94	13:48
	DSSINS.BAT	-		15,910	04-19-94	8:56
	INSTALL.BAT	-		4,239	04-19-94	8:57
	README.TXT	-		3,008	04-19-94	11:24
	READMEZ.BAT	-		2,103	03-01-94	10:57
DSS_DISK2						
	DISK ID	-		79	04-19-94	16:14
	DISK2 EXE	DSS5T6 EXE	120,837	264,322	02-16-94	14:30
		DSSIN EXE	91,506	181,260	02-16-94	14:30
		DSSITS EXE	80,167	160,918	02-16-94	14:30
		DSSPD EXE	75,423	149,498	02-16-94	14:30
		DSSSHF EXE	125,280	430,622	04-05-94	19:04
		DSSTS EXE	90,064	177,606	02-16-94	14:30
		DSSTXT EXE	97,562	199,722	02-16-94	14:30
		NWSDSS EXE	98,267	454,992	02-09-94	15:17

Disk Volume Label	Disk File Name	Uncompressed File Name	Compressed File Size	Uncompressed File Size	File Date	File Time
		REPGEN.EXE	163,282	568,046	02-09-94	15:49
		SHFDSS EXE	118,022	440,372	04-05-94	08:32
		WATDSS EXE	90,508	186,584	02-16-94	14:30
	DSS.DAT	-		1,600	03-24-94	10:37
	INSTALL.BAT	-		4,239	04-19-94	8:57
DSS_DISK3						
	DISK ID	-		77	04-19-94	16:14
	DISK3 EXE	HECDATA/DSPLAY/	0	0	03-29-94	11:44
		HECDATA/DSPLAY/DSPMAC	826	2,082	03-31-94	17:49
		HECDATA/DSPLAY/GENENV	0	0	03-29-94	15:01
		HECDATA/DSPLAY/GENFUN	17	38	03-31-94	17:51
		HECDATA/DSPLAY/RUNDEMO.BAT	34	41	11-22-93	18:43
		HECDATA/DSPLAY/SAMPLE.DSC	584	2,534	03-10-94	16:50
		HECDATA/DSPLAY/SAMPLE.DSS	26,906	94,204	03-17-94	15:56
		HECDATA/DSSMATH/	0	0	02-25-94	16:54
		HECDATA/DSSMATH/1A.DSS	3,257	11,260	02-18-94	15:58
		HECDATA/DSSMATH/COMPSOR.DSS	2,201	23,548	02-18-94	15:58
		HECDATA/DSSMATH/ECI.DSS	5,916	69,628	02-18-94	15:56
		HECDATA/DSSMATH/FIXED.DSS	18,471	92,668	02-18-94	15:58
		HECDATA/DSSMATH/HEC101.DSS	2,477	62,976	02-25-94	18:13
		HECDATA/DSSMATH/LHPRDSS.DSS	87,437	307,708	02-18-94	15:55
		HECDATA/DSSMATH/MASTDB.DSS	15,113	41,468	02-25-94	18:13
		HECDATA/DSSMATH/MATHMAC	5,947	22,891	03-01-94	17:13
		HECDATA/DSSMATH/MREG.DSS	59,091	141,308	02-18-94	15:57
		HECDATA/DSSMATH/RMS.DSS	12,978	186,364	02-18-94	15:57
		HECDATA/DSSMATH/TESTDB.DSS	76,739	434,684	02-18-94	15:51
		HECDATA/DSSMATH/WS6N.DSS	4,479	40,956	02-18-94	15:57
		HECDATA/DSSSHF/	0	0	04-06-94	16:57
		HECDATA/DSSSHF/FLOW.DSS	2,552	22,012	04-06-94	15:05
		HECDATA/DSSSHF/RUN.BAT	33	40	04-06-94	14:59
		HECDATA/DSSSHF/SHFDSSP	137	278	04-06-94	14:49
		HECDATA/DSSSHF/SHFIN	115	183	04-06-94	14:49
		HECDATA/NWSDSS/	0	0	03-29-94	11:32
		HECDATA/NWSDSS/NWSDATA	2,672	38,784	04-03-91	17:52



Disk Volume Label	Disk File Name	Uncompressed File Name	Compressed File Size	Uncompressed File Size	File Date	File Time
		HECDATA/NWSDSS/NWSIN	45	45	04-04-91	18:23
		HECDATA/NWSDSS/RUNNWS.BAT	52	59	04-03-91	18:06
		HECDATA/REPGEN/	0	0	03-29-94	15:25
		HECDATA/REPGEN/DATA.DSS	2,683	21,500	08-24-93	09:15
		HECDATA/REPGEN/RUN.BAT	50	58	03-29-94	11:47
		HECDATA/REPGEN/SAJ.IN	1,189	5,330	03-29-94	11:48
		HECDATA/SHFDSS/	0	0	03-29-94	11:32
		HECDATA/SHFDSS/RUNSHEF.BAT	53	72	03-29-94	11:31
		HECDATA/SHFDSS/TEST.DAT	705	2,820	04-05-94	08:33
		HECDATA/SHFDSS/TEST.PAR	501	2,138	02-26-91	23:48
		HECDATA/SHFDSS/TEST.SEN	85	792	02-26-91	23:48
		HECDATA/WATDSS/	0	0	03-29-94	11:32
		HECDATA/WATDSS/RUNWAT.BAT	56	60	04-03-91	18:06
		HECDATA/WATDSS/STATIONS	40	42	04-04-91	18:25
		HECDATA/WATDSS/WATDATA	4,161	20,407	04-03-91	18:06
	DSS.DAT	-		1,296	04-19-94	17:07
	INSTALL.BAT	-		4,239	04-19-94	8:57
Total			2,834,111	8,153,086		



## APPENDIX G: LIST OF FILES ON 3½ INCH GSS DRIVERS DISKETTE

Disk Volume Label	Disk File Name	Uncompressed File Name	Compressed File Size	Uncompressed File Size	File Date	File Time
GSS_DISK1						
	ASKME.COM	-		75	09-29-89	13:34
	ATI256.ZIP	ATI256.SYS	24,636	41,228	09-13-90	10:13
	CALCOMPA.ZIP	CALCOMPA.SYS	4,759	9,416	05-11-90	15:38
	CALCOMPB.ZIP	CALCOMPB.SYS	3,660	6,616	02-28-89	12:03
	CALDISPA.ZIP	CALDISPA.SYS	26,356	50,244	07-28-89	13:59
	CALDISPB.ZIP	CALDISPB.SYS	11,347	25,932	03-20-90	16:44
	CGI.CFG	-		706	05-30-89	22:52
	CGI6300B.ZIP	CGI6300B.SYS	23,407	37,032	08-23-88	14:45
	CGI6300C.ZIP	CGI6300C.SYS	25,320	40,768	09-15-88	10:44
	CGIDGIS.ZIP	CGIDGIS.SYS	18,163	30,496	05-17-89	16:22
	CGISTUB.ZIP	CGISTUB.SYS	245	268	10-12-90	09:40
	CGITEST.ZIP	CGITEST.EXE	12,996	28,891	02-23-89	10:29
	COED.EXE	-		211,949	11-17-88	10:15
	COMPAQ3.ZIP	COMPAQ3.SYS	20,714	32,056	07-11-87	12:09
	CONFIG.SYS	-		61	11-17-88	17:17
	DISK.ID	-		91	03-23-94	14:02
	DRIVERS.ZIP	DRIVERS.EXE	4,179	10,304	10-12-90	09:25
	DSP.BAT	-		41	04-26-91	24:00
	FONTDRV.ZIP	FONTDRV.SYS	7,019	11,972	10-15-90	09:07
	FONTLOAD.ZIP	FONTLOAD.EXE	15,531	33,493	08-01-90	05:08
		FONTLOAD.TXT	626	947	10-04-90	16:02
	GSS.DAT	-		2,037	03-23-94	13:20
	GSSCGI.ZIP	GSSCGI.SYS	22,273	32,608	11-02-90	14:33
	HERCBW.ZIP	HERCBW.SYS	23,457	37,224	05-04-88	19:34
	HERCINCO.ZIP	HERCINCO.SYS	25,259	40,748	05-04-88	19:34
	HIRESEGA.ZIP	HIRESEGA.SYS	27,514	42,760	09-20-88	14:56
	HREGA.ZIP	HREGA.SYS	26,903	42,084	08-20-90	10:21
	HRVGA.ZIP	HRVGA.SYS	26,224	41,208	08-01-90	17:00
	HRVGA256.ZIP	HRVGA256.SYS	24,630	41,212	09-13-90	10:05
	IBMAIH.ZIP	IBMAIH.SYS	31,790	56,328	08-01-90	17:22

Disk Volume Label	Disk File Name	Uncompressed File Name	Compressed File Size	Uncompressed File Size	File Date	File Time
	IBMAIL.ZIP	IBMAIL.SYS	30,017	50,852	08-01-90	17:35
	IBMBW.ZIP	IBMBW.SYS	22,657	34,620	05-04-88	19:34
	IBMCO.ZIP	IBMCO.SYS	24,088	37,720	05-04-88	19:34
	IBMEGA.ZIP	IBMEGA.SYS	27,023	42,144	12-19-89	16:35
	IBMVGA11.ZIP	IBMVGA11.SYS	23,612	36,460	05-04-88	19:34
	IBMVGA12.ZIP	IBMVGA12.SYS	26,720	41,912	12-19-89	17:00
	IBMVGA13.ZIP	IBMVGA13.SYS	23,449	38,400	08-17-88	17:02
	INCOED.	-		28	06-17-93	15:35
	INSTALL.BAT	-		7,823	09-14-93	16:00
	INSTFONT.ZIP	INSTFONT.EXE	8,788	15,106	02-01-89	09:30
	JUNK.TST	-		37	06-17-93	15:06
	OPTIONS.CGI	-		16,797	09-14-93	16:00
	PACKING.LST	-		28,806	09-14-93	16:00
	PKUNZIP.EXE	-		19,041	09-24-91	14:34
	README.TXT	-		12,607	09-14-93	16:00
	SETUP.EXE	-		99,282	11-07-90	13:18
	T3100.ZIP	T3100.SYS	21,617	33,388	12-17-87	16:30
	T5100.ZIP	T5100.SYS	26,104	40,704	08-29-89	10:51
	V7HREGA.ZIP	V7HREGA.SYS	27,617	43,096	01-12-90	14:48
	V7HRVGA.ZIP	V7HRVGA.SYS	26,763	41,808	01-12-90	15:08
	V7VGA256.ZIP	V7VGA256.SYS	24,718	41,340	09-14-90	09:55
GSS_DISK2						
	AFMTOCGI.ZIP	AFMTOCGI.EXE	12,434	26,393	06-13-90	13:14
	CANL8II.ZIP	CANL8II.SYS	23,808	44,072	08-24-90	13:38
	CGCGI.ZIP	CGCGI.SYS	14,485	25,356	09-29-88	11:17
	CGIPOST.ZIP	CGIPOST.SYS	18,322	38,092	10-17-90	13:59
	CGIPREP.ZIP	CGIPREP	2,125	7,278	10-06-90	13:01
	DIAB150.ZIP	DIAB150.SYS	23,561	42,776	05-27-87	10:51
	DICONIXH.ZIP	DICONIXH.SYS	24,138	44,076	02-02-87	16:53
	DICONIXL.ZIP	DICONIXL.SYS	23,871	42,220	02-02-87	16:53
	DXFTEXT.ZIP	DXFTEXT.SYS	14,469	32,644	10-02-90	11:00
	DXF_CGI.ZIP	DXF_CGI.LIN	187	366	10-02-90	13:07
	EPEX1000.ZIP	EPEX1000.SYS	25,572	43,292	05-27-89	20:06
	EPEX800.ZIP	EPEX800.SYS	25,445	43,148	05-25-89	08:53

Disk Volume Label	Disk File Name	Uncompressed File Name	Compressed File Size	Uncompressed File Size	File Date	File Time
	EPLX800.ZIP	EPLX800.SYS	22,887	39,372	08-23-90	13:20
	EPS6000.ZIP	EPS6000.SYS	25,121	47,704	01-25-90	14:53
	EPSONLQ.ZIP	EPSONLQ.SYS	28,070	52,860	08-29-90	09:53
	EPSONLQC.ZIP	EPSONLQC.SYS	27,021	45,960	08-27-90	09:26
	EPSONX.ZIP	EPSONX.SYS	22,862	39,308	08-27-90	09:52
	HILOTTR.ZIP	HILOTTR.SYS	13,474	27,812	03-19-90	10:40
	HPDJET.ZIP	HPDJET.SYS	27,995	52,944	10-03-90	12:41
	HPGLPLTR.ZIP	HPGLPLTR.CAP	1,461	10,078	10-25-90	08:26
		HPGLPLTR.SYS	16,188	30,680	10-25-90	08:35
	HPLASERP.ZIP	HPLASERP.SYS	25,934	47,756	10-26-90	16:32
	HPPJ180.ZIP	HPPJ180.SYS	25,427	43,552	10-10-90	14:04
	HPPJ90.ZIP	HPPJ90.SYS	25,118	42,000	10-10-90	14:53
	HPLOT.ZIP	HPLOT.SYS	15,148	31,388	05-02-89	01:08
	IBMGIOY.ZIP	IBMGIOY.SYS	3,497	6,708	01-27-86	18:03
	IBMGPR.ZIP	IBMGPR.SYS	23,810	42,096	02-02-87	16:54
	IBMPRCOL.ZIP	IBMPRCOL.SYS	20,975	39,724	05-27-87	12:05
	IBMPRO.ZIP	IBMPRO.SYS	23,295	39,988	08-27-90	09:44
	IBMPROXL.ZIP	IBMPROXL.SYS	27,085	47,872	08-27-90	15:26
	IBMQW2.ZIP	IBMQW2.SYS	26,678	47,324	08-28-90	10:50
	IBMQW3.ZIP	IBMQW3.SYS	24,657	44,888	05-26-87	07:56
	IBMXL24.ZIP	IBMXL24.SYS	28,035	52,824	08-28-90	14:04
	IHW12X16.ZIP	IHW12X16.FNT	2,485	8,804	04-10-89	16:26
	IHW12X24.ZIP	IHW12X24.FNT	2,136	13,140	01-16-89	09:43
	IHW12X48.ZIP	IHW12X48.FNT	2,628	26,148	02-15-89	09:19
	IHW12X8.ZIP	IHW12X8.FNT	1,386	4,468	01-16-89	09:25
	IHW18X24.ZIP	IHW18X24.FNT	2,648	26,148	01-16-89	09:54
	IHW24X24.ZIP	IHW24X24.FNT	4,911	26,148	04-12-89	08:08
	IHW6X16.ZIP	IHW6X16.FNT	1,770	8,804	01-16-89	09:21
	IHW6X8.ZIP	IHW6X8.FNT	1,177	2,300	01-17-89	14:54
	INCOED	-		28	06-17-93	15:35
	INSTALL.BAT	-		7,823	09-14-93	16:00
	JUNK.TST	-		37	06-17-93	15:06
	LJTRUN.ZIP	LJA.1	187	762	05-04-88	19:34
		LJA.2	187	763	05-04-88	19:34

Disk Volume Label	Disk File Name	Uncompressed File Name	Compressed File Size	Uncompressed File Size	File Date	File Time
		LJA.3	201	767	05-04-88	19:34
		LJB.1	942	1,983	05-04-88	19:34
		LJB.2	879	1,981	05-04-88	19:34
		LJB.3	878	1,981	05-04-88	19:34
		LJB.4	943	1,981	05-04-88	19:34
		LJB.5	904	1,981	05-04-88	19:34
		LJB.6	211	767	05-04-88	19:34
		LJF.1	963	1,983	05-04-88	19:34
		LJF.2	922	1,981	05-04-88	19:34
		LJF.3	915	1,981	05-04-88	19:34
		LJF.4	948	1,981	05-04-88	19:34
		LJF.5	907	1,980	04-14-89	09:25
		LJF.6	214	766	05-04-88	19:34
		LJL.1	190	762	05-04-88	19:34
		LJL.2	191	762	05-04-88	19:34
		LJL.3	206	766	05-04-88	19:34
		LJM.1	204	762	05-04-88	19:34
		LJM.2	203	762	05-04-88	19:34
		LJM.3	204	762	05-04-88	19:34
		LJN.1	204	762	05-04-88	19:34
		LJN.2	202	762	05-04-88	19:34
		LJN.3	203	762	05-04-88	19:34
		LJPC.1	2,443	5,385	09-27-89	11:35
		LJPC.10	254	1,228	09-26-89	18:00
		LJPC.11	205	762	09-26-89	18:00
		LJPC.12	204	762	09-26-89	18:00
		LJPC.13	351	2,164	09-26-89	18:00
		LJPC.14	204	762	09-26-89	18:00
		LJPC.15	203	762	09-26-89	18:00
		LJPC.16	209	766	09-26-89	18:01
		LJPC.2	2,504	5,386	09-26-89	17:59
		LJPC.3	1,752	3,690	09-26-89	17:59
		LJPC.4	2,501	5,385	09-26-89	18:00
		LJPC.5	1,734	3,690	09-26-89	18:00

Disk Volume Label	Disk File Name	Uncompressed File Name	Compressed File Size	Uncompressed File Size	File Date	File Time
		LJPC.6	1,796	3,690	09-26-89	18:00
		LJPC.7	203	762	09-26-89	18:00
		LJPC.8	251	1,226	09-26-89	18:00
		LJPC.9	250	1,226	09-26-89	18:00
		LJZ.1	4,412	10,665	04-17-89	19:43
		LJZ.2	4,466	10,666	04-18-89	14:44
		LJZ.3	3,062	7,210	04-18-89	14:46
		LJZ.4	4,392	10,665	04-18-89	15:40
		LJZ.5	4,458	10,666	04-18-89	16:11
		LJZ.6	3,126	7,210	04-18-89	16:24
		LJZ.7	214	1,278	09-26-89	12:48
		TRB0000S.FNT	1,819	3,712	10-15-90	22:37
		TRI0000S.FNT	1,872	3,712	10-15-90	22:37
		TRJ0000S.FNT	1,889	3,712	10-15-90	22:37
		TRR0000S.FNT	1,833	3,712	10-15-90	22:37
		UNB0000S.FNT	1,867	3,712	10-15-90	22:37
		UNI0000S.FNT	1,940	3,712	10-15-90	22:37
		UNJ0000S.FNT	1,938	3,712	10-15-90	22:37
		UNR0000S.FNT	1,887	3,712	10-15-90	22:37
	META.ZIP	META.SYS	11,058	25,240	10-02-90	16:44
	METABIN.ZIP	METABIN.SYS	11,009	25,048	10-02-90	17:01
	METACHAR.ZIP	METACHAR.SYS	9,980	21,512	10-03-90	08:02
	METATEXT.ZIP	METATEXT.SYS	12,216	29,108	10-02-90	17:11
	MOUSESYS.ZIP	MOUSESYS.SYS	3,347	6,256	02-28-89	12:18
	MSMOUSE.ZIP	MSMOUSE.SYS	2,917	5,788	10-06-88	11:50
	NECP5.ZIP	NECP5.SYS	27,847	52,548	05-24-89	10:46
	NECP5XL.ZIP	NECP5XL.SYS	27,167	47,128	05-22-89	21:31
	OKID290.ZIP	OKID290.SYS	26,065	43,192	09-27-90	13:57
	OUTTOCOM.ZIP	OUTTOCOM.EXE	8,942	18,123	08-17-89	13:23
	PPD.ZIP	APPLE230.PPD	2,742	8,337	01-20-89	15:57
		APPLE380.PPD	3,249	10,505	01-20-89	15:57
		APPLE422.PPD	3,232	10,489	01-20-89	15:57
		AST_470.PPD	3,366	11,054	01-20-89	15:57
		DATA462.PPD	3,292	10,706	01-20-89	15:57

Disk Volume Label	Disk File Name	Uncompressed File Name	Compressed File Size	Uncompressed File Size	File Date	File Time
		L100_380.PPD	3,456	16,068	01-20-89	15:57
		L300_470.PPD	3,552	15,815	01-20-89	15:57
		LWNTX470.PPD	3,318	10,634	01-20-89	15:58
		LWNT_470.PPD	3,287	10,553	01-20-89	15:57
		NEC__470.PPD	3,087	10,271	01-20-89	15:58
		QMS81470.PPD	3,096	10,071	01-20-89	15:58
		QMS8P461.PPD	3,122	10,341	01-20-89	15:58
		QMS8_461.PPD	2,952	9,259	01-20-89	15:58
		QUME_470.PPD	2,921	9,338	01-20-89	15:58
		TI08_450.PPD	2,902	9,212	01-20-89	15:58
		TI15_470.PPD	3,143	10,111	01-20-89	15:58
		VT600480.PPD	2,853	8,572	01-20-89	15:58
	PS2MOUSE.ZIP	PS2MOUSE.SYS	2,804	5,640	10-19-88	14:06
	PS_ZIP	PS_COB.FNT	5,002	20,623	06-13-90	13:18
		PS_COO.FNT	5,125	20,623	06-13-90	13:20
		PS_HV.FNT	5,230	20,623	06-13-90	13:24
		PS_HVB.FNT	5,187	20,623	06-13-90	13:21
		PS_HVO.FNT	5,301	20,623	06-13-90	13:23
		PS_TIB.FNT	5,267	20,623	06-13-90	13:25
		PS_TII.FNT	5,361	20,623	06-13-90	13:26
		PS_TIR.FNT	5,212	20,623	06-13-90	13:28
	QUIETJET.ZIP	QUIETJET.SYS	23,856	43,972	02-03-87	09:06
	ROLAND.ZIP	ROLAND.SYS	16,061	32,732	03-06-90	14:19
	SMICROII.ZIP	SMICROII.SYS	4,803	9,496	04-24-90	07:18
	SUM1812.ZIP	SUM1812.SYS	3,389	6,316	04-04-89	17:50
	SUMMATB.ZIP	SUMMATB.SYS	5,204	11,112	03-06-89	08:14
	TEK4695.ZIP	TEK4695.SYS	23,560	42,808	05-27-87	12:12
	TEK4697.ZIP	TEK4697.SYS	25,499	44,604	01-08-90	16:34
	THINKJET.ZIP	THINKJET.SYS	26,164	46,904	10-10-90	13:16
	TOSHIBA.ZIP	TOSHIBA.SYS	27,752	52,884	10-10-90	13:24
	XER4045.ZIP	XER4045.SYS	23,117	42,828	10-10-90	09:19
Total			1,886,736	4,052,926		