



**US Army Corps
of Engineers**

Hydrologic Engineering Center

Proceedings of a Seminar on

Hydrologic Aspects of Project Planning

7 - 9 March 1972
Davis, CA

REPORT DOCUMENTATION PAGE

Form Approved OMB No. 0704-0188

The public reporting burden for this collection of information is estimated to average 1 hour per response, including the time for reviewing instructions, searching existing data sources, gathering and maintaining the data needed, and completing and reviewing the collection of information. Send comments regarding this burden estimate or any other aspect of this collection of information, including suggestions for reducing this burden, to the Department of Defense, Executive Services and Communications Directorate (0704-0188). Respondents should be aware that notwithstanding any other provision of law, no person shall be subject to any penalty for failing to comply with a collection of information if it does not display a currently valid OMB control number.

PLEASE DO NOT RETURN YOUR FORM TO THE ABOVE ORGANIZATION.

1. REPORT DATE (DD-MM-YYYY) 7 - 9 March 1972		2. REPORT TYPE Seminar Proceedings		3. DATES COVERED (From - To)	
4. TITLE AND SUBTITLE Hydrologic Aspects of Project Planning				5a. CONTRACT NUMBER	
				5b. GRANT NUMBER	
				5c. PROGRAM ELEMENT NUMBER	
6. AUTHOR(S) CEIWR-HEC				5d. PROJECT NUMBER	
				5e. TASK NUMBER	
				5f. WORK UNIT NUMBER	
7. PERFORMING ORGANIZATION NAME(S) AND ADDRESS(ES) US Army Corps of Engineers Institute for Water Resources Hydrologic Engineering Center (HEC) 609 Second Street Davis, CA 95616-4687				8. PERFORMING ORGANIZATION REPORT NUMBER SP-5	
9. SPONSORING/MONITORING AGENCY NAME(S) AND ADDRESS(ES)				10. SPONSOR/ MONITOR'S ACRONYM(S)	
				11. SPONSOR/ MONITOR'S REPORT NUMBER(S)	
12. DISTRIBUTION / AVAILABILITY STATEMENT Approved for public release; distribution is unlimited.					
13. SUPPLEMENTARY NOTES Collection of papers presented at a seminar held at the Hydrologic Engineering Center, Davis, CA on 7 - 9 March 1972					
14. ABSTRACT A seminar on Hydrologic Aspects of Project Planning was held on 7 - 9 March 1972 at the Hydrologic Engineering Center (HEC) in Davis, California. The purpose of the seminar was to provide a forum for hydrologic engineers, planners, economists, and others to discuss the best means and timing for integrating hydrologic studies in the Corps water resources planning process. These included exchanging views and having discussions on such topics as: case studies of integrated planning-hydrologic studies; state of the art correlation of project hydrologic outputs with planning objectives; development and application of integrated hydrologic-economic computer models; role of hydrologic engineering in plan formulation and evaluation; hydrologic engineering data and analysis requirements in plan formulation and evaluation; and, application of hydrologic engineering techniques in planning for flood plain management.					
15. SUBJECT TERMS hydrologic, project planning, engineers, planners, economists, hydrologic studies, case studies, planning, computer models, plan formulation, plan evaluation, flood plain management, simulation models, water resource, urban area, drainage, rainfall, runoff, reservoir temperature					
16. SECURITY CLASSIFICATION OF:			17. LIMITATION OF ABSTRACT UU	18. NUMBER OF PAGES 172	19a. NAME OF RESPONSIBLE PERSON
a. REPORT U	b. ABSTRACT U	c. THIS PAGE U			19b. TELEPHONE NUMBER

Proceedings of a Seminar on

Hydrologic Aspects of Project Planning

7 - 9 March 1972

Attendees:

Corps of Engineers

Location:

US Army Corps of Engineers
Institute for Water Resources
Hydrologic Engineering Center
609 Second Street
Davis, CA 95616

(530) 756-1104

(530) 756-8250 FAX

www.hec.usace.army.mil

SP-5

FOREWORD

1. The purpose of this seminar was to provide a forum for hydrologic engineers, planners, economists, and others to discuss the best means and timing for integrating hydrologic studies into the Corps water resources planning process by exchanging views and discussion on such topics as:

a. Case studies of integrated planning-hydrologic studies. The case studies may include either a discussion of a unique problem and its solution or a discussion of existing procedures as applied to an unusual problem.

b. State of the art of correlation of project hydrologic outputs with planning objectives such as national and regional income, environmental quality, and social well-being.

c. Development and application of integrated hydrologic-economic computer models.

d. Role of hydrologic engineering in plan formulation and evaluation.

e. Hydrologic engineering data and analysis requirements in plan formulation and evaluation.

f. Application of hydrologic engineering techniques in planning for flood plain management.

2. Papers and discussions are, in general, frank evaluations by the authors and are not official Corps documents. The views and conclusions expressed herein are those of the individual seminar participants, and are not intended to modify or replace official guidance or directives such as engineer regulations, manuals, circulars, or technical letters issued by the Office of the Chief of Engineers.

CONTENTS

	Page
INTRODUCTORY REMARKS	
Augustine J. Fredrich Chief, Planning Analysis Branch The Hydrologic Engineering Center	1
HYDROLOGIC ENGINEERING TECHNIQUES: ARE THEY RESPONSIVE TO PLANNING REQUIREMENTS?	
Augustine J. Fredrich	3
REGIONAL PLANNING POTENTIAL OF DETERMINISTIC HYDROLOGIC SIMULATION MODELS	
B. O. Benn Research Civil Engineer Waterways Experiment Station	13
DIGITAL MODELING FOR EVALUATING WATER RESOURCE DEVELOPMENTS	
Harold E. Kubik Hydraulic Engineer The Hydrologic Engineering Center	40
HYDROLOGIC ASPECTS OF PLANNING IN AN URBAN AREA	
Richard F. Astrack Hydraulic Engineer St. Louis District	57
RAINFALL RUNOFF FROM URBAN DRAINAGE AREAS	
Clark L. Carter Chief, Hydraulics Section Savannah District	71

	Page
AN EVALUATION OF RESERVOIR TEMPERATURE PREDICTION METHODS	
Earl Eiker Chief, Hydraulics Section Philadelphia District	81
OPPORTUNITIES FOR HYDROLOGIC-ECONOMIC MODELS: A CASE STUDY	
William Boodt Gerald C. Johnston Regional Economist and Civil Engineer Portland District Portland District	
and	
Billy J. Thomas Assistant Chief, Hydrologic Engineering Section North Pacific Division	92
SOCIO-ECONOMIC ASPECTS OF PLANNING FOR THE UPPER ST. JOHNS RIVER BASIN	
Theodore E. Haeussner Chief, Water Management Section Jacksonville District	114
THE INTERRELATIONSHIPS BETWEEN PLANNING OBJECTIVES AND HYDROLOGIC ANALYSIS IN WATER RESOURCES DEVELOPMENT	
Lloyd G. Antle Center for Economic Studies Institute for Water Resources	127
THE ROLE OF HYDROLOGIC ENGINEERING IN THE CORPS WATER RESOURCES PLANNING PROCESS	
David Sveum Water Control Center North Central Division	135

	Page
FORMULATING FLOOD CONTROL CAPABILITY OF WATER RESOURCE PROJECTS	
Vernon K. Hagen Acting Chief, Hydrologic Engineering Branch Office, Chief of Engineers	143
EFFECTIVE USE OF HYDROLOGIC ANALYSIS IN INTERDISCIPLINARY PLAN FORMULATION	
Carl H. Gaum Assistant Chief, Interagency and Special Studies Branch Office, Chief of Engineers	153
SUMMARY AND CONCLUSIONS	
Darryl W. Davis Planning Analysis Branch The Hydrologic Engineering Center	161

SEMINAR ON
HYDROLOGIC ASPECTS OF PROJECT PLANNING

INTRODUCTORY REMARKS

by

AUGUSTINE J. FREDRICH
Chief, Planning Analysis Branch
The Hydrologic Engineering Center

I want to welcome you to The Hydrologic Engineering Center and to the beautiful city of Davis. We hope that this seminar on Hydrologic Aspects of Project Planning will be fruitful in describing the nature of the problems to the profession and in stimulating interest and thought on your part that can be directed toward the solution of these problems.

This is the fifth seminar of this type that has been conducted in the Center. Perhaps it would be of value to review very briefly the purposes and functions of the HEC and how a seminar of this type fits into our general program.

The Center has four basic missions: Research, Training, Methods Systemization, and Special Assistance. Research activities are directed toward the solution of problems that have developed in recent years because of the increased interest and activity in water resources development. I am sure that the presentations and discussions in this seminar will illustrate the extreme complexity of some of these problems, which are associated with the great diversity of hydrologic phenomena, economic factors, legal and institutional constraints, and social needs.

The Training program of the Center is intended to familiarize engineers throughout the Corps with the new techniques and to train the younger engineers in the traditional methods, as well as in the new techniques. This program is implemented primarily with a series of eight or ten formal training courses per year, each lasting about 2 weeks and covering a special area of hydrologic engineering. These courses are supplemented by individual training tailored to specific needs, as well as by seminars such as this.

The Methods Systemization program of the Center is intended to develop manuals, step-by-step instructions, and computer programs that can be readily used in each office for training as well as for actual design and operation studies.

The Special Assistance program provides consulting services on specific problems associated with authorized reports and projects in the various Corps offices. It is these special problems that instigate a good deal of the research and provide excellent means of testing the results of research and methods systemization work.

This particular seminar topic was selected, because the problems associated with hydrologic analysis for project planning are extremely complex and because new solution techniques show considerable promise but have not yet been demonstrated to apply effectively and generally to some important problems that exist. The gap between origination of new techniques and their implementation in planning is not due, as many may think, principally to reluctance or lack of understanding on the part of the planner, but rather to the fact that the development process of applying new techniques to real problems is difficult and time-consuming. Consequently, a major objective of this seminar is to outline to the profession the real nature of these problems, so that application of new techniques can be facilitated.

The purposes of this seminar are to provide statements of specific problems in hydrologic analysis for project planning that face the Corps of Engineers today, to describe the solution techniques that are currently implemented, and to discuss the potential development of the technology. I hope that each of you will keep these points in mind as you make your presentation. We hope that while you are here you will become acquainted with the staff at the Center and with the work that we are doing. If there is any way that we can help in regard to your accommodations or travel or other matters while you are here, please let us know.

HYDROLOGIC ENGINEERING TECHNIQUES: ARE THEY
RESPONSIVE TO PLANNING REQUIREMENTS?(A)

By

Augustine J. Fredrich^(B)

INTRODUCTION

During the past two decades the complexity of water resources planning has increased significantly. In addition to the complexities resulting from the requirements for considering factors that were not considered 20 years ago (and the number and significance of these alone would probably reduce to relative unimportance problems that were once considered to be of major importance), there are complexities that result solely from the development that has occurred during the past 25 or 30 years. Because of this development, problems that would have been "simple" project planning problems 20 years ago now become complex comprehensive planning problems that require consideration of the integrated effects of existing and proposed developments.

Despite this increase in complexity of planning studies, it appears that the technical studies--including the hydrologic investigations--which form the basis for the overall planning effort have been continually modified and improved so that the increase in technological capability has at least kept pace with the increase in complexity. Improvements in technical methodology have resulted from increased understanding of physical processes, better conceptualization of the physical processes for use in engineering and planning studies, and increases in availability and utility of electronic computers for engineering studies. Beard (1) and Fredrich and Hawkins (2) have discussed the impact of changes in technology on the techniques used for hydrologic engineering investigations. Beard suggests that only through intelligent application of the electronic computer can the hydrologic engineer maintain analytical capability that is commensurate with the ever-expanding problem complexity. Fredrich and Hawkins indicate that the changes in planning study requirements and recent innovations in computers and in hydrologic theories have created an atmosphere conducive to the development of new hydrologic engineering techniques.

(A) For presentation at the HEC Seminar on Hydrologic Aspects of Project Planning.

(B) Chief, Planning Analysis Branch, The Hydrologic Engineering Center, Davis, California.

Although technology is definitely changing in fields such as hydrologic engineering, and despite the fact that these changes are probably occurring at least as fast as the requirements for planning studies are changing, it is worthwhile to examine the question of whether technological changes are really responsive to the changes in requirements or whether they are merely changes which produce the same old solutions at a lower cost or in a shorter time. For if the latter is true, there is undoubtedly a limit to the effort which could be devoted to producing this type of change. Although efficiency is certainly a worthwhile objective in some cases, there usually comes a time when additional efficiency is not only not worthwhile but also counterproductive. That is, it is not only futile to build a better mousetrap if mice are no longer a problem, but it is also wasteful to devote resources to mousetrap improvement if cockroaches are the cause for concern.

HYDROLOGIC ENGINEERING TECHNIQUES

In general the types of hydrologic engineering methods used in conjunction with planning studies can be classified in three categories according to the objective of the hydrologic investigation: development and analysis of basic hydrologic data; development and analysis of criteria and project features based on hydrologic variables; and analysis of effects of hydrologic variations on alternative plans of development. The first category includes such hydrologic investigations as streamflow frequency analysis, regional correlation studies, estimation of flows from ungaged areas, and streamflow simulation. The second category includes investigations such as unit hydrograph and loss rate determinations, computations of hypothetical floods, and some types of channel and reservoir routing studies. The third category consists primarily of various types of hydrologic simulations such as reservoir operation studies, water surface profile determinations, and flood hydrograph routing and combining.

In most instances hydrologic engineers have proceeded, more or less independently, to improve existing techniques or to develop new techniques in the first two categories without much consultation with other technical specialists. The rationale for this has been that the hydrologic engineer is, in general, the direct user of the output from the techniques. Consequently, he is the person most qualified to assess both what is available as input and what is required as output. To the extent that he is cognizant of the ultimate use of the results of his study and the effect that this use should have on the techniques employed, there is no question that he is solely qualified to develop or select the proper technique for use in either of the first two categories.

IMPACT OF PLANNING OBJECTIVES

Despite the facts that objectives of planning investigations have been shifting continuously for the past 30 years and that some of the shifts have been of major magnitude, the impact of the shifts on hydrologic investigations of the first two types have been very small. In most cases the ultimate planning objectives are so far removed from basic analyses such as these, that extreme changes in objectives can be accommodated with little or no change in technology at this level. This is particularly true in the case of techniques for developing and analyzing basic hydrologic data. Most frequently changes in techniques for accomplishing this type of work result from advancements in the technology itself (such as methods for streamflow simulation) or from the availability of better "tools" for accomplishing the work (such as the availability of electronic computers). Nevertheless, even at this level there are sometimes instances where a change in planning objectives can demand changes in technology, even at a very basic level. For instance, the adoption of the comprehensive basin planning philosophy had a major impact on the hydrologic data requirements for planning studies. The result was an increase in emphasis on regional correlation analyses and the development of techniques that would provide coordinated estimates of streamflow quantities at numerous points within a basin.

Although there are situations in which the change in planning objectives stimulate new developments in hydrologic engineering methods at the basic data analysis level, it is not usually necessary for the hydrologic engineer to consult extensively with planners to ascertain the specific requirements for the new techniques. A perceptive hydrologic engineer would probably discern the shift in emphasis and the resultant impact on requirements for hydrologic data, but he might find it necessary to consult with planners to establish the requirements for relative accuracy of the hydrologic data because of the large influence of the planning study objectives on data accuracy needs.

As the results of hydrologic engineering investigations become more the input into a planning analysis rather than the input into another hydrologic analysis, there is an increase in the extent to which the hydrologic engineer must coordinate modifications of existing techniques and development of new techniques. Hydrologic investigations which are closely associated with important planning decisions can be greatly influenced by relatively minor changes in planning objectives, and the hydrologic engineer must coordinate closely with planners to insure that the hydrologic studies are relevant to and commensurate with the planning objectives.

TRENDS FROM THE PAST

Computer programs that incorporate many of the existing hydrologic engineering techniques have enabled the hydrologic engineer to provide

quick answers to traditional problems at a relatively low cost. In the earliest comprehensive planning efforts, these answers were incorporated into the overall studies to the satisfaction of both the engineer and the planner.

As the scope of the comprehensive study increased and as more beneficial uses of water began to be considered, it became apparent that computerization of existing techniques would not completely satisfy the emerging requirements. Not only were existing techniques inadequate for supplying answers to the relatively new problems--it was discovered that in many instances the answers produced by traditional techniques were not consistent with the scope and objectives of the comprehensive study. Consequently, money and time were being consumed in the production of answers which were not always really commensurate with the requirements for the overall study. Thus, it became apparent that the real need was for new techniques--techniques developed with consideration being given to the ultimate applications of the results and which would employ the capabilities of the computer to go beyond techniques primarily oriented toward manual computation.

Several factors have traditionally influenced the development of new hydrologic techniques. First, there have been notable communication failures between persons responsible for overall planning of a study and persons responsible for conducting the hydrologic analyses. Differences in planning objectives are not always effectively communicated to the hydrologic engineer, and consequently there are too many instances where the hydrologic analyses are not completely responsive to the overall study needs. Expensive restudies are sometimes required and the overall study progress can be delayed until they are completed. On the other hand, the hydrologic engineer sometimes fails to clearly identify the problems associated with the analysis of basic hydrologic data. When this happens, the planner is unable to properly program the hydrologic analyses, and the usual result is that the time and funds allowed for hydrologic analyses are not adequate.

Another factor which has adversely affected the development of new techniques is the imposition of arbitrary standards of accuracy or reliability upon the results produced by new techniques. Hydrologic engineers and water resources planners must work together to clearly identify the significance and limitations of results from new procedures rather than to unilaterally impose arbitrarily high standards of accuracy which might not be consistent with the intended use of the results or with the accuracy of the available basic data.

Finally, the development of new techniques has been impeded when engineers or planners refuse to deviate from traditional techniques, irrespective of the applicability or utility of the techniques to the problem at hand. As long as this attitude exists, there is little opportunity for innovative engineering work to respond to new challenges.

DEVELOPMENT OF NEW TECHNIQUES

In the previously referenced paper by Fredrich and Hawkins (2) the factors which are important considerations in the development of new techniques are discussed as follows:

"The developers of the methods must have a thorough understanding of the problem to be solved, the data available for use in the solution, the time and funds constraints which will be imposed upon the users, and the potential uses of the results. The engineers who will actually employ the techniques must, of course, understand the application of the technique, develop the required data, be able to explain how the method was used, and be capable of describing the accuracy or reliability of the results and the limitations on their use. The persons responsible for directing the planning study must insure that the scope and objectives of the planning are fully understood, develop chronological schedules and fund allotments which are consistent with the required hydrologic analyses, acquire an understanding of the technique and the results in order to insure proper integration of the results into the overall effort, and develop a means of presenting the results in a way which minimizes the possibility of invalid use of the results without destroying the credibility of the work for its intended purposes."

Hydrologic investigations would always be in near-perfect harmony with planning objectives if the above-described guidelines were always considered. However, it appears that this is not always the case--in fact, it appears that in some cases the hydrologic engineers and planners are both intent on extending their respective "spheres of influence" to cover as much of the other's discipline as possible. This, of course, will almost always be disastrous. Planning study objectives, which are often dictated by law, cannot be modified to accommodate an unresponsive result from a hydrologic investigation, and hydrologic principles cannot be abandoned to accommodate an unfounded planning supposition.

Developers of new hydrologic techniques must rely on advice and guidance from planners who will use the techniques or the results of the techniques. If they do not, they may find themselves in the role of a consultant rather than that of a team member or partner in the planning study. When this occurs the most likely outcome is that which is so aptly illustrated by a recent television commercial. The proponent of a new technique encourages "Try it, you'll like it" and the embittered user later bemoans "So I tried it. Thought I was going to die."

ARE HYDROLOGIC ENGINEERING TECHNIQUES RESPONSIVE?

I think that, in general, hydrologic engineering techniques have been responsive to planning requirements, but I think that a major reason for this is that the hydrologic factors in planning problems dominated the problems to the extent that they received a great deal of attention and a relatively large portion of the total budget for technical studies. Also, many of the water resources planners in the past have had strong hydrologic engineering backgrounds. Consequently, they were aware of and attentive to the hydrologic factors, and could communicate readily with the hydrologic engineer about the specifics of many problem areas. In a sense, hydrologic engineers were at the leading edge as the scope of water resources planning expanded.

Now, however, the number of factors to be considered in even a project planning study is so large that hydrologic problems no longer dominate the picture. Also, the funding for water resources planning efforts has not increased rapidly enough to satisfy the needs for investigations in every pertinent technical area, and the proportion of funds available for "well-understood" problems is continuously decreasing. Furthermore, persons in high planning echelons now may have followed any of a number of career avenues to reach their present position. Hydrologic engineers can no longer claim almost complete domination of the planning field.

The cumulative effect of all these changes could well be a serious decrease in the responsiveness of hydrologic engineering techniques to planning problems. Already, there are signs that hydrologic engineers are failing to produce efficient and effective techniques for use in planning problems that are of current importance. We are struggling in urban hydrology, we are stumbling in flood plain and flood insurance hydrology, we are lagging in hydrologic studies for environmental problems, and we are groping for techniques to more effectively analyze natural and man-modified hydrologic systems. In short, we seem to be reacting rather than anticipating. When situations are changing rapidly, it is very difficult to be responsive by simply reacting--anticipation is essential to responsiveness.

In order to anticipate the need for new or modified hydrologic engineering techniques, we must identify potential problems early enough to provide some lead time in which to develop solutions. However, anticipation alone will not suffice. The necessity for innovation must be communicated to planners and other technical specialists so that their insights and evaluations can be considered during the development of the new techniques.

Although the emergence of many new areas of technical consideration has diluted the relative importance of hydrologic engineering in water resources planning, the fundamental importance is unchanged. Regardless

of the number of disciplines which will have to be considered in the future, the basic necessity for understanding the occurrence and movement of water in the natural environment and the reaction of natural water systems to man's activities will persist. The role of hydrologic engineering in future water resources planning will depend on how well we respond to the changes in what is demanded of us.

REFERENCES

1. Beard, Leo R., "Closing the Technology Gap," Proceedings of A Seminar on Computer Applications in Hydrology, The Hydrologic Engineering Center, Davis, California, 1971.
2. Fredrich, Augustine J. and Hawkins, Edward F., "Hydrologic Engineering Techniques for Regional Water Resources Planning," Water Resources Bulletin, American Water Resources Association, Vol. 6, No. 2, April, 1970.

HYDROLOGIC ENGINEERING TECHNIQUES:
ARE THEY RESPONSIVE TO PLANNING REQUIREMENTS?

Question, Mr. Auburg: There has been an artificial distinction between "hydrologic engineering" and the planning process. The implication is that hydrologic engineering is something above or separate from other analyses required to complete the planning process. Would you comment on that?

Reply, Mr. Fredrich: First, let me say that I don't think that the distinction between hydrologic engineering and the planning process is at all artificial. It seems to me that hydrologic engineering is one of the many technical areas involved in the planning of water resources development - a very important area and one that is quite distinct from the planning process. There are numerous hydrologic engineering functions that are not concerned in any way with planning of water resources projects or systems. Hydrologic studies for flood operation and flood forecasting are examples of functions that are not planning-related. If I implied that hydrologic engineering is "above" the other analyses, I did not mean to do so. There is certainly no question as to the importance of hydrologic engineering in water resources planning since it is the field of endeavor that encompasses the various types of studies that deal with the primary resource being dealt with - water. However, I certainly wouldn't want to have my remarks interpreted to imply that I feel that economics, foundation engineering, structural engineering, or any of the other technical areas are subordinate to hydrologic engineering.

Comment, Mr. Harrison: In solving a complex planning problem, it is not useful to categorize each individual rigidly within a field of specialization in which he is expected to contribute to the plan. What is useful is that each individual be identified according to his particular expertise, and that he also share in the full responsibility for defining the problem and contributing to the final solution, including the report, the design and construction, the construction, and the operation after construction. I think this concept of shared responsibility will lead us to the solution we seek.

Reply, Mr. Fredrich: I fully agree with the idea of shared responsibility as described by Mr. Harrison. There is no doubt in my mind that it is wrong to attempt to solve a complex planning problem by limiting each individual to a narrow specific area of work or by limiting the analyses for a given technical area to a few specialists. I think we are talking about the difference between multi-disciplinary and interdisciplinary, and the latter seems to me to be the more productive - just as you suggest.

Question, Mr. Gaum: (1) What is a hydrologist-hydrologic engineer; what are his areas of experience; and what is his role in planning?
(2) What is the answer to the question in the title of the paper?

Reply, Mr. Fredrich: (1) To me there is a distinction between the terms hydrologist and hydrologic engineer. A hydrologist is a scientist who studies the occurrence and movement of water in the hydrologic cycle - that is, in the atmosphere, on the earth's surface, and beneath the earth's surface. A hydrologic engineer, on the other hand, is an engineer who understands the science of hydrology and who uses this understanding - together with an understanding of basic engineering principles - in technical studies associated with the planning, design, and operation of water resources developments. His experience would include academic and on-the-job training in both hydrology and engineering and in other technical fields that are required for the particular type of hydrologic engineering work he performs. These fields could include such areas as water chemistry, meteorology, geology, economics and hydraulics. I think the hydrologic engineer's role in planning must be determined by his functional responsibility in the particular organization where he works. In some cases he will be involved in plan formulation and broad evaluation of alternative plans of development. In others he will be little more than a technical specialist performing specific studies of very limited scope. I personally feel that the former role is more appropriate than the latter.

(2) As I stated - maybe not too clearly - in the summary of my paper, I feel that hydrologic engineering techniques have generally been responsive to planning requirements in the past, but I think the planning requirements are changing rapidly and I am not sure that hydrologic engineering techniques are changing rapidly enough to keep pace. Consequently, there is a real danger that we (hydrologic engineers) will soon find ourselves in the position of not being able to fully respond to planning requirements.

Comment, Mr. Gaum: Don't plan in isolation. Communicate with other disciplines prior to detailed hydrologic studies.

Question, Mr. Antle: Isn't one of the basic difficulties in project planning the lack of interplay with other disciplines? For instance, future runoff coefficients are heavily dependent upon land use and design criteria of new developments. Is this solely the province of hydrologic analysis?

Reply, Mr. Fredrich: I agree that one of the basic difficulties in planning has been the lack of adequate communication among various disciplines. However, in your example of runoff coefficients for future developments, I'm not sure just how much interplay there should be. I would say that the determination of the runoff coefficients is the direct responsibility of the hydrologic engineer, and that this determination should be based on analyses of the changes in hydrologic response of watersheds as they undergo development. This, to my mind, is a straightforward hydrologic determination. Now, if you are suggesting that the hydrologic engineer should consult with planners, sociologists, economists, and others about anticipated changes in a watershed before defining the conditions upon which the selection of an appropriate coefficient should be based in a particular case, I would certainly agree.

REGIONAL PLANNING POTENTIAL OF DETERMINISTIC
HYDROLOGIC SIMULATION MODELS

By

Bob O. Benn*

1. The determination of acceptable uses of land for industry, agriculture, forestry, recreation, transportation, living space, etc., can be made only after studying the interaction of a large number of resource parameters (natural, technological, labor, finance, etc.). Land use and resource parameters are dynamic; therefore, land analysis cannot be done once and for all, but must be updated as required for decision making. The determination of land use in the modern society must be aimed at obtaining maximum benefit for specific purposes without undue detriment to other purposes. This paper addresses the development of procedures for predicting the interaction of phenomena in complex environmental systems concerning large land areas. These predictions provide the basis for value judgments concerning the degree of optimization that can be allowed for one land use at the expense of others.

2. The Terrain Analysis Branch, Mobility and Environmental Division, Waterways Experiment Station (WES), has been engaged for the past 10 years in research to develop analytical procedures for predicting quantitatively the performance of men and machines in various military operational environments. During the course of this research a concept for area analysis applicable to both military and civil projects has evolved. The steps required in this concept to make an area evaluation for specific purposes are as follows:¹

- Step 1. Development of performance prediction models. This involves the development of mathematical simulation of the interaction of the activity and the environment. For example, the cross-country locomotion model developed at WES simulates a vehicle traversing specific terrains and predicts its speed.
- Step 2. Acquisition of environmental inputs to the performance prediction models. In Step 1, specific quantitative environmental factors were identified as input requirements to the mathematical expression. The areal distribution of the factors must be determined at a scale or degree of detail commensurate with model requirements, and the factors then must be synthesized and stored for efficient manipulation. Many of the factors required are dynamic and often have to

* Research Civil Engineer, Terrain Analysis Branch, Mobility and Environmental Division, USAE Waterways Experiment Station, Vicksburg, Miss.

be predicted using models of the phenomenology involved, i.e. in many instances the dynamics of the input variables are controlled by the hydrology of the area. For example, in the case of the land locomotion model, the water width and depth of streams are environmental input parameters.

Step 3. Display of the performance predictions over the area of interest in a form that is nonambiguous and easy to interpret.

3. The model is considered the keystone to the area evaluation process, and considerable research and engineering are devoted to this development. For example, several comprehensive computer models for relating the performance of such diverse military activities as land locomotion, bridging of tactical gaps, battlefield surveillance, construction of roads, helicopter landing zones and airfields, and munition effectiveness have been developed and used in major projects at WES in recent years. However, in applying the three-step concept (para. 2 above) to the study of real-world situations, our experience has shown that Step 2 is by far the most time consuming and difficult. The problems associated with Step 3 usually result from the fact that the product must often serve such diverse users as operations research analysts, strategic planners, and even tacticians. The requirements of the user dictate the nature of the mathematical model, as well as the scale and degree of generalization.

4. Regional studies for military and civil purposes in many instances have parallel problems and similar solutions. Thus, it seems practical to directly transfer experience gained in military research and development to the civil sphere, especially in such areas as the definition of study objectives, the size of the study area, degree of detail required, analytical tests, and presentation of findings.

5. Two projects have been selected to illustrate the WES area evaluation concept, and to demonstrate the generic similarities between military and civil problems. The first, entitled "European Waterways Study,"² specifically illustrates the propositions (and some solutions) associated with Step 2 of the WES concept (see para. 2 above) when it is applied to a waterway network problem. The second, entitled "The Rowlesburg Lake Model System," illustrates the utilization of mathematical simulation models in an area of civil works interest.

European Waterways Study

6. The WES effort was to support a Combat Developments Command (CDC) investigation to determine future materiel requirements for a highly mobile army. The specific problem CDC was addressing was: "Does the Army need a vehicle that swims, or can its future needs be met by other gap-crossing systems?" It is clear that this question can be objectively answered only

if the frequencies with which tactical gaps* of specific kinds will be encountered are known. Since there was adequate evidence to demonstrate that different geographic regions exhibit different numbers and kinds of tactical gaps, it was essential that a consistent and objective procedure be developed which, when used, would define the tactical gap characteristics of any geographic region to which it was applied.

7. In view of these considerations, two of the major objectives were:

- a. To develop a widely applicable procedure for the acquisition of reliable data on the characteristics of a militarily significant tactical gap (hereafter called "gap"). The procedures which were to be developed were to be as general as possible so that only a minimum of modification would be required to make them applicable to any region of the world.
- b. To develop a procedure for presenting the acquired gap data in a form in which they could be readily used in operation research models dealing with the prediction of performance of various tactical gap crossing systems (bridging, rafting, fording, swimming) and their related engineering activities (grading, mat laying, surfacing).

8. At the time of initiation of the project, there were no performance prediction models for the various gap-crossing systems. Lacking the identification of significant terrain factors that would have been provided by the models, it was thus necessary to study the various gap-crossing systems in considerable detail. From this examination, all terrain attributes that could be hypothesized to affect tactical gap-crossing materiel and activities were derived. Table 1 is a matrix illustrating the relations among terrain factors and gap-crossing systems.

9. Even before data collection can begin, there are always two nagging sets of problems that must be resolved. First, since the significant factors are distributed in both time and space, the method of presenting the data for use or analysis must be established. In most instances, this is some form of map. The fact that maps are to be used raises the second question, namely, classification. Because classification is an unavoidable concomitant of any mapping process, consideration of the nature of an ideal classification system is relevant and, indeed, essential. There is one overwhelming requirement. The class intervals should be such that any point selected between class limits would introduce only an acceptably small error in prediction. That is, if all other factor values are held constant, the difference in prediction that would result from accepting a point taken near the lower end of the class range and

*A tactical gap is a linear terrain feature (such as a ditch, canal, or river) which tends to impede the cross-country movement of personnel or vehicles.

one taken near the upper end of the class range would be small enough to be acceptable to the user. The problem is thus to select class ranges for all terrain factor variables in such a way as to minimize the effect of stratification. This ideal must, of course, be tempered by practicality; class intervals too small to be identified by any practical interpretation or mapping process must be avoided. In this case, because the mathematical models relating the gap crossing system to the environment had not been formulated, the basic or primary data were recorded in actual values; that is, measurements of factors were not in classes but rather in absolute values. The overriding reason is that data collected and stored in this way can be classified in a number of different ways and are thus useful for a wide variety of models or other purposes, whereas data collected in terms of classes can be used only for the one purpose for which the classes were designed. Because the mathematical models of the various systems were not available, considerable judgment had to be used in the selection of the class intervals for the various factors when they were actually mapped. The class ranges for the significant factors are identified in Table 2.

Acquisition of basic data

10. The numerical values for the factors listed in Table 1 were obtained by photogrammetry, photo interpretation, literature search, and by field measurements in the study area (fig. 1). Photogrammetry was used where possible to obtain measurements of water width, bank height, bank angle, gap width, number of trees per unit area, and vegetation band width. Often, however, the geometric properties of the gaps could not be measured because of obscuration by vegetation and photographic scale limitations. In such instances, the descriptive data were estimated using photo interpretation techniques. The reliability of photo interpretation is directly proportional to the quantity and excellence of "ground truth" data, which are the links between ground conditions and the photo image. Accordingly, every effort was made to obtain abundant ground truth data from both literature sources and field measurements.

11. Published literature on the required factor data was found to be almost nonexistent, so arrangements were made for a German-speaking WES employee to visit the various German agencies dealing with hydrographic studies to obtain existing long-term hydrographic and engineer records. The records were very valuable to the study, but they had significant gaps and constraints. For example, most sites were descriptions of locations chosen specifically for gaging stations, and thus tended to be in straight reaches where the channel was artificially constrained and geometrically regular, or at bridges or other works which produce anomalous but regular channel configurations. Thus, the data on water level fluctuations at gaging stations could not, for example, be directly applied to the natural and irregular reaches of the channel. The records also lacked soil strength and vegetation data.

12. To fill in the gaps, field measurements were made at various sites in the study area. The sites were selected on the basis of preliminary air photo interpretation of the study area. Two fundamental criteria were used: first, they represented what appeared to be commonly recurring gap types; and second, they represented points or places in which no interpretation could be made because the combinations of features were unfamiliar to the interpreters.

13. The field data collection was designed to acquire the maximum possible amount of basic data so that they would be as widely useful as possible. For example, bed and bank configurations were recorded as a vertical profile across the gap. From such data the various geometric factors (such as gap width, bank angles, bank heights) can be readily calculated.

Gap conditions as a function of time

14. A condition of the project was that the final description be such that the gap conditions for any time of the year could be defined. To achieve this, a method was developed and used for "predicting" the condition of every gap throughout a yearly cycle.

15. The literature data (i.e. the stream hydrograph data) commonly included stage and discharge data, usually in such form that mean stage and its correlative discharge by month could be readily obtained. With these data, combined with a gap cross section, it was possible to compute all of the pertinent geometric factors (water depth, water width, gap width, bank angles, and bank heights) for any water level. Some, but not all, of the literature sites also included current velocity data. In those instances where such data were available, the current velocity for any water level could also be computed. In those instances where current velocity data were not included, it was necessary to calculate the velocities by indirect methods. This was done by using the "Manning equation," with the required longitudinal slope value obtained from topographic maps. "Manning's n," the "roughness number," was obtained by photo interpretation. The solution of the Manning equation provides a mean velocity value which can then be adjusted to give maximum velocity. Thus, at this point, all literature sites were represented by complete hydrologic and geometric data (bank angles, bank heights, gap width, water width, water depth, and maximum current velocities) for any month or for any arbitrary water level.

16. The field data (i.e. that collected by the field team), of course, recorded only one point in time, and thus no stage or water level data were available except for the day on which the gap was measured. For these sites, geometric data (gap width, water width, water depth, bank angles, bank

heights) could be calculated for any arbitrary water level, but no monthly values could yet be assigned since there were no monthly stage data. However, current velocities could be estimated through the entire range of water level, the longitudinal slope could be measured, and Manning's n could be readily calculated. With this value, current velocities for all water levels could be computed. Then a regression line was calculated which related current velocity to the cross-sectional area of that portion of the channel occupied by water, with the velocity/area relation calculated for each of many small increments of water level change (fig. 2). The slope and intercept of the regression line are then characteristic of the type of channel and water regime at that site. Now, turning again to the literature sites, the same process was used to obtain regression lines which characterize those sites.

17. In topographically and climatically similar regions, streams of equivalent size (or discharge) will exhibit similar channel geometries if their discharge regimes are similar. By extension, streams which exhibit similar water level/discharge (or water level/current velocity) relations will exhibit similar discharge (or stage) regimes. The procedure was then to match the slope and intercept values of the velocity/area regression line of each field site with its closest equivalent among the velocity/area regression lines of the literature sites; when a close fit was found, the stage regime of the literature site was assigned to the related field site. With stage relations thus assigned, the various factors describing the field sites could be readily calculated for each month. Thus, all geometric and hydrologic factors could be completed for both field and literature sites (fig. 3).

18. The digits in the "Stage" columns in the part of fig. 3 labelled "Factor Complex" are arranged in the following left-to-right sequence: Depth, water width, left bank height, right bank height, left bank angle, right bank angle, velocity. The numerical value of the digits correspond to the class of the respective factor in Table 2. For example, the number 3 in the upper left corner means the water depth for the mean high stage conditions for 15 January in water depth class 3, i.e. > 100-200 cm.

19. The soil strength (cone index value) and vegetation factors were, as previously mentioned, completely absent from the literature site descriptions and were, of course, available for the field sites only at the time the site was visited by the field team. Since vegetation structure is not time-dependent (at least on the scale of time considered for this work) the factor values for all sites remained a constant throughout the year. Factor descriptions were obtained directly from field data for the field sites, while photo interpretation techniques were used to provide these data for the literature sites.

20. Soil strength, however, is quite variable and changes with changes in water content of the soil. Thus, the cone index values of all soils not continually saturated (such as those on the bottoms of nonperennially wet gaps) change with seasonal fluctuations of moisture content. They change with any moisture content change, of course, and so react to rainfall at any time of the year. However, the only available data were the cone index values obtained at each field site and these represented the condition only at the moment of measurement. While there are methods of relating cone index value, soil type (USCS or USDA), and moisture content, they are not very reliable and, at best, depend upon highly accurate determinations of soil moisture. Since soil moisture could not be reliably estimated, it was decided to record the measured cone index values and not to attempt to predict seasonal values. There were, of course, neither soil type nor cone index data for the literature sites and, indeed, no reliable method for estimating them.

21. The cone index values were problems only for the top-of-bank positions; soils were assumed to be perennially saturated in the bottoms of wet gaps as well as the water level locations, and therefore the measured values at those points remained valid for all seasons.

Areal distribution of the factors

22. The areal distributions of the factors were mapped by photo interpretation. First, the locations of the sample sites were plotted on the topographic maps and aerial photography, and all of the gap profiles were drawn to a common scale and grouped into classes on the basis of visual similarity to the "type classes." Since the sample sites were deliberately scattered across the entire study area, this provided a reasonably uniform coverage of all variations in the region.

23. Next, every gap which could be recognized on the aerial photography was traced and classified according to the factor classes defined in Table 2. This process involved the development of a set of recognition criteria for each factor or factor set, using the sample sites as ground truth. To the extent possible, each factor was mapped individually, but there were exceptions. For example, all vegetation factors were mapped simultaneously so that in that instance the gap segments were assigned a two-part code, one digit of which represented the stem diameter/stem spacing category, and the other the vegetation band width.

24. Upon completion of the photo interpretation, the product was an array of planimetrically accurate factor maps covering the area of interest.

25. The next step was therefore to compile a "factor complex map." It will be recalled that each factor (or factor set) varied independently. Thus, for example, a section of gap might be subdivided into two segments: at one point on the basis of cone index values, and at quite another place on the basis of bank heights. The problem, then, is to combine all of the factor maps into a single map on which is identified each gap segment that displays a unique combination of factor values. In effect, this process identifies what might be called "gap types," a gap type being defined as a segment of gap exhibiting a specific combination of factor value classes throughout its length. The compilation of the factor complex map (or the gap type map) was achieved by successively overlaying the factor maps on a suitable base map (see fig. 4), and accumulating the data. When all the factor maps had been overlain in this fashion, the resulting factor complex map included a delineation of every gap type found in the area. The completed factor complex maps (fig. 5) represent the completion of the acquisition of all available descriptive data. This provides a concise data base that allows estimates of stream environment conditions that vary in both time and space for a sizeable area in the real world.

Comments

26. It should be specifically noted that the European Waterways Study concluded with a procedure that is entirely descriptive in nature; it does not predict conditions except in the almost trivial sense of "predicting" what the current velocities should be in a given channel at a given water level. The point is that the entire study was devoted to Step 2 (data acquisition) of the WES terrain analysis concept. It has been used as a demonstration of the fact that acquiring quantitative terrain data is not a trivial problem, but it can be done.

27. One obvious conclusion which may be drawn from the foregoing discussion is that a deterministic hydrologic model that would predict stream flow as a function of basic watershed parameters is very badly needed, since it would allow the generation of information similar to that developed in the European Waterways Study, at the same time circumventing the necessity for the elaborate statistical "fitting" procedures used therein to obtain hydrograph and related data. Hydrologists have sought an analytical synthesis of the full hydrologic cycle during the last decade and several "models" have been developed. Probably the most complete model is that developed by Crawford and Linsley.³ Other important models include the Kansas Model, developed by Lumb,⁴ and a model developed by the Agricultural Research Service (Holtan and Lopez).⁵ These models have all been used to reconstruct hydrographs that match well with the measured flows. However, their use requires considerable "juggling" of input parameters to obtain the desired fit. Further, the input parameters are usually seldom explicit measurable environmental factors. This seriously restricts the use of the model in unaged watersheds. Also, it negates the model for use in studies dealing with the effects of various land modification and resource management concepts. Holtan, in describing his model, states, "Our model is currently a

series of empiricisms selected to provide a mathematical continuum from ridgetop to watershed outlet in terms of input readily available to the analyst. The restriction of input information to that "readily available" to the analyst appears contrary to the development of a model truly capable of simulating the various subsystems of the hydrologic cycle.

28. The point here is that a deterministic streamflow model will surely require a detailed quantitative description of the drainage basin. In fact, the required description can be conjectured to consist of two fundamental parts: (a) a stream channel network description, somewhat after the pattern of that produced for the European Waterways Study; and (b) a description of the interfluvial terrains designed in terms of all of the factors that influence runoff, infiltration, storage, and transpiration. It seems clear that a system for describing a watershed in these terms must be developed prior to or concurrently with the model which it is intended to feed. Almost surely the descriptors will be environmental factors not now "readily available" to the analyst; it is therefore mandatory that hydrologists face the cruel fact that new data acquisition procedures, perhaps similar to those used in the European Waterways Study, will have to be developed and used.

29. The development of a physically based simulation model of all the various subsystems of the hydrologic cycle appears to be a monumental effort. Although many hydrologists^{6,7} feel that such a model can be developed, it is generally agreed that relating the various subsystems to specific environmental descriptors is a prerequisite to the completion of the general model. Once the relevant descriptors are identified and watersheds can be described in terms of the descriptors, the completed model would provide deterministic predictions of streamflow.

The Rowlesburg Lake Model System

30. Having arrived at the conclusion that the quantitative terrain description part of the problem of creating deterministic models can be solved, an example of such a model is in order. The following discussion concerns a model developed by WES for the Pittsburgh District to assist in a study of possible alternates to the construction of a large multipurpose dam on the Cheat River at Rowlesburg, West Virginia (fig. 6).

31. The Rowlesburg Lake was planned as the last of a system of reservoirs in the Ohio River Valley system of flood control. Although the project had been authorized since the 1940's, construction was not planned to begin until 1970 or 1971. The initial environmental impact statement submitted by the Pittsburgh District was deemed lacking in detail and comprehensiveness by the Environmental Protection Agency (EPA). A major problem at Pittsburgh in performing impact studies was the development of capability

to consider costs and adequacy of alternate reservoirs and/or systems of reservoirs to the one planned for Rowlesburg. WES was asked to put together an analytical system capable of providing a quick evaluation of alternate reservoir systems. The funding level was low (\$16,000) and time was short (6-8 wks) for this effort.

32. Because of this it was necessary to put together an analytical system consisting of highly generalized subsystems. The overall analytical system is conceptualized in fig. 7 and described in the following paragraphs.

33. Blocks 1 through 5 represent the data base from which input to the models identified in blocks 6-16 is obtained. Block 1 represents a data store of xyz coordinates obtained by digitizing the topographic maps. Block 2 represents a store of 40 years of rainfall and runoff records for the Cheat River valley. Block 3 represents the store of data on the availability and costs of materials for the construction of the reservoir and its appurtenances, e.g. recreation facilities, etc. Block 4 deals with the cultural habits and distribution of the population. Block 5 is concerned with inventories of the wildlife resources (habitat, fisheries, hunting, etc.) obtained from game and fish management agencies, primarily to be used to determine the necessary requirements to meet wildlife mitigation.

34. The runoff subroutine, Block 6, required inputs of the channel cross-sectional area and the stage and velocity measurements obtained from the 40 years of record. From these data the program computed the average monthly runoff.

35. The lake capacity subroutine, Block 7, takes inputs of runoff, digitized contours from USGS maps, and dam coordinates and outputs water surface area, volumetric capacity and approximate length of shoreline for 10-ft increments of elevation. The basic method is as follows: Contours are taken at about 50-ft elevation intervals. The area and perimeter calculations are made for the lowest contour included in the reservoir area. The area at the next lowest even 50- or 100-ft elevation is assumed to be zero. Direct interpolation of area and perimeter is made at 10-ft increments between this zero area and that already calculated at the first digitized contour. The next higher contour is read in and the area and perimeter calculated. Intermediate 10-ft contour values are interpolated and the process repeats until a specified maximum water surface elevation is reached. Volume calculations are then made by the average end area method.

36. The visitation subroutine, Block 8, accepts as inputs the number of access roads of interstate quality, number of paved roads, number of unimproved roads, surface area of reservoir, shoreline length, topography classification, number of competing facilities, distance to competing facilities, size of competing facilities, number of counties in proposed reservoir area, population density of each county, median income of each county, urban population of each county, distance to populated center of each county, and population of each county.

37. The physical and socioeconomic characteristics are entered for a proposed reservoir and the program chooses from the two most similar reservoirs, one physical and one socioeconomic. Then the "per capita use rate versus distance" curves of the two similar reservoirs are averaged, giving one "per capita use rate versus distance to populated center" curve for the proposed reservoir. The distance to the populated center of the county from the proposed reservoir is substituted into this equation to give a per capita use rate. This per capita use rate is then multiplied by the county population to give an initial annual visitation for that county. This is done for all counties and summed to get the expected annual visitation for the proposed reservoir. The expected camping use is added to this figure to give the total initial annual visitation for the proposed reservoir.

38. The flood storage subroutine, Block 9, requires as input the effective drainage area, full pool storage, current pool, minimum pool storage, and average monthly runoff. The program computes the runoff for a given month (J) using the average monthly runoff. It then cycles to see if the reservoir can store this runoff and allow enough space to compensate for a flood (3 in. or 5 in. of runoff from the area above the dam). If these conditions are met, then the flow program is run for month J. If the reservoir cannot store the runoff, then the flow program is run for the previous month (J-1), discharging water at a faster rate so that the reservoir will have enough space to hold the runoff for month J. This procedure continues until either there is not enough water available to satisfy the flow requirement in the flow program, or the reservoir cannot be drawn down to a level that will allow acceptance of the monthly runoff. The output states whether the reservoir satisfies or does not satisfy flood storage requirements.

39. The flow augmentations subroutine, Block 10, requires as input the minimum discharge requirement at Lock and Dam No. 2, water available for flow, and excess discharge rate (may be zero). The model determines if there is sufficient water available to meet the flow requirement at Lock and Dam No. 2 for a 30-day period. If the reservoir (or any reservoir in the system of reservoirs) fails, the requirement is not met and the program ends. If the requirement is met for a given month (J), the routine repeats the computation for the next month (J+1). This procedure is continued until the reservoir fails or the time period in question is completed. The program outputs a statement of whether the flow requirement is or is not met for the month or year in question.

40. The dam construction subroutine, Block 11, computes the cost of dam and appurtenances as a function of maximum discharge rate of the dam. The model is based on a direct relationship between discharge rate and cost of dam and appurtenances. This relationship was derived from the Rowlesburg General Design Manual (GDM) and from data from existing reservoirs in the Rowlesburg area.

41. The recreation facilities model, Block 12, accepts the number of visitors in days per year and computes the cost of the recreation facilities. The model uses the annual visitation as a basis to compute the Design Load. The Design Load is then used to compute the anticipated number and type of facilities that will be required. Unit and total costs for the facilities are computed.

42. The reservoir preparation subroutine, Block 13, accepts the total acreage of the reservoir at full pool, type of land to be cleared, vegetation density, slope class, and type of floatables, based on correlations of the above factors (i.e. acreage, land type, vegetation, slope, etc.). The unit cost per acre for land clearing and removing of floatables is computed.

43. The relocation subroutine, Block 14, requires inputs of land use classification, miles of interstate roads, paved two-lane roads, and gravel roads to be relocated, miles of railroads, number of cemeteries, and full pool acreage. From the Rowlesburg GDM and data from existing reservoirs in the area, relationships were derived to compute the quantity of bridges, culverts, power lines, telephone and telegraph lines and gas lines to be relocated. The program also computes unit costs for each item to be relocated.

44. The land acquisition subroutine, Block 15, uses the full pool acreage as the basis for computing the quantity of each land use type and structure that must be purchased. Using data from the Rowlesburg GDM and from existing reservoirs in the area, unit cost per acre and per structure are computed, and total cost calculations are made.

45. The maintenance and operations subroutine, Block 16, uses the cost of dam and appurtenances, land available for public use, visitation, and full pool acreage as inputs, coupled with relations derived from the Rowlesburg GDM and data from existing reservoirs in the area, to compute the maintenance and operations costs for a proposed reservoir.

46. The accuracy of the model was roughly checked by comparing the cost of the Rowlesburg project, as computed by the model, against the costs estimated in the Rowlesburg GDM. The two values differed by less than two percent.

47. The model was intended for use as a rapid way of estimating the total systems costs of a number of alternate plans, each plan consisting of a different combination of dam heights and locations within the Cheat River drainage basin. It was obviously critical that the flood control capability of each proposed alternate system be within acceptable limits, which is why it was necessary to incorporate the relatively sophisticated flood storage and release routines. The resulting model, even though many of the subroutines are very generalized, appears to be a highly useful tool. If the reservoir

storage and release subroutines were somewhat improved and a river channel storage and flow subroutine added, there is reason to believe that it could be used not only to plan reservoir systems but to manage the flow regimes of those systems after they were constructed. The model when completed will be a very practical engineering tool. We feel that the continued development of the model should have high priority in the Corps of Engineers. Of course, considerable development and validation will have to be done before the model can be used with confidence on routine engineering problems.

Summary

48. Rational judgments concerning the degree of optimization that can be allowed for one land use at the expense of others can be made only if procedures are available predicting the effectiveness of the land use in complex environmental systems. The systems analysis procedures involve three major steps: (a) development of performance prediction models, (b) acquisition of environmental inputs to the performance prediction models, and (c) display of the performance over the area of interest. The WES in the course of performing regional studies in relation to military activities, i.e. land locomotion, battlefield surveillance, construction of roads, and others has developed procedures that are accurate and practical. Details of a military and civil project (European Waterways Study and the Rowlesburg Lake Model System) are presented to illustrate Steps 1 and 2 of the three-step concept. The procedures have applicability in a wide range of civil works and it seems prudent to transfer experience gained in military research and development to the civil sphere.

References

1. Benn, B. O. and Grabau, W. E., "Terrain Evaluation as a Function of User Requirements," published in Land Evaluation, Papers of a CSIRO Symposium organized in cooperation with UNESCO, Division of Land Research CSIRO, Canberra, Australia, 1968.
2. Friesz, R. R. et al., "European Waterways Study, A Procedure for Describing Tactical Gaps" (in 3 vols), Technical Report M-70-12, July 1970, U. S. Army Engineer Waterways Experiment Station, CE, Vicksburg, Miss.
3. Crawford, N. H. and Linsley, R. K., "Digital Simulation in Hydrology, Stanford Watershed Model IV," 1966, Stanford University, Stanford, Calif.
4. Lumb, A. M., "Development and Testing of Water Budget Models for One Hundred Ten Mile Creek, Kansas," 1966, University of Kansas, Lawrence, Kans.
5. Holtan, H. N. and Lopez, N. C., "USDAHO-70 Model of Watershed Hydrology," 1970, Agriculture Research Service, U. S. Department of Agriculture, Washington, D. C.
6. Freeze, R. A. and Harlan, R. L., "Blueprint for a Physically Based, Digitally-Simulated Hydrologic Response Model," Journal of Hydrology, Vol 9, pp 237-258, 1969.
7. Eagleson, P. S., Dynamic Hydrology, McGraw-Hill, New York, 1970.

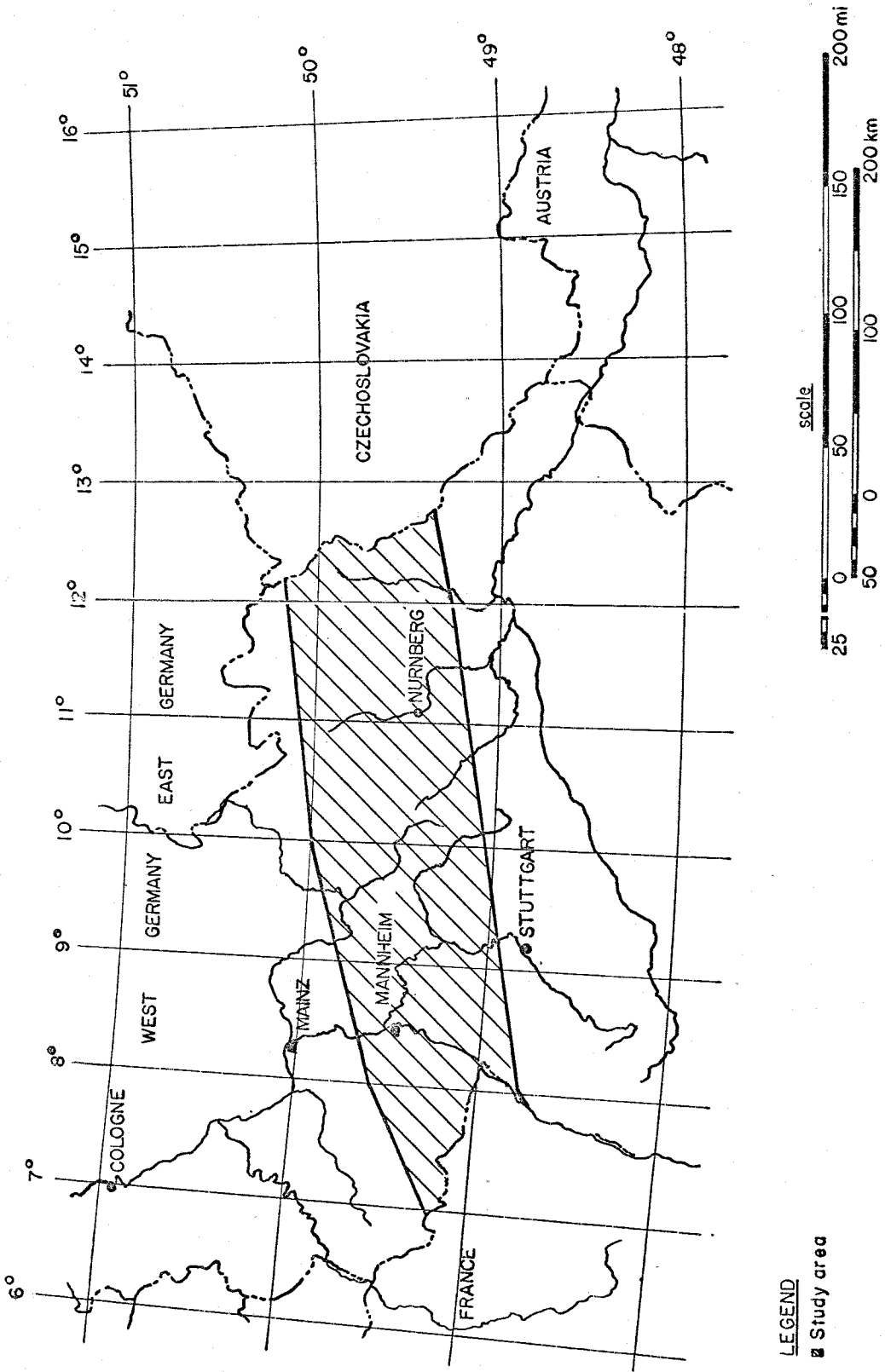

Fig. 1. European Waterways Study Area

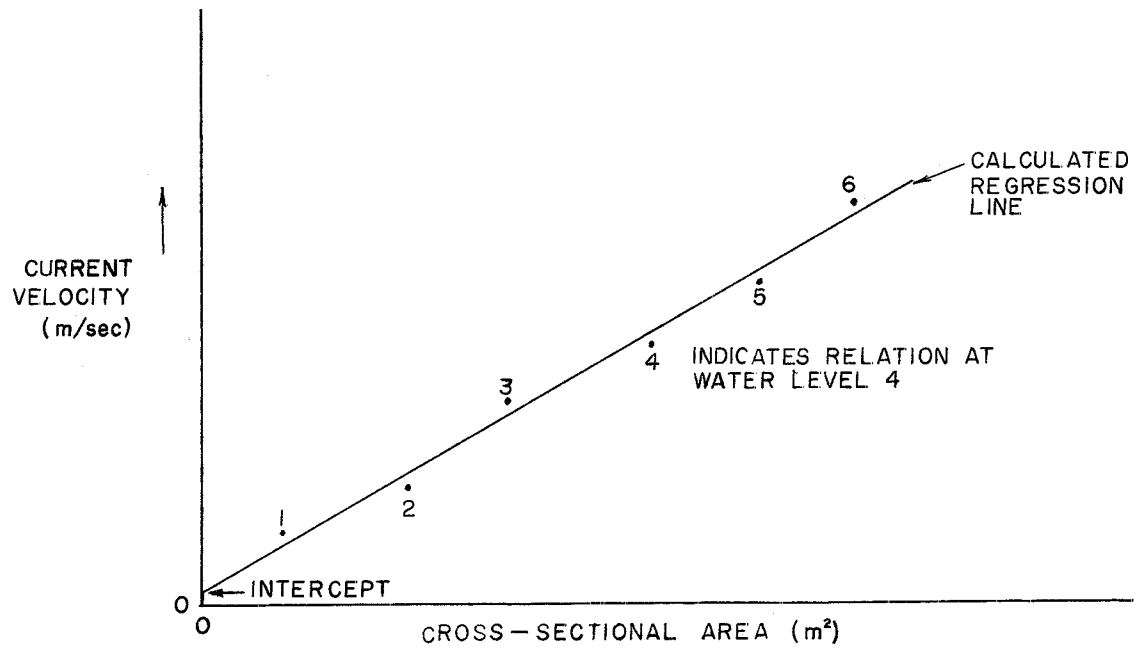
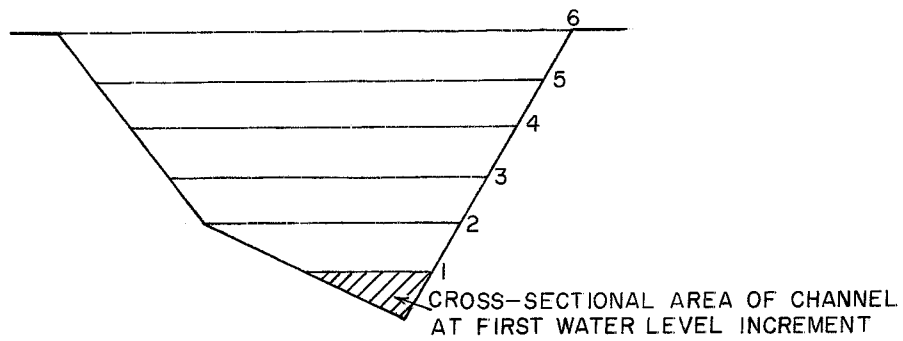

Fig. 2. Determination of velocity-area relation

S I T E I D E N T I F I C A T I O N

SITE NO.	MIL. GRID ZONE DES.	100,000 SO. DES.	AMS MAP SERIES	GRID COORDINATES (E. AND UP)
2085	J2U	PV	M745	7275 7135

H Y D R O L O G I C G E O M E T R Y

DEPTH (CM)	VELOCITY (MPS)	HEIGHT OF BANK (CM)		BANK ANGLE (DEG)		WATER WIDTH (M)	GAP WIDTH (M)
		LEFT	RIGHT	LEFT	RIGHT		
10	0.39	129	209	50	52	4.5	11.6
20	0.62	119	199	50	52	4.7	11.6
30	0.80	109	189	50	52	4.9	11.6
40	0.95	99	179	50	52	5.0	11.6
50	1.09	89	169	50	52	5.2	11.6
60	1.21	79	159	50	52	5.3	11.6
70	1.31	69	149	43	41	5.5	11.6
80	1.41	59	139	43	41	5.8	11.6
90	1.50	49	129	43	41	6.0	11.6
100	1.59	39	119	43	41	6.2	11.6
110	1.67	29	109	43	41	6.4	11.6
120	1.74	19	99	43	41	6.6	11.6
130	1.81	9	89	43	41	6.9	11.6
140	1.86	0	79	5	7	7.2	11.7
150	1.74	0	69	5	7	9.1	12.8
160	1.65	0	59	3	7	11.2	14.2
170	1.46	0	49	3	88	15.6	15.7
180	1.51	0	39	3	88	17.1	17.2
190	1.56	0	29	3	88	18.6	18.7
200	1.61	0	19	3	88	20.1	20.2

W A T E R D E P T H (CM)

	JAN	FEB	MAR	APR	MAY	JUN	JUL	AUG	SEP	OCT	NOV	DEC
MEAN HIGH	168	169	208	106	138	172	180	58	97	54	98	78
MEAN MEAN	74	68	94	79	87	92	66	53	60	50	46	55
MEAN LOW	45	51	46	68	68	69	57	49	53	45	36	45

C R O S S - S E C T I O N C O - O R D I N A T E S (CM)

X	Y	X	Y	X	Y	X	Y	X	Y	X	Y
0	0	1500	0	2250	50	2420	65	2500	140	2550	200
2750	204	2990	204	3040	140	3120	65	3345	35	3573	35
3574	0	3575	-15	4215	-125	5715	-125				

MONTH	M E A N H I G H S T A G E					F A C T O R C O M P L E X					M E A N L O W S T A G E									
	MEAN	STAGE	MEAN	STAGE	MEAN	STAGE	MEAN	STAGE	MEAN	STAGE	MEAN	STAGE	MEAN	STAGE						
JAN	3	7	1	1	5	3	2	3	1	2	3	3	3	2	3	1	2	4	4	3
FEB	3	7	1	1	5	3	2	3	1	2	3	3	3	2	3	1	2	4	4	3
MAR	3	8	1	1	5	3	2	4	1	2	3	3	3	2	3	1	2	4	4	3
APR	3	4	1	2	3	3	3	2	3	1	2	3	3	3	2	3	1	2	3	3
MAY	3	4	1	1	1	3	3	2	3	1	2	3	3	3	2	3	1	2	3	3
JUN	3	7	1	1	5	3	2	4	1	2	3	3	3	2	3	1	2	3	3	3
JUL	2	4	1	2	3	3	3	2	3	1	2	3	3	3	2	3	1	2	4	3
AUG	2	4	1	2	4	3	3	2	3	1	2	4	3	3	2	3	1	2	4	3
SEP	2	4	1	2	3	3	3	2	3	1	2	4	3	3	2	3	1	2	4	3
OCT	2	3	1	2	4	4	3	2	3	1	2	4	3	3	2	3	1	2	4	3
NOV	2	4	1	2	3	3	3	2	3	1	2	4	3	3	2	3	1	2	4	3
DEC	2	3	1	2	3	3	3	2	3	1	2	4	3	3	2	3	1	2	4	3

Fig. 3. Example of the summary of Geometric and Hydrologic data for each site

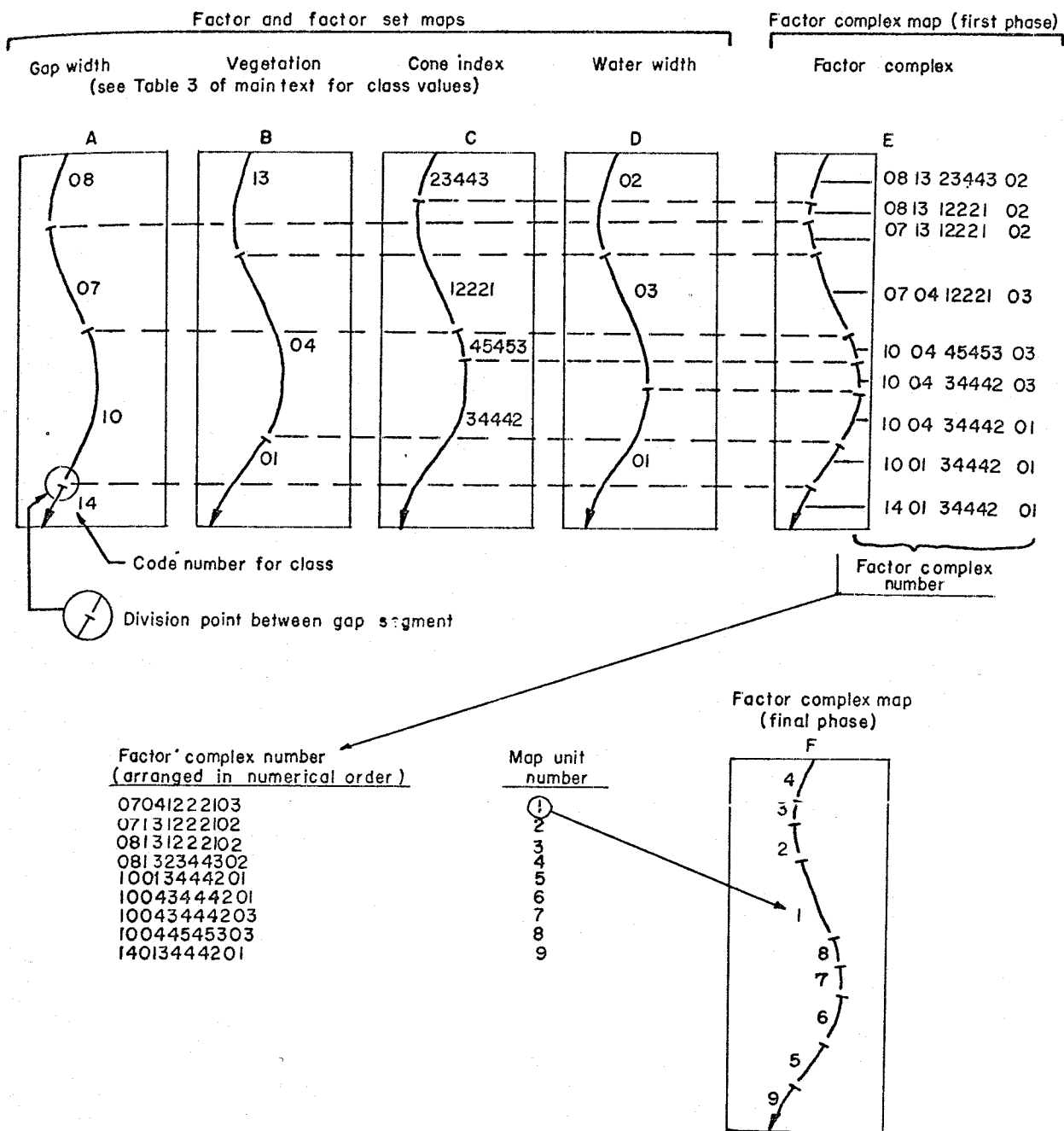
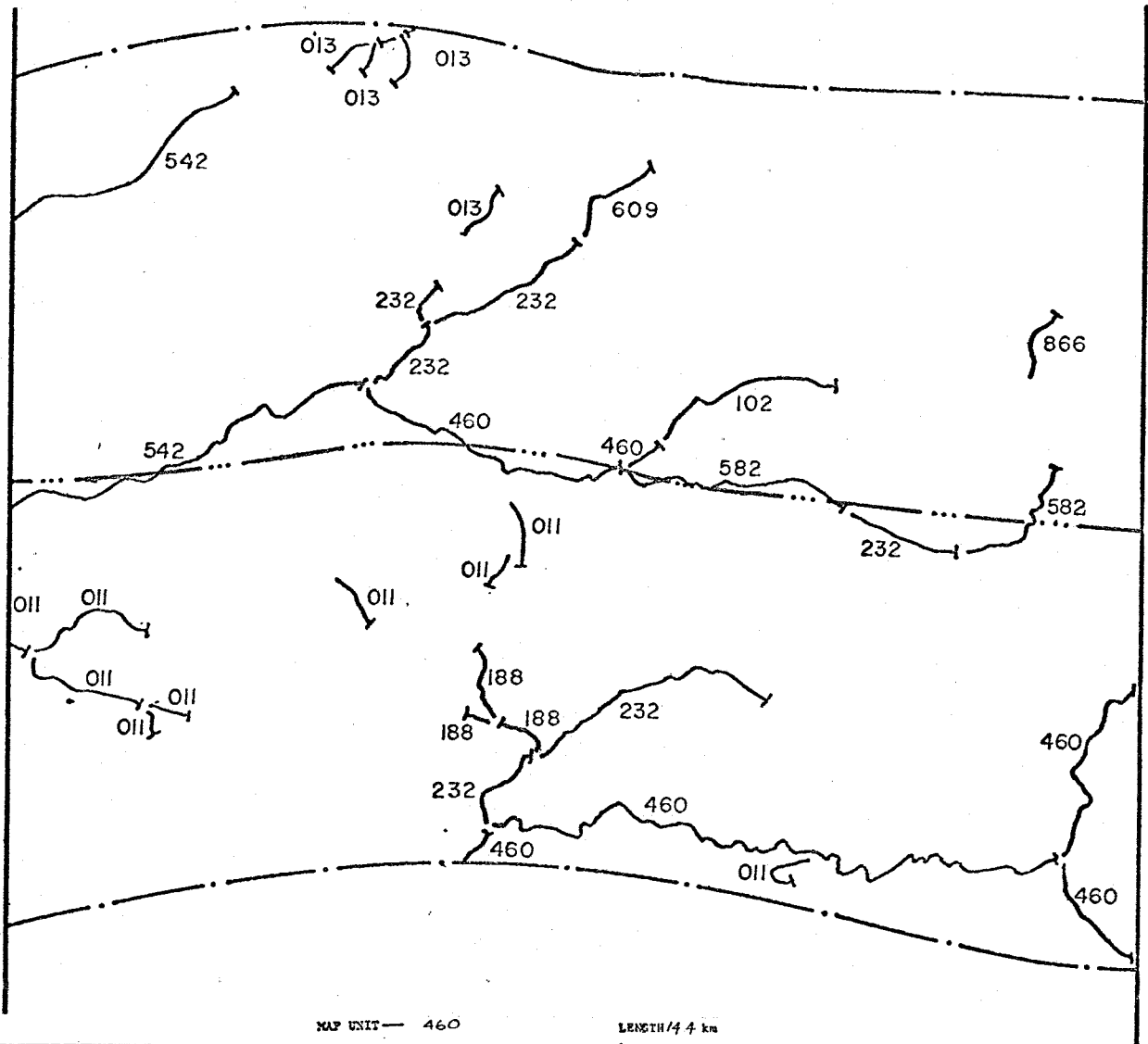
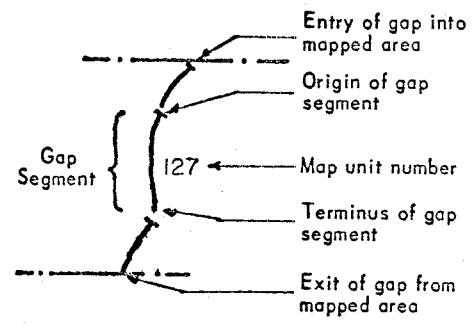

Fig. 4. Example of annotation system for factor, factor set, and factor complex maps



MONTH	MEAN HIGH STAGE	MEAN STAGE	MEAN LOW STAGE
JAN	2 3 1 1 3 3 4	2 3 1 1 4 4 3	2 3 1 1 4 4 3
FEB	2 3 1 1 3 3 4	2 3 1 1 3 4 4	2 3 1 1 4 4 3
MAR	2 3 1 1 3 3 4	2 3 1 1 4 4 3	2 3 1 1 4 4 3
APR	2 3 1 1 3 3 4	2 3 1 1 4 4 3	2 3 1 1 4 4 3
MAY	2 3 1 1 3 3 4	2 3 1 1 4 4 3	2 3 1 1 4 4 3
JUN	2 3 1 1 3 3 4	2 3 1 1 4 4 3	2 3 1 1 4 4 3
JUL	2 3 1 1 3 3 4	2 3 1 1 4 4 3	2 3 1 1 4 4 3
AUG	2 3 1 1 3 3 4	2 3 1 1 4 4 3	2 3 1 1 4 4 3
SEP	2 3 1 1 3 3 4	2 3 1 1 4 4 3	2 3 1 1 4 4 3
OCT	2 3 1 1 3 3 4	2 3 1 1 4 4 3	2 3 1 1 4 4 3
NOV	2 3 1 1 3 3 4	2 3 1 1 4 4 3	2 3 1 1 4 4 3
DEC	2 3 1 1 3 3 4	2 3 1 1 4 4 3	2 3 1 1 4 4 3



00241030322322

Top Right	C I
Interface R.	O N
Stream Bed	N D
Interface L.	E E
Top Left	X
Stem Dia.	V
Density Cont.	E
Veg. B.W.-R.	C
Stem Dia.	.
Density Cont.	.
Veg. B.W.-L.	.
Gap Width	.

SOIL TYPE: MH

- Velocity
- Bank Angle- Right
- Bank Angle- Left
- Bank Height- Right
- Bank Height- Left
- Water Width
- Depth

Fig. 5. Example of completed factor complex map

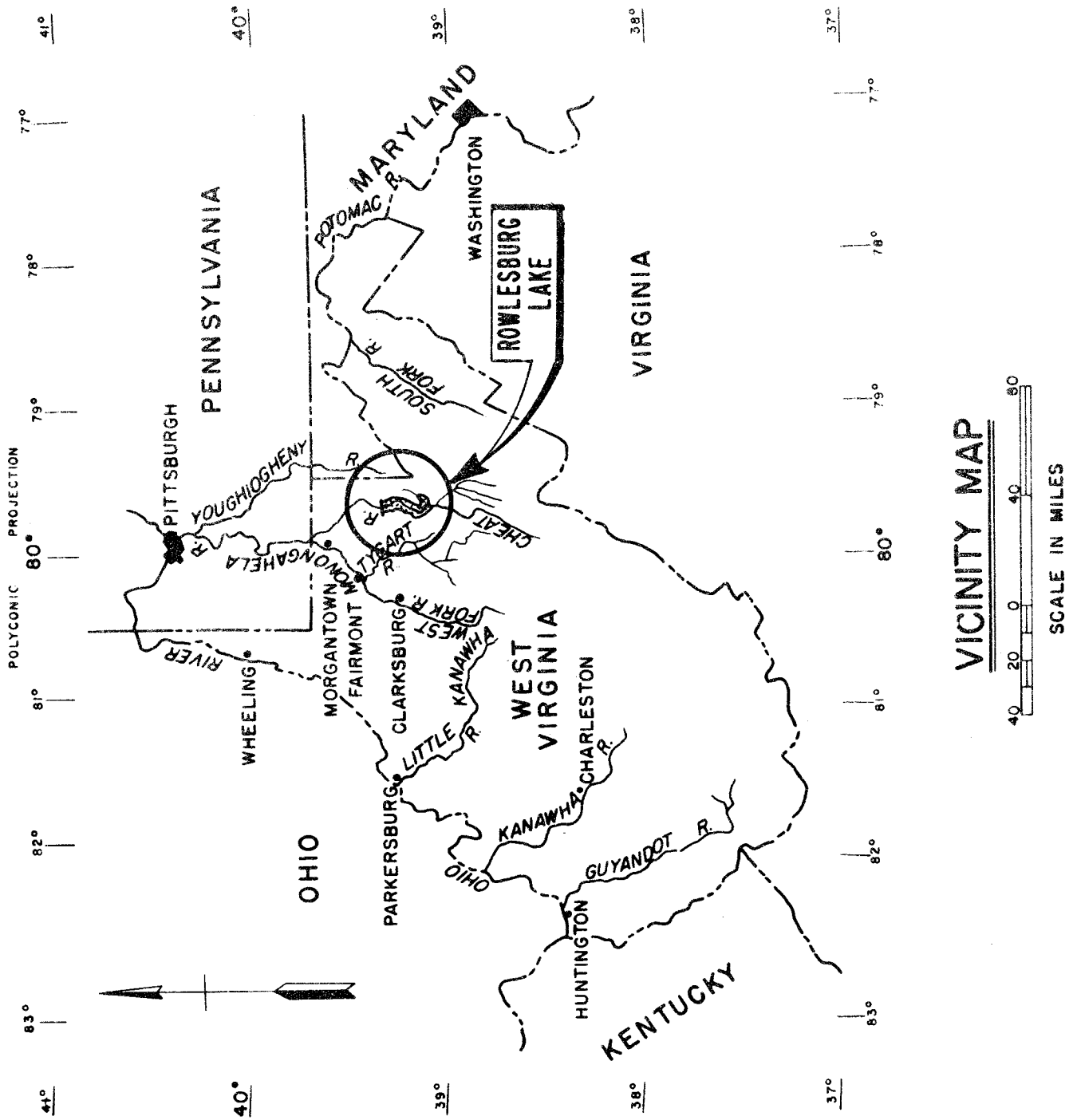

Fig. 6. Rowlesburg Lake, Cheat River, West Virginia

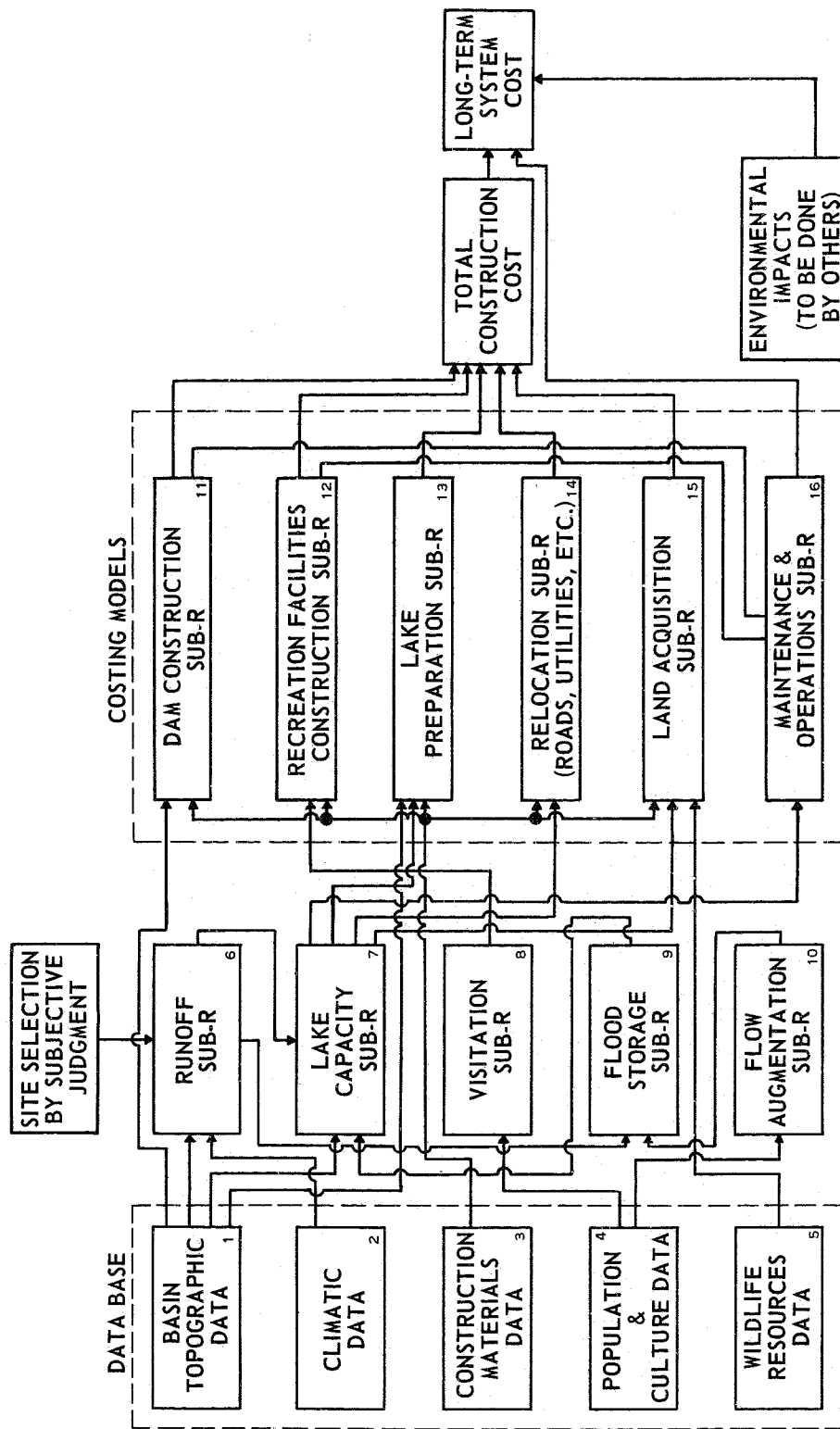

Fig. 7. Rowlesburg Lake Model System

Table 1

Factors Significant to Gap-Crossing Activities

FACTORS	Bridge Constr.		Raft Utilization	Vehicle Locomotion (Unaided)		Infantry Movement	Engineering Act.
	Floating	Fixed		Fording	Swimming		
Water width	x	x	x		x	x	x
Maximum water depth	x		x	x	x	x	x
Maximum current velocity	x		x	x	x	x	x
Bank height, left bank	x	x	x	x	x	x	x
Bank angle, left bank	x	x	x	x	x	x	x
Bank height, right bank	x	x	x	x	x	x	x
Bank angle, right bank	x	x	x	x	x	x	x
Cone index value, top left bank	x	x	x	x	x	x	x
Cone index value, top right bank	x	x	x	x	x	x	x
Cone index value, bottom*	x			x		x	x
Cone index value, water level left bank**				x	x	x	x
Cone index value, water level right bank**				x	x	x	x
Gap width		x					x
Tree stem diameters, right bank	x	x	x	x	x		x
Number of trees, right bank	x	x	x	x	x		x
Vegetation band width, right bank	x	x	x	x	x		x
Tree stem diameters, left bank	x	x	x	x	x		x
Number of trees, left bank	x	x	x	x	x		x
Vegetation band width, left bank	x	x	x	x	x		x

Time Dependent#

Time Independent

#All time-dependent factors change according to seasonal and, in some cases, even diurnal cycles

*Included among time-dependent factors because not all gaps contain water all of the time; thus, the soil strength in the bottom of a dry gap is time-dependent.

**These two factors are not applicable in the case of dry gaps.

Table 2
Class Ranges of All Significant Factors

<u>Class</u>	<u>Gap Width (m)</u>	<u>Class</u>	<u>Gap Width (m)</u>	<u>Class</u>	<u>Water Depth (cm)</u>
1	>0-3	46	>205-210	1	No water
2	>3-6	47	>210-215	2	0-100
3	>6-9	48	>215-220	3	>100-200
4	>9-12	49	>220-225	4	>200-500
5	>12-15	50	>225-230	5	>500
6	>15-18	51	>230-235		
7	>18-21	52	>235-240		
8	>21-24	53	>240-245		
9	>24-27	54	>245-250	<u>Class</u>	<u>Current Velocity (mps)</u>
10	>27-30	55	>250-255		
11	>30-35	56	>255-260	1	No water
12	>35-40	57	>260-265	2	0-1
13	>40-45	58	>265-270	3	>1-2
14	>45-50	59	>270-275	4	>2-3.5
15	>50-55	60	>275-280	5	>3.5
16	>55-60	61	>280-285		
17	>60-65	62	>285-290		
18	>65-70	63	>290-295		
19	>70-75	64	>295-300		
20	>75-80	65	>300-305	<u>Class</u>	<u>Height of Bank (cm)</u>
21	>80-85	66	>305-310		
22	>85-90	67	>310-315	1	0-100
23	>90-95	68	>315-320	2	>100-200
24	>95-100	69	>320-325	3	>200-300
25	>100-105	70	>325-330	4	>300-500
26	>105-110	71	>330-335	5	>500
27	>110-115	72	>335-340		
28	>115-120	73	>340-345		
29	>120-125	74	>345-350		
30	>125-130	75	>350-355	<u>Class</u>	<u>Bank Angle (deg)</u>
31	>130-135	76	>355-360		
32	>135-140	77	>360-365	1	0-10
33	>140-145	78	>365-370	2	>10-20
34	>145-150	79	>370-375	3	>20-45
35	>150-155	80	>375-380	4	>45-75
36	>155-160	81	>380-385	5	>75
37	>160-165	82	>385-390		
38	>165-170	83	>390-395		
39	>170-175	84	>395-400		
40	>175-180	85	>400-405	<u>Class</u>	<u>Cone Index Value</u>
41	>180-185	86	>405-410		
42	>185-190	87	>410-415	1	0-20
43	>190-195	88	>415-420	2	>20-40
44	>195-200	89	>420-425	3	>40-75
45	>200-205	90	>425-430	4	>75-300
				5	>300

Table 2 (con.)

<u>Class</u>	<u>Water Width (m)</u>	<u>Class</u>	<u>Water Width (m)</u>
1	No water	47	>205-210
2	>0-3	48	>210-215
3	>3-6	49	>215-220
4	>6-9	50	>220-225
5	>9-12	51	>225-230
6	>12-15	52	>230-235
7	>15-18	53	>235-240
8	>18-21	54	>240-245
9	>21-24	55	>245-250
10	>24-27	56	>250-255
11	>27-30	57	>255-260
12	>30-35	58	>260-265
13	>35-40	59	>265-270
14	>40-45	60	>270-275
15	>45-50	61	>275-280
16	>50-55	62	>280-285
17	>55-60	63	>285-290
18	>60-65	64	>290-295
19	>65-70	65	>295-300
20	>70-75	66	>300-305
21	>75-80	67	>305-310
22	>80-85	68	>310-315
23	>85-90	69	>315-320
24	>90-95	70	>320-325
25	>95-100	71	>325-330
26	>100-105	72	>330-335
27	>105-110	73	>335-340
28	>110-115	74	>340-345
29	>115-120	75	>345-350
30	>120-125	76	>350-355
31	>125-130	77	>355-360
32	>130-135	78	>360-365
33	>135-140	79	>365-370
34	>140-145	80	>370-375
35	>145-150	81	>375-380
36	>150-155	82	>380-385
37	>155-160	83	>385-390
38	>160-165	84	>390-395
39	>165-170	85	>395-400
40	>170-175	86	>400-405
41	>175-180	87	>405-410
42	>180-185	88	>410-415
43	>185-190	89	>415-420
44	>190-195	90	>420-425
45	>195-200		
46	>200-205		

Table 2 (con.)

No. of stems/1000 m ²	Stem diameter (cm)		
	5-25	>25-50	>50
None	1	1	1
1-10	2	2	2
>10-40	3	3	3
>40	4	4	4

Theoretical arrays include any possible combination of stem diameter classes, with the absence of plants in any stem diameter class recorded as 1. Thus, a vegetation structure covering 1000 m² consisting of 30 stems each 20 cm in diameter would be recorded as 311. Similarly, a structure covering 1000² consisting of 60 stems each 5 cm in diameter, 30 stems each 30 cm in diameter, and 10 stems each 50 cm in diameter would be recorded as 432. However, not all theoretically possible combinations were found. Those actually recorded were as follows:

<u>Unit Code</u>	<u>Stem diam/No. of stems array</u>
1	111 (no vegetation)
2	131
3	144
4	221
5	231
6	241
7	321
8	331
9	342
10	411
11	413
12	421
13	431
14	432
15	433
16	441
17	442
18	444

<u>Class</u>	<u>Vegetation Band Width (m)</u>
1	0
2	>0-5
3	>5-15
4	>15

REGIONAL PLANNING POTENTIAL OF
DETERMINISTIC HYDROLOGIC SIMULATION MODELS

Comment, Mr. Thomas: Your allegations about no predictive model being available are unfounded. I suggest that WES become familiar with several computer programs that are available, in particular the SSARR model of North Pacific Division.

Reply, Mr. Benn: The WES, in its efforts to assess the environmental constraints or impacts on both military and civil activities, has recognized the need for large-scale simulation of virtually all of the processes in the hydrologic cycle.

For example, procedures for estimating soil trafficability require an accurate estimate of soil moisture with depth for very specific locations. I emphasize specific locations because the vast majority of the world's soils does not present a trafficability problem, but there is a trafficability problem as a whole, because of the manner in which the relatively few problem soils are distributed in the landscape. Recently the WES has studied many of the existing hydrologic simulation models, including the Kentucky, Stanford, USDA, USGS, Texas, Kansas, and the HEC hydrograph package. All these models are optimized to reproduce storm hydrographs, and a significant attribute of the models is the fact that they all use "lumped" or watershed average values to estimate transpiration, interception, water storage changes, infiltration, etc. Further, the specific values for input functions are determined by forcing the predicted hydrograph to fit the measured hydrograph. This result is a calibration or solution for a specific watershed with little assurance that the input functions are related to the real world, or indeed even to each other, in a unique way. I feel that practical improvements in the existing models can be made by developing methods for simulating the various hydrologic process as a function of specific measurable terrain parameters. This would result in more suitable models for solving a wider range of Corps of Engineers' problems in worldwide terrain conditions.

Comment, Mr. Fredrich: Although I agree with the need for models that can be adjusted to reflect the effects of potential changes in the physical system, I'm not certain that what is needed is a runoff model that more closely simulates the physical processes involved in the rainfall-runoff transformation. I think that perhaps we should study more closely the process that we have modelled so that we can identify the factors that are important in changes and the degree of change in a factor necessary to produce a change in output. I'm not sure that more "sophisticated" models are warranted, given the data availability usually encountered in planning studies.

Reply, Mr. Benn: Viable solutions in regional planning studies are obtained by estimating the impact of alternatives. To properly study alternatives it is often as important to understand what is happening to water in the transformation from rainfall to runoff as it is to determine time history of runoff itself. For example, a method under consideration for wastewater disposal is to apply the water periodically to the land surface. This scheme envisions the soil and its organisms fixing or degrading contaminants before the water is conducted to streams and/or groundwater. The feasibility of this system for a given area can only be evaluated by considering the rates of water acceptance, retention, and migration, which, of course, are functions of site properties and the hydrology of the area. Many other problems can be cited in both the civil and military areas where predictions of the state-of-the-ground are critical to the design and successful performance of an activity or item of hardware, i.e., battlefield surveillance, munition effectiveness, cross-country locomotion, forest harvesting, agricultural soil preparation, etc. Thus, I believe the need for better analytical tools is undeniable. The problem of data acquisition and manipulation for the improved models is indeed a monumental one. The terrain analysis techniques developed at WES rely heavily on the ability to acquire and manipulate large volumes of environmental data. I feel these procedures or similar ones can be applied to the hydrologist's data acquisition and manipulation problems.

DIGITAL MODELING FOR EVALUATING
WATER RESOURCE DEVELOPMENTS

by

Harold E. Kubik

INTRODUCTION

A water resource development plan today requires that attention be given to a multitude of considerations. As stated by the Water Resources Council:

Plans for the uses of the Nation's water and land resources will be directed to improved contributions to the multiobjectives of National economic development, environmental quality, social well-being, and regional development. Planning for the use of water and land resources in terms of these multiobjectives will aid in identifying courses of action and will provide the type of information needed to improve the public decision-making process.⁶

The evaluation of the effects of a proposed development plan requires the merging of advanced hydrologic techniques and creative planning concepts. Such techniques require evaluating the effects of many alternative plans, levels of development, and operation criteria. Only by use of the computer can extensive simulation analyses be made within reasonable cost and time limitations. To illustrate the application of digital computer models, several special assistance projects undertaken by The Hydrologic Engineering Center (HEC) will be described.

North Atlantic Regional Study - North Atlantic Division

Objective. The North Atlantic Regional Water Resources Study was directed towards planning for the optimum development of water and related land resources. It was a framework type of study to provide an overview of regional needs and to furnish guidelines for future developments in the region by illuminating alternative plans of improvement for the decision maker. The HEC assisted the North Atlantic Division office in developing

Hydraulic Engineer, Special Assistance Branch, The Hydrologic Engineering Center.

a generalized procedure for evaluating the regulatory effects of possible reservoir projects and for assessing flood damages for natural and regulated conditions. The generalized procedure was used in the screening analysis of possible reservoir projects and systems to determine the better alternative plans of basin development for flood control.

Data Requirements:

- a. Hypothetical storm representative of large-area storms of intermediate magnitude
- b. Generalized unit hydrograph and rainfall loss-rate criteria
- c. Channel flood-routing criteria
- d. Location of index stations, stage-discharge-damage relations, and discharge-frequency relations
- e. Location and size of existing and proposed reservoir projects

Study Procedure and Results. Each major river basin was divided into subareas averaging about 300 square miles in size and generalized unit hydrograph and rainfall loss-rate criteria were developed. Historical storm data were studied to determine criteria for a well-balanced hypothetical storm of intermediate magnitude. Using the above data, a hypothetical flood was computed. Ratios of the hypothetical flood were used for computing other floods of various magnitudes. The flood hydrograph package program, HEC-1¹, was adapted to compute, route, and combine flood hydrographs simultaneously for many flood sizes. The regulatory effects of reservoir projects on downstream flooding were determined for each flood size and the damage reduction was computed. Generalized relations for damage reduction were developed as a function of the percent area controlled, the level of development, and the relative location of the control. These relationships are shown in Figures 1 and 2.

Tibbee River - Mobile District

Objectives. The objectives of the Tibbee River study were to determine the effect of alternative channel improvement schemes on flood runoff in the Tibbee River basin (Figure 3), to determine the reductions in flood damage associated with each scheme, and to select that plan that would most economically mitigate the flood damages. The proposed channel improvements will lower the stage for a given flow rate, but the improved channels can collect water faster and cause higher flow rates for given rainfall conditions. To accomplish the study objectives, a hydrologic-economic

model was developed to simulate the effect of various plans of improvement on flood flows and resulting flood damages.

Data Requirements. A generalized computer program, HEC-1, was used for modeling purposes and required definition of the following hydrologic and economic inputs:

- a. Unit hydrograph and loss-rate coefficients
- b. Channel routing criteria and stage-discharge relations.
- c. Synthetic pattern storm
- d. Discharge-frequency relations
- e. Stage-damage relations

Study Procedure and Results. Unit hydrograph and rainfall loss-rate coefficients were derived (by use of HEC-1) for 22 streamgage locations by an analysis of historic streamflow and rainfall data for 89 runoff events (2 to 8 per location). The results of this analysis were used to develop generalized coefficients to be applied to the 216 subareas of the Tibbee River basin.

Extensive backwater computations were made by use of computer program HEC-2² for existing conditions and each proposed plan of improvement to determine stage-discharge relations, water-surface profiles, and storage-outflow relations (channel routing criteria).

A uniform areal distribution of rainfall was used as the pattern storm over the Tibbee River basin. The total storm rainfall was determined for a rainfall intensity with a 5-year recurrence interval, a rainfall duration of 48 hours, and an area of 200 square miles.

The discharge-frequency relations for natural conditions were derived from regional relationships determined by a statistical analysis of the annual peaks for gaging stations in the basin and surrounding area. It was necessary to modify the discharge-frequency relations for improved conditions to reflect the higher discharges resulting from improved channel efficiency (peaking effect). The peaking effect on the Tibbee River is shown in Figure 4.

To formulate the optimal plan of channel improvement for the Tibbee River basin, estimates of flood damage reduction attributable to each alternative plan of improvement were computed. Figure 5 illustrates the output from such computations. Details of this study have been presented by Reese and others⁵.

Caldwell Creek - Mobile District

Objective. Water-surface profiles for flows with selected return intervals were needed on Caldwell Creek to evaluate the flood risk at various points on the flood plain. The basin is on the northern boundary of Atlanta, Georgia, and there are several restrictive waterway openings and high embankments associated with roads and streets within the flood plain.

Data Requirements.

- a. Flood plain cross-section data
- b. Unit hydrograph coefficients and rainfall loss rates for each subarea
- c. Depth-duration curves for the 10- and 100-year frequency rainfall events
- d. Standard project storm magnitudes and durations
- e. Muskingum channel routing coefficients
- f. Discharge-frequency data

Study Procedure and Results. Hypothetical runoff hydrographs were computed from the 10-, 100-year and standard project rainfall by use of a rainfall-runoff simulation model (HEC-1). The loss rates were adjusted to provide computed flood peaks which were very near the regional-discharge frequency values. The peak flow values from these hydrographs represented a natural condition (no road constrictions) for the selected frequency events. Water-surface profiles were then computed (by use of computer program HEC-2) based on these flow values and the existing road crossing flood plain condition. The resulting storage-outflow relations were used with a nonlinear storage routing method to determine the flows as modified by the channel constrictions. The water-surface profiles corresponding to the modified flows were then determined, and these profiles were assigned the frequency values of the input rainfall. The results are summarized in Figure 6.

Red River of the North - St. Paul District

Objectives. Although a general study delimiting the problem areas is in progress by the Souris Red Rainy River Basin Commission, the Water Resources Council recommended that a more detailed study that outlines possible plans of improvement be undertaken of the Red River basin. The District assigned to the HEC the reservoir system analysis portion of the study. The objectives of the conservation aspects of the study were:

a. to simulate the operation of the existing reservoir projects to meet current and future water supply needs,

b. to simulate the operation of the existing and authorized projects for the above needs, and

c. to simulate the system operation with the addition of several proposed projects.

Data Requirements. For the conservation studies, the types of data needed for each reach or project were:

- a. Historic monthly streamflow records
- b. Historic consumptive use
- c. Historic channel losses
- d. Desired and required flow requirements
- e. Channel capacities
- f. Physical characteristic of the projects
- g. Project operation criteria

Study Procedure and Results. To properly evaluate the effects of different operation criteria, it was necessary to obtain unregulated streamflow data at each location for the period of analysis, 1930-1969. This required removing the effect caused by the existing projects and accounting for historic consumptive use and channel losses. This task was accomplished by simulating the operation of the system for a portion of the record with the projects that existed during that period (see Figure 7 for the basin schematic).

Portions of streamflow records at some of the stations had to be estimated by stochastic procedures (computer program HEC-4^h). At some stations, regulated flows were estimated to provide input to the system model and then using the computed unregulated flows to derive the necessary statistics, unregulated flows were estimated to complete the record for the period of interest.

After deriving unregulated flows at all points in the basin, the performance of the various projects was evaluated by simulating the system operation for various demand levels and reservoir operation criteria. About 20 different runs were made, with the District office evaluating the impact of the various operation decisions. Simulation of the system

operation for flood control purposes is scheduled to begin in the near future.

Minnesota River - St. Paul District

Objectives. The Hydrologic Engineering Center was asked to provide assistance in analyzing the flood control potential of proposed reservoirs and channel improvements in the Minnesota River basin and to evaluate benefits which would accrue to these projects.

Data Requirements:

- a. Historic daily streamflow
- b. Physical characteristics of the proposed reservoirs
- c. Discharge-damage-frequency data
- d. Existing channel capacities at control points
- e. Channel capacities under improved conditions
- f. Operational criteria for each reservoir

Study Procedure and Results. Meeting the objective required operating a system of reservoirs in conformance with specified operation rules and constraints. The existing reservoir system analysis program (HEC-3³) was selected as a tool because of its flexibility in operating reservoirs to meet specified constraints. The program was modified for the flood control studies by allowing the input of flows representing any selected time span and computation interval, adding reservoir level balancing routines for the flood control space, and adding a surcharge routine to the operation capabilities at reservoirs. The input daily flows were translated by the appropriate lag time, but no attenuation of the flows was made in the channel routings. Where attenuation is large between control points, routed inflows should be used as input.

The modified program was tested using the daily flows for the 1965 and 1969 flood events on the Minnesota River. For the damage integration computation, the two floods were each multiplied by seven ratios to obtain 14 floods with peaks distributed throughout the range of the peak discharge-frequency curves. Five different models were formulated for the basin, from the New Ulm dam site to the Carver gaging station, by using various combinations of three potential reservoirs, New Ulm, Blue Earth, and Cottonwood, and possible channel improvements. A summary of the results is shown in Figure 8.

CONCLUSIONS

The foregoing projects illustrate the use of large generalized computer programs in providing rapid evaluation of proposed system characteristics and operation criteria. The output can include not only hydrologic information, but also economic information. Some of the studies have shown the need to link two or more programs together to reduce the amount of data handling and time required to obtain answers. Any such linking will require innovating programming techniques to keep the computer storage capacity within reasonable size. Also, automated screening of the results will be required before the generated data are used in succeeding computations.

Future research must give attention to methods of selecting the "best" plans of development. There are many papers in the literature discussing the application of mathematical techniques in selecting optimal development and/or operation plans. The success of these techniques has been evaluated by Dracup⁷.

The realization that there were now available recently-developed mathematical techniques which might be applied to "optimally allocate limited resources among competing activities," resulted in an almost frantic drive on the part of researchers to apply these techniques. Here at last was believed to be the key to the comprehensive analysis of water resources systems. The results, after almost two decades of work, have been less than satisfactory.

* * *

With few successful applications of optimization techniques to cite in water resource systems analysis, an assessment of accomplishments may be premature at best.

ACKNOWLEDGEMENTS

The work described herein was conducted in The Hydrologic Engineering Center of the Corps of Engineers. The studies were accomplished with the guidance and financial support of the following Corps offices: North Atlantic Division, St. Paul District, and Mobile District. Mr. L. R. Beard, Director, provided several ideas for this paper; and Mr. H. O. Reese, Chief, Special Assistance Branch, assisted in preparing the information and provided many useful suggestions.

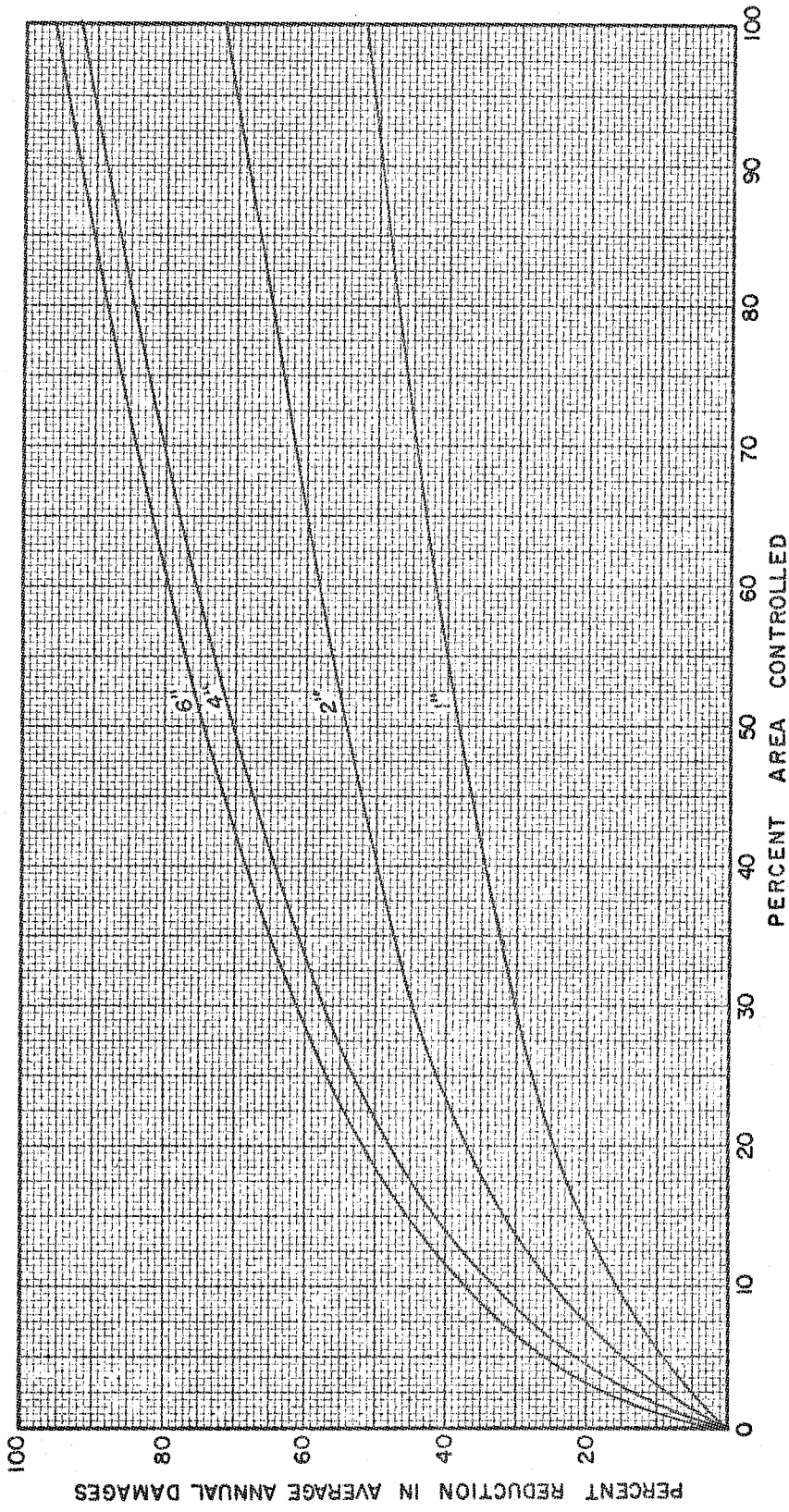

PERCENT REDUCTION IN AVERAGE ANNUAL DAMAGES

RTF = absolute value of $1 - \frac{0.6L_P + L}{0.6L_T}$

where: RTF = Relative Timing factor

L_P = Length of longest watercourse for the subarea

L_T = Length of longest watercourse for the total area

L = Length of watercourse between the subarea outlet and the total area outlet

PERCENT DAMAGE
REDUCTION
FOR

RELATIVE TIMING FACTOR OF ZERO

The Hydrologic Engineering Center
April 1970

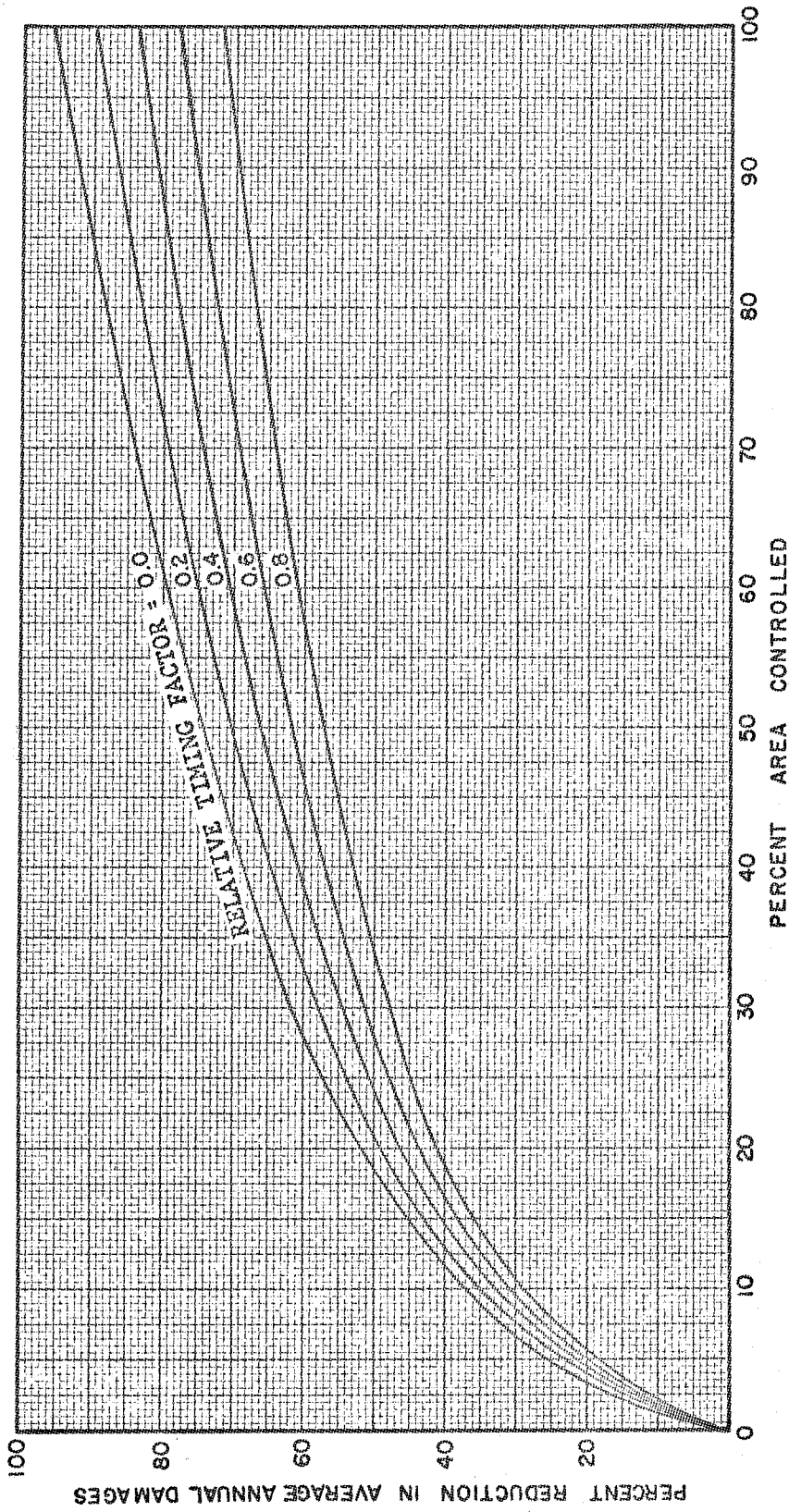

$$RTF = \text{absolute value of } 1 - \frac{0.6L_P + L}{0.6L_T}$$

where: RTF = Relative Timing factor

L_P = Length of longest watercourse for the subarea

L_T = Length of longest watercourse for the total area

L = Length of watercourse between the subarea outlet and the total area outlet

PERCENT DAMAGE
REDUCTION
FOR
6 INCHES OF STORAGE

The Hydrologic Engineering Center
April 1970

FIGURE 2

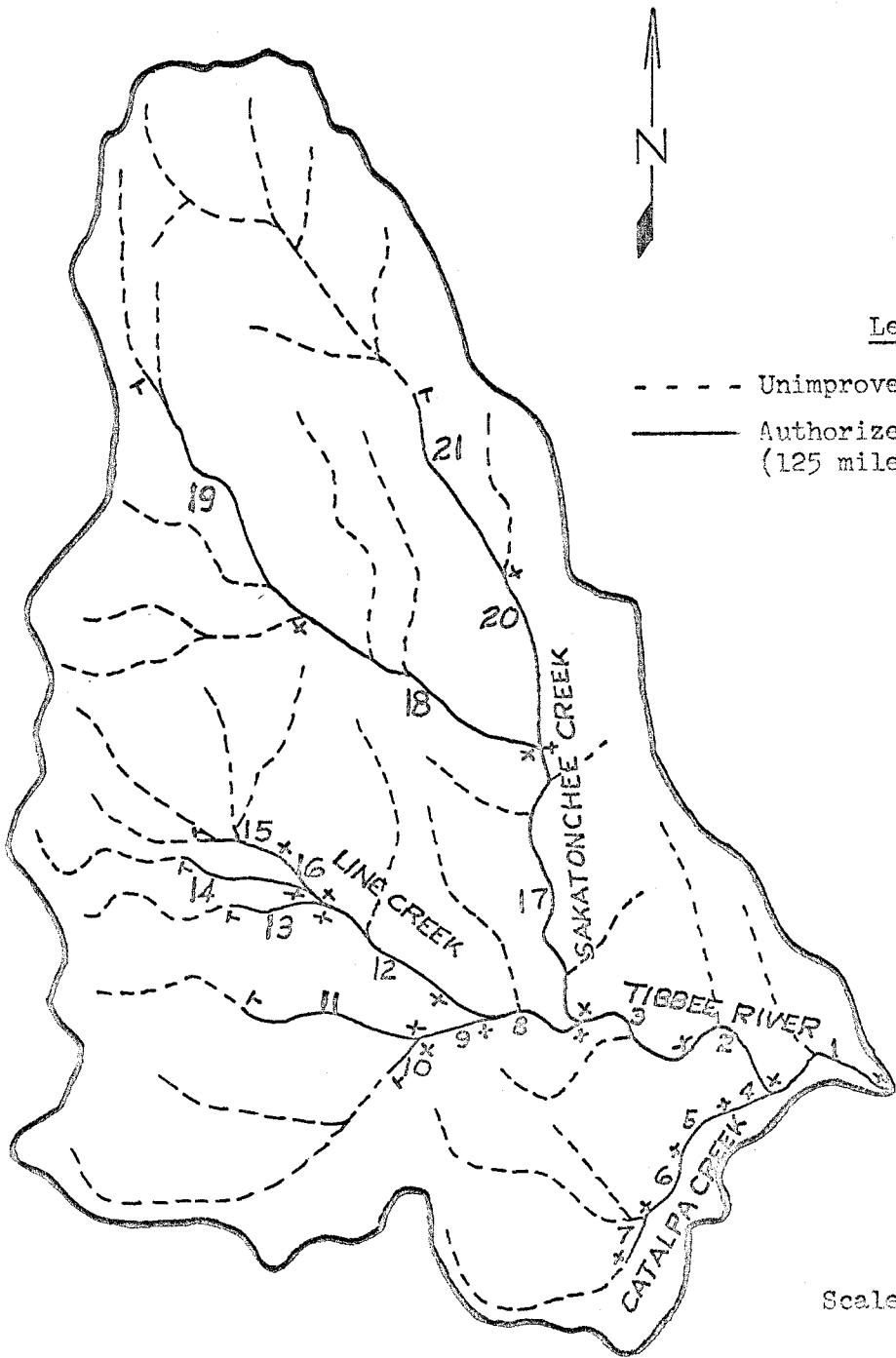

Legend:

- - - - Unimproved channels
- Authorized Improved Channels (125 miles)

Scale - 1 inch = 8 miles

TIBBEE RIVER BASIN (1,121 sq. mi.)

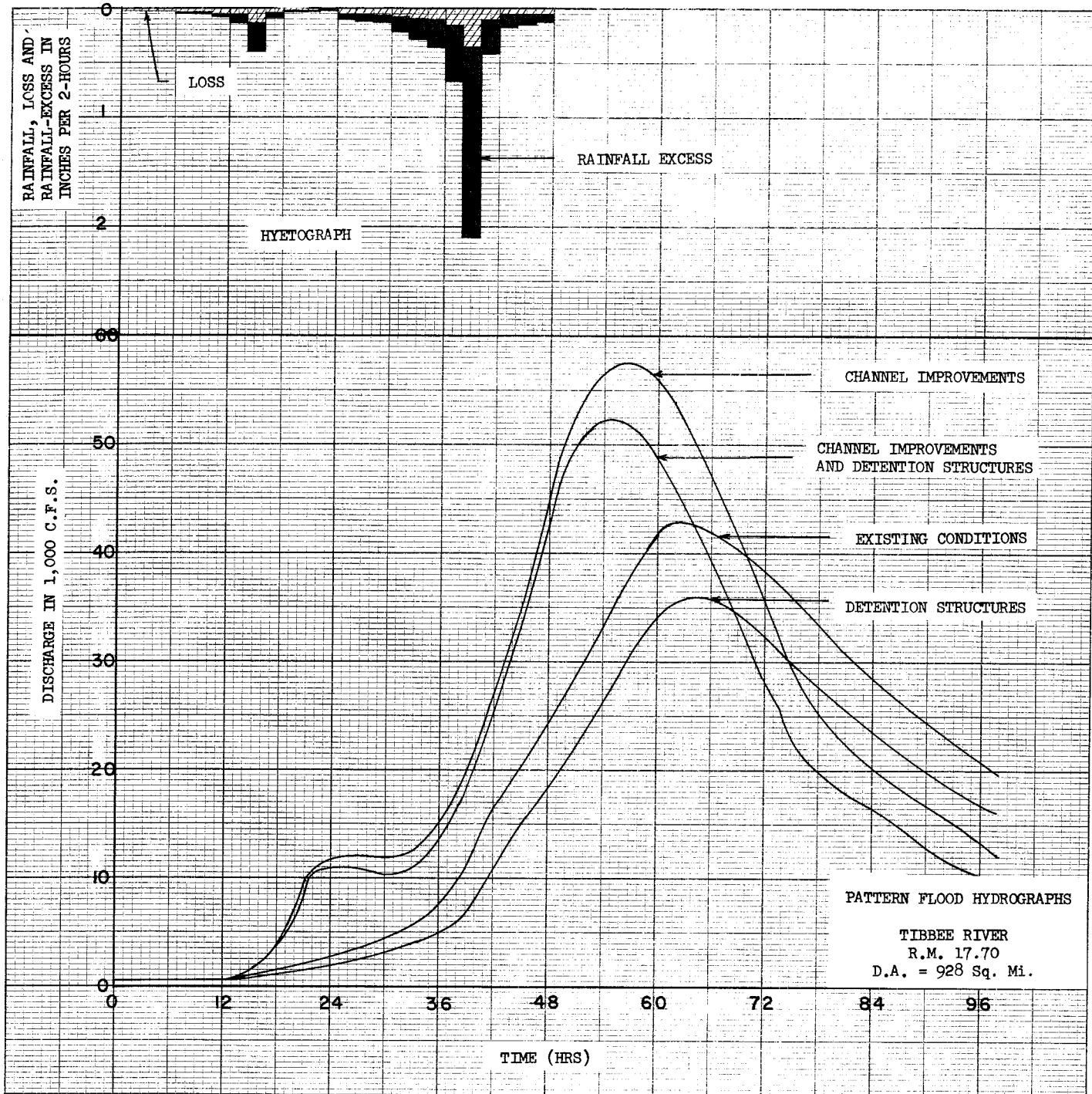

FIGURE 4

90%

FLOW-PROBABILITY-DAMAGE RELATIONS
TIBBEE RIVER
R.M. 17.70

EXISTING CONDITIONS

FLOOD DAMAGES FOR STATION			
NO.	FLOW	PROB	SUM
1	6449	3.269	16.83
2	9712	1.237	20.97
3	14663	.896	23.27
4	20554	.646	22.87
5	28948	.455	21.73
6	42723	.304	18.43
7	62073	.134	9.71
8	90665	.048	4.39
9	133410	.022	2.56
AVG ANN DMG			140.76

DETENTION STRUCTURES

FLOOD DAMAGES FOR STATION			
NO.	FLOW	PROB	SUM
1	5786	3.269	13.13
2	8802	1.237	18.46
3	12989	.896	20.92
4	17963	.646	20.11
5	24925	.455	19.39
6	35973	.304	16.72
7	52740	.134	8.93
8	76572	.048	3.94
9	113200	.022	2.29
AVG ANN DMG			123.90
DAMAGE REDUCTION			16.87

NOTE: Pattern Flood is Flood 6

CHANNEL IMPROVEMENTS

FLOOD DAMAGES FOR STATION			
NO.	FLOW	PROB	SUM
1	15029	3.269	0.
2	20448	1.237	1.53
3	27221	.896	5.21
4	34666	.646	11.65
5	44442	.455	12.40
6	57666	.304	11.39
7	77062	.134	6.66
8	106189	.048	3.34
9	149526	.022	2.06
AVG ANN DMG			54.23
DAMAGE REDUCTION			86.54

CHANNEL IMPROVEMENTS AND
DETENTION STRUCTURES

FLOOD DAMAGES FOR STATION			
NO.	FLOW	PROB	SUM
1	13767	3.269	0.
2	19046	1.237	.65
3	25614	.896	3.44
4	32242	.646	8.99
5	40671	.455	11.00
6	52450	.304	10.25
7	68274	.134	5.93
8	92347	.048	2.88
9	129277	.022	1.80
AVG ANN DMG			44.93
DAMAGE REDUCTION			95.83

PEAK DISCHARGE AND WATER SURFACE ELEVATION SUMMARY
CALDWELL CREEK, FULTON COUNTY, GEORGIA

River Mile	No Road Conditions		Existing Road Conditions				
	Peak Discharge, 10-Year	Peak Discharge, cfs 100-Year	Peak Discharge, cfs 10-Year	Peak Discharge, cfs 100-Year	SPF	Water Surface Elevations, msl 10-Year	Water Surface Elevations, msl 100-Year
.14	1110	2030	1040	1350	1950	795.49	795.90
.38	1100	1990	1040	1350	1950	804.85	813.24
.70	1070	1930	1060	1800	2520	813.99	815.05
.97	940	1700	940	1700	2390	820.88	821.64
1.06	960	1720	960	1720	2410	821.11	822.17
1.21	850	1540	850	1540	2110	825.83	826.97
1.54	700	1260	700	1260	1710	843.02	845.82
1.78	450	790	450	790	1060	850.74	852.22
2.20	350	620	350	620	820	876.48	877.39

(1) These flow values have been rounded from comparable values in table 5.

RED RIVER MAIN STEM

CANADA

EMERSON 34

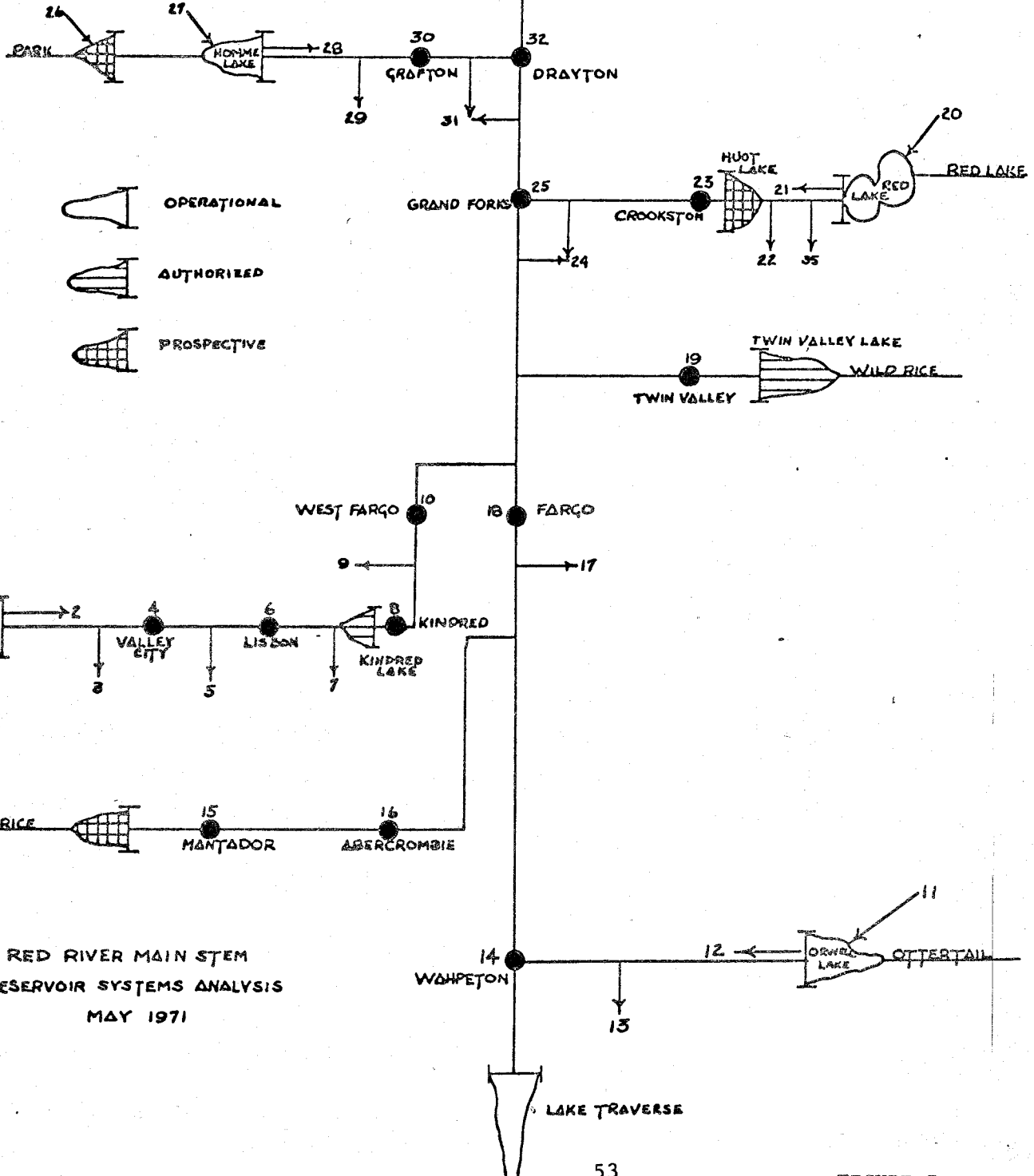

RED RIVER MAIN STEM
RESERVOIR SYSTEMS ANALYSIS
MAY 1971

FIGURE 7

SUMMARY OF PRELIMINARY DAMAGE INTEGRATION RUNS
MINNESOTA RIVER - NEW ULM TO CARVER
RATIOS OF 1965 and 1969 FLOODS

AVERAGE ANNUAL DAMAGE IN THOUSAND DOLLARS

MODEL	Control Point Number						TOTAL	DAMAGE REDUCTION
	5	9	11	12	13	14		
Existing Conditions	2.8	192.2	1195.5	309.8	688.3	54.6	2443.2	-----
Blue Earth Reservoir	2.8	192.2	548.3	134.3	363.3	13.9	1254.8	1188.4
New Ulm Reservoir	0.1	49.5	772.7	265.7	627.5	48.2	1763.7	679.5
Blue Earth and New Ulm Reservoirs	0.1	49.5	229.6	46.9	159.4	5.8	491.3	1951.9
Blue Earth, New Ulm, and Cotton- wood Reservoirs	0.1	4.1	193.4	19.2	52.7	3.5	273.0	2170.2
Channel Improve- ment Only	2.8	66.7	1195.5	224.2	596.4	53.9	2139.5	303.7
Blue Earth and New Ulm Reservoirs Plus Channel Improvement	0.1	22.4	210.7	28.5	54.0	5.6	321.3	2121.9

REFERENCES

1. The Hydrologic Engineering Center, Generalized Computer Program, "HEC-1 Flood Hydrograph Package," Corps of Engineers, October 1970.
2. The Hydrologic Engineering Center, Generalized Computer Program, "HEC-2 Water Surface Profiles," Corps of Engineers, August 1971.
3. The Hydrologic Engineering Center, Generalized Computer Program, "HEC-3 Reservoir System Analysis," Corps of Engineers, February 1971.
4. The Hydrologic Engineering Center, Generalized Computer Program, "HEC-4 Monthly Streamflow Simulation," Corps of Engineers, February 1971.
5. Reese, Howard O. and others, "Design of Flood Control Improvements by Systems Analysis: A Case Study," presented at the ASCE National Meeting on Environmental Engineering, October 1971.
6. Water Resources Council, "Principles for Planning Water and Land Resources," Report to the Water Resources Council by the Special Task Force, July 1970.
7. Dracup, John A. and others, "An Assessment of Optimization Techniques as Applied to Water Resource Systems," Environmental Dynamics, Inc., August 1970.

DIGITAL MODELS FOR EVALUATING
WATER RESOURCE DEVELOPMENTS

Comment, Mr. Harrison: The principal impacts to an economic analysis are costs and benefits that are manipulated by various techniques for projection, optimization, etc. Hydrologic analyses contribute principally to the benefit side of the picture. Techniques for computer analysis of economic projections and optimization have now gotten far ahead of computer techniques for quickly turning out realistic costs for the very large number of alternate solutions needed for any comprehensive economic analysis. The precision or the credibility of a B/C ratio is no better than the weakest part of the quotient. Sophisticated analysis to determine the numerator is a waste of time if the denominator is obtained from very generalized cost curves or other crude techniques.

I think we should turn part of our attention for the next year or so away from benefit evaluation and toward automation of design and cost estimates of typical project elements.

Reply, Mr. Kubik: I agree with you. For the Tibbee River study, the hydrology of several channel improvement schemes was being studied. Later in the study the economists provided cost values which disclosed that the cost of some of the improvement schemes would have exceeded the existing damages; therefore, unnecessary work had been done.

Comment, Mr. Gaum: Show stage discharge curve to go with figure 4.

Question, Mr. Gaum: What was the nature of the storm pattern used in analysis for effect of 6" of storage in NAR study?

Reply, Mr. Kubik: The same storm pattern was used for each of the assumed storage magnitudes. The magnitude of the rainfall for each subarea was a function of the drainage area size and was assumed to be uniform over the subarea.

HYDROLOGIC ASPECTS OF PLANNING IN AN URBAN AREA

By

Richard F. Astrack¹

INTRODUCTION

The period since the end of World War II has experienced a general migration of the nation's population to the urban centers, particularly to the suburbs. Subdivisions and shopping centers were and are being constructed with little or no regard for their effects on rainfall runoff and subsequent streamflow problems. Small, meandering streams have become raging torrents as their drainage systems, in changing from rural to urban, convey storm water through the basin several times more effectively than in the past. Erosion and bank caving problems are chronic. During normal flow, the streams are used as trash dumps and, consequently, as breeding grounds for all manner of vectors. Watercourses in urban areas are fast becoming public eyesores during normal flow and public menaces during floods. The St. Louis area is no exception to this problem.

The St. Louis District, Corps of Engineers, has been assigned the task of determining ways and means of solving the environmental problems associated with surface water runoff within the City of St. Louis and St. Louis County, Missouri. The total area for this study is about 517 square miles, and includes 23 stream basins with a population of approximately 1.6 million people. The Metropolitan St. Louis Sewer District (MSD) is responsible for sanitary and stormwater control over 229 square miles of the study area. St. Louis County has similar general jurisdiction over the remaining 288 square mile study area. Initially, the study is concentrating on one pilot basin - Maline Creek - where the problems are the most urgent. The degree of urbanization of these basins is quite evident as witnessed by the highly developed transportation network (Figure 1).

Floods have occurred on all the various watercourses and channel conditions are steadily deteriorating as urbanization continues. Six lives have been lost during floods; with five drownings since 1964, further illustrating the effect of people pressures and, in many areas, unplanned urbanization. Since separate sanitary sewer systems serve essentially all of the pilot study area, stormwater runoff and its effects are the chief problems for which a solution is needed.

This paper will discuss possible plans to solve these urban stormwater problems. The overall planning of the study is presented herein, with the emphasis on the development of a hydrologic-economic model for use in evaluating preproject and project conditions.

¹Hydraulic Engineer, General Hydrology Section, St. Louis District, Corps of Engineers.

History

Authority for the St. Louis Area Study was provided by three resolutions adopted by Congress in 1966, 1970 and 1971, in response to local requests. The first resolution was a single-purpose flood control authority. The second resolution expanded the effort to include not only flood control, but also "other water and related land resource purposes." The third resolution specified that a plan be prepared to include analysis of, but not be limited to, waste water management facilities, regional water supply, wise use of flood plain lands, flood control, recreation, fish and wildlife, water quality and environmental enhancement for the entire 517 square mile City of St. Louis and St. Louis County Area.

Work was initiated in December 1967 with the advice of allotment of funds. In June 1968, the initial public hearing was held with more than 100 persons attending. Improvements were requested to prevent loss of life due to drowning and to control stormwater, backwater and erosion. There was and is no known opposition to the proposed study. The final Detailed Plan of Survey, submitted in October 1970, provided for three area-wide special studies and a detailed pilot study of the problems of surface water runoff for the first basin to be analyzed: Maline Creek. The three area-wide studies are: environmental; socio-economic; and hydrologic. The environmental and socio-economic area-wide studies will be performed for the City of St. Louis and surrounding seven counties (Figure 2). The hydrologic study will be confined to areas where adequate streamflow data exists. At present, this consists of the City of St. Louis and St. Louis County (Figure 3).

AREA-WIDE STUDIES

Environmental

The area-wide environmental study will cover all necessary aspects of the St. Louis Metropolitan Area. An environmental inventory will be provided for such factors as: flora; fauna; geomorphology; soil type; and archeological and historic sites. Some environmental needs and problems include: retarding erosion; preservation of remaining open space; environmental enhancement, and water-use improvements.

A water quality sampling program is also underway. Monthly samples are taken at 25 sites within the MSD area during periods of normal and stormwater flow. The testing includes determination of physical, chemical and biological parameters. This information will help determine the feasibility of water-related recreation in the basins. Results to date indicate problems exist during periods of low flow due to insufficient dissolved oxygen (DO). The flow is not currently toxic.

Socio-economic

The framework for the socio-economic analysis will be provided by a metropolitan land-use allocation model. Using detailed data on current land use, population distribution and associated physical land characteristics, along with projections of population and employment, probable future development will be determined by census tracts for the City of St. Louis and seven surrounding counties.

A local industrial planning group has updated a shift-share analysis of the St. Louis regional economy which projects population, employment, and payrolls (by selected industry groups), on a county basis for the period 1980-2020. Another local agency is collecting detailed land use information and, together with representatives of the Corps of Engineers, will attempt to weight the variables to reflect their impacts on private development decisions. Finally, an operations research specialist from the University of Missouri, St. Louis, is developing a computer model which will determine probable future development of each land unit. Calibration of the model will be accomplished employing sensitivity analysis to define the most relevant variables and any potential need to refine the existing data base.

Output will be in the form of land-use projections, by tract, for 10-year intervals. Modification of the assumptions regarding development criteria will enable the model to show how development patterns would differ as alternate land-use decisions are made: for example, how the overall pattern of land-use would differ with and without flood control projects. This increases objectivity in evaluating alternatives to flood-plain development sites.

Hydrologic

The area-wide hydrologic study was conceived as an analysis of the hydrologic relationships of the major streams in the MSD area. In July 1967 the U.S. Geological Survey, in cooperation with the Metropolitan St. Louis Sewer District (MSD), initiated a five-year program to collect meteorologic and hydrologic data in developed urban areas throughout St. Louis. A network of 18 rainfall and 23 runoff recording gages were installed in these basins (Figure 3). Collected data is recorded in 5-minute intervals. It is planned to use the data collected in a generalized hydrologic analysis. Because the period-of-record is short, no frequency analysis is planned. Instead, the highest floods for each gage will be selected and the rainfall runoff data obtained from USGS. With this data, unit hydrograph and rainfall loss factors will be determined by using the HEC-1 (Flood Hydrograph Package) Computer Program. Generalized relationships will be developed between hydrologic characteristics and basin parameters, such as, unit hydrograph and rainfall loss factors correlated with drainage basin characteristics. It is hoped that the detailed information developed for the MSD area will be generally applicable to the entire Metropolitan St. Louis Area.

MALINE CREEK STUDY

General Planning Approach

The Maline Creek Basin is being used as the pilot study for the analysis of surface water runoff problems for the stream basins in Metropolitan St. Louis. This basin was selected because of the intense local interest, as evidenced by self-imposed taxes to meet any local contribution required. In addition, the Maline Creek Basin exhibits the full range of water-resource problems likely to be found in the other 22 basins. Therefore, the successful completion of the Maline Creek Basin Study will provide a sound basis of experience for resolving the remaining study area problems.

The Maline Creek Study is an examination of the future trends of socio-economic and hydrologic conditions, with and without Corps improvements. Possible improvements could be structural (trapezoidal, concrete-lined channels) or non-structural (parks, greenways, natural earth channels) or various combinations thereof. With the formulation and analysis of two plans depicting the full range of potential improvements engineeringly possible, the public will be requested to actively participate in formulating a third plan. After these three plans have been evaluated, a Pre-Formulation Public Hearing will be held and all three plans formally presented and discussed. From the reaction at the public hearing, it is hoped that broad support will be generated for one of the three plans. Following more detailed analysis of the selected plan, the Maline Creek Interim Report will be prepared.

Plans of Improvement

The three alternative plans of improvement to be evaluated will be carefully designed to respond to the multi-purpose needs of the area. Only the means of meeting the multi-purpose needs vary from one alternative to the next. These means are briefly described as follows:

a. Plan "A" is a structurally-oriented plan of improvement, consisting mainly of rectangular and trapezoidal concrete-lined channels with possible enlargement of bridge openings, designed in an environmentally compatible manner. In the areas where the stream passes through parks, gabion-lined channels will be fully considered. A few small upland detention reservoirs, somewhat similar to Soil Conservation Service detention reservoirs, may be used to enhance low flow water quality.

b. Plan "C" is a non-structurally oriented plan emphasizing the use of natural channels, open space and land-use regulations. Where channel stabilization is necessary, natural looking materials, such as gabions, will be used to retard erosion and degradation. A large number of upland dry reservoirs will provide a measure of flood protection, with the pool areas used as parks and open space during non-flood periods.

Permanent-pool reservoirs may be used for low flow augmentation to enhance water quality. In the park areas, weirs or inflatable rubber dams will be analyzed to create small channel pools for esthetic and recreation purposes.

c. Plan "B" will probably be a combination of the other two plans, as selected through local participation and public workshops. All three alternative plans will be designed to resolve the same multi-purpose needs of the area through installation of various kinds or types of improvements.

General Hydrologic Approach.

A hydrologic-economic model of the Maline Basin is established to obtain stage and damage data throughout the watershed for various frequency floods. These data are developed from flood frequency profiles and stage damage data for both existing and future pre-project conditions. With an economic and hydrologic base established, profiles and damages are determined for each of the three alternate plans. When the selected plan is known, a more detailed hydraulic analysis would be performed.

Hydrologic Analysis

Because of a decision to accelerate the originally scheduled completion date of the Maline Creek Interim Report, the area-wide analysis was postponed. Present plans call for completion of this analysis after the Maline Creek Interim Report and before initiation of the next basin study. Therefore, the basic data to formulate a hydrologic model was derived for only those gages in the Maline Creek Basin.

The main problem with almost any urban hydrology study is a lack of adequate streamflow data. The Maline Creek Study is no exception. No rainfall or streamflow records were kept in the basin prior to 1967, when the U.S. Geological Survey program began. The short period-of-record of these gages does not allow for any frequency analysis and no large floods have occurred during the period-of-record. At present, four USGS rain gages, located in and around the Maline Creek Basin, and three USGS stream gages served to supply the basic data to construct the hydrologic model. From the short period-of-record, the four largest floods were selected and the rainfall-streamflow data obtained from USGS. Additional highwater mark data were obtained from USGS staff gages for selected floods occurring since the start of recorded data in 1967.

Using the HEC-1 (Flood Hydrograph Package) computer program's unit hydrograph optimization routine, the recorded rainfall and streamflow data were used to optimize six variables defining the unit hydrograph and infiltration loss factors for each gage. Two of the variables define time of

concentration and attenuation of the Clark Unit Hydrograph. The other variables establish the HEC-1 program's exponential rainfall loss curve. Reconstitution of the flow hydrograph, using these variables, was excellent, as seen in Figure 4. The next step was the development of the hydrologic basin model. In the model, the Maline Basin is divided into 48 sub-basins with unit hydrograph variables chosen for each area. Sub-basin selection was based on the number of Maline tributaries to be analyzed and the number of routing reaches required for damage evaluation. Using HEC-1, sub-basin hydrographs are computed, routed and combined to determine streamflow throughout the system. The hydrologic model was tested by closely reproducing the recorded streamflow data at the three USGS streamflow gages. One hydrograph reproduced by the model is shown in Figure 5. Concurrently, water surface profiles are computed using the HEC-2 (Water Surface Profiles) Computer Program to reproduce the available high water marks using the flows developed by the model for each of the four storms. In this way, a cross check of the model verifying both recorded flow hydrographs and water surface elevations is achieved.

With the basin hydrologic model verified, it was then used to compute various frequency flood events. Rainfall for the 2- through 100-year frequency storms was taken from National Weather Service frequency rainfall curves which were developed for the City of St. Louis Gage. This frequency rainfall was applied to the model and the resultant floods routed through the present stream system using the HEC-1 Program. Flow-stage relationships developed from backwater computations and stage-damage data are also inputted into the HEC-1 Program to obtain water surface elevations and corresponding economic damages at desired locations in the stream system. Frequency-damages are thus established for present conditions. After modifying the unit hydrographs, infiltration, and routing characteristics in the basin model to reflect future changes in population density and land use, the hydrologic model is rerun for future ultimate development without stream improvements. Therefore, a hydrologic-economic base is established for present and future basin conditions without improvements. This is the point presently reached by the St. Louis District as of March 1972.

The hydrologic-economic model is then modified to briefly evaluate each of the possible plans of improvement. The structurally-oriented, Plan A, will be analyzed by modifying the data used in HEC-2 to determine the water surface profiles for pre-project conditions. Reach lengths, channel dimensions and values of channel friction may be varied to determine the effects of channel straightening, increased channel capacity and paving, respectively. The new storage-discharge relationships obtained from profile computations would be used in the hydrologic model during the routing of the sub-basin hydrographs. The effect of small detention areas will be studied by inputting the reservoir storage and outflow relationships. With the various structural changes included, the hydrologic-economic model is operated to compute the new frequency discharge-damage

relationships. The non-structural Plan C and combination Plan B would be evaluated in a similar manner by, again, modifying the cross sections in the HEC-2 program to show the effects of each plan. The extensive use of gabions, enlarged earth channels, upstream detention areas and channel weirs, as well as uses of flood plain areas as parks and open space, can be studied in the model.

When the preferred plan is selected, a more detailed hydraulic study will be conducted. Hydraulic design criteria will then be finalized for the Maline Creek Interim Report. Hydraulic criteria to be determined include: optimum channel sizes; type and alignment of channel; reservoir storage volume and outlet sizing; bridge modifications (opening) required; and frequency profiles with the selected plan of improvement.

SUMMARY

The St. Louis District, Corps of Engineers, has embarked on one of the first major urban studies encompassing nearly all surface water-related problems. The Maline Creek Interim Report is expected to be a model of Corps response to urban surface runoff problems. Methods used in the analysis and the potential solutions being considered are believed to be innovative and unique for the Corps of Engineers.

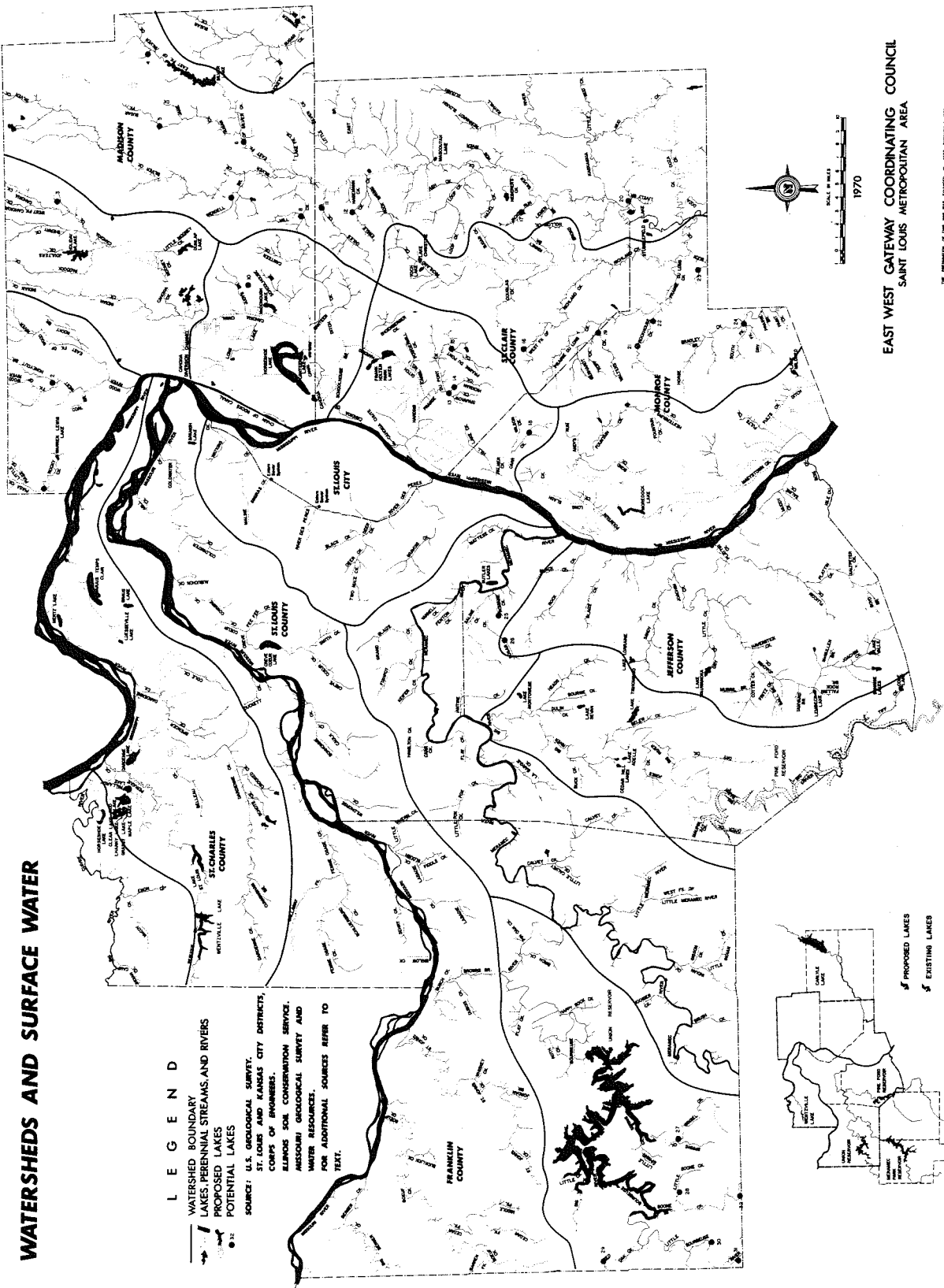
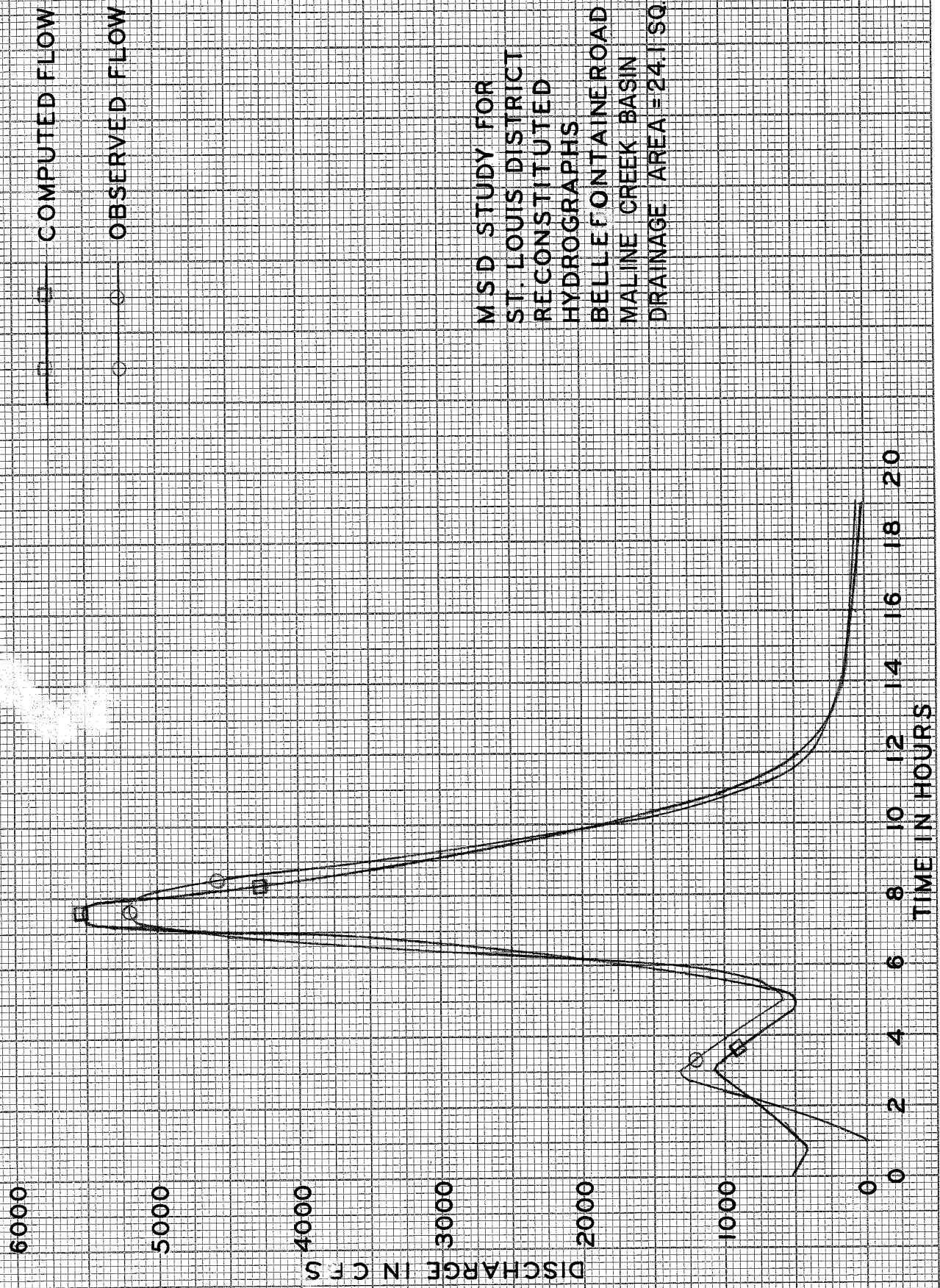

Figure 2



M.S.D. STUDY FOR
ST. LOUIS DISTRICT
RECONSTITUTED
HYDROGRAPHS
BELLEFONTAINE ROAD
MALINE CREEK BASIN
DRAINAGE AREA = 24.1 SQ. MI.

FIGURE 4

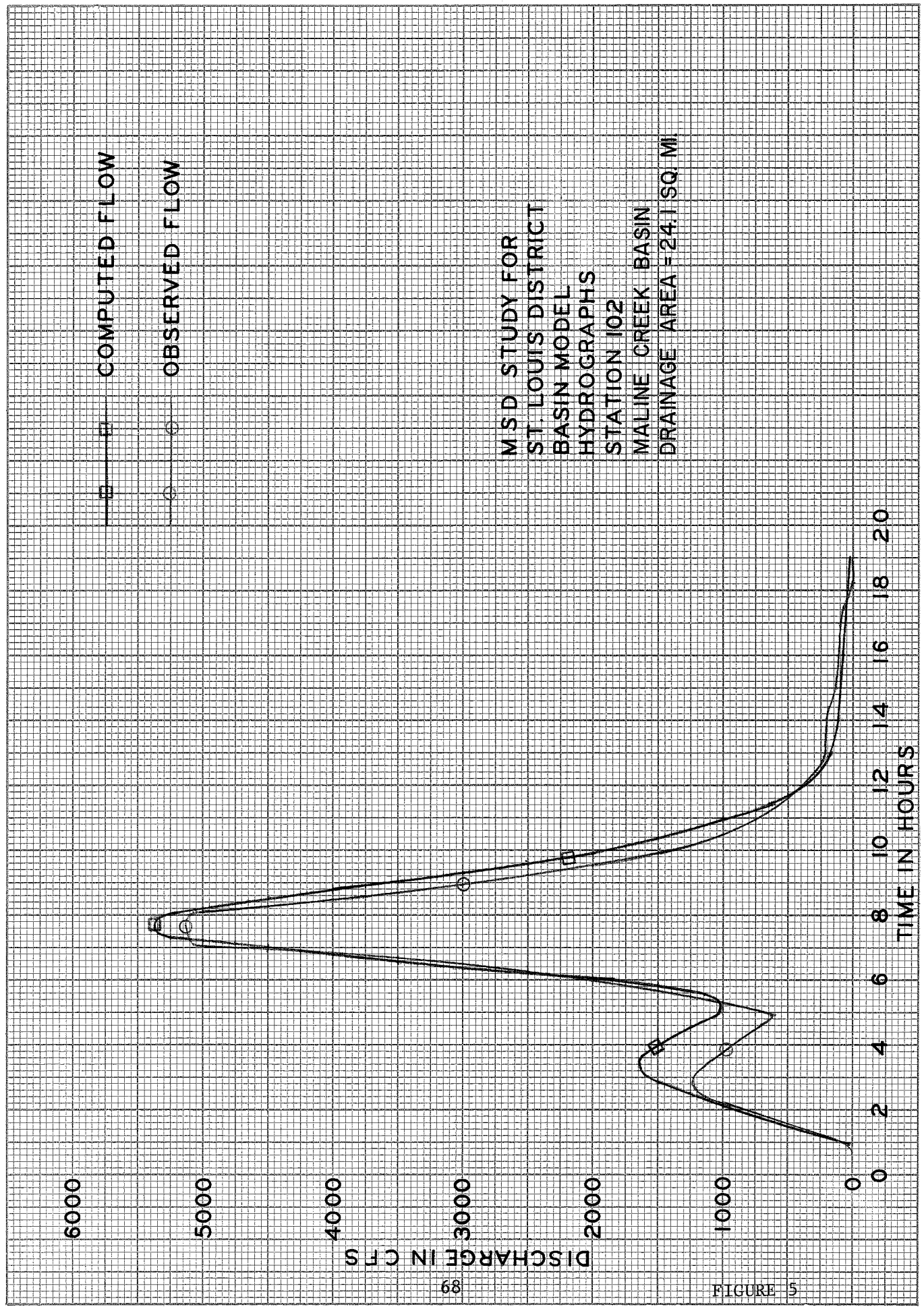

FIGURE 5

HYDROLOGIC PLANNING IN AN URBAN AREA

Question, Mr. Antle: Can two plans be developed with exactly equal outputs for all of the multiple functions? I believe that this strategy is inconsistent. While the attempt at public involvement proposed is to be applauded - would it not be preferable to seek participation earlier in the process, e.g., hypothesizing objectives, rather than just to ascertain the project function mixes involved in selecting a proposed course of action?

Reply, Mr. Astrack: The paramount key to effective urban planning is considered to be implementation. This goal clearly rests in the hands of local "publics" and "implementors." Accepting and appreciating this primary concept has resulted in developing an urban planning approach which tends to maximize early and continuing public participation and local decision making.

A short discussion of this planning approach is available from the St. Louis District, Corps of Engineers, entitled "Abbreviated Multi-component Urban Planning Approach," March 1972. In summary, this approach hinges on comprehensive, effective public participation. It is assumed that there is only one all-encompassing objective for any area, and that is the well being of all the people. Anything less is unacceptable, and all other objectives (i.e., flood control, water quality, recreation, etc.) can be stated as a component need under this one all encompassing goal. Once this concept is accepted, the task becomes one of specifying the multi-component needs of the problem. The proposed approach is based on the "publics" and "implementors" first clearly establishing each of the needs, and then actively deciding on minimum publicly acceptable satisfaction levels.

Effective implementation lies with the regional, state, local governments and ultimately with individual citizens. Therefore, this proposed approach assigns to these "implementors" the earliest possible role and continuing maximum control.

Question, Mr. Gaum: Why is the public participating in only one plan?

Reply, Mr. Astrack: The public is participating in the creation of one plan because it will be the recommended plan. The other two potential plans have been assembled by technical experts only as a means of focusing public attention within the reasonable range of alternatives that are engineeringly possible and economically feasible.

Question, Mr. Gaum: Why not integrate the best of the three plans rather than choosing one of the three?

Reply, Mr. Astrack: The "people's plan," or Plan B, may be either Plan A or C, a combination of these two alternatives, or an entirely new plan.

Question, Mr. Gaum: Will the SCS type detention structures be efficient in low flow supplementation for water quality improvement? Is storage-yield sufficient to provide outflow for the period of needs? Operation for period of need?

Reply, Mr. Astrack: These studies have not yet been undertaken. However, it is anticipated that SCS type detention structures will not, in general, provide low flow augmentation in significant amounts. These structures appear to have greatest value with regard to flood control and downstream erosion retardation.

Comment, Mr. Gaum: Label hydrograph as to basin name, DA, and type of storm. I think it would be more appropriate to call the storage sites shown temporary ponding areas rather than "reservoirs."

RAINFALL RUNOFF FROM URBAN DRAINAGE AREAS
by CLARKE L. CARTER¹

INTRODUCTION

General

Numerous cities and towns in Georgia are frequently experiencing flood problems, not necessarily from rivers with thousands of square miles of drainage area, but from small brooks with watersheds varying from a few hundred acres to 5 or 10 square miles. The peaceful brook that formerly experienced infrequent floods causing nondamaging inundation of the swamplands and meadows, now is a wall-lined channel or a buried conduit with inadequate capacity for the accelerated runoff. Typical excerpts from Georgia newspapers follow:

a. The Athens Banner-Herald had this to say about the June 1963 storm: "Some five and one-half inches of rain fell on Athens-Clark County Wednesday causing heavy damage to homes, places of business, streets and automobiles. City Engineer, Jack Beacham, said that more damage was done by the storm last night than he has ever seen since becoming City Engineer in 1930."

b. A similar event occurred in May 1966. The Athens Daily News made the following statement about this storm: "Major flooding, triggered by a nine-inch rainfall in Athens Thursday night blocked roads, forced many families to flee their homes and caused heavy damage throughout the area ... two rain gages in Athens recorded over nine inches of rain while the official U. S. Weather Bureau Station at the airport had only a comparatively light 2.35 inches. The city water plant gage showed 9.1 inches of rain fell from 10:00 p.m., Thursday until 3:00 a.m., Friday. It was this downpour that quickly flooded storm sewers beyond capacity and made rivers of city streets, stranding cars in low places."

c. The Savannah Morning News had this to say about the August 1970 storm that struck the southside of Savannah-Chatham County: "A lingering chain of thunderstorms unloaded at least 5.8 inches of rain on parts of Chatham County yesterday and turned some southside subdivisions into virtual disaster areas with floods that routed scores from their homes (rescue workers estimated that from 145 to 175 families had been routed). Many streets were impassable and dozens of cars were inundated. Parts of the subdivisions were totally cut off for hours."

d. The Savannah Evening Press had this to say about the August 1971 Flood: "Torrential rains bombarded the whole of Chatham for hours, deluging the area with more than seven inches of rain -- more than half of it

¹Chief, Hydraulics Section, Savannah District

between 7 p.m. and 11 p.m. Thousands of stunned Savannahians and County residents watched as the "Hundred Year Flood" of August 1970 happened again. Only this time, just over a year later, it struck in an incredibly large area, leaving hundreds of people -- many of them poor families -- homeless and their possessions destroyed.

These excerpts from the Athens and Savannah Georgia papers are not unique, but may be found in every urban-suburban area newspaper in Georgia and elsewhere in the United States.

Many metropolitan areas are good examples of unwise land use. The use of much of this land was predicated on studies for natural basin conditions, resulting in flood plains being used for both residential and commercial developments. Rapid suburban development has greatly increased flood runoff factors in these basins and flood damage has become more frequent and severe. In completely developed areas, we find great public pressure for flood reduction measures. However, the options available for solving these problems now have become extremely limited.

Flood damages in many metropolitan areas are ballooning and much could have been prevented by timely land-use planning. However, to adequately plan for the development of suburban areas there is needed a more accurate definition of flood frequencies in metropolitan areas. If this information were available, the planner could project the type and density of land use development that will occur in a basin, and zone land according to the projected profile of stream elevations for discharges of various frequencies. This determination is not possible at the present time because of inadequate streamflow data for metropolitan areas.

Scope of Paper

This paper describes the features of a current urban flood runoff study by the Savannah District Corps of Engineers and U. S. Geological Survey personnel in Georgia. This study was determined necessary because frequently in project planning studies associated with urban-suburban areas, streamflow records are lacking as a base of reference for estimating flood magnitudes and frequencies.

DESCRIPTION OF STUDY

Urbanization creates a special demand for hydrologic data. There is a need to redefine the water regime, both quality and quantity, in the new environment. Data are needed for the design of water-supply facilities and protection of raw water suppliers; for planning the disposal of waste; for determining the optimum pattern of land use; and for the adequate design of storm-drainage facilities.

Flood magnitudes and frequencies are generally derived by the Corps from criteria and methods presented in "Statistical Methods and Frequencies in Hydrology" by Leo R. Beard. In drainage basins where there is a lack of

streamflow records, a regional frequency analysis is derived using other stream-gaging stations in the same hydrologic region. These criteria and methods, however, cannot be adopted for determining flood magnitudes and frequencies in urban-suburban areas in Georgia. Urbanization produces vast changes in the flood runoff characteristics of watersheds; therefore, natural (rural) basin flood-frequency relations are not applicable to urban streams. Figure 1 gives a good pictorial view of the problem being encountered in many urban areas. The solid line hydrograph Q_n in figure one represents a flood from a natural drainage basin. Many of our structures within urban areas were designed based on flood hydrographs resulting from natural conditions. Improvement of the drainage system by adding storm sewers and aligning stream channels will result in the runoff leaving the basin sooner as shown by the dotted line hydrograph Q_s . However, these improvements will have little effect on the volume of rainfall excess so the volume of runoff represented by the area under each hydrograph is approximately equivalent for these two conditions. As a drainage basin develops, construction of buildings, highways, and parking lots reduce the amount of precipitation that infiltrates into the ground, thereby increasing the amount of rainfall excess and direct runoff, and results in the hydrograph as shown by the dashed line Q_u . These hydrographs assume uniform areal distribution of development within the basin. A concentration of development at either the lower or upper part of the basin could result in hydrographs quite different. In actual basin development the drainage-channel improvement and impervious area construction often occur concurrently and it is not possible to observe directly the individual effects of either change. Further complicating our problem is the fact that few hydrologic data observations currently are available for streams in metropolitan areas. In designing a data collection system to obtain the necessary information, it is important to first consider how the information may be analyzed because the analytical method determines the type of data required. The U. S. Geological Survey personnel in Georgia proposes to use a hydrologic model which is discussed briefly in an attachment to this paper. The proposed data collection system will be designed to furnish input to this model. The rainfall-runoff data obtained from the data network could be utilized readily in other models because the data will be prepared for computer input on cards and/or magnetic tape.

The use of a hydrologic model offers a more sophisticated approach to the definition of flood frequencies in metropolitan areas than methods currently being used. However, sophistication does not necessarily produce better answers. The hydrologic model proposed offers the combination of the ability to use the best hydrologic relations available from theoretical and applied research and the facility for rapidly solving some complex mathematical expressions using large amounts of data through the use of the computer.

The hydrologic model considered here is a set of mathematical statements that attempt to describe the land phase of the hydrologic cycle. It performs a continuous accounting of the moisture within a drainage basin. Using a series of precipitation observations as input, the model attempts

to continually assess the changes in moisture levels and to route the excess moisture through the basin so as to simulate the streamflow that would be observed at the basin outlet.

Data will be collected from about 20 urban basins in the Atlanta metropolitan area which will be selected to represent a range in drainage area (1 to 20 square miles), imperviousness, drainage channel improvement including storm sewers, the location (lower or upper portion) of the development within the basin, etc. The sites selected will include a sample of various types of urban, suburban, and industrial development as well as a range of topographic variables. Basins with "complete" development will be preferred and those undergoing change or where changes are anticipated will be avoided. Gaging stations at the outlets of the selected basins will be equipped with two digital recorders to obtain flood hydrograph and storm rainfall data at 5- to 15-minute intervals.

For basins larger than 10 square miles, an additional rain gage may be installed in the headwater area. Because of the traffic congestion and the rapid surface runoff response to rainfall, most stations will be located at culverts so that high-water stage-discharge relations can be determined directly. Current-meter verifications of these ratings will be obtained where possible.

Depending upon the number of storm rainfall events experienced, data will be collected for about eight years. When sufficient data (about 30 significant runoff events) are available at a site, the rainfall runoff model will be calibrated. U. S. Weather Bureau rainfall data at Atlanta will be utilized to simulate a long peak runoff record for the site from which synthetic flood-frequency data can be generated. When sufficient sites, representing varying degrees of urbanization, have been analyzed, a regionalized urban flood frequency relationship can be developed.

The value of the study to the development of appropriate hydrologic criteria and to much of the project design activities and flood plain information studies of the Savannah District is recognized by SAD and OCE. It has been suggested by OCE that the District investigate the possibility of coordinated study with participation with other Federal, state and/or local agencies. It is also noted that the proposed study is considered by HEC to be within the framework of their ongoing research project on urban hydrology; but they indicate that funding for the collection and processing of basic data is not considered a function chargeable to HEC Research funds. They indicate, however, that the analytical development could be funded or supported by HEC.

The regional urban flood frequency relationship developed as a result of this research study will be made available to all Federal, state and/or local agencies when complete. Under current funding schedules and personnel availability, it is anticipated that the study will be concluded in FY 1983.

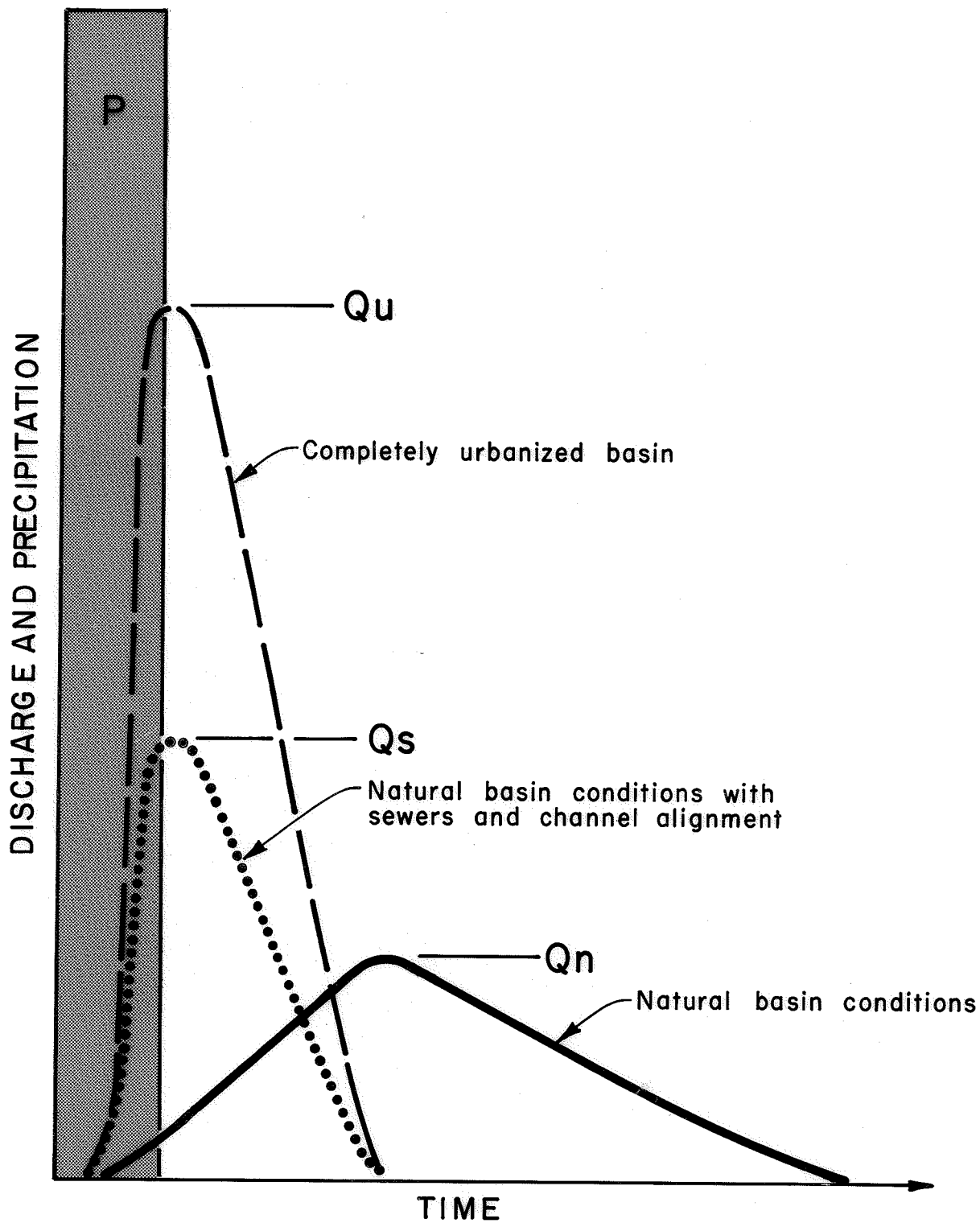

FLOOD HYDROGRAPHS

FIGURE 1.

USGS RAINFALL-RUNOFF MODEL
AND FLOOD-FREQUENCY REGIONALIZATION

The USGS has developed a small streams rainfall-runoff model, which simulates surface runoff response (with emphasis on the flood peak) to storm rainfall. The model is based on the infiltration method for computing runoff from storm rainfall and consists of three components:

1. Soil moisture - computes soil-moisture conditions at beginning of storm period using a moisture accounting technique which utilizes an input of daily rainfall and evaporation and model parameters EVC, BMSM, RGF, RR, and DRN (See table 1).
2. Rainfall excess - computes rainfall excess from an infiltration equation which utilizes an input of storm rainfall at a specified time interval and model parameters PSP, KSAT, RGF, and BMSM (See table 1). The base flow contribution to the flood hydrograph is not considered and the results are biased to that extent.
3. Routing - routes the rainfall excess through a time-area histogram and linear storage at the basin outlet (Clark method). Linear storage is represented by a time characteristic model parameter. The time-area histogram is initially triangular and defined by two parameters.

Initially the ten parameter values are estimated and the model computes an output of flood peaks and volumes. The measure of the "goodness of fit" of the simulated data is the objective function which has components as follows:

Peaks	$U_1 =$	$(\log_e \text{ simulated peak} - \log_e \text{ observed peak})^2$
Volumes	$U_2 =$	$(\log_e \text{ simulated volume} - \log_e \text{ observed volume})^2$
Peak/Volume	$U_3 =$	$U_1 + 1/2 U_2$

The parameter values are automatically adjusted by a modified Rosenbrock technique to produce a minimum objective function (U_1 , U_2 , or U_3 selected by the analyst).

Table 1. -- Soil moisture and infiltration hydrologic model parameters and their physical interpretation

<u>Parameter Identifier</u>	<u>Units</u>	<u>Interpretation</u>
PSP	inches	Defines with RGF the relationship between soil moisture conditions and effective soil suction pressure used in the computation of infiltration rates.
RGF	--	See PSP
KSAT	inches per hour	The minimum (saturated) value of hydraulic conductivity used to determine infiltration soil rates.
BMSM	inches	Soil moisture storage volume at field capacity.
EVC	--	Coefficient to convert pan evaporation to potential evapotranspiration values.
DRN	inches per hour	A constant drainage rate for redistribution of soil moisture.
RR	--	Proportion of daily rainfall that infiltrates the soil.

The rainfall-runoff model is used to extend a flood record in time. Observations of streamflow and rainfall collected at a given site over a study period are used to define the model parameters. Long-term records of rainfall are used with defined model parameters at a given site to generate a long-term record of peak discharge. Flood frequency is then defined at each site using the log-Pearson method adopted by the Water Resources Council.

Transfer of frequency data to ungaged sites will be accomplished by multiple regression regionalization techniques. The basins with defined flood-frequency characteristics will represent the range in physical variables that describe urban development; therefore, regression equations that express the relation between floods of selected frequency and the physical measures of the basin can be computed for the metropolitan area. For example,

$$Q_{50} = f(\text{Area, slope, imperviousness, percent of area with storm sewers, etc.})$$

This method of extending and regionalizing urban flood data does not depend upon the physical significance of the individual model parameters, but only upon the accuracy of the model, and upon the accuracy of the regression equations for estimating floods of selected recurrence intervals.

RAINFALL RUNOFF FROM URBAN DRAINAGE AREAS

Comment, Mr. Fredrich: It seems that there are at least three or four major factors that should be investigated in any program designed to determine the effects of urbanization on runoff. First, for a given watershed, it would be desirable to observe the change in runoff characteristics resulting from changes in the degree of urbanization. Also, it would be desirable for one or more of the gage records to be maintained long enough to observe a fairly wide range of runoff magnitudes. Finally, it would be desirable for the gaged watershed to represent a relatively large variation in size of drainage area. Using information on the relationships between rainfall-runoff model parameters and the physical difference, hydrologic engineers can develop a basis for inferential judgements concerning the way in which model parameters should be adjusted to reflect each of these types of changes - either independently or jointly.

Reply, Mr. Carter: It would be desirable to observe changes in runoff characteristics resulting from the degree of urbanization; however, funding of this study has limited the scope of the study preferably to the completely urbanized areas. The integration of varying degrees of urbanization would distract from the reliability of results obtained.

The continuation of one or more of the gage records will be considered so as to observe a wider range of runoff magnitudes.

The drainage basins within the study area will range in size from 1 to 20 square miles.

Question, Mr. Kubik: What criteria was used to establish that "39 significant runoff events" that would be needed at each site for sufficient data?

Reply, Mr. Carter: The number of significant runoff events should have read 30. The paper has been corrected accordingly. The split-sample technique will be used to define the values of the model parameters; therefore, it is estimated that data from about 30 significant runoff events will be necessary to define and evaluate the model. One-half the data will be used to define the parameters and the other half will be used to calibrate the model.

Question, Mr. Astract: Have you considered possibly using HEC-1 Flood Hydrograph Package for this regional study rather than the USGS model?

This would seem feasible especially since GS seemed to require 39 storm events per gage for calibration, whereas HEC-1 can probably be calibrated with a considerably lesser number of storm events.

Reply, Mr. Carter: Currently there are many hydrologic models being utilized and improved. Therefore, after data for this urban study has been collected, it may be more feasible to utilize some method other than the GS model currently being considered. Present plans are to utilize the HEC-1 Flood Hydrograph Package as a comparison of results obtained from the GS model.

AN EVALUATION OF RESERVOIR TEMPERATURE PREDICTION METHODS

by EARL E. EIKER¹

INTRODUCTION

The growing concern with the environment over the last five years has made analysis of potential environmental problems essential. It is no longer possible to ignore environmental factors, even at the preliminary planning stage. Environmental considerations must be studied along with engineering and economic factors when evaluating the desirability of a particular project. The impact of a reservoir project on water quality is a primary concern. An accurate, thorough water quality study must be accomplished early in the planning phase in order to anticipate potential problems.

Generally the most important parameter in a reservoir water quality study is temperature. Since the density of water is a function of temperature, and density differences are the controlling influence on the hydrodynamics of an impoundment, it is apparent that distribution of all water quality parameters within the reservoir is greatly dependent on temperature distribution. The only way by which an evaluation of reservoir water quality can be accomplished is by beginning with an accurate prediction of the temporal and spatial variation of water temperature that will exist within the impoundment. The following discussion will present approaches to the thermal simulation problem that have been used by the Corps of Engineers, and suggest some possible improvements to the techniques now in use.

RESERVOIR HEAT BUDGET

The prediction of temperature variations within an impoundment is a very complex problem. Heat may be added to a reservoir by inflows, removed from the reservoir by outflows and either gained or lost by heat transfer at the air-water interface. Some heat transfer may also occur across the solid boundaries, but generally this may be neglected based on order of magnitude arguments. The distribution of heat within the impoundment is affected by horizontal and vertical advection and diffusion processes. The dominant factors in the development and variation of the thermal structure of a reservoir may be any combination of these mechanisms. Without a knowledge of the effect of each mechanism on the thermal regime of the particular reservoir under study, it is difficult to eliminate any of the potential heat sources from consideration.

¹Chief - Hydraulics Section, Philadelphia District

In a study of reservoir temperatures the interest is primarily directed to temperature variations along the vertical axis. The one dimensional partial differential equation for conservation of heat along the vertical axis of the reservoir may be written as follows:

$$\frac{\partial T}{\partial t} + \frac{\partial (V(z) \cdot T)}{\partial z} = K \frac{\partial^2 T}{\partial z^2} + T_{in} \cdot V_i(z) - T_{out} \cdot V_o(z) + \frac{\partial H}{\partial z} \quad (1)$$

where: T is temperature in °F
 t is time in SEC
 z is depth in FT
 V(z) is vertical velocity in FT/SEC
 K is the diffusion coefficient in FT²/SEC
 V_i(z) is velocity of inflow in FT/SEC
 V_o(z) is velocity of outflow in FT/SEC
 and $\frac{\partial H}{\partial z}$ is an external heat source term

With the exception of the external heat source term all the terms of equation (1) are self-explanatory. The external heat source term is made up of the seven heat exchange processes which operate at the air-water interface and may be written as:

$$H_n = H_s - H_{sr} + H_a - H_{ar} \pm H_c - H_{br} - H_e \quad (2)$$

where: H_n is the net heat transfer
 H_s is the short wave solar radiation arriving at the water surface
 H_{sr} is the reflected short wave radiation
 H_a is the long wave atmospheric radiation
 H_{ar} is the reflected long wave radiation
 H_c is the heat transfer due to conduction
 H_{br} is the back radiation from the water surface
 and H_e is the heat loss due to evaporation
 All the heat exchange processes are in units of BTU/FT²/TIME.

Complete discussions of the individual terms are presented by Anderson (1) and in Tennessee Valley Authority report No. 14 (12). All of the heat transfer mechanisms at the water surface, with the exception of short wave solar radiation, affect only the top one or two feet of the reservoir. Short wave radiation, however, penetrates the water surface and may affect water temperatures at great depths. This depth of penetration varies from reservoir to reservoir and is a function of absorption and scattering properties of the water (8).

Analytical solutions of equation (1) have been accomplished, but their practical application is restricted by the number of assumptions necessary to effect the solution. Numerical methods are considered to be the only means by which a workable solution

to equation (1) may be obtained. Approximations of equation (1) have also been utilized with varying success to obtain predictions of reservoir temperature variations. Both approximate and numerical solutions are accomplished by beginning from a known or assumed condition and stepping forward in time using constant increments for hydrologic and meteorologic input.

PLANNING REQUIREMENTS

The ideal approach to temperature prediction would be to evaluate the effects of temperature on project objectives over the life of the project. Long term variations in temperature and project capabilities to perform adequately under predicted conditions have been studied using techniques based on mean monthly hydrologic and meteorologic data. Theoretical justification for the methods employed, however, has generally been deficient. Also, it is not clear what meaning monthly temperature predictions have with respect to project operations. Certainly a reservoir is not operated on a monthly basis. Perhaps a monthly approach could be used to isolate periods of critical hydrologic and meteorologic combinations. These periods could then be studied using mean daily or shorter time intervals. It is extremely important that project operations be evaluated for short time intervals because of the large range of temperature that may occur over a period as long as a month (8). The diurnal fluctuation of surface temperature alone may be as much as 5°F while over the course of a month 15° fluctuations are not uncommon.

Whatever technique is chosen for analysis of reservoir temperature, it is important that all of the physical and meteorological heat exchange processes are included, so that the overall heat balance of the reservoir is assured. A sound theoretical approach based on the conservation of heat equation will insure this. The simulation should provide a realistic assessment of the interrelationship between project operations and the thermal variation within the reservoir. The use of input data which cannot be measured "in situ" should be kept to a minimum in order to insure that possible bias in results is eliminated. Finally, application should be straightforward and follow standard accepted procedures in order to provide confidence and guarantee uniformity in results.

AVAILABLE TECHNIQUES

One approach that has been utilized by various Corps offices to evaluate variations in water temperatures at reservoir projects is a model developed by Wunderlich and Elder (13) for the Tennessee Valley Authority. The TVA model is founded on the assumption that the most important factors influencing the thermal structure of an impoundment are the quantity, distribution and temperature of

inflows and the schedule of regulation. A depth of epilimnion is estimated and this water is assumed to be effectively insulated from the hypolimnium. Internal heat transfer by diffusion processes is neglected. Application of the method is straightforward and is discussed in the reference above. Although this method has been successful in certain cases, its general use is prohibited due to the restrictive assumptions upon which it is based.

Another attempt at studying temperature variations has been developed by the Hydrologic Engineering Center (2). The HEC model considers a "simplified" heat budget and weights each of the terms by use of empirically determined coefficients. The model reflects the heat exchange resulting from the inflow-outflow relationship, diffusion, short wave solar radiation, evaporation, and a combination of long wave radiation and conduction. Heat transfer at the air-water interface is assumed to affect the top 10 meters of the reservoir. The reservoir is divided into horizontal layers of uniform temperature and a given thickness. Inflow is assumed to enter the reservoir at a layer of corresponding temperature adjusted for mixing with layers above while it descends. Outflow is assumed to be drawn from the layer at the bottom of the outlet.

Application of the model is accomplished through use of a computer program prepared by HEC. Generalized coefficients to weight the various heat exchange processes have been developed for use in pre-impoundment studies. Input data basically consists of the physical parameters of the reservoir and outlet facilities, mean monthly inflows and outflows, inflow temperatures, target release temperatures and required meteorological data. A uniform temperature may be assumed at the beginning of computation and a monthly stepwise simulation of temperature variations is then carried out.

Analyses that have been carried out utilizing short time steps have been based on a more theoretical approach. One such model was developed by Orlob and Selna (10) of Water Resources Engineers Inc.(WRE) and has been successfully used in pre-impoundment studies by the North Pacific Division(NPD), Ohio River Division (ORD), and the Philadelphia District (NAP). The model is based on the one-dimensional conservation of heat equation and computes the variation in vertical temperature distribution of a reservoir as a result of heat exchanges due to inflows, outflows, the seven mechanisms of heat transfer at the air-water interface and internal heat transfer processes.

Input requirements to the model are quite voluminous, although data preparation is straightforward. For example, application of the model using three hourly time steps requires mean daily values of inflows, outflows, inflow temperatures and objective temperatures

and three hourly values of pertinent meteorologic variables. Physical characteristics of the reservoir and outlet works facilities are also required. The final and most difficult input consideration is the estimate of the "effective diffusion" coefficient. Suggestions for evaluation of the diffusion coefficient are presented in a discussion of the computer application of the WRE model prepared by the North Pacific Division (9). Assistance in application of the model may be obtained through NPD or ORD.

IMPROVEMENT OF TECHNIQUES

The above methods have been offered as approaches to the temperature simulation problem. However, they tend to be difficult to apply during pre-impoundment studies due to their dependence on variables which cannot be measured or computed from measured data. The HEC approach utilizes empirical coefficients which cannot be accurately determined, except where measured temperature data for the reservoir under study are available. The "effective diffusion" coefficient used in the WRE model to describe the internal heat transfer process also presents the same problem. In addition, both the HEC and WRE models do not adequately consider the hydrodynamics of the reservoir with regard to withdrawal characteristics of the outlet. The remainder of this discussion will present suggestions by which available methods may be improved and also describe another approach developed by the Philadelphia District for application in pre-impoundment studies.

One of the more difficult aspects of the temperature prediction problem has been an accurate description of the heat transfer at the air-water interface. The need to determine all seven of the heat exchange mechanisms acting between the atmosphere and water has led many investigators, except when using large mathematical models, to neglect some of the heat exchange processes. Even in more sophisticated approaches the quantity of heat transfer due to those mechanisms which are dependent on surface water temperature has been computed based on surface temperature existing at the end of the previous time step. A procedure that would allow consideration of the variation in surface temperature over the selected time interval would be a great improvement.

An approach to the evaluation of net heat transfer at the air-water interface has been proposed by Edinger and Geyer (6). Their method utilizes the concepts of equilibrium temperature and coefficient of surface heat exchange. The equilibrium temperature may be defined as that water temperature at which the net rate of heat exchange between a water surface and the atmosphere will be zero. The coefficient of surface heat exchange is the rate at which the heat transfer process will proceed. The equation to describe this relationship may be written as follows:

$$H_n = K(E - T_s) \quad (3)$$

where: H_n is the net rate of heat transfer in BTU/FT²/Time
 K is the coefficient of surface heat exchange in BTU/FT²/Time
 E is the equilibrium temperature in °F
and T_s is the surface temperature in °F

Computation of E's and K's is dependent solely on meteorological variables and is outlined in the literature (5). Since all seven heat exchange mechanisms are included in the computation of E and K, an exact heat budget is retained.

A cursory examination of equation (3) shows that the net rate of heat exchange is a function of the exchange coefficient and the difference between equilibrium and water surface temperatures. Approaches which relate heat transfer to air temperature do not account for this principle. Equilibrium temperature is constantly changing in response to changes in meteorological conditions. Water temperature at the same time is being driven toward the equilibrium temperature.

It is suggested that incorporation of the concepts of equation (3) into the temperature prediction methods described in the previous section will materially improve the theoretical basis for the models. If these concepts are utilized in the HEC model, the empirical coefficients which are needed to describe the effects of air-water heat transfer could be eliminated. Also, all the heat exchange mechanisms at the air-water interface would be included in the computations. In models similar to the WRE model, utilization of equation (3) would allow a simultaneous determination of interfacial heat transfer within the framework of the numerical solution of the conservation of heat equation.

Another important aspect of air-water heat transfer is the internal heating effects of the incoming solar radiation. Using laboratory and analytical studies, Dake and Harleman (4) have developed an equation to describe the distribution of heat input due to solar radiation penetration below the water surface. Their approach is based on a surface absorption of the shorter wave lengths of radiation and an exponential decay with depth for the remaining wave lengths of radiation. The equation to describe this exponential decay is:

$$\Phi(z) = (1 - \beta) \Phi_0 e^{-\lambda z} \quad (4)$$

where: $\Phi(z)$ is the quantity of radiation arriving at a horizontal plane (z feet below the water surface) in BTU
 B is the fraction of radiation absorbed by the top foot of water in the reservoir.
 Φ_0 is total incoming radiation in BTU
 λ is the average absorption coefficient of the water in FT^{-1}
and z is depth below the water surface in FT

It is hypothesized by Harleman, based on simulation of measured field data, that the phenomenon described by equation (4) has a greater influence on the internal heat distribution of an impoundment than diffusion processes. Sonnichsen and Oster (11) also arrived at basically the same conclusion in their studies of Pend Oreill Lake in northwestern Idaho. If an approach such as this is accepted, the difficulty of describing "a priori" the variation in the diffusion term of equation (1) is eliminated and the diffusional transport of heat may be assumed to be caused entirely by molecular diffusion. It should be noted that the conservation of heat for the impoundment is not violated in any respect by this theory.

It is easy to see the advantages of utilizing a theory such as this in planning studies. If used in the HEC model, the coefficient to weight the diffusion mechanism may be disregarded. In the WRE model the judgement decisions surrounding selection of the "effective diffusion" coefficient will not be required. The absorption coefficient, which is easier to estimate due to its dependence on physical characteristics of the impounded water, can carry the major burden of prediction of the internal temperature distribution of the reservoir.

The final consideration deals with the hydrodynamics of the reservoir associated with the withdrawal of water for downstream releases. The Office of the Chief of Engineers has recommended the use of TR-H-69-10 and TR-H-71-4 published by the Waterways Experiment Station (3,7) for computations of selective withdrawal characteristics for submerged orifices and weirs, respectively. None of the models previously discussed uses these techniques. The methods, developed through laboratory studies and verified to some extent by field data, are considered to be the best available approaches to describe withdrawal characteristics. Preimpoundment studies have been conducted to date by taking the temperature profile output and applying the WES methods to determine withdrawal characteristics. This is not a wholly acceptable approach, however, because the development of the temperature profile itself is dependent on withdrawal characteristics of the outlets. A temperature prediction model that would utilize the WES methods would alleviate the need to study thermodynamic and hydrodynamic factors

separately. It should be recognized, however, that combining these two considerations would only be meaningful in a model that uses short time steps.

The suggested improvements outlined above have been utilized by the Philadelphia District in the development of a mathematical model based on conservation of heat principles. The model uses numerical techniques to solve the conservation of heat equation and considers all the heat exchange processes included in the overall heat budget. Verification of the model is presently nearing completion. Confirmation of the mathematical techniques has been made and presently the model sensitivity to variations in input parameters is being studied. The model will be used in a cooperative study between ORD and NAP this spring to develop techniques for predicting the temperature variations in shallow impoundments. Application of the model is in two phases with the first part setting up the meteorological data and the second part performing the actual simulation. The model was structured in this manner so that equilibrium temperatures and coefficients of surface heat exchange which are output in the first phase could be used in other applications, such as power plant siting and stream temperature prediction problems.

CONCLUSION

A review of reservoir temperature prediction methods has been made with an eye toward suggesting possible techniques by which application of the models might be facilitated. It is felt that the suggested techniques, if incorporated in these models, will greatly improve the theoretical basis for the methods discussed. The suggested improvements have been utilized by the Philadelphia District, and their general applicability to reservoir temperature prediction problems has been established.

REFERENCES

1. Anderson, E. R., Energy budget studies, "Water Loss Investigations: Lake Hefner Studies", Tech Rept., Proj. Paper 269, Geol. Survey, U.S. Dept. of Interior, Washington, D.C., 1954.
2. Beard, L. R., and Willey, R. G., "An Approach to Reservoir Temperature Analysis", Tech. Paper No. 21, Hydrologic Engineering Research Center, Corps of Engineers, Davis, California, 1970.
3. Bohan, J. P. and Grace, J.L., "Mechanics of Flow from Stratified Reservoirs in the Interest of Water Quality", Technical Report H-69-10, U.S. Army Engineer Waterways Experiment Station, Corps of Engineers, Vicksburg, Miss. July 1969.
4. Dake, J.M.K. and Harleman, D.R.F., "An Analytical and Experimental Investigation of Thermal Stratification in Lakes and Ponds", Hydrodynamics Laboratory Rept. No. 99, Mass. Inst. of Technology, Cambridge, Mass. Sept. 1966.
5. Edinger, J.E., Dutweiler, D. W. and Geyer, J. C., "The Response of Water Temperatures to Meteorologic Conditions" Journal of Water Resources Research, Vol. 4, No. 5, October 1968, pp 1137 - 1143.
6. Edinger, J. E. and Geyer, J. C., "Heat Exchange in the Environment", Dept. of Sanitary Engineering and Water Resources, Research Project No. 49, The Johns Hopkins University, Baltimore, Maryland, June 1, 1965.
7. Grace, J. L., "Selective Withdrawal Characteristics of Weirs", Tech. Report H-71-4, U.S. Army Waterways Experiment Station, Corps of Engineers, Vicksburg, Miss. June 1971.
8. Hutchinson, G.E. "A Treatise on Limnology", Volume I, Geography, Physics and Chemistry, John Wiley and Sons, Inc., New York, 1957.
9. North Pacific Division, Corps of Engineers, "Application of WRE Reservoir Temperature Simulation Model", Portland, Oregon, September 1970.
10. Orlob, G. T. and Selna, L. G., "Prediction of Thermal Energy Distributions in Deep Reservoirs", Proceedings, 6th Annual Sanitary and Water Resources Engineering Conference, Vanderbilt University, 1967.
11. Sonnichsen, J. C. and Oster, C. A., "Examination of the Thermocline", Journal of the Sanitary Engineering Division, ASCE, Vol. 96, No. SA2, Proc. Paper 7219, April 1970, pp 353 - 364.
12. Tennessee Valley Authority, Division of Water Control Planning, Engineering Laboratory, "Heat and Mass Transfer Between a Water Surface and the Atmosphere", Water Resources Research, Lab. Rept. No. 14, Norris, Tennessee, July 1967, rev. May 1970.
13. Wunderlich, W. O. and Elder, R. A., "The Influence of Reservoir Hydrodynamics on Water Quality", Proceedings, 6th Annual Sanitary and Water Resources Engineering Conference, Vanderbilt University, 1967.

AN EVALUATION OF RESERVOIR TEMPERATURE
PREDICTION METHODS

Comment, Mr. Fredrich: (In reply to Harrison's comment on generation of synthetic meteorologic data.) I'm not sure that the development of logical relationships among the variables is as simple as you imply and the development of these relationships is mandatory for reasonable generation of interrelated data sets.

Question, Mr. Fredrich: Do you intend to run your model with long time-steps (months) or short time-steps (days or less)?

Reply, Mr. Eiker: Short time-steps.

Question, Mr. Fredrich: Then how do you intend to account for the long-term-operation-policy influences on your temperature profiles?

Reply, Mr. Eiker: As indicated in the paper, some thought should be given to studying long term operations based on a monthly simulation technique (i.e., the HEC model). I must emphasize again, however, that critical shorter time periods and their effects on project performance must also be studied. This approach would be similar to the manner in which flood control and power studies are now made.

Question, Mr. Thomas: Do you feel that, in shallow reservoirs, reservoir recreation has any effect on temperature, either by warming or mixing. If it does have an effect, how is it accounted for in the model?

Reply, Mr. Eiker: Reservoir recreation, particularly that related to motorboats, would have an effect on mixing in the epilimnion. The timing and degree of this effect is impossible to predict. In the models discussed today that are based on numerical solution schemes this process along with wind induced mixing is handled in an indirect manner. A mechanism which has been termed "convective mixing" is assumed to operate within the surface layers of the reservoir. This mechanism accounts for the fact that any surface disturbance whether natural or man-induced, will cause mixing down into the reservoir. The depth of this forced mixing is computed based on stability considerations within the impoundment.

Question, Mr. Gaum: Can we assume that outflow is drawn from the layer at the bottom of the outlet? What does outflow network look like and what are relative temperatures drawn from different levels through the selected outlet?

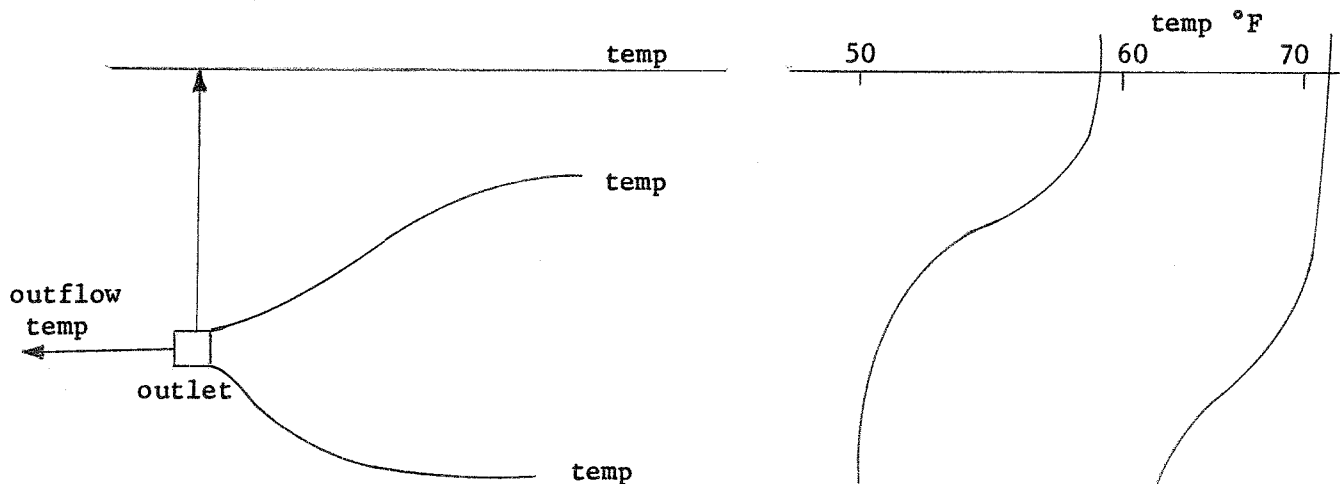

Typical for 2 Sample Situation

Reply, Mr. Eiker: The question pertains to one of the assumptions upon which the HEC model is based. This is not a valid assumption in describing the hydrodynamics associated with reservoir withdrawal. However, it must be recognized that errors resulting from this assumption tend to be balanced out by vertical advection and diffusion terms when using monthly time steps. The outflow distribution actually would spread over several vertical layers in the reservoir. The quantity of outflow per layer is dependent on density differences and may best be analyzed by methods found in Technical Report H-63-10 as discussed in the paper.

OPPORTUNITIES FOR HYDROLOGIC-ECONOMIC MODELS
A CASE STUDY

By

1
William Boedt, Gerald C. Johnston, and Billy J. Thomas

2

3

WILLAMETTE BASIN COMPREHENSIVE STUDY

This paper will discuss, as a case study, various aspects of the Willamette Basin Comprehensive Study. That study was initiated in 1963 under the direction of a Task Force made up of representatives of the State of Oregon; the U. S. Departments of Agriculture, Army, Commerce, Interior, Labor, and Health, Education & Welfare; and the Federal Power Commission. The Task Force assignment was to develop a plan to meet early-action and long-range water resource needs. That plan was to be an expansion of the basin plan which had been evolving in the area since the 1930's. Further, that plan was to include projects and programs and to provide specific service in all functional fields currently recognized by Congress and where needs were known to exist.

This was an inter-agency multidisciplinary study; over 30 state and Federal agencies participated in its preparation. The study objective was to formulate, for the basin, a plan for water and related land resource use and development which would utilize available resources to meet current, intermediate, and long-range needs. The plan would provide, consistent with private development and to a degree directed by judgment and economic considerations, for control, conservation, and use of the water and related land resources of the basin in the interests of the well-being of the people of the basin and the State.

Only the Senate Document 97 statement of three primary national objectives was available when the Willamette study was initiated. The Task Force recognized that complete attainment of the development and preservation objectives probably would not be possible. Development and preservation considerations often present a need for reasoned choice; the well-being of people may be a deciding factor in such cases. However, it was recognized that other considerations might be pertinent, and that more detailed expressions of goals and objectives were needed to guide the planning effort.

- 1 Regional Economist, Corps of Engineers, Portland District
- 2 Civil Engineer, Corps of Engineers, Portland District
- 3 Asst. Chief, Hydrologic Engineering Section, C.O.E., North Pacific Division

To provide that guidance and facilitate best use of resources for the well-being of people, the Task Force early established five broad goals. Listed without order of priority, those goals are:

a. Economic growth. - To insure economic growth and production consistent with efficient allocation of resources.

b. Conservation. - To conserve land and natural resources, and to preserve and/or enhance their potential for use.

c. Environment. - To maintain a pleasant place for people to live.

d. Health and safety. - To provide for the health and safety of human and animal life.

e. Leisure. - To increase the choice of leisure time activity consistent with people's desires.

Willamette River Basin is a rectangular drainage trough 150 miles long and about 75 miles wide lying between the Cascade and Coast Ranges in northwestern Oregon. The Willamette (including Sandy River Basin because of its importance for water supply to the Portland metropolitan area) drainage comprises about 12,000 square miles, which is approximately 12 percent of Oregon's total land area. The basin's population accounts for nearly two-thirds of the State total.

The basin has a moderate marine climate with relatively wet winters and dry summers (see Map 1). Average yearly precipitation is about 63 inches, with local precipitation varying from about 40 inches along the valley floor and increasing to 130 inches on the Cascade slopes. Its climate reflects influences of the Pacific Ocean, the Coast Range, the Cascade Range, and the Columbia River Gorge (see Map 2). Larger air masses from the Pacific Ocean bring vast amounts of moisture to the basin, but the Coast Range diminishes violent storms and intercepts considerable precipitation (up to 200 inches annually near the crest) before these air masses reach the basin. The Cascade Range, which is much higher than the Coast Range, again lifts the air masses, causing considerable precipitation on the east side of the basin. That range also blocks large continental air masses which would otherwise move into the basin from the north and east, thus decreasing the possibility for extremes of hot and cold that are prevalent to the east. The Columbia River Gorge functions as a drain which may allow dense air to flow into the basin from the west in late summer afternoons, thus moderating the hot summer days. The gorge also drains the cold, dry continental air from the east into the basin in the winter, causing colder weather in the basin than would otherwise have occurred. There is a constant movement of air in the immediate gorge area with resulting temperature extremes.

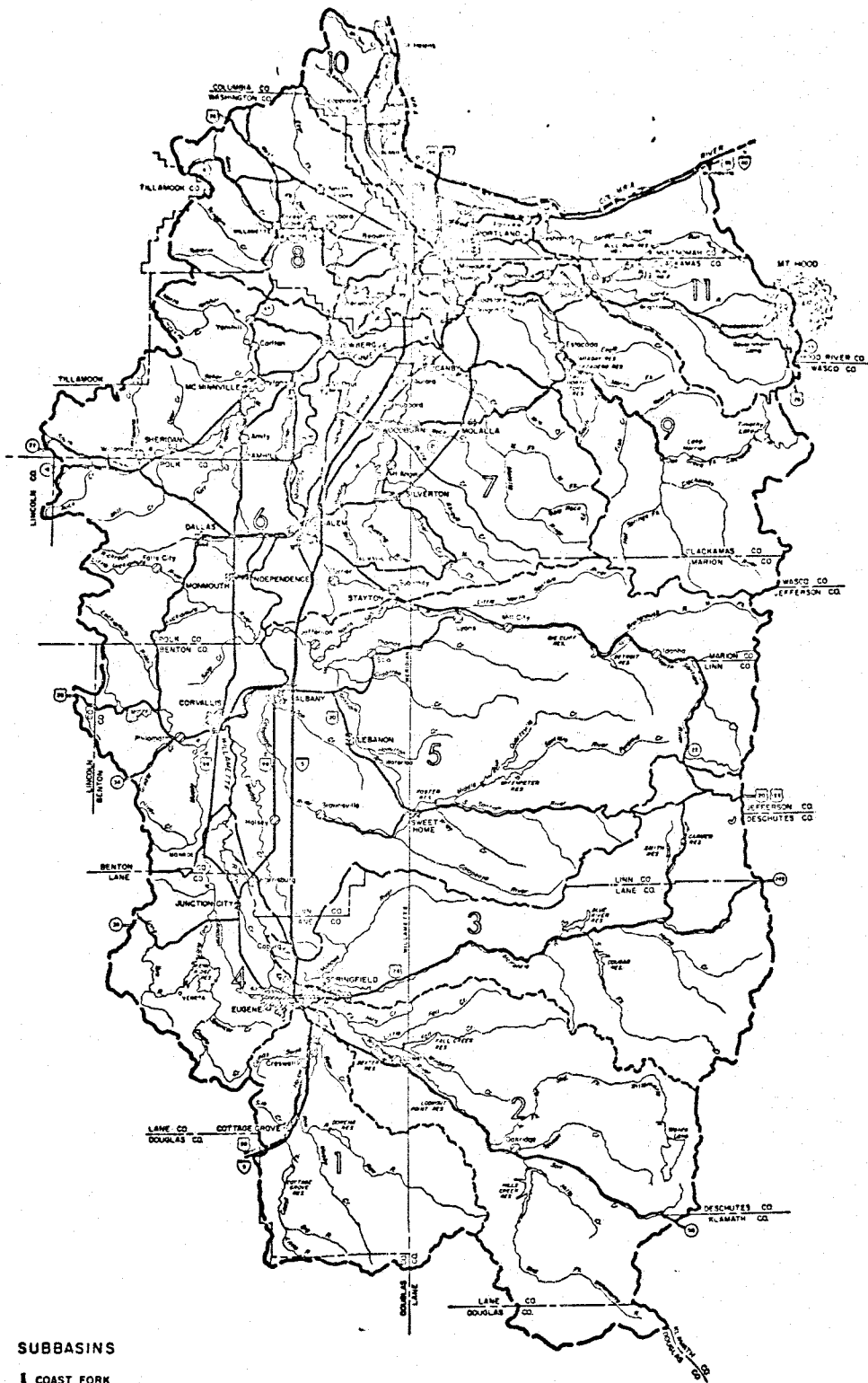

SUBBASINS

- 1 COAST FORK
- 2 MIDDLE FORK
- 3 MCKENZIE
- 4 LONG TOM
- 5 SANTIAM
- 6 COAST RANGE
- 7 PUDDING
- 8 TUALATIN
- 9 CLACKAMAS
- 10 COLUMBIA
- 11 SANDY

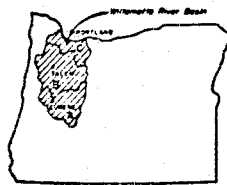

LOCATION MAP

- SUBAREAS**
 A UPPER
 B MIDDLE
 C LOWER

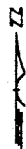

**WILLAMETTE RIVER BASIN
 OREGON**



Map 1

8196

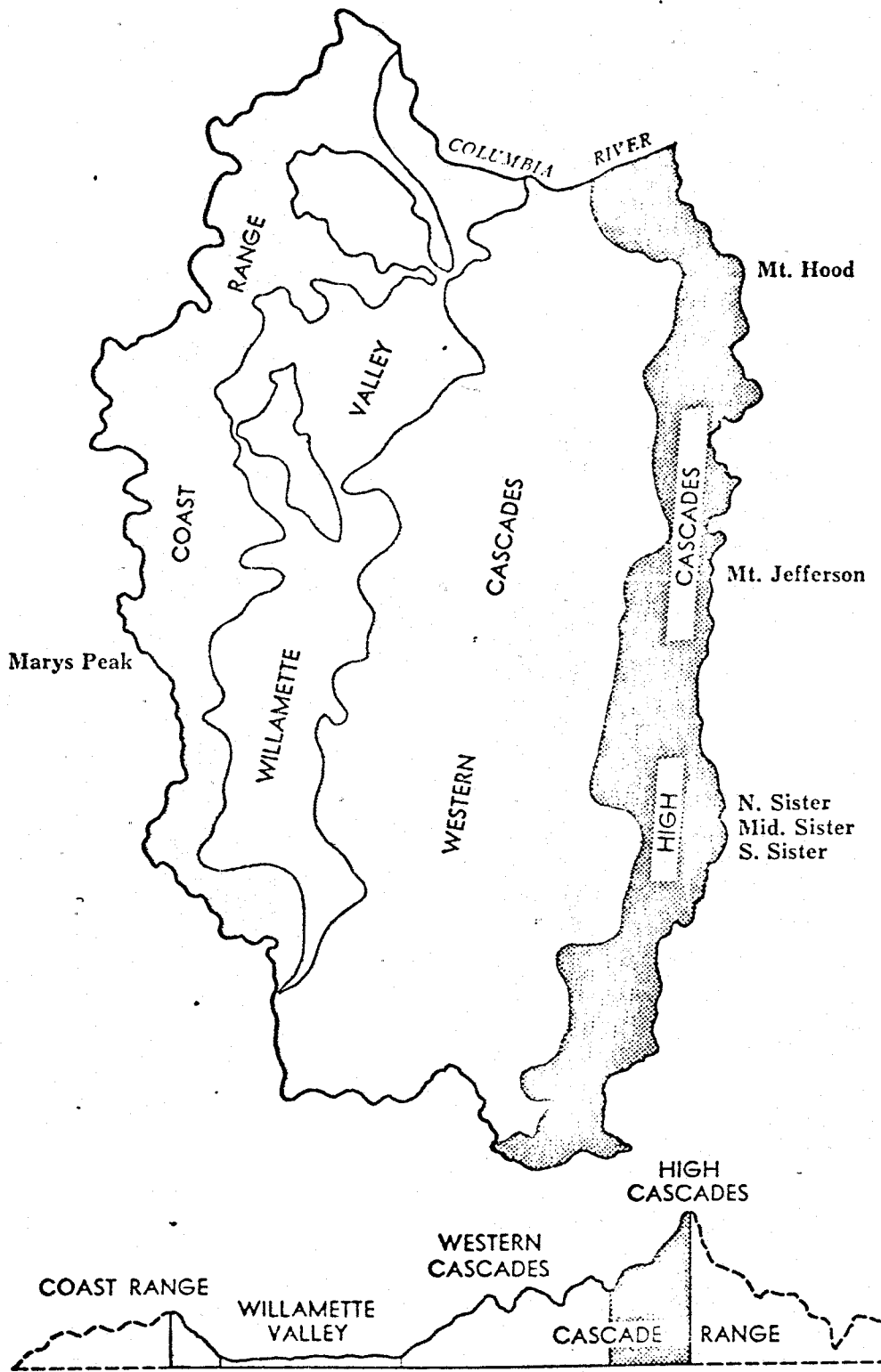

Physiographic units.

Map 2

The upper slopes of Willamette Basin are heavily timbered. Below these are rolling foothills used predominantly for forestry with significant portions of range and pastured forest land. Below the foothill transition area lies the valley floor. This area, which includes the largest block of humid-climate arable land in the Pacific Northwest, includes cultivated croplands, improved pasture, and the urban complexes of Portland, Salem, Albany, Corvallis, Springfield, and Eugene, as well as smaller communities.

Population estimates indicated that by the year 2020 the basin's population would more than triple (somewhat faster than for the State and the Nation); thus, the need for water control and for water and related land resource development would greatly increase. Although much has been done, serious problems of flood control and water conservation remain unsolved. Major existing projects and project authorizations do not include specific provisions for the potential new primary project functions of fish and wildlife enhancement, water supply, water quality control, and recreation.

There are many opportunities for resource development. Serious flooding on the larger streams and main stem has occurred as recently as January 1972; many smaller streams flood annually. There is substantial interest in additional irrigation development. A number of areas require drainage and erosion control. A need and an opportunity exist for enhancement of the extensive anadromous fish resource. Future municipal and industrial water supply needs will require additional storage. Serious water pollution problems exist and are projected to continue even with high levels of treatment at the waste sources; thus, additional streamflow will be required to assist in water quality control. The growing population will create an increased demand for recreational facilities. Present in-basin power development does not meet basin needs; however, power supply is based on optimum use of regional power resources whether within or outside the basin. Also, there may be a need for increased navigation development on the Willamette River. In summary, the rapidly expanding population will bring the full range of water and related land resource problems and needs in increasing intensity.

The Task Force study evaluated present and projected future needs for population, land base, flood control, irrigation, power, navigation, fish and wildlife, recreation, water supply, and water quality control. It resulted in a framework plan as a guide to the nature and timing of continuing development, both immediate and long range, consistent with recognized need to maintain a desirable environment for present and future populations.

DESCRIPTION OF HYDROLOGIC MODELS USED

A. Hydrology of study. - At the start of the Willamette Basin Review Study, it was apparent that great amounts of hydrologic data would have to be analyzed. There would be regulation of the existing reservoir system under several alternatives. Several different reservoir systems, reservoir sizes, and plans of operation would be projected. Realizing that we had a monumental task, we decided to seek labor-saving methods. We sought the advice of Mr. Beard of the then newly established Hydrologic Engineering Center (HEC). The Center was in the process of writing a computer program to analyze a reservoir system for another district; due to the degree of development already present in Willamette Basin, the Willamette promised to be an excellent test basin. Thus, the Reservoir System Program was adopted for use in the Willamette Study. The study period investigated was the 40-year period from 1926 to 1965 inclusive. That period was selected mainly because it was when most stations had recorded data and because much of the recorded period occurred prior to significant stream-flow modification by Willamette Basin reservoirs or by basin development. Also, that period was particularly significant for the study because it contained not only the lowest year of record (1943) but also because it contained the lowest consecutive five-year period of record (1931-1935). It was felt that these two low periods would give us a good feel for our capabilities to refill reservoirs and to meet low flow requirements during drought periods.

The period of study and the model to be used for the study were primary considerations; the hard part was yet to come -- that of collecting the data and actually doing the study.

Data had to be collected for all control points, diversion points, and reservoirs in the system; program requirements dictated that data be for natural (pre-project) conditions. In order to derive natural flow data from the recorded data, we had to remove all regulation that had taken place and we had to put back into the streamflows all of the irrigation withdrawals on a year-by-year basis. Reservoir regulation was Corps business but for the irrigation we looked to either the Bureau of Reclamation or the Oregon State Engineers Office.

B. Operation of program. - The Reservoir System Analysis (HEC-3) program is described fully in the HEC user manual. 1/ The description included here sets the stage for the study. HEC-3 is a multireservoir computer program which performs a monthly routing while operating to satisfy downstream control points. The program is written in such a manner as to allow the user to specify monthly reservoir operation rule curves, downstream flow needs, and diversions. The program will account

for evaporation from reservoirs; it will indicate hydropower generation and will calculate local flows into reservoirs and control points. Considering all of these parameters, the program will operate to supply specified water requirements at downstream points. It supplies these downstream requirements in an upstream to downstream order; therefore, the critical points may occur anywhere in the system.

The input data required to perform a system operation are system configuration, natural flows, diversion flows, minimum desired and/or required flows for all control points. For reservoirs, data requirements (in addition to the data required for control points) include power generation data, evaporation data, operating levels (rule curves) and storage-area capacity.

Only two of the above parameters are nonstandard, as far as normal terminology is concerned, and need additional explanation; they are reservoir levels and diversion flows. Reservoir levels are specified up to seven levels per month. The seven levels have no restrictions except that levels 7 and 1 are maximum and minimum pools, respectively. Level 2 is referred to as a buffer level, a level below which storage will not be evacuated except to meet specified power generation. If the reservoir is not a power reservoir, then level 2 has no meaning and should be set equal to level 1. The specification of the intermediate levels, though they have no specific meaning alone, will determine the operation of that reservoir with respect to the rest of the system. The program is written so all of the reservoirs will be drafted to the same relative level at the end of each complete period. In other words, the program will try to have all reservoirs at the same relative level, say 2.3, at the end of a particular period. Therefore, the storage space in each level will determine the amount of storage that is evacuated or stored in any one project during any period.

The other parameter that might be considered as nonstandard is diversion flow. Diversion flow is in reality a net diversion, or the total amount of water diverted from the system less that amount that is returned to the system. This net diversion is only for that part of the system between the point in question and the next point upstream.

C. Results. - The simulation studies produced, for each control point, information on flows and diversion supplied, shortages, inflow to points, and local and unregulated flows for each point. For reservoirs, in addition to the values presented for control point, printouts also include evaporation, end of period storage and elevation, power generated and power that could have been generated, if any (see Chart 1 for example of printout). In addition to monthly printouts with all the above data shown by years, it is possible to obtain summaries of particular elements such as flows or shortages or pool elevations or just reservoir data; these

48 ALBANY

SERVED BY 13 14 10 11 24 12 15 16 18
 LOCAL DIVERSICNS 42 41 43 44 45 46 48

YR	1930	AVG	JULY 1-15AUG	16-31AUG	SEPT	OCT	NOV	DEC	JAN	FEB	MAR 1-15APR	16-30APR	MAY	JUN
LOC FLW	4529	1637	1620	1366	1313	1425	2761	3613	6048	5064	8430	23465	3576	3345
UNRFG	7601	3052	2485	2159	2153	2461	5194	6350	5967	8279	17557	38200	6231	5043
INFLOW	7514	4868	4440	4381	3625	4656	8664	6405	10000	6985	10877	28761	5156	5502
PEQ CIV	63.3	661.0	256.0	272.0	-36.0	-159.0	-142.0	-107.0	-79.0	-56.0	0.0	3.0	73.0	363.0
DIVERPSN	35.1	406.3	157.4	167.2	-36.0	-159.0	-142.0	-107.0	-79.0	-56.0	0.0	3.0	73.0	343.0
SHCRTGE	23.1	254.7	58.6	104.8	0.0	0.0	0.0	0.0	0.0	0.0	0.0	0.0	0.0	35.0
RIV FLW	7479	4462	4282	4213	3661	4815	8806	6512	10077	7041	10877	28758	5093	5154
DES FLW	4151	5000	5000	5000	5000	5000	5000	0.	0.	5000	5000	5000	5000	5000
SHCRTGE	225	538	719	787	1339	185	0.	0.	0.	0.	0.	0.	0.	0.

20 CASCADIA RES

SERVED BY 20 22 39 49 50 51
 SERVING

YR	1930	AVG	JULY 1-15AUG	16-31AUG	SEPT	OCT	NOV	DEC	JAN	FEB	MAR 1-15APR	16-30APR	MAY	JUN
LOC FLW	95	58	58	42	50	100	425	340	645	385	1370	2300	260	215
UNRFG	446	58	58	42	50	100	425	340	645	385	1370	2300	260	215
INFLOW	446	58	58	42	50	100	425	340	645	385	1370	2300	260	215
POP STR	126683	120761	113902	113902	91409	42000	15000	15000	15000	19721	85513	124000	127601	117555
POP FL	826.73	826.31	822.34	805.95	753.61	707.00	707.00	707.00	707.00	716.40	801.46	822.22	830.26	824.46
EVAP0	3253	324	313	383	120	120	0.	0.	0.	0.	0.	131	493	559
PEQ KW	0	0	0	0	0	0	0	0	0	0	0	0	0	0
GEN KW	5247	3898	3654	3634	5932	10864	7344	2210	4192	2055	3276	14196	4612	5544
SHCRTGE	0	0	0	0	0	0	0	0	0	0	0	0	0	0
PEAK KW	99999	95999	99999	99999	99999	99999	99999	99999	99999	99999	99999	99999	99999	99999
CASE	3901	5001	5001	5001	5001	2003	2003	2003	2003	2001	2001	2003	3901	3901
LEVEL	2.77	2.73	2.68	2.92	3.00	3.00	6.00	1.00	1.00	2.08	2.76	3.00	2.78	2.71
CSV REL	231	246	248	248	422	177	100	0	0	300	300	300	307	374
PTV FLW	469	246	248	248	422	902	879	340	645	300	300	1002	307	374
DES FLW	165	100	100	100	100	100	100	0	0	300	300	300	300	300
SHCRTGE	0	0	0	0	0	0	0	0	0	0	0	0	0	0

CHART 1

849%

summaries proved to be invaluable for use in analyzing results of the various configurations. Charts 2 and 3 show types of summaries available.

Studies were made on the existing system under the three levels of development (1980, 2000, and 2020). This was the basis for all comparisons which were to be made throughout the remainder of the study. We also considered two new systems of reservoirs: (1) a system which added projects considered to be underway within the next 10-15 years, called "Early Action Reservoirs," and (2) a system which includes all of the above plus 37 reservoirs proposed to meet long-range basin needs.

With so many projects to incorporate into the study, we exceeded program and computer limits; accordingly, the basin was separated into parts. This was accomplished by taking a subbasin (such as the Santiam) out of the study and operating it as a separate system, and then taking the resultant flows from this subsystem as input to the basin model, and similarly for other subbasins.

After deriving the natural flows for all points of interest in the basin, we then began the task of performing system regulation studies with various reservoirs and for various levels of development. The purpose of these studies was to determine which demands the system could meet with various configurations and operation schemes. An example of the kind of question we wanted to answer follows.

At Salem on the Willamette River the Corps of Engineers projects, are among other things, dedicated to maintaining a flow of 6,000 cfs to provide navigation depths. Observed flows for some early years, and consequently the natural flows, at Salem were below the 6,000 cfs figure; at times, the mean monthly flows had been as low as 1,200 cfs. Though these low flows had occurred prior to present regulation we were asked, "If we had the present system of reservoirs and present demands for water during those low flow years, could we have still met the navigation requirement?" We set the system up using the Reservoir System Program, specified present water demands on the system, and allowed the program to perform a regulation on the entire 40-year period. Results showed that for those same periods, when natural flows had been down to as low as 1,200 cfs, with only the present reservoir system in operation, we were able to meet our minimum navigation flow of 6,000 cfs in all months without excessively shorting other functions. When we put in other reservoirs, as you would expect, we were able to supply all functions with ease (see chart 2).

At the conclusion of our hydrologic studies, we were able to give planners a detailed list of accomplishments that could be expected for each project in each of the systems for each time frame. These results, in the form of tabulations, formed the bases for economic analysis of benefits for the various functional parameters.

50 SALEM DIV REGULATED FLOW 1980 BASE

YEAR	JAN	FEB	MAR	APR	MAY	JUN	JUL	AUG	SEP	OCT	NOV	DEC
1926	17856.	54439.	14663.	8672.	7742.	6065.	6000.	6000.	6000.	8703.	33259.	41091.
1927	51341.	57339.	23734.	13962.	18005.	16147.	7659.	9903.	9394.	21828.	53869.	34451.
1928	47841.	16697.	27919.	39822.	16988.	6145.	6145.	7687.	7369.	10166.	16509.	19146.
1929	28341.	19454.	15626.	22114.	18239.	15385.	6674.	9270.	7651.	9928.	10592.	33146.
1930	15141.	44239.	14013.	11119.	11424.	7959.	6000.	6774.	6444.	8417.	15863.	11246.
1931	19341.	12665.	17533.	35057.	9374.	7013.	6000.	6406.	6113.	9782.	27871.	31746.
1932	46941.	19971.	52361.	29737.	24175.	16251.	8181.	10154.	7590.	11208.	32264.	33446.
1933	50241.	29905.	28775.	19392.	29857.	35423.	12248.	10785.	9877.	13100.	18469.	58856.
1934	52141.	13253.	13275.	15828.	9651.	6000.	6000.	6000.	6000.	7497.	41012.	52751.
1935	43091.	21751.	25865.	20645.	17727.	9675.	6821.	9240.	7486.	10550.	16070.	13726.
1936	80481.	22225.	20231.	17306.	21636.	11468.	7020.	9486.	7870.	9780.	10260.	10169.
1937	10571.	37719.	29143.	52188.	29597.	26743.	10379.	10755.	8530.	13418.	54864.	54196.
1938	53686.	36515.	49031.	30311.	21265.	8150.	6670.	8350.	7407.	9975.	23129.	24906.
1939	25816.	32464.	25642.	14082.	9905.	7228.	6150.	8142.	6990.	10329.	11249.	20951.
1940	21851.	45178.	35363.	16133.	10232.	6213.	6000.	6107.	6446.	7225.	25290.	28611.
1941	34371.	12790.	9208.	10292.	10652.	7286.	5689.	5787.	6424.	7308.	32850.	61791.
1942	31246.	26485.	13709.	9939.	13179.	10946.	6877.	9326.	6443.	6911.	55600.	83376.
1943	73121.	39082.	16234.	35562.	16293.	18434.	8948.	10894.	8560.	16617.	26959.	17661.
1944	19866.	19521.	14287.	18031.	10458.	6930.	6000.	6773.	6432.	6908.	14876.	9014.
1945	31468.	40354.	33280.	20673.	32551.	10511.	8032.	8325.	8048.	9016.	42363.	56836.
1946	64971.	26884.	36551.	15994.	16121.	11023.	7437.	9594.	7587.	14408.	49359.	64216.
1947	31226.	29570.	22452.	26694.	9510.	10455.	7889.	10665.	8430.	37858.	60219.	29051.
1948	63471.	22145.	28614.	25915.	27863.	16378.	8651.	11180.	9305.	14904.	32389.	60406.
1949	17851.	52454.	28378.	20585.	33740.	11683.	8229.	9236.	8228.	13478.	22064.	26966.
1950	50511.	50544.	52469.	25222.	26471.	23610.	10175.	10665.	7892.	31235.	76992.	58536.
1951	72426.	43869.	32549.	18765.	19162.	7851.	6466.	8035.	7471.	25557.	37549.	63156.
1952	37221.	42849.	27789.	25666.	21017.	12786.	11196.	10504.	8145.	9678.	12254.	16966.
1953	93605.	58830.	28594.	17654.	31191.	22918.	9909.	11406.	8887.	13825.	47124.	78781.
1954	64046.	46074.	20086.	25179.	12185.	14354.	8844.	10863.	9349.	14556.	22004.	22571.
1955	33861.	16394.	22926.	35833.	25676.	21755.	11138.	10754.	6674.	21319.	58534.	98774.
1956	61609.	50802.	39199.	25734.	27507.	18985.	10092.	11162.	8034.	16920.	28240.	44144.
1957	18271.	27910.	56739.	23826.	16651.	9066.	6897.	9997.	7756.	11842.	18402.	59929.
1958	56400.	61464.	19958.	25147.	14492.	11200.	7876.	10112.	8198.	10741.	47694.	30588.
1959	65187.	35022.	19872.	18360.	18767.	9070.	6533.	9142.	9227.	20284.	21807.	13069.
1960	12661.	34540.	42248.	37525.	36320.	14961.	8477.	9712.	8477.	11720.	54546.	30892.
1961	26589.	72098.	65877.	18116.	22031.	9659.	7239.	9304.	8296.	14562.	25671.	56657.
1962	27043.	18247.	31011.	27561.	24904.	12902.	8206.	11470.	8538.	19849.	38278.	33518.
1963	13160.	36349.	15147.	39000.	37442.	9491.	9496.	11203.	8311.	12496.	45930.	23257.
1964	71415.	20939.	23390.	15272.	17719.	20752.	9659.	11467.	8118.	10696.	27139.	95911.
1965	90078.	62369.	12463.	13095.	12359.	8353.	7272.	9459.	7032.	10050.	20783.	20390.
AVERAGE	43514.	35619.	27871.	23506.	19757.	12947.	7876.	9322.	7838.	13671.	33011.	40624.

50 SALEM DIV 2000 BASE REGULATED

YEAR	JAN	FEB	MAR	APR	MAY	JUN	JUL	AUG	SEP	OCT	NOV	DEC
1926	17875.	54425.	14555.	8871.	7600.	6000.	6000.	6000.	6000.	8748.	33200.	41031.
1927	51300.	57325.	23726.	13958.	18251.	16238.	6490.	9930.	9390.	21700.	53884.	34431.
1928	47800.	16682.	27911.	39818.	16970.	6145.	6145.	7687.	7374.	10150.	16510.	19132.
1929	28300.	19440.	15618.	22110.	17621.	12654.	6674.	9270.	7601.	9928.	10592.	33126.
1930	15100.	44225.	14009.	11115.	11407.	7957.	6000.	6700.	6400.	8400.	15860.	11240.
1931	19300.	12671.	17525.	35052.	9300.	6700.	6000.	6000.	6000.	6000.	12001.	11232.
1932	46900.	19970.	52351.	29737.	24175.	16241.	7167.	10154.	7580.	11208.	32260.	33440.
1933	50200.	29900.	28770.	19392.	29857.	35413.	12248.	10785.	9877.	13100.	18460.	58850.
1934	52100.	13243.	13270.	15828.	9650.	6000.	6000.	6000.	6000.	7497.	41010.	52741.
1935	43080.	21740.	25860.	20640.	17727.	9670.	6821.	9240.	7486.	10550.	16070.	13720.
1936	80480.	22220.	20230.	17306.	21636.	11468.	7020.	9486.	7870.	9780.	10260.	10169.
1937	10570.	37710.	29143.	52188.	29597.	26743.	10379.	10755.	8530.	13418.	54864.	54196.
1938	53680.	36510.	49030.	30310.	21265.	8150.	6670.	8350.	7407.	9975.	23129.	24900.
1939	25810.	32460.	25640.	14082.	9905.	7228.	6150.	8142.	6990.	10329.	11249.	20950.
1940	21850.	45170.	35363.	16133.	10232.	6213.	6000.	6107.	6446.	7225.	25290.	28610.
1941	34370.	12790.	9208.	10292.	10652.	7286.	5689.	5787.	6424.	7308.	32850.	61790.
1942	31240.	26485.	13709.	9939.	13179.	10946.	6877.	9326.	6443.	6911.	55600.	83376.
1943	73120.	39080.	16234.	35562.	16293.	18434.	8948.	10894.	8560.	16617.	26959.	17660.
1944	19860.	19520.	14287.	18031.	10458.	6930.	6000.	6773.	6432.	6908.	14876.	9014.
1945	31468.	40354.	33280.	20673.	32551.	10511.	8032.	8325.	8048.	9016.	42363.	56836.
1946	64971.	26884.	36551.	15994.	16121.	11023.	7437.	9594.	7587.	14408.	49359.	64216.
1947	31226.	29570.	22452.	26694.	9510.	10455.	7889.	10665.	8430.	37858.	60219.	29051.
1948	63471.	22145.	28614.	25915.	27863.	16378.	8651.	11180.	9305.	14904.	32389.	60406.
1949	17851.	52454.	28378.	20585.	33740.	11683.	8229.	9236.	8228.	13478.	22064.	26966.
1950	50511.	50544.	52469.	25222.	26471.	23610.	10175.	10665.	7892.	31235.	76992.	58536.
1951	72426.	43869.	32549.	18765.	19162.	7851.	6466.	8035.	7471.	25557.	37549.	63156.
1952	37221.	42849.	27789.	25666.	21017.	12786.	11196.	10504.	8145.	9678.	12254.	16966.
1953	93605.	58830.	28594.	17654.	31191.	22918.	9909.	11406.	8887.	13825.	47124.	78781.
1954	64046.	46074.	20086.	25179.	12185.	14354.	8844.	10863.	9349.	14556.	22004.	22571.
1955	33861.	16394.	22926.	35833.	25676.	21755.	11138.	10754.	6674.	21319.	58534.	98774.
1956	61609.	50802.	39199.	25734.	27507.	18985.	10092.	11162.	8034.	16920.	28240.	44144.
1957	18271.	27910.	56739.	23826.	16651.	9066.	6897.	9997.	7756.	11842.	18402.	59929.
1958	56400.	61464.	19958.	25147.	14492.	11200.	7876.	10112.	8198.	10741.	47694.	30588.
1959	65187.	35022.	19872.	18360.	18767.	9070.	6533.	9142.	9227.	20284.	21807.	13069.
1960	12661.	34540.	42248.	37525.	36320.	14961.	8477.	9712.	8477.	11720.	54546.	30892.
1961	26589.	72098.	65877.	18116.	22031.	9659.	7239.	9304.	8296.	14562.	25671.	56657.
1962	27043.	18247.	31011.	27561.	24904.	12902.	8206.	11470.	8538.	19849.	38278.	33518.
1963	13160.	36349.	15147.	39000.	37442.	9491.	9496.	11203.	8311.	12496.	45930.	23257.
1964	71415.	20939.	23390.	15272.	17719.	20752.	9659.	11467.	8118.	10696.	27139.	95911.
1965	90078.	62369.	12463.	13095.	12359.	8353.	7272.	9459.	7032.	10050.	20783.	20390.

CHART Z

DESCRIPTION OF ECONOMIC MODELS USED

A. Economic models. - Economic models are basically of two types. The most common, the micro-economic model, analyzes the production function of an individual firm or enterprise. Models of this type analyze an enterprise's costs, output, and revenue functions. This is the model commonly used in solving the maximization problem.

Macro-economic models address the problem of an entire economic environment; such aggregate parameters as gross national product, regional product, regional employment, and personal income are used. Adam Smith, the father of the classical school of economics, dealt with aggregates in his path-breaking book, "The Wealth of Nations," in 1776. However, little more was done with aggregate models until John Maynard Keynes wrote his "General Theory of Employment, Interest, and Money" in 1936. Models of this type have been very important to economic thought during the past 30 years.

Each type model was used in the Willamette Basin Comprehensive Study. A regional or "economic base" model was used to analyze the Willamette Basin economy and to project the basin's future economic pattern. These projections were based upon national parameters and a basin share of national growth. This model was presented in Appendix C - The Economic Base - which was used as a guide to basin planning activity.

The objective of the Economic Base Study was to provide the basis for determining the scale, sequence, and timing of water and related land resources development. Those considerations are based upon estimates of future economic activity within the Willamette River Basin and the characteristics and size of the population. In other words, the Economic Base Study describes the setting of the area's future economy. Economic parameters projected by this study were of use in determining needs for such resource planning objectives as:

Navigation. - The volume of production or use of major commodities which are or may be expected to be transported by water.

Flood control. - Industrial development, agricultural production pattern, and population change which will influence land use and development in the flood plain.

Water supply. - Production of industries using large quantities of water, and population numbers and distribution.

Water pollution. - Production of industries whose effluent may contribute significantly to waste discharge, and population numbers and distribution.

Fish and wildlife. - Population and population characteristics including age, sex, and per capita income.

Irrigation. - Agricultural production requirements and preliminary estimates of irrigated acreage are reported. Final determination was made in the irrigation appendix.

Hydroelectric power. - Industries using large quantities of electric energy, and population numbers and distribution.

Recreation. - Population and population characteristics including age, sex, and per capita income.

This study used a regional model; however, each of its parameters was handled in aggregate, and this is clearly a macro-economic model.

Other uses for macro-economic models are input-output studies, economic impact studies, inter-regional studies, and the development of regional multipliers. Models of these types will be used in developing secondary benefits and in adapting methods for following the most recent principles and standards for planning water and related land resources as proposed by the Water Resources Council.

Micro-economic models are useful in evaluating individual projects and specific project functions. Many projects have an economic life of 100 years; thus, we must analyze benefit increments that will accrue many years into the future. The time period of money dictates that future benefits be discounted--a factor that complicates analysis and model specification. On that basis, a model variation may be necessary for analyzing costs and benefits for each project output or service. Also, an additional model will be necessary for formulating each individual project.

In the Willamette Comprehensive Study, a variety of methods were used to estimate functional needs now and in the future. Needs--a proxy for demand--were articulated in each of the functional appendices. Potential project benefits from serving those needs were evaluated using micro-economic models. Many models were of the most simple type; many benefits were calculated using simple manual methods.

B. Flood control. - The Portland District was assigned the lead task in preparing the Flood Control Appendix. Analysis of flood plain development, potential damages, and future flood prevention needs was achieved using a computer program developed by the Portland District for that purpose. At constant price levels, flood plain developments and thus potential benefits change from year to year; that program synthesizes benefits.

Flooding is a problem that requires some measures defining its magnitude. Reduction of such problems and efficiency of proposed solutions must also be measurable. One way to measure the size of the problem and evaluate solutions is by describing physical parameters of water causing the flood. We measure gage heights or water depths, velocities, and period of inundation. Total discharges of a river system may be calculated. We can also measure the surface area of the flood plain. However, the final indicator describing flood problems is the dollar damages. We generalize upon that and describe an ongoing damage situation, rather than list the history of the floods and their corresponding damages. It is more meaningful to calculate an average annual damage estimate. In physical terms, we can describe the reduction in flow, or stage, or flood plain area which would result from a specific solution; dollar damages are the common denominator. Ultimately we would be asked how much average annual damages would be reduced by various alternatives. This metric, a basic dollar amount, helps decision makers evaluate economic feasibility of a proposal. Information on flows and stages is essential when evaluating modifications to an existing hydrologic configuration. Hydrologic studies are essential whenever we intend to evaluate solutions. In Willamette Basin, 30 reaches or tributaries were defined for independent evaluation of the flooding problem.

Flood plain development and potential damages were analyzed for each of the 30 reaches. Also, three categories of flood damages were defined. These categories were related to disparate types of growth patterns which would result from different regional growth influences. Thus, we were analyzing damages at ninety different cells. Within each cell (reach and category), a control point was identified for which discharge-frequency curves were developed. Unregulated discharge-frequency curves were derived in accordance with standard methods outlined by Water Resources Council. ²⁷ Also, using historical relationships for discharges and damages, damage-discharge curves were developed. The resulting damage-frequency relationships--average annual damages--were furnished for each cell. To avoid much manual computation and to ease problems of updating for price and development levels a computer was used. Use of the computer also facilitated bringing in the problem of the time horizon and handled the problem of applying the interest rate. In addition, the computer program incorporated the steps necessary to project patterns of average annual damages within each cell over a long enough period to satisfy a 100-year project life when evaluating such proposed solutions as dams. A discount equation provided benefit figures in equivalent annual amounts according to the selected interest rate. Hydrologic input was in the form of frequency of exceedence for 16 levels of discharge at each control point.

Economic inputs to the program were damage amounts for 16 levels of discharge for each cell and such regional growth and development factors as local population growth rates, changes in per capita incomes, potentials of soil productivity, rates of land use shift out of agriculture, changes in agricultural productivity, and cropping patterns. Those factors, within a program subroutine, developed localized growth projections. Other economic inputs were the economic life of the project and the interest rate. Each program run will provide average annual damage amounts, by cell at the start of project life, for a base condition; the program would also analyze five alternative conditions. The program calculated both initial and future benefits by cell for each alternative.

C. Other project outputs. - Synthesizing benefits of other project functions by computer model is a task that lies mostly in the future. Since plan formulation of the Willamette Study, a computer program has been developed that permits analyses of recreation costs and benefits. This permits analyses of a much broader range of recreation investment alternatives and at savings of time and cost.

D. Summary. - There are four general stages in water and related land resources planning. Hydrology and economics are both active in each stage. The first is a matter of inventory, involving the aggregation of economic and hydrologic data so that the planning process has a starting point. This requires the extrapolation of historic data to describe probable hydrology. The second stage brings a broad range of disciplines together, problems are investigated, and alternative solutions proposed for study. In the third stage, a team of hydrologists and economists assemble data that are basic to the proposed alternatives. That data is necessarily estimated since both are attempting to describe equilibrium that have not existed historically. Comparison of alternative proposals compared with the existing or "no change" situation yields differences that may be defined in cost-benefit terms. Different base conditions may be assumed. In the Willamette Study, an authorized system of 14 major multipurpose reservoirs were assumed to be in place prior to study of alternatives. The fourth stage is that of plan formulation. Teamwork of hydrologists and economists is necessary to develop data that will describe and permit evaluation of all combinations of proposed systems and operations in search of the optimum development. That development is the one that maximizes net benefits.

OTHER MODELS USED AND BEING DEVELOPED

Simulation has been used for testing alternatives. It is not a simple process; constructing large models, involving many items, is difficult and time consuming. Also, it is difficult to validate the model. As a water resource development and regional planning tool, it is useful, however, to decision makers in tracing consequences of management decisions before their implementation.

Comprehensive modeling of not only the physical environment but also the economic environment of an entire river basin was initiated in 1956 with the Harvard Water Program.^{3/} Relatively long stream flow periods were synthesized and the economic benefits of the system were determined from the beneficial use and control of water moving through the system. The objective of the Harvard study was to improve methodology of systems design and, if possible, identify optimums.

About 8 years later, a different approach was developed by Battelle Memorial Institute.^{4/} That approach studied economic interrelations in a river basin in an attempt to ascertain what influences economic growth of an area. Demographic, water, and employment interrelations within areas were studied. Major water uses considered in that approach are: water quality, water supply (agricultural, urban, and industrial), recreation, flood control, and electric power. That model used the DYNAMO language and its structure proved sufficiently flexible to fit a variety of forms and types of economic systems and problems.

Calapooia River Basin, one of the Willamette subbasins, was simulated in a study by Doctors Halter and Miller at Oregon State University in 1966.^{5/} That study modeled and simulated the hydrologic characteristics of the basin and evaluated 4 beneficial uses of water. These were flood control, irrigation, soil drainage, and fish life enhancement; the model was used for formulation rather than to estimate or determine benefits.

The Calapooia study was generally in two major divisions: hydrology and economics. A stochastic approach to hydrology data was used where the flows on any particular day follow a determined frequency function. The hydrologic input is a crucial phase of river basin simulation. Considerable time was spent in developing a hydrologic sequence from the historical record and from bench-mark floods. The time shape of flows, including magnitude and duration of flood flows, determines benefits obtainable from proposed development. Sufficient detail was included in order to approach reality.

The economic section consists of a series of equations which relate fulfillment of different water needs to dollars. Those equations specify benefits to the water-system project to the degree capabilities of use are satisfied. Generally, within a project, competition exists among alternative water uses for available water. Consequently, many needs will likely be served less than 100 percent of the time. Larger projects will provide additional water, if available, but only at additional cost; and a larger project can only be economically justified if the marginal benefit is greater than the marginal cost.

In the Calapooia simulation, irrigation benefits are a function of storage capacity. Flood control and fishery benefits are a function of both reservoir size and channel capacity. Soil drainage is related to size and depth of channel.

For example, maximum annual fishery benefits of \$530,000 are achievable if all flows for fishery purposes are met. Minimum flow requirements are shown in Table 1, while the fish life benefit function is shown in Figure 1. The minimum mean-daily flow, occurring in the channel during any one year, divided by the fishery requirement, established the percentage of the fishery requirement met. Thus, fishery benefits are a function of the percentage of the fishery requirement met.

Other benefits were evaluated in a similar manner.

The Halter-Miller simulation produced several tentative conclusions. It suggested a reservoir and channel capacity combination that would provide the maximum net benefits. In the Calapooia Basin, it articulated the importance of channel capacity in optimizing the project. It also indicated how management practices could be modified to produce greater net benefits, and it also showed how hydrologic forecasting could increase net benefits by modifying the rule curve and thus reservoir operation.

About 3 years later, Dr. Ken Kerri of Sacramento State College ran a second simulation of the Calapooia. 6/ That study articulated complementary and competitive aspects of water storage for water quality control.

That study used techniques of marginal analysis to analyze benefit functions of water uses and to allocate scarce water on the basis of economic efficiency. The economic model was expanded to include project recreation. Several water quality parameters, including water temperature, were added to the hydrologic and economic systems. This research project indicated that flow augmentation is an economically feasible means of achieving and maintaining water quality objectives; also small frequent shortages will be encountered by water users and occasional flood damages will be encountered when the project is formulated to the economic efficiency objective.

TABLE 1
FISHLIFE REQUIREMENTS AND
CHANNEL MINIMUM FLOWS
CALAPOOIA RIVER

Month	Downstream ¹ minimum flow (c.f.s.)	Fishery ² requirement (c.f.s.)	Fishery ³ need (c.f.s.)
Jan	55	140	85
Feb	90	140	50
Mar	60	140	80
Apr	25	140	115
May	0	140	140
Jun 15	0	90	90
Jun 30	0	70	70
Jul	0	50	50
Aug	0	50	50
Sep 15	0	50	50
Sep 30	0	160	160
Oct	0	160	160
Nov	0	140	140
Dec	0	140	140

- 1 Estimated minimums from the 20 years of historical data available.
- 2 As obtained from fishery agencies.
- 3 Need is the difference between requirement and minimum flow.

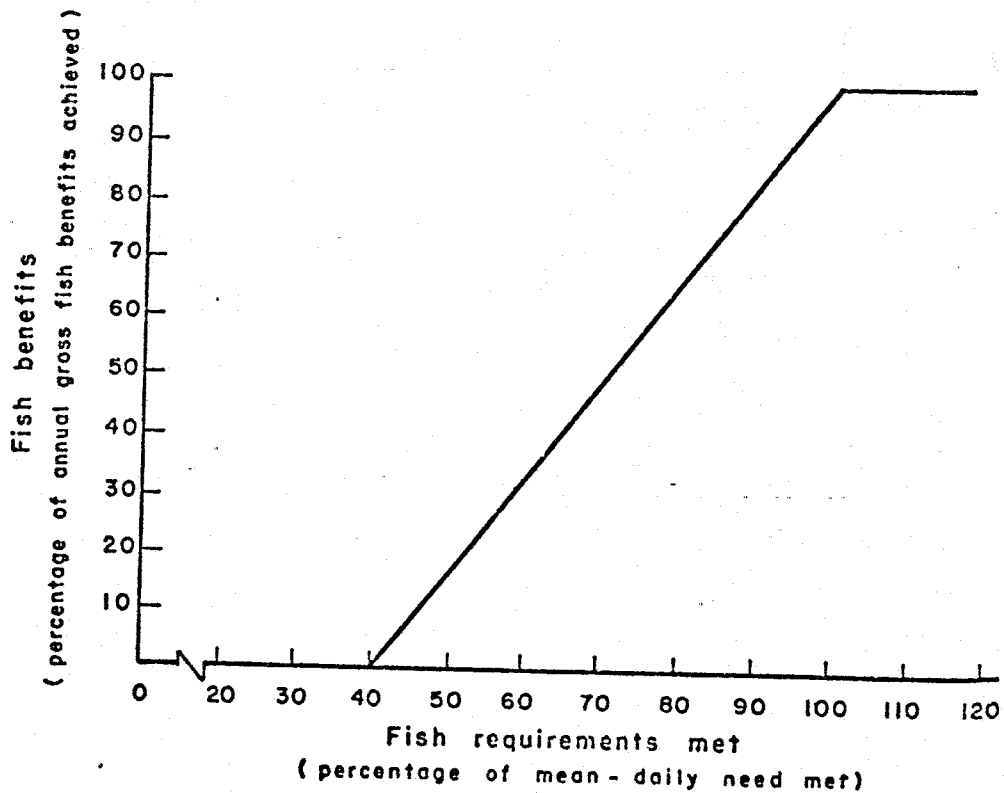

Figure 1. Fish life benefit function, Calapooia River.

Another simulation study was made for an area in eastern Oregon--the Grande Ronde River Basin--a basin that is sparsely settled and that is primarily an agricultural and lumbering area with considerable irrigation potential. That study was a Ph.D. dissertation by Gary Ray Wells, A Sensitivity Analysis of Simulated River Basin Planning for Capital Budgeting Decisions, University of Utah, 1971. That study was based upon established relationships between physical units for seven possible benefit changes and benefit and cost data. The HEC-3 program was used as a basis for benefit evaluation. The study model provides net benefits and benefit-cost ratios after determining benefit flows and comparing them with cost flows.

SUMMARY AND CONCLUSIONS

The Willamette Basin Comprehensive Study accomplished its specific purpose of developing a plan to meet early-action and long-range water resource needs. The study developed three base appendices -- Study Area, Hydrology, and Economic Base,-- nine functional appendices, and a plan formulation appendix. The first three appendices developed the areal setting, while the functional appendices developed measures of needs. Plan formulation evaluated needs of a physical and biological system using economic criteria. The finalized plan includes both projects and programs to provide a variety of authorized functional services for present and projected needs. Copies of the Main Report are available for participants of today's meeting.

Although the formulation of an optimum plan is complex, it basically involves comparing several alternative systems to determine the best plans or plan. Even though our formulation model in the Willamette was accomplished manually, use of a computer program would facilitate a more thorough search. Reliability of the formulation procedure is a function of the precision of benefit and cost estimates as well as how these economic flows (estimates) relate to hydrologic parameters. Our computer programs enabled a more detailed analysis in the development of hydrologic flows and in evaluating flood control needs and benefits. Our confidence in the resulting plan was increased significantly.

Development of better ways to evaluate needs and benefit flows for other functions will continue to improve our evaluations; this has been done with a recreation program.

Society's goals in water resources development planning are becoming broader and more sophisticated; also the "state of the arts" in planning is expanding rapidly. Such arbitrary design criteria as protection from 100-year flood frequency at the site are no longer sufficient. While such economic criteria as the maximization of net benefits are extremely important, they may not be completely adequate. Environmental considerations and social wellbeing will weigh heavily in future investment decisions.

One basic problem with which we are faced in analyzing development alternatives is to learn more about the economic parameters; we will also have to learn more about physical relationships. Rather than using needs as a proxy for demand, we should develop a satisfactory measure of price, more accurately estimate demand, and establish requirements over an entire range of prices. We must project more precisely what future conditions to anticipate. We must determine whether the coefficients that we are using will change and, if so, at what rates.

It is not likely that the complete planning process can be handled in one computer model. Multidisciplinary models are desirable and have been proposed. As analyses become more sophisticated, procedures become more complicated. Planning is and will continue to be layered and complex. Computer models can facilitate benefit evaluation and plan formulation, as well as other planning functions.

The Willamette Study followed the broad guidance of the Task Force in developing a plan for the wellbeing of people. This study used the latest methods available; the results have been generally accepted.

REFERENCES

- 1/ User Manual, HEC-3 Reservoir System Analysis, Hydrologic Engineering Center, U.S. Army Engineer District, Sacramento, California, December 1968.
- 2/ A Uniform Technique for Determining Flood Flow Frequencies, Water Resources Council, Washington, D. C., December 1967.
- 3/ Arthur Maas, et al, Design of Water Resource Systems, Cambridge: Harvard University Press, 1963.
- 4/ H. R. Hamilton, et al, A Dynamic Model of the Economy of the Susquehanna River Basin, A Progress Report, Columbus, Battelle Memorial Institute, 1964.
- 5/ A. N. Halter and S. F. Miller, River Basin Planning: A Simulation Approach, Oregon State University, 1966.
- 6/ K. D. Kerri, Complementary-Competitive Aspects of Water Storage, U.S. Dept. of Interior, FWPCA, 1969.

OPPORTUNITIES FOR HYDROLOGIC-ECONOMIC MODELS
A CASE STUDY

Question, Mr. Antle: What opportunities do you see for the use of computerized hydrologic-economic models in River Basin Studies? Would they be efficient? Would they give credible information?

Reply, Mr. Boodt: There are important opportunities for the use of models of this type as has been exhibited by this paper. These are in the synthesizing and evaluation of multi-parameter models. We should expect to develop models that are more and more sophisticated, and we should expect our evaluations to become more and more complete. Such models will be efficient in that they facilitate, and even permit, mass data handling; also they facilitate iterations that are important to refined analysis. Increased sophistication of modeling will continue to enhance the credibility of information generated; sensitivity analysis will provide a ready check upon reliability.

Models of the type discussed will facilitate needed interdisciplinary approaches which will further permit development of models not previously considered feasible. Such models will increase choice alternatives for resource investment decisions. Such an example is exhibited by Dr. Gary Wells' paper relating to capital budgeting decisions.

SOCIO-ECONOMIC ASPECTS OF PLANNING
FOR THE UPPER ST. JOHNS RIVER BASIN

By

Theodore E. Haeussner¹

INTRODUCTION

A comprehensive plan of improvement for the upper St. Johns River Basin was authorized by the Flood Control Act of 1954. Today, some 18 years later after several basic plans and seemingly innumerable coordination meetings, resultant changes and modifications, only a small segment of the latest plan has been constructed. Environmental concerns and questions raised about the probable effects of the latest plan on water quality, both in the basin and downstream, have effectively halted all work in the last 2 years and generated a controversy as to the socio-economic aspects of further plans for the basin.

This paper presents a brief description of the basin, a summary of the alternative plans studied to date as well as some of the environmental problems encountered. A resume¹ of the various approach methodologies proposed for a socio-economic study is offered together with a brief discussion of the basic planning alternatives for the basin and their probable short and long range effects.

Lastly, the paper attempts to present some of the soul-searching questions going through the mind of the engineer-planner who is faced with the task of evaluating and deciding on the relative merits of project alternatives for an area.

* * * * *

The St. Johns River flows northward some 220 miles from its headwaters in Lake Hellen Blazes to the city of Jacksonville, Florida, where it enters the Atlantic Ocean. However, that part of the upper St. Johns River basin lying in the Central and Southern Florida Project area only extends over some 80 miles of that reach. The basin averages about 22 miles in width. It has a drainage area above Lake Harney of

¹Chief, Environmental Resources Section, Jacksonville District

some 1,910 square miles, which includes some 20 odd miles of the St. Johns River marshes lying above the headwaters of the river. Indian River, a shallow broad tidal estuary, flanks the basin to the east, some 8 to 10 miles distant. Normal lake levels range from 23 feet, m.s.l. in Lake Wilmington to 12 feet in Lake Poinsett, and to 3 feet in Lake Harney, involving a total fall of about 20 feet in 80 miles, or 3 inches per mile. To the west of the river the topography of the upland area rises to elevations of 65-70 feet. From north to south within the project area are the Econlockhatchee River and 5 major creeks, Taylor, Jane Green, Wolf, Blue Cypress, and Fort Drum, which drain upland runoff to the valley below. The occurrence of a 6-inch rain over the basin, not too uncommon in Florida, can dump over half-a-million acre feet of water into the valley to be contained in and moved downstream through the valley floodway.

In the interglacial geologic period the St. Johns River valley was a large intercoastal lagoon which drained to the ocean through shallow, poorly-drained tidal outlets. Subsequent sand movement built up a low coastal ridge blocking those outlets. An extensive growth of peat-producing plants gradually filled the valley developing highly-productive peat soils bordering the river. The river marshes vary in width from 1 to 10 miles.

As early as 1910 agricultural interests began reclamation of the marshlands on a large scale. Five large local drainage districts ditched, diked, and attempted to drain valley lands for improved pasture, agricultural crops, and citrus production. Encroachment on and in the floodway was common. Within the east flood plain of the upper river local dikes now extend almost continuously for about 35 miles. One district alone has over 200 miles of canals and dikes. South of the Lake Washington outlet the flood plain at one time contained about 608 square miles during a severe flood. By 1945 levee encroachment reduced that area to 490 square miles. Now it has been reduced to about 250 square miles. As a result, flood levels which formerly rose 2 to 3 feet above normal, now rise nearly twice that height. In the 10 year period 1947 to 1956, five floods caused damages exceeding \$12 million. About a dozen small cities and towns lie along the coastal ridge east of the river. As yet urban development has not expanded westward to the river to any great extent. However, plans are underway for cut-and-fill type developments in several areas east of the river which will replace some of the valley agricultural lands. Within the next 15-20 years population projections for the 5 counties in and near the basin are upwards of a million people, a large portion of which will be dependent upon the project for a reliable surface water supply. At the present time shallow well fields east of the river encounter brackish-saline water, especially during a prolonged dry season and in drought periods.

In the course of planning for the upper St. Johns basin several plans were studied. The Comprehensive Report Plan in the project document⁽¹⁾ consisted of a "diversion" plan with three major outlet canals to divert floodwaters eastward to Indian River from Lakes Wilmington, Washington, and Poinsett. The downstream project limit was Lake Poinsett. Details of that plan can be seen on Figure 1. Sixty percent of the benefits with that plan were from reduction in flood damages with the remaining 40% of the benefits from increased land use with a dependable irrigation supply. Besides being economically unfeasible significant opposition developed from the U.S. Fish & Wildlife Service to the large freshwater flood discharges to the brackish Indian River. A storage plan was needed. In 1955 an effort was made by the Florida Legislature to set aside a portion of the flood plain from further encroachment. They defined the flood plain and required permits for in-zone development. However, that law was soon declared unconstitutional.

In 1957 a "floodway and storage" plan was suggested by the local sponsor⁽²⁾ consisting of 2 large conservation areas with 115 miles of levees along their eastern boundaries and four control structures. That plan provided approximately 2 feet of flood control storage, some 493,000 acre feet. Flood damage reduction accounted for 33% of the benefits and increased land use 66%, with 1% fish and wildlife benefits. Although the plan was economically feasible it was not entirely acceptable to the local sponsor as it required fee simple title or flowage easements on over 200,000 acres of valley land, a large amount of it under intensive cultivation, at a cost in excess of \$6 million. Also, the plan provided no flood protection for landowners west of the river who were still subject to upland runoff. The basic features of that plan can be seen on Figure 2.

In 1962 a modified plan was proposed by the Jacksonville District⁽³⁾ consisting of three large "side-hill" reservoirs on the upland, parallel to the river alignment, with 3 valley conservation and flood storage reservoirs, a weir-type structure near Puzzle Lake for low-water control, plus a diversion canal from Lake Wilmington to Indian River to be used for "emergency" discharge only. Figure 3 shows the details of that plan. Flood control and increased land-use benefits for that plan were about 50-50. The plan was found to be economically feasible, however costs increased from \$34.5 million up to \$46.8 million. Valley land requirements were reduced under that plan. Upland storage area requirements consisted of low-cost unimproved pasture and native range land. However, by 1969 problems of land acquisition developed surprisingly, in the southern upland reservoir areas. Landowners objected to permanent seasonal inundation. As a result land costs

skyrocketed and an impasse developed on land procurement in the Blue Cypress Creek and Fort Drum Creek reservoir areas. To resolve it, conservation area storage was eliminated from those two reservoirs and temporary flood storage detention up to 60 days maximum was substituted as the only condition acceptable to landowners. Additional conservation storage was added to the downstream valley reservoir (Lake Wilmington) to partially replace that lost in the upland.

Shortly after enactment of the Environmental Protection Act of 1969 the Federal Water Pollution Control Administration and the Florida Department of Pollution Control strongly objected to the pollution problems they considered potentially inherent in the plan. Their concern centered around increased agricultural land use, direct drainage from irrigated areas into the reservoirs, reductions in the flood plain marshes, increased eutrophication, high pesticide residues, and potential downstream deterioration in water quality resulting from extensive project channelization and rapid transfer of flood waters out of the area. They proposed collection basins for ag runoff with return pumping to the upland reservoirs for reuse. The Corps agreed to reduce valley channelization to the maximum extent practicable and to investigate other solutions for resolving some of the associated environmental concerns, which are:

1. The potential elimination of a commercially significant annual shad migration in the upper headwater areas, which would be blocked or prevented by construction of the valley control structures and tieback levees. (This problem has not been resolved and is still under study.)
2. A threat to the Dusky Seaside Sparrow, an endangered species of some 800-900 birds, which nest in the area north of Lake Poinsett and whose prime habitat, *Spartina Backeri*, could have been destroyed or radically reduced by project construction and operation. A Corps proposal to relocate that valley control structure and eliminate its eastern tieback levee has satisfactorily resolved that problem.
3. Local landowners in the upland reservoir areas flatly refused to permit access to or the use of reservoir lands and water areas for recreational purposes and made this a contingent to obtaining the necessary storage and flooding easements. Recreational development under P.L. 89-72 requires sponsorship and acquisition of lands in fee title. The sponsoring agency, the Flood Control District, refused to sponsor recreational plans because of such commitments made to the landowners. The problem has not yet been resolved satisfactorily.

In various meetings held in 1969 and 1970 the Federal Water Pollution Control Administration and its State counterpart agreed to continued construction of the upland Jane Green Lake complex, subject to water quality monitoring and studies in the Taylor Creek portion, but strongly objected to any additional valley construction. Water quality monitoring programs were initiated in both the upland and valley during 1970. Late in 1970 the F.W.P.C.A. proposed that a socio-economic study be made to determine the costs of providing protection to the valley agricultural lands, with and without channelization, as compared with the losses entailed by removing varying amounts of land from agricultural production. The Corps and sponsor readily agreed to such a study since it appeared to be the only means of resolving the stalemate.

During the last 9 months numerous meetings and discussions have been held with professors from the environmental research staff of the University of Florida to arrive at an approach methodology. Various procedures are available for project evaluation in a regional setting.

Dr. Howard Odum⁽⁴⁾ views the system in terms of "energy flows" in which the energy values in kilogram calories of all components in the present valley area, versus the resultant effects of project works, channelization, changes from a free-flowing riverine environment to a semi-static reservoir environment, are evaluated against a balanced ecosystem. His theory is that the maximum energy values accompany maximum contributions to human money economy from all inputs, both monied and non-monied. His overall objective is to find the optimum ratios of man to nature.

The methodology proposed by Drs. James Heaney and Wayne Huber⁽⁵⁾ would synthesize and expand on several independently developed, yet related, approaches to obtain a comprehensive model. They referred specifically to the economic approach of Leontief⁽⁶⁾ who used Input-Output Models wherein dollars are the commodity being inventoried and analyzed; to the materials balance approach of Dr. W. Isard⁽⁷⁾ who developed a model linking socio-economic and ecological systems; and to that of Gibbs and Loehman⁽⁸⁾ who proposed an "Accounts Model" for determining the regional effect of a proposed investment project. Common to all of these is the concept of budgeting or tracking the movement through the environment of some commodity, or group of commodities.

Drs. Heaney and Huber propose to divide the basin into subset areas, establish time periods for analysis, collect data on population (human and animals), rainfall, land use, drainage, soils, water movement, vegetation types, flora and fauna, agricultural patterns,

recreation usage, fertilizer application, and many others. Sources and sinks would be established for each commodity. Several flow models would be developed similar to those of Orlob and Wood⁽⁹⁾ involving surface and subsurface flows for three interconnected subsystems. The models would require establishing relative criteria relating to commodity values as well as changes to be expected in those values due to the interaction of commodities within each subset area, and their effects on adjacent subset areas with time.

As yet, a firm decision has not been reached, although the proposal of Drs. Heaney and Huber is favored.

Regardless of the model selected three basic developmental alternatives must be considered in terms of their socio-economic impact. Essentially, they are:

1. Do nothing in the valley, as far as further project construction is concerned.
2. Analyze various structural alternatives, that is ... the current plan, as well as modifications thereto.
3. Analyze non-structural alternatives, such as buying the flood-plain lands to various limits and control their use.

The impacts of these three alternatives provide considerable food for thought. For example, if no further construction is undertaken and the valley flood-plain lands are not purchased, urban expansion relating to the trend for waterfront homesties and waterborne recreation will most surely increase. Further destruction of the marsh would result from cut-and-fill development, already underway on a limited scale. A reevaluation of remaining flood control and water supply benefits from the presently-completed upland works would become necessary. Improved pasture and agricultural lands in the valley, now subject to periodic flooding, would undoubtedly be supplanted in time by urban housing. If, on the other hand alternative 3 is considered, ie., buy up additional flood plain lands in an effort to preserve, enhance, and restore the marshes, sufficient environmental justification will be necessary for its purchase. For in buying additional lands, which would include large agricultural tracts, the land removed from production would not only represent an economic monetary loss to the region but would also, in large measure, eliminate the necessity for a project by reducing basic project benefits in that category.

Alternative 2, involving modifications to the current valley plan, at present, appears to have the most merit from the standpoint of what would best satisfy the needs of the region. It is possible that some additional purchase of lands on the western foothills, if allowed to revert back to a natural vegetative cover, would serve a nutrient removal traps for upland runoff and discharge.

These then are some of the environmental problems which require an intensive evaluation before a decision can be reached on a course of action for the upper St. Johns River basin. The use of a socio-economic model is recognized as one means available to provide answers to the many questions at hand. However, it must be recognized also that the answers obtained from any model will only be as valid as the decision variables used in determining cause- and -effect and the impact of each alternative tested. As a result, some of the questions uppermost today in the minds of those faced with the responsibility for water resource planning and management could well be ...

Has the current state of the art relating to multiple objective planning advanced to the extent that a sound and reliable solution can be found through its use? and ...

Recognizing that expenditure of public funds should add more to the welfare of society than it subtracts, can some quantifiable common denominator be found for measuring all project effects, both beneficial and detrimental?

For example, we know that flood-damage reduction of a project can be quantified and valued as well as irrigation, recreation, and fish and wildlife benefits. However, project effects of "n" number of alternatives on such things as environmental quality, scenic beauty, aesthetics, and the like are exceedingly more difficult to place a value on, if at all. Furthermore, if regional development is recognized as one of the objectives in the decision-making process of project evaluation just how can the engineer-planner be sure that a decision, obtained through maximizing all variables, for example ... to "do nothing" ... is really the best solution for the people in that area.

In summary, it would appear that the time has passed when a decision to provide flood control, water supply, or navigation facilities to an area such as the upper St. Johns River basin was a relatively simple matter involving basic project formulation and an evaluation of available hydrologic data, project benefits, and costs. Today the procedures facing the engineer-planner are becoming more detailed

and involved, requiring consideration of complex alternatives to what would appear to be the most direct solution of the problem. A systems analysis approach, involving the quantification and application of physical, social, economic, and environmental parameters, often becomes a necessity to provide a sound basis for planning and engineering decisions. The engineer-planner of today must therefore be prepared to continually expand his knowledge in these relatively new areas and to utilize those new tools and skills both logically and objectively. Totally new concepts in project planning are emerging generated by an awareness of mans' relation to his environment. Many questions remain to be resolved which will require interdisciplinary coordination and cooperation for their ultimate solution and resolution.

REFERENCES

1. House Document No. 643, Eightieth Congress, 2nd Session, Comprehensive Report Plan, December 19, 1947.
2. Central and Southern Florida Flood Control District, A Plan for Flood Control and Water Conservation in the Upper St. Johns River Basin, May 1960.
3. Jacksonville District, Corps of Engineers, Addendum 1 to Supplement 2, General Design Memorandum, Part III, Revised Plan of Improvement for Upper St. Johns River Basin, February 15, 1962.
4. Odum, Howard T., Energy, Power, and Society, McGraw-Hill, (1971).
5. Heaney, James P., and Huber, Wayne C., Generalized Methodology for Developmental Decision Making in a Selected Portion of the Upper St. Johns River Basin, (Working Paper), University of Florida, November 30, 1971.
6. Leontief, W.W., Input-Output Economics, Oxford University Press, New York (1965).
7. Isard, W.W., et al., On the Linkage of Socio-Economics and Ecologic Systems, Regional Science Association Papers (1967).
8. Gibbs, K.C. and Loehman, E.T., Impacts of Watershed Projects, Final Project Report, Economic Research Service, U.S.D.A. (1971).
9. Orlob, G.T. and Woods, P.C., Water Quality Management in Irrigation Systems, Journal of Irrigation and Drainage Division, ASCE, 93 IR2 (1967).

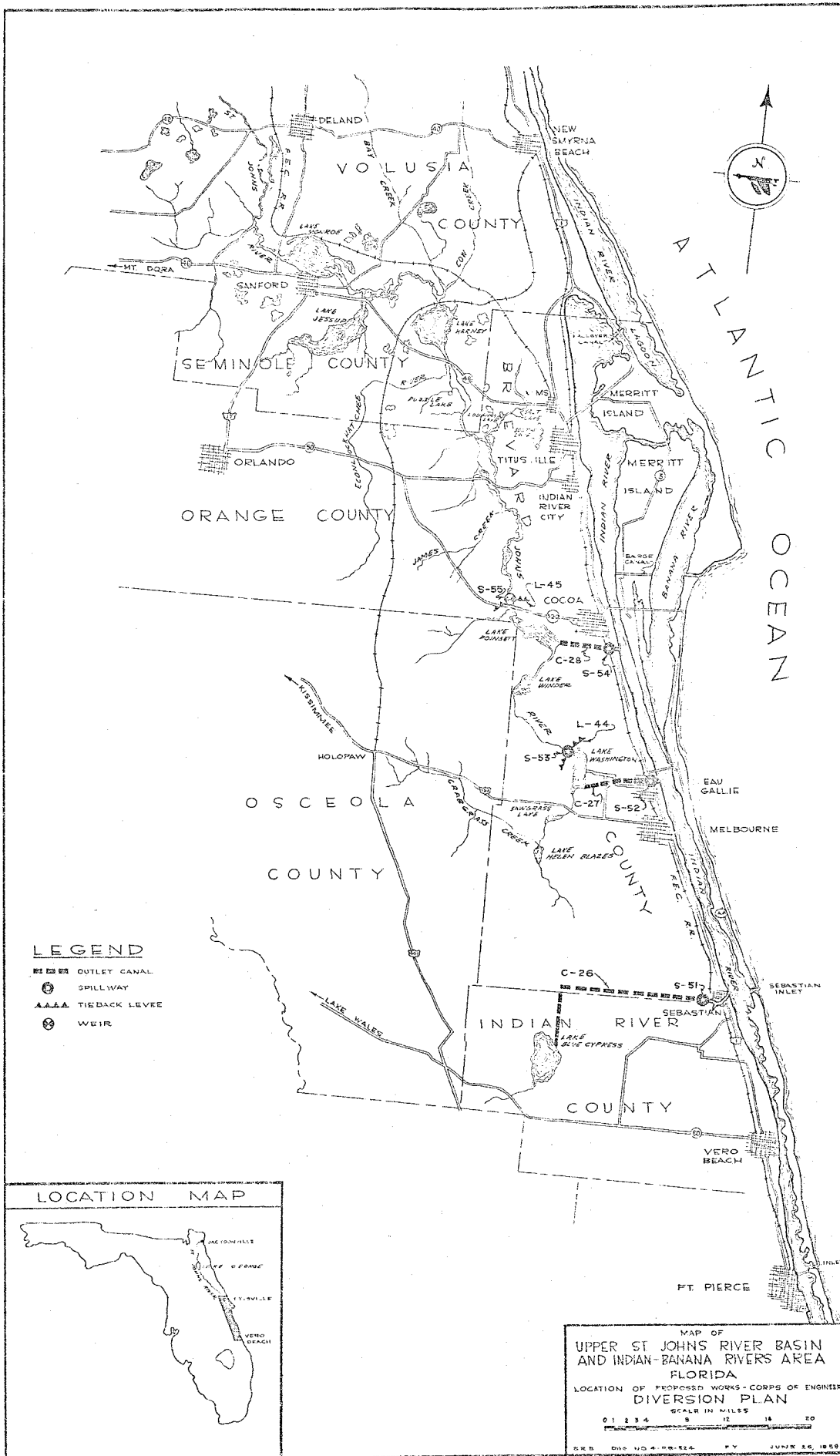

FIGURE 1

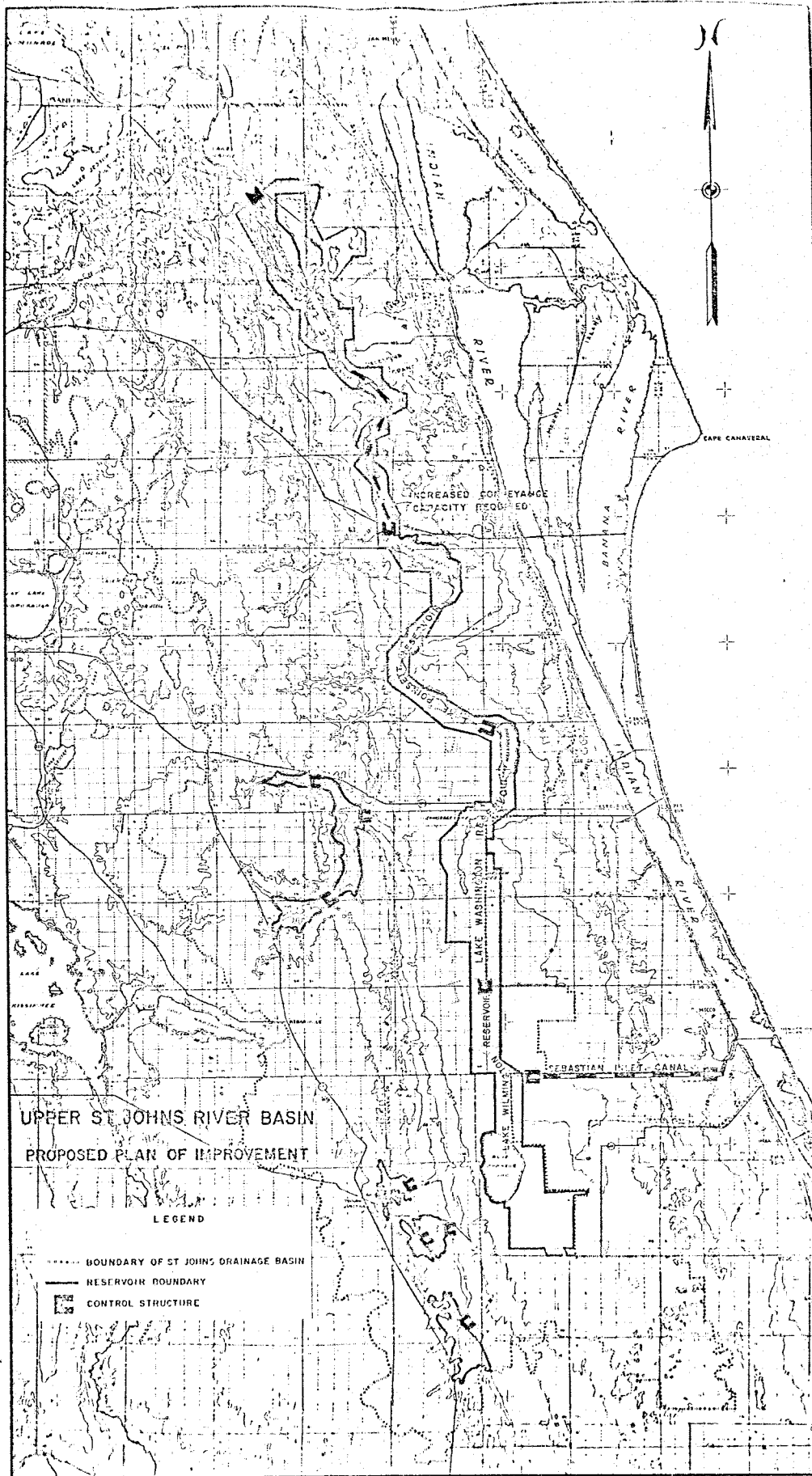
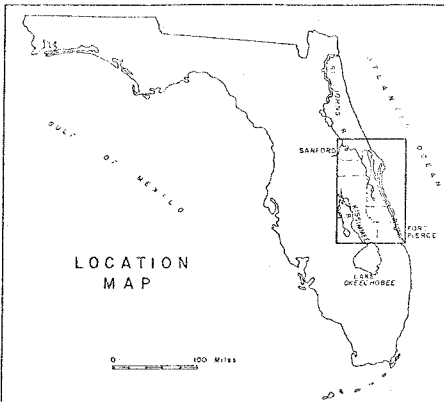
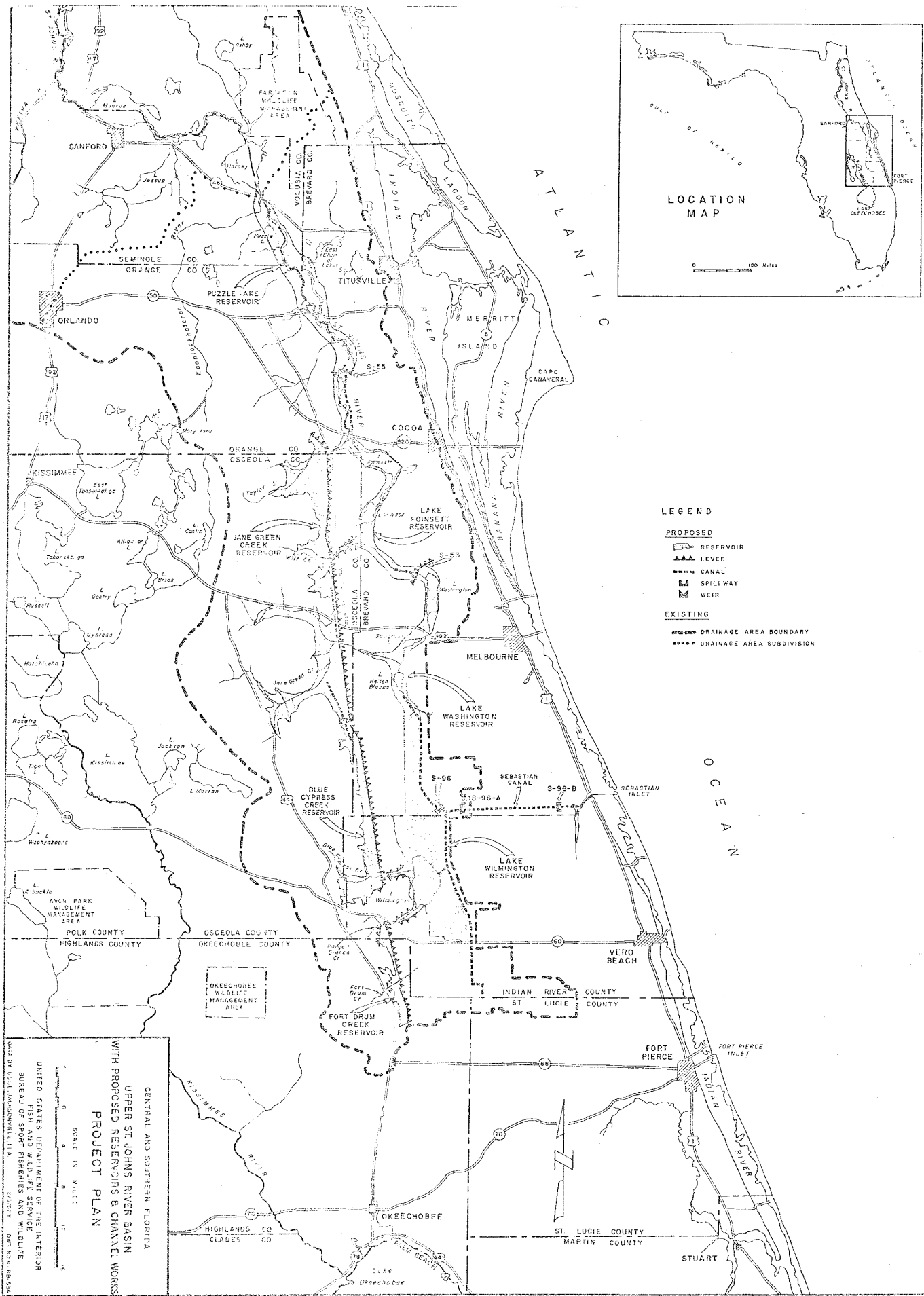

FIGURE 2:
 125

969



- LEGEND**
- PROPOSED**
- RESERVOIR
 - LEVEE
 - CANAL
 - SPILLWAY
 - WEIR
- EXISTING**
- DRAINAGE AREA BOUNDARY
 - DRAINAGE AREA SUBDIVISION

CENTRAL AND SOUTHERN FLORIDA
 UPPER ST. JOHNS RIVER BASIN
 WITH PROPOSED RESERVOIRS & CHANNEL WORKS
PROJECT PLAN
 SCALE IN MILES
 UNITED STATES DEPARTMENT OF THE INTERIOR
 BUREAU OF SPORT FISHES AND WILDLIFE
 WASHINGTON, D. C. 20250
 DATE: 10/1/54

FIGURE 3
 126

84071

THE INTERRELATIONSHIPS BETWEEN PLANNING OBJECTIVES AND
HYDROLOGIC ANALYSIS IN WATER RESOURCES DEVELOPMENT

By

Lloyd G. Antle¹

A reluctant leap forward in water resources planning and analysis is signaled by the publication of the controversial "Principles and Standards for Evaluation of Water and Related Land Resource Projects," by the Water Resources Council in the Federal Register, 21 December 1971. Whether we agree on the relevancy of "Principles and Standards" or not, the considerable effort put forth by the Federal agencies, the interest exhibited in the academic circles, the response of the Office of Management and Budget, and the Congress, and finally the various citizen groups either proponents or opponents of various kinds of water resource development, in bringing the report to this point signal the importance of the document across the diverse and pluralistic society of this Nation.

The "Principles and Standards" set forth the argument for moving away from the single objective of economic efficiency spelled out in an agency, particularly Corps of Engineers regulations concerning project formulation and evaluation. Although Senate Document 97 called for formulation and evaluation from the standpoint of Federal, regional and local viewpoints, with careful articulation of any divergence between various viewpoints, agency practice moved only slightly in this direction during the 1960's.

Why should agency practice remain so static following publication of SD 97 in 1962. For one reason, there was developing across the nation a strong opposition to the Federal water resource programs from a new coalition of interests focused upon the natural environment, those interests dislocated by Federal water resources projects and from the interests who felt competition from the output of Federal water projects. For another, there is something less than a clear consensus about how to conduct planning efficiently and effectively when the planner must communicate with, perceive and accommodate the needs of a diverse and conflicting set of public interests. The days of dominance of information and competence by the Federal Water Resource agencies have ended. The days of satisfying only a small well organized local or regional group of proponents have ended. Even the credibility of elected officials to articulate the interests of all their constituents is under serious and persistent attack.

¹Economist, Institute for Water Resources, Corps of Engineers.

Section 122 of the Rivers and Harbors Act of 1970 puts a requirement on the Corps of Engineers to:

"... submit to Congress and not later than 90 days after submission, promulgate guidelines designed to assure that possible adverse economic, social and environmental effects relating to any proposed project have been fully considered in developing such project, and that the final decisions on the project are made in the best overall public interest taking into consideration the need for flood control, navigation and associated purposes, and the cost of eliminating or minimizing such adverse effects and the following: (1) air noise and water pollution; (2) destruction or disruption of man-made and natural resources, esthetic values, community cohesion and the availability of public facilities and services; (3) adverse employment effects and tax and property value losses; (4) injurious displacement of people, business and firms; and (5) disruption of desirable community and regional growth. Such guidelines shall apply to all projects authorized in this Act and proposed projects after the issuance of such guidelines."

The National Environmental Protection Act of 1969 requires substantial analysis of the potential impacts of public works projects on the environment (broadly defined) and requires considerable discussion of alternatives to the proposed action. Already the practical effects of this Act have been to slow report processing and greatly reduce the rate of accomplishment of reports and construction. Some projects have been halted with as much as 70 percent of construction complete. The effects of operating projects will come under scrutiny with a similar emphasis on relevant alternatives to approved operating procedures.

Dr. G. Patrick Johnson of the Institute for Water Resources has attempted to portray the thrust of these developments in terms of the increase in complexity of the Corps of Engineers planning. (See Graph, page 3). Again, we may argue about the slope of the function, but there are some very obvious points to his argument. There is a significant acceleration in the rate of change between "eras," from in excess of 50 years between the building and control phases to less than 10 years between the allocation and environmental phases. Can a large organization adjust to this rate of change? I believe the Chief of Engineers is looking to the Institute for Water Resources to develop this competence, first inside IWR and then perhaps to develop some recommendations for the larger organization.

What Can be Done?

The Corps is not helpless in spite of the apparent confusion in the organization. There is one noticeable attribute of the Corps, the can do spirit and the pool of competence and capability.

ERAS

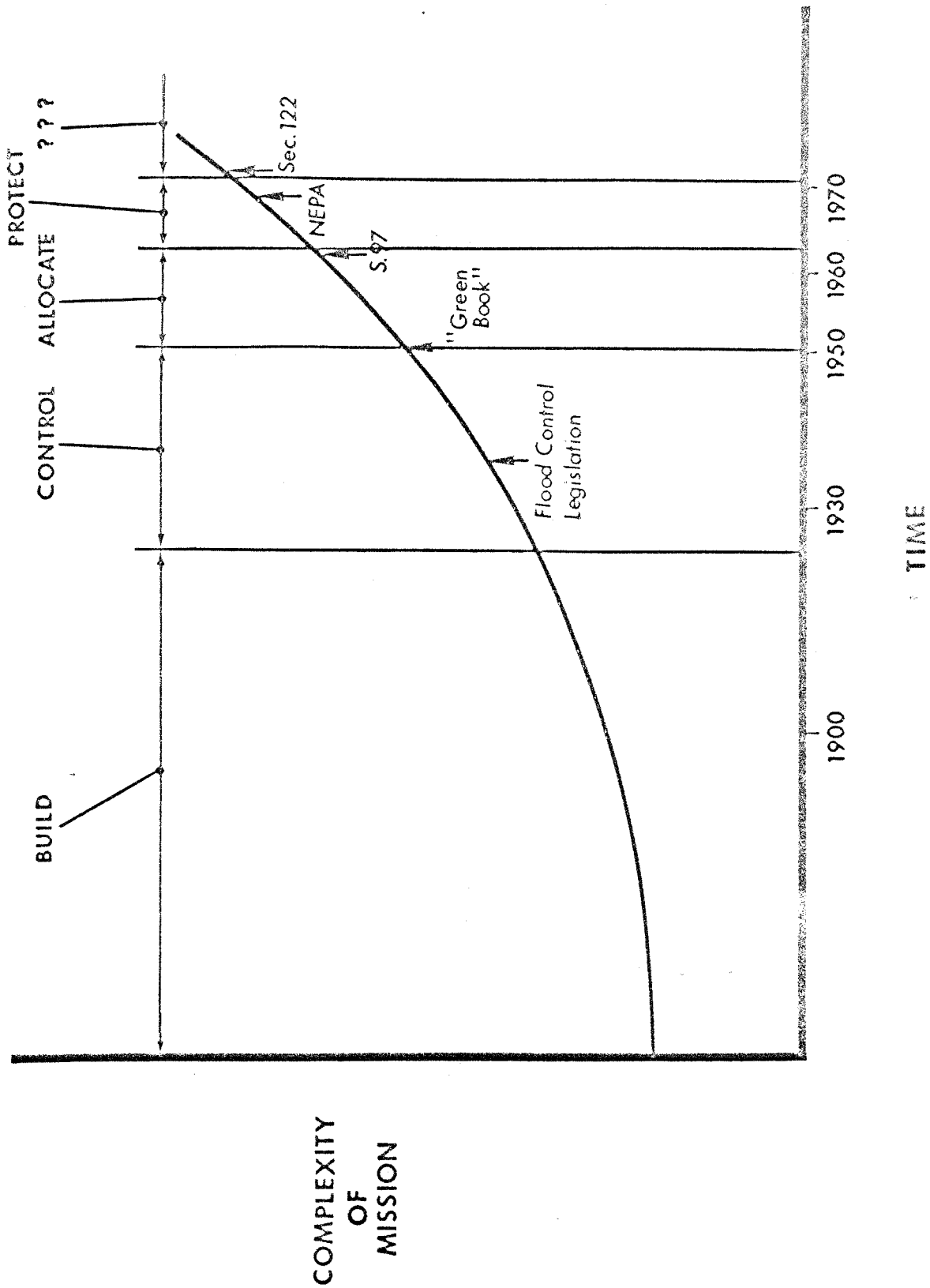

Let's review the bidding--the move to comprehensive river basin planning, signaled by SD 97 and earlier documents is being rapidly implemented, although primarily oriented to single objective planning. Although the notion of comprehensiveness is a vague and at best ambiguous term, at least river basin plans have been developed and some analysis of the interrelationships between a set of projects in the river basin has been introduced. Single purpose and single projects are displaced by multiple purpose and multiple unit projects. Considerable experience and proficiency has been developed in formulating a system which optimizes a single purpose, given constraints from other purposes. A good deal less accomplishment can be demonstrated in optimizing complex systems. Much of the success at systems analysis is attributed to hydrologists, including the work at HEC, although the criteria for optimization was articulated by economists in the Green Book.

A shift away from a viewpoint of dominance of the Feds was explicitly introduced in the Appalachian Water Resources Survey (AWRS) and the Susquehanna River Basin Survey. The AWRS emphasized the reporting of a wider range of project outputs than is normally presented in Corps reports. Also, there was a conscious attempt to blend Federal and regional economic development objectives into an acceptable posture. The Susquehanna River Basin report concentrated on the formulation of at least three plans emphasizing national efficiency, regional development and environmental enhancement objectives. An elaborate strategy of conducting local meetings to get an expression of local response to the three plans and an indication of a preferred mix was implemented.

The Corps has implemented a Planning, Programming and Budgeting System (PPBS) at considerable effort in all levels. The Corps system is unique in its emphasis on the Division Engineers analysis and recommendations, and in common with other agencies has found considerable difficulty in arriving at a consensus or even an understanding of "needs for water resource development." The "needs" form the primary parameters setting regional allocations for planning and construction starts. Upon recognition of the importance of "needs," there arose a mighty storm from the Division Engineers about their essential "softness." A task force of field personnel was formed to study the problem and recommend procedures for improvement by the Chief of Engineers early in 1971. About the only obvious conclusion of the task force was that the notions about needs are highly diverse. One of the fundamental problems is that the "needs" that we all talk about are somewhat ambiguous combinations of the objectives of water resource development. There is a range of opinion (inside the Corps) in terms of the specific content of the objectives of water resource development and an almost infinite range of opinion about the relative weights that should be attached to each objective vis-a-vis the other objectives. The task force recommended further work in cleaning up "needs" estimates with respect to each objective.

Additional field studies of selected proposed procedures were conducted in Los Angeles, Portland and Jacksonville Districts this past fall and the results are under consideration by OCE at this time.

What Next?

All of the threads of shifting priorities and adjustment by agencies including the Corps, lead to some conclusions about the future. A conscientious effort to articulate an effective role for water resources development in the coming decade holds primary importance. This effort should result both in new programs and a considerable shift in the way we manage older programs. Simultaneously, the organization must adjust to the new roles. This provides a challenge to hydrologic analysis which acquired a crucial role during the reservoir era.

What emphasis will future programs have:

(1) Urban centered. The problems of water resource development are in the urbanized areas of our nation. A historical orientation to rural areas will have to be adjusted to accommodate this reality. Urban drainage, pollution control, space management, open space and recreation are likely to be a focus of emphasis. Planning and implementation of viable programs will require collaboration with a broad representation from diverse and perhaps competitive interest groups. We will have to develop the competence to keep competitive interests bargaining towards eventual coalescence around some strategy. Dominance of one particular technological set (particularly the reservoir, levee and channel improvement combination) will no longer be possible. We will have to be flexible in the kinds of solution that the Corps will support. The use of water as an "organizing concept" can increase to place new emphasis on joint strategies between a number of programs. Engineers and scientists will have to play an increasing role of providing technical information in a way that laymen can perceive it. The relative importance of flood plain information systems should increase geometrically from its position today.

(2) Program Orientation. The stance of planners should shift from an individual project basis to a greater program orientation. This requires conscious effort to organize the "needs" in a program set (reflecting fairly explicit weights and priorities between objectives and competing programs) and to formulate alternatives to meet the "needs." Much additional information will have to be formally collected, analyzed and presented in our reports. This requires the development of additional data systems capability so that planners are not encumbered by the mass of data, and that their publics and their bosses can understand what is going on. Certainly, every report will have to display the connection between a recommended course of action to the needs of the locality, region and nation and how the recommendation fits to ongoing and anticipated actions and programs.

(3) Flexible Plans. Flexibility will become an outstanding attribute of acceptable plans and programs. We know that projections are at best a wide range of possible futures, so narrowly conceived plans which resist alternation will become even less desirable.

(4) Emphasis on Operating System. The days of new large reservoirs are numbered. Only a deep and fundamental revision in public concerns and priorities will change this conclusion. Projects which possess the characteristics of serious dislocation of people, communities and ecological populations are no longer acceptable, unless the need is overwhelming. This will lead to a need for conscious and continuous study of the operation of going projects. Fortunately, the Corps has a framework for this emphasis through their Reservoir Regulation Centers located in most Divisions. A considerable effort will be required to set up the necessary flow of information about needs of the nation and the region and the range of alternative operating policies for operating projects. Further development of simulation and optimizing models will be required to implement this analysis.

(5) A Philosophical Adjustment. The change to urban orientation, flexible plans, emphasis on information services and improving the effectiveness of operating systems imply a rather dramatic adjustment of philosophy. This change is away from an objective of controlling the nation's river systems to an objective of managing the nation's river systems to satisfy a people oriented set of needs. Rejection of the almost obsessive concern about maximum site development in favor of wise use of flood plains and concentration on reuse rather than inter-basin transfers of water are implicit in this sort of an adjustment.

(6) A Management Adjustment. Organization of Corps personnel to conduct studies most frequently partitions the hydrologist from the foundations people and from the economists, environmental resource specialists and the other members of the planning team. Some of the most difficult problems in Corps project reports, however, arise from this arrangement. Somehow, implications of urban development from economists or urban planners on runoff patterns never reach the hydrologist, thus projected runoff coefficients miss the mark and a fundamental error is introduced to the project analysis. A high degree of interaction should be encouraged between all persons and disciplines engaged in planning studies, something that management can expedite and something that the individuals must endeavor to do.

There is a significant bias among Corps managers to view the Corps activities as a series of projects in the planning, design, construction and operation pipeline. Thus, an unusual emphasis is placed upon discrete parts of the Corps program. Deliberate emphasis on looking at all projects in a program context is needed. The Planning Program and

Budgeting System offers an unusually effective means of comparing the output of going and potential projects to meet needs. This analysis can be productively utilized at the Division and District level as well as OCE level. Too often PPBS is viewed as a sort of nuisance done only for OCE and the Office of the Secretary of the Army. Continuous and careful study of needs and opportunities can lead to identification of potential reorientation to going surveys as well as reorientation of going projects. About the only problem for field offices when they recognize the need for reorientation is to get some authority for expanded or reoriented studies. Since resolutions appear to be almost free goods, the problem resolves to a resource allocation problem, something that the field has a great deal of discretion available to it. This means taking it from one area lower priority and giving to an area of higher priority.

THE INTERRELATIONSHIP BETWEEN PLANNING OBJECTIVES
AND HYDROLOGIC ANALYSIS IN WATER RESOURCES DEVELOPMENT

Question, Mr. Harrison: How can we manage this complex planning process so we can pull out those projects that are obviously needed and well justified and start building them now without awaiting the consummation of 5 or 10 years of planning?

Reply, Mr. Antle: Projects obviously needed can be recognized if our assessment of needs are consistent with the communities (local, regional, national). The urgency must be, however, conditioned by the level of uncertainty about potential impacts, both desirable and undesirable. Therefore, the only compelling reason for additional study is to reduce uncertainty to a level acceptable to the community.

Question, Mr. Harrison: Is it necessary for us to prepare detailed alternate plans for each objective or for the plan that we develop can we merely show how objectives were considered and prepare a display or check-off in which we show how our plan impacts on environmental aspects of each objective?

Reply, Mr. Antle: We should develop enough alternative plans to demonstrate the bounds in the range of impacts across the various objectives. Probably, the planning process will include several levels of aggregation, such that potential conflicts can be identified and resolved in a systematic manner and the hard needs for additional information identified. It is obvious that rigorous study of foundation, hydrologic and detailed economic, social and environmental studies should not be made until regional needs and national priorities are consistent. Fairly rough approximations can establish whether regional needs and national priorities are consistent or at least define the areas of conflict.

THE ROLE OF HYDROLOGIC ENGINEERING
IN THE CORPS' WATER RESOURCES
PLANNING PROCESS

By

David L. Sveum*

INTRODUCTION

The Civil Works Program for development of water resources by the Corps of Engineers is the largest and most diverse public works program in the Federal service. The existing and future needs for flood control, irrigation, navigation, municipal and industrial water supply, maintenance of water quality, preservation and enhancement of fish and wildlife, water oriented recreation and for other water uses have been recognized at Federal, State and local interest levels. Assuming a continuation of existing legislative policies, the Corps will continue to be assigned the responsibility for the planning, design, construction and operation of a large proportion of these needed projects.

Purpose

The purpose of this paper is to discuss the role of hydrologic engineering in the Corps' water resources planning process. Efficient water resources developments for the future will require comprehensive studies and engineering analyses involving application of the most advanced techniques and criteria afforded by professional experience and engineering training. Hydrologic engineering plays a role of fundamental importance in this effort. Applications of hydrologic engineering and the importance of integrating the results of these studies into the planning process are discussed. The Corps organizational structure for planning and hydrology is also reviewed and conclusions are drawn about what is needed if the Corps is to develop technically sound comprehensive plans to meet water resources needs.

Objectives of Water and Related Land Resources Planning

"Broadly, the objectives of planning are to provide a guide for Federal, State and local interests to conserve, develop and utilize their water and related land resources in an efficient and timely manner. Further, such planning should provide a sound basis for rational, well considered decisions among alternatives or competing uses of these resources--the meeting of needs and desires of people which includes the improvement in the quality of the environment, the enhancement of national economic development, the betterment in the quality of life, and the stimulation of regional development." (1)**

* Hydraulic Engineer, Water Control Center, North Central Division

** Refers to references listed at the end of the paper

APPLICATIONS OF HYDROLOGIC ENGINEERING

Definition

As a natural response to needs of the time, several new fields of engineering have evolved within recent years. Among these is an area of professional specialization best described as "hydrologic engineering." (2) Hydrologic engineering is identified as an area of civil engineering practice in which applications of professional knowledge of hydrology constitute key elements in the planning, design, construction and operation of water resources developments. (3)

Analyses of Basic Data

The analyses of basic data are one phase of the overall water resources study effort where hydrologic engineers can make a unique contribution. Design capacities and operational characteristics of individual projects and systems are based on estimates of probable future hydrologic events that are assumed to occur within the effective life of such projects. These estimates normally are based on inference drawn from the analyses of records of hydrologic events that have been observed over a period of years. However, a large amount of thoughtful deliberations must enter into the analyses of "basic data" before logical deductions regarding future recurrences of events can be drawn.

There are very few streams in the country whose runoff characteristics have not been changed to some extent by the works of man. For example, stage-discharge relations may be altered repeatedly during the period of observation at a particular stream gaging station by the construction of levees, channel improvements, bridges, or other local features; valley storage effects may be modified by natural or artificial changes in the flood plain; the construction of reservoirs, land treatment measures, irrigation practices, and other causes affecting evaporation and runoff often result in substantial changes in both the quantity and rate of streamflow. A variety of correlation and routing techniques are available to hydrologic engineers for use in analyzing streamflow records and in adapting them to reflect current conditions for use in project studies. The capability of hydrologic engineers to analyze streamflow records and to relate them to a common base should be integrated into the water resources planning process.

Generalized Estimates

In some cases the adapted streamflow records should serve as a basis for preparation of generalized estimates of hydrologic conditions for use in project studies. Realistic generalized hydrologic relations can

usually be developed with less expenditure of time and money than would be required for preparation of independent estimates for a large number of locations in a drainage basin. Generalized relationships provide a consistent basis for estimating runoff from ungaged drainage areas, for analyzing storage capacity allocations corresponding to hydrologic events having various probabilities of occurrence, and for establishing design criteria that are consistent for each component of the system. These generalized estimates, prepared by hydrologic engineers, can be especially useful to planners in the preliminary phases of project formulation studies.

Comprehensive Basin Plans

Recent innovations in mathematical modeling of hydrologic systems have provided hydrologic engineers with a flexible tool to analyze systems for meeting specific needs and conditions. Systems analyses should be integrated into the planning process during detailed studies to assist in evaluating the alternatives. Analyses should first be made for systems for meeting single purpose needs such as flood control, irrigation or maintenance of water quality. For example, systems of structural and non-structural measures whose objective is to provide what could be called "ideal flood protection" could be developed. In this paper "ideal flood protection" is defined as the degree of protection that is desirable, but may not be attained because of economic infeasibility, environmental objections or other constraints. The initial goal of this type of study effort should be to develop a plan for providing standard project flood protection for all urban areas and to provide a reasonable degree of protection to the agricultural and sparsely developed areas within the floodplain.

This type of study by hydrologic engineers is a logical first step in developing a comprehensive basin plan, even though project formulation analyses during later stages of the study may show that complete regulation by structural measures alone or in combination with non-structural measures is infeasible. An optimum plan for providing ideal flood protection may also serve as a guide for future development of projects throughout the basin because some of the components which are not feasible at the time of the study may become feasible in the future due to changes in policy, public attitude or increased development of the basin.

The basic hydrologic model of the basin that was developed for a single purpose can readily be revised to reflect other needs or conditions. Most likely revisions will be required during the course of the study because of conflicting basin requirements and inadequate supplies to meet all needs. Some basins are sensitive to a mix of purposes and trade-offs must be evaluated. Hydrologic models can be of great assistance in evaluating multi-purpose projects.

CORPS ORGANIZATIONAL STRUCTURE FOR
PLANNING AND HYDROLOGIC ELEMENTS

Coordination

When studies are made for a relatively small project at one site, only minimum coordination is required during the course of the study. However, during comprehensive basin studies that include an evaluation of several alternatives, there is need for frequent joint discussions between participating elements to assess the direction and status of the study effort. Project formulation elements must learn about the capability of hydrologic engineers and utilize that capability by requesting the type and scope of hydrologic studies that will help to insure sound project formulation. Hydrologic engineers must understand the total study effort involved so they are prepared to furnish their input when it is needed and in a form that can readily be used in formulation of specific projects. Recently there has been a trend toward the development of complex models such as those used for simultaneous solution of hydrologic conditions and economic evaluations. More coordination will be required in the future as a result of this trend. Higher study costs, delays in study completion and a lower quality study effort will result if inadequate coordination is affected. Therefore, it is important that District offices develop the capability for close coordination within their organizational structure.

Organizational Structure

The organizational structures of the 36 Districts located within the 10 continental Divisions of the Corps were reviewed to assist in determining the magnitude of the coordination problem. The titles of each division, branch, section and unit shown on the August 1971 District organizational charts were reviewed. The location of the project formulation and hydrology specialties within the District organizational structure were identified as reliably as possible from the organizational charts. It is recognized that either plan formulation or hydrology may be performed in more than one element in some District offices. The titles of the elements in each District office that suggested responsibility for planning and hydrologic studies for comprehensive basin plans were tabulated. A summary of these tabulations follows:

LOCATION OF PROJECT FORMULATION
AND HYDROLOGY ELEMENTS IN DISTRICT OFFICES

<u>Location</u>	<u>Number</u>
Same Branch, Same Division	16
Separate Branch, Same Division	17
Separate Branch, Separate Division	<u>3</u>
Total Number of Districts	36

The table shows that the responsibilities for project formulation and hydrologic studies in over one-half of the Districts are assigned to separate branches with three Districts having established planning divisions. The trend for more Districts to establish planning divisions is quite clear. It is my view that the overall result of continued development of the planning elements in District offices will improve the capability of the Corps in water resources planning. However, this type of organizational structure places several supervisory positions between working-level planners and hydrologic engineers thereby necessitating additional coordination. It also could create the problem of establishing compatible priorities within the separate elements. It appears that the best type of organizational structure for establishing a close working relationship exists in those Districts where project formulation and hydrology have been established as sections in the same branch in the engineering division. The branch chief can then establish consistent priorities for both sections and can direct the branch effort in an efficient manner. However, this type of organizational structure does not emphasize planning for water resources development to the extent that is desired.

The problem of coordination has been recognized by many leaders in the Corps. For example, Robert E. Jordan, Special Assistant to the Secretary of the Army (Civil Functions) pointed this out in a Memorandum for the Planning Study Contractor, dated 29 January 1971. He stated the following: "a key element in formulating water resource plans is hydrology, yet the hydrology function in OCE is located in the Engineering Division. The pros and cons of this organization arrangement for hydrology should be examined." It is my view that the advantages of consolidating all of the District expertise in the field of hydrology into one unit outweighs the disadvantages since applications of hydrology exist in the planning, design, construction and operation phases of the Civil Works Program. A strong unified hydrologic element should be retained in the engineering division of each District office because this is the best means of developing and maintaining expertise in the field. Nevertheless it may pose a problem in coordination.

It is evident that planners and hydrologists must maintain both formal and informal lines of communication. When more Districts establish planning divisions, the need for informal communication between planners and hydrologic engineers will become even more urgent. Supervisors should encourage informal coordination at the study working level in order to bridge any barriers to formal coordination that may occur as a result of organizational structures. This informal coordination is needed if the Corps is to develop technically sound comprehensive plans to meet water resources needs.

There are several examples where efforts have been made to improve coordination for solution of specific problems of high priority by establishing groups such as task forces, ad hoc committees and planning teams. Membership of these groups have consisted of several disciplines including planning, hydrologic engineering, economics and other specialties. In some cases this has been an effort to formalize an informal relationship where working level personnel can get together at

regular intervals. After the group has been established through the proper supervisory chain of command, it can perform on an informal basis. It appears that this method of achieving coordination should be more widely used for major studies within the Corps. The resultant coordination and exchange of ideas may materially improve the quality of planning for water resources development.

Grade Levels

During the review of organizational charts it was observed that in about one-third of the Districts the chief of the element which has responsibility for project formulation is one grade higher than his counterpart in hydrology. It was also noted that only 16 of the 36 Districts had established hydraulic or hydrologic engineering branches in the engineering division. These two facts seem to indicate that in spite of the vital role the hydrologic engineer plays in maintaining the quality of planning and engineering accomplishments, his stature is not always equitable with that of his associates in planning or some of the other engineering disciplines. This does not provide proper emphasis of this field in view of the major influence that hydrologic estimates have, not only in the planning of projects, but in the design and operation of projects as well. This lack of stature is a source of discouragement to some capable hydraulic engineers and it is creating a problem in attracting and retaining engineers in this field, particularly in those Districts where a grade differential exists. The end result is that the capability of District offices to perform high quality hydrologic and hydraulic studies needed by planning and other elements is reduced.

There are only a limited number of personnel outside government service who have the necessary training and experience that would qualify them to perform comprehensive hydrologic studies on a consulting services basis. This situation makes it mandatory for Corps organizations to develop and maintain expertise in hydrologic engineering. To successfully do so, grades established for hydraulic engineer positions, which includes hydrologic engineers, within the Corps must be comparable with those of planning and other disciplines in order to attract, recruit and retain the high quality staffs that are needed in this field.

CONCLUSIONS

It is anticipated that the Corps will continue to be assigned the responsibility for planning a large portion of the nation's needed water resources projects.

Hydrologic engineering plays a role of fundamental importance in the Corps' water resources planning effort. The analyses of basic data is one phase of the overall study effort where hydrologic engineers can make a unique contribution. Preparation of generalized hydrologic relations for use in basin studies can save time and money, particularly

during preliminary phases. Hydrologic engineers have increased their capability for developing mathematical models of hydrologic systems. This capability should be integrated into the planning process during detailed studies to assist in evaluating alternatives.

The trend for more Districts to establish planning divisions is quite clear. This type of organizational structure places several supervisory positions between working level planners and hydrologic engineers. In such cases supervisors should encourage informal coordination at the working level to bridge any barriers to formal coordination that may occur as a result of the Corps organizational structures. The use of groups such as task forces, ad hoc committees and planning teams composed of several disciplines should be more widely used within the Corps. The resultant coordination and exchange of ideas may materially improve the quality of planning for water resources development.

In spite of the vital role the hydrologic engineer plays in maintaining the quality of planning, design and operation of projects, his stature is not always equitable with that of his associates in planning. Expertise in the field of hydrologic engineering must be developed and maintained within the Corps organization. Therefore, grades established for hydrologic engineers within the Corps must be comparable with those of planning and other disciplines in order to attract, and retain the high quality staffs that are needed in this field.

Regardless of the degree of recognition that is accorded in specific Corps offices, the nature and importance of hydrologic engineering should be recognized. Special efforts should be made to assure that pertinent hydrologic analyses receive proper attention during all phases of studies related to water resources development.

REFERENCES

1. Policy Statement on Water and Related Land Resources Planning. Water Resources Council, Washington, D.C., 1970.
2. Civil Works Engineer Letter 63-11. Hydrologic Engineering Associated With Water Resources Development. Office of the Chief of Engineer, Washington, D.C., 1963.
3. Guidance Memorandum: HEC. The Hydrologic Engineering Center, Corps of Engineers, 650 Capital Mall, Sacramento, California, 1968.

FORMULATING FLOOD CONTROL
CAPABILITY OF WATER RESOURCE PROJECTS

By

Vernon K. Hagen¹

BACKGROUND

In the development of our Nation's water resources, flood control has and will continue to be a prime objective. The Corps of Engineers and other entities have been actively engaged in the prevention of flood damages for many years, yet the annual flood damage continues to mount. Some experts direct all fault to the unwise development of flood plains primarily by the unknowing or uninformed. However, this does not explain why individuals with many years of flood control training and expertise continue to invest in property that is flood prone. The priorities of these individuals and companies must be closely examined to understand this apparent lack of good judgement. The individual with a home located along the banks of the Willamette River in Oregon or near a beach in Florida is primarily concerned with the aesthetics and convenience of his chosen location. Economic optimization and even hazards to his very life may have been given secondary consideration. The businessman may be essentially concerned with increasing his earning power. Locations near inexpensive transportation such as navigation facilities may be a more compelling force than the occasional direct flood damages and loss of business. Then of course there is always the possibility of a governmental entity providing some form of flood protection to further enrich his holding. This paper is not directed toward the issue of personal vs. governmental obligations in the development of flood control measures. It is, however, intended to illustrate many of the factors that should be considered in formulating flood control plans. The role of the hydrologic engineer in this important decision making process will be stressed and his interface with the planning discipline emphasized.

FLOOD DAMAGE PREVENTION MEASURES

Probably the only fully effective non-structural method of preventing flood damages is the zoning of lands subject to inundation. Flood insurance provides a method for lifting the burden of flood

1. Acting Chief, Hydrologic Engineering Branch, Office, Chief of Engineers

damage from the individual by Federal subsidy and by spreading the loss among many. It also makes the loss less painful by converting losses to annual payments. Inability to obtain flood insurance or variable premium rates tend to discourage people from living in areas frequently flooded because of lack of insurance or high costs.

Guidance can be provided thru the use of tools such as the flood plain information report but little will be gained without laws to prevent development or at least to regulate development. Land use plans can be effectively developed by city and regional planners when they have sufficient information on flood levels and velocities as well as the probability of their occurrence. Other aspects that may influence land use are the rate of rise and duration of flood waters; also, the saturation of land by abnormally high levels of ground water can cause extensive flood damage. All this information on flood characteristics should be developed by individuals competent in the hydrologic engineering discipline. Inaccurate information may result in unwise zoning and improper development.

Information on flood characteristics is equally, if not more, essential in the formulation of structural flood damage prevention measures than nonstructural measures. Structural techniques that have been successfully utilized in preventing flood damages include:

- a. Floodproofing
- b. Relocation
- c. Channel improvements
- d. Diversions
- e. Land treatment
- f. Levees and floodwalls
- g. Reservoirs

Each type of flood protection is unique and sound planning and design requires analyses of flood characteristics that would have any significant effect on decisions regarding the selection and sizing of structural facilities. The choice of facilities to prevent or reduce flood damages can be a complex process, particularly, where a system of many alternatives is possible. Occasionally, a flood problem can be solved by the provision of one type structure with all its complimentary facilities. However, in present day planning such relatively simple solutions are becoming the exception to the rule. Most engineers and planners have their own idiosyncrasies when it comes to selecting

and sizing flood control works. These traits may be passed on from supervisors, obtained from instructors and written material, or developed from personal experiences. Regardless of bias, there are certain capabilities connected with each type structure that should be analyzed and weighted on the planning scales. Comments on the limitations and advantages of alternative structural measures are presented in the subsequent paragraphs. Complete treatment of the subject is not intended; however, illustrations are given to indicate the dependency on hydrologic engineering information and judgement.

Floodproofing is an important technique that can be utilized by individuals and corporations in the flood protection of their property. This procedure is generally not recommended for Federal investment on private property but may be used on governmental facilities. Hydrologic engineering information can be obtained from private engineering firms or governmental agencies but it is important to have accurate and complete information. Data on flood levels and their probability of exceedence under present day conditions will usually not be adequate for the life of the proposed structure. Urban and other development can rapidly alter the hydrologic characteristics of relatively small streams. Future conditions must be anticipated and studies adjusted accordingly. Velocity of flow and ground water conditions are essential ingredients in the design of floodproofing facilities. Caution should be exercised in the use of floodproofing on existing buildings unless there is good information on the original design and present condition. The degree of deterioration of a structure is usually difficult to establish and flood loads could cause sudden failure. Floodproofing measures are particularly attractive when facilities are located at some distance from other structures and common flood control works are not practicable.

The relocation of facilities from flood prone areas to avoid future damages has generally not been practiced by the Federal government except for property located in potential reservoir areas. This procedure is difficult to implement unless provided for at governmental expense. There is at least one instance where the Corps has recommended Federal participation in relocation of facilities from a flood plain as the solution to a flood problem. Most property owners are reluctant to bear the expense of relocation and are willing to take their chances with future floods. In an effort to force the abandonment of the flood plain to flood resistant activities some local entities are refusing rebuilding permits for those structures damaged by floods. Although formal hydrologic engineering studies are not utilized in these circumstances, experienced hydrologic events provide the basis for permit refusals. Relocations in reservoir areas are governed to a large extent by hydrologic factors which may include pool level probabilities, wave action, tributary flows, ground water, and backwater effects of the reservoir on stream flow profiles.

Channel improvement works have significant advantages as well as difficult problems which should be considered before selection as a method of flood protection. Features which tend to favor their construction are the smaller acquisition of land, minimum requirements for side drainage facilities, and the ability to provide reduction in flood levels for floods greater than the design flood. Negative factors can include the increase of flood flows downstream from the improvement, costly bridge and utility relocations, and difficult maintenance problems. Many people have adverse feelings about the aesthetics of channel improvements especially if they are concrete lined. Others may not be offended by an additional ribbon of concrete thru their city. However, this blow to mans' sensitive nature can often be eased by enclosing the channel with a city street or by some architectural or landscape treatment. A common oversight or deficiency in channel improvement design is the lack of adequate protective covering. Although sized to pass flows of sufficient magnitude, many denuded channels can be seriously eroded by floods substantially less than the design flow. Deposition of this eroded material also creates problems at downstream locations. Hydrologic characteristics essential for channel design include probabilities, durations, velocities, and magnitudes of flow. In some cases it is necessary to have hydrographs for routing flows in relatively long river reaches. Water surface profiles for conditions without a project must be compared with profiles for conditions assumed with the improvement to evaluate the effect of the proposed changes. Flows from side drainage should be determined to permit sound design of inlet structures.

Channel diversions should not be contemplated without serious deliberation concerning the consequences of such action. Unwise design can frequently result in creating flood problems in areas previously immune from such disasters. Conversely, the loss of water supply by man-made structures could provide the basis for complaints and legal action. Much of the success of a diversion plan depends on the design of the diversion dam or dike. Facilities may be required to insure passage of low and normal flows down the original channel. Overflow provisions should be made to avoid diverting more flow than the diversion channel can safely pass. The dam or dike must also be designed in such a manner to avoid sudden failure and the creation of a flood wave thru the protected area. The planning and design of a diversion plan requires hydrologic information similar to the channel improvement. There may also be a need to assess the changes in ground water conditions created by a channel improvement or diversion.

Land treatment measures have been actively promoted and pursued as an effective means of reducing the potential for flood damage. Probably the most dramatic example of the effect of ground cover on runoff occurs in and around the Los Angeles area. Rain storms subsequent to burnoffs

or forest fires result in substantially greater and more rapid runoff. Large volumes of debris are carried by the fast moving flood waters and cause damages much greater than by the water itself. Until these areas can be reforested, flood hazards are much more intense for areas downstream. Design of flood protection and flood information should be based on appropriate considerations for changes in land treatment. Many channel improvement projects should include appropriate debris basins otherwise their effectiveness may be negated by the deposition and the erosiveness of the debris. Effects of land treatment are difficult to quantify and are further complicated by the uncertain nature of future land use. Although research has been conducted on runoff changes due to land treatment, it is virtually impossible to transpose this information from one basin to another because of the indeterminate correlation of runoff characteristics. Some of the more important variable hydrologic factors affected by land treatment include roughness factor, infiltration, time of concentration, soil moisture, and surface storage.

Levees and floodwalls are traditional methods of providing localized flood protection. Although greater in numbers of projects, this technique has several inherent disadvantages. Sudden failure of a high levee or floodwall could in many cases result in catastrophic conditions. Attendant facilities must be properly designed and operated otherwise the project may not function as intended. Closure structures and interior drainage facilities are critical elements of these projects. The use of valuable land will usually have to be foregone because it is needed to place structures or to provide ponding areas. In some cases scenic waterways or beaches are screened from the view of the protected populace. Despite serious shortcomings, levees and floodwalls are often recommended because there is no alternative method available to provide flood protection or to provide a high degree of protection. During the planning of levees and floodwalls, studies should be made to ascertain any adverse effects which they may have on river characteristics in adjacent or other areas. Hydrologic information required is similar to that needed for channel improvement. However, the rate of river rise and fall can be most critical in project design and operation. Pumping plants and some types of closure structures may not be effective in rapidly peaking and short duration floods. Anticipated wave action can also establish specific design requirements, especially when the dike is a hurricane barrier being provided to protect coastal inhabitants from ravage by the sea.

Reservoirs have been used universally to control or reduce the destructive power of floods. Sites for dams are becoming scarce and there is a growing concern over the desecration of our natural waterways. Therefore, considerable opposition will likely develop whenever future reservoirs are proposed. The adverse effects of reservoirs can be numerous if all facets are not studied and mitigating measures taken to offset losses. While the disadvantages can be significant, the benefits are so great in some cases that the construction of reservoirs should not be arbitrarily discontinued to satisfy special interests. Each case should be decided on its own merits and losses. The effectiveness

of reservoirs in controlling floods depends on the types of facilities provided, the amount of storage available, the percent of drainage area controlled, and the method of operation. Hydrologic engineering expertise should always be utilized in planning reservoir projects to avoid impractical recommendations. There is a tendency to select the least expensive facilities in planning studies to show favorable benefit/cost ratios. This practice can lead to complications in the detailed design phase when alternate facilities of substantially more cost are selected. It behooves the planner to ascertain the real-time practicability of proposed plans before final recommendations. For example, when spillway gates are proposed, it must be demonstrated that trained operators will be available and have sufficient time to manipulate the gates according to instructions from reservoir regulation personnel or predetermined operating procedures. All phases of hydrologic engineering expertise should be brought to bear in planning, design, construction, and operation of reservoir projects.

FORMULATION BIAS

In the formulation of plans to reduce flood damages there are many special interests. Each interest has its own brand of importance and should be given an equitable share of consideration in the formulation process. Hydrologic engineering plays a significant role in many of the decisions of special interests.

The economist must take a major part in selecting flood control facilities both in the private and public sector for there is considerable competition for the use of available funds. Unless a public endeavor can show some sort of benefits in excess of costs, the Congress and executive branch are reluctant to sponsor such activities in the development of our water resources. Therefore, the economist has to diligently search for those projects and systems that provide the greatest return for the investment. Hydrologic engineering studies provide many of the relationships that are needed to assess the worth of projects. Backwater studies and flood routings are used to develop water surface profiles with and without proposed improvements. Statistical procedures are used to estimate the probability of reservoir pool levels and the exceedence chances for flood events. Synthetic floods are developed to measure standards of performance. Hydrologic relationships are combined with damage and cost relationships to provide the economic worth of the proposed plan or portions thereof. Elements of the plan can thus be measured in various combinations until the optimum economic plan evolves.

The design engineer has personal built in bias just as the economist. His primary goal is to design a project that is functionally sound and secure from safety hazards. Failure of an important engineering work

such as a major dam could mean the end of a professional career or even the demise of a Federal agency. Therefore, it is essential that the design engineer have hydrologic information on probable maximum and standard project floods to size spillways, select tops of dams and levees, ascertain design loads, etc. It is also necessary for him to know about ground water conditions, probabilities of floods during and after project construction, and many other hydrologic factors.

The ecologist has a vital interest in flood control development for he is basically concerned about the quality of life. However, his concern is generally not directed toward human activities but is rather devoted to wildlife creatures which are essentially helpless as man invades their environment. In his assessment of proposed flood control plans, the ecologist must also have access to extensive hydrologic information. It is important for him to know how a reservoir pool will fluctuate in order to evaluate its effect on nesting grounds, migration habits, and other environmental concerns of the wildlife. Changes in hydrologic regime brought about by flood control activities should be analysed to determine their effect on ecosystems. The net effect of these changes can very well result in improved conditions; therefore, the ecologist should be concerned with both the positive and negative effects of the project.

Local interests should have a significant voice in the formulation of flood control plans. They should also play an important role in the achievement of their objectives. Land use planning, zoning, building codes, and citizen participation are all techniques that should be employed by local governments in reducing their flood losses. However, the average citizen is uninformed regarding many flood characteristics and alternative ways of reducing their damages. He must be made aware of the potential hazards from floods and inadequate types of protection. Local interests are often inclined to direct their efforts toward the activities that are least costly to them in terms of money and inconvenience. Some Federal programs base their support on certain minimum levels of flood protection. In order to participate in these programs, local interests will sponsor flood protection works based on these minimum levels without due consideration of the potential consequences of their action. Therefore, it is necessary that local interests be aware of hydrologic engineering information that would have impact on their decisions and recommendations.

Now that some of the special interests have been brought to light, it appears appropriate to examine the hydrologic engineer and planner in terms of bias. Theoretically, these two disciplines should have little reason for bias in the formulation of flood damage prevention methods. Their approaches should apparently be indiscriminating with just consideration of all aspects. Traditionally, planners have tended to give most

weight to economic optimization in their selection of flood protection plans. This attitude is primarily based on the limited Federal budget in water resource development and the desire to provide as many as possible with the advantage of flood control. While this is a worthwhile goal, intangible considerations can be overlooked or given cursory treatment. Hydrologic engineers on the other hand have been primarily concerned about the functional capability and safety aspects of individual projects. While this viewpoint results in effective projects, it also limits the number of people and communities that can be benefited by flood control works.

ELEMENTS OF FORMULATION

The determination of economic optimization of a flood protection plan will depend to a large extent on assumptions made in the evaluation. Many of these assumptions should be made by experts in hydrologic or other engineering fields. The operation of a reservoir for example will depend on the capability and reliability of facilities provided as well as downstream controls and the availability of qualified personnel to perform the operation. A good many regulation schedules are based on inflow forecasts which are difficult to make with a high degree of accuracy. It is therefore important that reservoir control assumed in planning studies be based on realistic forecasts, rather than on perfect hindsight obtained from flows of record. The type of flood protection provided will also have a significant impact on how the benefits are determined. Some projects such as channel improvements may continue to provide benefits when the design flood is exceeded. In other projects benefits cease when the design flood is exceeded because of loss of control or failure of the project.

Generally, benefits are not claimed for the freeboard range on proposed levees and floodwalls. Freeboard is designed to assure passage of the project design flood and is provided to account for those uncertain factors not included in hydraulic computations. However, there is usually reasonable assurance that a flood somewhat larger than the design flood could be passed without failure if there is no significant erosion or structural collapse. Therefore, if structural conditions are particularly good, there may be a basis for partial credit of freeboard benefits. This credit would also depend on the absence of restricting bridge openings or other problem areas where debris could accumulate. When evaluating the benefits of existing projects, the uncertainty of freeboard utilization may have been reduced by the actual passage of floods greater than the design flood. However, consideration should be given to those factors permitting passage of the flood without damage, as fortuitous conditions may have been prevalent which would not be likely during a subsequent flood. Caution is directed against claiming the ability to pass floods greater than the design flood even if some economic benefit is claimed for freeboard allowance.

The well being of protected citizenry has to be evaluated if flood control plans are to be properly conceived. Although an important element in formulation, well being is much more difficult to determine than economic evaluation. One basic tool in this evaluation is establishing the consequences of exceeding the design flood. If a sudden failure of the project or an abrupt increase in flood discharge could occur, caution should be exercised in providing an intermediate degree of protection for an urban area. It may be better to select a lower or higher degree of protection to minimize the possibility of a catastrophic event. The higher degree of protection reduces the probability of the event whereas the lower degree reduces the severity of the event. Some aspects of well being which are not subject to economic assessment are (1) removal of the constant fear of being flooded, (2) improved neighborhood pride, (3) reduction in health hazards, and (4) ability to obtain loans and insurance.

A measure of well being in flood protection is the performance standard or degree of protection. It has been generally concluded that flood protection from the standard project flood would be about the upper limit of protection sought, provided economic and other considerations warrant. Therefore, flood protection approaching the standard project flood should give a high sense of well being. A common failing in the formulation of flood protection has been the reluctance to carry project design beyond the point of economic optimization. In order to show allowance for well being and other intangibles, the selected degree of protection must be greater than the tangible optimum. Otherwise, it must be concluded that the only return from the project is monetary benefit.

Aesthetic considerations are a must in flood control formulation, particularly in these days of environmental concern. Without such treatment there is little likelihood of having plans accepted by local interests. There have been many notable instances in recent years where large sums of money have been expended to preserve an item of archaeological interest. In other locations dams have been prohibited or changed to another site to prevent the loss of a scenic view. Certainly, most employees of the Corps are involved in some way with the environmental impact statements required for flood control activities as well as other Federal programs. These statements are to include all significant impacts of a project; however, aesthetics and ecology have been receiving major emphasis.

CONCLUSION

In conclusion it seems inevitable that an interface between the planner and the hydrologic engineer must be consummated to arrive at a proper mix of performance with economic gain in sound flood control

formulation. This mix should be blended with other ingredients on ecology, aesthetics, and local participation to achieve a project, formulated with equity for all considerations. In selecting the proper design flood perhaps we should impose rules that would increase project costs beyond maximum net tangible benefits to a somewhat larger design flood. Minimum percentage amounts could be provided depending on the type of area being protected. This would assure an automatic allowance for those intangible benefits associated with all projects. If flood protection plans are to be adopted in the future, their impact on mankind as well as wildlife must be emphasized. Impact statements should not be developed with a negative tone unless a particular project would in fact cause net adverse effects. In such cases the Corps should not be recommending the development of the project. However, when a good project is proposed, the impact statement should not be confined to magnifying minute adverse effects. As that old song lyric goes, we have to "accentuate the positive" and "latch on to the affirmative."

EFFECTIVE USE OF HYDROLOGIC ANALYSIS IN INTERDISCIPLINARY PLAN FORMULATION

by

Carl H. Gaum 1/

INTRODUCTION

The development and presentation of hydrologic data and analysis for Corps of Engineers reports must in this age of multi-objective planning be more responsive to the needs of the various disciplines involved in water resources planning. In the past the major effort has been to determine the criteria for hydraulic design and for the economic analysis of the project. Only minor effort was devoted to some of the environmental and social problems. However with new and often major interest in these areas, new parameters must be given attention in the hydrologic studies. The audience that previously reviewed our reports has also changed. Today we have biologists, geographers, naturalists, environmentalists interested in water resources planning, ranging from the expert who has devoted his life to some speciality to the grade school child. These people are wanting to know what it is we are proposing to do and how it will effect the natural and social environment. In this paper some of these new interests and how they effect our studies will be discussed. The presentation emphasizes the environmental issues since the tools for analysis of the basic physical data and economic factors are generally available.

Framework Plans.

The nation recognizes that in many cases we are approaching the limits of use of our resources. One of the areas of concern, at least for particular sections of the country, is water resources. There are few areas of the United States which will not be hard hit by the next major drought. Most western state have over allocated irrigation water for a dry year and in the eastern states resources will not be able to meet demands for municipal and industrial water supply, thermal power cooling and waste effluent assimilation. In order to determine how the nations water resources availability can be best utilized to meet present and future needs the Water Resources Council has been making framework studies. The studies determine the needs of an area to include water supply, irrigation, conventional and pumped storage, navigation, recreation, fish and wildlife, water quality, environment and flood control. Related lands needs such as shore and land erosion prevention,

1/ Assistant Chief, Interagency and Special Studies Branch, Planning Division, OCE

drainage and irrigation acreage are also included. These studies examine in broad terms the alternative ways in which the water and related land resource needs can be met.

One way to more effectively utilize the resource at hand is through proper utilization and control. In many cases the extremes of runoff can be further modified to provide for our objectives. However in doing this we often change the balance of nature by changing the instream and shoreside regimen. In the nations early development it seemed as if our resources were inexhaustible and the changes brought about appeared insignificant. However today we must be aware of the results of our action on the environment over the longer period. The hydrologic analysis should be able to anticipate some of these problems or at least give the various experts in the field the basic data needed to pass judgement on the effects of further development or modification.

The framework studies do give general background data to help in defining some of the problems to be expected and point out geographic areas which deserve more detailed study. The framework studies hydrologic analysis generally consists of typical hydrographs for a few selected locations, high and low flow peak frequency curves, storage yield curves and some indication of sediment loads. Little attention has been paid to water quality except to present average chemical content and total organic waste loads and determine flows required to assimilate secondary treated wastes. Obviously much more data is needed. For example generalized curves and regional data concerning ranges in chemical quality and water temperature over time are required. Generalized heat budget analysis for typical reservoirs in various parts of the region would be helpful. Flow volume analysis for selected locations would also be helpful to obtain the quantity of chemical constituents in the stream, lake or estuary at any time. In our studies of estuaries many needed hydrologic analysis covering all parameters are lacking. Guidance is needed from ecologists to select key parameters needed for further study of the estuaries life cycles and regimen.

Regional or River Basin Plans

The river basin and regional studies under the Water Resources Council are assigned to determine for smaller hydrologic units or major metropolitan areas, the time and place of needs and develop an early action plan to provide for these needs. The early action plan will present the location of the needs and indicate the best alternatives to be further investigated in the implementation studies of the individual agency, state or local interests.

For these regional or river basin studies hydrologic analysis should be in more detail (than for frameworks) for the selected alternatives and hence generally require only minor modification for use in the

survey report. The hydrologic analysis should cover the broad spectrum of all problems and needs and the interdisciplinary means of solution. For example, ground water when available should be considered as an alternative for low flow supplementation in lieu of reservoirs storage, and advance waste treatment considered in lieu of flow supplementation. Nevertheless the full effect of these alternatives must be carefully evaluated. For example excessive pumping of ground water may change the low flow regimen of a stream and modify the base flow rates after pumping ceases. Tertiary treatment where the effluent is used for irrigation or otherwise diverted may reduce the base stream flow since withdrawal has not been returned to the stream. The return flows are often needed downstream for water supply or waste assimilation. In heavy industrial areas consumptive uses, particularly for power plant evaporative cooling, may be so great as to require make up from reservoir releases to assure that the existing stream regimen is maintained. The quality of water being released from the reservoir must also be recognized prior to construction if flow supplementation is to be effective. In areas where there are large irrigation return flows to streams the dissolved solids may be increased significantly. The hydrologist should consider the effect of these types of modification in his analysis for the regional or river basin plans. The volume of flow and data on average water quality are no longer sufficient. Maps should indicate those areas where we need to be particularly careful in our project analysis to be sure we cover aspects that are important to all environmental concerns, not just fish and wildlife. For example, there is a plan to use water from the Potomac upper estuary in time of drought for water supply for Washington, D. C. The water is generally fresh but contains the effluent from waste treatment plants from most of the Washington area. Since the Nations Capitol attracts persons from all over the world, there would appear to be a great danger of disease vectors, particularly the viruses. We must be sure that waste and water supply treatment techniques are available which will remove all risks prior to using this alternative.

SURVEY REPORTS

In the early stages of the survey report or implementation studies we have selected the specific problems to be solved and have narrowed down the alternative solutions to those which have a reasonable likelihood of being economically feasible. Often we have selected the best engineering method of satisfying the needs but have not adequately considered environmental or social factors. We now need the more specific data to make sure the project has overall feasibility not just economic. We must answer the questions: Is what we propose to do economically sound? Is it environmentally acceptable? Will it provide for the physical and social needs of the area and does it fit logically into other plans and programs for the region or area? Will the project itself create problems by attracting undesirable development?

I believe the water resources planner should also ask the question, if we build this project will it have a long range benefit on the area and its people or will it in future years create just another blight. We must therefore be able to project the hydrologic affects needed for analysis of a broader spectrum of factors than in the past. The hydrologic analysis for survey reports must be fairly well refined and the accuracy of the work reliable and within the limits of the other parameters available. Nevertheless, it is obviously wastefull to spend a great deal of time to refine hydrologic analysis when the remainder of the data if must be used with is not of similar accuracy. Often much time is spent on mathematical computation to improve accuracy to the "nth" decimal point when the basic data or the comparative data it will be used with are not of that high a quality. In many cases details are developed which are not needed but are obtained in case questions should arise. Unfortunately the files are full of answers that do not fulfill the answers to questions that later arise. On the other hand, many reports reviewed do not present the basic data needed to analyze the alternatives used to formulate a plan. Much detailed data is often presented but it is not in the right format or of the right accuracy to be useful. Often the problem is that information is not presented in a logical sequence or in a manner easy to understand. Therefore, the hydrologist should have some knowledge for what purpose and by whom studies and calculations are to be used. He should therefore communicate with the other disciplines who will be using his data and determine what information will be useful to them prior to getting involved in detailed analysis. He must remember his basic calculations are the tools with which others are to analyze various inputs to do the job of plan formulation and often are not an end in themselves. Just as it has taken time to learn to communicate with economists we must now learn the language and needs of the environmentalists.

Water resources planners whether they are engineers, economists, geographers or what have you, generally do have a basic knowledge of fundamental principals of hydrology. However, they are experts in their own fields and unable to take the time to review large amounts of background data even if intensely interested. Therefore, one of the ways to make hydrologic analysis more effective in project planning is to present it in simplified summary form. The various alternatives considered should have brief discussion. Those considered in more detail in the analysis should be backed up by simplified data and perhaps the ranges could be shown most effectively on concise graphs. The detailed mathematical and other data should go in the appendices. However, the key data for each alternative should be given in the basic report in such a way that it can be easily compared.

Good simple diagrams having the critical data for each alternative highlighted can help the planner and reviewer. Detailed diagrams which require major study are not necessary or desired and may be confusing in the basic reports. However they should be available when needed for the more specific design analysis.

Remember the purpose of the survey report is to determine if the project is engineeringly sound, has economic feasibility, is environmentally acceptable and that the selected project or program can be operated in a manner to achieve the benefits desired over a long period of time. The benefits may be in dollars, environmental or social betterment and all must be considered. Today's projects generally serve several purposes and no major conflicts in use or effort should occur, or should be minimized.

DESIGN MEMORANDUM OR DEFINITE PROJECT REPORT

At this stage we are defining the actual design criteria and must have the specific data required to make the project function safely, economically and with reliability. At this point the selected alternative chosen in the survey report to solve the problem deserves detailed hydrologic analysis sufficient to assure adequate hydraulic design. For example if it is a dam, the elevation and size of spillway must be selected to pass the design flood and give the desired flow control downstream, assure that velocities will not exceed those acceptable for materials in the spillway and keep the pool within that stage allowed by shoreside conditions. The effect of various alternatives should be carefully evaluated to assure that the best combination is selected for economic, environmental and social considerations. The outflow hydrograph should be shown not only at the dam site but also for several critical points for long distances downstream. In some areas the length of time the stream is above flood stage may be the critical factor.

A range of historical floods or selected frequency floods should be routed through the reservoir and the results summarized in simplified terms. The public has a right to know in language that they can understand what the reservoir can do and cannot do. People generally relate better to known past events rather than theoretical data. The interested public should be involved in the basic planning and operation decisions and their views and comments should be sought.

At this stage the objective should be to fully test the plan formulated, modifying it when necessary to make it more effective and to point out the fact if one finds that the project is really incompatible with the area in which it lies. At times the detail analysis discovers problems not previously anticipated which can have serious consequences if the project is implemented without giving them full consideration.

Problems in current reports

Review of reports recently submitted to OCE have indicated several areas requiring immediate attention. Some of the problem areas are associated with the environmental aspects. The outflow from reservoirs has recently received major emphasis. These problems range from the reliability of gated spillways at times of the spillway design flood to adequate control in selecting minimum discharges and obtaining the desired temperatures and dissolved oxygen at times of low flows releases to benefit downstream areas. The control towers and gates are therefore coming in for much greater scrutiny during reviews. Instead of waiting until final design some of these items deserve attention much earlier in the study program.

In many cases problems result from reporting. The hydrologist has often made the necessary studies but fails to make their results clear in the report. Misunderstanding caused by lack of presentation of basic data or possibility of wrong interpretation of that which is presented results in lost time in approving reports. Often time consuming and hence costly meetings are required to resolve questions whose answers should have been obvious.

Another area of concern has been interior drainage at levee and flood-wall local protection projects. Hydrographs are seldom developed or presented. Generally one is given a peak discharge for a single design storm. The only problem is that storms normally don't occur this way and a range of conditions would be more useful in presenting the effectiveness of the proposed plan. The volume of interior runoff over various periods of time may be more important than a peak discharge for small drainage areas where pumping or ponding is necessary when the stream is in flood. We have recently reviewed a report in OCE where combined sanitary and storm sewer discharge bypassing the treatment plant during high flows created serious environmental problems. The hydrologic and hydraulic design was quite adequate but the ponding area created unacceptable health and aesthetic problems. In this particular case until the combined sewers are eliminated, the total problem can't be solved. However when such a plan is developed we should make it clear to the people in the community that we are reducing the number of times they will be exposed to sewage in their back yards and playgrounds, and not solving the entire problem. Although it is not economically justified by present standards to provide the pumps to solve the problem perhaps the health needs may be the overriding factor.

There are indications that in some reservoirs the storage of acid mine drainage resulted in the loss of the natural buffering action of the stream and the released flows are less satisfactory than the natural ones. Much more study is needed to determine the long term effects on waters stored in reservoirs.

The hydrologic analysis of estuaries deserve detailed emphasis. Much is being done but more work is needed to help the marine biologists. Studies are being made to determine the effects of heat loads from nuclear generating plants on Chesapeake Bay. Research indicates that sudden changes in heat loads may be more critical than temperature increases themselves. In other cases pollution has caused organisms to be less tolerant to heat changes. Data on natural background variation in temperature is of extreme importance to these researchers in applying the results of their studies to project field conditions.

We need much more data including models of how micro organisms may behave under varied hydrologic conditions. In the past most of hydrologic planning has been for instantaneous conditions. The variations over time both short and long range need much more study. For example does the flushing of a stream or estuary by floods have a benefit and is it required in the life cycle of certain species? Or on the other hand does the building of dams deprive downstream areas of sediment, nutrients and organisms which under normal flow condition have a major effect on the stream? After the dam is built or the channel dredged we seldom can ever go back to the previous condition yet adequately planned resource development must continue if we are to meet the nations needs. I have touched on only a few of the problems that require the help of hydrologists. Table 1 presents a list of a few items which may be useful to environmentalists in planning water resources projects.

The hydrologist has been doing a good job and has often been ahead of other disciplines. He must however now apply his natural curiosity and problem solving techniques to a broader area. We have generally solved the problems of "static hydrology" or equilibrium conditions but must now turn attention to "dynamic hydrology" if we are to more fully evaluate the impact of our actions in the field of water resources development.

TABLE 1

Items which could receive attention by Hydrologists in Water Resources Planning to assist environmentalists in their analysis.

1. Water temperature - distance profiles downstream of low flow reservoir outlets.
2. Seasonal impounded and estuary water temperature curves by various depths.
3. Isothermal maps for reservoirs and estuaries.
4. Iso-chemical maps for reservoirs and estuaries.
5. Dissolved solids vs season and runoff.
6. Suspended solids vs season and runoff.
7. Reservoir stage frequency during drawdown, or because of evaporation.
8. Mud flat exposure frequency maps.
9. Wind roses at reservoir surface to determine concentration of wind blown pollutants.
10. Seasonal nutrient frequency curves for combination with temperature data to determine algae growth predictions.

SUMMARY AND CONCLUSIONS

by

Darryl W. Davis ⁽¹⁾

Papers and discussions at this seminar focus on the role that hydrologic engineering has played in past and current planning efforts. Hydrologic engineering analysis techniques for use in planning activities have been presented and discussed. Forecasts of future relationships between hydrologic engineering and planning ranged from the view that hydrologic engineers are in fact planners to the view that hydrologic engineering is a specialty subject area that needs little interaction with the planning discipline. The range of viewpoints was conveyed through (a) case studies, (b) descriptions of integrated computer model development, (c) descriptions of the hydrologic engineer's role in plan formulation and evaluation and (d) descriptions of hydrologic engineering data and analysis requirements for plan formulation and evaluation. Although the subject was within the scope of the seminar as originally defined, no presentations were made on the important topic of correlating hydrologic outputs with the objectives for the development and management of the nation's water resources.

The hydrologic engineer historically assumed a major role in the Corps' planning activities, primarily because of the fundamental importance of hydrology in management of water resources. The planning emphasis is shifting from that of control to that of management in a broader context. The hydrologic engineer's role will probably shift as a consequence from that of the central figure to that of a partner or team member. However, hydrology is no less fundamental today, and the hydrologic engineer's work will continue to be fundamental to planning efforts.

The relationship among planning participants who have the responsibility for the final product of a planning effort was the subject of considerable discussion. The conventional viewpoint is that the professional planner in charge of the study should assume ultimate and final responsibility for the plan. The seminar participants agreed on a more enlightened and broader based concept of "shared responsibility." In this concept, all participants in a planning study should share the ultimate and final responsibility for the plan. The consensus was that the shared responsibility concept should also extend through the project construction and operation phases as well.

Considerable evidence presented indicates that the focus of Corps planning activities, and thus the studies required by the hydrologic

(1) Hydraulic Engineer, Planning Analysis Branch, The Hydrologic Engineering Center, US Army Corps of Engineers, Davis, California.

engineer will be in the urban areas with its attendant problems of environmental quality, open space, and recreation. The market for the more traditional Corps products of large-scale water resource developments seems to be diminishing, at least for the immediate future.

There is also evidence that because of the rapidity with which specific objectives of society are changing, and further because of rapidly changing conditions in the watershed, that study schedules are being accelerated and will probably continue to be accelerated in the future. This was forcefully emphasized in the case study presentations, each of which was on an accelerated schedule.

The implications of accelerated schedules and the shift to an urban orientation are many-fold. It is clear that the present technology for urban hydrologic studies is inadequate. The hydrologic analysis must consider runoff conditions on watersheds whose runoff characteristics are changing very rapidly. The historic records are no longer reliable samples of what the future runoff might be, and the changed watershed conditions that may be encountered are functions of the planning activity itself. Alternative future land use patterns can be substantially influenced by alternative plans and thus cannot be studied in isolation. This further serves to emphasize the increased coordination and interaction needed between all elements of the planning team: the hydrologic engineer, those studying land use projections, those formulating alternative plans and those who must coordinate all activities.

The types of alternatives to be evaluated in urban areas will focus on the microscale. Many small 10- to 50-acre detention storage reservoirs may be the only feasible means of storing storm water. The storage sites will undoubtedly have to serve other open space uses, such as parks, green-belts and golf courses. The programs devised must be in intimate consonance with community objectives since the facilities become a part of the fabric of the community. The hydrologic engineer and other members of the planning team will have no choice but to get involved with the public if they are to propose and evaluate viable alternative programs to meet the goals of the urban dweller.

New types of hydrologic and other integrated computer models will probably be required. The traditional model has been one that simulates a particular alternative in considerable detail and is thus quite useful in determining the attributes of various alternatives of scale, i.e., different sizes of a given reservoir or channel. In the urban setting, many different alternatives in kind will need to be formulated and evaluated. Models are needed that will permit evaluation of these many alternative kinds of programs if planning is to do justice to the multiple objective philosophy of management in an extremely dynamic environment.

There was considerable discussion on the philosophy of model development and application. Some seminar participants argued that the models should be firmly founded on the physics of the process. It was agreed that this was a desirable goal, but others countered that the present state of technology in hydrologic engineering, economics and other disciplines is such that recourse to empiricism is necessary now and will probably continue to be necessary for quite some time.

The important concern should be that the model be constructed so that it can be easily changed to correspond to differing assumed future conditions. In other words, it is important that the model parameters be related to the physics of the process being modeled, but it is not necessarily important that the parameters themselves be physical quantities. The models discussed at the seminar were primarily concerned with traditional analysis techniques and were constructed by use of parameters related to physical quantities.

Many implied definitions of planning were used by the seminar participants during their presentations and discussions. Those who implicitly defined planning as problem solving seemed to limit the alternatives to those that would immediately solve the identified problem. Others who implicitly defined planning as devising means to achieve goals and objectives had a considerably broader viewpoint of the alternatives available for consideration. It is suggested here that it would be to the advantage of all to broaden the concept even further to consider planning as "those activities needed to define the objectives (often not considered part of planning but as given by others) and devise the action programs that will best meet the objectives." In this light, "needs" that must be met (a fallacy) are not included, nor are "problems" specifically identified as requiring "solutions." This proposed viewpoint in planning should lead to a broader perspective of the planning task by the participants in planning activities.

Conclusions that appear appropriate as a result of this seminar are:

1. Hydrologic engineering continues to be a fundamental component of planning. The planning "team" should include a hydrologic engineer.
2. Research efforts to improve the technology for performing urban hydrology studies should be continued at a high rate.
3. Research to develop techniques for rapidly evaluating alternatives in kind as well as alternatives in scale should be undertaken.
4. Planning should be considered as the activities needed to define the objectives and devise the action programs necessary to meet those objectives.