



**US Army Corps
of Engineers**

Hydrologic Engineering Center

Proceedings of a Seminar on

Calibration and Application of Hydrologic Models

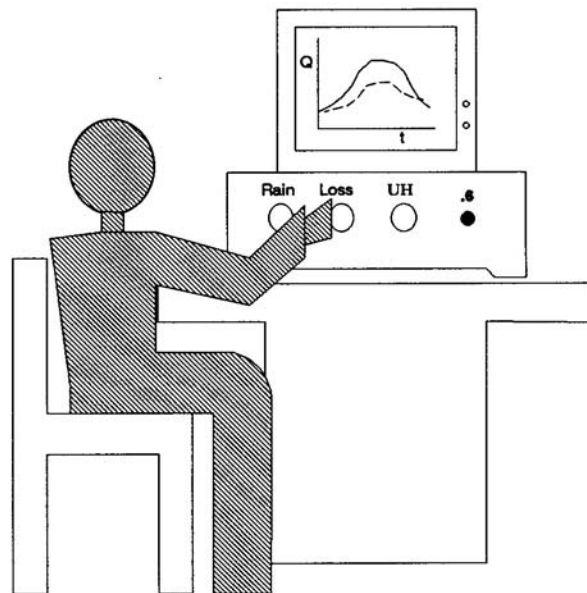

18 - 20 October 1988
Gulf Shores, AL

REPORT DOCUMENTATION PAGE

Form Approved OMB No. 0704-0188

The public reporting burden for this collection of information is estimated to average 1 hour per response, including the time for reviewing instructions, searching existing data sources, gathering and maintaining the data needed, and completing and reviewing the collection of information. Send comments regarding this burden estimate or any other aspect of this collection of information, including suggestions for reducing this burden, to the Department of Defense, Executive Services and Communications Directorate (0704-0188). Respondents should be aware that notwithstanding any other provision of law, no person shall be subject to any penalty for failing to comply with a collection of information if it does not display a currently valid OMB control number.

PLEASE DO NOT RETURN YOUR FORM TO THE ABOVE ORGANIZATION.

1. REPORT DATE (DD-MM-YYYY) 18 - 20 October 1988		2. REPORT TYPE Seminar Proceedings		3. DATES COVERED (From - To)	
4. TITLE AND SUBTITLE Calibration and Application of Hydrologic Models			5a. CONTRACT NUMBER		
			5b. GRANT NUMBER		
			5c. PROGRAM ELEMENT NUMBER		
6. AUTHOR(S) CEIWR-HEC			5d. PROJECT NUMBER		
			5e. TASK NUMBER		
			5f. WORK UNIT NUMBER		
7. PERFORMING ORGANIZATION NAME(S) AND ADDRESS(ES) US Army Corps of Engineers Institute for Water Resources Hydrologic Engineering Center (HEC) 609 Second Street Davis, CA 95616-4687				8. PERFORMING ORGANIZATION REPORT NUMBER SP-20	
9. SPONSORING/MONITORING AGENCY NAME(S) AND ADDRESS(ES)				10. SPONSOR/ MONITOR'S ACRONYM(S)	
				11. SPONSOR/ MONITOR'S REPORT NUMBER(S)	
12. DISTRIBUTION / AVAILABILITY STATEMENT Approved for public release; distribution is unlimited.					
13. SUPPLEMENTARY NOTES Collection of papers presented at a seminar held at Gulf Shores, Alabama on 18 - 20 October 1988.					
14. ABSTRACT A seminar on Calibration and Application of Hydrologic Models was held on 18 - 20 October 1988 at Gulf Shores, Alabama. The purpose of the seminar was to share ideas and experiences involving the use of hydrologic models in floodplain management and the planning of water resource projects.					
15. SUBJECT TERMS hydrologic models, calibration, urban hydrology, hydrologic analysis, stormwater, HEC-1, runoff, forecasting, inflows, radar, detention sites, basement, flooding, urbanization, sensitivity, base condition, discrete, event, drainage system, kinematic wave, SWMM, quantification, flood warning system, SSARR-8, rainfall, impact, design flow, reservoirs					
16. SECURITY CLASSIFICATION OF:			17. LIMITATION OF ABSTRACT UU	18. NUMBER OF PAGES 262	19a. NAME OF RESPONSIBLE PERSON
a. REPORT U	b. ABSTRACT U	c. THIS PAGE U			19b. TELEPHONE NUMBER

Proceedings of a Seminar on

Calibration and Application of Hydrologic Models

18 - 20 October 1988

Attendees:

Corps of Engineers

Sponsored By:

US Army Corps of Engineers
Institute for Water Resources
Hydrologic Engineering Center
609 Second Street
Davis, CA 95616

(530) 756-1104

(530) 756-8250 FAX

www.hec.usace.army.mil

SP-20

TABLE OF CONTENTS

PREFACE

Paper 1. HEC-1 STORMWATER RUNOFF MODEL AT FAIRFIELD, OHIO

Theodore L. Reverman, Jr.
Louisville District

Paper 2. FORECASTING LAKE WAPPAPELLO INFLOWS USING RADAR IMAGERY

Gary R. Dyhouse and Robert L. Davinroy
St. Louis District

**Paper 3. CASE STUDY: STREAMFLOW CALIBRATION AND VERIFICATION
IN AN URBAN WATERSHED - THE IDEAL VS. THE REALITY**

Joel W. James
Savannah District

**Paper 4. HYDROLOGIC MODEL CALIBRATION PROBLEMS ENCOUNTERED
IN PUERTO RICO**

Michael L. Choate
Jacksonville District

**Paper 5. HYDROLOGIC MODELING TECHNIQUES FOR URBAN FLOOD WATER
DETENTION SITES - MINGO CREEK, OKLAHOMA**

Brenda K. Kinkel
Tulsa District

Paper 6. HYDROLOGIC MODELING OF BASEMENT FLOODING

Thomas J. Fogarty
Chicago District

**Paper 7. NORTH BRANCH CHICAGO RIVER URBANIZATION SENSITIVITY
STUDY**

James G. Mazanec
North Central Division

TABLE OF CONTENTS - cont.

Paper 8. BUILDING A FLEXIBLE BASE CONDITION USING DISCRETE EVENT MODELING FOR A LARGE URBAN DRAINAGE SYSTEM

Nick N. Adelmeyer
Los Angeles District

Paper 9. URBAN WATERSHED MODELING WITH HEC-1 KINEMATIC WAVE

Gary W. Brunner
Hydrologic Engineering Center

Paper 10. A COMPARATIVE ANALYSIS OF SWMM AND HEC-1 APPLICATIONS

Wallace R. Stern
Omaha District

Paper 11. THE QUANTIFICATION OF URBANIZATION IMPACTS ON RUNOFF THROUGH HEC-1 MODELING

Thomas P. Smyth and Peter Koch
New York District

Paper 12. WARNING TIME DETERMINATION USING HEC-1 ROANOKE, VA, FLOOD WARNING SYSTEM

Linwood W. Rogers
Wilmington District

Paper 13. APPLICATION OF SSARR-8 RAINFALL RUNOFF MODEL TO METROPOLITAN SEATTLE, WASHINGTON, AND CONTIGUOUS URBAN AREAS

Lawrence O. Merkle
Seattle District

Paper 14. CALIBRATING AND APPLYING A HYDROLOGIC MODEL OF THE COLUMBIA RIVER BASIN

Douglas D. Speers
North Pacific Division

TABLE OF CONTENTS - cont.

Paper 15. **HYDROLOGIC SAFETY CONSIDERATIONS IN THE SELECTION
OF LEVEL OF PROTECTION AT HARLAN, KENTUCKY**

Dennis R. Williams
Nashville District

Paper 16. **IMPACT OF WATER SUPPLY RESERVOIRS ON DEVELOPING
A DESIGN FLOW**

Herbert W. Hereth
Sacramento District

WORKSHOP PARTICIPANTS

PREFACE

The sixteen papers in these Proceedings were presented at a Corps of Engineers Workshop at Gulf Shores State Park on October 18-20, 1988. It was suggested by a participant that the title of the Workshop be "A Shot in the Dark", which reflects the difficulty and frustration commonly associated with calibrating and applying hydrologic models.

Flood-plain management and the planning of water resource projects (structural or non-structural) requires probabilistic estimates of the future occurrence of streamflow and associated stage. In order to reflect land use changes and/or the effects of projects, it is generally necessary to employ a hydrologic model to simulate precipitation-runoff processes. The purpose of the Workshop was to share ideas and experience involving the use of such models.

Approximately two-thirds of the papers deal with hydrologic analysis in urban watersheds. Papers 1, 3 and 5 apply to basins for which there is little or no streamflow data. Paper 11 illustrates a method for adjusting peak discharges in an annual series to obtain a series consistent with current land-use conditions. The emphasis of Paper 5 is on the design of excavated detention basins. Paper 7 applies to an urban basin in which there is extensive streamflow data, but for which there is substantial uncertainty associated with the future effects of land use changes, channel modifications, etc.. Papers 6, 8 and 13 describe major studies for large metropolitan areas (Chicago, Los Angeles and Seattle, respectively). The Chicago study is unique in that it is concerned with estimating basement flooding from backup of combined sewers; primary calibration in this case was based on surveys of incidence of basement flooding.

The computer program used most frequently in the studies described herein is HEC-1. However application of the SSARR program is described in two studies (papers 13 and 14), and components of the SWMM program in two others (papers 6 and 10). Most studies involved use of the unit hydrograph to simulate runoff. Papers 9 and 10 describe use of kinematic wave techniques.

The geographic and aerial scope of the papers is broad. To illustrate, paper 4 deals in general terms with basin modeling in Puerto Rico, while paper 14 deals with continuous simulation of runoff (including snow melt) from the 250,000⁺ square mile Columbia River Basin in the Pacific Northwest.

A problem in using a discrete-event program like HEC-1 for flood analysis in basins in which reservoirs exist involves determining the initial storage for the reservoirs. Determination of initial storage for water supply reservoirs is addressed in paper 16.

The use of local warning systems as components of flood control plans is increasing. A key factor influencing the design of a system is the warning time that the system will provide. Papers 12 and 15 pertain to the use of hydrologic models for estimation of warning time.

Estimation of the spatial and temporal variation of precipitation is invariably a major concern in application of hydrologic models. Paper 2 discusses the use of radar imagery in conjunction with precipitation measurements to obtain improved precipitation estimates for runoff forecasting.

Total attendance at the Workshop was 29; a list of participants is included at the back of the Proceedings. Persons not presenting papers were involved in chairing sessions and preparing summaries of discussions. The discussions are printed on blue paper immediately following each paper.

The Planning Committee for this Workshop was Lewis Smith from the Corps' Headquarters, George Atkins and Howard Whittington from the Mobile District, Douglas Speers from the North Pacific Division and John Peters (Chairperson) from the Hydrologic Engineering Center. The Mobile District made all local (facility) arrangements. Proceedings were published by the Hydrologic Engineering Center.

It is hoped that these Proceedings will provide useful information for anyone involved in calibrating and applying hydrologic models. Perhaps some of the methods and ideas reported herein will enable future applications to be less of a "shot in the dark."

John Peters
Hydrologic Engineering Center

HEC-1 STORMWATER RUNOFF MODEL
AT FAIRFIELD, OHIO

by
Theodore L. Reverman, Jr.¹

Study Purposes. The objective of this study was to develop a model which would predict hypothetical flows under then present flows (1979), and then under projected land uses of 1995. Also, we wanted a model which would reflect the effects of any proposed flood control structures, such as dry bed reservoirs in any combination.

Some of the key issues regarding the calibration of this model was the time of travel through the watershed, what type of unit hydrograph parameters to use, the time duration of the computation interval, and how good were the computed 1-through 500-year peak discharges under 1979 land uses.

Results of the calibration and application of this model yielded very reasonable results when compared to observed and regional flow data. The effects of dry bed reservoirs in any combinations yielded reasonable answers.

Basin Description. Fairfield, Ohio is located about fifteen miles north of Cincinnati. Pleasant Run originates in northern Hamilton County, and flows approximately eight miles to its confluence with the Great Miami River in adjacent Butler county. The Pleasant Run watershed drains about fourteen square miles, and drops about 350 feet from the basin rim to its juncture with the Great Miami River.

A number of tributaries form Pleasant Run. East Fork, High School Tributary, and General Motors (G.M.) Ditch are the larger streams in the basin. Flow from East Fork, High School Tributary, and Pleasant Run above East Fork comprise the main source of flooding at Fairfield. G.M. Ditch is a flat gradient stream, with a large amount of natural storage area above Symmes Road. As a result, G.M. Ditch does not contribute significantly to the flooding problem, even though it flows through industrial, commercial, and residential areas.

The East Fork Tributary originates on the southeastern side of Fairfield, and flows generally in a northern direction. Water from the East Fork contributes significantly to the flooding problem of Fairfield. The lower reach of East Fork flows through a highly residential area of suburban Fairfield. The East Fork drains 3.6 square miles of watershed at its mouth, and falls about 310 feet in 4.0 miles from the basin rim to its mouth.

High School Tributary originates on the eastern side of Fairfield, and flows approximately 3 miles to its confluence with Pleasant Run. The lower 0.6 mile of High School Tributary appears to be a man-made channel.

¹ Hydraulic Engineer, Louisville District, U.S. Army Corps of Engineers

Spoil banks are in evidence in this reach and the height of these spoil banks varies from 1.5 to 4.5 feet, with the average height being about 2 feet. The spoil bank below Winton Road is located on the right bank only, whereas above Winton Road, they are on both banks. This reach of High School Tributary is also characterized by a wider flood plain than Pleasant Run and East Fork. High School Tributary drains 1.5 square miles of water-shed at its mouth, and falls about 290 feet in 3 miles from the basin rim to its mouth.

G. M. Ditch also originates on the eastern side of Fairfield, and flows approximately 3 miles to its confluence with Pleasant Run. The lower 1.6 miles also appear to be a man-made channel. Spoil banks are also in evidence for the lower 1.2 miles. The height of these spoil banks varies from 2 to 9.5 feet, with the average height being about 3 feet. G. M. Ditch drains 1.5 square miles of watershed at its mouth, and falls about 50 feet in 3 miles from the basin rim to its mouth.

Land uses in the Pleasant Run watershed are predominantly residential and commercial, with some industry east of Dixie Highway. The flood plains are primarily occupied by single family residences. The High School Tributary flood plain east of Winton Road and west of Dixie Highway (S. R. 4) is also occupied by apartment complexes.

The Pleasant Run watershed has experienced a very rapid growth rate. This growth has been south, because of the physical constraints of the area; the Great Miami River on the west, the city of Hamilton, Ohio, to the north; and the flat uninhabitable flood plains east of the Baltimore and Ohio Railroad. This growth rate is moving into the upper watershed which produces the high degree of runoff from the Pleasant Run Basin. Not only has Fairfield moved south, the metropolitan area of Cincinnati is continuing to move north. Consequently, the rapid growth rate of the watershed has continued as expected. This rapid growth rate is reflected in the following tabulation. The source of this data is topographic maps and 1977 aerial photography. The percent urbanization for selected calendar years is shown below.

<u>Calendar</u> <u>Year</u>	<u>Percent</u> <u>Urbanization</u>
1965	10
1974	30
1977	42
1979	50 (Projected)

The projected percent urbanization for 1979 was extrapolated on semi-logarithmic paper for purposes of evaluating the August 1979 flood discussed in succeeding paragraphs.

With the rapid growth of the Pleasant Run watershed, it was necessary to determine future land uses. The local Planning and Zoning Commission for Butler County was contacted in 1977 for this information. These projections indicated that future land uses would continue to be residential and commercial, and that approximately 90 percent of the watershed would be developed. Site visits to Fairfield during these studies confirmed these projections.

Significant flooding on Pleasant Run in recent years has been caused by convective storms. Convective storms are typified by the thunderstorm, and are often marked by periods of intense rainfall for short durations, and may be extremely variable in the area covered. Runoff is often increased by antecedent conditions. Flooding on Pleasant Run can also be caused by frontal system storms, such as occurred in January 1959. Frontal system events are characterized by rainfall that is widespread in coverage, and generally moves up the Ohio River valley on a line from southeastern Missouri to western New York. Again, runoff is often increased by antecedent conditions.

Data Availability. No organized streamflow records were available on Pleasant Run. However, in August 1979, the most serious flooding occurred since January 1959, and resulted in the installation of a continuous recording gage, setting of numerous highwater marks, and two peak discharge estimates by the USGS and the Miami Conservancy District (MCD). Rainfall data was collected at MCD's rainfall station at the Hamilton Sewage Treatment Plant, and from bucket-type surveys from the upper Pleasant Run watershed. Frequency rainfall data were taken from TP-40 and Technical Memorandum NWS HYDRO-35. Land use maps were obtained from the Butler County Planning and Zoning Commission to project future land uses. Hydrologic soil type was determined from the Butler and Hamilton Counties Soil Maps. Channel velocity data was obtained from accompanying HEC-2 models. The regular topographic maps (1:24,000) were of sufficient accuracy to determine watershed drainage areas, subwatershed drainage areas, and stream mileages. More detailed mapping was used to determine reservoir storage data for survey scope and design studies.

Although only 1.91 inches of rainfall was recorded at the sewage treatment plant on 1 August 1979, amounts up to 3.43 inches were recorded in the upper watershed for the same 2-hour period. Rainfall amounts were high for the month of July 1979. About 5.1 inches were measured at the sewage treatment plant. Of this total, about 2.4 inches fell between 24-29 July in the vicinity of the Pleasant Run watershed. Consequently, on 1 August, the ground was relatively saturated, thereby capable of producing a high percentage of runoff. The maximum intensity measured at the sewage treatment plant was 0.82 inch in a 15-minute period. The average rainfall above the Nilles Road gage for 1 August 1979 storm was about 3 inches. Assuming that the rainfall occurred over the Pleasant Run watershed above Nilles Road in a similar pattern to that recorded at the Hamilton Sewage Treatment Plant, the storm would appear as follows:

<u>Time</u>	<u>Rainfall</u> (inches)
3:00 PM	0
3:00 - 3:15	1.29
3:15 - 3:30	0.14
3:30 - 3:45	0.38
3:45 - 4:00	0.24
4:00 - 4:15	0.56
4:15 - 4:30	0.32
4:30 - 4:45 PM	<u>0.07</u>
Total	3.00

Rainfall totals from Technical Paper No. 40, "Rainfall Frequency Atlas of the United States," show the following values for return intervals of 10-, 25-, and 100-years at Fairfield:

<u>Duration</u> (hours)	<u>Rainfall (Inches)</u>		
	<u>10-Yr.</u>	<u>25-Yr.</u>	<u>100-Yr.</u>
30 minutes	1.5	1.8	2.2
1	1.9	2.2	2.8
2	2.4	2.7	3.3
3	2.6	3.0	3.6
6	3.1	3.5	4.1

As mentioned before, numerous highwater elevations were obtained in connection with the 1979 flood. No stage hydrograph data are available for the 1979 flood. However, residents in the area of Nilles Road have indicated that water began spilling out of the banks 1 to 2 hours after the storm began. This indicates that Pleasant Run is an extremely fast rising stream.

Rainfall Runoff Model. The rainfall-runoff model for the Pleasant Run watershed through High School Tributary was developed using the HEC-1 Flood Hydrograph Package. SCS dimensionless unit hydrographs based on the time of concentration were used to represent runoff regimes for each of seventeen subbasins. The time of concentration for each subbasin was calculated using either previous HEC-2 computer runs, slope area computations based on Manning's equation for an average channel, or overland flow based on nomographs for the particular land use. Sometimes a combination of all three were used. The computation interval used for this model was 15 minutes.

Loss rates were based on SCS curve numbers. The values reflect land use in each subbasin and hydrologic soil type as determined from the Butler and Hamilton Counties Soil Maps.

A tabulation of present and future land use SCS curve numbers and time of concentration (t c) values are given in Table 1. These are for the subbasins shown on Plate 1. The drainage areas, in square miles, are also given in Table 1.

The model generated by the techniques described above was verified by comparison with data collected during the August 1979 event. This event was chosen because it was the only well documented flood on Pleasant Run. The available information included highwater marks, 15-minute rainfall, and reliable estimates of peak discharges at two locations. Both discharge locations are downstream of the HEC-1 model, and both reflect diversion, weir flow, and storage routings. The U.S. Geological Survey computed a peak discharge of 5,430 cfs at East River Road. This computation was made using

the contracted opening procedure, plus weir flow over East River Road in the left overbank. MCD determined the peak discharge at Nilles Road to be 5,200 cfs. This determination was made based on highwater marks and extrapolation of their rating curve through these highwater marks. Based on the pattern rainfall under historical Floods, the best reproduction using the HEC-1 model was 5,850 cfs at East River Road and 5,350 cfs at Nilles Road. This considered diversion flow, weir flow, and HEC-1 storage routings at two locations below High School Tributary.

TABLE 1.

PRESENT AND FUTURE
RUNOFF PARAMETERS

Sub-Area Number	Drainage Area (Sq. Mi.)	Curve Number (CN) <u>3/</u>		Time of Concentration (Tc) - Hours		
		Present _{1/}	Future _{2/}	Present _{1/}	Future _{2/}	Comments
1	1.47	89	92	1.18	1.00	Site "D"
2	1.04	90	93	1.32	1.20	Site "D"
3	0.54	91	94	0.50	0.43	
4	0.63	92	95	0.58	0.49	
5	0.37	92	95	0.88	0.75	
6	0.21	92	95	0.64	0.54	
7	0.48	92	92	0.63	0.63	
8	0.29	89	90	0.43	0.40	
9	0.29	88	88	0.48	0.48	
10	0.25	90	92	0.55	0.50	Site "C"
11	1.50	91	95	0.96	0.82	Site "C"
12	0.74	91	93	1.08	1.00	Site "C"
13	0.70	91	91	0.67	0.67	Site "C"
14	0.43	91	93	0.45	0.40	
15	0.93	89	93	0.65	0.55	Site "A"
16	0.60	89	91	0.62	0.53	
17	<u>0.11</u>	90	90	0.47	0.47	

10.58 Sq. Mi.

Notes

1/ Present represents 1979 Conditions — 50% development.

2/ Future represents 1995 Conditions — 90% development.

3/ Represents Type II Conditions from SCS reference data.

With the rapid growth of the Pleasant Run watershed, it was necessary to consider future land uses. Local officials and agencies were contacted to see if any regulations were in effect controlling the runoff from future development. These officials indicated there have been regulations on the books for some time, but have not been strictly adhered to. Consequently, the Butler County Planning and Zoning Commission was contacted for its projections of future land uses. These future land uses are residential and commercial, and indicate that approximately 90 percent of the watershed in Butler County would be developed. Hamilton County was not contacted for its land use plans in the Pleasant Run watershed. However, it appears the same land uses are developing as in Butler County. Therefore, it was assumed that 90 percent of the Pleasant Run watershed in Hamilton and Butler Counties would be developed for residential and commercial purposes.

The next step was to overlay these projected land uses on the Pleasant Run watershed. In doing this, it was found that no future land uses are projected for G. M. Ditch. Even if they were, the large amount of flood plain storage above Symmes Road, mile 2.1, would moderate the effects of this development. Consequently, runoff conditions for G. M. Ditch will remain the same. The anticipated increased runoff is expected to come from the upper Pleasant Run, East Fork, and High School Tributary basins.

Only those subbasins having projected land uses were changed, and resulted in quicker response times and increased storm runoff. Those subbasins not affected by these projected land uses were not changed, and were generally located in the lower part of the model watershed. Table 1 shows the changed time of concentration and Curve Number values discussed above.

Since Pleasant Run streamflow records were not available for statistical analysis, flood probabilities were based on results from the rainfall-runoff model.

Rainfall frequency values for duration from 5 minutes to 24 hours, and return intervals from once every year to once every 100 years were obtained from Technical Paper 40 and Technical Memorandum NWS HYDRO-35 by the National Weather Service. 500-year values were extrapolated from these data. However, because of the very short watershed response time, durations greater than 2 hours did not appreciably increase peak discharges. The time of concentration that was discussed in Rainfall-Runoff Procedures indicates it takes about 2 hours to travel from the rim of the basin to the vicinity of High School Tributary. Therefore, the maximum 2-hour storm rainfall for each return interval was used in the HEC-1 computer model to determine discharge frequency data for normal flooding conditions.

The 15-minute precipitation increments were arranged in a sequence based on a study of seven area storms of record. These storms occurred in January 1959, March 1964, May 1968, July 1973, June 1974, August 1979, and July 1985. The items investigated, and the resulting average percentages are given in Table 2. The percentages did not vary greatly among the seasons of the year. The adopted distribution agrees very closely with SCS distribution of frequency rainfall. Plate 2 shows the January 1959 mass rainfall curve, and the particular distribution as described in Table 2.

TABLE 2
STORM PERCENTAGES

Item	Percent Adopted
Percent of total storm length used for the initial loss	25
Percent of total storm rainfall considered as initial loss	15
Percent of total storm length considered as the main part of the storm	40
Percent of total storm rainfall considered as the main part of the storm	80

Flood probabilities were based on rainfall probabilities with adjustment in loss rate determination. As stated earlier, SCS curve numbers were used for rainfall loss calculations. Streamflow calculations using HEC-1 with 15-minute computation intervals were computed for storms with 1-, 2-, 5-, 10-, 25-, 100-, and 500-year return intervals. Type II (normal) antecedent conditions were assumed for the 1-year and 2-year floods. Type III (wet) antecedent conditions were assumed for the 10-year and larger floods. An antecedent condition midway between Types II and III was assumed for the 5-year event. Varying the curve numbers to account for different antecedent conditions is based on the logic that large events normally occur when conditions favor runoff. More common events often occur with average soil conditions. The frequencies where the transitions take place were estimated from experience with other studies. No changes were made to the 15-minute rainfall distribution in changing from a Type II to a Type III antecedent condition when future land uses were incorporated. As discussed under Rainfall-Runoff Procedures, only those subbasins having projected future land uses were changed, and these changes were shorter response time and new curve numbers to reflect the future land use.

Study Results. Plate 3 shows the natural discharge-frequency curves on Pleasant Run at Nilles Road for both present (1979) and future (1995) land uses.

Verification of this procedure is founded on a comparison with the limited historical information for the August 1979 flood. Conditions at the beginning of the August 1979 flood indicated the ground was in a wet condition, corresponding to Type III conditions. Satisfactory reproduction of this storm was obtained with these curve numbers, as attested to the calibration of the 1979 flood discussed under Rainfall-Runoff Procedures. The 2-hour rainfall total for the August 1979 storm indicates it to be greater than a 25-year event, as shown by the rainfall data discussed under Historical

Floods. The August 1979 storm, according to residents, reached the highest elevations since the January 1959 flood. The discharge-frequency curve for Pleasant Run at Nilles Road shows the 1979 flood to be slightly greater than a 25-year event; see Plate 3.

No other flood of lesser magnitude has sufficient rainfall, discharge, or highwater data to verify the HEC-1 model. However, a regional discharge frequency study was performed in connection with Flood Insurance Studies for Preble, Montgomery, Shelby, and Miami Counties, Ohio. WRC guidelines were adhered to for this regional analysis. This study included streams in urbanized areas, and also considered the parameters of drainage area, average watershed slope, and percent urban development. Over 20 stream gaging stations were used in the regional analysis. A skew coefficient of -0.2 best fitted the data, and is the same skew coefficient adopted for an earlier, and a more comprehensive, Indiana regional frequency study.

Plate 4 shows the 10- and 100-year discharge versus drainage area curves derived from the above study. For drainage areas greater than 20 square miles, a series of parallel lines were formed for long term gages. For drainage areas less than 10 square miles, there was sufficient long term data to develop a relationship of 10- and 100-year discharges to percent urbanization and average basin slope. Results from other studies for 10 square miles or less (Jefferson County, Kentucky; Marion County, Indiana; and Hamilton County, Ohio) show that these two factors were important influences on frequency discharges, and that a series of parallel lines was formed for different streams. The slope of the parallel lines was selected by first plotting all 100-year discharges computed in the gage analysis for long term stations, and checking it against the slopes for the January 1959 discharges. The 1959, 10- and 100-year curves have essentially the same slopes. The values assigned to the curves for 10 square miles and less are the percent urbanization and the average basin slope (feet per mile) above the gaged point, respectively.

As of 1979, about 50 percent of the Pleasant Run watershed above Nilles Road had been urbanized. The average basin slope above Nilles Road is about 65 feet per mile. The 10- and 100-year discharges generated by HEC-1 for Pleasant Run at Nilles are 4,700 cfs and 6,250 cfs, respectively, for percent (1979) condition. When plotted on Plate 4, they match reasonably well with the percent urbanization and basin slopes for gaged areas below the 100 square miles. This was considered reasonable confirmation of the frequency discharges generated for Pleasant Run by the HEC-1 computer model.

Conclusions. The HEC-1 model was able to verify, within acceptable limits, the August 1979 event. The computed frequency discharges compared very well with regional flow data. With the flexibility of the model, drybed reservoirs were included in the model. The effects of the three drybed reservoirs are also included on Plate 3, and appear reasonable.

The only two hindsight observations regarding the HEC-1 model is that possibly a shorter computation interval could have been used; and secondly, the model could have been enlarged to include the areas downstream of Nilles Road.



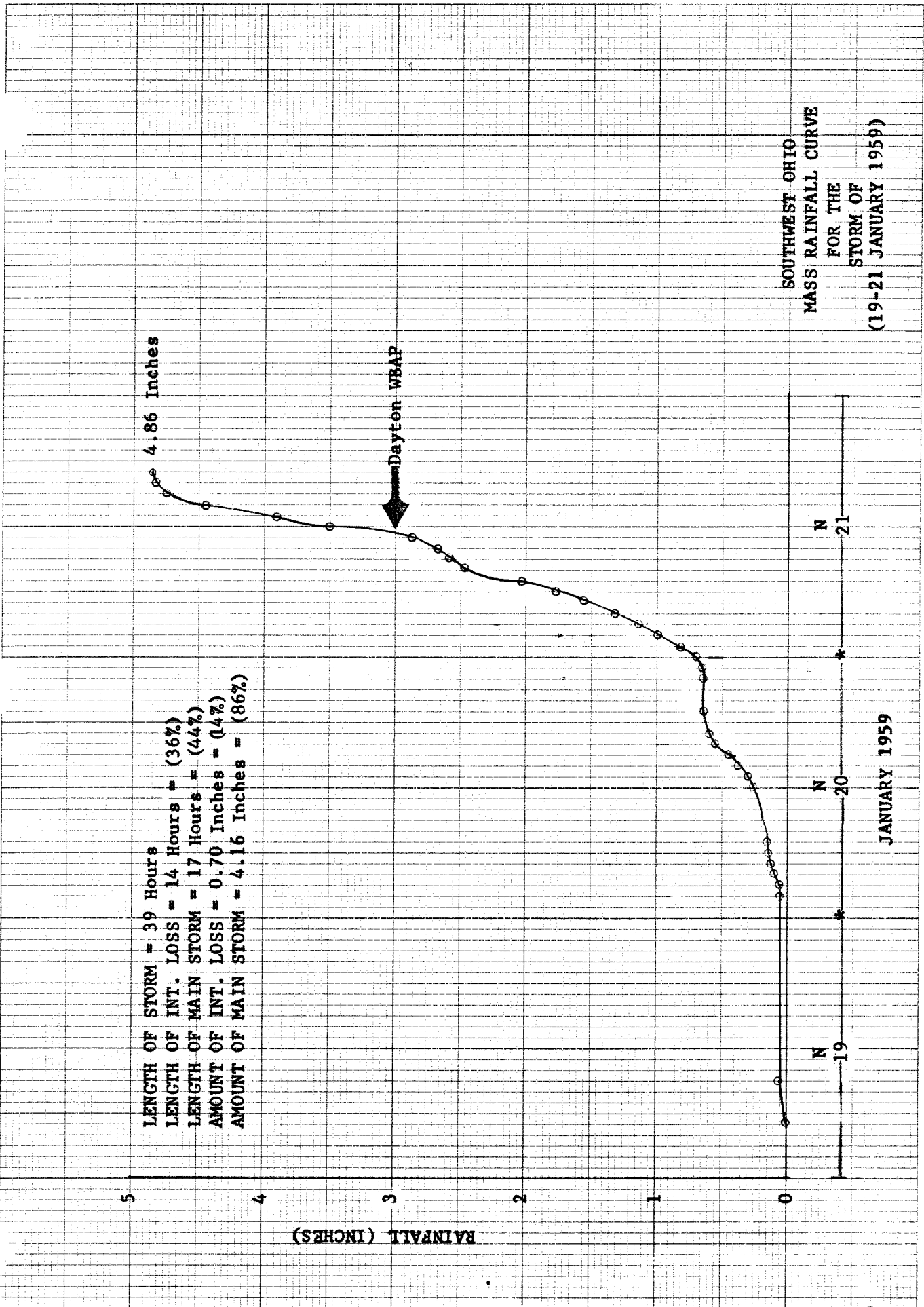

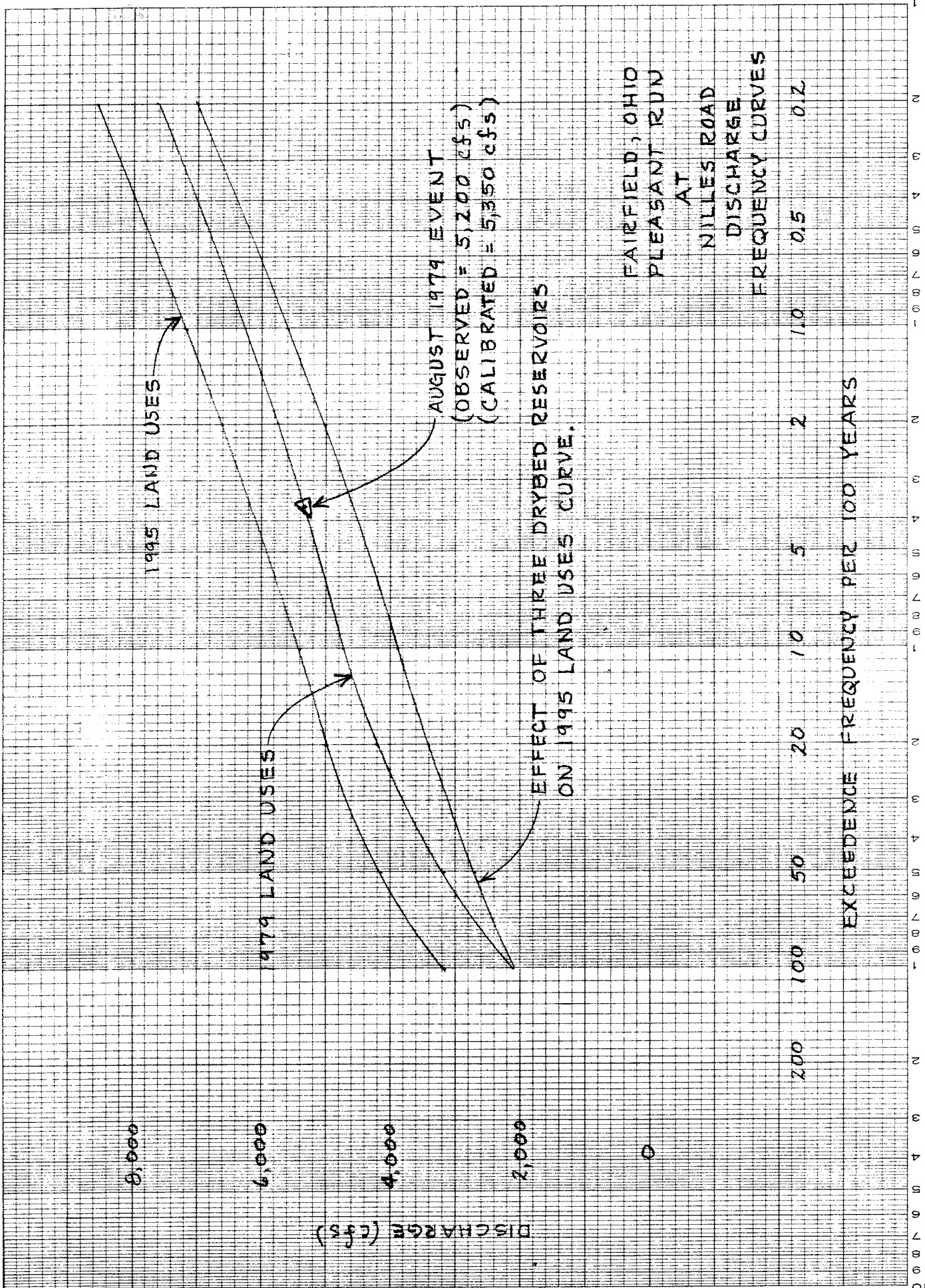

FAIRFIELD, OHIO
PLEASANT RUN
AT
NILLES ROAD
DISCHARGE
FREQUENCY CURVES

EXCEEDENCE FREQUENCY PER 100 YEARS

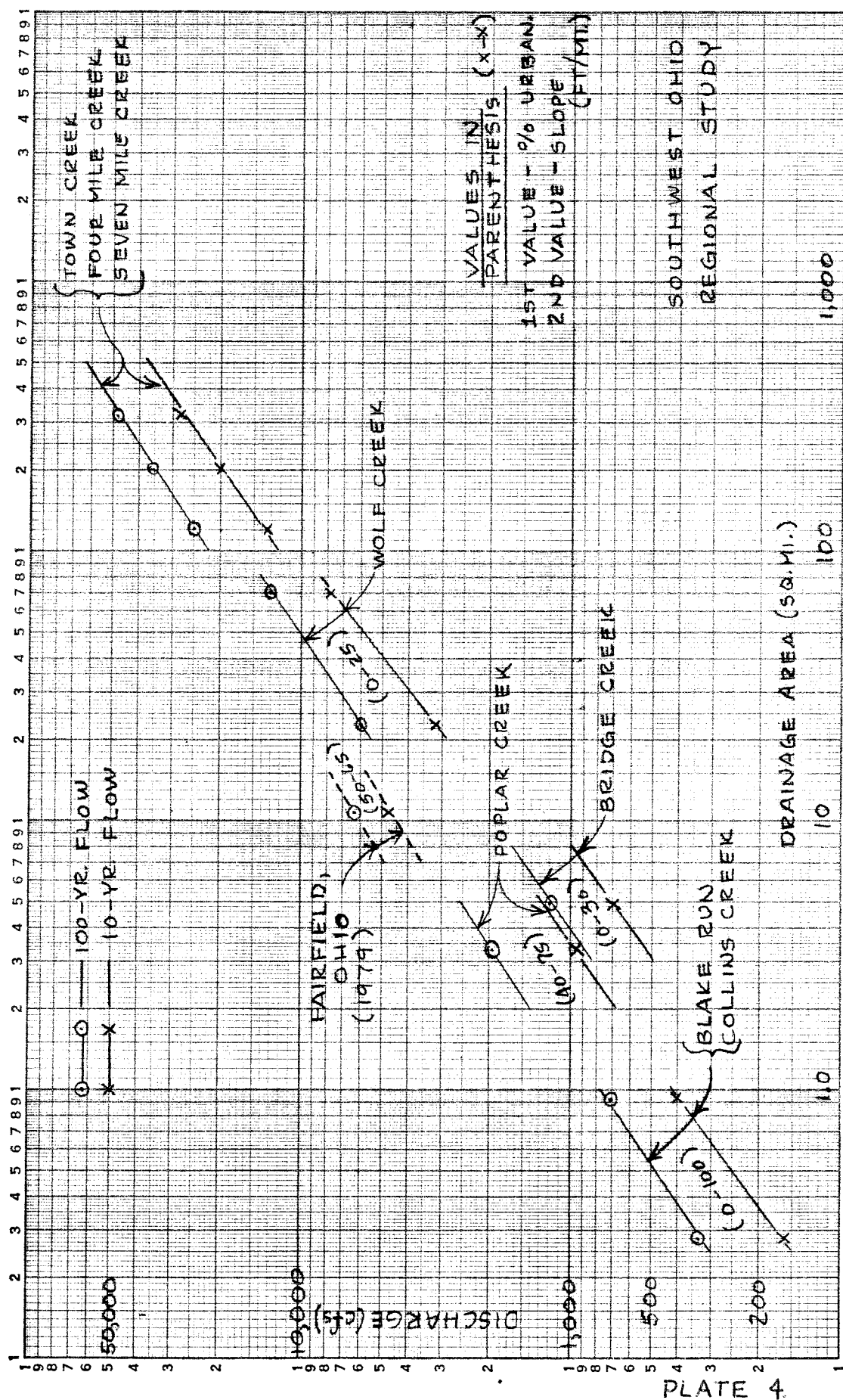

PLATE 4

HEC-1 STORMWATER RUNOFF MODEL
AT FAIRFIELD, OHIO

by

Theodore L. Reverman, Jr.

Summary of Discussion

by

Jack Cunningham ¹

The regional data used in the study were taken from an area in Indianapolis which has steep gradient streams and rapidly changing land use similar to the study area. A large amount of gage data was available from this area.

The study relied on two historical storms and TP-40 rainfall and no thought was given to producing precipitation-frequency curves from local data.

Some concern was expressed over the fact that the natural and urbanized curves were parallel instead of converging at the less frequent end of the curve which is to be expected in steep gradient, urbanized streams. It was stated that most of the damages were caused by floods in the 5 to 10 year range and the economics were not affected by the fact that the curves did not converge. The model results closely approximated, within 5 to 10 percent, the results of a similar study done by the Miami Conservancy District (MCD) for the city of Fairfield.

The adopted plan was three dry bed reservoirs and a channel improvement downstream in the vicinity of Morse Road. The MCD, the local sponsor, required that the spillway crest be set at the 500 year frequency event. The 1913 event, which was in excess of a 100 year event in that region of Ohio, was routed through the reservoirs and did not exceed the spillway crest at any of the reservoirs.

The reservoir outflow is controlled by the size of the pipe through the dam. The reservoirs are emptied in 12 to 18 hours so there is little problem with series storms causing overtopping. Nomographs from Kentucky and Indiana were used to adjust for various land uses. These nomographs have proved to be reasonably accurate.

General Motors has left Fairfield so the tax base has been affected and the city is trying to scale down the scope of the project. Reservoir Site A has been subdivided by a developer and the city can not afford to purchase that area. Site C pool area

¹ Hydraulic Engineer, Mobile District, U.S. Army Corps of Engineers

has already been purchased by the city. The FDM for Site C has been completed and waiting for the city to give the go ahead. This does not appear likely since two bond issues have failed in the past two years. The city has hired an AE to help them find ways to finance the project.

The city is supposed to have some regulations controlling runoff from developed areas, but only a couple of detention areas were found in the drainage areas above the reservoirs.

Determining the effective length of record for expected probability adjustments to regional frequency curves is somewhat arbitrary and depends to a large degree on the situation and the data used in the regional study. The problem with using the rainfall record length to make the expected probability adjustment is that there is no direct conversion from rainfall to runoff frequency so some accuracy is lost as this is not taken into account.

FORECASTING LAKE WAPPAPELLO INFLOWS USING RADAR IMAGERY

by

Gary R. Dyhouse and Robert L. Davinroy¹

Abstract

The St. Louis District (SLD) is implementing a real-time precipitation data collection system, utilizing radar imagery, for forecasting flood hydrographs. The St. Francis River Basin, upstream of Wappapello, Missouri, has been chosen as a test site to demonstrate the viability of collecting rainfall data through use of radar, calibrating with on-the-ground raingage data, and applying the average rainfall hyetograph from the calibrated radar imagery to a hydrologic model for forecasting reservoir inflow. All hardware needed for the system has been purchased and is in place. Computer software has been developed by SLD and Waterways Experiment Station (WES) personnel and has been successfully subjected to limited testing. The drought experienced throughout 1988 has prevented the completion of the calibration phase of the program. With more-normal rainfall patterns, the system is expected to be fully operational during Fiscal Year 1989 for use during potential flood events.

Introduction

The 1980's have seen several major floods in the SLD, both on the Mississippi River and its tributaries. The SLD has the responsibility for minimizing the effects of these flood events through regulating its five reservoirs on major tributaries to the Mississippi, as well as continuing to maintain navigation through its five navigation locks and dams. The need for accurate real-time data for adequate forecasts is critical, especially early in a flood event. However, with the continuing decline in funding for the collection of water data, other means besides additional gages are necessary to supplement the limited gage data now available. The use of radar imagery to supplement and improve the results from the existing raingage network was a logical means to achieve this data collection need.

Test Site. Wappapello Dam was constructed by the Memphis District for flood control and placed in operation in the early 1940's. The dam controls all runoff from the upper St. Francis River Basin in Missouri. The entire basin, including the dam, was transferred from the Memphis District to St. Louis District on 1 October 1982. Regulation of the dam up to that time was

¹ Chief, Hydro. Engr. Section, and Hydr. Engr., Potamology and Water Data Section, Hydro.& Hydr. Br., SLD, CE

largely dependent on rule curves utilized by dam personnel, with a minimum of real-time data that was telephoned to the dam site by residents of the watershed. No remote sensing or automated equipment was used to estimate inflows to the lake. During December 1982, a major flood occurred in the upper St. Francis. Peak inflow to Lake Wappapello exceeded 150,000 cfs, nearly filling the reservoir. Less severe floods occurred in April 1983 and November 1985, and all were marked by a lack of early rainfall data to allow prompt forecasting of flood magnitude and reservoir inflow. Better real-time information was obviously necessary if the maximum effectiveness in regulation of the project was to be achieved. The only affordable source of additional real-time rainfall data appeared to be through application of radar imagery, part of an ongoing military hydrology program underway at WES, (Miers and Huebner, 1985). Consequently, it was decided to test the practicality of using radar imagery to supplement the automatic rainfall gages reporting to the SLD office.

Physical Setting and Available Data

Upper St. Francis Basin. The Upper St. Francis Basin is located due south of St. Louis, in the southeastern portion of Missouri. The St. Francis River flows generally south to Lake Wappapello. The basin consists of typical Ozark Highlands topography with a total drainage area at the dam of 1310 sq. mi. (Figure 1). Slopes average 8-10 feet per mile on the main stem of the St. Francis with steeper slopes on its tributaries. Terrain is rough with elevations varying from about 1700 NGVD near the headwaters to about 600 NGVD at the dam. Watershed travel time to the reservoir is two to three days. The major tributaries are the Little St. Francis River (115 sq. mi.) and Big Creek (90 sq. mi.). The soil is rather permeable and underlain with limestone, with land use being primarily forest with interspersed agricultural activities. Downstream of the dam, the St. Francis enters the Mississippi River delta and is in the jurisdiction of Memphis District. Outflow from the reservoir is controlled by sluice gates with releases based on inflow and gage readings at Fisk, about 24 miles downstream, and at St. Francis, about 67 miles downstream. As nearly 1000 miles of uncontrolled drainage area enters the St. Francis between Lake Wappapello and the St. Francis gage, reservoir inflow and downstream local inflow must be closely monitored to minimize releases during a potential flood situation.

Available Data. Since coming under jurisdiction of the SLD, seven rainfall reporting stations have been placed in operation, which are interrogated directly by the Geodetic Orbiting Environmental Satellite (GOES) at four hour intervals. Rain gages are all tipping bucket gages with accumulated depths of rainfall recorded at 15 minute intervals. Six of the seven gages include a TeleMark backup reporting system for phone

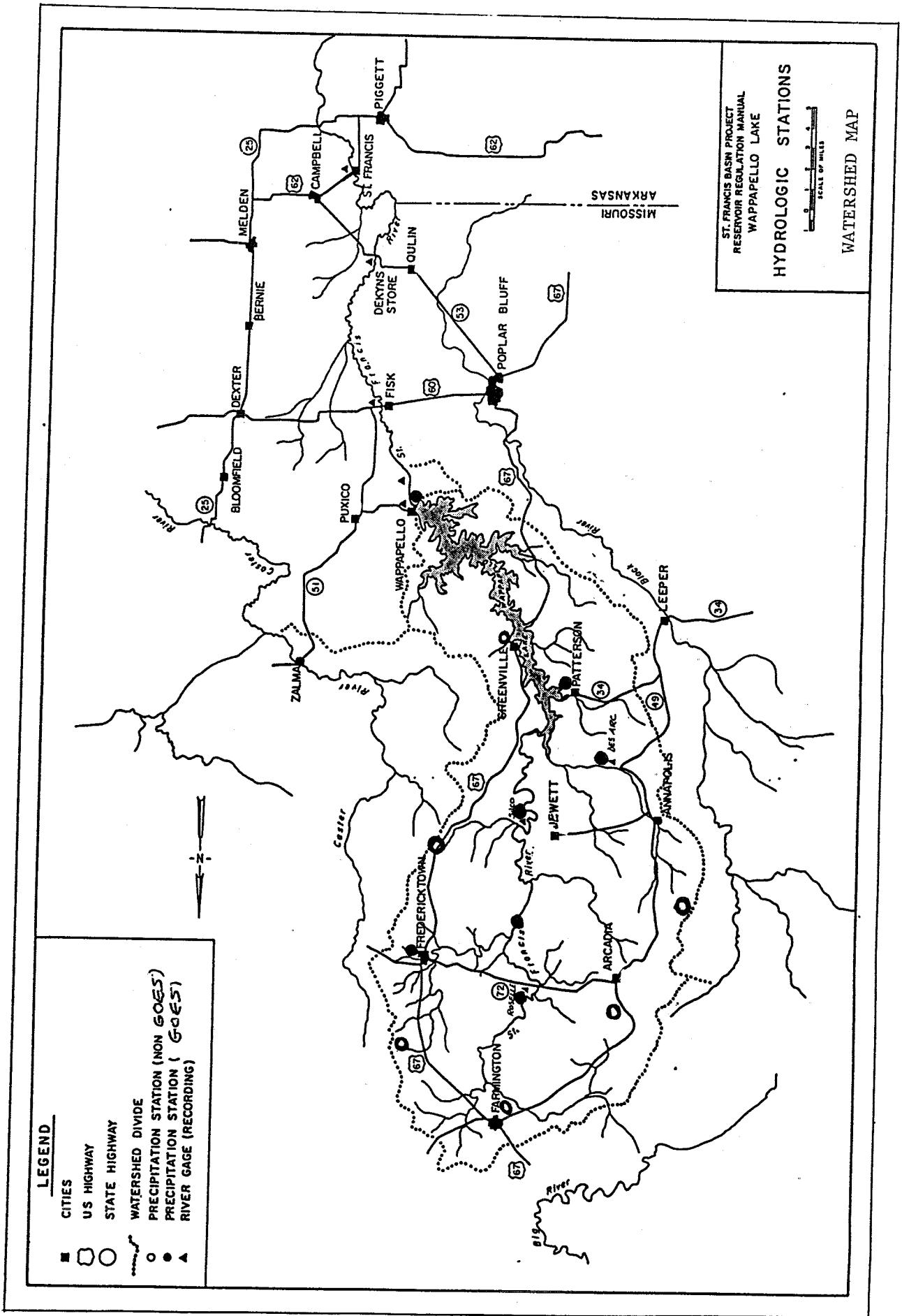

Figure 1

interrogation, if needed. Six additional rain gages, currently accessible by phone lines only, have also been installed in the watershed. Figure 1 shows gage locations. Radar imagery is obtained from the National Weather Service radar for St. Louis, located about 100 miles north of the centroid of the Upper St. Francis watershed. The entire Upper St. Francis Basin is encompassed by the St. Louis radar sweep, with all the watershed lying well within the 200 nautical mile (NM) scan.

Hardware/Software Requirements

A general schematic for acquiring weather radar information at the District office is shown on Figure 2 (Engdhal, 1988).

AUTOMATED ACQUISITION OF WEATHER RADAR DATA

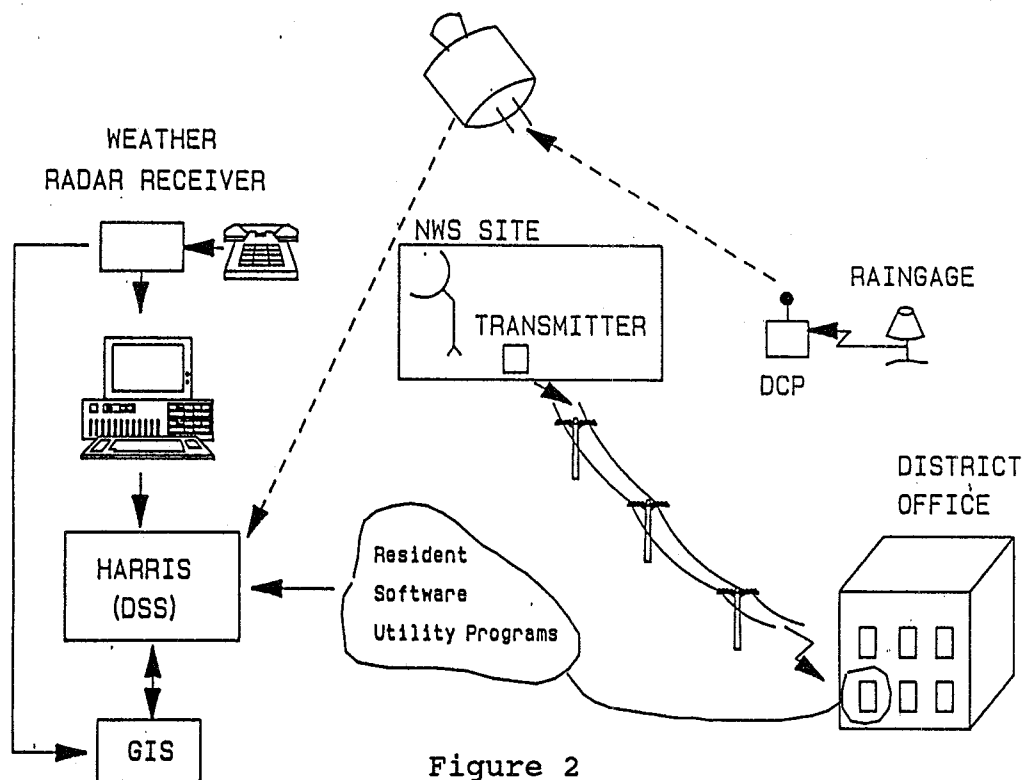

Figure 2

The radar signal is received from the National Weather Service's (NWS) RADAC WSR-57S weather radar for St. Louis, located about 35 miles from the District office. The reflectivity collected at the NWS site is converted to Video Integrated Processor (VIP) levels and this x-y array is transmitted via telephone lines to commercially-available weather radar receiving units. The SLD uses an Alden C2000R receiving unit, which can store 64 images in Random Access Memory (RAM) or 240 images on a Winchester permanent disk drive. A Sony Trinitron color monitor displays the radar image for review, prior to being sent through a serial

port on the Alden C2000R to an IBM PC AT 386 with math co-processor and hard disk. The data are transformed from a direct access to an ASCII file (required by the Harris system) and is sent directly to the SLD Harris 1000 computer. Software developed at WES converts the VIP level x-y array to precipitation intensities. Additional WES software is used to calibrate the radar imagery with selected gage data in the watershed and adjust the precipitation values accordingly. SLD-developed software for the Harris system accumulates the precipitation intensity values from each radar sweep recorded, and adjusts and arranges the data in time to obtain even 15-minute values of rainfall on the hour. Final output is HEC-DSS formatted hyetographs or mass curves of rainfall for predefined areas for user-specified time intervals. The calibrated hyetograph of basin rainfall is then stored for later use in an HEC-1 (HEC, 1981) computer model of the Upper St. Francis Basin.

Three-dimensional plot routines, developed by WES, can be utilized to review basin rainfall totals. Figure 3 illustrates the use of this package and also points out the powerful advantage that radar imagery (in conjunction with rain gages) gives for more accurate basin-wide precipitation analysis. Review of an entire storm can be obtained through application of the commercially-available software package "ShowPartner" (Brightbill-Roberts, 1986). The storm data are displayed through ShowPartner's animation routines to show the movement of a storm in time across the watershed. This feature could see future use in transposing a historical storm to a different watershed for runoff evaluation, if desired.

Procedures

General procedures for processing weather radar data in near real-time are shown in Figure 4 (Engdhal, 1988). During any given storm period, the radar receiving unit would capture an image at pre-selected time intervals. A sample image is shown in Figure 5 for a storm recorded on a 200 NM sweep. Radar reflectivity (VIP) levels are shown by 6 different colors, with each representing a different rainfall intensity in inches/hour. The image appears on a 256 by 240 pixel grid, which includes a SLD boundary map broken into 21 sub-areas. Also included with the storm data file is a header record which identifies the range of the sweep, the NWS site and the time the image was received. Each pixel in the grid has a unique identification code which, along with pixel locations for watershed boundaries and for stream gages, are stored in a separate file in the Harris 1000. Each pixel represents about one square mile at the 100 NM sweep or about two square miles at 200 NM range. One complete 360 degree radar sweep requires about two minutes, after which the image is scanned if specified to do so by the user. These scanned data include the header information and the VIP level (color) for each pixel. Scanned data for the complete 256 by 240 grid for that individual sweep are passed to the PC,



Spatial Distribution of Interpolated Rain Gage Data

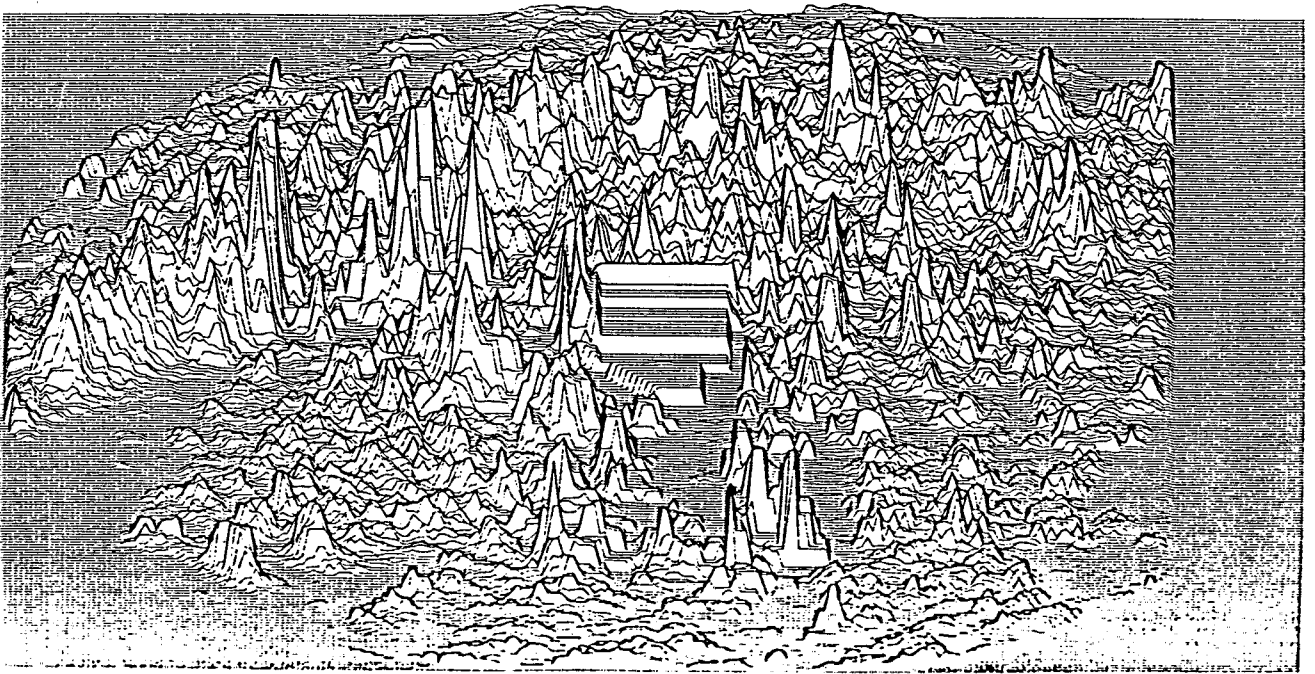

Spatial Distribution of Radar Observations

Figure 3

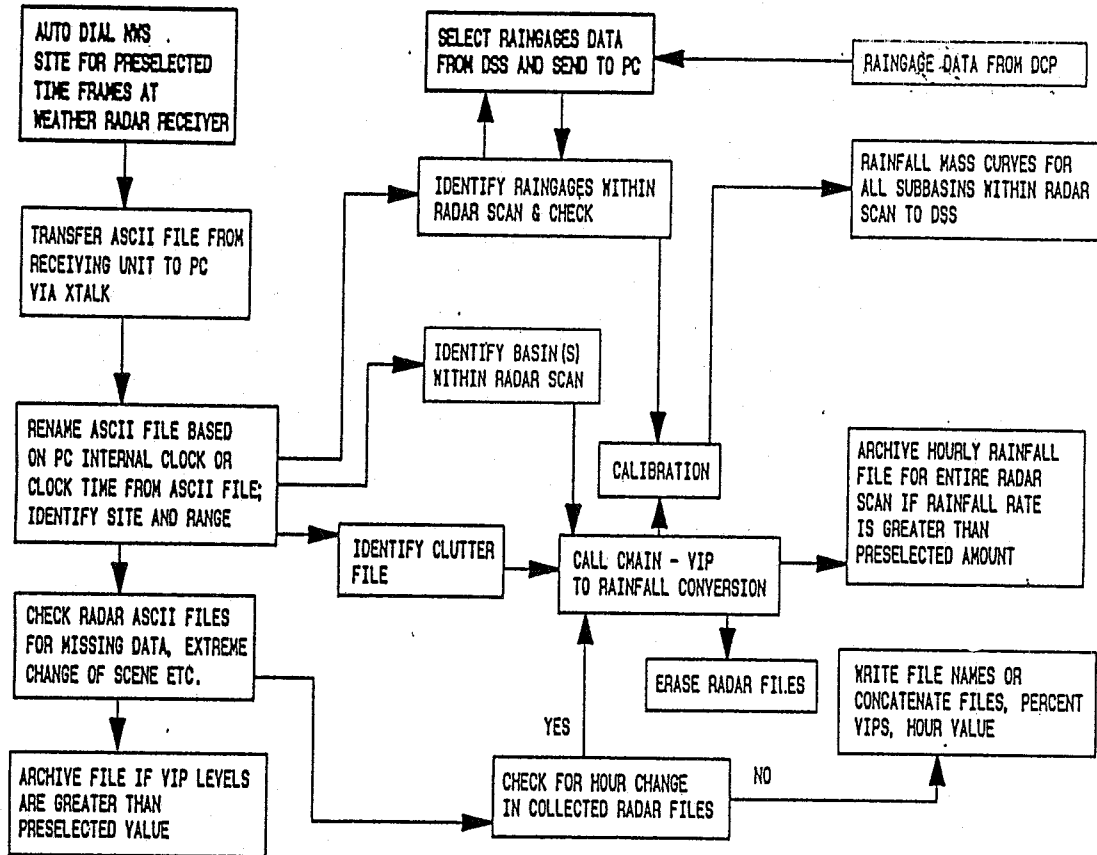
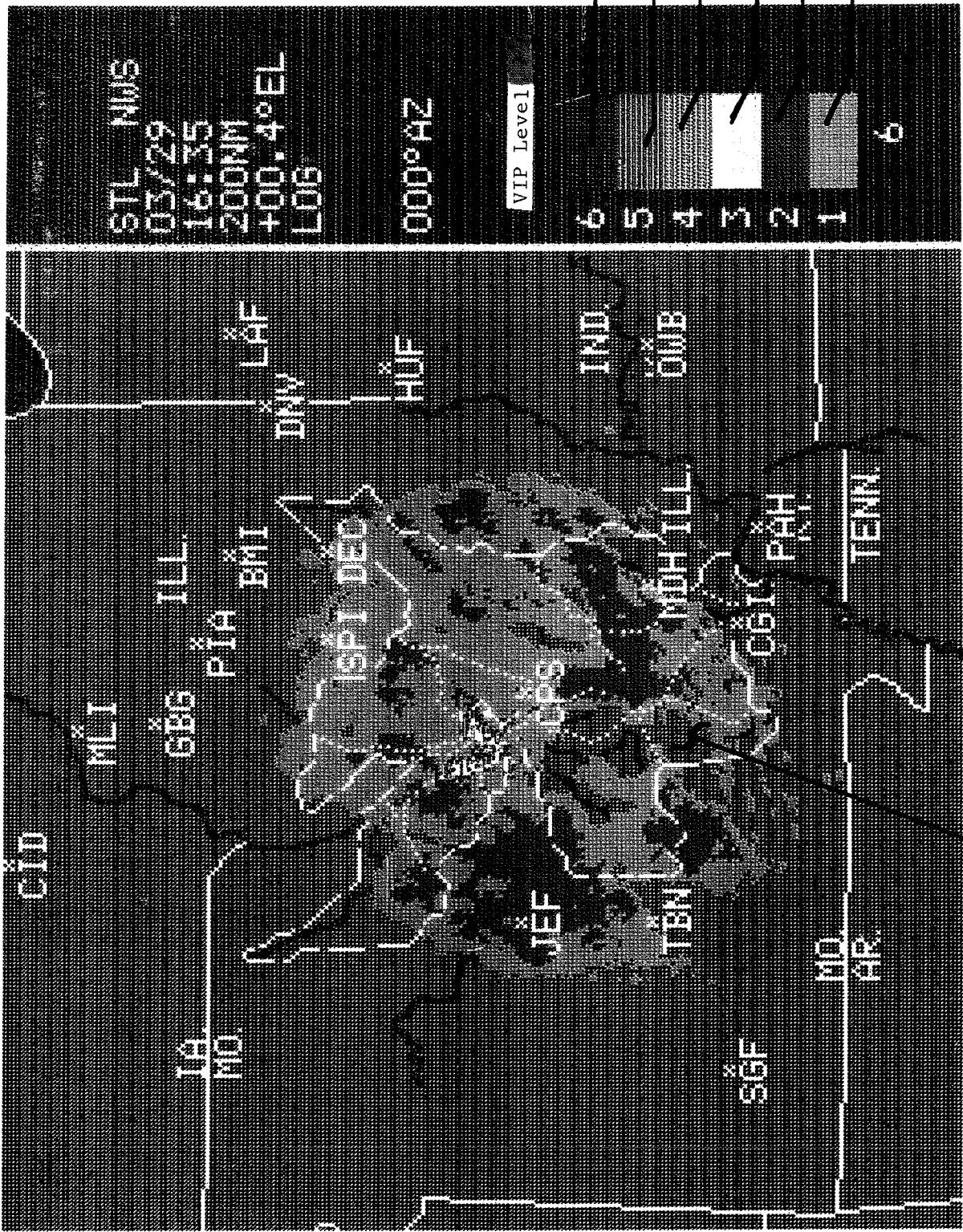

Figure 4--Processing Procedures

which transforms the grid data to an ASCII file. This scanning and data transfer process also requires one to two minutes. Although 15-20 sweeps and transfers can be accomplished each hour if desired, only one image every 10-12 minutes is necessary to adequately define convective activity (Huebner, 1986). Thus, six images per hour would adequately depict a storm event and minimize transmission and processing times. These data may be saved automatically at specified time intervals, or only when specified by the user.

Although not necessary for the Upper St. Francis Basin, an Alden software routine allows the elimination of ground clutter (the high intensity precipitation shown in the center of Figure 5), which is always present around the radar site. This clutter blanking routine is used for the site of interest and then the precipitation for the "blanked out" area would be filled in by using an image from a different radar site.

After precipitation totals are collected by radar for an hour or more, the accumulated rainfall data can be calibrated from available gage records. For the Upper St. Francis Basin, the calibration data would be the seven precipitation gages



Upper St. Francis Basin

transmitting through the GOES system at four hour intervals and from the other six gages accessible only by phone lines. If less than four hour updates and calibrations are necessary from the GOES stations, the gages may also be interrogated via phone lines. Calibrating and updating rainfall files would be an on-going process throughout the storm but, for a large watershed like the Upper St. Francis, would likely be necessary only 1-4 times per 24 hours, depending on precipitation and flood conditions. After calibration, the adjusted radar precipitation totals are used to develop a basin-wide precipitation hyetograph for input to a hydrologic model. A Harris software program takes the calibrated rainfall value for each pixel, determines time-weighted precipitation values, sums and groups the data into 15 minute precipitation values. Table 1 illustrates typical, HEC-DSS compatible, uncalibrated output from the program. The software routine can prepare either calibrated or uncalibrated precipitation hyetographs. This precipitation hyetograph is stored for later use in running the HEC-1 model of the Upper St. Francis watershed, thus developing an inflow hydrograph for Wappapello Lake.

TABLE 1
Sample Output for Watershed Precipitation

MTIME= 1445										
1451	1502	1511	1516	1518	1523	1529	1533	1535	1545	←(1)
1448	1456	1506	1513	1517	1520	1526	1531	1534	1540	←(2)
BASIN=MERAMEC ←————— Watershed										
SUBBASIN=MERAMEC										
0.105	0.107	0.078	0.069	0.058	0.047	0.054	0.045	0.036	0.019	←(3)
1445	1500	1515	1530	1545	1600					← Clock Time
0.000	0.023	0.021	0.013	0.008	0.005					←(4)
BASIN=ST. FRANCES										
SUBBASIN=ST. FRANCES										
0.000	0.000	0.000	0.000	0.000	0.000	0.000	0.000	0.000	0.000	
1445	1500	1515	1530	1545	1600					
0.000	0.000	0.000	0.000	0.000	0.000					
BASIN=KASKASKIA										
SUBBASIN=KASKASKIA										
0.114	0.131	0.131	0.136	0.132	0.146	0.150	0.161	0.133	0.129	
1445	1500	1515	1530	1545	1600					
0.000	0.026	0.033	0.036	0.034	0.032					

- (1) Time of radar sweep
- (2) Adjusted time of sweep
- (3) Precipitation intensity from radar, in./hr.
- (4) Weighted precipitation intensity, in./15-min.

Calibration Procedures

Radar precipitation for the pixel at each rain gage location is calculated for a specific time period (normally one

hour or more) and compared to that actually measured at the gage. A comparison of radar precipitation computed for nine different pixels located in the immediate vicinity of an actual gage catch is shown on Figure 6. A calibration factor (CF) of

Fredericktown Radar Precipitation vs. RAIN GAGE
April 14, 1987

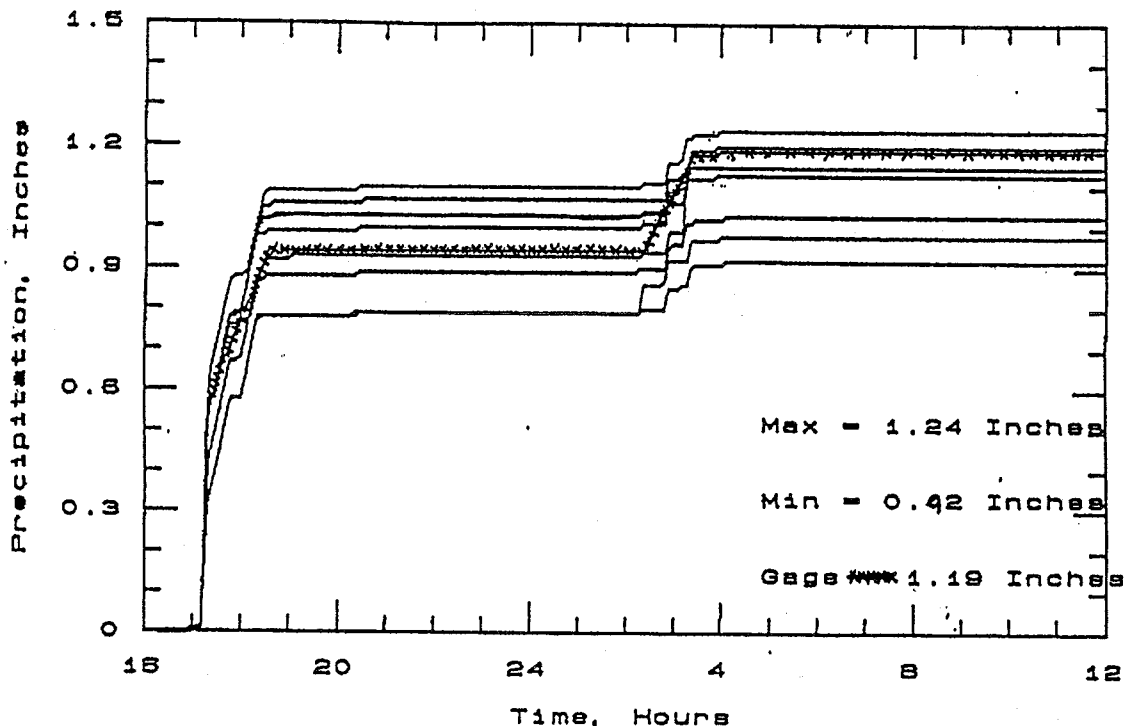

Figure 6

gage total divided by a radar total for each of the designated gages (as many as 13 in the Upper St. Francis basin) is determined for the time increment under evaluation. A separate calibration factor for each pixel in the 256 by 240 grid is then calculated, based on gage CF's. The CF for each pixel is based on the gage ratios for the nearest three gages to each pixel in the grid, weighted with an inverse square of the distances relationship between the pixel and each of the three gages. The array of CF's for the grid is then integrated with the array of precipitation intensities to obtain a calibrated grid of rainfall intensities. All pixels within the Upper St. Francis watershed boundary (600-700) are then integrated spatially to calculate a basin hyetograph for the hydrologic model, as shown in Table 1. Although a lack of storms in the test basin has so far precluded this phase of the testing in the SLD, these procedures have been satisfactorily applied by WES to storms in the Vicksburg area.

Results to Date

The system hardware described has been in-place since January 1988, with the software procedures becoming available during the spring and early summer. The only stumbling block for successful application of the overall procedure has been the lack of significant precipitation events to refine and check-out the calibration procedures and workings of the system. With a resumption of normal rainfall, it is expected that the real-time precipitation data acquisition system through use of radar imagery will be operational in Fiscal Year 1989.

Future Plans

Even though the final system is not yet fully operational, the SLD feels this process is sufficiently successful to consider future improvements. These currently include:

(1) Improved evaluation of soil moisture conditions through automated probes to better estimate precipitation losses during flood events. Existing procedures utilize the Soil Conservation Service Curve Number technique, with a relationship of CN vs. initial discharge into Lake Wappapello at the start of the storm.

(2) Develop the necessary sub-routines to perform all scanning, calibration, precipitation calculation and storm storage on the PC without the additional time required by data transfer to the Harris system. Processing time is expected to be cut in half without the Harris. WES is currently undertaking this procedure. WES is also continuing to make the overall procedure as fully automated as possible, minimizing the amount of operator time required.

(3) The 21 major watersheds (averaging about 1400 square miles each) in the SLD can now have a precipitation hyetograph developed through radar imagery. It is planned to further sub-divide many of these watersheds into three to six sub-basins to better capture the areal variations in precipitation. Application of the calibration routine to many of these watersheds is also planned.

(4) More emphasis on computer graphics is planned to better facilitate the decision making process for non-hydraulic personnel.

(5) Incorporate the use of composite imagery, using multiple radar sites, to further improve on rainfall accuracy (under development by WES).

Conclusions

A working system utilizing radar imagery to calculate basin-wide precipitation for watersheds in the St. Louis District is in place and in the final stages of calibration and refinement. Results to date show great promise for improvement of flood inflow predictions to reservoirs and of improved flood hydrograph predictions from Mississippi River tributaries. Of potentially greater importance will be the ability to accurately forecast flood magnitudes very early in a storm event and maximize downstream flood warning times.

Acknowledgements

Many Corps personnel are involved in this effort, with special mention appropriate for two individuals. Mr. Edward Pucel, Computer Specialist, Information Management Division, SLD, developed the necessary software for utilizing the Harris system in these procedures. Mr. Thomas Engdhal, Environmental Lab, WES, has overseen the considerable effort expended by WES personnel in developing the data transfer and calibration routines, in adapting previously-developed routines to the Alden system, in furnishing SLD personnel with advice and guidance on the use of radar imagery to effectively compute basin precipitation, and in providing valuable technical review for this paper.

References

Brightbill-Roberts & Co., "ShowPartner" Users Guide, 1986

Engdhal, Thomas L., "Weather Radar as a Hydrometeorological Tool", 1988

HEC-1 Users Manual, Hydrologic Engineering Center, 1981

Huebner, George L., Military Hydrology, Draft Report, "Sampling Rate Effects on Radar-Derived Rainfall Estimates", April 1986.

Miers, Bruce T. and Huebner, George L., Miscellaneous Paper EL-79-6, Military Hydrology, Report 8, "Feasibility of Utilizing Satellite and Radar Data in Hydrologic Forecasting", September, 1985.

Forecasting Lake Wappapello Inflows Using Radar Imagery

by

Gary R. Dyhouse and Robert L. Davinroy

SUMMARY OF DISCUSSION

by

Lewis A. Smith¹

Discussion ensued after the presentation with the following noted.

The four gages used as an example will not always be high or low consistently unless some topographic feature unduly influences the imagery. The calibration of the runoff model for these gages can be every hour to help reduce the uncertainty about actual intensity values.

The District is covered by other radar systems located in other cities. This other coverage is simply obtained by another computer dialup. The areal extent of coverage allows most of the District to be covered by radar.

Archiving of the radar imagery is not presently done by the National Weather Service (NWS). St. Louis District is selectively saving on disk storage significant events.

The technical resources to do this work are primarily from the Waterways Experiment Station (WES) associated with the military hydrology program. District resources come from O&M funds and require about \$12,000 - \$20,000 for computer hardware. The range depends on the quality of the hardware.

The next generation of radar being funded by NWS is NEXRAD. With this new NWS system the effort at St. Louis District appears redundant. However, the new radar system is not programmed for the St. Louis District for years to come. In addition, NWS has to fund adjunct systems such as new computers to use and make available the new radar information. All of this will take another decade. The work being undertaken in the District will bridge this availability gap. When NEXRAD is available the Corps will have a computer access port to tap the information base.

WES, Rock Island and St. Louis Districts are working on a technical paper on the system and processes to use the information. The paper should be available in the coming year.

¹ Hydraulic Engineer, Hydrology Section, Headquarters (HQUSACE)

Case Study: Streamflow Calibration and Verification in an Urban Watershed - The Ideal vs. the Reality

by

Joel W. James¹

Study Focus

The management of urban runoff is recognized worldwide as an acute problem associated with urbanization. Poor management causes pollution of receiving water bodies and problems of sanitation, flood damage, and urban decay. The recent attention given this problem is a signal that the significance of the problem is just now becoming fully recognized. The severity of the problem of increased runoff rates is being recognized to the extent that several cities are requiring developers (particularly those upstream) to provide sufficient storage in order to inhibit high runoff rates that would otherwise occur as a result of new development.

The intent of this paper is to show how urban runoff analysis techniques can be effectively incorporated in to the planning and design of urban flood control measures.

Introduction

Once it has been accepted that the runoffs are random variables and that dealing with long-term average values, where available, cannot provide acceptable rules of operation from at least a legal standpoint, it becomes necessary to describe the runoff by a suitable stochastic model. Immediately the question arises as to what constitutes a suitable model, and the literature describes a broad variety of models.

The first model I will examine is a regional model. Many hydrologic parameters have a regional variation. Examples of these parameters are flows, log, regression coefficients of a correlation between mean runoff or its standard deviation, or its coefficient of skew, basin terrain and climatic characteristics; the coefficients used in a unit hydrograph technique, or a recession curve; the parameters of a rainfall - runoff model, etc. Regionalization of hydrologic parameters is most often used because of a lack of knowledge of the specific conditions of an area. The limitations of our knowledge require that we develop and apply approximate models of the hydrologic phenomena. In areas in which the hydrologic regime is not affected by man, the models are simpler to develop and apply. Significant complications appear, however, when one attempts to develop a model in a basin in which the hydrology is affected by man's intervention. The requirements for most urban flood control models are that not only must the model account for previous man-made intervention, but must also estimate the effects of the planned modifications.

¹Supervisory Hydraulic Engineer, Savannah District, U.S. Army Corps of Engineers

I will illustrate concepts of regional and rainfall-runoff modeling, and the effects of urbanization on hydrologic parameters, using a model developed for Oates Creek at Augusta, Georgia, an ungaged and highly urbanized watershed.

Physical Setting and Available Data

Oates Creek is a major conveyor of flood waters from the Augusta Metropolitan area. The creek has a drainage area of 4.7 square miles, one half of which is within the city limits of Augusta, Georgia; however, flood problems along the stream are almost entirely confined to the area of Richmond County, outside the Augusta City limits. Oates Creek flows into Beaver Dam Ditch and the Phinizy Swamp which are tributary to Butler Creek. Butler Creek enters the Savannah River downstream of New Savannah Bluff Lock and Dam.

Oates Creek drainage basin may be characterized as heavily urbanized. The slope of the watershed is relatively flat, from the mouth upstream to Milledgeville Road. The portion of the watershed upstream of Milledgeville Road exhibits a drastic change in topography. The terrain is very hilly and steep; the watershed and floodplain are composed of highly erodable, coarse sands. The steep slopes and the extensive upper-basin development make the broad, flat downstream flood plain very susceptible to flooding during periods of high-intensity short duration rainfall. As the metropolitan area has expanded, homes and buildings have been developed in flood-prone areas along Oates Creek. Urbanization of the watershed has further increased the frequency and heights of damaging flood, as more efficient storm drains and additional impervious area, such as streets and parking lots, have been constructed. The latter changes increase the rate at which storm runoff moves across the basin and enters Oates Creek, and they decrease the amount of infiltration within the watershed. The area is highly urbanized so future land use was not a consideration.

There are no stream gaging stations located on Oates Creek or in the general area of the Oates Creek watershed. The nearest gaging station is located on the Savannah River; however, it is not applicable to the Oates Creek watershed. The availability of streamflow, stage, water quality and sediment data would create the ideal environment to establish pre-project conditions.

Study Approach

Because of the lack of local data, empirical methods were used to determine streamflow for Oates Creek. The model used was based on previous studies of the effects of urbanization in other parts of the United States and on the natural flood-frequency and rainfall-frequency characteristics of the local area. Methods of estimating magnitude and frequency of floods in urban areas have been the subject of several reports by various investigators during recent years. Examples of such reports are Anderson (1970), Carter (1961), Gann (1966), Espey and others (1966), Espey and Winslow (1966). Sauer (1974) combined a summary of data and methods from these reports with local rainfall-intensity and natural floodflow frequency data to define urban flood-frequency equations.

Regional Model

The Sauer Method (1974), developed for urban areas is based on the earlier work by Leopold (1968) that summarized the results of urban flood studies in the United States and developed an urbanization effect graph (Figure 1). This graph, a family of curves, shows the effect of urbanization (ratio of peak discharge under urbanized conditions to the peak discharge under rural conditions) on the mean annual flood for a 1 mi² (square mile) area. The measures of urbanization are a percentage of drainage area that is impervious and percentage of drainage area served by storm sewers. Leopold stated that this "graph will be different for different drainage area sizes and for different flow frequencies." Sauer states that the curves were developed from data for basins of 1 to 40 mi² in Oklahoma. On this basis he applied the R_L factor to the mean annual flood equation for natural (rural) streams to obtain mean annual flood data.

The urban adjustment ratios from Figure 1 are not directly applicable to flows greater than the mean annual flood. A method for determining the frequency and magnitude of floods greater than the mean annual floods using Leopold's urban adjustment ratios was developed by Sauer based on Anderson's study in Northern Virginia. Anderson (1970) suggested that the ratios of selected recurrence interval floods to the mean annual flood for a 100 percent impervious area should approach the respective ratios for rainfall-intensity-frequency ratios. For a fully developed basin, Sauer assumed that the ratios of flood magnitudes of selected recurrence intervals to the mean annual flood would be equal to those for rainfall magnitudes of the same recurrence intervals. For example, if the rainfall magnitude ratio 50- to 2- year for a 100 percent impervious and 100 percent storm - sewer basin is assumed to be 2.21, while it is unlikely that an urban basin would ever reach this degree of development, the assumption serves to set an upper limit for purposes of interpolating flood frequency for intermediate degrees of development.

The preceding assumption and the maximum value of R_L=7 for a 100 percent impervious and 100 percent storm-sewer basin can be used to compute the upper limiting flood-frequency curve for a fully developed basin. The 5-, 10-, 25-, 50- and 100-year urban floods are computed using the urban mean annual flood (R_L=7) times the same ratios as the equivalent rainfall-frequency data. The flood-frequency curve for natural conditions (R_L=1) defines the lower limiting flood-frequency curves. Interpolation of Q_x(u), the urban peak discharge for recurrence interval x, can be expressed by the general equation, where R_x is average rainfall intensity ratio for recurrence interval x.

$$Q_x(u) = \frac{7R_x Q_2(r) (R_L - 1)}{6} + \frac{Q_x (7-R_L)}{6}$$

Q is 2-year natural flood discharge,
R_L is the urban adjustment ratio for the mean annual flood,
Q_x is natural flood discharge for recurrence interval x

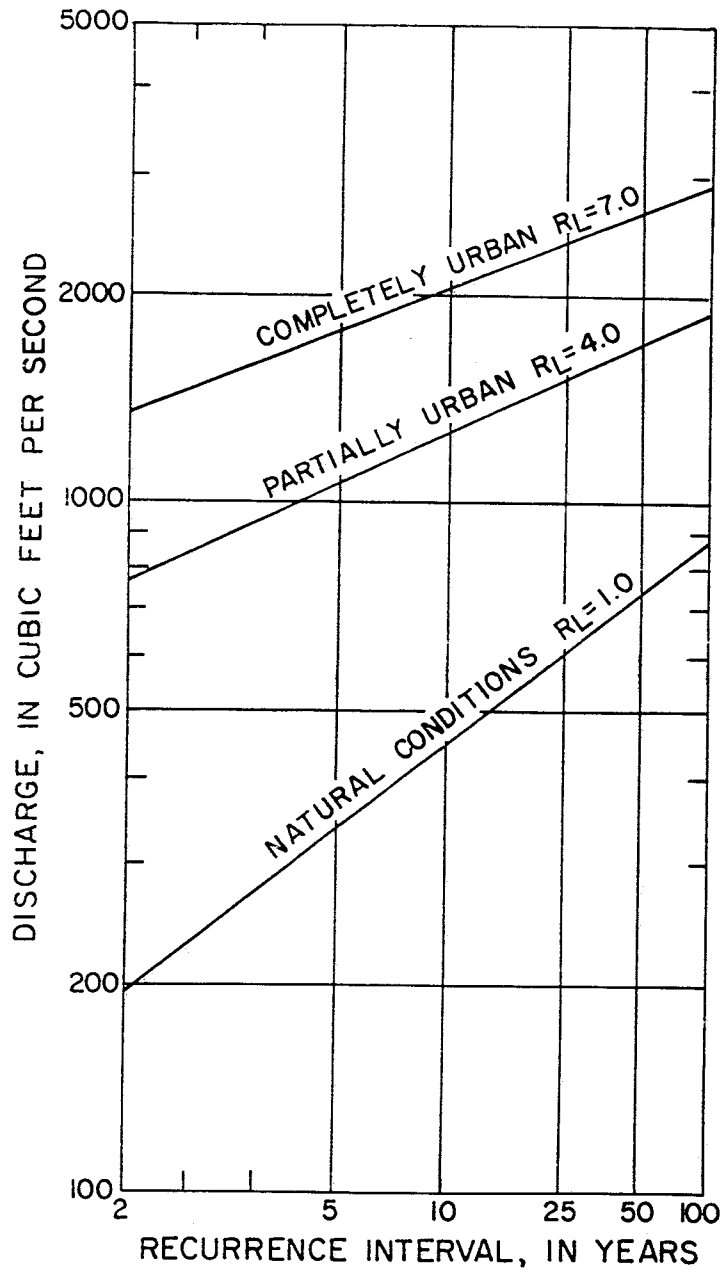

COMPARISON OF NATURAL AND URBAN FLOOD-FREQUENCY CURVES FOR A HYPOTHETICAL 1-SQUARE-MILE BASIN.

FIGURE 1

The urban adjustment ratio developed by Leopold and used by Sauer was based on analyses using the mean annual flood. Current use of log-Pearson type III flood-frequency analysis has resulted in a change to the 2-year recurrence interval flood as the base flood. For rural Georgia streams the 2-year flood is about 0.9 the mean annual flood. So as not to add to the assumptions in this analysis, the urban adjustment ratios defined by the mean annual flood were not adjusted to the 2-year flood.

Rainfall-intensity-frequency curves for Augusta were developed and published by the National Weather Service. Average intensity ratios based on the 5 minute through 24-hour rainfall duration data are as follows:

Augusta, Georgia

Frequency, x, in years	Rainfall-intensity ratio, R_x
2	1.00
10	1.59
25	1.88
50	2.09
100	2.33

Natural streamflow equations for the Piedmont physiographic province developed by Golden and Price are as follows:

$$\begin{aligned}
 Q_2(r) &= 202A^{0.6} \\
 Q_{10}(r) &= 415A^{0.6} \\
 Q_{25}(r) &= 525A^{0.6} \\
 Q_{50}(r) &= 606A^{0.6} \\
 Q_{100}(r) &= 687A^{0.6}
 \end{aligned}$$

Sauer type equations were developed for the Augusta area using local area rainfall-frequency data and the equations for rural Georgia as shown in the following example:

$$Q_{10} = \frac{7R_x(10) Q_2(r) R_L^{-1}}{6} + \frac{Q_{10}(r) (7-R_L)}{6}$$

where $R_x(10) = 1.59$

$$\begin{aligned}
 Q_2(r) &= 202A^{0.6} \\
 Q_{10}(r) &= 415A^{0.6}
 \end{aligned}$$

then,

$$Q_{10}(u) = \frac{7(1.59)(202A^{0.6})(R_L - 1)}{6} + \frac{415A^{0.6}(7 - R_L)}{6}$$

Regional equations adjusted for the Augusta area are as follows:

$$Q_2(\text{urban}) = R_L \frac{Q}{2} (\text{rural})$$

$$Q_{10}(u) = 376A^{0.6}(R_L - 1) + 69A^{0.6}(7 - R_L)$$

$$Q_{25}(u) = 442A^{0.6}(R_L - 1) + 88A^{0.6}(7 - R_L)$$

$$Q_{50}(u) = 493A^{0.6}(R_L - 1) + 101A^{0.6}(7 - R_L)$$

$$Q_{100}(u) = 543A^{0.6}(R_L - 1) + 115A^{0.6}(7 - R_L)$$

The R_L factor for Oates Creek was determined to be 2.1 from Figure 2. Discharges computed by the above equations for selected locations along Oates Creek are shown in Table 1.

Rainfall Runoff Model

The HEC-1, "Flood Hydrograph Package", dated September 1981, authored by the Hydrologic Engineering Center, Davis, CA, was used to verify the resultant estimates of magnitude and frequency of floods for the Oates Creek watershed, which were obtained from use of the Sauer Method.

Discharge - frequency estimates were developed for various sites along Oates Creek. This was accomplished by computing the peak runoff which would result from storms (rainfall) of a given exceedance frequency. Data from the National Weather Service Technical Paper No. 40 were utilized to generate 2-, 10-, 25-, 50-, and 100-year hypothetical 24-hour rainfall. Procedures given in Corps of Engineers EM 1110-2-1411 were utilized to distribute the rainfall from the storms with maximum centering over all subbasins simultaneously. The curve number method described in the Soil Conservation Service National Engineering Handbook, Section 4, Chapter 7-10, was used to determine the runoff resulting from the hypothetical flood events. This method uses the soil name, series, soil type, land use, slope of the watershed and the antecedent moisture condition in determining the basin lag. The SCS curve number method has been programmed into the HEC-1 model and is used to develop consistent results when evaluating the effects of changes in land use. From published soil surveys of the surrounding area and information given by the local SCS, the soils in the Oates Creek basin are predominantly hydrologic soil Group B. The Oates Creek basin was divided into 7 subbasins and the average hydrologic soil group of each subbasin was determined as a weighted average of the area; rainfall loss curve numbers were designated for each soil group and land use associated with each subbasin was obtained from USGS land use maps.

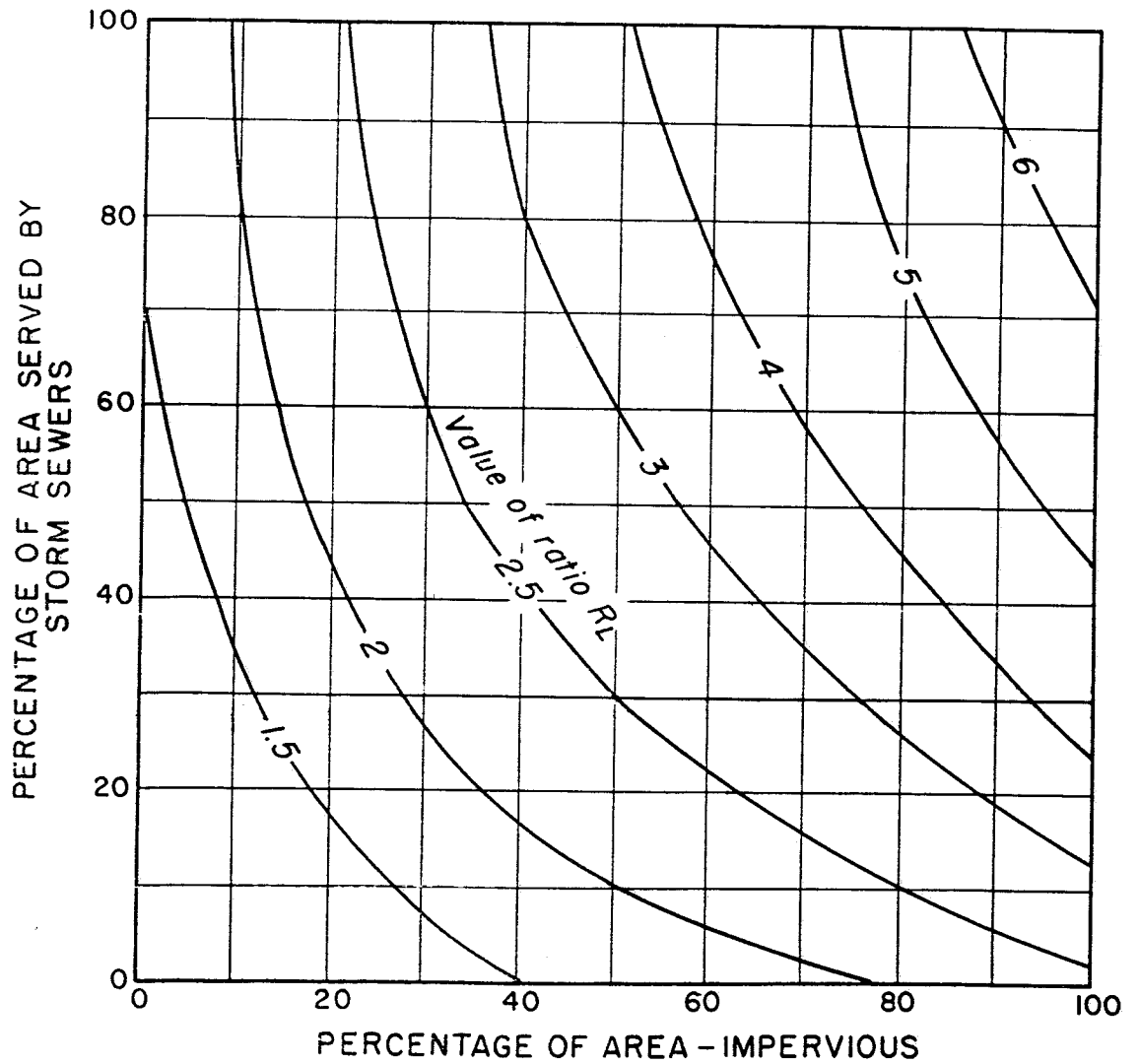

GRAPH SHOWING URBAN ADJUSTMENT RATIO, R_L , FOR MEAN ANNUAL FLOOD [FROM LEOPOLD (1968) AND SAUER (1974)].

FIGURE 2

TABLE 1
OATES CREEK DISCHARGES - SAUER METHOD

STATION NUMBER	SECTION NUMBER	LOCATION	DRAINAGE AREA (SQ.MI.)	DISCHARGE IN C.F.S.					
				MEAN ANNUAL	10 YEAR	25 YEAR	50 YEAR	100 YEAR	STD. * PROJECT
MAIN STREAM									
0 + 00	0-1	@ mouth	4.7	1073	1905	2318	2627	2952	5501
75 + 60	0-10	Old Savannah Road	4.2	1004	1781	2168	2456	2760	5353
108 + 40	0-14	below Milledgeville Rd	3.7	930	1650	2009	2276	2558	4648
NORTH FORK									
134 + 22	OT-1	White Road	2.1	662	1175	1429	1619	1820	2764
139 + 87	OT-2	Olive Road	1.8	603	1070	1303	1476	1659	2488
148 + 93	OT-3	White Road	1.7	584	1036	1260	1428	1605	2408
SOUTH FORK									
15 + 99	OB-16	Olive Road	0.60	311	553	673	762	857	1286
31 + 30	OB-18	Tubman Home Road	0.46	267	473	576	652	733	1100
75 + 80	OB-19	Polo Road	0.17	147	261	317	359	404	606
76 + 25	OB-20	Kissingbower Road	0.14	130	231	281	319	358	537

Sauer Method (R = 2.1)

*HEC-1 Computation

Curve number (CN) relationships shown in Table 2 are based on an intermediate value of antecedent moisture condition (AMCII). As stated previously, the Oates Creek basin is highly urbanized and expected land use changes are minimal; therefore, new curve numbers were not determined for future conditions.

Unit hydrographs were computed for each subbasin in the Oates Creek watershed utilizing HEC-1. Lag time was determined from the following equation:

$$L \text{ (lag in hours)} = T \text{ (Time of Concentration)} (.6)$$

$$T = (11.9L^3 / H)^{0.385}$$

L = Length of longest watercourse in miles
H = Difference in elevation in feet

All data used to compute unit hydrographs for the Oates Creek watershed are shown in Table 2.

Channel routing for the main water course between subarea combining points was based on the HEC-2 water surface profile computations which established a relationship between storage and discharge for each channel reach. The modified Puls Method was used in HEC-1 to route through subbasin reaches.

The peak flows computed by the rainfall runoff model (HEC-1) were compared with those derived by the Sauer Method. A comparison of these flows at selected locations are shown in Table 3. The variation in the flows computed by the two was small in most instances. The difference in flows were explored further in sensitivity tests of the water surface profiles to these differences.

As a result of these comparisons, water surface profiles for the two-year through 100-year peak flood discharges were derived by the regional flood frequency studies (Sauer Method) and the Standard Project Flood (SPF) peak discharges were developed from the HEC-1 rainfall-runoff model.

The SPF for Oates Creek was computed using the SCS curve number routine of the HEC-1, Flood Hydrograph Package. The Oates Creek model was calibrated using the urban runoff equations for the Augusta area. The models as used to reproduce the 10- and 100- flood peaks given in Table 1. The SPF features of HEC-1, along with the Standard Project Storm criteria given in EM 1110-2-1411, were used to compute the SPF peaks shown in Table 1.

Conclusions

Models of the first type present a convenient method of estimating urban runoff in the absence of gage data. From our analyses, the result are within reasonable bounds when compared to peak discharges derived from hypothetical rainfall-runoff modeling techniques. The most important weakness of this approach is that only peak flows are estimated, whereas the entire hydrograph is needed for design of urban

TABLE 2

OATES CREEK

SUBBASIN CHARACTERISTICS

<u>SUBBASIN</u>	<u>LOCATION</u>	<u>DRAINAGE AREA SQ. MI.</u>	<u>CN</u>	<u>ELEVATION (FT)</u>	<u>LENGTH (FT)</u>	<u>TC</u>	<u>LAG IN HOURS</u>
1A	N. Branch at Olive Rd	1.8	75	120	8,400	.7	.42
2	White Rd	.3	82	17	4,000	.63	.38
3	above Milledgeville Road	1.0	85	205	12,800	.82	.49
20	S. Branch Kissingbower Rd	.14	77	76	4,600	.42	.25
16	S. Branch Olive Rd	.60	85	35	5,400	.77	.46
10	Old Savannah Rd	.50	75	35	5,200	.68	.41
1	@ Sta 5+00	.50	82	53	9,600	1.2	.72

TABLE 3

COMPARISON OF DISCHARGES AT SELECTED SITES ALONG OATES CREEK

Sect.	LOCATION	DRAINAGE AREA (SQ. MI.)	MEAN ANNUAL	10			25			50			100			STANDARD PROJECT
				Sauer	HEC-1	YEAR	Sauer	HEC-1	YEAR	Sauer	HEC-1	YEAR	Sauer	HEC-1	YEAR	
	MAIN STREAM		Sauer	HEC-1	YEAR	Sauer	HEC-1	YEAR	Sauer	HEC-1	YEAR	Sauer	HEC-1	YEAR	HEC-1	
0-10	@ Mouth	4.7	1073	807	1905	1509	1741	2318	1904	2627	2023	2952	2466	7526		
0-10	Old Savannah Road	4.2	1004	884	1781	1741	2168	2302	2456	2377	2760	2863	7590			
0-14	blw.M'ledgev'le Rd	3.7	930	809	1650	1606	2009	2138	2276	2206	2558	2591	6935			
	North Branch															
OT-1	White Road	2.1	662	598	1175	1265	1429	1546	1619	1605	1820	1823	4752			
OT-2	Olive Road	1.8	603	620	1070	1181	1303	1468	1476	1528	1659	1762	4412			
	SOUTH BRANCH															
OB-16	Olive Road	0.60	311	222	553	377	673	455	762	471	857	533	1252			
OB-18	Tubman Road	0.46	267	210	473	352	576	423	652	437	733	494	1127			
OB-20	Kissingpower Rd	0.14	130	66	231	121	281	149	319	154	348	177	429			

(49)

flood control measures. The storage effects indicative coastal plains areas cannot be accounted for in this analysis. The rainfall-runoff model has as assumption the fact that the 10-year rainfall is assumed to produce the 10-year runoff, etc. Manmade storage and transport facilities are easily included in this model. However, when gage data is available, calibration of a deterministic rainfall-runoff model, rarely results in an exact fit to available data. The residuals may be represent discrepancies due to truly random influences (e.g., measurement error) as well as incompletely modeled relationships (e.g., infiltration processes).

Lastly, it should be remembered that imbedded in every design problem is an operational problem and alternatives developed from regional regression analysis may lose the advantage to evaluate a project on a real-time basis.

REFERENCES

- Anderson, D. G., 1970, Effects of urban development on floods in northeast Virginia: U.S. Geol. Survey Water-Supply Paper 2001-C, 22 p.
- Carter, R.W., 1961, Magnitude and frequency of floods in suburban areas, in short papers in the geologic and hydrologic sciences: U.S. Geol. Survey Prof. Paper 424-B p. B9-B11.
- Espey, W. H., Morgan, W. H., Morgan, C. W., Mash, F. D., 1966, Study of some effects of urbanization on storm runoff from a small watershed: Texas Water Devel. Board Rept. 23, 109 p.
- Espey, W. H., Jr., and Winslow, D. E., 1974, Urban flood frequency characteristics: Proc. Am. Soc. of Civil Engineers, Jour. Hydraulics Div., v. HY2, pp. 279-293.
- Gann, E. E., 1971, Generalized flood-frequency estimates for urban areas in Missouri: U.S. Geol. Survey open-file report, 18 p.
- Golden, H. G., and Price, M., 1976, Flood-frequency analysis for small natural streams in Georgia: U.S. Geol. Survey open-file report, 76-511, 75 p.
- James, L. D., 1965, Using a computer to estimate the effects of urban development on flood peaks: Water Resources Research, v., 1, no. 2, p. 223-234.
- Leopold, L. B., 1968, Hydrology of urban land planning guidebook on the hydrologic effects of urban land use: U.S. Geol. Survey Circ. 554, 28 p.
- Martens, L. A., 1968, Flood inundation and effects of urbanization in metropolitan Charlotte, North Carolina: U.S. Geol. Survey Water Supply Paper 1591-C, 28 p.
- Sauer, V. B., 1974, An approach to estimating flood frequency for urban areas in Oklahoma: U.S. Geol. Survey Water Resources Inv. 23-74, 10 p.
- U.S. Weather Bureau, 1955, Rainfall intensity-duration-frequency curves: U.S. Weather Bureau Tech. Paper 25.
- Wilson, K. V., 1966, Flood frequency of streams in Jackson, Mississippi: U.S. Geol. Survey open-file report, 6 p.

Case Study: Streamflow Calibration and Verification in an Urban
Watershed - The Ideal vs. the Reality

by

Joel W. James

SUMMARY OF DISCUSSION

by

Bert Holler¹

A question was raised as to the actual data available in the study area with which to test the empirical relations that were derived. There was one rainfall event (about a 25 year rainfall) from three storms at two locations. The empirical equations appear to be a good tool for use in a recon type report when there may not be much hydrologic data available.

There was discussion on how well the regional equations had checked out in the watersheds for which they were developed. The equations appear to produce good relationships for watersheds in the metropolitan Atlanta area.

A question was asked as to the routing method used. The modified Puls method was used.

The rainfall losses accounting method was questioned. The curve number method using the same API for all events was used.

The use of TP 40 and HEC-1 produced answers that were reasonably close to the Sauer method.

¹ Chief, Hydrology and Hydraulics Section, South Atlantic Division

HYDROLOGIC MODEL CALIBRATION PROBLEMS
ENCOUNTERED IN PUERTO RICO

by
Michael L. Choate¹

General. Puerto Rico, which was ceded to the United States in 1898, is the smallest and easternmost of the West Indies group known as the Greater Antilles. Lying 1000 miles southeast of Miami, Florida at 18 degrees north latitude, the main island is about 96 miles long east to west and 35 miles north to south with interior elevations reaching 4,400 feet above sea level. Puerto Rico offers a full range of challenges to the Hydraulic Engineer. Mountain watersheds with steep slopes, super-critical flow regimes and relatively high annual rainfall rates that flow into flat (usually two-dimensional) coastal floodplains with low annual rainfall rates and tidal outlets.

Some of the topics we will discuss will be topography, areal rainfall distribution, temporal rainfall distribution, times of concentration, model selection and, as the title suggests, "calibration" with or without historical data. The thought processes of the Hydraulic Engineer, in a natural order of progression, will be followed.

Topography. The interior mountain range of Puerto Rico runs east to west and forms the headwaters for most of the major watersheds. This central mountain range acts as a drainage divide between north and south and east and west. The forested upper reaches of these watersheds have very steep slopes, approaching 45 degrees, and well defined watershed boundaries. Leaving the mountains, the streams flow through the foothills generally with slopes of about 50 feet per mile and still well defined watershed boundaries. Nearing the coast, the land becomes very flat, with ill defined flood boundaries which are affected by flooding from adjacent watersheds and fluctuating tides. Karst topography also adds difficulty during the calibration process since these "non-runoff producing areas" can contribute significant runoff during the larger events.

Rainfall Distribution. The hydrologist traditionally has the leeway to use his professional judgement in selecting the areal and temporal distribution of rainfall; however, the calibration process adds to his insight. For example while doing the original hydrology for the Portugues and Cerrillos Reservoirs, located on the south coast of Puerto Rico, it became quickly evident that the rainfall characteristics over the basin were not in the least homogeneous. The rainfall in the mountains average 80 to 87 inches annually while rainfall in the coastal town of Ponce averages about 35 inches. The variation between wet and dry years can be over 50 inches. For example, in 1979 Ponce received 50 inches

¹ Supv. Hydraulic Engineer, Jacksonville District, U.S. Army Corps of Engineers.

and the mountains over 116 inches; but in 1967, Ponce had only 15 inches and the mountains less than 60 inches. In order to calibrate to historical events, the basin was divided into three regions; mountains, foothills and coastal. These divisions were also used for the design storm conditions with Thiessen polygons and local gages providing the rainfall for the frequency events.

Few historical storm events are well enough documented to provide sufficient data for calibration. Time delay between peak rainfall and peak runoff often times provides the best insight into the areal distribution of rainfall. Analysis of storm events in Puerto Rico has shown that intense rainfall in the mountains are responsible for a significantly higher percent of floods in the foothills and coastal floodplain. Very little attenuation of flood peak occurs in the steep narrow mountain valleys and time of concentration is easily optimized using the assumed rainfall distribution during calibration. Double or multiple peaks in the recorded hydrograph provide invaluable information for both areal and temporal rainfall distribution patterns. An isohyetal map using all available rain gage data will also show if high intensity rainfall had an influence on the recorded peak.

Storm Analysis. The rainfall atlas most frequently used in Puerto Rico is Technical Paper No.42, Generalized Estimates of Probable Maximum Precipitation and Rainfall-Frequency Data for Puerto Rico and Virgin Islands (U.S. Weather Service, 1961). This paper provides rainfall durations from 30-minutes to 24-hours. When calibrating to historical events where rainfall was reported only daily, we might use TP-42 along with nearby recording gages to synthesize a distribution. Generally, TP-42 is most commonly used to develop rainfall for our balanced storms. A balanced storm is setup by making sure that short duration, more intense rainfall is always inside of the longer durations, ie. the peak 1-hour is inside the 3-hour, which is inside the 6-hour etc. The most compelling argument for this distribution is that no matter what the critical duration for each watershed, the rainfall depth always has the proper frequency. An example of this occurred in October 1985.

Tropical Storm Isabel hit the island of Puerto Rico with torrential rains from 5 through 8 October with a total of over 22 inches. The peak daily total of 18.2 inches occurred on 6 October and was widely reported as a 100-year rainfall. It, in fact, exceeded the 100-year; so why didn't the Corps 35-year design channels in Ponce exceed bank full capacity? Modeling of this event, based on recorded rainfall, produced peaks of about the 25-year return period and matched the recorded storm hydrograph. The reason of course was that the short durations of rainfall, those critical to the contributing watersheds, varied between 5-year and 25-year frequencies and produced corresponding peaks. The end result of this tragic storm was that the primary cause for the loss of life was the "100-year storm" saturated soil conditions resulting in numerous landslides, not the 25-year peak discharges in the channels. During the calibration process it is extremely important that the time step match the smallest watershed.

Arguments against the balanced storm concept generally involve the rainfall intensity differences associated with long and short duration events. Meaning,

cloud bursts often occur with afternoon thunder storms and not necessarily with the longer duration hurricanes or frontal passages. However, by including the high intensity short duration rainfall increments, the small watersheds are allowed to respond to the design storm and the larger watersheds, or those with storage, assimilate the spikes with very little impact on peak discharge. When calibrating a design storm to a frequency analysis of historical data this is very important on the high end for design purposes and on the low end for economic reasons.

The typical study procedure would be to develop design storms of 2-, 5-, 10-, 25-, 50-, 100-year and SPF at antecedent moisture condition (AMC)II (Soil Conservation Service, 1972) and attempt to match the historical estimate produced by the log Pearson Type III analysis plotted on log probability paper. The large events are generally underestimated while the more frequent storm are overestimated. This trend has held consistently and compensated for by lowering the curve numbers to drier conditions for the smaller storms and creating much wetter antecedent conditions for the large events. This calibration procedure should be documented in the report writeup and used without change for the design and future conditions. Method justification generally discusses the rainfall sample and the joint probability with the AMC. While rainfall is relatively independent and categorized by duration, peak discharge is a product of the rainfall depth and duration, areal storm coverage and AMC probabilities. To recognize that peak discharge is the product of multi-dimensional probabilities is important to the hydraulic engineer and his understanding of the calibration process.

Reliance on a best-fit frequency analysis to predict discharges beyond the period of record can also lead to errors. When attempting to calibrate to the upper (extrapolated) portion of a frequency analysis, some form of hydraulic model should be used to verify the conveyance capacity of the floodway. Negative skewness of the frequency curve can be caused by floodwaters overtopping ridge lines, highways and roadways resulting in diverted flows. This overflow point may have never been reached by historical events, especially if the record is short, and would not be evident in the extrapolated curve.

Travel Time. This important variable is one of the most difficult to estimate. If historical hydrographs are not available for the optimization of the time of concentration, then it is best to compute lag using several empirical methods as well as by overland flow formulae using slope, friction and reach length. Most important at this point is to define the input variable your model is requesting. For example, HEC-1 (Hydrologic Engineering Center, 1985) uses (Snyder's) T_p or SCS lag on the UD card which is measured from the center of unit rainfall to the peak of the unit hydrograph. However, the manual does not specify which T_p to use. Had you used SCS's T_p , then your estimate would have been off by one-half the unit rainfall interval. Time of concentration (T_c) is defined as the time required for surface runoff from the remotest part of the drainage basin to travel to the point being considered. This value may be computed by backwaters, however, for large basins it must be reduced by up to 40 percent to equal lag since T_c measures to the point of inflection on the descending limb. In Puerto Rico, Kirpich and SCS lag have been the most

successful in estimating lag time with SCS lag prevailing when antecedent moisture conditions influence velocities.

Model Selection. In the mountains, with headwater control, HEC-1 has always given reliable results. Even the 484 peaking factor has been left alone. Karst areas are treated by deleting or adding drainage area based on engineering judgment and historical storm hydrographs of varying sizes. Inflow is routed from the top of its respective reach using sloping pool modified Puls when valley storage is sufficient to warrant routing. When flood waters transition from well defined channels and valleys to the coastal floodplain, the flow becomes two-dimensional and may be complicated by more than one stream flowing into the same floodplain. The model used is the quasi two-dimensional link node version of the Receiving Water Quality Model developed for the Storm Water Management Model (Lager, Pyatt and Shubinski, 1971). Data to calibrate a two-dimensional model is very difficult to obtain. Therefore, calibration is accomplished by first running low and in-bank flows to establish the proper conveyance in the main channels and identify overflow points. Calibration of the model is usually done by running historical events that are documented in U.S. Geological Survey, Water Resource Investigations, Open-File Reports. These reports usually come as 24x36 inch folded maps with flood limits colored and isoelevation lines delineated. A description of the storm event, dates and times, and damages are also included around the periphery of the map. If available, an Open-File Report from another event is used for verification. Rainfall-runoff calculations are carried out by HEC-1 in the coastal floodplain, however, the two-dimensional routings require the predominance of calibration efforts. Occasionally, the peaking factor in HEC-1 will need to be changed and the Q_p and T_p ratios must also be carefully adjusted inside the computer coding.

Continuous Record Models. Seldom at the survey level investigation do we need a continuous record model. However, during the design and permitting stage the continuous model provides support for environmental studies, long term economic impacts and pumping and maintenance costs. The continuous record model also can enhance public involvement by showing how a project would have performed over the years had it been in place. It has been our experience that the best method of calibration involves a long term water balance, usually monthly or yearly. Even though evapotranspiration is usually the most important variable we always use the adjusted pan evaporation as published. Infiltration coefficients describing the groundwater-surfacewater exchange are the most significant calibration adjustments. These models are generally not considered design tools, however, they have been very successful and provided important information.

Conclusion. As you may have noticed in the title, this paper has discussed the problems encountered while calibrating models in Puerto Rico. Solutions to the calibration problems would have been the preferred topic; however, this is not the case. Each of us, I'm sure, are facing similar problems no matter what part of the country we are from. Lack of data, or if there is data, lack of credible data is the biggest problem during calibration and verification. Hastily prepared reports, documenting historic events, can mislead the hydraulic

engineer and cause hours of frustration. A good modeler should have a well rounded knowledge of hydrology, hydraulics, physics and the computer models he is using. But most of all, he should have an open mind and a basic distrust of easy solutions.

REFERENCES

1. U.S. Weather Bureau, 1961, Generalized Estimates of Probable Maximum Precipitation and Rainfall-Frequency Data for Puerto Rico and Virgin Islands, Technical Paper No. 42, U.S. Dept. of Commerce
2. U.S. Soil Conservation Service, National Engineering Handbook, Hydrology, Section 4, U.S. Dept. of Agriculture
3. Hydrologic Engineering Center, 1985, HEC-1 Flood Hydrograph Package, U.S. Army Corps of Engineers
4. Lager, J.A., Pyatt, E.E., Shubinski, R.P., 1971, "Storm Water Management Model," Vol 1, Final Report, 110240C07/71, Environmental Protection Agency, U.S. Government Printing Office, Washington, D.C.

HYDROLOGIC MODEL CALIBRATION PROBLEM
ENCOUNTERED IN PUERTO RICO

by

Michael L. Choate

Summary of Discussion
by George H. Atkins¹

Question: Do you have any gage data at all?

Answer: Yes, we have up to 20 years of record in the islands. We will do several types of frequency analyses using both rain and runoff data. We have found that regional data from USGS studies are many times unreliable.

Question: Do politics have an influence; i.e., do the locals accept your answers?

Answer: Yes, politics have a great influence in relation to project authorization and funding; however, the local people generally accept our technical answers.

Question: What type of studies are required in support of the permit program in the Jacksonville District?

Answer: In Florida, most of the studies are in response to environmental questions. As an example, the speaker described a reservoir storage problem where a continuous model was developed to route recorded flows beginning in the 1950's and continuing to the present. This study showed that the project actually aided the area downstream environmentally.

Generally, continuous models are developed specifically for individual projects, are based on volume rather than peak flows, and are used in environmental evaluations. The models may be based on daily, weekly, or monthly volumes.

S. K. Nanda closed the discussion by observing that many of our younger engineers want "canned computer programs" to solve any engineering problem that arises, with the result that we are losing our "Engineering Judgment".

¹Chief, Hydrology and Hydraulics Branch, Mobile District

HYDROLOGIC MODELING TECHNIQUES FOR URBAN FLOOD WATER DETENTION SITES MINGO CREEK, OKLAHOMA

by

Brenda K. Kinkel, P.E.¹

Summary

The purpose of this paper is to describe the methodology used to develop the HEC-1 hydrologic model for the Mingo Creek watershed in Tulsa, OK. This model was required to simulate the impacts of projected urbanization on the basin and to design and evaluate flood control alternatives which combined off-channel detention storage and channel improvements. The model was verified by reproducing available historical flood information. Peak discharge-frequency relationships were developed using TP-40 precipitation estimates and compared with U.S.G.S. regional regression methods. The design of the detention site components (storage requirements, control structures and weir configurations) was optimized using an in-house routing program specifically developed for this project. The resulting detention designs were incorporated in the HEC-1 model utilizing the diversion data option. The recommended plan is currently under construction and represents one of the first local cost-sharing agreements developed and signed under the criteria outlined in PL 99-662.

Basin Description

Mingo Creek is a right-bank tributary of Bird Creek. Mingo Creek flows from south to north through eastern Tulsa. Approximately 90 percent of the 61 square mile drainage area lies within the City of Tulsa. The watershed is roughly oval in shape, 7 miles wide at its widest point and 12 miles long. The broad, gently sloping flood plains and channels have been modified by land development and construction sites. The average slope of the creek, excluding the steep upper reaches, is about 8 feet per mile and the total fall from the headwater to the mouth is approximately 200 feet.

Historical Floods

General. Mingo Creek floods about once every 2 to 3 years, although as many as three floods have been recorded in 1 year. These flash floods rise over the banks within 30 minutes of a heavy rain, precluding comprehensive warning and hampering evacuation efforts. Floodwaters generally recede quickly, returning within banks in 1 to 6 hours.

Flood of 30 May 1976. The 30 May 1976 flood is the second largest flood on Mingo Creek in recent history. The storm deposited a maximum of 10 inches of rainfall in 3 hours. Nine recording rainfall stations were in operation in and around the Mingo Creek basin. Flooding occurred for 12 hours and resulted in two deaths. Peak discharge on Mingo Creek was estimated at 22,000 cfs.

¹ Hydraulic Engineer, Tulsa District, U.S. Army Corps of Engineers.

Flood of 27 May 1984. The flood of record for Mingo Creek occurred on 27 May 1984. This flood was the result of an average of 11.3 inches of rainfall over the basin between 10 p.m., 26 May, and 6 a.m., 27 May. Maximum rainfall recorded by a resident was 15 inches. Seven recording precipitation stations were in operation in the Mingo Creek basin. Twelve inches fell in a 3 hour period and 2 inches within 15 minutes in some parts of the city. Flooding occurred for approximately 12 hours. The death toll on Mingo Creek was 5; primarily motorists washed from bridges into the floodwaters. Peak discharges exceeded the SPF in some reaches of the watershed. After the 1976 flood, a stream gaging station was established on Mingo Creek. The station was washed out during the 1984 flood prior to the peak. The estimated peak discharge at the mouth of Mingo Creek is 55,000 cfs.

Hydrologic Model Development

General. The basin was modeled using HEC-1. Unit hydrograph parameters were derived synthetically based on regionalized information. Modified Puls storage-routing criteria were developed using HEC-2 backwater computations. The hydrologic model was divided into 90 subareas, 63 routing reaches and 99 combining points in order to properly model stream confluences, detention site locations, underground conduits, and channel improvement reaches.

Unit Hydrograph Development. Since actual hydrograph data was not available, Snyder's unit hydrograph coefficients, t_p and C_p , were derived synthetically based on Tulsa District regionalized curves (Reynolds, 1980) which relate stream slope, basin shape, percent channelization (urbanization), and peaking time. The following relationships were derived from regression analysis of 53 natural basins and 11 urbanized basins varying in size from 0.26 to 1,492 square miles.

$$1) \quad t_p = 1.40(LLca/S.5)^{0.376} \quad (\text{correlation coeff} = 0.9604)$$

$$2) \quad q_p = 375/t_p^{0.908} \quad (\text{correlation coeff} = 0.9768)$$

t_p = Snyder's basin lag (natural)
 L = length of main stream
 Lca = stream length to centroid
 S = weighted stream slope

The effects of urbanization were correlated with t_p . It was found that the percent of channel improvement was a more direct measurement of the actual effects of urbanization. This result was compatible with the results of a previous study of urban runoff models and their applicability to the Tulsa area (Beard, 1978). The derived adjustment for urbanization is as follows:

$$3) \quad t_p \text{ adjusted} = t_p \text{ natural} / 10^{.0034(\%Ch)}$$

$\%Ch$ = percent of the main watercourse improved by channelization

The relationship between q_p and t_p are the same for urban and natural basins.

Calibration. The HEC-1 model was calibrated to both the 1976 and 1984 floods. Between the 1976 and 1984 floods, rapid urbanization and development had occurred. In the wake of the 1976 flood, the city of Tulsa initiated and constructed the Mingo Creek Improvement Project (MCIP) which consisted of 3.5 miles of channelization on the mainstem of Mingo Creek. These changes necessitated modification of the routing reaches affected by the MCIP and adjustment of Snyder's unit hydrograph coefficients in the recently developed areas to represent the conditions present at the time of the 1984 flood. The computed peak discharges throughout the basin were input to the HEC-2 backwater model. For the 1984 flood, the backwater model was modified to include the MCIP. The calibration was verified by reproducing known highwater marks.

Assumptions. The following assumptions were made in using this type of calibration method.

- 1) The HEC-2 model accurately represents the hydraulic conditions present during the flood event.
- 2) The highwater mark information is accurate.
- 3) The rainfall information adequately represents the areal extent of the storm and basin average rainfall.
- 4) Estimated loss rates are reasonable.

This method of calibration requires iterations between the HEC-2 and HEC-1 model assumptions. At hydrologic locations where unreasonable adjustments to the HEC-1 model would be required to reproduce the HEC-2 discharge estimate, the sensitivity of the HEC-2 discharge rating to Manning's "n" value changes was tested. Where applicable, adjustments were made to the HEC-2 model.

Discharge-Frequency Analysis

General. There were no stream gaging stations in the Mingo Creek basin with adequate records to determine discharge-frequency relationships. The gage established on Mingo Creek after the 1976 flood had been turned over to the city of Tulsa for operation and maintenance in 1980. Tulsa failed to keep adequate records. In previous studies conducted by the Tulsa District, it was found that discharge-frequency curves developed from U.S.G.S. regression equations (U.S.G.S., 1977) underestimated frequency-discharges, but exhibited a slope parallel to curves developed from statistical analysis of gaged discharges.

Methodology. A discharge-frequency curve was developed at the major damage center for the Mingo Creek basin (confluence with Tupelo Creek - RB6) using the U.S.G.S regression equations. Parameters used in the regression equations were: drainage area, main channel slope, mean annual precipitation, percentage of the basin impervious, and percentage of the basin served by storm sewers. A discharge-frequency curve was developed using TP-40 frequency rainfall estimates adjusted to annual series (Commerce Dept, 1961). An initial loss rate of 0.5 inches and an average loss rate of 0.04 inches per hour was found to produce a discharge-frequency curve with the same slope as the

U.S.G.S. curve. The computed discharge-frequency curve was adjusted for expected probability assuming 40 years of record. This assumption was based on the fact that a dense network of long-term 24-hour stations with a minimum of 40 years of record was used to compute the 100-year to 2-year ratios which were subsequently used to develop the isopluvial maps. A partial duration curve was computed using regional adjustments derived from eight rural gages in the vicinity of Tulsa and two urbanized gages in the Dallas vicinity.

Detention Site Design

General. The excavated detention sites are designed to reduce peak discharges downstream and eliminate or reduce downstream channelization requirements. When channel flows approach downstream channel capacity, they would enter a detention pond through a concrete-lined, overflow weir. A concrete control structure would be constructed in the adjacent channel at required locations to regulate the discharge passing downstream and to improve flow into the site. Existing stream structures, such as bridges can be used as control structures. When creek flows recede, the pond would empty.

Methodology. On Mingo Creek and its tributaries, the detention sites were designed based on the 100-year fully urbanized discharge. The weir lengths and crest elevations were set to permit filling under these conditions. The stored water is released by gravity flow in the stream through discharge pipes designed to empty the site in 24 to 48 hours. The design of the control structure and weir configuration was optimized using a Tulsa District program, "CONTROL", developed by Thomas Horner. The program performs iterative routings of various control structure and weir designs until input design constraints are satisfied and the detention site fills during the design flood. The following information is input to the program: design inflow hydrograph to the reach, channel invert elevation, maximum desired water surface elevation, detention pond invert elevation, desired design spillway head, desired maximum downstream flow through the control structure, and detention storage available. The design inflow hydrograph was computed by applying the 100-year TP-40 precipitation adjusted to reproduce the expected probability and partial duration adjustments to the HEC-1 model. Once the detention site design was optimized, the design was incorporated in the HEC-1 model utilizing the diversion data option. The HEC-1 model was again run and the inflow hydrograph to the next downstream detention site was determined. In this manner, the detention sites were designed from the upper reaches of the basin, downstream.

Observations. The design of each site is dictated by the inflow hydrograph. This necessitates accurate hydrologic modeling of the effects of urbanization and channelization on the runoff response of the watershed. Inaccuracies in the design hydrograph can lead to:

- 1) An under-designed project which fills on the rising limb of the hydrograph and results in little or no reduction of the peak discharge.
- 2) An over-designed project which does not fill during the design flood and requires a retrofit of the inlet weir in order to achieve maximum reduction of the design flood peak.

The methods used to optimize the detention site control structure and weir configuration use simplifying assumptions to determine the discharge ratings. Currently, the Mingo Creek project is undergoing feature design efforts. To date, the discharge ratings developed at the sites using more sophisticated methods have not varied greatly from those developed in the GDM studies.

The methods used to model the effects of the detention site do not model the effect of releases made through the gravity outlet on the recession limb of the hydrograph. The assumption has been made that these releases would not affect the peak discharge downstream of the site.

Conclusions

HEC-1 appears to be the best tool available for modeling the hydrologic effects of detention storage on the watershed. It can be time consuming to use since the upstream detention sites must be designed and incorporated in the model prior to the design of downstream sites. The effect of releases made from the detention site on the recession limb of the hydrograph cannot be modeled by HEC-1. However, it appears that this would not significantly affect the design of the project. Due to the dependency of the detention site design on the inflow hydrograph, care must be taken to validate the methods used to simulate urbanization and channelization effects on the watershed runoff characteristics. This can be accomplished by calibration of the hydrologic model to available historical storm data and by determining the relationship between Snyder's unit hydrograph parameters and urbanization in the study area.

REFERENCES

1. Beard, Leo R. and Chang, Shin, An Urban Runoff Model for Tulsa, Oklahoma, Center for Research in Water Resources, University of Texas, Austin, Texas, August 1978.
2. Commerce Department, Weather Bureau, Rainfall Frequency Atlas of the United States for Durations from 30 Minutes to 24 Hours and Return Periods from 1 to 100 Years, Technical Paper No. 40, Washington, D.C., May 1961.
3. Reynolds, H. Dale, Regional Relationships for Unit Hydrograph Coefficients Natural and Urbanized Basins, Unpublished Paper, Department of the Army, Tulsa District, Corps of Engineers, Tulsa, Oklahoma, May 1980.
4. United States Geological Survey, Techniques for Estimating Flood Discharges for Oklahoma Streams - Techniques for Calculating Magnitude and Frequency of Floods in Oklahoma from Rural and Urban Areas under 2500 Square Miles, with Compilations of Flood Data through 1975, Water Resources Investigation 77-54, Oklahoma City, Oklahoma, June 1977.

Hydrologic Modeling Techniques for Urban Flood Water Detention Sites
Mingo Creek, Oklahoma

by

Brenda K. Kinkel

SUMMARY OF DISCUSSION BY S. K. NANDA

The assumption of low loss rates was questioned especially when the synthetic flows were consistently higher than the results obtained by the US Geological Survey regression analysis. The author, however, was comfortable with the loss rates of the model that was calibrated to the major floods in the basin.

Another assumption for the expected probability adjustments was questioned as to the validity of using 40 years of record. This was an administrative decision by the Headquarters, and the future adjustments will be done more appropriately by using 20 years of record.

A discussion on the sensitivity of the detention storage on the design inflow hydrographs followed. There was agreement that either under-designed or over-designed projects could lead to substantially different results.

Another discussion about the verification of the model-flows during the 1984 flood followed. Since the gage ceased to function during the peak event, highwater marks were calibrated with, in the absence of flow data.

There were general discussions about matching the results from probabilistic concepts versus deterministic concepts. Some held the view that since 1 percent rainfall application does not yield 1 percent run-off, theoretically, both the results should not match. However, others felt that, traditionally, this matching process has yielded close results.

S. K. Nanda, Hydraulic Engineer, Rock Island District Corps of Engineers

HYDROLOGIC MODELING OF BASEMENT FLOODING

by

Thomas J. Fogarty¹

Introduction

The intent of this paper is to describe in general terms the methodology used to analyze basement flooding for the Chicagoland Underflow Plan Study (CUP). The portion of the study area considered here is the combined sewer area tributary to the Mainstream, Des Plaines, and Calumet Systems of the Tunnel and Reservoir Plan (TARP). The TARP plan is being instituted to reduce basement flooding, raw sewage bypasses to local watercourses and backflows to Lake Michigan. The above three system, plus the O'Hare System, constitute the 353 square-mile combined sewer service area (see Figure 1) under the jurisdiction of the Metropolitan Sanitary District of Greater Chicago.

Description of Problem

Within the study area the flooding problem takes two forms, overbank flooding and sewer backup. The sewer backup flooding problem in the CUP area is attributable to either inadequate sewer capacity or to sewer outfall submergence.

The watercourses in the study area consist of the North Shore Channel, the Chicago River and the Chicago Sanitary and Ship Canal in the Mainstream System; the Des Plaines River and Salt Creek in the Des Plaines System; and the Calumet River, the Little Calumet River and the Calumet-Sag Channel in the Calumet System. The drainage pattern in the study area is mainly from north to south through these watercourses and into the Illinois River Basin.

Within the Chicago area there are four controlling works which are used in setting the elevations in the watercourses. The three controlling works along the Lake Michigan shoreline (on the Chicago River at Wilmette, downtown on the Sanitary and Ship Canal, and on the Calumet-Sag Channel) are used to divert water to and from Lake Michigan. During severe rainfall events, storm runoff is allowed to backflow into the lake to relieve high water levels in the canal system. The Lockport Controlling Works and Powerhouse, downstream of the study area on the Sanitary and Ship Canal, is used to draw down the waterway system to create floodwater storage and increase the capacity of the canal.

¹Chief, Hydrology and Hydraulics, Chicago District, COE

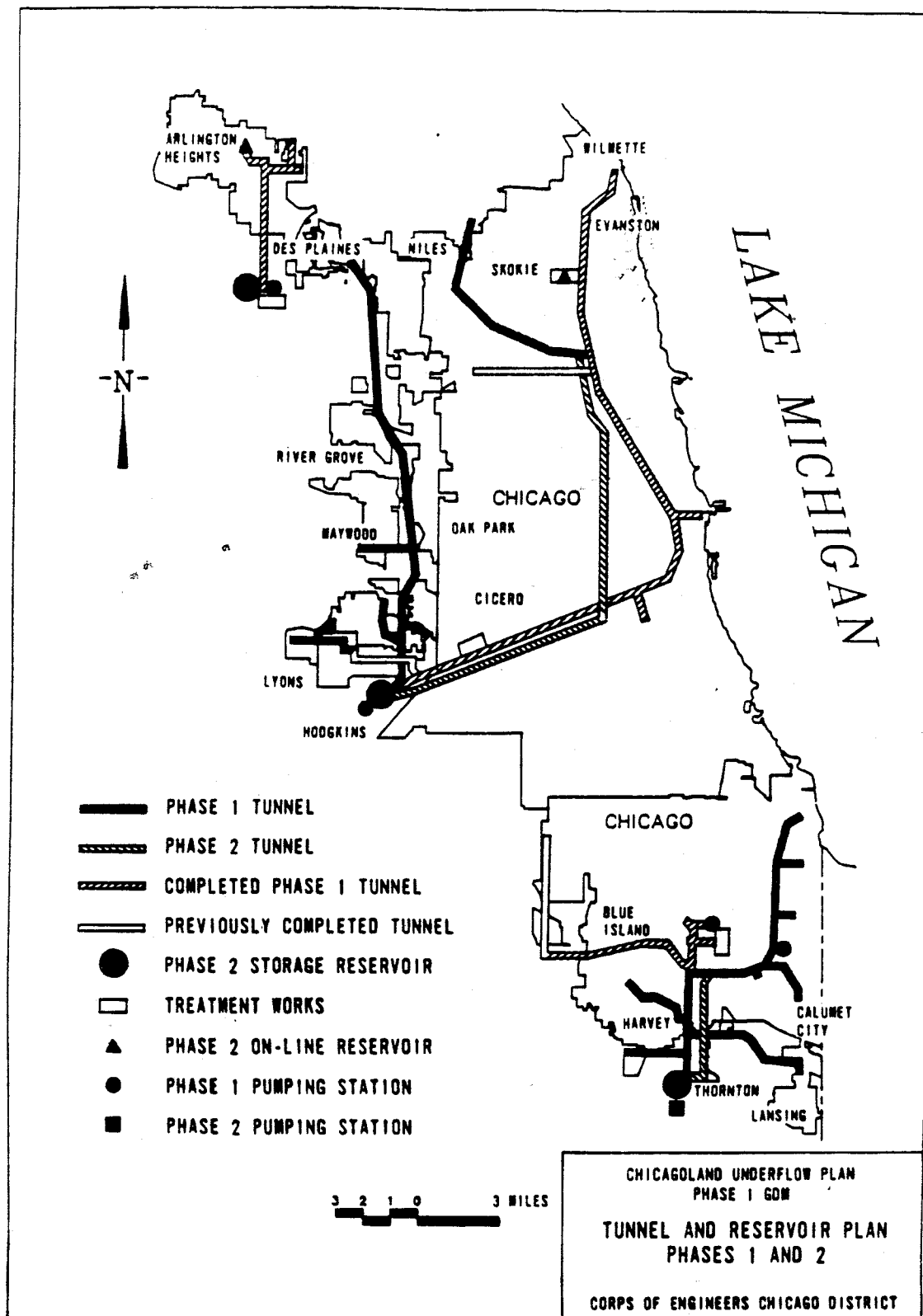

FIGURE 1

The features of a typical combined sewer system within the study area are illustrated in Figure 2. This type of system transports both sanitary waste water and storm water runoff in a single pipe. Sanitary water, foundation drainage, and roof runoff from individual houses are carried by house drains to lateral sewers located in the streets. Stormwater runoff from enters the lateral sewers through catch basin drains. Under normal dry weather conditions, sewer flows move from lateral sewers through submains and main sewers into interceptor sewers which convey the flow to a waste treatment plant. When the capacity of an interceptor is exceeded by storm flow, the untreated excess runoff overflows directly into a local watercourse.

Methodology

The methodology used in the analysis of basement flooding is based on three components:

- 1) Development of hydrologic and hydraulic basement flooding models for pilot subarea that are typical of the overall study area.
- 2) Calibration of the basement flooding model.
- 3) Generalization of the results of the basement flooding model to all subareas with the study area.

Basement Flooding Model. The CUP study area is too large to be studied and analyzed in detail. However, to gain an understanding of the complex hydraulic problems several representative areas were studied in extensive detail. Eight representative, or pilot, areas were selected that are hydraulically, physically and economically similar to many subareas within the study area.

The Stormwater Management or SWMM model (Environmental Protection Agency, 1981) was selected as the tool to analyze the pilot areas. SWMM is a comprehensive unsteady flow model that simulates urban runoff quantity and quality for use within either storm or combined sewer systems. For the pilot area analysis the RUNOFF and EXTRAN blocks from the SWMM model were employed. The RUNOFF block generates surface runoff based on rainfall hyetographs, antecedent conditions, land use, and topography. The EXTRAN block routes the flows generated by the RUNOFF block through the modeled sewer system based on the full St. Venant equations and is able to simulate surcharge conditions.

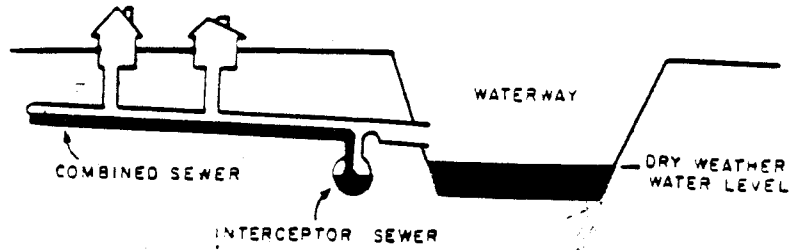

OPERATION OF EXISTING OUTFALL DRY WEATHER CONDITION

Under dry weather conditions, the combined sewer system carries sanitary sewage to treatment plants via interceptor sewers. The system has sufficient capacity to handle dry weather flow without backup into basements or discharge into streams.

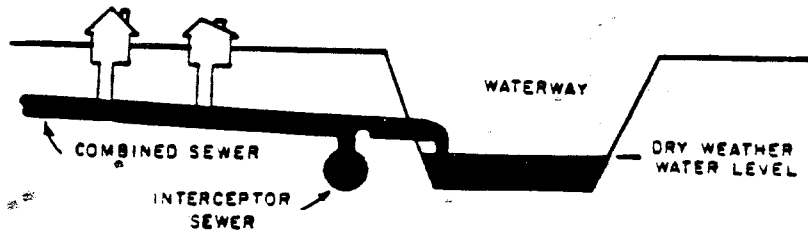

OUTFALL IN OPERATION AFTER INTERCEPTOR CAPACITY IS EXCEEDED

At the beginning of a storm period, river levels are low. As rain continues, the sewer system fills up. To relieve pressure in the sewer system, a mixture of storm runoff and sanitary sewage is discharged, untreated, from sewer outfalls into streams.

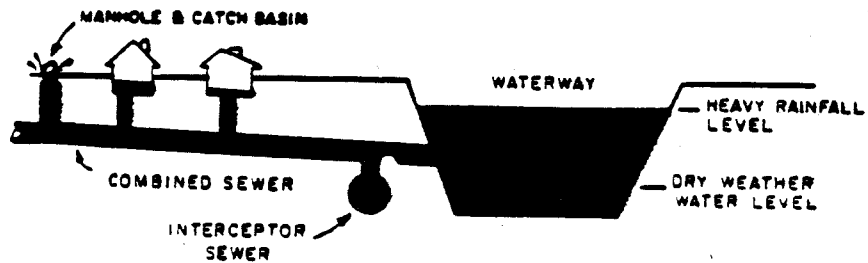

OPERATION OF EXISTING OUTFALL-HEAVY RAIN CONDITION

During periods of continuing rainfall, river levels rise, submerging the relief outfalls. Pressure then builds up within the sewer system, causing storm water, mixed with raw sewage, to back up from the sewers into basements and streets.

CHICAGO LAMB UNDERFLOW PLAN
 PHASE I GOM
 COMBINED SEWER
 OUTFALL SUBMERGENCE
 CORPS OF ENGINEERS CHICAGO DISTRICT

FIGURE 2

For each pilot area a bilevel SWMM model was constructed (see example shown in Figure 3). The model consists of a pilot area model of a subarea that is divided into smaller sub-basins and at least one basement model of a one to two block area within the subarea. The SWMM models of the pilot areas were constructed using the actual physical dimensions of the watersheds and sewer networks. A stage hydrograph of the appropriate receiving water was used as the downstream control for each pilot area model.

Basement models were developed for one or two sub-basins of each pilot area to obtain more detailed information regarding basement and street flooding. Each basement model contains storage reservoirs to represent the basement and street storage volumes within the basement model area. A basement model shares a common junction with a pilot area model. Stage hydrographs computed by a pilot area model for the common junction were used as the downstream control for the basement model.

Both pilot area and basement model calibrations were performed in the CUP SWMM analysis. For pilot area calibration historical stage hydrographs were required. For some pilot areas stage hydrographs were obtained from previous studies (Harza Engineering, 1978 and Metcalf and Eddy, 1979). Additionally, the Chicago District undertook a sewer stage monitoring program within a pilot area. This monitoring program used continuous ultrasonic meters to record sewer stage hydrographs during rainfall events.

The basement models in each pilot area were calibrated to an average depth of flooding that could be expected in basements within the given pilot area (the determination of this depth is detailed in the next section). Using this method the computed flood volumes are representative of the entire pilot area.

Due to the sensitivity of sewer flows to rainfall intensity, storm duration plays an important role in the magnitude and the duration of basement flooding. To capture the impact of this phenomena, synthetic storm events of 2, 6 and 12-hour durations were simulated. For each of these durations, ten storm depths were run including the 1, 3 and 6-month and the 1, 2, 5, 10, 25, 50 and 100-year recurrence interval events. This range of depth-duration storms define the envelope of basement flooding within a pilot area. For each combination of storm depth-duration basement flood volumes were determine for each pilot area basement model.

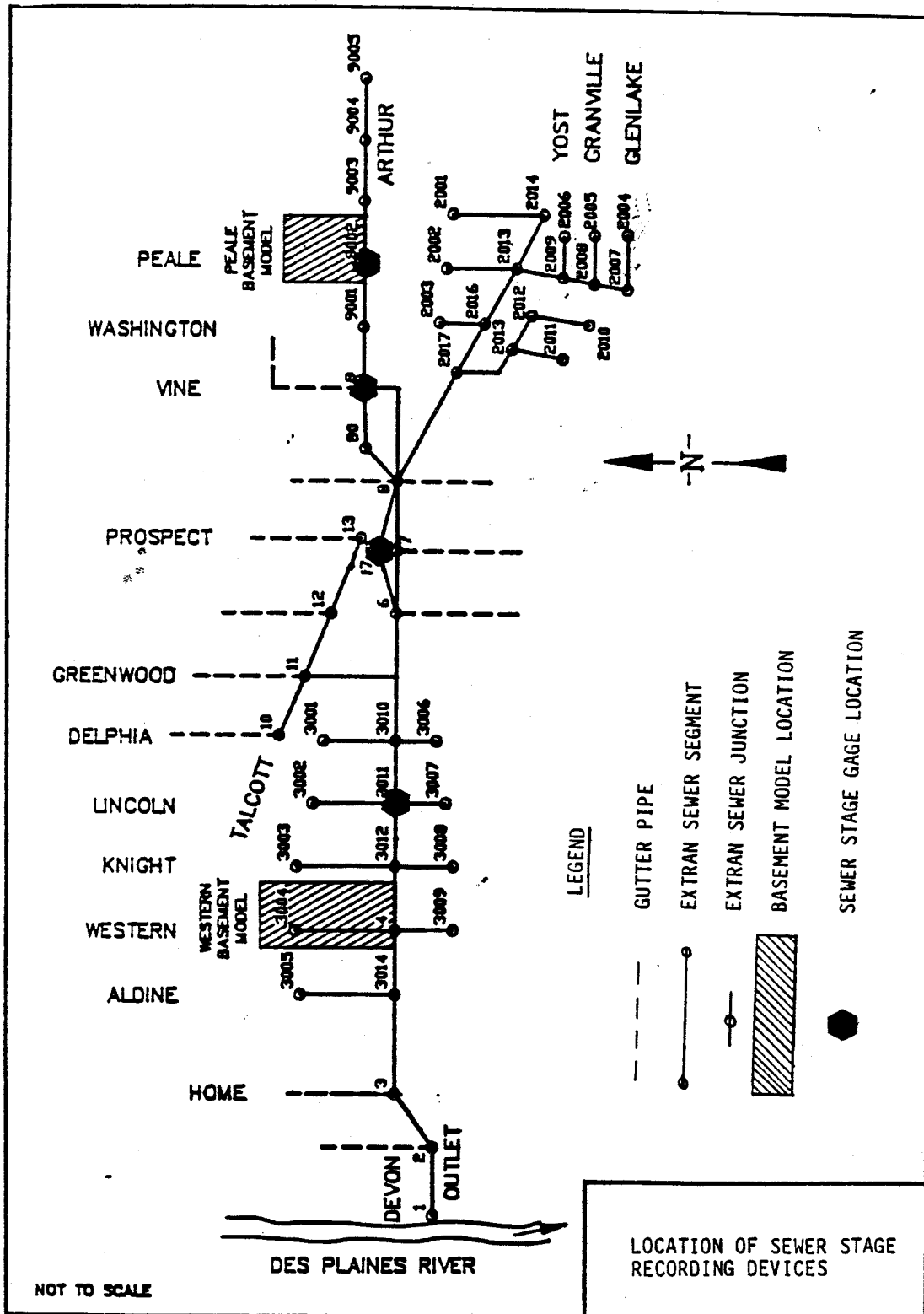

FIGURE 3

Calibration. Basement flooding is a phenomena that is not directly measurable. That is, unlike normal flood control studies, it is not possible to directly gage or measure the depths or incidence of basement flooding. To characterize the basement flooding problem in the CUP study area the District's Economic Analysis Branch undertook two major sampling based data collection studies: The Real Time Rain Event Surveys (RTS) and the Basement Use Survey (BUS). The RTS were designed to collect storm specific data for select drainage areas. For each area, a random sample of households were preselected. When a significant event ended telephone calls to these households were made and residents were queried relative to their flood depth, incidence and damage experience. This data was used in calibrating the SWMM basement models.

The data obtained from the BUS included the determination of flood depths, incidence and damages. The periods for which this information was obtained included a typical event, a typical year, a 3 year time frame preceding the survey period, and the worst event experienced in the current structure. The BUS data produced statistically significant flooding depths and incidence. The data has been interpreted to provide average annual and 10 to 25-year values of flood depths and the associated incidences.

The key to the basement flooding methodology is the extensive surveys that were undertaken to establish flooding patterns throughout the CUP study area. This data provides a "known" level of flooding that can be used to calibrate the hydraulic and economic models. To put things in perspective, since the "existing" level of flooding is known, the major purposes for the hydraulic modeling are to match the known levels of flooding and then to predict the changes in flooding due to future without project conditions and project implementation.

Generalization of Results. The results are generalized via a process of transferring the basement surcharge flooding volumes developed for the pilot areas to the remaining areas within the CUP study area. From these transferred volumes, damage levels are then computed. The procedure used to transfer the surcharges consists of applying two set of regression equations. In the first set of equations the basement flooding volumes, at given frequencies and durations, are used as dependent variables and rainfall depth is used as the independent variable. In the second set of equations the independent variables are descriptive parameters of each subarea (i.e. land use, sewer and basement characteristics) and the dependent variables are the regression coefficients from the first set of equations. This procedure is analogous to the standard COE procedure for determining flood flows on ungauged watersheds (Beard, 1962).

For the first set of equations the calibrated normalized basement volumes generated from the eight pilot area SWMM models are regressed against their respective recurrence interval rainfall depths. A linear regression model of the following form was developed for each pilot area for each storm duration:

$$V = M + S * \log_{10}D \quad (\text{Equation 1})$$

- Where: V: Normalized Basement Flood Volume
(acre-feet per acre)
- D: Rainfall Depth (inches)
- M: Regression Model Constant (Intercept)
- S: Regression Model Coefficient (Slope)

Once these linear regression equations had been developed for each pilot area a multiple regression analysis was performed to develop relationships between drainage area parameters (independent) and the M and S regression parameters (dependent) using the following form:

$$M = B_0 + B_1P_1 + B_2P_2 + \dots B_nP_n \quad (\text{Equation 2})$$

$$S = B_0 + B_1P_1 + B_2P_2 + \dots B_nP_n \quad (\text{Equation 3})$$

- Where: M: Intercept values from pilot area linear regression models
- S: Slope values from pilot area linear regression models
- B_0 : Multiple regression constant
- B_1, B_2, \dots, B_n : Multiple regression coefficients
- P_1, P_2, \dots, P_n : Independent parameters

Using the results of the application of these regression models to the CUP subareas the Economic Analysis Branch computed damages through the execution of their Chicagoland Area Surcharge Problem Simulation Model (CASPSM). In a series of sequential steps CASPSM allocates water to basements, starting with those at the lowest elevations and moving to successively higher elevations until all floodwater volume is exhausted. Damages were then computed using flood depth versus damage relationships developed from BUS data. The results included a frequency specific tabulation of damages for each drainage area.

Conclusions

It is recognized that the paucity of data (i.e. the small number of pilot area models) precludes obtaining predictive results from the regression analyses. However, the results of the analysis can be verified through confirmation with the economic survey data. CASPSM was used to allocate flood water volume to basements in the primary subareas (i.e. the largest subareas, with populations in excess of 30,000) and to compute the associated damages and incidences. Additional output included comparable data annualized based upon expected value computations. This output was then compared with values derived from the BUS and RTS to establish the models ability to reproduce flood experience data for the primary subareas (see Figure 4 for a comparison of Mainstream pilot area model results versus the acceptable range of depths, for a given subarea, from the BUS). Overall, the comparison of CASPSM and BUS results for the primary subareas are extremely satisfactory. The CASPSM model certified that the surcharge volumes used as input gave a valid and accurate assessment, given the calibration of incidence. Also, the damage estimate for existing conditions produced by the final calibrated surcharge levels are within the bounds projected by the BUS responses.

References

Beard, Leo, "Statistical Methods in Hydrology", USACE, Sacramento District, January 1962.

Environmental Protection Agency, "Stormwater Management Model User's Manual Version III", November 1981.

Harza Engineering Company, "Combined Sewer Conveyance Problems of Skokie", May 1978.

Metcalf and Eddy, Incorporated, "The Village of Elmwood Park, Illinois - For Supplemental Facilities Planning of Combined Sewer System", March 1979.

Mainstream System

Computed Depth versus BUS Ranges

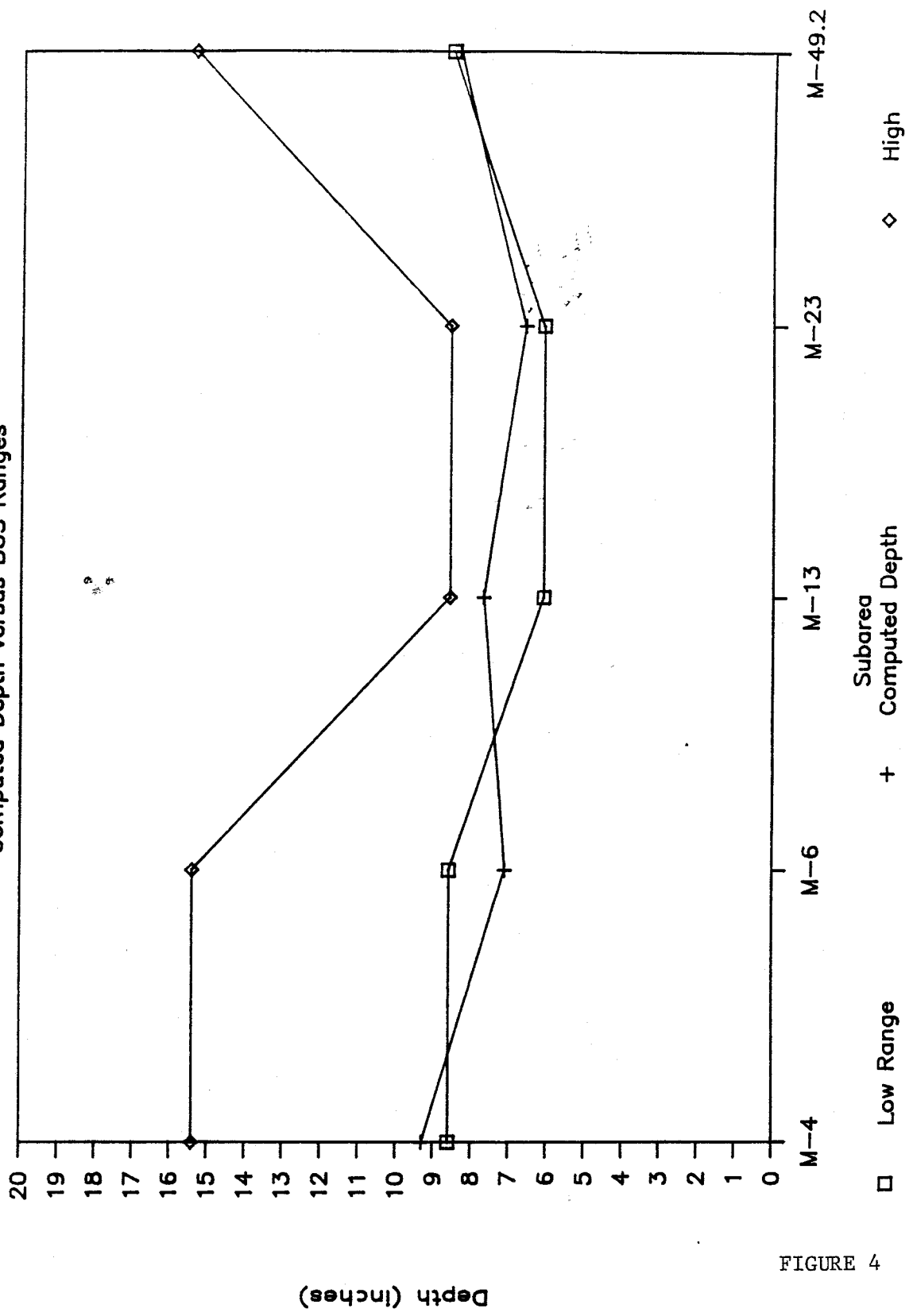

FIGURE 4

SUMMARY OF DISCUSSION

Compiled by A. S. Harrison¹

The following questions were clarified:

Were the evacuation times and discharges into the tunnels from the storage reservoirs taken into account in the basement model? Free outfalls into the tunnels were assumed in the SWMM basement model. Reservoir operation was studied in a separate runoff model.

What was your basis for validating the model? Validation was inferred from the results of three checks: (1) Basement (SWMM) model results and resultant regression equations, tied into surveyed damages; (2) Damage reduction prediction as matched by SWMM model; (3) detailed check on 30 areas revealed reasonable results from SWMM.

Did you also do gaging? A real-time survey was made on two earlier events and on one of four that occurred during the study period.

Is this a natural run-off condition or man-made?

The problem is man-made due to the lack of an adequate storm runoff capacity in the sewer system. Separate systems for sanitary and storm sewage would be too costly.

The speaker also clarified that the principal outfalls for the system are to Lake Michigan, to the Sanitary Canall, and to the Illinois River.

¹Chief, Technical Engineering Branch, Missouri River Division

North Branch Chicago River
Urbanization Sensitivity Study

by 1
James G. Mazanec

Introduction

General. The North Branch Chicago River watershed with a drainage area of about 100 sq.mi. is actively changing due to the pressure of urbanization (Figure 1). The downstream third of the watershed is almost totally developed. It is estimated that by the year 2020 the entire watershed will be fully urbanized. Land use planning and flood control planning for this watershed have been given a high priority since the mid 1960s. Floodplain regulation mapping and land use development regulations have been in effect since the early 1970s.

Watershed Description and Available Data

General. Unlike the conventional (average) river basin, the North Branch Chicago River watershed is very elongated, relatively narrow, encompassing three distinct subwatersheds, likewise, long and narrow. They are the Skokie River on the east, the North Branch Chicago River in the middle referred to as the Middle Fork, and the West Fork North Branch Chicago River on the west. Each basin has a width ranging from 3 to 5 miles. Some of the difficulties associated with the development of the hydrology of the basin can be attributed to the low width to length ratio.

West Fork. The West Fork is the most intensely developed watershed and has an average slope of about 3.9 feet per mile. Channel modifications and filling of the floodplain in the lower reaches as well as improvements of upland drainage have been extensive.

Middle Fork. The Middle Fork has a slope of 5.8 feet per mile in the upper watershed and flatter slopes in the middle of the watershed at 1.8 feet per mile. There has been very little channel modification on the Middle Fork. The upper watershed upland area still contains many areas of depression storage which are poorly drained. The floodplain of this stream is wide compared to the width of the watershed.

Skokie River. The slope of the Skokie River is approximately 4 feet per mile in its headwaters area and approximately 1 foot per mile in its lower watershed down to the Skokie Lagoons. The most significant modification of the channel and floodplain is located between Willow Road and Dundee Road, where the Willow Road Dam retains the Skokie Lagoons. The lagoons contain approximately 1,100 acre-feet of flood water storage and moderate flows at the lower end of this watershed.

1

Hydraulic Engineer, North Central Division, U. S. Army Corps of Engineers

Figure 1 - Basin Map

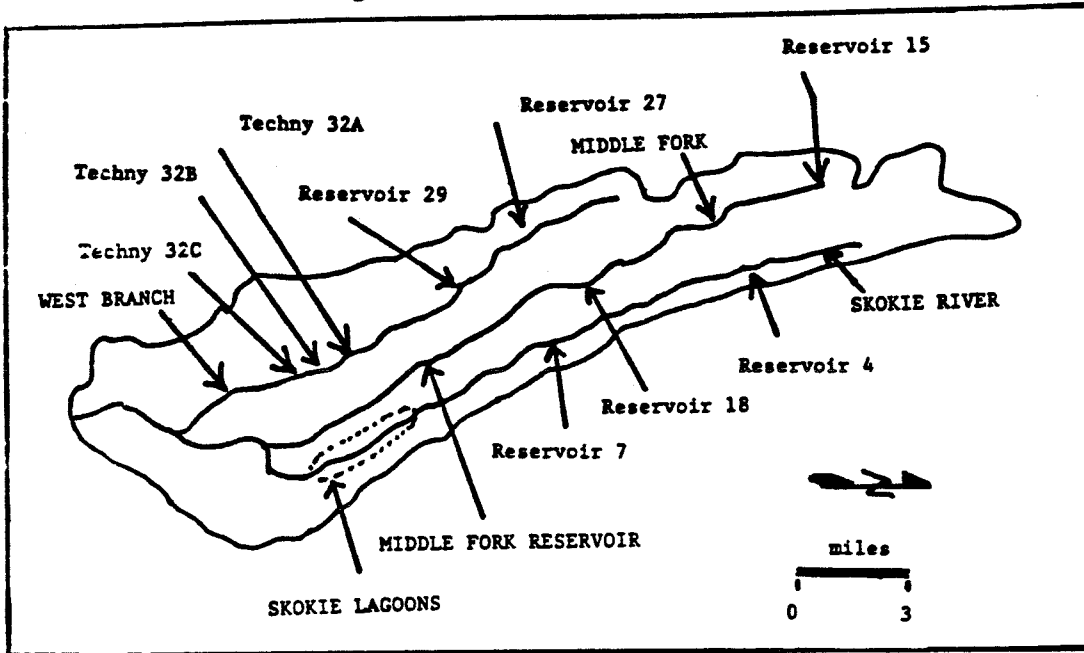
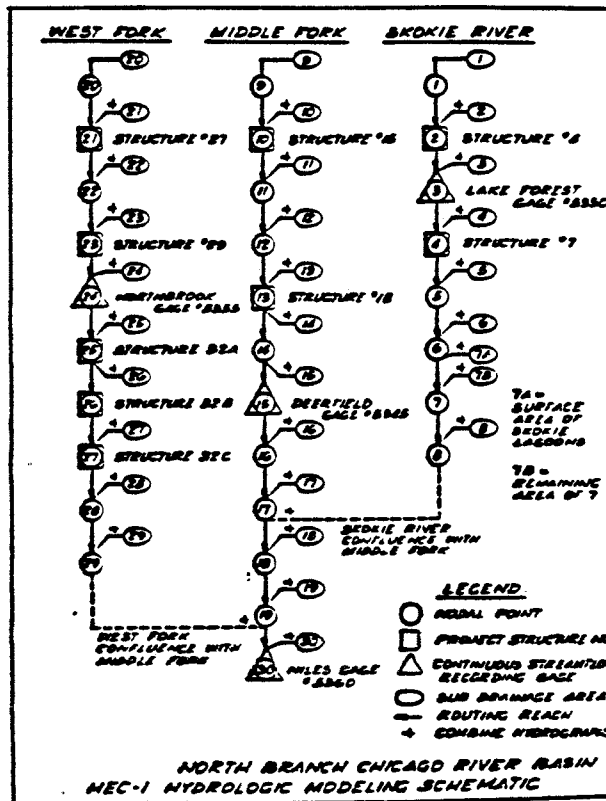

Figure 2 - Basin Schematic



Available Data. Precipitation data for the watershed are taken from three recording stations and eight non-recording stations. Continuous stream flow gages within the watershed consisted of the stations as shown in Table 1. These stations are also located on Figure 2, a schematic of the watershed.

Table 1 - Continuous Recording Streamflow Gages

USGS No.	Beginning of Record (year)	Station Name
5345	1952	North Branch Chicago River at Deerfield, Illinois
5350	1951	Skokie River at Lake Forest, Illinois
5355	1952	West Fork North Branch Chicago River at Northfield, Illinois
53507	1967	Skokie River at Clavey Road, Illinois
5360	1950	North Branch Chicago River at Niles, Illinois

Flood Control Study History

General. In the early 1970s the Soil Conservation Service (SCS) entered into an agreement with local sponsors to evaluate the watershed with the objective of developing an optimal flood control plan. These studies concluded that excavated flood storage reservoirs were the best plan for the watershed in conjunction with floodplain regulations. After completion of these studies the local sponsor sought Congressional authorization for the Corps of Engineers to implement the plan. Congress provided funding for the completion of a reaffirmation study.

The Plan. The plan as envisioned by the SCS consisted of nine excavated floodwater storage reservoirs located at seven sites. The locations of these reservoirs are shown on Figure 1. One other structural feature of the plan consists of modifications to Willow Road Dam downstream of the Skokie Lagoons. One existing storage reservoir (600 ac-ft) at Northbrook was built by the Metropolitan Sanitary District of Greater Chicago (MSDGC) in 1975 and is an integral part of the watershed control plan. These reservoirs capture 2 to 2-1/2 inches of runoff. While this study was being done, the MSDGC was constructing, in 1980, under funding separate from Federal sources three of the plan's reservoirs on the West Fork (known as the Techny Site) with a total storage capacity of 1400 acre-feet.

Reevaluation Report Hydrology and Hydraulic Evaluation.

1) The hydrologic studies were developed using an HEC-1 model for a 100-square mile system comprised of 30 subareas. Based on records from 16 discharge gaging stations within and near the watershed, regression models

for computing Clark's TC and R unit graph parameters were developed. The catchments of these gaging stations range from 7 to 300 square miles. Impervious basin factors tied to population density were the link for estimating changes in TC and R values in the regression models. The form and characteristics of the regression models are as follows:

$$TC + R = 0.4097*((DA/K)**0.3630) * (S** -.5274)$$

$$R = 0.7720*((DA/(K*S))**0.3613)$$

using the transformation $K=1.0 + 0.1I$

where:

- TC = Clark's time of concentration (hours)
- R = Clark's basin storage coefficient (dimensionless)
- DA = Drainage area (square miles)
- S = Basin slope (dimensionless)
- I = Basin impervious factor (dimensionless)

For the equations presented above, adjusted determination coefficients (\bar{R}^2) of 0.887 and 0.678, respectively were computed.

2) Based on the regression models, HEC-1 computer models were constructed for 1950, 1976, and year 2000 urban conditions. Modified Puls routing criteria were developed for the river segments of the models. Based on the population projections and land use maps, reductions in the overbank storage, reflected in changes to the Modified Puls routing criteria, of 0-10 percent were adopted for the year 2000 urban condition model. The 1976 model was calibrated to three recent flood events prior to finalizing the other land use HEC-1 computer models. Next, these models were used to develop adjustment curves from which the historic gage records were adjusted to a current time base. Using the adjusted data sets, frequency curves were developed for baseline (year 1976) conditions using the Log Pearson Type III distribution. The model through loss rate adjustment was calibrated to match these frequency relationships using synthetic storm rainfall. The hydrology developed was then converted to water surface profiles using an HEC-2 model of the watercourse. This model was comprised of 241 valley sections which included 53 bridge sections over a total of approximately 50 miles of stream length. The results of the study at selected gaging station locations are provided on Table 2 for without-project conditions. The weighted average impervious factor for cumulative drainage areas above each gaging station is provided in parentheses.

3) In general, it can be seen that for the three tributaries the runoff per square mile of drainage area is related closely to the impervious factor which represents the general degree of urbanization. However, for small changes in the impervious factor, as shown in Table 2 for the land use year 1976 to year 2000 conditions, the peak flow does not change proportionally to changes in the impervious factor. The factors of individual basin slope, overbank storage, and location in increases in upland development relative to the location of the gaging station tend to play a

significant role in the resultant magnitude of the peak flow at the respective gaging station.

Table 2 - Revaluation Study Results Regarding Impacts of Urbanization on Peak Flow Magnitude - 100 Year Event

Station	Drainage Area (sq.mi.)	YR-1976 Condition (cfs)	YR-2000 Condition (cfs)	% Increase
5345 - Middle Fork at Deerfield	20.7	831 (22)	1030 (27)	24%
5350 - Skokie River at Lake Forest	12.8	730 (27)	847 (39)	16%
5355 - West Fork at Northbrook	11.5	1323 (32)	1441 (38)	8%
5360 - North Branch at Niles	100.0	3148 (34)	3437 (38)	9%

() - Average weighted basin impervious factor in percent.

Concerns Regarding the Revaluation Study Results. The Revaluation Report recommended, based on comparison of project benefits versus project costs, that all reservoirs on the West Fork were economically viable and warranted Federal participation. The Illinois Department of Transportation, Division of Water Resources (DOWR) expressed substantial concern regarding the future development conditions used in the development of future condition hydrology and the resultant lack of economic feasibility for the other sites. Discussions were subsequently held with the State of Illinois during which time the State indicated the changes it expected to take place in the watershed with the urbanization. Based on these discussions, it was judged to be reasonable to use future watershed development conditions compatible with the State's assumptions.

Detailed Review of Urbanization Factors and Impacts on Peak Flow Predictions

General. A detailed sensitivity evaluation was conducted for the Middle Fork portion of the watershed down to the Deerfield Gage. This portion of the watershed is representative of areas in the watershed which are still prone to high urbanization. Four factors in the urbanization process as related to peak flow magnitudes were evaluated:

- 1) upland development;
- 2) bridge modification;
- 3) channel maintenance and modification; and
- 4) floodplain filling.

Upland Development. In the original HEC-1 model, upland development was captured through the sub basin TC and R values developed through regression analysis. The regression models were related to population density. Further investigation of land use trends suggested that since the mid 1970s, typical household size has shifted from 3-5 to 2-3 people per housing unit and also lot and home sizes expected to be developed within the area on the North Branch watershed will be generally larger than in other suburbs of Chicago. From this information revised impervious values were developed and are shown on Table 3 along with the original projections.

Table 3 - Watershed Impervious Factors (in percent)

Subarea	Impervious Factor	Impervious Factor	Impervious Factor
	Year 1976 Landuse	Initial Report Year 2000 Landuse	Revised Analysis Year 2000 Landuse
9	18.3	20.0	23.8
10	24.1	30.1	36.4
11	23.0	28.8	35.7
12	15.7	17.9	22.7
13	16.1	19.2	26.9
14	32.2	35.4	37.5
15	38.7	42.9	49.0

- 1) The original HEC-1 modeling used high/flat hydrograph recession parameters for the less urbanized portions of the Middle Fork and Skokie River segments as compared with parameters which would result in a faster recession as used for the more fully developed West Fork. Recession parameter activation was as follows:
 - a) 13% of peak flow for the Upper Skokie;
 - b) 20% of peak flow for the Middle Fork; and,
 - c) 7% of peak flow for the West Fork.

- 2) Of concern with the use of the higher impervious factors was the creation of excessive run-off on the Middle and Skokie Rivers, because of high impervious factors, without an appropriate method for cutting back the influence of the recession parameters. Based on new historic calibrations, the following recession parameter relationships (Figures 3 and 4) were developed. Such calibrations included comparisons to historic rainfall/runoff volumes for specific events ranging from the 20% (5-Yr) event to the 1% (100-Yr) event as well as a comparison to statistical volume frequency results computed using the historic gage

Figure 3 -

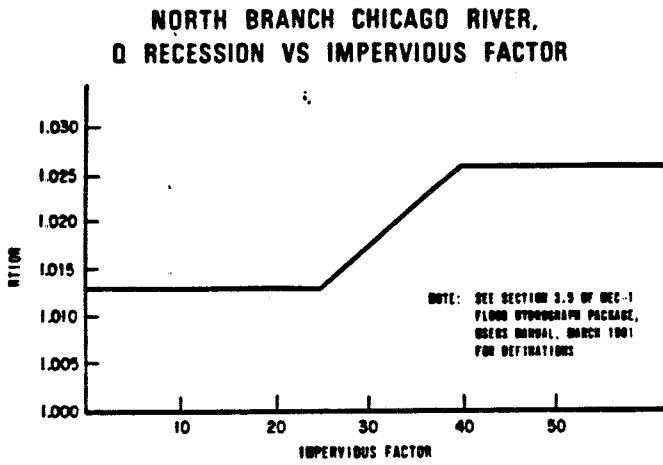

Figure 4 -

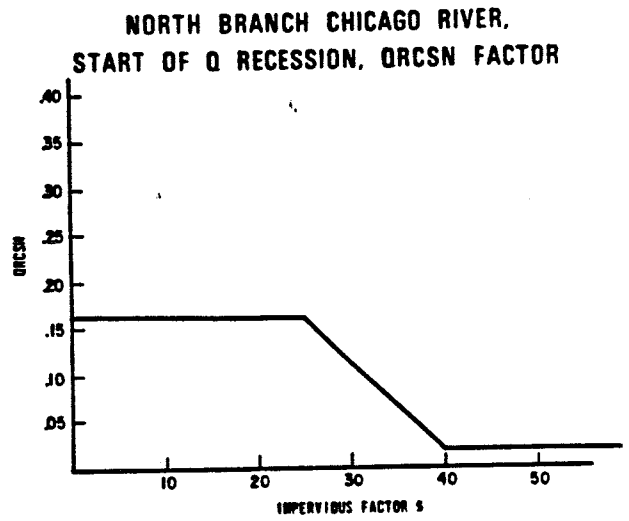
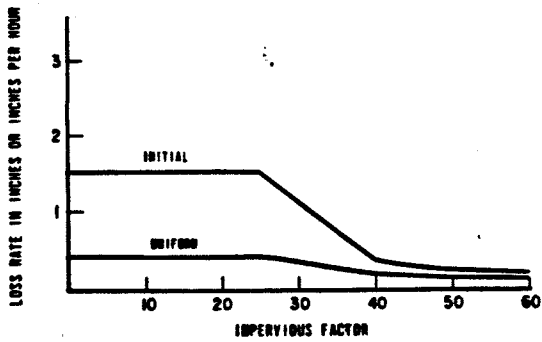
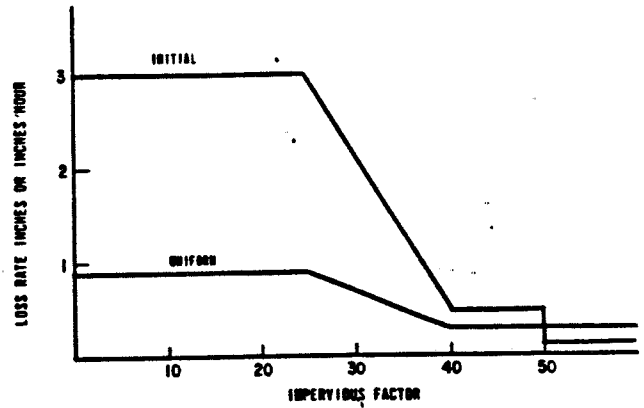

Figure 6 -

Figure 5 -
LOSS RATE FUNCTION, 10-YEAR EVENT



LOSS RATE FUNCTION, 100-YEAR EVENT



records. Also developed were similar relationships for rainfall, uniform and constant loss rate parameters as shown in Figures 5 and 6. The model was rerun for the revised upland development changes. The results at the Deerfield Gage for the 100 year flood event are provided on Table 4.

Table 4 - Detailed Middle Fork Study - Impacts on 100-Year Peak Flow Magnitude. (Deerfield Gage) - Flow in cfs

1976 Landuse Condition	Bridge Modifications (1)	Improved Channel Maintenance (2)	Fringe Removal (3)	Upland Development (4)
850	862	1109	1090	1002

Peak Flow for Various Elements Combined

Elements (2)+(3)+(4) = 1,615 cfs
 Elements (1)+(2)+(3)+(4) = 1,684 cfs

Bridge Replacement. Though not all bridges will be replaced in a 20-year period, some bridges will be replaced through normal maintenance. The State provided estimated bridge modifications for specific bridges on the Middle Fork. Table 5 lists the changes.

Table 5 - Middle Fork, Bridge Modifications

Bridge Name	Mile (sq.mi.)	Elevation Decrease with Modification (feet)	Present Opening (sq.ft.)	Proposed Opening (sq.ft.)
Willow Rd	123.86	-0.21	160	520
Old Willow Rd	124.32	-0.79	144	540
Dundee Rd.	127.37	-0.06	323	634
Old Mill Rd.	133.50	-0.00	169	504
Waukegan Rd.	133.57	-0.08	215	306
Milwaukee RR.	138.42	-0.02	149	640
Elgin & Joliet RR.	139.31	-4.36	42	369
Rockland Rd.	139.44	-2.18	96	358

The HEC-2 backwater model was modified to reflect these changes. The HEC-1 computer model utilized the Modified Puls routing criteria. A revised set of Modified Puls routing criteria was developed from the backwater model

results to reflect the impact on peak flow magnitudes due to potential bridge changes. The impact of bridge changes on the 100-year flood is shown on Table 4.

Flood Fringe Filling. The watershed has been regulated under the floodplain program since the early 1970s. Floodplain filling can reduce natural floodplain storage and thus increase downstream peaks due to reductions in upstream natural attenuation. For purposes of the evaluation and using the floodplain mapping as a guide, the backwater model through use of X3 encroachment card option was modified to reflect filling of the flood fringe. Based on the modified HEC-2 model, new modified puls routing relationships were developed and incorporated into the HEC-1 model. Results of this evaluation on peak flow at the Deerfield Gage are also provided on Table 4.

Channel Maintenance. In many urbanizing regions it is a well known fact that urbanization also brings with it a significant improvement in stream channel maintenance. Also, there are some instances where fill material for local construction purposes has been obtained from nearby channels, thus increasing local channel capacities. Mannings "n" values of 0.035-0.06 for channels and 0.05-.10 for overbanks were used as the base condition in the HEC-2 model. For the improved channel maintenance portion of the sensitivity study, values of 0.035 for channel segments and 0.075 for overbank segments were adopted. New modified puls routing relationships based on the revised backwater model were used to evaluate the impacts on peak flow magnitude at the Deerfield Gage. Results on peak flows are shown on Table 4.

Conclusion

The evaluation summarized on Table 4 indicates that bridge modifications would have the smallest expected increase in downstream peak flows while improved channel maintenance, upland development and fringe filling were of equal significance. All changes together would cause a doubling of the 100-year peak flow. The economic analysis from the revised future condition hydrology resulted in justification of an additional reservoir on the Middle Fork. The three reservoirs identified as having a Federal interest are scheduled for construction during the 1988 and 1989 seasons. Two of the remaining reservoirs not identified as having a Federal interest are scheduled for construction using State and local funding in 1990. The lower site on the Skokie River was lost through development and is no longer available. Of general importance to the evaluator is that for mild to flat basins with significant overbank storage any projection of future basin condition hydrology should give consideration to projected changes along the main water courses as well as upland sub basin development. For flat watersheds with significant overbank storage significant increase in peak flow rates can occur even for watersheds with very strict watershed development guidelines.

References

1. Draft Reevaluation Report North Branch Chicago River, U. S. Army Corps of Engineers - 1979
2. HEC-1, Flood Hydrograph Package, Users Manual, Hydrologic Engineering Center, 1981
3. HEC-2, Water Surface Profiles, Users Manual, Hydrologic Engineering Center, 1981
4. Revised Draft Reevaluation Report North Branch Chicago River U. S. Army Corps of Engineers 1981

NORTH BRANCH CHICAGO RIVER URBANIZATION SENSITIVITY STUDY

By James G. Mazanec

SUMMARY OF DISCUSSION Compiled By H. Estus Walker¹

The high loss rates that resulted from HEC-1 model adjustment were questioned. The possibility that the high loss rates could be an indication that the overbank storage was improperly handled was posed. Ensuing discussion was directed toward the extensive use of/and-use maps during the model calibration process, as well as the length of record and number of gages in the basin. It was also brought out that the model was calibrated for volume and to reproduce the peaks of the hydrographs. In addition, the Hydrological Engineering Center, Davis, California, had reviewed the study and found results to be reasonable. This review had been conducted as a result of concerns regarding future conditions that were expressed by the State of Illinois.

It was pointed out that the record was not homogenous. It was also suggested that had the record been adjusted to existing conditions at the time of the study, peaks would have probably been higher. It was also noted that the higher discharges in more recent years could have been the result of higher rainfall, i.e., a wetter period. The more recent period of record subsequent to the study also suggests that urbanization was not solely responsible for the relative increase in runoff with time.

Notwithstanding the open discussions, there appeared to be a concensus that the methology used in model calibration produced a satisfactory model for purposes of projecting future flows as a result of future urbanization within the watershed.

¹CHIEF, WATER MANAGEMENT BRANCH, SOUTHWESTERN DIVISION

**BUILDING A FLEXIBLE BASE CONDITION USING DISCRETE
EVENT MODELING FOR A LARGE URBAN DRAINAGE SYSTEM**

by **NICK N. ADELMAYER¹**

INTRODUCTION.

PURPOSE. This report presents a description of the process used to model runoff in the Los Angeles County Drainage Area (LACDA), Los Angeles County, California. The drainage area and a location map are shown on figure 1. The study has been limited to the Los Angeles River (LAR) and San Gabriel River (SGR) and their tributaries. This report has the following major objectives: (a) to present the meteorologic and hydrologic characteristics of the study region; (b) to outline methods and techniques used to model the rainfall runoff process; and (c) to establish base condition discharge frequency values for mainstem LAR and SGR locations.

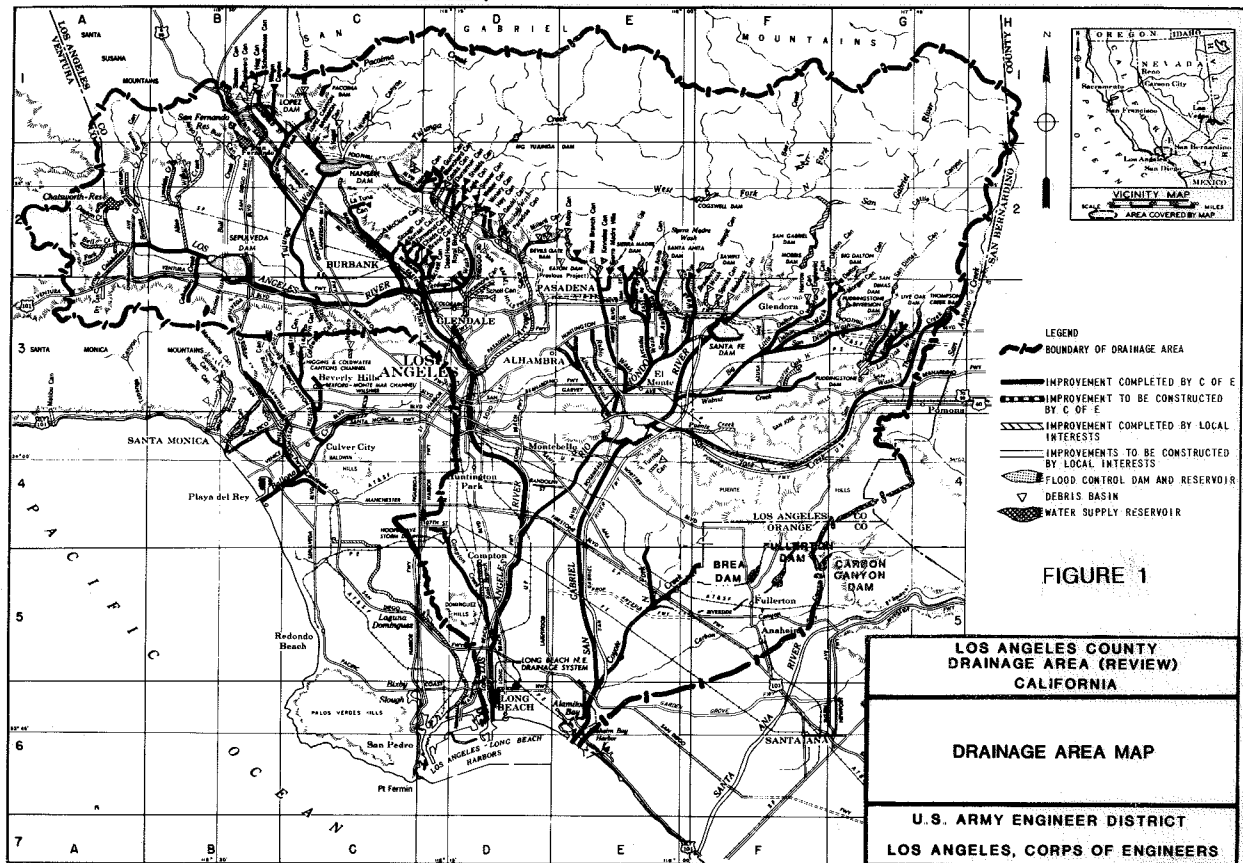

SCOPE. Discharge frequency analyses were conducted for uncontrolled gauged sites. Next, adjustments were made to frequency discharges to account for the effect of urbanization in areas unaffected by reservoir operation. Finally, for areas downstream of reservoirs, frequency discharges were

¹ Hydraulic Engineer, Los Angeles District, U.S. Army Corps of Engineers

determined by simulating reservoir response to runoff events and combining the results with intermediate tributary inflow. The HEC-5 computer program was able to meet the system operation requirement and provide a flexible base for alternative project analysis. The system operation requirements made the use of a rainfall runoff model to compute reservoir inflow and simultaneous runoff in downstream subareas a necessity. Accordingly, the present conditions discharge frequency analysis was conducted in the following steps:

(1) Reconstitution of selected flood events to determine rainfall runoff parameters for gauged subareas within the LACDA study area not affected by upstream reservoir operations; these parameters were developed for typical hydrologic regions within the LACDA basin: mountain, foothill, and valley (urbanized).

(2) Determination of n-year, 24-hour frequency rainfall depths for each subarea, and the time distribution of the rainfall.

(3) Computation of n-year subarea hydrographs resulting from use of the n-year, 24-hour rainfall with a rainfall runoff model (in this case HEC-1).

(4) Development of n-year frequency discharges at selected major control or concentration points in the LACDA system, utilizing a data model of the Los Angeles River (LAR) -- San Gabriel River (SGR) system (fig. 2), and executing that data via the HEC-5 reservoir routing program.

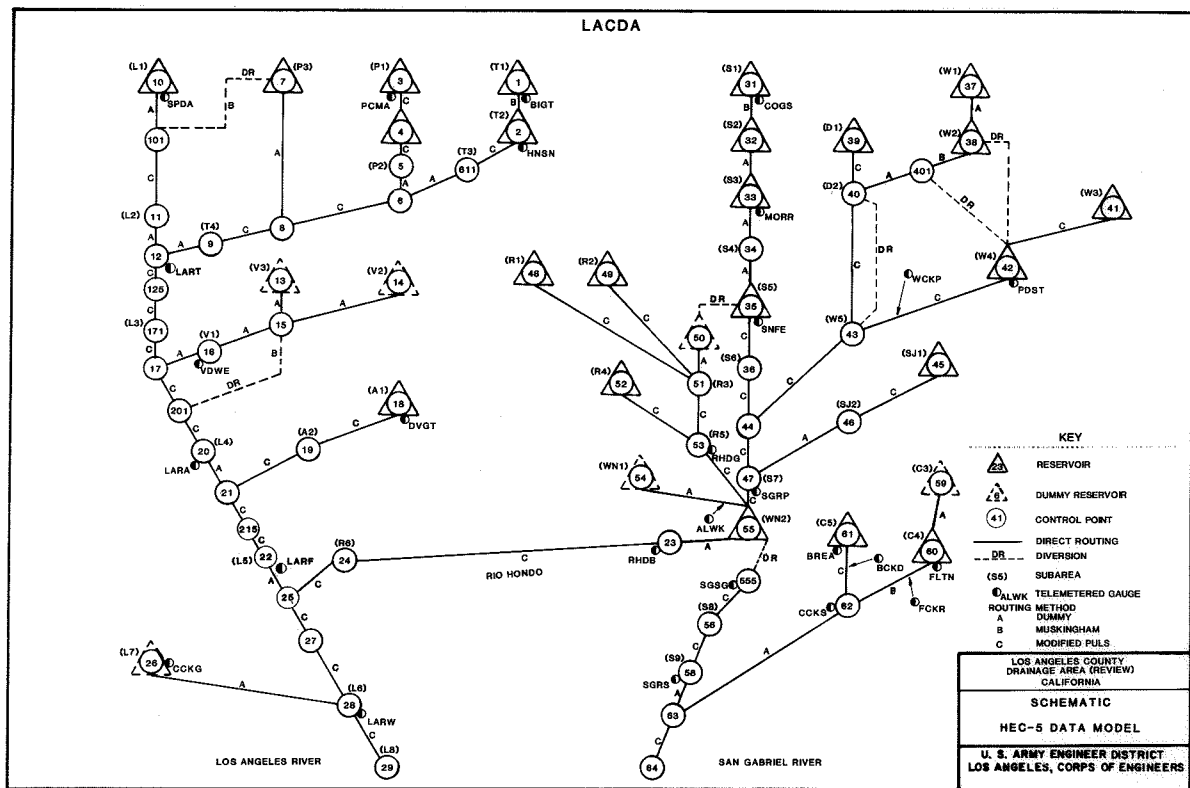

FIGURE 2

The initial results of this phase of the analysis were based upon the assumption that all Corps of Engineers (COE) flood control dams operate for their immediate downstream channel only, and that all flows remain within the channels or river reaches.

SUMMARY. The approach selected, discrete event rainfall runoff analysis, provided estimates of peak floodflows throughout the basin, and also made available flood hydrographs at any location of interest. The basis of this approach -- frequency rainfall and subarea runoff calibrated to observed flow -- provided a sound basis for computation of frequency runoff. Finally, the dynamics of urbanization were quantified by establishing a "current" discharge frequency relationship for observed flow for urbanized locations. The rainfall runoff model was able to replicate these floodflow trends, especially in the downstream reaches.

Since the upstream flows were calibrated to observed results, and since simulation of the rainfall runoff process (including reservoir releases), results in downstream runoff which agrees with observed flows, it is reasonable to expect that the intermediate results are also representative of base conditions. Furthermore, the modeling process provides these frequency results, as well as hydrographs, in a format which allows consistency and the ability to be manipulated while analyzing project alternatives.

GENERAL DESCRIPTION OF DRAINAGE AREA.

BASIN DRAINAGE. The LACDA basin lies mostly in Los Angeles County, Ca., although portions lie in San Bernardino and Orange Counties. Elevations in the San Gabriel and Santa Susana Mountains, which form the northern boundary of the watershed, vary from 3,000 feet in the west to over 9,000 feet in the east. The Santa Monica Mountains, Montebello Hills and Puente Hills separate the San Fernando and San Gabriel valleys from the coastal plain, and range from 500 to 1,500 feet in height.

Principal streams in LACDA are the Los Angeles River (LAR) which has a drainage area of 824 square miles at the mouth (including the Rio Hondo above Whittier Narrows Dam (WNRS) and its tributaries), and the San Gabriel River (SGR) which has a drainage area of 635 square miles at the mouth. The lower Rio Hondo Diversion Channel brings water from the SGR system to the LAR and may effectively increase the drainage area of the LAR during periods of high runoff. The main channel of the LAR is approximately 50 miles long and its tributaries have an aggregate length of about 225 miles. The SGR is approximately 58 miles long and its tributaries total about 76 miles in length. The Rio Hondo, although tributary to the Los Angeles River, connects with the San Gabriel River in the Whittier Narrows Flood Control Basin. The tributary area of the Rio Hondo is 137 square miles or about 9 percent of the basin. Its length is approximately 20 miles and the aggregate length of its tributaries is about 60 miles. Stream slopes range from very steep in the mountains, with slopes over 200 feet per mile common, to approximately 3 feet per mile in the coastal plain.

RUNOFF CHARACTERISTICS. In the mountains, runoff concentrates quickly from the steep slopes; hydrographs show that stream flow increases rapidly in response to excess rainfall. High rainfall rates, in combination with the effects of shallow surface soils, impervious bedrock, fan-shaped stream systems, steep gradients, and occasional denudation of the area by fire, result in intense debris-laden floods. However, flood and debris flows are regulated at existing dams and debris basins.

Runoff from urban watersheds is characterized by high flood peaks of short duration that result from high-intensity rainfall on watersheds that have a

high percentage of impervious cover. Flood hydrographs from single storm events are typically of less than 12 hours duration and are almost always less than 48 hours duration. An example of the quick response to excess rainfall is shown on figure 3 for the February 1980 flood. During this event the flow rate increased from 2/3rds channel capacity (86,000 cfs) to full (129,000 cfs) in the LAR at Wardlow in less than an hour; 2 hours later the flow rate was back to 2/3rds channel capacity.

SOILS. Soils in the LACDA basin can be generally classified as either mountain or valley. Mountain soils consist of a relatively thin mantle of residual soils, which are coarse, porous, and rocky. The valley soils, classified as recent alluvium and older alluvium, vary from coarse sand and gravel at canyon mouths to silty clay, and clay in the lower areas.

VEGETAL COVER.

Well-developed growths of ponderosa pine, incense cedar, juniper, and oak occur along the summits and in the higher ravines of the mountains. Cottonwoods, box elders, sycamores, oaks, willows, and alders grow along the water courses at lower mountain elevations. In general, the remainder of the mountains is covered with chaparral, consisting of California lilac, scrub oak, mountain mahogany, sumac, laurel, sage, and manzanita. The chaparral is extremely susceptible to fires during the long, dry summers, and large areas of mountain watersheds are frequently denuded by fire. This causes a dramatic increase in the runoff and debris production potential in these areas. Few areas of native vegetation exist in the highly developed valleys. The pervious areas that remain are mostly landscaped.

STRUCTURES AFFECTING RUNOFF. The water resources of the LACDA basin are very intensely managed. Numerous multipurpose and special purpose dams and diversion structures, debris basins, channel improvements, and levees exist in the basin. The functions of major structures include flood control, water supply, water conservation, recreation, and debris control.

Twenty-two dams or diversion structures were of sufficient influence on runoff to be considered in this study. Seven dams are owned and operated by the Corps of Engineers. All are authorized as single purpose flood control projects. None have a permanent pool. Of the seven, only Whittier Narrows Dam currently has water conservation activities. Of the 15 non-Federal dams considered, 14 are owned and operated by the Los Angeles County Department of Public Works (LACDPW). All are multipurpose, most being both flood control and water conservation structures. Systemwide reservoir storage capacity totals about 223,230 acre-feet (AF), with 120,235 AF in Federal projects and 102,995 AF in non-Federal projects.

Most streams in the valleys and coastal plain are improved, while most

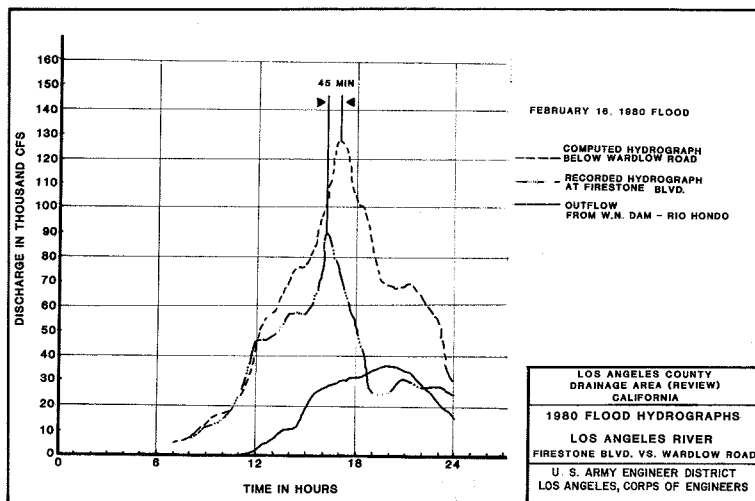

FIGURE 3

mountain streams are natural. Channel improvements have significantly affected runoff: straightening and lining have reduced the amount of flood peak attenuation due to routing and have shortened floodflow travel time. Design capacities of bridges and culverts in most cases match that of the channel they span; they are seldom a constriction.

CLIMATE. The climate of LACDA varies considerably with elevation and distance from the coast. The entire region is Mediterranean, with dry summers and mildly wet winters. The coastal zone is subtropical, with cool summers and mild winters. The intermediate valleys and foothills are temperate, with warm summers and mild winters. The climate in the mountains ranges from temperate, with warm summers and cool winters at the resort levels (5,000-6,000 feet), to alpine, with cool summers, and cold winters over the highest peaks (9,000-10,000 feet). Normal annual precipitation in LACDA ranges from about 12 inches along the coast to more than 44 inches in the East Fork drainage of the San Gabriel River. About 90 per cent of the season's total precipitation normally falls from November through April, with December-March as the wettest months. Extreme monthly precipitation totals in the drainage range from zero to more than 50 inches atop the wettest mountain peaks. As can be seen by these extremes, and as can be computed from NOAA Atlas 2 for any duration or for any return period, the rainfall depth over the higher mountains is considerably greater than the corresponding depth on the coastal plains. The mountain/coastline ratios can be as high as 3 to 1 for durations of 6 hours and as high as 4 to 1 for 24 hours.

RAINFALL RUNOFF ANALYSIS.

GENERAL. The form of the rainfall runoff analysis used in this study was a discrete event analysis. Selected rainfall frequency events were simulated over the basin, and coupled with the loss rates and unit graphs developed through reconstitutions, runoff hydrographs were developed. These hydrographs were used to represent the magnitude of runoff occurring during the selected event, and were given that same frequency.

A calibration process was developed to generalize adjustments to the rainfall runoff computational algorithm for subareas with stream gauges and extended to ungauged subareas. This calibration was made in order to link the frequency of the computed runoff to the frequency of the rainfall, and to provide consistency of frequency throughout the basin. Loss rate parameters were developed for gauged mountain and valley subareas in the calibration process. These generalized loss rates were then used in subarea runoff computations for all mountain or valley subareas.

Twenty-four hour precipitation was used to simulate the rainfall runoff events because the key flood control storage reservoirs within the LACDA system, Sepulveda (SPDA), Hansen (HNSN), Santa Fe (SNFE), and Whittier Narrows (WNRS) - total flood control capacity about 115,000 AF - are capable of being evacuated within a day due to their large outlet capacities, the large corresponding channel capacities below these dams, and the quick response of downstream urban areas.

The rainfall runoff hydrographs resulting from 24-hour precipitation were computed for a 48-hour duration to allow time for the SGR peak flows to occur. The lag on the SGR above the COE reservoirs is longer than on the LAR. In addition, the largest flows occur on the downstream SGR as a result of spills

from the upper San Gabriel Canyon Reservoirs. Because of time required to fill these reservoirs and surcharge their spillways, these events take place later in the flood analysis. However, peak flows on the LAR and its tributaries generally occur during the second half of day 1 of the simulated flood events (hour 14 to hour 16), and closely follow the maximum precipitation.

To maintain the integrity of the basin storms, i.e., the character of the precipitation, with typically much higher totals in the high upper watershed regions compared to the low coastal plains, subarea precipitation used in rainfall runoff modeling was distributed over the basin in accordance with its relative depth. For example, in this study subarea S1 in the San Gabriel Mountains has a 100-year 24-hour precipitation depth of 18 inches, while subarea L8, along the LAR in the Long Beach vicinity has a 100-year 24-hour depth of 6 inches: both depths are components of the 100-year 24-hour precipitation for the entire LACDA basin.

SUBAREA PRECIPITATION. Rainfall frequency data is available from the National Weather Service (NWS) Isopluvial Maps (NOAA Atlas 2, Volume XI) for durations of 6- and 24-hours for southern California. Intermediate duration precipitation depths can be computed from statistical relationships developed by the NWS and presented within the NOAA Atlas, based upon the 6- and 24-hour depths. N-year, 6- and 24-hour area-weighted average point precipitation depths were converted to areal depths for all LACDA subareas, by means of depth-area-duration relationships. A list of n-year average precipitation frequency depths for the LACDA basin is shown in table 1.

TABLE 1: LACDA BASIN 24-HOUR PRECIPITATION FREQUENCY DEPTHS

100-year	50-year	25-year	10-year	5-year	2-year
9.78 in.	8.60 in.	7.45 in.	5.67 in.	5.06 in.	3.42 in.

Subarea precipitation depths were computed for n = 2-, 5-, 10-, 25-, 50-, and 100-year frequencies by multiplying the subarea average point rainfall by the basin point precipitation reduction factor.

A precipitation-frequency curve for LACDA was constructed from table 1 data and the 200-year and 500-year basin average depths were estimated (200-year depth = 11.0 in., 500-year depth = 12.4 in.). Subarea precipitation depths for 200-, and 500-year frequencies were determined by apportioning the total basin rainfall over the subareas in the same relative quantities as the 100-year precipitation. In this manner, relative precipitation depths for the variety of subareas maintain their meteorological character.

TEMPORAL PRECIPITATION DISTRIBUTION PATTERN. Based upon the computed basin average 6- and 24-hour precipitation depths, 12-hour, 1-, 2-, and 3-hour depths were determined for the LACDA basin from NOAA Atlas 2 regression relationships. These incremental values were put into dimensionless form and distributed over time as shown in table 2.

TABLE 2: INCREMENTAL 100-YEAR PRECIPITATION PATTERN IN PERCENT

Period (15 min)	Percent Total Precipitation								
1-8	0.63	0.63	0.63	0.64	0.63	0.63	0.63	0.63	0.64
9-16	0.63	0.63	0.63	0.64	0.63	0.63	0.63	0.63	0.64
17-24	0.63	0.63	0.63	0.64	0.63	0.63	0.63	0.63	0.64
25-32	1.23	1.24	1.24	1.24	1.23	1.24	1.24	1.24	1.24
33-40	1.23	1.24	1.24	1.24	1.16	1.16	1.16	1.16	1.16
41-48	1.16	1.16	1.16	1.16	1.16	1.16	1.16	1.16	1.16
49-56	1.45	1.46	1.46	1.46	1.43	1.43	1.43	1.43	1.44
57-64	3.60	3.60	3.61	3.61	1.24	1.24	1.24	1.24	1.24
65-72	1.24	1.24	1.24	1.24	1.24	1.24	1.24	1.24	1.24
73-80	0.63	0.63	0.63	0.64	0.63	0.63	0.63	0.63	0.64
81-88	0.63	0.63	0.63	0.64	0.63	0.63	0.63	0.63	0.64
89-96	0.63	0.63	0.63	0.64	0.63	0.63	0.63	0.63	0.64

The rainfall distribution developed for the total basin was then applied in the same relative manner to each subarea in order to compute subarea hydrographs.

COMPUTATION AND CALIBRATION OF SUBAREA RUNOFF HYDROGRAPHS.

GENERAL. The next phase of the rainfall runoff process was determination of subarea runoff. LAPRE-1 was used to compute component hydrographs for each of the 50 subareas LACDA was subdivided into. The planned process was to compute n-year hydrographs for each gauged subarea using reconstituted rainfall runoff parameters and then modify those parameters in a calibration sequence.

The computed n-year (n = 2-, 5-, 10-, 25-, 50-, and 100-year) peak flows based upon rainfall runoff analysis were compared to corresponding peak discharges statistically derived from streamflow record at 22 sites to determine the ability of the synthetic rainfall runoff process to reproduce streamflow frequency relationships. These 22 locations were comprised in general of uncontrolled subbasins, or basins which were only partially regulated with little impact on peak flow rates; they were selected to correspond to subareas delineated in this study. Examination of the initial results indicated a wide variability between subarea peak discharge and statistically determined discharge frequency relationships; i.e., computed discharges ranged from much larger to much smaller than frequency results for gauged streamflow in different subareas. A requirement of any calibration process is the development of a "system" or algorithm by which computed flows could be adjusted to match known frequency discharges, and which could then be extended to subareas for which frequency discharges were unavailable. Since loss rates resulting from reconstitutions were based upon the geography of each subarea (general classifications were mountain or valley-foothill), the calibration process focused on two separate adjustments -- one for valley-foothill subareas and one for mountain subareas.

LOSS RATE ADJUSTMENTS. Loss rates and unit graphs were obtained from a study of the relationship between significant gauged runoff events and storms.

The study was carried out using the HEC-1 Flood Hydrograph Model in a mode where observed rainfall and subsequent runoff were input, and loss rate and unit graph parameters were optimized based upon a prescribed form (loss rate selected was the HEC Loss Function, wherein loss decreases exponentially based on cumulative loss) and selected initial and boundary conditions. Two loss functions were described: a mountain loss rate and a valley-foothill loss rate.

a. Antecedent Loss (DLTKR). The reconstituted loss function used for synthetic flood determination initially set watershed soil moisture at the saturated level (DLTKR = 0.0). The range of moisture levels determined during reconstitutions was examined; subsequently, a value of DLTKR = 1.5 was selected for subarea discharge computations for 2-year events, and 1.0 for the remaining events with a frequency less than 50 years (5-, 10-, and 25-yr). For more extreme events (50-, 100-, 200-, and 500-yr) DLTKR = 0.0 (saturated conditions) was used to produce higher runoff volumes in conjunction with observed results. The determination of peak discharges was not very sensitive to the value of DLTKR, especially for large floods.

b. Starting Loss (STRKR). The loss function determined from reconstitutions indicated a mountain value of 0.35 inch/hour and a valley rate of 0.25 inch/hour for STRKR were generally applicable. This value was found to compare well with observed analytical results for 50-year and greater frequency peak discharges in the mountain subareas. A starting loss of 0.60 in./hour (which was within the range of reconstituted STRKR values) was used for 2-year determinations, and provided the best generalized comparison to observed results for 5-, 10-, and 25-year mountain subarea peak discharges as well. The valley peak runoff computations were dependent on impervious cover, and as a result, loss rate was less important. The starting value of 0.25 inch/hour was retained for all valley-foothill subarea runoff computations.

c. Percent Impervious Cover (PIC). Results from degree of urbanization and development studies were combined with flood reconstitutions to produce effective impervious cover values for each subarea. No changes were made to PIC values determined for valley-foothill subareas. To reproduce the 2-year subarea runoff adequately for the generalized calibration of mountain subareas, a PIC value of 5 percent was used.

CALIBRATION RESULTS. The preceding loss rate parameters were varied for each discrete frequency runoff determination (2-year, 5-year, ... 100-year) in a manner which resulted in the "best composite fit" of subarea discharges to analytical frequency discharges for each frequency. Because of the wide range of relative frequency flows (gauged vs. computed), no general systematic approach could lower the high results, as well as raise the low results. The "best composite fit" concept attempted to produce a normal distribution of relative peak discharges. Ratios of gauged to computed discharges were determined for each discrete frequency for the calibration subareas, and the loss adjustment parameters then modified to produce the most normal distribution of these ratios about 1.0 as the mean. An example of this best composite fit process is shown for the 100-year calibration in table 3.

TABLE 3: CALIBRATION COMPUTATION FOR 100-YEAR PEAK FLOW

CALIBRATION SUBAREA	GAUGED DRAINAGE AREA (sq.mi.)	GAUGED EXPECTED Q PEAK (cfs)	RAINFALL RUNOFF QPEAK ⁽¹⁾ (cfs)	Q _{peak} RATIO GAUGED/ RAINFALL RUNOFF
S1	39.2	39,000	29,700	1.31
S1+S2	202.7	155,000	115,000	1.35
SJ1	3.5	2,100	2,820	0.74
SJ2	79.9	27,900	24,600	1.13
W1	16.2	8,200	10,600	0.77
W3	2.3	860	1,640	0.52
WN1	15.2	10,400	9,260	1.12
R1	10.8	9,200	9,320	0.99
R2	3.2	2,120	2,800	0.76
R4	12.4	7,900	9,590	0.82
P1	28.2	10,100	8,840	1.14
C5	23.8	5,100	5,850	0.87
L1	152.0	103,000	82,500	1.25
L7	41.2(s)	24,600(E.1)	16,500	1.49
D1	4.5	4,500	3,110	1.45
T1	82.3	51,000	41,400	1.23
T3	6.34(s)	2,590(E.2)	3,740	0.69
SJ1+SJ2	83.4	30,000	27,400	1.09
R1+R2+R3+R4+R5	85.2(s)	52,800(E.3)	63,100	0.84
T1+T2	151.9	75,000	73,100	1.03
V1+V2+V3	28.83(s)	15,500	23,200	0.67
A1	31.9	17,000	19,300	0.88
				AVG. = 1.006

- (s) - Represents drainage area of subareas when gauge location is not a CP.
- (E) - Estimated gauged flow adjusted for difference between area at gauged site and nearest subarea outlet.
- | | Range: | Number of Occurrences |
|---|-------------|-----------------------|
| | 0 - .25 | 0 |
| | .26 - .50 | 0 |
| E.1: L7= 41.2 sq. mi., gauge = 22.6 sq. mi.
ratio = 41.2/22.6 = 1.82 | .51 - .75 | 4 |
| | .76 - 1.00 | 7 |
| E.2: T3 = 6.34 sq. mi., gauge = 5.01 sq. mi.
ratio = 6.34/5.01 = 1.27 | 1.01 - 1.25 | 7 |
| | 1.26 - 1.50 | 4 |
| E.3: R1-R5 = 85.2 sq. mi., uncontrolled
gauge = 64.8; ratio = 85.2/64.8 = 1.32 | 1.51 - 1.75 | 0 |
| | 1.76 - 2.00 | 0 |
- (1) HEC-1 results: does not include routing and combining effects (HEC-5), since upstream calibration was preliminary step.

The computed ratios of peak gauged flow to peak rainfall runoff results, using generalized loss rate parameters for all mountain and valley-foothill subareas, were grouped into increments of 25 percent and plotted in histogram form. The 100-year calibration histogram was shown on figure 4. Both table 3 and figure 4 contain an urbanization adjustment based on a detailed analysis of the homogeneity of streamflow record in the dynamic LACDA basin.

The generalized values of these loss parameters were then input into the HEC-1 rainfall runoff model along with appropriate reconstituted unit graph parameters for each of the 50 LACDA subareas.

Examples of resulting rainfall runoff frequency discharge are shown on figures 5 and 6 along with gauged results. Because of the nature of a normal distribution, some data is above or below the mean (i.e., ratio of 1.0), which translates into computed frequency discharges above or below the gauged results. Most are within 1-2 standard deviations. The results are, therefore, within the range of those generated by other types of regional frequency analyses. The calibration methodology used herein is simply another form of regional frequency determination with the additional benefit that subarea hydrographs are available, and that timing and routing effects can thus be accounted for.

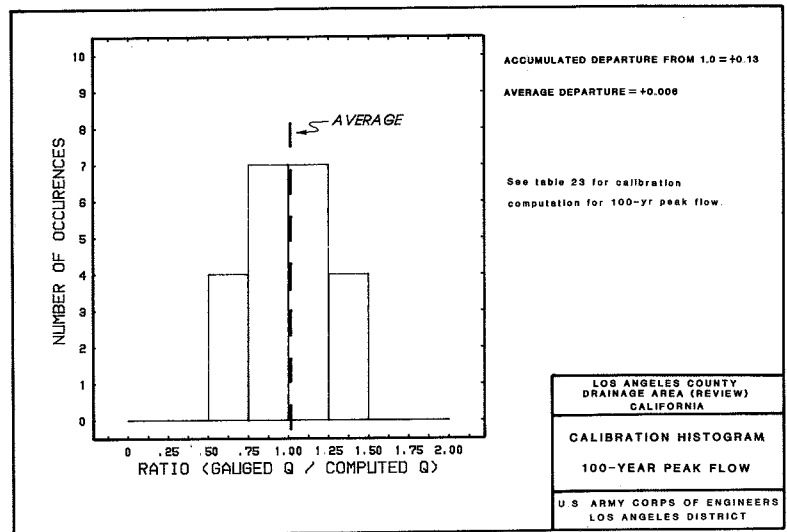

FIGURE 4

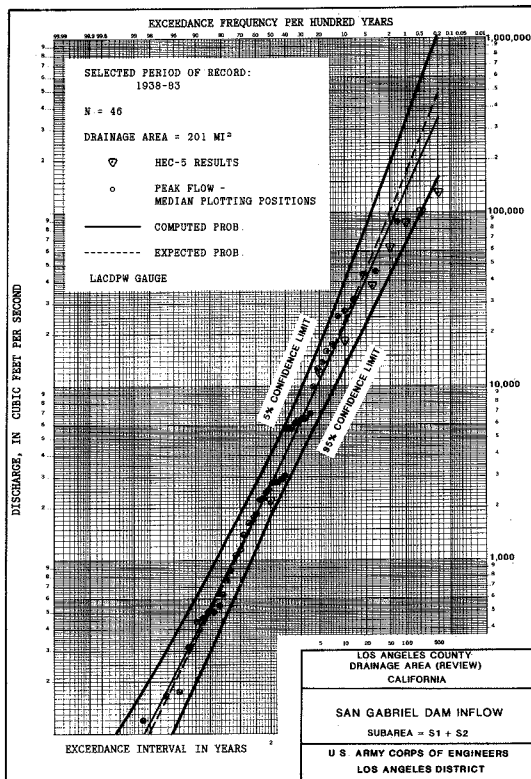

FIGURE 5

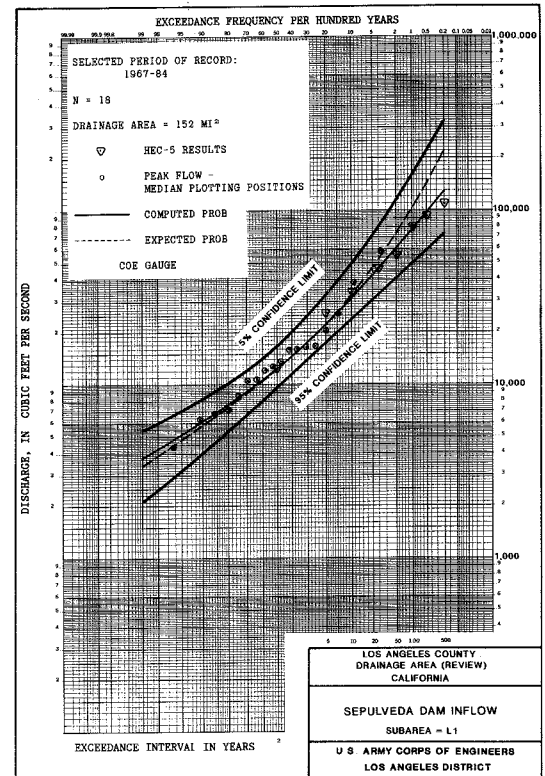

FIGURE 6

RESERVOIR SIMULATION AND STREAM SYSTEM ROUTING (HEC-5).

RESERVOIR OPERATION CRITERIA. The initial reservoir conditions and water control criteria applied during the LACDA Review Study to generate base condition hydrology are described herein. Wet conditions in response to antecedent storms were expected to exist at the start of each flood. Accordingly, reservoir debris pool and conservation storage would initially be full for each event. LAD normally impounds water to form debris pools at the start of major floods. When a series of storms threatens the LACDA area, reservoir evacuation in preparation for the next event is normally curtailed at the debris pool level. Consequently, outflow-equal-inflow operations are commonly practiced between storms to maintain debris pool levels.

CHANNEL ROUTING CRITERIA. Simulation of the rainfall runoff process within the LACDA basin included computation of reservoir inflows and tributary flows as a function of time, reservoir routing, and finally, channel routing of reservoir releases and combination with tributary flows. Travel times were computed assuming normal depths throughout, using the relationship between available storage and discharge for prismatic cross-sections, for channel flows in the 1/2 to full range in which velocities are fairly constant.

$$T_t = (S/Q) 726;$$

where: T_t = travel time, (minutes)
S = channel storage, (AF); (for given Q), where $S = A \times L$
A = channel cross-sectional area, (ac)
L = channel length, (ft)
Q = representative discharge, (cfs)
726 = conversion factor.

The flood hydrograph incremental time periods were selected to be 15 minutes for computation purposes because of small lag times for urban tributary subareas. Routing reaches were divided into segments with 15-minute travel time so that the storage available for attenuation of the flood hydrograph in each reach was consistent with the progress of the flood wave.

To provide an initial estimate of the statement of the protection afforded by the LACDA system reservoir releases plus downstream tributary inflows were combined and routed through the LACDA system assuming all flow stayed within the channel confines - "infinite" channels. Since no overbank flow was allowed to occur during this simulation, and the channels are regular in shape (little variation in cross-section), attenuation of peak flow was expected to be minimal. For this reason the infinite channel routing parameters were restricted to coefficients of lag only, as previously determined from travel time computations. The infinite channel model frequency discharges were compared to existing channel capacity (table 4) to indicate locations and degree of potential deficiencies for specific levels of protection.

TABLE 4: DISCHARGE FREQUENCY RESULTS -- "INFINITE CHANNEL"

C.P.	D.A. (sq.mi.)	FREQUENCY (yrs)					REV. DESIGN CHAN. CAP.	
		10	25	50	100	200		500
2	.	6350	13800	31300	44200	60200	72200	.
Outflow.	152	4420	9240	15800	18900	20800	26200	21000
611	158	4810	9440	16000	19700	21200	26700	20800
6	211	7540	15300	20300	29600	36300	42000	27000
9	229	10100	17100	24700	34900	41900	48900	29000
.
10	.	34300	47300	54900	82500	94700	109000	.
Outflow.	152	12800	14700	15600	17000	40600	77600	16900
11	174	16200	20300	22400	29400	44100	83000	20300
12	403	26300	34900	47100	64200	77000	123000	48700
171	465	38200	51400	66200	88500	104000	141000	40000
17	493	43900	61000	77800	99500	115000	151000	59000
20	514	46100	64300	83000	103000	120000	156000	83700
21	561	49700	73900	95600	119000	138000	177000	104000
22	620	53400	80000	101000	126000	147000	181000	110000
25	752	87700	122000	143000	169000	190000	223000	156000
27	766	88400	123000	144000	169000	192000	224000	133000
28	808	91600	126000	149000	173000	197000	227000	129000
29	824	91600	127000	150000	174000	197000	227000	133000
.
55	.	46700	70700	105000	136000	163000	182000	.
Outflow.	437	5000	5000	5000	5000	44200	85700	13500
56	459	8550	9820	10800	12200	45100	89200	19500
58	475	9430	12400	14500	17100	45700	91100	20000
63	625	25300	36000	44800	55900	64400	108000	58000
64	635	25300	36000	43900	53900	62000	108000	55600
.
55	.	48800	73100	109000	136000	163000	182000	.
Outflow.	110	34000	40000	40000	40000	40000	40000	36500
24	132	36100	43700	46400	49800	51200	52900	36500

Discharges in cubic feet per second

DISCHARGE FREQUENCY ANALYSIS.

BACKGROUND DISCHARGE FREQUENCY ANALYSIS FOR UNCONTROLLED LOCATIONS.

a) General. The LACDA drainage area encompasses four general types of watersheds. The first drainage area type consists of natural mountain and foothill watersheds with a land use cover unaffected by human activities. The second category consists of valley-foothill basins with a land use cover almost entirely influenced by urbanization. A third category includes natural drainage areas controlled by upstream regulation. The fourth area, and the one most critical to this study, is comprised of controlled urban watersheds. Separate hydrologic engineering methods were required for each

watershed type. Discharge-frequency analyses for undisturbed, uncontrolled, gauged mountain watersheds were the foundation for all subsequent hydrologic investigations.

Discharge-frequency analyses for gauged natural mountain basins conformed to the procedures described in Water Resources Council (WRC) Bulletin 17B "Guidelines for Determining Flood Flow Frequency." The annual series of peak flows were fitted to the log Pearson Type III probability distribution, using the station skew in each case.

Hydrologic engineering methods employed for the valley-foothill region followed the same procedural order as the mountain region. The gauged peak discharge-frequency curves were initially determined following WRC guidelines. Adjustments were later made to the streamflow record to account for urbanization.

No specific guidelines are provided in WRC Bulletin 17B for controlled or urban watershed discharge-frequency analyses. Consequently, alternative methods were developed utilizing conventional and unique hydrologic procedures.

b) Runoff Records. The data base consisted of the annual series of peak and volume flows. Data sources included various publications and files of the United States Geological Survey (USGS), Los Angeles County Flood Control District (LACFCD), Corps of Engineers (COE), Orange County Environmental Management Agency (OCEMA) and the San Bernardino County Flood Control District (SBCFCD).

The stations analyzed in the study and their period of record are given in tables 5 and 6. The 11 natural stations in table 5 include homogeneous stations of record length greater than 18 years located within the LACDA hydrologic regime and used in the calibration sequence.

TABLE 5: NATURAL GAUGED STATIONS USED FOR CALIBRATION

Station	Calibration Subarea	Gauge Number	Number of Years of Record	Period of Record
1. Cogswell Dam	S1	LACDPW	47	1937-83
2. Big Dalton Dam	D1	LACDPW	52	1931-82
3. San Dimas Dam	W1	LACDPW	49	1934-82
4. Live Oak Dam	W3	LACDPW	47	1933, 35, 37-79, 81-82
5. Thompson Creek Dam	SJ1	LACDPW	47	19-33, 38-82
6. Santa Anita Dam	R1	LACDPW	50	1933-82
7. Sawpit Dam	R2	LACDPW	48	1932, 34-36, 38, 40-82
8. Brea Dam	C5	COE	44	1942-85
9. Big Tujunga Dam	T1	LACDPW	63	1917-30, 34-82
10. Pacoima Dam	P1	LACDPW	59	1914, 17-25, 27, 34, 36-82
11. Devil's Gate Dam	A1	LACDPW	50	1934-83

NOTE: COE = Corps of Engineers.

LACDPW = Los Angeles County Department of Public Works.

**TABLE 6: URBANIZED AND CONTROLLED GAUGED STATIONS
USED FOR CALIBRATION OR EVALUATION**

Station	Calibration Subarea(s)	Gauge Number	Number of Years of Selected Record	Selected Period of Record
URBANIZED UNCONTROLLED STATIONS				
1. Eaton Wash Dam	R4	LACDPW	16	1967-82
2. Alhambra Wash	WN1	F81D-R, LACDPW	19	1967-85
3. Branford St. Channel	T3(79%)	F342-R, LACDPW	21	1962-82
4. Sepulveda Dam	L1	COE	18	1967-84
5. Verdugo Wash	V1-V3	F252-R, LACDPW	18	1966-83
6. Compton Creek	L7(59%)	F37B-R, LACDPW	17	1966-82
NATURAL CONTROLLED STATIONS				
1. San Gabriel Dam	S1+S2	LACDPW	46	1938-83
2. Hansen Dam	T1+T2	COE	48	1933-36, 1938, 1941-83
URBANIZED CONTROLLED STATIONS				
1. Walnut Creek above Big Dalton Wash	EVAL	F304-R, LACDPW	19	1966-84
2. San Jose Creek above San Gabriel River	SJ1+SJ2	F312-R, LACDPW	19	1966-84
3. Rio Hondo above Whittier Narrows	R1-R5	11101250, USGS	19	1967-85
4. San Gabriel River below Railroad	EVAL	11087500, USGS	19	1966-84
5. San Gabriel River above Coyote Creek	EVAL	11088000, USGS	18	1966-83
6. Coyote Creek Above San Gabriel River	EVAL	11090700, USGS	19	1965-83
7. Los Angeles River below Tujunga Wash	EVAL	F300-R, LACDPW	19	1967-85
8. Los Angeles River above Arroyo Seco	EVAL	F57C-R, LACDPW	19	1966-84
9. Los Angeles River above Rio Hondo	EVAL	F34D-R, LACDPW	18	1966-83
10. Whittier Narrows Diversion	EVAL	11102300, USGS	16	1967-82
11. Rio Hondo above Los Angeles River	EVAL	11102500, USGS	19	1966-84
12. Los Angeles River below Wardlow Road	EVAL	F319-R, LACDPW	18	1966-83

Note: EVAL = Evaluation of Combined and Routed Hydrographs, no Calibration.
LACDPW = Los Angeles County Department of Public Works.
USGS = United States Geological Survey.
COE = Corps of Engineers.

Use of WRC guidelines assumes that the watersheds in question are homogeneous. Watersheds whose flow regime has been modified by human influences are considered to be non-homogeneous or disturbed watersheds, and require separate hydrologic engineering methods. Decisions regarding the homogeneity of station records were based upon information obtained from agency publications, consultations with local agencies, topographic maps, aerial photographs and District engineering experience. Watershed factors examined included drainage area changes resulting from gauging site relocation, urbanization, regulation by upstream reservoirs, channelization, diversion and addition of significant quantities of upstream water, and major land use changes. Upstream debris basins were generally not considered to significantly affect station records. Watershed fire history was considered independent from floods, and excluded from the analysis.

The urban or controlled stations analyzed in the study are listed in table 6, along with their period of record. The 18 urban stations in table 6 are a representative sample of the numerous urban stations within LACDA, and include all of the urban stations free from upstream control. Of the 20 controlled and/or urban stations in table 6, 10 were used in the calibration study; the remaining 10 were used to establish the validity of the upstream calibration and subsequent reservoir and channel routing and tributary combination sequence.

c) Mountain Watersheds. The Flood Flow Frequency Analysis computer program (HECWRC) was used to compute the discharge-frequency curves for the natural, homogeneous mountain stations.

d) Valley-Foothill Watersheds. In general the valley-foothill gauged locations are either controlled by upstream reservoirs, urbanized, or both.

1. Controlled Locations. The methods employed for controlled watersheds were discussed previously, and essentially involve use of the gauged subarea discharge frequency results to compute frequency hydrographs for the entire LACDA basin (50 subareas) being studied in this report through a parameter calibration sequence. Subsequently, the subarea frequency hydrographs were routed through the appropriate reservoirs and channels and combined at physical concentration point locations to produce frequency hydrographs at all downstream controlled locations. The peak flow rate for each frequency hydrograph was reported as the specified frequency discharge at each of these locations.

2. Uncontrolled Locations. For urban watersheds whose streamflow record is not homogeneous due to changes in development during the period of record, results were modified by establishing the applicability of the data through comparison of subsets of the entire record. Ultimately the final results for mainstem locations were determined using the HEC-5 modeling process.

VOLUME FREQUENCY COMPARISONS.

GENERAL. In areas where reservoirs have a major role in flood control, volume frequency information is often of more value than peak flow data since

maximum flood releases or spills are the product of the volume and duration of flood waters reaching the reservoir rather than a function of the peak flow rate. The LACDA system affords two varieties of flood control: (1) upstream flood control dams which provide partial regulation to 940 sq. mi. of the basin, and (2) downstream and tributary flood control channels of which 520 sq. mi. is uncontrolled.

To provide an accurate picture of the amount of protection provided by the existing LACDA system along the mainstem channels below the flood control dams (especially Sepulveda, Hansen, and Whittier Narrows), both peak flow rates (to compare with channel capacities) and volumes of runoff (to determine maximum reservoir outflow) are necessary.

Development of peak flow rates has already been discussed. The calibration procedure resulted in frequency hydrographs for each of the 50 LACDA subareas in this study. These hydrographs contain calibrated peak flow rates as well as volumes of flow resulting from application of the generalized loss rate and unit graph parameters to 24-hour frequency rainfall. Peak flow rates are sufficient to determine the level of protection afforded by the LACDA network of channels, but peak tributary flow must be supplemented by reservoir outflow rates to completely define the quantities of flow for the downstream channels.

To evaluate the viability of using the frequency hydrographs resulting from the calibration process to generate peak reservoir outflow, 24-hour maximum flow rates for each simulated frequency flood hydrograph were compared to statistically derived maximum 1-day frequency flow rates at five reservoirs: Hansen, Sepulveda, and Devil's Gate Dams on the LAR and tributaries; Cogswell and San Gabriel Dams on the SGR. Santa Fe and Whittier Narrows Dams were excluded from analysis because their maximum volume inflows were regulated by upstream SGR dams, especially Cogswell and San Gabriel Dams.

RAINFALL RUNOFF VS. SYSTEMATIC RECORD RESULTS. A comparison of rainfall runoff results to systematic estimates for all dams analyzed is shown in table 7. Examples for San Gabriel and Sepulveda Dam inflow volume frequency are shown on figures 7 and 8.

TABLE 7: VOLUME FREQUENCY COMPARISON.

LOCATION	FLOOD CONTROL		100-YEAR	
	D.A. (sq. mi.)	STORAGE (AF)	1-DAY AVE. SYSTEMATIC	FLOW (cfs) RAINFALL RUNOFF
Hansen Dam	152	24,000	21,000	16,000
San Gabriel Dam	201	34,000	41,500	44,000
Sepulveda Dam	152	20,800	13,500	11,100
Devil's Gate Dam	31.9	27,700	5,600	6,200
Cogswell Dam	39.2	8,100	18,500	20,400

In general there is good agreement between 1-Day systematic frequency estimates and 24-hour rainfall runoff estimates. No further adjustments were made to the calibrated rainfall runoff parameters.

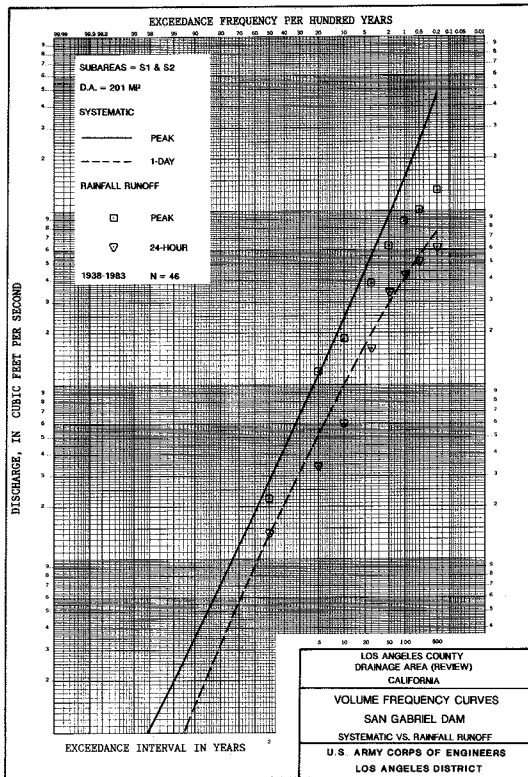

FIGURE 7

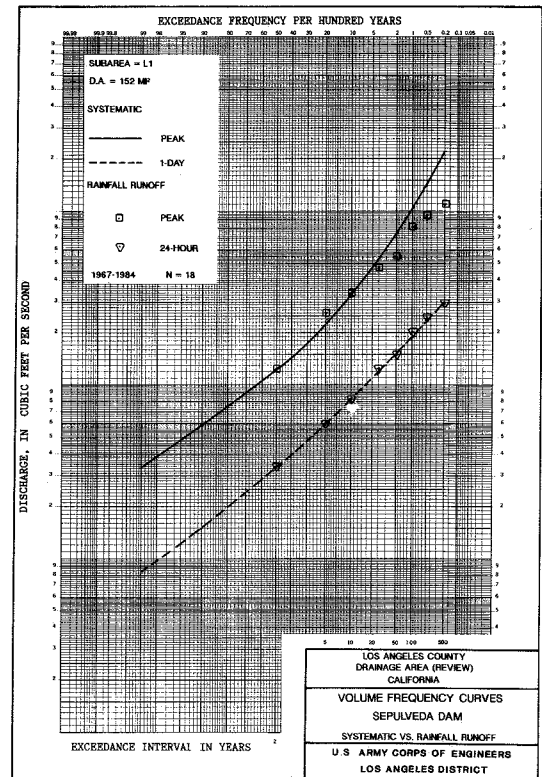

FIGURE 8

EVALUATION OF RESULTS.

SYSTEMATIC RUNOFF VARIATION WITH TIME. To evaluate the routed and combined floodflows, a non-rigorous statistical process was used. Mainstem channel peak observed floodflow data was selected and broken down into three subsets based generally on the rate of urban development within the LACDA basin: current, 1966 through 1984; post World War II, 1948-1966; and early years, 1930 through 1948. These periods were not definitively unique, but rather represent a series of snapshots of the dynamic basin. No attempt was made to include or exclude any single event in one period or another by selection of the subject periods. The overall objective was to compare the results of three separate runoff periods, fairly uniform in length, which also correspond to three diverse rainfall regimes. Parallel studies conducted to evaluate the impacts of urbanization have indicated that the 1966-1984 and 1930-1947 periods were wet, and the 1948-1966 period very dry. Therefore a correlation showing high direct runoff during wet periods and low direct runoff during the dry period would indicate no impact from urban growth. Instead a dramatic portrait of the dynamics of the basin was evident (figs. 9 - 12). At urbanized locations, the early wet period (1930-1948) resulted in the least runoff estimate; the second, dry period (1948-1966) resulted in a higher runoff estimate, despite reduced precipitation and the latest wet period (1966-1984), indicated a still higher runoff estimate. The key ingredient in these comparisons is the increasing runoff estimate, regardless of the quantity of the rainfall. This result led to use of the 1965-1984 peak runoff subset for evaluation of mainstem locations in the LAR-SGR where urbanization was an important factor.

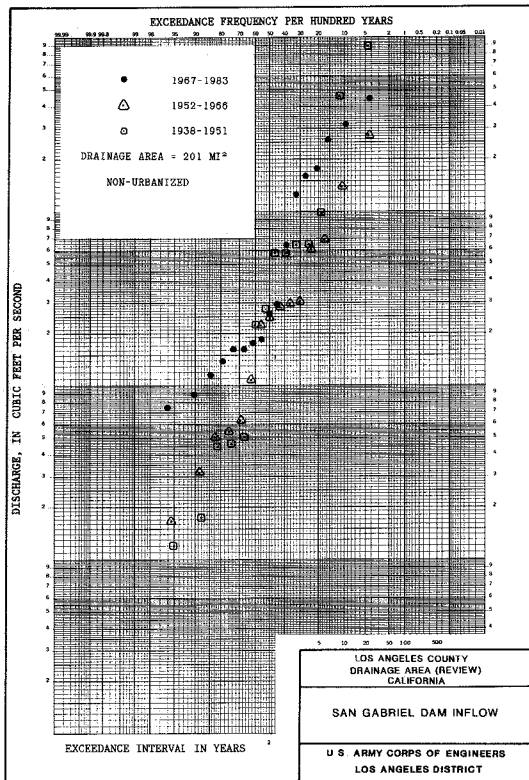

FIGURE 9

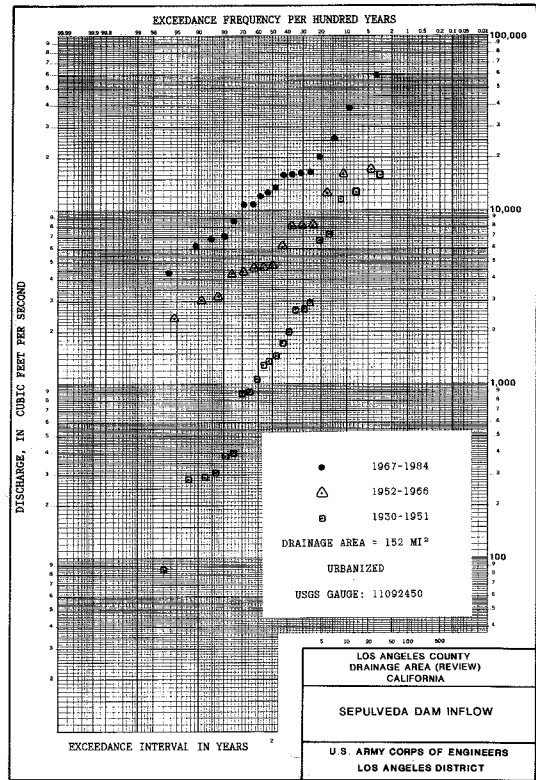

FIGURE 10

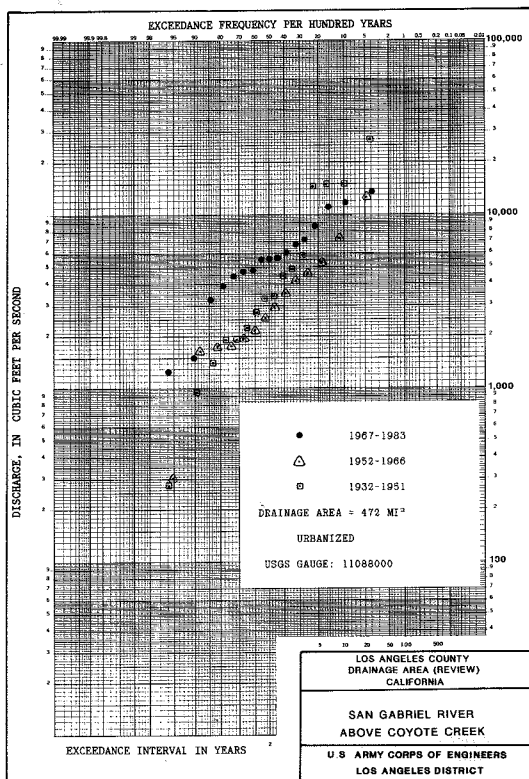

FIGURE 11

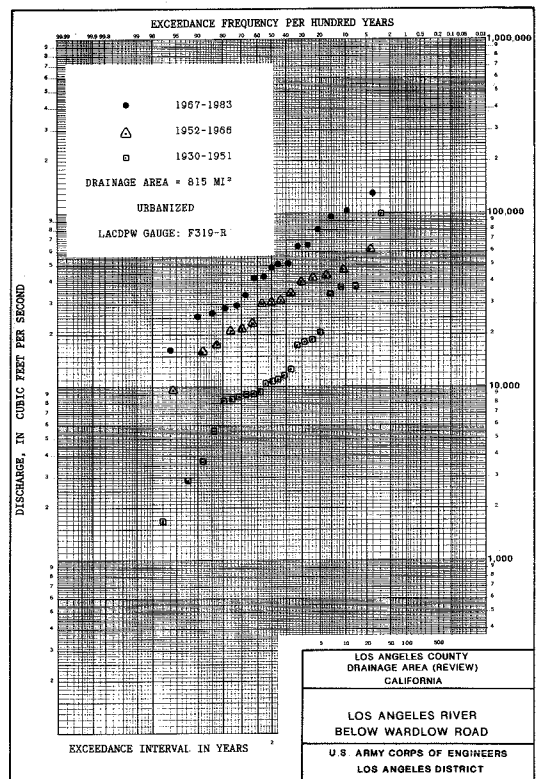

FIGURE 12

The station data for the 1966-1984 subset was assumed to fit a Log-Pearson Type III distribution (for evaluation purposes only), and the peak flows were plotted on log probability paper using median plotting positions. Computed and expected probability discharges were determined using statistical procedures (HECWRC-Flood Flow Frequency Analysis Program), as well as 5 percent and 95 percent confidence limits. The n-year peak discharges computed for the station locations using n-year runoff components, reservoir routing, and channel routing and combining (HEC-5), were plotted along with analytical results for the appropriate station. Subset comparisons for a few downstream controlled stations with sufficient length of record are displayed on figures 13, 14, and 15. In general, where effects of urbanization have been observed, the rainfall runoff results fit well within the current subset confidence limits. In some instances (which do not fit within a rigorous analytical frequency framework) upstream reservoir spills occur for large (rare) events, based upon rainfall runoff. In these cases the observed downstream data range does not reflect this possibility, and the sudden variation or departure from the norm (measured by the slope of the curve or standard deviation) of the computed rainfall runoff discharges, caused by the non-linear effects of spillway flow, results in peak flows beyond the upper bound of the confidence band (e.g., fig. 13, SGR above Coyote Creek). In other cases (e.g., fig. 14, WNRS Diversion), the simulated upstream reservoir operation limits releases for a wide range of floodflows, resulting in computed peak rainfall runoff discharges which are constant (departing from the analytical standard deviation), and thus fall below the confidence limits beyond the range of observed flows.

MAINSTEM LOS ANGELES RIVER RESULTS. The mainstem LAR gauged locations -- at Tujunga, above Arroyo Seco, at Firestone (above the Rio Hondo), and at Wardlow (below Compton Creek) - showed an increasingly consistent agreement between analytically derived results and rainfall runoff results. The upstream difficulties in matching computed and observed peak flow rates relate to the inability of the observed flood subset to predict the peak discharge relationship resulting from an upstream reservoir spill. These upstream spills (downstream of Hansen and Sepulveda Dams) have much less impact on peak flows as the comparison moves downstream and the uncontrolled tributary area increases. Thus, the nearly complete accord at Wardlow Road (fig. 15) between computed and observed peak flows is a strong indicator of the validity of the rainfall runoff results, and, coupled with the overall agreement between analytical and rainfall runoff results at other major tributaries below the COE flood control structures, provides high confidence in the base condition discharge frequency results and the ensuing problem identification.

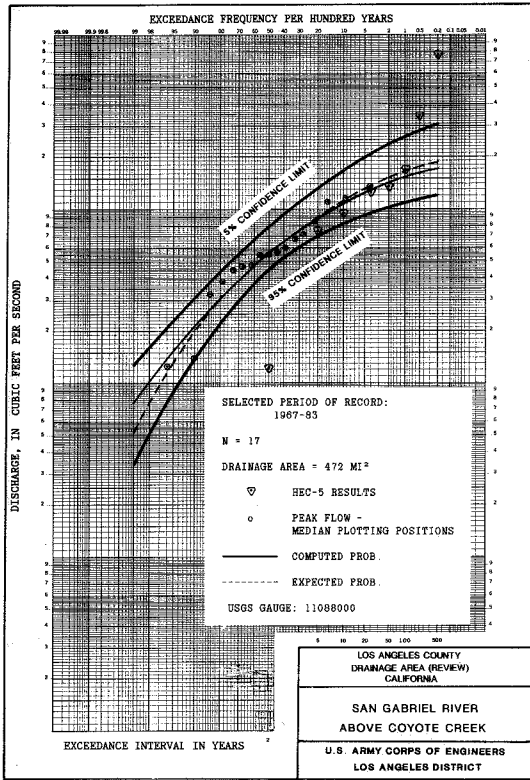

FIGURE 13

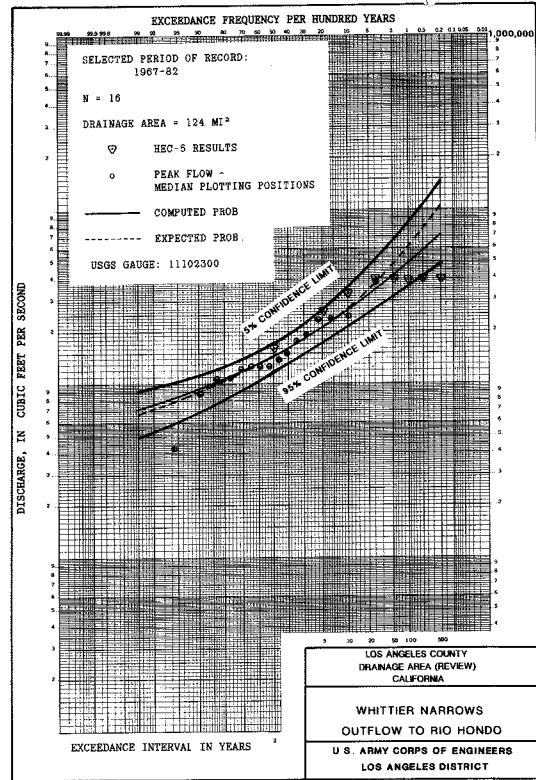

FIGURE 14

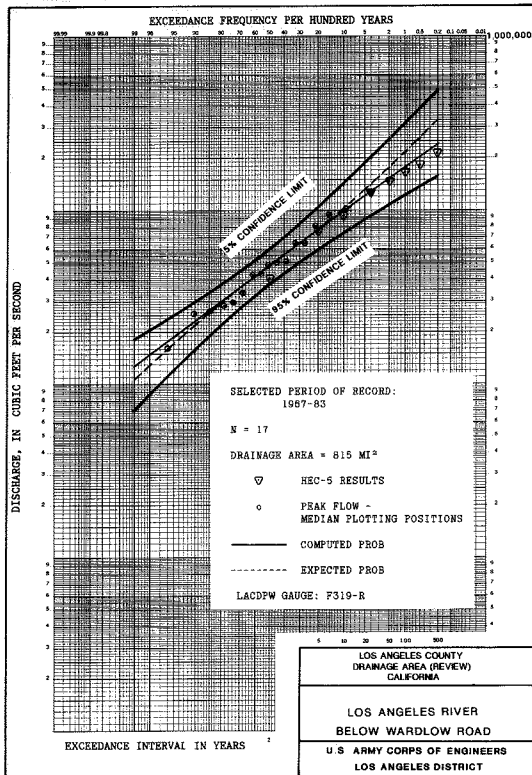

FIGURE 15

REFERENCES

1. Hydrologic Engineering Center, 1981. HEC-1, Flood Hydrograph Package, Users Manual. Davis, Ca.
2. Los Angeles District, U.S. Army Corps of Engineers. LAPRE-1 Users Manual, 22 October 1987 updated version.
3. Hydrologic Engineering Center, 1982. HEC-5, simulation of Flood Control and Conservation Systems Users Manual. Davis, Ca.
4. Hydrologic Engineering Center, October 1986. HEC-5, Exhibit 8 of Users Manual, Input Description. Davis, Ca.
5. Hydrologic Engineering Center, 1982. OPROUT Streamflow Routing Optimization Users Manual. Davis, Ca.
6. Hydrologic Engineering Center 1966. Technical Paper No. 2, Optimization Techniques for Hydrologic Engineer. Davis, Ca.
7. Los Angeles District, U.S. Army Corps of Engineers, May 1938, Flood Control in the Los Angeles County Drainage Area. Los Angeles, Ca.
8. Los Angeles District, U.S. Army Corps of Engineers 1939. Hydrology in the Los Angeles County Drainage Area. Los Angeles, Ca.
9. Los Angeles District, U.S. Army Corps of Engineers, 1944. Hydrology, San Gabriel River and the Rio Hondo Above Whittier Narrows Flood Control Basin. Los Angeles, Ca.
10. Los Angeles District, U.S. Army Corps of Engineers, April 1945. DPR - Whittier Narrows Flood.
11. Los Angeles District, U.S. Army Corps of Engineers, December 1944 (revised July 1946). Hydrology, San Gabriel River and the Rio Hondo above Whittier Narrows Flood-Control Basin with Addendum on the Hydrologic Effect of Diverting Outflow from Whittier Narrows Flood-Control Basin to Los Angeles River via the Rio Hondo.
12. Los Angeles District, U.S. Army Corps of Engineers, Dec. 1946. Restudy of Whittier Narrows Project and Alternative Plans for Flood Control.
13. Los Angeles District, U.S. Army Corps of Engineers, 1960. Hydrology for San Gabriel River, Whittier Narrows Dam to Pacific Ocean. Los Angeles, Ca.
14. Los Angeles District, U.S. Army Corps of Engineers, 1981. Los Angeles District Flood Hydrograph Package (LADFHP) Users Manual. Los Angeles, Ca.
15. Los Angeles District, U.S. Army Corps of Engineers, Dec. 1975. Operations and Maintenance Manual, Los Angeles County Drainage Area Project, Ca.

SUMMARY OF DISCUSSION

Compiled by A. S. Harrison¹

It was pointed out at the onset that upgrading the Los Angeles flood drainage system was potentially one of the most significant future flood control jobs for the Corps.

In response to a question about the accuracy of measured discharges in view of the fast-rising and fast-filling hydrographs, the speaker replied that these were concrete channels with stable rating curves that could be defined fairly accurately by measurements obtained over the years.

A question about how reservoir operation is now coordinated in the Los Angeles Basin, led to clarification of the objective of the current study and the constraints on effective flood control operation. It was brought out that one purpose of the study is a plan for operation of the reservoirs as a system rather than as individual reservoirs, as at present. Presently the reservoirs tend to be operated for the benefit of the reach just downstream at the expense of the main Los Angeles River Channel. A number of constraints, however, "cast a shadow" on the flood control improvement that might be achieved along the main stem of the Los Angeles River: (1) the channel capacity of the Los Angeles River with freeboard is deficient; (2) time of travel is too rapid for prediction and effective reservoir operation decisions (see figure 3 in the paper); the L. A. County Flood Control District has water supply as well as flood control objectives which may be in conflict with the Corps' flood control objective.

Concerning future watershed conditions, the speaker pointed out that little future urban development is predicted, except for the sub-watershed above Sepulveda Dam.

Concerning the status of the study, it was started in 1984 and continues. Two related studies have been funded separately, a system modeling study (the subject of this paper) and a reservoir regulation study.

There was agreement that a rainfall runoff model, when calibrated against observed events, can be used to simulate the outflows from other specific rainfall events. A heated debate followed, however, on the validity of deriving a discharge frequency curve by running the rainfall for each frequency through a watershed runoff model. This assumes, for example, that the 100-year rainfall produces the 100-year discharge at a downstream point. Some argued that this cannot be true because similar rainfalls on a watershed often produce different runoff responses, depending on the condition of the watershed. Furthermore, the rainfall rarely is conveniently distributed evenly over the watershed which is the usual assumption when producing discharge frequencies from rainfall frequencies. They argue that the present practice is only a convenient but unproven expedient. The advocates of the method argued that the use of rainfall frequencies with uniform rainfall distribution is an averaging process that seems to produce reasonable results

¹Chief, Technical Engineering Branch, Missouri River Division

when model outputs are calibrated and adjusted against known discharge-frequency relationships. The use of rainfall runoff models in this manner to produce discharge frequency curves is prevalent in the Corps. It would seem that development of rainfall runoff modeling techniques to produce discharge frequencies is a ripe subject for research by HEC.

Another question raised was the validity of using expected probability adjustments to frequency curves derived from runoff modeling. Expected probability originally was a refinement of the statistical analysis of a set of annual peak discharges with a limited length of record.

URBAN WATERSHED MODELING WITH HEC-1 KINEMATIC WAVE

By

Gary W. Brunner¹

Introduction

Purpose. The purpose of this study was to review an application of the HEC-1 kinematic wave runoff model to the Las Vegas Basin in Nevada. The Las Vegas watershed model was developed by a consulting firm as part of a Master Plan Drainage study for Clark County, Las Vegas. Specifically this report provides information on the applicability of the kinematic wave model for a feasibility-level study.

Objectives. The objectives of this study were: to become familiar with the hydrology of the Las Vegas Basin; to review the assumptions and methodologies that were used to develop the HEC-1 model; to analyze and evaluate the kinematic wave parameters that were chosen for subbasin runoff; and finally, to make recommendations on how the model could be improved for use in an urban drainage study.

Key Issues. The key issues centered around the evaluation of the model's capability to provide a good representation of the watershed's physical processes. This entailed the following: 1) checking to see if the kinematic wave elements were used in the proper fashion to represent subbasin runoff in an urban setting; 2) testing the validity of using the kinematic wave equations in a flat area like Las Vegas; 3) making sure that kinematic wave channel routing was not used in problem areas where flows could go out of bank or where backwater problems could occur; and 4) evaluating the choice of the computation interval to ensure that the solution of the kinematic wave equations was accurate.

Physical Setting and Available Data

General Description of the Watershed. The Las Vegas Basin is located in Clark County, the southernmost portion of Nevada. The basin is surrounded by steep mountain ranges that generally run north to south. The watershed is approximately 30 miles wide (east to west) and 50 miles in length with a drainage area of 1,590 square miles. The runoff from Las Vegas Wash goes directly into Lake Mead, a man-made lake created by Hoover Dam. The Las Vegas

¹Hydraulic Engineer, The Hydrologic Engineering Center, U.S. Army Corps of Engineers.

Wash, a typical ephemeral desert stream, originates in the mountains of the north-west corner of the basin and flows generally south-east. The principal tributaries of the main stream are Tropicana Wash, Flamingo Wash, Range Wash, Pittman Wash, and Duck Creek. The gradient of the streams ranges from about 400 feet per mile in the mountains to about 25 feet per mile in the vicinity of Las Vegas.

At the base of the mountains are alluvial fans comprised of well graded gravels, sand, silt, and caliche, with coarser material predominating. The central valley floor consists of unconsolidated alluvial materials and dense lacustrine silts and clays. Most of the high mountain areas are covered with dense brush and trees, while the valley is typical of a desert region and consists of varieties of yucca, cactus, mesquite, creosote bush, tamarisk, and sagebrush.

The climate in Las Vegas is arid, with hot dry summers and mild winters. Precipitation results from mild winter storms and occasional heavy thunderstorms in the summer. The mean seasonal precipitation in Las Vegas and vicinity ranges from about 4 inches in the southeastern part of the valley to more than 20 inches atop Charleston Peak in the Spring Mountains.

The Las Vegas area is currently undergoing intensive urbanization. Future growth (year 2055) is predicted to be the effective topographic limits of construction. That is, future development will cover the entire valley floor.

None of the watercourses in the Las Vegas Basin flow perennially from natural runoff. Generally, runoff occurs only during and after precipitation events. Significant runoff can occur during the summer from heavy thunderstorms. Stream channels are well defined in the mountain ranges, but upon reaching the valley transition they spread out over the alluvial fans, becoming braided and poorly defined. Several detention structures have been built to capture the runoff coming off of the alluvial fans before it reaches the urbanized area. Within the valley, development has taken place along the washes with no systematic engineering considerations, until recently. Highway embankments and bridges have caused significant obstructions to flow, and have forced the design of more efficient channels.

Available Data. Precipitation records are available for 19 gages in and near the watershed, of which only 11 are currently operating. Two of the precipitation sites have recording gages, Las Vegas WB AP (McCarran Airport) and the Las Vegas gage (recording only from 1939 to 1943). Streamflow records are available for 19 gages within the Las Vegas basin, of which six are recording type gages. The longest available record is at Las Vegas Wash near Henderson, which has 31 years of record (1957 to 1988).

Nearly all of the major historical runoff events have resulted from local summer thunderstorms. There are only a few historical thunderstorms for which total storm precipitation data were sufficient to prepare an isohyetal analysis. However, streamflow data has been limited due to unreliable stage estimates during the events. Therefore, adequate rainfall and runoff records that could be used in calibration are available for only one historical event.

Study Approach

Procedures Adopted. The Las Vegas watershed is a very large and complex basin. An in-depth review of each subbasin would be very time consuming and costly. Given the constraints of this project (time and money), the HEC's approach was to select several subbasins and routing reaches with varying hydrologic responses, and to analyze them in detail. Evaluations are also made of the modeling approach in general, but in-depth comparisons of the kinematic wave parameters were limited to the selected subbasins and routing reaches chosen.

Five subbasins were chosen on the basis of hydrologic variability. These subbasins consist of two fully urbanized catchments, two partially urbanized catchments, and one catchment that was completely undeveloped. Two of the subbasins, Flamingo Wash and Tropicana Wash, were chosen for their history of flooding problems.

Analysis of these five subbasins consisted of the following procedure:

1. Evaluate and choose kinematic wave parameters for each subbasin using the data provided (topographic maps and aerial photos).
2. Compare these parameters with those chosen by the contractor on the basis of applicability to the actual physical characteristics of each subbasin.
3. Develop HEC-1 models for HEC's and the contractor's chosen values for each subbasin and apply the 1% chance, 3-hour rainfall event.
4. Compare the resulting hydrographs for differences in peak flow, timing, and hydrograph shape.

Three routing reaches were chosen for detailed study: Flamingo Wash, Tropicana Wash, and the Gravel Pits. As mentioned previously, these three reaches have a history of flooding problems with flows going out of bank due to constrictions.

It should be noted that the results of this study were not based on comparisons with gaged data. Rather, they were based on the HEC's experience in watershed modeling and knowledge of the HEC-1 program. Therefore, the comparisons between resulting hydrographs are used to provide insight into any differences that may occur between the contractor's model parameters and the HEC's. Also, differences in modeling approaches are evaluated on the same basis.

Key Assumptions. The kinematic wave method is a quasi-physically based overland and channel routing procedure, in which model parameters can be chosen directly through the use of topographic maps, aerial photographs, land

use and soils information. This method is considered physically-based because it uses the principles of continuity and energy to model the flow process. The method is not completely physically based (i.e. quasi) because several approximations are made in solving the equations and the parameters of the model are chosen in a conceptual manner. HEC-1's overland kinematic wave routing scheme utilizes the following data parameters:

- L = Overland flow length (ft)
- S = Representative slope (ft/ft)
- N = Roughness coefficient
- A = Percentage of subbasin area that the element represents (percent)

HEC-1's kinematic wave channel routing capabilities can be used either in conjunction with or separately from the overland flow portion of the model. The parameters used for kinematic wave channel routing are the following:

- L = Channel length (ft)
- S = Channel slope (ft/ft)
- n = Channel roughness (Manning's n)
- CA = Contributing area to a typical collector (sq mi)
- SHAPE = Shape of the cross section (trapezoidal, triangular, rectangular, circular)
- WD = Channel bottom width or diameter (ft)
- Z = Side slope, horizontal to vertical

All of the above parameters were evaluated for reasonableness in comparison to each subbasin's physical characteristics.

The kinematic wave method differs from traditional unit hydrograph theory in many ways. First, the method takes a distributed view (a more physically complete conceptualization) of a subbasin rather than a lumped parameter approach. The distributed viewpoint allows the model to capture the different responses of pervious and impervious surfaces within a single subbasin. Secondly, the kinematic wave technique produces a nonlinear response to rainfall excess, while the unit hydrograph is a linear model.

Study Results

Summary of Results. Kinematic wave parameters for each of the five subbasins were calculated and compared to those obtained from the contractor's model. In general the average land slopes, roughness values, and percent imperviousness were approximately the same. The only major difference was in the estimate of the overland flow lengths. This was, for the most part, due to the fact that the contractor did not use two overland flow planes to model the pervious and impervious areas separately. Therefore, the contractor's overland flow lengths represent the average of both surfaces. Impervious surfaces (i.e., rooftops, driveways, parking lots, and streets) tend to have much shorter overland flow lengths and lower roughness values than pervious surfaces. Because of this, water flowing over impervious surfaces will get to a channel much quicker than flow from pervious surfaces. Pervious and

impervious surfaces generally have different response times, and should be modeled separately. This does not mean that a gaged hydrograph could not be reproduced by only using one overland flow plane. It just means that the actual processes would be better represented by separating the two surfaces.

When modeling a subbasin with one plane, losses and rainfall excess are calculated with the impervious area being expressed as a percentage of the subbasin. The rainfall excess is then distributed evenly across the whole subbasin area. When separating the two surfaces, the impervious plane will have rainfall falling on to the area associated with that surface alone. While the pervious area will have losses extracted, then the remaining rainfall excess is applied to the pervious plane. In the two-plane case there is no lumping of the net rainfall excess across the whole subbasin area. The rainfall excess at the beginning of a storm is usually due only to the impervious area, while initial losses are being satisfied on the pervious areas. If the rainfall excess is lumped together and distributed across the whole subbasin area, the intensity of that rainfall excess is decreased. Separating the two planes will keep the rainfall intensity intact for each area throughout the storm.

Kinematic wave stream routing parameters for each of the subbasins were also analyzed. In general, the parameters that the contractor picked were very similar to those chosen by HEC. However, there were some differences in the shape and size of the channels. The original model's collector and subcollector channels were very wide trapezoids. Experience has shown that water tends to collect towards the sides of the street due to the natural crown of the road. This process is especially true at the subcollector level, where there is usually not enough flow to cover the whole street. In this case a more reasonable approximation of the channel would be to model the gutter with a triangular cross section. If there is enough flow to cover the whole road, then a wide rectangular channel, such as the shapes that the contractor used, would be the best approximation.

After comparing the kinematic wave parameters qualitatively, the differences in modeling approaches were determined by comparing runoff predictions. An HEC-1 model was developed for the five subbasins analyzed. This model included the parameters that the contractor estimated and the same subbasins with the parameters that HEC estimated. The 1% chance, 3-hour storm event was applied to each subbasin. Losses were extracted using an initial and constant loss procedure. Table 1 contains the rainfall and losses for each of the subbasins modeled. The rainfall and losses were taken straight from the model, except for the losses concerned with Subbasin R-5. Subbasin R-5 has estimated losses that exceed the 1% chance rainfall event. Therefore, this rainfall event and estimated loss values would produce zero runoff for Subbasin R-5. In order to compare the parameters chosen for R-5, a hypothetical storm event of 1.0 inch rainfall excess, distributed over 5 hours, was applied to this basin alone.

Table 1.

Rainfall and Loss Rate Values

<u>Subbasin</u>	<u>1% Chance Rainfall (in)</u>	<u>Initial Loss (in)</u>	<u>Constant Losses (in/hr)</u>
B-20	1.40	0.96	0.18
CE-8C	1.46	0.70	0.13
F-15	1.46	1.08	0.20
T-10	1.46	0.82	0.18
*R-5	1.0	0.0	0.0

* One inch of rainfall excess over five hours, not the 1% chance event for this basin.

Figures 1 through 4 show extreme differences in the resulting runoff hydrographs. These differences are for the most part due to the fact that the contractor did not separate the pervious and impervious areas into two overland flow planes. In the case of urbanized subbasins, such as B-20 and CE-8C, the major contributor to the runoff hydrograph is the impervious surface. Impervious surfaces tend to have high peaking, quick responding hydrographs. As shown in Figures 1 and 2, the HEC hydrographs had a much higher peak flow, and the time to the peak was much shorter. For the 1% chance storm event and loss values used in this comparison, the pervious areas will not contribute very much runoff to the resulting hydrographs. Therefore, the resulting hydrographs are very dependent upon the parameters chosen for the impervious areas. Since the contractor did not separate the two surfaces, the average parameters they chose did not reflect the impervious surfaces, which are the major contributors to the runoff hydrographs for subbasins B-20 and CE-8C.

For the partially urbanized subbasins (F-15 and T-10), the impervious area does not account for as high of a percentage of the resulting hydrograph as the impervious area did in the fully developed basins. Subbasin T-10 has only about 10 percent of the area that is impervious. For this subbasin both pervious and impervious areas will contribute to the resulting hydrograph. As shown in Figure 3, the contractor's hydrograph had a higher peak than the HEC hydrograph, but the time to peak was much later. Subbasin F-15 has around 15 to 20 percent impervious area. As shown in Figure 4, the HEC hydrograph rises sooner and has a higher peak. In this case the higher peak could be due to the fact that HEC estimated the subbasin as being 20% impervious while the contractor estimated 15%. The difference in timing of the peaks is due to the way losses and rainfall excess are accounted for by each method.

COMPARISON OF KINEMATIC WAVE SUBBASINS
 100 yr. 3-hr Storm Event With Losses
 SUBBASIN B-20

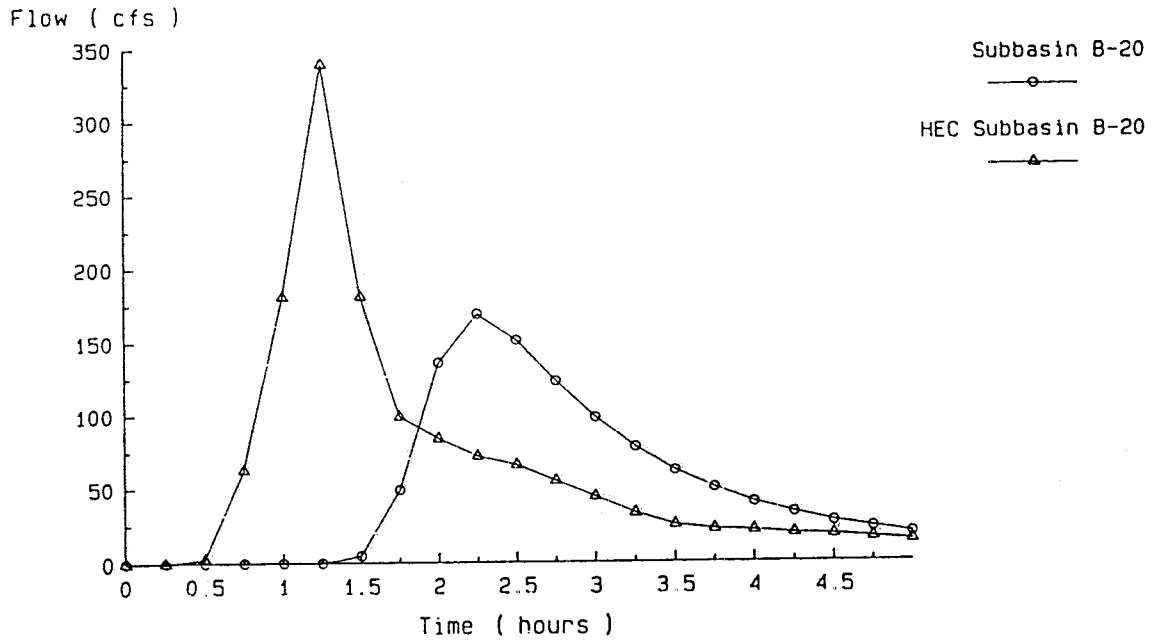

Figure 1. Subbasin B-20 (fully urbanized) runoff comparison.

COMPARISON OF KINEMATIC WAVE SUBBASINS
 100 yr. 3-hr Storm Event With Losses
 SUBBASIN CE-8C

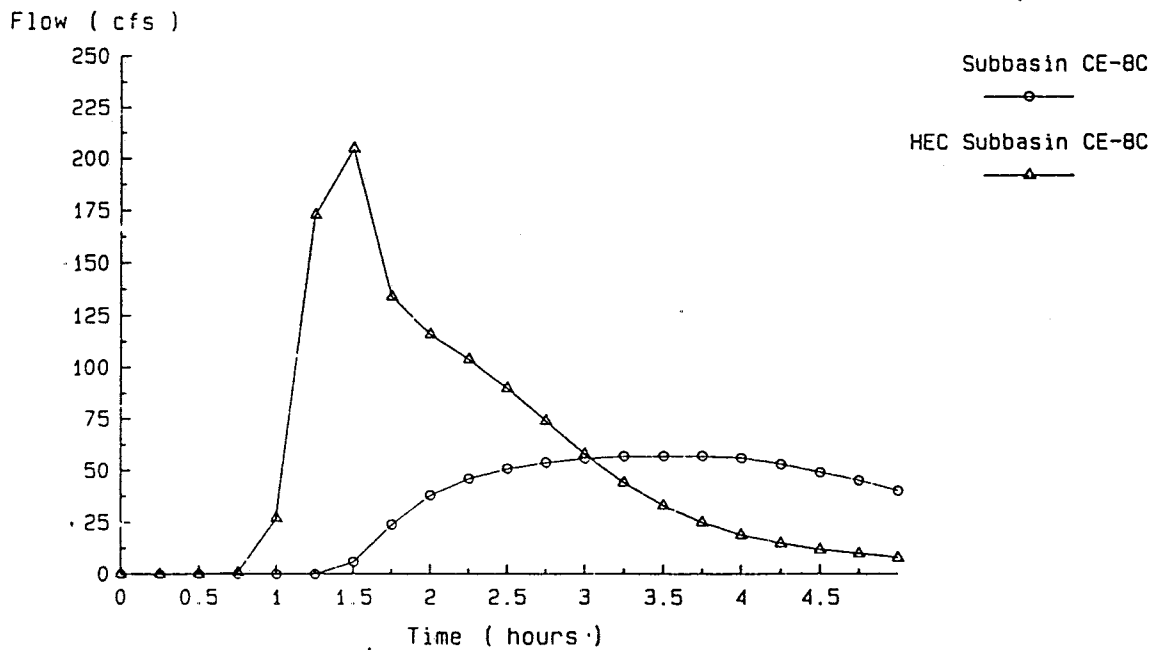

Figure 2. Subbasin CE-8C (fully urbanized) runoff comparison.

COMPARISON OF KINEMATIC WAVE SUBBASINS
 100 yr. 3-hr Storm Event With Losses
 SUBBASIN T-10

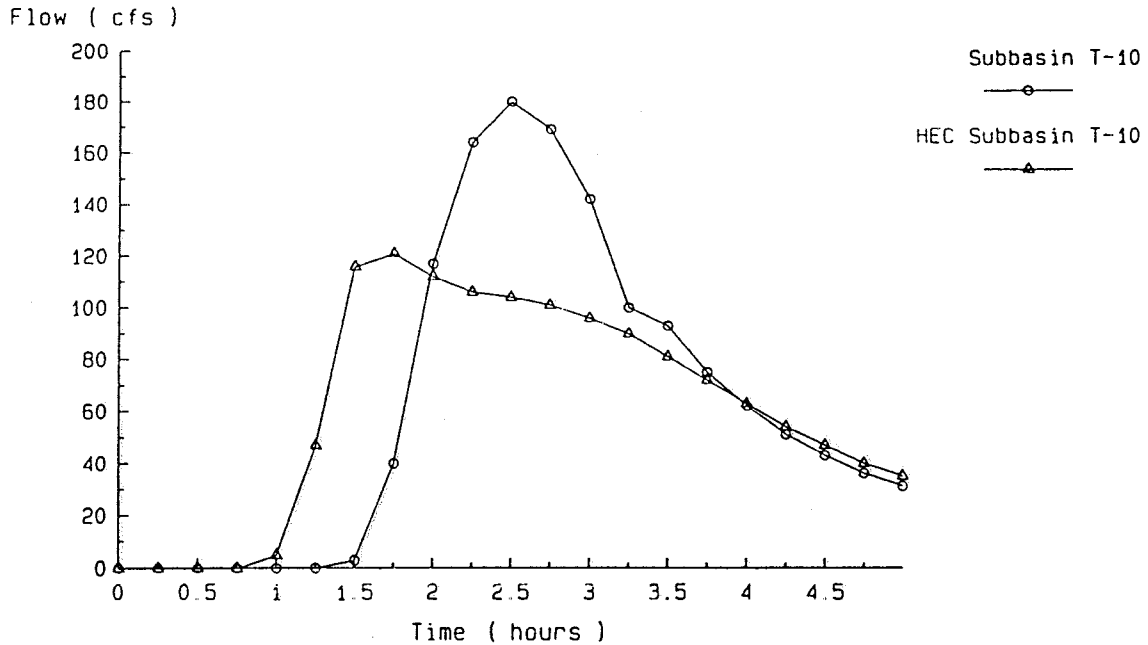

Figure 3. Subbasin T-10 (partially urbanized) runoff comparison.

COMPARISON OF KINEMATIC WAVE SUBBASINS
 100 yr. 3-hr Storm Event With Losses
 SUBBASIN F-15

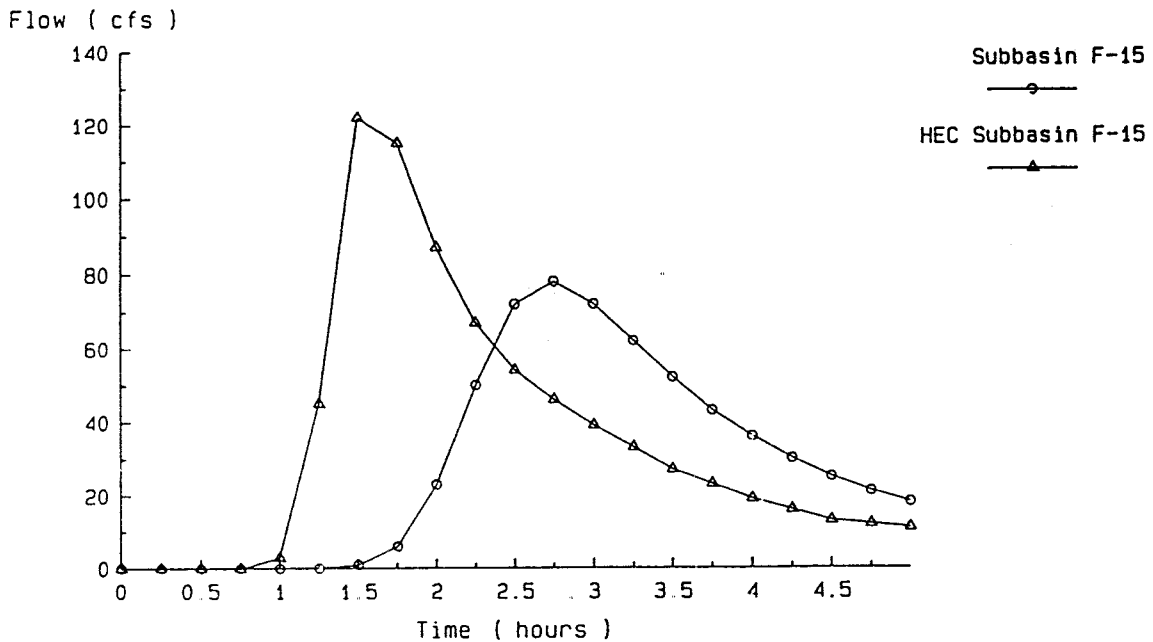

Figure 4. Subbasin F-15 (partially urbanized) runoff comparison.

COMPARISON OF KINEMATIC WAVE SUBBASINS
1 in. of Rainfall Excess Over 5 Hours
SUBBASIN R-5

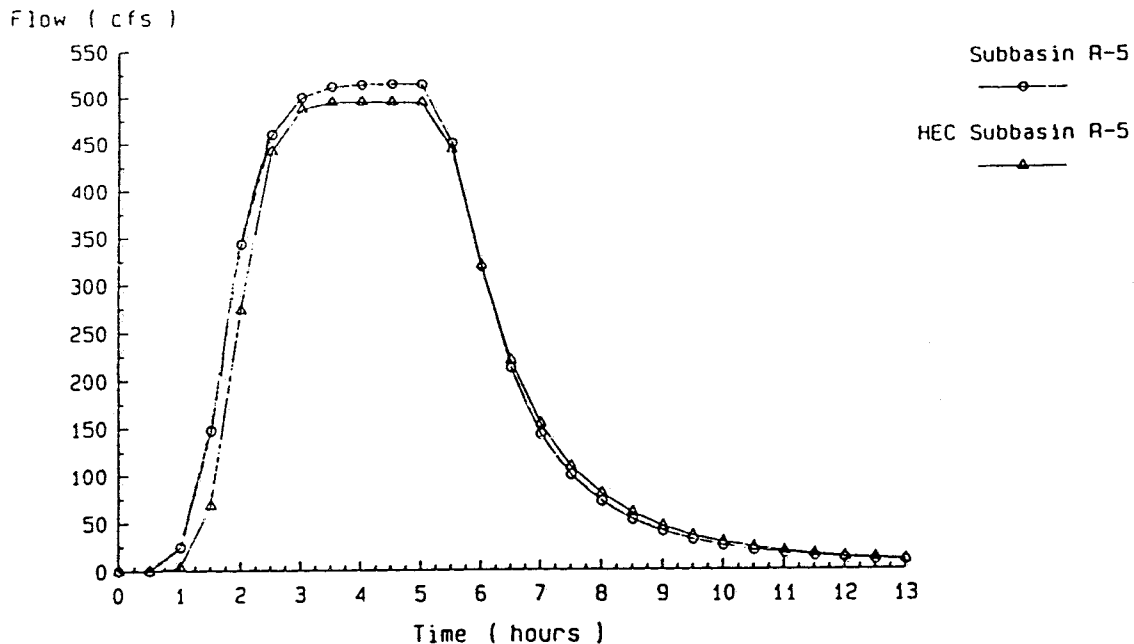

Figure 5. Subbasin R-5 (non-urbanized) runoff comparison.

Subbasin R-5 has zero percent impervious area. Because the basin is completely homogeneous, one overland flow plane would be sufficient to model this subbasin. HEC's values were very similar to the contractor's, as a result the two hydrographs produced from the one inch of rainfall excess were extremely close (Figure 5).

The next area of concern was to check if the kinematic wave equations apply in a flat area such as Las Vegas. The basis of the kinematic approximation is that the force of gravity is equal to the frictional forces acting on the water, and that their magnitude is greater than any other forces. As the bed slope decreases, the force due to gravity also decreases. Therefore, in a flat area the kinematic approximation should be checked to ensure its applicability. This can be checked by applying Woolhiser and Liggett's (1967) formula for overland flow, and also Ponce's (Ponce, et al., 1978) equation for channel flow. The equations must be satisfied or the kinematic approximation will not apply.

Overland Flow

$$K = \frac{g S L}{V^2} \geq 10 \quad (\text{Woolhiser \& Liggett's equation})$$

where: g = Acceleration due to gravity
 V = The average velocity of the peak flow rate
 S = Slope of overland plane
 L = Length of overland plane

The worst case in Las Vegas would be a very flat surface with a short overland flow length, such as the impervious roads, driveways, and parking lots. Some extreme values for Las Vegas are the following:

$S = 0.001$ (lowest possible)
 $L = 40$ ft (shortest possible)
 $N = .01$ (lowest possible)
 $i = 1.0$ in/hr excess (high rainfall excess)

$$Q_{\max}/ft = i L = \frac{(1.0 \text{ in/hr})(40 \text{ ft})}{(3600 \text{ sec/hr})(12 \text{ in/ft})} = .00093 \text{ cfs/ft}$$

$$(Q_{\max}/ft) W = \frac{1.49}{n} AR^{2/3} S_o^{1/2}$$

where: $R \approx Y$ (wide channel assum.)
 $A = Y W$

$$Q_{\max}/ft = \frac{1.49}{n} Y^{5/3} S_o^{1/2}$$

$$Y = 0.00599 \text{ ft of water}$$

$$V = \frac{Q}{A} = \frac{Q_{\max}/ft}{Y} = \frac{.00093 \text{ cfs/ft}}{.00599 \text{ ft}} = 0.155 \text{ ft/sec}$$

$$K = \frac{g S_o L_o}{v^2} = \frac{(32.2 \text{ft/sec}^2) (.001) (40 \text{ft})}{(.155)^2} = 53.6$$

$$K = 53.6 \geq 10 \quad \text{"OK"}$$

This shows that the kinematic approximation applies to the worst condition possible in Las Vegas for overland flow. Therefore, it can be assumed that it will apply anywhere in Las Vegas.

Channel Flow

$$\frac{T S V}{Y} \geq 171 \quad \text{(Ponce's Equation)}$$

where: T = Time base of hydrograph in seconds
 S = Slope ft/ft
 V = Average velocity ft/s
 Y = Depth ft

The worst conditions for Las Vegas are:

T = 12 hrs (3 hr storms were used in model)
 = 43,200 seconds (from small subbasins)

$S_o = .002$ (very mild slope)

$V_o = \text{assume } 2 \text{ ft/s}$ (very slow velocity)

Y = 3 ft (depth)

$$\frac{T S_o V_o}{Y} = \frac{(43,200) (.002) (2)}{3} = 57.6$$

57.6 < 171 No good, could have problems.

There could be some problems for the areas that have a very mild slope when routing a high peaking, short time base hydrograph. This should be looked at closely for each channel in the flat areas. However, the kinematic approximation seems to be applicable for most of the study area.

Three of the problem areas were checked to see if the parameters were within the limits of the kinematic wave method. These areas were Flamingo Wash (F-13 and F-16), Tropicana Wash (T-10), and the Gravel Pits (R-6, F-8). For all of the areas the following was assumed:

$$T = 12.0 \text{ hrs} \quad (\text{Time base of hydrograph})$$

The depth and velocities were calculated with Manning's equation, using the peak flows from the 1975 calibration event. Ponce's criteria for stream routing was then applied:

Area	T	S _o	n	Q	Y	V _o	T S _o V _o
							Y
Flamingo Wash	12	.008	.020	4562	4.05	15.5	1327
Tropicana Wash	12	.0139	.029	2881	5.80	16.0	1663
Gravel Pits	12	.010	.030	3475	6.10	13.4	950

As shown in the above table, all of the parameters used by the contractor in these areas are within the limits of the kinematic wave approximation for channel routing.

In general, kinematic wave routing is most appropriate for prismatic channels (such as pipes, concrete lined channels, etc. . .) that have little storage within reaches or have little possibility of flowing out of bank. The kinematic wave method does not account for storage within a reach or for overbank flows. When analyzing a reach that will attenuate a hydrograph due to large amounts of storage, flows going out of bank or flows affected by backwater, it would be more appropriate to use an alternative routing method that can account for this, such as the Modified Puls technique.

For some of the areas in the Las Vegas Basin, such as Tropicana Wash and Flamingo Wash, Modified Puls routing would be more appropriate than kinematic wave routing. The data needed for this method would consist of discharge vs. storage curves for the specific reach and an estimate of the number of routing steps (NSTPS) to use. The discharge vs. storage curves can be obtained from HEC-2 simulations at several flow levels. The number of steps (NSTPS) is normally a calibration parameter. Using NSTPS = 1 would represent a reservoir situation, where water would pond due to some control structure. As NSTPS

becomes very large the resulting hydrograph will have less attenuation and will converge towards the kinematic wave solution. If gaged data were available the value of NSTPS could be calibrated. In the ungaged case, a value for NSTPS will have to be estimated on the basis of experience and engineering judgment. For situations where severe backwater problems are occurring, NSTPS will be very close to or even possibly equal to 1.

One other analysis was made to make sure that the kinematic wave scheme was being used correctly. The contractor used a time step of $\Delta T = 5$ minutes in all calculations. The choice of this time step can be very crucial to the peak flow of the resulting hydrographs. To ensure that a time step of 5 minutes was adequate, a run with $\Delta T = 2$ min. was made. The resulting hydrographs were virtually the same. Since there is no significant difference between the hydrographs, a time step of $\Delta T = 5$ min. was assumed to be adequate.

Basis for Validity of Results. As mentioned previously, the results of this study were not based on comparisons with gaged data. Rather, they were based on the HEC's experience in watershed modeling and knowledge of the HEC-1 kinematic wave procedures. Therefore, the comparisons between model parameters and resulting hydrographs were used to provide insight into any differences between the contractor's modeling approach and the HEC's.

Upon completion of this project, the Las Angeles District modified the contractor's model in accordance with the recommendations of the HEC. The model was calibrated to a single storm event by modifying loss rate parameters. Verification of the model was accomplished through comparisons with frequency curves from gaged locations. Hypothetical storm events were derived for the 10%, 2%, and 1% chance events. The three storm events were then simulated with the calibrated model and peak flows were calculated at gaged locations. The derived peak flows were compared to discharge frequency curves at gaged locations. Shown in Figure 6 is an example plot for the Flamingo Wash gage. The kinematic wave model produced similar results to the gaged frequency data, and was therefore considered adequate for a feasibility level study.

Summary and Conclusions

A kinematic wave model for the Las Vegas Basin was evaluated with an in-depth analysis of the kinematic wave parameters for five subbasins and three routing reaches. After completing this in-depth analysis the following recommendations were made to the Los Angeles District:

1. For the urban and partially urban subbasins, the pervious and impervious areas should be treated with separate overland flow planes in order to model their responses more accurately.
2. For those areas in which flows will go out of bank, or where there is a significant amount of channel storage, kinematic wave channel routing should not be used. Rather, it would be better to use some

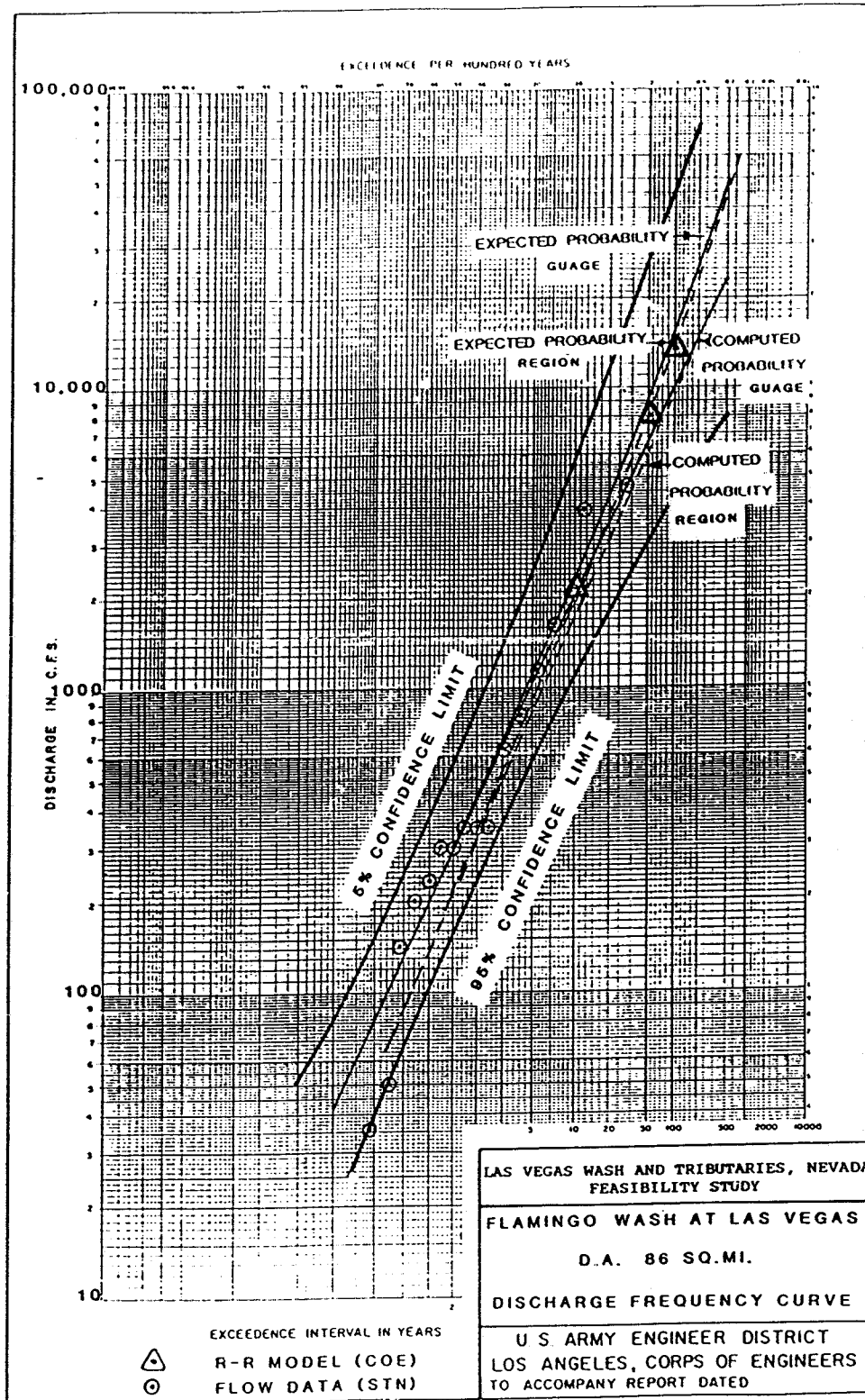

Figure 6. Comparison of kinematic wave model to gaged frequency curves.

type of routing method that can account for overbank and in-channel storage, such as Modified Puls Routing. Also, for those areas in which a culvert or a bridge is creating a backwater problem, due to the fact that its capacity has been reached, it would be much better to model this as a reservoir, with Modified Puls Routing, rather than to use kinematic wave routing. For areas such as Flamingo and Tropicana Wash, use kinematic wave routing for the local subarea runoff, but use Modified Puls to route the upstream hydrograph through the reach. Then combine the two hydrographs at the outlet. There is no reason to stay with one routing method throughout an entire basin model, unless there are similar types of channel flow in every subbasin. In general, picking the most applicable method for each individual routing reach is suggested.

3. When modeling flow down streets with collectors, it is generally more appropriate to use a triangular channel than a wide, rectangular channel. It would be appropriate to use a rectangular channel if there were enough flow to cover the whole road.

V. REFERENCES

1. Evelyn, Joseph B., 1988. "Hydrologic and Hydraulic Analysis for Las Vegas Wash and Tributaries, Nevada," Presented at the August 1988 seminar on Flood Damage Reduction for Reconnaissance Phase Studies, Los Angeles District, U.S. Army Corps of Engineers, Los Angeles, CA.
2. Los Angeles District, U.S. Army Corps of Engineers, April 1988. "Hydrologic Documentation for Feasibility Study, Las Vegas Wash and Tributaries, Clark County, Nevada", Los Angeles, CA.
3. Ponce, V.M., Li, R. M., and Simons, D. B., 1978. "Applicability of Kinematic and Diffusion Models," Journal of the Hydraulic Division of the American Society of Civil Engineers, V. 104, HY3, pp. 353-360.
4. U.S. Army Corps of Engineers, 1985. "HEC-1 Flood Hydrograph Package," User's Manual, The Hydrologic Engineering Center, Davis, California.
5. Woolhiser, D. A., and Liggett, J. A., 1967. "Unsteady, One-dimensional Flow Over a Plane: The Rising Hydrograph," Water Resources Research, V. 3, No. 3, pp. 753-771.

Urban Watershed Model With HEC-1 Kinematic Wave

by

Gary W. Brunner

SUMMARY OF DISCUSSION BY S. K. NANDA

There were questions regarding consistency of the assumption of the overland flow length. Different modelers could arrive at different flow lengths. The author agreed and pointed out that, in his comparison of the results, this assumption contributed to the major differences. The contractor's overland flow lengths were lumped for pervious and impervious areas which sacrificed the distributed viewpoint of the method.

There was a comment about the K value for flat slopes. Even at $K=10$ there could be 10 percent difference in results by eliminating the dynamic terms in the momentum equation.

MRD representatives mentioned that they have considerable experience in routings and have modified the SWMM model for better accuracy. Apparently, by keeping overbank flows separate from the channel flows, there is better control in the flood routing process. When the friction slope is equal to bed slope, the problem simply reduces to storage routing in a system of linear reservoirs. The kinematic wave routing model will develop problems for the areas with very mild slope and with fast rising, short time-base hydrographs. The author recommended the use of modified Puls method for the cases where the flows go out of bank or where there is significant amount of channel storage.

S. K. Nanda, Hydraulic Engineer, Rock Island District Corps of Engineers

A Comparative Analysis of
SWMM and HEC-1 Applications

by

Wallace R. Stern ¹

1. In addition to providing a comparative analysis of using SWMM and HEC-1 for a flood control study of Perry Creek, Iowa, this report presents some of the background information that was used to develop the logic that SWMM can be used for watersheds that are not necessarily urbanized or have drainage area sizes that exceed 5000 acres. The key issue in this analysis was the selection of methods used to determine the effects of two dams (see Attachment 1) that were being considered in connection with a channel improvement and an underground tunnel (see Attachment 2) to solve all flooding problems up to the 100-year level through Sioux City. It was determined with this study that SWMM is a valid tool for evaluating controlling effects of reservoirs on downstream flood peaks.

2. Perry Creek basin is a left bank tributary of the Missouri River located in northwestern Iowa. It has an average width of about 3 1/2 miles and a length of 20 miles. Its drainage area at the mouth is 72 square miles. General basin topography varies from moderate to steeply rolling hills in the upstream portion to rugged, steeply sloping bluff land in the lower portions of the basin. Slopes along the main channel increase from 10 to 14 feet per mile while moving upstream. Average flood plain widths vary from 500 feet about a fifth of the way up the basin to 2000 feet near the mouth. Drainage channels in the lower part of the basin are well defined. The largest flood of record in the Perry basin occurred in July 1944 when a late afternoon to early morning thunderstorm produced a basin average rainfall of 5 inches. Although the 38th street gaging station had been operating as a crest station since 1939, this event destroyed the gage and a peak stage of 25.5 feet and a peak discharge of 9600 c.f.s. were estimated from high-water marks. The second largest flood of record occurred 10 September 1949 when after heavy general rains on the 3, 4 and 5th of September an intense rainfall of over 4 inches covered the entire Perry Creek basin. The USGS gaging station at 38th street which had been converted to a recorder in 1945 stayed put and valuable information on the flood characteristics of the basin became available. This gage remained in operation as a recorder until 1969.

3. Although the key issue in this analysis was the selection of a procedure to properly evaluate the controlling effects of two dams proposed for the Perry Creek basin, a discussion of the circumstances leading up to this issue is necessary to understand why this issue even arose. In preparing the original scope of work for that portion of the Sioux City Metro Study, which included Perry Creek, the locals had expressed an interest in developing a flood control plan with dams. They

¹ Chief, Hydrology & Meteorology Section, Omaha District, Corps of Engineers

were interested in small SCS type structures located throughout the basin. As a result preliminary plans were developed to look at 23 dams and 120 dams (see Attachment 3). In this regard it looked like the hydrologic modeling process used by SWMM would be ideal, particularly, since we had worked with this model earlier in making studies of the South Platte River through Denver. As a result of the Denver studies, deficiencies were encountered and corrected in the following manner. The ability to add overbank floodway sections to either gutters or pipes was included in the program. The ability to add a detention dam to gutter or pipe section was included. The infiltration loss algorithm was changed to limit the magnitude of the loss rate to no more than the rainfall specified for any given period, except when rainfall stops, then 5% of the infiltration rate is applied to the runoff volume.

Although the following calibration steps were taken to verify the Perry Creek SWMM, when the issue of the validity of the controlling effects of the remaining two dam plan arose, additional verification was requested.

RECONSTITUTION OF 1949 FLOOD

The 1949 flood on Perry Creek recorded at the 38th Street gage was selected for use in calibrating the SWMM model because of the magnitude and spatially uniform rainfall that produced it. A reasonably good reconstitution of this flood using the model is shown on Attachment 4. The time variation of the storm over the entire basin was based on the rainfall recorder located 4 miles west of Hinton, Iowa. The infiltration index for this basin (Missouri River Basin Comprehensive Infiltration Index) begins at 0.6 inch per hour; however, a rate of only one-fourth of an inch per hour was required to make the model runoff comparable to the actual event. Since the storm period causing the flood was preceded by significant rainfall amounts, a few days earlier, the high antecedent moisture condition in the basin provides a logical explanation for the lower loss rates that prevailed during this flood event.

RECONSTITUTION OF COMPUTED DISCHARGE FREQUENCY CURVE

The 31-year record of peak annual discharges on Perry Creek at the 38th Street gage was used to develop a discharge-probability curve for Perry Creek at this location. Development of the curve was based on a computerized analysis which uses the procedures recommended in the Water Resources Council (WRC) Bulletin No. 17, including expected probability and confidence limits. These results shown on Attachment 5 were also used to calibrate the SWMM model at the 38th street gage site. The change in urbanized development for the record period from 1939 to 1969 was assumed to have not had an impact on peakflows at the gage. Rainfall-probability values for 3-hour durations were obtained from the NWS publication, Technical Paper No. 40. The values were adjusted for the basin size and then applied to the model. Through a trial-and-error process, the infiltration loss rate of 0.60 inch per hour provided the best

reconstitution of the computed frequency curve. Since this loss rate figure was within the range of infiltration rates specified for this area, the model which otherwise produced consistent results in the two calibration procedures, was accepted as a useful tool for making comparative evaluations of the flood control alternatives being considered in the plan formulation studies.

4. Because the modified SWMM program was in somewhat of a developmental stage we agreed to undertake additional studies which would compare SWMM and HEC-1 methodologies as related to the controlling effects of the two dams being considered.

In order to properly compare the hydrology simulated by HEC-1 and the SWMM programs, hydrologic parameters used in both programs had to be consistent and comparable. For this comparison the values used in the SWMM analysis were applied to the HEC-1 when use of the same data was appropriate. Data required for HEC-1 but not required for SWMM were estimated from available data. The 15 square-mile downstream area not controlled by the two dam system was divided into 24 subareas sized from about 0.1 to 1.5 square miles. The channel system was divided into 13 main reaches and 6 tributary reaches. Precipitation values used in SWMM were used assuming uniform distribution over the entire watershed. A constant infiltration loss rate was applied on the pervious portion of each subarea and subtracted from the storm precipitation to compute the excess rainfall. It was assumed that no losses would occur on the impervious portions of the subareas.

In HEC-1 the instantaneous unit hydrograph of Clark's method was used to provide runoff from each subarea. Runoff was routed through the respective reaches using one of the two following routing methods. For those reaches proposed for channelization, the modified Puls method was selected. For other reaches the Muskingum method was used.

The results produced by both the HEC-1 and SWMM at the tunnel entrance are shown in the following table. The first set of discharges are the results with existing urbanization and the second set of discharges are the results with future urbanization. The 100-year hydrographs for existing urbanized conditions are compared on Attachment 6.

Comparison of Simulated Hydrology at
Tunnel Entrance with Two Dam System

Event	Existing Urbanization (c.f.s.)		Future Urbanization (c.f.s.)	
	HEC-1	SWMM	HEC-1	SWMM
SPF	14,600	23,500	16,200	24,500
100-year	8,700	10,800	10,700	13,000
10-year	4,800	5,000	6,200	6,000

A comparison of the values shown in the table indicates that the two models provide essentially the same results for a 10-year event. For the 100-year event, however, the HEC-1 model provides peak discharges that are as much as 18 to 19 percent lower than those provided by the SWMM. SWMM provides results of higher variability which, when projected out to the SPF level, indicate significantly larger discharges. Experience has indicated that, in the absence of significant valley storage, the peak discharge of large floods, like an SPF, will tend to deviate from the linearity of unit hydrograph theory. Historical information on large floods within the Omaha District support this concept. Two examples are the 1963 flood on Wahoo Creek at Ithaca, Nebraska, and the 1965 flood on Bijou Creek, Colorado. Both of these floods had peak discharges considerably higher than would have been calculated by applying the actual runoff to previously available unit hydrograph data.

5. In conclusion, this comparative analysis indicated that both models yield comparable discharge values for the more frequent events while HEC-1 results in lower peak discharges for the more infrequent events such as the 100-year and SPF. There is not enough information available from these studies to make a clear choice as to which model best approximates the frequencies and magnitudes of actual flood characteristics of the basin.

Evaluation and assessment of detailed plans were accomplished using the SWMM results. Plan formulation based on SWMM resulted in higher costs for channel improvements downstream from dams and somewhat lower benefits for the dam alternatives if it had been compared with the HEC-1 results. In view of the strong opposition voiced by the local interests against the dams, along with the relative insensitivity of benefit-cost computations to the variation in the magnitude of the infrequent flood events, detailed plan formulation using the HEC-1 model results were not accomplished.

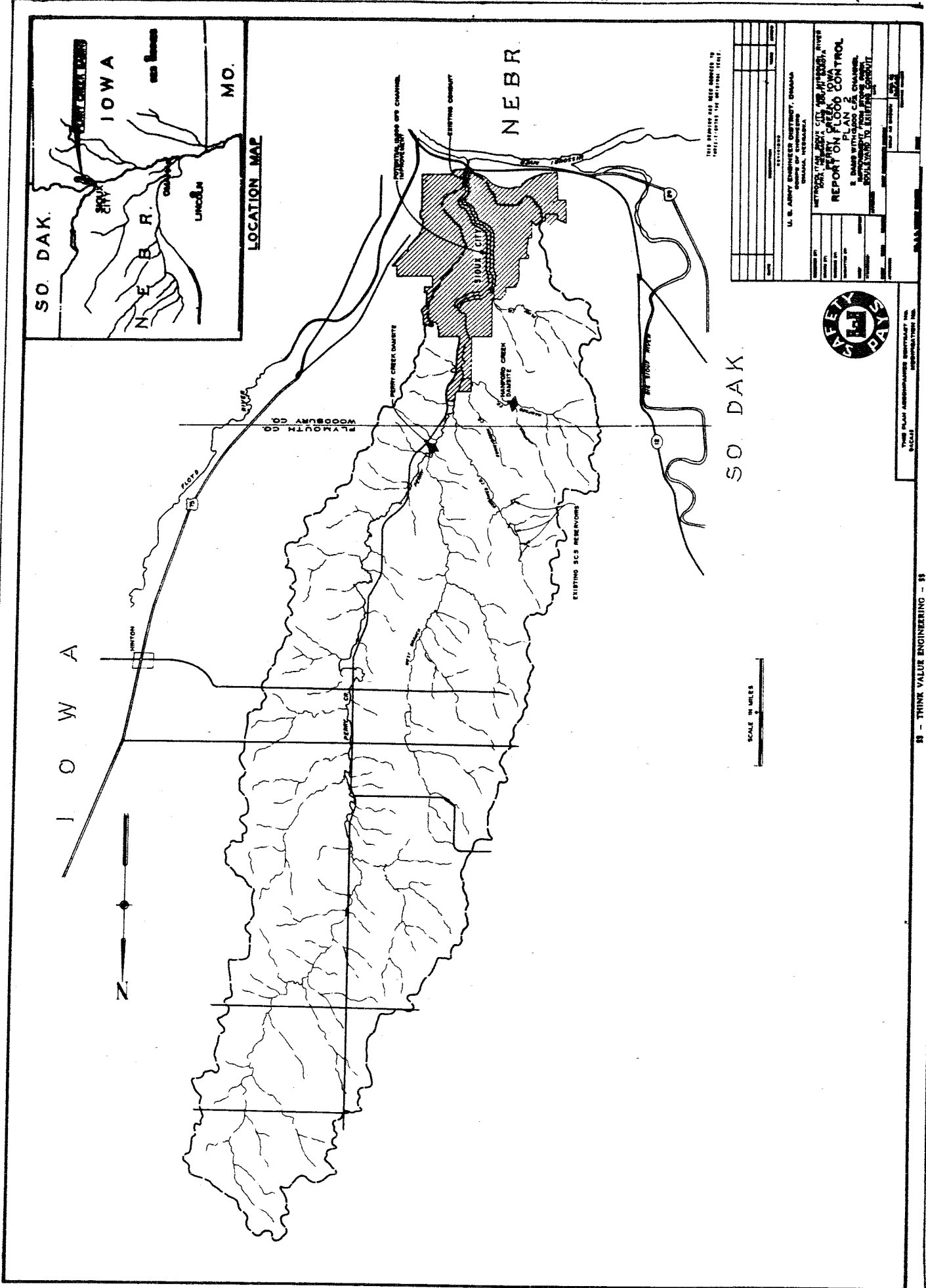

THE REPORT HAS BEEN REVIEWED TO
 CONFIRM THE DATA FOR THE ORIGINAL REPORT.

U. S. ARMY ENGINEER DISTRICT, DAKOTA SIOUX FALLS, S. DAK.	
PROJECT NO. _____ DRAWING NO. _____	SHEET NO. _____ TOTAL SHEETS _____
REPORT ON FLOOD CONTROL PLAN 2 DAM WITH LOGS FOR CHANGES IOWA RIVER AT IOWA CITY, IOWA	
PREPARED BY: _____ CHECKED BY: _____ DATE: _____	



88 - THINK VALUE ENGINEERING - \$8

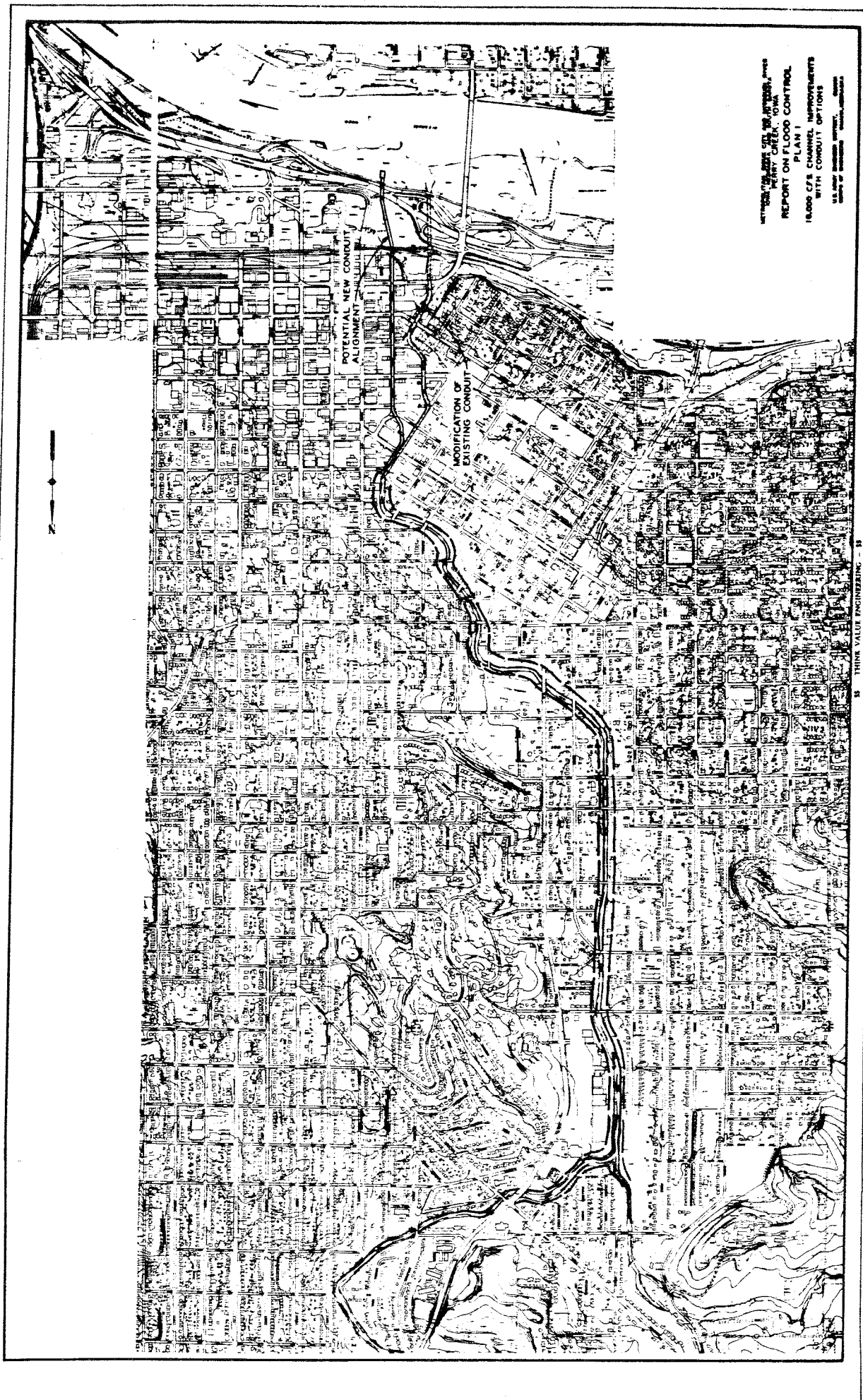

ATTENTION: THE STATE OF IOWA
 PERRY CREEK, IOWA
 REPORT ON FLOOD CONTROL
 PLAN I
 18,000 CFS CHANNEL IMPROVEMENTS
 WITH CONDUITY OPTIONS
 U.S. Army Corps of Engineers
 DISTRICT OF COLUMBIA

\$5 THINK VALUE ENGINEERING



Perry Creek - SWMM

(143)

PAPER 10

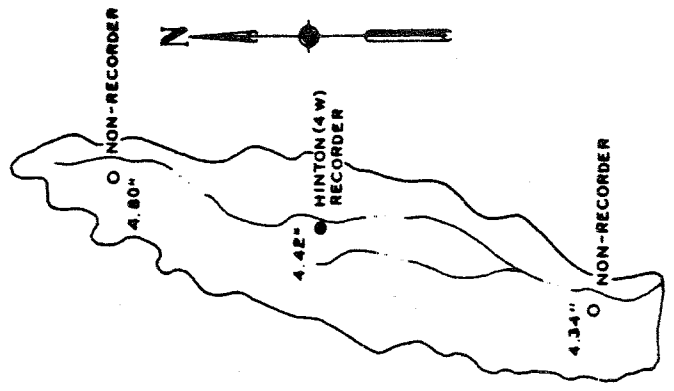
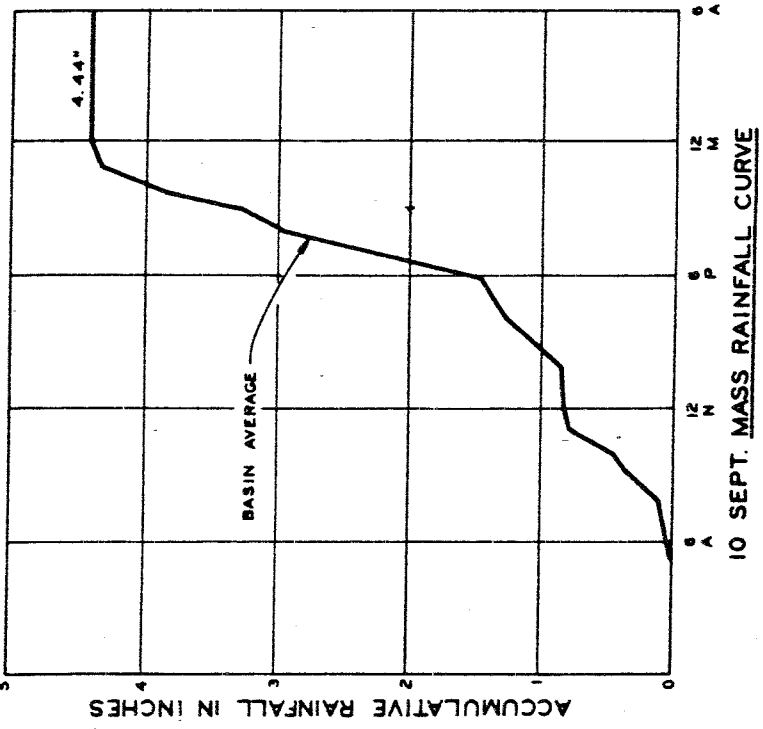
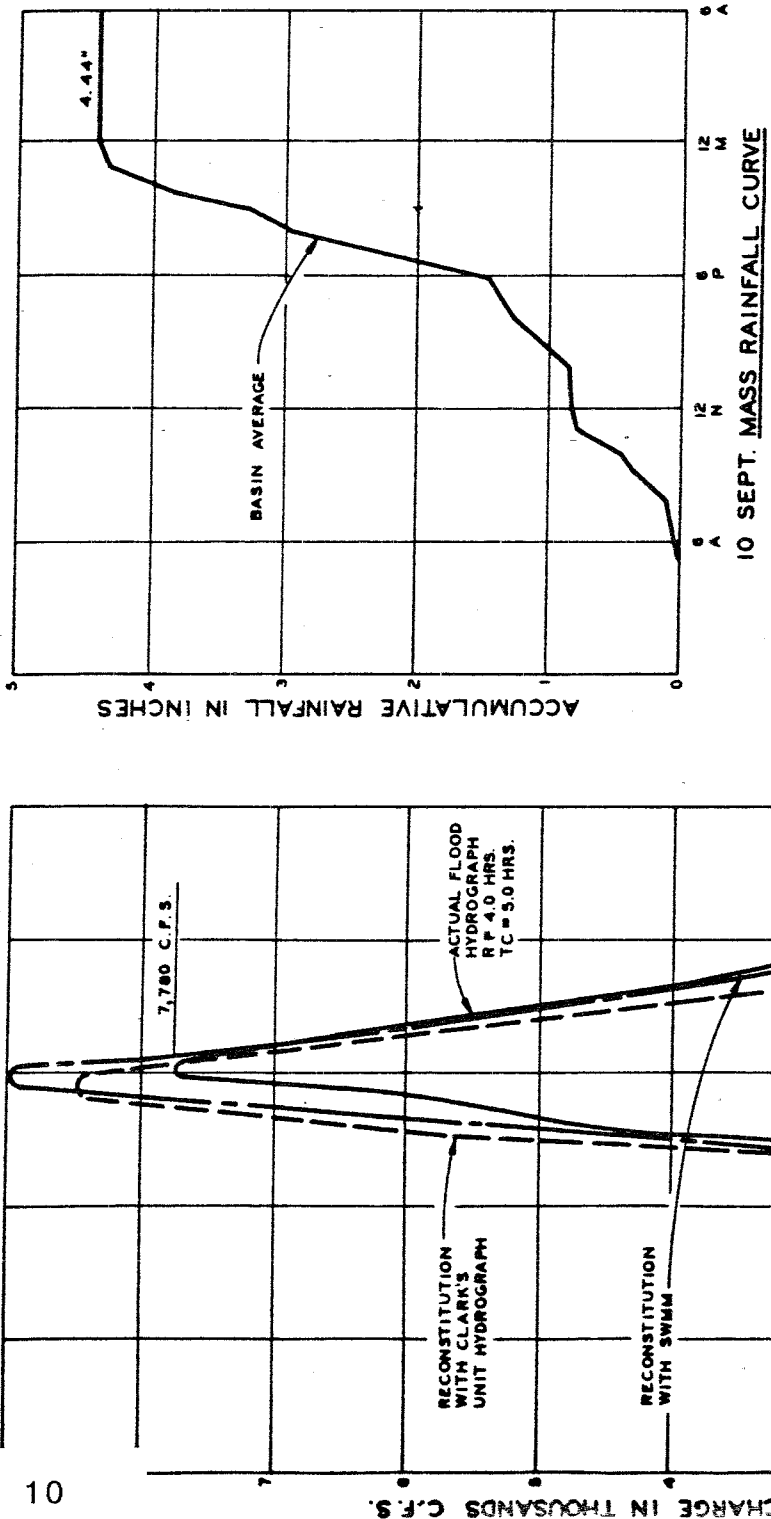

BASIN MAP
STORM OF 10 SEPT. 1949

METROPOLITAN SIOUX CITY AND MISSOURI RIVER
IOWA, NEBRASKA AND SOUTH DAKOTA
PERRY CREEK IOWA
REPORT ON FLOOD CONTROL
10 & 11 SEPTEMBER 1949
FLOOD RECONSTITUTION

U. S. ARMY ENGINEER DISTRICT OMAHA NEBRASKA
CORPS OF ENGINEERS OMAHA NEBRASKA

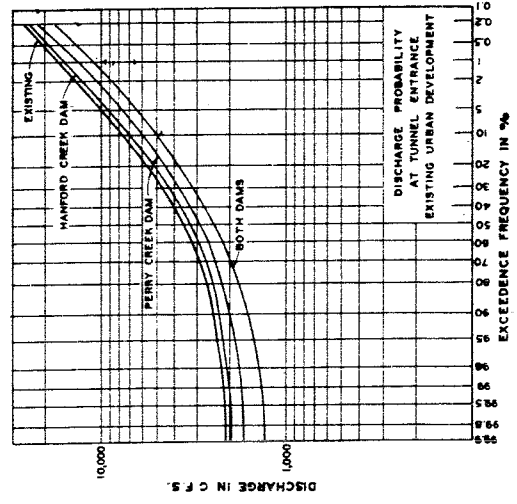
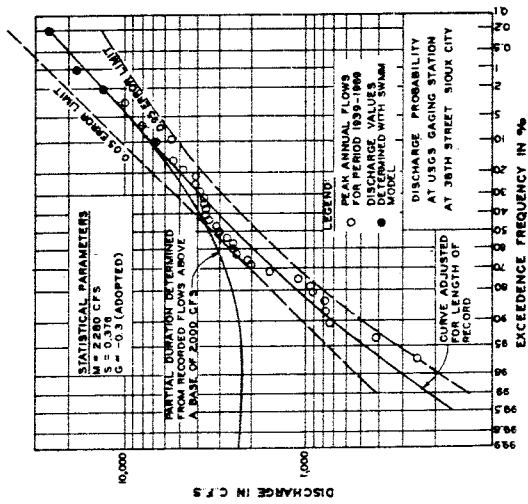
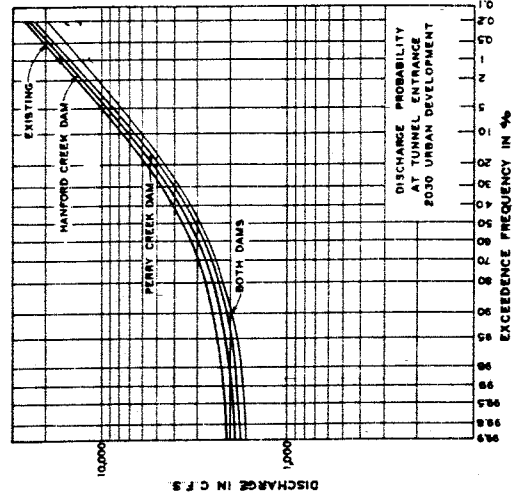
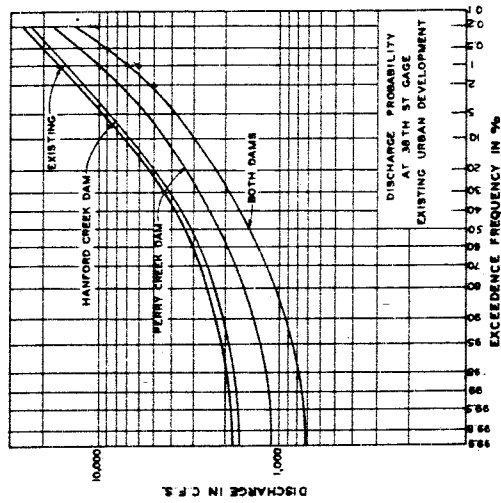
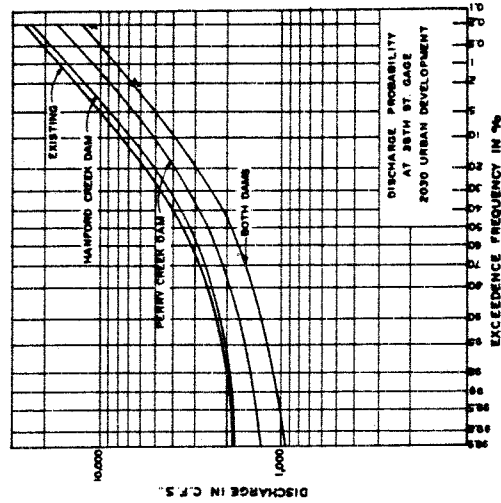

METROPOLITAN SIOUX CITY, IOWA AND MISSOURI RIVER IOWA, NEBRASKA, AND SOUTH DAKOTA
PERRY CREEK, IOWA
REPORT ON FLOOD CONTROL DISCHARGE PROBABILITY CURVES AT 38TH ST. & THE TUNNEL ENTRANCE
U.S. ARMY ENGINEERS DISTRICT, OMAHA
CORPS OF ENGINEERS OMAHA, NEBRASKA

145

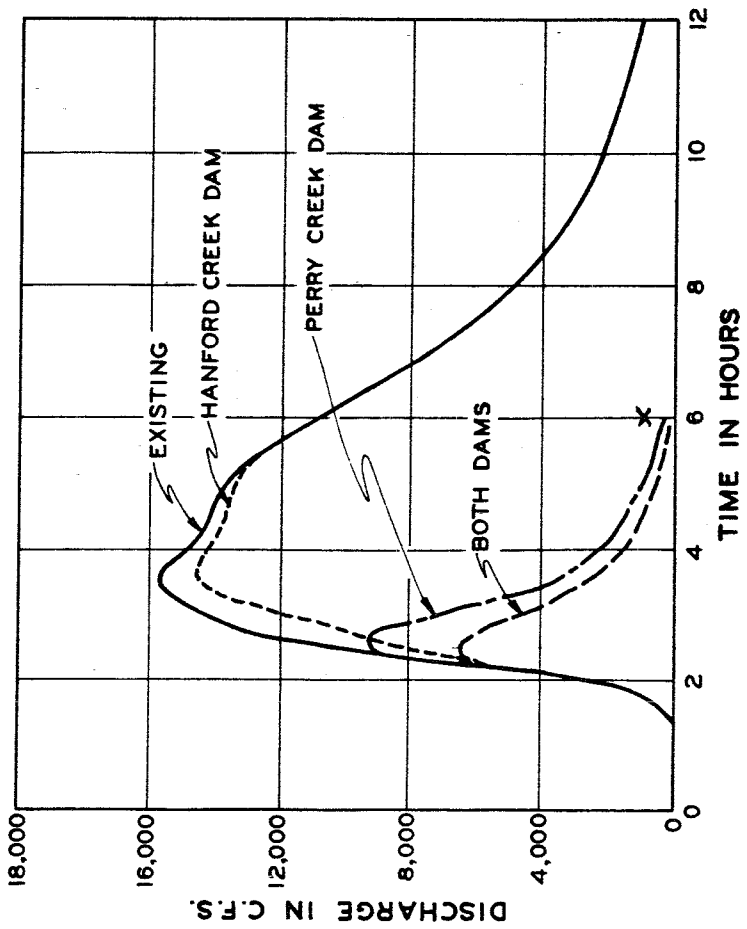

AT 38 TH ST. GAGE

NOTE: HYDROGRAPHS TAKEN DIRECTLY FROM SWMM RUNS. THEY DO NOT REFLECT THE PEAK DISCHARGE ADJUSTMENTS THAT RESULTED FROM FREQUENCY CURVE SMOOTHING.

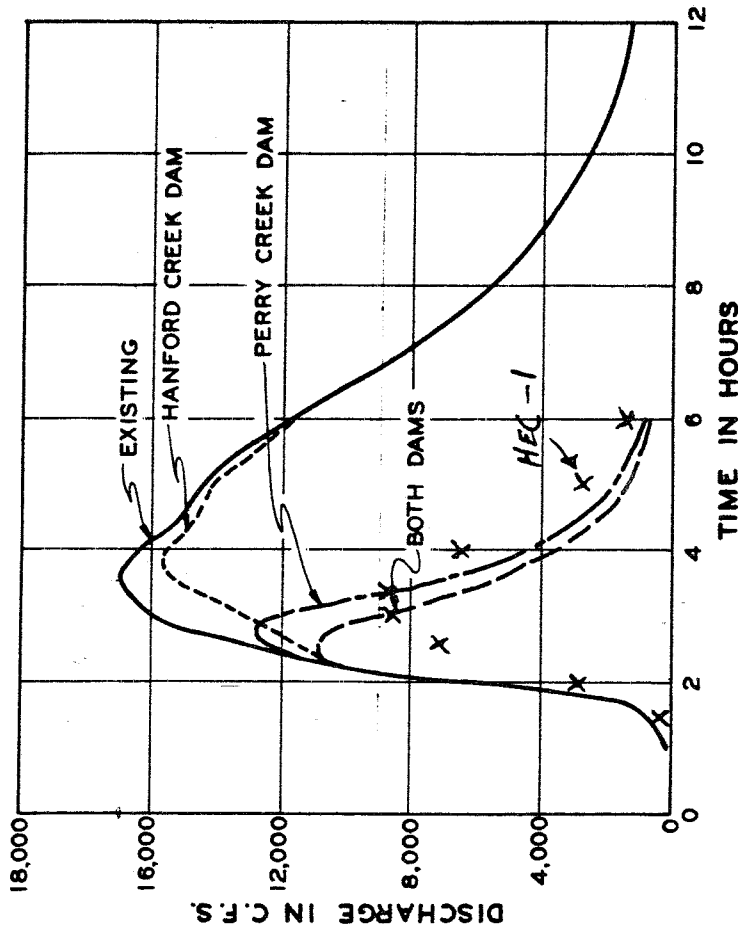

AT TUNNEL ENTRANCE

METROPOLITAN SIOUX CITY AND MISSOURI RIVER
IOWA, NEBRASKA AND SOUTH DAKOTA
PERRY CREEK, IOWA
REPORT ON FLOOD CONTROL
100-YEAR HYDROGRAPHS AT
38 TH ST. AND THE TUNNEL ENTRANCE
(EXISTING URBAN DEVELOPMENT)
U. S. ARMY ENGINEER DISTRICT OMAHA
CORPS OF ENGINEERS OMAHA, NEBRASKA

A COMPARATIVE ANALYSIS OF
SWMM AND HEC-1 APPLICATION

by

Wallace R. Stern

Summary by Gene R. Russell¹

One of the first observations was the runoff block contained in the SWMM model might be more closely related to the runoff block in the Kinamatic Wave portion of the HEC-1 model rather than the Snyder's unit hydrograph method utilized. However, the Kinamatic Wave model was developed about the same time that this study was underway and may not have been available.

Another comparison was given where the SWMM model was used on Cherry Creek, Colorado. This is a long, narrow basin of about 200 square miles and very good Snyder's unit hydrograph constants were available for a nearby basin. This study was part of a Section 22 effort to establish 100-year hydrographs of the State of Colorado.

Studies done with SWMM, HEC-1, and by the State of Colorado produced compatible results for the upper end of the basin but varied considerably at the lower end. There was some general discussion that the variations might be due to routing methods. Also discussed were the prevalent storm tracks across this region and their effects on peak flows.

There was an expression of concern that some items of adjustment such as rainfall loss rates should be explained by the physical components that determine their selection.

¹Hydraulic Engineer, Mobile District

THE QUANTIFICATION OF URBANIZATION IMPACTS ON RUNOFF
THROUGH HEC-1 MODELING

by

Thomas P. Smyth and Peter Koch¹

1. OBJECTIVES

To develop the design flood flows for the lower Robinson's Branch watershed.

A) A key problem was that the Robinson's Branch watershed has undergone significant population change and associated urbanization since 1940. These changes have caused an upward trend in the magnitude of annual peak discharges at the Robinson's Branch gage, located about 1.2 miles upstream from the mouth. This upward trend required that an adjustment for historic urbanization be made to the sample of peak discharges, before a peak discharge vs. frequency relation could be determined by accepted statistical procedures.

2. PHYSICAL SETTING AND AVAILABLE DATA

Robinson's Branch

A) A tributary of the Rahway River in northeastern N.J., Robinson's Branch has a total drainage area of 23.5 square miles. Its watershed map is shown on Figure 1. The upper Robinson's Branch watershed has undergone significant suburban development, while the lower basin has experienced both suburban and commercial development. The upper basin contains the Ash Brook Swamp Reservation, which functions as a natural flood-retention area. The drainage area of Robinson's Branch upstream of Ash Brook Swamp is 13.8 square miles. Flow is further regulated by Middlesex Reservoir, which is used for municipal water supply. There is a long term recording stream gage located 1 mile downstream from Middlesex Reservoir Dam and 1.2 miles upstream from the mouth, with records dating back to 1940. There are 2 recording and 2 non-recording precipitation gages surrounding the Robinson's Branch watershed.

1

Hydraulic Engineers, New York District, U.S. Army Corps of Engineers.

3. STUDY APPROACH

A. Non-homogeneity of observed peak discharges.

1) Evidence that the sample of observed peak discharges is non-homogeneous with respect to time due to man-made changes in the basin falls into three categories:

a) Population and land use. Population in the Robinson's Branch basin has greatly increased from 1940 (the year the stream gage was installed) to the present. This can be seen from population data in Table 1. Land use in the basin has also changed from mostly rural in 1940 to a present condition that is mostly either urban or suburban. This can be seen from the outline maps of land use of the Robinson's Branch basin at the end of calendar year 1943 and in its present condition (Figures 2 and 3).

b) Recent occurrence of five largest historic floods. The Robinson's Branch stream gage has operated continuously since 1940. But the five largest historic flood peaks (May 1968, August 1969, August 1971, August 1973, and July 1975) have all occurred relatively recently.

c) Upward Trend of Observed Annual peaks. When magnitude of observed annual peak discharge in cfs is plotted versus time elapsed since January 1, 1940, a distinct upward trend appears. The least-squares regression line of best fit to this data shows this upward trend. Its correlation coefficient is positive (0.3861) and its slope is positive (19.81 cfs per year). This data is shown in Table 2 and on Figure 4.

TABLE 1
ROBINSON'S BRANCH OF THE RAHWAY RIVER - RAHWAY, N.J.
POPULATION DATA: COMMUNITIES THAT CONTAIN ROBINSON'S
BRANCH BASIN

CALENDAR YEAR:

COMMUNITY	1940	1950	1960	1970	1980
EDISON	11470	16348	44799	67120	70193
SCOTCH PLAINS	4993	9069	18491	22279	20774
FANWOOD	2310	3228	7963	8920	7763
CLARK	2083	4352	12195	18829	16699
WESTFIELD	18848	21243	31447	33720	30447
WOODBIDGE	27141	35758	78846	98944	90074
RAHWAY	17498	21290	27699	29114	26723
CRANFORD	12860	18602	26424	27391	24573

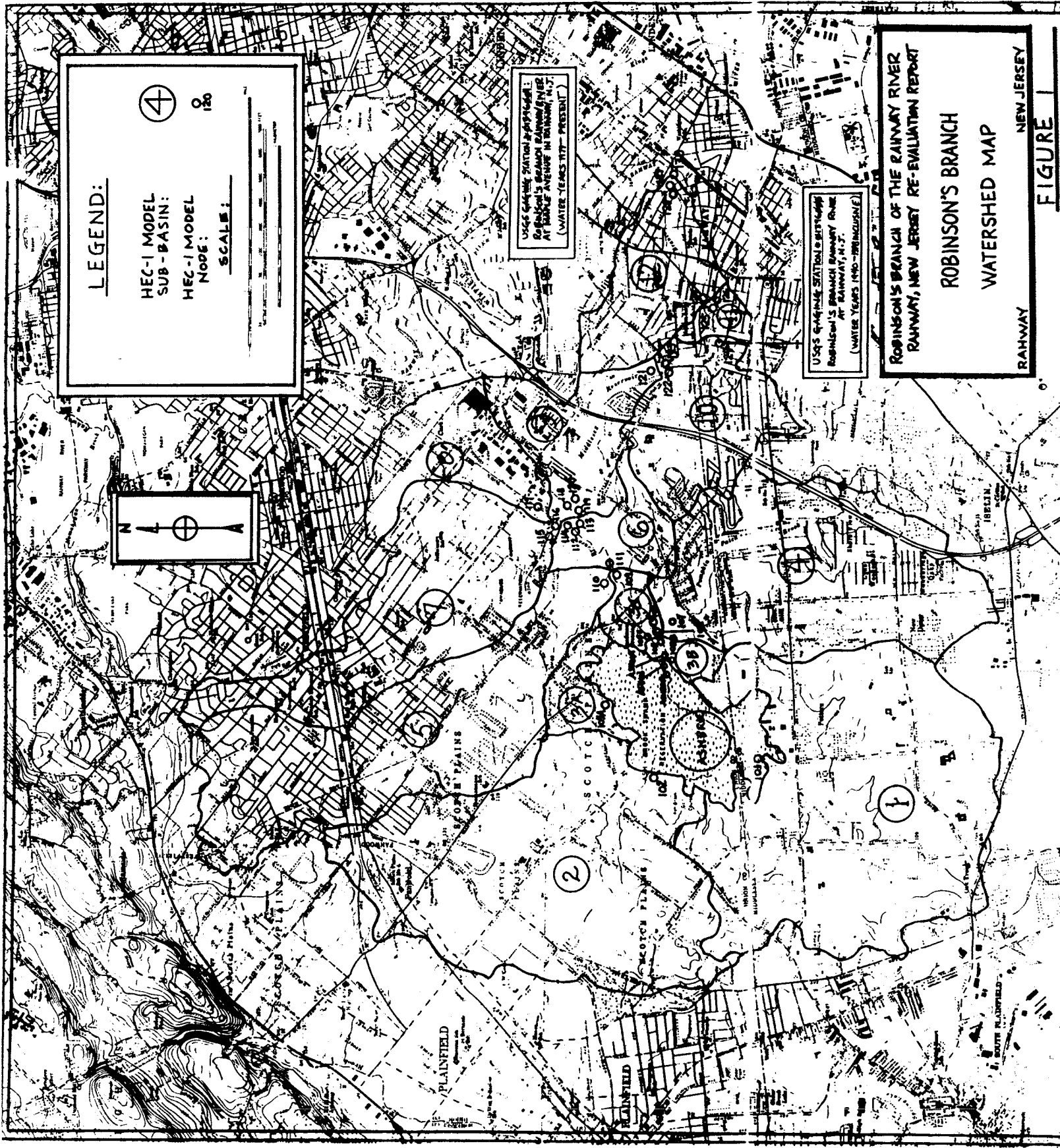

LEGEND:

- ④ HEC-I MODEL SUB-BASIN:
- HEC-I MODEL NODE:

SCALE:

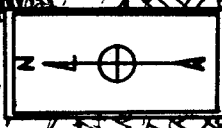

USGS GAUGING STATION #27584: ROBINSON'S BRANCH RAINWATER AT BARKLEY AVENUE IN BARKLEY PARK (WATER YEARS 1977 - PRESENT)

USGS GAUGING STATION #27584: ROBINSON'S BRANCH RAINWATER AT BARKLEY AVENUE IN BARKLEY PARK (WATER YEARS 1940 - 1950)

ROBINSON'S BRANCH OF THE RAINWAY RIVER
RAHWAY, NEW JERSEY RE-EVALUATION REPORT

ROBINSON'S BRANCH
WATERSHED MAP

NEW JERSEY
RAHWAY

FIGURE 1

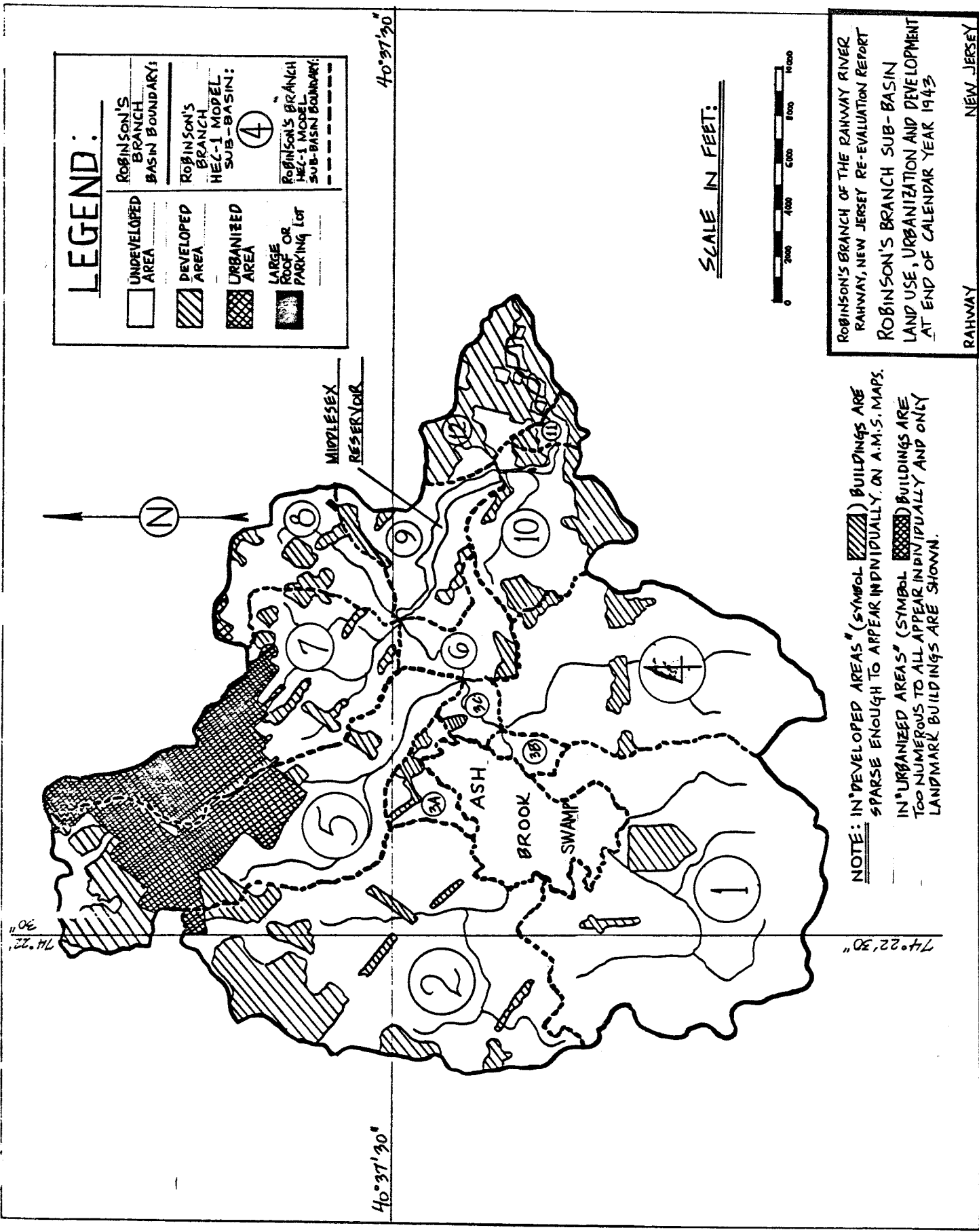

FIGURE 2

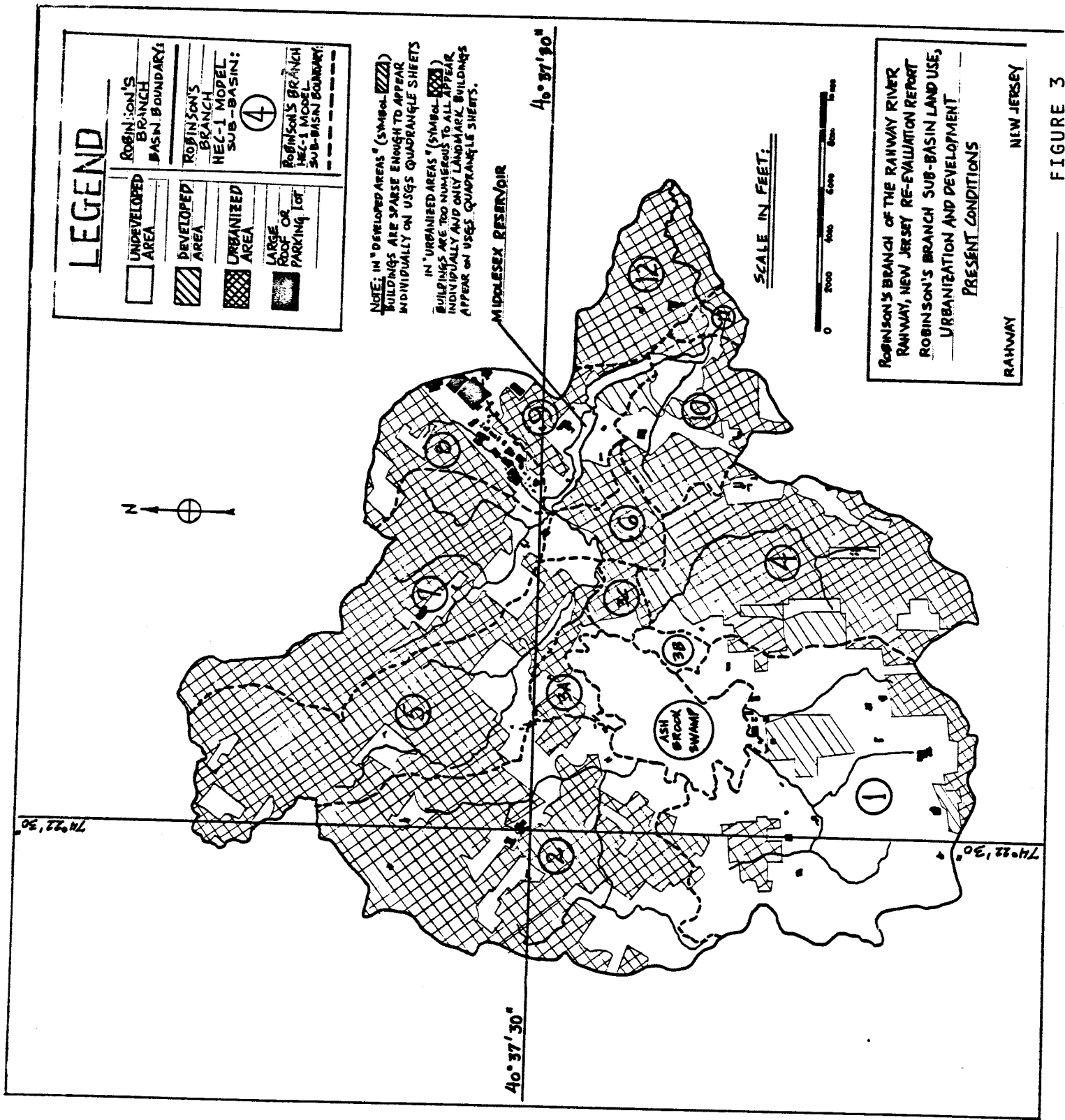

FIGURE 3

TABLE 2

ROBINSON'S BRANCH OF THE RAHWAY RIVER
RAHWAY, N.J.

OBSERVED ANNUAL PEAK DISCHARGES

ROBINSON'S BRANCH STREAM GAGE - D.A. = 21.6 SQUARE MILES

WATER YEAR	ANNUAL PEAK DISCHARGE, CFS
1940	1400
1941	832
1942	1240
1943	673
1944	819
1945	1010
1946	932
1947	535
1948	1070
1949	899
1950	512
1951	789
1952	1300
1953	1490
1954	387
1955	1000
1956	515
1957	557
1958	1110
1959	1080
1960	1190
1961	868
1962	1120
1963	632
1964	667
1965	605
1966	1030
1967	1390
1968	2550
1969	2590
1970	1070
1971	2550
1972	1080
1973	2380
1974	1280
1975	3110
1976	868
1977	1200
1978	1820
1979	1470
1980	1290
1981	561
1982	1200
1983	1300

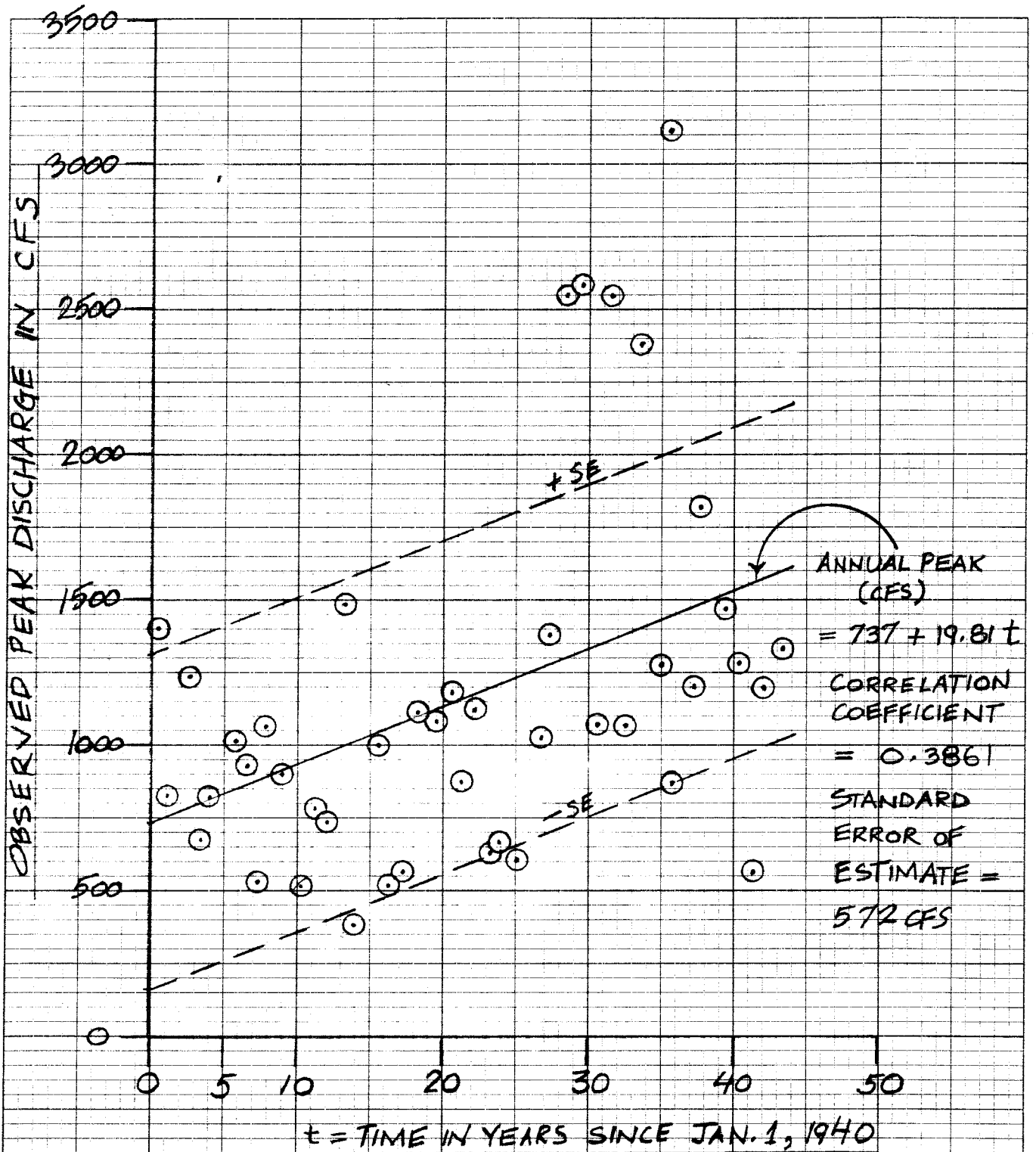

LEGEND:

- ⊙ OBSERVED ANNUAL PEAK DISCHARGE, CFS
- LEAST-SQUARES LINE OF BEST FIT
- ± STANDARD ERROR OF ESTIMATE (SE)

**ROBINSON'S BRANCH OF THE RAHWAY RIVER
RAHWAY, NEW JERSEY RE-EVALUATION REPORT
UPWARD TREND OF OBSERVED ANNUAL
PEAK DISCHARGES
ROBINSON'S BRANCH GAGE
RAHWAY NEW JERSEY**

B. Adjustment of observed peak discharges for historic urbanization.

1) When average population change over ten-year intervals for the Robinson's Branch basin is plotted versus the midpoints of those intervals (i.e., at 1945, 1955, 1965, and 1975), it can be seen that population in the basin reached zero growth rate and began decreasing approximately at the beginning of calendar year 1968. Because population decrease in urban and suburban areas does not necessarily mean the removal of man-made structures and/or impervious cover whose appearance accompanied the prior population increase, it can safely be said that the Robinson's Branch basin reached its present condition of urbanization at the beginning of calendar year 1968 (zero population growth rate) and has remained constant from then to the present. The data is shown below in Table 3.

TABLE 3

ROBINSON'S BRANCH AT GAGE POPULATION CHANGE DATA:

END OF CALENDAR YEAR	t	P	P	$\frac{P}{T}$
1940	1.00	22089		
1945	6.00		+8001	+800
1950	11.00	30090		
1955	16.00		+28453	+2845
1960	21.00	58543		
1965	26.00		+14150	+1415
1970	31.00	72693		
1975	36.00		-4196	-420
1980	41.00	68497		

Notes: t = Time in years since January 1, 1940.

P = Approximate population in persons (area-averaged)

P = Change in population in persons between successive census years.

$\frac{P}{T}$ = Approximate average rate of change of population (persons/year).

This was corroborated by USGS quadrangle maps based on aerial photography taken in 1970 and 1979 that show no change in percent impervious cover that would affect flood runoff between these two times.

2) The five large calibration events (May 1968, August 1969, August 1971, August 1973 and July 1975) can then be safely said to have taken place when the basin was at its present condition of urbanization because they all occurred after the beginning of calendar year 1968. Therefore, the HEC-1 rainfall-runoff model of the Robinson's Branch basin that was calibrated using these events can be said to accurately reproduce the rainfall-runoff behavior of the basin in its present condition. The observed flood hydrographs of these events were reproduced well by one set of land use-based unit hydrographs and values of sub-basin percent impervious cover. The HEC-1 model of the basin in its present condition was then used to adjust the sample of observed peak discharges for the historic urbanization that took place between the installation of the Robinson's Branch stream gage in 1940 and the present.

3) To track historic urbanization in the Robinson's Branch basin versus time, the following analysis was done:

For each sub-basin of Robinson's Branch, percent impervious cover based both on population and land use, were determined as functions of time, beginning at January 1, 1940 (a convenient time before the systematic record of observed peak discharges at the Robinson's Branch stream gage began), and continuing on to the end of calendar year 2030 A.D., the date selected as the future condition for analysis. For the above sub-basins, percentages by area in each New Jersey community were determined from the outline map of the Rahway River basin showing community boundaries (Figure 5). These percentages are given in Table 4. For each appropriate New Jersey community, population density in persons per square mile was determined from the population data in Table 1 and the areas of communities in square miles. Percent impervious cover was determined for each community from its population density using the equation relating population density and percent impervious cover contained in (USGS Special Report 38, Magnitude and Frequency of Floods in New Jersey with Effects of Urbanization, Stankowski, 1974).

TABLE 4

ROBINSON'S BRANCH OF THE RAHWAY RIVER RAHWAY N.J.

SUB-BASIN PERCENTAGES, BY AREA, IN EACH NEW JERSEY COMMUNITY:

ROBINSON'S BRANCH, SOUTH BRANCH, AND RAHWAY MAINSTREAM SUB-BASIN RAH-P

COMMUNITY:

	EDISON	SCOTCH PLAINS	FANWOOD	CLARK	WESTFIELD	WOODBRIDGE	RAHWAY	CRANFORD	LINDEN
BASIN:									
ROBINSON'S BRANCH:									
1	85	14		1					
2		85	15						
3A		100							
3B		20		80					
3C		50		50					
4	34			13		53			
5		55			45				
6		30		70					
7		5			95				
8				50	25			25	
9				100					
10		44		38			18		
11							100		
12				20			80		

Example: 85% of Robinson's Branch sub-basin 1 lies in Edison.
 14% lies in Scotch Plains.
 1% lies in Clark.

Note: Ash Brook Swamp is not divided among communities and therefore does not appear in this table because its population is zero.

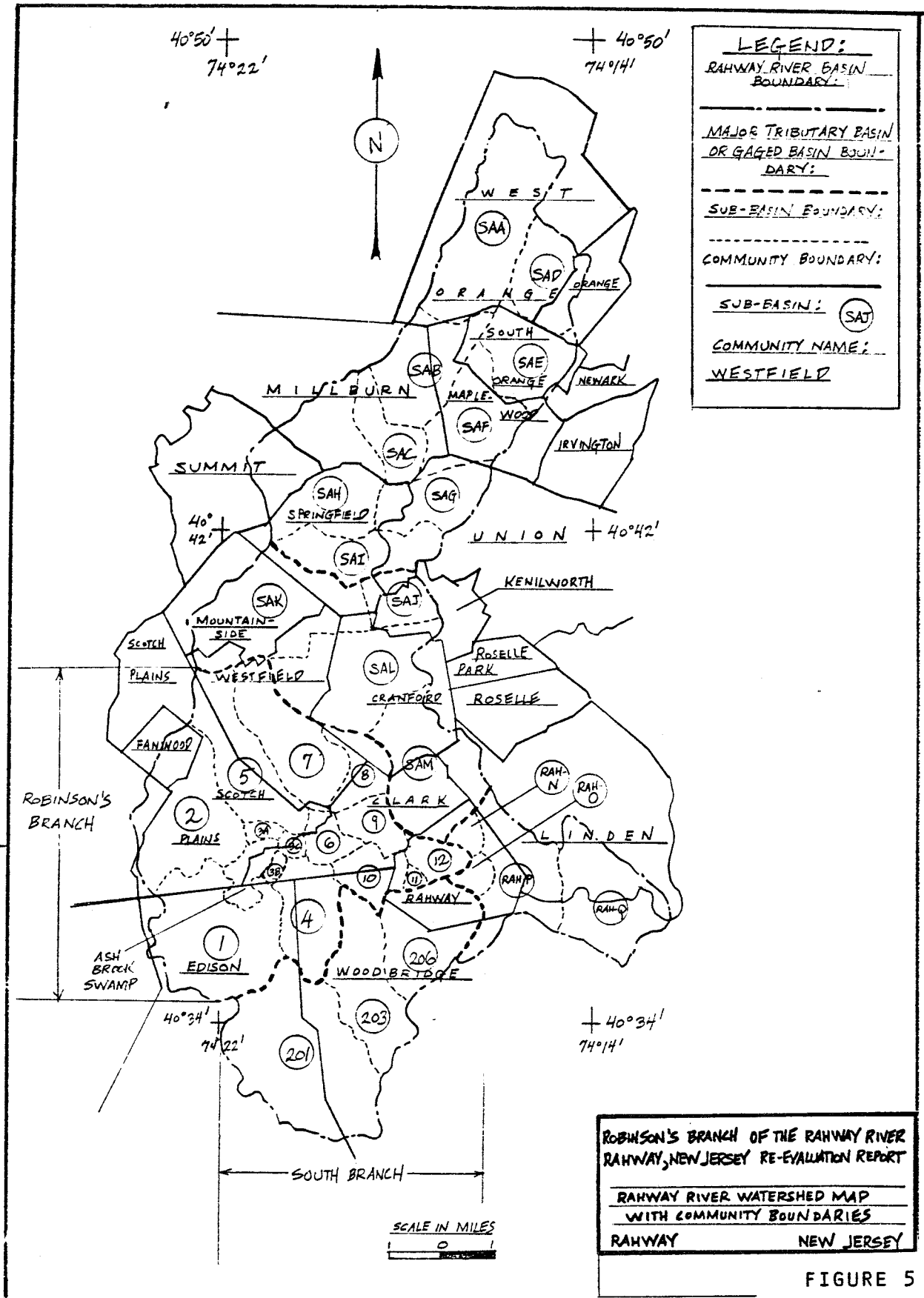

FIGURE 5

The equation is:

$$I = 0.117 D^{0.792 - 0.039 \log D}$$

where

I = percent impervious manmade cover

D = population density, persons per square mile.

The resulting values of I(P) (I based on population) for each community are given in Table 5.

For some communities, population in a census year, or a projected population (2030 A.D.) is less than in a preceding year. It was assumed that manmade impervious cover which increases flood runoff increases with population but that if population subsequently decreases, the impervious cover corresponding to the population's maximum value remains and continues to affect flood runoff behavior.

4) The percentages of sub-basin area in each New Jersey community given in Table 4 were applied to the population-based values of I(P) determined for each community to give values of population-based percent impervious cover (I(P)) for each sub-basin for each year in which population data or population projections were available. These values of I(P) are given in Table 6.

5) 1943 Army Map Service maps of New Jersey, U.S. Geological Survey quadrangle maps dated 1955 and 1970 and Tri-State Regional Planning Commission Aerial photography were used to determine land use-based values of percent impervious cover (I(L.U.)) for sub-basins of Robinson's Branch. Three categories of land use were established for this determination. They are shown on Figures 2 and 3. The categories are: urbanized, developed, and undeveloped. Urbanized areas contain buildings in such density that only landmark buildings appear on USGS quadrangle maps and 1943 A.M.S. maps. Percent impervious cover for these areas was determined using Tri-State Regional Planning Commission Aerial photography via roadway and building counts. In developed areas, buildings are sparse enough to appear individually on USGS quadrangles and AMS maps, and percent impervious cover for these areas was determined by counting roadways and buildings directly from the maps. In undeveloped areas, buildings and roadways are too sparse to appreciably affect flood runoff. Totally impervious areas large enough to appear individually on USGS quadrangles and AMS maps, such as roofs of large buildings and large parking lots, were measured and included in the determination of percent impervious cover for each sub-basin. This data was used to supplement the analysis based on population.

TABLE 5
ROBINSON'S BRANCH OF THE RAHWAY RIVER RAHWAY N.J.

Population, Population Density, and Population
Based Percent Impervious Cover for Rahway River Basin Communities
All Values are at End of Indicated Calendar Year

Community	Area Square Miles		1920	1930	1940	1950	1960	1970	1980	2000	2030
Edison	30.19	P	--	--	11470	16348	44799	67120	70193	89105	12744
		D	--	--	380	542	1484	2223	2325	2951	4421
		I	--	--	7.11	8.75	15.41	19.15	19.61	22.22	26.72
Scotch Plains	9.41	P	--	--	4993	9069	18491	22279	20774	21363	22279
		D	--	--	531	964	1965	2368	--	--	--
		I	--	--	8.65	12.14	17.93	19.80	19.80	19.80	19.80
Fanwood	1.29	P	--	--	2310	3228	7963	8920	7763	7983	8325
		D	--	--	1791	2502	6173	6915	--	--	--
		I	--	--	17.06	20.38	32.35	34.22	34.22	34.22	34.22
Clark	4.63	P	794	1474	2083	4352	12195	18829	16699	17173	17909
		D	172	318	450	940	2634	4067	--	--	--
		I	4.40	6.40	7.85	11.97	20.94	26.22	26.22	26.22	26.22
Westfield	6.39	P	9063	15801	18848	21243	31447	33720	30447	31311	32653
		D	1418	2473	2950	3324	4921	5277	--	--	--
		I	15.03	20.26	22.22	23.64	28.88	29.92	29.92	29.92	29.92
Woodbridge	23.20	P	--	--	27141	35758	78846	98944	90074	114343	163540
		D	--	--	1170	1541	3399	4265	--	4929	7049
		I	--	--	13.52	15.73	23.91	26.87	26.87	28.91	34.55
Rahway	4.10	P	11042	16011	17498	21290	27699	29114	26723	27491	28659
		D	2693	3905	4268	5193	6756	7101	--	--	--
		I	21.19	25.68	26.88	29.65	33.83	34.67	34.67	34.67	34.67
Cranford	4.90	P	6001	11126	12860	18602	26424	27391	24573	25270	26353
		D	1225	2271	2624	3796	5393	5590	--	--	--
		I	13.87	19.36	20.90	25.31	30.23	30.79	30.79	30.79	30.79
Linden	10.55	P	6612	21206	24115	30644	39931	41409	37836	38910	40577
		D	627	2010	2286	2905	3785	3925	--	--	--
		I	9.52	18.15	19.43	22.04	25.28	25.75	25.75	25.75	25.75

Notes: P = population in persons. D = P/area in square miles = population density, persons per square mile
I = percent impervious cover where:

$$I = 0.117D^{0.792 - 0.039 \text{ Log } D}$$

For each sub-basin a smooth curve of percent impervious cover (I) vs. time was drawn.

TABLE 6

ROBINSON'S BRANCH OF THE RAHWAY RIVER RAHWAY N.J.

POPULATION-BASED PERCENT IMPERVIOUS COVER FOR SUB-BASINS OF ROBINSON'S BRANCH

ROBINSON'S BRANCH SUB-BASINS:	1940	1950	1960	1970	1980	2000	2030
1	7.33	9.26	15.82	19.31	19.70	22.00	25.74
2	9.91	13.38	20.09	21.96	21.96	21.96	21.96
3A	8.65	12.14	17.93	19.80	19.80	19.80	19.80
3C	8.25	12.06	19.44	23.01	23.01	23.01	23.01
4	10.60	12.87	20.63	24.16	24.32	26.29	30.80
5	14.76	17.32	22.86	24.35	24.35	24.35	24.35
6	8.09	12.02	20.04	24.29	24.29	24.29	24.29
7	21.54	23.07	28.33	29.41	29.41	29.41	29.41
8	14.71	18.22	25.25	28.29	28.29	28.29	28.29
9	7.85	11.97	20.94	26.22	26.22	26.22	26.22
10	10.95	13.74	20.83	24.60	24.83	25.98	27.93
11	26.88	29.68	33.83	34.67	34.67	34.67	34.67
12	23.07	26.14	32.98	32.98	32.98	32.98	32.98

NOTES: NO FIGURES APPEAR FOR ASH BROOK SWAMP BECAUSE ITS POPULATION IS ZERO AND NO FIGURES APPEAR FOR SUB-BASIN 3B BECAUSE AT ALL TIMES IT IS TOTALLY PERVIOUS.

6) Nine past annual peak discharge-containing floods were selected from the time period over which historic urbanization took place. They range in time from August 9, 1942 to September 12, 1960. The observed peak discharges range from 387 cfs to 1240 cfs. Precipitation observed at the appropriate stations in or near the basin for these past events was input to the HEC-1 model and spatial distributions determined via Thiessen networks. Values of percent impervious cover were determined for each sub-basin for each past event using the curves of I versus time. Values of Clark unit hydrograph parameters t_c and R were determined for each sub-basin for each past event from these values of percent impervious cover and from the values of drainage area and watercourse slope via the modified regression equations (developed by the Hydrologic Engr. Center, 1976) shown below.

$$t_c = 8.29(1 + .03 I)^{-1.28} (DA/S)^{0.28}$$

$$R = (tc + R) = 0.65 \text{ or } R = 1.85 \text{ } tc$$

where: DA = drainage area in square miles

S = average slope of longest sub-basin watercourse between points 10 and 85 percent of the distance upstream from the basin outlet to the sub-basin boundary.

I = percent of sub-basin area that is impervious

Base flow and recession parameters STRTQ, QRCSN and RTIOR were determined from semilogarithmic plots of the observed historic urbanization flood hydrographs. The above parameters were then input to the HEC-1 model of the basin to create an HEC-1 model of each historic urbanization flood, with parameters specific to the time at which it occurred. Within each historic urbanization flood model, infiltration loss parameters STRTL (initial loss in inches) and CNSTL (constant loss rate in inch/hour) were adjusted until the observed historic urbanization flood hydrographs were matched closely. Final infiltration loss parameters, and total rain, total excess and the ratio of total excess to total rain was determined. This ratio had an average value of 0.63 for the five recent calibration floods in 3B)2) above but varied as a function of time in years since January 1, 1940.

7) Having reproduced the nine historic urbanization floods, the next step was to determine the peak discharges of the historic urbanization floods under present conditions. To do this, present values (1980) of sub-basin unit hydrograph parameters, percent impervious cover and base flow and recession parameters as determined from model calibration using the five large recent historic floods, were input to the HEC-1 models of the nine historic urbanization floods. Infiltration loss parameters typical of present conditions were also input to the HEC-1 models to determine what peak discharge would result at the Robinson's Branch stream gage from the nine past historic urbanization storms if they occurred over the basin in its present condition. Values of infiltration loss parameters were adjusted so that the ratio of excess to rainfall for each of these updated past events was 0.63, the average value for the five recent large historic storm-flood events used for calibration. One result obtained for each historic urbanization flood is the ratio:

$$\frac{\text{updated peak discharge, cfs}}{\text{observed peak discharge, cfs}}$$

8) Next, a relationship between this ratio of peak discharges and time elapsed since the systematic record of peaks began in 1940 was sought. 0000 hours, January 1, 1940 was chosen as time zero for convenience. A least-squares

linear regression was performed on this data, with the common logarithm of the ratio as dependent variable and time in years elapsed since January 1, 1940 as the independent variable. The analysis yielded the following equation for peak discharge ratio as a function of time:

$$\text{RATIO} = (2.06) 10^{-0.011t}$$

where RATIO = updated peak Q (cfs) / observed peak Q (cfs)

and t = time in years elapsed since January 1, 1940

The equation has a correlation coefficient of -0.9215 and a standard error of estimate 0.0279. The equation of peak discharge ratio as a function of time was applied to all peak discharges recorded by the Robinson's Branch stream gage before May 1968 (occurrence of first calibration event). Table 8 gives the observed peak discharges, the dates on which they occurred, their values of the variables t and RATIO, and the resulting values of updated peak discharges. These updated peak discharges were combined with those peak discharges that needed no updating to form a homogeneous sample of peak discharges from which a peak discharge vs. frequency relation was determined.

4. STUDY RESULTS

A comparison of the peak discharge versus frequency data before and after the historic urbanization adjustment was made:

TABLE 7
PEAK DISCHARGES IN CFS:

EXCEEDENCE FREQUENCY IN %	NO HISTORIC URBANIZATION ADJUSTMENT	WITH ADJUSTMENT	PERCENT CHANGE
100	900	1200	+ 33
10	2000	2400	+ 20
4	2700	2980	+ 10
2	3250	3500	+ 8
1	3840	4070	+ 6
0.5	4530	4600	+ 2

Note that percent change increases along with exceedence frequency. This is of interest because it can increase benefits for a Corps project.

5. CONCLUSIONS

Hydrologic models can be a useful tool to modify observed peak discharges to any condition of urbanization, whether it be past, future, or present, as in this paper.

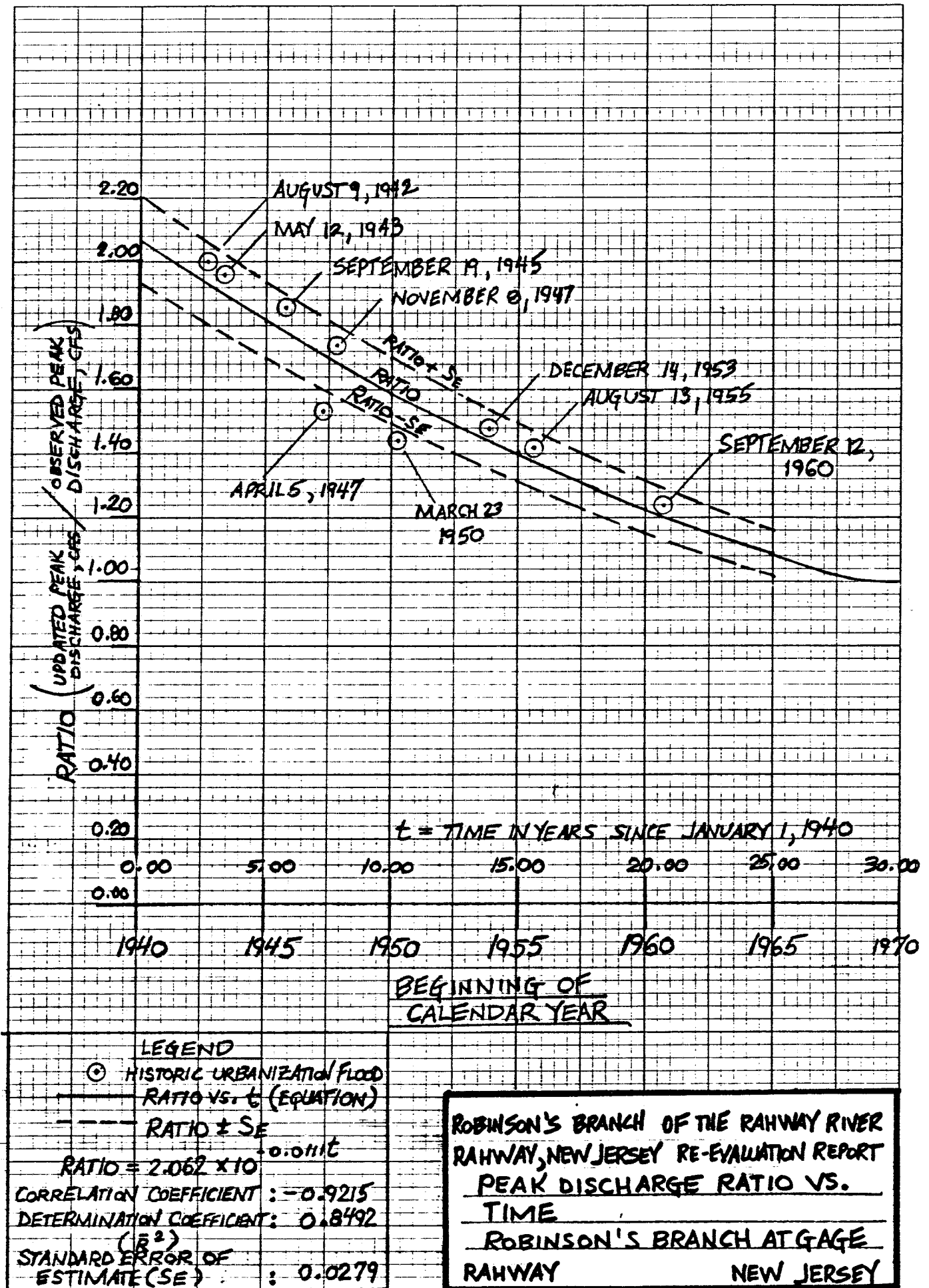

FIGURE 6

TABLE 8
ROBINSON'S BRANCH OF THE RAHWAY RIVER
OBSERVED AND UPDATED PEAK DISCHARGES: ROBINSON'S BRANCH STREAM GAGE

WATER YEAR	DATE	OBSERVED PEAK DISCHARGES, CFS	t	RATIO	UPDATED PEAK DISCHARGE, CFS
1940	05/31/40	1400	0.42	2.04	2856
1941	02/07/41	832	1.08	2.01	1669
1942	08/09/42	1240	2.59	1.93	2394
1943	05/12/43	673	3.34	1.89	1275
1944	01/06/44	819	4.00	1.86	1525
1945	09/19/45	1010	5.75	1.78	1798
1946	06/02/46	932	6.42	1.75	1631
1947	04/05/47	535	7.25	1.71	916
1948	11/08/47	1070	7.84	1.69	1806
1949	12/31/48	899	9.00	1.64	1472
1950	03/23/50	512	10.25	1.59	812
1951	03/30/51	789	11.25	1.55	1220
1952	12/21/51	741	12.00	1.52	1124
1953	03/13/53	1490	13.17	1.47	2193
1954	12/14/53	387	13.92	1.44	559
1955	08/13/55	1000	15.58	1.38	1384
1956	04/08/56	515	16.25	1.36	701
1957	04/05/57	557	17.25	1.33	739
1958	02/28/58	1110	18.17	1.30	1438
1959	08/09/59	1080	19.58	1.25	1349
1960	09/12/60	1190	20.67	1.21	1446
1961	03/23/61	868	21.25	1.20	1039
1962	03/12/62	1120	22.17	1.17	1309
1963	03/06/63	632	23.17	1.14	720
1964	11/07/63	667	23.83	1.12	747
1965	02/08/65	605	25.08	1.09	657
1966	09/21/66	1030	26.75	1.04	1071
1967	03/07/67	1390	27.17	1.03	1430
1968	05/29/68	2550	--	--	2550
1969	08/15/69	2590	--	--	2590
1970	07/31/70	1070	--	--	1070
1971	08/27/71	2550	--	--	2550
1972	06/22/72	1070	--	--	1070
1973	08/02/73	2380	--	--	2380
1974	12/21/73	1280	--	--	1280
1975	07/15/75	3110	--	--	3110
1976	11/12/75	868	--	--	868
1977	03/22/77	1200	--	--	1200
1978	11/08/77	1820	--	--	1820
1979	05/23/79	1470	--	--	1470
1980	04/28/80	1290	--	--	1290
1981	05/11/81	561	--	--	561
1982	01/04/82	1200	--	--	1200
1983	04/10/83	1330	--	--	1330

NOTES: t = TIME IN YRS SINCE JAN 1, 1940, UPDATED PEAK DISCHARGE, CFS -0.011 t
RATIO = $\frac{\text{UPDATED PEAK DISCHARGE, CFS}}{\text{OBSERVED PEAK DISCHARGE, CFS}}$, RATIO = (2.06)*10

REFERENCES

- a. Stankowski, S. J., Magnitude and Frequency of Floods in New Jersey with Effects of Urbanization, Special Report 38, U. S. Geological Survey, 1974.
- b. Hydrologic Engineering Center, Special Projects Memo No. 469, Hydrologic - Hydraulic Simulation, Rahway River Basin, New Jersey, 1976.

THE QUANTIFICATION OF URBANIZATION IMPACTS ON RUNOFF THROUGH HEC-1
MODELING

By Thomas P. Smyth and Peter Koch

SUMMARY OF DISCUSSION
Compiled By H. Estus Walker¹

Discussion on this paper was limited, probably due to its comprehensive nature and detailed description of procedures used in the study. However, it was pointed out that one should exercise care in relating basin runoff characteristics to population alone. In many instances, population may level off, but the watershed may continue to become more impervious as streets, parking lots, etc., are paved and improved. In addition, storm sewers may be installed at different rates than population growth. Further, declines in population do not indicate that such facilities are removed once constructed.

It was pointed out that loss rates were indications of the changing land use. Volumes of the individual storms used in the study were considered in the modeling effort, and although rainfall trends were not analyzed in detail, rainfall trends were accounted for in reconstitution of the nine historical floods.

¹CHIEF, WATER MANAGEMENT BRANCH, SOUTHWESTERN DIVISION

WARNING TIME DETERMINATION USING HEC1
ROANOKE, VA, FLOOD WARNING SYSTEM

BY

LINWOOD W. ROGERS, P.E.

Background.

Basin Description. The City of Roanoke is located in the mountainous region of South Central Virginia. As shown in Figure 1, the City of Roanoke is part of a larger metropolitan region known as the Roanoke Valley which also includes the City of Salem, the Town of Vinton and surrounding Roanoke County. The area is a thriving, progressive industrial and commercial area which is served by an excellent transportation system including major railroad lines and interstate highways. This valley area is surrounded by the Appalachian Mountains on the north and west and the Blue Ridge Mountains on the south and east. The Roanoke River with its headwaters in the mountains to the west flows through the valley, and the metropolitan area providing a natural resource which has been a valuable asset to the growth of the area. Due to the topography and, in some cases, the need to have a water source, the flat areas of the Roanoke River floodplain have become extensively developed. Some of the development is residential, but the majority of the properties are commercial and industrial oriented and suffer severe losses during flood events.

Being located in the Appalachian chain, the topography of the area is characterized by high mountain ridges, narrow valleys, and steep stream gradients. The Roanoke River is formed by the confluence of the two main headwater tributaries, the North Fork Roanoke River and South Fork Roanoke River, which rises in the steep mountains to the west of Roanoke. Two other major tributaries, Masons Creek and Tinker Creek enter the River from the north within the metropolitan area. Due to their physical characteristics, the streams are subject to high peaks, high rates of rise, and high velocities during flood events. Table 1 gives pertinent data on the stream characteristics of the Roanoke River above Roanoke.

Hydrologic Characteristics. The climate of the Roanoke region is temperate with warm summers and generally mild winters. Temperatures generally range from an average low temperature of 35 degrees in January to a average high temperature of 74 degrees in July. Rainfall is generally abundant during most years. The average rainfall is approximately 40 inches per year and is evenly distributed throughout the year. The rainfall is slightly more in the summer months with approximately 28 percent of the rainfall occurring in the summer.

1

Supervisory Hydraulic Engineer, Wilmington District, U.S. Army Corps of Engineers

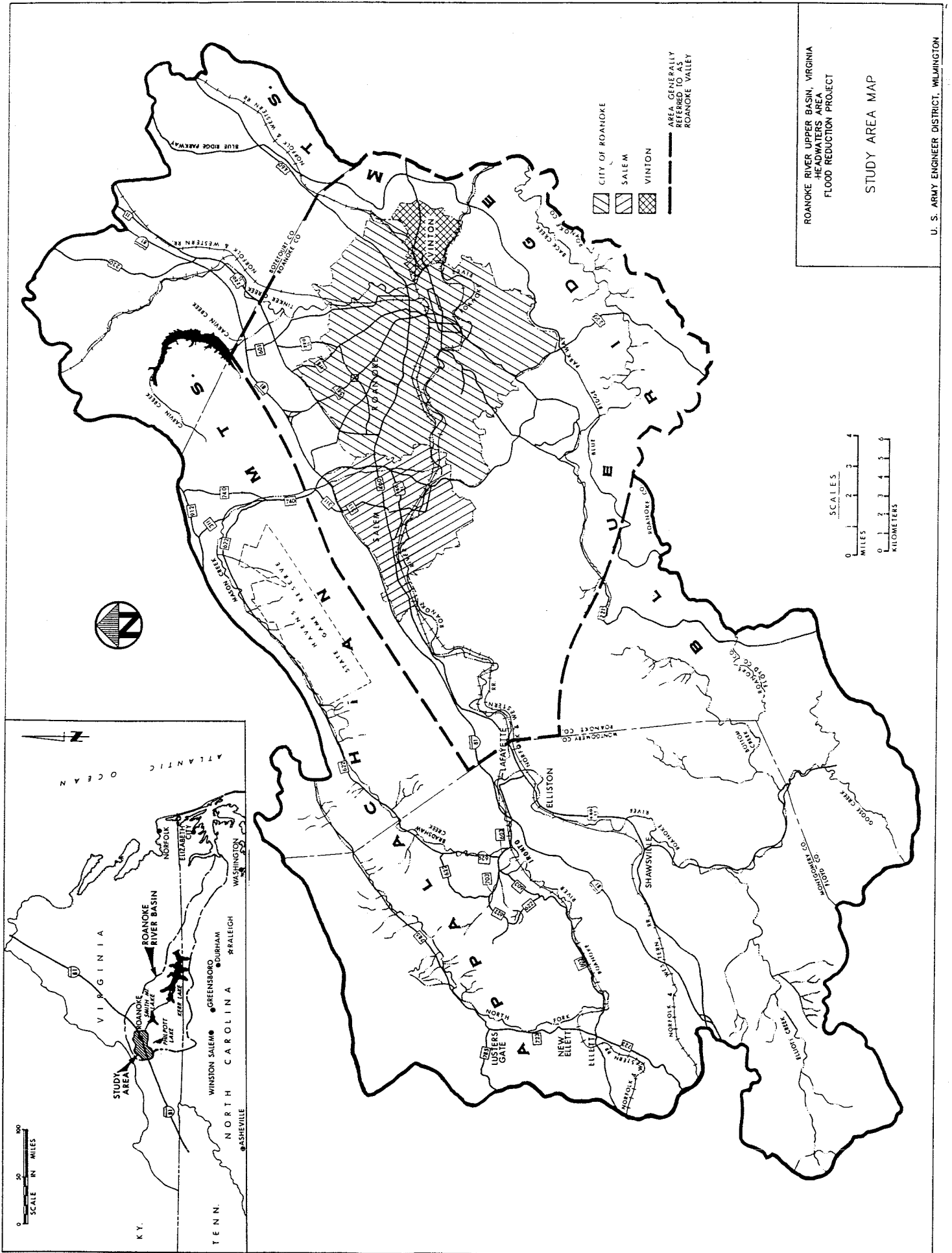

FIGURE 1. STUDY AREA MAP

TABLE 1
Pertinent Stream Characteristics

	Drainage Area (sq.mi.)	Length (miles)	Slope (ft/mi)	Characteristics
South Fork Roanoke	139.	16.6	20	Steep slopes with wide flood plains in areas
North Fork Roanoke	118.	30.8	34	Steep slopes with narrow flood plains
Roanoke River	512.	28.7	12.5	Moderate slopes and wide valleys
Masons Creek	29.4	16.4	56.1	Extremely steep valleys and slopes, high ridges
Tinker Creek	111.	19.1	34.5	Extremely steep valleys and slopes, high ridges

(1) Drainage area at Niagara Gage

(2) Length is distance from Niagara Gage to confluence of North and South Forks of the Roanoke River

Gaging network. Hydrologic data is collected at various locations throughout the study area. The area is served by streamflow and rainfall gages which provide adequate data for hydrologic evaluations. Figure 2 shows the present gaging network in the region. The National Weather Service publishes rainfall data and the U.S. Geological Survey publishes streamflow data at gages along the river in its water supply papers.

Storms and Flood Events. The Roanoke Valley is subject to floods during all seasons of the year. Generally, the most severe flood producing storms occur during the summer months and are the result of tropical hurricanes which have tracked up through the Gulf States or the South Atlantic States. However, flood producing storms can occur during other seasons of the year and are usually the result of frontal systems which tract from the west. Table 2 gives pertinent data for the four largest floods at the Roanoke, Va., stream gage.

Table 2
Floods, Roanoke, VA

Date	Peak Flow (c.f.s.)	Rainfall (inches)
4 Nov 1985	32,300	6.6
21 Jun 1972	24,300	6.3
26 Apr 1978	24,100	5.8
14 Aug 1940	22,800	9.8

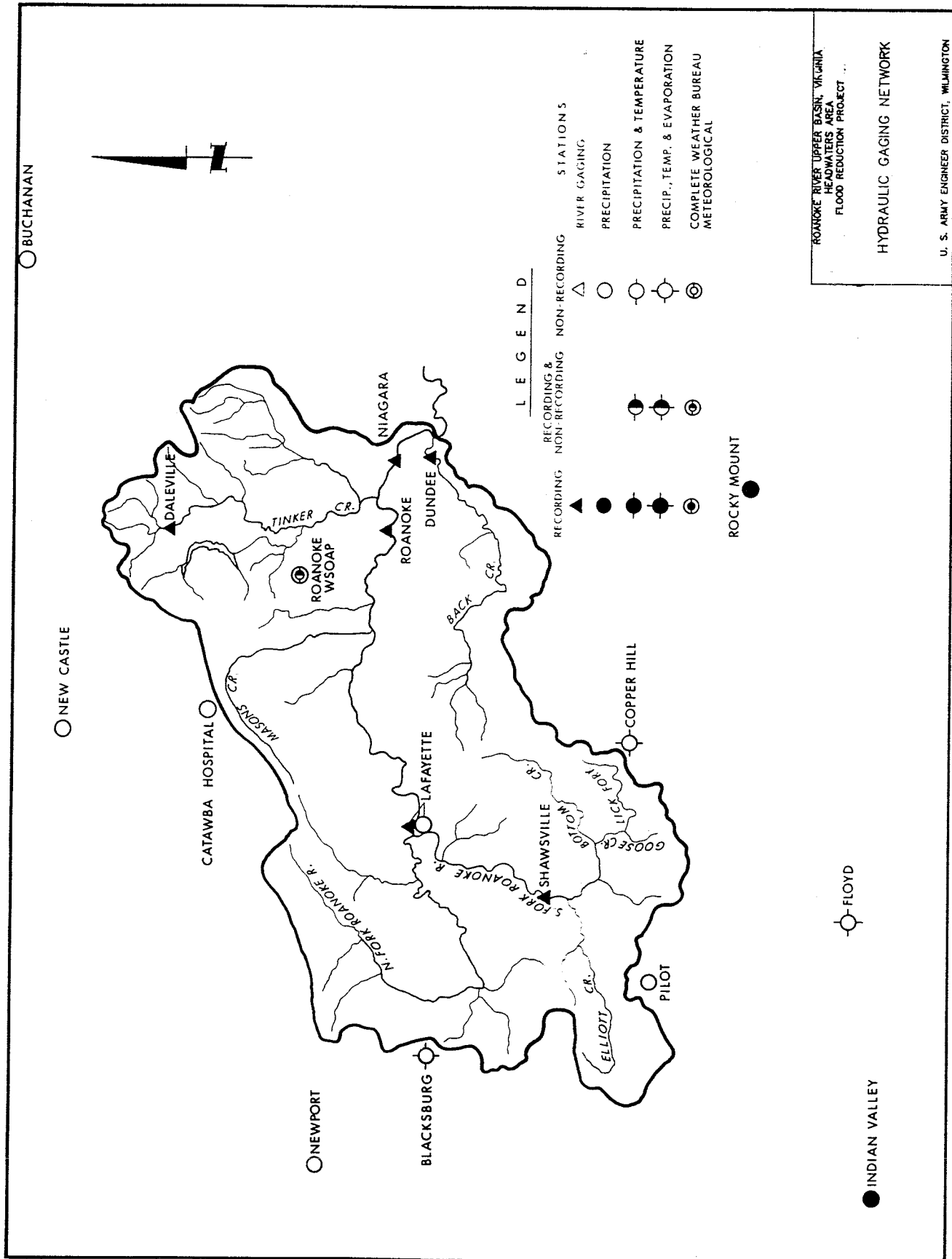

ROANOKE RIVER UPPER BASIN, VIRGINIA
 HEADWATERS AREA
 FLOOD REDUCTION PROJECT
 HYDRAULIC GAGING NETWORK
 U. S. ARMY ENGINEER DISTRICT, WILMINGTON

FIGURE 2. HYDRAULIC GAGING NETWORK

174

Flood Warning System Design. The flood warning system proposed for Roanoke will be fully automated to provide accurate and adequate data for the area to aid them in reducing damages during floods and serve as an added benefit to the flood reduction channel modification project proposed for a ten mile reach of the river through Roanoke. The flood warning system proposed for Roanoke is shown in Figure 3. The location of the rainfall and streamflow gages for Roanoke were placed so as to give representative samples of the precipitation and streamflow throughout the basin surrounding Roanoke. Streamflow gages were placed on the major headwater streams in order that stream rises could be quickly and accurately determined. The Flood Warning System will be based on the Automated Local Evaluation in Real Time (ALERT) flood warning system originally developed by the National Weather Service and will utilize gage equipment and data obtained from the Integrated Flood Observing and Warning System (IFLOWS) which has recently been installed in the Roanoke Basin. The location of the IFLOWS gages was fully coordinated such that the ALERT system for Roanoke will enhance the IFLOWS system and not be a duplication of effort.

Flood Warning Time. The primary purpose of a flood warning system is to increase the available time that a community has to take appropriate measures to reduce property damage and save lives. The warning time is dependent on many variables and is not necessarily the same for all flood events. Warning time varies primarily due to the spatial and temporal distribution of rainfall and runoff associated with the storm being evaluated. Factors such as antecedent soil moisture conditions also enter into the analysis. Figure 4 illustrates the basic methodology used for determining the warning time for damage centers at Roanoke. As indicated, the maximum potential warning time (T_{wp}) would be the time from the first indication of rainfall until flooding begins at the damage center. This is not a practical representation of warning time since flooding does not occur each time there is a rainstorm. There would always be a reaction time (T_r) associated with flood warning. This is the time required for enough rainfall to collect in the gages in order to indicate a potential flood situation and for the emergency personnel to issue a warning. This is the most judgmental part of flood warning. The actual warning time (T_w) is the difference between the potential warning time and the reaction time. The primary objective of the warning system is to increase the actual warning time until it is as close to the potential warning time as practical.

Warning Time Modeling.

Modeling Criteria. It is important that the person developing the model be very familiar with the hydrologic and physical characteristics of the watershed. Questions which should be considered before the model is developed are:

1. Where are the damage centers? Do the damage centers consist of single structures or are they clustered development? Also whether the structures are commercial or residential is important.

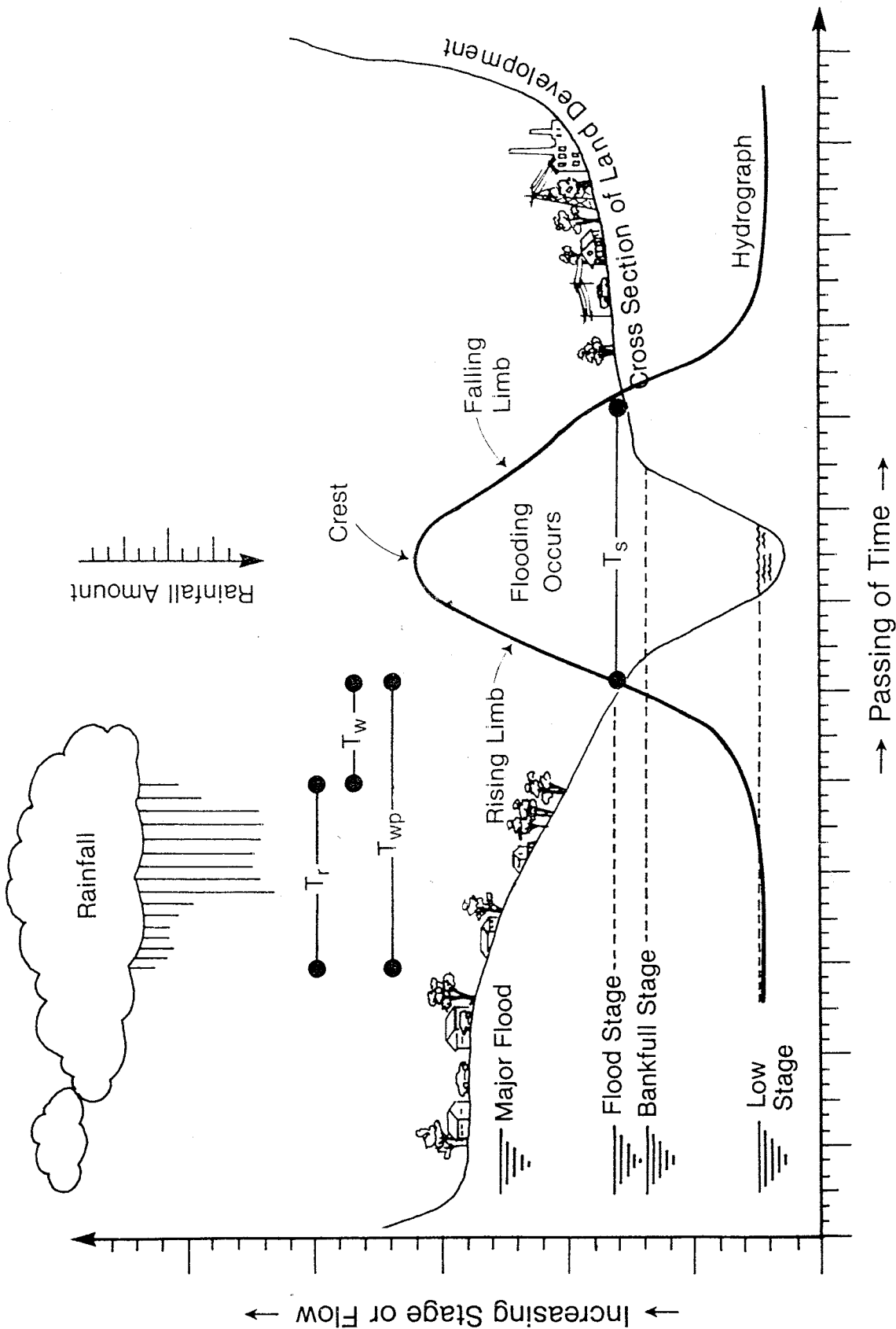

FIGURE 4. TYPICAL WARNING TIMES

The relation between a flood hydrograph and land development along a stream is shown. The hydrograph with rainfall amounts is shown in the darker tones with adjacent scales. A distorted cross section of land development is in lighter tones. The vertical scale is the same as the stage for the hydrograph. No horizontal scale is proved for cross section.

Source: Guidelines on Community Local Flood Warning and Response Systems. August 1985

2. What type damage occurs and what preparations must be made? Do goods need to be moved or do stop logs or other waterproofing measures need to be put in place?

3. At what stage does flooding potential occur? Such things as flooding of evacuation routes and rate of rise of the stream should be considered. This was generally more critical in determining warning times in Roanoke since flooding cuts off escape routes and the rate of rise of the streams is vary rapid.

Computer Model. The HEC 1 Flood Hydrograph Package was well suited for modeling the watershed above Roanoke to determine warning times for the planning and design of the flood warning system. Having determined damage centers in Roanoke, the model was structured such that flood hydrographs in the headwater tributaries could be routed to the damage centers to determine warning times possible with an automated warning system. The modeling procedure was basically accomplished in three steps:

1. Develop and calibrate the model using historical data
2. Route historical floods
3. Determine warning times

Historical Storm Data. Historical storm data and flood hydrograph data were available from published records of gages in the basin. Rainfall data was obtained from National Weather Service published records and flood hydrographs were obtained from the U.S. Geological Survey records. The choice of events used was based on the following criteria:

1. The availability of adequate data defining the rainfall and streamflow to analyze the event.

2. Independent flood events which had well defined peaks

3. Events in which the spatial and temporal distribution of rainfall was different. This was in order to have a series of events which would be typical of storms occurring in various parts of the basin and not just one portion.

Storm events used in calibrating the model and determining warning times were the August 1940, the June 1972, the April 1978 and November 1985 storms. The data developed for the June 1972 flood is presented as an example.

Calibration of Model. The routing model was calibrated using the historical data from the storms and floods mentioned above. Rainfall patterns were determined and applied to unit hydrographs to develop flood hydrographs. Routing coefficients were then developed and verified using the known stream flows from stream gaging records.

1. Rainfall Patterns. Rainfall for the storms analyzed was obtained from published National Weather Service records for rainfall gages in the area. The rainfall pattern was then developed for the basin. Figure 5

shows the rainfall pattern for the June 1972 flood. This storm is typical of storms which would cause flooding in Roanoke.

2. Unit Hydrographs. Unit hydrographs had been developed for previous studies in the basin. Natural unit hydrographs were developed from recorded data. These unit hydrographs were then used in developing synthetic unit hydrographs for intervening areas.

3. Flood Hydrographs. The rainfall and unit hydrograph data developed above were used as input to the HEC 1 model to develop the flood hydrographs for the routing model. Initial losses and infiltration were subtracted from the rainfall and the runoff was applied to the unit hydrographs to develop flood hydrographs.

4. Routing Coefficients. Routing coefficients were developed using the progressive average lag method of routing. This method was chosen for two reasons (a) data from previous studies using this method were available and (b) this method affords a quick efficient method of determining flood discharges downstream based on a known flood hydrograph at an upstream location. Trial routing coefficients were developed for the known historical flood events by routing between gaged locations. Final routing coefficients were then developed for each stream reach by continuous routings of the several historical events and compared with the observed flood hydrographs at stream gages. Figures 6 and 7 shows the routed flood hydrographs compared to the observed hydrographs at two streamflow locations.

Warning Time Determination

Procedure. Once the routing model was calibrated and historical floods were routed to damage points, the next step was to determine appropriate warning times. This, as stated earlier, requires a knowledge of the area to be protected. As an example of how warning times were developed. Two damage centers will be illustrated. One is an area of concentrated commercial and industrial development known as the Victory Park Area and the other is the Roanoke Regional Sewage Treatment Plant.

Stage Hydrographs. In order to determine flood stages, it was necessary to first convert flood hydrographs at the damage centers to stage hydrographs. This was accomplished using rating curves developed from HEC 2 runs and used as input to the HEC1 routing model to convert flood hydrographs to stage hydrographs.

Flood Stages. The flood stage at each of these damage centers was determined based on topographic maps and knowledge of the area and flood history. In the case of the commercial area known as the Victory Park Complex, flood stages for warning occur as soon as flood waters overtop the banks at the river. Streets become flooded and evacuation becomes difficult. Flood stages used for warning at the treatment plant were tied to the elevation of the low point of the access road. The stage hydrographs for the 1972 flood are shown at the two locations in figures 8 and 9.

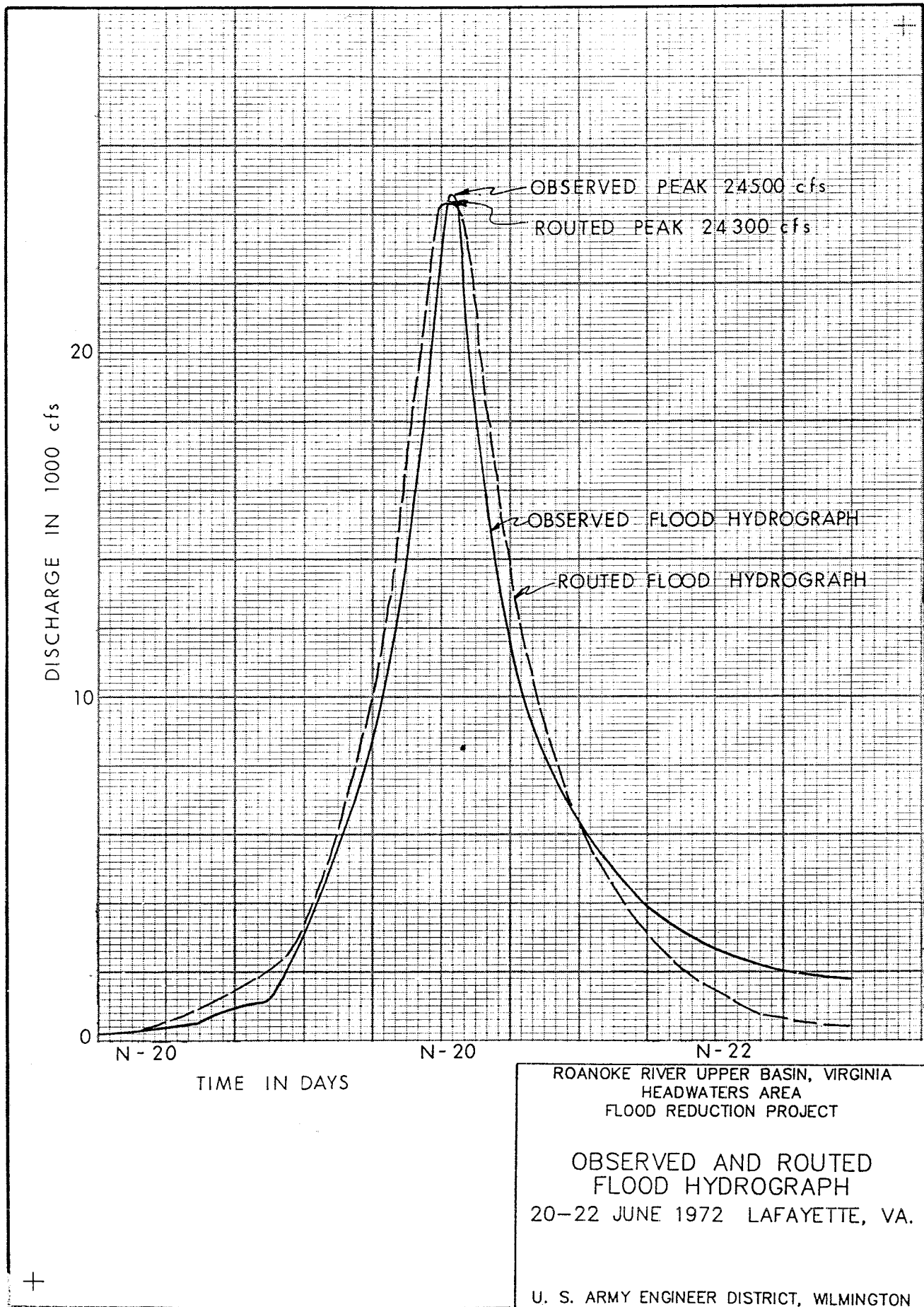

FIGURE 6. OBSERVED AND ROUTED FLOOD HYDROGRAPH

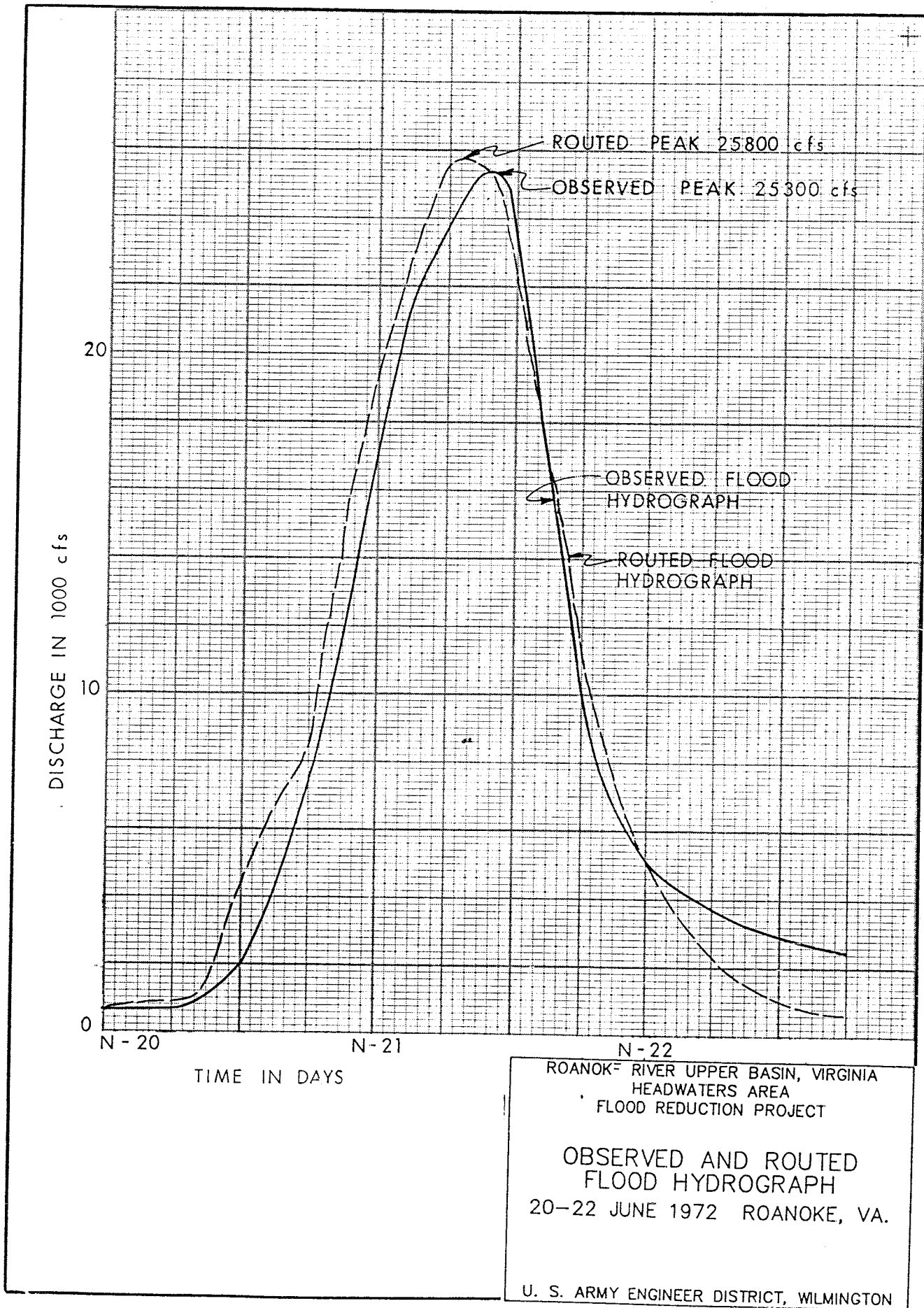

FIGURE 7. OBSERVED AND ROUTED FLOOD HYDROGRAPH

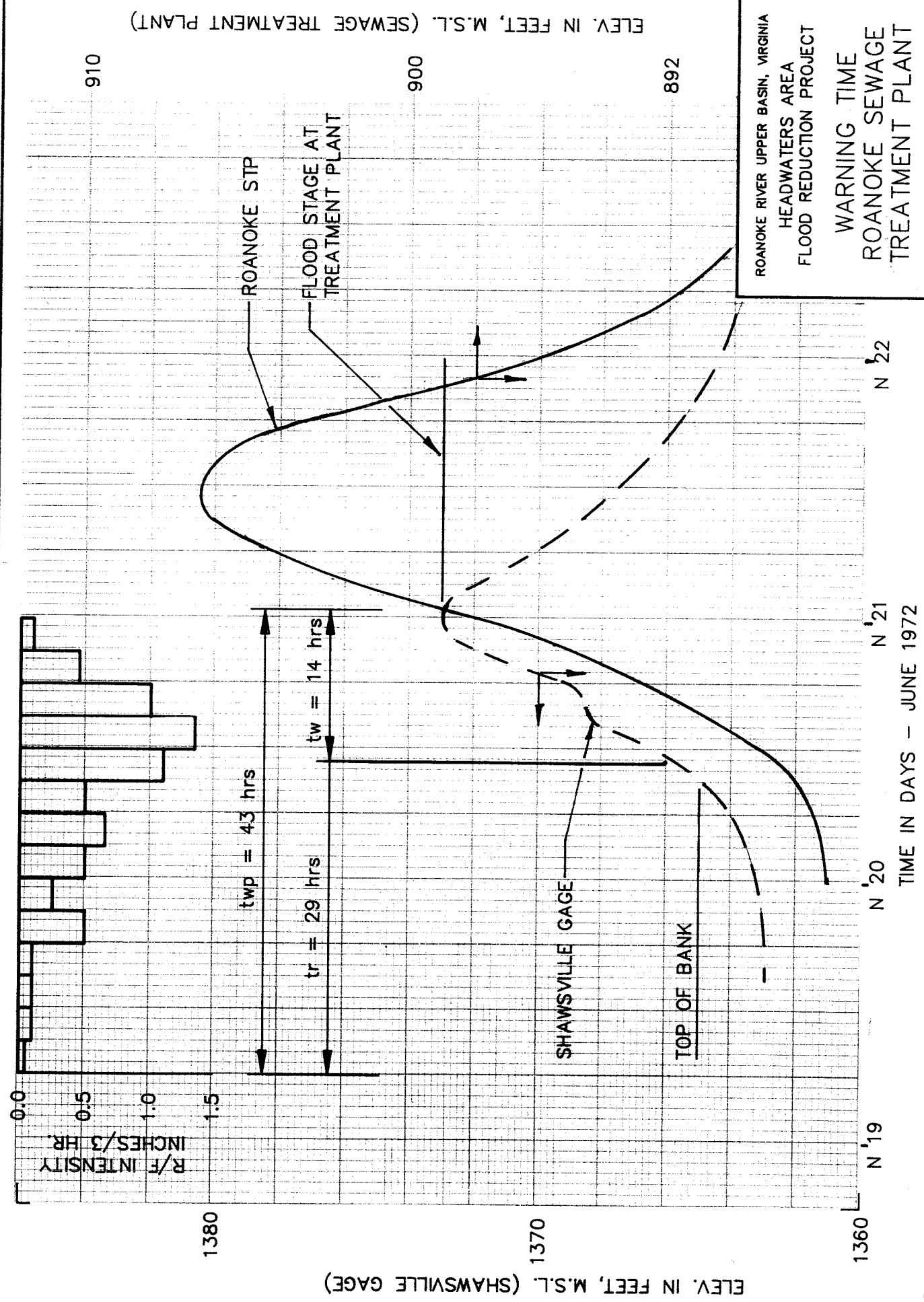

FIGURE 8. WARNING TIME - ROANOKE SEWAGE TREATMENT PLANT PAPER 12

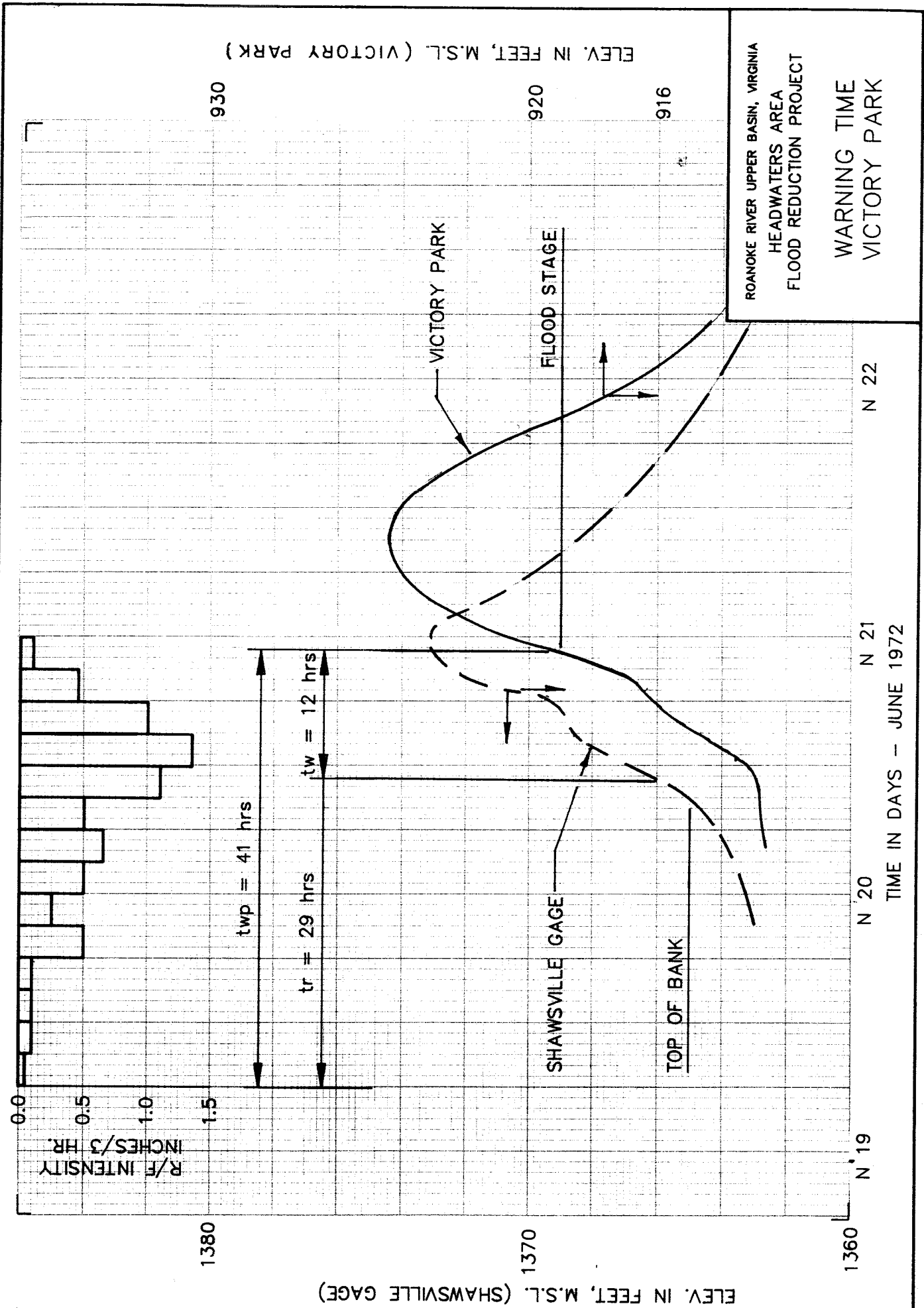

FIGURE 9. WARNING TIME - VICTORY PARK

Warning Time. The methodology used was discussed earlier and shown in Figure 4. The actual warning time, as stated earlier, is the time interval available from the time the potential for a flood situation is declared until the flood stage. This was determined for Roanoke by comparing stage hydrographs at the upstream gages with those at the damage centers.

1. Potential Warning Time. This is the time from the beginning of rainfall until the flood stage was reached at the damage centers.

2. Reaction Time. The reaction time was determined by analyzing the rainfall patterns and the rise of the hydrographs in the headwaters during floods. The reaction time was considered in two parts. First, the time required for enough rainfall to be collected in the gages to indicate a possibility of flooding and show up as a significant rise in stages reported from the headwater stream gages. Second, time for the emergency personnel to analyze the incoming gage data and issue a warning. This was somewhat arbitrary and considered to be two hours. Based on rainfall analysis it takes approximately 2 inches of rainfall to cause significant rises in stream flows in the headwater areas. This was the first indicator for warning time. The incoming data on streamflows was the second indicator used to determine reaction time. When bankfull stage was reached at the headwaters gages and if it was still raining it was assumed that the emergency personnel would be notified. As stated above it was assumed that the reaction time for them to analyze the incoming data and issue a warning would generally be two hours.

3. Warning time. The warning time was then determined to be the difference between the potential warning time and the reaction time. The warning times varied depending on the storm pattern and the location of the damage center. Table 3 illustrates the difference in warning times at the Sewage Treatment Plant.

TABLE 3
Warning Times-Sewage Treatment Plant

Flood Event	Warning Time (hours)
August 1940	9
June 1972	14
April 1978	8
November 1985	5

Conclusions. The modeling techniques in HEC1 provided what was felt to be a reliable tool for determining flood warning times for planning and design of the flood warning system. Several observations were made as a result of the modeling.

1. The warning time varies from storm to storm depending on the storm patterns.

2. The assumption of when the warning time begins is arbitrary and could vary depending on the assumptions of the modeler.

3. The experience of the person preparing the model could be very important to the outcome of the warning time.

REFERENCE

"Guidelines on Community Local Flood Warning and Response Systems", Hydrology Subcommittee of the Federal Interagency Advisory Committee on Water Data, August 1985.

WARNING TIME DETERMINATION USING HEC-1
ROANOAK, VA. FLOOD WARNING SYSTEM

by

Linwood W. Rogers

Summary of Discussion

by

Jack Cunningham ¹

The streamgages used in the Roanoak system were bubbler type. This type gage works well because they can be installed anywhere and don't have to be right next to the stream. The raingages were tipping bucket type with a transmitter that sends a signal to the central computer every millimeter of rain.

The main manufacturer of the equipment is Sierra-Misco, but there are several other companies attempting to get into the business. Handar is one of them.

SONAR streamgages were not in place during the 1985 flood. The USGS gage that is in place is not high enough. It has been in place since 1898 and has gone out of operation twice due to high water. There are no plans to move the gage at the present time.

One of the main problems of warning systems is to warn the local residents when a flood is coming but to not give false alarms. False alarms cause the public to distrust the system and ignore the warnings. The design study assumed that the rain would continue after the warning elevation was reached. This may not be true in real life, but the raingages are located around the perimeter of the basin and should give an accurate picture of what is coming.

Relying on the Weather Service for information on rainfall during an actual event may be a problem. They have been reluctant in the past to do that. If they don't cooperate then how will the local people obtain information about the rainfall that may or may not occur?

One District stated that it has had problems with the Sierra-Misco equipment used in one warning system. Pressure transducer gages were used but they had not been designed properly and had to be replaced. This was done free of charge. Since then there have been two hard disk failures in the central computer. The last one was due to a surge on the line and each repair cost \$900. The city has since stopped using the system.

The question was then raised as to what is the minimum sized

¹ Hydraulic Engineer, Mobile District, U.S. Army Corps of Engineers

drainage basin in which you could install a warning system. The answer was that it depends entirely on the situation. The TVA has installed a warning system in Gatlinburg, Tennessee in a very steep mountainous area which has essentially zero warning time. The fact that there is very little warning time is better than the alternative, which is allowing the 5,000 to 10,000 tourists sleeping in motels on a summer evening to have no warning at all in the event of a flood.

The area around Roanoke does not have a warning problem caused by rain on snow. The mountainous areas get very little snow and it does not stay on the ground for any length of time.

APPLICATION OF THE SSARR-8 RAINFALL RUNOFF MODEL TO
METROPOLITAN SEATTLE, WASHINGTON, AND CONTIGUOUS AREAS

by

Lawrence O. Merkle 1/

Study Purpose

Acknowledgement. The runoff model discussed in this paper was developed in 1987 by the U.S. Army Corps of Engineers (USACE), Seattle District, with the assistance of Northwest Hydraulic Consultants (NHC), Kent, Washington.

Objective of the Study. The principal objective of the study was to provide an evaluation of the use of a continuous rainfall-runoff model for reproducing the hydrologic regime of the lower Lake Washington Basin which includes Metropolitan Seattle in Washington State and contiguous urban areas, and the Lake Washington Ship Canal (LWSC) and Hiram Chittenden locks owned and operated by USACE. The locks are located at the outlet to Lake Washington within the city of Seattle principally to pass commercial and recreational vessels between the lake and Puget Sound. Water to operate the locks is provided through local runoff and limited storage in Lake Washington. These sources of supply are subject to considerable stress from M&I users, urbanization, and diverse hydrometeorologic factors. Competition for the available water resource has become increasingly acute between USACE and city of Seattle which obtains nearly 70 percent of its M&I supply from the Cedar River, the main tributary to Lake Washington. Therefore, it is considered important that use of a continuous daily runoff model be investigated for forecasting the runoff available from sources other than the Cedar River to operate the locks and evaluate water conservation measures during low flow periods. To accomplish this task North Pacific Division's "Streamflow Synthesis and Reservoir Regulation Model - Version 8" (SSARR8) was selected to ensure that a large number of variables could be analyzed independently. Results of the calibration work would determine the value of such a model for reconstituting and forecasting daily streamflows and lake elevations, particularly during low flow sequences.

Key Issues. There was initial skepticism toward development of a Lake Washington Basin runoff model due to the large number of unmeasured or difficult to measure variables. The most important of these variables are: the METRO storm/sewer diversions; impervious area runoff; evaporation from Lake Washington; lack of gaged inflow data and measured outflow data (particularly the volume of water passed through the locks and appurtenant facilities); and the limited number of precipitation stations from which to determine the areal variation in rainfall. Therefore, model calibration was attempted on a preliminary/trial basis for just the lower Lake Washington Basin (excluding most of the Sammamish and Cedar rivers) to ascertain the effect and relevance of these variables on runoff.

1/ Supervisory Hydraulic Engineer, U.S. Army Corps of Engineers, Seattle District

Summary. Calibration results were much better than initially anticipated. Many of the components thought to be highly influential in affecting runoff and possibly very difficult to model without exorbitant amounts of data or intricate modeling routines, actually had little impact on calibration of the hydrologic model. The model structure and calibration effort were greatly simplified by combining or eliminating irrelevant or insignificant elements.

Physical Setting and Available Data

General Basin Description. The Lake Washington hydrologic system (Figure 1) lies on the west slope of the Cascade Mountain Range approximately 100 miles east of the Pacific Ocean. The system drains 609 square miles and is comprised of three major drainage basins: the Cedar River; the Sammamish River, including Lake Sammamish; and Lake Washington. Approximately 43 percent of the total Lake Washington inflow is contributed by the Cedar River above Renton, 21 percent by the Sammamish River above Woodinville, and the remaining 36 percent primarily by eight small independent streams surrounding Lake Washington and by direct precipitation on the lake. Most of the streams surrounding Lake Washington are contained in heavily urbanized areas. The most important streams for this study are Mercer and Swamp Creeks. Elevations within the Lake Washington system range from near sea level to less than 1,400 feet around the lake, nearly 2,800 feet in the Sammamish River Basin, and 5,500 feet in the Cedar River Basin near Snoqualmie Pass in the Cascade Mountains. Pertinent data on basin characteristics are provided in Table 1.

TABLE 1
BASIN CHARACTERISTICS

LOCATION	DRAINAGE AREA (sq. mi.)	AVERAGE FLOW ^{2/} (CFS)
Locks	266 ^{1/}	1,437
Cedar R. at Renton	184	641
Sammamish R. near Woodinville	159	335
Swamp C. at Kenmore	23.1	34.9
Mercer Cr. near Bellevue	12	22.7
Lake Washington	36.2	-

- Notes: 1. Drainage area between the Locks, Cedar R. at Renton and Sammamish R. nr. Woodinville
2. Average flow for Water Years 1981-1983

Lake Washington Ship Canal. The 8-mile long LWSC, constructed about 1916, forms the present outlet system to Lake Washington. The LWSC with appurtenant locks, dam, fish ladder, and spillway connects Puget Sound and the Pacific Ocean with the freshwater inland system. Operation of the locks causes saltwater intrusion, which if left unattended could extend to Lake

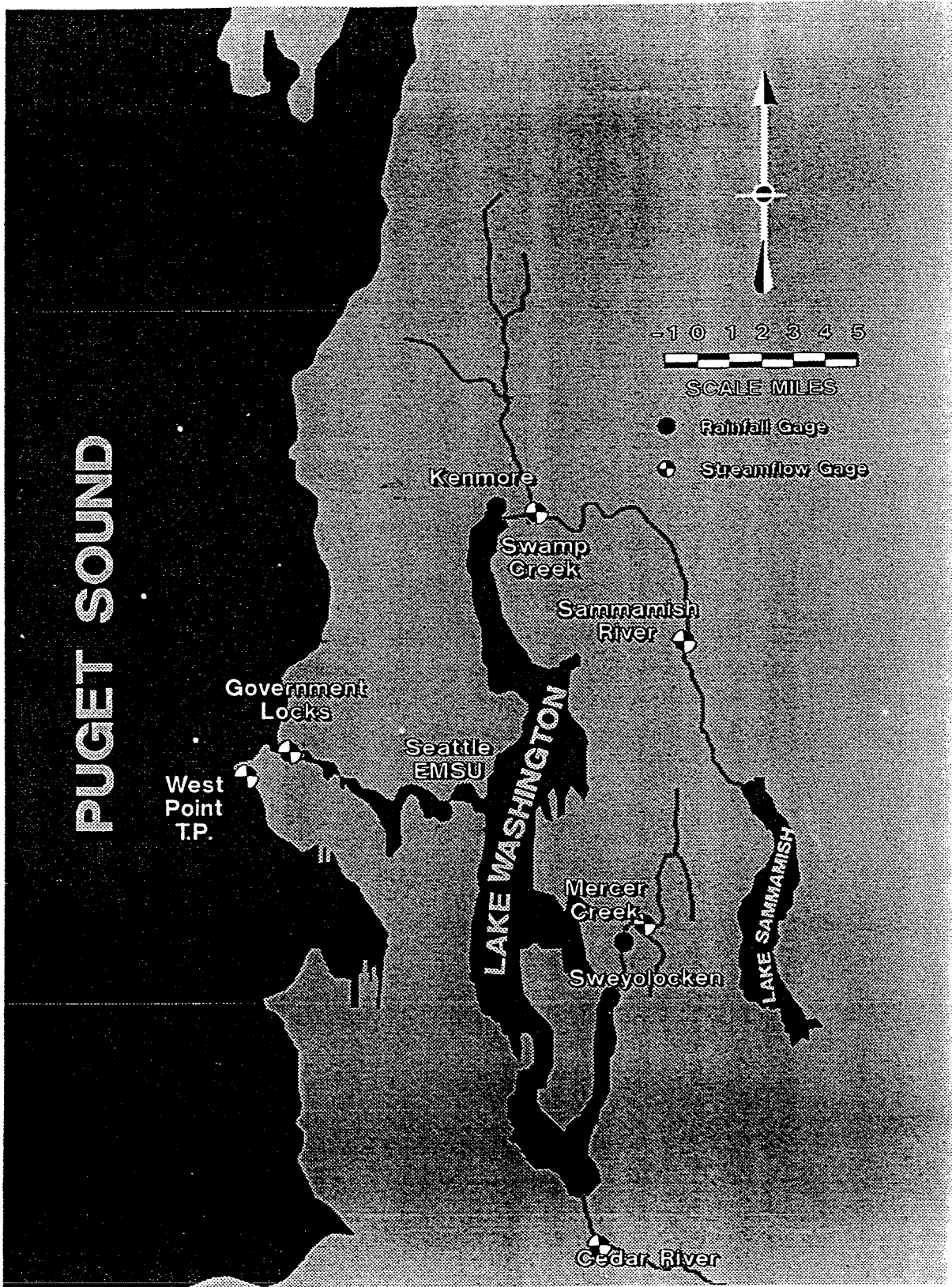

Figure 1

Washington and result in possible environmental damage. Flows through the LWSC facility are regulated to control the level of the lake between 20 and 22 feet (USACE datum) for flood and shoreline erosion control, navigation, recreation, and to prevent damage to two large floating bridges. Lowest and highest lake levels recorded are 18.4 and 22 feet, respectively.

METRO Storm/Sewer System. Much of the lower Lake Washington Basin is served by storm drainage and sewer systems operated by a regional authority known as METRO. The effects of these systems were considered.

Geology. The geologic story of the area is one of repeated glacial erosions and depositions. Glaciers advanced and retreated over the area at least four times. The glaciation created the major landforms around Seattle, and produced the north-south running basins of Lake Sammamish and Lake Washington and the many north-south trending hills of the city. Throughout the area there are often several hundred feet of stratified and unstratified glacial deposits, including glacial outwash material deposited by meltwater streams.

Groundwater. Natural discharge of groundwater occurs mostly in the lower drainages of the Cedar and Sammamish rivers and into Lake Washington and Lake Sammamish, as well as Puget Sound. No significant groundwater sources have been identified in the study area. Streamflow records indicate that groundwater into Lake Washington is probably less than 7 percent of the average annual surface flow.

Fisheries. The Lake Washington drainage basin contains about 650 linear miles of rivers and creeks. Many of these streams provide suitable spawning and rearing habitat or transportation for anadromous and resident fishes. The major fish-producing streams are the Sammamish and Cedar rivers.

Water Quality. A major pollution threat to Lake Washington is saltwater intrusion associated with lock operation. Each time the locks are used, fresh water is released from the system and salt water intrudes into the ship canal. A special drain and operating system are employed for flushing out the salt water. At times, this flushing requires a greater amount of water than operation of the locks and can be especially critical during the low flow summer months.

Climatology. Westerly prevailing maritime air currents from the Pacific Ocean bring the study region considerable moisture, cool summers, and comparatively mild winters. Major storm activity occurs during the winter when the basin is subjected to rather frequent heavy frontal rains associated with cyclonic disturbances from the Pacific Ocean. The weather during the summer months is relatively warm and dry by comparison.

Annual precipitation increases from about 35 inches in lowlands adjacent to Puget Sound to 150 inches or more on the wettest slopes of the Cascade Mountains. Total rainfall for July and August is less than 5 percent of the annual. Snowfall is infrequent, generally less than a few inches each year, and usually melts within a few days to a week of accumulation.

Temperatures in the study area generally range from about the mid-70's in the summer months to the 30's and 40's in the winter months. Maximum temperature in Seattle has never exceeded 100°F, and although Seattle is at the same latitude as northern Maine, minimum temperature has never fallen below 0°F. This illustrates the moderating effect which the Pacific Ocean and low elevation have on the climate.

Annual pan evaporation is estimated at 25 to 35 inches. Maximum evaporation rate is 5 to 7 inches per month in midsummer. Monthly evaporation on Lake Washington ranges from less than one-half inch in February and March to about 5 inches in July and August in very warm years.

Potential evapotranspiration in midsummer exceeds actual evapotranspiration by approximately 2 inches in the drier areas and by 1 inch on the wetter slopes of the Cascades.

Available Hydrometeorologic Data. A tabulation of the hydrometeorologic data used in the study is provided in Table 2, and the locations of recording stations are shown on Figure 1. The accuracy of most published data is quite good (error less than 5 percent in most cases); however, the accuracy of flow estimates for the LWSC facilities and evaporation and precipitation estimates on Lake Washington has not been verified since direct measurement of these discharges cannot reasonably be made. Lake Washington elevations are recorded at the locks and are subject to some variation due to surges from lock operations. A minimum number of climatic stations were selected for use in model calibration based primarily on location and quality of record. Evaporation data for Lake Washington was obtained from a study performed by USACE in 1987 with the assistance of NHC using the general mass transfer equation. The effect of precipitation on Lake Washington was included based upon recorded precipitation data.

TABLE 2
HYDROMETEOROLOGIC DATA
1981-1983

STATION	I.D.	SOURCE	TYPE
LWSC facilities	-	USACE	flow
Cedar R. at Renton	12119000	USGS	"
Sammamish R. at Woodinville	12125200	USGS	"
Swamp Creek at Kenmore	12127100	USGS	"
Mercer Creek near Bellevue	12120000	USGS	"
Lake Washington	-	USACE	elevation
"	-	USACE	evaporation
Seattle-EMSU <u>1/</u>	7458	NWS	temperatures
"	"	"	precipitation
Sweyolocken	-	METRO	"
Kenmore	-	"	"

1/ Environmental Meteorological Support Unit

Study Approach

Modeling Strategy. The approach adopted for modeling local inflows was to calibrate the SSARR-8 runoff model against recorded flows on two tributary streams (Swamp Creek and Mercer Creek). The parameters obtained by calibration were then assumed to apply to the remaining ungaged tributary area, with appropriate modifications for diversions of stormwater by METRO. The SSARR routing model was then used to combine all elements of the hydrologic system including those for Lake Washington. Final calibration was made against observed Lake Washington elevations.

The period of time initially selected for calibration was January 1981 through December 1983, which coincided with a period of relatively complete data on stormwater diversions and overflows from the METRO system. The starting date for calibration was subsequently changed to October 1980 from January 1, 1981, immediately after a major storm to avoid difficulties in determining initial soil moisture and runoff conditions.

Daily rainfall data for the modeling effort were obtained from the National Weather Service's Seattle-EMSU gage, and from gages operated by METRO at Sweyolocken and Kenmore. Short periods of missing data in the Sweyolocken and Kenmore records were replaced by data from the EMSU gage. The Kenmore rainfall data appeared to be unreasonably low and, consequently, were not used in the modeling effort. This station was replaced by the EMSU gage which provided better results.

Daily temperature data for the model study were also obtained from the EMSU gage for use in computing evapotranspiration and depleting soil moisture.

Swamp Creek Subbasin Model. Flows in the Swamp Creek subbasin were modeled by splitting the area into two segments by land use: one segment representing runoff from undeveloped or pervious areas; the second representing runoff from impervious areas. The percentage of impervious surface in the watershed, as judged from available mapping and the response of the stream to small summer storms, was about 9 percent or 2 sq. mi. out of a total watershed area of 23.1 sq. mi. Rainfall data for input to the Swamp Creek model were obtained from the Seattle-EMSU gage (see Figure 1).

The initial calibration for Swamp Creek used disaggregated monthly pan evaporation data from Puyallup as input to the model. Initial calibration runs were unable to reproduce the response of the catchment to small summer storms. This problem was corrected in part by adjusting the SMI curve and the impervious area of the catchment, and in part by altering the way in which evapotranspiration was estimated. Use of daily potential evapotranspiration (PET) estimates derived by disaggregation of monthly pan evaporation recorded at Puyallup produced unreasonably large evaporation amounts during rainy periods. Daily PET was subsequently estimated using a tabulated relationship between mean daily air temperature at the EMSU gage and daily PET. The temperature vs. PET relationship was derived using the Thornthwaite method, as described in the SSARR User Manual. This relationship was then adjusted to more closely match the available data from Puyallup. PET estimates were

further adjusted to reflect reduced PET on rainy days, as described in the SSARR User Manual.

Aside from the difficulty in simulating summer storm events, the main problem in the calibration was in producing a satisfactory simulation of summer and fall low flows. This was achieved by adjustments to the base flow percent (BFP) curve, the percent of base flow input to lower zone (PBLZ) and the base flow and lower zone times of storage.

An example of simulated and observed daily flows for the final calibration are shown in Figure 2 along with recorded daily rainfall at EMSU.

The results show that for the 39-month calibration period, the simulated runoff is 14 percent greater than recorded. However, the simulation of summer low flows is quite good, and the overall simulation is adequate given the length of calibration period, the limited number of precipitation stations, and the effort required of a feasibility level study. Substantial improvements in the simulation of flood hydrographs is unlikely because of the difficulty in obtaining representative local rainfall data (the EMSU gage is about 13 miles from the centroid of the Swamp Creek watershed). However, an improvement in simulation accuracy would be expected if accurate data could be obtained from METRO's Kenmore gage.

Mercer Creek Subbasin Model. The calibration of the model against flows on Mercer Creek was carried out in a similar manner to the calibration against Swamp Creek flows. The initial parameters used to represent Mercer Creek were the final parameters obtained for Swamp Creek. Rainfall data for input to the Mercer Creek model were obtained from METRO's Sweyolocken gage (see Figure 1).

Initial calibration runs for Mercer Creek using the Swamp Creek parameters greatly undersimulated summer low flows. Summer low flow runoff per square mile in Mercer Creek is usually about double that in Swamp Creek. No obvious reasons for the differences in the flow regime of the two streams were found. However, both streams flow through glacial outwash material, which has a large natural variability in providing and sustaining base flows.

The simulation of low flows in Mercer Creek was improved by increasing the proportion of runoff going to base flow, by increasing the percentage of base flow going to lower zone runoff, and by increasing the lower zone time of storage.

A comparison of simulated and observed daily flows for the final calibration is shown in Figure 3 along with recorded daily rainfall at Sweyolocken.

The results show that for the 39-month calibration period, the simulated runoff is 15 percent greater than recorded. However, as with Swamp Creek, the simulation of summer low flows is good, and the overall simulation is adequate for the level of effort required of this study.

METRO Storm Sewer System. Stormwater collected from the Metropolitan Seattle area is diverted from the Lake Washington basin to the West Point

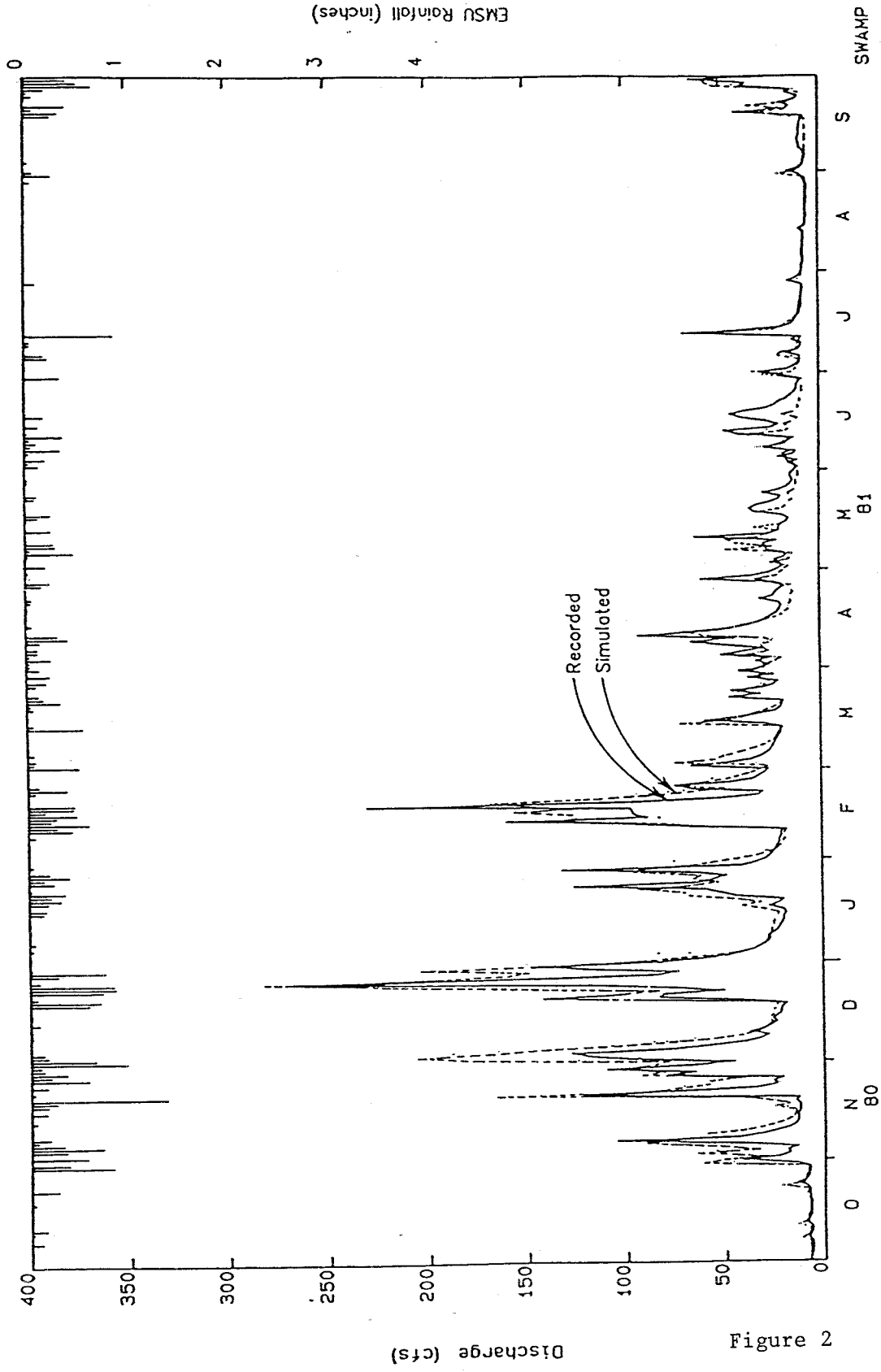

Swamp Creek Simulation Results

Figure 2

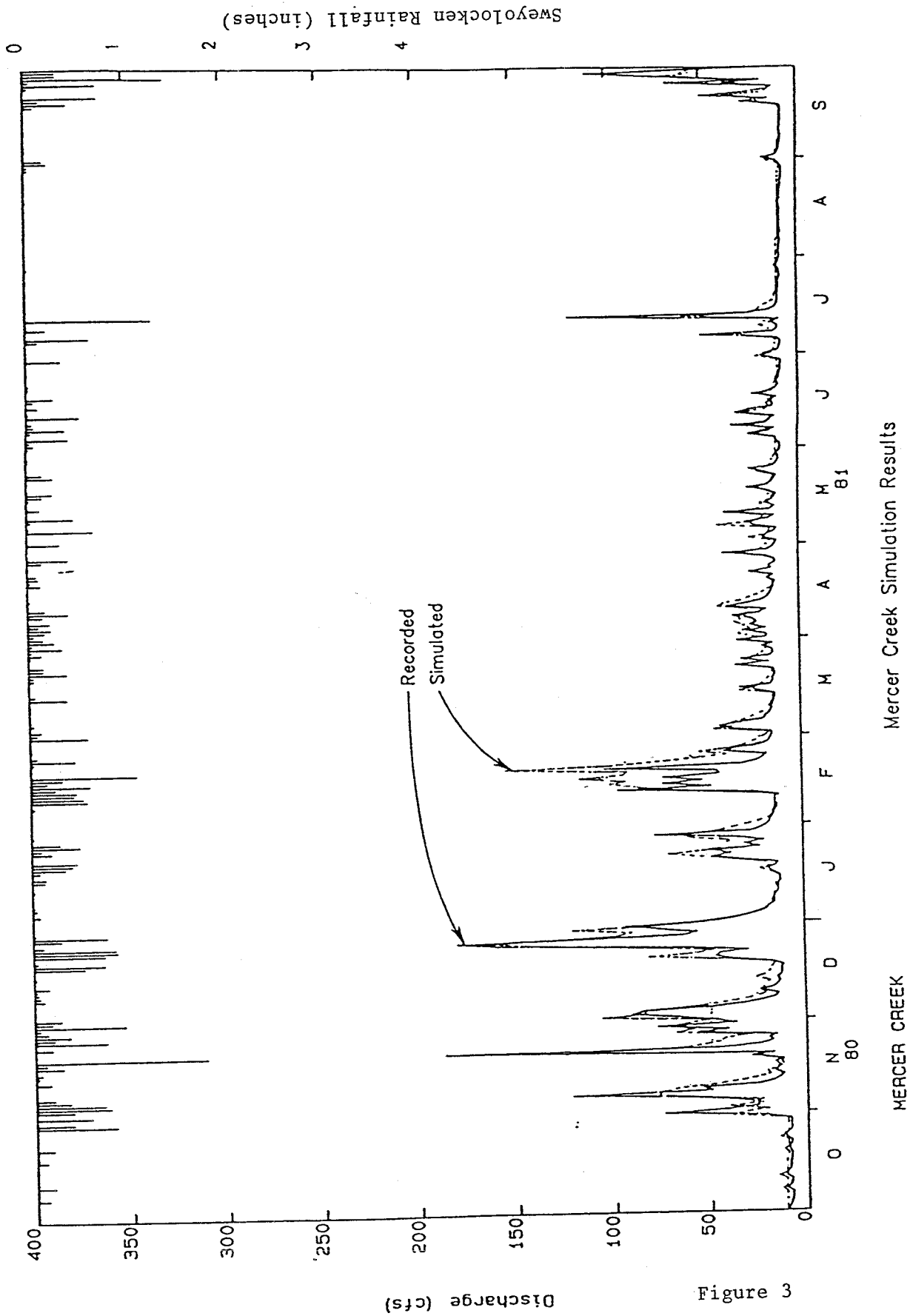

Figure 3

Discharge (cfs)

Sveyolocken Rainfall (inches)

MERCER CREEK

MERCER CREEK

Treatment Plant via a combined stormwater-sanitary sewer system. Overflows from this system to Lake Washington occur during severe storms but are so small (a maximum of 6 cfs) that they were ignored. Efforts to model stormwater runoff proved quite successful. The amount of water involved, however, was small enough (average annual diversion about 50 cfs; maximum daily diversion about 200 cfs) that for this feasibility study a simple reduction in Lake Washington drainage area of 14.3 sq. mi. was used to account for the diversion. Stormwater diversion from the east side of Lake Washington was determined to be much less significant than that on the west side and was ignored.

Lake Washington Routing Model. A schematic of the daily water balance components of Lake Washington is given in Figure 4. The daily water balance for the lake can be written as follows:

$$\Delta S = Q_{\text{Cedar}} + Q_{\text{Sammamish}} + Q_{\text{local}} + P - E - Q_{\text{locks}}$$

where the variables are defined in Figure 4. Note that diversions of stormwater out of the Lake Washington Basin do not appear in the water balance equation since they are assumed to be reflected in the local inflow Q_{local} . A SSARR routing model was developed based on the daily water balance equation to simulate variations in the level of Lake Washington for the calibration period October 1980 through December 1983.

Of the variables in the water balance equation, Q_{Cedar} , $Q_{\text{Sammamish}}$, and Q_{locks} are all measured flows for the period of interest. Daily rainfall on the lake (P) was assumed to equal the average of recorded daily rainfall at EMSU and Sweyolocken. Daily lake evaporation (E) was estimated by disaggregating monthly lake evaporation into daily amounts. The disaggregation approach adopted was to simply fit a smooth curve representing the daily values through the monthly evaporation. The detailed form of the curve was selected so that the disaggregated daily data preserved the original monthly evaporation depths.

Estimates of the final component of the water balance, Q_{local} were based on the results of the simulations described previously. It was assumed that the hydrologic regime of the local tributary area could be represented by the SSARR parameters developed for modeling either Swamp Creek or Mercer Creek flows. The Mercer Creek model parameters were assumed to apply to the 75.7 sq. mi. area on the east of Lake Washington, south of the Sammamish River and north of the Cedar River. As with the simulation of Mercer Creek, 10 percent (7.6 sq. mi.) of this area was assumed to be impervious. The Swamp Creek model parameters were assumed to apply to the remaining 139.4 sq. mi. tributary area which was reduced by 14.3 sq. mi. to represent stormwater diversions as previously discussed. Approximately 13 percent (17.8 sq. mi.) of the 139.4 sq. mi. area was assumed to be impervious as against 9 percent assumed for Swamp Creek. The larger percentage of impervious area reflects heavily developed areas within Metropolitan Seattle contributing stormwater flows directly to Lake Washington.

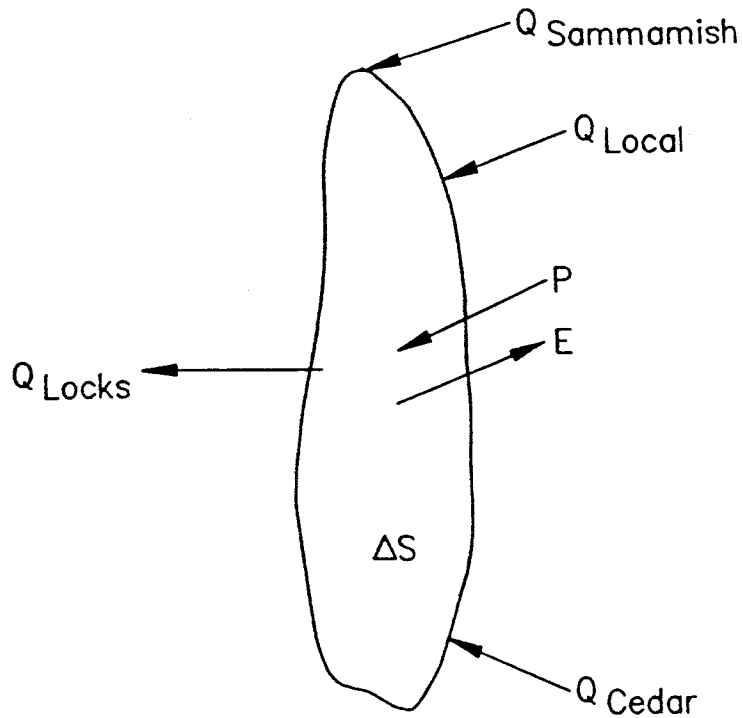

Q_{Locks} = Daily flow past the Government Locks

Q_{Cedar} = Daily inflow to Lake Washington from the Cedar River at Renton

$Q_{Sammamish}$ = Daily inflow to Lake Washington from the Sammamish River at Woodenville

Q_{Local} = Daily local inflow to Lake Washington

P = Daily precipitation on the lake surface

E = Daily evaporation from the lake surface

ΔS = Daily change in lake storage

Schematic Representation of the Water balance Components of Lake Washington

Figure 4

Study Results

A comparison of the daily simulated and observed lake elevations from the routing study are shown on Figure 5. The maximum difference in computed and observed lake elevations is about 1.4 feet over the 3 year simulation period. (For reference, 0.1 foot on Lake Washington equals about 2,325 acre-feet or 1,170 cfs for 1 day.) The most significant errors in simulation of Lake Washington elevations are believed to be caused by a lack of precisely measured and recorded flow data at the locks, the transcribing of lock water logs to the model data base, the limited areal coverage of precipitation stations, and the selection of runoff parameters to model the ungaged local runoff.

The lack of reliable flow measurements and good records at the locks is especially evident during new operations, particularly at the onset. An example of this occurred at the beginning of the new "mini-flush" operation for controlling salt intrusion using the large lock culverts rather than the salt drain. During the initiation of this operation, May 11-16, 1982, it was uncertain from the logs whether one or two culverts were being used which could affect lake levels by as much as 0.3 foot. Errors in transcribing the lock data are also frustrating and hard to detect due to the voluminous amounts of data involved. A spot check of the spill data at a few points uncovered transcription errors resulting in up to 0.2 foot of change in the lake. The effects on lake simulation due to limited areal coverage of precipitation stations used has not been evaluated analytically, but it does not appear to be as significant or dominant as originally thought. The most noticeable errors are those involved with the estimation of basin runoff parameters for ungaged areas. Although calibration of Swamp and Mercer creeks was quite good, direct transfer of their runoff parameters to the large remaining ungaged portions of the Lake Washington Basin is questionable due to the difference in hydrology of the basins. A significant portion of the Lake Washington Basin appears to be subject to considerable infiltration, and produces little surface runoff, quite the opposite of the Swamp and Mercer creek basins. The effects of using these parameters are most noticeable during high runoff months from about November through February. Runoff during these periods as modelled produced mostly surface runoff which resulted in a significant increase in the computed lake stage, whereas the observed lake was nearly flat in most cases. Reconfiguration of the basin model to produce more subsurface runoff and a longer subsurface lag time should eliminate this problem to a great extent.

Despite the difficulties in reproducing observed lake levels in some periods of time, simulation results are good for individual periods up to 6 months long. Results in the late spring and early fall months are especially encouraging. It can be seen from Figure 5 that if, for example, simulation had started on May 1, 1981, with recorded and simulated lake levels equal, results through September 1981 would have been excellent. This suggests that the SSARR model developed may be very useful for forecasting and for investigating the short term low flow operation of the lower Lake Washington system.

LAKE WASHINGTON

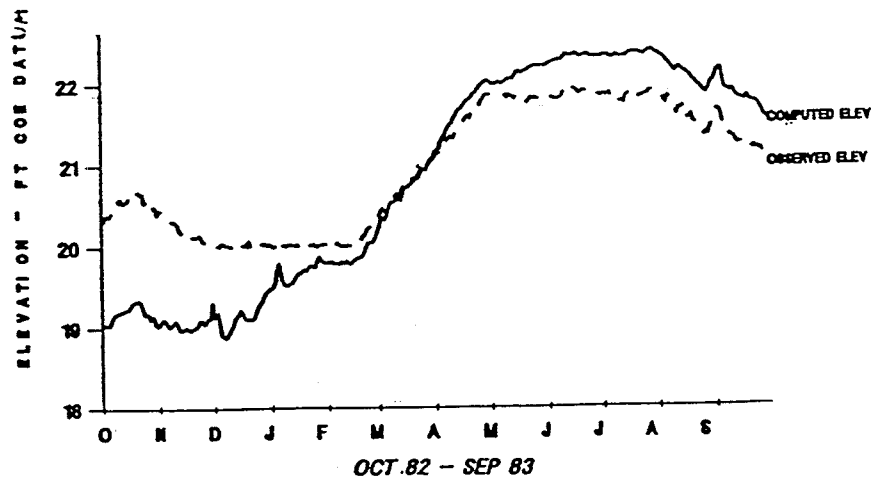
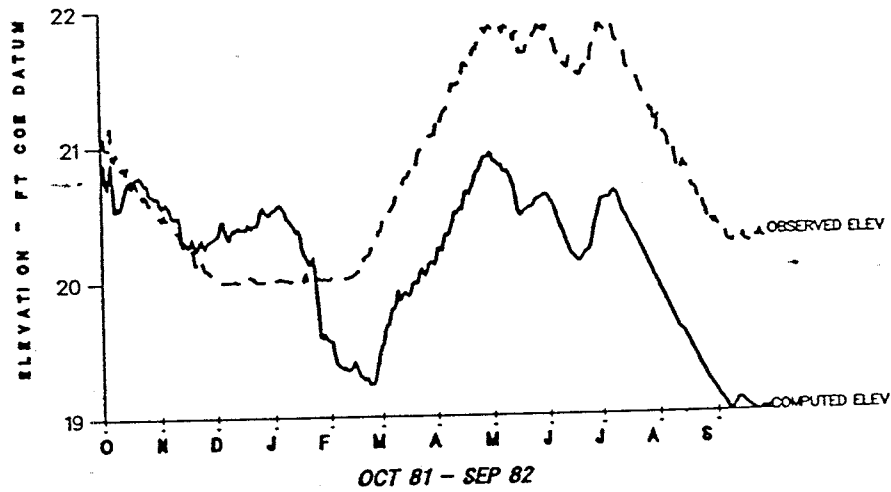
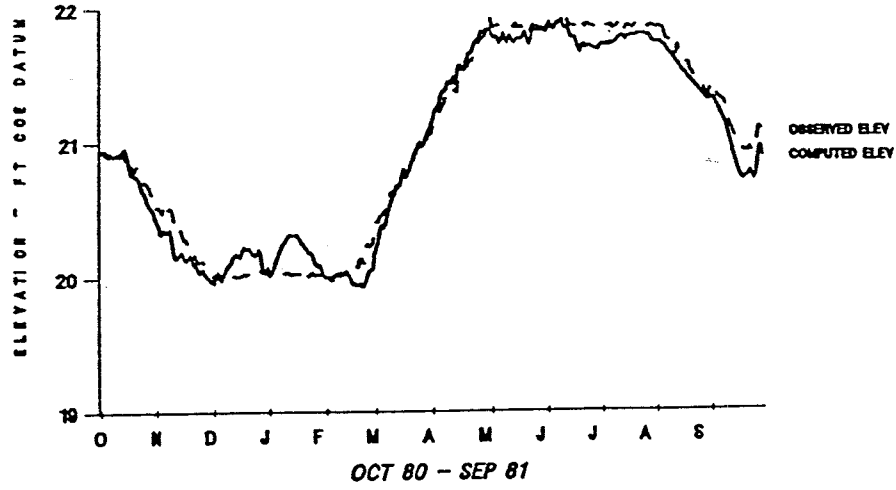

Figure 5

Conclusions

The results presented here suggest that the SSARR model, although perhaps not presently useful for reconstituting lake levels over an extended period of time, may be very useful as a forecasting tool for short-term operation of the lower Lake Washington system, particularly during the critical summer and low flow periods. The following specific conclusions may be drawn:

1) Despite a lack of accurate and representative daily rainfall data, the simulation results for Swamp Creek and Mercer Creek were quite promising with good simulation results in the summer and early fall low flow periods.

2) The sparsity of dependable precipitation gages in the basin does not appear to be an insurmountable problem, although better data is highly desirable.

3) Simulation of the West Point Treatment Plant stormwater flows was adequate with good simulation of long-term volumes. The impact of errors in the simulation of stormwater diversions and overflows is small relative to other errors, most notably the potential errors in flow measurements at the Government locks and on the Cedar and Sammamish rivers. This is especially true during the summer and fall low flow periods.

4) Simulation of lake elevations is very sensitive to errors in the measurement of both inflows and outflows.

5) The simulation of lake elevations for summer and fall months for periods up to 6 months long was often good. This indicates that the model can track lake elevations well during the critical summer and fall low flow months and suggests that the model may be extremely useful in the short-term or seasonal operation of lower Lake Washington system.

Recommendations

Further studies or actions in the following areas may be warranted:

1) A detailed and formal error analysis for the simulated lake elevations should be performed. This may allow the true source of error in lake level simulations to be identified.

2) The calibration period for Swamp Creek, Mercer Creek, and the Lake Washington Basin should be extended through 1986 to include a period of improved recordkeeping at the locks. Model verification should be performed for the low flow period June through December 1987, one of the lowest streamflow periods on record.

3) Modeling of local inflows should be extended to include other gaged streams such as Juanita Creek.

4) The cause of error in METRO's Kenmore rainfall data should be investigated and appropriate action taken.

5) Consideration should be given to establishing an integrated system of rainfall gages in the lower Lake Washington Basin.

6) The use of the SSARR model in an operational forecasting setting should be investigated by performing retrospective simulations of critical summer and fall low flow periods.

7) Recompute spillway and lock outflow rating curves to test improvement in model calibrations.

8) Check spill calculations and all lock flow data to ensure they have been accurately transcribed and documented.

Application of SSARR-8 Rainfall Runoff Model
to Metropolitan Seattle, Washington and Contiguous Urban Areas

by

Lawrence Merkle

SUMMARY OF DISCUSSION

by

Jaime Merino¹

Questions about this paper centered around getting a better understanding of the hydrologic system and the SSARR model. The 5000 AF storage in the two foot operating range of Lake Washington was also one of the questions asked. This discussion on the storage in Lake Washington, and in general in the basin, led to a discussion on how the SSARR model handled river routing. After explaining that it uses a system that simulates a series of reservoirs with variable time of storage, the discussion then focussed on the groundwater storage in the basin and whether that shouldn't also be modeled to achieve better accuracy. The author concluded by stating that there had already been considerable effort (and money) expended in the study for the present study stage and that in the next iteration there would probably be a need to model the groundwater also.

¹ Hydraulic Engineer, South Pacific Division

CALIBRATING AND APPLYING A HYDROLOGIC MODEL OF THE COLUMBIA RIVER BASIN

by

Douglas D. Speers, P.E. (1)

Introduction

Objectives. This study was a subset of a major reevaluation of flood control rule curves on the Columbia River, brought about by two initiatives. First, new regional incentives for management of the salmon fishery resulted in a request to the Corps of Engineers to evaluate whether modification of flood control criteria might improve the fishery migration. Second, there was need to evaluate and improve in-house operating plans in light of current operating objectives. These factors pointed toward the development of a hydrologic model capable of simulating various combinations of snow and rain scenarios, as well as being able to model the operation of the reservoir system in the basin.

Key issues. The major concern faced in the study was the size and scope of the effort. The model had to be relatively detailed, yet applicable to the entire Columbia basin with a drainage area of 260,000 sq mi. The SSARR ("Streamflow Synthesis and Reservoir Regulation") program was a logical choice to use since it is used for operational forecasting of the Columbia; however, for the study certain options of the model not used in forecasting would have to be utilized thus requiring calibration of new models. Data requirements also would be demanding for the large area involved. The time frame that was set up (approximately 2 years) was less than adequate for as complete an analysis as would be desirable; thus some short-cut procedures would have to be taken.

Findings. With the help of three district offices the calibration, testing and application of the SSARR model was accomplished. The simulations that it provided (1) confirmed existing flood control criteria for certain regions on the rule curves for four projects in the basin; (2) revealed that some raising of the rule curves would be possible without changing overall flood control objectives. The calibration and application of the model was considered satisfactory, although the application proved to be less "straight-forward" than originally anticipated. The model will continue to be used to refine and formalize the flood control curves under investigation, and to assist in formulating new and improved regulation tools for the Columbia system.

Physical Setting and Available Data

The Columbia River basin, shown in Figure 1, comprises five states in the Pacific Northwest as well as part of the province of British Columbia, Canada. It is primarily a snow-melt river having one large and relatively broad flood peak in the spring, the result of melting of the winter's accumulation of snow. However, it is also affected by rainstorms, both during the winter in the lower river basins, and sometimes during the spring runoff. The latter type of event is of particular concern in determining flood control criteria so it was modeled extensively in the study.

(1) Supervisory Hydraulic Engineer, North Pacific Division, U.S. Army Corps of Engineers

COLUMBIA RIVER AND COASTAL BASINS

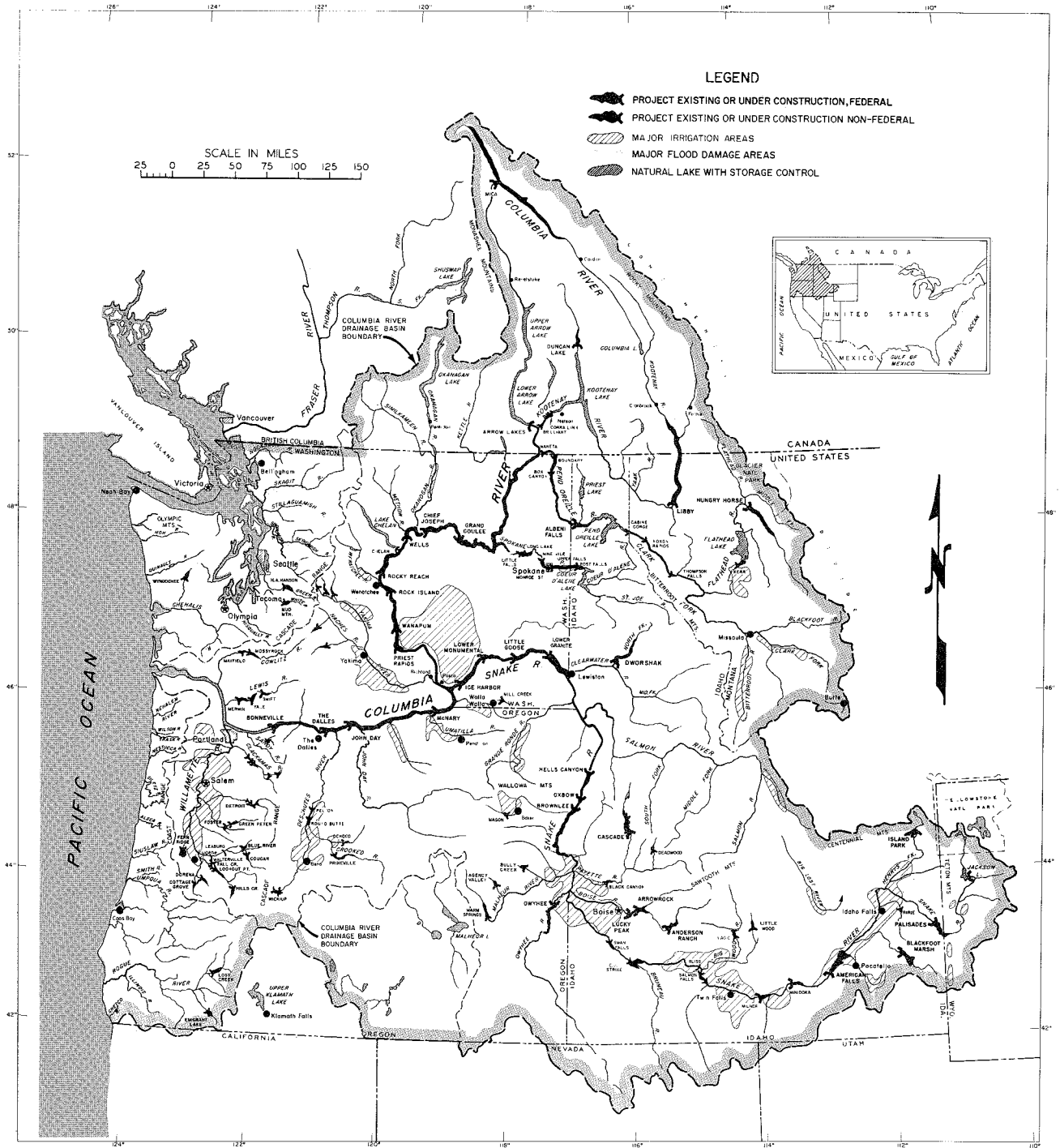

FIGURE 1. MAP OF COLUMBIA BASIN

The basin is highly developed, having about 50 dams and reservoirs that are considered significant in system operations. Of these, 14 are designated flood control projects, having a combined storage of about 40 million acre-feet (maf). With an average annual runoff of 140 maf and with major flood years approaching 200 maf, complete control of the river is not possible; thus, a variable controlled flow objective for the Columbia River at The Dalles is used. Studies have shown that a 50-year flood can be regulated to just below major damage level in the Portland-Vancouver vicinity. A major tributary, the Willamette River, enters the Columbia at Portland, adding another 25 maf of runoff. This tributary, with a drainage area of 11,000 sq miles, is subject to winter rain floods and is not a significant contributor of runoff during the spring flood on the Columbia River. Portland is therefore subject to a second source of flooding, when in the winter the Willamette and lower Columbia River tributaries can combine to produce a rain (plus snowmelt) flood. This type of event was also modeled in the study.

Because of the large drainage area involved, extensive amounts of data were required for calibration of the models and for the intended hydrologic analyses. Data types needed were precipitation, temperature, snow water equivalent, streamflow, and reservoir elevations. At the outset of the study the decision was made to use a basic computational time increment of 24 hours, which greatly simplified the task of preparing data. For most subbasins in the Columbia this is a satisfactory time step. In the Willamette basin model, however, a shorter time increment was used for the model calibration. Archive data tapes were purchased from the USGS, National Weather Service, and Canadian streamflow and weather agencies, and an on-line database was developed as described below.

Study Approach

The flood control curves under investigation are a variable criteria, in which the variable parameter is the long-term forecast of spring runoff volume. Typical of such curves is that for Libby project in Western Montana, shown on Figure 2. The forecast parameter is made possible by the fact that the snow pack water equivalent (and winter precipitation), usually gives a reasonably accurate index of spring runoff volume, even as early in the year as 1 January. The Libby curves, and those for most of the other projects in the basin, were developed in the 1960's based upon historic flood records. An important consideration in their derivation was the possibility that unforecastable spring rain could result in runoffs significantly exceeding the volume indicated by the nominal forecast, thereby resulting in a reservoir drawdown that may not be adequate to regulate the flood. The 1948 flood in the Columbia River was a key example of such an event, in which a moderate snowmelt flood was augmented significantly by rains during late May. This led to a disaster in the Portland vicinity, completely inundating the city of Vanport and causing several deaths. The 1948 flood data were in fact used in the early studies to develop what amounts to a factor of safety that was added to the nominal forecast parameter, thereby lowering the curve from its "snowmelt only" level. The problem with the existing flood control curves was that (1) the "factor of safety" was not rigorously quantified with respect to probability and magnitude; and, (2) the higher parameter curves (lower runoff forecast) had never been fully analyzed with respect to flood control. The lack of analysis for the lower runoff curves was due to the fact that floods of that magnitude had not been an operational concern when they were developed. Now, with greater emphasis on conserving water for fisheries and power operations, they were being called into question.

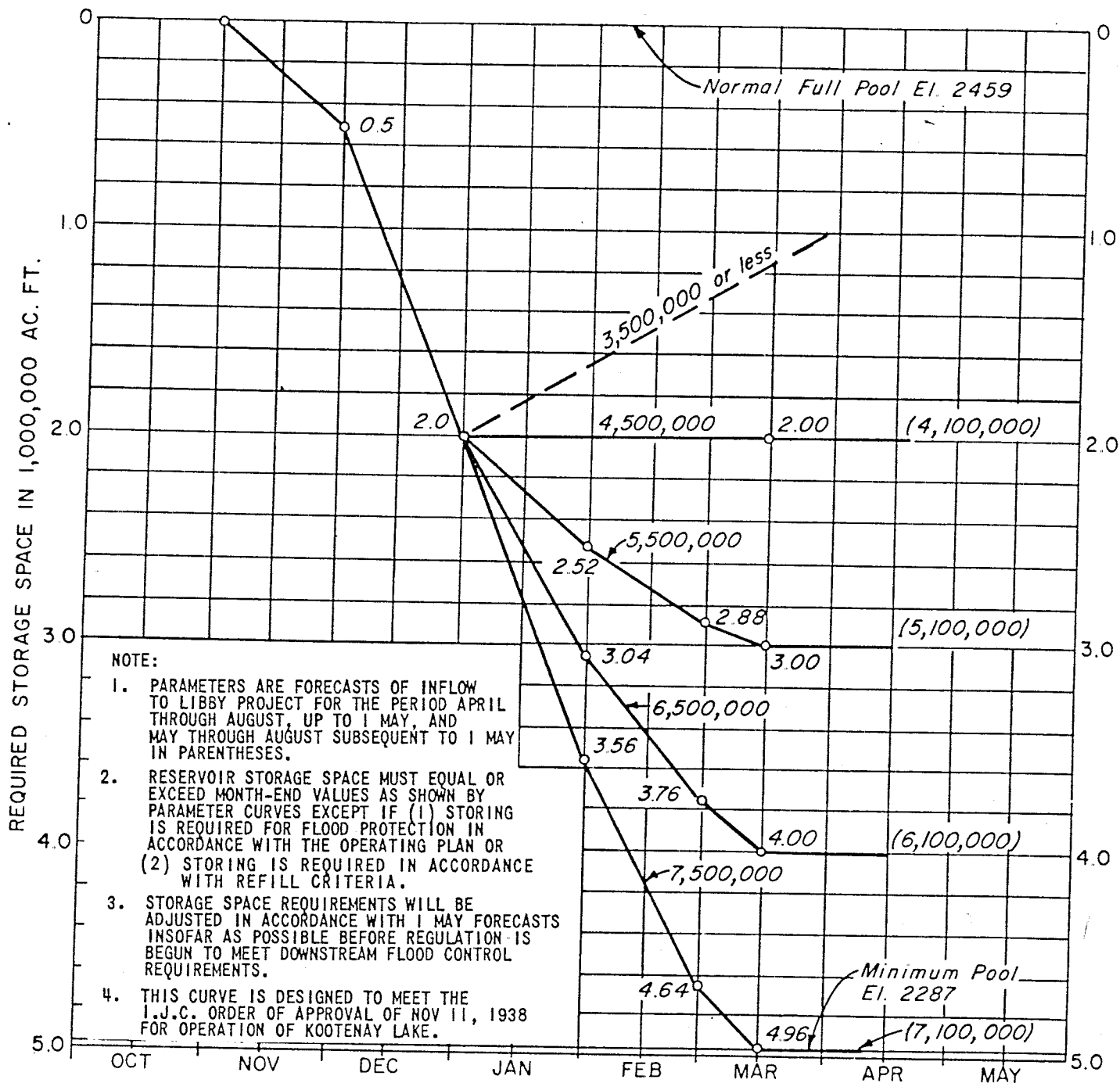

LIBBY PROJECT
FLOOD CONTROL
STORAGE RESERVATION DIAGRAM

FLOOD CONTROL OPERATING PLAN
COLUMBIA RIVER TREATY
SEPTEMBER 1972

FIGURE 2. EXISTING OFFICIAL LIBBY FLOOD CONTROL CURVES

212

Since there were few if any recorded records of spring rain-on-snow occurrences for other than the 1948 flood, particularly for lower than normal snowpacks, it was clear that the flood events would have to be simulated with a hydrologic model. Once done, the flood control requirement could be established, associated with varying magnitudes of snowpack, which would provide adequate control of a spring rainstorm that could occur. This would have to be done not only for subbasin damage centers but for the entire basin as well, since the reservoirs are operated both for local control and for system control at The Dalles. The model used would have to be able to simulate varying snow conditions in detail, would have to be able to operate continuously throughout winter and summer seasons, and would have to be accurate in low runoff conditions as well contend with extreme flood events. The SSARR program, which has been used for daily forecasting and studies in the Columbia, was ideally suited for this task. However, because the "snowband" option would have to be used - in which the basin is subdivided into bands of equal elevation to account for snow conditions in a distributed fashion - new models would have to be calibrated and tested before application. The SSARR model is not described in this paper, but references 1 and 2 provide a detailed description of the model.

Model Development

The following are brief summaries of the steps that were required to develop, calibrate, and test the comprehensive hydrologic model of the Columbia basin. All computer applications were done on the NPD Amdahl 470 computer in Portland. Most of the data processing and database work utilized the SAS software system available from the SAS Institute Inc., Cary, N.C.

Streamflow database. A significant effort in the study was the development of a database of year-around mean daily streamflows. This involved "unregulating" most of the years of record to remove the effects of reservoir operations and computing local inflows, an operation that was performed using the SSARR program. The completed database eventually contained 41 years of record for 120 locations in the basin. These data reside online in a SSARR bulk file, and are callable to the SSARR program with a simple reference code.

Precipitation/temperature database. A total of 175 precipitation and temperature stations (daily max and min) for 35 years of record were loaded in the SSARR bulk file. These data had to be first screened, and missing data estimated using adjacent stations in the region.

Model configuration. The model was configured into 70 watersheds, following the subdivision used for forecasting and previous study applications. Each subbasin was in turn subdivided into bands of equal elevation. Generally, 5-10 bands were used.

Subbasin watershed model calibration. This activity required the greatest amount of manpower since each subbasin had to be calibrated independently. Assistance was provided by district offices so that there were as many as 8 persons involved at one time. Generally, calibration was done on 5-10 years of record, operating continuously. This process led to the selection of hydromet stations to use for input, station weightings, and model parameters.

Total basin model. When the subbasin watershed models were completed they were combined into a total model of the basin, along with characteristics of river routing reaches, lakes, diversions, and reservoirs. These characteristics were taken from the existing forecast model. A schematic of the basin upstream

of The Dalles is shown in Figure 3. This is the largest and most complex hydrologic model ever put together by the NPD office. In addition, a similar model was constructed of most of the Columbia basin and including the Willamette basin for the purpose of simulating winter flood events. The model was tested on several floods, and Figure 4 shows the simulation of the 1948 flood.

Model Application

Many application simulations were made with the model, both for individual subbasins and for the Columbia River as a whole. These typically involved applying a synthetic rainstorm to various assumed alternative conditions of snow and reservoir elevation. The major steps in this process were:

Development of synthetic rainstorms. The objective in this part of the modeling study was to develop basin rainstorms with a specific probability, and with alternatives of areal extent and pattern. The method employed was to derive an annual index quantity for each year in the period of record which represented the weighted average of up to 60 selected precipitation stations in the basin. Probability curves of the index "station" were then developed for specified durations of precipitation. Next, several historic rainstorms were analyzed as to pattern, time distribution, and date of occurrence, and the same index was computed for the storm durations. A synthetic storm could then be derived by factoring all station amounts in the pattern storm by the ratio of, say, a 100-year index amount divided by the pattern storm index amount, considering the standard deviation of the station statistics. In this way several 100-year (or any magnitude) rainstorms having various patterns and timing could be easily derived. Similar indexes and patterns were also developed to study individual subbasins, and a winter index was used reflecting the inclusion of the Willamette basin into the entire Columbia basin. A paper by Wortman (Reference 3) describes this phase of the study in more detail.

Flood simulations. Figure 5 illustrates the simulation of several alternative inflow hydrographs to the Libby project, created by applying 100-year storms having several patterns to a snowpack that is about 70% of normal. Other runs were made with different snowpack assumptions, and in each case the reservoir was regulated, given the starting elevation that is based on the snowpack condition. The objective was to test alternative rule curve starting conditions for each snowpack, including the existing official rule curve. Conclusions could be drawn regarding the varying starting elevations by seeing how well the reservoir was able to control flooding at the downstream control point. This process was repeated for the four reservoirs studied, and for the reservoir system as a whole.

Study Results

The model analysis showed that for three of the four projects studied the lower runoff parameter curves could be raised by varying degrees without affecting the project's overall flood control capability. For higher runoff forecasts (generally greater than 100% of normal), however, the existing flood control parameters should not be changed. The changes in the rule curves for the Libby project, shown on Figure 6 is typical of the other three reservoirs. These changes don't necessarily result in more water being available in the reservoir in low runoff years, since the reservoir may be operated below the rule curve for other project purposes such as serving firm energy loads.

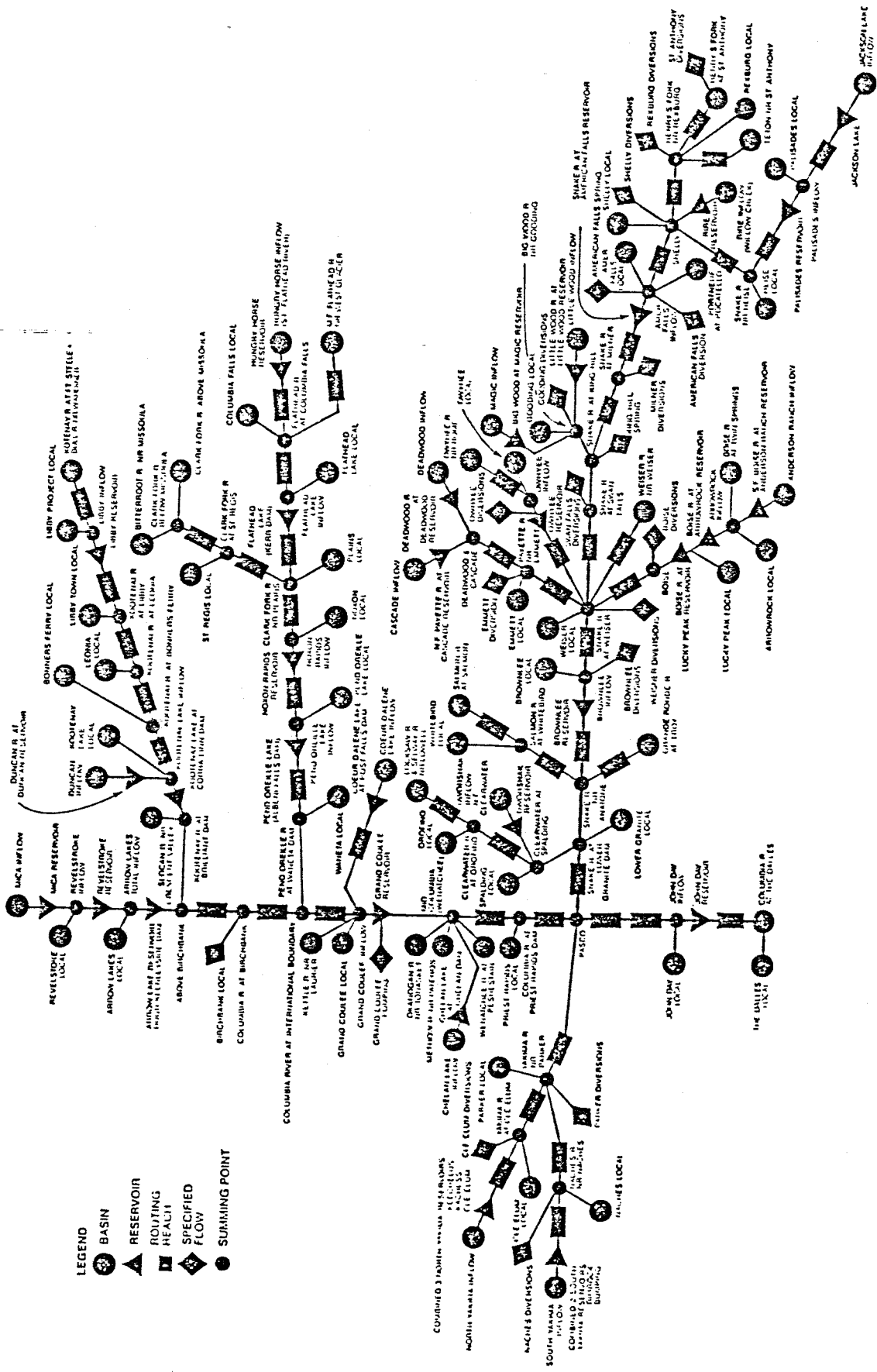
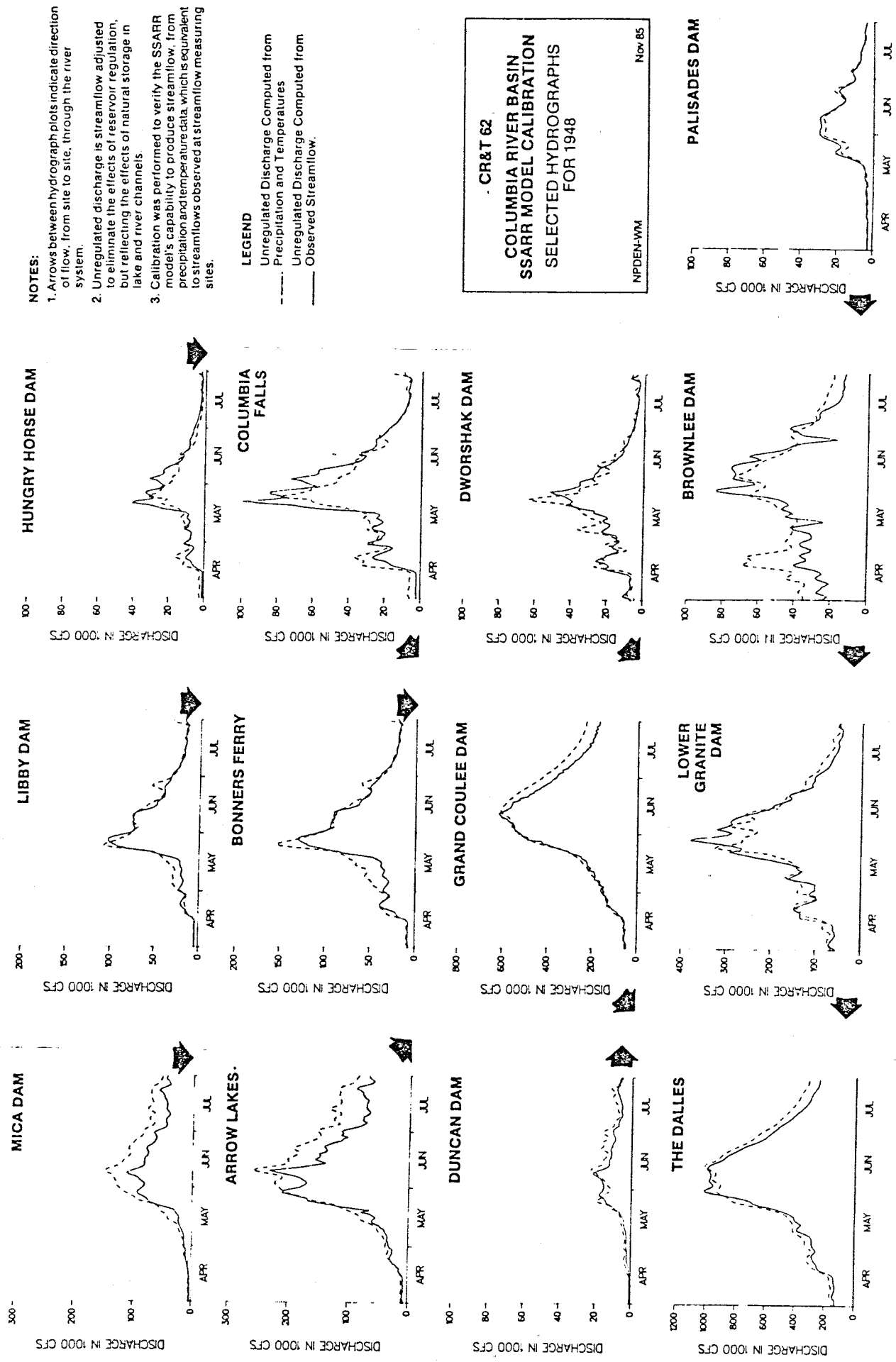

FIGURE 3. SCHEMATIC OF SSARR MODEL, COLUMBIA RIVER ABOVE THE DALLES



NOTES:
 1. Arrows between hydrograph plots indicate direction of flow, from site to site, through the river system.

2. Unregulated discharge is streamflow adjusted to eliminate the effects of reservoir regulation, but reflecting the effects of natural storage in lake and river channels.

3. Calibration was performed to verify the SSARR model's capability to produce streamflow, from precipitation and temperature data, which is equivalent to streamflows observed at streamflow measuring sites.

LEGEND
 - - - - - Unregulated Discharge Computed from Precipitation and Temperatures
 ————— Unregulated Discharge Computed from Observed Streamflow.

CR&T 62
 COLUMBIA RIVER BASIN
 SSARR MODEL CALIBRATION
 SELECTED HYDROGRAPHS
 FOR 1948
 NPDEN-WM Nov 65

FIGURE 4. SIMULATION OF THE 1948 FLOOD

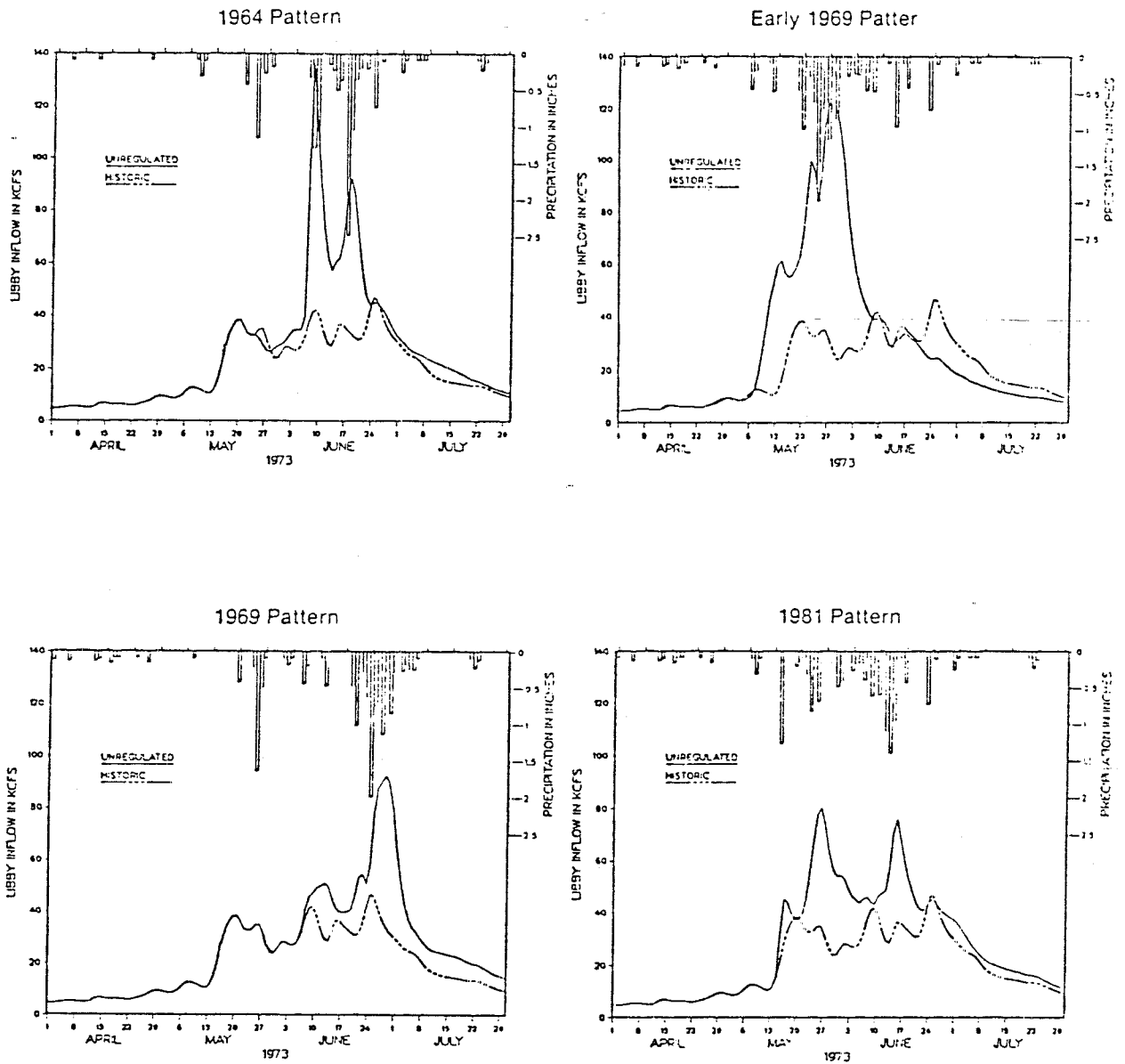

CRT-63
 Columbia River Flood Control Study
 Libby Inflow
 1973 Initial Conditions
 100 Year, 30 Day Precipitation
 August 87

FIGURE 5. SIMULATION OF RAIN-ON-SNOW FLOODS

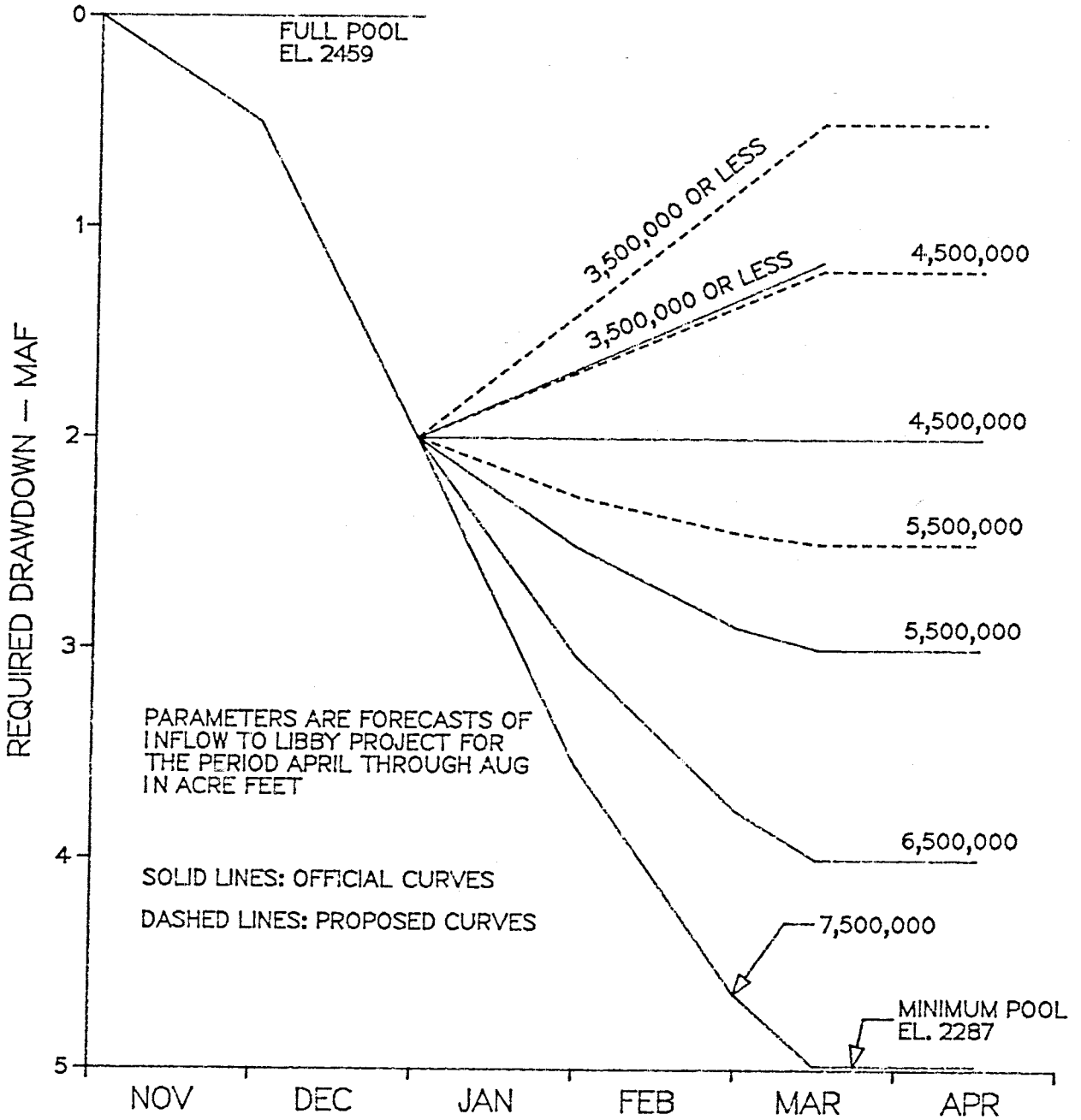

FIGURE 6. PROPOSED ADJUSTED RULE CURVES,
LIBBY PROJECT

Conclusions

In retrospect it is believed that the modeling effort was as satisfactory as can be expected under the time and funding constraints that were available. The calibrations were definitely not as thorough as would be desired, yet little could be done to improve them without devoting significant additional resources. This may be done at a later date as time is available.

The study pointed out that model development may be the most simple and straight forward part of the study compared to its application. In this study, considerable time was spent applying the model, attempting to understand and interpreting results that were being obtained, and dealing with inconclusive and conflicting results that invariably occurred. As it turned out, considerable personal judgement had to be applied in reaching the conclusions that were desired; however, the model was invaluable in making those judgements.

The type of analysis used should be useful for other basins of a similar nature, where soil moisture or snow conditions that provide a degree of long-term forecastability are combined with an unforecastable design rainstorm that determines the reservoir storage needed. The method could lead to refinements in rule curves that are otherwise difficult to determine except by a modeling effort of this type.

References

1. Corps of Engineers, NPD; User Manual for the SSARR Model, August, 1987 (draft).
2. Speers, D.D., Kuehl, D., Schermerhorn, U., "Development of the Operational Snow Band SSARR Model," Proceedings, Modeling of Snow Cover Runoff, U.S. Army Cold Regions Research and Engineering Laboratory, Hanover, New Hampshire, September, 1978.
3. Wortman, Randal T., "Synthetic Design Storms for the Columbia River," North Pacific Division, Corps of Engineers, Portland, OR; presented at AGU Fall Meeting, San Francisco, CA; Dec, 1985.

CALIBRATING AND APPLYING
A HYDROLOGIC MODEL OF
THE COLUMBIA RIVER BASIN

by

Douglas D. Speers, P.E.

Summary by Gene R. Russell¹

The presentation was followed by a discussion of future availability of water resources in the region. Earlier studies have suggested that there is presently an abundance of water in the Columbia River system but, within this century, increased irrigation may be the cause of conflicts with water allocations. It was pointed out that the studies described in the report considered irrigation depletions. Actually, such depletions were determined in a separate study and the flows were subtracted at the projects as a first priority. These volumes were relatively small, however, amounting to about 10% of the volume.

It was pointed out that for much of this study, which related to flood periods, irrigation withdrawals are not a factor. There is little irrigation in the early spring flood periods with withdrawals beginning in May and June.

Another point brought up is that the Columbia River is presently the largest river in the United States based on flow. With the drought in the Southeast, the Columbia has a higher flow than the Mississippi River.

¹Hydraulic Engineer, Mobile District

Hydrologic Safety Considerations
In The Selection Of
Level Of Protection At
Harlan, Kentucky

by

Dennis R. Williams¹

Purpose, Issues, and Summary

Objective. The Harlan, Kentucky Area Local Protection Project (LPP), a levee/floodwall system, presented a unique level of protection (LOP) justification problem to the hydrologic modeler. The primary objective of the modeling effort was to determine catastrophic consequences of overtopping the proposed Harlan LPP assuming a Congressionally-mandated LOP equal to the flood of record (April 1977) in place.

Key Issues. Important factors in the design of the project centered around the use of a rainfall-runoff model to attempt to accurately forecast the stream(s) while at low levels, the safe evacuation of residents during an overtopping event, and the risk of overtopping the mandated level of protection.

Summary of Primary Findings. Modeling efforts for two vital floodwall/levee designs showed that forecasts could not accurately be made for a project with an April 1977 LOP. Therefore the hydrologic security of the project could not be guaranteed and a higher level of protection, Standard Project Flood (SPF), could be justified.

Physical Setting

Study Area. Harlan is located in the Appalachian Mountains of southeastern Kentucky near the confluence of three streams that form the Cumberland River. Plate 1 is a basin map of the region. As shown on Plate 2, the town sprawls on the hills and horseshoe-shaped floodplain of the Clover Fork. The Martins Fork merges with Clover Fork at the Harlan central business district. Clover Fork flows another 1.4 miles to its confluence with Poor Fork to form the Cumberland River. The study area also includes the downstream communities of Loyall and Rio Vista. Plate 2 also shows the relative locations of the three towns. The reach for which protection was required at Harlan was 4.0 miles along Clover Fork, and 1.2 miles adjacent to Martins Fork. Loyall and Rio Vista required 3.6 miles of protective works along the Cumberland River.

Topography. The Cumberland River Basin above Cumberland Falls is a cone-shaped area with rolling hills in the western portion of the basin rising into steep, irregular mountains for the eastern portion. Elevations range from 1100 feet at Cumberland Falls up to 5500 feet along Black Mountain upstream of Harlan.

¹Chief, Hydrologic Engineering Section, Nashville District, U.S. Army Corps of Engineers

The study area is characterized by steep-sided valleys with most commercial and residential development and associated transportation and communication facilities concentrated in the floodplains.

Climate. The Upper Cumberland Basin has a generally moderate climate, locally modified by the mountainous terrain. The mean annual temperature is 55°F with average temperatures ranging from 75°F in July to 33°F in January. Precipitation averages 49 inches annually, with greatest amounts occurring during late winter or early spring. Snowfall averages 125 inches annually but does not contribute significantly to runoff in the Upper Cumberland Basin.

Available Data

Precipitation. Daily precipitation records have been collected by the National Weather Service (NWS) since 1940 for the Baxter gage, located near the mouth of Poor Fork. Hourly values are also available at the Corps' Martins Fork Dam (Mile 15.6, Martins Fork) since 1978. Assorted records also exist for various periods for special NWS gages upstream of Harlan. Plate 3 shows the location of all precipitation gages in the study area and also for the basin above Harlan.

Streamflow. The U.S. Geological Survey maintains two Corps of Engineers' gaging stations within the project area: Cumberland River near Harlan (Mile 691.8) and Clover Fork at Harlan (Mile 1.5). Continuous records exist for the "near Harlan" gage since November 1941 and for the Clover Fork gage since October 1977.

In the basin above Harlan, other stations are located at Cumberland and Smith. The lengths of continuous record for these stations are from 1940 and 1971, respectively. Plate 3 shows the locations of these stations.

Storms and Floods. Major floods result at Harlan after large rapidly-moving frontal systems cross the area. Area precipitation records have shown that rainfall intensities and durations can vary significantly for the three basins above Harlan because of orographic effects.

Records beginning in 1918 have shown that numerous large floods have occurred in the Harlan area. Significant events were observed in January 1918, January 1946, January 1957, March 1963 (three separate floods), December 1969, and April 1977. As usually is the case, the centerings of these events varied; for example, the January 1957 storm centered over the Poor Fork basin, the December 1969 event over Clover Fork, and the storm which produced the flood of record, April 1977, over the Clover Fork and Martins Fork basin divide.

The most intense storm recorded, which resulted in flood heights in the Harlan area several feet higher than any previously documented event, was the April 1977 storm. This event which occurred from April 3-6, not only produced record flooding in the Upper Cumberland River Basin but also in the Tug and Levisa Forks of the Big Sandy River in the Huntington District. During the critical period of the storm, which lasted from 1800 hours on April 3 to 2400 hours on April 4, an average of 7.5 inches of rainfall was observed for the total Cumberland River basin above Harlan. At the near Harlan gage, the Cumberland River crested at 1170.4 feet, 5.4 feet higher than the previous floods of record at Harlan, March 1963 and December 1969. Downstream cities

also experienced record flooding. At Pineville, 38 miles downstream from Harlan, the floodwall built to protect the city from the January 1946 flood of record, was overtopped by two feet. The Barbourville area, some 19 miles downstream from Pineville, experienced record flooding. Sandbagging the existing levee prevented the central part of the city from being flooded. Total damages at these cities, the remaining three Upper Cumberland cities and the rural areas, resulted in \$115 million damages (1988 dollars). The Tug and Levisa Forks received total damages amounting to \$750 million (1988 dollars).

Project Description

Section 202. As a result of the unparalleled damages in the Upper Cumberland and Levisa and Tug Fork Basins, Congress provided in Section 202 of the Energy and Water Development Act of 1981 (Public Law 96-367), authority for the Chief of Engineers to:

(1) Design and construct, at full Federal expense, flood control measures in the portions of the Big Sandy (Levisa and Tug Forks) and Cumberland River Basins damaged by the April 1977 flood.

(2) Afford a level of protection to these communities and their immediate environs on the Cumberland River, sufficient to prevent any future losses to the community from a recurrence of a flood such as the April 1977 flood.

The Supplemental Appropriations Act, Public Law 97-257, passed in September 1982 stated that:

"Flood control measures authorized by Section 202 of the 1981 Energy and Water Development Appropriations Act involving high levees and floodwalls in urban areas should provide for a Standard Project Flood level of protection where the consequences from overtopping caused by large floods would be catastrophic."

April 1977 Level of Protection. The most cost effective features to meet the requirements of PL 96-367 involved structural and nonstructural features. Some five miles of levee, nine pumping stations, 13 gravity outlets, and 24 closure structures were necessary for the structural component of providing April 1977 LOP for Harlan, Loyall, and Rio Vista. The nonstructural portion of the plan involved floodproofing (raising) 168 homes in the floodway fringe and permanently evacuating some 227 residential structures in the floodplain.

Standard Project Flood Level of Protection. The plan justified by the procedure described in subsequent paragraphs and meeting the intent of the Supplemental Appropriations Act (above) also consisted of structural and nonstructural features. The structural component of the SPF LOP involved levees/floodwalls and river diversions. Plate 2 shows the major structural features. The Loyall Diversion Channel, a 3800 foot open cut, eliminates the expensive requirement of paralleling levees/floodwalls through Loyall.

The Harlan Diversion Tunnels which totally diverts the Clover Fork, consist of four, 32 foot horseshoe-shaped tunnels. The Harlan tunnels also eliminate the need for paralleling floodwalls/levees along the Clover Fork. The

tunnels were selected as the most cost-effective design alternative for SPF protection over an open cut diversion after extensive hydrologic safety analyses were performed.

The SPF LOP requires levees/floodwalls averaging 23 feet high and extending some 14,170 feet at Harlan and Loyall/Rio Vista. Ten closure structures are also part of the plan.

The nonstructural component of the SPF plan requires removal of some 157 residences located in the floodplain and floodproofing (raising) 189 other homes in the floodway fringe.

Modeling Efforts

General. "HEC-1, Flood Hydrograph Package," was used to derive the basic rainfall-runoff model for the basin upstream of Harlan. The model consisted of two segments of varying time intervals. A three hour time increment was used for Martins Fork with a drainage area at mouth of 117.0 square miles to sufficiently describe the reductions due to the Corps' Martins Fork Reservoir, which controls a 55.7 square mile rapidly-peaking basin. Six hour unit hydrographs were used to model the Poor Fork drainage basin of 150.0 square miles and Clover Fork (drainage area, 105.0 square miles). Plate 6 shows a schematic of the rainfall-runoff model for the basin above Harlan.

Model Calibration and Verification. The April 1977 storm and flood was used for model calibration. Available data for this record event included hourly rainfall at the Baxter and Martins Fork precipitation gages and discharge hydrographs for Martins Fork near Smith, Poor Fork at Cumberland, and Cumberland River near Harlan. Plate 3 shows the locations of the gages. Plates 4 and 5 show the isohyetal pattern and mass rainfall curves, respectively, for the Upper Cumberland area.

Using unit hydrographs and Muskingum routing coefficients derived from previous studies, the April 1977 hydrographs were reproduced in peak flow and time to peak by slightly adjusting the routing coefficients. Table 1 shows the relationship between observed and computed flow and timing.

Table 1
April 1977 Flood Reproduction

<u>Location</u>	<u>Observed</u>		<u>Reproduction</u>	
	Peak Q ¹ (cfs)	Time to Peak (date-hrs)	Peak Q (cfs)	Time to Peak (date-hrs)
Cumberland River near Harlan	64,500	4/5 0130	64,400	4/5 0000
Clover Fork at Central St.	44,000	4/4 n/a	39,000	4/5 0000
Martins Fork near Smith	9,000	4/4 1630	8,400	4/4 1800
Poor Fork at Cumberland	11,000	4/4 1630	12,700	4/4 1800

¹Flows based on USGS rating.

Three other large historical floods were used to verify the HEC-1 model: March 1963, December 1969, and May 1984. The same basic data was available for these events as for the April 1977 storm and flood. Applying each storm's rainfall to the calibrated model and using reasonable loss rates for the storms, the calibrated model accurately reproduced these floods. Therefore, the model provided a good representation of the basin and was valid to use in the development of the larger event used in the catastrophic analysis, the SPF.

Standard Project Flood Derivation. Because of the relative closeness in size of the three basins converging at Harlan, five centerings of the Standard Project Storm (SPS) were investigated to determine maximized flood heights at Harlan. Referring to Plate 3, these centerings were: (1) above Harlan (over Clover Fork basin above Harlan proper), (2) over Clover Fork/Martins Fork basins (over Clover Fork and Martins Fork Divide), (3) over Martins Fork basin, (4) over Poor Fork basin, and (5) over Clover Fork and Poor Fork divide above their junction. The centering that gave the maximum flood heights within the project area was the above Harlan centering (No. 1). This centering did not give the maximum discharge at all locations in the project area as shown in Table 2. However, it gave the maximum discharge at the near Harlan gage, producing backwater depths along the Clover Fork at Harlan greater than headwater flooding depths. Plate 7 shows the critical centering of the SPS giving maximized flood depths in the Harlan area.

Table 2
SPF Discharge Regulated by Martins Fork Dam

<u>Location</u>	<u>Adopted¹ Discharge (cfs)</u>	<u>Maximum Discharge (cfs)</u>	<u>Maximum Discharge Centering</u>
Cumberland River near Harlan	122,300	122,300	Above Harlan
Clover Fork at Central St.	75,100	75,700	Over Martins Fork Basin
Clover Fork above Martins Fk.	52,800	52,800	Above Harlan
Martins Fork at Mouth	35,800	41,200	Over Martins Fork Basin
Poor Fork at Mouth	48,100	56,800	Over Poor Fork Basin

¹Adopted discharges are based on "above Harlan Centering."

Standard Project Flood LOP Justification

General. Given the most cost-effective plan for April 1977 LOP as mandated by Public Law 96-367, the consequences of overtopping the lower level levee/floodwall system were analyzed, as required by Public Law 97-257. If the April LOP could not be designed to prevent a catastrophe, a higher LOP was clearly justified.

For the purposes of this study, a catastrophe was defined as an event producing unusually high economic losses and high potential for loss of life.

Procedure. An analysis which only showed the consequences of a large flood overtopping the April 1977 LOP would be beneficial, but a more conclusive approach would be to compare the consequences of overtopping that level with overtopping the SPF LOP.

Overtopping Floods. The SPF was selected to overtop the April 1977 LOP. It was chosen because of the relative ease of derivation, is well defined, and represents a standard which allows the degree of protection and overtopping impacts to be compared with other Corps projects. Plate 8 shows the SPF stage hydrograph at Central Avenue at Harlan.

A 125 percent SPF was selected to overtop the SPF LOP. Clearly it was a much larger event than the SPF, and it would present sudden and unique impacts necessary in catastrophic analyses. Other percentages could just as easily have been selected. The 125 percent event was derived by calculating a peak discharge 25 percent larger than the SPF, and adjusting the rainfall excess values in the HEC-1 model until the higher peak discharge was reproduced. Plate 8 also shows the 125 percent SPF at Central Avenue in Harlan.

April 1977 LOP Overtopping Analysis. In an attempt to prevent high economic losses during overtopping, the initial April 1977 LOP design provided for overtopping to occur at the downstream portion of the levee/floodwall system. This allowed water to back into the protected area versus overflowing from the upstream portion of the protection works, creating high property damaging velocities.

The second component of a catastrophe, potential for loss of life, could best be minimized through a reliable and effective flood warning and evacuation plan. An attempt to develop such a plan was based on using an evacuation time for the protected area of three hours. This time was reliably established based on the experienced evacuation time for the protected area at Barbourville, Kentucky during the April 1977 flood. Using the three hours and the stage hydrograph for Harlan as shown on Plate 9, evacuation would have to begin at an extremely low point on the hydrograph. The hydrograph at Loyall/Rio Vista shows a similar situation. Plate 9 also shows that the most intense period of SPS rainfall was occurring at this time. The decision to evacuate would necessarily have to be based on an immediate and accurate knowledge of observed and forecast rainfall. Such knowledge in the mountainous area above Harlan was not possible.

Plate 10 demonstrates this concept using observed rainfall near the time evacuation would have to be initiated. Using observed rainfall at the time of evacuation is required to begin (corresponding to Hour 64) in the calibrated HEC-1 model, hydrograph "A" results. The forecast shows overtopping but 4 hours after the protection works actually overtops. Using the more likely time that a forecast would be made because of required lead time, at hour 63, hydrograph "B" which does not predict overtopping, results.

Considering these forecasts using observed rainfall, the most likely way to evacuate Harlan would be based on stage. That is, once a specific stage is reached, evacuation is initiated. This corresponds to Elevation 1176.0 shown on Plate 10. This stage would be reached by an event having an average frequency of occurrence of once every eight years. Inspection of the period of

record showed that five false evacuations would have been experienced with the April 1977 LOP in place, with four of these in the last 25 years. Obviously, such an evacuation plan based on stage would not be believed by the local residents. Similar conclusions result at Loyall/Rio Vista.

Forecast Rainfall. Speculation could be made that the use of forecast rainfall versus only using observed rainfall to make river forecasts at Harlan would result in more definite information regarding proper evacuation times. However, an accurate rainfall forecast for each of the three basins that merge at Harlan would be required, since each basin is capable of producing flood events at Harlan. Such precision in rainfall forecasting for sufficient evacuation lead times is not possible for the mountainous areas above Harlan that experience highly-varying rainfall intensities.

Modified April 1977 LOP Overtopping Analysis. In an attempt to reduce the number of false evacuations, the April 1977 LOP design was drastically modified to slow the rate of interior filling such that the evacuation routes were not inundated as rapidly. The length of the downstream overflow weir was reduced from 550 feet to 100 feet, requiring 4.5 feet of additional freeboard along the upstream section. The rate of fill was reduced by this modification such that the evacuation routes were inundated one hour after overtopping began. With this modification, only two hours notice to evacuate would have to be given. The increment to project costs because of additionally required upstream freeboard to control downstream overtopping was \$12 million. Additionally, there was much greater potential for local residents to sandbag the smaller weir section to prevent overtopping.

The modified April 1977 LOP reduced the average frequency of evacuation to once in 19 years. However, this recurrence interval was unacceptable, particularly when considering risk associated with various periods of time. This, combined with the much greater possibility for sandbagging the smaller overtop weir showed that a potential catastrophe had not been diminished by the drastic modification in project design.

Standard Project Flood LOP Overtopping Analysis. Plate 11 shows that the overtop level for a SPF LOP is 1195.5 feet. With a three hour evacuation period, evacuation would have to begin at Elevation 1189.5 at Harlan during the occurrence of an overtopping flood, the 125 percent SPF. This corresponds to an average frequency of occurrence of once every 500 years. Further, at the time evacuation is to begin, the most intense period of SPS rainfall has occurred, giving greater knowledge of observed rainfall, and allowing prediction of overtopping with the established rainfall runoff model. A similar situation also results in Loyall/Rio Vista.

Summary and Comparison. Table 3 shows the results of the catastrophic analyses for the two April 1977 LOP designs, and the SPF LOP. Based on this comparison, the determination was made that a flood overtopping either April 1977 LOP would be catastrophic in terms of economic loss and loss of life. Public Law 97-257 was therefore applicable, and the SPF LOP became the selected plan for the Harlan area.

Table 3
Comparison of Harlan Project Impacts¹

	<u>Alternative Plan</u>	
	<u>A-77</u>	<u>B-SPF</u>
Overtop Flood	SPF	125%SPF
Number of Units Flooded	352	407
Flood Damages, \$M	35 ²	17
Risk of Overtopping in:		
50 years	30%	5%
100 years	51%	10%
Projected Frequency of False Evacuations (Yrs)	8 19 ³	500
Number of False Evacuations		
Period of Record	5	0
Last 25 years	4 1 ³	0
Forecasting Capability Prior to Evacuation Start	Very Poor	Excellent

¹Harlan values only presented for brevity. Loyall/Rio Vista impacts led to similar results.

²Reflects uncontrolled overtopping of A-77 design.

³Modified A-77 Design

Conclusions

The above analysis underscores the importance of investigation of the consequences of providing a low level of flood protection for communities. Paragraph c.(2) of EC 1165-2-144, dated 1 June 1987, entitled "Policy Guidance for New Start Construction Projects", also suggests that project safety should be addressed. This is particularly important since current cost-sharing guidelines may initially lead to reduced scopes of local protection projects. From a hydraulic engineer's perspective, any project with a low level of protection should be investigated for hydrologic safety.

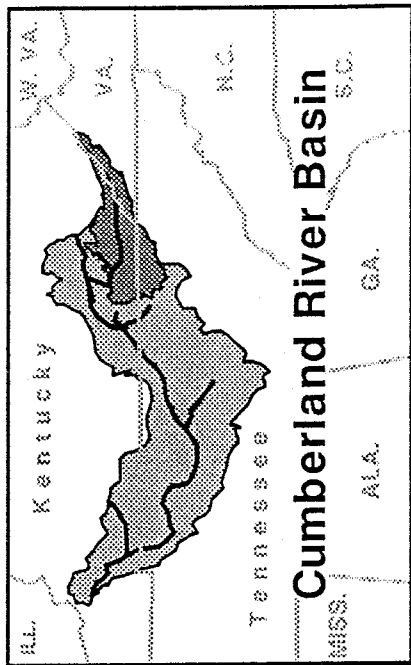
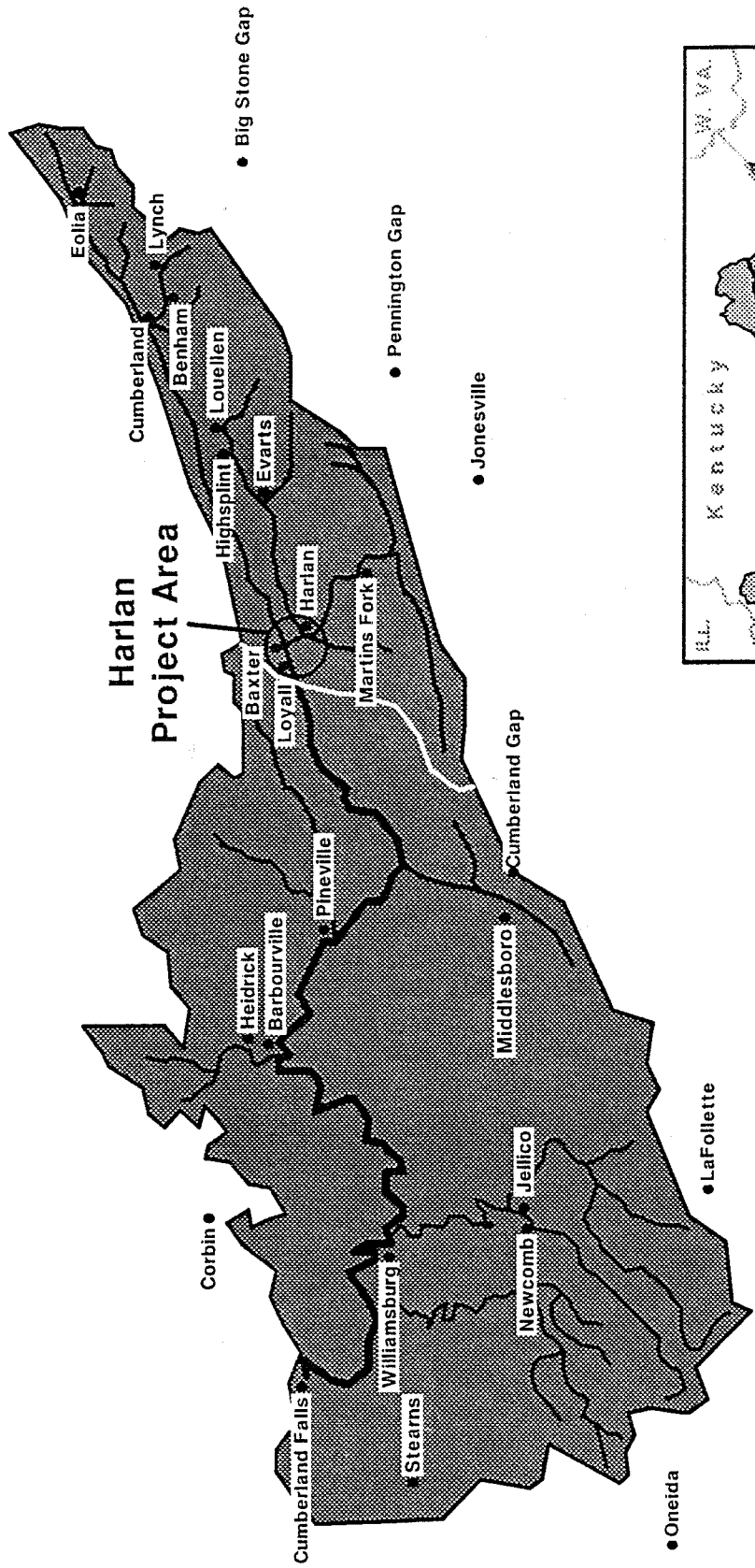

Upper Cumberland River Basin
 Harlan, Kentucky
Basin Map
 U.S. Army Engineer District, Nashville

Plate 1

231

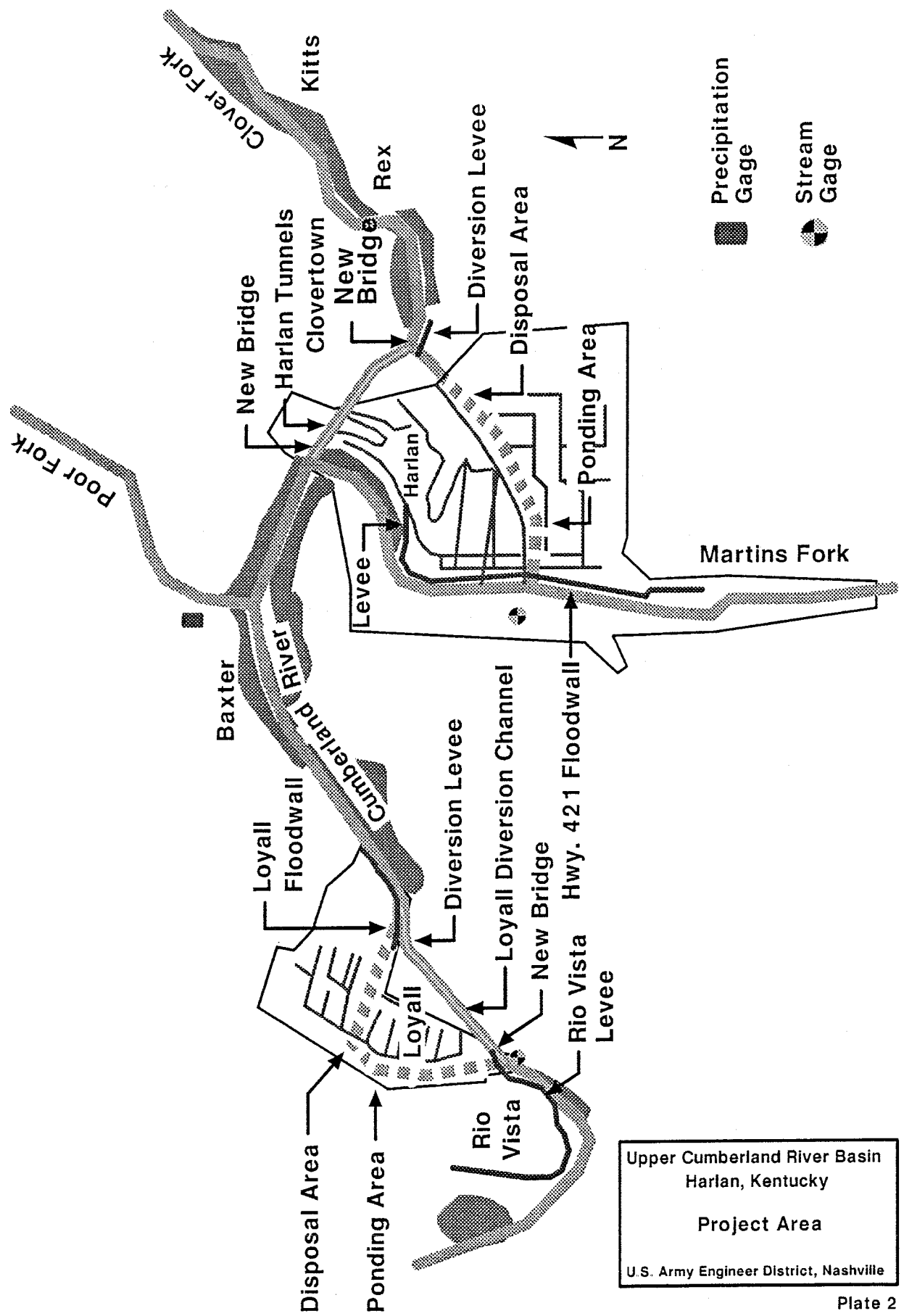

Upper Cumberland River Basin
 Harlan, Kentucky

Project Area

U.S. Army Engineer District, Nashville

Plate 2

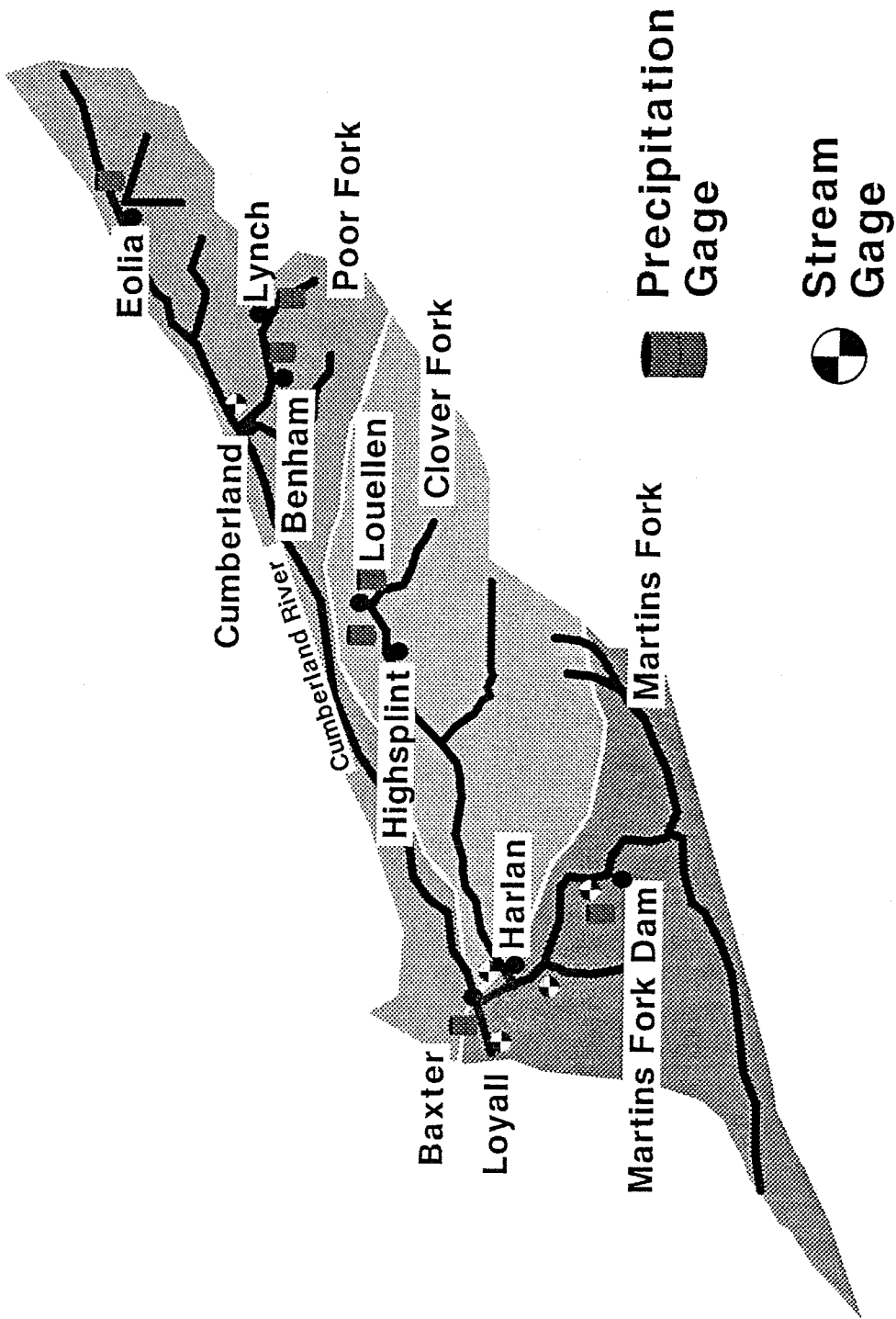

Upper Cumberland River Basin
 Harlan, Kentucky
 Streamflow &
 Precipitation Gages
 Upstream of Harlan
 U.S. Army Engineer District, Nashville

Plate 3

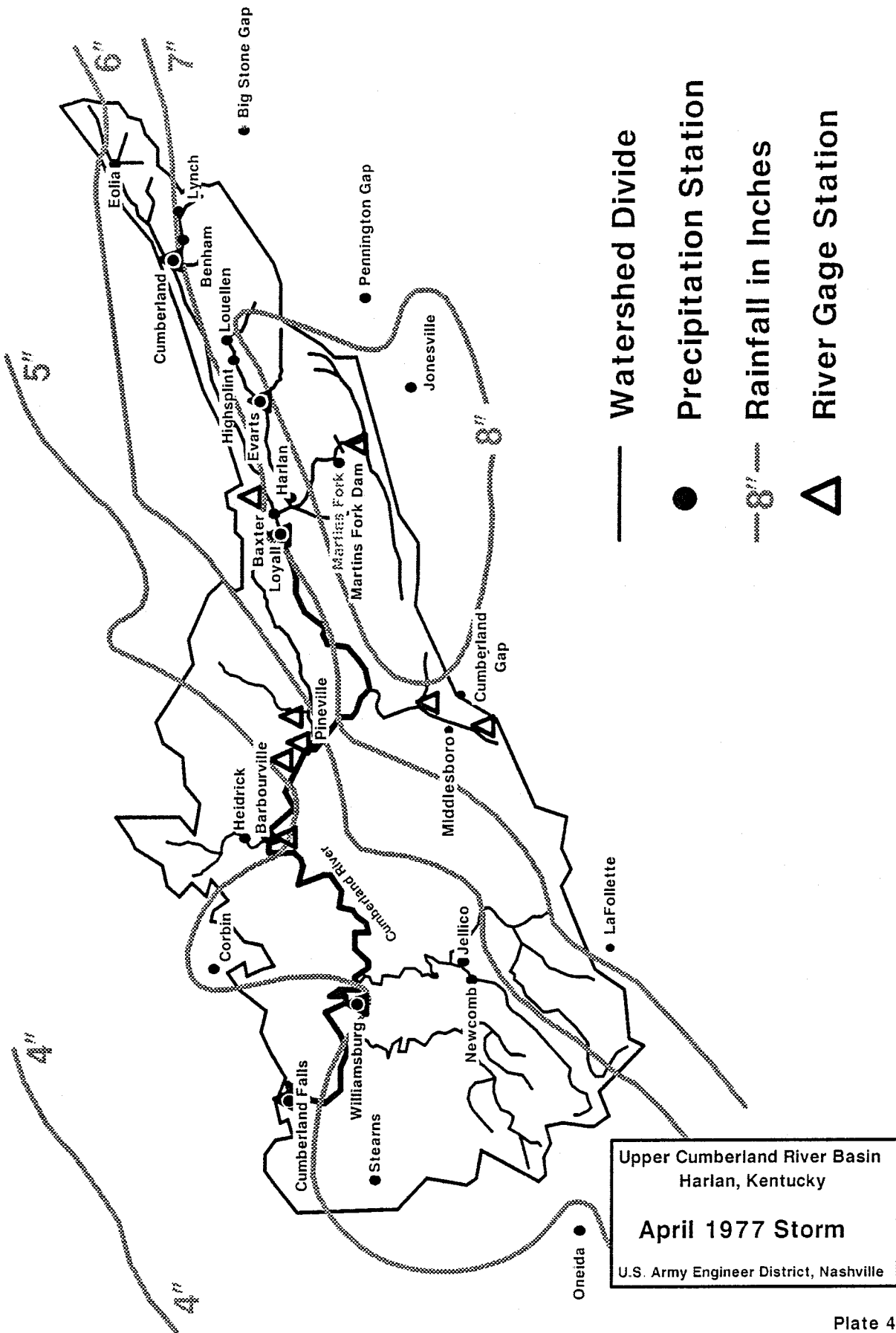

Upper Cumberland River Basin
 Harlan, Kentucky
April 1977 Storm
 U.S. Army Engineer District, Nashville

Plate 4

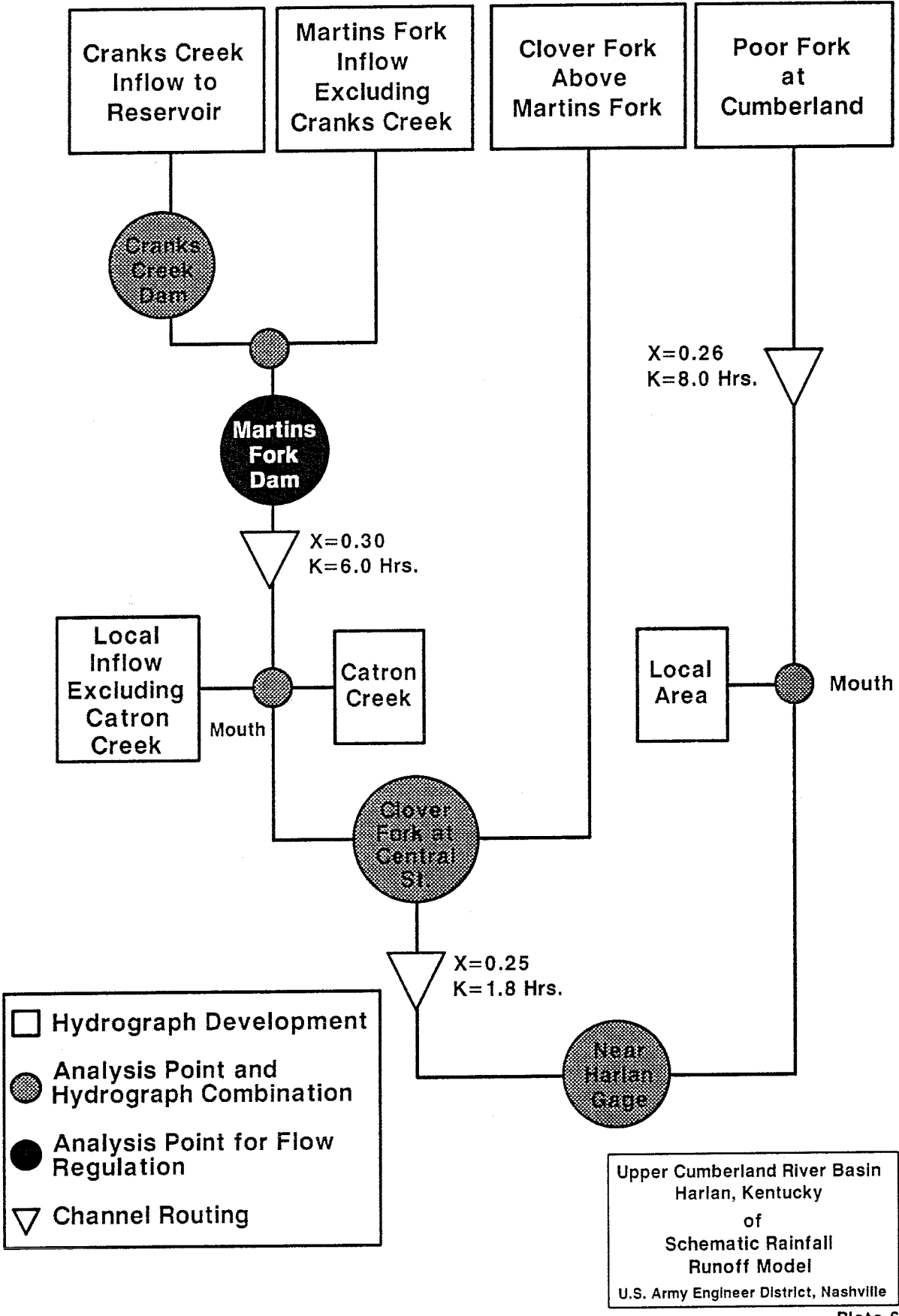

Plate 6

SPS Centering Above Harlan

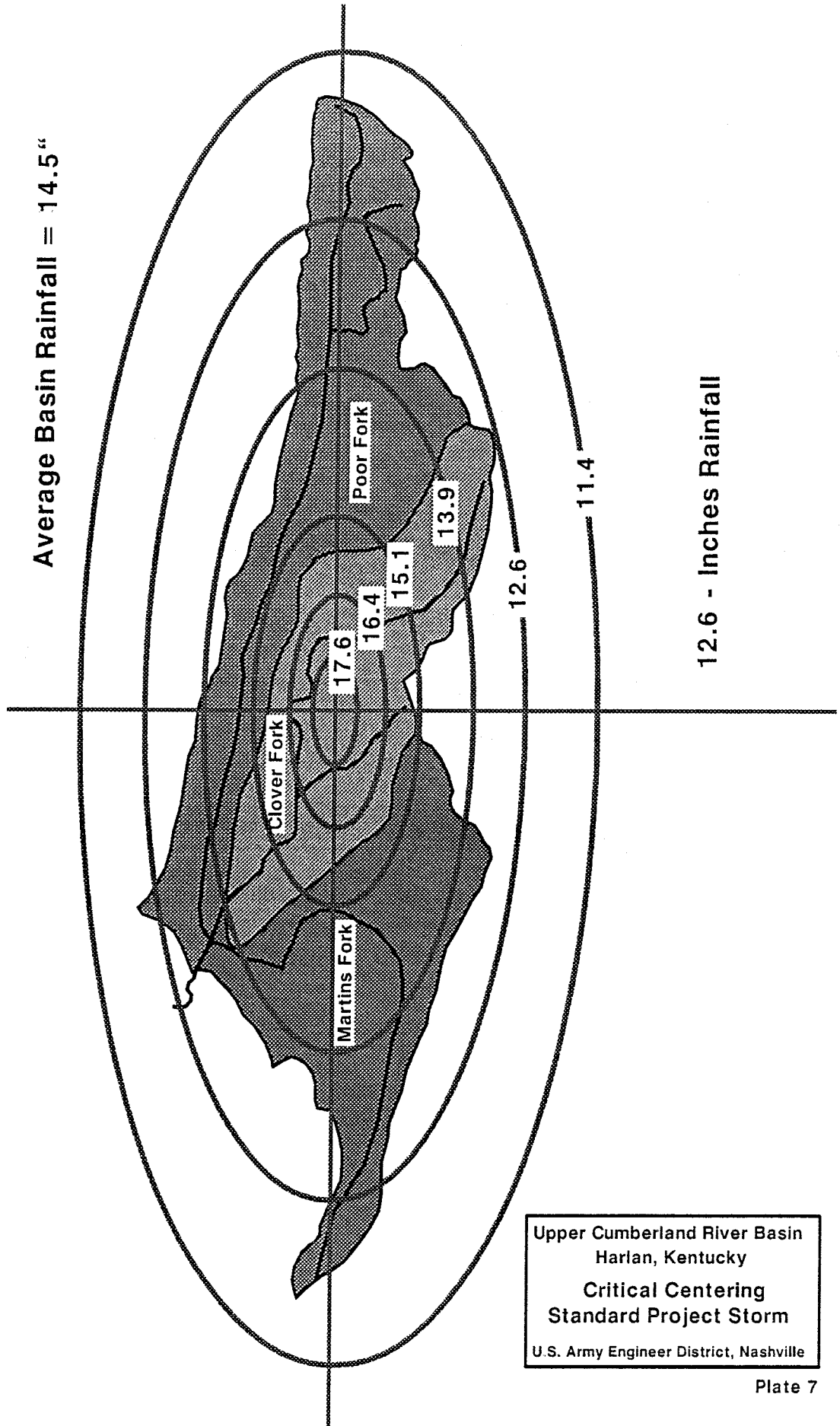
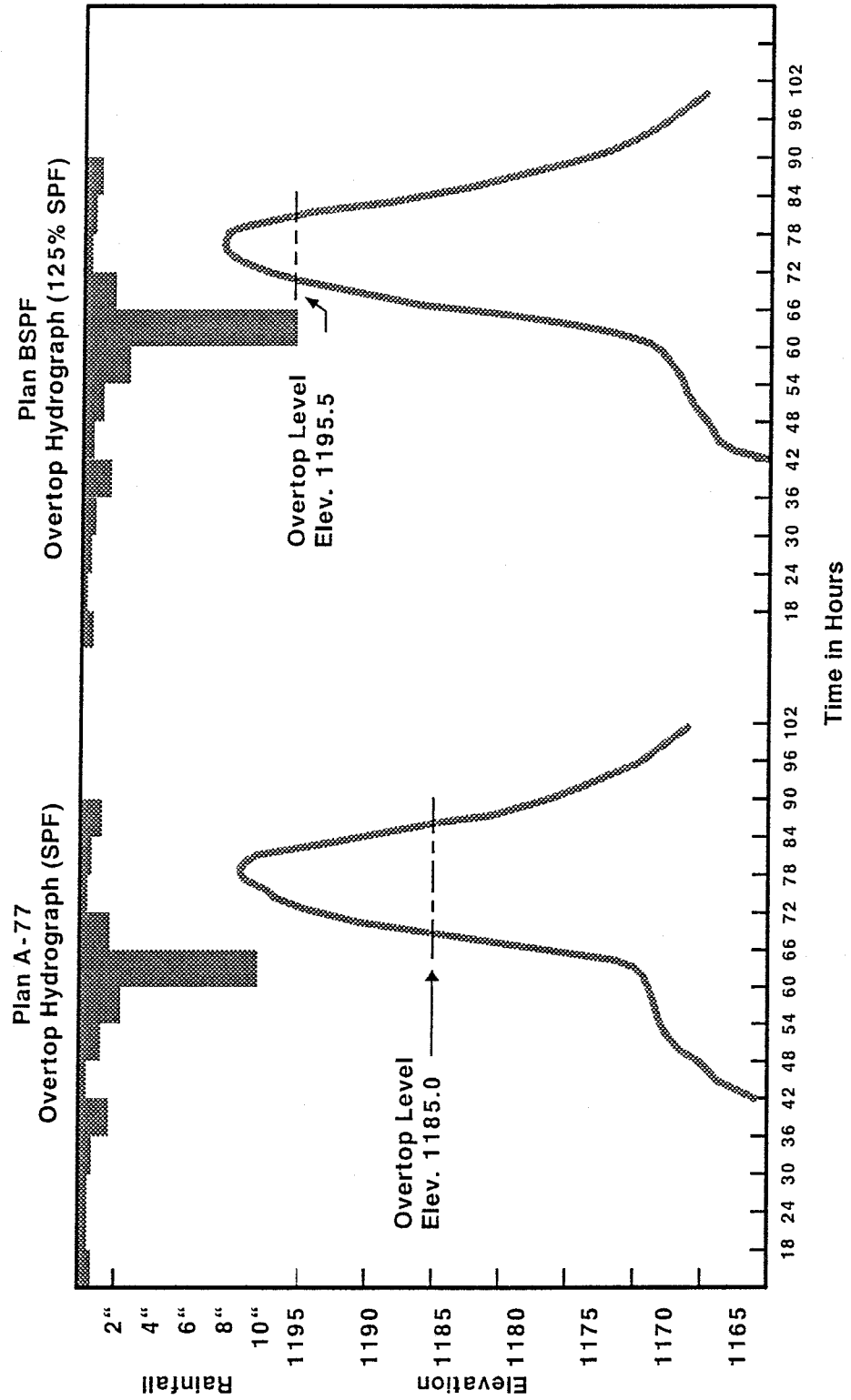
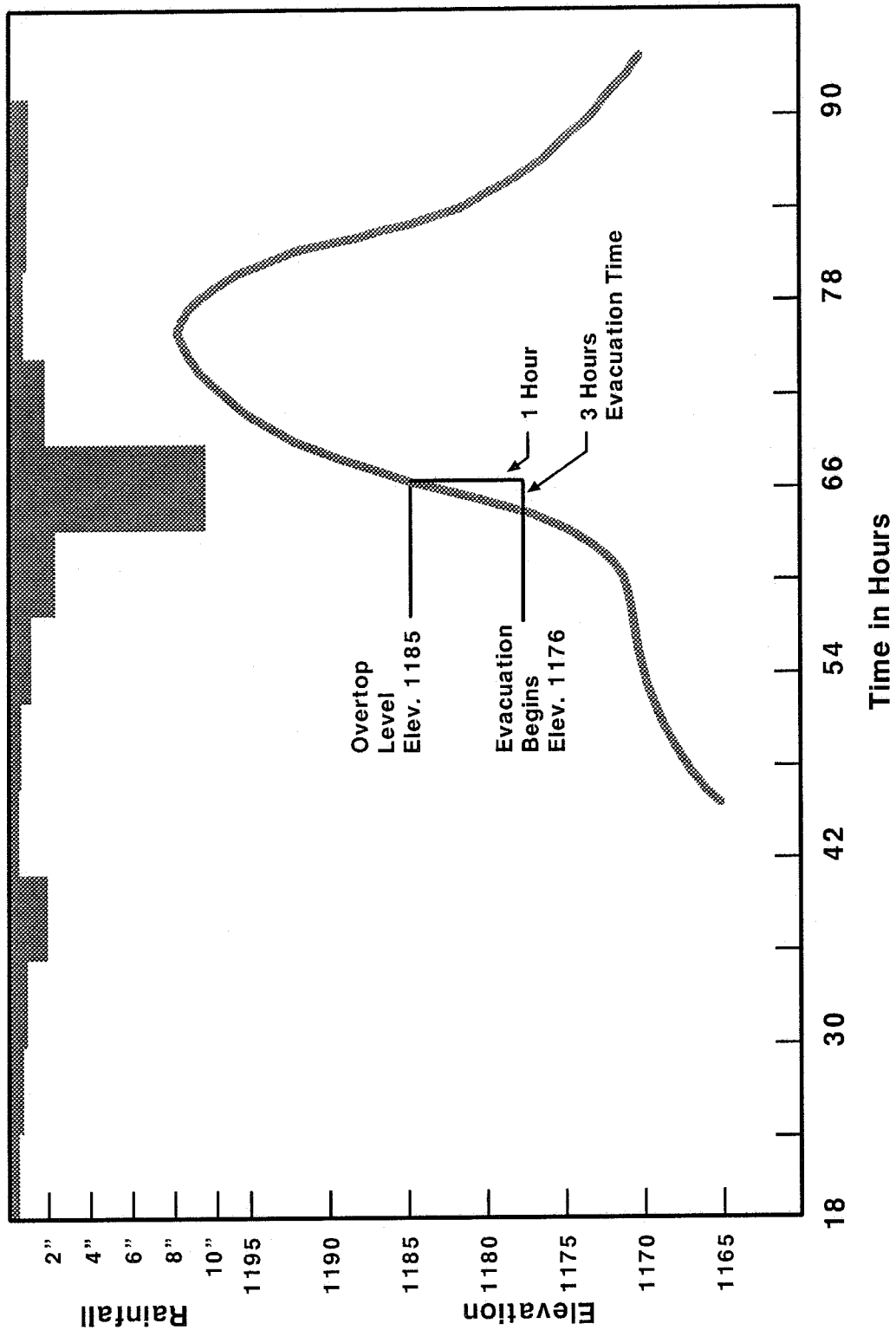

Plate 7

Elevation At Central Street Bridge / Harlan



Upper Cumberland River Basin
 Harlan, Kentucky
 SPF + 125% SPF
 Overtop Hydrographs
 U.S. Army Engineer District, Nashville



Upper Cumberland River Basin
 Harlan, Kentucky
SPF Overtop Hydrograph
(3 Hrs. Evacuation Time)
 U.S. Army Engineer District, Nashville

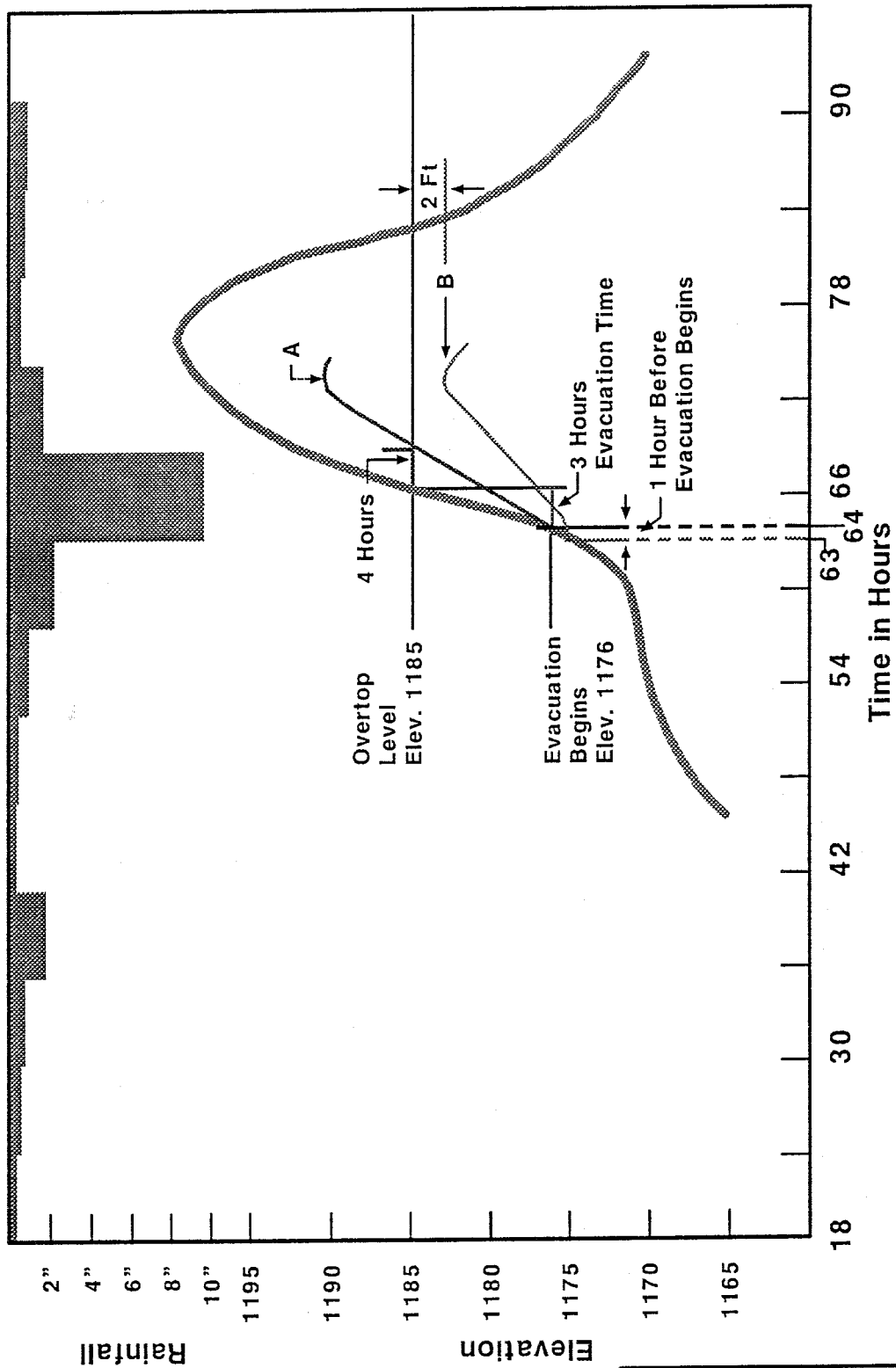

Upper Cumberland River Basin
 Harlan, Kentucky
 SPF Overtop Hydrograph
 With Forecast
 U.S. Army Engineer District, Nashville

Elevation At Central Street Bridge / Harlan

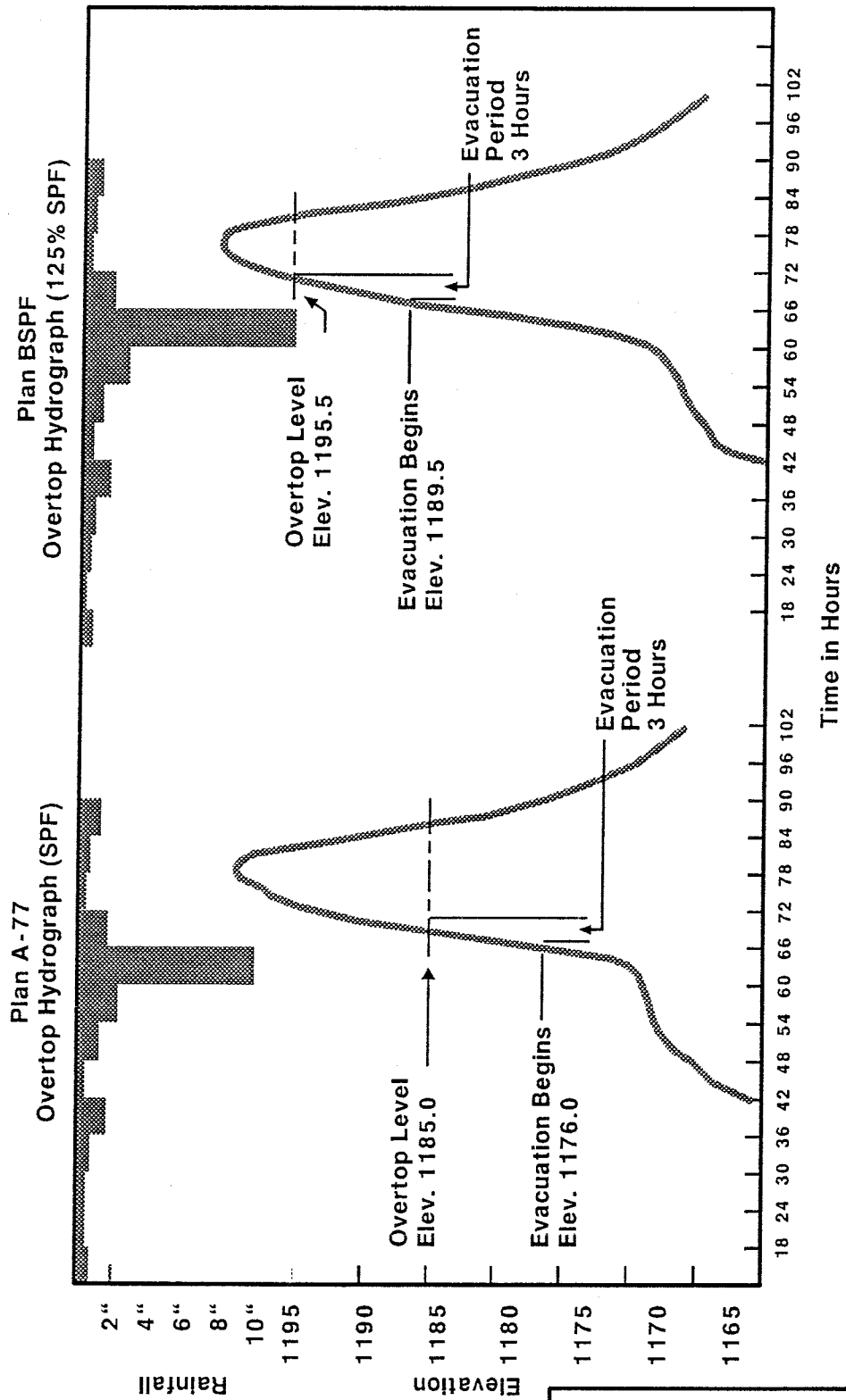

Upper Cumberland River Basin
 Harlan, Kentucky
 SPF + 125% SPF
 Overtop Hydrographs
 (Evacuation)
 U.S. Army Engineer District, Nashville

241/242 Blank

Hydrologic Safety Considerations
in the Selection of Levels of Protection
at Harlan, Kentucky

by

Dennis R. Williams

SUMMARY OF DISCUSSION

by

Bert Holler¹

There was initial discussion on the SPF producing less dollar damages than the 1977 flood event design. This may be related to the volume of flood water and whether or not a breach occurs.

The cost to benefit ratio was questioned. The answer given was that the benefits appeared to be equal to the costs. Loss of life is a very important consideration that does not fully appear in BCR analysis.

There was considerable discussion on the variation of costs between plans. SPF protection totaled \$150 M while protection from the April 1977 flood costs \$125 M. The cost of the parallel levees became quite high.

Flood warning systems were discussed. There are flood warning systems (complementary) in the area. However, there is not enough lead time from the start of rainfall with the Alert system. False evacuations ("cry wolf") were discussed and are a serious concern. The District will review any proposed forecasting procedures.

The possibility of the Harlan Diversion tunnels becoming blocked was mentioned. Solutions proposed included annual inspections and periodic (every 20 years) alerts.

¹ Chief, Hydrology and Hydraulics Section, South Atlantic Division

IMPACT OF WATER SUPPLY RESERVOIRS
ON DEVELOPING A DESIGN FLOW
by

Herbert W. Hereth¹

Purpose and Scope

The purpose of this paper is to discuss how water supply reservoirs can impact on the development of design flows. A hydrologic analysis for a channel project with four upstream water supply reservoirs is described, and considerations associated with the operations of water supply reservoirs are discussed. The project is the Guadalupe River channel improvement project, which is located in the San Jose, California area (Figures 1 & 2).

Summary of Project Hydrology

The hydrologic analysis of the Guadalupe River basin (Reference 1) included a statistical evaluation of annual maximum discharges of each reservoir in the basin. This statistical evaluation of historical events was then used to establish starting storages at the reservoirs for events of selected frequencies, and was used to develop design discharges in the project area. Thus, the predicted discharges for these events include the effects of varying amounts of flood storage in the basin's reservoirs, incidental to their water conservation function, which are nevertheless reflected in the history of reservoir operation and conditions in the basin.

An analysis of design discharges for the Guadalupe River was also performed assuming all the basin's reservoirs were full at the beginning of the flood event and provided no "incidental" flood control function. Under this scenario, the one percent chance peak discharge would be almost twice the design flow (which used the reservoir operations which are reflected in the historical record). However, this greater discharge for the one percent chance event is not supported by the discharge-frequency analysis for the Guadalupe River based on historical streamflow records. Therefore it was concluded that beginning the one percent chance storm event with all reservoirs (Lexington in particular) full is unlikely and is expected to occur much less frequently than the one percent event.

Basin Description

Physiography. The Guadalupe River basin is located at the south end of the San Francisco Bay (Figure 3). The drainage area is about 160 square miles above its confluence with Coyote Creek near San Francisco Bay, and 144 square miles upstream at the U.S.G.S. gage and the project site. The basin is bounded on the west by the Santa Cruz Mountains and on the east by Coyote Creek and further east by the Diablo Mountain Range. Elevations within the

¹Chief, Hydrology Section, Civil Design Branch, Engineering Division,
Sacramento District, Corps of Engineers

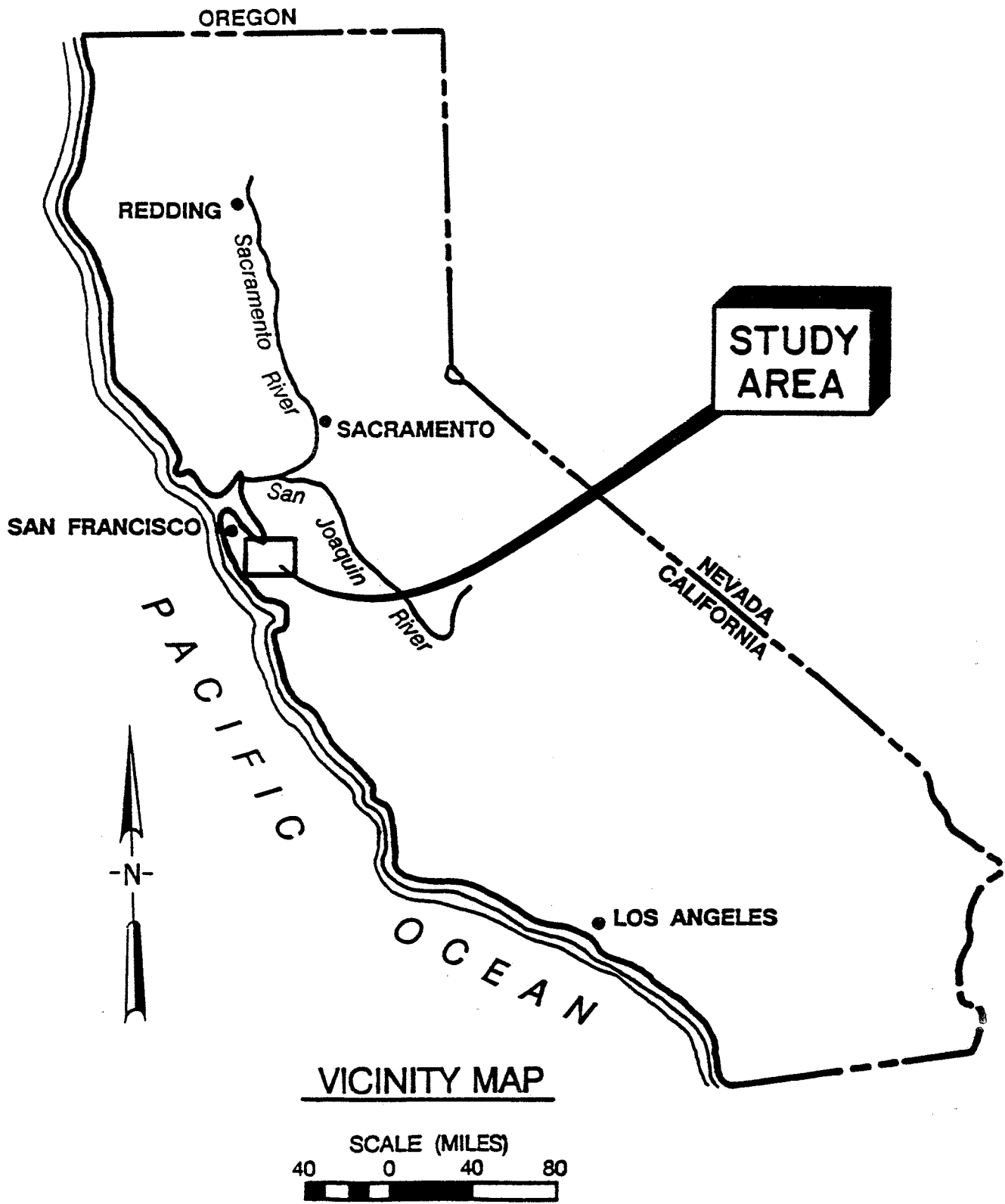
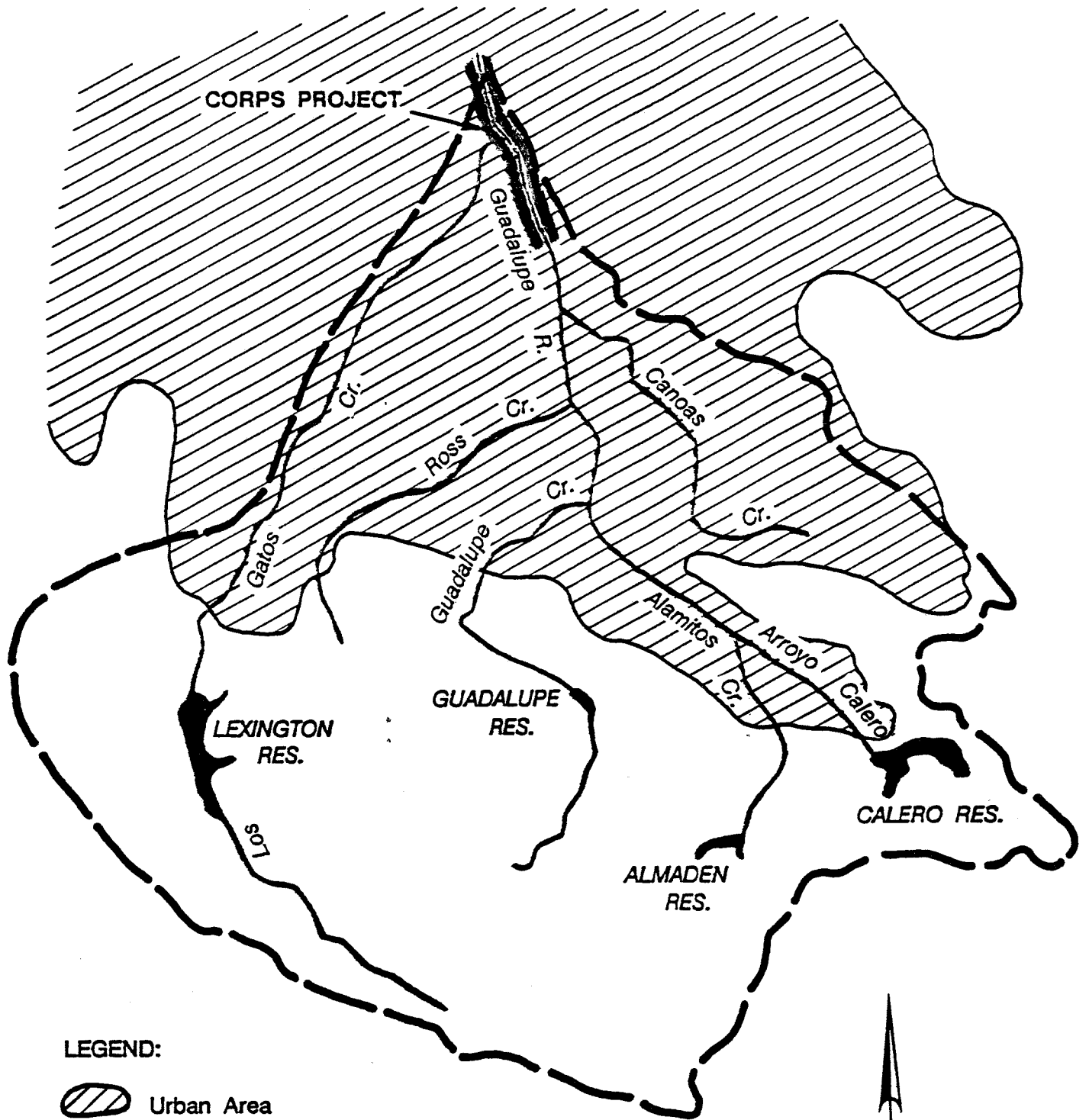

Figure 1



LEGEND:

 Urban Area

GUADALUPE RIVER BASIN

SCALE (MILES)

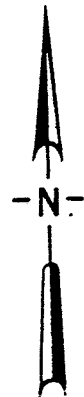
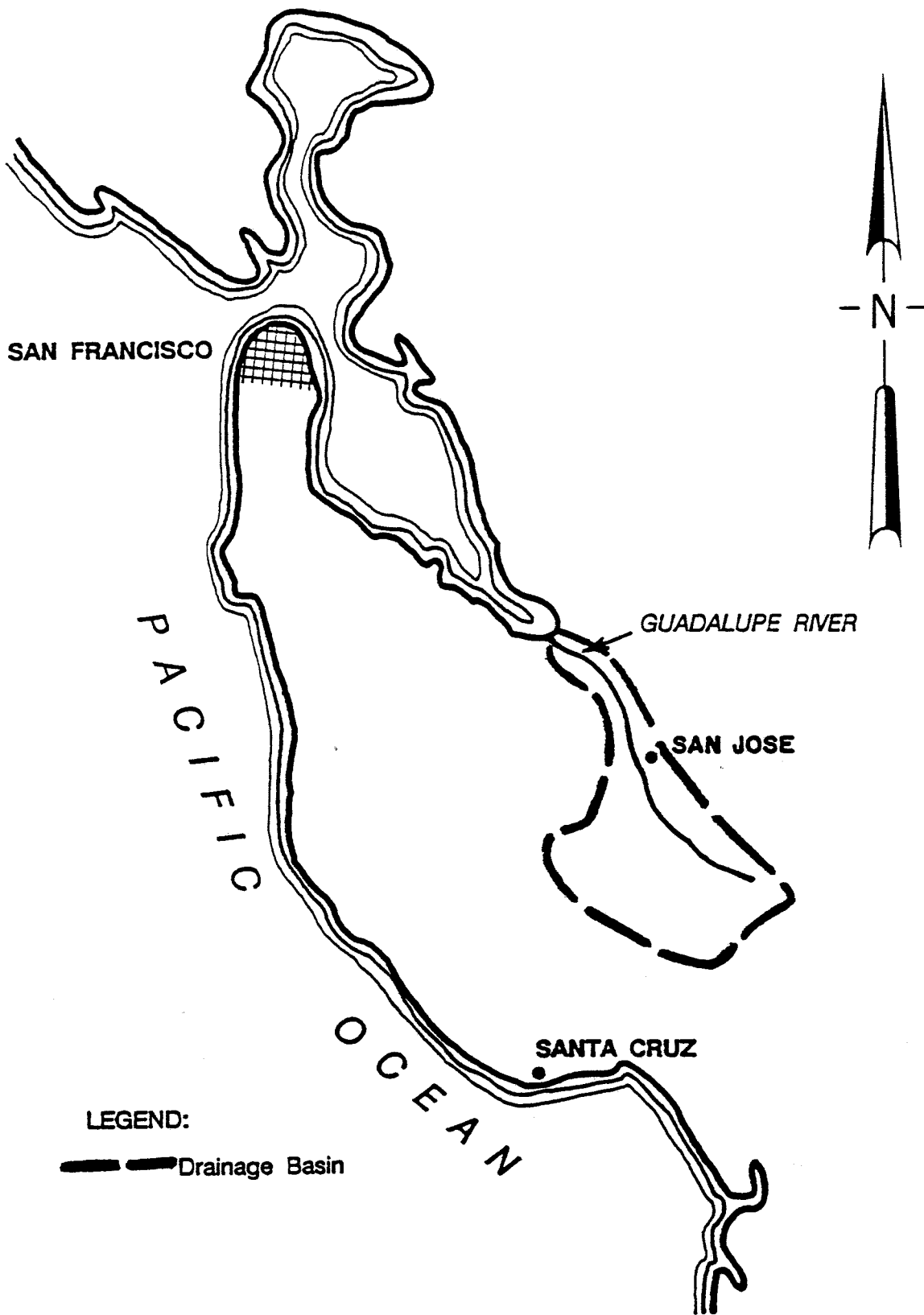

Figure 2



LOCATION MAP

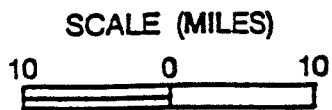

Figure 3

248

basin vary from sea level to 3,791 feet above sea level atop Loma Prieta. The basin is characterized by a perimeter of high, steep natural slopes with a large, wide valley below. Valley land use has changed from agriculture to urban community over the last 40 years. The runoff from the mountainous areas is affected by reservoirs, which control 63 square miles of the basin.

Climate. The climate of the Santa Clara Valley has summers that are warm and dry, and winters that are mild and moderately wet. Summer weather is dominated by sea breezes caused by differential heating between the interior valleys and the coast, while winter weather is dominated by storms from the North Pacific which produce virtually all the rainfall in the area. Ninety percent of the rainfall occurs in the late fall and winter months; January is usually the wettest month.

Precipitation. Precipitation data is available at numerous stations within the watershed area, some of which have been in operation for about a century. Table 1 indicates that over 90 percent of the normal annual precipitation occurs in the six-month period, November through April. The normal annual precipitation varies from less than 14 inches near San Francisco Bay to over 50 inches near the crest of the Santa Cruz Mountains in the Guadalupe River basin. The normal annual precipitation of the Guadalupe River basin (Figure 4) is about 20 inches.

TABLE 1

MONTHLY RAINFALL IN PERCENT OF NAP

JAN	FEB	MAR	APR	MAY	JUN	JUL	AUG	SEP	OCT	NOV	DEC
21.1	16.5	14.0	8.7	2.4	0.4	0.1	0.2	0.9	4.7	11.9	19.1

Runoff Characteristics. Runoff from the study area is extremely variable and has been highly modified by storage and diversion facilities. The natural average annual runoff past the San Jose gaging station on the Guadalupe River in the City of San Jose for the period 1931-1960 was estimated to be 35,500 acre-feet (4.5 basin-inches). Runoff has ranged from zero acre-feet in 1931 to over 123,000 acre-feet in 1938. As indicated in Table 2, virtually all runoff in the Guadalupe River occurs during the five-month period of December through April.

TABLE 2

MONTHLY RUNOFF
PERCENT OF AVERAGE ANNUAL RUNOFF

JAN	FEB	MAR	APR	MAY	JUN	JUL	AUG	SEP	OCT	NOV	DEC
19.8	32.6	20.5	10.9	0.3	0.0	0.0	0.0	0.0	0.0	1.0	14.9

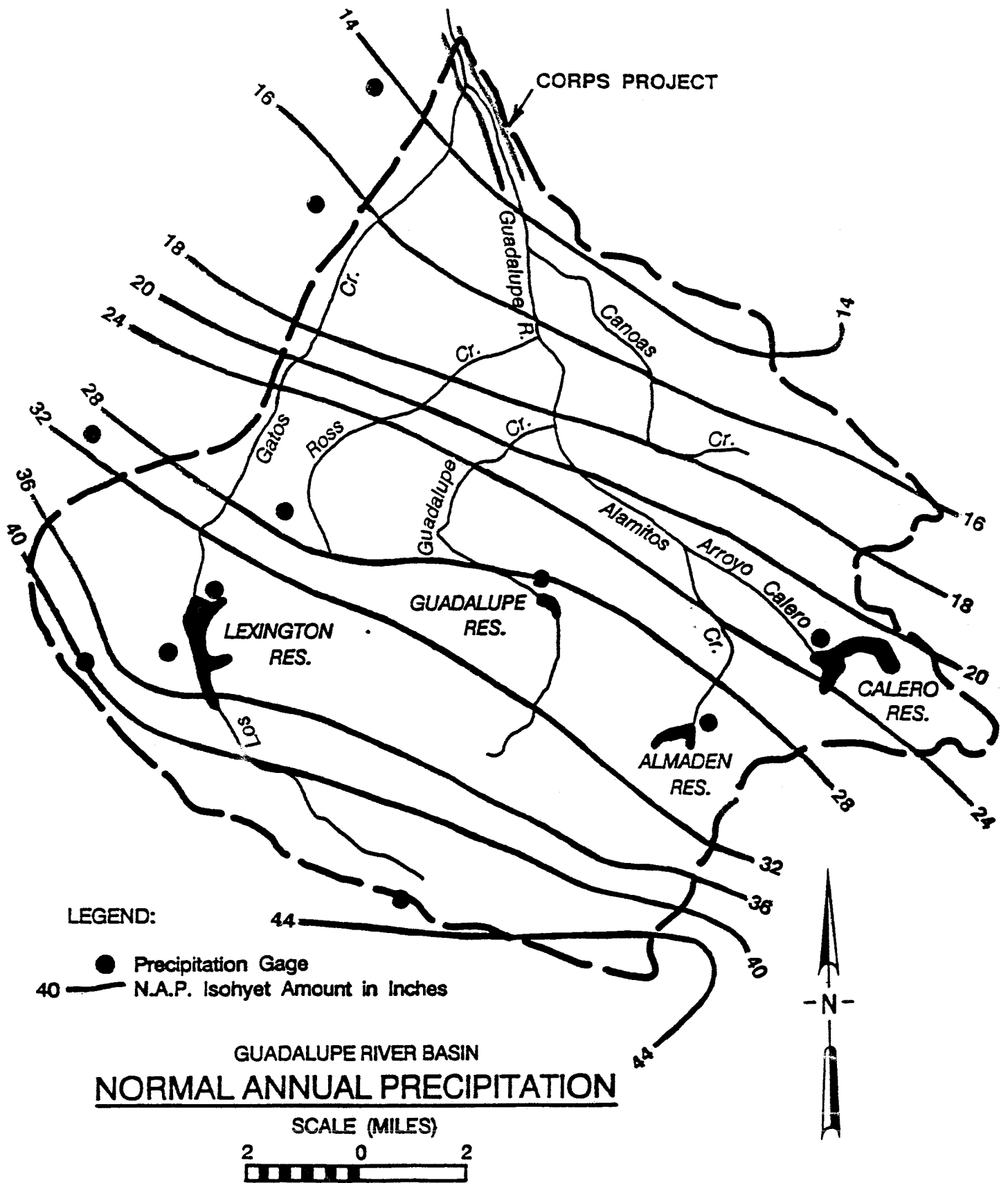

Figure 4

Existing Water Resources Development. The Santa Clara Valley Water District (SCVWD) has the responsibility for providing potable water for many of the valley's residents and industries. The District initiated a construction program to create dams and reservoirs in 1933; their latest development, Lexington Reservoir, was completed in 1952. The SCVWD operates eight dams and reservoirs in the Santa Clara Valley. The main purpose of the reservoirs is to recharge the valley's groundwater basins through natural percolation areas along the valley's streams, and through a number of man-made percolation ponds.

The four largest reservoirs in the Santa Clara Valley and their storage capacities are shown on Table 3. The reservoirs have no space allocated for flood control purposes. Some flood control is attributable to the reservoirs early in the flood season, when storage space is available as a result of summer drawdown for water supply and groundwater recharge.

TABLE 3

SANTA CLARA VALLEY RESERVOIRS

RESERVOIR	OWNER	STORAGE CAPACITY (Ac. Ft.)
Almaden	SCVWD	1,780
Calero	SCVWD	10,160
Guadalupe	SCVWD	3,740
Lexington	SCVWD	20,210

Study Approach

Guadalupe River Basin Model. The Guadalupe River system was divided into sub-basins to analyze the basin hydrologically.

Unit hydrographs, loss rate data, base flows, and channel routing criteria were developed for the basin model.

- The unit hydrographs were developed using a summation curve (S-curve) typical of the area.
- The loss rates for the sub-basins were developed from rainfall-runoff analysis of several historical events.
- The base flow for each sub-basin was also developed from these historical events.
- The Muskingum routing method was used, supplemented with the Modified Puls data developed from HEC-2 runs to route the flood flows within the basin.

- The Modified Puls routing method was used to route the runoff through the reservoirs.
- Loss rate data were estimated for future land conditions.

The basin model was calibrated using the three largest historical floods of December 1955, April 1958, and March 1967, to represent present land use conditions. The calibrated model was run for present and future conditions.

Statistical Analysis.

1) Basin Wide

Nine streamflow stations within the basin provided the runoff data used in this study (Figure 5 shows six of these gages). The most important gage was the "Guadalupe River at San Jose" gage, since it is in the middle of the Corps project. This gage has a drainage area of 144 square miles and has a continuous flow record since 1927. The runoff past this gage is mainly during the months of December to April (note Table 2). The "San Jose gage" peak discharge data were plotted and a regulated statistical relationship was developed (Figure 6), which reflects present land use conditions.

To understand what might happen to the flows at the project site when all of the reservoirs went into an "uncontrolled" situation, an unimpaired flow frequency curve was developed. This unimpaired curve was derived by:

- placing a one percent chance storm over the basin;
- assuming no reservoirs existed;
- using the basin hydrologic model;
- calculating the one percent chance runoff at the San Jose gage location;
- graphically drawing an "UNIMPAIRED" curve through the one percent chance computed value; (basically parallel to the "San Jose" statistical curve - Figure 6)

To determine the one percent chance flood peak flow at the San Jose gage location under project conditions, a statistical analysis of reservoir inflows and outflows were made for each of the four reservoirs.

2) Water Supply Reservoir Statistics. The four principal reservoirs, Lexington, Guadalupe, Almaden, and Calero, are committed for water supply purposes, yet they have a substantial impact on reducing flood runoff. To evaluate this impact on floodflows in the river system, inflow and outflow volume-frequency curves were developed for each reservoir. In addition, each reservoir's annual storages were analyzed to determine the appropriate storage in each reservoir at the start of the synthetic one percent chance storm event that would yield the one percent chance peak outflow.

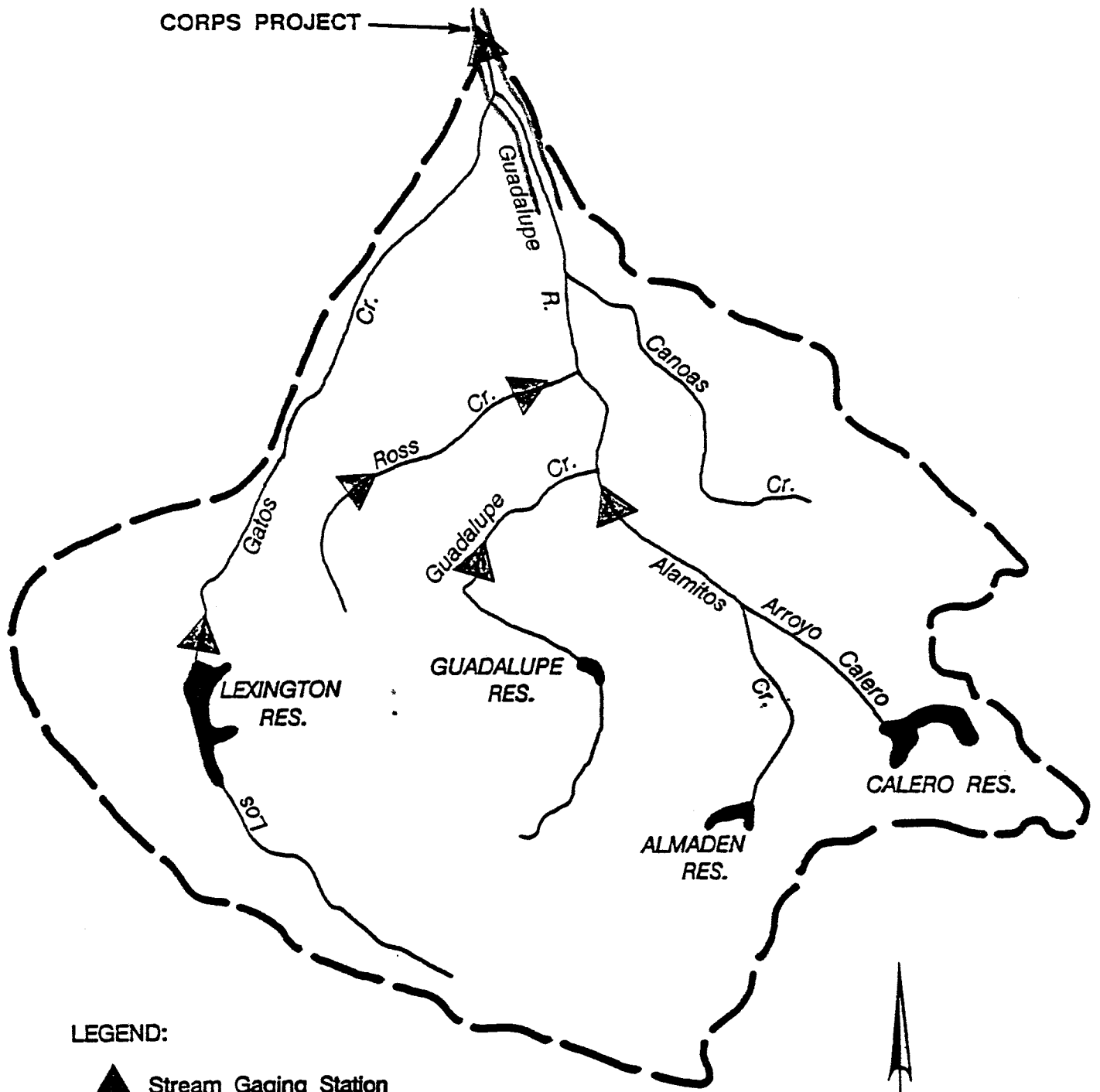
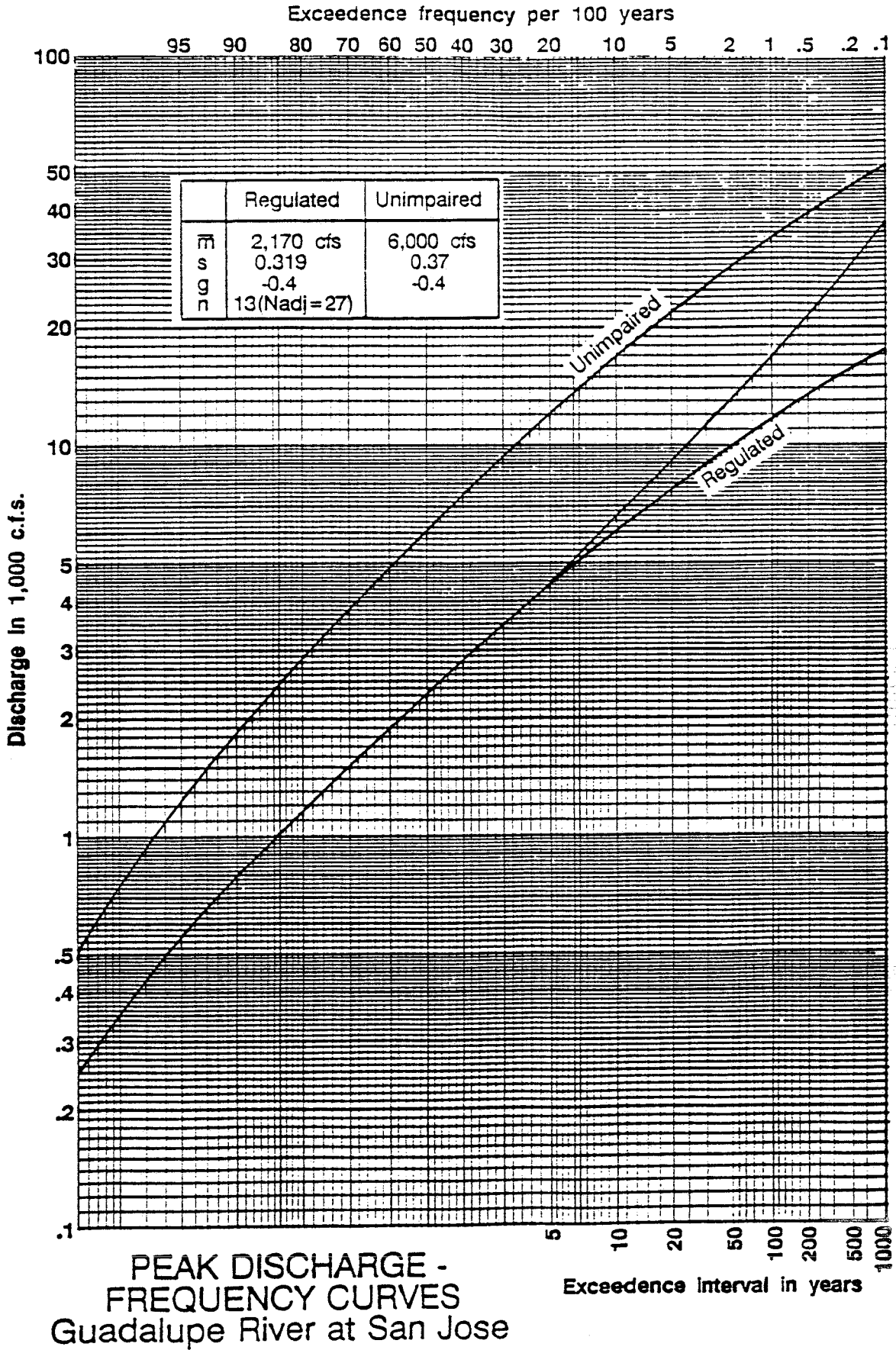

Figure 5



Daily records of outflow and reservoir level are available for each reservoir since it was built. The statistical analysis of the reservoir data began with a review of these data and it was decided that three-day change-of-storage data would be more reliable than one-day change-of-storage data and the three-day would be the shortest duration studied. Since most storms in this region have durations of three days or less, three-day change-of-storage data should reasonably represent the total storm runoff. The maximum annual three-day change-of-storage at each reservoir was determined from the daily reservoir stages. Maximum three-day releases and spillway discharges and releases during the maximum three-day change-of-storage at each reservoir for each year were tabulated and compared. For each year at each reservoir the larger of (1) the maximum three-day change-of-storage plus any releases made during the three days, or (2) the maximum three-day spillway discharge (surcharge is very small), was adopted as the largest three-day inflow for the year.

The data developed by the procedures described above were analyzed according to the flow frequency guidelines prepared by the Water Resources Council. Low outliers, for the purposes of this section of the report, were considered to be those years in which storm runoff was almost non-existent. Maximum three-day reservoir inflow and outflow frequency curves for each reservoir were prepared by analyzing data collected by the SCVWD, as previously discussed, except in the case of Lexington Dam. The outflow records at Lexington Dam were extended by using USGS data from 1939 to 1952 to perform an approximate, continuous routing assuming Lexington Dam was operated as it is today, during the 1939-1952 period. A typical set of inflow and outflow three-day volume vs. frequency curves are presented on Figure 7. Peak inflow and outflow frequency curves are shown on Figure 8.

Design (One Percent Chance) Flood. In order to determine the outflow from each reservoir during a one percent chance flood the one percent chance peak outflow value was used. The one percent chance inflow hydrograph (for a given reservoir) was routed through each reservoir, for a given reservoir starting storage, and the outflow hydrograph calculated. The peak flow of the outflow hydrograph was compared with the statistical one percent chance peak flow and the difference was used as a guide as to whether to adjust the reservoir starting storage either up or down. This trial and error procedure was used until the computed peak flow of the outflow hydrograph matched the statistical outflow peak flow of the reservoir.

The final one percent chance outflow hydrograph from each reservoir was input into the basin model and routed (and combined with the uncontrolled runoff) down to the Corps project reach (San Jose gage location). The calculated one percent chance peak flow at this location is 17,000 cfs.

A curve was graphically drawn from the regulated curve up towards the unimpaired curve, through the one percent chance value of 17,000 cfs, to demonstrate the impact of the reservoirs going from a controlled status to an uncontrolled situation (Figure 6). This graphical curve was started at the 5-year event to provide a smooth transition from the regulated curve up through the 17,000 cfs value.

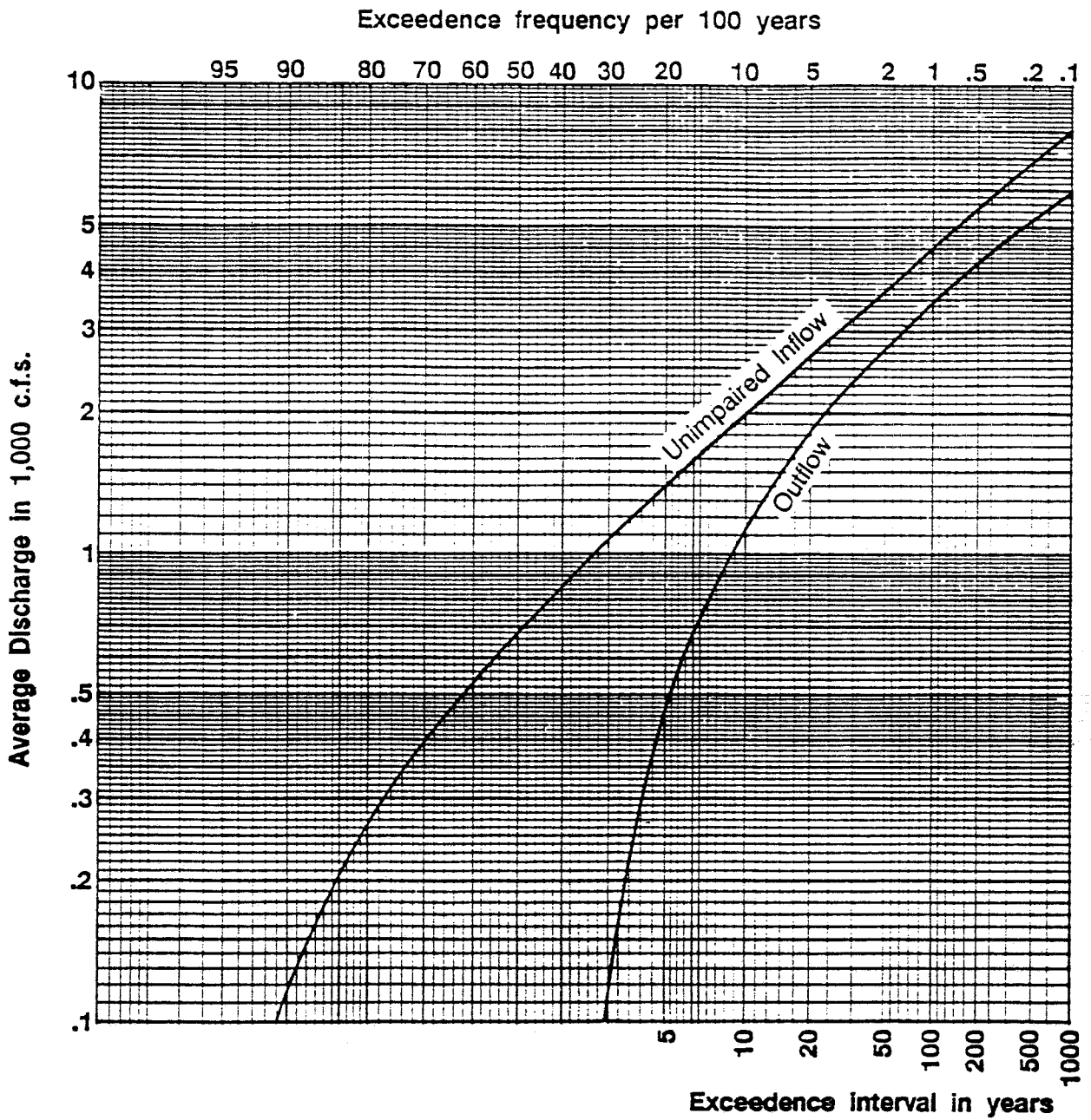

TYPICAL RESERVOIR 3-DAY
VOLUME INFLOW - OUTFLOW
FREQUENCY CURVES

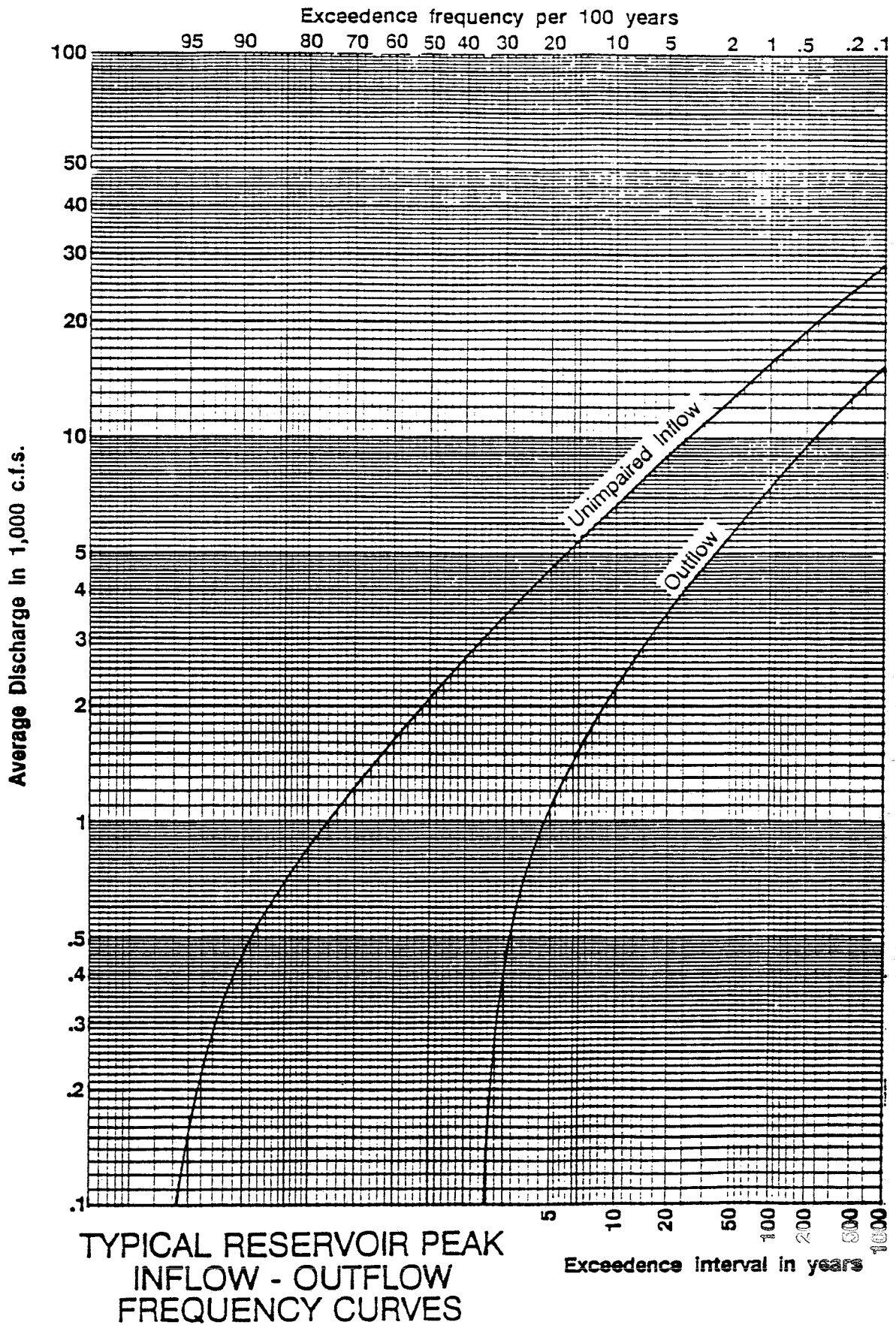

TYPICAL RESERVOIR PEAK
INFLOW - OUTFLOW
FREQUENCY CURVES

1980 Update Study

There have been five seasons, since the 1977 report, in which the peak floodflow of the Guadalupe River exceeded 6,000 cfs (10 percent chance event) at the San Jose gage. Table 4 lists these large peak flows for the San Jose gage. The two 1982 floods, 1983, and 1986 floods were the most significant events. The 1986 flood peak value nearly equalled the historic maximum of 1958.

TABLE 4

GUADALUPE RIVER AT SAN JOSE

PEAK FLOWS (cfs)

JAN 82	MAR 82	JAN 83	FEB 86
5660	7340	7130	9140

The reservoir storage content in the basin prior to the floods is an important factor in the magnitude of peak flows downstream. This is shown in Table 5, which presents the starting storages in the reservoirs and the critical 24-hour inflow into the reservoirs during the four 1980's floods.

TABLE 5

GUADALUPE RIVER

RESERVOIR INFLOWS

Date	Antecedent	<u>MAXIMUM 24 HOUR INFLOW TO RESERVOIRS</u>			
	Reservoir Storage	Lexington Res. (20,200)	Guadalupe Res. (3,700)	Almaden Res. (1,800)	Calero Res. (10,160)*
	% Full	Ac. Ft.	Ac. Ft.	Ac. Ft.	Ac. Ft.
Jan 82	25%	4,100	900	1,800	1,400
Mar 82	80%	2,400	800	1,500	800
Jan 83	50%	no data	--	--	--
Feb 86	50%	6,800	1,300	2,750	1,100

*Values in parentheses are reservoir capacities in acre-feet.

The December 1955 flood continues to be the most critical recorded historical event with its 11,000 ac. ft., 24-hour inflow to Lexington Reservoir. The recorded peak at Guadalupe River at San Jose was 5,570 cfs, but if all the reservoirs had been full, the peak would have been about 17,000 cfs.

Conclusions

Case Study. During the last twenty years, the Guadalupe River reservoirs have been filled to a greater extent more frequently and for longer periods than ever before, yet major floods have been reduced. The project design flood flow for the Guadalupe River at the San Jose gage was estimated using the basin gages and reservoir's historic records. To insure that this design flood is adequate in the future, it is necessary for the reservoirs to be operated as they have been in the past. It is important that during future operations, excessive amounts of stored water are not carried over into the next winter. If the reservoir carryover is excessive, then the 17,000 cfs design flow will have a greater chance of occurring.

Special Considerations. The "flood control" operation of water supply reservoirs should consider utilizing the water supply storage so as to obtain the lowest lake level prior to winter runoff without conflicting with water supply objectives. The control the water supply reservoirs have for reducing flood flows has to be identified. Of particular concern in calculating a design flow is the effects of the various reservoirs in reducing the peak flow. The initial storage used in the design flood routings has to be determined and presented to the agency controlling the reservoir(s). If a reservoir's annual maximum storage is at an elevation other than the spillway crest, then consideration should be given to having the agency controlling the reservoir sign a "letter of understanding" about how the reservoir will be operated to provide the design flow.

It is understood that where historical evidence has indicated that the water supply reservoirs will not be full when a major storm event occurs, it is difficult to justify using a full reservoir for calculating a design flood-flow. However, it is very common to have rare peak flood events occur in wetter than normal runoff years. Thus, when developing design flows for flood control structures, local interests should be aware that water supply reservoirs could potentially be full, that reservoir operations could change, and that the design flows will occur more frequently than the one percent chance event. This awareness needs to be emphasized when the potential for property damage and loss of life is high.

References

1. Hydrologic Engineering Office Report, "Guadalupe River and Coyote Creek, Santa Clara County, California", June 1977
2. Bulletin #17B, "Guidelines for Determining Flood Flow Frequency", September 1981

The Impact of Water Supply Reservoirs
on Developing a Design Flow

by

Herbert W. Hereth

SUMMARY OF DISCUSSION

by

Jaime Merino¹

This paper elicited considerable discussion both from a technical point of view as well as from a policy standpoint.

Technical comments centered around the use of N frequency rainfall to obtain N frequency runoff, i.e. why should the 100 year rain cause the 100 year flood. This question came up on several other papers also. Discussion on this issue centered what to do in ungaged basins.

The next question discussed was the effect of water supply storage on the unimpaired flow and what effect this had on the design discharge. In this particular case the storage assumed for the water supply reservoirs has a major impact on the runoff. By using the average storage in the reservoirs as a starting point, it is felt that the benefits are more accurately reflected, but during a wet year, the reservoirs fill up and this then becomes a conditional probability problem with one of the conditions satisfied. Because BERH review constantly questions the benefits and because of our current restriction on cost growth imposed by PL 99-662 (Water Resources Development Act of 1986), this problem requires considerable effort at a very early stage where there is neither the time nor the money to adequately study the problem.

The last area of discussion revolved around what restrictions the government should (or can) place on a local sponsor in regard to the operations on other projects in the basin. This question was never really addressed and probably should be explored further at a later time.

¹ Hydraulic Engineer, South Pacific Division

