

Hydrologic Engineering Center A Quarter Century 1964 - 1989

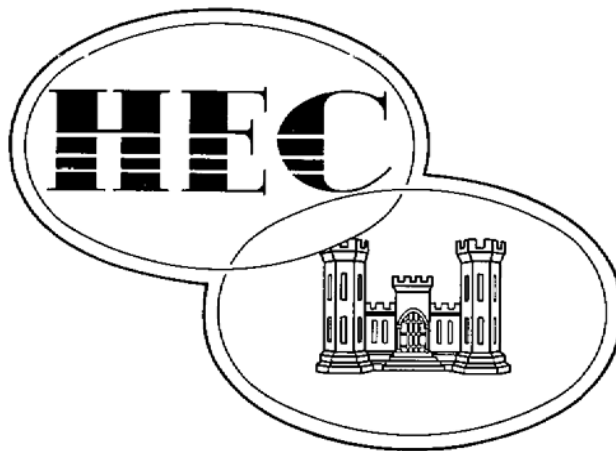

**US Army Corps of Engineers
Water Resources Support Center
Hydrologic Engineering Center
609 Second Street
Davis, California 95616
1989**

REPORT DOCUMENTATION PAGE			<i>Form Approved OMB No. 0704-0188</i>		
<p>The public reporting burden for this collection of information is estimated to average 1 hour per response, including the time for reviewing instructions, searching existing data sources, gathering and maintaining the data needed, and completing and reviewing the collection of information. Send comments regarding this burden estimate or any other aspect of this collection of information, including suggestions for reducing this burden, to the Department of Defense, Executive Services and Communications Directorate (0704-0188). Respondents should be aware that notwithstanding any other provision of law, no person shall be subject to any penalty for failing to comply with a collection of information if it does not display a currently valid OMB control number.</p> <p>PLEASE DO NOT RETURN YOUR FORM TO THE ABOVE ORGANIZATION.</p>					
1. REPORT DATE (DD-MM-YYYY)		2. REPORT TYPE		3. DATES COVERED (From - To)	
1989		Administrative Report			
4. TITLE AND SUBTITLE			5a. CONTRACT NUMBER		
Hydrologic Engineering Center A Quarter Century 1964 - 1989					
			5b. GRANT NUMBER		
			5c. PROGRAM ELEMENT NUMBER		
6. AUTHOR(S)			5d. PROJECT NUMBER		
CEIWR-HEC			5e. TASK NUMBER		
			5f. WORK UNIT NUMBER		
7. PERFORMING ORGANIZATION NAME(S) AND ADDRESS(ES)			8. PERFORMING ORGANIZATION REPORT NUMBER		
US Army Corps of Engineers Institute for Water Resources Hydrologic Engineering Center (HEC) 609 Second Street Davis, CA 95616-4687					
9. SPONSORING/MONITORING AGENCY NAME(S) AND ADDRESS(ES)			10. SPONSOR/ MONITOR'S ACRONYM(S)		
			11. SPONSOR/ MONITOR'S REPORT NUMBER(S)		
12. DISTRIBUTION / AVAILABILITY STATEMENT					
Approved for public release; distribution is unlimited.					
13. SUPPLEMENTARY NOTES					
14. ABSTRACT					
This publication documents the history of the Hydrologic Engineering Center (HEC) from 1964 through 1989, twenty-five years. Provides insight into the creation of HEC, how the structure of the Center has changed and evolved, and the direction of software and publications the HEC has developed.					
15. SUBJECT TERMS					
Hydrologic Engineering Center, HEC, center of expertise, hydrologic engineering					
16. SECURITY CLASSIFICATION OF:			17. LIMITATION OF ABSTRACT	18. NUMBER OF PAGES	19a. NAME OF RESPONSIBLE PERSON
a. REPORT	b. ABSTRACT	c. THIS PAGE			
U	U	U	UU	74	

Foreword

A history celebrating a silver anniversary provides a chance to reminisce. As the Hydrologic Engineering Center (HEC) turns 25 and its parent organization, the Water Resources Support Center, turns ten, the staff has had the opportunity to look back and remember. Seven of our staff members have worked at HEC more than 20 years. By coincidence, a member of the HEC staff during the first nine years is on sabbatical from the University of Southern Indiana and is back at HEC. These eight people offer a unique perspective of the HEC's historical beginnings, its organization, and its scientific and technical contributions. The rest of the current staff also made outstanding contributions to this publication.

Special recognition goes to Lee Pendergrass, our contracted historian/writer from PenSEC, Inc., in Edmonds, Washington; Lynne Stevenson, our editor from the Corps' Sacramento District; Penni Baker of HEC for her graphics and photographic work; Diane Harris and Rhonda Barrow of HEC for typing the manuscript; and Barbara Davy of the Sacramento District for the cover and her artistic judgments regarding layout. Thanks to all the contributors for their many hours of effort.

This report was prepared by R.G. Willey under the supervision of Arlen Feldman, Chief of the Research Division, Bill Eichert, who was HEC Director through January 1989 and Darryl Davis since July 1989.

Contents

Foreword.....	i
HEC's Founding Father and Directors.....	1
Organization of the Center	9
Executive Office	9
Research Division	11
Training Division.....	13
Technical Assistance Division.....	17
IHD Project	19
Groundwater Branch.....	20
Planning Division.....	21
Computer Support Center	22
Technology and Methods Development.....	25
Watershed Modeling.....	25
Remote Sensing	26
River Hydraulics.....	25
Reservoir Systems.....	27
Statistical Hydrology	30
Sedimentation	31
Water Quality	33
Data Storage System.....	34
Flood Damage Computations	35
Systems Analysis	37
Water Control	38
Personnel and Other Resources.....	41
Corps Staff on Temporary Duty	42
Universities	42
Consultants.....	42
Computers.....	43
Annual Budget	45
Computer Program Distribution	45
Students Trained	45
Current Perspectives	47
Executive Office	47
Research Division.....	47
Planning Division.....	49
Training Division.....	50
Technical Assistance Division.....	50
A Final Reminiscence	53

Contents

Appendices	55
A - Former HEC Staff.....	57
B - University Support.....	58
C - Student Support.....	60
D - Consultants	61
E - HEC Training Courses Conducted.....	64
F - HEC Seminars Conducted.....	68

HEC's Founding Father and Directors

The need for the Hydrologic Engineering Center (HEC; also referred to as the Center) was first recognized by Albert L. Cochran of the Office of the Chief of Engineers (OCE). Cochran ensured the Center's conception and birth, organized it within the Sacramento District Corps of Engineers, and persuaded Leo R. Beard to be its first director. Beard, a hydrologic engineer internationally known as an expert in statistical methods for hydrologic analysis, was in charge of the Reservoir Regulation Section of the Sacramento District when HEC was established in 1964. His expertise shaped the structure and character of HEC in its formative years.



Albert L. Cochran
Founder of HEC

Beard vividly remembers the beginnings of HEC:

I well remember the weekend in April 1964 spent at Al Cochran's house in Silver Spring, Maryland. Al had been Chief of Hydraulics and Hydrology at OCE for many years, and I, in fact, worked under him there from 1949 to 1952. We spent that weekend in 1964 talking about the need for a Corps center of expertise in "hydrologic engineering" (a term coined that weekend). I simply served as a sounding board while Al's ideas evolved. On Monday I had a meeting with the U.S. Geological Survey (USGS) on another matter. When I returned after lunch Al was upset that I was away because he had already sold his idea for a Hydrologic Engineering Center to Wendell Johnson, Chief of the Engineering Division in OCE. Al wanted to proceed as rapidly as possible to set up funding and organization and to get approval from the Sacramento District to establish the Center there. Although OCE and the Corps' Waterways Experiment Station (WES) in Vicksburg were considered as sites, Sacramento was selected because Al wanted me to be director and I could not convince my wife to leave California again.

By July 1964, the Hydrologic Engineering Center with a staff of five was set up as an administrative unit under Amalio Gomez, Chief of the Planning Branch and later Chief of the Engineering Division of the Sacramento District. "Joe" Gomez provided a

great deal of valuable guidance in administering the Center, but gave me a free hand otherwise.

When the Chief of Engineers Lieutenant General W.K. Wilson, Jr., announced the establishment of HEC on July 10, 1964, Cochran and Beard already had a clear vision of HEC's threefold mission: research, training, and technical assistance in the application of hydrologic engineering methodology. HEC was established to serve all Corps offices in the area of hydrologic engineering, bridging the gap between state-of-the-art technology as reflected in current research by universities and other research institutions, and the practical application of that technology by the Corps field offices.

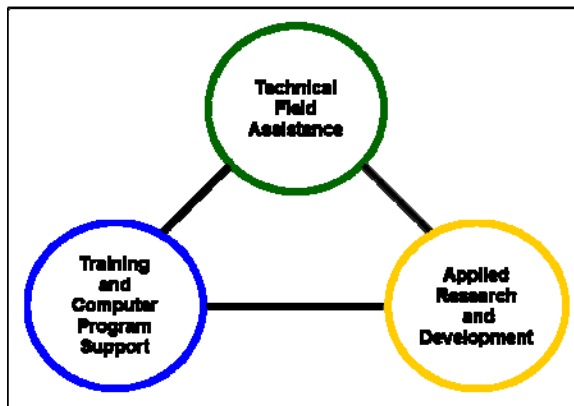

Activities of HEC

Hydrologic engineering was a new field in 1964. HEC's founder described and defined it this way:

As a natural response to needs of the time, several new fields of engineering have evolved within recent years. Among these is an area of professional specialization best described as "Hydrologic Engineering." Whereas scientific hydrology pertains essentially to the study of the various elements ... of the hydrologic cycle ..., hydrologic engineering involves the application of knowledge of these hydrologic elements and other knowledge of engineering principles in the planning, design, construction and operation of facilities associated with water resources development

...hydrologic engineering like all other phases of engineering is founded basically on mathematics, physics, chemistry, and other fundamental sciences. A relatively broad general experience in civil engineering is required as a background for a hydrologic engineer, inasmuch as the determinations he is called upon to make are closely associated with the elements of civil engineering.

A thorough background and substantial specialized knowledge of fluvial hydraulics involves the channel phase of the hydrologic cycle and is intimately involved in hydrologic determinations required for the improvements of rivers, channels, etc. Specialized knowledge of hydrometeorology is also a fundamental requirement for hydrologic engineering, inasmuch as precipitation and other weather factors govern the flow of streams, and consequently the magnitude and nature of structures and measures required for streamflow regulation.

A reasonable familiarity and basic knowledge of certain elements of the social sciences and economics are necessary qualifications of a hydrologic engineer, inasmuch as his primary mission is to assist in the planning, design, and operation of structures to meet human needs in an efficient and economical manner. The role of hydrologic engineering is as broad as the field of water resources development.

Hydrologic engineering plays a major role in water resource development. Al Cochran's description of hydrologic engineering is as accurate today as it was 25 years ago.

HEC Chronology

- 1964:** HEC established through efforts of Al Cochran, Chief of H&H, OCE
Leo R. Beard is appointed Director
Center administered by the Sacramento District Engineer
Office space in Sacramento District for staff of five
Annual budget of \$114,000
Technical expertise: hydrology, hydraulics, and statistics
- 1965:** Three Corps Training courses provided
First ten computer programs released
A series of technical research papers by staff members was initiated
- 1968:** First HEC Package Programs (HEC-1, 2, 3 & 4) were released
Initiated International Hydrological Decade (IHD) documentation on "Hydrologic Engineering Methods for Water Resource Development"
- 1969:** Center moves 12 miles west to Davis near the University of California campus
Initiated IHD Water Resource Studies in Peru and Guatemala
- 1972:** Planning Analysis Branch established
Beard retires
Bill S. Eichert is appointed Director
One-month training course given to representatives from 21 nations
Activities were extended to international assistance
- 1974:** HEC is ten years old with a staff of 26 and an annual budget of \$1 million
- 1975:** One-month training course given to representatives from 18 nations
- 1977:** International Hydrological Decade work is completed:
12 volumes of Hydrologic Engineering Methods for Water Resource Development published
- 1979:** HEC designated a separate Field Operating Activity in January
Water Resources Support Center (WRSC) is formed in June and HEC is attached to WRSC
- 1984:** HEC's Robert MacArthur is selected as Corps' Engineer of the Year
- 1985:** First personal computer version of HEC-1 and HEC-2 released
- 1988:** HEC has 17 technical specialties
3,800 copies of HEC personal computer programs are distributed from a library of 52 personal computer and 129 mainframe programs
Seventeen Corps training courses and workshops are given
Staff of 40 operates on an annual budget of \$3 million
- 1989:** Eichert retires; 25th Anniversary
- 1989:** Darryl W. Davis is appointed Director

As the Center developed, it provided substantial assistance to the 52 Corps field offices with civil works missions. A large number of field-office personnel attended HEC courses. Most of these were either one- or two-week short courses providing intensive instruction on a single subject. Up to half were presented outside HEC on the road during the early 1970's. Hydrologic engineers in the field needed help keeping up to date as research led, for example, to more efficient application technologies and methods for computing flood and low-flow probabilities.

Sometimes a field office with a special problem would temporarily assign one of its engineers to HEC to work directly with HEC's specialists. Other times, because they lacked the necessary expertise or manpower, the field offices relied entirely on HEC staff.

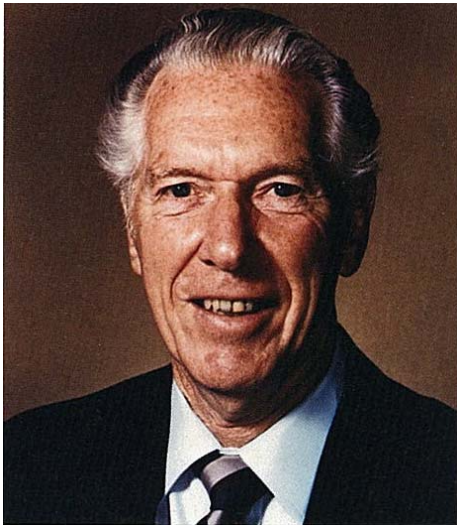

Leo R. Beard

HEC Director: 1964-1972

HEC benefitted from these associations as much as the field offices. HEC's reputation grew, and HEC personnel became acquainted in detail with the foremost hydrologic problems throughout the Corps. Helping to solve these problems added greatly to HEC capability. As the organization grew, its reputation enabled it to draw on the very best personnel within and, to some extent, outside the Corps. Growth was constrained mainly by availability of top-quality personnel. Consequently, the organization evolved slowly, but surely, into a group of capable and enthusiastic experts. Morale and enthusiasm were high, with little competition as everyone worked to serve the Corps Divisions, Districts, and field offices. Each member was encouraged to pursue his own interest within the work program.

Since its founding, HEC has had only two directors. Beard served as director for eight years at a time when computers were changing from machines capable of performing relatively simple repetitive computations to complex systems, making it possible to solve problems that hadn't been feasible to attempt just a few years earlier. As many of the Corps' hydrologic engineering procedures as possible were adapted to the computer and supplemented by new design algorithms, computers freed junior engineers from the tedium of manual calculations. Rather than concentrating on masses of detail, hydrologic engineers at all levels could postulate, analyze, interpret, and search for practical solutions to real-life problems.

Beard's successor, Bill S. Eichert, who had been HEC's Assistant Director and the Chief of the Training Division, became an expert in developing pro-grams that made the institution distinctive. Born in Abilene, Texas, and raised in Southern California and New Mexico, Eichert was a graduate of New Mexico University and Oklahoma University in civil engineering. Before accepting an appointment to HEC in 1964, he had been at the Tulsa District of the Corps of



Bill S. Eichert
HEC Director: 1972-1989

Engineers for six years. When Eichert retired in January 1989, he had spent 24 years at HEC, over 16 of them as director during years when HEC was contributing to such important projects as the Tibbee River Navigation Project, the Susquehanna River Basin Study, and the National Hydropower Study. In July 1989, Darryl W. Davis was appointed as the new director of HEC. Davis had been Chief of the HEC's Planning Division since 1973.

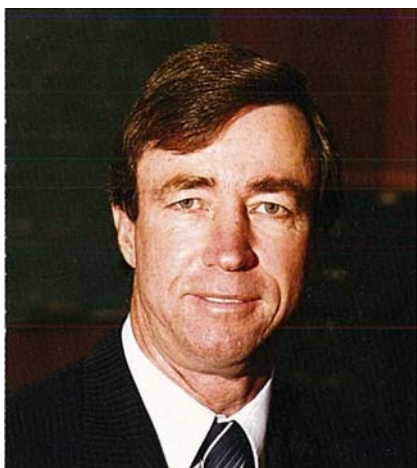

Darryl W. Davis
HEC Director: 1989-present

Currently HEC is located in Davis, California, but it began operating in 1964 from the seventh floor of the Federal Building at 650 Capitol Mall, Sacramento, California, as part of the Sacramento District. When the District became short of office space, HEC volunteered to move.

In January 1969, HEC moved 12 miles to a leased building in downtown Davis to obtain more space and to more closely align itself with the University of California at Davis (UCD). The small university town atmosphere, the potential for short bike trips from home to the office, and HEC's easy access to the University faculty and computer facilities, made the move appealing. Attempts were made to locate the Center right on campus, but the combination of university and General Services Administration (GSA) red tape appeared to be insurmountable. As the Center grew, it secured more space at the same location on two different occasions.

After the first year of operation during which it reported to Joe Gomez, HEC reported directly to the Sacramento District Engineer for administrative matters and to OCE for technical guidance between 1966 and 1979. On 10 January 1979, HEC became a separate field operating agency under the staff supervision of the Director of Civil Works, OCE. On 15 June 1979, HEC was reassigned from OCE to the Director of the newly created Water Resources Support Center at Fort Belvoir, Virginia.

Always facing new challenges, the Corps constantly seeks to improve its planning and engineering techniques and procedures. Under the leadership of Beard and Eichert, HEC contributed to this goal from its beginning. From a staff of five and a budget of \$114,000, it has expanded to a staff of nearly 40 and a budget of \$3 million.



Federal Building, 650 Capitol Mall, Sacramento, California



Hydrologic Engineering Center, Davis, California

Organization of the Center

Over the years HEC's organizational structure has changed and evolved. Sometimes new sections were created to meet immediate but temporary needs and then disbanded. Other times new sections or divisions have been long-lived and durable. Today HEC's organization remains relatively simple, considering the variety of services HEC provides.

Beard and Eichert both held dual appointments at HEC. In addition to serving as HEC's director, Beard was also Chief of the Hydrologic Research Section, one of HEC's three original units. Eichert, in addition to serving as Assistant Director, also served as Chief of the Training and Methods Section. This willingness to keep the organization simple and to play several roles at once, has kept HEC flexible. This flexibility is one of the keys to HEC's success.

Executive Office

This office provides general administration for the Center. Personnel, finance and accounting functions are provided by the Sacramento District via a service agreement. John Dralle has been HEC's Administrative Officer since 1968 and maintains close coordination with Sacramento. In addition to administrative duties, the staff in the Executive Office has been directly involved in developing computer models since 1964. While Director, Leo Beard developed the initial versions of HEC-1 and HEC-3, and Bill Eichert developed HEC-5.

Executive staff also contributed to research activities, computer program support and technical assistance programs. Some specific projects include:

- Assistance in system hydropower analysis for 15 reservoirs in three river basins in the South Atlantic Division.
- Performance of flood control simulations for Savannah River Basin reservoirs to determine regulated flow-frequency curves for Savannah District.
- Assistance in modeling hydropower and water supply systems in Albuquerque.
- Assistance in modeling proposed pumped-storage hydropower projects in Philadelphia District.
- Real-time reservoir flood control simulation in the Allegheny River Basin for the Pittsburgh District.
- Cooperation in international projects with UNESCO and UNDP.



UNESCO's International Hydrological Program Working Group, 1980

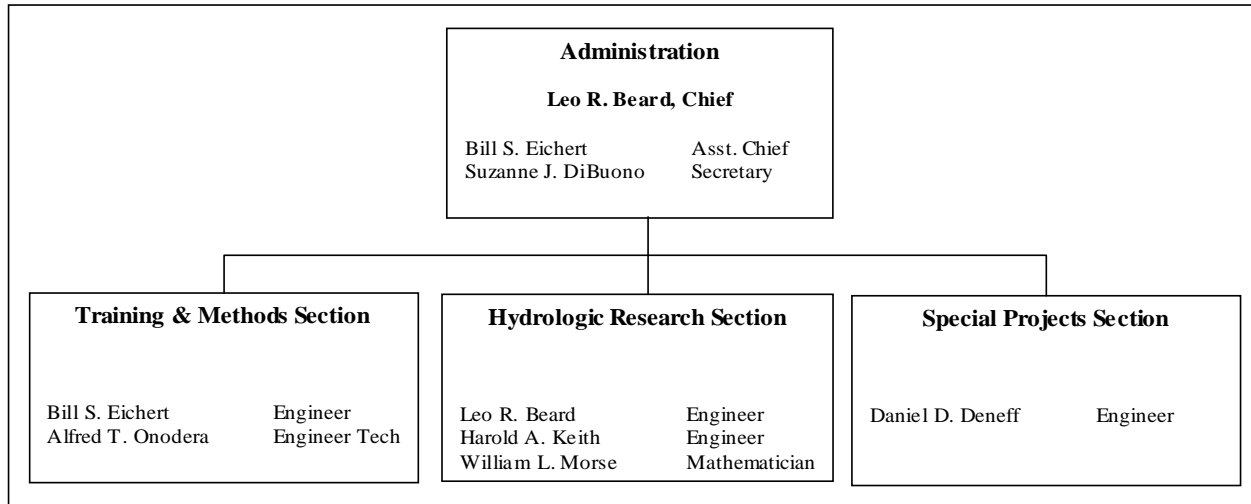

Organization Chart, 1964

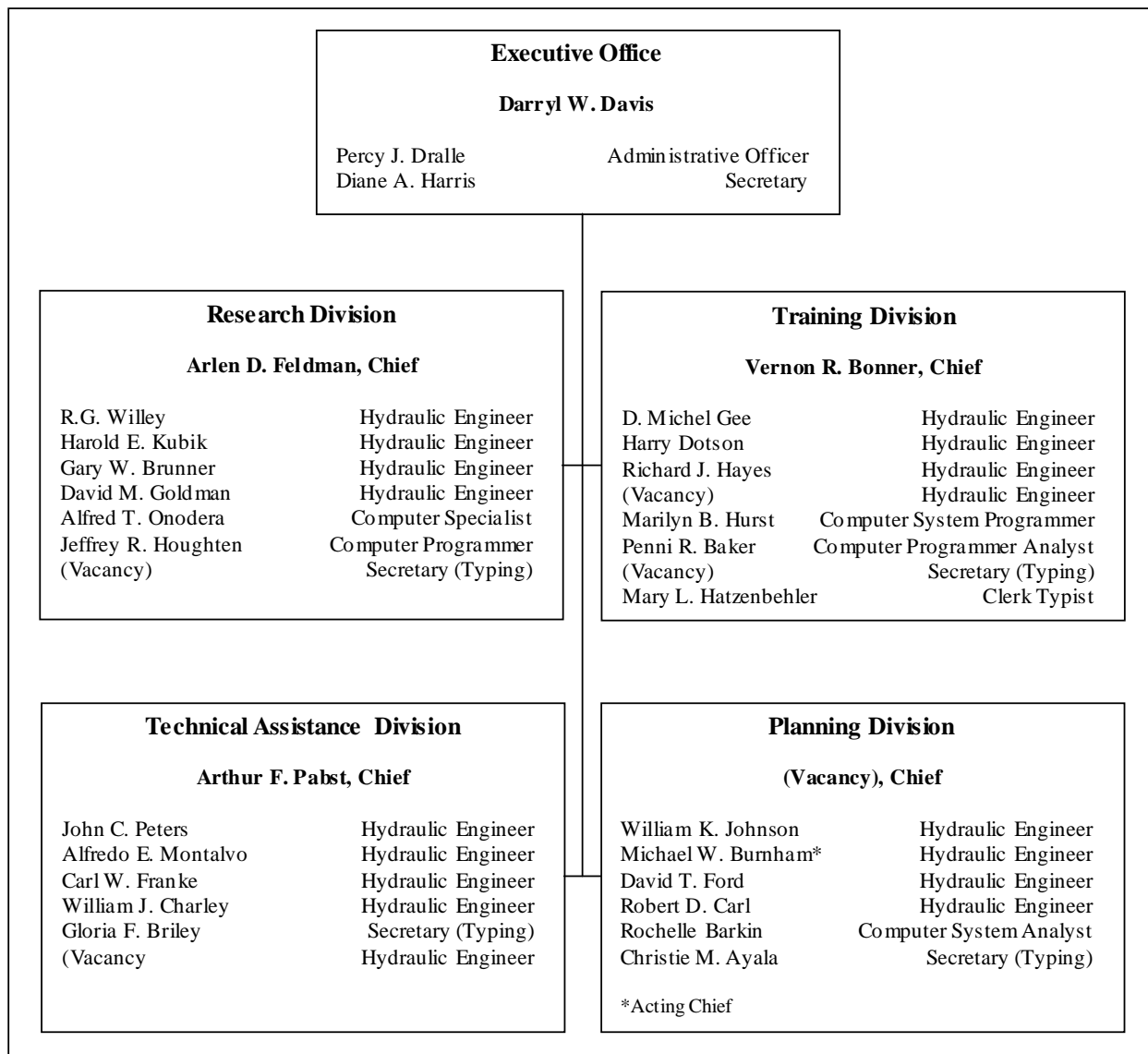

Organization Chart, 1989

- Publication of "Methods of Hydrological Computations for Water Projects" in cooperation with UNESCO.

Research Division

From the outset the Research Division assumed the lead in organizing and managing HEC's research program, but other units also carried out extensive research. In addition to custom designing problem solving techniques for Corps District and Division offices, HEC research staff tracked new methods developed by others and evaluated their potential for helping the Corps' civil works mission. Since 1964, four people have served as chief of the Research Branch and overseen this work. They are:

Leo R. Beard	1964 - 1970
A.J. Fredrich	1971 - 1972
W.A. (Tony) Thomas	1973 - 1976
Arlen D. Feldman	1977 - Present

Within a spectrum ranging from basic scientific research to applied research, HEC has always been closer to the applied research end of the spectrum. Requests by field personnel for technical assistance often helped HEC identify the need for such research. Often HEC took roughly described problems and developed sophisticated procedures for solving them. HEC's system for relating research work to field needs predated the formal Corps-wide research needs system by several years.

An HEC research and development (R&D) project usually begins with the expression of technical needs in a Corps field office. HEC inputs ideas to the Corps R&D system (consisting of Headquarters, field and laboratory personnel) for relative ranking. When a project, known as a work unit, is funded, technology development begins. HEC often hosts a seminar of experts from private industry, federal agencies, universities, and field office representatives to discuss capabilities and needs.

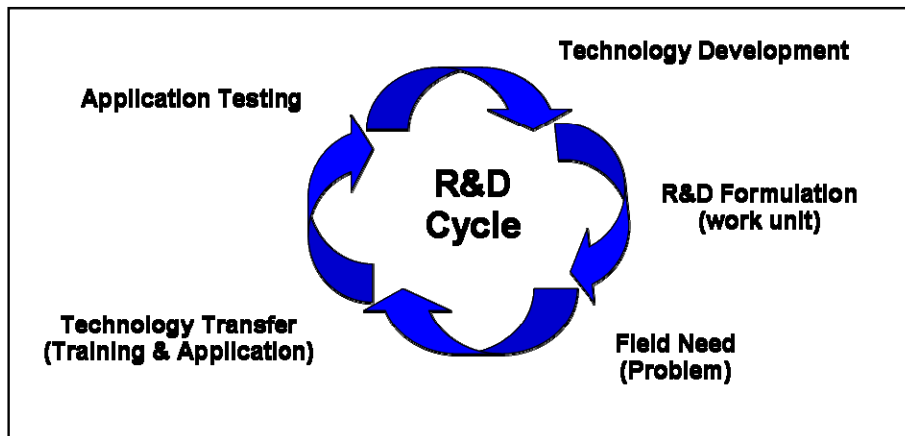

Research and Development Cycle

In the development of a product, the technology is continually field tested. As the product becomes more final, it is transferred to the field through project applications and training. HEC's

objective is to make the field proficient in the use of the technology; HEC does not have the staff for routine project studies.

HEC and the Corps' R&D system try to foresee future technology needs and be ready for them. Sometimes events occur that require R&D action before the "R&D system" can react. This was the case for the Federal Dam Safety and National Non-Federal Dam Safety programs in which existing R&D funds were diverted to meet the new needs. Then a formal program was developed.

Sometimes an R&D program is started through the action of Corps headquarters. William Gianelli, the former Assistant Secretary of the Army for Civil Works, began an R&D program by requiring new analyses for dam safety improvements, which precipitated the Corps' Dam Safety Risk Analysis program.

Early research focused on developing generalized computer programs for hydrologic design and water resource management including rainfall-runoff analysis, water surface profile analysis, reservoir system operation and hydrologic frequency calculations. Manual techniques for solving problems in all of these areas were reasonably well developed as HEC began developing computer models. Adapting these techniques to the computer led first to new computational methods that would reproduce the results obtained with manual methods. This led to the next step - methods specifically designed to take advantage of the unique capabilities of computers.



Arlen D. Feldman
Chief, Research Division

In addition to developing generalized computer programs, early research explored new techniques in stochastic hydrology. The Research Branch also looked for ways to generalize from hydrologic and climatological data and fill in missing data, and developed techniques for performing hydrologic studies that screened alternatives proposed by water resources planners.

As HEC's mission and budget expanded to meet the needs of a growing civil works program, HEC had to augment its in-house research capabilities with outside contractors, so HEC initiated a modest contract research program in 1969 to support in-house research. Eventually this

program expanded to permit HEC to solicit proposals from outsiders to do research within HEC's general research areas, but the contracted work no longer had to be connected to a specific in-house project. The program provides the flexibility to respond to short-term changes in research priorities within the constraints imposed by year-to-year fluctuations in research funds.

The results of HEC research are disseminated within the Corps in a variety of ways. Technical papers and manuals, computer program documentation, and regularly scheduled training courses and seminars all help spread the word. Interested field offices are also assisted in applying research results to specific field problems upon request. HEC also communicates with the water resources profession worldwide through professional conferences and symposia. Staff members have made hundreds of oral and written technical presentations in this country and in more than 20 foreign countries.

To assure that the HEC research program remains relevant to the day-to-day hydrologic engineering problems of the Corps, research personnel are not isolated from all the Center's other activities. They participate in HEC's training and special assistance programs.

Training Division

The basic purpose of training provided by the Center has always been to improve the Corps ability to accomplish its civil works mission through increased understanding of hydrologic engineering. The most important purpose of this training is to assure that effective and economical water resources development results from increased technical capability. Specialized training contributes to more efficient performance of technical studies associated with planning, design and operation of civil works, which is essential to meet the responsibilities of the Corps.

Over the past 25 years five persons have served as chief of HEC's Training Division. One of them has served twice:

Bill S. Eichert	1964 - 1969
A.J. Fredrich	1970
Bill S. Eichert	1971 - 1972
John C. Peters	1973 - 1977
William K. Johnson	1978 - 1980
Vernon R. Bonner	1980 - Present

The training program conducted or sponsored by the Center is diversified in subject, scope, and style of presentation:

- (1) Training courses, usually one to two weeks
- (2) Short conferences or seminars
- (3) Individual or small group training assignments
- (4) Special training activities
- (5) Distribution of publications to field offices
- (6) Arrangements with universities for short courses
- (7) Participation in technical society meetings

Some activities concentrate on current techniques and procedures to shorten the on-the-job "breaking-in" period for either new employees or employees who change from other positions in the Corps to hydrologic engineering. These courses increase the efficiency of employees and reduce costs, time and manpower needed to prepare studies and reports without reducing quality. Other activities give experienced engineers advanced training in highly specialized phases of hydrologic engineering, including educating them on the results of current research projects. These courses are essential because they speed the acceptance and practical application of new techniques and equipment in water resources engineering.

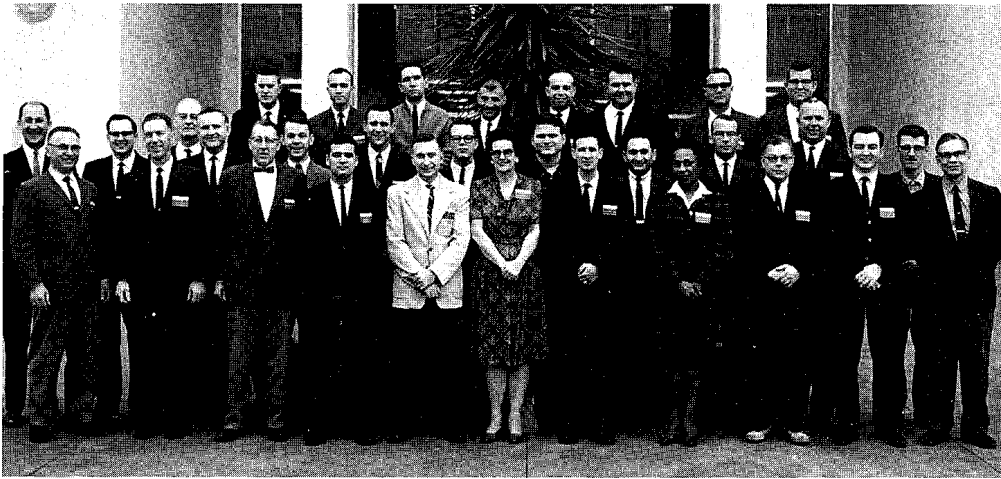

The First HEC Training Course (1965)
(course on Streamflow Probabilities taught in Sacramento, California)

Training of Corps personnel is associated with practically every activity of the Center. Early courses were entitled:

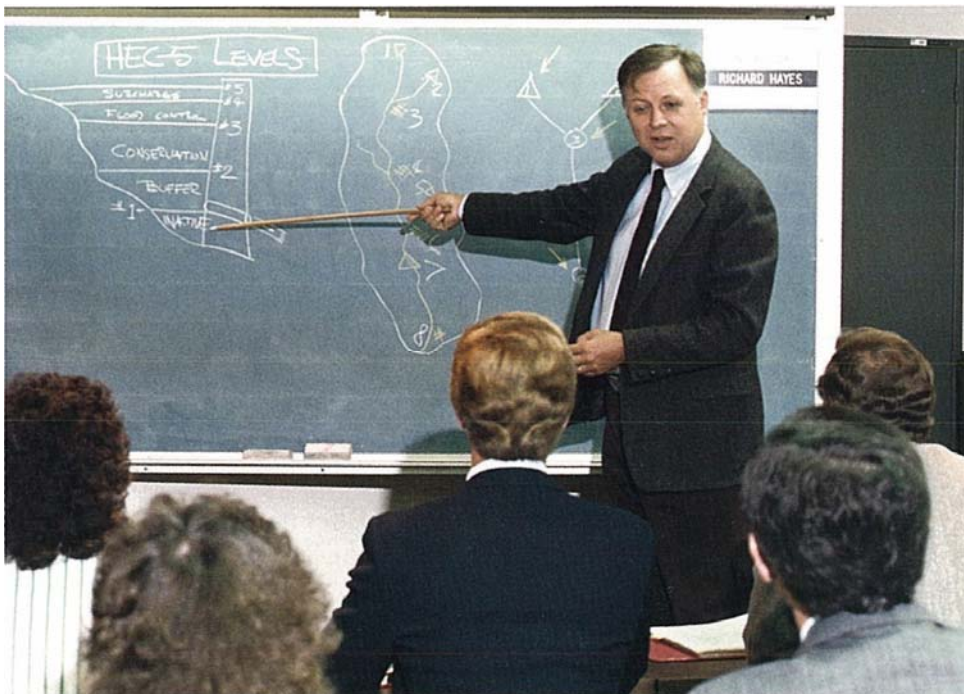

Richard Hayes Providing Instruction to a Training Class

Principles and Procedures of Hydrology
Flood Hydrograph Analysis
Hydrologic Probabilities
Storage Yield
Reservoir System Analysis
Computer Applications
Water Quality Management
Flood Plain Management
Ground Water Hydrology

In addition to these formal courses, much training is effectively given through short discussions with individuals by telephone or during visits associated with other activities, and through correspondence.

Courses were created through field surveys of requirements and by coordinating with the Hydraulics and Hydrology Branch of the Chief's Office in Washington, DC. These courses were an extension of the research program, which funded most courses. When the Corps established the Central Training program in 1978, HEC courses were incorporated into the Proponent-Sponsored Engineer Corps Training (PROSPECT) program.

The PROSPECT program conducts an annual registration for courses offered the next fiscal year. All approved courses are listed in a Training Handbook commonly called "The Purple Book" which describes each course, its purpose, and its prerequisites. HEC, along with other Corps offices, submits a schedule for the next fiscal year along with budget requirements. The selection of courses is based on past demand and input from a course proponent, usually a senior technical specialist at OCE. Courses with sufficient enrollment are presented the next fiscal year. Presently, HEC has 24 courses in the PROSPECT system.



Vernon R. Bonner
Chief, Training Division

Besides the PROSPECT short courses, HEC offers workshops when District and Division offices request them. The workshops are treated like any other reimbursable project. Content is usually based on existing course materials. Workshops are most often given when an office has a group of people who need the training. Usually such workshops are held at the District or Division that initiated the request. Often other offices in the region are invited. In the past, Eileen Tomita

organized and administered the logistics of HEC's extensive training courses. More recently Jan Ferguson has provided that administrative assistance.

In 1974 HEC started video taping courses. These tapes were loaned along with a copy of the lecture notes to people unable to attend. As the number of tapes and requests grew, the task became unmanageable with existing HEC resources. Between 1983 and 1988, Modern Talking Pictures operated a loan service under contract, with HEC providing the funding. A total of 1,695 tapes were loaned during FY 1988, the last year of the free loan service. Then HEC could no longer afford to fund the free loan service. HEC transferred the tapes to a contractor who provides copies of the tapes and lecture notes for a nominal fee.

Prior to 1985, the Training Division was titled the Training and Methods Branch. The goal of the Methods Section was to "systemize" hydrologic procedures rather than to "standardize" them. This is an important distinction. Methods systemization expresses the Center's objective to develop technical procedures and document them for distribution to field offices. Strict "standardization" of hydrologic engineering procedures "without variations or irregularities" is not technically sound nor is it good engineering.

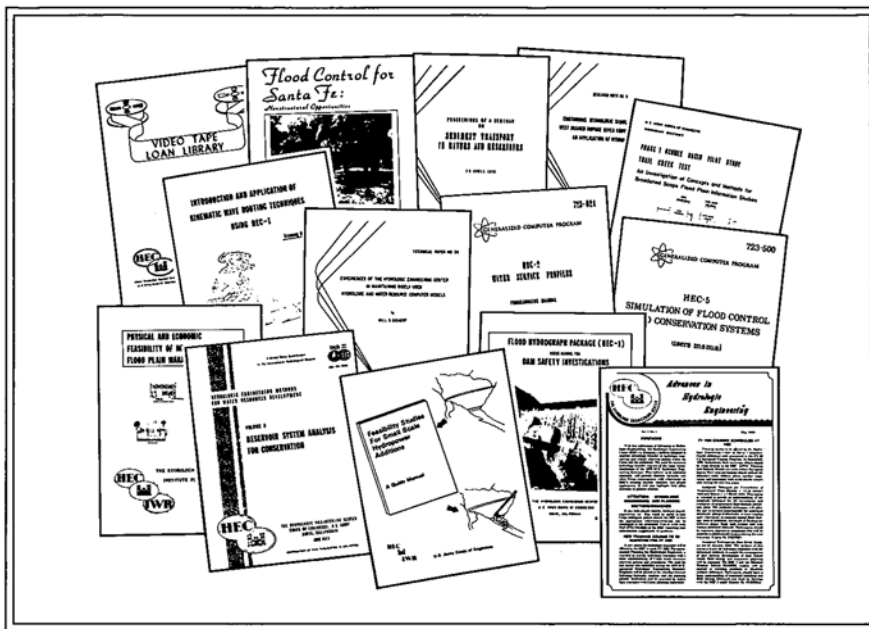

Selected HEC Publications

Proper "systemization" of technical procedures satisfies two crucial objectives. First, experienced specialists can save time and expense applying the procedures in planning and design studies. Second, less experienced personnel can follow the procedures more easily. The increased efficiency improves the planning and design of water resources developments, and usually results in substantial savings in manpower and money.

"How-to-do-it" manuals were the earliest form of systemization. HEC published its first one, "Methods Systemization Manual, Reservoir Storage-Yield Procedures," in May 1967. However, computer programs to perform the calculations were also developing during those early years. The Unit Hydrograph programs released in 1966 are an example. These programs were the basis of the Flood Hydrograph Package, HEC-1. Since then program development has continued to

advance with HEC's computer resources and with funding support, primarily from the research program. Today, HEC's published documents include:

- 69 Computer Program User's Manuals
- 122 Technical Papers
- 18 Seminar Proceedings
- 26 Training Documents
- 12 IHD Volumes
- 30 Research Documents

Leo Beard, HEC's first director, recognized that there is a third element just as important as computer programs and user support. That element is the wisdom and common sense of the engineers applying the programs. Beard warned:

I have witnessed too many cases where the mechanics of using HEC computer programs has occupied the primary attention of practicing engineers without adequate attention to sound engineering and where the reputation of a computer program has gained acceptance of inferior work. We cannot overemphasize the fact that HEC products do not replace engineers but are simply valuable tools that make possible an ever-higher level of sound engineering.

Technical Assistance Division

In the early years a technical assistance organizational unit, the Special Projects Section, provided technical assistance. The original Special Projects Section eventually became the Special Projects Branch and then, in 1985, the Technical Assistance Division. Technical assistance refers to work that is done on a reimbursable basis for another office, generally for a District, a Division, a Corps research laboratory or Headquarters. Occasionally work is done for another federal (or other governmental) agency. Over 600 project reports have been provided to Corps offices and others requesting HEC assistance.



Technical Assistance Project Briefing, 1978

Dale Burnett, Marilyn Hurst, Harold Kubik, Mike Burnham, and Gary Franc

Some technical assistance projects are done entirely by HEC personnel. Others are done cooperatively with personnel from the sponsoring office. The latter is attractive because the representative of the sponsoring office can provide knowledge and information regarding site-specific aspects of the project. Also, technology transfer can occur which can help the sponsoring office perform future projects without assistance. Working on current field office problems helps HEC stay abreast of technology needs and provides an environment in which new technology can be tested and evaluated.

The original staff of one grew to a staff of five, supplemented by the temporary employment of up to four students. Five different chiefs have led the technical assistance unit. They are:

Daniel D. Deneff	1964 - 1968
Lewis G. Hulman	1968 - 1969
Howard O. Reese	1969 - 1973
Dale R. Burnett	1973 - 1981
Arthur F. Pabst	1981 - present

During Deneff's tenure, much of the technical assistance work was for the Corps' South Pacific Division. Substantial effort went into the development of site-specific and generalized criteria representing major (i.e., Standard Project) storms for the Colorado River Basin.

Under Hulman the technical assistance unit did a systems analysis screening study of water supply reservoirs and conveyance systems for New York City and northern New Jersey metropolitan areas as part of the Northeast Water Supply Study for the Corps' North Atlantic Division and a water management study for operation of the Panama Canal.

Under Reese, the unit analyzed alternative channel improvements and Soil Conservation Service (SCS) reservoirs in the Tibbee River Basin. Done for the Corps' Mobile District, this project required development of a generalized unit hydrograph and loss-rate relationships, determination of channel routing criteria, computation of water surface profiles and creation of a methodology to analyze hydrologic effects of selected channel improvement schemes and authorized SCS detention structures. Former HEC Director Eichert considered this one of the three especially noteworthy projects at HEC because it greatly impacted other activities at HEC. HEC underestimated the work involved and got behind schedule. The whole technical staff had to do HEC-2 runs for several weeks to complete the study. The Tibbee River Navigation project was one of the few projects where HEC staff extensively used HEC-2 to determine storage data to establish routing criteria for HEC-1.

While Burnett was in charge, a number of flood hydrology studies were performed, primarily for the Philadelphia District. In each case the end product was a set of peak-discharge frequency relationships for gaged and ungaged locations in a basin under existing and anticipated future (i.e., urban) land use conditions. In another significant study, HEC evaluated various methods for estimating interior flooding (on the landward side of a levee) at Moline, Illinois, for the Corps' Rock Island District. Other applications included flood control and water supply systems in several districts including Tulsa and Fort Worth.

Under Pabst, projects related to real-time water control have been the primary focus. The intent is to enhance the ability of Corps water control managers to make optimal operational decisions.

For example, HEC products help water control managers to decide when and how much water to release from reservoirs during a flood. Several projects have been completed for the Huntington and Pittsburgh Districts.

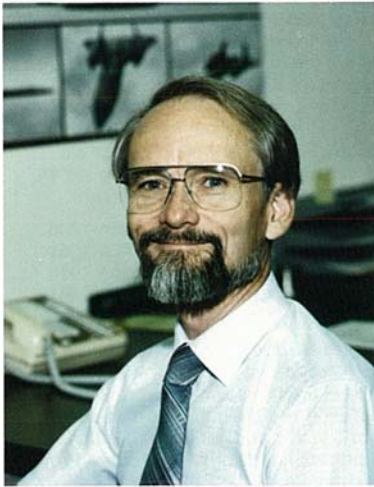

Arthur F. Pabst
Chief, Technical Assistance Division

At HEC, technical projects vary from small ones requiring a few person-days to major projects requiring several persons for a year or more. Among the latter, two of the most notable were the post-flood studies of Hurricane Agnes and analyses for the National Hydropower Study.

In June 1972, Hurricane Agnes devastated the eastern seaboard. The accompanying floods created one of the United States' greatest natural disasters. The Corps asked HEC to prepare computer simulation models for four of the hardest-hit basins. These would reevaluate discharge frequency relationships based on information from Hurricane Agnes, and assess the performance of various flood control measures. The work required a major staff commitment, particularly to analyze proposed flood control reservoirs and levees in the Susquehanna River Basin. HEC took several unusual steps to provide the necessary manpower. It secured two people from Corps District offices; it cancelled several training courses; and it hosted two private contractors for many months.

HEC's other major study, to determine the maximum energy potential of all existing reservoirs in the United States, grew out of the energy crisis of the 1970's. Completed in the late 1970's after several years of work, the National Hydropower Study represented a massive undertaking for the Corps of Engineers. Corps District offices used computer software developed by HEC to do the work. About 17,000 sites were identified. Of these, 6,000 were selected for more detailed evaluation. Some 689 data items were used to describe each potential site. HEC developed a six-volume guide for investigating the feasibility of adding small hydropower facilities to existing impoundments.

IHD Project

The International Hydrologic Decade (IHD) fostered other notable projects and led eventually to creation of a temporary special IHD project unit. IHD was a worldwide effort to advance the

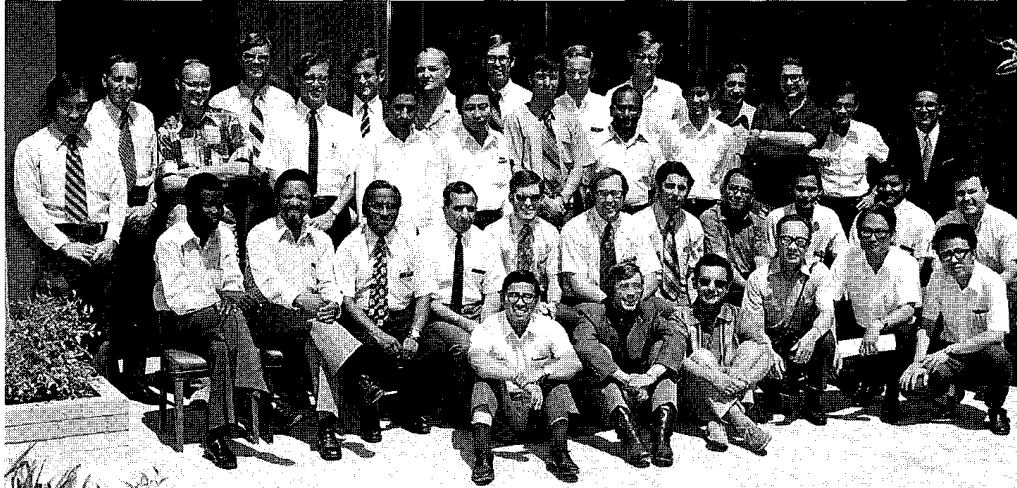

1972 International Workshop in Hydrologic Engineering

knowledge of water resources under the international leadership of the United Nations Educational, Scientific and Cultural Organization. The idea originated in the United States and was enthusiastically accepted by about 80 nations throughout the world. In 1966 funds were appropriated for two projects by the Center. Then in 1968 a special project unit was established with A.J. Fredrich as Chief to oversee development of a 12-volume set of documents that hydrologists in developing countries could use. Ed Hawkins continued with the IHD project after Fredrich became Chief of Research. A primary objective of this project was to document state-of-the-art hydrologic engineering techniques, with particular emphasis on applying those techniques to solving water resources problems when little hard data was available. Produced in 1972, the documents are still used as a reference for some training courses. As part of its work on the IHD project, HEC offered special training courses in 1972 and 1975 for engineers from 28 developing countries and undertook demonstration projects in Peru and Guatemala. These were among HEC's first international projects.



Ed Hawkins

Providing Assistance to International Students, 1972

Groundwater Branch

In December 1967, during the IHD project, a Groundwater Branch was created whose first chief was Dr. Paul Hughes. In 1968 two additional groundwater geologists joined HEC. They were Drs. Richard Cooley and John Harsh. Activities between 1968 and 1970 included one- and two-

week training courses on groundwater hydrology and special consultation with the Tulsa, Jacksonville and New York Districts.

Research focused on making a contribution to the IHD. This was published as Volume 10, *Principles of Ground-Water Hydrology*. Other research led to a new computer program, "Finite Element Solution of Steady-State Potential Flow Problems," developed by Cooley and John Peters. Cooley also explored the use of a finite difference method in variably saturated porous media.

When staff changes occurred between 1970 and 1972, the Groundwater Branch was eliminated and the work was dispersed into other HEC branches. In 1978 research emphasis shifted to examining ground and surface water conjunctively and interactively. A study for the Albuquerque District developed a supply-use water balance for the region surrounding Albuquerque, New Mexico.

HEC offered a biennial one-week training course in "Ground Water Hydrology" in 1982. Since the profession had developed several good finite difference and finite element groundwater models, the need no longer existed for HEC to develop its own. In 1982 HEC used a USGS two-dimensional simulation model to simulate groundwater flow for a groundwater aquifer study at Fort Wingate, New Mexico.

Today the interaction of surface and ground water is still the focus for research and special project work. In 1988 HEC published two research documents, "Elements of Conjunctive Use Planning" and "Desktop Techniques for Analyzing Surface-Ground Water Interactions."

Planning Division

The Planning Analysis Branch formed after the Groundwater Branch disbanded. This new branch would help the Corps planning community benefit from HEC's computer-based analytical skills. Activities included applied research, training courses, and technical assistance to Corps planning and hydrologic engineering professionals.

Historically hydrologic engineering has been a critical element of planning activities. The branch's primary goal was to form a better bridge between hydrologic engineering products and planning activities such as problem identification, plan formulation, and plan evaluation. Its secondary goal was to improve the performance of interface tasks that neither planners nor hydrologic engineers seemed to be doing well.

Early efforts focused on adding simple damage computation routines to existing HEC programs. Shortly thereafter, programs that performed plan formulation functions automatically - such as finding optimum plans involving flood control measures - were devised. Then analytical methods and routines not directly derived from existing HEC programs began to emerge. These extensions made more complete analysis possible. The family of flood damage analysis computer programs, discussed in a later section, is an example. Another example is in the area of spatial data management. A family of computer programs was developed to create and link geographic data to standard HEC hydrologic engineering, flood damage, and other evaluation programs. The branch briefly engaged in habitat-based environmental analysis, but then

refocused its attention on traditional hydrologic engineering and closely associated planning analysis technical areas.

The Planning Analysis Branch, renamed the Planning Division in 1985, has been led by two men, A.J. Fredrich during 1972, and Darryl W. Davis, from 1973 to 1989. During 1989, Michael W. Burnham was appointed Chief.



Michael W. Burnham
Chief, Planning Division

Computer Support Center

The Computer Support Center was formed in 1976 to assist in computer programming and to manage computer equipment procurement, operations, and services contracts. The Center later became responsible for participating in nationally focused projects, maintaining HEC's computer program libraries, managing the in-house Harris computer system, helping other Corps offices procure automated data processing equipment (ADPE), and distributing HEC software. Many computer programs and Harris system routines were developed by the Computer Support Center for use at HEC and other Corps offices.



Harris H1000 Computer

The Computer Support Center took the lead in preparing the solicitation document, benchmark procedures, benchmark tests, and final benchmark validation of prospective vendors for the Corps' Teleprocessing Services Program (TSP). TSP, administered by the GSA, was the primary source by which the Corps obtained its scientific and engineering computer processing from 1976 through 1984.

Lowell Glenn and others played an active role in configuring and developing specifications and benchmarks for procurement of the water control ADPE for Corps field offices. The Center made early contributions to the Corps mainframe change project, later renamed CE-80 and now called the Corps of Engineers Automation Plan. In response to the rapid change from mainframe-based computing to personal computer (PC) or microcomputer-based computing, the Center also researched new PC equipment and guided HEC's transition into the microcomputer environment. Al Onodera, one of the original HEC staff, has provided computer expertise to the Center from the early mainframes to the current PC's.

Between 1982 and 1986, the Chief of the Computer Support Center was a Senior Hydraulic Engineer position rotated among the staff. Art Pabst, 1978 - 1982; Mike Burnham, 1983 - 1984; Mike Gee, 1985; and Harold Kubik, 1986, have served as Chief. The rest of the staff consisted of a computer analyst (Onodera), two computer programmers (Lowell Glenn and Jeff Houghten), and a computer operator (Penni Baker). Baker has been a key person in the changing computer support functions at HEC. In 1986 the Computer Support Center was dissolved and its primary functions integrated into existing HEC Divisions.

Technology and Methods Development

Since 1964, HEC's branches, sections and divisions have made significant contributions to the technology and methods of water resources planning and management. The range of HEC research and training programs has changed dramatically over the years from watershed modeling, remote sensing, and river hydraulics to reservoir systems, statistical hydrology, sedimentation, water quality, flood damage computation, systems analysis, and water control.

Watershed Modeling

Early watershed runoff simulation models were limited by the memory of computers. In 1966, HEC published the first components of a watershed runoff model. The Basin Rainfall and Snow-melt Computation, Unit Graph and Hydrograph Computation, Hydrograph Combining and Routing, Unit Graph and Loss Rate Optimization, and Streamflow Routing Optimization programs were largely the effort of Leo R. Beard, HEC's first director. They were executed individually, the output from one providing input to another until the entire river basin streamflow was computed. Of special note was the optimization program; it was the first program to calibrate rainfall-runoff models automatically.

In 1968 when computer memory increased, the individual components were brought together into a single model, the HEC-1 Flood Hydrograph Package. Once these basic components were in place, additions could be made to the model as hydrologic and project performance investigations demanded and as computer capacity allowed. This combination of individual programs into a "package" was a real innovation. The user could then employ a batch of linked, interrelated programs - each depending upon another for some part of its input - without handling intermediate output results.

HEC-1 was one of the first comprehensive hydrologic simulation models in the world. Not only did the model permit the user to analyze the response of watersheds in transforming rainfall to runoff, it also provided users with numerous choices for the types of analytical methods to be employed in each of the individual processes involved in the transformation. In essence this allowed each user to tailor the "generalized" model to the specific conditions encountered in a particular geographic area.

One of the first additions to HEC-1 was the automatic computation of several different-sized storms over a basin for different project developments. The computation of expected annual damage was incorporated to facilitate project evaluations. Automatic plotting routines were devised and incorporated. Ed Hawkins and others assisted the many users of HEC-1 as its popularity and applicability expanded.

In 1973 and again in 1980, major changes were made by Arlen Feldman and Paul Ely to the input data structure and simulation capabilities. New features were added by several staff members as HEC-1's applications expanded. Kinematic wave runoff for urban hydrology, dam overtopping and breach for dam safety, and project size optimization are some examples. The kinematic wave runoff routines came from the Massachusetts Institute of Technology's catchment model. David Goldman continued the development and improvement of the kinematic

wave routines into the present version of HEC-1. Darryl Davis and Michael Burnham designed and implemented the project size optimization capability for flood control systems evaluation.

In 1982 new criteria for probable maximum precipitation computation were developed by an interagency committee. HEC's John Peters and Paul Ely created the program HMR52 to automate the complex calculations required by the new criteria. The resulting precipitation is input into HEC-1 to compute the corresponding probable maximum flood.

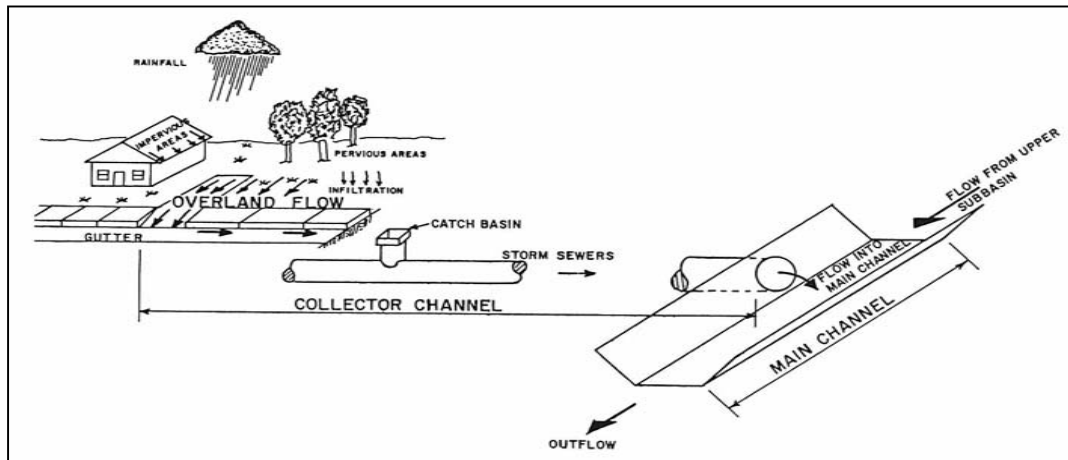

Urban Watershed Planning

The latest release of HEC-1 coincides with HEC's 25th anniversary. This release marks the first full implementation of the mainframe program on the PC. It includes data storage system and graphics interfaces. New hydrologic algorithms have also been added. Gary Brunner was instrumental in the PC implementation of HEC-1.

The future of HEC's watershed modeling lies in the PC workstation. The PC facilitates simplified input menus along with expert system features to guide the user and verify data. Current computer memory and speed allow validity checks of hydrologic simulations and automatic adjustment of numerical solutions to fit each application.

HEC-1's traditional storm event orientation will be maintained for stormwater runoff computations. A new version is being developed that simulates the hydrologic process continuously. Historically computer-limited sizes and times are being eliminated so that any watershed and project situation can be simulated and evaluated for any length of time from two days of one-minute analyses to 50 years of daily analyses.

Remote Sensing

Better measurement of hydrologic and meteorologic phenomena is always on the minds of water resource engineers. The traditional point measurements of precipitation and soil moisture may not be indicative of the real spatial variation in these important hydrologic data. Large watersheds of heterogeneous land use, soils and vegetative cover are often averaged in hydrologic models. This limits the effectiveness of hydrologic models. Aircraft photos of land use and snow cover are important tools of the hydrologic engineer, but these surveys are expensive and cannot be repeated as desired. The space program offers important new data

sources to the hydrologic engineer. Automated digital methods for land use identification have evolved from the first LANDSAT satellite images.

Geographic information systems emerged from landscape architecture technology at Harvard. These systems provided a way to capture land use in hydrologic models. HEC's Darryl Davis, Pat Webb, Bob Cermak and Arlen Feldman developed methodologies for determining hydrologic parameters from LANDSAT images via the geographic information system. Those parameters, unit graphs and infiltration measures were automatically saved on computer files for use in HEC-1.

With this new technology, the Corps began a new era of "Expanded Flood Plain Information Studies." Several case studies demonstrated the potential of this technology, but computer resources and data management/analysis tools were not advanced enough to use the technology on a regular basis. With recent advances in computers and satellite imagery, there is a resurgence of interest in these capabilities.

Remote sensing can also be used in precipitation measurement. The U.S. National Weather Service (NWS) has developed new weather radars, which HEC is testing in its watershed models. HEC is developing a method to use common ground gage data and radar and satellite measurement of cloud-top temperatures to estimate precipitation.

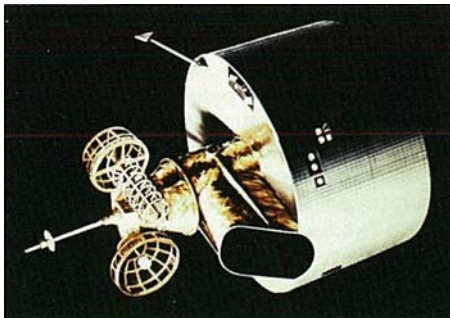

GOES Satellite

River Hydraulics

Eichert's development of HEC-2, "Water Surface Profiles," established HEC's role in river hydraulics. This program became an internationally accepted standard tool for computing water surface elevations and an integral part of the Federal Emergency Management Agency's (FEMA) flood insurance studies as well as the Corps' economic (cost/benefit) and design studies. HEC-2 has continually been improved and enhanced by Bill Johnson, John Peters, Richard Hayes, Art Pabst, Vern Bonner, Al Montalvo and Randy Hills in response to changing needs. User support was also provided by Allan Oto, Richard Hayes and others. For many years, HEC has provided training courses for both basic and advanced HEC-2 applications. It was the first computer program that HEC issued for microcomputers (1984).

When dam safety and potential dam failures became an issue in the late 1970's, HEC began investigating using unsteady flow numerical models (that combine the flood routing of HEC-1 and stage computations of HEC-2) to predict the downstream consequences of dam failures. Ultimately this resulted in collaboration with the NWS where Dr. Danny Fread had developed a

dam-break flood routing model. HEC modified this model for Corps use and presented the results in several HEC training courses. It then incorporated elements of the model into HEC-1 for quick screening studies of the consequences of dam failures. After the Corps completed the dam safety studies, HEC discontinued the training course in Dam Failure Analysis.

Over the last 15 years, HEC (R&D) and field project applications have used and developed several generalized unsteady flow models. The first was a model developed by the Tennessee Valley Authority (TVA) and modified by Tony Thomas. Currently a finite element unsteady flow model, known as SHP, is being used to generate hydraulic information for river water quality analyses. Another unsteady flow model, known as DWOPER, is also being maintained by HEC as part of liaison work for the NWS and various Corps offices. For a number of years, HEC has also provided an Unsteady Flow training course every other year.

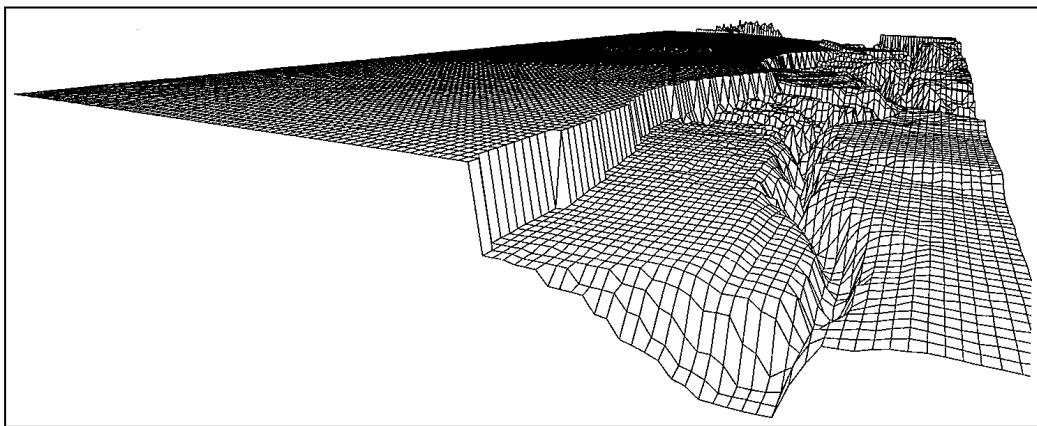

Computer Graphic of the Fulda River Channel

Recognizing the needs for detailed velocity distributions for certain studies, such as constituent transport and hydraulic design, HEC acquired expertise in two-dimensional flow modeling. This effort began in the early 1970's with a study of Lower Granite Reservoir sponsored by the Walla Walla District. Close collaboration of WES, HEC's Michael Gee and Corps field offices fostered the continued development and application of this technology. The products of this work are available on supercomputers (TABS-II) and microcomputers (RMA-2). Recent work at HEC has focused on the application of this program to broad, flat floodplains.

River hydraulics work at HEC has been driven by several technology needs and funding sources. As Corps studies of river mechanics (sediment transport) and water quality required information different from, or in addition to, that needed for flood studies, HEC provided the needed computational capabilities. R&D funding in this area has only provided a portion of the support needed. Many, if not most, computer program enhancements have been in response to specific field office study needs. These needs are communicated to HEC through day-to-day contact with District offices, consultation agreements, and training courses. HEC's philosophy has been to generalize these specific enhancements to the maximum extent in order to gain the greatest overall technology for Corps activities.

Future work will focus on making the software presently available for river hydraulics studies into a consistent system. That system should recognize both contemporary and future hardware characteristics

Reservoir Systems

Major programs created by HEC to simulate reservoir operations began with RESYLD, developed in 1966 by Beard to simulate the monthly operation of one conservation reservoir for one downstream demand center. In 1968 Beard produced, with able assistance from others, a generalized multi-reservoir program. Later titled HEC-3, it would simulate the operation of any configuration of conservation reservoirs and demand points. Both of these models operated for conservation, purposes (i.e., water supply, diversions and hydropower) as opposed to flood control. Eventually HEC-3 provided system power capabilities based on computation schemes developed in the Little Rock and Tulsa Districts. These techniques were initially implemented by A.J. Fredrich. Of special note are the reservoir balance routines improvised for HEC-3; they permit great flexibility in the interaction of several reservoirs' operations.

Summary of Reservoir Operation Programs Developed at HEC		
Program Name	Year Released	Purpose/Capabilities
RESYLD	1966	Simulates monthly conservation operation of one reservoir for one downstream location.
HEC-3	1968	Simulates monthly conservation operation of multi-reservoir systems.
HEC-5	1973	Simulates flood control and conservation operation of multi-reservoir systems.

Eichert wrote a program in 1973 similar to HEC-3 to simulate flood movement in a river system with flood control reservoirs. This model, which incorporated most of HEC-3, became HEC-5. It initially considered only flood control operational constraints for a single event. When HEC-5 was expanded to include all the conservation capabilities in the HEC-3 model, including continuous simulation, support of the latter model was reduced. Since 1976 most reservoir modeling development has concentrated on the HEC-5 model. Flood control, water supply, hydropower and real-time flood operation capabilities have been added at the request of Corps field offices. This work was accomplished by Eichert, Hurst and others.

In 1980, as a result of the HEC's work on the National Hydropower Study, Gary Franc produced the HYDUR program. It is used to analyze hydropower production at run-of-the-river reservoirs using flow duration techniques. Since 1983, Eichert and others developed several utility programs to facilitate HEC-5 applications. These programs were: INCARD for streamflow data interpolation; CKHEC5 for data validity checking; INFIVE for input data organization assistance; and MOD5 for interactive updates to input data. MOD5 provides a simplified data interface for new or infrequent users of the program. In 1988, new color graphics and interactive output displays were added and HEC-5 was implemented on the PC. A generalized control program, MENU5, was written to interface these various utility programs and HEC-5. HEC's data editor, COED, and graphics program, DSPLAY, are integral parts of MENU5.

While development of comprehensive computer programs is a key to the effective use of models to solve engineering problems, user support is just as important. Several HEC staff have devoted much of their careers to providing this support. Since Beard retired in 1972, Harold Kubik has been the principal supporter of the HEC-3 model. HEC-5 has been supported by several people

besides the program author. Bonner's principal responsibility from 1975 to 1980, when he became Chief of the Training Division, was the support of the HEC-5 program. Hayes has served as the principal supporter of HEC-5 since that time. He was also ably assisted for parts of that time by Marilyn Hurst and others.

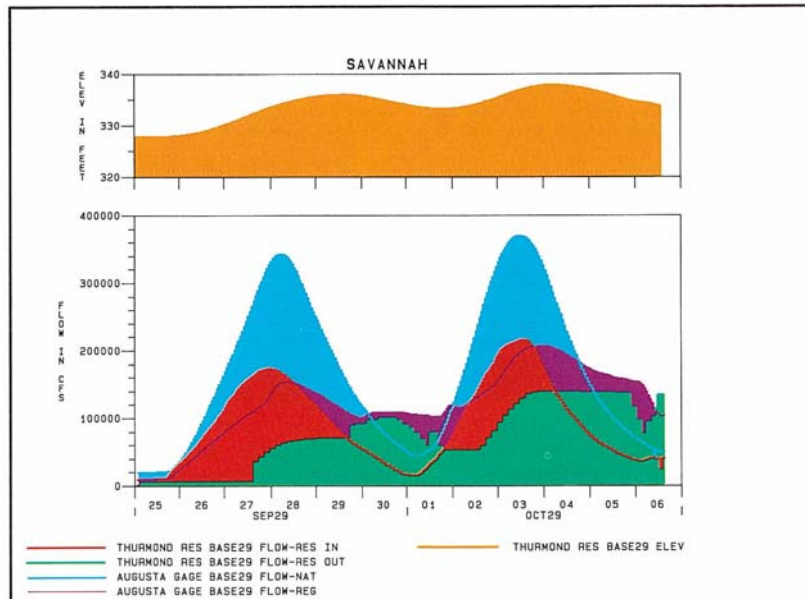

Computer Graphics of a Reservoir Operation

Statistical Hydrology

Beard's interest in statistics predated the formation of HEC. He helped prepare technical reports (as part of the Corps' Civil Works Investigations) on Flood Volume-Duration Frequency in 1955, Low Flow Volume-Duration Frequency in 1960, and Statistical Methods in Hydrology in 1962. In the early 1960's, he became excited by a new technique for generating synthetic streamflow (the Thomas-Fiering model, 1962), and he began research in this area.

HEC's first technical publication was "Simulation of Monthly Runoff," Technical Bulletin #1, November 1964, written by Beard, with assistance from H.A. Keith. In December 1964 a computer program was released. Continued research led to the development of a completely new computer program, "Monthly Streamflow Simulation," in July 1967. A modified version, HEC-4, appeared in February 1971 through the efforts of Beard and Kubik. Although never highly touted, a daily (as opposed to a monthly) streamflow generation model was released in April 1968.

Research in statistical procedures nearly always led to another computer program. Additional examples include "Partial Duration Independent Low-Flow Events," July 1966; "Frequency Statistics of Annual Maximum or Minimum Flow Volumes," November 1966; "Regional Frequency Computation," July 1967; "Flood Flow Frequency Analysis," June 1976; and "Statistical Analysis of Time Series Data" (STATS), 1981. Statistical hydrology was so important that the first two formal training courses offered by HEC covered "Streamflow

Probabilities." Later this two-week course became "Hydrologic Probabilities" and now is called "Statistical Methods in Hydrology." In 1976 the adoption of the Water Resource Council's (WRC) Bulletin 17, "Guidelines for Determining Flood Flow Frequency" by federal agencies created the need for computer methods and a training course entitled, "Application of WRC Guidelines for Flood Flow Frequency Analysis." Later HEC renamed the course "Flood Frequency Analysis."

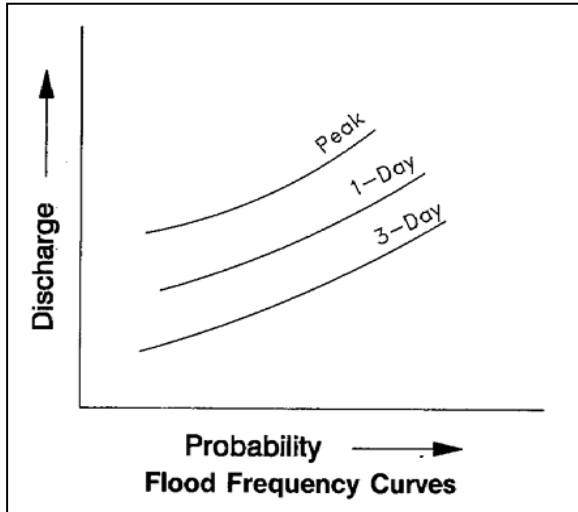

Probability Flood-Frequency Curves

Sedimentation

Since the mid-1960's HEC has produced significant applied research, training and technical assistance products in sedimentation engineering for Corps field offices. Charles Abraham developed a set of computer programs to help engineers and planners evaluate the consequences of sedimentation in Corps reservoirs. The following table lists the sediment-related computer programs that have been written by HEC and are presently used by Corps.

Summary of Sediment Programs Developed at HEC		
Program Name	Year Released	Purpose/Capabilities
Deposit of Suspended Sediment	1967	Computes the distribution of sediments along the length of a reservoir.
Reservoir Data Sedimentation	1967	Computes the expected ultimate profile of sediment deposits forming the delta at a reservoir inflow location.
Suspended Sediment Yield	1968	Computes annual suspended sediment load.
HEC-6	1976	Simulates one-dimensional sediment transport, scour, and deposition in a river system that may have reservoirs. It accounts for armoring and simulates the movement of a range of grain sizes from clays to coarse gravels.
Mudflow 1-D and 2-D	1986	One- and two-dimensional models for dynamic flood routing of mudflows and hyperconcentrated flows.

Perhaps the most extensive and significant sedimentation work completed by HEC began in 1971 with the development of a generalized computer model to evaluate sedimentation processes in rivers and reservoirs. While working for the Little Rock District in 1967 and 1968, Tony Thomas developed a first-generation computer model to assess some of the sediment problems of navigation structures on the Arkansas River. Dr. Vito Vanoni, professor of civil engineering and hydraulics at the California Institute of Technology, and an expert in sediment transport, was the technical advisor to the Little Rock District.

Vanoni was the first to propose that the Corps use computers to evaluate time sequences of flows to simulate sediment transport phenomena in rivers. He formulated the conceptual approach and encouraged Thomas to develop the computer model. Thomas created the Corps' first sediment transport computer program that employed a time sequence of flows to route the sediments through a river reach for various operating pool elevations. The computer program was originally run on a G.E. 225 computer with 8K memory and four magnetic tape units. The computer nearly filled the room. Because one 50-year simulation took 16 hours, production runs had to be conducted late at night or over weekends.

Thomas left the Little Rock District and joined HEC in February 1969. However, despite his expertise his first assignments were evaluating dam-break floods rather than sedimentation processes. Then in 1971, the Walla Walla District called HEC for assistance with sedimentation problems in the Lower Granite Reservoir on the Snake River. The model that resulted from the Lower Granite Reservoir study became HEC's first version of HEC-6 (although it wasn't to be called HEC-6 for quite some time). At the time, no one else in the country had a mathematical model with the same capabilities

Data collected since then in the Lower Granite Reservoir indicate that the sediment deposition zones and profiles predicted by this HEC-6 predecessor are accurate. Results from that study surprised a number of people and opened the door for further program development of "mobile boundary modeling techniques."

In 1972, HEC began receiving a small amount of research money to improve and generalize the code and to prepare user documentation. Late in 1973, the first complete documentation of what was to become the "HEC-6 computer model" was completed, and three years later the first "Sediment Transport" training course was conducted. HEC-6 was officially released to the public at that time. Since then the program and users manual have been updated to correct some weaknesses and expand its capabilities. Presently HEC and the Corps' Waterways Experiment Station, where Tony Thomas now works, are improving the HEC-6 computer code.

HEC has continued to be active in the field of sediment transport since Little Rock District's original Arkansas River program. Robert MacArthur, Tony Thomas and Michael Gee provided sediment-related assistance to numerous district and division offices. HEC representatives serve on the Corps' Channel Stabilization Committee, on various American Society of Civil Engineers technical committees related to sediment research, and coordinate and participate in workshops and assistance projects throughout the U.S. and overseas. Recent assistance has been provided to several Corps Districts and FEMA for simulation of mud and debris flows and alluvial fan flooding.

Future assistance will likely concentrate on six areas: (1) alluvial fan flooding processes; (2) one- and two-dimensional mud and debris flow modeling; (3) improving methods for simulating armoring and sorting; (4) improving multidimensional sediment modeling methods; (5) developing methods for simulating bank erosion and river meander processes; and (6) improving and simplifying procedures for evaluating sediment problems.

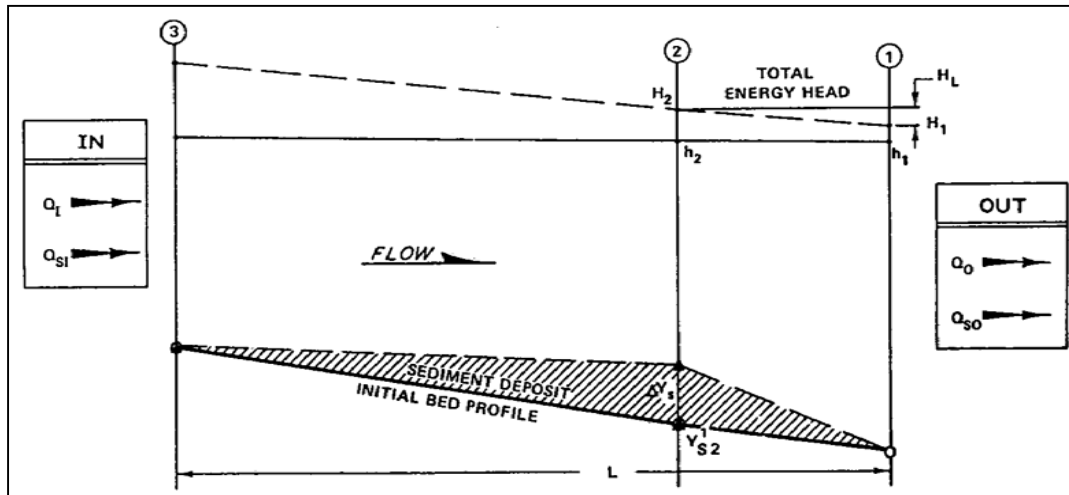

Definition Sketch for HEC-6 Modeling Computations

Water Quality

Leo Beard and R.G. Willey initiated work in water quality studies in 1968 at the request of the Sacramento District. The mathematical model for simulating reservoir water temperature at the Marysville Reservoir was the result.

In 1972, the Fort Worth District requested a water quality study of two reservoirs, numerous navigation projects, and a flood control channel on the Trinity River. This study led to a state-of-the-art aquatic ecologic simulation model that achieved nation-wide status. The model, known as "Water Quality for River and Reservoir Systems" (WQRRS), is actually a package of computer programs developed by Water Resources Engineers (WRE) under contract to HEC. It analyzes water quality problems in comprehensive water resources systems. As the Corps undertook waste water management studies and later, urban studies, the WQRRS programs received additional emphasis.

In 1972, the San Francisco District requested that HEC establish a water quality monitoring program with the USGS. The study objectives involved data being collected to be used for model prediction of runoff water quality into San Francisco Bay. Castro Valley was adopted as the representative watershed for San Francisco Bay drainage. The data has been used as typical urban storm runoff test data for numerous model tests.

When the Corps embarked on an urban stormwater quantity and quality program in the early 1970's, Arlen Feldman, Jesse Abbott and WRE under contract developed the STORM model for simulation of storage and treatment facilities for urban runoff. After the Environmental Protection Agency (EPA) took over this national responsibility, HEC's STORM model was used extensively in EPA studies nationwide, such as the EPA's 208 Urban Water Quality Studies.

The multi-year phased development of the HEC's newest water quality model began in 1979. Consisting of a water quality algorithm attached to the existing HEC-5 program, "Simulation of Flood Control and Conservation Systems," this version, known as HEC-5Q, provides a complex optimization approach to evaluate a 'best' regulation operation for water quality control in large reservoir systems. The model has been applied to numerous studies ranging from a single reservoir like Sacramento District's Warm Springs project to the North Pacific Division's 20 reservoirs on the Columbia and Snake River system. A user's manual and several other documents describe the model's concepts and show how to apply the model to reservoir systems.

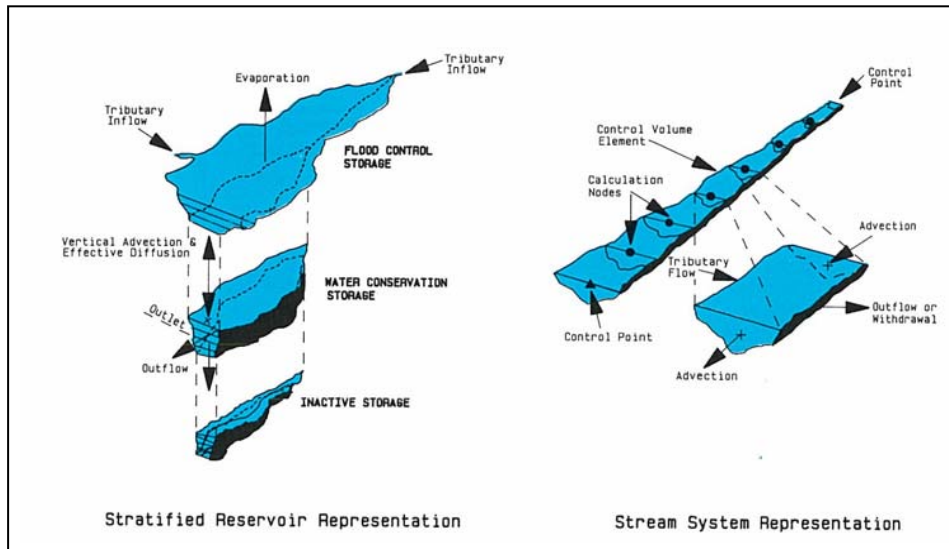

Reservoir and River Water Quality Computation Segments

HEC water quality efforts have been coordinated with the EPA, Bureau of Reclamation, TVA, United Nations, Departments of Environmental Resources at the state level, and Corps Districts, Divisions and Laboratories. As a member of the Corps' Committee on Water Quality since the Committee's inception, Willey has coordinated seven seminars. He has also coordinated HEC's courses, workshops and seminars. HEC staff have participated in EPA national workshops and been detailed to the U.S. Fish and Wildlife's Instream Flow Group in Ft. Collins, Colorado.

Data Storage System

The HEC developed the Data Storage System (DSS) to manage data storage and retrieval needs for water resource studies. The system, whose development has been guided by Pabst since 1979, enables efficient storage and retrieval of hydrologic and meteorologic time-series data. The DSS consists of a library of subroutines that can be readily used with applications programs to enable retrieval and storage of information. At present approximately 20 applications programs have been adapted in this fashion, including the widely used program Flood Hydrograph Package (HEC-1) and the Expected Annual Damage (EAD) program.

Approximately 17 DSS utility programs have been developed. A number of these programs are for data entry from such files as the USGS' WAT-STORE data base or from the NWS precipitation data files. Other utility programs include a powerful graphics program developed by Montalvo, a general editor developed by Bill Charley, and a program for performing mathematical transformations developed by Bob Carl. Macros, selection screens, and other user

interface features combine with DSS products to provide a set of tools whose application is limited only by the ingenuity of the user.

The DSS was the outgrowth of a need that emerged in the mid 1970's. During that time most studies were performed in a step-wise fashion, passing data from one analysis program to another in a manual mode. While this was functional, it was not very productive. Programs that used the same type of data, or were sequentially related, did not use a common data format. Also, this required that each program have its own set of graphics routines, or other such functions, to aid in the program's use.

The Kissimmee River study performed by the HEC for the Jacksonville District began in 1978 and required that an orderly approach be used to properly manage the study data and the analysis results. A large number of alternative plans and conditions were to be processed in this project. This study gave birth to the first version of DSS. The basic design provided for the storage of data in a standard form, independent of any particular program. The data would be provided to the programs when it was needed, and results would be stored in the same independent form for use by utilities and other applications programs.

The early design of DSS was conceived to support files containing many hundreds of data sets, or even as many as a few thousand. As the use of DSS expanded into real-time water control applications, data files were written to manage as many as 10,000 to 20,000 records. The current DSS version is now designed for rapid storage and retrieval from files containing as few as 40 to 50 sets, or as many as 100,000 or more.

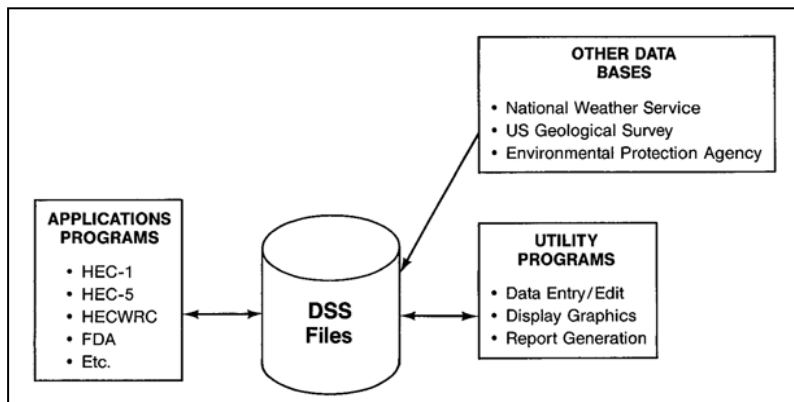

Data Storage System

Flood Damage Computations

As an essential component of Corps flood control analytical work, flood damage computations at HEC encompass a variety of computational tools. Although basic computation routines reside in the HEC-1 and HEC-5 programs, the more comprehensive product in this area is the Flood Damage Analysis (FDA) package. It includes computer programs in hydrologic and hydraulic engineering, flood damage analysis, and data management.

While the package operates on both the Harris minicomputer and MS-DOS microcomputers, the microcomputer version is the focus of development and support efforts. It consists of flood damage computation programs, the data management system, supporting utilities, and a menu

feature that promotes easy user interface and control. Current efforts are expected to further improve the user interface of individual programs by replacing their batch-oriented interface with direct screen entry and output viewing capability.

The evolution of the package is an interesting case study of how capabilities developed over time. In the late 1960's a basic flood damage evaluation routine was added to the HEC-1 program to permit the Tulsa District to study a large number of small detention reservoirs. Later a stand-alone program (called AAD, now retired) was created by Kubik to allow computations separate from HEC-1. Sometime later, during the early 1970's, a study for the Philadelphia District required a more comprehensive flood damage program. The present EAD program was designed and developed by Davis, Johnson and Kubik to meet this need.

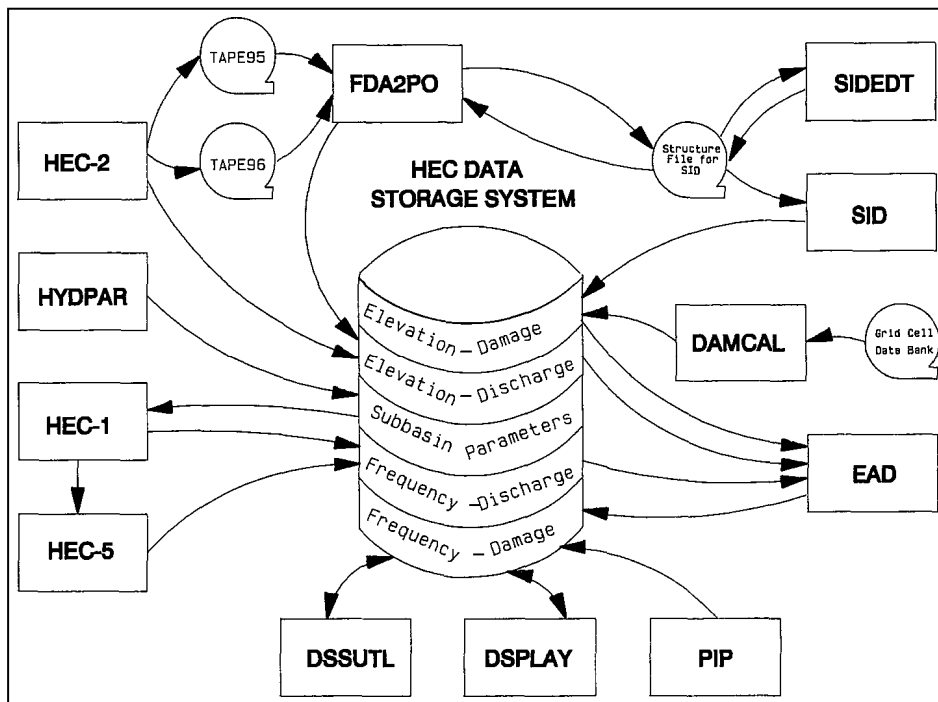

Flood Damage Package

As national policy in flood damage reduction shifted for structural flood control projects to non-structural flood control measures, it became apparent that new types of analytical tools would be needed. These new tools were necessary to plan and design systems that would reduce flood losses through combinations of structural and nonstructural means. Both the types of data and the level of detail needed to properly evaluate non-structural components were significantly different from what had been required for traditional flood control structures. The report "Physical and Economic Analysis of Nonstructural Measures" prepared by Johnson and several planning division staff was a landmark product in this field and continues in active use today.

Floodplain management and project evaluation studies require spatially distributed data about flood damage potential. These needs prompted the development of a program (DAMCAL) that would help construct elevation-damage relationships from land use and topographic data while considering a wide range of potential non-structural flood damage reduction measures. DAMCAL was created by Darryl Davis and Pat Webb. The geographic information system approach to this and other applications has been carried forward by Rochelle Barkin. A few years

later, several districts that had profited from DAMCAL expressed an interest in a program that would perform similar functions for structure inventory data sets (rather than the geographic data sets required by DAMCAL). SID was the result and was initially developed by Webb.

The following year one of these districts undertook a massive investigation involving some 50,000 structures, hundreds of damage reaches, and a multitude of alternative flood damage reduction plans. Fortunately, HEC's data management system had recently been used for a comprehensive study by the Jacksonville District. The data management system was used for the 50,000-structure project and the result was the rudimentary FDA package. Later improvements (with research funding) yielded the minicomputer FDA system now available. Shortly thereafter, the PC arrived on the scene, offering considerable opportunities to ease program operation for the user. Carl assembled the program elements into the now powerful PC-based FDA package.

System Analysis

HEC has also developed and supported a full range of simulation models for understanding how water resources systems function. They assume that experienced professionals can "reason out" the appropriate solution to a problem given the insight provided by selective execution of the simulation models. This has always been the dominant rationale for planning and operational decisions in the water resources community.

During the early 1960's system analysis, sometimes called operations research, promised great advances in systemizing and automating decision making for water resources issues. However, efforts to capitalize on the promise have largely eluded the water resources community. There are many reasons for this: the unwillingness of experienced hands to try something new, the failure of field professionals to understand the methods involved, and the fact that sometimes the actual physical system must be inordinately simplified to enable operations research techniques to be used.

In addition to the early optimization (model calibrations) routines in HEC-1, HEC used system-analysis methods in a variety of situations with notable success. Its guiding principles have been: apply the techniques to solvable problems; adapt the solution to the problem (not the other way around); avoid inappropriate simplification of the problem; use traditional simulation analysis tools in the system analysis solution where appropriate; and use system-analysis tools in an explainable manner.

Three examples illustrate the successful application of these principles. In 1975, Davis and Burnham enhanced the HEC-1 program to automatically select and size a mix of urban flood damage reduction measures to achieve optimum economic efficiency. The technique used a well-known simulation model and implemented a gradient search procedure that was already a component of the program. The original project that fostered the enhancement is now under construction.

In 1978, an existing single reservoir simulation model that had been previously used by the field office staff was imbedded within a nonlinear-programming algorithm to search for optimal operating policies for the Sam Rayburn multipurpose reservoir project. The solution procedure developed by David Ford employed a logical strategy, and the system analysis tool continues to be used on an annual basis for the operation of the reservoir.

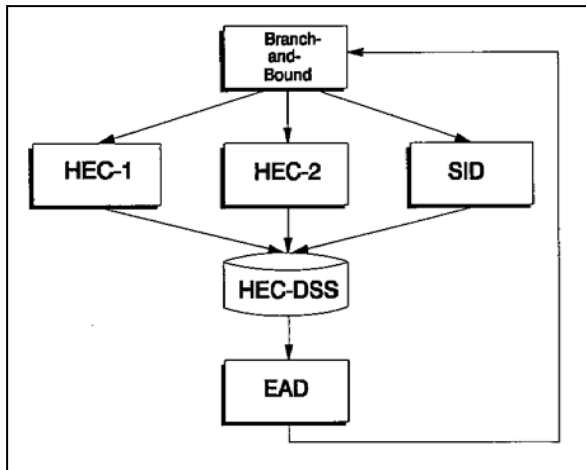

Branch-and-Bound Enumeration

In the Delaware estuary where dredged material disposal sites were becoming full, dredging needs continued. The correct decision - whether to buy new sites, extend leases and intensively manage existing sites, or close some navigation channels - was not obvious. Ford and Barkin created a minimum-cost network-flow programming model of the dredging-disposing system. The program formulates the optimization problem transparent to the user, solves the network, and presents the results in user-specified output reports. District staff now uses the program for strategic planning, six years after the original development. The solution method includes a network flow solver (linear programming solution), and enumeration (branch-and-bound) algorithm.

HEC's current thrust is to implement the branch-and-bound enumeration method for HEC computer programs. This method allows the nomination of alternatives in a manner consistent with current Corps planning practice. The alternatives are specified as distinct measures with specific sizes and operation characteristics. The method has been documented for manual application on flood control systems and successfully implemented using HEC-5 to analyze the effectiveness of a set of flood damage reduction measures and EAD to perform the economic analysis.

Water Control

The first development of real-time operation programs occurred in connection with a technical assistance study for the New England Division beginning in 1973. The Division requested a method to provide short-term forecasts based only on available streamflow data. HEC proposed using regression equations to extend flows a few hours into the future and routings that propagate the effects through the basin. These flows were input into the newly developed reservoir analysis program HEC-5. A graphical display program and a graphics tablet input menu helped improve the user interface. Although the New England Division never used these products, they formed a significant beginning point for later developments.

Activities at OCE and in various district and division offices stimulated HEC's involvement in water control. When divisions developed water control master plans, HEC focused its attention on the hardware and software that would be needed. HEC assisted the Southwestern Division (SWD) in the acquisition of mini-computer equipment for water control use. This led to a Corps-

wide water control acquisition. During this time, Pabst and others also helped SWD formulate a system of components that currently make up the Corps' water control software package.

The Huntington District became the first office to work with HEC in developing and applying flood forecasting tools. The Scioto River Basin model application was the prototype for other forecast models that followed. Ed Morris developed HEC's original flood forecasting methods through coordination with the National Weather Service. Peters and Ely followed with development of HEC-1F, the flood forecast version of the generalized watershed model HEC-1. These studies included the formation of district data bases, graphical display routines, forecast models, reservoir models, and associated software products.

Data communications with the NWS developed out of the TRADE agreement. This promoted interconnection between the Corps and NWS' River Forecast Center computer systems. Again the SWD played a significant role in funding the development of necessary communications-exchange software.

The strengthening of the DSS occurred when it was applied to real-time water control problems. The Rock Island District funded the development of the report generation program REPGEN. The Sacramento District funded the development of the report storage system, and user bulletin board software. The Vicksburg District recently has funded the migration of the NWS communications software into the UNIX PC work station environment. Dennis Huff, having had reservoir regulation experience in Sacramento, provided practical applications testing of the water control software.

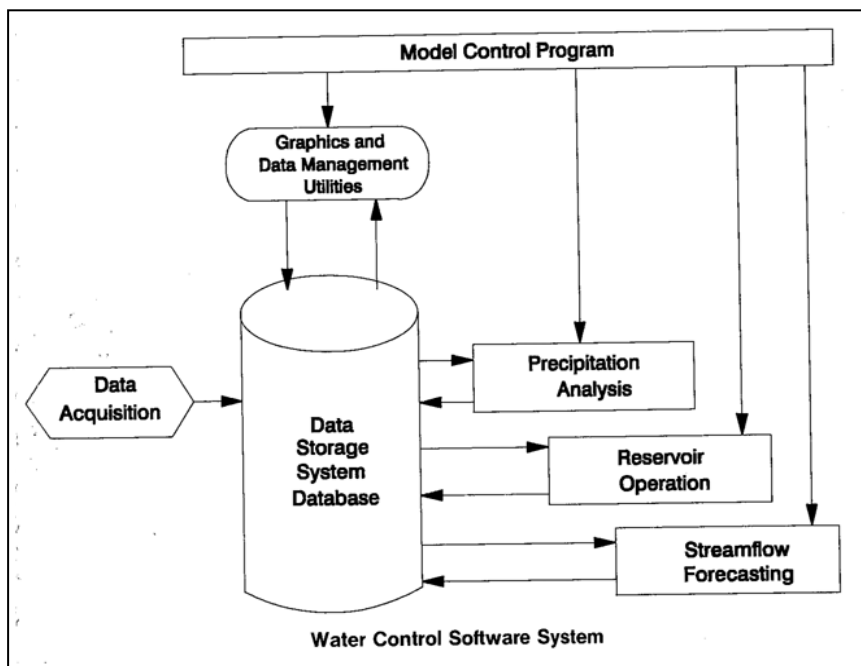

Water Control Software System

Throughout this period OCE's water control branch provided the support that allowed HEC to work in this area. R&D sources helped fund the development of DSS and its associated utilities. Operation and Maintenance funds helped field offices in the day-to-day application of all the software components. When the need for training became apparent, HEC offered a two-week

real-time water control class. An official Corps Engineering Manual, "Management of Water Control Systems" was prepared by a Corps-wide committee headed by Harry Dotson.

HEC's goal has always been to provide Corps field offices with tools to support water control. Each product is the direct result of input from working water control managers in Corps offices. HEC's tools meet the real needs of the user through documentation supported by training and telephone assistance. Offices are not required to use any of these products; they are used only when they are clearly the best choice to accomplish the water control mission.



Folsom Dam, American River, California

Personnel and Other Resources

By the end of 1964, the staff of HEC consisted of an engineering technician, a mathematician, four hydraulic engineers and a clerk-steno. During the last 25 years, staff members have included clerk-typists, secretaries, a librarian, a draftsman, an administrative officer, research hydrologists, research hydraulic engineers, civil engineers, an environmental resource planner, geologists, a biologist, hydrologic technicians, an administrative aid, a mathematics aid, a training assistant and computer programmers, technicians, systems analysts, specialists and operators. They are supervised by the Director and four Division Chiefs. (Appendix A contains a chronological list of past permanent and temporary HEC staff.) Personnel from federal, state and local governments, the university community, and private consulting companies have augmented the HEC staff.



HEC Staff of 1967

Al Cochran (OCE), Dan Deneff, Ed Hawkins, A.J. Fredrich, Al Onodera, Bill Eichert, Vilma Dudensing, Chuck Abraham, Denver Mills, Ed Jones, Harold, Kubik, Helen Nadolski and Leo R. Beard



HEC Staff of 1989

Back Row: Bill Johnson, Richard Hayes, Mike Burnham, John Peters, John Dralle, Shawn Mayr, Darryl Davis, Tom Cutter, Tracy Colwell, and Roger Kohne

Middle Row: Al Onodera, Bill Charley, Shelle Barkin, Gloria Briley, Mike Gee, Harry Dotson, Harold Kubik, Devon Tuck, Joan Tinios, Mary Hatzenbehler, Vern Bonner, and R.G. Willey

Front Row: Diane Harris, Al Montalvo, Marilyn Hurst, David Goldman, Jeff Houghten, Penni Baker, Gary Brunner, Chris Ayala, Bob MacArthur, Loshan Law, Arlen Feldman, Carl Franke, and Ralph Wurbs (Texas A&M)

Missing: Art Pabst, David Ford, Bob Carl, Troy Nicolini, Peter Miller, Kim Garcelon, and Cecilia Lee

Corps Staff on Temporary Duty

Over the years the Center has profited from individuals assigned to HEC on temporary duty to work on Corps projects related to the Center's research program. For example, Jim Dalton of the Southwestern Division and Richard McDonald from the Corps' Institute of Water Resources contributed to the extensive National Hydropower Analysis. In 1968 William Brick of the San Francisco District worked on an Interior Drainage Computer Program, and Frederick Brunner of the Sacramento District did a Reservoir Temperature Analysis. In 1972 Joseph Countryman of the Sacramento District and Stan Henzler of the Tulsa District helped with the Hurricane Agnes analysis. Toward the end of the decade, in 1979, Gary Dyhouse of the St. Louis District worked on HEC-1 applications. Two years later Russ Yaworsky from OCE worked on the continued development of the kinematic wave option in the HEC-1 watershed model. In 1983 Peter Koch from the New York District performed a Regionalized Frequency Analysis study. And in 1988 Robert Fitzgerald of the Vicksburg District assisted in scoping the requirements for a new Interior Drainage computer program. During 1988 and 1989, Gene Spangrude of the Walla Walla District worked on an application of HEC-6 to the Kaskaskia River in Illinois while working on his PhD at UCD as part of the Corps long-term training program.

Universities

Since moving to Davis in 1969, the Center has benefitted greatly from a close working relationship with UCD. The University Extension school sponsored numerous courses developed by HEC. Professors contributed to meeting HEC research goals and participated as teaching staff for HEC courses; two of the UCD staff have worked at HEC on sabbatical as Intergovernmental Personnel Act (IPA) employees. Besides UCD, Pennsylvania State University, University of Texas at Austin, University of Oklahoma, University of Wisconsin at Madison, University of Missouri at Rolla, Purdue University, Colorado State, Texas Tech and Texas A&M have sponsored courses developed by HEC. Numerous research contracts with universities have also expanded the Center's capability to address more varied and numerous subjects. (The names of the principal investigators are included in Appendix B.)

Appendix C lists the many students who assisted HEC either as seasonal or part-time employees. Two, Dennis Anderson and Fred Duren, were graduate students supported full-time by HEC so that they could complete their theses in subjects pertinent to the Center's mission. Three past employees began as entry-grade engineers while achieving MS and PhD degrees and eventually became GS-12 engineers.

Under the IPA, five university staff provided longer term assistance to HEC. These outstanding individuals were Drs. Joseph DeVries and Bruce Larock of UCD, Dr. Hubert Morel-Seytoux of Colorado State University, Dr. Daniel Hoggan of Utah State University, and A.J. Fredrich of University of Southern Indiana.

Consultants

In Appendix D, HEC gratefully acknowledges the outstanding contribution made to the work of the Center by the consulting engineering community, staff from other federal, state and local government offices such as TVA, NWS, EPA, USGS, the Bureau of Reclamation, and the

Federal Highway Administration, to mention a few. Edward Close of the USGS made significant contributions to HEC's stochastic hydrology research program. Neil Wellington, a Fulbright Scholar from Australia, helped improve HEC's dam safety risk analysis and water quality models.

Computers

Over the last quarter century, computer hardware has undergone enormous changes. Traditionally the Center has used the largest and best computer equipment. This promotes its state-of-the-art software development. Beard, for example, started the practice of contracting for computer services rather than using staff allocated to the Center for computer operations.

In 1964 HEC relied on the Sacramento District Automated Data Processing (ADP) Center's IBM 1620 computer. The system had 40,000 digits (comparable to bytes) of memory. Input and output depended on 80-column punched cards. A stand-alone IBM 407 card lister made the printed copy of the punched cards. To take advantage of the 120 columns on the printer using an 80-column card, a panel had to be wired on the 407 so that the code on one card told the printer to list a portion of the next card on the same line.

Because the IBM 1620 had limited memory and slow processing speed, it could run only small programs. As programs became larger and more complicated, a faster computer with more memory became desirable. In 1966, HEC chose a government-owned CDC 6600 at Lawrence Berkeley Laboratory (LBL). This system had 130,000 "words" of memory at 20 digits per "word." It also had a fast card reader and a 600 lines-per-minute printer. However, a job could be submitted only once a day. A courier service picked up input cards at the end of the day, delivered them to LBL 70 miles away for processing and returned the cards and output the following morning. Finally, in 1971 HEC leased a remote-job-entry (RJE) terminal.



Computer Punch Cards

The RJE terminal had a card reader and a high speed printer. It provided a way to transmit data to a remote computer via a telephone line. The output came back through the same line to the printer. Some of the RJE terminals from 1971 through the early part of the 1980's included a COPE 34, an XLO 7700, an M & M terminal, and a COPE 1200.

Although LBL was the primary site for ADP services, the long turn-around time and frequent downtime forced HEC to look for a backup commercial service. It found a commercial UNIVAC 1108 in Santa Clara for jobs requiring fast turn-around. HEC also used it when the LBL system went down. Commercial services included the Information System Design for a UNIVAC 1108, Computer Science Corporation for another UNIVAC 1108, The Boeing Computer Services for a

Cyber 175, and Control Data Corporation for their Cyber systems. In 1972, LBL replaced its CDC 6600 with a CDC 7600, which was four times faster.

Since the commercial service and the new system at LBL permitted interactive processing, HEC bought its first interactive terminal, a Tektronix 4014, in 1974. Interactive processing allows a user with a terminal to interact directly with a computer through the keyboard and monitor. The connection is usually through a telephone line. Other terminals followed, but the twelve TAB 132G graphics terminals purchased in 1983 for classroom workshops were probably the most significant.

With the advent of the minicomputer, an in-house computer became affordable. A minicomputer is a breed of computers smaller than a mainframe but larger than a desktop. In 1980 HEC leased a Harris H500 with an option to buy it. This system included a card reader, two high-speed printers, a tape drive, and two disk drives, each capable of holding 300 megabytes (Mbyte) of information. A megabyte is roughly a million bytes or characters. It was also connected to a key-punch machine for punched output. It had one Mbyte of memory, allowing for 12 Mbytes of virtual memory space. Virtual memory allowed the execution of programs that require more memory than is physically available by swapping small portions of the program from the disk. Individual terminals for interactive work were connected directly to the H500 by cables strung throughout the building.

HEC purchased its first PC's or desktop personal computers in 1983: two IBM PC/XTs with 640 Kilobytes of memory, a floppy disk drive, and a 10-Mbyte hard disk. Today each employee has a PC.

In 1985 HEC retired the Harris H500. With it went the cumbersome cards for input and output. To replace the H500, HEC purchased a Harris H1000. It was basically a faster and larger H500, but without a card reader or punch.

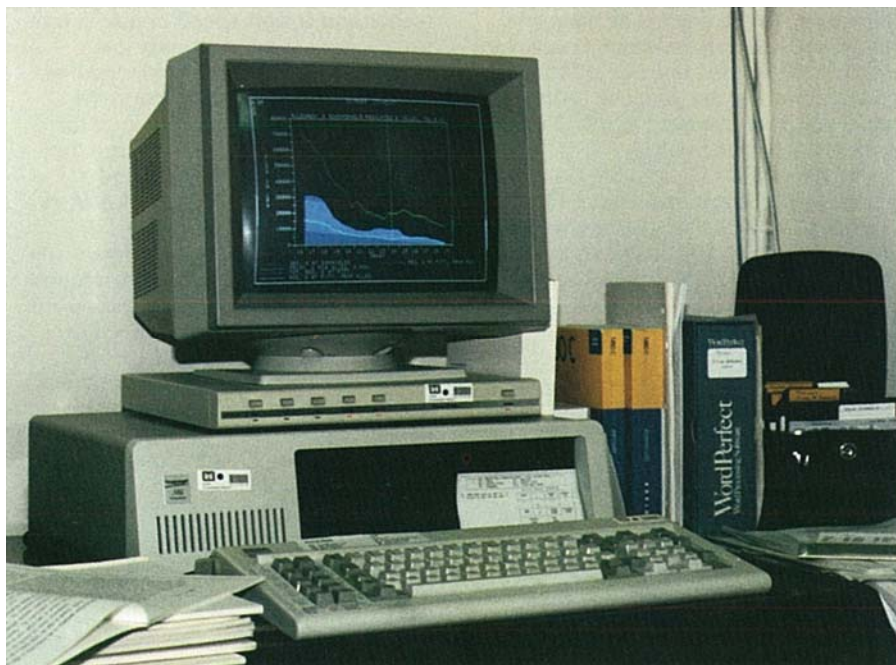

Personal Computer Configuration

Annual Budget

The following figure shows the growth of the annual HEC budget for the last 24 years. It represents the expanded work efforts in the HEC training program, computer program distribution, research and reimbursable project work. It also reflects changing costs. For example, in 1964 starting salaries ranged from \$3,305 for a GS-1 position to \$15,665 for a GS-15. By 1989 they had jumped to \$10,213 and \$57,158, respectively.

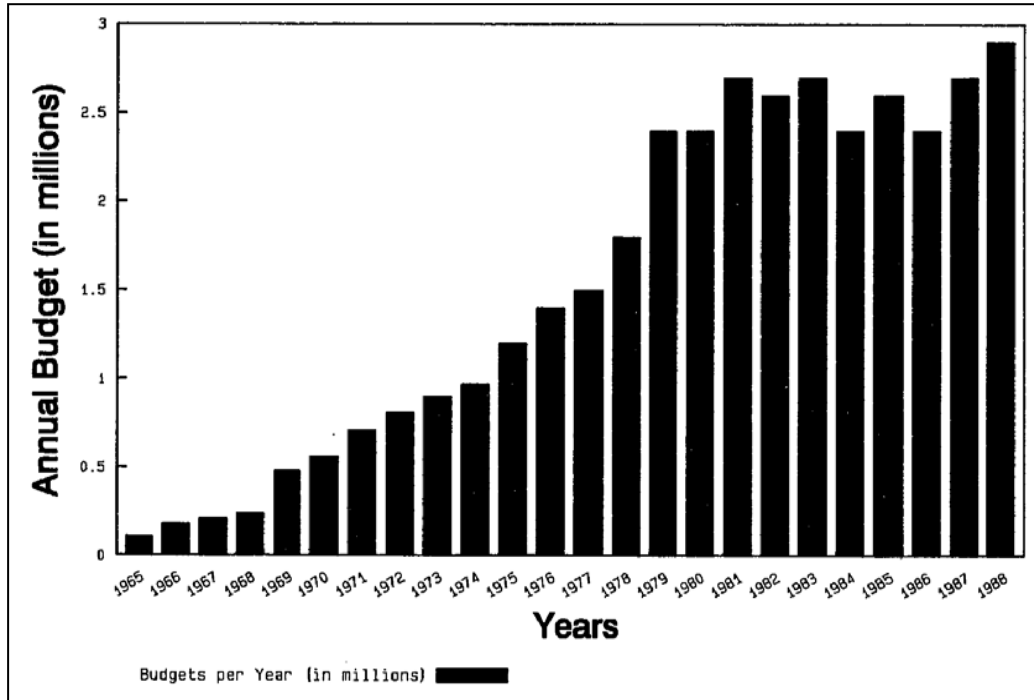

HEC Annual Budget

Computer Program Distribution

The annual and the accumulative requests for computer program distribution, since 1975 (earlier data not available), are shown in the following figure on program distribution. A significant increase occurred in 1985 when HEC programs were first released for personal computers. During 1987, several additional HEC programs became available for PC's and caused a significant increase in requests. The accumulative total programs distributed by the end of 1988 exceeded 20,000 copies.

Students Trained

The following figure on the training program shows the number of students trained each year. The accumulative totals are also shown. The number of total students trained by HEC will probably exceed 10,000 during 1990. Some of the past training course and seminar titles are shown in Appendices E and F.

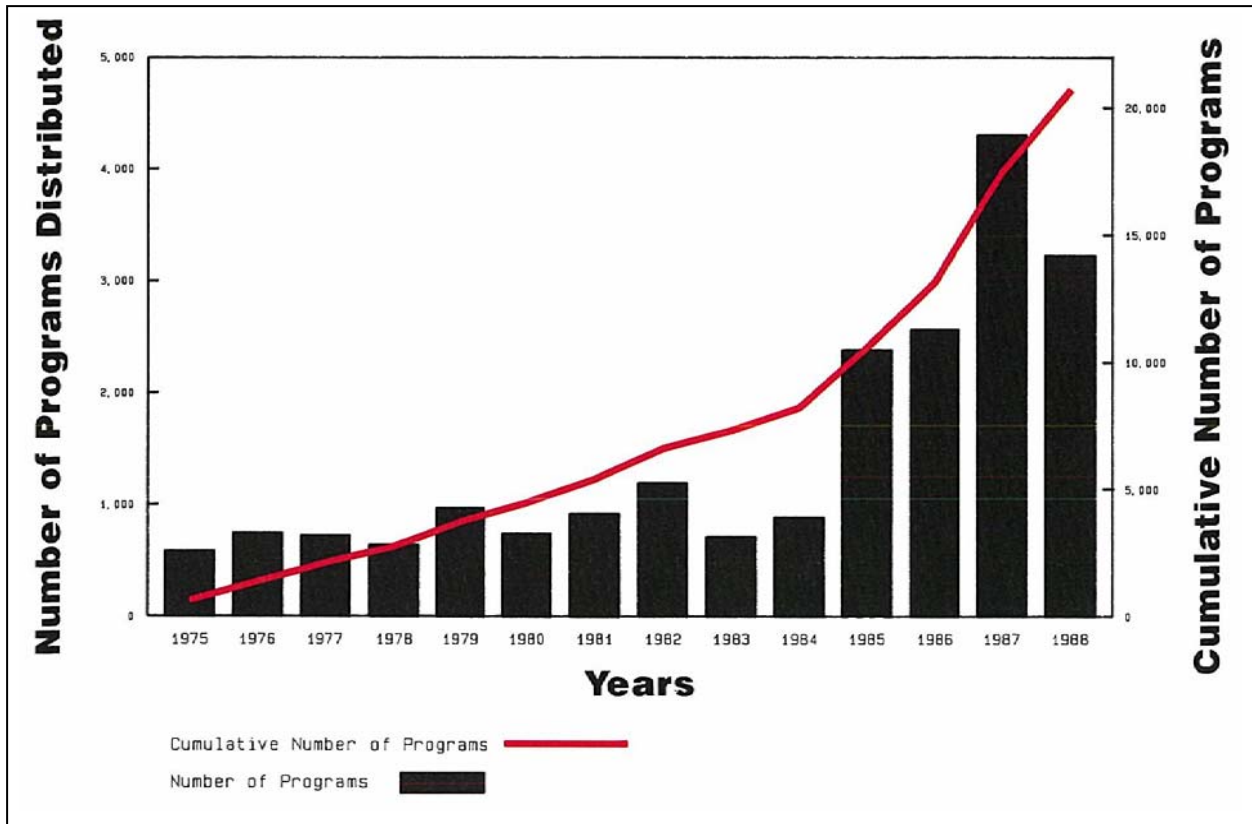

Number of Computer Programs Distributed

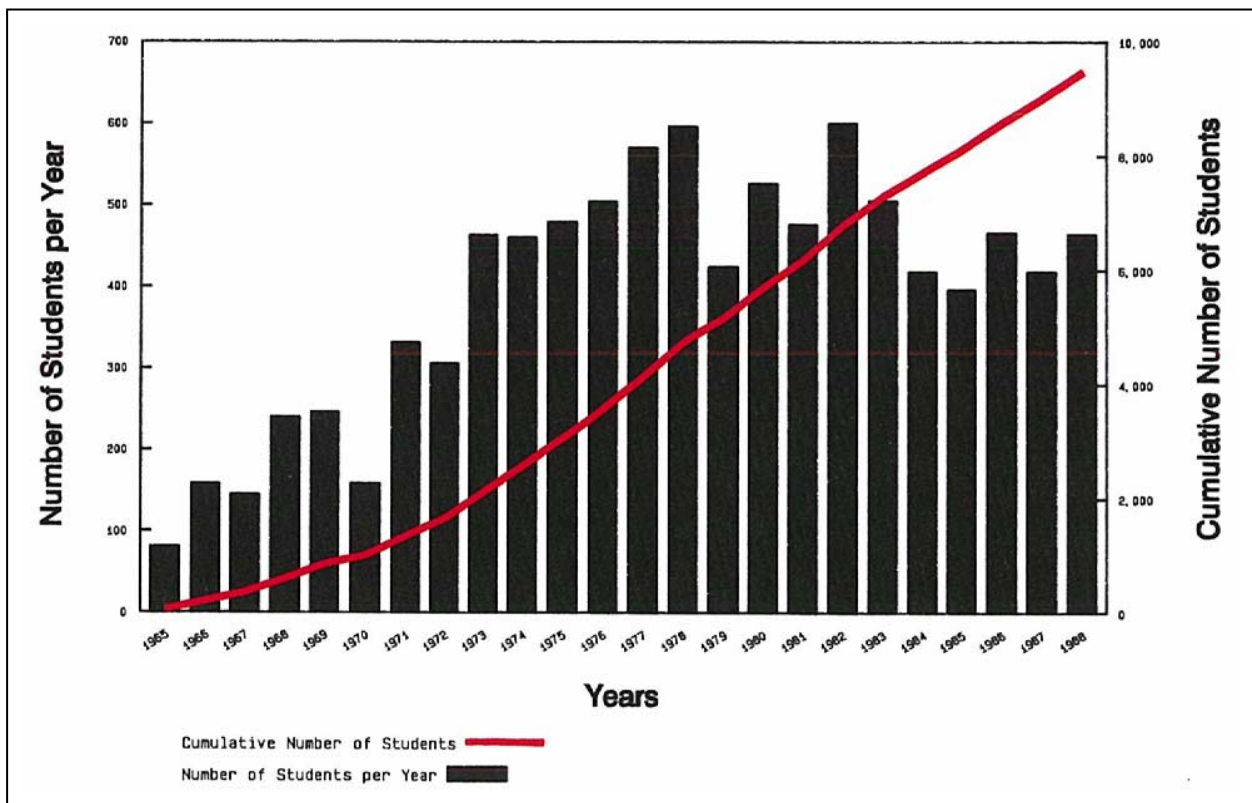

Number of Students Attending HEC Training Courses

Current Perspectives

Executive Office

The primary function of the Executive Office is to direct, supervise and coordinate technical and administrative activities within HEC and to provide administrative coordination with other Corps offices. The Administrative Officer of HEC coordinates with the Sacramento District and the South Pacific Division which provide administrative services to the HEC under support agreements for personnel, finance and management, and other matters. The Director participates in and manages technical activities within the Executive Office as well as throughout the Center.



Executive Office Staff of 1989

Standing: John Dralle, and Darryl Davis; Seated: Loshan Law, and Diane Harris

Research Division

In 1988 the Research Division began a major R&D program to develop the next generation watershed runoff model, HEC-1. This will include new simulation algorithms and new means to use the power of emerging PC workstations. A new R&D program in Statistical Methods in Hydrology is expected to begin in 1990, reflecting the Center's longstanding interest in hydrologic statistics. This new effort will assemble a package of statistical methods in hydrology and be integrated into the new PC environment.

Recent developments in reservoir regulation for water quality will receive increased emphasis. The complexity of these calculations requires advanced computational resources. As the new PC's become more widely available, these analyses will be more commonplace, and thus applications development will enhance this capability. Increasing concerns for environmental quality and the impacts of water quality on a river/reservoir system will certainly be in high

demand, as will risk and uncertainty in water resources planning, design and operation. Managers want to know the tradeoffs for different decisions dealing with physical impacts and the uncertainty of their occurrence. Hydrologic design criteria will not be taken for granted; they will have to be explained in terms of physical effects, risk and uncertainty.



Research Division Staff 1989

R.G. Willey, David Goldman, Harold Kubik, Arlen Feldman, Gary Brunner, Al Onodera, Tracy Colwell, and Jeff Houghten

The largest unknown in any hydrologic analysis is where and when the rain (snowmelt/precipitation) will occur. This is critical for effective flood forecasts. Remote sensing R&D will continue to seek answers to this problem. Current efforts are centered on developing better information about the spatial distribution of precipitation. Traditional ground gages are now being coupled with radar and satellite measurements to obtain a better evaluation of rainfall. Future improvements in computers and radar and satellite sensors will be coupled with new watershed models to improve flood forecasts

Currently HEC manages the Corps R&D programs in Hydrologic Engineering, Cost-Shared Hydrologic Analysis, and Water Source Interrelationships and Impacts. It is also involved in research programs in Remote Sensing, Planning, and Risk Analysis. Projects, which are called work units, vary in size from one-year \$50,000 efforts to six-year \$600,000 major projects.

The Hydrologic Engineering R&D program emphasizes traditional hydrologic and hydraulic developments together with water resource planning and management. Reservoir system regulation for flood control and water supply is also included. Current emphasis is on next generation math models for watershed runoff and river hydraulics. Analytical planning techniques and geographic information systems are also being pursued.

Cost-Shared Hydrologic Analysis became a new program in 1988 in response to the passage of the 1986 Water Resources Act, which mandated that local sponsors share in the developmental cost of a project. Its purpose is to develop materials (brochures, videos, etc.) to explain the Corps hydrologic analysis to local governments that must now share the cost of water resources development with the federal government. Improved communication about how water resource projects (e.g., dams, levees, floodplain management, etc.) work, and how severe the flood threat is, will yield better projects.

Improved understanding of the interaction of Corps water resource projects with regional water resources is the purpose of a new R&D program entitled Water Resource Interrelationships and Impacts. The program emphasizes the interactions between surface and groundwater so that the impact of Corps reservoirs and river regulation on regional aquifers can be identified. Future projects and operations can then minimize problems and facilitate development of all water resources.

Planning Division

Given the present federal government climate of decreasing manpower, cost-shared studies and projects with local partners, and extreme competition for budget dollars, efficiency and economy in study methods and tools is paramount. Near-term activities are therefore being directed to adapting existing computer programs, developing new ones, and devising applications strategies consistent with these facts. Division products are being specifically tailored to the microcomputer work environment.



Planning Division Staff of 1989

Mike Burnham, Bob Carl, Shelle Barkin, David Ford, Chris Ayala, Bill Johnson, Ralph Wurbs (Texas A&M), and Shawn Mayr

Work projects that illustrate the current focus are:

- Initial release of the Flood Damage Analysis Package for the personal computer.
- Completion of the Preliminary Analysis System for Water Surface Profile Computations (PAS) program for planning data acquisition for river hydraulics - exclusively for PC application.
- Publication of a series of policy support documents analyzing Corps response to recent droughts and the potential for reallocating storage in existing reservoirs.

- Design of comprehensive PC-based computer program for planning and design of interior flood control facilities.
- Publication of tutorial booklet directed to cost-share partners describing hydrologic risk as related to flood control.
- Establishment of PC work station for performing data entry, analysis, and display of geographic data - for project studies and research involving geographic information system data.
- Publication of guidelines for study of flood warning preparedness programs as measures to consider in lieu of or in conjunction with other flood damage reduction measures.
- Host seminar, publish proceedings, and prepare "ideal reconnaissance study model" to assist in implementing two-phased, cost-shared planning.

The Planning Division will move further into automated computations, data handling and display, and systematic applications methods for studies in the traditional area of flood damage reduction. Water supply and drought issues are expected to receive increased attention during the next decade.

Training Division

The Training Division is administratively responsible for many of the activities that provide technology transfer to the field. Besides the training program, the Division distributes video tapes and general assistance information. Catalogs for HEC products are provided free to all requestors in the free world. Computer program distribution that HEC once provided is now done by the National Technical Information Service (NTIS) and private distributors due to policy changes. The Center's publications are also available through the NTIS.



Training Division Staff of 1989

Michael Gee, Marilyn Hurst, Richard Hayes, Harry Dotson, Penni Baker, Joan Tinios, Vernon Bonner, and Mary Hatzenbehler

An increasing number of universities are providing short-course training comparable to HEC courses in HEC computer programs. HEC encourages them because this provides technology transfer to non-Corps' engineers who have little opportunity to attend HEC courses. With the use of HEC computer programs in the engineering curriculum also increasing, HEC is presently providing program user's manuals to several university book stores.

The goals of the training program will continue, but the technical topics and the methods will change with time. Training using other methods will increase. The short course away from the office is becoming expensive, and scheduling is getting more difficult. The use of packaged training with video tapes, computer programs, or video discs gives those in need of training another option. Except for video-taped live lectures, these options have not been used so far because the target population is small, there are funding limits, and technology continues to change constantly. Packaged training is best used with a fairly stable topic. Therefore, the early forms of packaged training will likely be fundamentals that remain stable.

The courses HEC presents will change. While technical activities continue, they are not at the same scale they were when new national programs brought considerable attention to them. As the R&D program produces new products and the national focus on water resource management shifts, HEC's courses will respond accordingly.

Technical Assistance Division

Technical assistance will continue to be a vital component of HEC's mission. Through technical assistance the HEC acquires an immediate knowledge of field office problems, as well as an opportunity to test recently developed technology. There is also the opportunity to foster technology transfer through working relationships with field office personnel. Thus there are a number of benefits in addition to the actual products of the assistance.



Technical Assistance Division Staff of 1989

Standing: Carl Franke, Tom Cutter, John Peters, and Devon Tuck
Seated: Al Montalvo, Arthur Pabst, Gloria Briley, and Troy Nicolini
Missing: Bill Charley

Future technical assistance will reflect the needs of field offices as they are faced with new challenges and demands. The assistance will provide a "test-bed" for the tools being produced through research. State-of-the-art computer technology will be used as appropriate in performing technical assistance.

An example of near-term assistance pertains to Corps water control activities. Already, the next generation forecast model with improved routing techniques is being developed that will use spatially distributed precipitation and employ continuous moisture accounting. The model will be operated continuously, with model parameters updated based on observed flow conditions, and will interface with the user primarily through temporal and spatial-based graphics displays. HEC will assist Corps water control centers in the implementation of such technology.

A Final Reminiscence

Bill Eichert on the eve of his retirement, just hours after a retirement dinner given by his staff, looked back and offered these related perceptions:

We have been blessed over the years with a highly capable staff. The reputation of the staff for their technical competence is outstanding, and they have provided support to thousands of people and hundreds of organizations throughout the years. In our training function alone we have supported over 10,000 people through the years. Programs developed by the staff are considered the state-of-the-art by many organizations and countries. Our staff has truly established HEC and the U.S. Army Corps of Engineers as organizations which are leaders in the water resources field.

During its 25-year history, HEC has grown in size. The scope of its mission has changed as the mission of the Corps has changed. In the beginning, the Center adapted traditional hydrologic engineering techniques to computers and trained and assisted Corps staff with their application. Over the years efforts have been directed towards adapting or developing newer state-of-the-art technology. These tools have included the latest mathematical procedures, such as systems analysis and stochastic processes. More recently, these tools have been enhanced by graphical displays, interactive user interfaces and selection menus.

In the early seventies, public concern for the preservation and enhancement of the country's natural resources warranted a reorientation of the Corps and HEC. Since that time, increased emphasis has been placed on developing hydrologic engineering techniques for evaluating environmental impacts due to changes in water resource system operations. The Center has developed computer models used worldwide by government and private organizations to analyze the effect of proposed and existing water resource development. Other areas of increased emphasis over the last two decades include hydropower, sedimentation, water supply, groundwater, and nonstructural planning technology.



The Hydrologic Engineering Center's Offices

Universities have been encouraged to conduct some of the traditional training courses as HEC has developed new and more advanced courses. Other university contacts include applied research in hydrologic engineering and related areas such as remote sensing. Federal agencies such as the National Aeronautics and Space Administration, USGS, and the Federal Highway Administration have either funded HEC research or cooperated with HEC on joint studies.

As he looked to retirement, Bill Eichert also reflected about the future:

The future of HEC and the Corps is somewhat uncertain. The Corps' traditional role of constructing large water resource projects is winding down, and the Corps is exploring the possibility of new missions. The Corps' solid reputation in engineering dictates that the Corps will be around for many years, and will be engaged in producing good engineering studies and projects. HEC will be following the Corps' lead and will develop and teach the technical capabilities needed to do whatever the Corps' future missions dictate.

While the names and faces will change over the years, the pride, the technical competence, and the friendly, supportive attitude of the HEC staff will remain.

Appendices

Former HEC Staff

Jesse Abbott	John Harsh	Kimberly Powell
Charles Abraham	Wenonia Harvey	Denise Powers
Abnish Amar	Edward Hawkins	Alan Prasuhn
Anna Sue Arnold	Herb Hereth	Howard Reese
Nicolette Baptista	Randy Hills	Jennifer Reich
Robert Barkau	Duane Hobart	Lorri Reiff
Susan Barth	Dennis Huff	Edward Reus
Leo Beard	Paul Hughes	Jan Rogers
Frances Beeman	Lewis Hulman	Lawrence Rollins
Margaret Bonhag	Kenneth Iceman	Mary Ann Ross
Sandra Brito	Rhonda Jackson	Betty Rudd
Kenneth Brooks	Pete James	Barbara Sawyer
John Buckley	Edward Jones	Albert Schultz
Dale Bunnett	James Jondle	Warren Sharp
Peggy Burris	Donna Keith	Kathleen Shelton
Sharon Cane	Harold Keith	Kittie Smallcombe
Josephine Carrasco	Deborah Kinkel	Brian Smith
Paul Caruso	Jon Lea	Mary Ann Smith
Robert Cermak	E. Roberta Lee	Sherri Smith
Ann Chance	Hal Lenderman	Teri Smith
Linda Chrisman	David Lewis	Vicki Smith
Lawrence Clay	Lola Longley	Margaret South
Richard Cooley	Judith Lynch	Shirley Sparks
Linda Countryman	Barbara Mazzola	Lynne Stevenson
Carol Crabill	Brent McCarthy	Jeanne Tew
D. Maries Davis	Janice Metrogen	Nancy Thomas
Daniel Deneff	Denver Mills	William Thomas
Suzanne DiBuono	Colleen Mitchell	Joseph Ticer
Jerrilyn DeLaney	Carol Mogg	Eileen Tomita
Vilma Dudensing	Edward Morris	Christine Tougas
Barbara Eberspacher	William Morse	Helen Villanueva
William Elder	Helen Nadolski	Peter Waller
Paul Ely	Denise Nakaji	R. Pat Webb
Barbara Evingham	Ann Negendank	Judith Weiss
Richard Fox	Roger Nutter	Paulette Whitemore
Gary Franc	Jane Nyberg	David Williams
Augustine Fredrich	Daniel O'Neill	Vernell Williams
Marguerite Gardner	Allan Oto	Paula Winter
Eileen Garoyan	Murland Packer	Judy Wolf
Janet Gift	Elaine Palmer	Clyde Wolfe
Lowell Glenn	Samuel Parino	Christopher Young
Nona Faye Griffin	Wayne Pearson	Carol Zickus
David Gundlach	Beverly Porter	

University Support

Name	University	Year
Myron B. Fiering	Harvard University	1967 - 1968
Leon Borgmann	University of California at Berkeley	1967 - 1968
Ken Kerri	California State University of Sacramento	1967
Roy Hann	Texas A&M University	1967
Armand Seri	California State University of Sacramento	1968
William C. Walton	University of Minnesota	1969
R.C. Cooper	University of California at Berkeley	1969
R.B. Krone	University of California at Davis	1969
G.T. Orlob	University of California at Davis	1969
E.D. Schroeder	University of California at Davis	1969, 1972 - 1973
Vujica Yevjevich	Colorado State University	1970
Paul A. Witherspoon	University of California at Berkeley	1970
P.H. McGauhey	University of California at Berkeley	1980
Yacov Y. Haimes	University of California at Los Angeles	1970
H.A. Einstein	University of California at Berkeley	1970
John R. Sheaffer	University of Chicago	1970
James Hackett	Virginia Polytechnic Institute	1970
L. Douglas James	Georgia Institute of Technology	1970
S.J. McNaughton	Syracuse University	1970
Peter A. Krenkel	Vanderbilt University	1970
Frank E. Peters	Massachusetts Institute of Technology	1970, 1972
George Bugliarello	University of Illinois	1970, 1972
John Shaake	Massachusetts Institute of Technology	1970
Charles R. Goldman	University of California at Davis	1970
George Tchobanoglous	University of California at Davis	1973 - 1975
Steve Hanke	John Hopkins University	1973
Leo R. Beard	University of Texas at Austin	1973 – 1976, 1979
Joseph B. Franzini	Stanford University	1973
John E. Edinger	University of Pennsylvania	1973
Jaime Amorocho	University of California at Davis	1973 – 1975, 1978
Richard L. Cooley	University of Nevada	1973
Arthur Pabst	University of Minnesota	1973
Douglas B. Lee	University of California at Berkeley	1974
Alvin Anderson	University of Minnesota	1974
Alan Prasuhn	California State University of Sacramento	1974 – 1977, 1979
Ray B. Krone	University of California at Davis	1974
Robert L. Smith	University of Kansas	1974
Henry P. Caulfield	Colorado State University	1974 – 1975
Seymour M. Gold	University of California at Davis	1974
Evan Vlachos	Colorado State University	1974
Tom Hinesly	University of Illinois	1974
Edward Kaplan	University of Pennsylvania	1974
Murland Packer	California State University of Sacramento	1974
Wayne C. Huber	University of Florida	1975
Victor A. Koelzer	Colorado State University	1975
William O. Pruitt, Jr.	University of California at Davis	1975
Kenneth Brooks	University of Minnesota	1976
Theodor S. Strelkoff	University of California at Davis	1976 – 1977, 1980
David Ford	University of Texas	1978

University Support (continued)

Name	University	Year
L. Douglas James	Utah State University	1978, 1986
Joe DeVries	University of California at Davis	1978, 1985 – 1988
Otto Helweg	University of California at Davis	1979 – 1980
Joseph Scalmanini	University of California at Davis	1979
V. Ralph Algazi	University of California at Davis	1979, 1982 – 1983, 1987
Miguel Marino	University of California at Davis	1980, 1985
James Lapsley	University of California at Davis	1980
Darrell Fontane	Colorado State University	1980
William Kovalak	University of Michigan	1980
Bruce Larock	University of California at Davis	1980
David Schamber	University of Utah	1984 – 1986
C.K. Shen	University of California at Davis	1984, 1986, 1988 – 1989
Robert Hicks	Arizona State University	1985 – 1986
A.W. Knight	University of California at Davis	1985
Hubert Morel-Seytoux	Colorado State University	1986
Paul Waite	Drake University	1986 – 1987
Jay Lund	University of California at Davis	1988
Dennis McLaughlin	Massachusetts Institute of Technology	1983 – 1988
Ian King	University of California at Davis	1986 – 1988
Augustine J. Fredrich	University of Southern Indiana	1989

Student Support

Belinda Allen	Donald Hansen	Mary Randall
Waleed Al-Rawi	Kristi Herrmann	Nolan Randall
James Alves-Foss	Derek Hilts	William Reagan
Dennis Andersen	Valerie Howarth	Madeline Roach
Ronald Andersen	Davis Ichikawa	Marcus Romani
Joan Astrue	Carol Johnson	Donna Rosby
Rhonda Barrow	Robert Kemmerle	Michael Rosendale
Barbara Bauer	Keith Knight	Yolanda Rush
Jean Beegle	John Koltz	Dwight Russell
Vernon Blakes	Lillian Kothny	Michael Sandberg
Teresa Bowen	Brook Kraeger	H. Nancy Schneider
Jacqueline Brown	Cecilia Lee	Margaret Schroeder
Russell Brown	Gary Lee	Paul Shoenberger
Charles Burnash	Cathy Lewis	Karen Southland
Donna Burnett	Mark Lewis	Alan Spence
Kim Choate	Robert Luethy	John Stayton
Alaric Clinton	Rodney Lutz	Adriene Stirling
John Colt	Helen Mar	William Stoner
Trudy Conley	Betty Martin	Eric Tavenier
Brent Cullimore	Laura Martin	Robert Thiem
Michael Deas	Robert Mattingly	Joan Tinios
Ajit Dulai	Dennis Metaxas	Bernita Toney
Fred Duren	John Miwa	John Tracy
Brian Ebel	Laura Mumford	Richard Ulm
Daniel Edwards	Loren Murray	Rosanna Vazquez
Marshall English	Keith Nelson	Katherine Wages
Chris Enright	Doanh Nguyen	Thomas Wakeman
Ralph Finch	John Nickell	Jean Washington
Will Folsom	Riccardo Notini	Jeff Whittaker
Lynne Fornasero	Kimberly Papailias	Steven Wilhelm
Nancy Foster	Julie Parker	Nicole Williams
Gary Goff	Gene Pennello	Clay Willis
Paul Hadley	Katherine Popko	Frederick Wong
Douglas Hamilton	Michele Powell	Rodney Wright
Rosita Hampton	Bruce Raabe	James Yost

Consultants

Name	Office	Year
Robert E. Bergstrom	Illinois State Geological Survey	1968
Robert W. Rex	Department of Geological Science	1968
Lou Sullivan	Beckman Instruments Company	1968
Bill Arvola	California Department of Water Resources	1968, 1970
Donald Van Sickle	Turner & Collier, Braden	1968, 1974, 1977
Donald E. Evenson	Water Resources Engineers	1969
Walter Wunderlich	Tennessee Valley Authority	1969, 1971
F.A. Cole	Water Research Association	1969
James Price	Tennessee Valley Authority	1969
Joseph N. Bradley	Consultant	1969
Manuel Benson	U.S. Geological Survey	1969
Michael B. Sonnen	Water Resources Engineers	1969
Robbin Clarke	Water Research Association	1969
T. O'Donnell	Hydraulics Research Station	1969
Larry A. Roesner	Water Resources Engineers	1969, 1974 – 1975
Kenneth Young	USGS	1969
Capt. Carl Strandberg	Aerial Reconnaissance	1970
David Wood	FWPCA	1970
James H. Brown	Los Angeles County, FC	1970
Richard Bain, Jr.	FWPCA	1970
William C. Johnson	FWPCA	1970
G.T. Orlob	Water Resources Engineers	1970 – 1974
Allen V. Kneese	Resources for the Future	1971
Anthony Mentink	U.S. Environmental Protection Agency	1971
Darrell Webber	U.S. Bureau of Reclamation	1971
F.J. Ludzack	U.S. Environmental Protection Agency	1971
H.C. Riggs	U.S. Geological Survey	1971
Henderson McIntyre	Bonneville Power Administration	1971
John Ferris	U.S. Geological Survey	1971
Ronald Hill	Environmental Protection Agency	1971
Walter Sutton	U.S. Department of HUD	1971
Norman Crawford	Hydrocomp	1971, 1973 – 1974, 1976
James E. Goddard	Consultant	1971, 1974, 1980
Lenard B. Young	U.S. Federal Power Commission	1971, 1977
Russell Culp	South Tahoe Public Utility District	1972
Gordon Koberg	U.S. Department of Interior	1972
Jacob Rosing	INTASA	1972
Leon W. Weinberger	Environmental Quality Systems	1972
Maurice Arnold	U.S. Department of Interior	1972
Richard Lijesen	INTASA	1972
John L. Mancini	Hydro-Science	1973
Albert E. Gibb	Bureau of Reclamation	1973
Donal E. Matschke	Bauer Engineering	1973
John Coscia	Delaware Valley Regional	1973
Philip Storrs	Engineering Science	1973
Thomas Davis	ADA Council of Governments	1973 – 1974
Robert P. Shubinski	Water Resources Engineers	1973 – 1974
Carl Chen	Tetra Tech	1973 - 1976

Consultants (continued)

Name	Office	Year
David Dawdy	U.S. Geological Survey	1973 – 1976
Dick Grantham	Office of Technical Coordination	1974
Donald A. Woolfe	San Mateo County	1974
E.M. Lofting	Consultant	1974
Edward Madden	Consultant	1974
Ernest Pemberton	U.S. Bureau of Reclamation	1974
Gordon A. Enk	Inst. on Man & Science	1974
Lawrence Costello	CH2M-Hill & Associates	1974
Pio S. Lombardo	Enviroquality	1974
M.B. McPherson	ASCE Urban Water Resources Research	1974 – 1975, 1977
Jack Dangermond	Environmental System Research Institute	1974, 1979
John Lager	Metcalf and Eddy	1974 – 1976
Don Hey	Hydrocomp	1975
Clarence Korhonen	Development & Resources	1975
Harry Schwarz	Consultant	1975
James Wright	Minnesota Dept. of Natural Resources	1975
John J. Buckley	Development & Resources	1975
Mike Savage	Development & Resources	1975
Nicholas Lally	U.S. Flood Insurance Administration	1975
Ralph Hwang	Development & Resources	1975
Saul E. Rantz	U.S. Geological Survey	1975
Thomas Maddock	U.S. Geological Survey	1975
Maria R. Eigerman	Consultant	1975
Anthony Slocum	Anderson-Nichols	1975 – 1976, 1984
Bill Gill	Development & Resources	1975 – 1976
Donald W. Newton	Tennessee Valley Authority	1975 – 1976
Brendan M. Harley	Resource Analysis	1976
David Fryberg	Consultant	1976
Dwight Russell	Consultant	1976
Francis M. McGowan	Lawler, Matusky & Skelly Engineers	1977
Gene Biggerstaff	U.S. Federal Power Commission	1977
James Schaaf	George S. Nolte & Associates	1977
Richard Males	W.E. Gates & Associates	1977, 1980
John R. Shaeffer	Shaeffer & Roland	1977, 1980
John Schaake	NOAA, Office of Hydrology	1978
Donald Smith	Resource Management Associates	1978 – 1989
David Willer	Tudor Engineering	1978
David Church	Tudor Engineering	1978
E. John Finnemore	Metcalf and Eddy	1978
E.H. Lessesne	Tennessee Valley Authority	1978
James L. Grant	Law Engineering Testing Company	1978
William A. Wahler	W.A. Wahler Associates	1978
Kenneth Young	GKY & Associates	1978
Tim Kelley	Geohydrology Associates	1978 – 1979
John Peckum	Marin Municipal Water District	1979
Thomas Weaver	Western Area Power Administration	1979
William Norton	Resource Management Associates	1979
Duke Altman	Espey Huston & Associates	1979
Mark Henwood	Auslam & Associates	1979 - 1980

Consultants (continued)

Name	Office	Year
Albert Halff	Halff and Associates	1980
Clint Keifer	Keifer Engineering	1980
Joseph Scalmanini	Luhdorff and Scalmanini Consult. Engrs.	1980
Lee Johnston	Geo-Graphics Decisions Systems	1980
William Carson	Carson & Associates	1980
William R. Norton	Resource Management Associates	1982 – 1984
Ranjan Ariathurai	Resource Management Associates	1982 – 1985
W.E. Gates	W.E. Gates	1982 – 1983, 1985
Ian King	Resource Management Associates	1983
G.T. Orlob	Orlob & Associates	1983
David Dawdy	Dezi M. Alverey	1983, 1985, 1989
William Hartman	Hartman Engineers	1983 – 1986
Dennis McLaughlin	Resource Management Associates	1983 – 1986
Paul Ely	Consultant	1984 – 1989
David Curtis	International Hydrological Services	1984
Tom Wakeman	Consultant	1984 – 1985
K. Sorrensen	Consultant	1984
R.E. Meyer	R.E. Meyer	1984
Glenn A. Brown	Consultant	1984
F. Borcalli	Borcalli, Ensign & Buckley	1985
Gary Franc	ACRES	1985
Kathleen Kliesse	Consultant	1985 – 1987
Robert MacArthur	Simons, Li & Associates	1986 - 1987
Art Miller	Consultant	1987
Nitin Pandit	Roy F. Weston	1987
Bill Bronner	Earth Satellite	1987
John J. Buckley	Borcalli, Ensign & Buckley	1987
Carl Franke	Carl Franke Technical Associates	1987 – 1989
Teresa Bowen	Bowen Engineering	1987 – 1989
H. James Owen	Flood Loss Reduction Associates	1988
David Williams	West Consultants	1988
Laura Martin	Consultant	1988
Keith Knight	Consultant	1988 – 1989
Roy Dodson	Dodson & Associates	1988
Douglas Hamilton	Simons, Li & Associates	1988
Jeff Whittaker	Consultant	1988 – 1989
Michael Tompkins	Consultant	1988 – 1989
Lee Pendergrass	PenSEC	1989

HEC Training Course Conducted 1965 - 1988

Hydrologic Analysis	
Course Titles	Years
Hydrograph Analysis & Hypothetical Floods	1965 – 1966
Hydrologic Engineering Principles & Procedures	1966
Hydrologic Analysis & Hypothetical Floods	1968
Flood Hydrograph Analysis	1969 – 1970
Computer Applications & Utilization for Engineering Executives	1971 – 1972
Hydrologic Systems Analysis	1972
Hydrometeorology	1972
Hydrologic Evaluation of Projects	1972
Snow Hydrology	1973
Hydrologic Analysis of Floods	1974, 1977, 1981, 1983, 1985
Urban Hydrology	1974 – 1977, 1978 – 1980
Rainfall-Runoff Analysis Using HEC-1	1978
Interior Drainage Hydrology	1978
Hydrologic & Hydraulic Aspects of Non-Federal Dam Safety	1978
Dam Break Analysis	1980 – 1981, 1984, 1986
HEC-1 Workshop	1980
Application of HEC-1 to Phase I Dam Safety Analysis	1980
Interior Flooding Hydrology	1982, 1984, 1986, 1988
Real-Time Water Control	1982, 1984, 1986, 1988
Hydrologic Data Management with HEC-DSS	1986 - 1989

River Mechanics

Course Titles	Years
Computer Applications to Backwater Profiles	1968
River Hydraulics	1969 - 1970
River Hydraulics & Sediment Transport	1974
Water Surface Profile Computation Using HEC-2 - Basic Course	1976 - 1979, 1981, 1983, 1985
Water Surface Profile Computation Using HEC-2 - Advanced Course	1980, 1982, 1986, 1988
Unsteady Flow Analysis	1976 - 1977, 1983, 1985 - 1986
Sediment Transport	1977, 1979, 1981, 1983, 1985

Reservoir Systems Analysis

Course Titles	Years
Storage Yield & Streamflow Simulation	1966
Reservoir Systems Analysis	1967, 1969, 1971, 1975, 1981, 1987
Water Resource System Analysis	1972
Real-Time Control of Water Resource Projects	1977

Water Quality

Course Titles	Years
Water Quality Management	1968 - 1970, 1972 - 1974
Water Quality in Rivers & Lakes	1971
Water Quality Modeling	1975, 1984 - 1985, 1987
Water Quality Analysis for Rivers & Reservoirs	1977
Water Quality & Ecosystem Modeling Techniques	1978
Water Quality Aspects of Water Control	1978, 1980, 1983

Water Resources Planning	
Course Titles	Years
Hydrologic Engineering for Water Resources Planners	1968
Hydrologic Engineering for Planning	1973 - 1974, 1976 - 1988
Planning Metro Water Systems	1974
Urban Region Water Planning	1975
Analytical Planning Techniques	1976 - 1978
Flood Control Planning	1978
Flood Damage Analysis	1978 - 1988
Analytical Techniques for Flood Control Planning	1979
Analytical Techniques for Formulation of Nonstructural Plans	1980 - 1981, 1983 - 1988
Spatial Data Management Techniques	1980 - 1981, 1983, 1985 - 1986
Planning for Hydrologic Engineers	1981, 1982, 1984, 1986, 1988
Planning Flood Loss Reduction	1982 - 1985, 1987

Hydrologic Probabilities	
Course Titles	Years
Streamflow Probabilities	1965
Hydrologic Probabilities	1967 - 1971, 1973, 1975 - 1976
Application of WRC Guidelines for Flood Flow Frequency Analysis	1967 - 1977
Flood Frequency Analysis	1979, 1981, 1984, 1986
Statistical Methods in Hydrology	1982, 1985, 1988

Flood Plain Hydrology

Course Titles	Years
Flood Plain Hydrology-Hydraulics Procedures	1968
Flood Insurance Hydrology	1971
Flood Plain Hydrology	1971 - 1979
Flood Plain Hydrology & Hydraulics	1982, 1984 - 1986, 1988
Flood Warning - Preparedness Programs	1988 - 1989

Hydropower

Course Titles	Years
Hydrologic Aspects of Hydropower Development	1971
Hydropower	1971 - 1978
Hydrologic Aspect of Hydropower	1979 - 1982, 1984, 1986
Hydropower Planning	1982 - 1984

Water Supply

Course Titles	Years
Ground Water Hydrology	1968 - 1971, 1979, 1982, 1984
Ground Water Quality	1971, 1988
Hydrologic Techniques for Determining Water Supply Potential	1978 - 1980
Water Supply Hydrology	1981 - 1983, 1985, 1987

**HEC Seminars Conducted
1965 - 1988**

Seminar Titles	Year
Reservoir Systems Analysis	1970
Sediment Transport in Rivers & Reservoirs	1970
Urban Hydrology	1970
Computer Applications in Hydrology	1971
Hydrologic Aspects of Project Planning	1972
Quality of Urban Storm Runoff	1973
Analytical Methods in Planning	1974
Real-Time Water Control Management	1976
Nonstructural Flood Control Measures	1976
Water Quality Data Collection & Management	1977
Variable Grid Resolution - Issues & Requirements	1977
Water Quality Data Interpretation	1978
Water Quality Evaluation	1980
Habitat Evaluation Procedure	1980
Two-Dimensional Flow Modeling	1982
Attaining Water Quality Goals Through Water Management	1982
Applications in Water Quality Control	1984
Water Quality R&D: Successful Bridging Between Theory & Applications	1986
Local Flood Warning-Response System	1987
Water Quality 1988	1988
Calibration & Application of Hydrologic Models	1988
Flood Damage Reduction Reconnaissance-Phase Studies	1988