



**US Army Corps
of Engineers**
Hydrologic Engineering Center

Regime Prescription Tool HEC-RPT

User's Manual

Version 1.0

September 2006

REPORT DOCUMENTATION PAGE

Form Approved OMB No. 0704-0188

The public reporting burden for this collection of information is estimated to average 1 hour per response, including the time for reviewing instructions, searching existing data sources, gathering and maintaining the data needed, and completing and reviewing the collection of information. Send comments regarding this burden estimate or any other aspect of this collection of information, including suggestions for reducing this burden, to the Department of Defense, Executive Services and Communications Directorate (0704-0188). Respondents should be aware that notwithstanding any other provision of law, no person shall be subject to any penalty for failing to comply with a collection of information if it does not display a currently valid OMB control number.

PLEASE DO NOT RETURN YOUR FORM TO THE ABOVE ORGANIZATION.

1. REPORT DATE (DD-MM-YYYY) July 2006			2. REPORT TYPE Computer Program Documentation		3. DATES COVERED (From - To)	
4. TITLE AND SUBTITLE Regime Prescription Tool HEC-RPT, User's Manual				5a. CONTRACT NUMBER		
				5b. GRANT NUMBER		
				5c. PROGRAM ELEMENT NUMBER		
6. AUTHOR(S) John T. Hickey				5d. PROJECT NUMBER		
				5e. TASK NUMBER		
				5f. WORK UNIT NUMBER		
7. PERFORMING ORGANIZATION NAME(S) AND ADDRESS(ES) US Army Corps of Engineers Institute for Water Resources Hydrologic Engineering Center (HEC) 609 Second Street Davis, CA 95616-4687				8. PERFORMING ORGANIZATION REPORT NUMBER CPD-84		
9. SPONSORING/MONITORING AGENCY NAME(S) AND ADDRESS(ES)				10. SPONSOR/ MONITOR'S ACRONYM(S)		
				11. SPONSOR/ MONITOR'S REPORT NUMBER(S)		
12. DISTRIBUTION / AVAILABILITY STATEMENT Approved for public release; distribution is unlimited.						
13. SUPPLEMENTARY NOTES						
14. ABSTRACT The Regime Prescription Tool (HEC-RPT) is a software tool designed to facilitate entry, viewing, and documentation of flow recommendations in real-time, public settings. HEC-RPT is primarily a visualization tool and is not intended to perform the detailed quantitative analyses (e.g., statistical analyses or reservoir and river routing) already performed by other software packages. Instead, HEC-RPT seeks to complement other software by making it easier to create flow times series that other software packages can import and use in their analyses. HEC-RPT will be available as an option from the Tools menu in version 4.0 of the reservoir simulation model HEC-ResSim and also has the ability to "stand alone" as an independent executable capable of accessing hydrologic data for reading, writing, and plotting data. Flow recommendations formulated in HEC-RPT can be exported to HEC-DSS (Data Storage System) and are thereby available for immediate analysis in other HEC software, including reservoir system simulation, river hydraulics, and ecosystem functions.						
15. SUBJECT TERMS Water management, flow regimes, instream flow analyses, environmental flow methods						
16. SECURITY CLASSIFICATION OF:			17. LIMITATION OF ABSTRACT Unlimited	18. NUMBER OF PAGES 36	19a. NAME OF RESPONSIBLE PERSON	
a. REPORT Unclassified	b. ABSTRACT Unclassified	c. THIS PAGE Unclassified			19b. TELEPHONE NUMBER	

Regime Prescription Tool HEC-RPT

User's Manual

Version 1.0

September 2006

US Army Corps of Engineers
Institute for Water Resources
Hydrologic Engineering Center
609 Second Street
Davis, CA 95616

(530) 756-1104

(530) 756-8250 FAX

www.hec.usace.army.mil

CPD-84

Table of Contents

Foreword.....	iii
Chapters	
1 Introduction.....	1-1
1.1 Purpose.....	1-1
1.2 Motivation.....	1-1
1.3 Sponsors.....	1-2
1.4 Programming Done By Utilization of Other Code.....	1-2
1.5 Software Details.....	1-2
2 Using HEC-RPT.....	2-1
2.1 Hierarchy of Terms.....	2-2
2.1.1 Project.....	2-2
2.1.2 System.....	2-2
2.1.3 State.....	2-2
2.1.4 Flow components.....	2-2
2.2 Starting or Accessing Projects.....	2-3
2.3 Naming the Systems.....	2-4
2.4 Defining States.....	2-4
2.4.1 Define state by name and year.....	2-6
2.4.2 Define state by scripting with time series.....	2-6
2.5 Populating Flow Recommendations.....	2-7
2.5.1 Adding low flows.....	2-7
2.5.2 Adding pulse and flood flows.....	2-8
2.6 Importing and Viewing Data.....	2-11
2.6.1 Main plot.....	2-12
2.6.2 Thumbnail plot.....	2-12
Predefined plots.....	2-12
All states for one system.....	2-12
One state for all systems.....	2-13
Multi-year traces.....	2-14
Percentile plots.....	2-14
2.6.3 Controls for the plots.....	2-15
2.6.4 Spin-off plots.....	2-16
2.6.5 Color management.....	2-17
2.6.6 XY Markers.....	2-17
2.7 Reporting.....	2-17
2.8 Data Management.....	2-19
2.9 Importers for Systems and Flow Components.....	2-19
2.9.1 Importing systems.....	2-20
2.9.2 Sharing flow components.....	2-21
3 Details about the Demonstration Project.....	3-1
4 References.....	4-1

List of Figures

Figure 2.1	Key components of the main interface. -----	2-1
Figure 2.2	Project, system, state and flow component structure. -----	2-2
Figure 2.3	Hydrograph separation into low, pulse, and flood flow components. ----	2-3
Figure 2.4	Menu option and interface for changing water year. -----	2-3
Figure 2.5	Menu option and interface for creating a new system. -----	2-4
Figure 2.6	Interface for "Define/Edit States". -----	2-5
Figure 2.7	Interface for "Assign Year State". -----	2-6
Figure 2.8	New states appear as colored lines along the X-axis of the main plot window. -----	2-7
Figure 2.9	Low flows are displayed for each state. -----	2-8
Figure 2.10	Menu option and interface for creating a new pulse or flood flow. -----	2-9
Figure 2.11	Date and flow ranges define an operation window for a recommended pulse (or flood) flow component. -----	2-9
Figure 2.12	Sample trace for the Demo Pulse. This trace has 7 peaks, each with the same magnitude but with different combination of timing, duration, and duration of peak. -----	2-10
Figure 2.13	Interface for importing DSS time series data. -----	2-11
Figure 2.14	Data list and DSS Selector button from main interface. -----	2-11
Figure 2.15	Menu options for the predefined plots. -----	2-12
Figure 2.16	Display for an "All States for one System" plot. -----	2-13
Figure 2.17	Display for a "One State for all Systems" plot. Wet state recommendations are plotted for three systems, Gravelly Riffles, Oxbow Flats, and Unified. -----	2-13
Figure 2.18	Options editor and plot display for a multi-year trace of two "average" years. -----	2-14
Figure 2.19	Options editor and display for a percentile plot. Percent non-exceedance lines are plotted for the 10, 50, and 90 percentiles. -----	2-15
Figure 2.20	Button controls for navigating plots. -----	2-16
Figure 2.21	XY Marker editor and use. -----	2-18
Figure 2.22	Excerpt of the System report for the Gravelly Riffles System. Text versions of report are available via the "Report – Save As" menu. ----	2-18
Figure 2.23	Menu option and interface for exporting flow recommendations to DSS. -----	2-19
Figure 2.24	Catalog of data exported for the Unified System. -----	2-20
Figure 2.25	Menu option and interface for importing systems. -----	2-20
Figure 2.26	Menu option and interface for importing flow components. -----	2-21
Figure 3.1	Project architecture for "Meandering River Demo.eco". -----	3-1

Foreword

The Regime Prescription Tool (HEC-RPT) is designed to help groups of scientists, engineers, and water managers access hydrologic data and draft flow recommendations while they formulate different ways to manage rivers.

HEC-RPT is the first joint software development by the U.S. Army Corps of Engineers and The Nature Conservancy. Development was undertaken in support of the Sustainable Rivers Project, which is an ongoing nation-wide partnership between the Corps and The Nature Conservancy to improve the health and life of rivers by changing the operations of Corps dams.

Development was performed at the Hydrologic Engineering Center (HEC), which is a division of the Institute for Water Resources, U.S. Army Corps of Engineers. Mr. John Hickey, HEC, Water Resource Systems Division, designed the software and managed its development. Mr. Shannon Newbold, Resource Management Associates (RMA), contributed to design and performed the programming. Mr. Andy Warner, The Nature Conservancy, contributed to design and led the Conservancy's participation. Ms. Mary Karen Scullion, Mr. Brad Bird, and Mr. Bruce Duffe, Portland District of the Corps, were instrumental in project initiation. Mary Karen led the District's participation. Mr. Chris Dunn helped manage the project and was Chief of the Water Resource Systems Division during development. Mr. Darryl Davis was Director of HEC during development.

CHAPTER 1

Introduction

1.1 Purpose

The Regime Prescription Tool (HEC-RPT) is a software tool designed to facilitate entry, viewing, and documentation of flow recommendations in real-time, public settings. HEC-RPT seeks to improve 1) communications in group settings by allowing real-time recording and plotting of the recommendations as they are developed and 2) the recommendations produced by making hydrologic information more immediately accessible to scientists, engineers, and water managers during the formulation process.

HEC-RPT is primarily a visualization tool and is not intended to perform the detailed quantitative analyses (e.g., statistical analyses or reservoir and river routing) already performed by other software packages. Instead, HEC-RPT seeks to complement other software by making it easier to create flow time series that other software packages can import and use in their analyses.

HEC-RPT will be available as an option from the Tools menu of the reservoir simulation model HEC-ResSim (version 4.0) and also has the ability to “stand alone” as an independent executable capable of accessing hydrologic data for reading, writing, and plotting data. Flow recommendations formulated in HEC-RPT can be exported to HEC-DSS (Data Storage System) and are thereby available for immediate analysis in other HEC software, including reservoir system simulation, river hydraulics, and ecosystem functions.

1.2 Motivation

The idea for this software was conceived during a Sustainable Rivers Project workshop for the Savannah River, where nearly 50 scientists worked together to formulate a set of flow recommendations designed to sustain the integrity of Savannah River ecosystems. The Sustainable Rivers Project partners the U.S. Army Corps of Engineers (Corps) and The Nature Conservancy in an ongoing effort to re-operate Corps dams to achieve more ecologically sustainable flows, while maintaining or enhancing project benefits. During the two-day workshop, sets of flow recommendations were created for three ecotypes of particular importance in the Savannah Basin (shoals, floodplain forest, and estuary). Each set was comprised of specified pulse, flood, and low flows for wet, average, or dry hydrologic conditions. After recommendations were prepared for the individual ecotypes, those three sets were unified into a single set of recommendations through the merging of features specified for each of the ecotypes.

Throughout this formulation and unification process, many hydrographs were created, discarded, and morphed. Facilitators were pressed to track all of the recommendations and lacked an easy way to present results electronically. It was noted that a tool capable of rapidly displaying, adjusting, and documenting hydrographs would make the formulation process easier and, if it were also capable of accessing and plotting historical hydrologic data to guide the scientists upon their request, then the product as well as the process would be improved.

1.3 Sponsors

HEC-RPT is the first joint software development by the Corps and The Nature Conservancy. Development costs (through the first release version) were shared between the Hydrologic Engineering Center of the Corps, the Portland District of the Corps, and The Nature Conservancy.

1.4 Programming Done By Utilization of Other Code

HEC-RPT progressed from an idea to a functional software tool in less than 8 months. This rapid development was made possible in part by the integration of several components already developed for other HEC software, including plotting windows and a database interface from HEC-DSSVue (Corps 2005) and an interface for scripting with time series from HEC-ResSim (Corps 2003). Without these components, HEC-RPT development would have been a much longer process and likely beyond the funding capacity of the sponsors.

1.5 Software Details

HEC-RPT is programmed in Java and is compatible with Windows 98, ME, NT, 2000, and XP. Using HEC-RPT requires use of HEC-DSSVue, but a copy of that software has been embedded in the HEC-RPT code and is part of the install package. Therefore, HEC-RPT does not require installation of any other software to be functional. The installation file and documentation are available for download at www.hec.usace.army.mil/software/. The executable and supporting files are installed to the default directory: C:\Program Files\HEC\HEC-RPT\. The demonstration project and supporting files are installed to a user specified directory via the software's "Help – Install Demonstration Project..." menu option.

CHAPTER 2

Using HEC-RPT

HEC-RPT is designed to be as simple as possible, while providing users with a tool for creating flow recommendations and viewing historical data that is flexible enough to accommodate a range of formulation approaches used in group settings. In HEC-RPT, the basic framework for flow recommendations is that flows are 1) created for different subjects of interest, 2) related to a hydrologic condition or season, and 3) expressed as combined time series of low flows, pulse flows, and flood flows. Figure 2.1 shows the components and controls of the main interface.

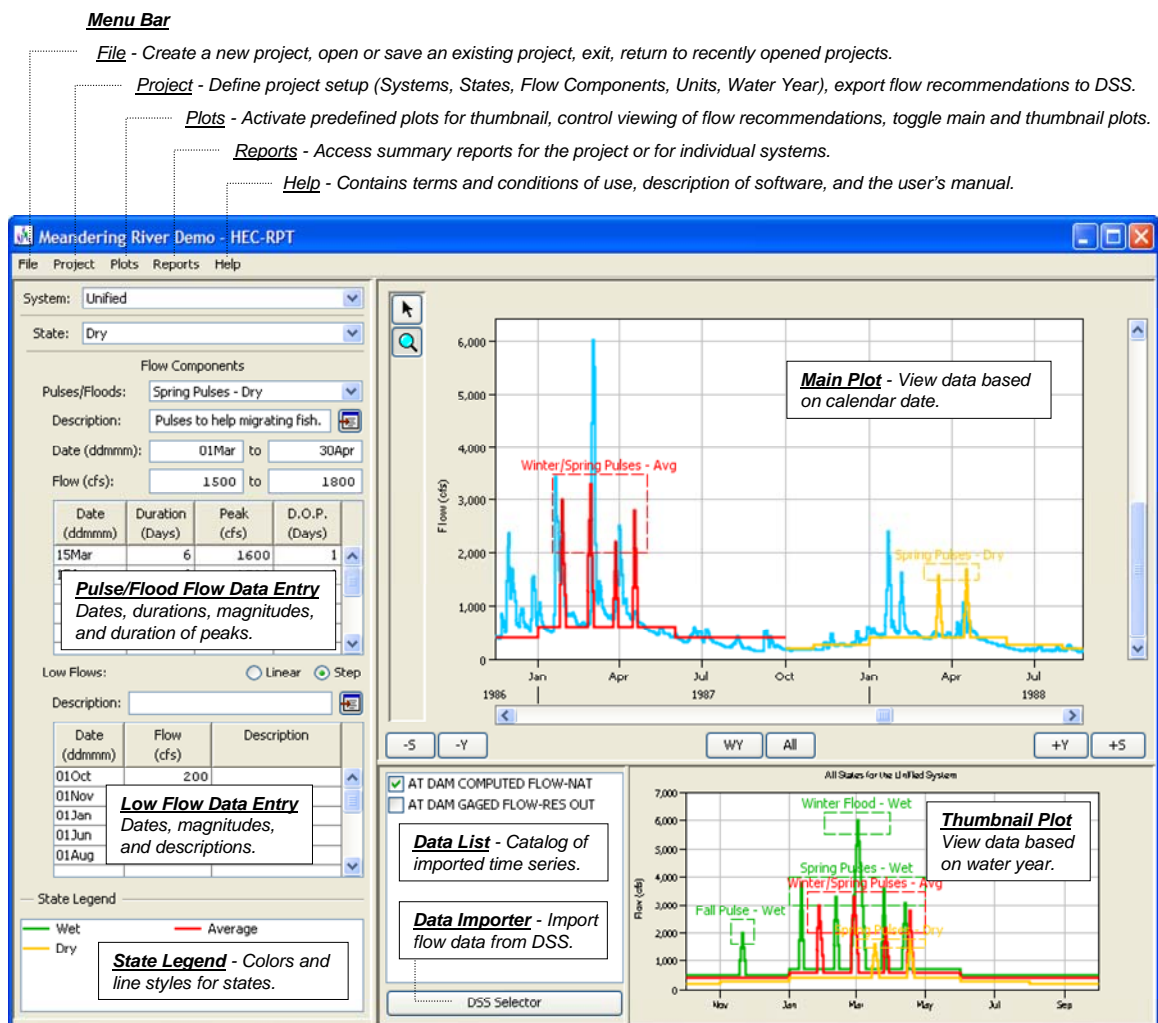

Figure 2.1 Key components of the main interface.

2.1 Hierarchy of Terms

2.1.1 Project

"Project" refers to the whole suite of flow recommendations, historical data, and hydrologic methods used during formulation and any ensuing refinement of flow recommendations (Figure 2.2). A project is typically defined in terms of a long stretch of river that has an independent (or nearly so) set of management strategies and infrastructure. Where a single set of reservoirs is used to manage waters of a whole basin, a single project is often used to encompass all flow recommendations for that basin.

2.1.2 System

"System" is the term used to describe a subject of interest for which flows will be recommended. There tends to be multiple systems within one project and there is no limit to the number of systems per project. A system may refer to a location on a river - such as an important gage location, or to an important ecosystem connected to the river - such as a floodplain forest community, or to a guild of creatures - such as fishes, or to different points of view for river management - such as water supply, hydropower operations, or recreation.

2.1.3 State

"State" refers to a prevailing hydrologic condition or season that is associated with a set of flow recommendations. There tends to be multiple states within one project and there is no limit to the number of states per project. The same set of states is used for all systems in a project. A sample set of three states is: wet, average, and dry. Flow recommendations are prepared for each state in each system.

2.1.4 Flow components

"Flow components" are the building blocks of a recommended flow time series. There are three types of flow components - low flows, pulse flows, and flood flows (Figure 2.3). Low flows are the foundation of the time series. Low flows are defined for each

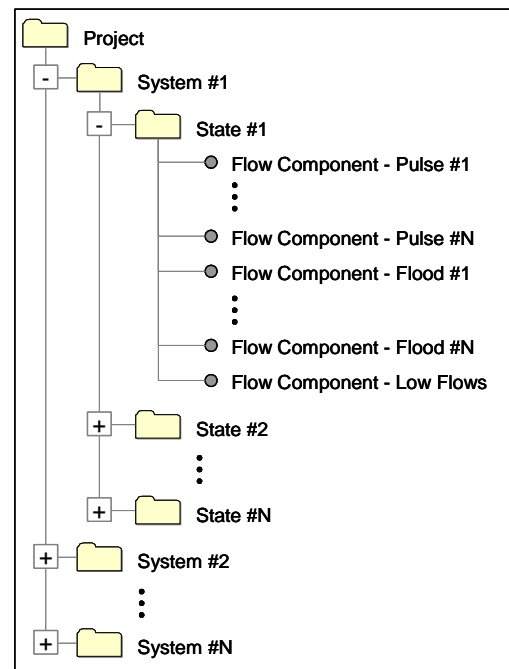

Figure 2.2 Project, system, state and flow component structure.

day in a water year (for each state in each system). Pulse flows and flood flows deviate from this base. A flow recommendation (for one state in a system) can have many pulses and floods, but only one series of low flows. Both pulses and floods are defined by timing, duration, magnitude, and duration of peak. This building block approach was developed by The Nature Conservancy (Richter et al. 2005) and was adapted in part from the "Building Block Methodology" (King et al. 2000) and the "Holistic Approach" (Arthington et al. 1992) methods for defining environmental flows, which were formalized and first used in South Africa and Australia in the 1990's.

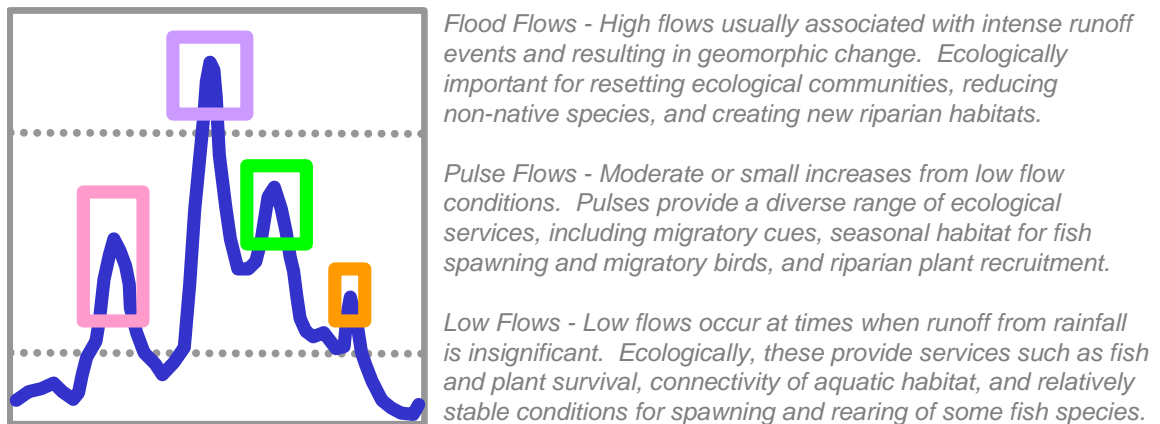

Figure 2.3 Hydrograph separation into low, pulse, and flood flow components.

2.2 Starting or Accessing Projects

Project creation and use in HEC-RPT follows the same procedures as common windows-based software. HEC-RPT can be activated from the Start menu ("Start – All Programs – HEC – HEC-RPT") or by double-clicking on the executable (.exe) file, on any shortcuts that target that executable, or on an existing project file (if the extension ".eco" has been associated with the program). Once the software is activated, project files can be saved, saved as, or new files can be created.

Each project has a user-defined water year. The default water year for HEC-RPT begins October 1 and ends September 30. To change this setting, go to the "Project – Define Water Year..." menu and enter a different start and end date (Figure 2.4).

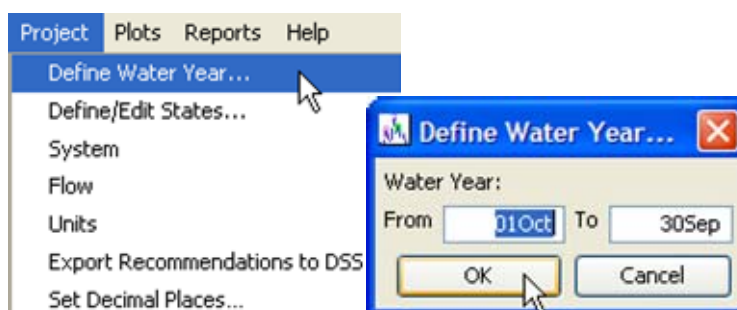

Figure 2.4 Menu option and interface for changing water year.

The basic sequence when a new project is being created follows: 1) name the systems, 2) define the states, and 3) populate the flow recommendations. At any time, historical data can be brought into the project to serve in the formulation process.

2.3 Naming the Systems

Systems are managed via the "Project – System" menu. This menu offers options to create new systems, rename, duplicate, or delete existing systems, and import systems from other projects (Figure 2.5).

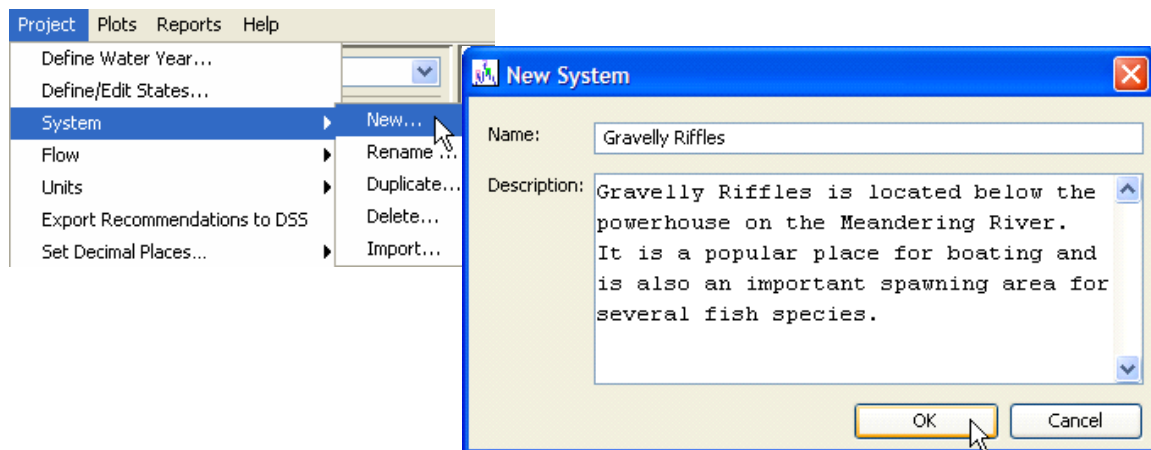

Figure 2.5 Menu option and interface for creating a new system.

All projects have an inherent system called "<Default>" that acts as a place holder for new projects, thereby allowing users to define states and even populate flow recommendations before creating new systems. However, because it is intended to be only a place holder, the default system has limited utility in HEC-RPT. If flow recommendations have been created for the default system and the user would like to use a feature not supported for the default system, then a new system can be created and flow components of the default system can be imported to the new system.

Details on importing systems and flow components are provided in the "Importers for Systems and Flow Components" section of this manual.

2.4 Defining States

There are two methods for defining states: 1) Define by name and year and 2) Define by scripting with time series. Selection of method is controlled by the radio buttons located to the left of the method titles (Figure 2.6). Only one method may be active; however information entered by the user for either option is stored to allow users to test or alternate between methods. The Define/Edit States editor is accessed via the "Project – Define/Edit States..." menu selection.

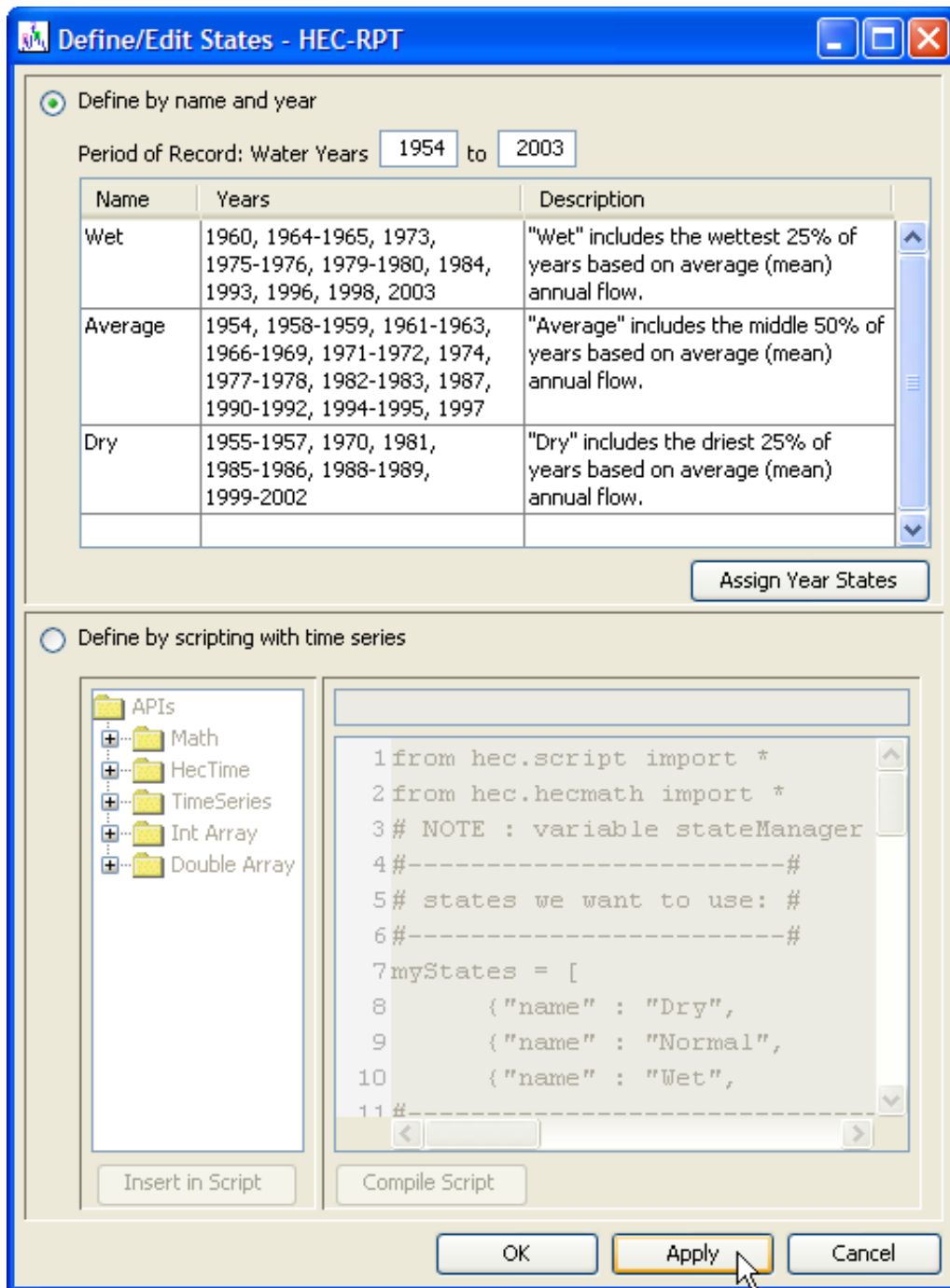

Figure 2.6 Interface for "Define/Edit States".

As settings are entered for defining states, that information can be applied to the Project by clicking the Apply button or the OK button, which applies the changes and closes the editor.

The demonstration project included as part of the HEC-RPT installation package contains information for both methods of defining state.

2.4.1 Define state by name and year

The "Define by name and year" method allows users to create states and then associate different water years with those states. In this method, each water year is represented by a single state. After states are entered into the "Name" column in the table, water years can be assigned to a state by either typing them into the "Years" column in the table or by clicking on the "Assign Year States" button, which offers drop down lists of states for each water year within the user-defined period of record (Figure 2.7). Flow recommendations will be plotted only within this period of record.

In the demonstration project, three states (Wet, Average, and Dry) were used and water years within the period of record were assigned to a state based on annual average flow (i.e., the wettest fourth (25%) of years in the period of record was classified as "Wet", the middle half (50%) as "Average", and the driest fourth (25%) as "Dry").

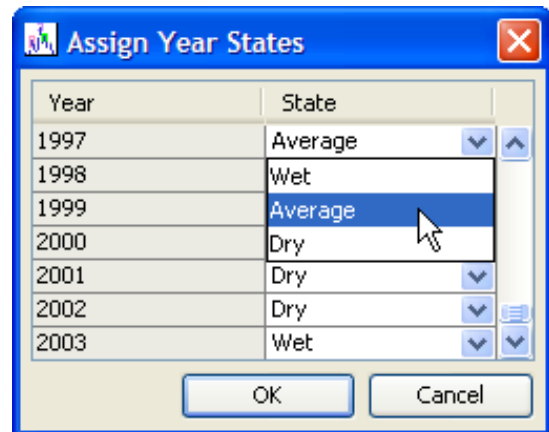

Figure 2.7 Interface for "Assign Year States".

2.4.2 Define state by scripting with time series

The "Define by scripting with time series" method involves scripting Jython code to set a period of record, import time series of data, perform calculations with those time series, and, ultimately, to use a logic statement to determine state (e.g., if X is less than 2, then state equals "Dry"). As many types of time series and computations can be used in scripting, this method opens up an unlimited number of ways to define state and allows HEC-RPT to assess scenarios from a perspective more akin to water management operations where hydrologic conditions can change many times over the course of a water year.

While this method offers a great deal of flexibility and power in defining states, it can also be complicated. Jython is an implementation of the computer language Python that has been adapted for use with Java. In other words, using Jython is essentially the same as writing computer code.

The demonstration project assigns a state to each day in the period of record by comparing that day's recent unimpaired flows (computed as a 90-day backward looking average) to the historical distribution of unimpaired flows for that calendar day (90-day averages for that calendar day were computed for many historical water years, which were then used to define a distribution). In this case, unimpaired is a term used to describe flow conditions without man-made effects.

For more information about creating and using scripts, please refer to Chapter 7 of the HEC-DSSVue User's Manual (Corps 2005).

2.5 Populating Flow Recommendations

As states are defined (and applied) a line along the X-axis of the main plot will appear. The colors of this line represent the different states and times within the period of record when a given state is in effect (Figure 2.8). Details about assignment and changing of colors are provided in the “Color management” section of this manual.

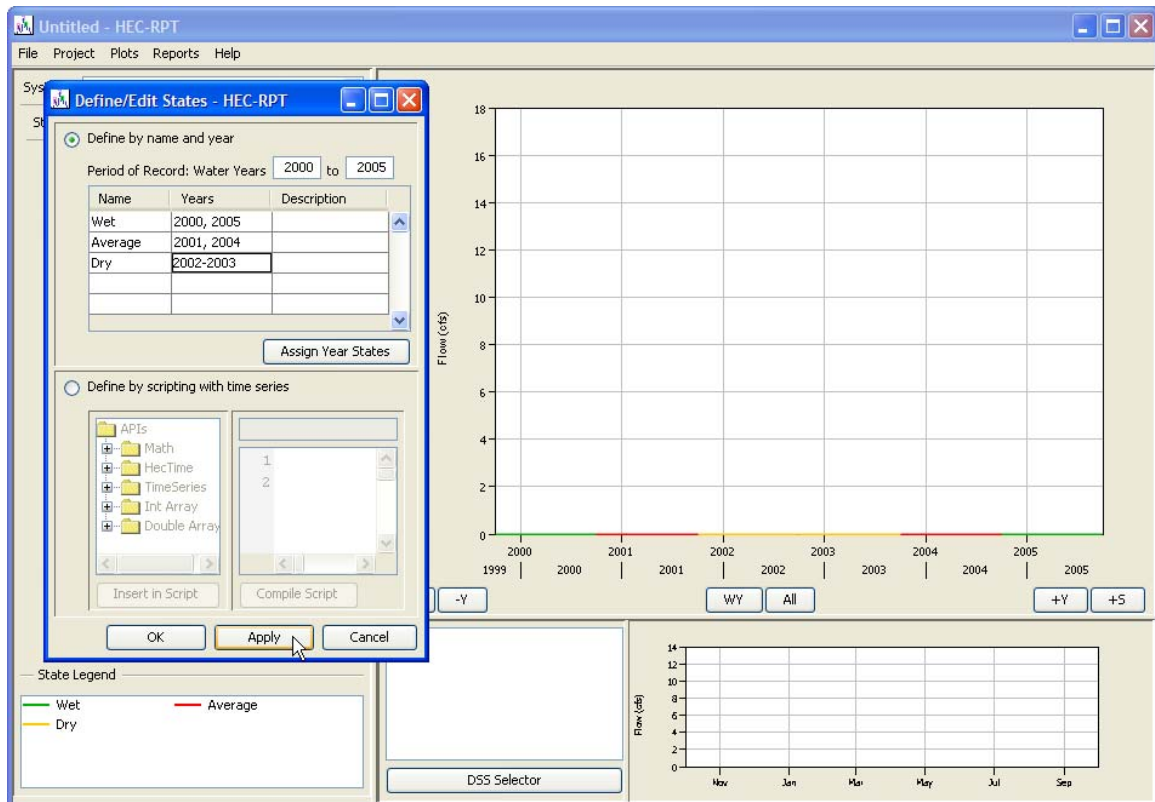

Figure 2.8 New states appear as colored lines along the X-axis of the main plot window.

When all time within the period of record has been assigned to a state, the colored line will appear continuous and represents a set of unpopulated flow recommendations.

2.5.1 Adding low flows

Low flows are assigned to each day of the water year for each state in each system. Low flow points (combinations of date and flow value) are entered into the low flow table. HEC-RPT will interpolate between these known points using either a linear method, which connects known points with a straight line of average daily low flows, or a step method, which holds low flows at the value of the last known point until the date of the next point is reached and then low flows step up or down to the flow value of that next point. Description fields are provided for the whole low flow category, where general approaches can be documented, as well as for the individual low flow points, where strategies for different points can be detailed. Choice of method is controlled by the radio buttons in the "Low Flows" area of the user interface (Figure 2.9).

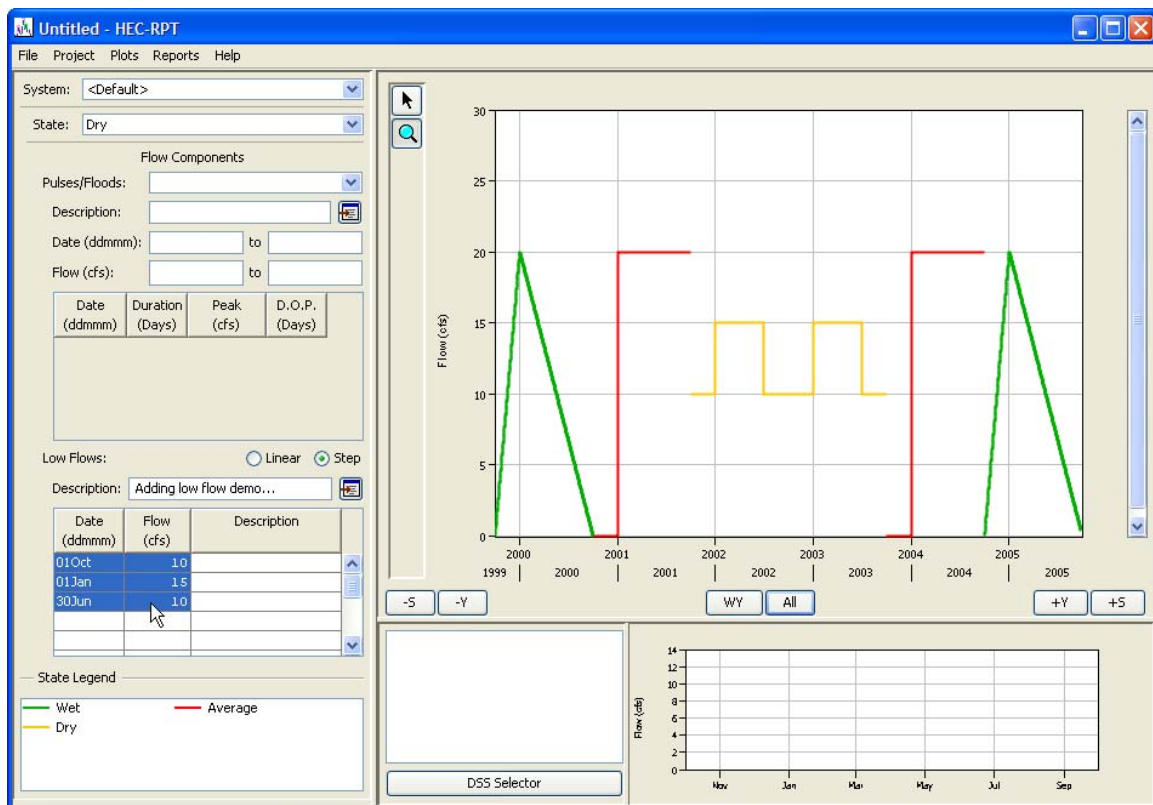

Figure 2.9 Low flows are displayed for each state.

Dry year values are highlighted in the figure and plotted in orange. Wet years (in green) and average years (in red) each have only one data point, 20-cfs on 01Jan. The difference between the two is that wet is using the linear interpolation method and average is using the step interpolation method.

To support plotting of low flows, zero flow points are used at the start of each water year for the step method and at the start and end of each water year for the linear method. To avoid seeing these zero points in plots, low flows for those dates need to be specified in the table.

2.5.2 Adding pulse and flood flows

Pulse and flood flows are managed via the “Project – Flow” menu option. This menu offers options to create new flows, rename, duplicate, or delete existing pulses and floods, and import flow components from other systems and states.

When "New..." is selected, a window opens that has a text entry field for name of new flow and a set of radio buttons to specify whether the new flow is a pulse or a flood (Figure 2.10). From a software perspective, there is no difference in the parameters that characterize pulses and floods – both are defined by name, range of possible dates and flows (a.k.a., graphical window), and a trace of the recommendations defined by date of start, duration, peak, and duration of peak. However, pulses and floods are catalogued

and reported as separate flow components in HEC-RPT because of their different physical and ecological effects.

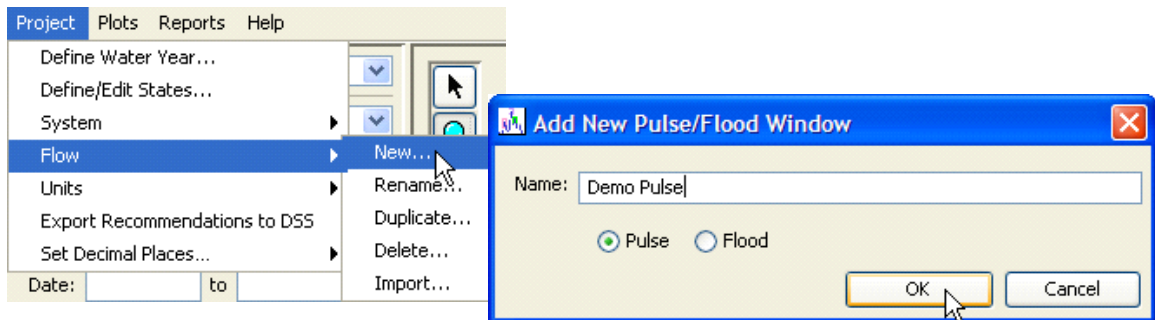

Figure 2.10 Menu option and interface for creating a new pulse or flood flow.

Settings for the pulse-flood parameters are entered into the flow components area of the HEC-RPT interface. Most parameters are for specifying the pulse-flood window and the pulse-flood trace (Figure 2.11). The window defines the date and flow ranges for a given pulse-flood (e.g., this pulse can occur anytime between 15Jan and 30Apr and be between 30- and 35-cfs). The trace is a single realization of that pulse event (e.g., plot a pulse that begins 30Jan, lasts 1-day, peaks at 30-cfs, and has a 1-day peak.)

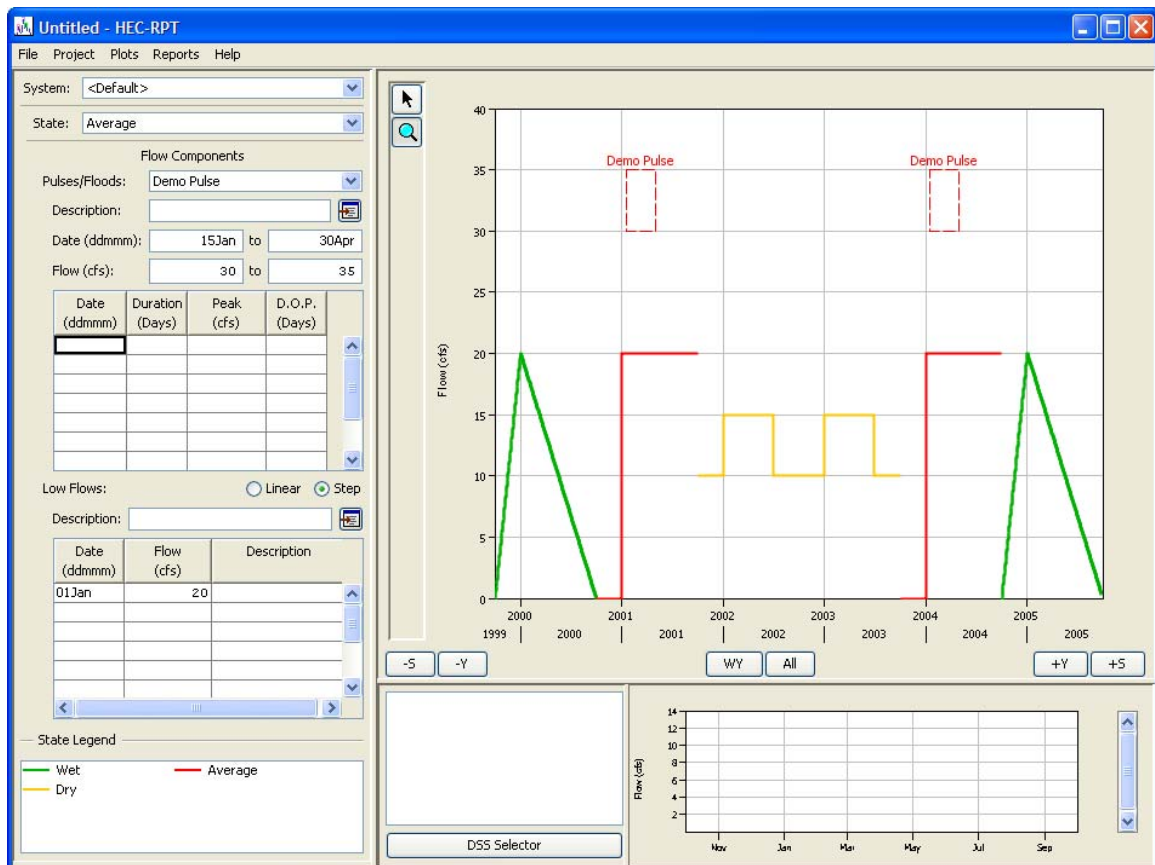

Figure 2.11 Date and flow ranges define an operation window for a recommended pulse (or flood) flow component.

Traced pulse-floods deviate from the low flow called for at the beginning of the rise and return to the low flow called for at the end. Between these points, the peak is as triangular as possible; when the duration and duration of peak do not allow a symmetric triangular peak, the extra day is added to the receding limb (Figure 2.12).

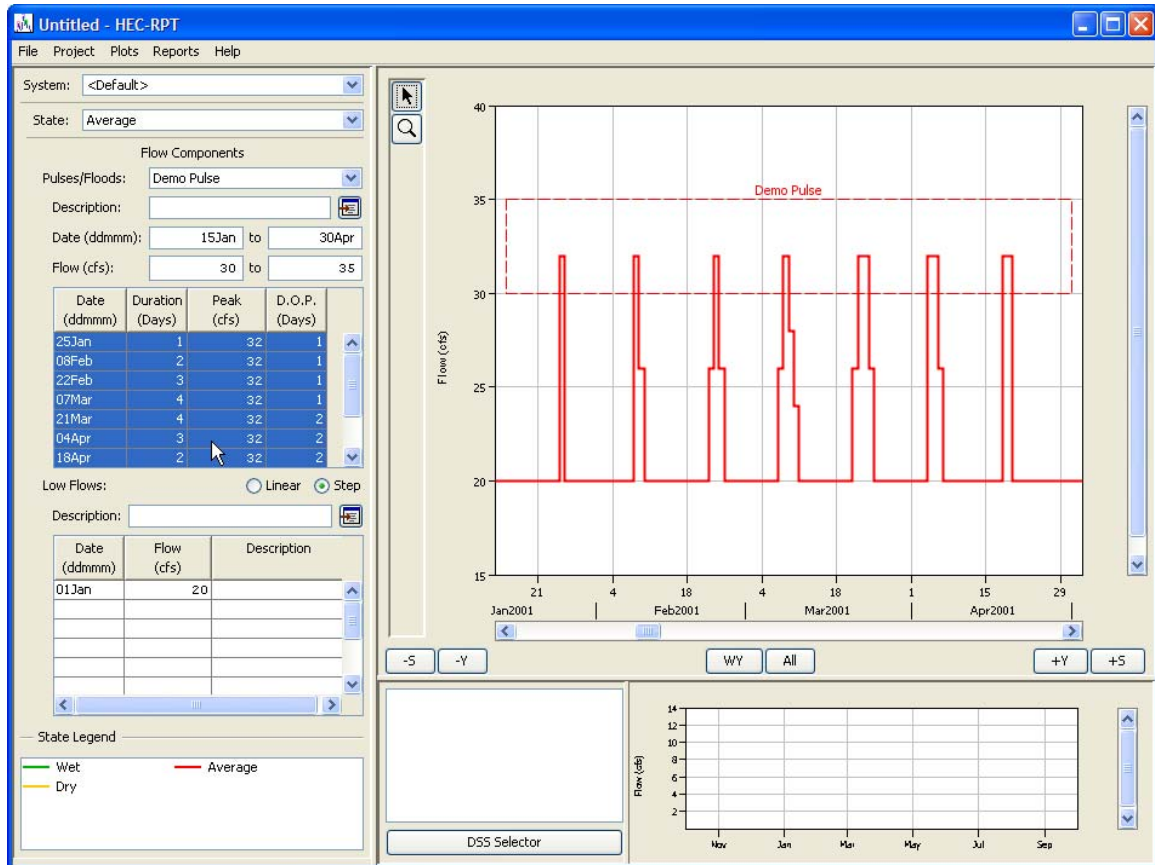

Figure 2.12 Sample trace for the Demo Pulse. This trace has 7 peaks, each with the same magnitude but with different combination of timing, duration, and duration of peak.

Traces can have multiple peaks for a single pulse-flood window. Overlapping departures from low flow will create oddities in the plotting of the traces and the output of the traced time series. Users are encouraged not to overlap multiple peaks within the same window. In the case of overlapping peaks in different windows, the trace will reflect the highest value required for each day being plotted.

Pulse-flood flows can also deviate from low flow towards zero, which might be useful in states that call for episodic extreme low flows. However, downward pulse-flood flows that fall to exactly zero will create errant data points in the output. Users are cautioned to have positive non-zero values as minima for inverted peaks (0.1-cfs or any small value would suffice).

2.6 Importing and Viewing Data

Data are imported to HEC-RPT projects from DSS files. Data in DSS are stored according to pathnames. These pathnames have six parts (a/b/c/d/e/f). Each pathname part represents a different characteristic of the data. Typically, a-part names the river, b-part names the location, c-part names the type of data (e.g., flow), d-part lists the start date of the data (or its period of record when viewing a condensed catalog as shown below), e-part notes the time step interval, and f-part is reserved for a user-defined tag.

The browser that accesses DSS files and allows users to select data to import is activated by clicking on the DSS Selector button. DSS files can be opened through this interface by clicking on the open folder icon in the upper left or via the "File – Open" menu. Data in the DSS file can be imported by highlighting the pathname of the data and clicking the Set Pathname button at the bottom of the browser (Figure 2.13).

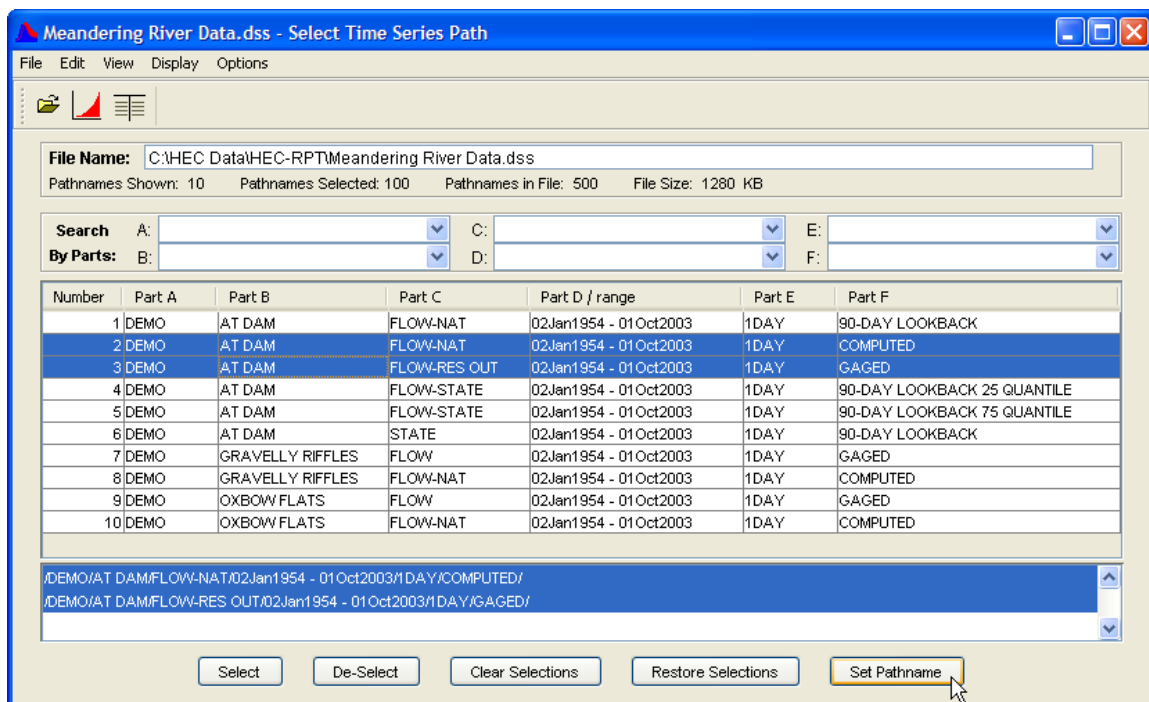

Figure 2.13 Interface for importing DSS time series data.

When imported, the time series will be plotted in the Main Plot window and shown as active in the window (b-, f-, and c-parts are listed) above the DSS Selector button. To hide the data while leaving it in the project, deactivate the pathname by un-checking its check box. To remove data from the project, right click on the pathname and select "Remove" (Figure 2.14). Currently, only flow data (regular and irregular series) for a wide range of time steps (1-min to yearly) may be imported.

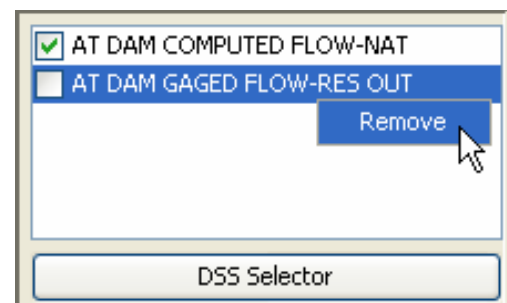

Figure 2.14 Data list and DSS Selector button from main interface.

The ability to plot and navigate hydrologic data is a strength of HEC-RPT. The software has two plot windows. Within these windows reside the main plot and the thumbnail plot. The main plot is inherently viewed in the upper right hand plot window and the thumbnail in the lower right, but their positions can be toggled via the "Plots – Toggle" menu option or by pressing the CTRL-T keys.

2.6.1 Main plot

The main plot displays time series based on *calendar date*. Imported time series are attached to a system. The range of time plotted for a system is bracketed with the earliest start and latest end dates of all time series imported or the period of record specified in the Define/Edit States editor. Flow recommendations entered for a system and state will populate this plot automatically.

2.6.2 Thumbnail plot

The thumbnail plot displays time series based on a 12-month *water year*, independent of calendar date. Several plot types are available via the "Plots – Predefined Plots" menu option, each focusing on a different perspective of the flow recommendations and historical data. As in the main plot, when a flow recommendation is entered, the selected thumbnail plot will display the change automatically (if the affected recommendation is part of the predefined plot option being displayed).

Predefined plots

Four different types of predefined plots are available via the "Plots – Predefined Plots" menu, including 1) multi-year traces, 2) all states for one system, 3) one state for all systems, and 4) percentile plots (Figure 2.15). The selected plot will remain in view until replaced by the user with a different predefined plot.

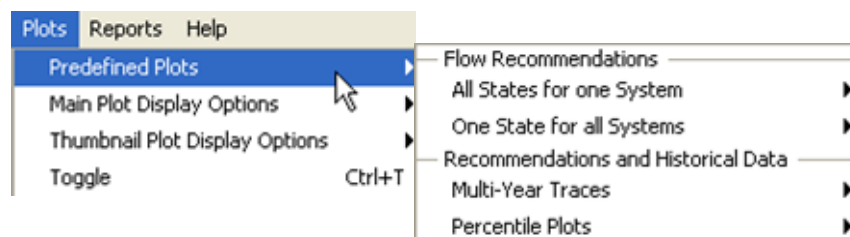

Figure 2.15 Menu options for the predefined plots.

All states for one system

This plot option displays flow recommendations for all states in a single system (Figure 2.16). This allows users to compare recommendations for the full range of states, which is typically a reflection of the spectrum of hydrologic conditions.

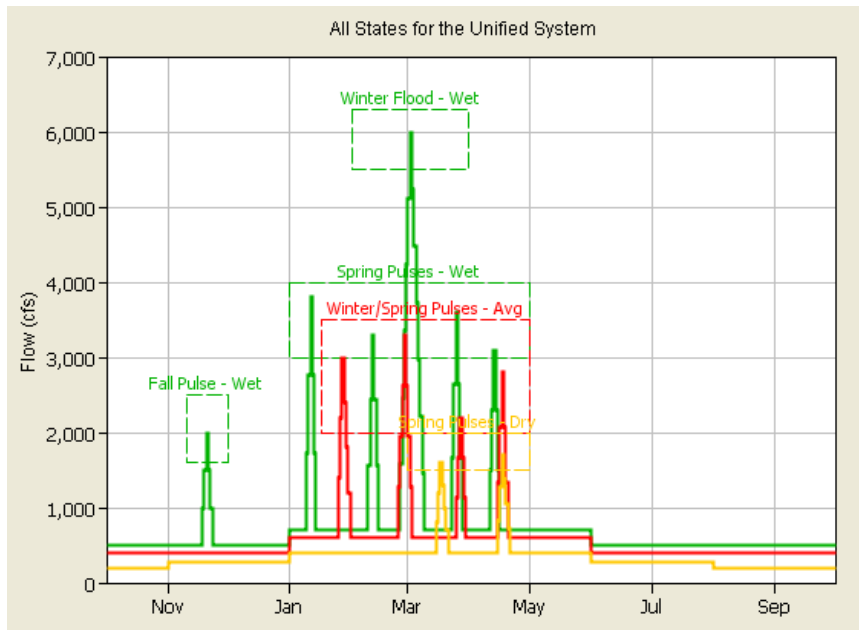

Figure 2.16 Display for an "All States for one System" plot.

One state for all systems

This plot option displays flow recommendations for a single state for all systems in the project (Figure 2.17). This allows users to compare state-based recommendations for different locations or guilds of creatures, which could be useful when merging or unifying different river management perspectives into a single set of recommendations.

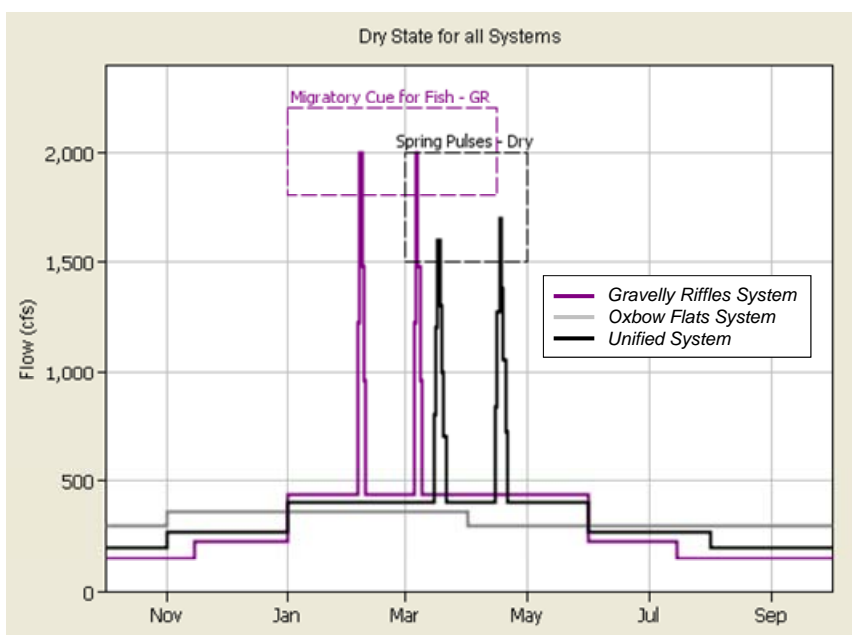

Figure 2.17 Display for a "One State for all Systems" plot. Wet state recommendations are plotted for three systems, Gravelly Riffles, Oxbow Flats, and Unified.

Multi-year traces

Multi-year traces display historical years of the same state over the same generic water year period. This allows users to investigate similarities and differences between years of the same state while formulating flow recommendations for that state.

The multi-year option is available only when state is defined by name and year. Plots are selected according to system and state. When selected, the user sets the time series to be plotted using the dropdown list of pathnames at the top of the options editor and has two options for displaying the plot. The first option is to plot a fixed number of historical years. The second is to plot specific historical years that are listed for the already selected state. If a fixed number of years are selected, the user will have the option to scroll through different years of that state by right clicking on the thumbnail and selecting the +1 and -1 year menu options.

Figure 2.18 shows the Multi-Year Options editor that appears when the user selects a multi-year trace through the “Plots - Predefined Plots” menu. Based on the settings in the figure, a multi-year trace with two historical years (fixed number of years option) of the AT DAM/FLOW-NAT time series would be plotted. The two historical years would be 1954 and 1958, which are the first two years classified as “Average” (Figure 2.6). Selecting +1 would change the years displayed to 1958 and 1959.

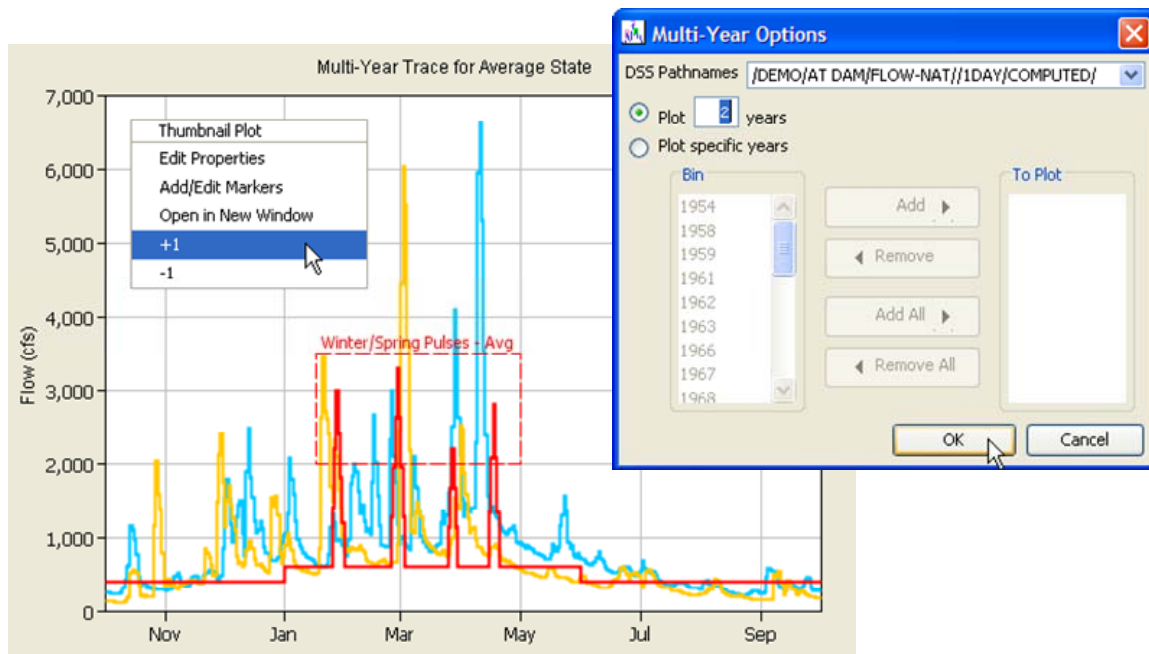

Figure 2.18 Options editor and plot display for a multi-year trace of two "average" years.

Percentile plots

Percentile plots show how river flows on any given date (day/month) are distributed. For instance, these plots can show river flows on 01Jan are above a certain flow rate in half of the historical years (50%). Plotting this percentile with other percentile lines

helps to clarify seasonal flow patterns and show the commonality of different magnitude flows.

Plots are selected according to system and state. When selected, the user sets the time series to be analyzed using the dropdown list of pathnames at the top of the options editor and presses the Compute button located below the dropdown list. Eleven different data sets are computed. The user selects all or a subset of these data sets for viewing. Clicking OK causes the selected data sets to be plotted (Figure 2.19).

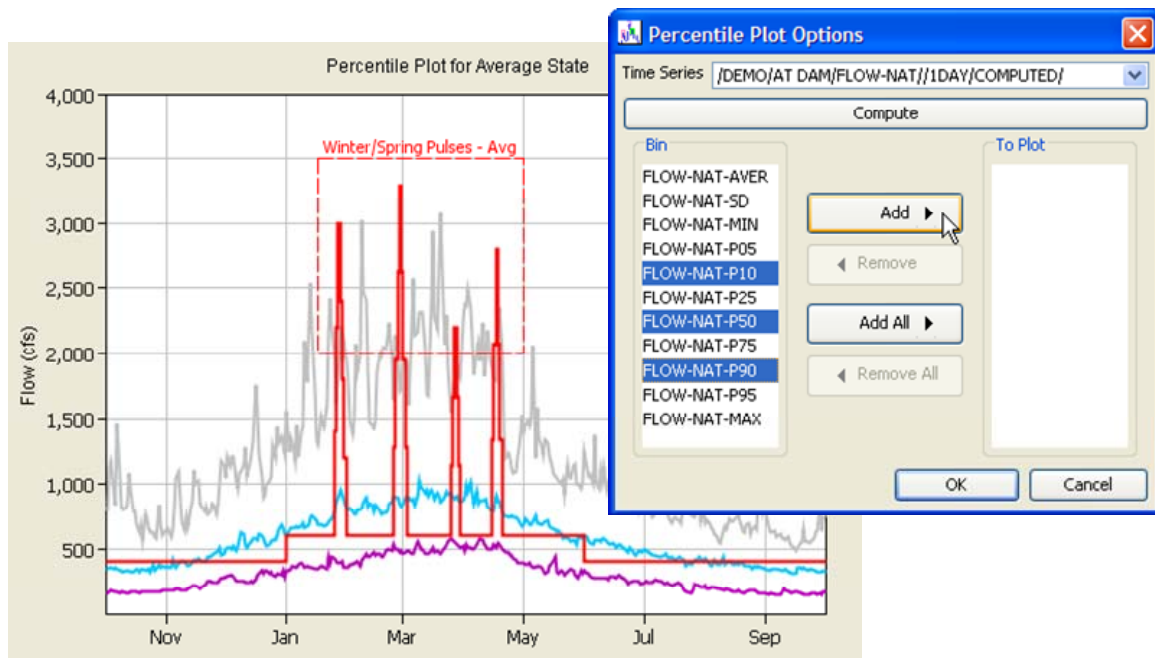

Figure 2.19 Options editor and display for a percentile plot. Percent non-exceedance lines are plotted for the 10, 50, and 90 percentiles.

2.6.3 Controls for the plots

A variety of controls are provided to facilitate use of the plot windows. Menu controls are available via the "Plots – Main Plot Display Options" and the "Plots – Thumbnail Plot Display Options" menus. These menus allow users to show or hide graphical windows, window labels, and flow recommendations in the plots and to prevent labels from overwriting. Tool buttons include pointer and zoom, located to the left of the upper plot window, and All, WY, +/- Y, and +/- S, which are located below the upper plot window (Figure 2.20). The main interface of HEC-RPT (Figure 1) has an upper and lower plot window. The user determines which of these windows displays the Main Plot and which displays the Thumbnail Plot by toggling via the "Plots – Toggle" menu option or by pressing the CTRL-T keys. In Figure 2.20, the Main Plot is being displayed in the upper window.

The pointer tool (identified as an arrow) is used to access right click menus associated with the upper and lower plots and to simply serve as a mouse controlled pointer. The zoom tool (identified as a magnifying glass) is used to zoom in and out of the plot in the

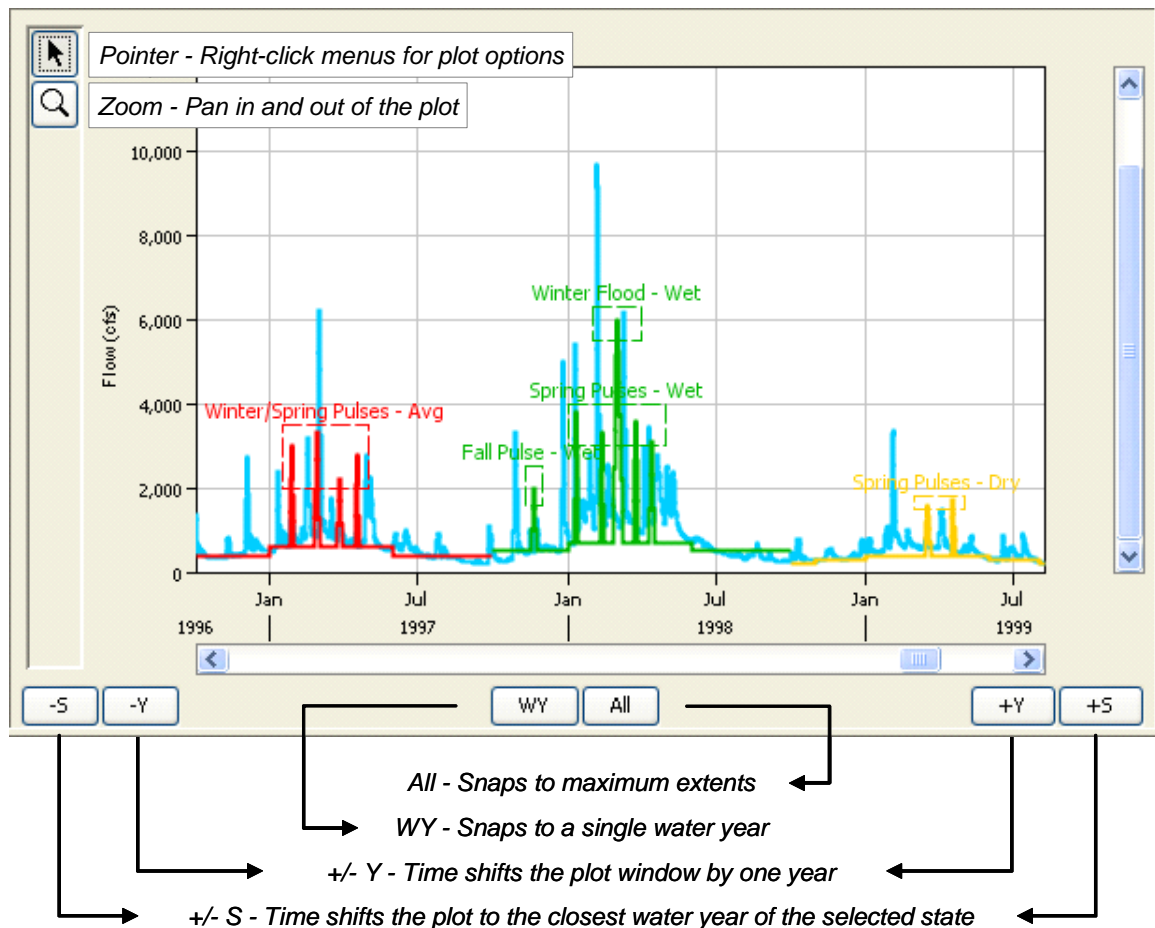

Figure 2.20 Button controls for navigating plots.

upper plot window. To zoom in, click on the plot and hold down the left mouse button. Move the mouse to draw a box. When the box covers the plot area of interest, release the mouse button. The plot window will change to show the area of interest. To zoom out, right click on the plot.

The All, WY, +/-Y, and +/-S buttons are controls for the Main Plot regardless of which plot window (upper or lower) it is in. If All is pressed, the main plot zooms out to its maximum extents. If WY is pressed, the main plot snaps to a view for a single water year. If more than one year is being viewed, when WY is pressed, then the plot snaps to the first water year of that view. If less than a full year is being viewed, then the plot snaps to the full water year. The +/-Y buttons advance/reverse the plot window by one water year. The +/-S buttons plot the next/previous water year of the state that is active in the state dropdown list in the upper left of the interface (this button is functional only when state is defined by name and year).

2.6.4 Spin-off plots

There is an option to "spin-off" copies of plots into separate, stand-alone windows. This option was added to enable different hydrologic plots to be maintained while the user creates new views using the plot windows embedded in the HEC-RPT interface.

To spin-off a plot, use the pointer tool, right click on a plot, and select the "Open in New Window" menu option. Plots that are spun-off may be saved in a number of formats (e.g., .jpg and .ps) for easy import to presentations and documents.

2.6.5 Color management

Colors are assigned to new time series on a first come - first serve basis using a standard set of eight colors. When all eight colors are used, the color sequence simply begins again and repeats indefinitely. Each state is assigned a color, which applies to its flow recommendations, graphical windows, and window labels for all systems in the project. Also, all instances of a single referenced time series use the same color. If the color of one of these instances or one state trace is changed by the user, then that change is applied to all instances or all traces for that state throughout the project.

The only exception to this rule is for the "One state for all systems" thumbnail plot. In this plot, visual differences between the systems are enhanced by assigning different colors to each system-state series. Color changes in this plot will not affect other plots and, conversely, color changes in other plots will not affect this thumbnail.

To change colors, use the pointer tool and move the pointer over the target time series in the plot. Right click and select "Edit Properties". Color, as well as line style, fill, and line symbols, can be changed.

2.6.6 XY Markers

Markers can be added to the main and thumbnail plots by right clicking on the plot window and selecting "Add/Edit Markers". An editor will appear that offers menu options to add new, duplicate, or delete a marker. For the main plot, markers are associated with a system and a state (or all states – as shown in Figure 2.21). For the thumbnail, markers are associated with individual predefined plot types (or all plots).

Markers can be applied to the plots iteratively by clicking on the Apply button or by clicking the OK button to apply the marker and close the editor. Markers can be used to delineate key times of the year, flow thresholds, or any other aspect of the plot window that might be of importance. Markers consist of lines, shading, and labels, all of which are controlled through the Add/Edit Markers editor. In Figure 2.21, the main plot shows three separate markers (Max Hydropower, Max Channel Capacity, and Peak Hurricane Season).

2.7 Reporting

HEC-RPT generates summaries of systems, states, and flow components that can be saved as text files. Reports can be generated for individual systems or for the whole project via the "Reports" menu (Figure 2.22).

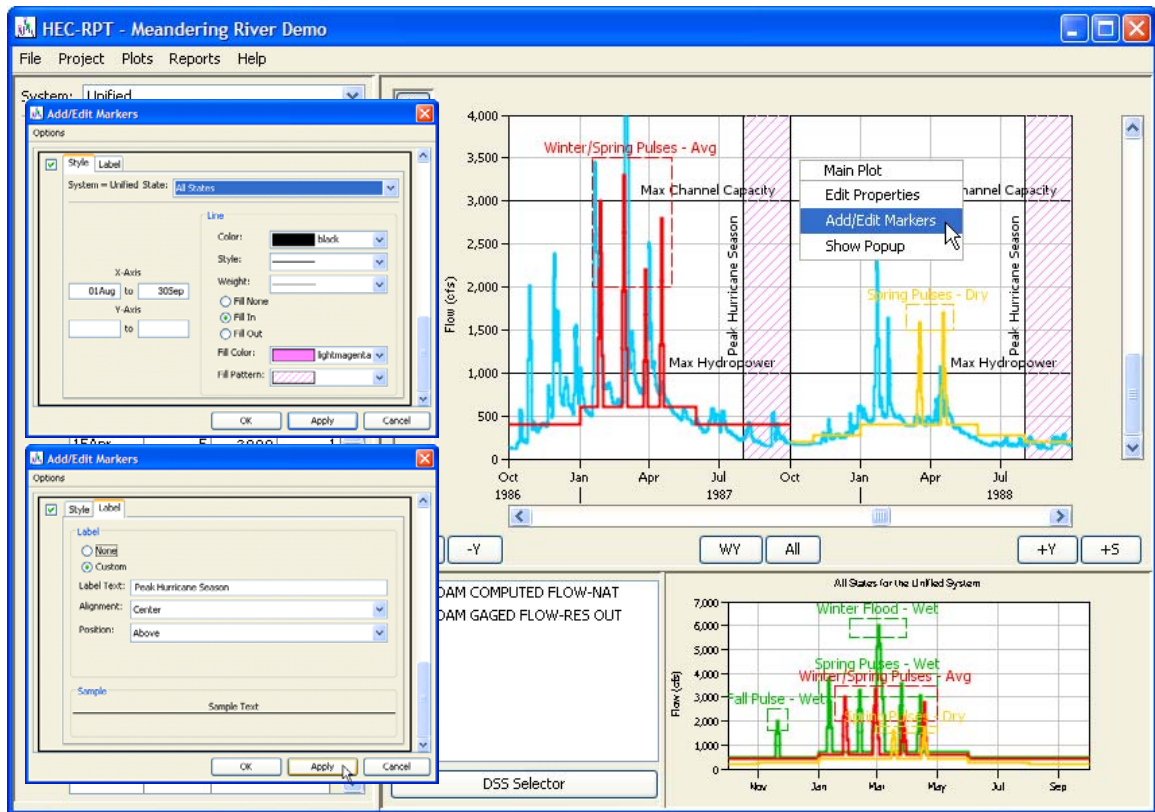

Figure 2.21 XY Marker editor and use.

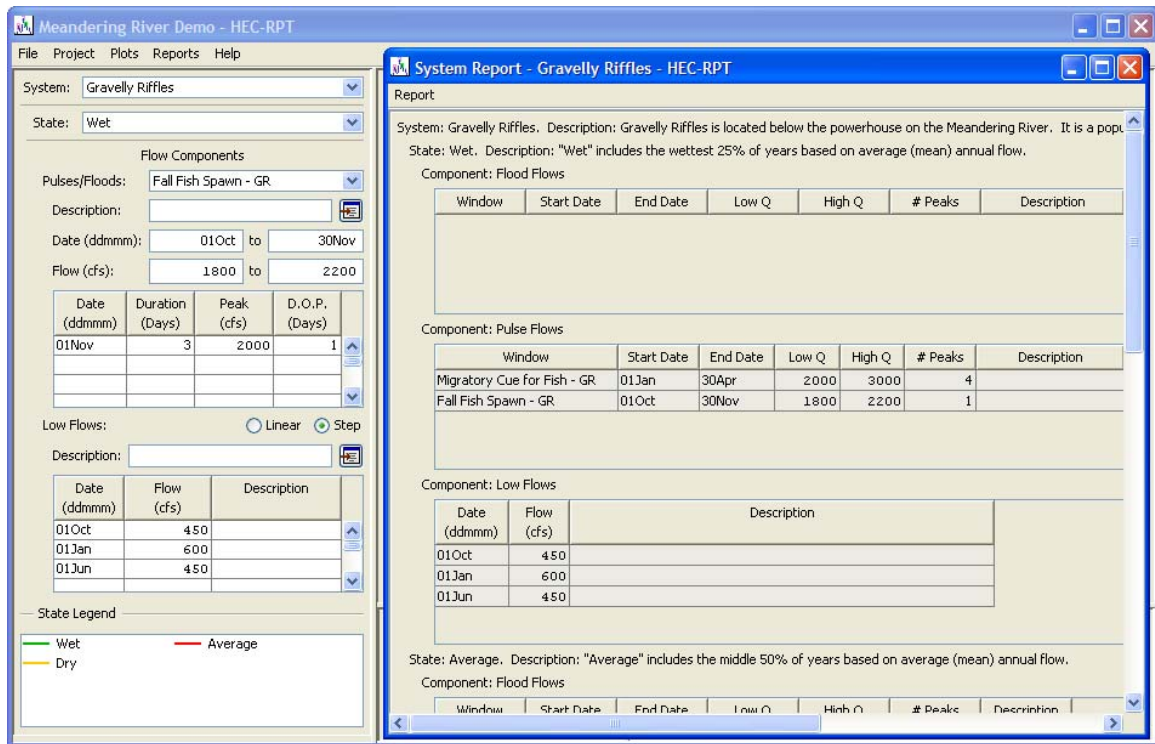

Figure 2.22 Excerpt of the System report for the Gravelly Riffles System. Text versions of report are available via the "Report – Save As" menu.

2.8 Data Management

Each project (.eco) has a companion DSS file named "Project (name) – ECO.dss" that is created by the software. Time series imported to the project are copied into this project DSS file and the location identifiers for that data are redirected from the source DSS files to the project DSS file. Creation of this project DSS file makes projects portable because all information for a project is thereby contained in "Project.eco" and its companion "Project – ECO.dss". To relocate or package a copy of the HEC-RPT project, simply move or duplicate those two files.

Flow recommendations can be exported to DSS (as time series of average daily flows) via the "Project – Export Recommendations to DSS" menu option. Recommendations are exported for the following combinations:

*/system/state/flow//1day/flow component/
 /system/all states/flow//1day/flow component/
 /system/state/flow//1day/all flow components/
 /system/all states/flow//1day/all flow components/*

By exporting the whole recommendation (all states – all components) and each of the parts, HEC-RPT sets the stage for future modeling and trade-off analyses that investigate the feasibility of implementing all or part of the flow recommendations (Figures 2.23 and 2.24).

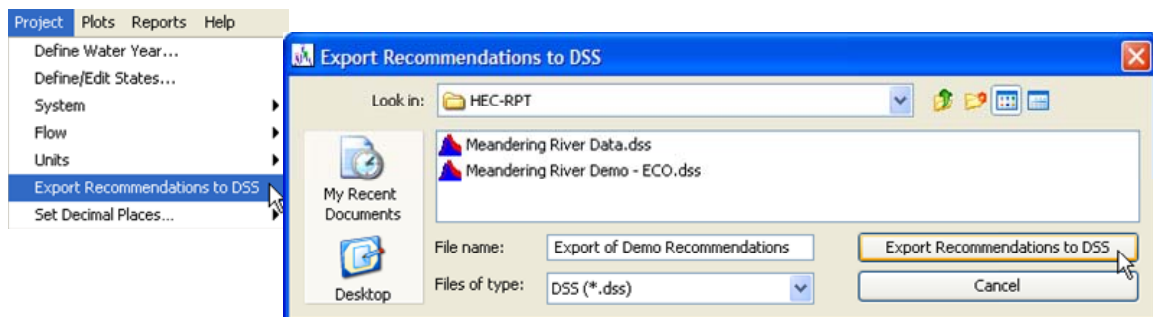

Figure 2.23 Menu option and interface for exporting flow recommendations to DSS.

2.9 Importers for Systems and Flow Components

Importers are provided which allow 1) systems to be imported to an open project from a source project and 2) flow components to be shared among the different systems and states of a single project.

Number	A part	B part	C part	D part / range	E part	F part
1	UNIFIED	ALL STATES	FLOW	01JAN1953 - 01JAN2003	1DAY	ALL COMPONENTS
2	UNIFIED	ALL STATES	FLOW	01JAN1953 - 01JAN2003	1DAY	FLOOD FLOWS
3	UNIFIED	ALL STATES	FLOW	01JAN1953 - 01JAN2003	1DAY	LOW FLOWS
4	UNIFIED	ALL STATES	FLOW	01JAN1953 - 01JAN2003	1DAY	PULSE FLOWS
5	UNIFIED	AVERAGE	FLOW	01JAN1953 - 01JAN2003	1DAY	ALL COMPONENTS
6	UNIFIED	AVERAGE	FLOW	01JAN1953 - 01JAN2003	1DAY	FLOOD FLOWS
7	UNIFIED	AVERAGE	FLOW	01JAN1953 - 01JAN1997	1DAY	LOW FLOWS
8	UNIFIED	AVERAGE	FLOW	01JAN1953 - 01JAN2003	1DAY	PULSE FLOWS
9	UNIFIED	DRY	FLOW	01JAN1953 - 01JAN2003	1DAY	ALL COMPONENTS
10	UNIFIED	DRY	FLOW	01JAN1953 - 01JAN2003	1DAY	FLOOD FLOWS
11	UNIFIED	DRY	FLOW	01JAN1954 - 01JAN2002	1DAY	LOW FLOWS
12	UNIFIED	DRY	FLOW	01JAN1953 - 01JAN2003	1DAY	PULSE FLOWS
13	UNIFIED	WET	FLOW	01JAN1953 - 01JAN2003	1DAY	ALL COMPONENTS
14	UNIFIED	WET	FLOW	01JAN1953 - 01JAN2003	1DAY	FLOOD FLOWS
15	UNIFIED	WET	FLOW	01JAN1959 - 01JAN2003	1DAY	LOW FLOWS
16	UNIFIED	WET	FLOW	01JAN1953 - 01JAN2003	1DAY	PULSE FLOWS

Figure 2.24 Catalog of data exported for the Unified System.

2.9.1 Importing systems

The system importer is accessed via the "Project – System – Import" menu (Figure 2.25). When activated, the user can specify the source project by clicking on the open button in the upper right corner of the Import System window. When a source project is opened, all systems in that project will appear in the right hand data panel. To import, highlight the system(s) to transfer, click the Import button, and then click the Apply or OK button. The Undo button will reverse any unapplied transfers.

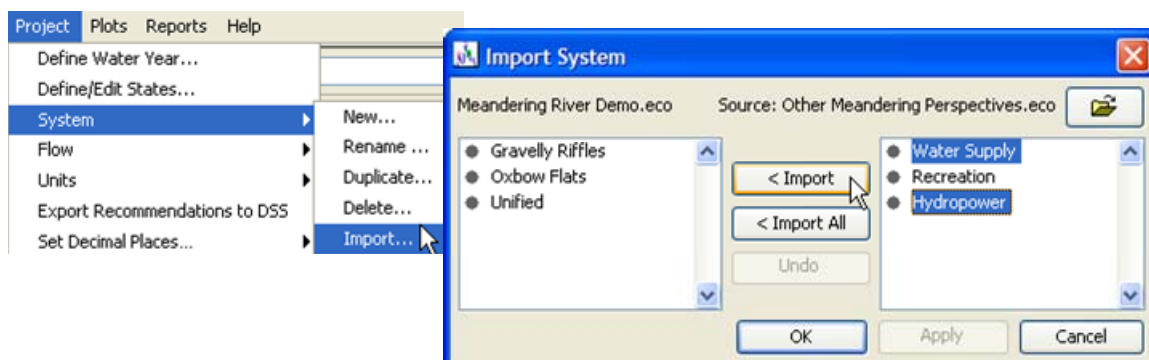

Figure 2.25 Menu option and interface for importing systems.

2.9.2 Sharing flow components

The flow component importer is accessed via the "Project – Flow – Import" menu (Figure 2.26). When activated, the user can transfer flow components between different systems and states. Individual components or sets of components defined for a system and state can be transferred. Transfers are made by highlighting the destination in the left hand data window and the source (or component to be transferred) in the right hand data window, clicking the Add button, and then by clicking the Apply or OK button. Transfers can be made from state to state or from component to state. The Undo button will reverse any unapplied transfers.

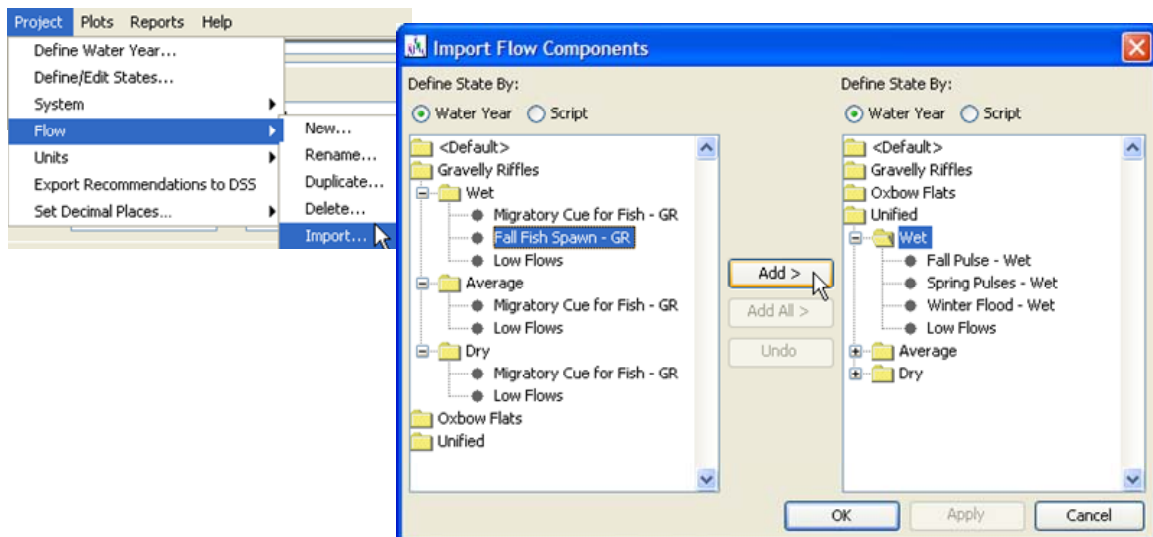

Figure 2.26 Menu option and interface for importing flow components.

CHAPTER 3

Details about the Demonstration Project

The demonstration project contains flow recommendations and hydrologic data for the fictional Meandering River. The project has three systems (Gravelly Riffles, Oxbow Flats, and Unified) and three states for each method of defining state (wet, average, and dry for "define state by name and year" and wet, normal, and dry for "define state by scripting with time series"). "Normal" was used to reflect use of the different "define state" methods and is analogous to average. Flow components are identical for the parallel system-state combinations (Figure 3.1).

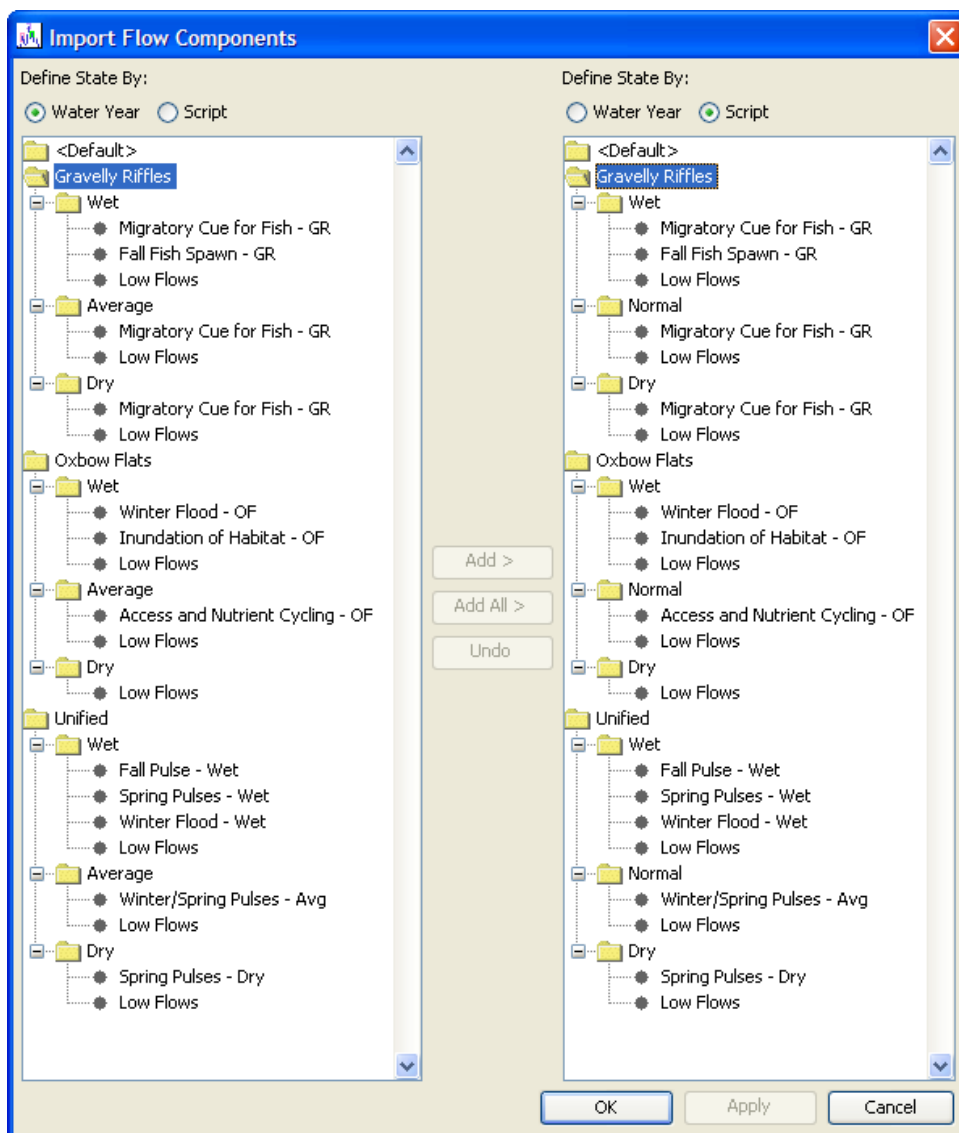

Figure 3.1 Project architecture for "Meandering River Demo.eco".

The demonstration project and three supporting files (Table 3.1) are installed to a user specified directory via the software's "Help – Install Demonstration Project..." menu option. To use the "define by scripting with time series" method for defining states, users will need to update a DSS file location in the script from "C:\HEC Data\HEC-RPT\" to the install location chosen for the demonstration project (see script line 14 in the project file "Meandering River Demo.eco"). The DSS file referenced should remain "Meandering River Data.dss".

Table 3.1 File names and descriptions for the demonstration project.

File	Description
Meandering River Demo.eco	Project file. Contains all interface settings and information entered for the demonstration project.
Meandering River Demo – ECO.dss	Project companion DSS file. This file was automatically created by the software when the demo project was saved. DSS data referenced in the project are copied from their source DSS file into this project archive.
Meandering River Data.dss	DSS data file for the Meandering River. Contains time series data for the damsite and downstream points of interest. This file also contains data required to run the script used in the project's "define by scripting with time series" method for defining states.
Export of Demo Recommendations.dss	Export of project flow recommendations. File contains recommendation time series for all systems in the project based on the "define state by name and year method". This file was generated by the export to DSS software function described in the Data Management portion of this manual.

After HEC-RPT is installed, open "Meandering River Demo.eco" and test some of the features described in this manual. This may seem like an overly short introduction to the demonstration project, but remember HEC-RPT is primarily a visualization tool. It is not intended to perform detailed quantitative analyses. Users should see the plot windows automatically respond to changes made to things like flow components, XY markers, and predefined plot selection, which makes HEC-RPT easy to experiment with and to learn. Enjoy!

CHAPTER 4

References

- Arthington, A. H., Bunn, S. E., Pusey, B. J., Bluhdorn, D. R., King, J. M., Day, J. A., Tharme, R. E., and O'Keefe, J. H. 1992. "Development of a holistic approach for assessing environmental flow requirements of riverine ecosystems." *Proc., International Seminar and Workshop on Water Allocation for the Environment*, Pigram, J. J., and Hooper, B. P. (eds). The Centre for Water Policy Research, University of New England, Armidale, Australia.
- King, J. M., Tharme, R. E., and de Villiers, M. S. (eds). 2000. *Environmental flow assessments for rivers: manual for the Building Block Methodology*. Water Research Commission Report TT 131/00, Pretoria, South Africa.
- Richter, B. D., Warner, A. T., Meyer, J. L., and Lutz, K. 2006. "A collaborative and adaptive process for developing environmental flow recommendations." *River Research and Applications*, 22, 297-318.
- U.S. Army Corps of Engineers (Corps). 2005. *HEC-DSSVue, HEC Data Storage System Visual Utility Engine, User's Manual*. CPD-79, Hydrologic Engineering Center, Davis, Calif.
- U.S. Army Corps of Engineers (Corps). 2003. *HEC-ResSim, Reservoir System Simulation, User's Manual*. CPD-82, Hydrologic Engineering Center, Davis, Calif.

