



Specialty Signs

- **Freestanding Stanchion Sign**
- **Freestanding Informational Signs**
- **Infection Control Sign**
- **Card or Paper Holder**
- **Chart, File, or Binder Holder**
- **Door Knob Hanger**
- **Frangible Room Number Sign**
- **Secure Facility Sign**
- **Reality Orientation Sign**
- **Memory Box**
- **LCD Memory Monitor**
- **Banners**
- **Construction Signs**
- **Construction Safety Sign**

This page is intentionally left blank.

Section 11: Specialty Signs

- Introduction 11-2-1
- Overview 11-3-1 – 11-3-3
- Specialty Signs 11-4-1 – 11-4-36
- Installation 11-5-1

This page is intentionally left blank.

This section of the Signage Design guide describes signs that are for special applications, both inside and outside of a facility.

One group of signs are freestanding signs used to display a variety of information, both permanent and temporary. Some signs relate to or advise on room usage. Other signs are for specific types of room identification or building conditions.

Signs include those related to operational conditions such as sanitation or patient information memory boxes displaying information about a patient.

Signs are provided for construction projects, and banners to highlight events, promotions, or seasonal themes.

Discuss requirements with sign manufacturers because many of these items are standard products which are illustrated in their catalogs and can be easily ordered.

This section is not all inclusive and specific conditions or situations may warrant design of sign solutions that are not shown.

This page is intentionally left blank.

SPECIALTY SIGN DESIGNATIONS

Each sign in the program guide has been given a specific sign type number designation. These designations provide a common description that can be referenced when programming a site and ordering signs. The following explains how the sign type designations are derived:

SP - 21.03A

SP Designates a Specialty Sign.

21 Two digit number identifies a particular sign type family.

.03 The two digit number following the period identifies a specific sign within the sign family.

A The letter designates a specific sign configuration, version and/or layout for graphics.

Sign Type SP-21

Specialty Signs

SP-21.01
Freestanding Stanchion Sign

SP-21.02
Freestanding Informational Sign

SP-21.03
Freestanding Informational Sign

SP-21.04
Freestanding Informational Sign

SP-21.05
Infection Control

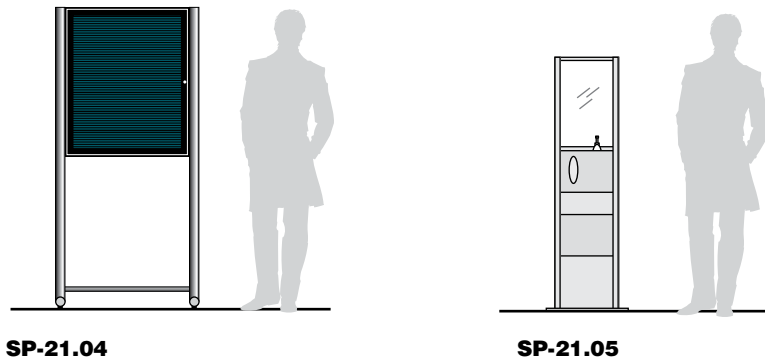

Sign Type SP-22
Specialty Signs

SP-22.01
Card or Paper Holder

SP-22.02
Chart, or File Holder

SP-22.03
Binder Holder

SP-22.04
Door Knob Hanger

SP-22.05
Tangible Room Number Sign

SP-22.06
Secure Facility Sign

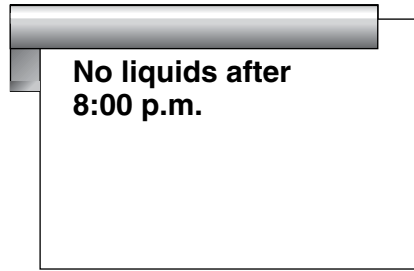

SP-22.01

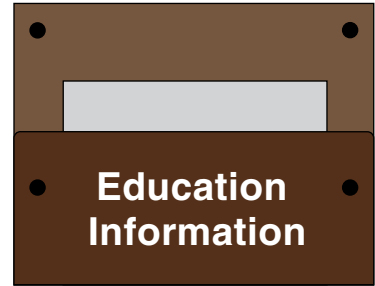

SP-22.02 / SP-22.03

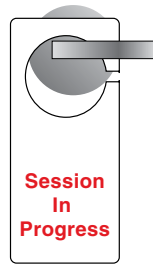

SP-22.04

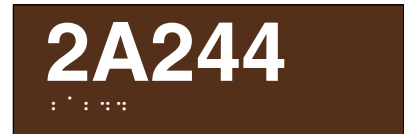

SP-22.05

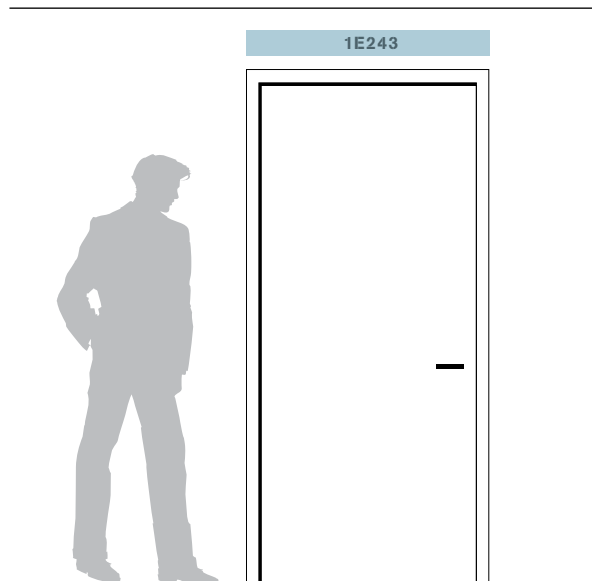

SP-22.06

Sign Type SP-22

Specialty Signs

SP-22.07

Reality Orientation



SP-22.07



SP-22.08

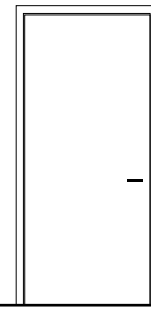

SP-22.09

SP-22.08

Memory Box

SP-22.09

LCD Memory Monitor

SP-23.01

Banners

SP-24.01

Construction Sign:
Coming Soon, Text Only

SP-24.02

Construction Sign:
Coming Soon with Rendering

SP-24.03

Construction Sign: Rendering

SP-24.04

Construction Sign: Safety

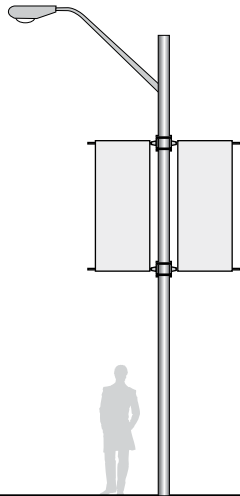

SP-23.01

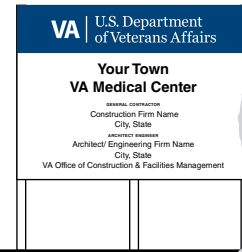

SP-24.01

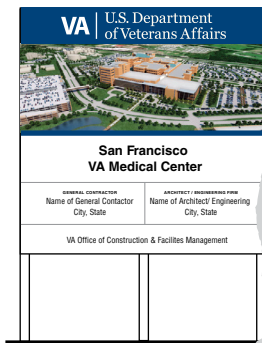

SP-24.02

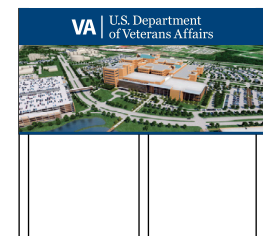

SP-24.03

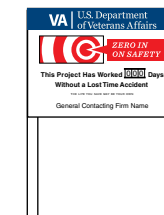

SP-24.04

This page is intentionally left blank.

Small Freestanding Stanchion Sign

Size

Sign Face:
457 mm H x 381 mm W
(18" H x 15" W)

Description

Small freestanding identification, information, and directional sign to provide temporary information or queuing for lines.

Message Configuration

(Refer to message layout drawing for dimensions).

Sign Components

Acrylic plaque and polished aluminum tube stanchion post and weighted base

Graphic Process

Surface applied vinyl letters

Colors

For background, type and post colors, refer to color chart.

Typography

Helvetica Bold

Mounting

Movable, weighted base

Installation

Use for aiding in temporary directions, designating waiting areas or directing people needing to line up for a service.

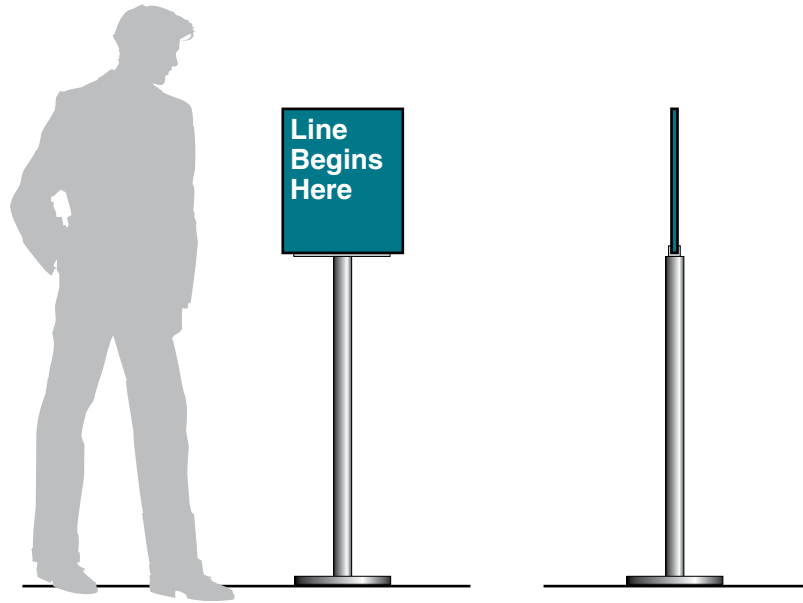

Message Layout A



Message Layout B

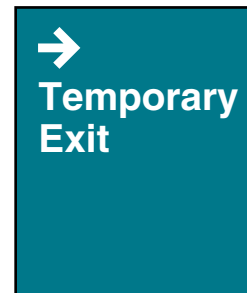

Pocket Sign

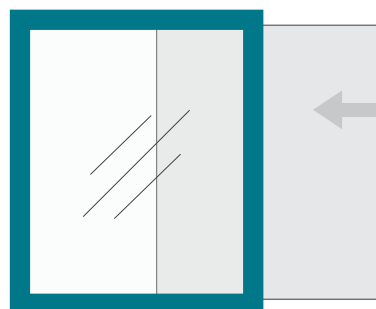

Paper Insert slides into frame opening.

Small Freestanding Stanchion Sign

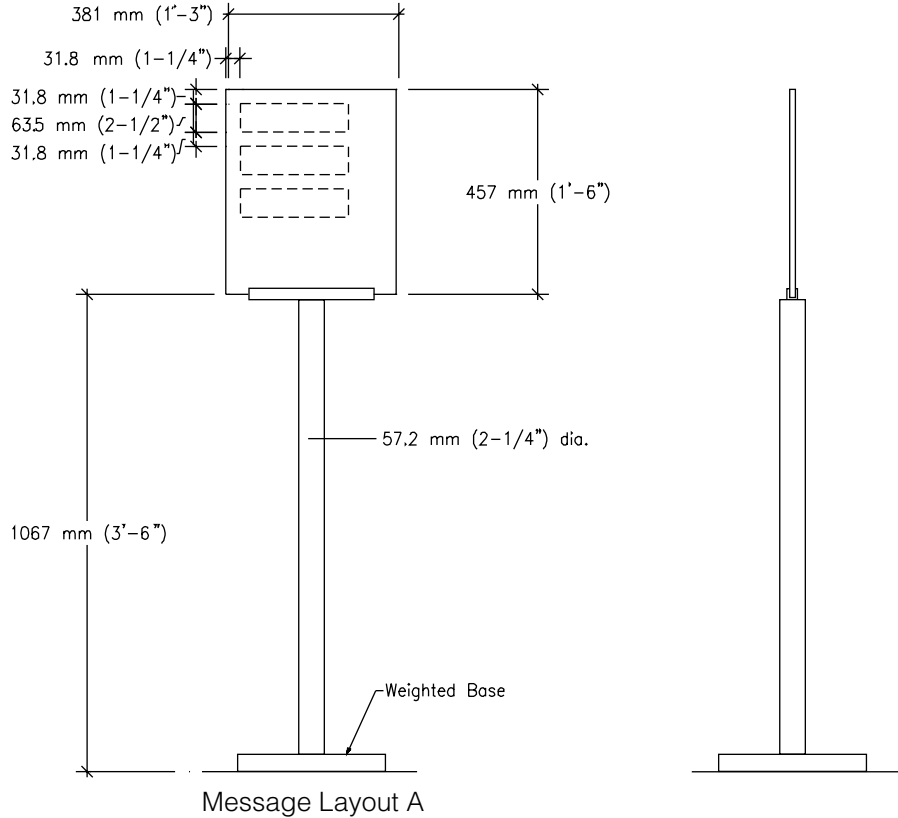

Message Layout A

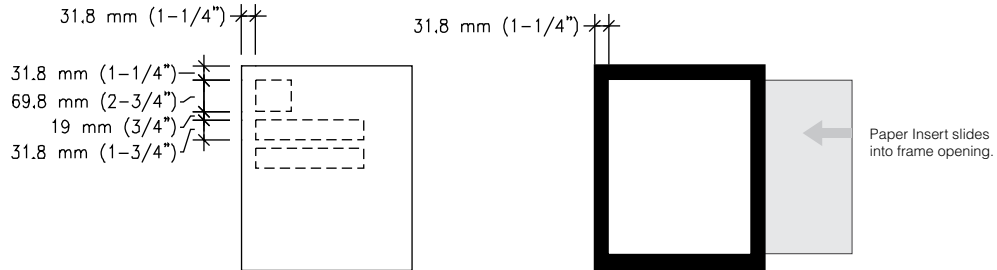

Message Layout B

Freestanding Informational Sign

Size

Sign Face:
610 mm H x 610 mm W
(24" H x 24" W)

Description

Freestanding identification, information, and directional sign to provide temporary information.

Message Configuration

(Refer to message layout drawing for dimensions). Layout A is for bold, short information. Layout B is for titles and text information.

Sign Components

Acrylic sign plaque on metal frame:
Polished aluminum tube frame and weighted base

Graphic Process

Surface applied vinyl letters

Colors

For background, type and post colors, refer to color chart.

Typography

Helvetica Bold

Mounting

Movable, weighted base

Installation

Use for aiding in temporary information and directions, designating waiting or directing people needing to line up for a service.



Message Layout A

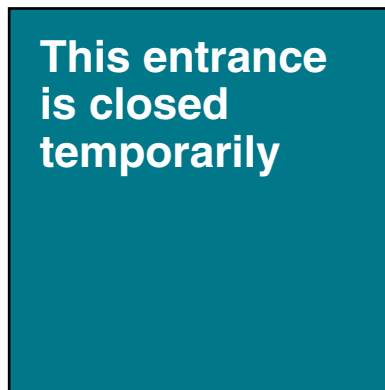

Message Layout B

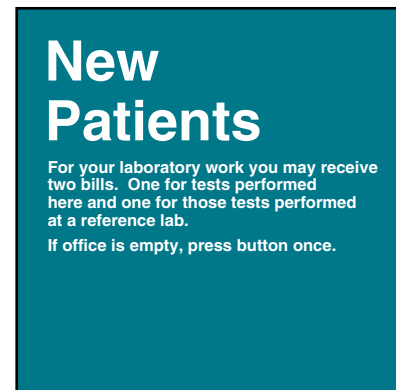

Freestanding Informational Sign

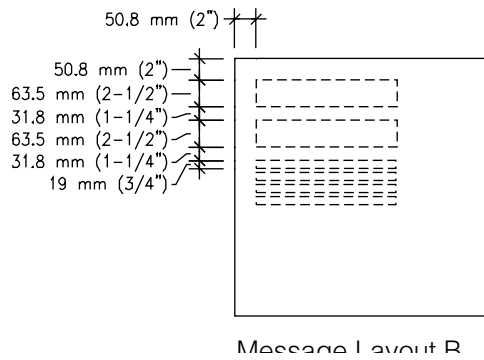
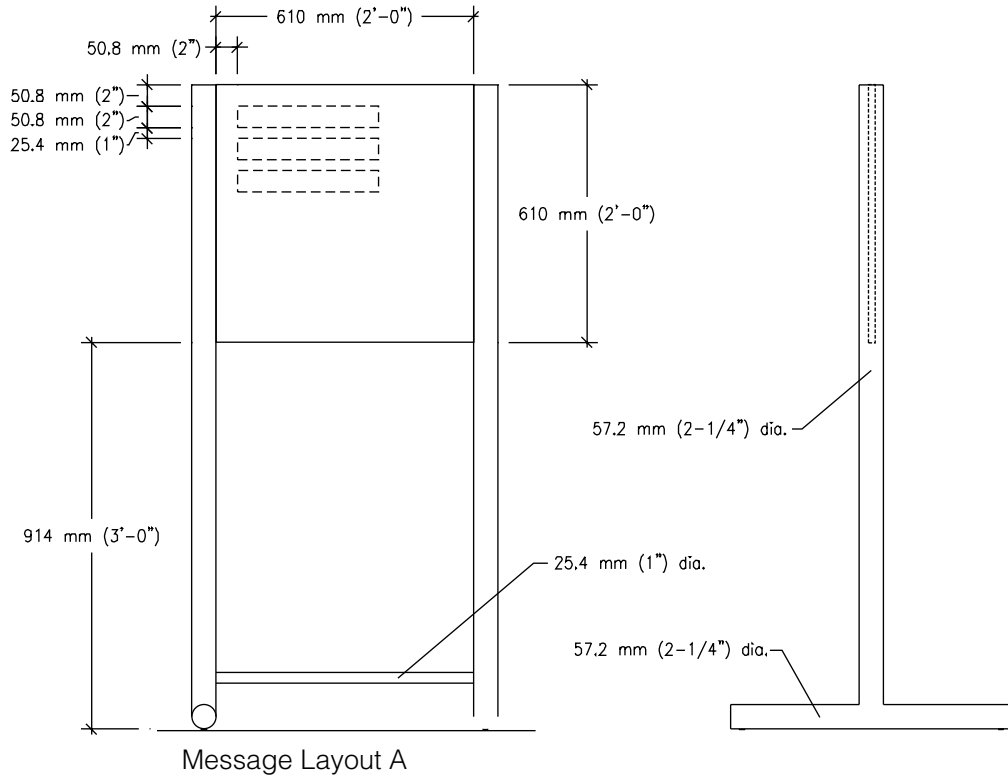

Freestanding Informational Sign for Changeable Messages

Size

Sign Face:
610 mm H x 610 mm W
(24" H x 24" W)

Description

Small freestanding information sign to provide temporary information.

Message Configuration

(Refer to message layout drawing for dimensions).
Layout A is changeable letters.
Layout B is a tackboard with a title header.

Sign Components

Polished aluminum case with glass locking door. Interior surface is a grooved felt covered changeable letterboard or a vinyl impregnated tackboard. Polished aluminum tube frame with weighted base.

Graphic Process

Surface applied vinyl to header above tack board

Colors

For header background, type colors, post, base, and case: refer to color chart.
Changeable letterboard felt: select from manufacturer's list.

Typography

Helvetica Bold

Mounting

Movable, weighted base

Recommendations

Use for aiding in temporary information and announcing events and meetings.



**Message Layout A
(Changeable Letter Board)**

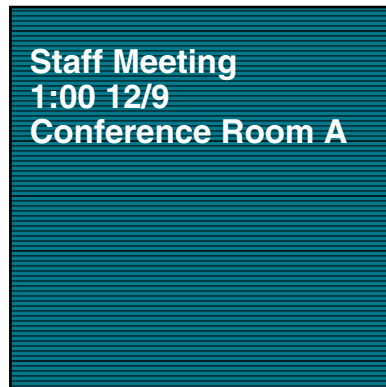

**Message Layout B
(Tack Surface)**

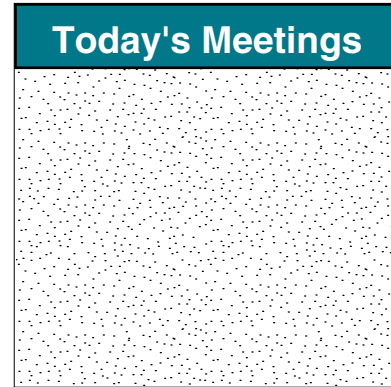

Freestanding Informational Sign for Changeable Messages

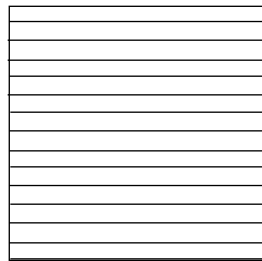
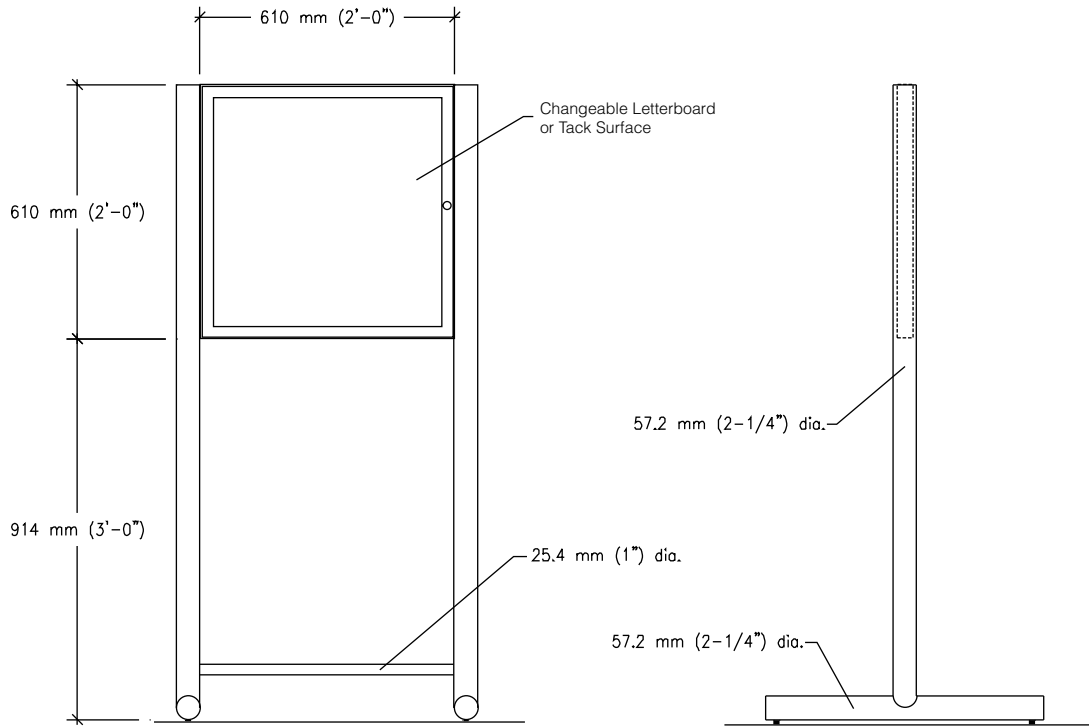

Message Layout A
(Changeable Letter Board)

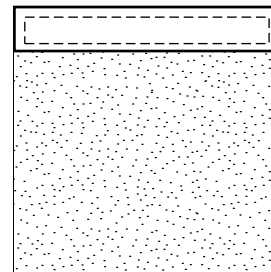

Message Layout B
(Tack Surface)

Large Freestanding Informational Sign for Changeable Messages

Size

Sign Face:
914 mm H x 762 mm W
(36" H x 30" W)

Description

Freestanding information sign to provide temporary information.

Message Configuration

(Refer to message layout drawing for dimensions).
Layout A is changeable letters.
Layout B is a tackboard with a title header.

Sign Components

Polished aluminum case with glass locking door. Interior surface is a grooved felt covered changeable letterboard or a vinyl impregnated tackboard. Polished aluminum tube frame with weighted base.

Graphic Process

Surface applied vinyl to header above tack board

Colors

For header background, type colors, post, base and case: refer to color chart.

Changeable letterboard felt: select from manufacturer's list of available colors.

Typography

Helvetica Bold

Mounting

Movable, weighted base

Recommendations

Use for aiding in temporary information and announcing events and meetings.

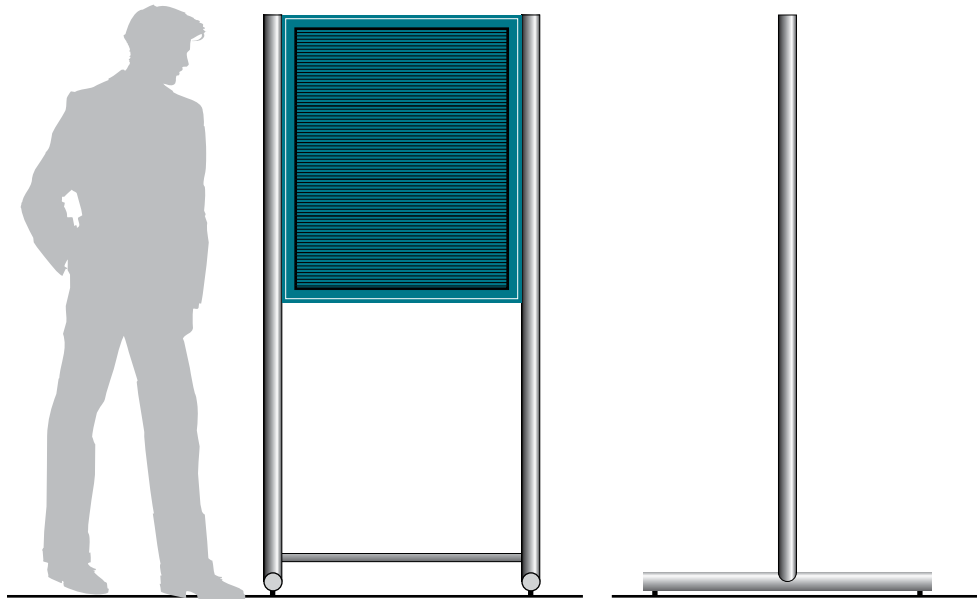

**Message Layout A
(Changeable Letter Board)**

TODAY'S MENU	
Ham Sandwich	\$2.50
Turkey Sandwich	\$2.75
Cheese Pizza	\$2.00
Macaroni & Cheese	\$1.70
Garden Salad	\$1.10
Tomato Soup	\$1.00
Vanilla Pudding	\$0.50
Ice Cream Sandwich	\$0.75
Chocolate Cookie	\$0.75

**Message Layout B
(Tack Surface)**

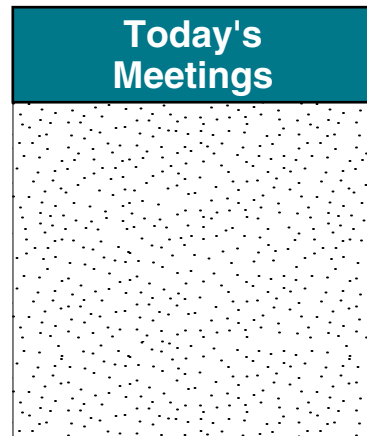

Large Freestanding Informational Sign for Changeable Messages

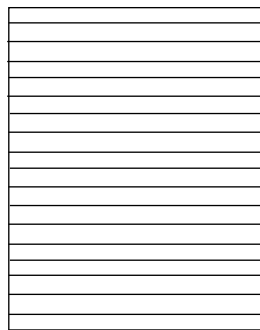
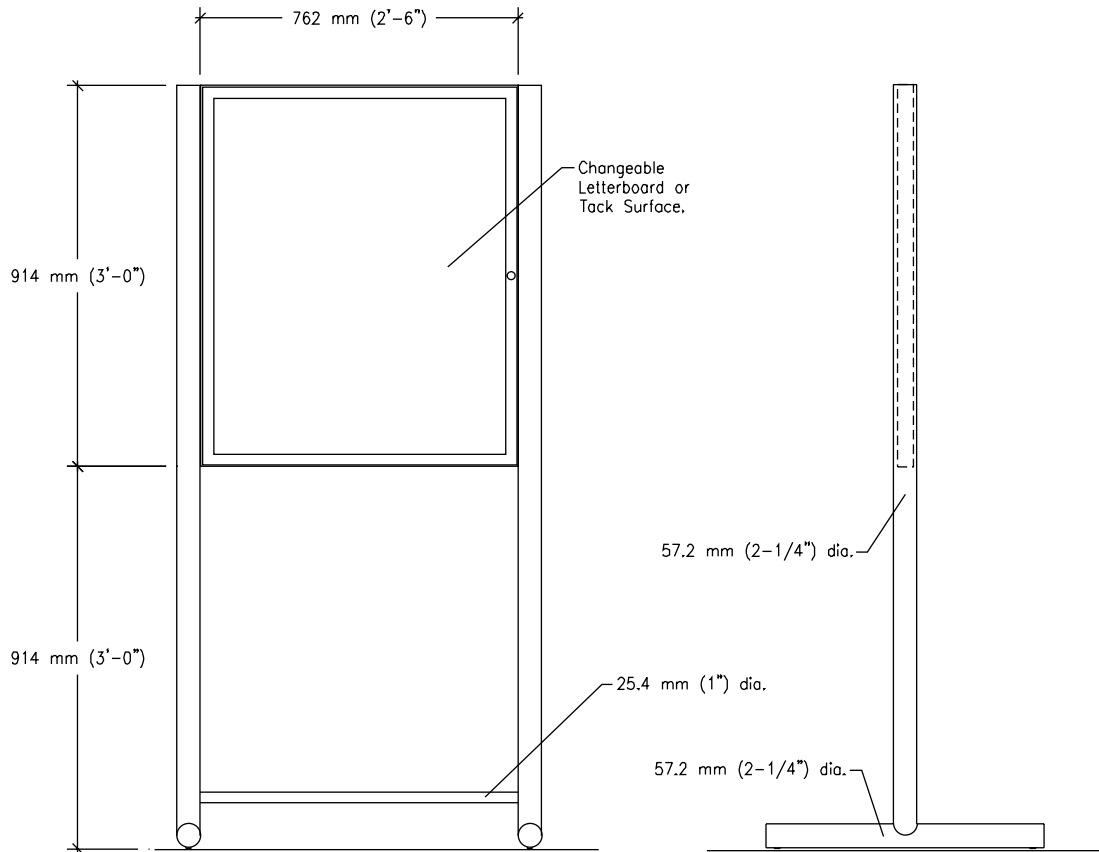

Message Layout A
(Changeable Letter Board)

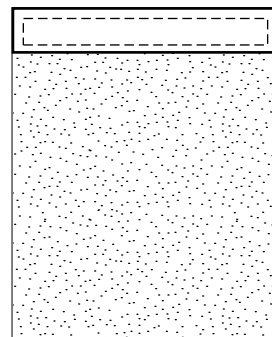

Message Layout B
(Tack Surface)

Infection Control Sign

Size

approximately
1524 mm H x 381 mm W
(60" H x 15" W)

Description

Non-illuminated, freestanding, single sided kiosk to provide hand sanitizer, tissues, gloves, information regarding infection control and (possibly) face-masks.

Sign Components

Freestanding kiosk structure with compartments to hold hand sanitizer dispenser, tissue dispenser, waste recepticle (for tissues), gloves, and acrylic sleeve to insert (11" x 17") printed graphic/ instructions.

Graphic Process

Printed paper

Colors

Colors and materials to match or compliment existing palette.

Mounting

Movable weighted base

Typography

Helvetica Bold

Installation

It is recommended that this sign be placed at building entries and high traffic areas such as the Canteen, Lobby, and Gift Shop.

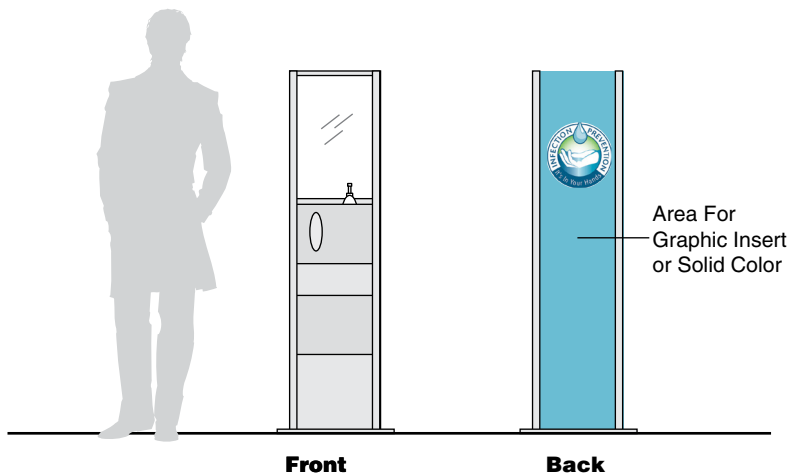
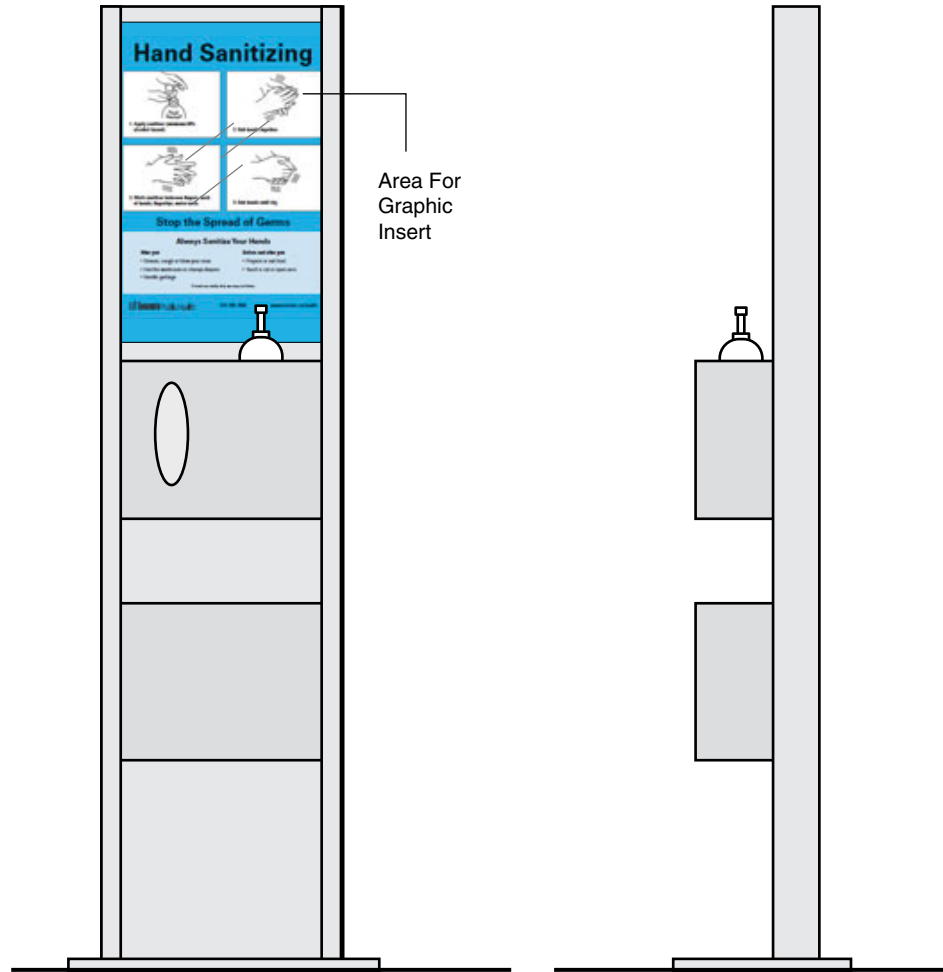

Infection Control Sign

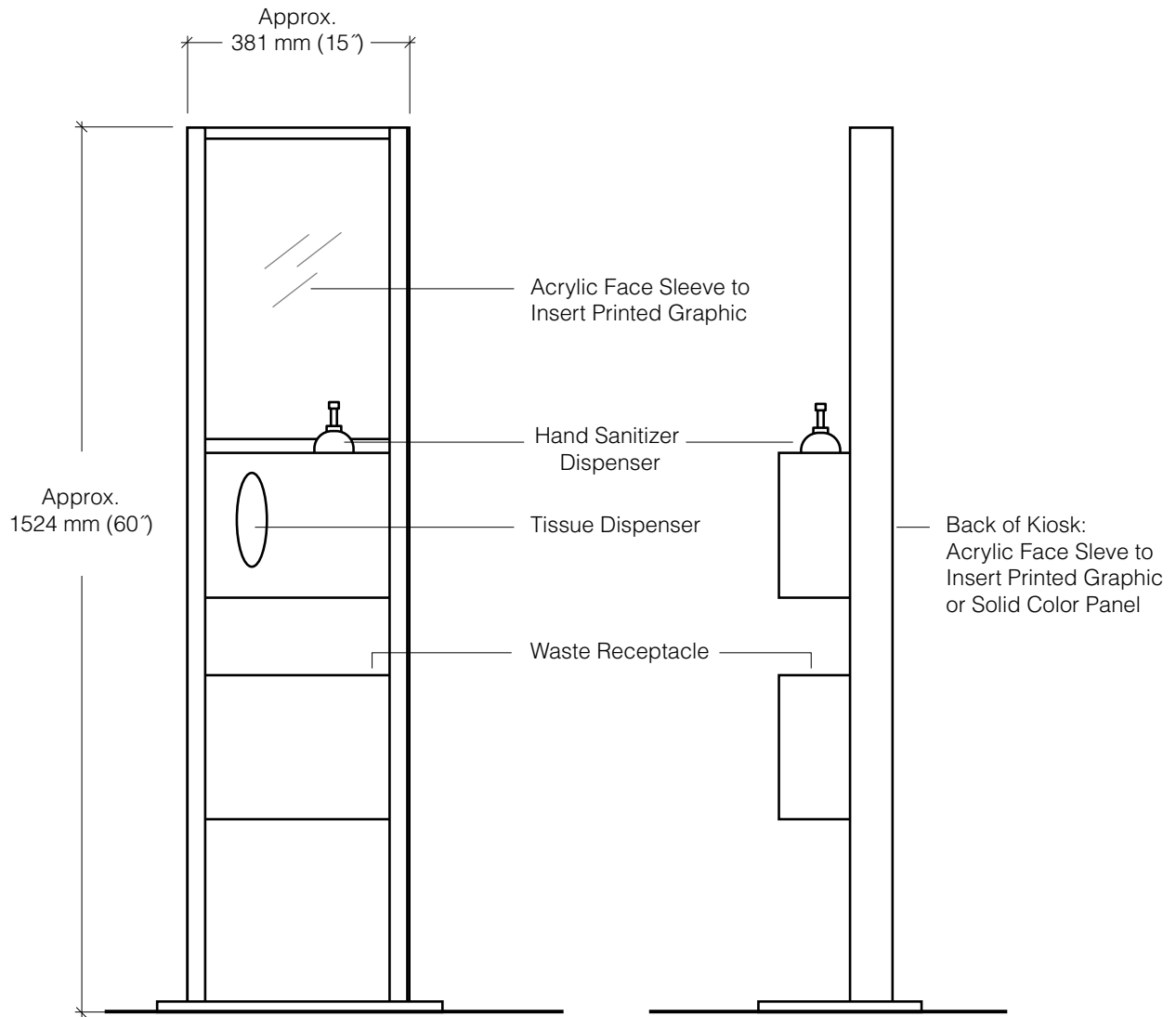

Card or Paper Holder

Size

Size to vary depending upon messaging requirement. Holders are available to accommodate small size inserts that are approximately 229 mm (9") W to larger/poster sized inserts, approx. 611 mm (24") W.

Description

Card or paper holder to temporarily hold paper or notices

Sign Components

Aluminum extrusion with ball or cylinder pinch roller

Colors

Per manufacturer

Mounting

Double sided foam tape or silastic adhesive

Installation

On wall directly under sign

Recommendations

Can be installed under a patient room sign or a patient bed sign to hold miscellaneous pieces of paper. Can be installed under office sign for use as a message placement holder or used at conference rooms to hold room schedules.

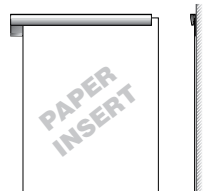
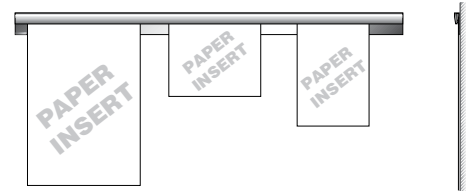
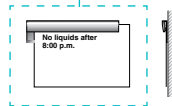
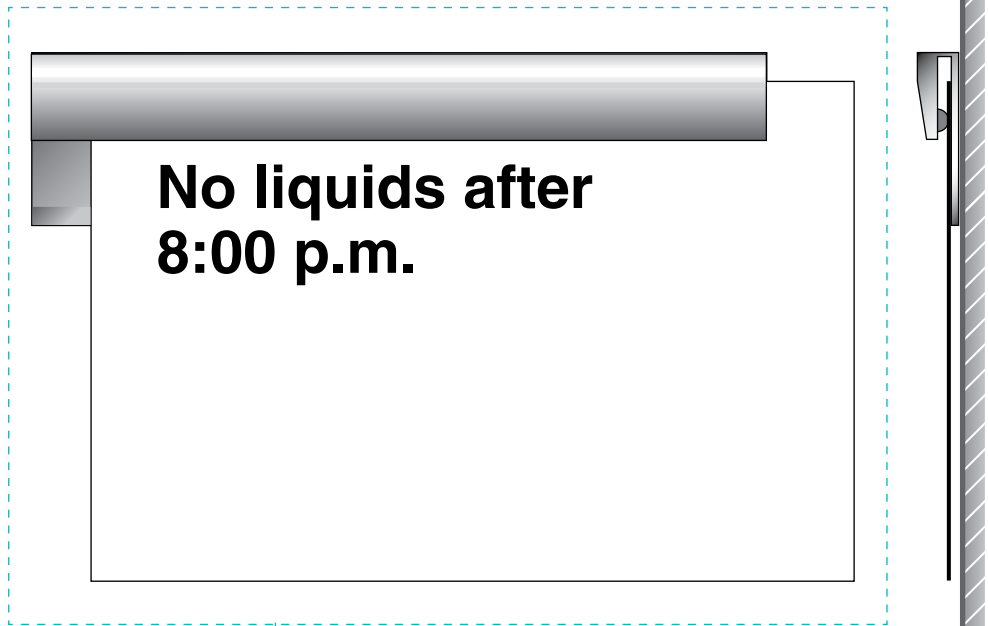

Above:

Examples of paper insert holders of various lengths to accommodate various sizes of paper inserts.

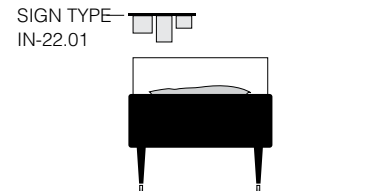
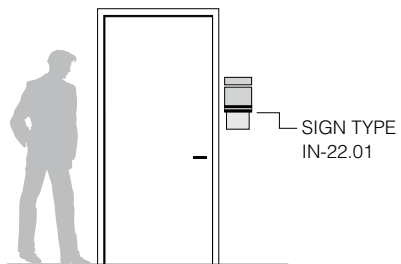

Card or Paper Holder

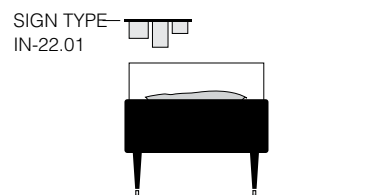
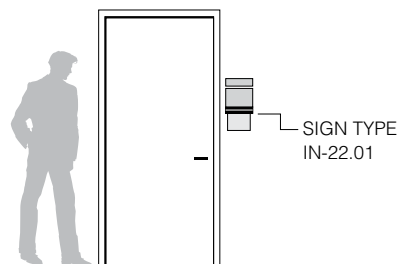
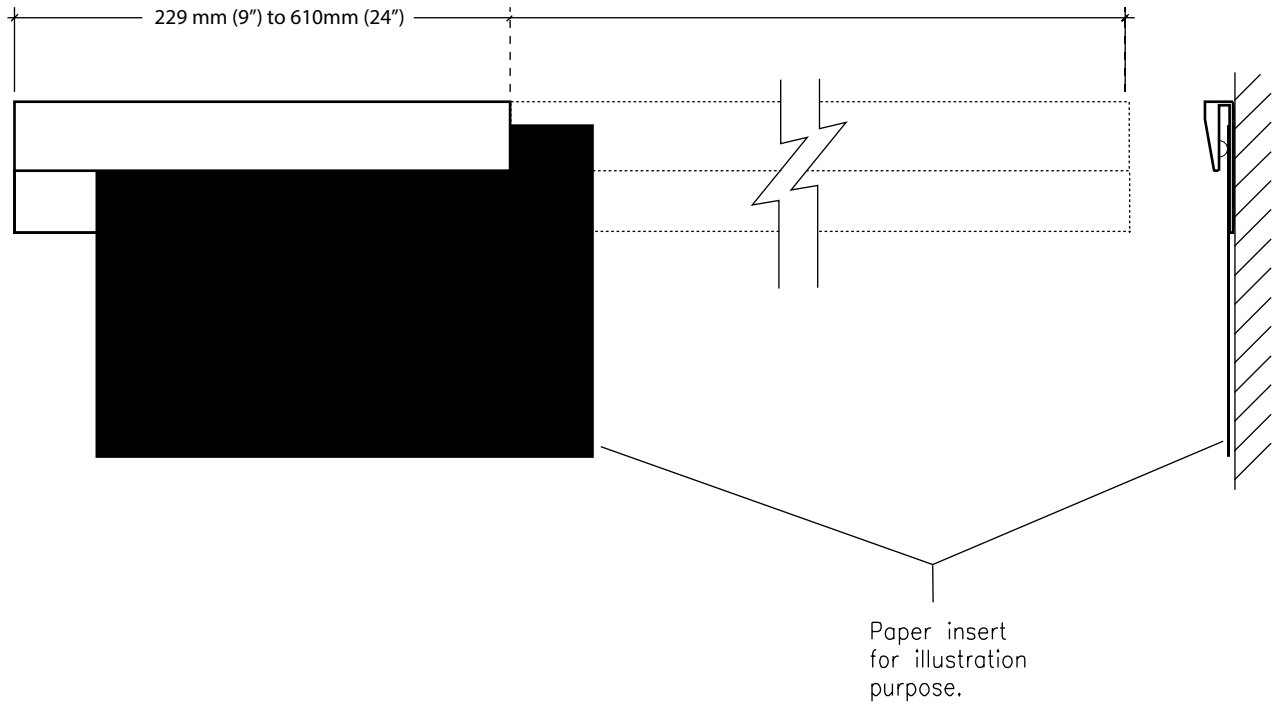

Chart, File, or Binder Holder

Size

Holder size:

IN22.02

298 mm x 381 mm x 64 mm
(11 3/4" x 15" x 2 1/2")

IN22.03

298 mm x 381 mm x 102 mm
(11 3/4" x 15" x 4")

Description

Chart, file or binder holder

Sign Components

Painted, formed metal

Colors

For background and type colors,
refer to color chart.

Mounting

Mechanical fasteners

Installation

On wall

Recommendations

Multipurpose

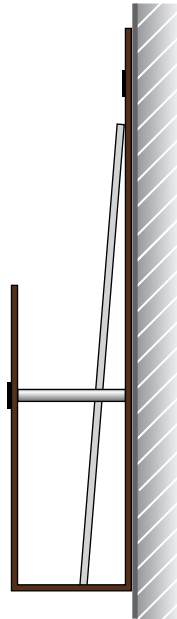
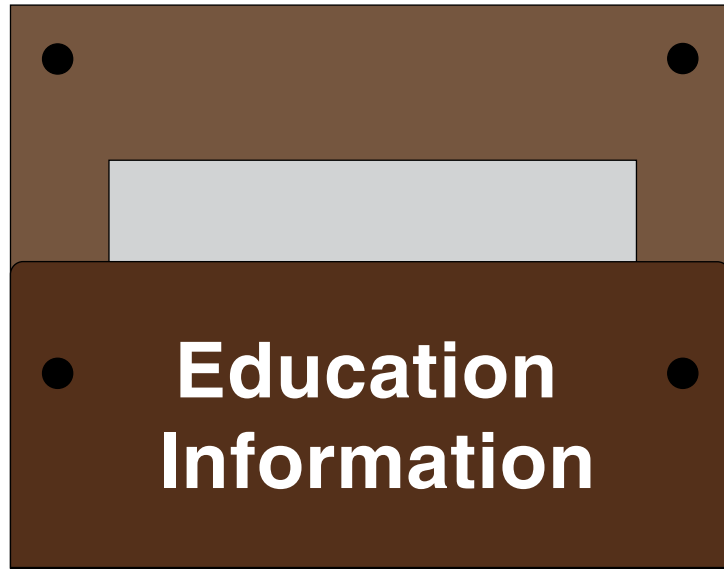

IN-22.02

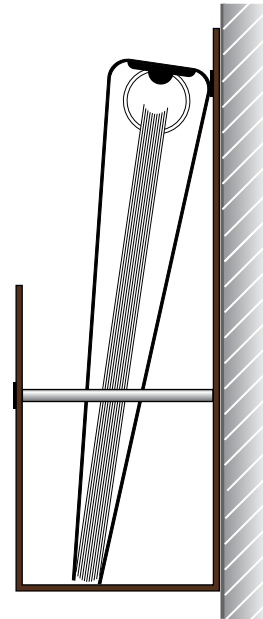

IN-22.03

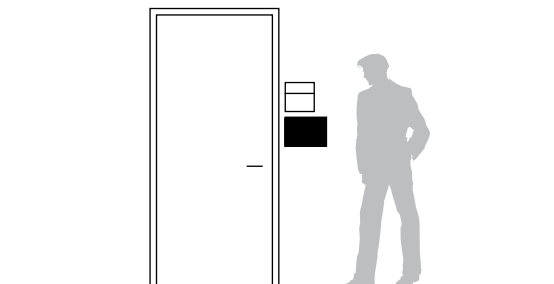

Chart, File, or Binder Holder

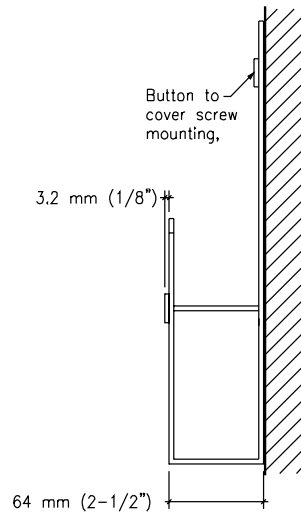
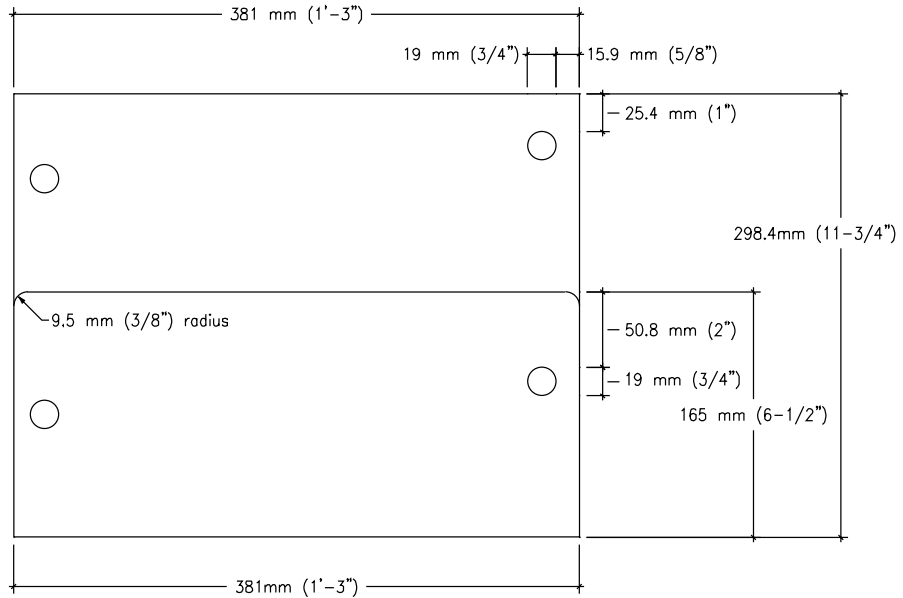

IN-22.02

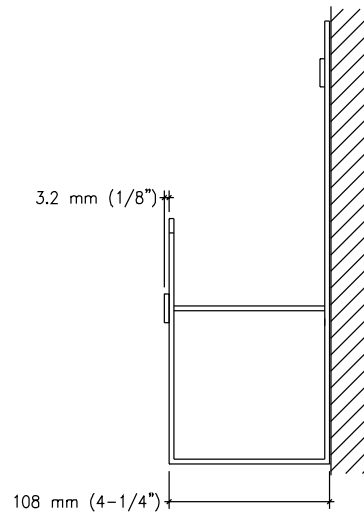

IN-22.03

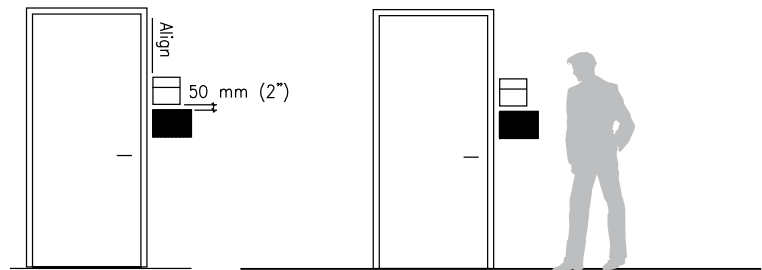

Door Knob Hanger

Size

Sign Face:
254 mm H x 115 mm W
(10" H x 4 1/2" W)

Description

Door knob hanger used to indicate room is in use.

Graphic Process

Silkscreened on styrene

Colors

Background: white
Text: red

Mounting

Hang over door handle.

Installation

Temporary

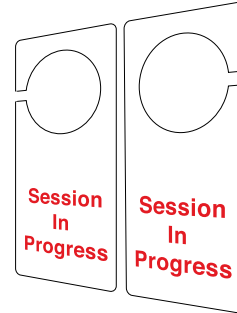
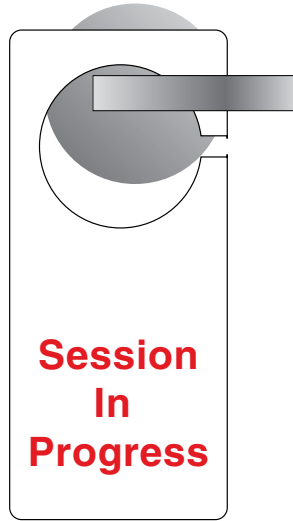

Front

Back

Message Layout A

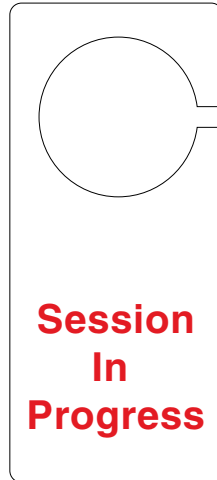

Message Layout B



Door Knob Hanger

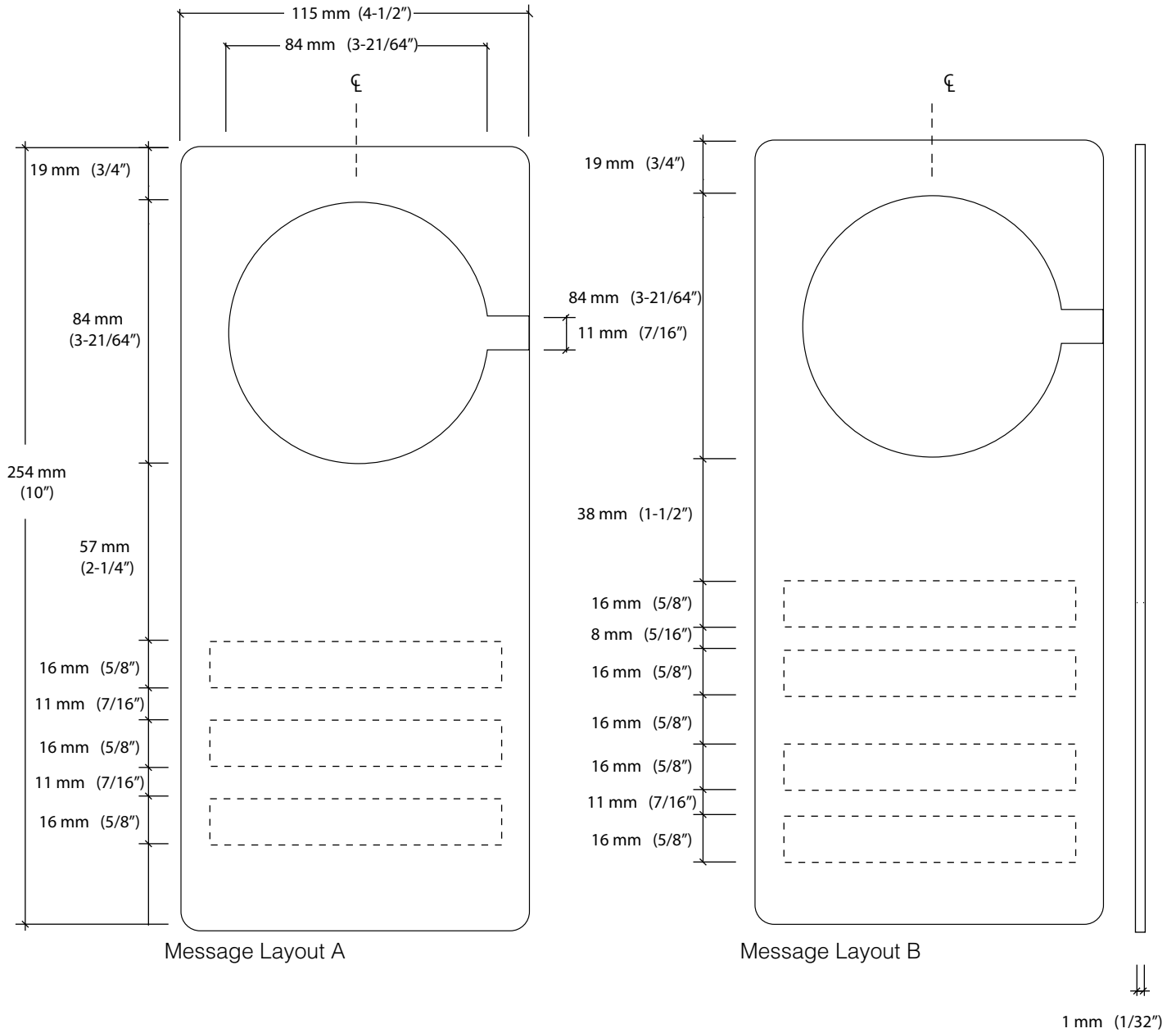

Tangible Room Number Sign

Size

Sign Face:
76 mm H x 229 mm W
(3" H x 9" W)

Description

Room number sign to be placed on all rooms that require identification.

Sign Construction

Polymer sign face laminated to polyester backing plate with full coverage application of VHB tape

Graphic Process

Tactile room number with accompanying Braille

Colors

Text: refer to color chart.
Background: refer to color chart.

Mounting

Flush mounted with double sided foam tape or silastic adhesive.

Installation

Knob side of door, 1575 mm (63") to top of sign and 50 mm (2") clear from door frame.

Recommendations

This sign is to be used for psychiatric areas or other secured areas where signs are required for license compliance and where signs cannot be used as weapons.

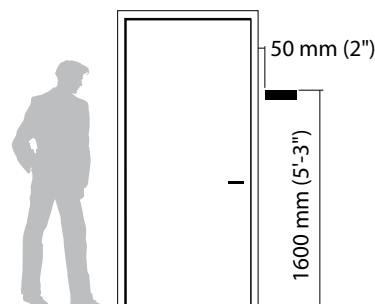

Frangible Room Number Sign

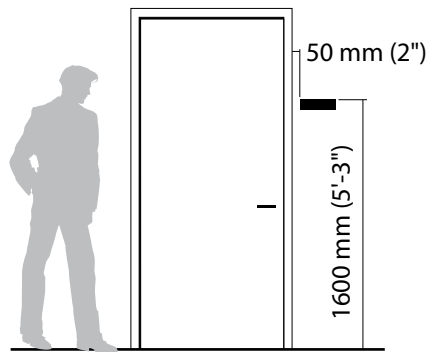
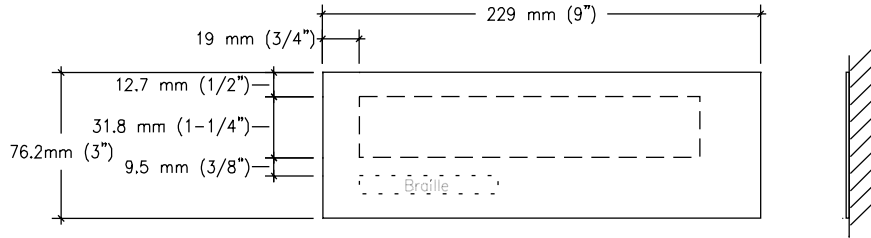

Secure Facility Sign

Size

76 mm H (4")

Description

Painted or screened room number, or name, at room entrance

Message Configuration

Refer to message layout drawing for dimensions.

Graphic Process

Painted background field with painted stenciled lettering

Colors

Colors to vary. Color scheme should match or complement existing palette. Background and type colors should have enough contrast to be easily readable. Background can be a dark color with light type, or the type could be a dark color on a light colored background.

Typography

AG Book Stencil

Installation

Painted sign background field to be positioned above door frame. The painted background field to be the width of the door frame and it's height as necessary to accommodate a 1 or 2 line message.

Recommendations

It is recommended that this sign be placed above door/entrance to room.

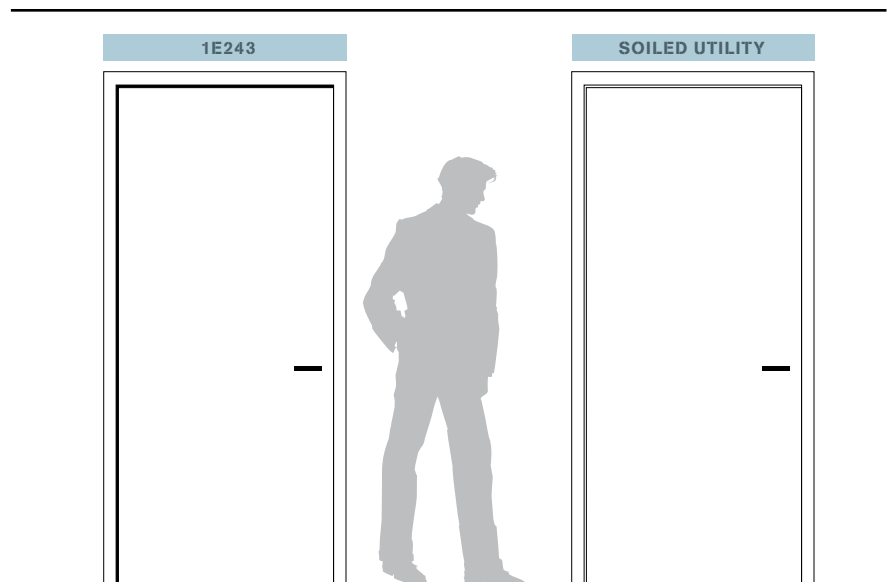
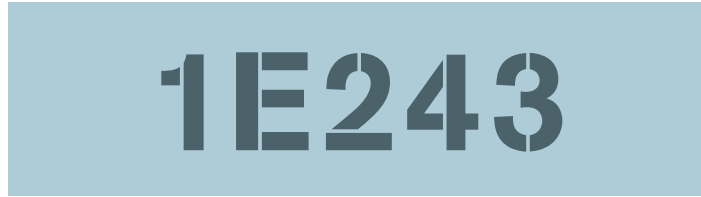

Secure Facility Sign

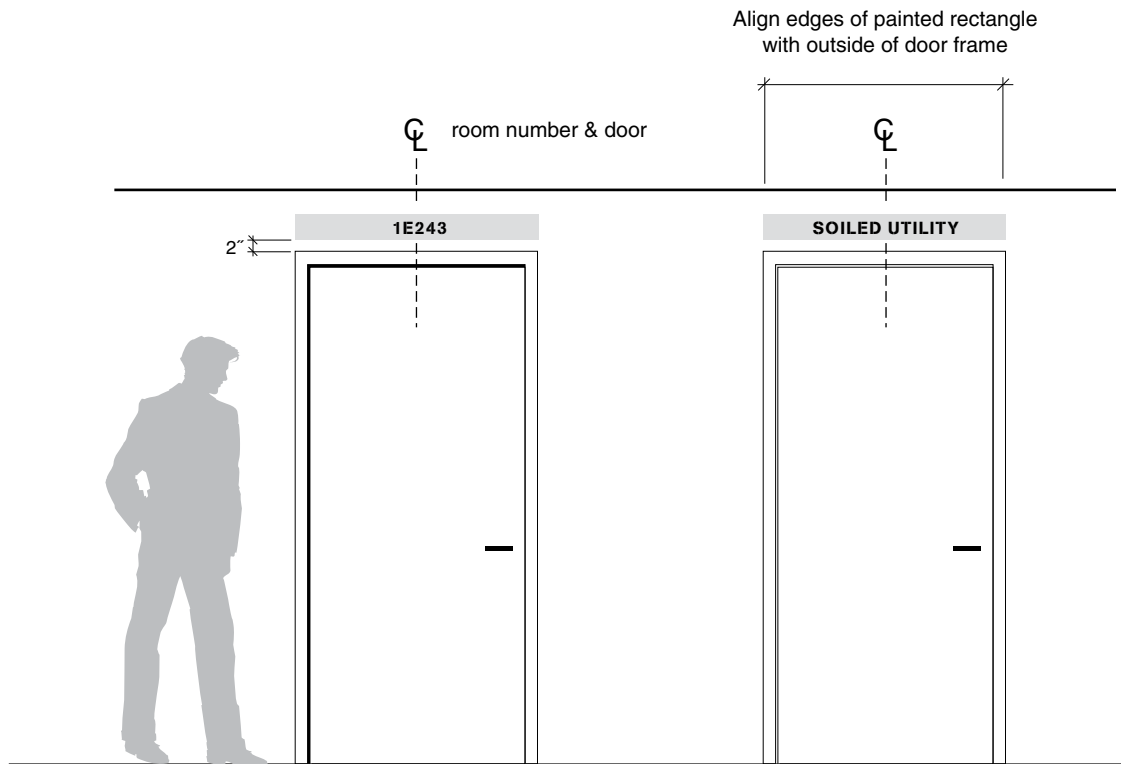

Reality Orientation Sign

Size

Varies to fit application.

Description

Message board on which staff members can display information such as time, place, and personnel information to persons with dementia.

Sign Components

Framed, erasable marker board with an adjacent pin tack surface and shelf for holding markers and push pins.

Alternate option: framed sign with glass face and a sleeve to accommodate a printed 11 x 17 inch paper insert. The glass face functions as an erasable writing surface.

Colors

Colors and materials to match or complement existing palette.

Mounting

Wall mounted

Installation

It is recommended that this sign be placed in patient's room visible from the patient's bed.

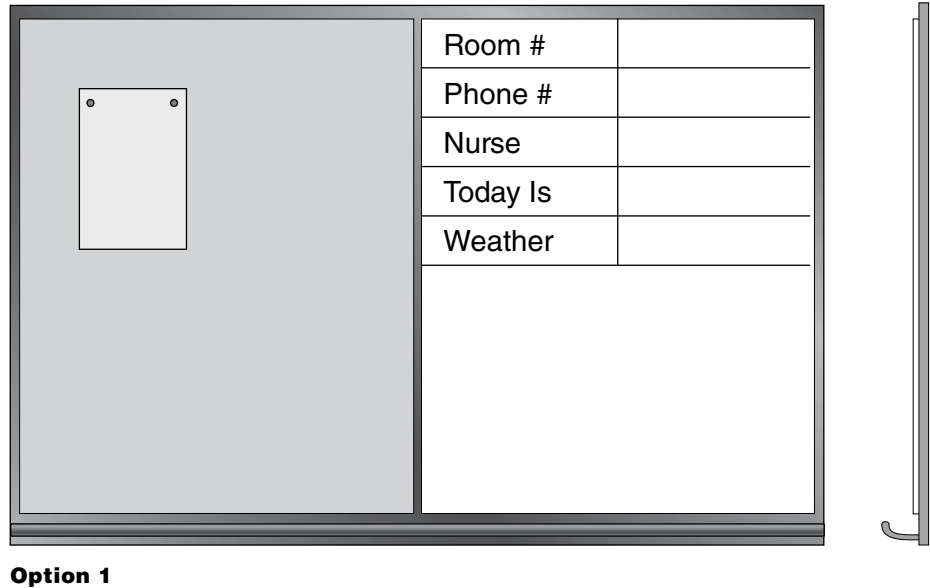

Option 1

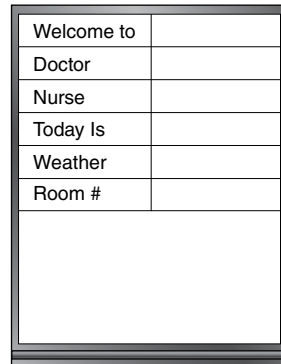

Option 2

Write and Wipe Reality Orientation sign dimensions and messaging tailored to facility needs. Board may, or may not require a pin-tac surface.

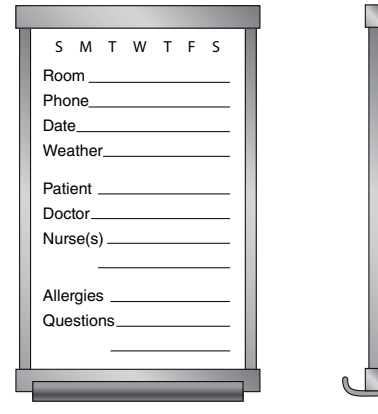

Option 3

Reality Orientation sign may be designed as a framed sign with a glass face and a sleeve to accommodate a printed 11x17 inch paper insert. The glass face functions as an erasable writing surface.

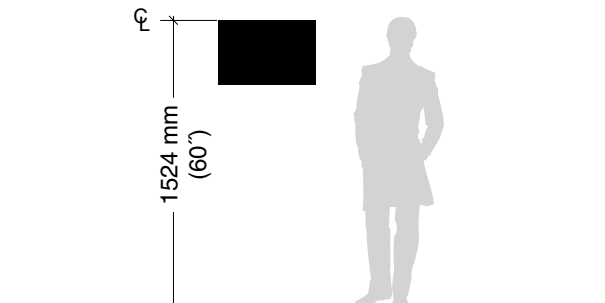

Reality Orientation Sign

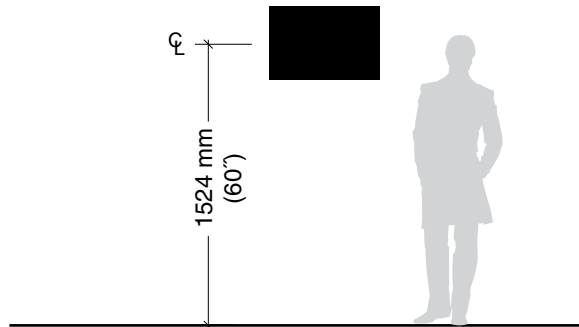
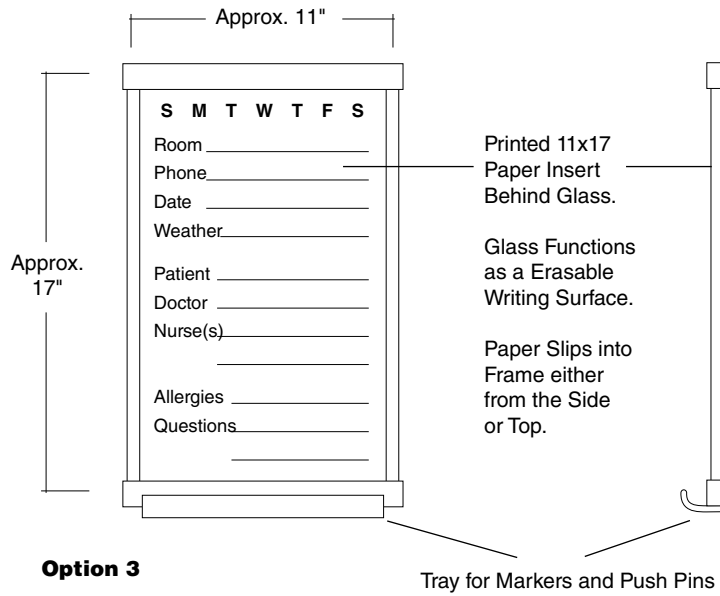
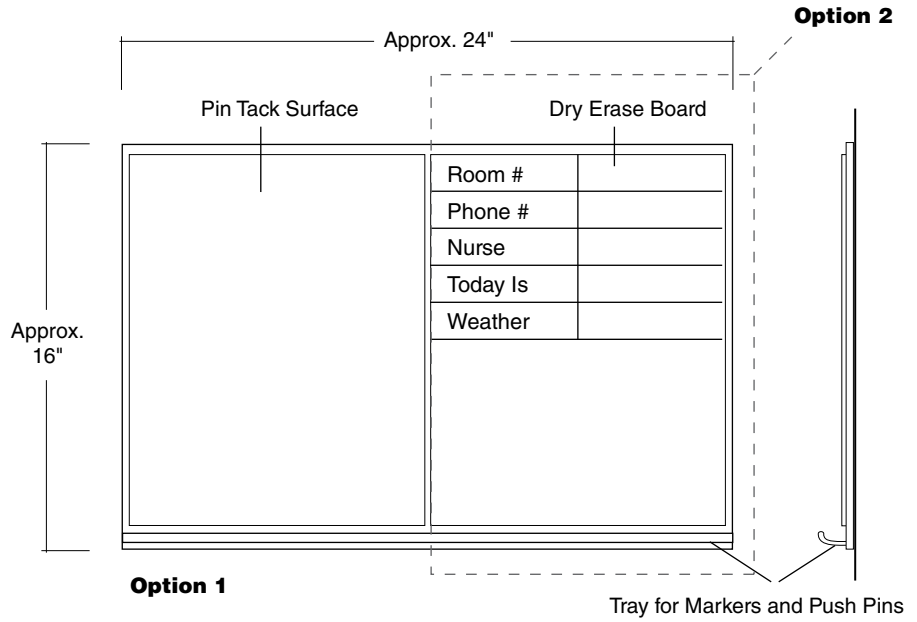

Memory Box

Size

Single Box, Approximately
 406 mm H x 305 mm W
 (16" H x 12" W)
 76 mm - 102 mm deep (3"-4")

Double Box, Approximately
 406 mm H x 610 mm W
 (16" H x 24" W)
 76 mm - 102 mm deep (3"-4")

Description

Non-illuminated display case to allow display pictures, cards, mementos, etc. Box can accommodate one person (a single box) or two people (a double box). Box can be designed to incorporate room number (this is optional, room number may be a separate sign). Box can be designed to be accessible from the front or from the back (from opposite side of wall)

Sign Components

Display case with one or two adjustable shelves and framed glass or acrylic. Front accessible box option to contain hinged door with possible lock.

Mounting

Recessed into wall.

Colors

Colors and materials of structure to match or compliment existing interior palette.

Installation

It is recommended that this sign be placed outside patient's room, adjacent to room sign next to entry door.

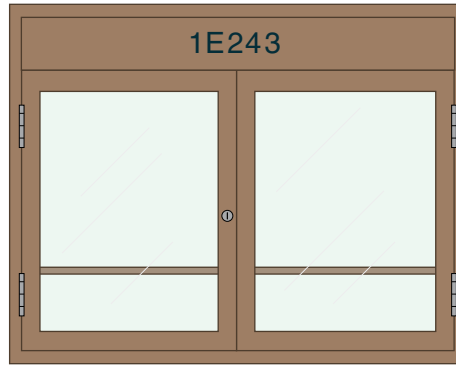

Front Accessible Double Box

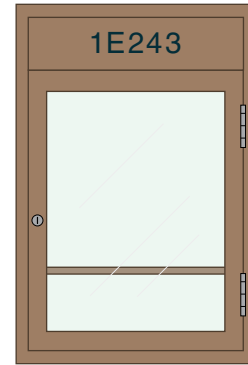

Front Accessible Single Box

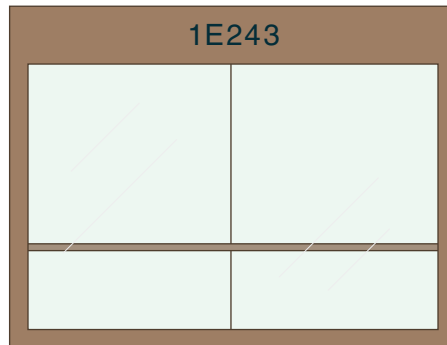
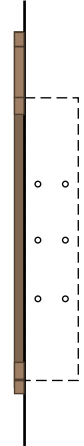

Rear Accessible Double Box

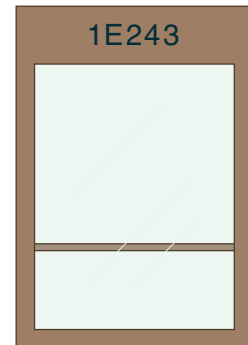

Rear Accessible Single Box

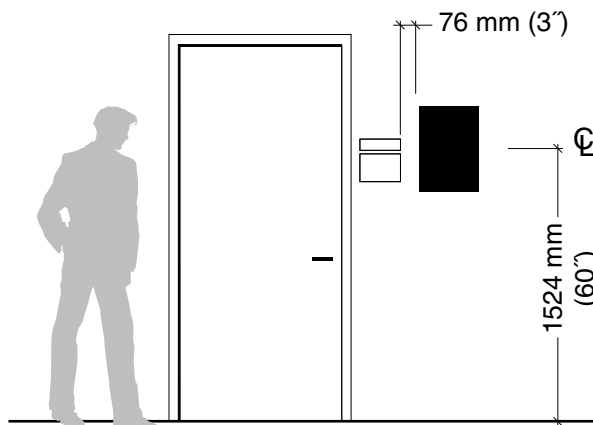
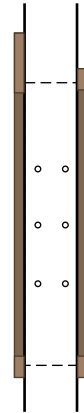

Memory Box

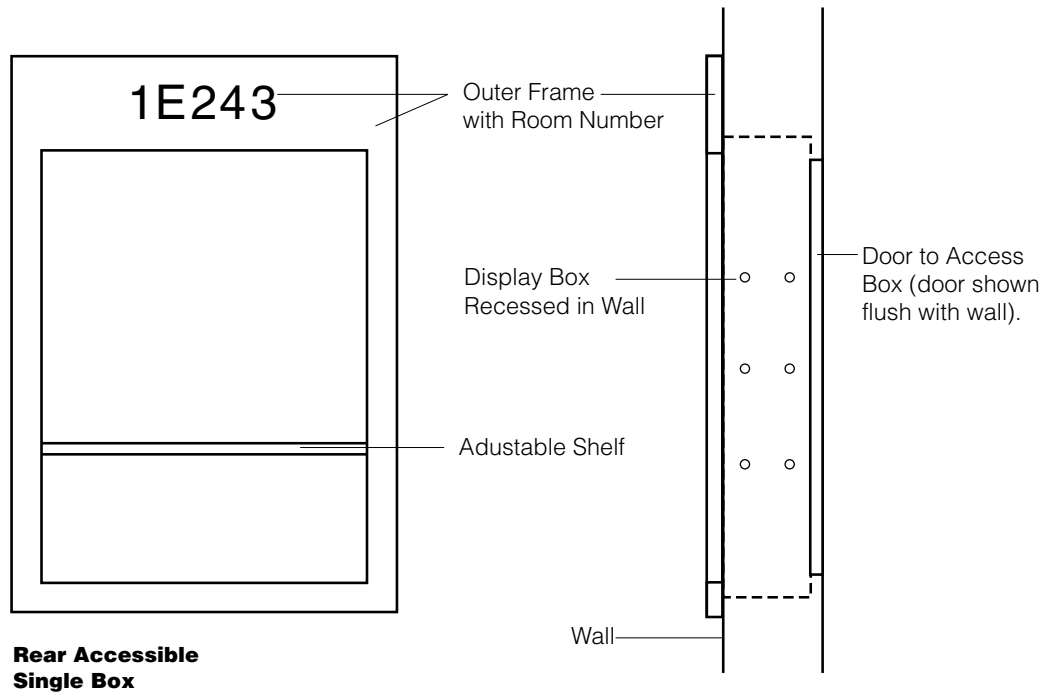
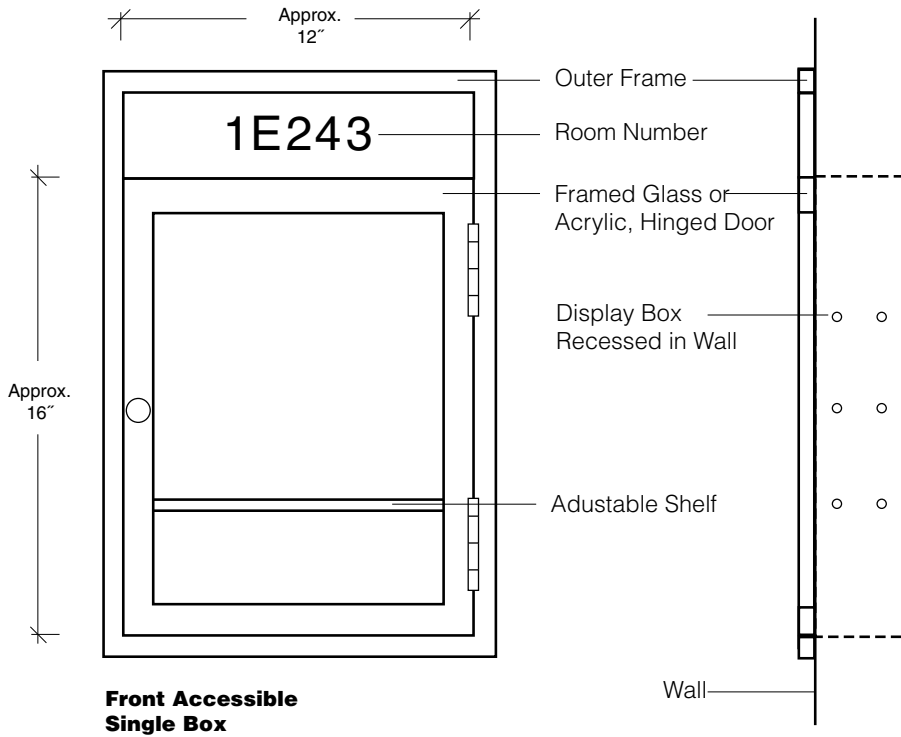

LCD Memory Monitor

Size

Approximately
152 mm H x 228 mm W x 76 mm D (6"
H x 9" W x 3" D)

Description

LCD monitor set in wall with front access cover. LCD Screen to display resident's pictures.

Use

Memory Monitors allow residents to display pictures and images of their life, family, and interests. The monitor can be positioned outside their doors to let others know a little bit about them and their families. Unit bezel can be finished to match the interior materials and finishes.

Sign Components

Recessed display space monitor and images by others.

Mounting

Recessed into wall.

Colors

Colors and materials of structure to match or complement existing interior palette.

Installation

It is recommended that this case with monitor be placed outside patient's room, adjacent to room sign next to entry door.

Recommendations

Small LCD screens are available, 178mm size are recommended.

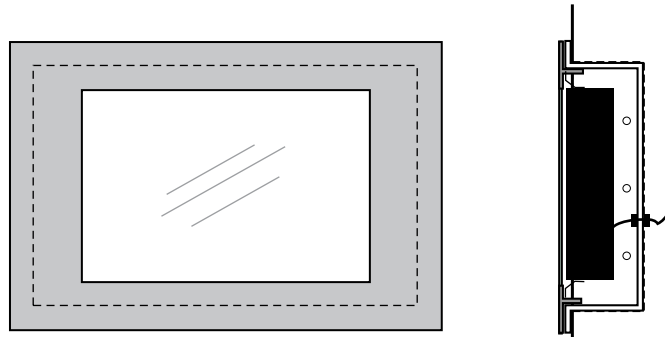

Small Memory Monitor Box
(Inset Into Wall)

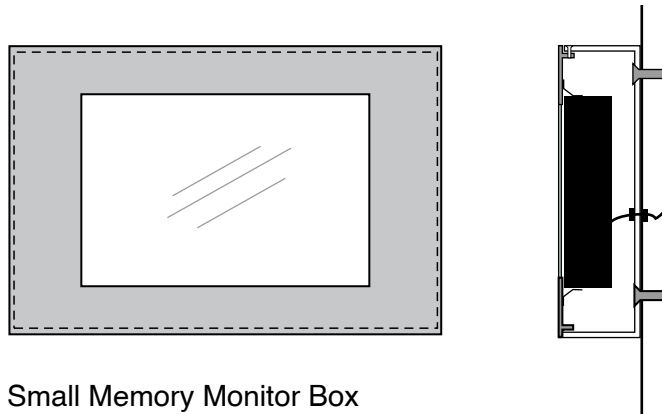

Small Memory Monitor Box
(Surface mount to Wall)

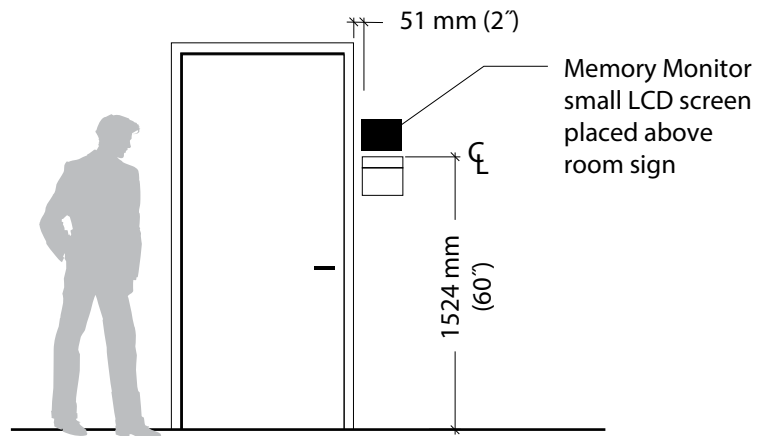

LCD Memory Monitor

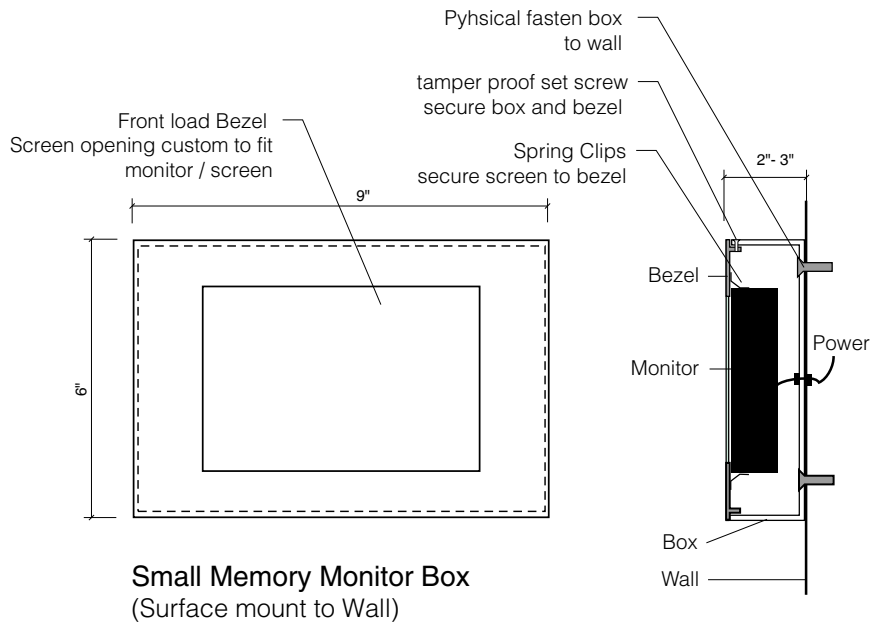
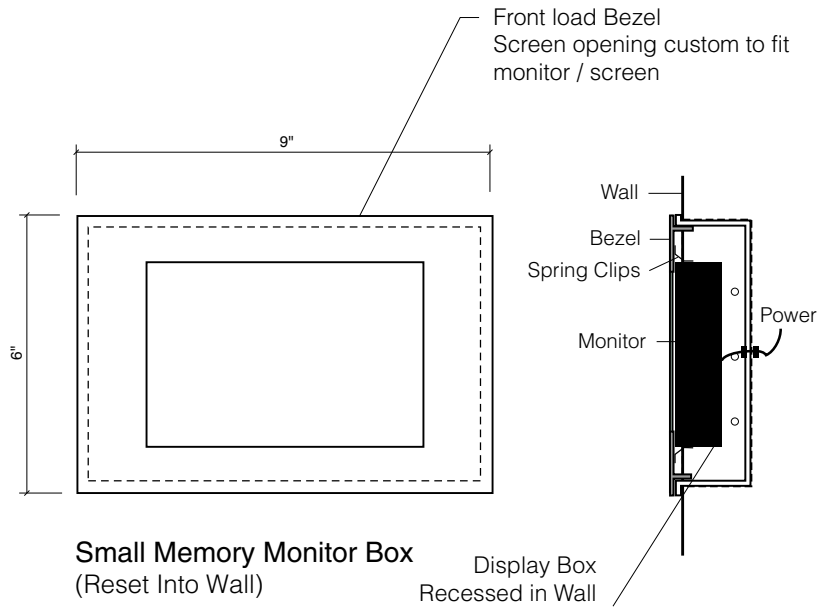

Banners: Pole Mounted

Size

Sizes to vary. Typical banner arm lengths are:

610 mm (24")

762 mm (30")

914 mm (36")

Typical banner widths are:

610 mm (24")

762 mm (30")

914 mm (36")

Description

Changeable exterior banners mounted perpendicular to light poles (or other existing poles or posts). Banners may be vinyl, canvas or nylon with printed or screened graphic imagery to vary. Banners may contain graphics on front and back sides of banner. Graphics may be informational or decorative.

Sign Components

Top and bottom pole mounted banner brackets, top and bottom banner bracket arms and banners. Brackets are available to hold a single banner or a double banner.

Mounting

Brackets mount to pole with heavy duty steel banding that wraps the pole to secure the bracket. Brackets can be mounted to a round, fluted or square pole. An arm is attached to each bracket. Banners contain top and bottom pockets that slip over bracket arms to secure placement.

Installation

On light pole or other exterior poles or posts at a minimum height of 3048 mm (10 feet) from the bottom of the banner to the ground.

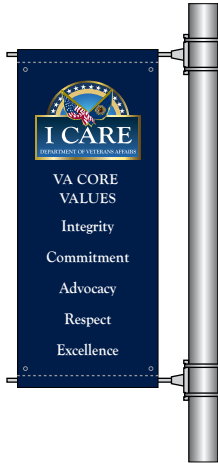

Single Banner Bracket



Double Banner Bracket

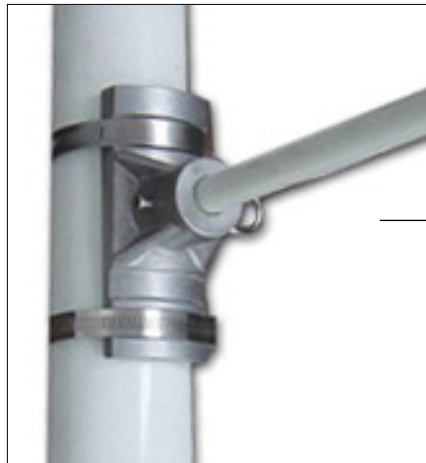

Banner Bracket Detail Photo

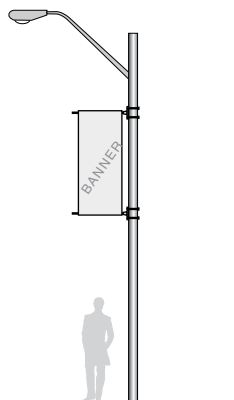

Single Banner Bracket

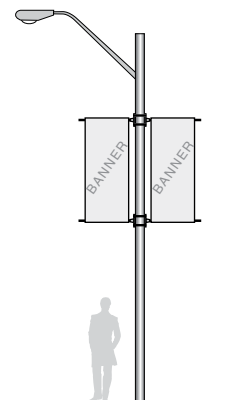

Double Banner Bracket

Banners: Pole Mounted

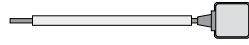

Plan Vw. for Square Post



Plan Vw. for Square Post



Plan Vw. for Round Pole



Plan Vw. for Round Pole

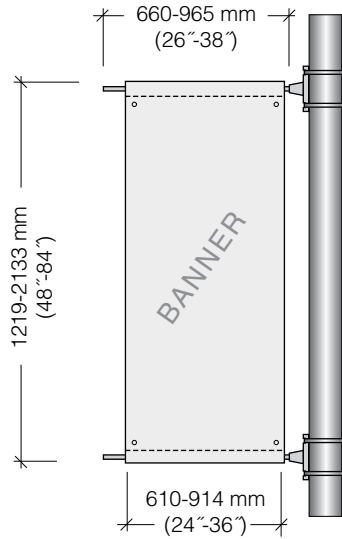

Single Banner Bracket:
For Round Pole or Square Post

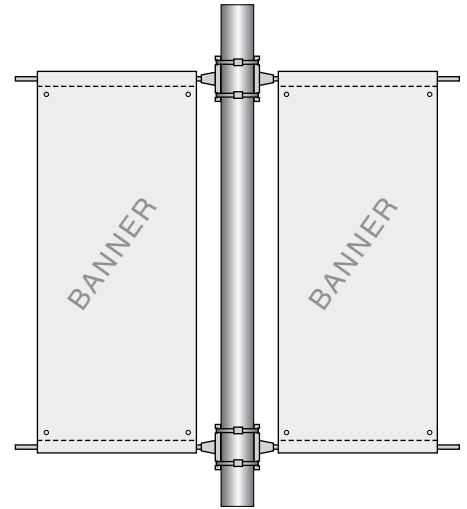

Double Banner Bracket
For Round Pole or Square Post

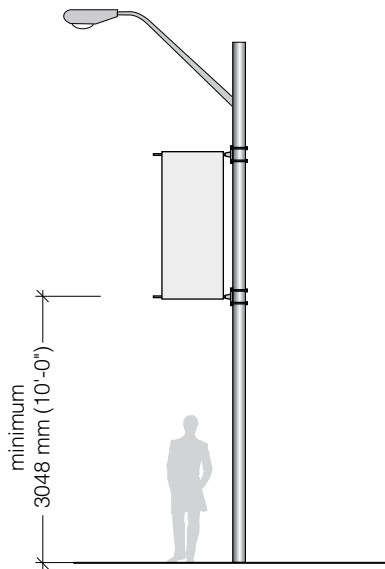

Single Banner Bracket

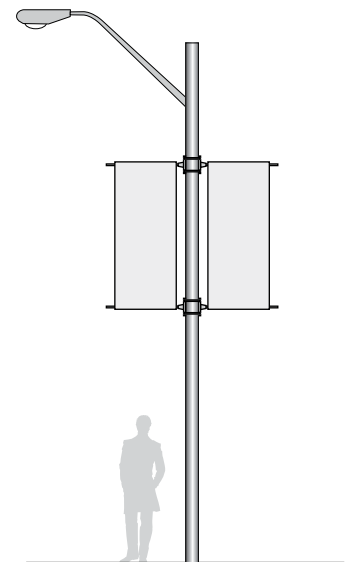

Double Banner Bracket

Construction Sign: Text Only

Size

Sign Panel:
1829 mm H x 2438 mm W
6' H x 8' W

Description

Sign used construction sites to provide information designating the specific "Department of Veterans Affairs" project under construction as well as the name of the general contractor and other project specific consultants.

Message Configuration

Refer to message layout drawing for dimensions.

Sign Components

Posts (metal or wood) and framed MDO plywood or aluminum sign panel

Graphic Process

Surface applied vinyl or screened graphics

Colors

Background: VA blue and white
Type: black
Refer to color chart.

Typography

Helvetica Bold

Mounting

Post mounted framed sign panel

Installation

It is recommended that this sign be placed at the entry, or a visible location, on a construction site.

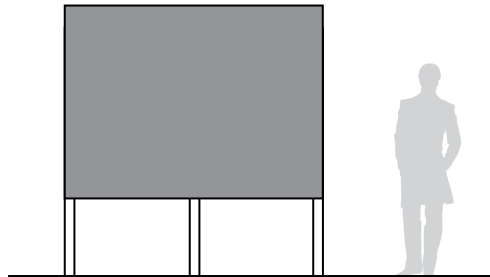
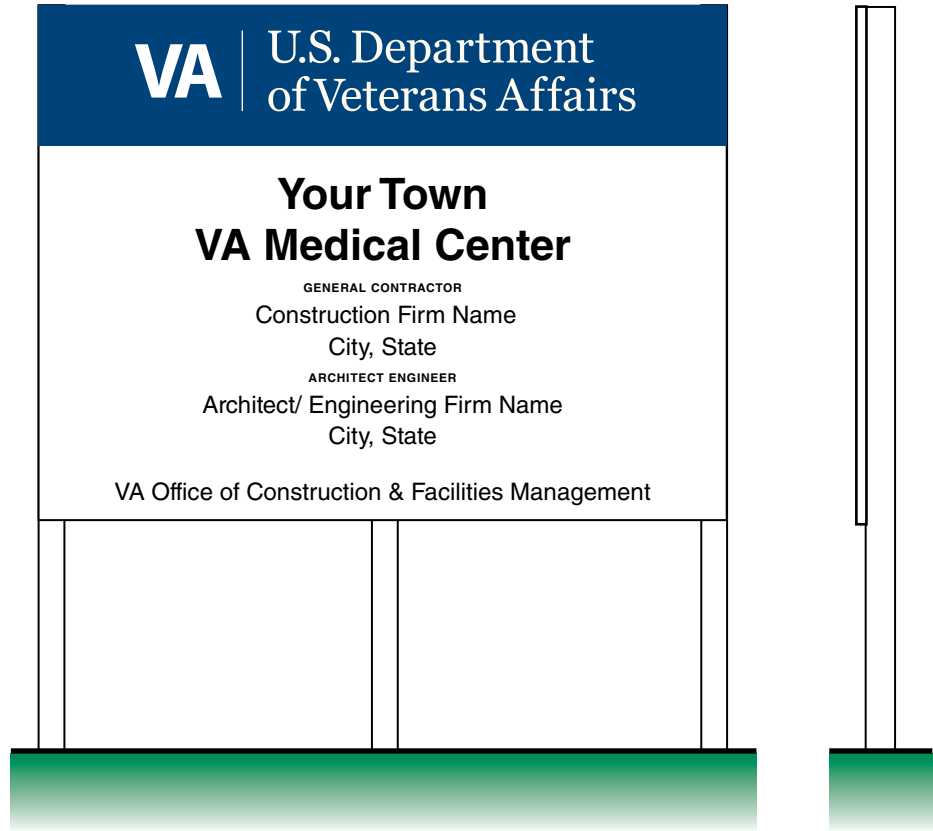

Construction Sign: Coming Soon, Text Only

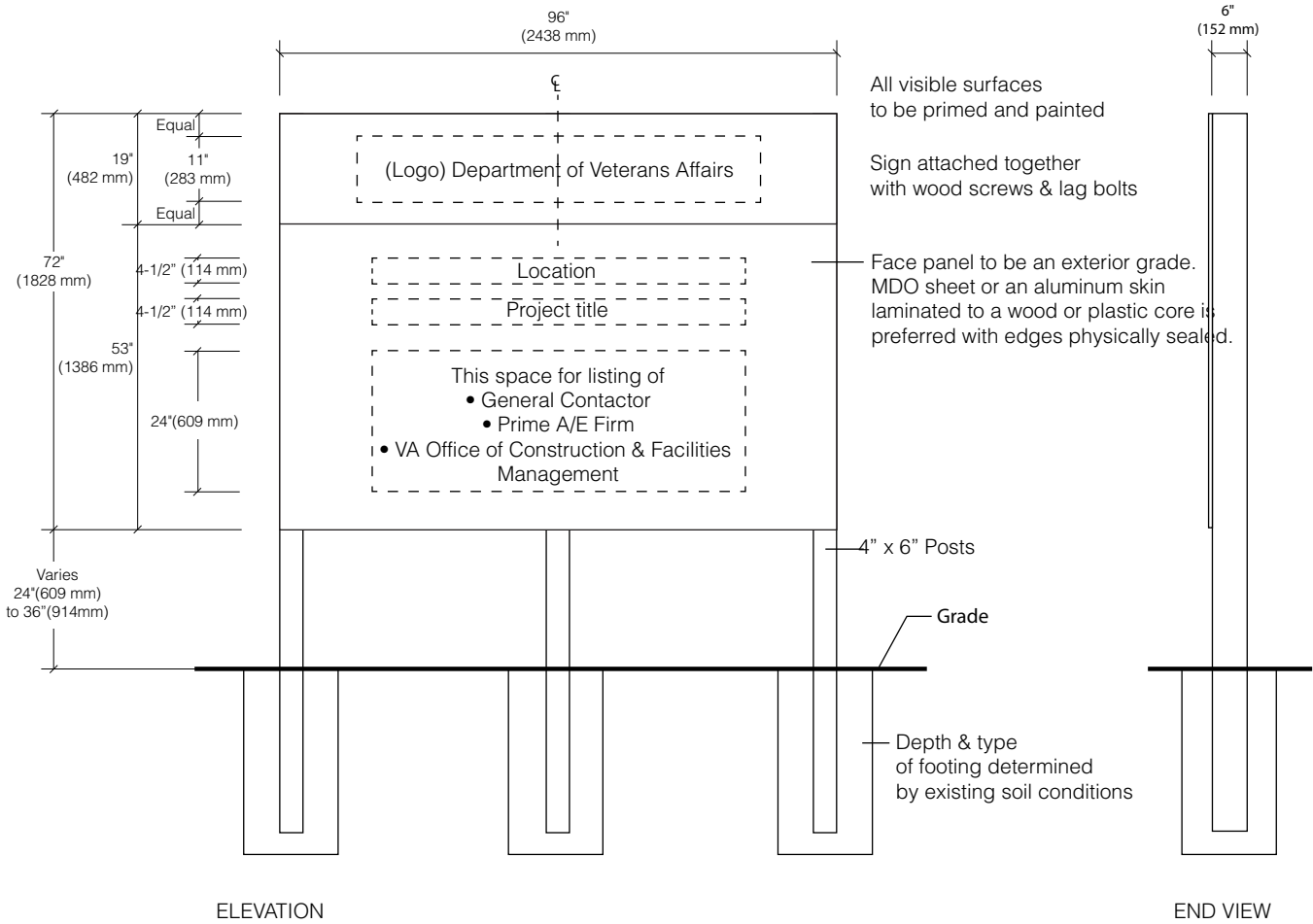
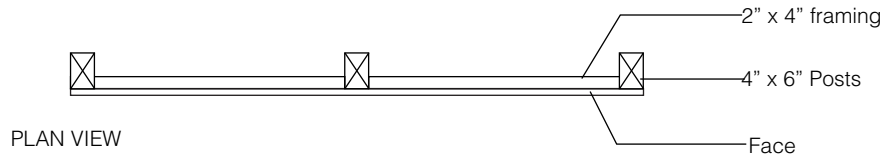

Construction Sign: Text with Rendering

Size

Sign Panel:
2438 mm H x 2438 mm W
8' H x 8' W

Description

Sign used at construction sites to provide information designating the specific "Department of Veterans Affairs" project under construction as well as the name of the general contractor and other project specific consultants.

Message Configuration

Refer to message layout drawing for dimensions.

Sign Components

Posts (metal or wood) and framed MDO plywood or aluminum sign panel

Graphic Process

Surface applied vinyl or screened graphics

Colors

Background: VA blue and white
Type: black
Refer to color chart

Typography

Helvetica Bold

Mounting

Post mounted framed sign panel.

Installation

It is recommended that this sign be placed at the entry to the construction site or along site perimeter at a major street.

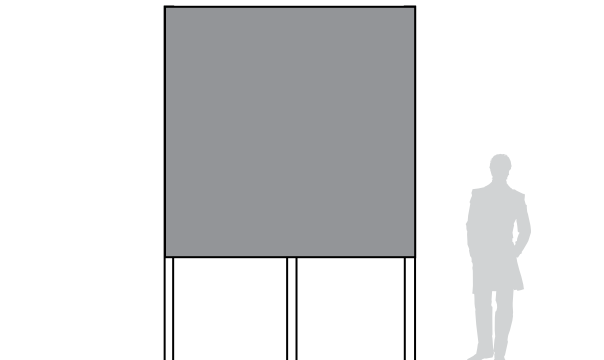
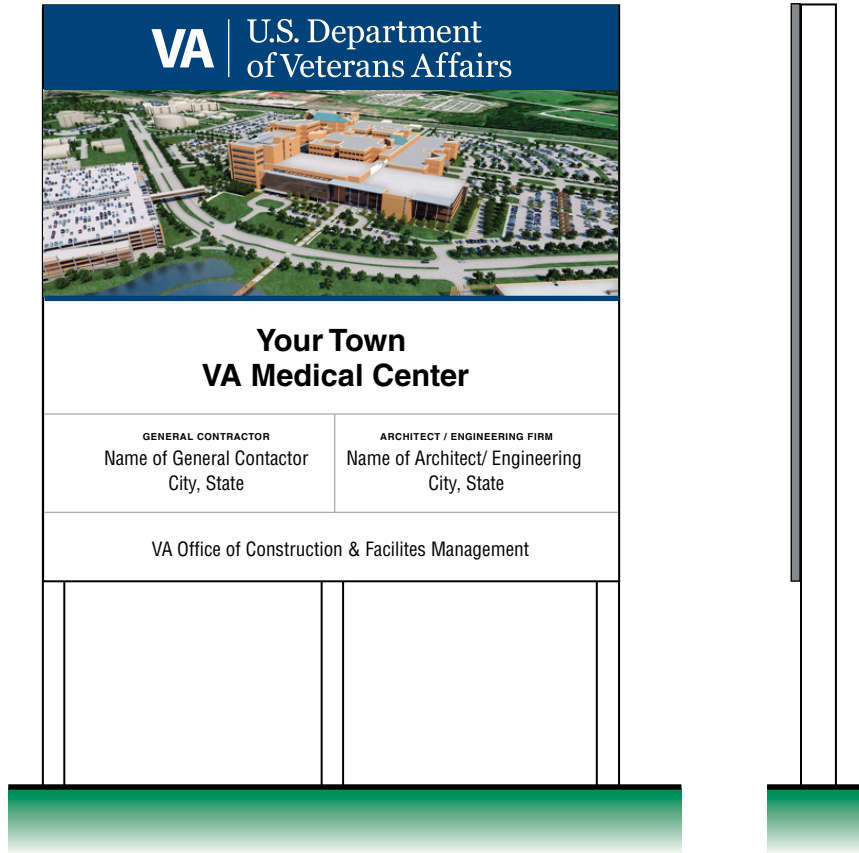

Construction Sign: Coming Soon with Rendering

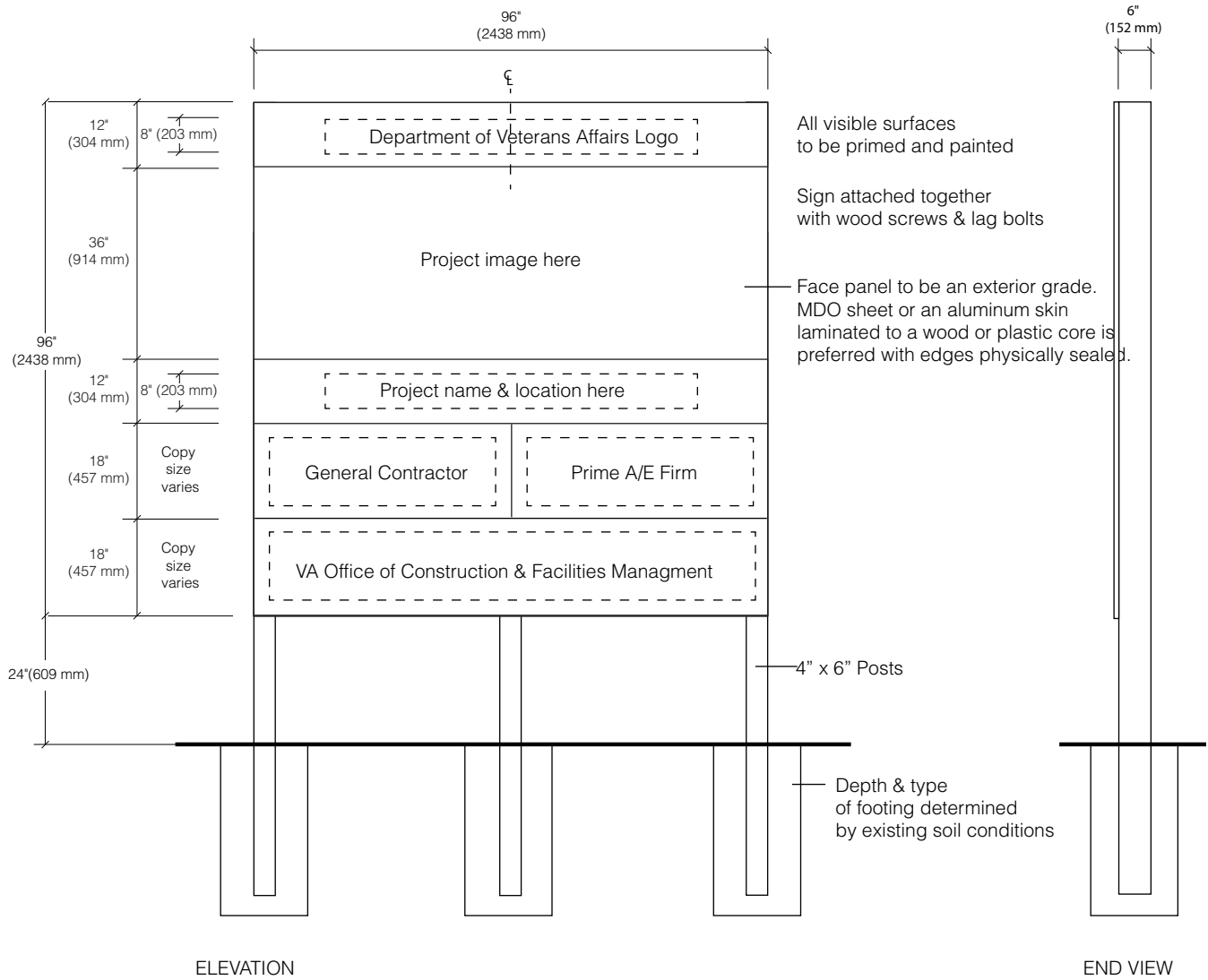
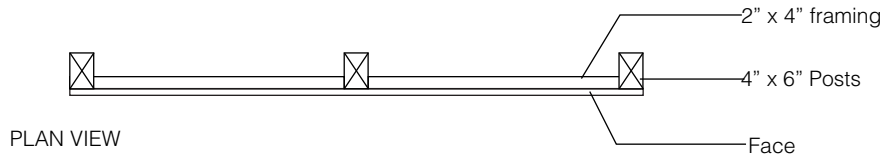

Construction Sign: Rendering

Size

Sign Panel:
1829 mm H x 2438 mm W
4' H x 8' W

Description

Sign used at construction sites to provide visual information specific to the "Department of Veterans Affairs" project under construction.

Message Configuration

Refer to message layout drawing for dimensions.

Sign Components

Posts (metal or wood) and framed MDO plywood or aluminum sign panel.

Graphic Process

Surface applied vinyl or screened graphics

Colors

For background, type and graphic colors, refer to color chart.

Typography

Helvetica Bold

Mounting

Post mounted framed sign panel

Installation

It is recommended that this sign be placed at the entry to the construction site or along site perimeter at a major street.

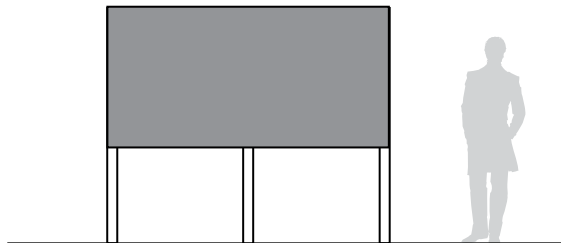
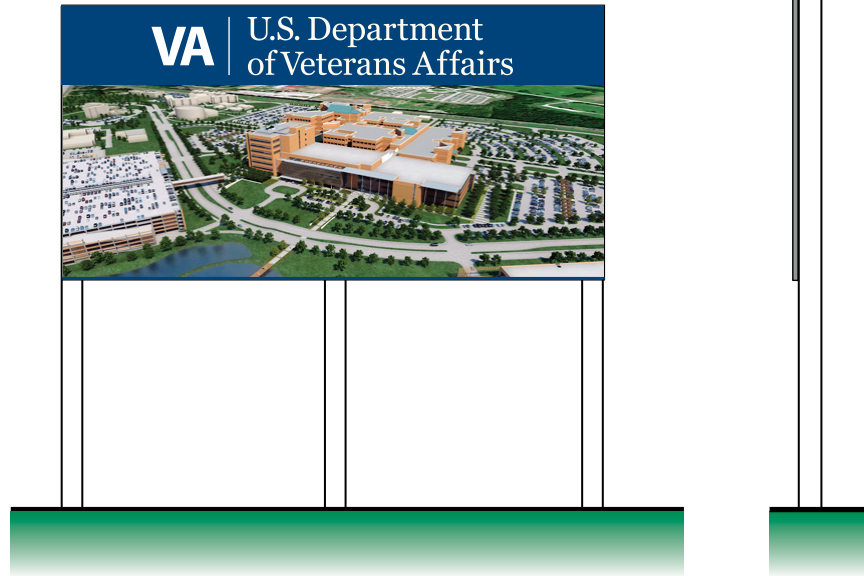

Construction Sign: Rendering

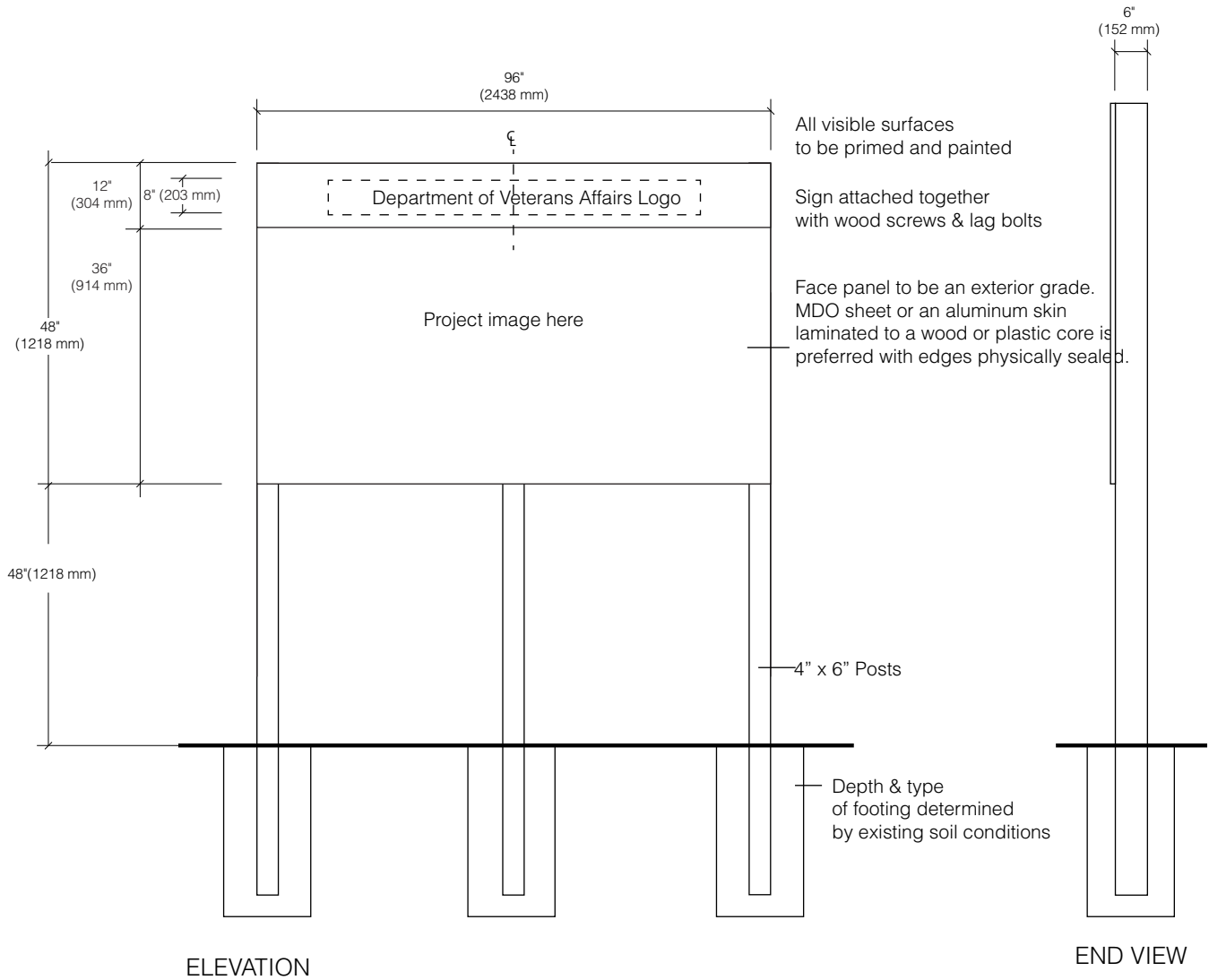
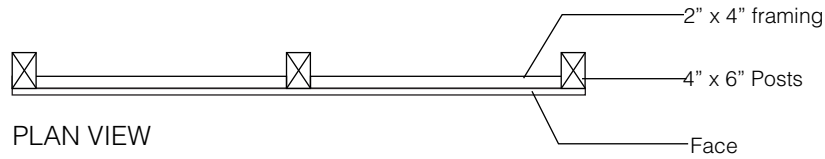

Construction Sign: Safety

Size

Sign Panel:
914 mm H x 1219 mm W
3' H x 4' W

Description

Sign used in construction sights to provide information regarding frequency of on site construction related accidents. Sign panel is built with a region to display changeable numbers to indicate the number of days since time was lost due to a construction accident.

Message Configuration

Refer to message layout drawing for dimensions.

Sign Components

Posts (metal or wood) and MDO plywood or aluminium sign panel. Sign panel may or may not be framed. Sign panel is equipped with a region to display changeable numbers.

Graphic Process

Surface applied vinyl or screened graphics

Colors

For background, type and graphic colors, refer to color chart.

Typography

Helvetica Bold

Mounting

Post mounted sign panel

Installation

It is recommended that this sign be placed at a visible location on a construction site near field office.

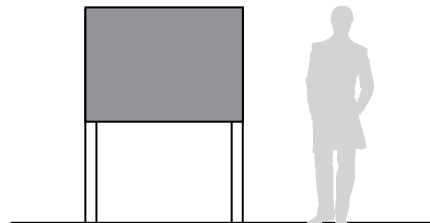
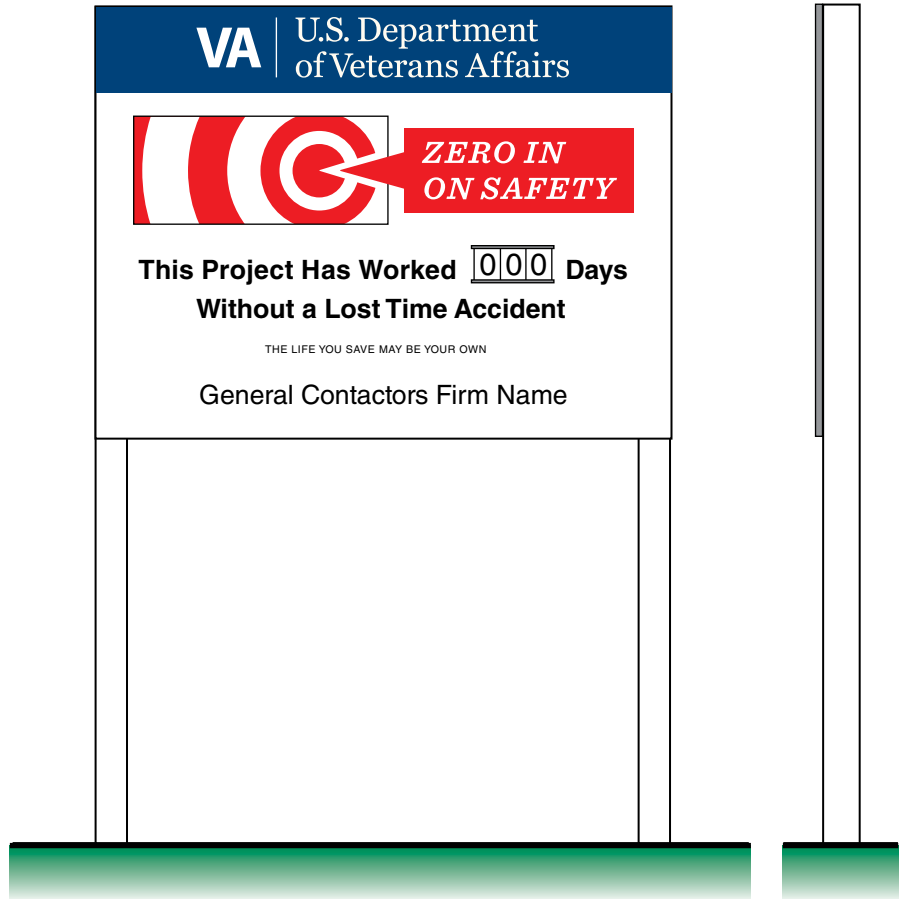

Construction Sign: Safety

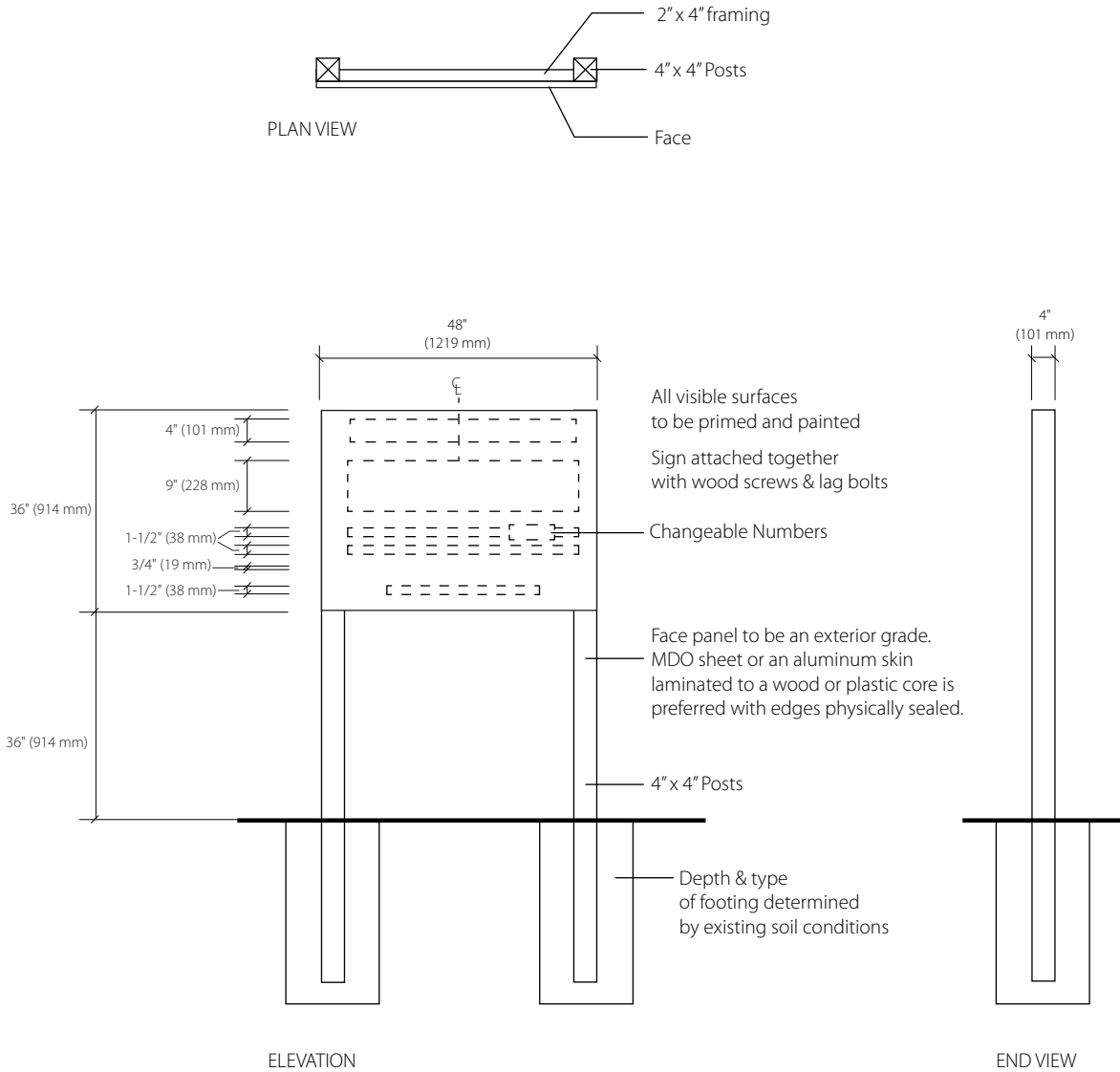

Photoluminescent Exit & Directional Signs

Description

Photoluminescent products are often used as egress marking systems to provide building occupants with a continuous pathway delineation for egress under all emergency conditions. Such markings, can address certain deficiencies in the traditional approach of energy lighting associated with power failure or smoke obscuration of high-mounted lighting.

Photoluminescent exit markings absorb light rays as it stores energy. Upon removal of the light source, the stored light is released, providing highly visible surface

Photoluminescent wayfinding system appear as a cost-effective addition to, or even a potential replacement for, traditional emergency lighting. Advantages are no additional consumption of energy, no additional wiring, minimal maintenance, and complete reliability when installed appropriately.

Photoluminescent egress path markings inside staircases are now detailed in the 2009 NFPA 101-Life Safety Code and 2009 NFPA 5000-Building Construction and Safety Code

Graphic Process

Painted on or applied decals

Colors

Colors are typically Green or Yellow

Installation

It is recommended that this be applied to:

- All doors entering a stairwell
- Obstacles in a stairwell
- Markings on each stair
- Markings on the leading edge of all landings
- Markings around the frame of final exit doors
- Along walls leading to the exit path

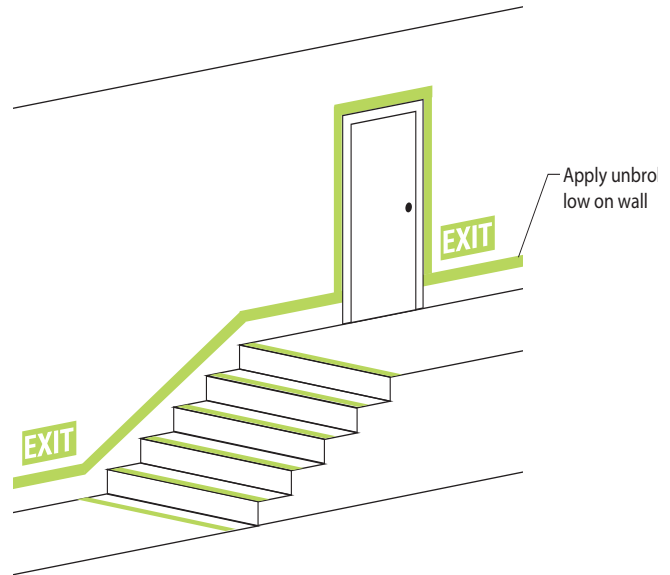

Size

Correct placement of signs will usually mean that fewer signs are required. Too many signs can create a cluttered appearance and increase the difficulty for a viewer to find the particular information they are seeking.

Detail 1

Installation detail sign type SP-22.01

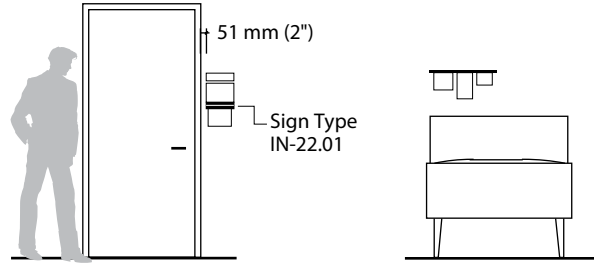

Detail: 1

Detail 2

Installation detail sign type SP-22.02 / SP-22.03

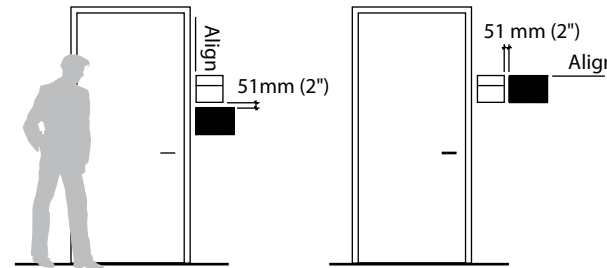

Detail: 2

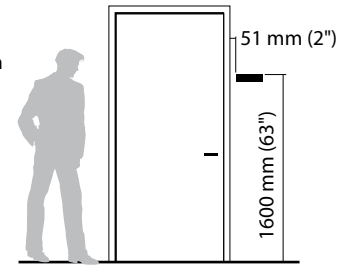

Detail: 3

Detail 3

Installation detail sign type SP-22.05

Detail 4

Installation detail sign type SP-22.06

Detail 5

Installation detail sign type SP-22.09

Detail 6

Installation detail sign type SP-23.01

Detail 7

Installation detail sign type SP-22.08

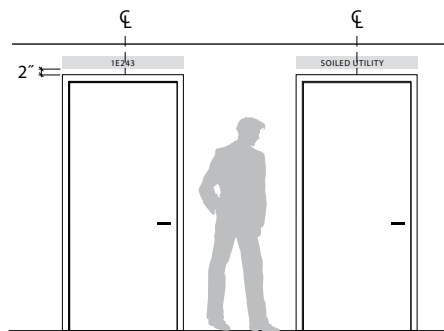

Detail: 4

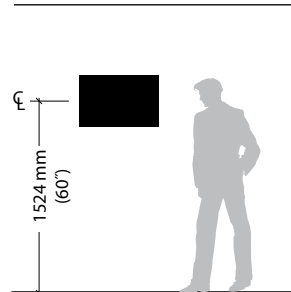

Detail: 5

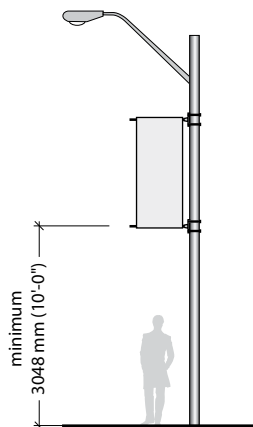

Detail: 6

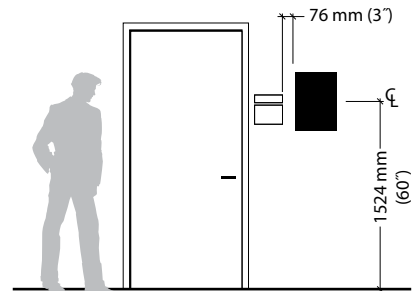

Detail: 7