



You Are Here Maps and Directories

- **Section Overview**
- **Presentation of Information**
- **Vehicular Maps**
- **Exterior Pedestrian Maps**
- **Interior Maps**
- **Evacuation Map**
- **Electronic Directories and Digital Signage**
- **Directories**

This page is intentionally left blank.

This section of the Sign and Graphic Design Guide will explain the different types of wayfinding / “You Are Here” maps and provide the basic information necessary to develop and correctly place these types of maps.

Every campus needs wayfinding and “You Are Here” maps throughout the site. Wayfinding maps fall into two basic categories, Visitor Orientation Maps and Evacuation Maps.

Visitor orientation maps are often incorporated into a directory and are designed to assist visitors in site and building navigation. Visitor orientation maps can be further divided into three subcategories, Vehicular Wayfinding Maps, Exterior Pedestrian Wayfinding Maps, and Interior Wayfinding Maps.

1. Exterior Pedestrian Wayfinding Maps provide exterior wayfinding information to pedestrians and are typically placed outside of the buildings, along pedestrian paths, leading to the facility. These maps include information related to the entire campus, such as roads, parking lots, walkways and specific buildings.
2. Vehicular Maps provide wayfinding information to motorists and are placed along roads within the site. These are simplistic and only provide wayfinding information related to vehicular paths of travel. Such information would include roads, points of entry and exit, designation of campus buildings and associated parking areas.
3. Interior Wayfinding Maps provide wayfinding information within a particular building. These types of maps provide information regarding the location of various departments and visitor related facilities, such as restrooms, patient rooms, and canteen, to name a few.
4. Evacuation maps are designed to provide emergency exit information in the event of a fire or disaster, where it may be necessary to evacuate a building quickly. Evacuation maps are located at building entrances, stairwells, elevators, and along intersecting corridors and provide only wayfinding information necessary to exit a building. These types of maps do not depict specific rooms or departments, instead they are simplified diagrammatic plans showing exit routes as well as the location of fire alarm pulls and fire extinguishers.

Following the discussion of “You Are Here Maps”, there is a subsection on directories. Many of the directories show inserts containing maps. These directories are in different sizes and have different applications. They can contain maps of a campus, building, or floors depending on their location.

Today’s technology allows for maps in a directory to be produced for moderate costs. Maintenance and map upgrades to directories are now easy to do as the same artwork used for web sites and brochures can be easily be produced as inserts for directories.

This page is intentionally left blank.

You Are Here Maps

Visitor Orientation Maps: Presentation Methods

There are different methods for displaying/presenting visitor orientation map information. Maps can be limited to a diagrammatic plan view of the site or building interior, or they can be more complex, including isometric, three dimensional or exploded views where multiple floors of a building are depicted in a single diagram.

Visitor orientation maps are often color coded to distinguish one area of a site or building from another. In addition to color coding, hatch patterns can be used to aid the color blind.

Plan View Diagram: This is the most common presentation method for depicting a visitor orientation map. This method displays the map information as a diagrammatic plan view of either the site or building interior.

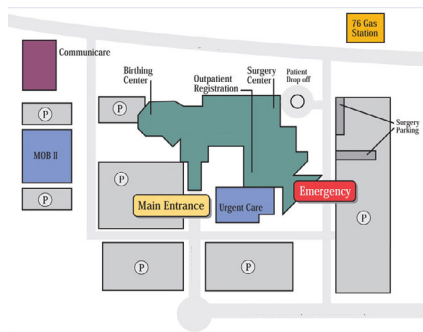

Plan Diagram: Site Wayfinding Map (simplified version)



Plan Diagram: site wayfinding map with color coded directory information

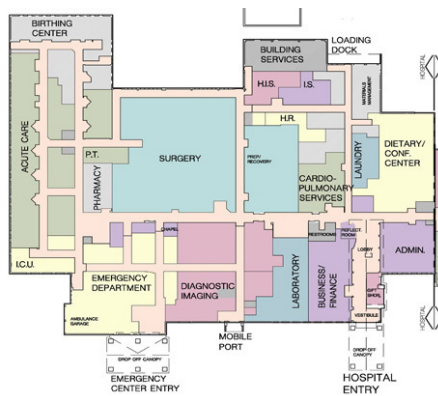

Plan Diagram: interior wayfinding map

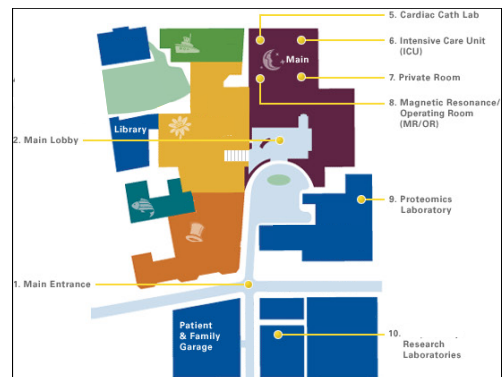

Plan Diagram: site wayfinding map, simplified and color coded

You Are Here Maps

Visitor Orientation Maps: Presentation Methods

Isometric View / Three Dimensional Illustration: This is a more complex method of depicting a map. The advantages of implementing this type of map is that it provides a more accurate visual representation of the site. This helps visitors translate orientation information. The disadvantage of this type of map is that the complexity of the illustration adds to the time and cost of development. Changes can also be difficult.



Isometric / Three Dimensional Rendering: Site map

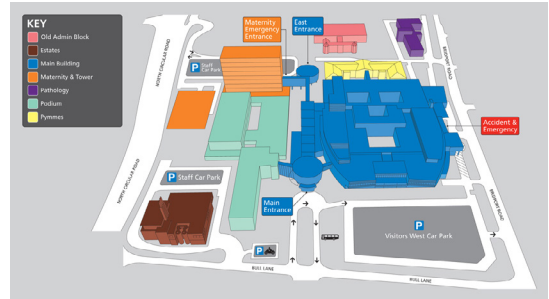

Isometric / Three Dimensional Illustration: Site map with three dimensional color coded simplified building forms

Exploded View; This method is useful when depicting wayfinding information on various levels of a multi level building in one diagram. This type of map has the same advantages and disadvantages as an isometric view.



Exploded View: Color coded interior wayfinding map showing two floors of a single building.

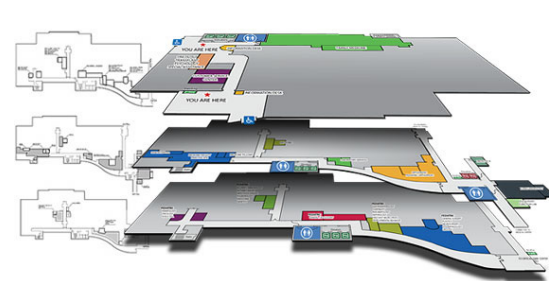

Exploded View: Interior wayfinding map showing three floors of a single building along with a corresponding plan view of each floor.

You Are Here Maps

Visitor Orientation Maps: Orientation

Orientation: All wayfinding / “You Are Here” maps should be positioned in the direction that the viewer is facing. This holds true for both Visitor Orientation Maps as well as Evacuation Maps. For example, if the map is situated so that the viewer is looking east, the map should be positioned so that the top of the map is also facing east.

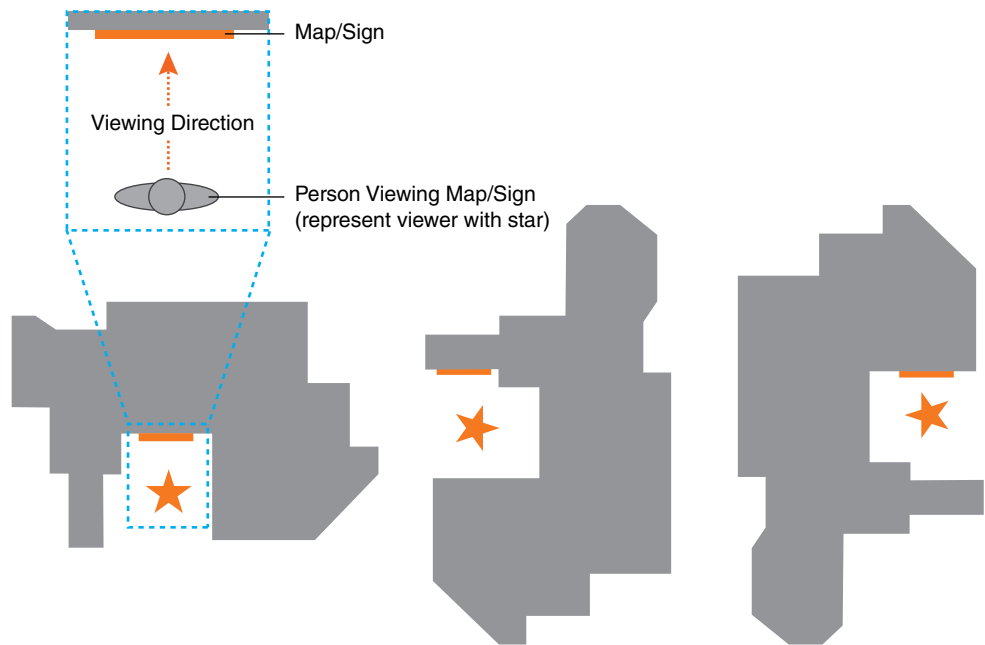

Diagram illustrates how maps should be oriented. Each map shows the “You Are Here” star in the same location, with the orange line indicating the location of the map. In each example, the map has been rotated to reflect the orientation of the map.

You Are Here Maps

Visitor Orientation Maps: Placement, Sizing, Mounting, and Content

Placement: Wayfinding maps need to be located along paths of travel or at points of decision making. Maps should be strategically placed so as visitors travel from one area of the site towards their destination there are maps along the way to provide orientation information.

Sizing and Mounting: All information should be presented at a size large enough to be easily readable and visible from the distance of the intended viewer.

Maps can be produced as a digital print on a variety of substrates such as vinyl, paper, or a laminated graphic. The method of production needs to be compatible with the environmental conditions as well as with the structure that the map is to be integrated with. For example, a digital print on paper will be suitable for an interior environment and placement under glass or acrylic. However, it will not be suitable for an exposed exterior application.

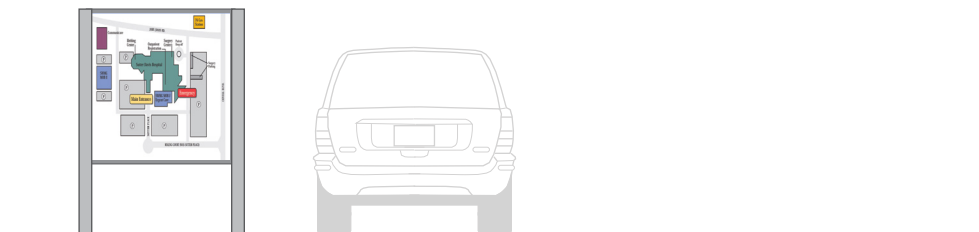

Freestanding Vehicular Wayfinding Map

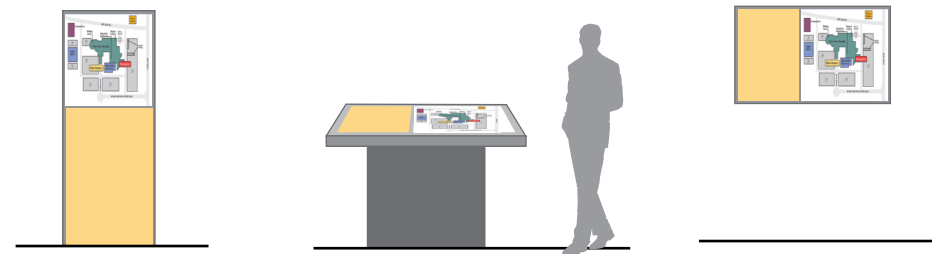

Map Displayed on a Freestanding Kiosk

Map Displayed on a Podium Type of Structure

Wall Mounted Map

The three examples above could be used for either pedestrian wayfinding maps or interior wayfinding maps

Content: Visitor orientation maps should only include information that is relevant to visitors. Areas such as a loading dock, laundry facility or utility rooms should be excluded.

Areas such as loading docks, laundry facilities, or utility buildings should not be identified on campus maps. Non-public buildings can be shown on a campus map, however, they should not be labeled or referenced. If buildings are identified by number, then the map should clearly show the number.

Symbols: Typical symbols that are shown on orientation maps are ones that are simple and common. These symbols should be reproduced in a size that is easy to identify and locate on a map.



North Arrow



Bus Stop Symbol



Building Identification Symbol



You are Here Symbol



Parking Symbol



Restroom Symbol

You Are Here Maps

Exterior Vehicular Maps

There are several considerations to address when developing vehicular wayfinding maps: as follows:

Orientation: Vehicle oriented “Campus You Are Here” maps should always be positioned in the direction that a vehicle is facing. For example, if the map is situated so that the viewer is looking down the main campus road, the map should be positioned so that the top of the map is also facing that direction.

If there are significant geographic or architectural features that will help a drivers orientation, these should be included on the map (e.g., a river that runs along the campus, an adjacent Interstate highway).

Placement: Vehicular wayfinding maps are intended to direct motorists from the site entry to the parking facility associated with their destination. Maps that are directed to drivers must be placed in a location where a driver can safely pull over and stop to read the map. Maps should not be read while driving.

A small campus will need only one map, but a large campus with a complex roadway system may need several maps at different locations. These maps are to be located along vehicular paths of travel. The maps should be strategically placed so that as visitors drive from one area of the site towards their destination there are additional maps and directional signage along the way to provide orientation information.

Sizing and Mounting: All information should be presented large enough so that it is easily readable and visible from an approaching vehicle. Because the map will be viewed from a vehicle, the information needs to be as simplified as possible. These types of maps are typically freestanding and should not obstruct the view of the motorist.

Content: Vehicular wayfinding maps should only include information that is relevant to vehicular wayfinding, no extraneous information should be included.

Information to include is as follows: site entries and exits, “You are Here” symbol, visitor accessible roads, and visitor related buildings, along with associated parking areas.

It may be helpful to color code maps to visually distinguish one area from another.

Directory: Campus maps that are directed toward vehicular viewing, or that contain a directory, require restraint when assembling the directory listings. Only the MAJOR destination should be listed in the directory – Main Entrance, Visitor Parking, Clinic Entrance, Hospital, Community Living Center, etc. Limiting the listings to only the important destinations will shorten the driver's viewing time and allow quicker decisions to be made as to where to go.

Directory listings need to be a minimum of 2-1/2" capital letter height to be able to be read from a car parked near a map.

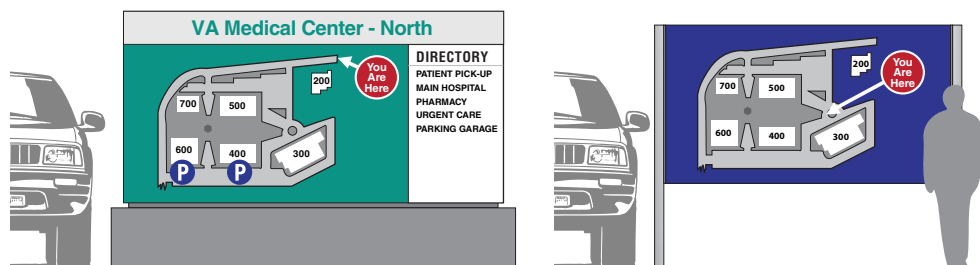

You Are Here Maps

Exterior Pedestrian Maps

There are a few considerations to address when developing exterior pedestrian wayfinding maps: as follows:

Orientation: Pedestrian oriented “You Are Here” maps should always be positioned in the direction that the walker or viewer is facing. For example, if the map is situated so that the viewer is looking down a pathway, toward a specific building, the map should be positioned so that the top of the map has that particular building and is also facing that direction.

If there are significant geographic or architectural features that will help pedestrian orientation, these should be included on the map (such as a river that runs along the campus, a building with a clock tower, a large sculpture).

Placement: Pedestrian wayfinding maps need to be located along paths of travel or at points of decision making. Maps should be strategically placed so that as visitors walk from one area of the site towards their destination there are maps along the way to provide orientation information. Exterior site maps should be placed along walkways leading from parking areas to the facility as well as along pathways leading from one building to another.

Sizing and Mounting: All information should be presented large enough so that it is easily readable/visible from a distance of approximately 3 to 5 feet. Pedestrian wayfinding maps may be freestanding, wall mounted, mounted to a vertically free-standing structure or kiosk, or podium mounted.

Content: Exterior wayfinding maps should only include information that is relevant to visitors. Areas such as a loading dock or administrative offices need not be labeled.

Information to include is as follows: “You Are Here” symbol, restrooms, main building entries, parking areas, various campus visitor related departments, and bus stops.

It may also be helpful to color code maps to visually distinguish one area from another.

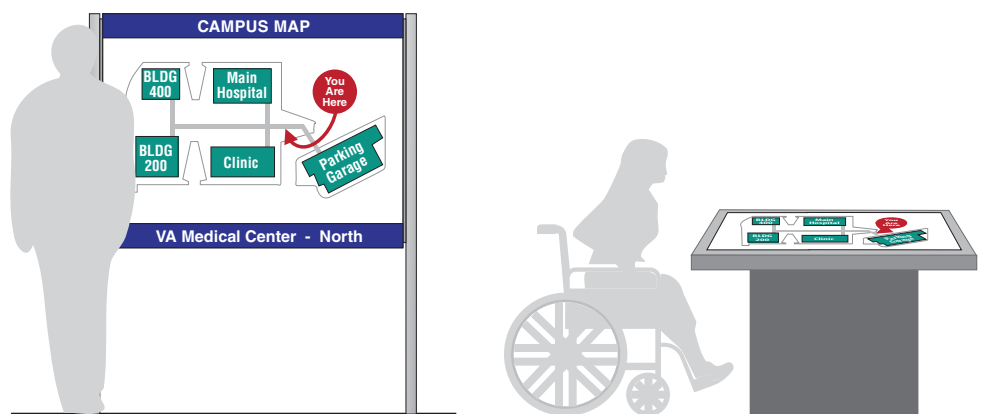

You Are Here Maps

Interior Maps

There are a few considerations to address when developing interior wayfinding maps: as follows:

Orientation: Interior pedestrian oriented “You Are Here” maps should always be positioned in the direction that the walker or viewer is facing. For example, if the map is situated so that the viewer is looking toward a hallway or elevator, the map should be positioned so that the top of the map has that particular elevator or hallway. If the viewer needs to turn left to get to the elevators, then the elevators should be shown to the left on the map.

If there are significant architectural features that will help pedestrian orientation in a building, these should be included on the map (e.g., an atrium, a piece of sculpture, elevators, etc.).

Placement: Interior wayfinding maps are to be located at building entry lobbies and at elevator lobbies on each visitor accessible floor.

Sizing and Mounting: All information should be presented large enough so that it is easily readable and visible from a distance of approximately 2 to 3 feet. These types of maps are typically wall mounted, however, they may also be free standing or podium mounted, depending upon the surrounding conditions.

Content: All interior wayfinding maps are to include “You Are Here” symbol. Those maps located at lobby entries are to include general information for the entire building, such as location of restrooms and various building departments (like Pharmacy, Blood Draw, Waiting Room, Clinics) as well as visitor related facilities (such as Canteen, Retail Store, vending machines).

Interior wayfinding maps found at elevator lobbies are to include more specific information regarding that particular floor. This information may include patient room numbers, and offices within a given department. Again, only information that is relevant to visitors is to be included. Areas such as laundry facilities, utility rooms, and other non public areas should not be shown.

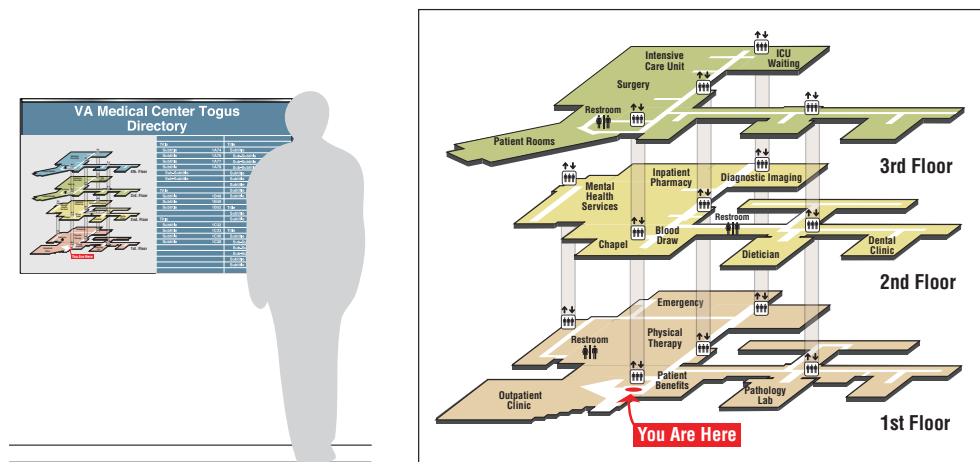

You Are Here Maps

Evacuation Maps

Evacuation maps are designed to provide exit information in the event of a fire or emergency. The only wayfinding information that is necessary are exit routes and main hallways or corridors leading to the exit routes. No additional wayfinding information is to be included.

Layout, Colors and Typography: Evacuation maps need not conform to a specific layout or color palette. The maps must contain the necessary content discussed above and be easily readable from a distance of 18–24 inches. It is important that all elements are in a contrasting value to the background on which they are placed (darker colors on lighter colors and vice versa). It is also important that the layout, typography and colors are consistent from one evacuation map to the next. Typography should be limited to a sans serif typeface, preferably Helvetica Bold.

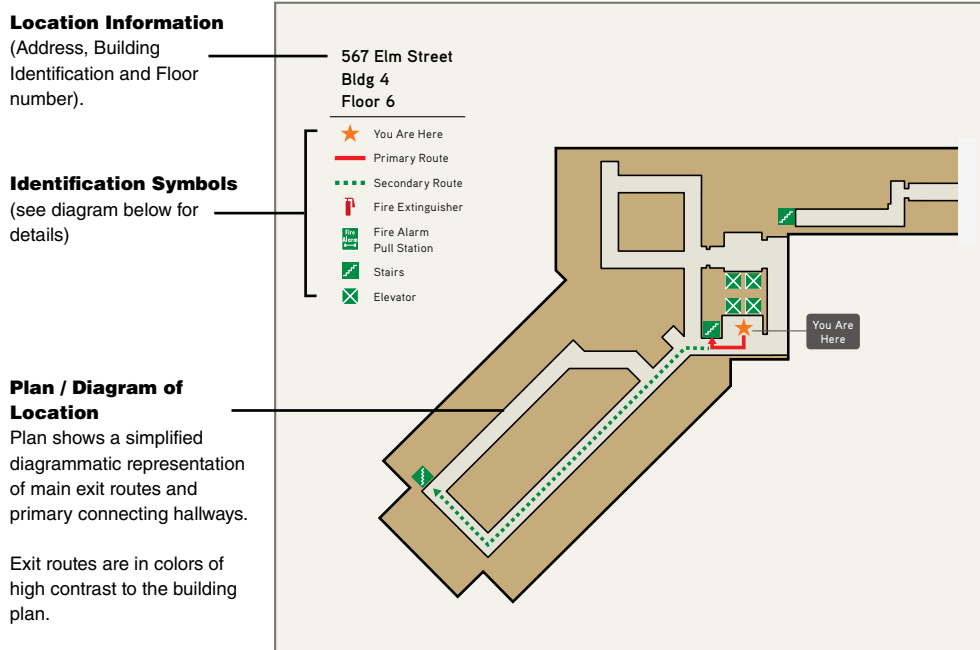







Evacuation Map: Not to Scale, Approx 1/3 of full size

You Are Here Maps

Evacuation Maps

Symbols and Necessary Content: The following information must be included on all evacuation maps: Location information such as address, building number and floor level (if applicable), "You Are Here" symbol, location of fire extinguishers and fire alarm pulls, location of stairwells and elevators (in multi-level buildings), a designated path of travel for a primary exit route, and an alternate (secondary) exit route.

-  **You Are Here Symbol:** To be placed on map at location of specific map.
-  **Primary Exit Route:** Used to show most direct route from location of map to exit.
-  **Secondary Exit Route:** Used to show alternate exit route from map location.
-  **Fire Extinguisher:** To be placed on map at location of fire extinguishers.
-  **Fire Alarm Pull Symbol:** To be placed on map at location of fire alarm pull
-  **Stair Symbol:** To be placed on map at location of stairwells.
-  **Elevator Symbol:** To be placed on map at location of elevators.

Evacuation Map Symbols: Full Size (symbols should be no smaller than those shown above)

Orientation and Placement: Evacuation maps are to be placed at any building transition: building exits, exiting doors, elevators and entrances to stairwells. In Hoptels they are also to be installed on the door, on the interior room side of the door.

NOTE: Evacuation maps are required in Hoptels or dormitories. They are optional in other types of buildings.

If a facility elects to install evacuation maps, the local Fire Department should be contacted for their specific requirements regarding content, size and layout of evacuation map information. These requirements should be obtained prior to developing and installing evacuation maps.

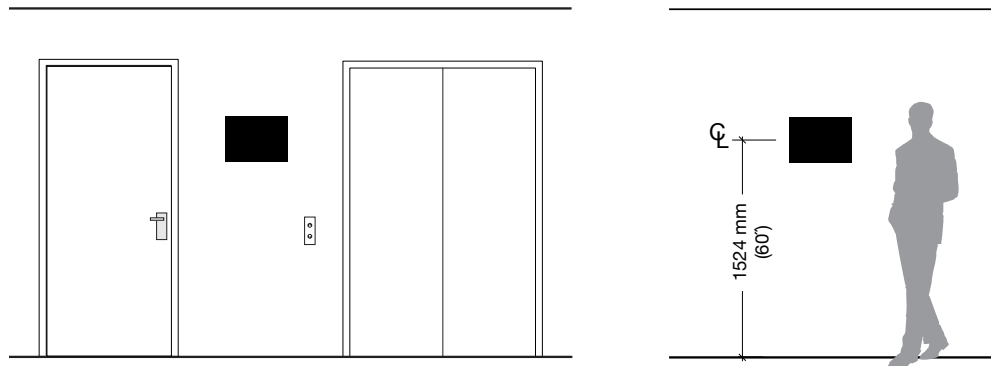

Evacuation Map Placement

Electronic Directories and Digital Signage

Electronic digital signage is a form of signage that involves the presentation of information through the use of an electronic display. This type of communication can be in the form of a static presentation such as a menu board or interactive involving a person touching and interacting with the images and messages on an electronic screen.

The following will focus on the use of electronic digital signage, in the form of directories.

Directories provide an important information resource for any wayfinding plan and they are often the first destination and interactive points for visitors and patients. Directories function to assist a person to find where they need to go within a building or complex of several buildings. In addition to providing a listing of information, directories can also display maps and provide a cross reference between the listings and a location on a map.

With the electronic technologies readily available today, directories can show a viewer the pathway on a map taking them from where they are located to the destination they are seeking. Directories must make a positive impression with a pleasing design, clear and simple operation with easy to read and understand graphics and provide CURRENT and CORRECT information.

Electronic directories can be wall-mounted, custom free standing kiosks, or displays. They should be placed in locations where they are readily visible. The location also needs to allow a user to interact with the unit without being in the way people trying to circulate. It is also critically important that the directories have their information coordinated with the exact location and orientation of the directory

Electronic directories are now the best way to present directory type information to patients and visitors. They can take many forms from a static display to those that are interactive, and others that can accommodate interactive activities such as patient registration.

Hand sanitizers should be provided in close proximity to interactive directories, along with instructions for their use. Considering the numbers of patients and visitors who would use these directories, the use of hand sanitizers would be a major help for maintain

Static Electronic Digital Display

A simple static electronic directory can be a LCD screen that displays a listing of the services and their location in the manner of an alphabetical listing as has been typically done for the last 100 years. This would be presenting the same information as a traditional and typical strip directory. With a static electronic directory it is very easy to move up a level of communication by add additional static images such as building floor plans to accompany the listings.

Computer programs are readily available for these type of directories and they are the cheapest to purchase, and simplest to maintain. Development of the content and its maintenance can be done by anyone with basic computer skills.

The next step with static electronic directories is adding images that create a visual theme and can provide a visually interesting background or theme. Banner elements can be run across the bottom of the screen to display the weather or activities taking place at the facility.

Computer programs are readily available to do this as well and they are inexpensive to purchase, and simple to maintain, but do require regular daily updating if they are

Electronic Directories and Digital Signage

displaying event messages. Development of the content and its maintenance can be done by anyone with basic computer skills.

There are companies that will install static directory displays, develop the content, and maintain them for minimal charge or even at no charge. They in turn sell advertising on the display to recoup their costs.

Interactive Electronic Digital Display

Interactive displays allow a user to interact with a touch screen monitor to obtain information that is available from the facility's website or a computer. The screens are typically placed in a kiosk arrangement where the person can stand in front of the screen and look for information by touching on messages, icons or images to gather the information they are seeking. The information can be the location of an individual in a building or the receptionist for a department. It can be the location of a restroom or the pathway to a department or service. The information request is specific to the individual interacting with the screen and thus the information custom tailored to that individual.

When developing an interactive electronic directory system for a medical center, flexibility, intuitiveness, and functionality are critical. Several elements are necessary for a interactive system to be developed for a facility. The elements all need to be developed together to ensure the system works as a whole.

The dynamic interactive display will contain a directory listing of all departments and services within the hospital that are to be able to be accessed in a directory. These will be identified by name, area or building, floor and room number.

Not all departments or services should be listed. For example, departments such as the Morgue, Boiler Room, Kitchens, and other similar non-public departments, rooms, and services. Some services or departments should be identified not necessarily by their location, but rather where people are to be directed. For example, to the Surgery Waiting Room, not the Surgical Department.

The interactive display will need to illustrate a map of the entire medical center campus showing all the buildings that contain services and departments that are to be accessed. The map will need to clearly show parking lots and structures as well as pathways to all the buildings.

The interactive display should also illustrate the different floor levels of each of the buildings. The map will need to clearly show the elevators servicing the floors as well as the public circulation stairs, entrances, lobbies, and significant architectural elements such as atriums and courtyards.

The maps will need to be oriented to the direction the user is facing the touch screen and in relation to the building orientation. When directories are located in multiple locations and if they are two sided, map orientations may need to be provided for four viewing directions. Consider all the locations and their orientation when planning for a interactive electronic directory system.

Operationally, when a user touches the directory listing for the department or service they are seeking, a route from the location of the kiosk to the department that has been touched, will be displayed on the map. This route will identify the "You Are Here" starting point, the path of travel, the elevator (if required), the path of travel from the elevator to the end destination, the name of the department at the end destination, and the room number. Systems are available that will also print out this route, thus giving the individual a "hard copy" map of the route; these require periodic paper replacement.

You Are Here Maps

Electronic Directories and Digital Signage

Future Interactive Directories and Check In Systems

Interactive directories can be completely developed by outside “consultants.” The consultants can provide regular maintenance as well as host the systems, off site, using the Internet and Cloud support.



In the immediate future, systems and technology will allow a patient to go on the Internet through their home computer or smartphone, confirm their appointment, find a map illustration for the facility showing where to park, view the pathway from parking to a electronic check in kiosk, then view the pathway to the department or service within the building.

When a visitor or patient arrives at a facility they will be able to interact, in the lobby, with a kiosk and check in. The electronic digital check in will function as a directory and show the patient the pathway to their department. This pathway can then be printed out giving them a map they can carry. The map and route information can contain references to key physical features within the building to aid in wayfinding, such as, “Turn right at the first corridor and walk past the atrium to the first corridor on the left”

For those who are seeking a department or an individual and do not require an appointment check in, they too will be able to look up a service listing or individual and interact with the touch screen display to find the pathway to the service, department or individual using the same wayfinding tools as an electronic patient check in procedure.

The information provided in this section is an overview. The intent has been to introduce options, systems, and products which are currently available. As with all technology, the development of new equipment, software and approaches to conveying information change rapidly, therefore, it is recommended that research be conducted to find a system that best fits the requirements of the facility and can be compatible with newer technologies as they become available.

This section of the VA Signage Design Guide provides for the types of directories that can be used for individual buildings.

This Overview Section gives general illustrations of directory sign type groups. Sign type drawings are on two pages with the front page illustrating the general descriptions and the second page providing the dimensions and graphic layouts.

IN - 17.01 A

IN Designates an interior sign.

17 Two digit number identify a particular directory family.

.01 The two digit number, following the period, identifies a specific directory within the directory family.

A The letter designates a specific sign configuration, version and/or layout for graphics.

IN-17.01
Strip Directory

IN-17.02
Large Strip Directory

| Directory | | |
|---------------|---------------|---------------|
| Title | Sub-Title | Sub-Sub-Title |
| 1A74 | Sub-Title | 2A42 |
| 1A76 | Sub-Sub-Title | |
| 1A77 | Sub-Sub-Title | |
| 1A78 | Sub-Sub-Title | |
| Sub-Sub-Title | Sub-Title | 2A44 |
| Sub-Sub-Title | Sub-Title | 2A45 |
| Sub-Sub-Title | Sub-Title | 2A46 |
| Title | Sub-Title | 2A48 |
| Sub-Title | Sub-Title | 2A52 |
| Sub-Title | Sub-Title | 2A55 |
| Title | Sub-Title | 2B32 |
| Sub-Title | Sub-Title | 2B34 |
| Sub-Title | Title | |
| Sub-Title | Sub-Title | 3A54 |
| Sub-Title | Sub-Sub-Title | |
| | Sub-Title | 3A55 |
| | Sub-Title | 3A56 |

IN-17.01

| Directory | | |
|---------------|---------------|---------------|
| Title | Sub-Title | Sub-Sub-Title |
| 1A74 | Sub-Title | 2A42 |
| 1A76 | Sub-Sub-Title | |
| 1A77 | Sub-Sub-Title | |
| 1A78 | Sub-Sub-Title | |
| Sub-Sub-Title | Sub-Title | 2A44 |
| Sub-Sub-Title | Sub-Title | 2A45 |
| Sub-Sub-Title | Sub-Title | 2A46 |
| Title | Sub-Title | 2A48 |
| Sub-Title | Sub-Title | 2A52 |
| Sub-Title | Sub-Title | 2A55 |
| Title | Sub-Title | 2B32 |
| Sub-Title | Sub-Title | 2B34 |
| Sub-Title | Title | |
| Sub-Title | Sub-Title | 3A54 |
| Sub-Title | Sub-Sub-Title | |
| | Sub-Title | 3A55 |
| | Sub-Title | 3A56 |

IN-17.02

IN-17.03
Strip Directory with Map

| VA Medical Center Togus Directory | | |
|-----------------------------------|---------------|---------------|
| Title | Sub-Title | Sub-Sub-Title |
| 1A74 | Sub-Title | 2A42 |
| 1A76 | Sub-Sub-Title | |
| 1A77 | Sub-Sub-Title | |
| 1A78 | Sub-Sub-Title | |
| Sub-Sub-Title | Sub-Title | 2A44 |
| Sub-Sub-Title | Sub-Title | 2A45 |
| Sub-Sub-Title | Sub-Title | 2A46 |
| Title | Sub-Title | 2A48 |
| Sub-Title | Sub-Title | 2A52 |
| Sub-Title | Sub-Title | 2A55 |
| Title | Sub-Title | 2B32 |
| Sub-Title | Sub-Title | 2B34 |
| Sub-Title | Title | |
| Sub-Title | Sub-Title | 3A54 |
| Sub-Title | Sub-Sub-Title | |
| | Sub-Title | 3A55 |
| | Sub-Title | 3A56 |

IN-17.03

IN-17.04
Large Strip Directory with Map

| Directory | | |
|---------------|---------------|---------------|
| Title | Sub-Title | Sub-Sub-Title |
| 1A74 | Sub-Title | 2A42 |
| 1A76 | Sub-Sub-Title | |
| 1A77 | Sub-Sub-Title | |
| 1A78 | Sub-Sub-Title | |
| Sub-Sub-Title | Sub-Title | 2A44 |
| Sub-Sub-Title | Sub-Title | 2A45 |
| Sub-Sub-Title | Sub-Title | 2A46 |
| Title | Sub-Title | 2A48 |
| Sub-Title | Sub-Title | 2A52 |
| Sub-Title | Sub-Title | 2A55 |
| Title | Sub-Title | 2B32 |
| Sub-Title | Sub-Title | 2B34 |
| Sub-Title | Title | |
| Sub-Title | Sub-Title | 3A54 |
| Sub-Title | Sub-Sub-Title | |
| | Sub-Title | 3A55 |
| | Sub-Title | 3A56 |

IN-17.04

IN-17.05
Strip Floor Directory

IN-17.06
Large Strip Floor Directory

| FLOOR TWELVE | | |
|--------------|---------------|---------------|
| Title | Sub-Title | Sub-Sub-Title |
| 1A47 | Sub-Title | 1A49 |
| 1A49 | Sub-Sub-Title | 1A50 |
| 1A50 | Sub-Sub-Title | |
| 1A52 | Sub-Title | 2A62 |
| 1A53 | Sub-Title | 2A63 |
| 1A54 | Sub-Title | 2A64 |
| 1A55 | Sub-Title | 2A65 |
| 1A56 | Sub-Title | 2A66 |
| Title | Sub-Title | 2B45 |
| Sub-Title | Sub-Title | 2B46 |
| Sub-Title | Sub-Title | 2B46 |

IN-17.05

| FLOOR TWELVE | | |
|--------------|---------------|---------------|
| Title | Sub-Title | Sub-Sub-Title |
| 1A47 | Sub-Title | 1A49 |
| 1A49 | Sub-Sub-Title | 1A50 |
| 1A50 | Sub-Sub-Title | |
| 1A52 | Sub-Title | 2A62 |
| 1A53 | Sub-Title | 2A63 |
| 1A54 | Sub-Title | 2A64 |
| 1A55 | Sub-Title | 2A65 |
| 1A56 | Sub-Title | 2A66 |
| Title | Sub-Title | 2B45 |
| Sub-Title | Sub-Title | 2B46 |
| Sub-Title | Sub-Title | 2B46 |

IN-17.06

IN-17.11
Directory with Insert

| Directory | | |
|--------------|------|--------------|
| Title | | |
| Subtitle | 1A71 | Subtitle |
| Subtitle | 1A76 | Sub-Subtitle |
| Subtitle | 1A77 | Sub-Subtitle |
| Subtitle | 1A78 | Sub-Subtitle |
| Sub-Subtitle | | Subtitle |
| Sub-Subtitle | | Subtitle |
| Sub-Subtitle | | Subtitle |
| Sub-Subtitle | | Subtitle |
| Title | | Subtitle |
| Subtitle | 1B48 | Subtitle |
| Subtitle | 1B49 | Subtitle |
| Subtitle | 1B52 | Subtitle |
| Title | | Subtitle |
| Subtitle | 1C32 | Subtitle |
| Subtitle | 1C33 | Title |
| Subtitle | 1C36 | Sub-Subtitle |
| Subtitle | 1C38 | Sub-Subtitle |
| | | Sub-Subtitle |
| | | Sub-Subtitle |
| | | Sub-Subtitle |
| | | Sub-Subtitle |

IN-17.11

| Directory | | |
|--------------|------|--------------|
| Title | | |
| Subtitle | 1A71 | Subtitle |
| Subtitle | 1A76 | Sub-Subtitle |
| Subtitle | 1A77 | Sub-Subtitle |
| Subtitle | 1A78 | Sub-Subtitle |
| Sub-Subtitle | | Subtitle |
| Sub-Subtitle | | Subtitle |
| Sub-Subtitle | | Subtitle |
| Sub-Subtitle | | Subtitle |
| Title | | Subtitle |
| Subtitle | 1B48 | Subtitle |
| Subtitle | 1B49 | Subtitle |
| Subtitle | 1B51 | Title |
| Subtitle | | Subtitle |
| Subtitle | | Subtitle |
| Subtitle | | Subtitle |
| Subtitle | | Subtitle |
| Title | | Subtitle |
| Subtitle | 1C34 | Subtitle |
| Subtitle | 1C37 | Title |
| Subtitle | 1C38 | Subtitle |
| Subtitle | 1C42 | Sub-Subtitle |
| | | Sub-Subtitle |
| | | Sub-Subtitle |
| | | Sub-Subtitle |
| | | Sub-Subtitle |

IN-17.12

IN-17.13
Directory with Map and Listing Insert

| VA Medical Center Togus Directory | | |
|-----------------------------------|--------------|------|
| | Title | |
| | Subtitle | 1A74 |
| | Subtitle | 1A76 |
| | Subtitle | 1A77 |
| | Subtitle | 1A78 |
| | Sub-Subtitle | |
| | Sub-Subtitle | |
| | Sub-Subtitle | |
| | Sub-Subtitle | |
| | Sub-Subtitle | |
| | Sub-Subtitle | |
| | Sub-Subtitle | |
| | Sub-Subtitle | |
| | Sub-Subtitle | |
| | Sub-Subtitle | |
| Title | | |
| Subtitle | 1B48 | |
| Subtitle | 1B49 | |
| Subtitle | 1B52 | |
| Title | | |
| Subtitle | 1C32 | |
| Subtitle | 1C33 | |
| Subtitle | 1C36 | |
| Subtitle | 1C38 | |

IN-17.13

IN-17.14
Large Directory with Map and Listing Insert

| Directory | | |
|-----------|--------------|------|
| | Title | |
| | Subtitle | 1A71 |
| | Subtitle | 1A76 |
| | Subtitle | 1A77 |
| | Subtitle | 1A78 |
| | Sub-Subtitle | |
| | Sub-Subtitle | |
| | Sub-Subtitle | |
| | Sub-Subtitle | |
| | Sub-Subtitle | |
| | Sub-Subtitle | |
| | Sub-Subtitle | |
| | Sub-Subtitle | |
| | Sub-Subtitle | |
| | Sub-Subtitle | |
| | Sub-Subtitle | |
| | Sub-Subtitle | |
| | Sub-Subtitle | |
| | Sub-Subtitle | |
| | Sub-Subtitle | |
| | Sub-Subtitle | |
| | Sub-Subtitle | |
| | Sub-Subtitle | |

IN-17.14

IN-17.15
Floor Directory with Insert

| FLOOR FOUR 4 | |
|--------------|------|
| Title | 1A37 |
| Subtitle | 1A39 |
| Subtitle | 1A50 |
| Sub-Subtitle | |
| Sub-Subtitle | |
| Title | 1A62 |
| Subtitle | 1A63 |
| Subtitle | 1A64 |
| Subtitle | 1A65 |
| Subtitle | 1A66 |
| Title | 1B45 |
| Subtitle | 1B46 |
| Subtitle | 1B46 |

IN-17.15

IN-17.16
Large Floor Directory with Insert

| FLOOR FOUR 4 | |
|--------------|------|
| Title | 1A47 |
| Subtitle | 1A49 |
| Subtitle | 1A50 |
| Sub-Subtitle | |
| Sub-Subtitle | |
| Title | 1A62 |
| Subtitle | 1A63 |
| Subtitle | 1A64 |
| Subtitle | 1A65 |
| Subtitle | 1A66 |
| Subtitle | 1A63 |
| Subtitle | 1A64 |
| Subtitle | 1A65 |
| Subtitle | 1A66 |
| Title | 1A62 |
| Subtitle | 1A63 |
| Subtitle | 1A64 |
| Subtitle | 1A65 |
| Subtitle | 1A66 |

IN-17.16

IN-27.01
Freestanding Information Kiosk



IN-27.01

IN-27.02
Wall Mounted Touch Screen
Directory



IN-27.02

IN-27.03
Freestanding Touch Screen
Directory



IN-27.03

Strip Directory

Size

762 mm H x 610 mm W
(2'-6" H x 2'-0" W)

Description and Use

Small size main lobby directory with 48 directory strips

Message Configuration

(Refer to layout drawing for lettering sizes and dimensions).

Header Layout A is for a basic directory header. Header Layout B is for a directory header to contain the name of the facility. Copy Strip A is for use with the main listings. Copy Strip B is for a secondary listing under a main listing or when the name is too long to fit on Strip A.

Sign Components

Sliding rail back; copy panel; top accent bar; end caps

Graphic Process

Surface applied vinyl

Colors

Text: Refer to color chart.
Background and accent bar: Refer to color chart.

Typography

Helvetica

Mounting

Mechanical fastener

Installation

Wall mounted

Recommendations

This directory is for use in the main lobby of small buildings which would typically have no more than 30 to 40 listings. All listings in a directory should be done in alphabetical order. List in the directory only services or departments which have contact with patients and public. Distribute any blank directory strips throughout the directory to provide spacing between groups of listings.

| Directory | | Directory | |
|--------------|------|--------------|------|
| Title | | Title | |
| Subtitle | 1A74 | Subtitle | 2A42 |
| Subtitle | 1A76 | Sub-Subtitle | |
| Subtitle | 1A77 | Sub-Subtitle | |
| Subtitle | 1A78 | Sub-Subtitle | |
| Sub-Subtitle | | Subtitle | 2A44 |
| Sub-Subtitle | | Subtitle | 2A45 |
| | | Subtitle | 2A46 |
| Title | | Subtitle | 2A48 |
| Subtitle | 1B48 | Subtitle | 2A52 |
| Subtitle | 1B49 | | |
| Subtitle | 1B52 | Title | |
| | | Subtitle | 2B32 |
| | | Subtitle | 2B34 |
| Title | | Title | |
| Subtitle | 1C32 | Subtitle | 3A54 |
| Subtitle | 1C33 | Sub-Subtitle | |
| Subtitle | 1C36 | Sub-Subtitle | |
| Subtitle | 1C38 | Sub-Subtitle | |
| | | Subtitle | 3A55 |
| | | Subtitle | 3A56 |



Header (Message Layout A)



Header (Message Layout B)

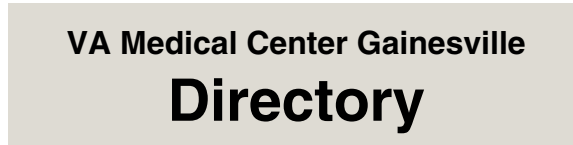

Copy Strip A

| | |
|-------|------|
| Title | 1A74 |
|-------|------|

Copy Strip B

| | |
|----------|------|
| Subtitle | 1B48 |
|----------|------|

Copy Strip C

| | |
|--------------|------|
| Sub-Subtitle | 1C49 |
|--------------|------|

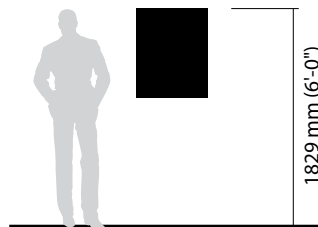

Strip Directory

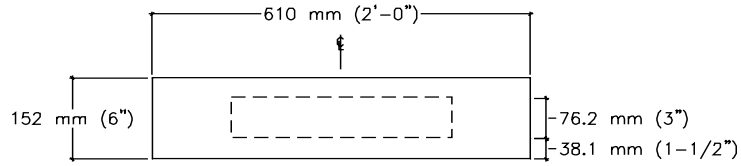
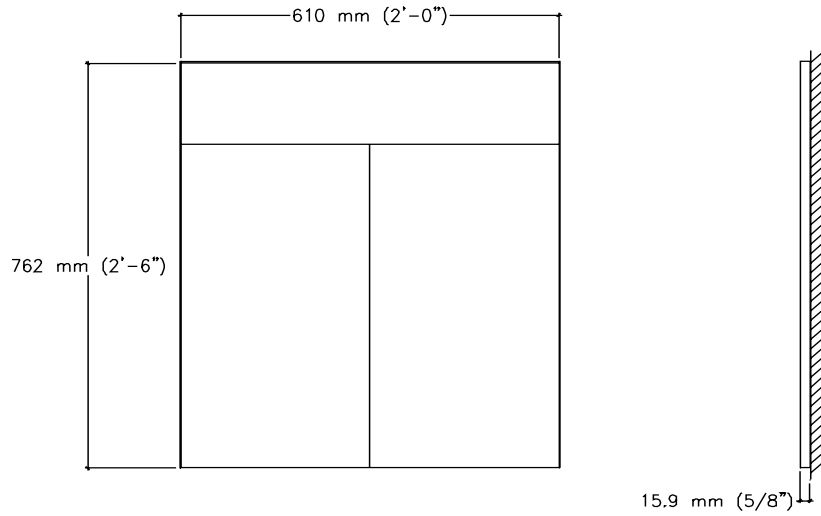

Header Layout A

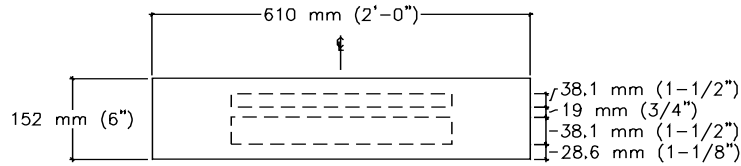

Header Layout B

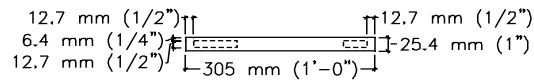

Copy Strip A

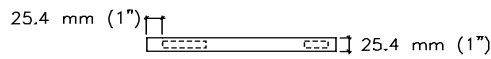

Copy Strip B

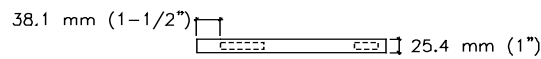

Copy Strip C

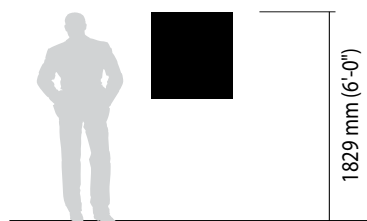

Large Strip Directory

Size

914 mm H x 914 mm W
(3'-0" H x 3'-0" W)

Description and Use

Main lobby directory with 90 directory strips

Message Configuration

(Refer to layout drawing for lettering sizes and dimensions)

Header Layout A is for a basic directory header. Header Layout B is for a directory header to contain the name of the facility. Copy Strip A is for use with the main listings. Copy Strip B is for a secondary listing under a main listing or when the name is too long to fit on Strip A.

Sign Components

Sliding rail back; copy panel; top accent bar; end caps

Graphic Process

Surface applied vinyl

Colors

Text: Refer to color chart.
Background and accent bar: Refer to color chart.

Typography

Helvetica Bold

Mounting

Mechanical fasteners

Installation

Wall mounted

Recommendations

This directory is for use in the main lobby of small buildings which would typically have no more than 60 to 80 listings. All listings in a directory should be done in alphabetical order. List in the directory only services or departments which have contact with patients and public. Distribute any blank directory strips throughout the directory to provide spacing between groups of listings.

| Title | | Title | | Title | |
|--------------|------|--------------|------|--------------|------|
| Subtitle | 1A74 | Subtitle | 2B37 | Subtitle | 2B37 |
| Subtitle | 1A75 | Sub-Subtitle | | Sub-Subtitle | |
| Subtitle | 1A77 | Sub-Subtitle | | Sub-Subtitle | |
| Subtitle | 1A78 | Sub-Subtitle | | Sub-Subtitle | |
| Sub-Subtitle | | Subtitle | 2B40 | Subtitle | 2B40 |
| Sub-Subtitle | | Subtitle | 2B41 | Subtitle | 2B41 |
| | | Subtitle | 2B42 | | |
| | | Subtitle | 2B44 | Title | |
| Title | | Subtitle | 2B45 | Subtitle | 2C50 |
| Subtitle | 1B48 | Subtitle | | Subtitle | 2C55 |
| Subtitle | 1B49 | | | | |
| Subtitle | 1B51 | Title | | Title | |
| | | Subtitle | 2C50 | Subtitle | 2C60 |
| | | Subtitle | 2C55 | | |
| Title | | Title | | Sub-Subtitle | |
| Subtitle | 1C34 | Sub-Subtitle | | Sub-Subtitle | |
| Subtitle | 1C37 | Sub-Subtitle | | Sub-Subtitle | |
| Subtitle | 1C38 | Subtitle | 2C60 | Sub-Subtitle | |
| Subtitle | 1C42 | Sub-Subtitle | | Subtitle | 2C61 |
| | | Sub-Subtitle | | Subtitle | 2C62 |
| | | Sub-Subtitle | | | |
| | | Subtitle | 2C61 | | |
| | | Subtitle | 2C62 | | |



Header (Message Layout A)



Header (Message Layout B)



Copy Strip A



Copy Strip B



Copy Strip C

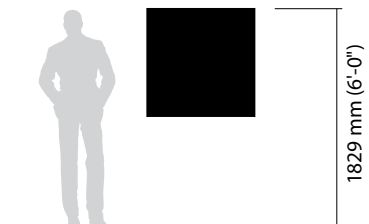

Large Strip Directory

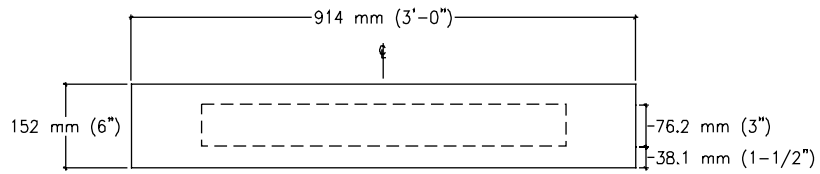
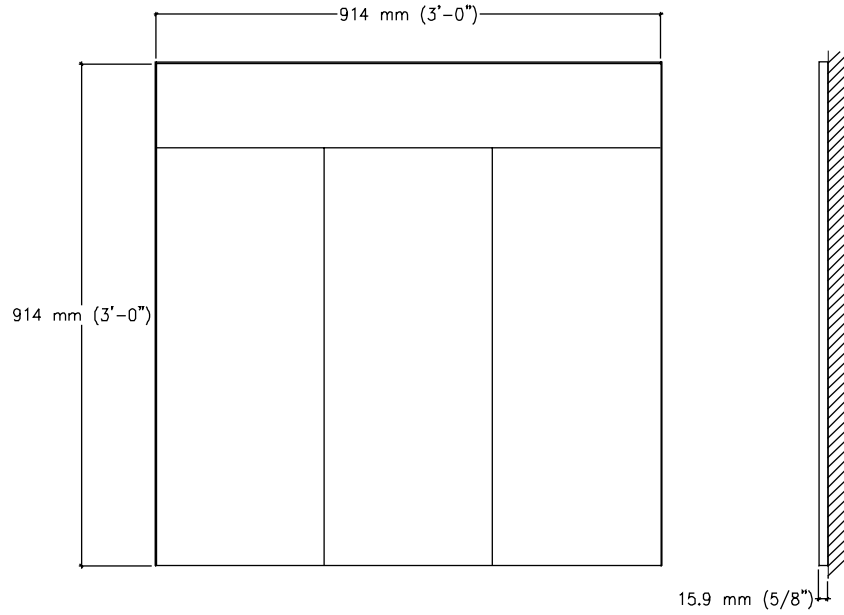

Header Layout A

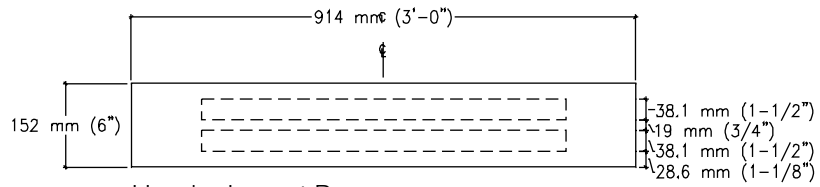

Header Layout B

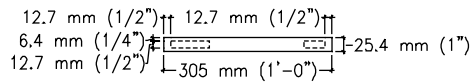

Copy Strip A



Copy Strip B

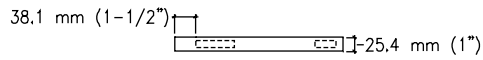

Copy Strip C

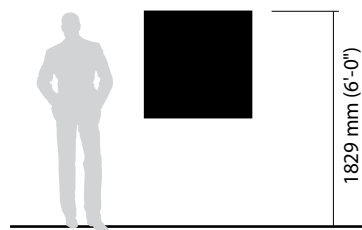

Strip Directory with Map

Size

762 mm H x 1219 mm W
(2'-6" H x 4'-0" W)

Description and Use

Small size main lobby directory with 48 directory strips and map of building

Message Configuration

(Refer to layout drawing for lettering sizes and dimensions)

Header Layout A is for a basic directory header. Header Layout B is for a directory header to contain the name of the facility. Copy Strip A is for use with the main listings. Copy Strip B is for a secondary listing under a main listing or when the name is too long to fit on Strip A.

Sign Components

Sliding rail back; copy panel; top accent bar; end caps

Graphic Process

Surface applied vinyl

Colors

Text: Refer to color chart.
Background and accent bar: Refer to color chart.

Typography

Helvetica Bold

Mounting

Mechanical fastener

Installation

Wall mounted

Recommendations

This directory is for use in the main lobby of small buildings which would typically have no more than 30 to 40 listings. All listings in a directory should be done in alphabetical order. List in the directory only services or departments which have contact with patients and the public. Distribute any blank directory strips throughout the directory to provide spacing between groups of listings.

Maps should be simple and show the corridor system, major departments and locations of elevators. If a building has multiple floors, then all floors should be shown. Orient floor plans to represent the building in the same direction as the map is being viewed.

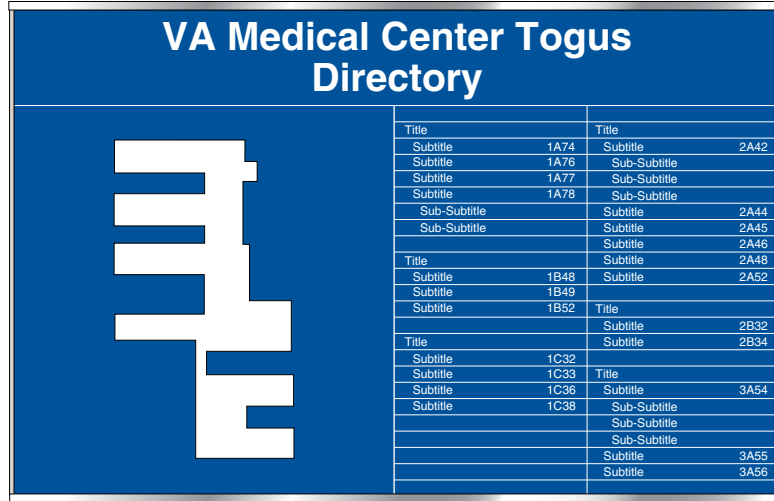

Header (Message Layout A)



Header (Message Layout B)



Map



Copy Strip A



Copy Strip B



Copy Strip C



Strip Directory with Map

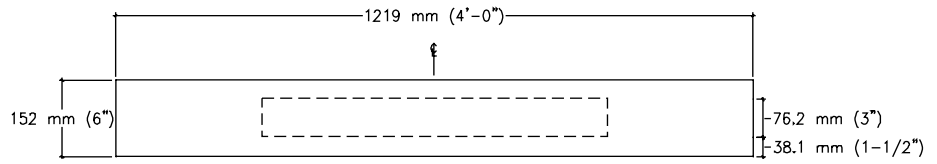
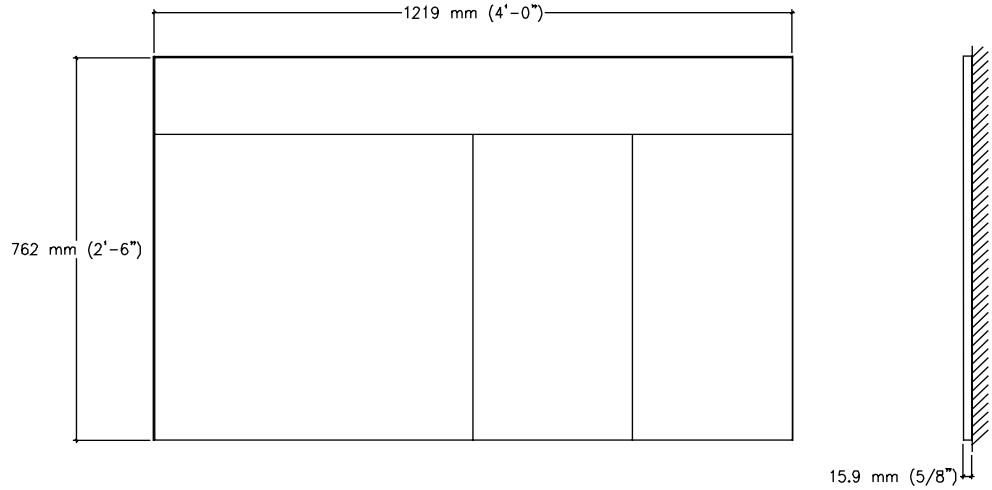

Header Layout A

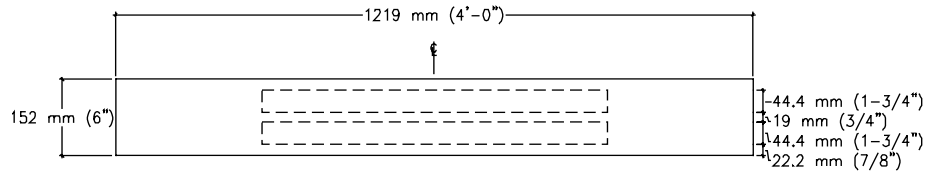

Header Layout B

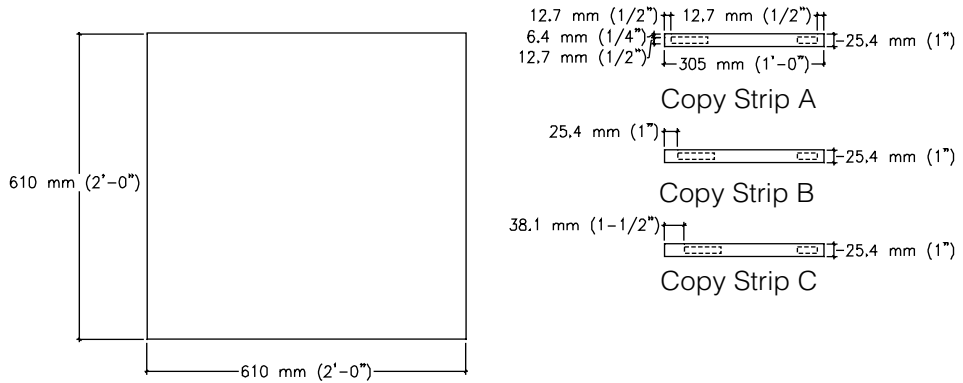

Map

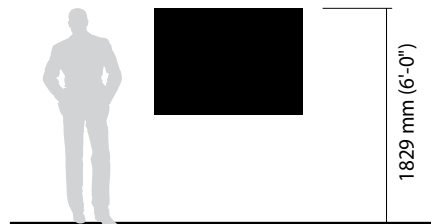

Large Strip Directory with Map

Size

914 mm H x 1524 mm W
(3'-0" H x 5'-0" W)

Description and Use

Main lobby directory with 90 directory strips and a map of the building.

Message Configuration

(Refer to layout drawing for lettering sizes and dimensions)

Header Layout A is for a basic directory header. Header Layout B is for a directory header to contain the name of the facility. Copy Strip A is for use with the main listings. Copy Strip B is for a secondary listing under a main listing or when the name is too long to fit on Strip A.

Sign Components

Sliding rail back; copy panel; top accent bar; end caps

Graphic Process

Surface applied vinyl

Colors

Text: Refer to color chart.
Background and accent bar: Refer to color chart

Typography

Helvetica Bold

Mounting

Mechanical fastener

Installation

Wall mounted

Recommendations

This directory is for use in the main lobby of small buildings which would typically have no more than 60 to 80 listings. All listings in a directory should be done in alphabetical order. List in the directory only services or departments which have contact with patients and the public. Distribute any blank directory strips throughout the directory to provide spacing between groups of listings.

Maps should be simple and show the corridor system, major departments and locations of elevators. If a building has multiple floors, then all floors should be shown. Orient floor plans to represent the building in the same direction as the map is being viewed.

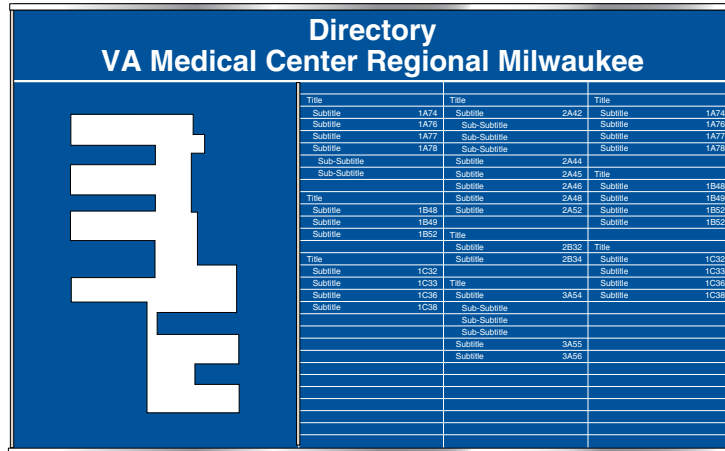

Header (Message Layout A)



Header (Message Layout B)



Map



Copy Strip A



Copy Strip B



Copy Strip C



Large Strip Directory with Map

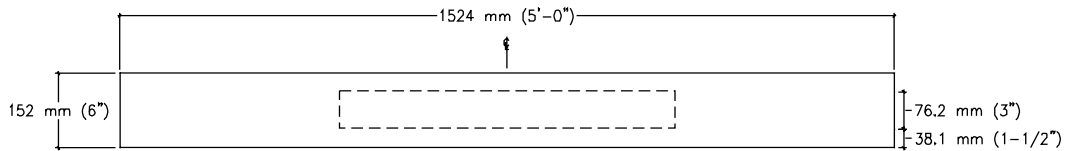
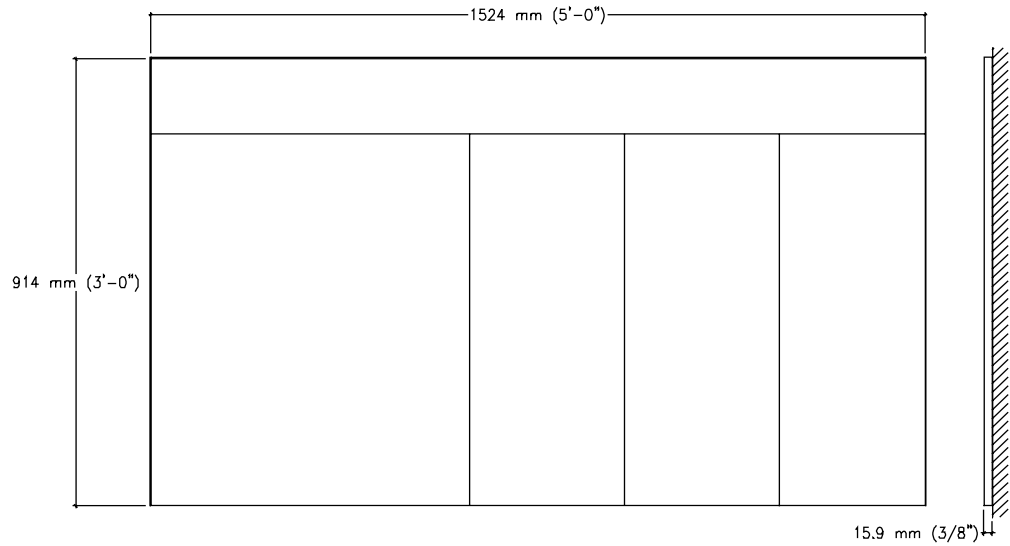

Header Layout A

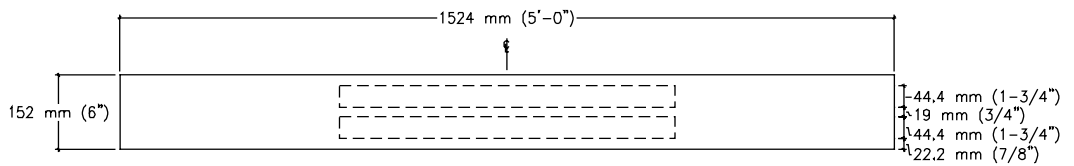

Header Layout B

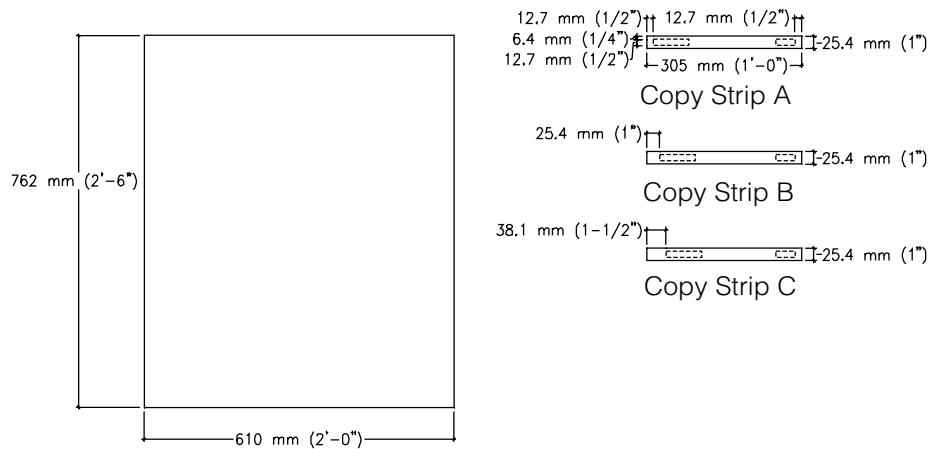

Map



Strip Floor Directory

Size

762 mm H x 305 mm W
(2'-6" H x 12" W)

Description and Use

Small size elevator lobby directory with 24 directory strips

Message Configuration

(Refer to layout drawing for lettering sizes and dimensions).

Header Layout A is for a single digit floor. Header Layout B is for a double digit floor. Copy Strip A is for use with the main listings. Copy Strip B is for a secondary listing under a main listing or when the name is too long to fit on Strip A.

Sign Components

Sliding rail back; copy panel; top accent bar; end caps

Graphic Process

Surface applied vinyl

Colors

Text: Refer to color chart.
Background and accent bar: Refer to color chart.

Typography

Helvetica

Mounting

Mechanical fastener

Installation

On wall adjacent to elevator

Recommendations

This directory is for use in the elevator lobbies of small buildings which would typically have no more than 20 listings. All listings in a directory should be done in alphabetical order. List in the directory only services or departments which have contact with patients and public. Distribute any blank directory strips throughout the directory to provide spacing between groups of listings.

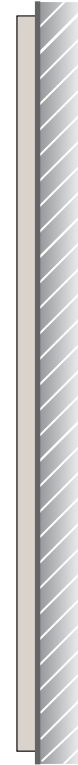
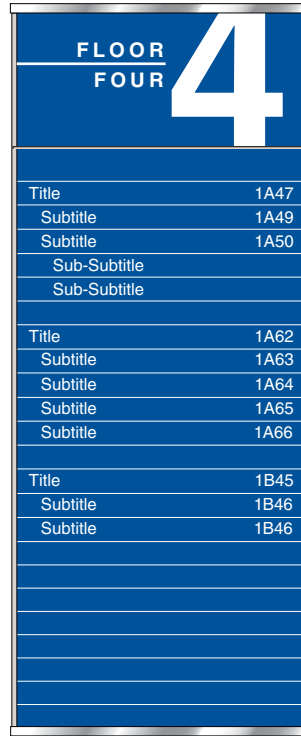

Header (Message Layout A)



Header (Message Layout B)



Copy Strip A



Copy Strip C



Copy Strip B

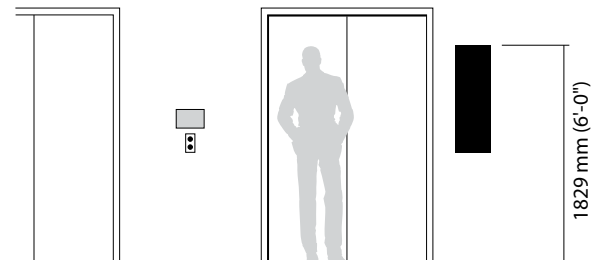

Strip Floor Directory

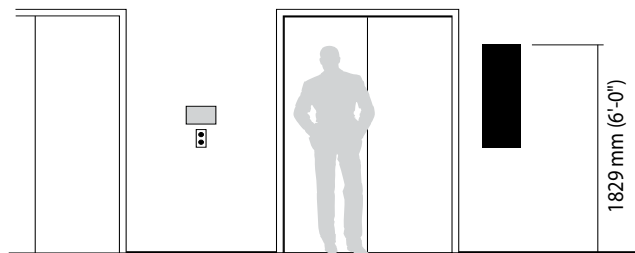
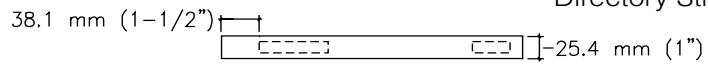
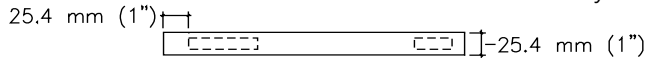
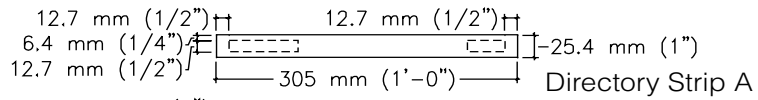
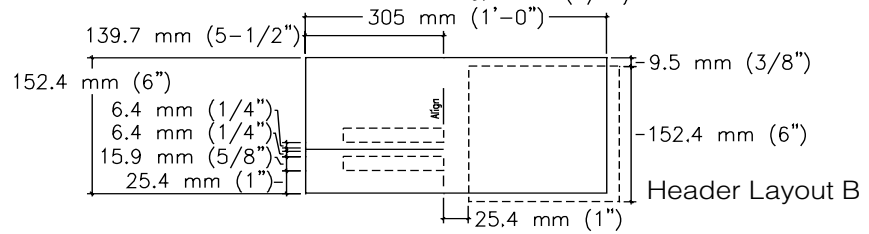
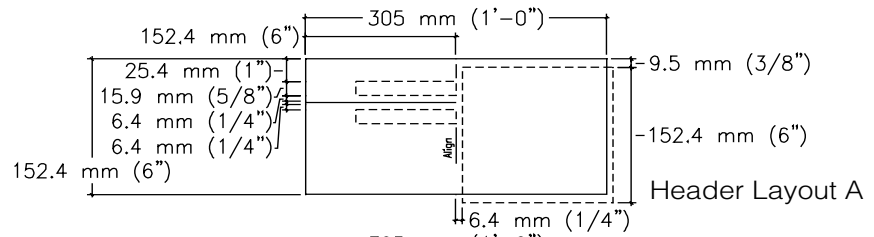
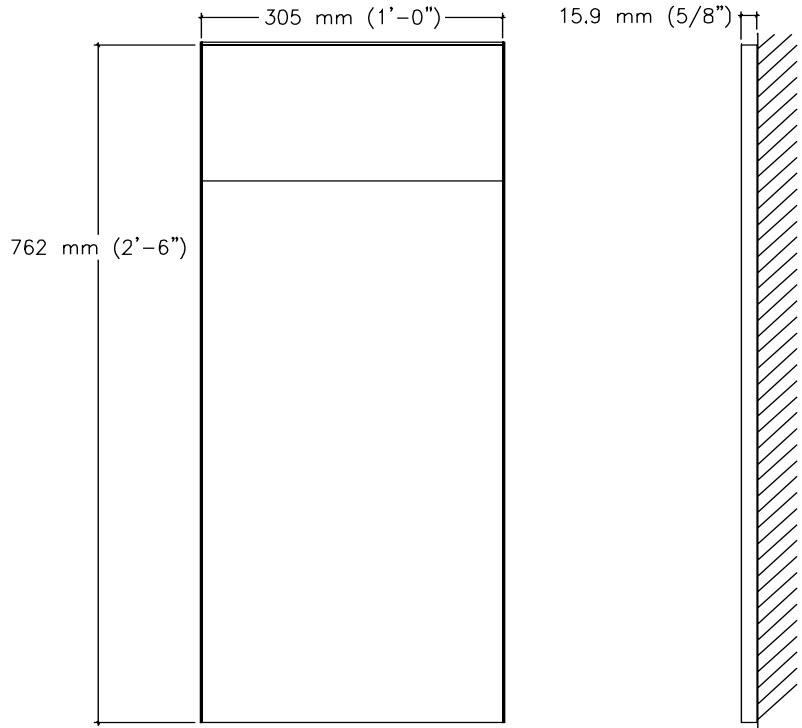

Large Strip Floor Directory

Size

762 mm H x 610 mm W
(2'-6" H x 2'-0" W)

Description and Use

Elevator lobby directory with 48 directory strips.

Message Configuration

(Refer to layout drawing for lettering sizes and dimensions).

Header Layout A is for a single digit floor. Header Layout B is for a double digit floor. Copy Strip A is for use with the main listings. Copy Strip B is for a secondary listing under a main listing or when the name is too long to fit on Strip A.

Sign Components

Sliding rail back; copy panel; top accent bar; end caps

Graphic Process

Surface applied vinyl

Colors

Text: Refer to color chart.
Background and accent bar: Refer to color chart.

Typography

Helvetica

Mounting

Mechanical fastener

Installation

On wall adjacent to elevator

Recommendations

This directory is for use in the elevator lobbies of small buildings which would typically have no more than 40 listings. All listings in a directory should be done in alphabetical order. List in the directory only services or departments which have contact with patients and public. Distribute any blank directory strips throughout the directory to provide spacing between groups of listings.

| | | | | |
|--------------|------|---------------|------|----------|
| | | FLOOR FOUR | | 4 |
| Title | 1A47 | Title | 1A47 | |
| Subtitle | 1A49 | Subtitle | 1A49 | |
| Subtitle | 1A50 | Subtitle | 1A50 | |
| Sub-Subtitle | | Sub-Subtitle | | |
| Sub-Subtitle | | Sub-Subtitle | | |
| Title | 1A62 | Title | 2A62 | |
| Subtitle | 1A63 | Subtitle | 2A63 | |
| Subtitle | 1A64 | Subtitle | 2A64 | |
| Subtitle | 1A65 | Subtitle | 2A65 | |
| Subtitle | 1A66 | Subtitle | 2A66 | |
| Subtitle | 1A64 | | | |
| Subtitle | 1A65 | Title | 2B45 | |
| | | Subtitle | 2B46 | |
| Title | 1A62 | Subtitle | 2B46 | |
| Subtitle | 1A63 | | | |
| Subtitle | 1A64 | | | |
| Subtitle | 1A65 | | | |
| Subtitle | 1A66 | | | |



Header (Message Layout A)

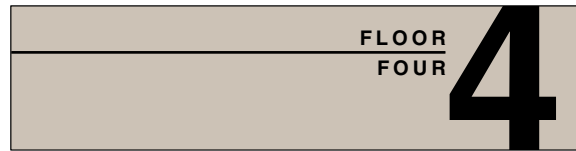

Header (Message Layout B)



Copy Strip A



Copy Strip C



Copy Strip B

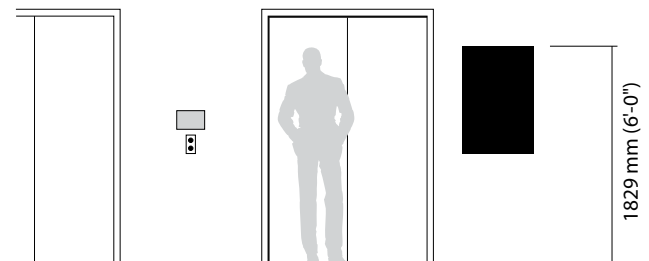

Large Strip Floor Directory

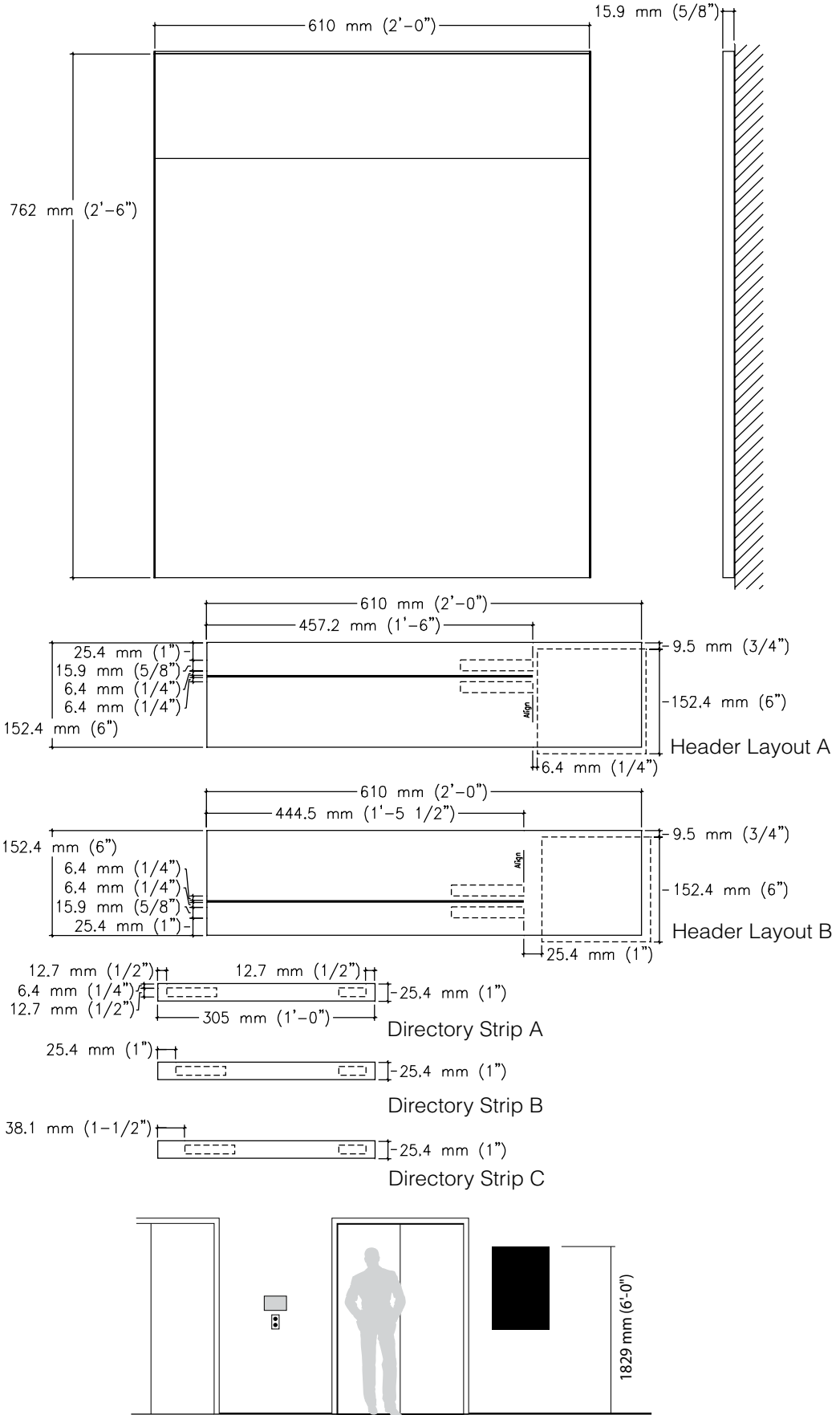

Directory with Insert

Size

762 mm H x 610 mm W
(2'-6" H x 2'-0" W)

Description and Use

Small size main lobby directory header and digital print insert.

Message Configuration

(Refer to layout drawing for lettering sizes and dimensions).

Header Layout A is for a basic directory header. Lower listing area is a digital print.

Sign Components

Fame sign system

Graphic Process

Surface applied vinyl or digital print insert

Colors

Text: Refer to color chart.
Background and accent bar: Refer to color chart.

Typography

Helvetica

Mounting

Mechanical fastener

Installation

Wall mounted

Recommendations

This directory is for use in the main lobby of small buildings which would typically have no more than 30 to 40 listings. All listings in a directory should be done in alphabetical order. List in the directory only services or departments which have contact with patients and public.

| Directory | | | |
|--------------|------|--------------|------|
| Title | | Title | |
| Subtitle | 1A74 | Subtitle | 2A42 |
| Subtitle | 1A76 | Sub-Subtitle | |
| Subtitle | 1A77 | Sub-Subtitle | |
| Subtitle | 1A78 | Sub-Subtitle | |
| Sub-Subtitle | | Subtitle | 2A44 |
| Sub-Subtitle | | Subtitle | 2A45 |
| | | Subtitle | 2A46 |
| | | Subtitle | 2A48 |
| Title | | Subtitle | 2A52 |
| Subtitle | 1B48 | | |
| Subtitle | 1B49 | Title | |
| Subtitle | 1B52 | Subtitle | 2B32 |
| | | Subtitle | 2B34 |
| Title | | | |
| Subtitle | 1C32 | Title | |
| Subtitle | 1C33 | Subtitle | 3A54 |
| Subtitle | 1C36 | Sub-Subtitle | |
| Subtitle | 1C38 | Sub-Subtitle | |
| | | Sub-Subtitle | |
| | | Sub-Subtitle | |
| | | Subtitle | 3A55 |
| | | Subtitle | 3A56 |



Header (Message Layout A)



Directory Listing (Digital Print)

| | | | |
|--------------|------|--------------|------|
| Title | | Title | |
| Subtitle | 1A74 | Subtitle | 2A42 |
| Subtitle | 1A76 | Sub-Subtitle | |
| Subtitle | 1A77 | Sub-Subtitle | |
| Subtitle | 1A78 | Sub-Subtitle | |
| Sub-Subtitle | | Subtitle | 2A44 |
| Sub-Subtitle | | Subtitle | 2A45 |
| | | Subtitle | 2A46 |
| | | Subtitle | 2A48 |
| Title | | Subtitle | 2A52 |
| Subtitle | 1B48 | | |
| Subtitle | 1B49 | Title | |
| Subtitle | 1B52 | Subtitle | 2B32 |
| | | Subtitle | 2B34 |
| Title | | | |
| Subtitle | 1C32 | Title | |
| Subtitle | 1C33 | Subtitle | 3A54 |
| Subtitle | 1C36 | Sub-Subtitle | |
| Subtitle | 1C38 | Sub-Subtitle | |
| | | Sub-Subtitle | |
| | | Subtitle | 3A55 |
| | | Subtitle | 3A56 |

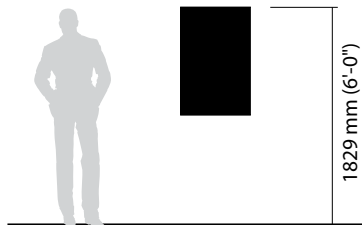

Directory with Insert

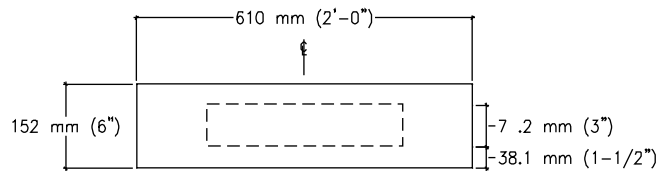
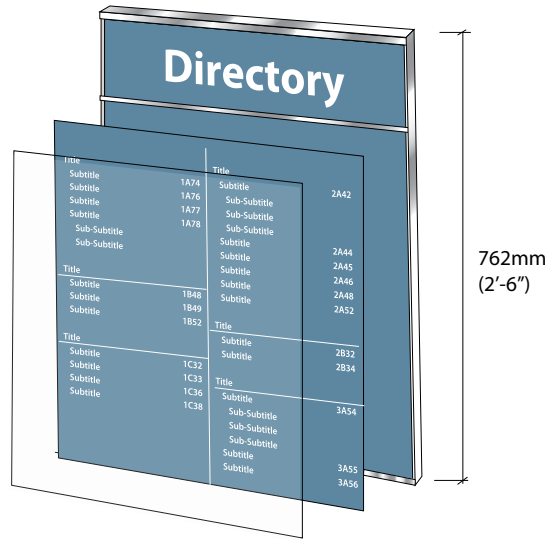

Header Layout A

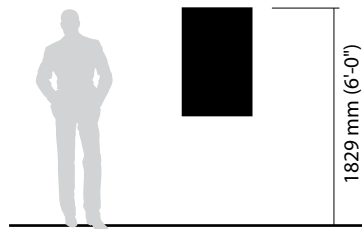
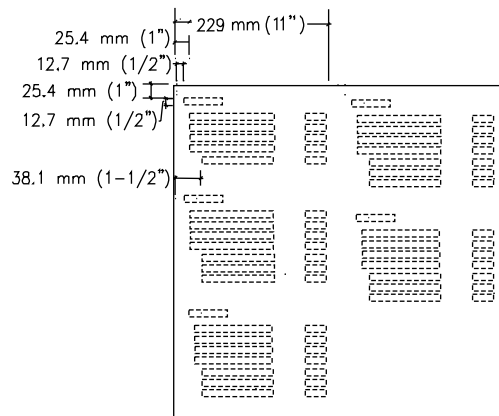

Large Directory with Insert

Size

914 mm H x 914 mm W
(3'-0" H x 3'-0" W)

Description and Use

Large size main lobby directory header and digital print.

Message Configuration

(Refer to layout drawing for lettering sizes and dimensions) Header Layout A is for a basic directory header. Lower listing area is a digital print.

Sign Components

Fame sign system

Graphic Process

Surface applied vinyl or digital print insert

Colors

Text: Refer to color chart.
Background and accent bar: Refer to color chart.

Typography

Helvetica

Mounting

Mechanical fastener

Installation

Wall mounted

Recommendations

This directory is for use in the main lobby of small buildings which would typically have no more than 60 to 80 listings. All listings in a directory should be done in alphabetical order. List in the directory only services or departments which have contact with patients and public.

| Directory | | | |
|--------------|------|--------------|------|
| Title | | Title | |
| Subtitle | 1A74 | Subtitle | 2B37 |
| Subtitle | 1A75 | Sub-Subtitle | 2B37 |
| Subtitle | 1A77 | Sub-Subtitle | 2B37 |
| Subtitle | 1A78 | Sub-Subtitle | 2B37 |
| Sub-Subtitle | | Subtitle | 2B40 |
| Sub-Subtitle | | Subtitle | 2B41 |
| | | Subtitle | 2B42 |
| | | Subtitle | 2B44 |
| | | Subtitle | 2B45 |
| Title | | Title | |
| Subtitle | 1B48 | Subtitle | 2C50 |
| Subtitle | 1B49 | Subtitle | 2C55 |
| Subtitle | 1B51 | Subtitle | 2C60 |
| Title | | Title | |
| Subtitle | 1C34 | Sub-Subtitle | 2C60 |
| Subtitle | 1C37 | Sub-Subtitle | 2C60 |
| Subtitle | 1C38 | Sub-Subtitle | 2C60 |
| Subtitle | 1C42 | Sub-Subtitle | 2C60 |
| | | Subtitle | 2C61 |
| | | Subtitle | 2C62 |

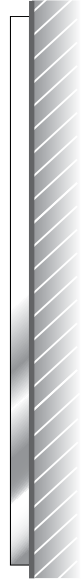

Header (Message Layout A)



Header (Message Layout B)



Directory Listing (Digital Print)

| | | | | | |
|--------------|------|--------------|------|--------------|------|
| Title | | Title | | Title | |
| Subtitle | 1A74 | Subtitle | 2B37 | Subtitle | 2B37 |
| Subtitle | 1A75 | Sub-Subtitle | 2B37 | Sub-Subtitle | 2B37 |
| Subtitle | 1A77 | Sub-Subtitle | 2B37 | Sub-Subtitle | 2B37 |
| Subtitle | 1A78 | Sub-Subtitle | 2B37 | Sub-Subtitle | 2B37 |
| Sub-Subtitle | | Subtitle | 2B40 | Subtitle | 2B40 |
| Sub-Subtitle | | Subtitle | 2B41 | Subtitle | 2B41 |
| | | Subtitle | 2B42 | Subtitle | 2B41 |
| | | Subtitle | 2B44 | | |
| | | Subtitle | 2B45 | Title | |
| Title | | | | Subtitle | 2C50 |
| Subtitle | 1B48 | | | Subtitle | 2C55 |
| Subtitle | 1B49 | Title | | | |
| Subtitle | 1B51 | Subtitle | 2C50 | Title | |
| | | Subtitle | 2C55 | Subtitle | 2C60 |
| Title | | Title | | Sub-Subtitle | |
| Subtitle | 1C34 | Subtitle | 2C60 | Sub-Subtitle | |
| Subtitle | 1C37 | Sub-Subtitle | 2C60 | Sub-Subtitle | |
| Subtitle | 1C38 | Sub-Subtitle | 2C60 | Subtitle | 2C61 |
| Subtitle | 1C42 | Sub-Subtitle | 2C60 | Subtitle | 2C62 |
| | | Subtitle | 2C61 | | |
| | | Subtitle | 2C62 | | |

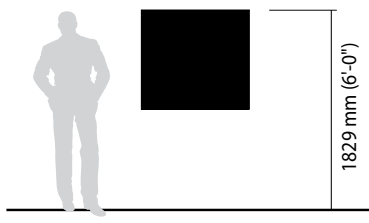

Large Directory with Insert

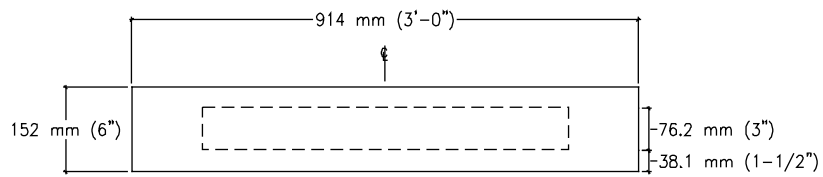
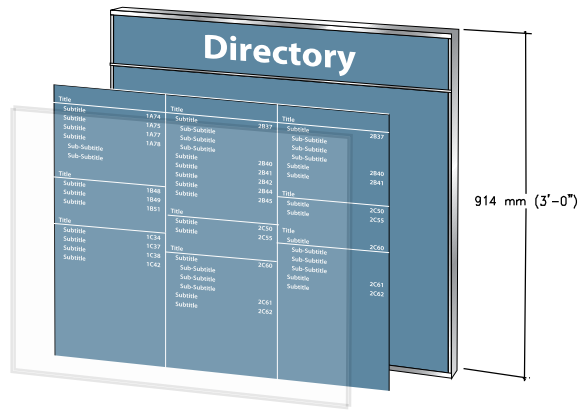

Header Layout A

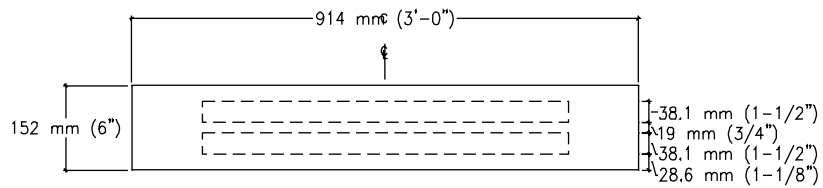

Header Layout B

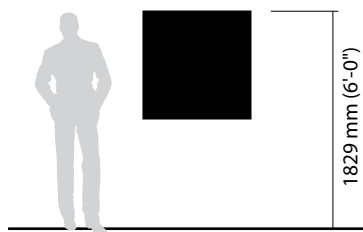
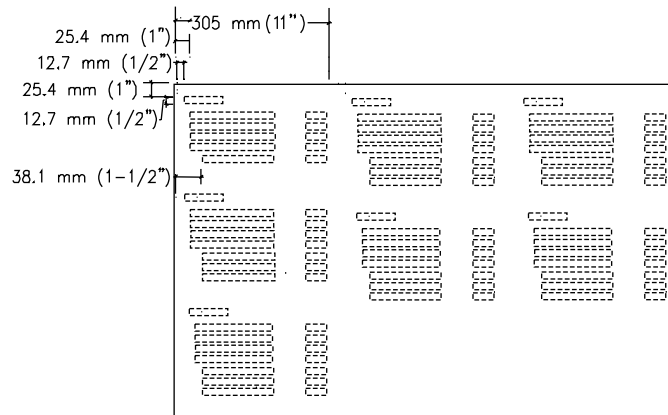

Directory with Map and Listing Insert

Size

762 mm H x 1219 mm W
(2'-6" H x 4'-0" W)

Description and Use

Small size main lobby directory header and digital print inserts.

Message Configuration

(Refer to layout drawing for lettering sizes and dimensions).

Header Layout A is for a basic directory header. Header Layout B is for a directory header to contain the name of the facility. Lower listing area digital print.

Sign Components

Fame sign system

Graphic Process

Surface applied vinyl or digital print insert for map and listings

Colors

Text: Refer to color chart.
Background and accent bar: Refer to color chart.

Typography

Helvetica

Mounting

Mechanical fastener

Installation

Wall mounted

Recommendations

This directory is for use in the main lobby of small buildings which would typically have no more than 30 to 40 listings. All listings in a directory should be done in alphabetical order. List in the directory only services or departments which have contact with patients and public.

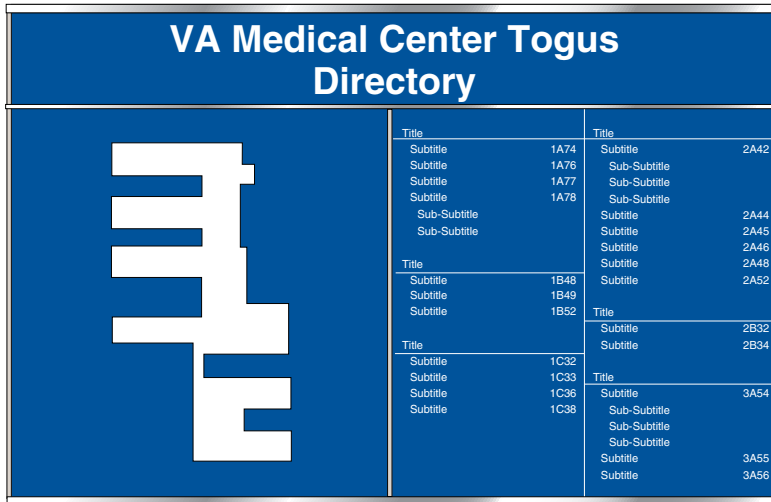

Header (Message Layout A)



Header (Message Layout B)



Map

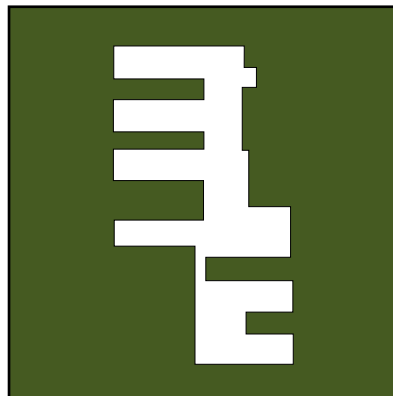

Directory (Digital Print)

| | | | |
|--------------|------|--------------|------|
| Title | | Title | |
| Subtitle | 1A74 | Subtitle | 2A42 |
| Subtitle | 1A76 | Sub-Subtitle | |
| Subtitle | 1A77 | Sub-Subtitle | |
| Subtitle | 1A78 | Sub-Subtitle | |
| Sub-Subtitle | | Subtitle | 2A44 |
| Sub-Subtitle | | Subtitle | 2A45 |
| | | Subtitle | 2A46 |
| Title | | Subtitle | 2A48 |
| Subtitle | 1B48 | Subtitle | 2A52 |
| Subtitle | 1B49 | | |
| Subtitle | 1B52 | Title | |
| | | Subtitle | 2B32 |
| Title | | Subtitle | 2B34 |
| Subtitle | 1C32 | | |
| Subtitle | 1C33 | Title | |
| Subtitle | 1C36 | Subtitle | 3A54 |
| Subtitle | 1C38 | Sub-Subtitle | |
| | | Sub-Subtitle | |
| | | Sub-Subtitle | |
| | | Subtitle | 3A55 |
| | | Subtitle | 3A56 |



Directory with Map and Listing Insert

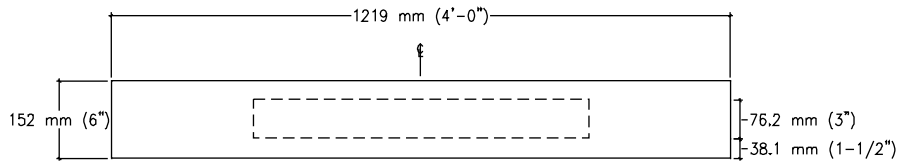
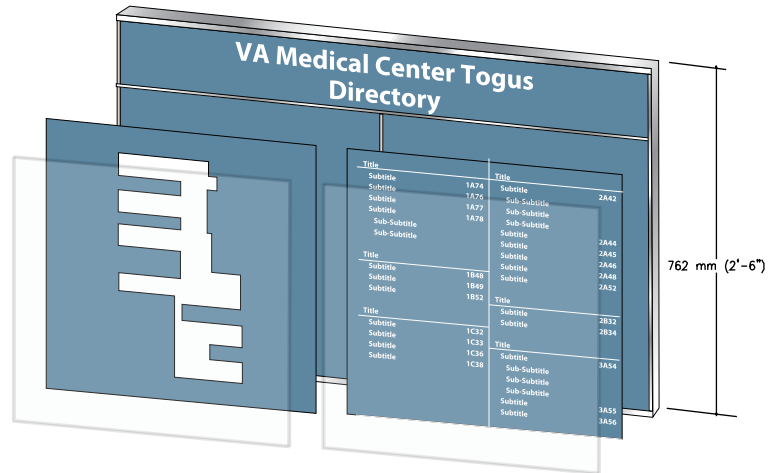

Header Layout A

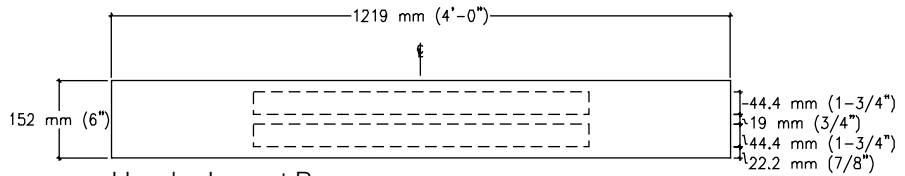

Header Layout B

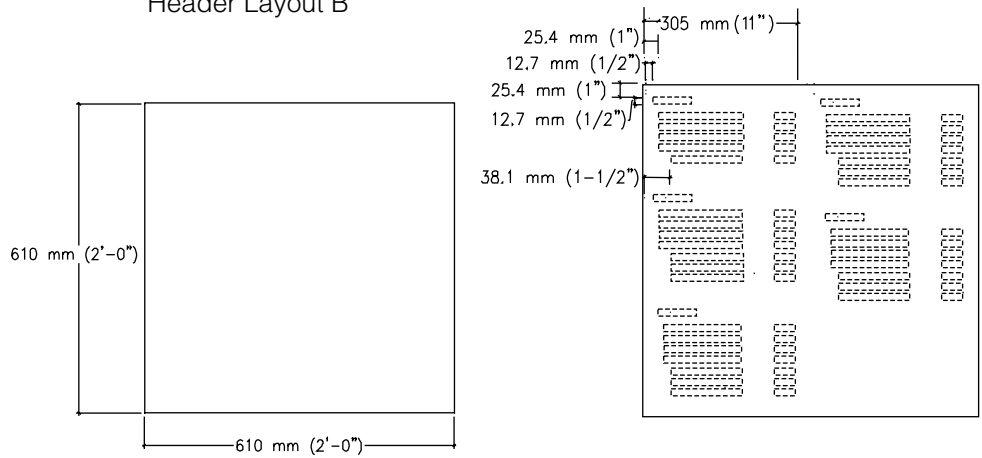

Map



Large Directory with Map and Listing Insert

Size

914 mm H x 1524 mm W
(3'-0" H x 5'-0" W)

Description and Use

Main lobby directory header and digital print with 90 directory listings.

Message Configuration

(Refer to layout drawing for lettering sizes and dimensions).

Header Layout A is for a basic directory header. Header Layout B is for a directory header to contain the name of the facility. Lower listing area digital print.

Sign Components

Fame sign system

Graphic Process

Surface applied vinyl or digital print insert for map and listings

Colors

Text: Refer to color chart.
Background and accent bar: Refer to color chart.

Typography

Helvetica

Mounting

Mechanical fastener

Installation

Wall mounted

Recommendations

This directory is for use in the main lobby of small buildings which would typically have no more than 90 listings. All listings in a directory should be done in alphabetical order. List in the directory only services or departments which have contact with patients and public.

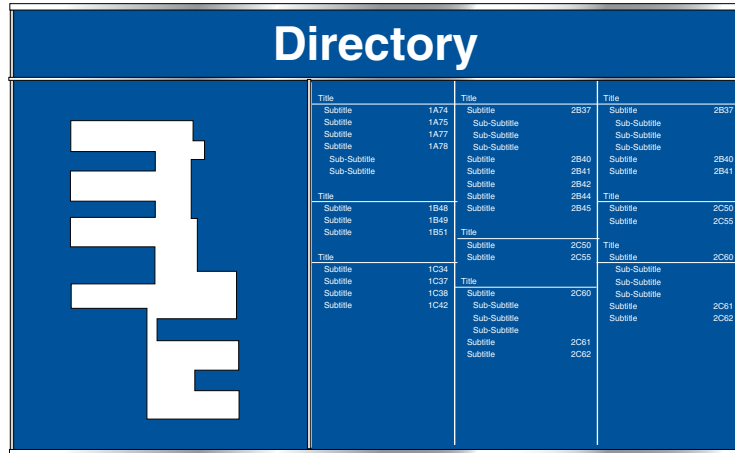

Header (Message Layout A)



Header (Message Layout B)



Map

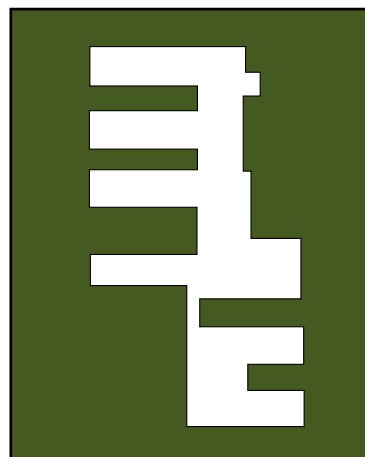

Directory Listing (Digital Print)

| | | |
|---------------|---------------|---------------|
| Title | Title | Title |
| Subtitle 1A74 | Subtitle 2B37 | Subtitle 2B37 |
| Subtitle 1A75 | Sub-Subtitle | Sub-Subtitle |
| Subtitle 1A77 | Sub-Subtitle | Sub-Subtitle |
| Subtitle 1A78 | Sub-Subtitle | Sub-Subtitle |
| Sub-Subtitle | Subtitle 2B40 | Subtitle 2B40 |
| Sub-Subtitle | Subtitle 2B41 | Subtitle 2B41 |
| | Subtitle 2B42 | |
| | Subtitle 2B44 | |
| | Subtitle 2B45 | |
| Title 1B48 | | Title 2C50 |
| Subtitle 1B49 | | Subtitle 2C55 |
| Subtitle 1B51 | | |
| | Title 2C50 | Title 2C60 |
| | Subtitle 2C55 | Subtitle 2C60 |
| Subtitle 1C34 | | Sub-Subtitle |
| Subtitle 1C37 | Title | Sub-Subtitle |
| Subtitle 1C38 | Subtitle 2C60 | Sub-Subtitle |
| Subtitle 1C42 | Sub-Subtitle | Sub-Subtitle |
| | Sub-Subtitle | Subtitle 2C61 |
| | Subtitle 2C61 | Subtitle 2C62 |
| | Subtitle 2C62 | |



Large Directory with Map and Listing Insert

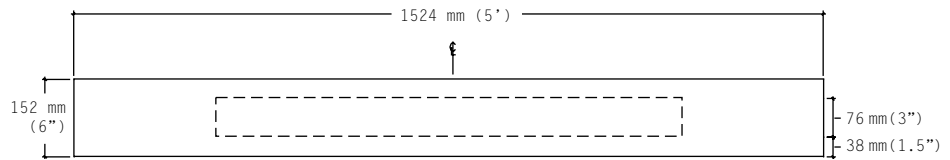
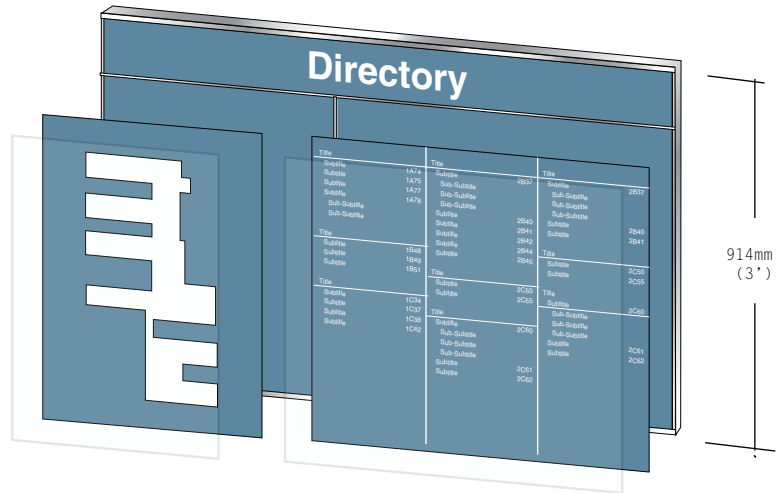

Header A

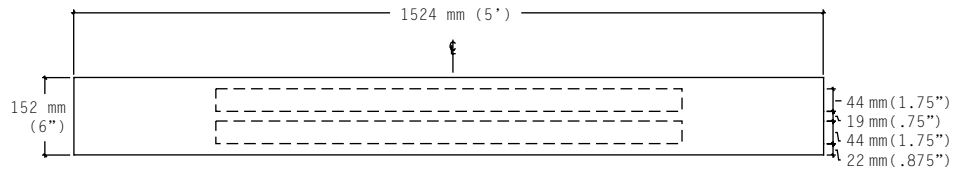

Header B

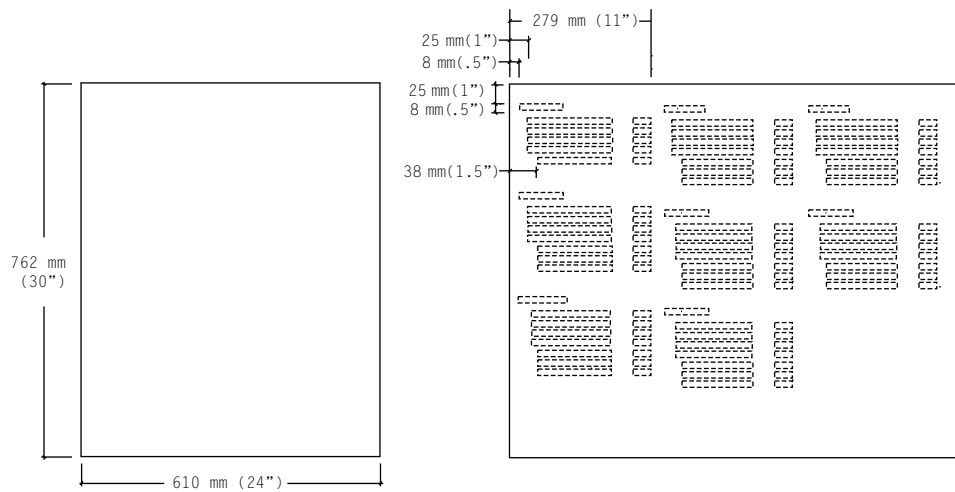

Map

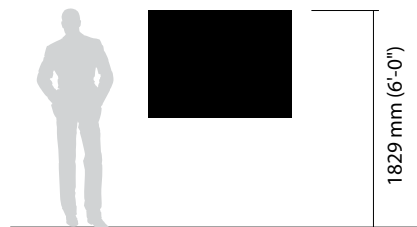

Floor Directory with Insert

Size

762 mm H x 305 mm W
(2'-6" H x 1'-0" W)

Description and Use

Small size elevator lobby directory. Directory header and digital print with 24 listings.

Message Configuration

(Refer to layout drawing for lettering sizes and dimensions). Header is for floor level identification. Lower listing area is a digital print.

Sign Components

Fame sign system

Graphic Process

Surface applied vinyl or digital print

Colors

Text: Refer to color chart.
Background and accent bar: Refer to color chart

Typography

Helvetica

Mounting

Mechanical fastener

Installation

Wall mounted

Recommendations

This directory is for use in elevator lobbies of small buildings which would typically have no more than 24 listings. All listings in a directory should be done in alphabetical order. List in the directory only services or departments which have contact with patients and public.

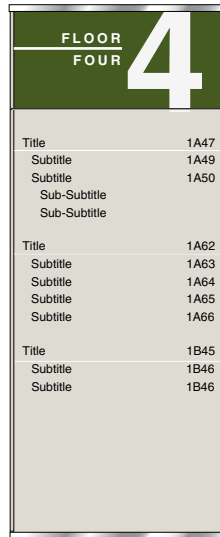
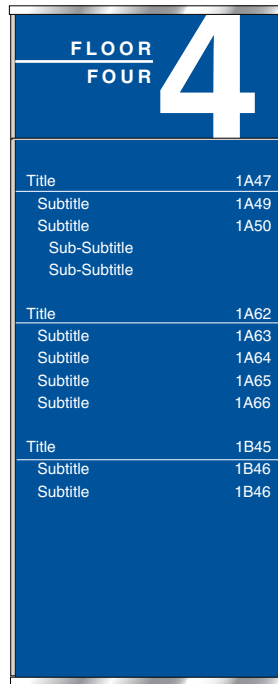

**IN-17.15
Elevator Directory**

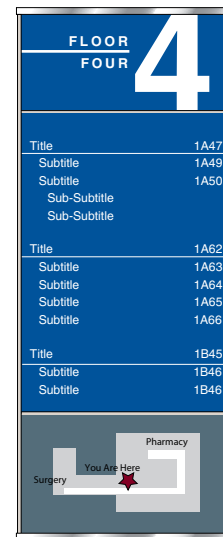

**IN-17.17
Elevator Directory
with Map**

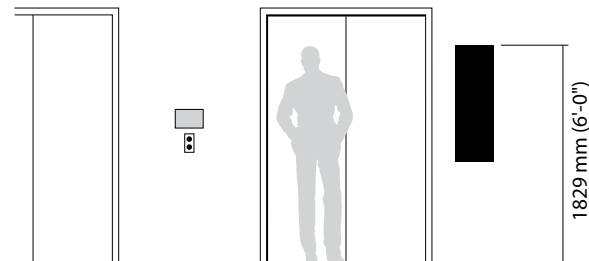

Floor Directory with Insert

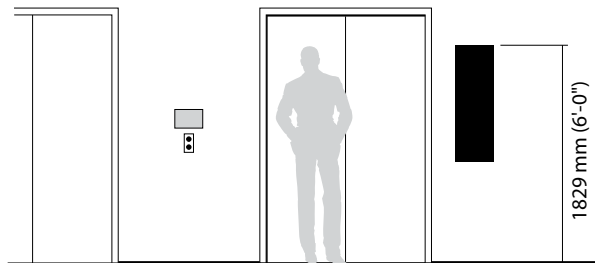
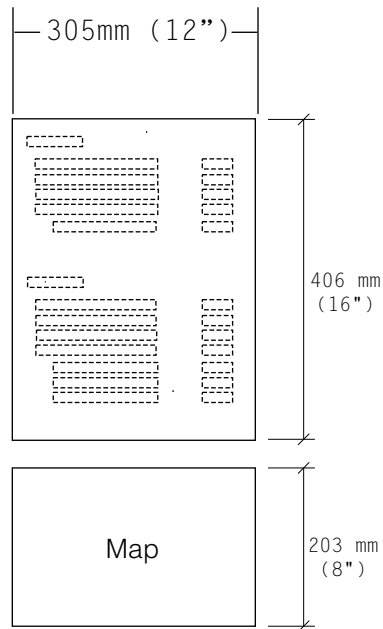
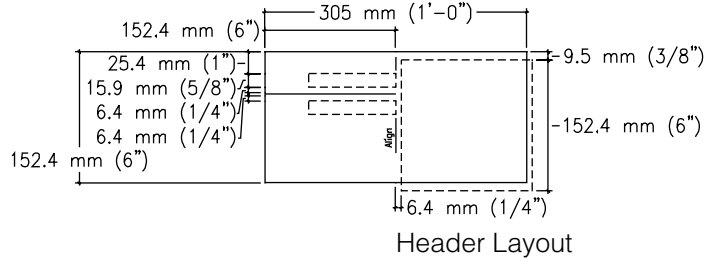
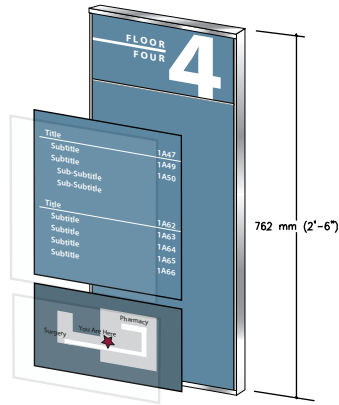

Large Floor Directory with Insert

Size

762 mm H x 610 mm W
(2'-6" H x 2'-0" W)

Description and Use

Elevator lobby directory. Directory header and digital print with 48 listings

Message Configuration

(Refer to layout drawing for lettering sizes and dimensions). Header is for floor level identification. Lower listing area is a digital print.

Sign Components

Fame sign system

Graphic Process

Surface applied vinyl or digital print insert

Colors

Text: Refer to color chart.
Background and accent bar: refer to color chart.

Typography

Helvetica

Mounting

Mechanical fastener

Installation

Wall mounted

Recommendations

This directory is for use in the elevator lobbies of small buildings which would typically have no more than 30 to 40 listings. All listings in a directory should be done in alphabetical order. List in the directory only services or departments which have contact with patients and public.

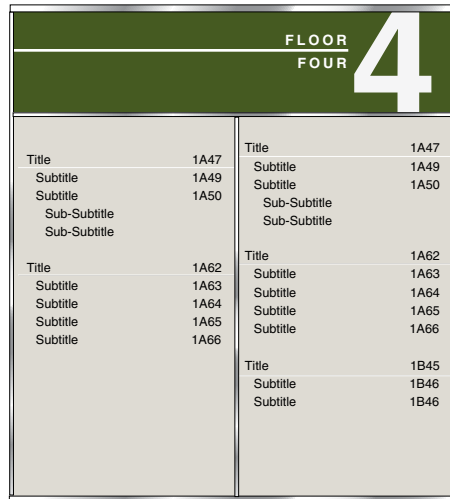
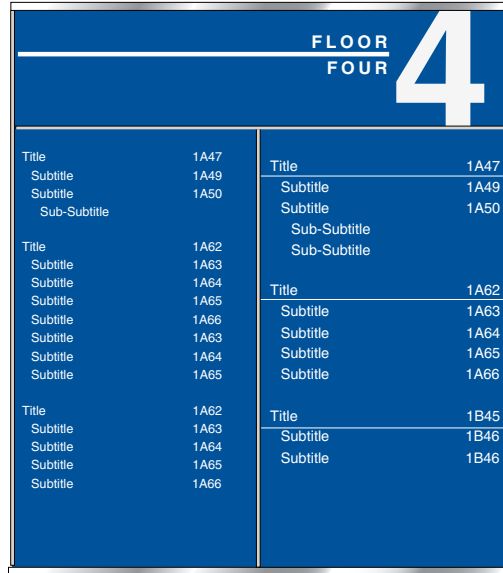

**IN-17.16
Elevator Directory**

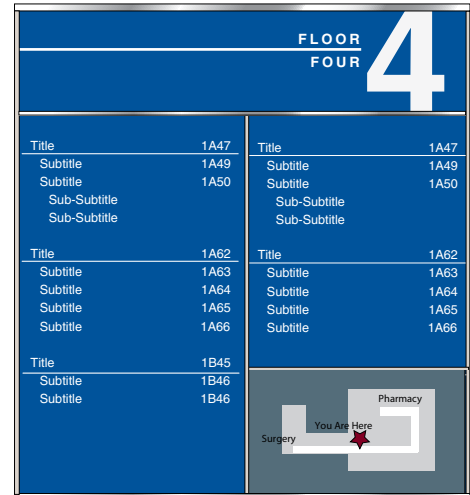

**IN-17.18
Elevator Directory
with Map**

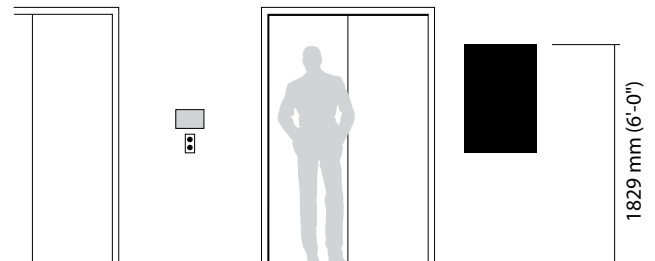

Large Floor Directory

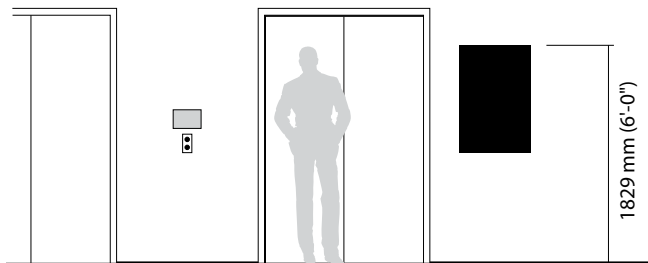
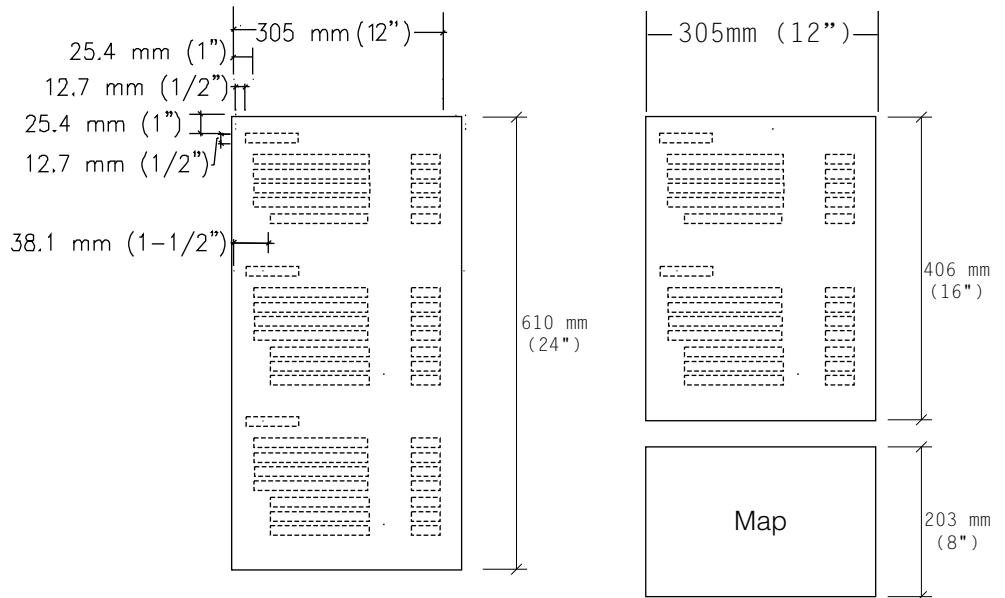
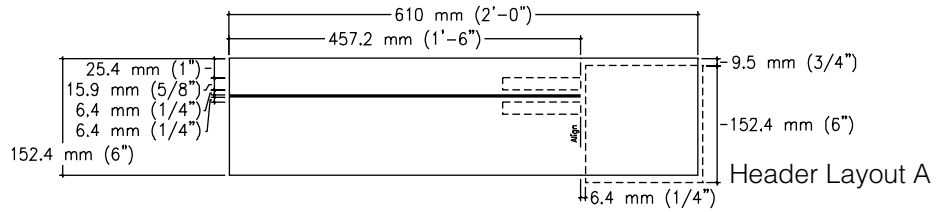
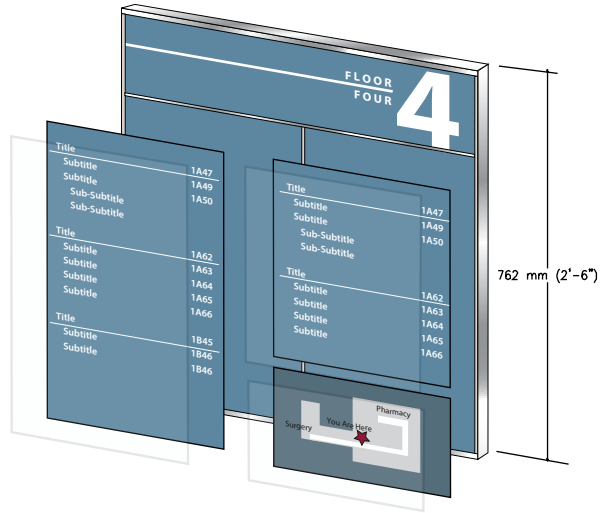

Freestanding Information Kiosk

Size

1067 mm H x 229 mm W x 152 mm D
(42" H x 9" W x 6" D)

Description and Use

Free Standing kiosk Identifies Information station or floor directory. Used where wall is not available.

Message Configuration

(Refer to layout drawing for lettering sizes and dimensions).

Sign Components

Frame system with digital or applied graphics

Graphic Process

Digital print or surface applied vinyl

Colors

Text: Refer to color chart.
Background: Refer to color chart.

Typography

Helvetica Condensed

Mounting

Free standing weighted base or secure to floor as needed.

Installation

In main entry area where traffic patterns allow

Recommendations

These signs bring attention and identification to Information or Registration stations.

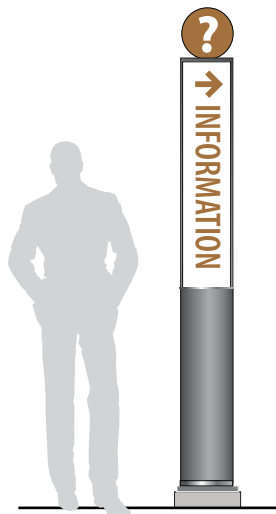

Freestanding Information Kiosk

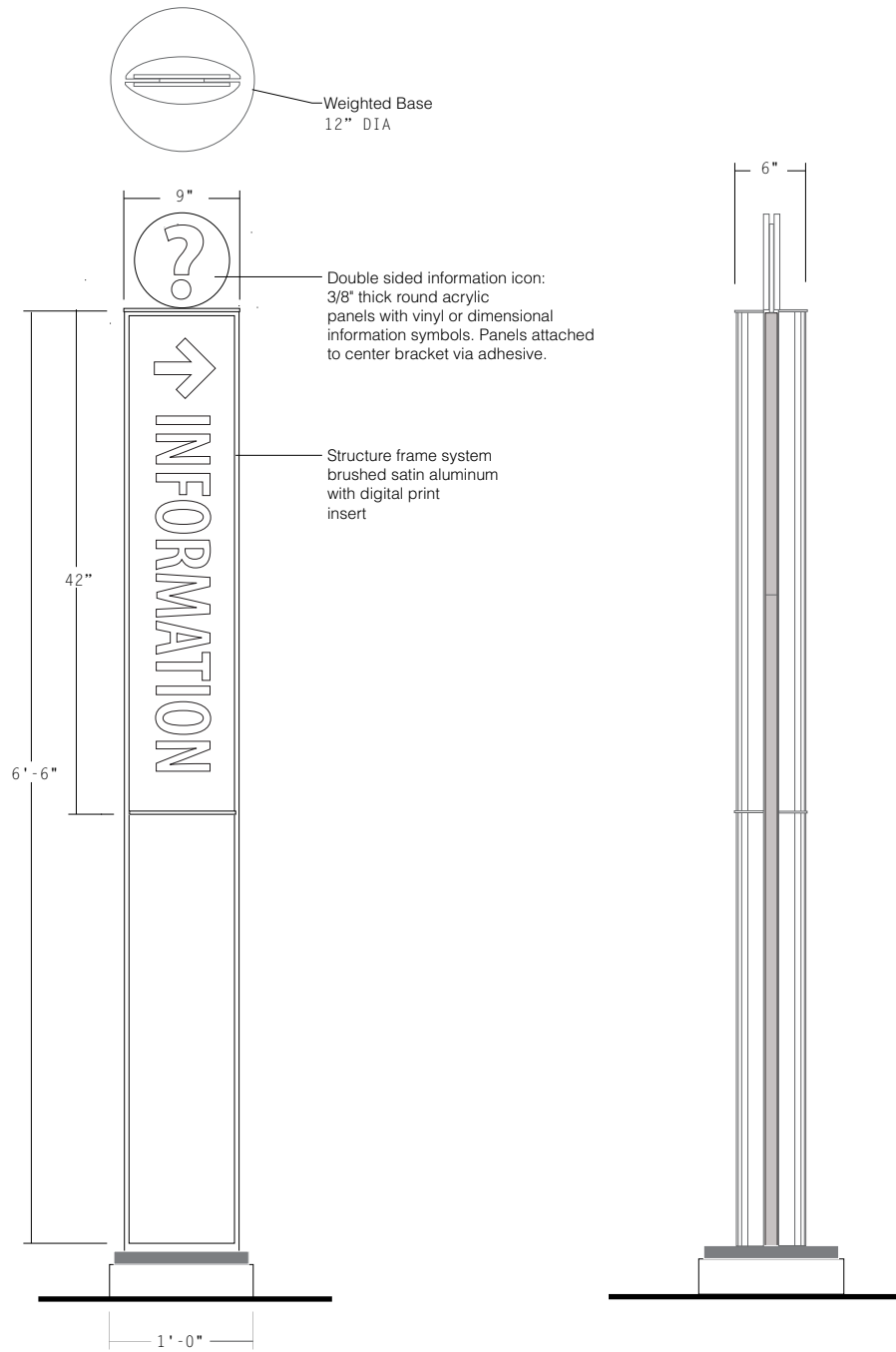

Wall Mounted Touch Screen Directory

Size

1295 mm H x 711 mm W
(4'-3" H x 2'-4" W)

Description and Use

Wall mounted interactive information station for identification of information service and department location. Monitor content is a separate project.

Message

(Refer to layout drawing for lettering sizes and dimensions).

Colors

Text: Refer to color chart for entry area. Color should have a high contrast with surrounding wall color and surface.

Typography

Helvetica Condensed

Installation

Wall mounted

Recommendations

Use appropriate mounting methods and hardware to accommodate weight of unit. Wireless network connections and power are required. Software and programming are necessary and require separate development. Monitor size and cabinet can vary.

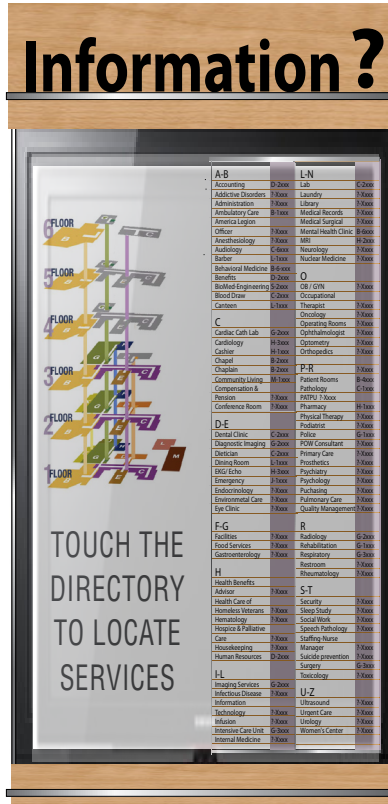

Wall Mounted Touch Screen Directory



Top view

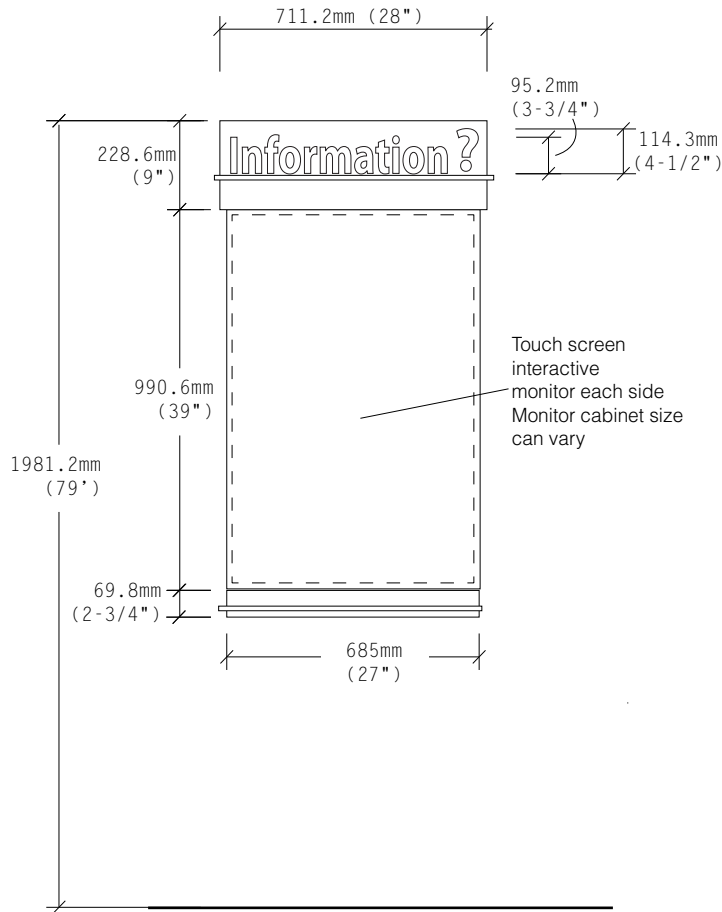

Front view



Side view

Freestanding Touch Screen Directory

Size

2134 mm H x 914 mm W x 381 mm D
(7'-0" H x 3'-0" W x 1'-3" D)

Description and Use

Freestanding interactive information station for identification of information service and department location. Monitor content is a separate project.

Message

(Refer to layout drawing for lettering sizes and dimensions).

Colors

Text: Refer to color chart for entry area. Color should have a high contrast with surrounding wall color and surface.

Typography

Helvetica

Installation

Secure to floor.

Recommendations

Floor mount unit for security and stability. Wireless network connections and power are required. Software and programming is necessary and requires separate development. Monitor size and cabinet can vary.

Provide hand sanitizer in close proximity.

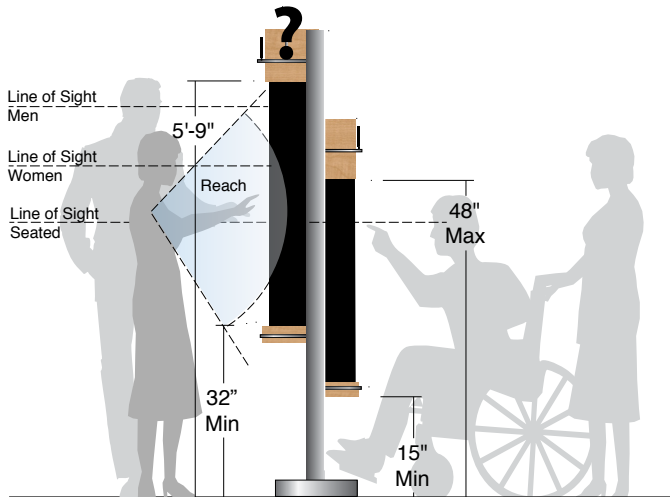

Freestanding Touch Screen Directory

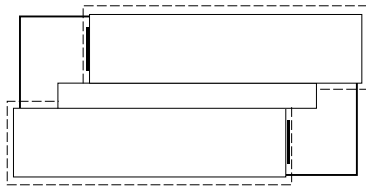

Top view

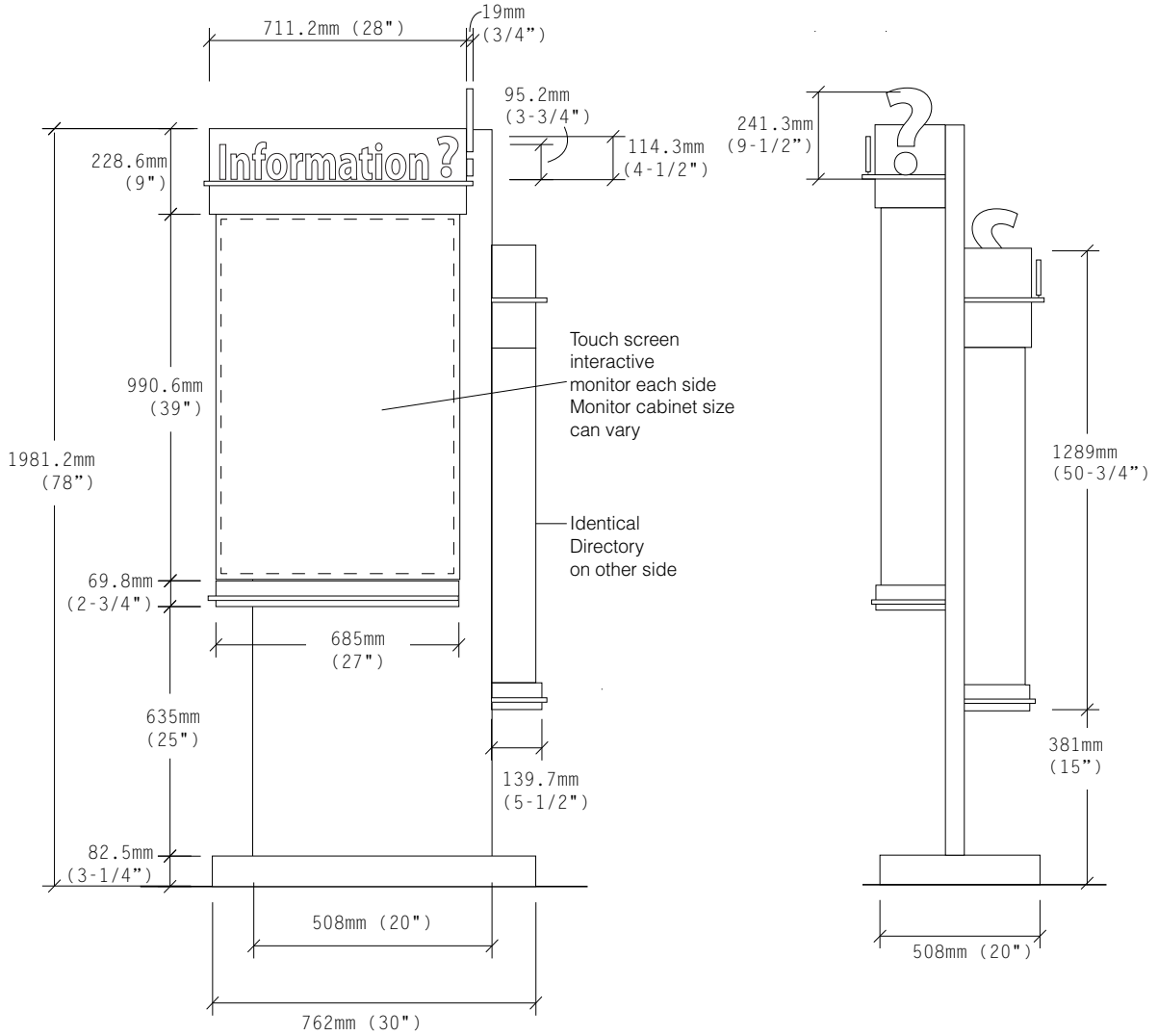

Front view

Side view

The specifications for signs are available in the Master Construction Specifications (PG-18-1) area of the VA Technical Information Library, which is available on the VA web site under Office of Construction & Facilities Management.

www.cfm.va.gov/til/

Refer to Signage in the specifications, Division 10, Section 10 14 00.

For more information regarding specifications, contact the Office of Construction & Facilities Management, Facility Standards Service.

The specifications require close coordination, taking into account the existing sign program at a medical center, any sign demolition, sign maintenance and future signing needs.

When preparing the specifications for a project, it will require editing to add and indicate new signs or eliminate signs that are not needed. Also, it will be necessary to adapt the specifications to project requirements required for the specific project in which they are intended.

The sign message schedule is considered a part of the specifications and would comprise a portion of the spec section. The configuration and format of the message schedule may vary according to individual project requirements. The sign message schedule format is shown in the Need a Sign Program section of the VA Signage Design Guide. It provides the method for identifying each sign location, type and message along with other notations. The sign schedule contains important information that the sign manufacturer and the sign installer will require for manufacturing and sign installation.

The sign message schedule must be coordinated with a sign location plan drawing showing where signs are to be placed within a building or on the site. Refer to the sign location plan example shown in the Need a Sign Program section of the VA Signage Design Guide.

For convenience, the sign type drawings can also be included in the specifications as it own section.

This page is intentionally left blank.

The type of interior directory system selected for a particular application or facility requires several decisions and involves different construction and assembly components to meet the desired results. This section provides an overview of the recommended criteria for interior directories.

Many sign manufacturers currently market extrusions, standard parts and component systems that will accomplish the illustrated objectives of the intended interior directory system. These extruded, molded, and fabricated component systems are acceptable as long as they adhere to the illustrated and stated specifications.

When a directory system is selected from a manufacturer, it will be necessary to continue a relationship with that manufacturer for regular directory updating with new strips and inserts. Component elements from directory manufacturer "A" will generally not work or fit in manufacturer "B's" directories. Component directory systems are available from many GSA approved sign manufacturers and sign manufacturers in the open market place.

Refer to the Interior Signs section of the Guide for details showing the construction of sign component systems and various sign types based on a component system. The illustrations are intended to show the desired configuration and intent of the various sign types. Sections of the extrusions and various parts are for illustration purposes only and have not been engineered or configured for extruding and do not represent a finished product.

The Interior Signs, Exterior Signs, and Specifications sections of the Guide should be read in conjunction with this section to provide an overview of the construction requirements, materials, and finishes.

This page is intentionally left blank.

Detail 1

Installation detail for sign types:
17.01, 17.02, 17.03, 17.04, 17.11,
17.12, 17.13, 17.14

Detail 2

Installation detail for sign types:
17.05, 17.06, 17.15, 17.16



Detail 1

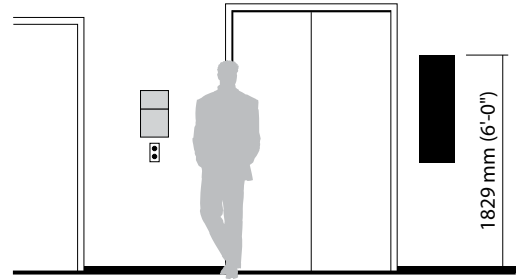

Detail 2

Wall Mounted Sign Detail

Interior wall bracing for directories

Stud Backing Plate A

1. Maximum weight- 25 lbs. point load. If sign load exceeds this use Stud Backing Plate B.
2. Attach plates to 3 studs minimum.
3. Verify length, height, location and number required.
4. Use #12 Self Tapping Screws when attaching items to backing, U.O.N.

Stud Backing Plate B

1. Maximum weight- 50 lbs. point load. If sign load exceeds this use Stud Backing Plate C.
2. Attach plates to 3 studs minimum.
3. Verify length, height, location and number required.
4. Use double stud when stud is supporting more than 2 backing plates.

Stud Backing Plate C

1. Maximum weight- 200 lbs./ft.
2. Attach plates to 3 studs minimum.
3. Verify length, height, location and number required.
4. Use double stud when stud is supporting more than 2 backing plates.

Stud Backing Plate D

1. Maximum weight- 300 lbs. point load.
2. Attach plates to 3 studs minimum.
3. Verify length, height, location and number required.

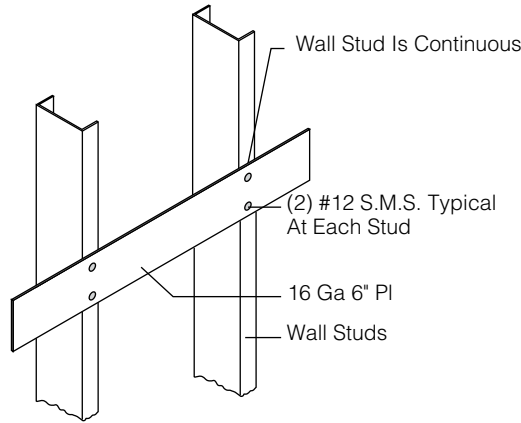

Stud Backing Plate A

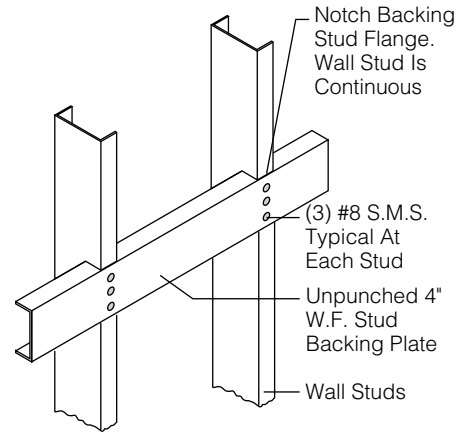

Stud Backing Plate B

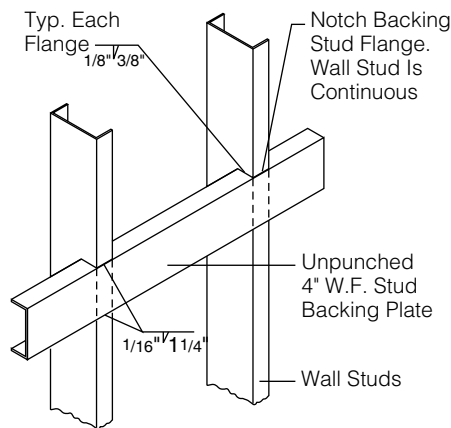

Stud Backing Plate C

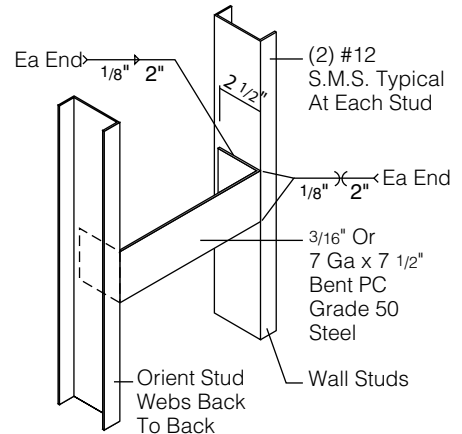

Stud Backing Plate D