



Interior Signs

- Room Identification
- Conference Room
- Wall Directional
- Ceiling Directional
- Department Identification
- Building Entrance
- Letters

This page is intentionally left blank.

Section 9 Interior Signs

• Products	9-1-1
• Planning	9-2-1 – 9-2-14
• Helpful Hints	9-3-1 – 9-3-2
• Historical	9-3-3
• Overview	9-4-1 – 9-4-9
• Sign Type Drawings	9-5-1 – 9-5-110
• Specifications	9-6-1
• Construction	9-7-1 – 9-7-9
• Installation	9-8-1 – 9-8-11

This page is intentionally left blank.

The interior sign section of the VA Signage Design Guide has incorporated styles of signs based upon new and evolving interior sign products.

Component Signs

The style of interior signs for VA facilities is based upon component sign systems that allow for easy and inexpensive updates and changes. The new styles of component sign systems can be updated with inserts that are printed on digital printers, allowing for immediate message replacements that can be created at the facility, rather than having to be ordered from a sign manufacturer. This approach applies to room signs as well as directional signs.

Various sign products are illustrated in this section showing flat signs as well as curved signs. Both styles work well in a medical facility, but it is **STRONGLY** recommended **NOT** to mix the two styles within the same facility.

A style of patient room signs is illustrated that can be custom tailored to support specific nursing operations related to patient care and safety is illustrated in this section.

Leaving the Past

The old style 80's VA acrylic signs, both framed and unframed, are no longer recommended for use.

They are expensive to replace or update. They do not meet ABA/ADA, and delivery of product can take considerable time. The old style of signs, with radius corners, is also no longer recommended.

The acrylic sign systems of the past provide a "dated" look to VA facilities and are not in appropriate in presenting a progressive health care environment.

Types of Signing

Within this section, interior signs have been identified on each page with a description of their use and application. Layouts for application of various messages are also shown along with recommended text sizes.

All rooms, with certain exceptions, in a facility should be labeled with a room number sign. Rooms such as toilet rooms within a patient room, closets, lockers, and cabinet style rooms can forgo a room number sign.

A room number sign can be substituted with another style of sign that incorporates the room number along with the capability of identifying the rooms use, function, service, or "content." For example: a "Soiled Utility" room would be labeled with a sign having a portion that includes text identifying the room, along with the room number; a "Conference Room", in addition to the room number would have a portion of the sign that contains the text identifying the room, as well as a slider to indicate whether the room is in use or not.

Wall, soffit, and ceiling mounted directional signs provide solutions for communicating wayfinding information in differing building conditions. Typically, ceiling or soffit mounted directional signs are used to display directional information for high traffic destinations such as the Pharmacy or Clinics.

Directories in lobbies and at elevator landings serve to assist people in locating or confirming the location of services within a building or in other buildings. Directories, because of their capacity to handle a large number of service listings, can include all of the departments or services within a facility. Refer to the Directories Section of the Guide for more information regarding directories.

This page is intentionally left blank.

Figure 1

Refer to the “Need A Sign Program Section” of the Signage Guide for additional supporting information on the process of developing, replacing or upgrading an interior sign program.



Site Review Obtain drawings

The first step in programming and planning is reviewing all the buildings. Obtain architectural drawings showing the floor plans of the entire building. Most facilities have building plans on file with the Engineering or Facilities Management Department. If the building has been remodeled or has additions obtaining current drawings may be a challenge. Drawings can be paper blueprints or electronic CAD “dwg” files. Request the document format that matches your software capabilities. (Note: CAD drawings can be saved as PDF drawings and imported into Adobe Illustrator or other similar programs).

Floor plans that show hallways, rooms, and doors will be needed. Use the architectural plan of the facility to identify points of entry, destinations, paths of travel (horizontal and vertical), intersections of hallways, and decision-making locations, such as lobbies.

Where are you going?

Look at the buildings from the perspective of a first time visitor and what they encounter when they come to a building.

Points of Entry and Destinations

- Identify the primary entry and exit points of the building.
- Identify the secondary entry and exit points of the building.
- Identify the destination points of primary departments and services.
- Identify the secondary destination points of departments and services.
- Identify the various points of vertical transition within the building. (elevators, stairs, ramps)
- Identify the various points of horizontal transition, within the building, that lead to other buildings (ramps, tunnels, tramways).

Paths of Travel

Primary paths of travel are from originating points or main entries to destinations.

A secondary travel path is from a service or location to another service or location, within the building, for example, from “Clinic B” to the “Pharmacy.” Paths of travel are both horizontal, e.g., along a hallway, and vertical, e.g., traveling up and down on elevator or stairs.

Intersections and Decision Making

Identify Hallways and Horizontal and Vertical Paths of Travel.

Intersections are locations where a visitor needs to make decisions whether to turn or continue forward. At intersections, wayfinding directional signs need to be posted leading the visitor in the proper direction. Major high traffic corridor intersections require more communication than smaller secondary intersections. Whether the signs are wall mounted or overhead will depend on the importance of the department or service and the architectural environment and conditions. Sight lines, issues of visibility, availability of wall space, ceiling height, lighting, and sprinklers all play into the type of sign solution selected for communication.

figure 2

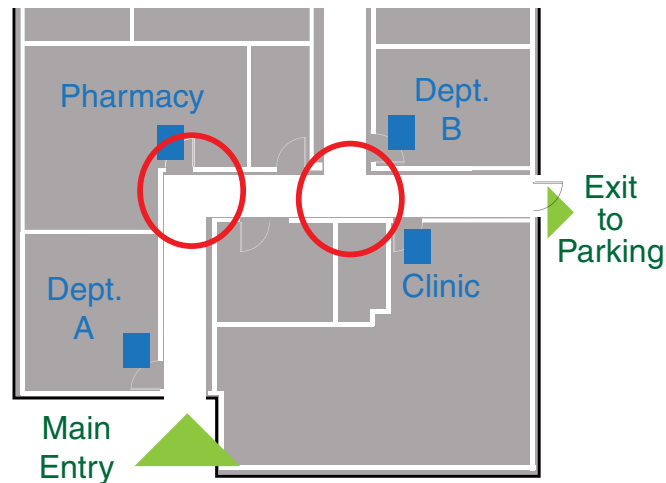

Evaluating a Site and Programming Sign Location

When Points of Entry, Destinations, Primary Paths of Travel (horizontal and vertical), and Intersections, have been identified, review the locations to identify a variety of additional environmental considerations.

Evaluate the site and ask, are the location of building entrances and elevators easily found? What is the character and configuration of the corridor system? Are the hallways wide or narrow and are they properly illuminated? Is there adequate lighting around intersections and Elevator Lobbies? What is the desired path of travel within the building for visitors and patients? Does a visitor walk around or through the building? Existing Pathways are not always the preferred and safest paths of travel. Do the employees access the building differently than the public? What is the desired path of travel within the building for employees? Is the building room and floor numbering system effective? Does each location have a unique and distinct number? Does the room numbering system follow a clear, understandable pattern? Are placements of signs in locations where people are expecting them to be? Which signs can have permanent messages, and which ones need to be changeable?

These considerations help establish the basis for a clear sign program that communicates information in a direct and simple manner.

Sign Types

A sign program for a building, that works well, is one that has been planned as an integrated whole. This means signs are coordinated from the main entrance, to the directional signs and department identification to room identification signs.

Interior Signs fall into various categories. This section covers Identification and Directional signs. Directories, Code, VA Mandatory and Specialty. Directories, Code, VA Mandatory and Specialty, signs are in other sections of this Guide.

Room Identification: All rooms in a facility should be labeled with a room number sign in tactile raised text and matching Braille to ABA/ADA specifications. Non-public rooms, not accessed by the public can have a simple sign. Signs communicating the room activity to the patient and public, such as identifying offices, exam rooms, and services need to be able to accommodate additional text.

Department Identification: All department rooms in a facility should be labeled with a room number sign in tactile raised text and matching Braille to ABA/ADA

specifications as well as be able to accommodate additional text and description of services. Departments that occupy larger areas, such as with waiting rooms, require additional identification designed to provide high visibility identification.

Directional: Wall, soffit, and ceiling mounted directional signs provide solutions for communicating wayfinding information in differing building conditions. Typically, ceiling or soffit mounted directional signs are used to display directional information for high traffic destinations like the Pharmacy or Clinics. Wall directional signs need to be obvious and present information in the order people will encounter the service or destination.

Directories: Directories in lobbies and at elevator landings serve to assist people in finding or confirming the location of services within a building or in other buildings. Directories, because of their capability to handle a large number of service listings, can include all of the departments or services within the facility. See information on directories in another section of this Guide.

Programming

Once the building review is complete, you can begin to program the building.

Programming is the Where? What? and How? of signage. The Sign Location Plan establishes “where” a sign is located, The Sign Message Schedule establishes “what” text message on the sign is to say. The Sign Type Drawings show the type of sign and establish how the information is displayed. These three documents are the main components of signage programming. To create the Sign Location Plan place a mark and a location number on the plan document as a placeholder for a sign type and sign message associated with the particular location.

In the Message Schedule spreadsheet enter the Location Plan number, corresponding Sign Type designation, and establish the text message of what that particular sign is to say. Sign type drawings are design documents that describe the sign size, text layouts and fabrication information. The VA has established sign types described in this section. This Programming process can be done for Code signs, Room/Department Identification and Wayfinding. These three categories of interior signs can be programmed concurrently or separately.

Wayfinding

“Wayfinding” is the term, that in recent years has been used to describe the process of finding a destination in the built environment. Signs play an active role in the process by providing the primary form of communication in wayfinding.

In developing a wayfinding system for the interior of a medical center, or the interior of a support building, follow some common guidelines. In the interior of a building it involves the corridor system from all the building entrances to the locations where patients and visitors are seeking a service. Wayfinding is then the process of communicating to people along the pathway, with appropriate directories, directional signs and service identification.

It is important to understand who will be using the wayfinding system. VA facilities will have a diverse clientele. A wayfinding system must take into account not only veterans of all ages and genders but family and friends that will need to locate patient rooms, departments, and services. Consideration of mobility, eye sight, the elderly walking stooped, or individuals using wheel chairs will effect sign position, location, and size of lettering.

It is new visitors who will depend the most on signs to navigate a facility. Be cautious, avoid information overload. Remember, once the viewer leaves the Directory, Map or Directional Sign, this new information will quickly fade. In the case of a “You Are Here” map, once they make the first turn, all their orientation will be lost.

When developing the information for directional signs, keep in mind that high traffic destinations should take top priority for being listed. Secondary services that are closest to the location of the sign then become the next group of items to list. Typically when including more that 6 to 8 destinations, people will stop reading a sign because of information overload.

The architectural environment will affect the wayfinding system. If the hall system is a maze, create a differentiation of floors and hallways. The colors of walls, memorable art work or unique interior details can help distinguish one floor from the next and one long corridor from another. Color and graphic treatments, changes in types of flooring and bright lighting at elevator lobbies and major intersections will aid in orienting the visitor.

Some older facilities that have been remodeled several times may have paths of travel that are blocked or inaccessible. The wayfinding path must catch and direct the visitor before they reach a blocked or limited path of travel. Signage cannot solve architectural problems.

**Wayfinding
Where to Start**

Start planning from the main lobby or entry. In this main entry area an overview map of the facility and the main directory must be located. Select a primary wall, one easily visible from the entry door or elevator lobby for the main directory location. The directory should list primary services and departments alphabetically, NOT by floors. A new visitor usually knows what they are looking for so Directories and Directional signs need to tell the visitor where the department, room or service is located.

Additional Elevator Lobby Directories can be used at the elevator lobbies. These directories should list the services found on that floor and that are accessible from that elevator.

“You Are Here” maps can sometimes aide in the wayfinding process but care must be taken to make sure the map is very simple and configured in a manner that makes it very easy to understand. It is important that “You Are Here” maps are placed in strategic locations where the viewer has a clear orientation to the building based upon the view of the map they are seeing. The orientation of a map, and the simple amount of information on it, play a critical role in assisting the viewer to understand what they are looking at.

You are Here Map

figure 3

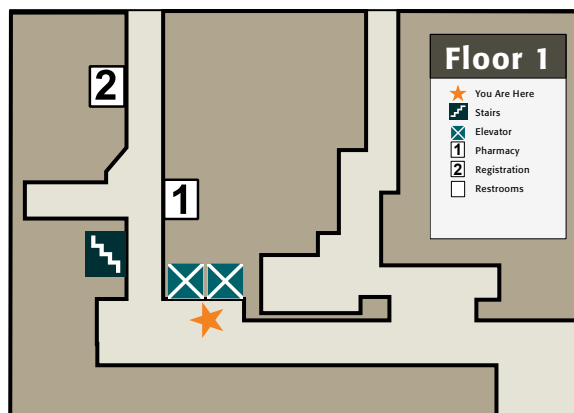

Placement must also be at a location in the building where the viewer can make connection with major visual objects like an atrium, or large “art” work, or a permanent architectural feature of the building.

Directional signs should be used on walls and overhead along the path of travel. In the path of travel there will be decision points at each intersection of hallways or when encountering building exits or transitions. At these decision points, information must be communicated in a priority of need. The priority of need is defined as those departments or services that have the highest percentage of people seeking them. The destinations with high demand for information must be communicated with the highest priority on directional signs along the most direct path of travel.

Overhead signs generally provide emphasis to high priority directional or destination information. Care must be taken with overhead signs to ensure that these signs can be seen from a distance. If the viewing distance is too short, those who walk stooped, are in walkers, or wheelchairs may have trouble viewing these signs. Also, the placement of overhead signs needs to take into account items that might obscure them, such as exit signs. Possible blocking of fire sprinklers also needs to be considered.

Secondary information or information that applies to a small percentage of individuals needs to be evaluated in regard to its importance. Secondary information should be relegated to the bottom of the signs and not be included if the space on the sign is limited.

Typically a person only reads 4 to 8 messages on a directional sign. Any information greater than this is simply not read. Prioritization of communication of information would then in most cases result in secondary or minor information left off the sign because it is not useful.

People that are walking have the opportunity to read more messages than an automobile driver, therefore interior directional signs can contain more listings of information. But more than 8 listings on a sign results in a sign so large that it is no longer readable. The viewer simply cannot comprehend all the information presented. Or they will not stand there long enough to read everything. When large amounts of information must be presented, break it down into smaller groups of information. Use 2 directional signs instead of 1. Place all the directional information for one direction on one sign, and then use another sign to convey the other directional information.

Sign Placement General

When evaluating intersections, remember to look at the location as if you are both entering and exiting the building. A path of travel may seem simple when entering, but complex or confusing to exit. Path of travel is a two way street. Placement of directional signs should be perpendicular to the path of travel. If a wall is not available at an intersection, use an overhead sign. Where a door to a department, restroom, phone or stairwell is recessed or not easily seen a Flag type sign can be used.

figure 4

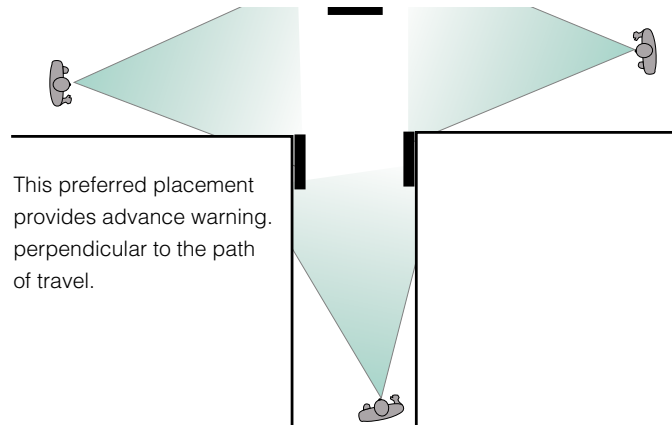

Placement on the Wall

Correct placement of signs is required for all interior room identification signs.

Refer to the detailed drawings and instructions covered both on the sign type page and in the Installation Section. These drawings, for each sign type, show the placement position required for its use.

Room identification signs are required to be installed in specific locations and conform to specific dimension parameters. Refer to the discussion on ABA/ADA requirements in the Design Elements Section of the Guide.

Correct placement of signs will result in the use of fewer signs. Too many signs in one location can create a cluttered appearance, cause confusion and increase the difficulty for a viewer to find the particular information they are seeking.

Interior lighting, wall colors and material finishes need to be taken into consideration because of their effect on the visibility of signs. Locations of glass sidelights, and their width, can affect the placement of the sign. Preferred location is to install the sign directly on the glass and install a blank glass back up panel on the opposite side to hide the adhesive.

Coordination must take into account items such as chart holders, bulletin boards, memory boxes, pictures, and artwork. These items may require relocation to meet the installation requirements of signs. Coordination must also take place with Code and Life Safety signs.

Care must be taken to locate signs in a manner that allows clear viewing. Placement of signs so they are not obscured by furniture or equipment is critical.

Conspicuous

Signs should be located where a user expects to find information. Signs contrasting with their surroundings aid those who are vision impaired. This particularly holds true for department identification and wayfinding signage.

As a general guide, is the sign conspicuous and does it stand out from visual clutter and its environment?

Legibility

The text size needs to be an appropriate height for the distance from which the message is being viewed and what's being communicated. Directional signs need to have text larger than room identification signs. Overhead signs and low light conditions require larger text size. ABA/ADA has certain text size requirements that must be met as well.

In general, a person with 20/20 vision requires a minimum of 1 inch capital letter height to be able to be read at 58 feet. The MUTCD recommends using 30 feet of legibility for each inch of letter height, as a design goal.

Line of Sight

Vision Field approx.
 135 Degrees
 60 Degrees Up
 75 Degree Down

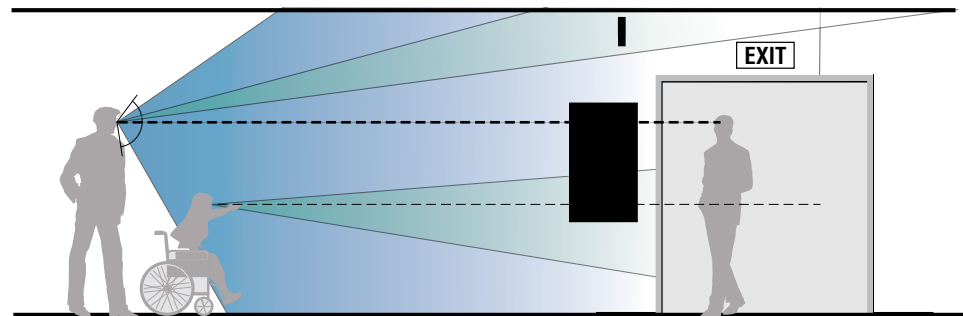

Line of sight

A complete evaluation of the building and site is important prior to placing signs. For an existing building, the evaluation of sign locations should be performed by actually visiting each sign location. For new buildings, in addition to evaluating the floor plans, one must study the elevation drawings and the reflected ceiling plans.

In addition to a location of a sign at a wayfinding decision point, the legibility of the message at that location must be considered. Evaluate sign locations for visibility from afar. Is the sign big enough and the text height adequate for the distance at which the sign will be read. Often times hallway ceilings have soffits and door openings which restrict visibility. Are there competing elements such as door way illuminated exit signs, pipes, ducts, and wall mounted devices? Existing equipment and architectural elements may effect the legibility of the sign as well.

Evaluate the lighting conditions at walls and ceiling. The available light at each location must be considered. Is the light level high enough to see the sign from a distance? Does existing lighting create a silhouette of the hanging sign? If the sign location was changed, could existing light indirectly illuminate a sign? Do the conditions change at night?

Surfaces and areas for proper sign placement do not always exist. Either the ceiling is too low to install an over head sign or the wall space is not available in the normal line of sight. Select the next best location. Overhead obstructions, narrow or irregular hallways with poor lighting are not ideal for effective signage.

Arrows

The proper use of arrows on directional signs is important to ensure that the reader quickly understands correct directional information.

Grouping all the information together that is in one direction and using one arrow is preferred. Using an arrow for each message makes the sign confusing and difficult to read.

Arrows should be placed to visually precede the message. This allows the reader to understand direction first and information second. It also allows the arrows to be visually separated from text.

Arrows should always be larger in size than the text they are affiliated with. For example, wall directional signs have a 2-1/2" arrow and the text has a 1-3/8" capital letter size.

Orientation of arrows is important to effectively communicate direction. The following illustrations give examples of the many varied conditions that can be encountered when providing direction information.

Arrows

figure 6

Number **Location Plan**
Orientation **Interpretation**

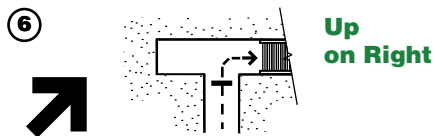
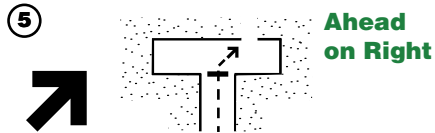
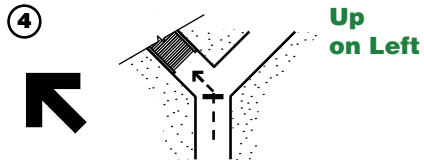
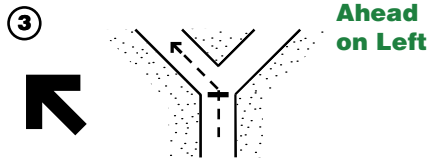
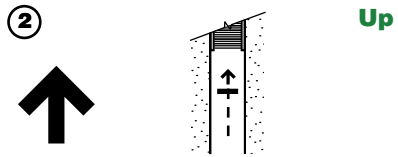
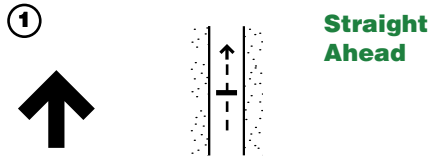

Number **Location Plan**
Orientation **Interpretation**

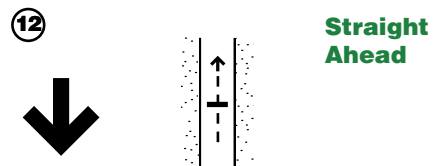
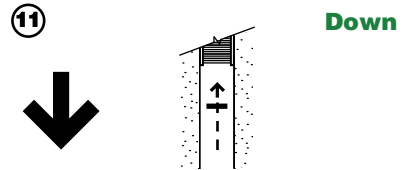
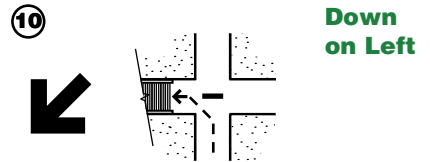
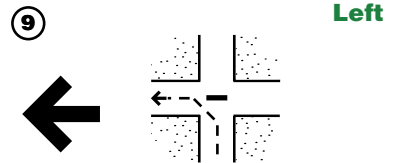
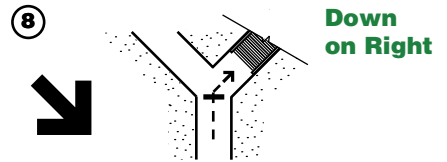
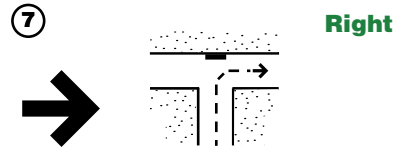

**Color and Design
Continuity**

All the signs in a sign program do not have to be uniform in color.

A variety of color combinations will work well together. For example, the wayfinding portion of the sign program can be in a color that is different from the room identification signs. Color is a strong design element helping to establish the mood and tone of an environment. Warm colors and cool colors as well as bright, saturated palettes can establish different styles and feelings for the interior environment. Also sign backer panels with contrasting color, finishes, patterns, or even photos can accent the desired color palette.

In the Design Elements section of the Guide a palette of colors has been prepared that work with most interior wall colors and finishes. If a color is selected that is not a part of the VA palette, it must meet the contrast requirements with the sign text that is called for by ABA/ADA.

figure 7

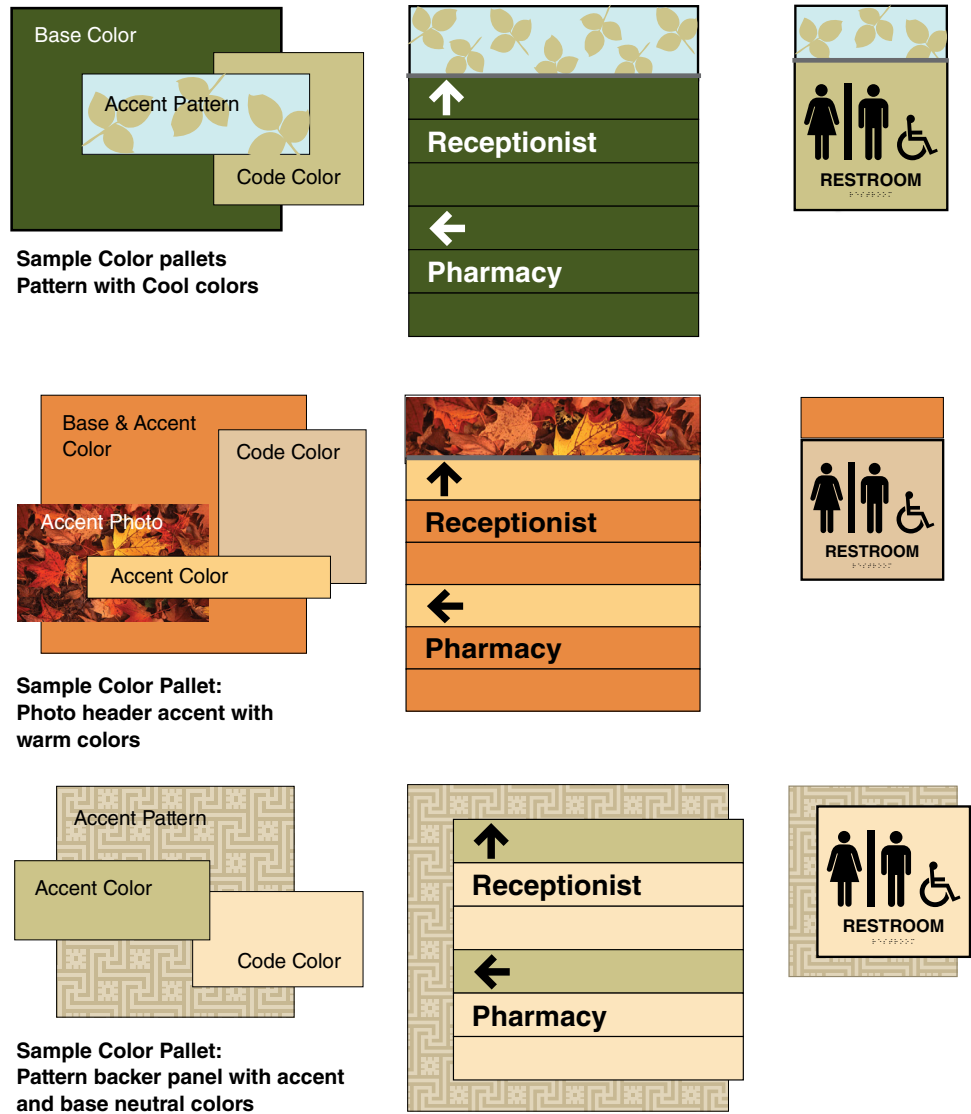

The above examples show the integration of photographic imagery, patterns or accent colors for a header or backer.

A bold color can be used for the directional signs and a soft neutral color for the code and room signs. This will allow the room signs to blend with the environment and the directional signs to pop off the walls.

The use of images or patterns, related to a common theme is another approach. This can be useful when implementing a sign system in a facility where different areas of that facility have been assigned different color and material palettes.

NOTE: Not all VA colors work well together. Consult your signage specialist to verify that the colors selected will work with your interior palette and that signage readability is maintained.

Sizes of Signs and Lettering

Interior sign sizes that are illustrated in this section have been determined to work in most situations. The size of text shown has also been determined to be the best compromise between readability and being able to fit text on the sign.

When planning a sign program, look for conditions that are within the building where signs will not fit. All buildings have these conditions. When encountered, have the specific sign, at that location, modified in size to fit the specific condition requirements.

Text size on signs has also been predetermined to meet ABA/ADA requirements for the vision impaired. Overhead signs require large size lettering and lettering on directional signs should be larger than on room identification signs.

figure 8

Contrast

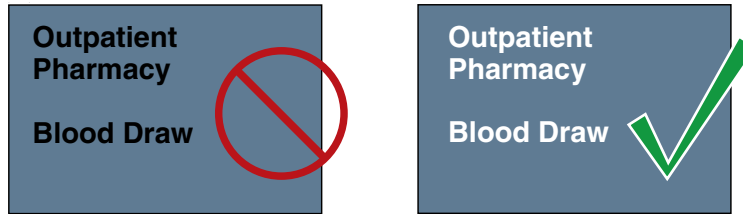

Select the proper text and field color to achieve a high level of contrast. In addition to the contrast and readability of a sign, the sign should also contrast with its surroundings. The color elements need to have adequate contrast for readability in low light levels. A sign with mid tone text and mid tone field color in low light levels is NOT effective.

Concise

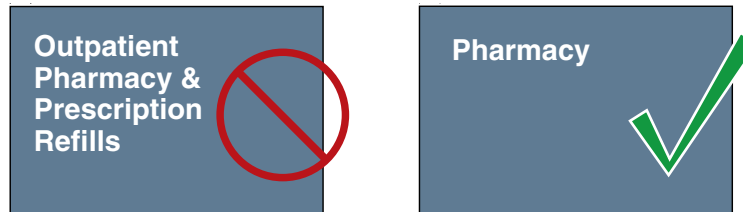

Simplify text and department names for a quick and easy read. Visitors and patients are not likely to spend more than a few seconds looking at a sign. The information presented needs to be simple, relevant and apply to the current location. The sign should also be located where a user expects to find information.

It is very important to use words and terminology that the average person understands. The words and terminology must be consistent throughout a sign program.

Complex medical terms, titles and names are generally NOT familiar to most people, so use terms easily understood by visitors and patients. And, acronyms are even less understood by visitors, patients and staff.

Readability

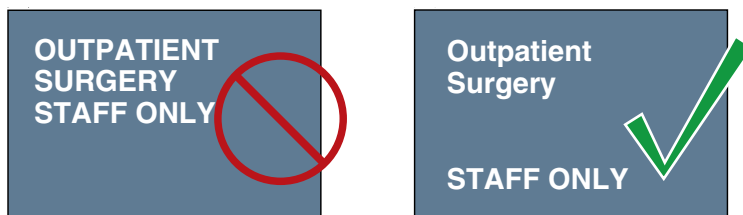

Use "initial caps" (upper and lower case). The initial cap text form is the most readable layout for messages. Save the use of "all capital letters" for warnings and emphasis.

Text layout and choice of words is critical to the readability and usefulness of a sign. Forgo the use of phrases like "Please" and "Thank you". Do not use redundant words when labeling a room. For example, use "Soiled Utility" not "Soiled Utility Room".

Placing several signs with the same message creates visual clutter. State your message once as simply and concisely as possible. Though there may be a temptation to fill empty space on a sign with extra words, don't. This will lessen the effectiveness and readability of a sign. Remember, visual clutter creates a visual overload similar to a loud noisy environment.

Existing Sign Program Removal

Before implementing a new interior sign program, perform a thorough evaluation of the demolition requirements of the current sign program and impact on the facility's walls, doors and ceilings.

Determine what is required to patch, seal and repair the building surfaces exposed as a result of removal of old signs or letters. Repairs should match adjoining surfaces. Evaluate if tile or stone surfaces require repair or refurbishment. Are doors going to need to be refinished or painted?

Make sure the sign removal scope of work requires the contractor to disconnect and remove any live electrical connections. Make sure existing conductors and conduit are removed to the nearest junction box and are made safe.

Be sure to clearly identify any signs that are to remain. It is especially important to save signs and plaques that relate to special dedications, donors or displays that may be of historical importance. Cover or protect signs that are to remain or catalogue, remove, safely store and then reinstall as necessary.

The following are some general “Dos and Don’ts” guidelines that one can use to develop a sign program.

The following is not intended to be a training section of the Guide, but to provide key information that will hopefully reduce the common errors made when developing an interior sign program.

General Guidelines

- All tactile room number signs or other tactile room identification signs are required to meet ABA/ADA requirement for height and Braille text.
 - Signs require maintenance. Periodic cleaning will extend the life of a sign program.
 - If overhead signs are used, make sure they have a minimum 84 inches of clearance from the bottom of the sign to the floor.
 - Signs identifying electrical closets, mechanical rooms and telecommunication rooms should consist of the room number only, which should follow the master building room numbering system. No descriptive name or title should be used nor should they have a unique number system.
 - Overhead signs must not visually block EXIT signs and shall not block fire sprinkler spray patterns.
-

Message Content

- Keep sign messages brief. Unnecessary information confuses the viewer. Typically, all signs, with the exception of directional signs, should convey no more than one name, title, concept, or thought.
 - Use words which are familiar and comfortable to the viewer, and use the same words consistently throughout the sign program.
 - On directional and informational signs, provide only information necessary to make a decision at that particular location.
 - Whenever possible, messages should be presented using positive information.
 - On directional signs, do not anticipate decisions that can be made later. Unnecessary or premature information will confuse the reader.
 - Messages placed on signs should be concise, preferably with no more than seven to ten words.
-

Message Layout

- Use upper and lower case text whenever possible. Upper and lower case text is easier to read and is understood faster than text in all capital letters.
- Line spacing between two different messages should be greater than line spacing between lines of the same multi-line message group.
- Generally sign text should be a minimum of 1/2” capital letter height. ABA/ADA tactile text is a minimum 5/8”.
- Text should not go right up to the edge of the sign.
- If a line of text needs to be reduced in order to fit on a sign, use only commonly understood abbreviations or reduce the size of the type for the entire message. DO NOT condense the type face.
- The most important message should appear as the first line of text.

- On wall mounted directional signs, the most important directional information should be at the top of the sign.
 - On a ceiling mounted directional sign, the most important directional information should be at the bottom of the sign.
-

Placement of Signs

- Signs should, if at all possible, always be perpendicular to the intended viewer.
- Position signs with a clear line of sight from the viewing point to the sign face.
- Always evaluate the lighting at a sign's location. Lighting conditions can have a significant effect on visibility, possibly making a particular location unsuitable.
- Evaluate the sign color selections for effective contrast and readability in the actual building condition or location where the sign will be installed.
- All signs should be placed in a location that will be clearly visible at all times.
- Signs may be installed on glass when there is no available wall surface. A blank glass back up is necessary on the opposite side of the glass, exactly behind the sign being installed.

Historic VA Buildings

Letting people know where they are and where they need to go is just as important in historical buildings.

In a historic building, if original signs exist, they should be used as a starting point for developing a new sign program that respects the original design look, but meets the current requirements for interior signs.

Sensitivity to colors, materials, finishes, building detail, and the original architects intent for the look of the building should be incorporated into the look and design of a new sign program. The sign product for a new sign program should be of the type that allows for updating and text changes to be conducted with out complete sign removal and reinstallation.

Care must be taken to not harm building materials when removing old signs and installing new ones. Placement of wayfinding signs in a historic building must take into account circulation constraints that are sometimes a part of older corridor systems, as well as vertical movement within a building. Glass doors, special doors, high wainscot, special paneling, carvings, and trim detail may require compromise on sign placement, but locating signs should follow the interior sign installation guidelines as closely as possible.

Keep signs to a minimum and consolidate them whenever possible. Signs in lobbies should be kept to a minimum and consist of only those necessary for people to find their way in the building. Announcement banners, notices and other “promotional” type items should be discouraged in lobbies and throughout the corridor system.

Additional assistance with sign programs for historical building is available from the Office of Construction & Facilities Management.

This page is intentionally left blank.

This section of the VA Signage Design Guide covers interior signs that would be necessary to sign an individual buildings, off site clinics or a complete medical center campus.

This Overview Section gives general illustrations of the sign type groups. Page section 9.5 identifies all interior room signs, identification, directional, wayfinding and informational signs. The sign type drawings are on two pages with the front page showing the general description and the back page illustrating the sign dimensions and graphic layouts.

Interior Sign Designations

Each sign in the program guide has been given a specific sign type number designation. This designation provides a description that can be referenced when programming a building and ordering signs. The following explains how the sign type designations are derived.

IN - 03 .01 A

IN Designates an interior sign.

03 Two digit numbers identify a particular sign type family.

.01 The two digit number following the period identifies a specific sign within the sign family.

A The letter designates a specific sign configuration, version or layout for graphics

IN-03.01
Room Number Identification



IN-03.01
Room

IN-04.01
Primary Room Identification
(Large)

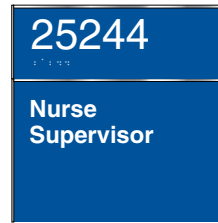

IN-04.01
Office (Large)

IN-04.02
Secondary Room Identification
(Small)



IN-04.02
Office (Small)

IN-04.03
Primary Room Identification
(Large with paper Insert and lens)

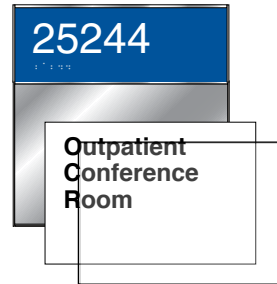

IN-04.03
Room (Large Insert)

IN-04.04
Secondary Room Identification
(Small with paper Insert and lens)

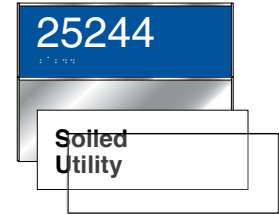

IN-04.04
Room (Small Insert)

IN-05.06
Patient Room Identification



IN-05.06
Patient Room Sign

IN-05.07
Patient Room Identification
with Patient Condition pull outs

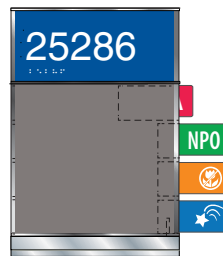

IN-05.07
Patient Room Sign
(With Patient Conditions
Pull outs)

IN-05.08
Double Patient Room Identification



IN-05.08
**Double Patient
Room Sign**
(With Patient Conditions
Pull outs)

IN-06.05

Patient Bed Sign



IN-06.05

IN-06.06

Patient Bed Sign with dry erase board, push pin surface, or magnetic board



IN-06.06

**IN-07.01, .02 and .03/
IN-07.05, .06 and .07**

Conference/Meeting Room Sign /
Room Sign with Indicator and Paper
Insert



**IN-07.01, and .03 /
IN-07.05, and .07**
Slider

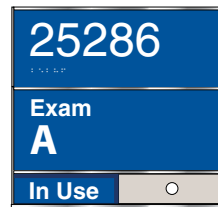

IN-07.02 / IN-07.06
Slider (Small)

IN-08.01

No Smoking



IN-08.01

IN-08.02

Prohibit, Instructional and Control
Sign



IN-08.02-4

**IN-09.01, .02, .03, .04, .05,
.06 and .07**

Restroom Signs



IN-09.01

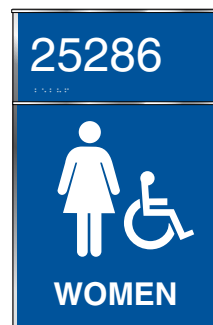

IN-09.02



IN-09.03

IN-09.08, .09

Pictogram and Symbol Sign



IN-09.08, .09

IN-10.01, .02, .03, .04, .05 and .06

Sign Frame

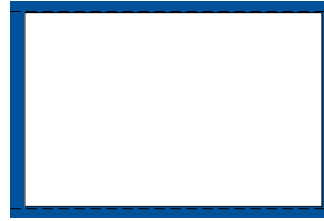

IN-10.01, .02, .03, .04, .05, .06
Pocket Insert

For Patient Information

Please use telephones located at the information desk in the main lobby.

IN-11.01, .02, .03 .04, .05, .06

IN-12.01, .02, .03 and .04

Desk, Counter Sign

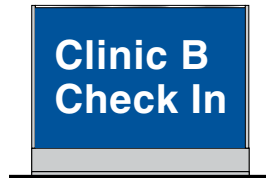

IN-12.01, .02, .03, .04
Desk Top

IN-13.01

Perpendicular (Flag) Mount Sign



IN-13.01
Flag

IN-14.01, .02, .03, .04, .05

Wall Directional Sign (Strips)

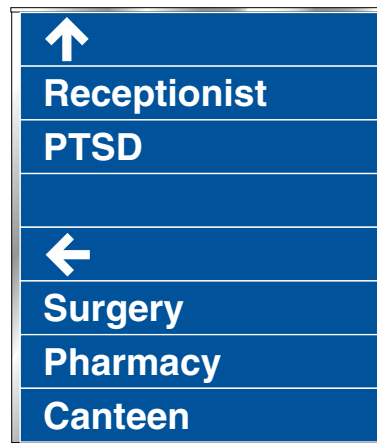

IN-14.01, .02, .03, .04, .05
Wall Directional
(strips)

IN-14.06, .07, .08, .09, 10

Wall Directional Sign
(Digital Insert)

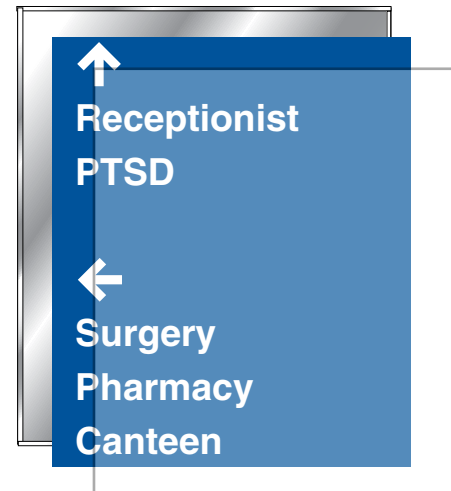

IN-14.06, .07, .08, .09, .10
Wall Directional
(Digital print insert)

IN-14.11, .12, .13, .14
Elevator/Floor Directional Sign
(Strips)

IN-14.15, .16, .17, .18
Elevator/Floor Directional Sign
(Digital Insert)

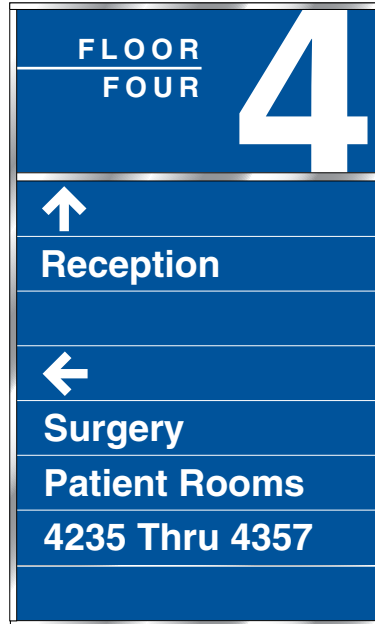

IN-14.11, .12, .13, .14
Elevator Directional
(strips)

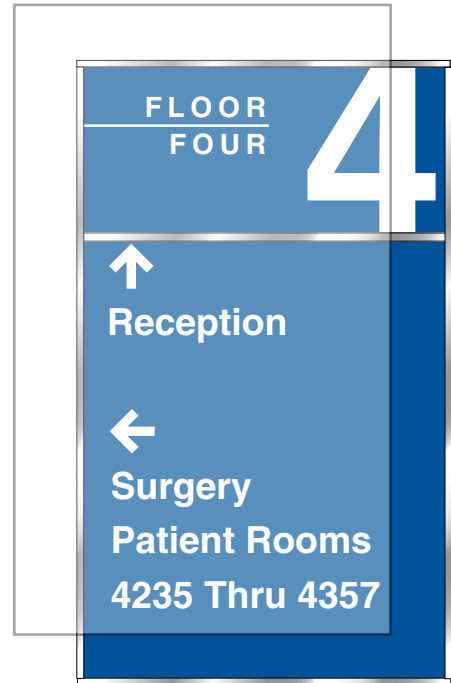

IN-14.15, .16, .17, .18
Elevator Directional
(Digital print insert)

IN-14.20, .21
Elevator/Floor Directional Sign
(Strips with Map)

IN-14.25, .26
Elevator/Floor Directional Sign
(Digital Insert with Map)



IN-14.20, .21
Elevator Directional
(strips with map)

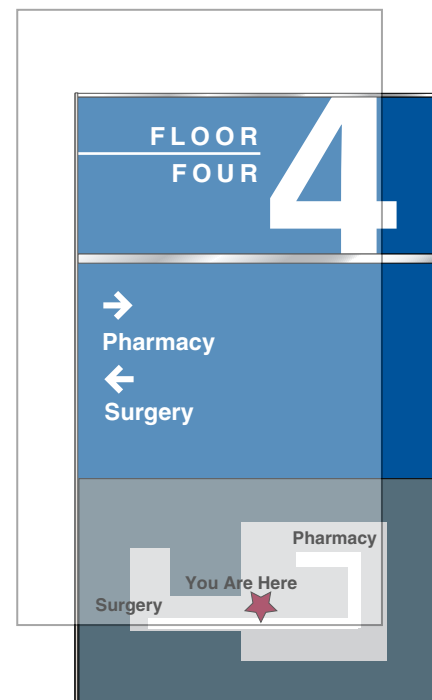

IN-14.25, .26
Elevator Directional
(digital print insert)

Overview

IN-15.51 (strips)
IN-15.55 (insert)
Ceiling Mounted Directional and
Department ID signs
6" H x 40" W
text size and layouts vary A–C

IN-15.52 (strips)
IN-15.56 (insert)
Ceiling Mounted Directional and
Department ID signs
12" H x 40" W
text size and layouts vary A–E

IN-15.53 (strips)
IN-15.57 (insert)
Ceiling Mounted Directional and
Department ID signs
18" H x 40" W
text size and layouts vary A–E

IN-15.61 (strips)
IN-15.65 (insert)
Ceiling Mounted Directional and
Department ID signs
6" H x 80" W
text size and layouts vary A–D

IN-15.62 (strips)
IN-15.66 (insert)
Ceiling Mounted Directional and
Department ID signs
12" H x 80" W
text size and layouts vary A–E

IN-15.63 (strips)
IN-15.67 (insert)
Ceiling Mounted Directional and
Department ID signs
18" H x 80" W
text size and layouts vary A–E

Interior Signs

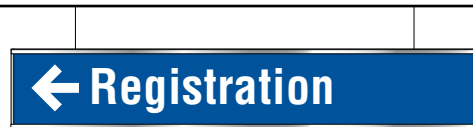

Example: IN-15.51A Component slats with 3" text



Example: IN-15.56B digital print insert with 3" text



Example: IN-15.57E digital insert with 2" & 3" text

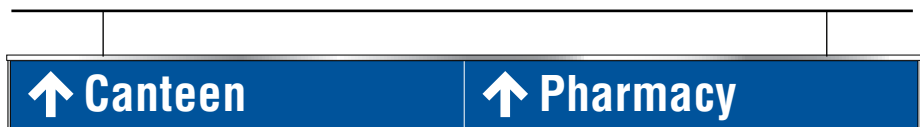

Example: IN-15.61 Component slats with 3" text

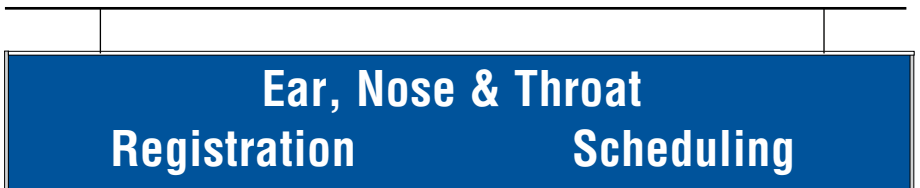

Example: IN-15.66 digital print insert with 3" text

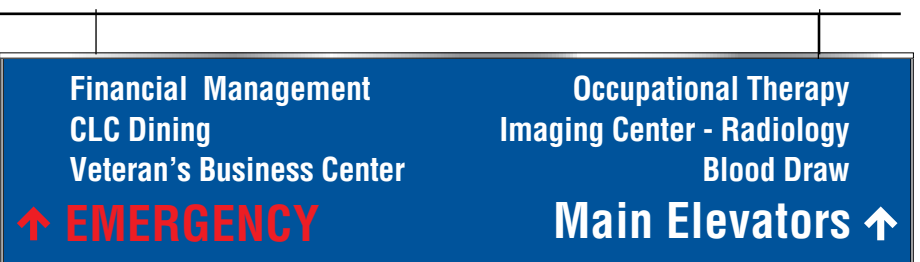

Example: IN-15.67 digital insert with 2" & 3" text

OVERHEAD Hanging Series IN-15.50-60

N15 series can be used for BOTH Directional and Department Identification. See specification page for directional and ID text layouts

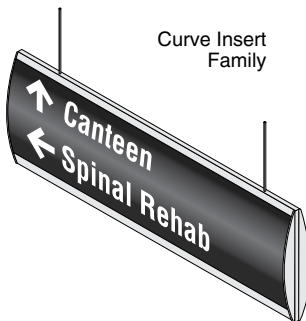
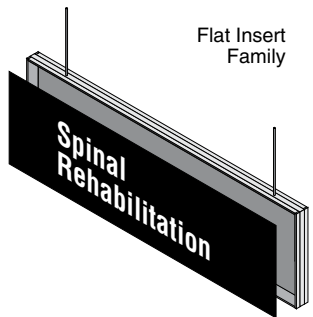
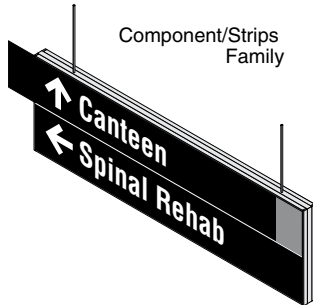

Sign Type	Layout	Width	Panel Height	Text Size	Family	Directional Arrows	Department ID
IN-15.51	A-C	40"	6"	3" & 2"	All	x	x
IN-15.55	A-C	40"	6"	3" & 2"	Insert	x	x
IN-15.52	A-E	40"	12"	3" & 2"	All	x	x
IN-15.56	A-E	40"	12"	3" & 2"	Insert	x	x
IN-15.53	A-E	40"	18"	3" & 2"	All	x	x
IN-15.57	A-E	40"	18"	3" & 2"	Insert	x	x
IN-15.61	A-C	80"	6"	3" & 2"	All	x	x
IN-15.65	A-C	80"	6"	3" & 2"	Insert	x	x
IN-15.62	A-E	80"	12"	3" & 2"	All	x	x
IN-15.66	A-E	80"	12"	3" & 2"	Insert	x	x
IN-15.63	A-E	80"	18"	3" & 2"	All	x	x
IN-15.67	A-E	80"	18"	3" & 2"	Insert	x	x

NOTE: Overhead sign IN15 series are double sided hanging signs. To determine sign type and size required at a specific location, Verify project sign family, ceiling height, distance the sign is to be viewed and quantity of text. 2" high copy is NOT recommended for long hallways or for a sign that will be read at a great distance.

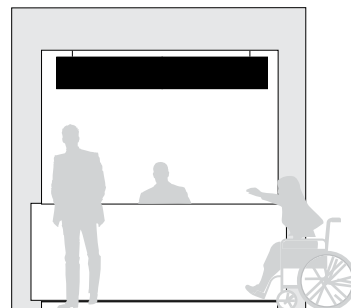
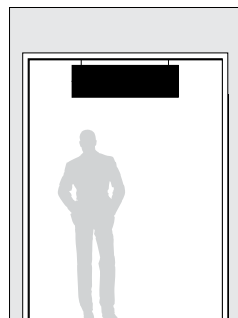

Overview

Interior Signs

IN-16.51 / IN-16.55

Soffit Mounted Directional and Department ID signs
6" H x 40" W
text size and layouts vary A-C



**Example: IN-16.51A Component slats with 3" text
Single sided soffit mount**

IN-16.52 / IN-16.56

Soffit Mounted Directional and Department ID signs
12" H x 40" W
text size and layouts vary A-E



**Example: IN-16.56B digital print insert with 3" text
Single sided soffit mount**

IN-16.53 / IN-16.57

Soffit Mounted Directional and Department ID signs
18" H x 40" W
text size and layouts vary A-E

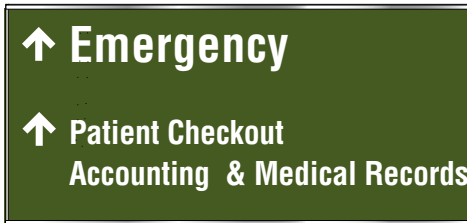

**Example: IN-16.57E digital insert with 2" & 3" text
Single sided soffit mount**

IN-16.61 / IN-16.65

Soffit Mounted Directional and Department ID signs
6" H x 80" W
text size and layouts vary A-D



**Example: IN-16.61 Component slats with 3" text
Single sided soffit mount**

IN-16.62 / IN-16.66

Soffit Mounted Directional and Department ID signs
12" H x 80" W
text size and layouts vary A-E



**Example: IN-16.66B digital print insert with 3" text
Single sided soffit mount**

IN-16.63 / IN-16.67

Soffit Mounted Directional and Department ID signs
18" H x 80" W
text size and layouts vary A-E

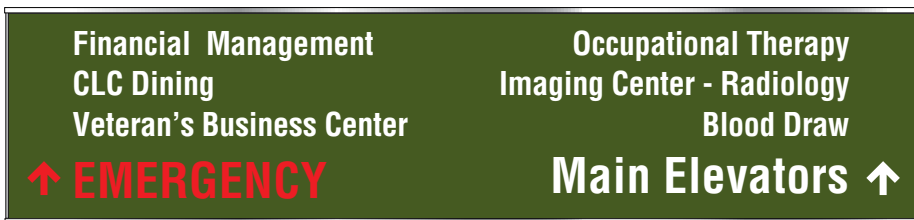

**Example: IN-16.67C digital insert with 2" & 3" text
Single sided soffit mount**

OVERHEAD Soffit Series
IN-16.50-60

Soffit mounted BOTH Directional and Department Identification. Single sided sign to identify and direct. See specification page for directional and ID text layouts

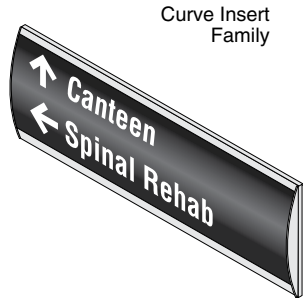
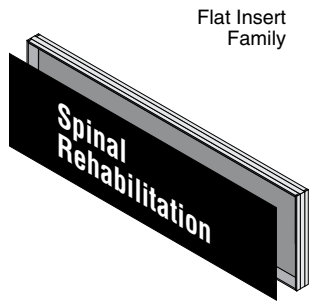
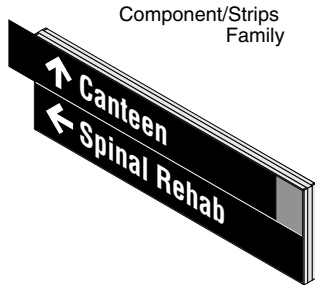

Sign Type	Layout	Width	Panel Height	Text Size	Family	Directional Arrows	Department ID
IN-16.51	A-C	40"	6"	3" & 2"	All	x	x
IN-16.55	A-C	40"	6"	3" & 2"	Insert	x	x
IN-16.52	A-E	40"	12"	3" & 2"	All	x	x
IN-16.56	A-E	40"	12"	3" & 2"	Insert	x	x
IN-16.53	A-E	40"	18"	3" & 2"	All	x	x
IN-16.57	A-E	40"	18"	3" & 2"	Insert	x	x
IN-16.61	A-D	80"	6"	3" & 2"	All	x	x
IN-16.65	A-D	80"	6"	3" & 2"	Insert	x	x
IN-16.62	A-E	80"	12"	3" & 2"	All	x	x
IN-16.66	A-E	80"	12"	3" & 2"	Insert	x	x
IN-16.63	A-E	80"	18"	3" & 2"	All	x	x
IN-16.67	A-E	80"	18"	3" & 2"	Insert	x	x

NOTE: Overhead sign IN16 series are soffit or wall mounted signs. To determine sign type and size required at a specific location, Verify project sign family, ceiling height, distance the sign is to be viewed and quantity of text. 2" high copy is NOT recommended for long hallways or for a sign that will be read at a great distance.

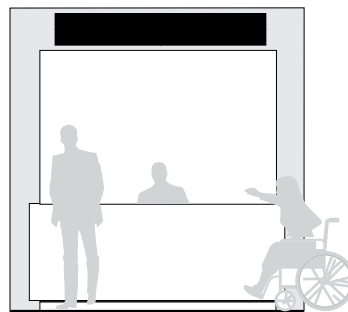
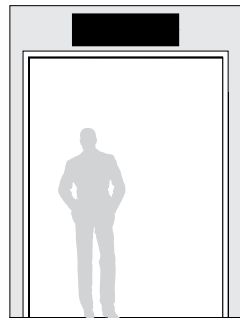

This page is intentionally left blank.

Room Number Identification

Size

76 mm H x 229 mm W
(3" H x 9" W)

Description and Use

Sign is to be used to identify rooms

Message Configuration

(Refer to layout drawing for lettering sizes and dimensions)

Sign Components

Varies by sign family component sign system, rails, curved and flat frames.

Graphic Process

Tactile room number with accompanying Braille.

Colors

Text: refer to color chart.
Background: refer to color chart

Typography

Helvetica
Grade 2 Braille

Mounting

Double sided foam tape, silastic adhesive or screw.

Installation

Knob side of door, 1524 mm (60") to top of sign and 50 mm (2") over from door frame.

Recommendations

This sign is to be used for all rooms, but can also be used to identify corridors and alcoves as necessary. Do not use on exterior and stairwell doors.

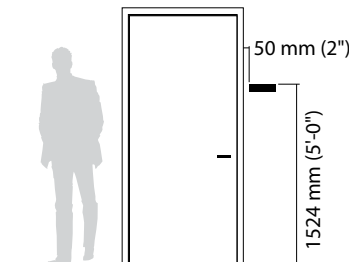
**Message Layout A**

Room Number Identification

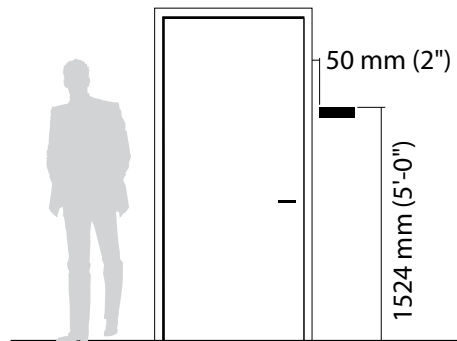
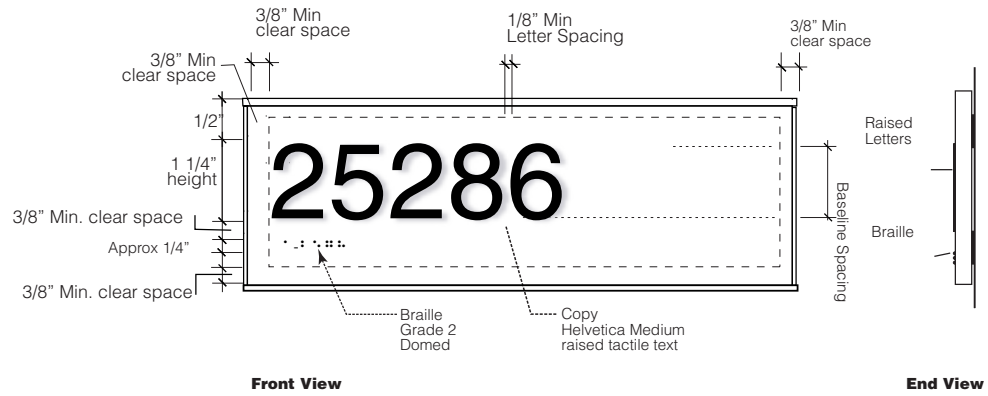
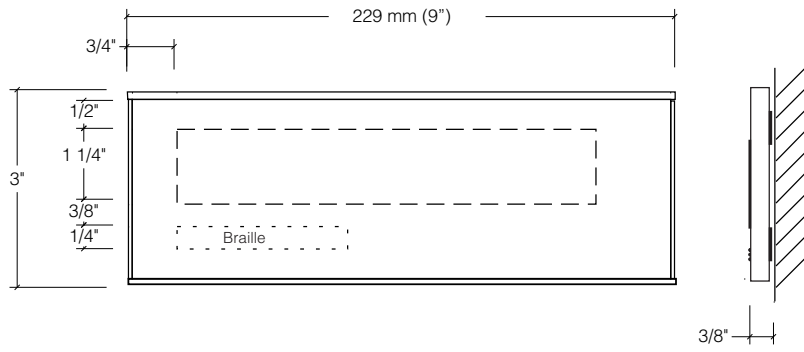

Primary Room Identification

Size

229 mm H x 229 mm W
(9" H x 9" W)

Description and Use

This sign has tactile number and Braille on the top sign component. The sign is to identify the occupant or activity within a room.

Message Configuration

(Refer to layout drawing for lettering sizes and dimensions) Layout A is suggested for department identification. Layout B for rooms and departments with long words or names. Layout C for rooms with a common name but need specific identification.

Sign Components

Vary by sign family, sliding rail component systems, curved and flat. Top section raised text and Braille. Lower section can be digital print, silkscreen or vinyl applied graphics.

Graphic Process

Tactile raised text and Braille on top section. Surface applied vinyl or insert in lower sign section.

Colors

Text: refer to color chart.
Background: refer to color chart

Typography

Helvetica Bold
Grade 2 Braille

Mounting

Double sided foam tape, silastic adhesive or screw.

Installation

Knob side of door, 1524 mm (60") to top of sign and 50 mm (2") over from door frame.

Recommendations

It is recommended that this particular sign type become the "building standard" for identification of all rooms.

Signs identifying electrical closets, mechanical rooms and telecommunication rooms should consist of only the room number (Sign type IN-03.01). The room number should follow the master building room numbering system. No descriptive name or title should be used nor should they have a unique number system.

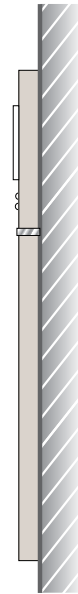

Message Layout A

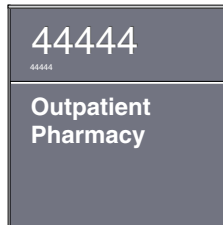

Message Layout B

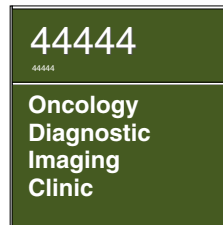

Message Layout C



Message Layout D

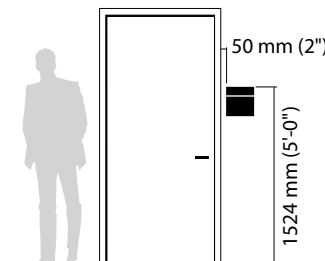
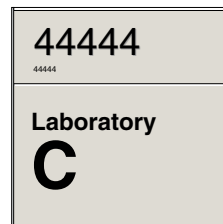

Primary Room Identification

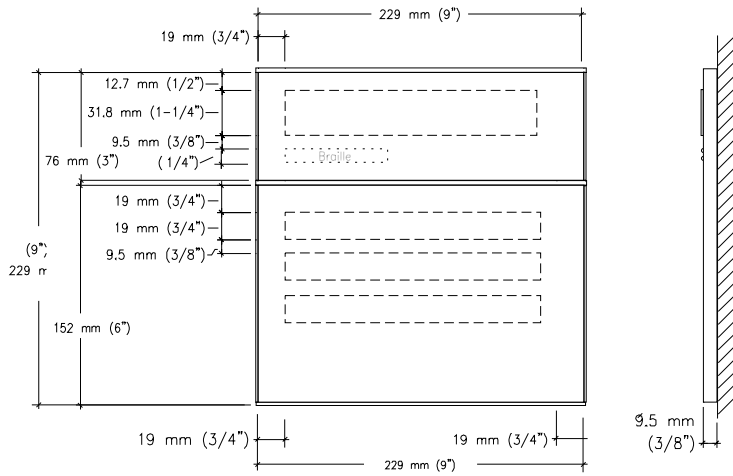

Message Layout A & B

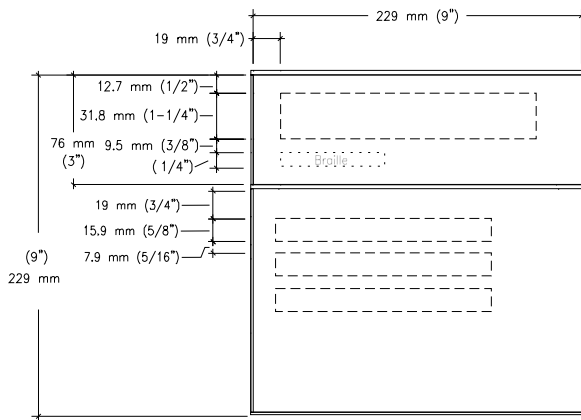

Message Layout C

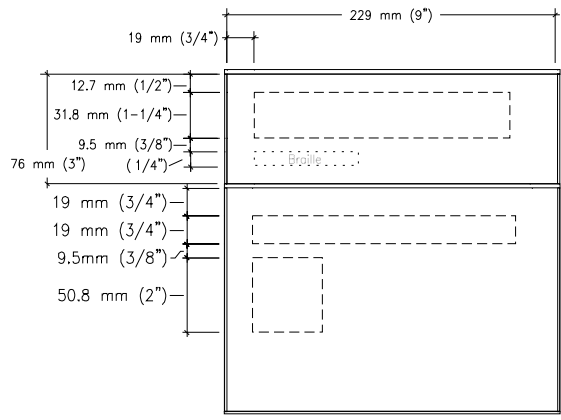

Message Layout D

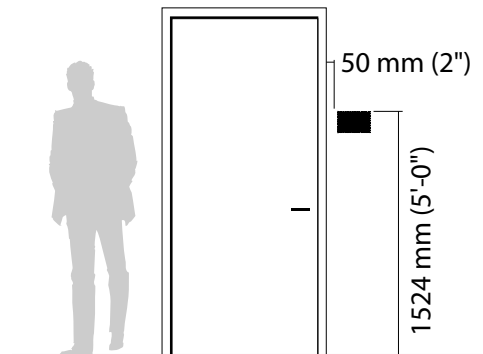

Secondary Room Identification

Sign Size

152 mm H x 229 mm W
(6" H x 9" W)

Description and Use

This sign always has a tactile number and Braille in its top sign component. This sign is used to identify secondary rooms or rooms that have short names.

Message Configuration

(Refer to layout drawing for lettering sizes and dimensions) Layout A is suggested for short titles. Layout B and C is for longer names or titles. Layout D is specific identification by number or letter.

Sign Components

Vary by sign family, sliding rail component systems, curved and flat. Top section raised text and Braille. Lower section can be digital print, silkscreen or vinyl applied graphics.

Graphic Process

Tactile raised text and Braille on top section. Surface applied vinyl, silkscreen or digital print in lower section.

Colors

Text: refer to color chart.
Background: refer to color chart

Typography

Helvetica Bold
Grade 2 Braille

Mounting

Double sided foam tape, silastic adhesive or screw.

Installation

Knob side of door, 1524 mm (60") to top of sign and 50 mm (2") over from door frame.

Recommendations

This sign is for rooms that do not require long or large text.

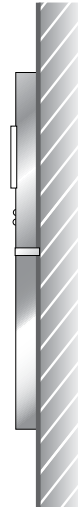
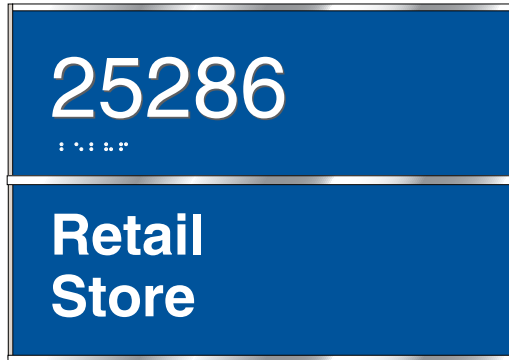

Message Layout A

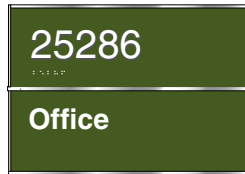

Message Layout B

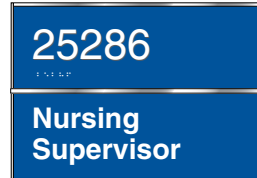

Message Layout C



Message Layout D

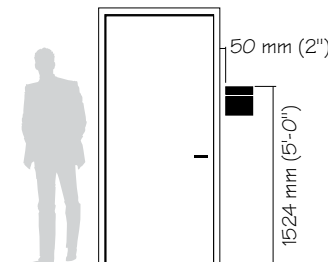
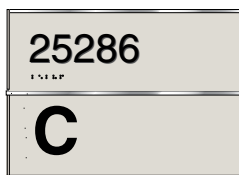

Secondary Room Identification

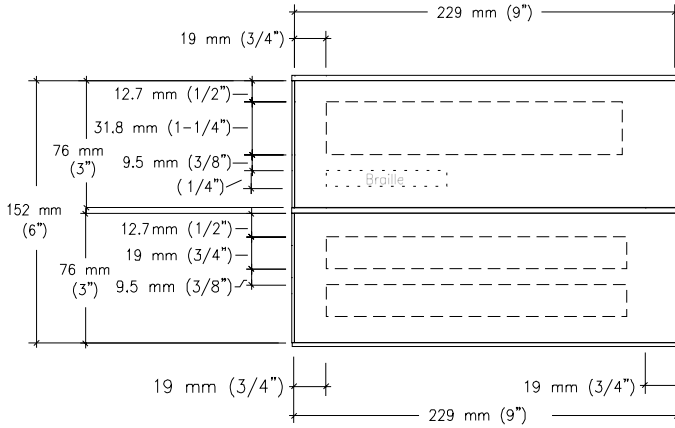

Message Layout A & B

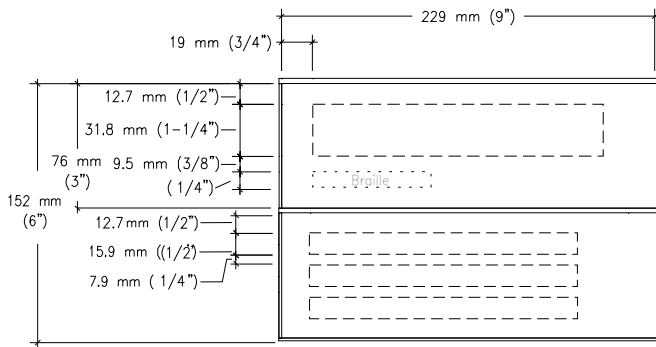
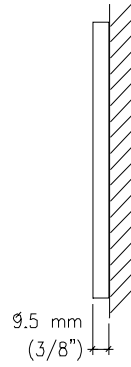

Message Layout C

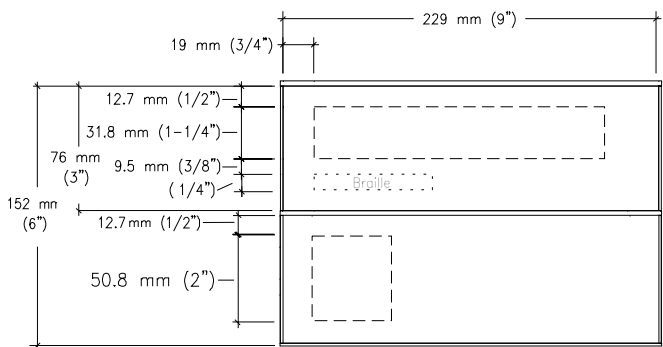

Message Layout D

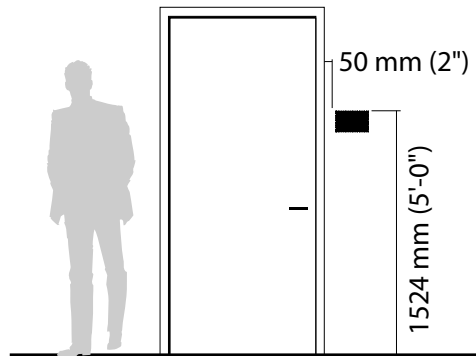

Primary Room Identification with Insert

Size

229 mm H x 229 mm W
(9" H x 9" W)

Description and Use

This sign always has tactile number and Braille as its top sign component. Lower section is for insert. Use this sign to identify the occupant or activity within a room.

Message Configuration

(Refer to layout drawing for lettering sizes and dimensions) Layout A is suggested for department identification. Layout B for rooms and departments with long words or names. Layout C and D for rooms with a common name but need specific identification.

Sign Components

Vary by sign family, sliding rail component systems, curved and flat. Top section raised text and Braille. Lower section can be inserted graphics.

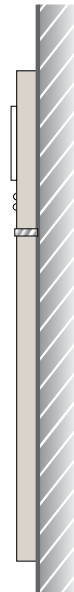
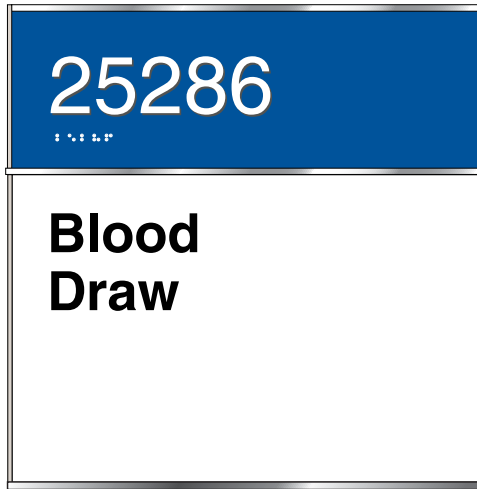

Graphic Process

Tactile raised text and Braille on top section. Insert with clear protector cover with surface applied vinyl on substrate or paper printed insert in lower sign section.

Colors

Text: refer to color chart.
Background: refer to color chart

Typography

Helvetica Bold
Grade 2 Braille
Lettering size is adaptable to allow messages to fit on to the sign. Refer to various layouts for reference.

Mounting

Double sided foam tape, silastic adhesive or screw.

Installation

Knob side of door, 1524 mm (60") to top of sign and 50 mm (2") over from door frame.

Recommendations

It is recommended that this particular sign type become the "building standard" for identification of all rooms.

Signs identifying electrical closets, mechanical rooms and telecommunication rooms should consist of only the room number (Sign type IN-03.01). The room number should follow the master building room numbering system. No descriptive name or title should be used nor should they have a unique number system.

Message Layout A



Message Layout B

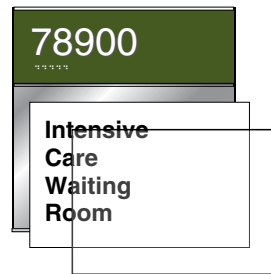

Message Layout C

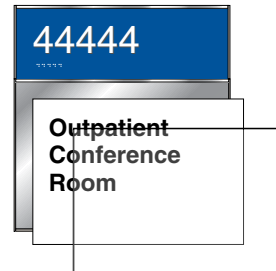

Message Layout D

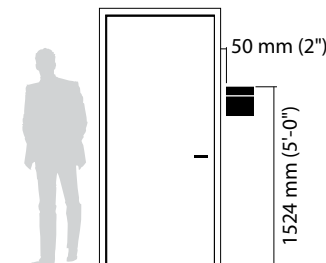
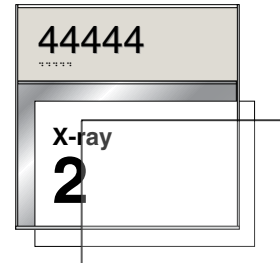

Primary Room Identification with Insert

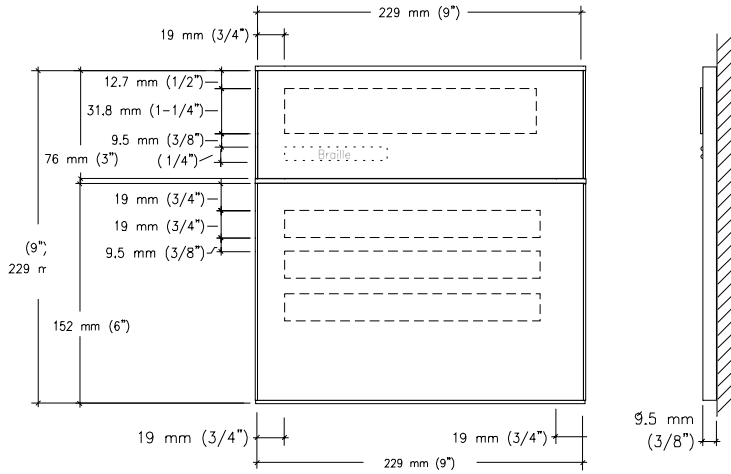

Message Layout A & B

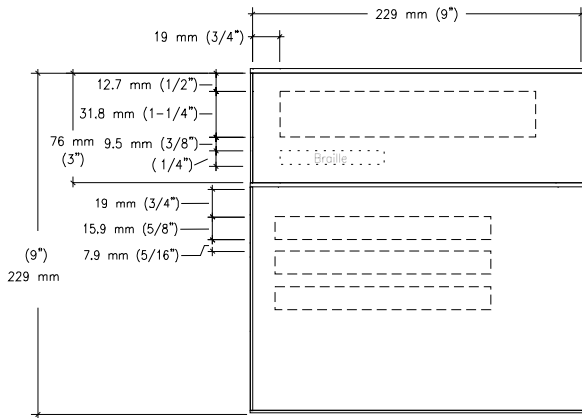

Message Layout C

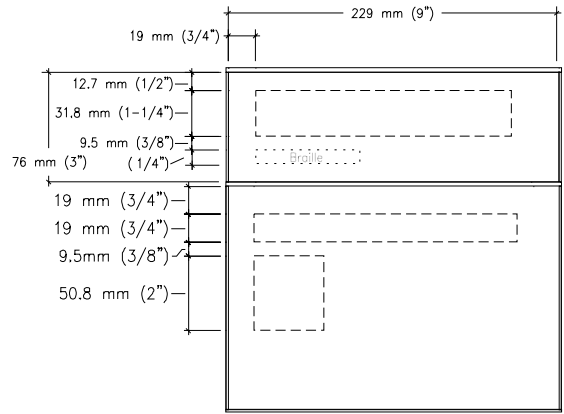

Message Layout D

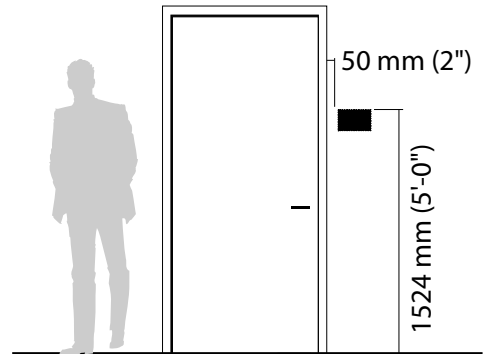

Secondary Room Identification with Insert

Sign Size

152 mm H x 229 mm W
(6" H x 9" W)

Description and Use

This sign always has a tactile number and Braille in its top sign component. Use this sign to secondary rooms or rooms that have short names.

Message Configuration

(Refer to layout drawing for lettering sizes and dimensions) Layout A is suggested for short titles. Layout B and C is for longer names or titles. Layout D is specific identification by number or letter.

Sign Components

Vary by sign family, sliding rail component systems, curved and flat. Top section raised text and Braille. Lower section is an inserted graphic.

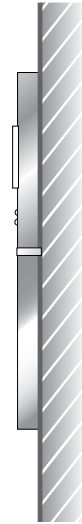

Graphic Process

Tactile raised text and Braille on top section. Insert with clear protector covering insert with surface applied vinyl on substrate or paper printed insert in lower sign section.

Colors

Text: refer to color chart.
Background: refer to color chart

Typography

Helvetica Bold
Grade 2 Braille

Mounting

Double sided foam tape, silastic adhesive or screw.

Installation

Knob side of door, 1524 mm (60") to top of sign and 50 mm (2") over from door frame.

Recommendations

This sign is for rooms that do not require long or large text.

Message Layout A

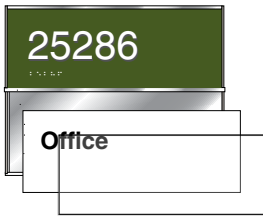

Message Layout B

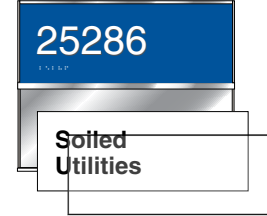

Message Layout C



Message Layout D

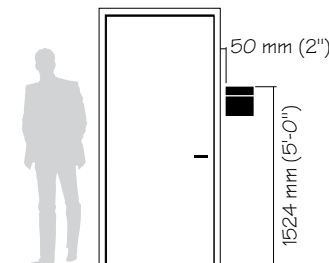
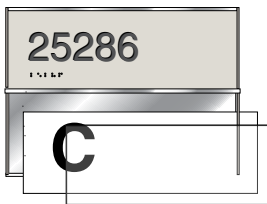

Secondary Room Identification with Insert

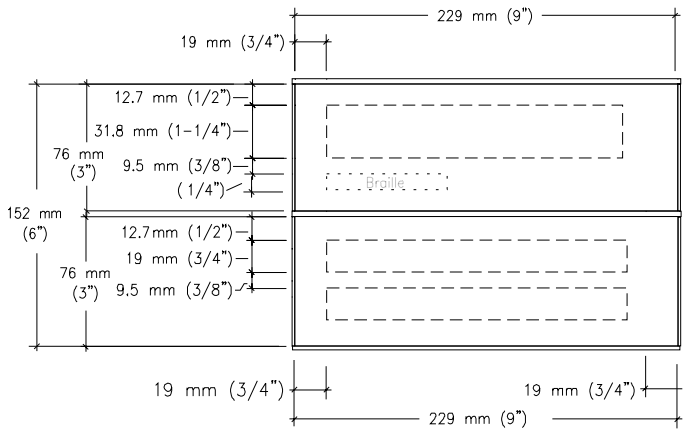

Message Layout A & B

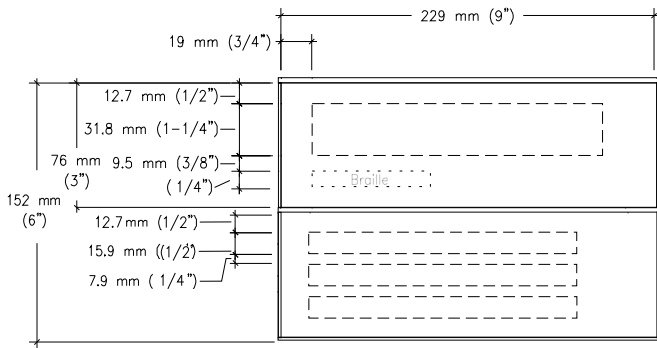

Message Layout C

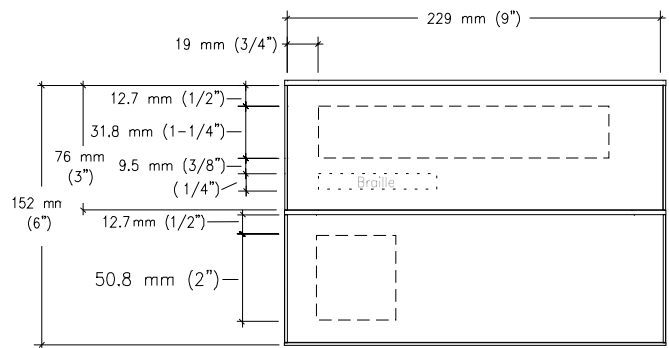

Message Layout D

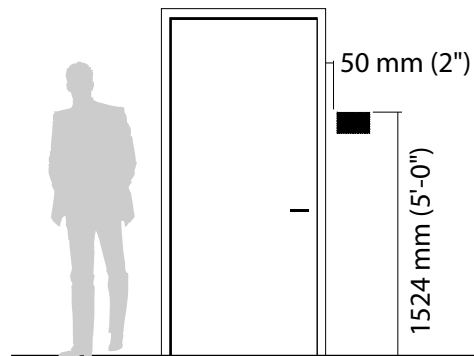

Patient Room Identification with Paper Holder

Size

229 mm x 152 mm
(9"H x 6"W)

Description and Use

Use this sign to identify patient room.

Message Configuration

Refer to drawings for lettering and sizes and dimensions.

Sign Components

Top section with raised tactile room number with accompanying Braille. Bottom sign section to be dry erase board or corkboard or push pin material. Bottom of sign to have a paper holder.

Color and Text

Text: refer to color chart
Background: refer to color chart

Typography

Helvetica
Grade 2 Braille

Mounting

Secure to wall with physical fasteners.

Installation

Knob side of Door 2" from door frame. Top of tactile Braille sign section to be max. 1524 mm (60") from floor.

Recommendations

This sign is for Patient Rooms with one or two beds.



Message Layout A



Message Layout B

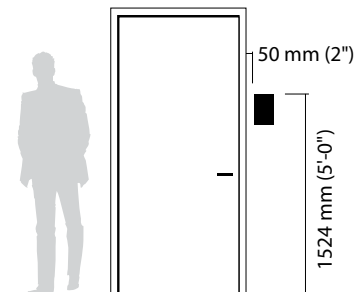
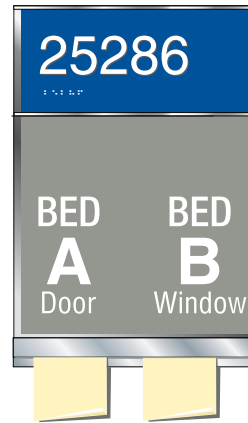

Patient Room Identification

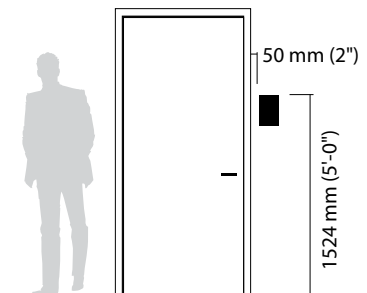
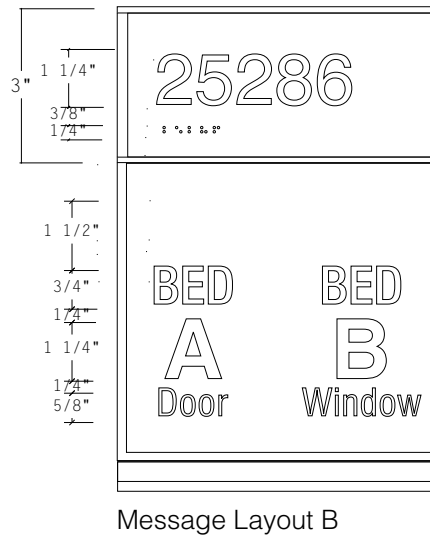
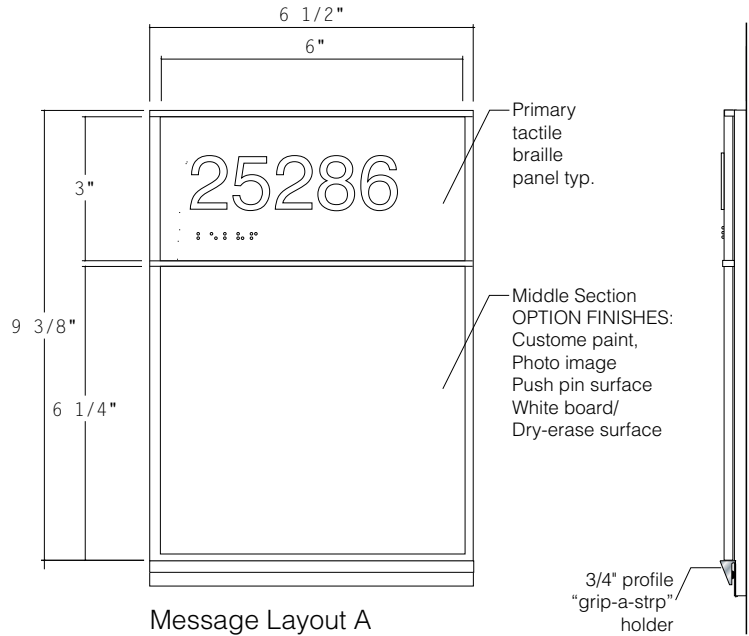

Patient Room Identification with Patient Condition Pullouts

Size

IN-05.07
229 mm x 152 mm
(9" H x 6" W)
(With Pull Out)

Description and Use

Sign is to be placed at patient rooms.

Message Configuration

Refer to drawings for lettering and sizes and dimensions.

Sign Components

Top section with raised tactile room number with accompanying Braille. Bottom sign section to be dry erase board or corkboard or push pin material in front of patient condition pullouts. Bottom to have a paper holder.

Color and Text

Text: refer to color chart
Background: refer to color chart

Typography

Helvetica
Grade 2 Braille

Mounting

Secure to wall with Physical fasteners.

Installation

Knob side of door 3" from door frame. Top of tactile Braille sign section to be max. 60" from floor.

Recommendations

This sign is for Patient Rooms with single beds with various conditions which need to be identified.

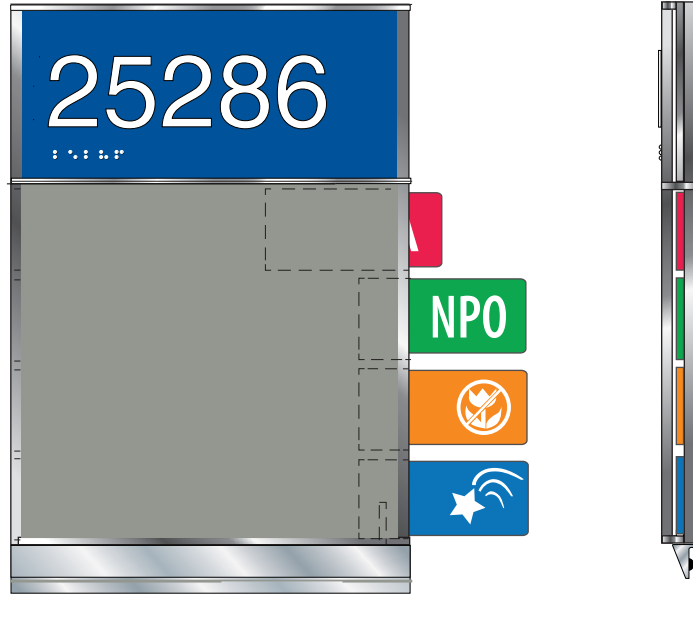

Patient Condition Call Outs Examples

Each medical department should determine the symbols and icons to be displayed outside their departments patient room. Use colors, letters, numbers and symbols to establish a code for staff and visitors. Beware that icons or text does not infringe on patient medical privacy as stated by (HIPPA) Health Insurance Portability and Accountability Act. Do Not describe a specific medical condition

Tab Examples

	Allergies Dizzy Do Not Disturb
	Fall Risk Flight Risk/ Tends to Wander Gown & Gloves required Hearing Impaired /TTY
	Interpreter Required Latex Allergy
	Nothing by mouth No Flowers No Fluids
	No Visitors NPO
	Oxygen Security Risk See Nurse Prior to Entry
	Quarantine Quiet Please

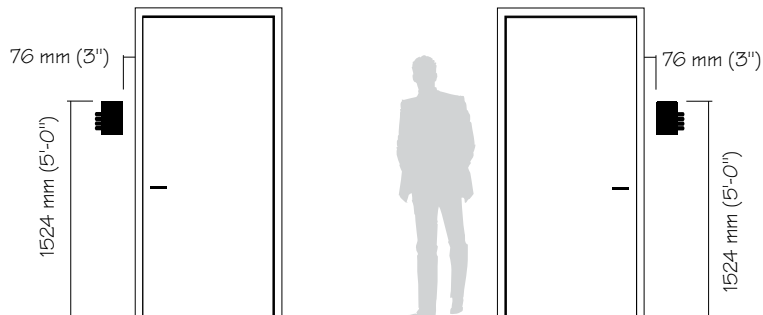

Left and Right configurations

Patient Room Identification with Patient Condition Pullouts

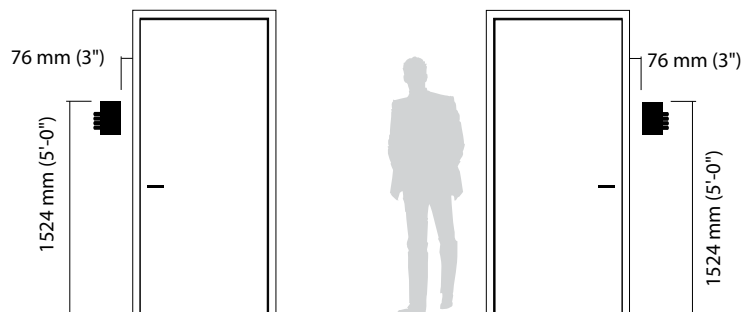
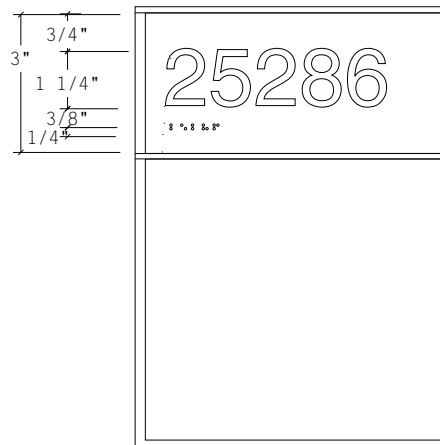
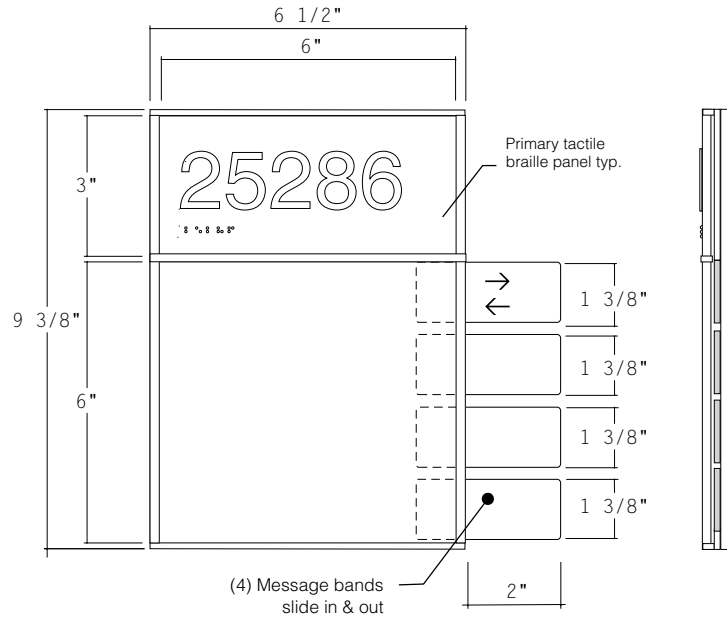

Left and Right configurations

Patient Room Identification (Two Bed Room)

Size

IN-05.08
229 mm x 152 mm
(9" H x 6" W)

Description and Use

Sign is to be placed at patient rooms.

Message Configuration

Refer to drawings for lettering and sizes and dimensions.

Sign Components

Top section with raised tactile room number with accompanying Braille.
Middle sign section to be printed paper insert behind clear lens.
Bottom of sign section to have a paper grip strip. Message bands located at side.

Color and Text

Text: refer to color chart
Background: refer to color chart

Typography

Helvetica Condensed
Grade 2 Braille

Mounting

Secure to wall with physical fasteners.

Installation

Knob side of door 3" from door frame. Top of tactile Braille sign section to be max. 60" from floor.

Recommendations

This sign is for two bed patient rooms with various patient conditions that need to be identified.

Note

Pull out tab icon examples shown with sign type IN-05.07

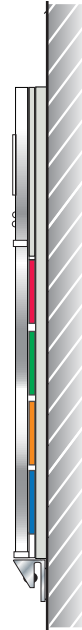
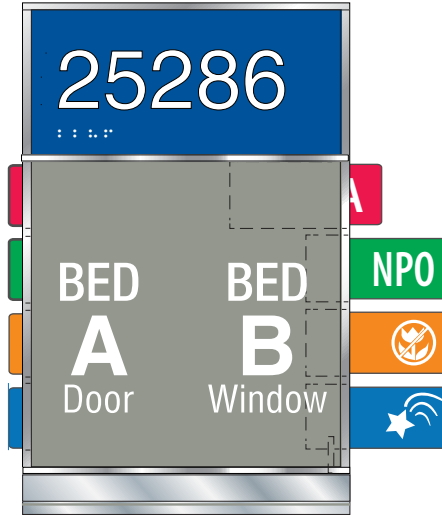

Message Layout A

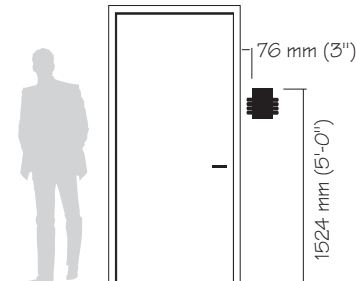

Patient Room Identification (Two Bed Room)

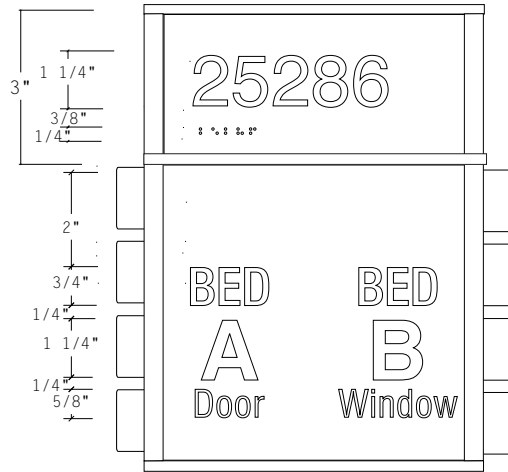
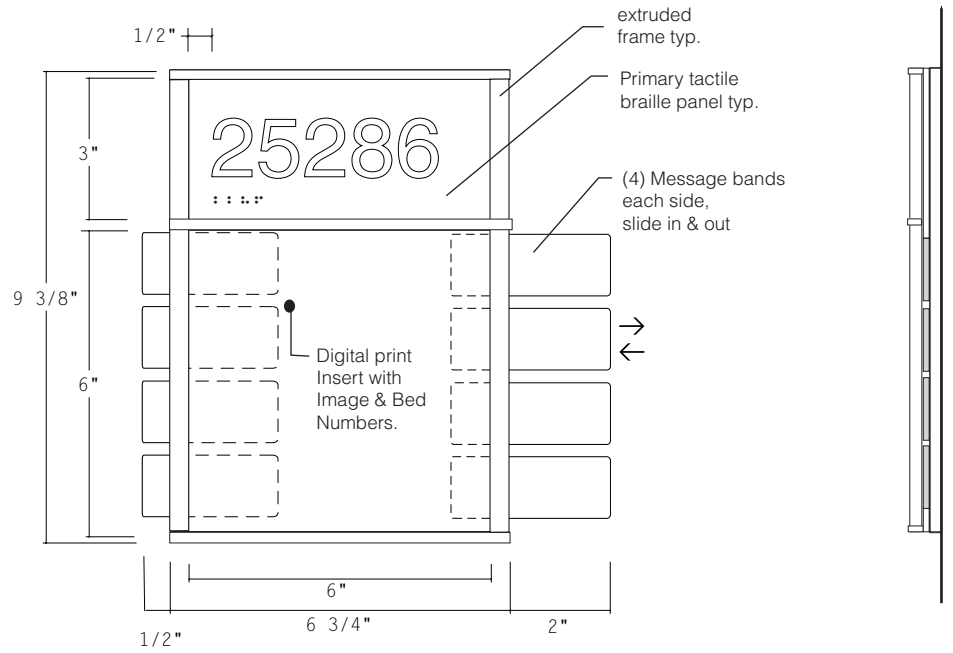

Text Layout

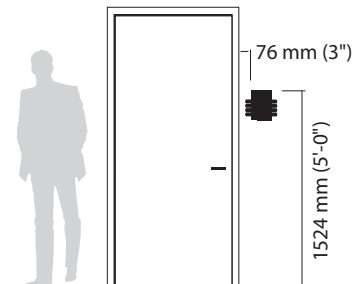

Patient Bed Sign

Size

IN-06.05
101 mm x 101 mm
(4" H x 4" W)

IN-06.06
229 mm x 101 mm
(9" H x 4" W)

Description and Use

Use this sign above patient beds to identify the bed.

Message Configuration

(Refer to layout drawing for lettering sizes and dimensions)
Bed number and location

Sign Components

Top section with bed number
middle section to be determined.
Option: photo, paint accent color, push pin surface, or dry erase dry erase board. Bottom with paper holder.

Graphic Process

Vinyl text surface applied.

Colors

Text: refer to color chart.
Background: refer to color chart

Typography

Helvetica Bold

Mounting

Secure to wall with physical fasteners.

Installation

On head wall above bed.

Recommendations

This sign is for use in patient rooms and is to be coordinated with the needs and function with nursing services.

Note

Pull out tab icon examples shown with sign type IN-05.07



IN-06.05



IN-06.06



3/4" profile "paper" holder

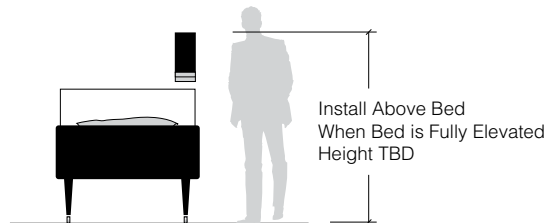

Patient Bed Sign

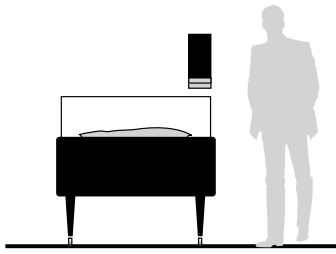
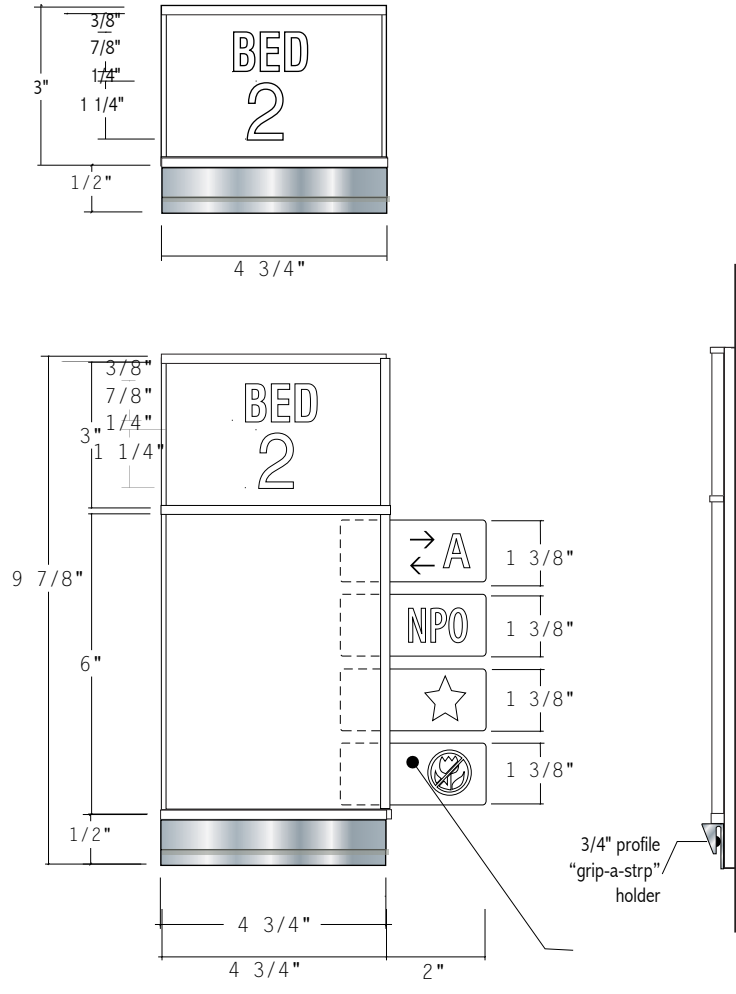

Room Sign with Indicator

Size / Sign Size

IN-07.01
229 mm x 229 mm (9" H x 9" W)

IN-07.02
152 mm x 229 mm (6" H x 9" W))

IN-07.03
203 mm x 229 mm (8" H x 9" W)

Description and Use

This sign always has tactile and Braille section at the top of the sign component. Use this sign for conference rooms, meeting rooms. This type of sign can also be used for exam rooms, treatment rooms, and offices where the occupants want to indicate that room is in use.

Message Configuration

(Refer to layout drawing for lettering sizes and dimensions) IN07.1, Layout A is for conference rooms, Layout B is for exam or treatment rooms. N07.3 Insert messages are prepared and removed based upon occupancy of the room. Selection of the text to appear behind the slider is to be determined by the sign users.

Sign Components

Vary by sign family, sliding rail component systems, curved and flat. Top section raised text and Braille. Mid section can be digital print or vinyl applied graphics. Lower section moving slider with graphic reveal.

Graphic Process

Slider section surface applied vinyl. Text behind slider is second surface.

Colors

Text: refer to color chart.
Background: refer to color chart

Typography

Helvetica Bold
Grade 2 Braille

Mounting

Double sided foam tape, silastic adhesive or screw.

Installation

Knob side of door, 1524 mm (60") to top of sign and 50 mm (2") over from door frame.

Recommendations

This sign is for use on rooms where and indication is needed in the hallway that the room is occupied or an activity is taking place in the room which should not be disturbed.



IN-07.01 (Message Layout A)

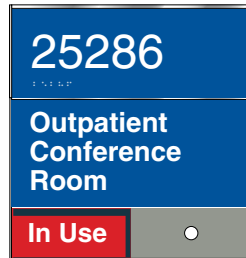

IN-07.01 (Message Layout B)

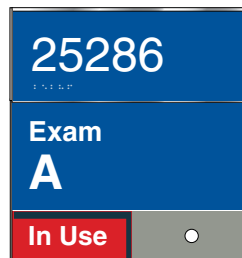

IN-07.02

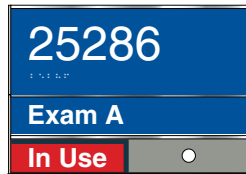

IN-07.03

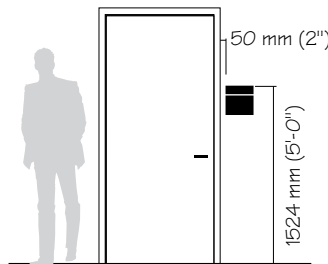
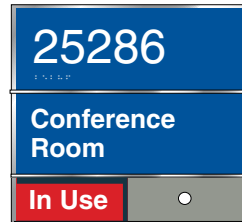

Room Sign with Indicator

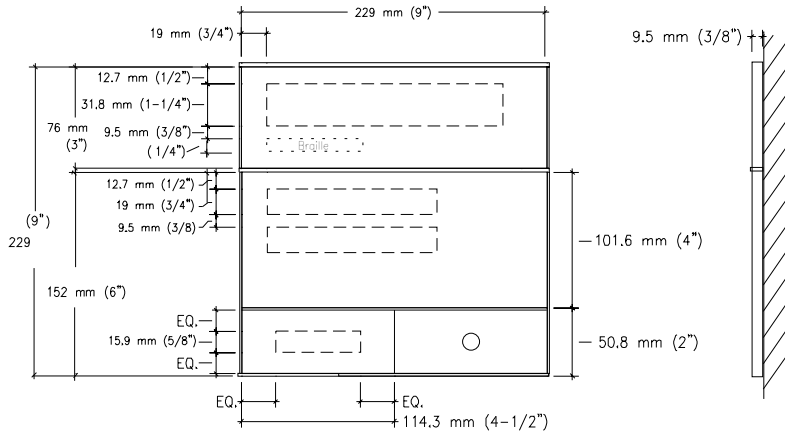

IN-07.01 (Message Layout A)

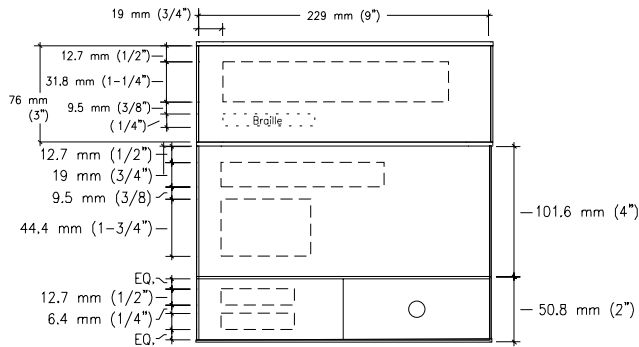

IN-07.01 (Message Layout B)

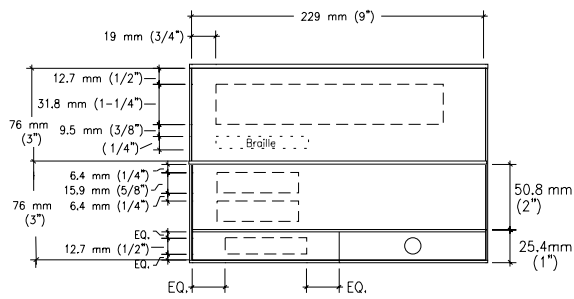

IN-07.02

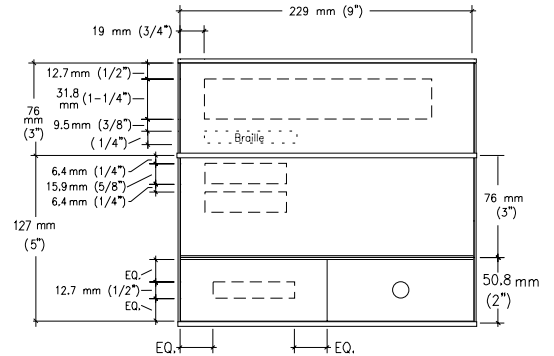

IN-07.03

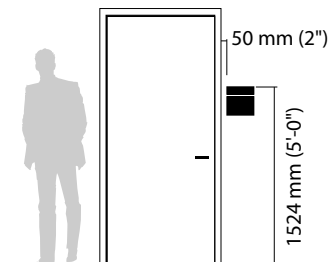

Room Sign with Indicator and Paper Insert

Size

Sign Size
IN-07.05
229 mm x 229 mm (9" H x 9" W)

IN-07.06
152 mm x 229 mm (6" H x 9" W)

IN-07.07
203 mm x 229 mm (8" H x 9" W)

Description and Use

This sign always has tactile and Braille section at the top of the sign component. Use this sign for conference rooms, meeting rooms. This type of sign can also be used for exam rooms, treatment rooms, and offices where the occupants want to indicate that room is in use.

Message Configuration

(Refer to layout drawing for lettering sizes and dimensions)

IN07.5, Layout A is for conference rooms, Layout B is for exam or treatment rooms. N07.7 Insert messages are prepared and removed based upon occupancy of the room. Selection of the text to appear behind the slider is to be determined by the sign users.

Sign Components

Vary by sign family, sliding rail component systems, curved and flat. Top section raised text and Braille. Mid section can be digital print insert. Lower section moving slider with graphic reveal.

Graphic Process

Slider section surface applied vinyl. Text behind slider is second surface.

Colors

Text: refer to color chart.
Background: refer to color chart

Typography

Helvetica Bold
Grade 2 Braille

Mounting

Double sided foam tape, silastic adhesive or screw.

Installation

Knob side of door, 1524 mm (60") to top of sign and 50 mm (2") over from door frame.

Recommendations

This sign is for use on rooms where and indication is needed in the hallway that the room is occupied or an activity is taking place in the room which should not be disturbed.



IN-07.05
(Message Layout A)



IN-07.05
(Message Layout B)

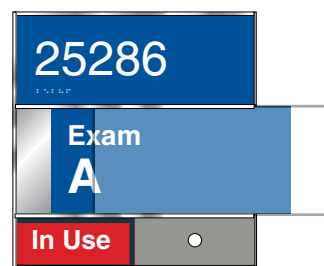

IN-07.06

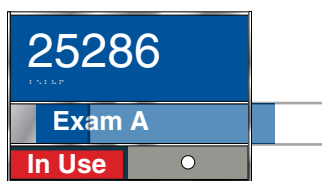

IN-07.07

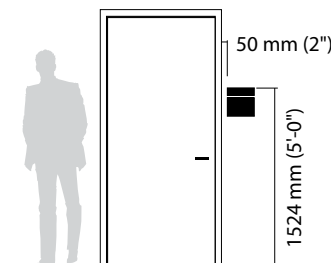
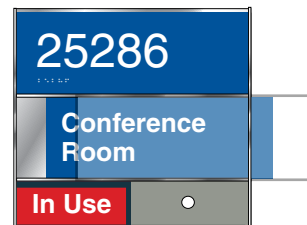

Room Sign with Indicator and Paper Insert

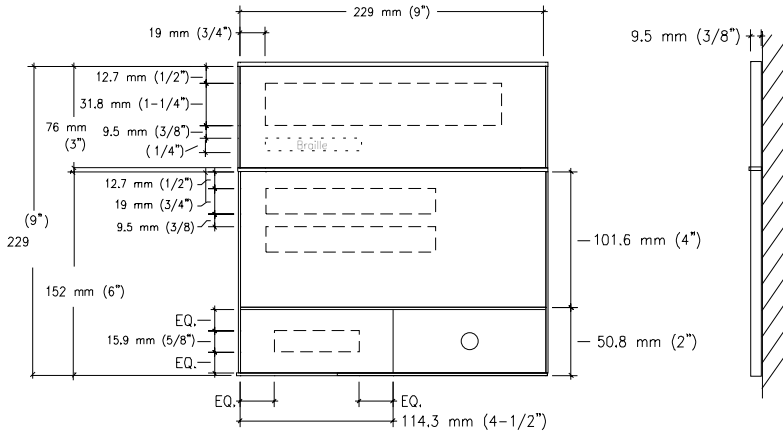

IN-07.05 (Message Layout A)

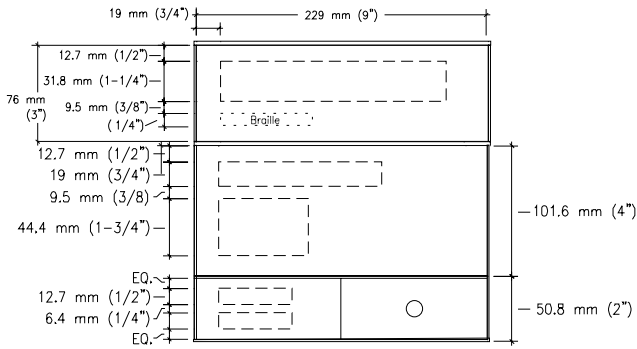

IN-07.05 (Message Layout B)

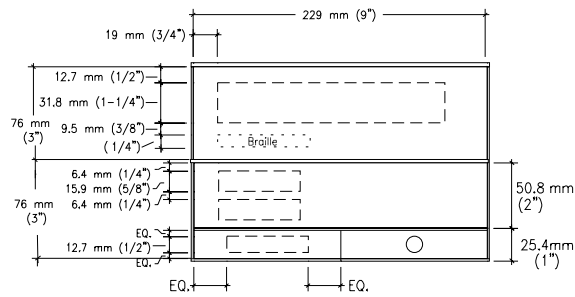

IN-07.06

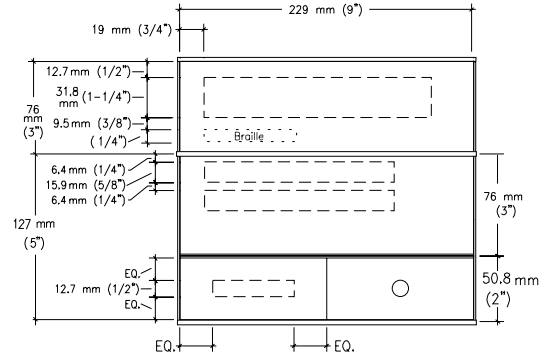

IN-07.07

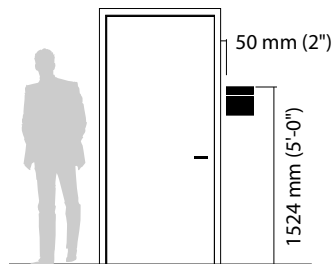

No Smoking

Size

229 mm H x 229 mm W
(9" H x 9" W)

Description and Use

Use these signs to inform "No Smoking" in a bold manner.

Message Configuration

(Refer to layout drawing for lettering sizes and dimensions)

Sign Components

Acrylic plaque.

Graphic Process

Silk-screened or surface applied vinyl.

Colors

Text: Black

Symbol: Red and Black Background: White

Typography

Helvetica Bold

Helvetica Bold Condensed

Mounting

Double sided foam tape or silastic adhesive.

Installation

On wall or door 1600 mm (63") to top of sign and on door, center.

Recommendations

This sign is for use when a strong communication of no smoking information is necessary.



Message Layout A



Message Layout B



Message Layout C



Message Layout D

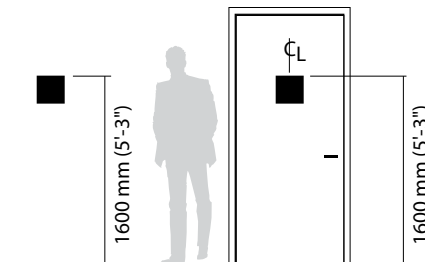

No Smoking

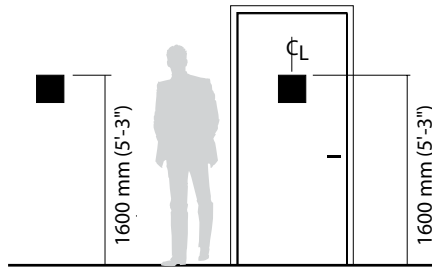
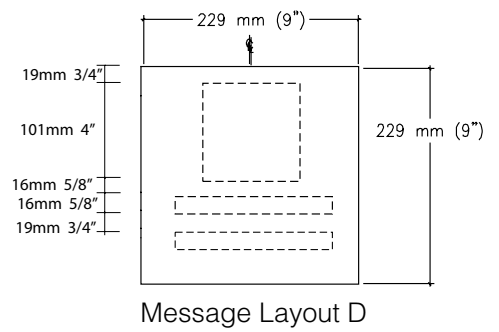
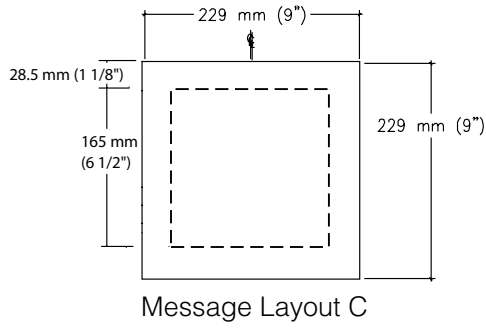
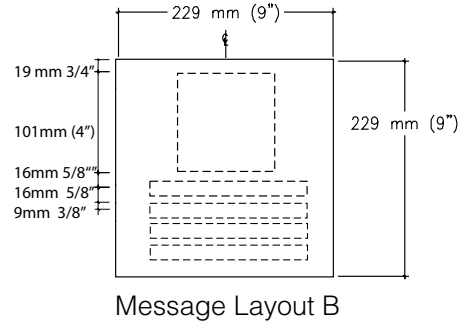
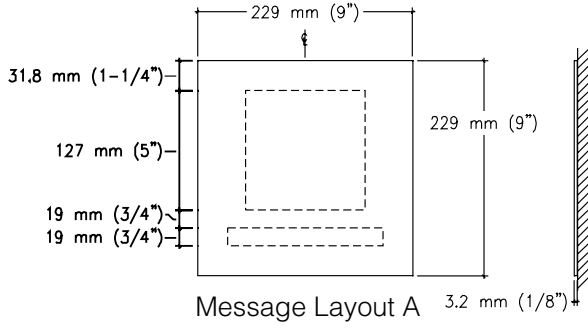

Prohibit Instructional and Control

Size

229 mm H x 229 mm W
(9" H x 9" W)

Description and Use

Use these signs to inform in a bold manner.

Message Configuration

(Refer to layout drawing for lettering sizes and dimensions)

Sign Components

Acrylic plaque.

Graphic Process

Silk-screened or surface applied vinyl.

Colors

Text: Black
Symbol: Red and Black Background: White

Typography

Helvetica Bold
Helvetica Bold Condensed

Mounting

Double sided foam tape or silastic adhesive.

Installation

On wall or door 1600 mm (63") to top of sign and on door, center.

Recommendations

This sign is for use when a strong communication of information is necessary. IN08.4 should be used carefully as it may have a negative reaction on the part of patients and visitors.



Message Layout A



Message Layout B



Message Layout C



Message Layout D

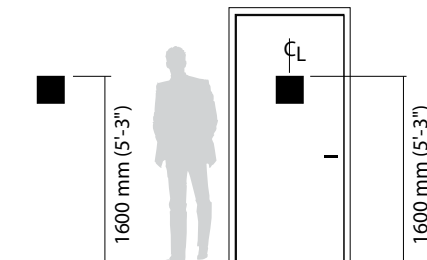

Prohibit, Instructional and Control

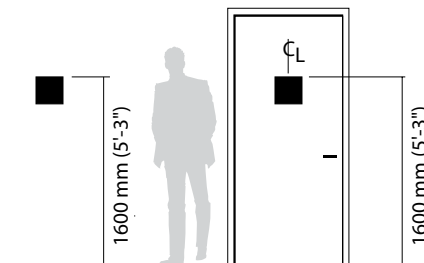
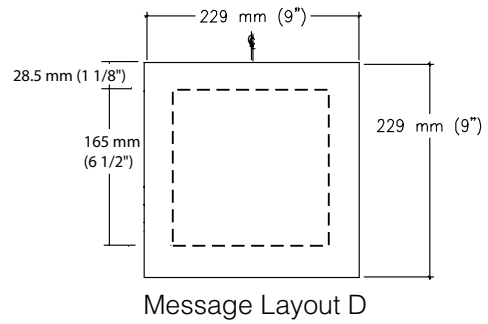
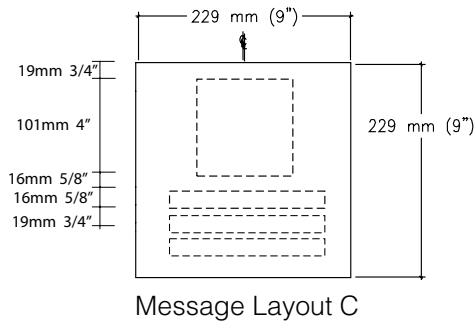
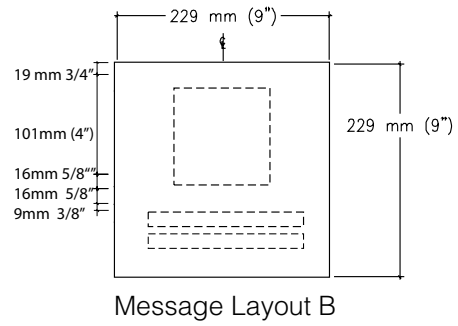
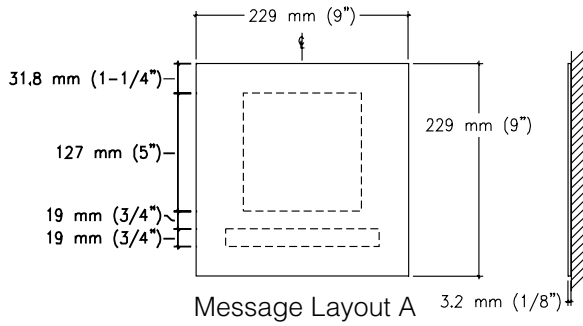

Restroom Identification

Size

311 mm H x 229 mm W
(12 1/4" H x 9" W)

Description and Use

Use these signs to inform with a symbol, tactile raised text and Braille.

Message Configuration

(Refer to layout drawing for lettering sizes and dimensions)

Sign Components

Vary by sign family, component systems, curved and flat. Top section raised text and Braille. Lower section to be raised graphic symbol.

Graphic Process

Tactile symbol and text with accompanying Braille.

Colors

Text: refer to color chart.
Background: refer to color chart

Typography

Helvetica Bold
Grade 2 Braille

Mounting

Double sided foam tape or silastic adhesive.

Installation

On wall or door 1524 mm (60") to top of sign and on door, center.

Recommendations

These signs are for use to identify restrooms.



IN-09.01



IN-09.02



IN-09.03



IN-09.04

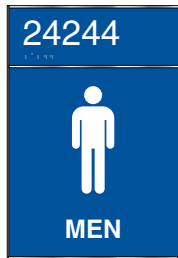

IN-09.05



IN-09.06

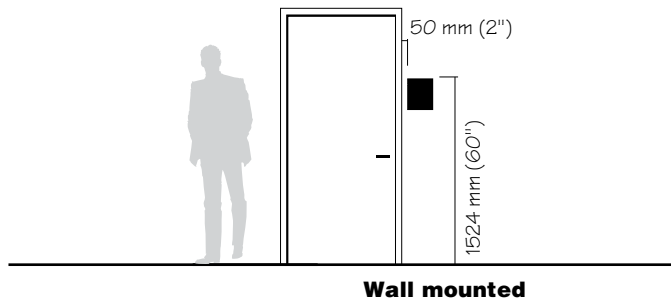

Wall mounted

Restroom Identification

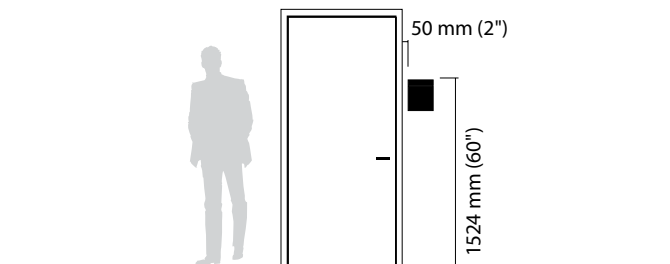
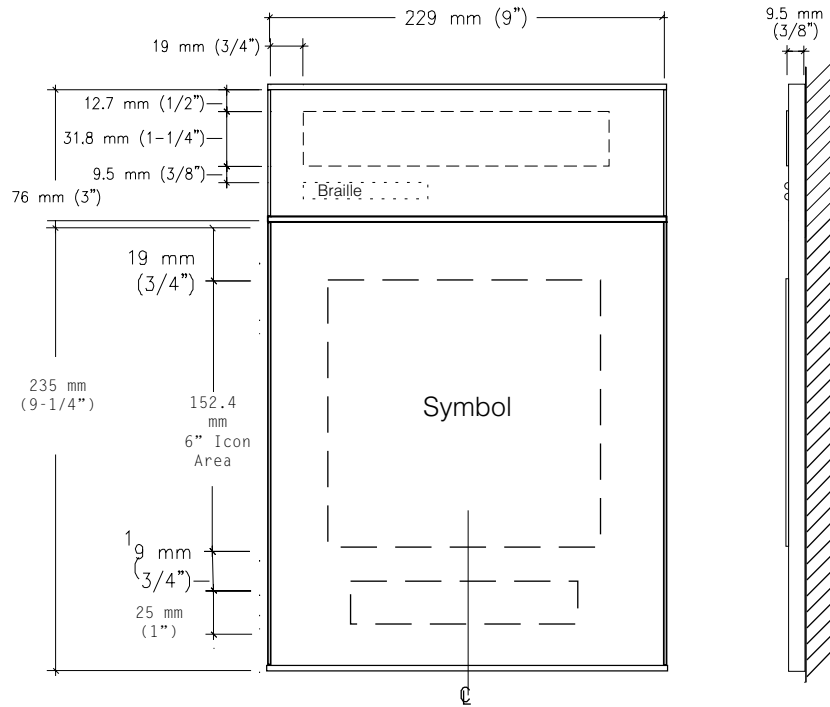

Pictogram and Symbol

Size

229 mm H x 229 mm W
(9" H x 9" W)

Description and Use

Use these signs to inform with a symbol as well as text.

Message Configuration

(Refer to layout drawing for lettering sizes and dimensions)

Sign Components

Vary by sign family, sliding rail component systems, curved and flat. Sign is a digital print, silkscreen or vinyl applied graphics.

Graphic Process

Silk-screened or surface applied vinyl.

Colors

Text: refer to color chart.
Background: refer to color chart

Typography

Helvetica Bold
Helvetica Bold Condensed

Mounting

Double sided foam tape or silastic adhesive.

Installation

On wall or door 1524 mm (60") to top of sign and on door, center.

Recommendations

These signs are for use when a symbol will help communicate.



Message Layout A



Message Layout B



Message Layout C



Message Layout D



Message Layout E



Message Layout F

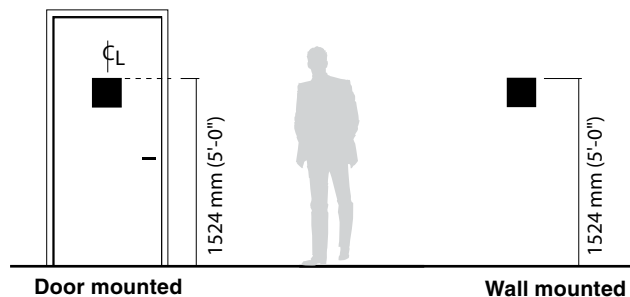

Pictogram and Symbol

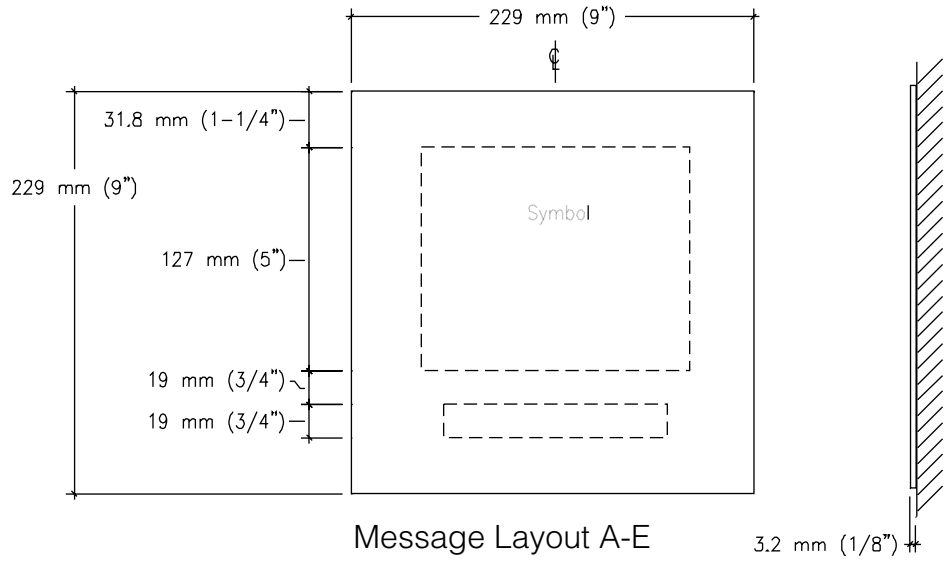

Message Layout A-E

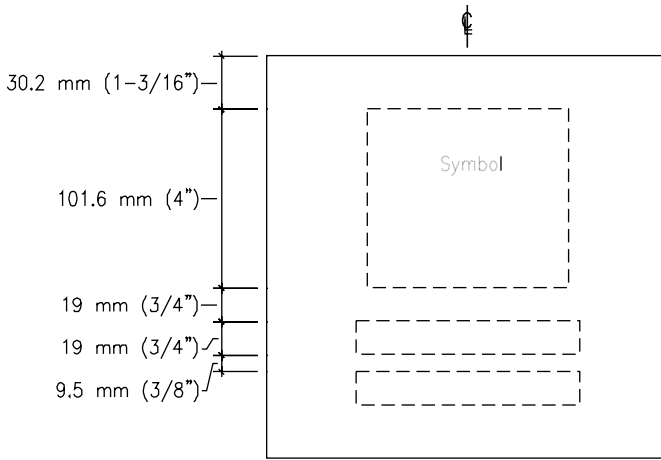

Message Layout F



Sign Frame

Size

IN-10.02
547 mm x 407 mm
(21 1/2" H x 16" W)

IN-10.03
457 mm x 305 mm
(18" H x 12" W)

IN-10.04
305 mm x 457 mm
(12" H x 18" W)

IN-10.05
305 mm x 242 mm
(12" H x 9 1/2" W)

IN-10.06
242 mm x 305 mm
(9 1/2" H x 12" W)

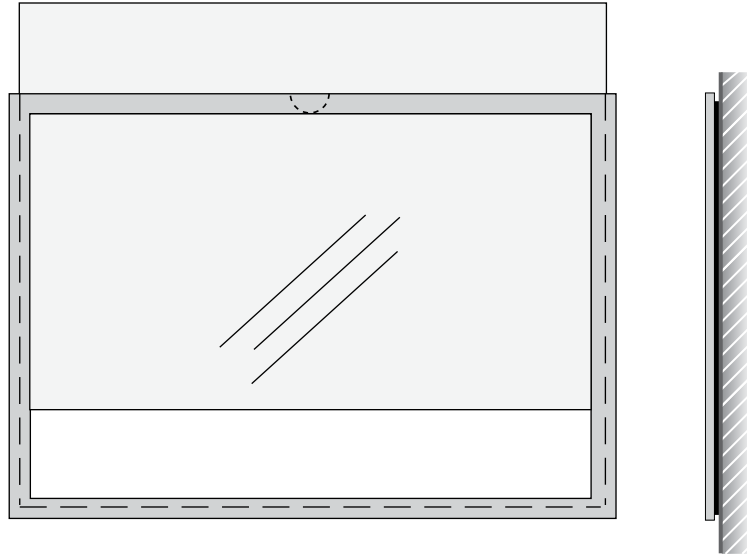

Description and Use

Use these signs to hold posters, fire alarm bell schedules, maps or other information sheets.

- 10.02 14" x 20" paper poster
- 10.03 11" x 17" paper, vertical
- 10.04 11" x 17" paper, horizontal
- 10.05 8 1/2" x 11" paper, vertical
- 10.06 8 1/2" x 11" paper, horizontal

Sign Components

Acrylic plaque.

Colors

Text: refer to color chart.
Background and Accent Bar: refer to color chart

Mounting

Double sided foam tape or silastic adhesive.

Installation

On wall

Recommendations

These signs are for use to hold papers and posters vertically or horizontally.

IN-10.02

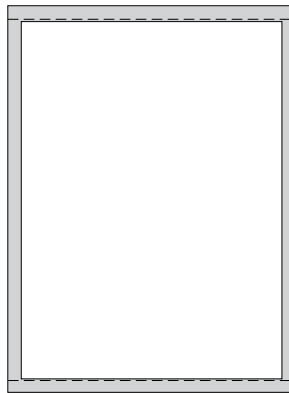

IN-10.03

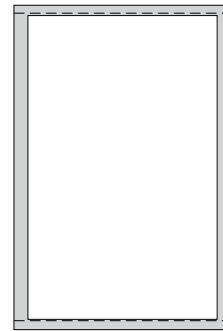

IN-10.04

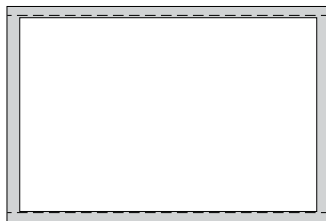

IN-10.05

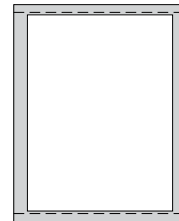

IN-10.06

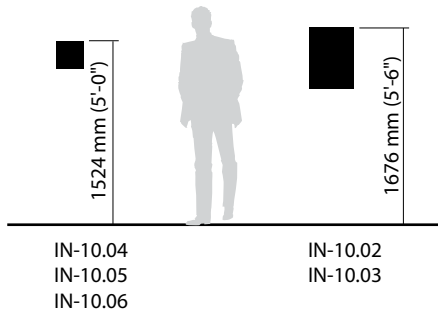
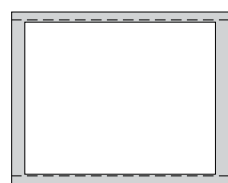

Sign Frame

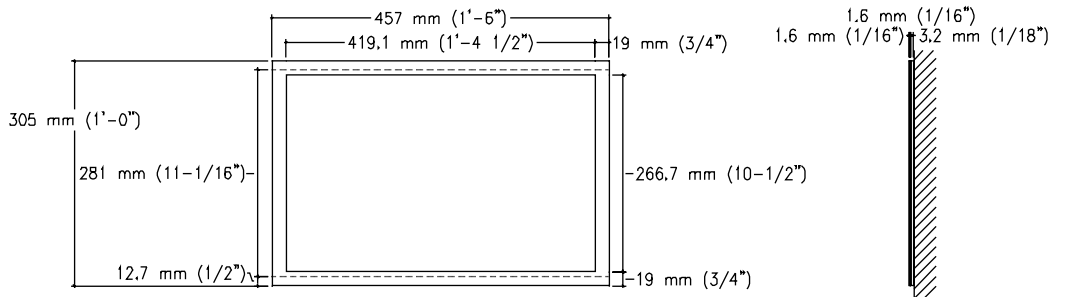

IN-10.04

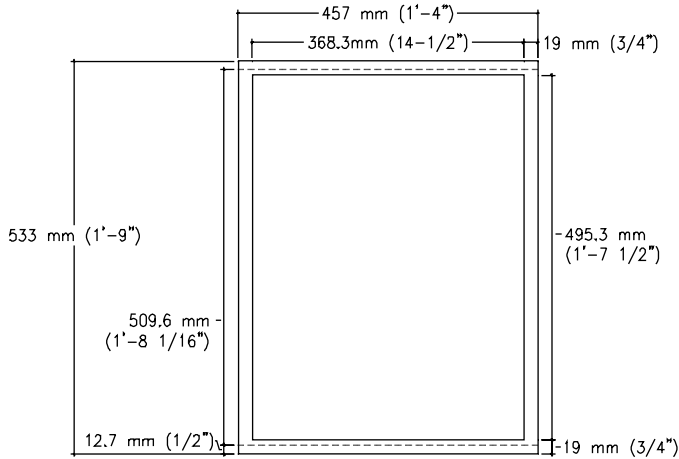

IN-10.02

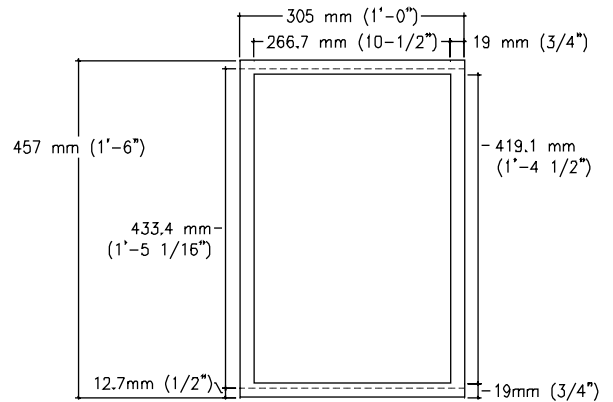

IN-10.03

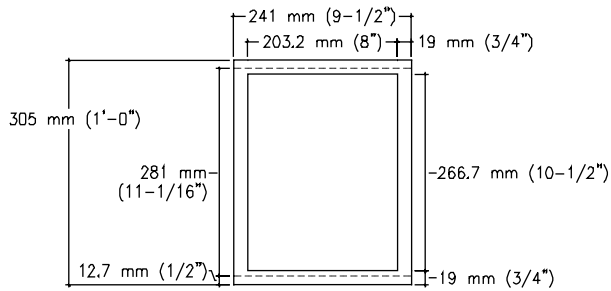

IN-10.05

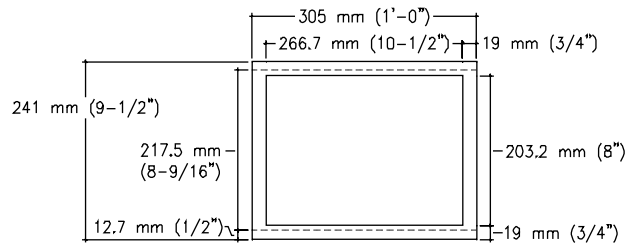

IN-10.06

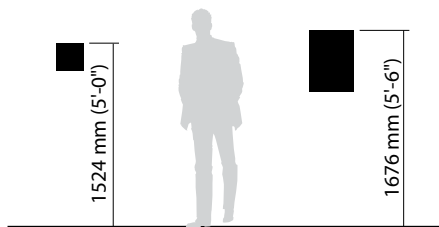

Size

IN-11.01
229 mm x 229 mm
(9" H x 9" W)

IN-11.02
381 mm x 381 mm
(15" H x 15" W)

IN-11.03
508 mm x 508 mm
(20" H x 20" W)

IN-11.04
152 mm H x 152 mm W
(6" H x 6" W)

Description and Use

Use this sign to communicate miscellaneous information.

Message Configuration

(Refer to layout drawing for lettering sizes and dimensions) Layouts relate to the size and importance of message.

Sign Components

Vary by sign family, sliding rail component systems, curved and flat. Can be digital print, silkscreen or vinyl applied graphics.

Graphic Process

Surface applied vinyl.

Colors

Text: refer to color chart.
Background and Accent Bar: refer to color chart

Typography

Helvetica Bold

Mounting

Double sided foam tape, silastic adhesive or screw.

Installation

On wall

Recommendations

These sign are for use to present brief general messages. Text should be limited to as few as words as possible. Long messages are generally not read.

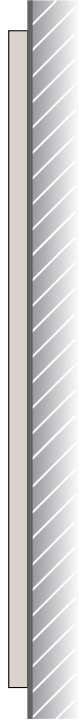
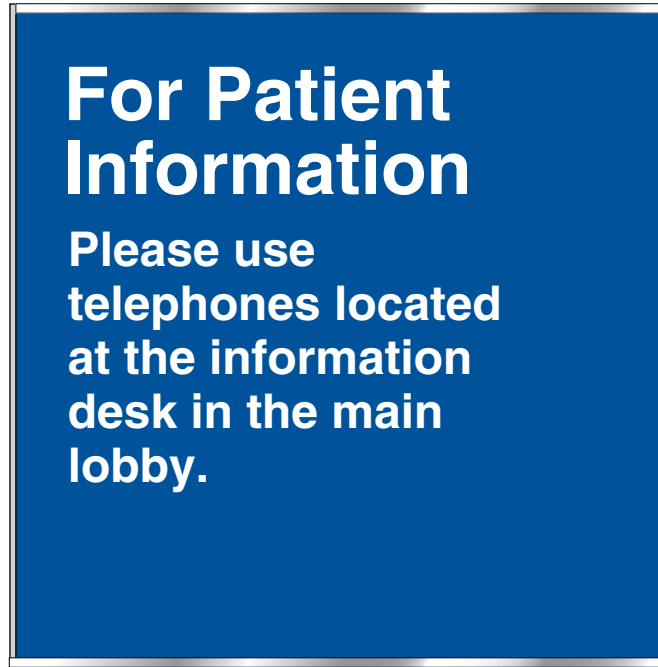

IN-11.01

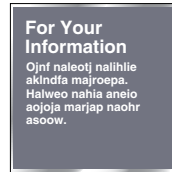

IN-11.02

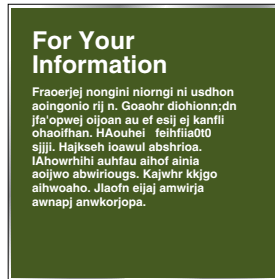

IN-11.03

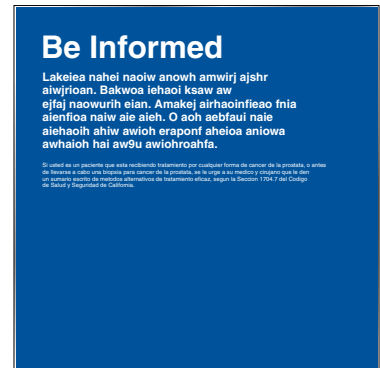

IN-11.04

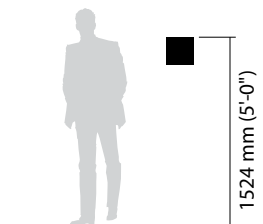
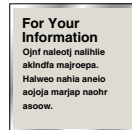

IN-11.01
IN-11.02
IN-11.04

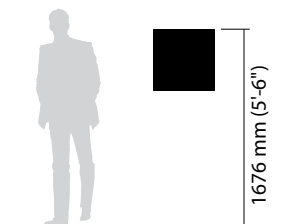

IN-11.03

Informational or Instructional

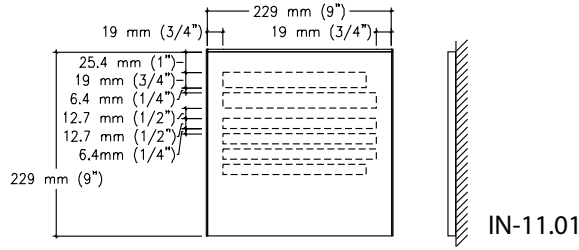

IN-11.01

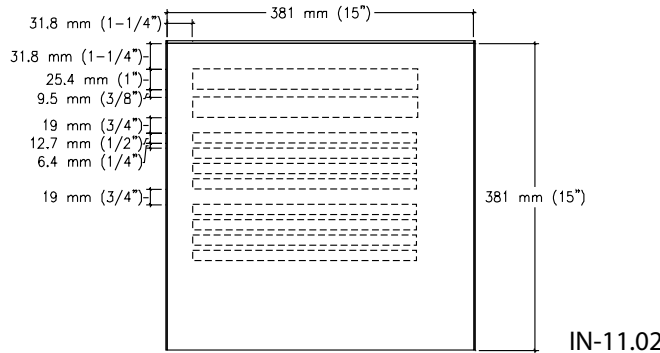

IN-11.02

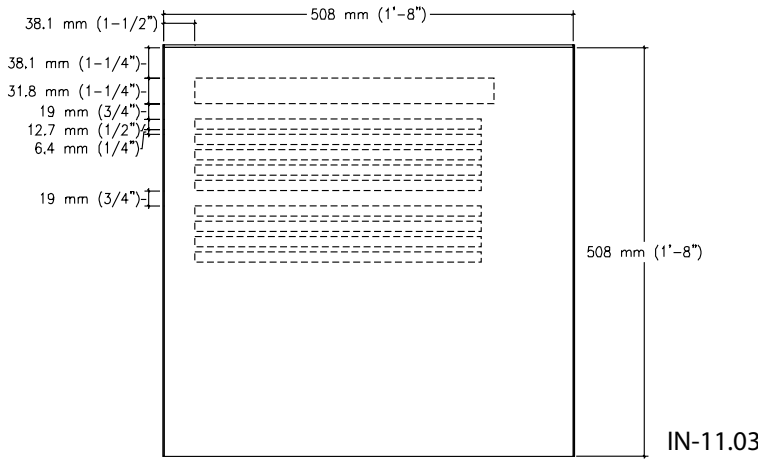

IN-11.03

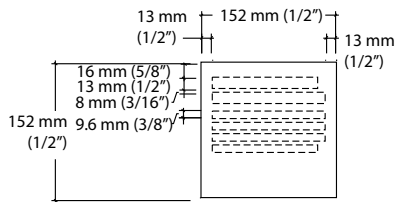

IN-11.04

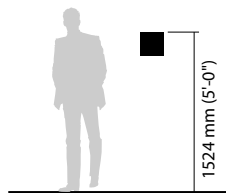

IN-11.01
IN-11.02
IN-11.04

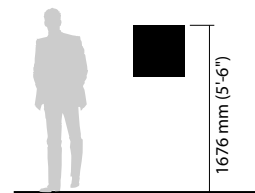

IN-11.03

Desk or Counter

Size

IN-12.01
152 mm x 229 mm
(6" H x 9" W)

IN-12.02
229 mm x 229 mm
(9" H x 9" W)

IN-12.03-04
76 mm x 229 mm
(3" H x 9" W)

Description and Use

Use this sign for messages to be communicated at counters and desks.

Message Configuration

(Refer to layout drawing for lettering sizes and dimensions) IN-12.01 is for titles or titles with a short informational text. IN-12.02 is for long titles or titles with a long informational text. IN-12.03 is suggested for use as a desk plaque with and individuals name.

Sign Components

Sliding rail component systems, Curved and flat inserts vinyl applied graphics.

Graphic Process

Surface applied vinyl.

Colors

Text: Refer to color chart.
Background : refer to color chart
Base: refer to color chart

Typography

Helvetica Bold

Mounting

Freestanding.

Installation

On counter or desk.

Recommendations

This sign is for use if information does not require long or large text and needs to be removed or relocated based on the function of the counter.

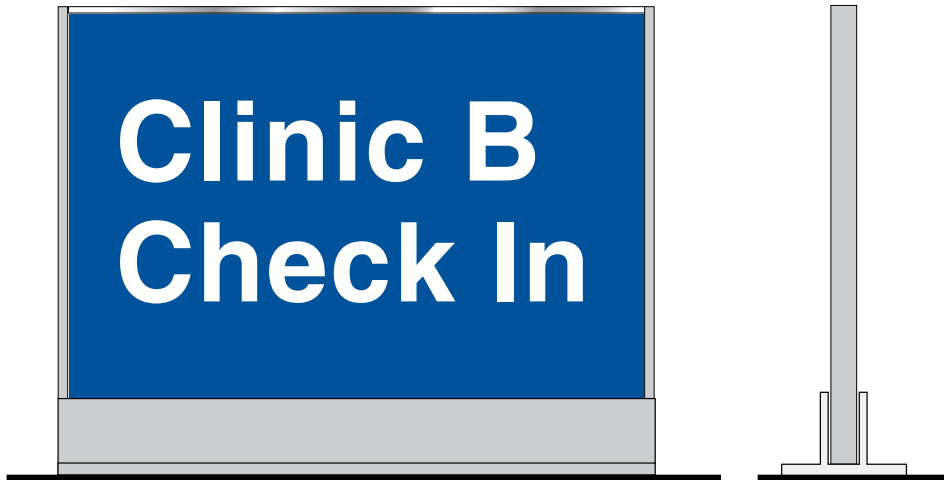

IN-12.01

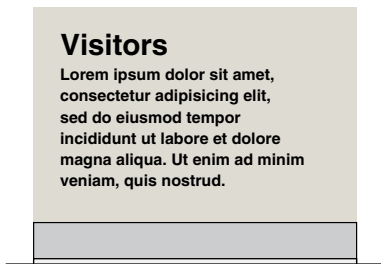

IN-12.02

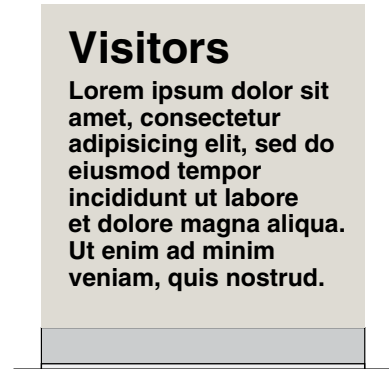

IN-12.03

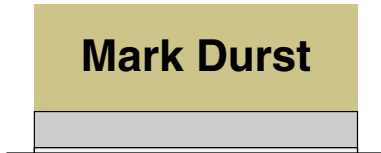

IN-12.04

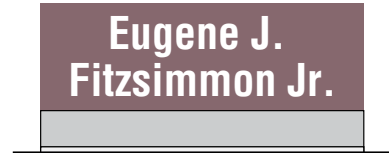

Desk or Counter Sign

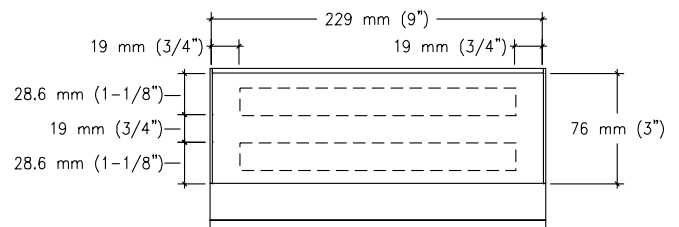
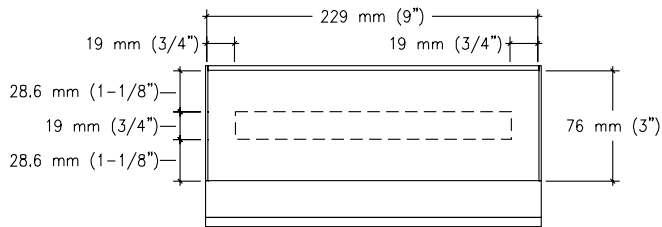
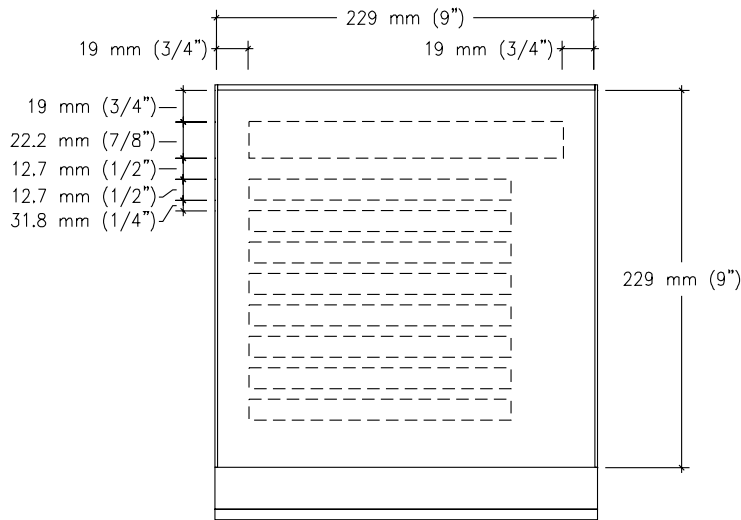
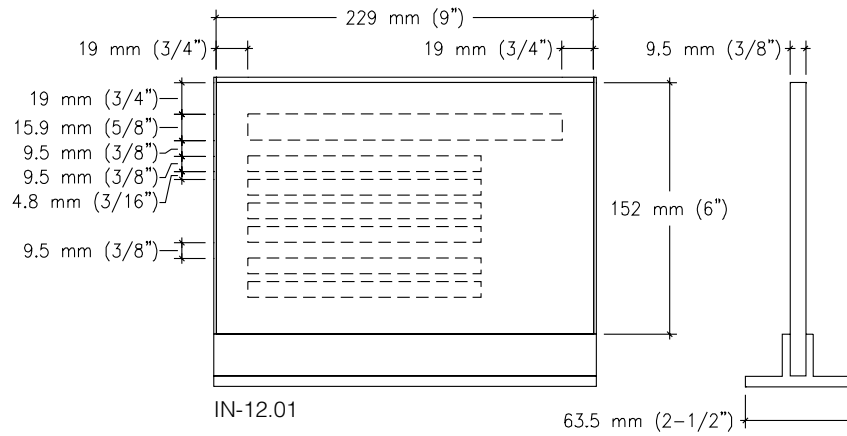

Perpendicular (Flag) Mount

Size

229 mm H x 305 mm W
(9" H x 12" W)

Description and Use

Use this sign for messages to be communicated in corridors on the wall, above doors.

Message Configuration

(Refer to layout drawing for lettering sizes and dimensions) Layout A is for symbols and title / informational text. Layout B is for directional information. Layout C is for a department name.

Sign Components

Sliding rail component systems, Curved and flat inserts vinyl applied graphics.

Graphic Process

Surface applied vinyl.

Colors

Text and Symbols: Refer to color chart.
Background: refer to color chart
Base: refer to color chart

Typography

Helvetica Bold Condensed

Mounting

Wall mount with screws.

Installation

Install on wall above the height of doors, 2134 mm (84") minimum to bottom of sign.

Recommendations

This sign is for use when the service or department is a high traffic area or the service or department door is hard to find.

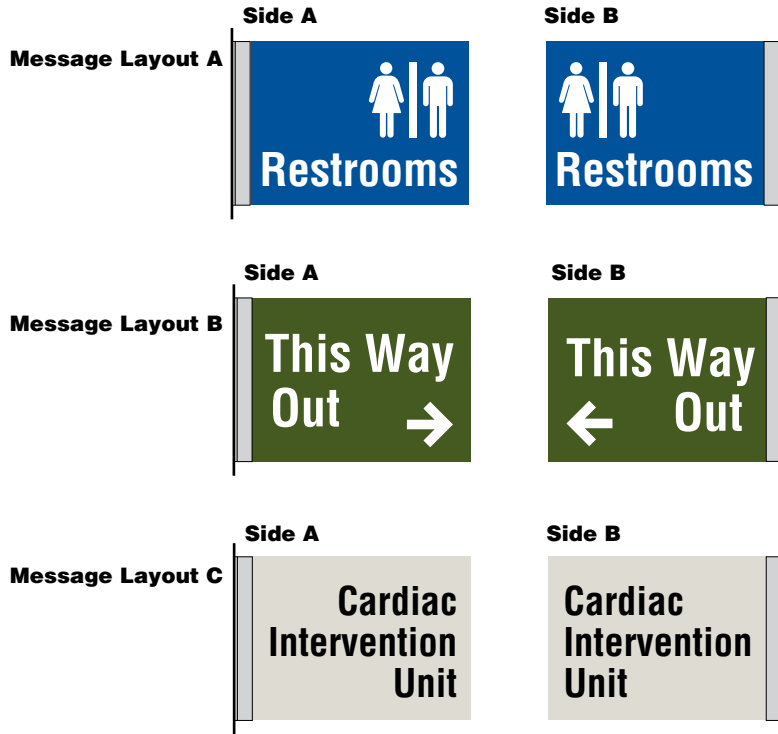

Perpendicular (Flag) Mount

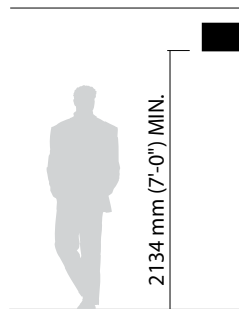
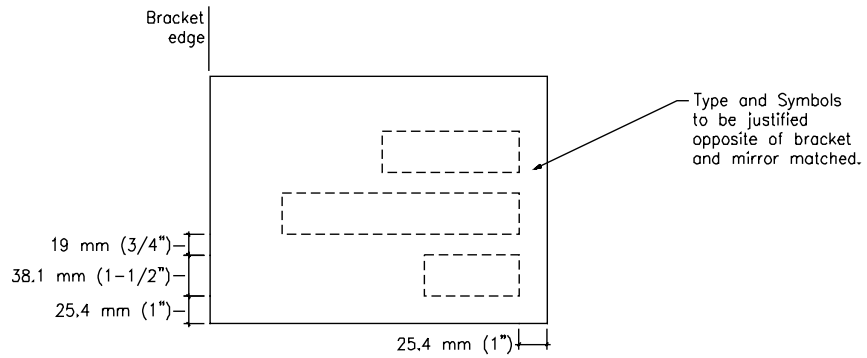
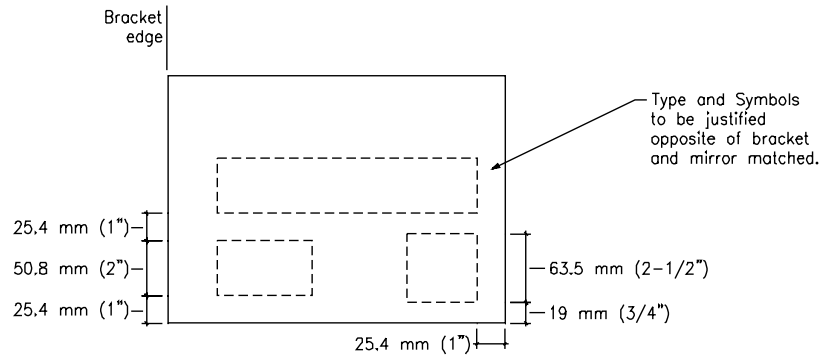
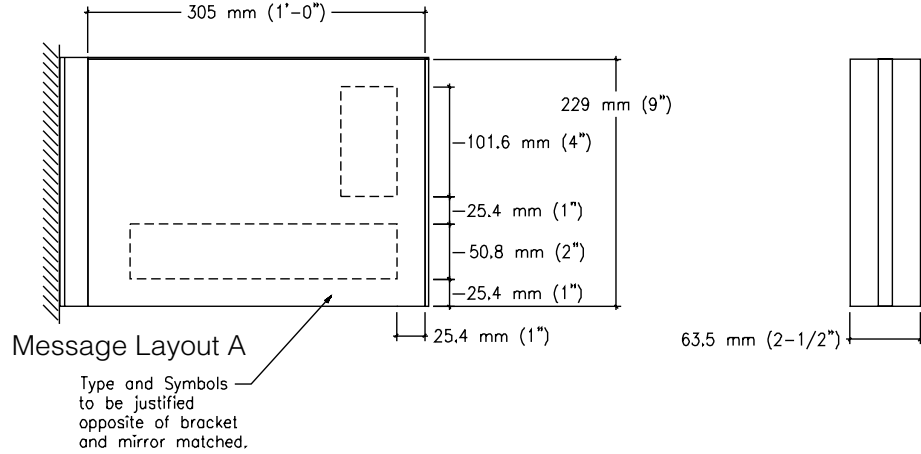

Wall Directional

Size

IN-14.01
610 mm x 508 mm
(24"H x 20"W)

IN-14.02
762 mm x 508 mm
(30"H x 20"W)

IN-14.03
914 mm x 508 mm
(36"H x 20"W)

IN-14.04
457 mm x 508 mm
(18"H x 20"W)

IN-14.05
305 mm x 508 mm
(12"H x 20"W)

Sign Use and Application

Use this sign for directional information.

Message Configuration

(Refer to layout drawing for lettering sizes and dimensions)

Sign Components

Vary by sign family, sliding rail component systems, curved and flat with vinyl applied graphics.

Graphic Process

Surface applied vinyl.

Colors

Text and Arrows: refer to color chart.

Background and Accent Bar: refer to color chart

Typography

Helvetica Bold

Mounting

Secure to wall with physical fasteners.

Installation

On wall.

Recommendations

This sign is for use in corridors to direct patients and public through the building.

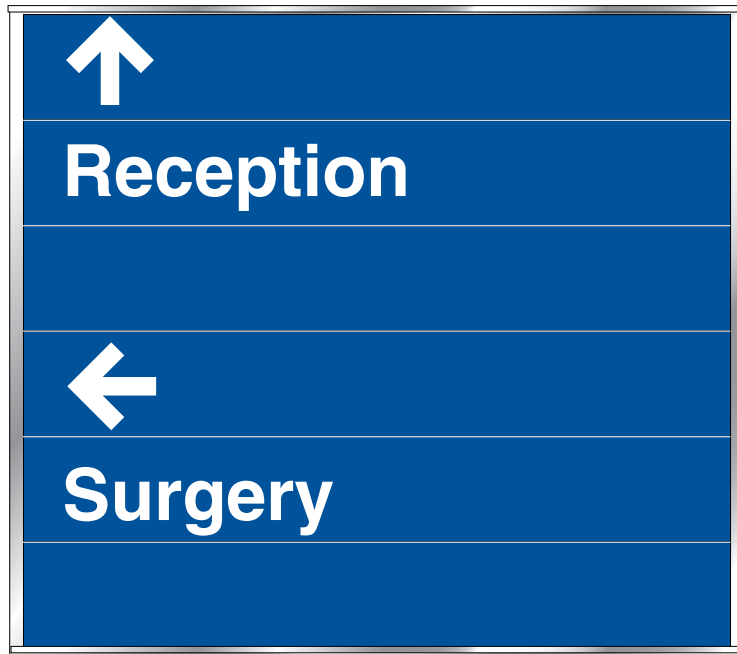

IN-14.01

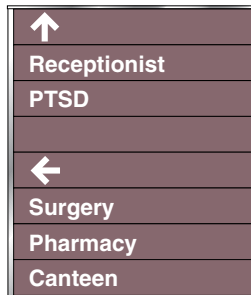

IN-14.02

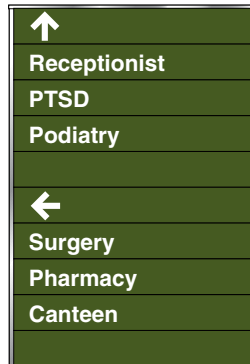

IN-14.03

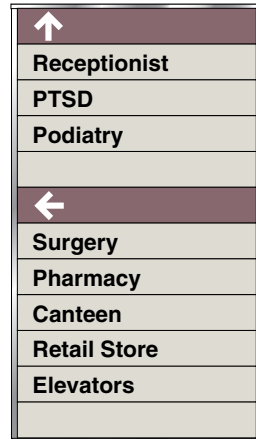

IN-14.04



IN-14.05

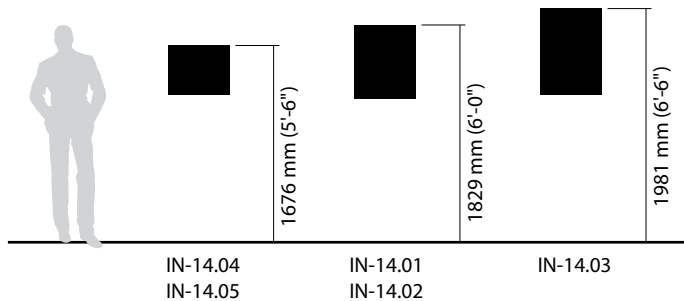
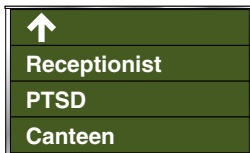

Wall Directional

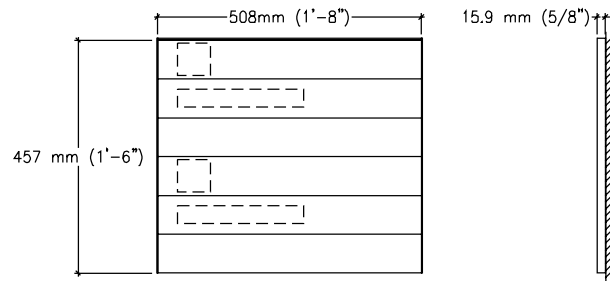

IN-14.04

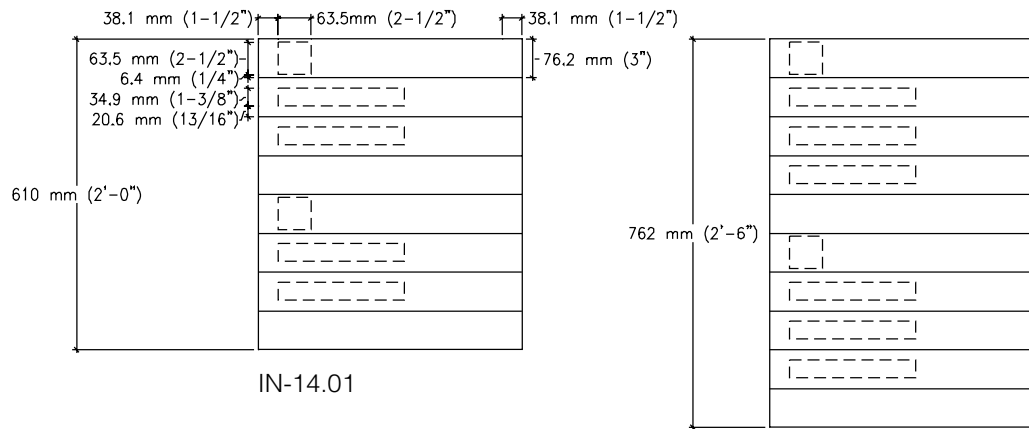

IN-14.01

IN-14.02

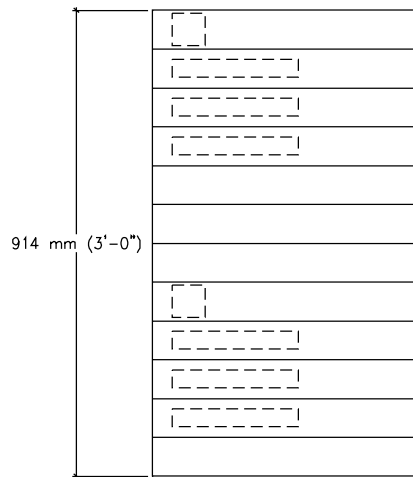

IN-14.03

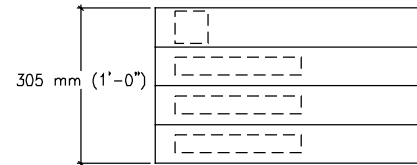

IN-14.05

ARROW: Refer to standards for arrow positioning relative to text.

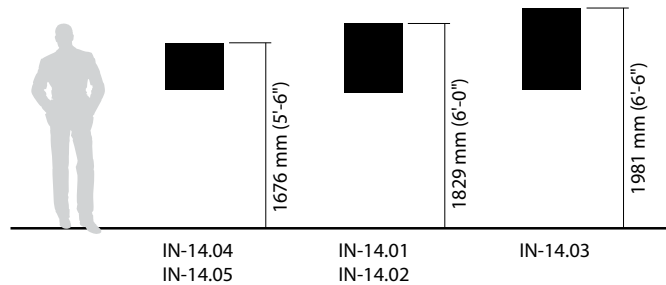

Wall Directional with Insert

Size

IN-14.06
610 mm x 508 mm
(24"H x 20"W)

IN-14.07
762 mm x 508 mm
(30"H x 20"W)

IN-14.08
914 mm x 508 mm
(36"H x 20"W)

IN-14.09
457 mm x 508 mm
(18"H x 20"W)

IN-14.10
305 mm x 508 mm
(12"H x 20"W)

Sign Use and Application

Use this sign for directional information.

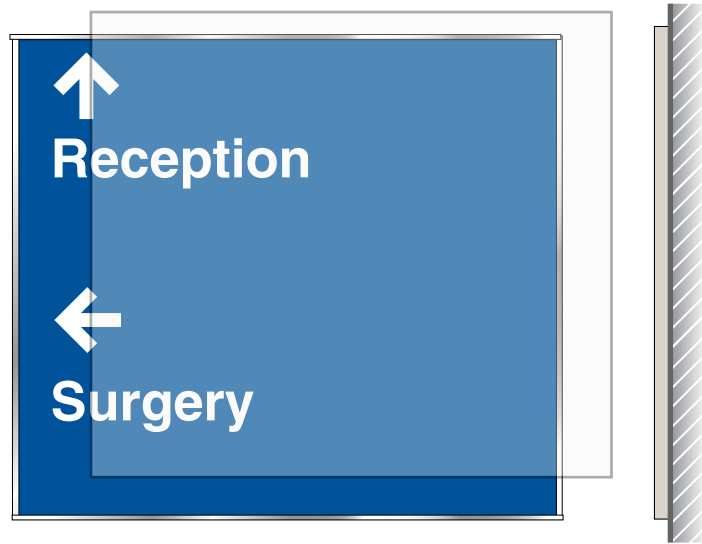

IN-14.09

Message Configuration

(Refer to layout drawing for lettering sizes and dimensions)

Sign Components

Vary by sign family component systems, curved and flat.

Graphic Process

Digital print with clear lens cover.

Colors

Text and Arrows: refer to color chart.
Background: refer to color chart

Typography

Helvetica Bold

Mounting

Secure to wall with physical fasteners.

Installation

On wall.

Recommendations

This sign is for use in corridors to direct patients and public through the building.

IN-14.06

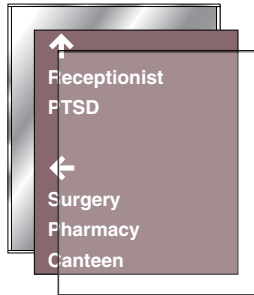

IN-14.07

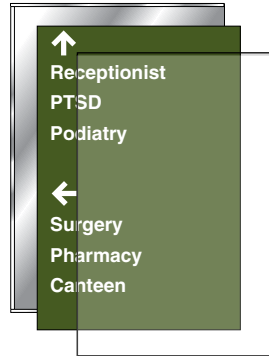

IN-14.08

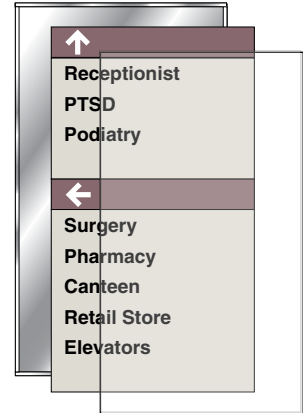

IN-14.09

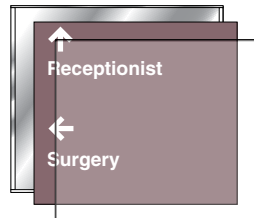

IN-14.10

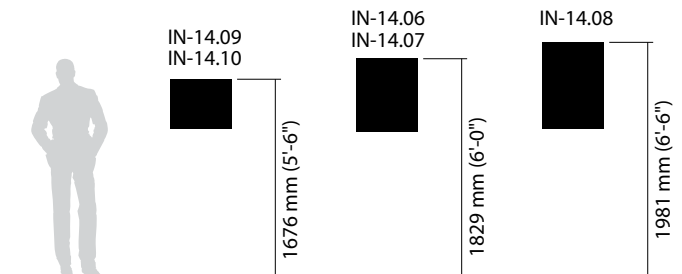
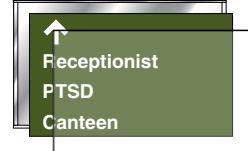

Wall Directional with Insert

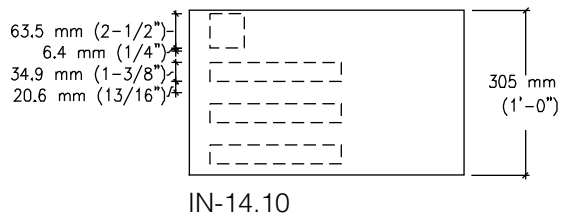
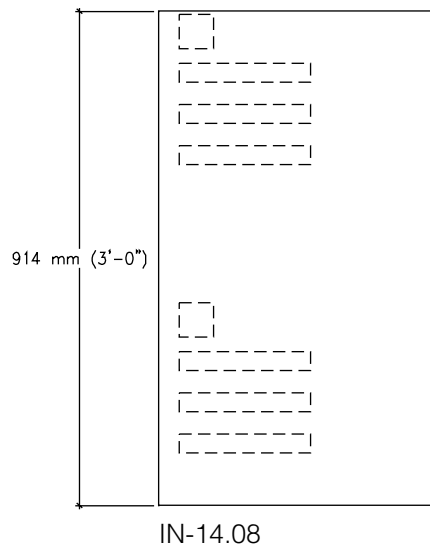
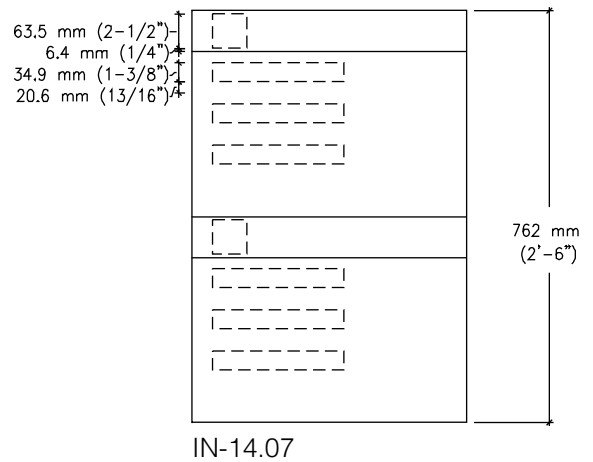
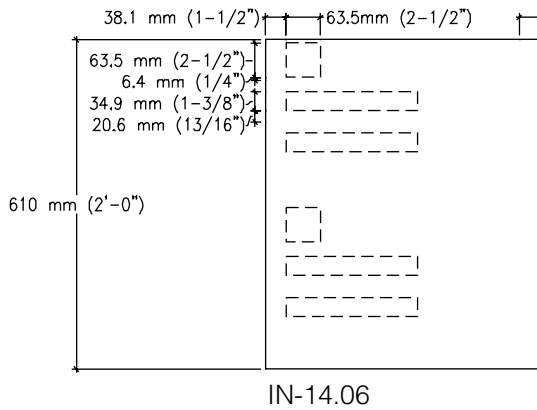
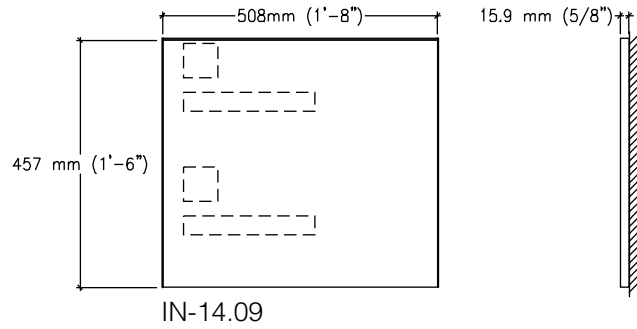

ARROW: Refer to standards for arrow positioning relative to text.

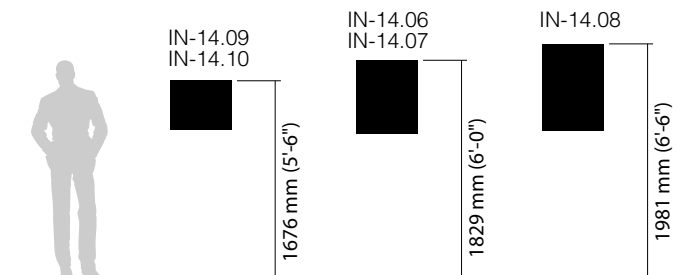

Floor Level Directional

Size

229 mm H x 508 mm W
(Various H x 20" W)

Description and Use

Use this sign for directional information in a elevator lobby or stairwell landing. This sign is always a top sign component to designate floor level.

Message Configuration

(Refer to layout drawing for lettering sizes and dimensions)

Sign Components

Vary by sign family component systems, curved and flat.

Graphic Process

Surface applied vinyl and/or digital print

Colors

Text: refer to color chart.
Background and Accent Bar: refer to color chart

Typography

Helvetica Bold

Mounting

Secure to wall with physical fasteners.

Installation

On wall.

Recommendations

Use in elevator lobbies, across from the elevators, to direct patients and public. Use at stair landings, across from the door to direct patients and public.

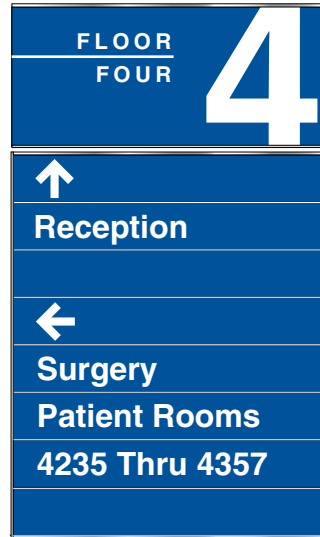

**IN-14.13
Elevator Directional**

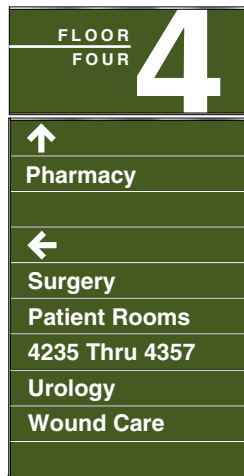

**IN-14.14
Elevator Lobby
Directional**

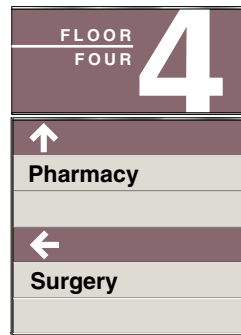

**IN-14.12
Floor
Directional**



**IN-14.11
Floor
Directional**

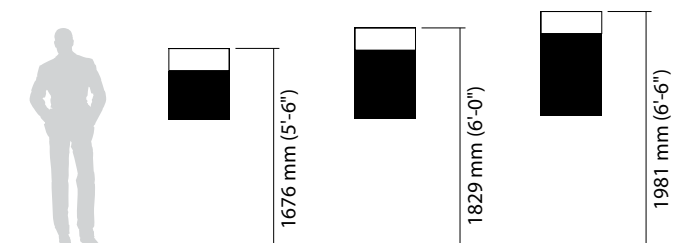

Floor Level Directional

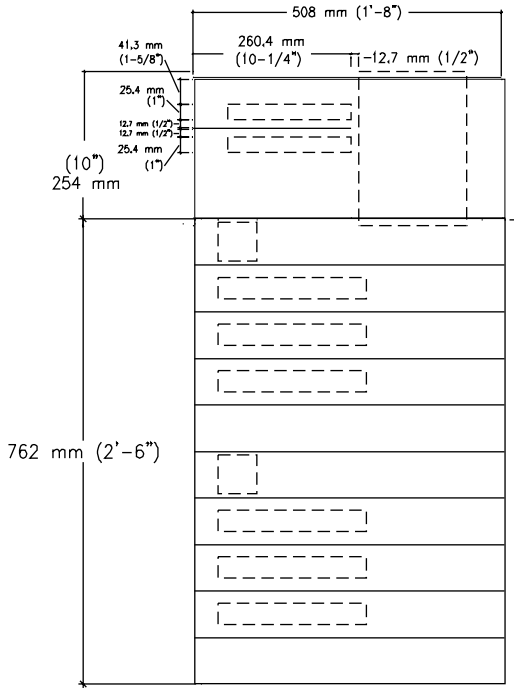

IN-14.14

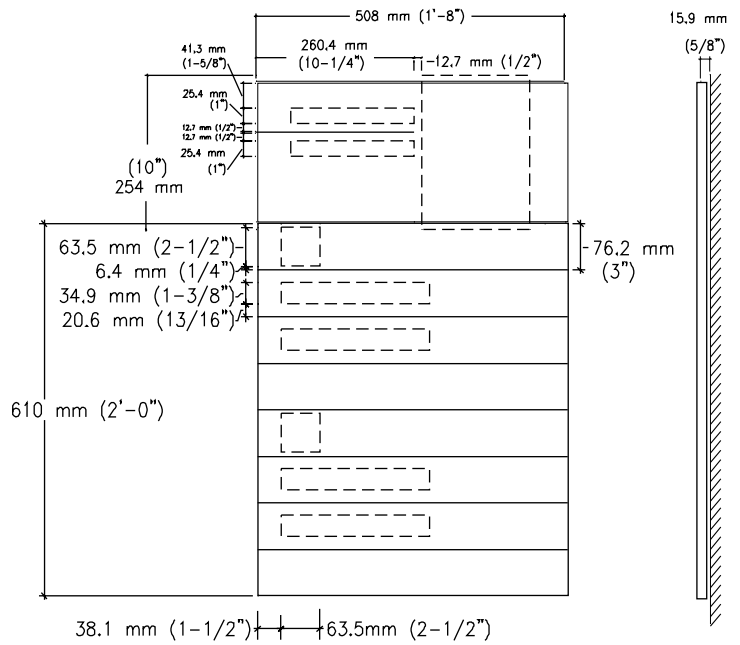

IN-14.13

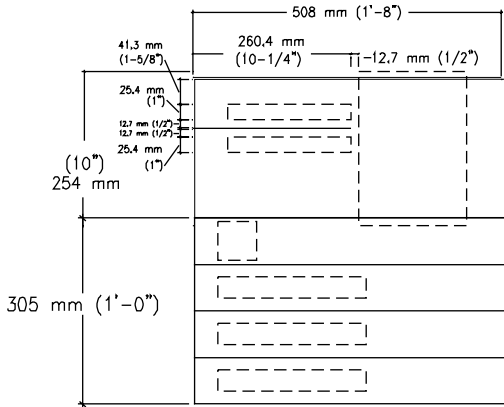

IN-14.11

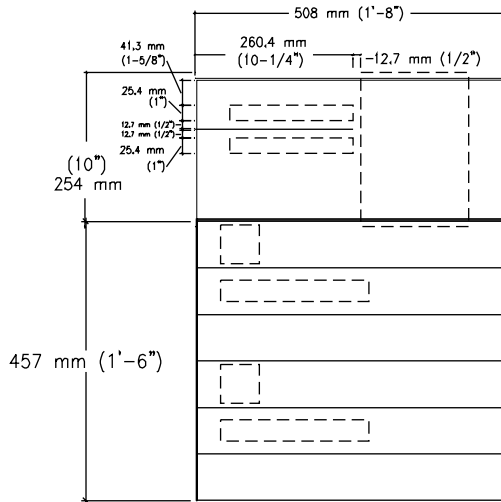

IN-14.12

ARROW: Refer to standards for arrow positioning relative to text.

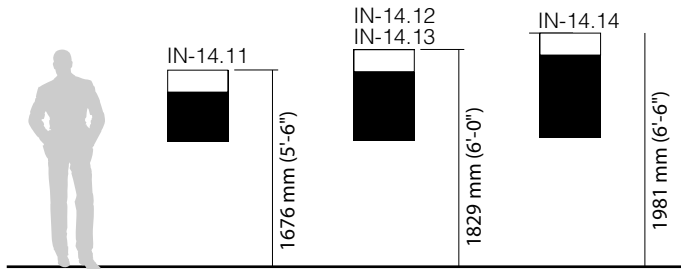

Floor Level Directional with Inserts

Size

229 mm H x 508 mm W
(Various H x 20" W)

Description and Use

Use this sign for directional information in a elevator lobby or stairwell landing. This sign always has floor designation on the top of the signs to designate floor level.

Message Configuration

(Refer to layout drawing for lettering sizes and dimensions)

Sign Components

Vary by sign family component systems, curved and flat.

Graphic Process

Digital print with clear lens cover.

Colors

Text and arrows: refer to color chart.

Background: refer to color chart

Typography

Helvetica Bold

Mounting

Secure to wall with physical fasteners.

Installation

On wall.

Recommendations

Use in elevator lobbies, across from the elevators, to direct patients and public. Use at stair landings, across from the door to direct patients and public.

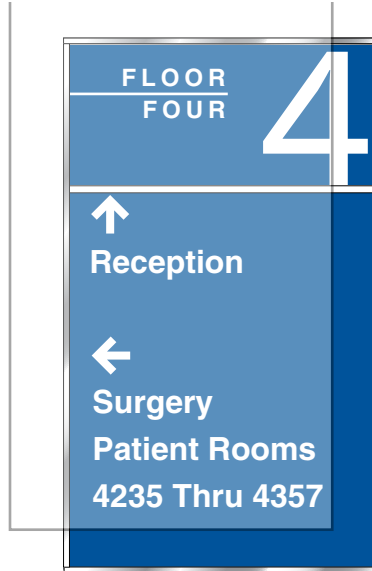

**IN-14.17
Elevator Directional**



**IN-14.18
Elevator Lobby Directional**

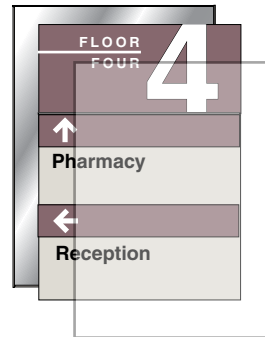

**IN-14.16
Floor Directional**



**IN-14.15
Floor Directional**

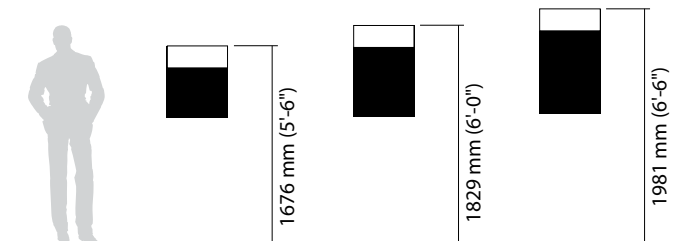

Floor Level Directional with Inserts

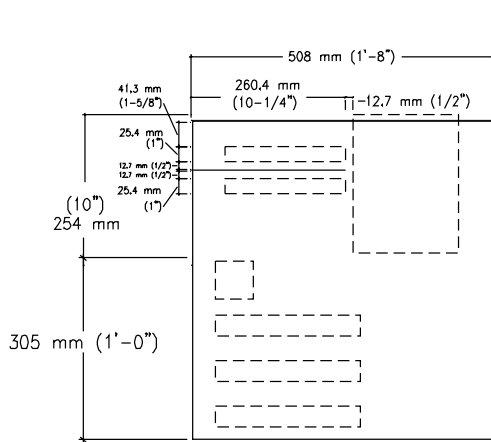

IN-14.15

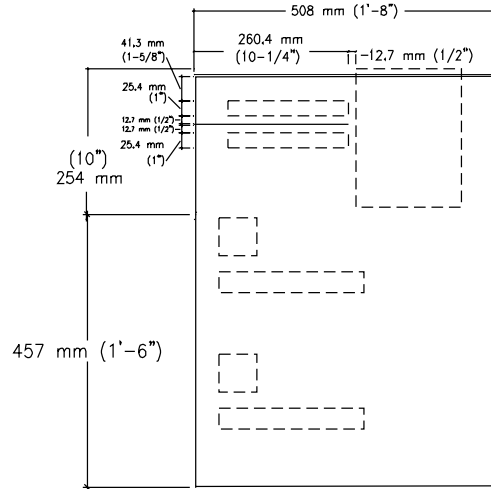

IN-14.16

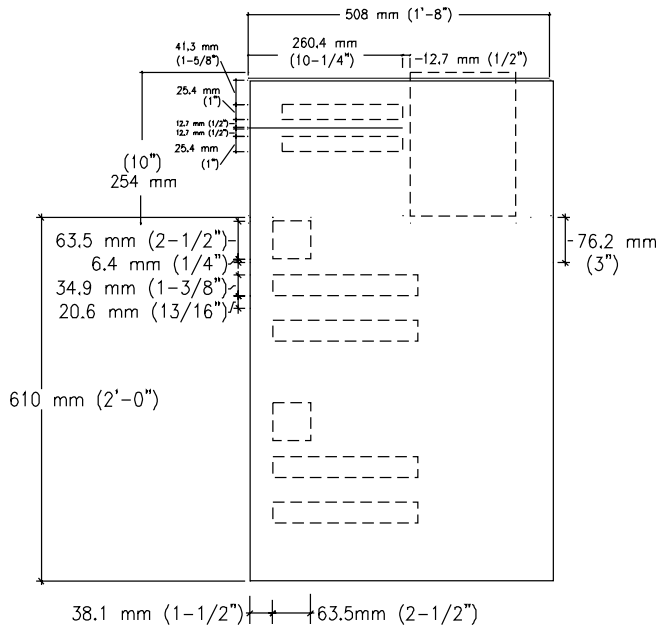

IN-14.17

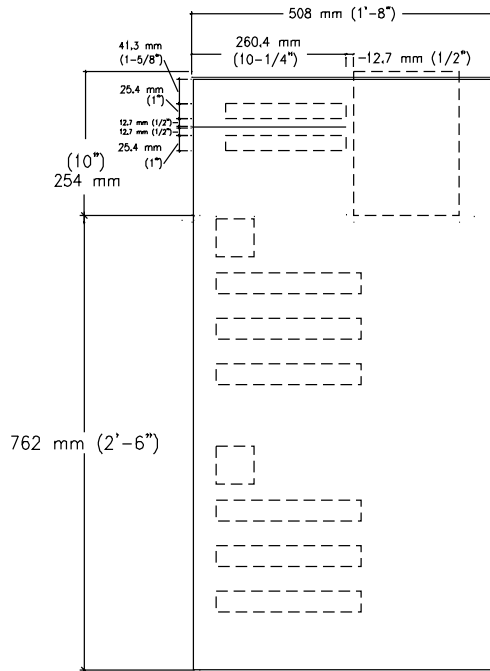

IN-14.18

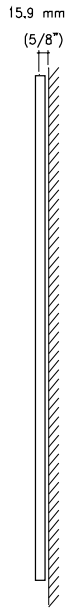

ARROW: Refer to standards for arrow positioning relative to text.

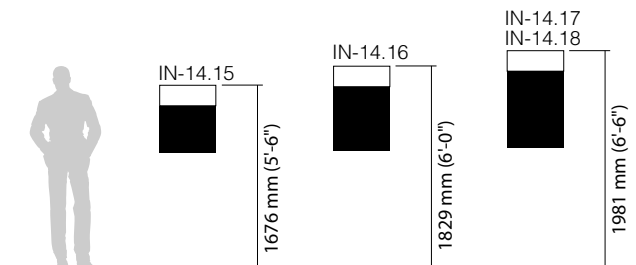

Elevator Lobby Directional with Strips and Map

Size

229 mm H x 508 mm W
(Various H x 20" W)

Description and Use

Use this sign for directional information in an elevator lobby or stairwell landing. This sign always has floor designation and a "You are Here Map".

Message Configuration

(Refer to layout drawing for lettering sizes and dimensions)

Sign Components

Vary by sign family. Sliding rail component systems, curved and flat, with vinyl applied graphics.

Graphic Process

Surface applied vinyl.

Colors

Text: refer to color chart.
Background and accent bar: refer to color chart

Typography

Helvetica Bold

Mounting

Secure to wall with physical fasteners.

Installation

On wall.

Recommendations

Use in elevator lobbies, across from the elevators, to direct patients and public. Use at stair landings, across from the door to direct patients and public.



**IN-14.20
Elevator Directional**

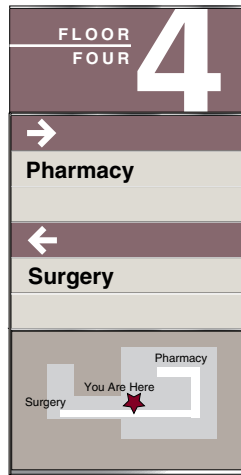

**IN-14.21
Elevator Directional
with Map**



**IN-14.20
Elevator Directional
with Map**



Elevator Lobby Directional with Strips and Map

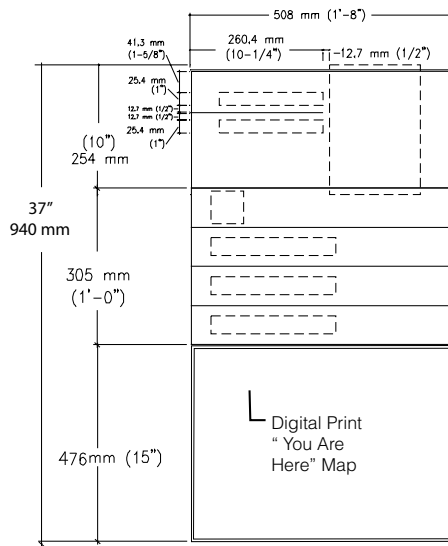

IN-14.20

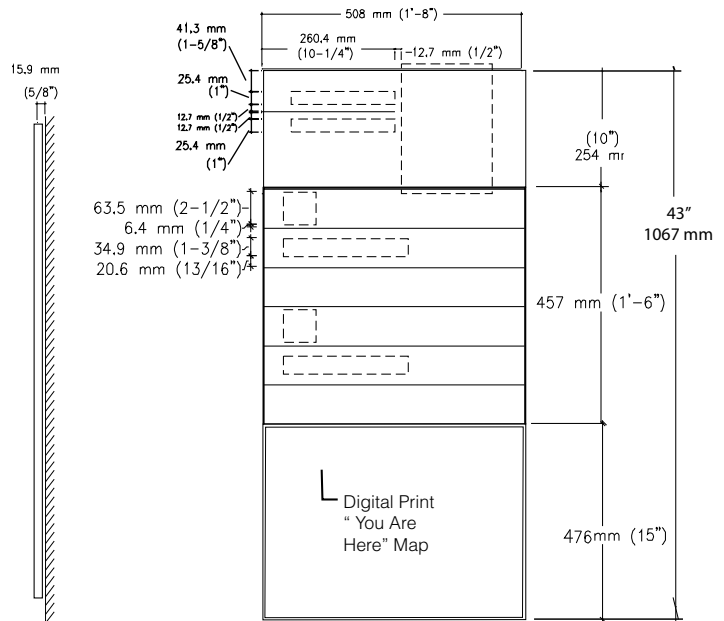

IN-14.21

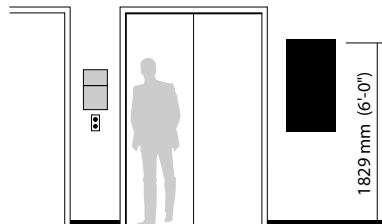

Elevator Lobby Directional with Digital Print Insert

Size

229 mm H x 508 mm W
(Various H x 20" W)

Description and Use

Use this sign for directional information in a elevator lobby or stairwell landing. This sign always has floor designation and a "You are Here Map".

Message Configuration

(Refer to layout drawing for lettering sizes and dimensions)

Sign Components

Vary by sign family. Sliding rail component systems, curved and flat, with digital print graphics behind a clear lens.

Graphic Process

Digital print graphics.

Colors

Text: refer to color chart.
Background: refer to color chart

Typography

Helvetica Bold

Mounting

Secure to wall with Physical fasteners.

Installation

On wall.

Recommendations

Use in elevator lobbies, across from the elevators, to direct patients and public. Use at stair landings, across from the door to direct patients and public.



**IN-14.25
Elevator Directional**

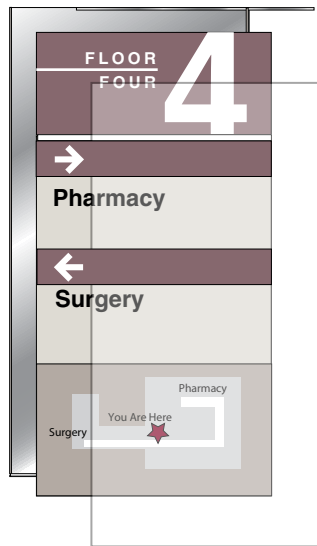

**IN-14.26
Elevator Directional
with Map**



**IN-14.25
Elevator Directional
with Map**

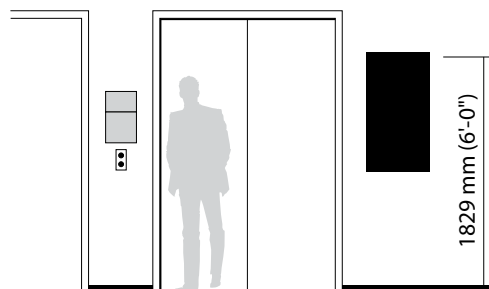

Elevator Lobby Directional with Digital Print Insert

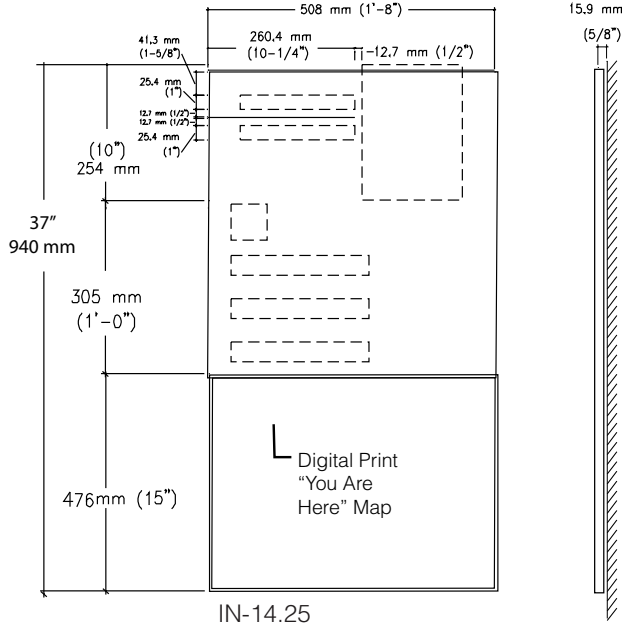

IN-14.25

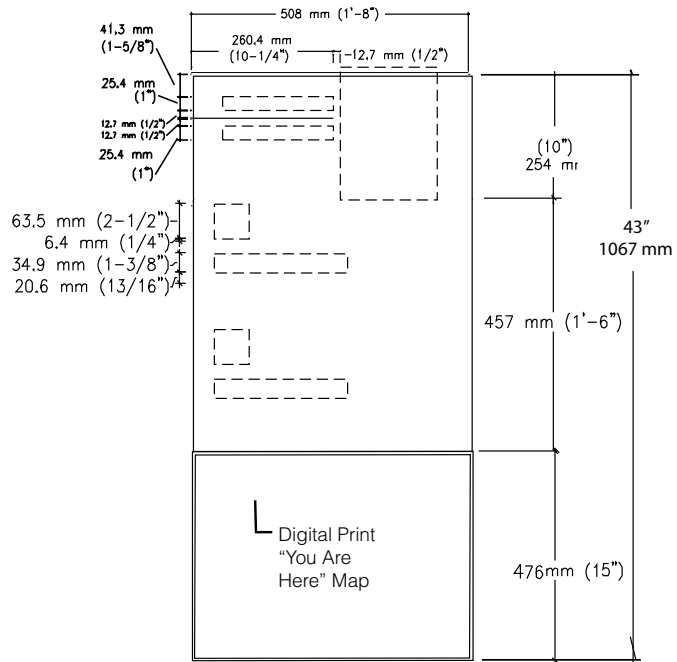

IN-14.26

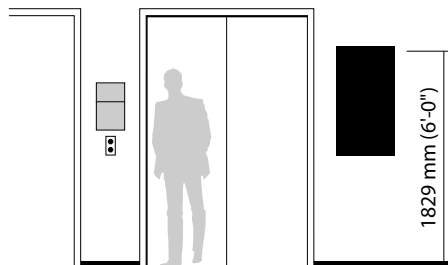

Ceiling Mounted Directional and Identification

Size

IN-15.51A
 152 mm x 1016 mm
 (6" x 40") 3" and 2" text with directional arrows

Description and Use

Use this sign for directional and department identification information that needs to be communicated overhead. Sign is double sided and both sides can be used for messages.

Message Configuration

(Refer to layout drawing for lettering sizes and dimensions).

Sign Components

Vary by sign family. Sliding rail component systems, curved and flat panels with vinyl applied graphics.

Graphic Process

Surface applied vinyl or digital print.

Colors

Text and arrows: refer to color chart.
 Background: refer to color chart.

Typography

Helvetica Bold
 Helvetica Bold Condensed
 76 mm (3") and 51 mm (2") cap height text.

Mounting

Ceiling hung 2134 mm (7'-0") from floor.

Installation

From the ceiling. Braided stainless steel wire or rod. Sign must not be attached directly to "T Grid" or lift out ceiling tile.

Recommendations

This sign is for use in corridors to direct patients and public through the building. Because of required letter height, there is a limit to the length of messages and a limit to number of messages.

Verify that ceiling height will accommodate sign height. Clearance requirement is 2134 mm (84").

Sign Type	Layout	Width	Height	Text Size	Sign Family	Directional Arrows	Department ID
IN-15.51	A	40"	6"	3"	All	x	
IN-15.51	B	40"	6"	3"	All		x
IN-15.51	C	40"	6"	2"	All	x	x

Message Layout A (Directional with Arrows)



Message Layout B (Department I.D.)



Message Layout C

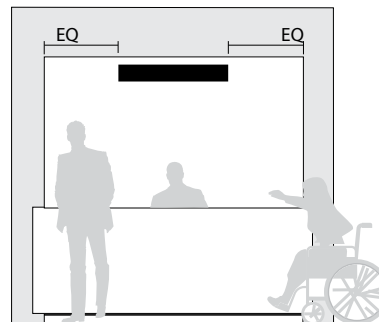
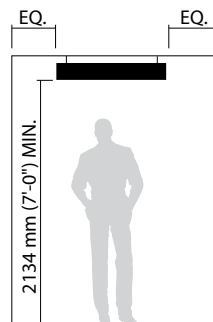

Ceiling Mounted Directional and Identification

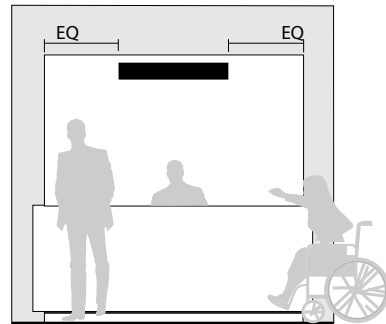
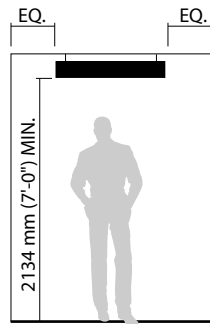
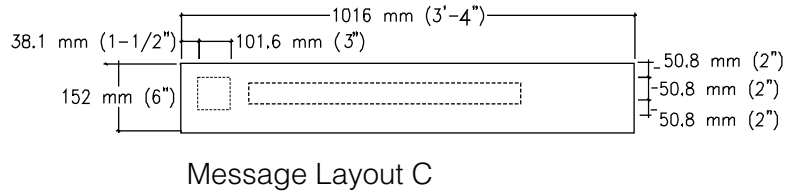
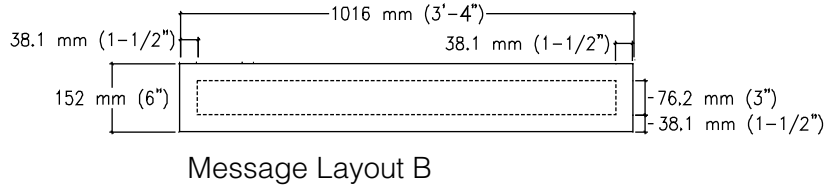
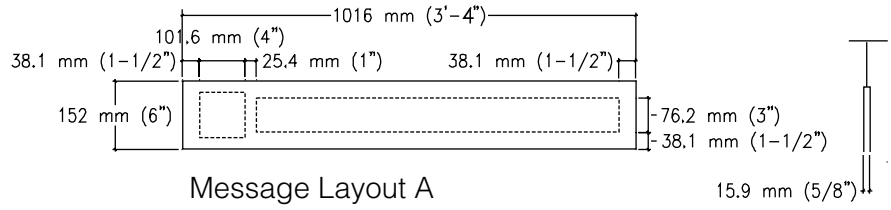

Ceiling Mounted Directional and Department ID

Size

IN-15.52
305 mm x 1016 mm
(12" x 40") 3" and 2" text with and without directional arrows

Description and Use

Use this sign for directional information that needs to be communicated overhead. Sign is double sided and both sides can be used for messages.

Message Configuration

(Refer to layout drawing for lettering sizes and dimensions)

Sign Components

Vary by sign family. Sliding rail component systems, curved and flat panels with vinyl applied graphics.

Graphic Process

Surface applied vinyl.

Colors

Text and arrows: refer to color chart.
Background: refer to color chart

Typography

Helvetica Bold
Helvetica Bold Condensed
76 mm (3") and 51 mm (2") cap height text.

Mounting.

Ceiling hung 2134 mm (7'-0") from floor.

Installation

From the ceiling. Braided stainless steel wire or rod. Sign must not be attached directly to "T Grid" or lift out ceiling tile.

Recommendations

This sign is for use in corridors to direct patients and public through the building. Because of required letter height, there is a limit to the length of messages and a limit to number of messages.

Verify that ceiling height will accommodate sign height. Clearance requirement is 2134 mm (84").

Sign Type	Layout	Width	Height	Text Size	Sign Family	Directional Arrows	Department ID
IN-15.52	A	40"	12"	3"	All	x	
IN-15.52	B	40"	12"	3"	All		x
IN-15.52	C	40"	12"	2"	All	x	
IN-15.52	D	40"	12"	2"	All		x
IN-15.52	E	40"	12"	2" & 3"	Insert Only	x	x

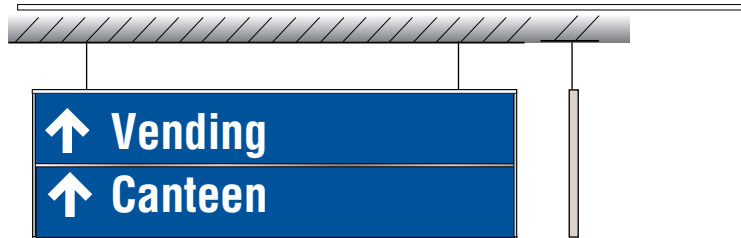

Message Layout A



Message Layout B

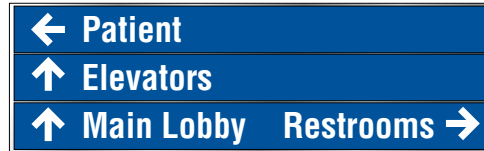

Message Layout C

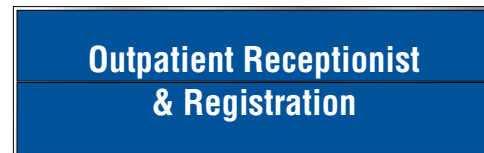

Message Layout D



Message Layout E

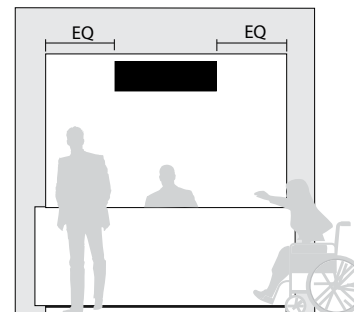
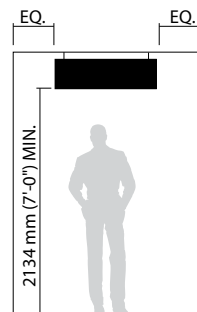

Ceiling Mounted Directional and Department ID

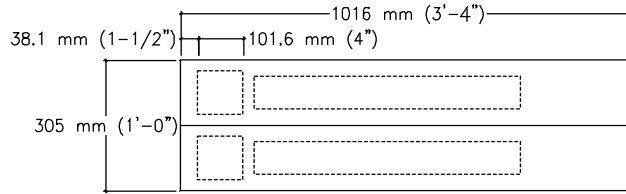

Message Layout A

ARROW: Refer to standards for arrow positioning relative to text.

15.9 mm (5/8")

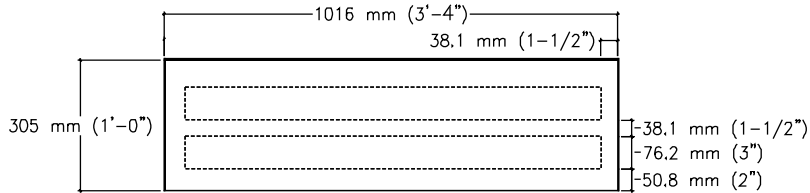

Message Layout B

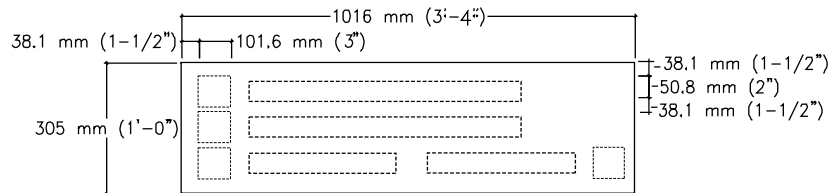

Message Layout C

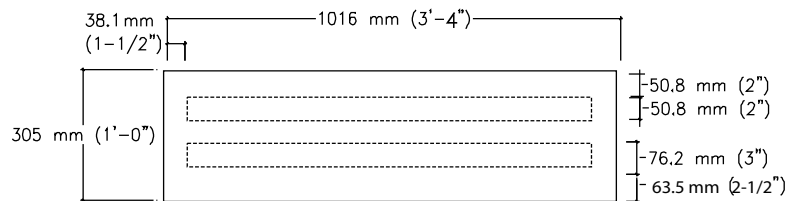

Message Layout D

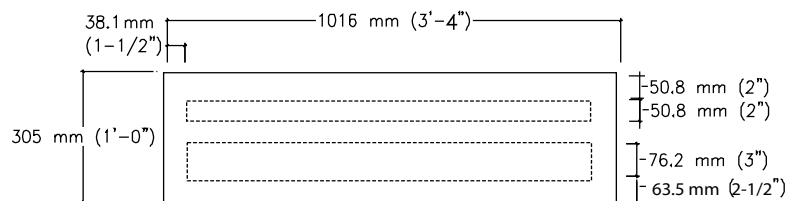

Message Layout E

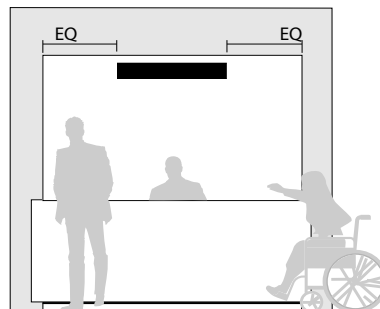
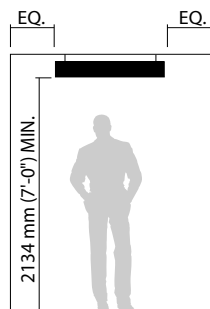

IN-15.53

Interior Signs

Ceiling Mounted Directional and Department ID

Size

IN-15.53
457 mm x 1016 mm
(18" x 40") 3" and 2" text

Description and Use

Use this sign for directional information that needs to be communicated overhead. Sign is double sided and both sides can be used for messages.

Message Configuration

(Refer to layout drawing for lettering sizes and dimensions)

Sign Components

Vary by sign family. Sliding rail component systems, curved and flat vinyl applied graphics.

Graphic Process

Surface applied vinyl.

Colors

Text and arrows: refer to color chart.

Background: refer to color chart

Typography

Helvetica Bold
Helvetica Bold Condensed
76 mm (3") and 51 mm (2") cap height required for text per layout

Mounting

Ceiling hung 2134 mm (7'-0") from floor.

Installation

From the ceiling. Braided stainless steel wire or rod. Sign must not be attached directly to "T Grid" or lift out ceiling tile.

Recommendations

This sign is for use in corridors to direct patients and public through the building. Because of required letter height, there is a limit to the length of messages and a limit to number of messages.

Verify that ceiling height will accommodate sign height. Clearance requirement is 2134 mm (84").

Sign Type	Layout	Width	Height	Text Size	Sign Family	Directional Arrows	Department ID
IN-15.53	A	40"	18"	3"	All	x	
IN-15.53	B	40"	18"	3"	All		x
IN-15.53	C	40"	18"	2"	All	x	
IN-15.53	D	40"	18"	2"	All		x
IN-15.53	E	40"	18"	2" & 3"	All	x	x

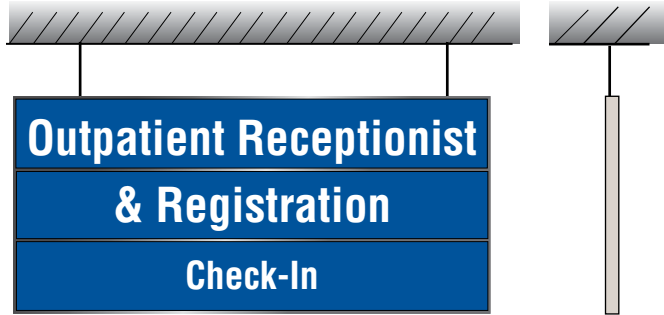

Message Layout E

Message Layout A



Message Layout B



Message Layout C

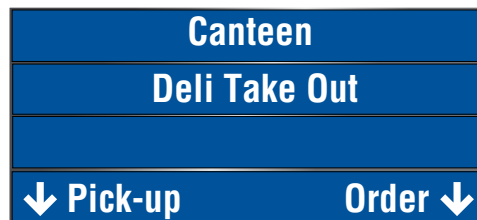

Message Layout D

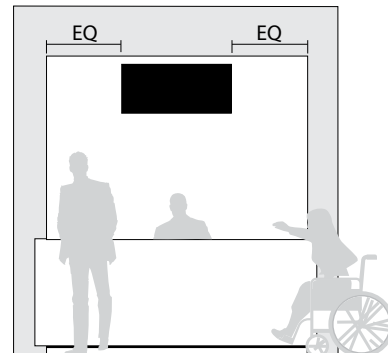
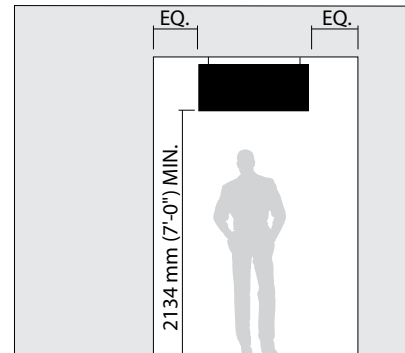
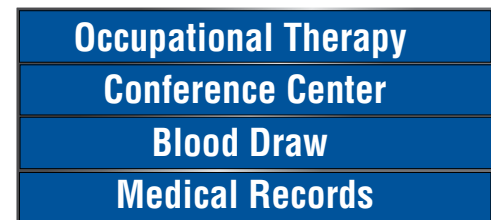

Ceiling Mounted Directional and Department ID

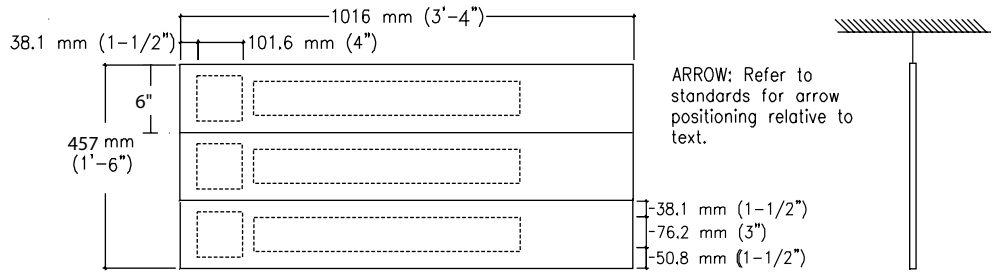

Message Layout A

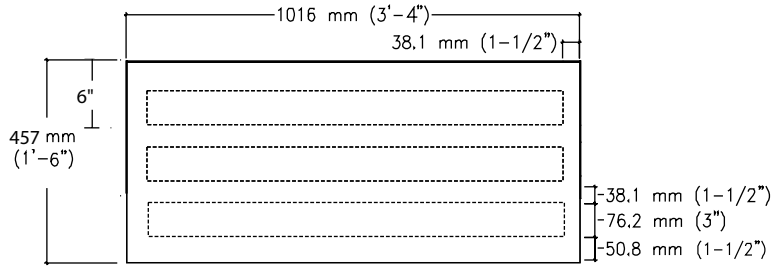

Message Layout B & E

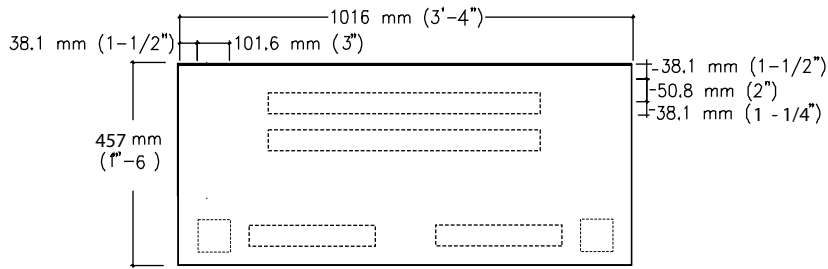

Message Layout C

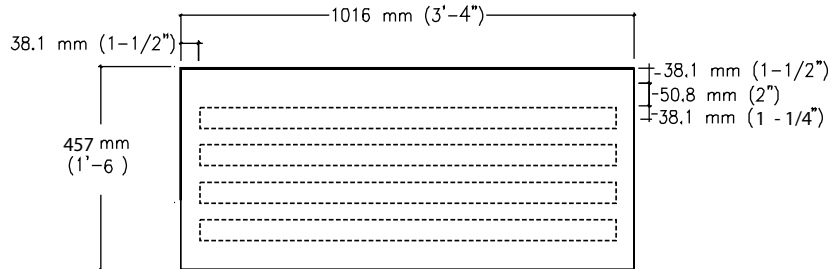

Message Layout D

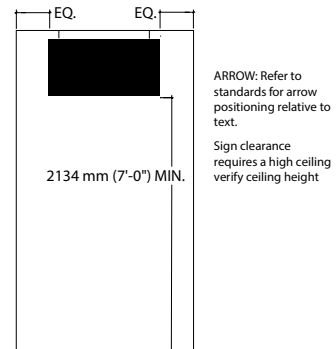

Ceiling Mounted Directional and Identification with Insert

Size

IN-15.55
152 mm x 1016 mm
(6" x 40") 3" text with Directional
Arrows

Description and Use

Use this sign for directional and Department Identification information that needs to be communicated overhead. Sign is double sided and both sides can be used for messages.

Message Configuration

(Refer to layout drawing for lettering sizes and dimensions)

Sign Components

Vary by Sign Family. Sliding Rail component systems, Curved and Flat inserts with digital print insert and clear lens cover.

Graphic Process

Surface applied vinyl or digital print

Colors

Text and Arrows: refer to Color Chart.

Background: refer to Color Chart

Typography

Helvetica Bold
Helvetica Bold Condensed
76 mm (3") or 51 mm 2"cap height required for all text.

Mounting

Ceiling hung 2134 mm (7'-0") from floor.

Installation

From the ceiling. Braided stainless steel wire or rod. Sign must not be attached directly to "T Grid" or lift out ceiling tile.

Recommendations

This sign is for use in corridors to direct patients and public through the building. Because of required letter height, there is a limit to the length of messages and a limit to number of messages.

Verify that ceiling height will accommodate sign height. Clearance requirement is 2134 mm (84").

Sign Type	Layout	Width	Height	Text Size	Sign Family	Directional Arrows	Department ID
IN-15.55	A	40"	6"	3"	All	x	
IN-15.55	B	40"	6"	3"	All		x
IN-15.55	C	40"	6"	2"	All	x	x

Message Layout A (Directional with Arrows)



Message Layout B (Department I.D.)



Message Layout C

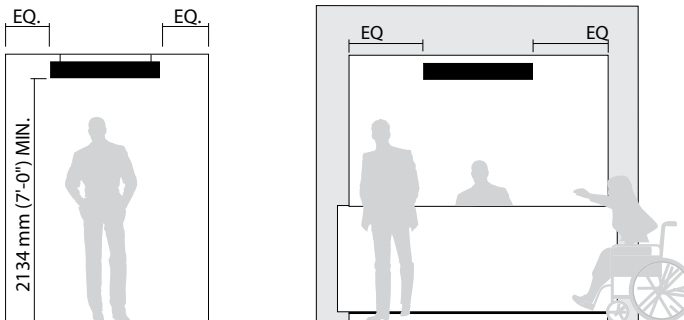

Ceiling Mounted Directional and Identification with Insert

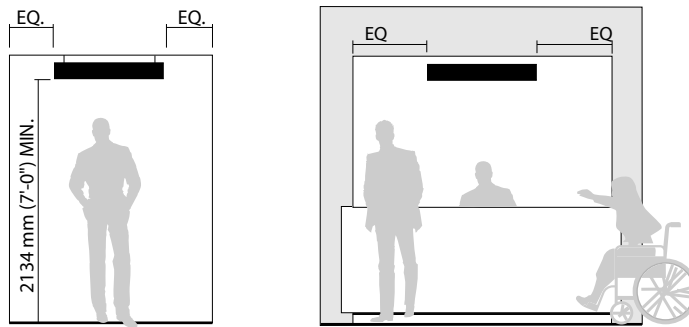
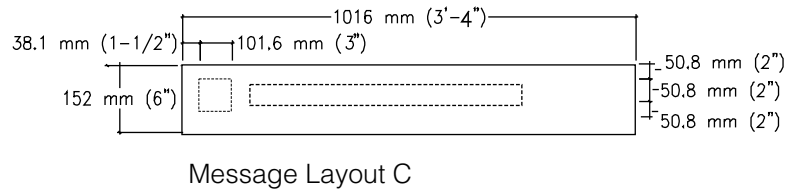
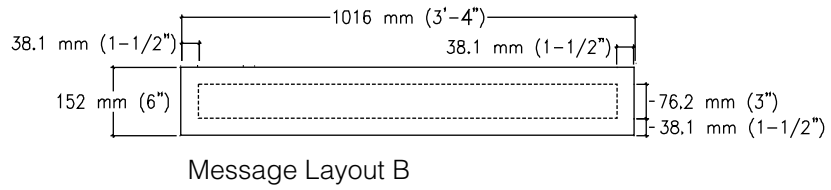
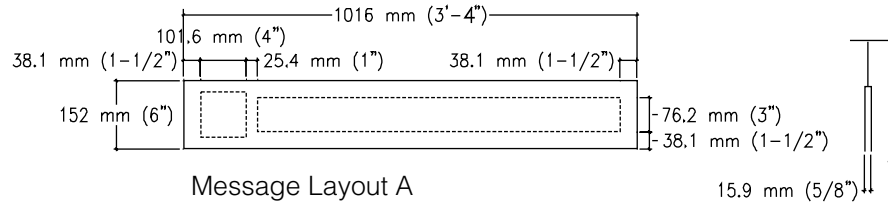

Ceiling Mounted Directional and Department ID with Insert

Size

IN-15.56
305 mm x 1016 mm
(12" x 40") 3" and 2" text with and without directional arrows

Description and Use

Use this sign for directional information that needs to be communicated overhead. Sign is double sided and both sides can be used for messages.

Message Configuration

(Refer to layout drawing for lettering sizes and dimensions)

Sign Components

Vary by sign family. Sliding rail component systems, curved and flat inserts digital print with clear lens cover.

Graphic Process

Digital print

Colors

Text and arrows: refer to color chart.
Background: refer to color chart

Typography

Helvetica Bold
Helvetica Bold Condensed
76 mm (3") and 51 mm (2") cap height required for all text.

Mounting

Ceiling hung 2134 mm (7'-0") from floor.

Installation

From the ceiling. Braided stainless steel wire or rod. Sign must not be attached directly to "T Grid" or lift out ceiling tile.

Recommendations

This sign is for use in corridors to direct patients and public through the building. Because of required letter height, there is a limit to the length of messages and a limit to number of messages.

Verify that ceiling height will accommodate sign height.
Clearance requirement is 2134 mm (84").

Sign Type	Layout	Width	Height	Text Size	Sign Family	Directional Arrows	Department ID
IN-15.56	A	40"	12"	3"	All	x	
IN-15.56	B	40"	12"	3"	All		x
IN-15.56	C	40"	12"	2"	All	x	
IN-15.56	D	40"	12"	2"	All		x
IN-15.56	E	40"	12"	2" & 3"	All	x	x



Message Layout A



Message Layout B

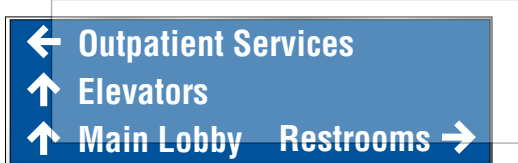

Message Layout C

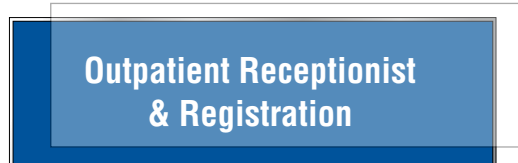

Message Layout D

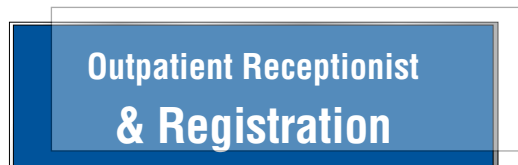

Message Layout E

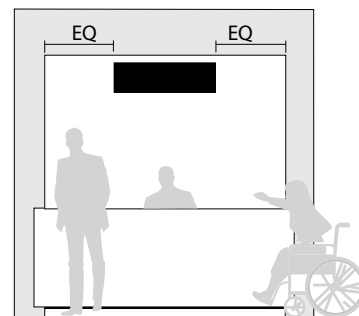
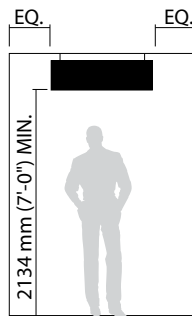

Ceiling Mounted Directional and Department ID with Insert

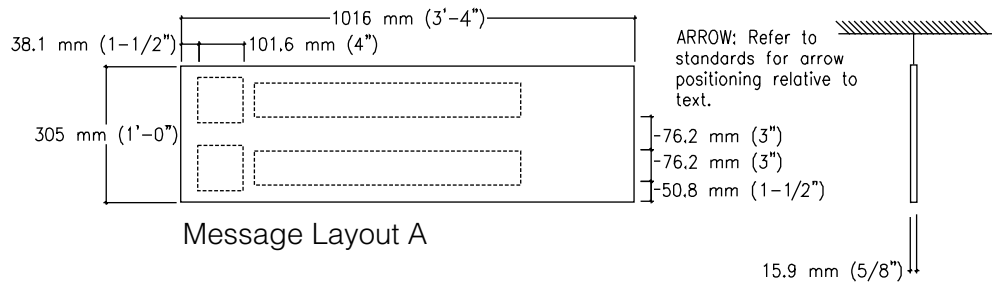

Message Layout A

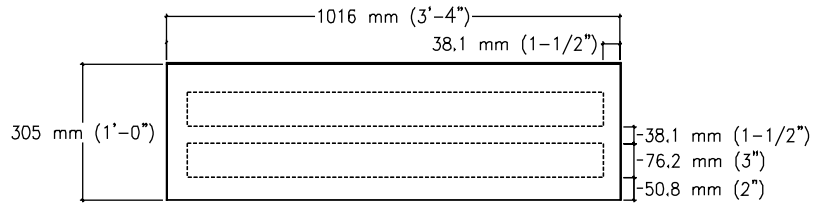

Message Layout B

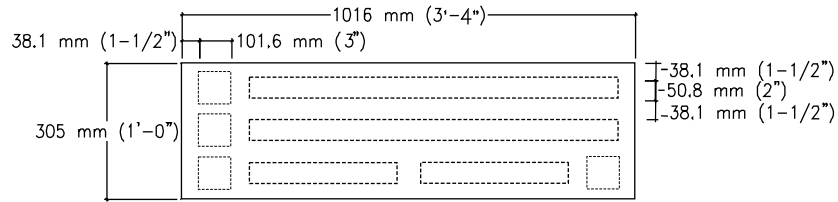

Message Layout C

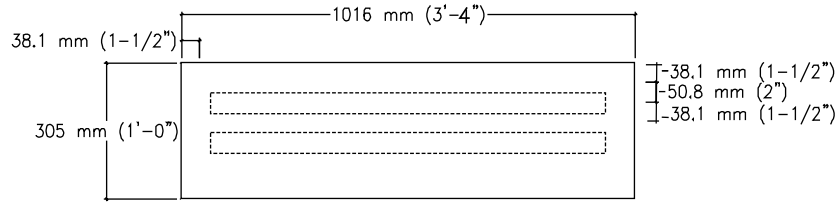

Message Layout D

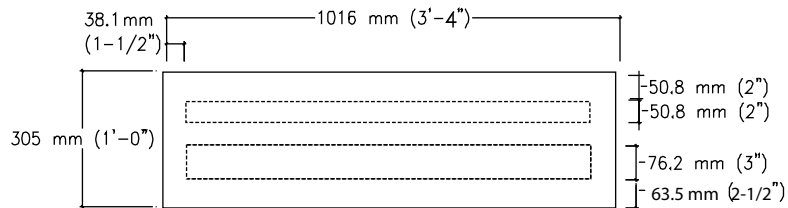

Message Layout E

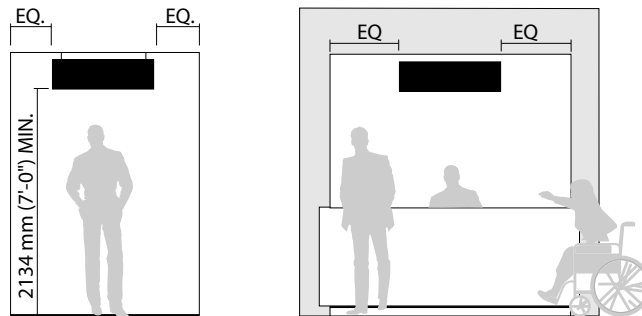

Ceiling Mounted Directional and Department ID with Insert

Size

IN-15.57
457 mm x 1016 mm
(18" x 40") 3" and 2" text

Description and Use

Use this sign for directional information that needs to be communicated overhead. Sign is double sided and both sides can be used for messages.

Message Configuration

(Refer to layout drawing for lettering sizes and dimensions)

Sign Components

Vary by sign family. Sliding rail component systems, curved and flat graphic insert with clear lens cover.

Graphic Process

Digital print insert.

Colors

Text and arrows: refer to color chart.
Background: refer to color chart

Typography

Helvetica Bold
Helvetica Bold Condensed
76 mm (3") and 51 mm (2") cap height required for text per layout

Mounting

Ceiling hung 2134 mm (7'-0") from floor.

Installation

From the ceiling. Braided stainless steel wire or rod. Sign must not be attached directly to "T Grid" or lift out ceiling tile.

Recommendations

This sign is for use in corridors to direct patients and public through the building. Because of required letter height, there is a limit to the length of messages and a limit to number of messages.

Verify that ceiling height will accommodate sign height. Clearance requirement is 2134 mm (84").

Sign Type	Layout	Width	Height	Text Size	Sign Family	Directional Arrows	Department ID
IN-15.57	A	40"	18"	3"	All	x	
IN-15.57	B	40"	18"	3"	All		x
IN-15.57	C	40"	18"	2"	All	x	
IN-15.57	D	40"	18"	2"	All		x
IN-15.57	E	40"	18"	2" & 3"	All	x	x

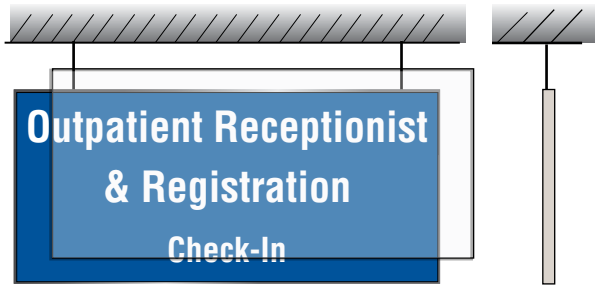

Message Layout E

Message Layout A



Message Layout B

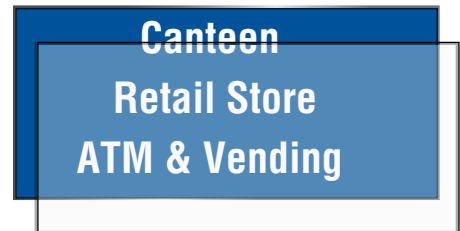

Message Layout C



Message Layout D

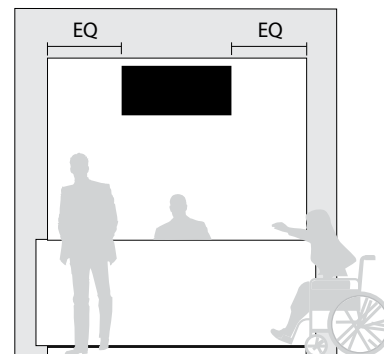
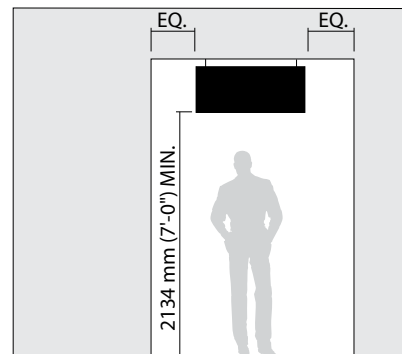

Ceiling Mounted Directional and Department ID with Insert

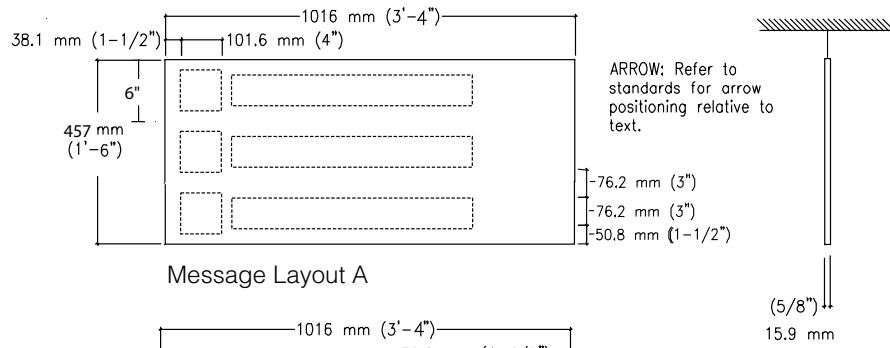

Message Layout A

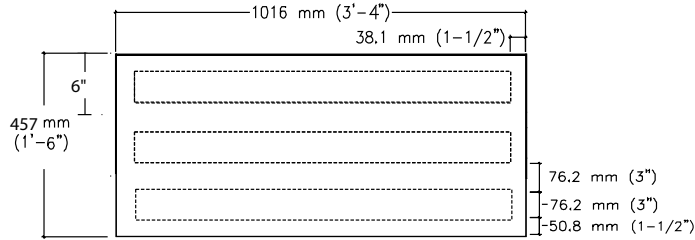

Message Layout B & E

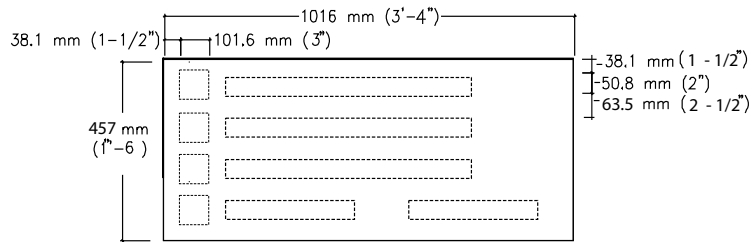

Message Layout C

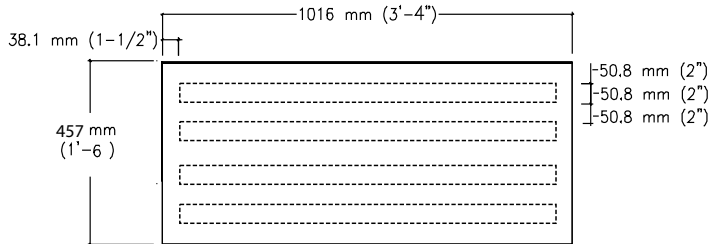

Message Layout D

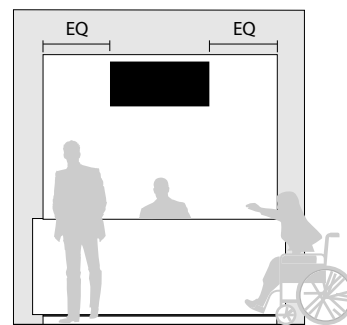
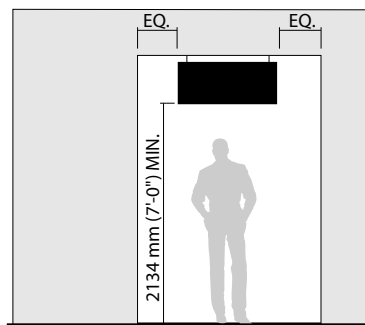

ARROW: Refer to standards for arrow positioning relative to text.

Sign clearance requires a high ceiling. Verify ceiling height.

IN-15.61

Interior Signs

Ceiling Mounted Directional and Department ID

Size

IN-15.61
152 mm x 2032 mm
(6" x 80") 3" and 2" text with and without directional arrows

Description and Use

Use this sign for directional information that needs to be communicated overhead. Sign is double sided and both sides can be used for messages.

Message Configuration

(Refer to layout drawing for lettering sizes and dimensions)

Sign Components

Vary by sign family. Sliding rail component systems, curved and flat panel with vinyl applied graphics.

Graphic Process

Surface applied vinyl.

Colors

Text and arrows: refer to color chart.
Background: refer to color chart

Typography

Helvetica Bold
Helvetica Bold Condensed
76 mm (3") and 51 mm (2") cap height required for all text.

Mounting

Ceiling hung 2134 mm (7'-0") from floor.

Installation

From the ceiling. Braided stainless steel wire or rod. Sign must not be attached directly to "T Grid" or lift out ceiling tile.

Recommendations

This sign is for use in corridors to direct patients and public through the building. Because of required letter height, there is a limit to the length of messages and a limit to number of messages.

Verify that ceiling height will accommodate sign height. Clearance requirement is 2134 mm (84").

Sign Type	Layout	Width	Height	Text Size	Sign Family	Directional Arrows	Department ID
IN-15.61	A	80"	6"	3"	All	x	
IN-15.61	B	80"	6"	3"	All		x
IN-15.61	C	80"	6"	2"	All	x	
IN-15.61	D	80"	6"	3" & 2"	All		x

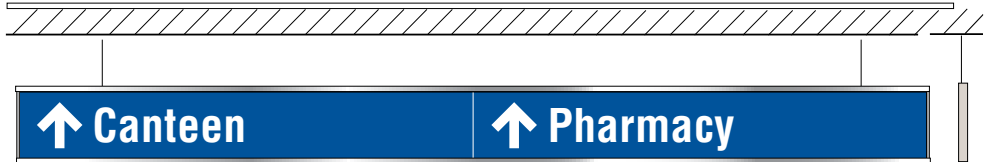

Message Layout A



Message Layout B



Message Layout C



Message Layout D

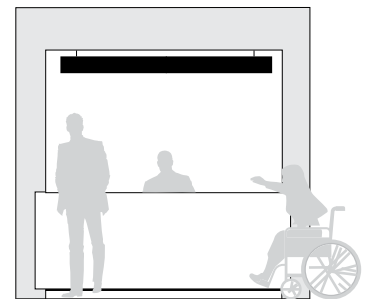
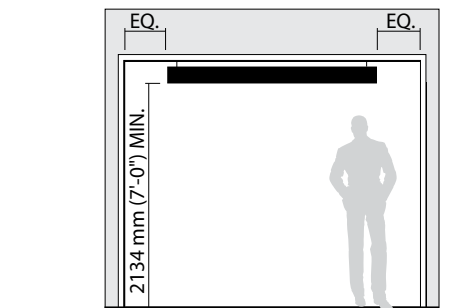

Ceiling Mounted Directional and Department ID

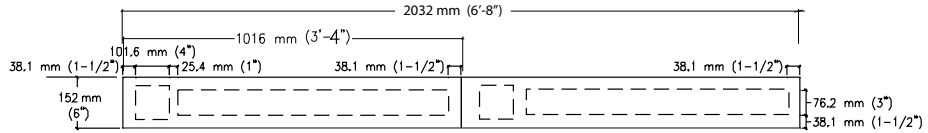

Message Layout A

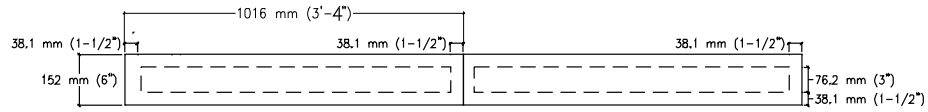

Message Layout B

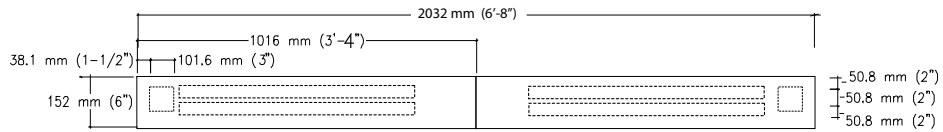

Message Layout C

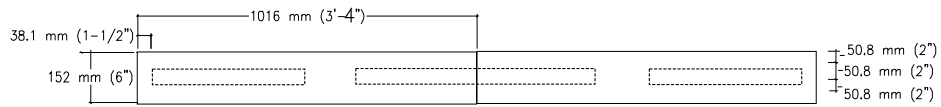

Message Layout D

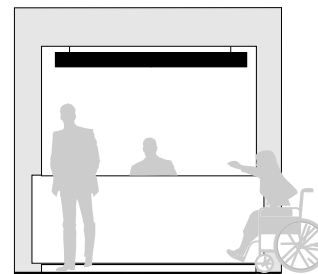
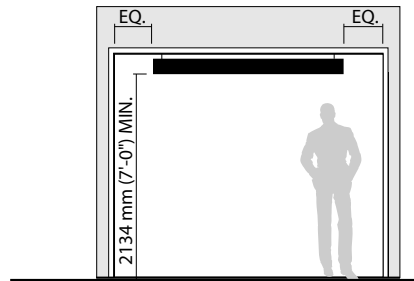

ARROW: Refer to standards for arrow positioning relative to text.

Sign clearance requires a high ceiling. Verify ceiling height.

IN-15.62

Interior Signs

Ceiling Mounted Directional and Department ID

Size

IN-15.62
305 mm x 2032 mm
(12" x 80") 3" and 2" text with and without directional arrows

Description and Use

Use this sign for directional information that needs to be communicated overhead. Sign is double sided and both sides can be used for messages.

Message Configuration

(Refer to layout drawing for lettering sizes and dimensions)

Sign Components

Vary by sign family. Sliding rail component systems, curved and flat panels with vinyl applied graphics.

Graphic Process

Surface applied vinyl

Colors

Text and arrows: refer to color chart
Background: refer to color chart

Typography

Helvetica Bold
Helvetica Bold Condensed
76 mm (3") and 51 mm (2") cap height required for all text.

Mounting.

Ceiling hung 2134 mm (7'-0") from floor.

Installation

From the ceiling. Braided stainless steel wire or rod. Sign must not be attached directly to "T Grid" or lift out ceiling tile.

Recommendations

This sign is for use in corridors to direct patients and public through the building. Because of required letter height, there is a limit to the length of messages and a limit to number of messages.

Verify that ceiling height will accommodate sign height. Clearance requirement is 2134 mm (84").

Sign Type	Layout	Width	Height	Text Size	Sign Family	Directional Arrows	Department ID
IN-15.62	A	80"	12"	3"	All	x	
IN-15.62	B	80"	12"	3"	All		x
IN-15.62	C	80"	12"	2"	All	x	
IN-15.62	D	80"	12"	2"	All		x
IN-15.62	E	80"	12"	2" & 3"	Insert Only	x	x

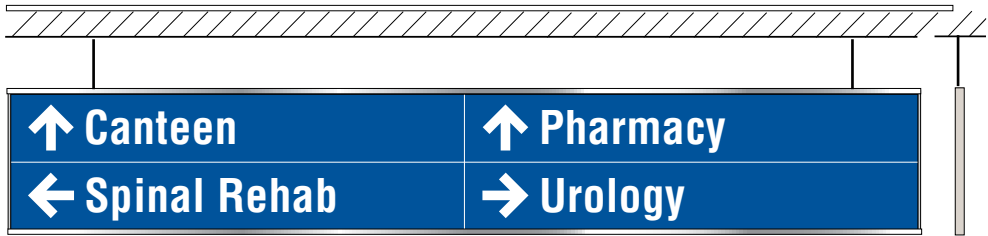

Message Layout A



Message Layout B

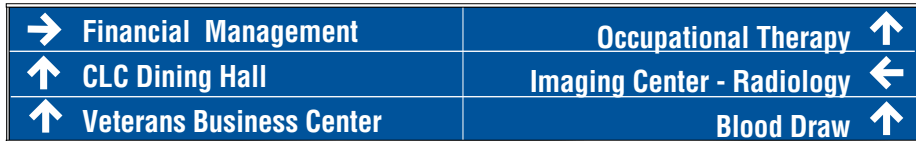

Message Layout C

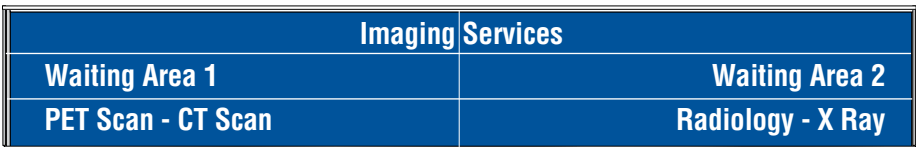

Message Layout D

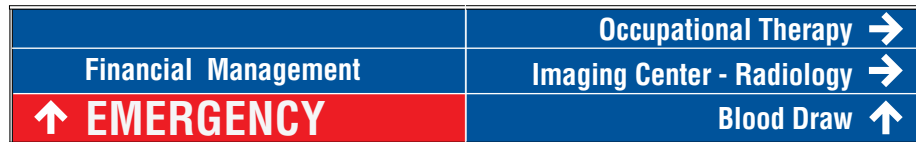

Message Layout E

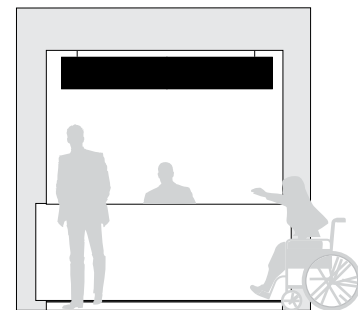
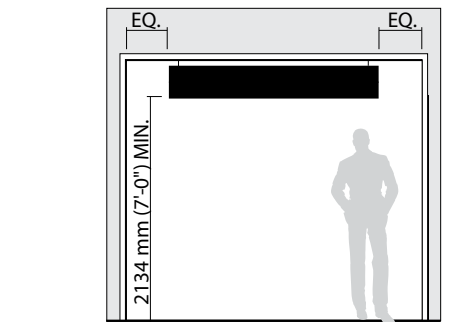

Ceiling Mounted Directional and Department ID

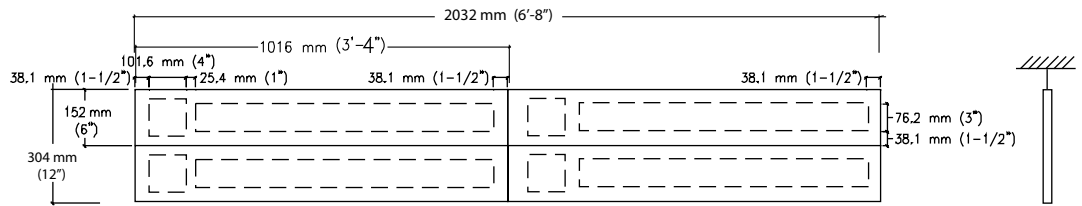

Message Layout A

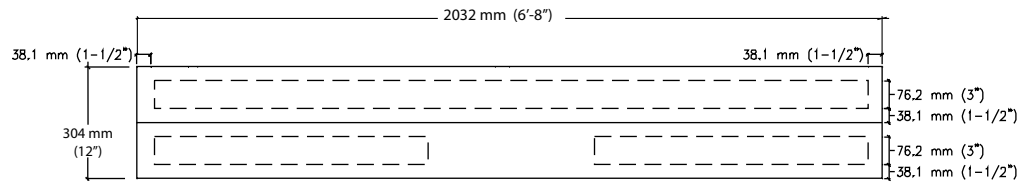

Message Layout B

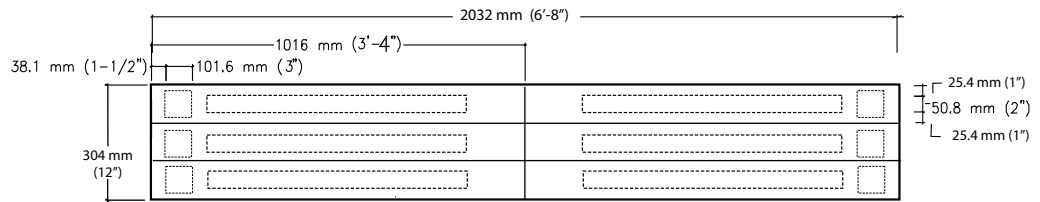

Message Layout C

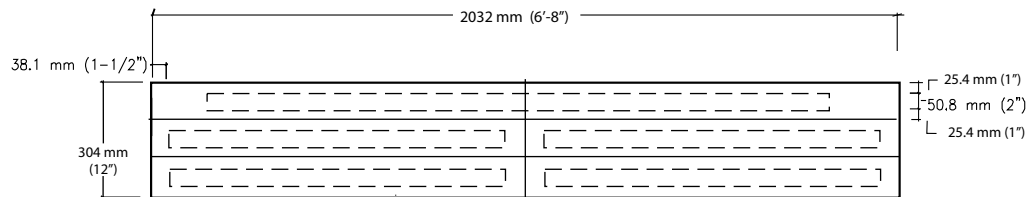

Message Layout D

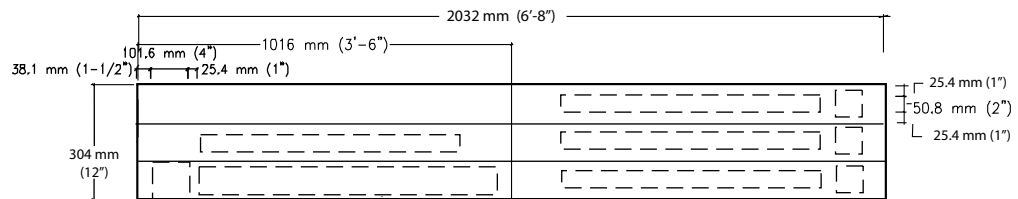

Message Layout E

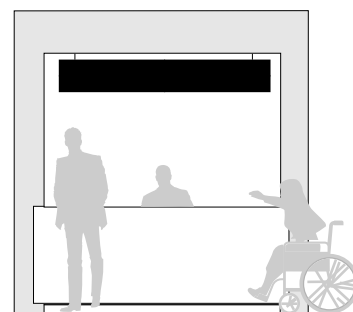
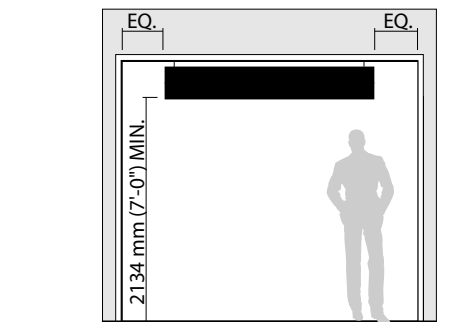

Ceiling Mounted Directional and Department ID

Size

IN-15.63
457 mm x 2032 mm
(18" x 80") 3" and 2" text with and without directional arrows

Description and Use

Use this sign for directional information that needs to be communicated overhead. Sign is double sided and both sides can be used for messages.

Message Configuration

(Refer to layout drawing for lettering sizes and dimensions)

Sign Components

Vary by sign family. Sliding rail component systems, curved and flat panels with vinyl applied graphics.

Graphic Process

Surface applied vinyl.

Colors

Text and arrows: refer to color chart
Background: refer to color chart

Typography

Helvetica Bold
Helvetica Bold Condensed
76 mm and 51 mm (3" and 2") cap height required for text per layout

Mounting

Ceiling hung 2134 mm (7'-0") from floor.

Installation

From the ceiling. Braided stainless steel wire or rod. Sign must not be attached directly to "T Grid" or lift out ceiling tile.

Recommendations

This sign is for use in corridors to direct patients and public through the building. Because of required letter height, there is a limit to the length of messages and a limit to number of messages.

Verify that ceiling height will accommodate sign height. Clearance requirement is 2134 mm (84").

Sign Type	Layout	Width	Height	Text Size	Sign Family	Directional Arrows	Department ID
IN-15.63	A	80"	18"	3"	All	x	
IN-15.63	B	80"	18"	3"	All		x
IN-15.63	C	80"	18"	2"	All	x	
IN-15.63	D	80"	18"	2"	All		x
IN-15.63	E	80"	18"	2" & 3"	All	x	x

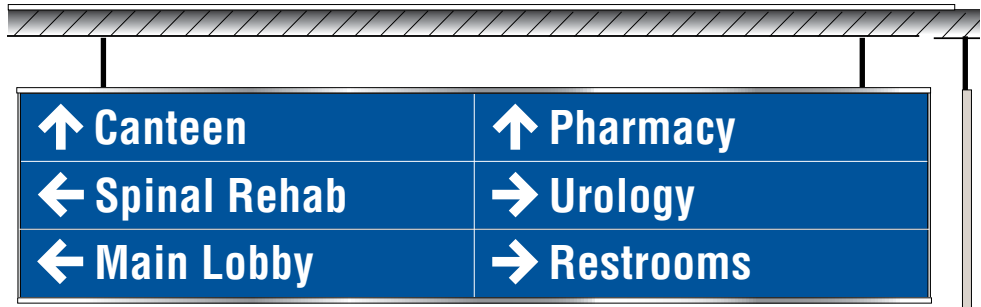

Message Layout A

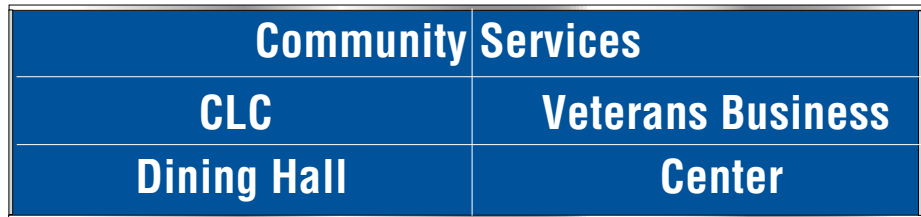

Message Layout B



Message Layout C

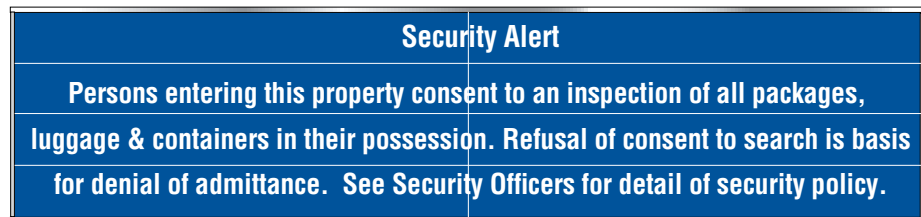

Message Layout D



Message Layout E

Ceiling Mounted Directional and Department ID

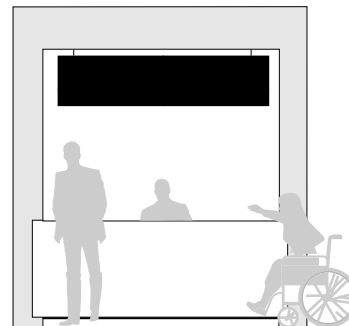
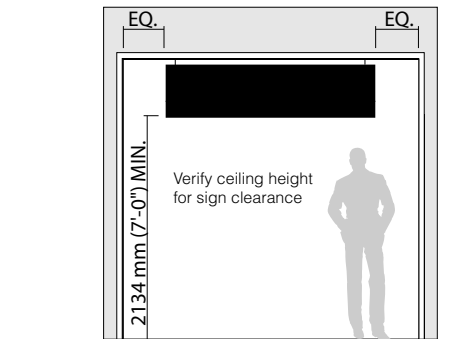
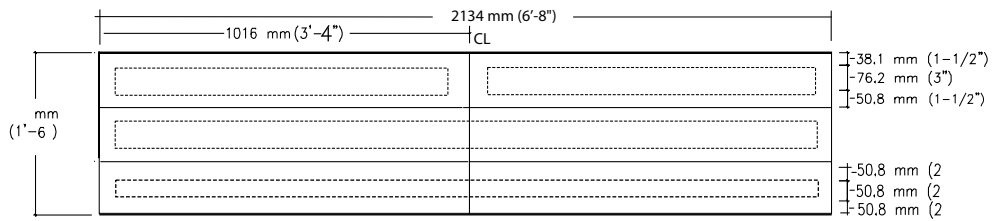
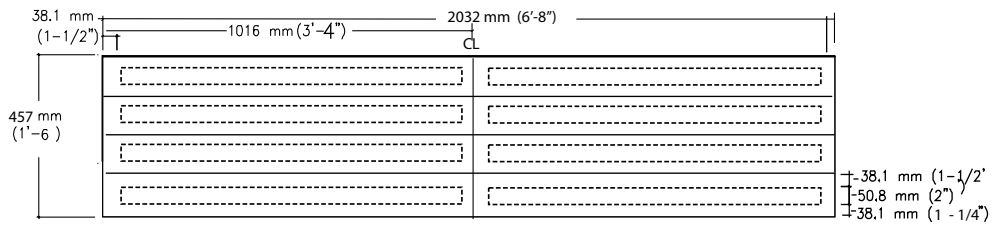
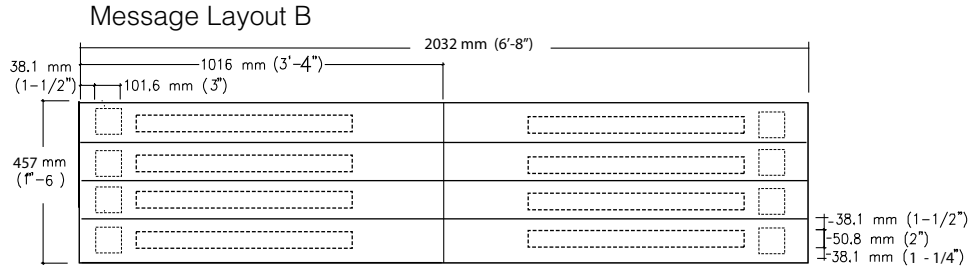
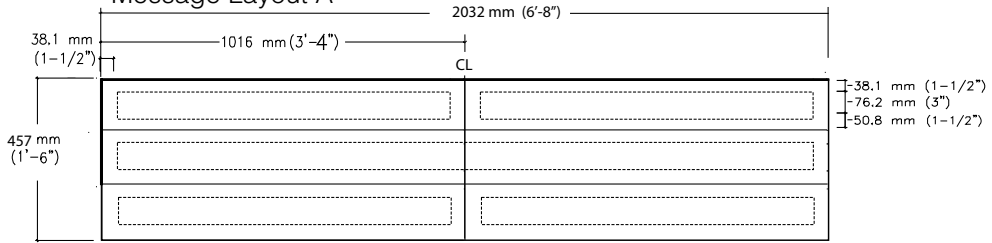
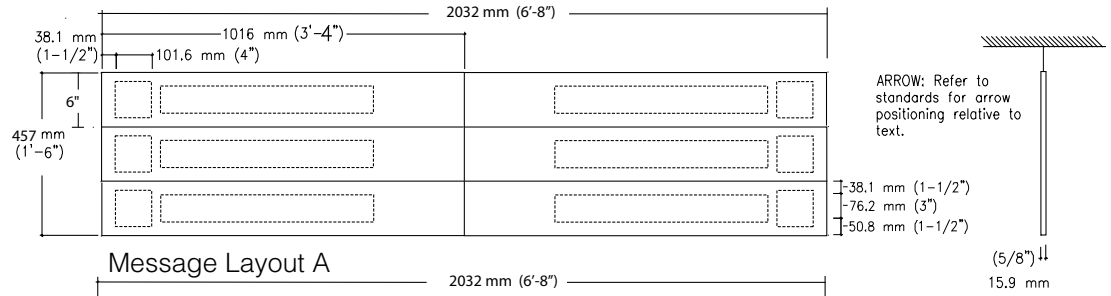

IN-15.65

Interior Signs

Ceiling Mounted Directional and Department ID with Insert

Size

IN-15.65
152 mm x 2032 mm
(6" x 80") 3" and 2" text with and without directional arrows

Description and Use

Use this sign for directional information that needs to be communicated overhead. Sign is double sided and both sides can be used for messages.

Message Configuration

(Refer to layout drawing for lettering sizes and dimensions)

Sign Components

Vary by sign family. Sliding rail component systems, curved and flat with inserts digital print.

Graphic Process

Digital print with clear lens cover

Colors

Text and arrows: refer to color chart
Background: refer to color chart

Typography

Helvetica Bold
Helvetica Bold Condensed
76 mm (3") and 51 mm (2") cap height required for all text.

Installation

Hang from ceiling 2134 mm (7'-0") from floor

Recommendations

This sign is for use in corridors to direct patients and public through the building. Because of required letter height, there is a limit to the length of messages and a limit to number of messages.

Verify that ceiling height will accommodate sign height.
Clearance requirement is 2134 mm (84").

Sign Type	Layout	Width	Height	Text Size	Sign Family	Directional Arrows	Department ID
IN-15.65	A	80"	6"	3"	All	x	
IN-15.65	B	80"	6"	3"	All		x
IN-15.65	C	80"	6"	2"	All	x	
IN-15.65	D	80"	6"	3" & 2"	All		x

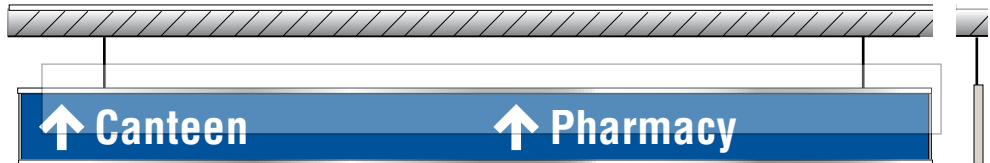

Message Layout A



Message Layout B



Message Layout C



Message Layout D

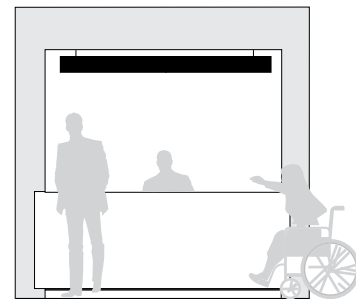
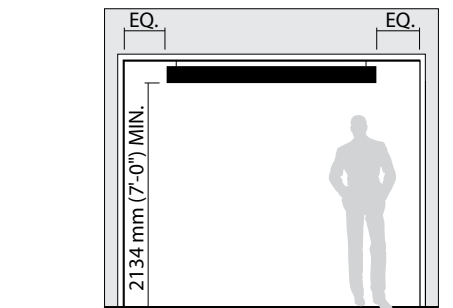

Ceiling Mounted Directional and Department ID with Insert

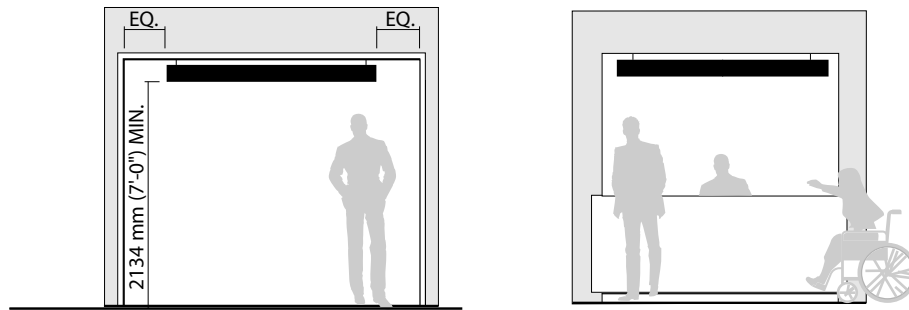
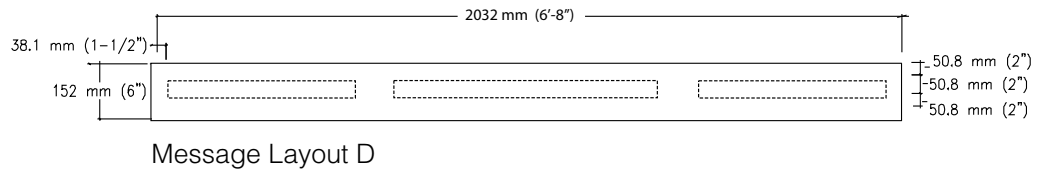
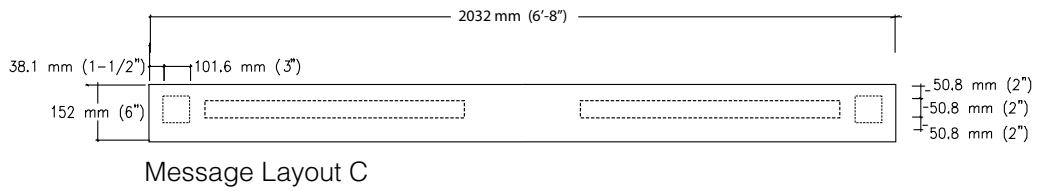
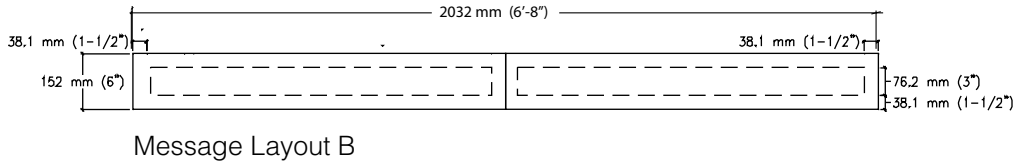
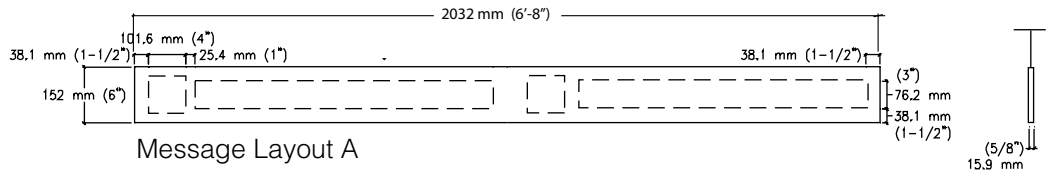

IN-15.66

Interior Signs

Ceiling Mounted Directional and Department ID with Insert

Size

IN-15.66
305 mm x 2032 mm
(12" x 80") 3" and 2" text with and without directional arrows

Description and Use

Use this sign for directional information that needs to be communicated overhead. Sign is double sided and both sides can be used for messages.

Message Configuration

(Refer to layout drawing for lettering sizes and dimensions)

Sign Components

Vary by sign family. Sliding rail component systems, curved and flat panels with digital print inserts.

Graphic Process

Digital print insert with clear lens cover.

Colors

Text and arrows: refer to color chart
Background: refer to color chart

Typography

Helvetica Bold
Helvetica Bold Condensed
76 mm (3") and/or (2") cap height required for text per layout.

Mounting

Ceiling hung 2134 mm (7'-0") from floor.

Installation

From the ceiling. Braided stainless steel wire or rod. Sign must not be attached directly to "T Grid" or lift out ceiling tile.

Recommendations

This sign is for use in corridors to direct patients and public through the building. Because of required letter height, there is a limit to the length of messages and a limit to number of messages.

Verify that ceiling height will accommodate sign height. Clearance requirement is 2134 mm (84").

Sign Type	Layout	Width	Height	Text Size	Sign Family	Directional Arrows	Department ID
IN-15.66	A	80"	12"	3"	All	x	
IN-15.66	B	80"	12"	3"	All		x
IN-15.66	C	80"	12"	2"	All	x	
IN-15.66	D	80"	12"	2"	All		x
IN-15.66	E	80"	12"	2" & 3"	All	x	x

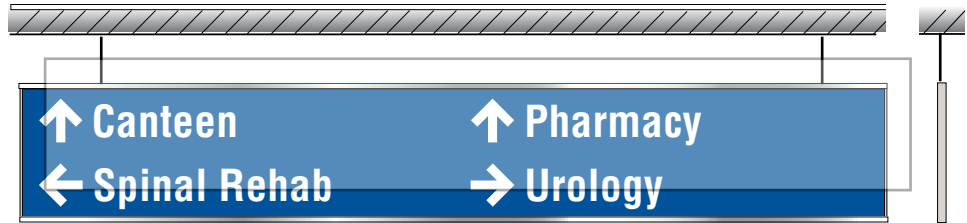

Message Layout A



Message Layout B

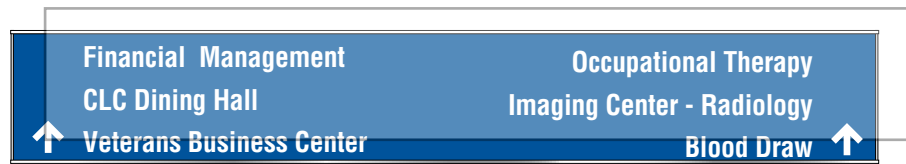

Message Layout C

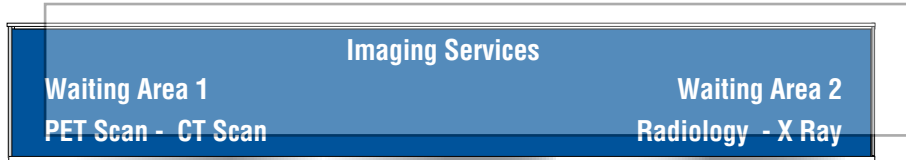

Message Layout D

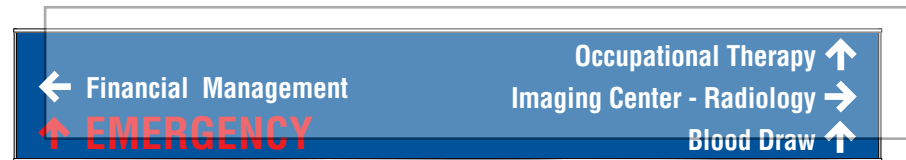

Message Layout E

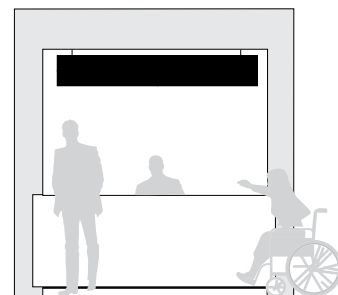
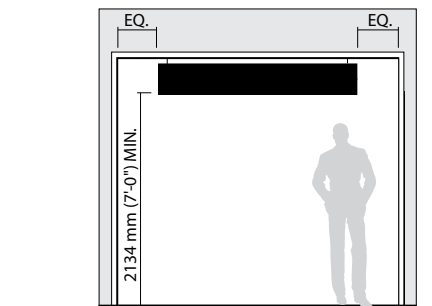

Ceiling Mounted Directional and Department ID with Insert

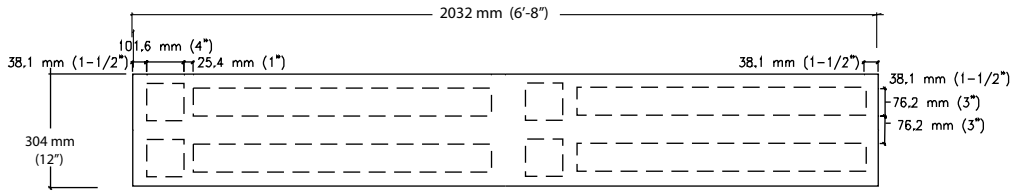

Message Layout A

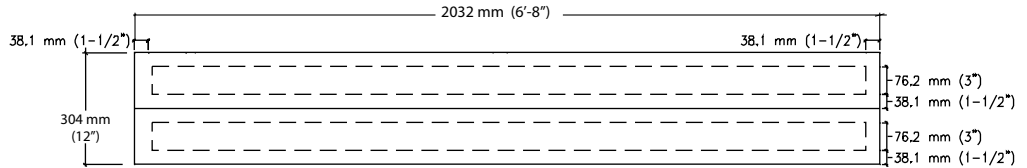

Message Layout B

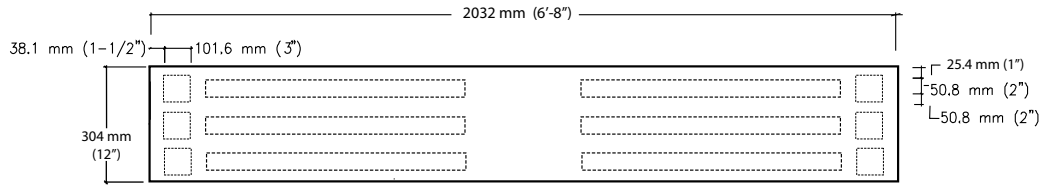

Message Layout C

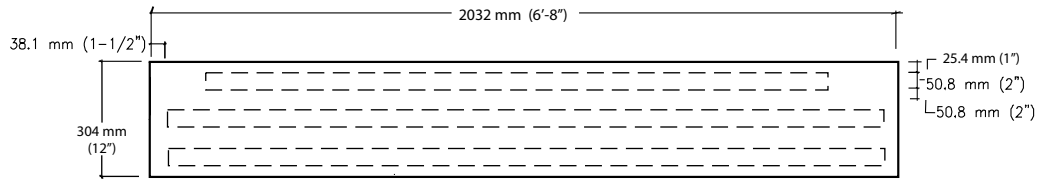

Message Layout D

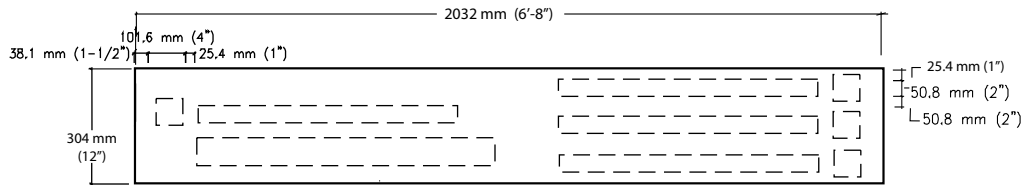

Message Layout E

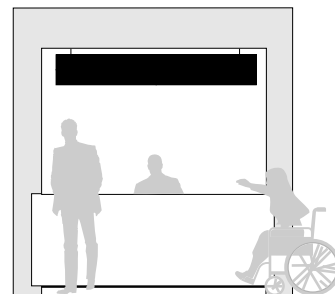
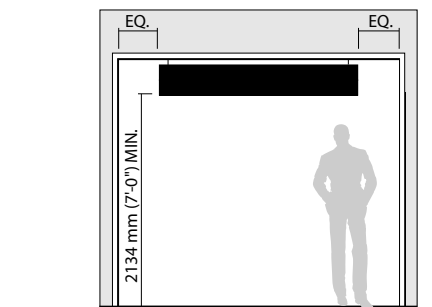

Ceiling Mounted Directional and Department ID with Insert

Size

IN-15.67
457 mm x 2032 mm
(18" x 80") 3" and 2" text with and without directional arrows

Description and Use

Use this sign for directional information that needs to be communicated overhead. Sign is double sided and both sides can be used for messages.

Message Configuration

(Refer to layout drawing for lettering sizes and dimensions)

Sign Components

Vary by sign family. Sliding rail component systems, curved and flat panels with digital print graphic.

Graphic Process

Digital print insert with clear lens cover.

Colors

Text and arrows: refer to color chart
Background: refer to color chart

Typography

Helvetica Bold
Helvetica Bold Condensed
76 mm (3") and/or (2") cap height required for text per layout.

Mounting

Ceiling hung 2134 mm (7'-0") from floor.

Installation

From the ceiling. Braided stainless steel wire or rod. Sign must not be attached directly to "T Grid" or lift out ceiling tile.

Recommendations

This sign is for use in corridors to direct patients and public through the building. Because of required letter height, there is a limit to the length of messages and a limit to number of messages.

Verify that ceiling height will accommodate sign height. Clearance requirement is 2134 mm (84").

Sign Type	Layout	Width	Height	Text Size	Sign Family	Directional Arrows	Department ID
IN-15.67	A	80"	18"	3"	All	x	
IN-15.67	B	80"	18"	3"	All		x
IN-15.67	C	80"	18"	2"	All	x	
IN-15.67	D	80"	18"	2"	All		x
IN-15.67	E	80"	18"	2" & 3"	All	x	x

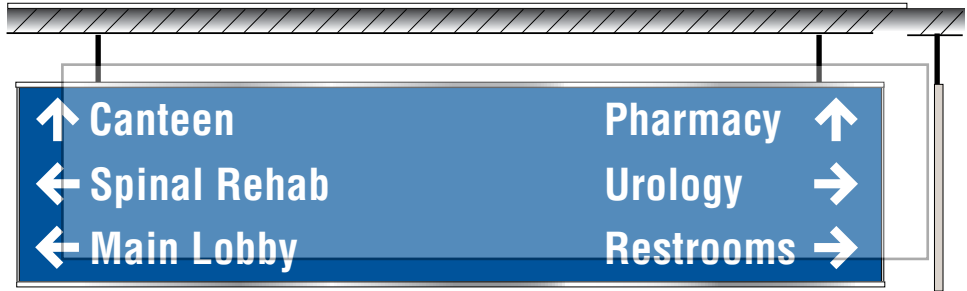

Message Layout A

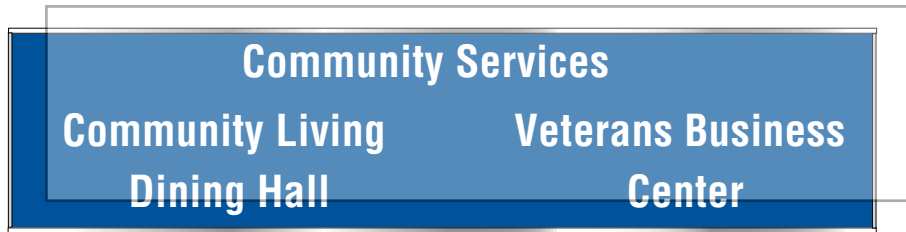

Message Layout B

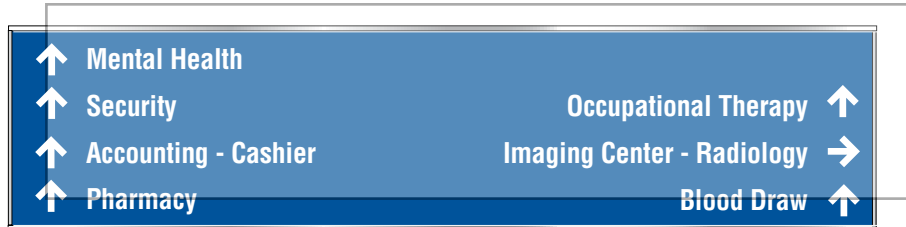

Message Layout C



Message Layout D

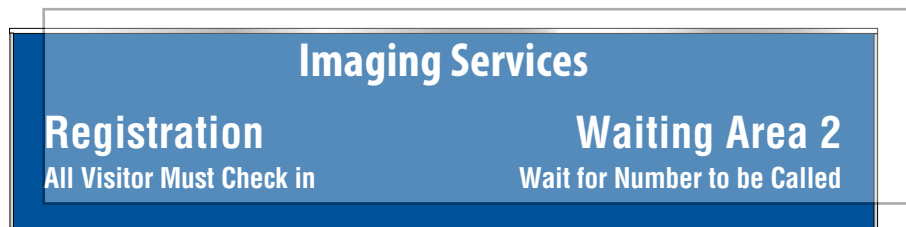

Message Layout E

Ceiling Mounted Directional and Department ID with Insert

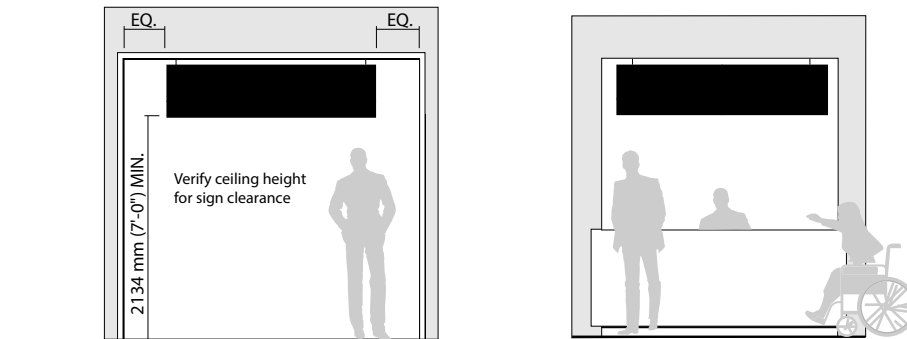
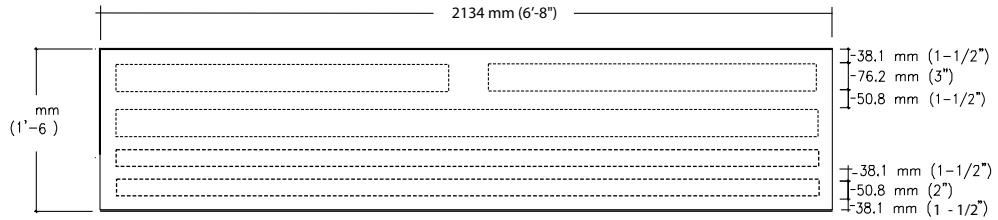
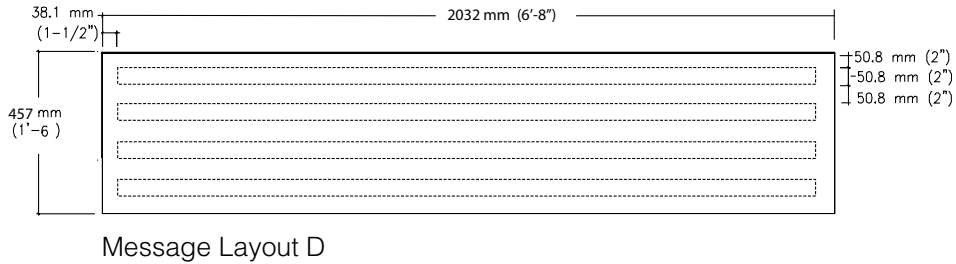
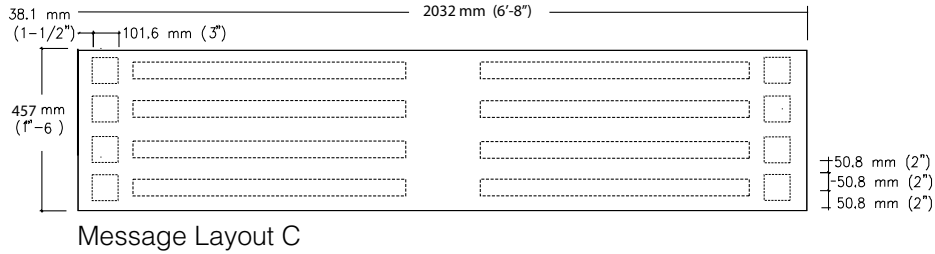
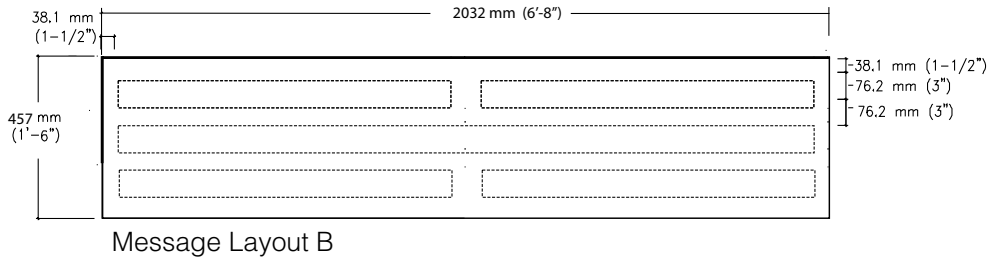
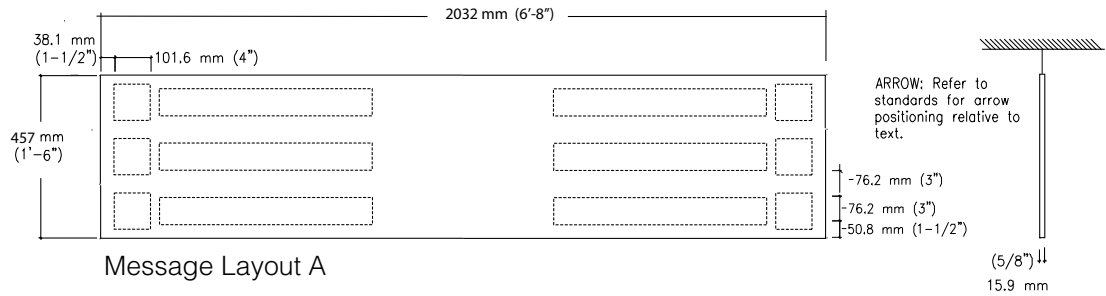

Soffit Mounted Directional and Identification

Size

IN-16.51
152 mm x 1016 mm
(6" x 40") 3" and 2" text with and without directional arrows

Description and Use

Use this sign for directional and department identification information that needs to be communicated overhead. Sign is single sided mounted on wall or over doorway.

Message Configuration

(Refer to layout drawing for lettering sizes and dimensions)

Sign Components

Vary by sign family. Sliding rail component systems, curved and flat panels with vinyl applied graphics.

Graphic Process

Surface applied vinyl

Colors

Text and arrows: refer to color chart
Background: refer to color chart

Typography

Helvetica Bold
Helvetica Bold Condensed
76 mm (3") and 51 mm (2") cap height.

Installation

Secure to wall with physical fasteners

Recommendations

This sign is for use in corridors to direct patients and public through the building. Because of required letter height there is a limit to the length of messages and a limit to the number of messages.

Sign Type	Layout	Width	Height	Text Size	Sign Family	Directional Arrows	Department ID
IN-16.51	A	40"	6"	3"	All	x	
IN-16.51	B	40"	6"	3"	All		x
IN-16.51	C	40"	6"	2"	All	x	x

Message Layout A (Directional with Arrows)

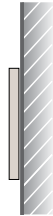

Message Layout B (Department I.D.)



Message Layout C

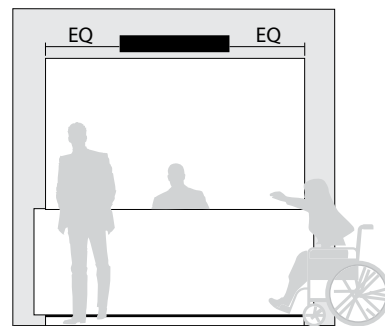
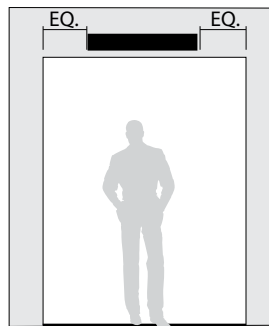

Soffit Mounted Directional and Identification

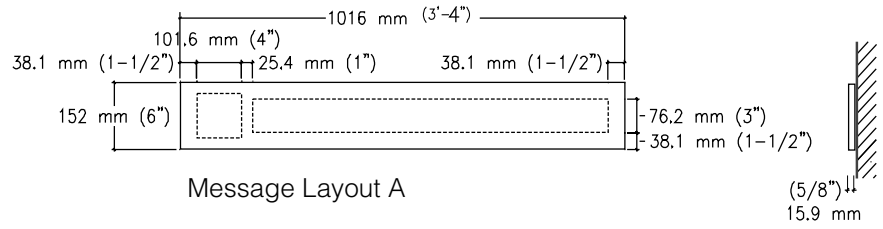

Message Layout A

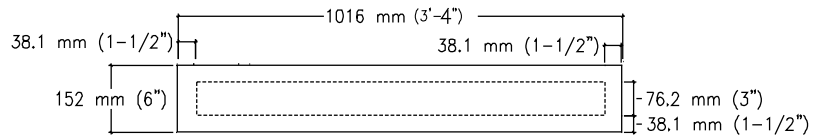

Message Layout B

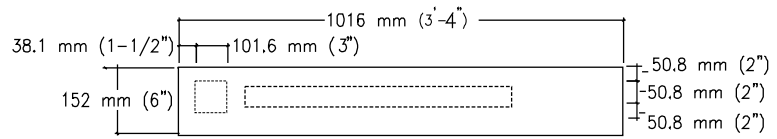

Message Layout C

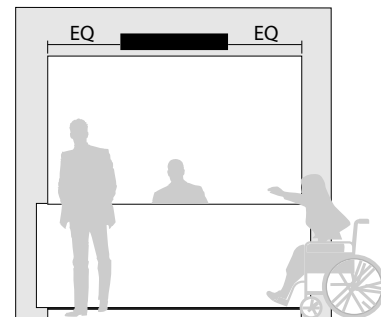
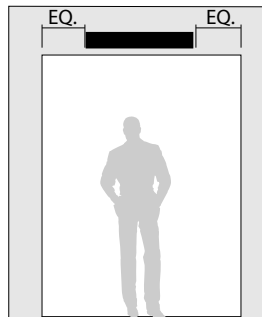

Soffit Mounted Directional and Identification

Size

IN-16.52
305 mm x 1016 mm
(12" x 40") 3" and 2" text with and without directional arrows

Description and Use

Use this sign for directional information that needs to be communicated overhead. Sign is single sided soffit mount

Message Configuration

(Refer to layout drawing for lettering sizes and dimensions)

Sign Components

Vary by sign family. Sliding rail component systems, curved and flat panels with vinyl applied graphics.

Graphic Process

Surface applied vinyl,

Colors

Text and arrows: refer to color chart.
Background color: refer to color chart

Typography

Helvetica Bold
Helvetica Bold Condensed
76 mm (3") and 51 mm (2") cap height

Installation

Secure to wall with physical fasteners.

Recommendations

This sign is for use in corridors to direct patients and public through the building. Because of required letter height there is a limit to the length of messages and a limit to the number of messages.

Sign Type	Layout	Width	Height	Text Size	Sign Family	Directional Arrows	Department ID
IN-16.52	A	40"	12"	3"	All	x	
IN-16.52	B	40"	12"	3"	All		x
IN-16.52	C	40"	12"	2"	All	x	
IN-16.52	D	40"	12"	2"	All		x
IN-16.52	E	40"	12"	2" & 3"	All	x	x

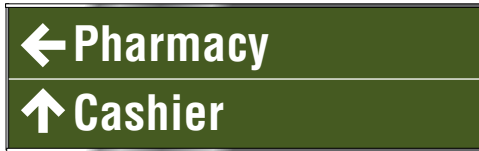

Message Layout A

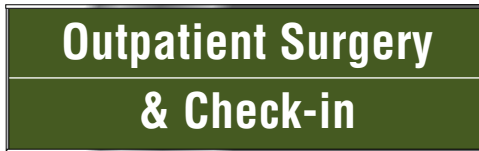

Message Layout B

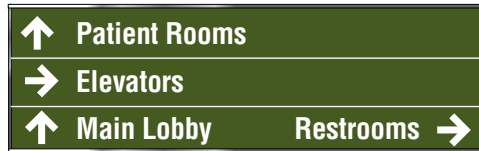

Message Layout C



Message Layout D



Message Layout E

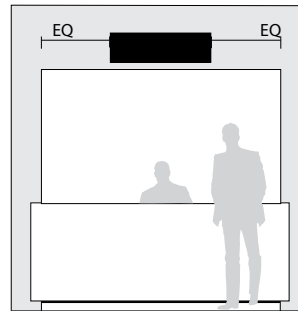
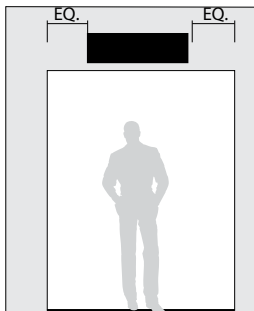

Soffit Mounted Directional and Identification

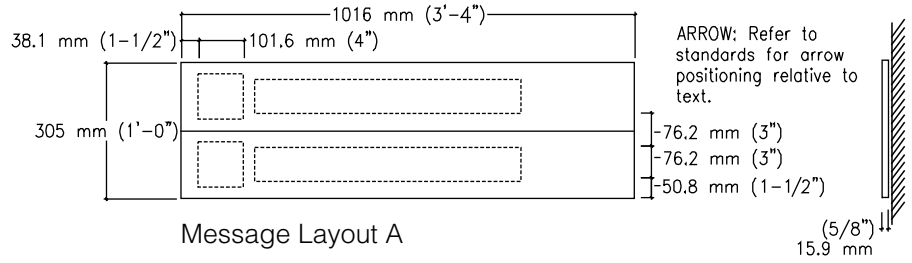

Message Layout A

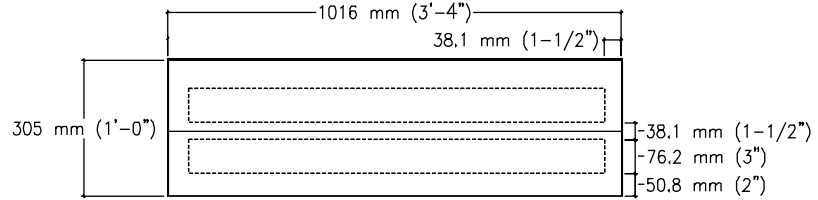

Message Layout B

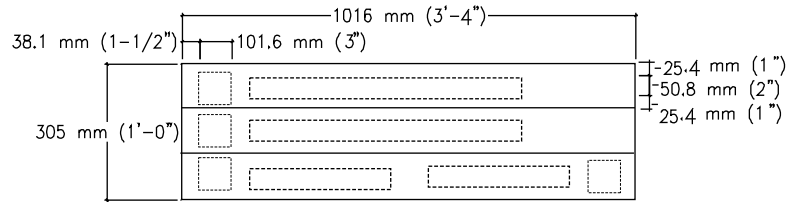

Message Layout C

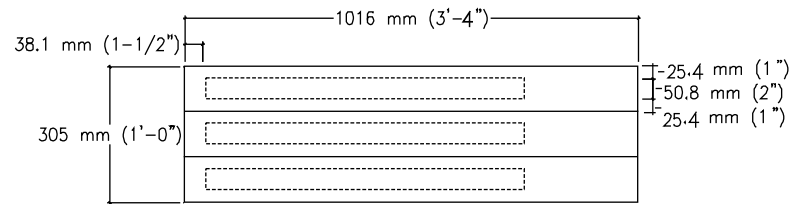

Message Layout D

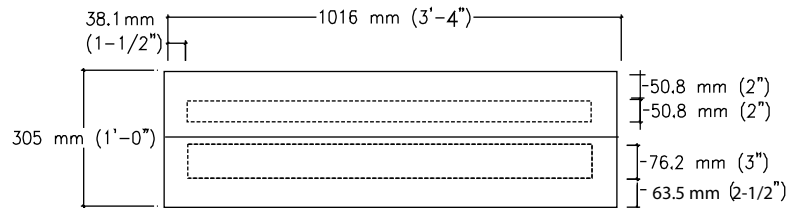

Message Layout E

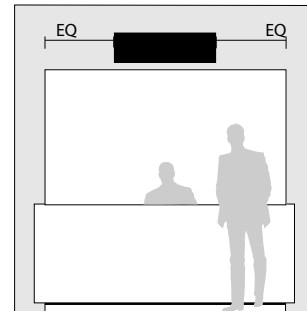
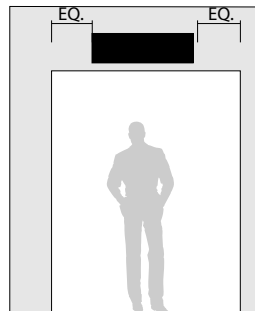

Soffit Mounted Directional and Identification

Size

IN-16.53
457 mm x 1016 mm
(18" x 40") 76 mm (3") and 51 mm
(2") text with and without directional
arrows

Description and Use

Use this sign for directional
information that needs to be
communicated overhead. Sign
is single sided wall mount over
header or doorway.

Message Configuration

(Refer to layout drawing for lettering
sizes and dimensions)

Sign Components

Vary by sign family. Sliding rail
component systems, curved and
flat vinyl applied graphics.

Graphic Process

Surface applied vinyl.

Colors

Text and arrows: refer to color
chart.
Background: refer to color chart.

Typography

Helvetica Bold
Helvetica Bold Condensed
76 mm (3") and 51 mm (2") cap
height required for text per layout.

Installation

Secure to wall with physical
fasteners.

Recommendations

This sign is for use in corridors to
direct patients and public through
the building. Because of required
letter height there is a limit to the
length of messages and a limit to
the number of messages.

Sign Type	Layout	Width	Height	Text Size	Sign Family	Directional Arrows	Department ID
IN-16.53	A	40"	18"	3"	All	x	
IN-16.53	B	40"	18"	3"	All		x
IN-16.53	C	40"	18"	2"	All	x	
IN-16.53	D	40"	18"	2"	All		x
IN-16.53	E	40"	18"	2" & 3"	All	x	x

Message Layout A



Message Layout B



Message Layout C



Message Layout D



Message Layout E

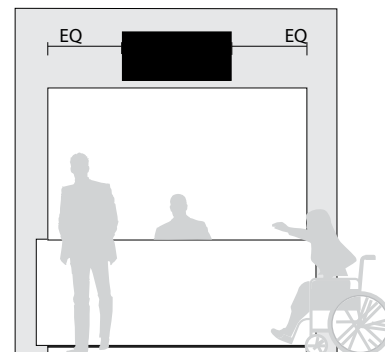
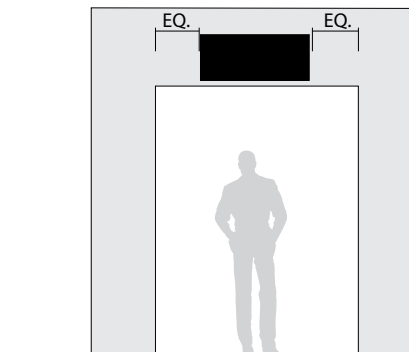

Soffit Mounted Directional and Identification

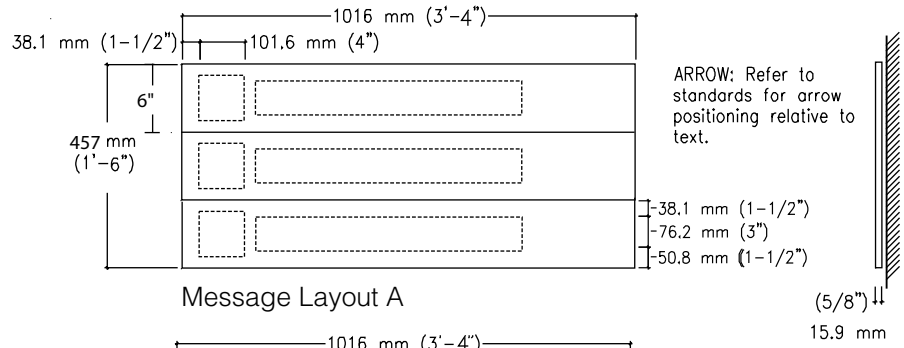

Message Layout A

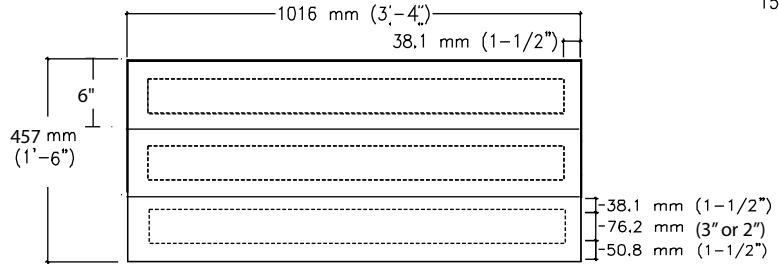

Message Layout B & E

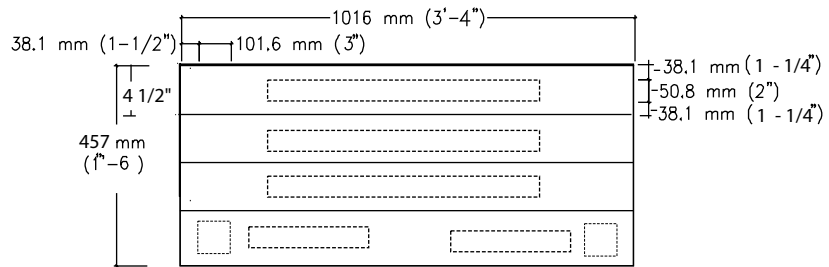

Message Layout C

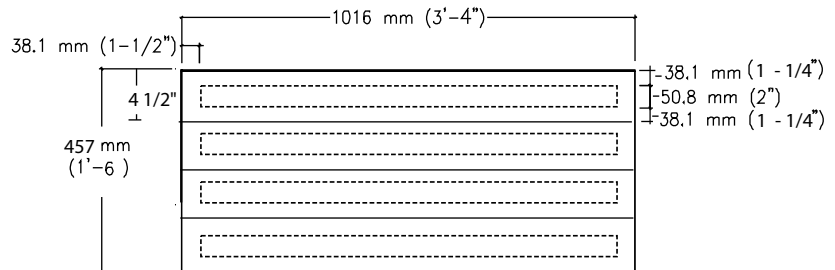

Message Layout D

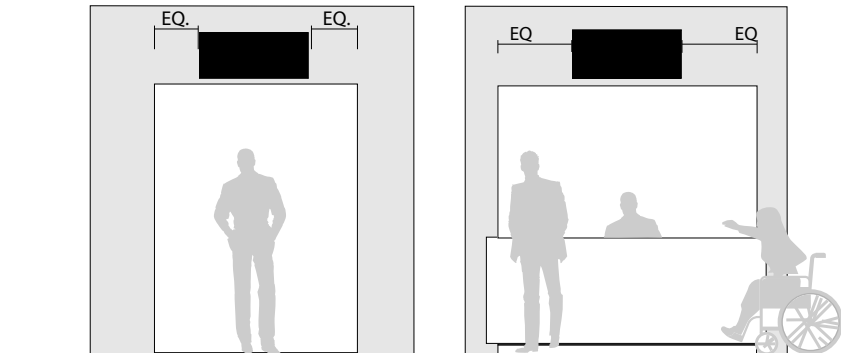

Soffit Mounted Directional and Identification with Insert

Size

IN-16.55
152 mm x 1016 mm
(6" x 40") 3" and 2" text with and without directional arrows

Description and Use

Use this sign for directional and department identification information that needs to be communicated overhead. Sign is single sided mounted on wall or over doorway

Message Configuration

(Refer to layout drawing for lettering sizes and dimensions).

Sign Components

Vary by sign family. Sliding rail component systems, curved and flat panels with digital graphic insert.

Graphic Process

Digital print graphic insert with clear lens cover.

Colors

Text and arrows: refer to color chart
Background: refer to color chart

Typography

Helvetica Bold
Helvetica Bold Condensed
76 mm (3") and 51 mm (2") cap height.

Installation

Secure to wall with physical fasteners.

Recommendations

This sign is for use in corridors to direct patients and public through the building. Because of required letter height there is a limit to the length of messages and a limit to the number of messages.

Sign Type	Layout	Width	Height	Text Size	Sign Family	Directional Arrows	Department ID
IN-16.55	A	40"	6"	3"	All	x	
IN-16.55	B	40"	6"	3"	All		x
IN-16.55	C	40"	6"	2"	All	x	x

Message Layout A (Directional with Arrows)



Message Layout B (Department ID)



Message Layout C

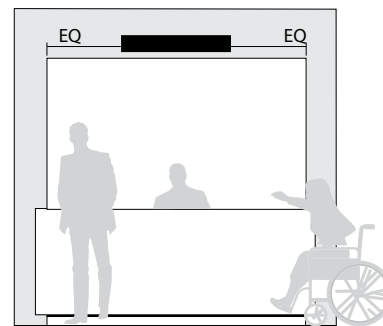
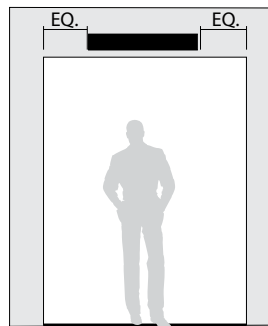

Soffit Mounted Directional and Identification with Insert

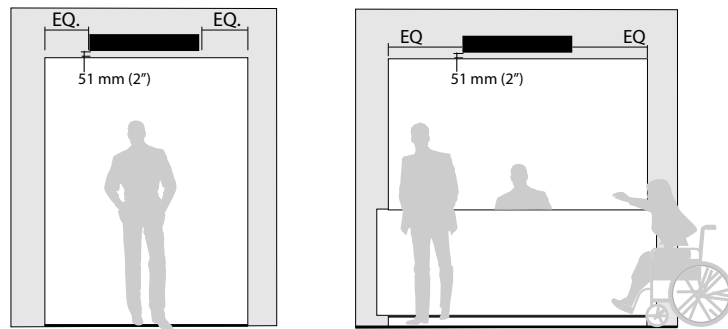
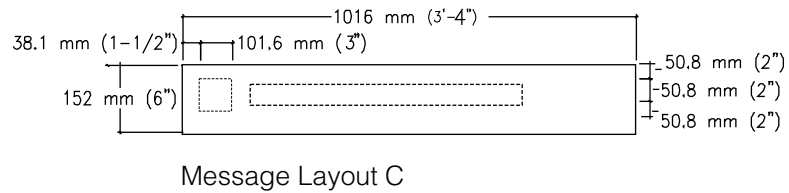
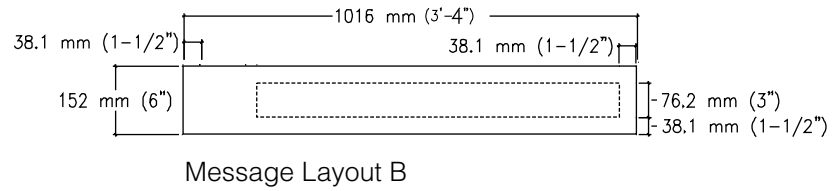
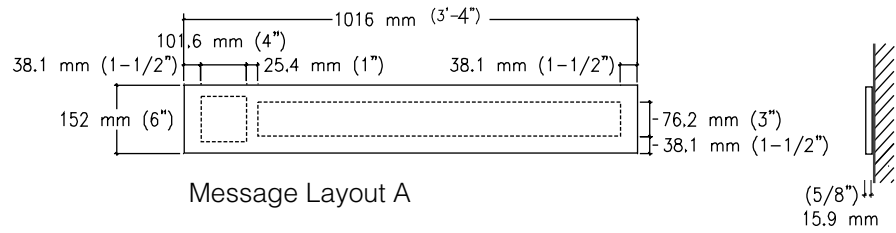

Soffit Mounted Directional and Identification with Insert

Size

IN-16.56
305 mm x 1016 mm
(12" x 40") 3" and 2" text with and without directional arrows

Description and Use

Use this sign for directional information that needs to be communicated overhead. Sign is single sided soffit mount.

Message Configuration

(Refer to layout drawing for lettering sizes and dimensions).

Sign Components

Vary by sign family. Sliding rail component systems, curved and flat panels with digital insert graphics.

Graphic Process

Digital print with clear lens cover.

Colors

Text and arrows: refer to color chart.
Background: refer to color chart.

Typography

Helvetica Bold
Helvetica Bold Condensed
76 mm (3") and 51 mm (2") cap height

Installation

Secure to wall with physical fasteners.

Recommendations

This sign is for use in corridors to direct patients and public through the building. Because of required letter height there is a limit to the length of messages and a limit to the number of messages.

Sign Type	Layout	Width	Height	Text Size	Sign Family	Directional Arrows	Department ID
IN-16.56	A	40"	12"	3"	All	x	
IN-16.56	B	40"	12"	3"	All		x
IN-16.56	C	40"	12"	2"	All	x	
IN-16.56	D	40"	12"	2"	All		x
IN-16.56	E	40"	12"	2" & 3"	All	x	x

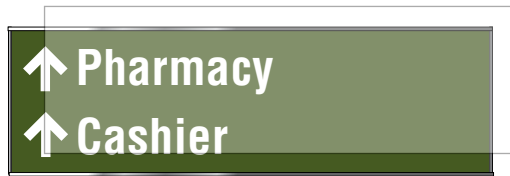

Message Layout A

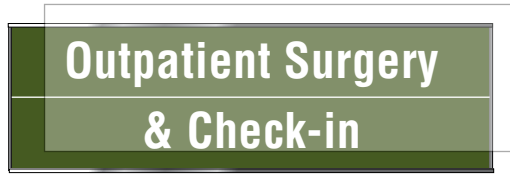

Message Layout B

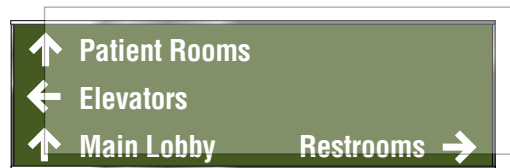

Message Layout C

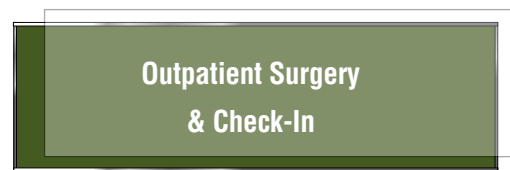

Message Layout D

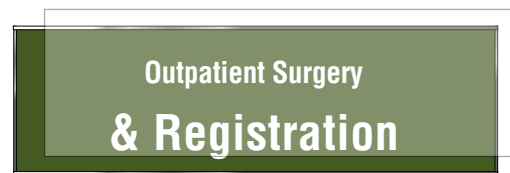

Message Layout E

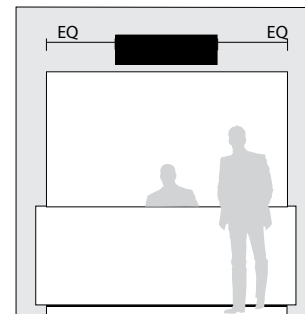
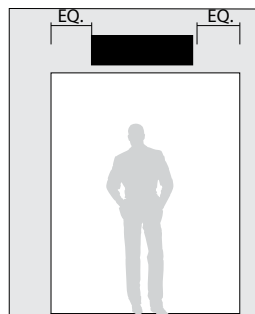

Soffit Mounted Directional and Identification with Insert

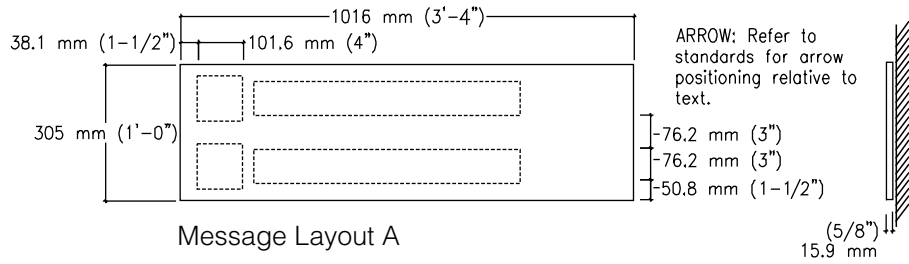

Message Layout A

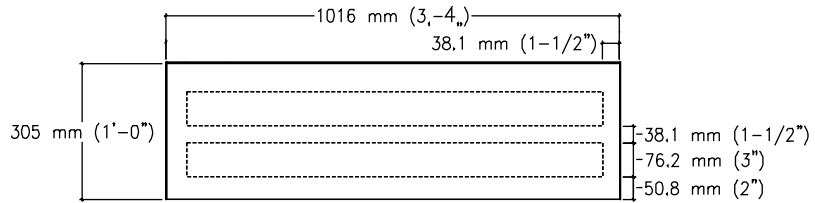

Message Layout B

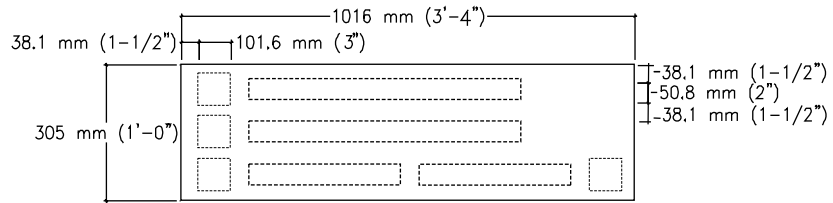

Message Layout C

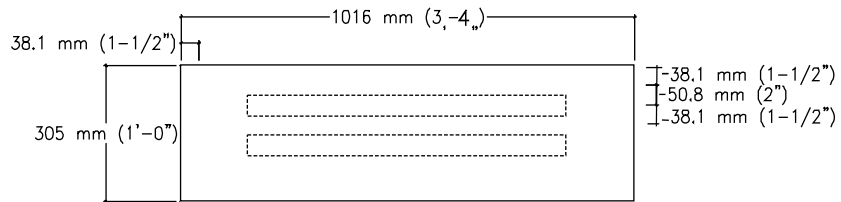

Message Layout D

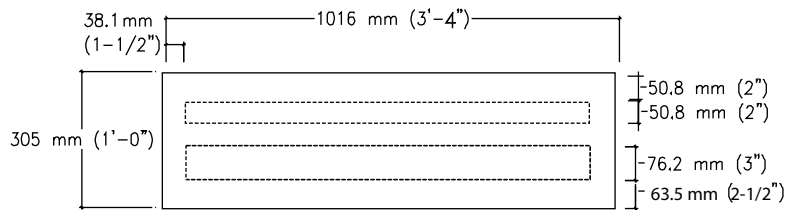

Message Layout E

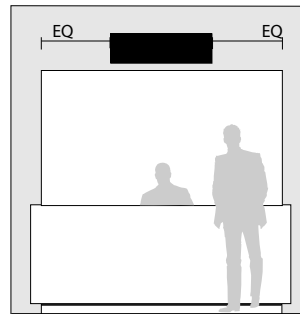
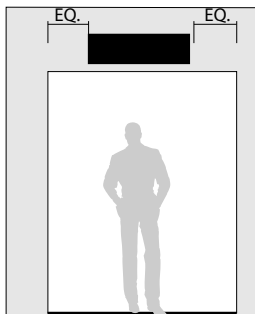

Soffit Mounted Directional and Identification with Insert

Size

N-16.57
457 mm x 1016 mm
(18" x 40") 3" and 2" text with and without directional arrows.

Description and Use

Use this sign for directional information that needs to be communicated overhead. Sign is single sided wall mount over header or doorway.

Message Configuration

(Refer to layout drawing for lettering sizes and dimensions)

Sign Components

Vary by sign family. Sliding rail component systems, curved and flat panels with digital print inserts.

Graphic Process

Digital print insert with clear lens cover.

Colors

Text and arrows: refer to color chart
Background: refer to color chart

Typography

Helvetica Bold
Helvetica Bold Condensed
76 mm (3") and 51 mm (2") cap height text

Installation

Secure to wall with physical fasteners.

Recommendations

This sign is for use in corridors to direct patients and public through the building. Because of required letter height there is a limit to the length of messages and a limit to the number of messages.

Sign Type	Layout	Width	Height	Text Size	Sign Family	Directional Arrows	Department ID
IN-16.57	A	40"	18"	3"	All	x	
IN-16.57	B	40"	18"	3"	All		x
IN-16.57	C	40"	18"	2"	All	x	
IN-16.57	D	40"	18"	2"	All		x
IN-16.57	E	40"	18"	2" & 3"	All	x	x

Message Layout A



Message Layout B



Message Layout C

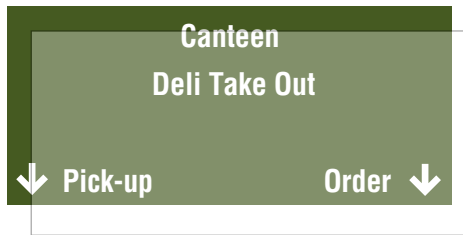

Message Layout D



Message Layout E

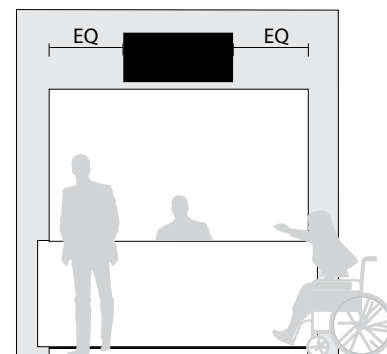
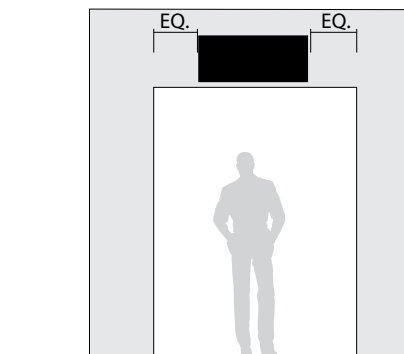

Soffit Mounted Directional and Identification with Insert

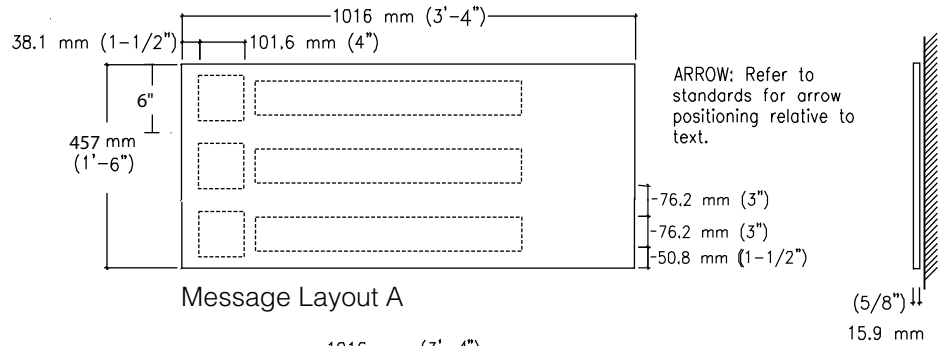

Message Layout A

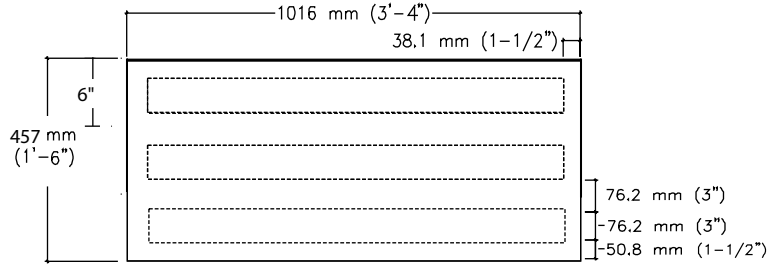

Message Layout B & E

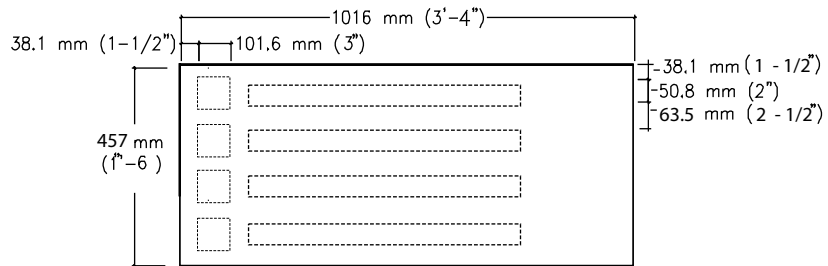

Message Layout C

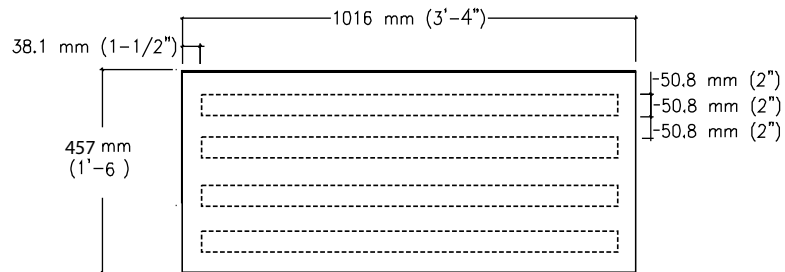

Message Layout D

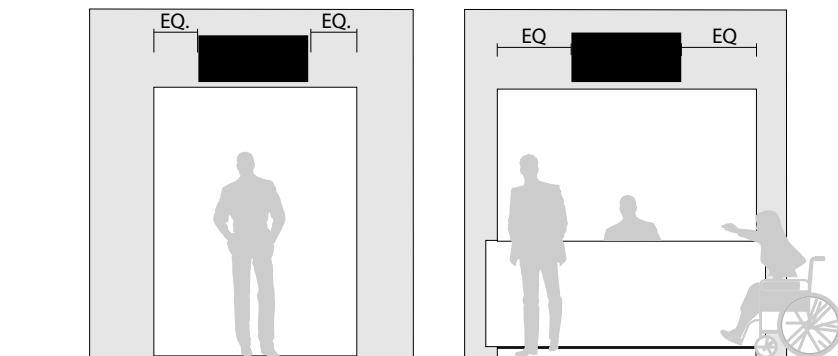

Soffit Mounted Directional and Identification

Size

IN-16.61
152 mm x 2032 mm
(6" x 80") 3" and 2" text with and without directional arrows

Description and Use

Use this sign for directional information that needs to be communicated overhead. Single sided wall mount over header or doorway.

Message Configuration

(Refer to layout drawing for lettering sizes and dimensions)

Sign Components

Vary by sign family. Sliding rail component systems, curved and flat panels with vinyl applied graphics.

Graphic Process

Surface applied vinyl.

Colors

Text and arrows: refer to color chart
Background: refer to color chart

Typography

Helvetica Bold
Helvetica Bold Condensed
76 mm (3") and 51 mm (2") cap height.

Installation

Secure to wall with physical fasteners.

Recommendations

This sign is for use in corridors to direct patients and public through the building. Because of required letter height there is a limit to the length of messages and a limit to the number of messages.

Sign Type	Layout	Width	Height	Text Size	Sign Family	Directional Arrows	Department ID
IN-16.61	A	80"	6"	3"	All	x	
IN-16.61	B	80"	6"	3"	All		x
IN-16.61	C	80"	6"	2"	All	x	
IN-16.61	D	80"	6"	2"	All		x



Message Layout A



Message Layout B

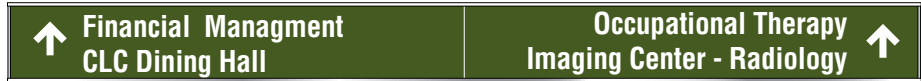

Message Layout C



Message Layout D

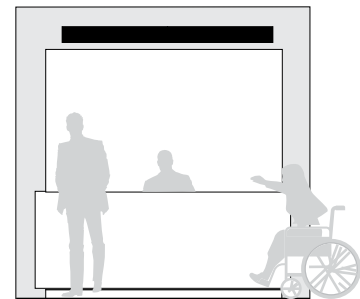
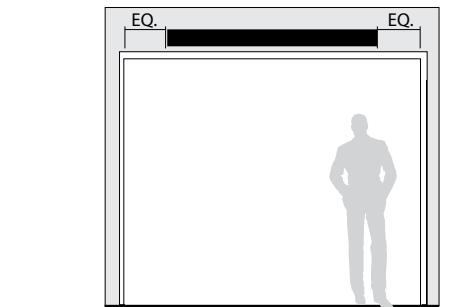

Soffit Mounted Directional and Identification

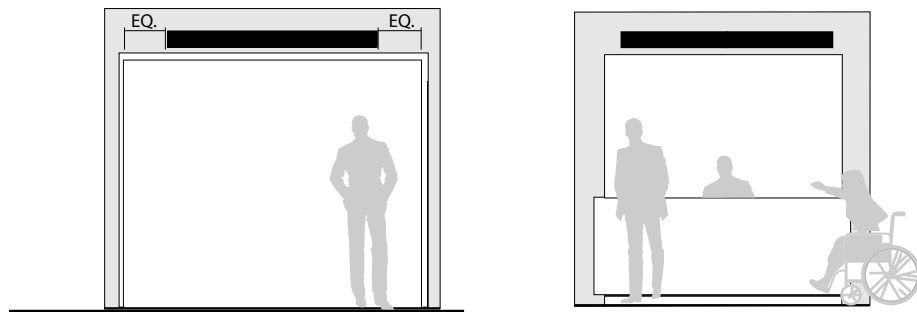
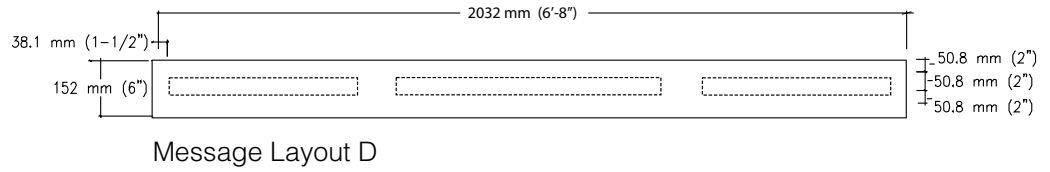
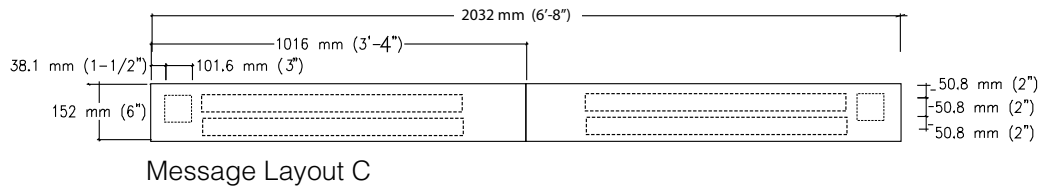
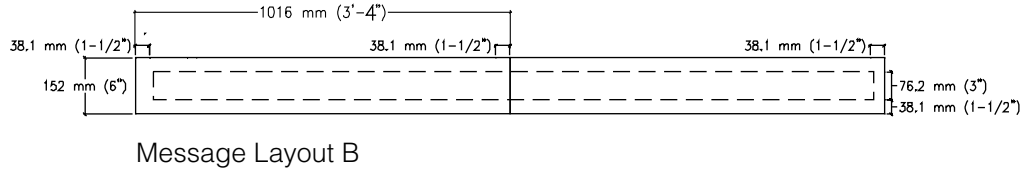
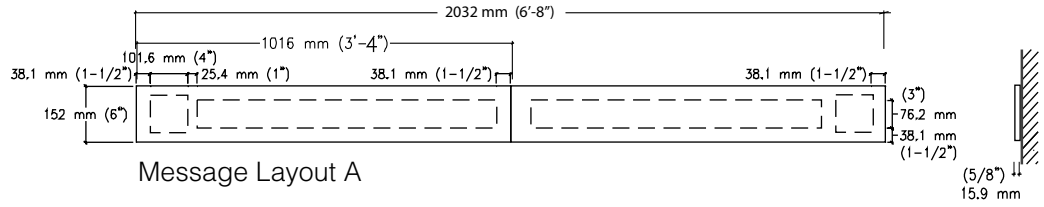

Soffit Mounted Directional and Identification

Size

IN-16.62
305 mm x 2032 mm
(12" x 80") 3" and 2" text with and without directional arrows

Description and Use

Use this sign for directional information that needs to be communicated overhead. Single sided wall mount over header or doorway.

Message Configuration

(Refer to layout drawing for lettering sizes and dimensions)

Sign Components

Varies by sign family. Sliding rail component systems, curved and flat panels with vinyl applied graphics.

Graphic Process

Surface applied vinyl.

Colors

Text and arrows: refer to color chart.
Background: refer to color chart.

Typography

Helvetica Bold
Helvetica Bold Condensed
75 mm (3") and or 50.8 mm (2") cap height

Installation

Secure to wall with physical fasteners.

Recommendations

This sign is for use in corridors to direct patients and public through the building. Because of required letter height there is a limit to the length of messages and a limit to the number of messages.

Sign Type	Layout	Width	Height	Text Size	Sign Family	Directional Arrows	Department ID
IN-16.62	A	80"	12"	3"	All	x	
IN-16.62	B	80"	12"	3"	All		x
IN-16.62	C	80"	12"	2"	All	x	
IN-16.62	D	80"	12"	2"	All		x

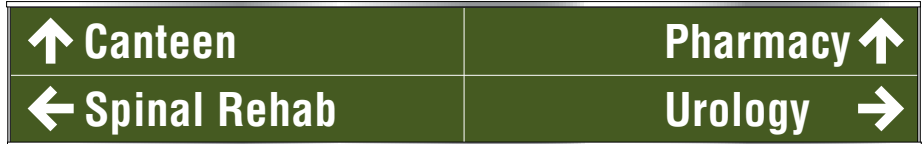

Message Layout A



Message Layout B

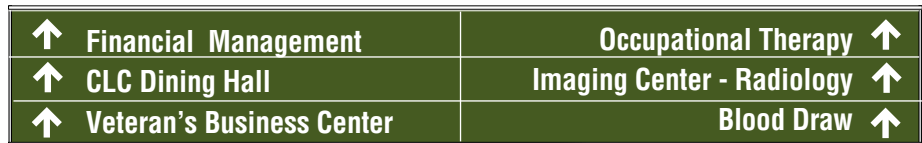

Message Layout C



Message Layout D

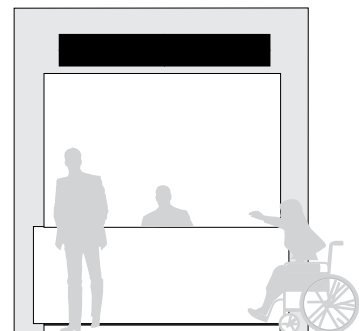
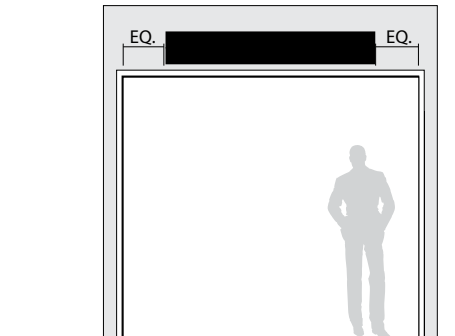

Soffit Mounted Directional and Identification

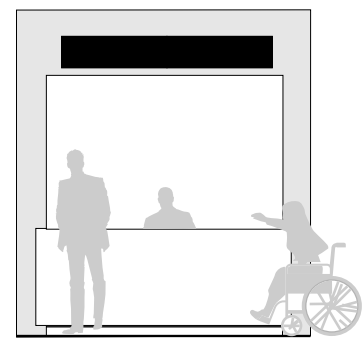
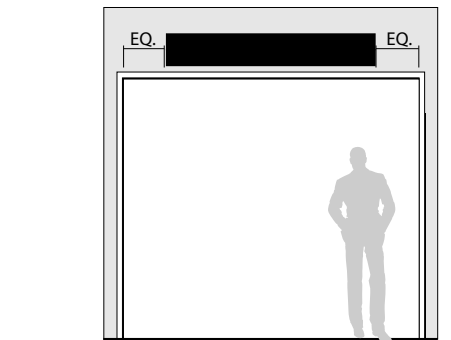
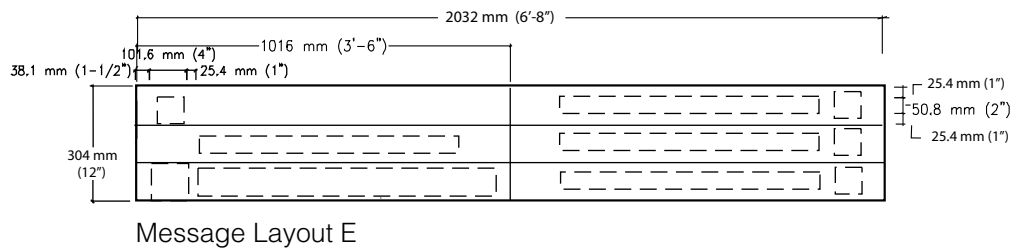
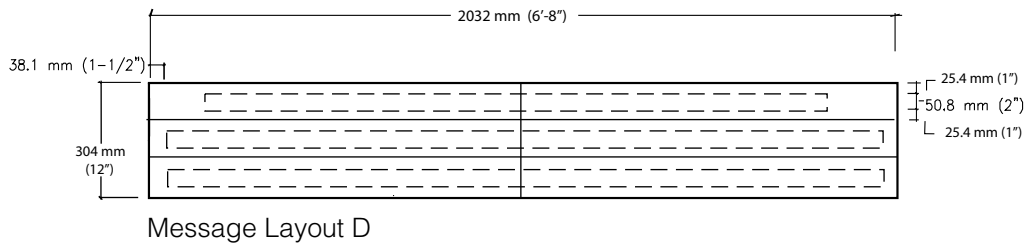
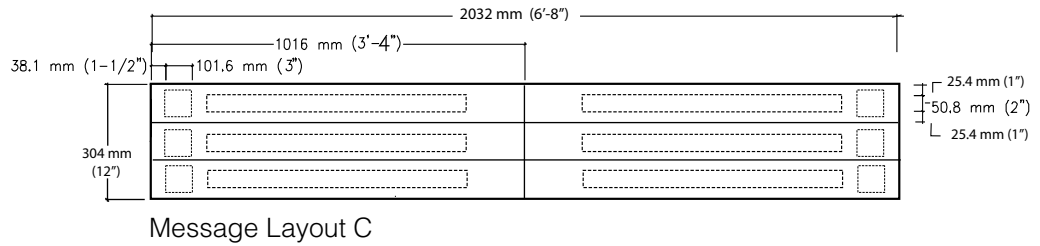
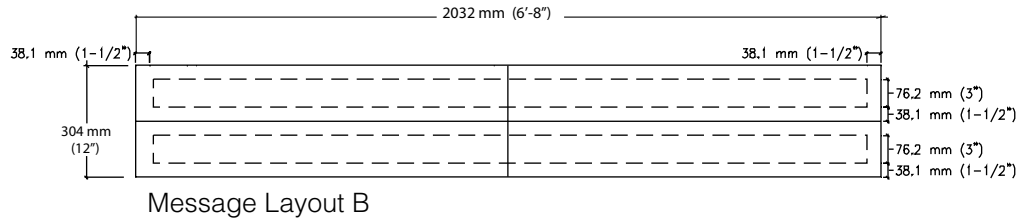
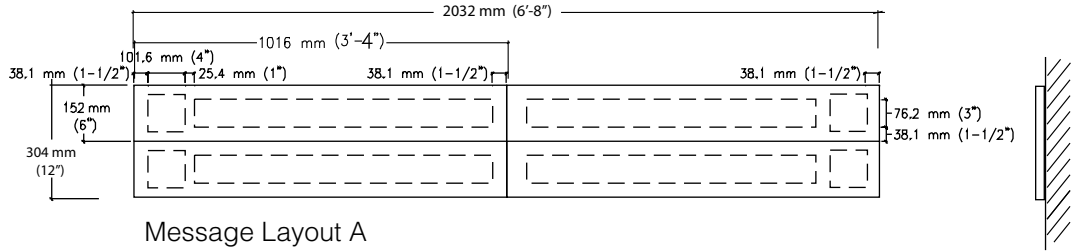

Soffit Mounted Directional and Identification

Size

IN-16.63
457 mm x 2032 mm
(18" x 80") 3" and 2" text with and without directional arrows

Description and Use

Use this sign for directional information that needs to be communicated overhead. Single sided wall mount over header or doorway.

Message Configuration

(Refer to layout drawing for lettering sizes and dimensions)

Sign Components

Vary by sign family. Sliding rail component systems, curved and flat panels with vinyl applied graphics.

Graphic Process

Surface applied vinyl.

Colors

Text and arrows: Refer to color chart
Background: Refer to color chart

Typography

Helvetica Bold
Helvetica Bold Condensed
76 mm (3") and 51 mm (2") cap height

Installation

Secure to wall with physical fasteners.

Recommendations

This sign is for use in corridors to direct patients and public through the building. Because of required letter height there is a limit to the length of messages and a limit to the number of messages.

Sign Type	Layout	Width	Height	Text Size	Sign Family	Directional Arrows	Department ID
IN-16.63	A	80"	18"	3"	All	x	
IN-16.63	B	80"	18"	3"	All		x
IN-16.63	C	80"	18"	2"	All	x	
IN-16.63	D	80"	18"	2"	All		x
IN-16.63	E	80"	18"	2" & 3"	All	x	x

↑ Canteen	Pharmacy ↑
← Spinal Rehab	Urology →
← Main Lobby	Restrooms →

Message Layout A

Community Services	
Community Living	Veterans Business
Dining Hall	Center

Message Layout B

↑ Mental Health	
← Security	Occupational Therapy ←
↑ Accounting - Cashier	Imaging Center - Radiology ↑
↑ Pharmacy	Blood Draw ↑

Message Layout C

Security Alert	
Persons entering this property consent to an inspection of all packages, luggage & containers in their possession. Refusal of consent to search is basis for denial of admittance. See Security Officers for details of security policy.	

Message Layout D

Imaging Services	
Registration	Waiting Area 2
All Visitor Must Check in	Wait for Number to be Called

Message Layout E

Soffit Mounted Directional and Identification

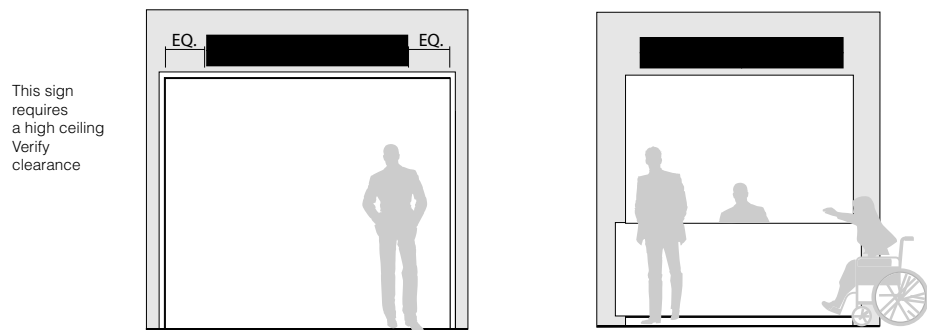
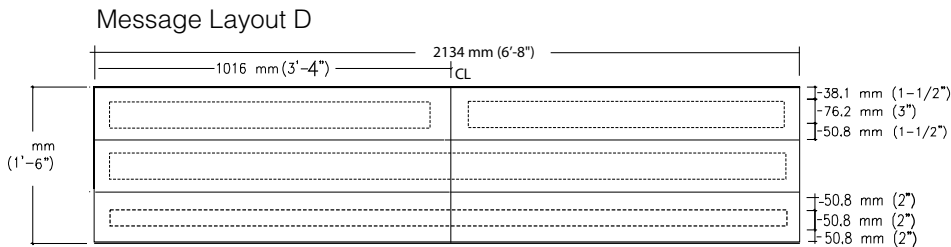
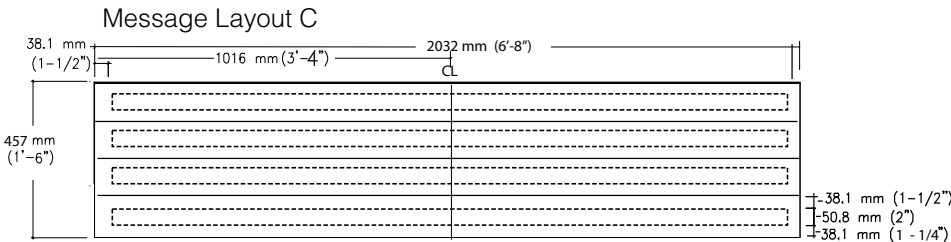
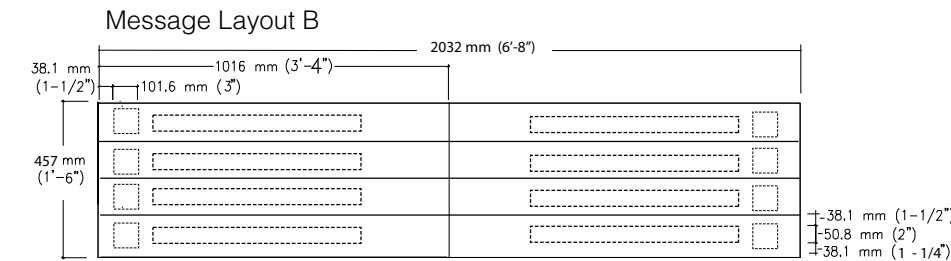
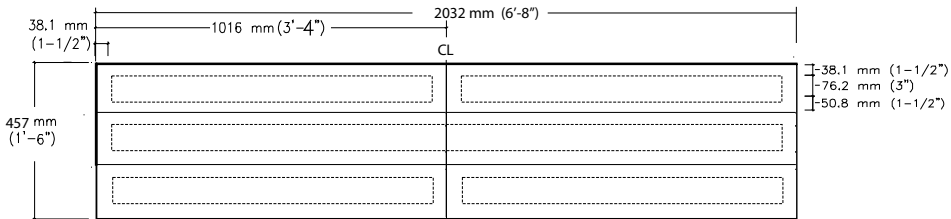
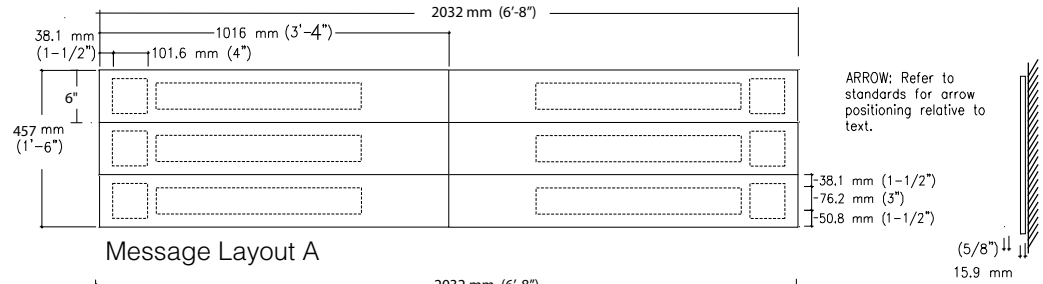

Soffit Mounted Directional and Identification with Insert

Size

IN-16.65
152 mm x 2032 mm
(6" x 80") 3" and 2" text with and without directional arrows

Description and Use

Use this sign for directional information that needs to be communicated overhead. Single sided wall mount over header or doorway.

Message Configuration

(Refer to layout drawing for lettering sizes and dimensions)

Sign Components

Vary by sign family. Sliding rail component systems, curved and flat panels with digital print insert.

Graphic Process

Digital print insert with clear lens cover.

Colors

Text and arrows: Refer to color chart.
Background: Refer to color chart.

Typography

Helvetica Bold
Helvetica Bold Condensed
76 mm (3") and 51 mm (2") cap height

Installation

Secure to wall with physical fasteners.

Recommendations

This sign is for use in corridors to direct patients and public through the building. Because of required letter height there is a limit to the length of messages and a limit to the number of messages.

Sign Type	Layout	Width	Height	Text Size	Sign Family	Directional Arrows	Department ID
IN-16.65	A	80"	6"	3"	All	x	
IN-16.65	B	80"	6"	3"	All		x
IN-16.65	C	80"	6"	2"	All	x	
IN-16.65	D	80"	6"	2"	All		x

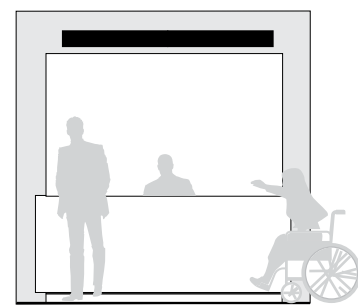
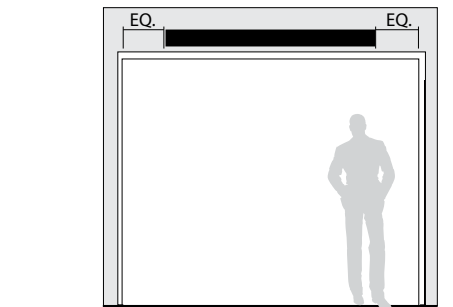
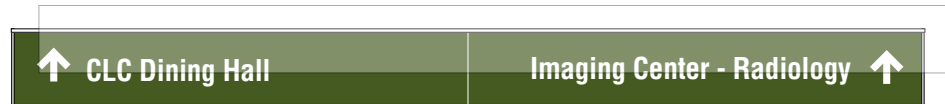
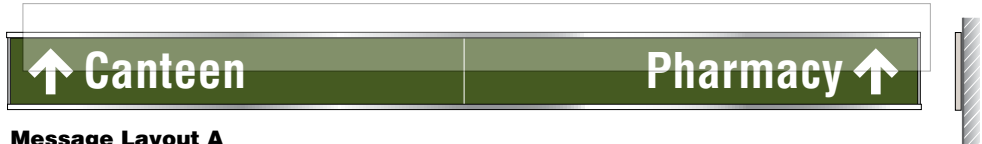

Soffit Mounted Directional and Identification with Insert

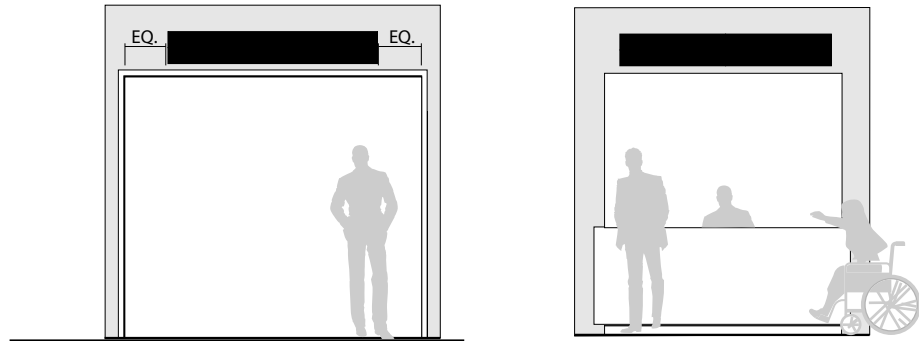
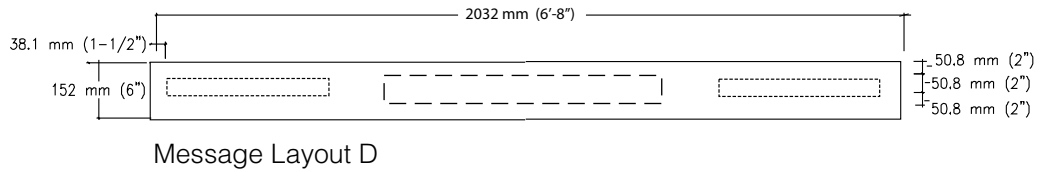
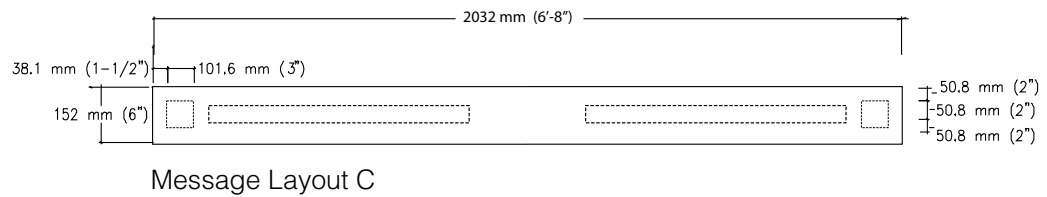
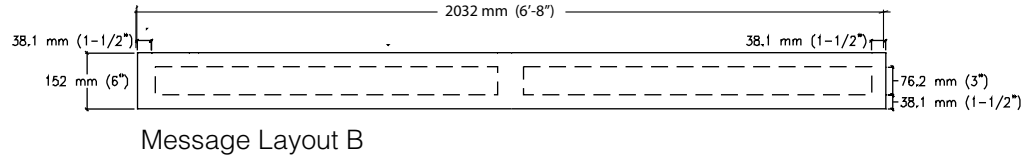
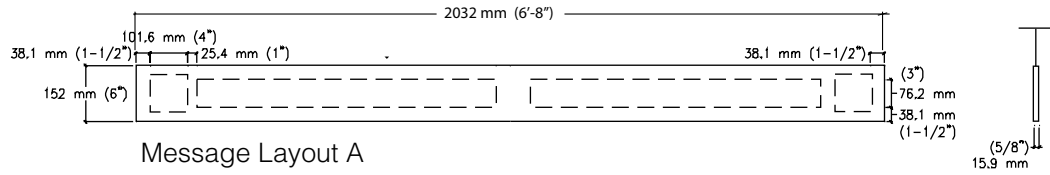

Soffit Mounted Directional and Identification with Insert

Size

IN-16.66
305 mm x 2032 mm
(12" x 80") 3" and 2" text with and without directional arrows

Description and Use

Use this sign for directional information that needs to be communicated overhead. Single sided wall mount over header or doorway.

Message Configuration

(Refer to layout drawing for lettering sizes and dimensions).

Sign Components

Varies by sign family. Sliding rail component systems, curved and flat panels with digital print insert.

Graphic Process

Digital print Insert with clear lens cover.

Colors

Text and arrows: refer to color chart.
Background: refer to color chart.

Typography

Helvetica Bold
Helvetica Bold Condensed
76 mm (3") and or 51 mm (2") cap height

Installation

Secure to wall with physical fasteners.

Recommendations

This sign is for use in corridors to direct patients and public through the building. Because of required letter height there is a limit to the length of messages and a limit to the number of messages.

Sign Type	Layout	Width	Height	Text Size	Sign Family	Directional Arrows	Department ID
IN-16.66	A	80"	12"	3"	All	x	
IN-16.66	B	80"	12"	3"	All		x
IN-16.66	C	80"	12"	2"	All	x	
IN-16.66	D	80"	12"	2"	All		x
IN-16.66	E	80"	12"	2" & 3"	Insert Only	x	x



Message Layout A

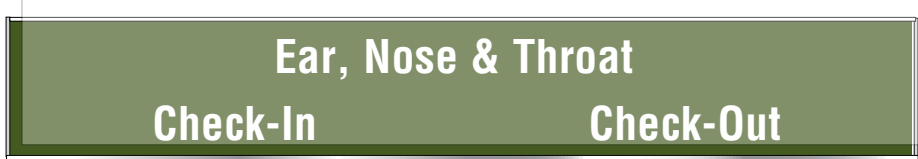

Message Layout B

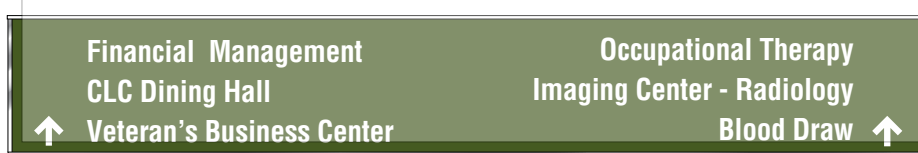

Message Layout C

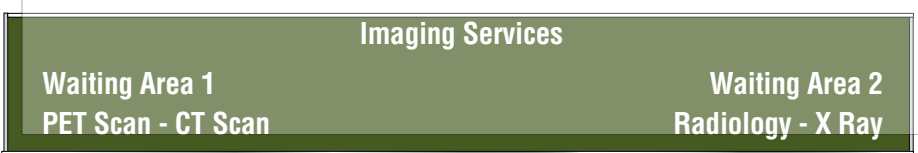

Message Layout D



Message Layout E

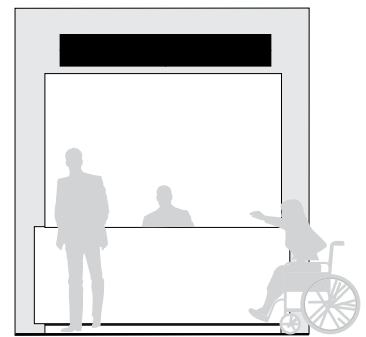
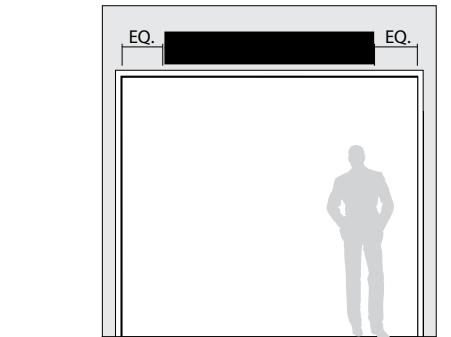

Soffit Mounted Directional and Identification with Insert

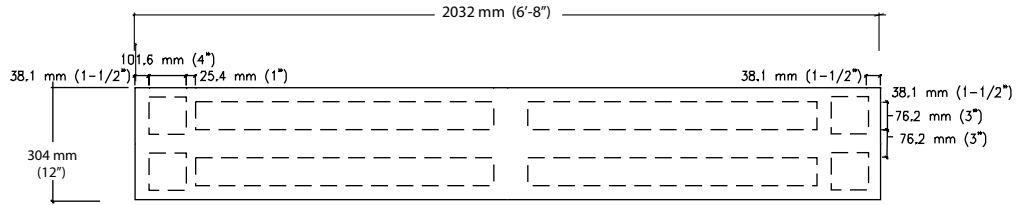

Message Layout A

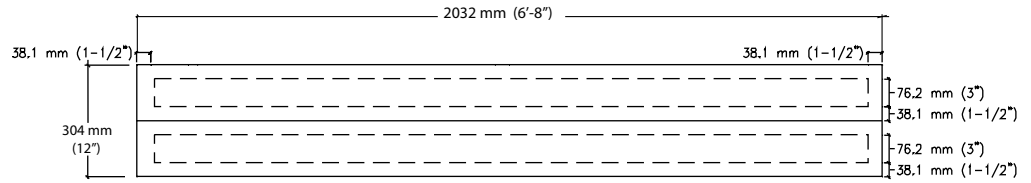

Message Layout B

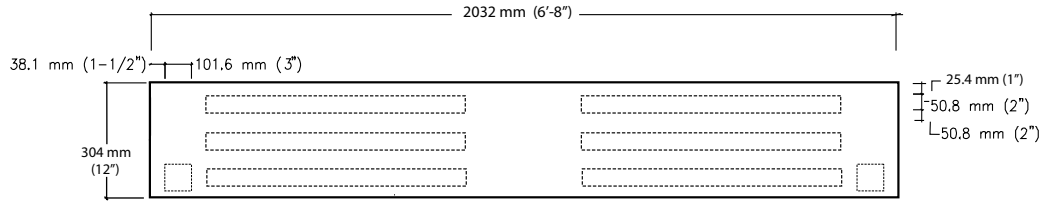

Message Layout C

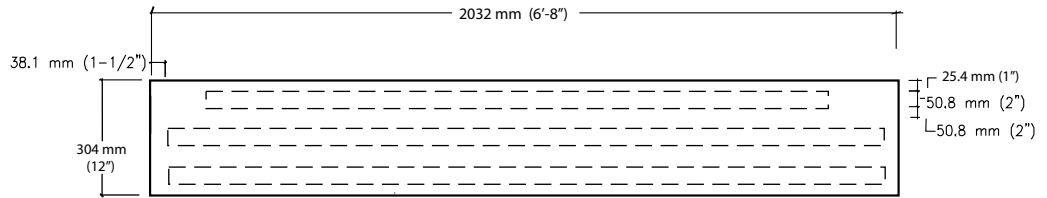

Message Layout D

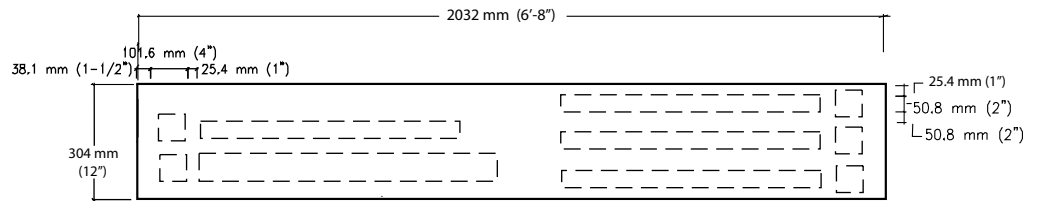

Message Layout E

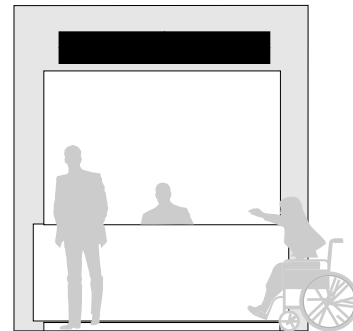
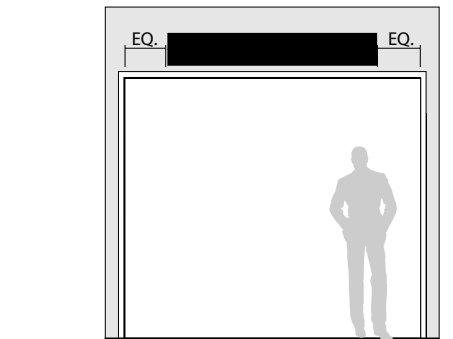

Soffit Mounted Directional and Identification with Insert

Size

IN-16.67
457 mm x 2032 mm
(18" x 80") 3" and 2" text with and without directional arrows

Description and Use

Use this sign for directional information that needs to be communicated overhead. Sign is double sided and both sides can be used for messages.

Message Configuration

(Refer to layout drawing for lettering sizes and dimensions).

Sign Components

Vary by sign family. Sliding rail component systems, curved and flat panels with digital print.

Graphic Process

Digital print with clear lens cover.

Colors

Text and arrows: refer to color chart.
Background: refer to color chart.

Typography

Helvetica Bold
Helvetica Bold Condensed
76 mm (3") and 51 mm (2") cap height

Installation

Secure to wall with physical fasteners.

Recommendations

This sign is for use in corridors to direct patients and public through the building. Because of required letter height there is a limit to the length of messages and a limit to the number of messages.

Sign Type	Layout	Width	Height	Text Size	Sign Family	Directional Arrows	Department ID
IN-16.67	A	80"	18"	3"	All	x	
IN-16.67	B	80"	18"	3"	All		x
IN-16.67	C	80"	18"	2"	All	x	
IN-16.67	D	80"	18"	2"	All		x
IN-16.67	E	80"	18"	2" & 3"	All	x	x



Message Layout A

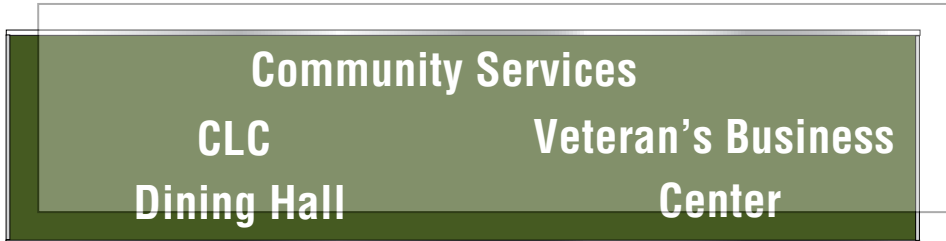

Message Layout B

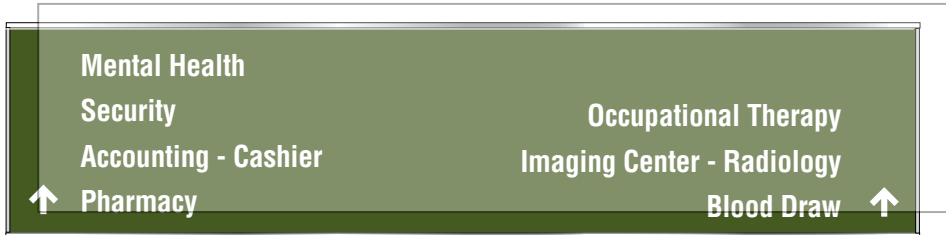

Message Layout C

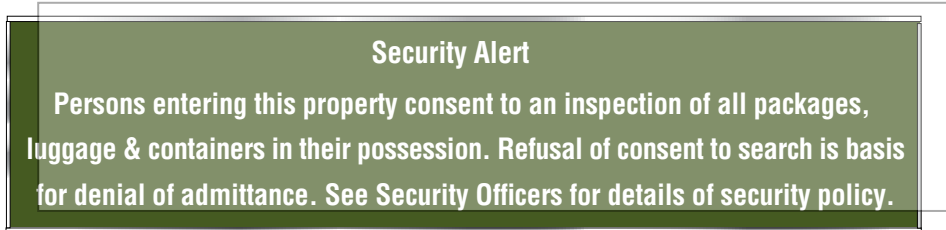

Message Layout D

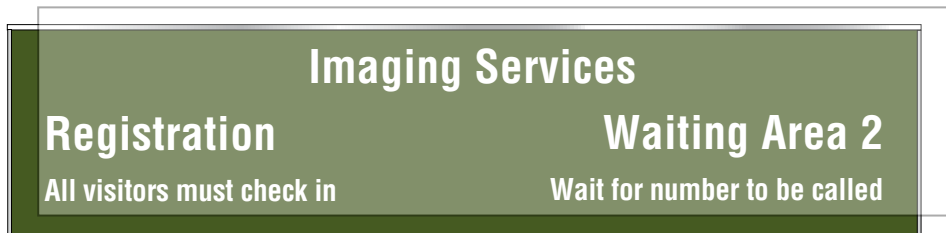

Message Layout E

Soffit Mounted Directional and Identification with Insert

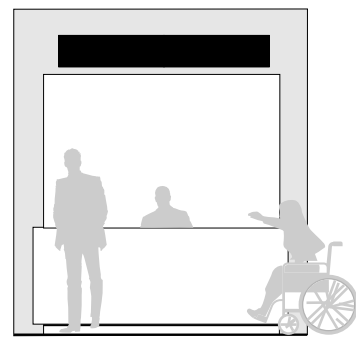
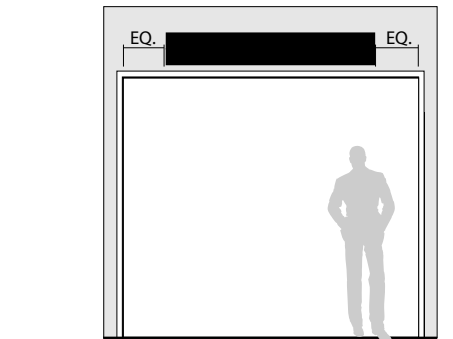
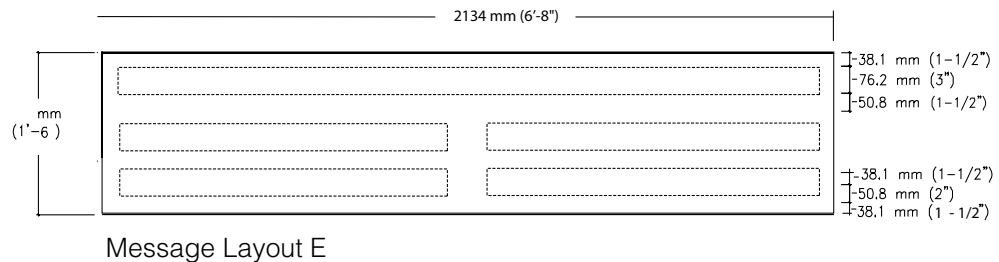
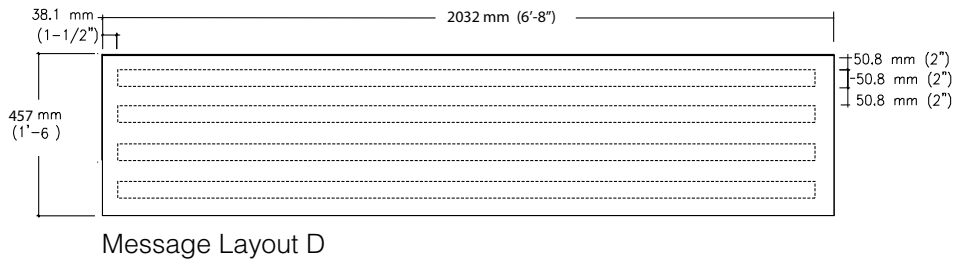
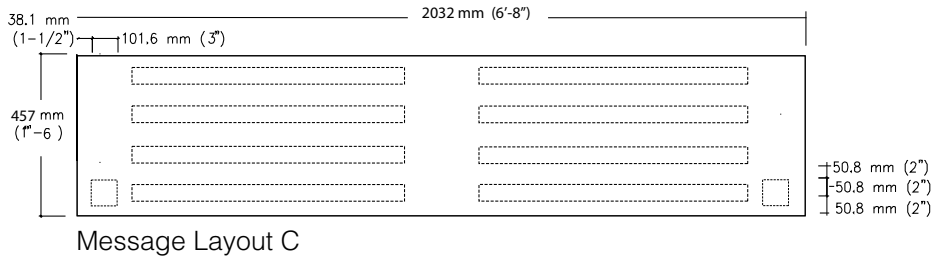
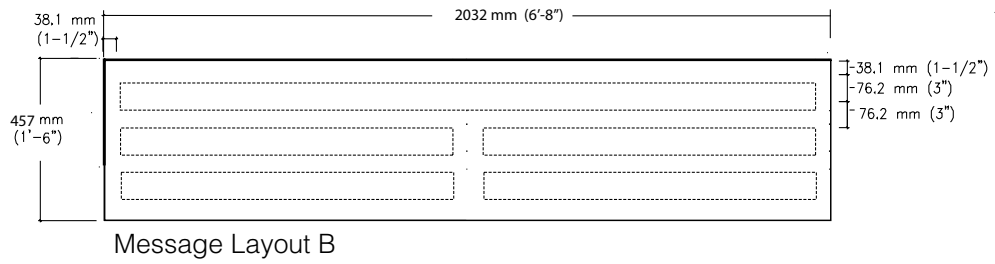
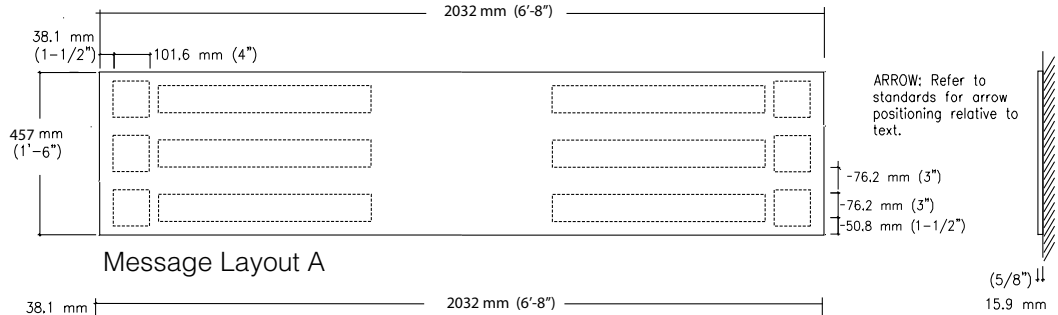

Glass Door and Side Light Graphics

Sign

38 mm H
 (1 1/2" H)
 51 mm H
 (2" H)
 (Other sizes as needed)

Description and Use

This sign is for use at glass entry doors to rooms or departments that are used by patients and public.

Message Configuration

(Refer to layout drawing for lettering sizes and dimensions).

Graphic Process

Surface applied white vinyl.

Colors

Text: White - T1
 Do not use black or colors.

Typography

Helvetica Bold

Mounting

Glass side light and glass doors.

Installation

Apply to front reading surface of glass or second surface of glass with reverse (backward) cut letters.

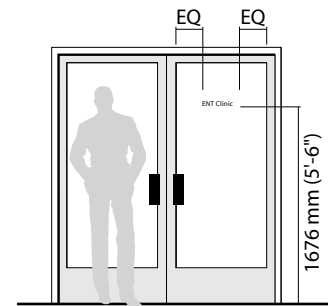
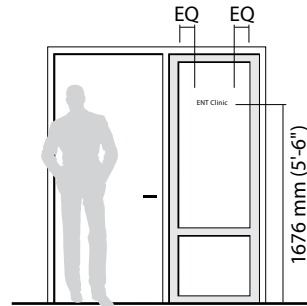
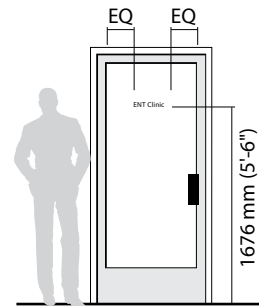
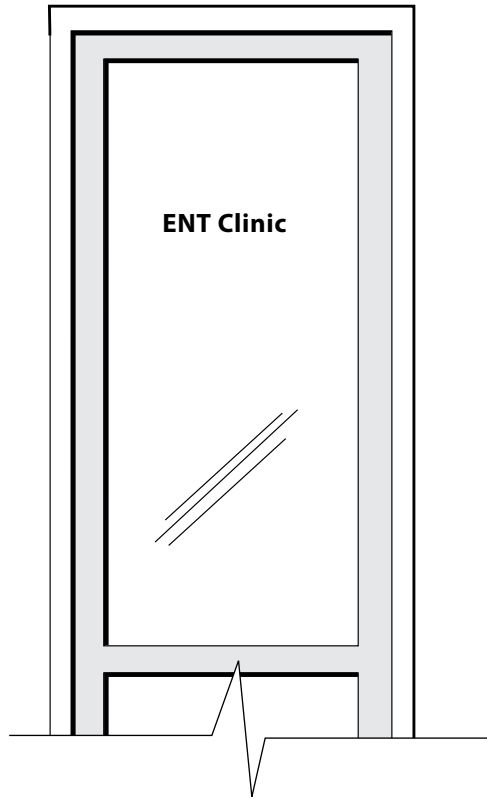

Side Light Graphics



Applied Digital Image and Graphic Text

Size

Digital image to cover elevator,
door size TBD

Description and Use

The sign is for use at the elevator
doors that are used by patients and
public.

Message Configuration

Refer to drawings for lettering sizes
and dimensions.

Graphic Process

Surface applied vinyl and digital
print.

Colors and Image

Text: per floor level
Image per elevator

Typography

Helvetica Bold
Helvetica Bold Condensed

Installation

Applied first surface of elevator
doors. Wrap image on overlapping
doors so that full image is visible
when doors are closed.



IN-18.05



IN-18.04

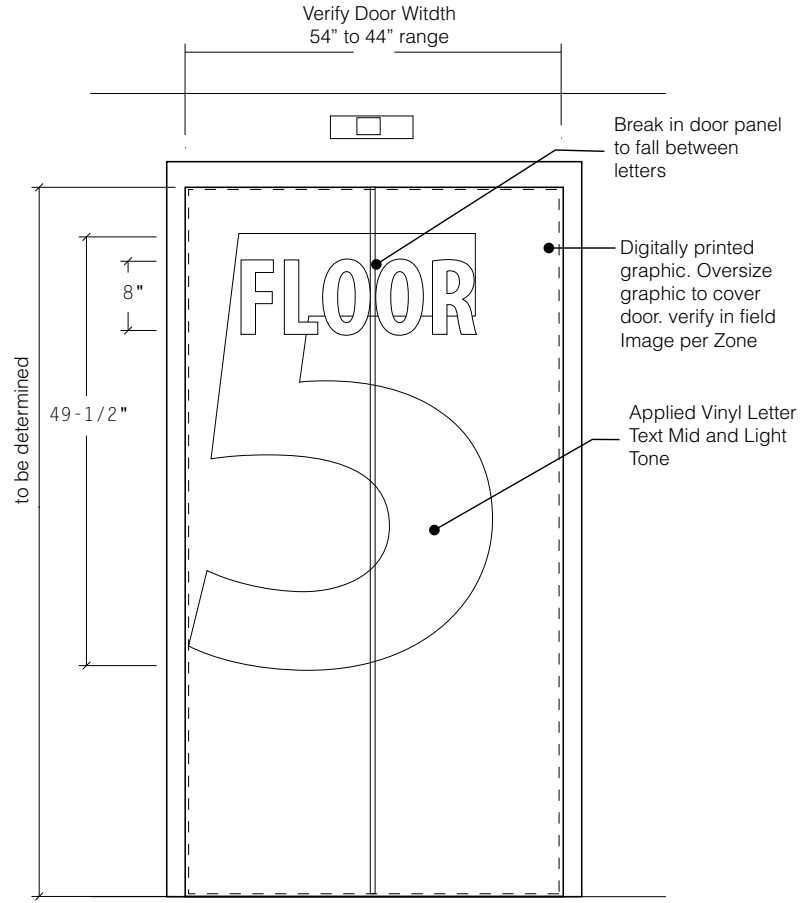

IN-18.05

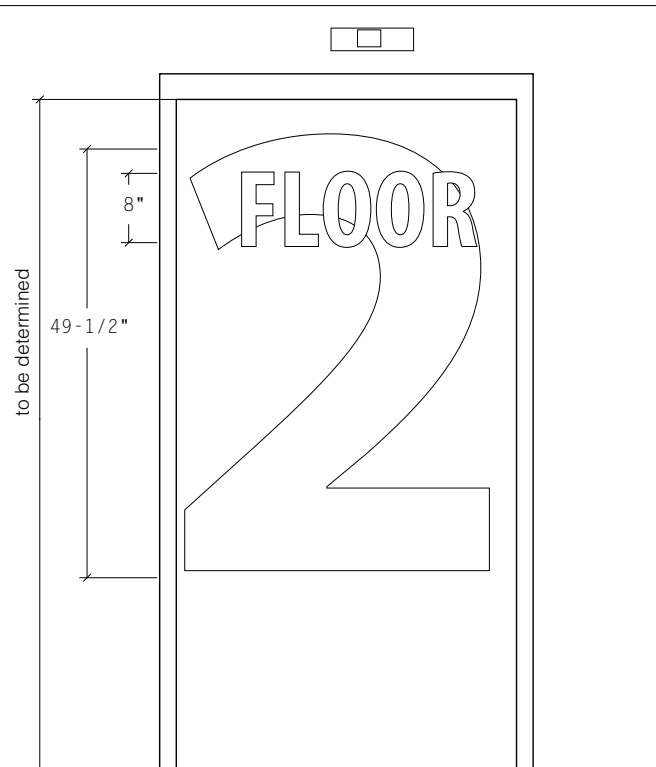

Dimensional Letters

Size

IN-19.01
76 mm H x 10 mm D
(3" H x 3/8" D)

IN-19.02
102 mm H x 10 mm D
(4" H x 3/8" D)

IN-19.03
152 mm H x 10 mm D
(6" H x 3/8" D)

Description and Use

Identification of information counters, major departments or services.

Message Configuration

(Refer to layout drawing for lettering sizes and dimensions).

Sign Components

Painted acrylic

Graphic Process

Cut out acrylic dimensional letters.

Colors

Text: refer to color chart
Color should have a high contrast with surrounding wall color and surface.

Typography

Helvetica Bold

Mounting

Silastic adhesive and studs.

Installation

On walls or soffits.

Recommendations

Dimensional letters provide high impact, high visibility and formal identification. Do not use for departments or services that have frequent relocation's or name changes. Suggested typical uses would be for Information, Check In, Canteen, Pharmacy, etc.

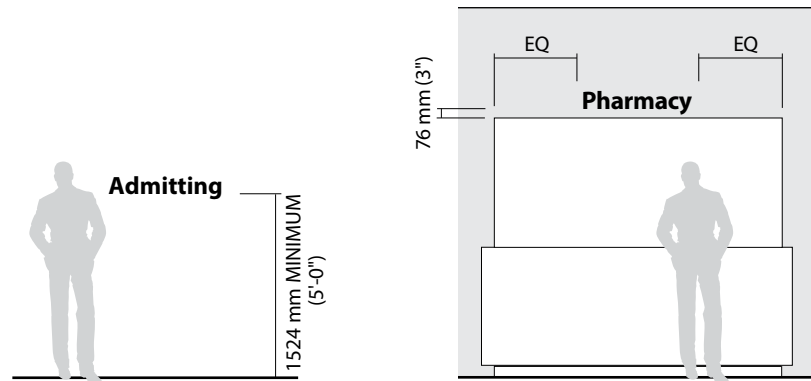

Dimensional Letters

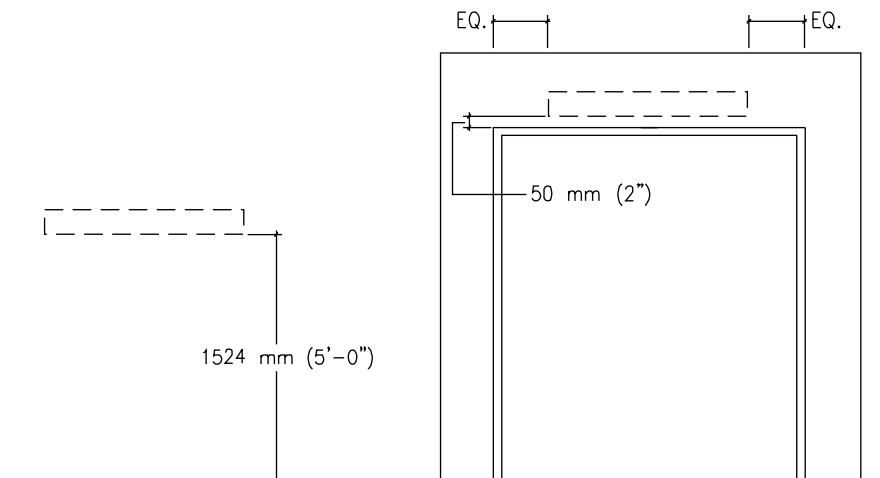
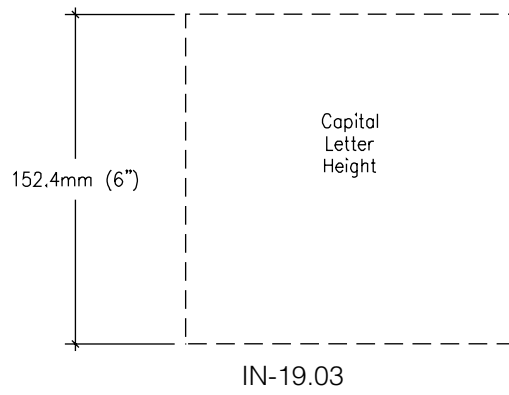
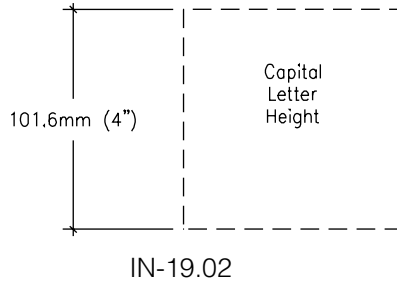
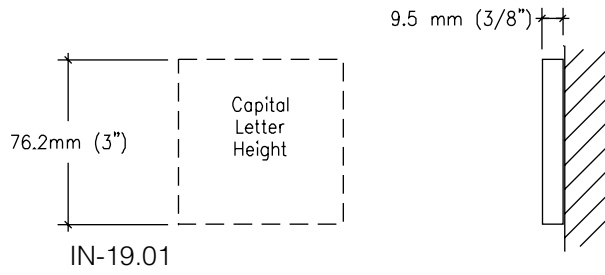

Instructional Sign

Size

152 mm x 152 mm
(6" H x 6" W)

Description and Use

Use this sign above handicap accessible automatic door opening buttons.

Message Configuration

(Refer to layout drawing for lettering sizes and dimensions)

Sign Components

Painted acrylic

Graphic Process

Silk-screened or surface applied vinyl.

Colors

Text: Refer to color chart
Background: Refer to color chart

Typography

Helvetica Bold

Mounting

Double sided foam tape or silastic adhesive.

Installation

On wall 6" above automatic door opening button.

Recommendations

These signs help bring attention and provide direction to doors with automatic opening capability.

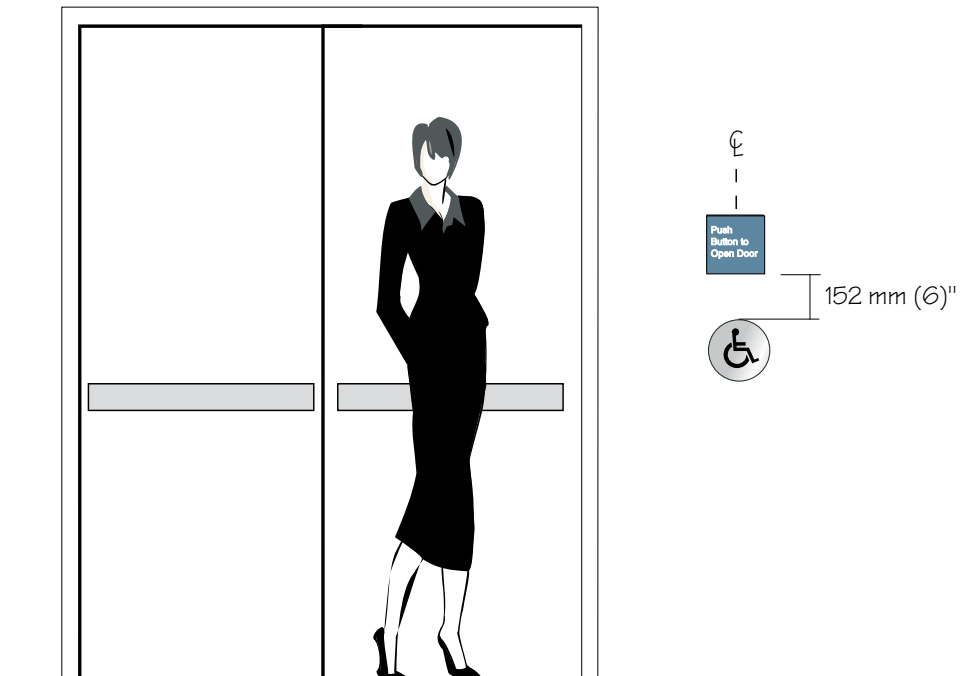
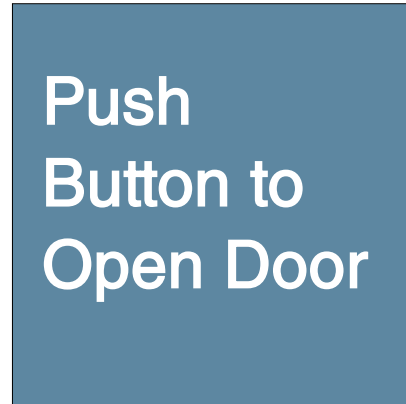

Instructional Sign

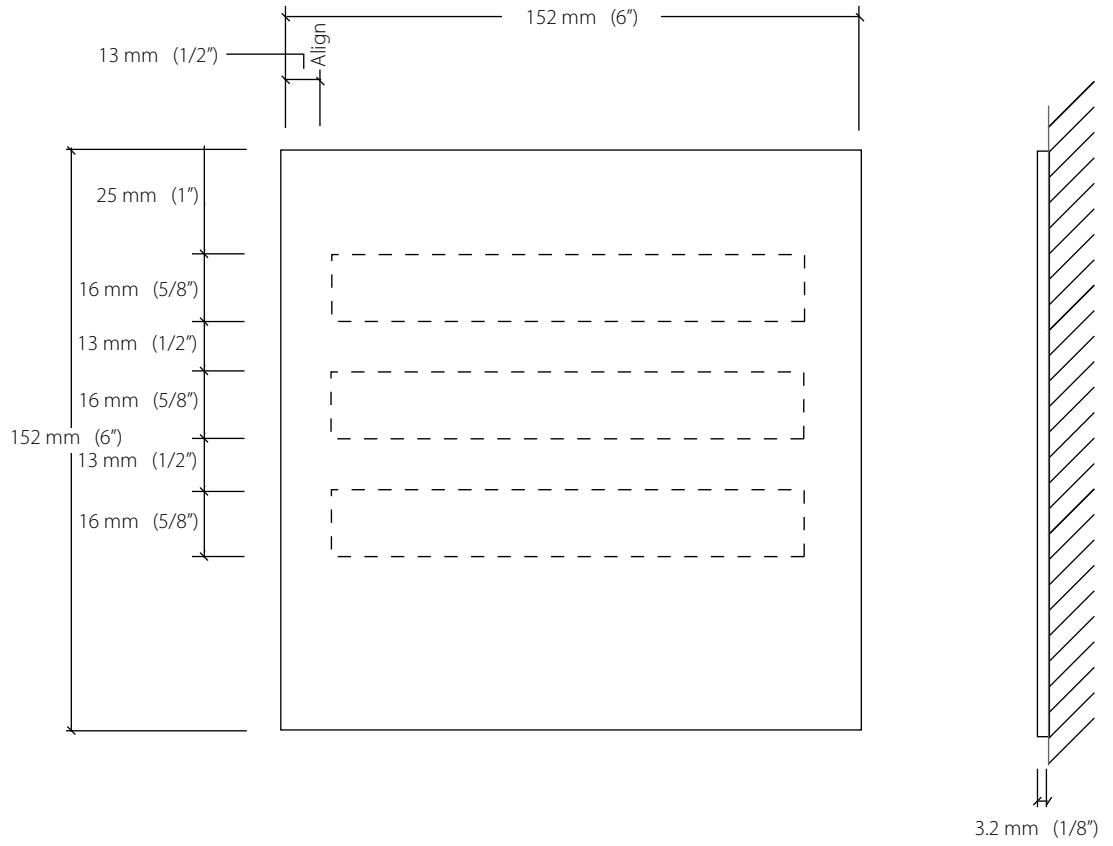

Size

2286 mm x 152 mm
(7' 6" H x 6" W)

Description and Use

Free Standing kiosk Identifies Information station or floor directory. Used where wall is not available.

Message Configuration

(Refer to layout drawing for lettering sizes and dimensions.)

Sign Components

Frame system with digital or applied graphics.

Graphic Process

Digital print or surface applied vinyl.

Colors

Text: refer to color chart.
Background: refer to color chart.

Typography

Helvetica Bold Condensed

Mounting

Free standing weighted base or secure to floor as needed.

Installation

In main entry area where traffic patterns allow.

Recommendations

These signs help bring attention and provide identification to Information stations or registration.



IN-27.01



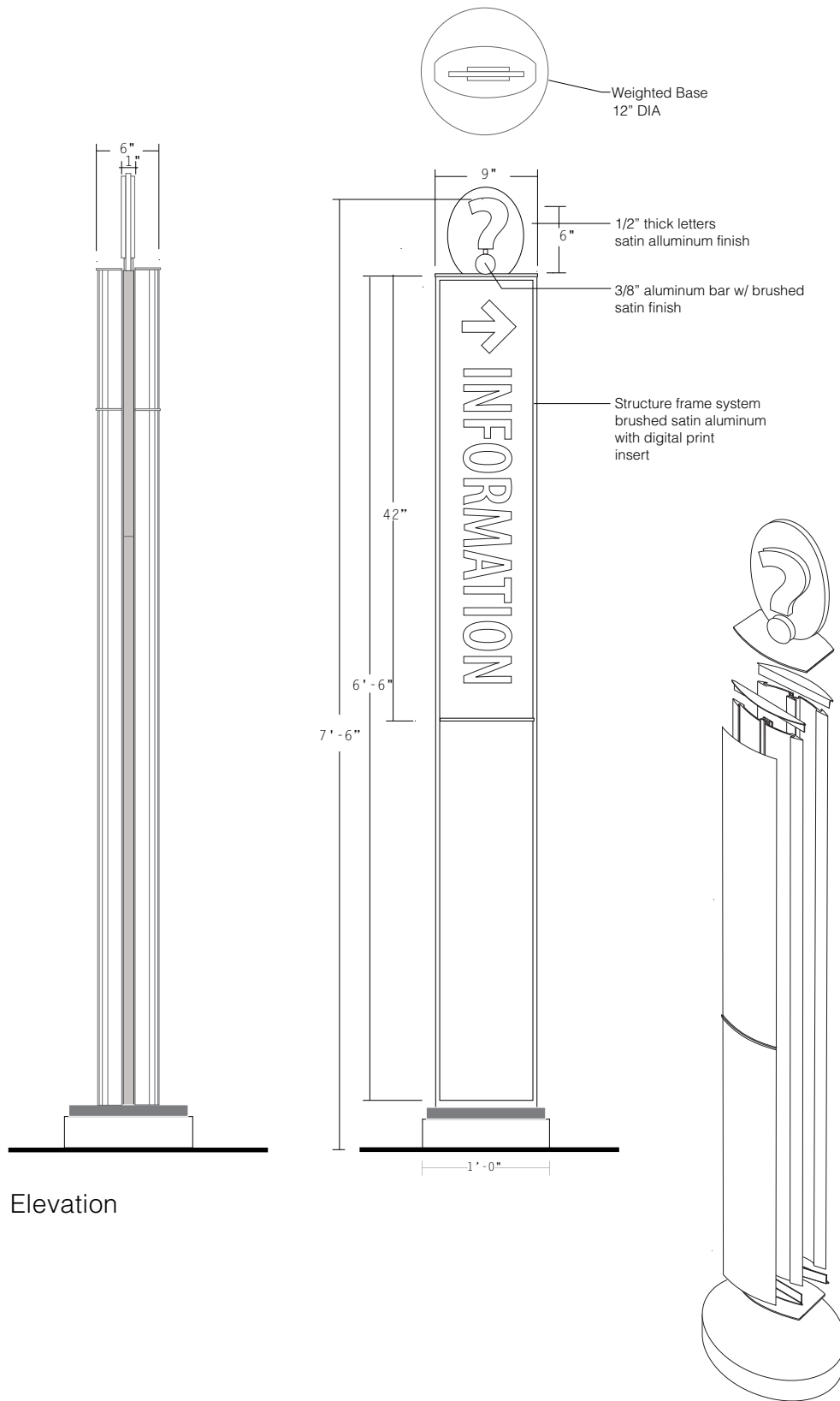

The specifications for signs are available in the Master Construction Specifications (PG-18-1) area of the VA Technical Information Library, which is available on the VA web site under Office of Construction & Facilities Management.

www.cfm.va.gov/til/

Refer to Signage in the specifications, Division 10, Section 10 14 00.

For more information regarding specifications, contact the Office of Construction & Facilities Management, Facility Standards Service.

The specifications require close coordination, taking into account the existing sign program at a medical center, any sign demolition, sign maintenance and future signing needs.

When preparing the specifications for a project, it will require editing to add and indicate new signs or eliminate signs that are not needed. Also, it will be necessary to adapt the specifications to project requirements required for the specific project in which they are intended.

The sign message schedule is considered a part of the specifications and would comprise a portion of the spec section. The configuration and format of the message schedule may vary according to individual project requirements. The sign message schedule format is shown in the Need a Sign Program section of the VA Signage Design Guide. It provides the method for identifying each sign location, type and message along with other notations. The sign schedule contains important information that the sign manufacturer and the sign installer will require for manufacturing and sign installation.

The sign message schedule must be coordinated with a sign location plan drawing showing where signs are to be placed within a building or on the site. Refer to the sign location plan example shown in the **Need a Sign Program** section of the VA Signage Design Guide.

For convenience, the sign type drawings can also be included in the specifications as its own section.

This page is intentionally left blank.

The type of interior sign and sign system being selected for a particular application or facility requires several decisions and involves different construction and assembly components to meet desired requirements. This section provides an overview of the intended criteria for interior sign programs.

Many sign manufacturers currently market extrusions, standard parts and component sign systems that meet the objectives of the intended interior sign system. These extruded, molded and fabricated component sign systems are acceptable as long as they conform to the illustrated and stated specifications.

The acrylic interior sign program, that has been in use since the 80's, can easily be replaced with a component system. A component sign program brings new products and solutions to meet various needs of the medical centers and are available from GSA approved sign manufacturers and sign manufacturers in the open market place.

The details showing the construction of the component sign system sign types are based on a system of standard parts. The illustrations are intended to show desired configurations and the intent of various sign types.

Sections of the extrusions and various parts are for illustration purposes and have not been engineered or configured for extruding, and do not represent a finished form.

With the component system, variations such as beveled and radius shapes in the accent rails and end caps do not conform to the VA sign program.

Elimination of the old style radius corners reduces costs, provides more flexibility and allow for the inter-changing of components.

Once a component system from a manufacturer is selected, it should become the standard for the facility. The component system has been designed to be compatible with an existing old style acrylic system in size, however there will be a significant difference in appearance.

A component system encourages the ongoing updating and maintenance of the sign program to be done by the facility. The component system uses vinyl letters as the method of producing the lettering. Engraving can also be used, but this increases the costs of the signs and the added cost does not provide significant benefits.

Using an insert style component system allows for the sign updates to be made by the facility using a digital or laser printer, allowing quick inexpensive updates.

The Specification section of the Guide should be read in conjunction with the Construction Details section. This will provide an overview of the interior sign construction requirements, materials and finishes.

The Guide illustrates component based sign systems for interior sign type families. Component systems use various interlocking elements which, when assembled, create a sign. They are available from several manufacturers and these general illustrations represent component systems that slide or snap together. The VA encourages each facility to select the same component system to be used throughout all the buildings.

A benefit of the component system is that it provides flexibility and simplicity in maintaining and adapting signs to ever changing needs. Components from one sign can be interchanged with components from another sign, of the same sign type, quickly and easily. Existing signs can be added to, or modified to perform another function. Changing directional signs is simple and adding new text and arrows and rearranging messages is always possible.

Implementation of a component system requires commitment to a specific manufacturer's system. Carefully review the advantages and disadvantages of various components systems from different manufacturer's, and contact facilities that have installed the system that is being considered.

In the following pages, the guide illustrates these sign systems:

- Sliding Rail Component System
- Frame Component Systems
- Insert and Frame Systems
- Curved Frame System

**Sliding Rail
Component System**

Sliding Rail Component systems use various interlocking elements which, when assembled, create a sign. The sign is framed with sides, top and bottom extrusions with sign panels secured to a back rail. The width and height of the frame varies with each sign type.

A benefit of the component system is that it provides flexibility and simplicity in maintaining and adapting signs to ever changing needs. Components from one sign can be interchanged with components from another sign quickly and easily. Existing signs can be added to or modified to perform another function.

Changing directional signs is simple. Adding new text and arrows and rearranging messages is always possible.

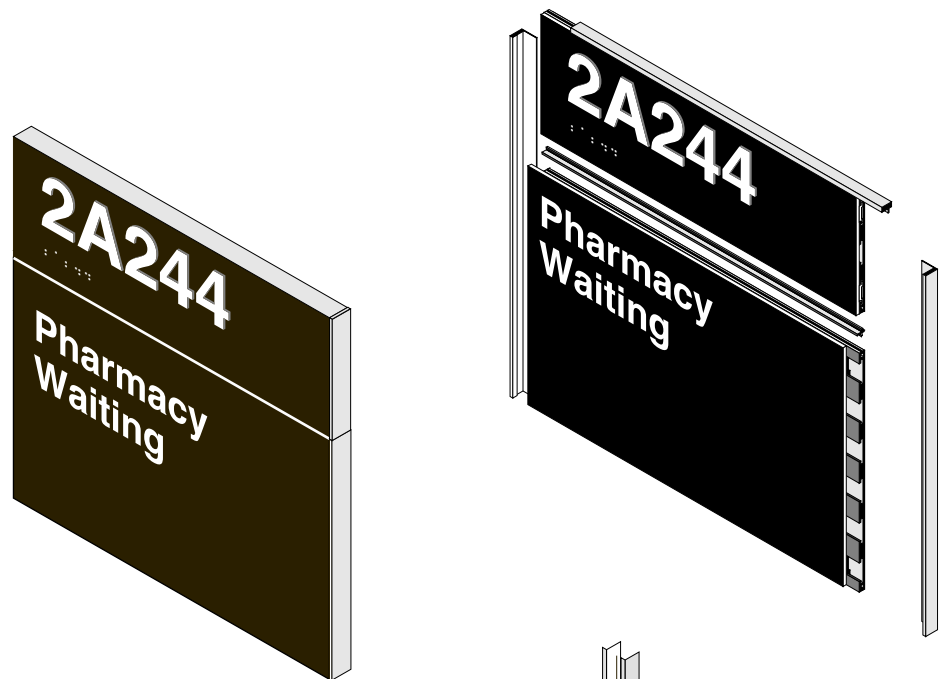
**Assembled Sign**

Snap Frame Component System

Snap Frame Component systems use various interlocking elements which, when assembled, create a sign. Clip or rails are secured to the back of the sign panels and side rails cap off the edges of the panels and secure the stacked configuration. The width and height of the frame varies with each sign type.

A benefit of the Snap Frame Component system is that it provides flexibility and simplicity in maintaining and adapting signs to ever changing needs. Components from one sign can be interchanged with components from another sign quickly and easily. Existing signs can be added to or modified to perform another function.

Changing directional signs is simple. Adding new text and arrows and rearranging messages is always possible.

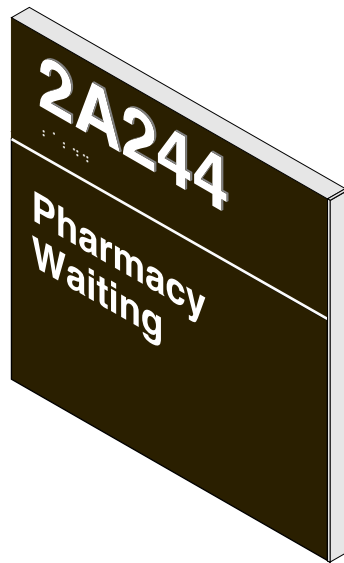

Assembled Sign

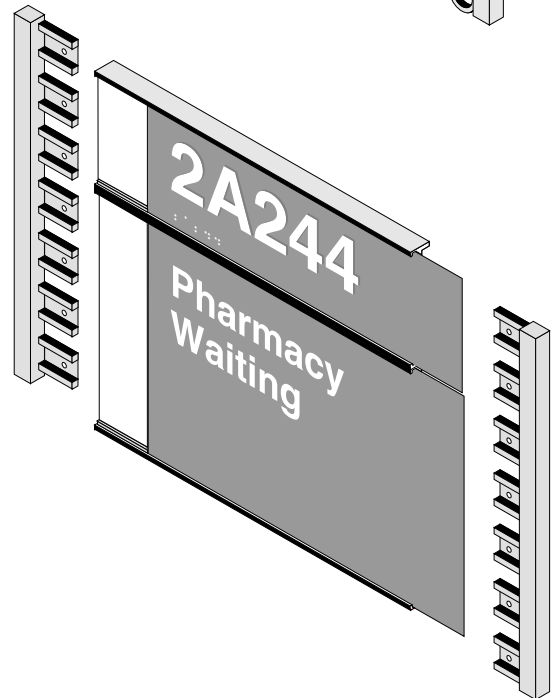

Frame and Insert Component System

Frame and Insert Component systems use various interlocking elements which, when assembled, create a sign. Side, top and bottom rails are secured together to hold in place the insert panels. The width and height of the frame varies with each sign type.

A benefit of the Frame and Insert Component systems is that it provides flexibility and simplicity in maintaining and adapting signs to ever changing needs. Components from one sign can be interchanged with components from another sign quickly and easily. Existing signs can be added to or modified to perform another function. A major advantage to this type of sign is that inserts can be fabricated inside at the facility or paper inserts can be printed "In House" on a laser printer.

Changing directional signs is simple. Adding new text and arrows and rearranging messages is always possible.

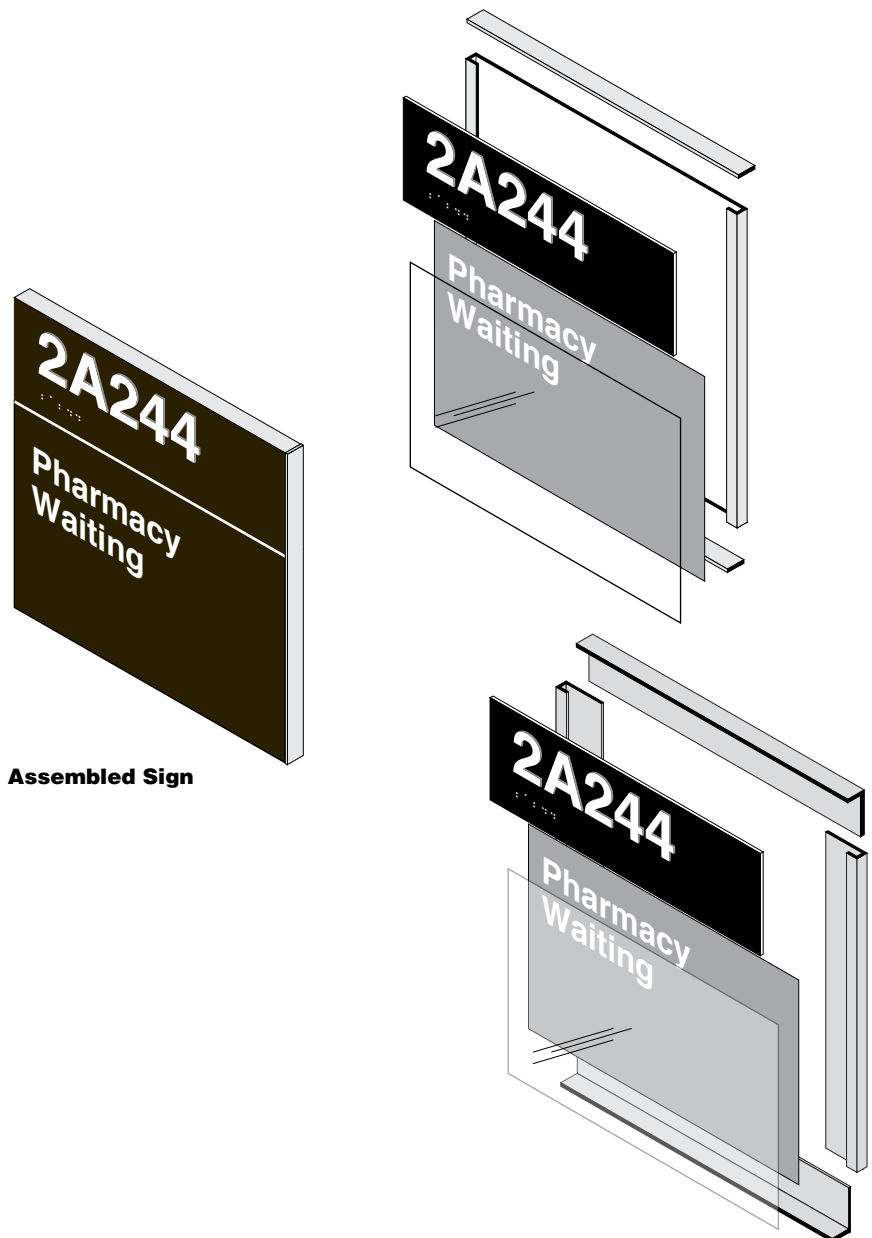

Curved Frame and Insert Component System

Curved Frame and Insert Component systems use various interlocking elements which, when assembled, create a sign. Side, top and bottom rails are secured together to hold in place the insert panels. The width and height of the frame varies with each sign type.

A benefit of the Curved Frame and Insert Component system is that it provides flexibility and simplicity in maintaining and adapting signs to ever changing needs. A major advantage is that inserts can be fabricated inside the facility, or paper inserts can be printed "In House" on a laser printer.

Changing directional signs is simple. Adding new text and arrows and rearranging messages is always possible.

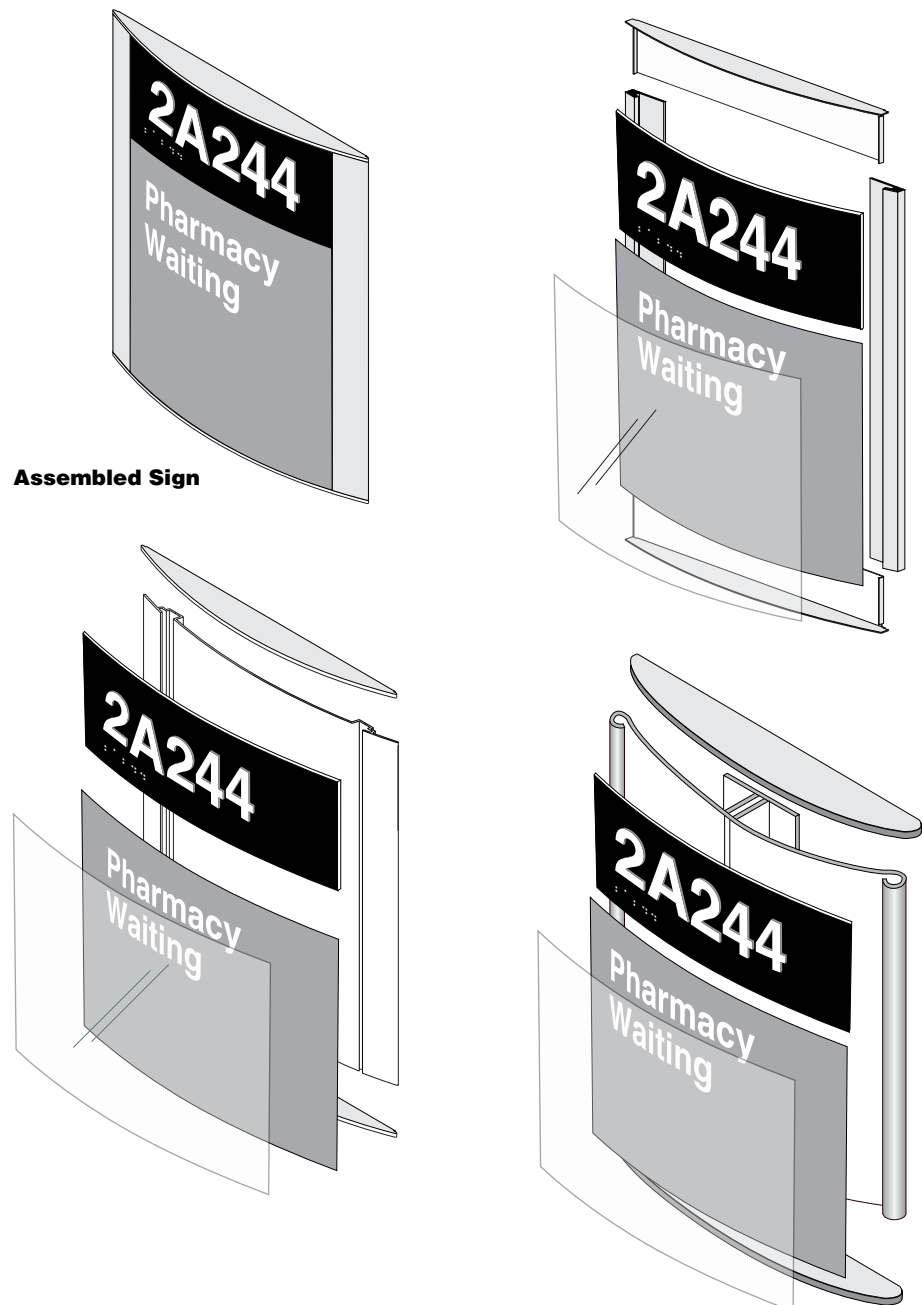

**Sliding Rail
Component Sign
Family**

The sliding rail component system uses various interlocking elements that slide together to create a sign. Room signs in the sliding rail type system are similar to the Snap Frame and Insert Frame systems.

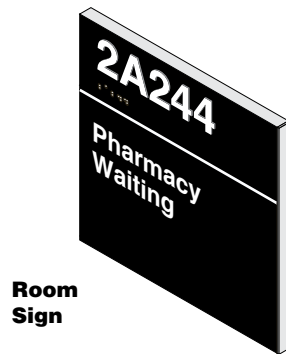

**Room
Sign**

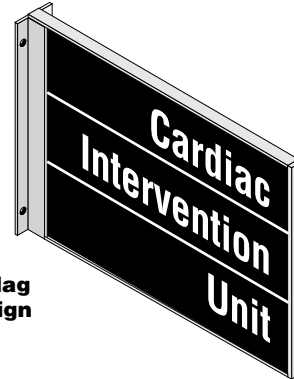

**Flag
Sign**

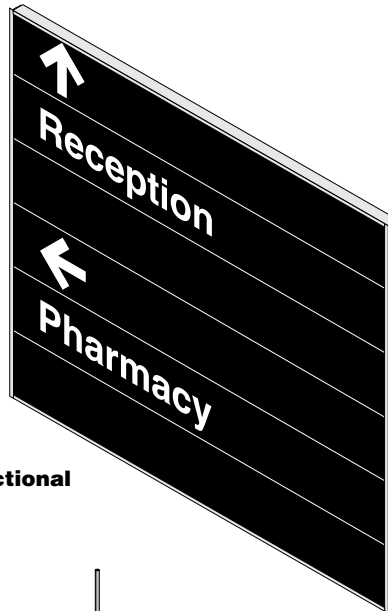

**Wall
Directional**

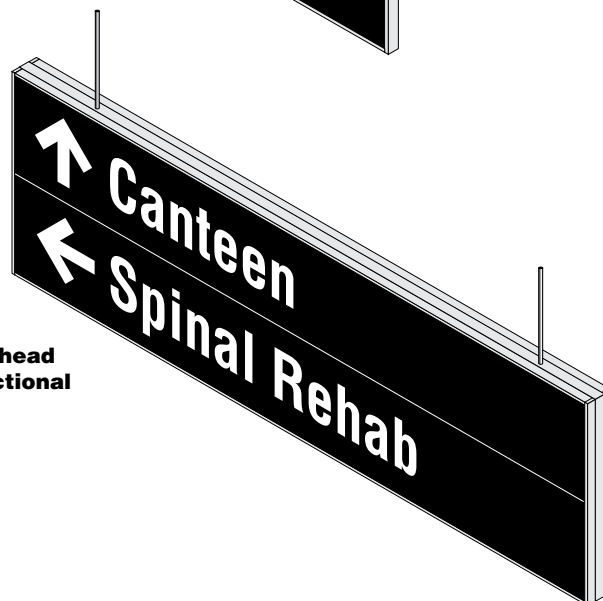

**Overhead
Directional**

**Snap Frame and
Frame and Insert
Component Sign
Family**

Once assembled the Snap Frame and Insert systems will look quite similar. The main difference between the systems will be how the sign insert/panels are produced. In house production will allow quick changes, if staff is assigned and trained to make inserts. If personnel in house are not available to maintain and produce graphics on site, sign maintenance should be performed by an outside service which may incur additional costs.

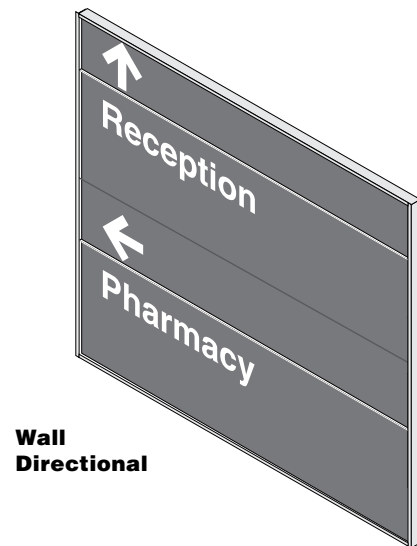
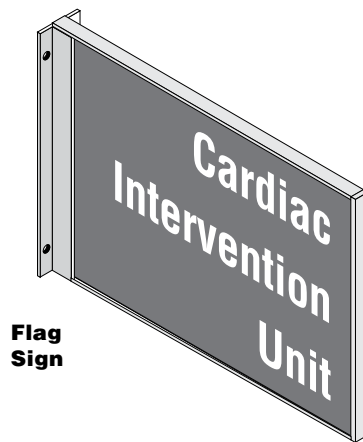
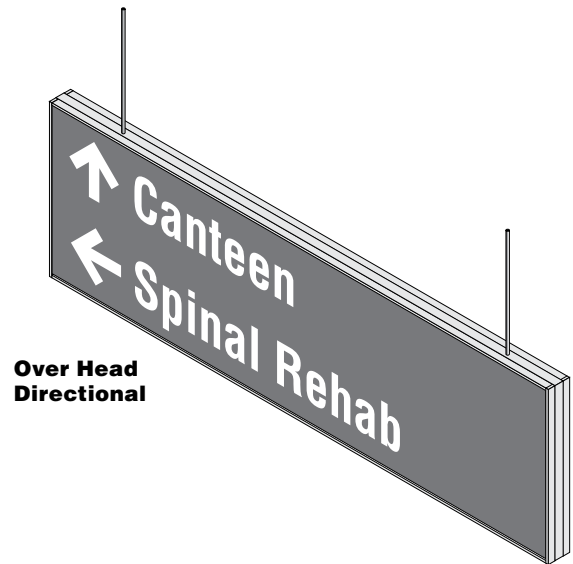
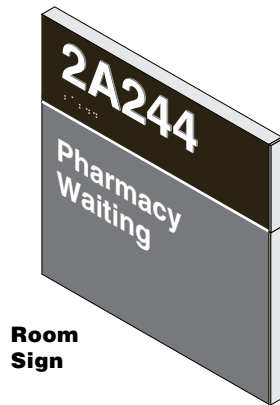

Curved Frame and Insert Sign Family

Curved Frame and Insert component systems are available to support a variety of sign types required to program a facility. Shapes and assembly methods vary by manufacturer. The style of frames also varies, therefore research the desired "look" before proceeding to order.

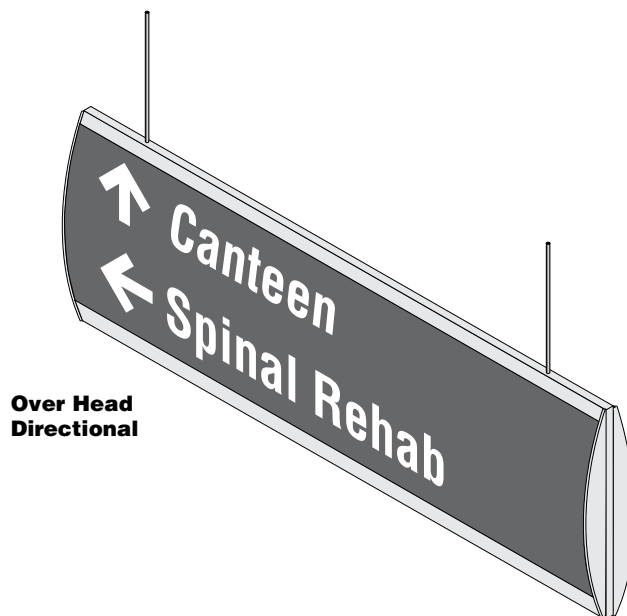
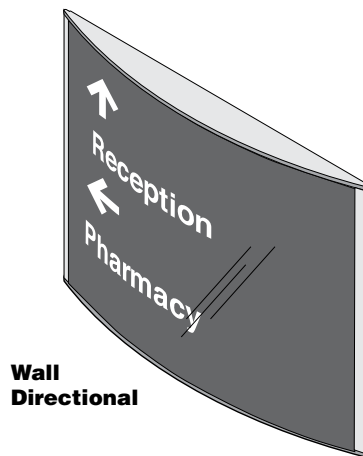
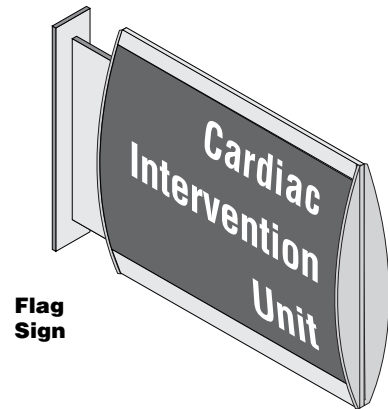
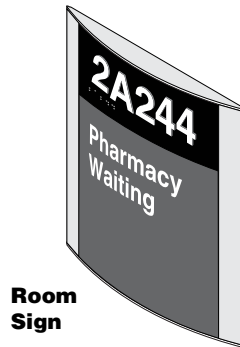

This page is intentionally left blank.

The installation of interior signs requires coordination of several interlaced criteria. Interior signs, especially directional signs, require coordination and careful consideration of the following:

Criteria

- Location of building entrances and elevators.
- Configuration of the corridor system.
- Desired path of travel within the building for visitors, patients and employees.
- Location of departments and clinics.
- A simple clear room numbering system that follows a clear, understandable pattern.
- Adequate light on and around directional signs.

Placement of signs in locations where people are expecting them to be.

Visibility

These elements help establish the basis of a clear sign program that communicates and informs in a direct and simple manner.

Interior signs function to communicate to both patients, visitors and staff. Their placements must be planned relative to the intended viewer, particularly the directional signs. Sign visibility to the intended user is a principal objective that forms the basis of correct sign placement.

Placement

Proper sign placement is part of a well-planned interior sign program.

In order to meet ABA/ADA guidelines, tactile room number signs must now always be specifically placed on the wall, on the strike/knob side of the door. Ceiling mounted signs require large lettering size, therefore, only short selective messages can be communicated.

Correct placement of signs will usually require fewer signs. Too many signs can create clutter and increase the difficulty for a viewer to find the particular information they are seeking. Placement of signs where there is sufficient lighting is critical.

Color selection is an element of the wayfinding system that effects the visibility of signs. Putting directional signs in a color that is different from room identification signs can be helpful to patients and visitors. Consistent use of sign color for a particular type of message reinforces the effectiveness of the sign program.

Planning

A sign program for a building, that works well, is one that has been planned as an integrated whole. All the way from the main entrance sign, to directional signs, room identification signs, informational signs, code required signs and life safety signs.

Installation Methods and Techniques Buildings

Different types of signs require different installation techniques, depending on their application or use, weight or size and whether the sign needs to be removed at some point in the future. Wall surfaces and materials need to be taken into consideration when deciding on the method to use.

Types of ceilings can have an impact on signage installation, particularly in regard to accessibility. Hard ceiling access to sign locations can be a problem if there is not an access door close to the sign location. Interlocking tile and T bar ceiling should not have signs directly attached to them as they are not designed to carry the weight of a sign. Additionally, they are not stable with additional sign loads in the event of earthquakes or severe storms.

Wall Signs

Double Sided Tape: is a common method to adhere small signs to an interior wall. The tape is quick, inexpensive and durable for most interior signs. There are two types of double sided tape. Double sided foam tape for light to medium duty applications and VHB (very high bond) double-sided acrylic tape heavy duty applications. Double-sided tape will stick to most surfaces with one exception. When adhering a sign to vinyl wall covering it is necessary to add a silicone adhesive to the back of the sign. The problem with using double sided tape is often the painted surface, or wall papered surface, will be damaged when a sign is removed.

Silastic Adhesive: is another quick and inexpensive way to install interior signs. A small piece of double sided tape is applied to the back of the sign or masking tape adhered to the front of the sign is used to hold the sign in place until the silicone sets. The drawback of using silicone is the odor the silicone emits until it has completely cured and hardened. A small amount of wall damage can be expected when removing the sign.

Mechanical fastener or screw mounting: is the strongest method for installing interior signs. Typically interior signs are lightweight enough and do not require this. When using wall anchors it is suggested that the fasteners penetrate a stud or backer behind the wall. An alternative to this would be using a hollow wall anchor. Screw mounting can prohibit vandalism to a certain degree, which can be taken one step further if tamper-proof fasteners are used. A benefit of using fasteners is it is only necessary to patch the small holes that remain when a sign is removed.

Flag Mounted Projecting Signs

Projecting signs must always be mechanically fastened to the wall with wall anchors penetrating a solid substrate such as a stud or backing material behind the wall. In corridors a flag mounted sign shall always be placed with the bottom of the sign height at 84" for clearance of pedestrians and equipment.

Ceiling Mounted Signs

Signs mounted above the pedestrian path of travel shall always be mechanically fastened to a solid substrate. These signs shall not be attached to the drop down T-bar ceiling grid. Typically, the placement of ceiling mounted signs are in the center of a corridor or over the pedestrian path of travel. Proper overhead clearance (84" minimum) must be maintained for clear path of travel for pedestrians and equipment.

Illuminated exit signs should not be blocked by ceiling signs and fire sprinkler heads should not have their spray pattern impacted by a ceiling sign. Sprinkler systems, exit signs, and other ceiling mounted items also must not block the clear viewing area of the sign. The sign should be relocated in any of these situations.

Vinyl Lettering and Graphics

Vinyl lettering can be installed on most hard clean surfaces. Plastic and glass should be cleaned and any dry matter, such as tape or glue, removed. Freshly painted surfaces should be allowed to dry for at least 72 hours prior to the application of vinyl graphics. This will allow any vapors to dissipate from the paint as it cures.

Dimensional Letters

Dimensional letters can be installed on most hard clean surfaces. Letters can be mounted with double sided tape or an adhesive appropriate for the wall surface. Typically letters larger than 4 inches also have studs attached to the back. These studs are imbedded into the wall surface to support the weight of the letters. Studs must be used when a surface is rough and high textured

Room Identification Signs

Height of tactile signs with Braille require specific placement and must conform to the Americans with Disabilities Act. Please refer to Accessibility requirements in another section of this Guide, and refer to the interior installation drawings at the rear of this chapter

Detail 1

Installation detail sign type 03, building standard, room number.

Detail 2

Installation detail sign types 04.01, 04.02, 04.03, 04.04, 05.06, 05.07, 05.08, 05.09, 07.01, 07.02, 07.03, 07.05, 07.06, 07.07. Building standard room number and name.

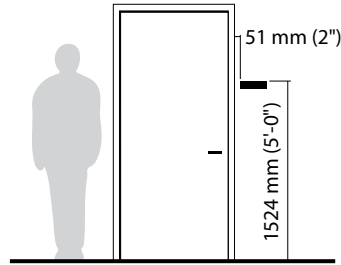

Detail 1

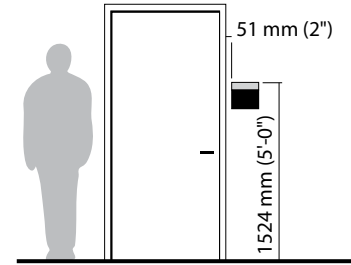

Detail 2

Detail 3

Installation detail sign types 08.01, 08.02, 09.01, 09.02, 09.03, 09.04, 09.05, 09.06, 09.07, 09.08, 11.01, 11.02, 11.04. Building standard.

Detail 4

Installation detail sign types 10.04, 10.05, 10.06.

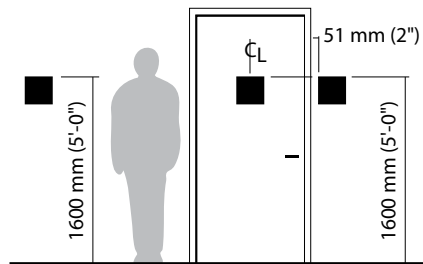

Detail 3

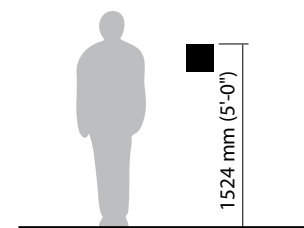

Detail 4

Detail 5

Installation detail sign types 10.02, 10.03, 11.03, 14.04, 14.05, 14.09, 14.10

Detail 6

Installation detail sign types 10.01, 14.01, 14.02, 14.06, 14.07, 14.20, 14.21, 14.25, 14.26,

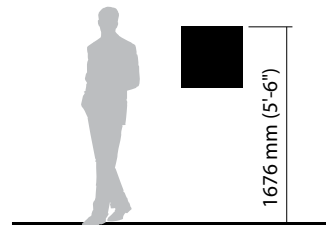

Detail 5



Detail 6

Detail 7

Installation detail sign types 14.03, 14.08, 14.11, 14.12, 14.13, 14.14, 14.15, 14.16, 14.17, 14.18.

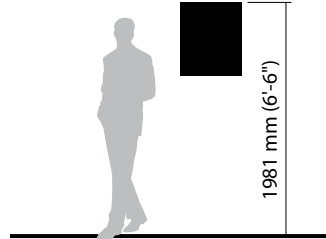

Detail 7

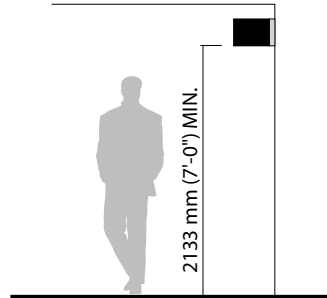

Detail 8

Detail 9

Installation detail sign types 15.51, 15.52, 15.53, 15.55, 15.56, 15.57

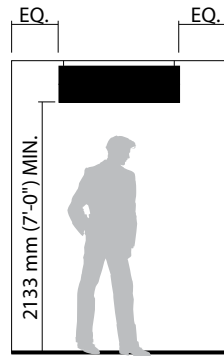

Detail 9

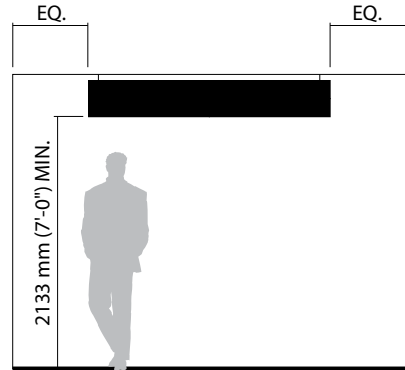

Detail 10

Detail 11

Installation detail sign types, 16.51, 16.52, 16.53, 16.55, 16.56, 16.57

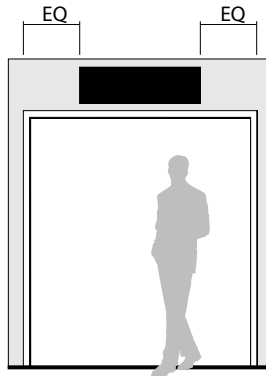

Detail 11

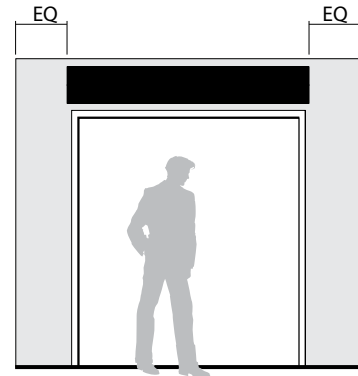

Detail 12

Detail 13

Installation detail sign types 15.51, 15.52, 15.53

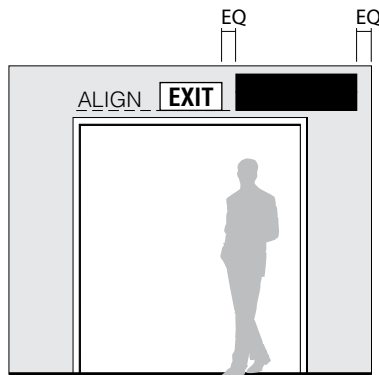

Detail 13

Detail 14

Installation detail sign types 06.05, 06.06.

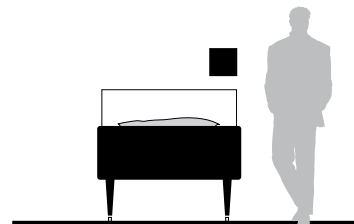

Detail 14

Detail 16

Installation detail sign type 18.01

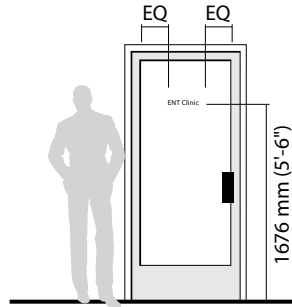

Detail 16

Detail 17

Installation detail sign type 18.01

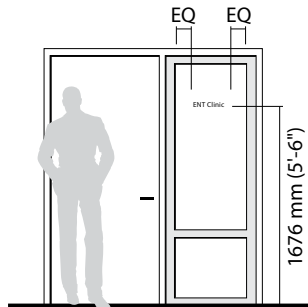

Detail 17

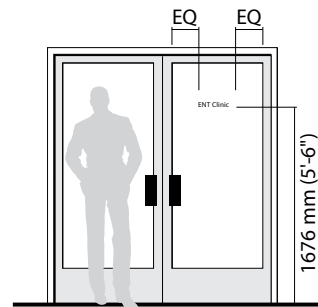

Detail 18

Detail 19

Installation detail sign types 19.01, 19.02, 19.03.

Detail 20

Installation detail sign type 08.02.

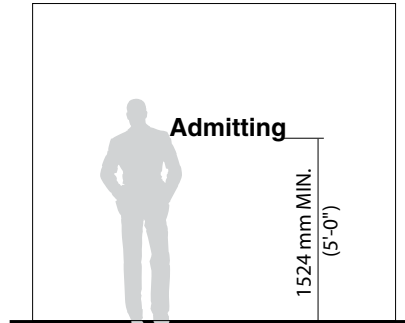

Detail 19

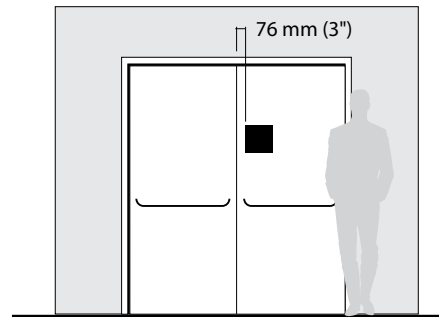

Detail 20

Detail 21

Installation detail sign types 19.01, 19.02, 19.03
DO NOT place 10" letters on 12" header

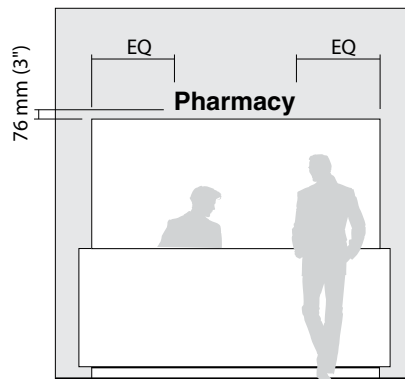

Detail 21

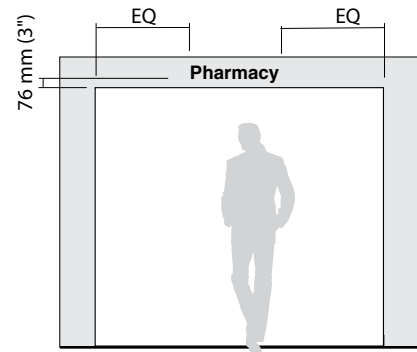

Detail 21: Small Header

Detail 22

Tile wainscot wall installation guide for room identification signs.

Detail 23

Room identification sign installation guide for spinal rehabilitation and nursing home facilities.

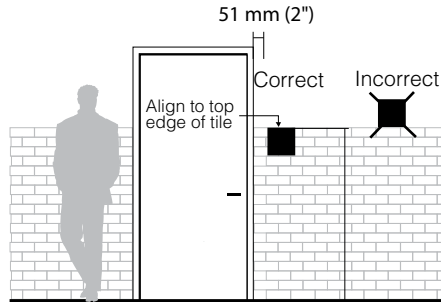

Detail 22

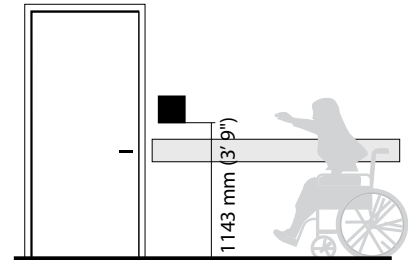

Detail 23

Detail 24

Overhead sign installation over counter or registration desk. Minimum 6'8" off the floor on a free hanging header.

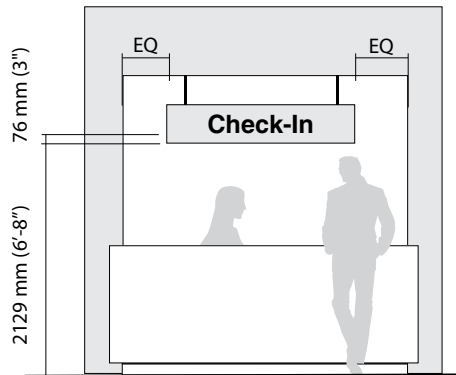

Detail 24

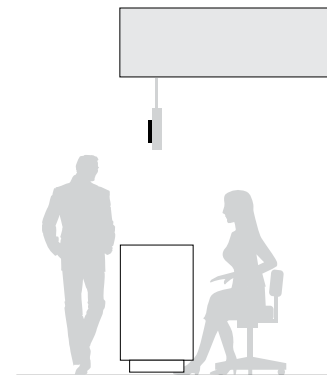

Detail 24: Side View

Detail 25

Overhead sign installation over opening with walk through and counter or registration desk minimum DO NOT place hanging header over opening. DO NOT place 10" letters on 12" header

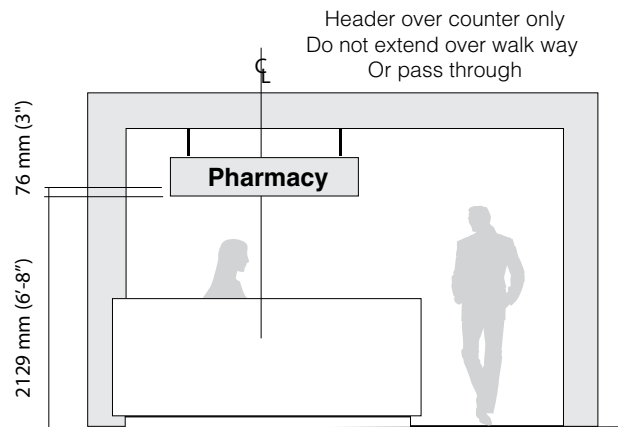

Detail 25

Hanging Header at counter with opening/pass through

Detail 26

Overhead hanging sign
Lobby or waiting room with high ceiling. DO NOT install hanging sign in areas with ceilings higher than 12'-0". Use a wall mount flag sign.

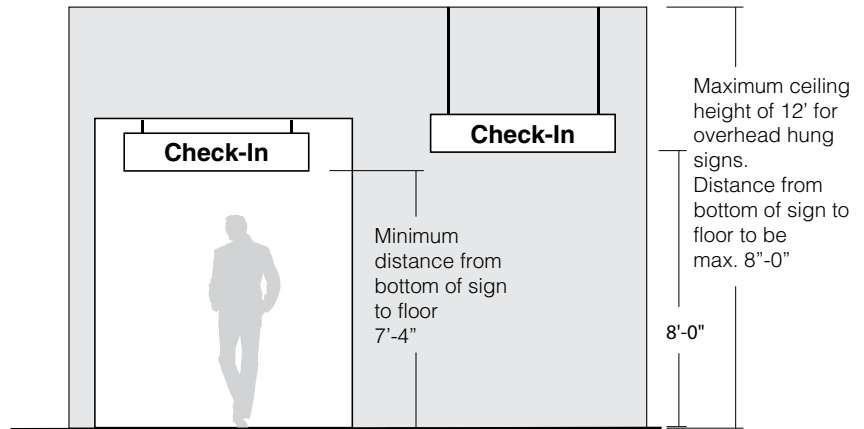

Overhead sign with installed in Lobby or Waiting areas with vaulted ceiling.

Interior wall bracing for heavy signs, directories and cast plaques.

Stud Backing Plate A

1. Maximum Weight- 25 lbs. point load. If sign load exceeds this use Stud Backing Plate B.
2. Attach plates to 3 studs minimum.
3. Verify length, height, location and number required.
4. Use #12 Self Tapping Screws when attaching items to backing, U.O.N.

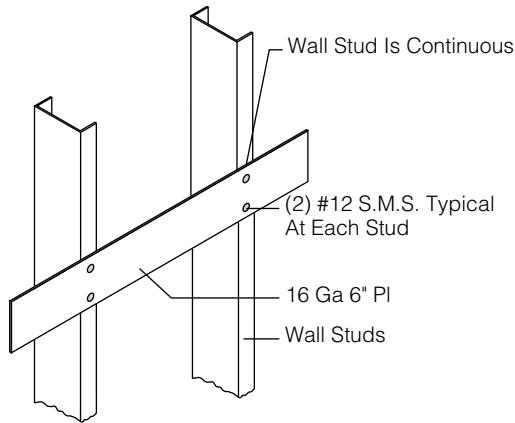

Stud Backing Plate A

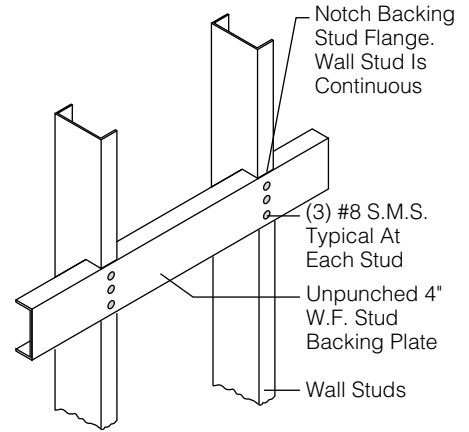

Stud Backing Plate B

Stud Backing Plate B

1. Maximum Weight- 50 lbs. point load. If sign load exceeds this use Stud Backing Plate C.
2. Attach plates to 3 studs minimum.
3. Verify length, height, location and number required.
4. Use double stud when stud is supporting more than 2 backing plates

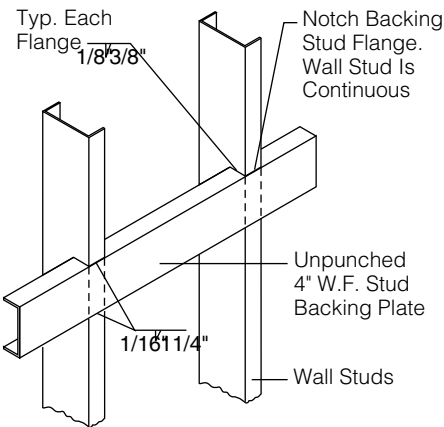

Stud Backing Plate C

Stud Backing Plate C

1. Maximum Weight- 200 lbs./ft.
2. Attach plates to 3 studs minimum.
3. Verify length, height, location and number required.
4. Use double stud when stud is supporting more than 2 backing plates

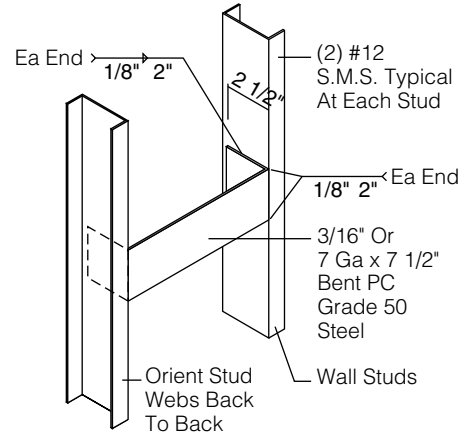

Stud Backing Plate D

Stud Backing Plate D

1. Maximum Weight- 300 lbs. point load.
2. Attach plates to 3 studs minimum.
3. Verify length, height, location and number required.

Glass Back Up

Certain signs may require installation on glass because there is no available wall surface.

When this situation occurs, a blank glass back up is required on the opposite side of glass exactly behind sign being installed.

This blank opaque glass back up is to be the same size and color as the sign being installed to effectively cover and hide the mounting of the sign to the glass.

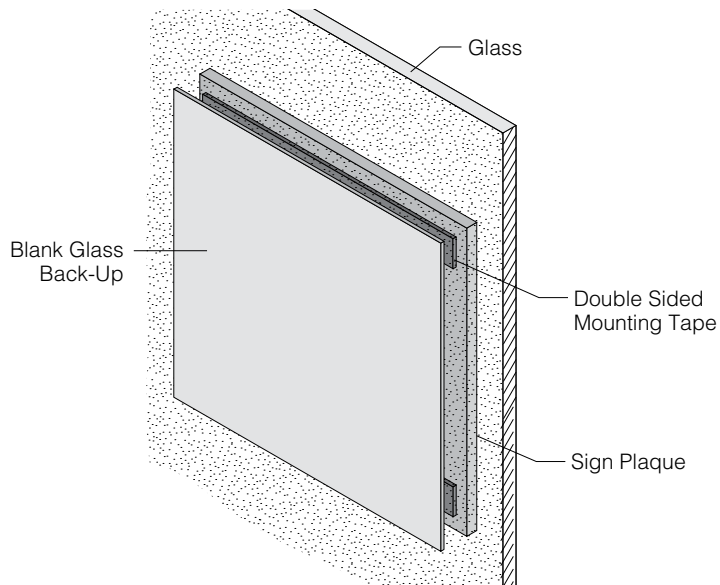

Ceiling Mounted Sign Detail

Use for signs that weigh over 20 pounds and are mounted from a suspended ceiling system.

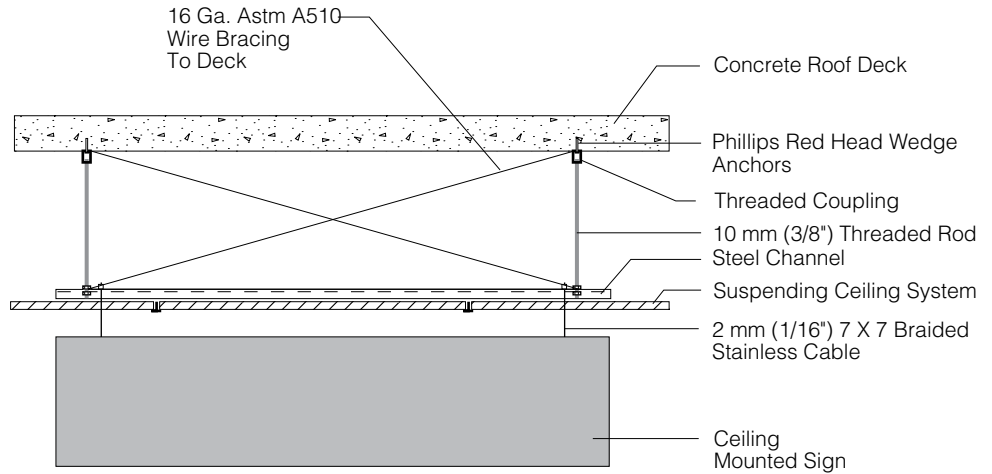

Front View

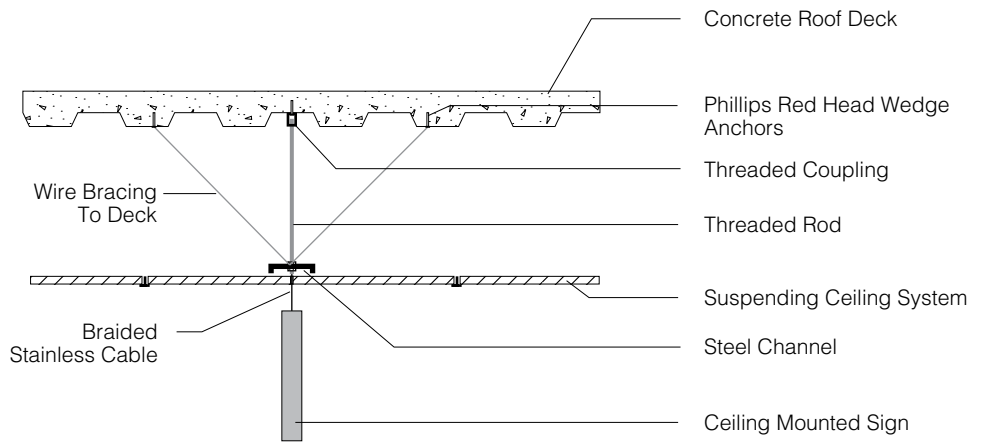

Side View

Ceiling Mounted Sign Detail

Use for signs that weigh over 20 lbs. and are mounted from above a suspended ceiling system where attachment to ceiling is not possible. Sign support to be distributed to load bearing walls additional unistrut beam may be required.

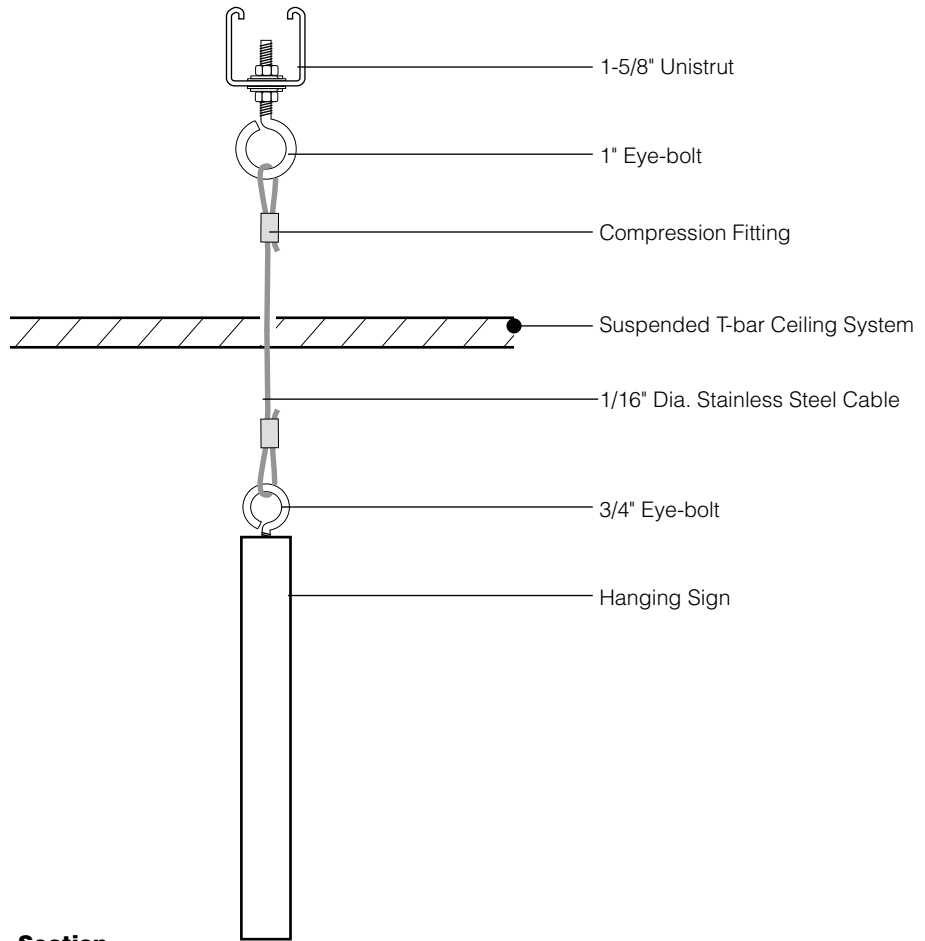

Section

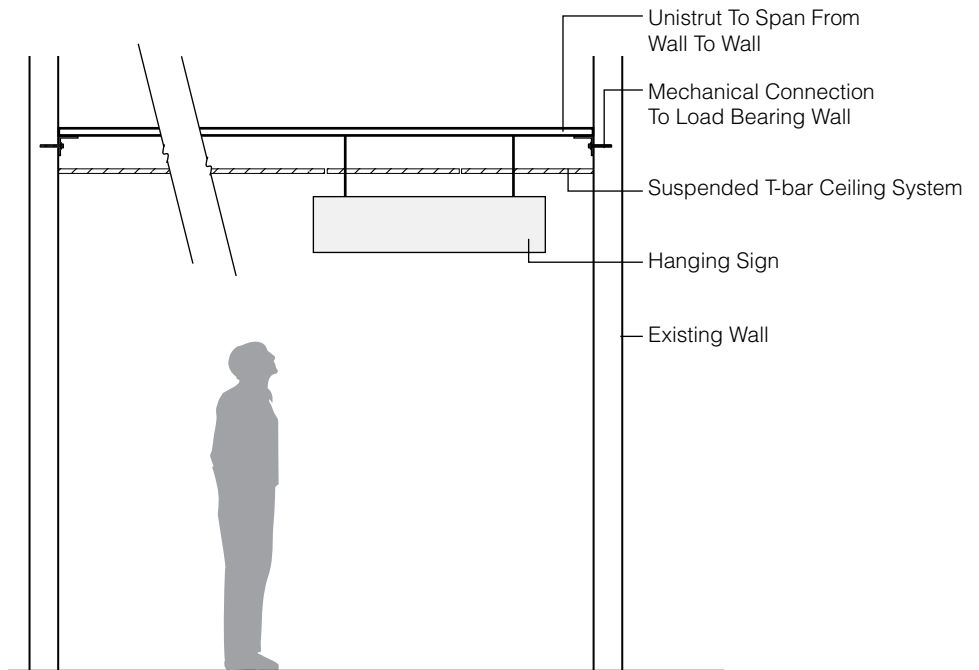

Elevation