



Code and Life Safety Signs

- Fire
- Evacuation
- Elevator
- Exit
- Door
- Caution
- Warning

This page is intentionally left blank.

Section 8: Code and Life Safety Signs

- Planning Pages 8-2-1 – 8-2-2
- Helpful Hints Pages 8-3-1
- Overview Pages 8-4-1 – 8-4-4
- Code and Life Safety Signs Pages 8-5-1 – 8-5-70
- Specification Pages 8-6-1
- Construction Pages 8-7-1
- Installation Pages 8-8-1 – 8-8-5

This page is intentionally left blank.

Planning a Code and Life Safety Sign Program

The development of an effective Code and Life Safety sign program requires the coordination of several related criteria and take in to account the following:

1. Location of building entrances, exits, and elevators.
2. Character and configuration of the corridor system.
3. Normal circulation patterns of people moving within and around the facility.
4. Code required path of emergency egress travel within the building for visitors, patients, and staff.
5. Location of emergency and fire equipment.
6. Placement of signs in locations where users customarily expect them or where they are required by codes.
7. OSHA and other regulatory agency sign requirements.
8. Which signs can have permanent messages and which ones need to be changeable.
9. Locations of other signs necessary for VA facility operations.

These elements help establish the basis of a clear code and life safety sign program that communicates and informs in a direct and simple manner.

Types of Signs

Code and Life Safety signs have been identified on each page with a description of use and application. These signs are in the color, size, and shape to conform with their respective function and application requirement. Some colors, sizes, and shapes are determined by code.

This section covers the known required signs at the time of publication. Regulations are constantly changing and revised signs may be required for code compliance.

Consult with the facility Safety Officer for the most current sign requirements.

Sizes of Signs and Lettering

Code and Life Safety sign sizes that are illustrated in this section have been determined to work in most situations and conform to regulations.

The text and its size, as shown, has been determined to conform to regulations.

Placement of Signs

Correct placement of signs is required for Code and Life Safety signs. Refer to the detailed drawings and instructions covered in the Installation pages for each sign type showing the placement position required for its use.

Care needs to be taken to place Code and Life Safety signs in a location that allow clear viewing. Place signs so they are not obscured by furniture or equipment.

The placement of code and life safety signs takes priority over placement of items such as chart holders, bulletin boards, pictures and art work. These types of items will have to be relocated to meet the installation requirements of Code and Life Safety signs.

Existing Sign Program

Before implementing a new Code and Life Safety sign program, perform a thorough evaluation of the demolition requirements of the current sign program and the effects and impact on the facilities walls, doors and ceilings.

Check to see what is required to patch, seal and repair the building surfaces as a result of removal of old signs. Repairs should be planned to match adjoining surface. Evaluate if tile or stone surfaces are going to require repair or refurbishment. Doors will need to be refinished or repainted.

Confirm that if the sign demolition scope of work requires the contractor to close off any live electrical connections, make sure existing conductors and conduits are removed to the nearest junction box and disconnected.

Do not remove any Code and Life Safety signs without having the replacement signs available and installed at the same time the old signs are removed.

This is not intended to be a training section of the guide, but to provide key information or instructions that will hopefully reduce some common errors that are made when working out a Code and Life Safety sign program.

The following are some general “Do’s and Don’ts” that can be referred to when developing a Code and Life Safety sign program.

General Guidelines

- Some Code and Life Safety signs have specific color requirements and they are not to be altered.
 - When selecting a background color for the signs that do not have a specific color requirement, seek a complementary color to the building wall colors and a color that conforms to the master sign program color.
 - Signs do require maintenance. Cleaning will extend the life of a sign program.
-

Message Content

- Code and Life Safety signs have specific text requirements and can not be altered.
 - Some signs will require specific text developed for each sign location. Refer to the sign type drawings.
-

Message Layout

- Some Code and Life Safety signs have specific text layout and text size requirements, and they are not to be altered.
-

Size of Sign to Use

- Some Code and Life Safety signs have specific size requirements and they are not to be altered.
-

Placement of Signs

- Some Code and Life Safety signs have specific placement and location requirements and they are not to be altered.
- Be mindful when coordinating ceiling mounted signs so they do not obstruct or block fire sprinkler systems, exit signs, or other signage.

This page is intentionally left blank.

This section of the VA Signage Design Guide provides sign guidelines for all the types of Code and Life Safety signs that are necessary to sign any individual building, regardless of size or type of use.

The following Overview illustrates the various types of signs in this section. The individual pages on each Sign Type provide more specific information and detailed layouts.

INTERIOR SIGN DESIGNATIONS

Each sign in the program guide has been given a specific sign type number designation. This designation provides a common description that can be referenced when programming a site and ordering signs. The following explains how the sign type designations are derived.

IN - 01.28.03C

IN Designates an interior sign.

01 Two digit number identifies the Code and Life Safety Sign Family.

.28 The two digit number following the period identifies a specific sign type within the sign family.

.03 The two digit number following the period identifies a specific sub-group of sign within the sign family.

C The letter designates a specific sign configuration, version and/or layout for graphics or symbols.

IN-01.01.01
Large Emergency Exit Plan

IN-01.01.03
Small Emergency Exit Plan, Hoptel
Room Emergency Exit Plan

IN-01.02
Fire Equipment Identification Sign

IN-01.03
Fire Procedure Sign

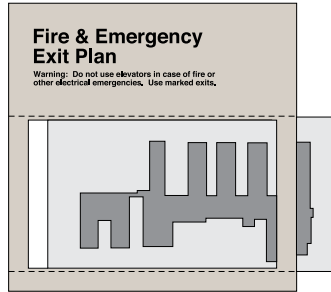

IN-01.01.01 & .03



IN-01.02

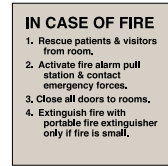

IN-01.03

IN-01.04
Elevator Call Button

IN-01.05
Fire Door Sign

IN-01.06
No Exit Sign



IN-01.04



IN-01.05



IN-01.06

IN-01.07.01
Exit Sign

IN-01.07.02
Exit Sign (Right Arrow)

IN-01.07.03
Exit Sign (Left Arrow)

IN-01.07.04
Exit Sign (Left and Right Arrows)



IN-01.07.01, .02, .03, & .04



IN-01.08



IN-01.09

IN-01.08
Automatic Fire Door (Hinged) Sign

IN-01.09
Automatic Fire Door (Roll Up) Sign

IN-01.10
Stair Identification Sign

IN-01.11
Stairwell Identification Sign

IN-01.12
Area of Refuge
(Evacuation Assistance)

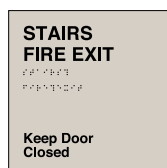

IN-01.10



IN-01.11



IN-01.12

IN-01.13
Push Alarm Identification Sign



IN-01.13



IN-01.14

IN-01.15
Hazard Material Information Sign



IN-01.15

IN-01.16
Oxygen In Use Warning Sign

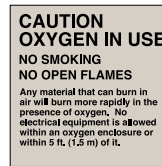

IN-01.16

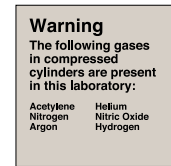

IN-01.17

IN-01.17
Compressed Gas Warning Sign

IN-01.18
Nonflammable Anesthesia Restriction Sign

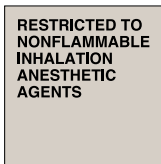

IN-01.18

IN-01.19
Radioactive Material Warning Sign



IN-01.19



IN-01.20

IN-01.20
Radioactive Area Warning Sign

IN-01.21
High Voltage Warning Sign



IN-01.21

IN-01.22
Biohazard Warning Sign



IN-01.22

IN-01.23
Laser Warning Sign



IN-01.23

IN-01.24

Occupational Exposure Area
Warning Sign

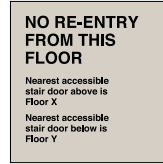
**IN-01.24****IN-01.25****IN-01.26****IN-01.25**

No Re-Entry Floor Sign

IN-01.26

Push to Exit Sign

IN-01.27

Emergency Push to Open Sign

**IN-01.27****IN-01.28****IN-01.29****IN-01.28**

Emergency Slide to Open Sign

IN-01.29

Direction of Exit Sign

IN-01.30

No Re-entry Sign

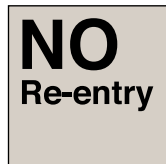
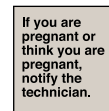
**IN-01.30****IN-01.31****IN-01.32****IN-01.31**

Fire Equipment Identification Sign

IN-01.32

Pregnancy Notification Sign

IN-01.33

Re-entry Sign

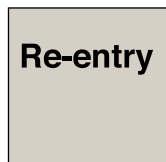
**IN-01.33**

Emergency Exit Plan

Sign

508 mm H x 508 mm W
(20" H x 20" W)

Description and Use

NOTE: This sign type is optional except for hoptels when they are considered a hotel/dormitory type occupancy.

Evacuation Map/Fire Exit Plan with pocket to accept map insert is to be placed at points of exit and transition in a building (all elevators, exits, and exiting stairwell doors); other locations as needed. Use this large size sign when large size maps are necessary.

Evacuation maps can be created by the medical center and inserted into the sign in accord with the facilities evacuation plan. The map must be oriented relative to the specific location of the sign i.e., (what is to the right on the drawing should be to the right of the viewer). Refer to the You Are Here section (Section 10) for additional information regarding maps.

Local fire departments may request these signs be installed. If requested, coordinate locations with their requirements.

Message Configuration

Refer to layout drawing for lettering sizes and dimensions.

Sign Components

Face: clear 1.5 mm (1/16") non-glare acrylic with subsurface background color creating a clear window.

Spacer to receive a clear 0.4 mm (1/64") insert. Backing plaque: surface painted 6 mm (1/4") acrylic.

Graphic Process

Sign: silk-screened. Insert: printed

Colors

Type: refer to color chart.
Background: refer to color chart.

Typography

Helvetica Bold

Mounting

Double sided foam tape or silastic adhesive.

Installation

On wall, 1600 mm (63") to top of sign

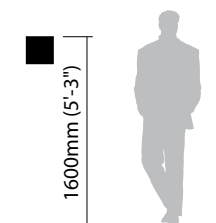
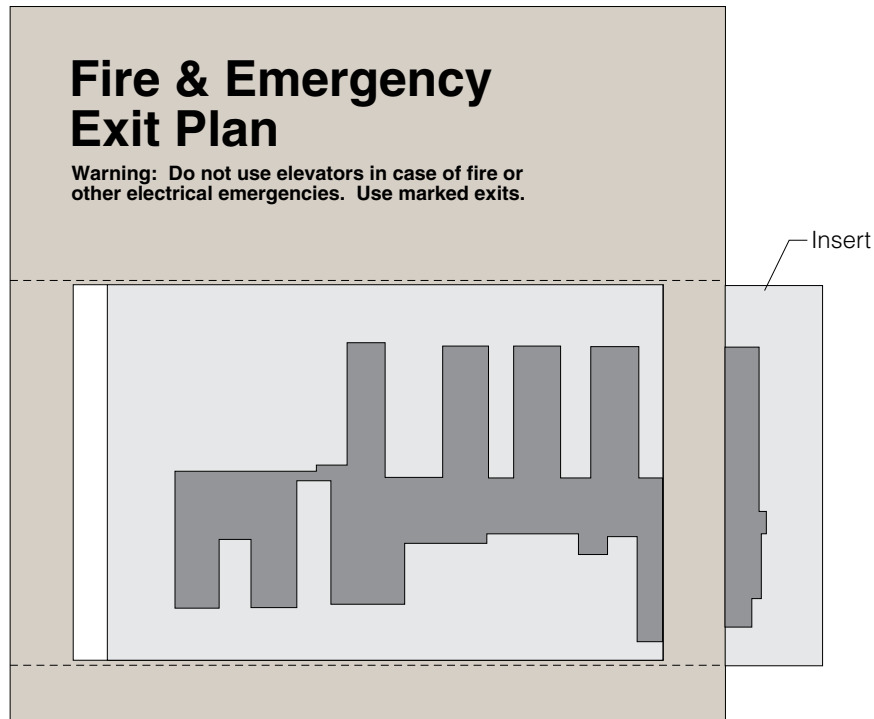

Emergency Exit Plan

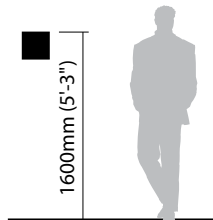
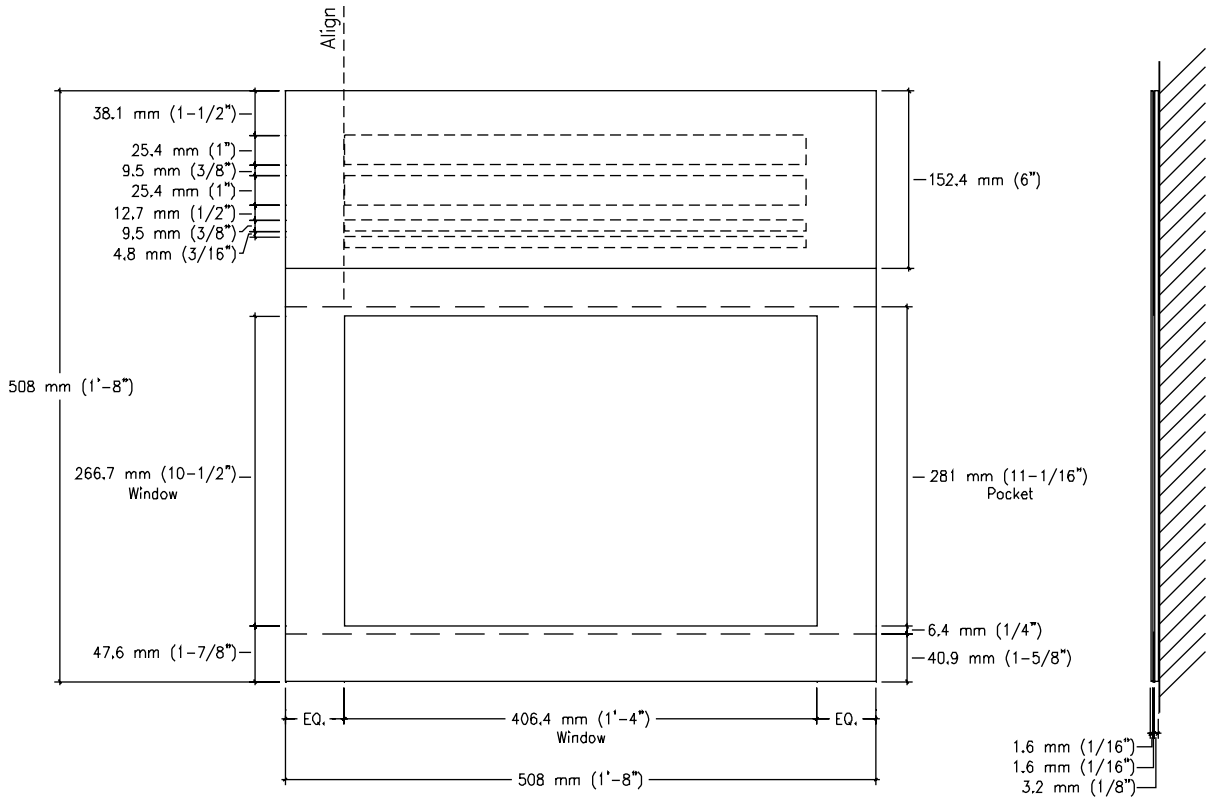

Emergency Exit Plan and Hoptel Door Emergency Exit Plan

Sign

330 mm H x 330 mm W
13" H x 13" W

Description and Use

NOTE: This sign type is optional except for hoptels when they are considered a hotel/dormitory type occupancy.

Evacuation Map/Fire Exit Plan with pocket to accept map insert is to be placed at points of exit and transition in a building (all elevators, exits and exiting stairwell doors); other locations as needed.

Evacuation maps can be created by the medical center and inserted into the sign in accord with the facilities evacuation plan. The map must be oriented relative to the specific location of the sign i.e., (what is to the right on the drawing should be to the right of the viewer). Refer to the You Are Here section for additional information regarding maps.

Local fire departments may request these signs be installed. If so, coordinate locations with their requirements.

For hoptel use, install on door inside every patient room with map insert to correspond with each location.

Message Configuration

(Refer to layout drawing for lettering sizes and dimensions).

Sign Components

Face: clear 1.5 mm (1/16") non-glare acrylic with subsurface background color creating a clear window.

Spacer to receive a clear 0.4 mm (1/64") insert. Backing plaque: surface painted 6 mm (1/4") acrylic

Graphic Process

Sign: silk-screened. Insert: printed

Colors

Text: refer to color chart.
Background: refer to color chart.

Typography

Helvetica Bold

Mounting

Double sided foam tape or silastic adhesive

Installation

On wall, 1600 mm (63") to top of sign. For hoptel: on back of door inside room, 1600 mm (63") to center of sign

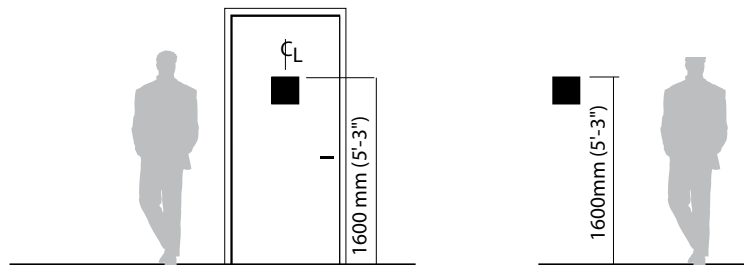
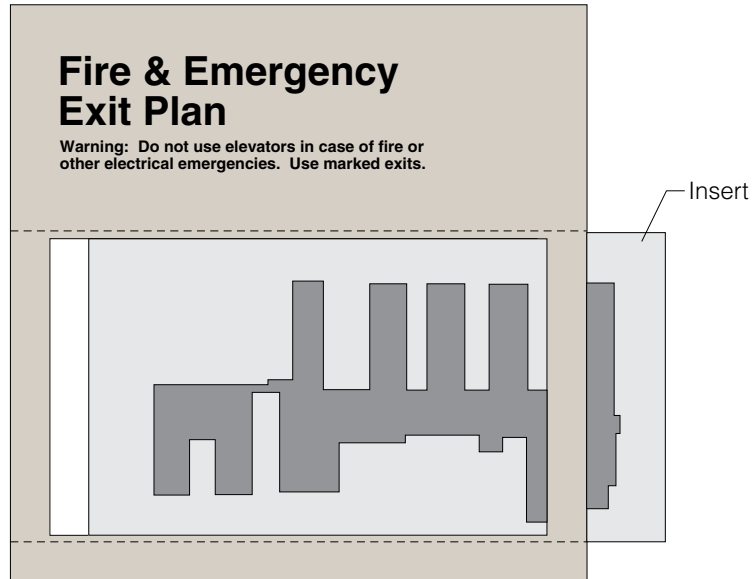

Emergency Exit Plan and Hoptel Door Emergency Exit Plan

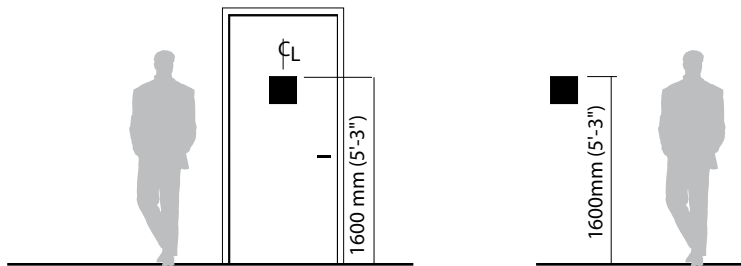
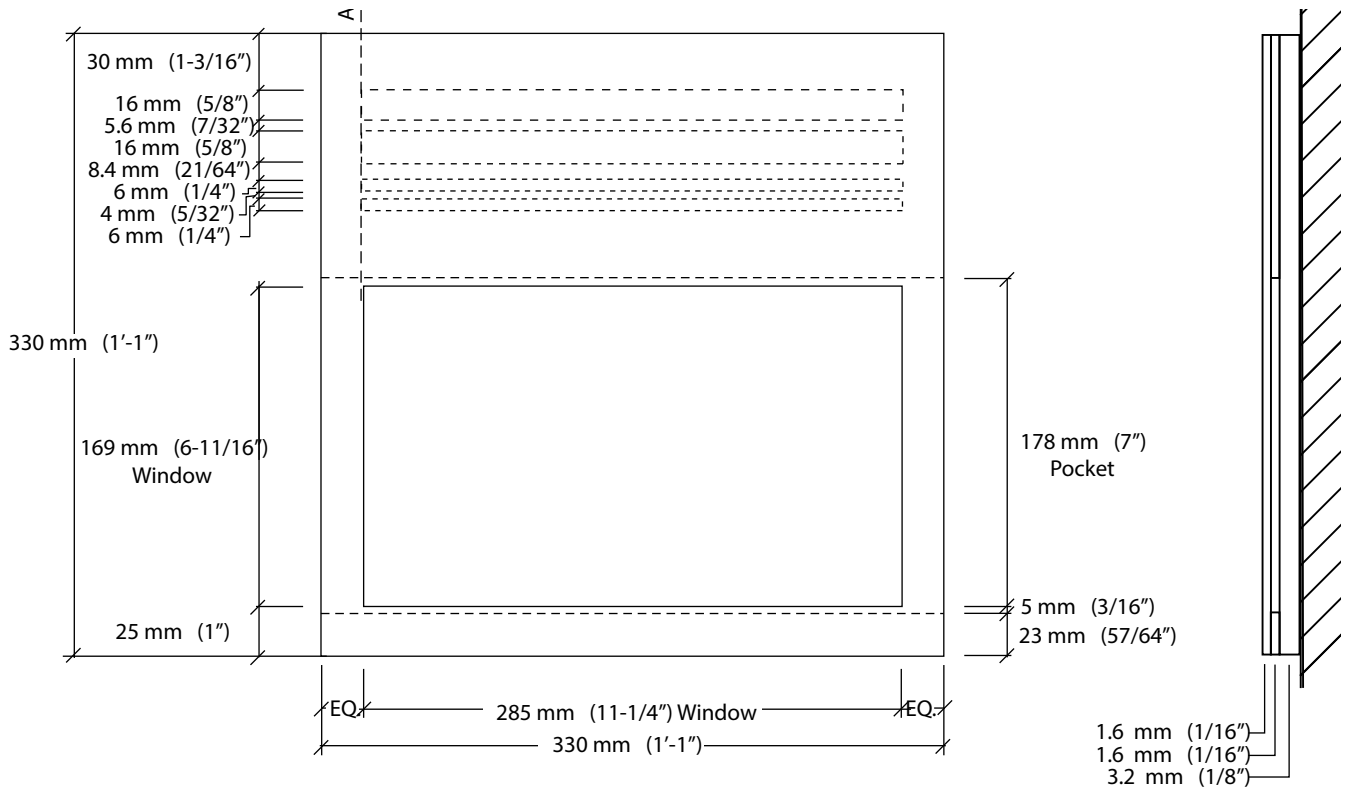

Fire Equipment Identification Sign

Sign

229 mm H x 229 mm W
(9" H x 9" W)

Description and Use

Fire equipment identification sign is used to locate and identify fire equipment cabinets.

Message Configuration

(Refer to layout drawing for lettering sizes and dimensions).

Sign Components

Acrylic plaque

Graphic Process

Silk-screened

Colors

Text and symbol: white
Background: red

Typography

Helvetica Bold

Mounting

Double sided foam tape or silastic adhesive

Installation

On wall, 1829 mm (72") to top of sign, perpendicular to wall: 2032 mm (80") clear above floor.

NOTE

Code requirements for identifying fire equipment state this sign is to be mounted above the fire equipment cabinet, flat against the wall. An alternate option for displaying this sign is to mount it in the same location, but perpendicular to the wall centered above the cabinet. Refer to sign type IN-01.31 for perpendicular/blade mounted option.

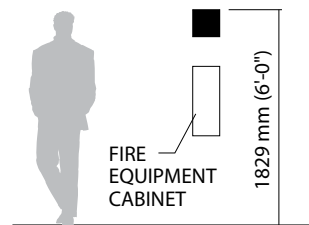

Fire Equipment Identification Sign

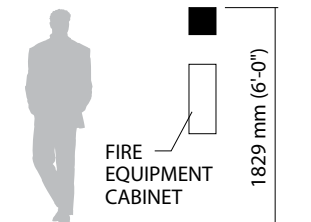
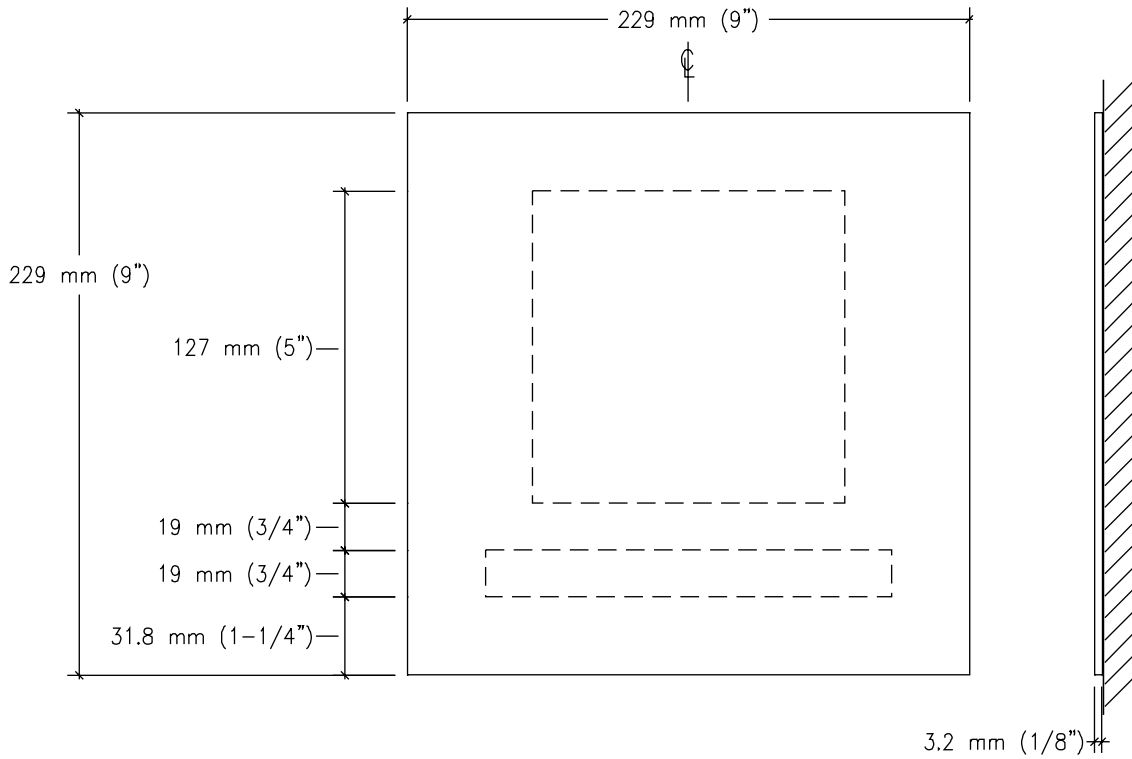

Fire Procedure Sign

Sign

229 mm H x 229 mm W
(9" H x 9" W)

Description and Use

Fire procedure sign to be installed at elevators, adjacent to stairwell doors, nurse stations, and other locations as needed. This sign is optional.

Some facilities indicate that "E" is to extinguish or evacuate. All of the information provided on these signs should be coordinated with the facility personnel who are responsible for the facility fire plan.

Message Configuration

(Refer to layout drawing for lettering sizes and dimensions).

Sign Components

Acrylic plaque

Graphic Process

Silk-screened

Colors

Text: refer to color chart.
Background: refer to color chart.

Typography

Helvetica Bold

Mounting

Double sided foam tape or silastic adhesive

Installation

On wall, 1600 mm (63") to top of sign

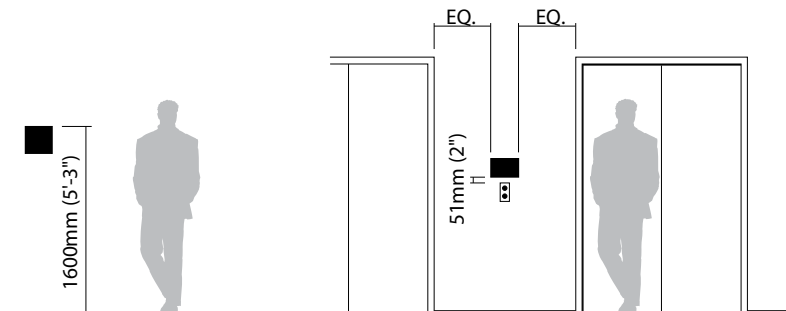
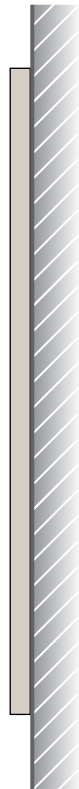
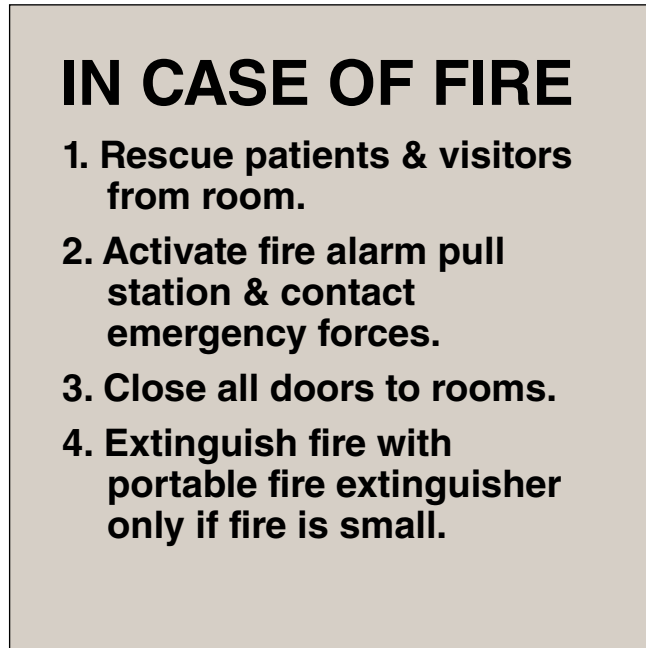

Fire Procedure Sign

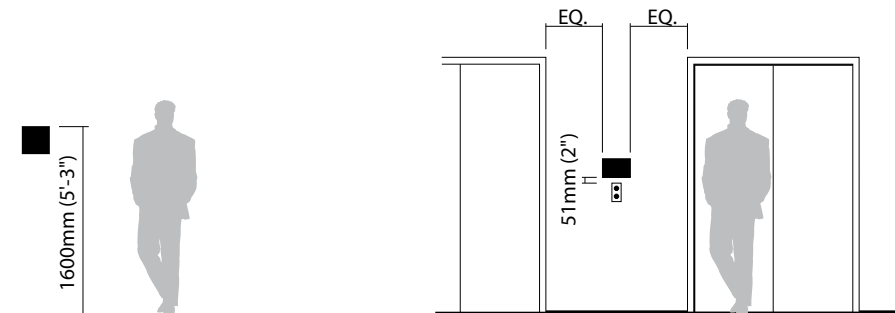
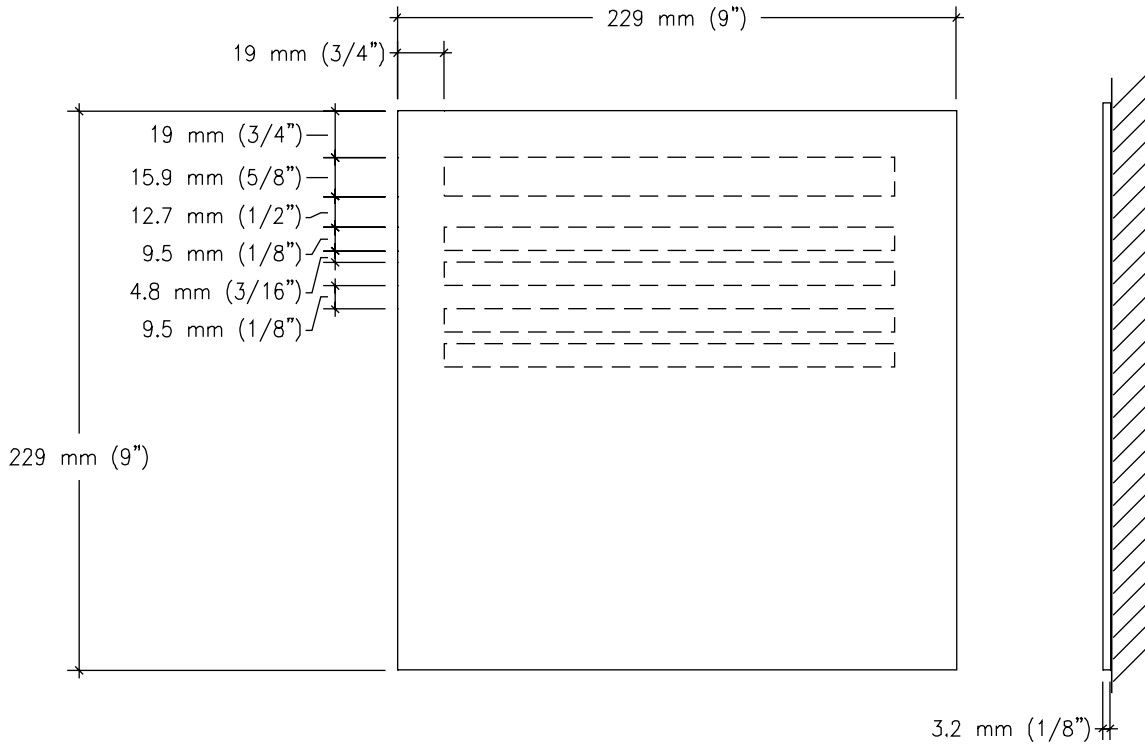

Elevator Call Button

Sign

152 mm H x 229 mm W
(6" H x 9" W)

Description and Use

Elevator call button fire procedure sign to be installed at elevators.
Position above type IN-01.03.

Message Configuration

(Refer to layout drawing for lettering sizes and dimensions).

Sign Components

Acrylic plaque

Graphic Process

Silk-screened

Colors

Text and symbols: white
Background: red

Typography

Helvetica Bold

Mounting

Double sided foam tape or silastic adhesive

Installation

Centered 51 mm (2") directly above elevator call button

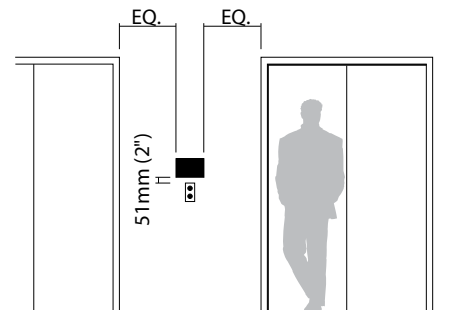

Elevator Call Button

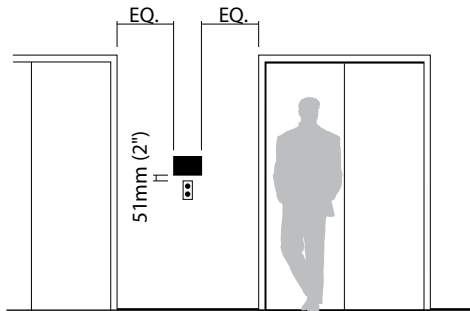
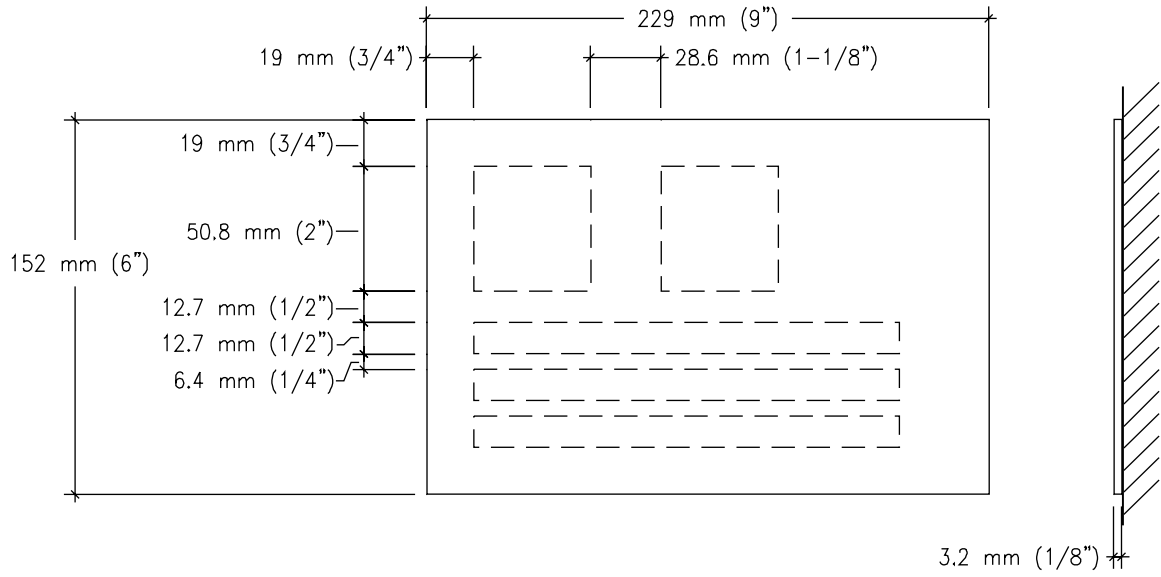

Fire Door Sign

Sign

229 mm H x 229 mm W
(9" H x 9" W)

Description and Use

Fire Door sign is used to identify a fire door. Exception: signs shall not be provided for fire doors that are held open by automatic devices.

This sign is optional and not required by the Life Safety Code.

Message Configuration

(Refer to layout drawing for lettering sizes and dimensions).

Sign Components

Acrylic plaque

Graphic Process

Silk-screened

Colors

Text: white
Background: red

Typography

Helvetica Bold

Mounting

Double sided foam tape or silastic adhesive

Installation

Centered on door, 1600 mm (63")
to top of sign.

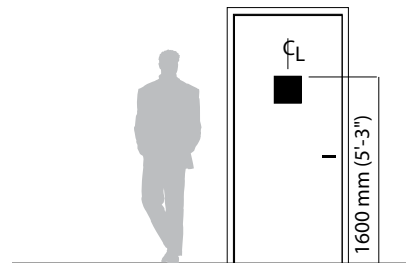
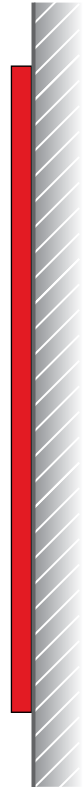

Fire Door Sign

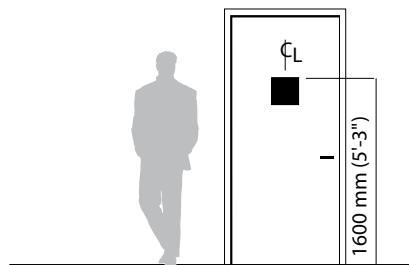
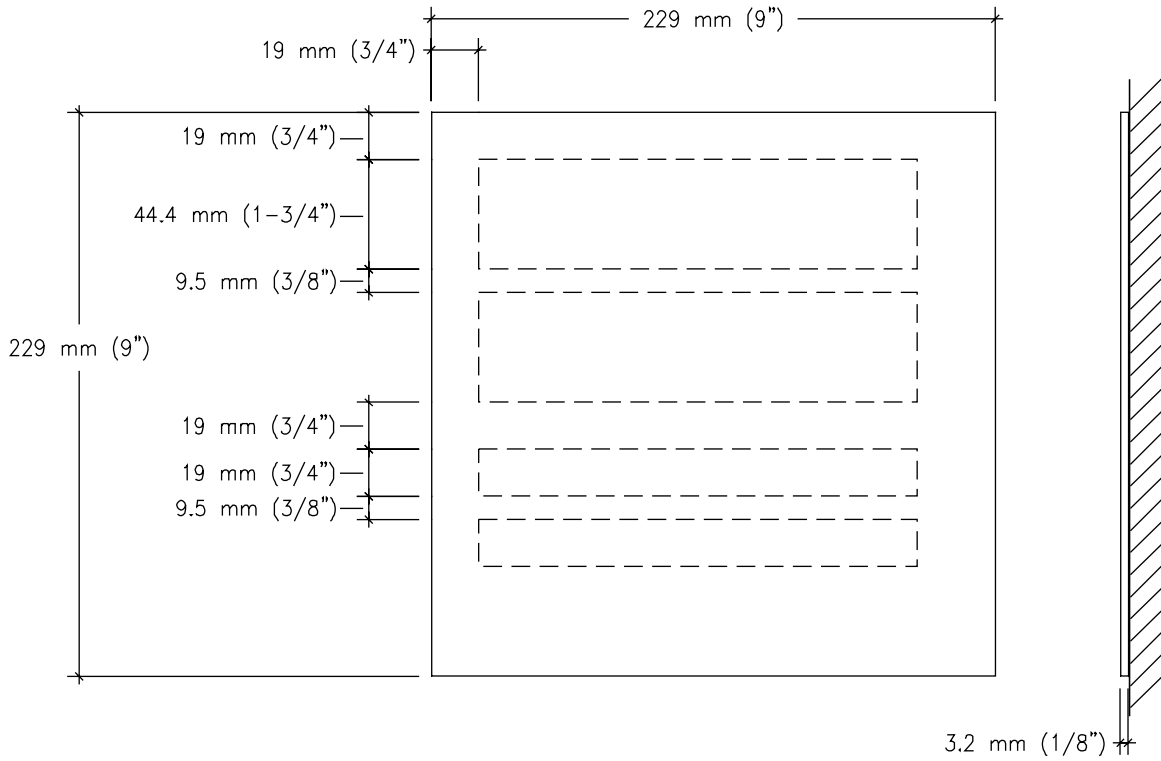

No Exit Sign

Sign

229 mm H x 229 mm W
(9" H x 9" W)

Description and Use

No Exit sign used to identify a door in a stairwell or other locations that are not exits.

Message Configuration

(Refer to layout drawing for lettering sizes and dimensions). Letters in "NO" must be 2" high and 3/8" stroke width; letters in "EXIT" must be 1" high and below "NO" per NFPA 101.

Sign Components

Acrylic plaque

Graphic Process

Silk-screened

Colors

Text: refer to color chart.
Background: refer to color chart.

Typography

Helvetica Bold

Mounting

Double sided foam tape or silastic adhesive

Installation

Centered on door, 1600 mm (63") to top of sign.

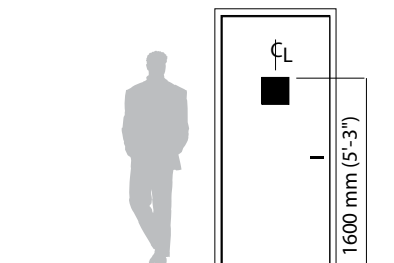
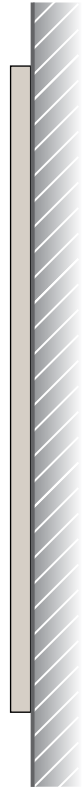

No Exit Sign

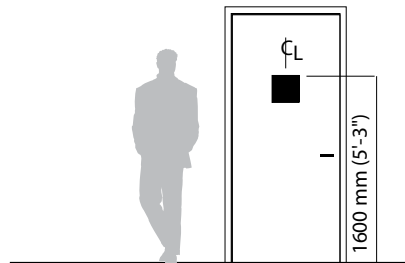
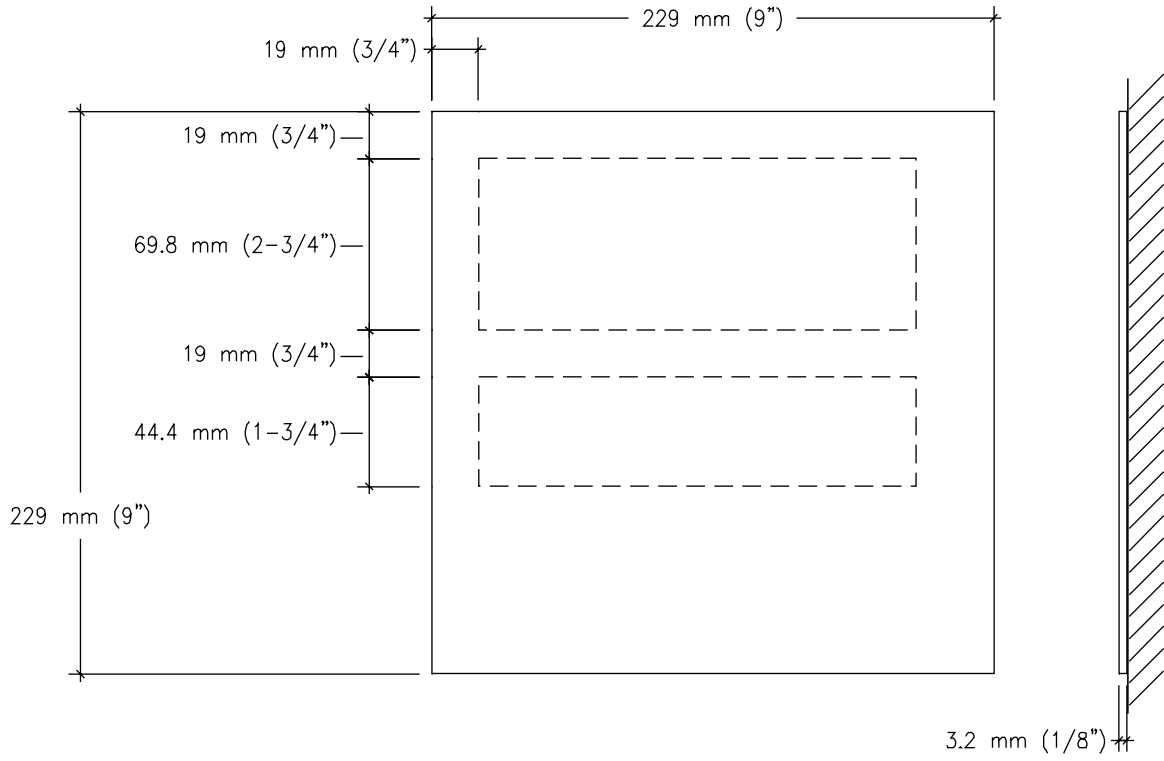

Exit Sign

Size

IN-01.07.01
229 mm x 559 mm
(9" x 22")

IN-01.07.02
229 mm x 559 mm
(9" x 22")

IN-01.07.03
229 mm x 559 mm
(9" x 22")

IN0-1.07.04
229 mm x 712 mm
(9" x 28")

Description and Use

Non-illuminated exit sign used to identify exit or direction to exit.

Message Configuration

(Refer to layout drawing for lettering sizes and dimensions). Letters must be no less than 6" in height per NFPA 101. Principal stroke of letters must be no less than 3/4" wide. Each letter must have a width of no less than 2" except the letter "I". Minimum spacing between letters must be no less than 3/8".

Sign Components

Acrylic plaque

Graphic Process

Silk-screened

Colors

Text: refer to color chart.
Background: refer to color chart.

Typography

Helvetica Medium Condensed

Mounting

Double sided foam tape or silastic adhesive

Installation

Center on soffit area directly above door frame.

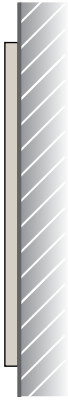
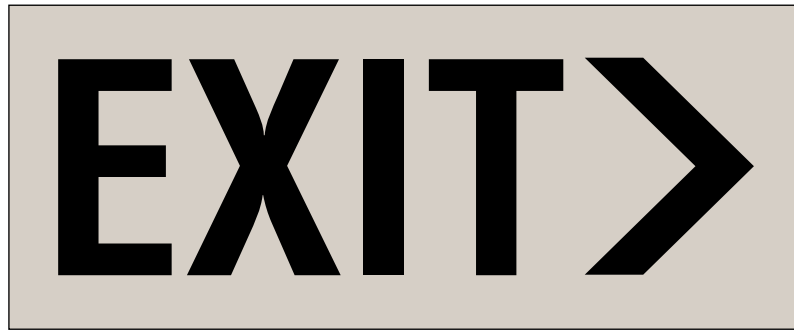

IN-01.07.01



IN-01.07.02



IN-01.07.03



IN-01.07.04

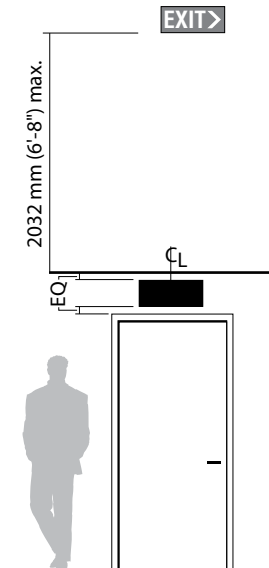

Exit Sign

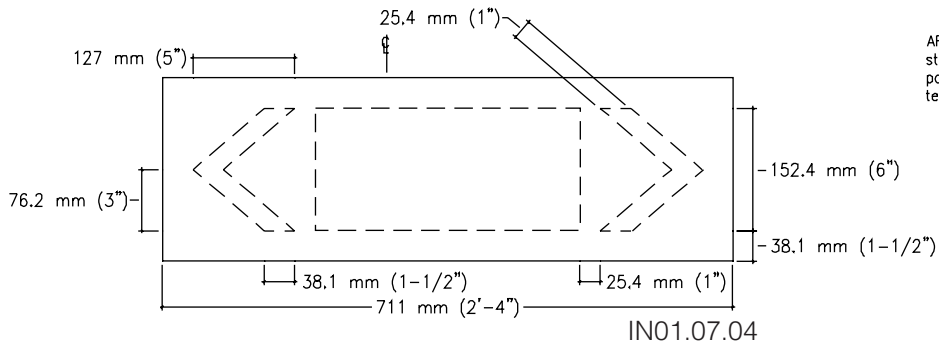
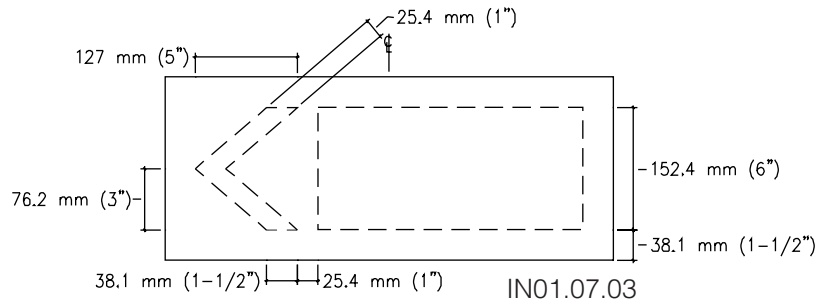
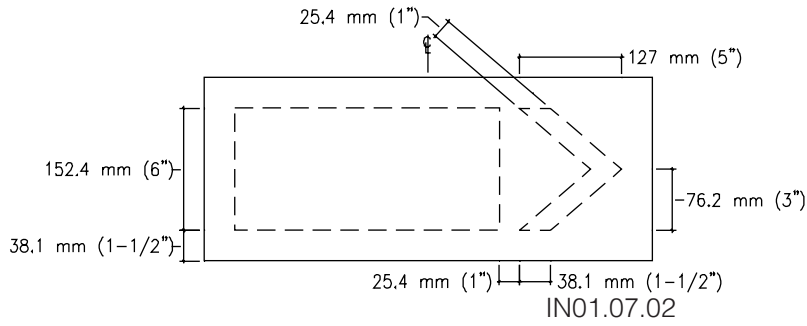
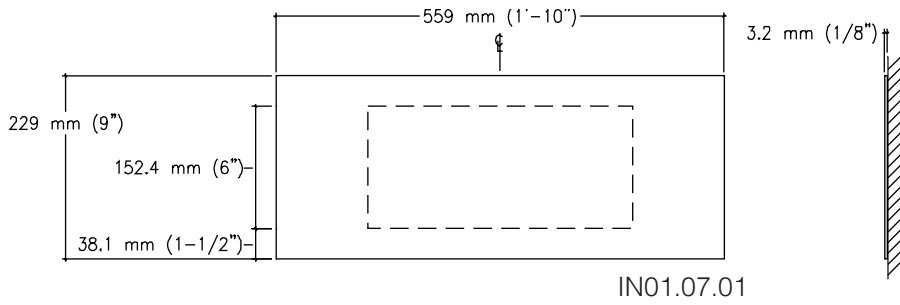

ARROW: Refer to standards for arrow positioning relative to text.

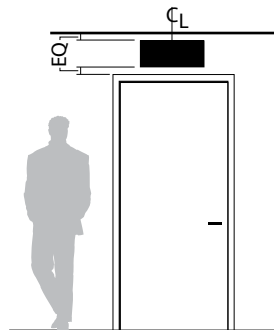

Automatic Fire Door Sign - Hinged Door

Size

229 mm H x 229 mm W
(9" H x 9" W)

Description and Use

Do Not Block information to be communicated at hinged fire doors held open by automatic devices.

Message Configuration

(Refer to layout drawing for lettering sizes and dimensions).

Sign Components

Acrylic plaque

Graphic Process

Silk-screened

Colors

Text: refer to color chart.
Background: refer to color chart.

Typography

Helvetica Bold

Mounting

Double sided foam tape or silastic adhesive

Installation

On door, 1600 mm (63") to top of sign and 76 mm (3") over from door edge. Install signs on both leaves of double doors.

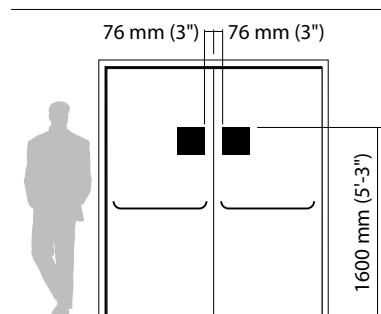
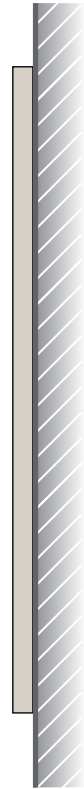
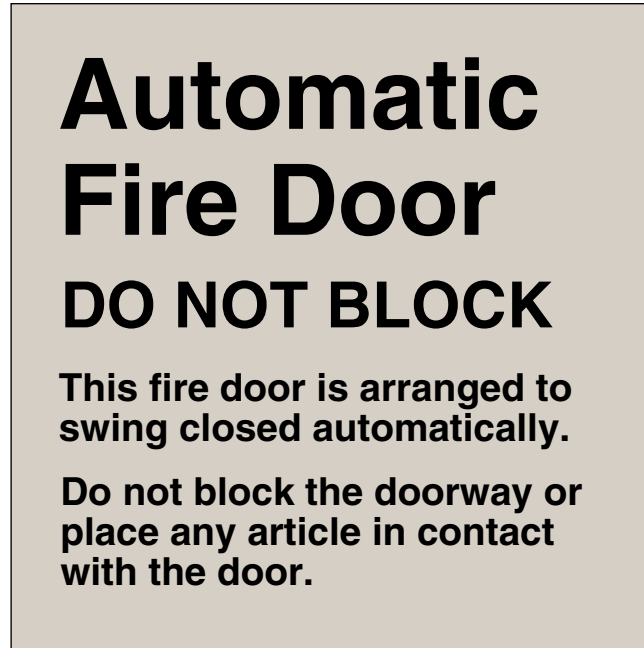

Automatic Fire Door Sign - Hinged Door

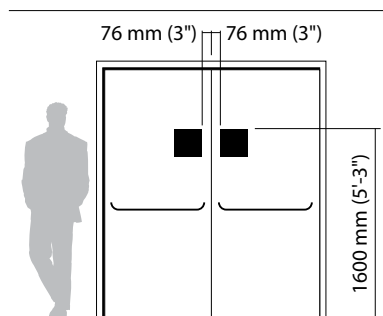
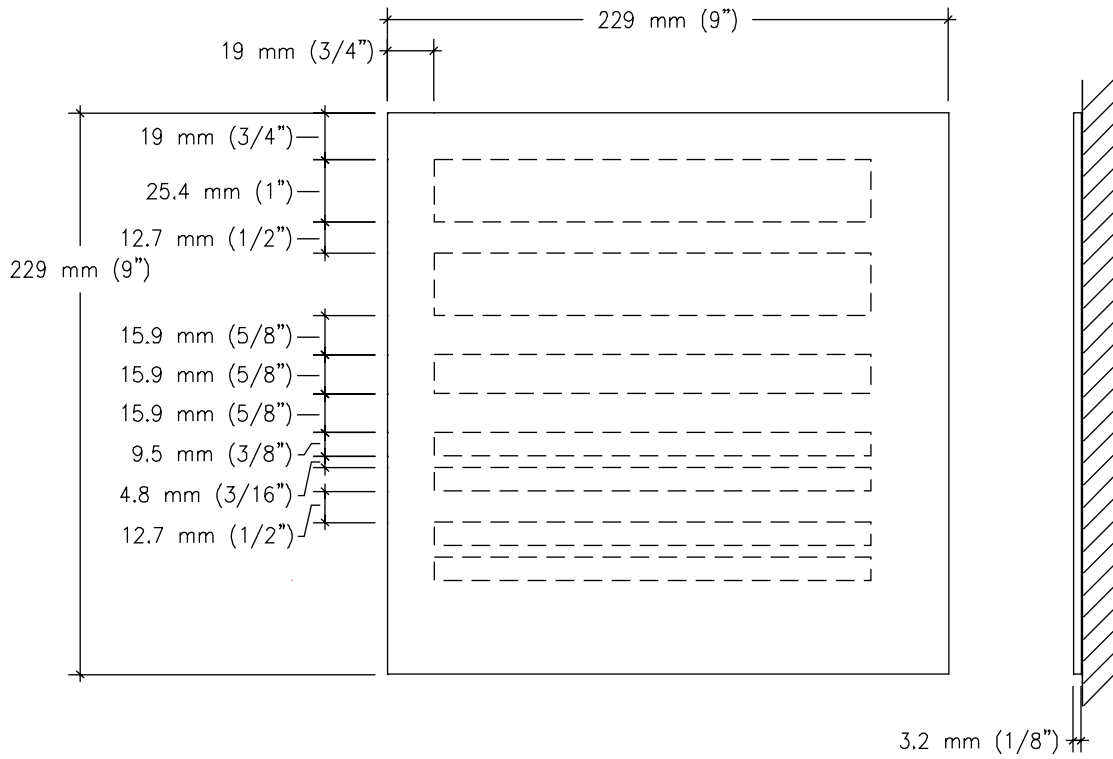

Automatic Fire Door Sign - Roll Up

Size

229 mm H x 229 mm W
(9" H x 9" W)

Description and Use

Do Not Block information to be communicated at roll down fire doors held open by automatic devices.

Message Configuration

(Refer to layout drawing for lettering sizes and dimensions).

Sign Components

Acrylic plaque

Graphic Process

Silk-screened

Colors

Text: refer to color chart.
Background: refer to color chart.

Typography

Helvetica Bold

Mounting

Double sided foam tape or silastic adhesive

Installation

On wall, adjacent to door, 1600 mm (63") to top of sign.

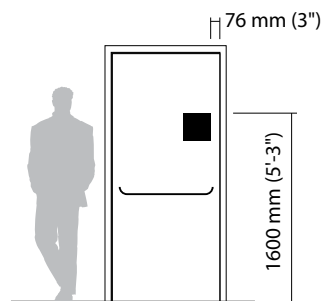
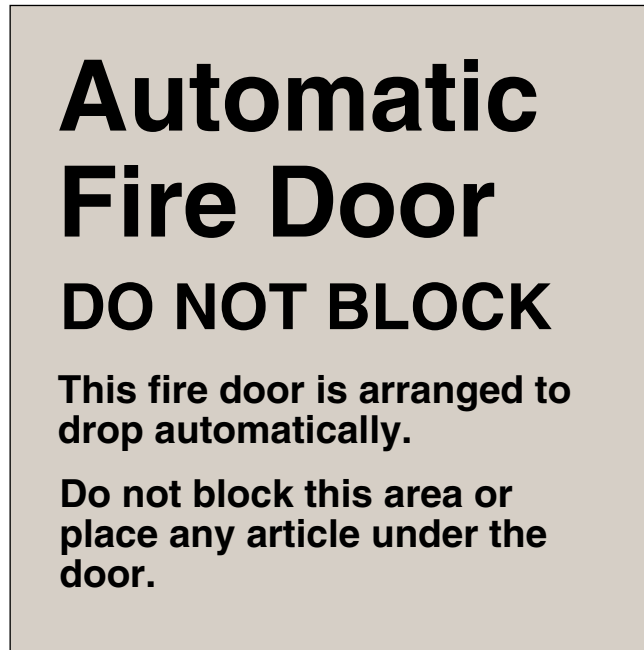

Automatic Fire Door - Roll Up

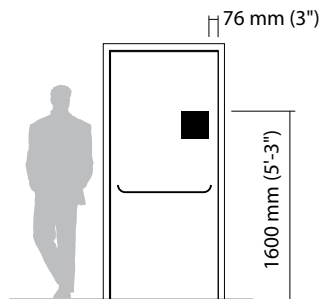
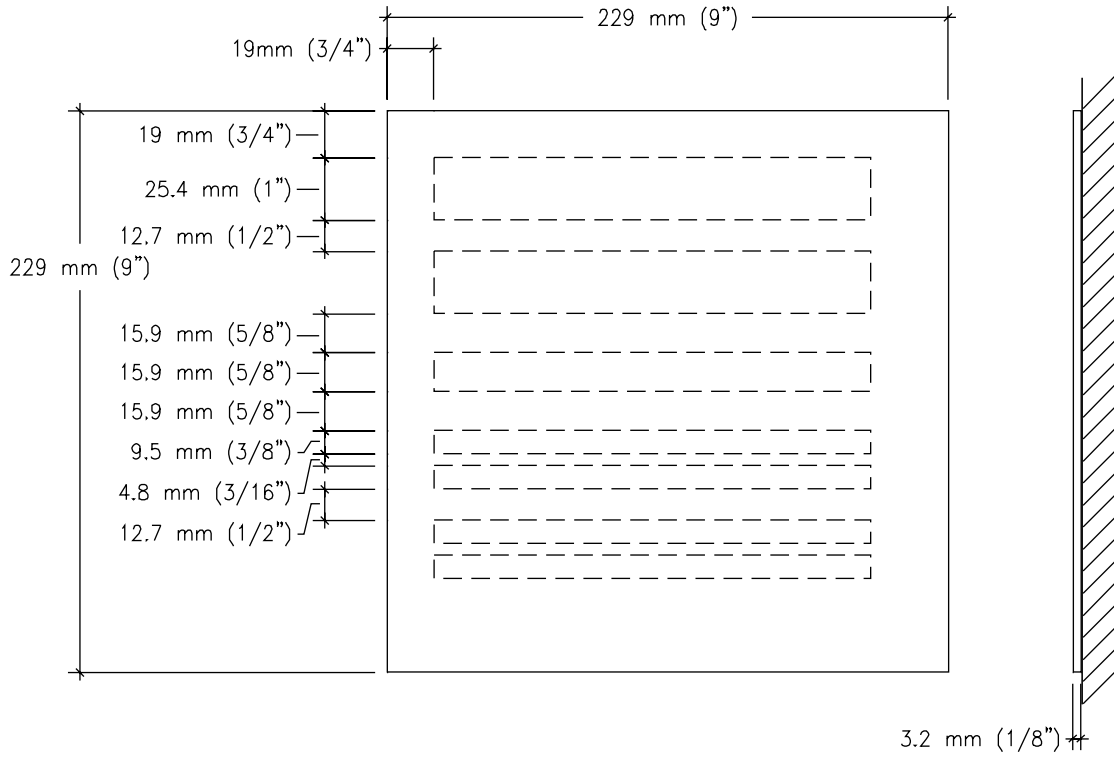

Stair Identification Sign

Size

229 mm H x 229 mm W
(9" H x 9" W)

Description and Use

Identifies stairwell doors that are fire exits.

Message Configuration

(Refer to layout drawing for lettering sizes and dimensions).

Sign Components

Etched sign face laminated to acrylic backing plaque

Graphic Process

Tactile text with accompanying Braille

Colors

Text: refer to color chart.
Background: refer to color chart.

Typography

Helvetica Bold
Grade 2 Braille

Mounting

Double sided foam tape or silastic adhesive

Installation

Knob side of door, 1600 mm (63") to top of sign and 51 mm (2") over from door frame

For sign placement refer to the Stairwell Guide in the Installation section.

Message Layout A

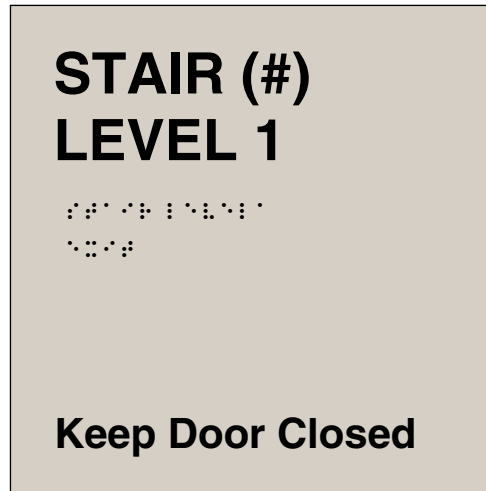

Layout A: To be used out side stairs access door at ground level.

Message Layout B

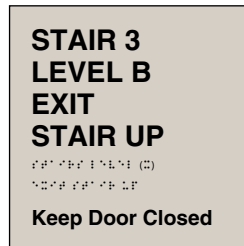

Message Layout C

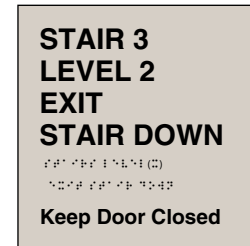

Message Layout D

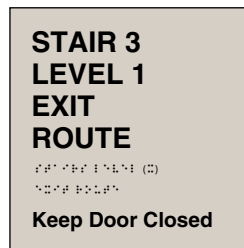

Message Layout E

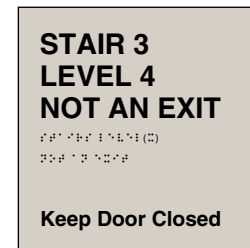

Layouts B, C, D, E: To be used out side stairs access door

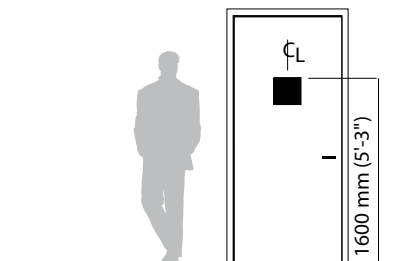

Stair Identification Sign

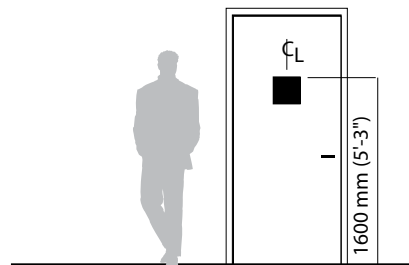
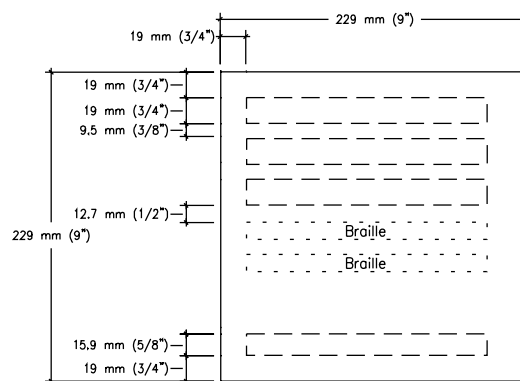
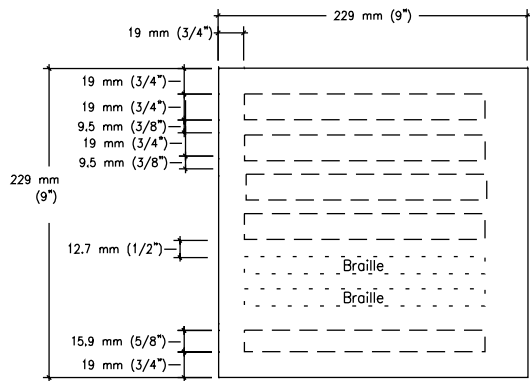
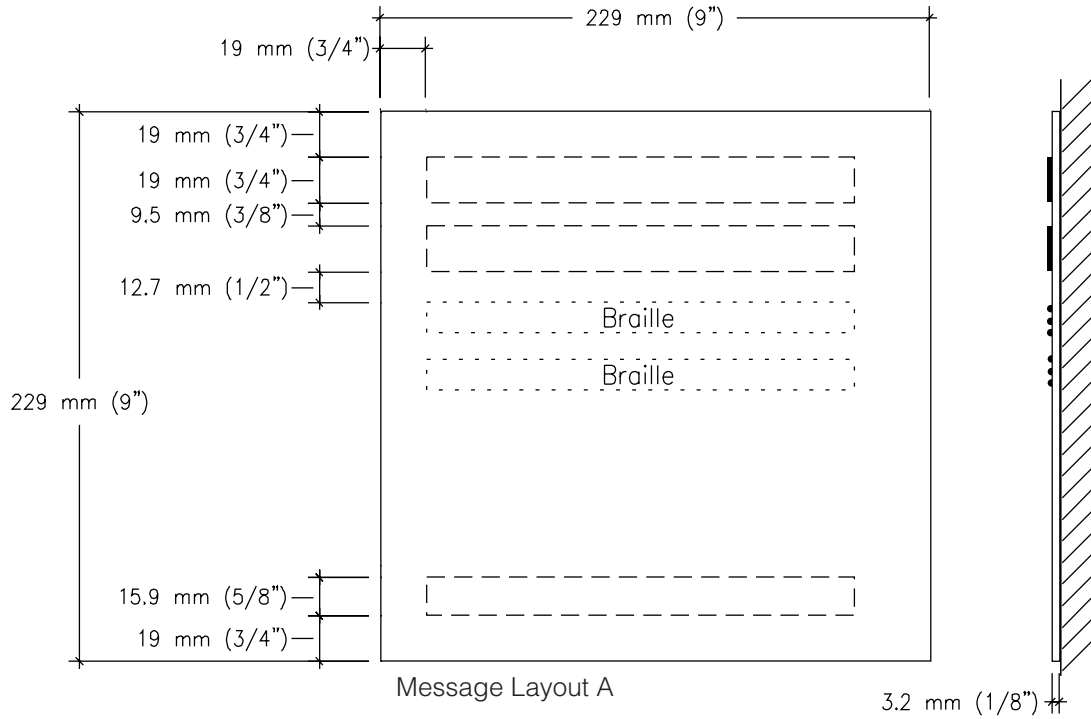

Stairwell Identification Sign

Size

457 mm H x 457 mm W
(18" H x 18" W)

Description and Use

Stairwell, floor level and egress information. Sign is located within the stair enclosure at each floor landing and must be readily visible when stair door is in open or closed position. Per NFPA 101, Section 7.2.2.5.4, Stairwell Identification signs are required only at new enclosed stairs serving three or more stories and at existing enclosed stairs serving five or more stories.

Message Configuration

(Refer to layout drawing for lettering sizes and dimensions).

Sign Components

Etched sign face laminated to acrylic backing plaque.

Graphic Process

Silk-screened text. Dimensional floor number. Tactile text with accompanying Braille.

Colors

Text: refer to color chart.
Background: refer to color chart.

Typography

Helvetica Bold

Mounting

Double sided foam tape or silastic adhesive

Installation

1524 mm (60") to bottom of sign

For sign placement refer to the Stairwell Guide in the Installation section.

Message Layout A

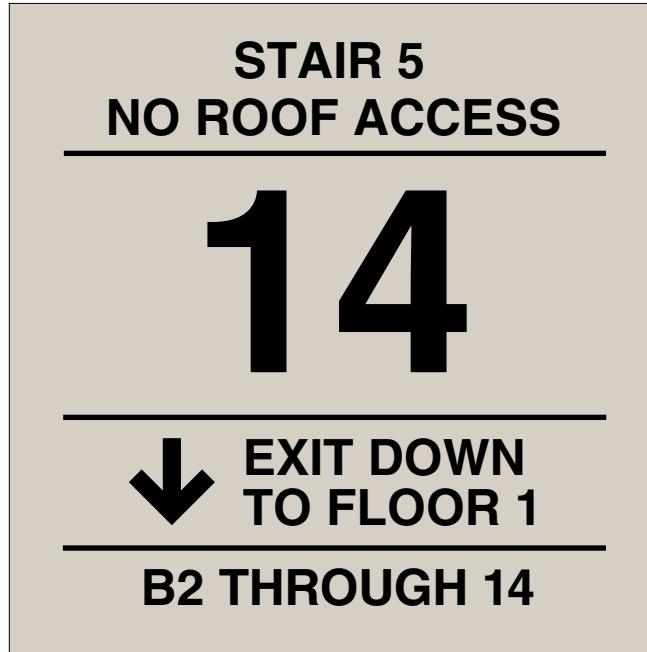

Message Layout B



Message Layout C

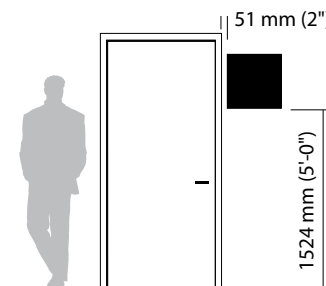

Stairwell Identification Sign

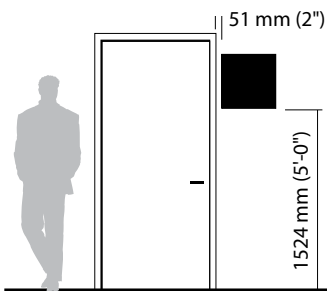
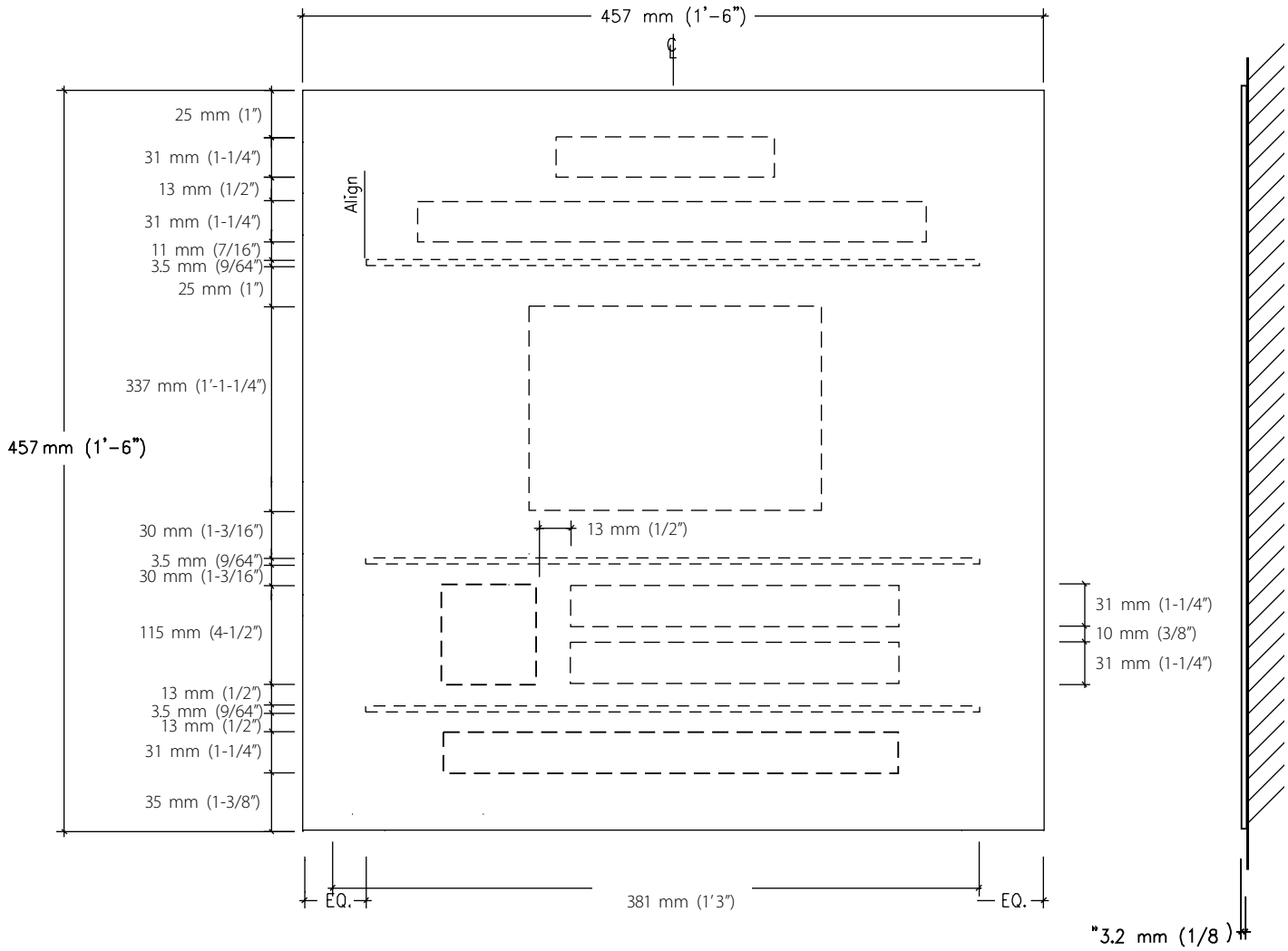

Area of Refuge (Evacuation Assistance)

Size

152 mm H x 229 mm W
(6" H x 9" W)

Description and Use

Disabled evacuation assistance directional sign indicating area of refuge for evacuation assistance.

Message Configuration

(Refer to layout drawing for lettering sizes and dimensions). Position arrow to communicate direction in relation to the placement of the sign in the building.

Sign Components

Etched sign face laminated to acrylic backing plaque

Graphic Process

Tactile text with accompanying Braille

Colors

Text: refer to color chart.
Background: refer to color chart.

Typography

Helvetica Bold
Grade 2 Braille

Mounting

Double sided foam tape or silastic adhesive

Installation

Knob side of door, 1600 mm (63") to top of sign and 51 mm (2") over from door frame or on wall
1600 mm (63") to top of sign.

Message Layout A

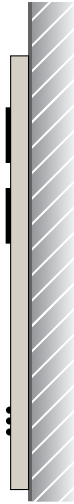
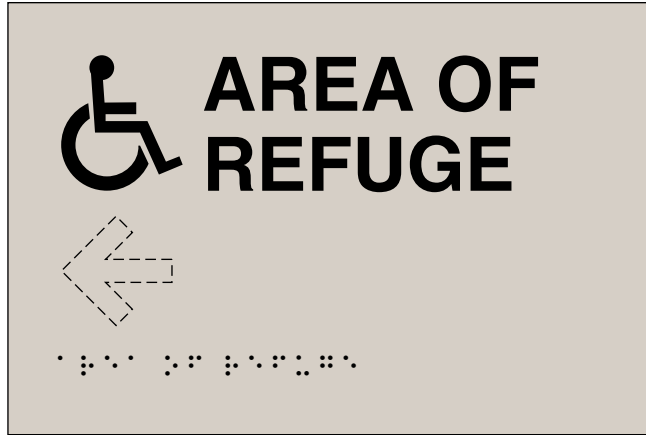

Message Layout B

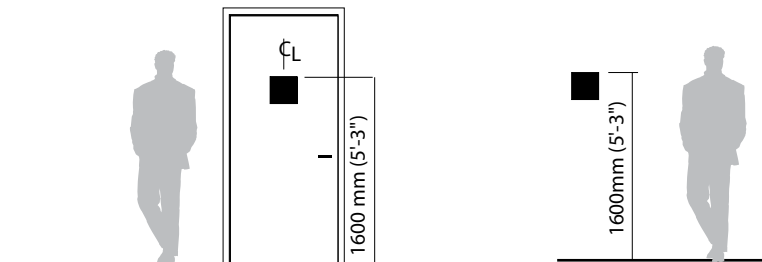

Area of Refuge (Evacuation Assistance)

Message Layout A

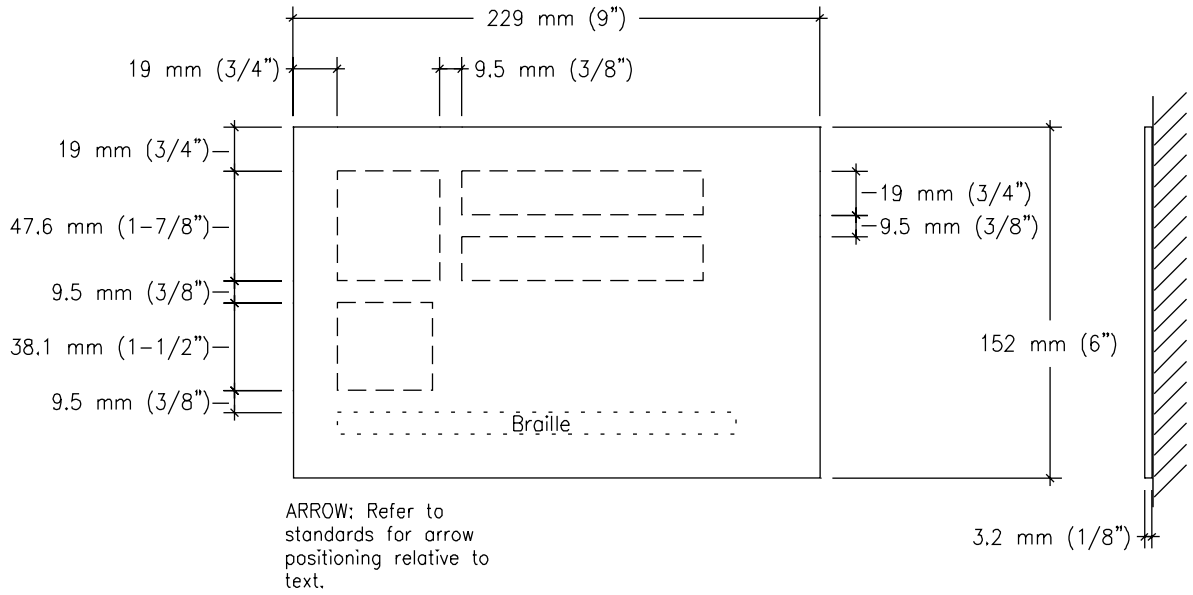

Message Layout B

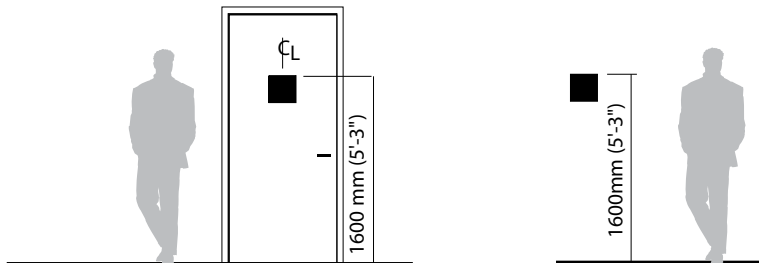
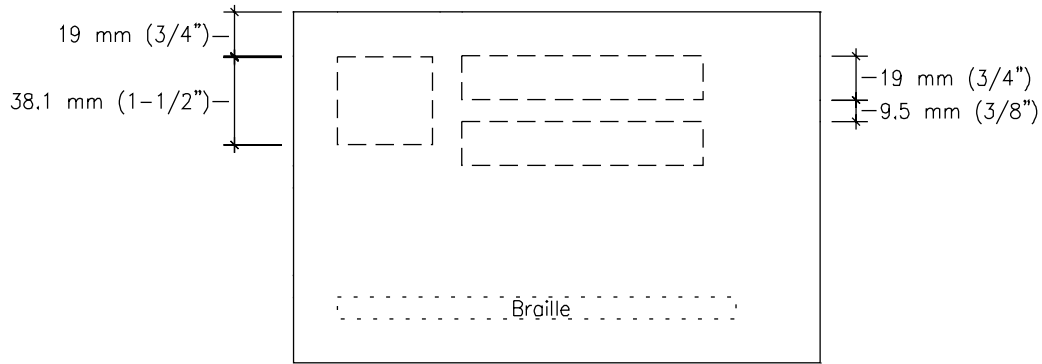

Push Alarm Identification Sign

Size

229 mm H x 381 mm W
(9" H x 15" W)

Description and Use

Push alarm identification sign is an instructional sign for push alarmed doors.

Message Configuration

(Refer to layout drawing for lettering sizes and dimensions).

Sign Components

Acrylic plaque

Graphic Process

Silk-screened

Colors

Text: refer to color chart.
Background: refer to color chart.

Typography

Helvetica Bold

Mounting

Double sided foam tape or silastic adhesive

Installation

Centered on door, 1600 mm (63")
to top of sign

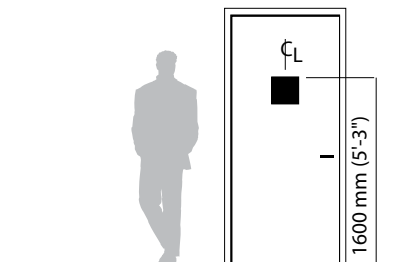
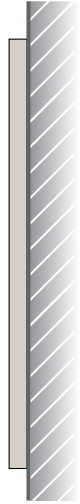
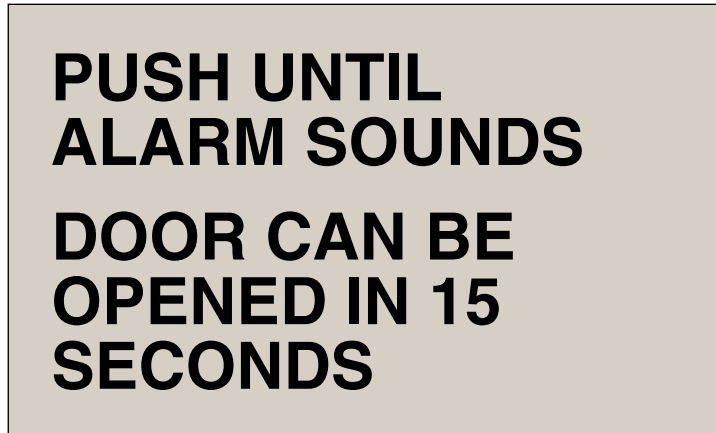

Push Alarm Identification Sign

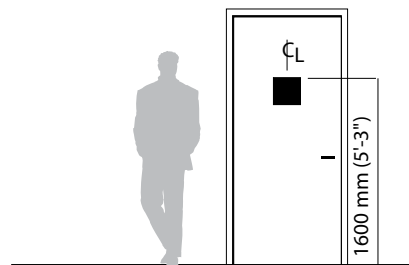
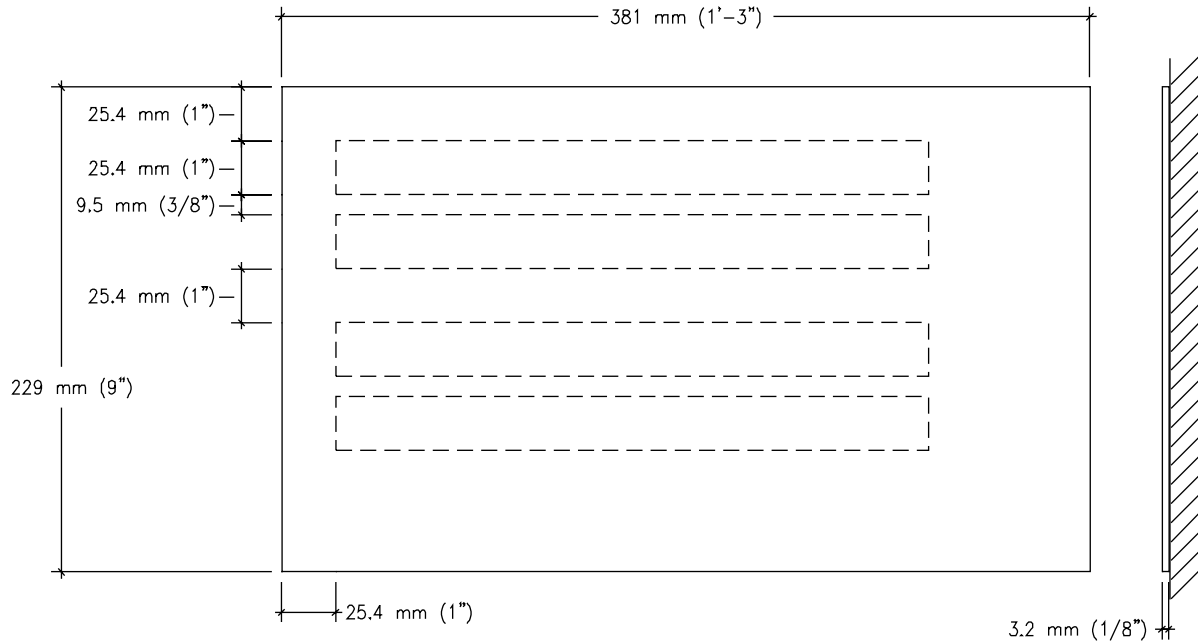

Open Door Fire Safety Sign

Size

77 mm H x 508 mm W
(3" H x 20" W)

Description and Use

Open door fire safety sign is used to identify a particular door is a fire safety door and is to remain open at certain times.

Message Configuration

(Refer to layout drawing for lettering sizes and dimensions)

Sign Components

Acrylic plaque

Graphic Process

Silk-screened

Colors

Text: Refer to color chart.

Background: Refer to color chart.

Typography

Helvetica Bold

Mounting

Double sided foam tape or silastic adhesive

Installation

Centered above door and 51 mm (2") above door frame



**THIS DOOR TO REMAIN UNLOCKED
WHEN THE BUILDING IS OCCUPIED**

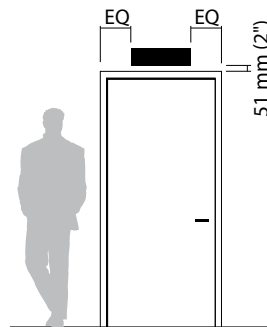

Open Door Fire Safety Sign

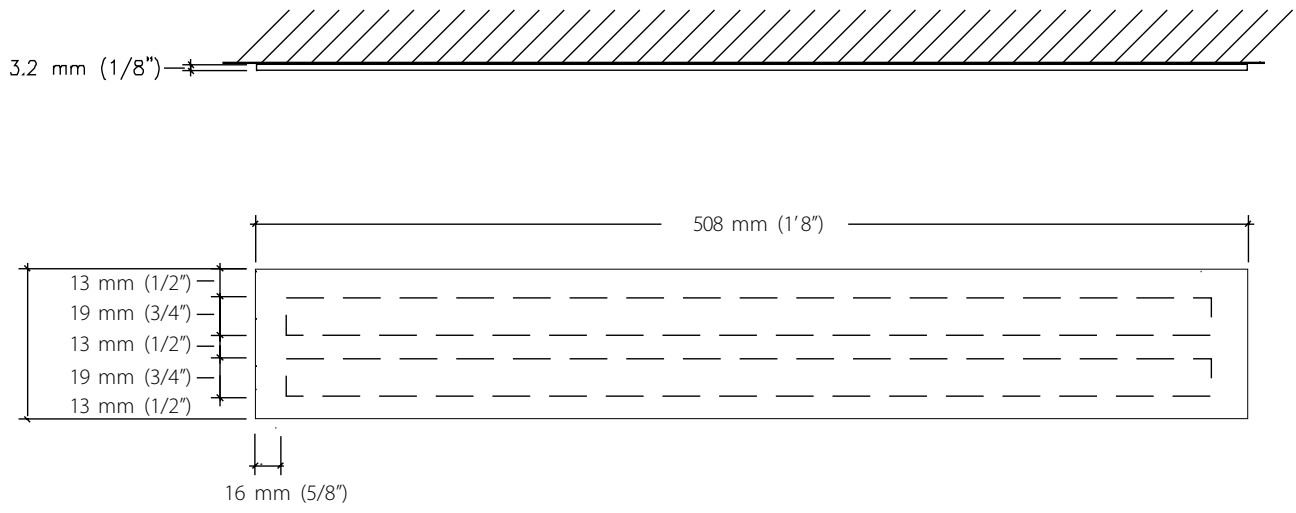

Hazardous Material Information Sign

Size

305 mm H x 305 mm W
(12" H x 12" W)

Description and Use

Hazardous materials information sign used to easily identify specific hazards within room, storage cabinet or locker.

Message Configuration

(Refer to layout drawing for lettering sizes and dimensions) Numbers shown on this drawing are for illustration purposes only. Provide correct numbers, text and colors to correctly identify the hazardous materials within a room. Refer to NFPA (National Fire Protection Association) or material data sheet relating to materials for more information regarding message.

- A Identifies specific hazard
- B Identifies health hazard
- C Identifies fire hazard
- D identifies reactivity

Sign Components

Acrylic plaque

Graphic Process

Silk-screened.

Colors

Text: black

Background:

- A white
- B safety blue (OSHA)
- C safety red (OSHA)
- D safety yellow (OSHA)

Typography

Helvetica Bold

Mounting

Double sided foam tape or silastic adhesive

Installation

Centered on door and 1524 mm (60") to center of sign

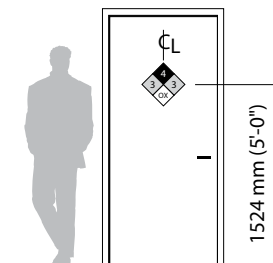
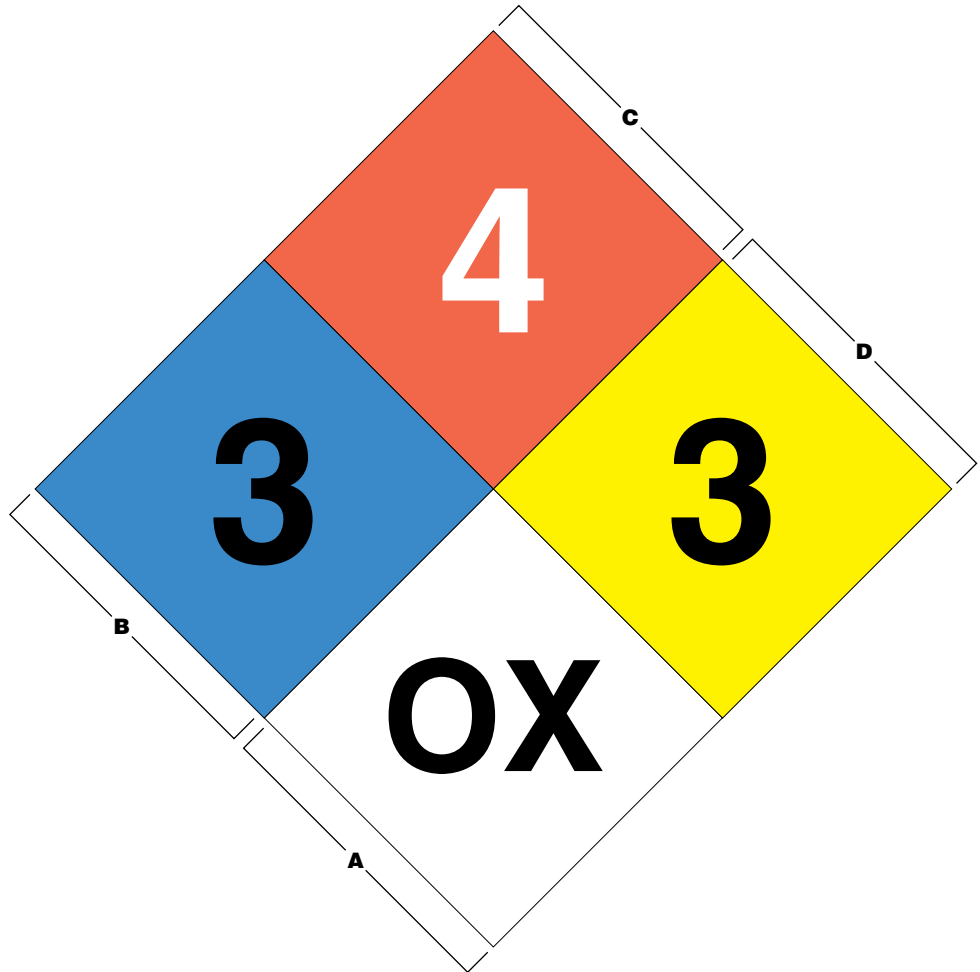

Hazardous Material Information Sign

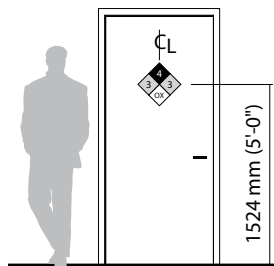
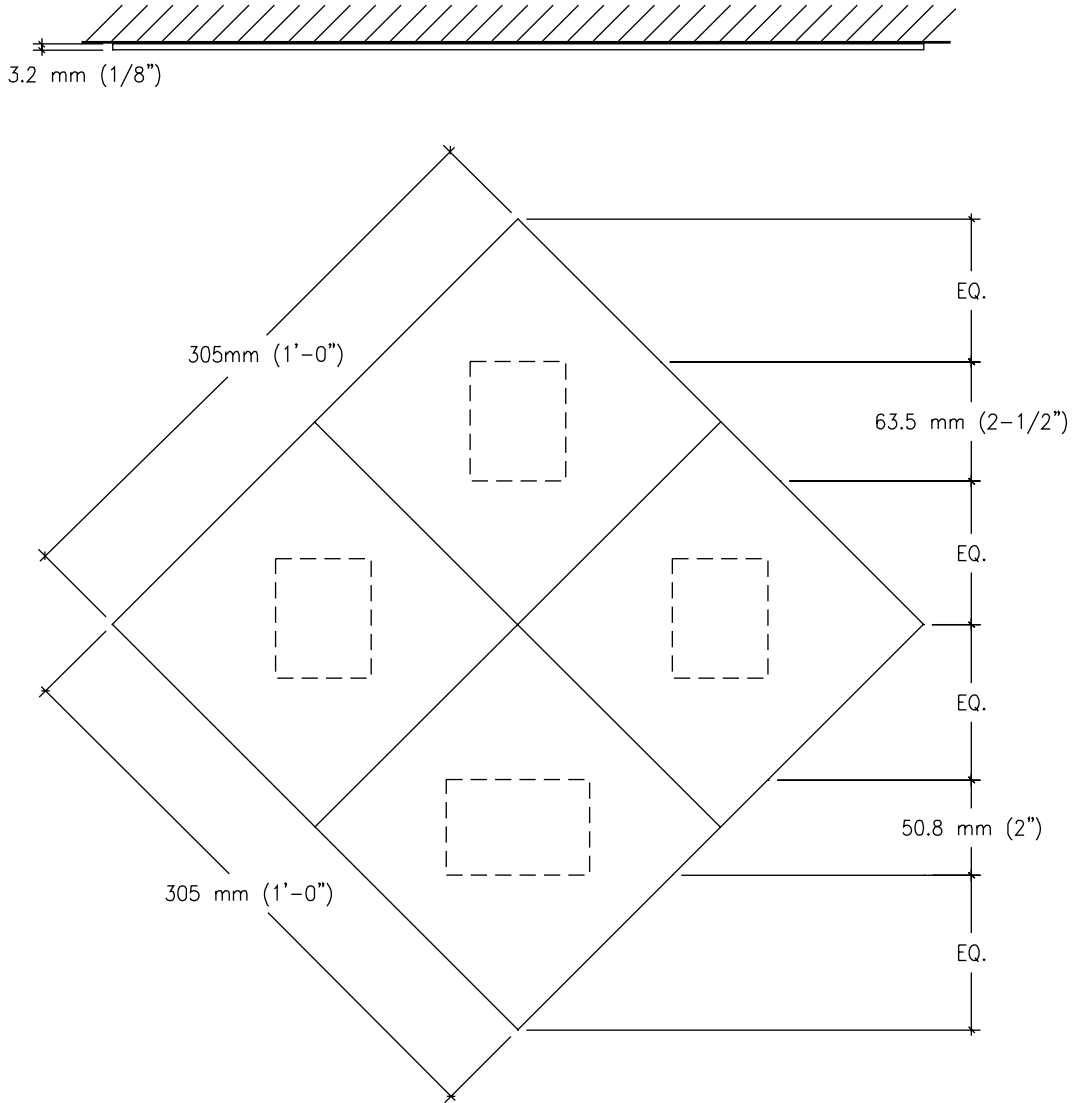

Oxygen In Use Warning Sign

Size

229 mm H x 229 mm W
(9" H x 9" W)

Description and Use

Caution information regarding oxygen in use. Sign must be installed on all doors to rooms in which oxygen is in use.

Messaging Configuration

(Refer to layout drawing for lettering sizes and dimensions).

Sign Components

Acrylic plaque

Graphic Process

Silk-screened.

Colors

Text: refer to color chart.
Background: refer to color chart.

Typography

Helvetica Bold

Mounting

Double sided foam tape or silastic adhesive

Installation

Centered on door, 1600 mm (63")
to top of sign

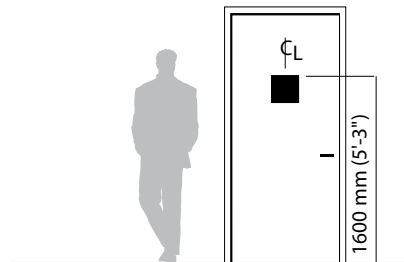
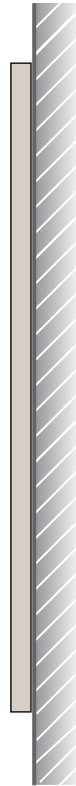
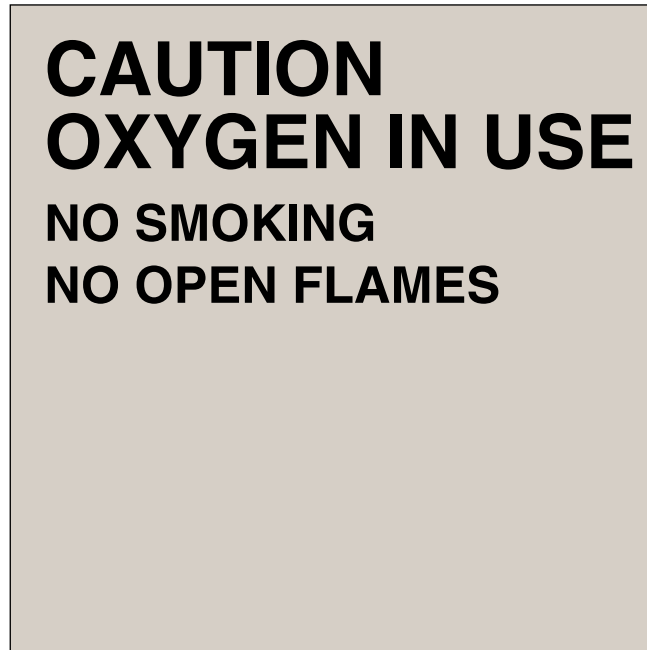

Oxygen In Use Warning Sign

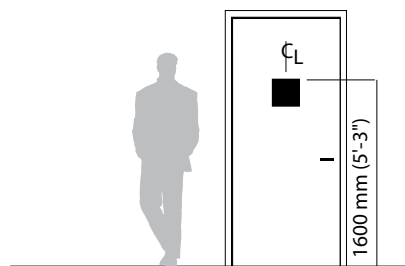
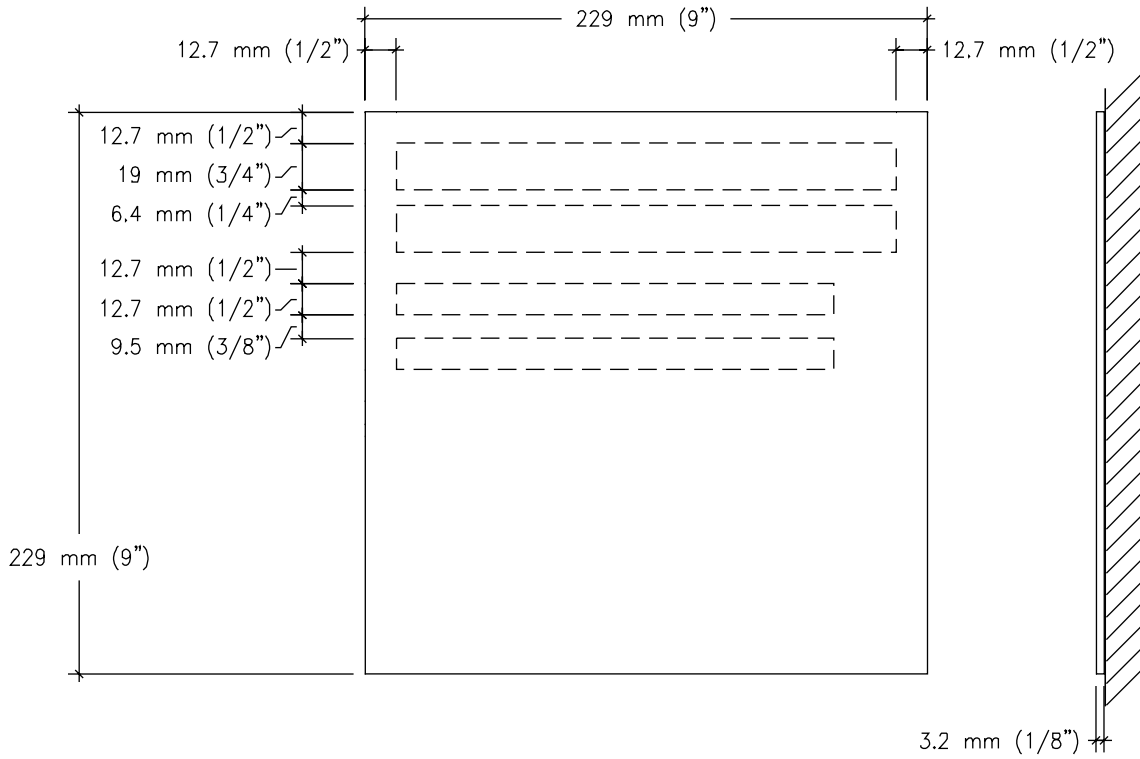

Compressed Gas Warning Sign

Size

229 mm H x 229 mm W
(9" H x 9" W)

Description and Use

Caution information regarding gases in use. Sign must be installed on all doors to rooms that contain the listed gases. Adjust the listing of gases to reflect the actual gases being used in the laboratory.

Message Configuration

(Refer to layout drawing for lettering sizes and dimensions).

Sign Components

Acrylic plaque

Graphic Process

Silk-screened

Colors

Text: refer to color chart.
Background: refer to color chart.

Typography

Helvetica Bold

Mounting

Double sided foam tape or silastic adhesive

Installation

Centered on door, 1600 mm (63")
to top of sign

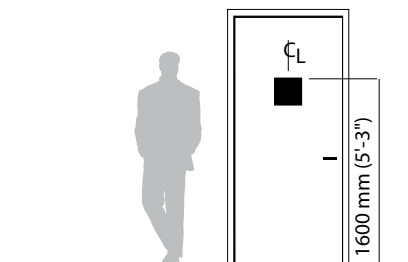
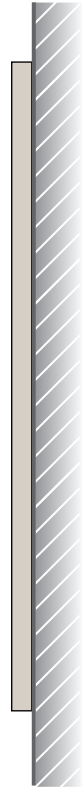
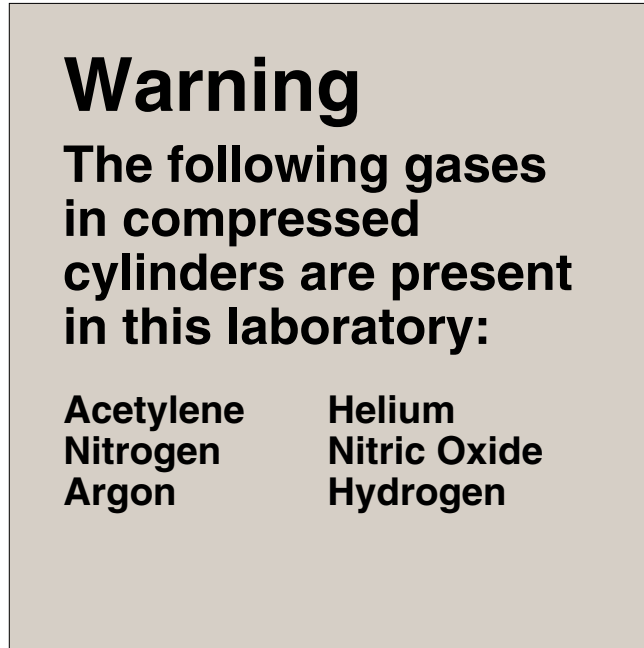

Compressed Gas Warning Sign

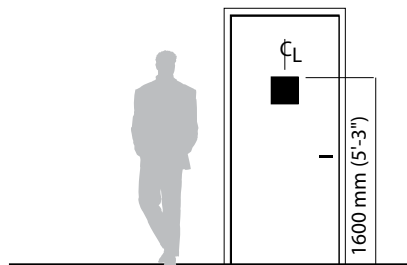
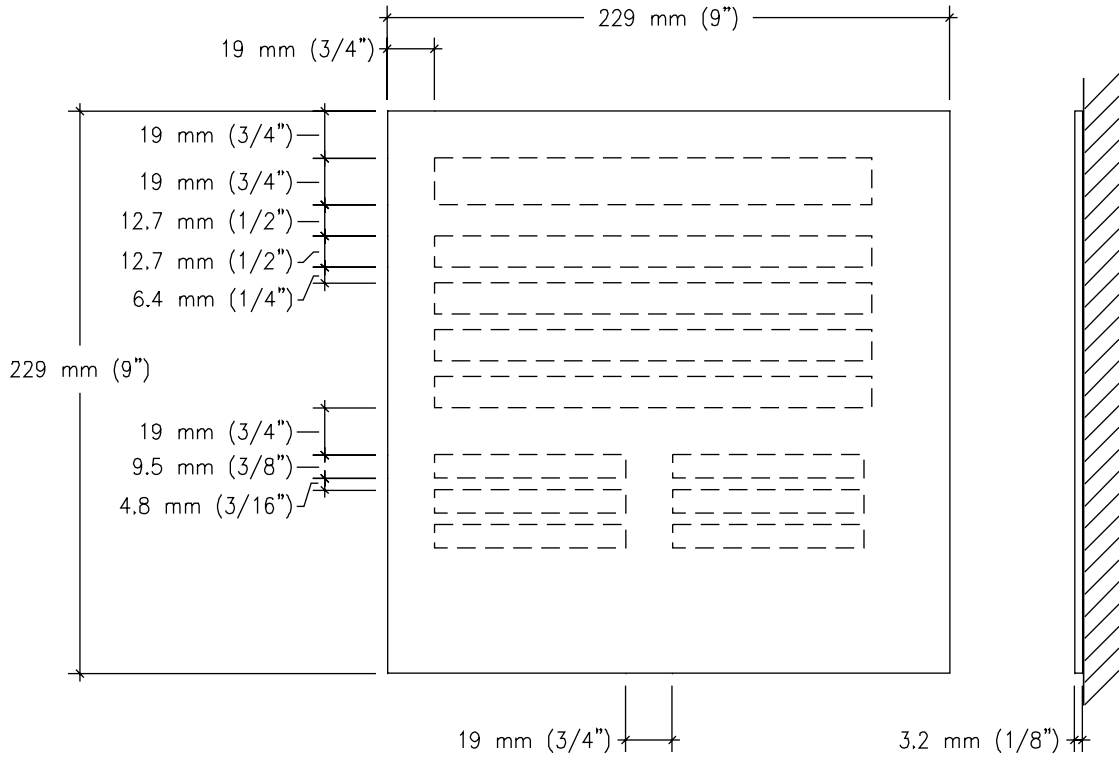

Nonflammable Anesthesia Restriction Sign

Size

229 mm H x 229 mm W
(9" H x 9" W)

Description and Use

Caution information regarding anesthetic agents in use. Sign is to be installed on the doors to all operating rooms.

Message Configuration

(Refer to layout drawing for lettering sizes and dimensions).

Sign Components

Acrylic plaque

Graphic Process

Silk-screened.

Colors

Text: refer to color chart.
Background: refer to color chart.

Typography

Helvetica Bold

Mounting

Double sided foam tape or silastic adhesive

Installation

Centered on door, 1600 mm (63")
to top of sign

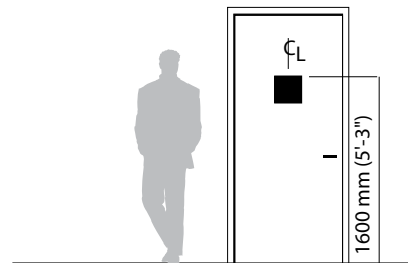
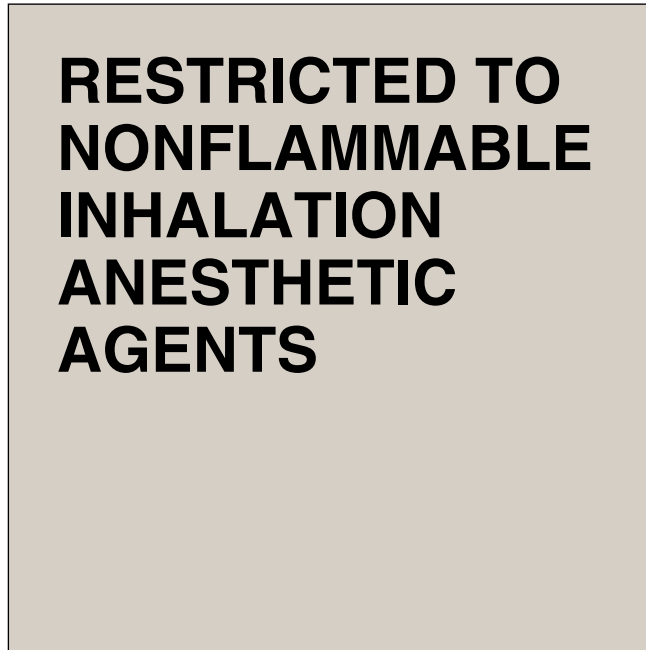

Nonflammable Anesthesia Restriction Sign

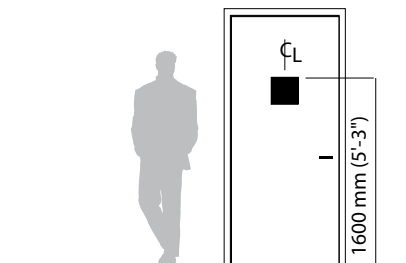
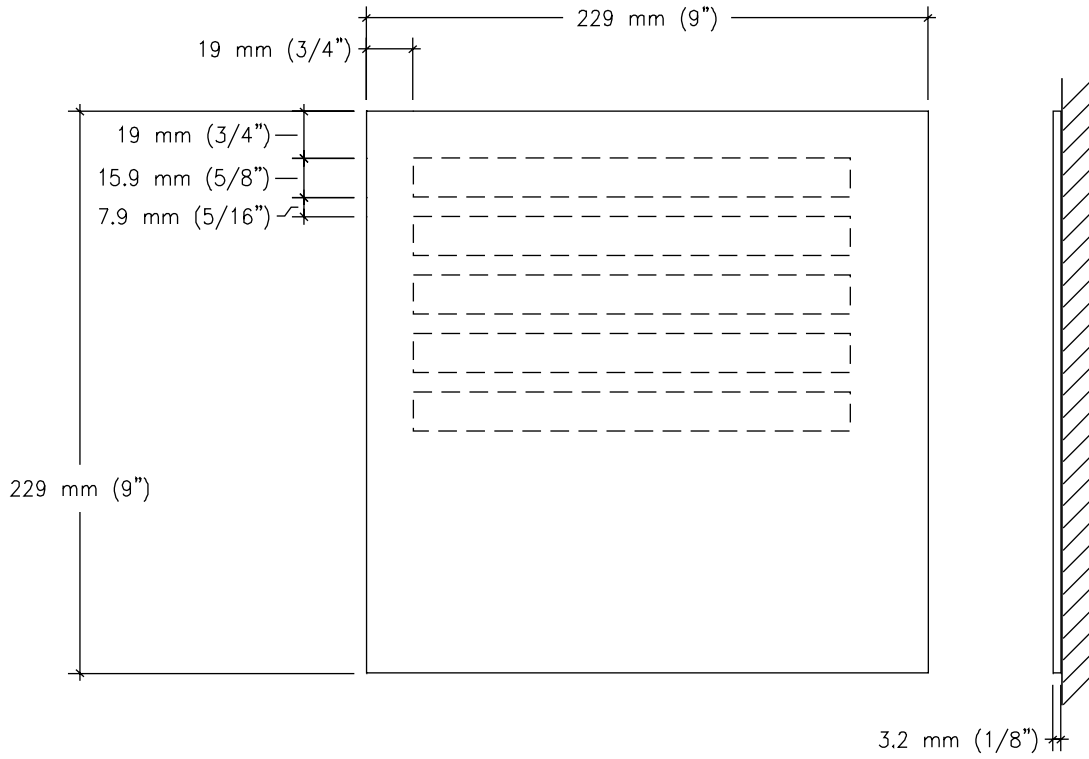

Radioactive Material Warning Sign

Size

229 mm H x 229 mm W
(9" H x 9" W)

Description and Use

Caution information regarding radioactive material. Sign is to be installed on the doors to all rooms where radioactive materials are in use or stored.

Message Configuration

(Refer to layout drawing for lettering sizes and dimensions).

Sign Components

Acrylic plaque

Graphic Process

Silk-screened

Colors

Text and symbol: purple
Background: yellow

Typography

Helvetica Bold

Mounting

Double sided foam tape or silastic adhesive

Installation

Centered on door, 1600 mm (63")
to top of sign

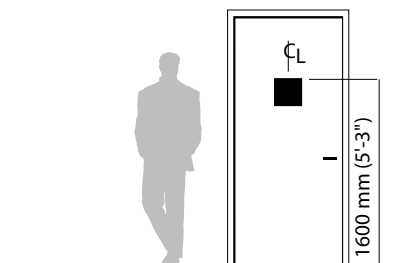

Radioactive Material Warning Sign

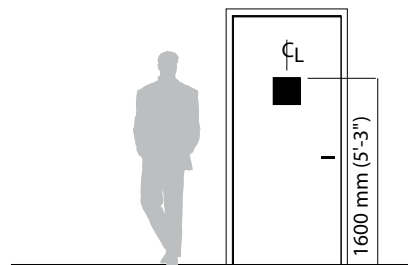
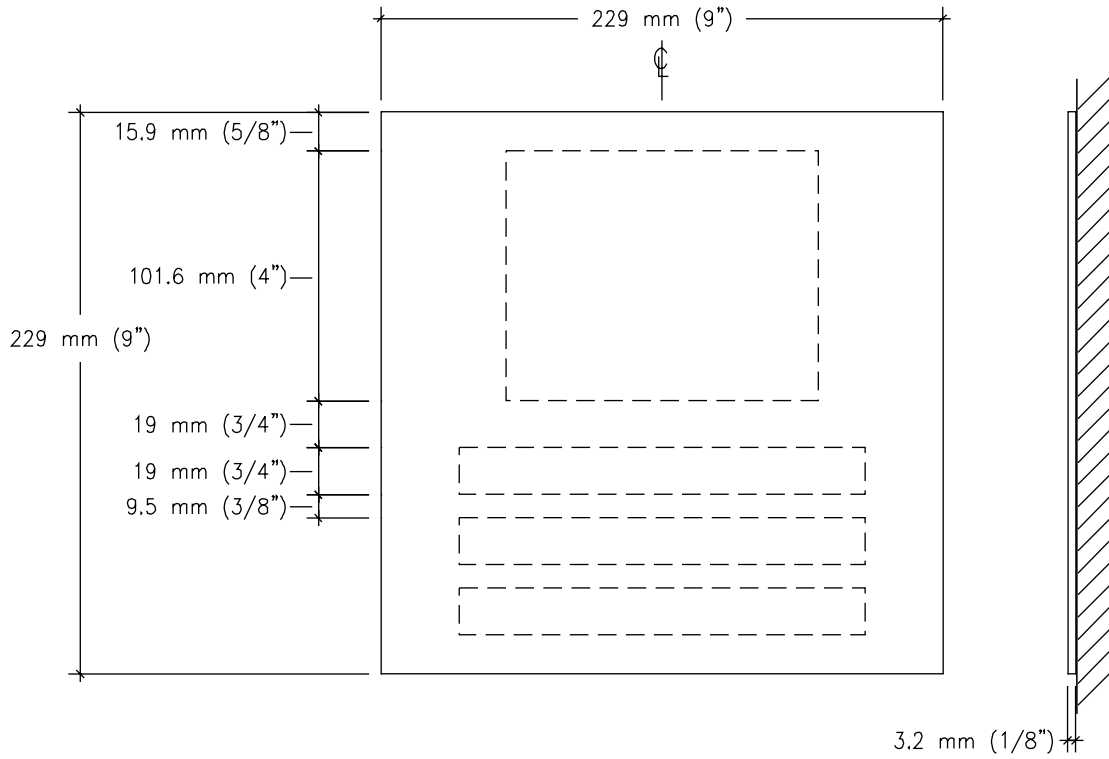

Radioactive Area Warning Sign

Size

229 mm H x 229 mm W
(9" H x 9" W)

Description and Use

Caution information regarding area with radioactive material. Sign must be installed in areas where radioactive materials are used or stored.

Message Configuration

(Refer to layout drawing for lettering sizes and dimensions).

Sign Components

Acrylic plaque

Graphic Process

Silk-screened

Colors

Text and symbol: purple
Background: yellow

Typography

Helvetica Bold

Mounting

Double sided foam tape or silastic adhesive

Installation

Centered on door, 1600 mm (63")
to top of sign

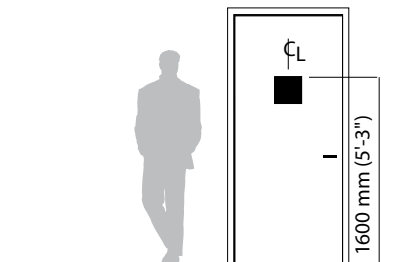

Radioactive Area Warning Sign

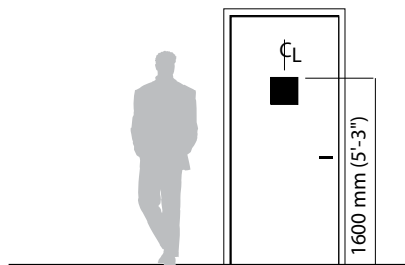
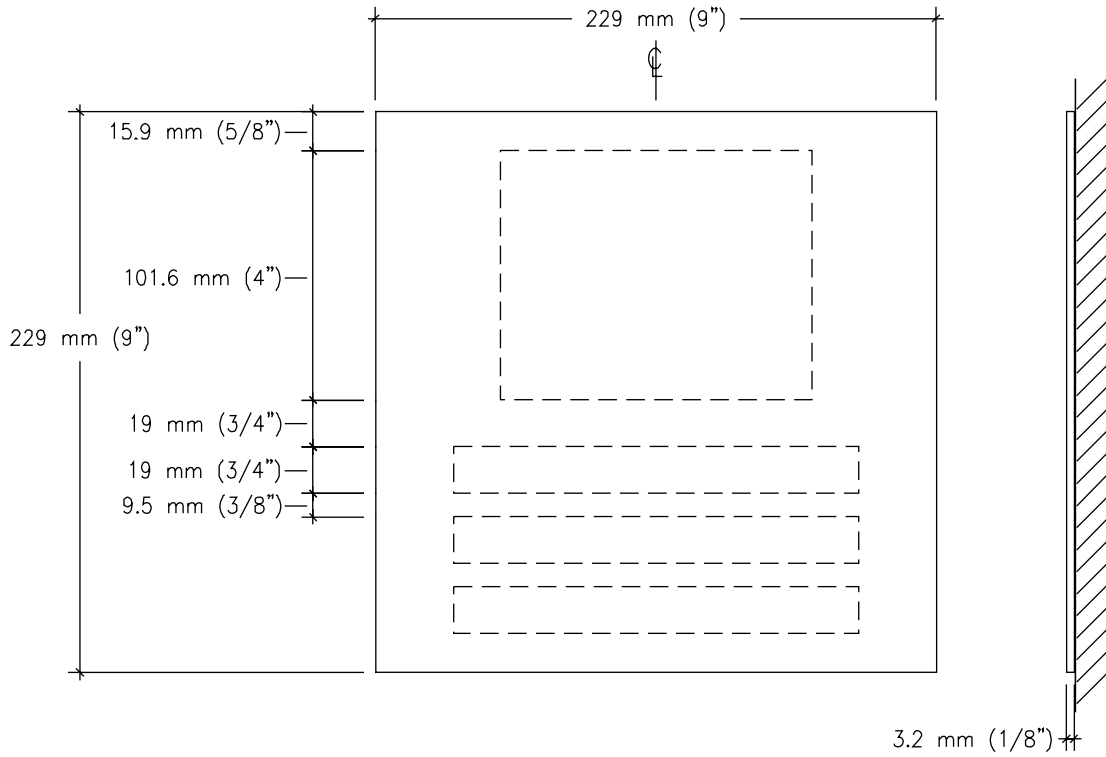

High Voltage Warning Sign

Size

229 mm H x 229 mm W
(9" H x 9" W)

Description and Use

Caution information regarding high electrical voltage. Sign must be installed on the doors to all rooms with high voltage (over 600 volt) equipment.

Message Configuration

(Refer to layout drawing for lettering sizes and dimensions).

Sign Components

Acrylic plaque

Graphic Process

Silk-screened

Colors

Text and symbol: black
Background: yellow

Typography

Helvetica Bold

Mounting

Double sided foam tape or silastic adhesive

Installation

Centered on door, 1600 mm (63")
to top of sign

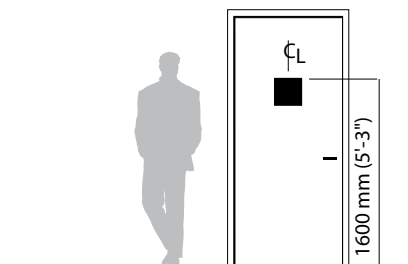
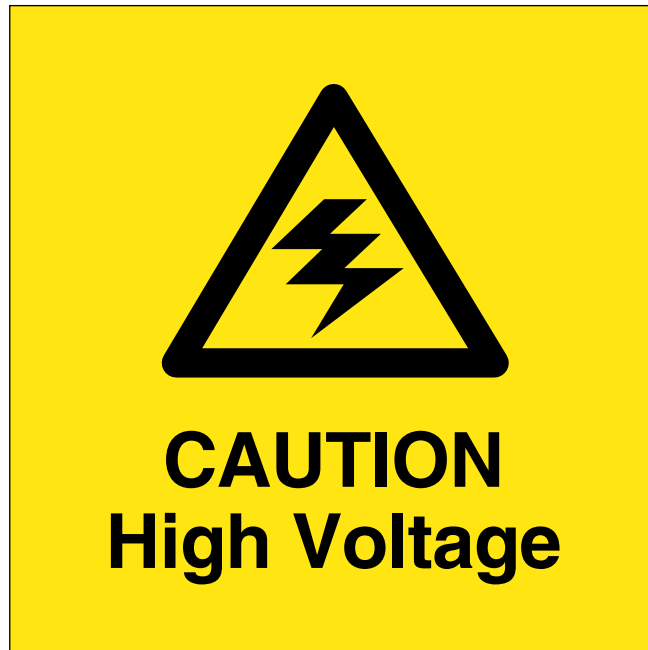

High Voltage Warning Sign

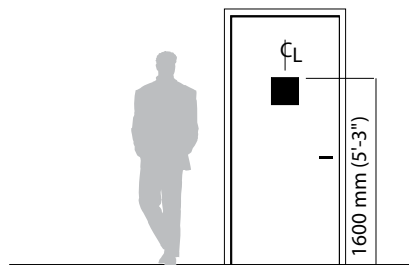
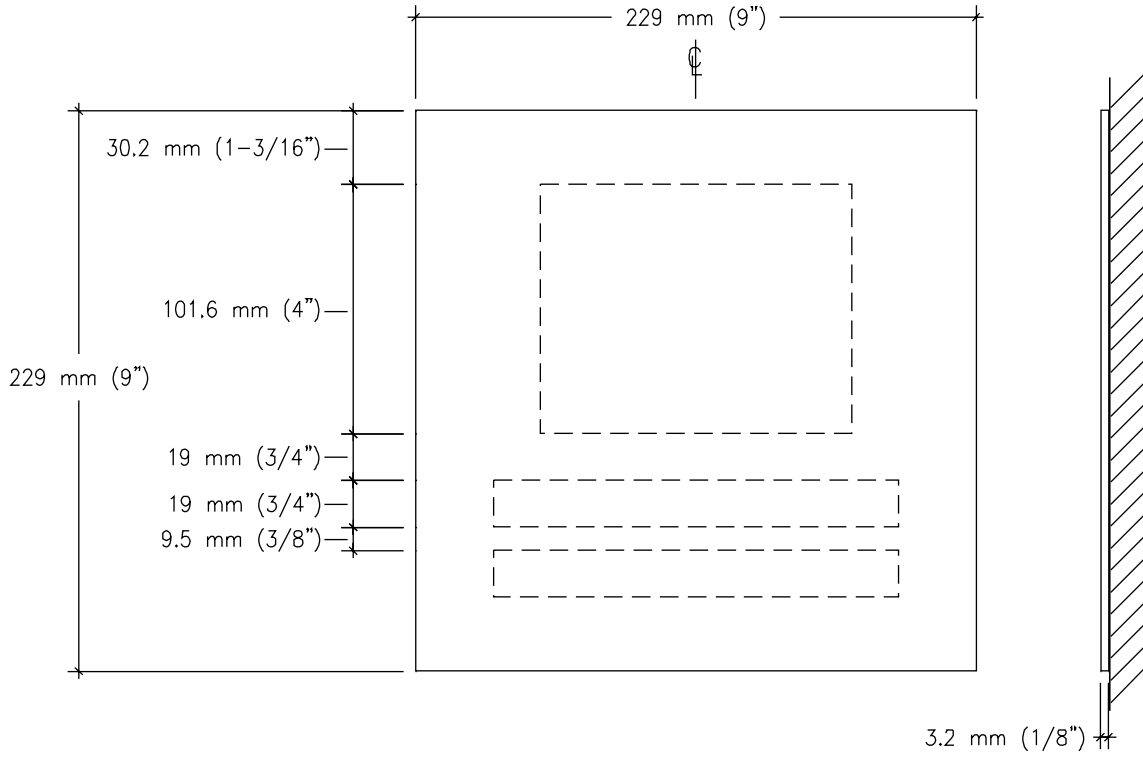

Biohazard Warning Sign

Size

229 mm H x 229 mm W
(9" H x 9" W)

Description and Use

Caution information regarding biohazard materials. Sign must be installed on the doors of all rooms where there is biohazard materials.

Message Configuration

(Refer to layout drawing for lettering sizes and dimensions).

Sign Components

Acrylic plaque

Graphic Process

Silk-screened

Colors

Text and symbol: black
Background: yellow

Typography

Helvetica Bold

Mounting

Double sided foam tape or silastic adhesive

Installation

Centered on door, 1600 mm (63")
to top of sign

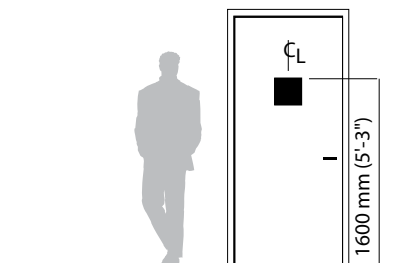

Biohazard Warning Sign

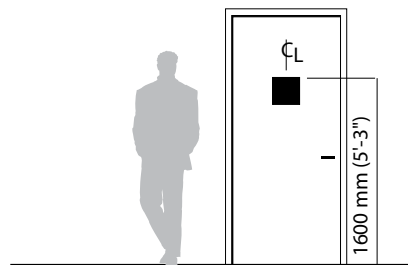
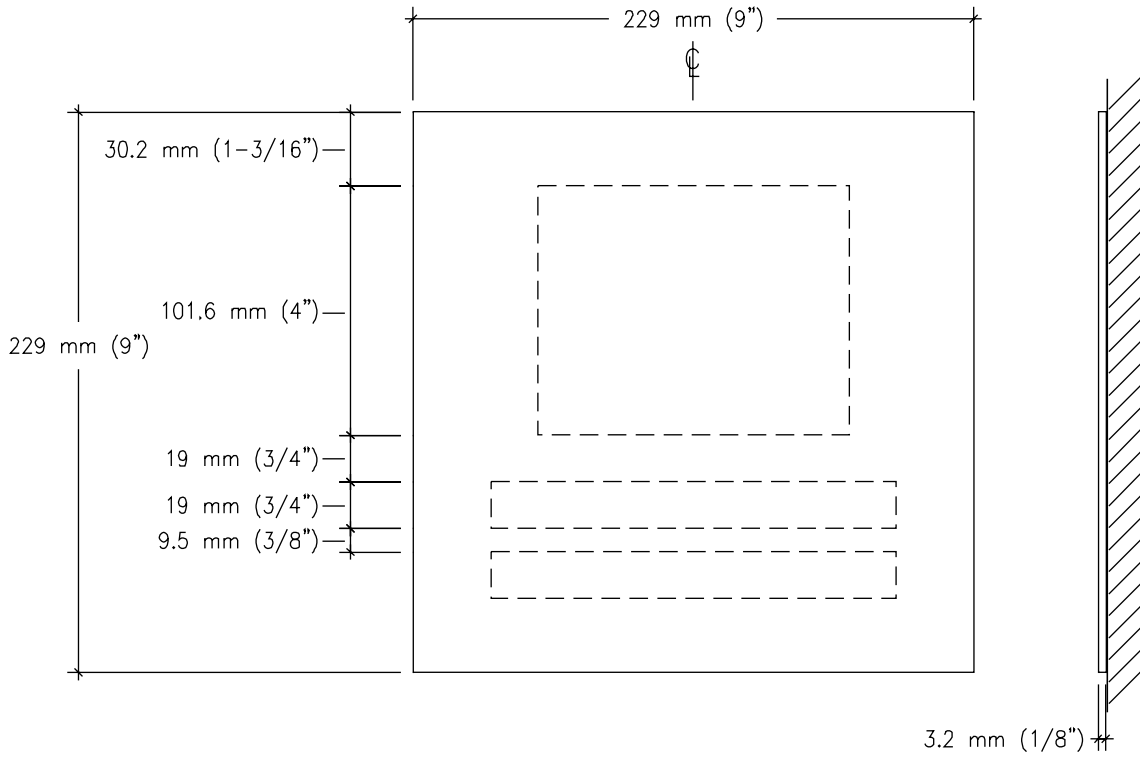

Laser Warning Sign

Size

229 mm H x 229 mm W
(9" H x 9" W)

Description and Use

Caution information regarding lasers. Sign must be installed on the doors to all rooms where lasers are used.

Message Configuration

(Refer to layout drawing for lettering sizes and dimensions).

Sign Components

Acrylic plaque

Graphic Process

Silk-screened

Colors

Text and symbol: black
Background: yellow

Typography

Helvetica Bold

Mounting

Double sided foam tape or silastic adhesive

Installation

Centered on door, 1600 mm (63")
to top of sign

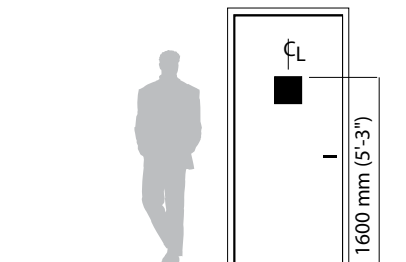

Laser Warning Sign

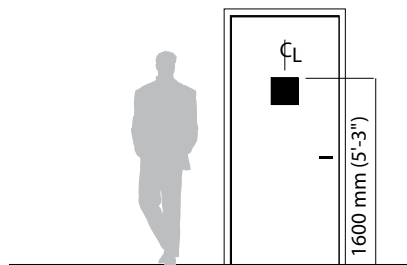
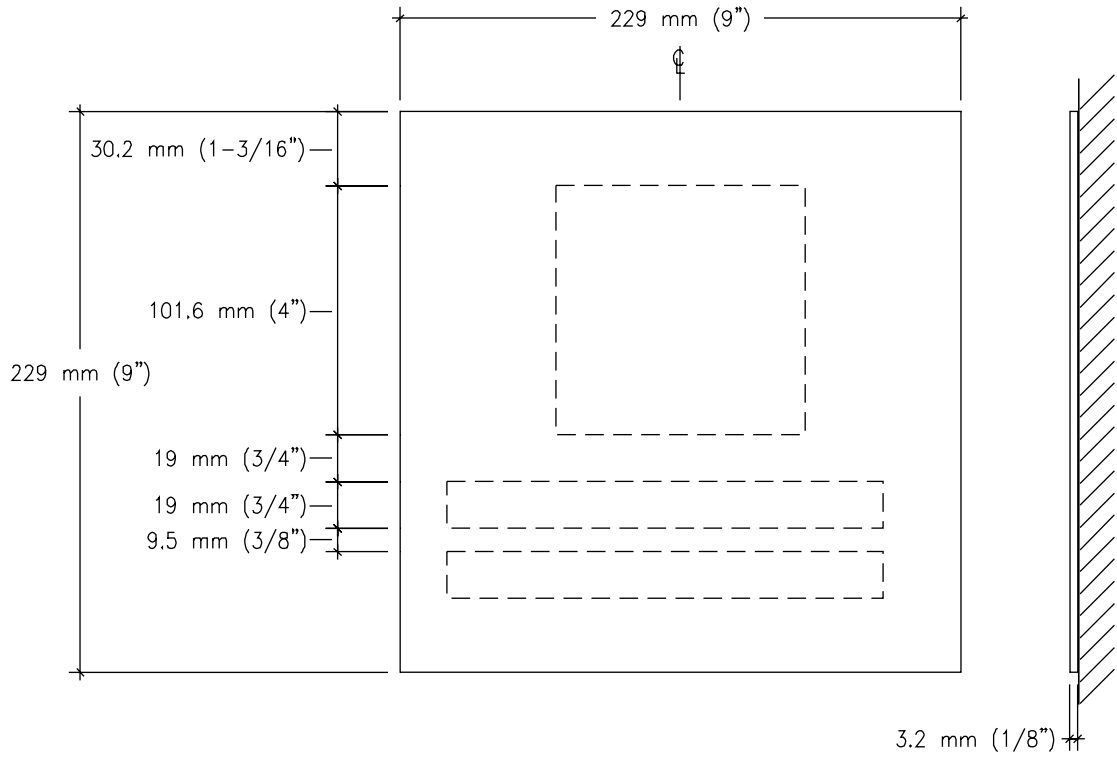

Occupational Exposure Area Warning Sign

Size

229 mm H x 229 mm W
(9" H x 9" W)

Description and Use

Caution information regarding occupational exposure. Sign is to be installed on doors to all rooms where there is occupational exposure.

Message Configuration

(Refer to layout drawing for lettering sizes and dimensions).

Sign Components

Acrylic plaque

Graphic Process

Silk-screened

Colors

Text: black
Background: yellow

Typography

Helvetica Bold

Mounting

Double sided foam tape or silastic adhesive

Installation

Centered on door, 1600 mm (63")
to top of sign

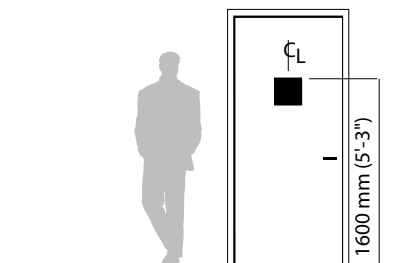

Occupational Exposure Area Warning Sign

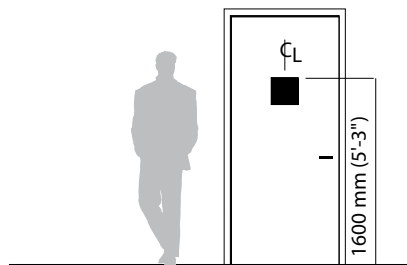
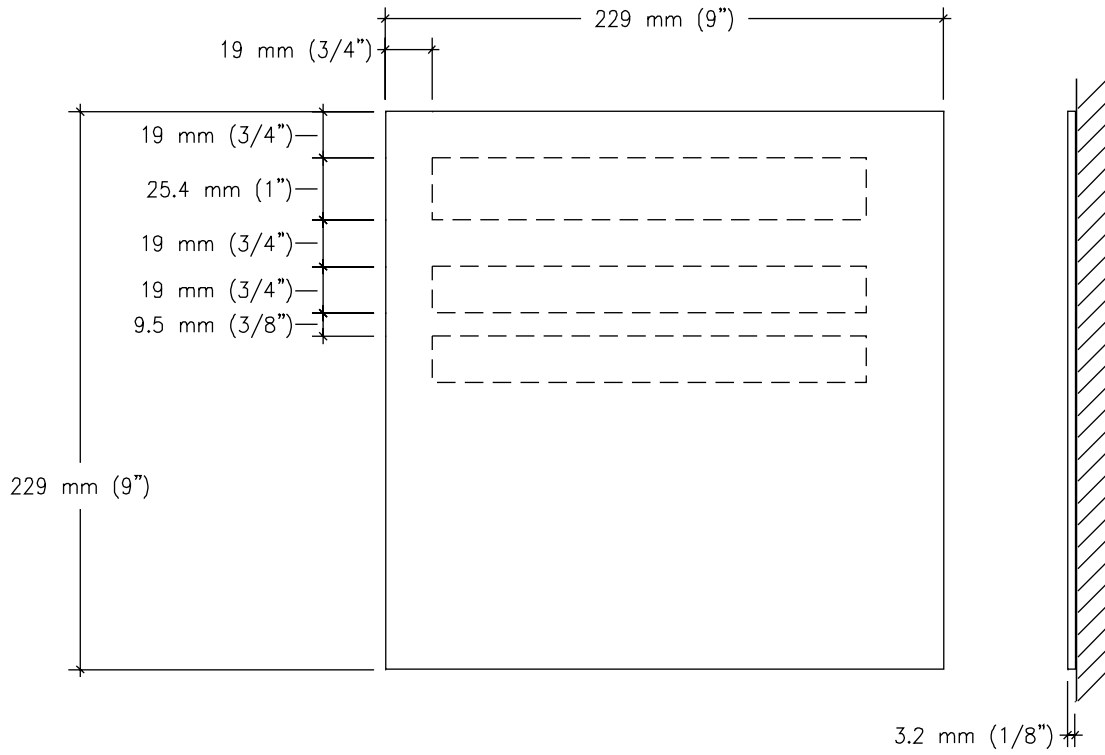

No Re-Entry Floor Sign

Sign Size

229 mm H x 229 mm W
(9" H x 9" W)

Description and Use

No re-entry floor sign is used to identify a door to a stairwell or other locations, which locks will not allow re-entry.

Message Configuration

(Refer to layout drawing for lettering sizes and dimensions).

Sign Components

Acrylic plaque

Graphic Process

Silk-screened

Colors

Text: refer to color chart.
Background: refer to color chart.

Typography

Helvetica Bold

Mounting

Double sided foam tape or silastic adhesive

Installation

Centered on door, 1600 mm (63")
to top of sign

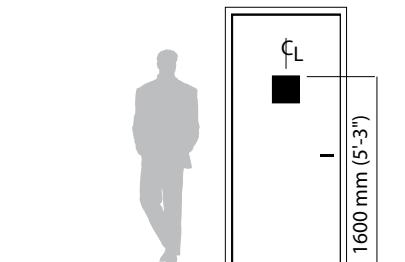
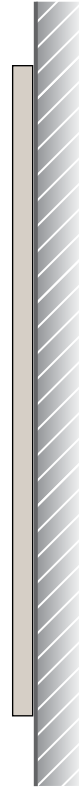
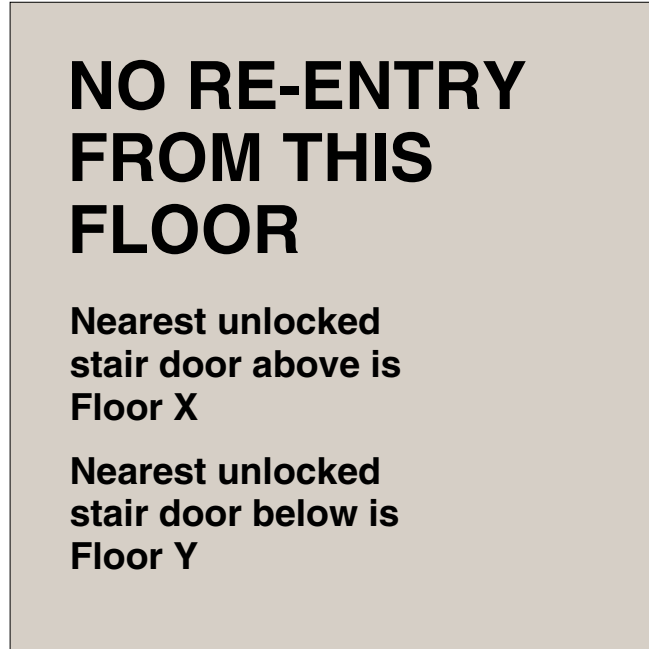

No Re-Entry Floor Sign

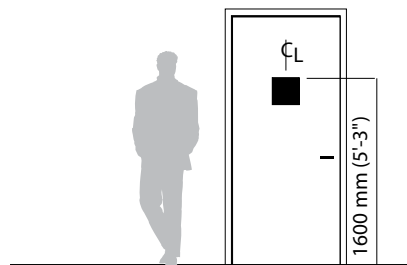
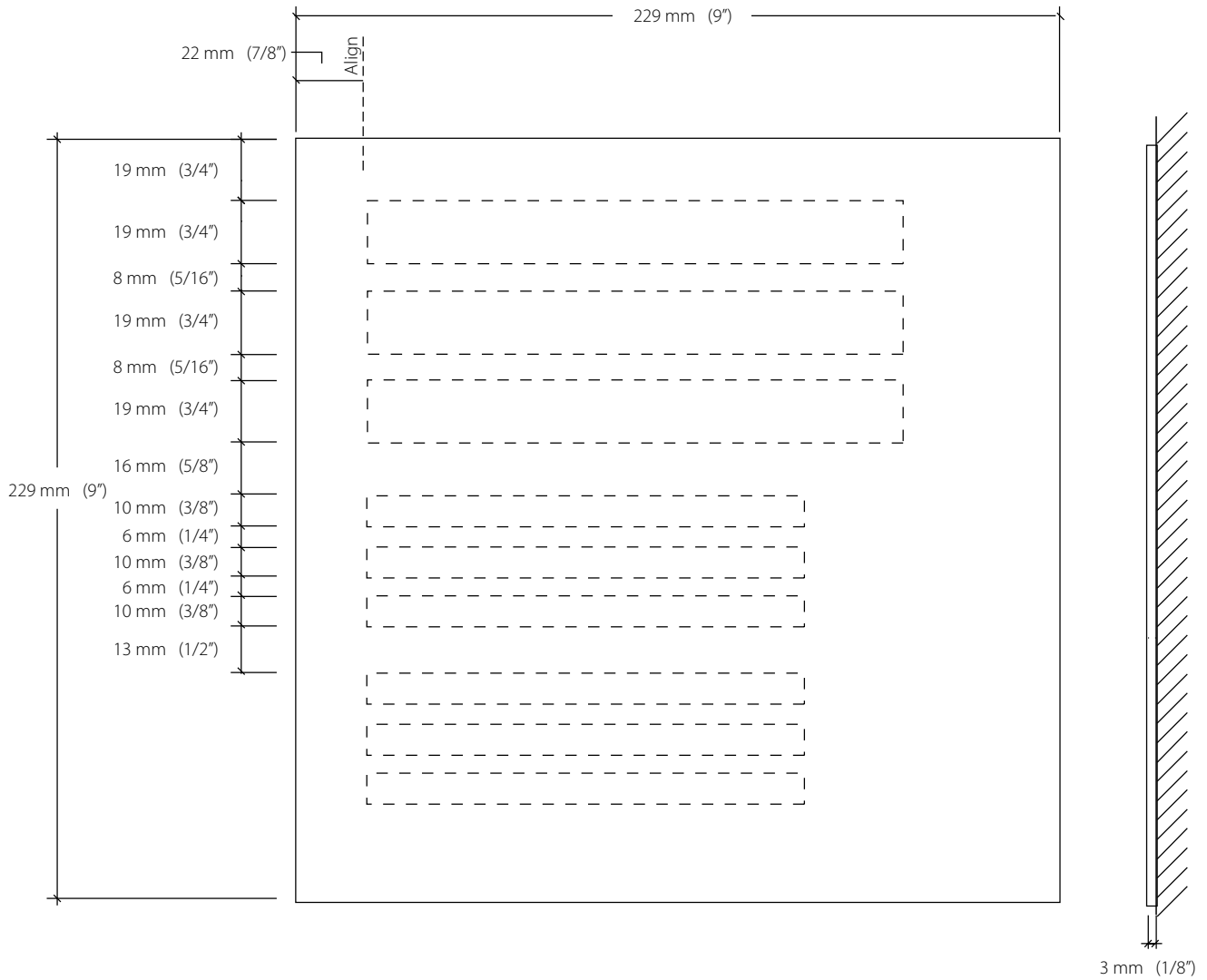

Push To Exit Sign

Size

152 mm H x 152 mm W
(6" H x 6" W)

Description and Use

Push to exit sign is used to inform type of action needed to activate door. Sign is to be installed on doors to all exits where push motion is needed to activate door.

Message Configuration

(Refer to layout drawing for lettering sizes and dimensions).

Sign Components

Acrylic plaque

Graphic Process

Silk-screened

Colors

Text: refer to color chart
Background: refer to color chart.

Typography

Helvetica Bold

Mounting

Double sided foam tape or silastic adhesive

Installation

1600 mm (63") to top of sign and
51 mm (2") over from door frame

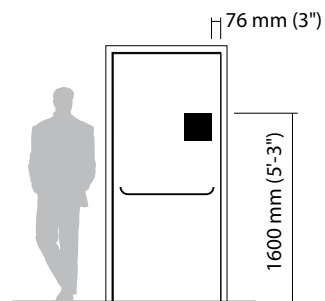

Push To Exit Sign

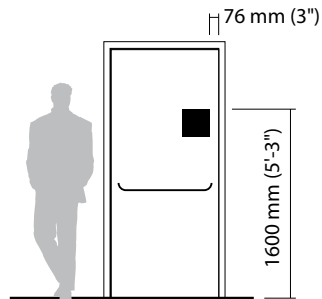
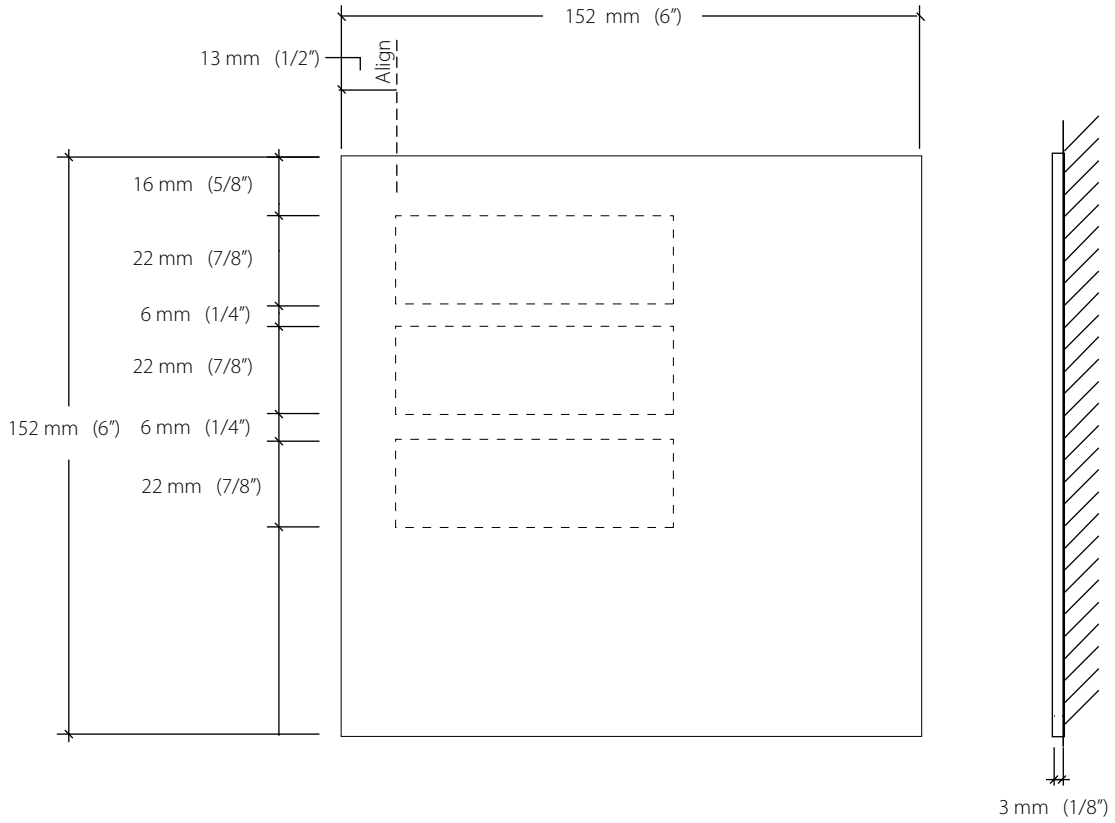

Emergency Push To Open Sign

Size

76 mm H x 229 mm W
(3" H x 9" W)

Description and Use

Emergency push to open sign is used to inform type of action needed to activate door in case of an emergency. Sign is to be installed next to doors at all exits where push motion is needed to activate door.

Message Configuration

(Refer to layout drawing for lettering sizes and dimensions).

Sign Components

Acrylic plaque

Graphic Process

Silk-screened

Colors

Text: refer to color chart.
Background: refer to color chart

Typography

Helvetica Condensed Bold

Mounting

Double sided foam tape or silastic adhesive

Installation

1600 mm (63") to top of sign and
51 mm (2") over from door frame

**In emergency
push to open**

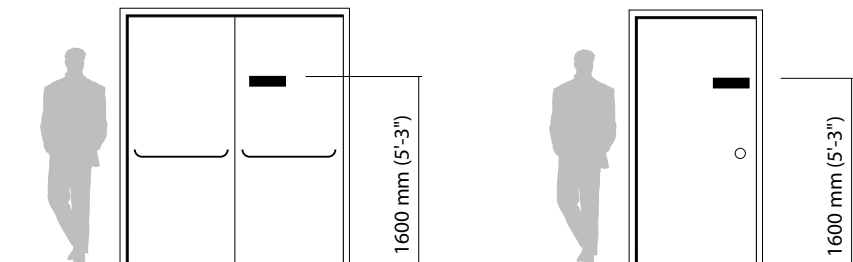
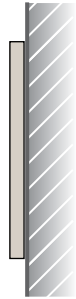

Emergency Push To Open Sign

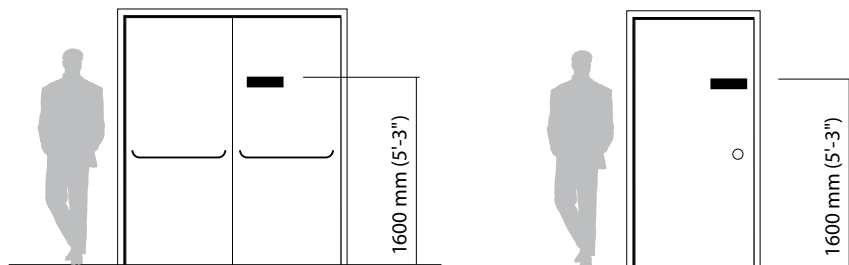
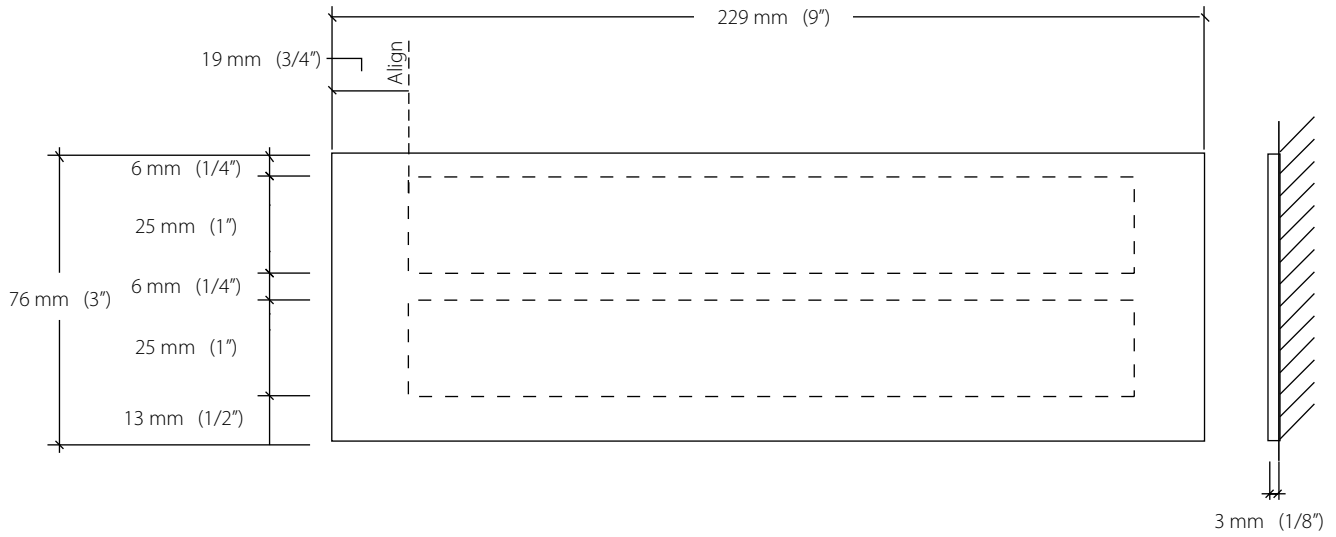

Emergency Slide To Open Sign

Size

76 mm H x 229 mm W
(3" H x 9" W)

Description and Use

Emergency slide to open sign is used to inform type of action needed to activate door in case of an emergency. Sign is to be installed next to doors at all exits where slide motion is needed to activate door.

Message Configuration

(Refer to layout drawing for lettering sizes and dimensions).

Sign Components

Acrylic plaque

Graphic Process

Silk-screened

Colors

Text: refer to color chart.
Background: refer to color chart

Typography

Helvetica Condensed Bold

Mounting

Double sided foam tape or silastic adhesive

Installation

Knob side of door, 1600 mm (63") to top of sign and 51 mm (2") over from door frame

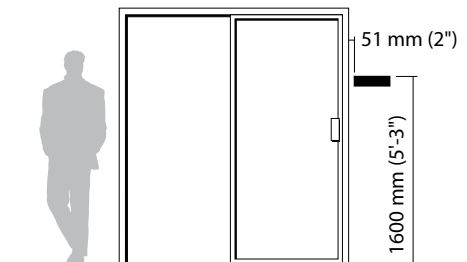
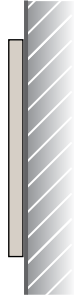

Emergency Slide To Open Sign

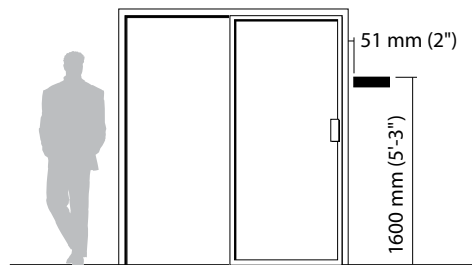
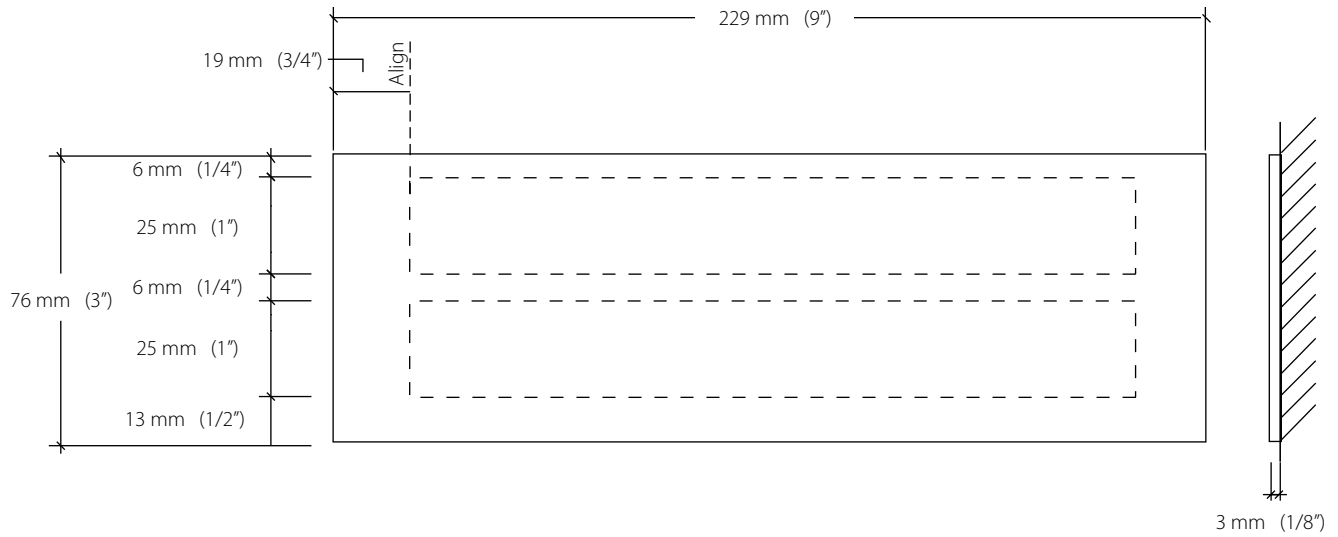

Direction Of Exit Sign

Size

229 mm H x 229 mm W
(9" H x 9" W)

Description and Use

Direction of exit sign used to indicate direction egress. Sign is to be installed next to doors at all exits where direction is needed to exit.

Message Configuration

(Refer to layout drawing for lettering sizes and dimensions).

Sign Components

Acrylic plaque

Graphic Process

Tactile text with accompanying Braille.

Colors

Text: refer to color chart.
Background: refer to color chart.

Typography

Helvetica Bold
Grade 2 Braille

Mounting

Double sided foam tape or silastic adhesive.

Installation

Knob side of door, 1600 mm (63") to top of sign and 51 mm (2") over from door frame

For sign placement refer to the stairwell guide in the installation section

Message Layout A



Message Layout B



Message Layout C

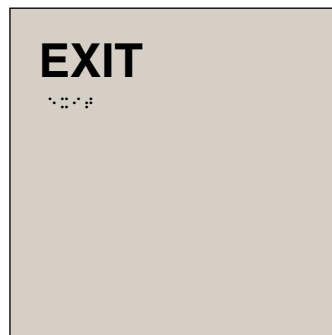

Message Layout D

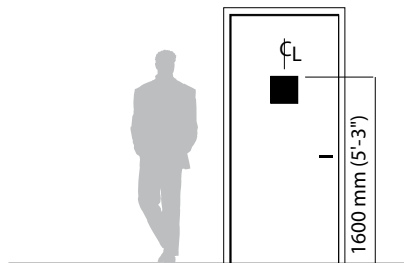

Direction Of Exit Sign

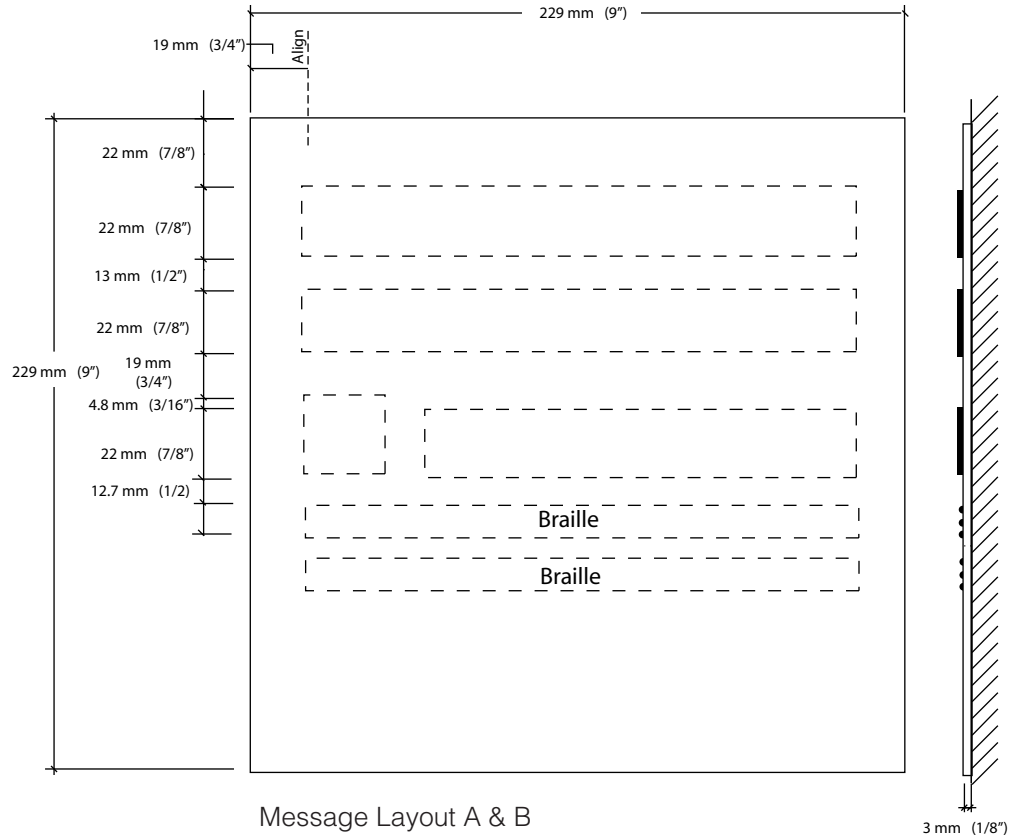

Message Layout A & B

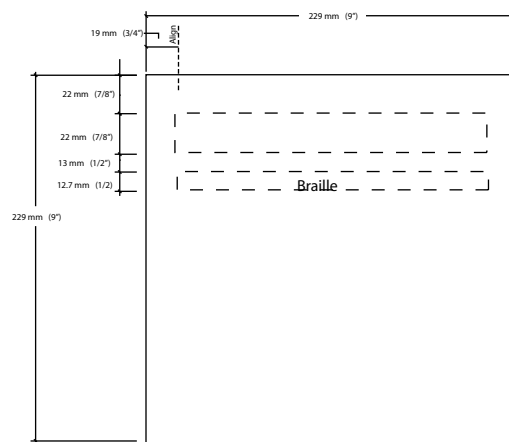

Message Layout C

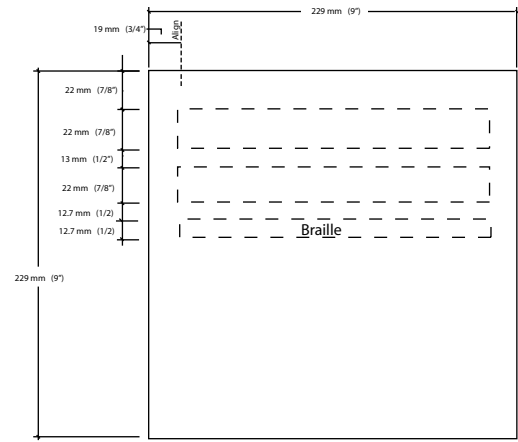

Message Layout D

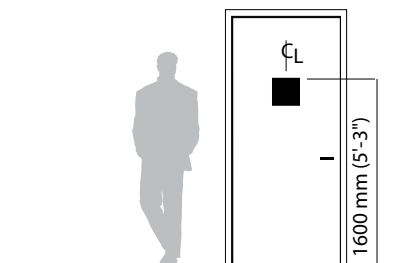

No Re-entry Sign

Sign Size

229 mm H x 229 mm W
(9" H x 9" W)

Description and Use

No re-entry sign is used to identify an exit door which will lock and not allow re-entry into room, floor or building.

Message Configuration

(Refer to layout drawing for lettering sizes and dimensions).

Sign Components

Acrylic plaque

Graphic Process

Silk-screened

Colors

Text: refer to color chart.
Background: refer to color chart.

Typography

Helvetica Bold

Mounting

Double sided foam tape or silastic adhesive

Installation

Centered on door, 1600 mm (63")
to top of sign

For sign placement refer to the stairwell guide in the installation section.

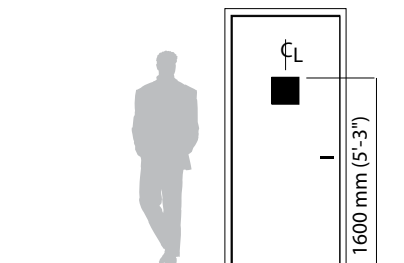
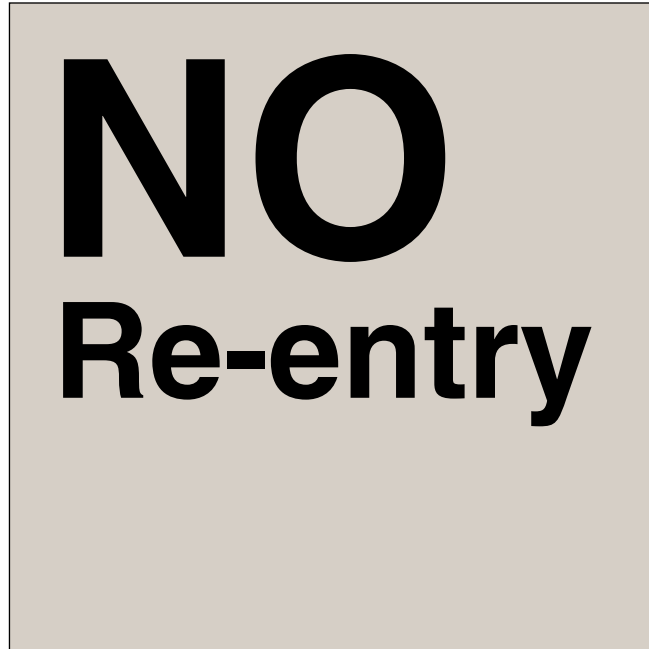

No Re-entry Sign

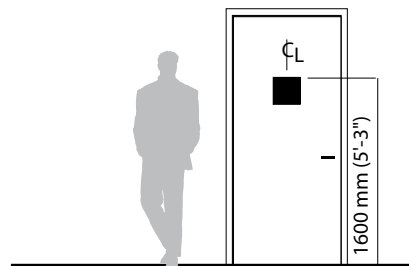
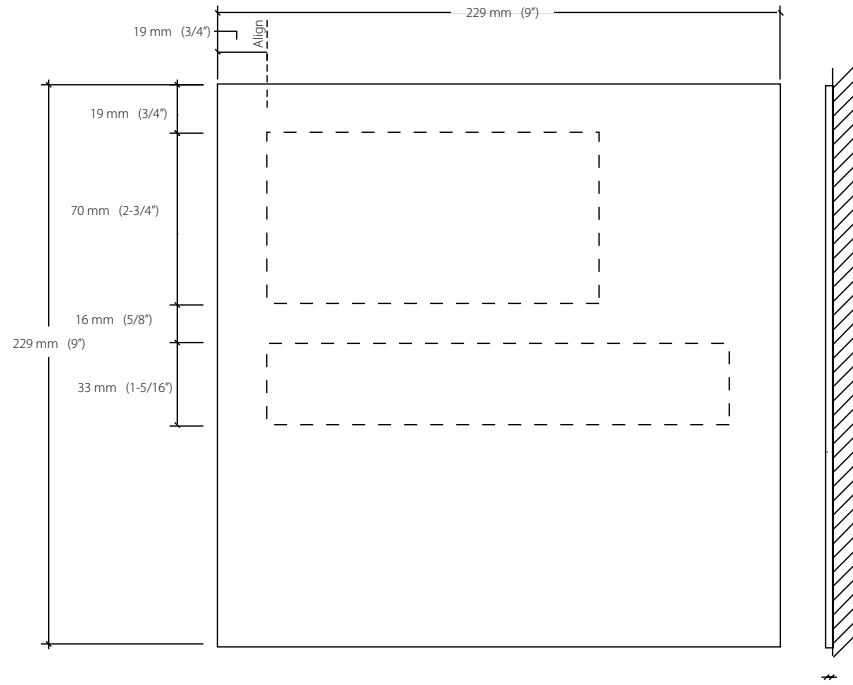

Fire Equipment Identification Sign

Sign Size

229 mm H x 229 mm W
(9" H x 9" W)

Description and Use

Fire equipment identification sign is a flag sign used to identify a fire equipment cabinet.

Message Configuration

(Refer to layout drawing for lettering sizes and dimensions).

Sign Components

Acrylic plaque with aluminum bracket for flag mounting

Graphic Process

Silk-screened

Colors

Text and symbol: white
Background: red
Bracket: aluminum

Typography

Helvetica Bold

Mounting

Mechanical fasteners with anchors

Installation

Centered above fire equipment cabinet a 2129 mm (7'-0") to bottom of sign; mechanically fastened to wall with expandable anchors as needed for wall type.

NOTE

Code requires that signage identifying fire equipment needs to be mounted above the fire equipment cabinet, flat against the wall. This perpendicular / blade mounted variation is an alternate option for displaying this information. Refer to sign type IN-01.02 for a wall mounted version of this sign.

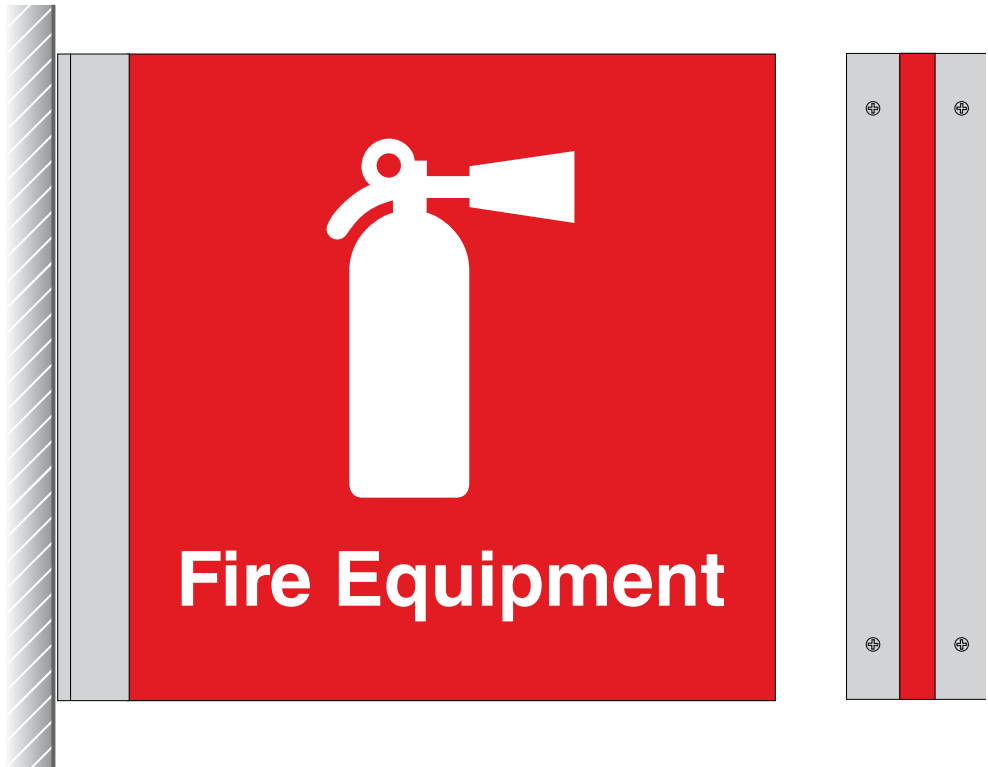

Side A



Side B

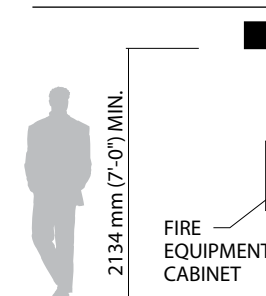

Fire Equipment Identification Sign

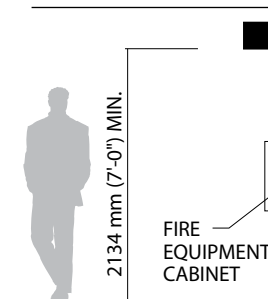
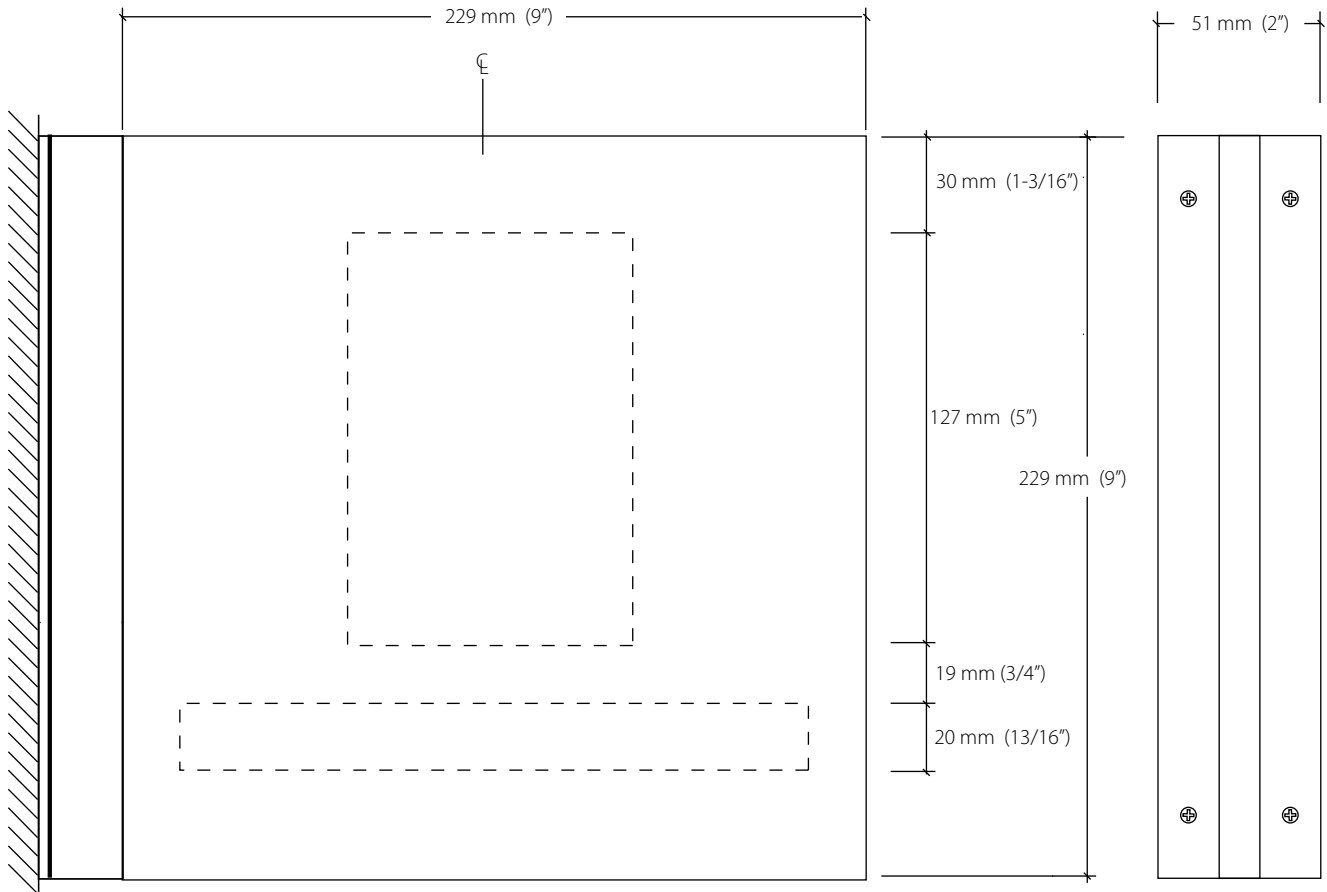

Pregnancy Notification Sign

Sign Size

152 mm H x 152 mm W
(6" H x 6" W)

Description and Use

Pregnancy notification sign is used to convey a request for patient information. Sign is placed in patient waiting areas, treatment rooms and dressing rooms.

Message Configuration

(Refer to layout drawing for lettering sizes and dimensions).

Sign Components

Acrylic plaque

Graphic Process

Silk-screened

Colors

Text: refer to color chart.
Background: refer to color chart.

Typography

Helvetica Bold

Mounting

Double sided foam tape or silastic adhesive

Installation

1600 mm (63") to top of sign

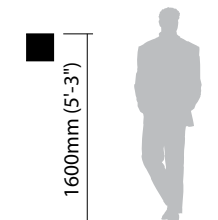
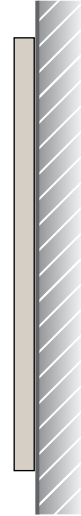
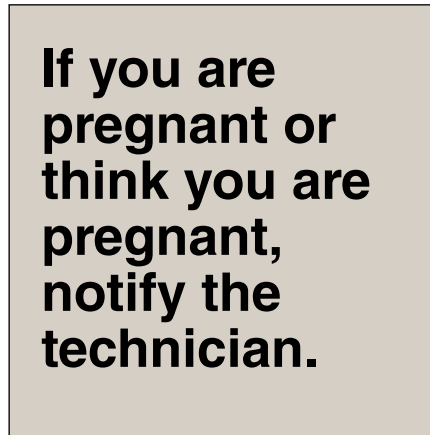

Pregnant Notification Sign

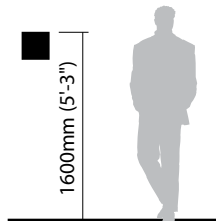
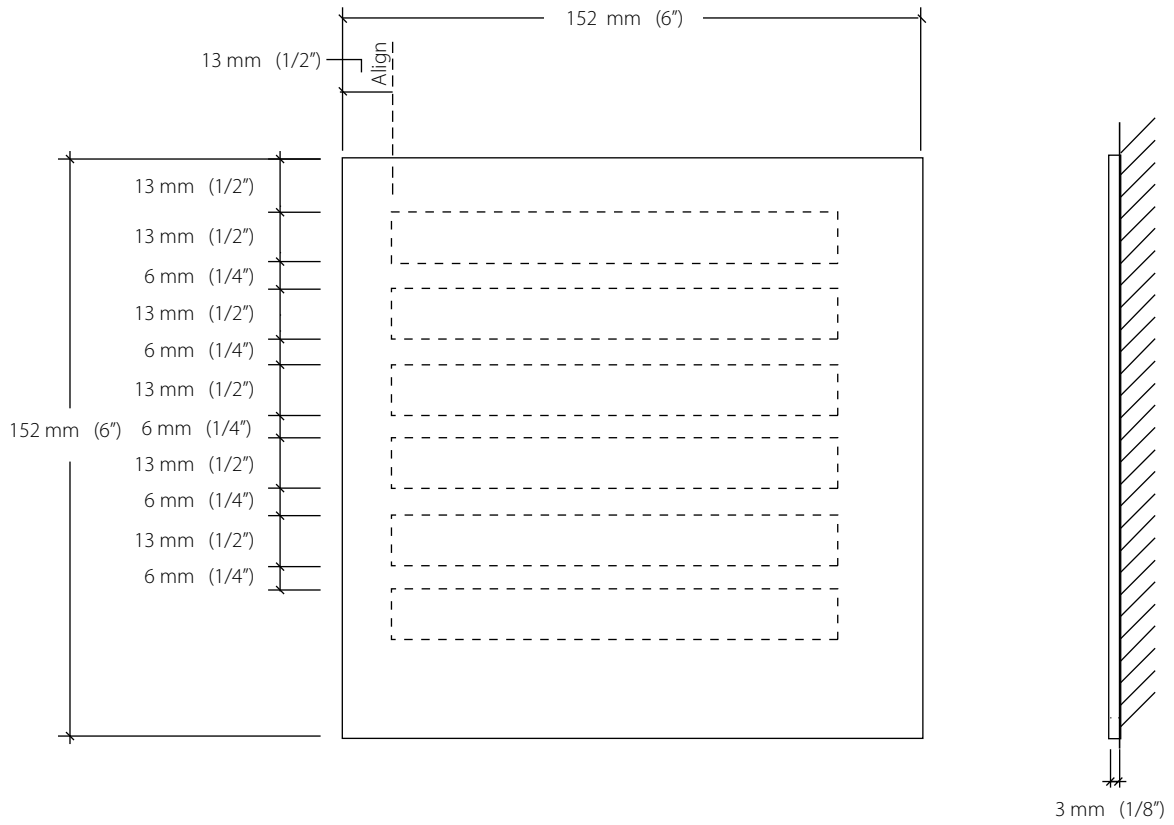

Re-entry Sign

Sign Size

229 mm H x 229 mm W
(9" H x 9" W)

Description and Use

Re-entry Sign is used to identify an entry door which will allow re-entry into room, floor, or building.

Message Configuration

(Refer to layout drawing for lettering sizes and dimensions).

Sign Components

Acrylic plaque

Graphic Process

Silk-screened

Colors

Text: refer to color chart.
Background: refer to color chart.

Typography

Helvetica Bold

Mounting

Double sided foam tape or silastic adhesive

Installation

Centered on door, 1575 mm (63")
to top of sign

For sign placement refer to the stairwell guide in the installation section.

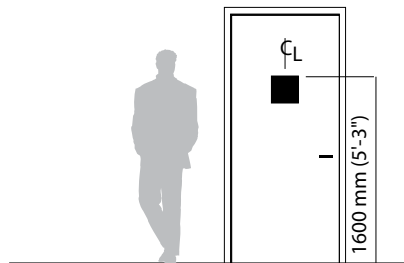
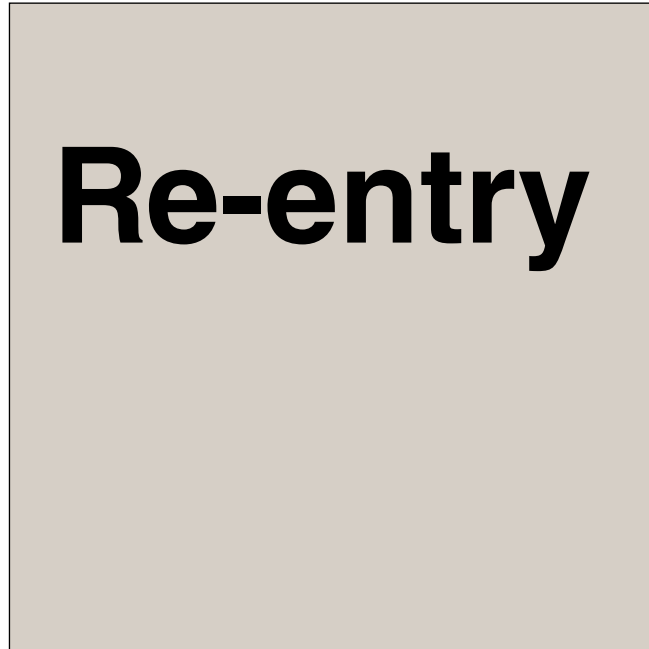

Re-entry Sign

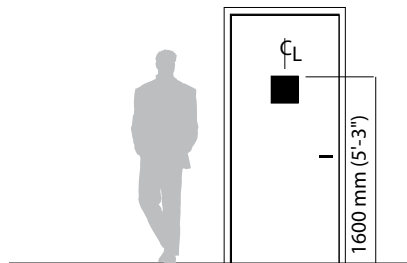
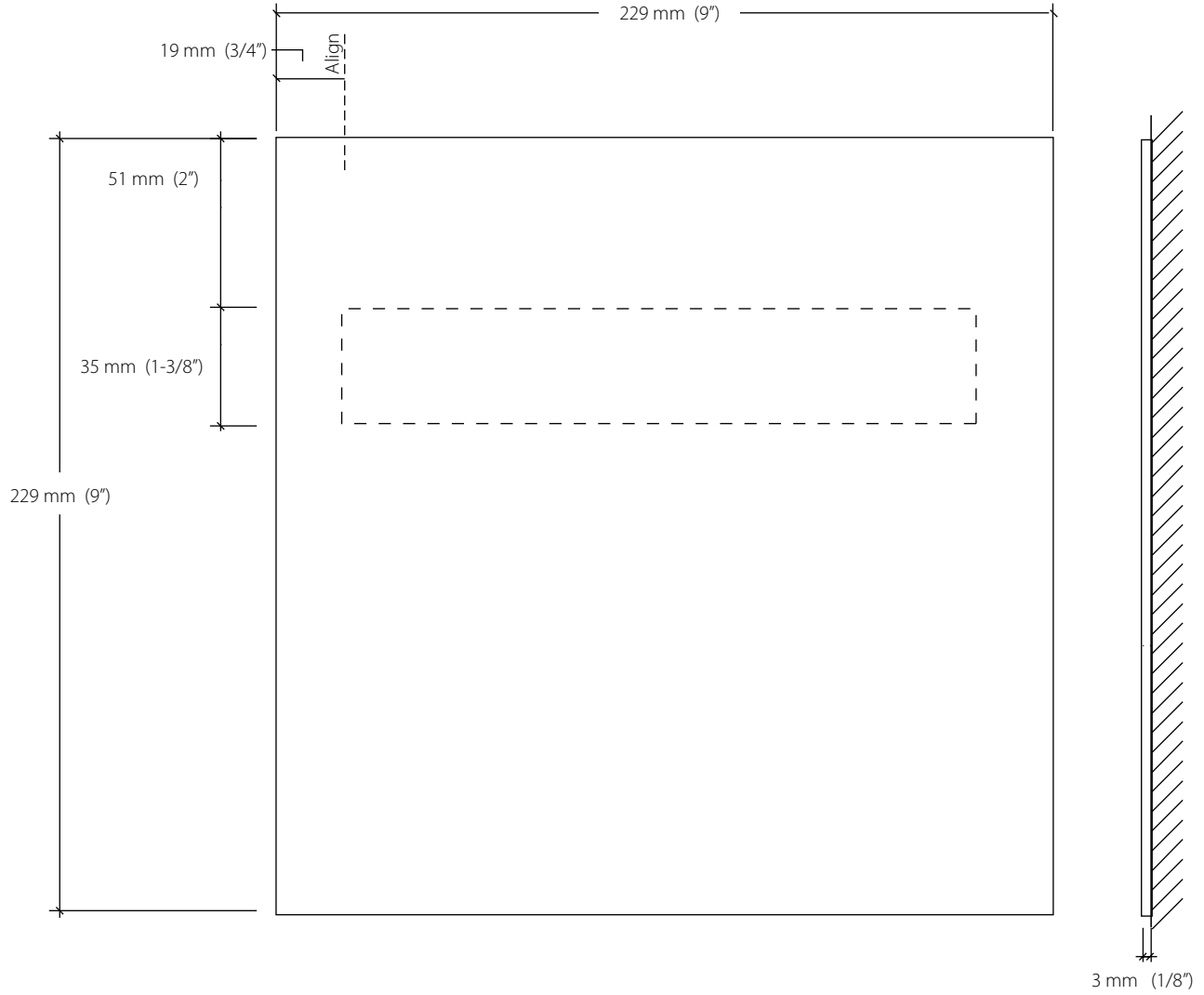

The specifications for signs are available in the Master Construction Specifications (PG-18-1) area of the VA Technical Information Library, which is available on the VA web site under Office of Construction & Facilities Management.

www.cfm.va.gov/til/

Refer to Signage in the specifications, Division 10, Section 10 14 00.

For more information regarding specifications, contact the Office of Construction & Facilities Management, Facility Standards Service.

The specifications require close coordination, taking into account the existing sign program at a medical center, any sign demolition, sign maintenance and future signing needs.

When preparing the specifications for a project, it will require editing to add and indicate new signs or eliminate signs that are not needed. Also, it will be necessary to adapt the specifications to project requirements required for the specific project in which they are intended.

The sign message schedule is considered a part of the specifications and would comprise a portion of the spec section. The configuration and format of the message schedule may vary according to individual project requirements. The sign message schedule format is shown in the Need a Sign Program section of the VA Signage Design Guide. It provides the method for identifying each sign location, type and message along with other notations. The sign schedule contains important information that the sign manufacturer and the sign installer will require for manufacturing and sign installation.

The sign message schedule must be coordinated with a sign location plan drawing showing where signs are to be placed within a building or on the site. Refer to the sign location plan example shown in the Need a Sign Program section of the VA Signage Design Guide.

For convenience, the sign type drawings can also be included in the specifications as it own section.

This page is intentionally left blank.

The Code and Life Safety sign types are constructed from painted acrylic panels with screened arrows, symbols and copy.

For Braille and assembled signs see Construction section from the Interior Signs section of the guide for more information.

This page is intentionally left blank.

**Placement:
Wall and Door Mounted
Signs**

The location and placement of Code and Life Safety signs are very specific and based upon their use, function, and code requirements.

Each type of sign should be installed as shown in the following illustration, without deviation. This may require that furniture be moved, bulletin boards be relocated, etc. to ensure the Code and Life Safety sign is installed in its correct location.

Refer to Interior Sign section for installation method and materials.

LS Installation Detail 1
Sign types: IN-01.01, IN-01.03, IN-01.05, IN-01.06, IN-01.10, IN-01.12, IN-01.16, IN-01.17, IN-01.18, IN-01.19, IN-01.20, IN-01.21, IN-01.22, IN-01.23, IN-01.24, IN-01.25, IN-01.29, IN-01.30, IN-01.32, IN-01.33

LS Installation Detail 2
Sign type: IN-01.02

LS Installation Detail 3
Sign type: IN-01.04

LS Installation Detail 4
Sign type: IN-01.07

LS Installation Detail 5
Sign type: IN-01.08

LS Installation Detail 6
Sign type: IN-01.09

LS Installation Detail 7
Sign type: IN-01.11

LS Installation Detail 8
Sign type: IN-01.14

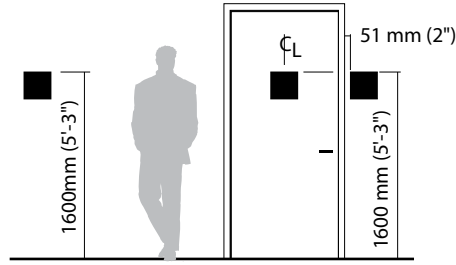

Detail: 1

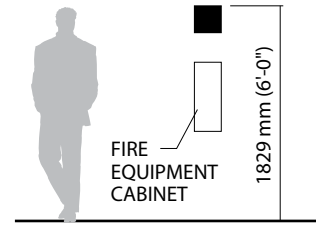

Detail: 2



Detail: 3

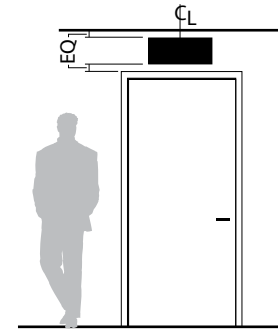

Detail: 4

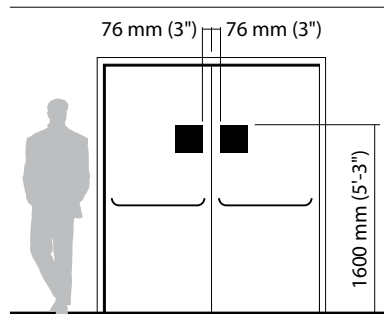

Detail: 5

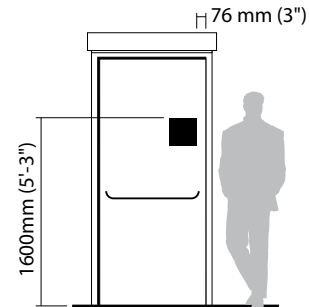

Detail: 6

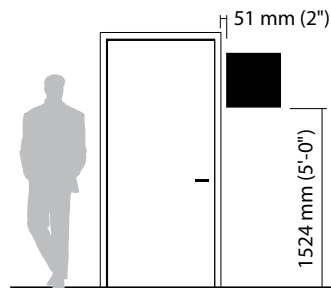

Detail: 7

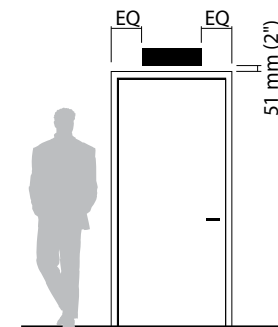

Detail: 8

LS Installation Detail 9

Sign types: IN-01.15

LS Installation Detail 10

Sign type: IN-01.26

LS Installation Detail 11

Sign type: IN-01.27

LS Installation Detail 12

Sign type: IN-01.28

LS Installation Detail 13

Sign type: IN-01.31

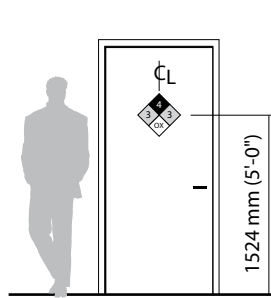

Detail: 9

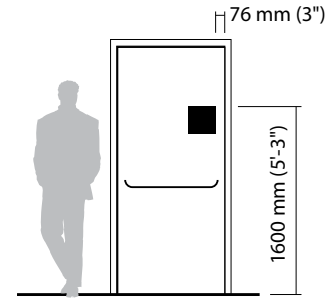

Detail: 10

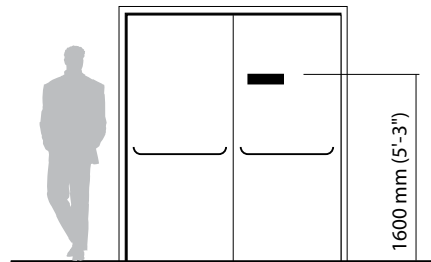

Detail: 11



Detail: 12

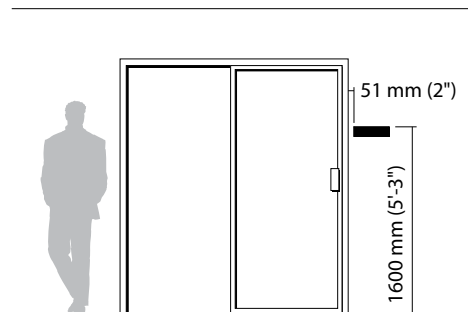

Detail: 13

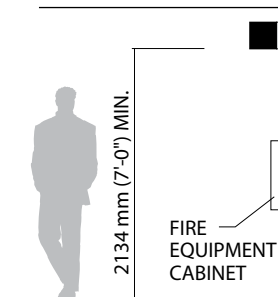

Glass Back Up

Certain signs may require that they be installed on glass because there is no available wall surface.

When this situation occurs, a blank, opaque glass back up is required to be placed on the opposite side of the glass exactly behind sign being installed.

This blank opaque glass back up is to be the same size and color as the sign being installed so it effectively covers and hides the mounting of the sign to the glass.

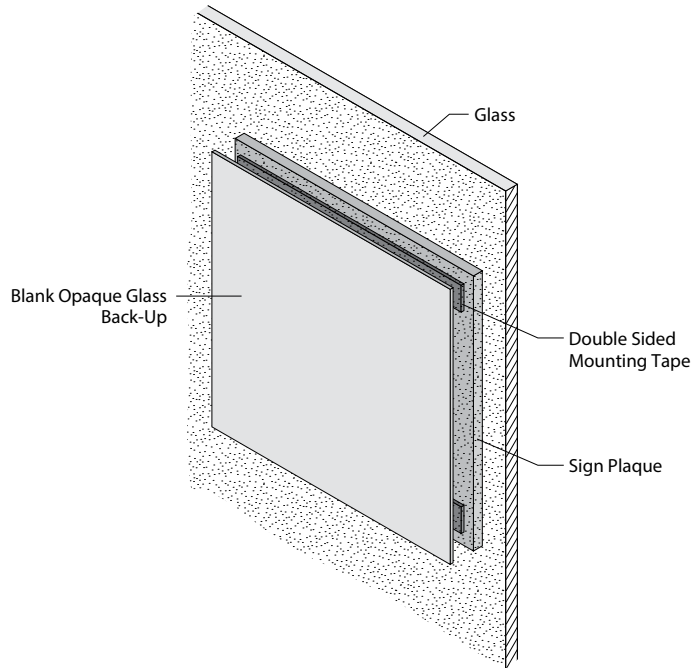

Stairwell Guide

Certain signs relating to stairs require that they be installed at specific locations as defined by what floor they are located on.

Illustration 1
Exit Level with Exterior Exit

Illustration 1

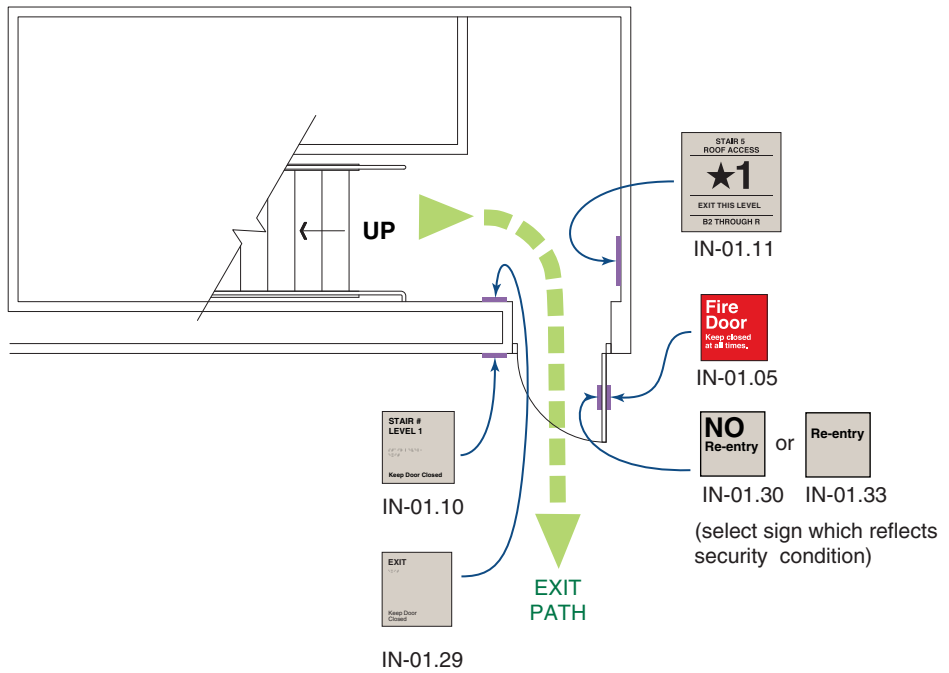

Illustration 2
Exit Level with Interior Exit

Illustration 2

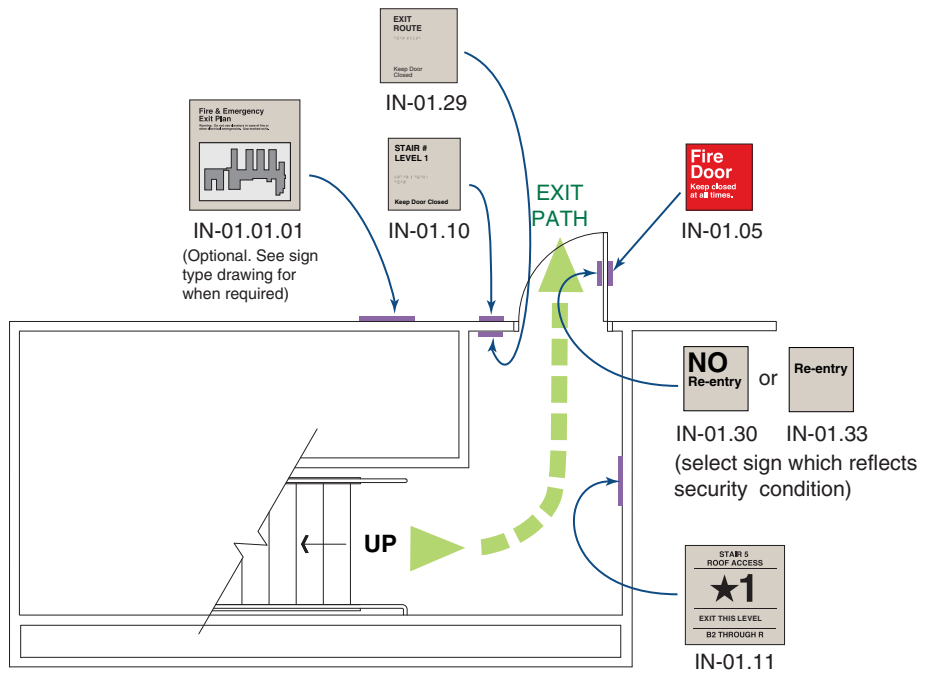

Illustration 3
Exit Level with Two Exit Doors

Illustration 3

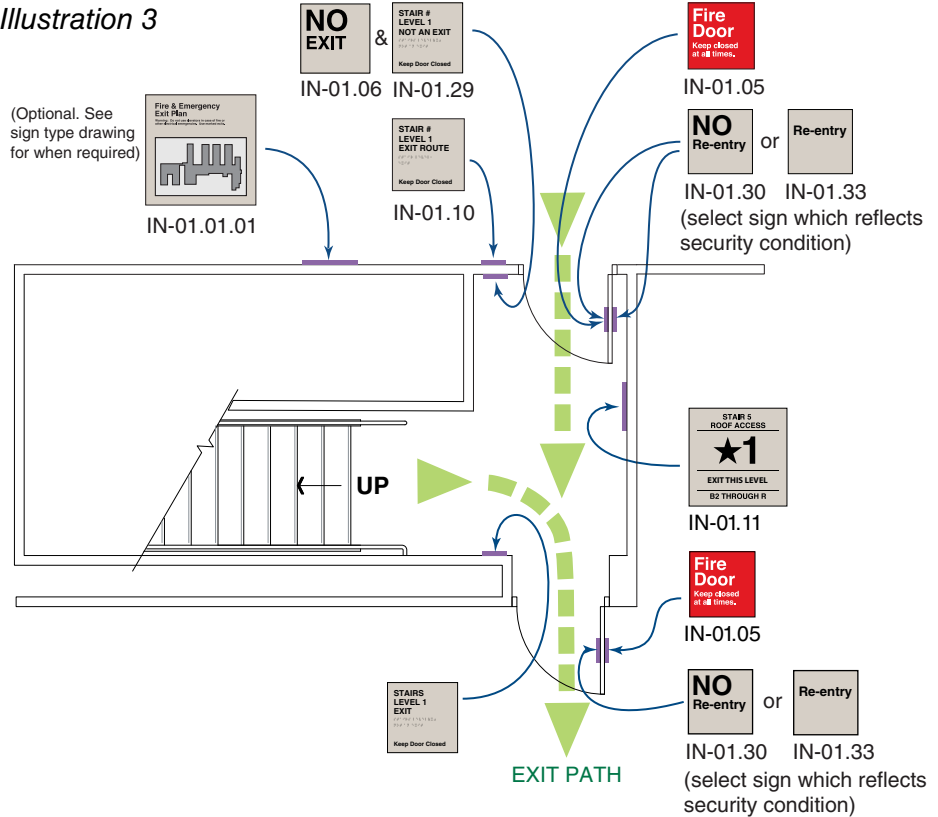

Illustration 4
Exit Level with Exit Path thru Interior Space

Illustration 4

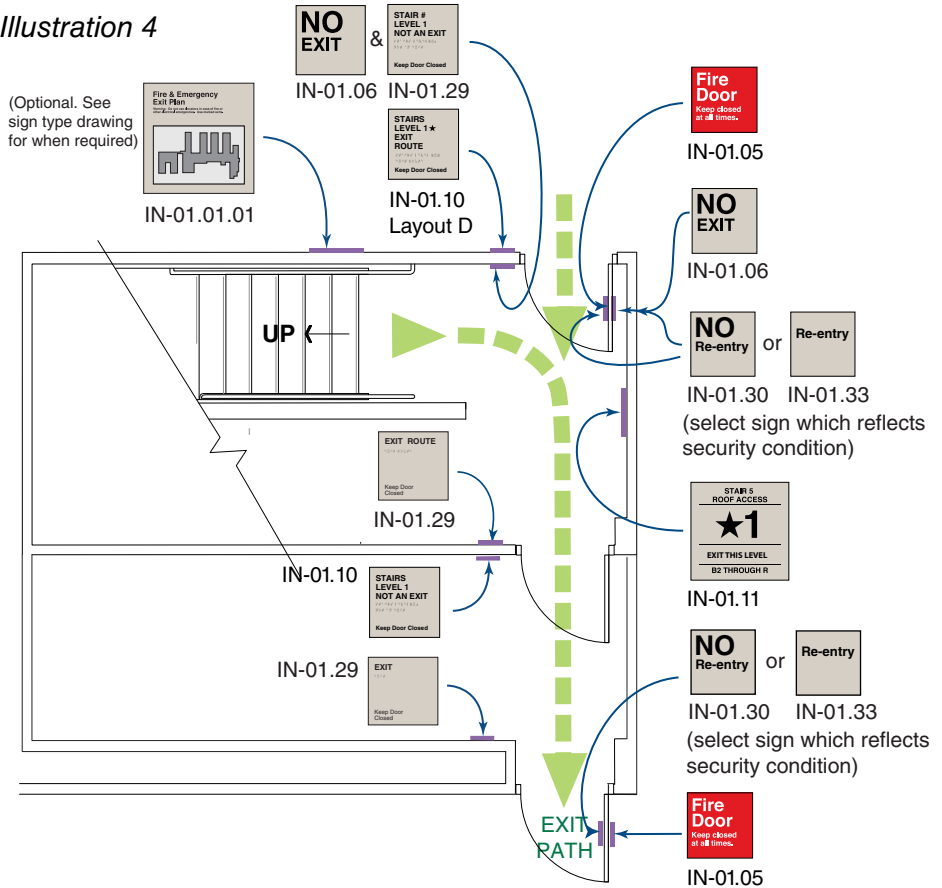

Illustration 5
Exit Level with Basement Stairs

Illustration 5

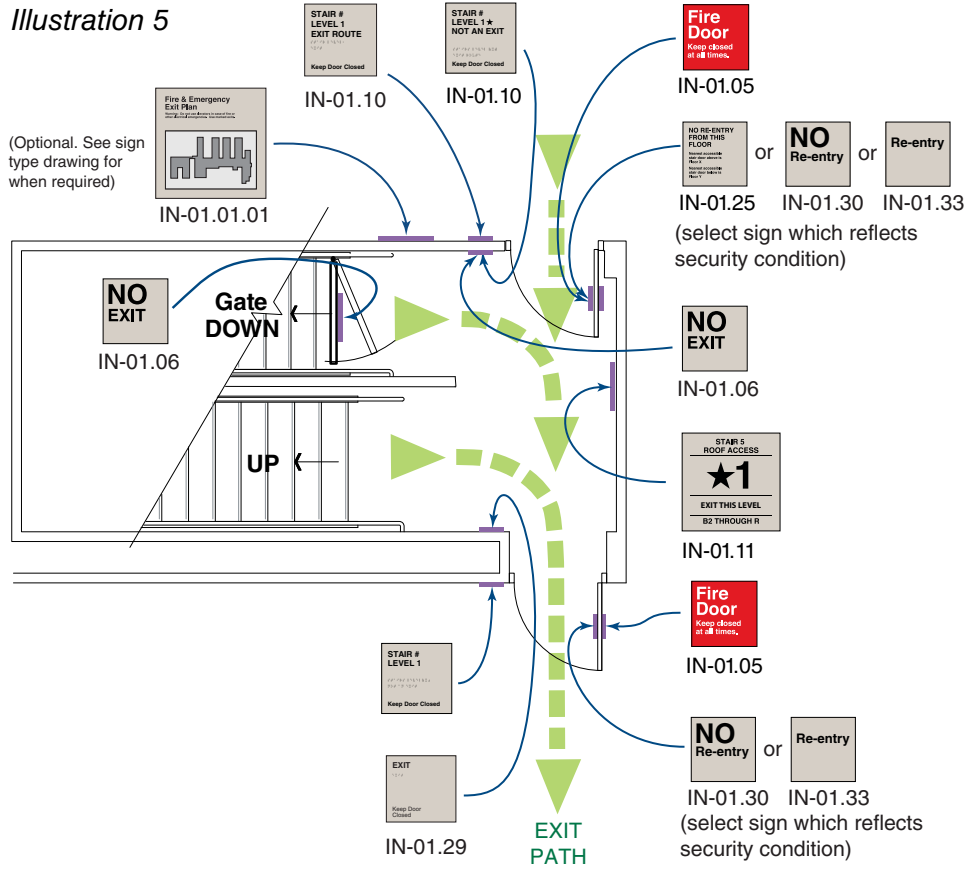

Illustration 6
Intermediate Floor Levels

Illustration 6

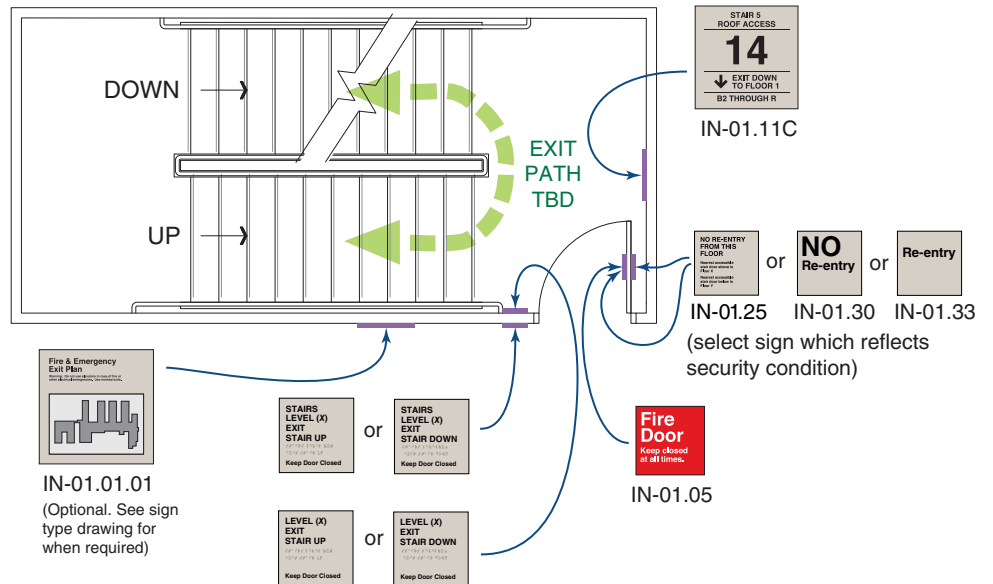

Illustration 7
Roof Level

Illustration 7

