



# United Nations Infantry Battalion Manual

Volume I



DEPARTMENT OF PEACEKEEPING OPERATIONS  
DEPARTMENT OF FIELD SUPPORT

AUGUST 2012

# **United Nations Infantry Battalion Manual**

**Volume I**



DEPARTMENT OF PEACEKEEPING OPERATIONS  
DEPARTMENT OF FIELD SUPPORT

AUGUST 2012



The first UN Infantry Battalion was deployed as part of United Nations Emergency Force (UNEF-I). UN infantry soldiers march in to Port Said, Egypt, in December 1956 to assume operational responsibility.



'The United Nations Infantry Battalion is the backbone of United Nations peacekeeping, braving danger, helping suffering civilians and restoring stability across war-torn societies. We salute your powerful contribution and wish you great success in your life-saving work.'

**BAN Ki-moon**  
**United Nations Secretary-General**





## Preface

I am very pleased to introduce the United Nations Infantry Battalion Manual, a practical guide for commanders and their staff in peacekeeping operations, as well as for the Member States, the United Nations Headquarters military and other planners.

The ever-changing nature of peacekeeping operations with their diverse and complex challenges and threats demand the development of credible response mechanisms. In this context, the military components that are deployed in peacekeeping operations play a pivotal role in maintaining safety, security and stability in the mission area and contribute meaningfully to the achievement of each mission mandate. The Infantry Battalion constitutes the backbone of any peacekeeping force and as such, its training, equipment and deployment is of great importance to the Troop-Contributing Countries, the mission leadership and the United Nations Headquarters alike.

To further improve the preparations, operational readiness and efficiency of the United Nations Infantry Battalions, the Department of Peacekeeping Operations and the Department of Field Support, with the support of Member States, peacekeeping missions, and partners throughout the United Nations system, have embarked on producing this Manual. By illustrating relevant strategic and operational issues, combined with guidelines on tactical employment of a United Nations Infantry Battalion, the Manual attempts to capture and consolidate all relevant dimensions of peacekeeping operations in a single reference document. I expect this to contribute to further enhancement of performance in the field.

I would like to express my sincere gratitude to the Member States, United Nations system partners, field missions, training institutions, and other peacekeeping practitioners and stakeholders for the dedicated support and substantial contribution they have provided in the development of this Manual. I further compliment the Office of Military Affairs for spearheading the initiative.

The United Nations Infantry Battalion Manual is a living document. As such, the Department of Peacekeeping Operations and the Department of Field Support will continue to refine and update this Manual to ensure its relevance to the changing operational environment and to meet the aspirations of the Member States and the United Nations.

**Hervé Ladsous**

Under-Secretary-General for Peacekeeping Operations



## Credits

Office of Military Affairs,  
Department of Peacekeeping Operations  
United Nations Secretariat  
One UN Plaza, New York, NY 10017  
Tel. 917-367-2487

Approved by Hervé Ladsous,  
USG/DPKO

August 2012

Contact: PDT/OMA /DPKO review date: September 2014

**Note:** New policies/guidelines/amendments issued from time to time prior to the first review will be uploaded in the web as an addendum to the UN Infantry Battalion Manual on as required basis.



Printed at the United Nations, New York

© United Nations 2012. This publication enjoys copyright under Protocol 2 of the Universal Copyright Convention. Nevertheless, governmental authorities or Member States may freely photocopy any part of this publication for exclusive use within their training institutes. However, no portion of this publication may be reproduced for sale or mass publication without the express consent, in writing, of the Office of Military Affairs, United Nations Department of Peacekeeping Operations.



# Contents

<b>Preface</b>	iii
<b>1. Purpose and Scope</b>	7
<b>2. Principles, Policies and Framework</b>	11
<b>3. Mandate, Directives and Orders</b>	47
<b>4. Capabilities</b>	67
<b>5. Tasks</b>	79
5.1 : Introduction.	79
5.2 : Purpose.	79
5.3 : Infantry Battalion Tasks.	79
5.4. : Task Descriptions.	81
<b>Primary Tasks</b>	81
5.4.1 : Patrolling.	81
5.4.2 : Observation Post.	82
5.4.3 : Checkpoint.	83
5.4.4 : Outreach and Engagement.	83
5.4.5 : Situational Awareness.	84
5.4.6 : Cordon and Search.	85
5.4.7 : Convoy and Escort.	86
5.4.8 : Operation Base.	87
<b>Support Tasks</b>	<b>88</b>
5.4.9 : Disarmament and Demobilization.	88
5.4.10 : Critical Infrastructure and Assets Protection.	89
5.4.11 : Crowd Management.	90
5.4.12 : Detention.	92
<b>Other Tasks</b>	<b>92</b>
5.4.13 : Buffer Zone.	92
5.4.14 : Joint Operations.	93
5.4.15 : Reinforce/Relief.	94
5.4.16 : Extract/Evacuate.	95
<b>6. Protection of Civilians</b>	99
<b>7. Mission Support</b>	109
<b>8. Organization and Equipment</b>	127
<b>9. Deployment</b>	159
<b>10. Training</b>	169
<b>11. Operational Readiness and Self-evaluation</b>	177
CD with Vol I, Vol II and Message from the Military Adviser	Enclosed







## Purpose and Scope

The purpose of this first edition of the United Nations Infantry Battalion Manual (UNIBAM) is to provide peacekeeping battalion commanders, their staff, company commanders and sub-unit leaders with a reference guide in support of their planning and conduct of operations to execute a United Nations (UN) mandate. As such, this Manual focuses on capability standards, tasks, a generic Table of Organization and Equipment, and operational readiness self-evaluation tools for a fully mission capable peacekeeping battalion.

While this Manual is primarily written for UN Infantry Battalions, it will also serve as a guide for national and United Nations Headquarters (UNHQ) planners and for those who train, support, and utilize UN Peacekeeping Infantry Battalions. It is designed to assist battalion commanders in the field and in the reorientation of their battalion from a national military entity into an integral part of a unified UN peacekeeping operation.

The Manual is based on UN official guidance including lessons learned, feedback from field missions and former battalion commanders, input from peacekeeping practitioners who have supported or operated with UN peacekeeping battalions and active consultation with the Troop-Contributing Countries (TCCs). It is a body of thought on how UN peacekeeping battalions could operate as an integral part of a UN Sector or Force Command. It does not attempt to impose solutions on TCC's training, operations or force structures, neither is it an instrument for selection.

Those TCCs experienced in peacekeeping operations can utilize the tools in the UNIBAM to augment national manuals. TCCs that are new to UN peacekeeping can use the Manual as a guide to build and field effective and capable peacekeeping battalions over time.

Creating a single structure to fit all peacekeeping scenarios is unrealistic. However, creating organizational models, as depicted in this Manual, equipped and prepared to defined standards and able to adapt structurally to fit the unique demands of a given mission mandate and TCC organiza-



tional structure is a significant benefit to TCCs and the UN. These models should not be considered as an “end state”, but as a “starting point”, whereby organizational elements can be “plugged in” or “plugged out”, as required. In the end, actual battalion structures shall be in accordance with the Memorandum of Understanding (MOU) between the UN and TCCs.

The UNIBAM consists of two volumes. Volume I of the UNIBAM focuses on peacekeeping oriented conceptual aspects pertaining to various UN policies, battalion capability standards, tasks in general, organization, evaluation and training requirements. Volume II covers in greater detail tasks, capability standards and self-evaluation checklists along with various templates and annexes as practical guidelines for execution of the functional responsibility.

The importance of training, as condition for a high-level performance in the field, cannot be stressed enough. Especially the training for the battalion commander, staff and company commanders, as mentioned in Chapter 10, requires close attention. Mission-specific, scenario-based modules are available and should be used to the maximum extent possible, not just during the predeployment phase but also in the field upon deployment.

In peacekeeping operations, the military components comprise units from different TCCs with different language, culture and professional ethos working together to maintain peace. This Manual establishes a common frame of reference which will bolster the interoperability.

Ultimately, it is the battalion commander, the well exercised and dedicated staff and a force of disciplined, motivated and well-trained soldiers that establish the flexibility and capabilities required for an infantry battalion to succeed in its UN mission.

## Background

The concept for this UN Infantry Battalion Manual originated as part of a comprehensive agenda for peacekeeping capability development, which seeks to bolster the interoperability and effectiveness of mission assets by matching existing UN Policies and Guidance with capability-based peacekeeping operations. This agenda was introduced in 2009 within the context of the “New Horizon” peacekeeping reform initiative and has been identified by Member States and the Secretariat as a central pillar of the collective effort to strengthen United Nations peacekeeping. It seeks to



build agreement around a vision for United Nations peacekeeping that places performance at the heart of operations.

The UNIBAM has been elaborated through a comprehensive process of consultation and collaboration among peacekeeping contributors, the United Nations Secretariat and field missions. This process has included a series of workshops and informal discussions and a review of UNIBAM content through a Technical Reference Group composed of Member State “subject matter experts” on infantry battalion peacekeeping operations, within permanent missions, their national counterparts, field missions, peacekeeping training centres, and the Secretariat.







## Principles, Policies and Framework

### 2.1 : General.

United Nations peacekeeping has evolved, particularly following the end of the Cold War in the 1990s, into one of the main tools used by the international community to manage complex crises that pose a threat to international peace and security. In recent years, UN peacekeeping operations have become multidimensional in nature, composed of a range of components, including military, police, political affairs, rule of law, human rights, reconstruction, public information, child protection and gender. Peacekeeping is no longer purely a military responsibility. Moreover, peacekeeping has also become more multinational, with an increasing number of TCCs.

### 2.2 : Purpose.

The purpose of this chapter is to give an overview of the United Nations principles, policies and framework, as applicable to peacekeeping operations that are overarching and cross cutting in nature. It provides strategic direction and establishes operational guidance for a greater understanding of divergent issues at the infantry battalion level.

### 2.3 : History of UN Peacekeeping Operations.

UN peacekeeping is based on the principle that an impartial presence on the ground can ease tensions between hostile parties and create space for political reconciliation. Peacekeeping might bridge the gap between the cessation of hostilities and a durable peace, but only if the parties to a conflict have the political will to reach this goal. Initially developed as a means of responding to inter-state conflict, peacekeeping has increasingly been used in the aftermath of intra-state conflicts and civil wars, which are often characterized by multiple armed factions with differing political objectives and fractured lines of command.

With the multidimensional aspect in mind, a battalion should be prepared to undertake diverse operational and non-operational tasks in a multi-



national, multicultural and multilinguistic environment. Increasingly, the Security Council has authorized the military components of peacekeeping operations to use force beyond self-defence to achieve certain mandated objectives, including but not limited to the protection of civilians. There are also a number of areas, such as mission support and security and safety of personnel, which remain essential to the success of peacekeeping, regardless of a particular mission's mandate.

**Reference:**

- Handbook on UN Multidimensional Peacekeeping Operations, 2003 (Foreword, The Evolution of Peacekeeping, United Nations).

## **2.4 : United Nations.**

The United Nations is an international organization whose stated aims are facilitating cooperation in international law, international security, sustainable development (socio-economic and environmental), social progress, human rights, and achievement of world peace. Peacekeeping operates within a changing physical, social, economic and political environment. There is the need for flexibility to address an evolving set of issues. Success is never guaranteed, particularly as UN peacekeeping missions are usually deployed in the most physically and politically difficult environments.

## **2.5 : The Basic Principles of UN Peacekeeping.**

Three basic principles have and continue to set UN peacekeeping operations apart as a tool for maintaining international peace and security:

- Consent of the parties.
- Impartiality.
- Non-use of force except in self-defence and defence of the mandate.

These principles are inter-related and mutually reinforcing. It is important that their meaning and relationship to each other are clearly understood by all those involved in the planning and conduct of UN peacekeeping operations, so that they are applied effectively.

**2.5.1 : Consent of the Parties.** UN peacekeeping operations are deployed with the consent of the main parties to the conflict. This requires a commitment by the parties to a political process (including a cease-fire agreement) and their acceptance of a peacekeeping operation mandated to support



that process. The consent of the main parties provides with the necessary freedom of action, both political and physical, to carry out mandated tasks. In the absence of such consent, a UN peacekeeping operation risks becoming a party to the conflict; and being drawn towards enforcement action, and away from its intrinsic role of keeping the peace. In the implementation of its mandate, a UN peacekeeping operation should work continuously to ensure that it does not lose the consent of the main parties, while ensuring that the political process moves forward.

This requires that all peacekeeping personnel have a thorough understanding of the history and prevailing customs and culture in the mission area, as well as the capacity to assess the evolving interests and motivation of the parties. The absence of trust between the parties in a post-conflict environment can, at times, make consent uncertain and unreliable. The peacekeeping operation should continuously analyze its operating environment to detect and forestall any wavering of consent. A peacekeeping operation should have the political and analytical skills, the operational resources, and be able to take the necessary action to manage situations where there is an absence or breakdown of local consent. In some cases this may require, as a last resort, the use of force.

**2.5.2 : Impartiality.** UN peacekeeping operations must implement their mandate without favour or prejudice to any party. Impartiality is crucial to maintaining the consent and cooperation of the main parties, and should not be confused with neutrality or inactivity. UN peacekeepers should be impartial and even-handed in their dealings with the parties to the conflict, but not neutral in the execution of their mandate. Notwithstanding the need to establish and maintain good relations with the parties, a peacekeeping operation must scrupulously avoid activities that might compromise its image of impartiality.

The need for even-handedness towards the parties should not become an excuse for inaction in the face of behaviour that clearly works against the peace process. Just as a good referee is impartial, but will penalize infractions, a peacekeeping operation should not condone actions by the parties that violate the undertakings of the peace process or the international norms and principles that a United Nations peacekeeping operation upholds.

A mission should not shy away from a rigorous application of the principle of impartiality for fear of misinterpretation or retaliation, but before acting it





is always prudent to ensure that the grounds for acting are well-established and can be clearly communicated to all. Failure to do so may undermine the peacekeeping operation's credibility and legitimacy, and may lead to a withdrawal of consent for its presence by one or more of the parties. Where the peacekeeping operation is required to counter such breaches, it must do so with transparency, openness and effective communication as to the rationale and appropriate nature of its response.

**2.5.3 : Non-use of Force Except in Self-defence and Defence of the Mandate.** UN peacekeeping operations are not an enforcement tool. However, they may use force at the tactical level, with the authorization of the Security Council, if acting in self-defence and defence of the mandate. The UN peacekeeping environments are often characterized by the presence of militias, criminal gangs, and other spoilers who may actively seek to undermine the peace process or pose a threat to the civilian population.

In such situations, the Security Council has given mandates authorizing certain missions to "use all necessary means" to deter forceful attempts to disrupt the political process, protect civilians under imminent threat of physical attack, and/or assist the national authorities in maintaining law and order. By proactively using force in defence of their mandates, these United Nations peacekeeping operations have succeeded in improving the security situation and creating an environment conducive to longer-term peacebuilding in the countries where they are deployed. Force should be used only as a measure of last resort, when other methods of persuasion have been exhausted, and an operation must always exercise restraint when doing so.

The ultimate aim of the use of force is to influence and deter spoilers working against the peace process or seeking to harm civilians and not to seek their military defeat. It should be calibrated in a precise, proportional and appropriate manner, within the principle of the minimum force necessary to achieve the desired effect, while sustaining consent for the mission and its mandate. Peacekeepers should always be mindful of the need for an early de-escalation of violence and a return to non-violent means of persuasion. Since use of force has political implications, decisions and judgements concerning its use will need to be made at the appropriate level within a mission, based on a combination of factors including mission capability; public perceptions; humanitarian impact; force protection; safety and security of personnel; and the effect on national and local consent for the mission.



**2.5.4 : Other Success Factors.** UN peacekeeping operations continue to be guided by the basic principles of consent, impartiality and the non-use of force except in self-defence and defence of the mandate. In order to succeed, UN peacekeeping operations must also be perceived as legitimate and credible, particularly in the eyes of the local population, and should promote national and local ownership, in order to contribute to the achievement of a sustainable peace.

**2.5.5 : Legitimacy.** International legitimacy is one of the most important assets of a UN peacekeeping operation. It is derived from the fact that it is established after obtaining a mandate from the UN Security Council, which has primary responsibility for the maintenance of international peace and security. The uniquely broad representation of Member States further strengthens this international legitimacy. So too does the fact that the operations are directed by the UN Secretary-General, an impartial and well-respected international figure, committed to upholding the principles and purposes of the Charter.

The manner in which a UN peacekeeping operation conducts itself may have a profound impact on its perceived legitimacy on the ground. The firmness and fairness with which the mission exercises its mandate, the circumspection with which it uses force, the discipline it imposes upon its personnel, the respect it shows to local customs, institutions and laws, and the decency with which it treats the local people all have a direct effect upon perceptions of its legitimacy. Peacekeeping missions must always be aware of and respect national sovereignty. As legitimate government structures emerge, the role of the international actors may well need to diminish quickly. They should seek to promote national and local ownership, be aware of emerging local capacities, and be sensitive to the effect that the behaviour and conduct of the mission has upon the local population.

**2.5.6 : Credibility.** The credibility of a UN peacekeeping operation is a direct reflection of the international and local communities' belief in the mission's ability to achieve its mandate. Credibility is a function of a mission's capability, effectiveness and ability to manage and meet expectations. Ideally, in order to be credible, a UN peacekeeping operation should deploy as rapidly as possible, be properly resourced, and strive to maintain a confident, capable and unified posture. Early establishment of a credible presence can help to deter spoilers and diminish the likelihood that a mission will need to use force to implement its mandate.



To achieve and maintain its credibility, a mission should therefore have a clear and deliverable mandate, with resources and capabilities to match; and a sound mission plan that is understood, communicated and impartially and effectively implemented at every level. The deployment of a mission will generate high expectations among the local population regarding its ability to meet their most pressing needs. A perceived failure to meet these expectations may cause a UN peacekeeping operation to become a focus for popular dissatisfaction, or worse, active opposition. The ability to manage these expectations throughout the life of a peacekeeping operation affects the overall credibility of the mission. Accordingly, the maintenance of credibility is fundamental to the success of a mission.

**2.5.7 : Promotion of National and Local Ownership.** National and local ownership is critical to the successful implementation of a peace process. In planning and executing a UN peacekeeping operation's core activities, every effort should be made to promote national and local ownership and to foster trust and cooperation between national actors. Effective approaches to national and local ownership not only reinforce the perceived legitimacy of the operation and support mandate implementation, but also help to ensure the sustainability of any national capacity once the peacekeeping operation has been withdrawn.

Partnerships with national actors should be struck with due regard to impartiality, wide representation, inclusiveness and gender considerations. National and local ownership should begin with a strong understanding of the national context (socio-political and economic context). A Peacekeeping operation may be obliged, in the short-term, to take on important State-like functions, such as the provision of security and the maintenance of public order. However, these functions should be conducted in a consultative manner. The aim should be always to restore, as soon as possible, the ability of national actors and institutions to assume their responsibilities and to exercise their full authority, with due respect for internationally accepted norms and standards. In building national capacity, women and men should have equal opportunities for training. Targeted efforts may need to address gender inequalities.

It is important for all members of the battalion to have a clear understanding of the UN principles and the time tested success factors and inculcate them in the performance of the peacekeeping tasks.

**Reference:**

- United Nations Peacekeeping Operations, Principles and Guidelines, 2008.



## 2.6 : Legal Framework of Peacekeeping.

The Charter of the United Nations was signed, in San Francisco, on 26 June 1945 and is the foundation document for all the United Nations work. The United Nations was established to “save succeeding generations from the scourge of war” and one of its main purposes is to maintain international peace and security. The Charter gives the United Nations Security Council primary responsibility for the maintenance of international peace and security. In fulfilling this responsibility, the Security Council may adopt a range of measures, including the establishment of a United Nations peacekeeping operation. The legal basis for such action is found in Chapters VI, VII and VIII of the Charter. While Chapter VI deals with the “Pacific Settlement of Disputes”, Chapter VII contains provisions related to “Action with Respect to the Peace, Breaches of the Peace and Acts of Aggression”. Chapter VIII of the Charter also provides for the involvement of regional arrangements and agencies in the maintenance of international peace and security.

Promoting and encouraging respect for human rights and fundamental freedoms for all, are purposes of the United Nations as defined by its Charter. The UN commitment towards human rights in the Charter was followed by the development of international human rights law which is an integral part of the normative framework for United Nations peacekeeping operations. The Universal Declaration of Human Rights, which sets the cornerstone of international human rights standards, emphasizes that human rights and fundamental freedoms are universal and guaranteed to everybody.

United Nations peacekeeping operations must be conducted in full respect of human rights and should seek to advance human rights through the implementation of their mandates. This point of doctrine has important operational implications for the work of UN military components, which are expected to promote and protect human rights while performing tasks such as patrolling, observation, liaison with host country military counterparts, training of local armed forces, etc. It is important that military personnel deployed in UN peace operations be trained and prepared to take up these functions.

International humanitarian law is known also as “the law of war” or “the law of armed conflict”, and aims to limit the effects of armed conflicts for humanitarian reasons by restricting the means and methods of armed conflict. International humanitarian law aims to protect persons who are not or are no longer taking part in hostilities, the sick and wounded, prisoners and



civilians, and to define the rights and obligations of the parties to a conflict in the conducts of hostilities. International humanitarian law is contained in the four Geneva Conventions of 1949 and their two Additional Protocols of 1977. International humanitarian law also includes conventions and treaties that prohibit the use of certain weapons and military tactics and protect certain categories of people and goods, as well as the protection of cultural property and the environment during armed conflict. The Secretary-General's Bulletin on the Observance by United Nations Forces of International Humanitarian Law of 6 August 1999 (ST/SGB/1999/13) sets out the fundamental principles and rules of international humanitarian law that are applicable to UN peacekeepers.

#### References:

- Charter of the United Nations, 1945.
- DPKO/DFS United Nations Peacekeeping Operations, Principles and Guidelines, 2008.

## 2.7 : Early Peacebuilding Activities.

**General.** The early peacebuilding strategy (The Contribution of UN Peacekeeping to Early Peacebuilding: A DPKO-DFS Strategy for Peacekeepers) provides guidance to UN peacekeepers on prioritizing, sequencing and planning critical early peacebuilding tasks. Priority initiatives are those that advance the peace process or political objectives of a mission and ensure security and/or lay the foundation for longer-term institution building. Sequencing will be determined in each setting, based on the feasibility of executing priority tasks.

These initiatives are undertaken in a phased manner, commencing with pre-deployment activities followed by operational initiatives, which may commence simultaneously and further two principal objectives:

- **Track 1.** Activities that provide security, facilitate and build confidence in a peace process, and provide space for other UN and international actors.
- **Track 2.** Initiatives that help to consolidate the peace process and facilitate a smooth peacekeeping exit by laying the foundation for longer-term institution building.

**Critical Risk/Success Factors.** Factors critical to the success of priority early peacebuilding initiatives include political will at national, regional, international levels; local knowledge through in-depth assessments; clear and



achievable mandate supported with adequate financing; strong leadership; partnerships that reflect clear roles, comparative strengths and integrated approaches; national and local ownership; popular engagement in prioritization; availability of appropriate skills and equipment; and rapid deployment capacity.

### Role of Military.

In most cases, military peacekeepers will be the first to deploy to a region in the aftermath of conflict. The Force Generation process to obtain new peacekeepers can only begin following authorisation from the UN Security Council and this invariably imposes a delay in initial deployment. Military enablers are also key at the early stages, to provide critical transport, medical and engineer assets. The immediate mandate of military peacekeepers will be to support the restoration of security and to provide a secure environment within which the humanitarian agencies and others can operate.

**Track 1.** activities for military peacekeepers are likely to include the provision of security at specific locations, such as national institutions, key installations, IDP camps, or working with UN Police (if deployed at this stage) in containing public disorder. Military peacekeepers will quickly establish a patrolling routine that can do much to calm a volatile situation, reassure the population, and provide a visible demonstration of external support in a time of need. As UN Police arrive, patrolling is likely to be done jointly, with the lead gradually shifting to the UN Police as the situation calms. Engagement will subsequently be made with key national civil and military leaders to provide reassurance and mutual awareness and understanding. Patrolling can then be expanded, and may include targeted patrols addressing recurrent human rights violations such as sexual and gender-based violence. This could, for example, include escorting women to gather firewood or crops, when they would otherwise routinely be attacked or assaulted.

**Track 2.** initiatives may include support to or training of some national forces, and could even be a step towards joint operations, if so mandated, as seen in the Democratic Republic of the Congo. These activities require basic military skills, which are then adapted to the peacekeeping environment to provide effective protection of civilians. Special-to-mission skills also need to be included in core military training to optimise effectiveness upon arrival in theatre, and these can include language training, training in specialist skills such as long-range patrolling and communications, and effective liaison with other contingents and factions. Reporting skills are



also vital, to enable military components to ensure that accurate and timely information is provided to the the Force HQ (FHQ), the Joint Operations Centre (JOC) and Joint Military Analysis Cell (JMAC) to inform the senior leadership. Other skills that can be developed include integrated planning, public information and Civil Military Cooperation (CIMIC).

This strategy aims to improve the capability of peacekeeping operations to deliver predictably, effectively and accountably in the complex areas of security, basic service provision, support to political processes, restoration and extension of state authority.

#### References:

- The Contribution of UN Peacekeeping to Early Peacekeeping: A DPKO/DFS Strategy for Peacekeepers, 2011.
- Peacekeeping and Peacebuilding: Clarifying the Nexus, September 2010.
- Report of the Secretary-General on Peacebuilding in the Immediate Aftermath of Conflict, A/63/881-S/2009/304.
- United Nations Peacekeeping Operations – Principles and Guidelines, 2008.

## 2.8 : Human Rights.

The maintenance of international peace and security and international cooperation in promoting and encouraging respect for human rights and fundamental freedoms for all are purposes of the United Nations as defined in the Charter. Respect for human rights is itself fundamental to the promotion of peace and security, and a unified United Nations approach to these ends is essential to the fulfilment of these two Charter-mandated objectives. Human rights violations are a constant feature of conflict situations in which peace operations are deployed. The protection and promotion of human rights are essential elements of United Nations efforts to prevent conflicts, to maintain peace, and to assist in post-conflict reconstruction endeavors, and due attention to human rights aspects of these various forms of responses is instrumental to the success of United Nations work in these areas. United Nations peacekeeping operations are increasingly multi-dimensional, with the frequent inclusion of human rights mandates and components, tasks and duties.

Commanders and soldiers have to realize that they do have roles and responsibilities in monitoring, promoting and protecting human rights through their functions and it is therefore essential to establish effective cooperation with the mission's Human Rights Officers in order to promote the human rights common agenda. Stronger partnerships between



human rights and military components can significantly strengthen peace operations' capacity to protect and lead to more timely threat assessments and effective advocacy with potential spoilers and human rights violators. They ultimately lead to better situational awareness and also peacekeepers' self-defence, as a deterioration of the human rights situation may signal a change of attitude and tactics by belligerent forces.

Military human rights responsibilities are spelt out in the DPKO/OHCHR/DPA/DFS Policy on Human Rights in UN Peace Operations and Political Missions, notably its provisions concerning the UN Military (paragraphs 84-88):

- Military play an important role in recording relevant human rights information, such as allegations or signs of risks of human rights violations (e.g., killings, rape, etc.), while performing patrolling, checkpoints and searches. Such allegations should be promptly shared with the human rights component for verification, investigation and follow up.
- All military personnel are required to be able to recognize a human rights violation and be prepared to intervene in accordance with the mandate and Rules of Engagement (ROE). In this regard, senior military commanders have two main responsibilities:
  - ★ Ensure that procedures are in place to guide peacekeepers' operations when confronted with human rights violations.
  - ★ Ensure that military personnel receive adequate training prior to deployment to develop a satisfactory level of understanding on how the implementation of their tasks intersects with human rights and to prepare them for these responsibilities.
- Military can provide important support to human rights staff by providing escort and/or military expertise in the conduct of human rights investigations. Military/human rights cooperation can also take the form of joint patrols or joint advocacy with alleged human rights perpetrators to stop those violations.
- Positive examples of military personnel contributions to human rights in peace operations settings can be found in a lessons learnt report compiled by the UN Office of the High Commissioner for Human Rights (OHCHR) – Human Rights Integration in the Work of UN Military Components (2010).

#### Reference:

- DPKO/OHCHR/DPA/DFS Policy on Human Rights in UN Peace Operations and Political Missions, September 2011.





## 2.9 : Safety and Security.

The primary responsibility for the security and protection of personnel employed by the UN system organizations, their recognized dependants and the organizations' property rests with the host government. Without prejudice to the above and while not abrogating host government from its obligations in this respect, the United Nations has a duty as an employer to reinforce and, where necessary, supplement the capacity of the host government to fulfil these obligations in circumstances where United Nations personnel are working in areas which are subject to conditions of insecurity and which require mitigation measures beyond those which the host government can reasonably be expected to provide.

Under Article 97 of the Charter of the United Nations, the Secretary-General is the Chief Administrative Officer of the Organization. The Secretary-General delegates to the Under- Secretary-General of the Department of Safety and Security (DSS) the authority to make executive decisions relevant to the direction and control of the United Nations security management system and the overall safety and security of United Nations personnel, premises and assets at both field and HQ locations. The DSS has overall responsibility for all safety and security matters for the United Nations worldwide.

The DSS is responsible for managing and responding to safety and security concerns at all UN facilities and installations. However, military peacekeepers also have the responsibility for ensuring the security of themselves and their equipment, as well as the security of other UN personnel, especially the civilian staff. The DSS promulgated Framework of Accountability specifies the responsibilities and accountabilities of United Nations officials and personnel at various levels of appointments. Specifically all UN peacekeepers are responsible for:

- Completing appropriate safety and security training.
- Conducting in a manner that does not endanger themselves or others.
- Reporting all safety and security incidents to the security focal point as soon as possible.
- Complying with all United Nations safety and security regulations and procedures whether on or off duty.
- Wearing your UN Pass on an outermost garment within visible range at all times while on UN grounds.



In addition:

- Battalion Commanders should coordinate and liaise with the Safety and Security Officer/Focal Point in the area of operations (AO).
- Infantry battalions should restore and preserve the safety and security environment in the AOR proactively.

Reference:

- United Nations Security Management System, 2008.

## 2.10 : Protection of Civilians.

Civilians continue to be the victims of human rights and International Humanitarian Law (IHL) violations in armed conflict. In the UN peacekeeping environment, the Security Council has mandated a number of peacekeeping operations with the mandate to protect civilians under imminent threat of physical violence. This challenging mandate is often the yardstick by which the international community, and those whom peacekeeping endeavors to protect, judge peacekeepers worth. These aspects will be addressed more in detail in Chapter 6.

In close coordination with other mission components, tasks related to the protection of civilians (POC) are carried out by the UN force on a daily basis. Commanders at all levels have to be aware of and have the responsibility to act upon existing threats to the population and their vulnerabilities and should incorporate relevant aspects of POC into the planning and implementation of their tasks. These aspects will be addressed in chapter 6 in more detail.

Reference:

- DPKO/DFS Operational Concept on the Protection of Civilians in United Nations Peacekeeping Operations (2009).

## 2.11 : Gender.

To enhance the role played by women in the maintenance of international peace and security, the UN Security Council has, to date, adopted four specific resolutions on women, peace and security: resolution 1325 (2000), resolution 1820 (2008), resolution 1888 (2009), resolution 1889 (2009) and resolution 1960. These mandates require that peacekeeping missions boost women's participation in post-conflict decision-making processes, prevent sexual violence, protect individuals, including women and girls, increase the presence of female peacekeeping personnel, and systematically train all peacekeepers to address gender issues in their work.



Against this backdrop, the performance of military tasks in multidimensional peacekeeping missions has increasingly come to require engagement with local populations. Identifying and responding to any differential impact of the work of military peacekeepers on different groups in the local population is, therefore, a necessary strategy for ensuring that the security concerns of women, men, girls and boys are adequately addressed throughout all phases of a peacekeeping mission. The approach requires harnessing the professional expertise of male and female military personnel to achieve optimum operational effectiveness.

#### References:

- DPKO/DFS Guidelines on Integrating a Gender Perspective into the Work of United Nations Military in Peacekeeping Operations, March 2010;
- DPKO/DFS Policy on Gender Equality in Peacekeeping Operations, 2010.

## 2.12 : Sexual Violence in Conflict.

The military component of peacekeeping operations play a vital role in the protection of women and children as part of its mandated task of protecting human rights, including in situations of imminent threat of physical violence. This means not only protecting women and men from sexual violence itself, but also being aware of the community dynamics at play regarding the social and economic reinsertion of survivors, and providing the necessary support. In support of these goals, the military is encouraged to recruit more women to address this critical aspect of security in peacekeeping operations, and more importantly to ensure that all UN personnel understand that enhancing women's safety also enhances mission success.

Enhancing effectiveness of the response to sexual violence as part of the challenges of conflict is an emerging field in peacekeeping and has been receiving increasing attention by the Security Council. The UN has provided clear examples and guidelines for uniformed peacekeepers on addressing conflict related sexual violence that increased awareness will lead to an improvement on the ground. The blue helmet must remain an emblem of hope, peace and progress for all civilians – men and women, boys and girls. The issue of protecting civilians from conflict-related sexual violence is not only a military task, but one that also requires the participation of a wide range of stakeholders to build a safe and secure environment.

Coordination of each unit's tasks should include all relevant mission components such as human rights, gender, child protection and members of



the UN Country Team (UNCT) in order to ensure that efforts to combat sexual and gender-based violence are multi-dimensional and harness the full capacity of the UN system, rather than working in silos. Civil Military Cooperation (CIMIC) officers can also act as an effective link between the force, humanitarian agencies and civilian components, such as human rights monitors for liaison and information management, to keep commanders apprised of protection activities, including with respect to sexual violence.

When sexual violence is used strategically for military or political gain, and/or is widespread and/or systematic, it is recognised as a war crime, a crime against humanity and as a constituent component of genocide which can impede the restoration of peace and security (refers to UN Security Council Resolutions 1820, 1888 and 1960). The Security Council has therefore introduced arrangements into the UN agenda to prevent and address sexual violence which include: a Special Representative of the Secretary-General on Sexual Violence in Conflict; a Monitoring, Analysis and Reporting Arrangement on conflict-related sexual violence to ensure improved prevention, response and accountability; the use of early warning indicators regarding conflict-related sexual violence; Women's Protection Advisers; a dialogue process for "commitments" with parties to the armed conflict to prevent and address incidents of sexual violence committed by the parties; and a listing (naming and shaming) procedure in the annual report of the Secretary-General of parties to conflict credibly suspected of committing conflict-related sexual violence (refer to Chapter 6 on POC). Emphasis has been placed on preventing sexual violence, improving coordination of partners and services for victims of sexual violence, and ensuring accountability for incidents of sexual violence.

#### Reference:

- Addressing Conflict-Related Sexual Violence, An Analytical Inventory of Peacekeeping Practice, 2010.

### 2.13 : Child Protection.

Protection of children in armed conflicts is a fundamental peace and security concern which is highlighted by eight Security Council resolutions on children and armed conflict (1261 of 1999, 1314 of 2000, 1379 of 2001, 1460 of 2003, 1539 of 2004, 1612 of 2005, 1882 of 2009 and 1998 of 2011). In addition, the Security Council has included specific provisions for the protection of children in several mandates of United Nations peacekeeping



operations. These resolutions and mandates require peacekeeping missions to undertake several activities to promote child protection, namely:

- Monitoring and reporting grave violations committed against children.
- Negotiating action plans for the release of children from armed groups, and other grave violations.
- Ensuring that all peacekeeping personnel are trained on child protection issues.

The DPKO-DFS Policy, Ref. [2009.17] on Mainstreaming the Protection, Rights and Well-being of Children Affected by Armed Conflict within UN Peacekeeping Operations dated 1 June 2009 provide detailed guidance on how all peacekeeping missions should work to integrate the protection of children in their work. Child Protection Advisers (CPAs) deployed in peacekeeping missions provide guidance, advice and support on child protection issues.

The military has a special role to play in promoting the protection of children in their areas of operation and in preventing violations, exploitation and abuse. Relevant issues that need to be considered by unit commanders include, but are not limited to, grave violations committed against children such as recruitment and use of children by armed forces and groups, rape and grave sexual violence, killing and maiming, abductions, attacks on schools and hospitals and denial of humanitarian access as well as child sensitive Disarmament, Demobilization and Reintegration (DDR), and detention of children.

Therefore, special attention must be paid to the protection needs of girls and boys who are extremely vulnerable in conflict. Important issues that require compliance by infantry battalions are:

- Children should not be put in the direct line of danger or used in information-gathering in military operations.
- Where children are captured or separated from armed groups, they should not be interrogated.
- When a child needs to be interviewed to establish evidence, civilian mission personnel, where present the child protection officer, should conduct the interview. Girls should preferably be interviewed by a woman.
- SOPs should be followed for the immediate hand-over to child protection actors.
- Schools shall not be used by the military in their operations.



- Military personnel should refrain from all forms of exploitation and abuse of children.
- The use of children under the age of 18 by the UN mission (including the Infantry Battalion) for purposes of labour or other rendering of services is strictly prohibited (DPKO/DFS policy on the prohibition of child labour in UN peacekeeping operations).

Where the mission has a child protection component, information on violations should be transmitted to the child protection officers. Information sharing protocols should be established with the child protection team taking into account confidentiality and the sensitivity of dealing with children's issues. To facilitate this, cooperation and to ensure sustained attention to child protection issues, the military should appoint child protection focal points within their structures in the field and at HQ level to coordinate and work closely with the UN Child Protection unit.

#### References:

- The DPKO-DFS Policy, Ref. [2009.17] on Mainstreaming the Protection, Rights and Well-being of Children Affected by Armed Conflict within UN Peacekeeping Operations dated 1 June 2009.
- DPKO/DFS Policy on the Prohibition of Child Labour in UN Peacekeeping Operations.

## 2.14 : Human Trafficking.

The occurrence of trafficking in peacekeeping areas of deployment is actively combated by the UN not only because it is a serious crime and a human rights violation, but also because of its very negative impact on the mission's legitimacy and its ability to achieve mandate implementation. Human trafficking is the illegal trade of human beings for the purposes of reproductive slavery, commercial sexual exploitation, forced labour, or a modern-day form of slavery. The Protocol to Prevent, Suppress and Punish Trafficking in Persons, especially women and children, was adopted by the United Nations in 2000. It is an international legal agreement which is included in the United Nations Convention against Transnational Organized Crime. Any involvement of peacekeeping personnel in human trafficking or any other form of sexual abuse or exploita-



tion constitutes an act of serious misconduct and grounds for disciplinary measures, such as dismissal or repatriation.

#### References:

- United Nations Office on Drugs and Crime, Vienna, ST/SGB/2004/6, 15 March 2004.
- Tool 9.17 Conduct of Peacekeepers and Other Law Enforcement Personnel.
- Recommended Principles and Guidelines on Human Rights and Human Trafficking: Commentary, 2010.

### 2.15 : HIV/AIDS Awareness.

HIV/AIDS continues to remain a formidable global challenge. More than 38 million people are living with HIV and AIDS, and millions more become infected each year. Medication now exists that can provide highly effective treatment though not a cure for AIDS. Recognizing that conflict and post-conflict areas are high-risk environments for the spread of HIV among peacekeepers and the community, UN Security Council Resolutions 1308 (2000) and 1983 (2011), underscore the importance of HIV/AIDS awareness training and prevention initiatives for UN peacekeepers. DPKO has developed modules on HIV/AIDS as part of predeployment training for TCCs. Mission-specific HIV/AIDS awareness is also included in induction upon arrival in the mission area along with other DPKO HIV interventions and services such as voluntary confidential counseling and testing (VCCT), condom programming and post-exposure prophylaxis (PEP) kits. Commanders shall nominate personnel for peer education training conducted by the HIV Unit, which shall be repeated to keep step with troop rotations.

#### Reference:

- DPKO/DFS Ref. [DPKO/DFS 2007/11] The Role and Functions of HIV/AIDS Units in United Nations Peacekeeping Operations and United Nations Security Management System, 2008.

### 2.16 : Conduct and Discipline.

The UN expects all peacekeepers to conduct themselves in a manner that befits mandates given to serve and protect, as envisaged in the Charter of the United Nations. The need to maintain the highest standards of integrity for all UN personnel is enshrined in the Charter.

UN peacekeepers undertake to conduct themselves in a professional and disciplined manner at all times, respect local laws, customs and practices, treat host country inhabitants with respect, courtesy and consideration



and act with impartiality, integrity and tact. The UN has a zero-tolerance policy with respect to sexual exploitation and abuse (SEA). UN rules forbid sexual relations with prostitutes and with any persons under 18, and strongly discourage relations with beneficiaries of assistance.

Sexual exploitation is defined as “any actual or attempted abuse of a position of vulnerability, differential power, or trust, for sexual purposes, including, but not limited to, profiting monetarily, socially or politically from the sexual exploitation of another”. Sexual abuse is defined as “the actual or threatened physical intrusion of a sexual nature, whether by force or under unequal or coercive conditions”. In his report to the General Assembly in 2002, the former Secretary-General Kofi Annan said: “Sexual exploitation and abuse by humanitarian staff cannot be tolerated. It violates everything the United Nations stands for. Men, women and children displaced by conflict or other disasters are among the most vulnerable people on earth. They look up to the United Nations and its humanitarian partners for shelter and protection. Anyone employed by or affiliated with the United Nations who breaks that sacred trust must be held accountable and, when the circumstances so warrant, prosecuted”.

Reiterating obligations contained in the Memorandum of Understanding between the United Nations and TCCs, the Secretary-General Bulletin on Special Measures for Protection from Sexual Exploitation and Sexual Abuse provides that:

- Sexual exploitation and sexual abuse constitute acts of serious misconduct and are therefore grounds for disciplinary measures, including summary dismissal.
- Sexual activity with children (persons under the age of 18) is prohibited regardless of the age of majority or age of consent. Mistaken belief in the age of a child is not a defence.
- Exchange of money, employment, goods or services for sex, including sexual favours or other forms of humiliating, degrading or exploitative behaviour, is prohibited. This includes any exchange of assistance that is due to beneficiaries of assistance.
- Sexual relationships between United Nations staff and beneficiaries of assistance, since they are based on inherently unequal power dynamics, undermine the credibility and integrity of the work of the United Nations and are strongly discouraged.





- Where a United Nations staff member develops concerns or suspicions regarding sexual exploitation or sexual abuse by a fellow worker, whether in the same entity or not and whether or not within the United Nations system, he or she should report such concerns via established reporting mechanisms.
- United Nations staff are obliged to create and maintain an environment that prevents sexual exploitation and sexual abuse. Commanders at all levels have a particular responsibility to support and develop systems that maintain this environment.

The Battalion Commander is responsible for the discipline and good order of all members of his/her unit, while assigned to United Nations' peacekeeping operations. This responsibility includes ensuring that all members of the national military contingent abide by the United Nations standards of conduct, mission-specific rules and regulations or the obligations towards national and local laws and regulations. The United Nations standards of conduct, as applicable to members of military contingents, are laid out in "We are the United Nations Peacekeeping Personnel" attached as **Annex A** (Vol. II, p. 243 of the UNIBAM). The actions to be taken to deal with disciplinary proceedings at the battalion level are amplified at **Annex B** (Vol. II, p. 246 of the UNIBAM).

Members of national military contingents are subject to their Government's exclusive jurisdiction in respect of any crimes or offences and to their Government's disciplinary jurisdiction in respect of all other acts of misconduct or serious misconduct.

#### References:

- DPKO/DFS Ref. 2011.01, Standard Operating Procedure on Implementation of Amendments on Conduct and Discipline in the Model Memorandum of Understanding, 2011.
- Secretary-General's Bulletin on Special Measures for Protection from Sexual Exploitation and Sexual Abuse [ST/SGB/2003/13].
- Memorandum of Understanding between the UN and TCCs (including Annex H of the MOU) A/61/19 (Part III).

### 2.17 : Cultural Awareness.

"Cultural shocks" are not unusual phenomena. They are merely the natural response of an individual when he/she is taken from a familiar environment to a new one, a process that may cause some discomfort or disorientation. Cultural awareness is the ability of an individual to look outside and



be aware of the cultural values and customs of the culture that we are in. What may be normal and acceptable to a group of people may be unusual or unacceptable in another culture. When one is in the company of people from a different culture, each individual should be aware of their beliefs and customs, and respect them. Developing cultural awareness results in an ability to understand, communicate with, and effectively interact with people across cultures.

An infantry battalion should understand the cultural diversities and sensibilities in a mission area (both UN mission entities and the local population) and ensure that all ranks respect and conduct themselves based on the guidelines and best practices.

#### Reference:

- Ethics in Peacekeeping, 2005.

### 2.18 : Civil Society.

Civil society actors, (including international civil society, non-governmental actors, potential implementing partners of UN, Agencies, Funds and Programmes [AFPs], etc.) represent a critical pillar for sustaining the peace process in fragile post-conflict countries. In most cases, even prior to the establishment of a peacekeeping mission, some local civil society actors will be at the forefront of efforts to find a peaceful resolution to the conflict. Equally, some sectors of civil society will have contributed to fuelling the conflict by overtly taking sides with the warring groups. Against this backdrop, there is the need for peacekeepers to engage with civil society actors in their areas of operation and engage with women and girls to ensure that their security concerns, vulnerabilities and needs are also addressed. Where necessary, their advice should be taken into consideration when planning military operations.

#### References:

- United Nations Peacekeeping Operations – Principles and Guidelines, 2008.
- Engaging Civil Society in Peacekeeping, 2007.

### 2.19 : Civil Affairs.

Usually deployed at the local level, Civil Affairs components facilitate the implementation of peacekeeping mandates sub-nationally and work to strengthen social and civic conditions necessary for peace. Civil Affairs Officers are often the primary interface between the mission and local interlocutors performing a variety of essential tasks.



A key characteristic of Civil Affairs components is their flexibility, their ability to adapt to different needs at different times and in different places. Conditions vary dramatically between peace missions and Civil Affairs have taken on a range of tasks and roles over the years to reflect the needs of these different missions. While tasks vary significantly, the DPKO/DFS Policy Directive on Civil Affairs (April 2008) sets out three core roles that are performed, depending on the mandate and the situation on the ground:

- **Role 1:** Cross-mission representation, monitoring the progress of the peace process and mandate implementation at the local level; provide the mission leadership with information about the local environment, conduct conflict analysis and early warning about local conflict, including efforts to protect civilians.
- **Role 2:** Confidence-building, conflict management and support to the development of political space are integral to UN Peacekeeping and central to civil affairs work. Through this role, Civil Affairs actively support the development of social and civic conditions conducive to sustainable peace and popular engagement and confidence in the peace process.
- **Role 3:** Support to the restoration and extension of state authority to stabilize fragile states has become an area of work in which Civil Affairs Officers have been increasingly engaged through the support to state institution and to good governance practices at the sub-national level.

**Quick Impact Projects (QIPs).** United Nations peacekeeping operations often implement QIPs, which are small-scale projects, used to establish and build confidence in the mission, its mandate, and the peace process, thereby improving the environment for effective mandate implementation. QIPs may take a number of forms, including infrastructure assistance or short-term employment generation activities, often these QIP are implemented with the collaboration of military forces.

The identification of suitable QIPs should consider gender, ethnicity and vulnerability, mindful of issues related to access to or benefit from the project for different sections of the community, such as women, young people, different ethnic groups or marginalized sections of the population. It is important to understand that such projects are not a substitute for humanitarian and/or development assistance. It is critical not to support projects that could be used to further political, ideological or religious objectives. For example, avoid building churches or mosques or directly supporting political parties.



The Battalion and company commanders should streamline their plans and activities in consonance with the civil affairs policies (including QUIPs) to ensure synergy and deliver the desired impact.

#### References:

- United Nations Peacekeeping Operations – Principles and Guidelines, 2008.
- DPKO/DFS Policy Directive on Civil Affairs (April 2008).
- Civil Affairs Handbook (April 2012).
- DPKO/DFS Policy Directive on Quick Impact Projects (February 2007).
- DPKO/DFS Guidelines on Quick Impact Projects (March 2009).

### 2.20 : Humanitarian Aspects.

Modern peacekeeping operations are often referred to as multidimensional operations because they include methods and missions that fall outside the traditional scope of peacekeeping. Functions include the facilitation of political peace processes, assistance to DDR, support the organization of elections, protect and promote human rights and assistance in restoring the rule of law. In addition, there are often a number of areas in which the role of peacekeeping operations is limited to facilitating the activities of other actors within and outside the United Nations system.

While the responsibility for the provision of humanitarian assistance rests primarily with the relevant civilian United Nations specialised agencies, funds and programmes, as well as the Red Cross/Red Crescent Movement and the range of international and local NGOs, peacekeeping operations are frequently mandated to support the provision of humanitarian assistance by providing a secure and stable environment within which humanitarian actors may carry out their activities. Such support to humanitarian operations may entail assisting or safeguarding the delivery of food and medical supplies, or the protection of civilians.

The dialogue, coordination and consultation with humanitarian actors by the military units is key to helping alleviate humanitarian concerns regarding the danger of compromising the real and perceived neutrality, impartiality and independence of humanitarian action, by political decisions and military activities concerning humanitarian operations. Mission/Force/Battalion leadership should be conscious of the fundamental need to maintain the civilian character of humanitarian assistance, and shall be asked to ensure that the use of military mission assets to support humanitarian assistance is appropriate, timely, unique in capability and



availability, based on identified needs, in conformity with international law and humanitarian principles, as well as internationally established guidelines, such as the Oslo Guidelines, the Guidelines on the use of Military and Civil Defence Assets to Support United Nations Humanitarian Activities in Complex Emergencies (MCDA Guidelines) and country/context-specific guidance where present. Commanders have to be prepared to participate in the dialogue with humanitarian actors. Potential tasks depend very much on the mission set up and the local actors.

#### References:

- Guidelines on the Use of Foreign Military and Civil Defence Assets in Disaster Relief (Oslo Guidelines).
- Guidelines on the Use of Military and Civil Defence Assets to Support United Nations Humanitarian Activities in Complex Emergencies (MCDA Guidelines).

### 2.21 : United Nations Country Team (UNCT).

The UN Country Team (UNCT) is composed of representatives of operational UN agencies, funds and programmes that carry out operational activities for development, emergency recovery and transition, within a particular country or territory. The UNCT ensures inter-agency coordination and decision-making at the country level. To improve and harness the cooperation, coordination and collaboration between peacekeeping missions, UN agencies/ UNCT and external partners, particularly in an integrated mission, the Resident Coordinators (RC)/Humanitarian Coordinators (HC) have been designated as the Deputy Special Representative of the Secretary-General (DSRSG) as part of the mission organization. Such an arrangement ensures integration and synergy amongst all actors in the field and fosters congruency and continuity between peacekeeping and peacebuilding efforts. Some of the elements that constitute UNCT include UNDP, UNHCR, UNHCHR, UN AID, UNICEF, UN Women, UNFPA, WHO, WFP, ILO, IMF/WB and the like. Important functions of UNCT include:

- Facilitating mutually supportive and coordinated activities of the UN system in the mission area by developing a clear and shared understanding of priorities based on the overall goal, identifying complementarities with the mission mandate and integrating its collective expertise into the overall political strategy.
- Creating greater strategic coherence and an effective transition from emergency relief to recovery, reconstruction, institution-building and longer term capacity-building.



- Facilitating implementation of timely, effective and well-coordinated humanitarian and developmental assistance which are also important elements of the mission mandate that are not covered in the mission's budget.
- Ensuring that mission planning and operations management are compatible with long-term national development goals and accordingly spearheads efforts for a return to normal economic activity at the community and national levels.
- Linking the different dimensions of peacebuilding to include the political, development, humanitarian, human rights, rule of law, social and security aspects to integrate into a coherent support strategy.
- Engaging a broad range of actors, including the national authorities, the local population, international financial institutions, NGOs, etc., in a long term peacebuilding effort by creating conditions for transition.
- The provision of security and protection arrangements for the staff of the UN funds, programmes and specialised agencies.
- A critical source of information concerning the local situation for a mission as the UNCT have often operated in the area for many years and maintain a widespread network of personnel and contacts.
- Monitoring and reporting on the impact of armed conflict on vulnerable groups, especially such as women and children.
- As per mission exit strategies, acting as a successor to take over and continue to build sustainable peace in post-conflict situations.

UN Infantry Battalions are expected to liaise with the elements of UNCT in their respective AOR and coordinate functions, security and/or any other support, as per operational requirement/environment as per mission policy.

## **2.22 : Civil Military Coordination.**

In United Nations peacekeeping operations, the role of UN Civil Military Coordination (CIMIC) is the operational and tactical coordination between the UN military and civilian partners, among them the civilian components of UN field missions, UN Police, UN agencies, funds and programmes, host national government, non-governmental organizations, and grass-roots organizations in line with their principles.



Within the UN integrated missions context, the focus is on coordination across the political, security, development, human rights and humanitarian dimensions, and rule of law. The UN-CIMIC concept is a military staff function in support of the Commander and the mission. UN Humanitarian-Civil-Military Co-ordination (UN-CMCoord), on the other hand, is a purely humanitarian function for humanitarian organizations and the wider humanitarian community. UN-CIMIC and UN-CMCoord should complement each other on the ground. Key to this is to have a good understanding of the roles and responsibilities of the functions. As defined by the Inter-Agency Standing Committee (IASC), UN-CMCoord is “the essential dialogue and interaction between civilian and military actors in humanitarian emergencies necessary to protect and promote humanitarian principles, avoid competition, minimize inconsistency, and when appropriate, pursue common goals.”<sup>1</sup> As defined and as practiced, UN-CMCoord is therefore a continuing process of dialogue guided by humanitarian principles.

#### References:

- United Nations Peacekeeping Operations – Principles and Guidelines, 2008,
- Civil Military Coordination in UN Integrated Peacekeeping Missions (UN-CIMIC), 2010.
- IASC Reference Paper on Civil-Military Relationship in Complex Emergencies, 28 June 2004.

### 2.23 : Rule of Law.

The Rule of Law, in its most basic form, is the principle that no one is above the law. The rule follows logically from the idea that truth, and therefore law, is based upon fundamental principles which can be discovered, but which cannot be created through an act of will. The most important application of the rule of law is the principle that governmental authority is legitimately exercised only in accordance with written, publicly disclosed laws adopted and enforced in accordance with established procedural steps that are referred to as due process. The principle is intended to be a safeguard against arbitrary governance, whether by a totalitarian leader or by mob rule.

The battalion commander should ensure that his troops abide by the laws of the host country, and do not do anything to tarnish the image of the UN.

---

<sup>1</sup> IASC Reference Paper on Civil-Military Relationship in Complex Emergencies, 28 June 2004.



They should respect the local population, their culture and customs, and should never treat them with contempt. The predeployment training and in-mission training should include training on rule of law.

UN Infantry Battalions should have an integrated approach in execution of their MET, involving civilian partners in furtherance of the mission mandate. It should foster partnership, collaboration and an inclusive outlook with others partners in the AOR.

**Reference:**

- United Nations Peacekeeping Operations – Principles and Guidelines, 2008.

## **2.24 : Security Sector Reform.**

It is essential that reform of a country's security sector takes place once a conflict has come to an end. It is vital for sustainable peace and development that people feel safe and secure, and has confidence in their State. The United Nations supports security sector reform (SSR) to ensure the development of effective, efficient, affordable and accountable security institutions. It is a process led by national authorities, and the reform should be undertaken without discrimination and with full respect for human rights and the rule of law.

No single model of a security sector exists. However, the UN considers that security sectors usually include structures, institutions and personnel responsible for the management, provision and oversight of security. These could include defence, law enforcement, corrections, information services and institutions responsible for border management, customs and civil emergencies. In some cases, elements of the judicial sector responsible for cases of alleged criminal conduct and misuse of force are included. The security sector should also include management and oversight bodies and, in some instances, may involve informal or traditional security providers.

The reform of a country's security sector is essential in post-conflict contexts. In those settings, making people feel safe and secure and (re)-building confidence between the State and its people are vital for sustainable peace and development. In other contexts, SSR can even prevent conflicts or crises from emerging or resurging, and it is also a process that many States undertake on a regular basis to respond to emerging threats or potential internal or external pressures. In the field, SSR teams in various missions support national authorities to:





- Facilitate national SSR dialogues.
- Develop national security and defence policies, strategies and plans.
- Strengthen oversight, management and coordination capacities.
- Articulate security sector legislation.
- Mobilize resources for SSR-related projects.
- Harmonize international support to SSR.
- Education, training and institutional capacity building.
- Monitor and evaluate programmes and results.

**Defence Sector Reform Policy.** The Defence Sector Reform (DSR) Policy guides UN staff engaged in support to Member States undertaking defence sector reform efforts. The UN support to national DSR efforts dates back to 2003 and the Security Council mandates have included DSR elements in at least five peacekeeping operations, while other UN actors have provided support on the basis of requests from Member States. However, this support was often times ad hoc and suffered from a lack of common principles, norms and approaches. In response to this deficit and following the request by the UN General Assembly, the DSR policy draws upon lessons learned and best practices from past endeavours and outlines the parameters and components of the UN's support to national DSR efforts, including elements for any mission concept, core tasks and constraints. The policy also highlights linkages between DSR and the broader processes of SSR, rule of law, early peacebuilding and longer-term development, among other priorities.

From the Organization's experience, it has become evident that an effective, efficient, accountable and affordable defence sector (an important component of the broader security sector) is essential for sustainable peace and development and should be considered an important dimension of UN assistance to Member States. In 2012, the policy will start to be implemented and sensitization and predeployment training packages for UN military staff will be developed. This includes DSR doctrine based on experience and lessons learned from our peacekeepers.

UN Infantry Battalions may have a limited role in providing training and other security support to the host security forces, within the overall DSR policy of the mission

#### References:

- Defence Sector Reform (DSR) Policy, 2011.
- Report of the Secretary-General Securing Peace and Development: The Role of the United Nations in Supporting Security Sector Reform (A/62/659).



## 2.25 : Disarmament, Demobilization and Reintegration (DDR).

The objective of the DDR process is to contribute to security and stability in post-conflict environments so that recovery and development can begin. DDR helps create an enabling environment for peace processes by aiming to deal with the post-conflict security problem that arises when ex-combatants (men and women) are left without livelihoods or support networks, other than their former comrades, during the vital transition period from conflict to peace and development. Through a process of removing weapons from the hands of combatants, taking the combatants out of military structures and helping them to integrate socially and economically into society, DDR seeks to support ex-combatants so that they can become active participants in the peace process. In addition to combatants within formal armed groups, today's DDR programmes often also include a focus on informal armed groups such as gangs and militias, as well as entire communities affected by violence.

In the typical operational environment in which United Nations peace-keeping missions take place, the primary contribution made by the military component of a mission to a DDR programme, if it has been mandated to do so, is to provide security. The military component could also contribute through the gathering and distribution of information specifically related to a DDR programme, as well as monitoring and reporting on security issues. Specialist military ammunition and weapon expertise could contribute to the technical aspects of disarmament.

In addition, military capabilities could be used to provide various aspects of logistic support, including camp construction, communications, transport and health, if spare capacity is available. It should be noted that unless specific planning for military DDR tasks has taken place, and forces generated accordingly, then military logistic capacity cannot be guaranteed. It is essential to the successful employment of any military capability in a DDR programme that it must be included in planning, be part of the endorsed mission operational requirement, be specifically mandated and be properly resourced. If this is not the case, the wider security-related function of the military component risks being negatively affected.

Battalion commanders should ensure that military personnel are trained on the military's role in DDR and approach these tasks in a gender sensitive manner. In the pre-deployment phase they should request for assistance from Integrated Training Services (ITS) and the DDR Section at UNHQ



and from the mission DDR and SSR office, while deployed. With DDR, the military may support with the establishment of camps, the collection of weapons and the establishment of programmes to enable ex-combatants transit into civil life or be integrated into national armies.

#### References:

- Refer to IDDRS 4.10 on Disarmament and IDDRS 4.20 on Demobilization.)
- Module 4.40: “UN Military Roles and Responsibilities” in the Integrated Disarmament, Demobilisation and Reintegration Standards, 2006.
- DDR Web–( [www.unddr.org](http://www.unddr.org) ).

### 2.26 : Mine Action.

Mine action entails more than removing landmines from the ground. It includes actions ranging from teaching people how to protect themselves from danger in a mine-affected environment to advocating for a mine-free world. Mine action is not just about landmines. In many countries, unexploded ordnance (UXO), poses an even greater threat to people’s safety. UXO comprises bombs, mortars, grenades, missiles or other devices that fail to detonate on impact but remain volatile and can kill if touched or moved. Mine-action programmes address problems of landmines, UXO and “explosive remnants of war”, which includes UXO and “abandoned ordnance”, or weapons left behind by armed forces when they leave an area.

Military commanders have to be aware that civilian or other military units may be deployed in their AOR and be coordinated by a UN Mine Action Coordination Centre (MACC) with units and teams tasked with mine and UXO clearing. It is important to set up a communication link with the MACC in order to ensure an information-flow between the mine-clearing elements and the military unit.

#### Reference:

- Mine Action and Effective Coordination: The United Nations Inter-Agency Policy (6 June 2005).

### 2.27 : Elections.

Elections are formal decision-making process by which a population (women and men) chooses an individual to hold public office. Elections have been the usual mechanism by which modern representative democracy operates. Elections may fill offices in the legislature, sometimes in the executive and judiciary, and for regional and local government. Electoral



reform describes the process of introducing fair electoral systems where they are not in place, or improving the fairness or effectiveness of existing systems. The battalion commander should note that, as part of the peacebuilding process in a post-conflict country, the UN may supervise elections and the battalion is likely to be tasked to support the process (provide overall security cover, including taking into consideration the different threats which may face women and men, escort of election staff and ballot boxes, guarding polling booths, logistics support, etc.) as part of the overall mission strategy.

#### Reference:

- Web ([www.un.org/en/peacekeeping/issues/electoralassistance.shtml](http://www.un.org/en/peacekeeping/issues/electoralassistance.shtml))

### 2.28 : Environment.

Environmental sustainability is part of the mandates of most United Nations organizations to help countries to develop and implement good environmental and natural resources management nationally and internationally. Environmental sustainability is also the seventh UN Millennium Development Goal. It is therefore important that any UN peacekeeping operation and its personnel operate in accordance with these UN goals in order to lead by example. To this end, since 2009 the DPKO and DFS have a dedicated Environmental Policy for UN Field Missions, which covers key areas such as energy, wastewater, water, waste, hazardous substances, wild animals and plants, and cultural and historical resources management.

The Environmental Policy clearly states that “All personnel shall conduct themselves in accordance with this document”, and also gives specific responsibility to the military officer to implement it. The Force Commander appoints a military officer to serve as the environmental focal point within the military component to liaise with the Mission Environmental officer. The military environmental focal point coordinates actions on environmental issues within the military component. The UN Infantry Battalion also has an environmental officer to coordinate implementation and provide environmental oversight.

It is the responsibility of the battalion commander to ensure that his/her troops are trained/aware of their environmental duties, do not degrade the environment in their area of responsibility, and liaise with the environmental focal point of the mission military component in order to implement the



mission environmental objectives. Main duties deriving from the Environmental Policy that the Infantry Battalion has to implement are the following:

- Containment basins with enough capacity have to be placed under all fuel tanks and fuel collection points.
- All wastewater has to be treated prior to being discharged to the nature.
- No burn pit. Segregation of waste (including hazardous waste) has to be undertaken for recycling and/or proper disposal in accordance with mission environmental objectives.
- Bring empty (plastic) water bottles used during patrols back to camps for proper disposal (Do not throw away bottles/wraps directly into nature).
- Undertake energy conservation measures: switch off all appliances, lights and air conditioning. Avoid vehicles idle time as much as possible.
- Undertake water conservation measures, especially in water scarce areas.
- Do not bring any plant/seeds from country of origin which is not endemic to country of deployment, and vice versa.
- Do not acquire wild plants and animals, live or dead. Avoid using charcoal.
- Know where the cultural, religious and historical sites are, and behave according to local sensitivities.

**Note:** Chapter 7 (Mission support) also highlights particular areas for contingents to look at re-mitigation of environmental impacts.

The battalions could also set an example to the local population on environmental management through activities such as tree planting and/or recycling projects, where appropriate and in accordance with the mission's QIPs policy and priorities. Natural resources may also be one of the drivers of the conflict, e.g., illegal exploitation of high-value and/or competition of scarce natural resources. It is thus important that the battalion is not seen as contributing to fuel the conflict by interfering with natural resources (e.g., using charcoal) and/or being seen as a "resource competitor" (e.g., water in water scarce areas) by the local population.

#### References:

- DPKO/DFS Environmental Policy for UN Field Missions, 2009.6.
- Draft DPKO/DFS Environmental Guidelines for UN Field Missions (2007).



## 2.29 : Public Information.

Public communications and information in a peacekeeping mission are directed by the Civilian Public Information Office/Section. This Office is usually headed by a Director or Chief, who develops a mission-wide public information strategy, advises the SRSG/Head of Mission on communication issues and coordinates all public information and outreach activities.

The key elements of Public Information in the UN peacekeeping context are:

- Public communications and information is a strategic force multiplier.
- One mission, one voice (civilian, military, police).
- Strategic and operational cooperation with civilian Public Information Officer (CPIO); partnership between Force Commander and the civilian director of CPIO.
- Timeliness of media work: brief early, brief often, brief regularly, correct misinformation, prepare for crisis communications, plan with the civilian CPIO.
- Media and communications are essential in cases of sexual exploitation and abuse involving military personnel, whilst maintaining the confidentiality of the victim: seek guidance from the civilian director of CPIO.
- Force generation: liaise with DPKO public affairs section at HQ to ensure effective communication products to assist in the outreach to TCCs.
- Internal communications across the military component.

The civilian director of public information will liaise with the military component to ensure communication efforts are integrated in order to achieve one mission – one voice. Public communications should be a strategic force multiplier, helping civilian and uniformed components of the mission to achieve their common objectives. The Force Commander should appoint an adequately skilled senior military public information officer and, when appropriate, additional public information officers (including photographer/videographer). In missions with large regional offices, the Force Commander should consider appointing PIO focal points within all regional offices.

Internal communications across the military component are also important. All serving military should be aware of the mission mandate, strategic goals and standards of conduct, including the importance of maintaining



the confidentiality and anonymity of victims of sexual violence. The director of public information can advise the Force Commander on internal communications, but is not responsible to conduct these within military components.

### 2.30 : Partnership.

In the peacekeeping mission area of operations there might be military units present from Member States, coalitions and regional organisations like, African Union (AU), European Union (EU) and North Atlantic Treaty Organisation (NATO). These deployments are either on invitation by the host nation, such as bi-lateral agreements on provision of security, training support etc. or mandated by the Security Council in support of the peacekeeping operation. The cooperation, coordination and integration of different military units in the peacekeeping mission area, will be defined through resolutions, agreements and orders and the UN Infantry Battalion Commander needs to take this into account, when planning and executing operations.











## Mandate, Directives and Orders

### 3.1 : General.

The composition of a UN peacekeeping operation depends on the mandate which the Security Council dictates in the light of the objectives to be achieved in the conflict area. In recent years, there has been a trend towards the deployment of multi-dimensional peacekeeping operations rather than the traditional operations focused primarily on ensuring and monitoring the separation of opposing armed forces. The command of peacekeeping operations is vested in the Secretary-General under the authority of the Security Council. The Secretary-General delegates the overall responsibility for the conduct and support of these operations to the Under-Secretary-General for Peacekeeping Operations, i.e. the Head of the Department of Peacekeeping Operations (DPKO).

### 3.2 : Purpose.

This chapter focuses on the peacekeeping mission structure at the operational level and describes the mission mandate, integrated strategic framework, concept of operations, operational orders, force generation, legal framework, generic mission organizational structures, command and control arrangements and other support measures. It provides a broad peacekeeping mission framework in which an infantry battalion will be functioning in accomplishment of the mandate.

### 3.3 : Mandate.

United Nations peacekeeping operations are deployed on the basis of a mandate from the United Nations Security Council. The tasks that a United Nations peacekeeping operation will be required to perform are set out in the Security Council resolution. Security Council mandates differ from situation to situation, depending on the nature of the conflict and the specific



challenges it presents. When United Nations peacekeeping operations are deployed to support the implementation of a cease-fire or a more comprehensive peace agreement, Security Council mandates are influenced by the nature and content of the agreement reached by the parties to the conflict.

Without prejudice to the inherent right of self-defence, the Security Council may and increasingly has authorized UN PK operations to use force beyond self-defence to achieve certain mandate objectives, including but not limited to the protection of civilians. The DPKO provides political and executive direction to UN peacekeeping operations around the world and maintains contact with the Security Council, troop and financial contributors, and parties to the conflict in the implementation of Security Council mandates. A generic structure of the DPKO and the role and functions of the Office of the Military Affairs (OMA) is displayed at [Annex D](#) (Vol. II, p. 260 of the UNIBAM).

### **3.4 : Mission Concept and Integrated Strategic Framework.**

Alongside the Mandate, the Mission Concept, including the Military Strategic Concept of Operations, Police Concept of Operations (CONOPS) and the Mission Support Plan, provides a common vision and framework for the UN Mission action. In order to maximize efficiency and effectiveness of the UN presence, the mission develops an Integrated Strategic Framework (ISF) with other UN interlocutors (such as the UN Country Team) to articulate a joint long term strategy. The ISF identifies the strategic objectives and the expected results that the UN should collectively achieve in a particular mission area.

### **3.5 : Military Strategic CONOPS.**

In the implementation of the Security Council mandate for a UN peacekeeping operation, the military strategic CONOPS articulates the strategic intent for the utilization of military capabilities to achieve an overall objective. The CONOPS should be consistent with the overall Mission Concept and should drive the formulation of component-level operational plans. As part of the CONOPS, the military capabilities and the composition of the force are stated in the Statement of Force Requirements (SFR). Following the SFR, the Statement of Unit Requirements (SUR) is produced for each unit of the force. The SUR includes mission, tasks, organization, equipment and personnel.



**3.5.1 : SFR.** The SFR will normally consist of one of the following:

- A force consisting of contingent troops with or without United Nations Military Observers (UNMOs) and/or Military Advisers or Military Liaison Officers (generic: United Nations Military Expert on Mission – UNMEMs).
- An observer mission comprising UNMOs / UNMEMs only.

**3.5.2 : Force Generation.** The requirements are generated through the Force Generation Process. DPKO/OMA starts the generation through the United Nations Standby Arrangements System (UNSAS) database, where an updated record of pledges, made by interested TCCs, is maintained. In addition, offers and pledges made by TCCs through formal/informal correspondence with DPKO and interaction between senior UN and national leadership are also considered. In the selection, numerous perspectives are taken into account, such as, political aspects, human rights, past performance, deployment timelines, resource availability, capabilities, training and readiness, limitations and acceptance by host nation/conflicting parties, to mention some. If selected, the TCC submits a Table of Organization and Equipment (TOE) and staff-list and DPKO confirms the acceptance of the pledge/offer.

The sequence of generating units and individuals in peacekeeping missions is graphically represented below:

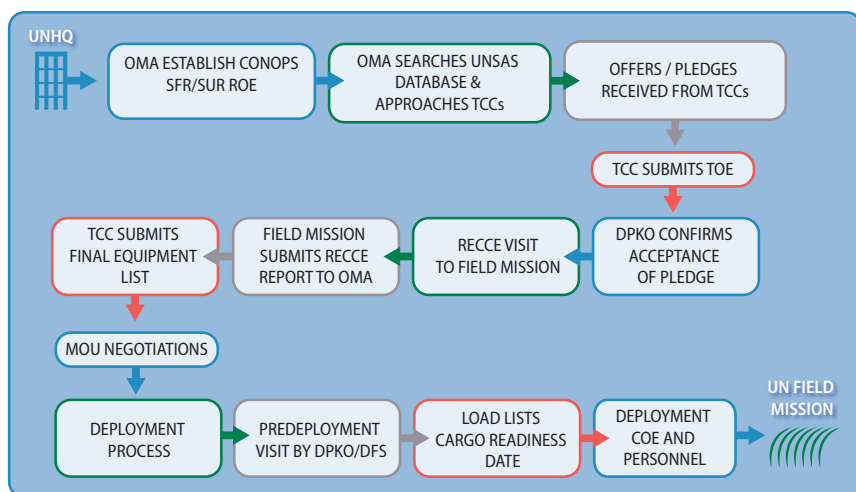



### 3.6 : Rules of Engagement.

Rules of Engagement (ROE) are issued by the USG/DPKO for each particular peacekeeping operation and provide the authority for the use of force and explain the legal framework, policies, principles, responsibilities and definitions of the ROE. ROEs must always be compliant with human rights and international humanitarian law, which are superior sources. ROE are directions to operational commanders, which delineate the parameters within which force may be used by the military component of the peacekeeping operation while executing its mandated tasks. They are founded on the relevant Security Council resolution(s).

Where issued as prohibitions; they are orders not to take specific actions. Where issued as permissions, they are the authority for commanders to take certain specific actions if they are judged necessary to achieve the aim of the peacekeeping operation. While remaining predominantly defensive in nature, the ROE allow for offensive action, if necessary, in order to ensure the implementation of the tasks mandated by the Security Council. The ROE also provide definitions of the circumstances in which the use of force, including deadly force, may be justified.

The ROE are governed by the purposes of the Charter of the United Nations and relevant principles of international law, including the Law of Armed Conflict. Military personnel are required to comply with International Law, including the Law of Armed Conflict, and to apply the ROE in accordance with those laws. ROE are addressed to the Force Commander, who is then responsible for issuing them to all subordinate commanders. While ensuring understanding, application and compliance with the ROE is the responsibility of commanders at all levels. The Force Commander is ultimately responsible for the enforcement of the ROE. A model ROE for the military component for peacekeeping missions is given at [Annex C](#) (Vol. II, p. 251 of the UNIBAM).

### 3.7 : Directive for the Head of the Military Component.

The directive for the Head of the Military Component (HoMC) is issued by the UN Headquarters and provides guidance and direction on the organizational and administrative responsibilities that a HoMC is required to exercise in the performance of his/her duties. Operational guidance and direction with respect to the employment of the military component is provided in the mission-specific CONOPS.



### 3.8 : Status of Forces Agreement/Status of Mission Agreement.

A Status of Forces Agreement (SOFA) or a Status of Mission Agreement (SOMA) is an agreement between a host country and the United Nations which embodies the consent of the host State to the presence of the peacekeeping operation on its territory and regulates the status, privileges and immunities of the peacekeeping operation in the host country.

Under the provisions of the SOFA or SOMA, a government hosting a UN body or entity, including a peacekeeping operation, is responsible for ensuring the safety and security of the peacekeeping operation, its personnel, premises, and property and to take measures to protect members of the peacekeeping operation and its personnel, premises and property from attack or any action that prevents them from discharging their mandate. The SOFA or SOMA also provides that all members are obliged to respect local laws and regulations and to refrain from any action or activity incompatible with the impartial and international nature of their duties.

Other provisions include issues like unrestricted freedom of movement, the wearing of uniforms, the carrying of arms, entry and exit into the country, immunity from legal process, and exemption from taxation. One of the most important provisions is the one which provides that military personnel of national contingents assigned to the military component of a peacekeeping operation are subject to the exclusive jurisdiction of their respective participating States in respect of any criminal offences which may be committed by them.

### 3.9 : Force Operations Order.

The Force Operations Order (OPORD) is developed from the CONOPS. Generally, the OPORD will be generated at a FHQ and issued to subordinate formations/sectors for executing the responsibility. Each subordinate military element, as they receive the OPORD, will develop their own orders.

In order to operate effectively in a dynamic mission environment, the military component should be flexible, pro-active and responsive. In order to achieve this, there is a need for reserves on all levels and use of both permanent and temporary bases to support operations. This will enable the force to undertake patrols, engage with the local population and deter spoilers. These activities will ensure support of the mission overall and other components. The military posture is driven by a comprehensive security



assessment, the identification of allocated tasks and the level of resources available.

The UN Infantry Battalion Commander, together with his/her battalion, needs an expeditionary mindset, willing to establish a temporary presence, employing reserves, and/or the relocation of elements of, or the entire, battalion when required. Company-size operating bases are considered the smallest that can be established permanently. However to enable operational flexibility, temporary operating bases of a platoon size unit may be established to expand the presence on a temporary basis.

### 3.10 : Command and Control Arrangements.

Military personnel contributed by Member States to a UN peacekeeping operation remain under the jurisdiction of their national armed forces. However, the operational authority over these forces and personnel is transferred to the unified UN command and control and vested in the Secretary-General. UN operational authority includes the authority to issue operational directives within the limits of a specific mandate, the mission area and for an agreed period of time, with the stipulation that an earlier withdrawal of a contingent would require the contributing country to provide adequate prior notification.

In some situations, where the peacekeeping operation is carrying out a strictly military mandate, the HoMC may also be the designated Head of Mission. The HoMC<sup>2</sup> is responsible to the SRSG for the implementation of the tasks assigned to the military component. The HoMC, when not serving as the HoM, reports to the HoM. The Force Commander (FC) exercises “operational control” over all military personnel, including military observers, in the peacekeeping operation. The FC may delegate “operational control” of the military observers to the Chief Military Observer (CMO). In many missions, the Deputy Force Commander (DFC) also acts as CMO. Commanders of the different contingents that make up the UN peacekeeping force report to the FC on all operational matters and should not be given or accept instructions from their own national authorities that are contrary to the mandate of the operation.

---

2 The term HoMC is used for both FC and any other Commander of a Military Component, for instance, a Commander in Observer or Liaison Mission.



The HoMC will establish the military operational chain of command, as follows: HoMC; Division; Brigade/Sector; Battalion; Company and sub-units. Where such defined military structure does not exist, the HoMC will establish the necessary chain of command as appropriate to the military deployment in the mission. This military operational chain of command shall be issued as a Field Command Framework. The HoMC shall ensure that staff officers are not placed in command of formations or units. Commanding officers have to be aware of the existing chain of command.

**United Nations Operational Authority.** It is the authority transferred by the member states to the United Nations to use the operational capabilities of their national military contingents, units, Formed Police Units and/or military and police personnel to undertake mandated missions and tasks. Operational authority over such forces and personnel is vested in the Secretary-General, under the authority of the Security Council. "United Nations Operational Authority" involves the full authority to issue operational directives within the limits of (1) a specific mandate of the Security Council; (2) an agreed period of time, with the stipulation that an earlier withdrawal of a contingent would require the contributing country to provide adequate prior notification; and (3) a specific geographic area (the mission area as a whole).

The 'United Nations Operational Authority' does not include any responsibility for certain personnel matters of individual members of military contingents, such as pay, allowances, and promotions etc. These functions remain a national responsibility. In regard to disciplinary matters, while the discipline of military personnel remains the responsibility of the troop contributing countries, the United Nations may take administrative steps in case of misconduct, including repatriation of military contingent members and staff officers as per the revised model MOU, A/61/19 part III.

As regards to the Experts on Mission, including United Nations police officers and military observers, the United Nations would take administrative actions and disciplinary measures in accordance with the UN Directives for Disciplinary Matters Involving Civilian Police Officers and Military Observers (DPKO/CPD/DCP0/2003/001, DPKO/MD/03/00994 of 2003, issued vide Code Cable 1810 dated 1 July 2003 and amended vide Code Cable 2697 dated 7 October 2005) and the General Assembly resolution on Criminal Accountability (N62163).





**Definitions.** Important terms with reference to command and control are defined as follows:

- **Command.** The authority vested in a Military leader for the direction, coordination and control of military forces/personnel. Command has a legal status and denotes functional and knowledgeable exercise of military authority to attain military objectives or goals.
- **United Nations Operational Control.** The authority granted to a Military Commander in a United Nations Peacekeeping Operation to direct forces assigned so that the Commander may accomplish specific missions or tasks which are usually limited by function, time, or location (or a combination), to deploy units concerned and/or military personnel, and to retain or assign Tactical Command or Control of those units/personnel. Operational Control includes the authority to assign separate tasks to sub-units of a contingent, as required by operational necessities, within the mission area of responsibility, in consultation with the Contingent Commander and as approved by the UN HQ.
- **United Nations Tactical Command.** The authority delegated to a military or police commander in a United Nations Peacekeeping operation to assign tasks to forces under their command for the accomplishment of the mission assigned by higher authority.
- **United Nations Tactical Control.** The detailed and local direction and control of movement, or manoeuvre, necessary to accomplish missions or tasks assigned. As required by operational necessities the Head of Military Component (HoMC) may delegate the Tactical Control of assigned military forces personnel to the subordinate sector and or unit commanders.
- **Administrative Control.** The authority over subordinate or other organizations within national contingents for administrative matters such as personnel management, supply, services and other non-operational missions of the subordinate or other organizations.



## Levels of Authority, Command and Control in UN Peacekeeping.

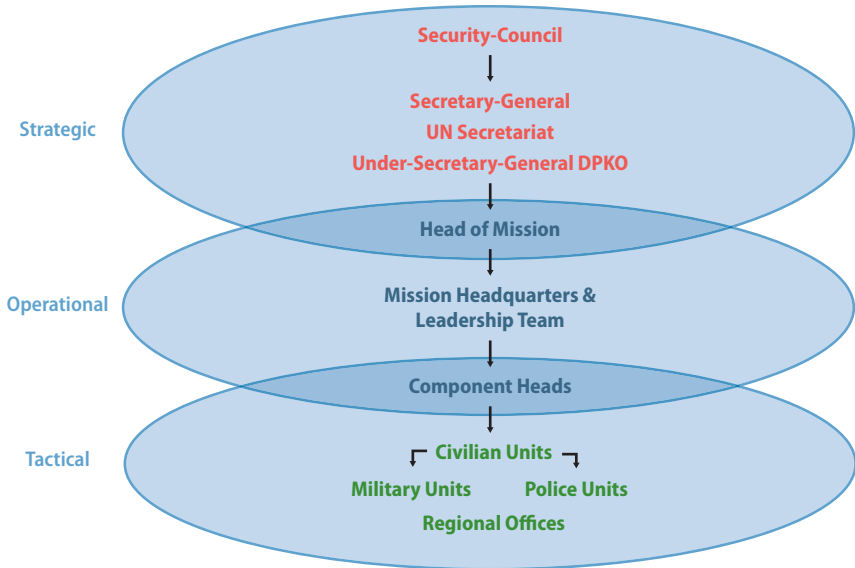

### References:

- United Nations, Department of Peacekeeping Operations Department of Field Support, Ref. 2008.4, Policy on "Authority, Command and Control in United Nations Peacekeeping Operations", February 2008.
- Handbook on UN Multidimensional Peacekeeping Operations, United Nations 2003, Chapter V: Military Command and Control.

### 3.11 : Mission Organization.

The arrangements established by the United Nations to direct and manage its peacekeeping operations are distinct from those of other organizations, particularly those only deploying a military capability. This is largely due to the fact that United Nations peacekeeping has evolved into a complex, multi-dimensional enterprise with an integrated structure, involving personnel from a wide range of nationalities, disciplines and professional cultures pursuing multiple lines of activity. Multi-dimensional, integrated missions include civilian, police and military components under the leadership of a civilian Head of Mission. In some cases, even relations outside the mission area exist, such as inter-mission cooperation which could be of relevance especially for military formations.



### 3.11.1 : Generic Mission Organization.

A Peacekeeping Mission HQ comprise the senior management team, the integrated decision making and support structures and various substantive components. A generic structure of Mission HQ is depicted below for reference:

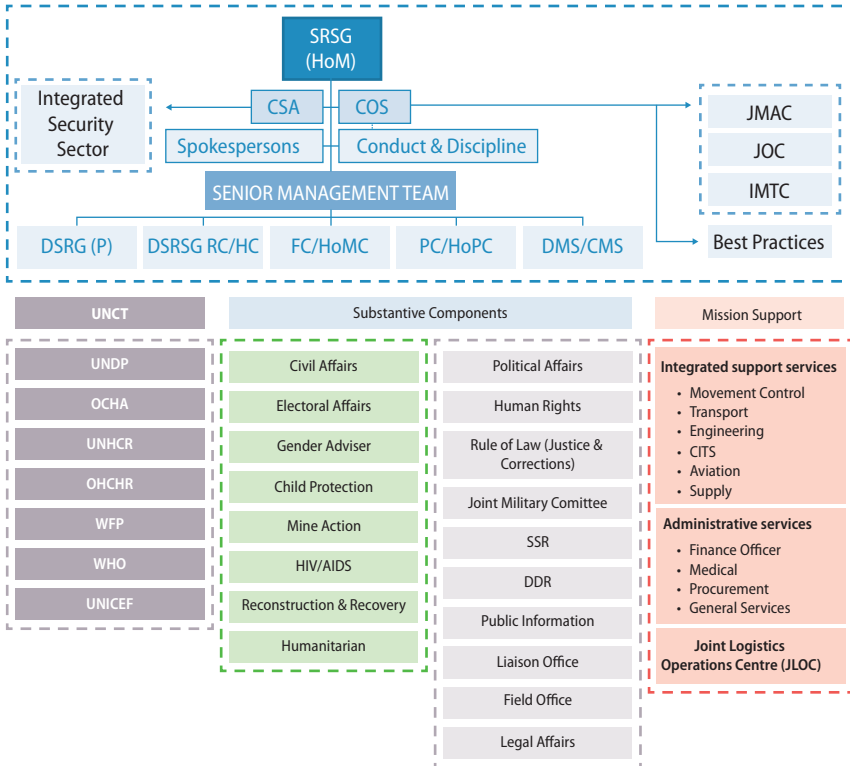

**Note:** The Mission HQ will also be interacting and coordinating with UNCT, through the DSRSG RC/HC.

**3.11.2 : Interaction with Mission Entities.** It is incumbent upon the peacekeeping operation to regularly meet and share information with all actors and to the extent possible, harmonize activities by seeking their input into the mission’s planning process. The battalion commander has to be familiar with the setup of the UN, international and national NGO, and host Nation authorities in the battalion AOR.



#### References:

- United Nations Peacekeeping Operations, Principles and Guidelines (Capstone Doctrine). Chapter 7, Managing United Nations Peacekeeping Operations.
- Handbook on UN Multidimensional Peacekeeping Operations, United Nations 2003. Chapter IV: Public Information Cooperation and Coordination with Key Partners.

### 3.12 : Military Component.

**3.12.1 : General.** UN peacekeeping operations have grown in complexity and scope from mainly military observer missions to multidimensional operations overseeing the implementation of comprehensive peace agreements. The tasks of the UN military components have become increasingly complex because conflicts in which they intervene no longer involve national military forces alone but irregular forces, guerrilla factions and even armed criminal gangs. Consequently, the military capability under UN command has also changed and is no longer lightly armed, which was typical during the Organization's first 40-50 years of peacekeeping.

**3.12.2 : Role.** The primary function of the military component is usually to provide a secure environment so that other elements of the peace process can be implemented, including the monitoring of human rights, national reconciliation and institution-building. Military components of UN peacekeeping operations increasingly have to work in conjunction with the military forces of other entities, such as regional organizations or international military coalitions and host military units. In this regard, due care must be taken to the risk that human rights violations may be committed by these forces and UN support must be provided in conformity with the Secretary-General's Human Rights Due Diligence Policy on UN Support to non-UN Security Forces. The increasing number of participating actors and the widening scope of work in multidimensional



peacekeeping operations require a broader interface between military and non-military components.

**3.12.3 : Force HQ.** The fundamental role of the FHQ is the command and control of the mission’s military operations in support of the implementation of the mission’s Mandate. Regardless of the nature of the mission, every FHQ has common functions executed by functional groups. A typical generic organization of the Force and Sector HQ is depicted below for reference:

**Generic Organization of Model Force HQ**

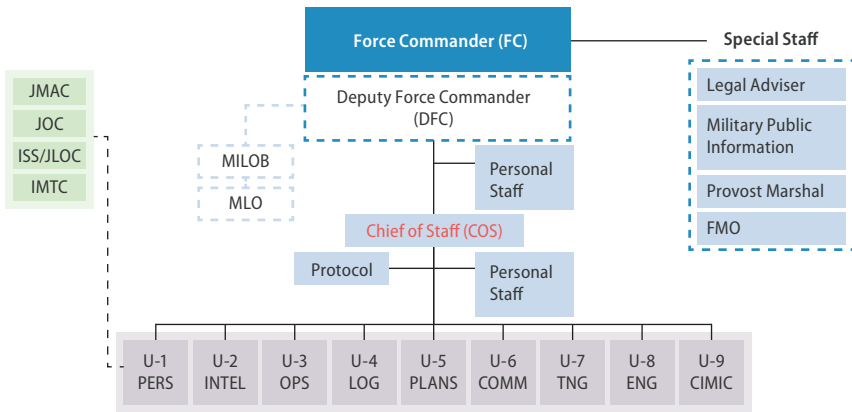

**3.12.4 : Sector/Brigade HQ.** The FHQ will have a number of Sector/Brigade HQs responsible for the execution of the mandate in a specified operational area, under which the infantry battalions will execute the assigned tasks. A typical generic organization of the Sector/Brigade HQ is depicted below for reference:

**Generic Organization of Model Sector HQ**

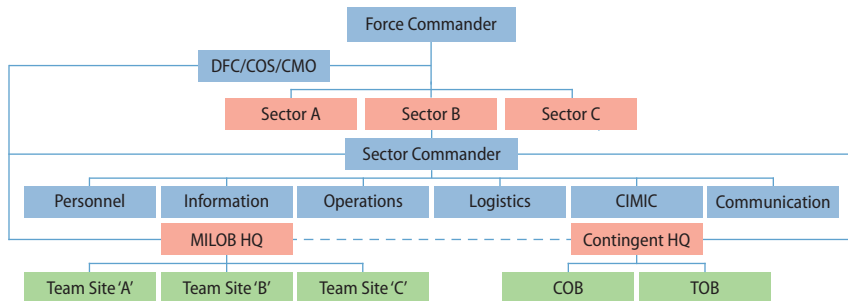



#### Reference:

- Handbook on UN Multidimensional Peacekeeping Operations, United Nations 2003, Chapter V: Military.

### 3.13 : Inter-Mission Cooperation.

Inter-Mission Cooperation (IMC) involves deployment or provision of operational and logistics assets of a particular mission in support of another mission for quick response in a crisis situation or filling the gap of a needed capability. It increases the UN operational flexibility, timely response and optimisation of resources. IMC is an interim solution in anticipation of possible force generation and is based on a politico-legal-military process involving the Security Council, UN HQ, TCCs, Mission HQ and the host nation. At the battalion level, there is no change in the modalities of conducting peacekeeping operations as part of IMC, except the change in command and control arrangements at mission level (National command and control remains intact), geographic location and operational environment.

### 3.14 : Knowledge Management.

Military commanders must clearly articulate and support the organization's expectation to learn and share knowledge through the use of standardized knowledge sharing tools. Military commanders should be aware of both the military and civilian best practice capacity and resources available in their mission, including the Peacekeeping Policy and Practice Database (PPDB); and, the Best Practices Toolbox. The PPDB contains lessons learned, best practices and approved peacekeeping policy and guidance; the Toolbox contains document templates and guidance for After Action Reviews (AAR), Handover Notes, End of Assignment Reports (EoAR), Survey of Practice and Lessons Learned. The PPDB and Toolbox are available from the Peace Operations Intranet (POINT).

The FHQ Best Practice Officer (BPO) will be responsible for facilitating organizational learning and improvement. Specifically, he/she is responsible for:

- Establishing, coordinating and providing guidance to a network of military best practice focal points.
- Ensuring the use of the standardized tools for the capture of lessons and best practices.



- Processing and analyzing best practice reports to identify major trends and issues.
- Sharing trends and emerging issues with the Military Commander and DPKO-DFS Policy and Best Practices Service.
- Maintaining a repository of lessons and best practices and share such lessons and practices with DPKO-DFS Policy and Best Practices Service.

UN Infantry Battalions shall have a battalion BPO, who will function in coordination with the Sector/FHQ BPO. The infantry battalion BPO is responsible for:

- Ensuring military personnel are aware of the DPKO Knowledge Sharing Policy.
- Ensuring military personnel responsibilities for compliance and contributions to the organizational learning and improvement of UN peacekeeping operations.
- Coordinating and conducting seminars on UN peacekeeping best practice approach and tools.
- Developing guidance to facilitate implementation and consistency in the use of BP tools (AAR, Lessons Learned, EoAR and Handover Notes).
- Ensuring timely completion of AAR, EoAR, Handover Notes and Lessons Learned.
- Serving as facilitator, as needed, for AAR and Lessons Learned.
- Providing Force/Sector HQ with completed AAR, Lessons Learned, EoAR and Handover Notes for inclusion in the PPDB.

**Reference:**

- (<https://point.un.org/UNHQ/SitePages/POHome.aspx>)

### **3.15 : Legal Aspects.**

During the conduct of peacekeeping operations, every Battalion Commander should ensure that personnel of his/her unit are properly educated about their legal rights and obligations. The unit commander should, inter alia, focus on the following legal aspects:

- Are all personnel sensitised to abide by the provisions of International Humanitarian Law and respect International Human Rights Law?
- Do all personnel understand the relevant local laws of the host nation, their customs, traditions and practices?



- Do the soldiers know the existing UN SOP concerning detention by UN personnel and are fully aware of the legal process for dealing with detainees?
- Are all ranks sensitized about the provisions, contained in SOFA/SOMA, ROE and all other Mission-specific UN Policies/SOPs, guidelines, administrative orders, etc.?
- Are they aware of the scope and nature of the privileges and immunities they enjoy?
- Does the unit have an effective internal oversight mechanism to monitor conduct of personnel, report any acts of alleged misconduct or serious misconduct, carry-out necessary investigations, discipline the involved individuals in order to ensure judicious disposal of cases? Attention is drawn to Chapter 9, Article 7 of the COE Manual 2011 read with A/61/19 (Part III) and GA/RES/61/267B.
- Is everyone aware of the UN policy concerning command and control mechanism in the mission area?
- Has everyone been fully acquainted with the overall UN legal mechanism concerning conduct and discipline and immunity matters?
- Have the important UN rules/regulations and policies/SOP been translated in TCCs national language for easy understanding of the soldiers?
- Are all personnel trained and adhere to conduct and discipline especially provisions concerning the special measures for protection from Sexual Exploitation and Abuse?

### 3.16 : Logistic Support.

Logistic support may come from several sources. Primary logistic support for the infantry battalion will come from a national military logistic support unit under the control of the TCC. Civilian contractors may also provide support. Major items of equipment may accompany deploying units or the United Nations may provide these in the mission area. The Department of Field Support (DFS) provides dedicated support to peacekeeping field missions in the areas of financial reimbursements, logistics, information, communication and technology (ICT), human resources and general administration to help missions promote peace and security. While support is delivered to the field missions, and in turn the TCCs, through DFS, the determination of financial reimbursement to UN Member States for





COE, etc. is established through the Contingent Owned Equipment (COE) Working Group and the UN legislative bodies. The details of this reimbursement at the Contingent-specific level are included in the Memorandum of Understanding (MOU). The MOU is the primary source of modalities of logistics support for a battalion in peacekeeping missions.

#### References:

- Manual on Policies and Procedures Concerning the Reimbursement and Control of Contingent-Owned Equipment of Troop/Police Contributors Participating in Peacekeeping Missions (COE Manual) A/C.5/66/8, dated 27 October 2011.
- LCS/SUPPLY/GT Sourcing of UNOE Weapons and Ammunition in Peacekeeping Operations, 25 September 2002.
- DPKO/DFS Ref. 2008.26 DPKO/DFS Fuel Operations Manual for Peacekeeping Missions.

### 3.17 : Medical Support.

The health and well-being of members of United Nations peacekeeping operations depend on planning, co-ordination, execution, monitoring and professional supervision of excellent medical care in the field. UN peacekeeping operations are characterized by unique features that impact fundamentally on the provision of medical support. These include:

- Political complexity and dynamic nature of peacekeeping operations.
- Geographic, demographic, cultural and linguistic variations within mission areas.
- Specific prevailing epidemiological and disease patterns.
- Multi-national participation in peacekeeping operations, with varying national standards of training, operational procedures, equipment and supplies.

Gender, cultural and religious sensitivities should be considered in the development of a medical support plan for each mission to meet specific operational demands. These should remain flexible to adapt to changing demands and circumstances. These plans should be acceptable to the respective Mission HQ and the participating TCCs, and are to be approved at the HQ level by DPKO. Adaptation to the national system in place may be necessary.

#### Reference:

- Medical Support Manual, 2012.
- Medical Support Manual for Peacekeeping Operations, (09/12/1999).



### 3.18 : Welfare.

The provision of welfare and recreation facilities is an essential part of ensuring a “healthy” working, living and recreational environment for all categories of UN personnel serving in peacekeeping operations. Such an environment is essential to the successful implementation of a mission mandate, as well as to promote good conduct and discipline. A Welfare and Recreation Committee will be established at the Mission HQ. The HoM shall designate regional welfare and recreation teams to implement the work plan of the Mission HQ Welfare Committee in the regions. As a minimum, the regional welfare and recreation teams shall include representatives of the civilian, police and military components of the mission. However, it does not preclude welfare arrangements made by battalions themselves.

#### Reference:

- United Nations Peacekeeping Operations – Principles and Guidelines.

### 3.19 : Result Based Budgeting.

Result Based Budgeting (RBB) is a management approach focused on achieving results; a broad management strategy aimed at changing the way UN agencies operate, with improving performance and achieving results as the central orientation. RBB is about formulating programme budgets driven by a number of desired results, articulated at the outset of the budgetary process, and against which actual performance is measured at the end of the annual financial year for the Support Account and in the biennium for the regular budget.

The process is defined by programme formulation and resources justification that involve a set of predefined objectives<sup>3</sup>, expected results, outputs, inputs (activities) and performance indicators which constitute a ‘logical framework’. The framework identifies expected results that justify resource requirements, which are derived from, and linked to outputs to be delivered, with a view to achieving such results. Finally, the actual performance in achieving results is measured by predefined performance indicators, and it is presented to legislative bodies in a form of performance reports.

---

3 Objectives should be SMART - **Specific** – concrete, detailed, and well defined, **Measurable** – numbers, quantity, and comparisons, **Attainable**- achievable and actionable, **Realistic** – considers resources, and can be achieved, **Time bound** – a defined time line in which activities are to be achieved



Each UN peacekeeping mission will develop its own annual RBB framework and resources requirements that would be developed and agreed to well in advance of the deployment of the unit to the mission. The infantry battalion, as an integral and important baseline instrument of UN peacekeeping operations, will play its role in achieving these defined outcomes and performance indicators. The battalion that is deployed will be the implementing agent of predefined objectives and indicators and will rarely have a direct input into defining these because of the budgetary process and the tenure of deployment of the unit. However, it is expected that through best practices processes and lessons learnt from the units, that the objectives and expected achievements of the RBB will be refined and adopted.









## Capabilities

### 4.1 : Introduction.

To function effectively in a complex and multidimensional mission environment, an infantry battalion needs to have multifaceted operational capability duly resourced with a correct mix of capacities of specialised personnel and equipment profile. The UN Infantry Battalion is configured with a specific focus to enhance operational efficiency for integrated employment in accordance with peacekeeping mission requirements. Building on the conventional infantry capabilities, the multidisciplinary non-organic entities in the UN Infantry Battalion are designed to complement the peacekeeping specific tasks and responsibilities.

In the peacekeeping context, “capability” is operationally defined as the ability and readiness to deliver against a reasonable standard. It encompasses the combination of capacities (personnel and equipment), preparedness (organization, process and training), and logistics sustainment required to accomplish assigned tasks.

### 4.2 : Purpose.

The purpose of this chapter is to lay down core capability standards required of the UN Infantry Battalion and its subordinate units to plan, organize, equip, train, deploy and conduct peacekeeping operations in support of the mission mandate.

### 4.3 : Role and Responsibilities.

The primary role of a UN Infantry Battalion is to restore and maintain a stable and secure environment in the battalion Area of Responsibility (AOR) as per relevant mission Operation Orders (OPORD). The AOR for the battalion and its subordinate units will be well defined and demarcated based on the capability of the battalion in terms of troops, resources, the extent



of their static and mobile area of influence, operational necessities, terrain imperatives, lines of communication, expectations of the local people and, most of all, the achievement of operational objectives. As a corollary, the battalion assets should be able to ensure freedom of movement, protect civilians and UN personnel, property, facilities and installations in the AOR. In addition to performing peacekeeping tasks (both operational and non-operational), the battalion should be trained to plan and conduct conventional offensive and defensive operations to protect the mandate and restore any adverse situation in the mission area.

#### **4.4 : Core Capabilities.**

The eight core capabilities envisaged for the UN Infantry Battalion, in order to perform its role, responsibilities and mission essential tasks as per mandate and Concept of Operations (CONOPS) are:

**4.4.1 : Command, Control and Communications (C3).** Battalion assets capable of:

- Exercising effective command and control of all subordinate and attached elements and resources with dependable, responsive and dynamic conventional C3 apparatus adapted to peacekeeping environment.
- Establishing clear channels of command and control with responsibilities and accountability for all subordinate elements and allocation of resources as per task.
- Maintaining effective control of ongoing operations in accordance with plans, directives and policies, and to direct events through the timely passage of orders in order to deliver effect.
- Undertaking operations in all weather conditions, by day and night, 24/7 in a designated AOR to perform mission essential tasks.

**4.4.2 : Firepower.** Battalion assets capable of:

- Having organic and attached weapons to protect, deter, dominate, or mitigate likely threats in its AOR in either lethal or non-lethal manner.
- Self-sufficiency in organic support weapons at Company Operating Base/ Temporary Operating Base (COB/TOB) level (with all the operational elements) and be able to employ the company support weapons on mobile platforms.
- Flexibility in deploying and grouping/re-grouping battalion support weapons as per tactical and ground situations.



- Processing and directing indirect fire and/or fire from attack helicopters when needed.

#### **4.4.3 : Mobility.** Battalion assets capable of:

- Exercising 24/7 unimpeded, safe, and secure freedom of movement for the battalion assets, UN elements and local population throughout the battalion AOR in all weather conditions, by day and night.
- Moving tactically and non-tactically to position military force to the most advantageous location by foot, motorized/APC, riverine or aerial means by the desired time.
- Conducting proactive mobile operations to dominate area of operations, monitor and verify peace arrangements, maintain visible presence in areas of potential threat, enhance security, encourage confidence with the local population and support the mission security framework.
- Maintaining protected mobility and rapid reaction capability at company and battalion levels for executing mandated tasks/dealing with any situational emergency.
- Securing a safe passage in a designated area for a specific duration with integral resources.

#### **4.4.4 : Force Protection.** Battalion assets capable of:

- Providing individual and collective force protection to all mission elements in the AOR, from direct and indirect threats.
- Establishing protective measures by effective combination of risk analysis, physical security, tactical measures, procedural measures, environmental and preventive medicine measures.
- Sensitization of all personnel to deliver measured and calibrated responses without collateral damage as per peacekeeping operational norms.

#### **4.4.5 : Tactical Information.** Battalion assets capable of:

Acquiring, processing, analyzing, and passage of tactical information proactively at battalion and company level with dedicated staff and multiple resources (including the use of early warning indicators).

- Maintaining 24/7 situational awareness for planning and executing battalion peacekeeping tasks, force protection, and protection of civilians (women, girls, boys and men).





- Integrating and optimising technological support to gain tactical and operational advantage and to support timely and coherent decision-making to further mission objectives.

**4.4.6 : Sustainment.** Battalion HQ and COBs to:

- Have fully self-sufficient and independently sustained logistic capability (to include food, water, accommodation, hygiene and sanitation (for women and men), mobility resources, repair and recovery, preventive maintenance, medical support, welfare, waste management, etc.).
- Support and accomplish unit operations through timely, effective, and enduring provision, stocking and replenishment.

**4.4.7 : Interoperability.** Battalion assets capable of:

- Operating effectively and efficiently in an integrated manner, either in a national or multinational context or in a multi-agency domain.
- Well coordinated C3 arrangements and interoperable communication systems for joint operations.
- Expertise in vernacular and mission language skills.
- Establishing Standardized Operating Procedures (SOP), common standards and foster shared vision.

**4.4.8 : Civil Interaction.** Battalion assets capable of:

- Undertaking outreach and engagement with the local population including women's groups and other civil society actors, through well coordinated and resourced Civil Military Coordination (CIMIC), welfare activities, gender-sensitive Quick Impact Projects (QIP), support to humanitarian operations, if requested, by the Humanitarian Country Team through the Resident/Humanitarian Coordinator (RC/HC) and other essential assistance at battalion and company levels.
- Providing effective leadership through commanders and staff in liaison, coordination and integration with other civilian elements within the mission, UN CIMIC Focal Point, UN agencies, funds and programmes, host national government, international organizations, NGOs and the host national civilian, security forces and local organizations.
- Coordinating and integrating with other actors in the field to address specific emergent issues affecting the population and carry out constructive engagement of all sections of the society in furtherance of the mandate.



- Liaising with the Civilian and Military Gender Advisers will help engagement with women from the local community, support gender sensitive protection arrangements and promote their participation and empowerment.

## 4.5 : Capability Standards.

**4.5.1 : General.** The UN Infantry Battalion should be capable of planning and conducting its designated mission essential tasks within the framework of the envisaged role and responsibility in furtherance of the mandate. The expected capability standards are peacekeeping operations specific, mandate and task oriented, measurable/quantifiable and are within the capacity of the UN Infantry Battalion and its subordinate units. The capability standards applicable at battalion, company and platoon levels described in succeeding sections are suggestive in nature and adaptable to different missions as per conditions on ground.

**4.5.2 : Employment Concept.** The operational parameters for employing the UN Infantry Battalion focus on the following interlinked aspects:

The Infantry Battalion composed of three or four self-sufficient Infantry Company Groups (ICG) capable of deploying and operating independently to execute mission essential tasks, roles and responsibilities as per mandate in the battalion AOR.

- The Companies with organic capabilities execute static and mobile operations from defensible, independent and logistically self-sustaining Company Operation Bases (COB) and Temporary Operating Bases (TOB).
- Maintain inherent rapid capability to establish/relocate static and mobile bases/posts to gain operational advantage and respond to dynamic situations with Quick Reaction Force/Teams (QRF/QRT) and reserves to stabilize any adverse situation/deteriorating security situation.
- Capability to group and regroup subordinate units and weapon platforms/systems (Mechanized elements, Infantry Mortars (IM), mobile Medium Machine Guns (MMG)/Automatic Grenade Launchers (AGL) detachments, etc.) for operational flexibility and cohesive employment for specific missions.
- Capability to take additional elements as attachments and detach elements as need be in support of other contingents in the mission, with clear C3 arrangements.



- The battalion as a whole will be responsible and accountable for conducting peacekeeping operations in the designated AOR with its assets and the companies will be responsible for their respective assigned AOR, under the battalion for conducting peacekeeping operations, within the framework of the Mandate and CONOPS.
- A UN Infantry Battalion has an obligation to execute its peacekeeping responsibility 24/7, day and night, for the period that it is deployed in a mission area.

#### 4.5.3 : Battalion Level Capabilities.

- **Mission Essential Tasks (MET).** The battalion and its subordinate units be trained, equipped and capable of performing the operational and non-operational METs in the designated AOR as per the mission Mandate, CONOPS and OPORD, within the organic resources. All commanders and staff should be capable of planning and conduct of the assigned tasks effectively.
- **Command Post.** Battalion HQ capable of deploying and sustaining a temporary Tactical Command Post by road or by air.
- **Force Reserve.** If earmarked as force reserve, train, equip and be capable of executing mission level tasks as per OPORD effectively to restore any adverse situation.
- **QRF.** Maintain and provide a composite company group as reserve/quick reaction force to be ready to move:
  - ★ Within two (02) hours to operate anywhere in the battalion AOR within integral resources.
  - ★ Within six (06) hours, anywhere in the mission AOR, with integral or additional mission resources.
  - ★ Within 24 hours for Inter-Mission Cooperation (IMC), supported by mission resources (conditions apply).
- **Reserves.** Be capable of detaching up to two companies (including QRF Company within 24 hours) for limited duration within 72 hours to deploy/conduct tactical operations anywhere in the mission area, with integral resources (mobility, firepower, C3 and self-sustaining capabilities) or with support of mission assets (helicopter/fixed wing aircraft, surface transport and additional logistics support), also under separate command and control arrangements.



- **Air Mobility.** The reserves (including QRF) and a platoon per company be trained and equipped to be air transported (helicopter or fixed wing aircraft).
- **Reinforcement.** Maintain ability to absorb under operational control and provide logistics support for additional one or two companies from another TCC contingent to operate within the battalion AOR.
- **Special Tasks.** Maintain a well trained and resourced platoon QRT to undertake special tasks including heli-borne operations in-mission area within two (02) hours.
- **QRT.** Maintain a platoon QRT at company level to be deployed anywhere in the battalion AOR.
- **TOB.** Be capable of establishing a TOB with a company or a platoon with including with appropriate facilities (including for other UN civilian and police personnel if required and separate for female staff), capable of sustaining for 30 days using organic resources and assisted by UN.
- **Long Range Patrol (LRP).** Be capable of undertaking minimum one (01) LRP with platoon strength for minimum seven days within integral resources and for longer duration with mission support to extend/out-reach UN presence and deter potential spoilers.
- **Joint Patrols.** Undertake minimum five (05) composite joint patrols with mission police or civilian components for specific mission or as part of outreach and engagement or as per ground requirement.
- **Operational Activities.** Be capable of establishing eight (08) Check Points (CP) and undertake fourteen (14) section level/six (06) platoon level (or a mix of both) patrolling activity within the battalion AOR in a 24 hour cycle as minimum operational engagement.
- **Re-deployment.** Be capable of relocation and re-deployment of operating bases where operational role has significantly reduced to potential threat areas within integral resources.
- **Joint Operations.** Be capable of undertaking joint operations with other national contingents, host country security forces and UN Formed Police Units.
- **Mobility.** Be capable of providing protected/motorised mobility to all operational elements and weapon systems of the battalion for speed of action and enhanced reach.



- **Battalion Operations Centre.** Maintain a 24/7 static and/or mobile Battalion Operations Centre (BOC) with electronic tracking equipment, communication arrangements including hotline and Video Tele-Conferencing (VTC) facilities to the Company Operations Centre (COC) and to next higher HQ for real time monitoring, control and coordination of operations. The functional modalities of the BOC are explained in [Annex E](#) (Vol. II, p. 264 of the UNIBAM).
- **Civil Unrest.** One company at battalion level and one platoon at company level be equipped and capable of responding to civil unrest.
- **Situational Awareness.** The Battalion HQ and Subordinate HQ up to platoon level, be capable of gaining early warning and generating situational awareness in the respective AOR.
- **Civil Interaction.** Battalion HQ staff and the COBs capable of extensive outreach and engagement of the local population and other actors in the AOR.

#### 4.5.4 : Company Level Capabilities.

- **MET.** Be able to perform designated mission essential tasks (operational and non-operational) either independently or as part of the battalion level operations in the company AOR.
- **QRF.** If designated as QRF Company, be ready to move in two (02) hours with integral or outside assistance (e.g., helicopters) to deploy in a designated area to conduct operations in the battalion AOR or within six (06) hours anywhere in the mission AOR or within 24 hours on IMC.
- **Reserve.** If designated as reserve company to deploy or conduct operations anywhere in the mission AOR, be ready to move within 72 hours with integral and/or battalion and/or mission resources.
- **Re-deployment.** Be prepared to get redeployed with a combined effort of air assets and surface transportation means within 48 hours to anywhere in battalion AOR.
- **Reinforcement.** Company HQ be capable of receiving, coordinating and operationally employing additional one or two platoons from other national contingents (including C3 and interoperability coordination).
- **Air Mobility.** Company HQ and all infantry platoons trained, task organised and equipped to undertake helicopter mounted operations with a platoon, within two (02) hours and a company (less a platoon) within six (06) hours.



- **Special Tasks.** If tasked, train and equip one platoon to conduct special helicopter borne operations.
- **QRT.** Maintain readiness to launch one self-contained reserve platoon as QRT within 30 minutes with integral transport to be deployed anywhere in the battalion AOR.
- **Local Reaction.** Maintain “Local Quick Reaction” capability with a platoon to be ready to move within ten (10) minutes.
- **Immediate Action.** The COB be capable of immediate action/response readiness at all times as per perceived threat. Other than the guards on duty, the personnel of the COB be able to “Stand To” to deal with any threat in two (02) minutes.
- **TOB.** Be capable of establishing a TOB with a composite platoon capable of sustaining for a specified duration using either organic resource and/ or with mission assets.
- **LRP.** Be capable of undertaking LRP with a composite platoon for minimum seven (07) days within integral resources and for longer duration with mission support.
- **Joint Patrols.** Undertake minimum two (02) composite joint patrols in a week (with mission police or civilian components) for specific mission or as part of outreach and engagement as per operational requirement.
- **Operational Activities.** Be capable of establishing two (02) CPs and undertake four (04) Section level/two (02) Platoon level (or a mix of both) patrolling activity within the Company AOR in a 24 hours cycle as minimum operational engagement.
- **Situational Awareness.** Be capable to maintain proactive situational awareness and tactical information database of the AOR with dedicated organic resources and additional battalion assets.
- **Protection.** Be capable of protecting the COB, UN property and personnel from all kinds of physical threat by layered obstacles, sentry posts, and entry exit control and by fire and observation.
- **Mobility.** Be able to move all operational elements and the Company Command Post on organic transport and Armoured Personnel Carriers (APC) to conduct robust mobile operations in the battalion AOR.
- **Equipment Profile.** Have effective day and night observation, electronic surveillance and support weapon platforms for force protection for all operational elements.



- **Operation Centre.** Establish a static or mobile operation centre (with VTC and hotline facility) to monitor and coordinate all the operations in the company AOR.
- **Civil Interaction.** Be able to exercise effective interoperability and civil interaction skills and conduct joint operations with other elements (UNPOL, civilian mission components, UN agencies, local police and security forces, etc.) in the mission.
- **Civil Unrest.** Maintain a platoon, trained and equipped to respond to civil unrest in the company or battalion AOR.

#### 4.5.5 : Platoon Level Capabilities.

- **MET.** Be able to perform the designated mission essential tasks (operational and non-operational) either independently or as part of the company level operations with integral C3, firepower, mobility and logistics resources.
- **Air Mobility.** Be trained and equipped to undertake air transported (fixed wing aircraft), heli-mounted or heli-borne (if tasked) operations as per situation.
- **QRT.** Be able to react within specified time within the company or battalion AOR.
- **TOB.** Establish a TOB/Patrol Base/OP as per specific task for 14 days or beyond with the support of organic resources and mission assets.
- **LRP.** Be able to undertake LRP anywhere in the battalion AOR for duration of seven (07) days with integral resources.
- **Operational Activities.** Be able to establish one (01) CP and undertake two (02) section level patrolling activities or one platoon level patrol in a 24 hours cycle.
- **Equipment Profile.** Have night vision goggles, GPS and inter-communication means (with redundancy) up to section level.
- **Outreach and Engagement.** Platoon and sections capable of exercising effective interoperability and civil interaction skills and conduct joint operations with other elements in the mission.



**4.5.6 : Stocking Capabilities.** The battalion and subordinate units will maintain the following minimum logistics stocking capabilities:

Serial	Category	Battalion Level	COB Level	TOB Level	Remarks
a	Ammunition	As per Guidelines on Levels of Ammunition for Peacekeeping Operations of September 2002 issued by OMA/DPKO			Or as specified by Field Missions / DFS
b	Ration (Dry and Tinned)	07 Days	07 Days	7 Days	
c	Drinking Water	Minimum 07 Days Bottled Water at Mission/Battalion/ Company Level		As per SOP	
d	Bulk Water	Minimum 03 Days Bulk Water at COB Level		As per SOP	
e	Medicines	03 Months	01 Month		
f	Petroleum, Oil and Lubricants (POL)	As per guidelines			
g	Spares/expendable	03 Months	01 Month		
h	General Stores	03 Months	01 Month		

**Note:** The timings, figures and tactical groupings are only suggestive in nature and do not override the mission-specific SOPs.

## 4.6 : Conclusion.

Based on mission environments and operational requirements, Office of Military Affairs (OMA) prepares the Statement of Force and Unit Requirements. The mission, tasks, organization, equipment and personnel requirements for the UN Infantry Battalion is described in the Statement of Unit Requirement. UN Infantry Battalions are required to execute the mission essential tasks within their capability in a given operational environment. The basic capability standards for the UN Infantry Battalion and its subordinate units will be supplemented with detailed criteria and checklists for commanders in Chapter 3, in Vol. II of this Manual. Achieving and maintaining these standards through deliberate force generation, careful resource allocation, integrated training and realistic rehearsals by the battalion is a prerequisite to ensure effective performance in the mission area.







## Tasks

### 5.1 : Introduction.

Operations conducted by military contingents in a peacekeeping mission should remain within the framework of the mission mandate with adherence to the core principles of consent, impartiality, and use of force in self-defence or in defence of the mandate and as otherwise authorized by the Security Council. The proactive, robust and determined posture of the battalion displayed through static deployments and dynamic prophylactic operations are critical for the success of a mission. Therefore, an infantry battalion plays a pivotal role in providing required stability in the AOR by performing its mandated tasks through people friendly and austere operations to gain moral ascendancy and establish faith of all parties to the conflict in the peace process.

### 5.2 : Purpose.

The purpose of this chapter is to provide information to the battalion commander, battalion HQ staff and the company commanders concerning the envisaged peacekeeping tasks to be undertaken in a mission area. It will facilitate planning and preparation, composing task organising groups, conducting task-oriented training and equipping the unit and subordinate units to perform the task effectively. In addition, it will aid the Sector and Force leadership in a mission area in correct employment of the battalion resources.

### 5.3 : Infantry Battalion Tasks.

An Infantry Battalion in a mission area is required to restore and maintain a safe and secure environment and freedom of movement to facilitate execution of the mandated objectives by a variety of peacekeeping oriented tactics, techniques and procedures. The Statement of Force/Unit Requirements, Mandate, Force Commander's Directive, the CONOPS and Operational Orders



will clearly outline the “Mission Essential Tasks” that are to be executed by the battalion in a designated AOR, subject to the applicable ROE. The following sixteen tasks have been identified as peacekeeping related tasks from which mission-specific essential tasks could be drawn out for a particular mission based on its particular mandate and operational environment. The detailed task descriptions including the purpose, planning considerations, modalities of execution, organizational and logistics support aspects for each task in a peacekeeping context are described in Vol. II of the Manual.

**5.3.1 : Primary Tasks.** Primary tasks are the basic tasks which form part of routine infantry battalion tasks to maintain visibility, observation and monitoring of activities, conduct of robust mobile and control operations, support protection of civilians activities and CIMIC activities, etc. These are:

- Patrolling.
- Observation Post.
- Check Point.
- Outreach and Engagement.
- Situational Awareness.
- Cordon and Search.
- Convoy and Escort.
- Operation Base.

**5.3.2 : Support Tasks.** The support tasks require specialised organizational and resource augmentation in support of the larger peacekeeping effort in a mission area. These are:

- Disarmament and Demobilization.
- Critical Infrastructure and Assets Protection.
- Crowd Management.
- Detention.

**5.3.3 : Other Tasks.** These are tasks that are specific to a particular operational situation for which an Infantry Battalion need to be trained and prepared, and include:

- Buffer Zone.
- Joint Operations.
- Reinforce/Relief.
- Extract/Evacuate.



In the performance of the above mentioned mission essential tasks, a UN Infantry Battalion may be required to detect and neutralize mines/UXOs and IEDs within the capability. Considering the increased threat of IED attacks against UN peacekeepers in complex peacekeeping missions, a suggested methodology of handling IEDs is attached as [Annex I](#) (Vol. II, p.282 of UNIBAM).

## 5.4. : Task Descriptions.

The brief descriptions of the battalion tasks to be executed in a peacekeeping context are described in succeeding sections.

### Primary Tasks

#### 5.4.1 : Patrolling.

Patrolling by multiple means (foot, mounted, vessels and heli-borne) is a core peacekeeping task. It is a means and method to promote UN visibility by robust posturing, to generate confidence in the peace process by establishing rapport and bridging the gap with the local people, to provide wide area mission security and protection, to identify threats to civilians, to facilitate freedom of movement and to support wider mandate implementation. Patrolling tasks are mission-specific and are stipulated in the mission Operational Orders and Standard Operating Procedures (SOPs). When planned effectively and executed robustly and intelligently, patrols can impart important tactical advantage for the force. Patrol planning and execution should conform to the mission CONOPS and OPORD.

Typically, patrolling activities may be undertaken for any one of the following purposes or a combination of these different objectives to include but not limited to: gain situational awareness and tactical information (including threats to civilian protection); to observe, monitor, supervise and verify cease fire lines/compliance of agreements/troop deployments and interpose amongst warring factions; observe and report on movements of other armed groups; inspect existing or abandoned positions; conduct inspections or verifications; investigate incidents; carry out reconnaissance to gather or confirm information; conduct route reconnaissance; establish a physical link and maintain lines of communication between adjoining but relatively isolated UN positions; establish mobile OPs/CPs, cover ground/gaps that fixed OPs and CPs cannot observe or



observe from isolated/unoccupied OPs; TOBs/Forward Operation Bases (FOB) or LRPs in specific areas to ensure an extended UN presence and to deter potential spoilers and human rights violators; conduct Joint Monitoring Team Patrols (including women) and for specific purposes; establish and maintain freedom of movement for UN forces and local population as per mandate; establish liaison with local leaders (men and women) and factions; reassure and protect isolated/threatened communities and displaced people; women at risk and in rural areas and who are moving for farming/agriculture, water/firewood collection or to market; provide protection to local population travelling without UN escort; to monitor curfews; to demonstrate the presence and visibility of the UN to all parties in the AOR.

**Note:** Detailed task description of Patrolling is at Vol. II, p. 27 of the UNIBAM.

#### **5.4.2 : Observation Post.**

An Observation Post (OP) is a manned peacekeeping position established to monitor and observe a certain area, object or event. An OP can be permanent, temporary, static, or mobile. Reports from OPs provide timely, accurate, and relevant information to higher HQ and adjacent units. Observing and reporting from OPs is a cornerstone peacekeeping operations task. A thorough analysis of accurate and timely OP observations and reports provide the battalion commander and staff with critical information required for recording and understanding developing situations that effect UN peacekeeping operations missions.

The purposes of an OP are to observe and report all relevant activities in the observation area to higher headquarters through established SOPs and to adjacent OPs or units as required or appropriate. It facilitates increased security in the Area of Operations (AO) by demonstrating a vigilant and visible peacekeeper presence to all parties and populations in the area; monitoring movement in and around airspace, coastal areas, airfields, buffer zones (BZ), cease-fire lines (CFL) boundaries, borders, and protected zones; counting of special traffic, such as military vehicles, tanks, Armored Personnel Carriers (APC), artillery, etc. monitoring of activities of parties involved in the conflict and all other abnormal or suspicious activities including armed actors suspected of sexual violence and other human rights violations; monitoring of violations of international agreements or



conventions; observing BZ and De-militarized Zone (DMZ) restrictions and support other battalion operations as required.

**Note:** Detailed task description of OP is at Vol. II, p. 37 of the UNIBAM.

### 5.4.3 : Checkpoint.

A Checkpoint (CP) is a manned and self-contained position deployed on a road or track to observe/check, inspect/search personnel or vehicles, prevent the trafficking of women and girls and the control of movement into and out of a designated area (e.g., buffer zone or DMZ, or a specific area in a Company AOR). A CP can be either permanent or temporary. Permanent CPs are established on the main access routes and these cannot be moved or closed without the authority of the Force Commander. Temporary checkpoints (vehicle based or foot based mobile CPs) may be set up on minor routes, for a specific duration, usually on the authority of the Battalion Commander.

CP is an important control measure undertaken by the infantry battalion to monitor and control movement, as well as to institute preventive security checks. CPs may generally include the UN Police and/or local police and civil administration officials. In addition, in particular situations, experts from the civilian components of the mission (e.g., DDR, public information, etc.) may also be positioned along with the CP. The CP personnel should have good cultural awareness, respect local customs and traditions, have functional linguistic ability and conduct in a friendly and professional manner.

**Note:** Detailed task description of CP is at Vol. II, p. 43 of the UNIBAM.

### 5.4.4 : Outreach and Engagement.

The creation and maintenance of a safe and secure environment that promotes peace, recovery and developmental process is the key responsibility of the battalion. The security, protection and empowerment of women are fundamental in order to achieve democratic governance. Therefore, the various commanders and staff in the battalion should maintain an excellent, cooperative relationship with other actors in a field mission and have good liaison with the local government authorities, including women in leadership and women's organizations, and parties to the conflict.

The aim of Outreach and Engagement is to reach out to all sections of the population, remote geographical locations in the AOR and the various



power centres to generate trust and faith in the peace process by undertaking genuine and purpose oriented confidence-building measures to establish normalcy, alleviate sufferings of the deprived, gain an understanding of the threats and vulnerabilities the local population faces, and find a sustainable solution.

Outreach and engagement comprises all actions taken by the battalion elements to carry out constructive and active engagement of the local population and other actors in the field (including women and youth groups, host civilian authorities, military and police organizations; the parties to the conflict and spoilers), the Civil Military Co-ordination (with UN system entities and other partners – IOs, ROs, NGOs, etc.), welfare activities and the planned Quick Impact Projects undertaken by the battalion in the AOR and coordinated as part of an integrated and comprehensive mission level effort.

**Note:** Detailed task description of Outreach and Engagement is at Vol. II. p. 49 of the UNIBAM.

#### 5.4.5 : Situational Awareness.

To create and maintain a peaceful and secure environment in the mission, military commanders at all levels require timely information to plan, prevent or respond appropriately to various challenges. The efficient gathering and processing of information and its dissemination, therefore is critical to the success of peacekeeping operations. To be effective, an Infantry Battalion should proactively acquire and deliberately analyse the information about the operational conditions in the mission area of responsibility.

UN Infantry Battalions often operate in hazardous and unpredictable conflict environments where establishing situational awareness is a critical task. Situational Awareness (SA) comprises knowledge, understanding and anticipation. Ensuring effective SA involves establishing information requirements; collecting and verifying information; collating information in data banks; analysing the information; and disseminating it to concerned parties in real time.

At the battalion level, the focus of information management is to corroborate the existing information, acquire and analyse changes in attitudes and perceptions, identify likely triggers and threats to civilians, and provide early warning (including with respect to threats of sexual violence and the specific requirements related to protection of women and girls) and to the mission leadership to assess the situation and institute preventive measures. Information on operational challenges and ability to constructively engage with



the local population and other key players contributes to force protection and prevent hindrance in execution of mandated tasks of the battalion. The ability to act faster than spoilers to a peace process is of paramount importance. Within its AOR, the battalion should strive to dominate the information landscape and anticipate the likely developments and react accordingly.

**Note:** Detailed task description of Situational Awareness is at Vol. II, p. 61 of the UNIBAM.

#### 5.4.6 : Cordon and Search.

A cordon and search operation is conducted to isolate a designated area to secure a targeted search where illegal objects, activities or wanted persons are expected to be, based on specific information. The purpose of search is to send a clear and consequent signal that any attempt to ignore applying regulations and laws will not be accepted and to increase the stability in the area by removing weapons, etc. that could be used against the peacekeeping units or against parties to the conflict.

In peacekeeping operations, the task would include locating and confiscating illegal weapons or war like stores (explosives, equipments, and materials); to find and confiscate contraband materials; to arrest and detain suspects, unauthorized personnel and wanted criminals or persons countering the reconstruction of peace and stability; to protect potential targets by timely action; to obtain evidence on ongoing illegal activities; to build confidence of the local population (especially of women) and deny access to belligerents to the area or population; to help advance demobilization and deter violence and risks of gross human rights violations and to display UN resolve to enforce the mandate for the furtherance of peace and security.

Invariably, the battalion cordon and search forces will also comprise women UN military/UNPOL or local police personnel, Military Police and local police personnel, civilian and military interpreters, CIMIC and situation awareness officers. It could also be grouped with an EOD team and working dogs to assist the operations. Local population should be informed about the reason for the effort and cordon and search operations should be linked to appropriate targeted welfare and CIMIC activities (medical assistance, distribution of food and basic necessities, assistance to the elderly, women and children, etc.) in support of well-being and confidence-building.





Gaining and maintaining the trust of local women is critical. Relevant mission civilian focal points should be consulted in order to ensure that any assistance/programming is appropriate and in accordance with identified mission priorities. No operation without actionable tactical information, since failing to disclose illegal activities will decrease the credibility of the force.

Troops should be prepared to face local resistance in differing forms including, but not limited to lack of cooperation, civil disobedience, peaceful resistance, stone pelting, physical assault, IED initiation, sniper fire, riot, or armed resistance from the local population, militia or regular armed forces. The force should be clear on modalities for effecting arrest, detention and turnover to the police in a peacekeeping environment, as per relevant SOPs and guidance documents. Any threat to the troops should be addressed tactically as per ROE. All efforts must be taken to avoid human rights violations and collateral damages. A post search damage assessment should be carried out to institute measures to mitigate any damages as per Mission SOP's. Battalion should carry out contingency planning to anticipate potential reprisals against the civilian population as a result of cordon and search operations. Exemplary conduct and respect for local customs must be adhered to. When possible, local leaders and/or elders should be consulted.

**Note:** Detailed task description of Cordon and Search is at Vol. II, p. 73 of the UNIBAM.

#### 5.4.7 : Convoy and Escort.<sup>4</sup>

Convoy operations are conducted to organize and escort a column of vehicles to facilitate a secure and frictionless movement from a designated start point to an intended destination. They are carried out for movement of UN personnel (civilians or military or both); force logistics supply; administrative convoys of deployed troops; movement of humanitarian aid and personnel; movement of election staff and equipment; escort for very important dignitaries and movement of refugees/displaced persons (including women and children), or prisoners/detainees. Threats may manifest themselves in the form of obstacles (unattended), roadblocks

---

<sup>4</sup> Humanitarian convoys should only be provided upon request from humanitarian actors. Please refer to the Use of Military or Armed Escorts for Humanitarian Convoys, IASC Discussion Paper and Non-Binding Guidelines on the Use of Military or Armed Escorts for Humanitarian Convoys, 14 September 2001.



(held by belligerents), mines and a variety of IEDs, penetration by other unauthorized vehicles, demonstrations or attacks by crowd, hostage taking, pilfering, stand-off fire including sniper fire, ambush, attack and plunder, traffic accidents and mechanical breakdowns.

Group the convoy with interpreters, mine protected vehicles, wheeled APC's, mobile IED jammers, ambulance, recovery vehicle and strengthen other utility trucks against small arms and IED threat. Key personnel should have appropriate linguistic skills to communicate with local counterparts. Whenever possible, women military personnel and interpreters may be grouped with the escort party. Thorough briefing and rehearsal, tactical move without complacency, display of distinctive signs and operational readiness for spontaneous and rapid response will add to the successful conduct. Where required, selective picketing, road clearance, aerial surveillance and contingency planning to reinforce or extract the personnel in the convoy should be undertaken. When faced with a potentially threatening situation caution should always be exercised and restraint employed to prevent escalation and negotiate an appropriate resolution while maintaining tactical balance.

**Note:** Detailed task description of Convoy Operations and Escort is at Vol. II, p. 83 of the UNIBAM.

#### 5.4.8 : Operation Base.

The establishment and maintenance of a secure and functional base of operations for the battalion and its sub-units is an important responsibility of the battalion commander. UN infantry battalions, in contrast to conventional infantry battalions, do not manoeuvre in offensive and defensive operations. UN infantry battalions and their sub-units operate from and return to static bases, which are also called COB. In addition, a TOB may be established for a specific purpose and duration as per operational necessities. Therefore, it is a prerequisite that battalion operational bases are secure and functional before the battalion and its sub-units can achieve overall mission success in the conduct of other battalion tasks. Secure bases also serve as the planning, administrative, and logistic hubs of UN mission support in the battalion AO.

Operational bases are established and maintained as secure locations for conducting operations and logistics support activities. Battalion and sub-unit operational bases should be dispersed and self-supporting projec-



tion platforms that enable operational coverage throughout the battalion AO. In most instances, UN Infantry Battalions establish or deploy to static base camps for the duration of their deployment. The commander must therefore carefully consider site suitability for an extended time as well as operational and environmental requirements as factors for site selection. These considerations are also applicable when selecting sites for TOB. Camp security requires the camp commander and troops to be prepared to respond to all feasible man-made and environmental contingencies that may affect base security and maintenance.

**Note:** Detailed task description of Operation Base is at Vol. II, p. 93 of the UNIBAM.

## Support Tasks

### 5.4.9 : Disarmament and Demobilization.

Disarmament, Demobilization and Reintegration (DDR) involves disarmament (removal of weapons), demobilization (disband military structures), reinsertion (transition from soldier to civilian and reinsertion into the community) and reintegration (giving viable economic alternatives). In addition, a DDR process may assist in bringing about basic change (adjust attitudes over time) and building a basis for the future (change attitudes of the next generation). The goal of DDR is to enhance and consolidate security in support of the political process so that post-conflict reconstruction and wider recovery can begin.

Primary responsibility for DDR programmes rests with national actors (host government or interim government, political parties, armed groups, local police and military, civil society) and in many contexts the United Nations supports the national actors in the establishment of a dedicated body for DDR matters (frequently called a DDR Commission). The UN's role is to support the DDR process as an impartial actor through the provision of technical expertise, advice to the national authorities and different types of resources (personnel, funds, logistics, etc.). Within the mission, the civilian DDR component plays a lead role and in general employs only unique military capabilities such as communications, aviation, engineering, and medical and logistic support.

However, an Infantry Battalion as a whole or in part may become either directly involved in the conduct of disarmament and demobilisation as per the mission mandate or may be tasked to provide assistance to the larger civilian effort. The tasks for an Infantry Battalion in support of dis-



armament and demobilization are based on the integrated gender sensitive DDR strategy specified in the Mission Concept of Operations.

Tasks may include creation and maintenance of a stable and secure environment in the AOR including maintaining freedom of movement; supporting disarmament (establish and man checkpoints, collection, registering, guarding weapon and ammunition storage sites and destruction of arms and ammunitions); supporting demobilization (including security for assembly and cantonment areas, escort duties and patrolling, providing transportation and safe custody of weapons and ordnance collected, maintaining law and order in the camps); gathering and disseminating information pertaining to DDR in coordination with the Joint Operations Centre (JOC) and Joint Mission Analysis Centre (JMAC) and carry out public information and sensitization campaigns as per mission policies and directives, monitoring and reporting on the progress of the DDR Programme, provide focal points (including women to reach out to women, combatants, dependents, etc.) for establishing contact with target groups or associated to target groups; provide special expertise and support (weapon/ammunition, communication, EOD and aviation assets); proactive engagement of armed groups including spoilers/belligerents; escort foreign forces and their weapons out of the country; assistance to UNMOs and UN Police when specially tasked; provide logistic/administrative support to the programme; support infrastructure creation; provide essential support to DDR staff (transportation, security, escort, communication, essential logistic cover, etc.) and facilitate reintegration.

**Note:** Detailed task description of Disarmament and Demobilization is at Vol. II, p. 103 of the UNIBAM.

#### **5.4.10 : Critical Infrastructure and Assets Protection.**

As part of the major responsibility of restoring, creating and preserving safety and security in the AOR, a UN Infantry Battalion may be involved in protection of various international organizations, as well as public and civilian infrastructure and assets that are vital to the peace process. These are identified, analysed and decided upon at the mission HQ level in consultation with the host national authorities and based on the risk assessment and operational conditions prevailing. These may include, various international/regional organizations, NGOs, host governmental offices and institutions, law enforcing entities, centres of basic amenities (power gen-



eration, water, etc.), lines of communication, communication centres, and the like, which may have an impact in the peace process.

Danger or damage to such assets may have serious functional and political implications for overall stability and security, as well as economic functioning and therefore may need to be protected temporarily by the UN forces until the host national security forces or agencies are capable of taking on the responsibility. Such functions have high public visibility and impact on the attitude of local people towards the UN and mission entities. The battalion should therefore take utmost care to prevent any untoward incident.

**Note:** Detailed task description of Critical Infrastructure and Assets Protection is at Vol. II, p. 117 of the UNIBAM.

#### 5.4.11 : Crowd Management.

A peacekeeping mission is deployed in the aftermath or against the backdrop of a heightened conflict situation, reflecting possible lawlessness, dysfunctional legal institutions and an ineffective police organization. Local populations may undertake demonstrations in towns and villages to air their concerns, project problems or protest issues that directly or indirectly affect them. Such gatherings, though mostly political and peaceful in nature, may turn violent, leading to disturbances/riots. The target of such demonstrations may be the host government, socio-political or ethnic groups, or the peacekeeping mission itself.

In principle, the responsibility for restoration and maintenance of law and order lies with the host state, with operational support or advice provided by a UN Formed Police Unit or with the UN police, in accordance with the mandate. UN police are usually in the lead for coordinating actions with local UN HQ, civil and police authorities. In the exceptional case that civil authorities are unable to cope, military assistance may be needed as long as the mandate permits action and the ROE specify the use of crowd management means by the military. It should be stressed that commanders are to request the presence of police personnel through the quickest means possible if not at the scene in an outbreak.

Crowd management is a sensitive operation requiring human rights compliance, training, appropriate equipment and clear command and control arrangements, to manage a calibrated and appropriate response to a volatile situation. It is important to allow the legitimate expression of views by



the assembled crowd, while preventing escalation, casualties and collateral damage.

An infantry battalion may be faced with crowd management in four particular situations:

- When charged with securing the perimeter of the tactical area of operation within which the host-State police and/or UN police are managing public order.
- When the situation is beyond the control of the host-State police and/or UN police and has evolved into a public disorder.
- When host-state police or UN police are not available or present at the time and cannot reach the area in a reasonable period of time.
- When called upon to protect UN staff, facilities, equipment, installations or institutions.

Crowd management is followed by civil police legal action, which may be reflected in procedures like registration of criminal cases, arrests, search and seizure and subsequent prosecution action in the courts. The civil and UN police are trained and equipped to handle these activities and battalion commanders should readily use this expertise in situations wherever necessary.

Whether carried out by UN or host-State police or by military peacekeepers, the graduated use of force in crowd control will be guided by the mandate and expressed within relevant operational documents (CONOPS, ROE, OPORD and DUFs). Advance planning and preparation, readiness to deal with various contingencies, allocating and maintaining adequate resources in terms of dedicated and trained troops, transport and specialized equipments, establishing a joint HQ to coordinate and integrate planning and conduct of operations, coordination and communication arrangements with all other actors in public order management, adherence to ROE and Directives on Use of Force, key leader engagement, incorporating female interpreters and military/police personnel in the forces, etc. are some of the important facets of crowd management in the UN peacekeeping operations context.

**Note:** Detailed task description of Crowd Management is at Vol. II, p. 123 of the UNIBAM.



#### 5.4.12 : Detention.

Detention and handover of prisoners is governed by “Detention in United Nations Peace Operations Interim Standard Operating Procedures”, dated 25 January 2011, which describes standards for handling persons detained by UN personnel in UN PK operations. This document dictates that detained personnel are handled humanely in a manner that is consistent with applicable international human rights, and refugee law, norms, and standards.

The Interim SOP applies to missions for which such authority has been mandated by the Security Council or General Assembly and its application shall be in compliance with Mission-specific military rules of engagement, Status of Forces Agreements (SOFA) and Status of Mission Agreements (SOMA), police directives on the use of force, and applicable international human rights, humanitarian and refugee law, norms and standards. Due consideration will also be taken of supplementary guidance issued by the Head of Mission or his/her delegate. While the Interim SOP provides internal operational guidance, it does not address issues of criminal procedures which are governed by the laws of the respective host State.

Procedures and principles involved with the battalion’s detention and turnover of detained personnel are detailed in the Interim SOP which is in operation until such a time as a final SOP is approved.

**Note:** Detailed task description of Detention is at Vol. II, p. 137 of the UNIBAM.

### Other Tasks

#### 5.4.13 : Buffer Zone.

A buffer zone (BZ) is an area established between belligerents and civilians that is protected and monitored by battalion peacekeeping forces and where disputing or belligerent forces and attacks on each other and the civilian population have been excluded. Battalion forces operate and monitor the BZ, including ceasefire line, to reduce the risk of renewed conflict. Establishing and maintaining a BZ is one of the main framework tasks in peacekeeping operations and may be the primary mission of a UN Infantry Battalion. The specific concept for force employment will be derived from the guiding mandate and will reflect the legal framework for either a Chapter VI or Chapter VII operation. New conflicts may require an initial entry peacekeeping battalion to conduct UN Chapter VII level



interposition operations in combination with other forces as a buffer and confidence-building measure.

BZ operations contribute to a stable and secure environment in which civilian agencies can achieve the long-term political and economic goals of the peace accord or United Nations mandate. A BZ can be local or transit the length of an entire country or countries. Battalion BZ operations are directed by UN CONOPS and its higher HQ which often establish battalion AOR with very specific sectors of responsibility, with elaborate verification systems, and responsibilities aimed to limit the amount of belligerent forces and weapons in layered areas up to the buffer zone. Agreements and treaties may also establish an elaborate system of rules, inspections, and apparent monitoring capability that battalion forces should enforce or document in order to ensure compliance by belligerent parties.

**Note:** Detailed task description of Buffer Zone is at Vol. II, p. 147 of the UNIBAM.

#### 5.4.14 : Joint Operations.

A UN Infantry Battalion may be required to carry out joint operations with UN Police and/or host police and/or host military forces, in support of peacekeeping operations. This section primarily deals with joint operations with UN police, with relevant amplifications on the modalities of conducting joint operations with host police and military forces.

Maintaining “Law and Order” is primarily a host nation responsibility. However, more often, there is a general breakdown of public order, with dysfunctional police and other security functions combined with non-existent or ineffective local administration. In such cases, UN Police play a vital role in providing advice, training, equipping and in certain cases taking on the responsibility temporarily to maintain law and order.

In most peacekeeping missions the UN Police components in the form of Individual Police Officers (IPO) and Formed Police Units (FPUs) operate in an integrated manner with other mission entities. Specific roles and responsibilities are laid down for all entities in a mission area. In addressing some critical issues, the military and police will operate jointly to accomplish common objectives or provide complementary support to their respective functions. The battalion chain of command and staff should recognize the capability of the UN Police and the strong interdependence of each other in a peacekeeping environment to develop collaborative strategies to bridge the functional gap and ensure convergence of effort. Visibility





of UN Police and/or Local Police enhances the legitimacy and credibility of the force. Particularly, during the stabilization phase of a peacekeeping operation, the complementary actions of both military and police facilitate outreach and engagement and restoration of safety and security. The battalion should take the initiative to liaise, coordinate and integrate to develop a coherent and comprehensive joint plan.

Due consideration should be given to the Secretary-General's policy on human rights due diligence on UN support to non-UN security forces. This policy requires all UN entities - including peacekeeping operations - contemplating providing support to non-UN security forces (for instance in the course of joint operations) to identify risks of grave human rights violations. Should these risks exist, peace operations are required to engage in a dialogue with the recipient entity to identify measures to eliminate or minimise that risk. Should grave violations occur after UN support is provided, peace operations should intercede with the relevant national authorities with a view to bring those violations to an end. However, if the situation persists, the UN is required to suspend or withdraw support from elements committing those violations.

**Note:** Detailed task description of Joint Operations is at Vol. II, p. 155 of the UNIBAM.

#### 5.4.15 : Reinforce/Relief.

##### **Part I: Reinforcement.**

A UN Infantry Battalion or its sub-unit may be tasked to carry out reinforcement or receive reinforcement in support of emergent vulnerable/deteriorating situations in peacekeeping operations. Reinforcement may take place for the purposes of interposition between warring factions, reinforcement of a COB within the battalion AOR, support and extract own troops under threat in performance of their duty, reinforce another contingent COB or military components in the process of execution of tasks, execute any mission related contingency tasks, assist host security forces when requisitioned or mandated or may be tasked to reinforce a potential threat area as an independent entity within the mission or even outside the mission AOR as part of Inter-Mission Cooperation. Timely employment of the force either pre-emptively when threat is imminent or when it has manifested would reflect UN resolve and solidarity in preventing a threat from emerging or deteriorating.



Maintaining dedicated, trained reserve forces in operational readiness, adequately configured with enablers and force multipliers, supported by fastest means of transportation for rapid action, aided by real time tactical information of ground situation, supported by effective C3 arrangements, deliberate planning, preparations and rehearsals and drills for link up are some of the critical aspects of reinforcement operations in a mission area.

### **Part II : Relief in Place.**

The purpose of relief in place is to relieve all or part of the force in a designated AOR by an incoming force. The underlying principle in relief operations is to sustain a level of operational capability while transferring the operational responsibility from one force to another and ensure the continuity of operations. Relief can be carried out as a routine time bound relief, to replace an existing force in an emergency, to take up part of the operational responsibility when situation demands and during change of role between two forces.

Coordination with Department of Field Support for movement and arrival/operational readiness/repatriation inspections (assessed value and numbers of COE being deployed or moved out), reconnaissance by command elements and key personnel, the dispatch of advance party, arrangements for movement, reception, guidance and deployment of the main body, security arrangements, joint familiarization with AOR and operational role, modalities for transfer of responsibility, and movement of outgoing unit and its repatriation has to be centrally coordinated by the local UN HQ concerned with the relieving and relieved units. Logistics sustainment for the move and for initial stages should be catered until routine replenishment from local dependency resumes.

**Note:** Detailed task description of Reinforce/Relief is at Vol. II p. 169 of the UNIBAM.

### **5.4.16 : Extract/Evacuate.**

#### **Part I : Extract.**

A UN Infantry Battalion may be confronted or tasked with the extraction of military peacekeepers, UN personnel or civilians (personnel from international organizations, NGOs, host nationals, etc.) who are either detained, taken hostage or under imminent threat. In such situations, the battalion is required to ensure rapid and spontaneous action from the nearest COB or the military element operating in the vicinity to safeguard UN or associated personnel. Extraction involves the mobilisation of appropriate force to the place of incident/action, negotiation to resolve the issue or release, isolation, containment and domination of the incident location, physical



extraction by military means as per rules of engagement and directives on the use of force and conduct of organized move out from the location. Maintaining centralised QRF/QRT at both battalion and COB levels, grouping enablers and force multipliers for rapid mobility and tactical support, effective tactical information management, proactive and prophylactic security measures, key leader engagement and negotiations to diffuse the situation, incorporation of local police, measured and calibrated tactical action to retain control of the situation are some of the important facets which need to be considered.

## **Part II : Evacuate.**

The deterioration of the security situation in a country and the resultant relocation or evacuation in a mission area encompass all the UN elements in the country and entails fine judgement of mission leadership, high degree of situational awareness, capability to respond adequately and flexibly in emergencies. In a UN peacekeeping mission, the HoM acts as designated official for ensuring safety and security of all the staff members, contingents and volunteers. A security management team is formed with the FC/DFC, DOA, UNDP/other relevant UN officials (most UN agencies, programmes and funds) and military components. The HoM functions in consultation with the mission crisis management team regarding significant security related incidents.

All UN Peacekeeping Missions have an overall security plan for managing security of its personnel which is coordinated and implemented centrally. It describes the various security measures to be taken and arrangements to be followed in the event of serious criminality or emergency situations such as hostilities, internal disorder or natural disasters. The "Mission Security Plan" lays down the responsibilities of specific individuals, the actions to be carried out and the sequence to be followed to execute evacuation and involves review of security situation and ensuring safety of UN personnel, preparation of contingency plans for movement and concentration of personnel and eventual evacuation to safe areas/safe heavens and coordination of all communication and transport resources for optimum utilization in case of an emergency. The role of military component in establishing dominance to ensure protection in vulnerable areas is very crucial in the implementation of the plan. More often, military contingent bases will act as temporary staging areas, where all UN personnel will concentrate. They will then be escorted to designated safe areas by military contingents.

**Note:** Detailed task description of Extract/Evacuate is at Vol. II, p. 175 of the UNIBAM.







## Protection of Civilians

### 6.1 : Background.

Over 90 percent of UN peacekeeping personnel are currently deployed in missions that the Security Council has mandated to “protect civilians under imminent threat of physical violence”<sup>5</sup>. The UN Protection of Civilians (POC) mandates are without prejudice to the responsibility of the host government. The host nation, local population and international community often measure the value of a peacekeeping operation, as well as the legitimacy and credibility of the UN, based on its success in protecting civilians. There are a number of actors in the mission area who contribute to the POC. However, the military component of the mission has a unique role to play in protecting civilians from physical violence. In this respect, missions with the POC mandate are authorized to use “all necessary means” to prevent, pre-empt and respond to POC concerns, including the use of force.

### 6.2 : Purpose.

The purpose of this chapter is to outline the peacekeeping approach to protecting civilians, and the role that battalions can play in protecting them and contains some key considerations to take into account when doing so. Further details on how specific tasks of the battalion contribute to POC are provided in Chapter 2 of Volume II. This chapter is most applicable for battalions deployed to peacekeeping missions with the mandate to “protect civilians under imminent threat of physical violence”.

### 6.3 : Comprehensive Approach to POC.

In addressing POC concerns, peacekeeping operations need to utilize the full range of the tools (civilian, military and police) at their disposal. In this

---

5 This Chapter only applies to battalions that are deployed to missions with this Security Council mandated task.



respect, the protection of civilians is a whole of mission effort. The DPKO-DFS Operational Concept on POC in UN peacekeeping illustrates how peacekeeping operations address POC through three tiers of action. These three tiers are mutually accommodating and should be taken forward simultaneously, in accordance with the priorities of the mission and in light of the circumstances on the ground. The specific roles that battalion commanders and staff can play in these tiers are elaborated below.

**6.3.1 : Tier 1–Protection Through Political Process.** The protection of civilians will be one of the key elements of the senior mission leadership’s political engagement with the parties. Battalion commanders and battalion staff will have an important role to play in supporting these efforts by building confidence with the parties to the conflict at the local level and in preventing POC incidents.

**6.3.2 : Tier 2–Providing Protection from Physical Violence.** Most of the tasks highlighted under Chapter 5, Vol. I will be undertaken in support of this tier. Lessons indicate that projecting mission presence, including through standing military patrols and other force deployments, is one of the most visible and reassuring forms of security that a mission can provide to the local population. The battalion may be required to use force to protect civilians from violence.

**Phases.** This tier can be categorized into 4 phases, as indicated below. The phases are not necessarily sequential, but can be undertaken simultaneously or independently, depending on the nature or imminence of the threats.

- **Phase 1–Assurance and Prevention:** The measures in this phase are aimed at reassuring the local population of the mission’s intent to protect them, largely through routine, passive measures. Conducting routine tasks by the battalion, such as patrols and information gathering and analysis are fundamental elements of this phase. Public information activities and key leader engagement are also important supporting efforts. Regular communication with the local population is essential.
- **Phase 2–Pre-emption:** Where measures under Phase 1 prove insufficient, or when heightened risks are detected, more active pre-emptive measures may be required. The military component will have to deploy forces and an increase in proactive, high-visibility patrolling could be employed. Increased liaison with government and non-government armed actors, and potential parties to a conflict, enhanced human rights monitoring, reporting, and



advocacy, as well as heightened political pressure should also be employed during this phase in order to deter violence against civilians.

- **Phase 3–Response:** When the threat of physical violence to civilians is apparent, and if actions under Phases 1 and 2 are not sufficient, more active measures aimed at deterring potential aggressors from conducting hostile acts may be necessary. The role of the military component will be critical in this phase. Direct military action should be considered as an option, such as the interposition of peacekeepers between a vulnerable population and hostile elements or the use of force as a last resort when the population is under imminent threat of physical violence.
- **Phase 4–Consolidation:** This range of activities addresses the stabilization of a post-crisis situation. The aim is to assist the local population and host authorities to return to a state of normalcy, and create the conditions in which a return to crisis is diminished.

**6.3.3 : Tier 3–Establishing a Protective Environment.** Peacekeeping operations undertake several activities to help establish an environment that enhances the safety and supports the rights of civilians. In this context, the battalion may be called upon to assist the mission in its implementation of DDR and SSR activities.

## 6.4 : Key Considerations.

The implementation of POC mandates in UN peacekeeping operations brings to light a number of complexities. Some of these areas include the challenge of prioritizing protection tasks over other mandated tasks, maximizing the use of limited resources, the application of force to protect civilians, including women and girls from sexual violence, and balancing the responsibility of the host authorities to protect civilians with the mission's mandate to do so. While senior mission leadership grapples with these complex issues, the following are key considerations for battalion commanders when fulfilling their responsibilities in the field.

**6.4.1 : Support to the Host Government.** As stated in the Operational Concept, the protection of civilians is primarily the responsibility of the host government and the mission is deployed to assist and build the capacity of the government in the fulfilment of this responsibility. However, in cases where the government is unable or unwilling to fulfil its responsibility, Security Council mandates give missions the authority to act independently to protect





civilians. Bearing in mind that missions operate within the principles of peacekeeping and in accordance with the mandate, missions are authorized to use force against any party, including elements of government forces, where such elements are themselves engaged in physical violence against civilians.

POC tasks undertaken by UN peacekeeping missions must reflect and uphold the principles of UN peacekeeping, namely, consent of the host government and the main parties to the conflict, impartiality, and the non-use of force except in self-defence and in defence of the mandate. Furthermore, missions are bound to respect and promote international human rights law, international refugee law and international humanitarian law. When the mission is providing support to non-UN security actors, the assistance must also be consistent with the UN's Purposes and Principles of the UN Charter and conditional on the host State's ability to assume its obligations under international law. Further guidance for such support is outlined in the "Secretary-General's Human Rights Due Diligence Policy on non-UN security forces".

**6.4.2 : Consent.** The strategic consent of the host government, as well as of the main parties to the conflict is a principle of United Nations peacekeeping. Without that consent, UN peacekeeping operations are not in a position to effectively carry out their mandates. Nevertheless, at the tactical and operational levels, armed elements of the main parties may be responsible for threatening civilians with physical violence, and peacekeeping operations are mandated to respond.

It is important that missions engage from the outset with the main parties through political channels to convey a clear message of the mission's mandate and intent to protect civilians and of the possible consequences for those who perpetrate violations of international law against civilians. Furthermore, battalion commanders need to be aware of and, if needed, inform parties about the political consequences that come with specific violations of international humanitarian law (sexual violence, child recruitment, attacks on schools and hospitals, killing and maiming of children, etc.).

Institutional structures to ensure information exchange and liaison between the mission and the national authorities at all levels, including between political and security officials, are critical. If the situation worsens or escalates to unmanageable proportions, the battalion commanders must raise their concerns through the senior mission leadership, to the level of the UN HQ and/or the Security Council. If the strategic consent of the main parties, especially



the host government, is withdrawn, a peacekeeping environment no longer pertains. In such circumstances, any further action by the international community would be determined by the Security Council.

#### **6.4.3 : Understanding the Security Council Mandate Language on POC.**

Security Council language on POC often authorizes the mission to take “all necessary action to protect civilians under imminent threat of physical violence”.

- “Necessary action” does not only refer to military action. It includes a range of civilian, police and military actions. As such, any preventative, pre-emptive, or responsive actions may be taken to avert, mitigate or respond to an identified threat.
- Effective prevention and pre-emption activities do not necessarily require the use of force. However, credible deterrence is based on the readiness to use force and the readiness to use force.
- A threat of violence against a civilian is considered “imminent” from the time it is identified as a threat, until such a time the mission can determine that the threat no longer exists. Peacekeepers with a POC mandate are authorized to use force in any circumstance in which they believe that a threat of violence against civilians exists.

The battalion commanders and their subordinate commanders and staff officers should refer to the mandate, the Concept of Operations, the ROE and international legal instruments when making decisions about their activities in the field. If peacekeepers have questions about the application of these instruments while undertaking their activities, these questions should be referred to their commanding officers and the mission’s legal adviser. If necessary, they may have to refer their questions to UN HQ.

**6.4.4 : Civilians and Combatants.** UN peacekeepers are expected at all times to make a clear distinction between civilians and combatants and between civilian objects and military objects. Under International Humanitarian Law, civilians are “protected persons” – they cannot be targeted and their life and dignity must be respected. Civilians are presumed not to directly participate in hostilities and are therefore entitled to full protection from attack. Civilians lose this protection only if, and for as long as, they “directly participate in hostilities”. The simple possession of a weapon does not necessarily give a person the status of “combatant”. Civilians who are in possession of arms (for example, for the purpose of self-defence or



the protection of their property, etc.), but who are not currently engaged in “hostilities” are entitled to protection.

**6.4.5 : POC Risk Assessment and Prevention.** Preventative action is the best form of protecting civilians. In undertaking their peacekeeping tasks, battalions are required to have a strong understanding of the threats faced by the population and their vulnerabilities (details of how to conduct such a POC risk assessment is highlighted in the DPKO/DFS Framework for Drafting Comprehensive POC Strategies in UN Peacekeeping Operations). These threats should be assessed from a gender sensitive perspective in order to address the threats against women, girls, boys and men, which will vary for example according to age, sex, ethnicity or religion. Such analysis should feed into the mission’s prioritization of the POC risks and mission’s mitigating measures to be addressed in coordination with other actors in the area of operations.

**6.4.6 : Children.** The United Nations have established special protection framework, the Monitoring and Reporting Mechanism (MRM) for children in armed conflict, which involves peacekeeping missions up to the members of the Security Council. In this framework, battalions play a key role as the first point of action. As eyes and ears on the ground, the battalion may witness the recruitment and use of children as child soldiers, sexual violence, killing and maiming of children, attacks on schools and hospitals, or abductions of children. If there are specific incidents that are brought to the attention of the battalion in relation to children, the military should inform the nearest child protection officer in the mission or alert the child protection agency (e.g. UNICEF) to send a trained monitor. However, the military should not directly interrogate the children or investigate the incident.

Under Security Council Resolutions 1539, 1612, 1882 and 1998, parties who commit the so-called six grave violations can be named and shamed by the Secretary-General, and the Security Council may impose sanctions against them.

**6.4.7 : Conflict-related Sexual Violence.** The Security Council has recognized that when sexual violence is used or commissioned as a tactic of war, or is used as part of a widespread or systematic attack against the civilian population, it can exacerbate armed conflict, and may impede the restoration of international peace and security (Security Council Resolutions 1820, 1888 and 1960 (Women, Peace and Security)). In order to address



this issue, the Security Council has introduced a strong accountability framework, and has highlighted the necessity to prevent and respond to such acts of sexual violence in order to contribute to the maintenance of peace and security. Under resolution 1960, parties to armed conflict credibly suspected of perpetrating sexual violence, can be named the Secretary-General. This information can be used by the Sanctions Committees.

Where conflict-related sexual violence is taking place, military battalions have a key role to play. Specifically, they will contribute by preventing the occurrence of conflict-related sexual violence and reporting threats and incidents through the appropriate chain of command. If there are specific incidents that are brought to the attention of the battalion in relation to sexual violence, the military should inform the nearest gender and/or human rights officer in the mission so that the appropriate response/action can be initiated. However, the military should not interrogate the women or investigate the incident directly.

**6.4.8 : Resources and Capabilities.** Security Council resolution 1894 (2009) has directed that protection of civilians activities should be given priority in decisions about the use of available resources and capacity in peacekeeping missions. Peacekeeping operations will always be faced with resource and capability constraints. Therefore, Battalion Commanders, in coordination with senior mission leadership, must be prepared to make decisions on how to prioritize the use of certain key resources and capabilities to fulfil the mission's POC mandate. The DPKO-DFS POC Resources and Capability Matrix will be useful in this regard.

**6.4.9 : POC Strategy.** Security Council resolution 1894 (2009) has also requested all peacekeeping missions with a POC mandate to draft mission-specific POC strategies. Battalion commanders and staff need to be engaged in the early stages of the POC strategy development and revision process, as the strategy will articulate the mission's POC priorities based on the risk assessment, key coordination structures and the roles and responsibilities of relevant POC actors, including UN humanitarian actors. The DPKO/DFS Framework for Drafting Comprehensive Protection of Civilians Strategies in UN peacekeeping operations provides a template and outlines a set of practical reminders for the development for such strategies. These POC strategies should be aligned with the vision and priorities set out by the Integrated Strategic Framework and other planning documents<sup>6</sup>.

---

6 For details on the Integrated Strategic Framework, please refer to the UN IMPP Guidelines: Integrated Planning for Field Presence.



**6.4.10 : Interaction with the Local Community.** The local community's (women and men) perception of the security situation is critical in understanding the POC threats it faces. As such, sustained dialogue with the local population, such as internally displaced, refugees, women and children, is necessary to identify the threats posed to them and their vulnerabilities, and to understand how the mission can support existing protection capacities within the local community. The information collected through such interaction should inform the appropriate protection response by the mission. This dialogue will also assist in communicating to the population what the mission can and cannot do to protect them. Consultations with the local population should include women, key civil society groups and boys and girls. The use of language assistants and women civilian staff and/or female military and police personnel on patrols and assessment missions has, at times, enabled troops to enhance their communication with the population.

**6.4.11 : Coordination with UN Police.** The battalion may be called upon to plan and coordinate with the UN Police component, especially where a situation may escalate to the level of a threat of a military nature. In circumstances that may require the sustained use of firearms or military weaponry, the military component should have primacy in support of or in cooperation with relevant host authorities. Details of such cooperation and coordination with the UN Police component are articulated in the DPKO/DFS Policy on Formed Police Units in UN Peacekeeping Operations and the DPKO-DFS Policy on Authority, Command and Control in UN Peacekeeping Operations. In this regard, refer to Vol. II, Chapter 2.11 on Crowd Management and 2.14 on Joint Operations.

**6.4.12 : Key UN and Non-UN POC Actors.** . In addition to ensuring a joint approach on POC of mission components (e.g., with human rights, child protection, gender, civil affairs, police, women protection advisors), the senior mission leadership is required to establish effective coordination and communication arrangements with UN and other agencies on POC. Humanitarian protection actors often have useful information and analysis which contribute to the peacekeeping operation's efforts to protect civilians and vice versa. However, keep in mind, that often protection information is sensitive and cannot be shared. The Protection Cluster, which is usually led either by UNHCR or OHCHR, is the standard forum through which the humanitarian community coordinates on protection issues. Upon deployment, the battalion commander should identify the existing coordination mechanisms with humanitarian actors and ascertain how



the military could best engage with them so as to ensure that there is a useful exchange of information and analysis, and modalities to provide support to humanitarian actors. COBs/TOBs should also interact with the Protection Clusters, which may be functioning at the sector levels.

**6.4.13 :In-mission POC Training.** Battalions should regularly conduct in-mission training, including on POC. DPKO/DFS recently finalized a training module on POC in UN peacekeeping, which includes 12 scenario-based exercises. While TCCs are already being encouraged to integrate them into their existing predeployment programmes, troops should regularly conduct in-mission training on POC to familiarize themselves with the context in which they are deployed. The POC experts in the mission and the trainers in the Integrated Mission Training Centres, who are trained on these modules, may be a useful resource for the troops. Additionally, battalions should carry out crisis management exercises based on potential scenarios to retain operational readiness and early response capabilities.

**6.4.14 : List of Key UN Guidance and Training Documents Relevant for POC.** PKO-DFS Operational Concept on POC in UN Peacekeeping (April 2010).

- DPKO-DFS POC Resources and Capability Matrix (February 2012).
- Secretary-General's Human Rights Due Diligence Policy on Non-UN Security Forces (July 2011).
- DPKO-DFS Specialized Training Materials on POC and Prevention and Response to Conflict-related Sexual Violence (November 2011).
- DPKO-DFS Operational Concept on POC in UN Peacekeeping (April 2010).
- DPKO/DFS Framework for Drafting Comprehensive POC Strategies in UN Peacekeeping Operations (April 2010).
- DPKO/DFS Policy on Formed Police Units in UN Peacekeeping Operations (March 2010).
- DPKO-DFS Policy on Mainstreaming the Protection, Rights and Well-being of Children Affected by Armed Conflict within UN Peacekeeping Operations (June 2009).
- DPKO-DFS Policy on Authority, Command and Control in UN Peacekeeping Operations (February 2008).





## Mission Support

### 7.1 : Introduction.

#### Department of Field Support (DFS).

The Department of Field Support (DFS) was established by the UN General Assembly in 2007 to strengthen the capacity of the organization to manage and sustain global peace operations. DFS provides dedicated support to peacekeeping operations, special political missions and other field presences in the areas of budget and finance, logistics, human resources, general administration, and information, and information and communication technology (ST/SGB/2010/2). DFS has five main offices in UN Headquarters in New York:

- **Offices of the Under-Secretary-General (USG) and the Assistant Secretary-General (ASG).** The Office of the USG and the Office of the ASG provide executive support to the USG and the ASG and, in addition to their personal staff, include the Global Field Support Strategy Team; the Senior Leadership Appointment Section; the Conduct and Discipline Unit; the Audit Response and Board of Inquiry Section; the Field Procurement Liaison Team; and the Air Transport Section.
- **Field Personnel Division.** The Field Personnel Division (FPD) designs, recruits, develops and maintains a civilian workforce for field operations.
- **Field Budget and Finance Division.** The Field Budget and Finance Division's (FBFD) mission is to provide peace operations with financial support services to ensure appropriate funding and responsible stewardship of funds. The Division includes the Budget and Performance Reporting Service and the Memorandum of Understanding and Claims Management Section. The Division is responsible for the overall management of the contingent-owned equipment (COE) system, the coordination of negotiations and preparation of Memorandum of Understandings with troop and police contributing countries, and the reimbursement of the provision of COE (Major Equipment and Self-Sustainment) and other claims. The Division also calculates and certifies all COE Letters of Assist





and Death and Disability claims for military contingents and formed police units and provides claims status updates.

- **Information and Communications Technology Division (ICTD).** The ICTD provides strategic, secure ICT services and solutions to field operations. The Division supports command, control, communications and computer functions, including coordination for military and police elements in field operations. The Division is comprised of the Field Communications and Information Technology Operations Service and the Field Technology and Security Operations Section. This Division is described in further detail in Volume II.
- **Logistics Support Division.** The Logistics Support Division (LSD) implements and monitors policies and procedures for all logistics issues in field operations, including planning and programme support; supply; engineering; contingent-owned equipment and property management; and cartographic and medical support, while minding the environmental footprint in the mission area. The Division also ensures the movement of military and civilian personnel and cargo to and from field missions by air, land and sea. The Division consists of two services: the Strategic Support Service and the Strategic Transport Service (<https://point.un.org/SitePages/lsd.aspx>).

## 7.2 : Purpose.

The Mission Support Chapter deals with broad logistics concepts in support of peacekeeping missions, highlighting the tasking/financial authority and the infantry battalion support structure (including the support capabilities, COE and MOU aspects, various administrative policies, movement and deployment of infantry battalion, etc.).

## 7.3 : Mission Support Concept.

**Logistics Concept.** The UN peacekeeping logistics support concept is based on the integration of UN-owned, contracted and contingent-provided resources. All mission support or service functions, regardless of their origins, are considered common to the mission as a whole and fall under the responsibility of the Director of Mission Support (DMS)/Chief of Mission Support (CMS), who liaises with all components and segments of the mission.



**Tasking Authority.** On behalf of the DMS/CMS, the Chief of Integrated Support Services (CISS) exercises tasking authority over all assigned uniformed logistics personnel and enabling units comprising medical, signal, logistics, construction engineering (except combat / field engineers), transportation and movements units, including military transport helicopters within the peacekeeping mission.

#### Reference

- DPKO/DFS Policy on Authority, Command and Control in United Nations Peacekeeping Operations, 2008.04).

**Goods and Services.** Common goods and services, include, but are not limited to the following:

- Medical, environmental health and, if specified, dental services.
- Construction and management of accommodation.
- Civil engineering projects.
- Environmental advice.
- Geographical Information System (GIS) services.
- Movement Control (MOVCON) and Air Transport services.
- Surface transportation services including riverine and/or coastal transportation.
- Installation and operation of communications and IT services.
- Accounting, storage and distribution of assets, materials and other life support commodities like fuel, water, rations.

**Financial Authority.** Only the DMS/CMS has the authority to commit mission financial resources for any purpose including making contractual arrangements for the use of local resources/services. All requirements for such resources/services should be addressed through the Joint Logistics Operations Centre (JLOC). These may include, but are not limited to, accommodation, POL (including aviation fuels), fresh rations, combat rations, water supply, equipment rental, public service facilities and civilian labour.

## 7.4 : Infantry Battalion Support Structure.

**7.4.1 : Initial Provisioning and Stock Holdings.** During the initial deployment, TCCs are to provide on a reimbursable basis initial provisioning of water, rations, fuel, oil and lubricants for a limited period, until the UN is able to provide these consumables. All formed contingents are to bring



the following levels of stock holdings to the mission area, unless requested otherwise by DFS/DPKO:

Initial Stock Holdings to Mission Area (To be determined for each particular mission)	
Composite/Field/Combat Rations	7 days food rations and minimum 7 days bottled water. Advance parties should be fully self-sustainable for drinking water.
Fuel and specific Lubricants	All vehicle fuel tanks are to be filled as per the applicable international regulations. Specific lubricants that are outside the normal UN stock for the first weeks are to be carried.
Ammunition and Explosives	Refer to "Guidelines on Levels of Ammunition for Peacekeeping Operations" September 2002, issued by OMA/DPKO.
Medical Supplies	Minimum of 60 days of medical supplies and consumables.
Spare/Repair Parts	Under wet lease arrangements, UN will provide transportation for spare parts for 90 days on initial deployment, after which it is a national responsibility.

- **Rations.** The UN arranges through a commercial contract, the supply of fresh, frozen, chilled and dry rations. The TCCs should order the initial supply of fresh, frozen, chilled and dry rations through LSD/DFS no less than 60 days prior to arrival.
- **Water.** The battalion should have water treatment and testing capability and bring company-scale water treatment plants with sedimentation, filtration and disinfecting capability, which meet WHO standards.
  - ★ The UN standardized scale to assure the health and maintain the duty performance of troops is as follows:

Type	Quantity
Safe drinking water (WHO Guidelines)	Potable water 4.5 litres/person/day x 7 days
Treated bulk water for cleaning, shower, ablutions and other uses	80.0 litres/person/day x 3 days

- ★ **Water Transport.** The battalion will need sufficient water trucks/trailers to transport raw water from the source to contingent camps. Water trucks are not to be used as part of the TCC water storage plan.
  - ★ **Water Storage.** Separate static water storage for drinking and bulk water is to be provided by the TCC. Storage capacities should be adequate to cater for three days water per person.
  - ★ **Waste Water.** All wastewater has to be treated prior to being discharged to the nature. Coordination with the civilian component is crucial.
- **POL.** Mission HQ will arrange a commercial "turnkey" contract for the supply, storage and delivery of bulk POL for vehicles, aircraft, and other



fuel using equipment such as generators and heaters. The storage and internal distribution within the battalion is a national responsibility and should comply with UN regulations for logging and distribution. Containment basins with sufficient capacity have to be placed under all fuel tanks and fuel collection points.

- **Additional Requirements of Rations, Water, POL and Other Supplies.** DFS will advise TCCs of any requirement for additional rations, potable water, POL and other supplies to be brought by military units at the time of initial deployment during the deployment planning and MOU negotiation.
- **Vehicles and Major Equipment.** Vehicles and major equipment should be in serviceable condition for use in its primary role and should be painted white overall with black UN markings. Ambulances and other vehicles dedicated to medical staff or medical supplies should be marked as per the Geneva Convention. UN will provide third party liability insurance cover for all COE vehicles. TCCs should forward details of all vehicles and equipment with their chassis and engine numbers to the receiving mission at the earliest possible time, before arrival for arrangements of insurance and number plates. All contingents are to deploy with integral repair and recovery capability to conduct the level of repair and recovery for contingent-owned vehicles as required by the MOU.

#### 7.4.2 : Categories of Support Capabilities.

**General Requirements.** In the mission area the battalion is expected to meet the standards of self-sustainment detailed in accordance with the terms of the MOU, SFR/SUR and as per the COE Manual (Chapter 9, Annex E). It will include the capability to provide and maintain the necessary resources and personnel to support the contingent administratively and logistically for the duration of the mission. Categories of self-sustainment needs to be deployed by TCCs will be based on “Statement of Unit Requirements”, the logistical support available from the Mission or other Units. A summary of self-sustainment categories are as follows:

- **Catering.** Each contingent should provide catering equipment, including kitchen, crockery and cutlery, storage capacity for cleaning equipment, and fresh (14 days), dry (28 days), chilled (14 days), and frozen rations (21 days), facilities for washing and storing utensils at each contingent location. All food storage facilities must include appropriate temperature monitoring/control devices ([Reference: DPKO/DFS Food Rations Management Guidelines](#)).



- **Communications.** Equipment for communications between the Mission HQ and the Sector/Battalion HQs, is provided by the UN as UNOE. The UN also provides a telephone network, within the Mission HQ and down to Battalion HQ level. The UN may provide communications down to the individual force level, or independent sub-units as required. The battalion is responsible for the rear link communications from the UN mission to the home country and for internal communications.
- **Office.** The battalion is expected to be self-sustained in this category as per the standards laid out in the COE Manual.
- **Electrical.** The battalion has to provide for its own major power generators above 20 KVA to meet the main power generating requirements, established at a standard scale of 2.5 KVA per person. It will be reimbursed as major equipment. The battalion should provide decentralized power for small sub-unit locations and provide redundant emergency back up. The UN provides diesel fuel for generators. The common operating voltage and frequency for field missions is 220 volt and 50Hz.
- **Minor Engineering.** Battalions deployed to the UN peacekeeping missions are generally self-sustained in “Minor Engineering”. Chapter 3, Annexes A and B, Appendix 16 of COE Manual (2011) explains the scope of the Minor Engineering Self-Sustained category and division of responsibilities between TCC and the UN. The battalion must be able, within its accommodation areas, to undertake non-field defensive minor construction, handle minor electrical repairs and replacement, undertake repairs to the plumbing and water system, and to conduct minor maintenance and provide all related workshop equipment, construction tools and supplies.
- **Explosive Ordnance Disposal (EOD).** When EOD self-sustainment is required from the Battalion, the contingent must have the capability for EOD to secure the unit’s accommodation areas.
- **Laundry.** The Battalion is to provide laundry services for all military and personal clothing services, (including the related equipment, maintenance and supplies) for all contingent personnel and ensure that all facilities have hygienic equipment that allows maintenance of a clean and healthy environment.
- **Cleaning.** Each contingent should provide cleaning facilities (including the related equipment, maintenance and supplies) for all contingent



personnel and ensure that all facilities have hygienic equipment that allows maintenance of a clean and healthy environment.

- **Tentage.** The battalion should be fully self-sustained in tentage, which includes tentage for temporary offices/workspaces and ablutions facilities (under tentage), for at least the first six months after its arrival. The UN will usually provide hard walled/semi-rigid accommodation, according to established UN scales, as soon as possible with priority given to those units whose roles involve operations from generally static locations. If the UN has not provided hard walled/semi-rigid accommodation after six months under tentage, the TCC will be entitled to reimbursement for both Tentage and Accommodation self sustainment. Due to their mobility requirements, some units which have been provided with UN hard walled/semi-rigid accommodation may need to retain a tentage capability (typically sufficient tentage for one Maneuver Company per battalion). The retained tentage will be included in the MOU as a major equipment item. Particular attention should be given to separate accommodation and ablution facilities for female personnel in all contingents.
- **Accommodation.** Normally, the UN will provide hard walled/semi-rigid accommodation to all contingents. However, the TCC may elect to provide this self sustainment capability to their contingents themselves. To receive the accommodation reimbursement rate, the TCC must purchase or construct permanent rigid structures to accommodate the contingent's personnel, fixed with heating and/or air conditioners, lighting, flooring, sanitation and running water and equipped with furniture where necessary for eating facilities and office/workspace. If the UN is unable to provide accommodation to an equivalent standard and the TCC rents suitable structures, the TCC will be reimbursed actual rental costs, on a bilateral special case arrangement between the TCC and the UN.
- **Firefighting.** Each battalion should provide sufficient basic firefighting equipment, fire detection and alarms, necessary minor equipment and consumables.
- **Medical.** The battalion is expected to be self-sustained in this category as per the standards laid out in the COE Manual, Chapter 3, para 43 to 61.
- **Observation.** The battalion should be able to carry out observation throughout their area of operation and to meet standards for general observation, night observation and positioning sub-categories.



- **Identification.** Each battalion must be able to conduct surveillance operations, process and edit the obtained visual information, and provide all related equipment, maintenance and supplies.
- **Field Defence Stores.** TCC is responsible for the field fortification of their camp, perimeter, accommodation and facilities using UN provided Field Defence Stores, minor electrical and their self-sustained engineering and labour capabilities.
- **High Risk Areas (Epidemiological).** High Risk Areas (Epidemiological) is a sub-category of the "Medical" self-sustainment category and the responsibility for its provision is agreed through the MOU. This covers medical supplies, chemoprophylaxis and preventive measures against common diseases found in the mission area, where there are no available vaccines. The provisions include but are not limited to malaria prophylactics, insect repellent, fogging solutions and chemicals, insecticides, rat poison, animal traps and other vector control measures.
- **Miscellaneous General Stores.** The Battalion is expected to be self-sustained under bedding, furniture, welfare, internet access sub-categories as per the standard laid out in the COE Manual, Chapter 3, para. 68.
  - ★ **Bedding.** Battalion personnel should have bed linen, blankets, mattress covers, pillows and towels. Sleeping bags may be an acceptable substitute for bed linen and blankets. Sufficient quantities must be provided to allow for rotation and cleaning.
  - ★ **Furniture.** The battalion should provide sufficient furniture including, bed, mattress, nightstand, table light and locker for each person, or other appropriate furniture to provide an adequate living space.
  - ★ **Welfare.** Appropriate levels of equipment and amenities across the spectrum of welfare to include entertainment, fitness, sports, games and communication must be provided in quantities appropriate to the number of troops at their respective locations in the mission area. Verification as to whether appropriate standards have been provided will be based on the agreed welfare arrangements between the TCC and the Secretariat, and detailed in Appendix 2 to Annex C to the MOU. An infantry battalion is entitled to USD 6.73, per person, per month for welfare in the unit.
  - ★ **Internet Access.** TCCs are encouraged to deploy with appropriate equipment and bandwidth necessary to provide voice and e-mail communications for their troops as a welfare measure. Internet access



is to be established by the troop/police contributors and not linked to existing United Nations communication systems.

- **Unique Equipment.** Any special minor equipment or consumables not covered in the above self-sustainment rates will be handled as unique equipment. These items will be handled on bilateral special case arrangements between the troop/police contributor and the UN.

**Note:** For more details on the verification and performance standards for minor equipment and consumables provided for each self-sustainment category, refer to the COE Manual, Chapter 3, Annex B.

#### 7.4.3 : Engineering Support.

- **Deployment.** Deployment discussions may resolve that a military engineer company will deploy in lieu of one Infantry Company for an agreed period. This deployment would occur to allow the TCC to establish the battalion's infrastructure facilities. An environmental baseline survey needs to be undertaken for each location to ensure that these are in accordance with the mission environmental objectives (refer Chapter 2, Section 2.23, Environment, for more information).
- As per the Global Field Support Strategy, the UN is to establish a wastewater collection/disposal system and solid waste management programme at all troop deployment sites. It is important that contingents observe practices in accordance with the mission environmental objectives. For example, the segregation of waste (including hazardous waste) has to be undertaken for recycling and/or proper disposal in accordance with mission guidance, not using open burn pits and treatment of wastewater prior to discharge into the nature.
- The engineer company would be in direct support of the infantry battalion and may be deployed during the start-up phase of a mission for the following reasons:
  - ★ In case a particular mission does not have the full capacity to undertake required engineering tasks and additional support is agreed.
  - ★ When the battalion is establishing a new base or bases and additional engineer support is required.

After completing its assigned tasks and as per the mission plan, the engineer company would be replaced by the TCC with one infantry or one motorized company.

- **Battalion Engineering Requirements.** Battalion engineering requirements are initially to be managed within battalion resources. Require-





ments beyond battalion resources are to be clearly identified and presented through the battalion engineer officer to the Force Engineer who will, in consultation with the mission's Chief Engineer, resolve the way forward including human resources, equipment and material.

- **Major Military Engineering Tasks.** Major military engineering tasks are a mission responsibility and are included in the mission's master engineering plan. The resources for engineering tasks are allocated based on mission priorities. The Force Engineer manages the military engineering tasks in coordination with the mission Chief Engineer, including the employment of military engineer companies.

#### 7.4.4: Contingent Owned Equipment (COE)/Memorandum of Understanding (MOU).

**General.** The types and number of COE are determined based on the levels established in this document, as well as the mission-specific guidelines to TCCs and the contingent-specific MOU. Verification of the COE, as per the MOU, is conducted on a regular basis including, upon arrival in the mission area, routinely throughout a battalion's deployment, and upon repatriation. Reimbursement is provided based on the completion of these verifications in accordance with the procedures detailed in the COE Manual. It is the contingent commanders responsibility to review and endorse (sign) all verification reports.

- **MOU Discussions.** Following the completion of the MOU discussions at UN HQ, the TCC should fax a list of any additional logistic support requirements to the LSD/DFS. Once the list is agreed upon, the UN is able to make alternative arrangements for known deficiencies in supplies and equipment.
- **Contingent Owned Equipment Verifications.** (COE Manual, Chapter 3, para. 10 and followings). The major equipment categories and self-sustainment capabilities brought in theatre by the battalion are subject to various on-site inspections, as described below:
  - ★ **COE Arrival Inspection.** This inspection is to take place immediately upon arrival and to be completed within one month. Where equipment and personnel are already in the mission area when the MOU is concluded, the first inspection is carried out on a date to be jointly determined by the mission and contingent authorities and is to be completed within one month of that date.



- ★ **COE Periodic Inspections.** The COE Unit of the field mission provides an Inspection Team to conduct periodic inspections. The reporting period is decided after consultation between the UN HQ and the mission, but is usually done quarterly. An inspection report, called verification report, is prepared by the Inspection Team after each inspection. The report describes the result of the inspection and is examined together with the battalion staff and signed by the Battalion representative and the FC. In a case where the Battalion has to fully or partially redeploy within a mission area, the time of the next periodic inspection in the new location will be carried out on a date to be jointly determined by the field mission and the Battalion Commander.
- ★ **Monthly Serviceability Reports.** Standard operational reports are drafted at the Battalion level on a monthly basis using a standardized form. These reports are maintained by the battalion for presentation to the COE Inspection Team upon request. The report must describe the actual state of equipment and services provided by the battalion and the UN.
- ★ **COE Operational Readiness Inspection (ORI).** ORIs must be carried out at least once in every six months during the battalion's deployment in the mission area, and any time the field mission believes the equipment or services do not meet the required standards. The condition of the major equipment and self-sustainment will be inspected with a view to assess whether the capability is sufficient and satisfactory.
- ★ **COE Repatriation Inspection.** This inspection shall account for all major equipment of the TCC to be repatriated and verify the condition of the major equipment provided under the dry lease arrangement, if any.

**7.4.5 : National Command/National Support Element.** A TCC may provide additional personnel as a National Support Element (NSE) at its own expense and with prior approval of the UN. There will be no payment for troop costs, rotation or self-sustainment and no other financial liability for the UN for NSE personnel. For legal purposes, these personnel shall be considered as part of the contingent. Personnel deployed at the request of the UN for specific tasks of limited duration may be covered by supplementary arrangements to MOU as appropriate. Civilian personnel provided by TCC who are serving as a part of formed body of troops shall



be assimilated with battalion. NSE personnel will be provided with UN ID, accoutrements, license plates, etc. However, they are not authorized any UN Medal. Typical NSE tasks may include:

- Communication between the battalion and its home country (at National expense).
- Contact point for battalion personnel members on national matters.
- Postal Office for the battalion, to and from the home country.
- Travel office for the battalion.
- Service office for the battalion personnel.
- National paymaster and money exchange office.
- Maintenance of records of reimbursement, including COE procedures.
- Handling of arrival and replacement of approved COE.
- Organization of national visits approved by UN HQ to the mission area.
- Support for hospitalized battalion personnel.
- Organization of national social activities.
- Coordination of supplies from national sources.
- Maintenance for all COE and any national equipment, in accordance with the MOU.

**7.4.6 : Letter of Assist (LOA).** Arrangements may be made by the UN to meet specific support requirements not included under an MOU or available through a commercial contract, to be met through a LOA. It is a contracting method by which the UN arranges for the provision of special supplies or services from a Member State. LOAs are used when:

- A TCC is to carry out the deployment or repatriation of their personnel and equipment using its own capacities.
- A TCC is to carry out the rotation of their personnel using its own capacities.
- A special need arises for essential equipment or services that are not available through normal sources of supply.
- The items or services required by the mission are not covered by an MOU.
- A TCC contributes aircraft or vessels to a mission.

#### **7.4.7 : Administrative Policies.**

- **Personnel.** TCCs shall ensure that the personnel it provides meet the standards established by the UN for service with the mission, inter alia,



with respect to rank, experience, physical fitness, specialization and knowledge of languages. The personnel shall comply with UN policies and procedures regarding medical or other clearances, vaccinations, travel, shipping, leave or other entitlements. The personnel shall be trained on the equipment with which the battalion is provided. Personnel with charges of criminal offences or international human rights law or international humanitarian law violations pending against them shall not be eligible for nomination and shall not be deployed as members of a UN military contingent.

- **Medical Standards.** Personnel assigned to peacekeeping missions could be exposed to hazardous conditions not normally associated with peacetime service. Moreover, due to a stressful and changed working environment, there is a potential of aggravation of any pre-existing medical conditions. Therefore, special considerations should be given to personnel with a history of medical problems.
- **Pre-deployment Medical Preparations.** A standard list of predeployment medical preparation conducted for their peacekeeping personnel prior to their deployment should be made available to DFS by the TCCs. This shall include any clinical examinations, X-rays and laboratory tests, as well as all vaccinations administered. The administration of vaccinations, as recommended by the UN, is a national responsibility. The UN will provide necessary information on what kind of vaccination and preventive measures will be given to all UN personnel prior to deployment.
- **Repatriation of Individuals.**
  - ★ **Repatriation on Compassionate Grounds.** The FC may recommend to the SRSG, the early repatriation of individuals before completion of his/her tour of duty for compassionate reasons, at the UN expense. Upon such recommendation, the CMS/DMS will make the necessary travel arrangements. Grounds for compassionate repatriation may include:
    - Critical or dangerous illness or injury of a close family member having a relation of the first degree (parent, spouse or child).
    - Critical or dangerous illness or injury of a brother, sister or other close relative who is the sole surviving relative of the individual.
    - Attending the funeral of one of the above-mentioned.
  - ★ **Early Repatriation.** If an individual is repatriated upon national request or for either failure to meet the necessary requirements or for disciplinary reasons, all costs associated with his travel home and arrival of his



replacement to complete the tour of duty will be at the expense of the national government.

- ★ **Medical Repatriation.** Battalion members may be repatriated to their home country if they are assessed to be unfit for duty for the next 30 days, or if they require treatment that is not available in the mission.
- ★ **Repatriation on Discipline Ground.** Personnel involved in discipline cases prior to the rotation (even as witnesses) who are subject of a board of Inquiry (BOI), shall remain behind for the inquiry and return to home country upon completion of BOI.
- **Repatriation of Remains (Death of a Battalion Member).** In the unfortunate event of the death of a member while serving in a peacekeeping mission, all costs and arrangements associated with the return of the remains to the home country and travel of a replacement to the mission area are performed by the UN.
- **Death and Disability Claims.** Guidelines for the submission of death and disability claims can be found in General Assembly documents A/52/369 of 17 September 1997 and A/63/550 of 17 November 2008.
- **Clothing and Personal Equipment.** All battalion personnel are to be equipped in accordance with Appendix 1 to Annex A of the MOU and their National scales of issue, including helmets and protective body armour/fragmentation jackets/vests. The UN will provide UN blue beret, field cap, metal badge, cloth shoulder patch, olive drab armband and neck scarf. Requirements for UN accoutrements are to be placed at least eight (08) weeks prior to deployment.
- **Personal Identification.** Battalion personnel should be in possession of identification (e.g., national passport) in accordance with their national regulations. UN peacekeeping mission identification cards will be issued to all members on arrival in a mission area.
- **Leave.** Battalion members are entitled to 2.5 days/month (15 days/6 months; 30 days/12 months) as actual leave.

## 7.5 : Movement of TCC Personnel and Contingent Owned Equipment.

**7.5.1 : General.** The Movement Control Section (MCS) of DFS/LSD will coordinate transportation for deployment, rotation and repatriation. The normal mode of transportation for personnel is by air, and for equipment by



sea. The MCS in the respective field mission will coordinate movements within the mission area between the Airport/Seaport of Disembarkation (APOD/SPOD) and the battalion AOR. The UN provides the transportation to/from the mission area for TCC personnel upon deployment, rotation and repatriation and for COE upon deployment and repatriation only. In coordination with the UN, TCCs may provide this service via a Letter of Assist. Battalion should plan its order of movement to ensure that personnel, deploying in the first phase of each movement, are capable of assisting with subsequent arrivals of their contingent.

**7.5.2 : Predeployment Planning and Information Requirements.** Subject to the mode of transportation, the MCS requires the movement information at least six (06) weeks, but preferably eight (08) weeks, prior to the planned movement or readiness date. Each TCC is requested to provide DFS with the following information:

- Address in the home country to which UN accoutrements will be delivered.
- Cargo load lists of air and sea shipments.
- List of equipment and stores being provided, including vehicles by type and quantity.
- List of equipment and/or stores the TCCs are unable to provide.
- Postal address in the home country.
- Copy of the national ration scale.
- List of the personal clothing, gear and equipment as well as personal weaponry and ammunition, which are issued under national regulations.
- Point of contact with the TCC Military HQs who has the authority to deal direct with DFS on deployment/re-deployment details.

**7.5.3 : Deployment/Rotation/Repatriation Movement Operations.** COE will only be moved at UN expense on deployment to and on repatriation from the mission area. The UN will arrange the movement of equipment from the point of arrival to the contingent's HQ camp in the area of operations. This movement is to be assisted by the TCC providing drivers and operators of the COE. Contingent personnel are rotated a maximum of once every six months at UN expense. Movement of an advance party comprised of up to 10 percent of the unit's strength, to affect an operational handover of the unit should be coordinated with DPKO/OMA. During rotations, only personnel are moved; COE is passed from the previous contingent to the new contingent in accordance with the MOU/LOA.



- **Baggage Entitlements for Battalion Personnel.** The following summarizes personal baggage entitlements for military contingents:
  - ★ For 12 months of tour of duty the entitled personal baggage is 100 kgs/0.6 m<sup>3</sup> per person.
  - ★ For less than 12 months the entitled personal baggage is 45 kgs/0.3 m<sup>3</sup>.
- **Loading.** Passenger and/or cargo loading conditions:
  - ★ IATA safety rules apply to embarking passengers and/or cargo.
  - ★ Personal weapons may be carried and stowed in the aircraft hold.
  - ★ Limited small arms ammunition (class 1.4S only) may be carried and stowed in the aircraft according to IATA safety regulations.
  - ★ TCC shall provide passenger manifest, Cargo manifest and Dangerous Cargo manifest.
- **Movement by Airlift.** The following information is required by the MCS:
  - ★ Place of embarkation, name and location of the airport of embarkation.
  - ★ Number of troops to be moved and dates the troops are ready for airlift.
  - ★ Point of contact in the TCC to coordinate the movement.
- If cargo is authorized for airlift by DPKO/DFS, the following information is required:
  - ★ Complete and accurate cargo load lists using the UN standard format.
  - ★ Cargo readiness dates.
  - ★ Confirmation that drivers will accompany vehicles on the airlift.
  - ★ Complete Dangerous Cargo information on any of the nine classes of DG.
  - ★ Any requirement for ground transport at the destination airfield.
  - ★ Consignor details for their shipment.
- **Cargo Movement by Sealift.** The following information is required by the MCS:
  - ★ Requirement for pre-carriage of cargo from unit location to the loading port.
  - ★ Preferred Seaport of Embarkation (SPOE).
  - ★ Date cargo is ready for collection at origin and/or loading at port.
  - ★ Complete and accurate cargo load lists using the UN standard format.
  - ★ Complete Dangerous Cargo information on any of the nine classes of DG.
  - ★ Requirement, if any, for passengers/supercargoes.



- ★ Point of contact in the TCC to coordinate the movement.
- ★ Consignor details for their shipment.
- **Dangerous Cargo.** The identification, packing, labelling and documentation of Dangerous Cargo rest with the shipper (the TCC). Dangerous Cargo that does not comply with the IMDG/IATA regulations will not be permitted on board UN chartered ships or aircraft.

## 7.6 : Conclusion.

Information provided in this section is subject to change and may be further clarified, or updated, during the Force Generation Process and specifically during predeployment activities, including the MOU negotiation. Refer to the policies and/or reference documents listed below for further guidance.

### References:

- Generic TCC Guidelines, 2012.
- COE Manual 2011.
- DPKO/DFS Environmental Policy for UN Field Missions (2009.6).
- DPKO/DPS Policy on Authority. Command and control in United Nations Peacekeeping Operations, 2008.04
- Draft DPKO/DFS Environmental Guidelines for UN Field Missions (2007).
- Guidelines on levels of ammunition for peacekeeping operations of September 2002, issued by OMA/DPKO.
- Guidelines for Death and Disability Claims—General Assembly document A/52/369 of 17 September 1997.
- UN ForceLink (<https://cc.unlb.org/>) MovCon tool for TCC deployments/rotation/repatriation.
- UN Field Mission Liquidation Manual.
- International Maritime Dangerous Goods (IMDG) Code.
- [International Air Transport Association](#) Dangerous Goods Regulations (IATA DGR).
- <https://point.un.org/sitepages/lzd.aspx>.
- DPKO/DPF Food Rations Management Guidelines.







## Organization and Equipment

### 8.1 : Introduction.

The UN Infantry Battalion organizational structure comprises three or four Infantry Company Groups (ICG) and a Support Company with strength of 850 personnel for deployment in most of the multidimensional peacekeeping missions. The organizational structure focuses on building and enhancing various multifaceted peacekeeping capacities expected of the battalion in a mission area by incorporating key capabilities to augment the performance. The organization is adaptable in its force composition and equipment profile to specific mission requirements and is flexible to adjust to the TCC organizational structure by plug in or plug off modules.

Based on the capability-driven approach, the force configuration of the battalion will depend on the number of concurrent designated tasks to be executed; the size of the force element conducting these tasks; the peacekeeping specific key capabilities, specialised skills and capacities required; the operational environment (pragmatic current and future threat analysis and mission mandate and objectives); the terrain imperatives and geographical spread/separation of deployment. It will be further complemented by the force-driving and underpinning variable factors of mobility, firepower and force protection requirements in a mission area.

### 8.2 : Purpose.

The purpose of this chapter is to lay down a base model organizational structure and equipment profile for a UN Infantry Battalion, adaptable and modifiable to specific mission requirements. It will provide guidance and assistance to the battalion commanders, the TCCs, the senior force and sector HQ leadership and staff in various missions and the DPKO and the DFS at the UN HQ in planning, structuring, equipping and employing the battalion in various multidimensional peacekeeping operations.



## 8.3 : Organizational Profile.

**8.3.1 : General.** The UN Infantry Battalion organization is designed on a modular structure with independent operational capability and logistic sustainment to be versatile and capable of performing multifaceted tasks unique to the peacekeeping environment. Various technical and skilled personnel, and specialised equipment enhancements in core capabilities suggested in the organization are designed for optimal performance in the mission area.

**8.3.2 : Features.** . The battalion will generally be deployed in three to four dispersed and self-sustained static operating bases from which it executes mission essential tasks by proactive robust mobile or static operations in all terrain, weather and visibility conditions to accomplish the mission. Some of the major features of the UN Infantry Battalion organization includes, maintaining inherent C3 capability up to section level; direct and indirect fire support capability augmented by mobile platforms up to platoon level; having credible protected mobility at company level; capability to rapidly mobilize all operational elements with integral transport; state of the art technological enhancements in surveillance, observation, monitoring, tracking and communication means; qualitative, specialized and self-sustained logistic support structure; dynamic and responsive potential to carry out outreach and engagement; peacekeeping-oriented structured and systematic capability building; maintaining high state of operational mission readiness, including the capability to conduct conventional offensive and defensive operations for the protection of the mandate, etc.

**8.3.3: UN Infantry Battalion Organizational Structure.** The organizational structure of the base model UN Infantry Battalion is shown below, followed by the detailed structure of the Battalion Headquarters, Support Company and the Infantry Company Group:



8.3.3.1 : UNITED NATIONS INFANTRY BATTALION ORGANIZATION - BASE MODEL

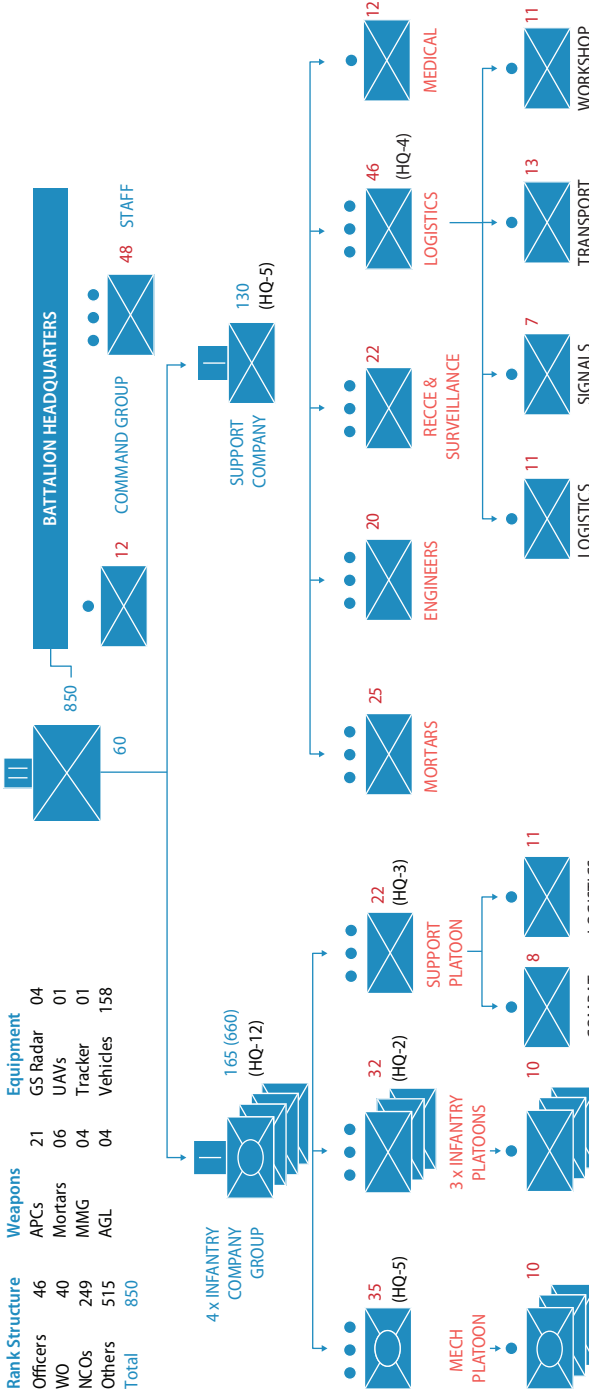

Notes:

- \* May consist of 3 or 4 companies.
- \* Each company with 3 or 4 platoons.
- \* Configuration based on mission operational requirements; TCC capabilities and MOU negotiations.
- \* Personnel and equipment are only a suggested figure for planning and preparations.
- \* Maximum multi-tasking recommended.
- \* Selection of battalion leadership and personnel is vital for effective performance.



8.3.3.2 : UNITED NATIONS INFANTRY BATTALION HEADQUARTERS- BASE MODEL

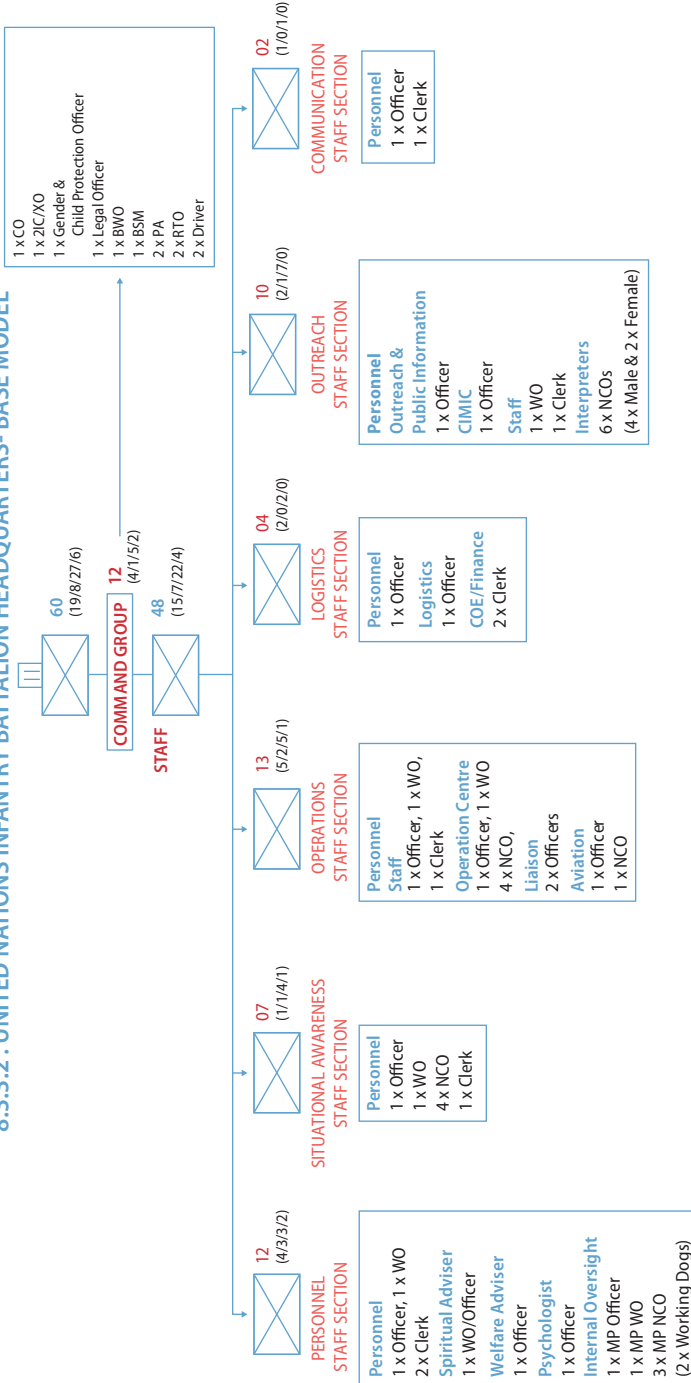

Notes:

- \* Multifaceted staff.
- \* Adequate female staff encouraged.
- \* Select experienced and qualified staff.
- \* Ensure cross training and effective integration.



8.3.3.3 : UNITED NATIONS INFANTRY BATTALION HEADQUARTERS- BASE MODEL SUPPORT COMPANY

COMPANY HEADQUARTERS

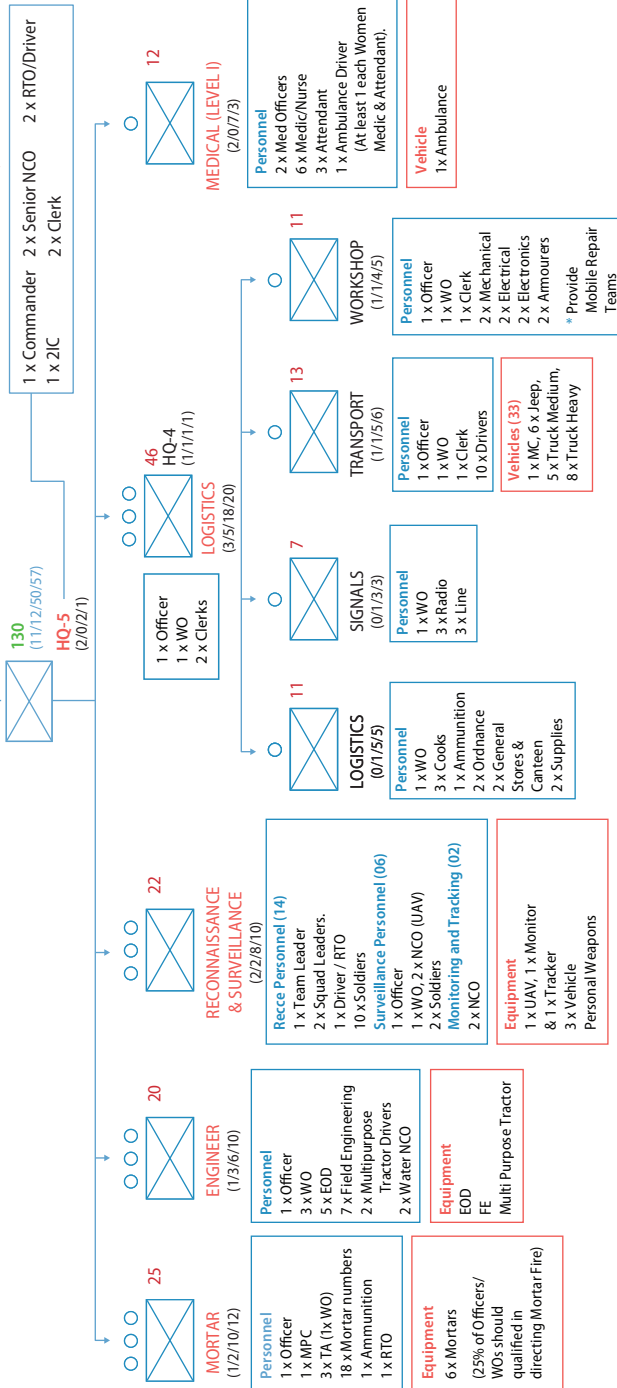

Notes:

- \* Trained, specialised and qualified personnel.
- \* Undertake additional responsibilities when not employed in primary task.
- \* Security and administrative support for Battalion HQ when co-located ICG is out on operations.
- \* Coordinate all logistics support aspects of ICGs and any other independent detachment operating away from static bases.



8.3.3.4 : UNITED NATIONS INFANTRY BATTALION HEADQUARTERS- BASE MODEL INFANTRY COMPANY GROUP

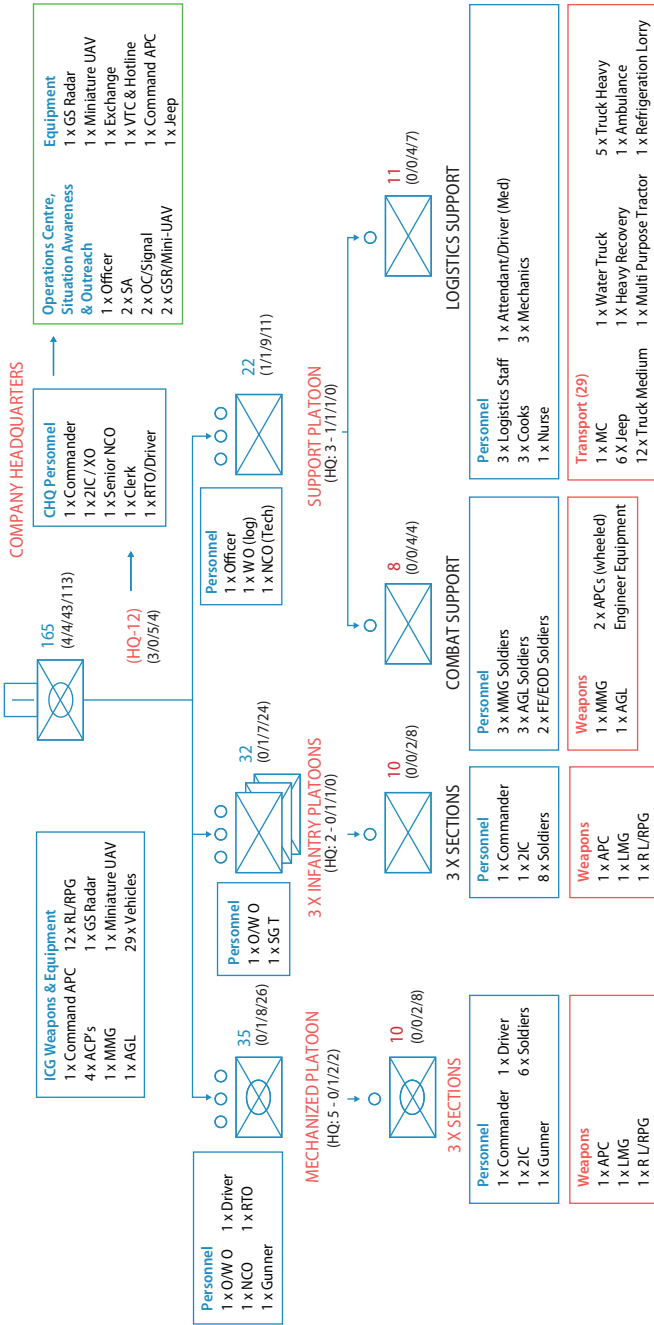

**Notes:**  
 \* High mobility & robust structure.  
 \* Plug in/plug off module.

\* Additional support weapons based on operational requirements.



**8.3.4 : Battalion HQ.** The Battalion HQ comprises sixty (60) personnel consisting of nineteen (19) Officers, eight (08) Warrant Officers, twenty seven (27) Non Commissioned Officers and six (6) enlisted personnel.

- **Command Group.** The battalion commander will be assisted by the Second-in-Command/ Executive Officer (2IC/XO), Battalion Senior Warrant Officer and Senior NCO in exercising his/her operational and administrative command responsibility. The Battalion Command Group will be assisted by a Legal Officer (for managing legal affairs of the unit), and a Gender and Child Protection Officer as advisers.
- **Battalion HQ Staff.** The battalion staff will function under the 2IC/XO and on his or her behalf, the Operations Officer will coordinate functions of all other staff sections. The staff will be responsible for planning, organizing, staffing, directing, controlling and sustaining all operational and administrative responsibilities of the battalion as per Standard Operating Procedures of the unit and the mission. Adequate representation of women in the staff should be ensured. The staff officers should be qualified in their respective field and should be cross trained to take on additional responsibilities as per Unit SOPs. In addition to conventional responsibilities, some of the important functions of the respective staff sections relevant in a peacekeeping environment are listed below:
  - ★ **Personnel/Human Resources Staff Section.** Personnel Staff Section comprises the Personnel Officer and staff, a Spiritual Adviser, a unit Welfare Adviser, a Psychologist and an Internal Oversight Officer and staff (military police personnel). It is responsible for personnel administration and welfare, morale and motivation and maintaining conduct and discipline in the unit. The Military Police with a working dog will also provide support cover for detecting IED, weapons, etc. in support of the battalion engineer EOD team
  - ★ **Situations Awareness (SA) Staff Section.** The SA Staff Section comprises one Officer, one Warrant Officer and four NCOs, to coordinate tactical information acquisition, collation, corroboration and dissemination for effective situational awareness of the AOR. They are augmented with dedicated personnel, surveillance devices and communication systems up to the ICG level. The Reconnaissance and Surveillance Platoon with real time monitoring and image analysis capability in the Support Company and SA Cell in the ICGs assist the section in maintaining the tactical information base. The section will also coor-





dinate activities of the Community Liaison Assistants and Community Alert Networks for timely passage/sharing of information.

- ★ **Operations Staff Section.** Operations Staff Section comprises an Operations Officer, Battalion Operations Centre staff, Liaison Officers and an Aviation Cell. The section coordinates all operational activities and movements within the AOR, carries out liaison, coordinates air movements and maintains the “Operations Centre” (with tracking and video-conferencing facility) in 24/7 operational readiness. It will coordinate employment of QRTs, QRF and Reserves as per operational situation. It is responsible for ensuring overall safety and security of personnel, materials and information. The section will establish and maintain liaison with neighbouring contingents and with the immediate higher HQ for coordination and control of activities. This section also will organize and coordinate negotiations and employment of interpreters in conjunction with the outreach and engagement staff. Important guidelines for carrying out negotiations and use of interpreters are given at [Annex F](#) and [Annex G](#) (Vol. II. p. 268 and p. 274 respectively of UNIBAM).
- ★ **Logistics Staff Section.** Logistics Staff Section comprises a Logistics Officer and a COE/Finance Officer. The section will coordinate all logistic support for the unit per MOU arrangements to plan, provision, stock and turnover; replenish supplies and stores; repair/replace and equipment management. It will ensure proper maintenance, serviceability and inspection of both UNOE and COE on the charge of the unit. It manages all financial transactions and accounting of the unit. The Logistics Officer will be in charge of the unit movement control (MOV-CON) and will act as “Environmental Focal Point”.
- ★ **Outreach Staff Section.** The Outreach Staff Section comprises an Outreach and Engagement/Public Information Officer (Outreach and Media Focal Point) and a CIMIC Officer (Humanitarian and CIMIC Focal Point). It coordinates with other mission components and undertakes appropriate outreach and engagement activities with the local population through confidence-building measures, community engagements, CIMIC/QIP/Welfare activities, public information and media management and key leader engagement. It will employ the battalion interpreters (four male and two female) appropriately in conjunction with local interpreters (minimum four per ICG). In close coordination with other civilian mission components, such as Civil Affairs and



Human Rights, it will establish liaison with the various humanitarian actors and other local stakeholders including spoilers and host security forces.

- ★ **Communications Staff Section.** Ensure provision and maintenance of multiple voice and data communication network with higher HQ and subordinate elements with redundancy.
- **Protection.** The Battalion HQ and Support Company will be co-located with an ICG which will provide incidental protection.
- **Quick Reaction.** The Battalion HQ at all times will maintain one Quick Reaction Team capable of executing special tasks. At each COB, a Platoon QRT will be maintained by respective companies to be employed by the Battalion HQ. The ICG co-located with the Battalion HQ will act as Quick Reaction Force.

**8.3.5 : Support Company.** The Support Company comprises 130 personnel consisting of eleven (11) Officers, twelve (12) Warrant Officers, fifty (50) Non Commissioned Officers and fifty seven (57) enlisted personnel. Being specialist in nature, all ranks of the company should be qualified in their respective functional specializations. The composition of the Support Company is given below:

- **Company HQ.** Responsible for providing operational support (with enablers) and logistics cover to the battalion under self-sustainment and coordinates the provisioning of UN mission support as per the MOU.
- **Mortar Platoon.** The platoon is equipped with six Infantry Mortars for providing indirect fire support and illumination cover to the battalion COBs. Based on the operational requirements and commander's appreciation, the mortar platoon may either be centrally kept or deployed at section level at COBs. The platoon operates under the Operations Staff Officer. At least 25 percent of Officers and WOs should be trained as Mortar Fire Controllers.
- **Engineer Platoon.** The Engineer Platoon operates under the Operations Staff Section. It provides and coordinates field engineering support to all COBs/TOBs and OPs, provides and maintains water supply and wastewater treatment systems, sets up solid waste (including hazardous) segregation areas, manages and provides electricity (static and generator based, including containment basins), maintenance of accommodation and allied infrastructure, emergency mine, IED and UXO clearance and provides engineering assistance to CIMIC/welfare activities as part of



outreach and engagement. The Engineer Officer will also act as “Engineer Adviser” to the battalion commander.

- **Reconnaissance and Surveillance Platoon.** The platoon operates under the Operations Staff Section. It has a specially trained Reconnaissance Section (which can also act as a special QRT) and a Surveillance Section with a tactical Unmanned Aerial Vehicle (UAV) and a communication monitor. The Surveillance Section coordinates the employment of Ground Surveillance Radars (GSR) and the miniature UAVs of the ICGs. The platoon activities are also coordinated with the SA Staff Section.
- **Logistics Platoon.** The platoon operates under the Logistics Staff Section. It comprises Logistics Section, Signal Section, Transport Section and a Field Workshop. It provides the sustainment and maintenance cover to the battalion and its subordinate units.
  - ★ **Logistics Section.** It coordinates provision and stocking of all categories of supplies, general stores, ordnance stores, ammunition, rations, and hygiene and sanitation stores.
  - ★ **Signals Section.** The section operates under the Communications Staff Section. It is responsible for establishing and maintaining unit and mission communication network as per SOPs and will handle the IED mobile jammer and the communications monitor at battalion level.
  - ★ **Transport Platoon.** Operates under the Operations and Logistics Staff Sections and provides technical assistance, recovery cover and dedicated drivers to support essential services. It also monitors the maintenance and repair of vehicles attached with the ICGs and ensures minimum serviceability standards.
  - ★ **Field Workshop.** The Field Workshop is responsible for providing the repair and recovery cover to the battalion (weapon, instruments, signal and engineer equipment, vehicles, etc.). It also coordinates the maintenance and repair of all small arms and equipment. It will provide Mobile Repair Teams to ICGs as required.

**Note:** All personnel of the Transport Section and Field Workshop should be qualified drivers (Dual Trade).
- **Medical Section.** The Battalion Level I Medical Clinic organization is based on the COE Manual 2011 Edition specifications, with an ability to deploy two Forward Medical Teams if required. For COBs that are deployed away from the support distance of the Battalion Level I Clinic, additional two paramedics/nurses may be included in accordance with



the MOU and operational requirements. The clinic functions under the Personnel Staff Section; it provides immediate life-saving medical support at the battalion level, ensures medical cover self-sufficiency of all ICGs and coordinates surface and air evacuation of casualty. It comprises two medical officers, six paramedics, three support staff (laboratory technician, dispenser and medical clerk) and an ambulance driver. The medical staff should have at least one each female medic and attendant. The section coordinates medical support and evacuation with the ICG Medical Detachment (one each of medic and attendant with an ambulance). The Level I Clinic may be required to provide medical assistance to civilian personnel in the AOR also. Depending on operational requirements, geographic separation and points of deployments, a UN Infantry Battalion may be grouped with an additional Level 1 medical facility.

**8.3.6 : Infantry Company Group (ICG).** An ICG comprises 165 personnel to include four (04) Officers, five (05) Warrant Officers, forty three (43) Non Commissioned Officers and one hundred and thirteen (113) enlisted personnel. The battalion may consist of either a three-company model or a four-company model, each with four platoons (1 x Mechanized Platoon and 3 x Motorized Rifle Platoons) and one Support Platoon with organic C3, fire power and mobility capabilities. With four Platoons, an ICG is able to undertake continuous and concurrent task-lines optimally to enhance the operational reach and visibility in the AOR. Based on the mission requirements and envisaged role, ICGs are responsive, adaptable, flexible and self-reliant up to the Section level in all respect. The important features of the ICG are:

- **Company HQ.** The Company HQ comprises the command post/Company Operations Centre, a Ground Surveillance Radar detachment and signals personnel. The Operations Centre will be mobile (motorized or wheeled APC based as per situation). It has the capability to acquire and process tactical information for augmenting situational awareness, conduct independent operations with logistics self-sustainment in the AOR and carry out effective outreach and engagement. The enhanced night vision and surveillance capabilities, effective communication systems and a balanced weapon profile of the ICG, optimizes the performance. The command responsibility will be exercised by the company commander. The company second-in-command, in addition to assisting the company commander, will also act as focal point/responsible for Outreach and Engagement, Situational Awareness, Gender, Child Protec-



tion, Environmental Issues, Company Welfare and Knowledge Management (database on Best Practices and Lessons Learnt).

- **Mechanized Platoon.** It acts as a rapid reaction platoon with protected mobility and firepower, complements motorized platoon operations where required, displays robust force capability and enhances operational presence and dominance in the company AOR.
- **Motorized Platoons.** Capable of undertaking robust mobile/on foot/Heli-transported operations with organic direct and indirect weapon systems and transport.
- **Support Platoon.** The Platoon HQ has an officer to coordinate the operational and logistics support of the company, aided by a Warrant Officer (Logistics) and a technical NCO. The Combat Support Section comprises a detachment of Medium Machine Gun (MMG) and Automatic Grenade Launcher (AGL) systems with mobile platform (Jeep based) and two Field Engineering/EOD specialists, provides operational support to the company. The Logistics Support Section provides the field kitchen; operation of water plants; provision and stocking of all types of supplies and ordnance stores; management of accommodation, ablutions and laundry; provision, maintenance and repair of the organic transport and provision of life-saving medical cover.

## 8.4 : Technology.

A capability-driven approach moves away from a “number-intensive” strategy to one that focuses on the skills, capacity and willingness of personnel, as well as high technology state-of-the-art equipment to deliver required results. Therefore, the significant developments in the field of military technology should reflect in the configuration of military components for the peacekeeping missions to gain operational advantage and enhance performance in the mission area. Details of some of the equipment that can augment peacekeeping performance are given in [Annex L](#) (Vol. II, p. 316 of the UNIBAM).

## 8.5 : Equipment Profile.

The suggested details of arms, instruments, equipment and stores for the UN Infantry Battalion is worked out with reference to the Contingent Owned Equipment Manual of 2011 and is laid out category wise with its



distribution to various tactical entities. These numbers have been established after due deliberations on the best practices and mission operational and logistics requirements.

However, the items and numbers suggested in the table are only for reference and do not replace the authorization given in the COE Manual. TCCs have the flexibility to adapt or modify the requirements during the MOU negotiation stage, based on the Status of Force Requirement. Equipment or stores that are not part of the current COE Manual may be provided by the TCCs. Some of the items which may not be available with certain TCCs, can be procured gradually, may be sourced through a bi-lateral arrangement with a third country, and/or may be provided by the UN on an interim basis as reflected in the MOU.

**Preventive Maintenance.** An infantry battalion should ensure high state of maintenance and serviceability of all weapons, instruments and equipment in the mission area. Poor maintenance and low serviceability (with resultant reduction in reimbursement) will adversely impact operational performance, particularly during critical times. Regular and periodic preventive maintenance, timely repairs and inspections by commanders at all levels will ensure optimum equipment readiness and performance.

**Note:**

- The UN Infantry Battalion organization is a suggested organization for planning and preparation purposes at the UN HQ, field missions and the TCCs. Actual force configuration will be based on the “Statement of Unit Requirements”, MOU Negotiations and operational imperatives of the specific mission concerned.
- Deployment of women as part of the battalion is particularly essential, for example, in areas affected by mass displacement, abductions, and conflict-related sexual violence.







### 8.5.1 : TABLE OF PERSONNEL.

SERIAL	NOMENCLATURE	BHQ	SUPPORT COMPANY	COMPANY TOTAL	COMPANY HQ	SUPPORT PLATOON	PLATOON TOTAL	PLATOON HQ	SECTION	GRAND TOTAL	REMARKS
PERSONNEL											
1	Officer @	19	11	04	03	01	0	0	0	46@	@ Tenable by both Officers and Warrant Officers
2	Warrant Officer @	08	12	05	0	01	01	01	0	40@	
3	NCO	27	50	43	05	09	07 (#08)	01 (#02)	02	249	# Mechanized Platoon
4	Private	06	57	113	04	11	24 (#26)	02	08	515	
5	Grand Total	60	130	165	12	22	32 (#35)	04 (#05)	10	850	
				4 x Companies			16 x Platoons		48 x Sections		

**Notes:**

- Rank Structure.** TCCs have flexibility to adjust the rank structure according to their organizational structure, but should ensure that the personnel have the requisite ability and are qualified in their respective fields. However, the minimum rank specified for Commanding Officer is Lieutenant Colonel, Company Commanders should be Major and Staff Officers should be Captains.
- Women Participation.** Adequate uniformed female military (or police personnel) should be included in the staff, interpreters and other operational and logistics duties of the battalion.
- Special Skills.** The battalion staff officers, Support Company command elements and personnel (Mortar, Engineer, Reconnaissance and Surveillance, Logistics (Signals, Transport and Workshop) and the Medical Platoons and Sections) should be qualified in their respective technical staff/operational role.
- Drivers.** Logistics and operational soldiers (other than specific personnel authorized in driver category) will double hat the responsibility of driving the vehicles on their charge. The battalion should train and test adequate personnel for driving skills.
- Communication.** All personnel should be able to operate communication equipments and have functional vernacular linguistic capability.
- NSE.** Concurrence of the UN for additional strength as part of NSE over and above the strength of 850 will be obtained.
- Interpreters.** In addition to six (06) military interpreters, each ICG and the battalion HQ will have four (04) local interpreters (total 20 local interpreters), who will also complement the outreach and engagement and situational awareness responsibilities.
- Working Dog.** The Military Police in Battalion HQ will have a working dog (specially trained for IED/ explosive detection).





### 8.5.2: TABLE OF EQUIPMENT.

SERIAL	NOMENCLATURE	BHQ	SUPPORT COMPANY	COMPANY TOTAL	COMPANY HQ	SUPPORT PLATOON	PLATOON TOTAL	PLATOON HQ	SECTION	GRAND TOTAL	REMARKS
1.	Rifle	30	90	120	07	12	25/27	01/03	08	600	
2.	Carbine/Auto Rifle	20	28	38	03	06	07/08	01/02	02	200	Personal Weapons as authorized
3.	Pistol	08	14	07	02	03	00/02	00/02	-	50	
4.	Crew Served Machine Gun	01	03	12			03		01	52	Light Machine Gun (up to 10 mm)
5.	Portable Rocket Propelled Grenade Launcher / Rocket Launcher	01	03	12			03		01	52	RPG / RL up to 84 mm
6.	Platoon Mortars			04				01		16	To be carried additionally if required (up to 60 mm)
7.	Crew Served Machine Gun			01		01				04	Medium Machine Gun With Day & Night Sight Vehicle/APC Mounted (11 – 15 mm)
8.	Automatic Grenade Launcher			01		01				04	<sup>1</sup> With Day & Night Sight Vehicle/APC Mounted
9.	Infantry Mortar		06							06	With Accessories
10.	Sniper System	01	01	01						06	<sup>1,3</sup>



SERIAL	NOMENCLATURE	BHQ	SUPPORT COMPANY	COMPANY TOTAL	COMPANY HQ	SUPPORT PLATOON	PLATOON TOTAL	PLATOON HQ	SECTION	GRAND TOTAL	REMARKS
ARMAMENTS & ACCESSORIES											
11.	Rifle Scope (Day)	01	03	12			03		01	52	1
12.	Rifle Scope (Night)	01	03	12			03		01	52	1
13.	Flare Gun	01	01	04			01	01		18	
14.	Range Finder		02	01						6	
15.	APCs Wheeled / Tracked			04	04					16	Armoured Personnel Carrier
15	Mobile Command post	01		01	01					05	Wheeled APC Based

**Remarks:**

- 1 Items if available in the TOE of the TCC Infantry Battalion Organization.
- 2 Items that may be used, only if host State permits the operational use.
- 3 Items which may not be paid through COE reimbursement if not authorized.
- 4 Beneficial to carry to the mission but not covered under the COE reimbursement.



SERIAL	NOMENCLATURE	BHQ	SUPPORT COMPANY	COMPANY TOTAL	COMPANY HQ	SUPPORT PLATOON	PLATOON TOTAL	PLATOON HQ	SECTION	GRAND TOTAL	REMARKS
ELECTRONIC EQUIPMENTS / INSTRUMENTS											
16.	Compass	02	10	22	02	04	04	01	01	100	
17.	Binoculars	05	12	22	02	04	04	01	01	105	
18.	Night Vision Devices	02	10	22	02	04	04	01	01	100	Man Portable
19.	Binocular / Spotter Scope	02	03	05	01		01			25	-Do- Tripod Mounted
20.	Night Observation Device	01	03	05			01			25	02 x Reserve Tripod Mounted
21.	GPS Man Portable	03	03	16			04	01	01	70	02 x Reserve
22.	GPS Vehicle Mounted									160	1 All Vehicles
23.	Electronic GPS Tracking System	01								01	1,2
24.	Video Conferencing System	01	02	01						07	1,3
25.	Surveillance Radars			01						04	1,2
26.	Sensors	02		02						10	1,2
27.	Tactical UAV	01								01	1,2
28.	Miniature UAVs			01	01					04	1,2
29.	Digital Camera	02	03	12			03		01	53	1,3
30.	Video Camera	01	02	04			01			19	1,3
31.	Search Light	03	03	26	02		04	01	01	110	02 x Reserve
32.	Flood Lights	04			04					20	04 x Reserve
33.	Thermal Imaging Ground System			01						04	1

**Notes:**

\* UAV's & Ground Surveillance Radars will be taken only if available with TCC's, \* For observation devices, GPS and range finders refer to Chapter 9, Annex E, required in the mission area and agreed upon in the MOU. Paragraph 62 of COE Manual.



SERIAL	NOMENCLATURE	BHQ	SUPPORT COMPANY	COMPANY TOTAL	COMPANY HQ	SUPPORT PLATOON	PLATOON TOTAL	PLATOON HQ	SECTION	GRAND TOTAL	REMARKS
<b>SIGNAL EQUIPMENTS</b>											
34.	Satellite Phone	02	02	02						12	3 01 Reserve
35.	Radio Stations	01	01	01						06	01 Reserve
36.	Exchange EPABX	01	01	01						06	Minimum 100 Lines
37.	Cell Phones @		03					01	01	120	4
38.	VHF Radios \$									110	
39.	HF Radios %									40	
40.	Telephones	10	10	5						40	1
41.	Monitor		01							01	1,2
42.	Ground to Air Communication Radio	02		01	01					06	Aviation Cell & COB to communicate with helicopter pilots

**Notes:**

- @ Cell Phones under TCC arrangements and where communication infrastructure is available in the mission area. (distribution - 48 x Sections, 16 x Platoons, 03 x Support Company, 1 x QRT, 28 x Officers, 20 x Special Appointments, 04 x Reserve).
- \$ VHF Radios Distribution - 48 x Sections, 16 x Platoons, 03 x Support Company, 01 x QRT, 5 x COB Exchanges, 28 x Officers, 5 x Special Appointments, 04 x Reserve.
- % HF Radios Distribution - 16 x Platoons, 03 x Support Company, 01 x QRT, 05 Company Exchanges, 05 x Command Net, 05 x Transport Platoon, 05 x Out Stations/Reserve
- # Signal communication monitor with battalion exchange for maintaining radio watch.
- \* In addition, UN will provide communication equipment as part of UNOE category as per at **Annex H** (Vol. II, p. 278 of the UNIBAM).



SERIAL	NOMENCLATURE	BHQ	SUPPORT COMPANY	COMPANY TOTAL	COMPANY HQ	SUPPORT PLATOON	PLATOON TOTAL	PLATOON HQ	SECTION	GRAND TOTAL	REMARKS
TRANSPORT											
43.	Jeep 4x4	05	06	06	02	03		01 (Mech Pl)		35	1
44.	Truck Utility / Cargo 2.5/5 Ton	02	05	12	01	01	03 (Per Pl 01 (Mech PL)		01 (x 3)	55	1
45.	Truck Utility / Cargo 7/10Ton	02	08	05		02		01 (Per Pl) (x 4)		30	
46.	Water Tanker		02	01		01				06	10,000 Litres
47.	Water Trailers		04	02		02				12	2000 / 7000 Litres
48.	Trailers Light		04	02		02				12	Medium Cargo
49.	Fuel Tanker		02							02	10,000 Litres
50.	Fuel Trailers		02	01		01				06	2000 - 7000 Litres
51.	Motor Cycle		01	01	01					05	1
52.	Recovery Light		01							01	
53.	Recovery Heavy		01	01		01				05	
54.	Repair Lorry		01							01	Truck Maintenance
55.	Engineer Tractors		01	01		01				05	Multipurpose
56.	Fork Lifts Light		01							01	
57.	Fork Lifts Heavy		01							01	



SERIAL	NOMENCLATURE	BHQ	SUPPORT COMPANY	COMPANY TOTAL	COMPANY HQ	SUPPORT PLATOON	PLATOON TOTAL	PLATOON HQ	SECTION	GRAND TOTAL	REMARKS
TRANSPORT											
58.	Ambulance Light		01							01	
59.	Ambulance Heavy		01	01		01				05	(APC Based)
60.	Refrigeration		02	01		01				06	Lorry
61.	APCs Recovery		01							01	
	Total	09	33	29	04	11	03/04	01/02	03	158	

**Notes:**

- Jeep & Truck Utility – Preferably include adequate number of Up Armoured and Mine protected Vehicles with facilities for mounting automatic weapon system as required.
- Modify all other troop carrying vehicles for protection against small arms fire and IED/Mine blast if the operational situation demands.
- One Jeep modified to accompany for battalion mobile command post.
- All vehicles to be fitted with a Radio and GPS.
- All vehicles to have hitch, tow and self-recovery facility (winch if available).
- Minimum 30 percent of the Battalion personnel should be trained, tested and qualified drivers, in addition to the Transport Section and Field Workshop Personnel of Support Company and the mechanics of the ICG's.



SERIAL	NOMENCLATURE	BHQ	SUPPORT COMPANY	COMPANY TOTAL	COMPANY HQ	SUPPORT PLATOON	PLATOON TOTAL	PLATOON HQ	SECTION	GRAND TOTAL	REMARKS
<b>ENGINEER EQUIPMENTS</b>											
62.	Remote Control Bomb Disposal Device		01							01	1
63.	Explosive Vapour Detector		01							01	
64.	Electronic Circuit Bomb Detector		01							01	
65.	IED Jammer		01							01	1 Neutralize IED
66.	Deep Search Mine Detector		02	01						06	
67.	Hand Held Metal Detectors		04	02						12	
68.	Exploider Dynamo									01	
69.	Prodders		04	02						12	
70.	Under Carriage Inspection Mirror		02	01						06	
71.	Assorted Explosives & Stores		30 KG							30 KG	Fuses, Cords, Devices



SERIAL	NOMENCLATURE	BHQ	SUPPORT COMPANY	COMPANY TOTAL	COMPANY HQ	SUPPORT PLATOON	PLATOON TOTAL	PLATOON HQ	SECTION	GRAND TOTAL	REMARKS
<b>ENGINEER EQUIPMENTS</b>											
72.	Bomb Disposal Suit & Equipments		01							01 Set	
73.	EOD Suit & Equipments		01							01 Set	
74.	Field Water Pumps		02	01						06 Sets	01 Reserve
75.	Field Defence Stores for COBs		01	01						06 Sets	
76.	Pioneer Tool Kit		01							01 Set	
77.	Chain Saw		02							02	
78.	Field Engineering Stores									05 Sets	Provided by UN
79.	Spike Belts		06	06						30	

**Notes:**

1. Engineer Section capable of Emergency Mine/UXO/IED clearance and Bomb/ Explosive Disposal.
2. Detection equipment at company level and neutralisation to be carried out by specialised personnel from Engineer Platoon or with assistance from the mission Mine Action Coordination Centre.
3. Field Engineering, water supply and capability to support Quick impact projects.
4. Vehicle mounted IED Jammer to accompany convoy as per operational requirements.





SERIAL	NOMENCLATURE	BHQ	SUPPORT COMPANY	COMPANY TOTAL	COMPANY HQ	SUPPORT PLATOON	PLATOON TOTAL	PLATOON HQ	SECTION	GRAND TOTAL	REMARKS
<b>GENERATORS &amp; ELECTRIFICATION</b>											
80.	51-75 KVA	02	03	* 03						17	* 4 x ICGs
81.	41-50 KVA		02							02	Level I Hospital
82.	31-40 KVA	@ 02	# 03	* 03						17	Reserve for TOBs Operational Base
83.	15-20 KVA	05	02	02						15	Towed / portable for mobile operations
84.	7.5-11 KVA	02	03	03						17	
85.	2.5-5 KVA	05	02	02						15	
86.	Electrical Accessories for COBs & Reserve									07 Sets	(Wires, holders, bulbs and other stores, flood lights)



SERIAL	NOMENCLATURE	CROWD/RIOT CONTROL EQUIPMENTS										REMARKS	
		SUPPORT COMPANY	COMPANY TOTAL	COMPANY HQ	SUPPORT PLATOON	PLATOON TOTAL	PLATOON HQ	SECTION	GRAND TOTAL				
87.	Megaphone											One Company Set and Three Platoon Sets	Public Announcement
88.	PA System												
89.	Tear Gas Launcher												
90.	Stun / Smoke Grenade												
91.	Protective Shield												
92	Elbow, Knee Shoulder protection												
93.	Helmet With Visor												Face Shield Ballistic
94.	Gas Mask												
95.	Baton												
96.	Signal Pistol/ Taser												
97.	Barricade Stores												



SERIAL	NOMENCLATURE	BHQ	SUPPORT COMPANY	COMPANY TOTAL	COMPANY HQ	SUPPORT PLATOON	PLATOON TOTAL	PLATOON HQ	SECTION	GRAND TOTAL	REMARKS
WATER STORAGE PUBLIC TREATMENT EQUIPMENT											
98.	Water Treatment Plants		01	01						05 Sets	1
99.	Water Treatment Devices	4		4						20 Sets	1
100.	500 Litres	5	4	4						25	
101.	1000 Litres	4	3	3						18	
102.	3000 Litres	2	2	2						12	
103.	Bladders	10	4	4						30	05 Reserve Vehicles
104.	Jerri Can		33	5						53	
FUEL OIL AND LUBRICANTS STORAGE											
105.	Barrels		30	15						90	
106.	Jerri Can		33	05	05					53	

**Note:**

Temporary accommodation/tents for living, storage, offices and miscellaneous purposes for the battalion should be catered.



SERIAL	NOMENCLATURE	BHQ	SUPPORT COMPANY	COMPANY TOTAL	COMPANY HQ	SUPPORT PLATOON	PLATOON TOTAL	PLATOON HQ	SECTION	GRAND TOTAL	REMARKS
MISCELLANEOUS STORES											
107.	Heliborne Operational Stores		01		01 Set		01 Set			05 Sets	As per operational requirement
108.	Fire Fighting Equipments	01	01	01						06 Sets	
109.	Field Kitchen	01	02	01						07 Sets	TCC Pattern
110	Laundry Equipment	01	01	01						06 Sets	
111.	Field Ablution Facility	01	01	01						06 Sets	
112.	Medical Equipments									01 Set	
113.	Containers	05	04	04						25	
114.	Tents/Portable Shelters									For complete battalion	TCC Pattern 1
115.	IT & Office Equipment									As Required	

**Note:** The battalion as a whole and ICGs independently must be equipped and fully self-sufficient in tentage for operational deployment away from static locations for specified number of days based on the operational situation, throughout the period of deployment. Necessary arrangements for portable small tents (pup tents/bivouacs) for small detachments will also be carried under TCC arrangement.



## 8.6 : Variants.

Based on the mission requirement and operational environments, a UN Infantry Battalion may be configured as a purely Mechanized Infantry Battalion or as a purely Motorized Infantry Battalion. The suggested organization for both these variants is appended at page 156 and 157:

## 8.7 : Conclusion.

The UN Infantry Battalion is configured with peacekeeping-oriented, task-organized, self-sustained and independent operational capabilities to optimize the personnel, equipment and capacity mix in accomplishment of the mandated objectives in a complex and multidimensional mission environment. An infantry battalion that is well resourced and adequately trained that is well resourced and adequately trained to carry out people friendly operations with dynamic and versatile battalion leadership can support the peace process in a significant manner.







8.6.1 : Variant - A (Heavy) UN MECHANIZED INFANTRY BATTALION ORGANIZATION.

Rank Structure	Weapons	Equipment
Officers 45	APCs 70	GS Radar 04
WO 45	Mortars 06	UAVs 01
NCOs 250	MMG 06	Tracker 01
Others 510	AGL 06	Vehicles 90
Total 850	ATGM 05	

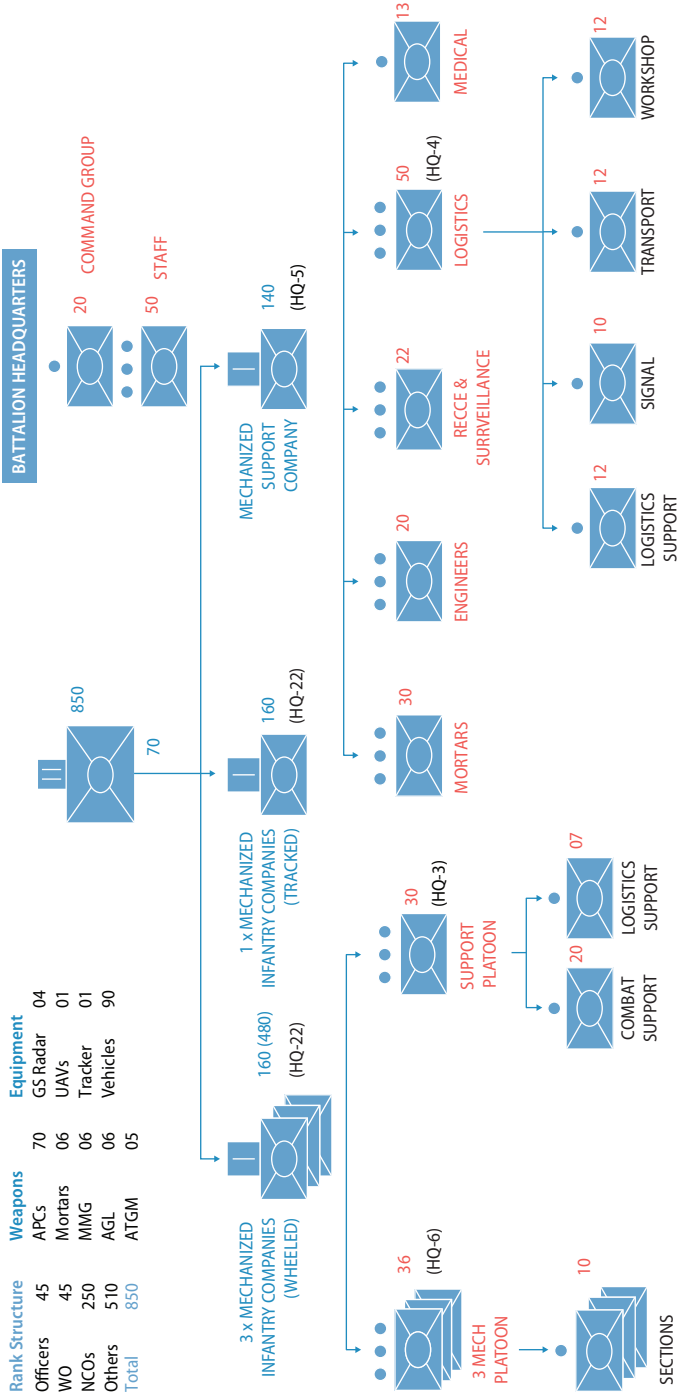



8.6.2 : Variant - B (LIGHT) UN INFANTRY BATTALION ORGANIZATION

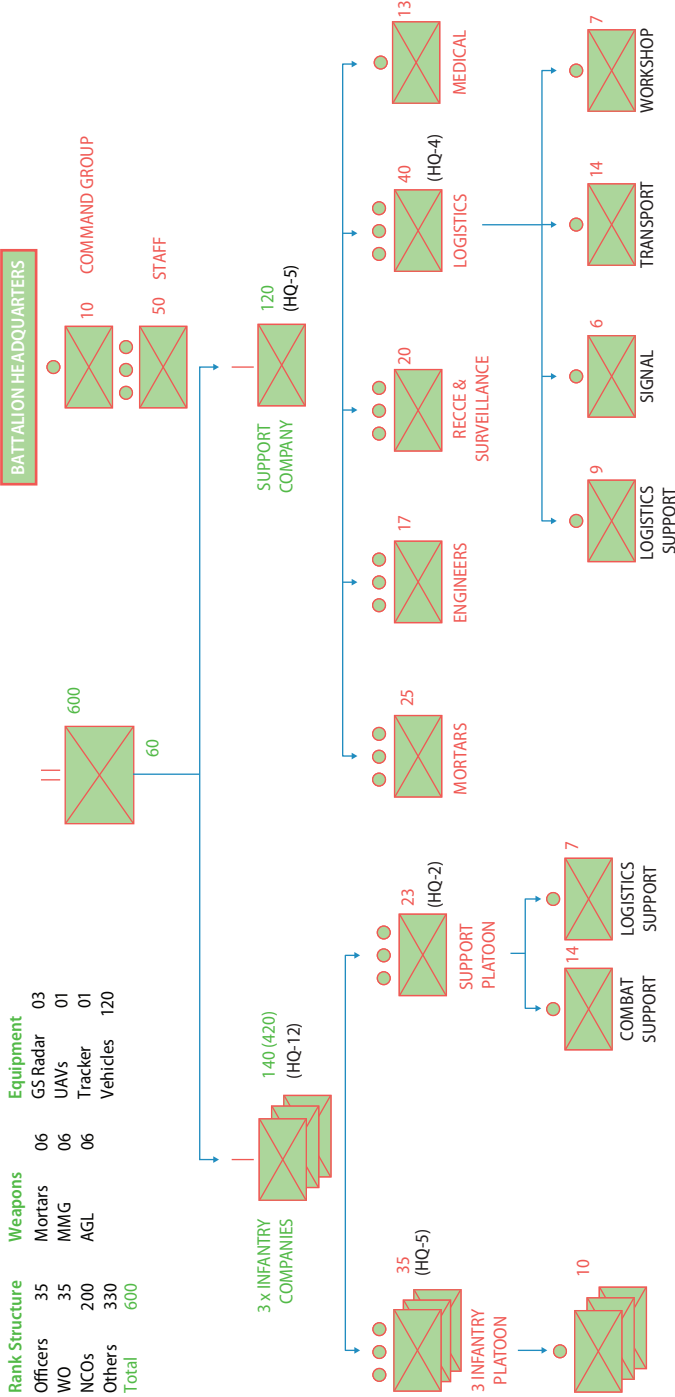







## Deployment

### 9.1 : Introduction.

The process of deployment begins with the selection of a TCC by the UN, which can supply a fully mission capable battalion for a UN peacekeeping operation and ends when a battalion repatriates to its country of origin. A battalion is considered either an initial entry battalion, which deploys with all equipment, or a rotational battalion that replaces another one already deployed with equipment in place/pre-positioned in the area of operation.

To support any TCC, DPKO/OMA has issued generic TCC Guidelines. This document, with inputs from other entities in DPKO and DFS, provides TCCs with information on administrative, logistics and political issues prior to deployment in a field mission.

### 9.2 : Purpose.

This chapter provides the input for the TCC and the battalion commander on what they should know, consider and act on, through the deployment phases following the selection. It consists of predeployment, deployment (including Transfer of Authority), re-deployment and repatriation.

### 9.3 : Deployment Timeline.

When selected, a deployment timeline is established and agreed through consultations between TCC and UN. The timeline is crucial, deploying the capabilities in concert with the operational needs. The timeline is closely monitored by DPKO and DFS.

### 9.4 : Predeployment.

**9.4.1 : TCC Force Generation.** A UN Infantry Battalion is configured and generated by the TCC in accordance with the SUR. It is envisaged that a TCC may generate the unit based on the following three primary configurations:

- **Priority I.** An organic Infantry Battalion with additional non-organic elements.



- **Priority II.** A mix of infantry subordinate units from several infantry units with additional non-organic elements.
- **Priority III.** An organic arm unit (non-infantry) with a mix of infantry personnel and other non-organic elements.

Considering the operational challenges and situational requirements, it is preferable to provide a cohesive, infantry based peacekeeping battalion. It is pertinent to note that the requirement projected through SUR is based on the premise that the TCCs will provide an organic infantry battalion duly augmented with additional elements as given in Priority I. Provision of a composite battalion (as given in Priority II and III) should be resorted to only in unavoidable circumstances.

**9.4.2 : Self-Sustainment and Reimbursement.** The Contingent Owned Equipment (COE) system was created to support TCCs that deploy units that can provide and maintain their own equipment, and be fully self sustaining in all of the categories explained in the COE manual. Rates are approved by the General Assembly to reimburse TCCs monthly for equipment and personnel.

**9.4.3 : TCC Reconnaissance (recce) and Final Equipment List.** When there is mutual agreement between the UN and the TCC on units to be deployed, in accordance with the SUR, a TCC recce to the mission area will be authorized and coordinated accordingly. A Policy Directive and an SOP on the subject explains the procedure to be followed in a TCC recce. It is expected that the TCC will initially bear the cost and be reimbursed by the UN, following deployment. A recce report should be agreed by both the field mission and the TCC. The field mission then submits the mutually agreed recce report to DPKO, which is followed by submission of the final equipment list by the TCC. DFS-MCMS will use the final equipment list as the basis of the draft MOU which will be negotiated at the UN HQ. Once a TCC military capability is deployed, there is no reimbursement by the UN for a subsequent relieving infantry battalion recce. It is strongly advised that every rotation is supported by a recce, giving the Battalion Commander the best pre-conditions possible.

**9.4.4 : Memorandum of Understanding (MOU) Negotiation Process.** The MOU Negotiation process begins after the Office of Military Affairs identifies a TCC, which has agreed to deploy its unit to a UN peacekeeping mission. These negotiations are conducted by a team from the TCC and concerned UN HQ staff from various departments and offices consisting of the experts in the field of Force Generation, the Logistics Support the DFS Field Budget



and Finance Division/MOU & Claims Management Section (FBFD/MCMS). FBFD/MCMS routinely process the claims for reimbursement of major equipment, self-sustainment, painting/repainting of major equipment, death and disability of contingent members (contingent troops and Staff Officers), and claims for LOA. MOU negotiations, and other meetings, are usually handled by this team, with OMA in lead. Normally, there is a separate MOU for each unit to be deployed.

The single reference for MOU negotiations is the COE Manual. The MOU consists of the main text and seven annexes, of which only Annexes A, B and C are negotiated. Annex A specifies the number of contingent troops in the unit, and includes the Soldiers Kit List; and it will mention any National Support Element (NSE) jointly agreed to by the UN and the TCC. Annex B covers all authorized major equipment. Annex C specifies all authorized and requested Self-sustainment categories. Annex G refers to the TCC Guidelines. It is essential that the representative(s) should be familiar with MOU/COE procedures before negotiations begin. The MOU is not an operational document and does not state operational requirements. Normally, the MOU process does not include the Battalion Commander.

**9.4.5. : Predeployment Visit (PDV).** After the MOU is signed and the training and preparations of the Infantry Battalion has commenced, a PDV is conducted by a team comprising key staff from DPKO/OMA, DFS and the mission. This team visits the TCC and verifies that the troops and equipment are up to the required UN standards. Shortfalls, if any, are indicated and commitment is sought from the TCC to rectify any deficiencies within a specified timeframe. The aim is to confirm that the major equipment to be deployed is in accordance with the negotiated MOU, and that the unit can meet the demands specified in the Statement of Unit Requirements. Prior to TCC departure, the PDV report should be agreed by the TCC and the PDV team. The PDV team also plays an advisory role in support of the TCC.

**Reference:**

- Policy Directive on Predeployment Visits (05/10/2005).

**9.4.6 : MOU Finalization.** Once the PDV is completed and any changes to the MOU are jointly accepted by the TCC and the Secretariat representatives, the MOU can be finalized by FBFD/MCMS. Annexes A, B and C of the MOU, will be reviewed in detail in the light of the conclusions and recommendations triggered by the PDV. MCMS internally circulates the final draft MOU to obtain concurrence from LSD and OMA. Once internal clearance is



complete, concurrence from the Permanent Mission of the TCC is sought. Finally, two originals of the final MOU are forwarded to the USG DFS for signature and onward transmission to the Permanent Representative of the Permanent Mission of the TCC for signature. TCCs are reimbursed “troop” costs with effect from their contingent’s arrival in the mission area, regardless of whether or not the MOU has been signed by the TCC. Reimbursement for major equipment does not start until the MOU has been signed, funds are available and the unit has effectively deployed with the negotiated equipment that will be verified upon arrival by the Mission’s COE Verification Team.

A change to the CONOPS, mission strength, and other factors can result in amendments to the MOU. Consultations between TCC and UN precede any amendment of the MOU.

## 9.5: Deployment.

**9.5.1: Load Planning Information.** TCCs have the option of having the UN arrange the deployment of their units’ personnel and equipment or, alternatively, arranging the deployment of their own personnel and/or equipment themselves under UN Letter of Assist (LOA). Should a TCC choose to arrange a deployment themselves, reimbursement is based on the lower figure of the TCC requested reimbursement or what it would have cost the UN to arrange (generally by commercial means). If the deployment is arranged by the UN, the DFS Movement Control Section (MOVCON) arranges the movement using a mode of transport (road, rail, sea or air) commensurate with practicality and the required deployment date.

The deployment of contingent personnel is usually done by air. The contracting process for UN arranged personnel or cargo movement, from the time accurate and workable cargo and passenger information is received from a TCC until a transportation asset is placed in a TCC home country, takes approximately 6 weeks. It is essential that the TCC provide an accurate General Cargo Load List, an accurate Dangerous Goods Load List, a confirmation on the number of contingent personnel to be deployed and a confirmation of equipment and personnel readiness to deploy before any contract action can be taken. It is important to note that any delay in receiving this essential information will result in a corresponding delay in the deployment.



**9.5.2 : Transfer of Authority.** When national contingents and military observers come under the control of a United Nations designated commander, the transfer of “operational authority” must be completed immediately. Generally, this transfer action occurs when uniformed personnel and units arrive in a mission area. If required, as dictated by operational necessities, the transfer of authority may be completed at a unit’s home station (before deployment in the area of operations) or at an intermediate staging base. However, the exact timing of the transfer of authority will be decided at the time of negotiations between United Nations and national authorities. Contributing Member States negotiate with UN HQ (DPKO-DFS) the specific date and location that the UN will assume ‘UN Operational Authority’ over their uniformed personnel and units.

TCCs are required to confirm, in an official communication to UN HQ (DPKO), when and where the transfer of ‘UN Operational Authority’ over their uniformed personnel units will occur, noting the composition and strength of groups or formed units. When UN ‘Operational Authority’ over uniformed units and personnel is withdrawn from the UN, the contributing Member State is again required to officially inform UN Headquarters (DPKO). The Operational Authority over Military and Police ‘Experts on Mission’, which includes Military Observers and Individual Police Officers/advisers, is considered to be automatically transferred to the UN when a contributed ‘Expert on Mission’ reports to the designated United Nations authority for his/her duties in the operational area of responsibility. The operational authority is reverted back to the respective national authorities on completion of assignment with the United Nations, or at the time of repatriation.

**9.5.3 : Handover.** Handing over of responsibility should be carefully planned and coordinated without compromising operational requirements. The considerations and modalities of handing over are described in Vol.II, Chapter 2, Section 2.15, Relief in Place and Reinforcement.

## **9.6 : Re-deployment.**

Re-deployment of a UN infantry Battalion may be carried out within a mission area or in adjacent mission area based on the operational requirements. The re-deployment might be temporary or definite. The process is the following:

- In-mission planning and consultation, and with adjacent mission when applicable.



- Force Commander coordinates the requirement with the UNHQ.
- Once coordination is finalized OMA will notify the Permanent Mission of the concerned TCC in New York.
- Handover to possible follow-on force and assuming responsibility of the new AOR.

In the new AOR, the battalion may move to existing UN compounds, or to entirely new camps. In either case, it is the responsibility of the DMS to ensure preparation of the camps, either before the move or after if the operational requirements demand an immediate deployment, and that logistic support will be organized in a proper manner.

The transport of the containers and COE will be organized by the Mission MOVCON and the battalion vehicles will usually move by organized convoys. The movement of the APC's and other heavier vehicles may be organized differently in order to save on engines hours and maintenance operations.

## 9.7 : Repatriation

The repatriation of a battalion may occur for a number of reasons. These include, amongst others:

- Decision by the Government of the TCC's to withdraw;
- Decision made by the UN Secretariat for either operational or disciplinary reasons, or because the PKO downsizing military component to prepare the transition to a stabilization or a political mission.

If the TCC elects to withdraw, the Secretariat receives the notification from the Permanent Mission of the TCC in New York. The Secretariat will then determine if a replacement unit is required and commence generation. Concurrently, it will liaise with the DMS/MOVCON to arrange the repatriation.

If the decision to repatriate emanates from the Secretariat, the latter handles the notification to the concerned Government and any subsequent discussion on the technicalities of the repatriation will commence. DMS/MOVCON will require at least six weeks for being able to put contracts in place for the movement of personnel and cargo back to the home country. Once agreed, the repatriation will follow a time line established by the mission.



In case, the Contingent wants to leave behind camp equipment it installed at a cost, and wishes to sell it to the UN, the negotiation will take place between the DMS and the representative designated by the Government. Likewise, selling unmovable infrastructure equipment to the relieving contingent (if it is contributed by a different TCC) stems from a bilateral agreement to be negotiated between both TCCs representatives.

Donating or selling COE to the host Government is a bilateral operation to be negotiated between the host Government and the TCC designated representatives. In any case, the Contingent Commander will take special care to ensure that waste management and any de-pollution operations are completed before the departure of the contingent.

## 9.8 : Battalion Deployment Checklist.

### 9.8.1 : Predeployment:

- Select and prepare troops and equipment in accordance with the SUR.
- Complete all documentation required well in time (TOE and staff list).
- Be well versed with the various documents pertaining to the preparation and deployment in the field.
- Preparation and conduct of recce.
- Ensure that all personnel and equipment are prepared and ready for the PDV, in accordance with DPKO requirements.
- Ensure that all deficiencies are met and all observations made by the PDV team are rectified prior to the move to the mission area.
- All packing is done as per specifications and accurate load lists are prepared in detail.

### 9.8.2: Deployment.

- Loading is done in time as per the agreed schedule.
- Personnel are ready for deployment with personal equipment, medical clearance, and up-to-date paperwork.
- Transfer of Authority to UN.
- Hand-over in mission, ensuring continuity of operations.

### 9.8.3 : Re-deployment.

- Arrange for a recce of the new AOR in the mission area.
- Receive the operational order from the higher HQ including necessary environmental background information. Establish liaison with existing UN entities and UN military units, if applicable.





- Ensure all necessary support will be ready for the new AOR: security conditions, accommodation, supplies, food, water, fuel, field defences, etc.
- Check on the conditions of transport of the COE and personnel (security, timing).
- In case the contingent (troops only) is replacing a previously deployed contingent from the same TCC, ensure that all documentation, including medical examination etc. is completed in all respects, well in time.
- Hand-over in mission, ensuring continuity of operations.

### 9.9 : Guidance to TCCs.

It is the responsibility of the TCC to ensure that each member of the UN Infantry Battalion it nominates has not been convicted of, or is not currently under investigation or being prosecuted for, any criminal offence, including violations of international human rights law or international humanitarian law. In the case of nominees who have been investigated for, charged with or prosecuted for any criminal offence but were not convicted, the National Government is requested to provide information regarding the investigation(s) or prosecutions concerned. The TCC is also requested to certify that it is not aware of any allegations against the nominated members that they have committed acts that may amount to violations of international human rights law or international humanitarian law.

Some of the additional points to be kept in mind are:

- TCCs are encouraged to familiarize themselves with UN systems and procedures in advance of making a pledge.
- When making pledges, TCCs are asked to provide as much detail of the equipment being offered as possible. This helps DPKO in making a more accurate assessment of the capabilities of the TCC.
- TCCs are encouraged to be as prepared as possible beforehand. They are given generic SURs to compare possible requirements and assets available. TCCs are encouraged to maintain constant liaison with DPKO regarding emerging requirements and are asked to keep OMA well informed about realistic timelines regarding approval of political/military leadership, procurement of equipment and availability for shipment to the mission area.
- TCCs are responsible for ensuring that selected personnel strictly adhere to the code of conduct and highest standards of professionalism and integrity.



- At times, TCCs are ready with the major equipment and manpower, but lack self-sustainment equipment such as field kitchens, ablution units, water purification plants, tents and shelters. Such deficiencies impact readiness and delay deployment to the field. Therefore, timely provisioning action for self-sustainment equipment is required.
- TCCs should endeavour to remain abreast of the existing/future capability gaps so as to make timely offers to the UN.
- TCCs with trained troops and ready resources often enjoy preference.

### Reference:

- UN ForceLink (<https://cc.unlb.org/>) MovCon tool for TCC deployments/rotation/repatriation.
- Generic TCC Guidelines, 2012.







## Training

### 10.1 : Introduction.

All UN peacekeeping training should be oriented toward, and contribute to improving mandate implementation. In order to ensure that all peacekeeping personnel have a common understanding of UN peacekeeping and are able to function in an integrated manner once deployed, the same principles and standards shall apply to both predeployment training delivered by Member States to military and police personnel and to training provided by the United Nations to peacekeeping personnel upon deployment.

Within the DPKO, the Integrated Training Service (ITS), as part of the Policy, Evaluation and Training Division (DPET), is responsible for providing peacekeeping training standards for all phases of training, based on departmental priorities and policies, lessons learned and best practices. It disseminates required standards to all peacekeeping training partners, including Member States and field missions.

Training of infantry battalions is a national responsibility. UN Infantry Battalions are normally regular or composite infantry units trained by the national training systems within the parameters set by the ITS/DPKO in consultation with Member States. Therefore, peacekeeping training is administered to an infantry unit already capable of undertaking a full range of tasks, in order to re-orientate its operational capacities to operate in a peacekeeping operational environment. The peacekeeping operational environment, which has an integrated framework with different components operating under a shared mandate and a set of objectives, will typically differ from the national (conventional operational environment) one. To address the issue up front in addition to this Manual, "Mission Specific Training Modules" have also been developed, which when applied to training will help transform/re-align a particular infantry battalion to the tasks/challenges with particular reference to peacekeeping operations.

### 10.2 : Purpose.

The purpose of this chapter is to provide an overview of the suggested methodology of conducting training of UN Infantry Battalions during the predeployment, induction and on-going phases, various steps, timings and standards that are currently in practice.



### 10.3 : Peacekeeping Training.

Broadly defined, peacekeeping training is any training activity which aims to enhance mandate implementation by equipping UN military, police and civilian personnel, both individually and collectively, with the knowledge, skills, and attitudes to enable them:

- To meet the evolving challenges of peacekeeping operations in accordance with DPKO/DFS principles, policies, and guidelines as well as lessons learnt from the field.
- To perform their specialist functions in an effective, professional, and integrated manner.
- To demonstrate the core values and competencies of the United Nations.

### 10.4 : Peacekeeping Training Phases.

Peacekeeping Training is divided in three phases:

**10.4.1 : Pre-Deployment Training (PDT).** PDT refers to generic, specialised, and where appropriate mission-specific peacekeeping training that is based on United Nations standards and takes place prior to deployment to field operations. This training is delivered by Member States to military and police personnel and formed units in their home country. For a UN Infantry Battalion, this is the most important and essential phase in which the unit should become proficient in peacekeeping techniques to deliver its operational outcomes in the field, preferably based on mission-specific aspects. In this phase, an infantry battalion re-orientates itself from conventional training to peacekeeping training aiming at achieving a high degree of readiness to be deployed in a peacekeeping mission.

**10.4.2 : Induction Training.** Induction training refers to training delivered to military, police and civilian personnel on arrival in peacekeeping missions. It is intended to supplement, the predeployment training. For an infantry battalion deployed in the mission, this phase should consist of a short orientation training of 1 to 2 weeks duration (depending on the time available for the component specific induction training). Such training is delivered by selected battalion training officers or key leaders who have already undergone a Training of Trainer (ToT) course organised by the Integrated Mission Training Cell (IMTC) prior to the induction training. The capacity of IMTCs to carry out the ToT course varies according to the mission.



**10.4.3 : Ongoing Training.** Ongoing training refers to any training or learning activity for military, police, or civilian peacekeeping personnel undertaken during their duty assignment, subsequent to induction. For a UN Infantry Battalion this phase may or may not be implemented depending on the availability of resources and time. Such training can take a form of maintenance of standards or remedial training (e.g. live firing exercises, scenario-based exercises). The Force Commander Training Directive is issued annually and provides mission-specific operational training guidance to deployed infantry battalions on how to address possible gaps and to reinforce existing capabilities. Joint training in the mission area is highly desirable to attain interoperability with other components (UN Police, civilians and other partners) and should also be an object of guidance from the Mission leadership.

## **10.5 : UN Infantry Battalion Training.**

Training for a UN Infantry Battalion is a national responsibility and may vary according to national peculiarities and resources. However, there are fundamental training characteristics that should be respected when preparing to deploy to a peacekeeping mission:

- Training should be realistic: all necessary efforts shall be fulfilled to replicate possible real situations that the battalion might face on the ground.
- Training should be mission-specific: there is a need to bring the mission operational reality to the training environment.
- Individual and collective training should be focused on interaction with different mission elements, mission partners and other actors present in the area of operations.
- Training methodology should be based on practice.
- Training should be undertaken exclusively based on applicable mission ROE.

Training on mission-specific aspects is essential to prepare the Unit for the challenges in the mission area. Therefore, all efforts should be made to incorporate, as much as possible, mission-specific aspects in the predeployment training phase. Mission-specific guidance can be obtained from documents issued by the OMA/DPKO (Statement of Unit Requirements and Guidelines to TCCs amongst others) and Integrated Training Service (Predeployment Information Packages), as well as by field missions (Force Commander Train-



ing Directive). A reconnaissance in the battalion AOR by the incoming battalion commander and staff is always recommended as an excellent means to bring mission-specific content to the battalion predeployment training.

### 10.6 : UN Infantry Battalion Training Programme.

A suggested training programme for a UN Infantry Battalion individual (commander, staff and key leaders) and collective (staff and troops) audiences is depicted below:

Home country				Mission area	
Pre-deployment					
Step 1	Step 2	Step 3	Step 4	Induction	On-going
Reinforcement on basic/ common infantry capabilities and skills as applicable to peacekeeping	Training on UN peacekeeping capabilities and skills	Training on mission-specific capabilities and skills  (Including scenario based training for sub units and below)	Conducting a battalion mission-specific field exercise	Battalion key leaders training of trainers course	* Training on scenario-based exercises for battalion staff  * Maintenance of capabilities and skills  * Training aiming at interoperability with other components  * Remedial training
Suggested Timings					
2 weeks	3 to 4 weeks	4 to 5 weeks	2 to 3 weeks	3 to 4 days	Unit tour of duty

These timings (approximately three months) are the basic minimum required for a fully trained conventional infantry battalion to train the battalion for developing peacekeeping operations orientation, prior to deployment. The assembling, grouping and equipping the battalion should be done prior to the minimum proposed period for predeployment training.

It is envisaged that, in total approximately 6 to 7 months will be required for a infantry battalion to train and prepare for the peacekeeping operations. Preferably, a UN Infantry Battalion, impending deployment, should have completed step 4, minimum a fortnight prior to actual deployment. The induction and on-going training in the mission area will be coordinated by the FHQ and guided by Force Commanders Training Directive.



## 10.7 : Training Standards.

Training for a UN Infantry Battalion shall observe and comply, as a minimum, with the existing UN training standards:

UN Training Standard	Audience	Objective	Remarks
<p><b>Core Pre-deployment Training Materials (CPTM)</b></p> <p><b>Unit 1</b> – A Strategic Overview of UN Peacekeeping</p> <p><b>Unit 2</b> - The Establishing and Functioning of UN Peacekeeping Operations</p> <p><b>Unit 3</b> - Effective Mandate Implementation</p> <p><b>Unit 4</b> - Standards, Values and Safety of UN Personnel</p>	<p>* Generic individual and collective training.</p> <p>* All peacekeepers, from the Battalion Commander to the enlisted soldier.</p>	<p>* To present the essential knowledge required by all peacekeeping personnel – military, police or civilian – to function effectively in a United Nations (UN) peacekeeping operation.</p>	<p>* This training package must be tailored to the needs of each battalion specific audience (Commander and staff; junior leaders; troops, etc.).</p> <p>* It is recommended to insert mission-specific content in the CPTM presentations and learning activities.</p>
<p><b>Specialised Training Materials for Military Staff Officers</b></p> <p><b>Module 1</b> - The Organization and Basic Staff Procedures In UN Mission HQ</p> <p><b>Module 2</b> - Legal Aspects of UN PK Operations</p> <p><b>Module 3</b> - Integrated Mission Planning Process (IMPP)</p> <p><b>Module 4</b> - Information Gathering</p> <p><b>Module 5</b> - Military Decision Making Process</p> <p><b>Module 6</b> - UN Logistics at Work</p> <p><b>Module 7</b> - Introduction to Crisis Management</p> <p><b>Module 8</b> - Staff Officers' Integrated Exercise</p>	<p>* Generic individual training.</p> <p>* Military Staff Officers at Force and Sector Headquarters</p>	<p>* To prepare individual military staff officers to perform in a complex field mission HQ.</p>	<p>* This training package contains all necessary contents to prepare individual staff officers for peacekeeping operations.</p> <p>* Battalion staff training on these materials would be highly beneficial.</p>
<p><b>Specialised Training Materials for UN Infantry Battalions</b></p> <p><b>Module 1</b> - CPX</p> <p><b>Module 2</b> - MONUSCO</p> <p><b>Module 3</b> - UNAMID</p> <p><b>Module 4</b> - UNMISS</p>	<p>* Mission-specific collective training.</p> <p>* Battalion Commander, Staff and Company Commanders</p>	<p>* To familiarize the Battalion Command element with specific mission operational aspects and to properly react to possible critical situations.</p>	<p>* This training package intends to prepare the Battalion Command and Staff elements to the challenges posed by complex operational environments in specific peacekeeping missions.</p>





## 10.8 : List of Relevant Training Documents.

Besides the training materials described in this chapter, the following list of training documents may be of value to infantry battalion commanders and their staff to better understand the peacekeeping training system, its participants' roles and responsibilities, and available resources.

**10.8.1 : Policy on Training for all United Nations Peacekeeping Personnel (2010).** This policy expresses the guiding principles and defines training roles, responsibilities and procedures in peacekeeping training.

**10.8.2 : Policy on Support to Military and Police Pre-deployment Training for UN Peacekeeping Operations (2009).** This policy defines peacekeeping standards, the provision of mission-specific information and training guidance, the process for training recognition, mobile training support teams and conducting of training of trainer's courses, and opportunities for information-sharing regarding peacekeeping training.

**10.8.3 : Guidelines on Roles and Training Standards for UN Military Staff Officers (2009).** These guidelines contain the core roles and skills of UN military staff officers and provide guidance to support the Heads of Military Components on the operational employment of military staff officers.

**10.8.4 : SOP on Training Recognition (2009).** This SOP gives clear guidance on how to request, review and provide official recognition of courses conducted by Member States.

**10.8.5 : SOP on Mobile Training Support Team (2009).** This SOP provides instructions for initiating, organizing and deploying UN mobile training support teams in order to direct support Member States military and police training.

**10.8.6 : SOP on Training of Trainers Courses (2009).** This SOP provides guidance on how to initiate, organize and conduct training of trainers' courses to support Member States and familiarising national trainers with new UN standards.

**10.8.7 : Predeployment Information Packages (PIP).** Mission-specific information will be contained in the PIPs, that are produced for each mission, to include useful information on the host country and mission information such as the mandate, the composition of the UN Country Team, conflict dynamics and culture.

### Reference:

- These documents are available at the Peacekeeping Resource Hub website: (<http://www.peacekeepingbestpractices.unlb.org/PBPS/Pages/Public/Home.aspx>).







## Operational Readiness and Self-evaluation

### 11.1 : Introduction.

Being the mainstay of multidimensional peacekeeping missions, a UN Infantry Battalion executes mandated tasks in a highly challenging and complex environment which often imposes tremendous operational constraints. To prepare and respond appropriately in pursuit of mission objectives in a professional and calibrated manner, it is imperative to maintain high standards of “Operational Readiness” by the battalion, including through “Self-evaluation”, amongst many other evaluation practices in vogue.

The operational readiness of a UN Infantry Battalion will encompass the synergistic capabilities of the conventional and peacekeeping standards; the tactics, techniques and procedures; the organization and equipment; training; morale, motivation and will; the responsiveness and leadership at all levels. Compliance with the minimum specified criteria and standards will contribute to high a state of operational readiness and help to project a more credible and deterrent posture, including the use of force in the mission area.

### 11.2 : Purpose.

This chapter lays down the methodology, structure and key evaluation criteria/standards required at the infantry battalion level. The “Self-evaluation” approach is built around the existing well-established practices of maintaining operational readiness and evaluation standards of the TCCs, combined with the UN policies and best practices to develop comprehensive peacekeeping oriented guidelines. It will be useful to DPKO planners, the mission leadership, TCCs and the Battalion Commander to organize, train, prepare, deploy and perform effectively on ground. The purpose of formalizing Operational Readiness and Self-evaluation is to assist the TCCs and Infantry Battalion Commanders to ensure operational readiness of a fully mission-capable and task-oriented battalion for peacekeeping operations for a specific mission by:

- Providing guidelines to the TCC and the Battalion Commander on the suggested methodology to carry out self-evaluation with measurable and quantifiable criteria and standards.



- Laying down measures to be taken during predeployment and in-mission evaluation.
- Providing timely evaluation to enable appropriate mid-course corrective actions well ahead of deployment.
- Facilitating planning, training and other preparations for peacekeeping operations.

### 11.3 : UN Assistance.

DPKO and the mission leadership play a supporting role to guide and facilitate achievement of operational readiness and also in conducting self-evaluation of the unit in the following manner:

**11.3.1 : DPKO.** DPKO (OMA & DFS) to promote self-evaluation, operational readiness and commitment to UN standards through the following measures:

- Guide, assist, facilitate or supplement TCC efforts in evaluation with a flexible and accommodative approach.
- Provide training assistance through the Integrated Training Service.
- Coordinate training and assistance through third party support.
- Conduct Predeployment Visit (for initial deployment only) to check availability and quality of equipment and to satisfy that provisions in the SUR/MOU are implemented.
- Provide Operational Advisory Teams of Military Planning Service/Office of Military Affairs to guide and assist emerging TCCs (for other TCCs assist on request).
- An independent senior level function in the DPKO will assist to assess and review the operational readiness and, monitor and report on the efficiency and effectiveness of the uniformed personnel in the implementation of mandated tasks, in compliance with UN policies, practices and standards.

**11.3.2 : Mission Leadership.** The mission leadership to coordinate and provide the following assistance:

- Inform TCCs on performance goals for the battalion, pre-deployment preparation requirements and mission-oriented training requirements.



- Coordinate pre-deployment reconnaissance, organize in-mission induction training through IMTCs, provide logistic support and lay down unambiguous operational tasks, roles and responsibilities for the battalion.
- Maintain ROE standards and coordinate additional operational mission support to the battalion.
- Carry out in-mission operational performance and logistics capability evaluation of the battalion, as and when required.
- Guide and support TCC and the battalion to improve shortfalls and adopt mid-course corrections and take actions at respective mission hierarchy on evaluation findings.
- Facilitate rotation schedules and smooth transfer of authority of operational role.

#### 11.4 : Self-evaluation Foundations.

In addition to the UN Infantry Battalion Manual, the following UN peace-keeping documents provide guidelines and standards with which infantry battalions are to comply for the self-evaluation and operational readiness:

- TCC Specific UN Peacekeeping Operations Manuals, Guidelines and SOPs.
- Mission Mandate, Memoranda of Understanding, Status of Forces Agreement and Rules of Engagement.
- Statement of Force/Unit Requirement issued by OMA.
- Mission Concept of Operations, Operational Directives and Orders, Operational Plans, SOPs and mission-specific case studies, etc.
- Generic Guidelines for Troop-Contributing Countries Deploying Military Units (2012), the COE Manual 2011 and Guidelines on the Peacekeeping Training (2011).
- Lessons Learnt and Best Practices of current and past peacekeeping missions.
- Information obtained during the Battalion Command Group reconnaissance visit and feedback from the unit being relieved.
- After Action Reports and End of Assignment Reports of units and various commanders.



## 11.5 : Methodology.

These guidelines are adaptable and to be used in consonance with the respective TCC military ethos, tradition, professional values and standards which cumulatively lay the foundation for achieving the mandated tasks in a mission area.

- **Functional Specializations.** A UN Infantry Battalion is expected to have a blend of three well-defined, comprehensive and self-sufficient functional specializations prior to deployment in a mission area. Firstly, it should have achieved a high level of basic infantry skills and operational capability at the conventional level; secondly, the battalion should specialize in UN peacekeeping generic aspects through reorientation and specific peacekeeping skill development; and thirdly, it should develop mission-specific, task-oriented expertise and capabilities. The synergistic capability and the optimal application of these three elements, comprehensively and collectively, contribute to mission effectiveness. Weakness in any one of these functional areas will adversely affect the performance of the battalion in the field.
- **Parameters.** The benchmarks for self-evaluation are based on measurable and quantifiable criteria and standards which are specific, achievable, realistic and time bound in nature.
- **Dedicated Team.** Training, preparing and maintaining operational readiness is a command responsibility. However, the battalion should be assisted by a dedicated team earmarked by the TCC for carrying out the training and support evaluation (e.g., a nominated field formation HQ, national peacekeeping training centre or national peacekeeping experts or practitioners).
- **Graduated Evaluation.** The evaluation may be conducted in a graduated manner in level (individual soldier–staff–commanders) and in activity (crew-section-platoon-company-battalion) in a task oriented manner to systematically build expertise and integrate capabilities for synergistic application.
- **Resources.** Adequate resources in terms of training area, trainers, ammunition for live firing, equipments/instruments for training akin to the mission environment will augment operational readiness.
- **Two Way Process.** The guidelines not only facilitate self-evaluation, but also act as a tool for the TCC and the battalion commander to take meas-



ures to plan, procure, train and provide the necessary support to the battalion.

- **Means of Evaluation.** The UN policies, directives, SOPs and guidelines; checklists on criteria and standards; informal assessments and formal evaluation through live firing, rehearsals and exercises are some of the suggested means.

## 11.6 : Foundations and Precursors that Assist Self-evaluation.

**11.6.1 : Predeployment.** Self-evaluation is a continuous and concurrent process in which the command element is expected to institute measures and build the organizational capacities to achieve the desired mission-specific capability through well defined means. It is assumed that an infantry battalion is well trained and assessed in basic military skills and conventional offensive and defensive tactics, techniques and procedures against specific national military standards prior to concentration for peacekeeping orientation training. An infantry battalion may undertake the following activities prior to the DPKO organised Predeployment Visit:

- Ensure timely assembly, grouping, and equipping of the infantry Battalion as per SUR and MOU.
- Conduct mission-specific scenario-based peacekeeping training.
- Develop mission-specific; task oriented, individual and collective expertise and capabilities.
- Identify shortcomings and institute remedial measures to support enhancement of capabilities.
- Utilise trainers and experienced peacekeepers from battalions that have recently returned to the country to train the new battalion awaiting deployment.
- Develop operational coherence through graduated integration through Company level task-oriented exercise, leading to UN peacekeeping operations command post rehearsals/exercises (including staff exercises) and culminating in battalion level collective rehearsals/exercise.
- Carry out timely adjustments/mid-course corrections.
- Final pre-deployment rehearsal of the entire battalion by national peacekeeping experts under TCC arrangements with role playing.





- Ensure continuation of training of rotation troops waiting at home country for deployment to the mission area.

**11.6.2 : In-mission.** Suggested methodology of maintaining operational readiness and carrying out self-evaluation are:

- Terrain familiarization, induction training and task-oriented rehearsals.
- Preferably carry out the first in-mission evaluation in the second month of deployment to validate and match the standards achieved prior to the deployment and operational performance in the mission in respective tasks, roles and responsibilities. This can be followed by quarterly/half yearly evaluations as per mission norms.
- Continuous and simultaneous monitoring and review of performance in-mission by the battalion command element and mission leadership is vital to maintain excellence.
- Identify the probable weak segments and institute periodic selective evaluations to administer corrective actions.
- Reassess the capabilities and skills when the mission operational situation changes or when there is a gap in ground reality and performance.
- Take particular note of clearly visible performance capability gaps during critical times and adverse situations and address them instantaneously.
- Validate key appointments in command and staff channel to match responsibility and potential, and provide guidance and support where required.
- Visit by TCC team from capital, comprising military officials and peace-keeping experts to monitor and validate unit performance.

## **11.7 : Self-evaluation Parameters.**

**11.7.1. Structure.** An infantry battalion's operational readiness can be evaluated based on distinct parameters like organizational structure, operational standards, the capability to perform mission essential tasks and non-military mission tasks, standards achieved in training, administrative and logistic standards, etc. This evaluation will address different levels within the battalion to include individuals, task oriented groups, sub-units, staff, commanders (section to battalion commanders) and analyze the task-oriented activities at the Section, Platoon, Company and Battalion HQ level. To assist this process, a comprehensive and consolidated peacekeep-



ing specific checklist for commanders is given in Section 3.5, p. 188, Chapter 3, Vol. II of the UNIBAM.

**11.7.2 : Predeployment Self-evaluation.** The suggested major determining factors (key pointers) for evaluation of operational readiness of an Infantry Battalion is summarized and given below:

Serial	Determining Factors	Evaluation	Remarks
a	<b>Conventional Skills.</b> Are all personnel (soldiers, staff and commanders) of the battalion trained and capable of performing basic infantry skills and conventional offensive and defensive, day and night, all weather operations in accordance with the national standards prior to the deployment in the mission area?		
b	<b>Generic Peacekeeping Skills.</b> Are all personnel (soldiers, staff and commanders) of the battalion trained on and sensitized to the generic policy guidelines and directives of conducting peacekeeping operations? Do they demonstrate a clear understanding of these guidelines and directives?		
c	<b>Mission-specific Peacekeeping Skills.</b> Are all personnel (soldiers, staff and commanders) of the battalion trained, equipped and organized to perform mission essential tasks as per peacekeeping norms?		
d	<b>Organization.</b> Is the unit organized in task oriented groups with support structure as per the force requirement?		
e	<b>Leadership.</b> Is the battalion chain of command capable, responsive and made accountable to deliver in a peacekeeping environment?		
f	<b>Staff.</b> Is the Battalion staff integrated, trained and capable of planning, organizing, coordinating and directing the multifaceted operational and non-operational tasks of the battalion in the peacekeeping environment?		
g	<b>Capabilities.</b> Does the unit maintain required standards in core capability functions of C3, mobility, firepower, tactical information, interoperability, civil interaction, logistic sustainment and force protection?		
h	<b>Training.</b> Has the Battalion undertaken peacekeeping-oriented and mission-specific training and achieved requisite standards as per UN guidelines?		
i	<b>Resources.</b> Is the unit carrying or in possession of the required number of personnel, arms, ammunition, equipment, accessories, spares, unit stores and expendables as per MOU and mission requirements?		



Serial	Determining Factors	Evaluation	Remarks
j	<b>Equipment Management.</b> Does the unit maintain minimum serviceability state of 90 percent and has the capability to organize preventive maintenance and repair/recovery in situ?		
k	<b>Weapons, Instruments &amp; Vehicles.</b> Are all weapons zeroed, instruments calibrated, vehicles maintained and inspected and certified for correctness and functionality as per required standards?		
l	<b>Logistics.</b> Are the COBs configured for independent and self-sustained logistics capability (food, water, accommodation, hygiene & sanitation, transport, medical, etc.)?		
m	<b>Medical.</b> Do all the personnel meet the requisite medical standards and have been inoculated as per mission requirements?		
n	<b>Integrity.</b> Are all members of the unit aware of applicable UN rules, regulations, and code of conduct and have demonstrated the highest standard of professionalism and integrity?		
o	<b>Morale and Motivation.</b> Are the troops well motivated to operate in a complex, restrictive, multinational and multidimensional environment and maintain high morale?		
p	<b>Welfare.</b> Does the unit maintain high standards of troop welfare as per national standards and mission requirements?		
q	<b>Legal.</b> Do the unit personnel and commanders clearly understand the responsibility to adhere, promote and protect the legal framework for UN Peacekeeping Operations with specific reference to SOFA/SOMA, ROE, Human Rights and Humanitarian Law, other relevant international legal statutes and the host national law?		
r	<b>Evaluation.</b> Has the unit carried out a formal self-evaluation of the battalion, have shortcomings been rectified, and have the TCC authorities certified the unit to be fit for deployment in the mission on time?		



**11.7.3 : In-mission Evaluation Parameters.** In addition to the determining factors mentioned in the preceding table, the battalion commander will have the following determinants in the mission area:

Serial	Criteria	Evaluation	Remarks
a	<b>Performance.</b> Does the unit perform all the mission essential tasks effectively as per peacekeeping norms and mission SOPs?		
b	<b>Shortcomings.</b> Has the unit taken remedial/corrective actions on shortcomings/gaps in performance/resources observed by the unit, COE team or the mission leadership?		
c	<b>On The Job Training.</b> Does the chain of command institute measures for on the job training of all personnel to maintain qualitative performance?		
d	<b>In-mission Training.</b> Is the Battalion carrying out periodic in-mission refresher, task oriented and mission-specific training as per IMTC guidelines?		
e	<b>Serviceability.</b> Is the unit carrying out preventive maintenance and repairs in time and replace items which are unserviceable?		
f	<b>Conduct and Discipline.</b> Does the unit continue to maintain high standards of conduct and discipline of all ranks?		
g	<b>Outreach and Engagement.</b> Has the unit been able to establish good rapport and effective interface with the local population through CIMIC, QIP and welfare activities?		

## 11.8 : Conclusion.

TCCs should streamline and formalize procedures and methodology to carry out their own evaluation and develop detailed standards and checklists, focusing on the peacekeeping operational and logistics preparedness, set against the expected UN standards and assess the correct level of readiness of the unit. Gaps in capabilities should be addressed at the apex level expeditiously and meaningfully to ensure timeliness and effectiveness of the force being deployed. Constraints in terms of finance/budget, infrastructure, equipment, specialised personnel and/or operational training should be addressed gradually within the national capacities or with support of a third party to meet the mission requirements. Where possible, the UN will also complement the effort of the TCC in meeting the standards. A realistic, honest and transparent evaluation by the TCC will ultimately contribute in deploying a fully mission capable battalion to a mission area.



United Nations Infantry Battalion:  
Protection, Peace and Prosperity

