

TECHNICAL MANUAL

ENGINEERING AND DESIGN
OF
MILITARY PORTS

This copy is a reprint which includes current
pages from Change 1.

HEADQUARTERS, DEPARTMENT OF THE ARMY
FEBRUARY 1983

REPRODUCTION AUTHORIZATION/RESTRICTIONS

This manual has been prepared by or for the Government and, except to the extent indicated below, is public property and not subject to copyright.

Copyrighted material included in the manual has been used with the knowledge and permission of the proprietors and is acknowledged as such at point of use. Anyone wishing to make further use of any copyrighted material, *by itself and apart from this text*, should seek necessary permission directly from the proprietors.

Reprints or republications of this manual should include a credit substantially as follows: "Department of the Army USA, Technical Manual TM 5-850-1, Engineering and Design of Military Ports, 15 February 1983."

If the reprint or republication includes *copyrighted* material, the credit should also state: "Anyone wishing to make further use of copyrighted material, *by itself and apart from this text*, should seek necessary permission directly from the proprietors."

CHANGE

No. 1

HEADQUARTERS
DEPARTMENT OF THE ARMY
WASHINGTON, DC, 11 March 1985

ENGINEERING AND DESIGN OF MILITARY PORTS

Changes have been made to correct dates and titles of referenced publications, and to update office symbols.

TM 5-850-1, 15 February 1983, is changed as follows:

1. New or changed material is indicated by a star.
2. Remove old pages and insert new pages as indicated below:

<i>Remove pages</i>	<i>Insert pages</i>
1-1	1-1
A-1	A-1
Bibliography-1	Bibliography-1

3. File this transmittal sheet in front of the publication for reference purposes.

The proponent agency of this manual is the Office of the Chief of Engineers, United States Army. Users are invited to send comments and suggested improvements on DA Form 2028 (Recommended Changes to Publications and Blank Forms) directly to HQDA (DAEN-ECE-G), WASH DC 20314-1000.

By Order of the Secretary of the Army:

Official:
DONALD J. DELANDRO
Brigadier General United States Army
The Adjutant General

JOHN A. WICKHAM, JR.
General United States Army
Chief of Staff

Distribution:

To be distributed in accordance with DA Form 12-34B requirements for TM 5-800 Series: Engineering and Design for Real Property Facilities.

**ENGINEERING AND DESIGN
 OF
 MILITARY PORTS**

CHAPTER		<i>Paragraph</i>	<i>Page</i>
1.	INTRODUCTION		
	Purpose and scope.....	1-1	1-1
	Changes	1-2	1-1
	Justification	1-3	1-1
	General design principles	1-4	1-1
2.	PORT SITE SELECTION		
	Basic port site selection considerations.....	2-1	2-1
	Factors affecting site selection	2-2	2-1
3.	LAYOUT OF HARBOR FACILITIES		
	Harbor entrance.....	3-1	3-1
	Breakwaters.....	3-2	3-2
	Jetties	3-3	3-2
	Anchorage basins.....	3-4	3-2
	Berthing basins.....	3-5	3-4
	Turning basins.....	3-6	3-4
4.	SITE INVESTIGATION		
	Background data	4-1	4-1
	Hydrographic and topographic surveys	4-2	4-2
5.	COASTAL PROTECTION		
	Shoreline stabilization.....	5-1	5-1
	Waves and wave pressures	5-2	5-2
6.	PIER AND WHARF LAYOUT		
	Introduction.....	6-1	6-1
	Deck structures	6-2	6-1
	Transit shed	6-3	6-2
	Approaches	6-4	6-3
	Roll-on/roll-off ramps	6-5	6-3
	Transportation facilities.....	6-6	6-3
7.	LIVE-LOAD REQUIREMENTS		
	Vertical loads	7-1	7-1
	Lateral loads	7-2	7-1
	Longitudinal loads.....	7-3	7-2
	Loading combinations.....	7-4	7-2
8.	STRUCTURAL DESIGN		
	Structural types	8-1	8-1
	Deck structure design	8-2	8-1
	Substructure design	8-3	8-2
	Miscellaneous considerations.....	8-4	8-2
9.	FENDER SYSTEMS		
	Function.....	9-1	9-1
	Types.....	9-2	9-1
	Selection of type	9-3	9-4
	Design procedure	9-4	9-5
10.	MOORING DEVICES		
	Types.....	10-1	10-1
	Capacity and spacing	10-2	10-1
	Anchorage	10-3	10-1
11.	DOCKSIDE UTILITIES FOR SHIP SERVICE		
	Water service	11-1	11-1
	Electric power.....	11-2	11-1
	Location and numbers of service points	11-3	11-1
	Miscellaneous.....	11-4	11-1
12.	CARGO HANDLING FACILITIES		
	Cargo transfer between dock and vessel.....	12-1	12-1
	Cargo handling in the shed and storage areas	12-2	12-6

*This publication supersedes TM 5-850-1, 1 July 1965

	<i>Paragraph</i>	<i>Page</i>
13. CONTAINER PORTS		
Planning.....	13-1	13-1
Types of container operations.....	13-2	13-2
Container handling equipment.....	13-3	13-2
Expedient container piers.....		13-4
APPENDIX A. References.....		A-1
B. Surfacing Requirements for Container Storage and Marshaling Areas.....		B-1
BIBLIOGRAPHY		BIBLIOGRAPHY-1

FIGURES

Use of Offset Breakwater Heads to Shelter Entrance.....	3-1	3-3
Unified Soil Classification.....	4-1	4-3
Wave Characteristics.....	5-1	5-4
Deepwater Wave Forecasting Curves (for fetches of 1 to 1,000 miles).....	5-2	5-5
Deepwater Wave Forecasting Curves (for fetches of 100 to more than 1,000 miles).....	5-3	5-6
Forecasting Curves for Shallow-Water Waves (constant depth = 5 feet).....	5-4	5-7
Forecasting Curves for Shallow-Water Waves (constant depth = 10 feet).....	5-5	5-8
Forecasting Curves for Shallow-Water Waves (constant depth = 15 feet).....	5-6	5-9
Forecasting Curves for Shallow-Water Waves (constant depth = 20 feet).....	5-7	5-10
Forecasting Curves for Shallow-Water Waves (constant depth = 25 feet).....	5-8	5-11
Forecasting Curves for Shallow-Water Waves (constant depth = 30 feet).....	5-9	5-12
Forecasting Curves for Shallow-Water Waves (constant depth = 35 feet).....	5-10	5-13
Forecasting Curves for Shallow-Water Waves (constant depth = 40 feet).....	5-11	5-14
Forecasting Curves for Shallow-Water Waves (constant depth = 45 feet).....	5-12	5-15
Forecasting Curves for Shallow-Water Waves (constant depth = 50 feet).....	5-13	5-16
Types of Pier and Wharf Layouts.....	6-1	6-5
Various Widths of Apron for Different Operating Conditions.....	6-2	6-6
Open-Type Wharf Construction with Concrete Relieving Platform on Timber Piles.....	8-1	8-4
Open-Type Wharf Construction with Concrete Relieving Platform on Steel Pipe Piles.....	8-2	8-5
Open-Type Wharf Construction with Concrete Relieving Platform on Concrete Piles.....	8-3	8-6
Open-Type Wharf Construction with Concrete Relieving Platform on Caisson Piles.....	8-4	8-7
High-Level Open-Type Wharf Construction with Concrete Deck on Timber Piles.....	8-5	8-8
High-Level Open-Type Wharf Construction with Concrete Flat Slab Deck on Steel Pipe Piles.....	8-6	8-9
High-Level Open-Type Wharf Construction with Concrete Deck on Steel Pipe Piles.....	8-7	8-10
High-Level Open-Type Wharf Construction with Concrete Deck on Precast Prestressed Concrete Caisson.....	8-8	8-11
High-Level Open-Type Wharf Construction with Precast Concrete Deck on Concrete Piles.....	8-9	8-12
High-Level Open-Type Wharf Construction with Concrete Deck on Prestressed Concrete Beams-Steel Pipe Piles.....	8-10	8-13
Solid Fill-Type Wharf Construction with Steel Sheet Pile Bulkhead.....	8-11	8-14
Solid Fill-Type Wharf Construction with Steel Sheet Pile Bulkhead and Relieving Platform Anchor.....	8-12	8-15
Solid Fill-Type Wharf Construction with Circular Steel Sheet Pile Cells.....	8-13	8-16
Solid Fill-Type Wharf Construction with Cellular Steel Bulkhead.....	8-14	8-17
Solid Fill-Type Wharf Construction with Reinforced Concrete Crib Wharf.....	8-15	8-18
Timber Deck Structure.....	8-16	8-19
Typical Expansion Joint Detail.....	8-17	8-20
Timber Pile-Fender Systems.....	9-1	9-10
Energy-Absorption Characteristics of Conventional Timber Pile Fenders.....	9-2	9-11
Hung Timber Fender System.....	9-3	9-12
Typical Retractable Fender Systems.....	9-4	9-13
Resilient Fender System (spring rubber bumper).....	9-5	9-14
Resilient Fender System (rubber-in-compression).....	9-6	9-16
Load-Deflection and Energy-Absorption Characteristics (radially loaded cylindrical rubber dock fenders).....	9-7	9-16
Load-Deflection and Energy-Absorption Characteristics (radially loaded rectangular rubber dock fenders).....	9-8	9-17
Load-Deflection and Energy-Absorption Characteristics (axially loaded cylindrical rubber dock fenders).....	9-9	9-18
Resilient Fender System (rubber in shear) by Raykin.....	9-10	9-19
Load-Deflection and Energy-Absorption Characteristics of Commercially Available Raykin Buffers.....	9-11	9-20
Typical Lord Flexible Fender Systems.....	9-12	9-22
Load-Deflection and Energy-Absorption Characteristics of Lord Flexible Fender.....	9-13	9-23
Rubber-In-Torsion Fender.....	9-14	9-24
Yokohama Pneumatic Rubber Fenders (jetty and quay use).....	9-15	9-25
Yokohama Pneumatic Rubber Fenders (dimension of jetty at the time of installation).....	9-16	9-26
Yokohama Pneumatic Rubber Fenders (this size used for berthing 5,000-to 20,000-ton ships).....	9-17	9-27
Yokohama Pneumatic Rubber Fenders (this size used for berthing 25,000-to 200,000-ton ships).....	9-18	9-28
Suspended Fender.....	9-19	9-29
Resilient Fender System (dashpot).....	9-20	9-30
Floating Camel Fenders.....	9-21	9-31

FIGURES

	<i>Paragraph</i>	<i>Page</i>
Single and Double Bitt Bollards	10-1	10-1
Plan and Elevation Views of a Corner Mooring Post	10-2	10-2
Plan and Elevation Views of an Open Wide-Base Cleat	10-3	10-2
Typical Chocks	10-4	10-3
Typical Pad Eye	10-5	10-3
Typical Power Capstan	10-6	10-4
Typical Releasing Hook	10-7	10-4
Typical Layout of Mooring Devices	10-8	10-5
Typical Water-Supply Connection in Deck of Pier	11-1	11-2
Burton System	12-1	12-4
Typical Heavy Duty, Rubber-Tired Gantry Crane	12-2	12-5
Typical Rail-Mounted Gantry Crane	12-3	12-6
Fixed Derrick	12-4	12-7
Container Off-Loading Through the use of Crawler-Mounted Cranes	12-5	12-8
Crane Capacities	12-6	12-9
Recommended Container Storage and Marshaling Area	13-1	13-3
LARC LX	B-1	B-8
Shoremaster	B-2	B-8
Clark 512	B-3	B-9
Belotti B67b	B-4	B-9
Hyster H620B	B-5	B-10
LeTro-Porter 2582	B-6	B-11
Lancer 3500	B-7	B-11
Travelift CH 1150	B-8	B-12
P&H 6250-TC	B-9	B-13
LeTro Crane GC-500	B-10	B-14
M52 Tractor-Trailer	B-11	B-15
CBR Required for Operation of Aircraft on Unsurfaced Soils	B-12	B-16
Flexible Pavement Design Curves for LARC LX (amphibian)	B-13	B-17
Flexible Pavement Design Curves for Shoremaster (straddle carrier)	B-14	B-18
Flexible Pavement Design Curves for Clark 512 (straddle carrier)	B-15	B-19
Flexible Pavement Design Curves for Belotti B67b (straddle carrier)	B-16	B-20
Flexible Pavement Design Curves for Hyster H620B (front-loading forklift)	B-17	B-21
Flexible Pavement Design Curves for LeTro-Porter 2582 (front-loading forklift)	B-18	B-22
Flexible Pavement Design Curves for Lancer 3500 (sideloading forklift)	B-19	B-23
Flexible Pavement Design Curves for Travelift CH 1150 (yard gantry)	B-20	B-24
Flexible Pavement Design Curves for P&H 6250-TC (mobile crane)	B-21	B-25
Flexible Pavement Design Curves for LeTro Crane GC-500 (mobile gantry crane)	B-22	B-26
Flexible Pavement Design Curves for M52 Tractor and Trailer (truck-trailer combination)	B-23	B-27

TABLES

Diameter of Berth (in Yards) Using Ship's Anchor and Chain	2-1	2-3
Diameter of Berth (in Yards) Using Standard Fleet Moorings, Telephone Buoy	2-2	2-4
Diameter of Berth (in Yards) Using Standard Fleet Moorings, Riser Chain	2-3	2-5
Pneumatic Fenders for Military Uses	9-1	9-3
Load-Deflection and Energy-Absorption Characteristics of Fixed-Unit Type of Pneumatic Tire-Wheel Fender (based on Firestone Burleigh Technical Data Sheet)	9-2	9-6
Energy to be Absorbed by Fenders	9-3	9-7
Comparative Merits of Different Construction Materials in Energy-Absorption Capacity	9-4	9-9
Characteristics of Various Commercially Available Cranes	12-1	12-3
Design Criteria Restrictions (200-10,000 Passes)	B-1	B-4
CBR and Thickness Requirements for 200 and 10,000 Passes of Container Handling Vehicles Operating on Unsurfaced Soils with Subgrade Strengths of 4 and 10 CBR ^a	B-2	B-5
Design Criteria Restrictions (200-50,000 Passes)	B-3	B-6
CBR and Thickness Requirements for 200, 10,000, and 50,000 Passes of Container-Handling Vehicles Operating on Soils Surfaces with M8A 1 Landing Mat and with Subgrade Strength of 4 and 10 CBR ^a	B-4	B-7

CHAPTER 1 INTRODUCTION

1-1. Purpose and scope.

This manual establishes criteria for guidance of Corps of Engineers personnel in the planning and design of proposed military ports. It includes site selection and evaluation, layout of harbor facilities, coastal protection methods, pier and wharf layout and design, fender systems, mooring devices, dockside utilities, and cargo handling facilities. Based on current trends in the shipping industry, it is anticipated that up to 90 percent of all cargo arriving in future Theaters of Operation (TO) will be by containers. Basic considerations in container terminal design, storage and marshalling areas, and container handling facilities are also included. This manual does not apply to ammunition-loading terminals.

1-2. Changes.

Users of this manual are encouraged to submit recommended changes or comments to improve it. Comments should be keyed to the specific page, paragraph, and line of the text in which the change is recommended. Reasons should be provided for each comment to ensure understanding and complete evaluation. Comments should be prepared using DA

Form 2028 (Recommended Changes to Publications) and forwarded direct to HQDA (DAEN-ECE-G) WASH DC 20314-1000. ★

1-3. Justification.

A new port or new facilities for an existing port will be justified by:

- a. The inability of existing facilities to handle the flow of materials.
- b. Shortening or improving transportation routes.
- c. The necessity for disposal of key military transportation establishments.

1-4. General design principles.

A high percentage of the cost of ship operation is due to ship time in ports. The design of ports shall take into consideration trends in ship design, locations for transit storage, adequacy of access by rail and highway, and types and capacities of cargo handling equipment. The size and capacity of the installation will be determined by a study of the volume and classes of cargo and the availability of labor and construction materials.

CHAPTER 2

PORT SITE SELECTION

2-1. Basic port site selection considerations.

Unless the site is determined by military considerations, several locations of the harbor shall be studied to determine the most protected locations involving the relatively low dredging cost and with the most favorable bottom conditions, as well as a shore area suitable for the development of the terminal facilities. Generally, three distinct situations may result:

a. A natural setting along a shoreline, such as a bay, lagoon, or estuary, that would provide suitable protection.

b. A setting where natural barriers to the seaward side of port locations, such as land arms, reefs, spits, tombolos, and islands, are inadequate for protective purposes but have been modified by engineering methods to increase protection capabilities.

c. A setting where the port location is not provided natural protection by seaward barriers, and where artificial protective measures, such as the construction of breakwaters and jetties are required. The construction of artificial protective devices is time-consuming and should be avoided in military port construction when alternate locations are available. Such requirements, however, could represent one of the principal criteria in the evaluation of port site locations. The port facility should additionally be adequate to handle the volume of shipping required to sustain the theater activity and to accommodate the vessels that will transport the required cargo.

2-2. Factors affecting site selection.

a. *Access.* Direct access or connection with existing means of internal communication and dispersion, such as rivers, highways, canals, or railways, is a major factor in the location of the port. Where the topography at sites contiguous to inland communication facilities is adverse, the costs of providing connection to such facilities against the savings in development costs at remote sites should be investigated.

b. *Water area.* Adequate water area to accommodate expected traffic should be available. Where there is inadequate area for free-swinging moorings, vessels may be crowded in by using fixed moorings or moorings in which a vessel's swing is restricted. Berths and other facilities may be dredged from inshore areas.

Breakwaters may be extended into deep water. The minimum and maximum area requirements shall be estimated in order to properly evaluate a proposed location. This requires estimating the capacity requirements, from which the area requirements for the anchorage, berthing, and other areas may be approximated.

(1) *Capacity requirements.* Ascertain the approximate, anticipated capacity requirements from the using agency, in terms of numbers, types, and sizes of vessels to be simultaneously anchored or moored within the harbor limits. Also, estimate the number of these vessels that must be simultaneously accommodated at pier or wharf berths.

(2) *Anchorage areas.*

(a) *Free-swinging moorings and standard fleet moorings.* The diameter of the swing circle and the area requirements per vessel are presented in tables 2-1, 2-2, and 2-3. Additional area allowance should be made for maneuvering vessels into and out of berths and for other space requirements necessary between adjacent berths.

(b) *Alternate method.* Requirements may also be approximated by comparison with areas provided in existing ports serving similar functions.

(3) *Berthing area.* See chapter 6 for the areas required for piers.

(4) *Other areas.* Allow additional area within the harbor limits for channels, special berths, turning basins, and other facilities.

(5) *Total area requirements.* Provide a total area inboard of breakwaters equal to the sum of the overall requirements set forth in b above.

(a) Generally, the total area should be available within the 50-foot depth contour to avoid breakwater construction in water of excessive depth.

(b) The area requirement can be considered in conjunction with the depth requirements to select a site requiring a relatively low dredging cost.

(c) In addition to the area requirements for anchorage areas, berthing areas, and other areas, space must be provided for future expansion and dispersion, where required for military considerations.

c. *Water depth.* Generally, the harbor area is of varying depth. Certain areas are set aside for small craft and other areas for larger ships. Provision for adequate water depth is essential to the functions of the port installation.

(1) *Anchorage and berthing areas.* For a given ship, the depth requirements at anchorage and berthing areas are the same. Except where heavy silting conditions require greater depth, at individual berths at low water, the depth should equal the maximum loaded draft of the largest vessel to be accommodated, plus 4 feet to protect the ship's condensers. For modern container ships, a water depth of 40 feet is required.

(2) *Channels.*

(a) Economic considerations can be weighed against depth requirements. In harbors where the tidal range is very large and particularly where an entrance channel is long, consider the possibility of restricting the entrance of the largest ships using the harbor to the higher tidal stages.

(b) Where hard bottoms exist and excavation costs are high, consider the exclusion of certain classes of deep draft vessels, with provisions of lighter service between deepwater anchorage and docks.

d. Physical and topographical features.

(1) *Sheltering from winds and ocean waves.* Natural sheltering features, such as headlands, promontories, offshore shoals, and bars, will substantially reduce artificial sheltering requirements (breakwaters) and overall project cost.

(2) *Bottom conditions.* Clay or other firm-tenacious materials furnish the best holding ground for anchors. Avoid sites where the bottom does not provide suitable holding ground for anchors. When very hard or soft bottoms exist, costly provisions (mooring islands, etc.) must be provided for securing ships.

(3) *Dredging.* Sites requiring excessive dredging of large quantities of rock or other hard bottoms should be avoided.

(4) *Shoreline relief.* Land adjacent to shorelines can gradually slope away from the beach. Avoid locations with pronounced topographic relief (cliffs) adjacent to shoreline.

(5) *Upland drainage.* Preferably the upland area shall be naturally well drained.

e. Hydrographic and hydrological factors.

(1) *Tidal range.* Tidal range should be minimum.

(2) *Bore.* Locations with a tidal bore should be avoided.

(3) *Currents.* Current velocity should be minimum. Except for the localized area or special considerations, should not exceed 4 knots.

(4) *Fouling rate.* Site should have a low fouling rate, be relatively free of marine borers, and have sufficient water movement to remove contaminations.

(5) *Stable shorelines.* Avoid locations having unstable shorelines or pronounced littoral drift. The history of erosion and deposition (shoreline changes) in the area should be thoroughly studied.

(6) *Tributary streams.* Location and depth of all streams emptying into the harbor should be determined. Depth and flow can be maintained in the final design to prevent a grading.

f. Meteorological factors.

(1) *Storm.* Avoid locations subject to pronounced, severe, and frequent storms.

(2) *Temperature.* Ocean temperature should be moderate to warm, and temperature range should be moderate.

(3) *Fog.* Avoid locations with a predominance of fog.

(4) *Ice.* Avoid locations that might be ice locked for several months a year.

g. Other factors.

(1) *Availability of construction materials.* Determine the availability of construction materials, particularly rock for breakwater and jetty construction.

(2) *Freshwater availability.* Ensure the availability of a potable water supply.

Table 2-1.
Diameter of Berth (in Yards) Using Ship's Anchor and Chain

Depth of water in ft at MLW	Length of various vessels in ft									
	100	200	300	400	500	600	700	800	900	1,000
10.....	165	235	300	365						
20.....	205	270	340	405	470	540				
30.....	245	310	380	445	510	580	645	710	780	
40.....	285	350	420	485	550	620	685	750	820	885
50.....	325	390	455	525	590	655	725	790	885	925
60.....	365	430	495	565	630	695	765	830	895	965
70.....	405	470	535	605	670	735	805	870	935	1,005
80.....	445	510	575	640	710	775	840	910	975	1,040
90.....	480	550	615	680	750	815	880	950	1,015	1,080
100.....	520	590	655	720	790	855	920	990	1,055	1,120
110.....	560	630	695	760	830	895	960	1,030	1,095	1,160
120.....	600	665	735	800	865	935	1,000	1,065	1,135	1,200
130.....	640	705	775	840	905	975	1,040	1,105	1,175	1,240
140.....	680	745	815	880	945	1,015	1,080	1,145	1,215	1,280
150.....	720	785	850	920	985	1,050	1,120	1,185	1,250	1,320
160.....	760	825	890	960	1,025	1,090	1,160	1,225	1,290	1,360
170.....	800	865	930	1,000	1,065	1,130	1,200	1,265	1,330	1,400
180.....	840	905	970	1,035	1,105	1,170	1,235	1,305	1,370	1,435
190.....	875	945	1,010	1,075	1,145	1,210	1,275	1,345	1,410	1,475
200.....	915	985	1,050	1,115	1,185	1,250	1,315	1,385	1,450	1,515

This table is based on the following assumptions:

- (a) Length of chain is equal to 6 times depth of water.
- (b) Anchor drags 90 ft from initial position.
- (c) Basic formula $B = \frac{2}{3} (0.987 \times 6D + L + C)$ for scope of chain of 6 times the depth of water. Correction to scope to get radius of swing = 0.987. Where:
 B = diameter of berth in yd.
 D = depth of water in ft at MLW.
 L = length overall of vessel in ft.
 C = 90 ft allowance for drag of anchor.
- (d) To maintain scope of chain of 6 times depth for rise in tide, add $\frac{2}{3} (5.92 T)$ to berth diameter where T = height of tide in ft.

Department of the Navy

Table 2-2.
Diameter of Berth (in Yards) Using Standard Fleet Moorings, Telephone Buoy

Depth of water in ft at MLV	Length of various vessels in ft									
	100	200	300	400	500	600	700	800	900	1,000
10.....	245	315	380	445						
20.....	250	315	380	450	515	580				
30.....	250	315	380	450	515	580	650			
40.....	250	315	385	450	515	585	650	715	785	850
50.....	250	320	385	450	520	585	650	720	785	850
60.....	255	320	385	455	520	585	655	720	785	855
70.....	255	325	390	455	525	590	655	725	790	855
80.....	260	325	395	460	525	595	660	725	795	860
90.....	265	330	395	465	530	595	665	730	795	865
100.....	265	335	400	465	535	600	665	735	800	865
110.....	270	335	405	470	535	605	670	735	805	870
120.....	275	340	410	475	540	610	675	740	810	875
130.....	280	345	415	480	545	615	680	745	815	880
140.....	285	350	420	485	550	620	685	750	820	885
150.....	295	360	425	495	560	625	695	760	825	895
160.....	300	365	435	500	565	635	700	765	835	900
170.....	310	375	440	510	575	640	710	775	840	910
180.....	320	385	455	520	585	655	720	785	855	920
190.....	330	400	465	530	600	665	730	800	865	930
200.....	350	420	485	550	620	685	750	820	885	950

This table is based on the following assumptions:

- (a) Chains are of the length called for by the drawings and are pulled out to obtain chain tension of about 12,000 lb with anchor in initial position.
- (b) Anchor drags 90 ft from initial position.
- (c) 180 ft of ship's chain used between vessel and buoy.
- (d) Basic formula $D = 2/3 (R + L + C2)$. Where:
 - D = diameter of berth in yd.
 - R = radius of swing of buoy in ft.
 - L = length overall of vessel in ft.
 - C2 = 270 ft (includes 180 ft from buoy to ship and 90 ft allowance for anchor drag). No correction for drop in waterline due to tide is required.

Department of the Navy

Table 2-3.
Diameter of Berth (in Yards) Using Standard Fleet Moorings, Riser Chain

Depth of water in ft at MLV	Length of various vessels in ft									
	100	200	300	400	500	600	700	800	900	1,000
10.....	275	340	405	475						
20.....	280	345	415	480	545	615				
30.....	285	355	420	485	555	620	685			
40.....	295	360	425	495	560	625	695	760	825	895
50.....	300	365	435	500	565	635	700	765	835	900
60.....	305	375	440	505	575	640	705	775	840	905
70.....	315	380	445	515	580	645	715	780	845	915
80.....	320	385	455	520	585	655	720	785	855	920
90.....	325	395	460	525	595	660	725	795	860	925
100.....	335	400	465	535	600	665	735	800	865	935
110.....	340	405	475	540	605	675	740	805	875	940
120.....	345	415	480	545	615	680	745	815	880	945
130.....	355	420	485	555	620	685	755	820	885	955
140.....	360	425	495	560	625	695	760	825	895	960
150.....	365	435	500	565	635	700	765	835	900	965
160.....	375	440	505	575	640	705	775	840	905	975
170.....	380	445	515	580	645	715	780	845	915	980
180.....	385	455	520	585	655	720	785	855	920	985
190.....	395	460	525	595	660	725	795	860	925	995
200.....	400	465	535	600	665	735	800	865	935	1,000

This table is based on the following assumptions:

- (a) Length of riser chain is equal to the depth of water at mean high water.
- (b) Ground chains are of length called for by drawings and are pulled taut when installed.
- (c) Anchor drags 90 ft from initial position.
- (d) 180 ft of ship's chain used between vessel and buoy.
- (e) Basic formula $B = \frac{2}{3} (D + L + C1)$. Where:
 - B = diameter of berth in yd.
 - D = depth of water in ft at MHW.
 - L = length overall of vessel in ft.
 - C1 = 300 ft (includes 30 ft allowance for increase in radius of berth for drop in waterline due to fall of tide, 180 ft from buoy to ship, and 90 ft allowance for drag of anchor).

CHAPTER 3

LAYOUT OF HARBOR FACILITIES

3-1. Harbor entrance.

a. *Location and orientation.* The following factors in the location and orientation of harbor entrances should be considered:

(1) *Water depth.* Locate the harbor entrances in an area where the natural water depth is adequate for passage of the largest ship.

(2) *Sheltering.* Locate on the lee side from most severe storm waves, and between overlapping breakwaters.

(3) *Channeling external disturbances.* Location and orientation will direct any external wave disturbances to areas of the harbor remote from locations of berthing and anchorage areas.

(4) *Navigation.* Navigation through the entrance should be easily accomplished. In particular, locate so that there will be strong beam currents in the harbor entrance at all tidal stages.

(5) *Littoral drift.* Orientation should prevent the entrance of littoral drift into the harbor. Where possible, the entrance will be located in an area relatively free of littoral drift.

(6) *Multiple entrance.* Where possible, provide two entrances with different exposures, which can be used as alternates depending on the direction of the wind. Multiple entrances are advantageous in wartime, since they make the harbor more difficult to block. Double entrances also reduce the velocities of the tidal currents because of the increased area.

b. *Channel entrance width.* Provide minimum channel entrance width consistent with navigation needs. The approximate requirements of channel entrance width related to size of vessel to be accommodated are as follows:

	<i>Width of</i>
<i>Harbor classification</i>	<i>entrance, ft</i>
Medium Vessel	300 to 500
Large Vessels	600 to 1,000

(1) *Entrance.* Except in unusual circumstances, a width of 1,000 feet is ample for very large container vessels, and under favorable conditions of entry, a width of 800 feet may be considered.

(2) *Secondary entrances.* For secondary entrances, or those not to be used by large ships, a width of 300 feet may be considered, provided that entrance conditions are favorable.

(3) *Currents.* Entrance widths should be adequate to reduce currents to acceptable values. The maximum

allowable current in the entrance channels is a function of the type of ship or ships to be accommodated. Except under special circumstances, current is not to exceed 4 knots. The maximum velocity of the tidal current through the entrance channels may be estimated from equation (3-1).

$$V = \frac{4}{5} \times \frac{\rho}{T} \times \frac{A}{S} \times H \tag{3-1}$$

where

V = maximum velocity of the tidal current occurring at the center of the opening, feet per second

T = period of the tide, seconds

A = surface area of the harbor basin, square feet

S = cross-sectional area of openings, square feet

H = range of the tide, feet

The tidal current in midchannel is about one-third stronger than that at each side.

(4) *Discharge of upland drainage.* Entrance widths must be adequate to discharge the accumulated upland drainage without exceeding the maximum permissible current value given in paragraph (3) above.

(a) The maximum velocity of the current resulting from discharge of a given flow may be roughly estimated from equation (3-1) by substituting the rate of upland drainage to be discharged for the quantity AHIT.

(b) The total current velocity in the entrance due to tidal influence plus runoff may be obtained by adding the value obtained from equation (3-1) and corrected for quantity AH/T.

(5) *Reduction of incident wave height through entrance.* Although the model tests will give a more accurate picture of wave conditions, the wave height within the harbor can be approximated from the following equation:

$$h = H \left[\sqrt{\frac{b}{B}} - 0.02 \sqrt[4]{D} \left(1 + \sqrt{\frac{b}{B}} \right) \right] \tag{3-2}$$

h = height of the wave at location "X", feet

H = height of the unrestricted wave at the harbor entrance, feet

b = width of the entrance, feet

B = breadth of the harbor at location "X", feet (this being the length of the arc with its center at the harbor entrance center and radius D)

D = distance from harbor to location "X", feet

Reduction of wave height through the entrance may be predicted more accurately by using diffraction and refraction diagrams. For the construction of diffraction and refraction diagrams, refer to Shore Protection Manual, Vol. I (app A).

3-2. Breakwaters.

a. Locations and alinement. A breakwater is normally the most costly single item required for the harbor development. Special care is required to minimize the length and height. The following factors in the location and alinement of breakwaters shall be considered:

(1) *Minimum height.* Locate the breakwater in the shallowest water consistent with harbor area requirements.

(2) *Flank protection.* Join headlands and rock outcrops to natural abutments on shore to prevent flanking.

(3) *Foundation conditions.* Where there is a choice, locate the breakwater along hard or sandy bottom, avoiding locations with poor foundation conditions.

(4) *Channeling incident waves.* Aline so that the refraction and reflection of incident waves are away from the entrance and toward the shore.

(5) *Sheltering entrance.* Stagger the breakwater head on the weather side of the entrance with respect to the breakwater head on the lee side (fig 3-1). This arrangement will minimize the risk of a ship being blown against the lee breakwater head. This configuration improves the entrance conditions and increases sheltering in the harbor.

(6) *Alinement.* Avoid a concave shape or one with reentrant angles, as entrapped waves will cause major disturbance in such areas.

(7) *Seiche.* If the occurrence of a seiche appears likely, realine the breakwater to reshape the harbor basin or provide structures for dissipating wave energy.

b. Types. There are two main types of breakwaters, the mound type and the wall type.

(1) *Mound-type breakwaters.* These types of breakwaters are generally constructed from natural rock, concrete block, a combination of rock and concrete block, or concrete shapes such as tetrapods, quadripods, hexapods, tribars, modified cubes, and dolosse. The mound type may also be supplemented in each case by concrete monoliths or seawalls to break the force of the waves and to prevent splash and spray from passing over the top.

(2) *Wall-type breakwaters.* These breakwaters can be classified as concrete-block gravity walls, concrete caissons, rock-filled sheet-pile cells, rock-filled timber cribs, or concrete or steel sheet-pile walls. The type of breakwater to be used is usually determined by the availability of materials at or near the

site, the depth of water, the condition of the sea bottom, its function in the harbor, and the equipment suitable and available for its construction.

3-3. Jetties.

a. Function. Harbor jetties function to prevent the movement of littoral drift into the entrance channel and are required in the case of natural harbors located in estuaries, in rivers, in lagoons, or other areas where sandbars or other offshore accumulations or silt and debris must be cut through for navigation channels; to ensure the required water depth.

b. Location and alinement. The factors influencing location and alinement of jetties are as follows: (1) Number required. Use two jetties where feasible. Where funds are limited or other restrictions apply, one jetty in the updrift side may be used.

(2) *Length.* Jetties shall line the entrance channel through the offshore bar and extend a sufficient distance past to reach the required water depth with allowance for assumed silt accumulation.

(3) *Cleansing velocity.* Current flow through the entrance channel shall be adequate to scour and remove silt accumulations. Where the natural current is inadequate, use offshore jetties to restrict the channel to reach the cleansing velocity.

(4) *Silting.* Where possible, orient the jetties perpendicular to the littoral drift.

(5) *Anchorage.* Anchor the jetty on shore to prevent flanking.

c. Form. The forms of jetties are as follows: (1) *Parallel jetties.* Use this form where the harbor entrance is not the mouth of a river having a pronounced flow or where the configuration of the existing, natural estuary indicates a prolongation in the form of parallel walls.

(2) *Divergent jetties.* Use this form in tidal estuaries or in lagoon inlets where ebb and flood flows are about equal. Under this circumstance, there is a tendency for a parallel channel to silt up due to the reduction in volume of the influence tide. The slope of the divergence shall be limited to about 2,000 feet per mile so that a bore will not be created.

(3) *Convergent jetties.* Use this form in lieu of parallel jetties where the attenuation of waves incident on the harbor entrance must be promoted by lateral expansion; that is, where the run-in is not adequate or where the wave traps are insufficient or undesirable.

3-4. Anchorage basins.

a. Location and size. The factors affecting the location and size of anchorage basins are as follows: (1) *Isolation.* Locate the anchorage basins near the entrance, away from channels, out of traffic, and in

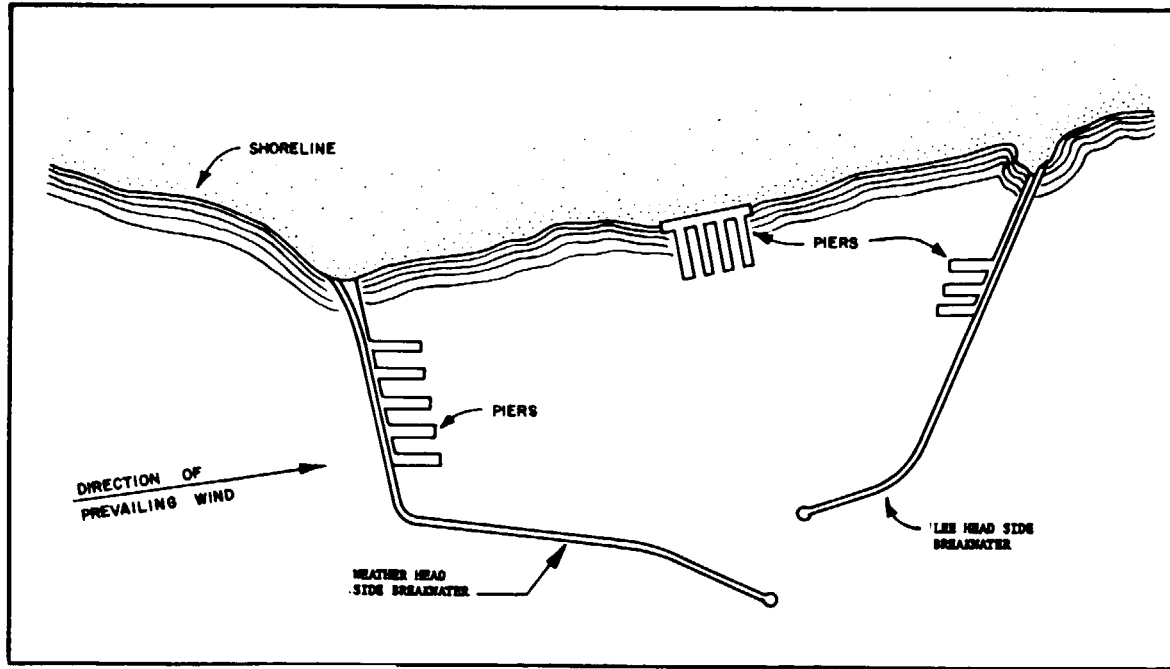

Department of the Navy

Figure 3-1. Use of offset breakwater heads to shelter entrance.

shelter. The area shall be isolated, insofar as possible, from attack by surface or subsurface craft.

(2) *Depth*. Locate in an area of sufficient natural depth to minimize dredging.

(3) *Currents*. The area shall be free from strong currents.

(4) *Accessibility of shore facilities*. The area shall be accessible to fresh water, fuel, and other shore facilities.

(5) *Foundation conditions*. Where possible, locate over a bottom of loose sand or gravel, clay, or soft coral. Avoid locations where the bottom consists of rock, hard gravel, deep mud, and deep silt.

(6) *Subaqueous structures*. Anchorage areas should be free of cables and pipe lines and cleared of wrecks and obstructions.

(7) *Expansion*. Provide for future expansion.

(8) *Size*. See chapter 2 for approximate overall size and depth requirements. Use free swinging moorings where the available area will permit. Where the available area is limited, use fixed moorings or moorings in which the swing of the vessel is restricted. Various types of moorings are discussed in TM 5-360 (app A).

b. Dangerous cargo. Anchorages for tankers and similar vessels will be at least 500 feet from adjacent berths, and located so that prevailing winds and currents carry any spillage away from general anchorage and berthing areas. For vessels carrying explosives, the anchorages will be separated in accordance with the criteria established in DoD 4270.1-M (app A).

3-5. Berthing basins.

a. Location. The wave height in the berthing basin should not exceed 2 feet for comfortable berthing, but in no case will the wave height exceed 4 feet. The factors influencing the selection of the location of berthing basins are as follows: (1) *Protection*. Locate berthing basins in harbor areas that are best protected from wind and wave disturbances in areas remote from the disturbances incident upon the harbor entrance.

(2) *Orientation*. Orient berths for ease of navigation to and from the entrance and the channel.

(3) *Offshore area*. Provide sufficient offshore area

for ship movement, preferably without use of tugs.

(4) *Quayage adequacy*. Adequate quayage shall be provided for the estimated traffic.

(5) *Supporting shore facilities*. Locate supporting shore facilities in proximity to their respective berths. Adequate space and access for roads and railroad facilities are essential.

(6) *Expansion*. Provide area for future expansion.

(7) *Fouling and borers*. Locate berthing basins in harbor areas to minimize fouling conditions and incidence of marine borers.

(8) *Foundations*. Locate foundations in an area of favorable subsoil conditions, to minimize the cost of berthing structures.

b. Arrangement of berths. The arrangement of berths and types of pier and wharf layout are discussed in chapter 6.

c. Size and depth of basin and berths. These characteristics are discussed in chapter 6.

3-6. Turning basins.

a. Use. Where space is available, provide turning basins to minimize the use of tugs. Where space is restricted, tugs may be used for turning vessels and turning basins eliminated.

b. Location. The following requirements should be met: (1) Locate one turning basin at the head of navigation.

(2) Locate a second turning basin just inside the breakwater.

(3) Where especially heavy traffic is anticipated, provide intermediate basins to reduce traffic congestion and save time.

(4) Where feasible, use an area of the harbor that forms a natural turning basin of the required size and depth.

(5) Provide a turning basin at the entrance to drydocks or at the inboard end of long piers or wharves.

c. Size and form. A vessel can normally be turned comfortably in a radius of twice its length or where maneuverability is not important, in a radius equal to its length. For shorter turning radii, the vessel must be turned around some fixed point, must utilize the ship's anchor, or must be assisted by tugs.

CHAPTER 4

SITE INVESTIGATION

4-1. Background data.

a. Introduction. The principal background intelligence data required to evaluate the suitability of an area for a military port are as follows: (1) Physical and cultural aspects of the shoreline and contiguous interior.

(2) Weather regimes, intensities, and extremes.

(3) Bathymetric and subbottom characteristics. The types of data from which this intelligence data may be derived can be categorized as maps, photography and imagery, documents and records, and historical data.

b. Maps.

(1) *Topographic maps.* Scales of these maps vary widely. Coverages of 1:50,000 and 1:250,000 are available for sizable portions of the world, although more extensively for highly developed areas. Slope, relief, and configurations of shoreline landscapes are obtainable directly from the maps, with the degree of accuracy being a function of the scale and contour interval. Drainage patterns, land use, natural vegetation, and cultivation are also portrayed on these maps, as well as population centers and transportation networks. Bathymetric contours and navigation hazards (e.g., mud, shoals, cock, coral, and other natural characteristics) are delineated.

(2) *Soil maps.* These maps are prepared for a variety of purposes, e.g., agricultural potential, land use, and construction. Soil surveys have been conducted for entire countries in some instances but more frequently cover only limited areas. The distribution of soils is portrayed on soil maps, and the descriptions are normally in textural terms. Soil depths data are available for portions of West Germany, while 1:1,000,000 maps represent the best coverage for certain poorly developed countries. World soil maps, excluding the United States, have been prepared by the United States Soil Conservation Service (USCS) with the descriptions in United States Department of Agriculture terms. The distribution of soils portrayed on these maps is usually determined by landform and physiographic association and is of questionable accuracy. Detailed soils maps prepared in support of agricultural and engineering studies provide comparative detail, but their occurrence is sporadic and unpredictable. In many cases, the descriptive agricultural terms used in soil surveys are translatable into the

engineering terms (USCS) required for site investigations (figure 4-1).

(3) *Geologic maps.* Geologic maps depict a number of geologic or geologic-related conditions, such as the surface and substrate distribution of formations, structure, and the distribution of landforms. Such maps often provide information regarding the configurations and dimensions of shoreline landforms, engineering characteristics of overburden materials, the nature of surficial soils, and classification and distribution of surface or near-surface rock and associated soils. In addition, the maps usually symbolize drainage patterns, land use, and vegetative patterns.

Geologic maps, when prepared in sufficient detail, can provide a general basis for the selection of construction sites as well as sources of suitable construction materials.

(4) *Pictomaps.* Pictomaps are usually large-scale maps, viz. 1:25,000, which have been prepared from controlled aerial photomosaics. Colors and symbols are used to denote vegetation, hydrologic and cultural patterns, which are superimposed upon the photographic image. Surface and bathymetric contours are included on the maps most frequently at 1-, 5-, and 10-metre intervals. The pictomap probably represents the most suitable base for generation of a three-dimensional terrain model of a port area.

(5) *Hydrographic charts.* These charts depict hydrologic conditions along and immediately inland of the shorelines of the world. Depth soundings in feet are presented for both offshore and inland waters.

Navigable waterways are indicated, and navigation hazards and man-made structures, such as platforms, stakes and markers, and lighthouses are located. Tidal information is provided for selected stations on the chart.

(6) *Climatic maps.* These maps may be compiled for individual countries; however, they are most often compiled for the entire world and thus are usually small scale. They portray the distribution of areas characterized by ranges of mean annual temperatures, precipitation, and climatic types determined by combinations of temperature ranges; amount and frequency of precipitation, and natural vegetation. Other climatic maps depict the distribution of major ocean currents, mean sea surface temperatures, hurricane tracks, air masses, and other relevant characteristics.

c. Photography and remote imagery. Photography

and imagery coverages of the areas being investigated

as potential port sites provide several definite advantages over other data types as follows: (1) Large-scale photography or photographic reproduction of imagery provides details that are not presented on topographic and other map coverages. For instance, even large-scale topographic maps with 5 and 10-metre contour intervals may fail to identify surface features or conditions that are relevant to port site investigation.

(2) Remote imageries can be obtained immediately after the occurrence of dramatic climatic or hydrologic events to permit assessment of damage or modification. Such events would include flooding, hurricanes, tidal surges, and other natural disasters. This information may often dictate the location for, type of, and method for construction.

(3) Photography and imagery coverage permits current assessments to be made of man-made features such as transportation networks, industrial complexes, urban development, and existing port facilities.

(4) Photography and imagery coverage permits periodic monitoring of shoreline evolution and modification to determine the influence of the physical and climatic elements on port location and construction.

(5) In the absence of map coverages, photography and imagery coverage would serve to provide topographical, geological, pedological, hydrographical, vegetational, and even cultural information required for site selection and investigation. Identification of the required physical and natural science features necessitates interpretation by personnel skilled in these various disciplines.

d. Documents and records. Documents and records are valuable sources of various types of topographical, hydrographical, and historical information. Some of the most common types of documents include: trade journals; geologic, geographic, soil and oceanographic bulletins; environmental handbooks; tourist guides and traveler accounts in periodicals and professional journals; published tide tables; pilot handbooks; economic and transportation atlases; climatic records; and various indigenous governmental reports. Unpublished environmental, meteorological, and scientific data are available at government offices and research centers in the continental United States (CONUS). Reference materials are also available from engineering firms, private societies, and individuals with personal interests.

e. Historical port intelligence data. Historical data concerning existing port facilities represent potentially the best source of information. The types and orientation of piers, breakwaters, and dock facilities, are often the result of comprehensive investigations or at worst trial-and-error type construction. The construc-

tion of these facilities is normally well documented, with feasibility and investigative reports being available at the old port headquarters; local governmental administrative offices; private engineering firms; or in government archives. The types of information to be expected include soil borings, soil bearing and shear tests, soil classification and analysis, pile friction tests, tidal station data, weather data, groundwater investigations, severity of flooding, locations and characteristics of construction materials, and bathymetric surveys indicating the slope and configuration of the harbor bottom and the presence of obstacles, such as rocks, reefs, and debris. Many potential military port locations will be devoid of existing facilities or in other cases, the facilities may be in evidence but lacking documentary data.

4-2. Hydrographic and topographic surveys.

a. Introduction. Although the general location of the port may be established by careful consideration of background information, the precise location of the component facilities, such as wharves, piers, and quay, shall result from comprehensive hydrographic and topographic surveys.

b. Hydrographic surveys. The surveys will include the collection, reduction, and analysis of hydrographic data and the effective presentation thereof to permit subsequent decisions. The following hydrographic parameters should be considered during the survey:

(1) *Depth of water.* Accurate bathymetric movements can be obtained throughout the port area as well as in seaward approaches to the facilities. Water depth is critical to the operation of ships and craft that will use the facility. The maximum draft for a container ship is expected to be 40 feet; pier construction and location should have suitable hydrographic conditions.

(2) *Bottom character.* Detailed determinations can be made as to the lithographic and microrelief character of the bottom. Foreign and random natural objects, such as boulders, oil drums, and ship wreckage, must be delineated to facilitate removal or ensure avoidance by using ships.

(3) *Tidal characteristics.* These characteristics are the controlling factors in the effective operation of a port. Tidal parameters requiring determination are heights, range, interval, times, and behavior of tidal currents; on a daily and seasonal basis, and during periods of unusual intensity resulting from storm activity. Significant daily tidal ranges in certain parts of the world may exceed 20 feet.

(4) Discharge volumes and flow velocities of rivers. Discharge volumes and flow velocities at or in the vicinity of the port are important considerations in the regulation of vessel traffic, location and orientation

of structures, sediment transport and deposition, and dredging.

(5) *Extent, duration, and causes of flooding.* Flooding at times during the year may affect the inland portions of a port. Harbor routine may vary during the flood season, and sediment introduced into the harbor areas may create navigation problems. Knowledge of the causes of flooding enables the adverse effects to be minimized. Examination of historical data permits reasonably accurate forecasts.

(6) *Tidal and river currents and velocities.* Current directions and velocities, such as longshore currents, wind currents, river currents, and permanent great currents, are a constant problem to navigation. In some cases, several of these currents may be in action concurrently, and the results should be considered.

(7) *Shoreline data.* The land-water interface can be established for the various daily and seasonal stages of the tide. Extreme tidal states occurring during severe storms can also be established.

(8) *Location of landmarks as navigational aids.* Location of landmarks can be greatly facilitated through the use of hydrographic and topographic maps and aerial photography. Field checks to ensure acceptable levels of visibility are required.

(9) *Location of structures in water and along shore margins.* These structures are currently being utilized or abandoned.

(10) *Subbottom characteristics.* Subbottom information includes data on the type of sediments, layering, bearing capacities, and consolidation.

c. *Topographic surveys.* All land-implemented surveys conducted in support of the construction of offloading, storage, and connection facilities should be included. Parameters to be considered as part of the topographic surveys are as follows: (1) Topographic detail at site locations. Fine detail will be

required to assure optimum layout of facilities and the transportation network required to service them. Land-water interfaces at all possible tide levels can be checked with the hydrographic surveys.

(2) *Pedologic parameters.* A comprehensive investigation of the pedologic character of surficial materials is considered essential. The ability of the soils to support various types of construction and the suitability of construction materials can be determined. The identification of soils can be greatly facilitated by use of aerial photographs.

(3) *Drainage characteristics.* Surface drainage patterns should be determined. Drainage can influence site selection, particularly if the overflow from streams cannot be controlled and the inundation of a site is possible. Streams may also provide convenient supplies of surface water for port use.

(4) *Surface rock.* An investigation of available sources of surface rock will be conducted to determine the suitability of local supplies to construction requirements.

(5) *Subsurface characteristics.* Investigation of subsurface soil conditions is required to determine the parameters relevant to pile-type construction at shore locations.

(6) *Vegetation types.* A survey of natural vegetation in the vicinity of the port is necessary to determine the construction effort required to clear an area to accommodate the port facilities, as well as the suitability of the timber for use in the construction of certain facilities, (e.g., wharves, piers, bridges, and warehouses).

(7) *Cultural features.* A survey is required at and in proximity to the port area, including private, business, and government buildings, the transportation network, utilities, recreation areas, and agricultural lands.

CHAPTER 5 COASTAL PROTECTION

5-1. Shoreline stabilization.

a. Methods. The shoreline stabilization methods can be generally classified as artificial nourishment and protective construction.

(1) *Artificial nourishment.* The artificial nourishment methods include the following:

(a) *Offshore dredging.* The material dredged elsewhere is deposited in a ridge offshore and updrift of the beach to be stabilized.

(b) *Stockpiling.* A beach is placed updrift, but not offshore, of the denuded area from which material is derived for replenishment of the downdrift area.

(c) *Continuous supply.* A pumping plant located on the updrift jetty at a harbor entrance bypasses the sand across the inlet to the eroding shore.

(d) *Direct placement.* This method is a variation on the use of a stockpile in that the fill is completed at one time over the entire area to be protected.

(2) *Protective construction.* The following protective structures may be used for shoreline stabilization:

(a) *Breakwaters.* Breakwaters reduce the wave force reaching the shore. Offshore breakwaters are more costly than onshore structures and are seldom built solely for shore protection, rather they are constructed mainly for navigational purposes. A breakwater protecting a harbor area provides shelter for all types of marine vessels.

(b) *Jetties.* Jetties are generally employed at inlets in connection with navigation improvements. They control sand movement and shoaling in channels. Jetties are similar in structure though larger than groins and sometimes extend from the shoreline seaward to a depth equivalent to the channel depth desired for navigation purposes.

(c) *Groins.* Groin is a barrier-type structure that extends from the backshore into the littoral zone. The basic purposes of a groin are to interrupt longshore sand movement, to accumulate sand on the shore, or to retard sand losses.

(d) *Shoreline armoring.* Bulkheads, seawalls, and revetments are wave-resistant walls used to armor the shore and provide a definite landwater boundary at a given location. The distinction between seawalls, bulkheads, and revetments is mainly a matter of purpose. In general, seawalls are the most massive of the three because they resist the full force of the waves. Bulkheads are next in size; their function is to retain fill, and they are generally not exposed to severe wave

action. Revetments are the lightest because they are designed to protect shorelines against erosion by currents or light wave action.

b. Selection of basic stabilization method.

(1) *Artificial nourishment.*

(a) *Advantage.* The artificial supply benefits not only the shoreline where it is placed but other shores as well.

(b) *Disadvantages.* Temporary changes in the shoreline due to individual storms are not prevented by artificial nourishment. The method is not suitable for stabilization of areas abutting buildings, pavements, or other structures. Also, the amount of supply must be balanced against the amount of decretion. An oversupply causes accretion, which may be detrimental; an inadequate supply will be ineffective in producing the desired stability.

(2) *Protective construction.*

(a) *Advantages.* Protective structures require little maintenance as compared to the continuing supply requirement involved in the use of artificial nourishment. Furthermore, the results are more positive than with the use of artificial nourishment.

(b) *Disadvantage.* In the highly developed areas, correction of localized deficiencies is not feasible. In such areas, protective structures must be installed over an extensive length of shoreline because their use in one location tends to produce decretion in adjacent downdrift areas.

c. Layout and design for stabilization by artificial nourishment. After the selection of artificial nourishment as the method of shoreline stabilization, layout and design can take into account the following factors: (1) Rate of loss of beach material. The loss rate may be measured by one of the following methods: (a) Measure the quantity of littoral current and the solid content of the suspended sediments. Use the difference in quantity between the updrift and downdrift ends of the site.

(b) Take beach-profiles over a period of time and determine the loss rate by section.

(c) Approximate the loss rate from aerial photography or maps of changes in the shoreline. Use the rule that a loss of 1 square foot of surface area represents a loss of 1 cubic yard of beach material. This rule has been found applicable for exposed seacoasts; for less exposed shores, it results in a conservative approximation.

(2) *Direction of littoral drift.* Determine the direction of littoral drift from these or similar observations: (a) Major accumulations of sediment at existing jetties and groins.

(b) Hindcast wave data refracted into shallow water.

(c) Shore patterns in the vicinity of headlands.

(d) Characteristics of beach and bed materials.

(e) Current measurements.

(3) Beach material. Select suitable material considering the following factors:

(a) Use clean sand. Some clay or silt admixtures are permissible; particles will be sorted by natural wave action.

(b) Proper gradation is required to produce the desired slope. The gradation should be the same as that of materials found on nearby beaches having slopes similar to those desired.

(4) *Crest height.* Match the existing beach crest or that of nearby beaches similarly exposed.

(5) *Miscellaneous.*

(a) The rate of supply of artificial nourishment must balance the rate of loss from an existing beach.

(b) Locate the stockpile of artificial nourishment updrift of the problem area. Do not place the toe of the stockpile in water depths exceeding 20 feet on seacoasts.

(c) Offshore dumping may be used. Deposits have been successfully made up to 0.5 mile offshore and in water depths up to 38 feet.

d. Sand bypassing system. A sand bypassing system consists of a stationary hydraulic-suction dredge pump, which dredges sand from the updrift side of an inlet and pumps it across the inlet channel, usually through a subaqueous pipe. The pump installation is usually at the head of the updrift jetty. Floating installations are possible but not desirable except under unusual circumstances. The design details are as follows: (1) Position the discharge pipe so that the sweep of the current will distribute the sand along the problem area.

(2) Govern the required discharge velocity with median grain-size sand.

(3) Provide auxiliary equipment for clearing a clogged discharge pipe, such as compressed air jets, complete with compressors, pumps, and tanks.

5-2. Waves and wave pressures.

a. *Individual wave characteristics.* Waves generated in deep water (generally considered as water having a depth $> L/2$, where L is the wavelength) are normally identified as the oscillatory type, in which particles of water oscillate in a circular pattern about some mean position. In shallow water, the particle paths are

elliptical rather than circular. Primary characteristics of individual waves are shown in figure 5-1. For the normal deepwater wave, the various wave characteristics are related by the following equations:

$$v = 2.26 \sqrt{L} = 5.12T \quad (5-1)$$

$$L = 0.195v^2 = 5.12T^2 \quad (5-2)$$

$$T = 0.442 \sqrt{L} = 0.195v \quad (5-3)$$

where

v = velocity of propagation of wave, feet per second

L = wavelength, feet T = wave period, seconds

b. *Tsunamis and hurricane surge.*

(1) Tsunamis are very long-period waves (usually 5 to 30 minutes in period) that are caused by a displacement of the ocean bottom due to seismic activity. Ports around the entire Pacific Ocean are susceptible to tsunami waves; however, the effects at different harbors vary considerably due to the local bathymetry from the continental slope shoreward and to the direction of approach by the tsunami. Ports and harbors bordering the Atlantic Ocean have practically no problem from tsunamis due to the lack of active seismic regions around the periphery of the Atlantic Basin.

(2) Hurricane surge (or typhoon surge) is more common than tsunami surge and presents a problem on the East and Gulf Coasts of North and Central America, the Eastern and Southeastern Coasts of Asia, and islands in that area of the Pacific. The occurrence of hurricanes and typhoons is fairly well documented (especially in the United States), and the frequency of occurrence of various intensity hurricanes and the resulting waves and hurricane surge can be calculated. It would be considerably beneficial to the site selection process to catalog all existing data on hurricanes and typhoons to assess the probability of port downtime for each year; and the probability of extensive damage from both hurricane surge and winds.

c. *Explosion-generated water waves.* Explosion-generated water waves exhibit the same characteristics as any waves produced by a local disturbance in deep water. A train of waves is generated where the maximum amplitude wave always has the same period (regardless of distance of propagation). The amplitude of this wave decreases as $1/R$ (R being the distance propagated from the source). If the explosion occurs in shallow water, the first wave is usually the largest, regardless of propagation distance, due to a very slow rate of dispersion. The amplitude and frequency of the largest wave are functions of the explosion yield, height or depth of burst, distance from the explosion, water depth, and bottom topography. An explosion is an inefficient method of generating water waves and a relatively large-yield nuclear explosion is required to create waves of appreciable height. The area affected by

explosion-generated waves is extremely localized when compared with the several-hundred-mile-wide area affected by a tsunami. The periods of nuclear-explosion-generated waves can roughly be classified as being between that of wind waves and tsunami waves, i.e., they are in the long-period wave region but can have amplitudes considerably greater than those of normal long-period waves found in the open ocean.

d. Design wave calculation.

(1) For preliminary study and/or structures where occasional damage may be permissible. One of the following procedures may be used:

(a) Refer to local records and experiences of longtime residents.

(b) Make observations at the site of such physical features as wash and runup marks and debris.

(c) Use the following empirical relations for open seas and inland lakes.

Open seas (Stevenson formula)

$$H = 1.5\sqrt{F} \text{ for } F > 30 \text{ nautical miles} \quad (5-4)$$

or

$$H = 1.5\sqrt{F} + 2.5 - \sqrt[4]{F} \text{ for } F < 30 \text{ nautical miles} \quad (5-5)$$

Inland lakes (Molitor formula)

$$H = 0.17\sqrt{UF} \text{ For } F > 20 \text{ nautical miles} \quad (5-6)$$

or

$$H = 0.17\sqrt{UF} + 2.5 - \sqrt[4]{F} \text{ for } F < 20 \text{ nautical miles} \quad (5-7)$$

where

H = wave height, feet

F = fetch, nautical miles

U = maximum wind velocity, miles per hour

(d) Where the wind speed is known and an adequate fetch for full development of the waves is assumed, equation (5-8) may be used for waves of low to moderate amplitude. This formula is not applicable to very high waves (more than 25 to 30 feet).

$$H = 0.026U^2$$

5-8)

where U represents wind velocity in knots.

(e) When the maximum wind velocity, as well as the fetch, is known, a more accurate determination of the design wave is possible using figures 5-2 through 5-13.

(2) *For final design of structures of major importance.* For such design or where the extent of the development warrants more accurate determination of the wave characteristics, follow the procedures given below:

(a) Make an analysis of a comprehensive series of aerial photographs of the incident waves generated by severe storms.

(b) Hindcast (i.e., calculate from historic, synoptic weather charts) the characteristics of waves resulting from several of the more recurrent deepwater storms. Determine the shallow-water characteristics of these waves by use of refraction and diffraction diagrams. The determination of the characteristics of the incident waves by hindcasting is the most reliable method for determining the design wave. Detailed wave and water level predictions are given in "Shore Protection Manual," Vol. 1. (See app A.)

e. *Wave pressure on vertical walls.* Wave pressures due to breaking and nonbreaking waves differ widely. The first step in the evaluation of wave forces is to determine if the structure will be subjected to forces from nonbreaking waves, breaking waves, or broken waves. The determination of wave pressure on vertical walls is explained in "Shore Protection Manual," Vol. II. (See app A.)

f. *Wave forces and movements on piles.* Waves acting on piles exert pressures that are the result of drag and inertial forces. The determination of waves forces and movements on piles can be found in "Shore Protection Manual," Vol. II. (See app A.)

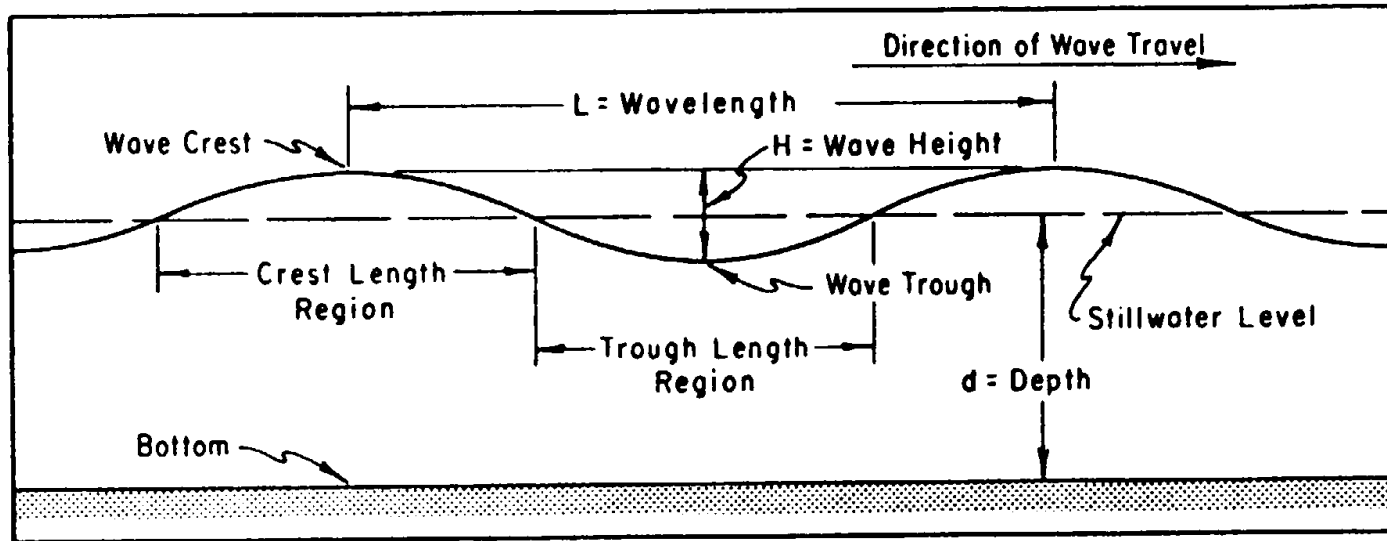

US Army Coastal Engineering Research Center

Figure 5-1. Wave Characteristics.

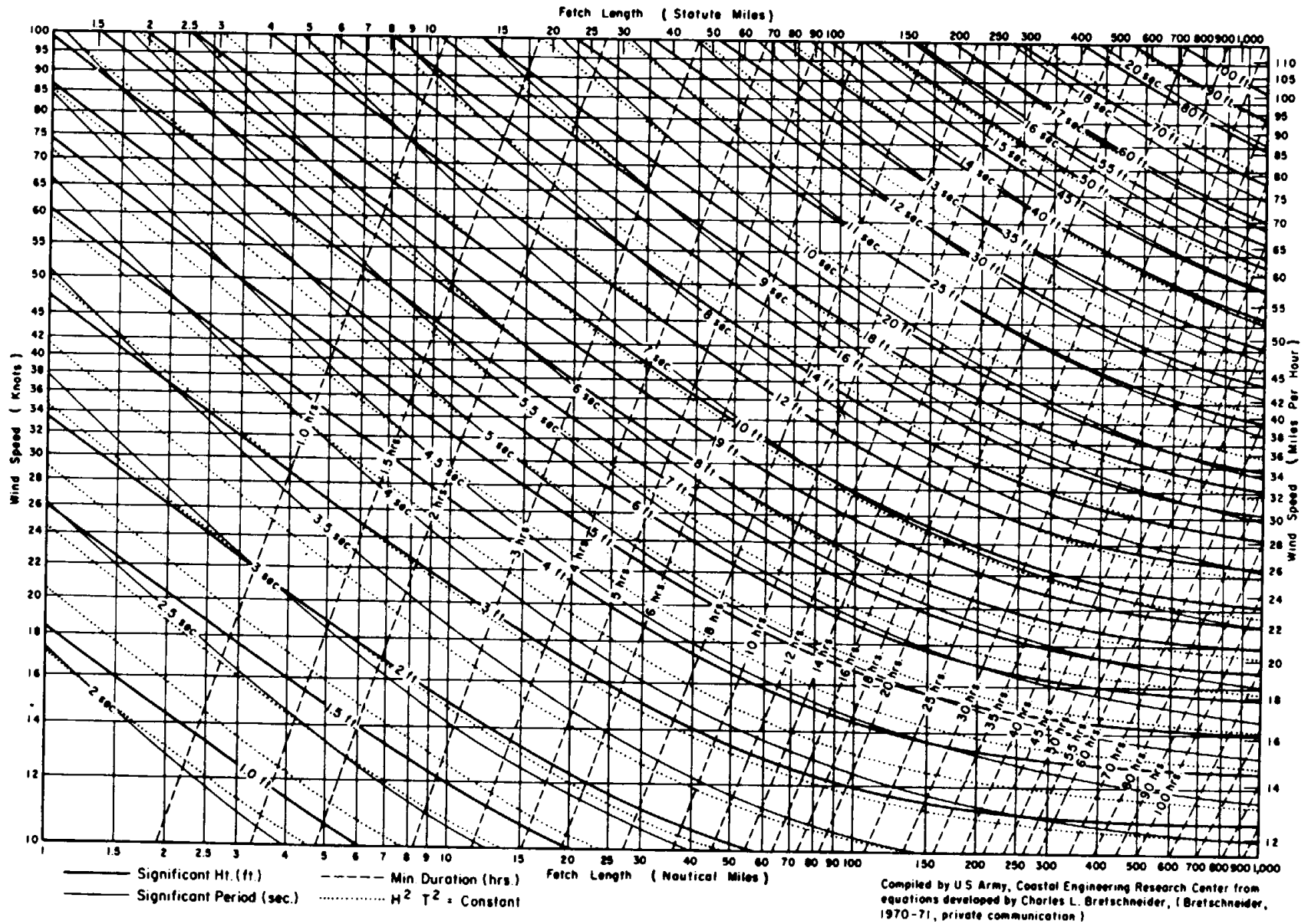

Figure 5-2. Deepwater wave forecasting curves (for fetches of 1 to 1,000 miles).

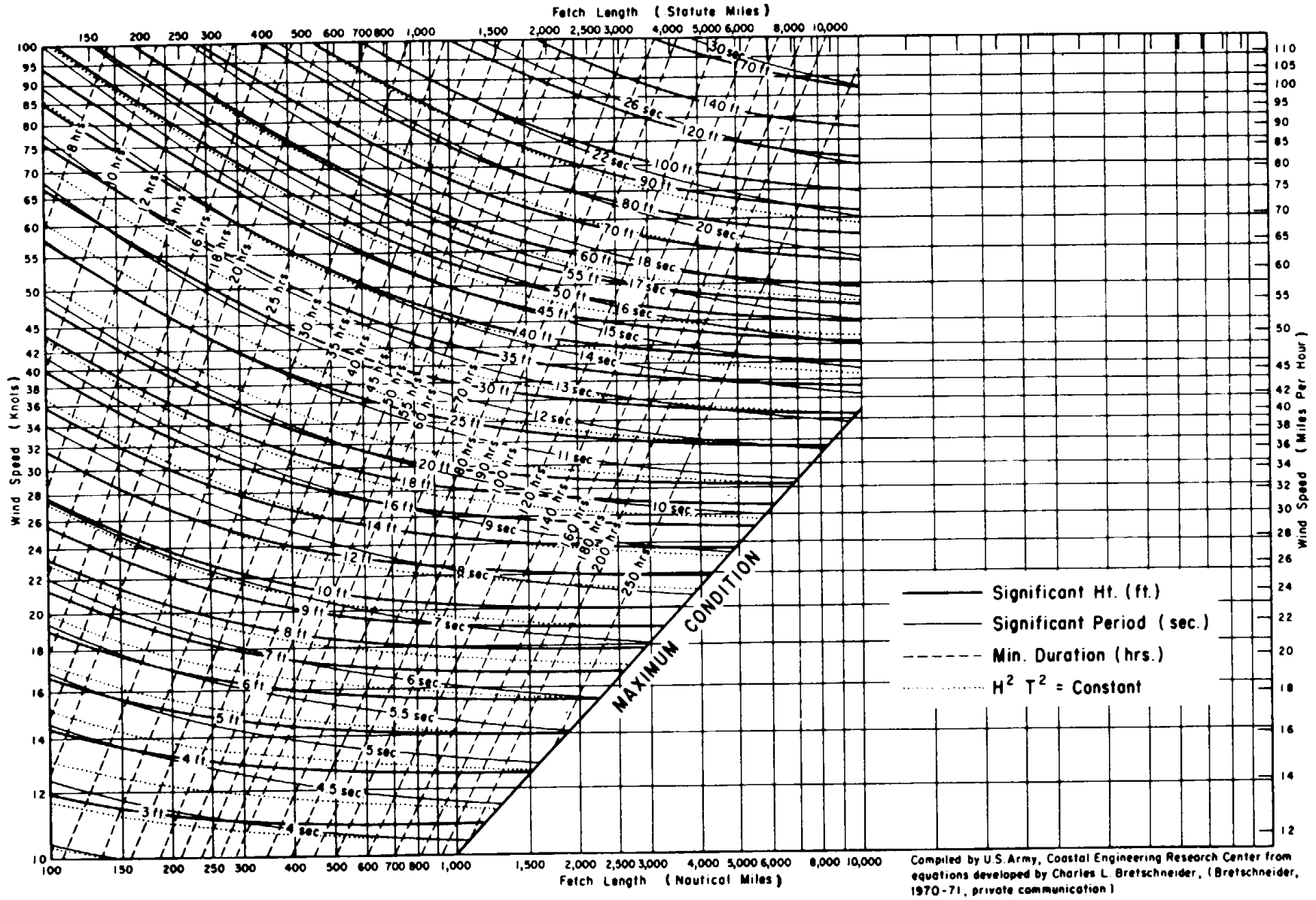
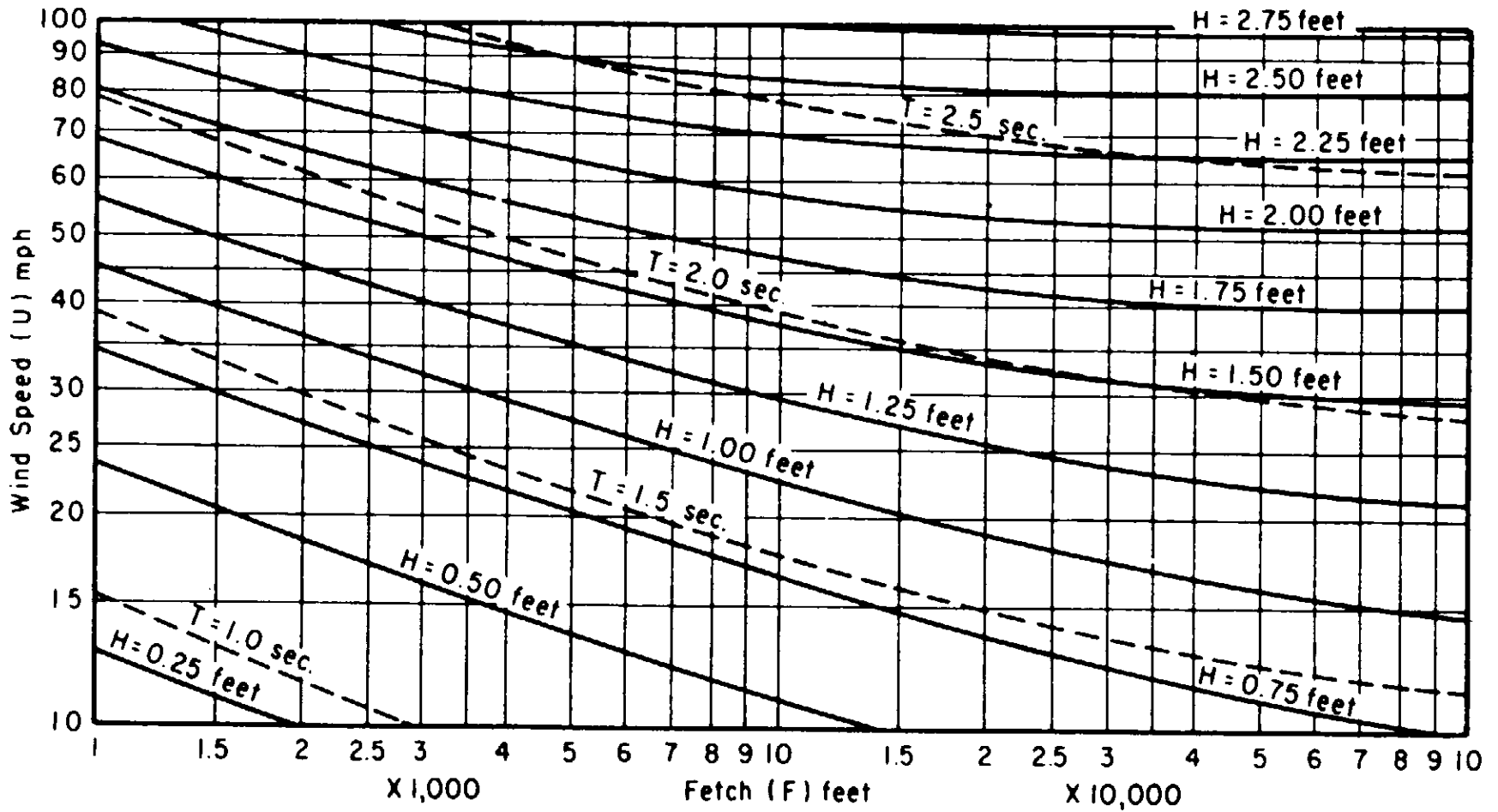
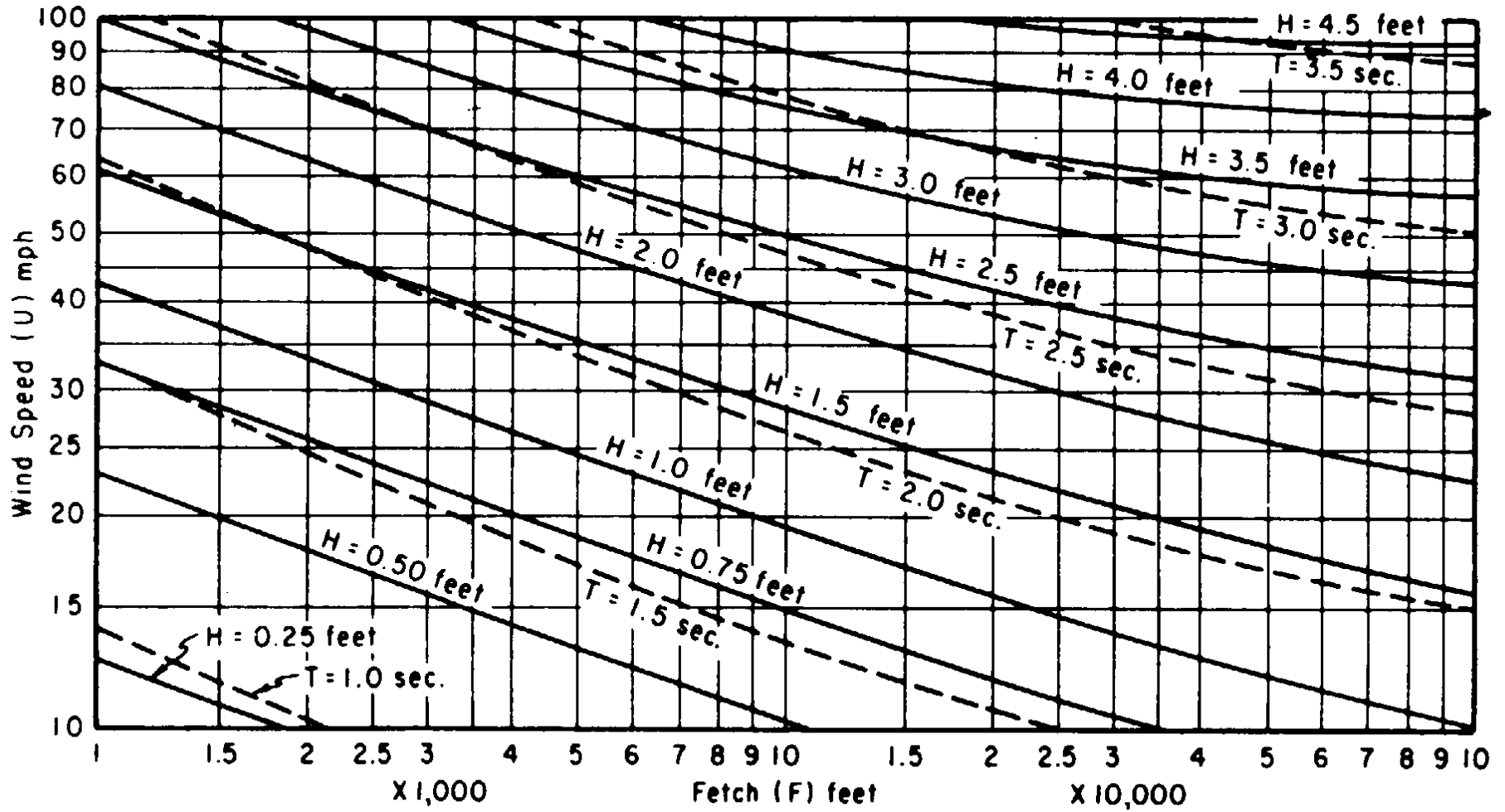

Figure 5-3. Deepwater wave forecasting curves (for fetches of 100 to more than 1,000 miles)



US Army Coastal Engineering Research Center

Figure 5-4. Forecasting curves for shallow-water waves (constant depth = 5 feet).



US Army Coastal Engineering Research Center

Figure 5-5. Forecasting curves for shallow-water waves (constant depth = 10 feet).

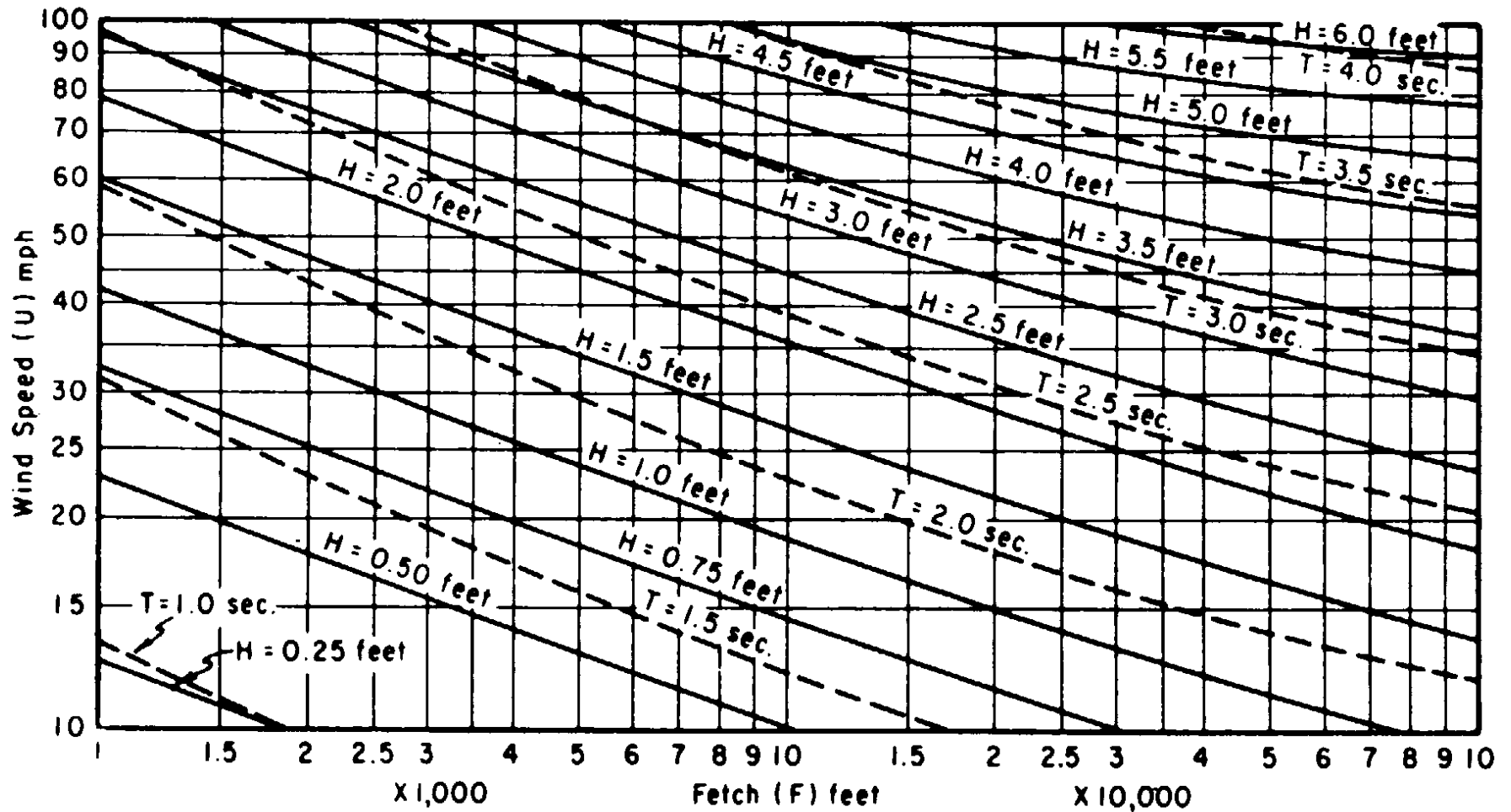

US Army Coastal Engineering Research Center

Figure 5-6. Forecasting curves for shallow-water waves (constant depth = 15 feet).

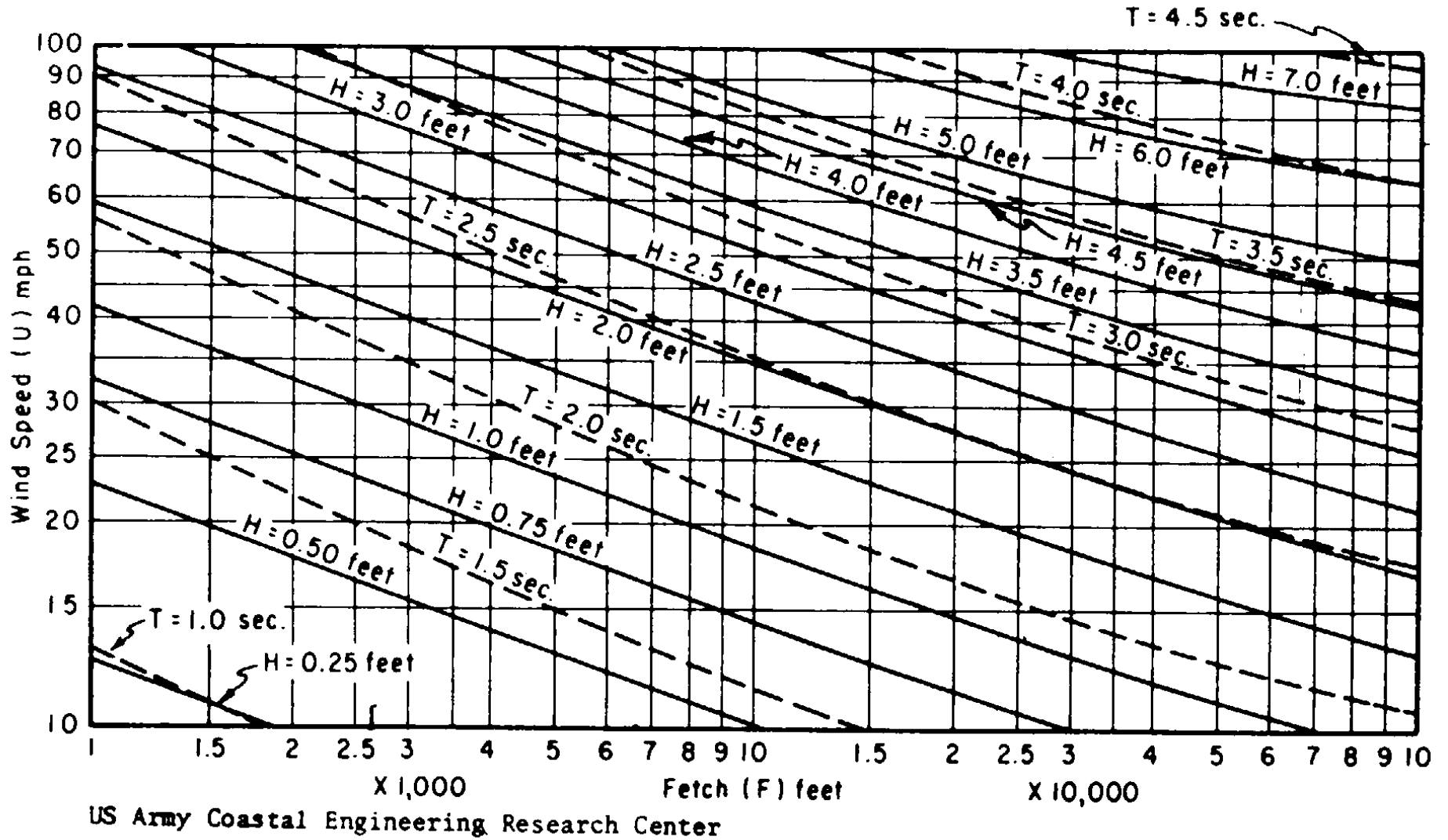
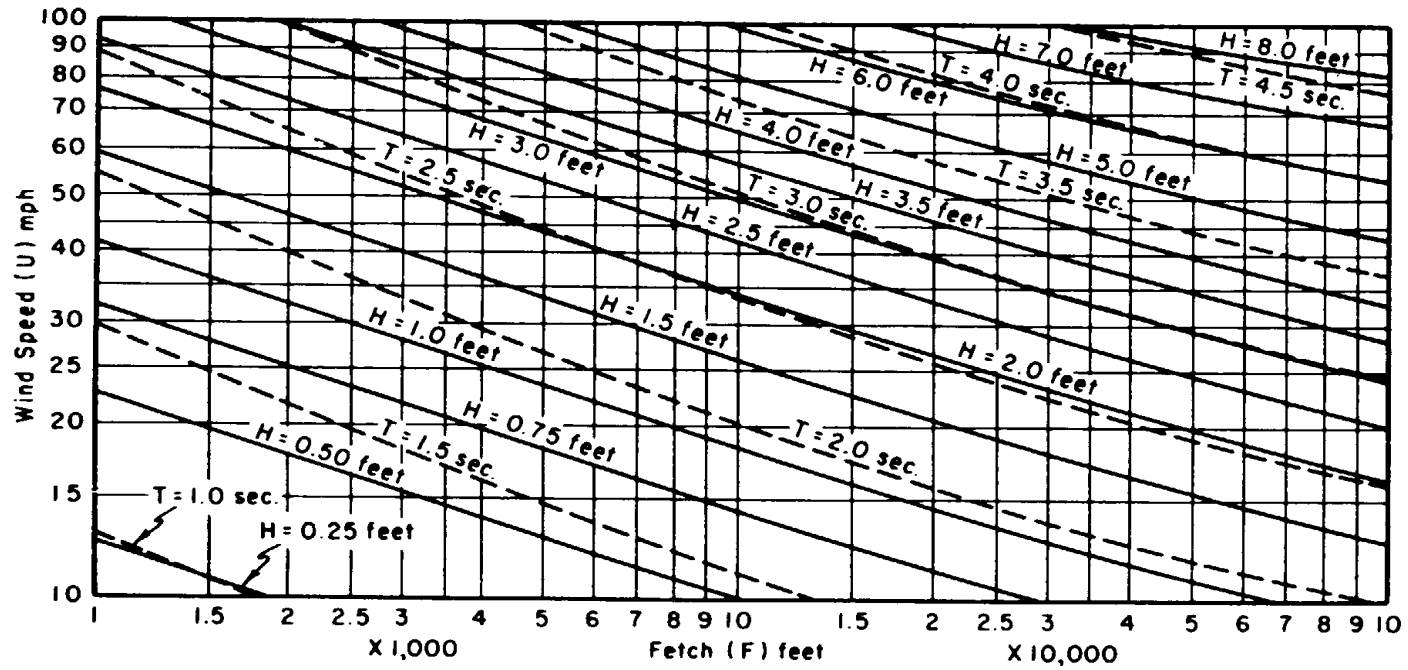

Figure 5-7. Forecasting curves for shallow-water waves (constant depth = 20 feet).



US Army Coastal Engineering Research Center

Figure 5-8. Forecasting curves for shallow-water waves (constant depth = 25 feet).

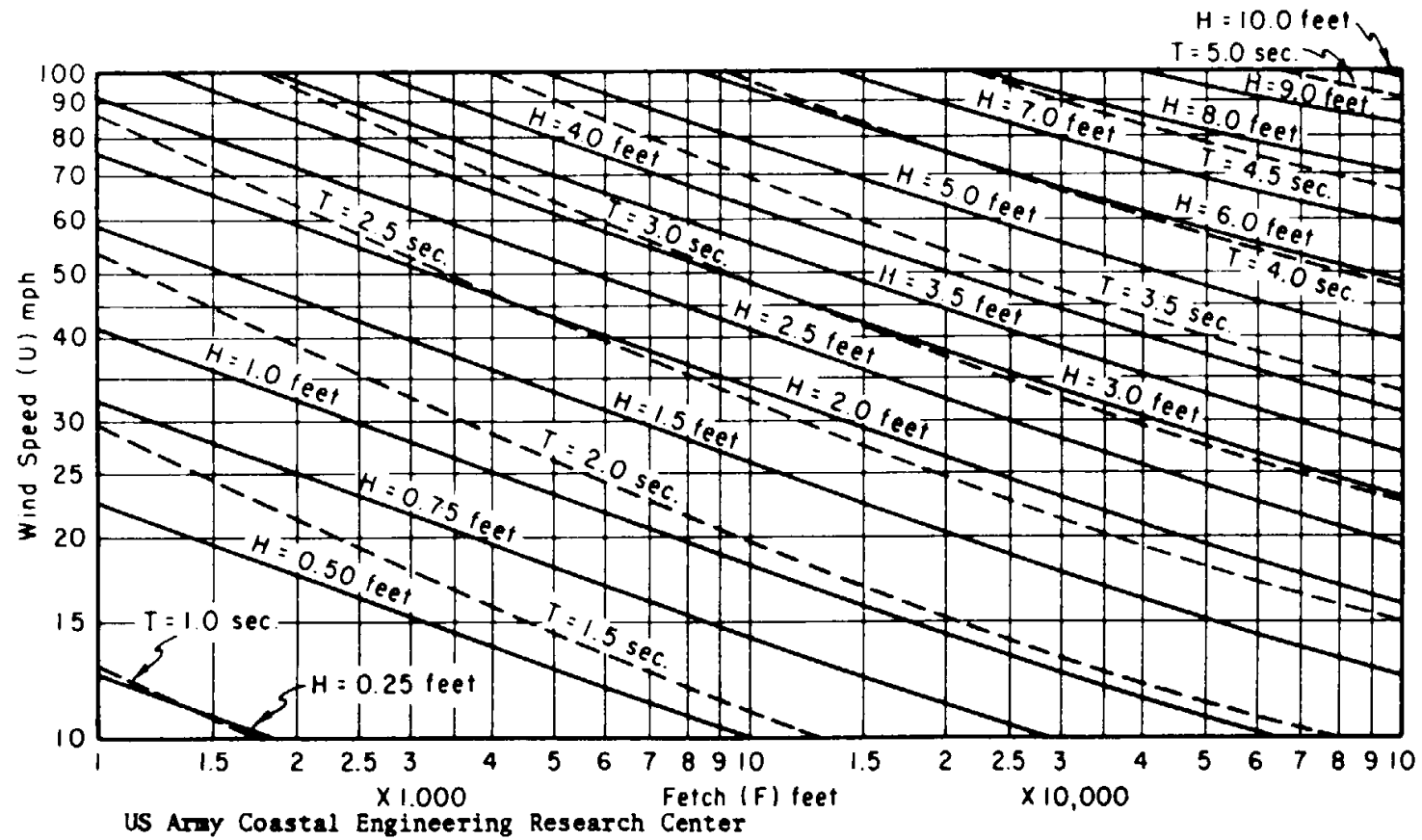
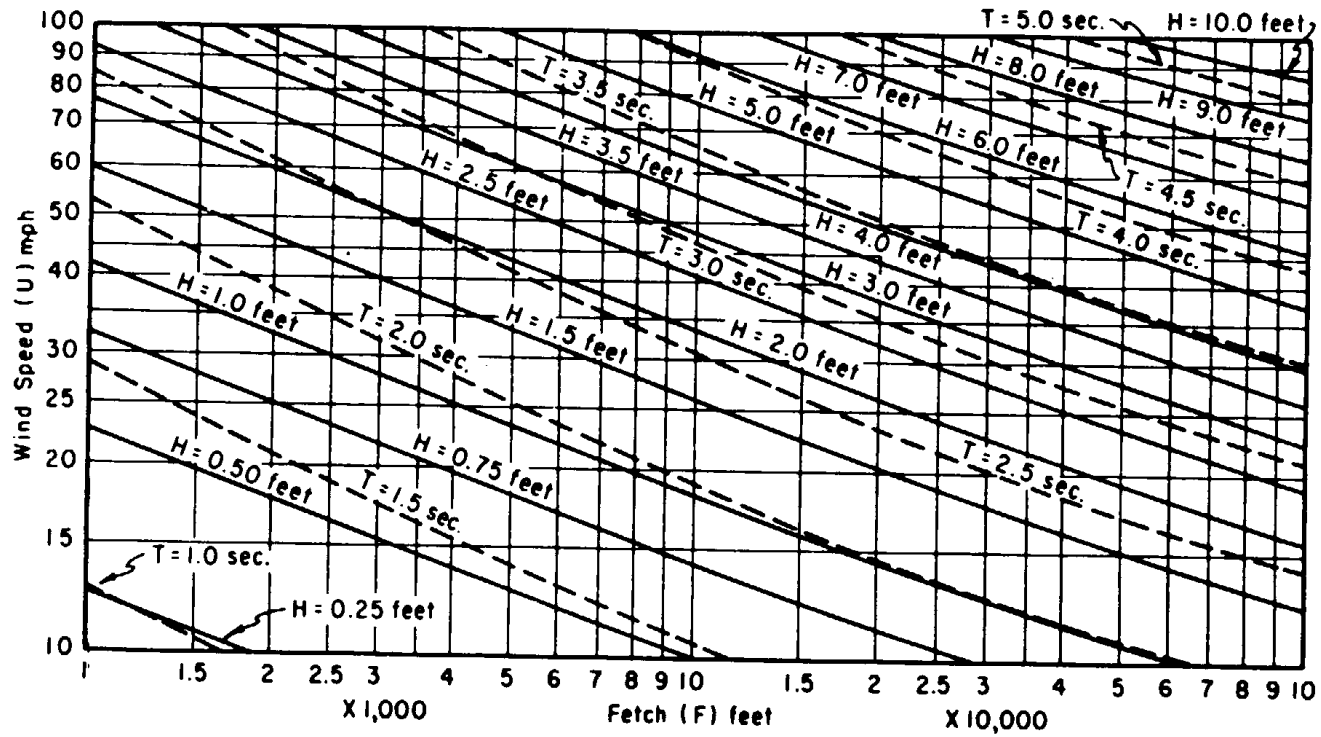
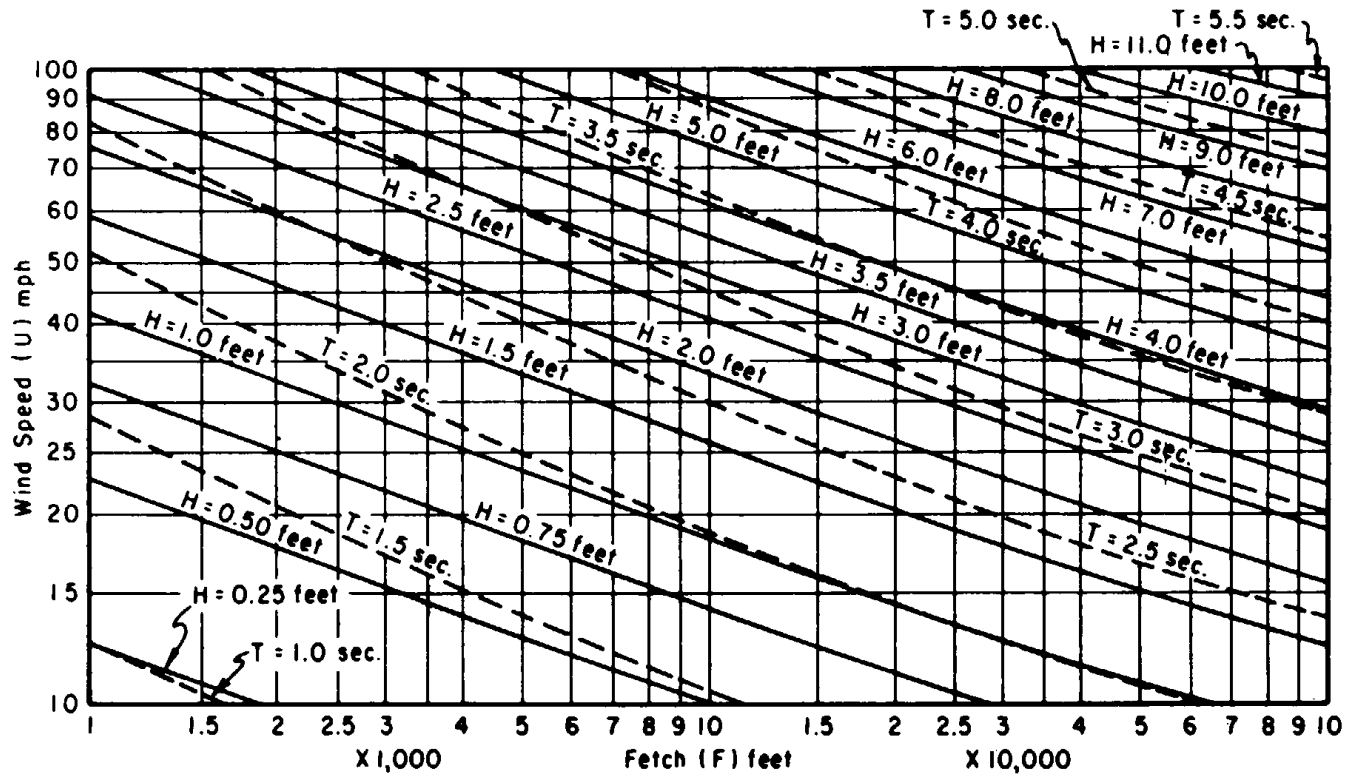

Figure 5-9. Forecasting curves for shallow-water waves (constant depth = 30 feet).



US Army Coastal Engineering Research Center

Figure 5-10. Forecasting curves for shallow-water waves (constant depth = 35 feet).



US Army Coastal Engineering Research Center

Figure 5-11. Forecasting curves for shallow-water waves (constant depth = 40 feet).

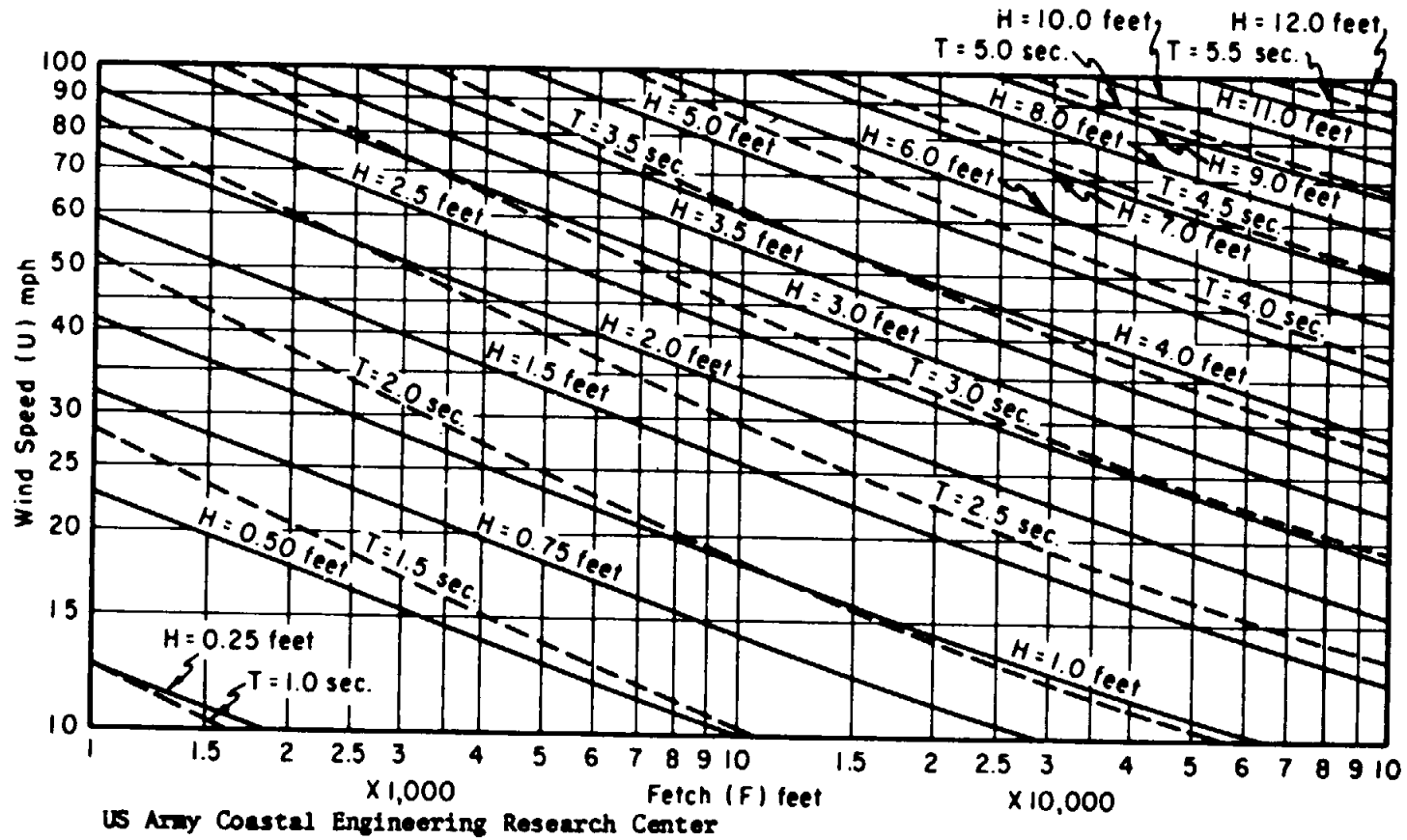
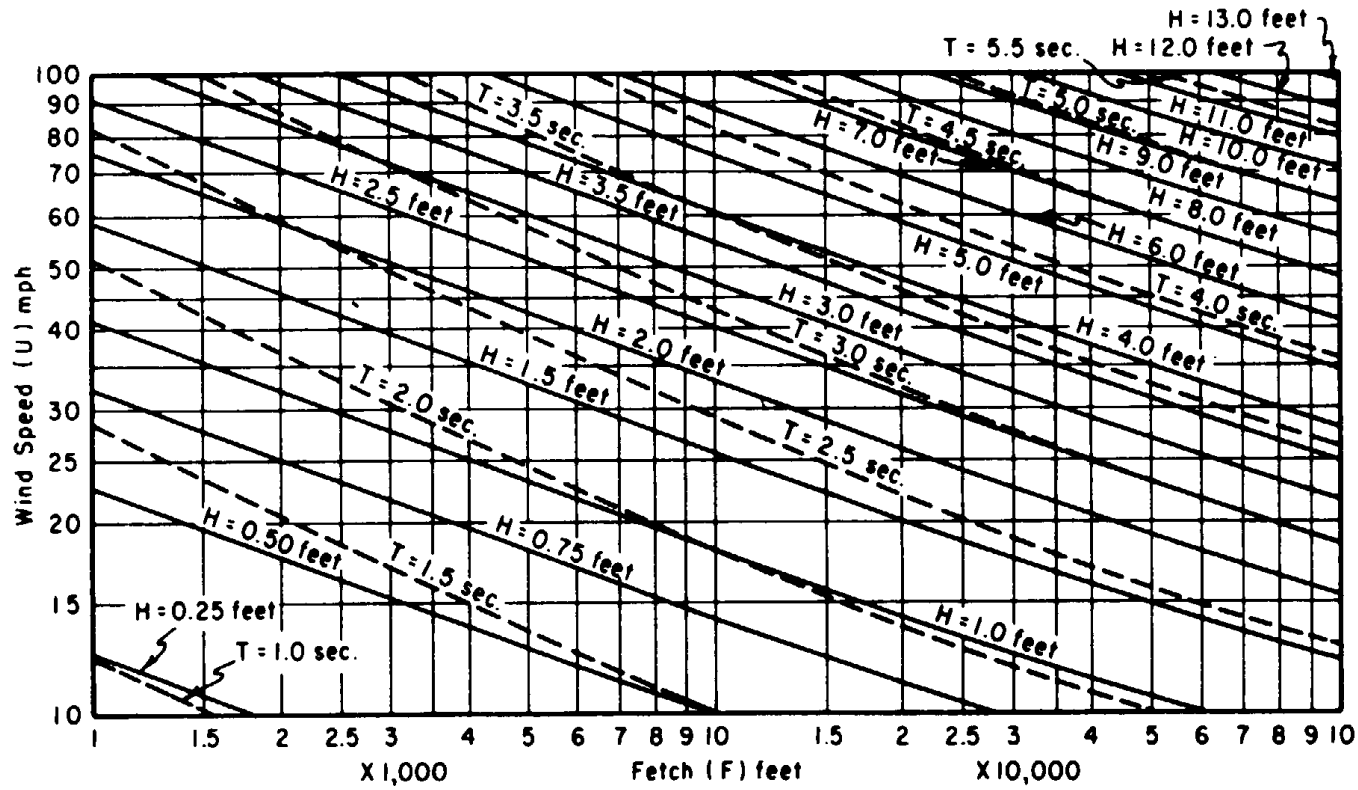

Figure 5-12. Forecasting curves for shallow-water waves (constant depth = 45 feet).



US Army Coastal Engineering Research Center

Figure 5-13. Forecasting curves for shallow-water waves (constant depth = 50 feet).

CHAPTER 6

PIER AND WHARF LAYOUT

6-1. Introduction.

a. Definition.

(1) *Pier.* A pier is a structure extending outward at an angle from the shore into navigable waters and normally permitting the berthing of vessels on both sides along its entire length.

(2) *Wharf.* A wharf is a structure extending parallel with the shoreline, connecting to the shore at more than one point (usually with a continuous connection), and providing, in most cases, berthing at the outshore face of the structure only.

b. *Functional requirements.* Piers and wharves provide a transfer point for cargoes and passengers between land and water transportation carriers. The pier/wharf complex may provide the following facilities:

- (1) Berth capacities of sufficient depths and widths to allow safe vessel approach and departure.
- (2) Sufficient mooring devices to safely secure vessel.
- (3) Access for railroad and highway facilities.
- (4) Storage space for open or covered cargoes.
- (5) Cargo handling equipment.
- (6) Fender system.
- (7) Administrative and maintenance facilities.
- (8) Fire protection and fire fighting equipment.

6-2. Deck structures.

a. *Pier or wharf arrangement.* The arrangement of berths should fit the proposed site without encroaching on pierhead or bulkhead lines, with consideration given to the depth contour below which the driving of piles is impractical. The types of pier and wharf layouts are shown in figure 6-1.

b. *Pier and wharf length.* Pier and wharf lengths should be as follows:

(1) *Single-length berth.* Dock length should equal the overall length of the largest vessel to be accommodated, plus an allowance of 75 feet at each end of the vessel. For preliminary design, the following approximate pier lengths may be used:

Vessel type	Pier length, ft
Lighters	150
Submarines and destroyers	450
General cargo ships	600
Cruisers	750
Container ships	1,000

(2) *Multiple-length berths.* Dock length should equal the total overall length of the largest vessels simultaneously accommodated, plus allowances of 75 feet between the inshore end of inboard vessels and the bulkhead and 75 feet between the outboard end of outboard vessels and the end of the pier. Allow about 50 feet between vessels. For preliminary design, pier lengths should be approximately (n) times the berth length given in paragraph 6-2b (1) (where n = number of vessels of a given type berthed end to end at a single pier face).

c. *Pier width.*

(1) *Berth in outboard face.* Outboard face berth widths should be adequate for vessel accommodation. The width requirements may be obtained from the pier lengths given in paragraph 6-2b.

(2) *Berths only alongside pier.* The total width should be the sum of the width requirements for the pier shed, aprons, and lanes for railroad, trucks, and crane service. In no case should the width be less than that required for lateral stability. The minimum pier width should be 25 feet clear between curbs. Where railroad tracks, truck lanes, or craneways are to be installed, the following width requirements should be followed:

(a) *Railroad tracks.* Except where local conditions require otherwise, standard gage should be used for trackage.

(b) *Truck lanes.* A minimum of 15 feet should be provided.

(c) *Craneways.* Width requirements depend on equipment selected for pier service.

d. *Wharf width.* There are no definite width requirements, but sufficient area should be provided for storage and for truck and rail access. An apron should be provided along the outboard face. For general cargo wharves, the required width for aprons, shed, and upland facilities should be about 300 feet. The width may be increased for container wharves.

e. *Slip width.* Clear distances between piers will be adequate for the safe berthing of the required maximum size vessels, plus clearances for the safe working of tugs and barges, lighters, and cranes operating between vessels. Where multiple berthing is provided, clearances shall be sufficient for dispatching the vessel at the inboard berth without moving the vessel at the outboard berth. The width should not be less than 3 to

4 times the largest accommodated vessel beam for single berthing, or 5 to 6 times the beam of the largest accommodated vessel for berthing two abreast. These requirements apply where vessels are berthed on both sides of the slip. Where vessels are berthed on one side only, the slip width may be reduced.

f. Aprons. The width of an apron will depend upon the use of portal or semiportal cranes and the number of railroad tracks and truck lanes, if any. The minimum width should be 20 feet. Where railroad tracks are carried on aprons, the apron width should allow for passing of train and trucks (or other material handling devices on the piers), plus allowances for the piled cargo on the aprons. Railroad tracks should be located along the outboard face of marginal wharves. Various apron widths for different operating conditions are shown in figure 6-2.

g. Deck elevation. Deck elevations for various types of construction and for particular situations are listed below. Except for the minimum elevations specified, pier deck levels should conform to the generally established levels of adjacent station property.

(1) *Flood protection.* To avoid flooding, provide deck elevations at or above maximum high water plus the half-height of an incident wave.

(2) *Two-deck piers.* Where a tidal range is large, deck height may interfere with cargo handling at low tide. In this case, the pier may be constructed with two levels, one for use at high tide and the other at low tide.

(3) *Concrete deck.* Where economically feasible, pile cap soffits should be 3 to 4 feet above mean high water.

(4) *Timber construction.* Where timber construction is used, the lowest tier of braces should be at or above the mean tide level, with the deck level adjusted for the required bracing depth.

(5) *Steel construction.* Except for piling, steel framing should be kept above mean high water. Adjust the deck level for the required construction depth.

(6) *Loading platforms.* Loading platforms are desirable on piers where materials are transferred by trucks or freight cars. The loading platform height should be 3 feet 9 inches, and the width should be 16 feet. On straight railroad tracks, a clearance of 6 feet should be provided between the edge of a loading platform and the center line of the adjacent railroad track. On curved tracks, this clearance should be increased by the amount of the center or end excess and provide access to platform ends by ramps.

(7) *Crane and railroad tracks.* These tracks should be flush with the pier decks or pavements.

h. Water depths in slips. Except where heavy silting conditions require greater depth, at individual berths at low tide, the depth should equal the maximum

loaded draft of the largest vessel to be accommodated, plus 4 feet. On a mud or silt bottom, consider increasing the water depth requirements if an investigation indicates probable fouling of condensers on the vessel due to proximity of the mudline to the bottom of the vessel. Where the vessels to be accommodated are specifically known, the following values may be used:

Vessels	Depth, ft ¹
Small boats and seaplanes	6 to 12
Submarines and destroyers	30 to 35
Cruisers and general cargo ships	35
Container ships	40

¹These depths are based on mean low water (MLW) or mean lower low water (MLLW) statistics for the area under study.

6-3. Transit shed.

a. Introduction. A transit shed is required for handling goods that must be protected from the weather. Where nonperishable goods (not subject to weather damage) are handled, open storage areas may be used in lieu of sheds. Covered sheds are not required for container slip wharves.

b. Storage area requirements. The total storage area in pier sheds should conform to project requirements. An area of 90,000 square feet has been found to be about the minimum space needed for one berth. For general cargo, allow 40 cubic feet of volume per ton and 50 percent of shed area for aisles. Upland storage for each berth can be provided equal to 2.5 to 5 percent of the annual general cargo volume handled.

c. Shed Width. Shed width shall conform to the following criteria:

(1) *Single-story sheds.* Transit sheds should be one story high. The width of a single-story shed (less width of the outboard apron) is obtained by dividing the pier storage area requirement (including allowances for office, toilet, passenger, and miscellaneous areas) by the length of the pier.

(2) *Multi-story sheds.* These sheds are not normally economical because of heavy line load requirements and operational difficulties. Where pier widths are limited because of adjacent piers, high costs, or limited availability of waterfront property, multi-story sheds may be required. The width of a multi-story shed equals the width required for a single-story shed divided by the number of floors (plus allowances for ramps and elevators between floors).

d. Vertical clearance. Provide 20-foot height or more to the undersides of beams or trusses. Clearances of 22 feet are required where railroad tracks are run into a shed and 24 feet where cargo is to be handled in the shed by mobile cranes. Clearances should comply with the loading capacities of forklift trucks or other cargo handling devices used on the piers.

e. *Column spacing.* Longitudinal and transverse spacing along and across the piers is specified as follows:

(1) *Longitudinal.* Column spacing along the length of the piers is generally determined by the sizes and spacing of the cargo doors with a column supporting a door buck. The shed columns should be located over the substructure pile caps. Column spacings of 15 and 25 feet are considered normal.

(2) *Transverse.* Spacing of columns across pier widths should allow for aisles between the stacked cargo to permit movement of forklift trucks and other cargo handling devices. A minimum aisle spacing of 40 feet should be provided. For single-story sheds, consider eliminating all interior columns where the roof live load does not exceed 30 to 40 pounds per square foot, and where the shed width does not exceed 100 to 130 feet.

f. *Door size and spacing.*

(1) *Cargo doors.* The cargo doors should be sized to accommodate any special packages handled at the building. The minimum size for cargo doors should be a 16by 18-foot clear opening. Spacing between cargo doors should be 36 to 38 feet with alternate dead panels, or 30 feet without alternate spacing. For narrow aprons, provide doors in every bay. Where apron widths are narrow, cargo door heights should be increased to permit sling loads to swing through the door. The rolling shutter or sectional, vertical lift type is preferable. Provide bolts and locks that are operated inside the shed and also wheel guards for the door frames.

(2) *Access doors.* Where trucks are permitted to enter a shed, access doors of the inboard face should be a minimum of 14 feet high by 12 feet wide.

(3) *Shed doors.* Along railroad tracks, space doors at 42or 44-foot intervals for the best corresponding spacing of railroad car doors. These shed doors should have minimum openings 14 feet wide by 12 feet high.

(4) *Truck loading.* At shipside and in truck loading areas, doors should be continuous with shed columns supporting the door bucks.

(5) *Railroad doors.* Doors through which railroad cars pass shall be 22 feet high. Widths shall conform to either single or double-trackage clearances, (figure 6-2).

g. *Fire protection.* Fire protection should be in accordance with AR-420-90.

h. *Miscellaneous.* Installation of lighting and ventilation should conform to those contained in appropriate Army manuals. Partitioned offices shall be provided for supervisory personnel. Rooms should also be provided for stevedore's gear, lockers, washroom, toilets, and guard rooms.

6-4. Approaches.

a. *Introduction.* Approaches are required where piers are located offshore. Approaches should be in the form of trestles or a causeway. Trestles should be used where tidal flow obstruction must be minimized.

b. *Dimensions and clearances.* Two truck lanes, plus necessary railroad or crane trackage, should be provided. The minimum width should be 24 feet clear between curbs. The 60-foot wide causeways are recommended for modern container wharves. For offshore wharves, where approaches are short and cargo handling requirements are heavy, provide double approaches for single berths and two-lane approaches at 500-foot intervals for multiple-length berths. This arrangement will provide continuous one-way traffic past each berth. A triangular deck area should be provided at the intersection of the approach with the wharf to permit 90-degree turns on and off the wharf. These triangular areas should be made at 45 degrees and are generally about 35 feet on a side. For marginal wharves, provide continuous access.

6-5. Roll-on/roll-off ramps.

No general solution was found to the problem of providing facilities for discharging commercial roll-on/roll-off ships. There appears to be no standard height above water level of either side doors or stern ramps. The difference between loaded and light draft of a ship may be as much as 20 feet, and the tidal variation within many harbors is 10 feet or more; provisions may be required to accommodate a change of as much as 30 feet in the elevation of stern and side doors. If the gradient on a ramp is limited to 30 percent to assure rapid discharge and loading of vehicles, a total ramp length of 60 to 70 feet may be required, depending on the elevation at the shore end.

6-6. Transportation facilities.

a. *Railroad facilities.* Access to two or more trunk lines is desirable. The capabilities of the serving railroads to handle the traffic should be investigated, and backhaul between the shipping points and the port can be avoided.

(1) *Receiving tracks.* The length of each receiving or interchange track should, if practicable, be equal to the length of the maximum single delivery of the serving railroad. The standing-room capacity of the receiving yard should be equal to the average daily volume of cars received in peacetime operation. The design should take into consideration the average or peak movements of cargo, the berthing capacity of the wharf facility, the types of military cargo, and the ship turnabout cycle.

(2) *Classification tracks.* The standing-room capacity of the classification yard should be equal to the

peak daily inbound movement when the port is operating at estimated maximum capacity. The number of tracks can be determined by the number of classifications, and their length by the cars in each classification.

(3) *Dispatching tracks.* The number and length of dispatching tracks can be determined by the same factors used in calculating the size and number of the receiving and classification tracks.

b. *Highway facilities.* The port should have access to two or more principal highway systems. The residential areas of the labor supply should be considered in designing the access or connecting highways.

(1) *Highway transport loop.* The loop system should provide highways to the wharves, transit sheds, and warehouses. Grade crossing should have maximum visibility, and the gradients of highway approaches may not exceed 3 percent. Space can be provided for grouping trucks and semitrailers by destination and commodity. A truck storage apron can be provided for the trucks required to handle the maximum daily cargo at the port.

(2) *Pavement design.* Roads, streets, and parking areas can be designed in accordance with the criteria in TM 5-822-5 and TM 5-822-6 (app A.)

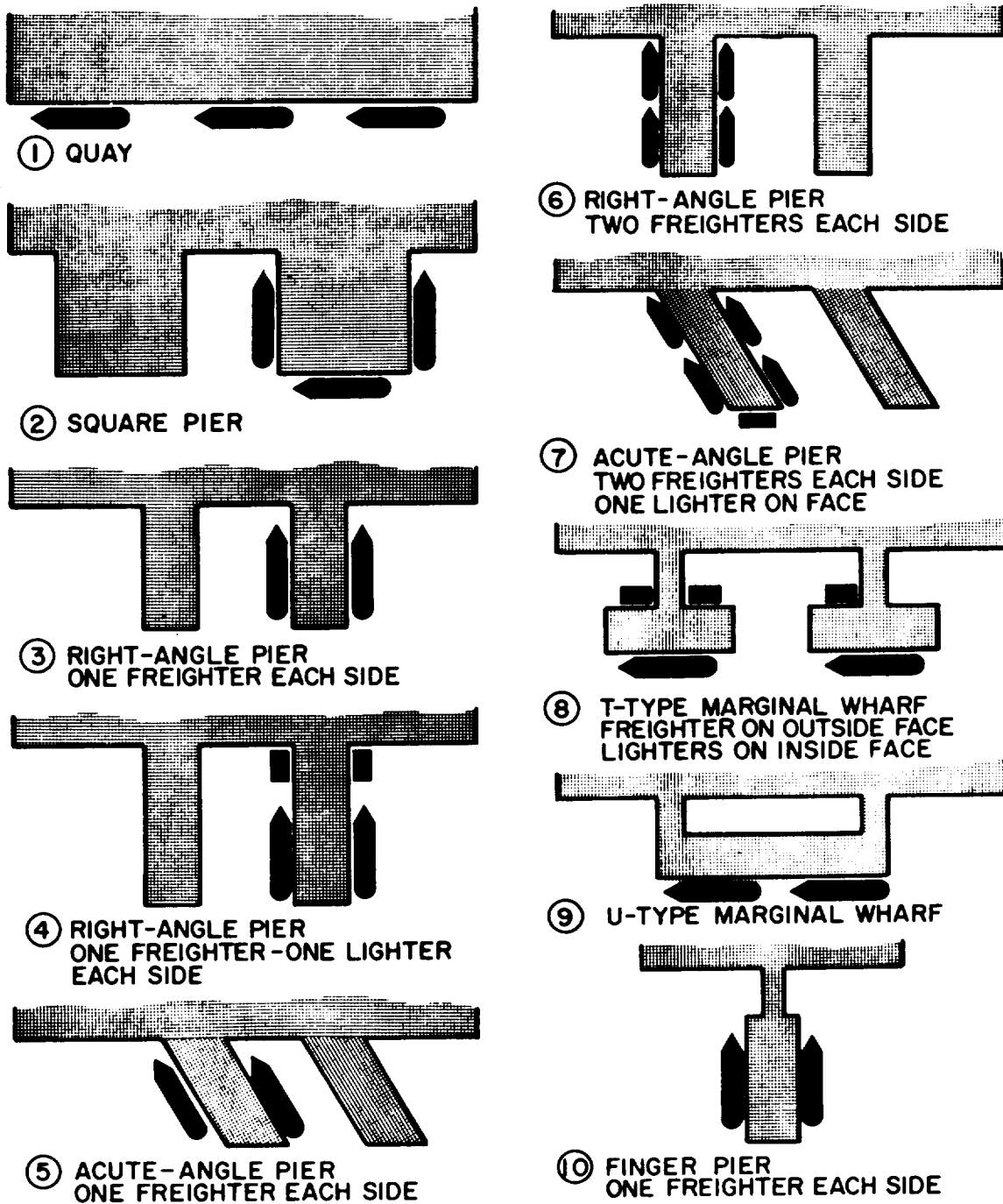

NOTE:

NOT TO SCALE. FOR EXPLANATION OF LAYOUT TERMINOLOGY ONLY.

Department of the Army

Figure 6-1. Types of pier and wharf layouts.

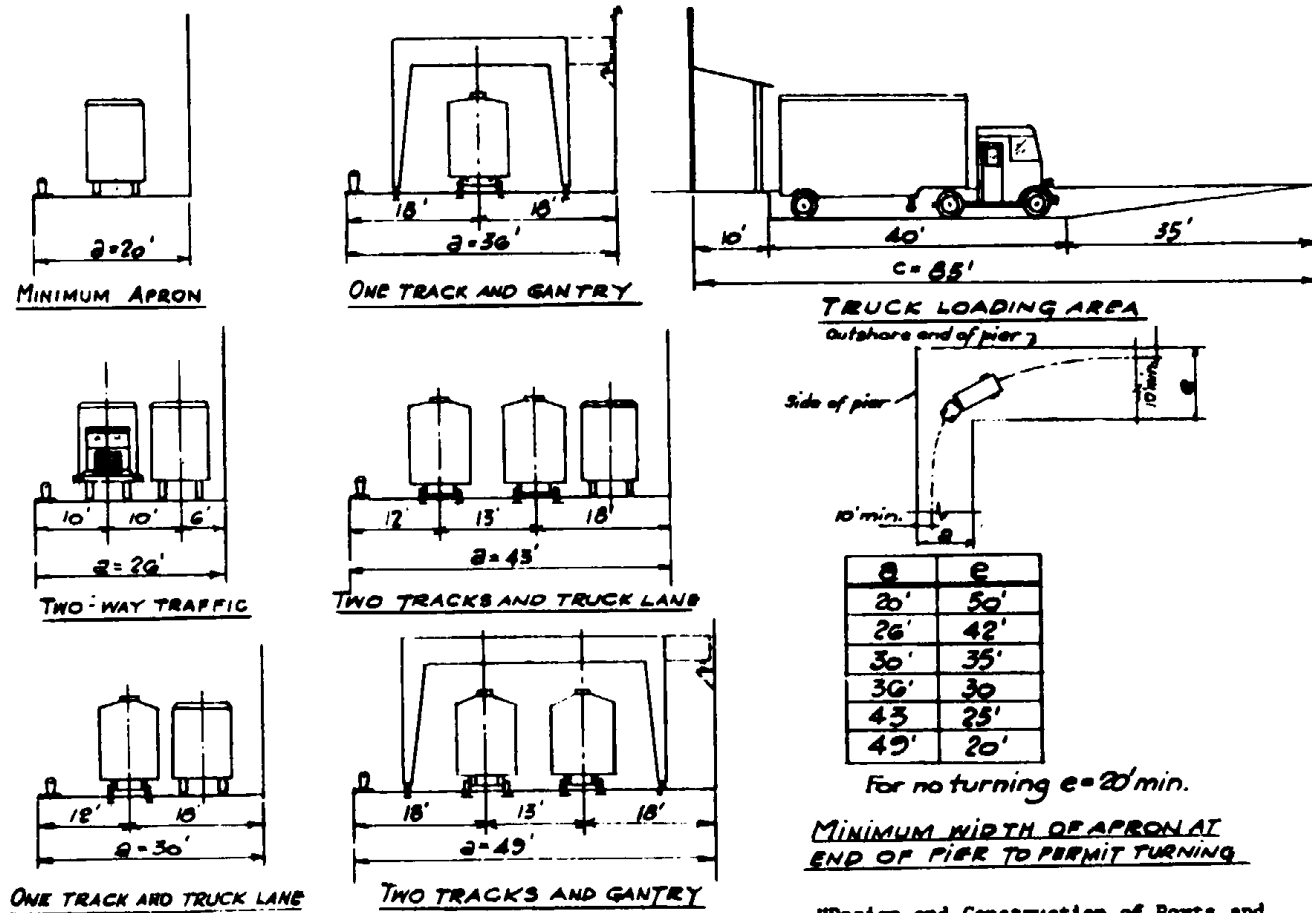

"Design and Construction of Ports and Marine Structures" by A. Quinn. Second Edition, 1972 McGraw-Hill Book Company. Used with permission of McGraw Hill Book Company.

Figure 6-2. Various widths of apron for different operating conditions.

CHAPTER 7

LIVE-LOAD REQUIREMENTS

7-1. Vertical loads.

a. *Uniform loads.* Uniform live loads of 600 and 1,000 pounds per square foot respectively should be used for the design of general berthing piers and container wharves.

b. *Truck loads.* American Association of State Highway and Transportation Officials (AASHTO) HS20-44 loadings will be used for all piers. (see app A.)

c. *Loads on railroad tracks.* American Railway Engineering Association (AREA) E-72 loadings will be used when the railroad is constructed on the pier. (see app A.)

d. *Crane loads.* Concentrated wheel loads due to crane reactions can be obtained from its manufacture. To compensate for infrequency of loading and other factors, only 75 percent of the wheel load values may be used in designing deck components (slabs and beams). When designing substructure components (piles and pile caps), 100 percent of wheel load values will be used. An impact factor of 20 percent should be added to the wheel load concentrations in the normal design of deck and stringers and 10 percent where two or more cranes act together; and 10 percent, in the design of pile caps and secondary framing members.

e. *Impact.* Impact factors should apply only to concentrated liveload conditions. Apply impact loadings to decks, stringers, girders, and pile caps; but not to piling or similar members supporting pile caps or girders.

7-2. Lateral loads.

a. *Docking impact.* The impact energy may be calculated according to the following equation:

$$E = K \frac{WV^2}{2g} \quad (7-1)$$

where

E= impact energy to be absorbed by the dock, foot-pounds

K= coefficient of restitutions

= .3 for light pile supported structures

= 0.5 for large, heavy pile supported structures

= 1.0 for solid fill structures

W= loaded displacement of vessel, pounds

V= component of velocity approaching vessel normal to the face of mooring, feet per second

g= 32.2 feet per second per second

The velocity and angle of approach used for design should be as follows:

(1) *Velocity of approach.* For destroyers and small craft, use 1.7 feet per second for normal berthing conditions. For a vessel with 50,000-ton loaded displacement or over, use 0.5 foot per second for normal berthing conditions, and for other vessels, allow 0.8 foot per second.

(2) *Angle of approach with respect to face of berth.* For destroyers and smaller craft, the angle of approach should be 20 degrees, and for larger vessels, 10 degrees.

b. *Forces from moored ships.* Forces due to winds and currents on moored ships may be estimated in accordance with the following: (1) Forces due to winds. The maximum wind force shall be calculated as follows:

$$W = A \times C \times P \quad (7-2)$$

where

W= wind force, pounds

A= exposed area of the broad side of the ship in a light condition, square feet

C= shape factor

= 1.3

P= wind pressure, pounds per square foot

= 0.00 256 vs

v= wind velocity, mile per hour

When ships are berthed on both sides of a pier, the total wind force acting on the pier, as a result of wind on the ships, should be increased by 50 percent to allow for wind against the second ship.

(2) *Forces due to current.* For salt water, the current pressure in pounds per square foot equals 15 V', where V is the velocity of the current in feet per second. This pressure will be applied to the area of the ship below the waterline when fully loaded. Since the ship is generally berthed parallel to the current, this force is seldom a controlling factor.

c. *Winds on piers and pier sheds.* The wind pressure on piers and pier sheds should be calculated for the maximum wind velocity in the area, and the proper shape factor applied for the type of structure on the pier.

d. *Earth pressure.* Earth pressure shall be considered in the design.

e. *Tidal lag.* Allow for pressures resulting from differences between tide levels. Unbalanced waterheads

due to tidal lags are usually assumed to be one-half of the mean-tide ranges.

f. Earthquake forces. Earthquake forces should be considered if in an area of seismographic disturbance.

g. Ice. The structure will be designed to resist all static and impact forces from ice. In some locations, ice may accumulate on the structure. Allowance should be made for the effect of this accumulation upon the stability of and upon the stresses in the structure.

7-3. Longitudinal loads.

a. In truck loading, provide for longitudinal forces due to traction and braking equal to 5 percent of the total truck live loading in any one truck lane.

b. For railroad and crane loading, provide for longitudinal forces equal to the larger of the following: (1) Due to braking-15 percent of live loading on any track without impact.

(2) Due to traction-25 percent weight on the driving wheels on any one track, without impact.

7-4. Loading combinations.

Piers and wharves should be designed for a combination of dead plus full live loading at normal allowable stresses; or a combination of dead plus full live loading, plus lateral loading on moored ships, plus wind loading on pier and pier shed at one-third increase in normal allowable stresses.

CHAPTER 8

STRUCTURAL DESIGN

8-1. Structural types.

a. Open piers and wharves. These piers and wharves have open water flowing underneath them and consist of platform structures supported on various types of piles. Open-type construction falls into two classifications:

(1) Relieving platform in which fill is superimposed, topped off by the finished deck.

(2) High-level superstructure in which the deck system is supported directly on the piles. The principal types of open pier and wharf construction are shown in figures 8-1 through 8-10. These types should be used where piers extend out board of legal bulkhead lines. Open construction is also used where tidal and stream prism restrictions should be minimized; where flows in which piers are built carry heavy silt loads; and where bottoms are soft. For pier widths up to 125 feet, open structures are usually more economical. Open pile structures are not advisable where heavy accumulations of sheet or drift ice occur. Open-type piers are suitable in any water depth.

b. Solid piers and wharves. The deck of a solid pier or wharf is supported in full, whereas the perimeter structure is essentially a continuous bulkhead or quay wall. The principal types of solid piers and wharves are shown in figures 8-11 through 8-15. Solid piers generally require less maintenance than open types. For pier widths greater than 125 feet, and where good foundation material exists at or above dredge levels, solid or combination piers are usually more economical.

c. Combination piers. These piers combine open and solid types with a filled center and open perimeter.

8-2. Deck structure design.

a. Concentrated load distribution to decks.

(1) *Truck loads.* Concentrated wheel loads (including impact) will be distributed to deck slab, stringers, and pile caps in conformity with distribution of wheel loads to deck slabs, stringers, and floor beams of highway bridges specified in AASHTO specification.

(2) *Railroad loads.* Concentrated wheel loads (including impact) will be distributed to supporting slabs, stringers, and pile caps of steel frame structures in accordance with AREA specifications. For concrete structures, the live loads (including impact) should be distributed over widths of tracks.

(3) *Wheel loads through fill.* These loads should be distributed in accordance with AASHTO specifications for truck wheels and the AREA specifications for railroad locomotive wheels.

b. Timber deck requirements (figure 8-16).

(1) *Caps.* Two types of caps are in general use: (a) single piece timbers across the tops of the piles (b) a pair of clamps dapped into the tops of piles at the sides. The single-piece cap is preferred. Caps will be strapped to piles.

(2) *Anchorage for deck fittings.* Bollards, bits, and cleats should be anchored to decks and piling by using spiral-drive drift bolts and metal straps.

(3) *Deck planks and treads.* In addition to planks, timber decks designed for truck loadings should be provided with treads. Treads should be 3 inches minimum. Do not consider treads as load-carrying members.

(4) *Bridging.* Place solid bridging between stringers over all pile caps. One intermediate line of solid bridging will be placed at the midpoints of all spans between 21 and 40 feet, and two lines at the third points of spans 41 to 60 feet.

(5) *Stringers.* These stringers will bear on full widths of caps and should lap adjacent stringers. Lapped ends of untreated stringers should be separated 0.5 inch and blocked.

c. Concrete deck requirements. General design requirements will conform to the current American Concrete Institute (ACI), AASHTO, and AREA specifications. Special reinforcement may be provided to distribute loads from deck fittings.

d. Composite deck requirements. For timber-concrete decks, concrete slab and timber caps shall conform to timber and concrete deck requirements specified above. For timber-steel and steel-concrete decks, concrete and timber slabs and caps should conform to timber and concrete deck requirements.

e. Solid and combination pier decks. Requirements for these types of decks are indicated below.

(1) *Interior columns for pier shed.* These columns should be carried on isolated pile caps or piers supported at or below the dredge line. Some loss of fill is inevitable. Therefore, this loading requirement is necessary to prevent undermining shallow supports.

(2) *Pavement.* Where cargos are stacked on pavements exposed to the sun or where iron-rimmed wood or similar wheeled vehicles run on pavement, use concrete slabs. Elsewhere, flexible pavements are preferable. Where concrete pavements are used, provide expansion joints where the pavement passes over the inboard edge of cells or relieving platform.

(3) *Railroad and crane tracks.* These tracks may be supported on ties and ballast placed directly on select fills. Where tracks run over relieving platforms, loads should be distributed to the platforms as specified for distribution of wheel loads through fill.

(4) *Deck fittings.* Connect bollards, bits, and cleats to separate foundations embedded in the fills or tie to bulkhead, platforms, or cell structures.

(5) *Lost fill.* Where feasible, provide access for replacement of fill losses in solid or combination structures (some losses through interlocks and other openings are inevitable).

f. Other requirements. Provide side curbs, 12 to 15 inches high, for decks. For drainage, decks should be crowned or pitched 0.0625 inch per foot, and deck drains or scuppers provided. Scuppers should be a minimum of 2 inches high. Provide minimum 3-inch downpipes for drains and weep holes in all rail slots. For deck finish, provide float finish (in shed areas, a floor hardener is desirable).

8-3. Substructure design.

a. Load combinations. Pier substructures should be designed for dead loads, plus vertical live loads, plus lateral load of mooring or berthing ship, with normal allowable stresses; and for dead load, plus half a vertical live load, plus seismic load (based on dead load plus half a live load), with a one-third increase in normal allowable stresses of allowable pile capacity.

b. Piling requirements. The design of pile foundations depends upon three basic considerations: first, a consideration of the soil properties and capacities usually determined from soil boring tests; second, the study of pile types and driving equipment using a dynamic pile-driving formula; and third, the study of pile carrying capacities using a static formula. Testpile and test-load results are usually combined with these studies to achieve best results in pile foundation design.

(1) The following factors should be considered when selecting pile material:

- (a) required length of life.
- (b) character of structure.
- (c) availability of materials.
- (d) type of loading.
- (e) factors causing deterioration.
- (f) amount and ease of maintenance.
- (g) estimated costs of types of piles,

taking into

consideration initial cost, life expectancy, and cost of maintenance.

(h) available funds.

(2) The principal factors which cause piles to deteriorate are:

- (a) corrosion.
- (b) decay.
- (c) insect attack.
- (d) marine-borer attack.
- (e) mechanical wear.
- (f) fire.
- (g) chemical reaction (concrete).

In the case of foundation piles buried in the ground, only the first three factors need to be considered. In the case of piles supporting water-front structures, all of these environmental factors must be considered.

c. Fill material. Coarse-grained materials, such as sand, gravel, and rock, are suitable for fill. Fine-grained materials such as silt, or cohesive materials such as clay, are generally not satisfactory because of shrinkage, expansion, or settlement and will result in high maintenance costs and an unsatisfactory base for floors. Coarse-grained, cohesionless materials will be compacted to at least 95 percent of modified AASHTO maximum density, and fine-grained cohesive materials to at least 90 percent of modified AASHTO maximum density.

d. Bent spacing. Pier supporting transit sheds should have substructure pile bents spaced at an integer fraction of the shed column spacing. Provide a pile cap located under each column. Bent spacing from 10 to 24 feet is common for piers without sheds.

e. Other requirements. As to resistance to longitudinal loads, piers wider than 60 feet, and with expansion joints more than 400 feet apart, do not require batter piles for longitudinal resistance, unless designed for multiple berthings. Piers less than 60 feet wide should be investigated for longitudinal loads due to wind, ice, current, traction, and braking. Batter piles or longitudinal braces required for longitudinal resistance may be grouped near the center of pier lengths. As to scouring, piling (and/or sheet piling) should be adequately embedded to provide for anticipated scourings.

8-4. Miscellaneous considerations.

a. Expansion joints. Typical expansion joint detail is shown in figure 8-17. Slip joints for all rails, pipes, and ducts should be provided.

(1) *Size.* Expansion joints should provide for temperature changes of 600 F in moderate climates and 700 F in cold climates.

(2) *Shear connectors.* Provide shear connectors to prevent relative transverse movements of pier sec

tions. Shear connectors may consist of wide flange sections cased in slip sleeves.

(3) *Spacing.* Make the spacing as large as possible but do not exceed 600 feet. Piling should be checked for bending due to longitudinal expansion caused by temperature changes.

b. Future expansion. Where consideration is being given to constructing a pier in stages, provide the following details in the structure to facilitate future expansions:

(1) *Concrete structures.* Leave dowel bars projecting from first-stage construction. Dowel bars should be enameled and wrapped for anchor rods. Leave keys in abutting faces, and let pile caps project beyond pier edges. Use timber instead of concrete curbs on the side or end for future enlargement.

(2) Timber structures. No special provisions are required.

c. Wind screens. Where sheltering in the form of buildings or similar features is lacking at a given site, and where exposure is severe, wind screens may be used to reduce difficulties of berthing.

d. Relation to upland facilities. Switch yards and turnarounds may be provided in close proximity to the inshore ends of piers.

e. Navigation aids. Detailed information is provided in U.S. Coast Guard Booklet CG-208, Aids to Navigation Regulations (see app A). A foghorn is needed and fog lights should be provided on pier ends.

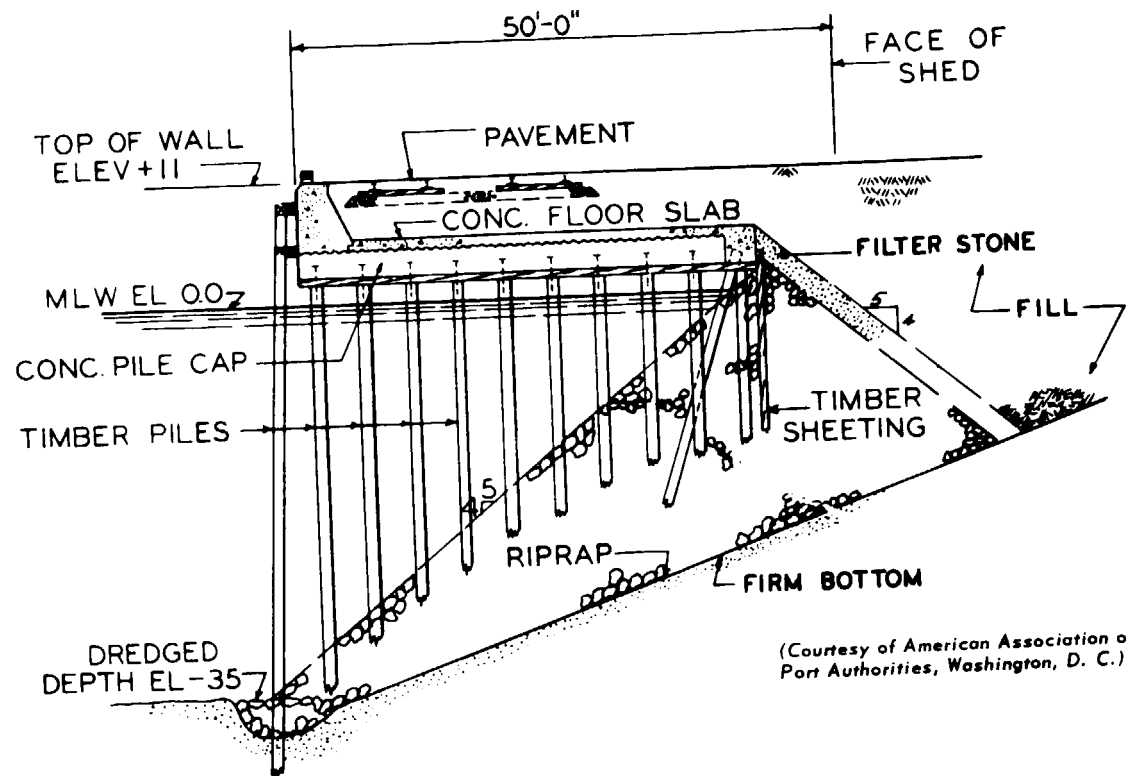

Figure 8-1. Open Type Wharf Construction with Concrete Relieving Platform on Timber Piles.

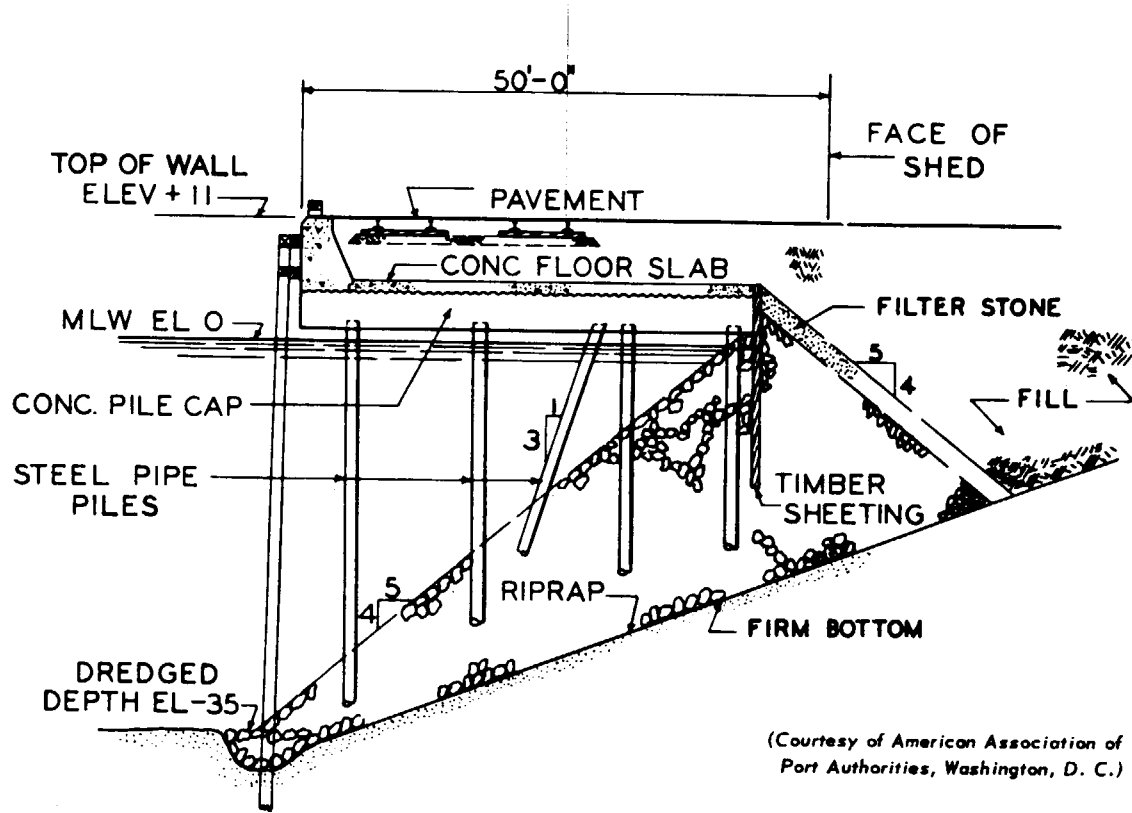

Figure 8-2. Open-Type Wharf Construction with Concrete Relieving Platform on Steel Pipe Piles.

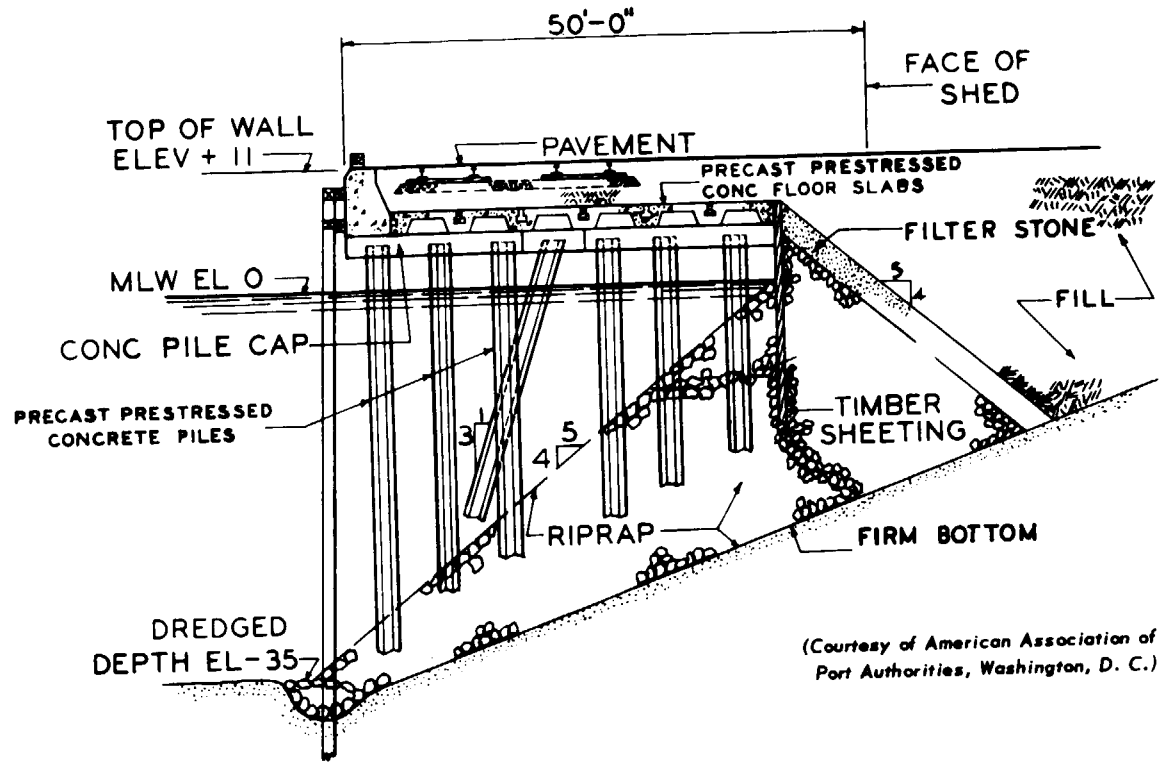

Figure 8-3. Open-Type Wharf Construction with Concrete Relieving Platform on Concrete Pile.

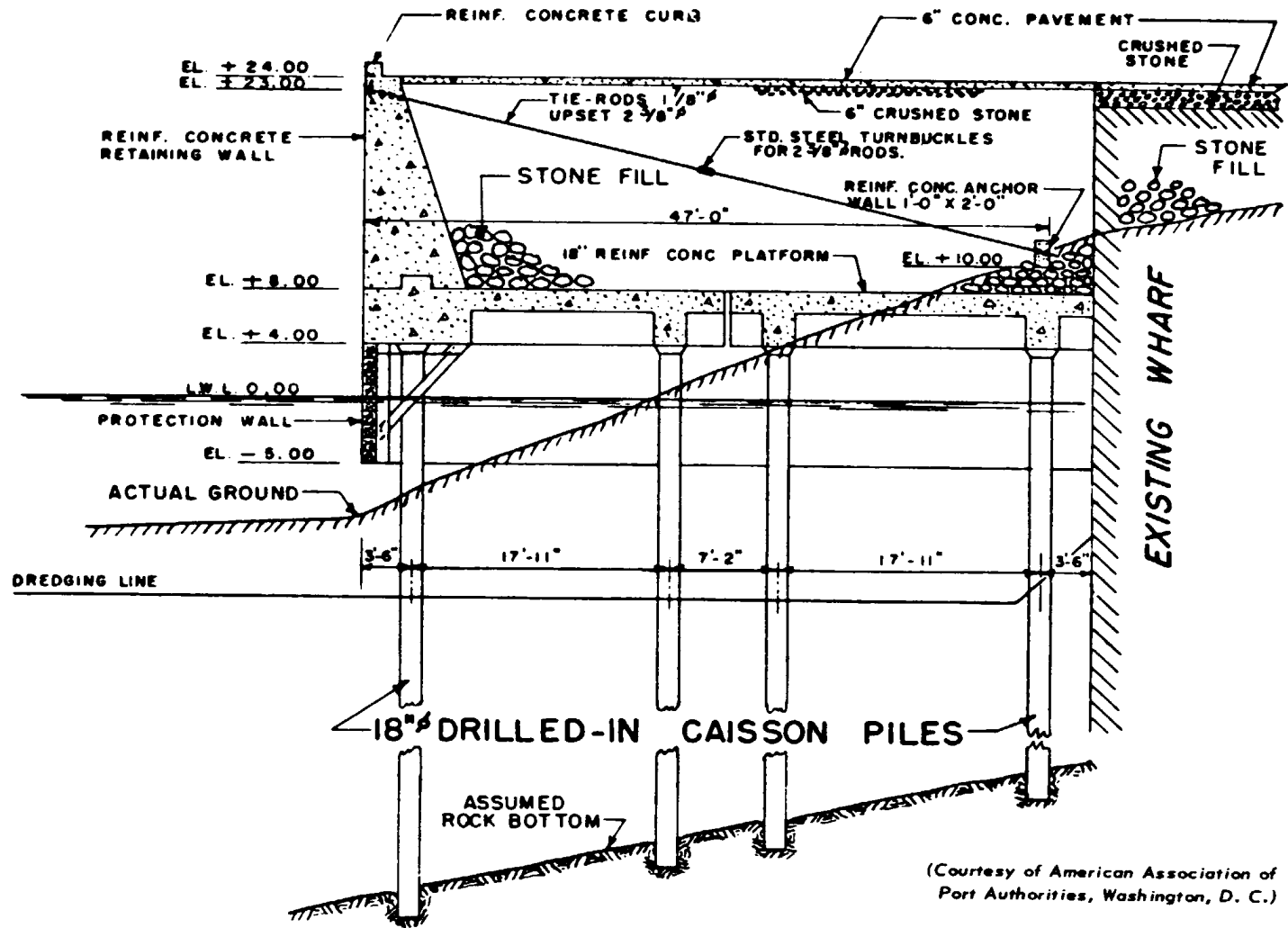

Figure 8-4. Open-Type Wharf Construction with Concrete Relieving Platform on Caisson Piles.

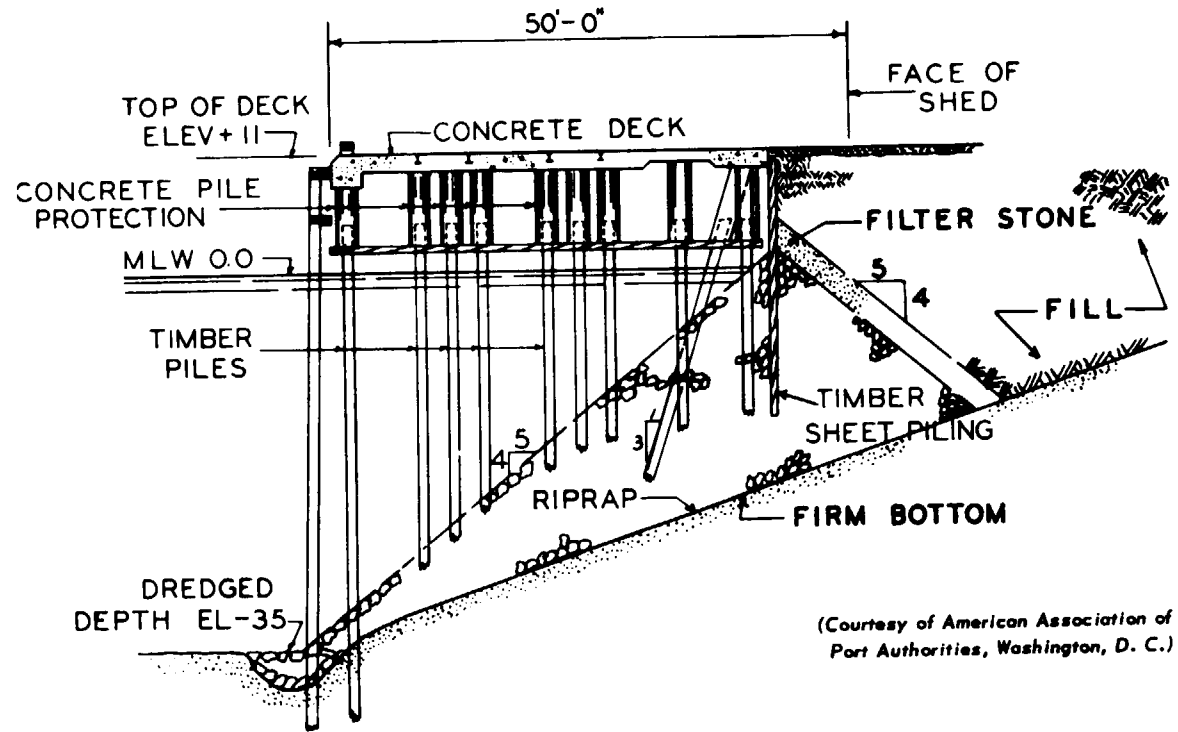

Figure 8-5. High Level Open-Type Wharf Construction with Concrete Deck on Timber Piles.

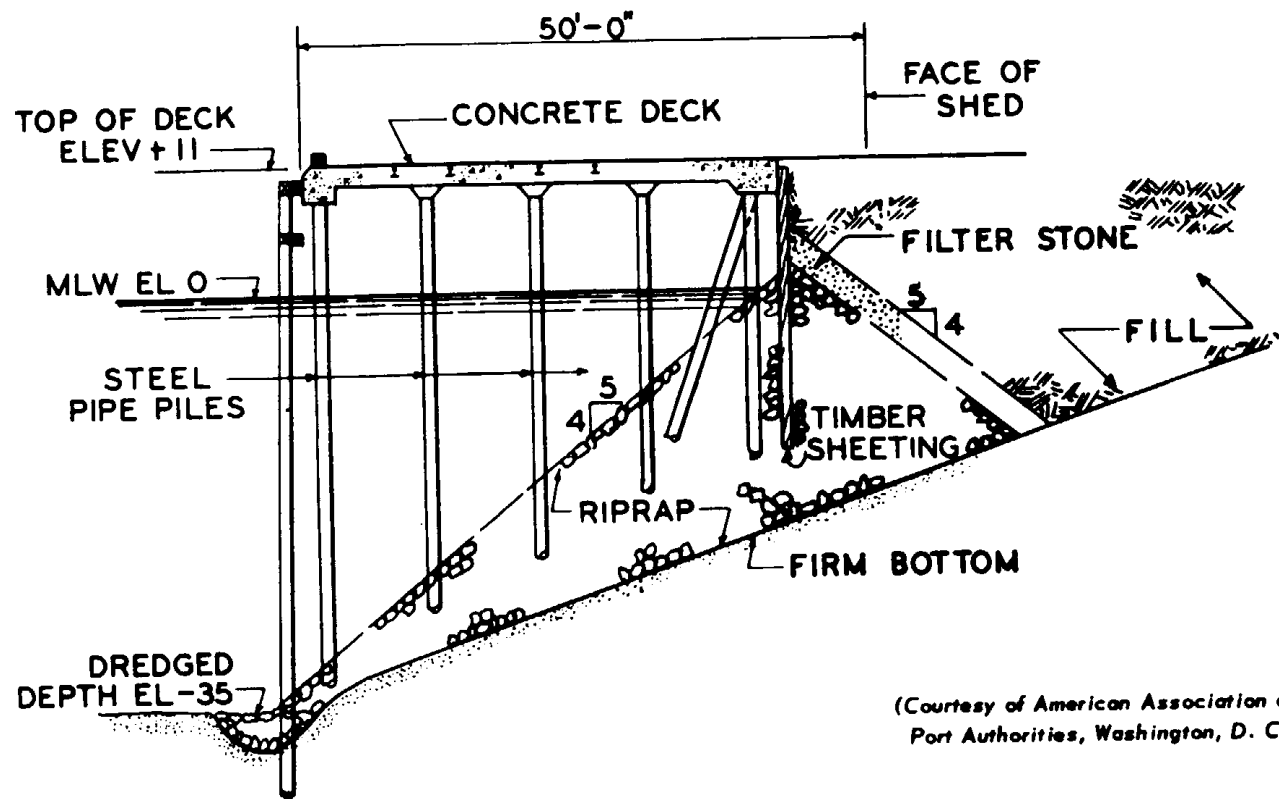

Figure 8-6. High-Level Open-Type Wharf Construction with Concrete Flat Slab Deck on Steel Pipe Piles.

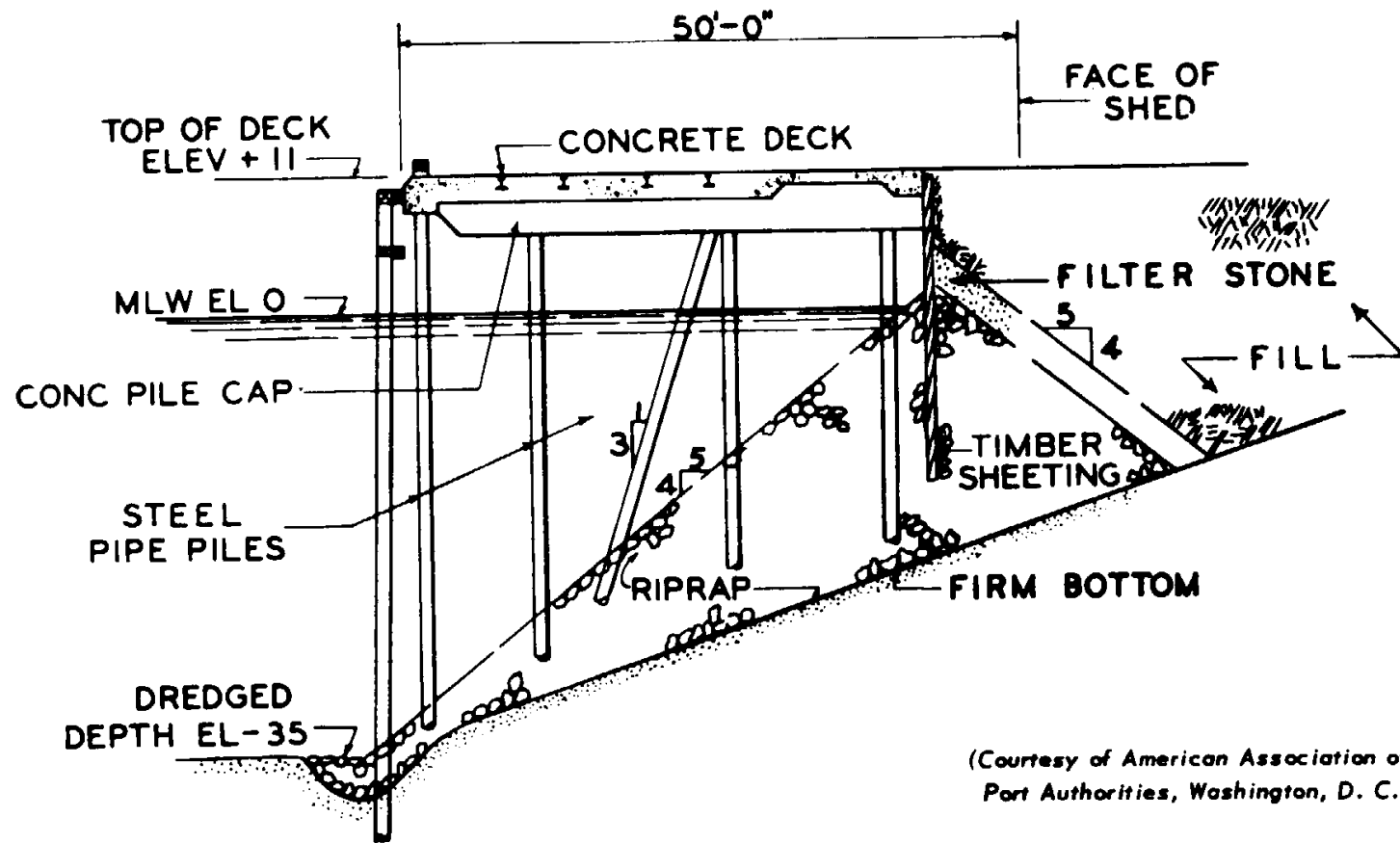

Figure 8-7. High-Level Open-Type Wharf Construction with Concrete Deck on Steel Pipe Piles.

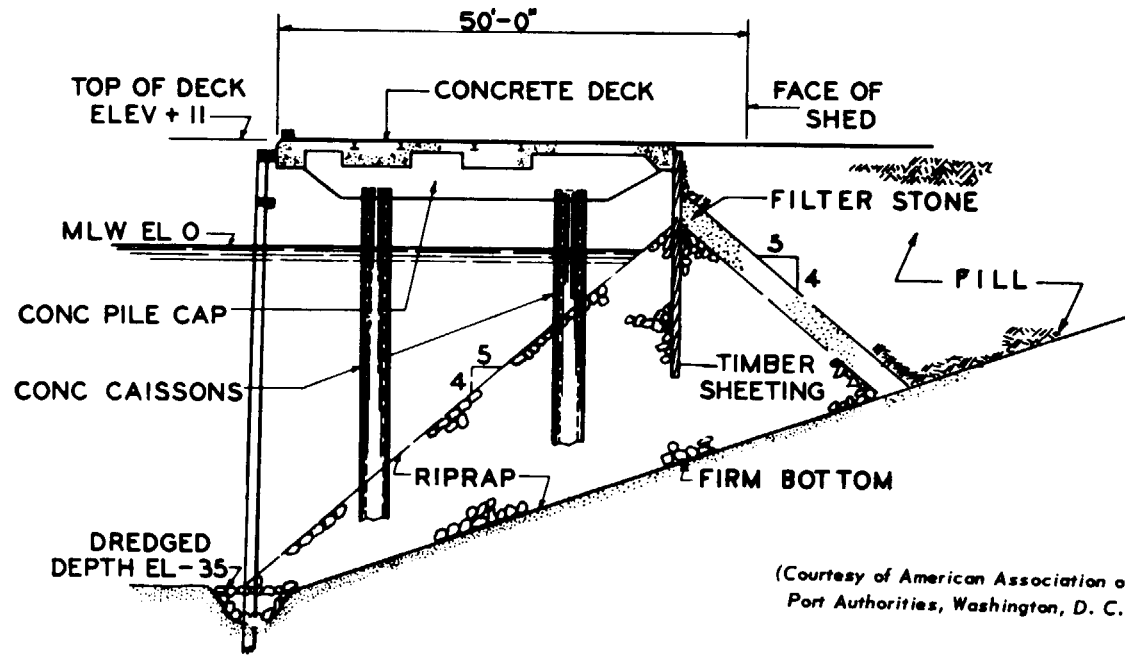

Figure 8-8. High-Level Open-Type Wharf Construction with Concrete Deck on Precast Prestressed Concrete Caissons.

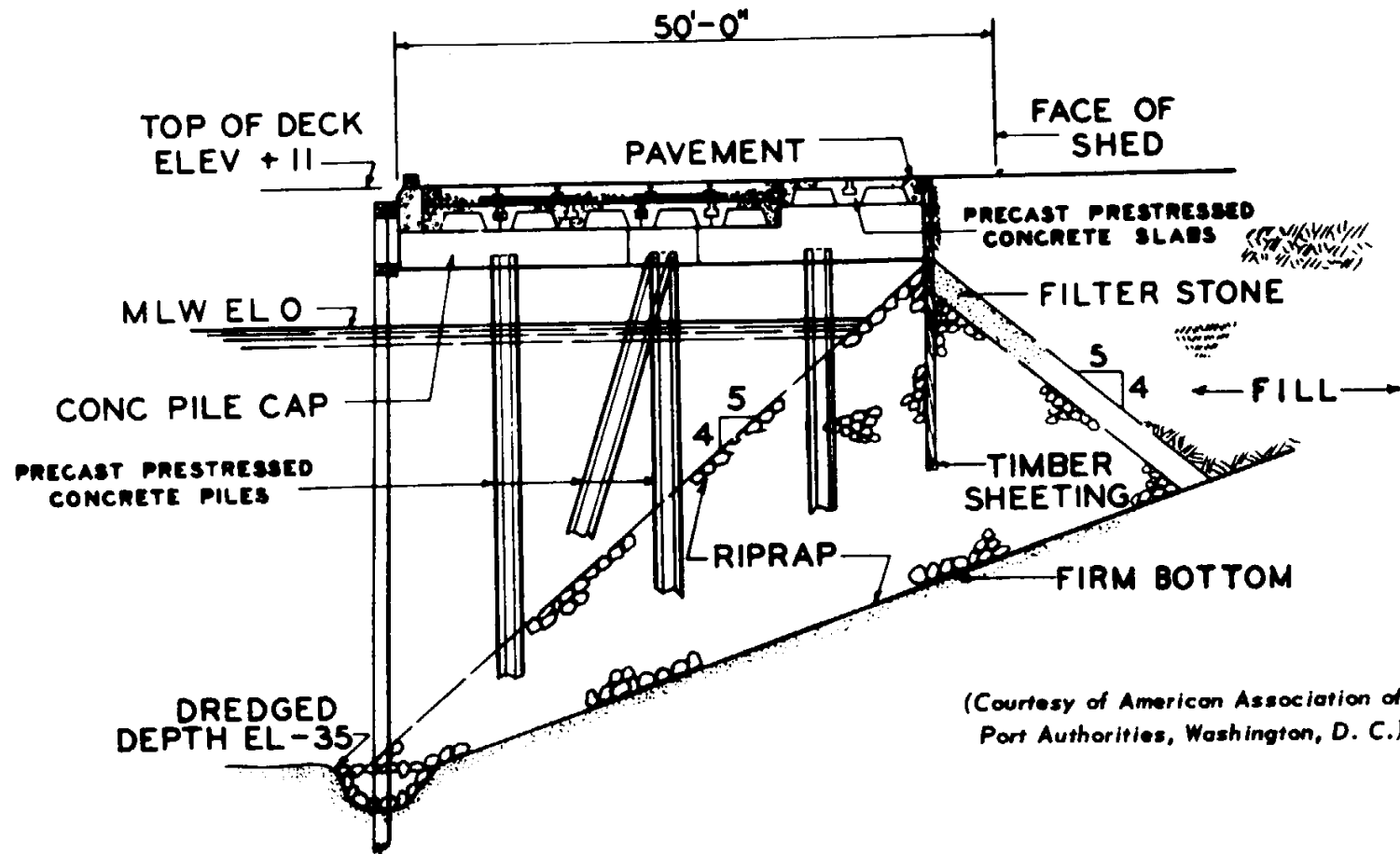

Figure 8-9. High-Level Open-Type Wharf Construction with Precast Concrete Deck on Concrete Piles.

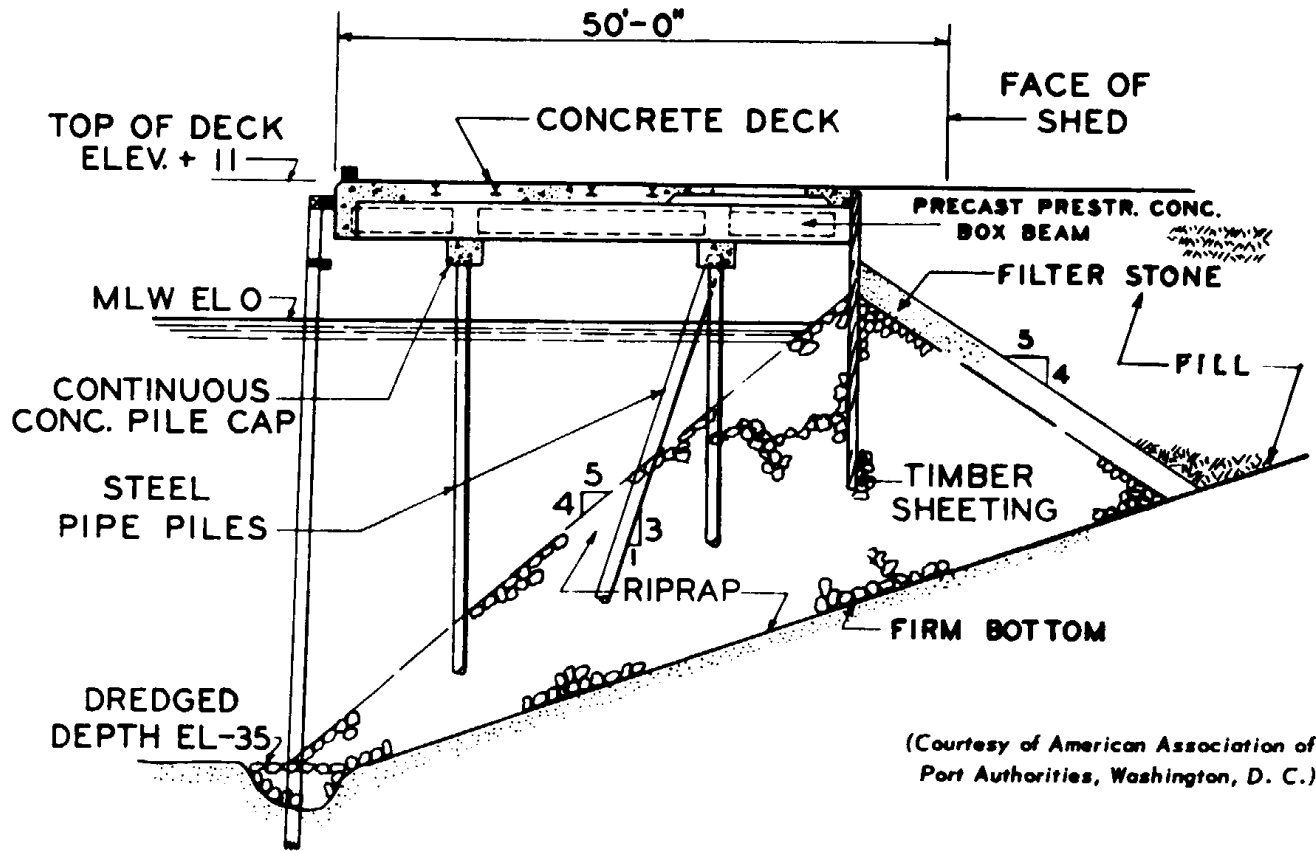

Figure 8-10. High-Level Open-Type Wharf Construction with Concrete Deck on Prestressed Concrete Beams-Steel Pipe Piles.

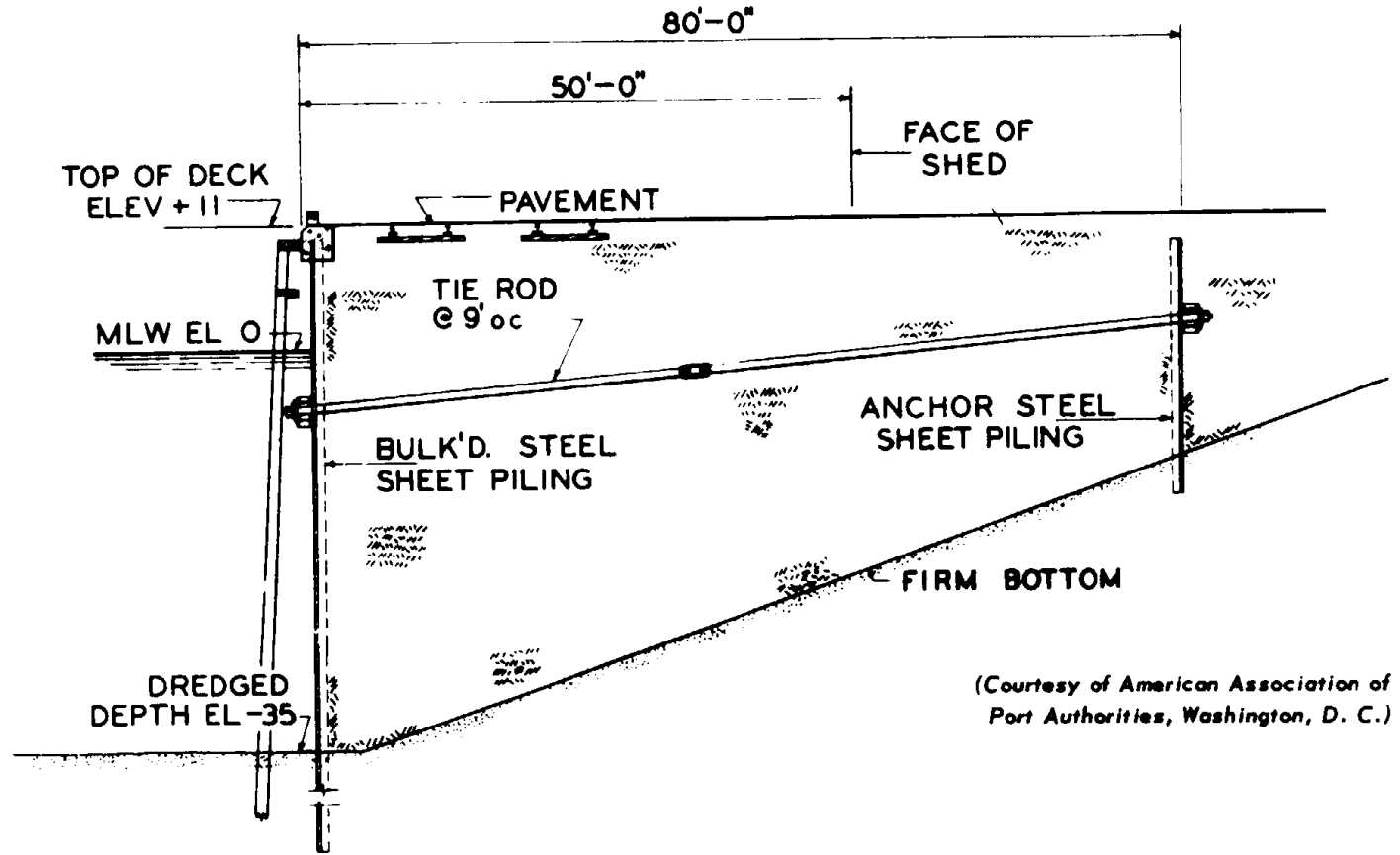

Figure 8-11. Solid fill-type wharf construction with steel sheet pile bulkhead.

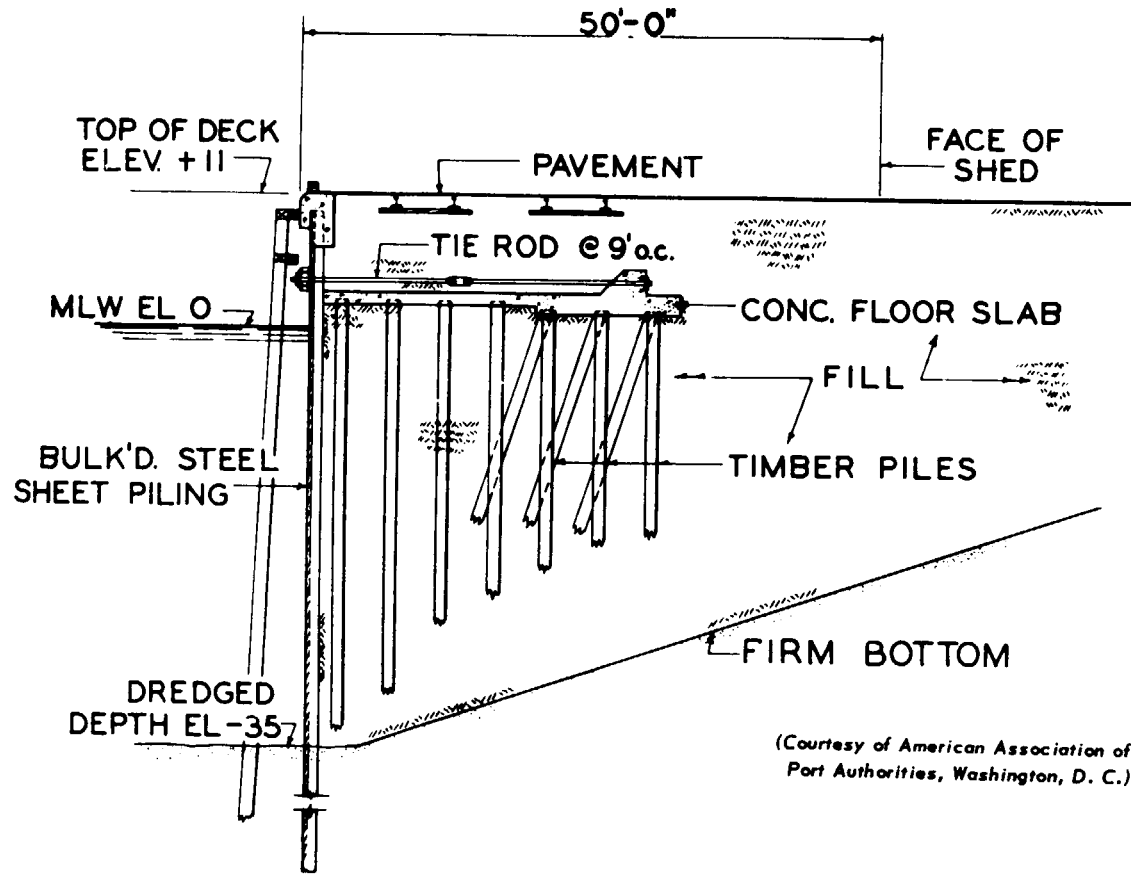

Figure 8-12. Solid fill type wharf construction with steel sheet pile bulkhead and relieving platform anchor.

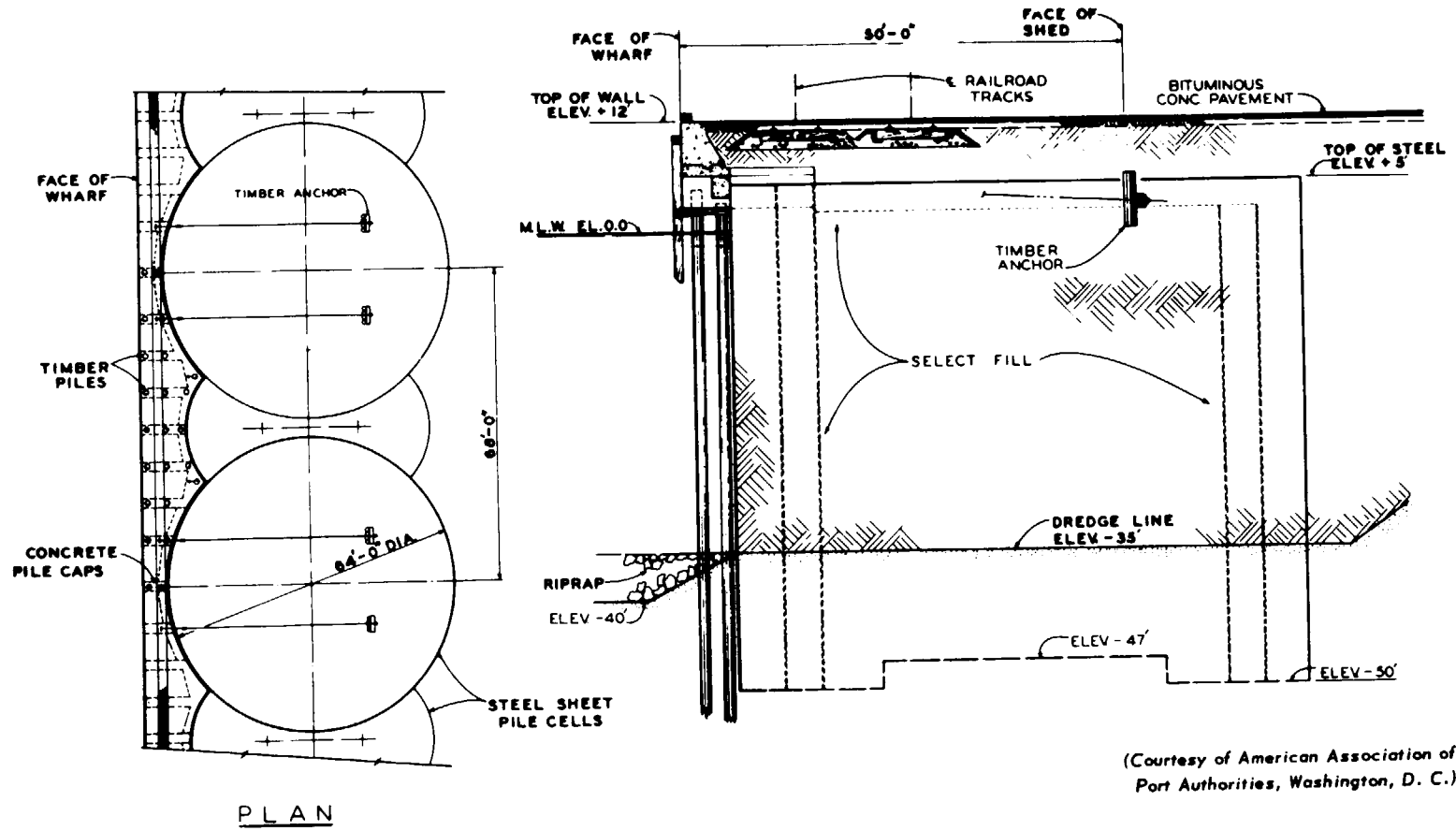

Figure 8-13. Solid fill-type wharf construction with circular steel sheet pile cells.

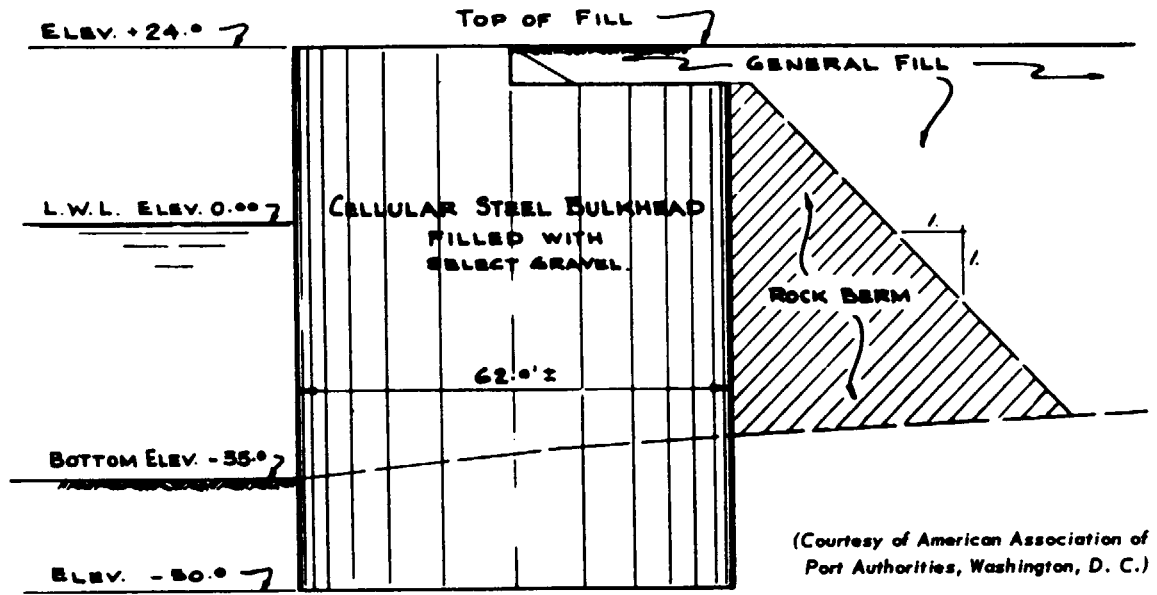
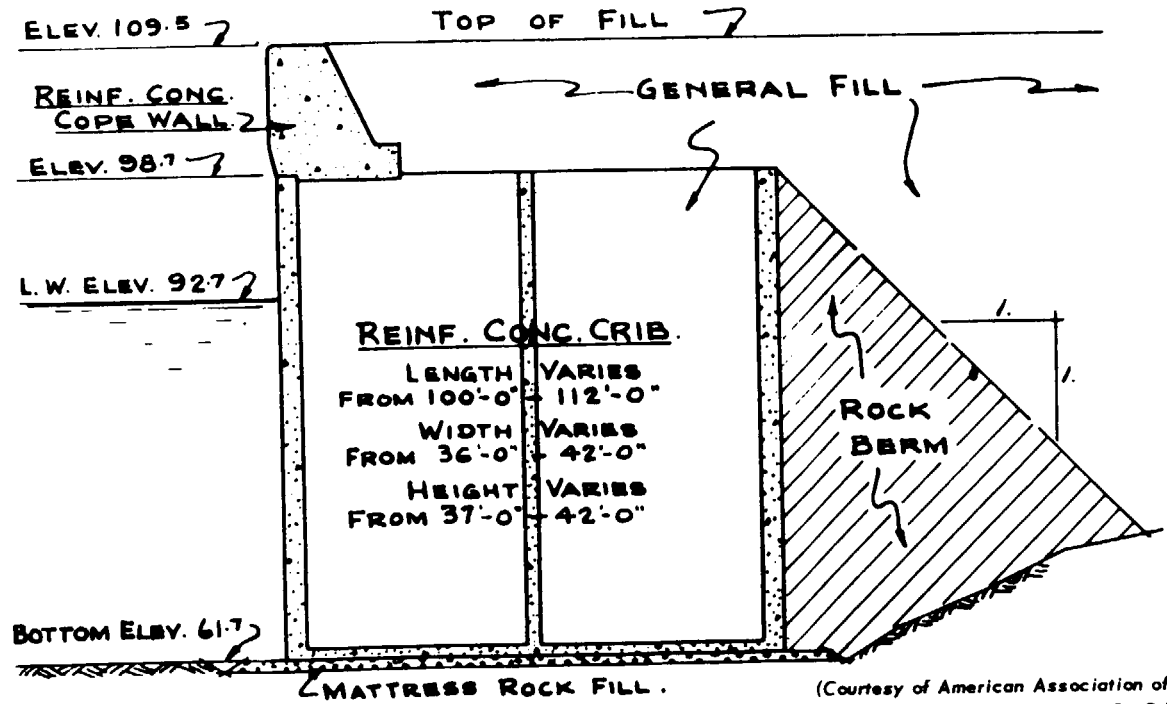
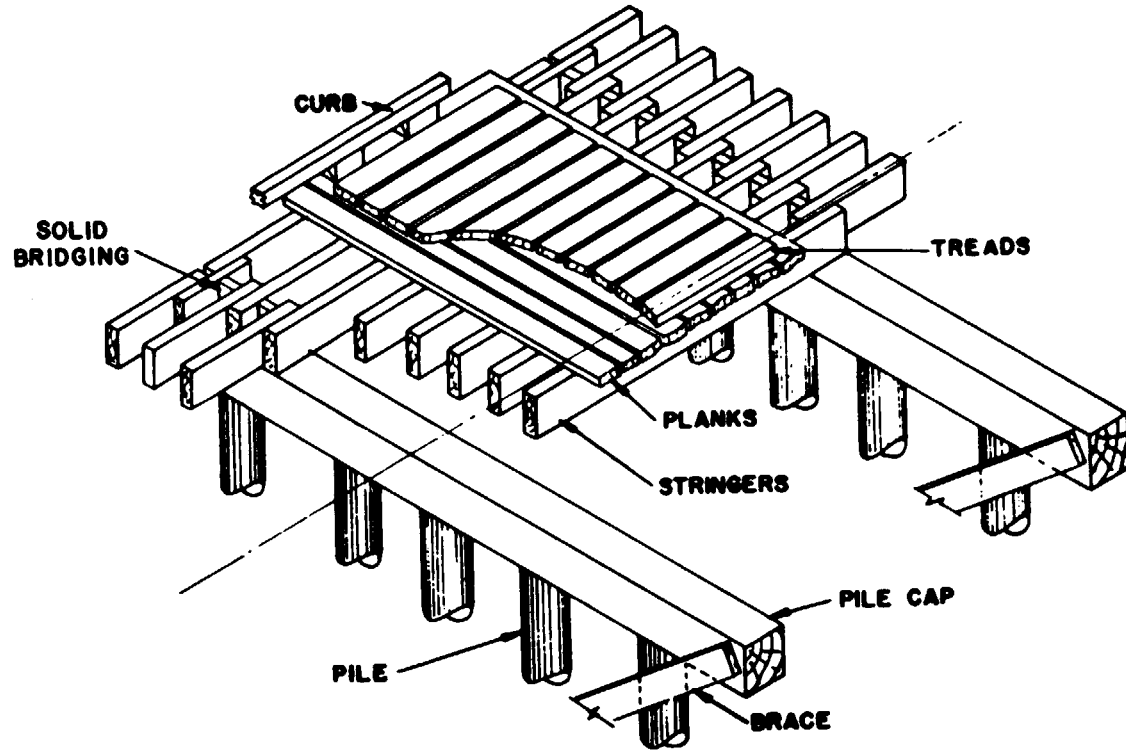

Figure 8-14. Solid fill-type wharf construction with cellular steel bulkhead



(Courtesy of American Association of Port Authorities, Washington, D. C.)

Figure 8-15. Solid fill-type wharf construction with reinforced concrete crib wharf.



Department of the Navy

Figure 8-16. Timber deck structure.

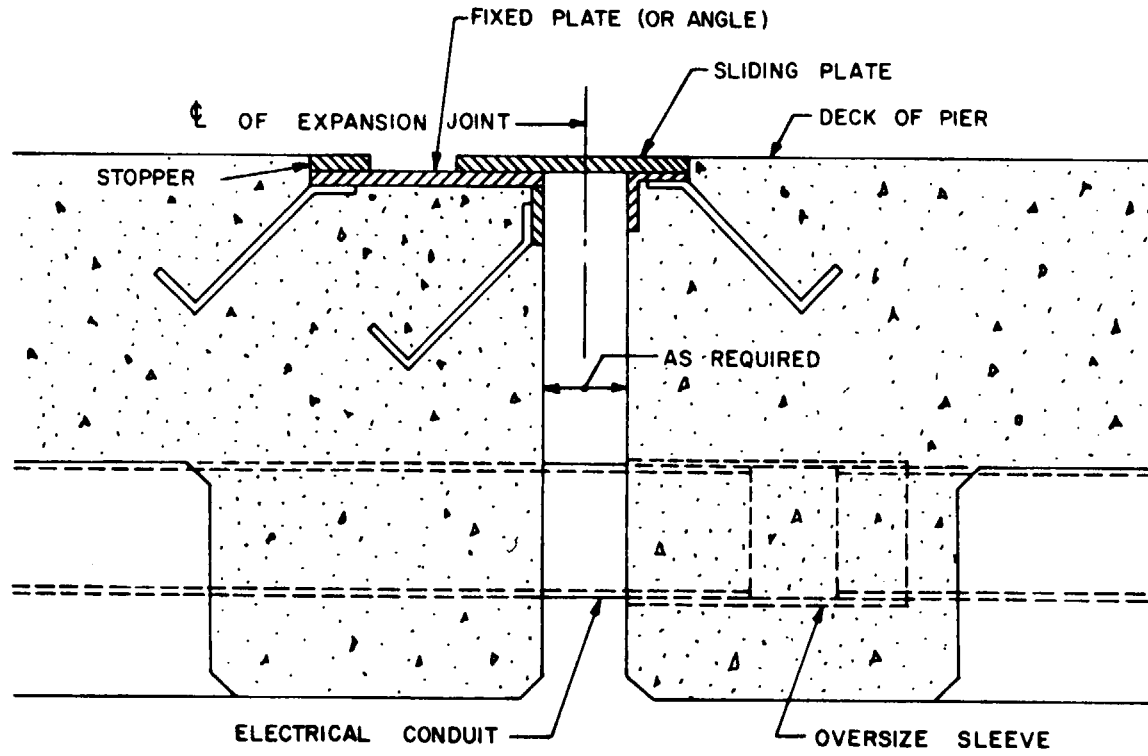

Department of the Navy

Figure 8-17. Typical expansion joint detail.

CHAPTER 9

FENDER SYSTEMS

9-1. Function.

The principal function of the fender system is to prevent the vessel or the dock from being damaged during the mooring process or during the berthing periods. Forces during the vessel berthing or anchoring may be in the form of impact, abrasive action from vessels, or direct pressure. These forces may cause extensive damage to the ship and structure if suitable means are not employed to counteract them.

9-2. Types.

General description of and applicable pertinent details associated with various types of fender systems are presented below.

a. Standard pile-fender systems.

(1) *Timber pile.* This system (fig 9-1) employs piles driven along a wharf face bottom. Pile tops may be unsupported laterally or supported at various degrees of fixity by means of wales and chocks. Single-or-multiple-row wales may be used, depending on pile length and on tidal variations. Impact energy upon a fender pile is absorbed by deflection and the limited compression of the pile. Energy-absorption capacity depends on the size, length, penetration, and material of the pile and is determined on the basis of internal strain-energy characteristics (fig 9-2).

(a) *Advantages.* The advantages are low initial cost and abundant timber piles.

(b) *Disadvantages.* The disadvantages include: limited energy-absorption capacity that declines as a result of biodeterioration; susceptibility to mechanical damage and biological deterioration; and high maintenance cost if damage and deterioration is significant.

(2) *Hung timber.* This system consists of timber members fastened rigidly to the face of a dock. A contact frame is formed that distributes impact loads (fig 9-3).

(a) *Advantages.* The advantages are very low initial cost and less biodeterioration hazard.

(b) *Disadvantages.* The disadvantages are low energy-absorption capacity and unsuitability for locations with significant tide and current effects.

(3) *Steel pile.* Steel fender piles are occasionally used in water depths greater than 40 feet or for locations where very high strength is required.

(a) *Advantages.* The advantages are high

strength and feasibility for difficult seafloor conditions.

(b) *Disadvantages.* The disadvantages are vulnerability to corrosion and high cost.

(4) *Concrete pile.* Reinforced concrete piles are not satisfactory because of their limited internal strain-energy capacity. Prestressed concrete piles with rubber buffers at deck level have been used.

(a) *Advantage.* The advantage is that this pile resists natural and biological deterioration.

(b) *Disadvantages.* The disadvantages are limited strain-energy capacity and corrosion of steel reinforcement through cracks.

b. Retractable fender system. A retractable fender system (fig 9-4) consists of vertical-contact posts connected by rows of wales and chocks. Contact posts are normally spaced 8 feet on centers. The interval between wales is dependent on the local tide range. Wales are fastened to holding posts suspended by pins from specially designed brackets. The fender retracts under impact, thus absorbing energy by action of gravity and friction. Energy-absorption capacity depends directly on the effective weights, the angle of inclination of the supporting brackets, and the maximum amount of retraction of the system. In designing this system, the tide effect on weight reduction of the fender frame should be considered. Use of composite inclined planes of supporting brackets and proper selection of maximum retraction are feasible means for attaining design capacity. Fenders are more easily removed from open pin brackets than from slot-type. In construction, the supporting brackets should be adequately anchored to the associated berthing structure. Deterioration of timber frames does not materially reduce energy-absorption capacity, as is found in timber piles.

(1) *Advantages.* The advantages include: negligible effects of biological deterioration on energy-absorption capacity; no heavy equipment required for fabrication and replacement; and low maintenance cost, plus minimum time loss during replacement.

(2) *Disadvantages.* The disadvantages are loss of effectiveness due to corrosion or damage to supporting brackets and high initial cost for use at open-type piers.

c. Rubber fender systems. Rubber fenders consist of

two major types, rubber-in-compression and rubber-inshear.

(1) *Rubber-in-compression.* This fender consists of a series of rubber cylindrical or rectangular tubes installed behind standard fender piles or behind hungtype fenders. The tubes may be compressed in axial or radial directions. Typical arrangements of rubber fenders in radial compression are shown in figures 9-5 and 9-6. Energy absorption is achieved by compression of the rubber. Absorption capacity depends on the size of the buffer and on maximum deflection. Loaddeflection and energy-absorption characteristics of various rubber fenders are illustrated in figures 9-7, 9-8, and 9-9. In design, a proper bearing timberframe is required for transmission impact force from ship to pier. Draped rubber tubes hanging from solid wharf bulkheads may be used as a rubber-in-compression system. The energy-absorption capacity of such a system can be varied by using the tubes in single or double layers, or by varying tube size. The energy absorption of a cylindrical tube is nearly directly proportional to the ship's force until the deflection equals approximately one-half the external diameter. After that, the force increases much more rapidly than the absorption of energy. Consequently, a large enough fender should be used so that the energy of the berthing ship will be absorbed without requiring a deflection of such magnitude that it results in a disproportionate increase in force.

(a) *Advantages.* The advantages include simplicity and adaptability plus effectiveness at reasonable cost.

(b) *Disadvantages.* The disadvantages are: high concentrated loading may result; frictional force may be developed if rubber fenders contact ship hull directly; and initial cost is higher than standard pile system without resilient units.

(2) *Rubber-in-shear.* This consists of a series of rubber pads bonded between steel plates to form a series of rubber sandwiches mounted firmly as buffers between a pile-fender system and a pier. Two types of mounting units are available: the standard unit (fig. 9-10), or the overload unit, which is capable of absorbing 100 percent more energy. Load-deflection and energy-absorption characteristics of Raykin rubber-inshear buffers are shown in figure 9-11.

(a) *Advantages.* The advantages include: capability of cushioning berthing impact from lateral, longitudinal, and vertical directions; most suitable for dock-corner protection; high energy-absorption capacity for serving large ships of relatively uniform size; and favorable initial cost for very heavy duty piers.

(b) *Disadvantages.* The disadvantages are: Raykin buffers are too stiff for small vessels and for moored ships subject to wave and surge action; steel plates subject to corrosion; problem with bond be-

tween steel plate and rubber; and high initial cost for general cargo berths.

(3) *Lord flexible fender.* This system (fig 9-12) consists of an arch-shaped rubber block bonded between two end steel plates. It can be installed on open or bulkhead-type piers, dolphins, or incorporated with standard pile or hung fender systems. Impact energy is absorbed by bending (buckling) the compression of the arch-shaped column. When an impact force is applied, it builds up a relatively high load with small deflection, buckles at still smaller deflections, and maintains a virtually constant load over the range of buckling deflection (fig. 9-13).

(a) *Advantages.* The advantages are high energy-absorption and low terminal-load characteristics.

(b) *Disadvantages.* The disadvantages include possible destruction of bond between steel plates and rubber plus possible fatigue problems.

(4) *Rubber-in-torsion fender.* This fender is a rubber and steel combination fabricated in cone-shaped, compact bumper form, molded into a specially cast steel frame, and bonded to the steel. It absorbs energy by torsion, compression, shear, and tension, but most energy is absorbed by compression (fig 9-14).

(a) *Advantage.* The advantage is being capable of resisting the impact load from all directions.

(b) *Disadvantages.* The disadvantages are possible destruction of the bond between steel casting and rubber and possible fatigue problems.

(5) *Pneumatic fender.* Pneumatic fenders are pressurized, airtight rubber devices designed to absorb impact energy by the compression of air inside a rubber envelope. Table 9-1 lists pneumatic-fenders that have been used by the US Armed Forces. These pneumatic fenders are not applicable to fixed dock-fender systems but are feasible for use as ship fenders or shock absorbers on floating fender systems. A proven fender of this type is the pneumatic tire-wheel fender, which consists of pneumatic tires and wheels capable of rotating freely around a fixed or floating axis. The fixed unit is designed for incorporation in concrete bulkheads. The floating unit may consist of two to five tires. Energy-absorption capacity and resistance load depend on the size and number of tires used and on the initial air pressure when inflated. Load-deflection and energy-absorption characteristics are shown in table 9-2. The Yokohama pneumatic rubber fender, which utilizes the compression elasticity of air, is shown in figures 9-15, 9-16, 9-17, and 9-18. It is constructed of an outer rubber layer, a reinforcement synthetic cord layer, and an interior rubber layer. To facilitate handling, the fender is slung in a wire rope net. The internal working pressure of these units is 7 pounds per square inch.

(a) *Advantages.* The advantages are that this fender is suitable for both berthed and moored ships

Table 9-1. *Pneumatic Fenders for Military Uses*

Pneumatic Fenders for Military Uses

Fender diameter (in.)	Fender length (in.)	Suspension cable diameter recommended (in.)	Initial air pressure recommended (lb/in. ²)	Application
40	60		3/4	12 US. Navy, Bureau of Ships (Mountcast, 1961), adopted in 1961. Used as hip fenders for Navy vessel to replace cocoa-mat fender.
24	48	3/8	7.5	
10	20	1/4	0	US. Army Transportation Board (1962). Recommended for use on amphibious landing craft and other marine TC vessels to replace old rope fenders.
18	36	1/4	7.5	
28	56	3/8	75	

Department of the Navy

and the fixed tire-wheel type is feasible for pier-corner protection.

(b) *Disadvantages.* The disadvantages include its use in fixed dock-fendering being limited to bulkhead-type structures and high maintenance cost.

d. *Gravity-type fender systems.* Gravity fenders (fig 9-19) are normally made of concrete blocks and are suspended from heavily constructed wharf decks. Impact energy is absorbed by moving and lifting the heavy concrete blocks. High-energy absorption is achieved through long travel of the weights. Movements may be accomplished by a system of cables and sheaves, a pendulum, trunnions, or by an inclined plane. The type of gravity fender suited to a given situation depends on tidal conditions, energy-absorption requirements, and other load environmental factors, such as exposures to wind, waves, and currents. Heavy, vertically suspended gravity fenders are commonly used in exposed locations that have large tidal ranges.

(1) *Advantages.* Smooth resistance to impacts can be induced by moored ships under severe wave and swell action. Also, high energy-absorption and low terminal load can be achieved through long travel for locations where the excessive distance between ship and dock is not a problem.

(2) *Disadvantages.* Heavy berthing structure is required; heavy equipment is necessary for installation and replacement; initial and maintenance costs are high; and the excessive distance between dock and ship caused by the gravity fender is undesirable for general military piers and wharves.

e. *Hydraulic and hydraulic-pneumatic fender systems.*

(1) *Dashpot hydraulic.* This system (fig 9-20) consists of a cylinder full of oil or other fluid so arranged that when a plunger is depressed by impact, the fluid is displaced through a nonvariable or variable orifice into a reservoir at higher elevation. When ship impact is released, the high pressure inside the cylinder forces the plunger back to its original position and the fluid flows back into the cylinder by gravity. This system is most commonly used where severe wind, wave, swell, and current conditions exist.

(a) *Advantages.* The advantages include favorable energy-absorption characteristics for both berthing and mooring ships.

(b) *Disadvantages.* The disadvantages are high initial and maintenance costs.

(2) *Hydraulic-pneumatic floating fender.* In this system, a floating rubber envelope is filled with water or water and air, which absorbs energy by viscous resistance or by air compression. This fender seems to meet certain requirements of the ideal fender but is

considered to be expensive in combined first cost and maintenance costs.

(a) *Advantages.* The advantages include favorable energy-absorption characteristics for both berthing and mooring ships.

(b) *Disadvantages.* The disadvantages are high initial and maintenance costs.

f. *Floating fender systems.* As a supplement to a number of the fender systems mentioned above, the floating fender, camel, or separator is often used. In its simplest form, the camel may consist of floating logs, which ride up and down against the timber breasting face and are attached to the face by chains or other means. Figure 9-21 shows two rolling type fenders, both built of timber, with one protected by heavy rubber. Another type of camel, occasionally used commercially and often used around naval establishments, is a heavy timber box section made up of timbers dapped and bolted together. This box-type of camel or separator is generally rectangular in shape, sometimes measuring to 30 feet in length, but may have different shapes in the plan designed to fit the contours of the ships being docked. This type of device may be used to absorb some of the breasting loads during docking but more generally is used to keep ships away from a dock or to separate ships tied up adjacent to one another.

9-3. Selection of fender system type.

A variety of factors affect the proper selection of a fender system. These include local marine environment, exposure of harbor basins, class and configuration of ships, speed and direction of approach of ships when berthing, available docking assistance, type of berthing structure, and even the skills of pilots or ship captains. It is considered impractical to standardize fender designs since port conditions are rarely identical. Previous local experience in the application of satisfactory fender systems should be considered, particularly as it applies to cost-effectiveness characteristics.

a. *Exposure conditions.* In exposed locations or in areas subject to seiche, a resilient system, such as a rubber fender system, should be used. In sheltered basins, a standard timber-pile system, a hung system, or a retractable system is generally used.

b. *Berthing ship versus moored ship.* The choice of a fender is dependent on whether its chief function is to absorb kinetic energy of berthing ships or to keep a ship safely moored during loading and unloading operations.

(1) For locations where berthing operations are hazardous, stiff fender systems with high energy-absorption characteristics, such as Raykin fenders or rubber-in-axial-compression pile fender systems, are advisable. This is the case when berthings are conducted

under action of winds, currents, and waves without tug assistance.

(2) For locations where the behavior of the moored ship is the governing factor, soft fenders combined with soft mooring ropes are successful in minimizing mooring forces and ship motion. A soft type fender system (e.g. rubber-in-radial-compression fenders) tends to increase the natural oscillation period of a moored ship so that a resonance with long-period waves or seiches can be avoided. The foregoing is applicable in harbors where berthings present no difficulty and are assisted with tugs; but oscillation of water in the harbor basin by seiche action is a significant factor governing the choice of fender.

(3) Where berthing operations and the behavior of moored ships seem to pose problems of equal importance, it is best to choose a fender of intermediate type, one that can act stiffly during berthing and softly when the ship is moored. Hydraulic-pneumatic fender systems meet such requirements.

c. Maximum allowable distance between moored ships and dock face. The distance required by the fender system should be limited so as to avoid inconvenience during cargo loading and unloading. Generally, the maximum limit is 4 to 5 feet. No problem exists if the fender system is for a tanker berth that involves fuel supply only.

d. Pier type as related to fender system selection. For mooring or berthing platform, consider a resilient fender, since the length of the structure available for distribution of berthing load is limited. For an open pier, any type of fender system may be applicable. For a solid pier, consider use of resilient or retractable fenders to minimize vessel damage.

e. Structural factors. Structural factors related to the fender system selection are indicated below.

(1) *Concentrated loads at pier ends and expansion joints.* Fender spacing should be reduced to half at those bents adjacent to expansion joints. Provide clusters of fender piles at the outboard end and exposed corners of pier. For corners subject to berthing impact or frequent use as a turning point for ship maneuvering, resilient corner fender systems should be considered.

(2) *Projections.* Fender systems should present a smooth face to berthing vessels and bolt heads should be recessed. It is of prime importance that fenders be spaced sufficiently close together to prevent the prow of a vessel from getting between the fenders at angles of approach up to 15 degrees (provide wales and chocks to prevent this).

(3) *Integral construction.* Pile, hung, and retractable fenders will be tightly chocked and constructed as an integral, interlocking unit. Chocks should be recessed back of vertical fender faces.

(4) *Tidal range construction.* Where tidal ranges are in excess of 5 to 6 feet, provide a lower line of fendering near mean low water, if possible. For open piers, lower fendering may be braced to pier structure.

(5) *Rubbing strips.* Where vessels are berthed against separators, use of steel or timber rubbing strips on fendering faces should be considered.

(6) *Hardware and treatment.* For pile and hung systems, use of treated timber and hardware may be optional. Untreated timber piles should be considered only for locations where mechanical damage is significant and where biological deterioration effect is negligible. For resilient systems, timbers should be treated and hardware galvanized, except that galvanizing of ogee washers may be optional. For all systems, cast iron bolt inserts are preferable to screw-type inserts for attaching fenders to concrete structures.

(7) *Moving parts.* Minimize the use of moving parts. When used, they should be greased and made of hard grade steel or fitted with hard bearing points.

f. Miscellaneous factors related to fender system selection. These include resistance to tangential forces, reliability in operation, and cost of maintenance. In addition, evaluation of systems that have given satisfactory service at or near the proposed installation, resistance to longitudinal component of berthing force, and ease and economy of replacement are important.

9-4. Design procedure.

a. General design procedure. The design of a fender system is based on the law of conservation of energy. The amount of energy being introduced into the system must be determined, and then a means devised to absorb the energy within the force and stress limitations of the ship's hull, the fender, and the pier. General design procedure for a fender system are as follows:

(1) Determine the energy that will be delivered to the pier upon initial impact (table 9-3). The selection of a design vessel should be based on recommendations from the Military Traffic Management and Terminal Service and the Military Sealift Command.

(2) Determine the energy that can be absorbed by the pier or wharf (distribution of loading must be considered). For structures that are linearly elastic, the energy is one-half the maximum static load level times the amount of deflection. Allowance should also be made in cases where other vessels may be moored at the pier. If the structure is exceptionally rigid, it can be assumed to absorb no energy.

(3) Subtract the energy that the pier will absorb from the effective impact energy of the ship to determine the amount of energy that must be absorbed by the fender.

(4) Select a fender design capable of absorbing the amount of energy determined above without exceeding

Table 9-2. Load Deflection and Energy-Absorption Characteristics of Fixed-Unit Type of Pneumatic Tire- Wheel Fender (based on Firestone Burleigh Technical Data Sheet)

**Load-Deflection and Energy-Absorption Characteristics
of Fixed-Unit Type of Pneumatic Tire-Wheel Fender**

(Based on Firestone Burleigh Technical Data Sheet)

Standard wheel size (OD, in.)	Inflation pressure (psi)	Maximum deflection of wheel (in.)	Maximum load per wheel (tons)	Energy-absorption capacity per wheel (in. - tons)
30.6	30	6.0	1.5	4.0
38.4	6	6.4	5.0	14.0
54.0	40	21.2	17.0	156.0
62.0	47	19.0	19.2	168.0
68.9	45	20.0	24.0	216.0
75.8	50	22.0	30.3	276.0
77.9	55	26.5	53.0	671.0
83.9	80	26.5	65.5	803.0
114.0	70	46.0	105.0	2,050.0

Department of the Navy

Table 9-3. Energy to be Absorbed by Fenders

Vessel	Length (ft)	Beam (ft)	Draft (ft)		DWT (long tons × 1,000)	Velocity ft/sec Sheltered	Energy ft-kips Sheltered	Velocity ft/sec Moderate	Energy ft-kips Moderate	Velocity ft/sec Exposed	Energy ft-kips Exposed
			Light	Deep							
Assault Ships											
LHA	820	106	—	26	—	0.3	91.7	0.4	163.0	0.6	366.7
LPD 4	570	84	17	22	7	0.3	40.3	0.5	111.96	0.7	219.3
LPA 209	564	76	22	27	6.1	0.3	40.2	0.5	133.86	0.7	262.4
LKA 113	573	82	15.1	25.5	14	0.3	31.0	0.55	104.10	0.8	220.3
LSD 36	555	84	15	19	5.5	0.3	31.1	0.55	110.12	0.7	169.6
LST 1179	518	68	11.5	15	3.5	0.35	25.5	0.6	74.80	0.9	168.5
Roll-on/Roll-off											
Comet	500	78	25	29	6.5	0.3	49.9	0.5	130.73	0.7	271.9
Sealife	540	83	19.5	29	12.1	0.3	57.2	0.5	150.00	0.7	311.2
Admiral Callaghan	694	92	19.5	27	13.5	0.3	60.5	0.5	160.00	0.7	329.3
General Cargo											
C-2	455	63	15	27	9.7	0.3	40.4	0.55	135.00	0.8	287.4
C-3	492	70	16	29	12.7	0.3	52.1	0.5	144.69	0.7	283.6
C-4	564	72	20	33	14	0.3	64.3	0.5	184.16	0.7	361.0
Tankers											
T-2	524	68	14	30	16.5	0.3	64.5	0.5	179.23	0.7	351.3
T-5	656	86	14.5	35	23.6	0.3	99.7	0.45	224.22	0.6	390.6
MSTS	595	84	14.5	32.5	25.5	0.3	86.9	0.45	195.52	0.6	347.6
AOR 2	659	96	21	35	25	0.3	86.6	0.45	194.87	0.6	346.4
Univers Ireland	1,135	175	26	79	326.5	0.2	497.5	0.3	1,119.66	0.4	2,904.7
Barge Transports											
LASH	860	107	20	37	44	0.3	161.5	0.35	219.03	0.5	440.6
Seabee	875	106	17.5	32	27.0	0.3	112.2	0.4	199.00	0.55	374.0
Breakbulk Freighter											
VC-2	455	62	15.5	29	10.6	0.3	46.1	0.5	127.91	0.8	327.4
Mariner	563	76	18	30	12.9	0.3	59.4	0.5	164.94	0.7	323.3
Gulf Banker	495	69	18.5	30	11	0.3	50.3	0.5	139.01	0.7	274.0
Freighter/Container											
Seamaster	572	82	21	30.5	12.8	0.3	62.5	0.5	173.60	0.7	340.3
Santa Lucia	560	81	20	30	12.7	0.3	59.1	0.5	164.23	0.7	321.9
Wolverine Mariner	564	76	21.5	32	12.7	0.3	65.7	0.5	182.61	0.7	357.9
Challenger	560	75	20	31.5	13.5	0.3	60.8	0.5	168.00	0.7	330.8
Container with Crane											
Pacific Trader	544	70	21	32	12.2	0.3	60.1	0.5	190.99	0.7	373.6
American Liberty	700	90	21	32	19	0.3	87.3	0.45	196.45	0.65	409.07
Container Without Crane											
Portland	523	72	22	31	9.7	0.3	38.6	0.5	142.64	0.7	318.8
Oakland	685	78	19	30	17	0.3	89.9	0.45	200.0	0.65	414.8
Jacksonville	524	68	19.5	31	11.6	0.3	60.5	0.5	190.34	0.7	373.1

^a by U. S. Army Engineer Waterways Experiment Station

the maximum allowable force in the pier. The comparative merits of different construction materials in energy-absorption capacity at allowable working stress due to transient loading is shown in table 9-4.

b. Pile fenders. Spacing, corner clustering, and embedment of pile fenders under various conditions are indicated below.

(1) Spacing. Where consistent with the requirements for strength, pile spacing should be as follows: for light service, 12 feet maximum (10 feet preferred); for cruisers and auxiliaries, 7 to 9 feet, with 8 feet predominating; for heavy service, 5 to 7 feet, usually at one-half the bent spacing. Pile spacing less than 5 feet is undesirable.

(2) Corner clusters. Outboard and exposed corners of piers may be protected by clusters of fender piles. For small vessels, including destroyers up to 3,000 tons, groups of seven to nine piles are arranged in two nesting rows at an exposed corner; for piers accommodating vessels larger than those indicated above, decks at exposed corners should be built in a circular arc with a 4 to 12-foot radius. Space fender piles closely in two staggered rows, except in cases of larger ships, for which three rows or even four rows may be provided if the location is severely exposed. The number of piles in these groups may vary from nine to thirty piles. If springs or rubber buffer blocks are used, fender piles are placed in two nesting rows and are bolted to segmental wales that bear against the energy-absorbing units. If tubular rubber absorbers are provided, fender piles are arranged in two separate rows connected by wire rope windings. The number of piles in a group will vary from 20 to 40. Chains or cables should be provided to restrain longitudinal and lateral movement of the entire group. For retractable systems, the corner cluster may be eliminated and a special corner section of retractable rendering substituted. Corner clusters should be tightly blocked and securely wrapped with galvanized wire rope at one or two levels above mlw, depending on the deck height.

(3) *Embedment.* Establish the embedment of fender piles in accordance with bottom firmness and the possibility of future deeper dredging. For firm bottoms below the final dredged depth, a penetration of 10 feet is sufficient. An appropriate increase may be made if deeper dredging is likely in the future. If a shallow layer of soft material less than 10 feet in thickness overlies a firm bottom, fender piles should penetrate the firm strata at least 8 feet and have a

minimum indicated bearing of 5 tons by the driving formula. For deep deposits of soft material, fender piles should extend at least to the penetration reached under the weight of the driving hammer and preferably to a bearing capacity of 2 to 3 tons by the driving formula. Experience has indicated that the bearing capacity increases sufficiently after completion of driving to provide the necessary resistance for fender piles.

(4) *Batter and chocking.* Fender piles should not be battered outboard more than 2 inches in 12 inches. Fender piles should be dapped and tightly chocked.

c. *Hung fenders.* Where consistent with requirement for strength spacing should be about 2 feet less than the values indicated for pile fenders with a minimum of 5 feet. Hung fenders will be tightly chocked. Check to make certain that the cantilever bolts are strong enough to support the suspended weight.

d. *Resilient fenders.* For springs or rubber buffers, where consistent with requirements for strength, spacing of vertical fenders may be increased to the upper limits of the spacings previously listed for the various classes of ships. For Raykin and dashpot types, spacing should conform to the load and energy-absorption requirements. For resilient fenders, metal or wood rubbing surfaces (or wales) are required, except for rubber bumpers, transversely loaded. Draped rubber bumpers should be provided with drain holes at the low point of the draped section. Eyebolts to hold the chains for rubber bumpers should be recessed into the pier structure.

e. *Suspended fenders.* Suspended fenders are widely spaced in multiples of the bent spacing and in accordance with the requirements for load and energy absorption. These fenders may be fitted with timber or metal rubbing surfaces. Furthermore, fenders must not swing in reacting to waves. Some motion is unavoidable; therefore, guides should be installed to prevent chattering. Consider any buoyancy acting on the suspended weight. Where possible, the weight will be concentrated above mean high water. Fenders must either resist longitudinal forces or be detailed to roll away from the longitudinal rubbing motion of ships. When possible, the weight of the fender should be formed from removable ballast. A full retraction fender rise may not cause the supports to project beyond the fender face. Full fender retraction force should not exceed the strength of either the pier or the ship's hull.

Table 9-4. Comparative Merits of Different Construction Materials in Energy-Absorption Capacity

**Comparative Merits of Different Construction Materials
In Energy-Absorption Capacity a**

Material	Modulus of elasticity (1,000 psi)	State bending stress		Internal strain ^b energy capacity (each pile)		No. of piles required ^c	Maximum spacing of fender piles ^d (ft)
		At proportional limit (psi)	At allowable working stress due to transient loading (psi)	At proportional limit (in.-tons)	At allowable working stress due to transient loading (in.-tons)		
Douglas Fir 12" x 12"	1,600	4,580 ^a	2,640	31.5	10.5	43	3.6
Southern Yellow Pine 12" x 12"	1,600	4,580 ^a	2,640	31.5	10.5	43	3.6
Douglas Fir or Southern Yellow Pine 14" diam.	1,600	4,580	2,640	25.2	8.4	54	2.8
Douglas Fir or Southern Yellow Pine 12" diam.	1,600	4,580	2,640	18.6	6.2	73	2.1
Greenheart 12" x 12"	3,200	12,000 ^a	6,900	108.0	36.0	13	12.5
Oak 12" x 12"	1,400	3,940	2,270	26.7	8.9	51	3.0
12WF190	29,000	36,000	20,000	28.2	16	10.0
12WF65	29,000	50,000	20,000	9.6	47	3.2
Steel cylindrical fender 34.5-inch diam by 0.5-inch thick.	29,000	36,000	20,000	18.7		
Steel cylindrical fender 34.5-inch diam by 0.5-inch thick.	29,000	62,000	34,400	53.0		
ASTM A-242, A-440 (rolled fender piles), A-441 (welded fender pile) 12" x 12" WF190.	29,000	50,000	27,800	54.4		
Reinforced concrete 12" x 12" (3,000 psi, n = 10).	29,000	1,200	1.16	387	Not suitable.
Prestressed concrete 14" x 14" (17-7/16" diam).	29,000	1,630	2.50	180	Not suitable when impact acted near waterline.

^a Assume 12% reduction of basic proportional limit of extreme fiber stress in bending at 5,270 psi, allowing for knots.
^b Assume the supported length of pile as 50 feet.
^c Number of piles required to absorb 450 in.-tons of designed capacity (transient-load allowable working stress) or to absorb 1,350 in.-tons of maximum capacity (stressed at nearly the safe elastic limit of materials).
^d Assume the ship berths broadside with a length of contact of 150 feet, which is the shortest parallel wall side of cargo ship

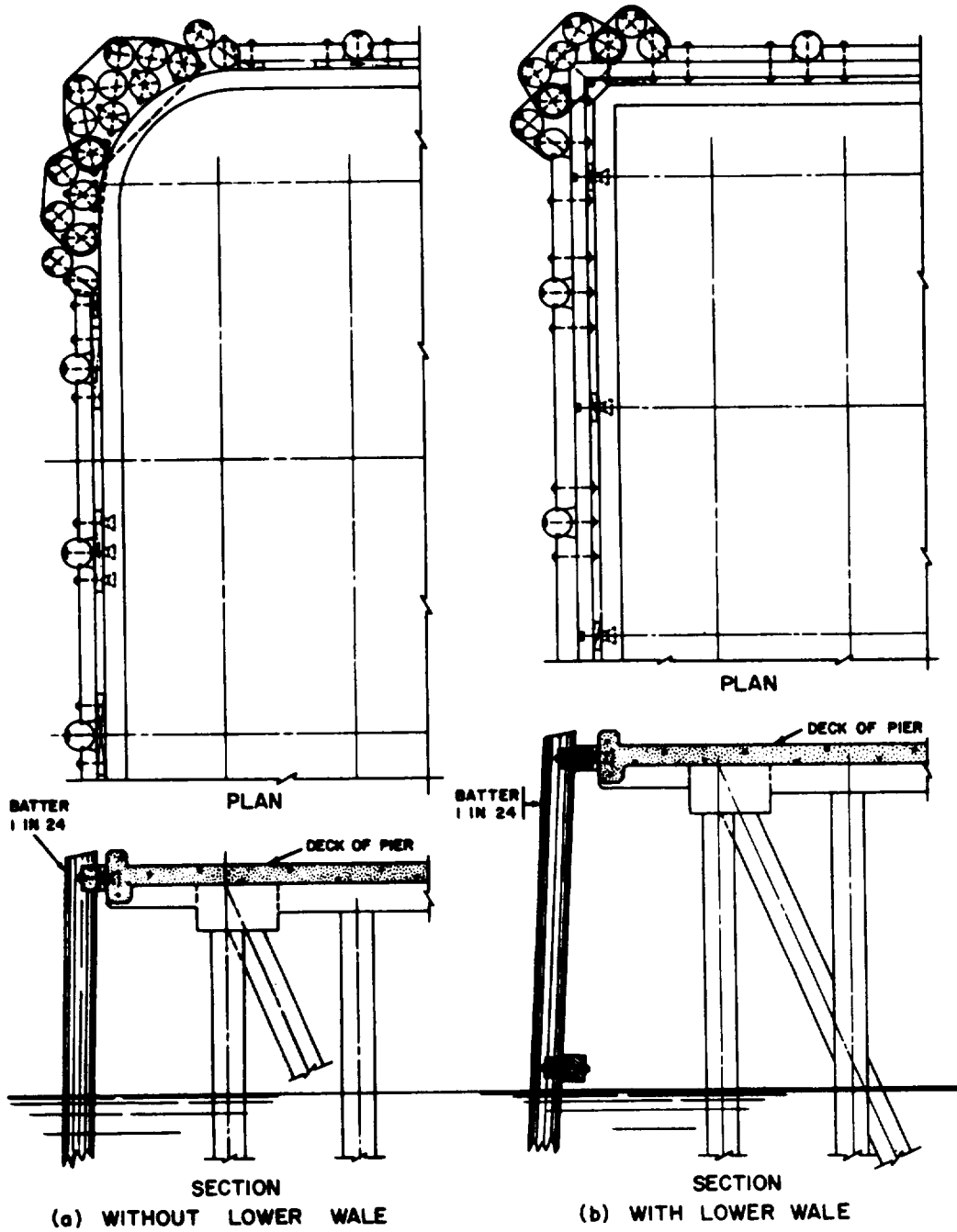

Department of the Navy

Figure 9-1. Timber pile-fender systems.

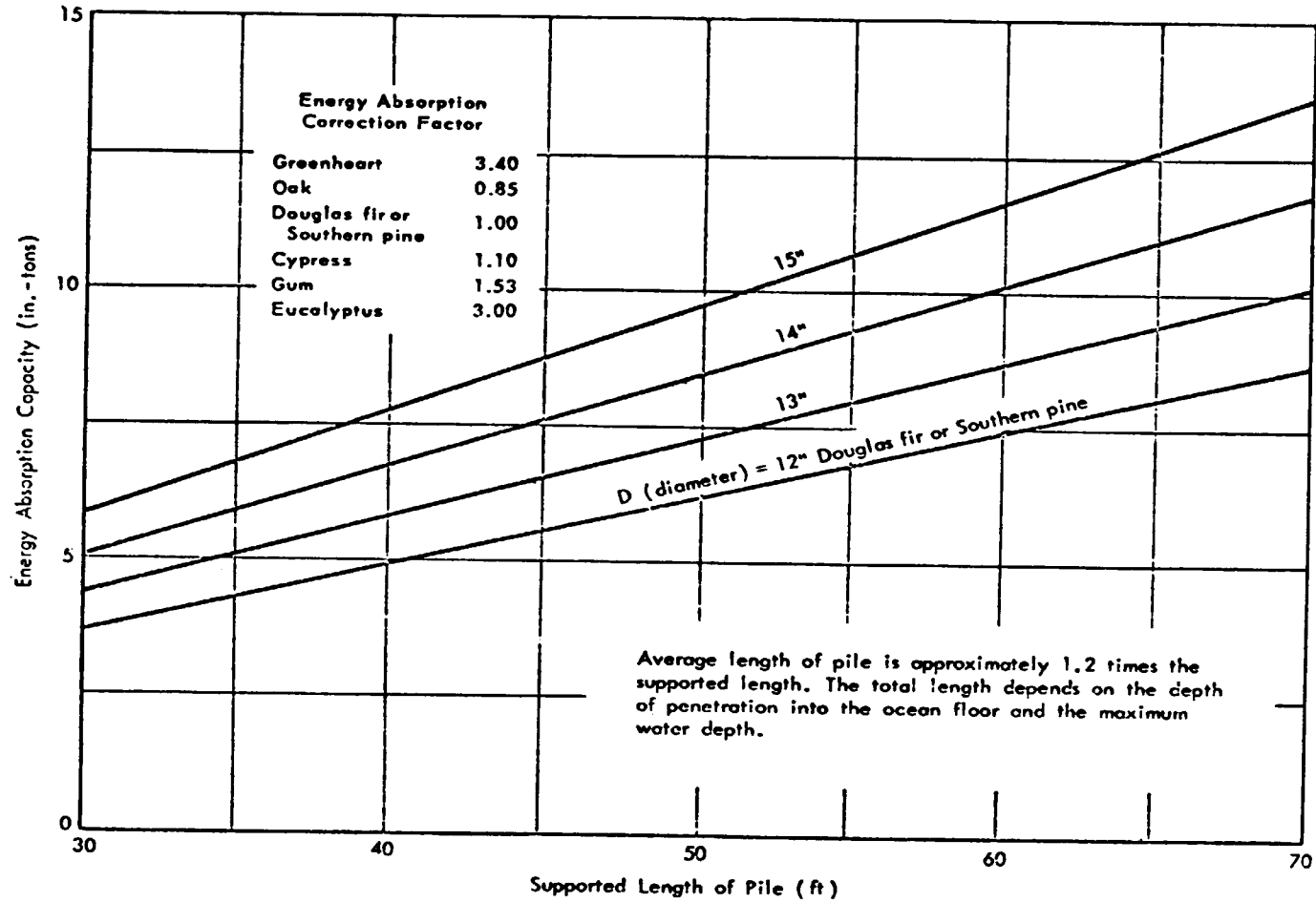

Note: The curves are based on Douglas fir or Southern pine.

Department of the Navy

Figure 9-2. Energy-absorption characteristics of conventional timber pile fenders.

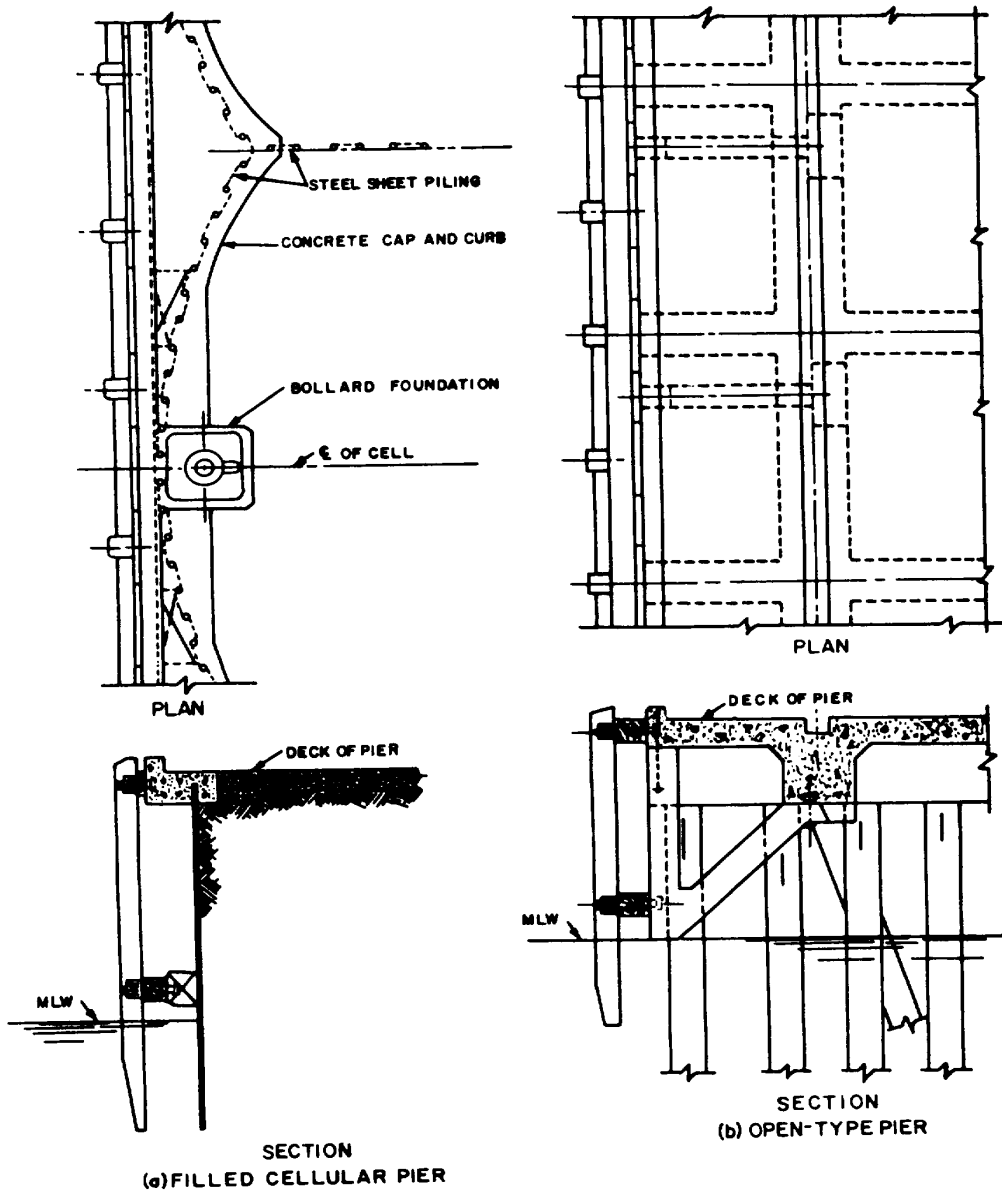

Department of the Navy

Figure 9-3. Hung timber fender system.

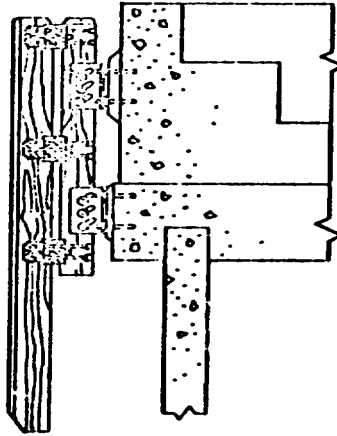

(a) Slotted supporting brackets

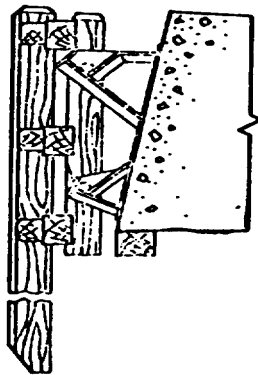

(b) Open pin supporting brackets

Department of the Navy

Figure 9-4. Typical retractable fender systems.

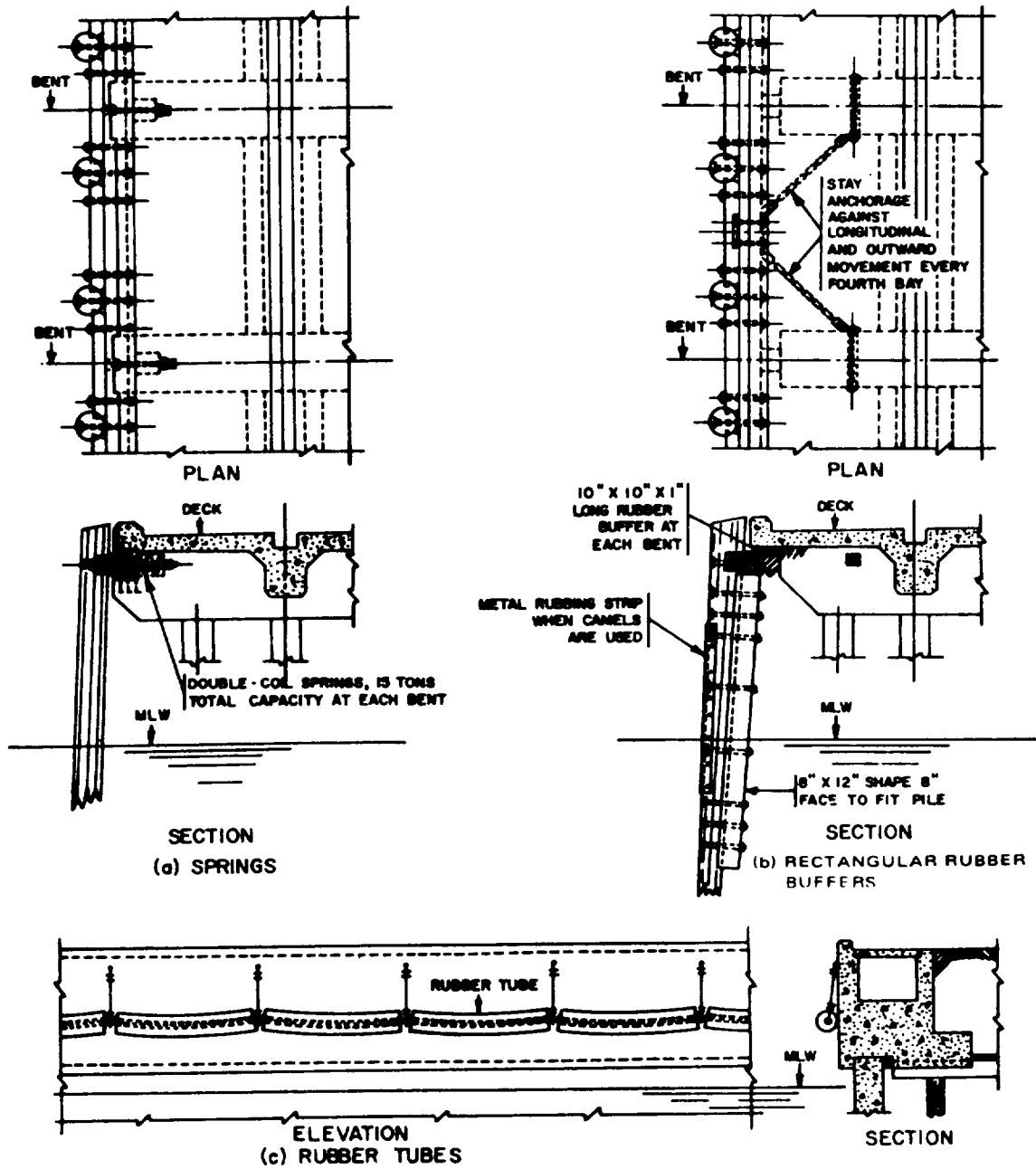

Department of the Navy

Figure 9-5. Resilient Fender System (spring rubber bumper).

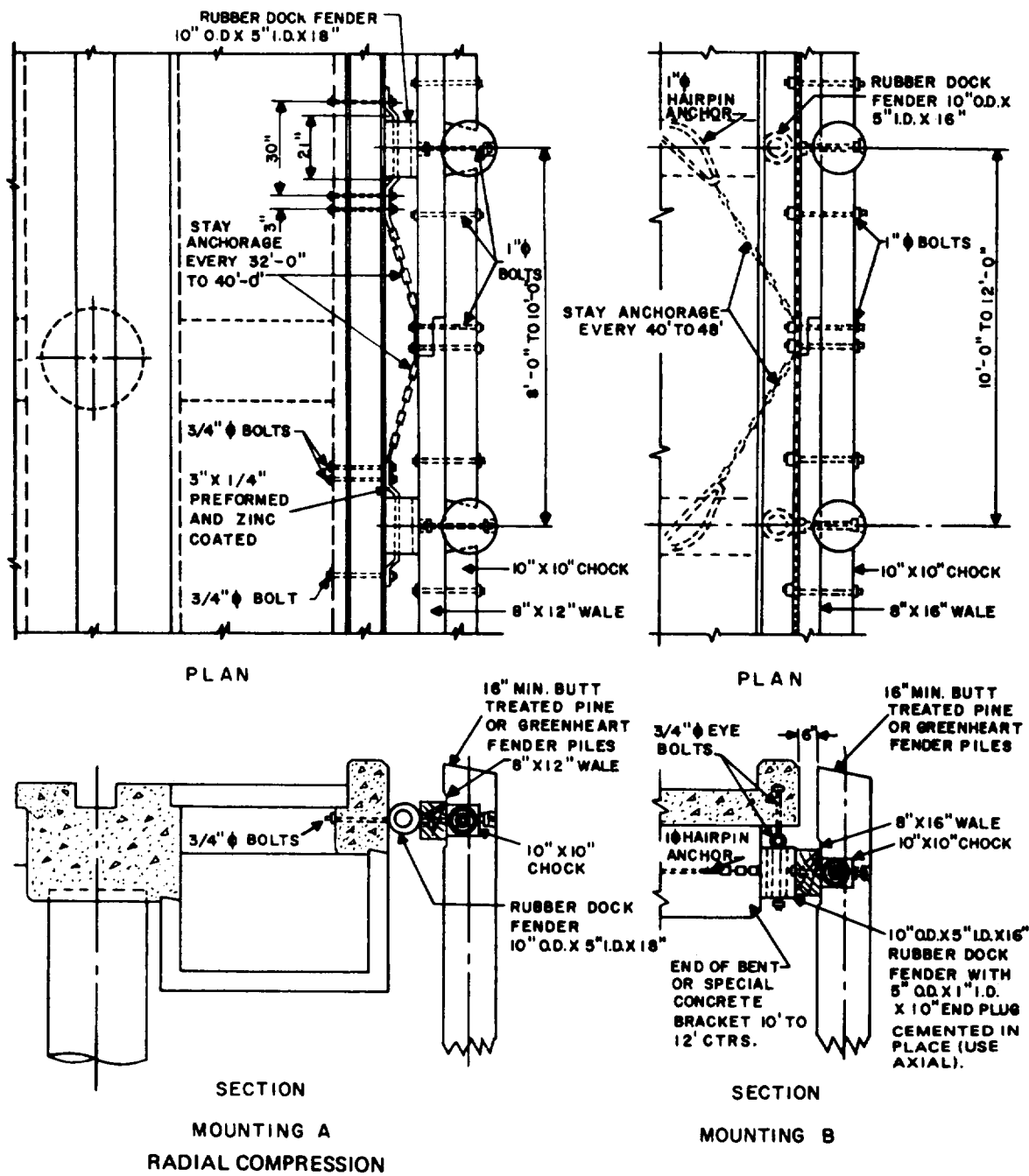

Figure 9-6. Resilient Fender System (rubber-in-compression).

Department of the Navy

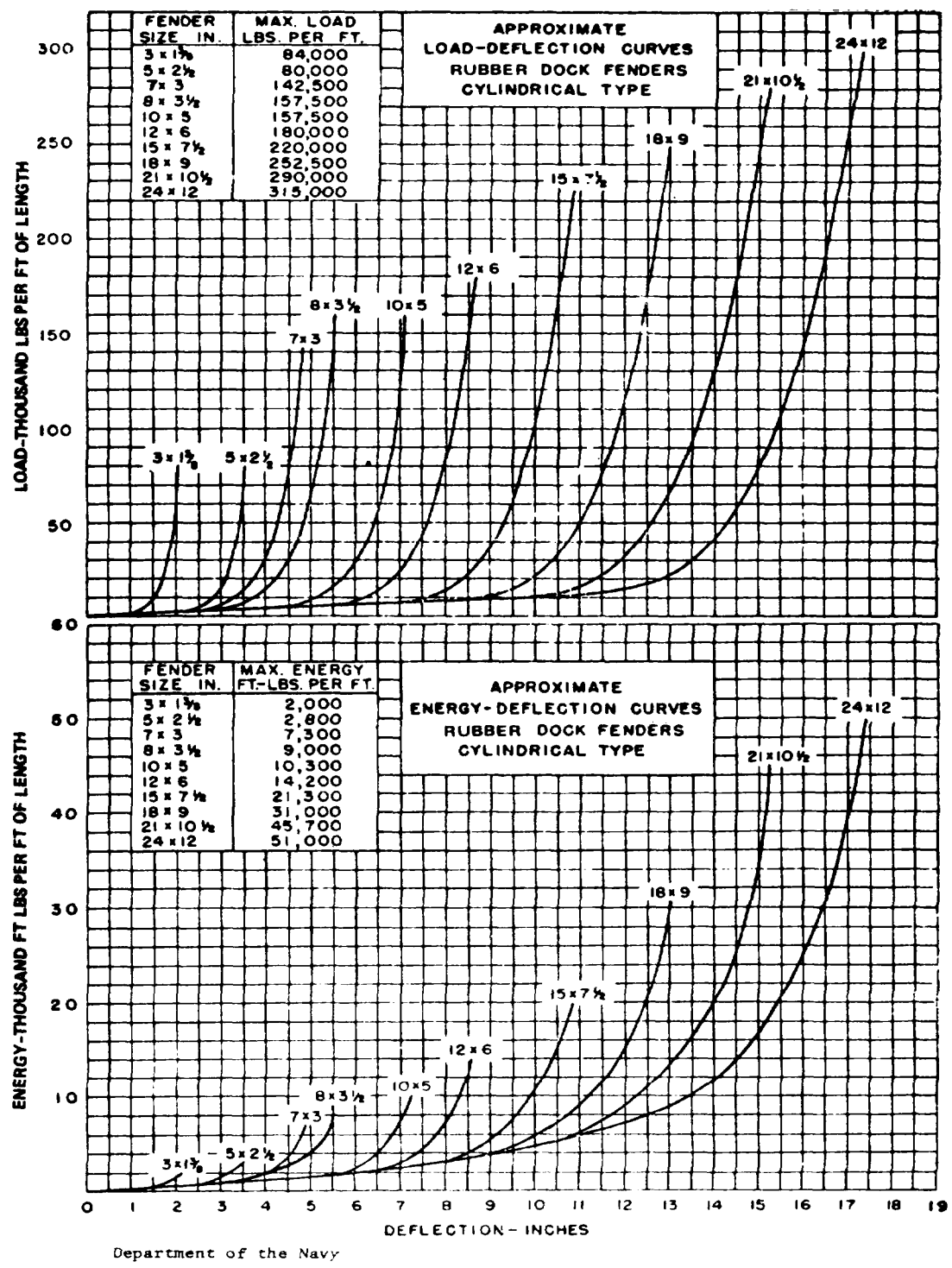

Figure 9-7. Load-Deflection and Energy-Absorption Characteristics (radially loaded cylindrical rubber dock fenders).

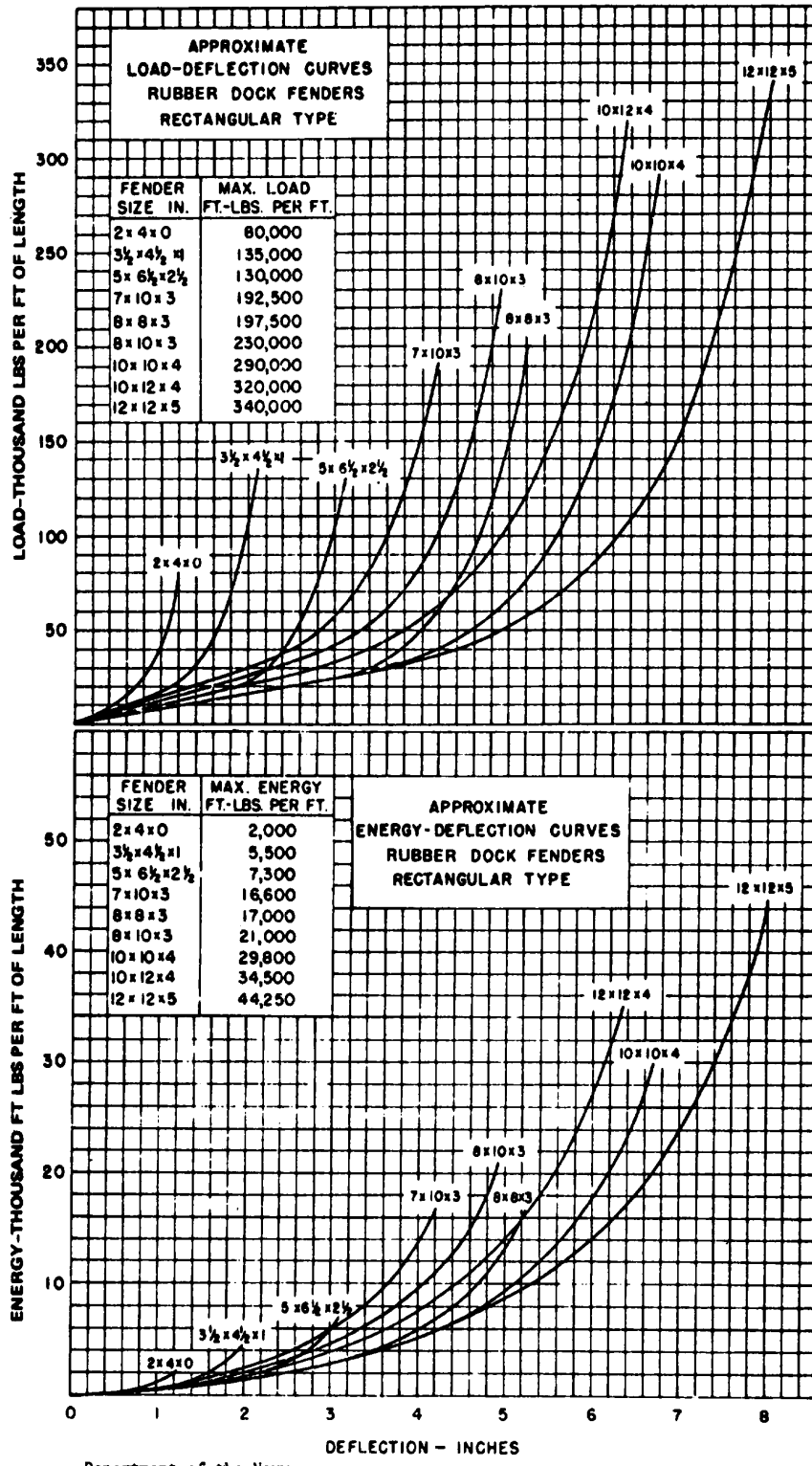
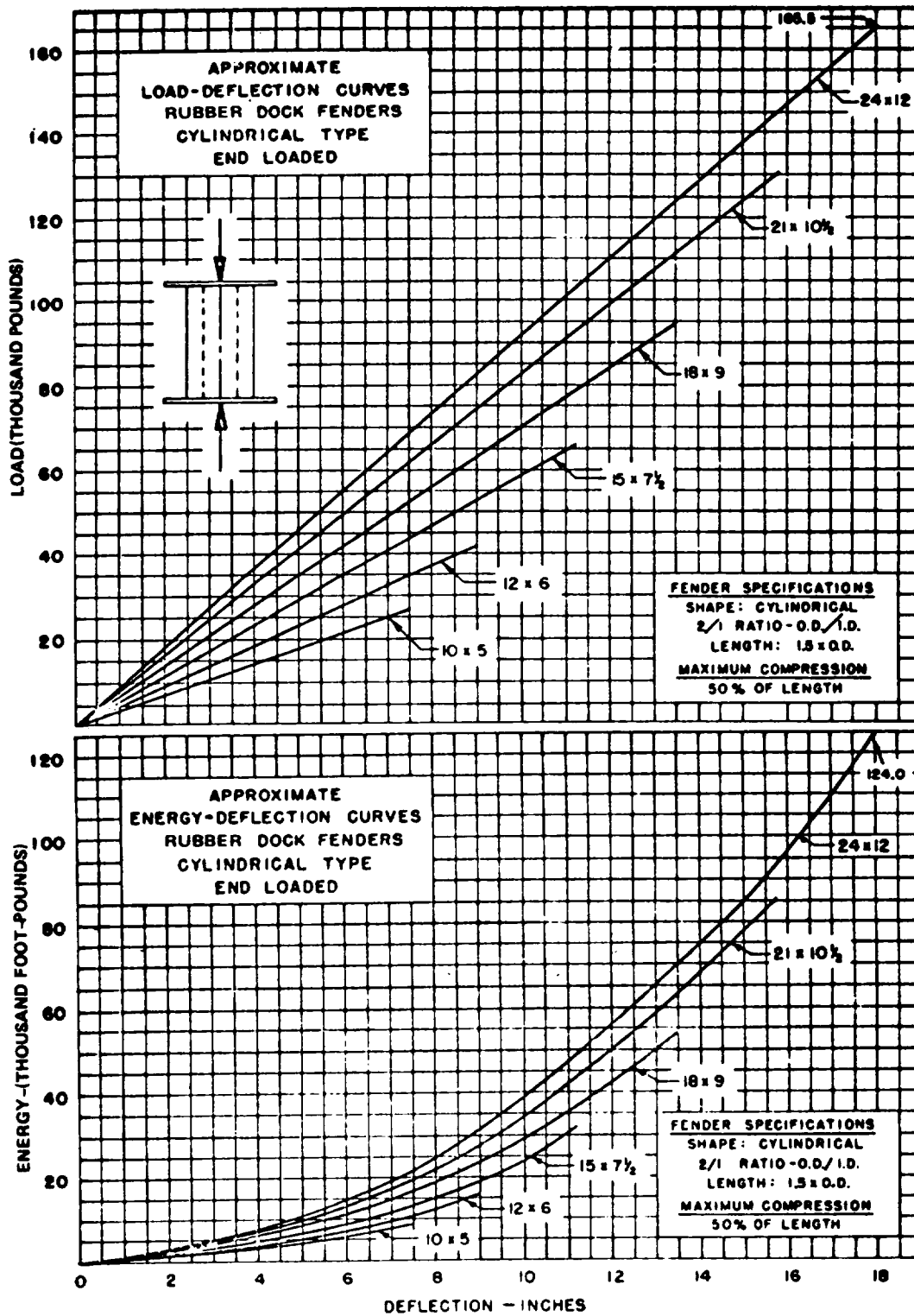
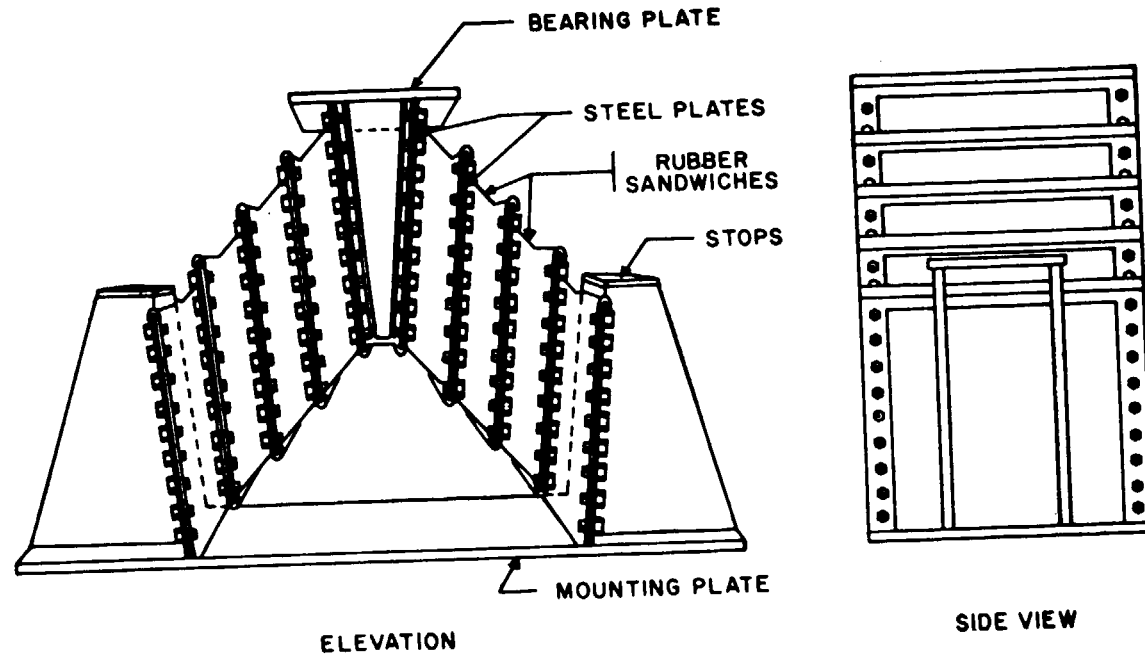

Figure 9-8. Load-Deflection and Energy-Absorption Characteristics (radially loaded rectangular rubber dock fenders).



Department of the Navy

Figure 9-9. Load-Deflection and Energy-Absorption Characteristics (axially loaded cylindrical rubber dock fenders).



NOTE: This patented system is presented for illustration purpose only and does not constitute an endorsement by the Army.

Department of the Army

Figure 9-10. Resilient fender system (rubber in shear) by Raykin

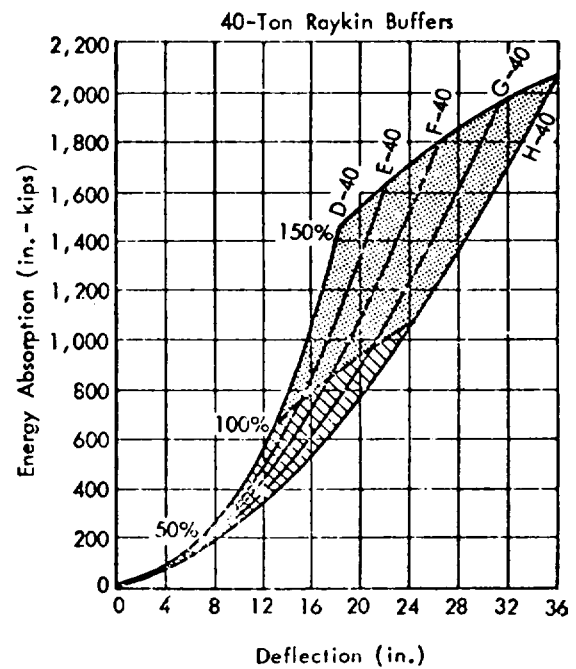
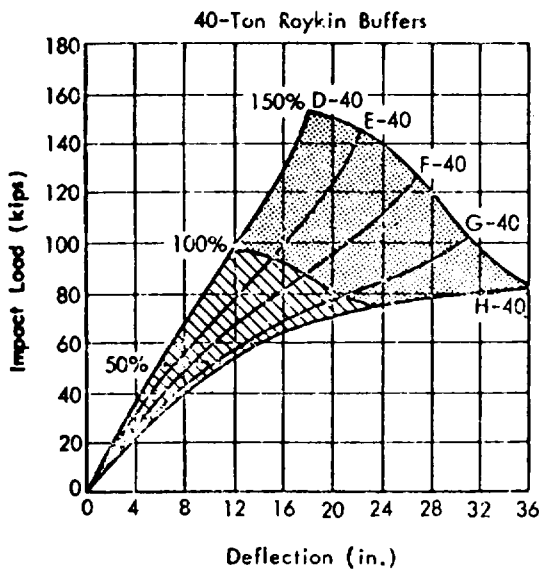
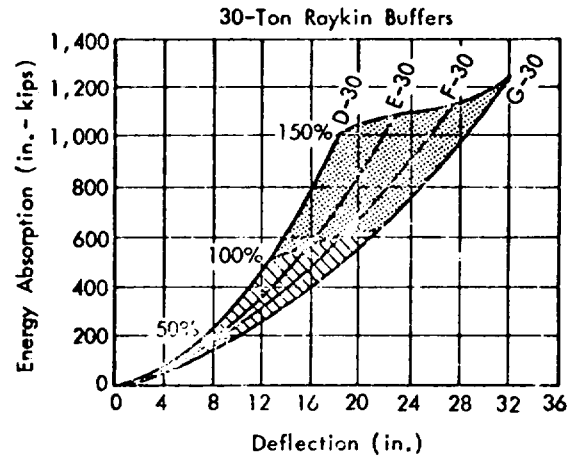
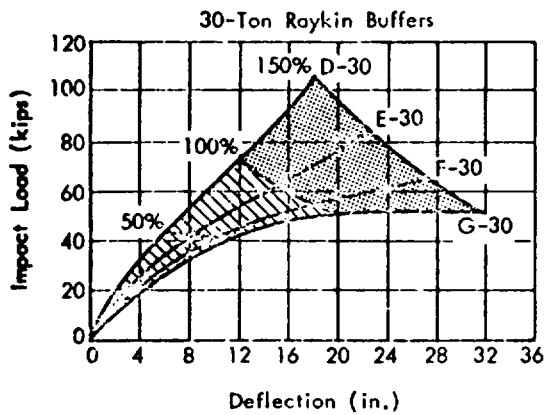
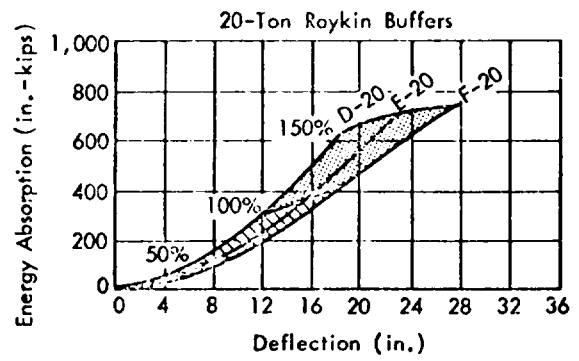
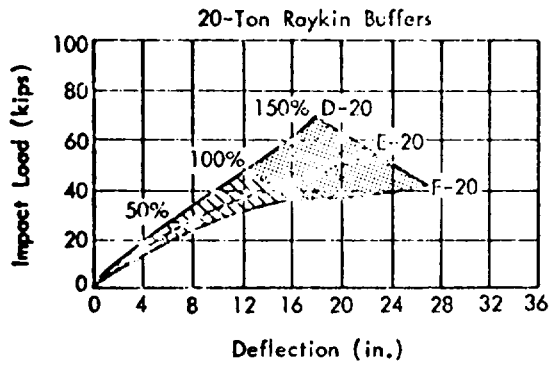

Department of the Navy

Figure 9-11. Load-deflection and energy-absorption characteristics of commercially available Raykin buffers.

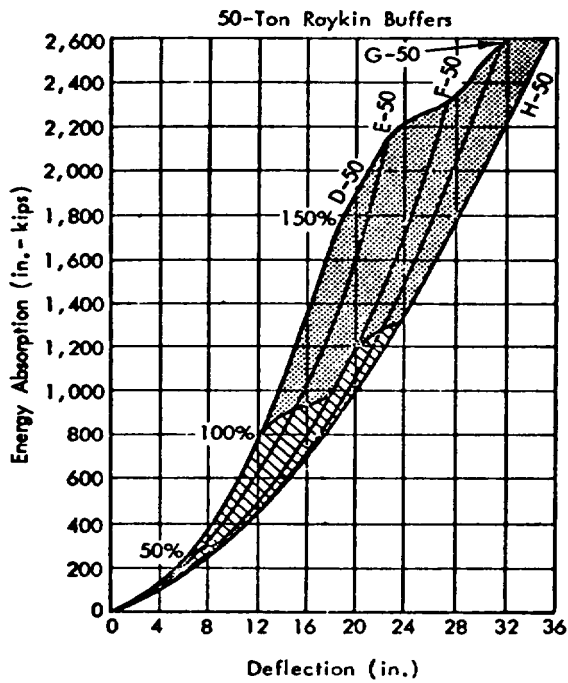
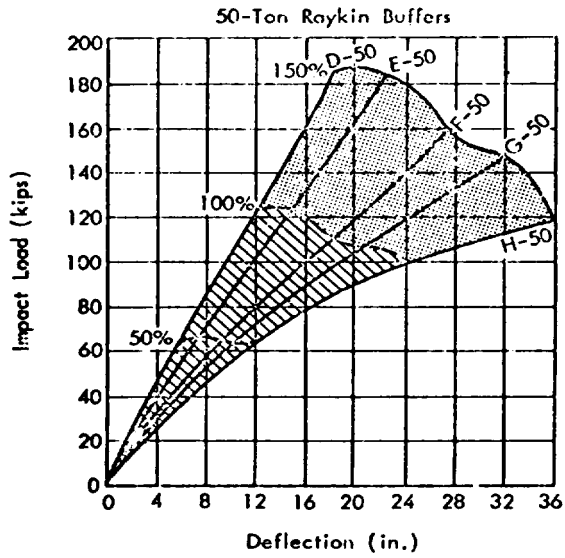

Notes:

- D - 4 rubber blocks on each side
- E - 5 rubber blocks on each side
- F - 6 rubber blocks on each side
- G - 7 rubber blocks on each side
- H - 8 rubber blocks on each side

Department of the Navy

Figure 9-11. Load-deflection and energy-absorption characteristics of commercially available Raykin buffer. (Continued)

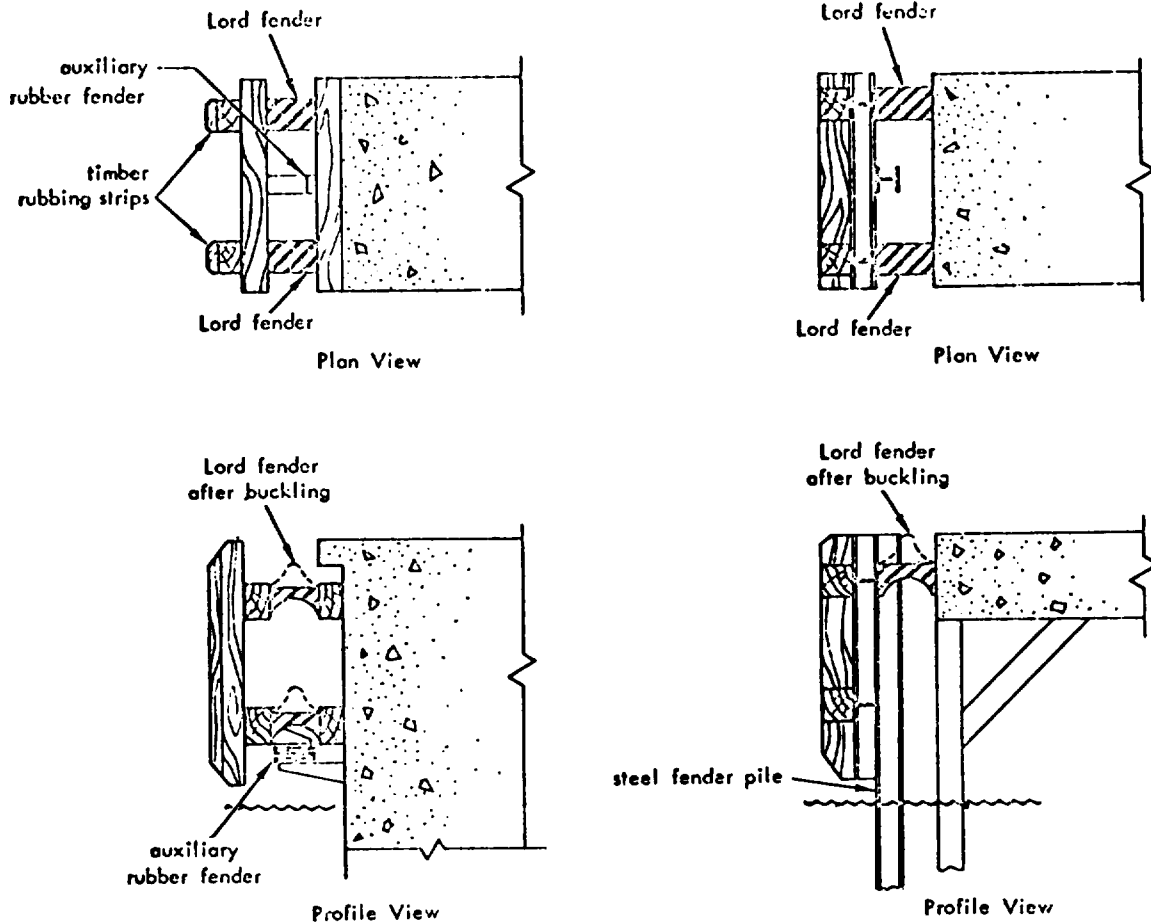

(a) Hung-type Lord fender system

(b) Fixed-pile Lord fender system

NOTE: This patented system is presented for illustration purpose only and does not constitute an endorsement by the Army.

Department of the Navy

Figure 9-12. Typical Lord flexible fender systems.

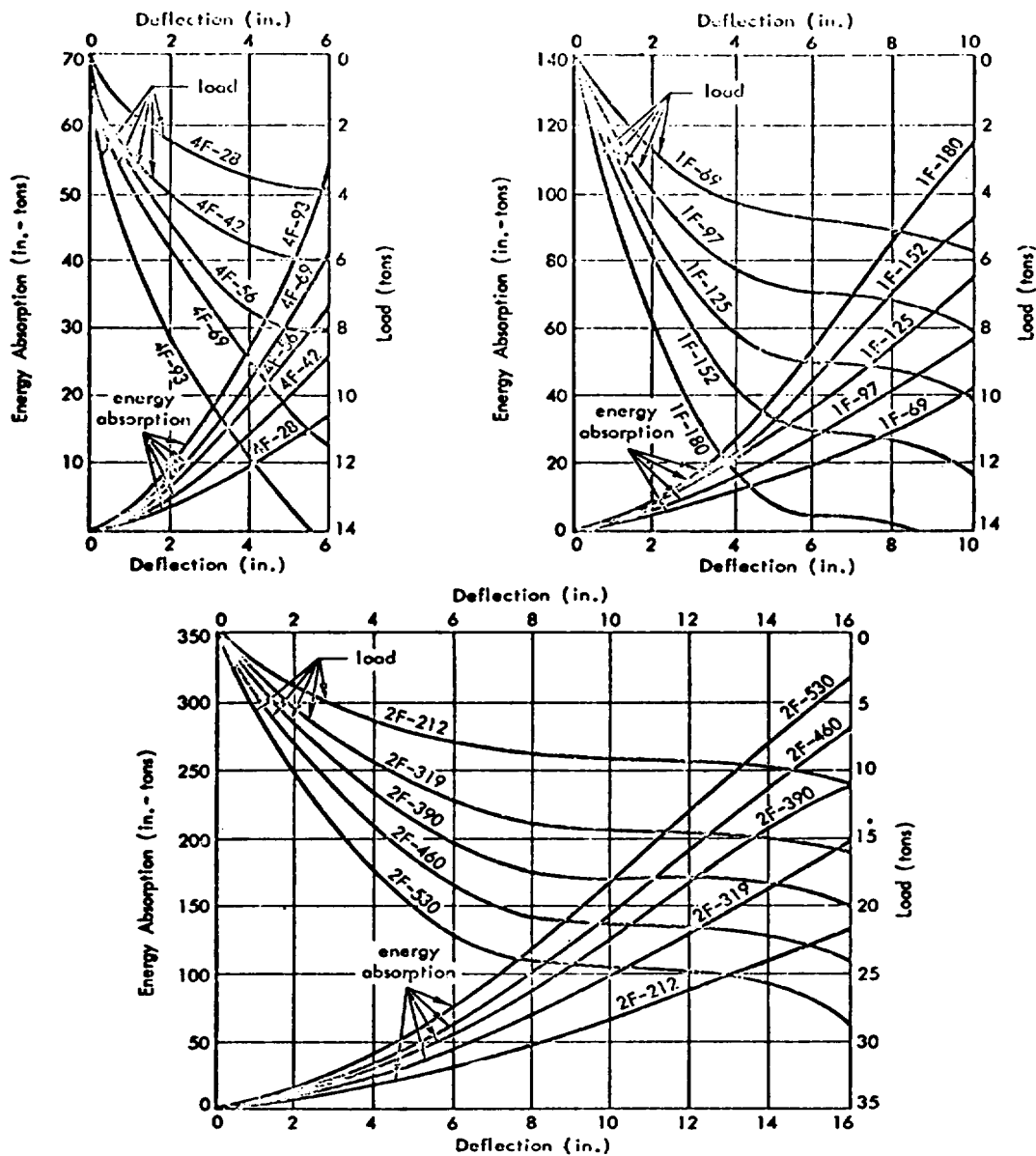

Note: The part number IF-69 is defined as a Lord rubber fender having an energy-absorption capacity of 6,900 foot-pounds at full deflection of 10 inches (for IF series). Full deflection for other series are: 2F series - 16 inches; 4F series - 6 inches.

NOTE: This patented system is presented for illustration purpose only and does not Department of the Navy constitute an endorsement by the Army.

Department of the Navy

Figure 9-13. Load-deflection and energy-absorption characteristics of Lord flexible fender.

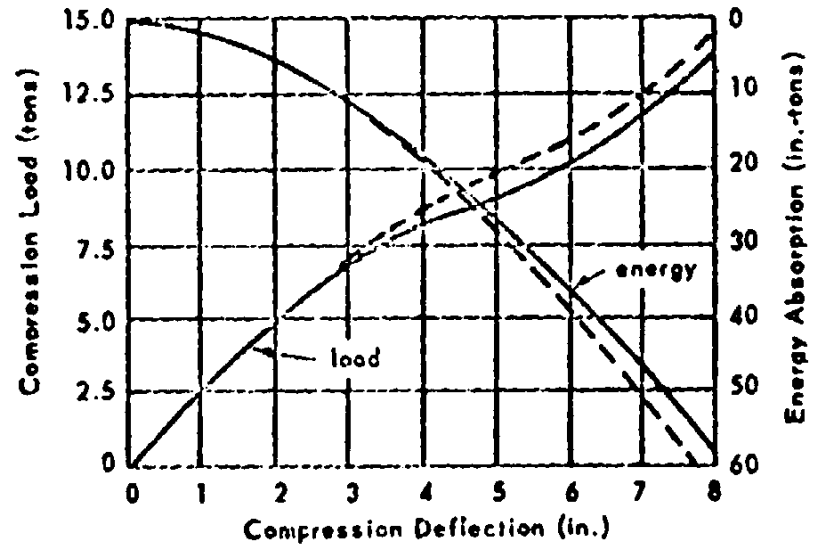

Legend

- After one cycle
- _____ After 1,000 cycles

Load-deflection and energy absorption characteristics

Department of the Navy

Figure 9-14. Rubber-in-torsion fender.

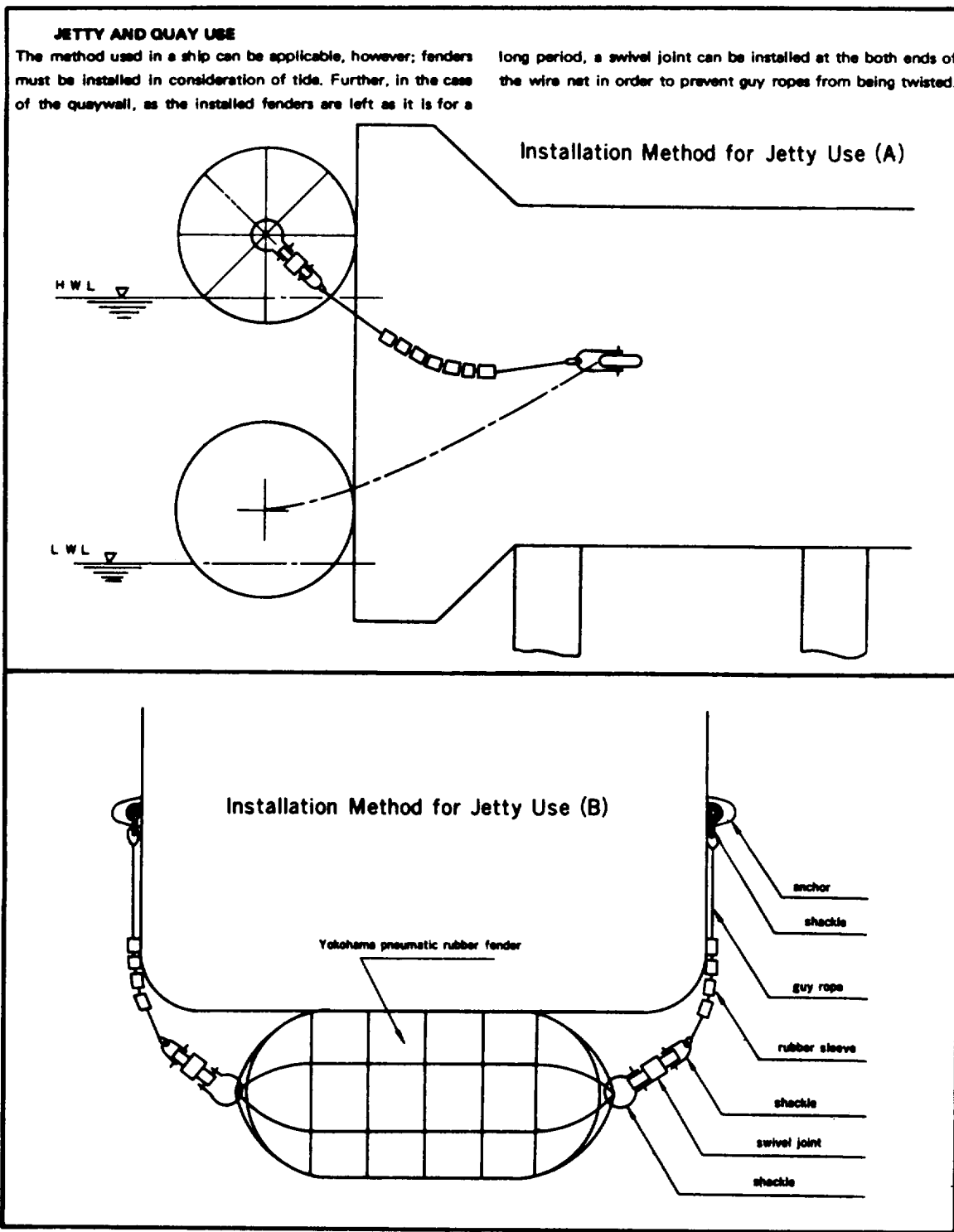

Department of the Navy

Figure 9-15. Yokohama Pneumatic Rubber Fenders (jetty and quay use).

DIMENSION OF JETTY AT THE TIME OF INSTALLATION.

In order that the pneumatic rubber fender exhibits its performances to the full, it is necessary to be compressed by two planes. In this case, one is the ship's side and the other is the quaywall; however, it is requested to design the quaywall so that the pneumatic rubber fender is in a state of plane contact, as shown below, even when it is being deflected.

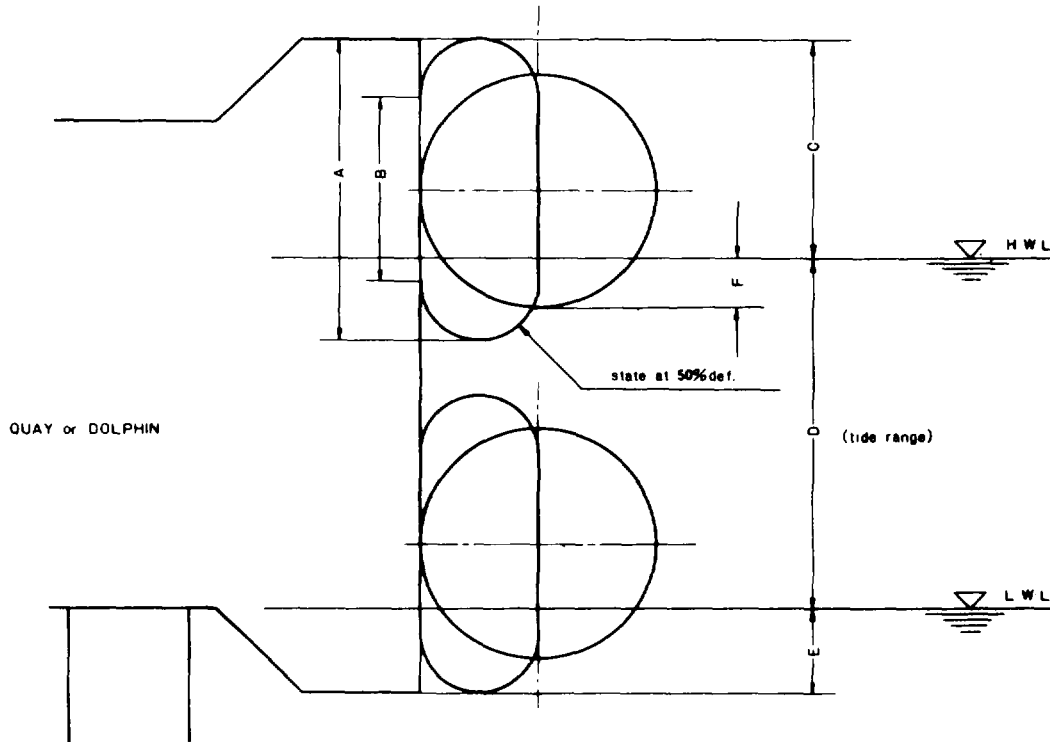

	A (m/m)	(ft)	B (m/m)	(ft)	C (m/m)	(ft)	E (m/m)	(ft)	F (m/m)	(ft)
	900	3.0	550	1.8	610	2.0	290	1.0	190	0.6
	1,280	4.2	790	2.6	880	2.9	400	1.3	260	0.9
	1,280	4.2	790	2.6	840	2.8	440	1.4	300	1.0
	1,540	5.1	940	3.1	1,030	3.4	510	1.7	340	1.1
	1,730	5.7	1,060	3.5	1,180	3.9	550	1.8	360	1.2
	1,940	6.4	1,180	3.9	1,300	4.3	640	2.1	420	1.4
	2,180	7.2	1,340	4.4	1,480	4.9	700	2.3	460	1.5
	2,580	8.5	1,570	5.2	1,760	5.8	820	2.7	530	1.7
	3,220	10.6	1,970	6.5	2,550	8.4	670	2.2	310	1.0
	4,240	13.9	2,590	8.5	3,340	11.0	900	3.0	430	1.4
	5,780	19.0	3,530	11.5	4,670	15.3	1,110	3.6	470	1.5

Department of the Navy

Figure 9-16. Yokohama Pneumatic Rubber Fenders (dimension of jetty at the time of installation).

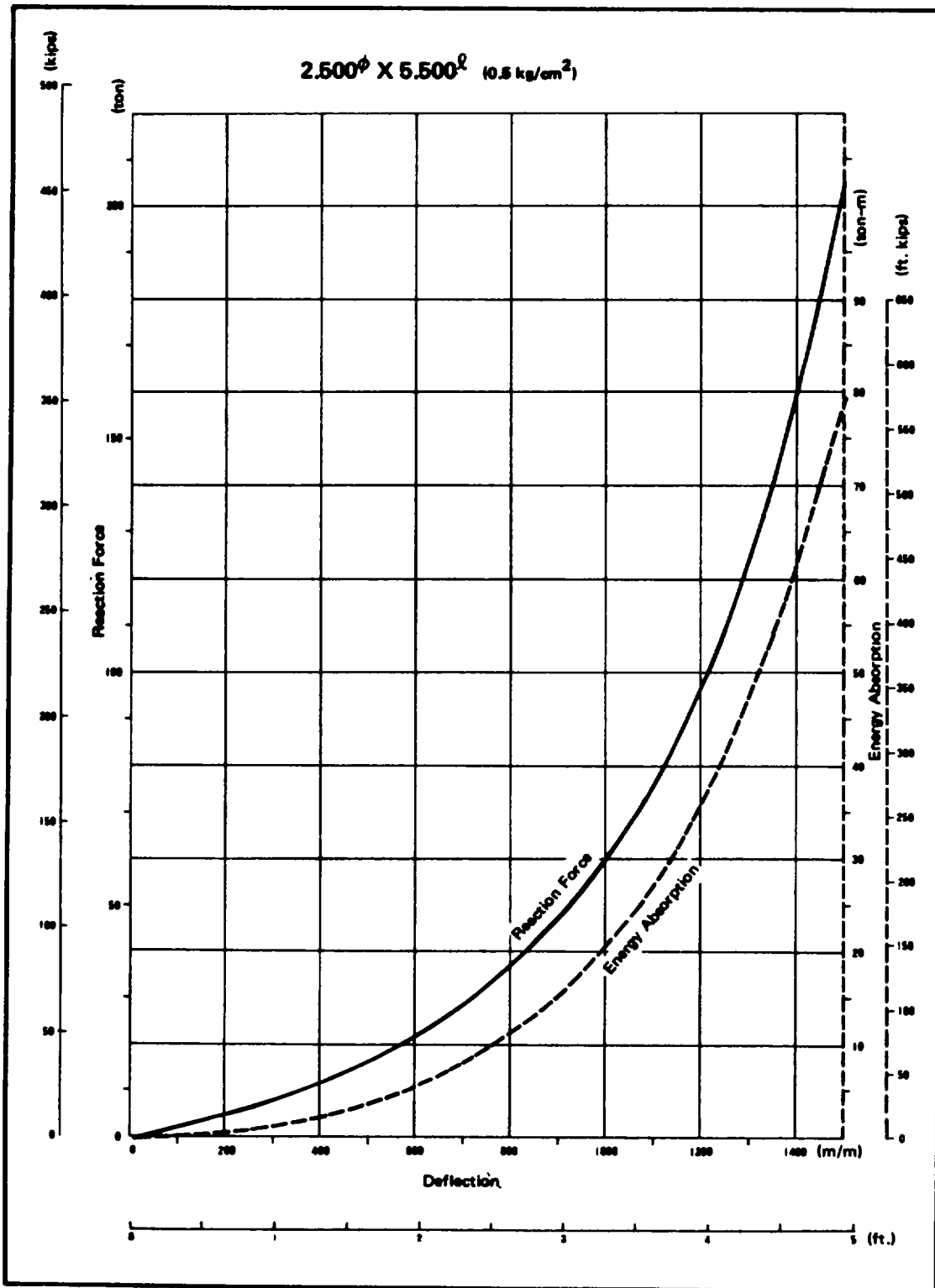

Department of the Navy

Figure 9-17. Yokohama Pneumatic Rubber Fender (this size used for berthing 5,000- to 20,000-ton ships)

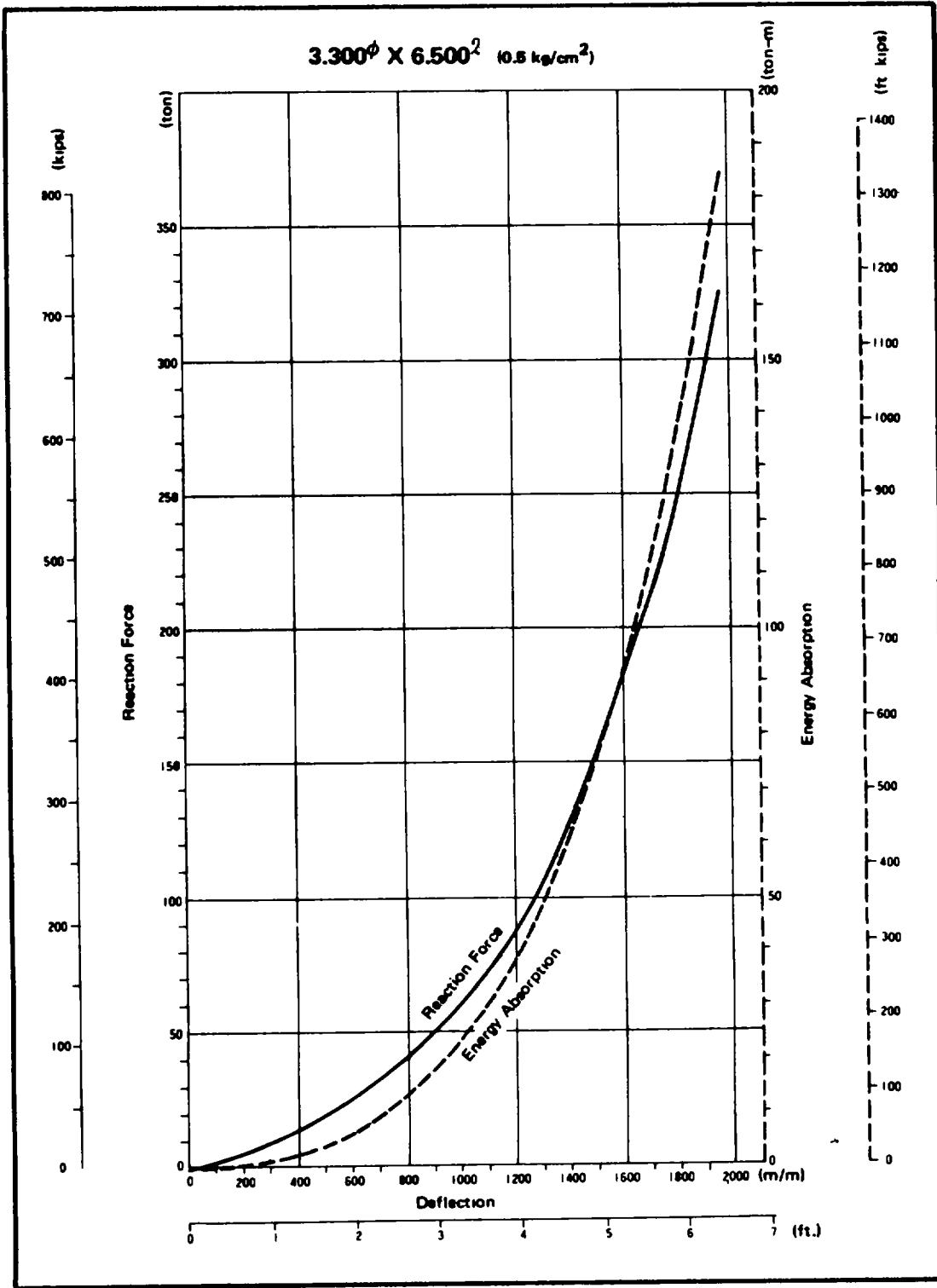

Department of the Navy

Figure 9-18. Yokohama Pneumatic Rubber Fenders (this size used for berthing 25,000- to 200,000 ton ship).

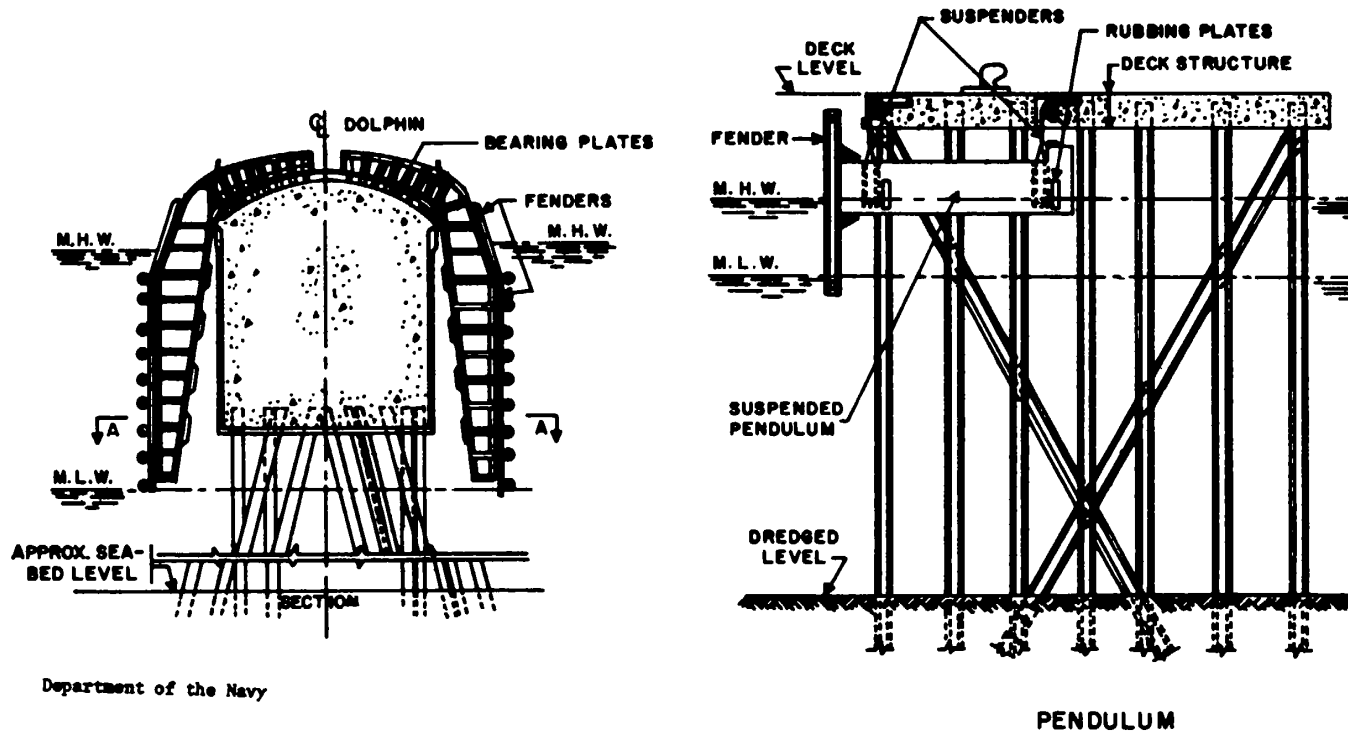
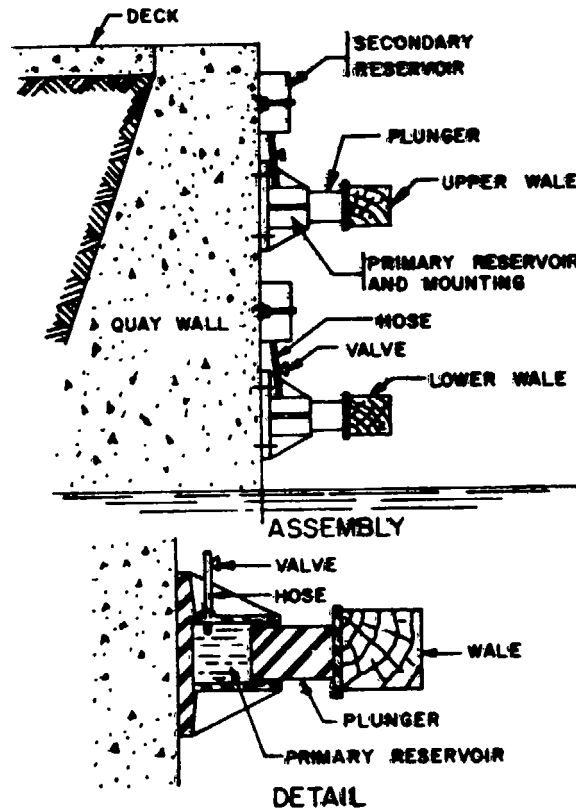

Figure 9-19. Suspended fender.
9-29



Department of the Navy

Figure 9-20. Resilient fender system (dashpot).

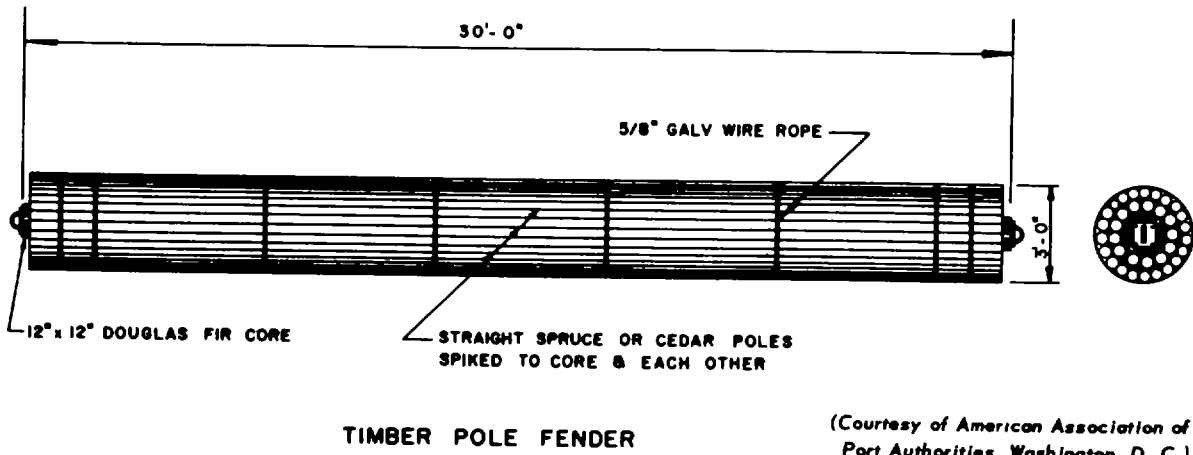
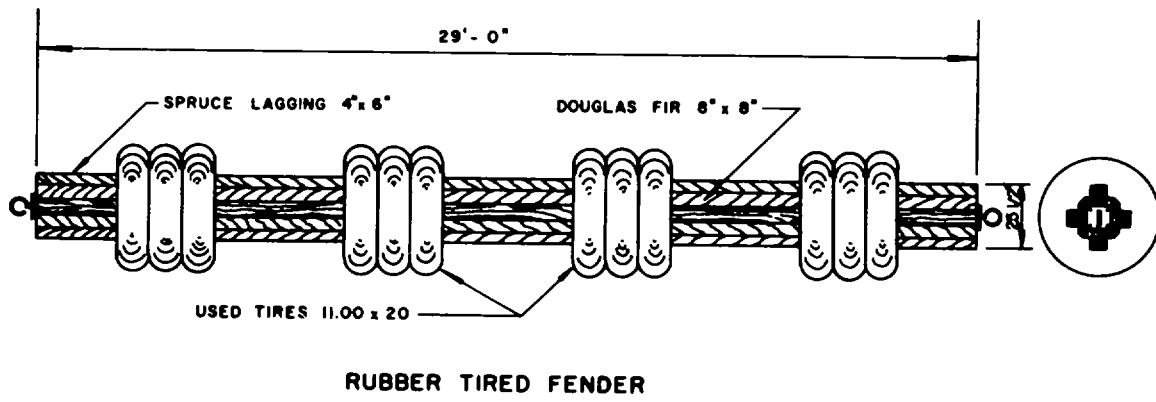

Figure 9-21. Floating camel fenders.

CHAPTER 10

MOORING DEVICES

10-1. Typos.

The types of mooring devices most commonly used in the berthing of both deep and shallow-draft vessels are as follows:

- a. Bollards(fig. 10-1)
- b. Corner mooring post (fig. 10-2)
- c. Cleats(fig. 10-3)
- d. Chocks(fig. 10-4)
- e. Pad eyes (fig. 10-5)
- f. Power capstan (fig. 10-6)
- g. Releasing hooks (fig. 10-7)

10-2. Capacity and spacing.

Mooring devices should be adequate in size, number, and spacing to resist the forces of wind, current, waves, ice, and other related natural elements.

a. *Capacity.* Mooring devices are sometimes assigned design capacities by the manufacturers. However, the specific operating conditions at a given berth should be considered in assessing the capacity of any

type of device and its anchorage. These devices and their anchorages should be designed to withstand a force 50 percent greater than the breaking strength of an attached hawser. The mooring force may be assumed in its most unfavorable design position, which is ordinarily horizontal and perpendicular to the long axis of the device when under stress. Furthermore, the capacity of a device of given size and shape will be affected by the type of metal used in its manufacture. Devices are normally available in cast iron, ductile iron, or cast steel in various stress-grades of each metal.

b. *Spacing.* The types and spacing chosen for a specific berth should be based upon the characteristics and convenience of the using vessel. A typical arrangement of mooring devices to service both small and large vessels is shown in figure 10-8.

10-3. Anchorage.

Mooring devices should be anchored firmly to their supporting structure. The uplift, horizontal forces, and overturning moments may be considered in selecting types of anchorage.

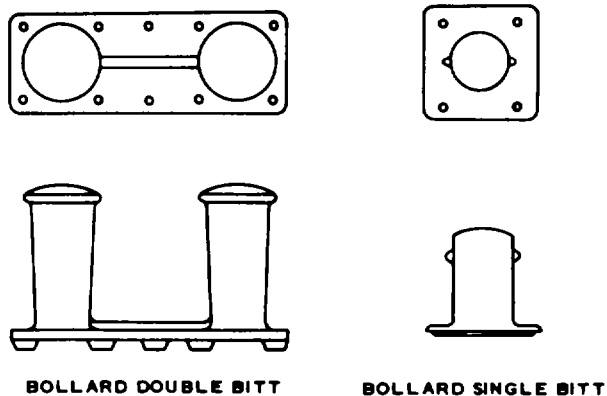

Department of the Army

Figure 10-1. Single and double bitt bollards

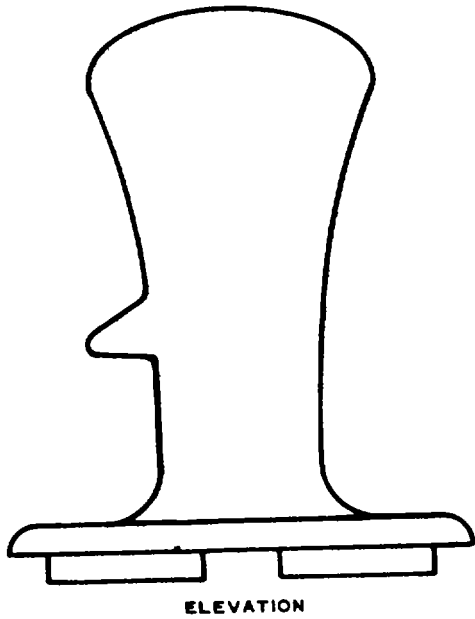
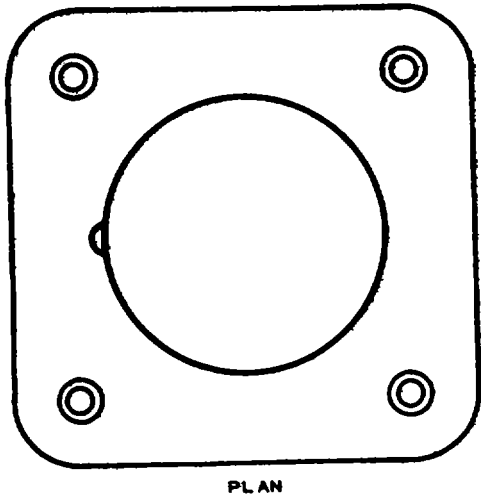

Department of the Army

Figure 10-2. Plan and elevation views of a corner mooring post.

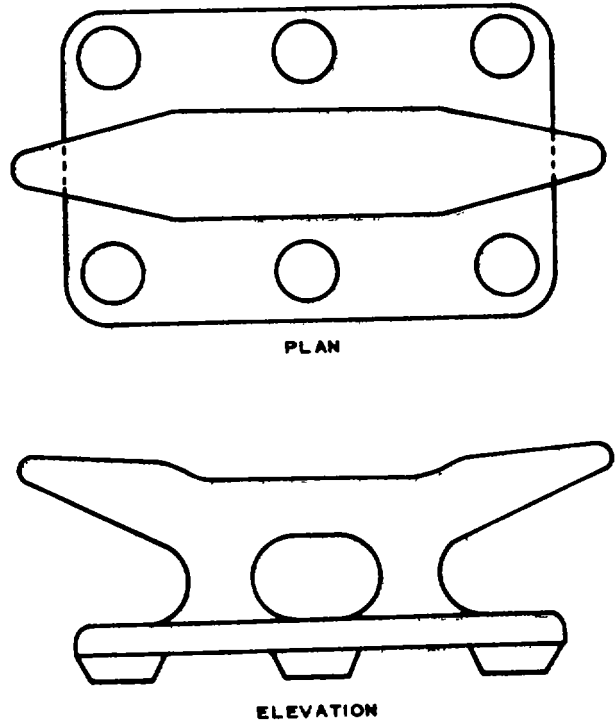

Department of the Army

Figure 10-3. Plan and elevation views of an open wide-base cleat.

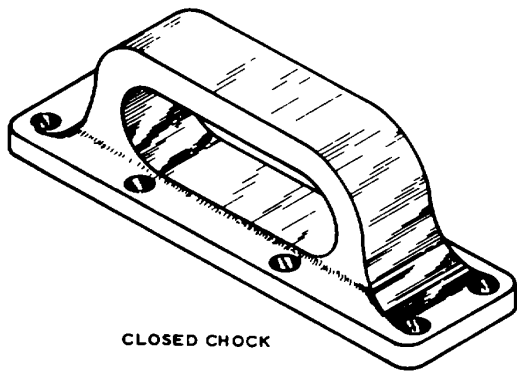

CLOSED CHOCK

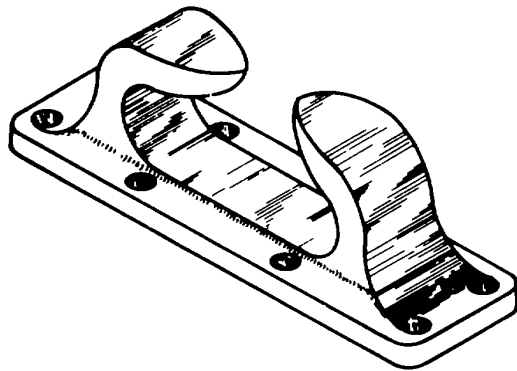

OPEN CHOCK

Department of the Army

Figure 10-4. Typical chocks.

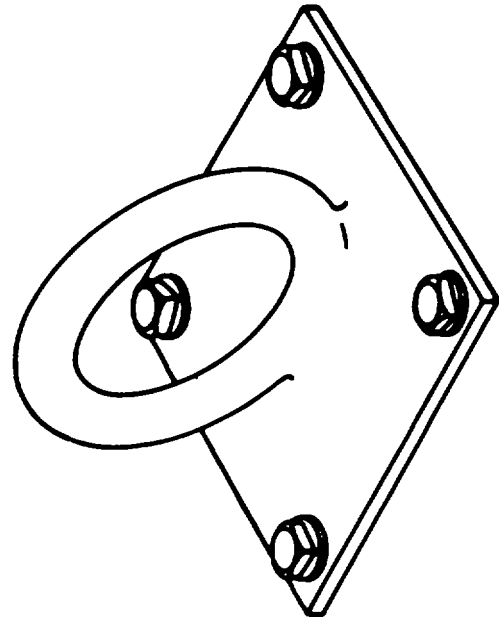

Department of the Army

Figure 10-5. Typical pad eye.

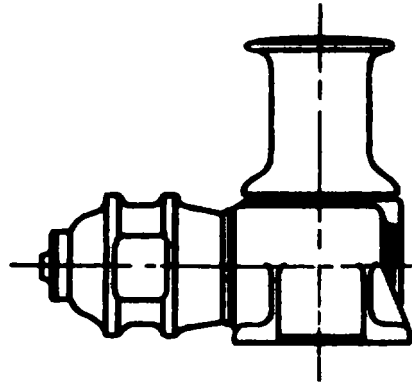

"Design and Construction of Ports and Marine Structures: by A. Quinn. Second Edition, 1972 McGraw-Hill Book Company. Used with permission of McGraw Hill Company.

Figure 10-6. Typical power capstan.

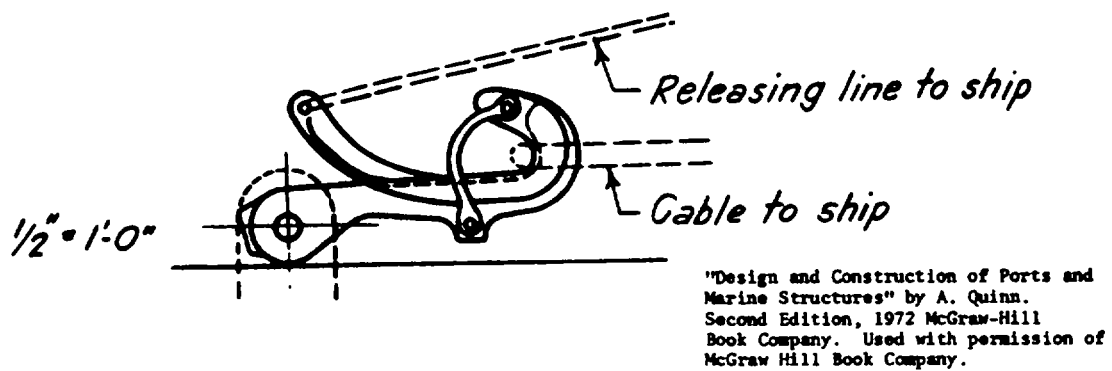

Figure 10-7. Typical releasing hook.

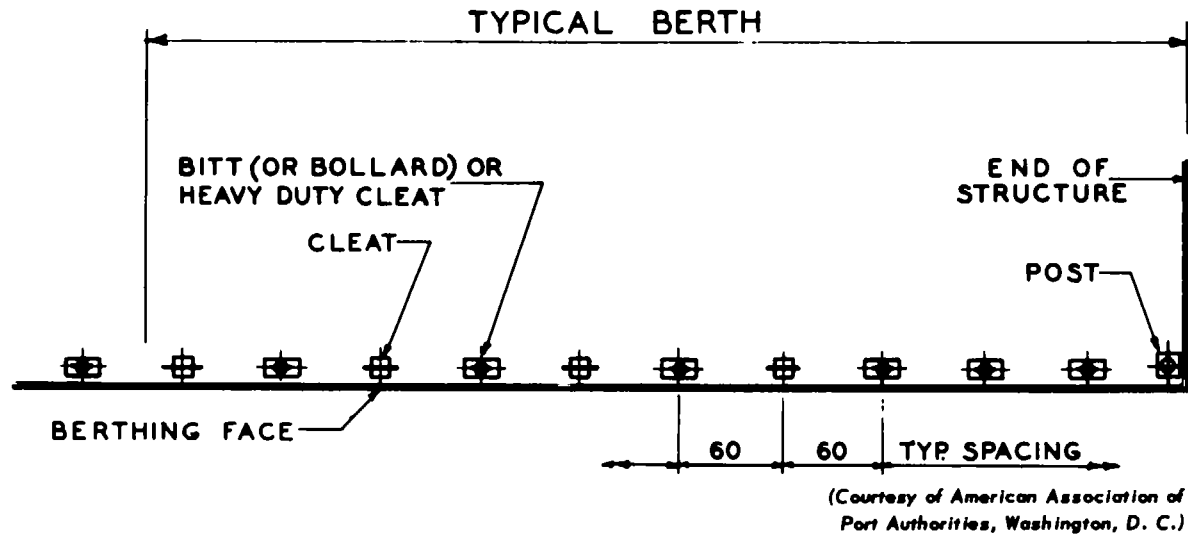

Figure 10-8. Typical layout of mooring devices.

CHAPTER 11

DOCKSIDE UTILITIES FOR SHIP SERVICE

11-1. Water service.

Water service should be provided in sufficient capacity to permit the filling of a vessel's tank in such time as to avoid delays in the operation of the vessel.

a. Quantity and pressure requirement. A minimum flow of 100 gallons per minute, with a minimum residual pressure of 25 pounds per square inch at the most remote outlet, should be provided.

b. Piping and outlets. One 2½ inch connection at each service outlet should be installed. All potable water outlets on piers and wharves may have a reduced pressure-type backflow prevention device. The piping will be insulated and electrically heat-traced if the lines are normally full of water and subject to freezing temperatures. Where thermal expansion is a problem, provision should be made for expansion joints or loops. Figure 11-1 shows a typical water-supply connection in the pier deck.

11-2. Electric power.

a. Electrical system characteristics. The main electrical system providing power to ships will be nominal 480 volts, three-phase, 60 Hertz, supplied from substations preferably located on piers. For lighting service, a 120-volt, 60-cycle, single-phase power may be provided.

b. Ground system. At piers, wharves, and other waterfront structures, a ground system that will measure not more than 3 ohms should be provided for all permanent electrical equipment.

11-3. Location and numbers of service points.

A minimum of two service points will be provided for each berth, located for the convenience of the using vessels. Each service point will supply electric power and water service as outlined above. Depending upon the details of each specific installation, the takeoff points for each service may be located in a single service box or placed in separate but closely grouped boxes. Boxes should be located as close as practicable to the berthing face of the structure so that connected hoses and electric cables are not subject to traffic damage.

11-4. Miscellaneous.

a. Telephone service. Telephone outlets should be installed at each ship's service outlet location.

b. Lighting. Satisfactory illumination should be assured for night operation. For open watering areas on the pier where ship loading or unloading occurs, a lighting intensity of at least 5 footcandles should be maintained. The illumination level of 5 footcandles should also be provided for warehouses or storage buildings.

c. Fire protection. Fire protection should be in accordance with AR 420-90 (See App. A).

d. Sanitary facilities and sewage disposal. Sanitary facilities are usually confined to such buildings as warehouses, transit sheds, administration rooms, and the like. Flow requirements for such facilities are very small, approximately 5 to 10 gallons per minute. A dockside connection to a sewage disposal system should be provided for the disposal of sewage and other wastes from vessels.

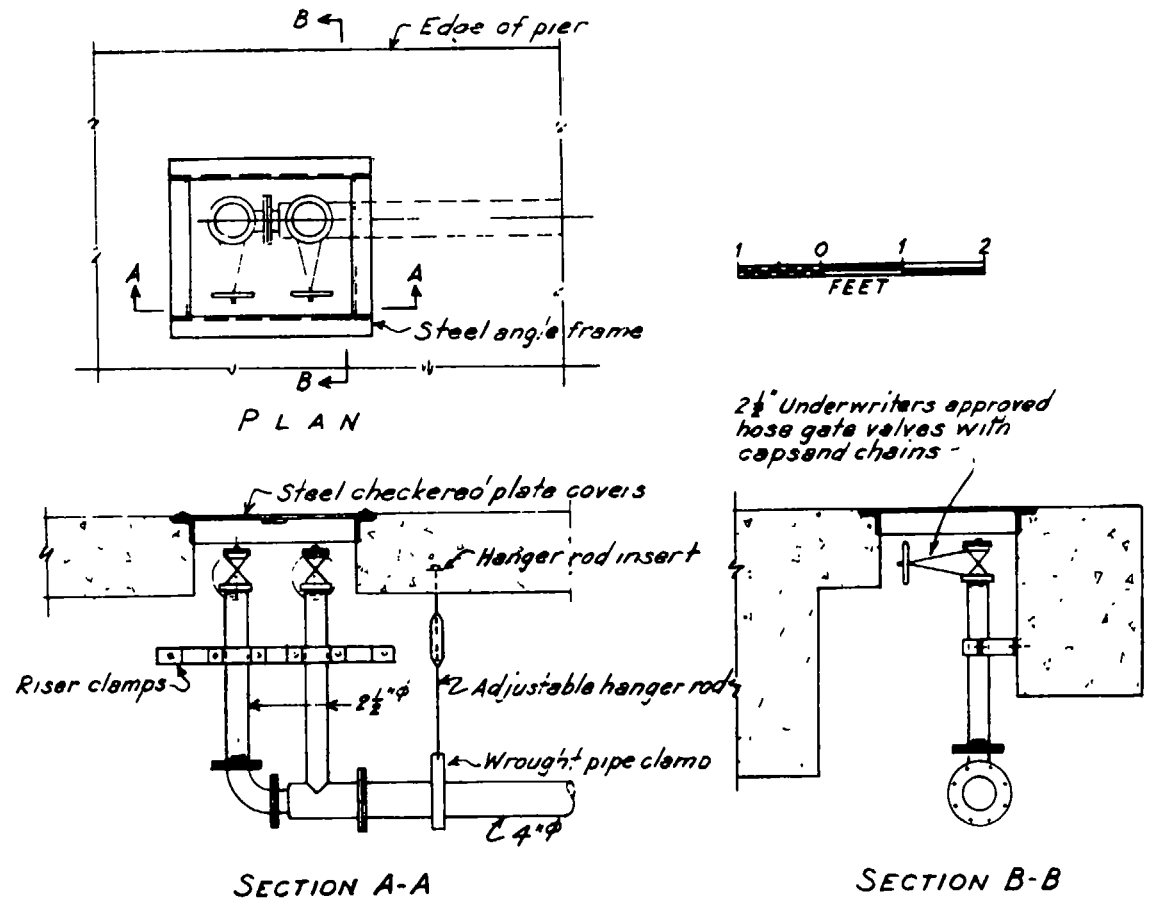

"Design and Construction of Ports and Marine Structures" by A. Quinn. Second Edition, 1972 McGraw-Hill Book Company. Used with permission of McGraw Hill Book Company.

Figure 11-1. Typical water-supply connection in deck of pier
11-2

CHAPTER 12

CARGO HANDLING FACILITIES

12-1. Cargo transfer between dock and vessel.*a. Use of lighters.*

(1) *Application.* In loading operations, cargoes are transferred from the dock to lighters and then into vessels. In unloading the process is reversed. This system is generally used where vessels are berthed offshore or where cargoes are brought to a berth by water rather than land transport.

(2) *Equipment required.* Transfer from lighter to vessel usually employs ship's rigging or, where heavy lifts are required, a floating crane. For transfer between lighter and dock, a dock crane, truck or railroad cranes, or forklift trucks and ramps are used.

b. Direct transfer between dock and vessel.

(1) *Application.* Where vessels are berthed at piers or wharves and where cargoes are delivered by truck or rail, direct transfer of cargo between dock and vessel may be made by using one of the systems set forth below.

(2) *Using ship's equipment.* This system employs ship-mounted equipment, either alone or with dockmounted equipment.

(a) *Conventional burtoning gear.* This system consists of a pair of ship's booms, each stepped at the foot of a kingpost, so that one boom is fixed fast over the ship's hatch and the other over the dock (fig. 12-1). Cargo falls, used to lift cargo, run from either hydraulic, electric, or steam-operated winches and pass through the boom head by means of fairleads (heel blocks, lizards, and head blocks), then married together at a common point above the cargo hook. Modifications and jury rigging of this gear is possible. The advantages include relatively simple design, economical first costs and maintenance, and elimination of highly skilled operators. The disadvantages are: maximum load limitation, lack of flexibility (fixed booms are deficient in spotting ability); time loss in reporting or doubling-up to maximum capacity, rigging dangers involved; and limited over-the-side reach.

(b) *Farrel rig.* This system is similar to conventional burtoning gears except that working guys are made fast to vang posts that are erected on deck, midship guy is nonexistent, and topping lift lead block assumes a position at or near the vessel's center line. Efficiency is improved by providing winches for the topping lifts. The advantages are: topping or lowering ac-

complished without lengthening or shortening the guys; greater spotting ability, reduction of port time, and greater safety than conventional burtoning system; and push-button control over topping lifts. The disadvantages include greater initial and maintenance costs of vang posts and topping lift winches. These disadvantages are minor.

(c) *Ebel rig.* This rig is similar to the Farrel rig but employs winches for both guying and topping. Vang posts are not used. The advantages of the Ebel rig are: loads up to maximum boom capacities can be handled if doubling-up blocks are properly employed; guying and topping are done completely with pushbutton control (if winches are provided with "joy stock" operated master switches, both motions can be controlled by one hand); greater spotting ability; increased safety; reduction of port time; and improvement in deck housekeeping.

(d) *Jumbo boom.* Practically all American cargo ships have one or more jumbo (heavy-lift) booms located at strategic hatches on the vessel. These booms are stepped in a pedestal mounted along the center line of the vessel. When not in use, they are kept collared aloft. The advantages are greater over-the-side reach than conventional burtoning gear and high capacity (when backstays are used, capacities up to 60 tons are common). The disadvantages are: greater number of personnel required to operate the system; slow in operation; boom must be slewed (used as swinging boom); limited maximum capacity; dangerous operation (particularly when lowering heavy weights); time required to ready gear from secured position, and additional space required to stow auxiliary gear when not in use.

(e) *Shipboard crane.* The shipboard crane is another means of handling cargo with ship's gear. It has been found, at least in certain trades, to be faster than the boommast/kingpost rigs. The advantages are: increase in spotting ability; increase in over-the-side reach when athwartship tracks are used; increase in safety about decks; and easier housekeeping. Deck watch officers at sea also find that a "forest" of masts, kingposts, and booms is eliminated when shipboard cranes are used. The disadvantage is that a highly skilled operator is required.

(f) *House fall.* Certain piers (particularly those having narrow aprons or two-deck levels) are equipped with cargo masts that may be used in combination with the vessel's regular cargo handling gear. The

usual method is to rig the ship's off-shore boom and winch to manipulate the up-and-down fall, and the cargo mast and dock winch to manipulate the burtoning fall, the latter being referred to as the house fall (fig. 12-1). This system has these advantages: increased over-the-side reach, sometimes being able to spot laterally the entire width of the pier apron; increased height that cargo can be worked by regular burtoning gear (being able to work second-deck levels); and since the onshore boom is not employed, the danger of this boom coming in contact with the pier terminal is eliminated.

(g) *Self-loading/unloading vessels.* Some bulk carriers are fitted with self-unloading conveyors, either of the endless-belt or scraper type. A few of the latest all-container vessels are fitted with self-loading/unloading shipboard transporter-type cranes. Such carriers have the advantage of flexibility of operation.

(3) *Using floating equipment.* The advantages of the floating cranes are high capacity and elimination of breaking-out the ship's jumbo boom. A disadvantage is the high cost of chartering the equipment, which may not be readily available. The use of floating cranes is usually limited to the offshore side of a ship during calm-to-moderate sea conditions.

(4) *Using shore-based equipment.*

(a) *Gantry cranes.* Gantry cranes are usually large frame-supported mobile cranes, which may be either rubber-tired (fig. 12-2) or railmounted (fig. 12-3). Cargo handling, especially containerized cargo, by gantry cranes directly to railway cars or tractor-trailers are effective methods of handling materials. Gantry cranes are also used as general purpose yard cranes, stacking containers two or three high, in conjunction with other materials handling equipment. Due to the trend toward containerization, most gantry cranes are now being manufactured with minimum lifting capacities and outward reaches of 40 tons and 130 feet, respectively.

(b) *Fixed derricks.* Fixed derricks on the wharf provide heavy lift (up to 100 tons in some commercial ports) for cargo handling (fig. 12-4). Fixed derricks are not considered to be as efficient as mobile gantry cranes.

(c) *Mobile cranes.* Truck or crawler-mounted cranes may be used to load and unload cargo ships (fig. 12-5). Table 12-1 and figure 12-6 present the manufacturer's rated capacities for a number of larger commercially available cranes. Figure 12-6 shows that the large mobile cranes are not capable of lifting 40-foot containers weighing 67,000 pounds beyond a 30-foot radius.

(d) *Conveyors.* Conveyors are used for handling bulk or relatively small packaged goods, but their limited maximum lifting capacity restricts their use to

relatively light cargoes. For example, the endless-belt conveyor is especially useful for side port discharge, the pneumatic or air conveyor, for handling large quantities of dry bulk commodities; the endless pocket conveyor, for handling small package units of cargo; the gravity roller conveyor, for side port handling when the endless-belt powered conveyor not available or prohibited; and the screw-type conveyor, for over-the-side or for side port handling of bagged goods. Also, the spiral conveyor utilizes gravity to propel cargo being worked.

(5) *Roll-on/roll-off system.* There are several ways in which containers can be handled in this type of operation. In most cases, the method of handling containers and design of the berth and layout of the port area is inextricably tied up with the design of the ship. A large number of new ships and new berths for this type of operation have been built or are under construction, which shows the importance of this type of operation. It will undoubtedly increase throughout the world, especially as feeder services on short sea routes from main container transshipment ports. Basically, there are three methods of handling containers on a roll-on/roll-off service:

(a) Trailer and tractor unit drives on, remains on the ship during its voyage, and drives off at the other end. This method can only be economical on very short sea journeys because the tractor unit is idle and burdens the ship's capacity during the sea journey. No special facilities or equipment are required in the port area except sufficient land for parking the trailer while waiting to drive on.

(b) The trailer unit only remains on ship during the sea journey. The tractor unit simply tows the container on its trailer from the storage area onto the ship and drives off leaving the container on its trailer. A further set of tractor units is required at the destination to tow the containers off the ship and to reload the ship for its return journey. The trailers may be normal road trailers suitable for driving on public roads or special small trailers suitable only for use in the port areas. The former is heavier and takes up more room on the ship but would be used where the container is driven some distance to the port and will be driven inland some distance to its destination. The latter would generally be used where the inland depot is in the port area so that the container is only handled in the port area, or where the container is delivered by rail and transferred to the trailer in the port area. This type of trailer is generally much lighter and cheaper than the normal road trailer and takes up less ship capacity. For the method where the road trailer is driven on and off the ship, no special equipment is required. Where the small trailer is used, equipment may be required for transferring the container from rail or road trailer to

Table 12-1. Characteristics of Various Commercially Available Cranes.

Characteristics of Various Commercially Available Cranes

Manufacturer	Model	Type of Lover Works	Length of Boom, ft	Hoist Speed with 50k Rig fpm	Approximate Gross Weight kips	Maximum Capacity at Minimum Radius, kips	Minimum Radius ft
PUH	6250 TC 80 tons	Truck	150 Container tip	140	384.0	160.0	35
American	9520	Truck	150 92" tubular	80	301.0	218.0	27
Lima	7700	Truck	150	150	398.0	279.6	35
Manitowoc	4600	Crawler	150	112	494.6	227.7	29
American	11250	Crawler	150	163	494.0	271.0	29
LeTourneau	GC500	Gantry Rubber tires	120	170	708.5	150.0	29
Butters	50 tons	Stiffleg	150	38		112.0	36
American	S-40	Stiffleg	180	90 (380 hoist) 180 (550 hoist)		179.0	40
American	S-50	Stiffleg	200	90 (380 hoist) 180 (550 hoist)		368.0	50
Floating Crane	261 B	Pedestal (barge)	123.5	56		200.0	55

by U.S. Army Engineer
Waterways Experiment Station

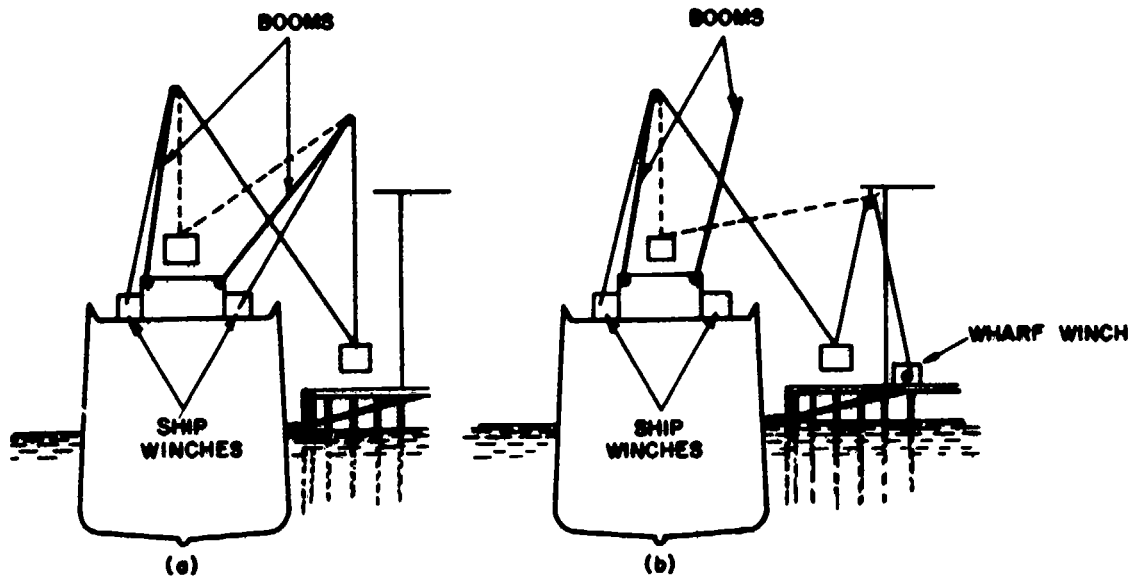

CONVENTIONAL

USING HOUSE FALL

Department of the Navy

Figure 12-1. Burton system.
12-4

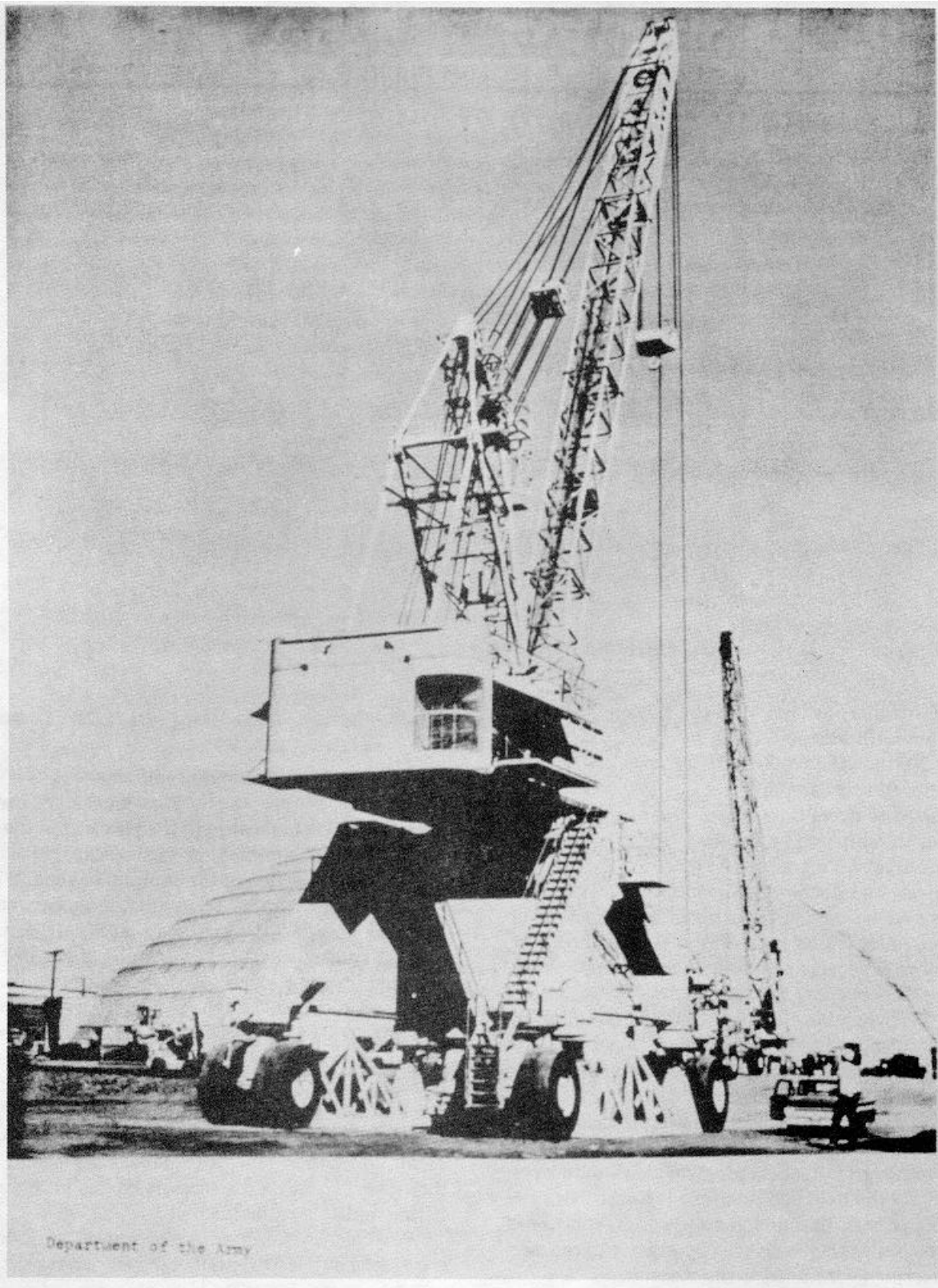

Figure 12-2. Typical heavy duty, rubber-tired gantry crane.



Figure 12-3. Typical rail-mounted gantry crane.

the special trailer; or load onto the trailer if the container is normally stacked on the ground.

(c) Neither the trailer nor tractor unit remains on the ship. In this case, either a straddle-type carrier must be used to drive the container onto the ship and stack it, or the ship itself must have lifting equipment, which can lift it off a trailer and stack it. This type of operation is generally more efficient because it enables containers to be carried two high, and there is no wasted space by trailer or tractors. It does, however, require more expensive container handling equipment.

(6) *Specialized port facilities.*

(a) *Coal handling facilities.* These facilities include the tilting system, unloading bridges, and unloading towers. The tilting system accomplishes the loading by tilting a car's load into a hopper and discharging it by gravity into the vessel. The unloading bridges span the storage pile and cantilever over the vessel. Trolley grab buckets are provided for recovering coal from the hold and dumping it in the stockpile or into hoppers in the unloading towers. From these towers, the coal is then conveyed by gravity to railroad cars or to a conveyor linked to the stockpile.

(b) *Oil terminals.* Equipment requirements are limited to storage tanks, hoses, and hose-handling facilities.

12-2. Cargo handling in the shed and storage area.

a. General cargo handling equipment.

(1) *Forklift trucks.* Forklift trucks are useful for handling palletized cargo in the pier and in the transit shed. They are available in various capacities and are generally most efficient for hauls up to about 200 feet.

(2) *Tractor trains.* Where distances between shipside and storage areas are too great for efficient use of forklift trucks, tractor-drawn trains of low-bed, small-wheeled trucks may be used. The trucks are loaded or unloaded at shipside by the shiploading gear and in the storage area by forklift trucks. These trains are also useful for transporting material that cannot be palletized, or is otherwise unsuitable for forklift operation.

(3) *Conveyors.* See paragraph 12-1b(4d).

(4) *Straddle trucks.* Straddle trucks are used for handling lumber, pipe, rails, steel shapes, and similar materials. The straddle truck may also be adapted for lifting multiple pallet loads.

(5) *Overhead cranes.* An overhead, underhung jib crane may be used to handle cargo in the transit shed.

b. Container handling equipment. The typical container handling equipment used in the storage and marshaling areas is contained in Appendix B.

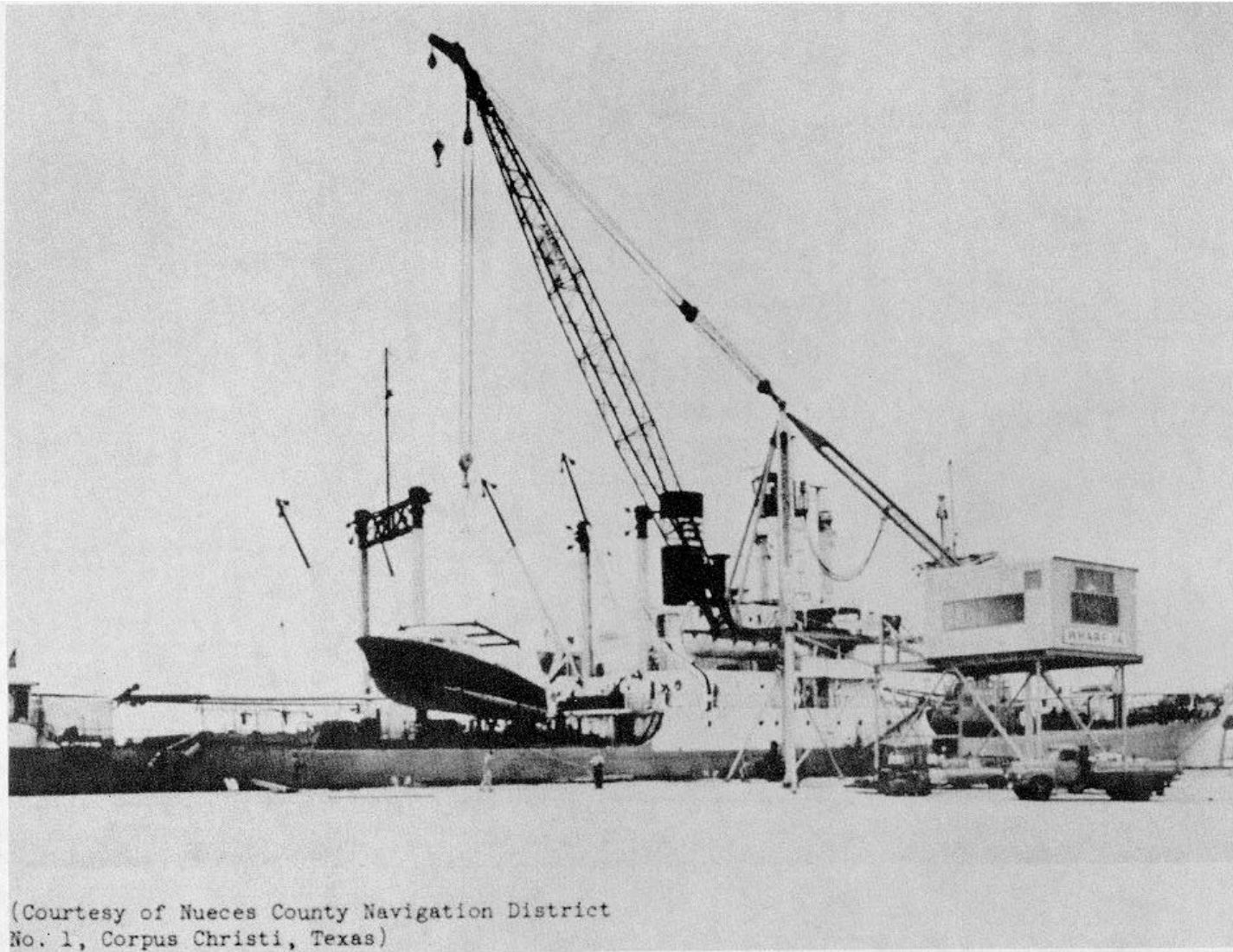
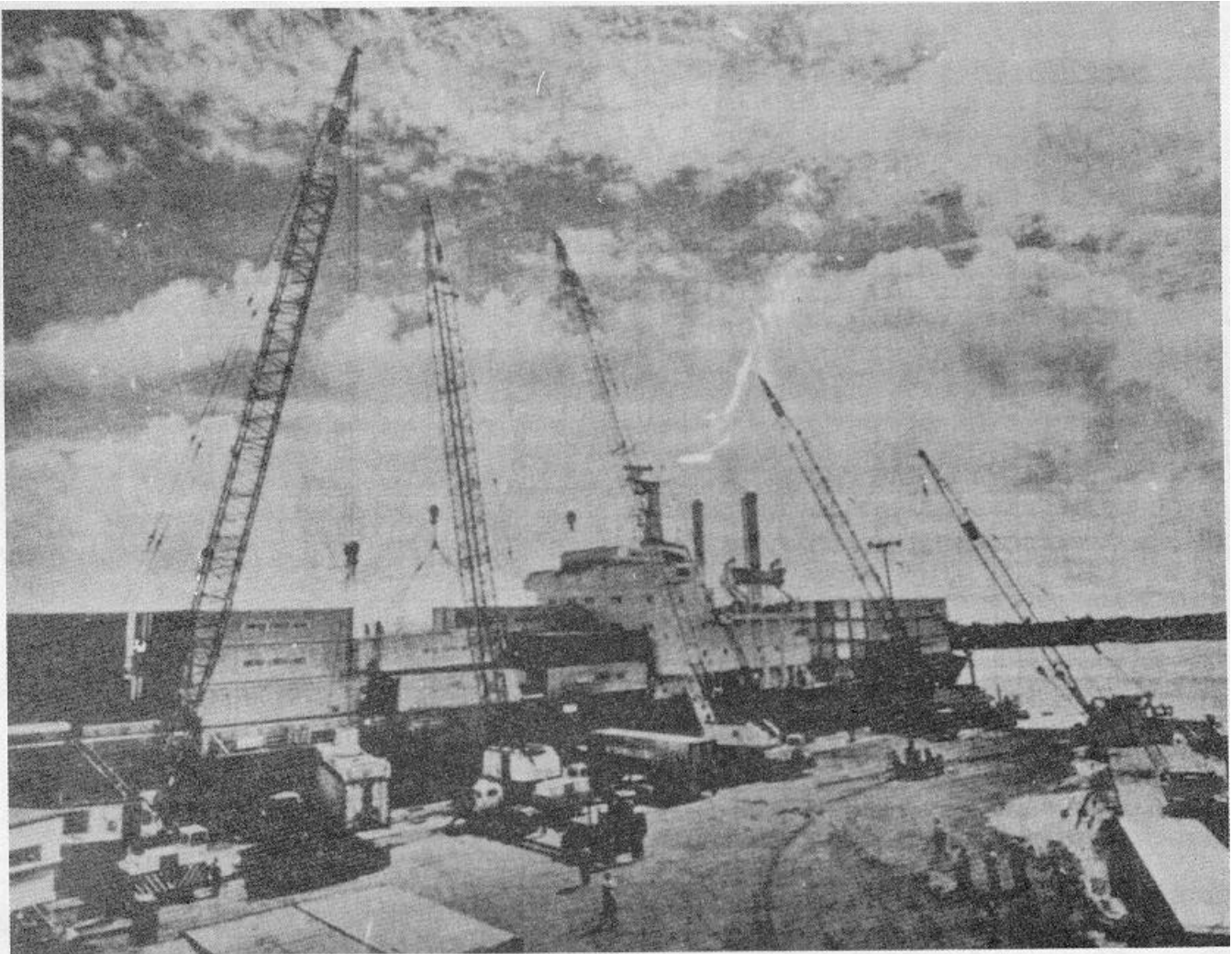

Figure 12-4. Fixed derrick.
12-7



(Courtesy of Manitowoc Engineering Corporation, Manitowoc, Wisconsin)

Figure 12-5. Container off-loading through the use of crawler-mounted cranes

by U.S. Army Engineer
Materials Experiment Station

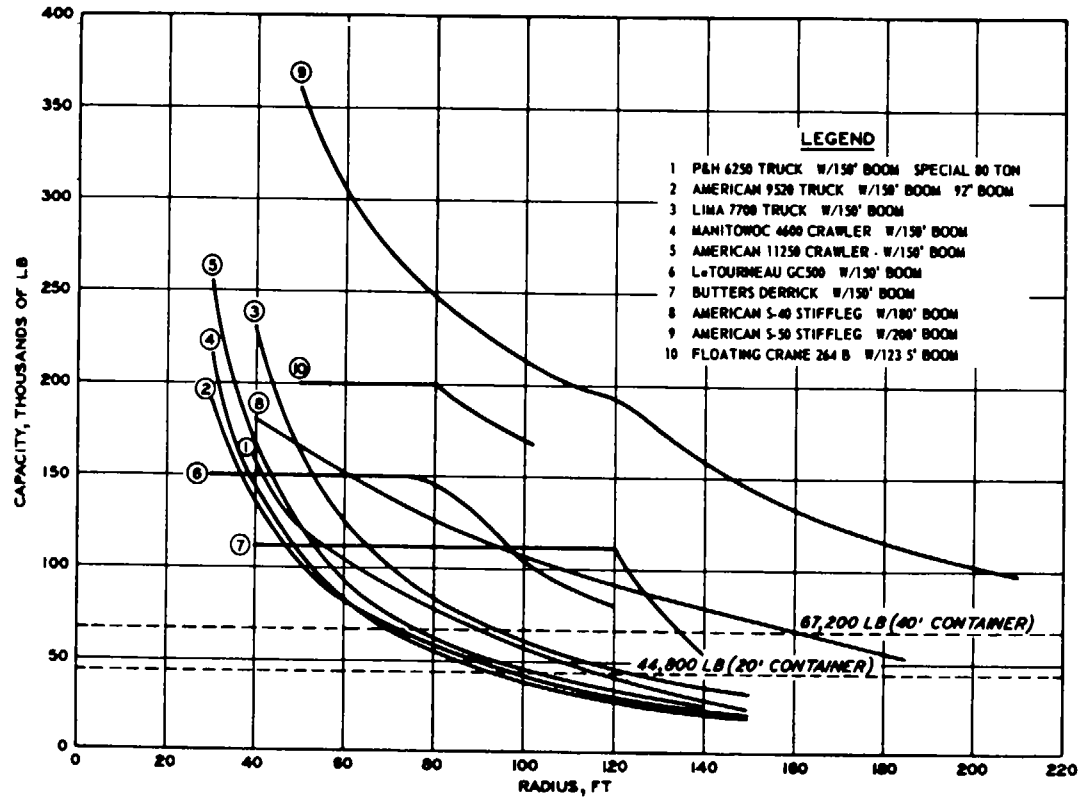

Figure 12-6. Crane capacity.

CHAPTER 13

CONTAINER PORTS

13-1. Planning.

a. Basic considerations. In container port design, the basic considerations are as follows:

- (1) Open space is needed in large amounts.
- (2) Railroads and trucks are both involved in feeding containers to the ship, and adequate space must be provided in the container yard for their operation.
- (3) Some buildings are required, although the number and area will be quite limited compared with those for break-bulk general cargo terminals.
- (4) Because of the large land area required, berths for containerships will be of the continuous bulkhead or wharf type of construction, rather than finger piers or dolphin-type construction.
- (5) Space will normally be required on the wharf for railroad tracks, operation of trailer and straddle trucks, and gantry cranes ranging from 25 to 35-ton capacity for handling containers. Therefore, the wharf will generally be wider than for break-bulk general cargo terminals.

b. Containership berths. Containership berth is generally a marginal-type wharf backed up by ample land for the operation. The design of the wharf is little different than that of any other wharf except for the following features:

- (1) Containerships are becoming larger than general cargo ships, requiring berths up to 900 to 1,000 feet long, whereas a 500 to 600-foot berth will serve most general cargo ships.
- (2) Provision must be made in the design of the deck for the support of the front gantry crane rail and possibly for the rear rail unless the gage is very wide. Because of the heavy loads to be lifted (up to 40 tons) and the long reach to load the far side of the ship (up to 110 feet), the wheel loads are very heavy, usually 100 to 115 kips on 4-foot centers.
- (3) The design live load is usually heavier than for break-bulk general cargo wharves, being 800 to 1,000 pounds per square foot, and the deck slab will normally have to be designed for the heaviest trailer truck wheel loads and for railroad wheel loads when the railroad is placed on the wharf.
- (4) Because of the high live load that can occur in back of the wharf, the structure must be designed for a relatively large horizontal surcharge load.
- (5) Because of the prevailing method of handling the containers on and off the ship by movable gantry

cranes on the wharf, except for a few ships equipped with their own gantries and for the roll-on/roll-off container type of operation, it is desirable that all the berths in a terminal be in a straight line.

c. Storage and marshaling area. The design criteria for storage and marshaling area are as follows: (1) One modern container ship will hold \pm one thousand 40-foot containers or equivalents. Based on commercially available materials handling equipment, approximately 12 acres of storage and marshaling area, including area for trailer chassis, will be required for off-loading one of the newer container ships. (fig. 13-1)

(2) Each storage and marshaling area should be designed to accommodate one of the most suitable types of commercial Materials Handling Equipment (MHE), which appeared to be either the heavy duty front loader, the side loader, or straddle carrier, in conjunction with the trailer chassis.

(3) Substantial amounts of base course and pavement surfacing must be provided each storage and marshaling area, otherwise failures can be expected from the loads exerted by either the loaded MHE or stacked containers, or possibly more so by combinations of each. Surfacing requirements are contained in appendix B.

(4) Most modern MHE needs to have the capability of stacking fully loaded 40-foot containers (67,200 pounds) three high; however, only two-high stacking is recommended due to additional weight and maintenance of pavement surface.

(5) Empty containers will not be stacked over three high unless wind screening is provided.

(6) Commercial storage and marshaling areas should be located as near the off-loading pier as possible. This could be a problem for military storage and marshaling areas because of the potential of enemy action damaging or destroying both structures at the same time.

(7) The surface gradient of the storage and marshaling areas should be as small as adequate drainage will allow so that stacked containers can be accommodated more efficiently.

(8) The placement of each container should be according to its scheduled movement from the storage and marshaling area.

d. Railroad and truck operation.

- (1) *Provision for railroad operation.* Container

ports may be provided with double-track sidings from a train makeup yard, which preferably should be outside the container yard. This railroad configuration should run the length of the wharf apron, with sufficient crossovers, so that empty or reloaded cars can be switched onto the outgoing track. Instead of the tracks running on the wharf, they may be located in back of the wharf, within reach of the inboard extension of the gantry crane bridge. A railway spur shall also run down one of the longitudinal aisles in the marshaling and storage yard so that a yard gantry crane, straddle truck, or forklift truck can transfer containers to and from the flatbed railway cars.

(2) *Provision for truck operations.* Container terminals should have provision for truck traffic. It is important in the location of a container facility that it be near main highway arteries. Traffic congestion may occur where the trailer trucks pass the control office. To prevent trailer truck traffic from blocking public highways leading to or passing by the container yard, adequate length of roadway or parking area should be provided inside the main entrance to the marshaling yard ahead of the control office. A Circumferential road may lead to the wharf to maintain through traffic along the wharf and not require turning on the apron. Longitudinal aisles may be provided between double rows of parked containers, stored on trailers, leading to transverse collecting aisles to the wharf. Aisles will normally be about 60 feet wide. AU areas within a container yard need to be paved and drained so that ponding will not take place. Subgrade conditions need to be carefully investigated, and pavements designed for the concentrated wheel loads; or when containers are placed on the ground, the loads will be concentrated at the corners. Excessive loads may result from containers being stacked too high.

13-2. Types of container operations.

Two completely different types of container operations have been developed. The two methods are identified by the way the ship is loaded and unloaded and are commonly referred to as lift-on container operation and roll-on-roll-off (ro-ro) operation.

a. *Lift-on container operation.* This operation is by far the most common type. In general, the two principal systems of lift-on operation are as follows:

(1) Inbound and outbound containers are stored in the marshaling yard on standard over-the-road chassis. Incoming containers are weighed, checked in, and dispatched to a predetermined parking location in the marshaling yard. The over-the-road tractor either

picks up a container and chassis or returns to its operations base empty. Yard tractors haul both exported and imported containers between the marshaling yard and the wharf. At the wharf, gantry cranes, either on the ship or on the wharf, lift export containers off the chassis and on board the ship, remove import containers from the hold, and place them on the tractor-driven chassis, which then returns to the marshaling yard.

(2) This system has the containers stored on the ground in the marshaling yard and serviced by straddle or forklift trucks. As an export container arrives, it is received in the marshaling yard, and a straddle truck removes the container from its chassis and moves it to its storage place on the ground or on top of another container, if stacked two high. The straddle truck loads the container on a yard tractor trailer for delivery to the dock, where it is loaded on board the ship. Import containers unloaded from the ship are carried to the marshaling yard by the tractor trailer, and the straddle truck moves them to their place in storage. When the containers are ready for delivery, the straddle truck places them on and over-the-road tractor and chassis.

b. *Roll-on/roll-off operation.* As the name implies, this operation differs from the lift-on container operation in that tractors deliver their trailers on wheels on board the ship, where they are detached from the tractor and secured to the deck. Then the tractor returns to shore to pick up another trailer. The operation of loading and unloading goes on simultaneously. More detailed discussion of roll-on roll-off operation is given in chapter 12.

13-3. Container handling equipment.

a. Efficient handling of large containers requires special equipment on the ship or on the wharf, the latter being the preferred method since it permits the gantry crane to reach a considerable distance inland as well as over the ship. A typical wharf-side traveling gantry crane is shown in figure 12-3.

b. When rehandling is necessary on land, this is accomplished by means of giant straddle carriers (fig B-3). Front loading container handlers (fig B-5) are also used and can stack the container three high. A heavy-duty side-loading container handler (fig B-7) can handle 40-foot containers two high. Likewise, the gantry cranes, on either rails or rubber tires (fig B-8), can stack containers four high on the ground, then pick them up and place them on a railroad flatcar or truck chassis.

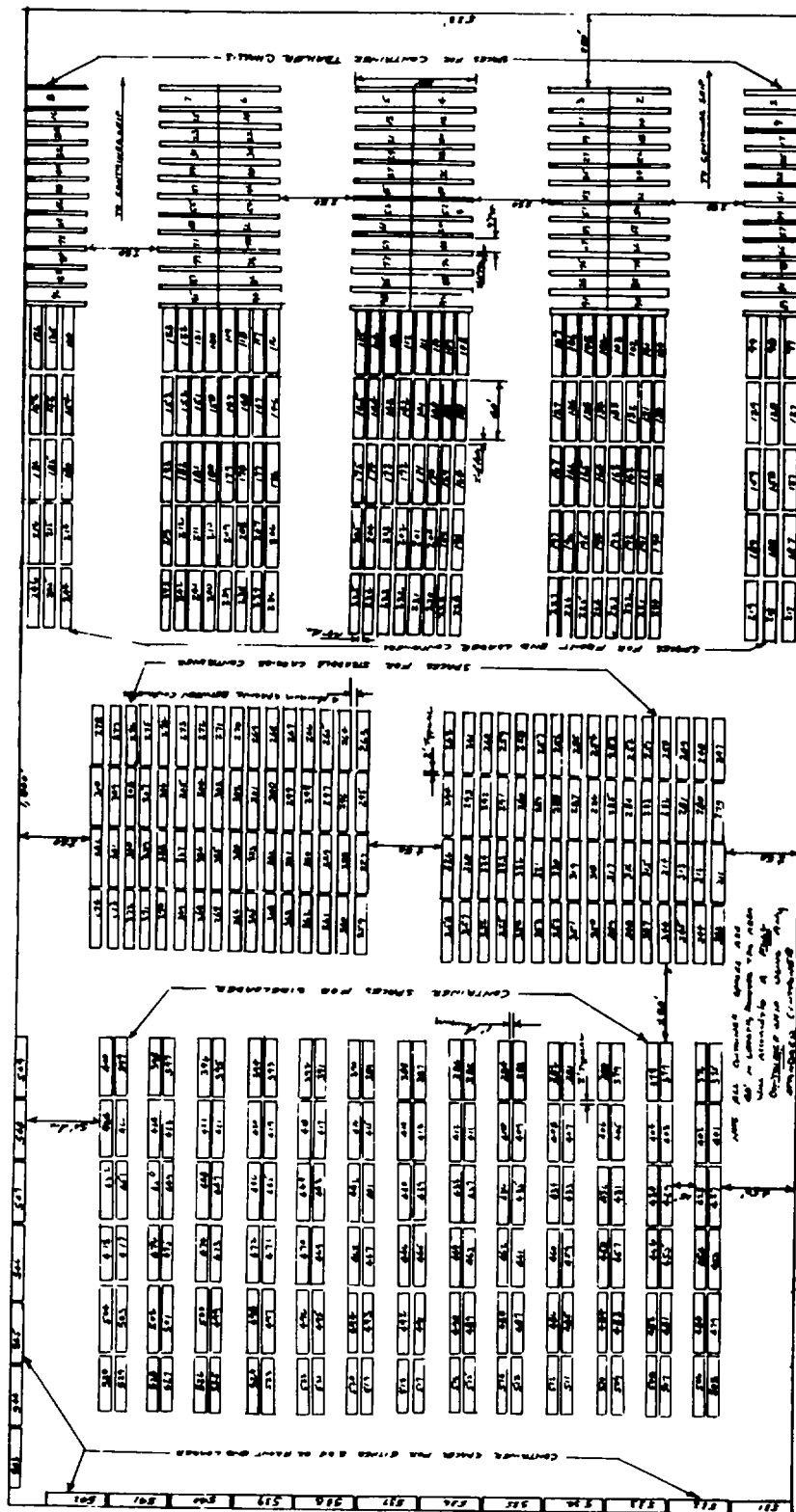

by U.S. Army Engineer
Waterways Experiment Station

Figure 13-1. Recommended container storage and marshaling area

APPENDIX A

REFERENCES

Government Publications**Department of Defense**

DOD 4270.1-M Construction Criteria Manual

★Department of the Army Regulation and Technical Manuals

AR 420-90

Fire Prevention and Protection

TM 5-360

Port Construction and Rehabilitation

★ TM 5-822-5

Flexible Pavements for Roads, Streets, Walks, and Open Storage Areas

TM 5-822-6

Rigid Pavements for Roads, Streets, Walks, and Open Storage Areas

Department of the Army, Corps of Engineers

★Alvin, R. G., "Multiple-Wheel Heavy Gear Load Tests; Basic Report," Technical Report S-71-17, Vol 1, Nov. 1971, U.S. Army Engineer Waterways Experiment Station, CE, Vicksburg, MS

Brown, D. N. and Thompson, O. O., "Lateral Distribution of Aircraft Traffic," Miscellaneous Paper S-73-56, Jul 1973, U.S. Army Engineer Waterways Experiment Station, CE, Vicksburg, MS

★"Shore Protection Manual," Vols 1-3, 1966, U.S. Army Coastal Engineering Research Center, Fort Belvoir, VA

U.S. Coast Guard Publication

"Aids to Navigation Regulations," USCG Booklet CG-208, Department of Transportation, Washington, DC 20314

Non-Government Publications

★American Association of State Highway and Transportation Officials (AASHTO), 444 North Capital, NW, Suite 225, Washington, DC 20001

★HB-12 Standard Specifications for Highway Bridges (12th Edition), 1977
Interim Specifications-Bridges 1978, 1979, 1980, 1981, 1982, 1983

★American Concrete Institute (ACI), PO Box 19150, Detroit, MI 48219

★318-83 Building Code Requirements for Reinforced Concrete

★American Railway Engineering Association (AREA), 2000 L. Street NW, Washington, DC 20036

★Manual for Railway Engineering (Fixed Properties) (Current to July 31, 1982) (Supplement 1982-83; Supplement 1983-84)

★Quinn, A. D., McGraw Hill Book Company, New York, New York

★"Design and Construction of Ports and Marine Structures" (Second Edition 1972)

APPENDIX B

SURFACING REQUIREMENTS FOR CONTAINER STORAGE AND MARSHALING AREAS

B-1. Introduction.

Many of the containership terminals are provided with from 12 to 18 acres of container storage and marshaling area per berth. Wheel loads and tire pressures of container handling equipment used at the commercial ports have been determined to be as severe as those of a C-130 aircraft. Therefore, it is absolutely essential that military port planners be able to determine the amount of surfacing that is required so that sufficient resources can be programmed into a base development plan.

B-2. Factors affecting surfacing requirements.

a. Vehicle characteristics. Vehicles with the same load-carrying capabilities may require extremely different surfacing, depending on individual vehicle characteristics. Surfacing requirements vary in type, thickness, and strength in accordance with wheel loads, number of wheels and their arrangement, and tire contact pressure and contact area. Because of this variation in pavement requirements, the engineering construction and maintenance effort may be several times greater for one vehicle than for another with equal load-carrying capability.

b. Traffic volume and flow patterns. Traffic volume is a primary consideration in the selection of the type of surfacing and its required thickness. It is essential that an adequate study be made to determine the number of vehicle passes and the traffic patterns of each vehicle under consideration so that a reasonable design volume for a particular facility and vehicle can be selected.

c. Container selectivity. Container selectivity involves the relative ease with which individual containers can be located and removed from a storage area. If containers are not stacked or are mounted on a chassis, selectivity would normally be considered 100 percent because no other containers would have to be moved in order to locate and remove a specific container from storage. Utilization of space is not particularly efficient, however, if containers are stacked two or three high or in blocks with very little space between containers. Space is sacrificed at the expense of selectivity. Both locating a container and removing it from the stack would be difficult. The need for selectivity varies considerably. Empty containers need virtually no degree of selectivity, but containers with

go suitable for throughput need a high degree of selectivity.

d. Area requirements. Another important factor affecting the effort involved in constructing adequate surfacing at military ports is the amount of area to be surfaced. It is extremely important that the total surface area be limited in order to minimize construction and maintenance efforts. Area requirements vary with vehicle characteristics, operational patterns, container sizes and weights, driver skill, number of vehicles, and protective measures taken.

(1) Trends at commercial ports in the United States indicate that up to 18 acres of storage and marshaling area may be required for each containership berth with a minimum retention time of two or three days. With a discharge rate of sixteen 20-foot containers per hour, a storage capacity of 320 containers would represent a one-day, one-direction retention time. Because an equal number of containers must be placed back on the ship, this quantity will double to 640 containers per containership berth per day. If these containers were temporarily stacked on a 40-foot trailer chassis, approximately 8 acres of surfacing would be required. In a chassis operation of this type, the spacing between trailers in rows and the width of aisles could depend on the skill of truck drivers, the load carrying capacity and characteristics of the vehicles. This variation can result in as much as a 20 percent reduction in the number of containers that can be stored per acre. If straddle carriers are employed, the 640 containers can be stacked two high in an area of only 3 acres.

(2) Dispersion or camouflage may, in some instances, be a factor in area requirements. Although camouflage is somewhat limited in effectiveness as a passive defensive measure for military ports, dispersion of materials awaiting shipment out of the port area is an important consideration. The number of required container handling vehicles is drastically increased in a vastly dispersed operation, and the required amount of finished surface area is drastically increased.

e. Staging of construction. Considering the many factors that may affect the construction effort relative to surfacing requirements, the decision confronting the military planner may become one of balancing available engineer and transportation resources. In the early stages of a major base development operation,

construction requirements usually greatly exceed the capabilities of available engineer units. Until critically needed facilities such as airfields become operational, all construction must be kept as austere as possible. The use of expedient surfaces such as landing mats is appropriate at this stage of the logistics support operation. The type of mat employed must be capable of withstanding sustained container handling operations over a several-month period without a major maintenance effort. After the demand for engineer troop units become less critical and sources of aggregate have been developed, the mat can be replaced with either flexible or rigid pavement.

B-3. Container handling vehicles.

Efficient handling of large containers requires special equipment. The minor categories of equipment currently being manufactured and capable of handling a container weighing 30 long tons are the forklift (front and side loading), straddle carrier, yard gantry, mobile crane, and tractor-trailer combination. Representative vehicles of each major category are distanced herein.

a. *LARC LX*. The LARC LX (fig B-1), formerly known as BARC, has the ability to operate on low-strength soils at a gross weight of 319,000 pounds (120,000-pound pay-load). The LARC LX is capable of lightering 40-foot containers, which can be discharged from the LARC by crane, narrow straddle carriers, or rollers similar to those used in unloading cargo aircraft.

b. *Shoremaster (straddle carrier)*. The Shoremaster (fig B-2) is constructed in such a manner as to distribute the load evenly on eight wheels with a maximum single-wheel load of 16,500 pounds at a rated gross weight of 132,000 pounds. This vehicle is also narrow enough (13 feet 3 inches) to negotiate the ramps of a LARC LX (13 feet 8 inches), an LCM (Landing Craft Medium)-VI (14 feet 6 inches), or a 1610 Class LCU (Landing Craft Utility) (14 feet) and has a minimum overhead clearance of 14 feet.

c. *Clark 512 (straddle carrier)*. This vehicle (fig B-3) is widely used in commercial shipping. Its width of 13 feet 6 inches allows it to enter the ramp opening of the LCM-VIII and the 1610 Class LCU.

d. *Belotti B67b (straddle carrier)*. The Belotti B67b (fig B-4) has the ability to hoist 20-foot containers out-board its basic frame. This allows it to stack 20-foot containers three high as well as to load them aboard rail cars. Containers longer than 20 feet can be stacked only two high because they extend beyond the end frame members and cannot be shifted to the side.

e. *Hyster H620B (front-loading forklift)*. This forklift (fig B-5) can handle 50,000-pound containers. The weight is distributed primarily on four front tires having single-wheel loads of 32,600 pounds at a gross vehicle weight of 140,710 pounds.

f. *Letro-Porter 2582 (front-loading forklift)*. This vehicle (fig. 6) is capable of operating on most sandy beaches; its articulated body also enhances its ability to operate on unsurfaced soils.

g. *Lancer 3500 (side-loading forklift)*. The lacer 3500 (fig. B-7) can handle 30-long-ton container loads. It can transport these containers at 25 miles per hour and stack the containers two high or load them on railroad cam.

h. *Travelift CH 1150 (yard gantry)*. This yard gantry (fig. B-8) has the ability to span six traffic lanes and is equipped with two large tires on each leg that distribute the load imposed by the weight of the gantry. Individual containers do not exert highly concentrated loads when stacked on the ground. These of this vehicle would allow five rows of containers to be stacked and require only two treadways and one 10-foot traffic lane to be surfaced. It was flit that a yard gantry of this size will permit the greatest concentration of containers for the least construction effort.

i. *P&H 6250-TC (mobile crane)*. This large mobile crane (fig. B-9) offers a quick solution to the problem of converting existing DeLong piers into container handling facilities. Of the four large-capacity truck cranes suitable for container discharge, the P&H 6250 truck crane is the only one that has wide usage in commercial operations at this time.

j. *LeTro Crane GC-500 (mobile gantry crane)*. The portal lower works of this crane (fig. B-10) permits operation on the deck of a DeLong barge while traffic passes beneath it. It is reported to be capable of handling up to 20 containers per hour.

k. *M52 Tractor-Trailer*. The M52 tractor (fig. B-11) is capable of handling a 20-foot container. However, it doe. not appear to be capable of handling a fully loaded 40-foot commercial container.

B-4. Soil strength and thickness requirements for vehicle operation.

a. *Unsurfaced soils*. Strength and thickness requirements for Unsurfaced soils can be determined through the us of the nomograph shown in figure B-12 and the following equation:

$$t = (0.176 \log C + 0.12) \sqrt{\frac{P}{8.1 \text{ CBR}} - \frac{A}{\pi}} \quad (\text{B-1})$$

where

- t = thickness of strengthening layer, inches
- C = traffic volume, coverages
- P = single- or equivalent single-wheel load (ESWL), pounds

CBR = measure of soil strength as determined by Test 101 specified in Military Standard No. MIL-STD-621A, "Test Methods for Pavement Subgrade, Subbase, and Base Course Materials," December 1964.

A = tire contact area, square inches
 The CBR and thickness requirements for 200 and 10,000 passes of container handling vehicles operating on unsurfaced soils with subgrade strength of four and ten CBR are contained in table B-1. These requirements may be used as design criteria in accordance with table B-2.

b. *Soils beneath landing mat.* Strength and thickness requirements for soils beneath landing mat are determined through use of the following equations:

$$CBR = \frac{P}{8.1 \left[\left(\frac{TR}{f} \right)^2 + \frac{A}{\pi} \right]} \quad (B-2)$$

$$t_{sm} = \left[(0.2875 \log C + 0.1875) \sqrt{\frac{P}{8.1 CBR} - \frac{A}{\pi}} \right] - TR \quad (B-3)$$

where

TR = thickness of flexible pavement structure replaced by landing mat, inches
 f = repetitions factor The soil strength and thickness requirements for container handling vehicles are given in table B-4. These requirements may be used as design criteria in accordance with the restrictions set forth in table B-3.

B-5. Thickness requirements for flexible pavements.

Thickness of flexible pavements can be determined through the use of the following equation:

$$t = a_1 \left\{ \sqrt{A} \left[-0.0481 - 1.1562 \left(\log \frac{CBR}{P_e} \right) - 0.6414 \left(\log \frac{CBR}{P_e} \right)^2 - 0.473 \left(\log \frac{CBR}{P_e} \right)^3 \right] \right\} \quad (B-4)$$

where

t = total thickness of superior material required above a layer of known strength to prevent shear deformation within this layer of soil, inches
 a₁ = load repetitions factor, which varies with number of wheels and volume of traffic
 P_e = SWL or ESWL₂ tire pressure, pounds per square inch. For single-wheel loads, P_e = SWL/A. This is an actual tire pressure and is generally equal to the tire inflation pressure. For multiple-wheel configurations, P_e = ESWL/A. This is an artificial tire pressure, consistent with use

of

the contact area of one tire, and has no relation to actual tire inflation pressure

Thickness requirements for various container handling vehicles were determined for 200 and 10,000 passes through the solution of equation (B-4), and the results of these computations are shown in figures B-13 through B-23.

¹Discussed in Technical Report S-71-17 by R. G. Alhvin.

²ESWL can be determined by methods given in Miscellaneous Paper 8-73-56 by D. N. Brown and O. O. Thompson.

Table B-1. Design Criteria Restrictions (200-10,000 Passes)

Traffic
Volume
in Passes

Restrictions on Use as Design Criteria

200	<p>CBR and thickness requirements shown in table B-2 may be used without restriction for the Shoremaster, Clark 512, Belotti B67b, Hyster H620B, Lancer 3500, P&M 6250-TC, and M52 tractor-trailer.</p> <p>CBR and thickness requirements given in table B-2 may be used if necessary and identified as <u>"tentative criteria"</u> for the LARC LX, LeTro-Porter 2582, and Travelift CH 1150.</p> <p>CBR and thickness requirements given for the LeTro Crane GC-500 <u>shall not be used for criteria in any case except under emergency conditions.</u> The reliability of these requirements is unknown.</p>
10,000	<p>Basic test data for operations of vehicles on unsurfaced soils are limited in scope to data from traffic volumes of less than about 5,000 passes. The reliability of requirements developed by extrapolation for volumes beyond the limits of basic test data is questionable. <u>The thickness and CBR requirements shown in table B-2 for 10,000 passes shall not be used for criteria except under emergency conditions.</u></p>

Table B-2. CBR and Thickness Requirements for 200 and 10,000 Passes of Container Handling Vehicles Operating on Unsurfaced Soils with Subgrade Strengths of 4 and 10 CBR^a

Vehicle	Gross Weight lb	Payload lb	Tire Pressure, psi		Tire Contact Area in. ²	Passes					
						200			10,000		
						Surface CBR	Thickness Requirements, in.		Surface CBR	Thickness Requirements, in.	
	4-CBR Subgrade	10-CBR Subgrade		4-CBR Subgrade	10-CBR Subgrade						
<u>Amphibian</u>											
LARC LX ^b	319,000	120,000	42	42	1898	10	22	0	20	35	16
<u>Straddle Carriers</u>											
Shoremaster	129,200	67,200	100	105	154	9	11	0	17	18	10
Clark 512	164,500	67,200	132	133	210	14	14	9	26	20	12
Belotti B67b	159,800	67,200	125	115	380	14	17	9	27	28	14
<u>Front-Loading Forklift</u>											
Hyster H620B	140,710	62,000 ^c	100	145	224	20	19	11	38	35	20
LeTro-Porter 2582	165,200	67,200	70	99	800	18	21	12	35	35	20
<u>Side-Loading Forklift</u>											
Lancer 3500	213,200	67,200	149	150	183	19	20	11	36	35	20
<u>Yard Gantry</u>											
Travelift CH 1150	223,200	67,200	146	146	280	24	22	12	45	36	21
<u>Mobile Cranes</u>											
P&H 6250-TC	396,021	o ^d	100	106	260	16	31	18	30	55	31
LeTro Crane GC-500	708,504	o ^d	35	69	1275	26	32	17	50	56	29
<u>Tractor-Trailer Combination</u>											
M52 Tractor and Trailer	100,000	67,200	80	68	82.5	5	10	0	10	18	0

- ^a Unsurfaced soil criteria limited to approximately 10,000 passes.
- ^b As is well known, the LARC LX was not specifically designed for container handling. It has been included in this study for comparative purposes because of its known operational capability on relatively low-strength soils.
- ^c Maximum payload for the Hyster H620B.
- ^d Zero payload while moving.
- ^e Criteria do not exist for loads imposed by vehicles on unsurfaced soils. Data shown are based on extrapolation and engineering Judgment.

by U.S. Army Engineer
Waterways Experiment Station

Table B-3. Design Criteria Restrictions (200-50,000 Passes)

Traffic Volume in Passes	Restrictions on Use as Design Criteria
200	<p>CBR and thickness requirements given in table B-4 may be used without restrictions for the Shoremaster, Clark 512, Belotti B67b, Hyster H620B, Lancer 3500, Travelift CH 1150, and M52 tractor-trailer.</p>
10,000	<p>CBR and thickness requirements given in table B-4 may be used if necessary and identified as "<u>tentative criteria</u>" for the LARC LX, LeTro-Porter 2582, P&H 6250-TC, and the LeTro Crane GC-500.</p> <p>CBR and thickness requirements given in table B-4 may be used if necessary and identified as "tentative criteria" for the Shoremaster, Clark 512, Belotti B67b, Hyster H620B Lancer 3500, Travelift CH 1150, and M52 tractor-trailer.</p> <p>CBR and thickness requirements given in table B-4 for the LARC LX, LeTro-Porter 2582, P&H 6250-TC, and LeTro Crane GC-500 <u>are not recommended for use as criteria except under emergency conditions.</u></p>
50,000	<p>A traffic volume of 50,000 passes is so far outside the limits of basic field test data that the reliability of i requirements shown in table B-4 is not known. <u>The CBR and thickness requirements shown in table B-4 shall not be used as criteria except on an experimental basis.</u></p>

Table B-4. CBR and Thickness Requirements for 200, 10,000, and 50,000 Passes of Container-Handling Vehicles Operating on Soils Surfaced with ISAI Landing Mat and with Subgrade Strengths of 4 and 10 CBR^a

Vehicle	Gross Weight lb	Payload lb	Tire Pressure, psi		Tire Contact Area in. ²	Passes								
			Inflation	Contact		200			10,000			50,000		
						Thickness Requirements in.		Surface CBR	Thickness Requirements in.		Surface CBR	Thickness Requirements in.		Surface CBR
						4-CBR Sub-grade	10-CBR Sub-grade		4-CBR Sub-grade	10-CBR Sub-grade		4-CBR Sub-grade	10-CBR Sub-grade	
<u>Amphibian</u>														
LARC LX ^b	319,000	120,000	42	42	1898	3.5	0	0	7	27	0	9	36	0
<u>Straddle carriers</u>														
Shoremaster	129,000	67,200	100	105	154	3.5	0	0	8	22	0	10	32	0
Clark 512	164,500	67,200	132	133	210	5	6	0	11	28	7	14	37	11
Belotti B67b	159,800	67,200	125	115	380	5	8	0	11	26	7	14	34	11
<u>Front-Loading Forklifts</u>														
Hyster H620B	140,710	62,000 ^c	100	145	224	6	10	0	13	40	6	19	51	20
LeTro-Porter 2582	165,200	67,200	70	102	800	12	21	6	22	51	21	25	65	27
<u>Side-Loading Forklift</u>														
Lancer 3500	213,200	67,200	149	150	183	6	13	0	14	43	13	17	56	21
<u>Yard Gantry</u>														
Travelift CH 1150	223,200	67,200	146	146	280	6	13	0	14	32	6	17	46	12
<u>Mobile Cranes</u>														
P&H 3250-TC	396,021	0 ^d	100	106	260	13	36	10	26	81	32	35	82	32
LeTro Crane GC-500 ^e	708,504	0 ^d	35	69	1275	15	37	11	23	82	33	25	99	44
<u>Tractor-Trailer Combination</u>														
M52 Tractor and Trailer	100,000	67,200	80	68	82.5	2.5	0	0	5	15	0	7	20	0

^a M8A1 landing mat was not designed for use with large loads imposed by most of the equipment listed nor for traffic volumes exceeding about 2000 passes.

^b As is well known, the LARC LX was not specifically designed for container handling. It has been included in this study for comparative purposes because of its known operational capability on relatively low-strength soils.

^c Maximum payload for the Hyster H620B.

^d Zero payload while moving.

^e Criteria do not exist for loads imposed by vehicles on M8A1 landing mat. Data shown are based on extrapolation and engineering judgment.

By U.S. Army Engineer Waterways Experiment Station

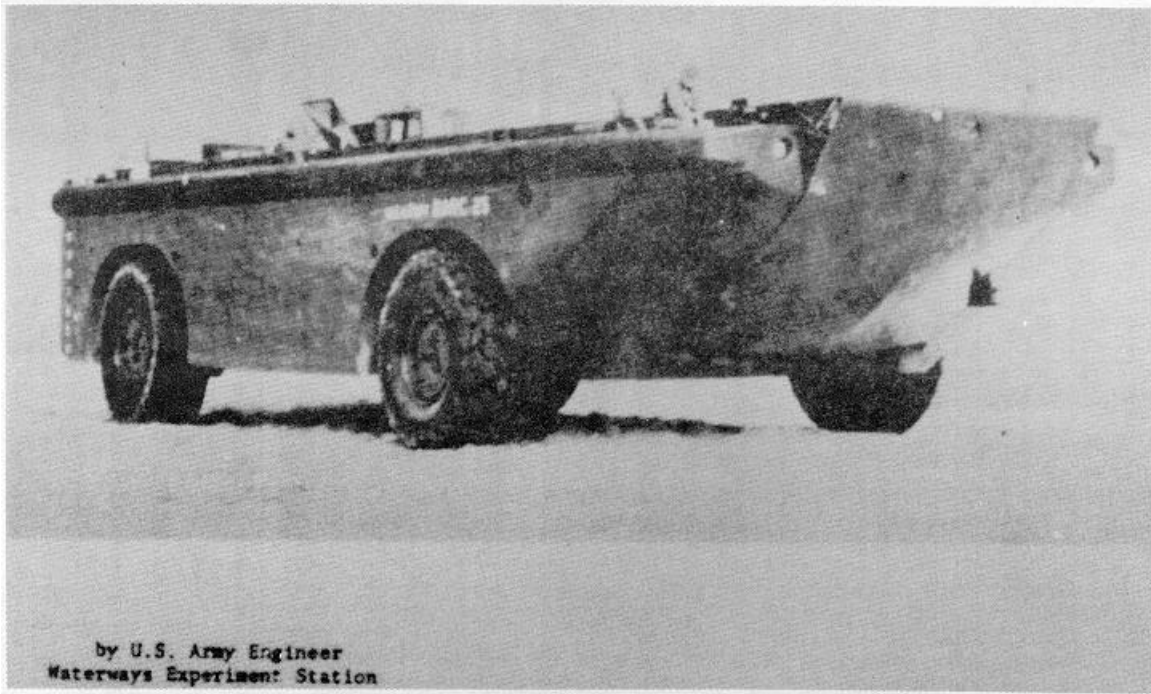

Figure B-1. LARC LX.



Figure B-2. Shoremaster.

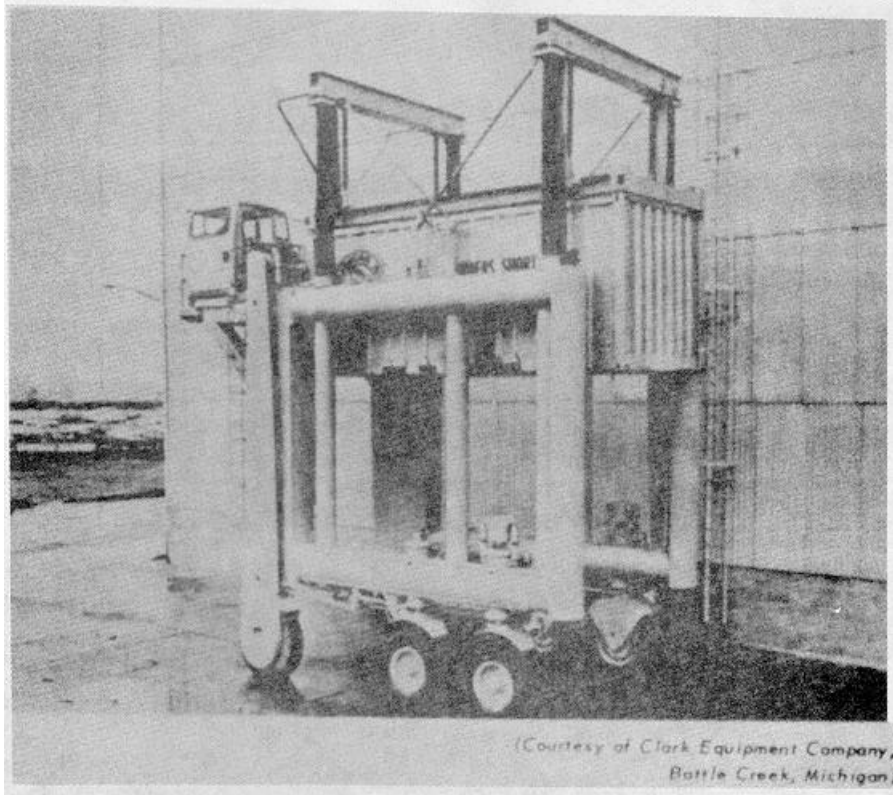

Figure B-3. Clark 512.

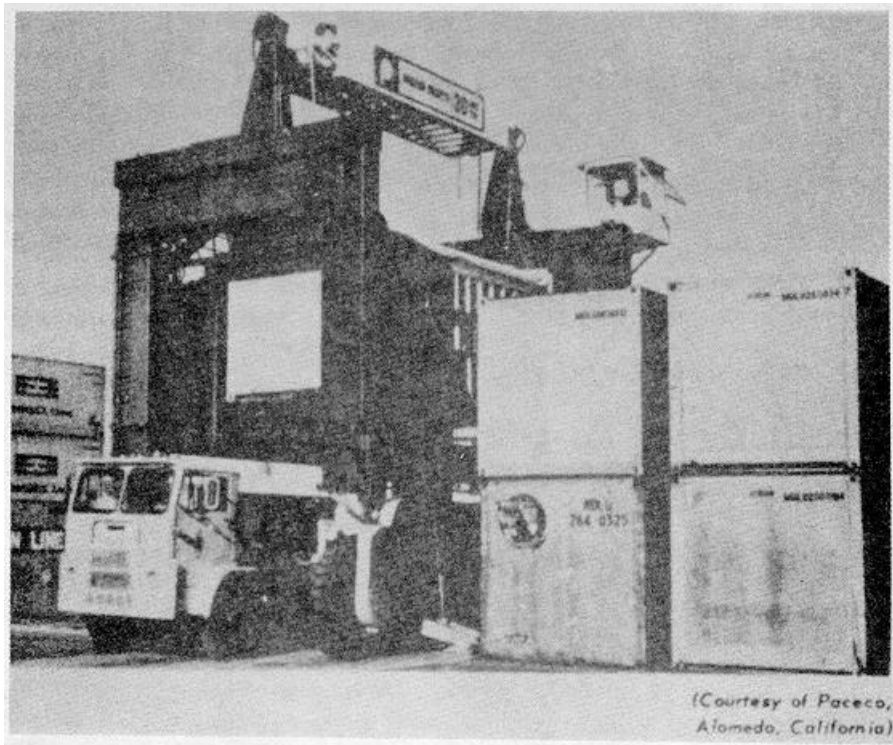

Figure B-4. Belotti B67b.

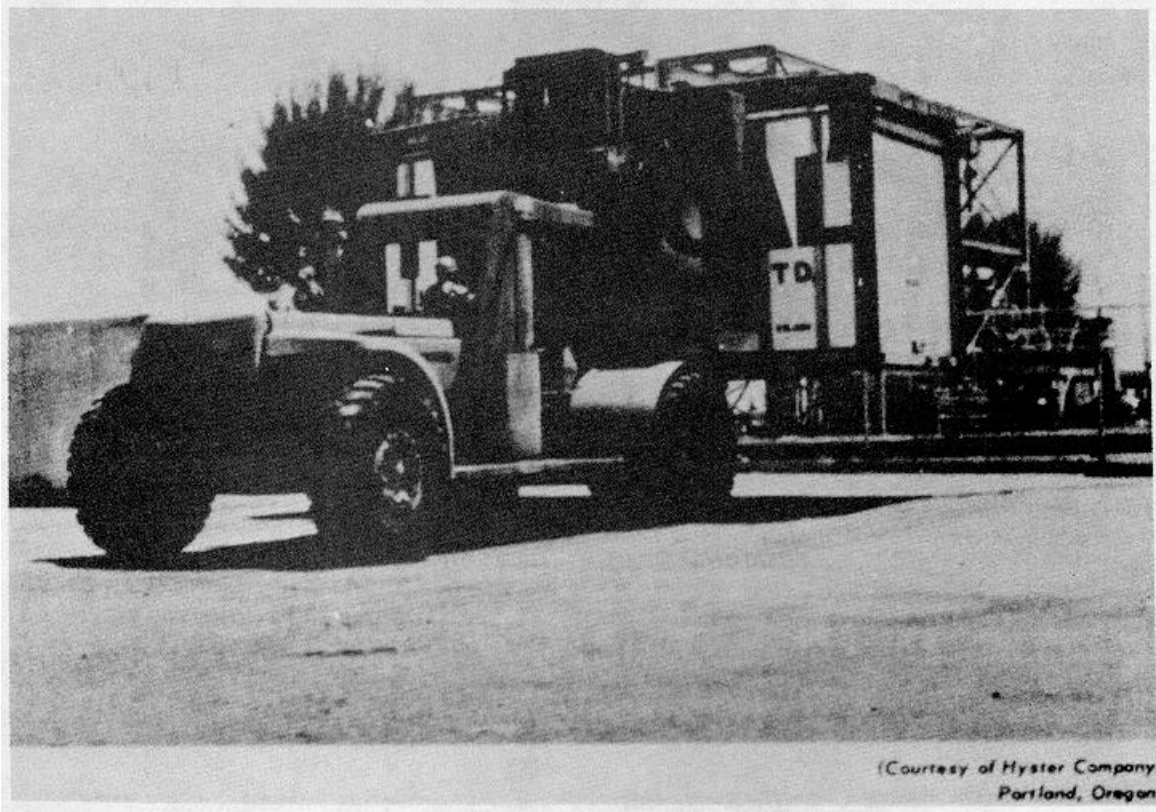

Figure B-5. Hyster H620B

B-10

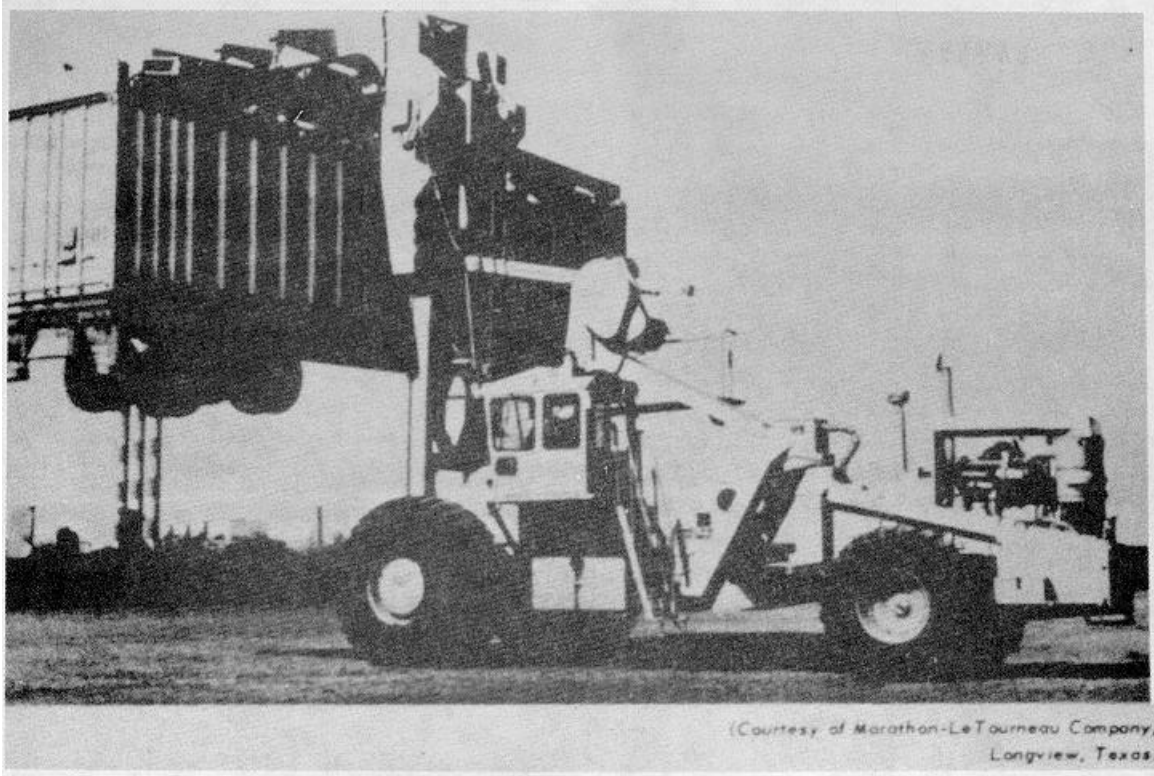

Figure B-6. LeTro-Porter 2582.

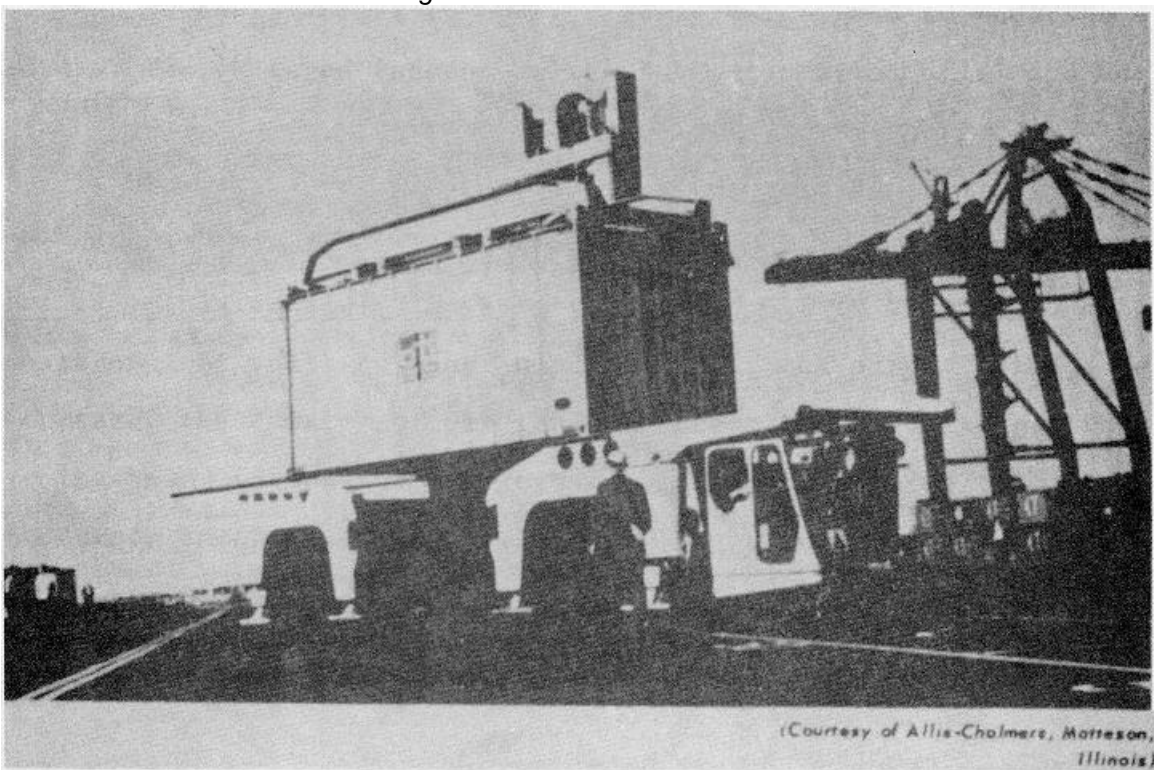

Figure B-7. Lancer 3500.

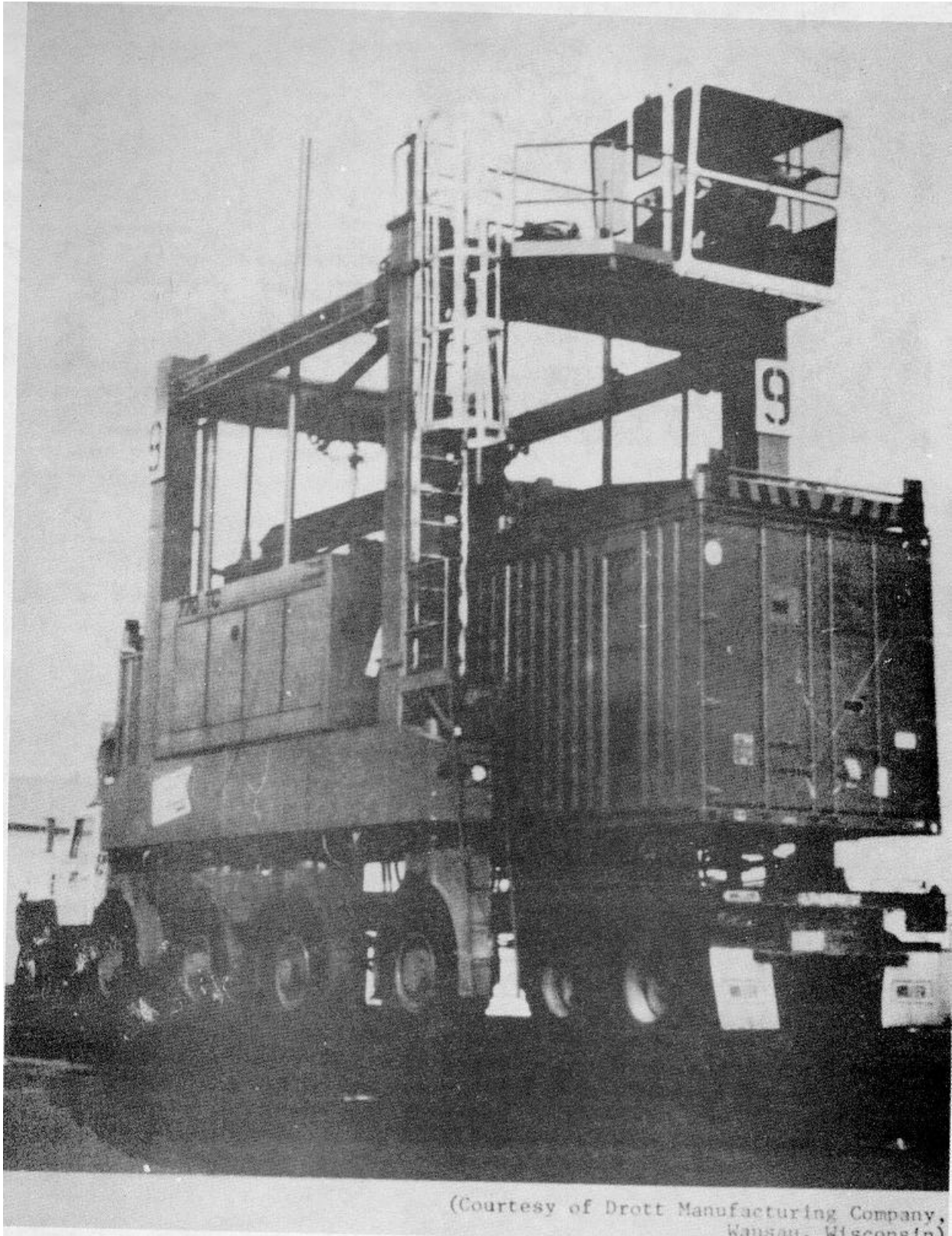

Figure B-8. Travelift CH 1150.

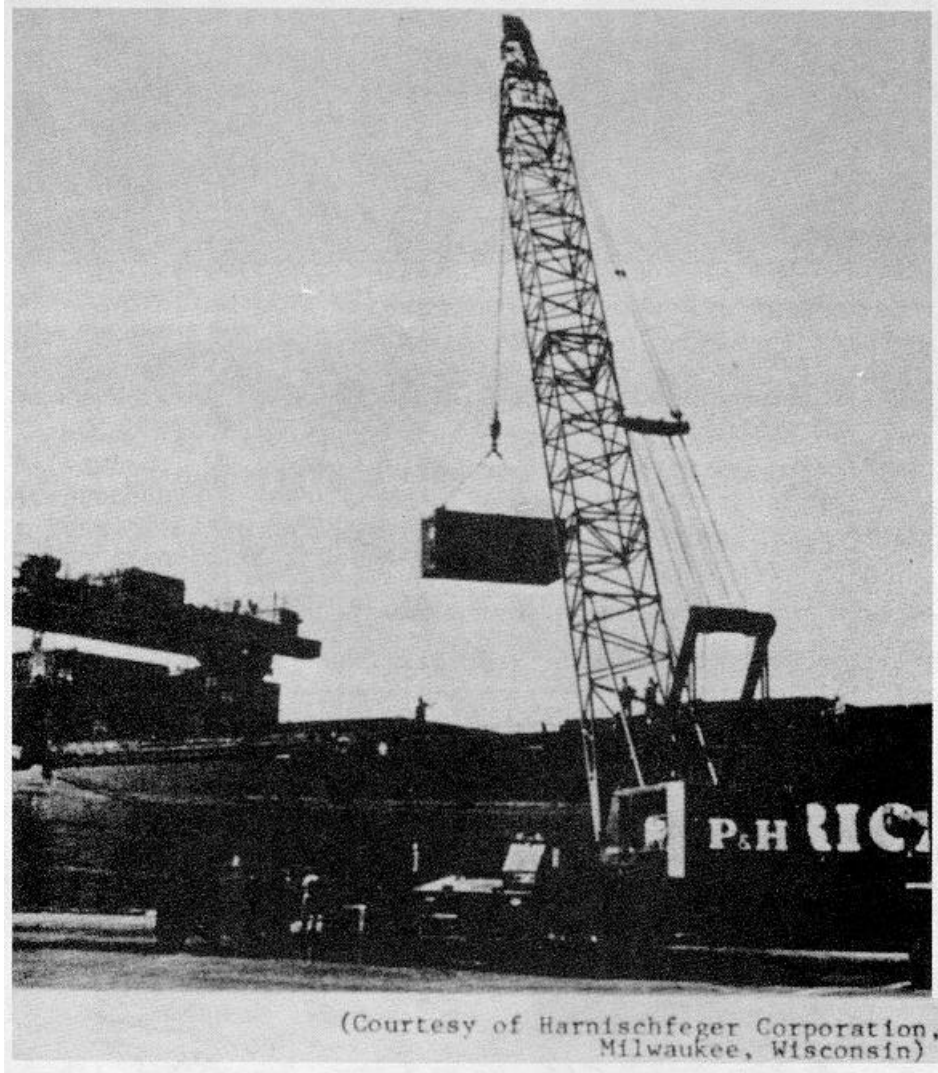

Figure B-9. P&H 6250-TC.

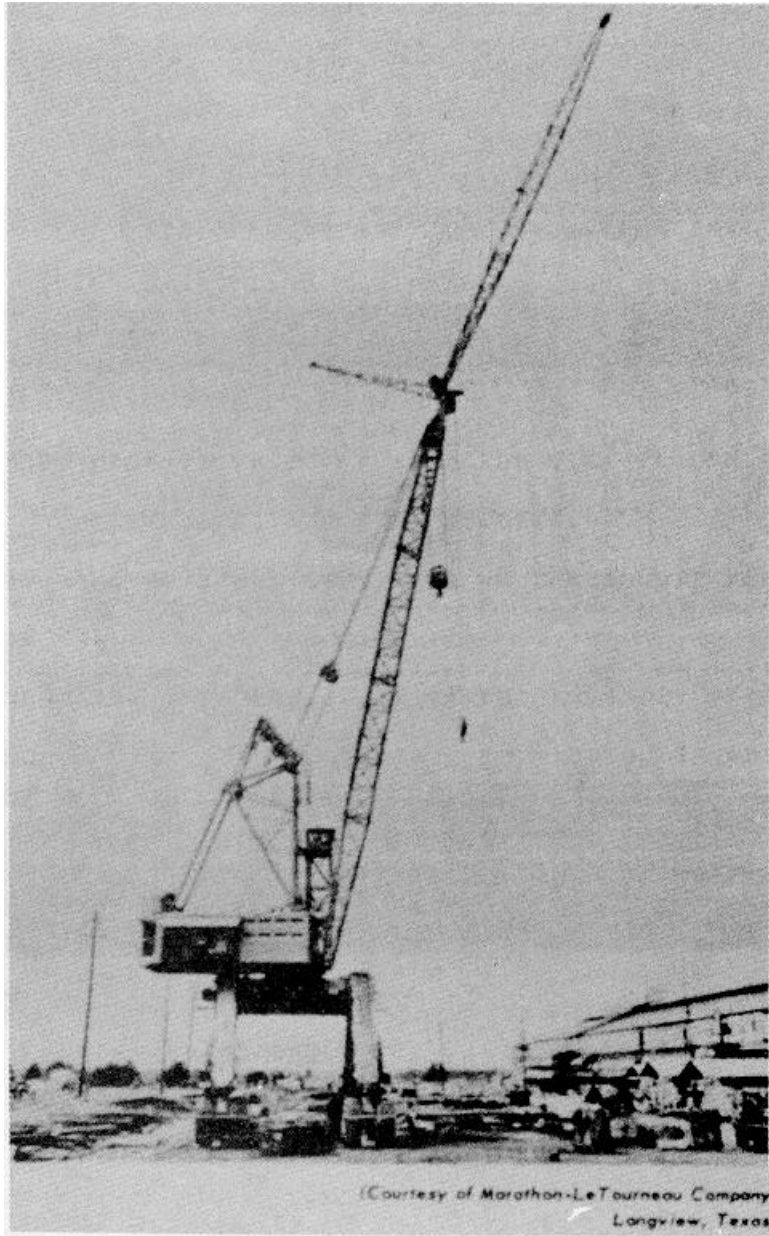

Figure B-10. LeTro Crane GC-500.

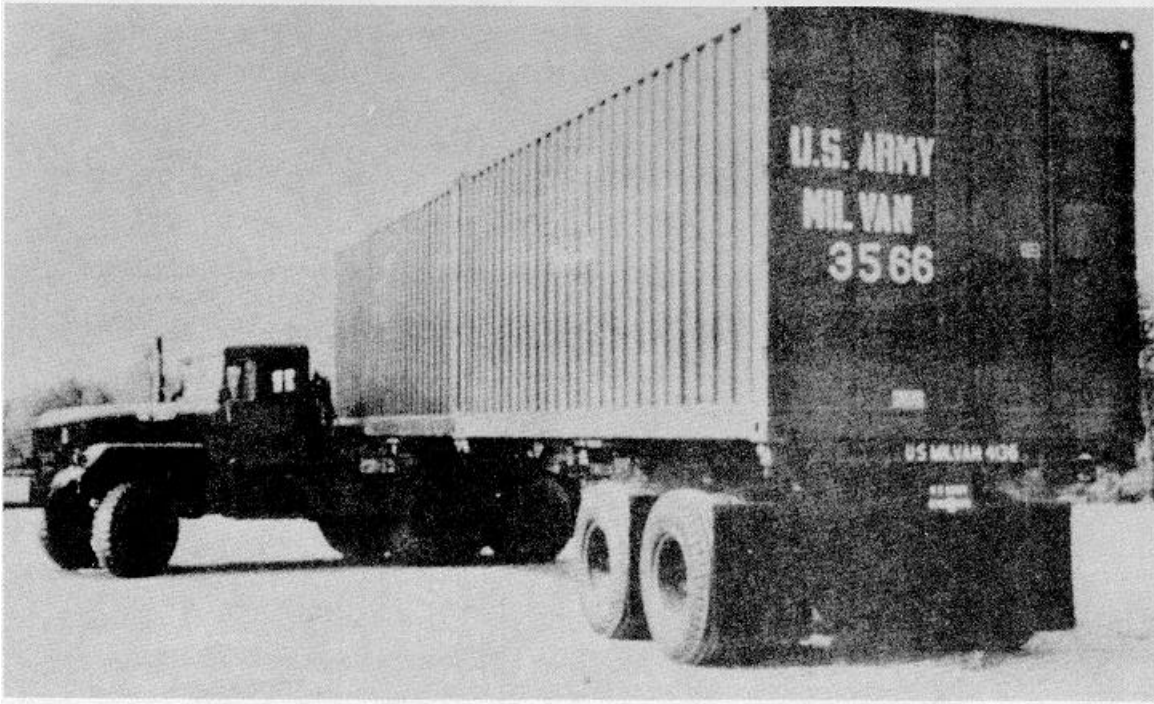
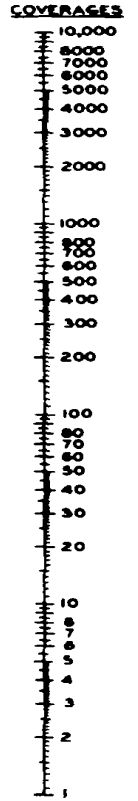
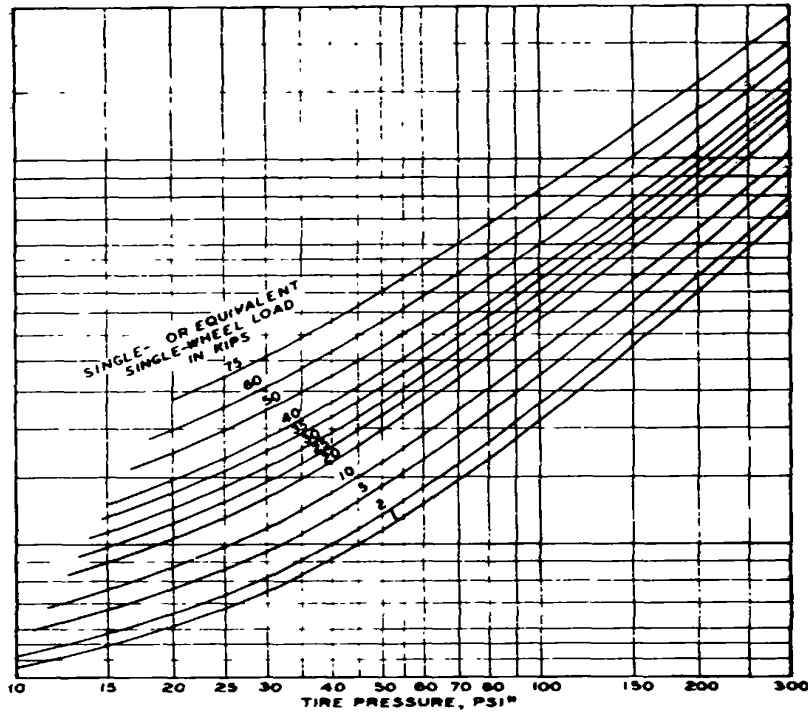

Figure B-11. M52 Tractor-trailer.

B-15



* USE TIRE INFLATION PRESSURE EXCEPT WHEN MORE PRECISE DETERMINATIONS ARE REQUIRED, THEN USE AVERAGE GROUND CONTACT PRESSURE

by U.S. Army Engineer
Waterways Experiment Station

Figure B-12. CBR required for operation of aircraft on unsurfaced soil.

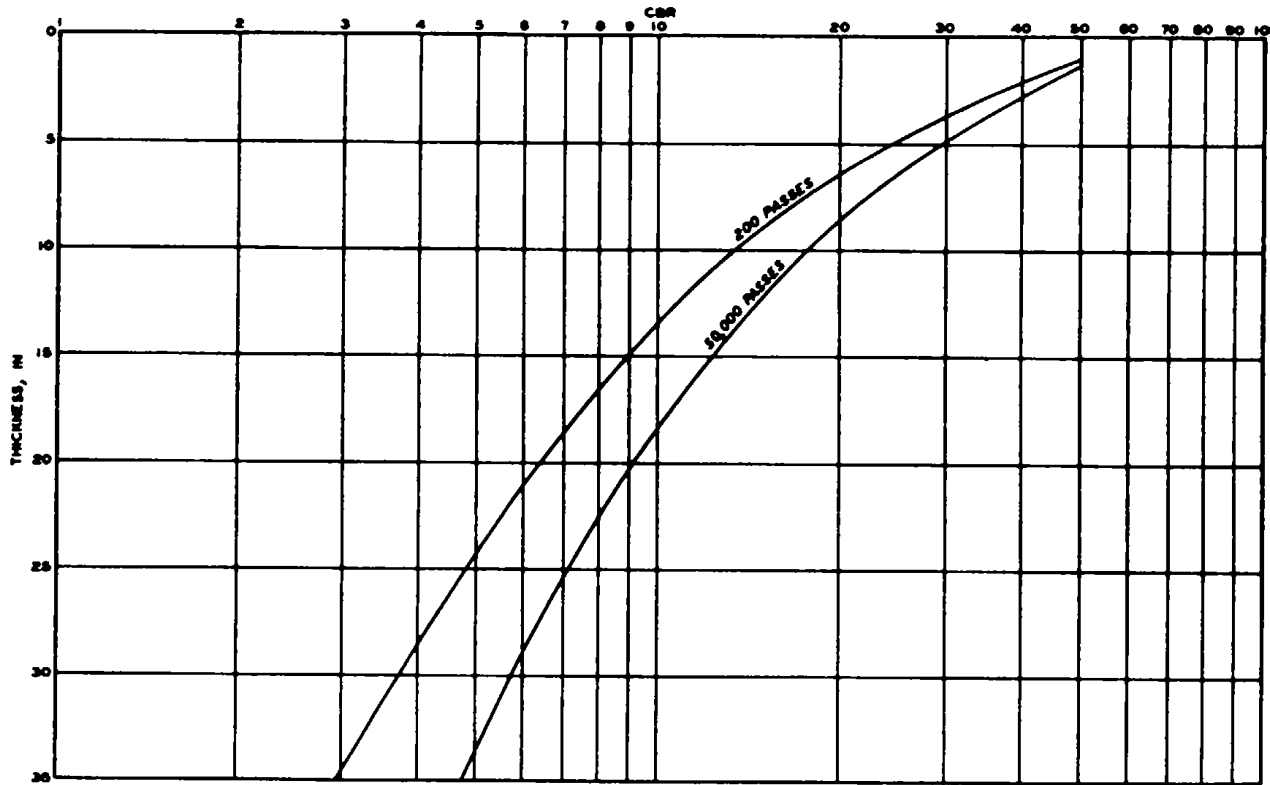

by U.S. Army Engineer
Waterways Experiment Station

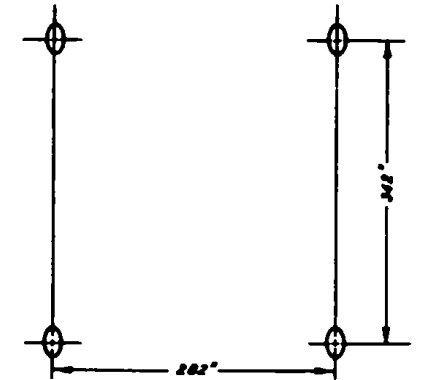

BASIS FOR DESIGN CURVES	
GROSS WEIGHT	= 318,000 LB
SINGLE-WHEEL LOAD	= 79,780 LB
TIRE INFLATION PRESSURE	= 42 PSI
CONTACT AREA	= 1,888 IN. ²
PAYLOAD	= 120,000 LB

WHEEL CONFIGURATION

Figure B-13. Flexible Pavement Design Curves for LARCLX (amphibian).

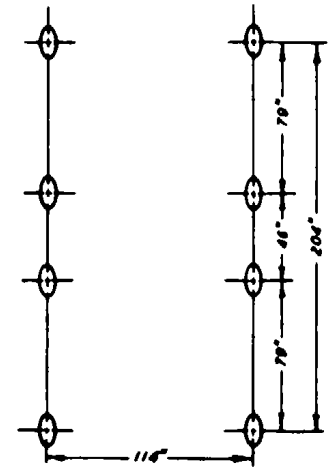
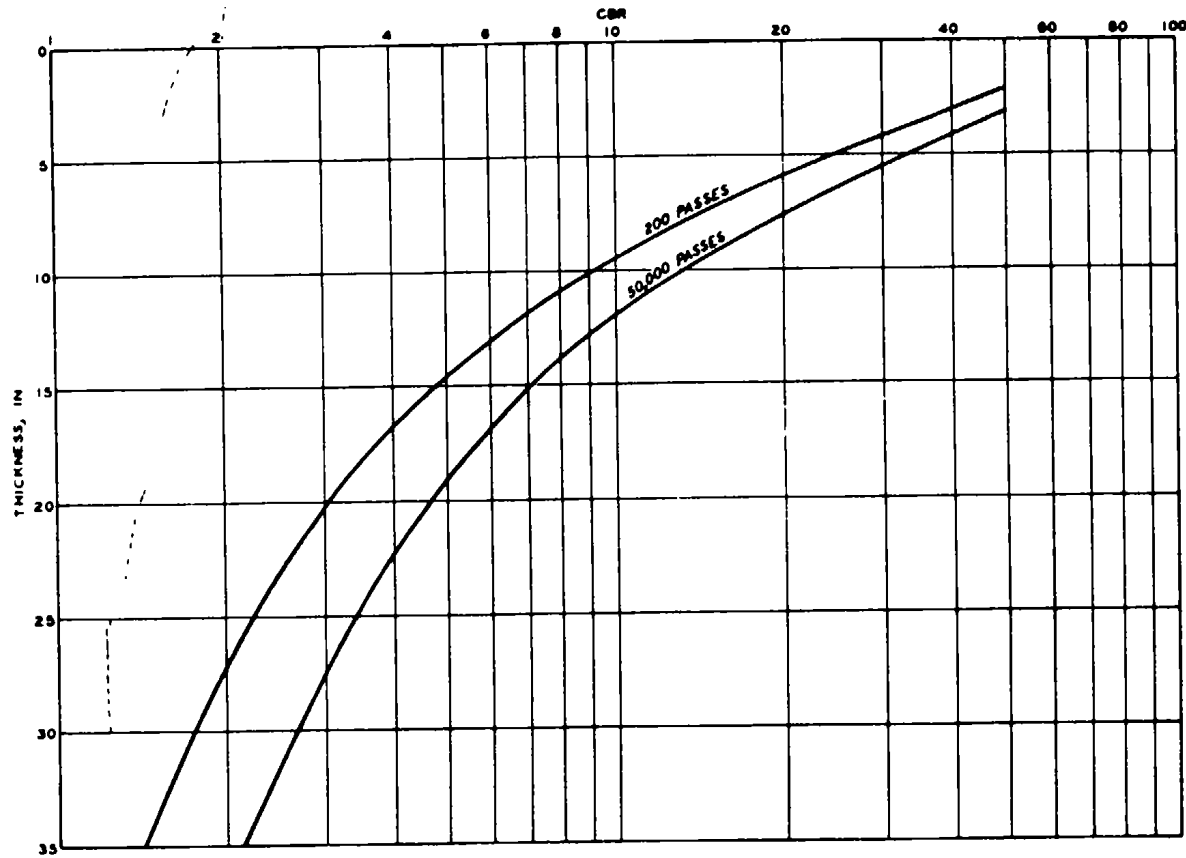

DATA FOR DESIGN CURVES

GROSS WEIGHT	=	128,200 LB
SINGLE-WHEEL LOAD	=	18,190 LB
TIRE INFLATION PRESSURE	=	100 PSI
CONTACT AREA	=	184 sq. ft.
PAYLOAD	=	97,200 LB

WHEEL CONFIGURATION

by U.S. Army Engineer
Waterways Experiment Station

Figure B-14. Flexible Pavement Design Curves for Shoremaster (straddle carrier).

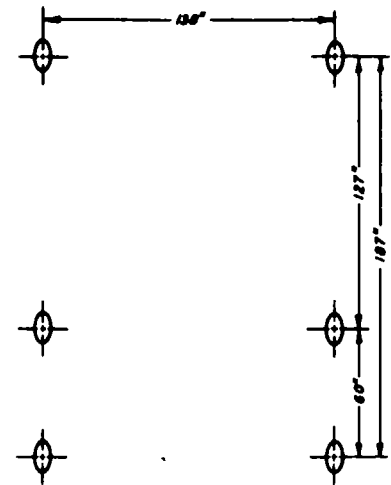
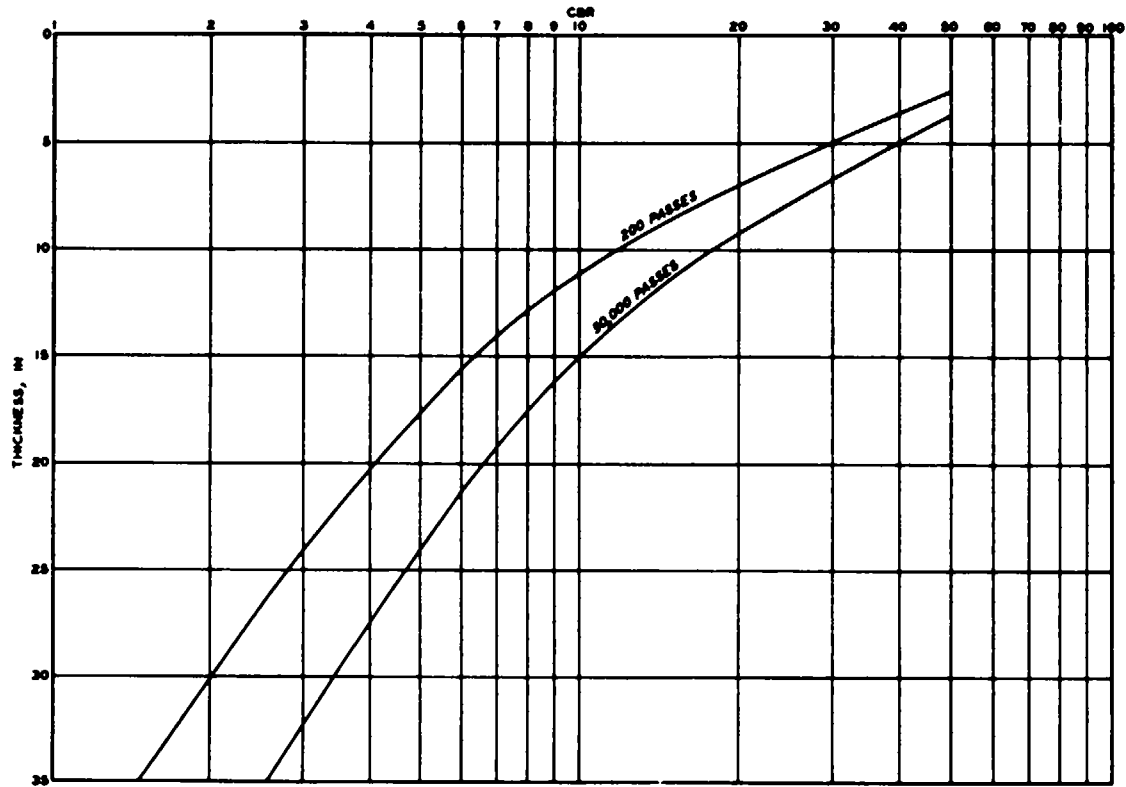

BASIS FOR DESIGN CURVES

GROSS WEIGHT	=	184,500 LB
SINGLE-WHEEL LOAD	=	27,000 LB
TIRE INFLATION PRESSURE	=	132 PSI
CONTACT AREA	=	210 IN. ²
PAYLOAD	=	67,200 LB

WHEEL CONFIGURATION

by U.S. Army Engineer
Waterways Experiment Station

Figure B-15. Flexible Pavement design Curves for Clark 512 (straddle carrier).

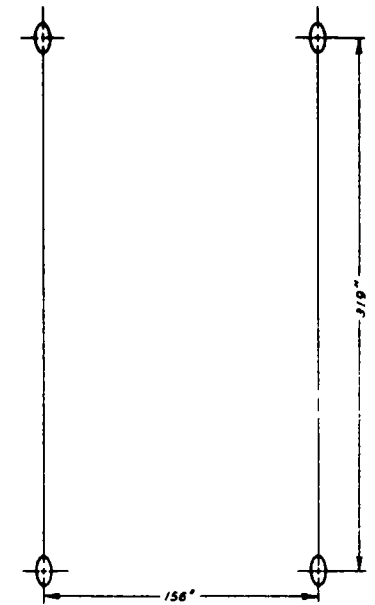
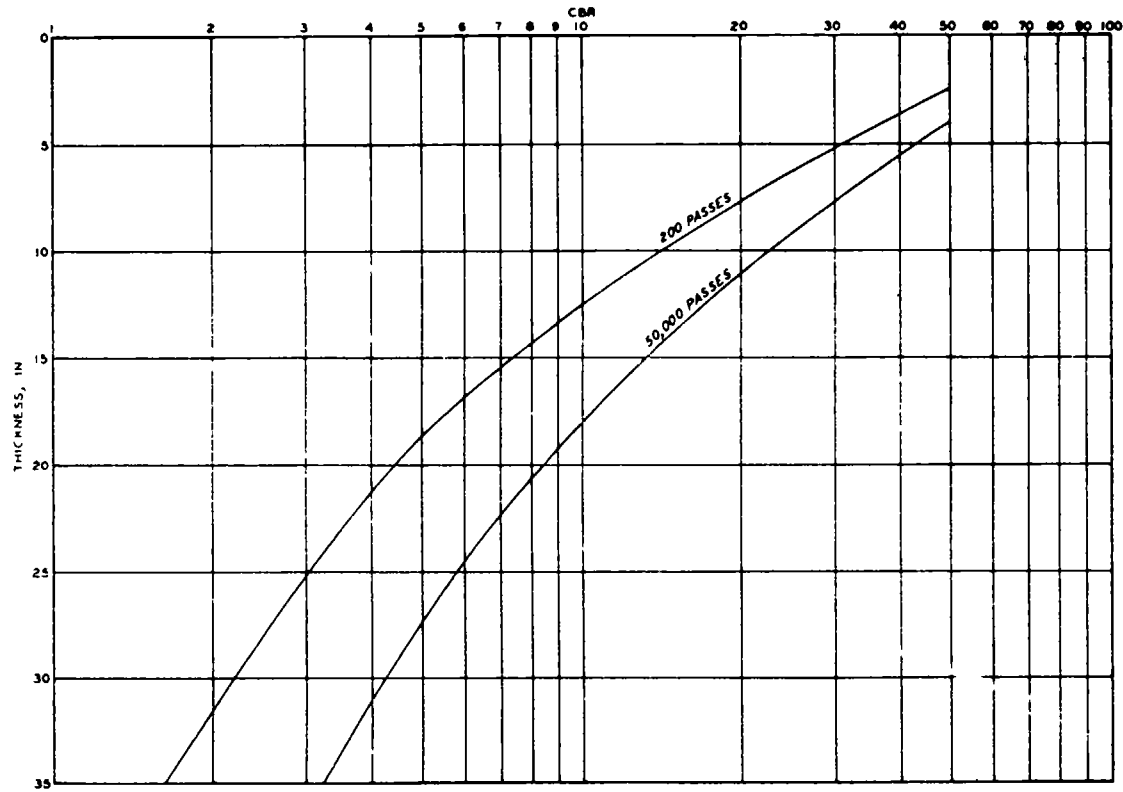

BASIS FOR DESIGN CURVES

GROSS WEIGHT	=	159,800 LB
SINGLE-WHEEL LOAD	=	43,900 LB
TIRE INFLATION PRESSURE	=	125 PSI
CONTACT AREA	=	380 IN ²
PAYLOAD	=	67,200 LB

WHEEL CONFIGURATION

by U.S. Army Engineer
Waterways Experiment Station

Figure B-16. Flexible Pavement Design Curves for Belotti B67b (straddle carrier).

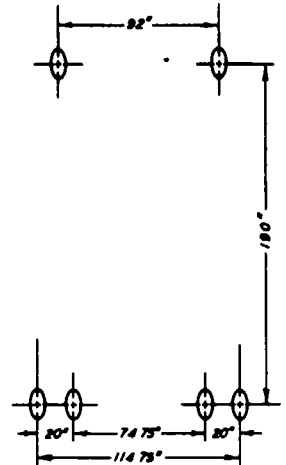
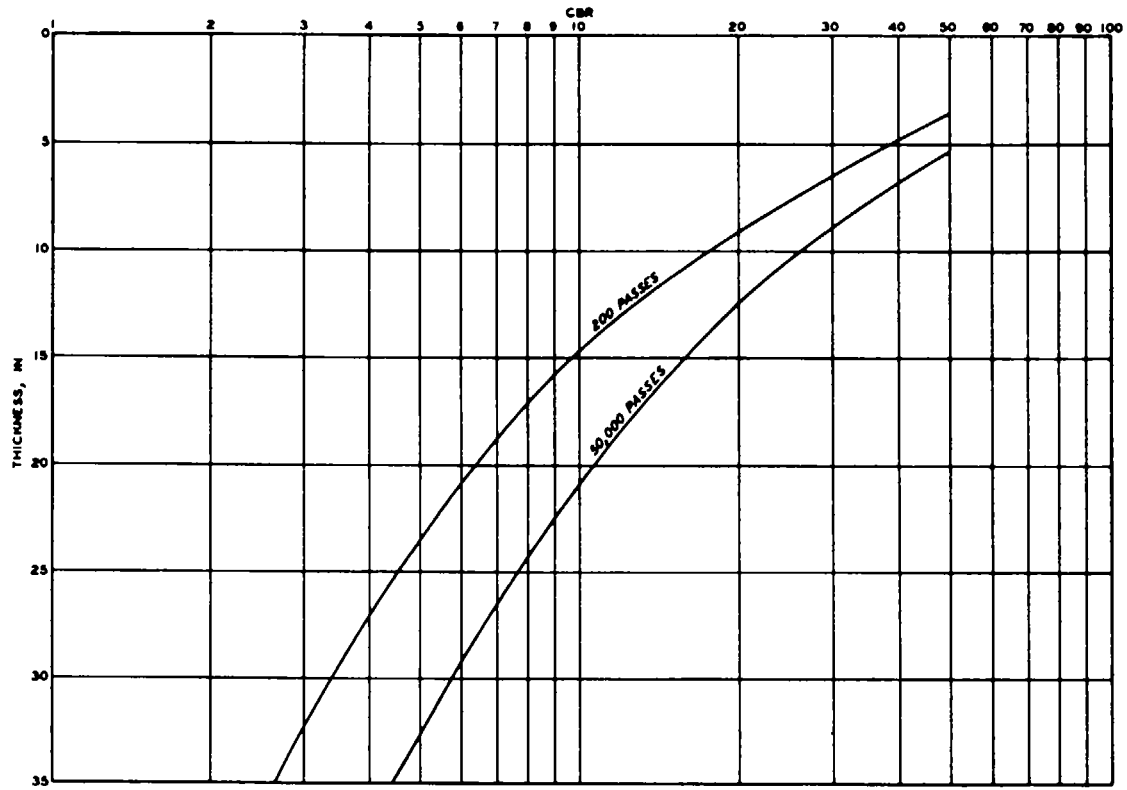

DATA FOR DESIGN CURVES

GROSS WEIGHT	=	140,710 LB
SINGLE-WHEEL LOAD	=	32,500 LB
TIRE INFLATION PRESSURE	=	100 PSI
CONTACT AREA	=	224 IN. ²
PAYLOAD	=	82,000 LB

WHEEL CONFIGURATION

by U.S. Army Engineer
Waterways Experiment Station

Figure B-17. Flexible Pavement Design Curves for Hyster H620B (front-loading forklift)

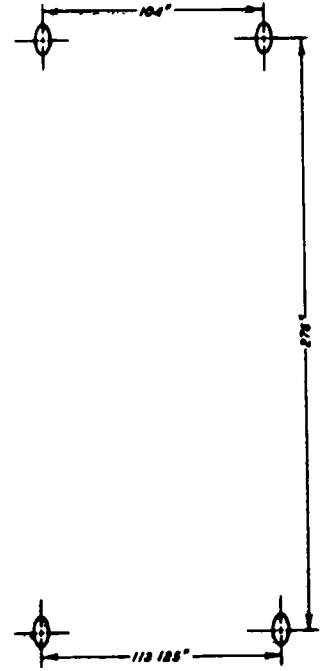
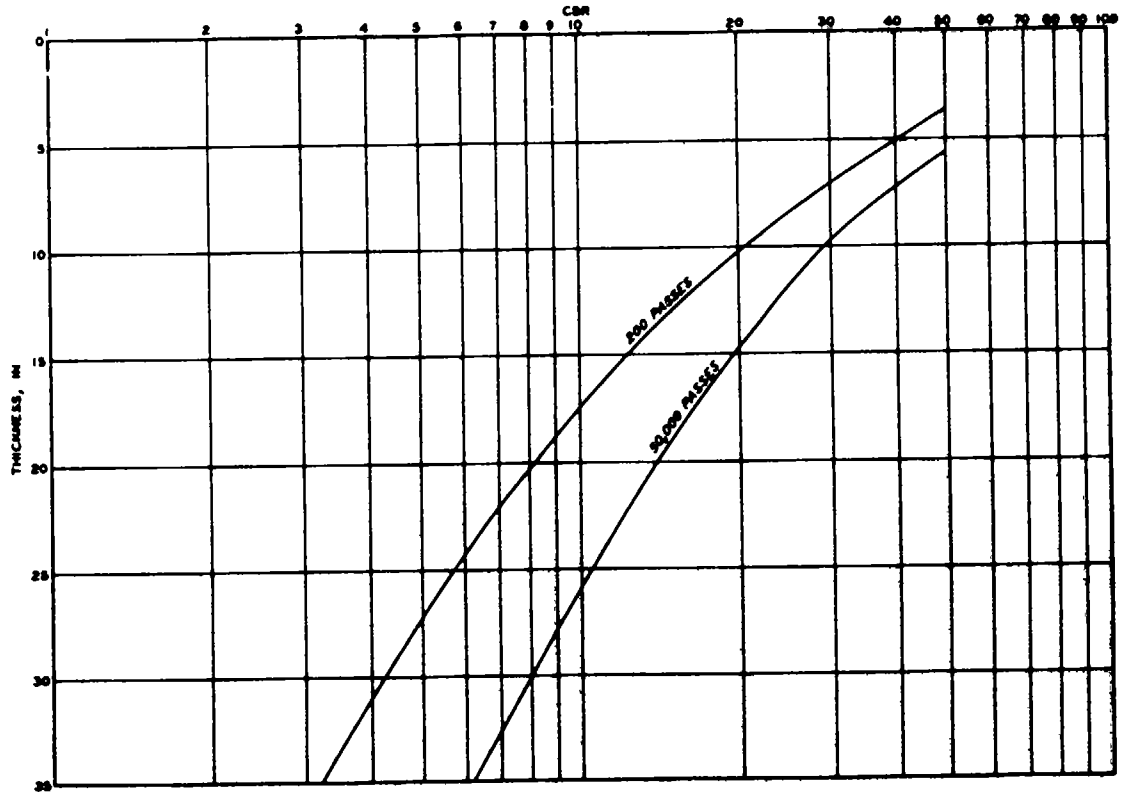

BASIS FOR DESIGN CURVES

GROSS WEIGHT	=	168,200 LB
SINGLE-WHEEL LOAD	=	70,200 LB
TIRE INFLATION PRESSURE	=	70 PSI
CONTACT AREA	=	800 IN. ²
RYLOAD	=	67,200 LB

WHEEL CONFIGURATION

by U.S. Army Engineer
Waterways Experiment Station

Figure B-18. Flexible Pavement design Curves for LeTro-Porter 2582 (front-loading forklift).

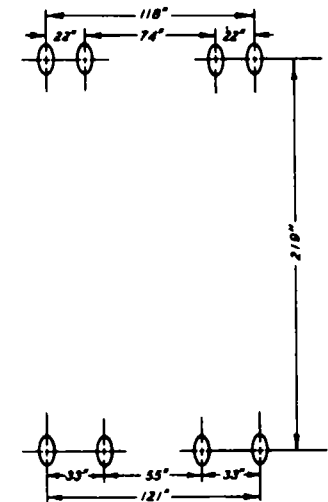
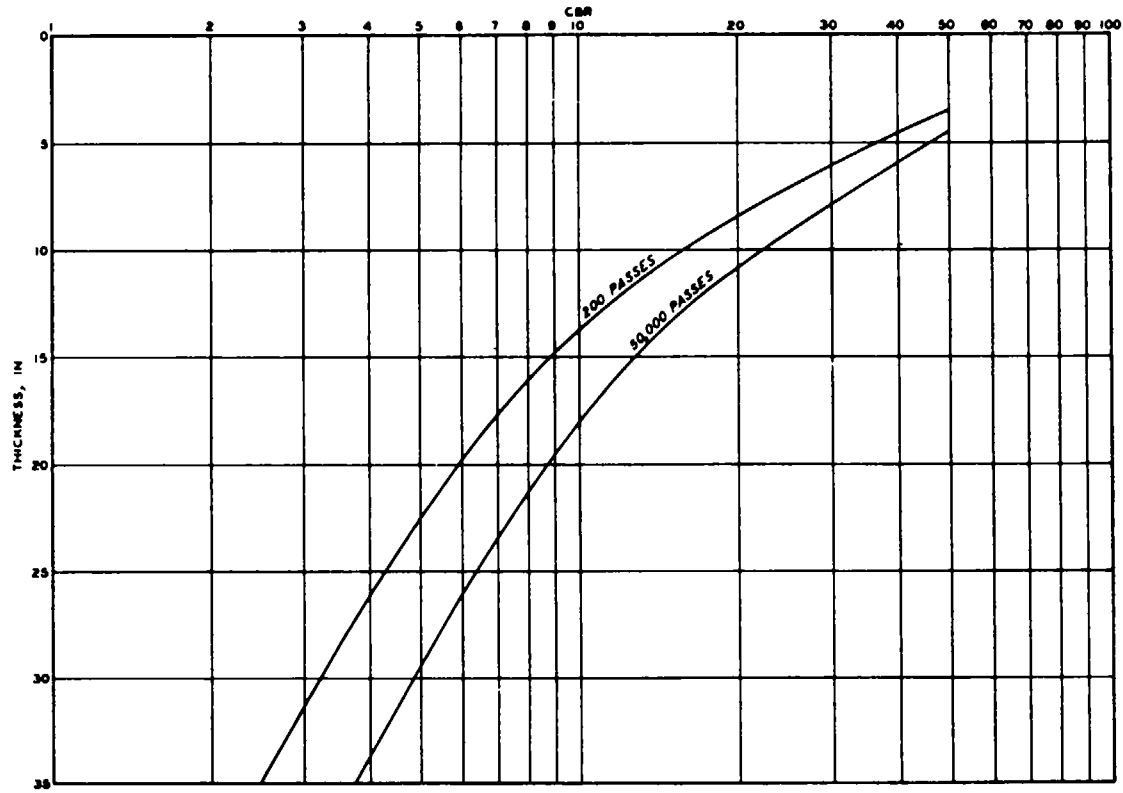

BASIS FOR DESIGN CURVES

GROSS WEIGHT	=	213,200 LB
SINGLE-WHEEL LOAD	=	27,500 LB
TIRE INFLATION PRESSURE	=	149 PSI
CONTACT AREA	=	1.83 IN ²
PAYLOAD	=	67,200 LB

WHEEL CONFIGURATION

by U.S. Army Engineer
Waterways Experiment Station

Figure B-19. Flexible Pavement Design Curves for Lancer 3500 (side-loading forklift).

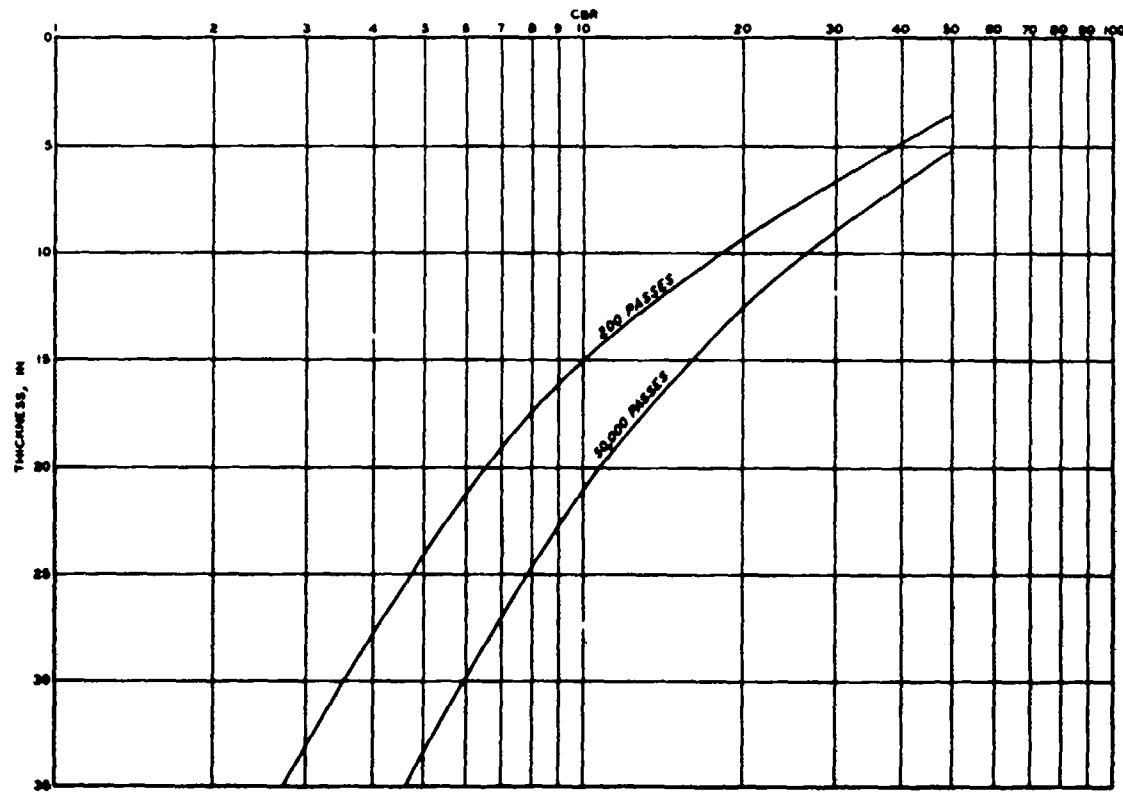

by U.S. Army Engineer
Waterways Experiment Station

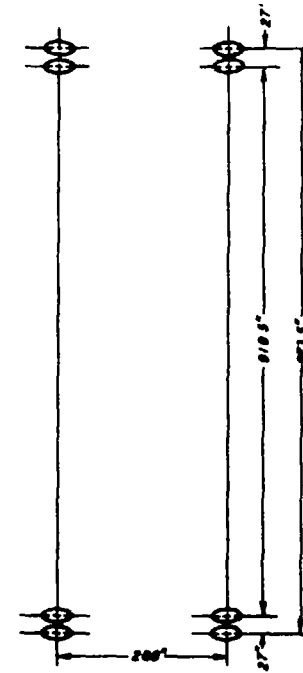

BASIS FOR DESIGN CURVES

GROSS WEIGHT	=	223,200 LB
SINGLE-WHEEL LOAD	=	40,365 LB
TIRE INFLATION PRESSURE	=	146 PSI
CONTACT AREA	=	200 IN. ²
PAYLOAD	=	97,200 LB

WHEEL CONFIGURATION

Figure B-20. Flexible Pavement Design Curves for Travelift CH 1150 (yard gantry).

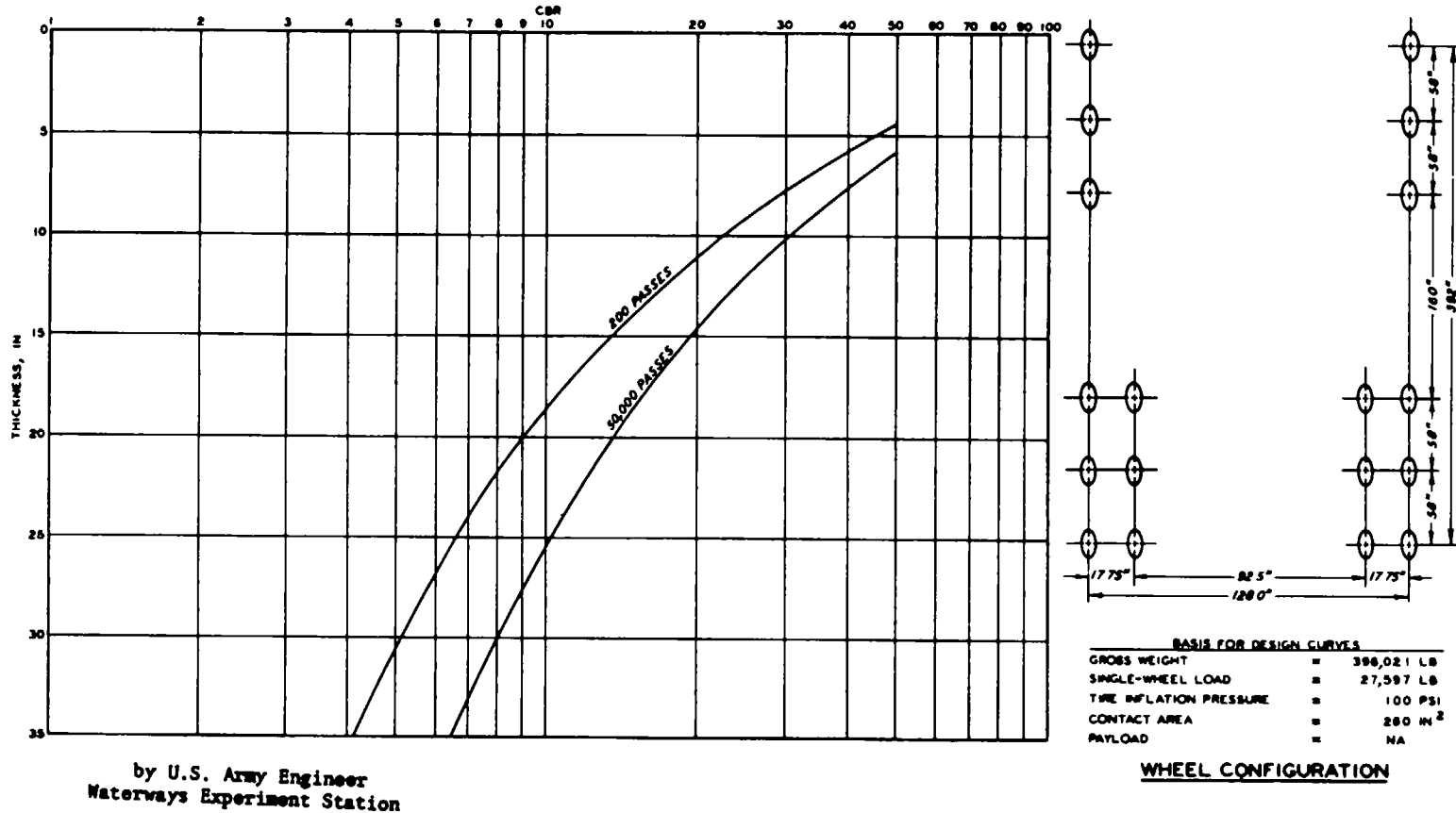

by U.S. Army Engineer
Waterways Experiment Station

Figure B-21. Flexible Pavement Design Curve for P&H 6250- TC(mobile crane).

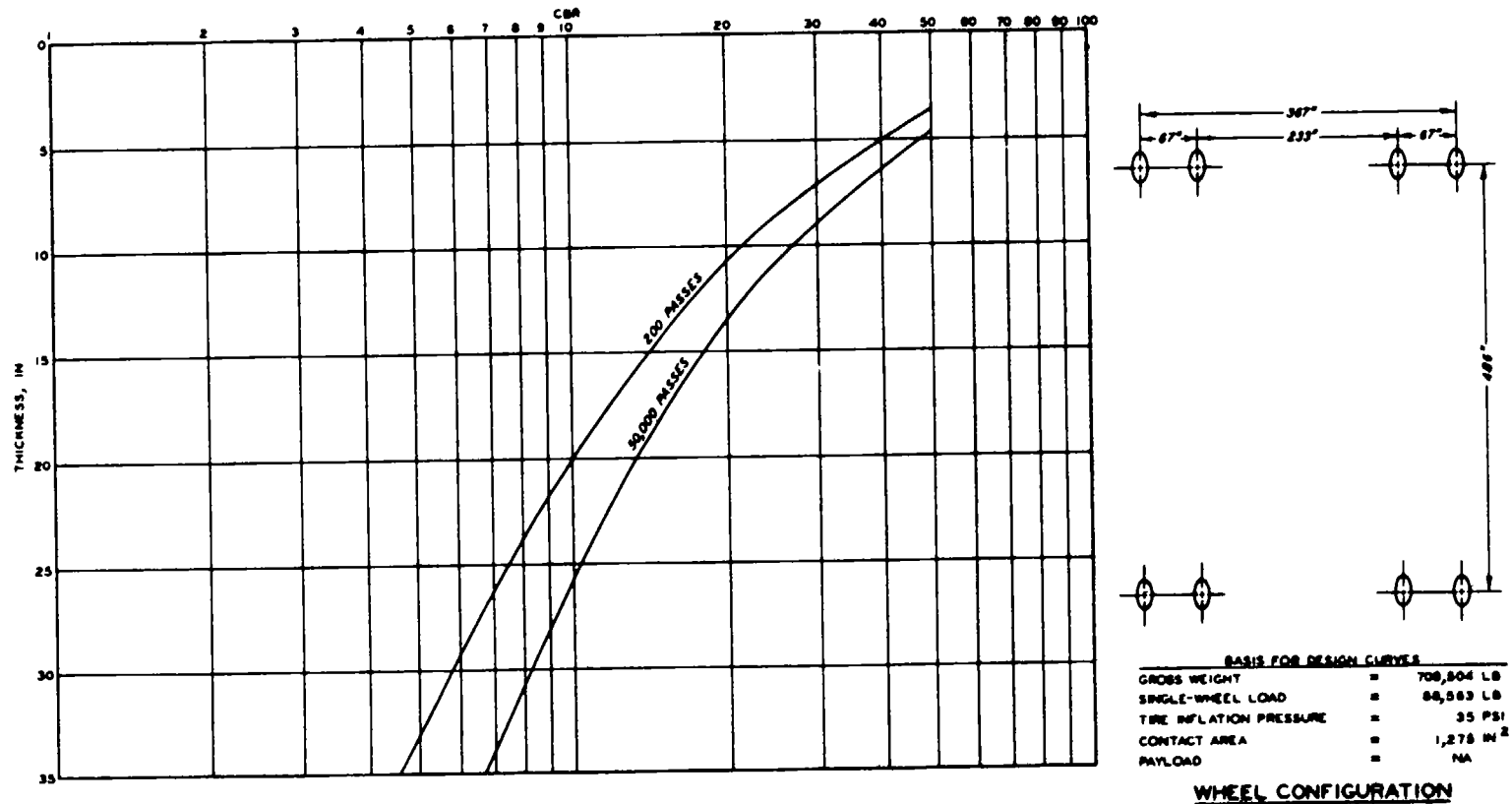

by U.S. Army Engineer
Waterways Experiment Station

Figure B-22. Flexible Pavement Curves for LeTro Crane GC-500 (mobile gantry crane).

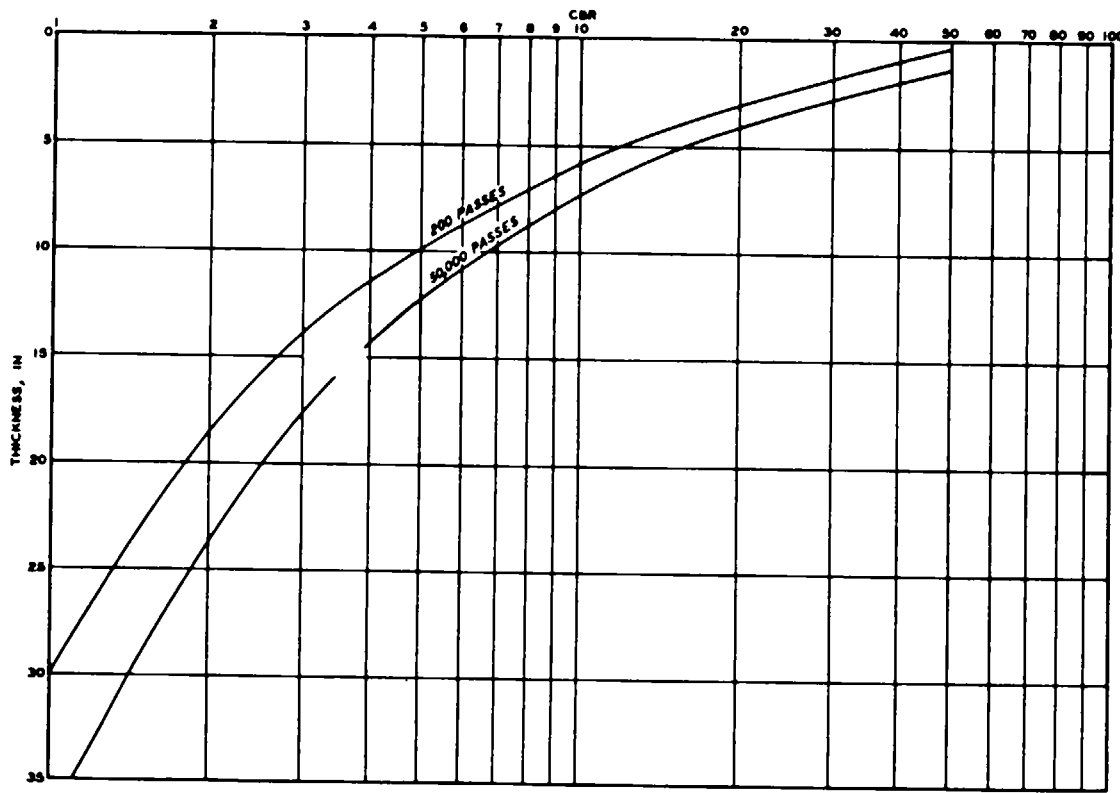

by U.S. Army Engineer
Waterways Experiment Station

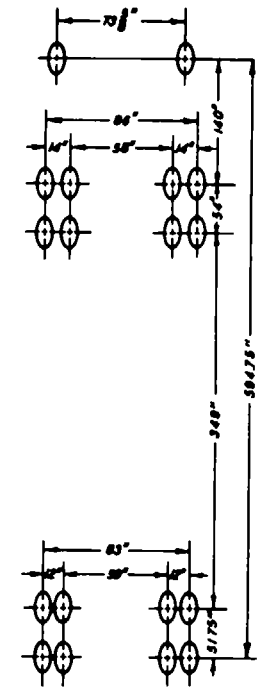

BASIS FOR DESIGN CURVES

GROSS WEIGHT	=	100,000 LB
SINGLE-WHEEL LOAD	=	5,025 LB
TIRE INFLATION PRESSURE	=	80 PSI
CONTACT AREA	=	0.25 M ²
PAYLOAD	=	87,200 LB

WHEEL CONFIGURATION

Figure B-23. Flexible Pavement Design Curves for M52 Tractor and Trailer (truck-trailer combination)

BIBLIOGRAPHY

- NAVFAC DM-25 Design Manual, Waterfront Operational Facilities. Naval Publications and Forms Center, 5801 Tabor Ave., Philadelphia, PA 19120.
- NAVFAC DM-26 Design Manual, Harbor and Coastal Facilities. Naval Publications and Forms Center, 580 1 Tabor Ave., Philadelphia, PA 19120.
- NAVFAC DM-29 Design Manual, Dry Dock Facilities. Naval Publications and Forms Center, 5801 Tabor Ave., Philadelphia, PA 19120.
- NAVFAC DM-401 Pontoon Gear Handbook, Navy Lightered (NL) Equipment, P Series. Naval Publications and Forms Center, 5801 Tabor Ave., Philadelphia, PA 19120.
- Clark, A. A. et al., "Port Construction in the Theater of Operations," Technical Report H-73-9, June 1973, U.S. Army Engineer Waterways Experiment Station, CE, Vicksburg, MS.
- Department of the Army, Container Port Construction (PORCON) (Working Draft), U.S Army Training and Doctrine Command, Fort Monroe, VA.

Change 1 Bibliography-1

The proponent agency of this publication is the Office of the Chief of Engineers, United States Army. Users are invited to send comments and suggested improvements on DA Form 2028 (Recommended Changes to Publications and Blank Forms) direct to HQDA (DAEN-MPE-D), WASH, DC 20314.

By Order of the Secretary of the Army:

Official:

ROBERT M. JOYCE
Major General, United States Army
The Adjutant General

E. C. MEYER
General, United States Army
Chief of Staff

DISTRIBUTION:

To be distributed in accordance with DA Form 12-34B requirements for TM 5-800 Series: Engineering and Design for Real Property Facilities.

U.S. GOVERNMENT PRINTING OFFICE : 1994 0 - 300-421 (00153)

RECOMMENDED CHANGES TO EQUIPMENT TECHNICAL PUBLICATIONS



THEN... JOT DOWN THE DOPE ABOUT IT ON THIS FORM, CAREFULLY TEAR IT OUT, FOLD IT AND DROP IT IN THE MAIL!

SOMETHING WRONG WITH THIS PUBLICATION?

FROM: (PRINT YOUR UNIT'S COMPLETE ADDRESS)

DATE SENT

PUBLICATION NUMBER

PUBLICATION DATE

PUBLICATION TITLE

BE EXACT... PIN-POINT WHERE IT IS

PAGE NO.

PARA-GRAPH

FIGURE NO.

TABLE NO.

IN THIS SPACE TELL WHAT IS WRONG AND WHAT SHOULD BE DONE ABOUT IT:

TEAR ALONG PERFORATED LINE

PRINTED NAME, GRADE OR TITLE, AND TELEPHONE NUMBER

SIGN HERE:

DA FORM 2028-2 JUL 79

PREVIOUS EDITIONS ARE OBSOLETE.

P.S.—IF YOUR OUTFIT WANTS TO KNOW ABOUT YOUR RECOMMENDATION MAKE A CARBON COPY OF THIS AND GIVE IT TO YOUR HEADQUARTERS.

