

**PROCEDURES FOR US ARMY AND US AIR FORCE AIRFIELD
PAVEMENT CONDITION SURVEYS**

HEADQUARTERS, DEPARTMENTS OF THE ARMY

July 1989

REPRODUCTION AUTHORIZATION/RESTRICTIONS

This manual has been prepared by or for the Government and is public property and not subject to copyright.

Reprints or republications of this manual should include a credit substantially as follows: "Joint Departments of the Army and the Air Force, USA, TM 5-826-6/AFR 93-5, Procedures for US Army and US Air Force Airfield Pavement Condition Surveys, dated 5 July 1989."



**PROCEDURES FOR US ARMY AND US AIR FORCE AIRFIELD
 PAVEMENT CONDITION SURVEYS**

	Paragraph	Page
CHAPTER 1. INTRODUCTION		
Purpose	1-1	1-1
Scope.....	1-2	1-1
Objectives.....	1-3	1-1
CHAPTER 2. BASIC AIRFIELD INFORMATION		
Basic airfield data	2-1	2-1
Desired data	2-2	2-1
CHAPTER 3. OUTLINE OF BASIC CONDITION RATING PROCEDURE		
Condition survey and PCI rating	3-1	3-1
Airfield pavement condition survey report.....	3-2	3-2
Distribution of condition survey reports.....	3-3	3-2
CHAPTER 4. SAMPLING TECHNIQUES		
General.....	4-1	4-1
Inspection	4-2	4-1
CHAPTER 5. DETAILED SURVEY PROCEDURE FOR RIGID PAVEMENT		
Sample unit inspection and record keeping.....	5-1	5-1
Inspection summary	5-2	5-1
Sample unit PCI.....	5-3	5-16
Feature PCI	5-4	5-18
CHAPTER 6. DETAILED PROCEDURE FOR FLEXIBLE PAVEMENT		
Sample unit inspection and record keeping.....	6-1	6-1
Inspection summary	6-2	6-1
Sample unit PCI.....	6-3	6-18
Feature PCI	6-4	6-18
APPENDIX A. AIRFIELD PAVEMENT DISTRESS IDENTIFICATION		A-1

List of Figures

Figure 3-1.	Steps for determining PCI of a pavement feature
4-1.	Selection of minimum number of sample units.
4-2.	Illustration of division of a jointed rigid pavement feature into sample units of 20 slabs
4-3.	Example division of flexible pavement feature into sample units.
5-1.	Jointed rigid pavements, example condition survey data sheet
5-2.	Rigid pavement deduct values, distress 61, blowup.
5-3.	Rigid pavement deduct values, distress 62, corner break
5-4.	Rigid pavement deduct values, distress 63, longitudinal/transverse/diagonal cracking
5-5.	Rigid pavement deduct values, distress 64, durability cracking.
5-6.	Rigid pavement deduct values, distress 65, joint seal damage.
5-7.	Rigid pavement deduct values, distress 66, small patch
5-8.	Rigid pavement deduct values, distress 67, patching/utility cut defect.

Figure	5-9.	Rigid pavement deduct values, distress 68, popouts.
	5-10.	Rigid pavement deduct values, distress 69, pumping.
	5-11.	Rigid pavement deduct values, distress 70, scaling.
	5-12.	Rigid pavement deduct values, distress 71, settlement.
	5-13.	Rigid pavement deduct values, distress 72, shattered slab
	5-14.	Rigid pavement deduct values, distress 73, shrinkage cracks.
	5-15.	Rigid pavement deduct values, distress 74, spalling along the joints
	5-16.	Rigid pavement deduct values, distress 75, spalling corner
	5-17.	Corrected deduct values for jointed rigid pavements
	5-18.	Airfield PCI and rating.
	5-19.	Feature summary, jointed rigid pavement
	6-1.	Flexible pavements, example condition survey data sheet.
	6-2.	Flexible pavement deduct values, distress 41, alligator cracking.
	6-3.	Flexible pavement deduct values, distress 42, bleeding.
	6-4.	Flexible pavement deduct values, distress 43, block cracking.
	6-5.	Flexible pavement deduct values, distress 44, corrugation
	6-6.	Flexible pavement deduct values, distress 45, depression
	6-7.	Flexible pavement deduct values, distress 46, jet blast erosion
	6-8.	Flexible pavement deduct values, distress 47, joint reflective cracking
	6-9.	Flexible pavement deduct values, distress 48, longitudinal and transverse cracking.
	6-10.	Flexible pavement deduct values, distress 49, oil spillage.
	6-11.	Flexible pavement deduct values, distress 50, Patching and utility cut
	6-12.	Flexible pavement deduct values, distress 51, polished aggregate.
	6-13.	Flexible pavement deduct values, distress 52, raveling/weathering
	6-14.	Flexible pavement deduct values, distress 53, rutting.
	6-15.	Flexible pavement deduct values, distress 54, shoving of flexible pavement by PCC slabs.
	6-16.	Flexible pavement deduct values, distress 55, shippage cracking.
	6-17.	Flexible pavement deduct values, distress 56, swell
	6-18.	Corrected deduct values for flexible pavements,
	6-19.	Feature summary for flexible pavements
	A-1.	Low severity alligator cracking, case 1
	A-2.	Low severity alligator cracking, case 2
	A-3.	Low severity alligator cracking, approaching medium severity.
	A-4.	Medium severity alligator cracking, case 1.
	A-5.	Medium severity alligator cracking case 2
	A-6.	High severity alligator cracking.
	A-7.	Bleeding.
	A-8.	Low severity block cracking, case 1.
	A-9.	Low severity block cracking, case 2
	A-10.	Low severity block cracking, case 3
	A-11.	Medium severity block cracking, case 1.
	A-12.	Medium severity block cracking, case 2.
	A-13.	High severity block cracking, case 1
	A-14.	High severity block cracking, case 2
	A-15.	Illustration of corrugation
	A-16.	Corrugation.
	A-17.	Low severity depression
	A-18.	Medium severity depression, case 1.
	A-19.	Medium severity depression, case 2
	A-20.	High severity depression
	A-21.	Jet blast erosion, case 1.
	A-22.	Jet blast erosion, case 2
	A-23.	Low severity joint reflection cracking.
	A-24.	Medium severity joint reflection cracking, case 1
	A-25.	Medium severity joint reflection cracking, case 2
	A-26.	High severity joint reflection cracking.
	A-27.	Low severity longitudinal crack.
	A-28.	Low severity longitudinal cracks, approaching medium
	A-29.	Low severity crack, porous friction course pavement.
	A-30.	Medium severity longitudinal construction joint crack, case 1.
	A-31.	Medium severity longitudinal crack. case 2.
	A-32.	Medium severity crack, porous friction course pavement.
	A-33.	High severity longitudinal crack.
	A-34.	High severity crack, porous friction course pavement
	A-35.	Oil spillage, case 1.
	A-36.	Oil spillage, case 2.
	A-37.	Low severity patch, case 1.
	A-38.	Low severity patch, case 2

Figure	A-39.	Medium severity patch
	A-40.	High severity patch.
	A-41.	Polished aggregate
	A-42.	Low severity raveling/weathering, case 1.
	A-43.	Low severity raveling/weathering, case 2.
	A-44.	Typical porous friction course surface with no raveling and weathering, case 1.
	A-45.	Typical porous friction course surface with no raveling and weathering, case 2.
	A-46.	Low severity raveling/weathering in porous friction course pavement
	A-47.	Medium severity raveling/weathering
	A-48.	Medium severity raveling/weathering in porous friction course pavement.
	A-49.	Medium severity raveling/weathering showing rough and pitted surface in porous friction course pavement
	A-50.	High severity raveling/weathering
	A-51.	High severity raveling/weathering in porous friction course pavement.
	A-52.	Low severity rutting.
	A-53.	Low severity rutting
	A-54.	Medium severity rutting
	A-55.	Medium severity rutting
	A-56.	High severity rutting
	A-57.	High severity rutting
	A-58.	Low severity shove on the outside and medium severity in the middle
	A-59.	High severity shoving.
	A-60.	Slippage cracking, case 1
	A-61.	Slippage cracking, case 2.
	A-62.	Low severity swell.
	A-63.	Medium severity swell
	A-64.	High severity swell.
	A-65.	High severity swell.
	A-66.	Low severity blowup.
	A-67.	Medium severity blowup.
	A-68.	High severity blowup.
	A-69.	Low severity corner break, case 1.
	A-70.	Low severity corner break, case 2
	A-71.	Medium severity corner break, case 1.
	A-72.	Medium severity corner break, case 2.
	A-73.	High severity corner break.
	A-74.	Low severity longitudinal crack.
	A-75.	Low severity filled longitudinal cracks.
	A-76.	Low severity diagonal crack.
	A-77.	Medium severity longitudinal crack
	A-78.	Medium severity transverse crack, case 1.
	A-79.	Medium severity transverse crack, case 2.
	A-80.	High severity transverse crack.
	A-81.	High severity longitudinal crack, case 1
	A-82.	High severity longitudinal crack, case 2.
	A-83.	Low severity D cracking
	A-84.	Medium severity D cracking, case 1.
	A-85.	Medium severity D cracking, case 2.
	A-86.	High severity D cracking.
	A-87.	Low-severity joint seal damage.
	A-88.	Medium-severity joint seal damage.
	A-89.	High-severity joint seal damage
	A-90.	High-severity joint seal damage
	A-91.	Low-severity small patch, case 1.
	A-92.	Low-severity small patch, case 2.
	A-93.	Medium-severity small patch, case 1
	A-94.	Medium-severity small patch, case 2
	A-95.	High-severity small patch
	A-96.	Low-severity patch, case 1.
	A-97.	Low-severity patch, case 2.
	A-98.	Low-severity utility cut
	A-99.	Medium-severity utility cut.
	A-100.	High-severity patch
	A-101.	Popouts.
	A-102.	Pumping.
	A-103.	Pumping (note stained pavement)
	A-104.	Pumping (fine materials collected on surface)
	A-105.	Pumping.
	A-106.	Counting procedure for pumping.

Figure	A-107.	Low-severity crazing
	A-108.	Medium-severity scaling.
	A-109.	High-severity scaling.
	A-110.	Close-up of high severity scaling
	A-111.	Low-severity settlement on apron, case 1
	A-112.	Low-severity settlement on apron, case 2.
	A-113.	Medium-severity settlement on apron
	A-114.	High-severity settlement on taxiway/runway, case 1
	A-115.	High-severity settlement, case 2
	A-116.	Counting procedure for settlement or faulting.
	A-117.	Low-severity intersecting cracks, case 1.
	A-118.	Low-severity intersecting cracks, case 2.
	A-119.	Medium-severity intersecting cracks, case 1.
	A-120.	Medium-severity intersecting cracks, case 2
	A-121.	Shattered slab
	A-122.	Shrinkage crack, case 1.
	A-123.	Shrinkage crack, case 2.
	A-124.	Low-severity joint spall, case 1
	A-125.	Low-severity joint spall, case 2
	A-126.	Medium-severity joint spall, case 1.
	A-127.	Medium-severity joint spall, case 2.
	A-128.	High-severity joint spall, case 1
	A-129.	High-severity joint spall, case 2
	A-130.	Low-severity corner spall, case 1.
	A-131.	Low-severity corner spa", case 2.
	A-132.	Medium-severity corner spall, case 1
	A-133.	Medium-severity corner spall, case 2
	A-134.	High-severity comer spall.
	A-135.	Flexible pavement condition survey data sheet.
	A-136.	Rigid pavement condition survey data sheet.

List of Tables

Table	A-1.	Frequently occurring identification problems in pavement distress identification
	A-2.	Summary of distress types and identification numbers.

CHAPTER 1 INTRODUCTION

1-1. Purpose. This manual gives the procedure for performing a pavement condition survey at all airfields with present or potential Army or Air Force missions. It is intended for use by all personnel responsible for such surveys.

1-2. Scope. The airfield pavement condition survey is a visual inspection of both rigid and flexible pavement for signs of pavement distress. The pavement condition index (PCI) is a numerical rating which indicates the type and severity of the inspected distress. The airfield condition survey and the resulting PCI are the primary means of obtaining and recording important airfield pavement performance data. This manual describes the condition survey of both flexible pavements (all pavements with conventional bituminous concrete surfaces) and rigid pavements (jointed portland cement concrete pavements with joint spacing not exceeding 25 feet), and the procedure for determining the PCI of pavement inspected.

1-3. Objectives. Specific objectives of a condition survey are to determine present condition of the pavement in terms of apparent structural integrity and operational surface condition, to provide a common index for comparing the condition and performance of pavements at all air stations along with a rational basis for justification of pavement repair projects, and provide feedback on pavement performance for validation and improvement of current pavement design, evaluation, and maintenance procedures.

CHAPTER 2 BASIC AIRFIELD INFORMATION

2-1. Basic airfield data. A considerable amount of basic airfield data is incorporated into the condition survey report. Most of this information is contained in construction and maintenance records and in previous condition survey reports.

2-2. Desired data. The following items should be compiled for subsequent use during the condition survey:

- a. *Design/construction/maintenance history.* The history of maintenance, repair, and reconstruction from original construction of the pavement system to the present.
- b. *Traffic history.* Aircraft traffic records, including aircraft type, typical gross loads, frequency of operation, percent runway usage, and taxiway and apron usage should be available.
- c. *Climatological data.* Annual temperature ranges and precipitation data.
- d. *Airfield layout.* Plans and cross sections of all major pavement components, including subsurface drainage systems should be available. These should be updated to reflect new construction upon completion of the project. In addition, known subsurface geologic data, especially ground water presence and direction of flow should be shown. Longitudinal and transverse grades should be indicated on runway and taxiway profile and cross-section drawings.
- e. *Frost action.* If applicable, records of pavement behavior during freezing periods and subsequent thaws should be recorded.
- f. *Photographs.* Photographs depicting both general and specific pavement conditions should be taken.
- g. *Pavement condition survey reports.* All previous pavement condition survey reports should be maintained to be referenced in the current report.

**CHAPTER 3
OUTLINE OF BASIC CONDITION RATING PROCEDURE**

3-1. Condition survey and PCI rating. The steps for performing the condition survey and determining the PCI rating are described below and in figure 3-1.

STEP 1 DIVIDE PAVEMENTS INTO FEATURES

STEP 2 DIVIDE PAVEMENT FEATURE INTO SAMPLE UNITS

STEP 3. INSPECT SAMPLE UNITS. DETERMINE DISTRESS TYPES AND SEVERITY LEVELS AND MEASURE DENSITY

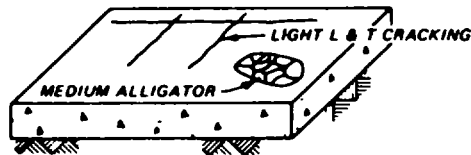

STEP 4 DETERMINE DEDUCT VALUES

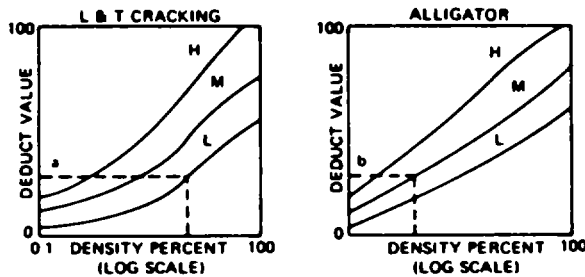

STEP 5 COMPUTE TOTAL DEDUCT VALUE (TDV) a + b

STEP 6. ADJUST TOTAL DEDUCT VALUE

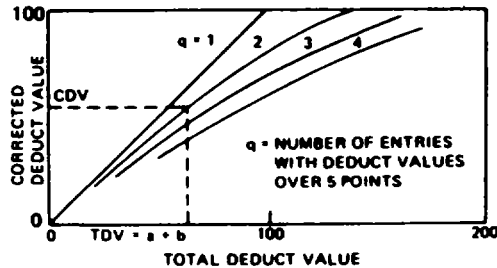

STEP 7 COMPUTE PAVEMENT CONDITION INDEX (PCI) = 100 - CDV FOR EACH SAMPLE UNIT INSPECTED

STEP 8 COMPUTE PCI OF ENTIRE FEATURE (AVERAGE PCI'S OF SAMPLE UNITS)

STEP 9 DETERMINE PAVEMENT CONDITION RATING OF FEATURE

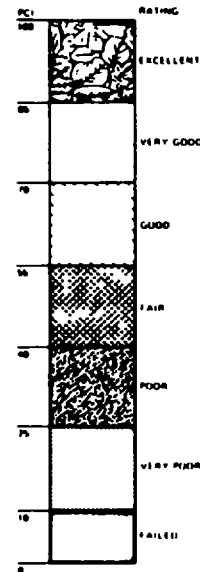

Figure 3-1. Steps for determining PCI of a pavement feature.

a. Station or mark off the pavements in 100-foot increments. This is done semipermanently to assure ease of proper positioning for the condition survey. The overall airfield pavements must first be divided into features based on the pavement's design, construction history, and traffic area. Therefore, a designated pavement feature has consistent structural thickness and materials, was constructed at the same time, and is subject to approximately the same traffic conditions. After initially designating the features on the airfield, a preliminary survey should be made. This survey will entail a brief but complete visual survey of all the airfield pavements. By observing distress in an individual feature, it may be determined whether there are varying degrees of distress in different areas. In such cases, the feature should be subdivided into two or more features.

b. The pavement feature is divided into sample units. A sample unit for jointed rigid pavement is approximately 20 slabs; a sample unit for flexible pavement is an area of approximately 5,000 square feet.

c. The sample units are inspected, and distress types and their severity levels and densities are recorded. Appendix A provides a comprehensive guide for identification of the different distress types and their

severity levels. The criteria in appendix A must be used in identifying and recording the distress types and severity levels in order to obtain an accurate PCI.

d. For each distress type, density, and severity level within a sample unit, a deduct value is determined from the appropriate curve.

e. The total deduct value (TDV) for each sample unit is determined by adding all deduct values for each distress condition observed.

f. A corrected deduct value (CDV) is determined using procedures in the appropriate section for jointed rigid or flexible pavements.

g. The PCI for each sample unit inspected is calculated as follows: $PCI = 100 - CDV$. If the CDV for a sample unit is less than the highest individual distress deduct value, the highest value should be used in lieu of the CDV in the above equation.

h. The PCI of the entire feature is the average of the PCI's from all sample units inspected.

i. The feature's pavement condition rating is determined from a correlation that presents pavement condition rating as a function of PCI value.

3-2. Airfield pavement condition survey report. a. The format for reporting findings of respective Air Force and Army airfield condition surveys has been designed to preclude the necessity of extensive drafting and typing. The pavement distress data and PCI computations can be presented as directly obtained from the manual calculations. Basic airfield data and load-carrying capacity evaluation primarily reflect changes in airfield pavement systems that have occurred since the last condition survey report.

(1) The report is prepared by the pavement engineer, on a recurring cycle, at intervals not to exceed 5 years. The results should be sent to the Major Command (MACOM) engineer for evaluation and further action.

(2) If significant changes in the PCI occur, the condition survey report should be updated. The update should include sections 4, 5, 6, and 7 of the report.

(3) The MACOM engineer must ensure that completed reports are standardized.

b. The results of the PCI condition survey are used by the MACOM to determine the rate of deterioration of pavement features and to justify pavement evaluations and maintenance and repair projects. Therefore, a condition survey for some features may be required more often than the specified 5-year interval, annually in some cases. The MACOM determines its frequency, based on the above factors and engineering judgment.

c. Pavement condition survey reports are filed and maintained with other pertinent airfield pavement data.

3-3. Distribution of condition survey reports. Distribution is as follows:

a. *Air Force*

Responsible MAJCOM/DE	As Required
HQMAC/DE	1 Copy
Scott AFB, IL 62225	
HQSAC/DE	1 Copy
Offutt AFB, NE 68113	
HQTACIDE	1 Copy
Langley AFB, VA 23665	
Responsible BCE	As Required
WESGI	1 Copy
PO Box 631	
Vicksburg, MS 39180	
HQ AFESC/DEMP	1 Copy
Tyndall AFB, FL 32403	
HQ AFESC/RDC	1 Copy
Tyndall AFB, FL 32403	

b. Army

Cdr, MTMCTEA ATTN: MTT-SVA PO Box 6276 Newport News, VA 23606-0276	1 Copy
Cdr, USACE ATTN: CEEC-EG Washington, DC 20314-1000	2 Copies
Crd, & Dir, USACERL ATTN: CERL-EM PO Box 4005 Champaign, IL 61820-1305	2 Copies
Cdr, FORSCOM ATTN: FCEN-RDF Ft. McPherson, GA 30330-5000	5 Copies
Crd, USA Aeronautical Services Office Alexandria, VA 22314	1 Copy
Cdr, USAEHSC ATTN: CEHSC-FB-P Ft. Belvoir, VA 22060-5516	1 Copy
Cdr, TRADOC ATTN: ATEN-FE Ft. Monroe, VA 23651-6720	2 Copies
Cdr, AMC ATTN: AMXEN-RI-IB Rock Island, IL 61201-5000	2 Copies
Cdr, AFESC ATTN: DEMP Tyndall AFB, FL 32402-6001	1 Copy
Cdr, USACE ATTN: CEIM-SL Washington, DC 20314-1000	1 Copy
Cdr, NAVFAC ATTN: J. Leimanis 200 Stovall Street Alexandria, VA 22332-2300	1 Copy
CEWES-GV-Z	1 Copy
CEWES-GP-IP	3 Copies
CEWES-IM-TL	
Facilities Engineer at installation where airfield is located	3 Copies
Commanding Officer of technical service having jurisdiction over the airfield	3 Copies
US Army Engineer Division which airfield is within	1 Copy
US Army Engineer District which airfield is within	1 Copy

Cdr, USAED, Missouri River ATTN: CEMRD-ED-G PO Box 1034, Downtown Station Omaha, NE 68101-0103	1 Copy
Crd, USAED, North Pacific ATTN: CENPD-EN-G PO Box 2870 Portland, OR 97208-2870	1 Copy
Cdr, USAED, South Atlantic ATTN: CESAD-EN-FS 510 Title Building 30 Pryor Street, SW Atlanta, GA 30335-6801	1 Copy

**CHAPTER 4
SAMPLING TECHNIQUES**

4-1. General. Inspection of an entire feature may require considerable effort, especially if the feature is very large. This may be particularly true for flexible pavements containing much distress. Because of the time and effort involved, frequent surveys of the entire feature may be beyond available manpower, funds, and time.

4-2. Inspection. All sample units should be surveyed if a pavement feature contains only five or fewer sample units. A statistical sampling plan was developed to obtain an adequate estimate of the PCI determined by inspecting only a portion of the sample units within normal size features (i.e., 20 + 5 slabs for rigid pavements, and 5,000 + 1,000 sq ft for flexible). Use of the statistical sampling plan described herein will considerably reduce the time required to inspect a feature without significant loss of accuracy. However, this sampling plan is optional, and inspection of the entire feature may be desirable in some cases.

a. Determination of pavement feature. The first step in the condition survey is the designation of pavement features. Each facility such as a runway, taxiway, etc., is divided into segments or features that are definable in terms of the same design, the same construction history, the same traffic area, and generally the same overall condition. General features can be determined from pavement design and construction records and can be further subdivided as deemed necessary based on a preliminary survey. It is important that all pavement in a given feature be such that it can be considered uniform. For example, the center part of some runways in the traffic lanes should be separate features from the portion outside the traffic lanes.

b. Selection of sample units to be inspected. Assuming a normal distribution of data, the number of sample units to be surveyed to provide a 95-percent confidence level can be determined from

$$(eq\ 4-1)\ n = \frac{N\sigma^2}{\frac{e^2}{4} (N - 1) + \sigma^2}$$

where

- n = number of sample units to be inspected
- N = total number of sample units in feature
- σ = one standard deviation in PCI between sample units within the feature
- e = allowable error in determining the true PCI

Data collected during the development of the PCI procedure gave average σ values of 10 and 15 for flexible and rigid pavements, respectively. These values should be used for determining the number of sample units to be inspected unless field data and experience indicate the higher or lower values would be more appropriate for military airfield pavements. The number of samples n obtained from the equation is the minimum number to be inspected in a given pavement feature in order to have 95 percent confidence that the PCI is within 5 points. The above equation is presented graphically in figure 4-1 to simplify its use in application.

c. The minimum number of sample units that must be surveyed to obtain an adequate estimate of the PCI of a feature is selected from figure 4-1. Once the number of sample units η has been determined from figure 4-1 the spacing interval of the units is computed from

$$(eq\ 4-2)\ i = \frac{N}{\eta}$$

where

- i = spacing interval of units to be sampled
- N = total number of sample units in the feature
- η = number of sample units to be inspected

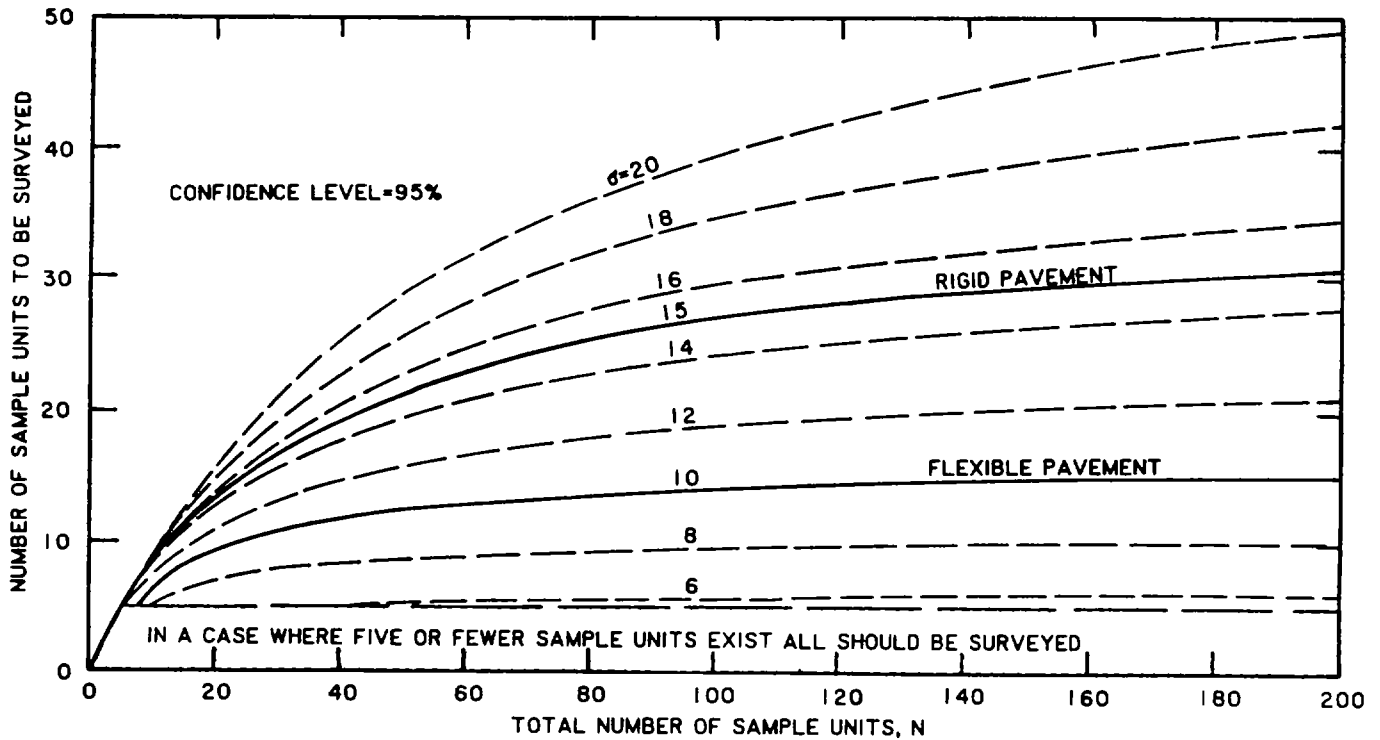

Figure 4-1. Selection of minimum number of sample units.

d. All the sample numbers within a feature are numbered and those that are multiples of the interval i are selected for inspection. The first sample unit to be inspected should be selected at random between 1 and i . Sample unit size should be 5,000 square feet (generally 50 by 100 feet) for flexible pavement and 20 adjacent slabs for rigid pavement. However, as necessary the following sample unit size variation is acceptable: flexible 500 SF \pm 1000 SF; rigid 20 \pm 5 slabs. Figures 4-2 and 4-3, respectively, illustrate the division of a jointed rigid pavement and flexible pavement feature into sample units. Each sample unit is numbered so it can be relocated for future inspections, maintenance needs, or statistical sample purposes. Each of the selected sample units must be inspected and its PCI determined. The mean PCI of a pavement feature is determined by averaging the PCI of each sample unit inspected within the feature. When it is desirable to inspect a sample unit that is in addition to those selected by the above procedure (because it is felt that very poor or excellent units were omitted), then one or more additional sample units may be inspected, and the mean PCI of the feature computed from

$$(eq\ 4-3)\ PCI_f = \frac{(N - A)}{N} + \frac{A}{N} \overline{PCI}_2$$

where

PCI_f = mean PCI of feature

N = total number of sample units in feature

A = number of additional sample units

\overline{PCI}_1 = mean of PCI for number of statistically selected units

\overline{PCI}_2 = mean of PCI for all additional sample units

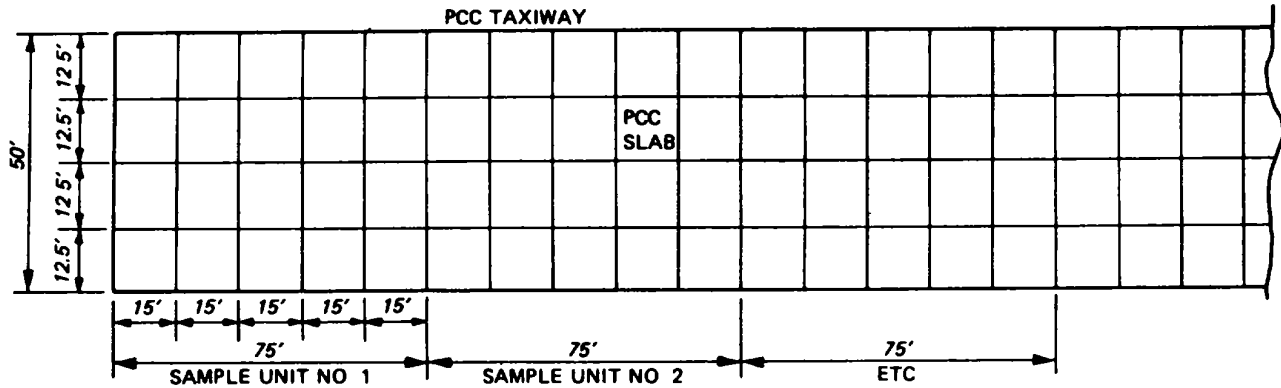
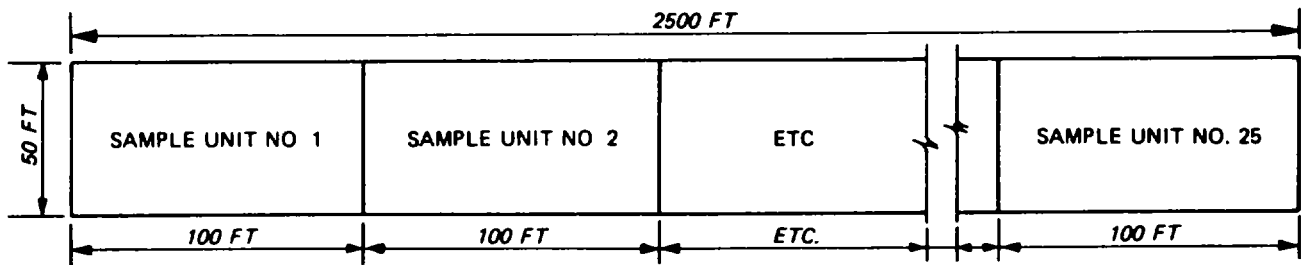

Figure 4-2. Illustration of division of a jointed rigid pavement feature into sample units of 20 slabs.



FEATURE DIMENSION = 50 X 2500 FT
 SAMPLE UNIT = 50 X 100 FT
 NUMBER OF SAMPLE UNITS = 25

Figure 4-3. Example division of flexible pavement feature into sample units.

e. Each sample unit should be identified adequately so that it can be relocated for additional inspections in order to be able to verify distress data, or for comparison with future inspections. If significant PCI variation exists within the sample units in a feature and/or large variation in distress types among sample units, a feature should be further subdivided into two or more features to facilitate future inspections or for maintenance purposes.

CHAPTER 5

DETAILED SURVEY PROCEDURE FOR RIGID PAVEMENT

5-1. Sample unit inspection and record keeping. Each sample unit, or those selected by the statistical sampling procedure, in the feature is inspected. The actual inspection is performed by walking over each slab of the sample unit being surveyed and recording distress existing in the slab on the jointed rigid pavement survey data sheet (fig 5-1). One data sheet is used for each sample unit. A sketch is made of the sample unit, using the dots as joint intersections. The appropriate number code for each distress found in the slab is placed in the square representing the slab. The letters L (low), M (medium), or H (high) are included along with the distress number code to indicate the severity of the distress. For example, 75L indicates that low severity corner spalling exists in the slab. Identification of distress types and their severity levels are contained in appendix A. These guidelines must be followed very closely.

5-2. Inspection summary. Space is provided on the jointed rigid pavement survey data sheet for summarizing the distresses and computing the PCI for the sample unit. The distress type numbers, their severity levels and the number of slabs in the sample unit containing each type and level should be summarized. The percentage of the total number of slabs in the sample unit containing each distress type and severity level should be calculated. Using figures 5-2 through 5-16, the deduct value for each distress type and severity level are determined. The deduct values should be calculated to obtain the deduct total.

JOINTED RIGID PAVEMENT CONDITION SURVEY DATA SHEET FOR SAMPLE UNIT			
AIRPORT WORLD INTERNATIONAL			DATE 5/28/79
FACILITY RWY 9-27	FEATURE R3		SAMPLE UNIT 12
SURVEYED BY JH/DE		SLAB SIZE 12.5 X 15 FT	

DISTRESS TYPES	
61 BLOW-UP	70 SCALING/MAP CRACK/CRAZING
62 CORNER BREAK	71 SETTLEMENT/FAULT
63 LONGITUDINAL/TRANSVERSE/DIAGONAL CRACK	72 SHATTERED SLAB
64 "D" CRACK	73 SHRINKAGE CRACK
65 JOINT SEAL DAMAGE	74 SPALLING-JOINTS
66 PATCHING, < 5 FT ²	75 SPALLING - CORNER
67 PATCHING/UTILITY CUT	
68 POPOUTS	
69 PUMPING	

DIST TYPE	SEV	NO SLABS	DENSITY %	DEDUCT VALUE
62	L	1	5	4
63	L	3	15	11
63	M	1	5	11
70	M	1	5	7
72	L	1	5	10
75	L	2	10	3
DEDUCT TOTAL				46
CORRECTED DEDUCT VALUE (CDV)				32
PCI = 100 - CDV = 68				
RATING = GOOD				

Figure 5-1. Jointed rigid pavements, example condition survey data sheet.

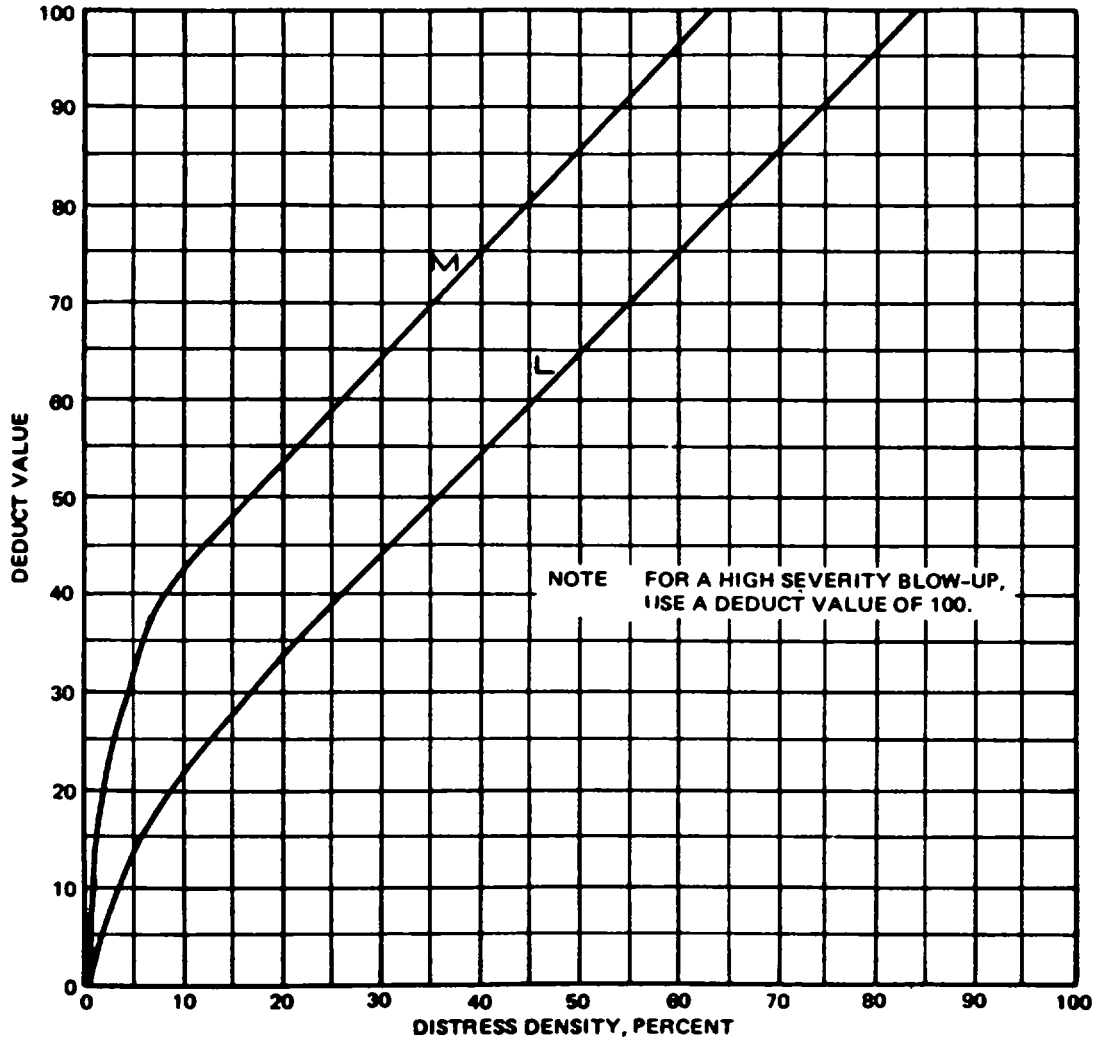

Figure 5-2. Rigid pavement deduct values, distress 61, blowup.

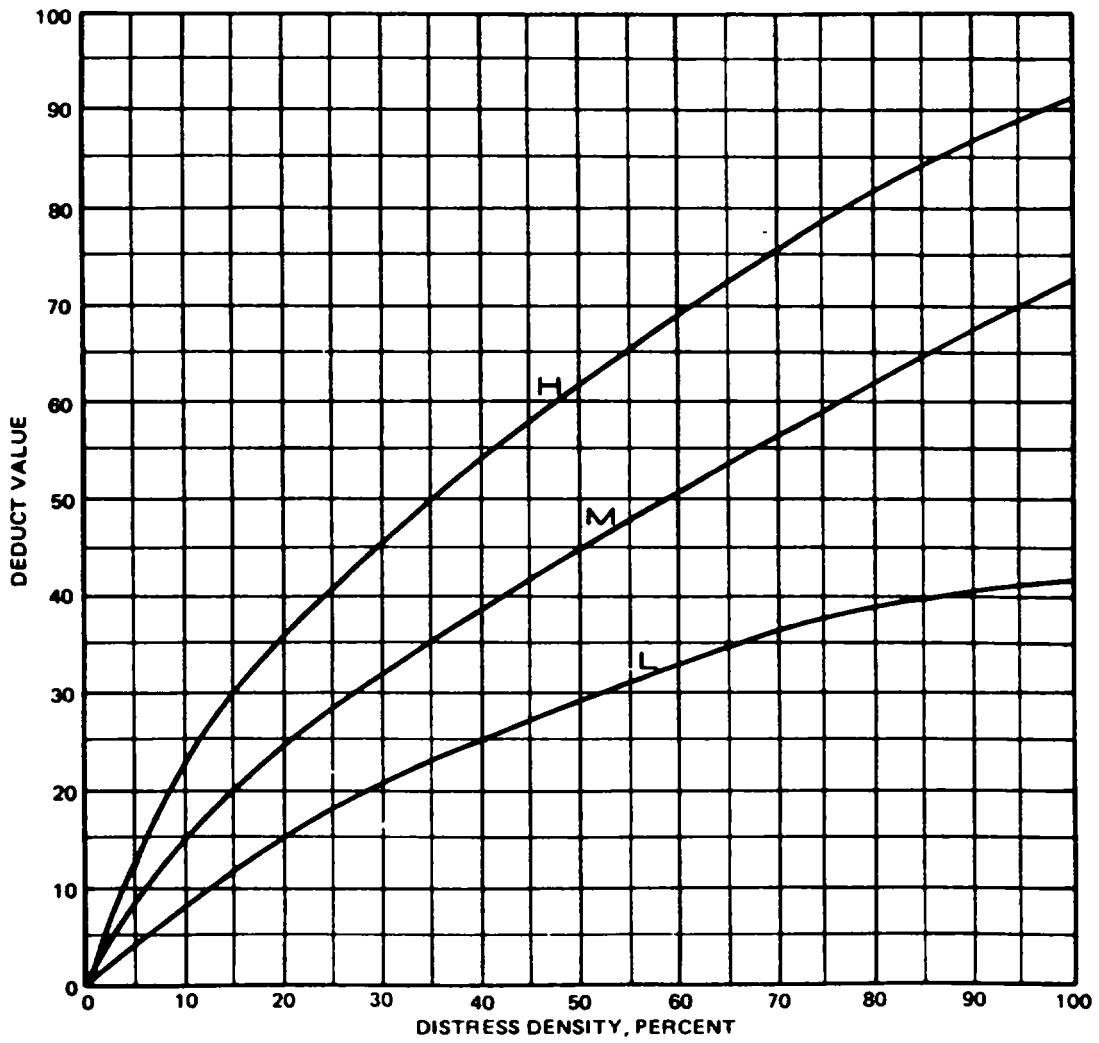

Figure 5-3. Rigid pavement deduct values, distress 62 corner break.

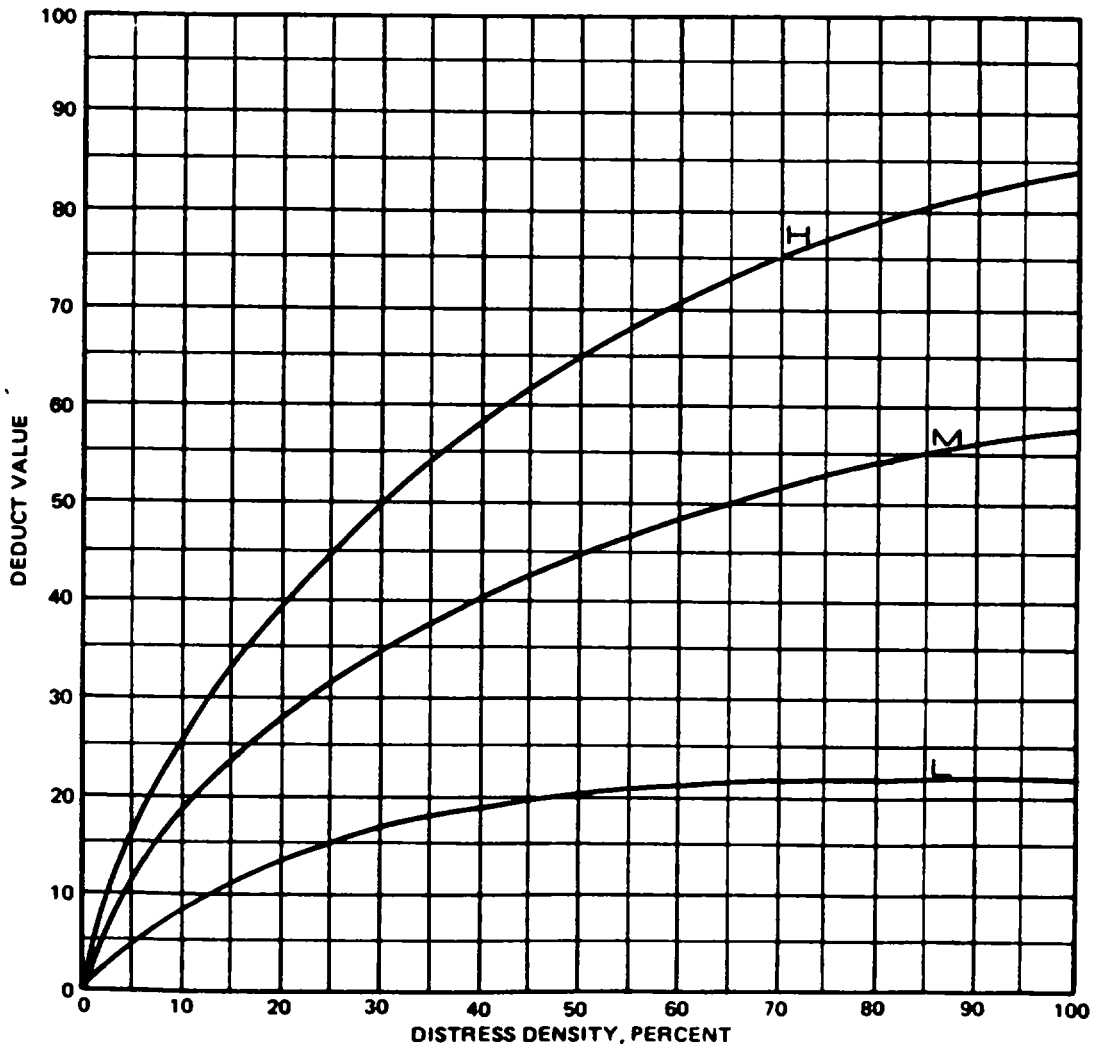

Figure 5-4. Rigid pavement deduct values, distress 63 longitudinal/transverse/diagonal cracking.

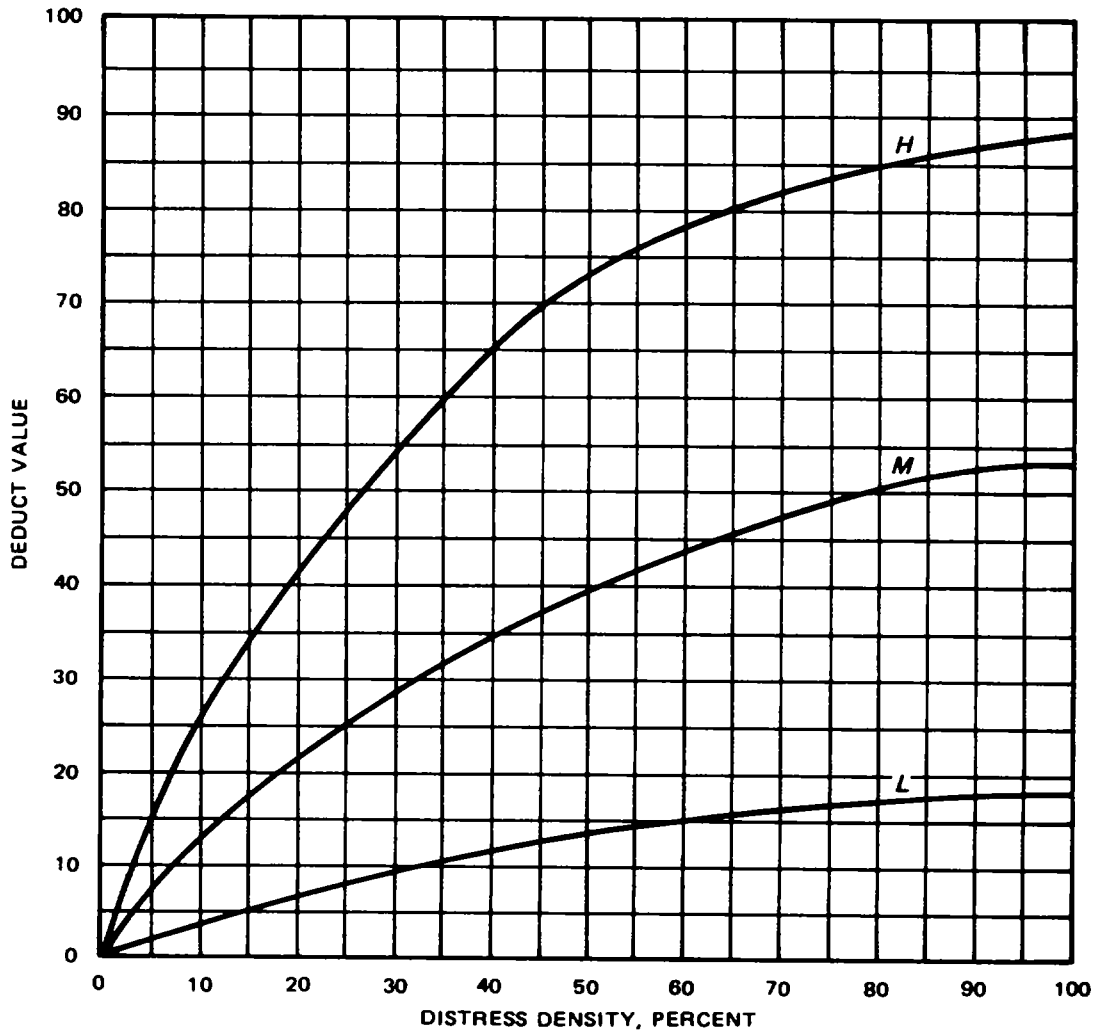

Figure 5-5. Rigid pavement deduct values, distress 64 durability cracking.

JOINT SEAL DAMAGE IS NOT RATED BY DENSITY, THE SEVERITY OF THE DISTRESS IS DETERMINED BY THE SEALANT'S OVERALL CONDITION FOR A PARTICULAR SECTION.

THE DUCT VALUES FOR THE THREE LEVELS OF SEVERITY ARE AS FOLLOWS:

1. HIGH SEVERITY - 12 POINTS
2. MEDIUM SEVERITY - 7 POINTS
3. Low SEVERITY - 2 POINTS

Figure 5-6. Rigid pavement deduct values, distress 65, Joint seal damage.

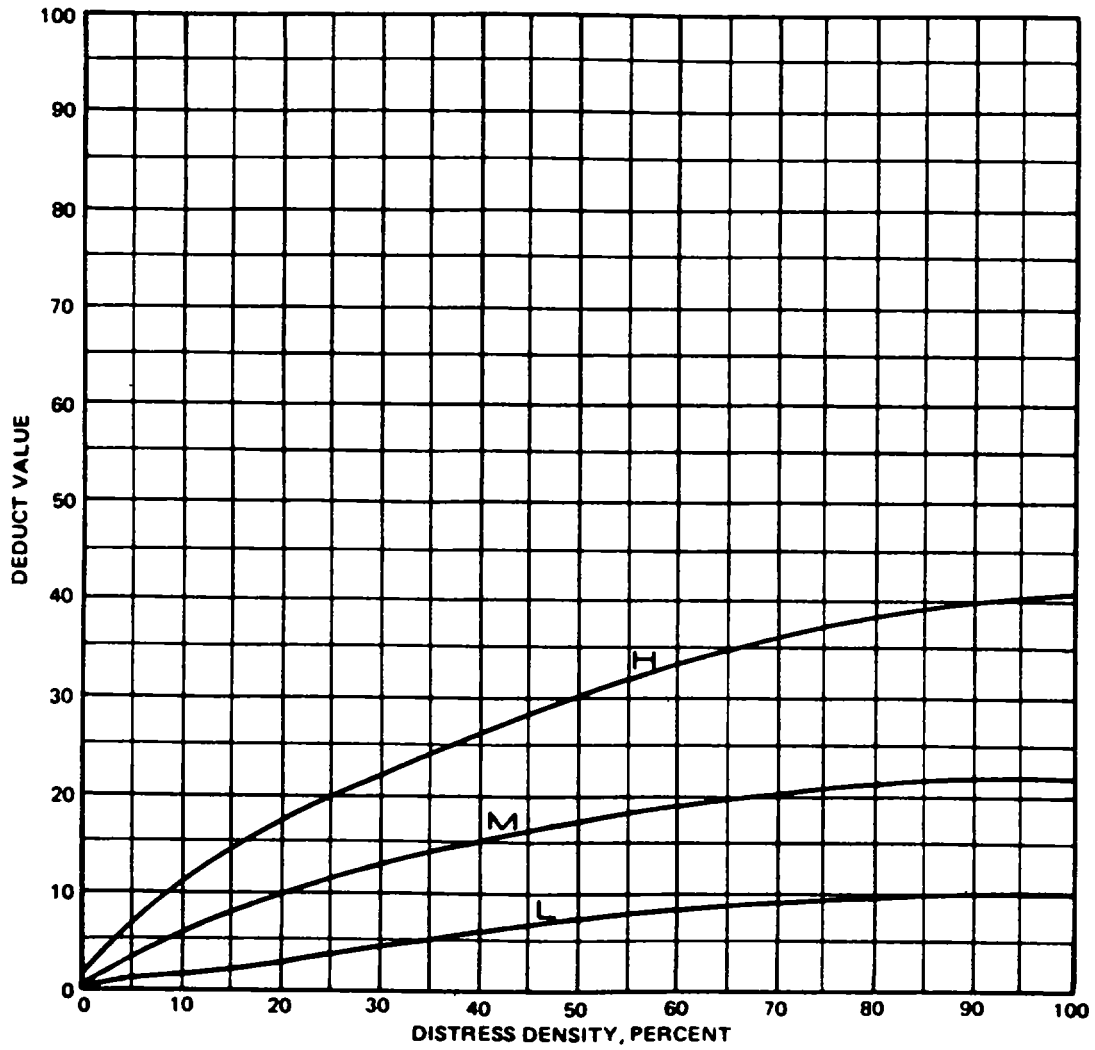

Figure 5-7. Rigid pavement deduct values, distress 66 small patch.

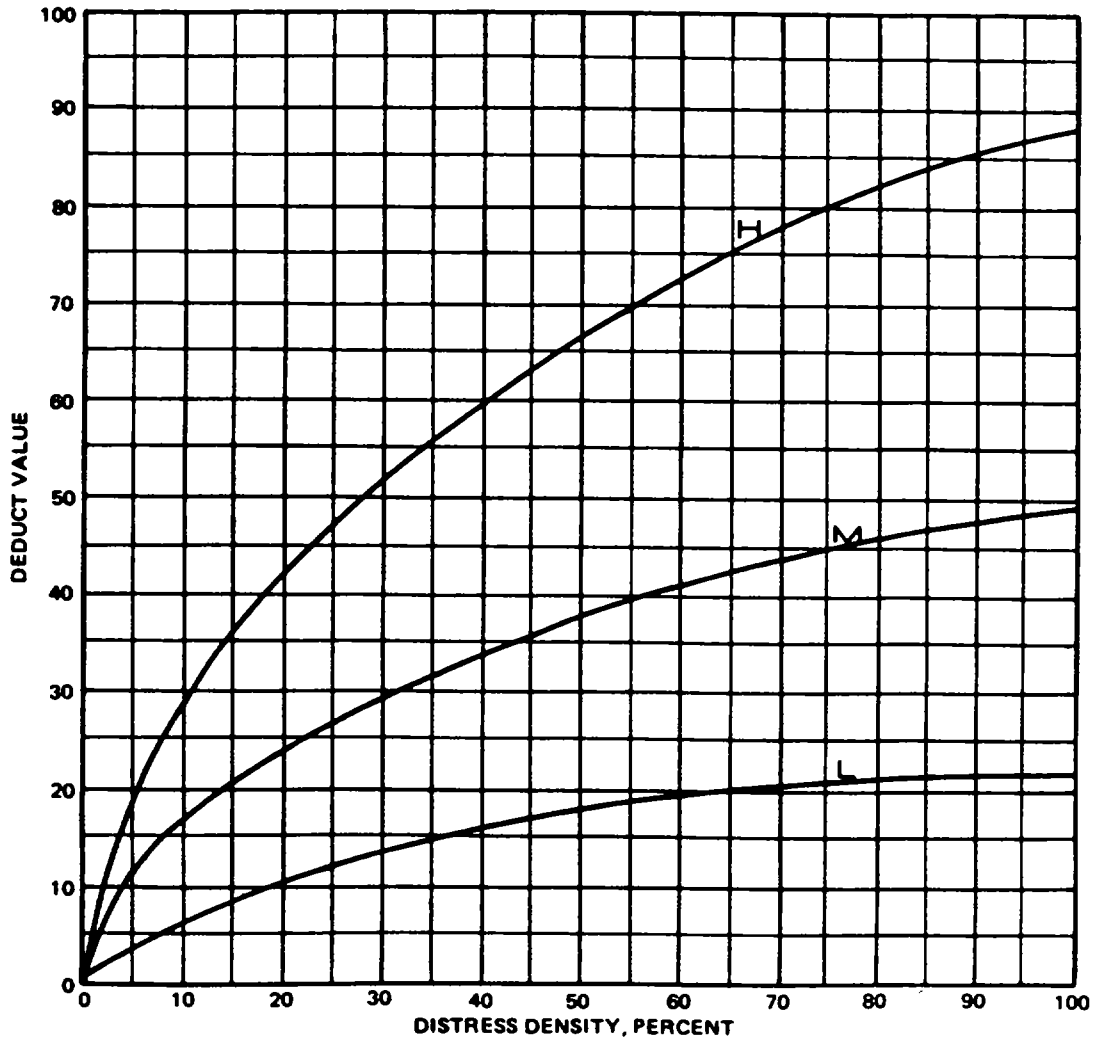

Figure 5-8. Rigid pavement deduct values, distress 67, patching/utility cut defect.

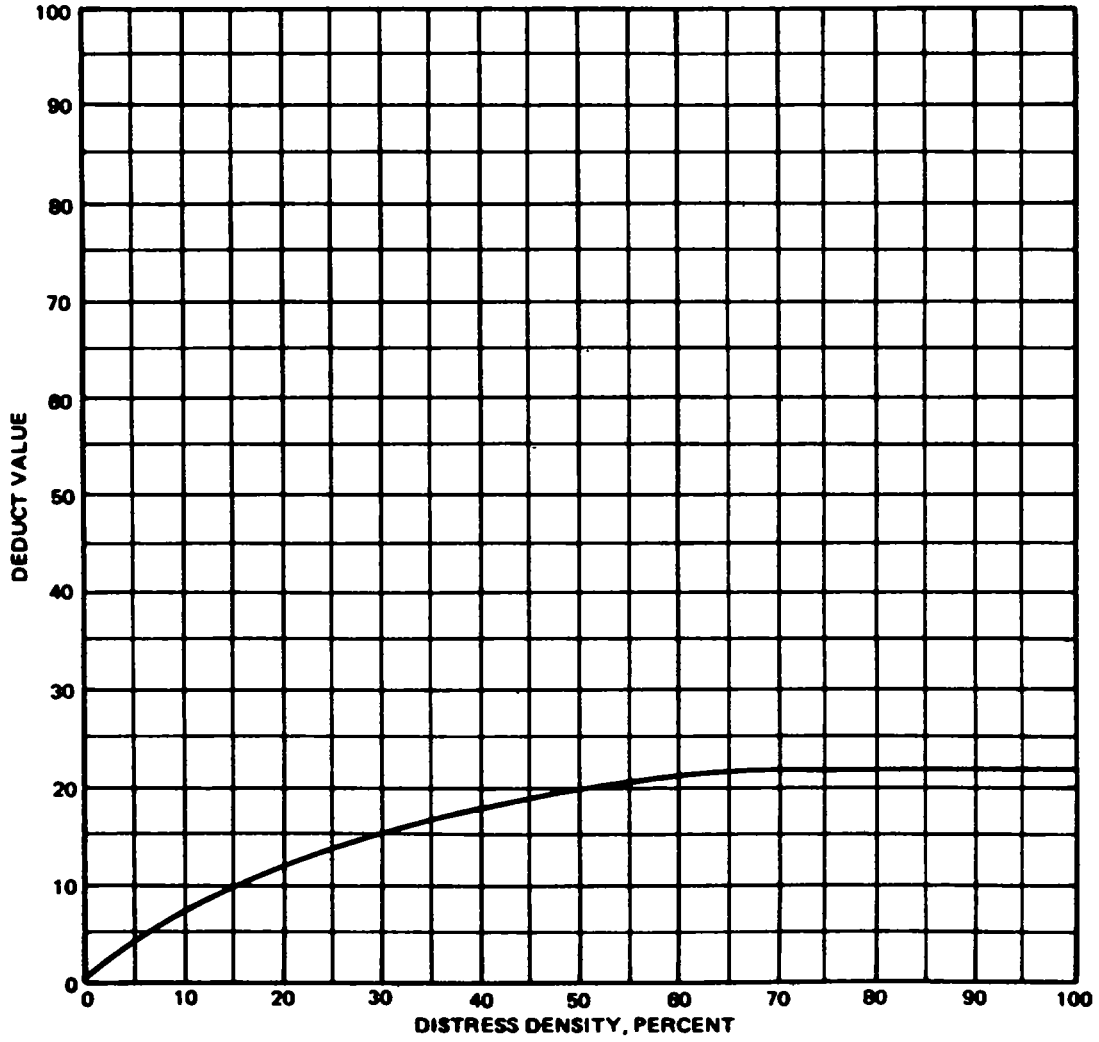

Figure 5-9. Rigid pavement deduct values distress 68 popouts.

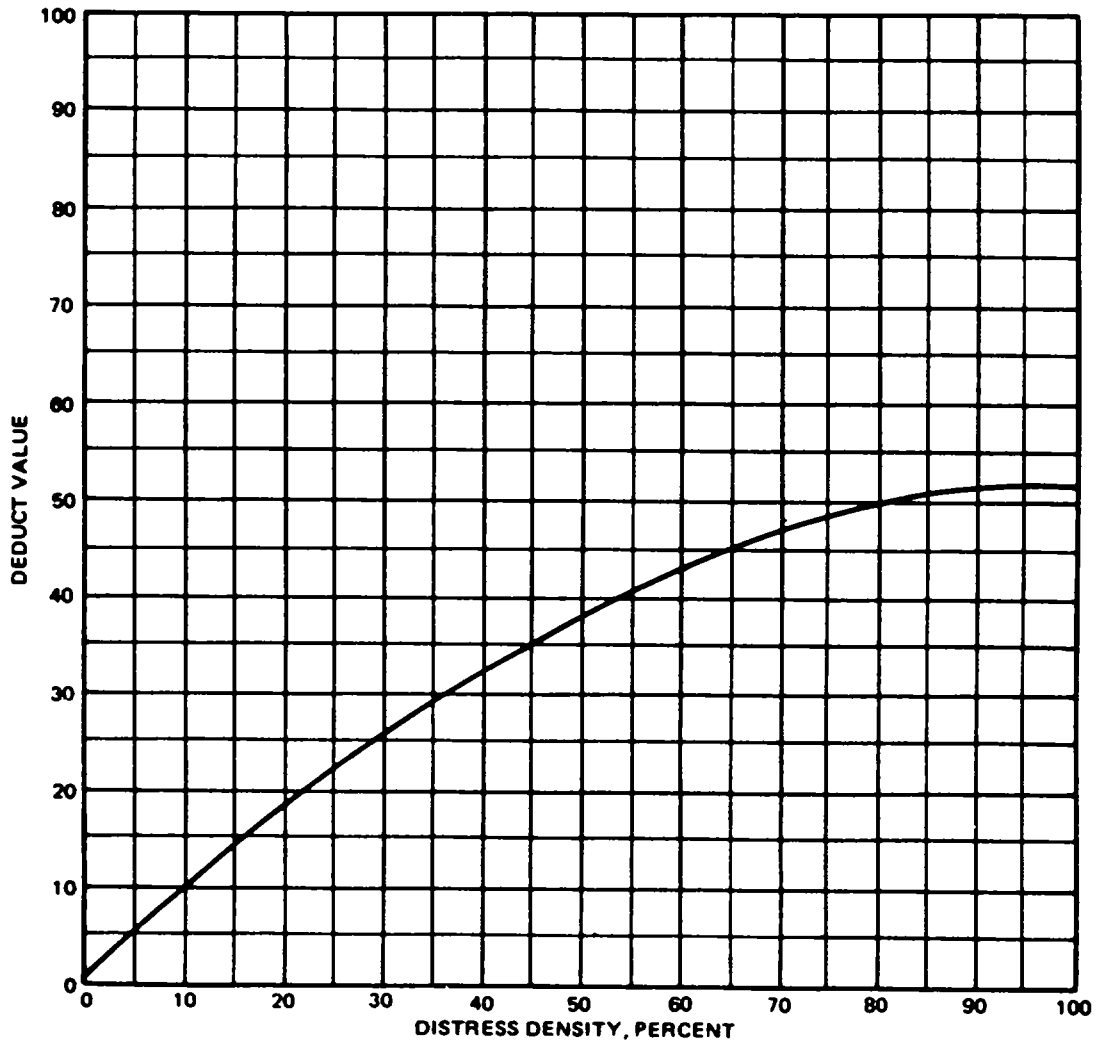

Figure 5-10. Rigid pavement deduct values, distress 69 pumping.

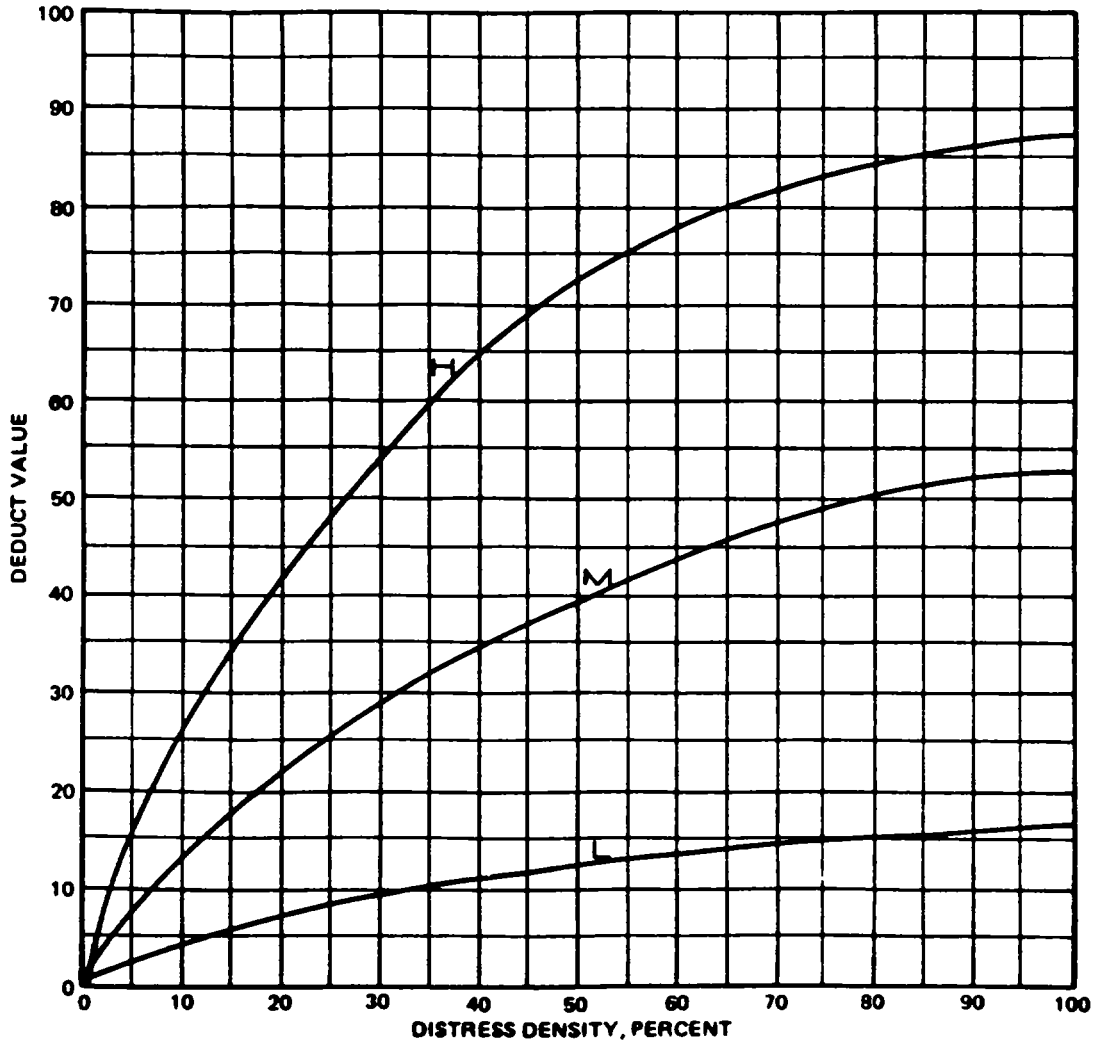

Figure 5-11. Rigid pavement deduct values, distress 70 scaling.

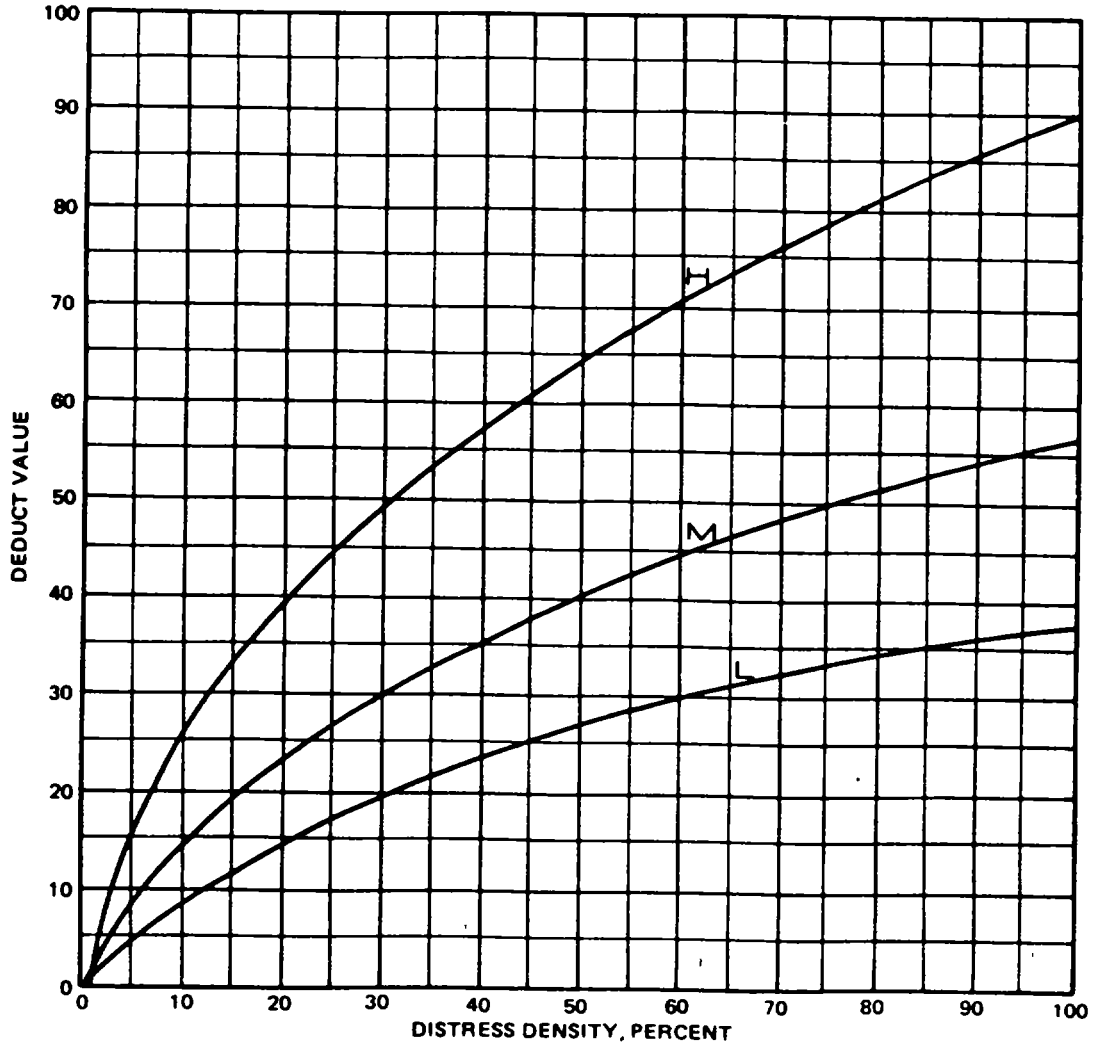

Figure 5-12. Rigid pavement deduct values, distress 71, settlement.

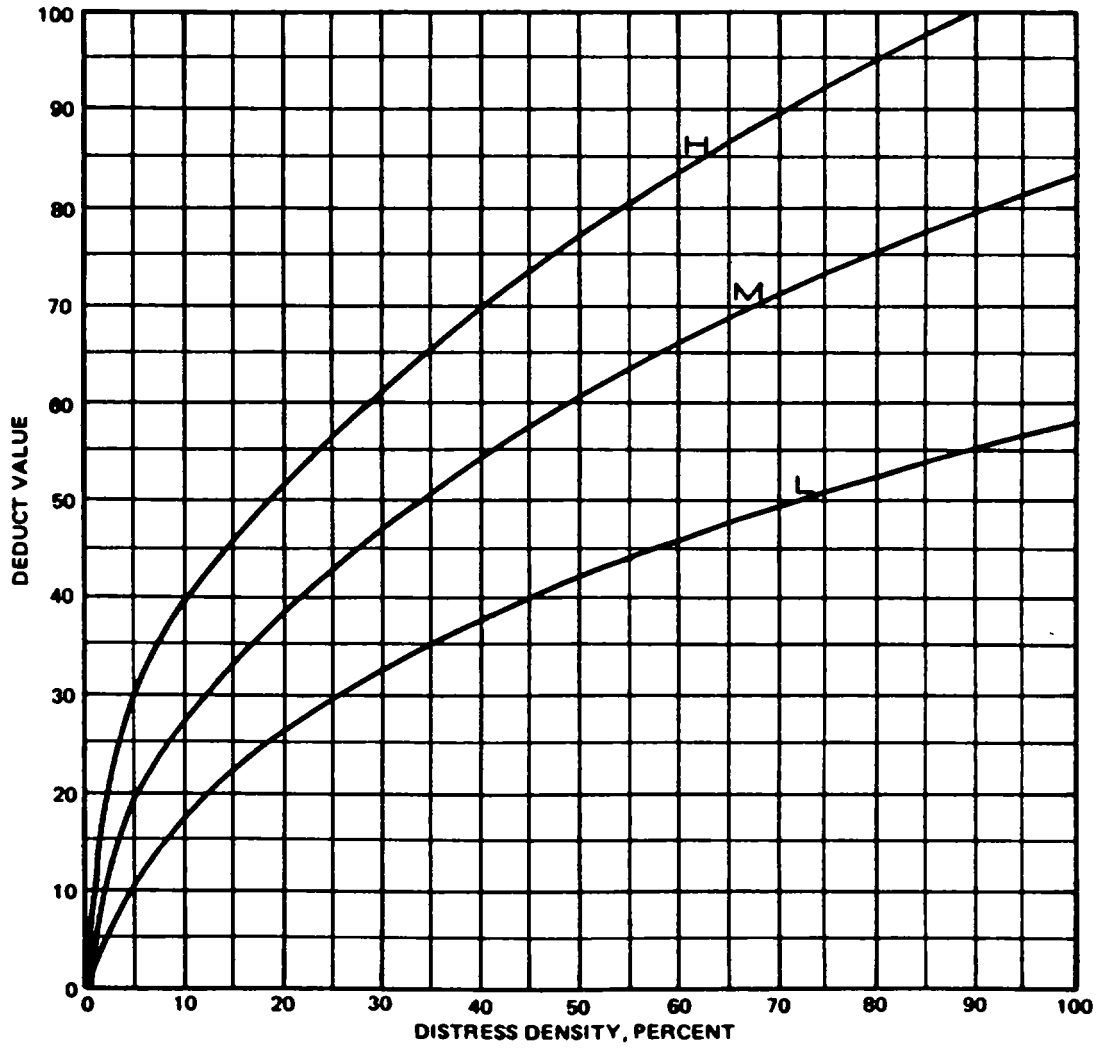

Figure 5-13. Rigid pavement deduct values, distress 72, shattered slab.

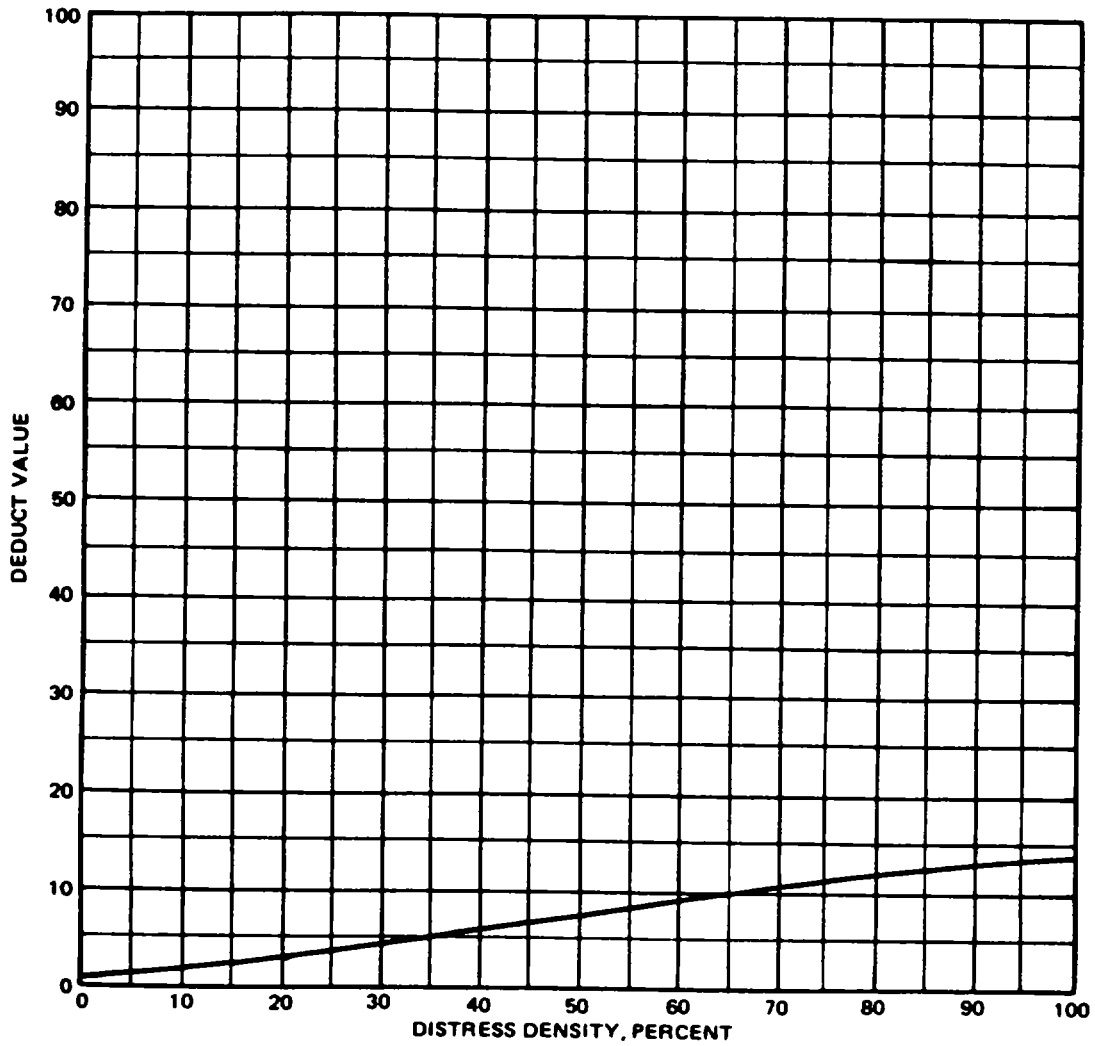

Figure 5-14. Rigid pavement deduct values, distress 7R shrinkage cracks.

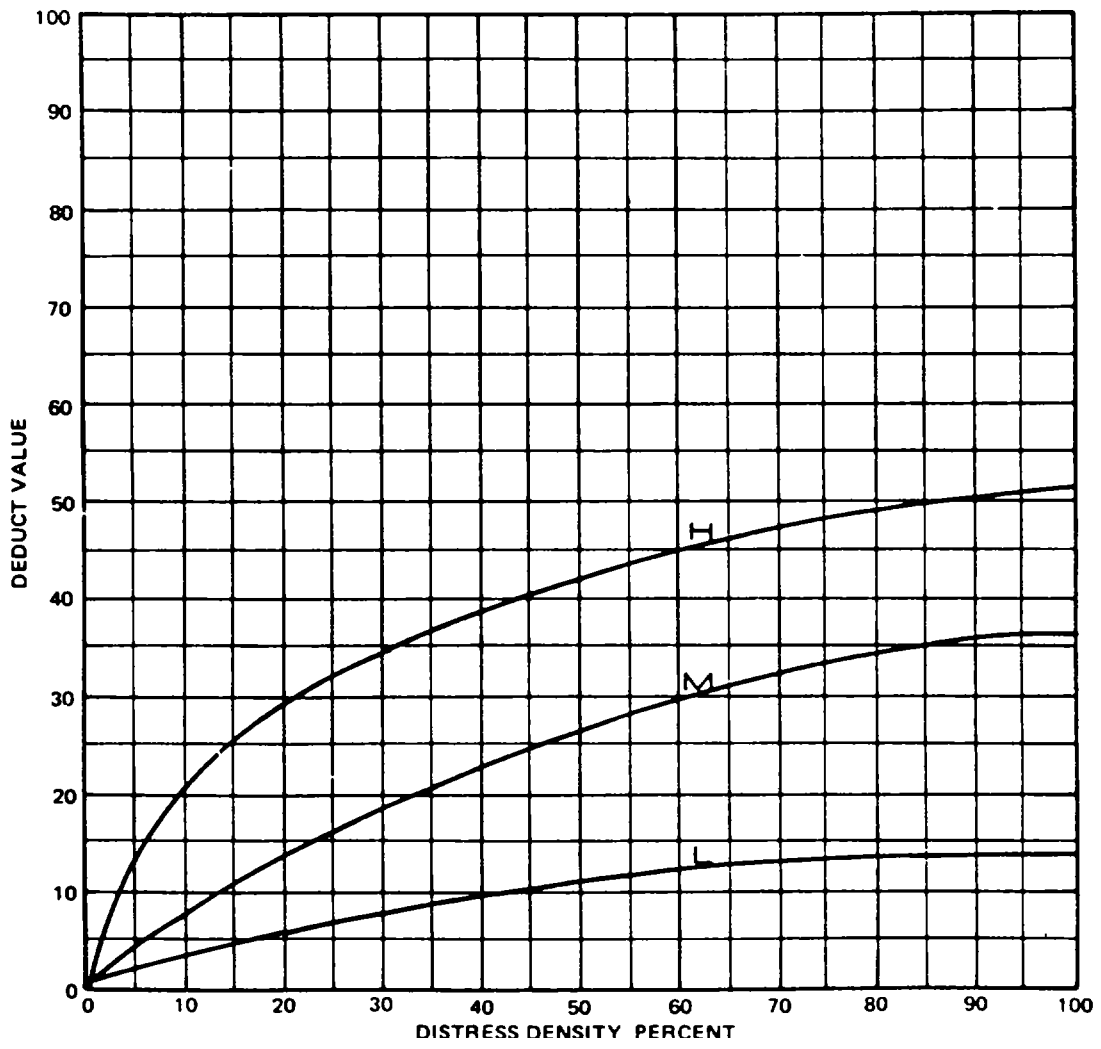

Figure 5-15. Rigid pavement deduct values, distress 74, spalling along the joints.

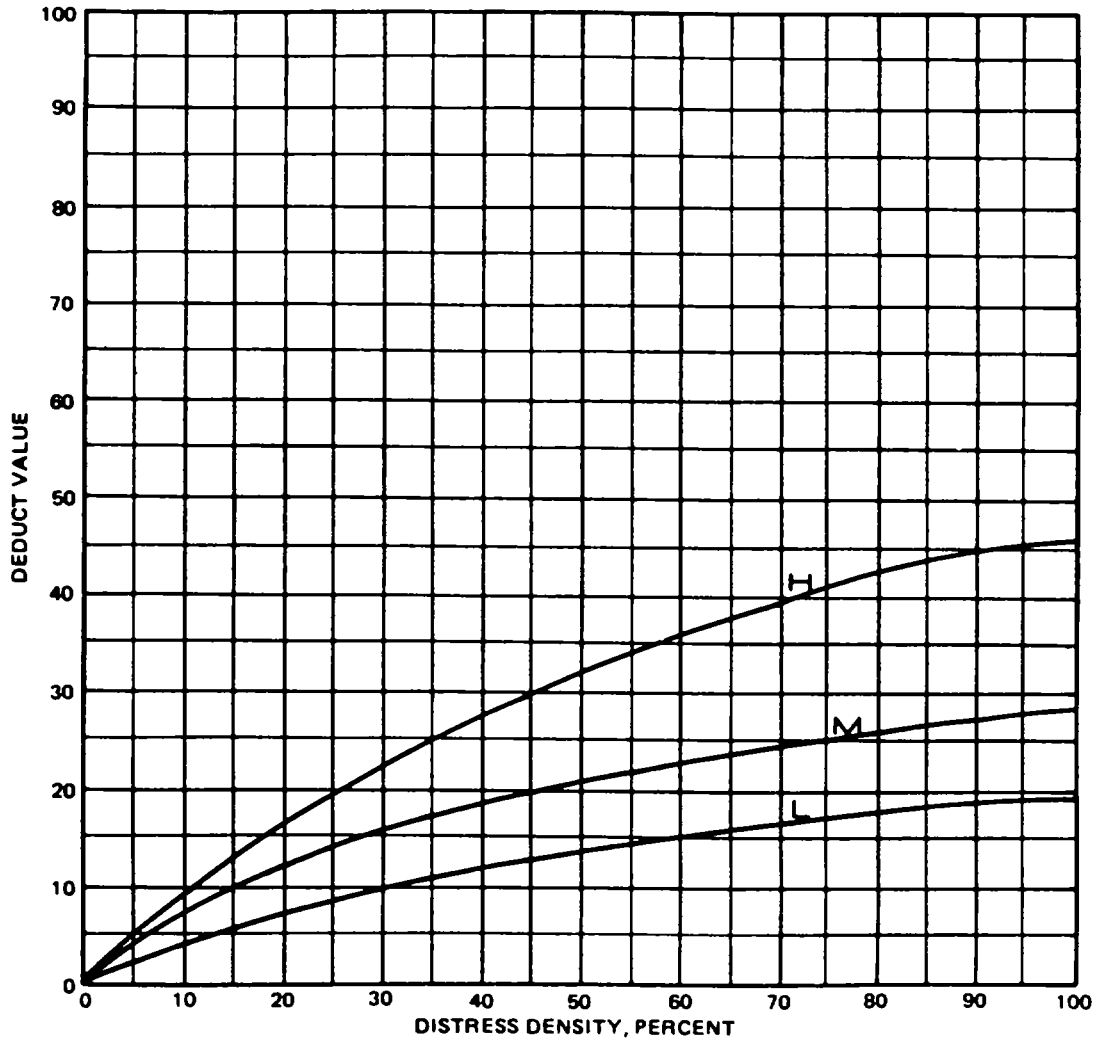

Figure 5-16. Rigid pavement deduct values, distress 75, spalling corner.

5-3. Sample unit PCI. Noting the number of individual deduct values that are greater than 5, one must consult figure 5-17 to obtain the CDV. The PCI is then calculated and the rating (from fig. 5-18) is entered on the jointed rigid pavement survey data sheet (fig. 5-1). If the CDV for a sample unit is less than the highest individual distress value, the highest value should be used in determining the PCI.

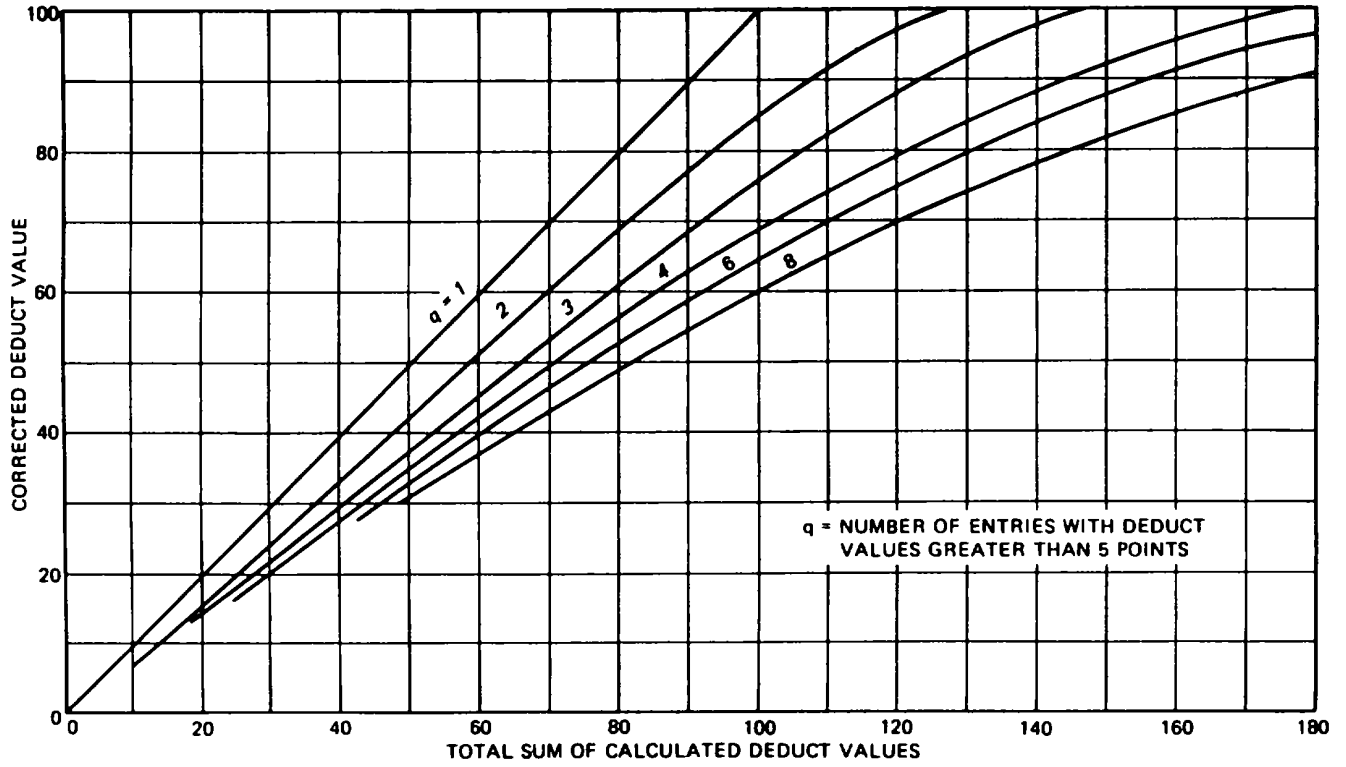

Figure 5-17. Corrected deduct values for jointed rigid pavements.

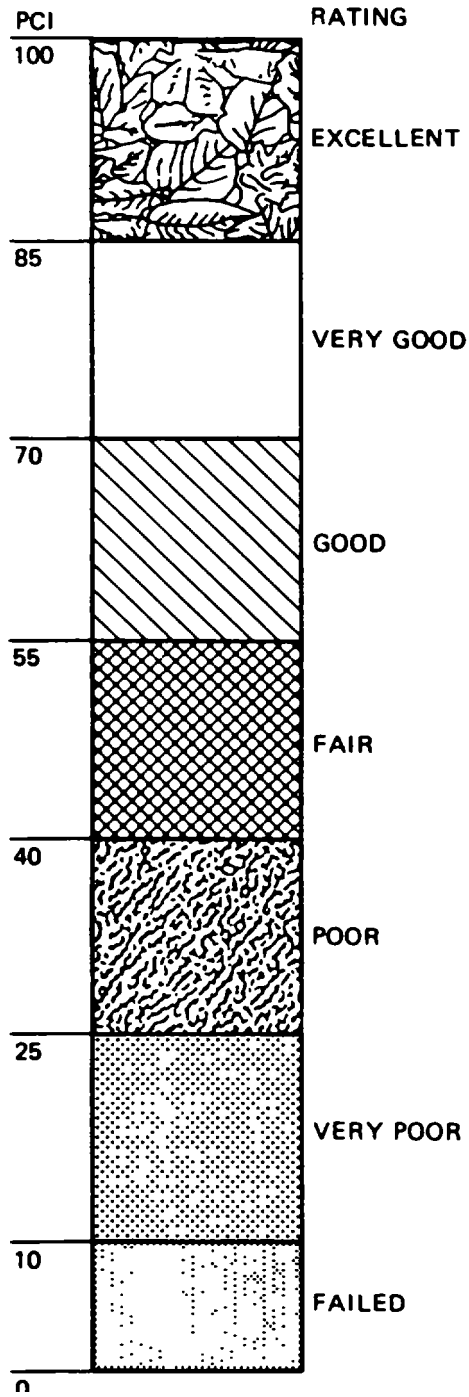

Figure 5-18. Airfield PCI and rating.

5-4. Feature PCI. The PCI's of all sample units in a feature are compiled into a feature summary, as shown in figure 5-19. The overall condition rating of the feature is determined by using the mean PCI and figure 5-18.

Airfield: World International

Airfield Facility: Taxiway 1

Total No. of Sample Units: 5

Date of Survey: 15 March 1979

<u>Sample Unit No.</u>	<u>No. of Slabs</u>	<u>Slab Size</u>	<u>PCI</u>
1	20	12.5 x 15	68
2	20	12.5 x 15	64
3	20	12.5 x 15	64
4	20	12.5 x 15	74
5	20	12.5 x 15	28

<u>Sample Unit No.</u>	<u>No. of Slabs</u>	<u>Slab Size</u>	<u>PCI</u>

Average PCI for Feature: 62

Condition Rating: Good

Figure 5-19. Feature summary, jointed rigid pavement.

CHAPTER 6

DETAILED PROCEDURE FOR FLEXIBLE PAVEMENT

6-1. Sample unit inspection and record keeping. Each sample unit, or those selected by the sampling procedure, in the feature is inspected. The inspection is conducted by walking over the sample unit measuring the distress type and severity, as stated in appendix A, and recording the data on the flexible pavement survey data sheet (fig. 6-1). One data sheet is used for each sample unit. A hand odometer is very helpful for measuring distress. A 10-foot straightedge and 12-inch scale must be available for measuring depths of ruts or depressions. Each column on the data sheet is used to represent a distress type, and the amount and severity of each distress located are listed in the column. For example, distress No. 45 (depression) is recorded at 6 X 4 feet and of low severity. Distress No. 48 (longitudinal and transverse cracking) is measured in linear feet; thus 10L indicates 10 feet of light cracking. This procedure is very convenient for recording data in the field.

6-2. Inspection summary. Space is provided on the flexible pavement survey data sheet for summarizing the distresses and computing the PCI for the sample unit. Each distress type and severity level are summed either in square feet or linear feet, depending on the type of distress. The total units, either in square feet or linear feet, for each distress type and severity level are divided by the area of the sample unit to obtain the percent density. Using figures 6-2 through 6-17, the deduct value for each distress type and severity level can be determined. The deduct values are summed to obtain the deduct total.

FLEXIBLE PAVEMENT CONDITION SURVEY DATA SHEET FOR SAMPLE UNIT																							
AIRPORT WORLD INTERNATIONAL					DATE 5/26/79																		
FACILITY TXY E		FEATURE T-11		SAMPLE UNIT 4																			
SURVEYED BY JH/DE			AREA OF SAMPLE 5000 SQ FT																				
<p style="text-align: center;"><u>DISTRESS TYPES</u></p> <table style="width:100%; border: none;"> <tr> <td style="width: 50%;">41 ALLIGATOR CRACKING</td> <td style="width: 50%;">50 PATCHING</td> </tr> <tr> <td>42 BLEEDING</td> <td>51 POLISHED AGGREGATE</td> </tr> <tr> <td>43 BLOCK CRACKING</td> <td>52 RAVELING/WEATHERING</td> </tr> <tr> <td>44 CORRUGATION</td> <td>53 RUTTING</td> </tr> <tr> <td>45 DEPRESSION</td> <td>54 SHOIVING FROM PCC</td> </tr> <tr> <td>46 JET BLAST</td> <td>55 SLIPPAGE CRACKING</td> </tr> <tr> <td>47 JT REFLECTION (PCC)</td> <td>56 SWELL</td> </tr> <tr> <td>48 LONG & TRANS CRACKING</td> <td></td> </tr> <tr> <td>49 OIL SPILLAGE</td> <td></td> </tr> </table>			41 ALLIGATOR CRACKING	50 PATCHING	42 BLEEDING	51 POLISHED AGGREGATE	43 BLOCK CRACKING	52 RAVELING/WEATHERING	44 CORRUGATION	53 RUTTING	45 DEPRESSION	54 SHOIVING FROM PCC	46 JET BLAST	55 SLIPPAGE CRACKING	47 JT REFLECTION (PCC)	56 SWELL	48 LONG & TRANS CRACKING		49 OIL SPILLAGE		<p style="text-align: center;"><u>SKETCH</u></p>		
41 ALLIGATOR CRACKING	50 PATCHING																						
42 BLEEDING	51 POLISHED AGGREGATE																						
43 BLOCK CRACKING	52 RAVELING/WEATHERING																						
44 CORRUGATION	53 RUTTING																						
45 DEPRESSION	54 SHOIVING FROM PCC																						
46 JET BLAST	55 SLIPPAGE CRACKING																						
47 JT REFLECTION (PCC)	56 SWELL																						
48 LONG & TRANS CRACKING																							
49 OIL SPILLAGE																							
EXISTING DISTRESS TYPES																							
TOTAL SEVERITY	L	41	45	48	52																		
		4 X 4 M	6 X 4 L	10 L	3 X 10 M																		
		2 X 3 L		5 L																			
				15 L																			
				5 M																			
				10 L																			
				5 M																			
	M	6 SQ FT	24 SQ FT	40 FT	30 SQ FT																		
	H																						
PCI CALCULATION																							
DISTRESS TYPE	SEVERITY	DENSITY %	DEDUCT VALUE	<p>PCI = 100 - CDV = <u>75</u></p> <p>RATING = <u>VERY GOOD</u></p>																			
41	L	0 22	7																				
41	M	0 32	19																				
45	L	0 48	2																				
48	L	0 80	5																				
48	M	0 20	5																				
52	M	0 60	7																				
DEDUCT TOTAL			45																				
CORRECTED DEDUCT VALUE (CDV)			25																				

Figure 6-1. Flexible pavements, example condition survey data sheet.

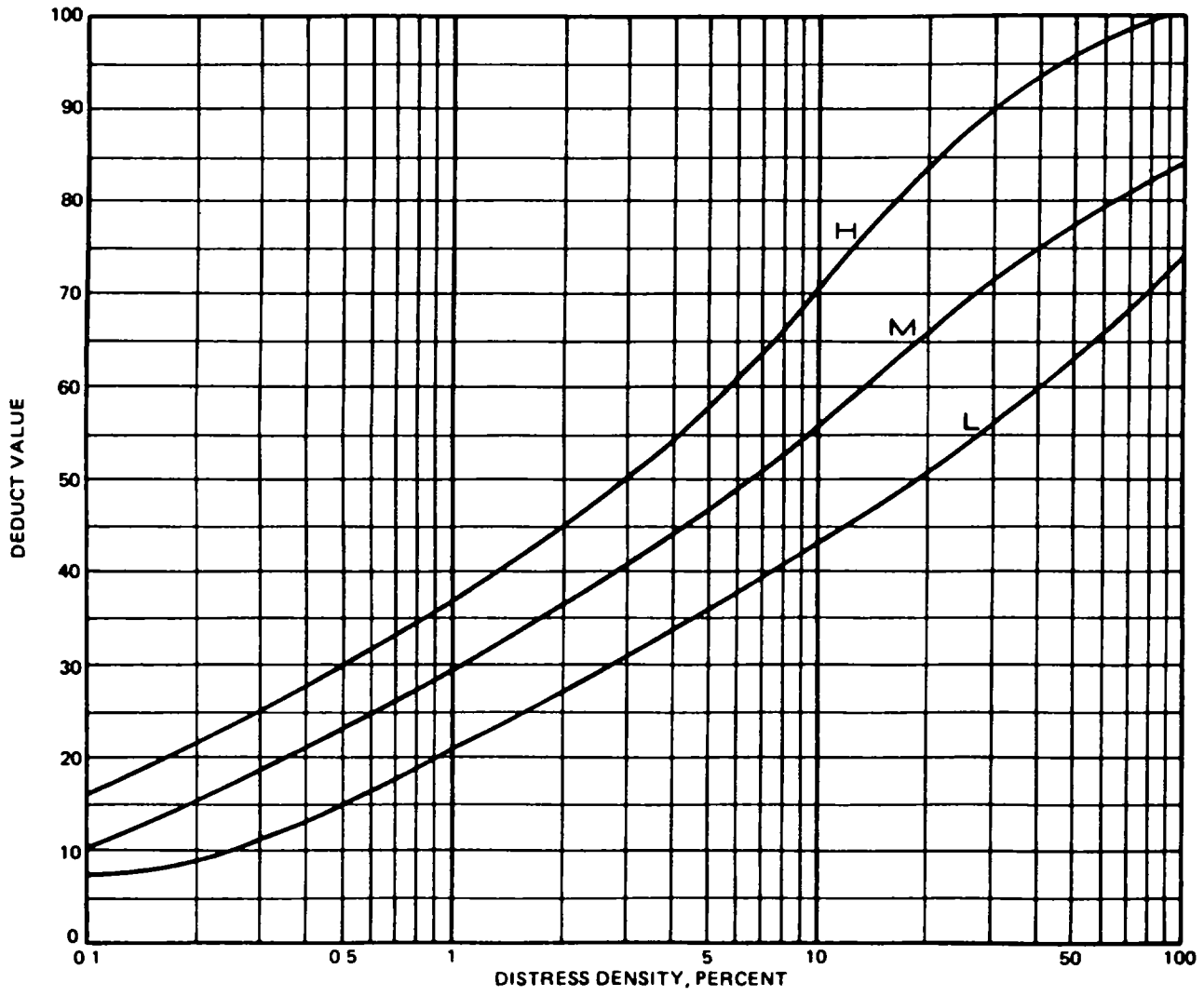

Figure 6-2. Flexible pavement deduct values, distress 41, alligator cracking.

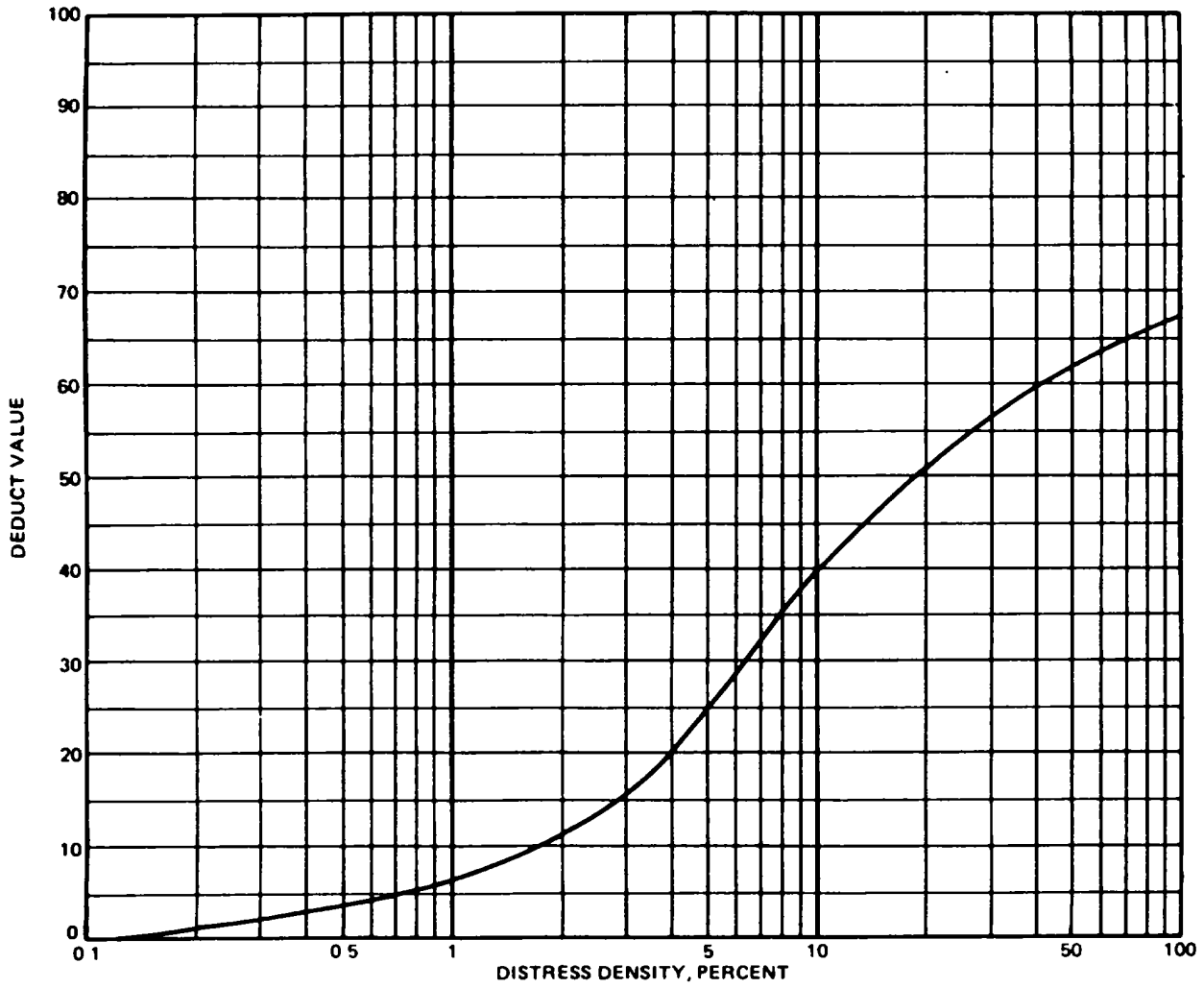

Figure 6-3. Flexible pavement deduct values, distress 42, bleeding.

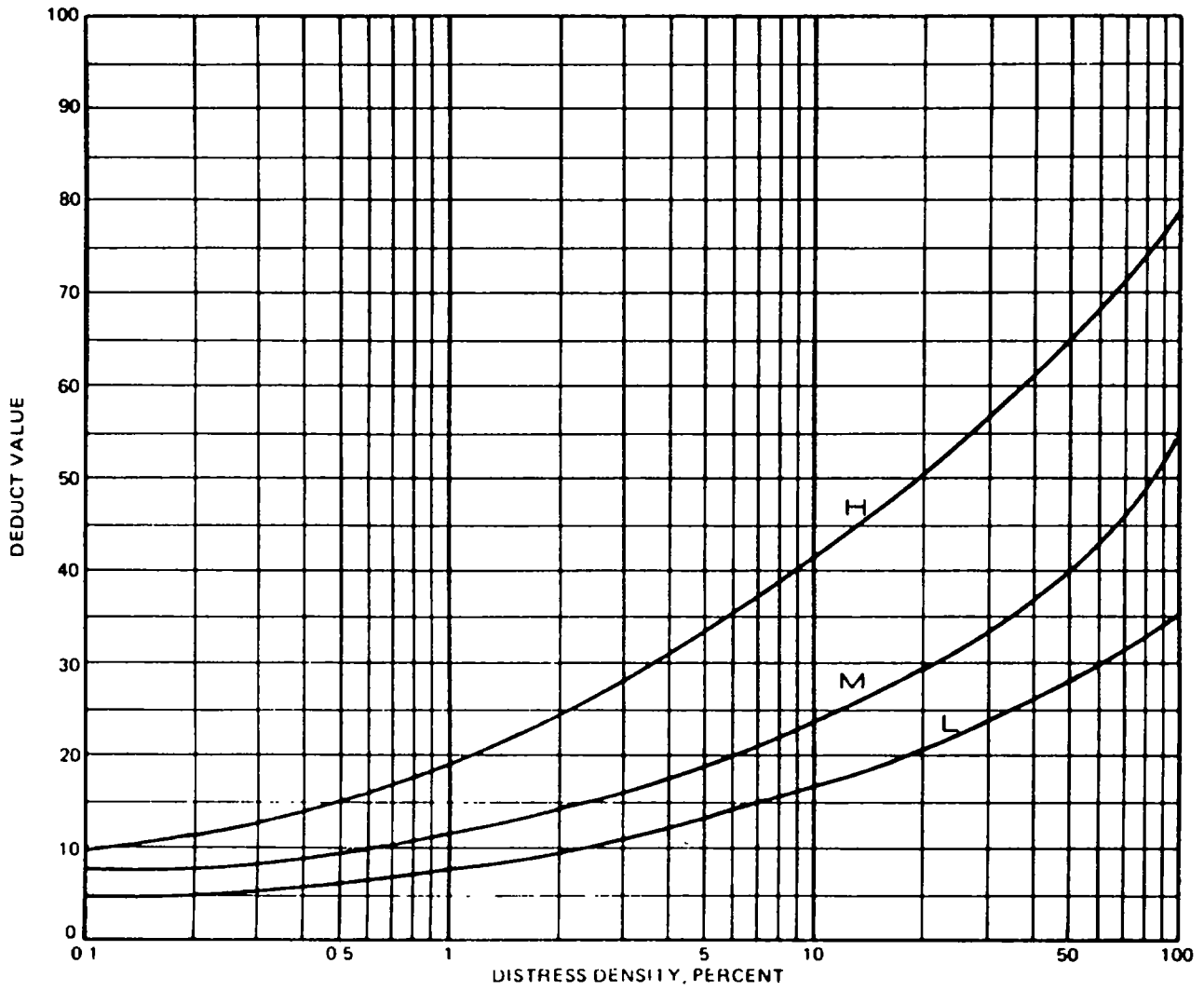

Figure 6-4. Flexible pavement deduct values, distress 43 block cracking.

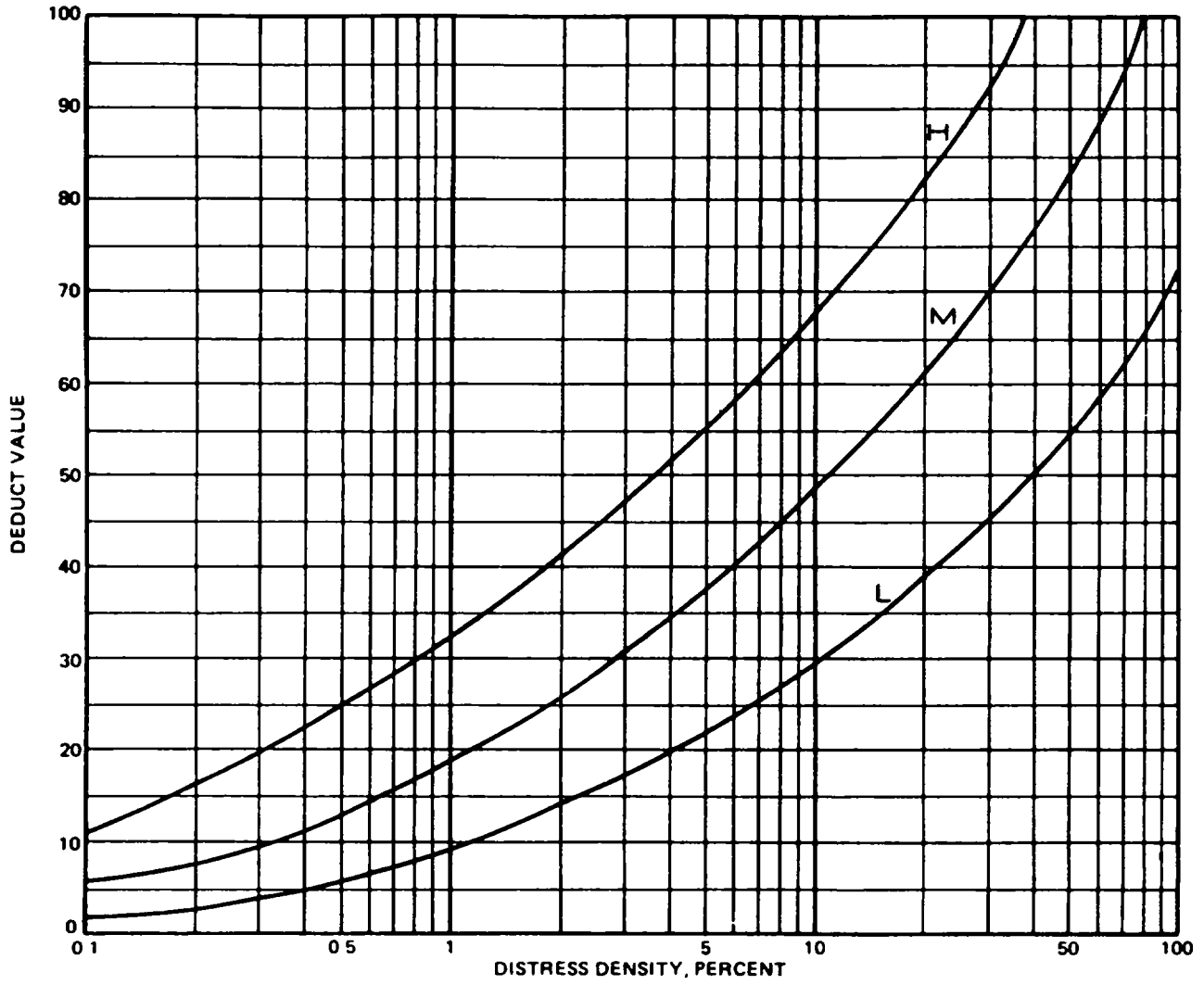

Figure 6-5. Flexible pavement deduct values, distress 44, corrugation.

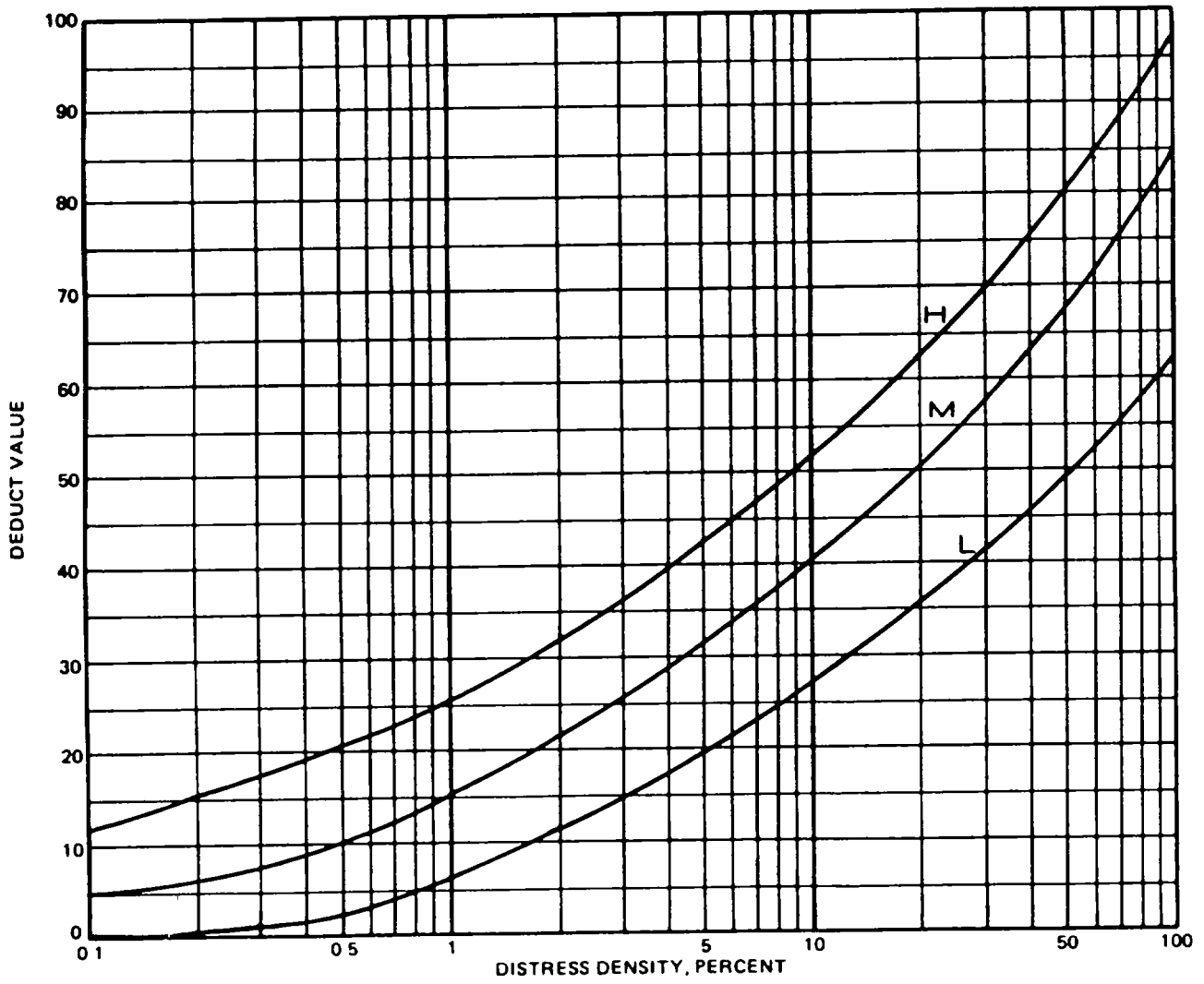

Figure 6-6. Flexible pavement deduct values, distress 45, depression.

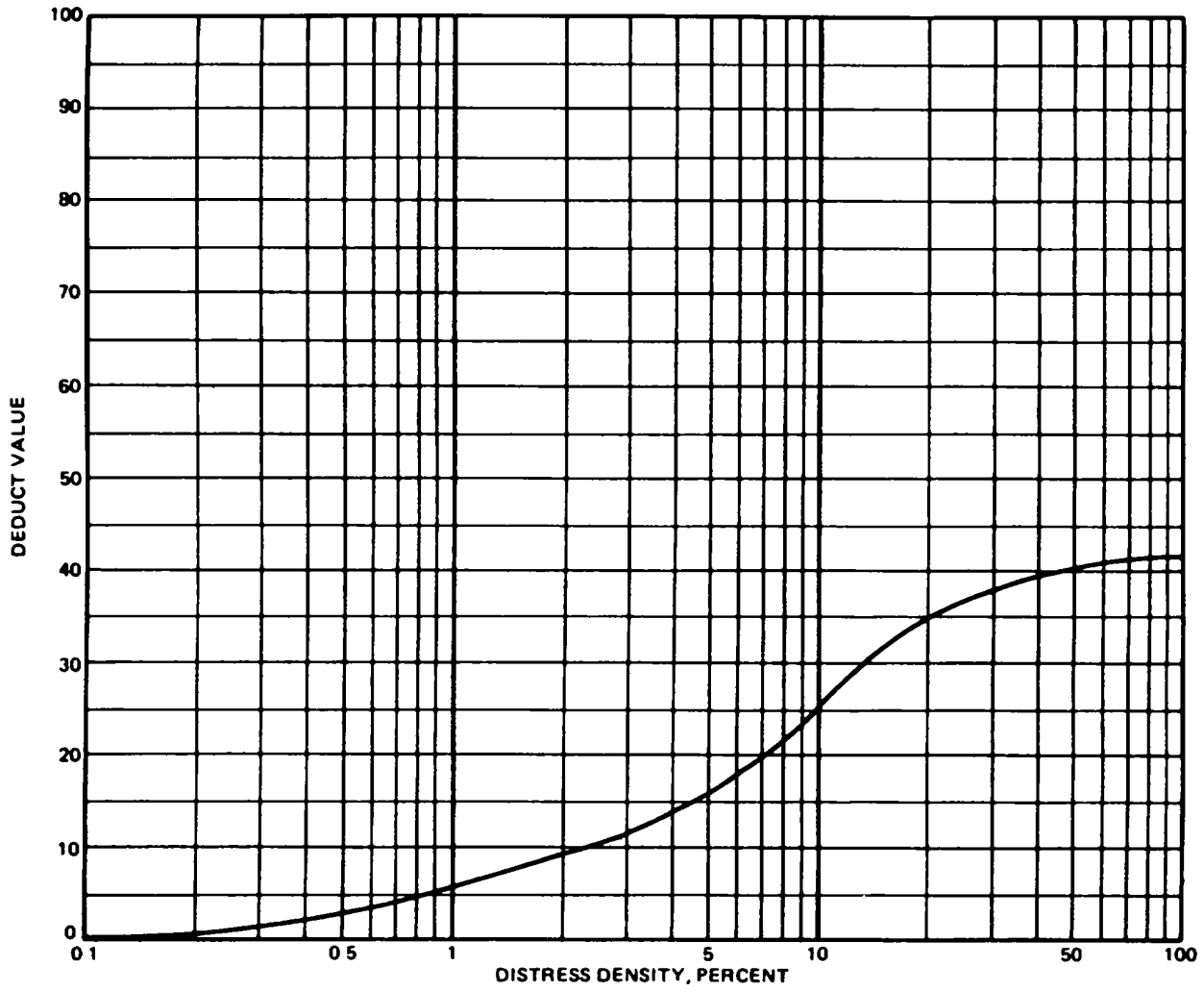

Figure 6-7. Flexible pavement deduct values, distress 46, jet blast erosion.

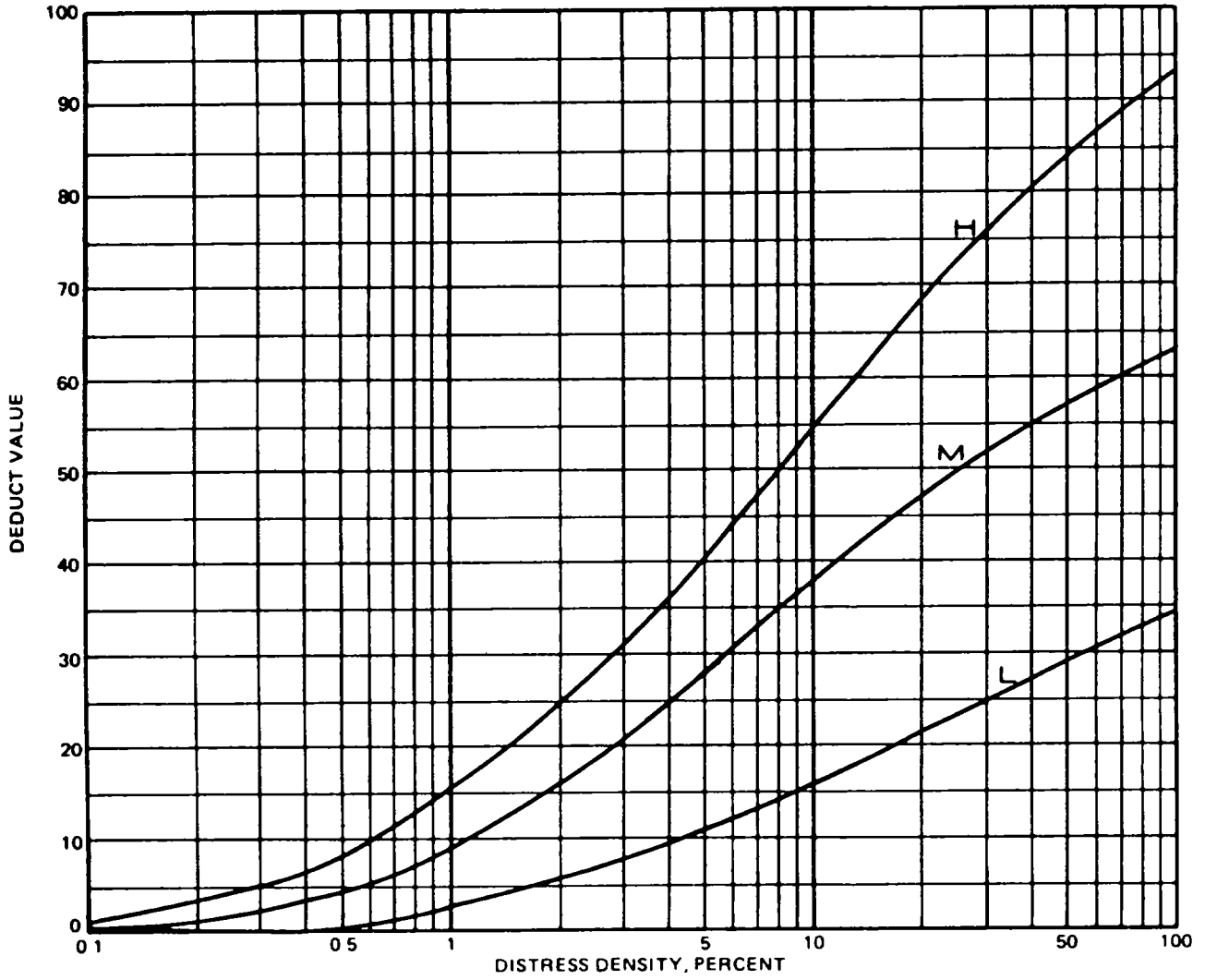

Figure 6-8. Flexible pavement deduct values, distress 47, Joint reflective cracking.

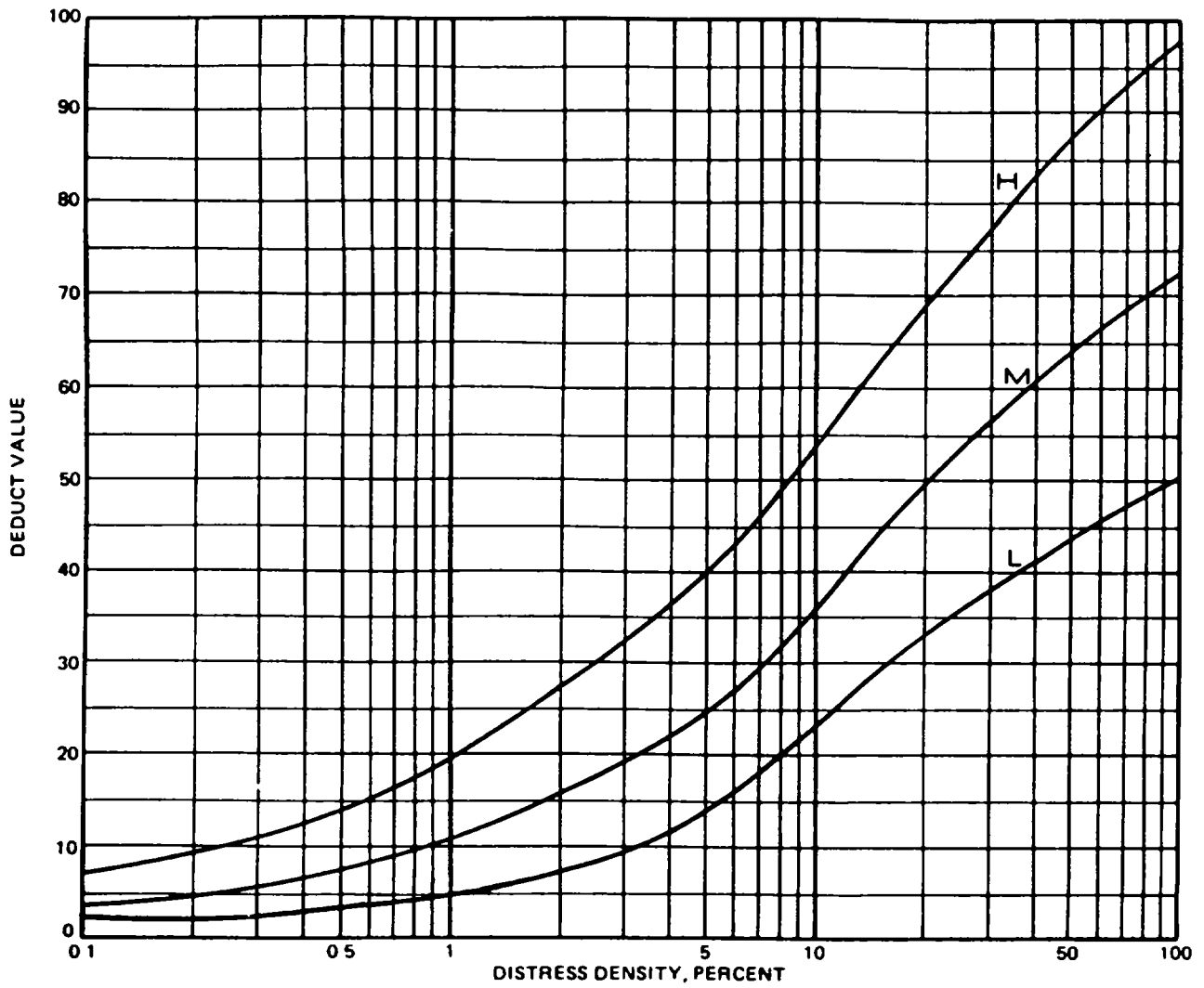

Figure 6-9. Flexible pavement deduct values, distress 48, longitudinal and transverse cracking.

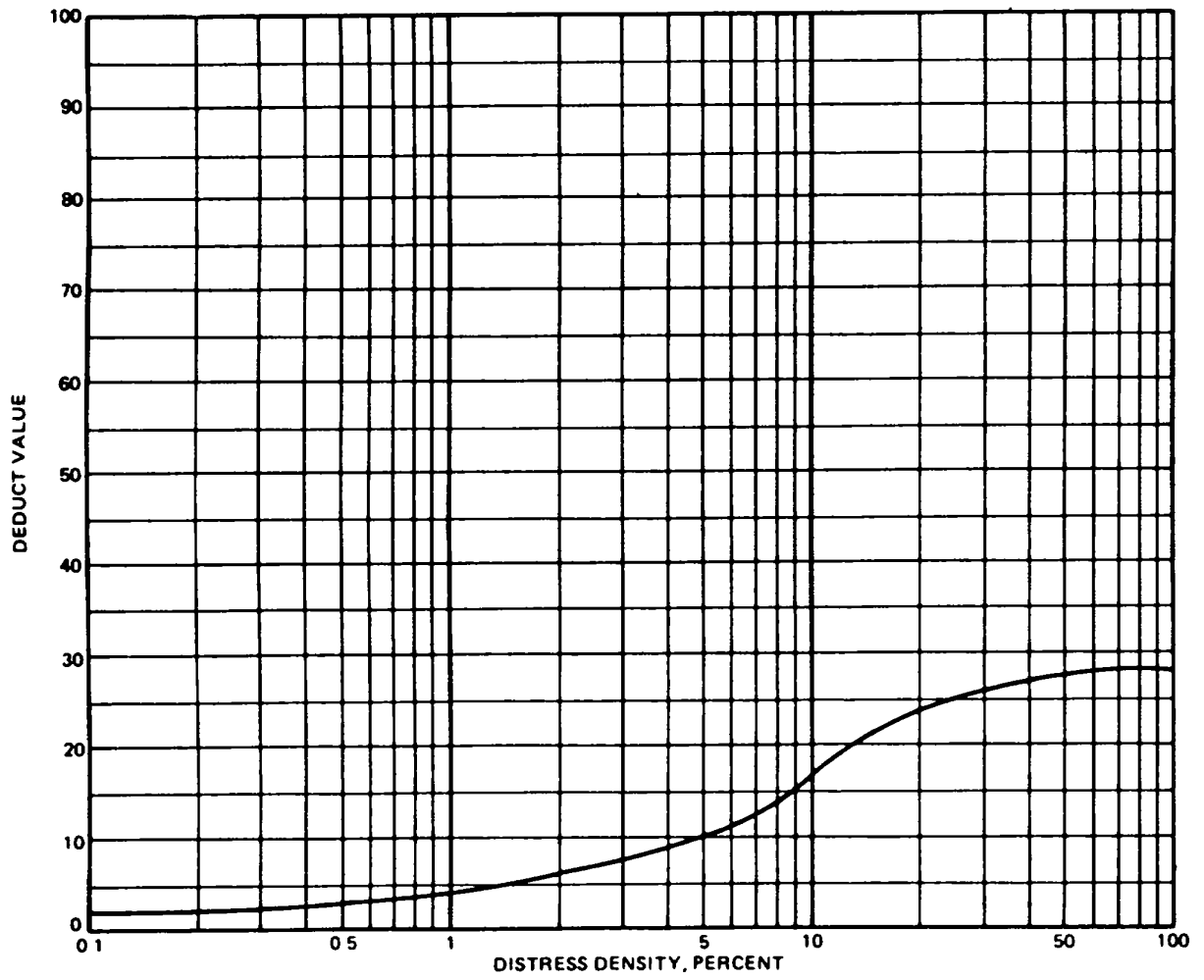

Figure 6-10. Flexible pavement deduct values, distress 49, oil spillage.

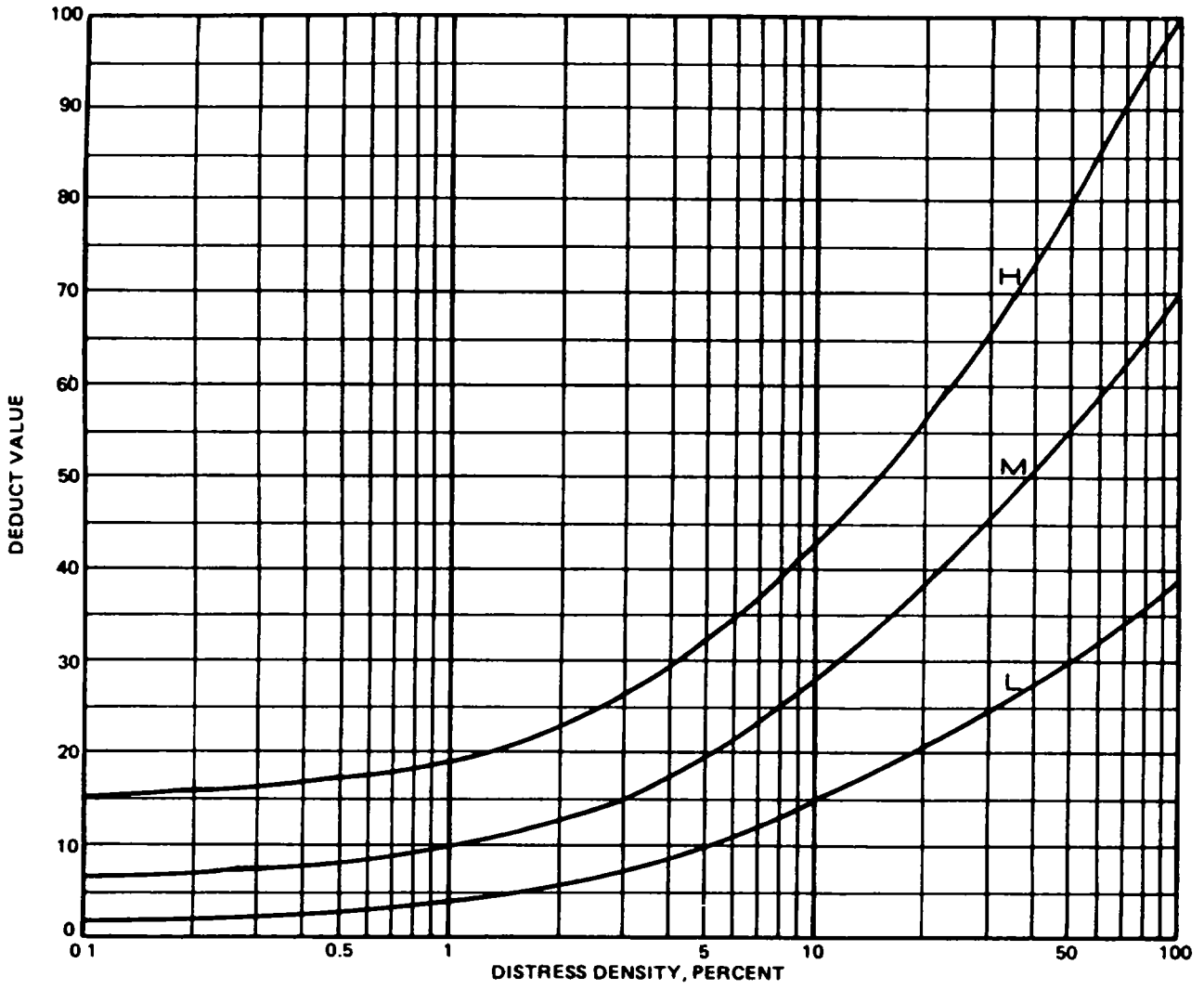

Figure 6-11. Flexible pavement deduct values, distress 50, patching and utility cut.

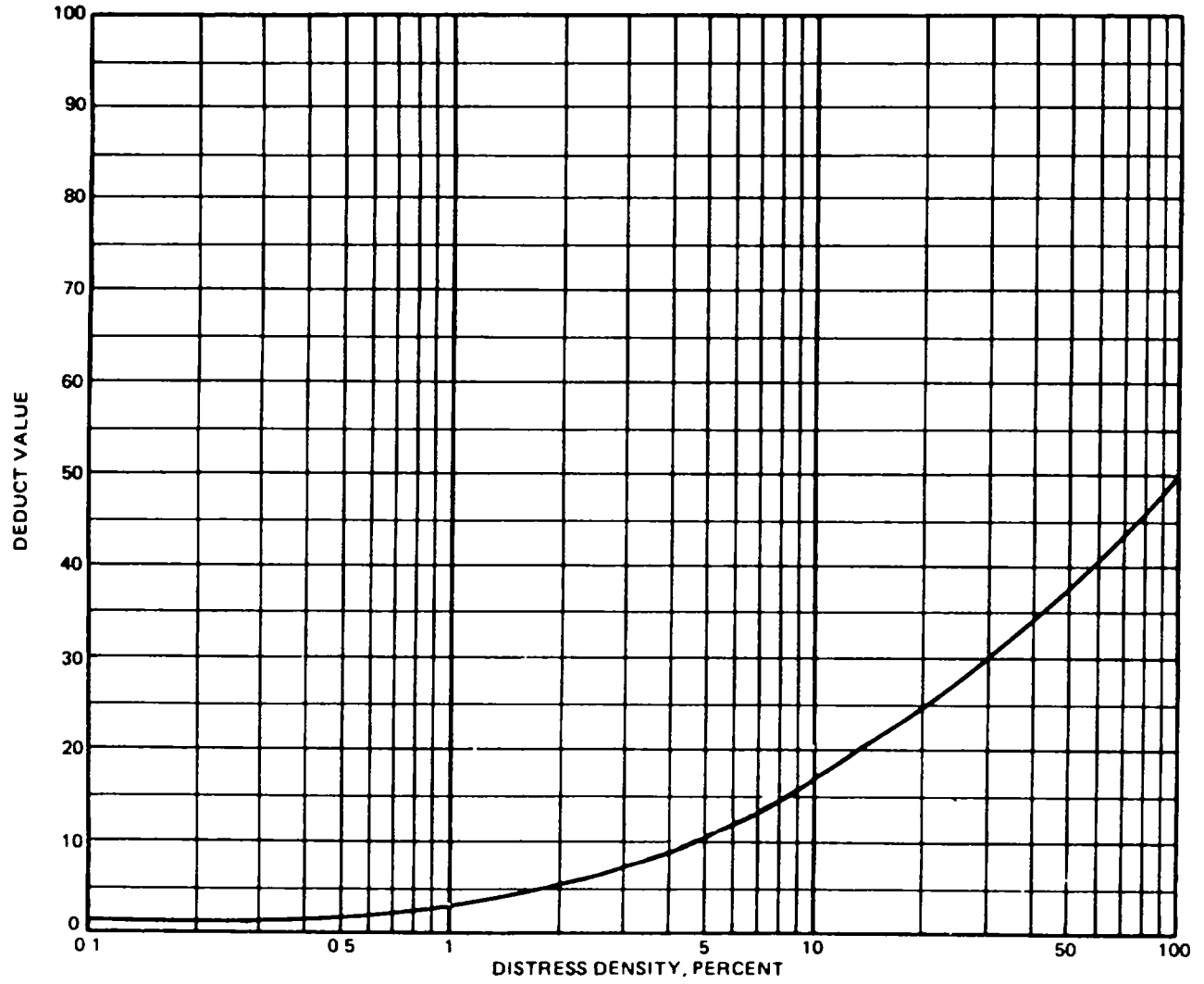

Figure 6-12. Flexible pavement deduct values, distress 51, polished aggregate.

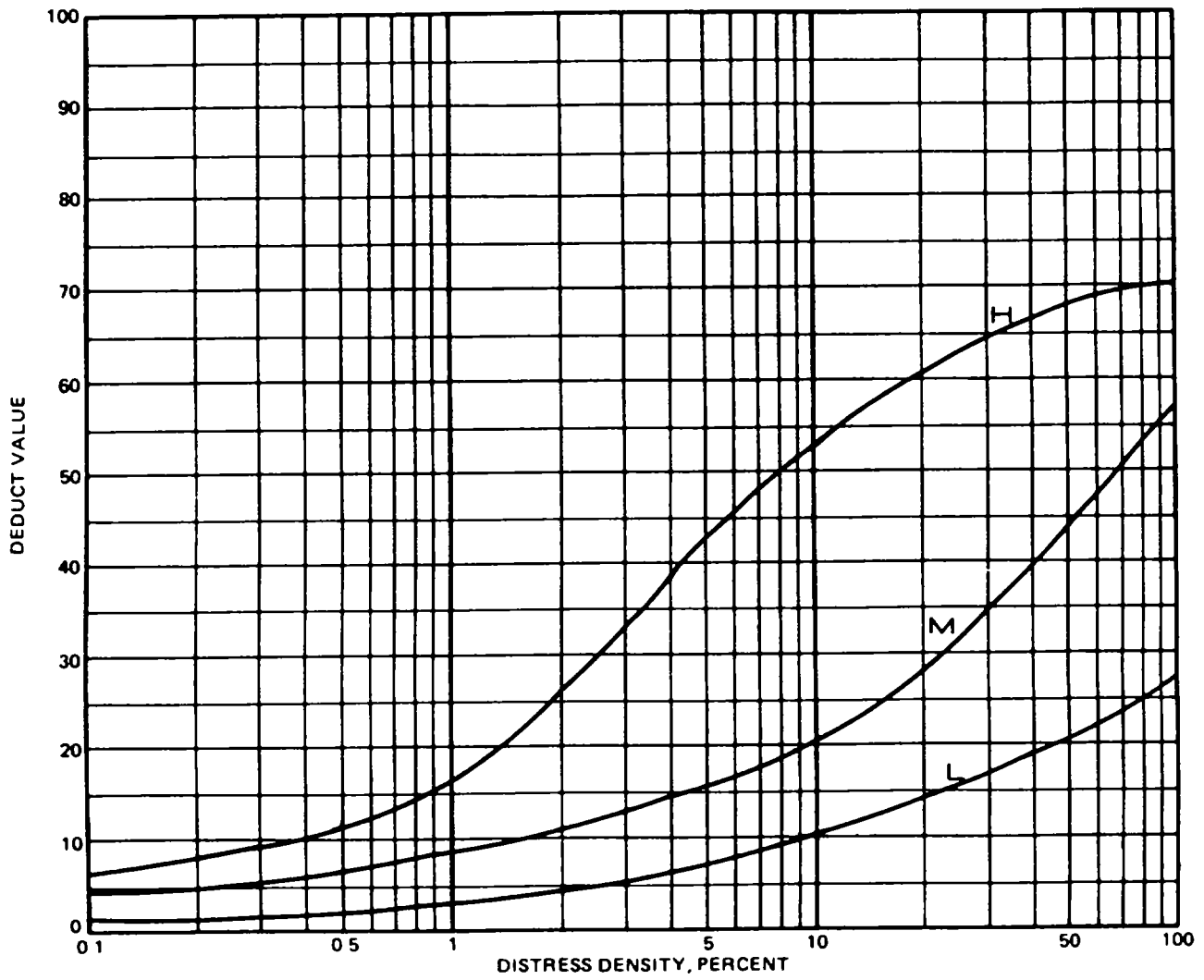

Figure 6-13. Flexible pavement deduct values, distress 52, raveling/weathering.

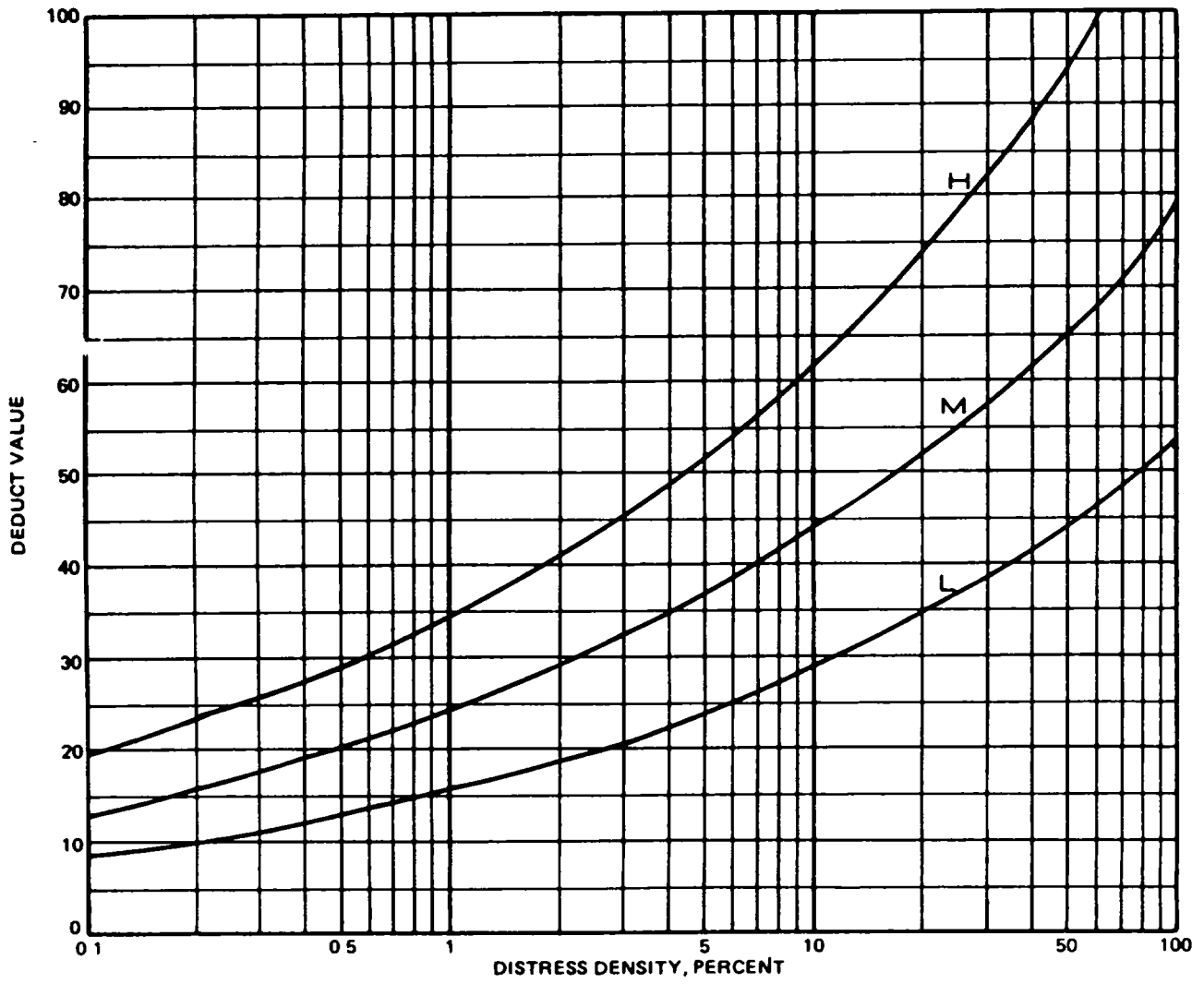

Figure 6-14. Flexible pavement deduct values, distress 53, rutting.

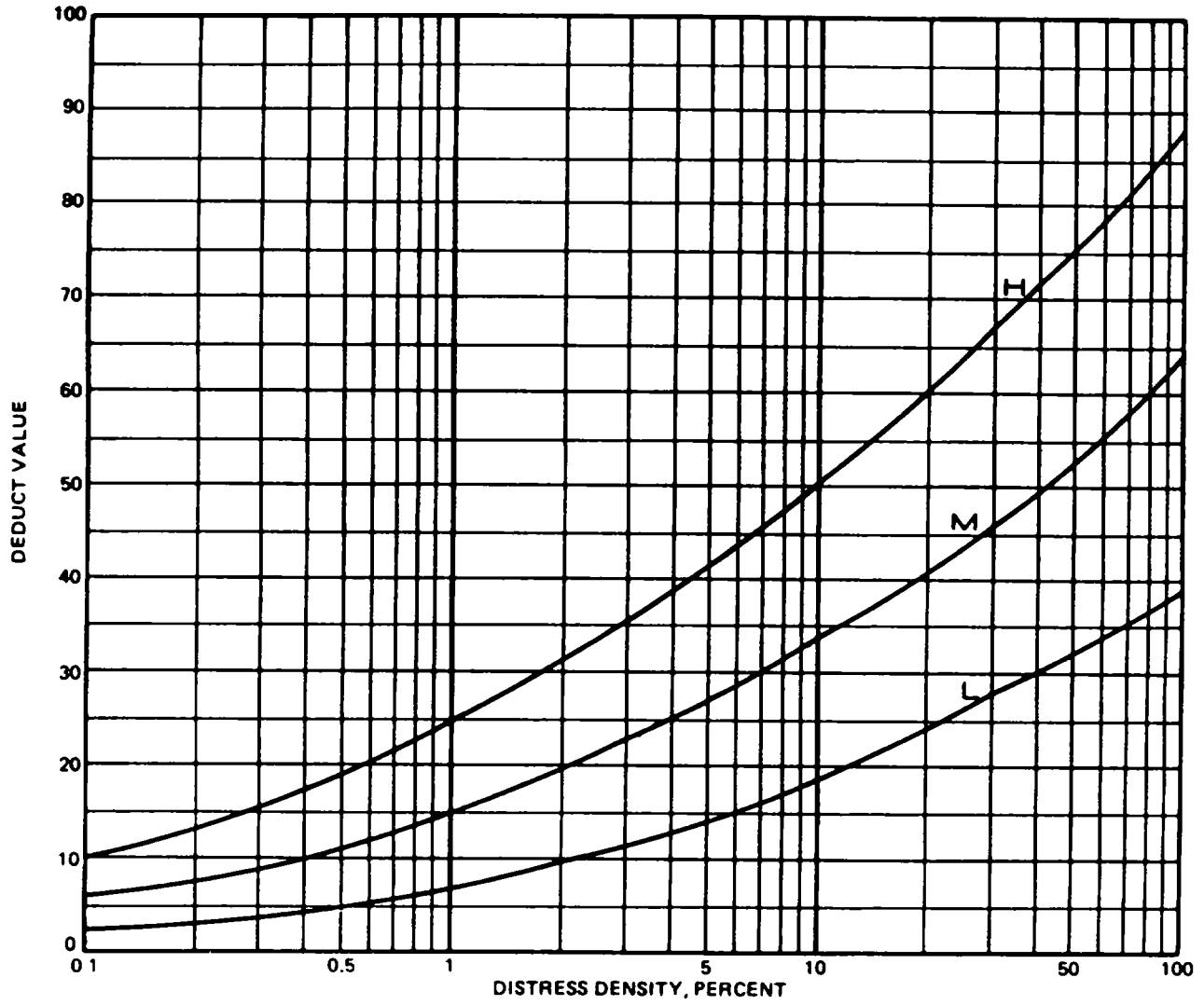

Figure 6-15. Flexible pavement deduct values, distress 54, shoving of flexible pavement by PCC slabs.

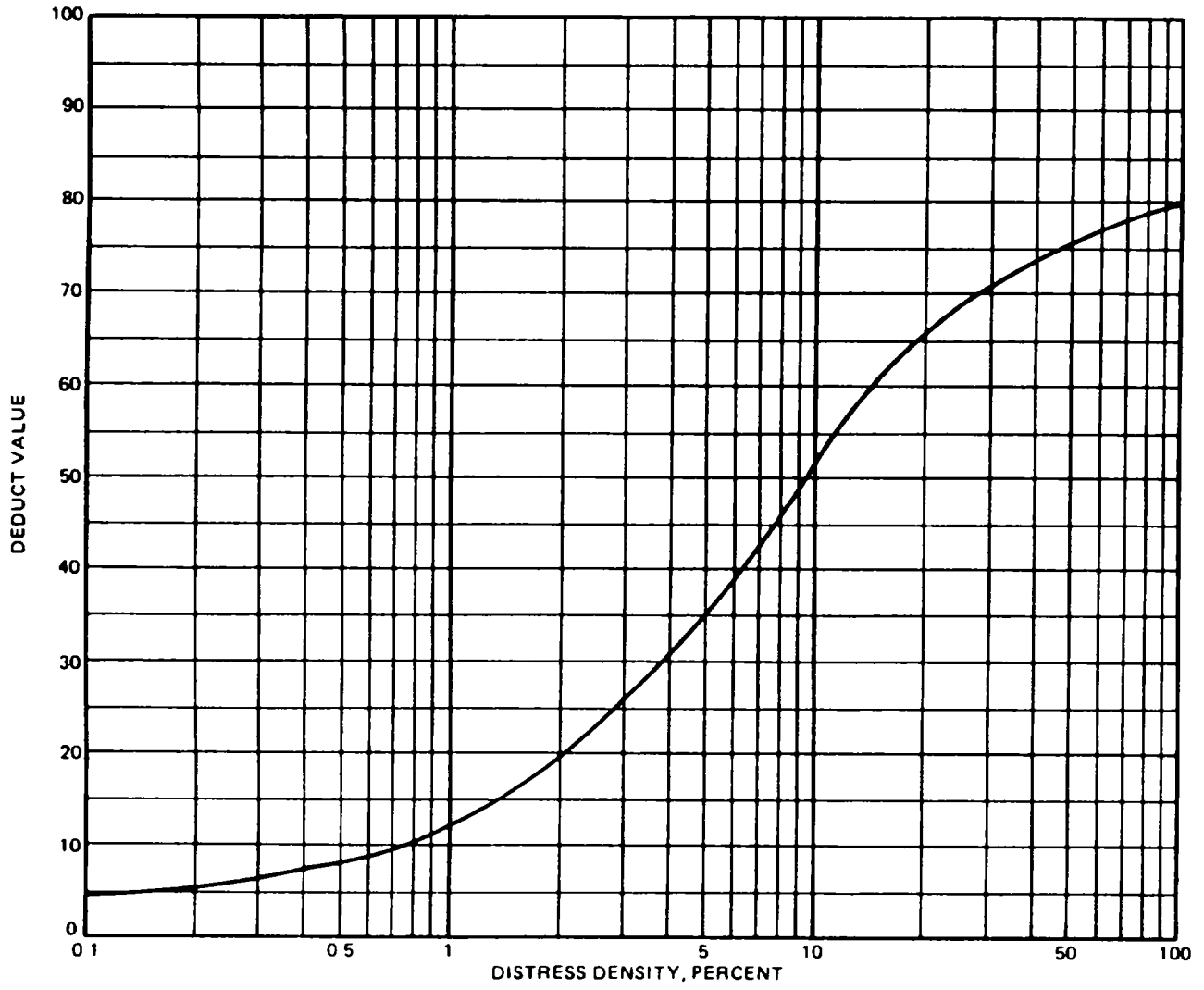

Figure 6-16. Flexible pavement deduct values, distress 55, slippage cracking.

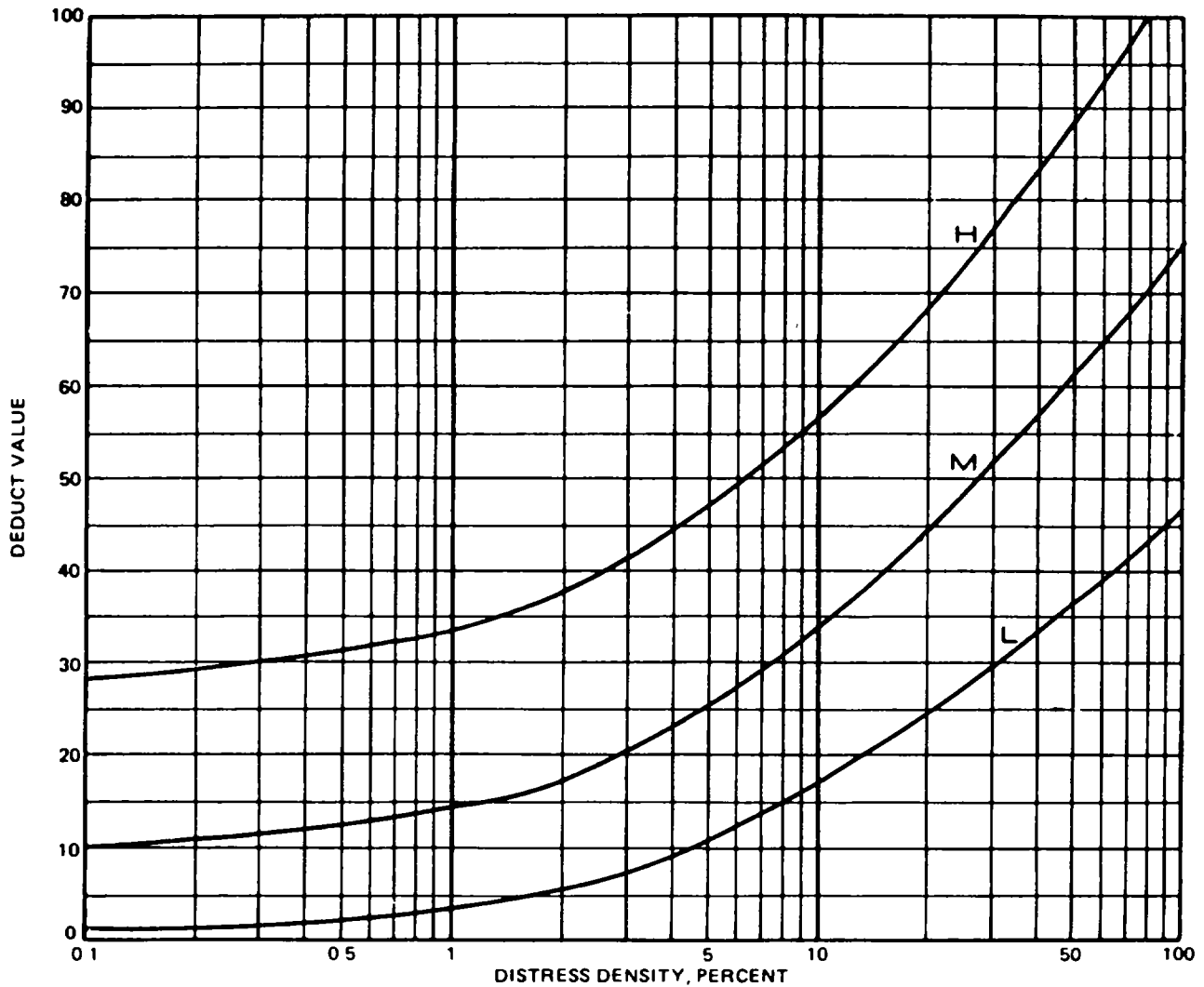

Figure 6-17. Flexible pavement deduct values, distress 56, swell.

6-3. Sample unit PCI. For each sample unit inspected, note how many individual deduct values are greater than 5, and use figure 6-18 to obtain the sample unit CDV. The sample unit PCI is then calculated, and the rating (from fig. 5-18) is entered on the flexible pavement survey data sheet. If the CDV for a sample unit is less than the highest individual distress deduct value, the highest value should be used in determining the PCI.

6-4. Feature PCI. The PCI's of all sample units inspected in a feature are compiled into a feature summary, as shown in figure 6-19. The mean PCI of the feature is then determined by averaging the individual sample unit PCI's. The overall condition rating of the feature is determined by using the mean PCI and figure 5-18.

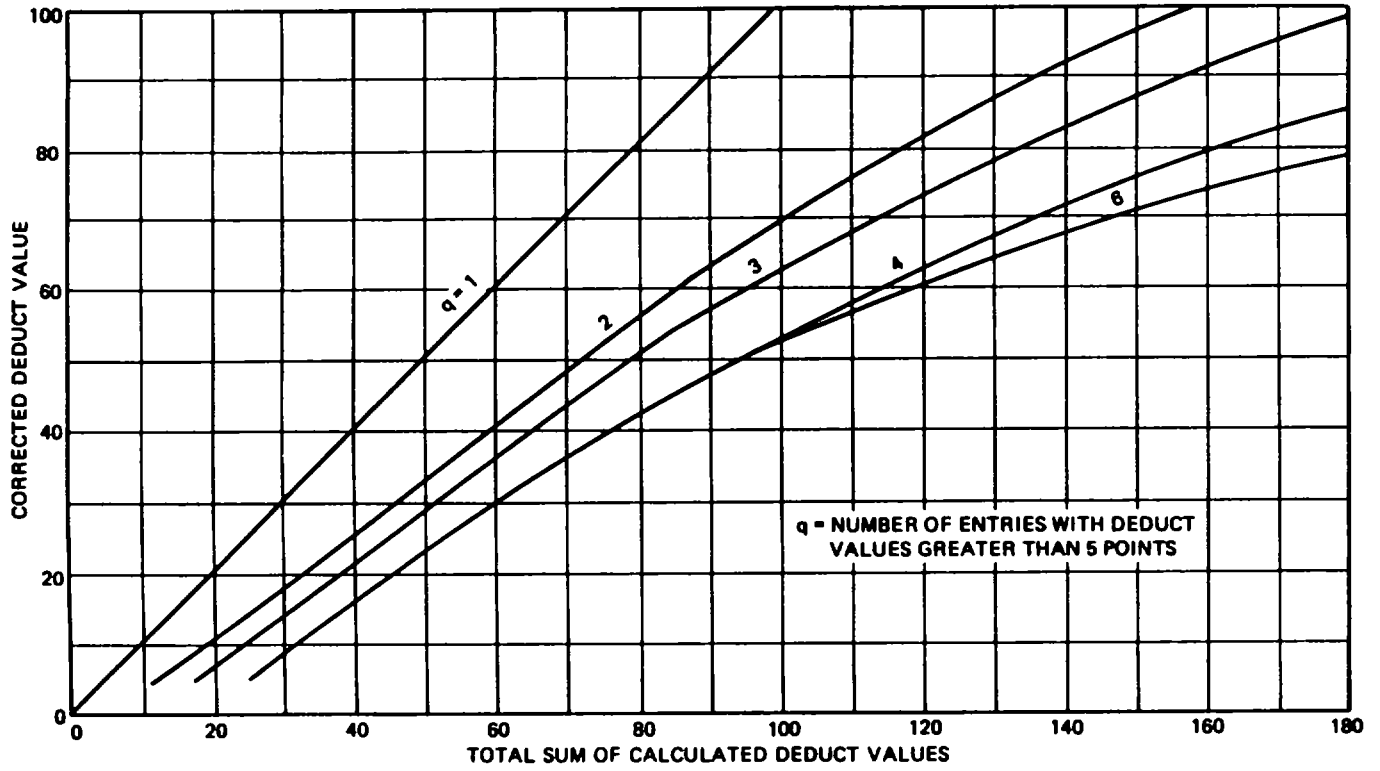

Figure 6-18. Corrected deduct values for flexible pavements.

Airfield: World International

Airfield Facility: Taxiway 5

Total No. of Sample Units: 25

Date of Survey: 26 March 1979

<u>Sample Unit No.</u>	<u>Sample Unit Area, ft²</u>	<u>PCI</u>
1	5000	42
2	5000	33
3	5000	53
4	5000	39
5	5000	23
6	5000	25
7	5000	36
8	5000	38
9	5000	35
10	5000	25
11	5000	32
12	5000	45
13	5000	40
14	5000	55
15	5000	46

<u>Sample Unit No.</u>	<u>Sample Unit Area, ft²</u>	<u>PCI</u>
16	5000	35
17	5000	22
18	5000	30
19	5000	39
20	5000	35
21	5000	32
22	5000	41
23	5000	49
24	5000	30
25	5000	22

Average PCI for Feature: 36

Condition Rating: Poor

Figure 6-19. Feature summary for flexible pavements.

APPENDIX A
AIRFIELD PAVEMENT DISTRESS IDENTIFICATION

A-1. Scope. This appendix provides pavement inspectors with a standardized reference for airfield pavement distress identification. The distress information presented herein is to be used in conjunction with the procedures described in the main text of this manual to determine pavement condition and maintenance and repair requirements.

A-2. Use of this appendix.

a. The types of airfield pavement distress are listed alphabetically under the major categories of flexible pavements and jointed rigid pavements. Names, descriptions, severity levels, photographs, and measurement or count criteria presented for each distress were established based on the effect of the pavement's structural integrity, operational condition, and maintenance and repair requirements.

b. It is very important that the pavement inspector be able to identify all distress types and their severity levels. The inspector should study this manual prior to performing an inspection and should carry a copy for reference during the inspection.

c. It should be emphasized that pavement inspectors must follow the distress descriptions in this appendix in order to arrive at meaningful and consistent PCI values.

d. Several items that are commonly encountered are outlined in table A-1 for emphasis, and the rater should be aware of these frequently occurring items before starting the condition survey. A summary of distress types and respective identification numbers are listed in Table A-2 for ready reference.

e. On some airfields an open-graded asphalt concrete mixture is used to obtain porous friction surfaces (PFS). The mix allows water to seep through the pore structure, thus increasing the skid resistance and reducing hydroplaning potential. The PFS are not load-carrying layers and are normally placed in thicknesses ranging from 5/8 to 7/8 inches. Separate distress criteria for PFS is used because the USAFE command pavement engineer noted that the calculated PCI for surface distress on PFS pavements using existing criteria was higher than would be expected from experienced engineers.

Table A-1. Frequently occurring identification problems in pavement distress identification

Situation	Action	Remarks
<u>Distress in Flexible Pavements</u>		
1. Alligator cracking and rutting in same area.	Record each separately at respective severity level.	
2. Bleeding has been counted in area.	Polished aggregate is not counted in same area.	
3. Polished aggregate in very small amount.	Do not count.	Polished aggregate is only counted when there is a significant amount.
4. Any distress (including cracking) in a patched area.	Do not record.	Effect of distress is considered in patch severity level.
5. For asphalt pavements if block cracking is recorded.	No longitudinal and transverse cracking should be recorded.	Does not apply to asphaltic concrete (AC) over portland cement concrete (PCC).
6. For asphalt overlay over concrete.	Block cracking, jointed reflection cracking, and longitudinal and transverse cracking reflected from old concrete is recorded separately.	AC over PCC could have, for example, 100 percent block cracking, 10 percent joint reflection cracking, and 1 percent longitudinal and transverse cracking.

(Continued)

Table A-1. Frequently occurring identification problems in pavement distress identification.

Table A-1. (Concluded)

Situation	Action	Remarks
<u>Distress in Jointed Rigid Pavements</u>		
1. Low-severity scaling (i.e., crazing).	Count only if it is probable future scaling will occur within 2 to 3 years.	
2. Joint seal damage.	This is not counted on a slab-by-slab basis.	A severity level based on the overall condition of the joint seal in the sample unit is assigned.
3. Joint spall small enough to be filled during a joint seal repair.	Do not record.	
4. For a medium- or high-severity intersecting crack (shattered slab).	No other distress should be counted.	
5. Corner or joint spalling caused by "D" cracking.	Only "D" cracking should be recorded.	If spalls are caused by factors other than "D" cracking, record each factor separately.
6. Crack repaired by a narrow patch (e.g., 4 to 10 in. wide.).	Record only crack and not patch at appropriate severity level.	
7. Original distress of patch is more severe than patch itself.	Original distress type should be recorded.	If, for example, patch material is present on scaled area of slab, only the scaling is counted.

Table A-1. Frequently occurring identification problems in pavement distress identification - continued

Table A-2. Summary of distress types and identification numbers

Identification Number	Distress Type	Page Number
<u>Flexible Pavement</u>		
41	Alligator cracking	A-3
42	Bleeding	A-6
43	Block cracking	A-8
44	Corrugation	A-11
45	Depression	A-14
46	Jet blast	A-16
47	Joint reflection cracking (PCC)	A-17
48	Longitudinal and transverse cracking	A-21
49	Oil spillage	A-25
50	Patching	A-26
51	Polished aggregate	A-28
52	Raveling/weathering	A-29
53	Rutting	A-33
54	Shoving of asphalt by from PCC	A-35
55	Slippage cracking	A-37
56	Swell	A-38
<u>Jointed Rigid Pavement</u>		
61	Blowup	A-40
62	Corner break	A-43
63	Longitudinal/transverse diagonal crack	A-47
64	Durability cracking	A-51
65	Joint seal damage	A-53
66	Patching <5 sq ft	A-56
67	Patching/utility cut	A-58
68	Popouts	A-61
69	Pumping	A-62
70	Scaling/map crack/grazing	A-64
71	Settlement/fault	A-67
72	Shattered slab	A-69
73	Shrinkage crack	A-71
74	Spalling joints	A-72
75	Spalling corner	A-76

Table A-2. Summary of distress types and identification numbers

A-3. Distresses In flexible pavements.*a. Alligator or fatigue cracking, distress 41.*

(1) Description

(a) Alligator or fatigue cracking is a series of interconnecting cracks caused by fatigue failure of the

asphalt concrete (AC) surface under repeated traffic loading. The cracking initiates at the bottom of the AC surface (or stabilized base) where tensile stress and strain are highest under a wheel load. The cracks propagate to the surface initially as a series of parallel cracks. After repeated traffic loading, the cracks connect, forming many-sided, sharp-angled pieces that develop a pattern resembling chicken wire or the skin of an alligator. The pieces are less than 2 feet on the longest side.

b. Alligator cracking occurs only in areas subjected to repeated traffic loadings such as wheel paths. Therefore, it would not occur over an entire area unless the entire area was subjected to traffic loading. Pattern-type cracking, which occurs over an entire area that is not subjected to loading is rated as block cracking, which is not a load-associated distress.

c. Alligator cracking is considered a major structural distress.

(2) *Severity levels.*

(a) *Low severity level (L).* Fine, longitudinal hairline cracks run parallel to one another with none or only a few interconnecting cracks. The cracks are not spalled (figs. A-1 through A-3).



Figure A-1. Low severity alligator cracking, case 1.



Figure A-2. Low severity alligator cracking, case 2.



Figure A-3. Low severity alligator cracking, approaching medium severity.

(b) Medium severity level (M). Further development of light alligator cracking into a pattern or network of cracks that may be lightly spalled (figs. A-4 and A-5).

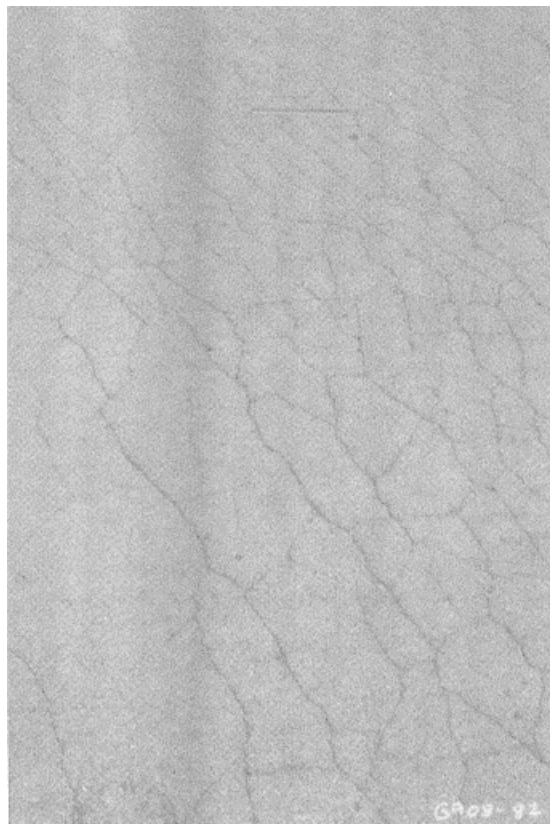

Figure A-4. Medium severity alligator cracking, case 1.

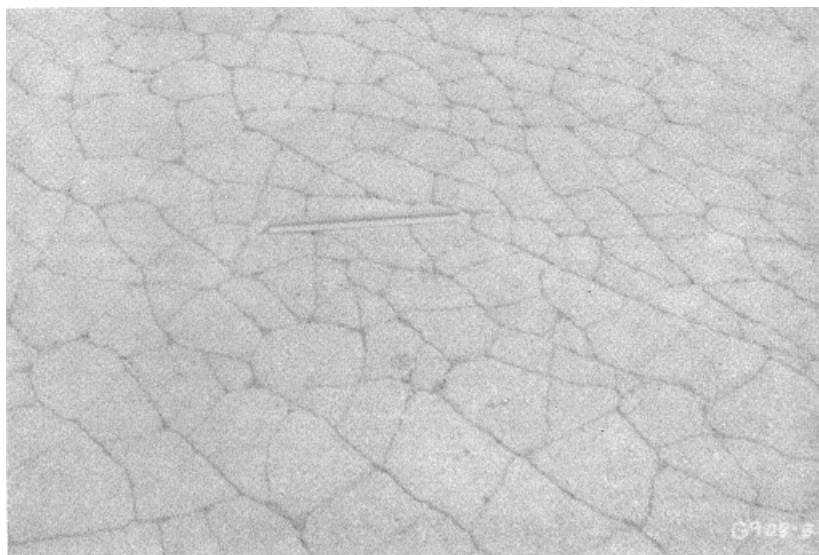

Figure A-5. Medium severity alligator cracking, case 2.

(c) *High severity level (H)*. Network or pattern cracking has progressed so that the pieces are well defined and spalled at the edges; some of the pieces rock under traffic (fig. A-6).



Figure A-6. High severity alligator cracking.

(3) *Measuring procedure*. Alligator cracking is measured in square feet of surface area. The major difficulty in measuring this type of distress is that frequently two or three levels of severity exist within one distressed area. If each level can be easily distinguished, they should be measured and recorded separately. However, if the different levels of severity cannot be easily divided, the entire area should be rated at the highest severity level present.

b. Bleeding, distress 42.

(1) *Description*. Bleeding is a film of bituminous material on the pavement surface that creates a shiny, glasslike, reflecting surface that usually becomes quite sticky. Bleeding is caused by excessive amounts of asphaltic cement or tars in the mix and/or low air void content. It occurs when asphalt fills the voids of the mix during hot weather and then expands out onto the surface of the pavement. Since the bleeding process is not reversible during cold weather, asphalt or tar will accumulate on the surface.

(2) *Severity levels.* No degrees of severity are defined. Bleeding should be noted when it is extensive enough to cause a reduction in skid resistance (figs A-7).



Figure A-7. Bleeding.

(3) *Measuring procedure.* Bleeding is measured in square feet of surface area.

c. *Block cracking, distress 43.*

(1) *Description.* Block cracks are interconnected cracks that divide the pavement into approximately rectangular pieces. The blocks may range in size from approximately 1 by 1 foot to 10 by 10 feet. When the blocks are larger than 10 by 10 feet, they are classified as longitudinal or transverse cracking. Block cracking is caused mainly by shrinkage of the asphalt concrete and daily temperature cycling (which results in daily stress/strain cycling). It is not load-associated. The occurrence of block cracking usually indicates that the asphalt has hardened significantly. Block cracking normally occurs over a large portion of the pavement area, but sometimes it will occur only in nontraffic areas. This type of distress differs from alligator cracking in that the alligator cracks form smaller, many-sided pieces with sharp angles. Also unlike block cracks, alligator cracks are caused by repeated traffic loadings and are, therefore, located only in traffic areas (i.e., wheel paths).

(2) *Severity levels.*

(a) *Low severity level (L).* Blocks are defined by cracks that are nonspalled (sides of the crack are vertical) or only lightly spalled with no loose particles, causing no foreign object damage (FOD) potential. Nonfilled cracks have 1/4 inch or less mean width, and filled cracks have a filler in satisfactory condition (figs. A-8 through A-10).



Figure A-8. Low severity block cracking, case 1.



Figure A-9. Low severity block cracking, case 2.



Figure A-10. Low severity block cracking, case 3.

- (b) *Medium severity level (M)*. Blocks are defined by one of three different ways.
- Filled or nonfilled cracks that are moderately spalled with some loose particles (some FOD potential).
 - Nonfilled cracks that are not spalled or have only minor spalling with few loose particles (some FOD potential), but have a mean width greater than approximately 1/4 inch.
 - Filled cracks that are not spalled or have only minor spalling with few loose particles (some FOD potential), but have filler in unsatisfactory condition (figs. A-11 and A-12).

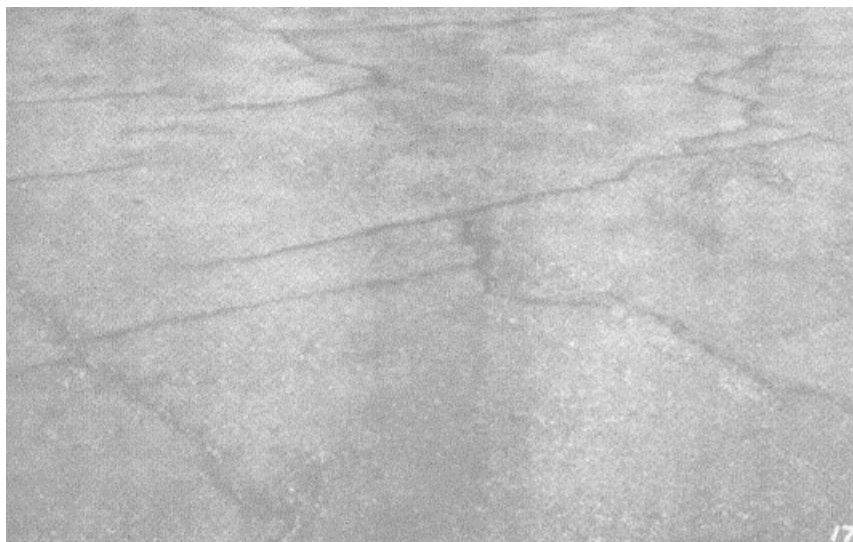

Figure A-11. Medium severity block cracking, case 1.

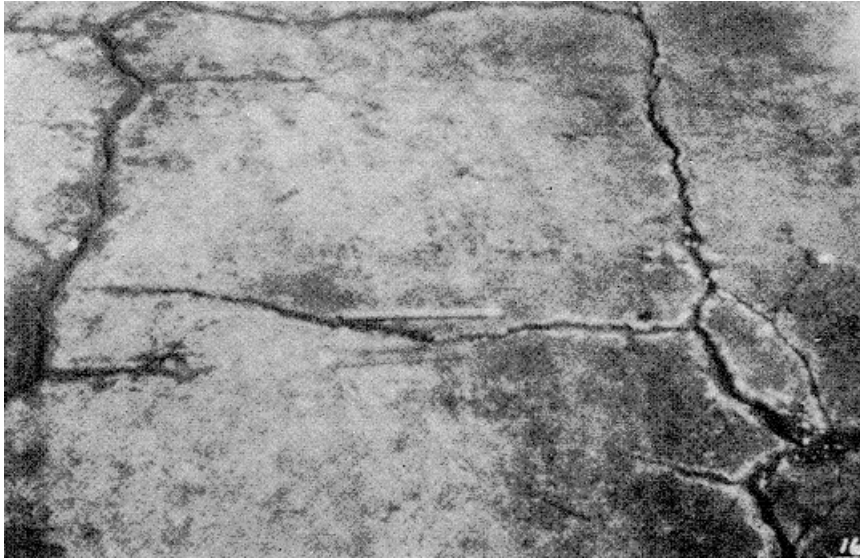

Figure A-12. Medium severity block cracking, case 2.

(c) *High severity level (H).* Blocks are well defined by cracks that are severely spalled with loose and missing particles, causing a definite FOD potential. Such an example is show in figures A-13 through A-14.



Figure A-13. High severity block cracking case 1.



Figure A-14. High severity block cracking case 2.

(3) *Measuring procedure.* Block cracking is measured in square feet of surface area and usually occurs at one severity level in a given pavement section. However, any areas of the pavement section having distinctly different levels of severity should be measured and recorded separately.

d. *Corrugation, distress 44.*

(1) *Description.* Corrugation is a series of closely spaced ridges and valleys (ripples) occurring at fairly regular intervals (usually less than 5 feet) along the pavement. The ridges are perpendicular to the traffic direction. Traffic action combined with an unstable pavement surface or base usually causes this type of distress.

(2) *Severity levels.*

(a) *Low severity level (L).* Corrugations are minor and do not significantly affect ride quality (see measurement criteria below and illustration in fig. A-15).

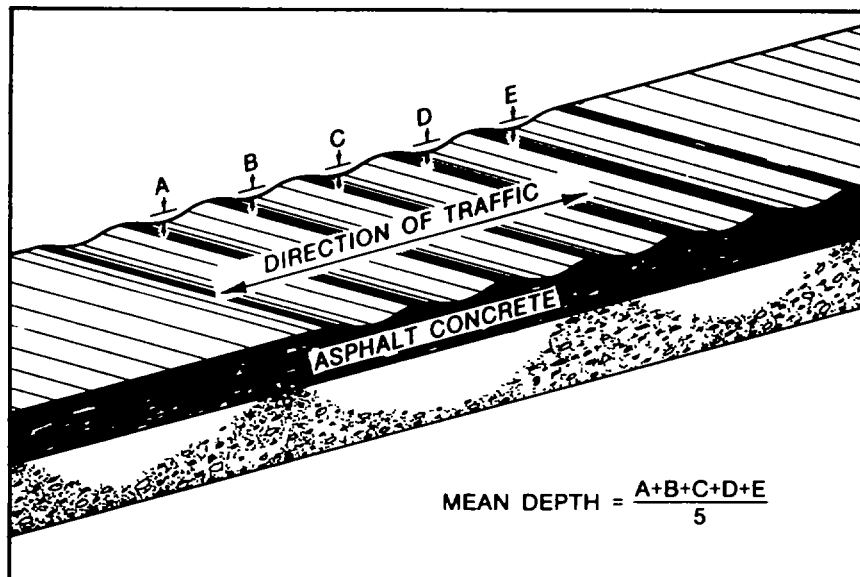

Figure A-15. Illustration of corrugation.

(b) *Medium severity level (M)*. Corrugations are noticeable and significantly affect ride quality (see measurement criteria below, (fig. A-16).

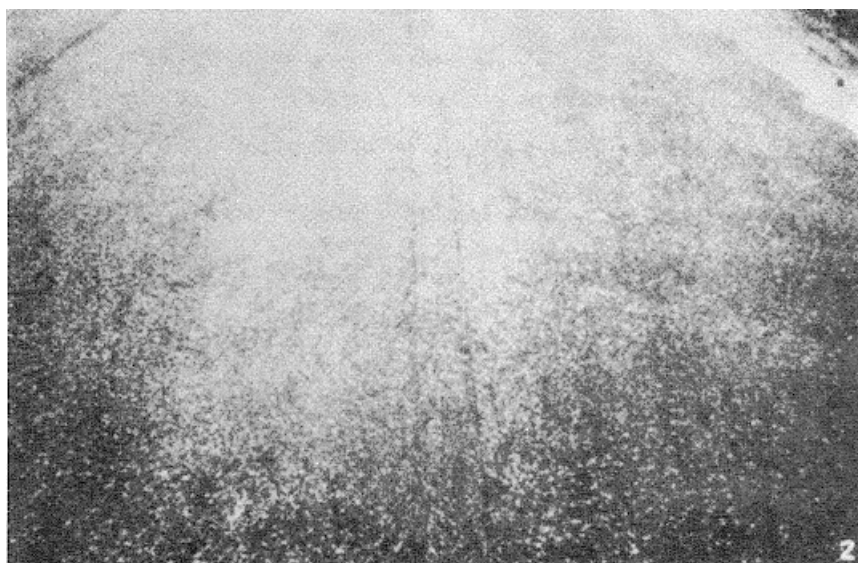

Figure A-16. Corrugation.

(c) *High severity level (H)*. Corrugations are easily noticed and severely affect ride quality (see measurement criteria below).

(3) *Measuring procedure*. Corrugation is measured in square feet of surface area. The mean elevation difference between the ridges and valleys of the corrugation indicates the level of severity. To determine the mean elevation difference, a 10-foot straightedge should be placed perpendicular to the corrugations so that the depth of the valleys can be measured in inches. The mean depth is calculated from the following measurements.

<u>Severity</u>	<u>Runways and High-Speed Taxiways</u>	<u>Taxiways and Aprons</u>
L	< 1/4 inch	< 1/2 inch
M	1/4 - 1/2 inch	1/2 - 1 inch
H	> 1/2 inch	> 1 inch

Some of the example photographs were taken on roads and streets because corrugation is not commonly found on airfield pavements.

e. *Depression, distress 45.*

(1) *Description*. Depressions are localized pavement surface areas having elevations slightly lower than those of the surrounding pavement. In many instances, light depressions are not noticeable until after a rain when ponding of water creates "bird-bath" areas, but the depressions can also be located without rain because of stains created by ponding of water. Depressions can be caused by settlement of the foundation soil or can be built during construction. Depressions cause roughness and, when filled with water of a sufficient depth, could cause hydroplaning of aircraft.

(2) *Severity levels.*

(a) *Low severity level (L)*. Depression can be observed or located by stained areas, only slightly affects pavement riding quality, and may cause hydroplaning potential on runways (see measurement criteria below) (fig. A-17).



Figure A-17. Low severity depression.

(b) *Medium severity level (M)*. The depression can be observed, moderately affects pavement riding quality, and causes hydroplaning potential on runways (see measurement criteria below) (figs. A-18 and A-19).

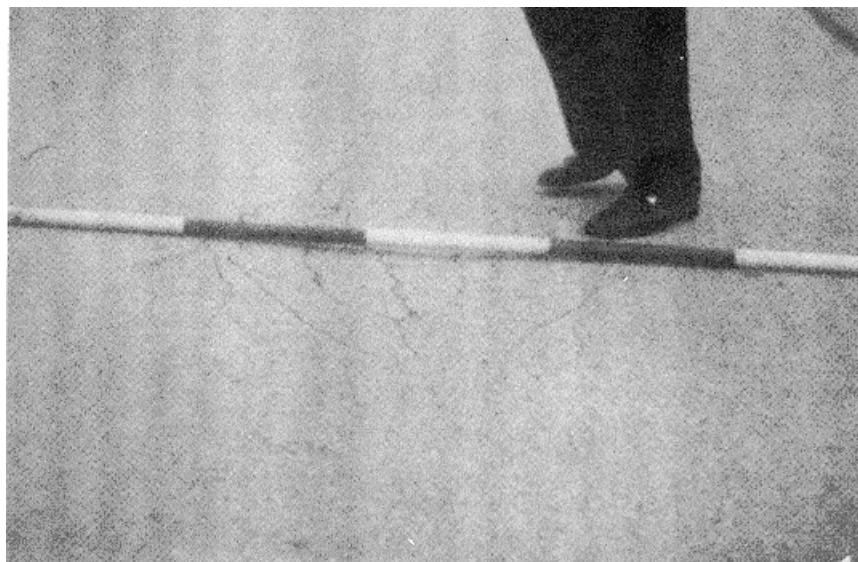

Figure A-18. Medium severity depression, case 1.

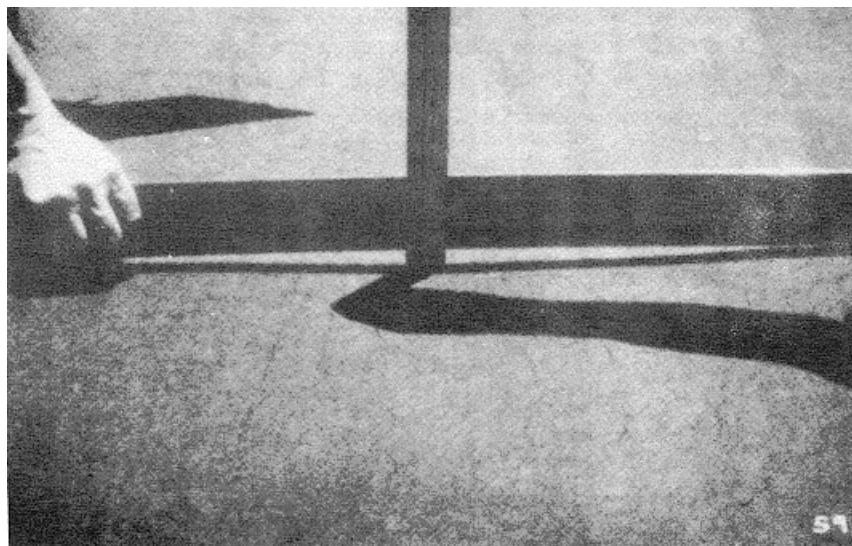

Figure A-19. Medium severity depression case 2

(c) High severity level (H). The depression can be readily observed, severely affects pavement riding quality, and causes definite hydroplaning potential (see measurement criteria below) (fig. A-20).



Figure A-20. High severity depression

(3) Measuring procedure. Depressions are measured in square feet of surface area. The maximum depth of the depression determines the level of severity. This depth can be measured by placing a 10-foot straightedge across the depressed area and measuring the maximum depth in inches. Depressions larger than 10 feet across must be measured by either visual estimation or by direct measurement when filled with water.

<u>Severity</u>	<u>Maximum Depth of Depression</u>	
	<u>Runways and High-Speed Taxiways</u>	<u>Taxiways and Aprons</u>
L	1/8 - 1/2 inch	1/2 - 1 inch
M	1/2 - 1 inch	1 - 2 inch
H	> 1 inch	> 2 inch

f. *Jet blast erosion, distress 46.*

(1) *Description.* Jet blast erosion causes darkened areas on the pavement surface where bituminous binder has been burned or carbonized. Localized burned areas may vary in depth up to approximately 1/2 inch.

(2) *Severity levels.* No degrees of severity are defined. It is sufficient to indicate that jet blast erosion exists (figs. A-21 and A-22).



Figure A-21. *Jet blast erosion, case 1.*

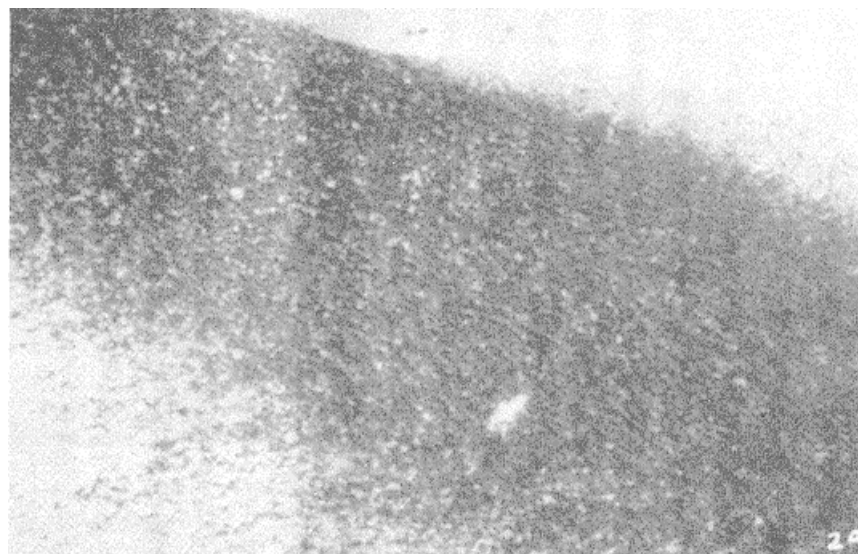

Figure A-22. *Jet blast erosion, case 2.*

(3) *Measuring procedure.* Jet blast erosion is measured in square feet of surface area.

g. *Joint reflection cracking from PCC (longitudinal and transverse), distress 47.*

(1) *Description.* This distress occurs only on pavements having an asphalt or tar surface over a portland cement concrete (PCC) slab. This category does not include reflection cracking from any other type of base (i.e., cement stabilized, lime stabilized). Such cracks are listed as longitudinal and transverse cracks. Joint reflection cracking is caused mainly by movement of the PCC slab beneath the AC surface because of thermal and moisture changes. It is not load-related. However, traffic loading may cause a breakdown of the AC near the crack, resulting in spalling and FOD potential. If the pavement is fragmented along a crack, the crack

is spalled. A knowledge of slab dimensions beneath the AC surface will help to identify these cracks.

(2) *Severity levels.*

(a) *Low severity level (L).* Cracks have only light spalling (little or no FOD potential) or no spalling and can be filled or nonfilled. If nonfilled, the cracks have a mean width of $\frac{1}{4}$ inch or less. Filled cracks are of any width, but their filler material is in satisfactory condition (fig. A-23).



Figure A-23. *Low severity joint reflection cracking.*

(b) *Medium severity level (M).* One of four possible conditions exists:

- Cracks are moderately spalled with some loose particles (some FOD, potential) and can be either filled or nonfilled and of any width.
- Filled cracks are not spalled or are only lightly spalled, but the filler is in unsatisfactory condition.
- Nonfilled cracks are not spalled or are only lightly spalled, but the mean crack width is greater than $\frac{1}{4}$ inch.
- Light random cracking exists near the crack or at the corners of intersecting cracks (figures A-24 through A-25).



Figure A-24. Medium severity joint reflection cracking case 1.

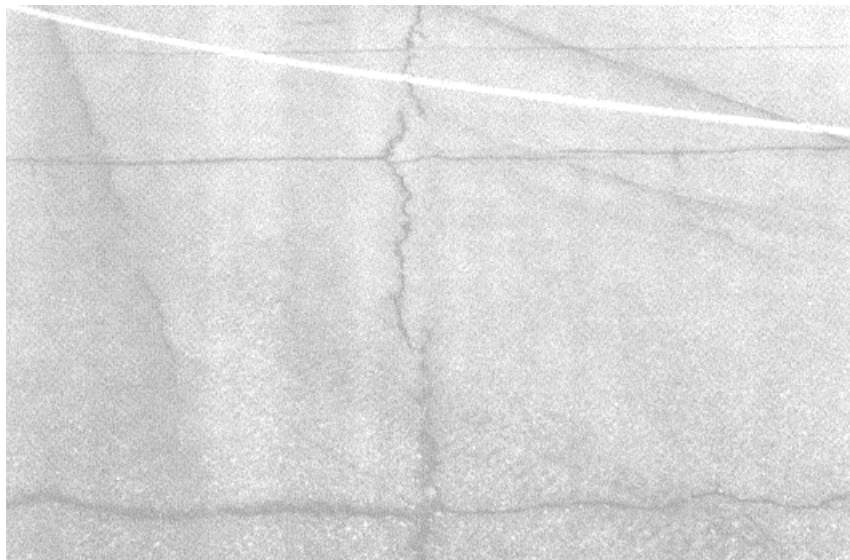

Figure A-25. Medium severity joint reflection cracking, case 2.

(c) *High severity level (H)*. Cracks are severely spalled with loose and missing particles (definite FOD potential) and can be either filled or nonfilled and of any width.



Figure A-26. High severity joint reflection cracking.

(3) *Measuring procedure.* Joint reflection cracking is measured in linear feet. The length and severity level of each crack should be identified and recorded. If the crack does not have the same severity level along its entire length, each portion should be recorded separately. For example, a crack that is 50 feet long may be 10 feet of a high severity cracking, 20 feet of a medium severity, and 20 feet of a light severity. These would all be recorded separately.

h. Longitudinal and transverse cracking (non-PCC joint reflective), distress 48.

(1) *Description.* Longitudinal cracks are parallel to the pavement's center line or laydown direction. They may be caused by (a) a poorly constructed paving lane joint, (b) shrinkage of the AC surface due to low temperatures or hardening of the asphalt, or (c) a reflective crack caused by cracks beneath the surface course, including cracks in PCC slabs (but not at PCC joints). Transverse cracks extend across the pavement at approximately right angles to the pavement's center line or direction of laydown. They may be caused by items b or c above. These types of cracks are not usually load-associated. If the pavement is fragmented along cracks, the crack is spalled.

(2) *Severity levels.*

(a) *Low severity level (L).*

- Cracks have either minor spalling with no loose particles (little or no FOD potential) or no spalling. The cracks can be filled or nonfilled. Nonfilled cracks have a mean width of 1/4 inch or less. Filled cracks are of any width, but their filler material is in satisfactory condition (figs. A-27 and A-28).
- For porous friction courses, the average raveled area around the crack is less than 1/4-inch wide (fig. A-29).

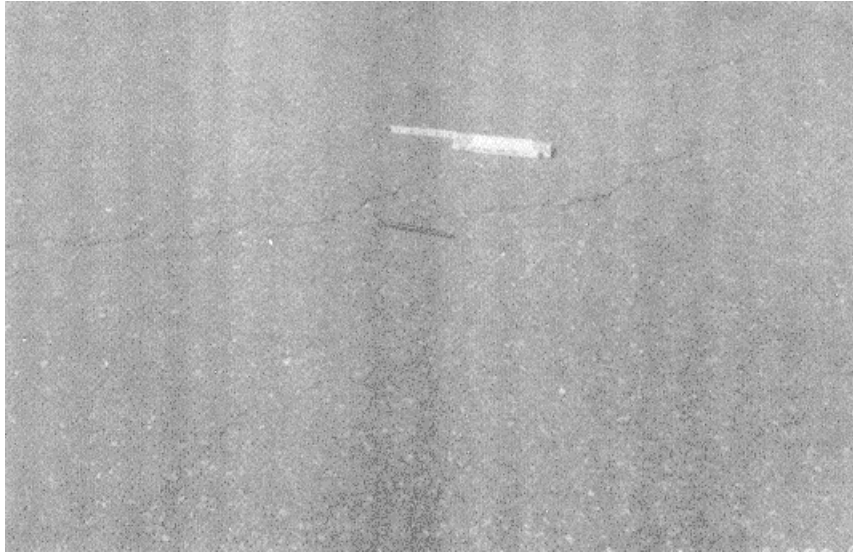

Figure A-27. Low severity longitudinal crack.

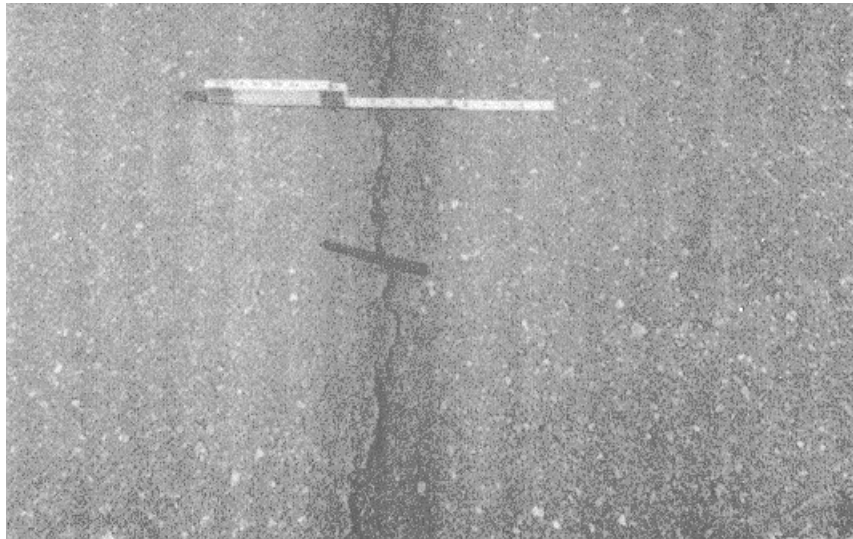

Figure A-28. Low severity longitudinal cracks, approaching medium.

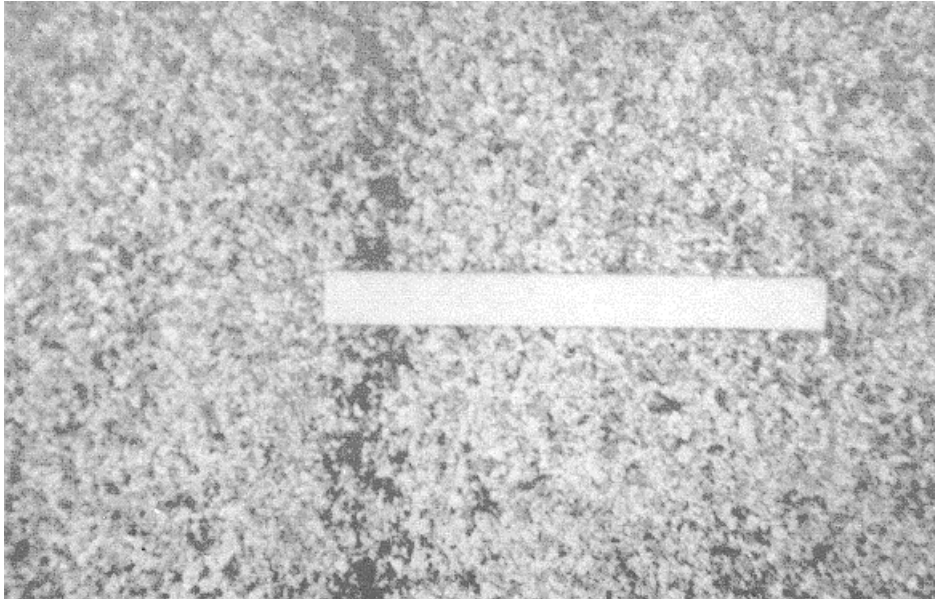

Figure A-29. Low severity crack, porous friction course pavement.

(b) *Medium severity level (M).*

- One of the following conditions exists:
 - Cracks are moderately spalled with few loose particles (some FOD potential) and can be either filled or nonfilled of any width.
 - Filled cracks are not spalled or are only lightly spalled, but the filler is in air unsatisfactory condition.
 - Nonfilled cracks are not spalled or are only lightly spalled, but mean crack width is greater than 1/4 inch.
 - Light random cracking exists near the crack or at the corners of intersecting cracks (figs. A-30 through A-31).
- For porous friction courses, the average raveled area around the crack is 1/4 to 1-inch wide (fig. A-32).

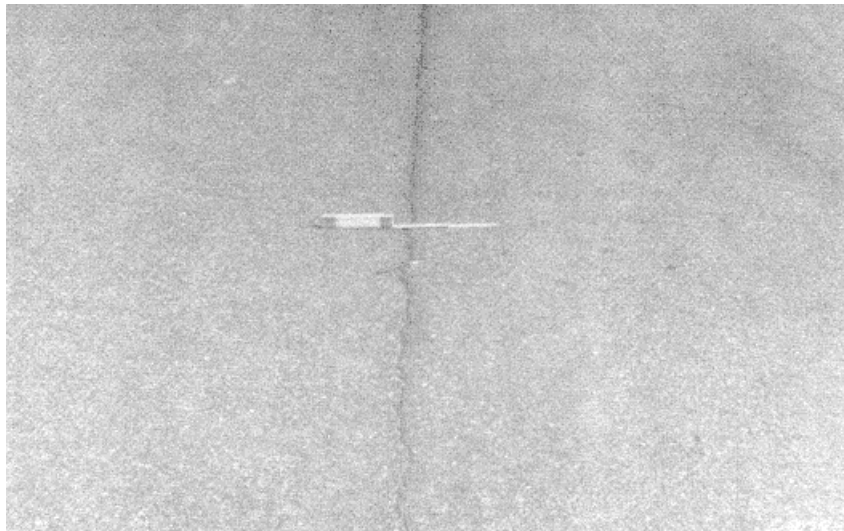

Figure A-30. Medium severity longitudinal construction joint crack, case 1.

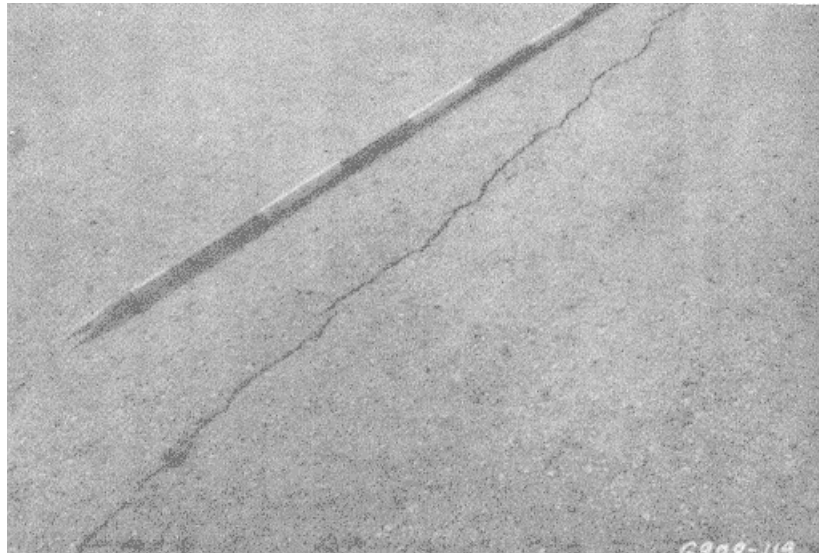

Figure A-31. Medium severity longitudinal crack, case 2.

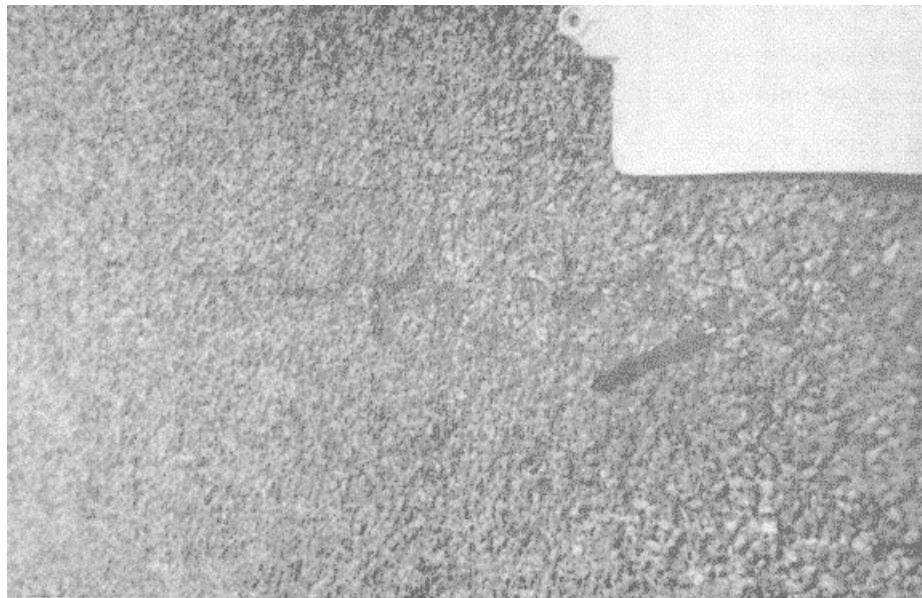

Figure A-32. Medium severity crack, porous friction course pavement.

(c) High severity level (H).

- Cracks are severely spalled with loose and missing particles, causing definite FOD potential. They can be either filled or nonfilled of any width (fig. A-33).
- Porous friction courses, average raveled area around the crack is greater than 1 inch wide (fig. A-34).



Figure A-33. High severity longitudinal crack.



Figure A-34. High severity crack, porous friction course pavement.

(3) *Measuring procedure.* Longitudinal and transverse cracks are measured in linear feet. The length and severity of each crack should be identified and recorded. If the crack does not have the same severity level along its entire length, each portion of the crack having a different severity level should be recorded separately. For an example, see joint reflection cracking.

i. Oil spillage, distress 49.

(1) *Description.* Oil spillage is the deterioration or softening of the pavement surface caused by the spilling of oil, fuel, or other solvents (figs. A-35 and A-36).

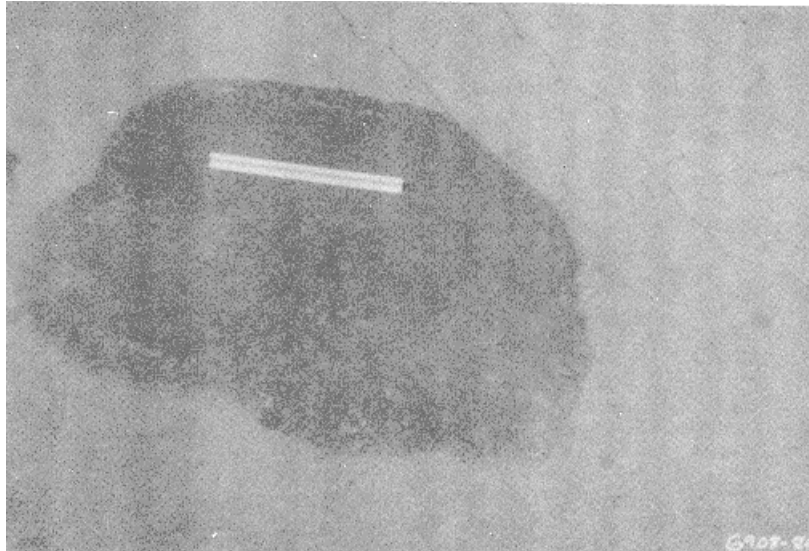

Figure A-35. Oil spillage, case 1.

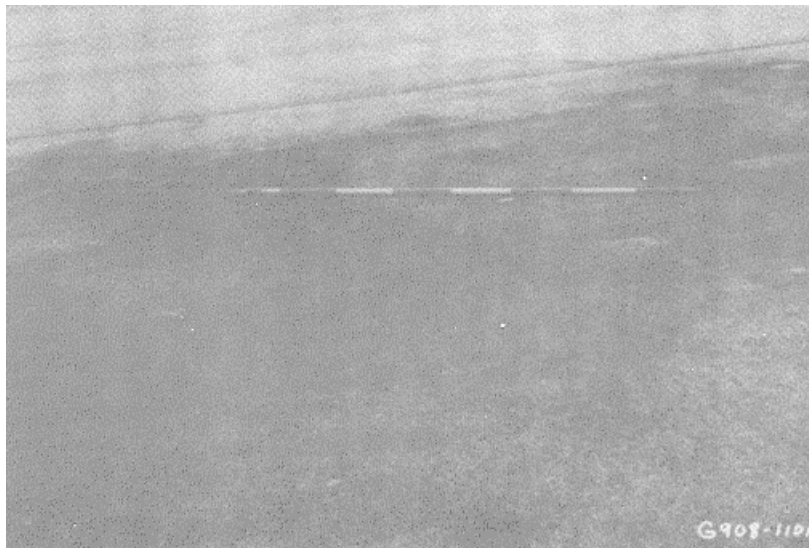

Figure A-36. Oil spillage, case 2.

- (2) *Severity levels.* No degrees of severity are defined. It is sufficient to indicate that oil spillage exists.
- (3) *Measuring procedure.* Oil spillage is measured in square feet of surface area

j. Patching and utility cut patch, distress 50.

- (1) *Description.* A patch is considered a defect, no matter how well it is performing.
- (2) *Severity levels.*

(a) *Low severity level (L).*

- Patch is in good condition and is performing satisfactorily (figs. A-37 and A-38).
- For porous friction courses. The use of dense-graded AC patches in porous friction surfaces causes a water damming effect at the patch, which contributes to differential skid resistance of the surface. Low-severity dense-graded patches should be rated as medium-severity due to the differential friction problem.

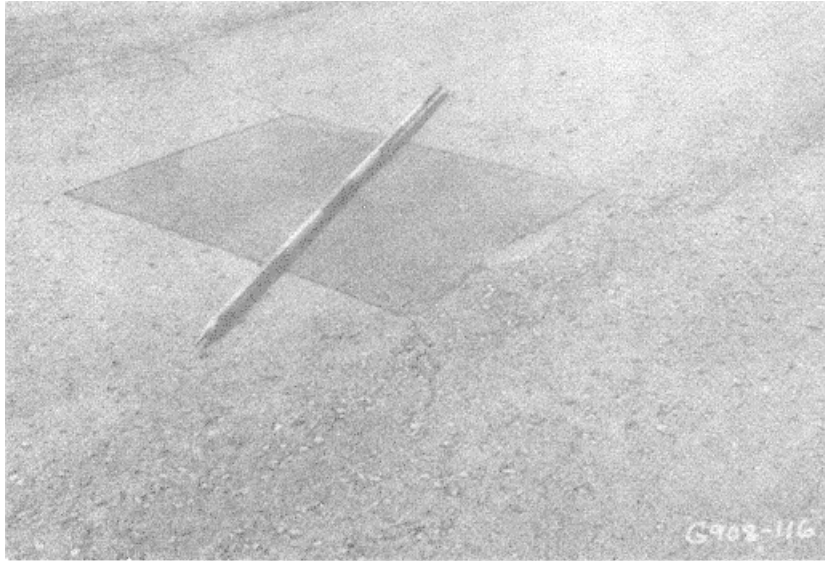

Figure A-37. Low severity patch, case 1.

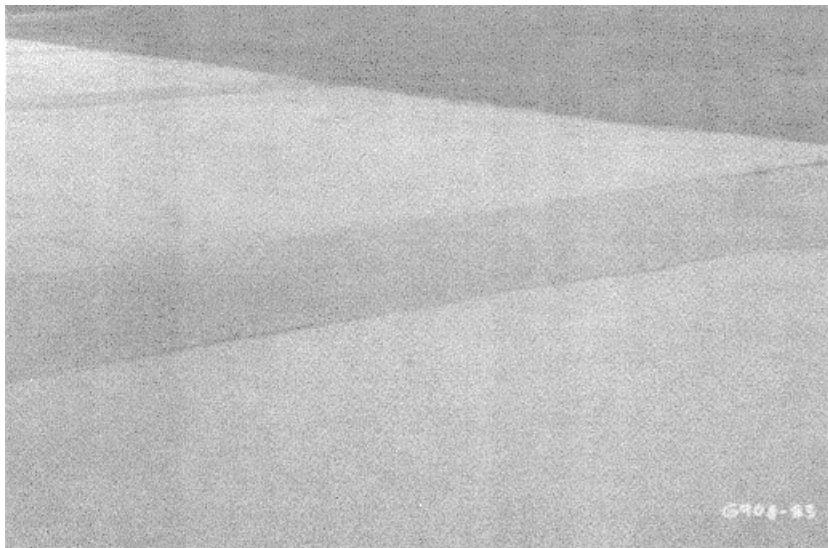

Figure A-38. Low severity patch, case 2.

(b) *Medium severity level (M)*. Patch is somewhat deteriorated and affects riding quality to some extent (fig. A-39).

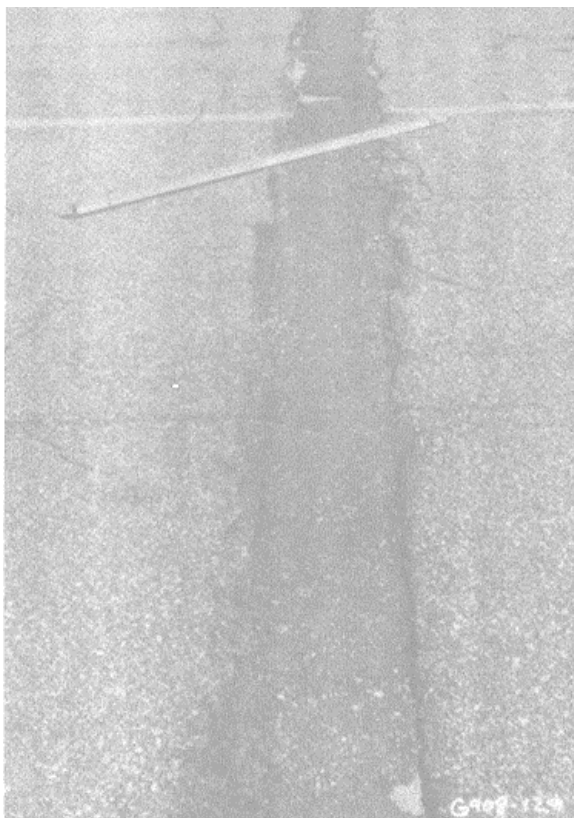

Figure A-39. Medium severity patch.

(c) *High severity level (H)*. Patch is badly deteriorated and affects ride quality significantly or has high FOD potential. Patch soon needs replacement (fig. A-40).



Figure A-40. High severity patch.

(3) *Measuring procedure*. Patching is measured in square feet of surface area. However, if a single patch has areas of differing severity levels, these areas should be measured and recorded separately. For example, a 25-square-foot patch may have 10 square feet of medium severity and 15 square feet of light severity. These areas would be recorded separately.

k. Polished aggregate, distress 51.

(1) *Description.* Aggregate polishing is caused by repeated traffic applications. Polished aggregate is present when close examination of a pavement reveals that the portion of aggregate extending above the asphalt is either very small or there are no rough or angular aggregate particles to provide good skid resistance.

(2) *Severity levels.* No degrees of severity are defined. Polished aggregate should not be counted unless detected on a runway or high speed taxiway and the degree of polishing should be significant before it is included in the condition survey and rated as a defect (fig. A-41).

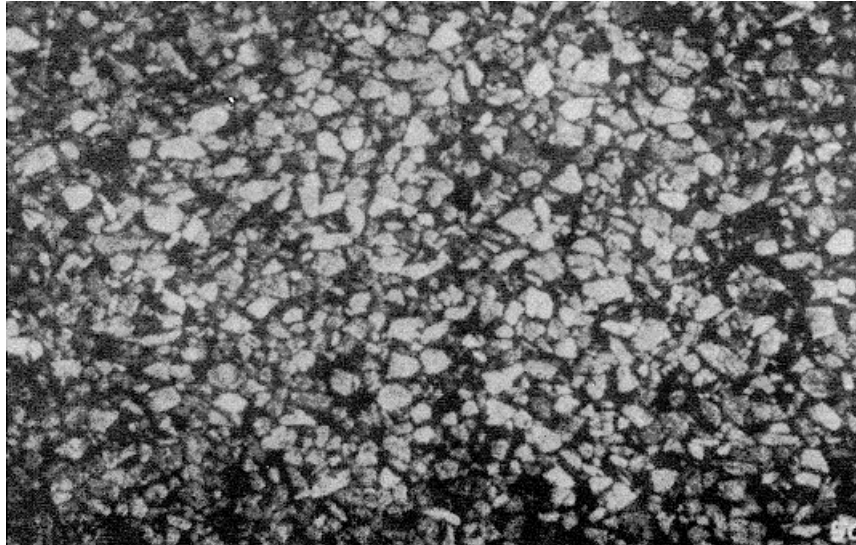

Figure A-41. Polished aggregate.

(3) *Measuring procedure.* Polished aggregate is measured in square feet of surface area.

l. Raveling and weathering, distress 52.

(1) *Description.* Raveling and weathering are the wearing away of the pavement surface caused by the dislodging of aggregate particles and loss of asphalt or tar binder. They may indicate that the asphalt binder has hardened significantly.

(2) *Severity levels.*

(a) *Low severity level (L).*

- Aggregate or binder has started to wear away with few, if any, loose particles causing little or no FOD potential (figs. A-42 and A-43).
- For porous friction courses, most of the fine aggregate (passing through the No. 4 sieve, i.e., less than 1/4 inch), have been lost and only a few of the larger pieces have been dislodged, causing little or no FOD potential (figs. A-44 through A-46).



Figure A-42. Low severity raveling/weathering, case 1.



Figure A-43. Low severity raveling/weathering, case 2.

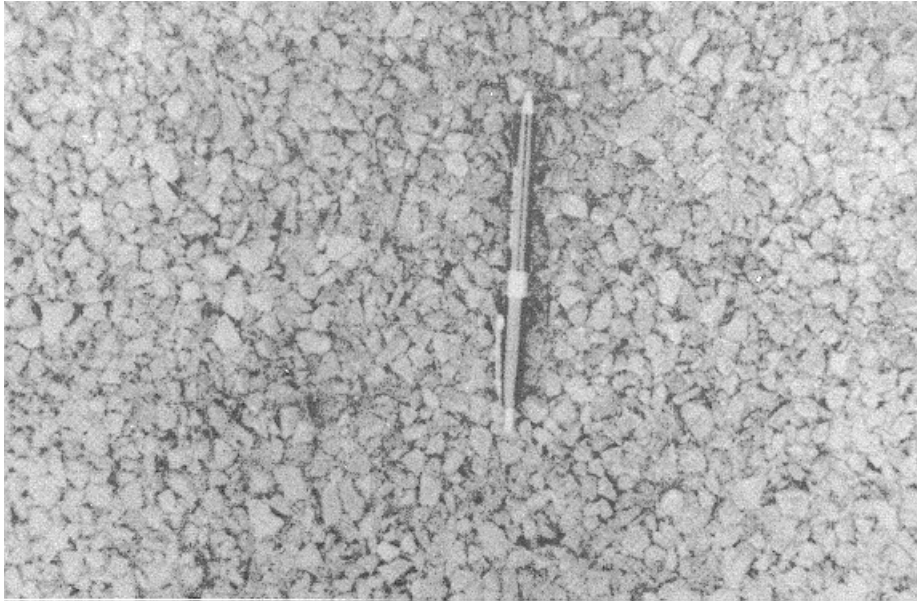

Figure A-44. Typical porous friction course surface with no raveling and weathering, case 1.

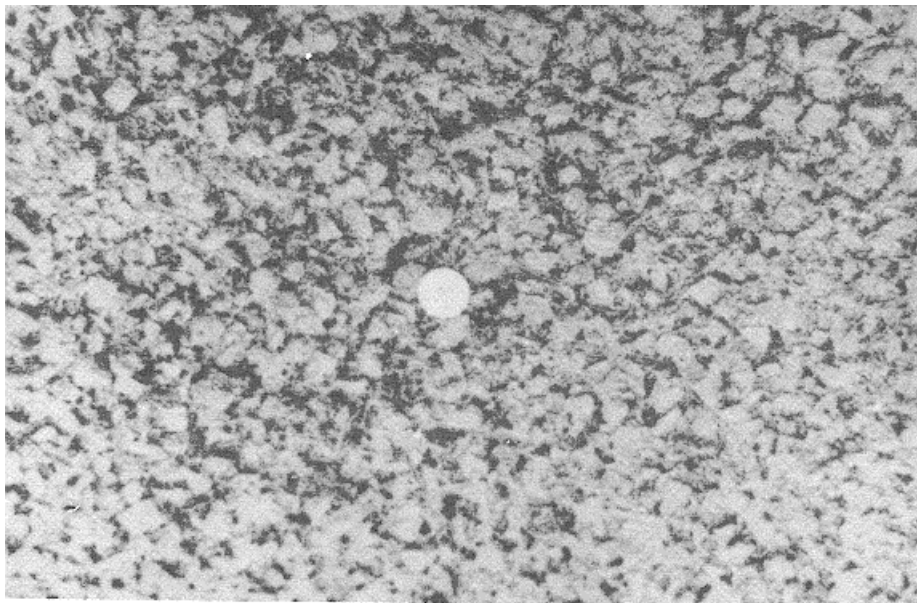

Figure A-45. Typical porous friction course surface with no raveling and weathering, case 2.



Figure A-46. Low severity raveling/weathering in porous friction course pavement.

(b) *Medium severity level (M).*

- Aggregate and/or binder has worn away with loose and missing particles causing some FOD potential. The surface texture is moderately rough and pitted (fig. A-47).
- For porous friction courses, fine aggregate is missing and many of the larger pieces are dislodged. The surface is rough and pitted, but average depth of erosion is less than 1/4 inch. Some FOD potential is present (figs. A-48 and A-49).

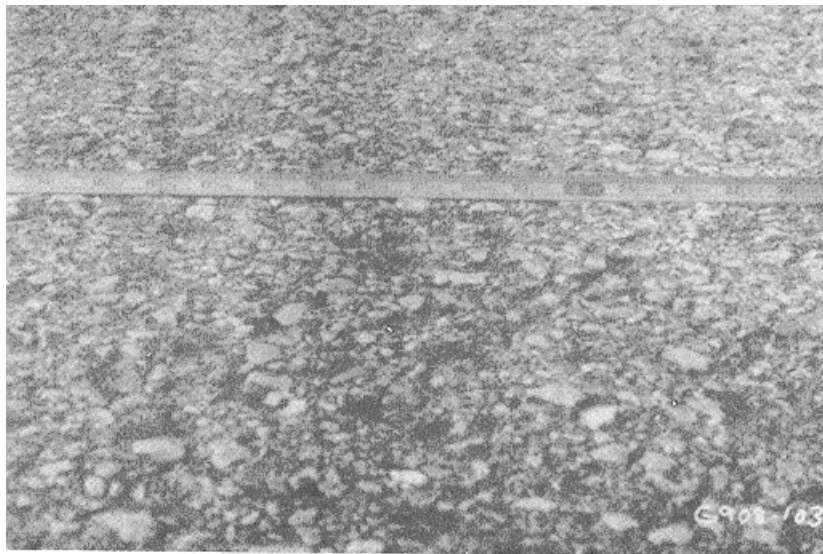

Figure A-47. Medium severity raveling/weathering.

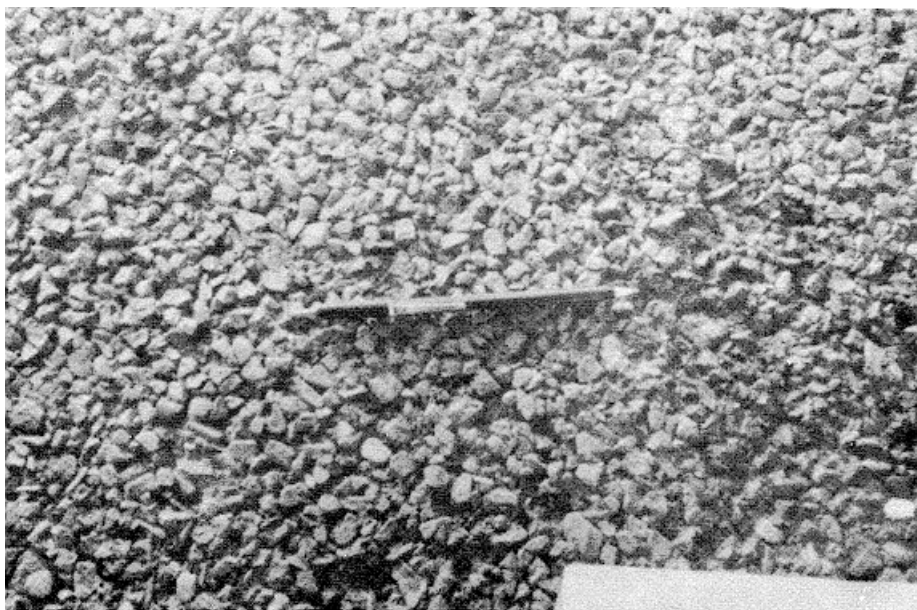

Figure A-48. Medium severity raveling/weathering in porous friction course pavement.



Figure A-49. Medium severity raveling/weathering showing rough and pitted surface in porous friction course pavement.

(c) High severity level (H).

- Aggregate and/or binder has worn away with a large amount of loose and missing particles causing a high FOD potential. The surface texture is severely rough and pitted (fig. A-50).
- For porous friction courses, surface texture is very rough and pitted. Erosion of aggregate pieces exceeds 1/4 inch in depth, and definite FOD potential exists (fig. A-51).



Figure A-50. High severity raveling/weathering.



Figure A-51. High severity raveling/weathering in porous friction course pavement.

(3) *Measuring procedure.*

(a) *Porous friction courses.* Raveling and weathering are measured in square feet of surface area. Mechanical damage caused by hook drags, tire rims, or snow plows are counted as areas of high-severity raveling and weathering.

(b) *All other flexible pavement surfaces.* Raveling and weathering are measured in square feet of surface area.

m. Rutting, distress 53.

(1) *Description.* A rut is a surface depression in the wheel path. Pavement uplift may occur along the sides of the rut; however, in many instances ruts are noticeable only after a rainfall, when the wheel paths are filled with water. Rutting stems from a permanent deformation in any of the pavement layers or subgrade, usually caused by consolidation or lateral movement of the materials due to traffic loads. Significant rutting can lead to major structural failure of the pavement.

(2) Severity levels.

<u>Severity</u>	<u>Mean Rut Depth Criteria</u>
	<u>All Pavement Sections</u>
L	1/4 - 1/2 inch (figs. A-52 and A-53)
M	> 1/2 - 1 inch (figs. A-54 and A-55)
H	> 1 inch (figs. A-56 and A-57)

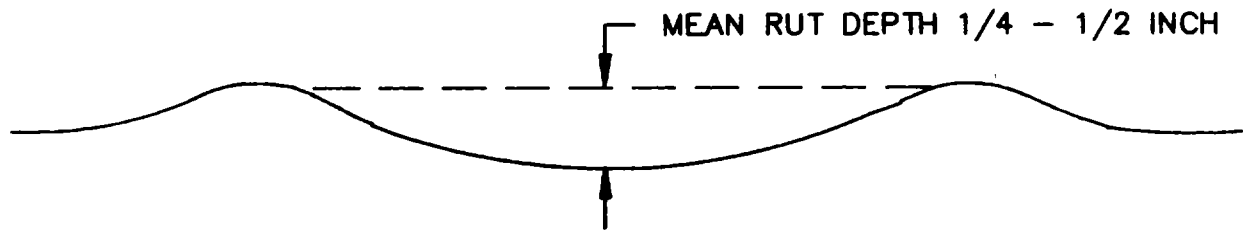

Figure A-52. Low severity rutting.

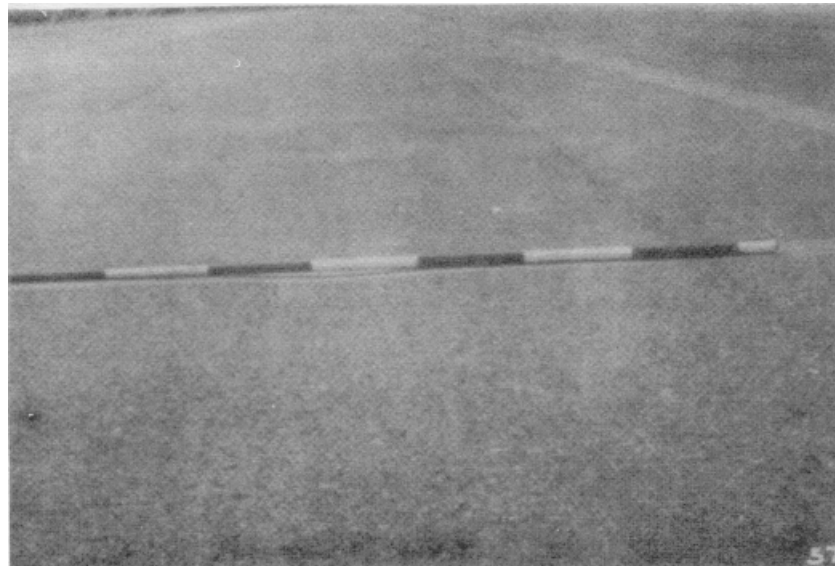

Figure A-53. Low severity rutting.

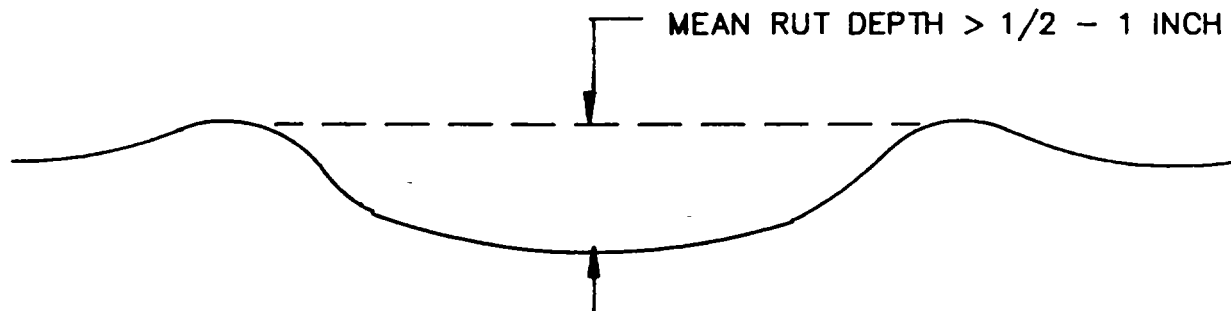

Figure A-54. Medium severity rutting.

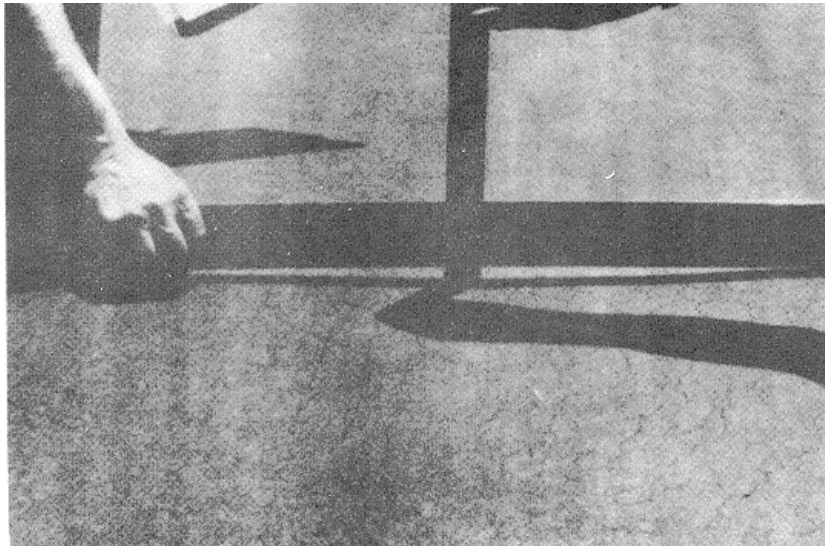

Figure A-55. Medium severity rutting.

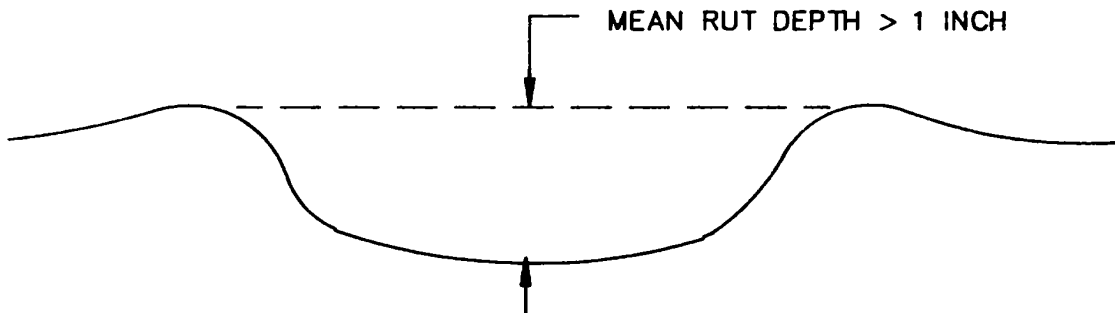

Figure A-56. High severity rutting.

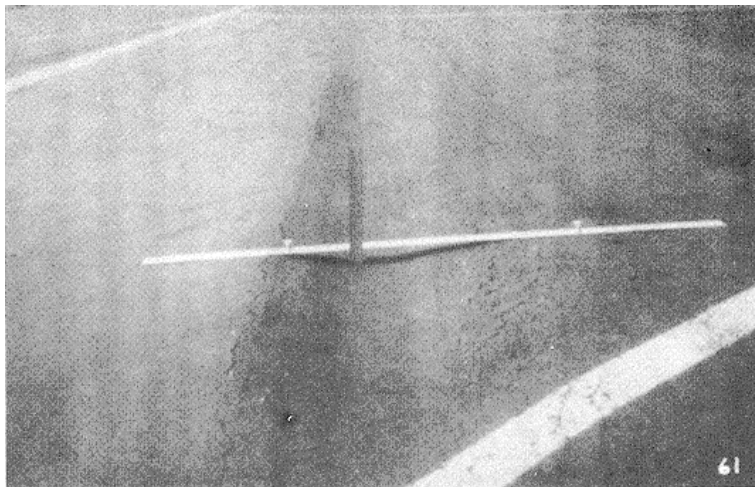

Figure A-57. High severity rutting.

(3) *Measuring procedure.* Rutting is measured in square feet of surface area, and its severity is determined by the mean depth of the rut. To determine the mean rut depth, a straightedge should be laid across

the rut and the depth measured. The mean depth in inches should be computed from measurements taken along the length of the rut.

n. Shoving of asphalt pavement by PCC slabs, distress 54.

(1) *Description.* PCC pavements occasionally increase in length at ends where they adjoin flexible pavements (commonly referred to as "pavement growth"). This "growth" shoves the asphalt- or tar-surfaced pavements, causing them to swell and crack. The PCC slab "growth" is caused by a gradual opening up of the joints as they are filled with an incompressible material that prevents the joints from reclosing.

(2) *Severity level.*

(a) *Low severity level (L).* A slight amount of shoving has occurred with little effect on ride quality and no breakup of the asphalt pavement (fig. A-58).



Figure A-58. Low severity shove on the outside and medium severity in the middle.

(b) *Medium severity level (M).* A significant amount of shoving has occurred, causing moderate roughness and little or no breakup of the asphalt pavement (fig. A-58).

(c) *High severity level (H).* A large amount of shoving has occurred, causing severe roughness or breakup of the asphalt pavement (fig. A-59).



Figure A-59. High severity shoving.

(3) *Measuring procedure.* Shoving is measured by determining the area in square feet of the swell caused by shoving.

o. Slippage cracking, distress 55.

(1) *Description.* Slippage cracks are crescent- or half-moon-shaped cracks having two ends pointed away from the direction of traffic. They are produced when braking or turning wheels cause the pavement surface to slide and deform. This usually occurs when there is a low strength surface mix or poor bond between the surface and next layer of pavement structure.

(2) *Severity levels.* No degrees of severity are defined. It is sufficient to indicate that slippage crack exists (figs. A-60 and A-61).

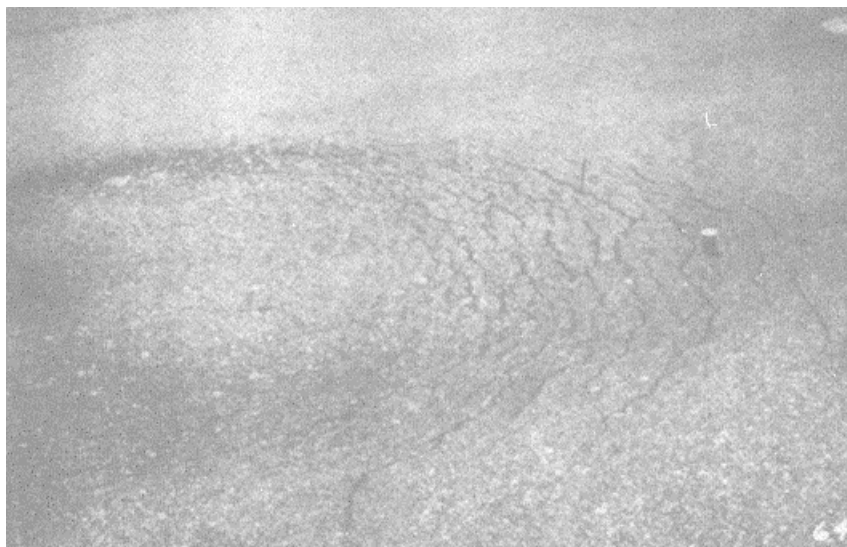

Figure A-60. Slippage cracking, case 1.

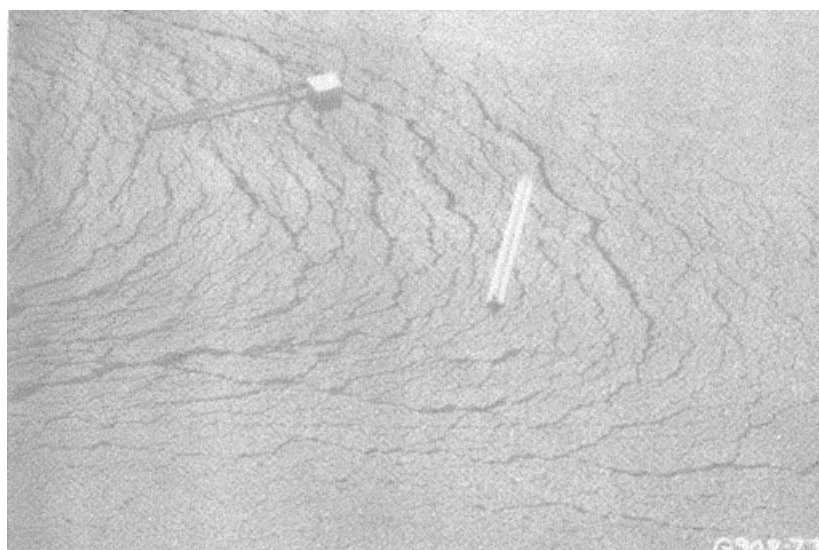

Figure A-61. Slippage cracking, case 2.

(3) *Measuring procedure.* Slippage cracking is measured in square feet of surface area.

p. Swell, distress 56.

(1) *Description.* Swell is characterized by an upward bulge in the pavement's surface. A swell may occur sharply over a small area or as a longer, gradual wave. Either type of swell can be accompanied by surface

cracking. A swell is usually caused by frost action in the subgrade or by swelling soil, but a small swell can also occur on the surface of an asphalt overlay (over PCC) as a result of a blowup in the PCC slab.

(2) Severity levels.

(a) *Low severity level (L)*. Swell is barely visible and has a minor effect on the pavement's ride quality as determined at the normal aircraft speed for the pavement section under consideration. (Low severity swells may not always be observable, but their existence can be confirmed by driving a vehicle over the section at the normal aircraft speed. An upward acceleration will occur if the swell is present) (fig. A-62).

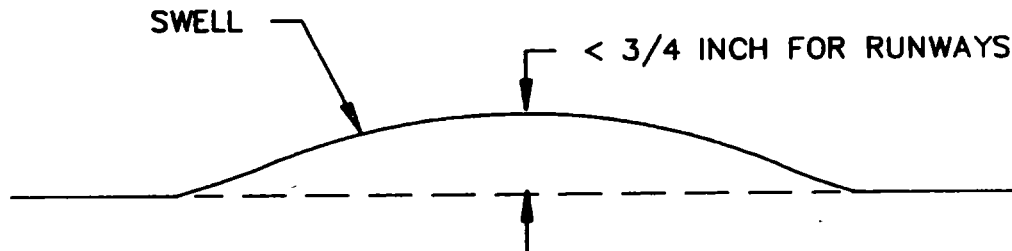

Figure A-62. Low severity swell.

(b) *Medium severity level (M)*. Swell can be observed without difficulty and has a significant effect on the pavement's ride quality as determined at the normal aircraft speed for the pavement section under consideration (fig. A-63).

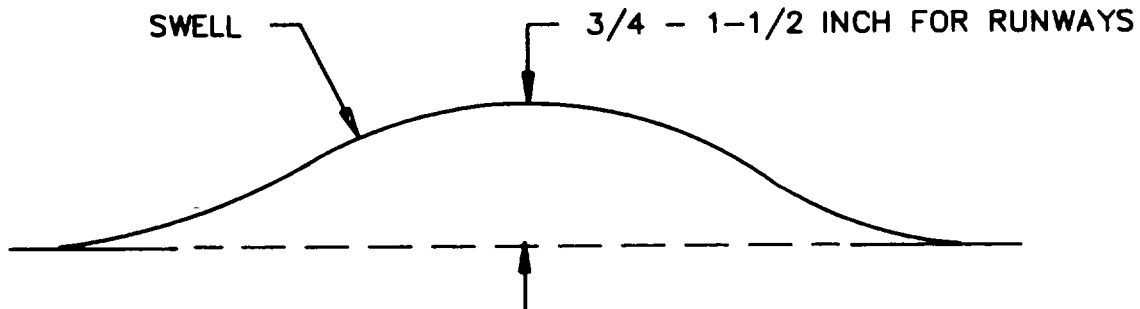

Figure A-63. Medium severity swell.

(c) *High severity level (H)*. Swell can be readily observed and severely affects the pavement's ride quality at the normal aircraft speed for the pavement section under consideration (figs. A-64 and A-65).

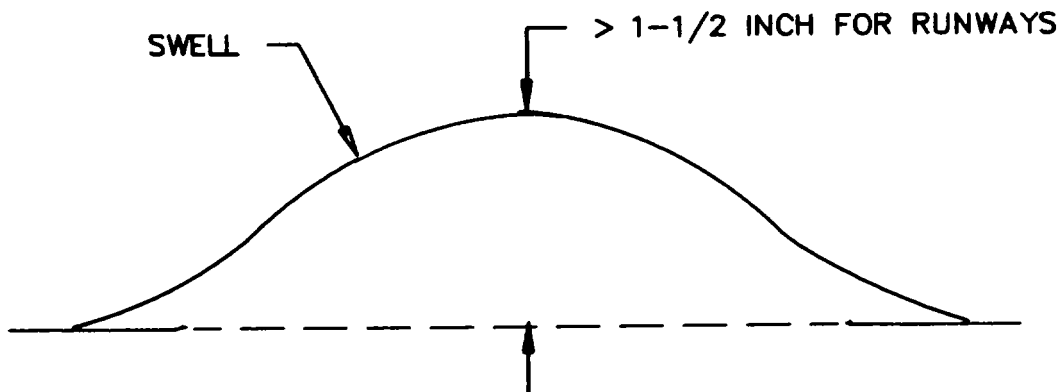

Figure A-64. High severity swell.



Figure A-65. High severity swell.

(3) *Measuring procedure.* The surface area of the swell is measured in square feet. The severity rating should consider the type of pavement section (i.e., runway, taxiway, or apron). For example, a swell of sufficient magnitude to cause considerable roughness on a runway at high speeds would be rated as more severe than the same swell located on an apron or taxiway where the normal aircraft operating speeds are much lower. The following guidance is approved for runways:

<u>Severity</u>	<u>Height Differential</u>
L	< 3/4 inch
M	3/4 - 1/2 inch
H	> 1-1/2 inch

q. *Blowup, distress 61.*

(1) *Description.* Blowups occur in hot weather, usually at a transverse crack or joint that is not wide enough to permit expansion of the concrete slabs. The insufficient width is usually caused by infiltration of incompressible materials into the joint space. When expansion cannot relieve enough pressure, a localized upward movement of the slab edges (buckling) or shattering will occur in the vicinity of the joint. Blowups can also occur at utility cuts and drainage inlets. This type of distress is almost always repaired immediately because of severe damage potential to aircraft. The main reason blowups are included here is for reference when closed sections are being evaluated for reopening.

(2) *Severity levels.*

(a) *Low severity level (L).* Buckling or shattering has not rendered the pavement inoperative, and only a slight amount of roughness exists (fig. A-66). Note that this would only be considered low severity if the shattering in the foreground was the only part existing and the foreign material removed.

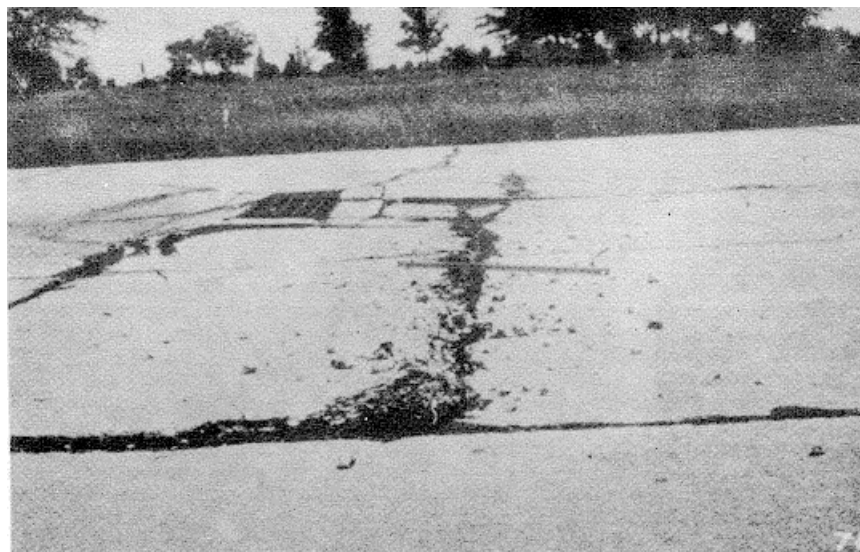

Figure A-66. Low severity blowup.

(b) *Medium severity level (M)*. Buckling or shattering has not rendered the pavement inoperative, but a significant amount of roughness exists (fig. A-67).



Figure A-67. Medium severity blowup

(c) *High severity level (H)*. Buckling or shattering has rendered the pavement inoperative (fig. A-68). For the pavement to be considered operational, all FOD material caused by the blowup must be removed.

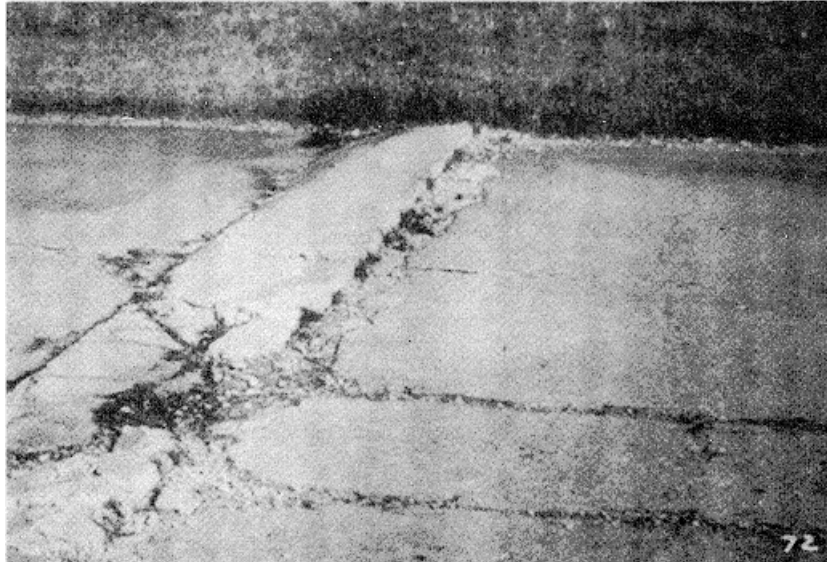

Figure A-68. High severity blowup.

(3) *Counting procedure.* A blowup usually occurs at a transverse crack or joint. At a crack, it is counted as being in one slab, but at a joint two slabs are affected and the distress should be recorded as occurring in two slabs.

r. Corner break, distress 62.

(1) A corner break is a crack that intersects the joints at a distance less than or equal to one-half of the slab length on both sides, measured from the corner of the slab. For example, a slab with dimensions of 25 by 25 feet that has a crack intersecting the joint 5 feet from the corner on one side and 17 feet on the other side is not considered a corner break; it is a diagonal crack. However, a crack that intersects 7 feet on one side and 10 feet on the other is considered a corner break. A corner break differs from a corner spall in that the crack extends vertically through the entire slab thickness, and a corner spall intersects the joint at an angle. Load repetition combined with loss of support and curling stresses usually cause corner breaks.

(2) Severity levels.

(a) *Low severity level (L).* Crack has either no spalling or minor spalling with no loose particles (no FOD potential). If nonfilled, it has a mean width less than approximately 1/8 in. A filled crack can be of any width, but the filler material must be in satisfactory condition. The area between the corner break and the joints is not cracked (figs. A-69 and A-70).



Figure A-69. Low severity corner break, case 1.



Figure A-70. Low severity corner break, case 2.

- (b) *Medium severity joint (M)*. One of four possible conditions exists:
- Filled or nonfilled crack is moderately spalled with loose particles (some FOD potential).
 - A nonfilled crack has a mean width between 1/8 and 1 inch.
 - A filled crack is not spalled or only lightly spalled, but the filler is in unsatisfactory condition.
 - The area between the corner break and the joints is lightly cracked (figures A-71 and A-72).

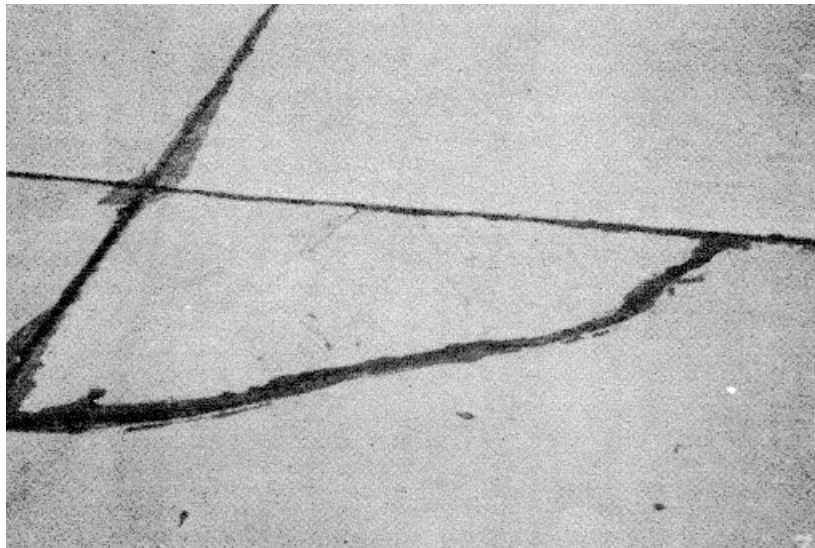

Figure A-71. Medium severity corner break, case 1.

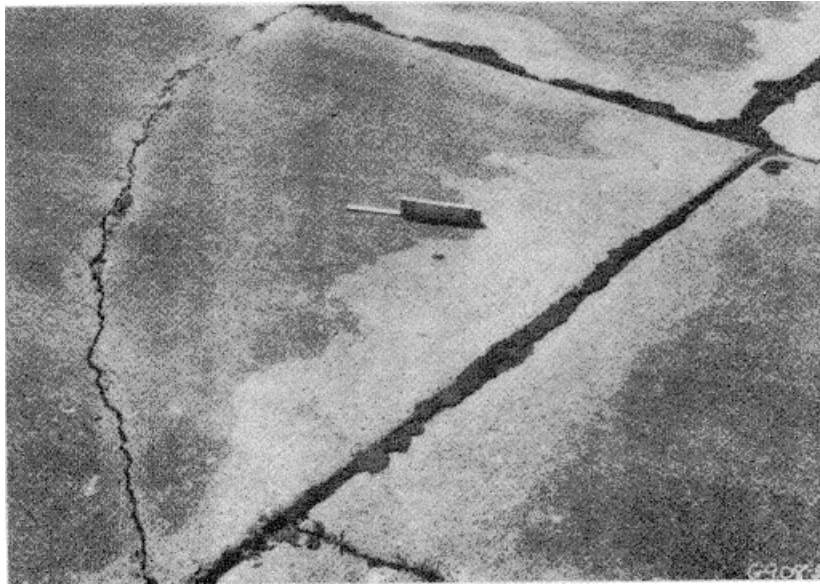

Figure A-72. Medium severity corner break, case 2.

(c) *High severity level (H)*. One of three possible conditions exists:

- Filled or nonfilled crack is severely spalled with loose and missing particles, causing definite FOD potential.
- A nonfilled crack has a mean width greater than approximately 1 inch, creating a tire damage potential.
- The area between the corner break and the joints is severely cracked (fig. A-73).



Figure A-73. High severity corner break.

(3) *Counting procedure*. A distress slab is recorded as one slab if it (a) contains a single corner break, (b) contains more than one break of a particular severity, or (c) contains two or more breaks of different severities. For two or more breaks, the highest level of severity should be recorded. For example, a slab containing both light and medium severity corner breaks should be counted as one slab with a medium corner break.

s. Longitudinal, transverse, and diagonal cracks, distress 63.

(1) *Description*. These cracks, which divide the slab into two or three pieces, are usually caused by a

combination of load repetition, curling stresses, and shrinkage stresses. (For slabs divided into four or more pieces, see shattered/intersecting cracks.) Low severity cracks are usually warping- or friction-related and are not considered major structural distresses. Medium or high severity cracks are usually working cracks and are considered major structural distresses. Hairline cracks that are only a few feet long and do not extend across the entire slab are rated as shrinkage cracks.

(2) *Severity levels, unreinforced PCC.*

(a) *Low severity level (L).* One of three conditions exists:

- Nonfilled cracks less than 1/8-inch wide with little or no spalling and no loose particles (no FOD potential) (figs. A-74 and A-76).
- Filled cracks of any width but filler material must be in satisfactory condition with no faulting or spalling and no FOD potential (fig. A-75).

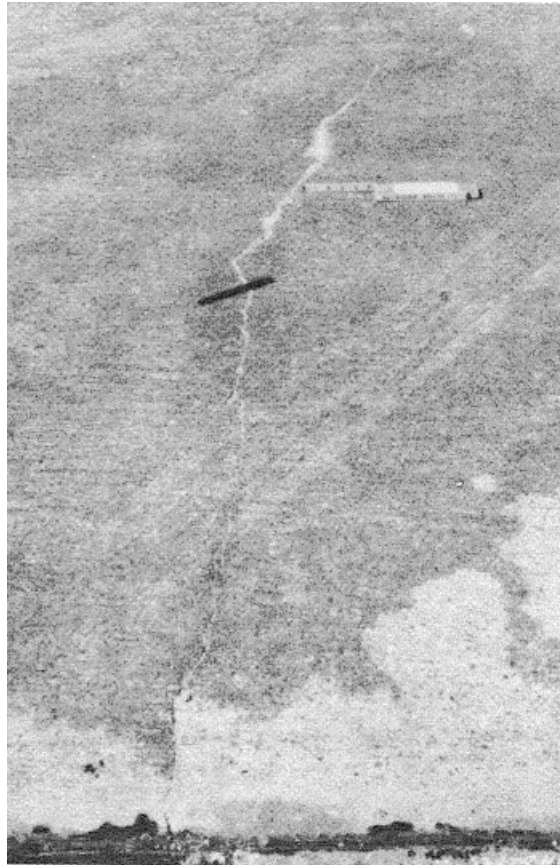

Figure A-74. Low severity longitudinal crack.

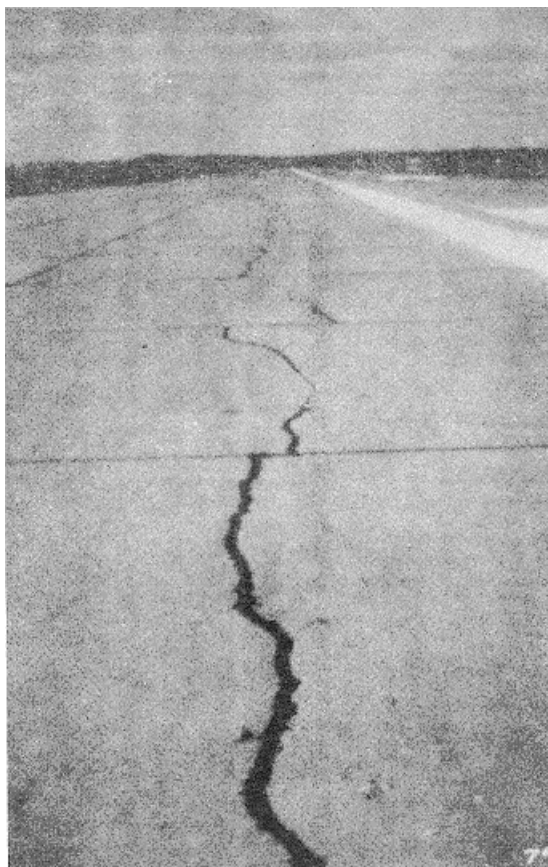

Figure A-75. Low severity filled longitudinal cracks.

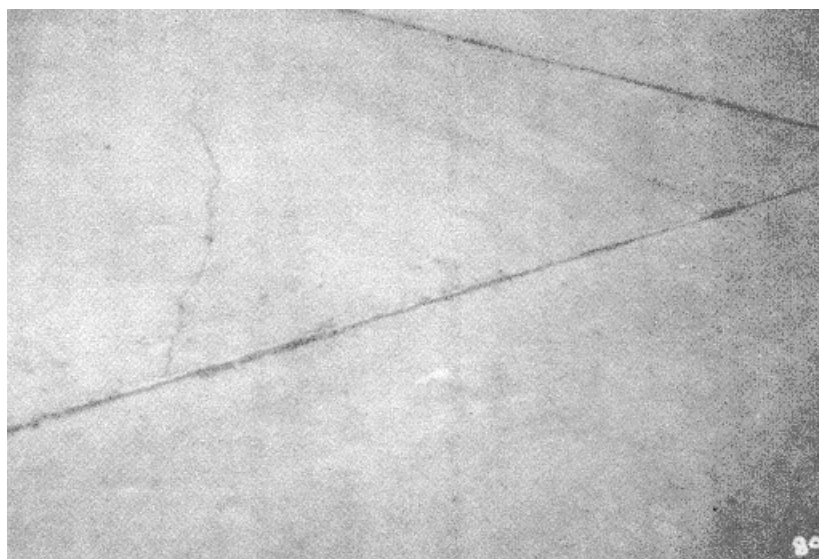

Figure A-76. Low severity diagonal crack.

- (b) *Medium severity level (M)*. One of these conditions exists:
- Nonfilled cracks with mean width between 1/8 and 1-inch (figs. A-77 and A-78).
 - Filled or nonfilled cracks moderately spalled with some loose or missing particles (some FOD potential) (fig. A-79).
 - Filled cracks with no minor spalling but with filler in unsatisfactory condition.

- The slab is divided into three pieces by two or more cracks, one of which is low severity.

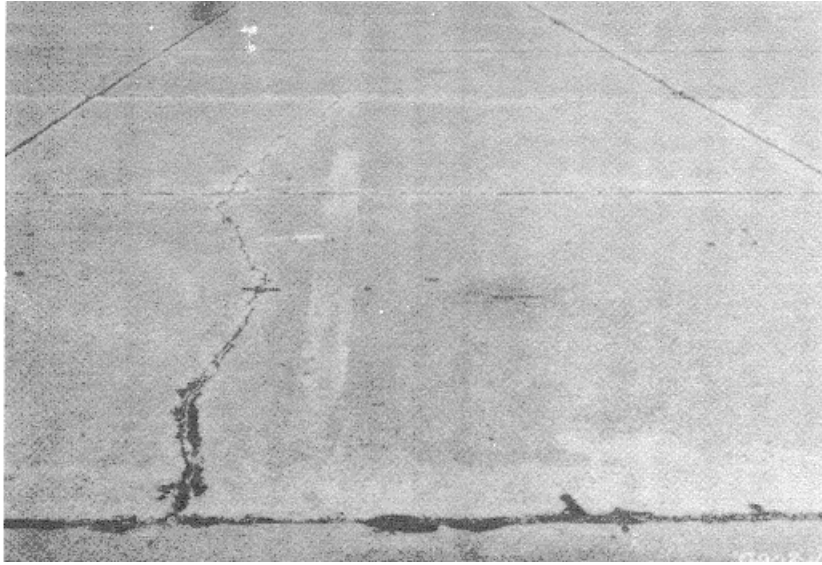

Figure A-77. Medium severity longitudinal crack.

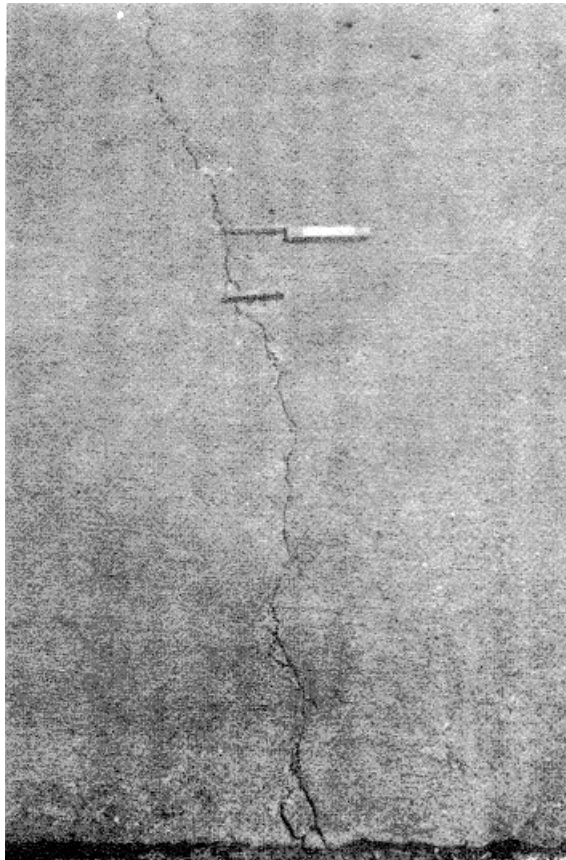

Figure A-78. Medium severity transverse crack, case 1.



Figure A-79. Medium severity transverse crack, case 2.

- (c) *High severity level (H)*. One of three conditions exists:
- Filled or nonfilled crack severely spalled with loose and missing particles (definite FOD potential) (figs. A-80 through A-82).
 - Nonfilled cracks with mean width greater than 1-inch creating tire damage potential.
 - The slab is divided into 3 pieces by two or more cracks, or one or more of which is medium severity.

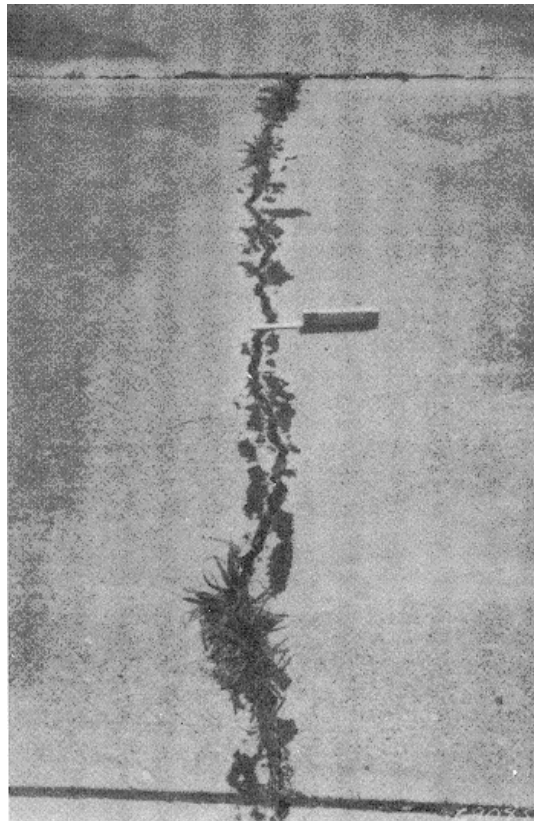

Figure A-80. High severity transverse crack.

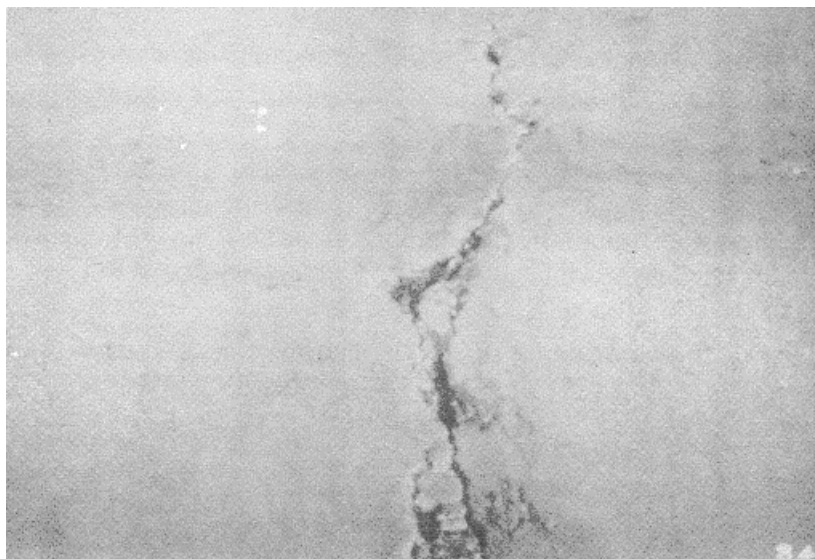

Figure A-81. High severity longitudinal crack, case 1.



Figure A-82. High severity longitudinal crack, case 2.

(3) Severity levels, reinforced PCC.

- (a) *Low severity levels (L)*. One of these conditions exists:
- Nonfilled cracks 1/8 inch to < 1/2 inch wide with no faulting or spalling.
 - Filled or nonfilled cracks of any width < 1/2 inch with low severity spalling.
 - Filled cracks of any width (filler satisfactory), with no faulting or spalling.
- (b) *Medium severity level (M)*. One of these conditions exists:
- Nonfilled cracks 1/2 inch to < 1 inch wide, with no faulting or spalling.
 - Nonfilled cracks of width < 1 inch with faulting < 3/8 inch or medium severity spalling.
 - Filled cracks of any width with faulting < 3/8 inch or medium severity spalling.
- (c) *High severity level (H)*. One of these conditions exists:
- Nonfilled cracks of width > 1 inch.

- Nonfilled cracks of any width with faulting $>3/8$ inch or medium severity spalling.
- Filled cracks of any width with faulting $> 3/8$ inch or high severity spalling.

(4) *Counting procedure.* Once the severity has been identified, the distress is recorded as one slab.

t. Durability ("D") cracking, distress 64.

(1) *Description.* D cracking is caused by the concrete's inability to withstand environmental factors such as freeze-thaw cycles. It usually appears as a pattern of cracks running parallel to a joint or linear crack. A dark coloring can usually be seen around the fine durability cracks. This type of cracking may eventually lead to disintegration of the concrete within 1 to 2 feet of the joint or crack.

(2) *Severity levels.*

(a) *Low severity level (L).* D cracking is defined by hairline cracks occurring in a limited area of the slab, such as one or two corners or along one joint, and where little or no disintegration has occurred, or no FOD potential exists (fig. A-83).



Figure A-83. Low severity D cracking.

(b) *Medium severity level (M).* D cracking has developed over a considerable amount of slab area with little or no disintegration or FOD potential; or D cracking has occurred in a limited area of the slab, such as in one or two corners or along one joint, but pieces are missing and disintegration has occurred with some FOD potential (figs. A-84 and A-85).

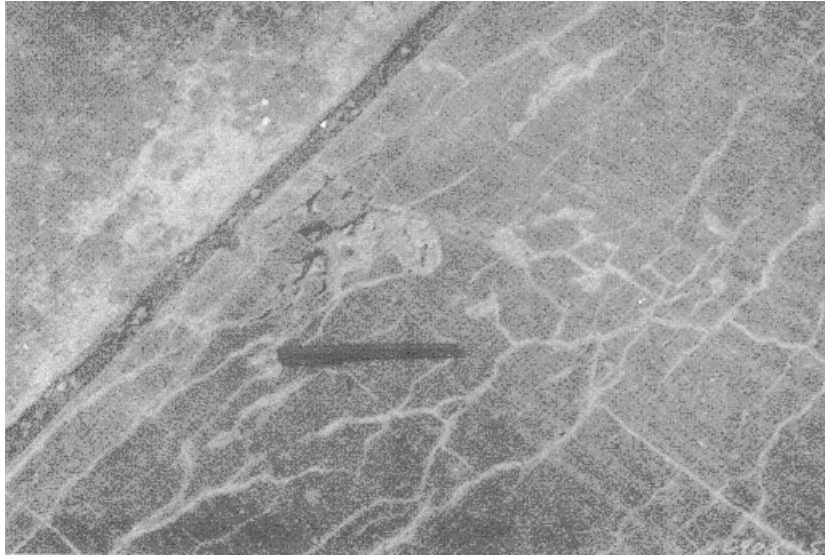

Figure A-84. Medium severity D cracking case 1.



Figure A-85. Medium severity D cracking case 2.

(c) *High severity level (H).* D cracking has developed over a considerable amount of slab area with considerable disintegration or FOD potential (fig. A-86).



Figure A-86. High severity D cracking.

(3) *Counting procedure.* When the distress is located and rated at one severity, it is counted as one slab. If more than one severity level is found, the slab is counted as having the higher severity distress. For example, if light and medium durability cracking are located on one slab, the slab is counted as having medium cracking only, or if D cracking is counted, scaling on the same slab should not be recorded.

u. Joint seal damage, distress 65.

(1) *Description.*

(a) Joint seal damage is any condition which enables soil or rocks to accumulate in the joints or allows significant infiltration of water. Accumulation of incompressible materials prevents the slabs from expanding and may result in buckling, shattering, or spalling. A pliable joint filler bonded to the edges of the slabs protects the joints from accumulation of materials and prevents water from seeping down and softening the foundation supporting the slab.

(b) Typical types of joint seal damage are stripping of joint sealant, extrusion of joint sealant, weed growth, hardening of the filler (oxidation), loss of bond to the slab edges, and lack or absence of sealant in the joint.

(2) *Severity levels.*

(a) *Low severity level (L).* Joint sealer is generally in good condition throughout the section. Sealant is performing well with only a minor amount of any of the above types of damage present (fig. A-87). Light-severity joint seal damage exists only on a few joints in the pavement section. If all joint sealant were as shown, it would have been rated medium.

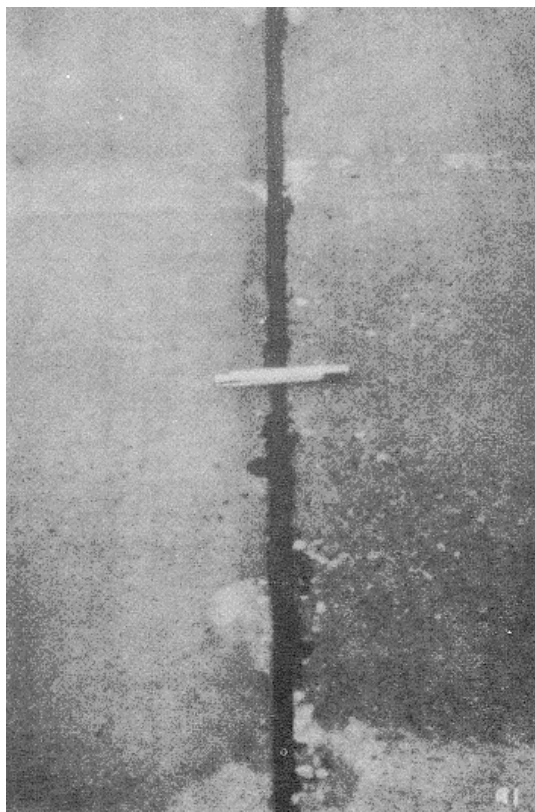

Figure A-87. Low-severity joint seal damage.

(b) *Medium severity level (M)*. Joint sealer is generally in fair condition over the entire surveyed section with one or more of the above types of damage occurring to a moderate degree. Sealant needs replacement within 2 years (fig. A-88). Note that sealant has lost bond and is highly oxidized.

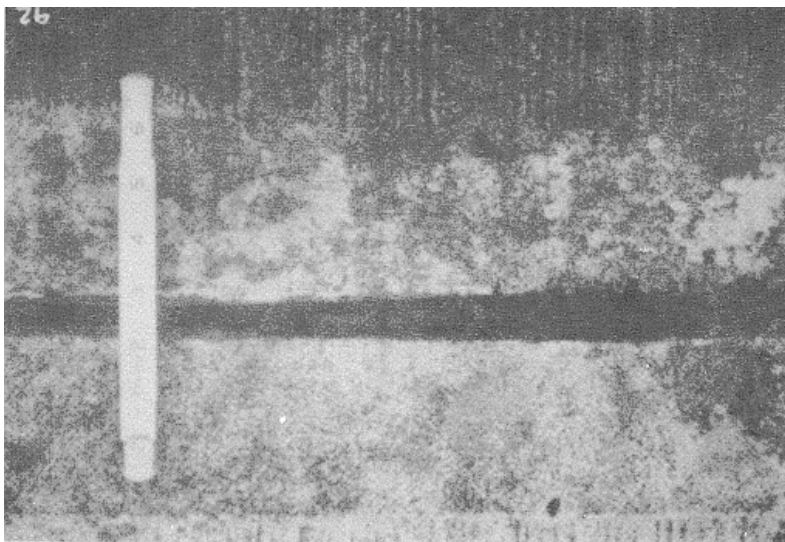

Figure A-88. Medium severity joint seal damage.

(c) *High severity level (H)*. Joint sealer is generally in poor condition over the entire surveyed section with one or more of the above types of damage occurring to a severe degree. Sealant needs immediate

replacement (figs. A-89 and A-90). There is a complete loss of sealant, and joint is filled with incompressible material (fig. A-89).

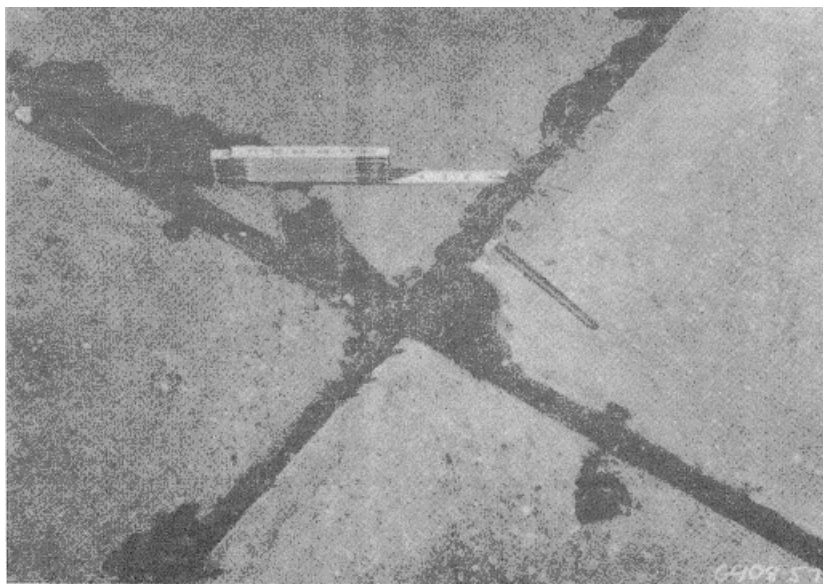

Figure A-89. High severity joint seal damage.

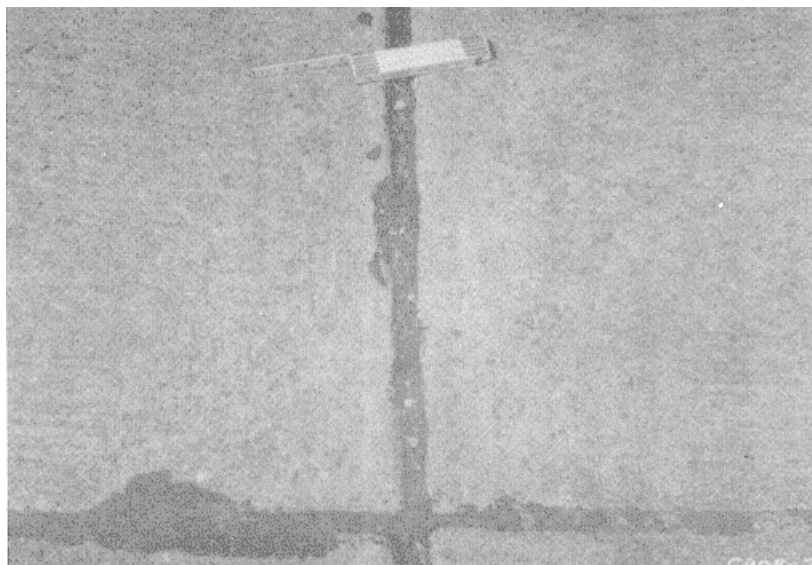

Figure A-90. High severity joint seal damage.

(3) *Counting procedure.* Joint seal damage is not counted on a slab-by-slab basis, but is rated based on the overall condition of the sealant over the entire section.

v. Small patching (less than 5 square feet), distress 66.

(1) *Description.* A patch is an area where the original pavement has been removed and replaced by a filler material. For condition evaluation, patching is divided into two types: small (less than 5 square feet) and large (over 5 square feet). Large patches are described in section w.

(2) *Severity levels.*

(a) *Low severity level (L).* Patch is functioning well with little or no deterioration (figs. A-91 and A-92).



Figure A-91. Low severity small patch, case 1.



Figure A-92. Low severity small patch, case 2.

(b) *Medium severity level (M)*. Patch has deteriorated and/or moderate spalling can be seen around the edges. Patch material can be dislodged with considerable effort (minor FOD potential) (figs. A-93 and A-94).

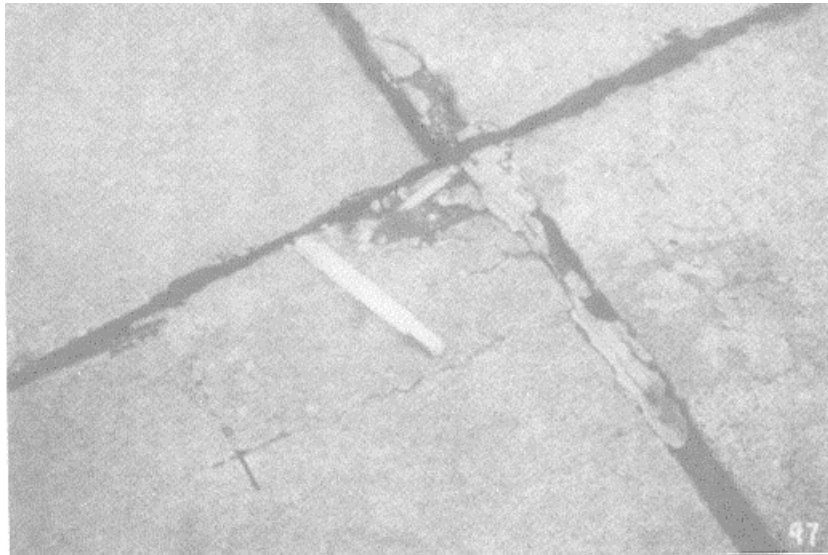

Figure A-93. Medium severity small patch case 1.

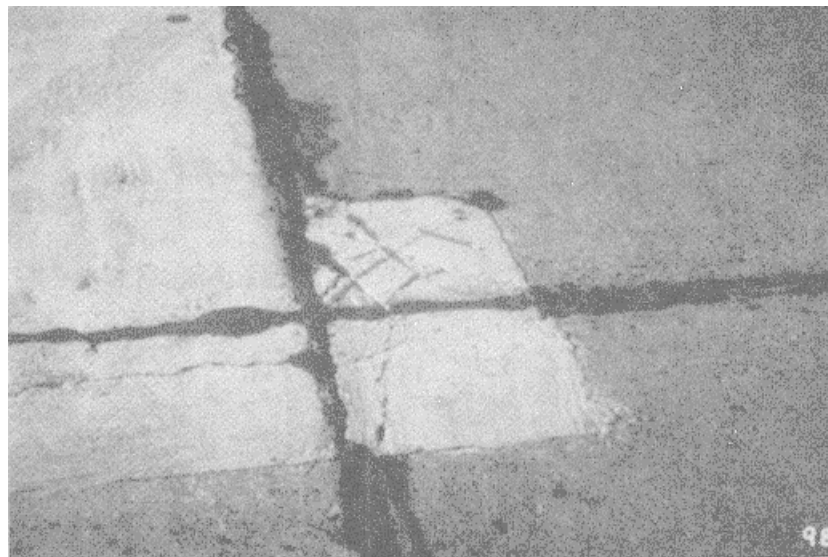

Figure A-94. Medium severity small patch case 2.

(c) *High severity level (H).* Patch has deteriorated, either by spalling around the patch or cracking within the patch, to a state which warrants replacement (fig. A-95).

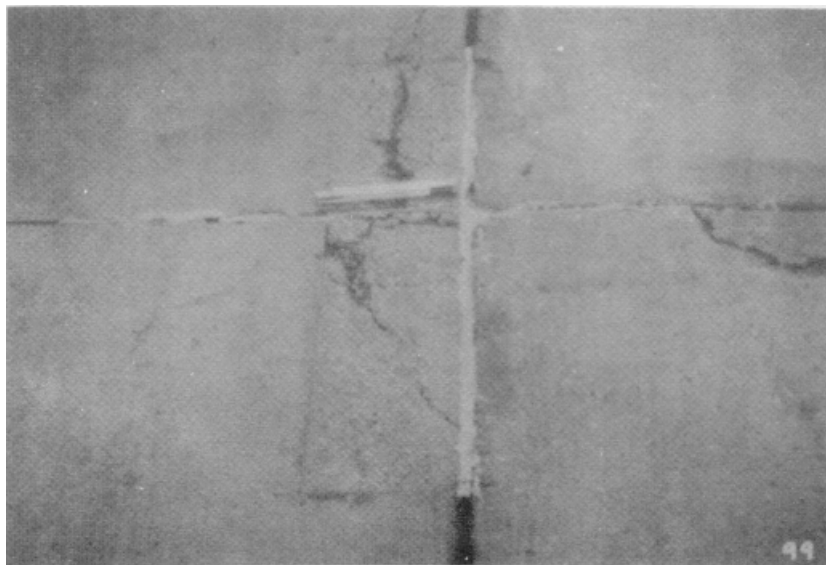

Figure A-95. High severity small patch.

(3) *Counting procedure.* If one or more small patches having the same severity level are located in a slab, it is counted as one slab containing that distress. If more than one severity level occurs, it is counted as one slab with the higher severity level being recorded.

w. Large patching (over 5 square feet) and utility cut, distress 67.

(1) *Description.* Patching is the same as defined in the previous section. Complete slab replacement is counted as a large patch. A utility cut is a patch that has replaced the original pavement because of placement of underground utilities. The severity levels of a utility cut are the same as those for regular patching.

(2) *Severity levels.*

(a) *Low severity level (L).* Patch is functioning well with very little or no deterioration (figs. A-96 through A-98).

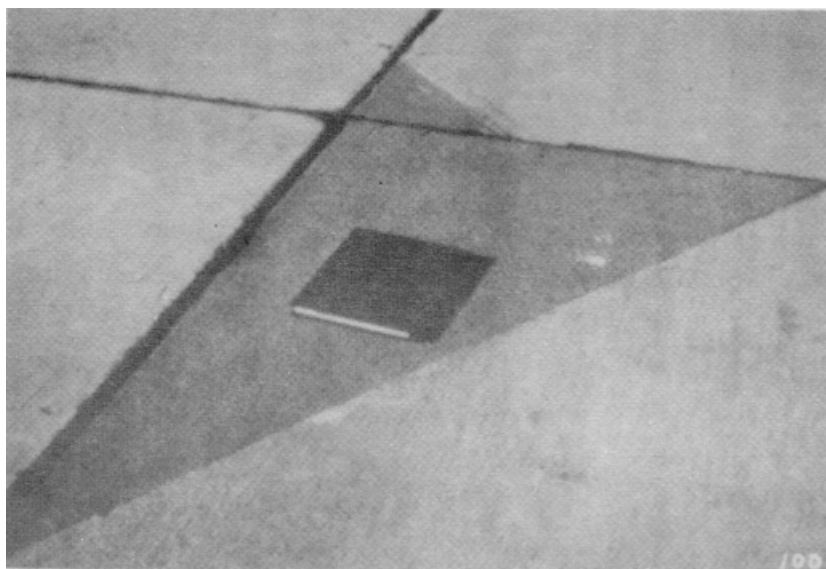

Figure A-96. Low severity patch, case 1.



Figure A-97. Low severity patch, case 2.



Figure A-98. Low severity utility cut.

(b) *Medium severity level (M)*. Patch is deteriorated and/or moderate spalling can be seen around the edges. Patch material can be dislodged with considerable effort causing some FOD potential (fig. 99).



Figure A-99. Medium severity utility cut.

(c) *High severity level (H)*. Patch has deteriorated to a state which causes considerable roughness with loose or easily dislodged material (high FOD potential). The extent of the deterioration warrants replacement of the patch (fig. A-100).

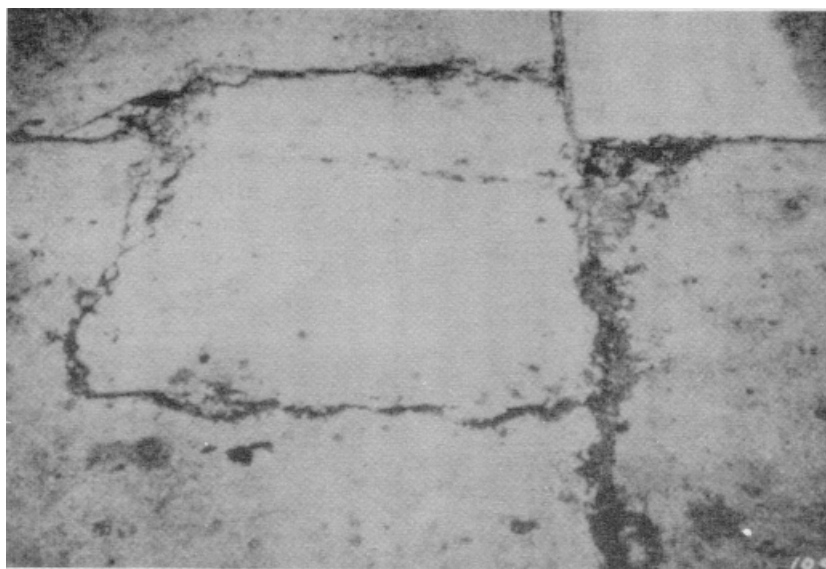

Figure A-100. High severity patch.

(3) *Counting procedure*. The criteria are the same as for small patches.

x. Popouts - distress 68.

(1) *Description*. A popout is a small piece of pavement that breaks loose from the surface due to freeze-thaw action in combination with expansive aggregates. Popouts usually range from approximately 1 to 4 inches in diameter and from $\frac{1}{2}$ to 2 inches deep.

(2) *Severity levels*. No degrees of severity are defined for popouts. However, popouts must be extensive before they are counted as a distress; i.e., average popout density must exceed approximately three popouts per square yard over the entire slab area (fig. A-101).



Figure A-101. Popouts.

(3) *Counting procedure.* The density of the distress must be measured. If there is any doubt about the average being greater than three popouts per square yard, at least three random 1-square-yard areas should be checked. When the average is greater than this density, the slab is counted.

y. Pumping, distress 69.

(1) *Description.* Pumping is the ejection of material by water through joints or cracks caused by deflection of the slab under passing loads. As the water is ejected, it carries particles of gravel, sand, clay, or silt resulting in a progressive loss of pavement support. Surface staining and base or subgrade material on the pavement close to joints or cracks are evidence of pumping. Pumping near joints indicates poor joint sealer and loss of support, which will lead to cracking under repeated loads.

(2) *Severity levels.* No degrees of severity are defined. It is sufficient to indicate that pumping exists (figs. A-102 through A-105). Fine material on surface that has been pumped out causing corner break, stains on pavement, and close-up of fine materials collecting in a joint are show in figures A-102 through A-105, respectively.



Figure A-102. Pumping.

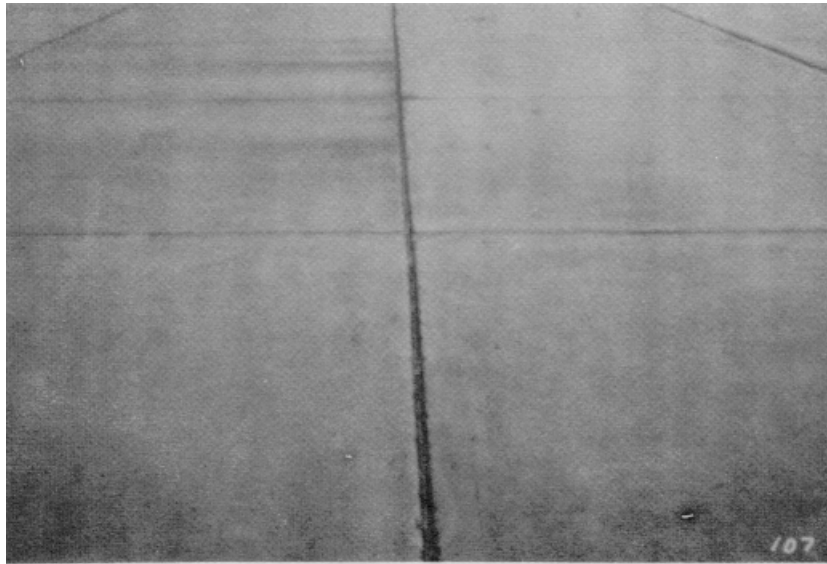

Figure A-103. Pumping (note stained pavement).

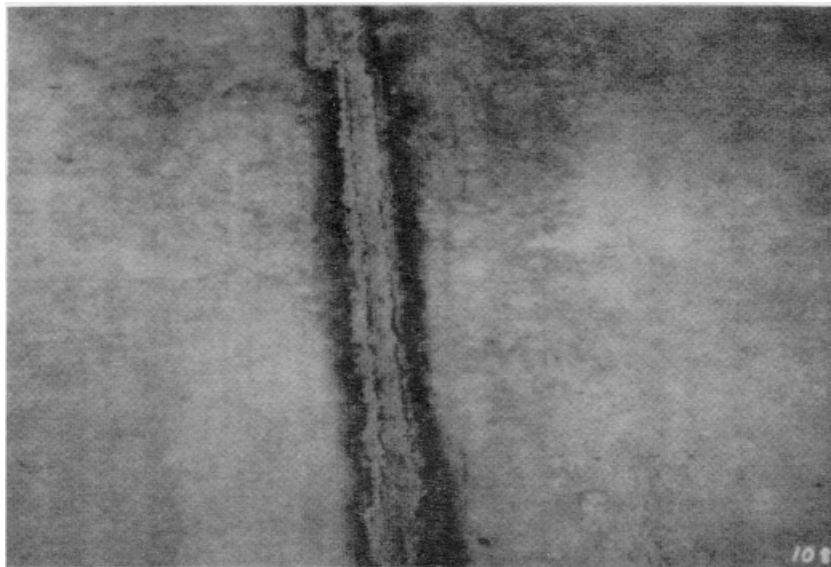

Figure A-104. Pumping (fine materials collected on surface).

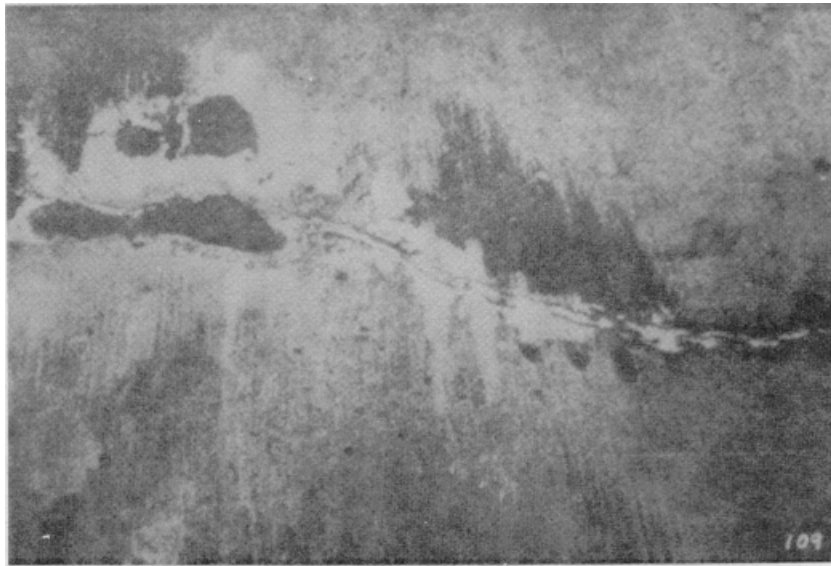

Figure A-105. Pumping.

(3) *Counting procedure.* Slabs are counted as indicated in figure A-106. One pumping joint between two slabs is counted as two slabs. However, if the remaining joints around the slab are also pumping, one slab is added per additional pumping joint.

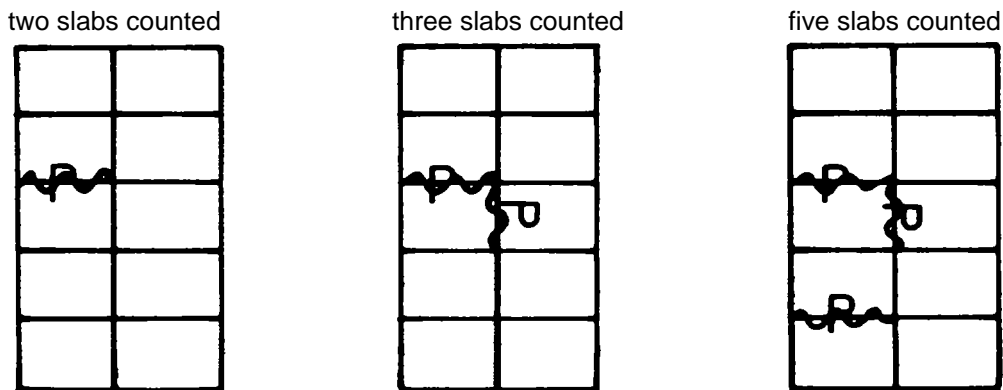

Figure A-106. Counting procedure for pumping.

z. Scaling, map cracking, and crazing, distress 70.

(1) *Description.* Map cracking or crazing refers to a network of shallow, fine, or hairline cracks that extend only through the upper surface of the concrete. The cracks tend to intersect at angles of 120 degrees. Map cracking or crazing is usually caused by overfinishing the concrete and may lead to scaling of the surface, which is the breakdown of the slab surface to a depth of approximately 1/4 to 1/2 inch. Scaling may also be caused by deicing salts, improper construction, freeze-thaw cycles, and poor aggregate. Another recognized source of distress is the reaction between the alkalis (Na_2O and K_2O) in some cements and certain minerals in some aggregates. Products formed by the reaction between the alkalis and aggregate result in expansions that cause a breakdown in the concrete. This generally occurs throughout the slab and not just at joints where D cracking normally occurs.

(2) *Severity levels.*

(a) *Low severity level (L).* Crazing or map cracking exists over most of the slab area. The surface is in good condition with no scaling (fig. A-107). The low severity level is an indicator that scaling may develop in the future. A slab should be counted only if in the judgment of the inspector scaling is likely to occur within a few years.

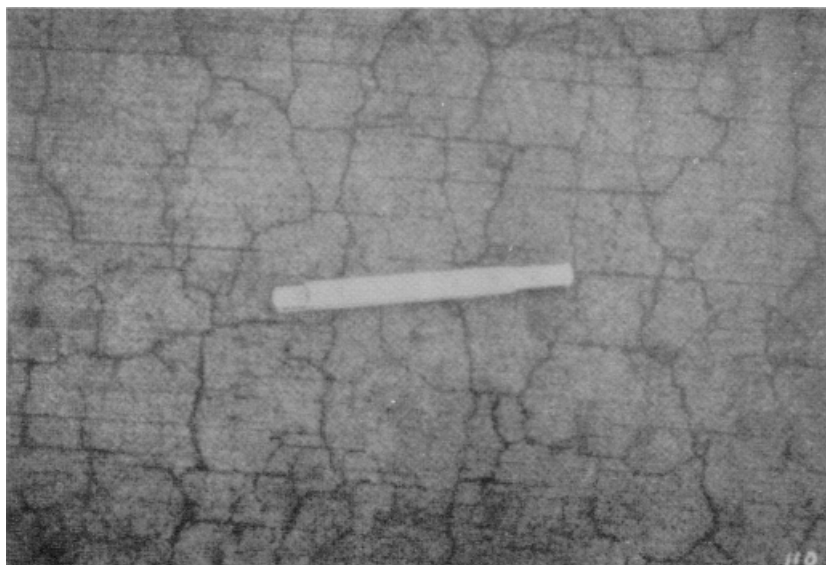

Figure A-107. Low severity crazing.

(b) *Medium severity level (M)*. Slab is scaled over approximately 5 percent or less of the surface with loose or missing material causing some FOD potential (fig. A-108).

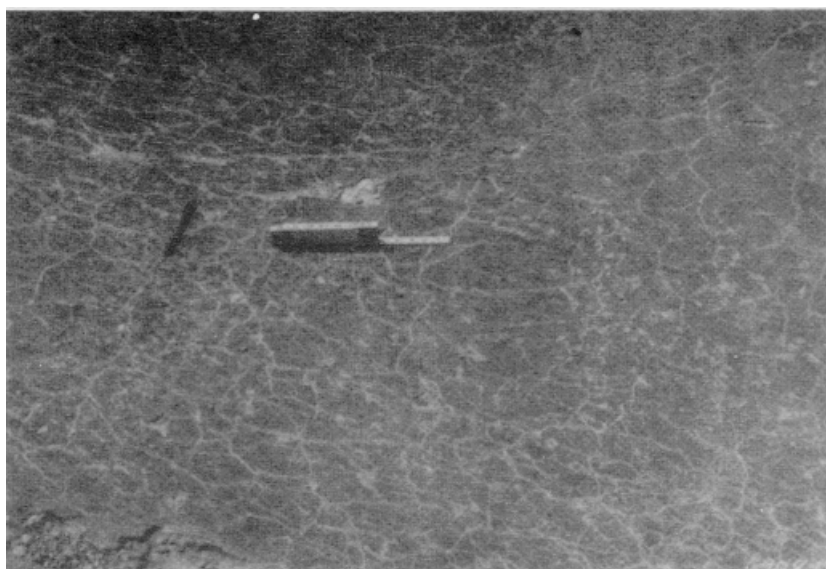

Figure A-108. Medium severity scaling.

(c) *High severity level (H)*. Slab is severely scaled with a large amount of loose or missing material causing a high FOD potential. Usually more than 5 percent of the surface is affected (figs. A-109 and A-110).



Figure A-109. High severity scaling.



Figure A-110. Close-up of high severity scaling.

(3) Counting procedure If two or more levels of severity exist on a slab, the slab is counted as one slab having the maximum level of severity For example, if both low severity crazing and medium scaling exist in one slab, the slab is counted as one slab containing medium scaling.

aa. Settlement or faulting, distress 71.

(1) *Description.* Settlement or faulting is a difference of elevation at a joint or crack caused by upheaval or consolidation.

(2) *Severity levels.* Severity levels are defined by the difference in elevation across the fault and the associated decrease in ride quality and safety as severity increases.

<i>Difference in Elevation</i>	
Runways/Taxiways	Aprons
L < 1/4 inch	1/8 - 1/2 inch
M 1/4 - 1/2 inch	(figs. A-111 and A-112)
H > 1/2 inch	1/2 - 1 inch
(figs. A-114 and A-115)	(fig. A-113)
> 1 inch	

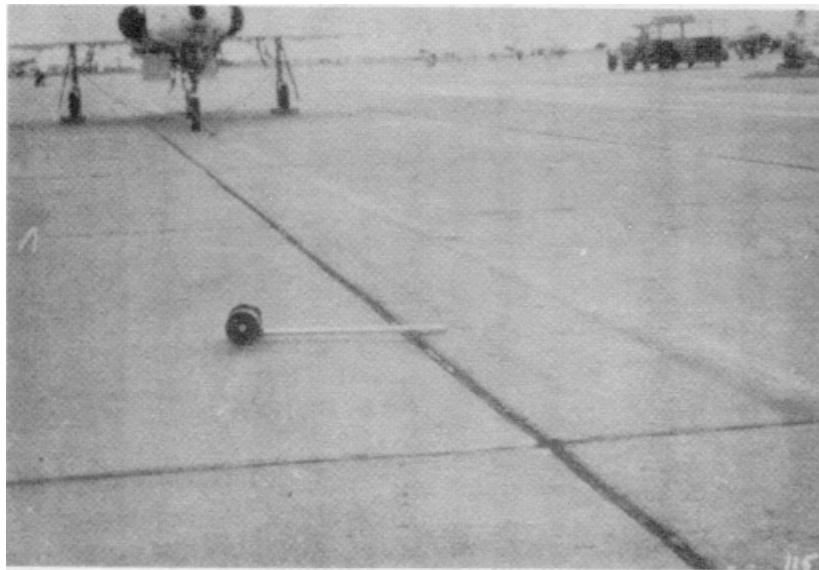

Figure A-111. Low severity settlement on apron, case 1.

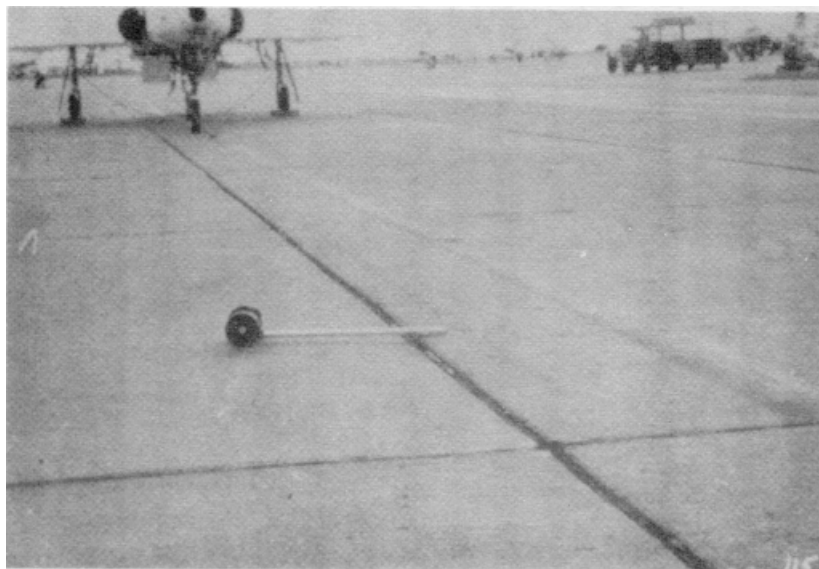

Figure A-112. Low severity settlement on apron, case 2.



Figure A-113. Medium severity settlement on apron.

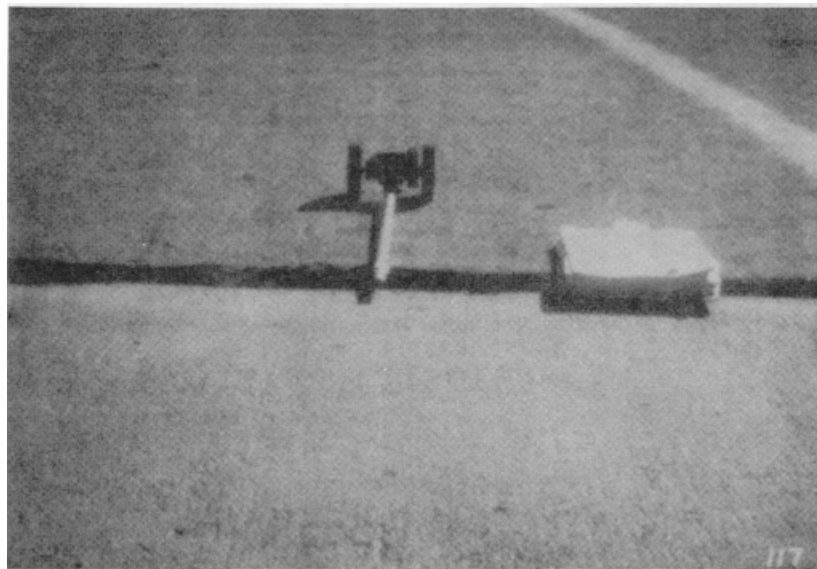

Figure A-114. High severity settlement on taxiway/runway, case 1.



Figure A-115. High severity settlement, case 2

(3) Counting procedure. In counting settlement, a fault between two slabs is counted as one slab (fig. A-116). A straightedge or level should be used to aid in measuring the difference in elevation between the two slabs.

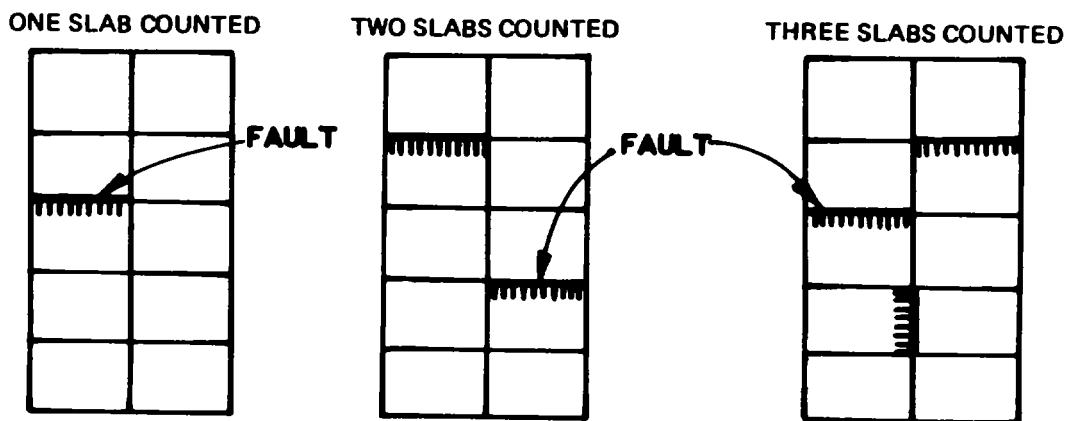

Figure A-116. Counting procedure for settlement or faulting.

bb. Shattered slab/intersecting cracks, distress 72.

(1) Description Intersecting cracks are cracks that break the slab into four or more pieces due to overloading and/or inadequate support. The high severity level of this distress type, as defined below, is referred to as shattered slab. If all pieces or cracks are contained within a corner break, the distress is categorized as a severe corner break.

(2) Severity levels.

(a) Low severity level (L). Slab is broken into four or five pieces with some or all cracks of low severity (figs. A-117 and A-118).

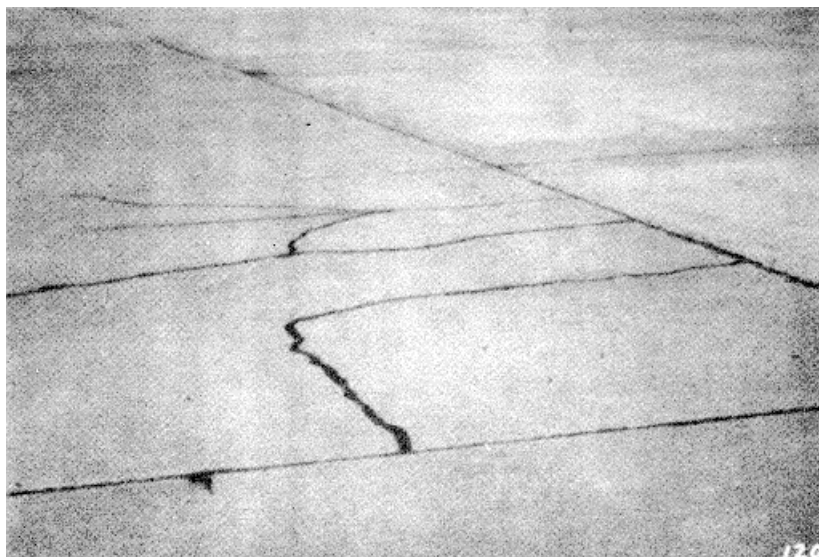

Figure A-117. Low severity intersecting cracks, case 1.

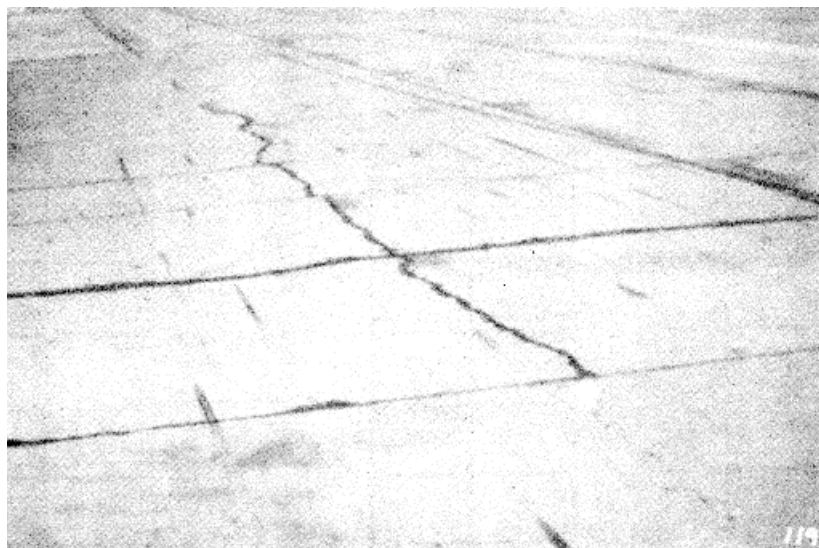

Figure A-118. Low severity intersecting cracks, case 2

(b) Medium severity level (M).

- Slab is broken into four or five pieces with some or all cracks of medium severity (no high severity cracks) (fig. A-119).
- Slab is broken into six or more pieces with all cracks of low severity (fig. A-120).

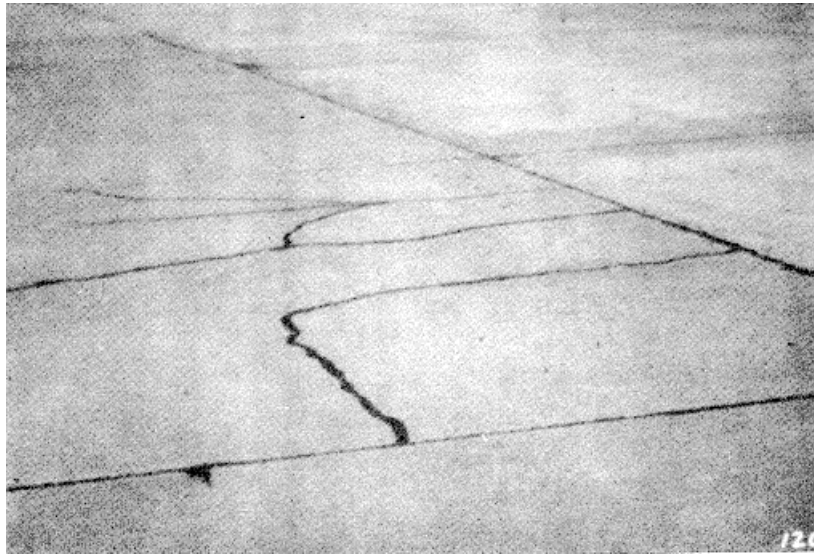

Figure A-119. Medium severity intersecting cracks, case 1.



Figure A-120. Medium severity intersecting cracks, case 2.

(c) High severity level (H). At this level of severity, the slab is called shattered.

- Slab is broken into four or five pieces with some or all cracks of high severity.
- Slab is broken into six or more pieces with some or all cracks of medium or high severity (fig. A-121).



Figure A-121. Shattered slab.

(3) Counting procedure. The deduct value for a shattered slab is high because this condition is essentially failure. Therefore, if a slab is evaluated as being either medium or high severity shattered slab, no other distress types should be counted because the counting of other distress types would tend to inordinately reduce the PCI.

cc. Shrinkage cracks, distress 73.

(1) Description Shrinkage cracks are hairline cracks that are usually only a few feet long and do not extend across the entire slab. They are formed during the setting and curing of the concrete and usually do not extend through the depth of the slab.

(2) Severity levels. No degrees of severity are defined. It is sufficient to indicate that shrinkage cracks exist (figs. A-122 and A-123).

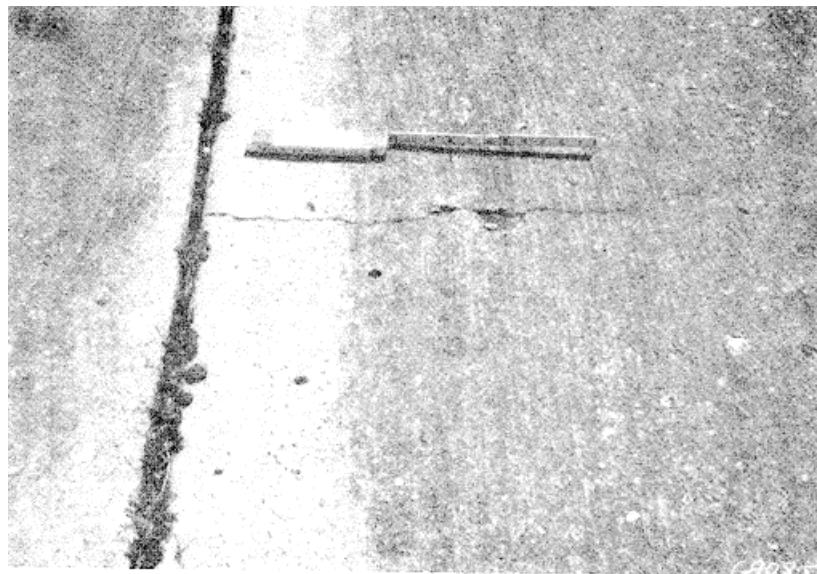

Figure A-122. Shrinkage crack, case 1

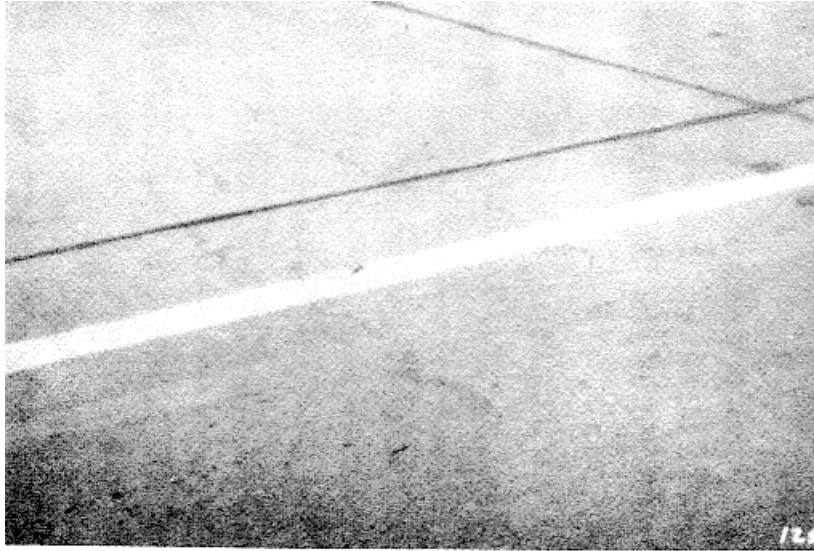

Figure A-123. Shrinkage crack, case 2

(3) Counting procedure. If one or more shrinkage cracks exist on one particular slab, the slab is counted: as one slab with shrinkage cracks

dd. Sapling (transverse and longitudinal joint), distress 74.

(1) Description. Joint sapling is the breakdown of the slab edges within 2 feet of the side of the joint. A joint spall usually does not extend vertically through the slab but intersects the joint at an angle. Sapling results from excessive stresses at the joint or crack caused by infiltration of incompressible materials or traffic load. Weak concrete at the joint (caused by overworking) combined with traffic loads is another cause of sapling.

(2) Severity levels.

(a) Low severity level (L).

- Spall over 2 feet long:
 - Spall is broken into no more than three pieces defined by low or medium severity cracks and little or no FOD potential exists.
 - Joint is lightly frayed with little or no loose or missing material (no FOD potential).
- Spall less than 2 feet long: spall is broken into pieces or fragmented with loose or missing material little FOD or tire damage potential) (figs. A-124 and A-125). If the frayed area was less than 2 feet long, it would not be counted.

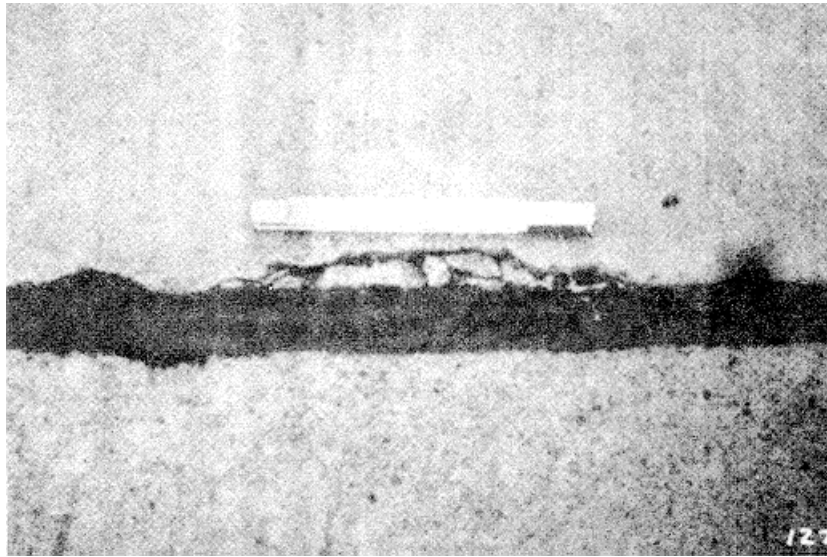

Figure A-124. Low severity joint spall- case 1



Figure A-125. Low severity Joint spall case 2

(b) Medium severity level (M)

- Spall over 2 feet long, one of three conditions exist:
 - Spall is broken into more than three pieces defined by light or medium cracks.
 - Spall is broken into no more than three pieces with one or more of the cracks being severe with some loose or missing material (some FOD potential)

- Joint is moderately frayed with some loose or missing material (some FOD potential).
- Spall less than 2 feet long: spall is broken into pieces or fragmented with some of the pieces loose or absent, causing considerable FOD or tire damage potential (figs. A-126 and A-127).



Figure A-126. Medium severity joint spay case 1.

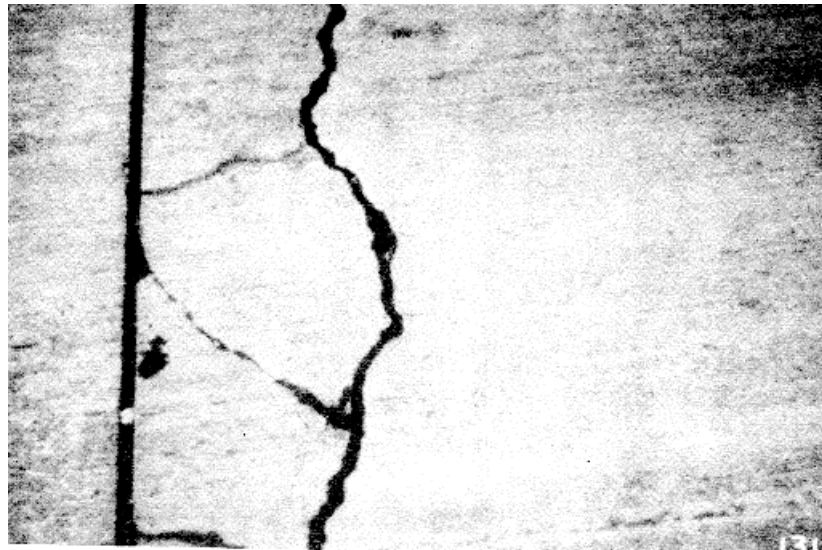

Figure A-127. Medium severity joint spay case 2

(c) High severity level (H). For spall over 2 feet long.

- Spall is broken into more than three pieces defined by one or more high severity cracks with possibility of the pieces becoming dislodged (high FOD potential).
- Joint is severely frayed with a large amount of loose or missing particles (high FOD potential (figs. A-128 and A-129). If less than 2 feet of the joint is lightly frayed, the spall should not be counted.

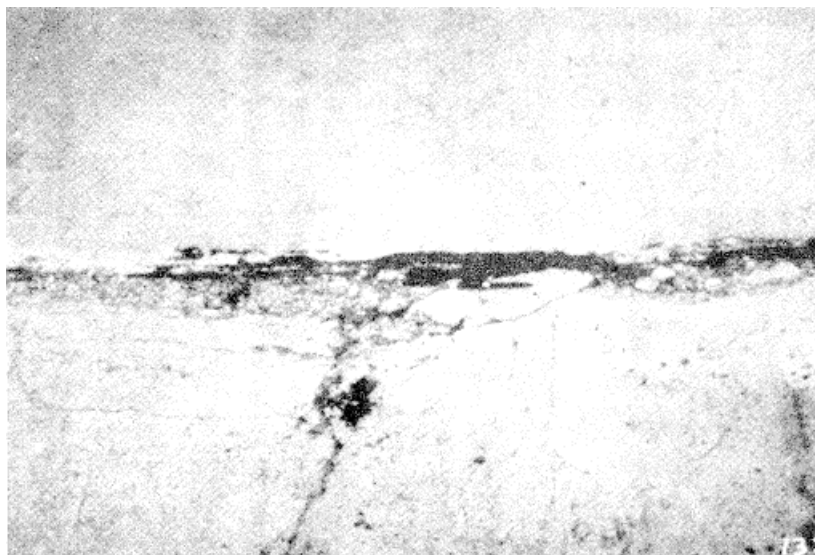

Figure A-128. High severity joint spall case 1.

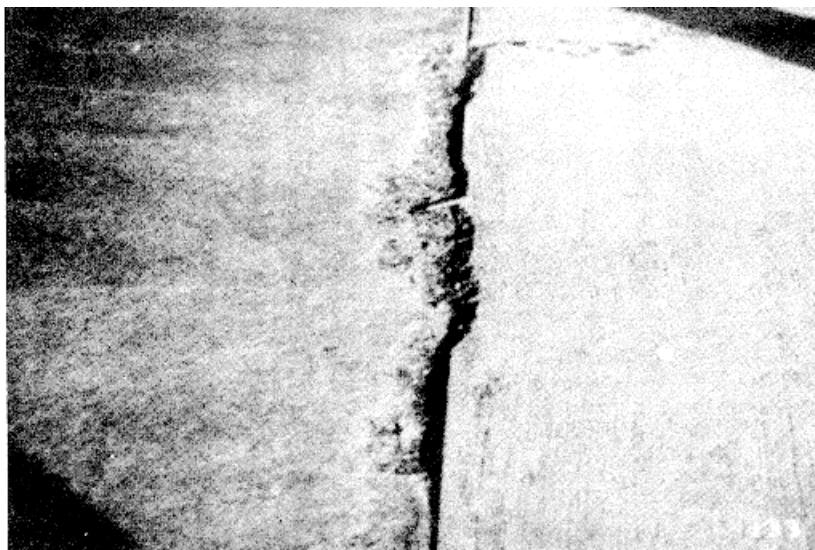

Figure A-129. High severity joint spall case 2

(3) Counting procedure. If the joint spall is located along the edge of one slab, it is counted as one slab with joint sapling. If sapling is located on more than one edge of the same slab, the edge having the highest severity is counted and recorded as one slab. Joint sapling can also occur along the edges of two adjacent slabs. If this is the case, each slab is counted as having joint sapling.

ee. Sapling (corner), distress 75.

(1) Description. Corner sapling is the raveling or breakdown of the slab within approximately 2 feet of the corner. A corner spall differs from a corner break in that the spall usually angles downward to intersect the joint while a break extends vertically through the slab.

(2) Severity levels.

(a) Low severity level (L). One of two conditions exists.

- Spall is broken into one or two pieces different by low severity cracks with pieces not easily dislodged (little or no FOD potential).
- Spall is defined by one medium severity crack with little or no FOD potential (figs. A-130 and A-131).



Figure A-130. Low severity corner spall; case 1.

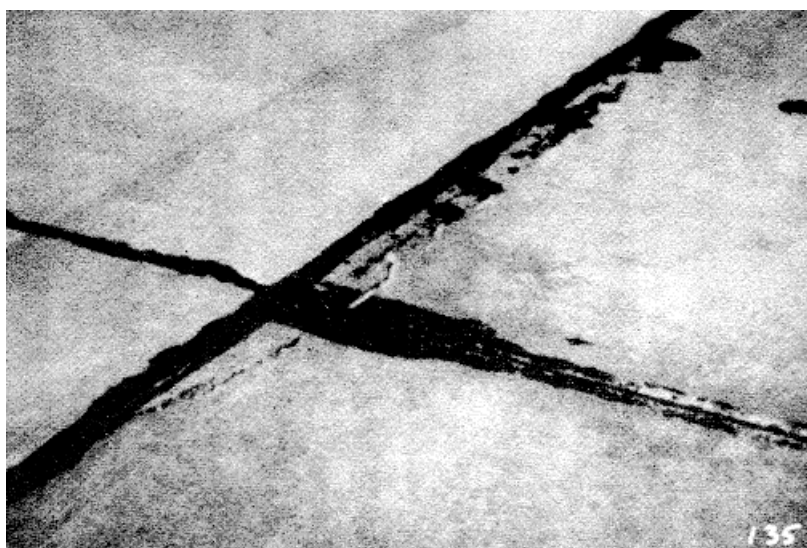

Figure A-131. Low severity corner spall, case 2

(b) Medium severity level (M). One of the three conditions exists:

- Spall is broken into two or more pieces defined by medium severity crack(s), and a few small fragments may be absent or loose.
- Spall is defined by one server, fragmented crack that may be accompanied by a few hairline cracks.
- Spall has deteriorated to the point where loose material causes some FOD potential (figs. A-132 and A-133).



Figure A-132. Medium severity corner spay case 1

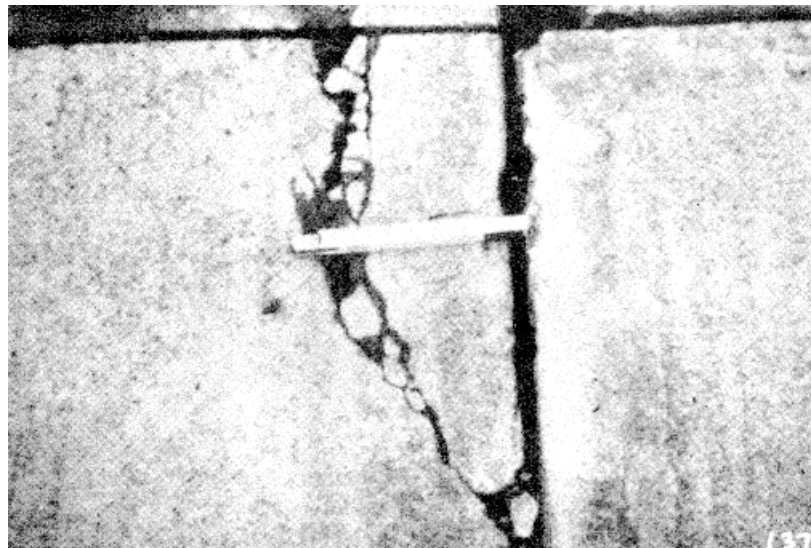

Figure A-133. Medium severity corner spay case 2

(c) High severity level (H). One of the three conditions exists:

- Spall is broken into two or more pieces defined by high severity fragmented crack(s) with loose or absent fragments (high FOD potential).
- Pieces of the spall have been displaced to the extent that a tire damage hazard exists (fig. A-134).
- Spall has deteriorated to the point where loose material is causing high FOD potential.



Figure A-134. High severity corner spall

(3) Counting procedure. If one or more corner spans having the same severity level are located in a slab, the slab is counted as one slab with corner spalling. If more than one severity level occurs, it is counted as one slab having the higher severity level.

A4. Sample PCI formats. Figures A-135 and A-136 show suggested formats that may be used in field surveys of pavement surface distress.

FLEXIBLE PAVEMENT CONDITION SURVEY DATA SHEET FOR SAMPLE UNIT							
AIRPORT					DATE		
FACILITY		FEATURE		SAMPLE UNIT			
SURVEYED BY			AREA OF SAMPLE				
<u>DISTRESS TYPES</u>			SKETCH				
41 ALLIGATOR CRACKING 50 PATCHING 42 BLEEDING 51 POLISHED AGGREGATE 43 BLOCK CRACKING 52 RAVELING/WEATHERING 44 CORRUGATION 53 RUTTING 45 DEPRESSION 54 SHOIVING FROM PCC 46 JET BLAST 55 SLIPPAGE CRACKING 47 JT REFLECTION (PCC) 56 SWELL 48 LONG & TRANS CRACKING 49 OIL SPILLAGE							
EXISTING DISTRESS TYPES							
TOTAL SEVERITY	L						
	S						
	H						
	PCI CALCULATION						
	DISTRESS TYPE	SEVERITY	DENSITY %	DEDUCT VALUE	PCI = 100 - CDV = _____ RATING = _____		
DEDUCT TOTAL							
CORRECTED DEDUCT VALUE (CDV)							

Figure A-135. Flexible pavement condition survey data sheet (sample format)

A-78

The proponent agency of this publication is the Office of the Chief of Engineers, United States Army. Users are invited to send comments and suggested improvements on DA Form 2028 (Recommended Changes to Publications and Blank Forms) direct to HOUSACE (CEEC-EG), WASH, D.C. 20314-1000.

By Order of the Secretaries of the Army and the Air Force:

CARL E. VUONO
General United States Army
Chief of Staff

Official:

WILLIAM J. MEEHAN II
Brigadier General United States Army
The Adjutant General

Official:

LARRY D. WELCH
General, USAF
Chief of Staff

Official:

WILLIAM O. NATIONS
Colonel, USAF
Director of Information Management
and Administration

Distribution:

Army: To be distributed in accordance with DA Form 12-34B,
Army Airfield Pavement Engineering & Design.

Air Force: F

*u. s. GOVERNMENT PRINTING OFF: 1993 0 - 342421 (80116)

RECOMMENDED CHANGES TO EQUIPMENT TECHNICAL PUBLICATIONS



THEN... JOT DOWN THE DOPE ABOUT IT ON THIS FORM, CAREFULLY TEAR IT OUT, FOLD IT AND DROP IT IN THE MAIL!

SOMETHING WRONG WITH THIS PUBLICATION?

FROM: (PRINT YOUR UNIT'S COMPLETE ADDRESS)

DATE SENT

PUBLICATION NUMBER

PUBLICATION DATE

PUBLICATION TITLE

BE EXACT... PIN-POINT WHERE IT IS

PAGE NO.

PARA-GRAPH

FIGURE NO.

TABLE NO.

IN THIS SPACE TELL WHAT IS WRONG AND WHAT SHOULD BE DONE ABOUT IT:

TEAR ALONG PERFORATED LINE

PRINTED NAME, GRADE OR TITLE, AND TELEPHONE NUMBER

SIGN HERE:

DA FORM 2028-2
1 JUL 79

PREVIOUS EDITIONS
• ARE OBSOLETE.

P.S.—IF YOUR OUTFIT WANTS TO KNOW ABOUT YOUR RECOMMENDATION MAKE A CARBON COPY OF THIS AND GIVE IT TO YOUR HEADQUARTERS.

PIN:066123-28449