

**SOILS AND GEOLOGY  
PROCEDURES FOR FOUNDATION DESIGN OF  
BUILDINGS AND OTHER STRUCTURES  
(EXCEPT HYDRAULIC STRUCTURES)**

---

DEPARTMENTS OF THE ARMY AND THE AIR FORCE

OCTOBER 1983

This manual has been prepared by or for the Government and, except to the extent indicated below, is public property and not subject to copyright.

Copyrighted material included in this manual has been used with the knowledge and permission of the proprietors and is acknowledged as such at point of use. Anyone wishing to make further use of any copyrighted material, *by itself and apart from this text*, should seek necessary permission directly from the proprietors.

Reprint or republication of this manual should include a credit substantially as follows: "Joint Departments of the Army and Air Force, USA, Technical Manual TM 5-818-1/AFM 88-3, Chapter 7, *Soils and Geology Procedures for Foundation Design of Buildings and Other Structures (Except Hydraulic Structures)*, 21 October 1983."

If the reprint or republication includes *copyrighted* material, the credit should also state: "Anyone wishing to make further use of copyrighted material, *by itself and apart from this text*, should seek necessary permission directly from the proprietors."

**SOILS AND GEOLOGY  
 PROCEDURES FOR FOUNDATION DESIGN OF  
 BUILDINGS AND OTHER STRUCTURES  
 (EXCEPT HYDRAULIC STRUCTURES)**

CHAPTER		<i>Paragraph</i>	<i>Page</i>
1.	INTRODUCTION		
	Purpose .....	1-1	1-1
	Scope .....	1-2	1-1
	Objectives of foundation investigations .....	1-3	1-1
	Report of subsurface and design investigations .....	1-4	1-1
2.	IDENTIFICATION AND CLASSIFICATION OF SOIL AND ROCK		
	Natural soil deposits .....	2-1	2-1
	Identification of soils .....	2-2	2-1
	Index properties .....	2-3	2-1
	Soil classification .....	2-4	2-5
	Rock classification .....	2-5	2-5
	Rock properties for foundation design .....	2-6	2-5
	Shales.....	2-7	2-13
3.	ENGINEERING PROPERTIES OF SOIL AND ROCK		
	Scope .....	3-1	3-1
	Compaction characteristics of soils .....	3-2	3-1
	Density of cohesionless soils .....	3-3	3-1
	Permeability .....	3-4	3-1
	Consolidation .....	3-5	3-5
	Swelling, shrinkage, and collapsibility .....	3-6	3-15
	Shear strength of soils .....	3-7	3-16
	Elastic properties (E, $\mu$ ) .....	3-8	3-22
	Modulus of subgrade reaction .....	3-9	3-22
	Coefficient of at-rest earth pressure .....	3-10	3-22
	Properties of intact rock .....	3-11	3-22
	Properties of typical shales.....	3-12	3-22
4.	FIELD EXPLORATIONS		
	Investigational programs .....	4-1	4-1
	Soil boring program .....	4-2	4-2
	Field measurements of relative density and consistency .....	4-3	4-5
	Boring logs.....	4-4	4-6
	Groundwater observations.....	4-5	4-6
	In situ load tests.....	4-6	4-9
	Geophysical exploration .....	4-7	4-9
	Borehole surveying .....	4-8	4-12
5.	SETTLEMENT ANALYSES		
	Settlement problems.....	5-1	5-1
	Loads causing settlement .....	5-2	5-1
	Stress computations .....	5-3	5-1
	Settlement of foundations on clay .....	5-4	5-4
	Consolidation settlement .....	5-5	5-4
	Settlement of cohesionless soils .....	5-6	5-10
	Eliminating, reducing, or coping with settlement .....	5-7	5-10
6.	BEARING-CAPACITY ANALYSIS		
	Bearing capacity of soils .....	6-1	6-1
	Shear strength parameters .....	6-2	6-1
	Methods of analysis .....	6-3	6-1
	Tension forces .....	6-4	6-5
	Bearing capacity of rock .....	6-5	6-5

---

\* This manual supersedes TM 5--818-1/AFM 88-3, Chapter 7, 15 August 1961.

CHAPTER		<i>Paragraph</i>	<i>Page</i>
7.	DEWATERING AND GROUNDWATER CONTROL		
	General.....	7-1	7-1
	Foundation problems.....	7-2	7-1
8.	SLOPE STABILITY ANALYSIS		
	General.....	8-1	8-1
	Slope stability problems.....	8-2	8-1
	Slopes in soils presenting special problems.....	8-3	8-1
	Slope stability charts.....	8-4	8-2
	Detailed analyses of slope stability.....	8-5	8-3
	Stabilization of slopes.....	8-6	8-3
9.	SELECTION OF FOUNDATION TYPE		
	Foundation-selection considerations.....	9-1	9-1
	Adverse subsurface conditions.....	9-2	9-2
	Cost estimates and final selection.....	9-3	9-2
10.	SPREAD FOOTINGS AND MAT FOUNDATIONS		
	General.....	10-1	10-1
	Adequate foundation depth.....	10-2	10-1
	Footing design.....	10-3	10-1
	Mat foundations.....	10-4	10-1
	Special requirements for mat foundations.....	10-5	10-5
	Modulus of subgrade reaction for footings and mats.....	10-6	10-5
	Foundations for radar towers.....	10-7	10-5
11.	DEEP FOUNDATIONS INCLUDING DRILLED PIERS		
	General.....	11-1	11-1
	Floating foundations.....	11-2	11-1
	Settlements of compensated foundations.....	11-3	11-1
	Underpinning.....	11-4	11-3
	Excavation protection.....	11-5	11-5
	Drilled piers.....	11-6	11-9
12.	PILE FOUNDATIONS		
	General.....	12-1	12-1
	Design.....	12-2	12-1
13.	FOUNDATIONS ON EXPANSIVE SOILS		
	General.....	13-1	13-1
	Foundations problems.....	13-2	13-1
14.	RETAINING WALLS AND EXCAVATION SUPPORT SYSTEMS		
	Design considerations for retaining walls.....	14-1	14-1
	Earth pressures.....	14-2	14-1
	Equivalent fluid pressures.....	14-3	14-1
	Design procedures for retaining walls.....	14-4	14-5
	Crib wall.....	14-5	14-9
	Excavation support systems.....	14-6	14-9
	Strutted excavations.....	14-7	14-11
	Stability of bottom of excavation.....	14-8	14-17
	Anchored walls.....	14-9	14-19
15.	FOUNDATIONS ON FILL AND BACKFILLING		
	Types of fill.....	15-1	15-1
	Foundations on compacted fills.....	15-2	15-1
	Compaction requirements.....	15-3	15-2
	Placing and control of backfill.....	15-4	15-2
	Fill settlements.....	15-5	15-4
	Hydraulic fills.....	15-6	15-4
16.	STABILIZATION OF SUBGRADE SOILS		
	General.....	16-1	16-1
	Vibrocompaction.....	16-2	16-1
	Vibrodisplacement compaction.....	16-3	16-10
	Grouting and injection.....	16-4	16-12
	Precompression.....	16-5	16-14
	Reinforcement.....	16-6	16-16
	Miscellaneous methods.....	16-7	16-16
17.	DESIGN FOR EQUIPMENT VIBRATIONS AND SEISMIC LOADINGS		
	Introduction.....	17-1	17-1
	Single degree of freedom, damped, forced systems.....	17-2	17-1
	Foundations on elastic soils.....	17-3	17-2

		<i>Paragraph</i>	<i>Page</i>
		Wave transmission, attenuation, and isolation .....	17-4 17-9
		Evaluation of S-wave velocity in soils .....	17-5 17-9
		Settlement and liquefaction .....	17-6 17-14
		Seismic effects on foundations .....	17-7 17-18
CHAPTER	18.	FOUNDATIONS IN AREAS OF SIGNIFICANT FROST PENETRATION	
		Introduction .....	18-1 18-1
		Factors affecting design of foundations .....	18-2 18-3
		Site investigations .....	18-3 18-5
		Foundation design .....	18-4 18-6
APPENDIX	A.	REFERENCES	

**LIST OF FIGURES**

			<i>Page</i>
Figure	2-1.	Distribution of natural soil deposits in the United States .....	2-4
	2-2.	Typical grain-size distribution curves .....	2-6
	2-3.	Weight-volume relationships .....	2-8
	2-4.	Modified core recovery as in index of rock quality .....	2-15
	2-5.	Classification of shales .....	2-16
	3-1.	Typical CE 55 compaction test data .....	3-2
	3-2.	Relation between relative density and dry density (scaled to plot as a straight line) .....	3-4
	3-3.	Angle of friction versus dry density for coarse-grained soils .....	3-4
	3-4.	Generalized curves for estimating $e_{max}$ and $e_{m,}$ from gradational and particle shape characteristics .....	3-5
	3-5.	A summary of soil permeabilities and method of determination .....	3-6
	3-6.	Examples of laboratory consolidation test data .....	3-7
	3-7.	Analyses of consolidation test data .....	3-8
	3-8.	Approximate relation between liquidity index and effective overburden pressure, as a function of the sensitivity of the soil .....	3-9
	3-9.	Approximate relation between void ratio and effective overburden pres- sure for clay sediments, as a function of the Atterberg limits .....	3-10
	3-10.	Approximate correlations for swelling index of silts and clays .....	3-13
	3-11.	Correlations between coefficient of consolidation and liquid limit .....	3-14
	3-12.	Predicted relationship between swelling potential and plasticity index for compacted soils. ....	3-15
	3-13.	Guide to collapsibility, compressibility, and expansion based on in situ dry density and liquid limit .....	3-16
	3-14.	Shear test apparatus and shearing resistance of soils .....	3-17
	3-15.	Remolded shear strength versus liquidity index relationships for differ- ent clays .....	3-18
	3-16.	Normalized variation of $s_u/p_o$ ratio for overconsolidated clay .....	3-19
	3-17.	General relationship between sensitivity, liquidity index, and effective overburden pressure .....	3-21
	3-18.	Empirical correlation between friction angle and plasticity index from triaxial compression tests on normally consolidated undisturbed .....	3-22
	3-19.	Relation between residual friction angle and plasticity index .....	3-23
	3-20.	Chart for estimating undrained modulus of clay .....	3-24
	3-21.	Coefficient of earth pressure at rest ( $K_o$ ) as a function of overconsolidat- ed ratio and plasticity index .....	3-25
	4-1.	Relative density of sand from the standard penetration test .....	4-5
	4-2.	Rough correlation between effective friction angle, standard blow, count and effective overburden pressure .....	4-6
	4-3.	Correction factor for vane strength .....	4-7
	4-4.	Typical log of boring .....	4-8
	4-5.	Typical details of Casagrande piezometer and piezometer using well screen.....	4-9
	4-6.	Determination of permeability from field pumping test on a fully penetrating well in an artesian aquifer .....	4-10
	5-1.	Vertical stress beneath a uniformly loaded rectangular area .....	5-5
	5-2.	Vertical stress beneath a triangular distribution of load on a rectangular area .....	5-6
	5-3.	Influence value for vertical stress under a uniformly loaded circular area .....	5-7
	5-4.	Example of settlement analysis .....	5-8
	5-5.	Time factors for various boundary conditions .....	5-9
	6-1.	Ultimate bearing capacity of shallow foundations under vertical, eccen- tric loads .....	6-3

	<i>Page</i>
Figure 6-2.	Ultimate bearing capacity with groundwater effect ..... 6-4
6-3.	Ultimate bearing capacity of shallow foundations under eccentric inclined loads ..... 6-5
6-4.	Example of bearing capacity computation for inclined eccentric load on rectangular footing ..... 6-6
6-5.	Ultimate bearing capacity of deep foundations ..... 6-7
6-6.	Bearing capacity factors for strip and circular footings on layered foundations in clay ..... 6-8
8-1.	Slope stability charts for $\phi = 0$ soils ..... 8-4
8-2.	Reduction factors ( $\mu_q$ , $\mu_w$ and $\mu'_w$ ) for slope stability charts for $\phi = 0$ and $\phi > 0$ soils ..... 8-5
8-3.	Reduction factors (tension cracks, $l_t$ ) for slope stability charts for $\phi = 0$ and $\phi > 0$ soils ..... 8-6
8-4.	Examples of use of charts for slopes in soils with uniform strength and $\phi = 0$ ..... 8-7
8-5.	Slope stability charts for $\phi > 0$ soils ..... 8-8
8-6.	Stability charts for infinite slopes ..... 8-9
8-7.	Slope stability charts for $t = 0$ and strength increasing with depth ..... 8-10
8-8.	Method of moments for $\phi = 0$ ..... 8-11
8-9.	Example problem for ordinary method of slices ..... 8-12
8-10.	Example of use of tabular form for computing weights of slices ..... 8-13
8-11.	Example of use of tabular form for calculating factor of safety by ordinary method of slices ..... 8-14
8-12.	Example of simplified wedge analysis ..... 8-15
10-1.	Example of method for selecting allowable bearing pressure ..... 10-2
10-2.	Proportioning footings on cohesionless soils ..... 10-3
10-3.	Distribution of bearing pressures ..... 10-4
11-1.	Effect of pore pressure dissipation during excavation and settlement response ..... 11-2
11-2.	Excavation rebound versus excavation depth ..... 11-3
11-3.	Probable settlements adjacent to open cuts ..... 11-4
11-4.	Methods of underpinning ..... 11-5
14-1.	Load diagrams for retaining walls ..... 14-2
14-2.	Active pressure of sand with planar boundaries ..... 14-3
14-3.	Passive pressure of sand with planar boundaries ..... 14-4
14-4.	Active and passive earth pressure coefficients according to Coulomb theory. .... 14-5
14-5.	Horizontal pressures on walls due to surcharge ..... 14-6
14-6.	Design loads for low retaining walls, straight slope backfill ..... 14-7
14-7.	Design loads for low retaining walls, broken slope backfill ..... 14-8
14-8.	Estimates of increased pressure induced by compaction ..... 14-9
14-9.	Design criteria for crib and bin walls ..... 14-10
14-10.	Types of support systems for excavation ..... 14-11
14-11.	Pressure distribution-complete excavation ..... 14-17
14-12.	Stability of bottom of excavation in clay ..... 14-18
14-13.	Typical tieback details ..... 14-19
14-14.	Methods of calculating anchor capacities in soil ..... 14-20
16-1.	Applicable grain-size ranges for different stabilization methods ..... 16-8
16-2.	Range of particle-size distributions suitable for densification by vibro-compaction ..... 16-9
16-3.	Sand densification using vibratory rollers ..... 16-11
16-4.	Relative density as a function of vibroflot hole spacings ..... 16-12
16-5.	Allowable bearing pressure on cohesionless soil layers stabilized by vibro-flotation ..... 16-13
16-6.	Soil particle sizes suitable for different grout types and several concentrations and viscosities shown ..... 16-15
17-1.	Response spectra for vibration limits ..... 17-2
17-2.	Response curves for the single-degree-of-freedom system with viscous damping ..... 17-3
17-3.	Six modes of vibration for a foundation ..... 17-3
17-4.	Equivalent damping ratio for oscillation of rigid circular footing on elastic half-space ..... 17-5
17-5.	Examples of computations for vertical and rocking motions ..... 17-6
17-6.	Coupled rocking and sliding motion of foundation ..... 17-8
17-7.	Distribution of displacement waves from a circular footing on the elastic half-space ..... 17-10

		<i>Page</i>
Figure	17-8. Theoretical relation between shear velocity ratio $V_p/N, V$ and Poisson's .....	17-11
	17-9. Idealized cyclic stress-strain loop for soil .....	17-12
	17-10. Variation of shear modulus with cyclic strain amplitude; $G_x = G$ at = 1 to 3 x 10 <sup>-7</sup> percent; scatter in data up to about +0.1 on vertical scale .....	17-15
	17-11. Variation of viscous damping with cyclic strain amplitude; data scat - ter up to about ± 50 percent of average damping values shown for any strain .....	17-16
	18-1. Frost and permafrost in North America .....	18-2
	18-2. Ground temperatures during freezing season in Limestone, Maine .....	18-4
	18-3. Ground temperatures during freezing season in Fairbanks, Alaska .....	18-4
	18-4. Design alternatives .....	18-7
	18-5. Heave force tests, average tangential adfreeze bond stress versus time , and timber and steel pipe piles placed with silt-water slurry in dry excavated holes. Piles were installed within annual frost zone only, over permafrost, to depths from ground surface of 3.6 to 6.5 feet .....	18-11

LIST OF TABLES

		<i>Page</i>
Table	2-1. A Simplified Classification of Natural Soil Deposits .....	2-2
	2-2. Determination of the Consistency of Clays .....	2-5
	2-3. Unified Soil Classification System .....	2-7
	2-4. Descriptive Soil Names Used in Local Areas (L) and Names Widely Used .....	2-9
	2-5. A Simplified Classification for Rocks .....	2-10
	2-6. Descriptive Criteria for Rock .....	2-11
	2-7. Engineering Classification of Intact Rock .....	2-14
	3-1. Typical Engineering Properties of Compacted Materials .....	3-3
	3-2. Estimating Degree of Preconsolidation .....	3-11
	3-3. Compression Index Correlations .....	3-12
	3-4. Value of Coefficient of Compressibility (mv) for Several Granular Soils During Virgin Loading .....	3-12
	3-5. Sensitivity of Clays .....	3-20
	3-6. Values of Modulus of Subgrade Reaction (ks) for Footings as a Guide to Order of Magnitude.....	3-24
	3-7. An Engineering Evaluation of Shales .....	3-26
	3-8. Physical Properties of Various Shales .....	3-27
	4-1. Types and Sources of Documentary Evidence.....	4-1
	4-2. Recommended Undisturbed Sample Diameters .....	4-3
	4-3. Recommended Minimum Quantity of Material for General Sample Lab - oratory Testing.....	4-4
	4-4. Surface Geophysical Methods.....	4-11
	4-5. Borehole Surveying Devices.....	4-13
	5-1. Causes of Settlement .....	5-2
	5-2. Values of Angular Distortion ( $\delta/t$ ) That Can Be Tolerated Without Cracking .....	5-3
	5-3. Empirical Correlations Between Maximum ( $\Delta$ ) and Angular Distortion ( $\delta/t$ ) .....	5-4
	5-4. Methods of Eliminating, Reducing, or Coping with Settlements .....	5-11
	6-1. Estimates of Allowable Bearing Pressur.....	6-2
	6-2. Allowable Bearing Pressure for Jointed Rock .....	6-9
	8-1. Methods of Stabilizing Slopes and Landslides .....	8-16
	9-1. Foundation Possibilities for Different Subsoil Conditions .....	9-1
	9-2. Checklist for Influence of Site Characteristics on Foundation Selection for Family Housing .....	9-3
	11-1. Excavation Protection .....	11-6
	11-2. Design Parameters for Drilled Piers in Clay .....	11-10
	14-1. Types of Walls .....	14-12
	14-2. Factors Involved in Choice of a Support System for a Deep Excavation. ....	14-14
	14-3. Design Considerations for Braced and Tieback Walls .....	14-15
	15-1. A Summary of Densification Methods for Building Foundations.....	15-3
	15-2. Compaction Density as a Percent of CE 55 Laboratory Test Density .....	15-4
	16-1. Stabilization of Soils for Foundations of Structures .....	16-2
	16-2. Applicability of Foundation Soil Improvement for Different Structures and Soil Types (for Efficient Use of Shallow Foundations) .....	16-7
	16-3. Vibroflotation Patterns for Isolated Footings for an Allowable Bearing Pressure .....	16-13

Table		<i>Page</i>
17-1.	Mass Ratio, Damping Ratio, and Spring Constant for Rigid Circular Foot- ing on the Semi-Infinite Elastic Body .....	17-4
17-2.	Values of $kL/k$ for Elastic Layer ( $k$ from Table 17-1) .....	17-7
17-3.	Attenuation Coefficients for Earth Materials.....	17-10
17-4.	Values of Constant $rY$ Used with Equation (17-23) to Estimate Cyclic Shear Modulus at Low Strains.....	17-13
17-5.	Values of Constant $K$ , Used with Equation (17-24) to Estimate Cyclic Shear Modulus at Low Strains for Sands .....	17-14
17-6.	Criteria for Excluding Need for Detailed Liquefaction Analyses.....	17-17



## CHAPTER 1

## INTRODUCTION

**1-1. Purpose.** This manual presents guidance for selecting and designing foundations and associated features for buildings, retaining structures, and machinery. Foundations for hydraulic structures are not included. Foundation design differs considerably from design of other elements of a structure because of the interaction between the structure and the supporting medium (soil and/or rock).

**1-2. Scope.** Information contained herein is directed toward construction usually undertaken on military reservations, although it is sufficiently general to permit its use on a wide variety of construction projects.

a. This manual includes-

(1) A brief summary of fundamental volumetric - gravimetric relationships.

(2) Summaries of physical and engineering properties of soil and rock.

(3) General descriptions of field and laboratory investigations useful for foundation selection and design.

(4) Design procedures for construction aspects, such as excavated slopes and shoring.

(5) Empirical design equations and simplified methods of analysis, including design charts, soil property-index correlations, and tabulated data.

(6) Selected design examples to illustrate use of the analytical methods.

b. Since the user is assumed to have some familiarity with geotechnical engineering, design equations and procedures are presented with a minimum of theoretical background and no derivations. The topics of dewatering and groundwater control, pile foundations, and foundations on expansive soils are covered in greater depth in separate technical manuals and are only treated briefly in this manual.

**1-3. Objectives of foundation investigations.** The objectives of foundation investigations are to determine the stratigraphy and nature of subsurface materials and their expected behavior under structure loadings and to permit savings in design and construction costs. The investigation is expected to reveal adverse subsurface conditions that could lead to construction difficulties, excessive maintenance, or possible failure of the structure. The scope of investigations depends on the nature and complexity of sub-surface materials and the size, requirements for, and cost of the structure.

**1-4. Report of subsurface and design investigations.** The report should contain sufficient description of field and laboratory investigation, subsurface conditions, typical test data, basic assumptions, and analytical procedures to permit detailed review of the conclusions, recommendations, and final design. The amount and type of information to be presented shall be consistent with the scope of the investigation. For some structures, a cursory review of foundation conditions may be adequate. For major structures, the following outline shall be used as a guide:

a. A general description of the site, indicating principal topographic features in the vicinity. A plan map that shows the surface contours, the location of the proposed structure, and the location of all borings should be included.

b. A description of the general and local geology of the site, including the results of the geological studies.

c. The results of field investigations, including graphic logs of all foundation and borrow borings, locations of and pertinent data from piezometers, and a general description of subsurface materials, based on the borings. The information shall be presented in accordance with Government standards. The boring logs should indicate how the borings were made, type of sampler used, split-spoon penetration resistance, and other field measurement data.

d. Groundwater conditions, including data on seasonal variations in groundwater level and results of field pumping tests, if performed.

e. A general description of laboratory tests performed, range of test values, and detailed test data on representative samples. Atterberg limits should be plotted on a plasticity chart, and typical grain-size curves on a grain-size distribution plot. Laboratory test data should be summarized in tables and figures as appropriate. If laboratory tests were not performed, the basis for determining soil or rock properties should be presented, such as correlations or reference to pertinent publications.

f. A generalized geologic profile used for design, showing properties of subsurface materials and design values of shear strength for each critical stratum. The profile may be described or shown graphically.

g. Where alternative foundation designs are prepared, types of foundations considered, together with evaluation and cost data for each.

h. A table or sketch showing the final size and depth of footings or mats and lengths and types of piles, if used.

i. Basic assumptions for loadings and the computed factors of safety for bearing-capacity calculations, as outlined in chapter 6.

j. Basic assumptions, loadings, and results of settlement analyses, as outlined in chapters 5, 6, and 10;

also, estimated swelling of subgrade soils. The effects of computed differential settlements, and also the effects of swell, on the structure should be discussed.

k. Basic assumptions and results of other analyses.

l. An estimate of dewatering requirements, if necessary. The maximum anticipated pumping rate and flow per foot of drawdown should be presented.

m. Special precautions and recommendations for construction. Possible sources for fill and backfill should also be given. Compaction requirements should be described.

## CHAPTER 2

## IDENTIFICATION AND CLASSIFICATION OF SOIL AND ROCK

**2-1. Natural soil deposits.**

*a.* The character of natural soil deposits is influenced primarily by parent material and climate. The parent material is generally rock but may include partially indurated materials intermediate between soil and rock. Soils are the results of weathering, mechanical disintegration, and chemical decomposition of the parent material. The products of weathering may have the same composition as the parent material, or they may be new minerals that have resulted from the action of water, carbon dioxide, and organic acids with minerals comprising the parent material.

*b.* The products of weathering that remain in place are termed residual soils. In relatively flat regions, large and deep deposits of residual soils may accumulate; however, in most cases gravity and erosion by ice, wind, and water move these soils to form new deposits, termed transported soils. During transportation, weathered material may be mixed with others of different origin. They may be ground up or decomposed still further and are usually sorted according to grain size before finally being deposited. The newly formed soil deposit may be again subject to weathering, especially when the soil particles find themselves in a completely different environment from that in which they were formed. In humid and tropical climates, weathering may significantly affect the character of the soil to great depths, while in temperate climates it produces a soil profile that primarily affects the character of surface soils.

*c.* The character of natural soil deposits usually is complex. A simplified classification of natural soil deposits based on methods of deposition is given in table 2-1, together with pertinent engineering characteristics of each type. More complete descriptions of natural soil deposits are given in geology textbooks. The highly generalized map in figure 2-1 shows the distribution of the more important natural soil deposits in the United States.

**2-2. Identification of soils.**

*a.* It is essential to identify accurately materials comprising foundation strata. Soils are identified by visual examination and by means of their index properties (grain-size distribution, Atterberg limits, water content, specific gravity, and void ratio). A description based on visual examination should include color, odor when present, size and shape of grains, gradation, and density and consistency characteristics.- Coarsegrained

soils have more than 50 percent by weight retained on the No. 200 sieve and are described primarily on the basis of grain size and density. With regard to grain-size distribution, these soils should be described as uniform, or well-graded; and, if in their natural state, as loose, medium, or dense. The *shape* of the grains and the presence of foreign materials, such as mica or organic matter, should be noted.

*b.* Fine-grained soils have more than 50 percent by weight finer than the No. 200 sieve. Descriptions of these soils should state the color, texture, stratification, and odor, and whether the soils are soft, firm, or stiff, intact or fissured. The visual examination should be accompanied by estimated or laboratory-determined index properties. A summary of *expedient tests* for identifying fine-grained soils is given in table 2-2. The important index properties are summarized in the following paragraphs. Laboratory tests for determining index properties should be made in accordance with standard procedures.

**2-3. Index properties.**

*a. Grain-size distribution.* The grain-size distribution of soils is determined by means of sieves and/or a hydrometer analysis, and the results are expressed in the form of a cumulative semilog plot of percentage finer versus grain diameter. Typical grain-size distribution curves are shown in figure 2-2. The knowledge of particle-size distribution is of particular importance when coarse-grained soils are involved. Useful values are the effective size, which is defined as the grain diameter corresponding to the 10 percent finer ordinate on the grain-size curve; the coefficient of uniformity, which is defined as the ratio of the  $D_{60}$  size to the  $D_{10}$  size (fig 2-2); the coefficient of curvature, which is defined as the ratio of the square of the  $D_{30}$  size to the product of the  $D_{10}$  and  $D_{60}$  sizes (table 2-3); and the 15 and 85 percent sizes, which are used in filter design.

*b. Atterberg limits.* The Atterberg limits indicate the range of water content over which a cohesive soil behaves plastically. The upper limit of this range is known as the liquid limit (LL); the lower, as the plastic limit (PL). The LL is the water content at which a soil will just begin to flow when slightly jarred in a pre

Table 2-1. A Simplified Classification of Natural Soil Deposits

	Major Divisions	Principal Soil Type	Pertinent Engineering Characteristics	
Residual Soils	Mineral	Material formed by distintegration of underlying parent rock or partially indurated materials	Residual sands and rock fragments of various sizes formed by solution and leaching of cementing material, leaving the more resistant particles; commonly quartz	Generally favorable foundation conditions.
			Residual clay, extremely finely divided clay material formed in place by the weathering of rock, derived either by the chemical decay of feldspar and other rock minerals or by the removal of nonclay-mineral constituents by solution from a clay-bearing rock.	Variable properties requiring investigation to determine depth and condition of weathering.
Organic		Accumulations of highly organic material formed in place by the growth and subsequent decay of plant life	Peat. A somewhat fibrous aggregate of decayed and decaying vegetable matter having a dark color and odor of decay Muck. Finely divided, well-decomposed organic material intermixed with a high percentage (20-50%) of mineral matter	Very compressible. Entirely unsuitable for supporting building foundations
		Material transported and deposited by running water	Floodplain deposits. Unconsolidated soils deposited by a stream within that portion of its valley subject to inundation by floodwater	Generally favorable foundation conditions.
Alluvial			Natural levees. Long, broad, low ridges of sand, silt, or silty clay deposited by a stream on its floodplain and along both banks of its channel during overbank flow.	Generally favorable foundation conditions.
		Point bar. Alternating deposits of arcuate ridges and swales (lows) formed on the inside or convex bank of migrating river bends. Ridge deposits consist primarily of silt and sand, swales are clay-filled	Generally favorable foundation conditions; however, detailed investigations are necessary to locate discontinuities. Flow slides may be a problem along riverbanks.	
		Channel fill. Deposits laid down in abandoned meander loops isolated when rivers shorten their courses. Composed primarily of clay; however, silty and sandy soils are found at the upstream and downstream ends	Fine-grained soils are usually compressible. Portions may be very heterogeneous. Silty soils generally present favorable foundation conditions	
		Backswamp. The prolonged accumulation of floodwater sediments in flood basins behind the natural levees of a river. Materials are generally clays but tend to become more silty near riverbank	Relatively uniform in a horizontal direction. Clays are usually subjected to seasonal volume changes	
		Terrace deposits. Unconsolidated alluvium (including gravel) produced by renewed downcutting of the valley floor by a rejuvenated stream	Generally favorable conditions. Usually not subject to flooding.	
		Fan Deposits. Alluvial deposits at foot of hills or mountains. Extensive plains or alluvial fans	Generally favorable foundation conditions	
Transported Soils	Lacustrine	Deltaic deposits. Deposits formed at the mouths of rivers which result in extension of the shoreline	Generally fine-grained and compressible. Many local variations in soil condition	
		Material deposited in a lake	Lacustrine deposits. Material deposited within lakes (other than those associated with glaciation) by waves, currents, and organo-chemical processes. Deposits consist of unstratified organic clay or clay in central portions of the lake and typically grade to stratified silts and sands in peripheral zones	Usually very uniform in horizontal direction. Fine-grained soils generally compressible
		Material deposited in an estuary	Estuarine deposits. Fine-grained sediment (usually silt and clay) of marine and fluvial origin mixed with decomposed organic matter laid down in brackish water of an estuary	Generally compressible. Many local variations
Aeolian		Material transported and deposited by wind	Loess. An unstratified calcareous deposit consisting predominantly of silt with subordinate grain sizes ranging from sand to clay. Often contains fossils and is traversed by a network of small, narrow, vertical tubes frequently filled with calcium carbonate concretions formed by root fibers now decayed. Dune sands. Mounds, ridges, and hills of uniform fine sand characteristically exhibiting rounded grains	Relatively uniform deposits characterized by ability to stand in vertical cuts. Collapsible structure. Deep weathering or saturation can modify characteristics Very uniform grain-size; may exist in relatively loose condition
		Glacial		Material transported and deposited by glaciers, or by melt water from the glacier

(Continued)

Table 2-1. A Simplified Classification of Natural Soil Deposits-Continued

	Major Divisions	Principal Soil Type	Pertinent Engineering Characteristics	
Transported Soils	Marine	Material transported and deposited by ocean waves and currents in shore and offshore areas	<u>Shore deposits.</u> Deposits of sands and/or gravels formed by the transporting, destructive, and sorting action of waves on the shoreline	Relatively uniform and of moderate to high density
			<u>Marine clays.</u> Organic and inorganic deposits of fine-grained material	Generally very uniform in composition. Compressible and usually very sensitive to remolding
	Colluvial	Material transported and deposited by gravity	<u>Talus.</u> Deposits created by gradual accumulation of unsorted rock fragments and debris at base of cliffs <u>Colluvial deposits.</u> Fine colluvium consisting of clayey sand, sandy silt, or clay <u>Landside deposits.</u> Considerable masses of soil or rock that have slipped down, more or less as units, from their former position on steep slopes	Previous movements indicate possible future difficulties. Generally unstable foundation conditions
Pyroclastic	Material ejected from volcanoes and transported by gravity, wind, and air	<u>Ejecta.</u> Loose deposits of volcanic ash, lapilli, bombs, cinders, etc	Typically shardlike particles of silt size with larger volcanic debris. Weathering and redeposition produce highly plastic compressible clay. Unusual and difficult foundation conditions	

U. S. Army Corps of Engineers

scribed manner. The PL is the water content at which the soil will just begin to crumble when rolled into threads 1/8 inch in diameter. Fat clays that have a high content of colloidal particles have a high LL, while lean clays having a low content of colloidal particles have a correspondingly low LL. A decrease in LL and PL after either oven- or air-drying usually indicates presence of organic matter. The plasticity index (PI) is defined as the difference between the LL and PL. The liquidity index (LI) is defined as the natural water content  $w_n$ , minus the PL, divided by the PI; i. e.,  $LI = (w_n - PL)/PI$ . The LI is a measure of the consistency of the soils. Soft clays have an LI approaching 100 percent; whereas, stiff clays have an LI approaching zero.

c. *Activity.* The activity, A, of a soil is defined as  $A = PI/( \% < 0.002 \text{ mm} )$ . The activity is a useful parameter for correlating engineering properties of soil.

d. *Natural water content.* The natural water content of a soil is defined as the weight of water in the soil expressed as a percentage of dry weight of solid matter present in the soil. The water content is based on the loss of water at an arbitrary drying temperature of 1050 to 1100C.

e. *Density.* The mass density of a soil material is its weight per unit volume. The dry density of a soil is defined as the weight of solids contained in the unit volume of the soil and is usually expressed in pounds per cubic foot. Various weight-volume relationships are presented in figure 2-3.

f. *Specific gravity.* The specific gravity of the solid constituents of a soil is the ratio of the unit weight of the solid constituents to the unit weight of water. For routine analyses, the specific gravity of sands and clayey soils may be taken as 2.65 and 2.70, respectively.

g. *Relative density.* Relative density is defined by the following equation:

$$DR(\%) = \frac{e_{max} - e}{e_{max} - e_{min}} \times 100 \quad (2-1)$$

where

$e_{max}$  = void ratio of soil in its loosest state

$e$  = void ratio in its natural state

$e_{min}$  = void ratio in its densest possible state

Alternatively,

$$D_R(\%) = \frac{y_d - y_{d_{min}}}{y_{d_{max}} - y_{d_{min}}} \times \frac{y_{d_{max}}}{y_d} \times 100 \quad (2-2)$$

where

$y_d$  = dry unit weight of soil in its natural state

$y_{d_{min}}$  = dry unit weight of soil in its loosest state

$y_{d_{max}}$  = dry unit weight of soil in its densest state

Thus,  $DR = 100$  for a very dense soil, and  $DR = 0$  for a very loose soil. Methods for determining  $e_{max}$  or corresponding densities have been standardized. Relative density is significant only in the case of coarse-grained soils.

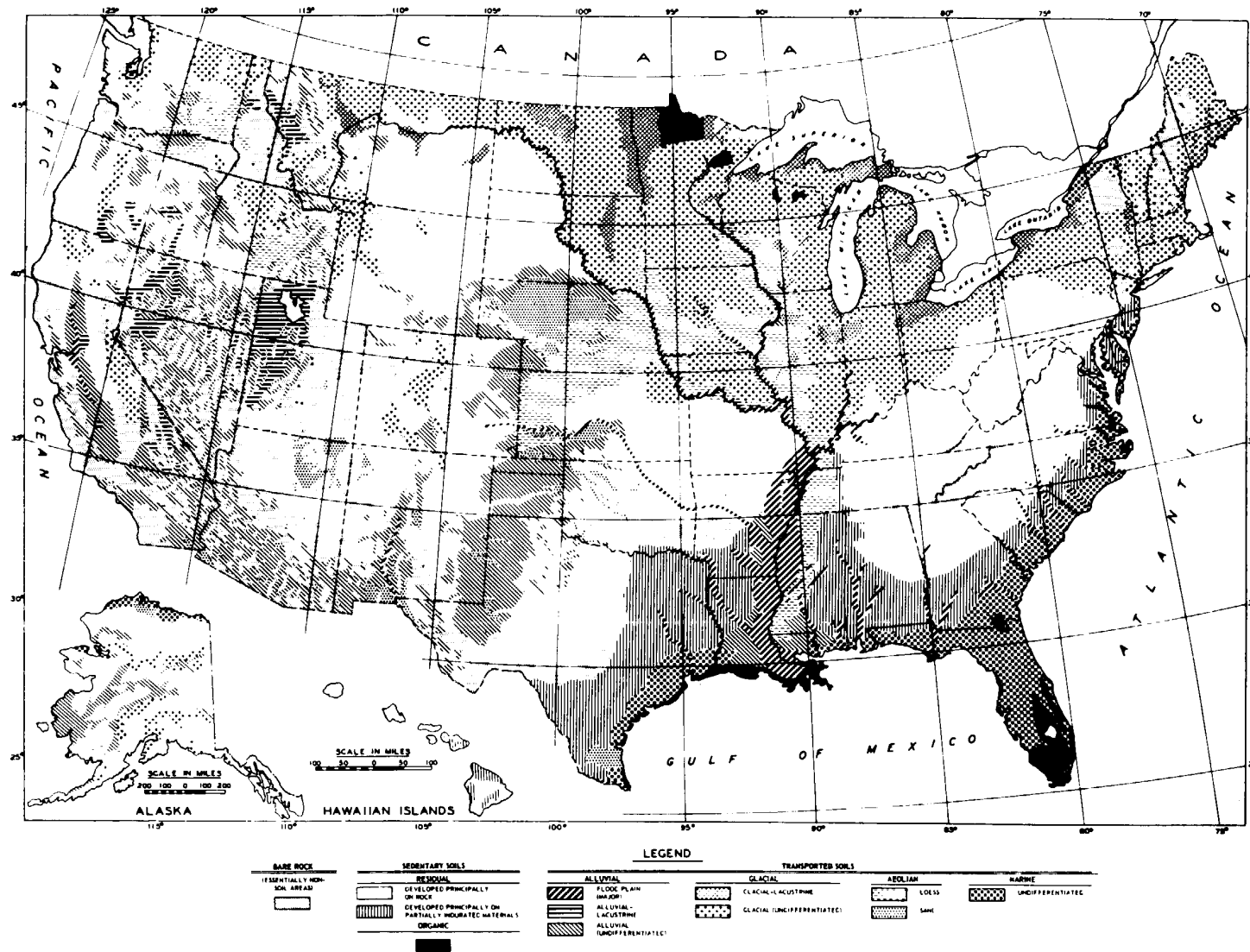

Figure 2-1. Distribution of natural soil deposits in the United States.

Table 2-2. Determination of the Consistency of Clays

Unconfined Compressive Strength, $q_u$ tsf	Field Identification	Consistency
Less than 0.25	Easily penetrated several inches by fist	Very soft
0.25 - 0.5	Easily penetrated several inches by thumb	Soft
0.5 - 1.0	Can be penetrated several inches by thumb with moderate effort	Medium
1.0 - 2.0	Readily indented by thumb but penetrated only with great effort	Stiff
2.0 - 4.0	Readily indented by thumbnail	Very stiff
Over 4.0	Indented with difficulty by thumbnail	Hard

U. S. Army Corps of Engineers

*h. Consistency.* The consistency of an undisturbed cohesive soil may be expressed quantitatively by the unconfined compressive strength  $q_u$ . Qualitative expressions for the consistency of clays in terms of  $q_u$  are given in table 2-2. If equipment for making unconfined compression tests is not available, a rough estimate can be based on the simple field identification suggested in the table; various small penetration or vane devices are also helpful.

**2-4. Soil classification.** The Unified Soil Classification System, based on identification of soils according to their grain-size distribution, their plasticity characteristics, and their grouping with respect to behavior, should be used to classify soils in connection with foundation design. Table 2-3 summarizes the Unified Soil Classification System and also presents field identification procedures for fine-grained soils or soil fractions. It is generally advantageous to include with the soil classification any regional or locally accepted terminology as well as the soil name (table 2-4).

**2-5. Rock classification.**

*a. Geological classification.* The geological classification of rock is complex, and for most engineering applications a simplified system of

classification, as shown in table 2-5, will be adequate. For any in-depth geology study, proper stratigraphic classification by a qualified geologist should be made to ensure that proper interpretation of profiles is being made. All the rock types in table 2-5 may exist in a sound condition or may be fissured, jointed, or altered by weathering to an extent that will affect their engineering behavior. Descriptive criteria for the field classification of rock is contained in table 2-6.

*b. Classification of intact rock.* An engineering classification of intact rock is contained in table 2-7. The classification is based on the uniaxial compressive strength and the tangent modulus.

**2-6. Rock properties for foundation design.**

*a.* The principal rock properties of concern for foundation design are the structural features and shear strength. Strength properties of rock are discussed in chapter 3. Structural features include-

- (1) Types and patterns for rock defects (table 2-6)-cracks, joints, fissures, etc.
- (2) Bedding planes-stratification and slope (strike and dip).
- (3) Foliation-a general term for a planar arrange-

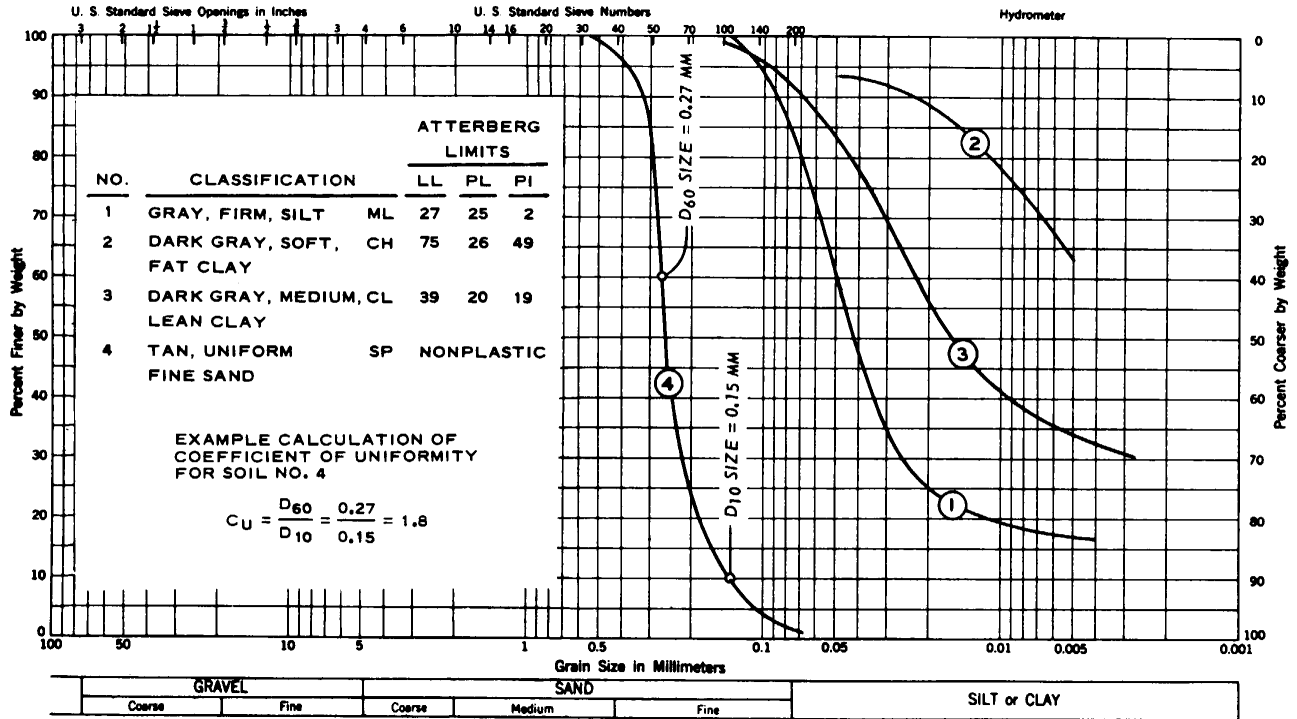

Figure 2-2. Typical grain-size distribution curves.



Major Divisions	Group Symbols	Typical Names	Field Identification Procedures (Excluding particles larger than 3 in. and bearing fractions on retained weights)	Information Required for Describing Soils	Laboratory Classification Criteria																
<p>Coarse-grained Soils</p> <p>More than half of material is larger than No. 200 sieve size.</p> <p>Gravel</p> <p>More than half of coarse fraction is smaller than No. 4 sieve size. It is larger than No. 4 sieve size (for visual classification, the 1/4-in. size may be used as equivalent to the No. 4 sieve size).</p> <p>Sand</p> <p>More than half of coarse fraction is smaller than No. 60 sieve size. It is larger than No. 60 sieve size (for visual classification, the 1/4-in. size may be used as equivalent to the No. 60 sieve size).</p> <p>Sands with (Appreciable Little or no fines)</p>	GW	Well-graded gravels, gravel-sand mixtures, little or no fines.	Wide range in grain sizes and substantial amounts of all intermediate particle sizes.	<p>For undisturbed soils add information on stratification, degree of compactness, cementation, moisture conditions, and drainage characteristics.</p> <p>Give typical name; indicate approximate percentages of sand and gravel, maximum size; angularity, surface condition, and hardness of the coarse grains; local or geologic name and other pertinent descriptive information; and symbol in parentheses.</p> <p>Example: Silty sand, gravelly; about 20% hard, angular gravel particles 1/2-in. maximum size; rounded and subangular sand grains, coarse to fine; about 15% nonplastic fines with low dry strength; well compacted and moist in place; alluvial sand; (SM).</p>	<p>Descriptive percentages of gravel and sand from grain-size curve; percentage of fines (percent finer than No. 200 sieve size); coarse-grained soils are classified as follows:</p> <p>Less than 5% = GW, GP, SW, SP, SM, SC, MC, CL, ML, OL, CH, MH, OH, PT</p> <p>More than 5% = GM, GC, SM, SC, MH, ML, OL, CH, OH, PT</p> <p>Use grain-size curve in identifying the fractions as given under field identification.</p>																
	GP	Poorly graded gravels or gravel-sand mixtures, little or no fines.	Predominantly one size or a range of sizes with some intermediate sizes missing.			<p>For undisturbed soils add information on structure, stratification, consistency in undisturbed and remolded states, moisture and drainage conditions.</p> <p>Give typical name; indicate degree and character of plasticity; amount and maximum size of coarse grains; color in wet condition; odor, if any; local or geologic name and other pertinent descriptive information; and symbol in parentheses.</p> <p>Example: Clayey silt, brown; slightly plastic; small percentage of fine sand; numerous vertical root holes; firm and dry in place; loess; (ML).</p>	<p> <math>C_u = \frac{D_{60}}{D_{10}}</math> Greater than 4  <math>C_c = \frac{(D_{30})^2}{D_{10} \times D_{60}}</math> Between 1 and 3                      Not meeting all gradation requirements for GW                      Afterberg limits below "A" line or PI less than 4                      Above "A" line with PI between 4 and 7 are borderline cases requiring use of dual symbols.                 </p> <p> <math>C_u = \frac{D_{60}}{D_{10}}</math> Greater than 6  <math>C_c = \frac{(D_{30})^2}{D_{10} \times D_{60}}</math> Between 1 and 3                      Not meeting all gradation requirements for GM                      Afterberg limits below "A" line or PI less than 4                      Above "A" line with PI between 4 and 7 are borderline cases requiring use of dual symbols.                 </p>														
	GM	Silty gravels, gravel-sand-silt mixture.	Nonplastic fines or fines with low plasticity (for identification procedures see MU below).					<p>Identification Procedures on Fraction Smaller than No. 40 Sieve Size</p> <table border="1"> <tr> <td>Dry Strength (Crushing characteristics)</td> <td>Dilatancy (Reaction to shaking)</td> <td>Toughness (Consistency near PL)</td> </tr> <tr> <td>None to slight</td> <td>Quick to slow</td> <td>None</td> </tr> <tr> <td>Medium to high</td> <td>None to very slow</td> <td>Medium</td> </tr> <tr> <td>Slight to medium</td> <td>Slow</td> <td>Slight</td> </tr> </table>	Dry Strength (Crushing characteristics)	Dilatancy (Reaction to shaking)	Toughness (Consistency near PL)	None to slight	Quick to slow	None	Medium to high	None to very slow	Medium	Slight to medium	Slow	Slight	<p>Use grain-size curve in identifying the fractions as given under field identification.</p>
	Dry Strength (Crushing characteristics)	Dilatancy (Reaction to shaking)	Toughness (Consistency near PL)																		
	None to slight	Quick to slow	None																		
	Medium to high	None to very slow	Medium																		
	Slight to medium	Slow	Slight																		
	GC	Clayey gravels, gravel-sand-clay mixtures.	Plastic fines (for identification procedures see CL below).						<p>For undisturbed soils add information on structure, stratification, consistency in undisturbed and remolded states, moisture and drainage conditions.</p> <p>Give typical name; indicate degree and character of plasticity; amount and maximum size of coarse grains; color in wet condition; odor, if any; local or geologic name and other pertinent descriptive information; and symbol in parentheses.</p> <p>Example: Clayey silt, brown; slightly plastic; small percentage of fine sand; numerous vertical root holes; firm and dry in place; loess; (ML).</p>	<p>                     Afterberg limits below "A" line or PI less than 4                      Above "A" line with PI between 4 and 7 are borderline cases requiring use of dual symbols.                 </p>											
	SW	Well-graded sands, gravelly sands, little or no fines.	Wide range in grain size and substantial amounts of all intermediate particle sizes.								<p>For undisturbed soils add information on structure, stratification, consistency in undisturbed and remolded states, moisture and drainage conditions.</p> <p>Give typical name; indicate degree and character of plasticity; amount and maximum size of coarse grains; color in wet condition; odor, if any; local or geologic name and other pertinent descriptive information; and symbol in parentheses.</p> <p>Example: Clayey silt, brown; slightly plastic; small percentage of fine sand; numerous vertical root holes; firm and dry in place; loess; (ML).</p>	<p>                     Afterberg limits below "A" line or PI less than 4                      Above "A" line with PI between 4 and 7 are borderline cases requiring use of dual symbols.                 </p>									
	SP	Poorly graded sands or gravelly sands, little or no fines.	Predominantly one size or a range of sizes with some intermediate sizes missing.										<p>For undisturbed soils add information on structure, stratification, consistency in undisturbed and remolded states, moisture and drainage conditions.</p> <p>Give typical name; indicate degree and character of plasticity; amount and maximum size of coarse grains; color in wet condition; odor, if any; local or geologic name and other pertinent descriptive information; and symbol in parentheses.</p> <p>Example: Clayey silt, brown; slightly plastic; small percentage of fine sand; numerous vertical root holes; firm and dry in place; loess; (ML).</p>	<p>                     Afterberg limits below "A" line or PI less than 4                      Above "A" line with PI between 4 and 7 are borderline cases requiring use of dual symbols.                 </p>							
SM	Silty sands, sand-silt mixtures.	Nonplastic fines or fines with low plasticity (for identification procedures see MU below).	<p>For undisturbed soils add information on structure, stratification, consistency in undisturbed and remolded states, moisture and drainage conditions.</p> <p>Give typical name; indicate degree and character of plasticity; amount and maximum size of coarse grains; color in wet condition; odor, if any; local or geologic name and other pertinent descriptive information; and symbol in parentheses.</p> <p>Example: Clayey silt, brown; slightly plastic; small percentage of fine sand; numerous vertical root holes; firm and dry in place; loess; (ML).</p>	<p>                     Afterberg limits below "A" line or PI less than 4                      Above "A" line with PI between 4 and 7 are borderline cases requiring use of dual symbols.                 </p>																	
SC	Clayey sands, sand-clay mixtures.	Plastic fines (for identification procedures see CL below).			<p>For undisturbed soils add information on structure, stratification, consistency in undisturbed and remolded states, moisture and drainage conditions.</p> <p>Give typical name; indicate degree and character of plasticity; amount and maximum size of coarse grains; color in wet condition; odor, if any; local or geologic name and other pertinent descriptive information; and symbol in parentheses.</p> <p>Example: Clayey silt, brown; slightly plastic; small percentage of fine sand; numerous vertical root holes; firm and dry in place; loess; (ML).</p>	<p>                     Afterberg limits below "A" line or PI less than 4                      Above "A" line with PI between 4 and 7 are borderline cases requiring use of dual symbols.                 </p>															
<p>Fine-grained Soils</p> <p>More than half of material is smaller than No. 200 sieve size.</p> <p>Silt and Clays</p> <p>Liquid limit is less than 50</p>	ML	Inorganic silts and very fine sands, rock flour, silty or clayey fine sands or clayey silts with slight plasticity.					None to slight	Quick to slow							None	<p>For undisturbed soils add information on structure, stratification, consistency in undisturbed and remolded states, moisture and drainage conditions.</p> <p>Give typical name; indicate degree and character of plasticity; amount and maximum size of coarse grains; color in wet condition; odor, if any; local or geologic name and other pertinent descriptive information; and symbol in parentheses.</p> <p>Example: Clayey silt, brown; slightly plastic; small percentage of fine sand; numerous vertical root holes; firm and dry in place; loess; (ML).</p>	<p>                     Afterberg limits below "A" line or PI less than 4                      Above "A" line with PI between 4 and 7 are borderline cases requiring use of dual symbols.                 </p>				
	CL	Inorganic clays of low to medium plasticity, gravelly clays, sandy clays, silty clays, lean clays.					Medium to high	None to very slow							Medium			<p>For undisturbed soils add information on structure, stratification, consistency in undisturbed and remolded states, moisture and drainage conditions.</p> <p>Give typical name; indicate degree and character of plasticity; amount and maximum size of coarse grains; color in wet condition; odor, if any; local or geologic name and other pertinent descriptive information; and symbol in parentheses.</p> <p>Example: Clayey silt, brown; slightly plastic; small percentage of fine sand; numerous vertical root holes; firm and dry in place; loess; (ML).</p>	<p>                     Afterberg limits below "A" line or PI less than 4                      Above "A" line with PI between 4 and 7 are borderline cases requiring use of dual symbols.                 </p>		
	OL	Organic silts and organic silty clays of low plasticity.					Slight to medium	Slow							Slight					<p>For undisturbed soils add information on structure, stratification, consistency in undisturbed and remolded states, moisture and drainage conditions.</p> <p>Give typical name; indicate degree and character of plasticity; amount and maximum size of coarse grains; color in wet condition; odor, if any; local or geologic name and other pertinent descriptive information; and symbol in parentheses.</p> <p>Example: Clayey silt, brown; slightly plastic; small percentage of fine sand; numerous vertical root holes; firm and dry in place; loess; (ML).</p>	<p>                     Afterberg limits below "A" line or PI less than 4                      Above "A" line with PI between 4 and 7 are borderline cases requiring use of dual symbols.                 </p>
	<p>Silt and Clays</p> <p>Liquid limit is greater than 50</p>	MH					Inorganic silts, micaceous or diatomaceous fine sandy or silty soils, elastic silts.	Slight to medium							Slow to none						
CH		Inorganic clays of high plasticity, fat clays.					High to very high	None							High	<p>For undisturbed soils add information on structure, stratification, consistency in undisturbed and remolded states, moisture and drainage conditions.</p> <p>Give typical name; indicate degree and character of plasticity; amount and maximum size of coarse grains; color in wet condition; odor, if any; local or geologic name and other pertinent descriptive information; and symbol in parentheses.</p> <p>Example: Clayey silt, brown; slightly plastic; small percentage of fine sand; numerous vertical root holes; firm and dry in place; loess; (ML).</p>	<p>                     Afterberg limits below "A" line or PI less than 4                      Above "A" line with PI between 4 and 7 are borderline cases requiring use of dual symbols.                 </p>				
<p>Highly Organic Soils</p>	PT	Peat and other highly organic soils.					Readily identified by color, odor, spongy feel and frequently by fibrous texture.											<p>For laboratory classification of fine-grained soils</p>			

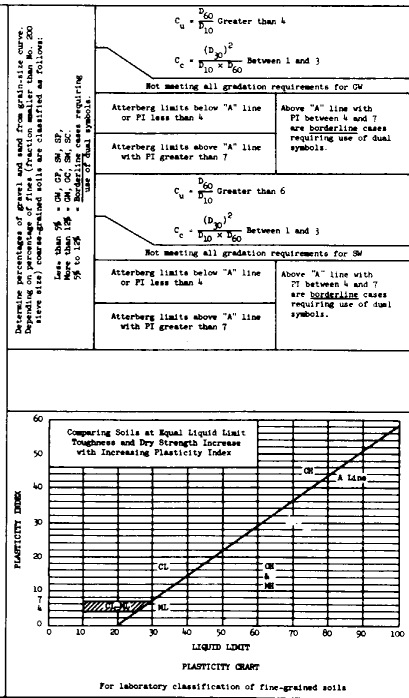
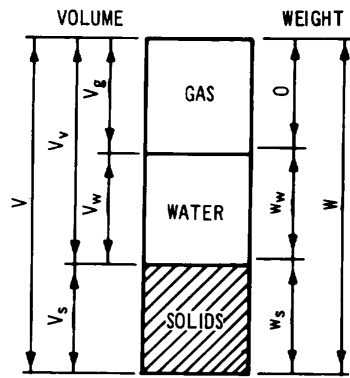

Table 2-3. Unified Soil Classification System



WATER CONTENT	$w = \frac{W_w}{W_s}$
SPECIFIC GRAVITY	$G_s = \frac{W_s}{V_s \gamma_w}$
VOLUME OF SOLIDS	$V_s = \frac{W_s}{G_s \gamma_w}$
VOLUME OF VOIDS	$V_v = V - V_s$
VOID RATIO	$e = \frac{V_v}{V_s} = \frac{n}{1 - n}$
POROSITY	$n = \frac{V_v}{V} = \frac{e}{1 + e}$
DEGREE OF SATURATION	$S = \frac{V_w}{V_v} = \frac{w G_s}{e}$
UNIT WEIGHT OF WATER (FRESH WATER)	$\gamma_w = \frac{W_w}{V_w} = 62.4 \text{ PCF}$
DRY UNIT WEIGHT	$\gamma_d = \frac{W_s}{V} = \frac{\gamma_m}{1 + w}$
WET UNIT WEIGHT	$\gamma_m = \frac{W}{V}$
SUBMERGED (BOUYANT) UNIT WEIGHT	$\gamma' = \gamma_m - \gamma_w = \frac{G_s - 1}{1 + e} \gamma_w$

U. S. Army Corps of Engineers

Figure 2-3. Weight-volume relationships.

U. S. Army Corps of Engineers

Table 2-4. Descriptive Soil Names Used in Local Areas (L) and Names Widely Used

Adobe	Calcareous silts and sandy-silty clays which are usually high in colloidal clay content, found in the semiarid regions of the southwestern United States and North Africa.	Loess	Silty soil of aeolian origin characterized by a loose, porous structure, and a natural vertical slope. It covers extensive areas in North America (especially in the Mississippi Basin), Europe, and Asia (especially North Central Europe, Russia, and China).
Alluvium	Deposits of mud, silt, and other material commonly found on the flat lands along the lower courses of streams.	Marl	A soft, calcareous deposit mixed with clays, silts, and sands, often containing shells or organic remains. It is common in the Gulf Coast area of the United States.
Argillaceous	Soils which are predominantly clay or abounding in clays or clay-like materials.	Micaceous soils	Soil which contains a sufficient amount of mica to give it distinctive appearance and characteristics.
Bentonite	A clay of high plasticity formed by the decomposition of volcanic ash; it has high swelling characteristics.	Muck (mud)	The very soft, slimy silt or organic silt which is frequently found on lake or river bottoms.
(L) Boulder clay	Another name, used widely in Canada and England, for glacial till.	Peat	A term which is frequently applied to fibrous, partially decayed organic matter or a soil which contains a large proportion of such materials. Large and small deposits of peat occur in many areas and present many construction difficulties. Peat is extremely loose and compressible.
(L) Buckshot	Clays of the southern and southwestern United States which, upon drying, crack into small, hard lumps of more or less uniform size.	Muskeg	Peat deposits found in northwestern Canada and Alaska.
(L) Bull's liver	This is a name used in some sections of the United States to describe an inorganic silt of slight plasticity. When saturated, it quakes like jelly from vibration or shock.	(L) Red dog	The residue from burned coal dumps.
Calcareous	Soils which contain an appreciable amount of calcium carbonate, usually from limestone.	Rock flour	A fine-grained soil, usually sedimentary, of low plasticity and cohesion. Particles are usually in the lower range of silt sizes. At high moisture contents, it may become "quick" under the action of traffic.
Caliche	This term is widely used in construction to describe deposits which contain various amounts of silt, clay, and sand cemented by calcium carbonate deposited by evaporation of groundwater, as found in France, North Africa, Texas, and other southwestern states.	Shale	A thinly laminated rock-like material resulting from consolidation of clay under extreme pressure. Some shales revert to clay on exposure to air and moisture.
(L) Coquina	Consists essentially of marine shells which are held together by a small amount of calcium carbonate to form a fairly hard rock. Coquina shells (and oyster shells) are widely used for granular stabilization of soils along the Gulf Coast of the United States.	Talus	A fan-shaped accumulation of mixed fragments of rock that have fallen, because of weathering, at or near the base of a cliff or steep mountainside.
Coral	Calcareous, rock-like material formed by secretions of corals and coralline algae.	Topsoil	A general term applied to the top few inches of soil deposits. Topsoils usually contain considerable organic matter and are productive of plant life.
Diatomaceous earth	Composed essentially of the siliceous skeletons of diatoms (extremely small unicelled organisms). It is composed principally of silica, is white or light gray in color, and extremely porous.	Tufa	A loose, porous deposit of calcium carbonate which usually contains organic remains.
(L) Dirty sand	A slightly silty or clayey sand.	Tuff	A term applied to compacted deposits of the fine materials ejected from volcanoes, such as more or less cemented dust and cinders. Tuffs are more or less stratified and in various states of consolidation. They are prevalent in the Mediterranean area.
Disintegrated granite	Granular soil derived from advanced weathering and disintegration of granite rock.	Varved clay	A sedimentary deposit which consists of alternate thin (1/8 in. to 1/2 in.) layers of silt and clay.
(L) Fat clay	Fine, colloidal clay of high plasticity.	Volcanic ash	Uncemented volcanic debris, usually made up of particles less than 4 mm in diameter. Upon weathering, a volcanic clay of high compressibility is frequently formed. Some volcanic clays present unusually difficult construction problems, as do those in the area of Mexico City and along the eastern shores of the island of Hawaii.
Fuller's earth	Unusually highly plastic clays of sedimentary origin, white to brown in color. Used commercially to absorb fats and dyes.		
(L) Gumbo	Peculiar, fine-grained, highly plastic silt-clay soils which become impervious and soapy, or waxy and sticky, when saturated.		
Hardpan	A general term used to describe a hard, cemented soil layer which does not soften when wet. Use of this term should be avoided since it implies a condition rather than a type of soil.		
Lateritic soils	Residual soils which are found in tropic regions. Many different soils are included in this category and they occur in many sections of the world. They are frequently red in color, and in their natural state have a granular structure with low plasticity and good drainability. When they are remolded in the presence of water, they often become plastic and clayey to the depth disturbed.		
Lean clay	Silty clays and clayey silts, generally of low to medium plasticity.		
(L) Limerock	A soft, friable, compact, cream-white, high-calcium limestone found in the southeastern United States which consists of coral and other marine remains which have been disintegrated by weathering.		
Loam	A general agricultural term which is applied most frequently to sandy-silty topsoils which contain a trace of clay, are easily worked, and are productive of plant life.		

Table 2-5. A Simplified Classification for Rocks

Color	Principal Minerals	Texture							
		Very Coarse, Irregular Crystalline	Coarse and Medium Crystalline	Fine Crystalline	Micro-crystalline	Glassy	Porous (Gas Openings)	Fragmental	
Light	Quartz and Feldspar	Pegmatite	Granite	Aplite	Felsite	Rhyolite	Pitchstone	Pumice	Ash (fine, loose), tuff (fine-cemented), breccia (coarse), cinders (variable)
	Feldspar, Little or no Quartz	Syenite Pegmatite	Syenite			Trachyte			
Intermediate	Feldspar and Hornblende	Diorite Pegmatite	Diorite	Diabase	Andesite	Basalt	Scoria or vesicular basalt		
Dark	Augite and Feldspar	Gabbro Pegmatite	Gabbro					Dolerite	
	Augite, Hornblende Olivine		Peridotite						

Group	Grain Size	Composition	Name	
Clastic	Appreciable quantity of grains more than 2-mm diameter	Rounded pebbles in medium-grained matrix	Conglomerate	
		Angular coarse rock fragments, often quite variable	Breccia	
	More than 50% of grains are 0.06-to 2.00-mm diameter	Medium quartz grains	Less than 10% of other minerals	Siliceous sandstone
			Appreciable quantity of clay minerals	Argillaceous sandstone
			Appreciable quantity of calcite	Calcareous sandstone
			Appreciable quantity of iron oxide cement	Ferruginous sandstone
			Over 25% feldspar; less than 75% quartz	Arkose
			10-50% feldspar and darker minerals; 30 to 40% quartz	Graywacke
	More than 50% of grains are 0.002-to 0.06-mm diameter	Fine to very fine quartz grains with clay minerals		Siltstone (if laminated, shale)
	Predominantly grains less than 0.002-mm diameter	Microscopic clay minerals	Less than 10% other minerals	Shale (if not laminated, claystone)
			Appreciable calcite	Calcareous shale
			Appreciable carbonaceous material	Carbonaceous shale
Appreciable iron oxide cement			Ferruginous shale	
Organic	Variable	Calcite and fossils	Fossiliferous limestone	
		Carbonaceous material	Bituminous coal	
Chemical	Microscopic	Calcite	Limestone	
		Dolomite	Dolomite	
		Quartz	Chert, flint, etc.	
		Iron compounds with quartz	Iron	
		Halite	Rock salt	
		Gypsum	Rock gypsum	

Foliation	Texture			
	Coarse Crystalline & Banded	Coarse Crystalline	Medium Crystalline	Fine to Microscopic Crystalline
Foliated	Gneiss	Schist { Sericite Mica Talc Chlorite Hematite, etc.	Phyllite	Slate
Non-Foliated		Marble Quartzite Serpentine Soapstone } <sup>a</sup>	Marble Quartzite Serpentine Soapstone } <sup>a</sup>	Hornfels Anthracite Coal Marble Quartzite Serpentine Soapstone } <sup>a</sup>

<sup>a</sup> Variable grain size.

Table 2-6. Descriptive Criter for Rock

1. Rock type
  - a. Rock name (Generic)
  - b. Hardness
    - (1) Very soft: can be deformed by hand
    - (2) Soft: can be scratched with a fingernail
    - (3) Moderately hard: can be scratched easily with a knife
    - (4) Hard: can be scratched with difficulty with a knife
    - (5) Very hard: cannot be scratched with a knife
  - c. Degree of weathering
    - (1) Unweathered: no evidence of any mechanical or chemical alteration.
    - (2) Slightly weathered: slight discoloration on surface, slight alteration along discontinuities, less than 10 percent of the rock volume altered, and strength substantially unaffected.
    - (3) Moderately weathered: discoloring evident, surface pitted and altered with alteration penetrating well below rock surfaces, weathering "halos" evident, 10 to 50 percent of the rock altered, and strength noticeably less than fresh rock.
    - (4) Highly weathered: entire mass discolored, alteration in nearly all of the rock with some pockets of slightly weathered rock noticeable, some minerals leached away, and only a fraction of original strength (with wet strength usually lower than dry strength) retained.
    - (5) Decomposed: rock reduced to a soil with relect rock texture (saprolite) and generally molded and crumbled by hand.
  - d. Lithology (macro description of mineral components). Use standard adjectives, such as shaly, sandy, silty, and calcareous. Note inclusions, concretions, nodules, etc.
  - e. Texture and grain size
    - (1) Sedimentary rocks

<u>Texture</u>	<u>Grain Diameter, mm</u>	<u>Particle Name</u>	<u>Rock Name</u>
*	< - 80	Cobble	Conglomerate
*	5 -. 80	Gravel	
Coarse grained	2 - 5	Sand	Sandstone
Medium grained	0.4 - 2		
Fine grained	0.1 - 0.4		

\* Use clay-sand texture to describe conglomerate matrix.

Table 2-6. Descriptive Criteria for Rock-Continued

<u>Texture</u>	<u>Grain Diameter, mm</u>	<u>Particle Name</u>	<u>Rock Name</u>
Very fine grained	> - 0.1	Clay, Silt	Shale, Claystone, Siltstone, Limestone

(2) Igneous and metamorphic rocks

<u>Texture</u>	<u>Grain Diameter, mm</u>
Coarse grained	> - 5
Medium grained	1 - 5
Fine grained	0.1 - 1
Aphanite	< 0.1

(3) Textural adjectives. Use simple standard textural adjectives such as porphyritic, vesicular, pegmatitic, granular, and grains well developed. Do not use sophisticated terms such as holohyaline, hypidiomorphic granular, crystalloblastic, and cataclastic.

2. Rock structure

a. Bedding

- (1) Massive: >3 ft thick
- (2) Thick bedded: beds from 1 to 3 ft thick
- (3) Medium bedded: beds from 4 in. to 1 ft thick
- (4) Thin bedded: beds less than 4 in. thick

b. Degree of fracturing (jointing)

- (1) Unfractured: fracture spacing greater than 6 ft
- (2) Slightly fractured: fracture spacing from 3 to 6 ft
- (3) Moderately fractured: fracture spacing from 1 to 3 ft
- (4) Highly fractured: fracture spacing from 4 in. to 1 ft
- (5) Intensely fractured: fracture spacing less than 4 in.

c. Shape of rock blocks

- (1) Blocky: nearly equidimensional
- (2) Elongated: rod-like
- (3) Tabular: flat or bladed

(Continued)

(Sheet 2 of 3)

Table 2-6. Descriptive Criteria for Rock-Continued

- 
- 3. Discontinuities
    - a. Joints
      - (1) Type: bedding, cleavage, foliation, schistosity, extension
      - (2) Separations: open or closed, how far open
      - (3) Character of surface: smooth or rough; if rough, how much relief, average asperity angle
      - (4) Weathering of clay products between surfaces
    - b. Faults and shear zones
      - (1) Single plane or zone: how thick
      - (2) Character of sheared materials in zone
      - (3) Direction of movement, slickensides
      - (4) Clay fillings
    - c. Solution, cavities, and voids
      - (1) Size
      - (2) Shape: planar, irregular, etc.
      - (3) Orientation (if applicable): developed along joints, bedding planes, at intersections of joints and bedding planes, etc.
      - (4) Filling: percentage of void volume and type of filling material (e.g. sand, silt, clay, etc.).
- 

(Sheet 3 of 3)

U. S. Army Corps of Engineers

ment of texture or structural features in any type of rock; e.g., cleavage in slate or schistosity in a metamorphic rock. The term is most commonly applied to metamorphic rock.

b. Samples that are tested in the laboratory (termed "intact" samples) represent the upper limit of strength and stress-strain characteristics of the rock and may not be representative of the mass behavior of the rock. Coring causes cracks, fissures, and weak planes to open, often resulting in a recovery of many rock fragments of varying length for any core barrel advance. Only samples (intact pieces) surviving coring and having a length/diameter ratio of 2 to 2.5 are tested. Rock Quality Designation (RQD) is an index or measure of the quality of the rock mass. RQD is defined as:

$$RQD = \frac{\sum \text{Lengths of intact pieces } \geq 4 \text{ in. long}}{\text{Length of core advance}}$$

Referring to figure 2-4, with a core advance of 60 inches and a sum of intact pieces, 4 inches or larger, of 34 inches, the RQD is computed as:

$$RQD = \frac{34}{60} = 0.57$$

Also shown in figure 2-4 is a qualitative rating of the rock mass in terms of RQD. RQD depends on the drilling technique, which may induce fracture as well as rock discontinuities. Fresh drilling-induced fractures may be identified by careful inspection of the recovered sample.

**2-7. Shales.**

a. Depending on climatic, geologic, and exposure conditions, shale may behave as either a rock or soil but must always be handled and stored as though it is soil. For these reasons, shale is considered separately from either soil or rock. Shale is a fine-grained sedimentary rock composed essentially of compressed

Table 2- 7. Engineering Classification of Intact Rock

I. On basis of strength, $\sigma_{ult}$ : <sup>a</sup>		
<u>Class</u>	<u>Description</u>	<u>Uniaxial Compressive</u>
A	Very high strength	Over 32,000
B	High strength	16,000 - 32,000
C	Medium strength	8,000 - 16,000
D	Low strength	4,000 - 8,000
E	Very low strength	Less than 4,000

II. On basis of modulus ratio, $E_t / \sigma_{ult}$ : <sup>a</sup>		
<u>Class</u>	<u>Description</u>	<u>Uniaxial Compressive</u>
H	High modulus ratio	Over 500
M	Average (medium) ratio	200-500
L	Low modulus ratio	Less than 200

<sup>a</sup> Rocks are classified by both strength and modulus ratio, such as AM, BL, BH, and CM.

<sup>b</sup> Modulus ratio =  $E_t / \sigma_{ult}$ , where  $E_t$  = tangent modulus at 50 percent ultimate strength and  $\sigma_{ult}$  = uniaxial compressive strength.

(Courtesy of K. G. Stagg and O. C. Zienkiewicz, Rock Mechanics in Engineering Practice, 1968, pp 4-5. Reprinted by permission of John Wiley & Sons, Inc, New York.)

and/or cemented clay particles. It is usually laminated from the general parallel orientation of the clay particles as distinct from *claystone*, *siltstone*, or *mudstone*, which are indurated deposits of random particle orientation. The terms "argillaceous rock" and "mudrock" are also used to describe this type of rock. Shale is the predominate sedimentary rock in the earth's crust.

b. Shale may be grouped as compaction shale, and cemented (rock) shale. Compaction shale is a transition material from soil to rock and can be excavated with usual large excavation equipment. Cemented shale generally requires blasting. Compaction shales have been formed by consolidation pressure and very little cementing action. Cemented shales are formed by a combination of cementing and consolidation pressure. They tend to ring when struck by a hammer, do not slake in water, and have the general characteristics of

good rock. Compaction shales, being of an intermediate quality, will generally soften and expand upon exposure to weathering when excavations are opened.

c. Dry unit weight of shale may range from about 80 pounds per cubic foot for poor-quality compaction shale to 160 pounds per cubic foot for high-quality cemented shale. Shale may have the appearance of sound rock on excavation but will often deteriorate, during or after placement in a fill, into weak clay or silt, of low shear strength. Figure 2-5 may be used as a guide in classifying shale for foundation use.

d. Compaction shales may swell for years after a structure is completed and require special studies whenever found in subgrade or excavated slopes. The predicted behavior of shales cannot be based solely upon laboratory tests and must recognize local experiences.



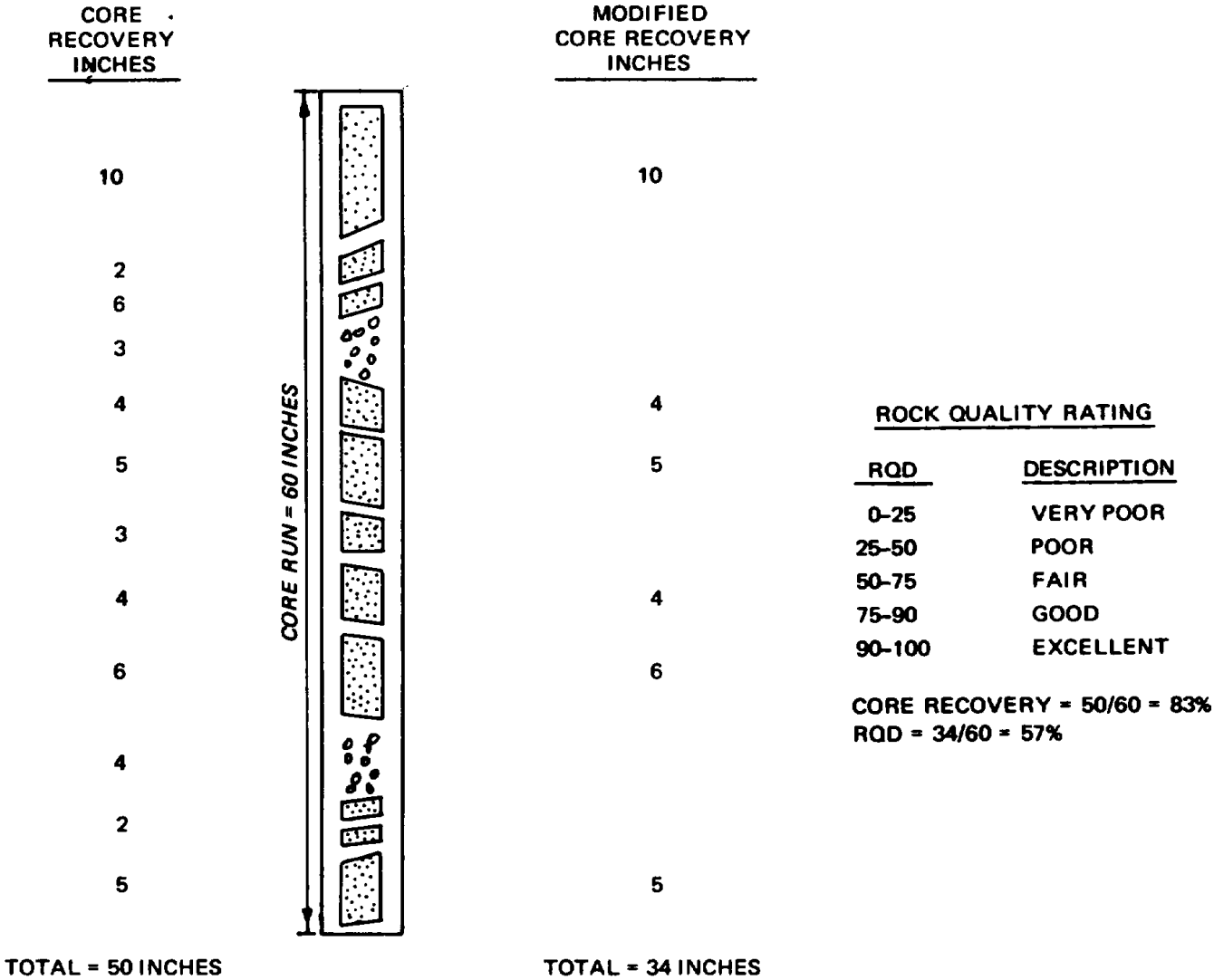

*(Courtesy of K. G. Stagg and O. C. Zienkiewicz, Rock Mechanics in Engineering Practice, 1968, p 15. Reprinted by permission of John Wiley & Sons, Inc. New York.)*

Figure 2-4. Modified core recovery as in index of rock quality.



CHAPTER 3

ENGINEERING PROPERTIES OF SOIL AND ROCK

3-1. Scope. This chapter considers engineering properties of soil and rock useful in designing foundations under static loading. Dynamic properties are discussed in chapter 17.

a. *Correlations.* Tables and charts based on easily determined index properties are useful for rough estimating or confirming design parameters. Testing procedures employed by different soil laboratories have influenced correlations presented to an unknown degree, and the scatter of data is usually substantial; caution should, therefore, be exercised in using correlation values. Undisturbed soil testing, either laboratory or field, or both, should be used for final design of major foundations. On smaller projects, an economic analysis should determine if a complete soil exploration/laboratory testing program is justified in lieu of a conservative design based on correlation data. Complex subsurface conditions may not permit a decision on solely economic grounds.

b. *Engineering properties.* Properties of particular interest to the foundation engineer include-

- (1) Compaction.
- (2) Permeability.
- (3) Consolidation-swell.
- (4) Shear strength.
- (5) Stress-strain modulus (modulus of elasticity) and Poisson's ratio.

3-2. Compaction characteristics of soils.

The density at which a soil can be placed as fill or backfill depends on the placement water content and the compaction effort. The Modified Compaction Test (CE 55) or comparable commercial standards will be used as a basis for control. The CE 55 test is described in TM 5-824-2/AFM 88-6, Chapter 2. (See app A for references.) Other compaction efforts that may be occasionally used for special projects include-

a. *Standard compaction test:* Three layers at 25 blows per layer Hammer = 5.5 pounds with 12-inch drop

b. *Fifteen-blow compaction test:*  
 Three layers at 15 blows per layer  
 Hammer = 5.5 pounds with 12-inch drop

The results of the CE 55 test are represented by compaction curves, as shown in figure 3-1, in which the water content is plotted versus compacted dry density.

The ordinate of the peak of the curve is the maximum dry density, and the abscissa is the optimum water content

$W_{opt}$ . Table 3-1 presents typical engineering properties of compacted soils; see footnote for compacted effort that applies.

3-3. Density of cohesionless soils.

a. Relative density of cohesionless soils has a considerable influence on the angle of internal friction, allowable bearing capacity, and settlement of footings. An example of the relationship between relative density and in situ dry densities may be conveniently determined from figure 3-2. Methods for determining in situ densities or relative densities of sands in the field are discussed in chapter 4.

b. The approximate relationship among the angle of friction,  $\phi$ , DR, and unit weight is shown in figure 3-3; and between the coefficient of uniformity,  $C_u$ , and void ratio, in figure 3-4.

c. The relative compaction of a soil is defined as

$$RC = \frac{Y_{field}}{Y_{max (lab)}} \times 100(\text{percent}) \quad (3-1)$$

where  $y_{field}$  = dry density in field and  $y_{max (lab)}$  = maximum dry density obtained in the laboratory. For soils where 100 percent relative density is approximately the same as 100 percent relative compaction based on CE 55, the relative compaction and the relative density are related by the following empirical equation:

$$RC = 80 + 0.2D_R(D_R > 40 \text{ percent}) \quad (3-2)$$

3-4. Permeability.

a. *Darcy's law.* The laminar flow of water through soils is governed by Darcy's law:

$$q = kiA \quad (3-3)$$

where

$q$  = seepage quantity (in any time unit consistent with  $k$ )

$k$  = coefficient of permeability (units of velocity)

$i$  =  $h/L$  = hydraulic gradient or head loss,  $h$ , across the flow path of length,  $L$

$A$  = cross-sectional area of flow

b. *Permeability of soil.* The permeability - depends primarily on the size and shape of the soil grains, void ratio, shape and arrangement of voids, degree of saturation, and temperature. Permeability is determined in the laboratory by measuring the rate of flow of wa-

ter through a specimen under known hydraulic gradient, i. Typical permeability values, empirical relationships, and methods for obtaining the coefficient of permeability are shown in figure 3-5. Field pumping tests are the most reliable means of determining the permeability of natural soil deposits (para 4-5). Permeability obtained in this

manner is the permeability in a horizontal direction. The vertical permeability of natural soil deposits is affected by stratification and is usually much lower than the horizontal permeability.

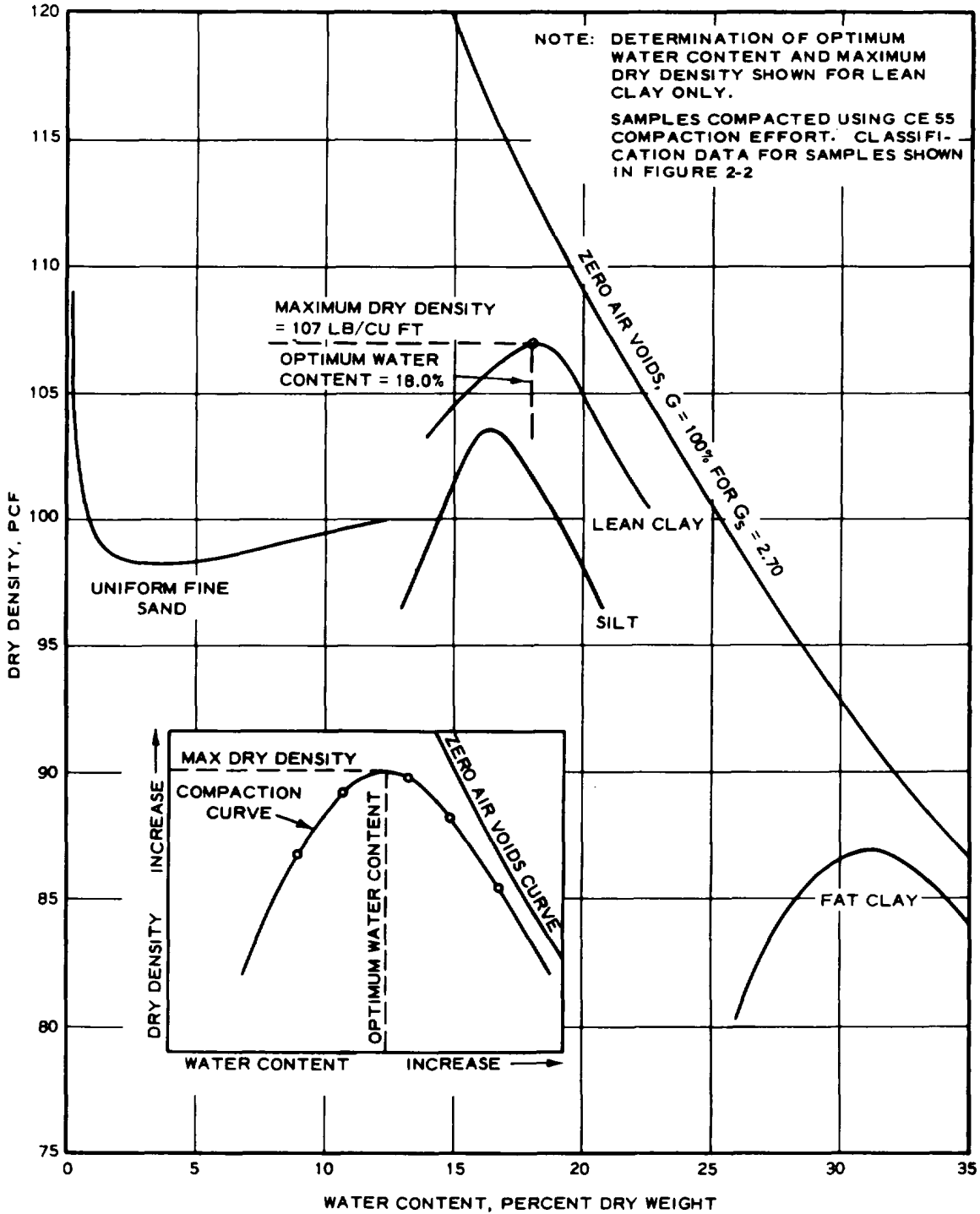

U. S. Army Corps of Engineers

Figure 3-1. Typical CE 55 compaction test data.

Table 3-1. Typical Engineering Properties of Compacted Materials

Group Symbol	Soil Type	Range of Maximum Dry Unit Weight, pcf	Range of Optimum Water Content Percent	Typical Value of Compression		Typical Strength Characteristics					Range of Subgrade Modulus k lb/cu in.
				At 2.5 ksf (20 psi) Percent of Original Height	At 7.2 ksf (50 psi)	Cohesion (As Compacted) psf	Cohesion (Saturated) psf	φ (Effective Stress Envelope) deg	Typical Coefficient of Permeability ft/min	Range of CBR Values	
GW	Well graded clean gravels, gravel-sand mixtures	125-135	11-8	0.3	0.6	0	0	>38	$5 \times 10^{-2}$	40-80	300-500
GP	Poorly graded clean gravels, gravel-sand mix	115-125	14-11	0.4	0.9	0	0	>37	$10^{-1}$	30-60	250-400
GM	Silty gravels, poorly graded gravel-sand-silt	120-135	12-8	0.5	1.1	.....	.....	>34	$>10^{-6}$	20-60	100-400
GC	Clayey gravels, poorly graded gravel-sand-clay	115-130	14-9	0.7	1.6	.....	.....	>31	$>10^{-7}$	20-40	100-300
SW	Well graded clean sands, gravelly sands	110-130	16-9	0.6	1.2	0	0	38	$>10^{-3}$	20-40	200-300
SP	Poorly graded clean sands, sand-gravel mix	100-120	21-12	0.8	1.4	0	0	37	$>10^{-3}$	10-40	200-300
SM	Silty sands, poorly graded sand-silt mix	110-125	16-11	0.8	1.6	1050	420	34	$5 \times 10^{-5}$	10-40	100-300
SM-SC	Sand-silt clay mix with slightly plastic fines	110-130	15-11	0.8	1.4	1050	300	33	$2 \times 10^{-6}$	.....	.....
SC	Clayey sands, poorly graded sand-clay mix	105-125	19-11	1.1	2.2	1550	230	31	$5 \times 10^{-7}$	5-20	100-300
ML	Inorganic silts and clayey silts	95-120	24-12	0.9	1.7	1400	190	32	$10^{-5}$	15 or less	100-200
ML-CL	Mixture of inorganic silt and clay	100-120	22-12	1.0	2.2	1350	460	32	$5 \times 10^{-7}$	.....	100-200
CL	Inorganic clays of low to med. plasticity	95-120	24-12	1.3	2.5	1800	270	28	$10^{-7}$	15 or less	50-200
OL	Organic silts and silt-clays, low plasticity	80-100	33-21	.....	.....	.....	.....	.....	.....	5 or less	50-100
MH	Inorganic clayey silts, elastic silts	75-95	40-24	2.0	3.8	1500	420	25	$5 \times 10^{-7}$	10 or less	50-100
CH	Inorganic clays of high plasticity	80-105	36-19	2.6	3.9	2150	230	19	$10^{-7}$	15 or less	50-150
OH	Organic clays and silty clays	75-100	45-21	.....	.....	.....	.....	.....	.....	5 or less	25-100

- Notes
1. All properties are for condition of "standard Proctor" maximum density, except values of k and CBH which are for CE55, maximum density.
  2. Typical strength characteristics are for effective strength envelopes and are obtained from ISBR data.
  3. Compression values are for vertical loading with complete lateral confinement.
  4. (>) indicates that typical property is greater than the value shown. ( ) indicates insufficient data available for an estimate.

(NAVFAC DM-7)

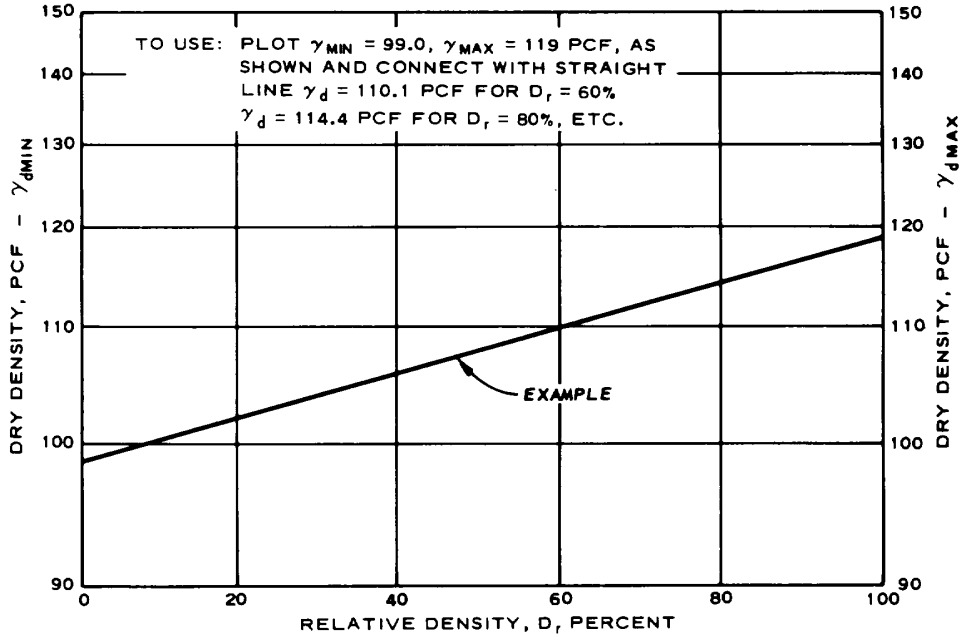

Figure 3-2. Relation between relative density and dry density (scaled to plot as a straight line).

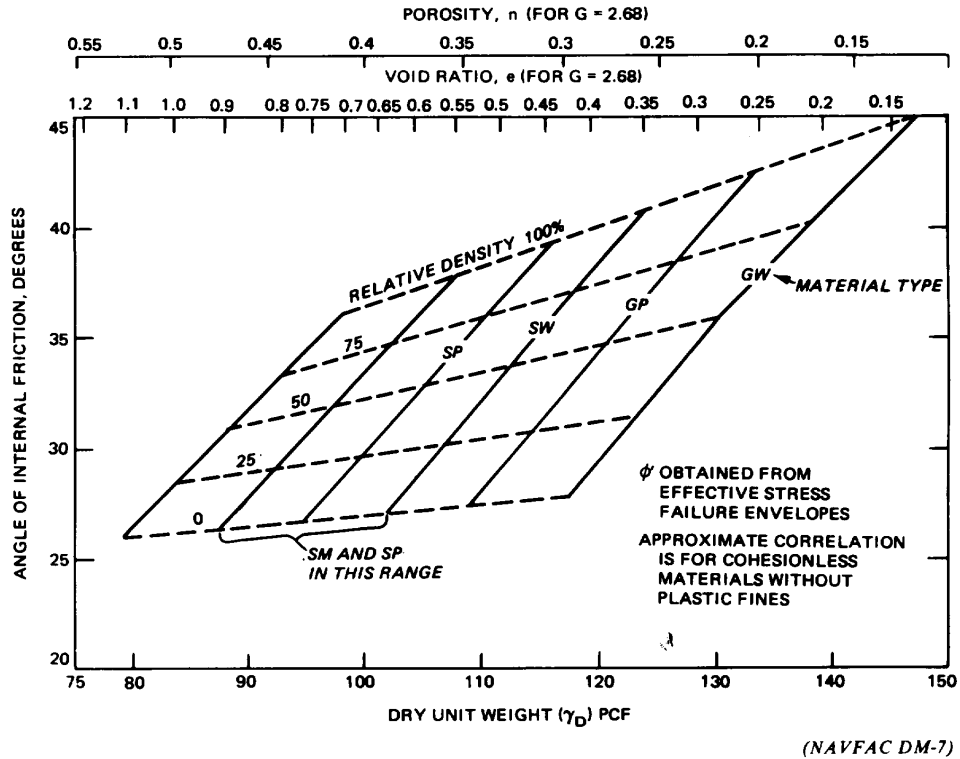

Figure 3-3. Angle of friction versus dry density for coarse-grained soils.

c. *Permeability of rock.* Intact rock is generally impermeable, but completely intact rock masses rarely occur. The permeability of rock masses is controlled by discontinuities (fissures, joints, cracks, etc.), and flow may be either laminar (Darcy's law applies) or turbulent, depending on the hydraulic gradient, size of flow path, channel roughness, and other factors. Methods for determining the in situ permeability of rock are presented in chapter 4.

**3-5. Consolidation.** Consolidation is a time-dependent phenomenon, which relates change that occurs in the soil mass to the applied load.

a. *Consolidation test data.* Consolidation or one-dimensional compression tests are made in accordance with accepted standards. Results of tests (fig 3-6) are presented in terms of time-consolidation curves and pressure-void ratio curves. The relationship between void ratio and effective vertical stress,  $p$ , is shown on a semilogarithmic diagram in figure 3-6. The

test results may also be plotted as change in volume versus effective vertical stress. Typical examples of pressure - void ratio curves for insensitive and sensitive, normally loaded clays, and preconsolidated clays are shown in figure 3-7.

b. *Preconsolidation pressure.* The preconsolidation stress,  $p_c$ , is the maximum effective stress to which the soil has been exposed and may result from loading or drying. Geological evidence of past loadings should be used to estimate the order of magnitude of preconsolidation stresses before laboratory tests are performed. The Casagrande method of obtaining the preconsolidation pressure from consolidation tests is shown in figure 3-7. Determining the point of greatest curvature

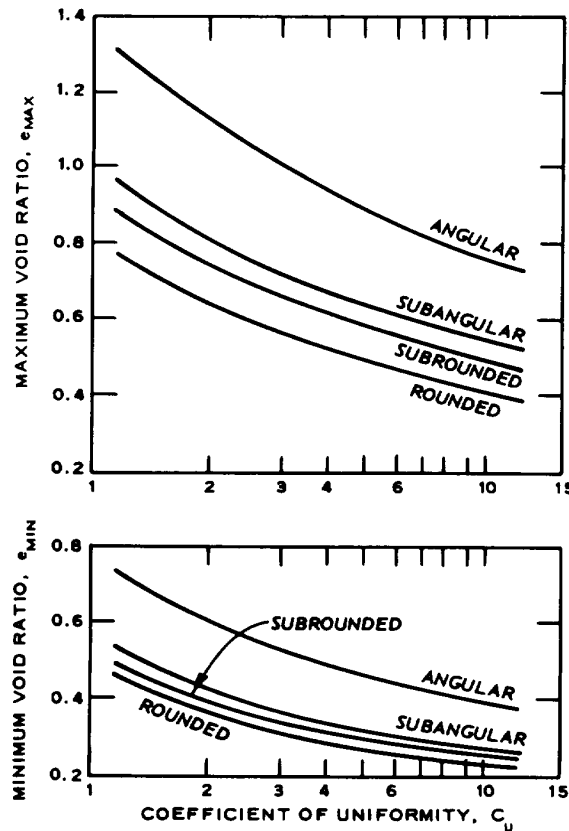

**NOTE:** THE MINIMUM VOID RATIOS WERE OBTAINED FROM SIMPLE SHEAR TESTS. CURVES ARE ONLY VALID FOR CLEAN SANDS WITH NORMAL TO MODERATELY SKEWED GRAIN-SIZED DISTRIBUTIONS.

(Modified from ASTM STP 523 (pp 98-112). Copyright ASTM, 1916 Race St., Philadelphia, PA. 19103. Reprinted/adapted with permission.)

Figure 3-4. Generalized curves for estimating  $e_{max}$  and  $e_{min}$  from gradational and particle shape characteristics.

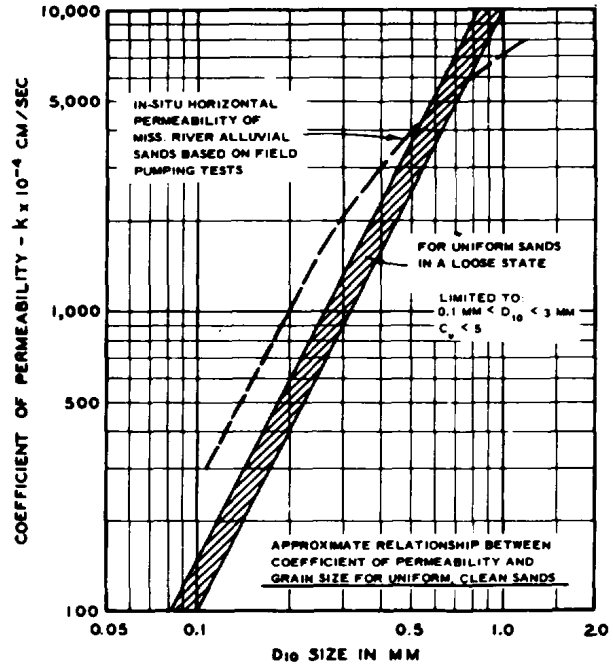
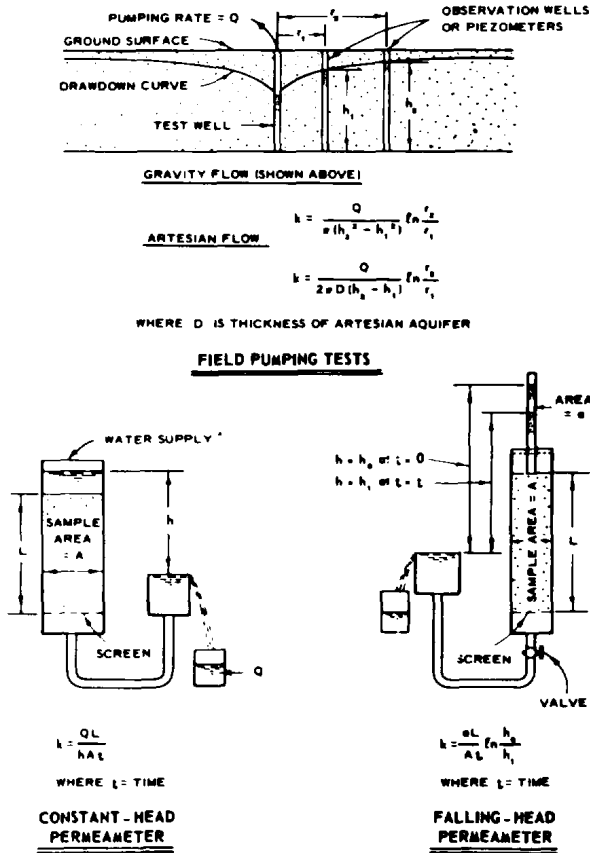

COMPUTATION OF PERMEABILITY FROM GRAIN SIZE

PERMEABILITY CHARACTERISTICS OF SOILS

Coefficient of Permeability, k			Relative Permeability	Soil Type	Method of Determination		
cm/sec	ft/min	ft/yr			Field pumping tests, reliable if properly executed	Falling-head permeameter	
10 1	20 2	$10.5 \times 10^5$ $1.05 \times 10^5$	High	Clean gravels Coarse sands		Reliable	Constant-head permeameter, reliable Computation from grain size
$1000 \times 10^{-4}$ $100 \times 10^{-4}$	0.2 0.02	10,500 1,050	Medium	Medium sands Fine sands and sand and gravel mixtures Very fine sand			
$1 \times 10^{-4}$ $0.1 \times 10^{-4}$ $0.01 \times 10^{-4}$	$2 \times 10^{-4}$ $0.2 \times 10^{-4}$ $0.02 \times 10^{-4}$	10.5 1.05 0.105	Low	Silty sands, organic silts Silts, glacial till Silty clay	Unreliable	Fairly reliable Computation from consolidation test data (reliable)	
$100 \times 10^{-9}$ $10 \times 10^{-9}$ $1 \times 10^{-9}$	$200 \times 10^{-9}$ $20 \times 10^{-9}$ $1 \times 10^{-9}$	$105 \times 10^{-4}$ $10.5 \times 10^{-4}$ $1.05 \times 10^{-4}$	Practically impervious	"Impervious" soils, e.g., homogeneous clays below zone of weathering			

U. S. Army Corps of Engineers

Figure 3-5. A summary of soil permeabilities and methods of determination.



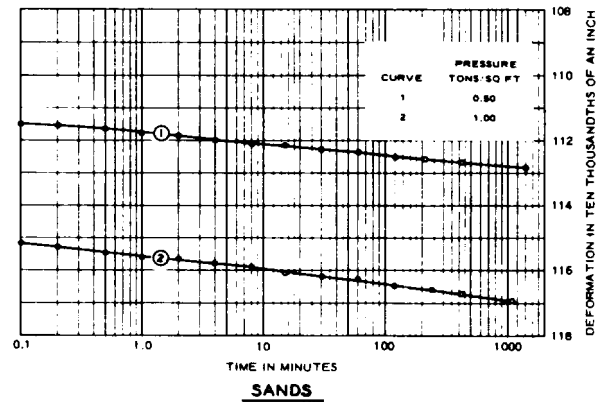
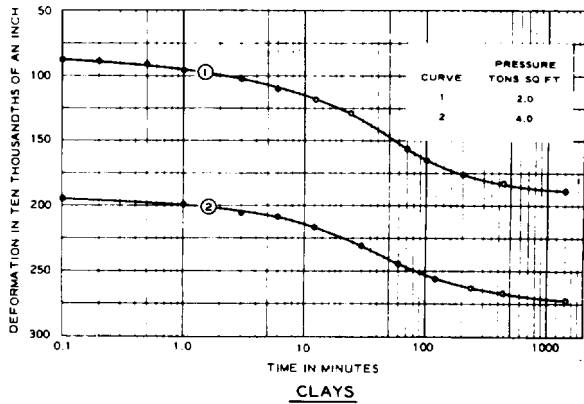
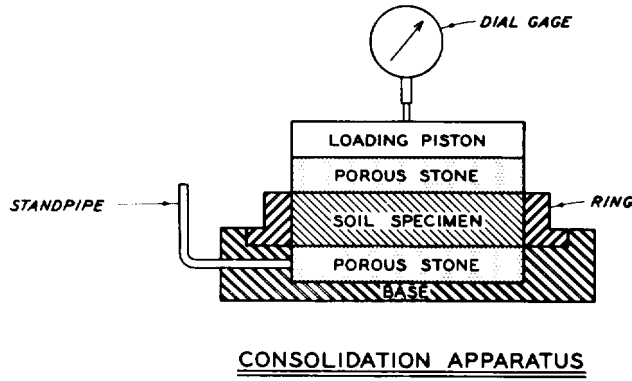

**EXAMPLES OF LABORATORY CONSOLIDATION CURVES**

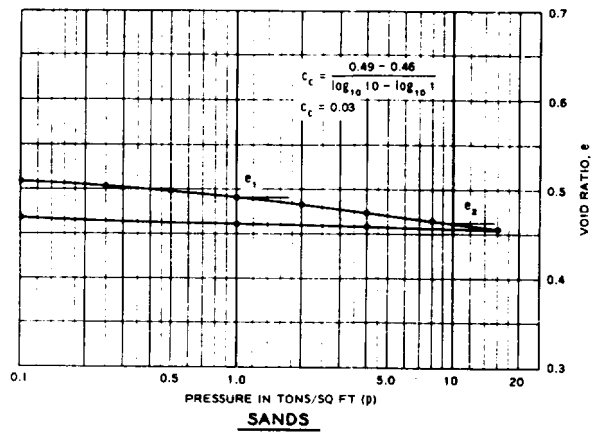
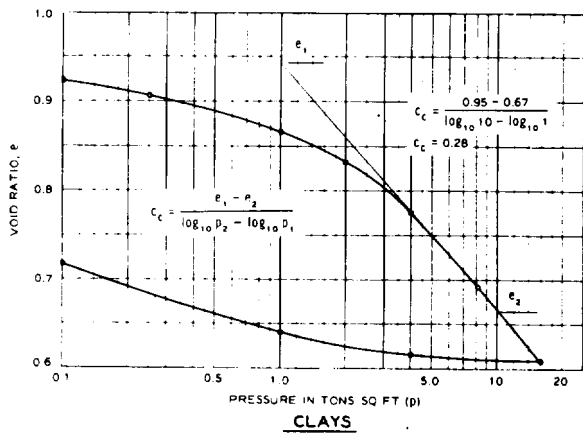

**EXAMPLES OF LABORATORY PRESSURE - VOID RATIO CURVES**

U. S. Army Corps of Engineers

Figure 3-6. Examples of laboratory consolidation test data.

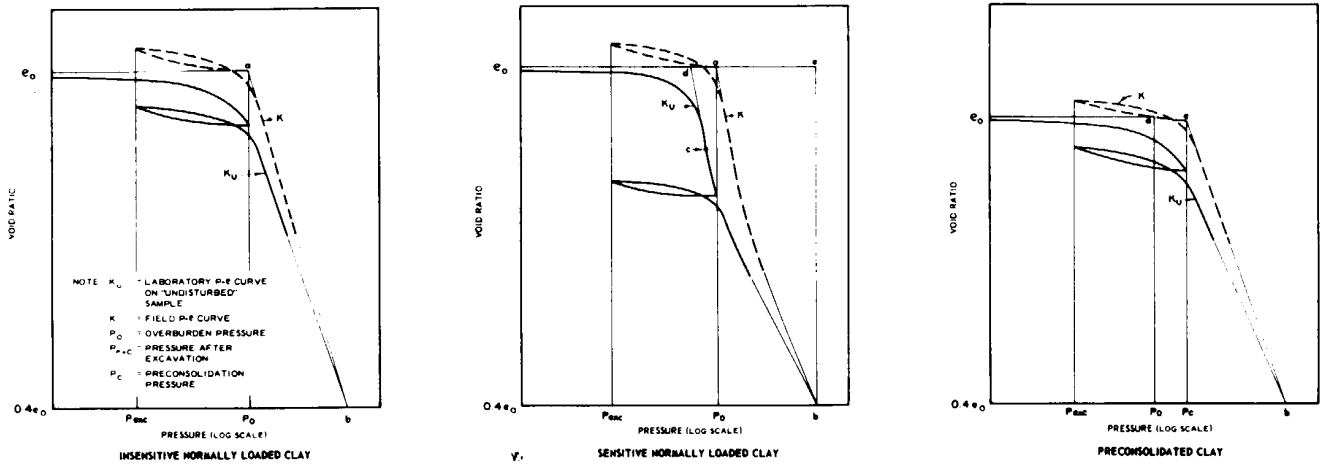

TYPICAL LABORATORY PRESSURE - VOID RATIO CURVES AND METHODS FOR CONSTRUCTING FIELD CONSOLIDATION CURVES

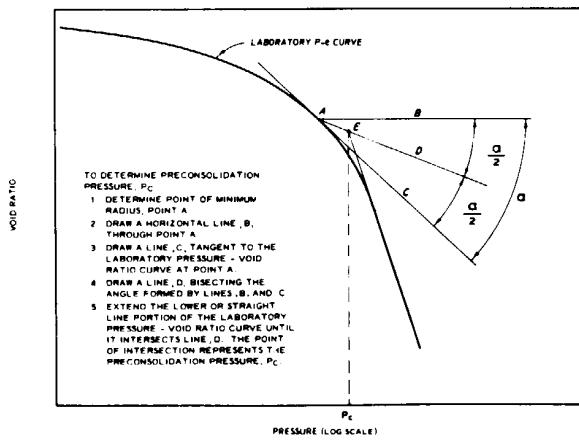

GRAPHICAL CONSTRUCTION OF PRECONSOLIDATION PRESSURE

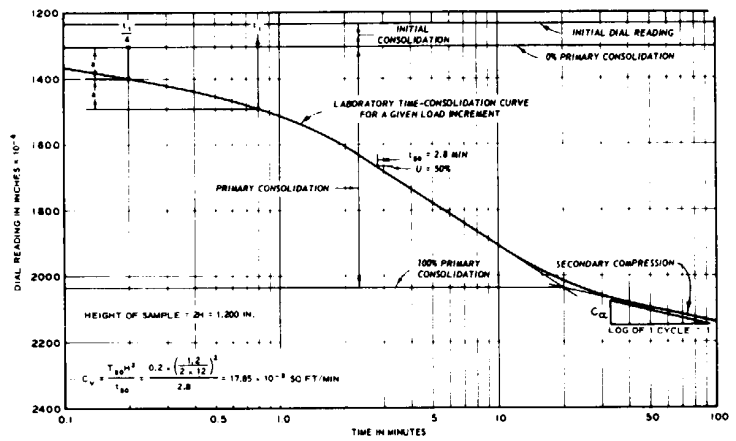

GRAPHICAL CONSTRUCTION FOR DETERMINING PRIMARY CONSOLIDATION AND CALCULATION OF COEFFICIENT OF CONSOLIDATION

Figure 3-7. Analyses of consolidation test data.

requires care and judgment. Sometimes it is better to estimate two positions of this point—one as small as likely, and the other as large as plausible, consistent with the data—and to repeat the construction for both cases. The result will be a range of preconsolidation stresses. Because the determination of  $p_c$  involves some inevitable inaccuracy, the range of possible values may be more useful than a single estimate which falls somewhere in the possible range. The higher the quality of the test specimen, the smaller is the range of possible  $p_c$  values. Approximate values of preconsolidation pressure may be estimated from figure 3-8 or 3-9. Table 3-2 can be used to obtain gross estimates of site preconsolidation. This table and figures 3-8 and 3-9 should be applied before consolidation tests are performed to assure test loads sufficiently high to define the virgin compression portion of  $e$ - $\log p$  plots.

c. *Compression index.* The slope of the virgin compression curve is the compression index  $C_c$ , defined in figure 3-6. Compression index correlations for approximations are given in table 3-3. When volume change is expressed as vertical strain instead of change in void ratio, the slope of the virgin compression part

of the  $\epsilon$  versus  $\log p$  curve is the compression ratio, CR, defined as

$$CR = \frac{\Delta \epsilon}{\log \frac{p_2'}{p_1'}} = \frac{C_c}{1 + e_0} \quad (3-4)$$

where  $\epsilon$  is the change in vertical strain corresponding to a change in effective stress from  $p_1'$  to  $p_2'$ , and  $e_0$  is the initial (or in situ) void ratio. An approximate correlation between CR and natural water content in clays is given by the following:

$$CR = 0.006 (w - 12)(3-5)$$

d. *Coefficient of volume compressibility.* The relationship between deformation (or strain) and stress for one-dimensional compression is expressed by the coefficient of volume compressibility,  $m_v$ , which is defined as

$$m_v = \frac{\Delta \epsilon}{\Delta p} = \frac{\Delta \epsilon}{\Delta p (1 + e_0)} = \frac{a_v}{1 + e_0} \quad (3-6)$$

$$m_v = \frac{0.434 C_c}{(1 + e_0)p'}$$

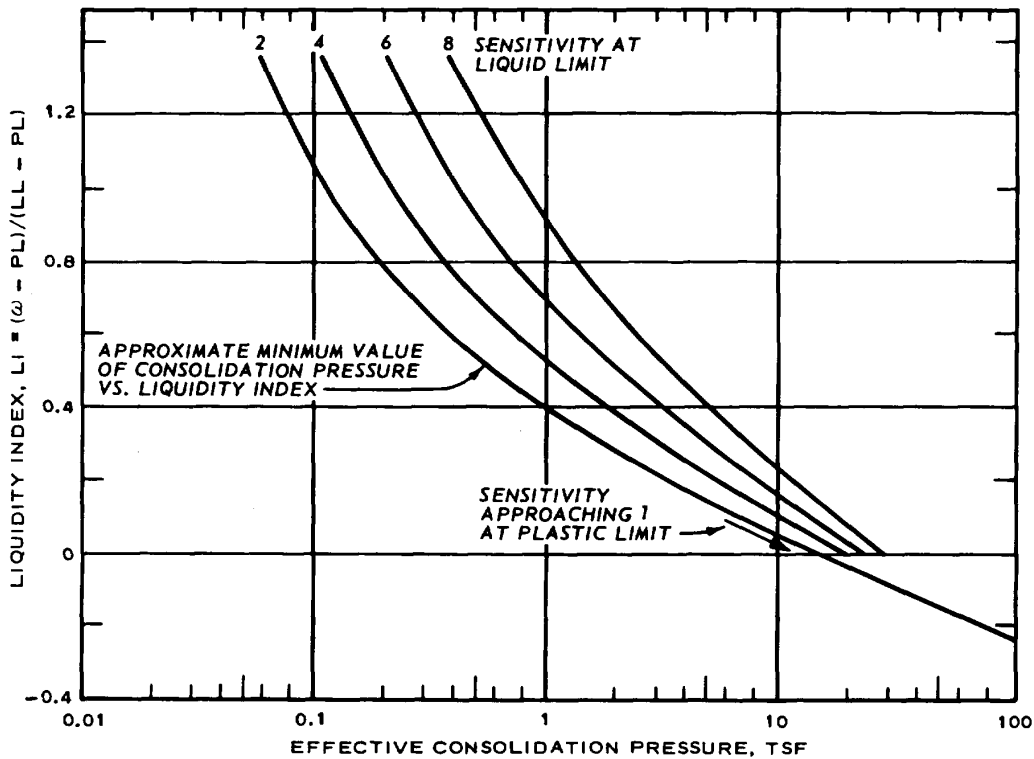

(NAVFAC DM-7)

Figure 3-8. Approximate relation between liquidity index and effective overburden pressure, as a function of the sensitivity of the soil

where

- $\Delta e$  = change in vertical strain
- $\Delta p$  =  $P_2 - p_1$  = corresponding change in effective vertical stress
- $a_v$  =  $A_e/A_p$  = coefficient of compressibility
- $p'$  = average of initial and final effective vertical stress

$$C_s = \frac{\Delta e}{\log \frac{p_2'}{p_1'}} \quad (3-8)$$

where  $A_e$  is the change in void ratio (strictly a sign applies to  $C_c$ ,  $C_{s'}$ ,  $C_r$ , and  $m_v$ ; however, judgment is usually used in lieu of signs). The swelling index is generally from one-fifth to one-tenth the compression index. Approximate values of  $C_s$  may be obtained from figure 3-10. The slope of the recompression curve is expressed by the recompression index,  $C_r$ , as follows:

$$C_r = \frac{\Delta e}{\log \frac{p_2'}{p_1'}} \quad (3-9)$$

The units of  $m_v$  are the reciprocal of constrained modulus. Table 3-4 gives typical values of  $m_v$  for several granular soils during virgin loading.

e. *Expansion and recompression.* If overburden pressure is decreased, soil undergoes volumetric expansion (swell), as shown in figure 3-7. The semilogarithmic, straight-line (this may have to be approximated) slope of the swelling curve is expressed by the swelling index,  $C_s$ , as

The value of  $C_r$  is equal to or slightly smaller than  $C_s$ . High values of  $C_r/C_s$  are associated with overconsolidated clays containing swelling clay minerals.

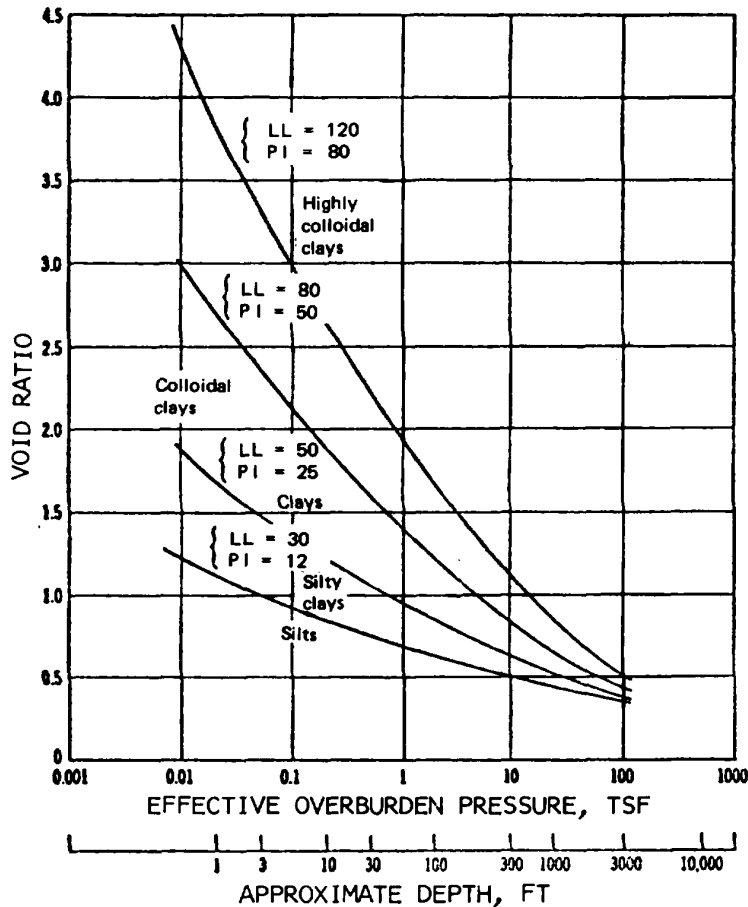

(Courtesy of T. W. Lambe and R. V. Whitman, *Soils Mechanics*, 1969, p 320. Reprinted by permission of John Wiley & Sons, Inc., New York.)

Figure 3-9. Approximate relation between void ratio and effective overburden pressure for clay sediments, as a function of the Atterberg limits.

Table 3-2. Estimating Degree of Preconsolidation

Method	Remarks
Surface topography	Soil below alluvial valley filling should generally have a preconsolidation stress at least corresponding to elevation of abutments. In wide river valleys with terraces at several elevations, an elevation corresponding to previous surface elevation in the river valley may be several miles distant
Geological evidence	Ask geologist for estimate of maximum preconsolidation stress. Erosion may have removed hundreds of feet of material even in abutment area
Water content	If natural water content is near PL or below it, anticipate high preconsolidation stress. A high natural water content is not, itself, a suitable indicator of absence of overconsolidation
Standard penetration resistance	If blow counts are high, anticipate high preconsolidation stress. From blow counts, estimate undrained shear strength, $s_u$ , in tons per square foot as approximately 1/15 of blow count. If estimated value is substantially more than corresponds to a $s_u/p_o$ ratio of about 0.25, anticipate high preconsolidation stresses
Undisturbed sampling	If soil was too hard to sample with piston sampler, and a Denison or similar sampler was required, suspect high preconsolidation stress
Laboratory shear strengths	If higher than those corresponding to a $s_u/p_o$ ratio of about 0.3, anticipate high preconsolidation stress
Compression index from consolidations tests	If compression index appears low for Atterberg limits of soil, suspect that test loads were not carried high enough to determine virgin compression curve and correct preconsolidation stress. Expected values for compression index can be estimated from correlations with water content and Atterberg limits (table 3-3)
Liquidity index and sensitivity	Estimate preconsolidation stress from figures 3-8 and 3-9 ( $p_c$ values may be low)

U. S. Army Corps of Engineers

f. *Coefficient of consolidation.* The soil properties that control the drainage rate of pore water are combined into the *coefficient of consolidation*,  $C_v$ , defined as follows:

$$C_v = \frac{k(1 + e_0)}{y_w a_v'} = \frac{k}{y_w m_v} \quad (3-10)$$

alternatively,

$$C_v = \frac{TH^2}{t} \quad (3-11)$$

where

- $k$  = coefficient of permeability in a vertical direction
- $e_0$  = initial void ratio
- $y_w$  = unit weight of water
- $a_v$  =  $\Delta e / \Delta p$  = coefficient of compressibility, vertical deformation
- $m_v$  = coefficient of volume compressibility
- $T$  = Time factor (para 5-5) that depends on percent consolidation and assumed pore pres-

Table 3-3. Compression Index Correlations

Clays	
$C_c = 0.012 w$ ,	$w_n$ in percent
$C_c = 0.01$	(LL-13)
Sand, uniform	
$C_c = 0.03$ ,	loose to $C_c = 0.06$ , dense
Silt, uniform	
$C_c = 0.20$	

U. S. Army Corps of Engineers

Table 3-4. Value of Coefficient of Compressibility ( $m_v$ ) for Several Granular Soils During Virgin Loading

Soil	Relative Density, $D_R$	$m_v \times 10^{-4}$ per psi Effective Pressure	
		9 to 14 psi	28 to 74 psi
Uniform gravel	0	2.3	1.1
1 < D < 5 mm	100	0.6	0.4
Well-graded sand	0	5.0	2.7
0.02 < D < 1 mm	100	1.3	0.6
Uniform fine sand	0	4.8	2.0
0.07 < D < 0.3 mm	100	1.4	0.6
Uniform silt	0	25.0	4.0
0.02 < D < 0.07 mm	100	2.0	0.9

(Courtesy of T W. Lambe and R. V. Whitman, *Soils Mechanics*, 1969, p 155. Reprinted by permission of John Wiley & Sons, Inc., New York.)

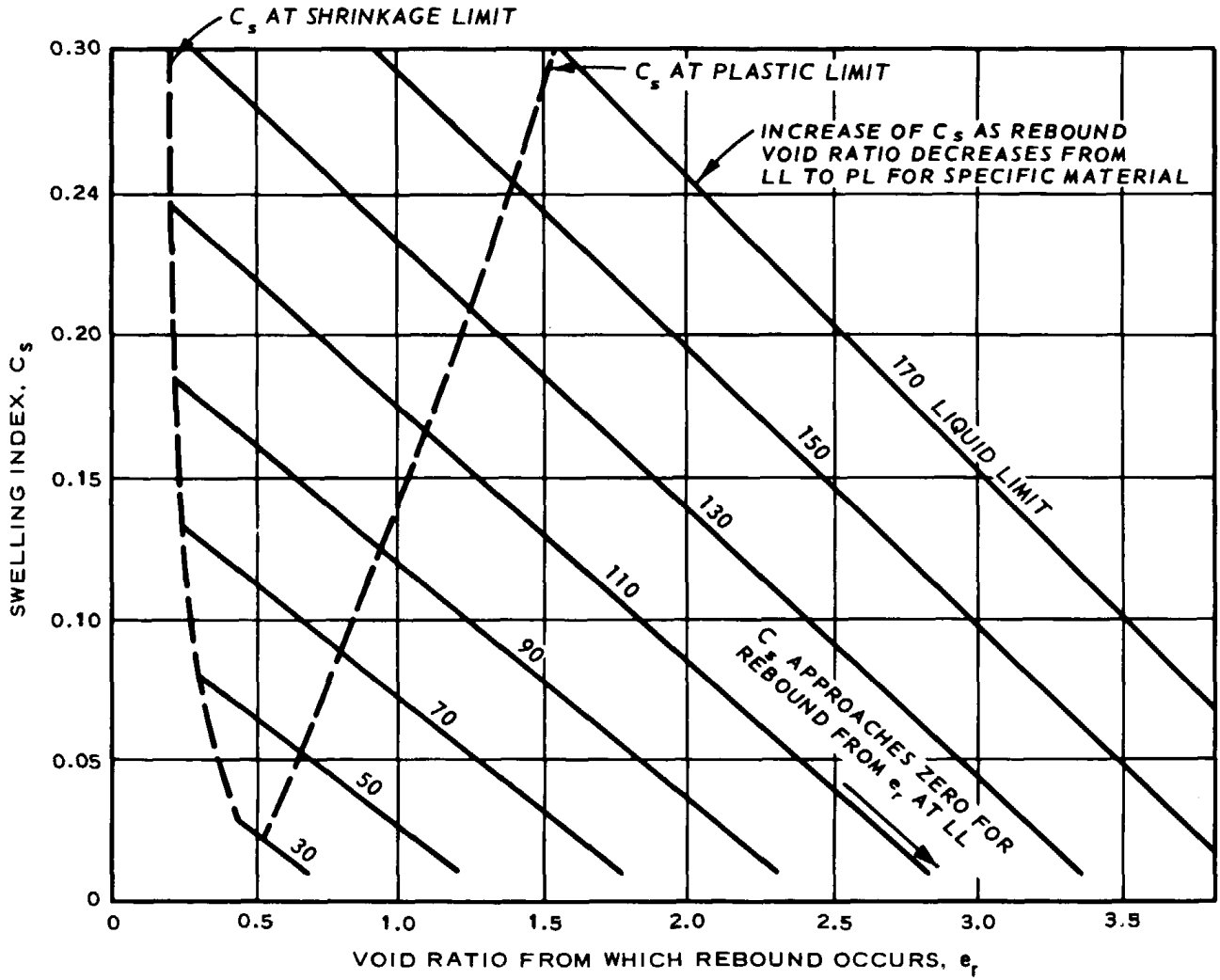

(NAVFAC DM-7)

Figure 3-10. Approximate correlations for swelling index of silts and clays.

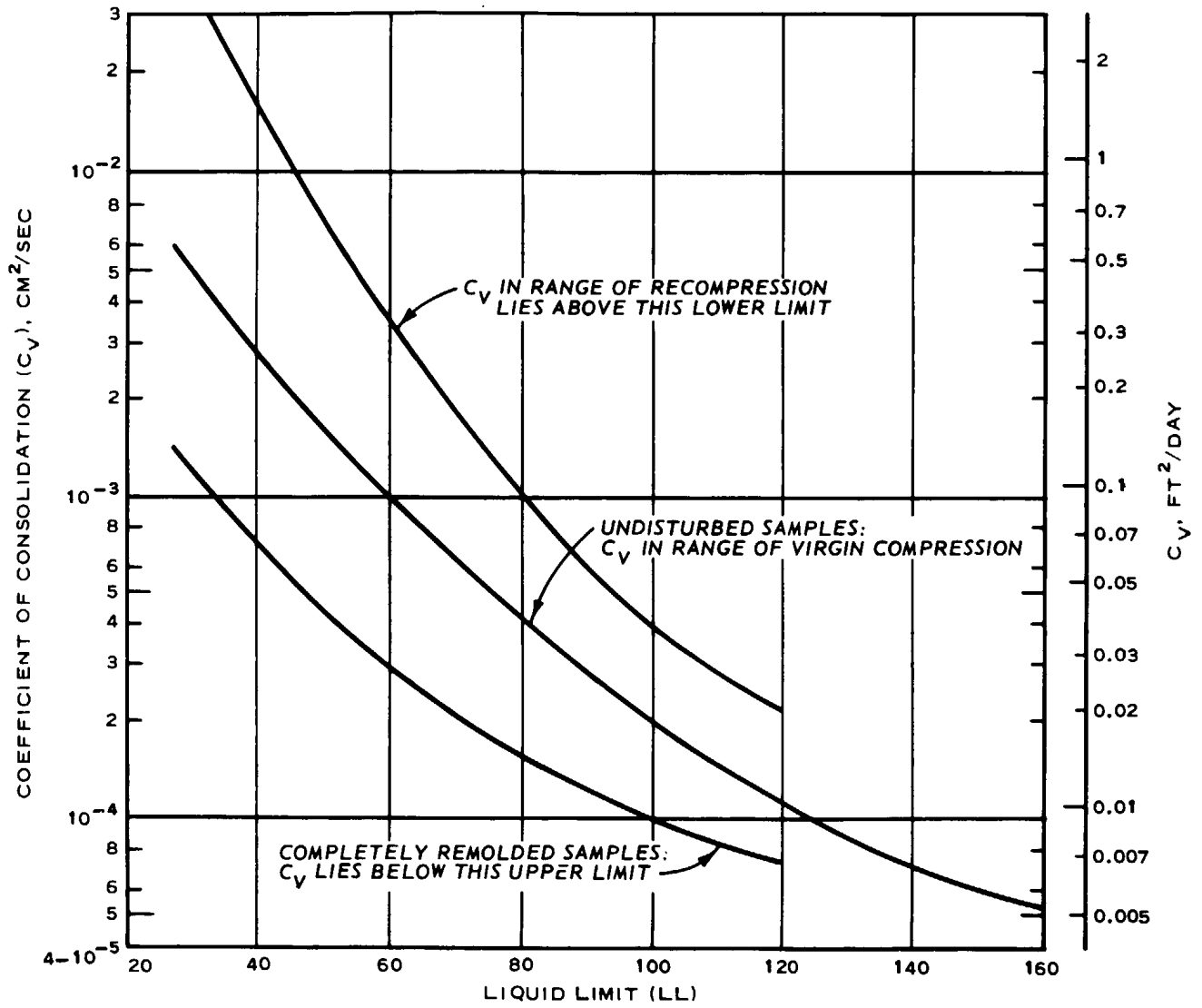

Figure 3-11. Correlations between coefficient of consolidation and liquid limit.



sure distribution in soil caused by load  
 H = length of longest drainage path (lab or field)  
 t = time at which the time factor is T for the degree of consolidation that has occurred (generally, use  $t_{50}$  for  $T = 0.197$  and 50 percent consolidation)

Correlation between  $C_v$  and LL are shown in figure 3-11 for undisturbed and remolded soil.

g. *Coefficient of secondary compression.* The coefficient of secondary compression,  $C_{\infty}$ , is strain  $\epsilon_z = \Delta H/H_0$ , which occurs during one log cycle of time following completion of primary consolidation (fig 3-7). The coefficient of secondary compression is computed as

$$C_{\infty} = \frac{\Delta \epsilon_z}{\log \frac{t}{t_p}} = \frac{\frac{\Delta H}{H_f}}{\log \frac{t}{t_p}} \quad (3-12)$$

where  $t_p$  is time to complete primary consolidation, and  $H_f$  is total thickness of compressible soil at time  $t_p$ . Soils with high compressibilities as determined by the compression index of virgin compression ratio will generally also have high values of  $C_{\infty}$ . Highly sensitive clays and soils with high organic contents usually exhibit high rates of secondary compression. Overconsolidation can markedly decrease secondary compression. Depending on the degree of overconsolidation, the value of  $C_{\infty}$  is typically about *one-half to one-third* as large for pressures below the preconsolidation pressure as it is for the pressures above the preconsolidation pressures. For many soils, the value of  $C_{\infty}$  approximately equals  $0.00015w$ , with  $w$  in percent.

h. *Effects of remolding.* Remolding or disturbance has the following effects relative to undisturbed soil:

(1) *e-log p curve.* Disturbance lowers the void ratio reached under applied stresses in the vicinity of the preconsolidation stress and reduces the distinct break in the curve at the preconsolidation pressure (fig 3-7). At stresses well above the preconsolidation stress, the e-log p curve approaches closely that for good undisturbed samples.

(2) *Preconsolidation stress.* Disturbance lowers the apparent preconsolidation stress.

(3) *Virgin compression.* Disturbance lowers the value of the compression index, but the effect may not be severe.

(4) *Swelling and recompression.* Disturbance increases the swelling and recompression indices.

(5) *Coefficient of consolidation.* Disturbance decreases the coefficient of consolidation for both virgin compression and recompression (fig 3-11) in the vicinity of initial overburden and preconsolidation stresses. For good undisturbed samples, the value of

$C_v$  decreases abruptly at the preconsolidation pressure.  
 (6) *Coefficient of secondary compression.* Disturbance decreases the coefficient of secondary compression in the range of virgin compression.

**3-6. Swelling, shrinkage, and collapsibility.**

a. The swelling potential is an index property and equals the percent swell of a laterally confined soil sample that has soaked under a surcharge of 1 pound per square inch after being compacted to the maximum density at optimum water content according to the standard compaction test method. Correlation between swelling potential and PI for natural soils compacted at optimum water content to standard maximum density is shown in figure 3-12.

b. The amount of swelling and shrinkage depends on the initial water content. If the soil is wetter than the shrinkage limit (SL), the maximum possible shrinkage will be related to the difference between the actual water content and the SL. Similarly, little swell will occur after the water content has reached some value above the plastic limit.

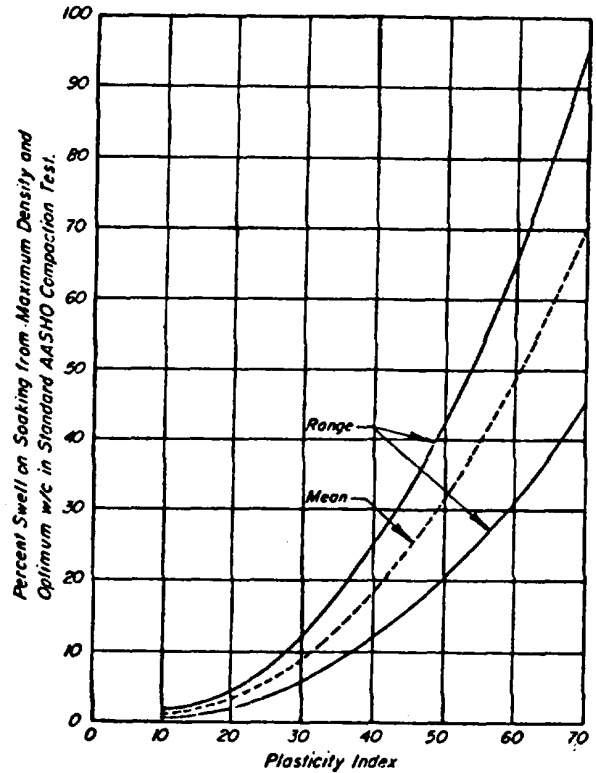

(Courtesy of H. B. Seed, J. Woodward, J and Lundgren, R., "Predication of Swelling Potential for Swelling Clay," *Journal, Soil Mechanics and Foundations Division*, Vol 88, No. SM3, Part I, 1962, pp 53-87. Reprinted by permission of American Society of Civil Engineers, New York.)

Figure 3-12. Predicted relationship between swelling potential and plasticity index for compacted soils.

c. Collapsible soils are unsaturated soils that undergo large decreases in volume upon wetting with or without additional loading. An estimate of collapsibility (decrease in volume from change in moisture available) and expansion of a soil may be made from figure 3-13 based on in situ dry density and LL.

**3-7. Shear strength of soils.**

a. *Undrained and effective strengths.* The shear strength of soils is largely a function of the effective normal stress on the shear plane, which equals the total normal force less the pore water pressure. The shear strength,  $s$ , can be expressed in terms of the total normal pressure,  $\sigma$ , or the effective normal pressure,  $\sigma'$ , by parameters determined from laboratory tests or, occasionally, estimated from correlations with index properties. The shear test apparatus is shown in figure 3-14. The equations for shear strength are as follows:

$$s = c + \sigma \tan \phi \text{ (total shear strength parameters)}$$

$$s' = c' + (\sigma - u) \tan \phi' \text{ (effective shear strength parameters)}$$

The total (undrained) shear strength parameters,  $c$  and  $\phi$ , are designated as cohesion and angle of internal friction, respectively. Undrained shear strengths apply where there is no change in the volume of pore water (i.e., no consolidation) and are measured in the laboratory by shearing without permitting drainage. For saturated soils,  $\phi = 0$ , and the undrained shear strength,  $c$ , is designated as  $s_u$ . The effective stress parameters,  $c'$  and  $\phi'$ , are used for determining the shear strength provided pore pressures,  $u$ , are known. Pore pressure changes are caused by a change in either normal or shear stress and may be either positive or negative. Pore pressures are determined from piezometer observations during and after construction or, for design purposes, estimated on the basis of experience and behavior of samples subjected to shear tests. Effective stress parameters are computed from laboratory tests in which pore pressures induced during shear are measured or by applying the shearing load sufficiently slow to result in fully drained conditions within the test specimen.

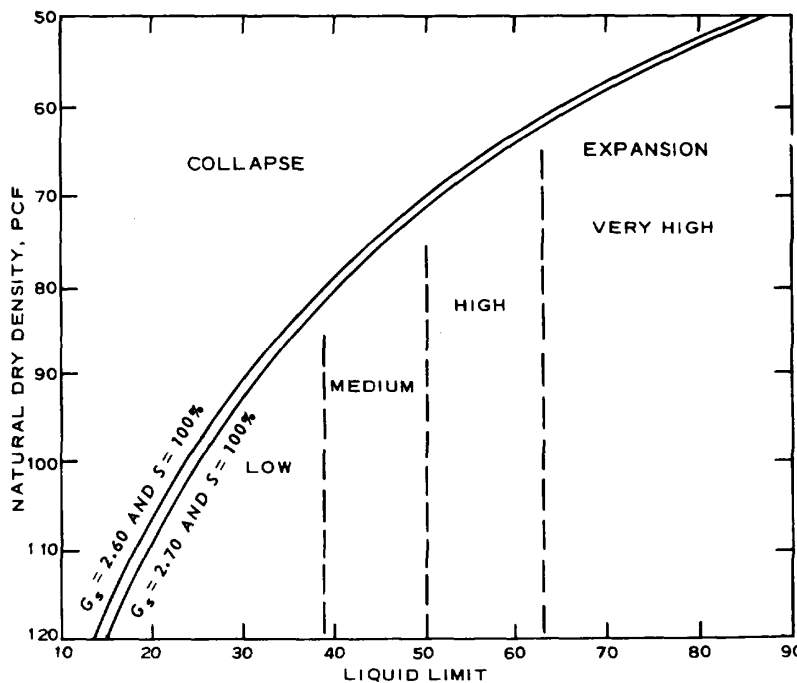

(Courtesy of J. K. Mitchell and W. S. Gardner, "In Situ Measurement of Volume Change Characteristics," *Geotechnical Engineering Division Specialty Conference on In Situ Measurement of Soil Properties*, 1975. North Carolina State University, Raleigh, N. C. Reprinted by permission of American Society of Civil Engineers, New York.)

Figure 3-13. Guide to collapsibility, compressibility, and expansion based on in situ dry density and liquid limit.

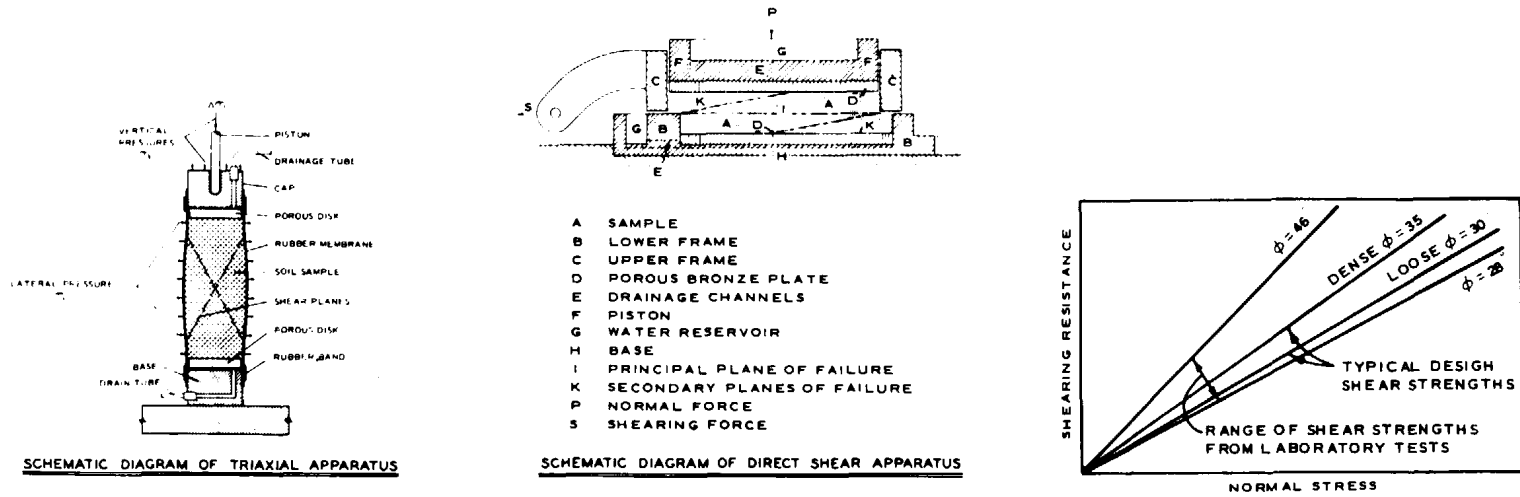

a. SHEAR TEST APPARATUS

c. SHEARING RESISTANCE OF SANDS

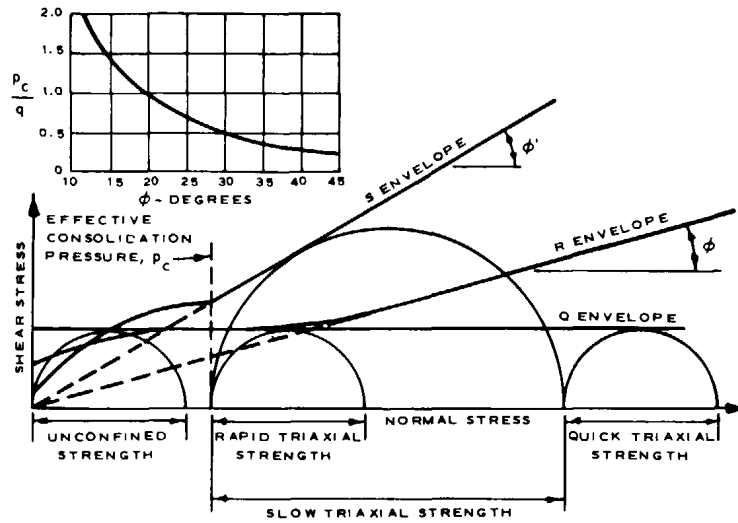

b. TYPICAL FAILURE ENVELOPES FOR Q, R, AND S TESTS

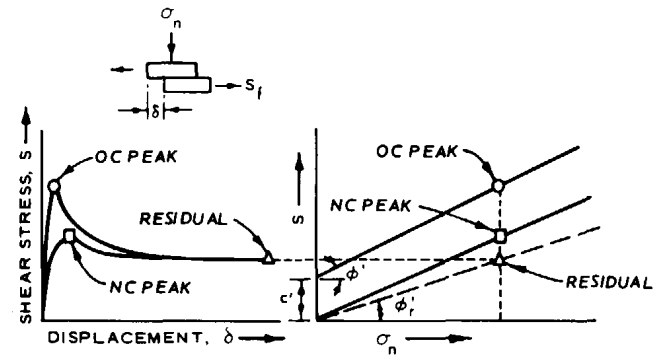

d. SHEARING RESISTANCE OF OVER-CONSOLIDATED (OC) AND NORMALLY-CONSOLIDATED (NC) CLAYS

Figure 3-14. Shear test apparatus and shearing resistance of soils.

b. *Undrained shear strength-cohesive soils.* Approximate undrained shear strengths of fine-grained cohesive soils can be rapidly determined on undisturbed samples and occasionally on reasonably intact samples from drive sampling, using simple devices such as the pocket penetrometer, laboratory vane shear device, or the miniature vane shear device (Torvane). To establish the reliability of these tests, it is desirable to correlate them with unconfined compression tests. Unconfined compression tests are widely used because they are somewhat simpler than Q triaxial compression tests, but test results may scatter broadly. A more desirable test is a single Q triaxial compression test with the chamber pressure equal to the total in situ stress. Unconfined compression tests are appropriate primarily for testing saturated clays that are not jointed or slickensided. The

Q triaxial compression test is commonly performed on foundation clays since the in situ undrained shear strength generally controls the allowable bearing capacity. Sufficient unconfined compression and/or Q tests should be performed to establish a detailed profile of undrained shear strength with depth. Undrained strengths may also be estimated from the standard penetration test, cone penetrometer soundings, and field vane tests, as discussed in chapter 4. For important structures, the effects of loading or unloading on the undrained shear strength should be determined by R (consolidated-undrained) triaxial compression tests on representative samples of each stratum.

c. *Strength parameters, cohesive soils.* The undrained shear strength of saturated clays can be expressed as

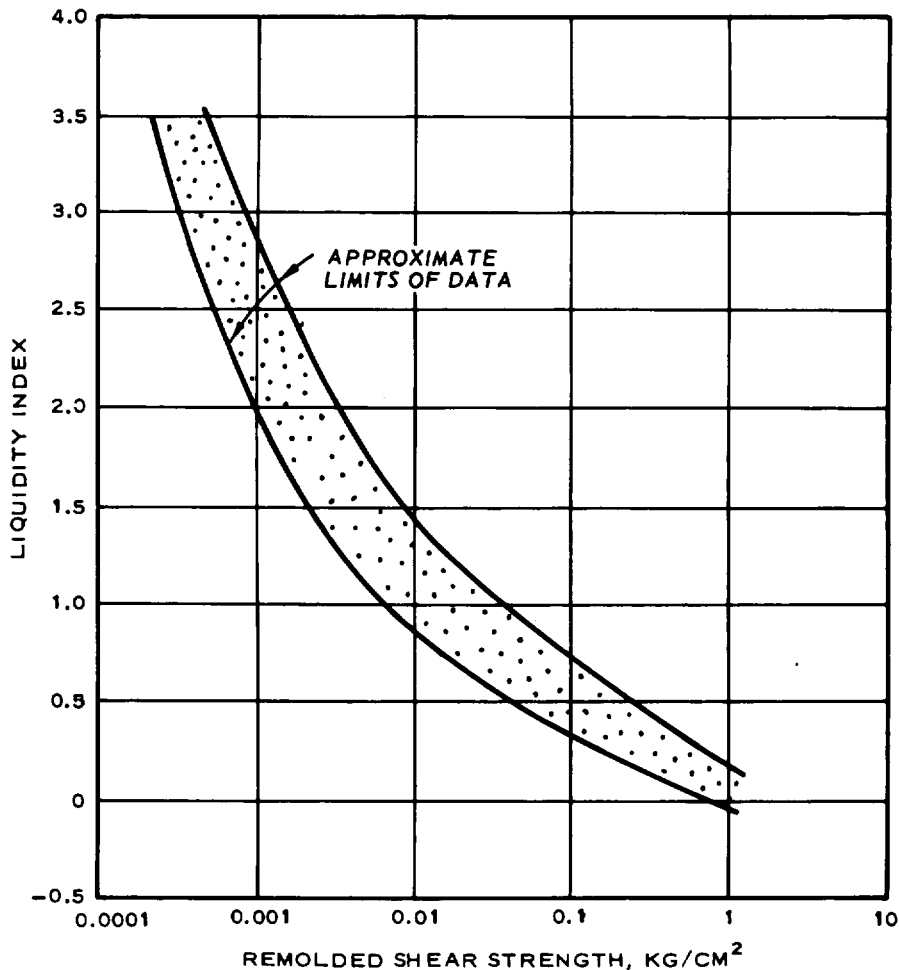

(Courtesy of W. N. Houston and J. K. Mitchell, "Property Interrelationships in Sensitive Clays," *Journal, Soil Mechanics and Foundations Division*, Vol 95, No. SM4, 1969, pp 1037-1062. Reprinted by permission of American Society of Civil Engineers. New York.)

Figure 3-15. Remolded shear strength versus liquidity index relationships for different clays.

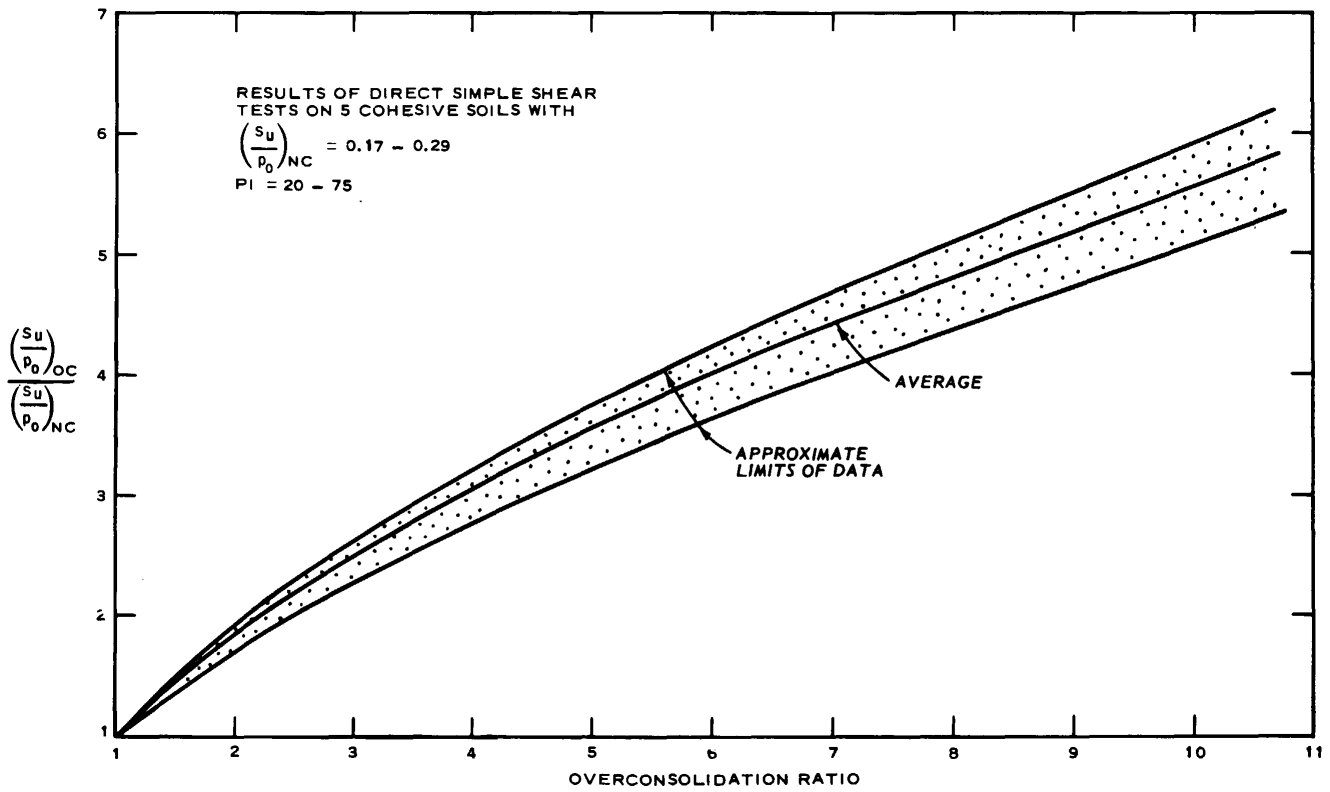

(Courtesy of C. C. Ladd and R. Foott, "New Design Procedure for Stability of Soft Clays," *Journal, Geotechnical Engineering Division*, Vol 100, No. GT7, 1974, pp 763-786. Reprinted by permission of American Society of Civil Engineers, New York.)

Figure 3-16. Normalized variation of  $s_u/p_0$  ratio for overconsolidated clay.

$$s_u = c_u \phi_u = 0 \quad (3-11)$$

$$s_u = \frac{1}{2} (\sigma_1 - \sigma_3) = \frac{q_u}{2} \quad (3-12)$$

and is essentially independent of total normal stress. The undrained cohesion intercept of the Mohr-Coulomb failure envelope is  $c_u$ .

(1) The undrained shear strength,  $s_u$ , of normally consolidated cohesive soils is proportional to the effective overburden pressure,  $p_0$ . An approximate correlation is as follows:

$$\frac{s_u}{p_0} = 0.11 + 0.0037 \text{ PI} \quad (3-13)$$

(2) A correlation between the remolded, undrained shear strength of clays and the liquidity index is shown in figure 3-15.

(3) A correlation between the normalized  $s_u/p_0$  ratio of overconsolidated soils and the overconsolidation ratio (OCR) is presented in figure 3-16. The value of  $p_0$  in  $(s_u/p_0)_{OC}$  is the effective present overburden pressure. Values of  $(s_u/p_0)$  may be estimated from this figure when  $(s_u/p_0)_{NC}$  and the OCR are known (NC signifies normally consolidated soils).

d. *Sensitivity, cohesive soils.* The sensitivity of a clay soil,  $S_t$ , is defined as follows:

$$S_t = \frac{\text{Undisturbed compressive strength}}{\text{Remolded compressive strength}} \quad (\text{at same water content})$$

Terms descriptive of sensitivity are listed in table 3-5. Generalized relationships among sensitivity, liquidity index, and effective overburden pressure are shown in figure 3-17. The preconsolidation pressure, rather than the effective overburden pressure, should be used for overconsolidated soils when entering this figure. Cementation and aging cause higher values of sensitivity than given in figure 3-17.

e. *Effective strength parameters, cohesive soils.* As indicated in figure 3-14, the peak and residual strengths may be shown as failure and postfailure envelopes. Values of the peak drained friction angle for normally consolidated clays may be estimated from figure 3-18. After reaching the peak shear strength, overconsolidated clays strain-soften to a residual value of strength corresponding to the resistance to sliding on an established shear plane. Large displacements are necessary to achieve this minimum ultimate strength requiring an annular shear apparatus or multiple reversals in the direct shear box. Typical values of residual angles of friction are shown in figure 3-19.

f. *Shear strength, cohesionless soils.*

(1) In sandy soils, the cohesion is negligible. Because of the relatively high permeability of sands, the angle of internal friction is usually based solely on drained tests. The angle of internal friction of sand is primarily affected by the density of the sand and normally varies within the limits of about 28 to 46 de-

Table 3-5. Sensitivity of Clays

Sensitivity	Descriptive Term
0-1	Insensitive
1-2	Low sensitivity
2-4	Medium sensitivity
4-8	Sensitive
8-16	Extra sensitive
>16	Quick

grees (fig 3-3). Approximate values of  $\phi$  are given as follows:

$$\phi = 30 + 0.15 \text{ DR for soils with less than 5 percent fines(3-14)}$$

$$\phi = 25 + 0.15 \text{ DR for soils with more than 5 percent fines(3-15)}$$

Values of  $\phi = 25$  degrees for loose sands and  $\phi = 35$  degrees for dense sands are conservative for most cases of static loading. If higher values are used, they should be justified by results from consolidated- drained triaxial tests.

(2) Silt tends to be dilative or contractive depending upon the consolidation stresses applied.

Thus, the back-pressure saturated, consolidated-undrained triaxial test with pore pressure measurements is used. If the silt is dilative, the strength is determined from the consolidated-drained shear test. The strength determined from the consolidated-undrained test is used if the silt is contractive. Typical values of the angle of internal friction from consolidated-drained tests commonly range from 27 to 30 degrees for silt and silty sands and from 30 to 35 degrees for loose and dense conditions. The consolidated-undrained tests yield 15 to 25 degrees. The shear strength used for design should be that obtained from the consolidated-drained tests.

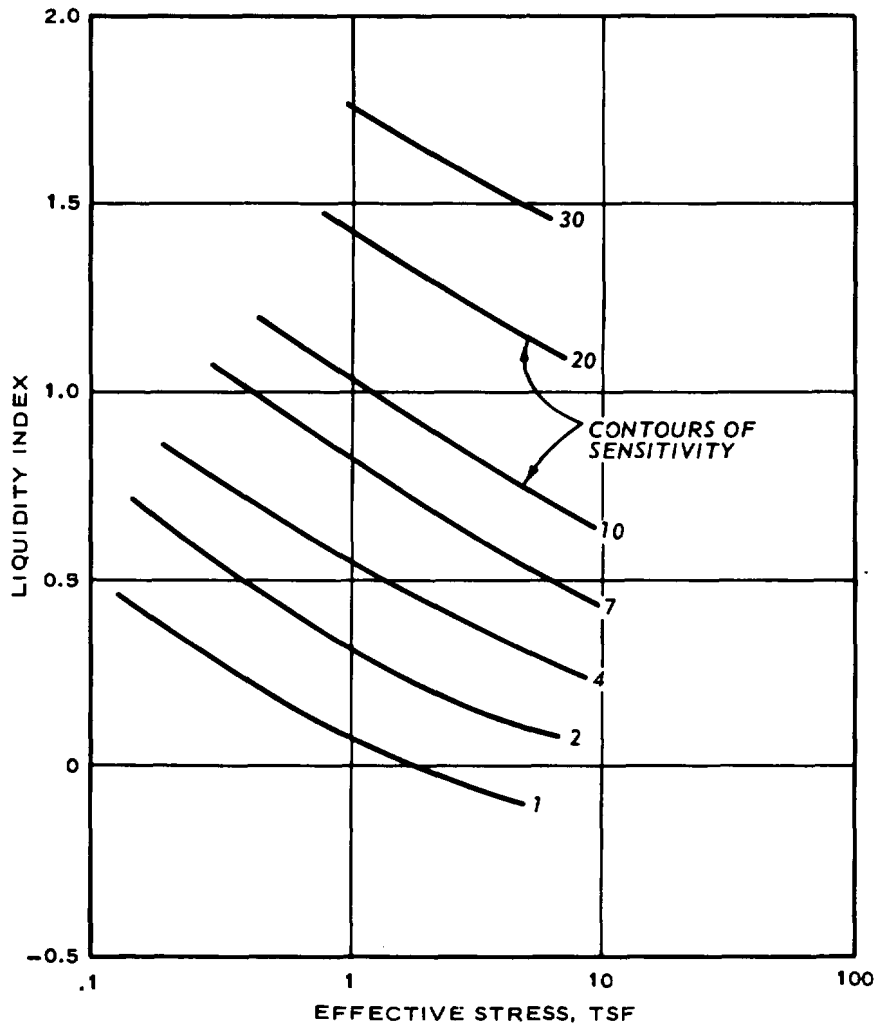

(Courtesy of W. N. Houston and J. K. Mitchell, "Property Interrelationships in Sensitive Clays," *Journal, Soil Mechanics and Foundations Division*, Vol 95, No. SM4, 1969, pp 1037-1062. Reprinted by permission of American Society of Civil Engineers, New York.)

Figure 3-17. General relationship between sensitivity, liquidity index, and effective overburden pressure.

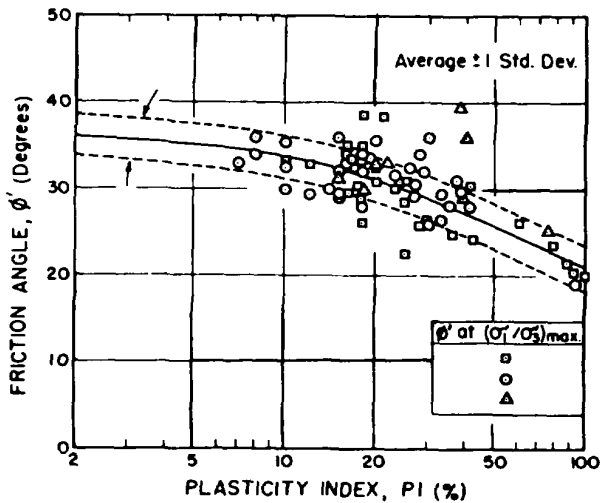

U. S. Army Corps of Engineers

Figure 3-18. Empirical correlation between friction angle and plasticity index from triaxial compression tests on normally consolidated undisturbed clays.

**3-8. Elastic properties (E, μ).** The elastic modulus and Poisson's ratio are often used in connection with the elasticity theory for estimating subsoil deformations. Both of these elastic properties vary nonlinearly with confining pressure and shear stress. Typical values given below refer to moderate confining pressures and shear stresses corresponding to a factor of safety of 2 or more.

a. In practical problems, stresses before loading are generally anisotropic. It is generally considered that the modulus of elasticity is proportional to the square root of the average initial principal stress, which may usually be taken as

$$\left( \frac{\sigma_v' (1 + 2K_0)^{1/2}}{3} \right) \quad (3-16)$$

where  $K_0$  is the coefficient of at-rest earth pressure (para 3-10) and  $\sigma_v'$  is the effective vertical stress. This proportionality holds for  $0.5 < K_0 < 2$ , when working stresses are less than one-half the peak strength.

b. The undrained modulus for normally consolidated clays may be related to the undrained shear strength,  $s_u$ , by the expression

$$\frac{E}{s_u} = 250 \text{ to } 500 \quad (3-17)$$

where  $s_u$  is determined from Q tests or field vane shear tests. The undrained modulus may also be estimated from figure 3-20. Field moduli may be double these values.

c. Poisson's ratio varies with strain and may

be as low as 0.1 to 0.2 at small strains, or more than 0.5.

**3-9. Modulus of subgrade reaction.**

a. The modulus of subgrade reaction,  $k_s$ , is the ratio of load intensity to subgrade deformation, or:

$$k_s = \frac{q}{\Delta} \quad (3-18)$$

where

q = intensity of soil pressure, pounds or kips per square foot

Δ = corresponding average settlement, feet

b. Values of  $k_s$  may be obtained from general order of decreasing accuracy:

- (1) Plate or pile load test (chaps 4 and 12).
- (2) Empirical equations (additional discussion in chap 10).
- (3) Tabulated values (table 3-6).

**3-10. Coefficient of at-rest earth pressure.** The state of effective lateral stress in situ under at-rest conditions can be expressed through the coefficient of earth pressure at rest and the existing vertical overburden pressure. This ratio is termed  $K_0$  and given by the following:

$$K_0 = \frac{\sigma_h'}{\sigma_v'} \quad (3-19)$$

The coefficient of at-rest earth pressure applies for a condition of *no lateral strain*. Estimate values of  $K_0$  as follows:

*Normally consolidated soil*

Sand:

$$K_0 = 1 - \sin \phi' \quad (3-20)$$

Clay:

$$K_0 = 0.95 - \sin \phi' \quad (3-21)$$

Figure 3-21 may be used for estimates of  $K_0$  for both normally consolidated and overconsolidated soils in terms of PI. For overconsolidated soils, this figure applies mainly for unloading conditions, and reloading may cause a large drop in  $K_0$  values. For soils that display high overconsolidation ratios as a result of desiccation,  $K_0$  will be overestimated by the relationship shown in figure 3-21.

**3-11. Properties of intact rock.** The modulus ratio and uniaxial compressive strength of various intact rocks are shown in table 2 -7.

**3-12. Properties of typical shales.** Behavioral characteristics of shales are summarized in table 3-7; and physical properties of various shales, in table 3-8. Analyses of observed in situ behavior provide the most reliable means for assessing and predicting the behavior of shales.



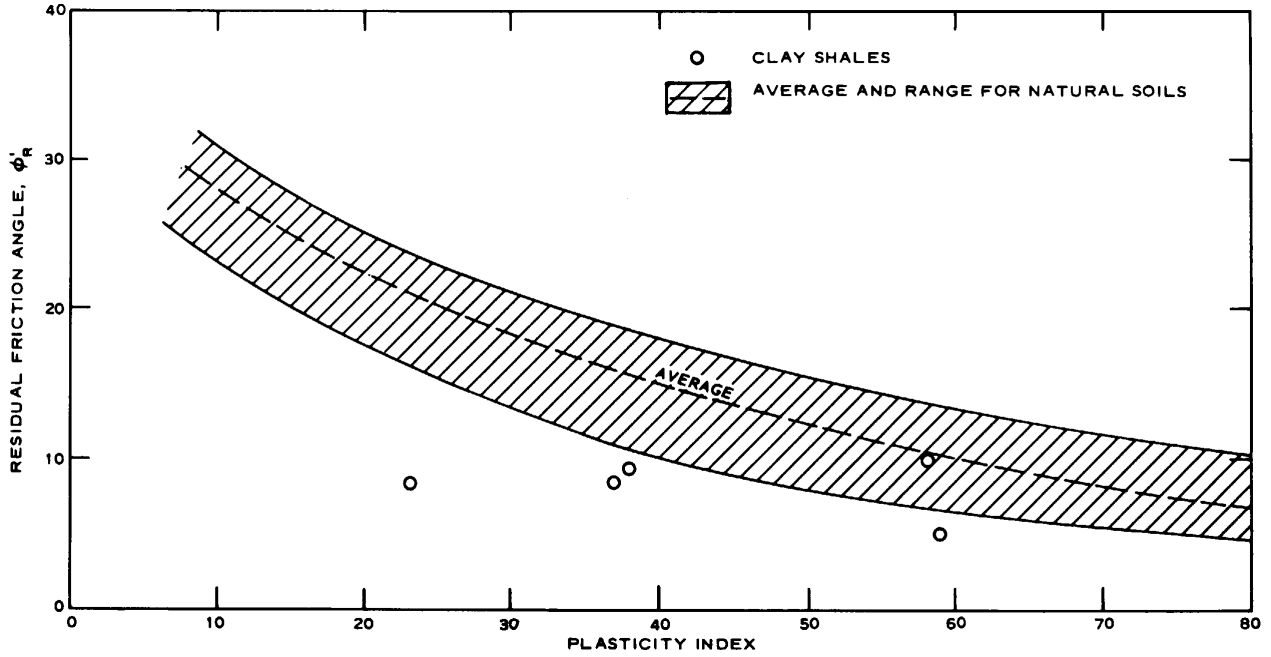
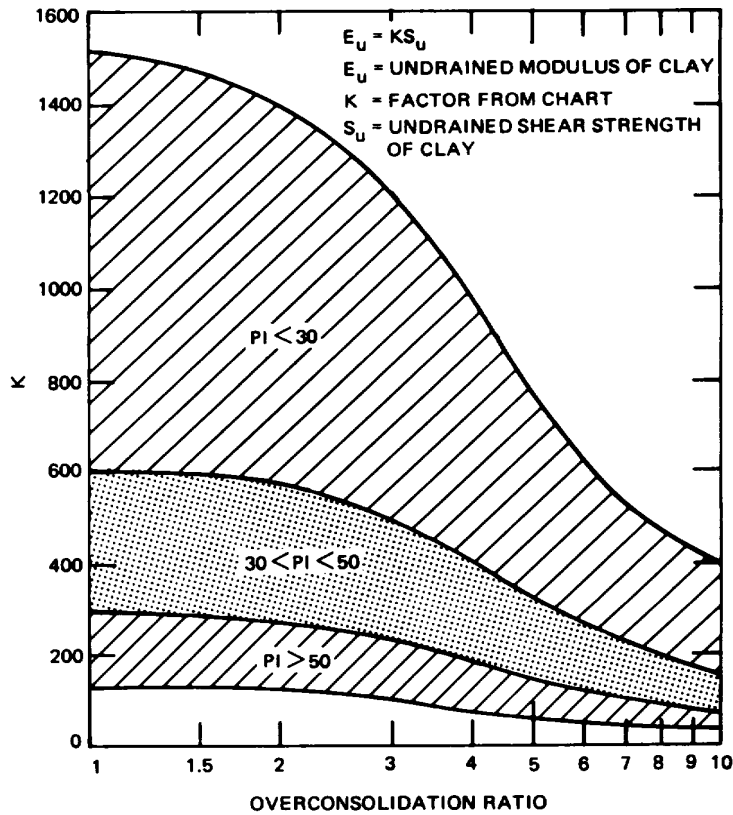

Figure 3-19. Relation between residual friction angle and plasticity index.



U. S. Army Corps of Engineers

Figure 3-20. Chart for estimating undrained modulus of clay.

Table 3-6. Values of Modulus of Subgrade Reaction ( $k_s$ ) for Footings as a Guide to Order of Magnitude

Soil Type	Range of $k_s$ , kcf <sup>a</sup>
Loose sand	30-100
Medium sand	60-500
Dense sand	400-800
Clayey sand (medium)	200-500
Silty sand (medium)	150-300
Clayey soil	
$q_u < 4$ ksf	75-150
$4 < q_u < 8$	150-300
$8 < q_u$	>300

<sup>a</sup> Local values may be higher or lower.

U. S. Army Corps of Engineers

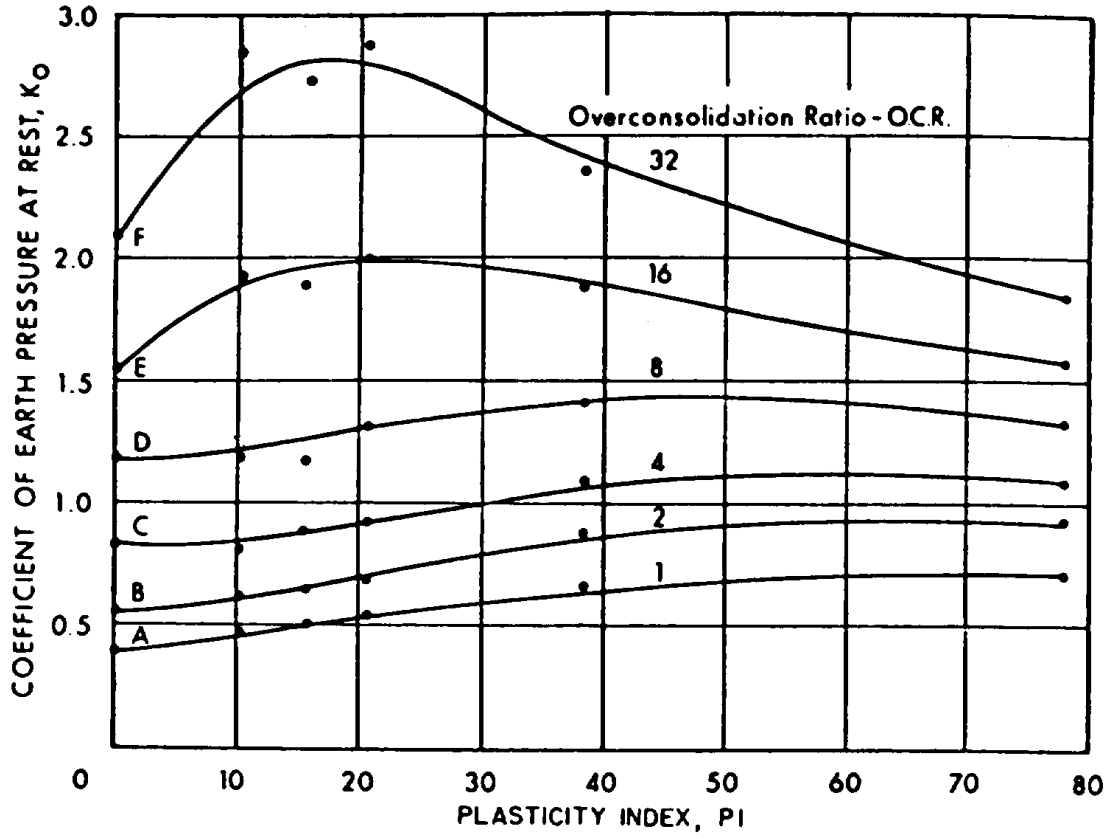

(Reproduced by permission of the National Research Council of Canada from the Canadian Geotechnical Journal, Volume 2, pp 1-15, 1965.)

Figure 3-21. Coefficient of earth pressure at rest ( $K_0$ ) as a function of overconsolidated ratio and plasticity index.

Table 3- 7. An Engineering Evaluation of Shales

Physical Properties			Probable <u>In-situ</u> Behavior						
Laboratory tests and <u>in-situ</u> observations (1)	Average range of values		High pore Pressure (4)	Low bearing capacity (5)	Tendency to rebound (6)	Slope stability problems (7)	Rapid slaking (8)	Rapid erosion (9)	Tunnel support problems (10)
	Unfavorable (2)	Favorable (3)							
Compressive strength, in pounds per square inch	50 to 300		✓	✓	---	---	---	---	---
		300-5000							
Modulus of elasticity, in pounds per square inch	20,000 to 200,000		---	✓	---	---	---	---	✓
		200,000 to $2 \times 10^6$							
Cohesive strength, in pounds per square inch	5 to 100		---	---	✓	✓	---	---	✓
		100 to >1500							
Angle of internal friction, in degrees	10 to 20		---	---	✓	✓	---	---	✓
		20 to 65							
Dry density, in pounds per cubic foot	70 to 110		✓	---	---	---	---	✓(?)	---
		110 to 160							
Potential swell, in percentage	3 to 15		---	---	✓	✓	---	✓	✓
		1 to 3							
Natural Moisture content, in percentage	20 to 35		✓	---	---	✓	---	---	---
		5-15							
Coefficient of permeability, in centimeters per second	$10^{-9}$ to $10^{-10}$		✓	---	---	✓	✓	---	---
		> $10^{-9}$							
Predominant clay minerals	Montmorillonite or Illite		✓	---	---	✓	---	---	---
		Kaolinite & Chlorite							
Activity ratio = $\frac{\text{Plasticity index}}{\text{Clay content}}$	0.75 to >2.0		---	---	---	✓	---	---	---
		0.35 to 0.75							
Wetting and drying cycles	Reduces to grain sizes		---	---	---	---	✓	✓	---
		Reduces to Flakes							
Spacing of rock defects	Closely Spaced		---	✓	---	✓	---	✓(?)	✓
		Widely Spaced							
Orientation of rock defects	Adversely Oriented		---	✓	---	✓	---	---	✓
		Favorably Oriented							
State of stress	>Existing Overburden Load		---	---	✓	✓	---	---	✓
		≅ Overburden Load							

(Courtesy of L. B. Underwood, "Classification and Identification of Shales," *Journal, Soil Mechanics and Foundations Division*, Vol 93, No. SM6, 1967, pp 97-116. Reprinted by permission of American Society of Civil Engineers, New York.)

Table 3-8. Physical Properties of Various Shales

Name of Shale Formation, Age, Locality (1)	Compressive strength, in pounds per square inch (2)	Modulus of Elasticity, in pounds per square inch (3)	Cohesion, in pounds per square inch (4)	Angle of Internal Friction, in degrees (5)	Dry Density, in pounds per cubic foot (6)	Potential Swell in percentage (7)	Natural Moisture in percentage (8)	Predominant Clay Minerals (9)	Activity Ratio (10)
Bearpaw, Cret., Canada									
Weathered-	7 to 84	7500	3 to 6	6 to 20	85-95	0.5%-2%	29 to 36	Illite, Montmorillonite	0.30 to
Unweathered-	154-406	18,000	22	30	95-108	5%-20%	19 to 27	Mixed-layer	>1.5
Pierre, Cret., So. Dakota	70-1400	20,000-140,000	2 to 30	8-25	95-110	3% to 5%	18 to 27	do	0.3 to >2
Ft. Union, Tert., No. Dakota	70-1050	11,200-56,000	10	20	95-115	2% (?)	16-24	Illite	—
Pepper, Cret., Texas	28-70	—	2-6	7-14	110	—	20%	Illite Mont. Kaolinite	1.2
Del Rio, Cret., Texas	56-154	—	1-8	19-28	119	—	17%	Illite, Kaolinite, Mont.	1.0
Trinity, Cret., Texas	30-170	2,400-33,000	0-7	26	115-133	—	11-17%	—	—
Taylor, Cret., Texas	250-550	6,000-20,000	1.5-25	8-30	112-118	—	15%-18%	—	—
Composite Cyclothem of Pennsylvanian Shales (Eastern Ohio and Western Penn.)	Silty Clayey	210	1,000,000	56	23	138	9.1	—	—
	Carbonaceous	4165	—	1562	16	—	—	—	—
	Clay Bonded	2084	—	931	7	—	—	—	—
	Clayey	1661	—	488	29	—	—	—	—
	Ferruginous Sandy	3674	486,500	1600	9	—	—	—	—
Niobrara, Calc. Sh., Cret., Colo.								Illite, Beid.	
Mowry, Cret., Colo.								Kaolinite, Chlorite Illite	
Graneros, Cret., Colo.								Kaol., Ill., Mix-layer	
Morrison, Jura, Colo.								Mont., Illite	
Laramie, Cret., Colo.								Illite, Beid.	
Mauv, Calc. Shale, Cam., Utah	5220	$2.3 \times 10^6$	1,160	64	164	—	2%	—	—
Quartzose Sh., Cam., Utah	17,770	$2.3 \times 10^6$	3,390	45	165	—	4%	—	—

1 Ton/sq. ft. = approx. 14 lbs. per inch<sup>2</sup>

(Courtesy of the American Society of Civil Engineers)

CHAPTER 4

FIELD EXPLORATIONS

**4-1. Investigational programs.** Field investigations can be divided into two major phases, a surface examination and a subsurface exploration:

<i>Surface Examination</i>	<i>Subsurface Exploration</i>
Documentary evidence	Preliminary
Field reconnaissance	Detailed
Local experience	

*a. Documentary evidence.* The logical and necessary first step of any field investigation is the compilation of all pertinent information on geological and soil conditions at and in the vicinity of the site or sites

under consideration, including previous excavations, material storage, and buildings. Use table 4-1 as a guide to sources and types of documentation.

*b. Field reconnaissance.* A thorough visual examination of the site and the surrounding area by the foundation engineer is essential. This activity may be combined with a survey of local experience. The field reconnaissance should include an examination of the following items as appropriate:

(1) *Existing cuts (either natural or man-made).* Railway and highway cuts, pipeline trenches, and

Table 4-1. Types and Sources of Documentary Evidence

Types	Sources	Descriptions
Topographic, soil, drift (overburden), and bedrock maps	Local, state, Federal, and university geologic and agricultural organizations	These maps provide information on lay of land, faulting (tectonics), and material types
Surface and subsurface mining data, present and past	U. S. Bureau of Mines and State mining groups	Such data help locate subsurface shafts and surface pits. The presence of cavities in the foundation must be known. Current and even old workings may represent material sources for construction. In addition, surface pits near site may provide opportunity to observe stratification of foundation and allow taking of disturbed samples
Aerial photographs, Continental U. S.	U. S. Government Printing Office	Aerial photos offer a valuable means of establishing some insight into the nature of foundation soils (2) and also expedite familiarization with the lay of the land
Aerial photographs, county and state areas	U. S. Soil Conservation Service, local or district office	
Local experience	Technical Journals and published reports; professional societies, universities, and state agencies	May include considerable boring data, test data, and descriptions of problems in construction
Boring logs, water-well records, and construction records	State Building Commission, City Hall, County Court House, private concerns	Some of these types of information can usually be obtained for existing public buildings and facilities. Private firms may cooperate in providing limited data
Hydrological and tidal data	State agencies, river boards, U. S. Coast and Geodetic Survey, and National Weather Service	Flood history, groundwater levels, and tidal data indicate protective measures required during and after construction. Any groundwater information may aid in dewatering facilities and safe excavation slopes

walls of river or stream valleys may reveal stratigraphy and offer opportunities to obtain general samples for basic tests, such as Atterberg limits and grain-size analysis for classification.

(2) *Evidence of in situ soil performance.* A study of landslide scars contributes greatly to the design of excavation slopes; it may indicate need for bracing or suggest slope maintenance problems because of groundwater seepage. Evidence of general or localized subsidence suggests compressible subsoils, subsurface cavities, or ongoing sink-hole formations as in areas of limestone formations or abandoned mine cave-ins. Fault scarps or continuous cracks suggest bedrock movements or mass soil movements.

(3) *Existing structures.* Careful observation of damage to existing structures, such as cracks in buildings (or poor roof alignment), misaligned power lines, pavement conditions, corrosion on pipelines, or exposed metal and/or wood at water lines, may suggest foundation problems to be encountered or avoided.

(4) *Groundwater.* The extent of construction dewatering may be anticipated from factors such as the general water level in streams, spring lines, marshy ground, and variations in vegetal growth. The effects of lowering the water table during dewatering on surrounding structures, as well as potential environmental effects, should be appraised in a preliminary manner. Drainage problems likely to be encountered as a result of topography, confined working space, or increased runoff onto adjacent property should be noted.

(5) *Availability of construction materials.* The availability of local construction material and water is a major economic factor in foundation type and design. Possible borrow areas, quarries and commercial material sources, and availability of water should be noted.

(6) *Site access.* Access to the site for drilling and construction equipment should be appraised, including the effects of climate during the construction season.

(7) *Field investigation records.* Considering the value and possible complexity of a field investigation, a well-kept set of notes is a necessity. A camera should be used to supplement notes and to enable a better recall and/or information transfer to design personnel.

c. *Local experience.* Special attention should be given to the knowledge of inhabitants of the area. Farmers are generally well informed about seasonal changes in soil conditions, groundwater, and stream flood frequencies. Owners of adjacent properties may be able to locate filled areas where old ponds, lakes, or wells have been filled, or where foundation of demolished structures are buried.

d. *Preliminary subsurface exploration.* The

purpose of preliminary subsurface explorations is to obtain approximate soil profiles and representative samples from principal strata or to determine bedrock or stratigraphic profiles by indirect methods. Auger or splitspoon borings are commonly used for obtaining representative samples. Geophysical methods together with one to several borings are often used in preliminary exploration of sites for large projects, as they are rapid and relatively cheap. Procedures for geophysical exploration are described in standard textbooks on geotechnical engineering. Borings are necessary to establish and verify correlations with geophysical data. Preliminary reconnaissance explorations furnish data for planning detailed and special exploration of sites for large and important projects. The preliminary exploration may be sufficient for some construction purposes, such as excavation or borrow materials. It may be adequate also for foundation design of small warehouses, residential buildings, and retaining walls located in localities where soil properties have been reasonably well established as summarized in empirical rules of the local building code.

e. *Detailed subsurface explorations.* For important construction, complex subsurface conditions, and cases where preliminary subsurface explorations provide insufficient data for design, more detailed investigations are necessary. The purpose is to obtain detailed geologic profiles, undisturbed samples and cores for laboratory testing, or larger and fairly continuous representative samples of possible construction materials. Test pits and trenches can be used to depths of 15 to 25 feet by using front-end loaders or backhoes at a cost that may compare favorably with other methods, such as auger borings. Test pits allow visual inspection of foundation soils; also, high-quality undisturbed block samples may be obtained. Continuous (2 1/2 - to 5-foot intervals) sampling by means of open-drive, piston, or core-boring samplers is used for deeper explorations. Penetration, sounding or in situ tests, such as vane shear, or pressuremeter tests may be conducted depending on sampling difficulty or desired information.

#### **4-2. Soil boring program.**

a. *Location and spacing.* Borings spaced in a rigid pattern often do not disclose unfavorable subsurface conditions; therefore, boring locations should be selected to define geological units and subsurface nonconformities. Borings may have to be spaced at 40 feet or less when erratic subsurface conditions are encountered, in order to delineate lenses, boulders, bedrock irregularities, etc. When localized building foundation areas are explored, initial borings should be located near building corners, but locations should allow some final shifting on the site. The number of borings should never be less than three and preferably five-one at each corner and one at the center, unless subsurface conditions are known to be uniform and the

foundation area is small. These preliminary borings must be supplemented by intermediate borings as required by the extent of the area, location of critical loaded areas, subsurface conditions, and local practice.

*b. Depth of exploration.* The required depth of exploration may be only 5 to 10 feet below grade for residential construction and lightly loaded warehouses and office buildings, provided highly compressible soils are known to not occur at greater depths. For important or heavily loaded foundations, borings must extend into strata of adequate bearing capacity and should penetrate all soft or loose deposits even if overlain by strata of stiff or dense soils. The borings should be of sufficient depth to establish if groundwater will affect construction, cause uplift, or decrease bearing capacity. When pumping quantities must be estimated, at least two borings should extend to a depth that will define the aquifer depth and thickness. Borings may generally be stopped when rock is encountered or after a penetration of 5 to 20 feet into strata of exceptional stiffness. To assure that boulders are not mistaken for bedrock, rock coring for 5 to 10 feet is required. When an important structure is to be founded on rock, core boring should penetrate the rock sufficiently to determine its quality and character and the depth and thickness of the weathered zone. Rock coring is expensive and slow, and the minimum size standard core diameter should be used that will provide good cores. NX or larger core sizes may be required in some rock strata. Core barrels can remove cores in standard 5-, 10-, and 20-foot lengths (actual core may be much fractured, however; see para

2-6). Detailed exploration should be carried to a depth that encompasses all soil strata likely to be significantly affected by structure loading. If the structure is not founded on piles, the significant depth is about 1 1/2 to 2 times the width of the loaded area. An estimate of the required depth can be made using the stress influence charts in chapter 5 to find the depth such that

$$\Delta q \leq 0.1q_0 \quad (4-1)$$

where  $\Delta q$  represents an increase in strata stress and  $q_0$  is the foundation contact pressure. Note that in the case of a pile foundation, stresses are produced in the ground to an appreciable depth below the tips of the piles. Procedures to obtain  $\Delta q$  apply as for other foundations. This depth criterion may not be adequate for complex and variable subsurface conditions.

*c. Plugging borings.* All borings should be carefully plugged with noncontaminating material if-

- (1) Artesian water is present or will be when the excavation is made.
- (2) Necessary to avoid pollution of the aquifer from surface infiltration, leaching, etc.
- (3) Necessary to preserve a perched water table (avoid bottom drainage through borehole).
- (4) Area is adjacent to stream or river where flood stage may create artesian pressure through the borehole.

*d. Sample requirements.* Table 4-2 may be used as a guide for required sizes of undisturbed samples, and table 4-3 for general samples. The sampling program

Table 4-2. Recommended Undisturbed Sample Diameters

Test	Minimum Sample Diameter, in.
Unit weight	3.0
Permeability	3.0
Consolidation	5.0
Triaxial compression <sup>a</sup>	5.0
Unconfined compression	3.0
Direct shear	5.0

<sup>a</sup> Triaxial test specimens are prepared by cutting a short section of 5-in.-diam sample axially into four quadrants and trimming each quadrant to the proper size. Three quadrants provide for three tests representing the same depth; the fourth quadrant is preserved for a check test.



may depend on drilling equipment available and laboratory facilities where tests will be performed.

(1) *Undisturbed samples.* Any method of taking and removing a sample results in a stress change, possible pore water change, and some structure alteration because of displacement effects of the sampler. Careful attention to details and use of proper equipment can reduce disturbance to a tolerable amount. Sample disturbance is related to the area ratio  $A_r$ , defined as follows:

$$A_r = \frac{D_0^2 - D_1^2}{D_1^2} \times 100 \text{ percent (4-2)}$$

where

$D_0$  = outside diameter of sampler tube

$D_1$  = internal diameter of the cutting shoe through which the sample passes (commonly the cutting edge is swedged to a lesser diameter than the inside tube wall thickness to reduce friction)

The area ratio should be less than 10 percent for undisturbed sampling. Undisturbed samples are commonly taken by thin-wall seamless steel tubing from 2 to 3 inches in diameter and lengths from 2 to 4 feet. Undisturbed samples for shear, triaxial, and consolidation testing are commonly 3 inches in diameter, but 5-inch-diameter samples are much preferred. An indication of sample quality is the recovery ratio,  $L_r$ , defined as follows:

$$L_r = \frac{\text{Length of recovered sample}}{\text{Length sample tube pushed}} \quad (4-3)$$

A value for  $L_r < 1$  indicates that the sample was compressed or lost during recovery, and  $L_r > 1$  indicates that the sample expanded during recovery or the excess soil was forced into the sampler.

(2) *Representative samples.* Samples can be obtained by means of auger or drive-sampling methods. Thick-wall, solid, or split-barrel drive samplers can be used for all but gravelly soils. Samples taken with a

Table 4-3. Recommended Minimum Quantity of Material for General Sample Laboratory Testing

Test	Minimum Sample Required lb (Dry Weight) <sup>a</sup>
Water content	0.5
Atterberg limits	0.2
Shrinkage limits	0.5
Specific gravity	0.2
Grain-size analysis	0.5
Standard compaction	30.0
Permeability	2.0
Direct shear	2.0
4-in.-diam consolidation	2.0
1.4-in.-diam triaxial (4 points)	2.0
2.8-in.-diam triaxial (4 points)	8.0
6-, 12-, or 15-in.-diam triaxial (4 Points)	Discuss with laboratory
Vibrated density	Discuss with laboratory

<sup>a</sup> Fine grained (all minus No. 4 sieve). For material containing plus No. 4 sieve sizes, the sampling requirements should be discussed with the laboratory. In the final analysis, it is the responsibility of the engineer requesting the tests to ensure that adequate size samples are obtained. Close coordination with the testing laboratories is essential.

drive sampler should be not less than 2 inches, and preferably 3 inches or more in diameter. Where loose sands or soft silts are encountered, a special sampler with a flap valve or a plunger is usually required to hold the material in the barrel. A bailer can be used to obtain sands and gravel samples from below the water table. Split-spoon samples should be used to obtain representative samples in all cases where piles are to be driven or the density of cohesionless materials must be estimated.

**4-3. Field measurements of relative density and consistency.**

a. *Standard Penetration Test (SPT).* This test is of practical importance as it provides a rough approximation of the relative density or consistency of foundation soils and should always be made when piles are to be driven. The split spoon is usually driven a total of 18 inches; the penetration resistance is based on the last 12 inches-the first 6 inches being to seat the sampler in undisturbed soil at the bottom of the boring. "Refusal" is usually taken at a blow count of 50 per 6 inches. (Commercial firms will usually charge an increased price per foot of boring when the blow count (N-value) ranges from greater than 50 to 60 blows per foot of penetration *due both* to reduced daily footage of drilling and wear of equipment.) An approximate correlation of results with

density for cohesionless soils is shown in figure 4-1, and with  $\phi$  in figure 4-2; but  $\phi$  values above 35 degrees should not be used for design on the basis of these correlations. There is no unique relationship between N-values and relative density (DR) that is valid for all sands. The SPT data should be correlated with tests on undisturbed samples on large projects.

b. *Cone penetration tests.* In this test, a cone-shaped penetrometer is pushed into the soil at a slow constant rate; the pressure required to advance the cone is termed the penetration resistance. The Dutch cone is the most popular. The penetration resistance had been correlated with relative density of sands and undrained shear strength of clays.

c. *Vane tests.* The in situ shear strength of soft to medium clays can be measured by pushing a small four-blade vane, attached to the end of a rod, into the soil and measuring the maximum torque necessary to start rotation (shearing of a cylinder of soil of approximately the dimensions of the vane blades). The undrained shear strength,  $s_u$ , is computed from this torque, T, as follows:

$$T = s_u \Pi \left( \frac{d^2 h}{2} + \frac{d^3}{4} \right) \quad (4-4)$$

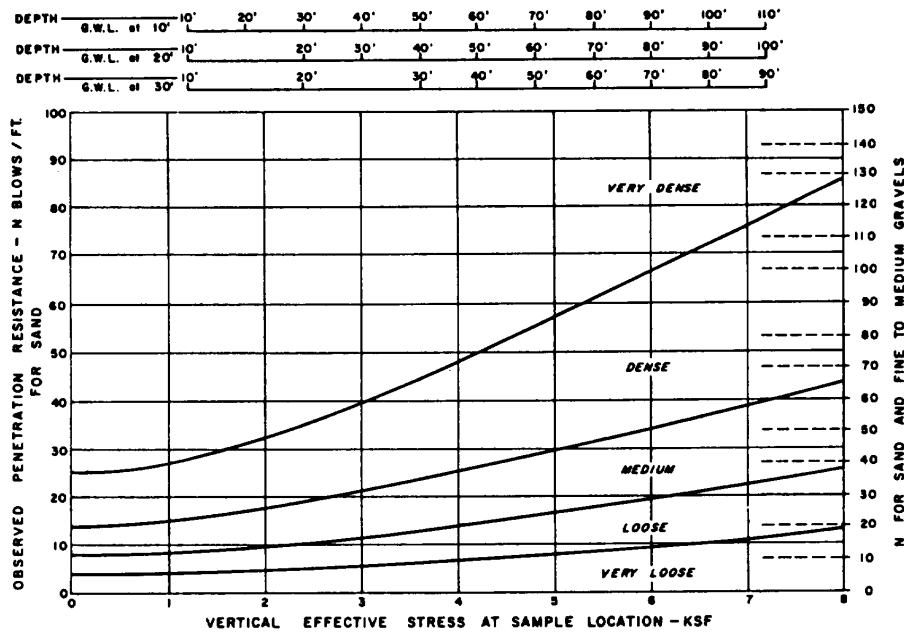

(Courtesy of the American Society of Civil Engineers. "Task Committee for Foundation Design Manual of the Committee on Shallow Foundations" *Journal, Soil Mechanics and Foundations Division*, No. SM6, 1972.)

Figure 4-1. Relative density of sand from the standard penetration test.

where

- d = diameter of vanes
- h = height of vane
- $\phi$  = 2/3 for uniform end-shear (usual assumption) distribution
- = 3/5 for parabolic end-shear distribution
- = 1/2 for triangular end-shear distribution

The vane shear is best adapted to normally consolidated, sensitive clays having an undrained shear strength of less than 500 pounds per square foot. The device is not suitable for use in soils containing sand layers, many pebbles, or fibrous organic material. Vane tests should be correlated with unconfined compression tests before they are used extensively in any area. Strength values measured using field vane shear tests should be corrected for the effects of anisotropy and strain rate using Bjerrum's correction factor,  $\lambda$ , shown in figure 4-3. This value represents an average and should be multiplied by 0.8 to obtain a lower limit. The correction is based upon field failures.

d. *Borehole pressuremeter test.* A pressuremeter can be used to obtain the in situ shear modulus and/or  $K_0$ . Several versions of the device exist including self-boring equipment, which tends to avoid the loss of  $K_0$  conditions caused by soil relaxation when a

hole is pre-drilled and then the device is inserted. The method is subject to wide interpretation and should not normally be employed in conventional investigations.

**4-4. Boring logs.** The results of the boring program shall be shown in terms of graphic logs of boring. The logs of borings shall be prepared in accordance with governmental standards. A typical log of boring is shown in figure 4-4.

**4-5. Groundwater observations.** In many types of construction it is necessary to know the position of the groundwater level, its seasonal variations, how it is affected by tides, adjacent rivers or canals, or the water pressures in pervious strata at various depths. Possible future changes in groundwater conditions, such as those resulting from irrigation or reservoir construction, should be anticipated.

a. *Boreholes.* With many fine-grained soils it may be necessary to wait for long time periods before water table equilibrium is reached in boreholes. Observations made in a borehole during or shortly after drilling may be misleading. Even with pervious soil, a water level

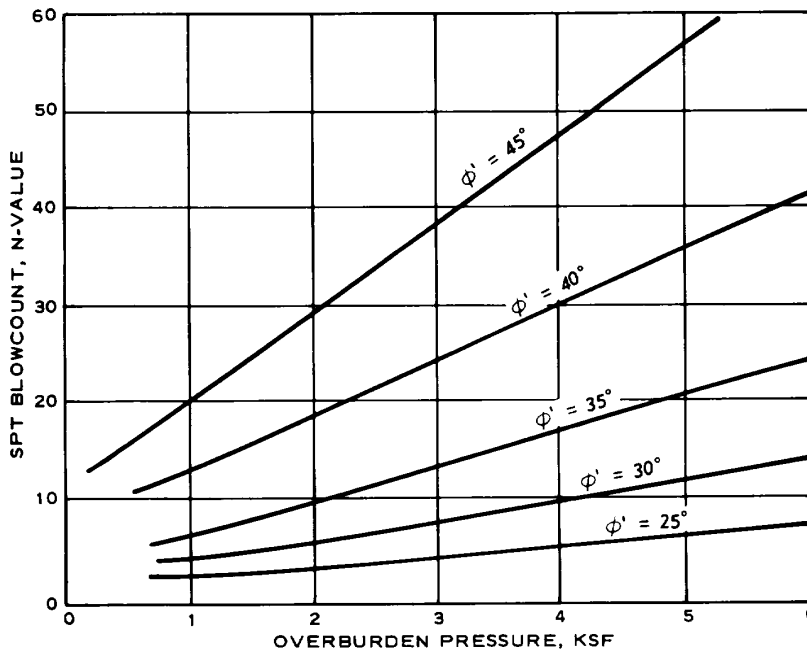

(Courtesy of J. H. Schmertmann, "The Measurement of In Situ Shear Strength," *Proceedings, Conference on In Situ Measurement of Soil Properties*, Raleigh, N. C., Vol 2, 1975, pp 57-180. Reprinted by permission of the American Society of Civil Engineers, New York.)

Figure 4-2. Rough correlation between effective friction angle, standard blow count, and effective overburden pressure.

reading should be taken 24 hours or more after drilling is stopped. Water level readings obtained in drill holes should be shown on the boring log with the date of the reading and the date when the drill hole was made.

b. *Piezometers.* Piezometers provide an accurate means for determining the groundwater level over a period of time. In pervious strata, a temporary piezometer may consist of a section of riser pipe, the open bottom end of which is placed in a bag (filter) of coarse sand or gravel. The annular space between the piezometer riser pipe and the drill hole immediately above the stratum in which the water level is to be

determined should be sealed off with well-tamped clay or cement, or chemical grout. In granular soils where a more permanent system is desired, a 2-foot section of well-point screen can be attached to the bottom of the pipe. A well-point screen should be selected that will prevent entrance of foundation materials into the screen, or else a suitable filter material should be used. For all piezometers, seal the top several feet below ground surface around the riser pipe to prevent infiltration of surface water. In granular soils, the riser pipe is normally about 1 1/4-inches inside diameter and generally made of plastic. In cohesive soils, a Casa-

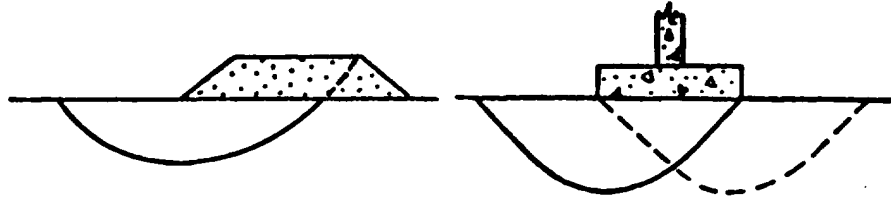

$$(s_u)_{\text{DESIGN}} = \gamma (s_u)_{\text{VANE}}$$

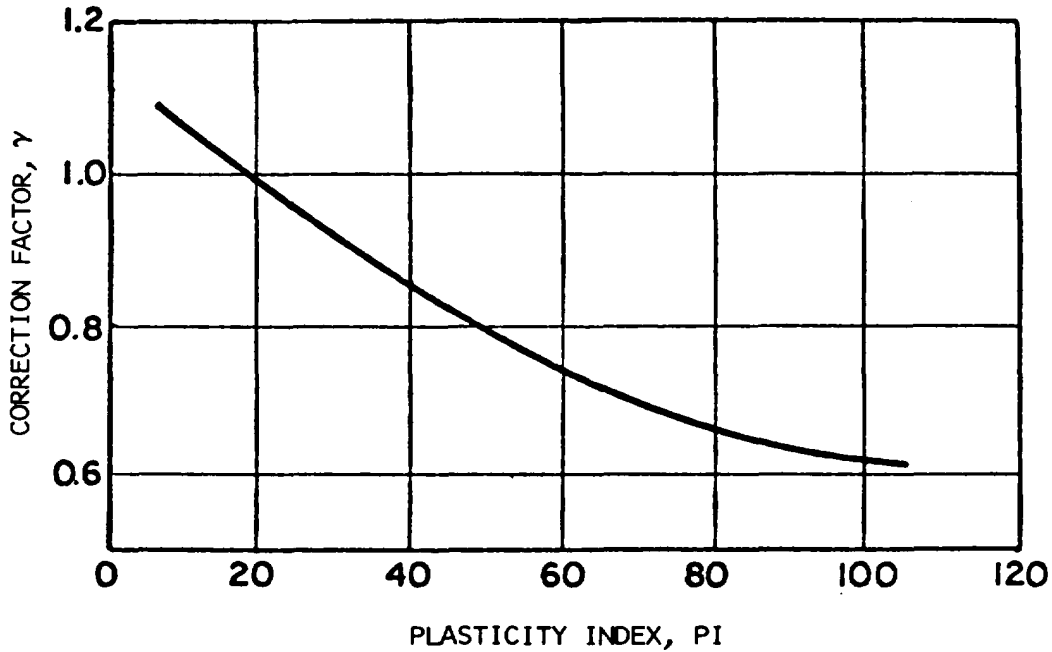

(Courtesy of L Bjerrum, "Embankment on Soft Ground, " *Proceedings, Conference on Performance of Earth and Earth-Supported Structures*. Purdue University. Lafayette, Ind., Vol2, 1975. Reprinted by permission of the American Society of Civil Engineers, New York.)

Figure 4-3. Correction factor for vane strength.

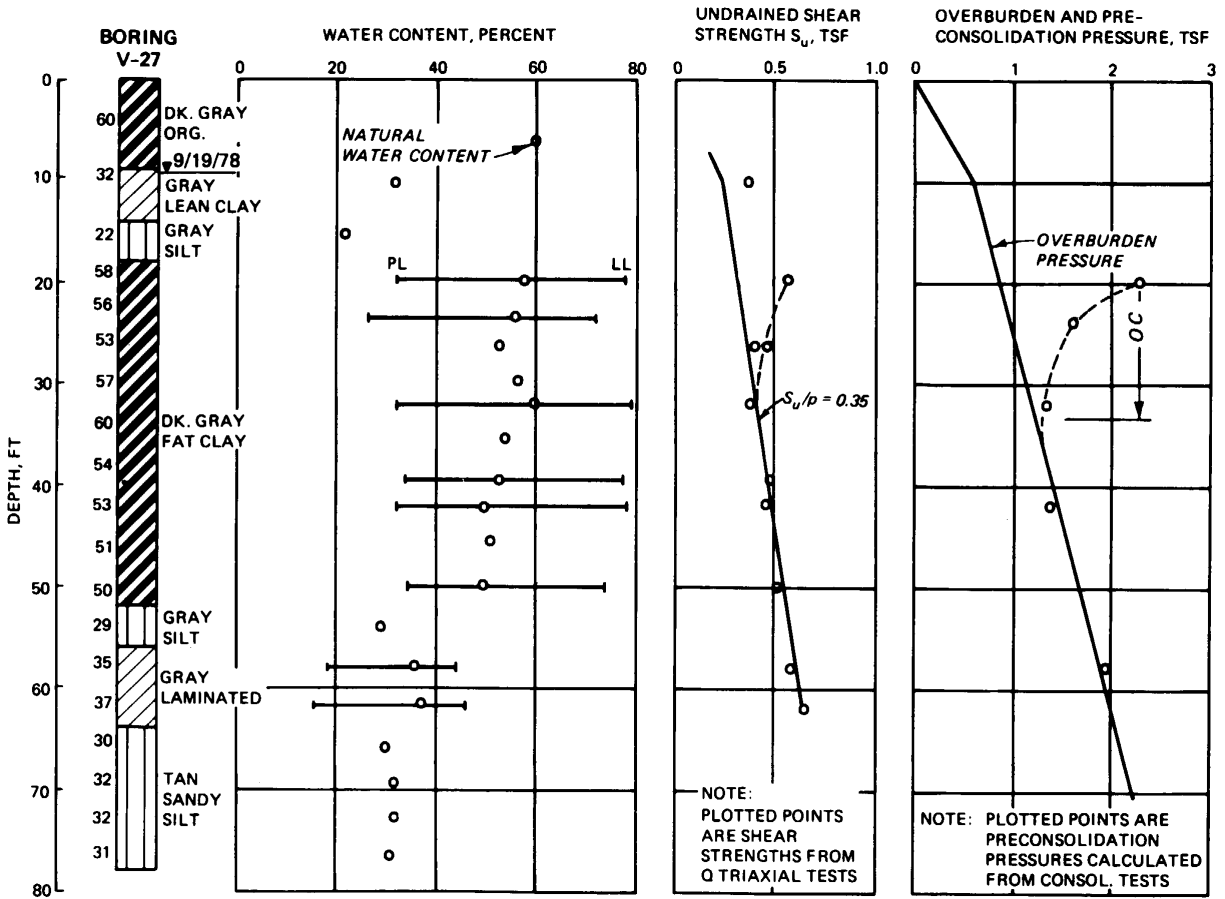

Figure 4-4. Typical log of boring.

grande-type piezometer (fig 4-5) is recommended. The water level in the piezometer is determined by means of a plumb line or sounding device. If the piezometric level is above ground surface, a manometer or a Bourdon gage can be connected to the riser pipe to greatly decrease the time for equilibrium to be achieved. If rapidly changing pore water pressures in clay are to be determined, use closed system piezometers.

c. *Field pumping tests.* Where accurate knowledge of the permeability of the foundation soils is necessary, field pumping tests offer the most reliable means. A rough estimate of the average permeability of the material around the bottom of a cased drill hole may be obtained by lowering or raising the water level in the casing and observing the rise and fall of the water level as a function of time with respect to the stabilized piezometric water level (TM 5-818-5/AFM 88-5, Chapter 6, para 38). A field pumping test is best performed by pumping from a well in which a constant flow is maintained until the drawdown has stabilized, and when groundwater levels are measured at several remote borings or piezometers. It is desirable that well screens fully penetrate the strata for which the permeability is to be measured. Formulas for computing the overall permeability of a pervious stratum exhibiting gravity or artesian flow are shown in figure 3-5. The formula for the special case of a fully penetrating well and artesian aquifer is given as an example in figure 4-6. Methods for

performing field pumping tests are described in TM 5-818-5/AFM 88-5, Chapter 6.

**4-6. In situ load tests.** Load tests are commonly made on test piles to confirm design capacity and may occasionally be used to determine bearing capacity and settlement characteristics. In general, specialized equipment and procedures are required to perform load tests and considerable judgment and expertise must be employed to interpret results. Plate load tests are occasionally used for bearing capacity determinations.

**4-7. Geophysical exploration.** Geophysical methods of subsurface exploration are well suited for large sites due to the increasing cost of borings. Table 4-4 summarizes those geophysical methods most appropriate for site exploration. These methods are useful for interpolation between borings. Geophysical data must be used in conjunction with borings and interpreted by qualified experienced personnel, or misleading information is almost certain to result. The two most applicable geophysical methods for exploring foundations currently in use are seismic refraction and electrical resistivity. Information secured by seismic refraction is primarily depth to bedrock and delineation of interfaces between zones of differing velocities. An electrical resistivity survey is superior in differ-

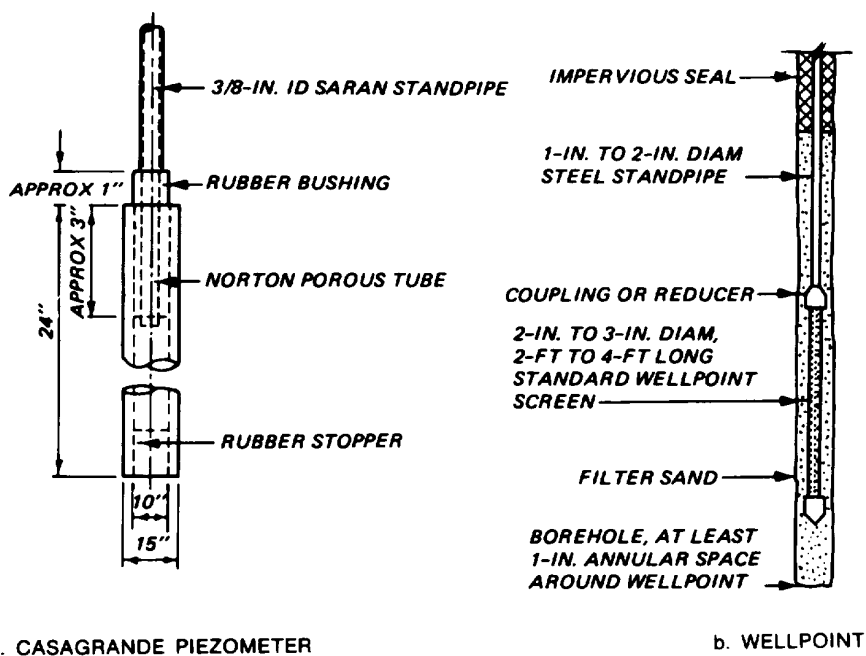

U. S. Army Corps of Engineers

Figure 4-5. Typical details of Casagrande piezometer and piezometer using uwell screen.

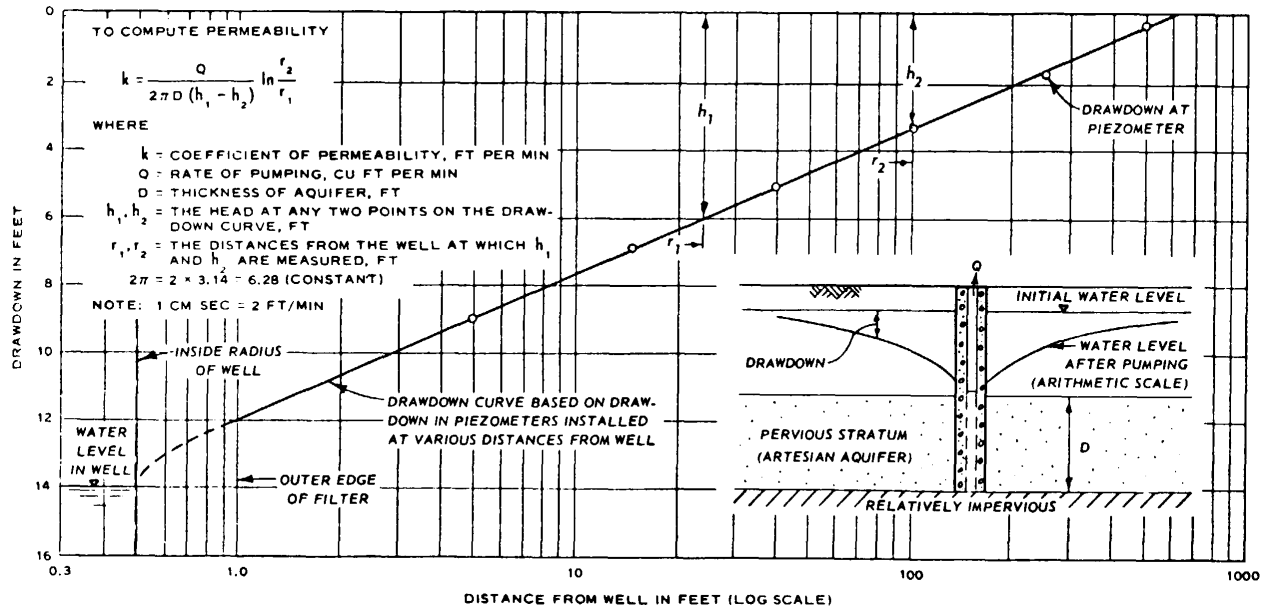

**NOTE. WELL SHOULD BE PUMPED AT A CONSTANT RATE OF FLOW UNTIL THE RATE OF DRAWDOWN IN WELL AND PIEZOMETERS IS ESSENTIALLY CONSTANT.**

**DRAWDOWN AT EQUILIBRIUM VERSUS DISTANCE FROM WELL PLOTS AS A STRAIGHT LINE ON SEMI- LOGARITHMIC PLOT.**

Figure 4-6. Determination of permeability from field pumping test on a fully penetrating well in an artesian aquifer.

Table 4-4. Surface Geophysical Methods

Name of Method	Procedure or Principle Utilized	Applicability
<u>Seismic methods:</u>		
Refraction	Based on time required for seismic waves to travel from source of blast to point on ground surface, as measured by geophones spaced at intervals on a line at the surface. Refraction of seismic waves at the interface between different strata gives a pattern of arrival times vs distance at a line of geophones.	Utilized to determine depth to rock or other lower stratum substantially different in wave velocity than the overlying material. Used only where wave velocity in successive layers becomes greater with depth. Used to determine rock type, rock and soil stratification, depth of weathered zone, etc.
Continuous vibration	The travel time of transverse or shear waves generated by a mechanical vibrator consisting of a pair of eccentrically weighted disks is recorded by seismic detectors placed at specific distances from the vibrator.	Velocity of wave travel and natural period of vibration gives some indication of soil type. Travel time plotted as a function of distance indicates depths or thicknesses of surface strata. Useful in determining dynamic modulus of subgrade reaction and obtaining information on the natural period of vibration for design of foundations of vibrating structures.
<u>Electrical methods:</u>		
Resistivity	Based on the difference in electrical conductivity or resistivity of strata. Resistivity of subsoils at various depths is determined by measuring the potential drop and current flowing between two current and two potential electrodes from a battery source. Resistivity is correlated to material type.	Used to determine horizontal extent and depth of subsurface strata. Principal applications for investigating foundations of dams and other large structures, particularly in exploring granular river channel deposits or bedrock surfaces, sources of construction material, potential infiltration and seepage zones, and in cavity detection.
Drop in potential	Based on the determination of the ratio of potential drops between three potential electrodes as a function of the current imposed on two current electrodes.	Similar to resistivity methods but gives sharper indication of vertical or steeply inclined boundaries and more accurate depth determinations. More susceptible than resistivity method to surface interference and minor irregularities in surface soils.
<u>Acoustic method</u>	The time of travel of sound waves reflected from the mud line beneath a body of water and a lower rock surface is computed by predetermining the velocity of sound in the various media.	Currently used in shallow underwater exploration to determine position of mud line and depth to hard stratum underlying mud. Method has been used in water depths greater than 100 feet with penetrations of 850 feet to bedrock. Excellent display of subsurface stratification. Used most efficiently in water depths up to 50 feet with penetrations of additional 350 feet to bedrock.

Note: Instrumentation for methods listed above currently available at WES. May be furnished as a service to Districts and Divisions on request. Table adapted from "Design Manual, Soil Mechanics, Foundations, and Earth Structures, " Department of the Navy. Bureau of Yards and Docks.



entiating between sand and clays. Both methods require distinct differences in properties of foundation strata materials to be effective. The resistivity method requires a high-resistivity contrast between materials being located. The seismic method requires that the contrast in wave transmission velocities be high and that any underlying stratum transmit waves at a higher velocity (more dense) than the overlying stratum. Some difficulties arise in the use of the seismic method if the surface terrain and/or layer interfaces are steeply sloping or irregular instead of relatively horizontal and smooth.

**4-8. Borehole surveying.**

*a.* Downhole surveying devices can be used in correlating subsurface soil and rock stratification and in providing quantitative engineering parameters, such as porosity, density, water content, and moduli. Once a boring has been made, the cost of using these tools in the borehole is relatively modest. Different devices currently in use are summarized in table 4-5.

*b.* These devices can allow cost savings to be made in the exploration program without lessening the quality of the information obtained.

Table 4-5. Borehole Surveying Devices

Device <sup>a</sup>	Measurement Obtained	Primary Use
Electric logging Spontaneous potential (SP)	Natural voltages between fluids in materials of dissimilar lithology	Differentiating between sands and clays
Single-point resistivity	Resistance of rock adjacent to hole	With SP log provides good indication of subsurface stratification and soil type
Multiple-point resistivity	Resistivity of formations	Determination of mud infiltration and effective porosity
Radiation logging Gamma	Natural gamma radiation of materials	Identification of clay seams, location of radioactive tracers, and with SP and resistivity logs provides information on relative porosity
Neutron	Hydrogen atom concentration	Determination of moisture content and porosity below zone of saturation porosity
Gamma-gamma	Gamma radiation absorption	Correlates with bulk density and useful to determine porosity if grain specific gravity is known
Sonic logging Acoustic velocity	Travel time of primary and shear wave velocities	With caliper and density logs determine dynamic elastic and shear moduli of in situ rock

(Continued)

<sup>a</sup> All devices currently available at WES. May be furnished as a service to Districts and Divisions on request.(Sheet 1 of 3)

Table 4-5. Borehole Surveying Devices-Continued

Device <sup>a</sup>	Measurement Obtained	Primary Use
Sonic logging (Continued)		
Acoustic Imagery	Reflected acoustic energy	Locate fractures and voids and strike and dip of joints, faults, bedding planes, etc.
Fluid logging Temperature	Temperature gradient in borehole	Determine geothermal gradient and defi- nition of aquifers
Fluid resistivity	Electrical resistance of borehole fluids	With temperature data the determination of dissolved solids--locate zones of water loss or gain
Trace ejector	Controlled ejection of trace elements	Groundwater flow patterns
Fluid sampler	Borehole or formation fluid from predeter- mined depths	Uncontaminated sam- ples for water quality studies
Visual logging		
Borescope	Visual image of the sidewalls of a bore- hole to depths of 100 ft or less--a peri- scopic instrument	Cheap, rapid examina- tion of borehole walls
Borehole camera	Photograph of a 360 deg sweep of the borehole wall taken approxi- mately at right angles to the wall. Expo- sures timed so that slight overlap of each photograph is obtained	Examination of bore- hole conditions, bedding, joints, etc.

(Continued)

(Sheet 2 of 3)

Table 4-5. Borehole Surveying Devices-Continued

<u>Device<sup>a</sup></u>	<u>Measurement Obtained</u>	<u>Primary Use</u>
Visual logging (Continued)		
Downhole camera	Photograph of the side-walls of the borehole taken from the bottom of the camera. Several feet of hole below device taken with each exposure	Examination of borehole conditions, bedding, joints, etc.
Borehole television	Image of the sidewalls of the borehole displayed at the time of exposure on a surface monitor	Rapid examination of borehole conditions as the device is lowered or raised
Miscellaneous logging Caliper	Borehole size	Washouts, fractures, etc., needed for interpretation of other logs
Borehole surveyor	Downhole directional survey	Precise location and attitude of features recorded on other logging tools

(Sheet 3 of 3)

## CHAPTER 5

## SETTLEMENT ANALYSES

**5-1. Settlement problems.**

*a.* Significant aspects of the settlement of structures are total settlement-magnitude of downward movements- and differential settlement-difference in settlements at different locations in the structure. Table 5-1 lists conditions that cause settlements which occur during construction and result in only minor problems and postconstruction settlements which occur after a structure is completed or after critical features are completed. Differential settlements distort a structure. A structure can generally tolerate large uniform, or nearly uniform, settlements.

*b.* Differential settlement can have a number of undesirable results:

(1) Tilting is unsightly. A tilt of 1/250 can be distinguished by the unaided eye.

(2) Moderate differential settlement causes cracking and architectural damage. With increasing differential settlement, doors and windows may become distorted and not open and close properly. Larger differential settlements may cause floors and stairways to become uneven and treacherous and windows to shatter. At this point, the usefulness of the building has been seriously impaired.

(3) Severe differential settlements may impair structural integrity and make structures susceptible to collapse during an earthquake or other major vibration.

(4) If a structure settles relative to the surrounding ground, or the ground settles relative to the structure, entryways may be disrupted, and utility lines may be damaged where they enter the structure.

*c.* Even if settlements are uniform or nearly so, large total settlements can also result in problems:

(1) Sites located near a river, lake, or ocean may flood during periods of high water.

(2) Surface drainage may be disrupted. If water ponds around and beneath structures, they may become inaccessible and subject to mildew and wood rot.

*d.* Experience provides a basis for estimating the magnitudes of differential settlement that cause cracking of architectural finishes, such as plaster, stucco, and brick facing. Differential settlement is best expressed as the angular distortion in radians between two points. Angular distortion, which always accompanies settlement of a building, is determined by the uniformity of foundation soils, the stiffness of the

structure and its foundation, and the distribution of load within the building. In conventional settlement analyses of the type described in this manual, the stiffness of the building and foundation are not considered. Tolerable angular distortions are listed in table 5-2, and empirical correlations that may be used to estimate probable angular distortions based on calculated maximum settlements are summarized in table 5-3. Because of the natural variability of soils, differential settlement will occur though total settlements are calculated to be uniform. An indirect means for controlling differential settlement is to limit total settlement to 3 inches for structures on clay and to 1 1/2 inches for structures on sand.

**5-2. Loads causing settlement.**

*a.* Loads causing settlement always include the estimated dead load and a portion or all of the live load. For office buildings, about 50 percent of the estimated building live load may be assumed to cause settlement. For heavily loaded warehouses and similar structures, the full live load should be used.

*b.* For many purposes, settlements need be computed only for the maximum dead load plus settlement-causing live load. Occasionally, settlements occurring during a part of the construction period must be computed. This may require additional stress computations for partial loading conditions.

*c.* Loads that are less than the preconsolidation stress cause minor settlements because only recompression of soil occurs. The increment of loading that exceeds the preconsolidation stress causes relatively large settlements and occurs along the virgin compression portion of laboratory consolidation curves. A careful estimate of preconsolidation stresses is essential for settlement analyses. Means for estimating such stresses are given in chapter 3.

**5-3. Stress computations.**

*a.* One of the first steps in a settlement analysis is computation of effective overburden stresses in the soil before and after loading. The initial stress  $p_1'$  at any depth is equal to the effective weight of overlying soils and may be determined by multiplying the effective unit weight of the soil by its thickness. It is customary to construct a load-depth diagram by plotting

Table 5-1. Causes of Settlement

Cause	Comment
Compression of foundation soils under static loads.	Soft, normally consolidated clays and peaty soils are most compressible. Loose silts, sands, and gravels are also quite compressible.
Compression of soft clays due to lowering ground-water table.	Increased effective stress causes settlement with no increase in surface load.
Compression of cohesionless soils due to vibrations.	Loose sands and gravels are most susceptible. Settlement can be caused by machine vibrations, earthquakes, and blasts.
Compression of foundation soil due to wetting.	Loose silty sands and gravels are most susceptible. Settlements can be caused by rise in groundwater table or by infiltration.
Shrinkage of cohesive soils caused by drying.	Highly plastic clays are most susceptible. Increase in temperature under buildings containing ovens or furnaces may accelerate drying. Wetting of highly plastic clays can cause swelling and heave of foundations.
Loss of foundation support due to erosion.	Waterfront foundations must extend below maximum erosion depth.
Loss of foundation support due to excavation of adjacent ground.	Most pronounced in soft, saturated clays.
Loss of support due to lateral shifting of the adjacent ground	Lateral shifting may result from landslides, slow downhill creep, or movement of retaining structures.
Loss of support due to formation of sinkhole.	Soils overlying cavernous limestone and broken conduits are susceptible.
Loss of support due to thawing of permafrost. foundation heat.	Permafrost should be insulated from
Loss of support due to partial or complete liquefaction.	Loose, saturated sands are most susceptible.
Downdrag on piles driven through soft clay.	Loading on piles is increased by negative skin friction if soil around upper part of pile settles.

stress versus depth, using average unit moist weights of soil above the water table and average unit submerged weights below the water table.

b. The final stress  $p$  at any depth is equal to the effective overburden stress after the structure is completed plus the stress resulting from the structure load. If the structure is founded on individual footings, the final stress is the sum of stresses imposed by all footings.

c. Foundation stresses caused by applied loads are generally computed assuming the foundation to consist of an elastic, isotropic, homogeneous mass of semiinfinite extent, i.e., the Boussinesq case. The increment of stress at various depths is determined by means of influence values, such as shown in figures 5-1 and 5-2, which give the vertical stress beneath a rectangular area for uniform and triangular distributions of load, respectively. Influence values for vertical

Table 5-2. Value of Angular Distortion ( $\delta/\theta$ ) That Can Be Tolerated Without Cracking

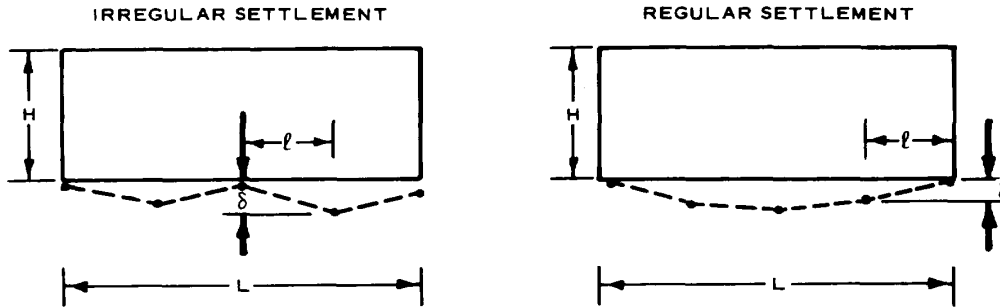

Type of Building	L/H	Allowable $\delta/\theta$
Steel frame with flexible siding	--	0.008
Steel or reinforced concrete frame with insensitive finish such as dry wall, glass, or moveable panels	--	0.002 to 0.003
Steel or reinforced concrete frame with brick, block, plaster, or stucco finish	$\geq 5$	0.002
	$\leq 3$	0.001
Load-bearing brick, tile, or concrete block walls	$\geq 5$	0.0008
	$\leq 3$	0.0004
Circular steel tanks on flexible base, with fixed top	--	0.008
Circular steel tanks on flexible base, with floating top	--	0.002 to 0.003
Tall slender structures, such as stacks, silos, and water tanks, with rigid mat foundations	--	0.002

stress beneath a circular area are shown in figure 5-3. If the foundation consists of a large number of individual footings, influence charts based on the Boussinesq case will greatly facilitate the computation of stresses. Programs for digital computers and programmable calculators are also available.

d. A structure excavation reduces stress in foundation subsoils. The decrease in vertical stresses caused by the weight of excavated material is computed in the manner described in the previous paragraph. The bottom of the excavation is used as a reference; vertical stresses produced by the weight of excavated material are subtracted algebraically from the original overburden pressure to compute final foundation stresses.

**5-4. Settlement of foundations on clay.**

a. When a load is applied over a limited area on clay, some settlement occurs immediately. This immediate settlement,  $\Delta H_i$ , has two components: that caused by distortion or change of shape of the clay beneath the loaded area, and that caused by immediate volume change in unsaturated soils. In saturated clays, there is little or no immediate volume change because time is required for water to drain from the clay.

b. Immediate settlements can be estimated using methods given in chapter 10. Values of undrained modulus determined from the slopes of stress-strain

curves from unconsolidated-undrained laboratory compression tests are frequently only one-half or one-third as large as the in situ modulus. This difference is due to disturbance effects, and the disparity may be even more significant if the amount of disturbance is unusually large. The undrained modulus of the clay may be estimated from figure 3-20. The values of the K in this figure were determined from the field measurements and, therefore, are considered to be unaffected by disturbance. The value of Poisson's ratio is equal to 0.5 for saturated clays. For partly saturated clays, a value of 0.3 can be assumed. Because immediate settlements occur as load is applied and are at least partially included in results of laboratory consolidation tests, they are often not computed and only consolidation settlements are considered to affect a structure.

**5-5. Consolidation settlement.** Consolidation settlement of cohesive soil is normally computed from pressure-void ratio relations from laboratory consolidation tests on representative samples. Typical examples of pressure-void ratio curves for insensitive and sensitive, normally loaded clays, and preconsolidated clays are shown in figure 3-7. Excavation results in a rebound of foundation soils and subsequent recompression when structure loads are added. This

Table 5-3. Empirical Correlations Between Maximum ( $\Delta$ ) and Angular Distortion ( $\delta/\vartheta$ )

Type of Foundation	Approximate Value of $\delta/\vartheta$ for $\Delta = 1$ in.
Mats on sand	1/750(0.0013)
Rectangular mats on varved silt	1/1000 to 1/2000 (0.001 to 0.0005)
Square mats on varved silt (0.0005 to 0.0003)	1/2000 to 1/3000
Mats on clay	1/1250(0.0008)
Spread footings on sand	1/600(0.0017)
Spread footings on varved silt	1/600(0.0017)
Spread footings on clay	1/1000(0.0010)

a  $\delta/\vartheta$  increases roughly in proportion with  $\Delta$ . For  $\Delta = 2$  in., values of  $\delta/\vartheta$  would be about twice as large as shown, for  $\Delta = 3$  inches, three times as large, etc.

(Courtesy of J. P. Gould and J. D. Parsons, "Long - Term Performance of Tall Buildings of New York City Varied Silts," *Proceedings, International Conference on Planning and Design of Tall Buildings*, Lehigh University, Bethlehem, Pa., 1975. Reprinted by permission of American Society of Civil Engineers, New York.)



sequence should be simulated in consolidation tests by loading the specimen to the existing overburden pressure  $p_0$ , unloading to the estimated stress after excavation  $p_{exc}$ , and reloading the specimen to define the p-e curve at loads in excess of overburden and

preconsolidation stresses. Curves designated  $K_u$  in figure 3-7 are laboratory p-e curves. Soil disturbance during sampling affects laboratory p-e curves so that it usually

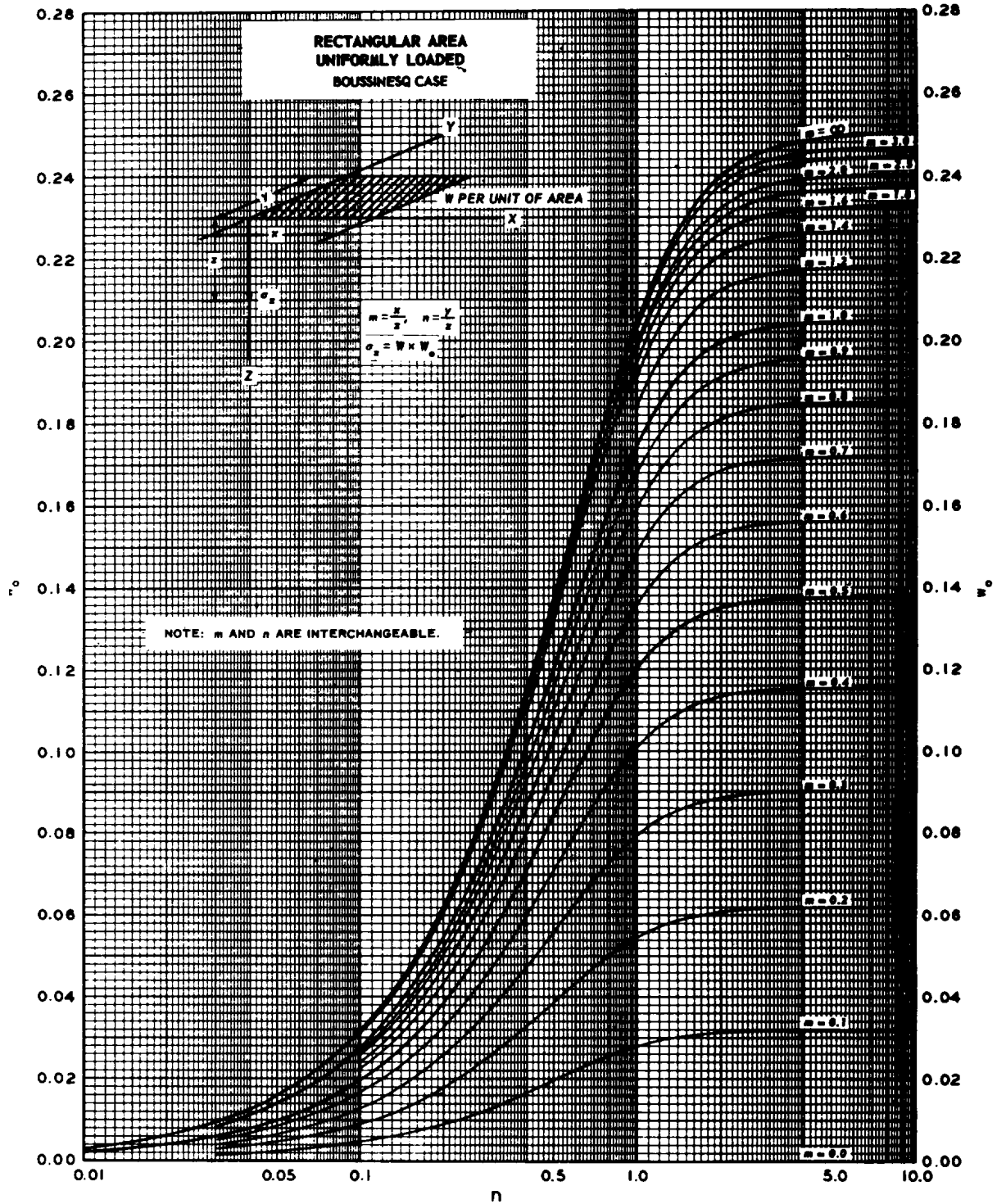

U. S. Army Corps of Engineers

Figure 5-1. Vertical stress beneath a uniformly loaded rectangular area.

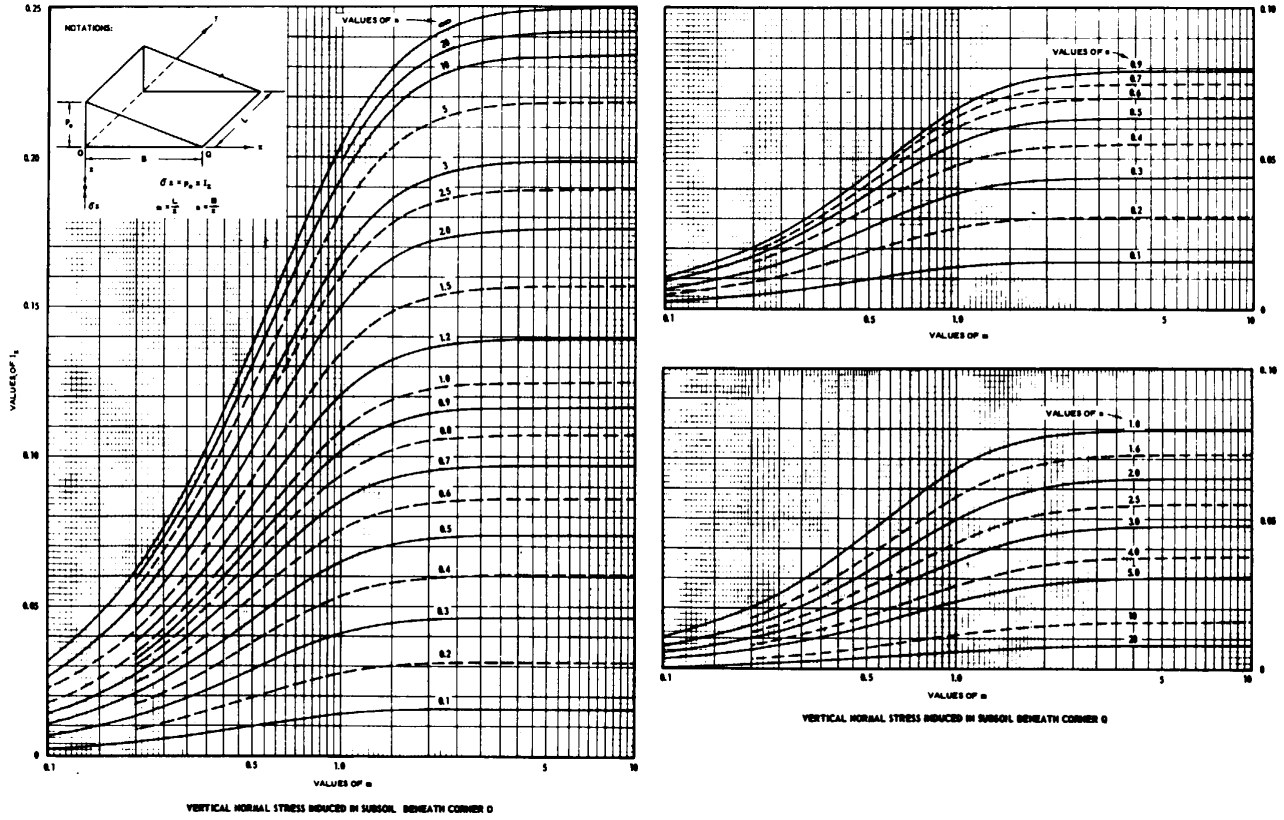

Figure 5-2. Vertical stress beneath a triangular distribution of load on a rectangular area.

becomes necessary to construct a field p-e curve simulating consolidation in the field. These constructions are also shown in figure 3-7. They are based on the assumption that the straight lower branch of the field p-e curve, K, intersects the laboratory curve at  $e = 0.4e_0$ . Furthermore, the field curve must pass through point a, corresponding to the present overburden pressure and the natural void ratio. The field compression index,  $C_c$ , is taken as the slope of the straight lower branch of K on the semilogarithmic diagram.

a. *Settlement computations.* The total settlement,  $\Delta H$ , of a foundation stratum is computed according to the following formula:

$$\Delta H = \frac{e_1 - e_2}{1 + e_0} H \quad (5-1)$$

where

- $e_1, e_2$  = initial and final void ratios, respectively, from the field pressure-void curves, corresponding to the initial and final effective foundation pressures
- $e_0$  = average initial void of the stratum
- $H$  = total thickness of the compressible stratum This formula also may be used to estimate foundation rebound due to excavation. When the lower portion of

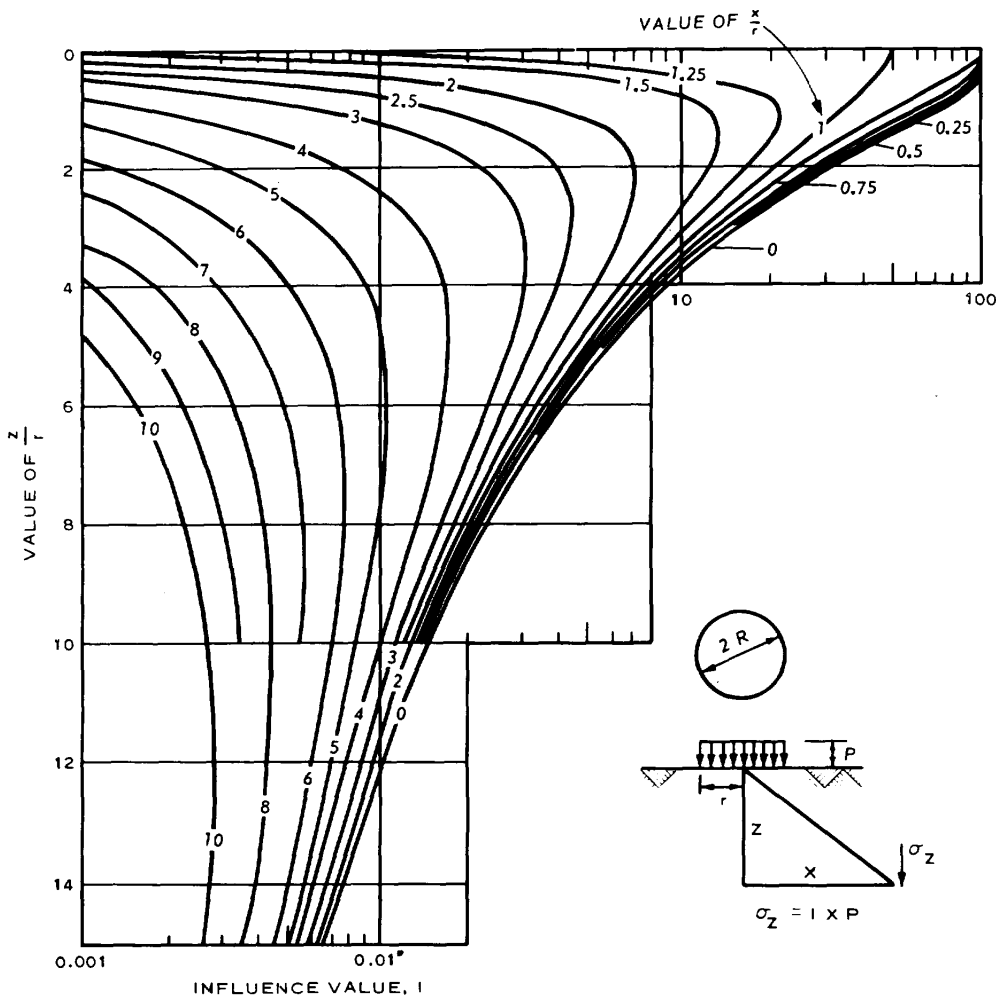

Figure 5-3. Influence value for vertical stress under a uniformly loaded circular area.

the pressure void ratio curve is fairly straight, it may be convenient to work with the compression index, in which case the formula for settlement is as follows:

$$\Delta H = \frac{C_c}{1 + e_0} H \log_{10} \frac{p_2'}{p_1'} \quad (5-2)$$

An example of a settlement analysis in which the rebound of the foundation and subsequent recompression under the building load are determined is shown in figure 5-4 for a normally consolidated foundation.

b. *Rate of settlement.* The rate of settlement is determined by means of the theory of consolidation. This

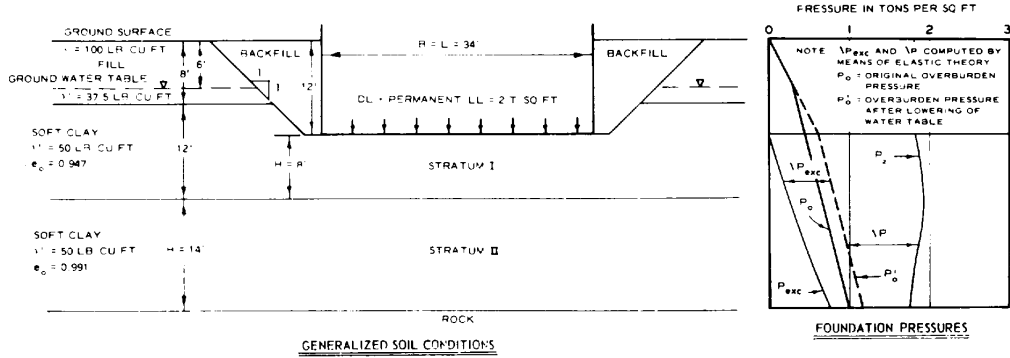

(a) COMPUTATION OF OVERBURDEN PRESSURES ( $P_o$ ) AND ( $P'_o$ ) AT MID-POINTS OF STRATA

INITIAL OVERBURDEN PRESSURE ( $P_o$ )		OVERBURDEN PRESSURE AFTER WATER TABLE IS LOWERED TO BASE OF EXCAVATION: $P'_o = P_o + \left(\frac{6 \times 62.4}{2000}\right)$	
STRATUM I	STRATUM II	STRATUM I	STRATUM II
$6 \times \frac{100}{2000} = 0.300$ T SQ FT	$6 \times \frac{100}{2000} = 0.300$ T SQ FT	$0.538 + \left(\frac{6 \times 62.4}{2000}\right) = 0.725$ T SQ FT	$0.813 + \left(\frac{6 \times 62.4}{2000}\right) = 1.000$ T SQ FT
$2 \times \frac{37.5}{2000} = 0.038$ T SQ FT	$2 \times \frac{37.5}{2000} = 0.038$ T SQ FT		
$8 \times \frac{50}{2000} = 0.200$ T SQ FT	$19 \times \frac{50}{2000} = 0.475$ T SQ FT		
$P_o = 0.538$ T SQ FT	$P_o = 0.813$ T SQ FT		

(b) COMPUTATION OF PRESSURE AFTER EXCAVATION ( $P_{exc}$ ) AT MID-POINT OF STRATA

STRATUM I	STRATUM II
PRESSURE BEFORE EXCAVATION ( $P_o$ ) = 0.725 T SQ FT	1.000 T SQ FT
PRESSURE RELEASE DUE TO EXCAVATION ( $P_{exc}$ ) = -0.620 T SQ FT	-0.512 T SQ FT
$P_{exc} = 0.105$ T SQ FT	0.488 T SQ FT

(c) COMPUTATION OF FINAL PRESSURE ( $P_2$ ) AT MID-POINT OF STRATA

NET LOAD AT BASE OF STRUCTURE		STRATUM I	STRATUM II
DL + PERMANENT LL = 2.000 T SQ FT			
SOIL REMOVED			
$8 \times \frac{100}{2000}$	} -0.625		
$4 \times \frac{112.5}{2000}$			
NET STRUCTURE LOAD = 1.375 T SQ FT			
		INITIAL OVERBURDEN PRESSURE ( $P_o$ ) = 0.538 T SQ FT	0.813 T SQ FT
		INCREASE IN FOUNDATION PRESSURE DUE TO NET STRUCTURE LOAD ( $\Delta P$ ) = 1.356 T SQ FT	1.040 T SQ FT
		$P_2 = 1.894$ T SQ FT	1.853 T SQ FT

NOTE:  $\Delta P$  = NET STRUCTURE LOAD +  $w_w$   
 $w_w$  OBTAINED FROM FIG. 5-1

(d) COMPUTATION OF FOUNDATION REBOUND

STRATUM	THICKNESS H	$P_o$ T SQ FT	$P_{exc}$ T SQ FT	$e_{p_0}$	$e_{p_{exc}}$	$\Delta e$	REBOUND $H \left( \frac{\Delta e}{1 + e_0} \right)$
I	8 FT	0.54	0.11	0.947	0.964	-0.017	0.07 FT
II	14 FT	0.81	0.49	0.991	0.999	-0.008	0.06 FT
							TOTAL REBOUND = 0.13 FT

(e) COMPUTATION OF FOUNDATION SETTLEMENT

STRATUM	THICKNESS H	$P_{exc}$ T SQ FT	$P_2$ T SQ FT	$e_{p_{exc}}$	$e_2$	$\Delta e$	SETTLEMENT $H \left( \frac{\Delta e}{1 + e_0} \right)$
I	8 FT	0.11	1.89	0.964	0.805	0.159	0.65 FT
II	14 FT	0.49	1.85	0.999	0.862	0.137	0.96 FT
							TOTAL SETTLEMENT = 1.61 FT

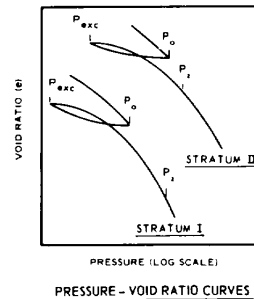

U. S. Army Corps of engineers

Figure 5-4. Example of settlement analysis.

theory relates the degree of consolidation and time subsequent to loading according to the following expression:

$$U(\%) = f(T) \quad (5-3)$$

with

$$T = \frac{c_v}{H^2} t \quad (5-4)$$

where

- U = degree of consolidation or ratio of settlement that has occurred at a given time to the ultimate settlement
- T = dimensionless number called the time factor that depends upon loading and boundary conditions
- $c_v$  = property of the soil known as the coefficient of consolidation

H = length of the drainage path, which in the case of a specimen or stratum draining from top and bottom would be half the thickness of the specimen or stratum

t = time corresponding to U

The relation between time factor and percent consolidation for various boundary conditions is shown in figure 5-5. If the values of  $c_v$  and H are known for a stratum of clay with given boundary conditions, the theoretical curve can be replotted in the form of a percent consolidation-time curve; if the ultimate settlement of the layer has been computed, the curve can be further modified into a settlement-time curve. In order to compute,  $c_v$ , it is necessary to transform the laboratory time-consolidation curve for the load increment in question into the theoretical curve. A method for adjusting the laboratory curve in order to compute the

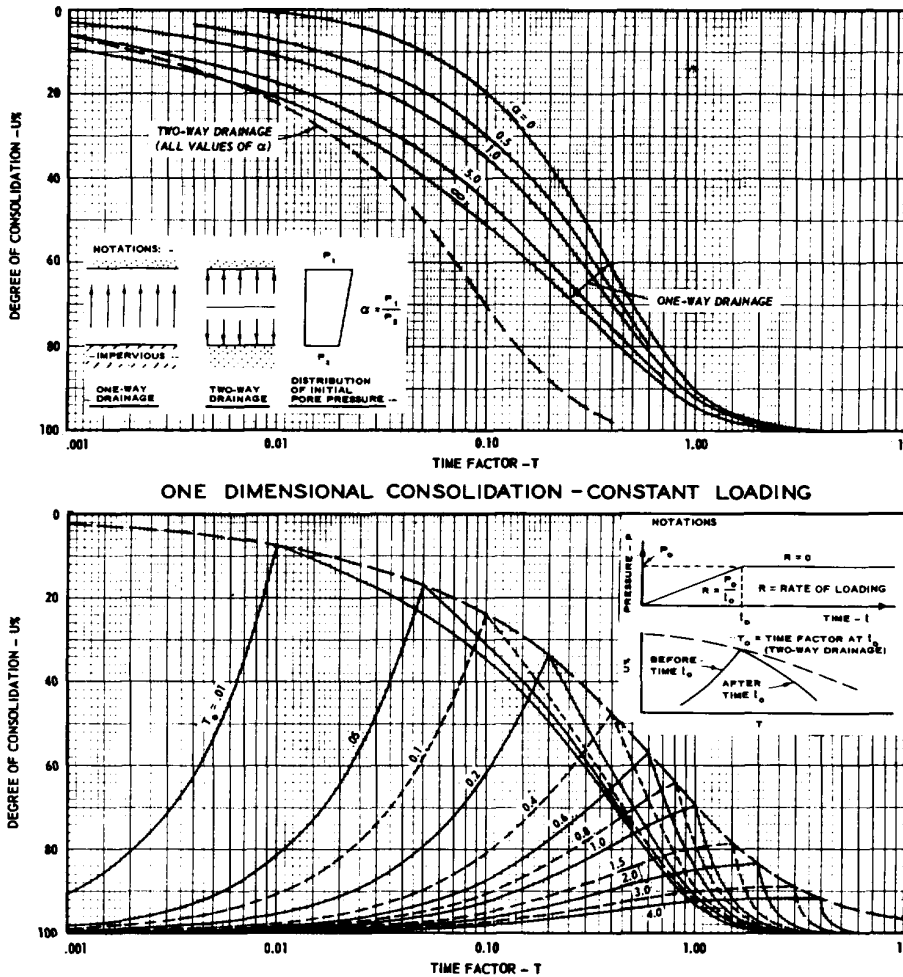

U. S. Army Corps of Engineers

Figure 5-5. Time factors for various boundary conditions.

coefficient of consolidation,  $c_v$ , is shown in figure 3-7. Thus, the actual time required for the various percentages of consolidation to occur in the field can be determined by the following formula:

$$t_f = \frac{T H^2}{c_v} \quad (5-5)$$

where

- $t_f$  = time for U(%) consolidation in the field stratum
- H = length of the drainage path in the field
- T = time factor corresponding to U(%) consolidation

When settlement occurring during the construction period may be of interest, the values of T and U also can be obtained from figure 5-5.

c. *Secondary compression.* For refined estimates and special purposes, settlement resulting from secondary compression may have to be evaluated. The amount  $\Delta H_s$  can be calculated as follows:

$$\Delta H_s = C_\alpha H \log \frac{t_{sc}}{t_p} \quad (5-6)$$

where

- $t_{sc}$  =  $t_p$  + time interval during which secondary compression settlement is to be calculated
- $t_p$  = time to complete primary consolidation

H = total thickness of compressible soil

Other terms have been previously defined. Secondary compression settlements may be important where primary consolidation occurs rapidly, soils are highly plastic or organic, and allowable settlements are unusually small.

**5-6. Settlement of cohesionless soils.** The permeability of cohesionless soils is usually sufficiently great that consolidation takes place during the construction period. For important projects, estimate settlement using consolidation tests on undisturbed samples or samples remolded at natural density. Alternately, settlements may be estimated from plate bearing tests described in chapter 4. Design of footings on cohesionless soils, based on settlement considerations using the Standard Penetration Test, is described in chapter 10.

**5-7. Eliminating, reducing, or coping with settlement.** Design techniques for ameliorating settlement problems are summarized in table 5-4. Differential settlements beneath existing structures can be corrected by releveling by jacks, grouting (i.e., mud jacking) beneath slab foundations, or underpinning. These techniques are expensive, to varying degrees, and require specialists.

Table 5-4. Methods of Eliminating, Reducing, or Coping With Settlements.

Method	Comment
Use of piles, piers, or deep footings.	Differential settlements between buildings and surrounding ground can cause problems.
Excavate soft soil and replace with clean granular fill.	Can be very costly if the compressible layer extends to large depth.
Displace soft soil with weight of granular fill or by blasting.	Difficult to control. Pockets of entrapped soft soil can cause large differential settlements.
Reduce net load by excavation.	Weight of one story building is equal to weight of one or two feet of soil.
Surcharge or preload site before construction.	Settlement is reduced by amount which occurs before construction. Preload may be limited by stability considerations.
Delay construction of buildings to be built on fills.	Settlement which occurs before construction does not affect building. Fill settlement can be accelerated using sand drains.
Use a stiff foundation with deep grade beams.	Can greatly reduce differential settlements.
Install leveling jacks between the foundation and the structure	Building can be releveled periodically as foundation settles.
Select a building type which has a large tolerance for differential settlement.	Steel frames, metal siding, and asphalt floors can withstand large settlements and remain serviceable.

## CHAPTER 6

## BEARING-CAPACITY ANALYSIS

**6-1. Bearing capacity of soils.** Stresses transmitted by a foundation to underlying soils must not cause bearing-capacity failure or excessive foundation settlement. The design bearing pressure equals the ultimate bearing capacity divided by a suitable factor of safety. The ultimate bearing capacity is the loading intensity that causes failure and lateral displacement of foundation materials and rapid settlement. The ultimate bearing capacity depends on the size and shape of the loaded area, the depth of the loaded area below the ground surface, groundwater conditions, the type and strength of foundation materials, and the manner in which the load is applied. Allowable bearing pressures may be estimated from table 6-1 on the basis of a description of foundation materials. Bearing-capacity analyses are summarized below.

**6-2. Shear strength parameters.**

*a. Appropriate analyses.* Bearing-capacity calculations assume that strength parameters for foundation soils are accurately known within the depth of influence of the footing. The depth is generally about 2 to 4 times the footing width but is deeper if subsoils are highly compressible.

(1) *Cohesionless soils.* Estimate  $\phi'$  from the Standard Penetration Test (table 4-5) or the cone penetration resistance. For conservative values, use  $\phi' = 30$  degrees.

(2) *Cohesive soils.* For a short-term analysis, estimate  $s_u$  from the Standard Penetration Test (table 4-5) or the vane shear resistance. For long-term loadings, estimate  $\phi'$  from correlations with index properties for normally consolidated soils.

*b. Detailed analyses.*

(1) *Cohesionless soils.* Determine  $\phi'$  from drained (S) triaxial tests on undisturbed samples from test pits or borings.

(2) *Cohesive soils.* For a short-term analysis, determine  $s_u$  from Q triaxial tests on undisturbed samples with  $\sigma_3$  equal to overburden pressure. For a long-term analysis, obtain  $\phi'$  from drained direct shear (S) tests on undisturbed samples. For transient loadings after consolidation, obtain  $\phi$  and  $c$  parameters from consolidated-undrained (R) triaxial tests with pore pressure measurements on undisturbed samples. If the soil is dilative, the strength should be determined from drained S tests.

**6-3. Methods of analysis.***a. Shallow foundations.*

(1) *Groundwater level (GWL).* The ultimate bearing capacity of shallow foundations subjected to vertical, eccentric loads can be computed by means of the formulas shown in figure 6-1. For a groundwater level well below the bottom of the footing, use a moist unit soil weight in the equations given in figure 6-1. If the groundwater level is at ground surface, use a submerged unit soil weight in the equations.

(2) *Intermediate groundwater levels.* Where the groundwater level is neither at the surface nor so deep as not to influence the ultimate bearing capacity, use graphs and equations given in figure 6-2.

(3) *Eccentric or inclined footing loads.* In practice, many structure foundations are subjected to horizontal thrust and bending moment in addition to vertical loading. The effect of these loadings is accounted for by substituting equivalent eccentric and/or inclined loads. Bearing capacity formulas for this condition are shown in figure 6-3. An example of the method for computing the ultimate bearing capacity for an eccentric inclined load on a footing is shown in figure 6-4.

(4) *Loading combinations and safety factors.* The ultimate bearing capacity should be determined for all combinations of simultaneous loadings. A distinction is made between normal and maximum live load in bearing capacity computations. The normal live load is that part of the total live load that acts on the foundation at least once a year; the maximum live load acts only during the simultaneous occurrence of several exceptional events during the design life of the structure. A minimum factor of safety of 2.0 to 3.0 is required for dead load plus normal live load, and 1.5 for dead load plus maximum live load. Safety factors selected should be based on the extent of subsurface investigations, reliability of estimated loadings, and consequences of failure. Also, high safety factors should be selected if settlement estimates are not made. In general, separate settlement analysis should be made.

*b. Deep foundations.* Methods for computing the ultimate bearing capacity of deep foundations are summarized in figure 6-5. These analyses are applicable to the design of deep piers and pile foundations, as subsequently described. When the base of the foundation is located below the ground surface at a depth greater



Table 6-1. Estimates of Allowable Bearing Pressure

(These presumed values of the allowable bearing pressure are estimates and may need alteration upwards or downwards. No addition has been made for the depth of embedment of the foundation. Reference should be made to other parts of the Manual when using this table.)

Group	Types and conditions of rocks and soils	Strength of Rock Material	Presumed Allowable Bearing Pressure Ton /sq ft	Remarks
Rocks	Massive igneous and metamorphic rocks (granite, diorite, basalt, gneiss) in sound condition <sup>a</sup>	High to very high	100	These values are based on the assumption that the foundations are carried down to unweathered rock.
	Foliated metamorphic rocks (slate, schist) in sound condition <sup>a, b</sup>	Medium to high	30	
	Sedimentary rocks: cemented shale, siltstone, sandstone, limestone without cavities, thoroughly cemented conglomerates, all in sound condition <sup>a, b</sup>	Medium to high	10-40	
	Compaction shale and other argillaceous rocks in sound condition <sup>a, d</sup>	Low to medium	5	
	Broken rocks of any kind with moderately close spacing of discontinuities (1 ft or greater), except argillaceous rocks (shale)		10	
	Thinly bedded limestone, sandstones, shale		See note c	
	Heavily shattered or weathered rocks		See note c	
Non-cohesive soils	Dense gravel or dense sand and gravel		>6	Width of foundation (B) not less than 3 ft. Groundwater level assumed to be at a depth not less than B below the base of the foundation.
	Compact gravel or compact sand and gravel		2-6	
	Loose gravel or loose sand and gravel		<2	
	Dense sand		>3	
	Compact sand		1-3	
	Loose sand		<1	
Cohesive soils	Very stiff to hard clays or heterogeneous mixtures such as till		3-6	Cohesive soils are susceptible to long-term consolidation settlement
	Stiff clays		1.5-3	
	Firm clays		0.75-1.5	
	Soft clays and silts		<0.75	
	Very soft clays and silts		not applicable	
Organic soils	Peat and organic soils		not applicable	
Fill	Fill		not applicable	

<sup>a</sup> Sound rock conditions allow minor cracks at spacing not less than 3 ft.

<sup>b</sup> The above values for sedimentary or foliated rocks apply where the strata or foliation are level or nearly so, and, then only if the area has ample lateral support. Tilted strata and their relation to nearby slopes or excavations shall be assessed by a person knowledgeable in this field of work.

<sup>c</sup> To be assessed by examination in situ, including loading tests if necessary, by a person knowledgeable in this field of work.

<sup>d</sup> These rocks are apt to swell on release of stress, and on exposure to water they are apt to soften and swell appreciably.

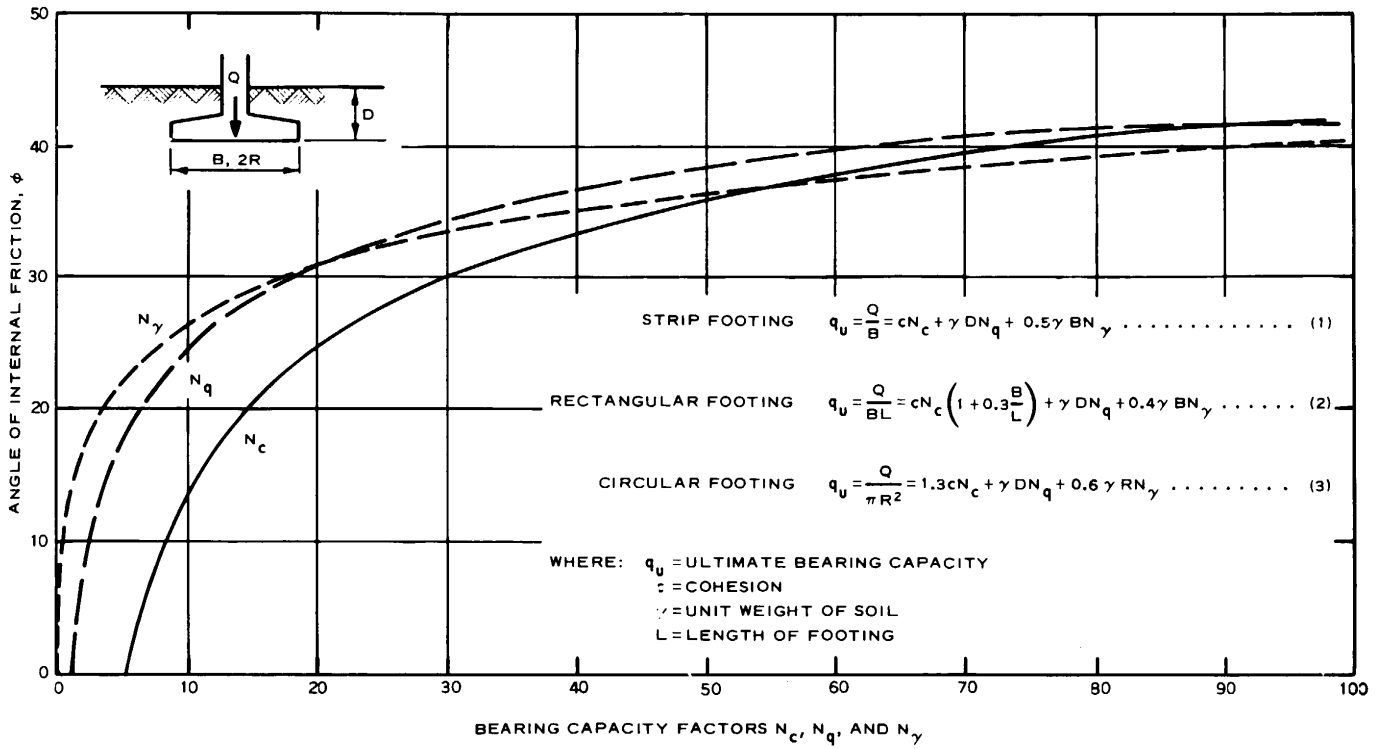
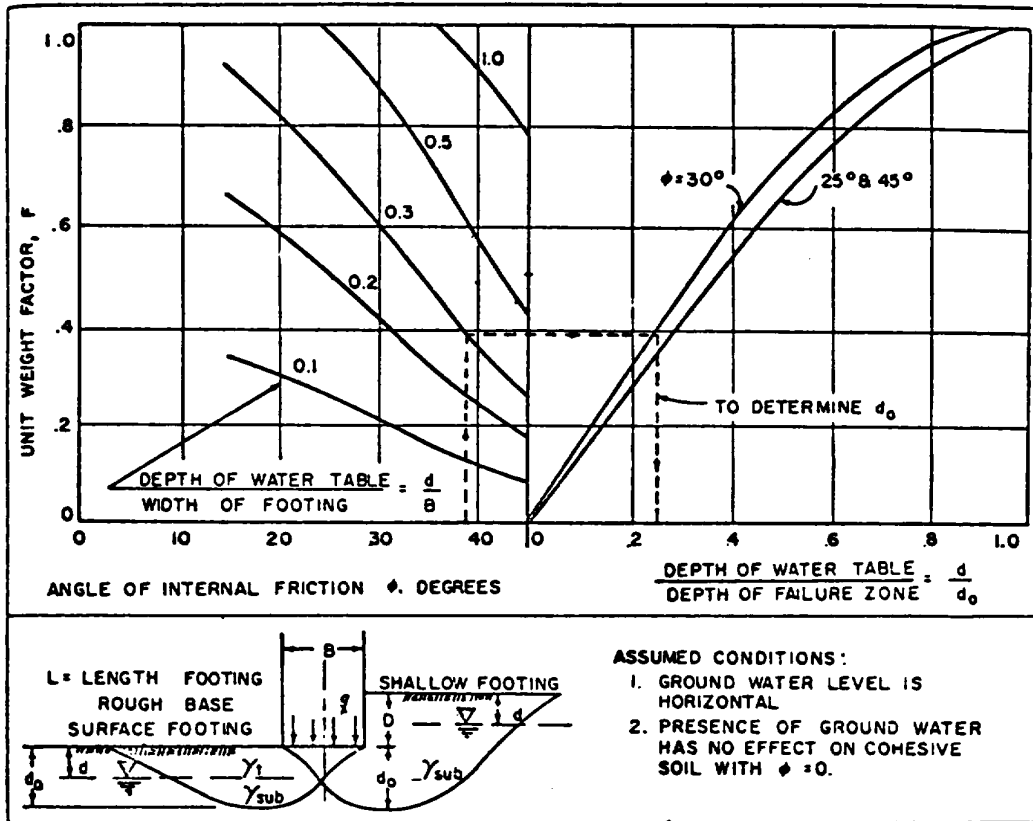

Figure 6-1. Ultimate bearing capacity of shallow foundations under vertical, eccentric loads.



**CONTINUOUS FOOTING:**

**SURFACE FOOTING:**  $D = 0$

$$q_{ult} = cN_c + \gamma_{SUB} + F(\gamma_T - \gamma_{SUB}) \frac{B}{2} N_\gamma$$

**SHALLOW FOOTING:**  $D < B$

IF  $d < D$

$$q_{ult} = cN_c + \gamma_{SUB} D + (\gamma_T - \gamma_{SUB}) d N_q + 0.5 \gamma_{SUB} B N_\gamma$$

IF  $D < d < (D + d_o)$

$$q_{ult} = cN_c + \gamma_T D N_q + \gamma_{SUB} + F(\gamma_T - \gamma_{SUB}) \frac{B}{2} N_\gamma$$

**RECTANGULAR FOOTING:**

**SURFACE FOOTING:**  $D = 0$

$$q_{ult} = cN_c (1 + 0.3 \frac{B}{L}) + \gamma_{SUB} + F(\gamma_T - \gamma_{SUB}) 0.4 B N_\gamma$$

**SHALLOW FOOTING:**  $D < B$ . IF  $d < D$

$$q_{ult} = cN_c (1 + 0.3 \frac{B}{L}) + \gamma_{SUB} D + (\gamma_T - \gamma_{SUB}) d N_q + 0.4 \gamma_{SUB} B N_\gamma$$

IF  $D < d < (D + d_o)$

$$q_{ult} = cN_c (1 + 0.3 \frac{B}{L}) + \gamma_T D N_q + \gamma_{SUB} + F(\gamma_T - \gamma_{SUB}) 0.4 B N_\gamma$$

**CIRCULAR FOOTING:** RADIUS =  $R = B/2$

**SURFACE FOOTING:**  $D = 0$

$$q_{ult} = 1.3 cN_c + \gamma_{SUB} + F(\gamma_T - \gamma_{SUB}) 0.6 R N_\gamma$$

**SHALLOW FOOTING:**  $D < 2R$ , IF  $d < D$

$$q_{ult} = 1.3 cN_c + \gamma_T - \gamma_{SUB} D + (\gamma_T - \gamma_{SUB}) d N_q + 0.6 \gamma_{SUB} R N_\gamma$$

IF  $D < d < (D + d_o)$

$$q_{ult} = 1.3 cN_c + \gamma_T D N_q + \gamma_{SUB} + F(\gamma_T - \gamma_{SUB}) 0.6 R N_\gamma$$

U. S. Army Corps of Engineers

Figure 6-2. Ultimate bearing capacity with groundwater effect.

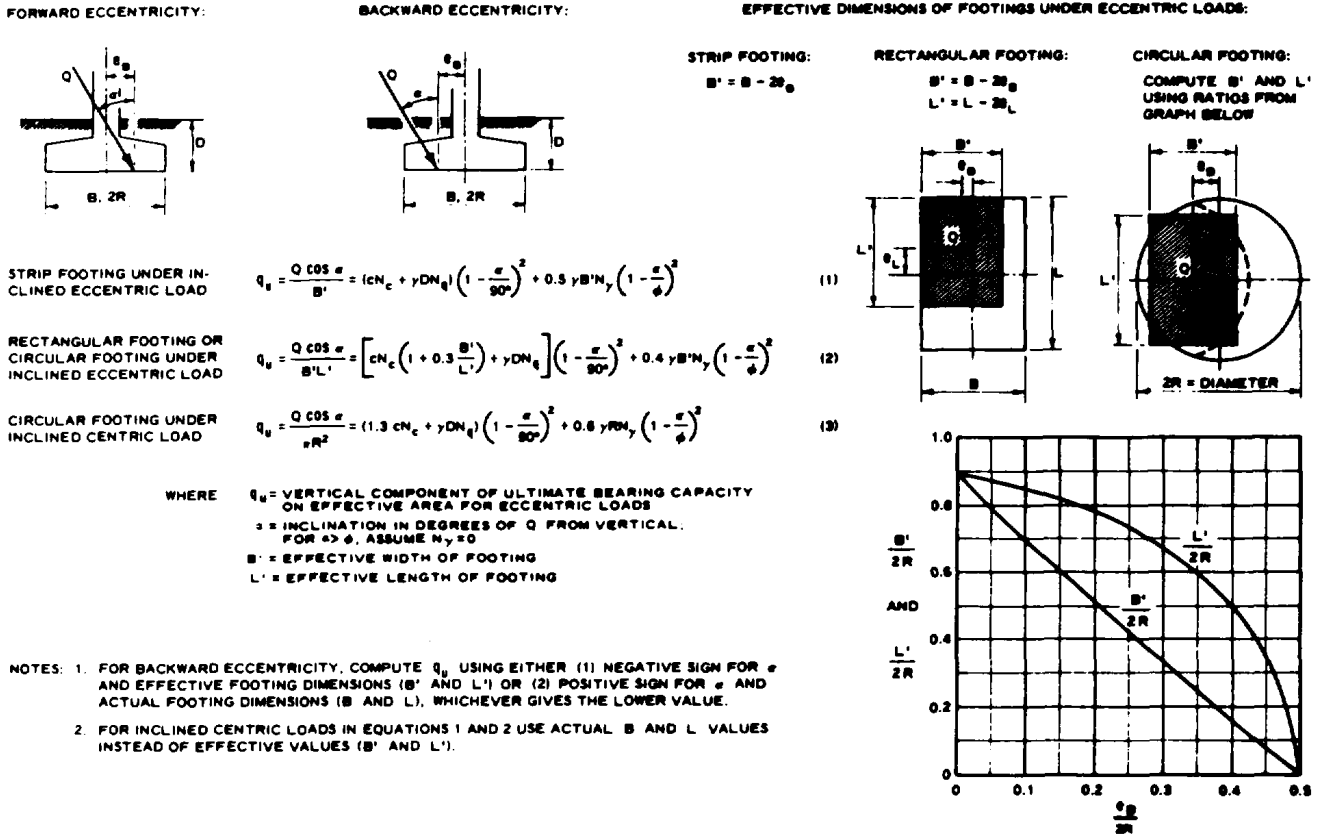

U. S. Army Corps of Engineers

Figure 6-3. Ultimate bearing capacity of shallow foundations under eccentric inclined loads.

than the width of the foundation, the factor of safety should be applied to the net load (total weight of structure minus weight of displaced soil).

c. *Stratified subsoils.* Where subsoils are variable with depth, the average shear strength within a depth below the base equal to the width of the loaded area controls the bearing capacity, provided the strength at a depth equal to the width of the loaded area or lower is not less than one-third the average shear strength of the upper layer; otherwise, the bearing capacity is governed by the weaker lower layer. For stratified cohesive soils, calculate the ultimate bearing capacity from the chart in figure 6-6. The bearing pressure on the weaker lower layer can be calculated by distributing the surface load to the lower layer at an angle of 30 degrees to the vertical.

**6-4. Tension forces.** Footings subjected to a sustained uplift force,  $T_u$ , should be designed with a minimum factor of safety of 1.5 with respect to weight forces resisting pullout expressed as

$$\frac{W}{T_u} \geq 1.5 \quad (6-1)$$

where  $W$  is the total effective weight of soil and concrete located within the prism bounded by vertical lines at the base of the footing. Use total unit weights above the water table and the buoyant unit weight below. If the shear resistance on the vertical sides of the prism defined above is considered, a minimum safety factor of 2 should be used. The lateral earth pressure on the vertical sides of the prism should not exceed earth pressure at rest and should be considered as active earth pressure if the soil is not well compacted.

**6-5. Bearing capacity of rock.** For a structure founded on rock, adequate exploration is necessary to determine the number and extent of defects, such as joints, shear zones, and solution features. Estimates of the allowable bearing pressure can be obtained from table 6-1. Conservative estimates of the allowable bearing pressure can be obtained from the following expression:

$$q_a = 0.2 q_u \quad (6-2)$$

Allowable bearing pressures for jointed rock can also be estimated from RQD values using table 6-2. Local experience should always be ascertained.

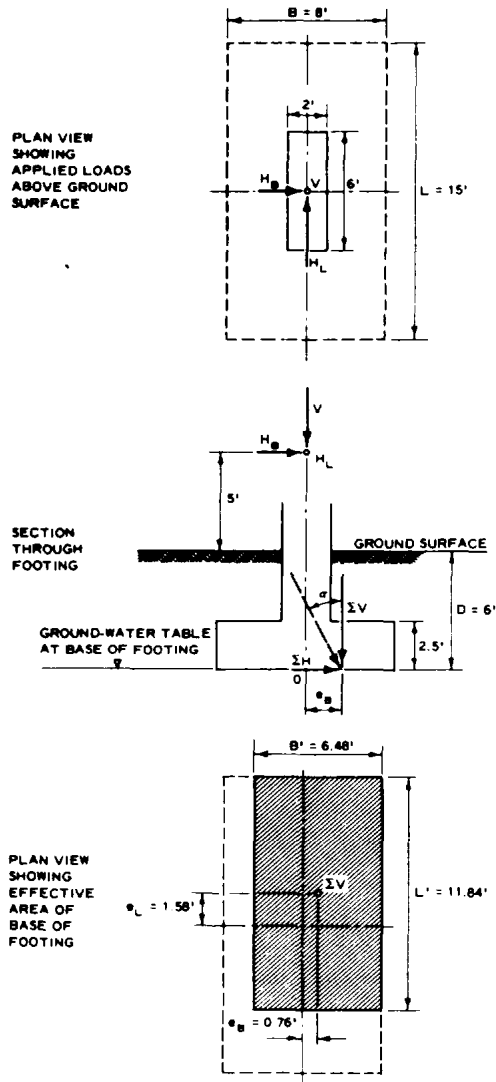

(A) SOIL AND LOADING CONDITIONS

UNIFORM SANDY SILT:

$\gamma = 112.5 \text{ LB/CU FT} = 0.056 \text{ TON/CU FT}$   
 $\gamma_{\text{SUB}} = 50 \text{ LB/CU FT} = 0.025 \text{ TON/CU FT}$   
 $c = 0.06 \text{ TON/SQ FT}$   
 $\phi = 25^\circ$

DL + NORMAL LL:

$V = 113 \text{ TONS VERTICAL}$   
 $H_H = 11 \text{ TONS LATERAL}$   
 $H_L = 23 \text{ TONS LONGITUDINAL}$

(B) COMPUTATION OF NET VERTICAL LOAD

VERTICAL LOAD ABOVE GROUND SURFACE =  $V = 113.0 \text{ TONS}$   
 EFFECTIVE WEIGHT OF SOIL ABOVE BASE OF FOOTING =  $\frac{(8 \times 15 \times 6) (112.5)}{2000} = 40.5 \text{ TONS}$   
 WEIGHT OF CONCRETE (150 LB/CU FT) IN FOOTING IN EXCESS OF DISPLACED SOIL  
 $= \frac{[(8 \times 15 \times 2.5) + (2 \times 6 \times 3.5)] (150 - 112.5)}{2000} = 6.5 \text{ TONS}$   
 NET VERTICAL LOAD =  $\Sigma V = 160.0 \text{ TONS}$

(C) COMPUTATION OF ECCENTRICITY (e) AND INCLINATION (alpha)

TAKING MOMENTS ABOUT O:

$e_B = \frac{\Sigma M_B}{\Sigma V} = \frac{11(5 + 6)}{160} = 0.76 \text{ FT}$   
 $e_L = \frac{\Sigma M_L}{\Sigma V} = \frac{23(5 + 6)}{160} = 1.58 \text{ FT}$   
 $\Sigma H = \sqrt{(11)^2 + (23)^2} = 25.5 \text{ TONS}$   
 $\alpha = \text{ARCTAN} \frac{\Sigma H}{\Sigma V} = \text{ARCTAN} \frac{25.5}{160} = \text{ARCTAN} 0.159 = 9^\circ$   
 $B' = B - 2e_B = 8 - 1.52 = 6.48 \text{ FT}$   
 $L' = L - 2e_L = 15 - 3.16 = 11.84 \text{ FT}$

(D) COMPUTATION OF VERTICAL COMPONENT OF ULTIMATE BEARING CAPACITY

$q_u = \left[ cN_c \left( 1 + 0.3 \frac{B'}{L'} \right) + \gamma D N_q \right] \left( 1 - \frac{\alpha}{90^\circ} \right)^2 + 0.4 \gamma B' N_\gamma \left( 1 - \frac{\alpha}{\phi} \right)^2$   
 $= \left[ 0.06 \times 24 \left( 1 + 0.3 \frac{6.48}{11.84} \right) + (0.056 \times 6 \times 13) \right] \left( 1 - \frac{9}{90} \right)^2 + (0.4 \times 0.025 \times 6.48 \times 10) \left( 1 - \frac{9}{25} \right)^2$   
 $= (1.67 + 4.36) (0.81) + (0.65) (0.41) = 4.88 + 0.27 = 5.15 \text{ TONS SQ FT}$

(E) COMPUTATION OF FACTOR OF SAFETY WITH RESPECT TO BEARING CAPACITY

ACTUAL BEARING PRESSURE =  $q_a = \frac{\Sigma V}{B' L'} = \frac{160}{6.48 \times 11.84} = 2.09 \text{ TONS SQ FT}$   
 FACTOR OF SAFETY =  $F.S. = \frac{q_u}{q_a} = \frac{5.15}{2.09} = 2.5 > 2.0 \text{ REQUIRED F.S. FOR DL + NORMAL LL}$

NOTE: COMPUTATION SHOULD BE REPEATED FOR DL + MAXIMUM LL. F.S. SHOULD BE GREATER THAN 1.5 FOR THIS CONDITION.

U. S. Army Corps of Engineers

Figure 6-4. Example of bearing capacity computation for inclined eccentric load on rectangular footing.

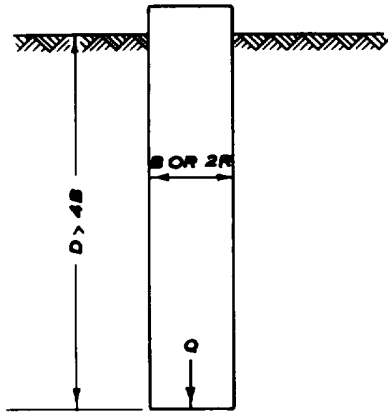

BEARING CAPACITY FACTORS,  $N_c$  FOR FOUNDATIONS IN CLAY ( $\phi = 0^\circ$ )

B/L	$N_c$
1 (SQUARE OR CIRCLE)	9.0
0.5	8.2
0 (STRIP FOOTING)	7.5

NOTE: BEARING CAPACITY FACTORS BASED ON A SMOOTH BASE AND D/B GREATER THAN 4

B = WIDTH OF FOOTING  
L = LENGTH OF FOOTING  
D = DEPTH OF FOOTING

$$Q/L = cBN_c + \gamma DB + 2Df_s \text{ (STRIP LOADING)}$$

$$Q = cB^2N_c + \gamma DB^2 + 4Bdf_s \text{ (SQUARE LOADING)}$$

$$Q = c\pi R^2N_c + \gamma D\pi R^2 + 2\pi Rdf_s \text{ (CIRCULAR LOADING)}$$

NOTE: THE SKIN FRICTION,  $f_s$ , IS USUALLY TAKEN AS ONE-HALF THE UNCONFINED COMPRESSIVE STRENGTH OF THE CLAY FOUNDATION. FOR PILES THE VALUE OF  $f_s$  SHOULD NOT EXCEED THE MINIMUM ADHESION VALUE GIVEN IN PARAGRAPH 46b. BECAUSE SKIN FRICTION,  $f_s$ , IS NOT ALWAYS RELIABLE, IT IS OFTEN IGNORED.

**(a) DEEP FOUNDATION IN HOMOGENEOUS CLAY**

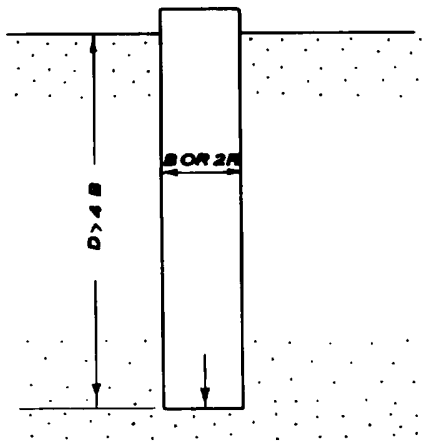

**COMPLETE EMBEDMENT IN SAND**

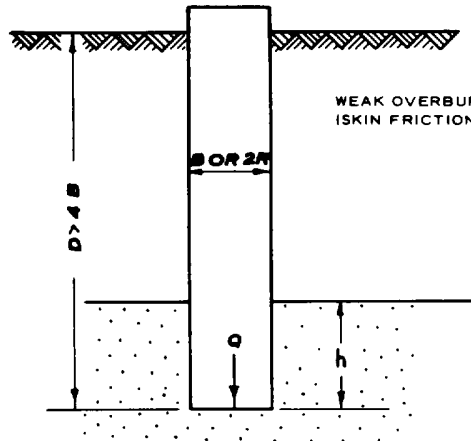

**PARTIAL EMBEDMENT IN SAND**

$$Q/L = \gamma DBN_q + 0.5\gamma B^2 N_\gamma + 2Df_s \text{ (STRIP LOADING)}$$

$$Q = \gamma DB^2N_q + 0.4\gamma B^3N_\gamma + 4Bdf_s \text{ (SQUARE LOADING)}$$

$$Q = \gamma D\pi R^2N_q + 0.6\gamma \pi R^3N_\gamma + 2\pi Rdf_s \text{ (CIRCULAR LOADING)}$$

$$Q/L = \gamma DBN_q + 0.5\gamma B^2 N_\gamma + 2hf_s \text{ (STRIP LOADING)}$$

$$Q = \gamma DB^2N_q + 0.4\gamma B^3N_\gamma + 4Bhf_s \text{ (SQUARE LOADING)}$$

$$Q = \gamma D\pi R^2N_q + 0.6\gamma \pi R^3N_\gamma + 2\pi Rhf_s \text{ (CIRCULAR LOADING)}$$

$$f_s = 1/2 K \gamma D \tan \delta$$

$$f_s = K \gamma (D - h/2) \tan \delta$$

WHERE K = COEFFICIENT OF EARTH PRESSURE DEPENDENT ON DENSITY OF SAND AND METHOD OF FOUNDATION PLACEMENT (SEE CHAPTER 12)

$N_q$  AND  $N_\gamma$  = BEARING CAPACITY FACTORS FOR SHALLOW FOUNDATIONS (SEE FIGURE 6.1)

$\delta$  = ANGLE OF FRICTION BETWEEN SAND AND FOUNDATION ( $\delta < \phi$ )

**(b) DEEP FOUNDATION IN SAND**

Figure 6-5. Ultimate bearing capacity of deep foundations.

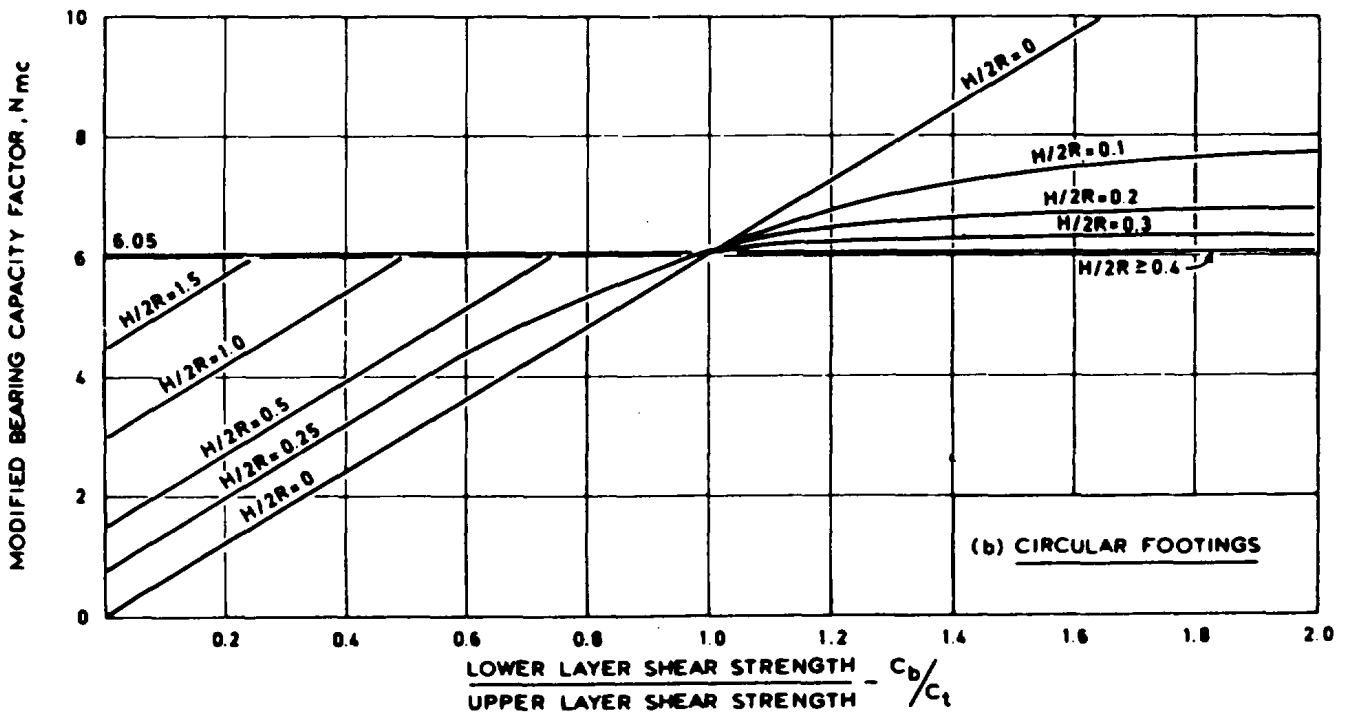
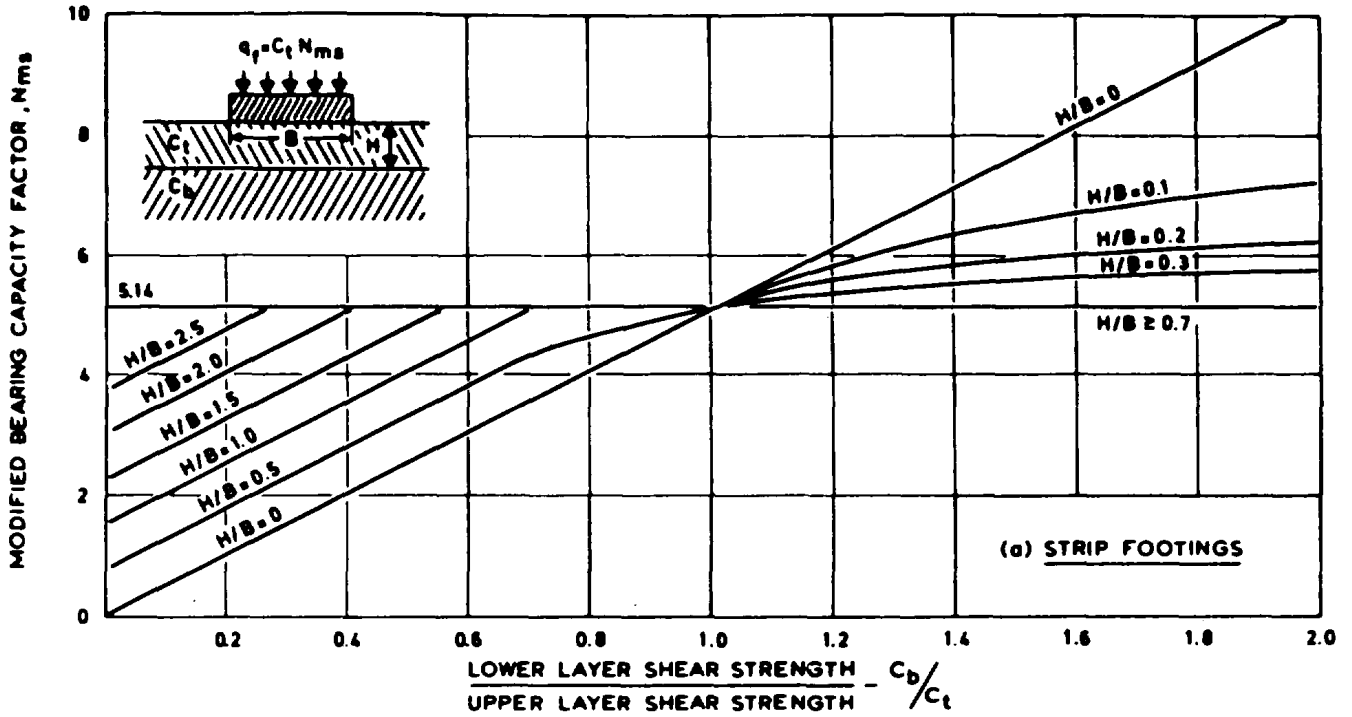

U. S. Army Corps of Engineers

Figure 6-6. Bearing capacity factors for strip and circular footings on layered foundations in clay.

Table 6-2. Allowable Bearing Pressure for Jointed Rock

<u>RQD</u>	<u>q<sub>a</sub></u> <u>tsf</u>
100	300
90	200
75	120
50	65
25	30
0	10

a If tabulated value exceeds unconfined compressive strength of intact samples of the rock, allowable pressure equals unconfined compressive strength.

U. S. Army Corps of Engineers



## CHAPTER 7

DEWATERING AND GROUNDWATER CONTROL

---

**7-1. General.** The following topics concerning foundation design using dewatering and groundwater control techniques are discussed in the latest revision of TM 5-818-5 / NAVFAC P-418 / AFM 88-5, Chap. 6:

- a. Excavations requiring drainage.*
- b. Seepage control.*
- c. Seepage cutoffs.*

- d. Control of surface waters.*
- e. Sheet-pile cofferdams.*
- f. Foundation underdrainage and waterproofing.*

**7-2. Foundation problems.** The problems concerning dewatering or groundwater control should be referred to the above-mentioned manual.

## CHAPTER 8

## SLOPE STABILITY ANALYSIS

**8-1. General.** This chapter is concerned with characteristics and critical aspects of the stability of excavation slopes; methods of designing slopes, including field observations and experience, slope stability charts, and detailed analyses; factors of safety; and methods of stabilizing slopes and slides. The emphasis in this chapter is on simple, routine procedures. It does not deal with specialized problems, such as the stability of excavated slopes during earthquakes.

**8-2. Slope stability problems.** Excavation slope instability may result from failure to control seepage forces in and at the toe of the slope, too steep slopes for the shear strength of the material being excavated, and insufficient shear strength of subgrade soils. Slope instability may occur suddenly, as the slope is being excavated, or after the slope has been standing for some time. Slope stability analyses are useful in sands, silts, and normally consolidated and overconsolidated clays, but care must be taken to select the correct strength parameter. Failure surfaces are shallow in cohesionless materials and have an approximately circular or sliding wedge shape in clays.

*a. Cohesionless slopes resting on firm soil or rock.* The stability of slopes consisting of cohesionless soils depends on the angle of internal friction  $\phi'$ , the slope angle, the unit weight of soil, and pore pressures. Generally, a slope of 1 vertical (V) on 1 1/2 horizontal (H) is adequate; but if the slope is subjected to seepage or sudden drawdown, a slope of 1V on 3H is commonly employed. Failure normally occurs by surface raveling or shallow sliding. Where consequences of failure may be important, required slopes can be determined using simple infinite slope analysis. Values of  $\phi'$  for stability analyses are determined from laboratory tests or estimated from correlations (para 3-6). Pore pressure due to seepage reduces slope stability, but static water pressure, with the same water level inside and outside the slopes, has no effect. Benches, paved ditches, and planting on slopes can be used to reduce runoff velocities and to retard erosion. Saturated slopes in cohesionless materials may be susceptible to liquefaction and flow slides during earthquakes, while dry slopes are subject to settlement and raveling. Relative densities of 75 percent or larger are required to ensure seismic stability, as discussed in Chapter 17.

*b. Cohesive slopes resting on firm soil or rock.* The stability of slopes consisting of cohesive soils

depends on the strength of soil, its unit weight, the slope height, the slope angle, and pore pressures. Failure usually occurs by sliding on a deep surface tangent to the top of firm materials. For relatively high slopes that drain slowly, it may be necessary to analyze the stability for three limiting conditions:

(1) *Short-term or end-of-construction condition.* Analyze this condition using total stress methods, with shear strengths determined from Q tests on undisturbed specimens. Shear strengths from unconfirmed compression tests may be used but generally may show more scatter. This case is often the only one analyzed for stability of excavated slopes. The possibility of progressive failure or large creep deformations exists for safety factors less than about 1.25 to 1.50.

(2) *Long-term condition.* If the excavation is open for several years, it may be necessary to analyze this condition using effective stress methods, with strength parameters determined from S tests or R tests on undisturbed specimens. Pore pressures are governed by seepage conditions and can be determined using flow nets or other types of seepage analysis. Both internal pore pressures and external water pressures should be included in the analyses. This case generally does not have to be analyzed.

(3) *Sudden drawdown condition, or other conditions where the slope is consolidated under one loading condition and is then subjected to a rapid change in loading, with insufficient time for drainage.* Analyze this condition using total stress methods, with shear strengths measured in R and S tests. Shear strength shall be based on the minimum of the combined R and S envelopes. This case is not normally encountered in excavation slope stability.

*c. Effect of soft foundation strata.* The critical failure mechanism is usually sliding on a deep surface tangent to the top of an underlying firm layer. Short-term stability is usually more critical than long-term stability. The strength of soft clay foundation strata should be expressed in terms of total stresses and determined using Q triaxial compression tests on undisturbed specimens or other methods described in chapter 4.

**8-3. Slopes In soils presenting special problems.**

*a. Stiff-fissured clays and shales.* The shearing resistance of most stiff-fissured clays and shales may be

far less than suggested by the results of shear tests on undisturbed samples. This result is due, in part, to prior shearing displacements that are much larger than the displacement corresponding to peak strength. Slope failures may occur progressively, and over a long period of time the shearing resistance may be reduced to the residual value—the minimum value that is reached only at extremely large shear displacements. Temporary slopes in these materials may be stable at angles that are steeper than would be consistent with the mobilization of only residual shear strength. The use of local experience and empirical correlations are the most reliable design procedures for these soils.

*b. Loess.* Vertical networks of interconnected channels formed by decayed plant roots result in a high vertical permeability in loess. Water percolating downward destroys the weakly cemented bonds between particles, causing rapid erosion and slope failure. Slopes in loess are frequently more stable when cut vertically to prevent infiltration. Benches at intervals can be used to reduce the effective slope angle. Horizontal surfaces on benches and at the top and bottom of the slope must be sloped slightly and paved or planted to prevent infiltration. Ponding at the toe of a slope must be prevented. Local experience and practice are the best guides for spacing benches and for protecting slopes against infiltration and erosion.

*c. Residual soils.* Depending on rock type and climate, residual soils may present special problems with respect to slope stability and erosion. Such soils may contain pronounced structural features characteristic of the parent rock or the weathering process, and their characteristics may vary significantly over short distances. It may be difficult to determine design shear strength parameters from laboratory tests. Representative shear strength parameters should be determined by back-analyzing slope failures and by using empirical design procedures based on local experience.

*d. Highly sensitive clays.* Some marine clays exhibit dramatic loss of strength when disturbed and can actually flow like syrup when completely remolded. Because of disturbance during sampling, it may be difficult to obtain representative strengths for such soils from laboratory tests. Local experience is the best guide to the reliability of laboratory shear strength values for such clays.

*e. Hydraulic fills.* See Chapter 15.

**8-4. Slope stability charts.**

*a. Uniform soil, constant shear strength,  $\phi = 0$ , rotational failure.*

(1) *Groundwater at or below toe of slope.* Determine shear strength from unconfined compression, or better, from Q triaxial compression tests. Use the upper diagram of figure 8-1 to compute the safety factor. If the center and depth of the critical circle are desired, obtain them from the lower diagrams of figure 8-1.

(2) *Partial slope submergence, seepage*

*surcharge loading, tension cracks.* The effect of partial submergence of a slope is given by a factor  $\mu_w$  in figure 8-2; seepage is given by a factor  $\mu_w'$  in figure 8-2; surcharge loading is given by a factor  $\mu_q$  in figure 8-2; and tension cracks is given by a factor  $\mu_t$  in figure 8-3. Compute safety factor from the following:

$$F = \frac{\mu_w \mu_w' \mu_q \mu_t N_0 C}{\gamma H + q - \gamma_w H_w'} \quad (8-1)$$

where

$\gamma$  = total unit weight of soil

$q$  = surcharge loading

$N_0$  = stability number from figure 8-1

If any of these conditions are absent, their corresponding  $i$  factor equals 1.0; if seepage out of the slope does not occur,  $H_w$  equals  $iH$ .

*b. Stratified soil layers,  $\phi = 0$ , rotational failure.*

(1) Where the slope and foundation consist of a number of strata, each having a constant shear strength, the charts given in figures 8-1 through 8-3 can be used by computing an equivalent average shear strength for the failure surface. However, a knowledge of the location of the failure surface is required. The coordinates of the center of the circular failure surface can be obtained from the lower diagrams of figure 8-1. The failure surface can be constructed, and an average shear strength for the entire failure surface can be computed by using the length of arc in each stratum or the number of degrees intersected by each soil stratum as a weighing factor.

(2) It may be necessary to calculate the safety factor for failure surfaces at more than one depth, as illustrated in figure 8-4.

*c. Charts for slopes in uniform soils with  $\phi > 0$ .*

(1) A stability chart for slopes in soils with  $\phi > 0$  is shown in figure 8-5. Correction factors for surcharge loading at the top of the slope, submergence, and seepage are given in figure 8-2; and for tension cracks, in figure 8-3.

(2) The location of the critical circle can be obtained, if desired, from the plot on the right side of figure 8-5. Because simple slopes in uniform soils with  $\phi > 0$  generally have critical circles passing through the toe of the slope, the stability numbers given in figure 8-5 were developed by analyzing toe circles. Where subsoil conditions are not uniform and there is a weak layer beneath the toe of the slope, a circle passing beneath the toe may be more critical than a toe circle.

*d. Infinite slopes.* Conditions that can be analyzed accurately using charts for infinite slope analyses shown in figure 8-6 are-

(1) Slopes in cohesionless materials where the critical failure mechanism is shallow sliding or surface raveling.

(2) Slopes where a relatively thin layer of soil overlies firmer soil or rock and the critical failure mechanism is sliding along a plane parallel to the slope, at the top of the firm layer.

*e. Shear strength increasing with depth and  $\phi = 0$ .* A chart for slopes in soils with shear strength increasing with depth and  $\phi = 0$  is shown in figure 8-7.

#### **8-5. Detailed analyses of slope stability.**

If the simple methods given for estimating slope stability do not apply and site conditions and shear strengths have been determined, more detailed stability analyses may be appropriate. Such methods are described in engineering literature, and simplified versions are presented below.

*a. The method of moments for  $\phi = 0$ .* This method is simple but useful for the analysis of circular slip surfaces in  $\phi = 0$  soils, as shown in figure 8-8.

*b. The ordinary method of slices.* This simple and conservative procedure for circular slip surfaces can be used in soils with  $\phi \geq 0$ . For flat slopes with high pore pressures and  $\phi > 0$ , the factors of safety calculated by

this method may be much smaller than values calculated by more accurate methods. An example is presented in figures 8-9 through 8-11. Various trial circles must be assumed to find the critical one. If  $\phi$  large and  $c$  is small, it may be desirable to replace the circular sliding surface by plane wedges at the active and passive extremities of the sliding mass.

*c. The simplified wedge method.* This method is a simple and conservative procedure for analyzing noncircular surfaces. An example is shown in 8-12. Various trial failure surfaces with different locations for active and passive wedges must be assumed. The base of the central sliding wedge is generally at the bottom of a soft layer.

**8-6. Stabilization of slopes.** If a slide is being stabilized by flattening the slope or by using a buttress or retaining structure, the shear strength at time of failure corresponding to a factor of safety of 1 should be calculated. This strength can be used to evaluate the safety factor of the slope after stabilization. Methods for stabilizing slopes and landslides are summarized in table 8-1. Often one or more of these schemes may be used together. Schemes I through V are listed approximately in order of increasing cost.

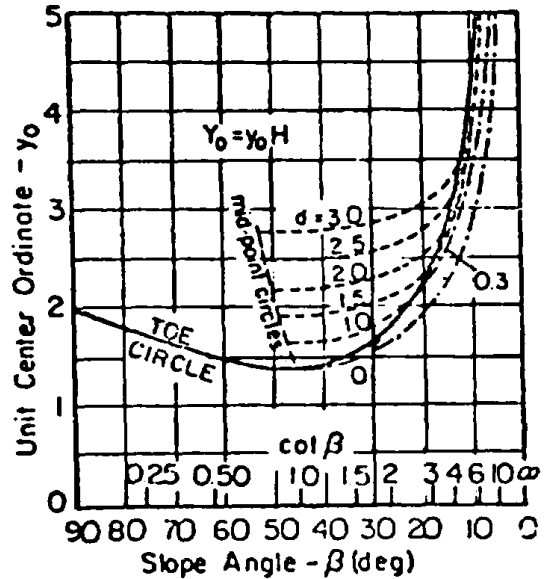
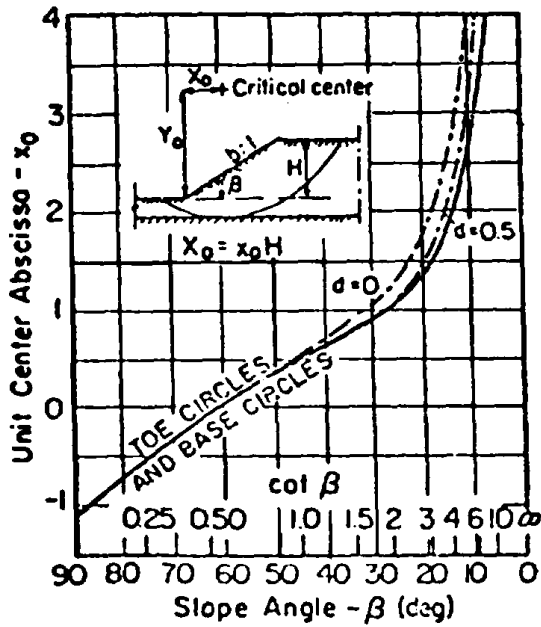
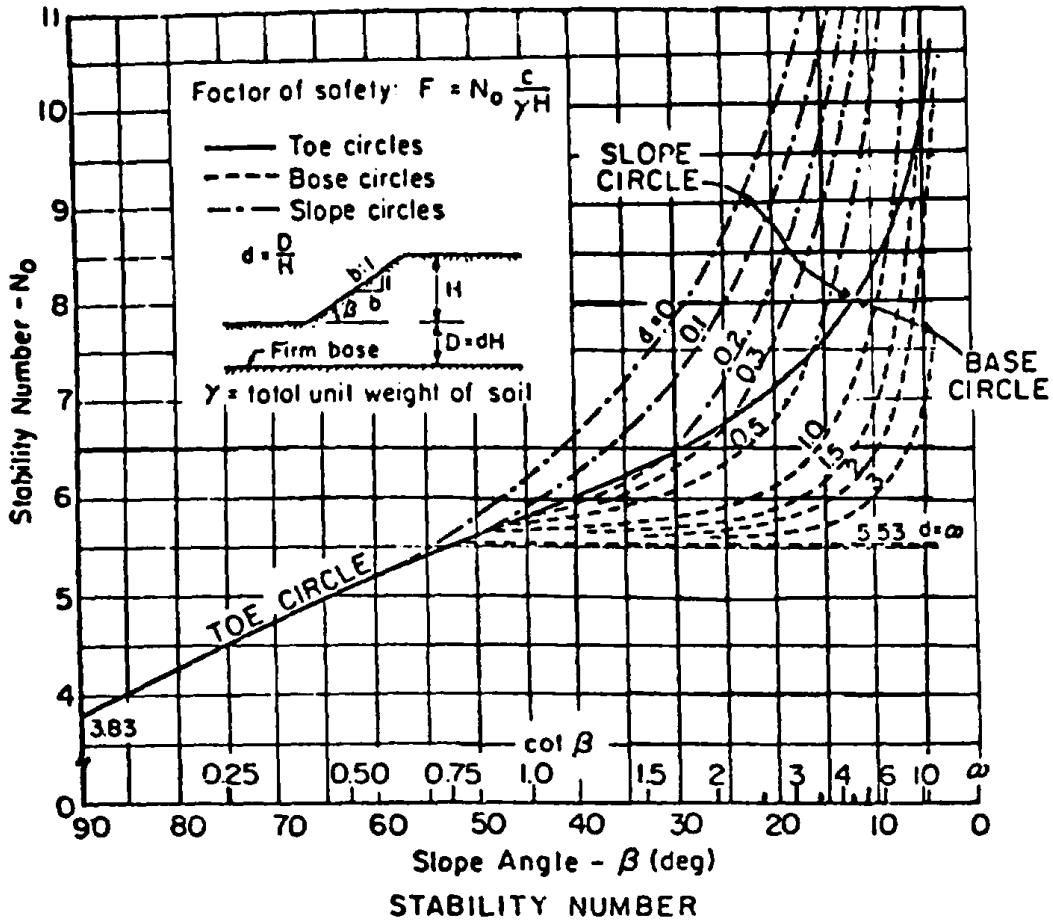

CENTER COORDINATES FOR CRITICAL CIRCLE

U. S. Army Corps of Engineers

Figure 8-1. Slope stability charts for  $\phi = 0$  soils.

REDUCTION FACTORS FOR SURCHARGE LOADING ( $\mu_q$ )

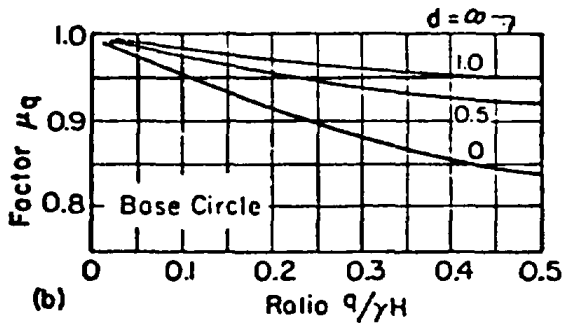
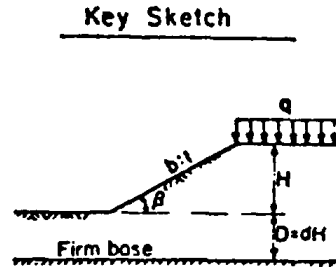
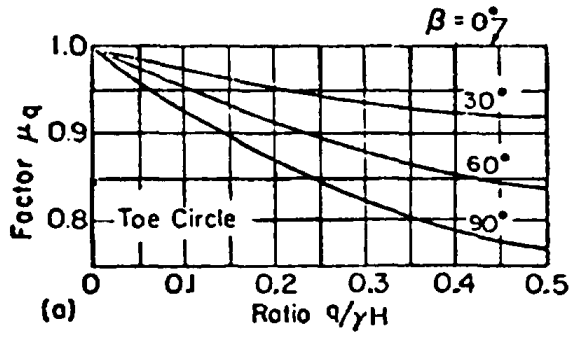

REDUCTION FACTORS FOR SUBMERGENCE ( $\mu_w$ ) AND SEEPAGE ( $\mu'_w$ )

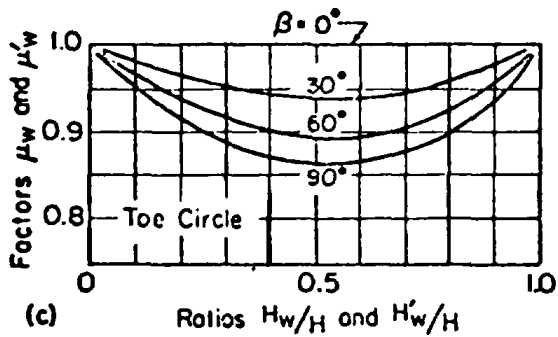

Key Sketches

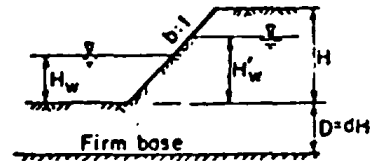
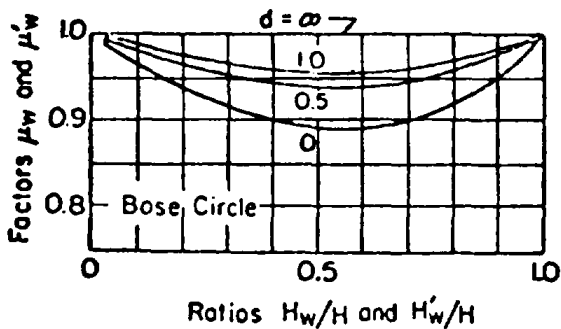
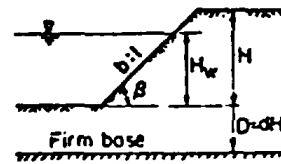

U. S. Army Corps of Engineers

Figure 8-2. Reduction factors ( $\mu_q$ ,  $\mu_w$ ,  $\mu'_w$ ) for slope stability charts for  $\phi = 0$  and  $\phi > 0$  soils.

REDUCTION FACTOR FOR TENSION CRACK  
No Hydrostatic Pressure in Crack

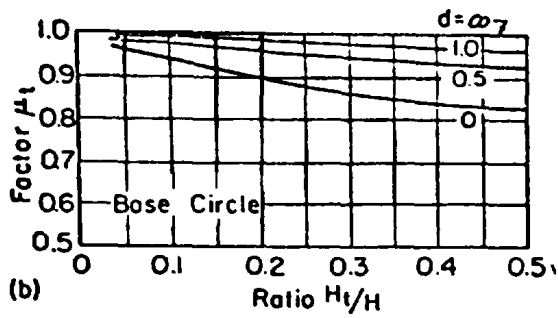
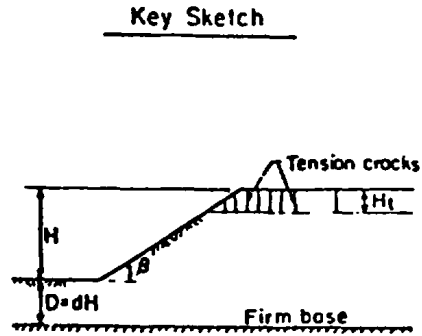
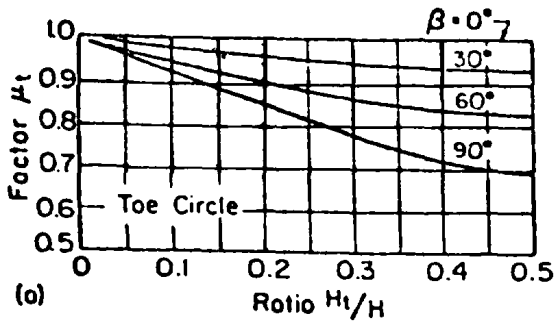

REDUCTION FACTOR FOR TENSION CRACK  
Full Hydrostatic Pressure in Crack

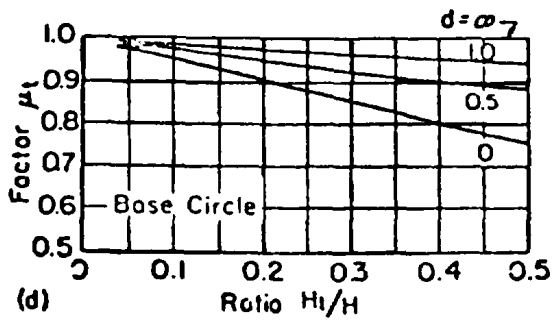
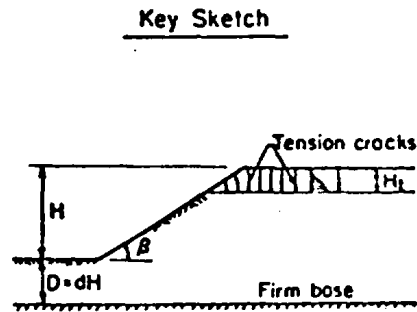
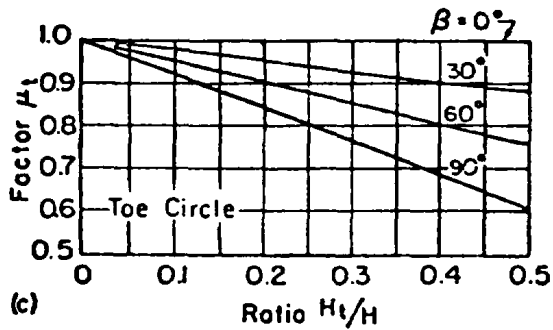

U. S. Army Corps of Engineers

Figure 8-3. Reduction factors (tension cracks,  $\mu_t$ ) for slope stability charts for  $\phi = 0$  and  $\phi > 0$  soils.





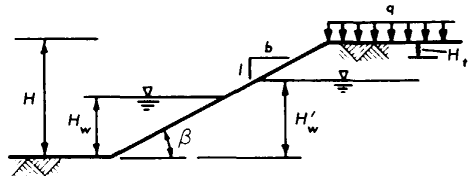
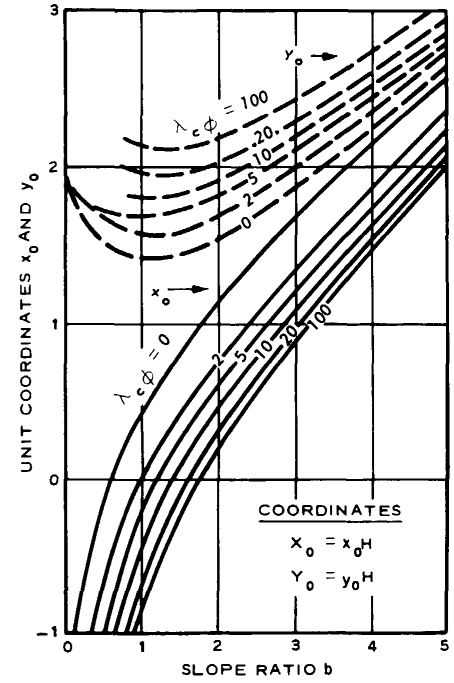
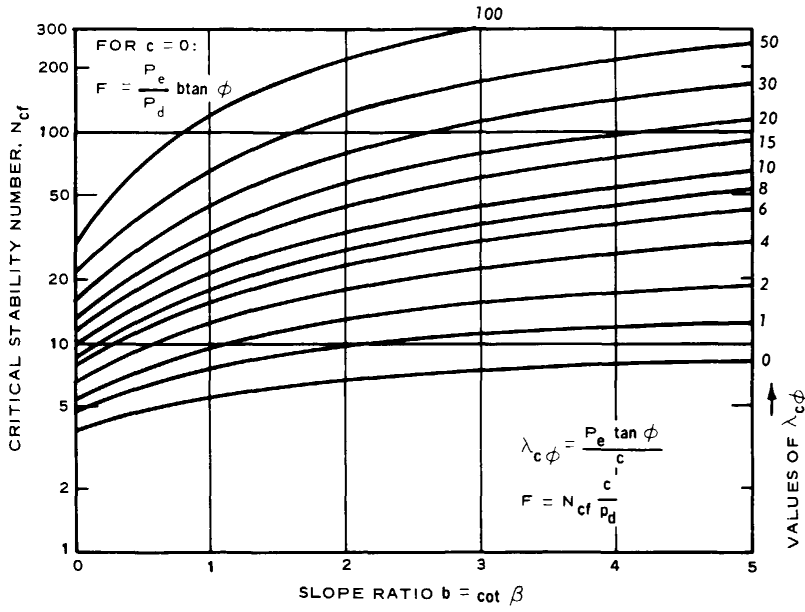

$$P_d = \frac{\gamma H + q - \gamma_w H_w}{\mu_q \mu_w \mu_t}$$

$$P_e = \frac{\gamma H + q - \gamma_w H'_w}{\mu_q \mu'_w}$$

(IN FORMULA FOR  $P_e$  TAKE  $q = 0$ ,  $\mu_q = 1$  FOR UNCONSOLIDATED CONDITION)

CENTER COORDINATES FOR CRITICAL CIRCLE

U. S. Army Corps of Engineers

Figure 8-5. Slope stability charts for  $\phi > 0$  soils.

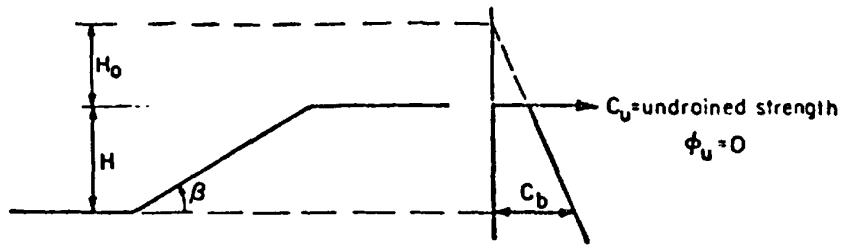

Steps:

- ① Extrapolate strength profile upward to determine value of  $H_0$ , where strength profile intersects zero
- ② Calculate  $M = H_0/H$
- ③ Determine stability number  $N$  from chart below
- ④ Determine  $C_b$  = strength at bottom of slope
- ⑤ Calculate  $F = N \frac{C_b}{\gamma(H+H_0)}$

Use  $\gamma = \gamma_{\text{buoyant}}$  for submerged slope

Use  $\gamma = \gamma_m$  for no water outside slope

Use average  $\gamma$  for partly submerged slope

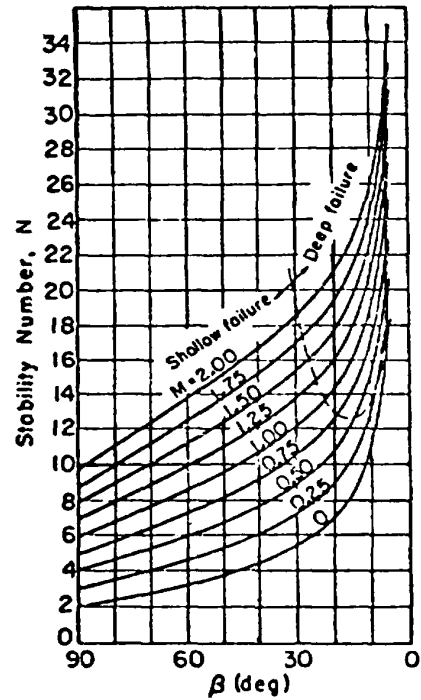

U. S. Army Corps of Engineers

Figure 8-6. Stability charts for infinite slopes.

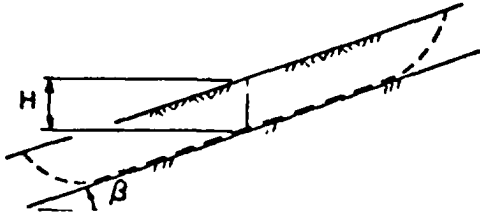

$\gamma$  = total unit weight of soil  
 $\gamma_w$  = unit weight of water  
 $c'$  = cohesion intercept } Effective Stress  
 $\phi'$  = friction angle }  
 $r_u$  = pore pressure ratio =  $\frac{u}{\gamma H}$   
 $u$  = pore pressure at depth H

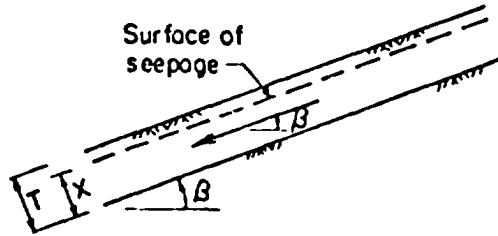

Seepage parallel to slope  
 $r_u = \frac{x}{T} \frac{\gamma_w}{\gamma} \cos^2 \beta$

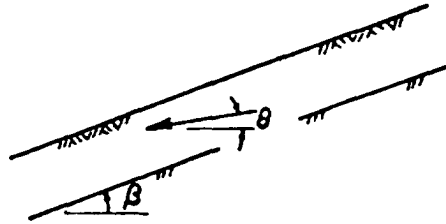

Seepage emerging from slope  
 at angle  $\theta$

$$r_u = \frac{\gamma_w}{\gamma} \frac{1}{1 + \tan \beta \tan \theta}$$

**Steps:**

- ① Determine  $r_u$  from measured pore pressures or formulas at right
- ② Determine A and B from charts below
- ③ Calculate  $F = A \frac{\tan \phi'}{\tan \beta} + B \frac{c'}{\gamma H}$

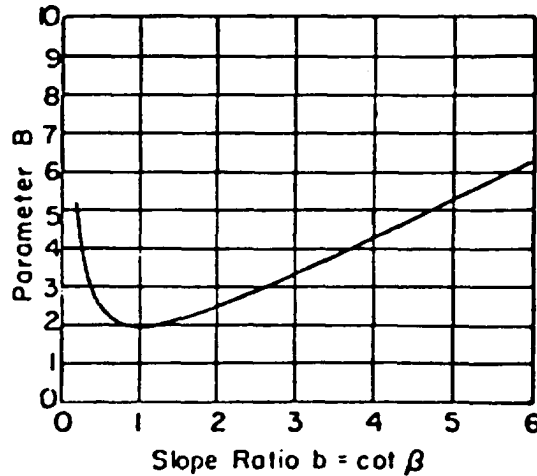
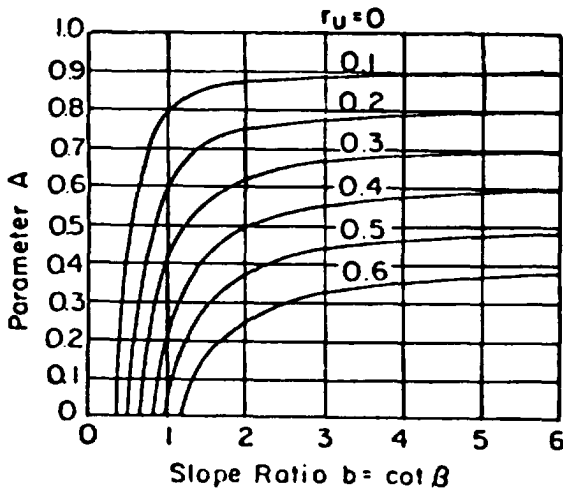

U. S. Army Corps of Engineers

Figure 8-7. Slope stability charts for  $\phi = 0$  and strength increasing with depth.

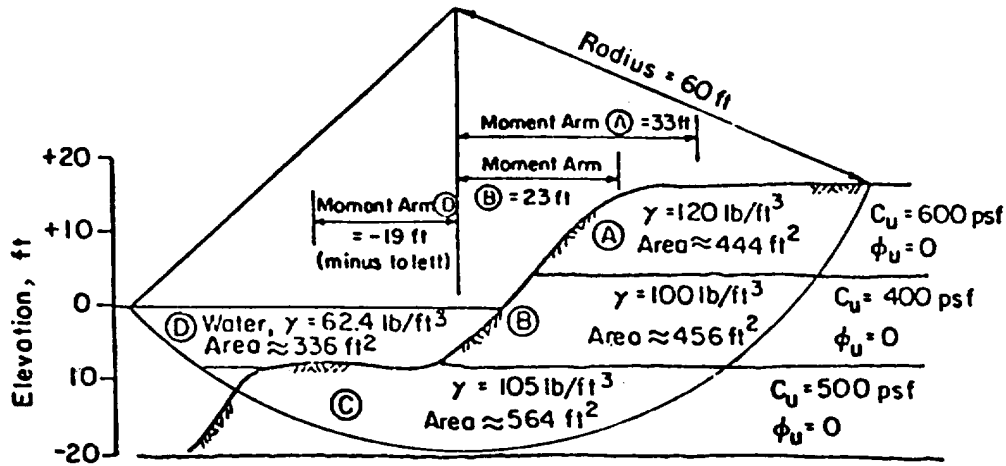

Section	Area (ft <sup>2</sup> )	$\gamma$ (lb/ft <sup>3</sup> )	Weight (lb/ft)	Moment Arm (ft)	Moment (ft-lb/ft)
Ⓐ	444	120	53,280	+ 33	+ 1.76 × 10 <sup>6</sup>
Ⓑ	456	100	45,600	+ 23	+ 1.05 × 10 <sup>6</sup>
Ⓒ	564	105	59,220	0	0.0
Ⓓ	336	62.4	20,970	- 19	- 0.40 × 10 <sup>6</sup>
<b>Total Overturning Moment =</b>					<b>+ 2.41 × 10<sup>6</sup></b>

Section	Ave. Length (ft)	C <sub>u</sub> (psf)	Force (lb/ft)	Moment Arm = Radius (ft)	Moment (ft-lb/ft)
Ⓐ	14	600	8,400	60	0.50 × 10 <sup>6</sup>
Ⓑ	16.5	400	6,600	60	0.40 × 10 <sup>6</sup>
Ⓒ	69	500	34,500	60	2.07 × 10 <sup>6</sup>
Ⓓ	18	0	0	60	0.00
<b>Total Resisting Moment =</b>					<b>2.97 × 10<sup>6</sup></b>

$$\text{Factor of Safety, } F = \frac{\text{Resisting Moment}}{\text{Overturning Moment}} = \frac{2.97 \times 10^6}{2.41 \times 10^6} = 1.23$$

U. S. Army Corps of Engineers

Figure 8-8. Method of moments for  $\phi = 0$ .

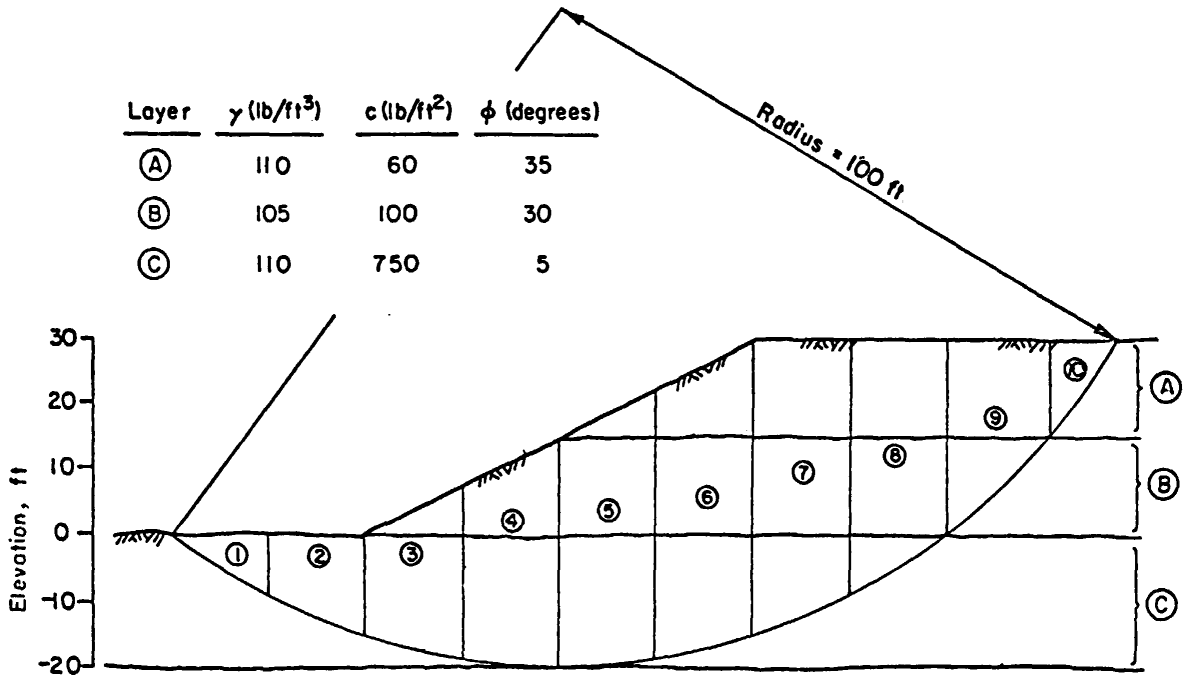

U. S. Army Corps of Engineers

Figure 8-9. Example problem for ordinary method of slices.

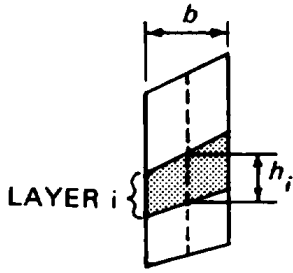

$\gamma_i$  = unit weight of layer  $i$

$h_i$  = height of layer at center of slice

$W_i$  = partial weight =  $bh_i\gamma_i$

$\Sigma W_i$  = total weight of slice

Slice No.	b ft	$h_i$ ft	$\gamma_i$ lb/ft <sup>3</sup>	$W_i$ lb/ft	$\Sigma W_i$ lb/ft
1	15	5	110	8,100	8,200
2	15	13	110	21,400	21,400
3	15	4	105	6,300	35,200
		17.5	110	28,900	
4	15	11.5	105	18,100	50,300
		19.5	110	32,200	
5	15	4	110	6,600	62,400
		15	105	23,600	
		19.5	110	32,200	
6	15	11.5	110	19,000	71,500
		15	105	23,600	
		17.5	110	28,900	
7	15	15	110	24,800	69,800
		15	105	23,600	
		15	110	21,400	
8	15	15	110	24,800	56,600
		15	105	23,600	
		5	110	8,200	
9	16	15	110	26,400	39,000
		7.5	105	12,600	
10	11	7.5	110	9,100	9,100

U. S. Army Corps of Engineers

Figure 8-10. Example of use of tabular form for computing weights of slices.

Slice No.	W kip/ft	ℓ ft	α deg	C kip/ft <sup>2</sup>	φ deg	<sup>u</sup> Zero for Total Stress Analysis	uℓ	W cos α kip/ft	W cos α - uℓ	W cos α - uℓ tan φ	cℓ	W sin α
1	8.2	17.5	-32	0.75	5			6.9		0.61	13.12	-4.35
2	21.4	16.2	-22	0.75	5			19.8		1.73	12.15	-8.22
3	35.2	15.5	-13	0.75	5			34.3		3.00	11.62	-7.92
4	50.3	15.1	-4	0.75	5			50.2		4.39	11.32	-3.51
5	62.4	15.1	4	0.75	5			62.2		5.44	11.32	4.35
6	71.5	15.5	13	0.75	5			69.7		6.10	11.62	16.08
7	69.8	16.2	22	0.75	5			64.7		5.66	12.15	26.15
8	56.6	17.5	32	0.75	5			48.0		4.20	13.12	30.00
9	39.0	22.0	43	0.10	30			28.5		16.45	2.20	26.60
10	9.1	18.5	55	0.06	35			5.2		3.64	1.11	7.45
									Σ 51.2	99.7	86.8	

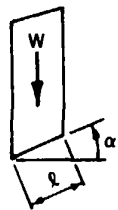

c = cohesion intercept  
 φ = friction angle  
 u = pore pressure

} at base of slice

$$F = \frac{\Sigma(W \cos \alpha - u\ell) \tan \phi + \Sigma c\ell}{\Sigma W \sin \alpha}$$

$$F = \frac{150.1}{86.8} = 1.74$$

Figure 8-11. Example of use of tabular form for calculating factor of safety by ordinary method of slices.

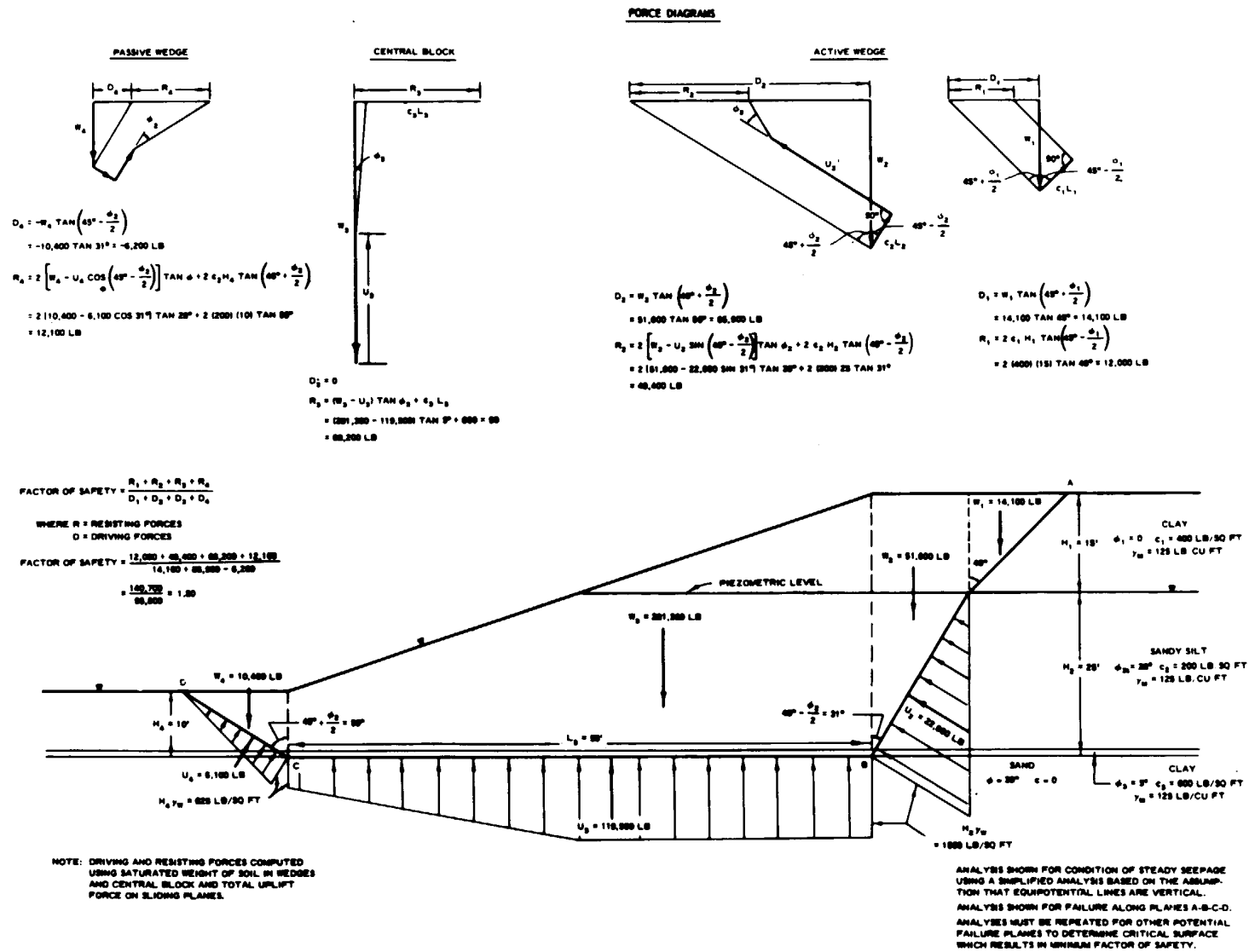
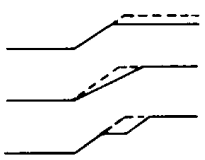
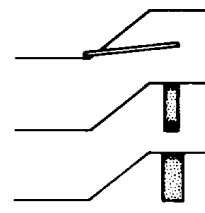
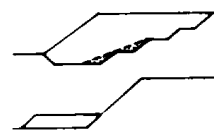
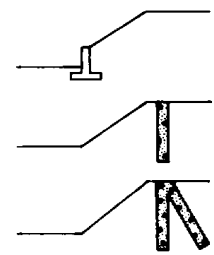

Figure 8-12. Example of simplified wedge analysis.



Scheme	Applicable Methods	Comments
<p>I. Excavation</p> 	<ol style="list-style-type: none"> <li>1. Reduce slope height by excavation at top of slope.</li> <li>2. Flatten the slope angle.</li> <li>3. Excavate a bench in upper part of slope.</li> <li>4. Excavate the entire slide mass.</li> </ol>	<p>Area has to be accessible to construction equipment. Disposal site needed for excavated soil. Drainage sometimes incorporated in this method.</p>
<p>II. Drainage</p> 	<ol style="list-style-type: none"> <li>1. Small diameter, horizontal drains (hydraugers).</li> <li>2. Continuous deep subdrain trench. Generally 3 to 15 ft deep.</li> <li>3. Drilled vertical wells - generally 18- to 36-in. diameter.</li> <li>4. Improve surface drainage along top of slope with open ditch or paved gutter. Install deep-rooted, erosion-resistant plants on slope face.</li> </ol>	<ol style="list-style-type: none"> <li>1. Most effective if can tap natural aquifer. Drains are usually free-flowing.</li> <li>2. Trench bottom should be sloped to drain and be tapped with an outlet pipe. Perforated pipe should be placed on trench bottom. Top of trench should be capped with impervious material.</li> <li>3. Can be pumped or tapped with a gravity outlet. Several wells in a row, joined at bottom can form a drainage gallery. Top of each well should be capped with impervious material.</li> <li>4. Good practice for most slopes. Direct the discharge away from slide mass.</li> </ol>
<p>III. Earth or rock buttress (or berm fill)</p> 	<ol style="list-style-type: none"> <li>1. Excavate slide mass and replace with compacted earth or rock buttress fill. Toe of buttress must be keyed into firm soil or rock below slide plane. Drain blanket with gravity flow outlet is provided in back slope of buttress fill.</li> <li>2. Compacted earth or rock berm placed at and beyond the toe. Drainage may be provided behind berm.</li> </ol>	<ol style="list-style-type: none"> <li>1. Access for construction equipment and temporary stockpile area required. Excavated soil can usually be used in fill. Underpinning of existing structures may be required. Might have to be done in shore sections if stability during construction is critical.</li> <li>2. Sufficient width and thickness of berm required so failure will not occur below or through berm.</li> </ol>
<p>IV. Retaining structures</p> 	<ol style="list-style-type: none"> <li>1. Retaining wall - crib or cantilever type.</li> <li>2. Drilled, cast-in-place vertical piles, bottomed well below bottom of slide plane. Generally 18 to 36 in. in diameter and 4- to 8-ft spacing.</li> <li>3. Drilled, cast-in-place vertical piles tied back with battered piles or a deadman. Piles bottomed well below slide plane. Generally 12 to 30 in. in diameter and at 4- to 8-ft spacing.</li> <li>4. Earth anchors and rock bolts.</li> <li>5. Reinforced earth.</li> </ol>	<ol style="list-style-type: none"> <li>1. Usually expensive. Cantilever walls might have to be tied back.</li> <li>2. Spacing should be such that soil can arch between piles. Grade beam can be used to tie piles together. Very large diameter (6 ft ±) piles have been used for deep slides.</li> <li>3. Space close enough so soil will arch between piles. Piles can be tied together with grade beam.</li> <li>4. Can be used for high slopes, and in very limited stress. Conservative design should be used, especially for permanent support.</li> <li>5. Usually expensive.</li> </ol>
<p>V. Special techniques</p>	<ol style="list-style-type: none"> <li>1. Grouting</li> <li>2. Chemical injection</li> <li>3. Electroosmosis (in fine-grained soils).</li> <li>4. Freezing</li> <li>5. Heating</li> </ol>	<ol style="list-style-type: none"> <li>1. and 2. Used successfully in a number of cases. Used at other times with little success. At the present, theory is not completely understood.</li> <li>3. Generally expensive.</li> <li>4. and 5. Special methods which must be specifically evaluated at each site. Can be expensive.</li> </ol> <p>All of these techniques should be carefully evaluated in advance to determine the probable cost and effectiveness.</p>

(Courtesy of W. J. Turnbull and M. J. Hvorslev, "Special Problems in Slope Stability," *Journal, Soil Mechanics and Foundation Division*, Vol 93, No. SM4, 1967, pp 499-528. Reprinted by permission of the American Society of Civil Engineers, New York.)

Table 8-1. Methods of Stabilizing Slopes and Landslides

CHAPTER 9

SELECTION OF FOUNDATION TYPE

**9-1. Foundation - selection considerations.** Selection of an appropriate foundation depends upon the structure function, soil and groundwater conditions, construction schedules, construction economy, value of basement area, and other factors. On the basis of preliminary information concerning the purpose of the structure, foundation loads, and subsurface soil conditions, evaluate alternative types of foundations for the bearing capacity and total and differential settlements. Some foundation alternatives

for different subsoil conditions are summarized in table 9-1.

a. Some foundation alternatives may not be initially obvious. For example, preliminary plans may not provide for a basement, but when cost studies show that a basement permits a floating foundation that reduces consolidation settlements at little or no increase in construction cost, or even at a cost reduction, the value of a basement may be substantial. Benefits of basement areas include needed garage space, office or stor-

Table 9-1. Foundation Possibilities for Different Subsoil Conditions

Subsoil Conditions	Foundation Possibilities	
	Light, Flexible Structure	Heavy, Rigid Structure
Deep compact or stiff deposit	Footing foundations	<ol style="list-style-type: none"> <li>1. Footing foundations</li> <li>2. Shallow mat</li> </ol>
Deep compressible strata	<ol style="list-style-type: none"> <li>1. Footing foundations on compacted granular zone<sup>a</sup></li> <li>2. Shallow mat<sup>a</sup></li> <li>3. Friction piles</li> </ol>	<ol style="list-style-type: none"> <li>1. Deep mat with possible rigid construction in basement</li> <li>2. Long piles or caissons to by-pass</li> <li>3. Friction piles</li> </ol>
Soft or loose strata overlying firm strata	<ol style="list-style-type: none"> <li>1. Bearing piles or piers</li> <li>2. Footing foundations on compacted granular zone<sup>a</sup></li> <li>3. Shallow mat<sup>2</sup></li> </ol>	<ol style="list-style-type: none"> <li>1. Bearing piles or piers</li> <li>2. Deep mat</li> </ol>
Compact or stiff layer overlying a soft deposit	<ol style="list-style-type: none"> <li>1. Footing foundations<sup>a</sup></li> <li>2. Shallow mat<sup>a</sup></li> </ol>	<ol style="list-style-type: none"> <li>1. Deep mat (floating type)</li> <li>2. Long piles or caissons to by-pass soft deposit</li> </ol>
Alternating soft and stiff layers	<ol style="list-style-type: none"> <li>1. Footing foundations<sup>a</sup></li> <li>2. Shallow mat<sup>a</sup></li> </ol>	<ol style="list-style-type: none"> <li>1. Deep mat</li> <li>2. Piles or caissons to underlying firm stratum to provide satisfactory foundation</li> </ol>

<sup>a</sup> Consider possible advantages of site preloading, with and without vertical sand drains to accelerate consolidation.

(Courtesy of L. J. Goodman and R. H. Karol. *Theory and Practice of Foundation Engineering*, 1968, p 312. Reprinted by permission of Macmillan Company, Inc New York.)

age space, and space for air conditioning and other equipment. The last item otherwise may require valuable building space or disfigure a roofline.

b. While mat foundations are more expensive to design than individual spread footings, they usually result in considerable cost reduction, provided the total area of spread footings is a large percentage of the basement area. Mat foundations may decrease the required excavation area, compared with spread footings.

c. The most promising foundation types should be designed, in a preliminary manner, for detailed cost comparisons. Carry these designs far enough to determine the approximate size of footings, length and number of piles required, etc. Estimate the magnitude of differential and total foundation movements and the effect on structure. The behavior of similar foundation types in the area should be ascertained.

d. Final foundation design should not be started until alternative types have been evaluated. Also, the effect of subsurface conditions (bearing capacity and settlement) on each alternative should be at least qualitatively evaluated.

e. A checklist of factors that could influence foundation selection for family housing is shown in table 9-2.

**9-2. Adverse subsurface conditions.** If poor soil conditions are encountered, procedures that may be used to ensure satisfactory foundation performance include the following:

a. Bypass the poor soil by means of deep foundations extending to or into a suitable bearing material (chap. 11).

b. Design the structure foundations to accommodate expected differential settlements. Distinguish between settlements during construction that affect a structure and those that occur during construction before a structure is affected by differential settlements.

c. Remove the poor material, and either treat and replace it or substitute good compacted fill material.

d. Treat the soil in place prior to construction to improve its properties. This procedure generally requires considerable time. The latter two procedures are carried out using various techniques of soil stabilization described in chapter 16.

**9-3. Cost estimates and final selection.**

a. On the basis of tentative designs, the cost of each promising alternative should be estimated. Estimate sheets should show orderly entries of items, dimensions, quantities, unit material and labor costs, and cost extensions. Use local labor and material costs.

b. The preliminary foundation designs that are compared must be sufficiently completed to include all relevant aspects. For example, the increased cost of piling may be partially offset by pile caps that are smaller and less costly than spread footings. Similarly, mat or pile foundations may require less excavation. Foundation dewatering during construction may be a large item that is significantly different for some foundation alternatives.

c. The most appropriate type of foundation generally represents a compromise between performance, construction cost, design cost, and time. Of these, design cost is generally the least important and should not be permitted to be a controlling factor. If a lower construction cost can be achieved by an alternative that is more expensive to design, construction cost should generally govern.

d. Foundation soils pretreatment by precompression under temporary surcharge fill, regardless of whether vertical sand drains are provided to accelerate consolidation, requires a surcharge loading period of about 6 months to a year. The time required may not be available unless early planning studies recognized the possible foundation cost reduction that may be achieved. Precompression is frequently advantageous for warehouses and one-story structures. Precompression design should be covered as a separate design feature and not considered inherent in structure design.

Table 9-2. Checklist for Influence of Site Characteristics on Foundation Selection for Family Housing

Site Characteristics		Foundations <sup>a</sup>			
		Post	Spread	Slab-on-Grade (all)	Basement
<u>Natural Ground</u>	<u>Grading</u>				
Level	None	--	--	--	1, 2, 3, 4, 5
Rolling	None	--	--	Requires grading	1, 2, 3, 4, 5
Rolling	Cut and fill	--	1, 2, 3, 4, 5	1, 2, 3, 4, 5	1, 2, 3, 4, 5
Hilly	None	--	--	Requires grading	1, 2, 3, 4, 5
Hilly	Cut and fill	--	1, 2, 3, 4, 5	1, 2, 3, 4, 5	1, 2, 3, 4, 5
<u>Groundwater</u>					
Surface		--	Requires temporary lowering	--	Do not use
Footing level below footing level		--	--	--	Use perimeter drainage
<u>Soil Type</u>					
GW, GP, GM, GC SW, SP, SM, SC		1, 2	1, 2	1, 2	1, 2
ML, CL, OL MH, CH, OH		3, 4, 5, 6	3, 4, 5, 6	3, 4, 5, 6	3, 4, 5, 6

- <sup>a</sup>
1. Compaction control - increase density if required, use compaction control in fills.
  2. Check relative density of cohesionless (GW, GP, SW, SP) soils; generally based on standard penetration resistance.
  3. Use undrained shear strength,  $s_u$ , to estimate bearing capacity and stress ratios for slab design.
  4. Check if settlement is a problem.
  5. Check liquidity index as indication of normally or preconsolidated clay.
  6. Check expansive properties.

## CHAPTER 10

## SPREAD FOOTINGS AND MAT FOUNDATIONS

**10-1. General.** When required footings cover more than half the area beneath a structure, it is often desirable to enlarge and combine the footings to cover the entire area. This type of foundation is called a raft or mat foundation and may be cheaper than individual footings because of reduced forming costs and simpler excavation procedures. A mat foundation also may be used to resist hydrostatic pressures or to bridge over small, soft spots in the soil, provided the mat is adequately reinforced. Although mat foundations are more difficult and more costly to design than individual spread footings, they can be used effectively.

**10-2. Adequate foundation depth.** The foundation should be placed below the frost line (chap 18) because of volume changes that occur during freezing and thawing, and also below a depth where seasonal volume changes occur. The minimum depth below which seasonal volume changes do not occur is usually 4 feet, but it varies with location. If foundation soils consist of swelling clays, the depth may be considerably greater, as described in TM 5-818-7. On sloping ground, the foundation should be placed at a depth such that it will not be affected by erosion.

**10-3. Footing design.**

*a. Allowable bearing pressures.* Procedures for determining allowable bearing pressures are presented in chapter 6. In many instances, the allowable bearing pressure will be governed by the allowable settlement. Criteria for determining allowable settlement are discussed in chapter 5. The maximum bearing pressure causing settlement consists of dead load plus normal live load for clays, and dead load plus maximum live loads for sands. Subsoil profiles should be examined carefully to determine soil strata contributing to settlement.

*b. Footings on cohesive soils.*

(1) If most of the settlement is anticipated to occur in strata beneath the footings to a depth equal to the distance between footings, a settlement analysis should be made assuming the footings are independent of each other. Compute settlements for the maximum bearing pressure and for lesser values. An example of such an analysis is shown in figure 10-1. If significant settlements can occur in strata below a depth equal to the distance between footings, the settlement analysis should consider all footings to determine the settlement at selected footings. Determine the vertical stresses

beneath individual footings from the influence charts presented in chapter 5. The footing size should be selected on the basis of the maximum bearing pressure as a first trial. Depending on the nature of soil conditions, it may or may not be possible to proportion footings to equalize settlements. The possibility of reducing differential settlements by proportioning footing areas can be determined only on the basis of successive settlement analyses. If the differential settlements between footings are excessive, change the layout of the foundation, employ a mat foundation, or use piles.

(2) If foundation soils are nonuniform in a horizontal direction, the settlement analysis should be made for the largest footing, assuming that it will be founded on the most unfavorable soils disclosed by the borings and for the smallest adjacent footing. Structural design is facilitated if results of settlement analyses are presented in charts (fig 10-1) which relate settlement, footing size, bearing pressures, and column loads. Proper footing sizes can be readily determined from such charts when the allowable settlement is known. After a footing size has been selected, compute the factor of safety with respect to bearing capacity for dead load plus maximum live load condition.

*c. Footings on cohesionless soils.* The settlement of footings on cohesionless soils is generally small and will take place mostly during construction. A procedure for proportioning footings on sands to restrict the differential settlement to within tolerable limits for most structures is given in figure 10-2.

*d. Foundation pressures.* Assume a planar distribution of foundation pressure for the structural analysis of a footing. This assumption is generally conservative. For eccentrically loaded footings, the distribution of the bearing pressure should be determined by equating the downward load to the total upward bearing pressure and equating the moments of these forces about the center line in accordance with requirements of static equilibrium. Examples of the bearing pressure distribution beneath footings are shown in figure 10-3.

**10-4. Mat foundations.**

*a. Stability.* The bearing pressure on mat foundations should be selected to provide a factor of safety of

at least 2.0 for dead load plus normal live load and 1.5 for dead load plus maximum live load. By lowering the base elevation of the mat, the pressure that can be exerted safely by the building is correspondingly increased (chap 11), and the net increase in loading is reduced. The bearing pressure should be selected so that the settlement of the mat foundation will be within limits that the structure can safely tolerate as a flexible structure. If settlements beneath the mat foundation are

more than the rigidity of the structure will permit, a redistribution of loads takes place that will change the pressure distribution beneath the structure, as subsequently described. The bearing capacity of loose sands, saturated silts, and low-density loess can be altered significantly as a result of saturation, vibrations, or shock. Therefore, the allowable bearing pressure and settlement of these soils cannot be determined in the usual manner for the foundation soils

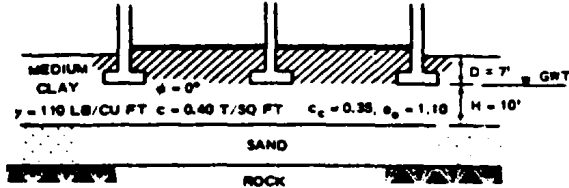

**BEARING CAPACITY ANALYSIS**

$$q_u = 1.3c_n + \gamma D N_q \text{ (SQUARE FOOTING)}$$

$$= (1.3 \times 0.40 \times 5.7) + \frac{(110 \times 7 \times 1)}{2000} = 3.26 \text{ T/30 FT}$$

MAX SAFE BEARING PRESSURE =  $q_u = q_u / FS$

$$q_u = \frac{3.26}{2.0} = 1.67 \text{ T/30 FT FOR DL + NORMAL LL}$$

$$q_u = \frac{3.26}{1.5} = 2.23 \text{ T/30 FT FOR DL + MAX LL}$$

**SETTLEMENT ANALYSIS**

NEGLECTING SETTLEMENT OF SAND LAYER, COMPUTE INFLUENCE VALUE ( $4W_0$ ) FOR STRESS AT MID-POINT OF CLAY STRATUM (FIG. 12).

WIDTH OF SQ FOOTING - FT	m/n	$W_0$	$4W_0$
2	0.20	0.018	0.072
4	0.40	0.08	0.240
6	0.60	0.108	0.424
8	0.80	0.148	0.584

$$\text{SETTLEMENT, } \Delta h = \frac{C_c}{1 + e_0} H \log_{10} \frac{P_0 + 4W_0 \cdot 1_p}{P_0}$$

$$P_0 = (7 \times 110) + (5 \times 47.8) = 0.804 \text{ T/30 FT}$$

$$\text{EQUATION 1 } \Delta h = \frac{0.35}{1 + 1.10} \times 10 \times \log_{10} \frac{0.804 + 4W_0 \cdot 1_p}{0.804}$$

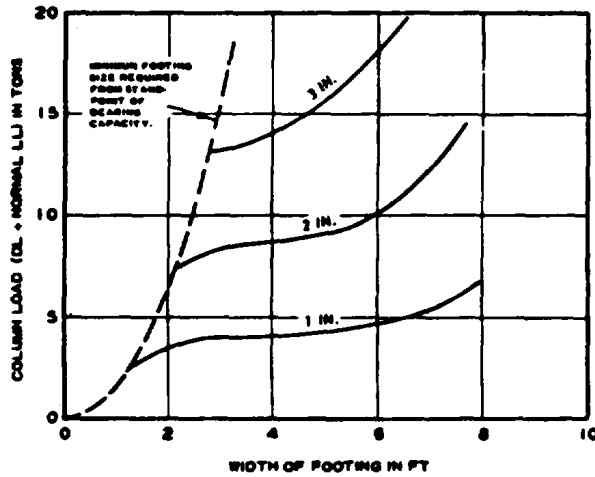
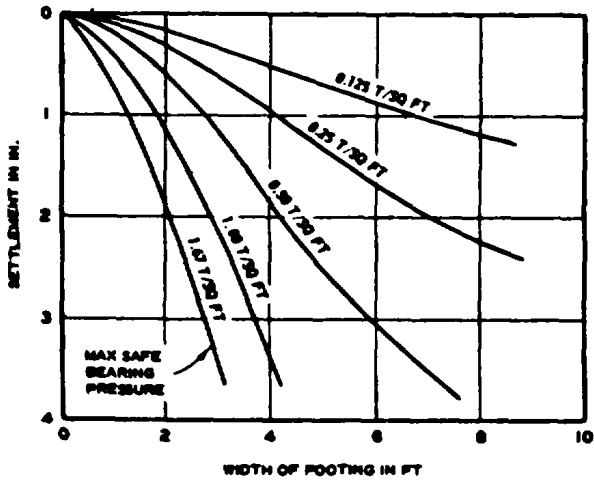

**EXAMPLE OF CHARTS FOR SELECTING ALLOWABLE BEARING PRESSURES AND FOOTING SIZES RESULTING IN EQUAL SETTLEMENT OF FOOTINGS. CURVES BASED ON EQ 1.**

NOTE: METHOD FOR CONSTRUCTING DESIGN CHARTS APPLICABLE ONLY WHERE MOST COMPRESSIBLE STRATA ARE ABOVE ZONE WHERE STRESSES BENEATH FOOTINGS OVERLAP  
 AFTER FOOTING SIZES ARE SELECTED ON THE BASIS OF SETTLEMENT, FOOTINGS SHOULD BE CHECKED TO ASSURE THAT THE COLUMN LOAD (DL + MAX LL) DIVIDED BY THE FOOTING AREA DOES NOT EXCEED 2.23 T/30 FT.

U. S. Army Corps of Engineers

Figure 10-1. Example of method for selecting allowable bearing pressure.

may be subject to such effects. Replace or stabilize such foundation soils, as discussed in chapter 16, if these effects are anticipated.

b. *Conventional analysis.* Where the differential settlement between columns will be small, design the mat as reinforced concrete flat slab assuming planar soil pressure distribution. The method is generally applicable where columns are more or less equally spaced. For analysis, the mat is divided into mutually perpendicular strips.

c. *Approximate plate analysis.* When the column loads differ appreciably or the columns are irregularly spaced, the conventional method of analysis becomes seriously in error. For these cases, use an

analysis based on the theory for beams or plates on elastic foundations. Determine the subgrade modulus by the use of plate load tests. The method is suitable, particularly for mats on coarse-grained soils where rigidity increases with depth.

d. *Analysis of mats on compressible soils.* If the mat is founded on compressible soils, determination of the distribution of the foundation pressures beneath the mat is complex. The distribution of foundation pressures varies with time and depends on the construction sequence and procedure, elastic and plastic deformation properties of the foundation concrete, and

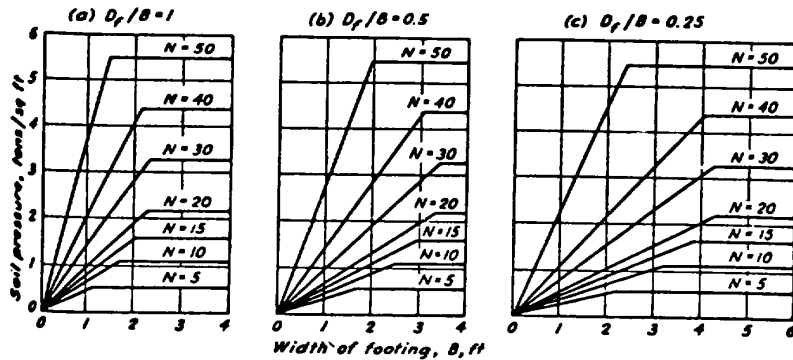

a. Design chart for proportioning shallow footings on sand.

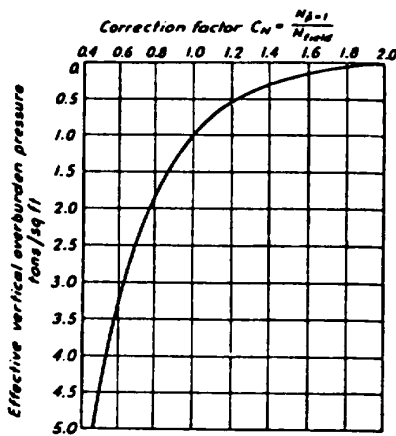

b. Chart for correction of  $N$ -values in sand for influence of overburden pressure

1. Determine  $N$  values at 2-1/2-ft intervals between base of footing and depth  $B$  below base. Calculate average  $N$  value.
2. Select allowable soil pressure from design chart (a) based on settlement of 1 in.
3. If effective overburden pressure corresponding to depth of footing differs greatly from 1 ton/sq ft, adjust  $N$  value according to chart (b).
4. Multiply allowable soil pressure by correction factor for depth to water table ( $D_w$ ).

$$C_w = 0.5 + 0.5 \frac{D_w}{D_f + B}$$

(Courtesy of R. B. Peck, W. E. Hanson, and T. H. Thornburn, *Foundation Engineering*, 1974, p 312. Reprinted by permission of John Wiley & Sons, Inc., New York.)

Figure 10-2. Proportioning footings on cohesionless soils.

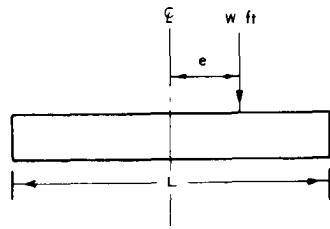

(1)  $e = 0$       $P_1 = P_2 = \frac{W}{L}$



(2)  $e < \frac{L}{6}$       $P_1 = \frac{W}{L} \left(1 - \frac{6e}{L}\right)$   
 $P_2 = \frac{W}{L} \left(1 + \frac{6e}{L}\right)$

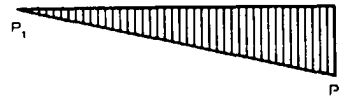

(3)  $e = \frac{L}{6}$       $P_1 = 0$   
 $P_2 = \frac{2W}{L}$

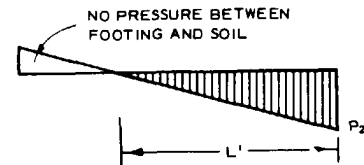

(4)  $e > \frac{L}{6}$       $P_2 = \frac{2W}{L'}$   
 $P_2 = \frac{4W}{3L} \left(\frac{1}{1 - 2e/L}\right)$

DISTRIBUTION OF BEARING PRESSURES BENEATH STRIP FOOTINGS

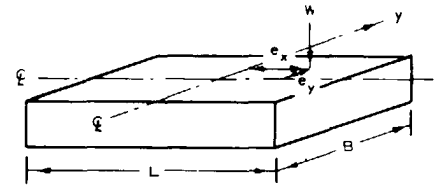

(1)  $e_x = e_y = 0$       $P = \text{CONSTANT}$

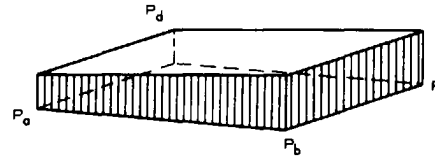

(2)  $e_x < \frac{L}{6}$       $P_a = P_d = \frac{W}{LB} \left(1 - \frac{6e_x}{L}\right)$   
 $P_b = P_c = \frac{W}{LB} \left(1 + \frac{6e_x}{L}\right)$

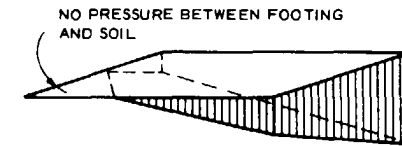

(3)  $e_x > \frac{L}{6}$   
 $e_y > \frac{B}{6}$   
**A PART OF THE SOIL PRESSURE WILL BE ZERO (SEE REF 26 FOR COMPUTATION OF PRESSURES)**

NOTE: NO ZERO PRESSURE WILL EXIST BENEATH THE FOOTING IF THE LOAD, W, IS APPLIED WITHIN THE RHOMBUS SHOWN AT RIGHT

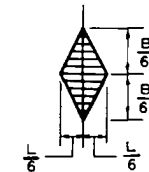

DISTRIBUTION OF BEARING PRESSURES BENEATH RECTANGULAR FOOTINGS

Figure 10-3. Distribution of bearing pressures.



time-settlement characteristics of foundation soils. As a conservative approach, mats founded on compressible soils should be designed for two limiting conditions: assuming a uniform distribution of soil pressure, and assuming a pressure that varies linearly from a minimum of zero at the middle to twice the uniform pressure at the edge. The mat should be designed structurally for whichever distribution leads to the more severe conditions.

**10-5. Special requirements for mat foundations.**

a. *Control of groundwater.* Exclude groundwater from the excavation by means of cutoffs, and provide for temporary or permanent pressure relief and dewatering by deep wells or wellpoints as described in TM 5-818-5/AFM 88-5, Chapter 6. Specify piezometers to measure drawdown levels during construction. Specify the pumping capacity to achieve required drawdown during various stages of construction, including removal of the temporary system at the completion of construction. Consider effects of drawdown on adjoining structures.

b. *Downdrag.* Placement of backfill against basement walls or deep raft foundations constructed in open excavations results in downdrag forces if weight of backfill is significant with respect to structural loading. Estimate the downdrag force on the basis of data in chapter 14.

**10-6. Modulus of subgrade reaction for footings and mats.**

a. The modulus of subgrade reaction can be determined from a plate load test (para 4-6) using a 1- by 1- foot plate.

$$k_{sf} = k_{sl} B \tag{10-1}$$

where

- $k_{sf}$  = the modulus of subgrade reaction for the prototype footing of width B
- $k_{sl}$  = the value of the 1- by 1-foot plate in the plate load test

The equation above is valid for clays and assumes no increase in the modulus with depth, which is incorrect, and may give  $k_1$ , which is too large.

For footings or mats on sand:

$$k_{sf} = k_{sl} \left( \frac{B + 1}{2B} \right)^2 \tag{10-2}$$

For a rectangular footing or mat of dimensions of B x mB:

$$(15m^5) \tag{10-3}$$

with a limiting value of  $k_{sf} = 0.667k_{sl}$ .

b.  $k_s$  may be computed as

$$k_s = 36q_a \text{ (kips per square foot)} \tag{10-4}$$

which has been found to give values about as reliable as any method. This equation assumes  $q_a$  (kips per square foot) for a settlement of about 1 inch with a safety factor,  $F \cong 3$ . A typical range of values of  $k_s$  is given in table 3-7.

**10-7. Foundations for radar towers.**

a. *General.* This design procedure provides minimum footing dimensions complying with criteria for tilting rotations resulting from operational wind loads. Design of the footing for static load and survival wind load conditions will comply with other appropriate sections of this manual.

b. *Design procedure.* This design procedure is based upon an effective modulus of elasticity of the foundation. The effective modulus of elasticity is determined by field plate load tests as described in subparagraph d below. The design procedure also requires seismic tests to determine the S-wave velocity in a zone beneath the footing at least 1 1/2 times the maximum size footing required. Field tests on existing radar towers have shown that the foundation performs nearly elastically when movements are small. The required size of either a square or a round footing to resist a specific angle of tilt,  $\alpha$ , is determined by the following:

$$B^3 = 4320(F) \frac{M}{\alpha} \left( \frac{1 - M^2}{E_s} \right) \text{ (square footing)} \tag{10-5}$$

$$D^3 = 6034(F) \frac{M}{\alpha} \left( \frac{1 - M^2}{E_s} \right) \text{ (round footing)} \tag{10-6}$$

where

- B, D = size and diameter of footing, respectively, feet
- F = factor of safety (generally use 2.0)
- M = applied moment at base of footing about axis of rotation, foot-pounds
- $\alpha$  = allowable angle of tilt about axis of rotation, angular mils (1 angular mil = 0.001 radian)
- $E_s$  = effective modulus of elasticity of foundation soil, pounds per cubic foot

The design using equations (10-5) and (10-6) is only valid if the seismic wave velocity increases with depth., If the velocity measurements decrease with depth, special foundation design criteria will be required. The discussion of these criteria is beyond the scope of this manual.

c. *Effective modulus of elasticity of foundation soil ( $E_s$ ).* Experience has shown that the design modulus of elasticity of in-place soil ranges from 1000 to 500, kips per square foot. Values less than 1000 kips per square foot will ordinarily present severe settlement problems and are not satisfactory sites for radar towers. Values in excess of 5000 kips per square foot may be encountered in dense gravel or rock, but such values are not used in design.

(1) Use equations (10-5) and (10-6) to compute-

(a) Minimum and maximum footing sizes using  $E_s = 1000$  and  $5000$  kips per square foot, respectively.

(b) Two intermediate footing sizes using values intermediate between  $1000$  and  $5000$  kips per square foot.

Use these four values of  $B$  or  $D$  in the following equations to compute the increase (or pressure change) in the live load,  $\Delta L$ .

$$\text{square footing } \Delta L = \frac{17.0M}{B^3} \text{ (pounds per square foot) (10-7)}$$

$$\text{round footing } \Delta L = \frac{20.3M}{D^3} \text{ (pounds per square foot) (10-8)}$$

(2) The  $E_s$  value depends on the depth of the footing below grade, the average dead load pressure on the soil, and the maximum pressure change in the live load,  $\Delta L$ , on the foundation due to wind moments. A determination of the  $E_s$  value will be made at the proposed footing depth for each footing size computed.

(3) The dead load pressure,  $q_0$ , is computed as the weight,  $W$ , of the radar tower, appurtenances, and the footing divided by the footing area,  $A$ .

$$q_0 = \frac{\Sigma W}{A} \quad (10-9)$$

The selection of loadings for the field plate load test will be based on  $q_0$  and  $\Delta L$ .

*d. Field plate load test procedure.* The following plate load test will be performed at the elevation of the bottom of the footing, and the test apparatus will be as described in TM 5-824-3/AFM 88-6, Chapter 3.

(1) Apply a unit loading to the plate equal to the smallest unit load due to the dead load pressure  $q_0$ . This unit loading will represent the largest size footing selected above.

(2) Allow essentially full consolidation under the dead load pressure increment. Deformation readings will be taken intermittently during and at the end of the consolidation period.

(3) After consolidation under the dead load pressure, perform repetitive load test using the live load pressure  $\Delta L$  computed by the formulas in paragraph

10-7c. The repetitive loading will consist of the dead load pressure, with the live load increment applied for 1 minute. Then release the live load increment and allow to rebound at the dead pressure for 1 minute. This procedure constitutes one cycle of live load pressure application. Deformation readings will be taken at three points: at the start, after the live load is applied for 1 minute, and after the plate rebounds under the dead load pressure for 1 minute. Live load applications will be repeated for 15 cycles.

(4) Increase the dead load pressure,  $q_0$ , to the second lowest value, allow to consolidate, and then apply the respective live load increment repetitively for 15 cycles.

(5) Repeat step 4 for the remaining two dead load pressure increments.

(6) An uncorrected modulus of elasticity value is computed for each increment of dead and live load pressure as follows:

$$E_s' = \frac{25.5 \Delta L}{S} (1 - \mu^2)$$

$E_s'$  = uncorrected effective modulus of elasticity for the loading condition used, pounds per square foot

$S$  = average edge deformation of the plate for the applied load, determined from the slope of the last five rebound increments in the repetitive load test, inches

$\mu$  = Poisson's ratio (see table 3-6).

(7) The above-computed uncorrected modulus of elasticity will be corrected for bending of the plate as described in TM 5-824-3/AFM 88-6, Chapter 3, where  $E'$  is defined above, and  $E_s$  is the effective modulus of elasticity for the test conditions.

*e. Selection of required footing size.* The required footing size to meet the allowable rotation criteria will be determined as follows:

(1) Plot on log-log paper the minimum and the maximum footing size and the two intermediate footing sizes versus the required (four assumed values) effective modulus of elasticity for each footing size.

(2) Plot the measured effective modulus of elasticity versus the footing size corresponding to the loading condition used for each test on the same chart as above.

(3) These two plots will intersect. The footing size indicated by their intersection is the minimum footing size that will resist the specified angle of tilt.

## CHAPTER 11

## DEEP FOUNDATIONS INCLUDING DRILLED PIERS

**11-1. General.** A deep foundation derives its support from competent strata at significant depths below the surface or, alternatively, has a depth to diameter ratio greater than 4. A deep foundation is used in lieu of a shallow foundation when adequate bearing capacity or tolerable settlements cannot be obtained with a shallow foundation. The term deep foundation includes piles, piers, or caissons, as well as footings or mats set into a deep excavation. This chapter discusses problems of placing footings and mats in deep excavations and design of drilled piers. Drilled piers (or caissons) are simply large-diameter piles, but the design process is somewhat different. An arbitrary distinction between a pile and pier is that the caisson is 30 inches or more in diameter.

**11-2. Floating foundations.** A foundation set into a deep excavation is said to be *compensated* or *floating* if the building load is significantly offset by the load of soil removed during excavation. The foundation is *fully compensated* if the structural load equals the load removed by excavation, *partially compensated* if the structural load is greater, and *overcompensated* if the structural load is less than the weight of the excavated soil. A compensated foundation requires a study of expected subsoil rebound and settlement, excavation support systems, means to maintain foundation subsoil or rock integrity during excavation, and allowable bearing pressures for the soil or rock.

**11-3. Settlements of compensated foundations.**

a. The sequence of subsoil heave during excavation and subsequent settlement of a deep foundation is illustrated in figure 11-1(a). If effective stresses do not change in the subsoils upon the initial excavation, i.e., the soil does not swell due to an increase in water content, and if no plastic flow occurs, then only immediate or elastic rebound from change in stress occurs. If the structural load is fully compensated, the measured settlement of the foundation would consist only of recompression of the elastic rebound, generally a small quantity, provided subsoils are not disturbed by excavation.

b. If the negative excess pore pressures set up during excavation "dissipate," i.e., approach static values, before sufficient structural load is applied, foundation swell occurs in addition to elastic rebound. (The original effective stresses will decrease.) The

foundation load recompresses the soil, and settlement of the foundation consists of elastic and consolidation components as shown in figure 11-1(b). Consolidation occurs along the recompression curve until the preconsolidation stress is reached, whereupon it proceeds along the virgin compression curve. Calculate the foundation heave and subsequent settlement using procedures outlined in chapter 5.

c. If the depth with respect to the type and shear strength of the soil is such that plastic flow occurs, loss of ground may develop around the outside of the excavation with possible settlement damage to structures, roads, and underground utilities.

d. The rate and amount of heave may be estimated from the results of one-dimensional consolidation tests; however, field evidence shows that the rate of heave is usually faster than predicted. A study of 43 building sites found that the field heave amounted to about one-third the computed heave. Where excavations are large and are open for substantial time before significant foundation loadings are applied, the actual heave may be close to the computed heave. Figure 11-2 is a plot of a series of field results of heave versus excavation depth, in which the heave increases sharply with the depth of excavation. An example of heave and subsequent settlement calculations for a compensated foundation is shown in figure 5-4.

e. The yielding of the excavation bottom can be caused by high artesian water pressures under the excavation or by a bearing capacity failure resulting from the overburden pressure on the soil outside the excavation at subgrade elevation. Artesian pressure can be relieved by cutoffs and dewatering of the underlying aquifer using deep wells. The pumped water may be put back in the aquifer using recharge wells outside the excavation perimeter to avoid perimeter settlements or to preserve the groundwater table for environmental reasons, but this operation is not simple and should be done only when necessary.

f. The likelihood of bearing capacity failure exists primarily in clayey soils and should be analyzed as shown in chapter 14. A factor of safety,  $F_s \geq 2$ , should ideally be obtained to minimize yielding and possible settlement problems. A large plastic flow may cause the bottom of the excavation to move upwards with re-

suiting loss of ground. To avoid this possibility, investigate-

- (1) Potential for plastic flow, i.e., relationship between shear stress and shear strength.
- (2) Sequence of placing wall bracing.
- (3) Depth of penetration of sheeting below base of excavation.

g. Two commonly used procedures to control bottom heave are dewatering and sequential excavation of the final 5 feet or more of soil. Groundwater lowering increases effective stresses and may reduce heave. Where subsoil permeabilities are not large, a deep and economical lowering of the groundwater to minimize

heave can sometimes be achieved by an educator-type wellpoint system. Permitting a controlled rise of the groundwater level as the building load is applied acts to reduce effective stresses and counteracts the effect of the added building load. Sequential excavation is accomplished by removing soil to final grade via a series of successive trenches. As each trench is opened, the foundation element is poured before any adjacent trench is opened. This procedure recognizes the fact that more heave occurs in the later excavation stages than in earlier stages and is frequently used in shales.

h. The tilting of a compensated foundation can occur if structural loads are not symmetrical or if soil

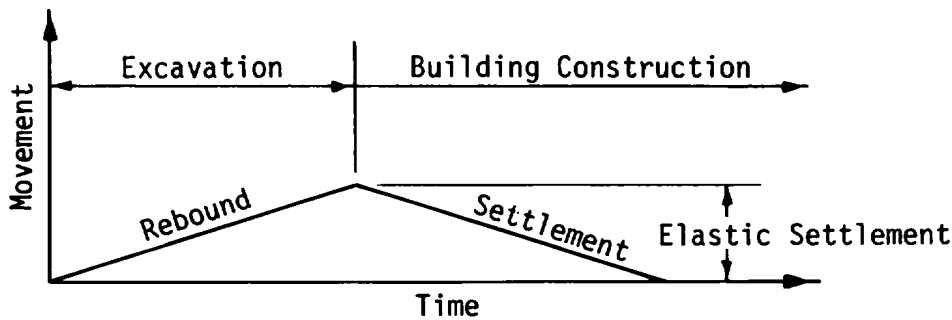

(a) No effective stress change during excavation

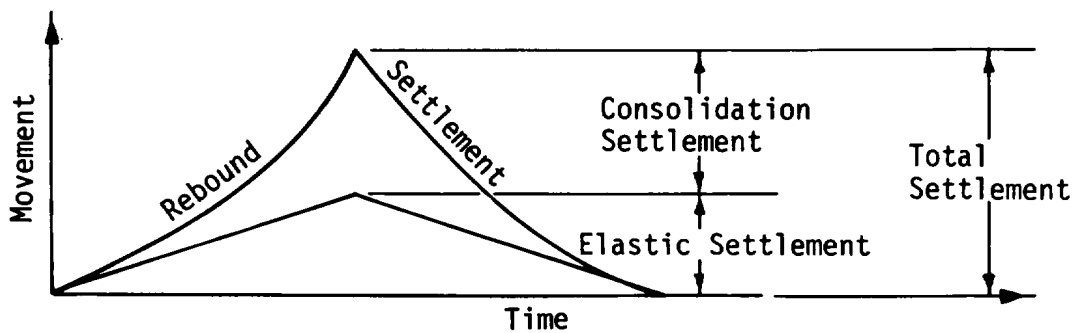

(b) Decrease in effective stress during excavation (causes subsoil rebound and leads to additional settlement)

Note: Figures (a) and (b) are illustrative only. Some rebound may continue after start of building construction until sufficient building load has been applied. Additional settlement exceeding that shown in figures occurs if building load exceeds weight of excavation.

U. S. Army Corps of Engineers

Figure 11-1. Effect of pore pressure dissipation during excavation and settlement response.

conditions are nonuniform. Tilting can be estimated from settlement calculations for different locations of the excavation. Control of tilt is not generally necessary but can be provided by piles or piers, if required. Bearing capacity is not usually important unless the building is partially compensated and founded on clay. The factor of safety against bearing failure is calculated (see chap 6 for quit) and compared with the final total soil stress using the building load,  $q_0$ , less the excavation stress as follows:

$$FS = \frac{q_{ult}}{q_0 - \gamma D} \quad (11-1)$$

The factor of safety should be between 2.5 and 3.0 for dead load plus normal live load.

i. Settlement adjacent to excavations depends on the soil type and the excavation support system method employed (chap 14). With properly installed strutted or anchored excavations in

cohesionless soils, settlement will generally be less than 0.5 percent of excavation depth. Loss of ground due to uncontrolled seepage or densification of loose cohesionless soils will result in larger settlements. Surface settlements adjacent to open cuts in soft to firm clay will occur because of lateral yielding and movement of soil beneath the bottom of the cut. Figure 11-3 can be used to estimate the magnitude and extent of settlement.

**11-4. Underpinning.**

a. Structures supported by shallow foundations or short piles may have to be underpinned if located near an excavation. Techniques for underpinning are depicted in figure 11-4. The most widely accepted methods are jacked down piles or piers, which have the advantage of forming positive contact with the building foundation since both can be prestressed. The use of drilled piers is of more recent vintage and is more economical where it can be used. In sandy soils, chemical

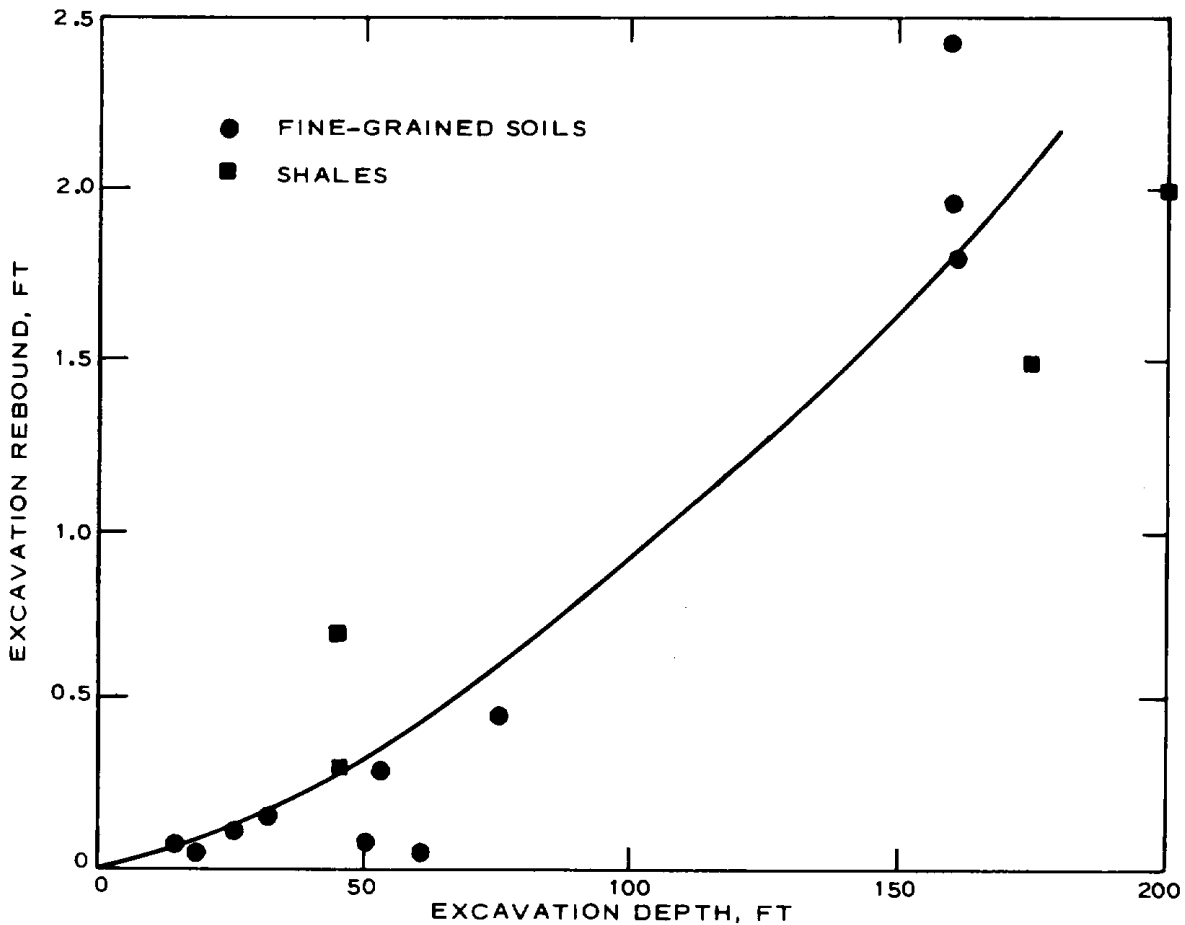

U. S. Army Corps of Engineers

Figure 11-2. Excavation rebound versus excavation depth.

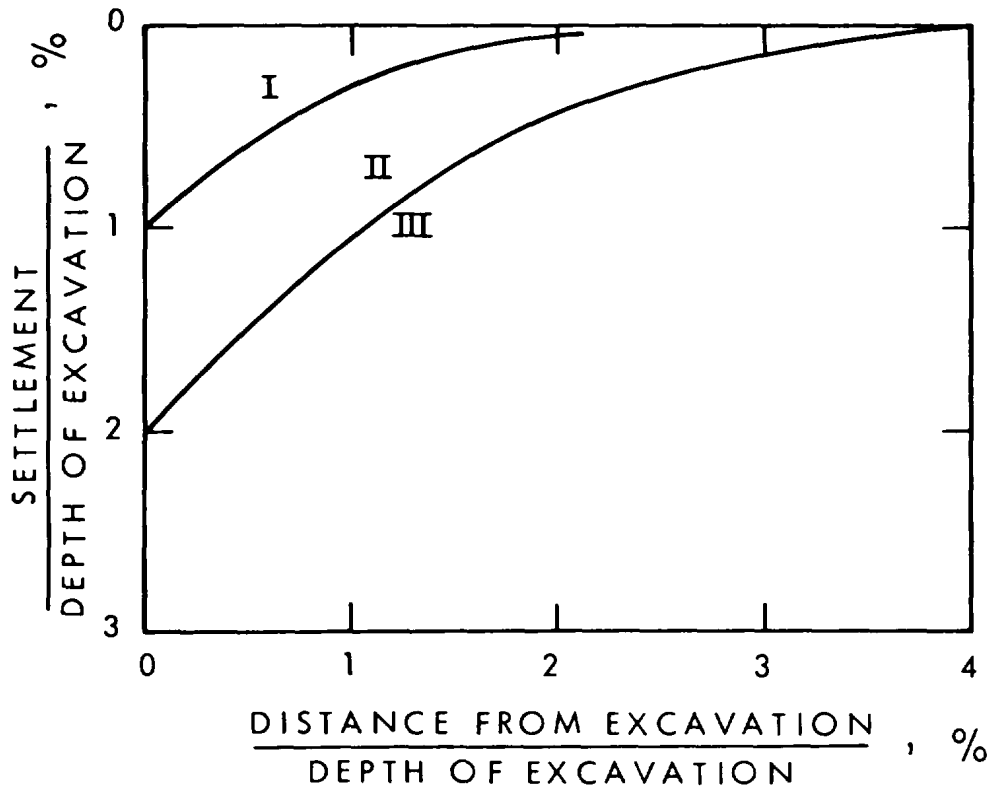

ZONE I - SAND AND SOFT TO HARD CLAY, ( $s_u > 500$  LB/SQ FT)

ZONE II - VERY SOFT TO SOFT CLAY ( $s_u < 500$  LB/SQ FT)  
 1) - LIMITED DEPTH OF CLAY BELOW BASE OF EXCAVATION  
 2) - SIGNIFICANT DEPTH OF CLAY BELOW BASE OF EXCAVATION WHERE  $\frac{\gamma H}{s_u} < 5$

ZONE III - VERY SOFT TO SOFT CLAY, ( $s_u < 500$  LB/SQ FT)  
 1) - SIGNIFICANT DEPTH OF CLAY BELOW BASE OF EXCAVATION AND WHERE  $\frac{\gamma H}{s_u} \geq 5$

U. S. Army Corps of Engineers

Figure 11-3. Probable settlements adjacent to open cuts.

injection stabilization (chap 16) may be used to underpin structures by forming a zone of hardened soil to support the foundation.

b. In carrying out an underpinning operation, important points to observe include the following:

(1) Pits opened under the building must be as small as possible, and survey monitoring of the building must be carried out in the areas of each pit to determine if damaging movements are occurring.

(2) Care must be taken to prevent significant lifting of local areas of the building during jacking.

(3) Concrete in piers must be allowed to set before any loading is applied.

(4) Chemically stabilized sands must not be subject to creep under constant load.

c. The decision to underpin is a difficult one because it is hard to estimate how much settlement a

building can actually undergo before being damaged. The values given in tables 5-2 and 5-3 may be used as guidelines.

**11-5. Excavation protection.** During foundation construction, it is important that excavation subsoils be protected against deterioration as a result of exposure to the elements and heavy equipment. Difficulties can occur as a result of slaking, swelling, and piping of the excavation soils. Also, special classes of soils can collapse upon wetting (chap 3). Methods for protecting an excavation are described in detail in table 11-1 along with procedures for identifying problem soils. If these measures are not carried out, soils likely will be subject to a loss of integrity and subsequent foundation performance will be impaired.

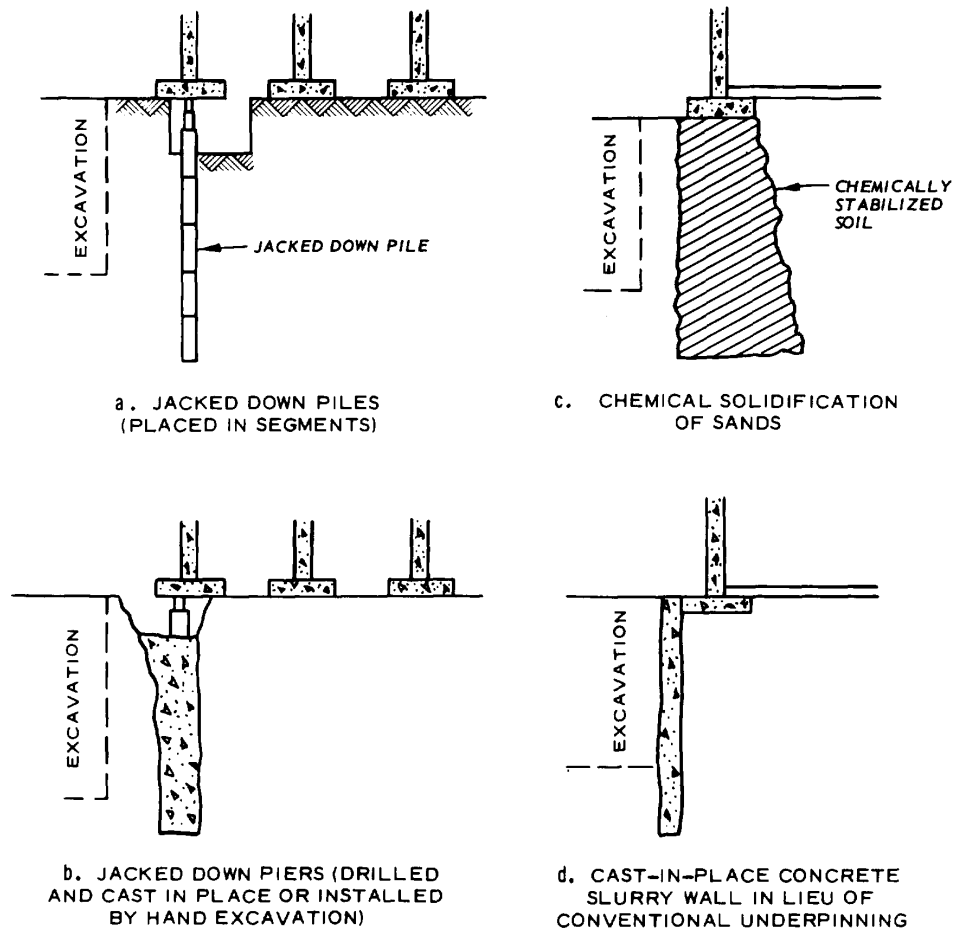

U. S. Army Corps of Engineers

Figure 11-4. Methods of underpinning.

Table 11-1. Excavation Protection.

Soil Type	Identification	Problems and Mechanism	Preventative Measures
Overconsolidated clays near plastic limit	(1) Stiff plastic clays, natural water content heave at excavation (2) See figure 3-14 for swelling potential	(1) One dimensional heave, maximum around excavation center (2) Swelling dependent on plasticity (3) Usually fractured and fissured. Excavation opens these, causing softening and strength loss	(1) Rapid collection of surface water, or grading (2) Deep pressure relief to minimize rebound (3) Place 4" - 6" working mat of lean concrete immediately after exposing subgrade (mat may be placed over underseepage and pressure relief systems placed in sand blanket) (4) If sloped walls, use asphalt sealer on vertical walls, burlap with rubber sheeting or other membrane on flatter slopes
Chemically inert, uncemented claystone or shale	(1) Lab testing (2) Soil and geologic maps (3) Local experience	(1) Swelling, slaking and strength loss if water infiltration (2) Rebound if overconsolidated (generally the case) (3) Cracking if dry or evaporation allowed	(1) Protect from wetting and drying by limiting area open at subgrade (2) Concrete working mat (3) Paving, impervious materials to avoid water infiltration; place sealing coats immediately after exposure (4) Reduce evaporation and drying to prevent swelling on resaturation
(Continued)			

(Sheet 1 of 3)



Table 11-1. Excavation Protection-Continued

Soil Type	Identification	Problems and Mechanism	Preventative Measures
Limestone	(1) Geologic maps and local experience (2) Borings and soundings to determine cavity locations	Open cavities and caverns; soft infilling in joints, cavities. Dewatering can cause cavity collapse or settlements of infilling materials	(1) Avoid infiltration; collect surface runoff and convey it to a point where its infiltration will not affect excavation (2) Eliminate leaks from utility or industrial piping and provide for inspection to avoid infiltration continuing after correction (3) Avoid pumping which causes downward seepage or recharging
Collapsing soils (primarily loess and volcanic ash)	(1) See figure 3-16, $Y_d$ vs $W_L$ plot (2) $Y_d < 85$ PCF (3) Large open "structure" with temporary source of strength (4) Liquid limit $< 45\%$ plasticity index 0-25% (5) Natural water content well below 100% saturation (6) Optimum water content for collapse between 13-39%(3)	(1) When infiltrated with water, sudden decrease in bulk volume; may or may not require loading in conjunction with seepage (2) Water action reduces temporary source of strength, usually capillary tension or root structure Low erosion resistance	(1) Drainage and collection system to avoid water infiltration (2) Preload excavation area, and pond with water to cause collapse prior to excavation

(Continued)

(Sheet 2 of 3)

Table 11-1. Excavation Protection-Continued.

Soil Type	Identification	Problems and Mechanism	Preventative Measures
Soft, normally consolidated or sensitive clays	(1) Recently deposited, or no geologic loading and unloading (2) Leached marine clays (3) Natural water content near or above liquid limit	(1) Primarily low strength, unable to support const. equipment (2) Remolded by construction activity, causing strength loss	Provide support, and prevent remolding: place timber beams under heavy equipment; cover excavation bottom with 1' - 2' of sand and gravel fill and/or 6" - 8" of lean concrete

(Sheet 3 of 3)

**11-6. Drilled piers.** Drilled piers (also drilled shafts or drilled caissons) are often more economical than piles where equipment capable of rapid drilling is readily available, because of the large capacity of a pier as compared with a pile.

a. *Pier dimension and capacities.* Drilled piers can support large axial loads, up to 4,000 kips or more, although typical design loads are on the order of 600 to 1,000 kips. In addition, drilled piers are used under lightly loaded structures where subsoils might cause building heaving. Shaft diameters for high-capacity piers are available as follows:

From 2- 1/2 feet      by 6-inch increments  
 From 5 feet            by 1-foot increments

Also available are 15- and 2-foot-diameter shafts. Commonly, the maximum diameter of drilled piers is under 10 feet with a 3- to 5-foot diameter very common. Drilled piers can be belled to a maximum bell size of three times the shaft diameter. The bells may be hemispherical or sloped. Drilled piers can be formed to a maximum depth of about 200 feet. Low capacity drilled piers may have shafts only 12 to 18 inches in diameter and may not be underreamed.

b. *Installation.* The drilled pier is constructed by drilling the hole to the desired depth, belling if increased bearing capacity or uplift resistance is required, placing necessary reinforcement, and filling the cavity with concrete as soon as possible after the hole is drilled. The quantity of concrete should be measured to ensure that the hole has been completely filled. Reinforcement may not be necessary for vertical loads; however, it will always be required if the pier carries lateral loads. A minimum number of dowels will be required for unreinforced piers to tie the superstructure to the pier. Reinforcement should be used only if necessary since it is a construction obstruction. Consideration should be given to an increased shaft diameter or higher strength concrete in lieu of reinforcement. In caving soils and depending on local experience, the shaft is advanced by:

(1) *Drilling a somewhat oversize hole and advancing the casing with shaft advance.* Casing may be used to prevent groundwater from entering the shaft. When drilling and underreaming is completed, the reinforcing steel is placed, and concrete is placed immediately. The casing may be left in place or withdrawn while simultaneously maintaining a head of concrete. If the casing is withdrawn, the potential exists for voids to be formed in the concrete, and special attention should be given to the volume of concrete poured.

(2) *Use of drilling mud to maintain the shaft cavity.* Drilling mud may be used also to prevent water from entering the shaft by maintaining a positive head differential in the shaft, since the drilling fluid has a

higher density than water. The reinforcing steel can be placed in the slurry-filled hole. Place concrete by tremie.

(3) *Use of drilling mud and casing.* The shaft is drilled using drilling mud, the casing is placed, and the drilling mud is bailed. Core barrels and other special drilling tools are available to socket the pier shaft into bedrock. With a good operator and a drill in good shape, it is possible to place 30- to 36-inch cores into solid rock at a rate of 2 to 3 feet per hour. Underreams are either hemispherical or 30- or 45-degree bell slopes. Underreaming is possible only in cohesive soils such that the underslope can stand without casing support, as no practical means currently exists to case the bell.

c. *Estimating the load capacity of a drilled pier.* Estimate the ultimate capacity,  $Q_u$ , of a drilled pier as follows:

$$Q_u = Q_{us(\text{skin resistance})} + Q_{up(\text{point})} \quad (11-2)$$

The design load based on an estimated 1-inch settlement is:

$$Q_d = Q_{us} + \frac{Q_{up}}{3} \quad (11-3)$$

(1) *Drilled piers in cohesive soil.* The skin resistance can be computed from the following:

$$Q_{us} = \alpha_{avg} \int_0^H C c_z dz$$

where

- $\alpha_{avg}$  = factor from table 11-2
- H = shaft length
- C = shaft circumference
- $c_z$  = undrained shear strength at depth z

Use table 11-2 for the length of shaft to be considered in computing H and for limiting values of side shear. The base resistance can be computed from the following:

$$Q_{up} = N_c C_B A_B \quad (11-5)$$

where

- $N_c$  = bearing capacity factor of 9 (table 11-2)
- $C_B$  = undrained shear strength for distance of two diameters below tip
- $A_B$  = base area

(2) *Drilled piers in sand.* Compute skin resistance from the following:

$$Q_{us} = \alpha_{avg} C \int_0^H P_z \tan \phi dz \quad (11-6)$$

where

- $\alpha_{avg}$  = 0.7, for shaft lengths less than 25 feet
- $\alpha_{avg}$  = 0.6, for shaft lengths between 25 and 40 feet
- $\alpha_{avg}$  = 0.5, for shaft lengths more than 40 feet

Table 11-2. Design Parameters for Drilled Piers in Clay

Design Category	Side Resistance		Tip Resistance $N_c$	Remarks
	$a_{avg}$	Limit on side shear - tsf		
A. Straight-sided shafts in either homogeneous or layered soil with no soil of exceptional stiffness below the base				
1. Shafts installed dry or by the slurry displacement method	0.6	2.0	9	
2. Shafts installed with drilling mud along some portion of the hole with possible mud entrapment	0.3 <sup>(a)</sup>	0.5 <sup>(a)</sup>	9	(a) $a_{avg}$ may be increased to 0.6 and side shear increased to 2.0 tsf for segments drilled dry
B. Belled shafts in either homogeneous or layered clays with no soil of exceptional stiffness below the base				
1. Shafts installed dry or by the slurry displacement methods	0.3	0.5	9	
2. Shafts installed with drilling mud along some portion of the hole with possible mud entrapment	0.15 <sup>(b)</sup>	0.3 <sup>(b)</sup>	9	(b) $a_{avg}$ may be increased to 0.3 and side shear increased to 0.5 tsf for segments drilled
C. Straight-sided shafts with basedry resting on soil significantly stiffer than soil around stem	0	0	9	
D. Belled shafts with base resting on soil significantly stiffer than soil around stem	0	0	9	

Note: In calculating load capacity, exclude (1) top 5 ft of drilled shaft, (2) periphery of bell, and (3) bottom 5 ft of straight shaft and bottom 5 ft of stem of shaft above bell.

U. S. Army Corps of Engineers

$p_z$  = effective overburden pressure at depth

$z$

$\phi$  = effective angle of internal friction

Arching develops at the base of piers in sand similar to piers in clay; thus, the bottom 5 feet of shaft should not be included in the integration limits of the above equations. The base resistance for a settlement of about 1 inch can be computed from the following:

where

$A_B$  = base area

$B$  = base diameter

$q_t$  = 0 for loose sand

$q_t$  = 32,000 pounds per square foot for medium sand

$q_t$  = 80,000 pounds per square foot for dense sand

$$Q_{up} = \frac{A_B}{0.6B} q_t = 1.31 B q_t \quad (11-7)$$

## CHAPTER 12

PILE FOUNDATIONS

---

**12-1. General.** Bearing piles are deep foundations used to transmit foundation loads to rock or soil layers having adequate bearing capacity to support the structure and to preclude settlement resulting from consolidation of soil above these layers. When the bearing strata are below the groundwater table, and when offshore structures are being built, piles may be the most economical type of deep foundation available

because they do not require dewatering of the site. Piles also may be used to compact cohesionless soils and to serve as anchorages against lateral thrust and vertical uplift.

**12-2. Design.** The selection, design, and placement of pile foundations are discussed in detail in the latest revision of TM 5-809-7.

CHAPTER 13

FOUNDATIONS ON EXPANSIVE SOILS

---

**13-1. General.** Natural and man-made deposits of soils that contain substantial proportions of clay minerals have a potential for swelling or shrinking with change in water content. Certain engineering aspects such as site studies, heave predictions, and foundation types are discussed in the latest revision of TM 5-818-7.

**13-2. Foundation problems.** The problems related to expansive soils should be referred to the above-mentioned manual.

## CHAPTER 14

## RETAINING WALLS AND EXCAVATION SUPPORT SYSTEMS

**14-1. Design considerations for retaining walls.**

a. *General.* Retaining walls must be designed so that foundation pressures do not exceed allowable bearing pressures, wall settlements are tolerable, safety factors against sliding and overturning are adequate, and the wall possesses adequate structural strength. Methods for evaluating earth pressures on retaining walls and design procedures are summarized herein for cohesionless backfill materials, which should be used whenever practicable.

b. *Forces acting on retaining walls.* Forces include earth pressures, seepage and uplift pressures, surcharge loads, and weight of the wall. Typical load diagrams for principal wall types are shown in figure 14-1. The magnitude and distribution of active and passive earth pressures are developed from the earth theory for walls over 20 feet high and from semiempirical curves for lower walls. The subgrade reaction along the base is assumed linearly distributed.

**14-2. Earth pressures.**

a. *Earth pressure at rest.* For cohesionless soils, with a horizontal surface, determine the coefficient of earth pressure at rest,  $K_0$ , from the following:

$$K_0 = 1 - \sin \phi \quad (14-1)$$

b. *Active earth pressure.* Formulas for calculating the coefficient of active earth pressure for a cohesionless soil with planar boundaries are presented in figure 14-2.

c. *Passive earth pressure.* Formulas for calculating the coefficient of passive earth pressure for a cohesionless soil with planar boundaries are presented in figure 14-3.

d. *Earth pressure charts.* Earth pressure coefficients based on planar sliding surfaces are presented in figure 14-4. The assumption of a planar sliding surface is sufficiently accurate for the majority of practical problems. A logarithmic spiral failure surface should be assumed when passive earth pressure is calculated and the angle of wall friction,  $\delta$ , exceeds  $\phi/3$ . Earth pressure coefficients based on a logarithmic spiral sliding surface are presented in textbooks on geotechnical engineering. Passive pressure should not be based on Coulomb theory since it overestimates passive resistance. Because small movements mobilize  $\delta$  and concrete walls are relatively rough, the wall friction can be considered when estimating earth pressures. In general, values of  $\delta$  for active earth pressures should not

exceed  $\phi/2$  and for passive earth pressures should not exceed  $\phi/3$ . The angle of wall friction for walls subjected to vibration should be assumed to be zero.

e. *Distribution of earth pressure.* A presentation of detailed analyses is beyond the scope of this manual. However, it is sufficiently accurate to assume the following locations of the earth pressure resultant:

- (1) For walls on rock:
  - 0.38H above base for horizontal or downward sloping backfill
  - 0.45H above base for upward sloping backfill
- (2) For walls on soil:
  - 0.33H above base of horizontal backfill
  - 0.38H above base of upward sloping backfill

Water pressures are handled separately.

f. *Surcharge loads.* Equations for concentrated point and line load are presented in figure 14-5. For uniform or nonuniform surcharge pressure acting on an irregular area, use influence charts based on the Boussinesq equations for horizontal loads and double the horizontal pressures obtained.

g. *Dynamic loads.* The effects of dynamic loading on earth pressures are beyond the scope of this manual. Refer to geotechnical engineering textbooks dealing with the subject.

**14-3. Equivalent fluid pressures.** The equivalent fluid method is recommended for retaining walls less than 20 feet high. Assign available backfill material to a category listed in figure 14-6. If the wall must be designed without knowledge of backfill properties, estimate backfill pressures on the basis of the most unsuitable material that may be used. Equivalent fluid pressures are shown in figure 14-6 for the straight slope backfill and in figure 14-7 for the broken slope backfill. Dead load surcharges are included as an equivalent weight of backfill. If the wall rests on a compressible foundation and moves downward with respect to the backfill, pressures should be increased 50 percent for backfill types 1, 2, 3, and 5. Although equivalent fluid pressures include seepage effects and time-conditioned changes in the backfill material, adequate drainage should be provided.



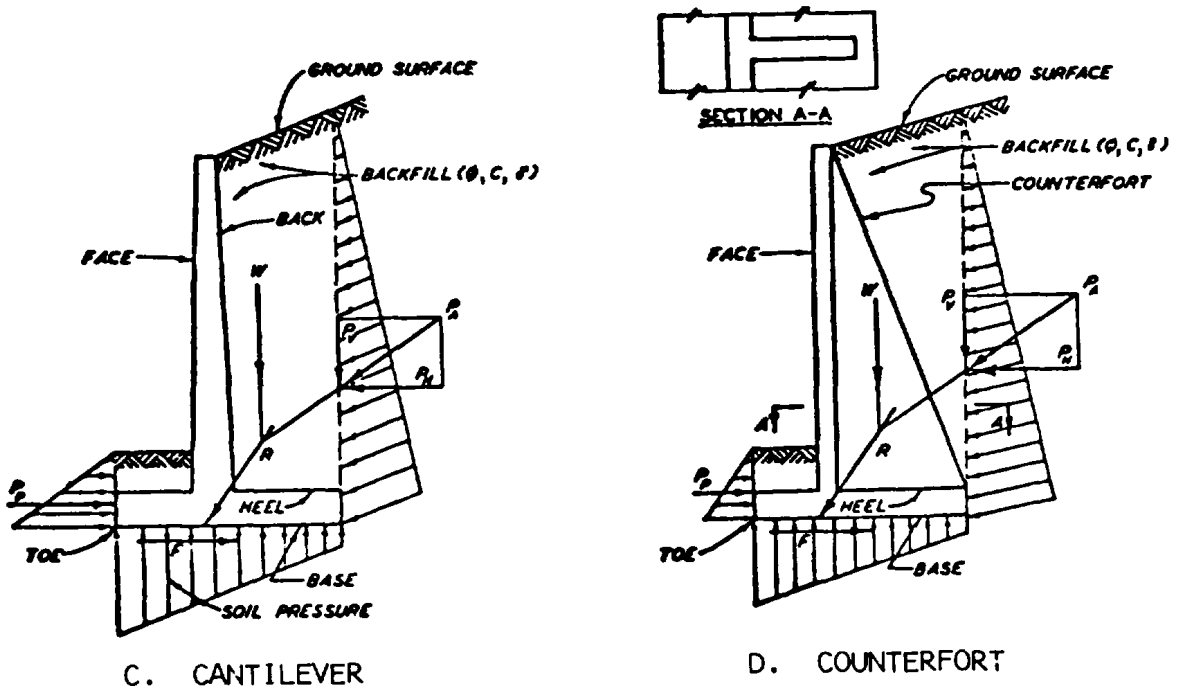
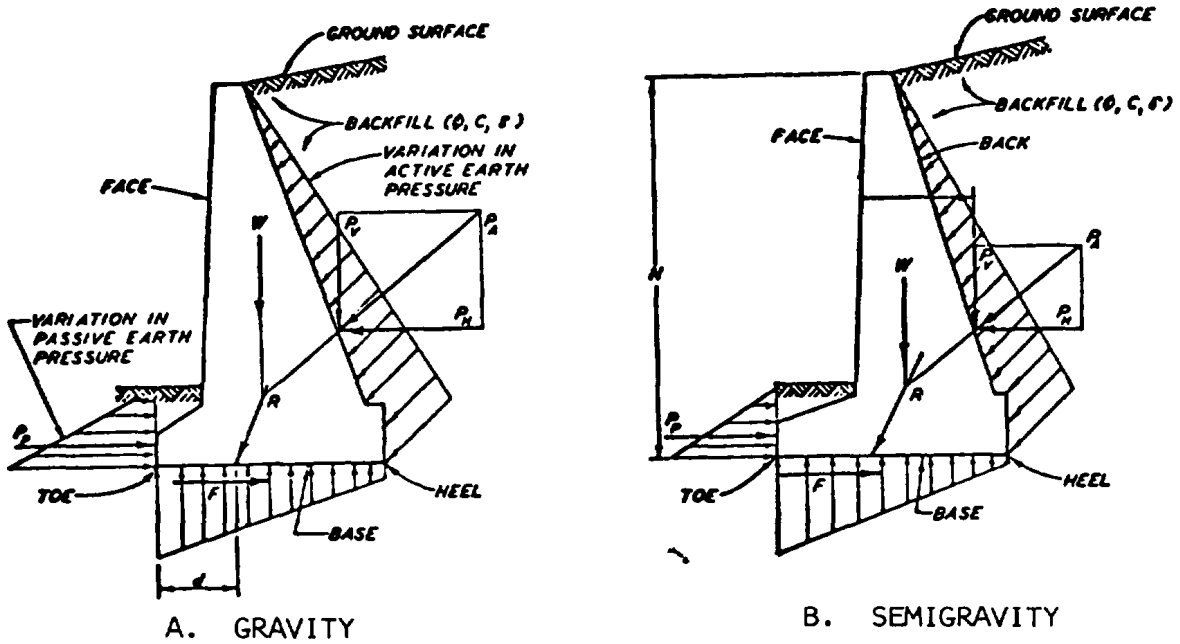

U. S. Army Corps of Engineers

Figure 14-1. Load diagrams for retaining walls.

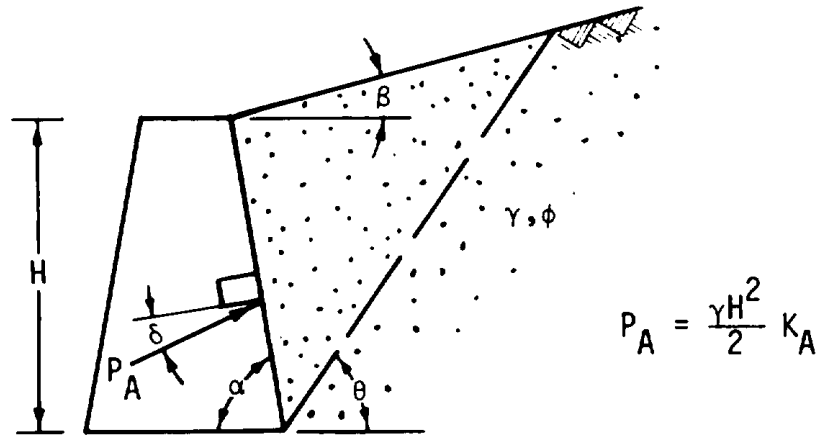

Where  $K_A = \frac{\sin^2 (\alpha + \phi)}{\sin^2 \alpha \sin(\alpha - \delta) \left[ 1 + \sqrt{\frac{\sin(\phi + \delta) \sin(\phi - \beta)}{\sin(\alpha - \delta) \sin(\alpha + \beta)}} \right]^2}$

$\therefore$  Component of  $P_A$  perpendicular to wall back is:

$$P_{AN} = P_A \cos \delta = \frac{\gamma H^2}{2} K_A \cos \delta$$

### Special cases

① If  $\alpha = 90^\circ$ ,  $\beta = 0^\circ$ , then:

$$P_A = \frac{\gamma H^2}{2} K_A$$

where  $K_A = \left[ \frac{\cos \phi}{\sqrt{\cos \delta} + \sqrt{\sin(\delta + \phi) \sin \phi}} \right]^2$

(Typical  $K_A$  values for this case are given in Fig. 14-4.)

② If, in addition,  $\delta = 0$ :

$$K_A = \frac{\cos^2 \phi}{(1 + \sin \phi)^2} = \frac{1 - \sin \phi}{1 + \sin \phi} = \tan^2 \left( 45 - \frac{\phi}{2} \right)$$

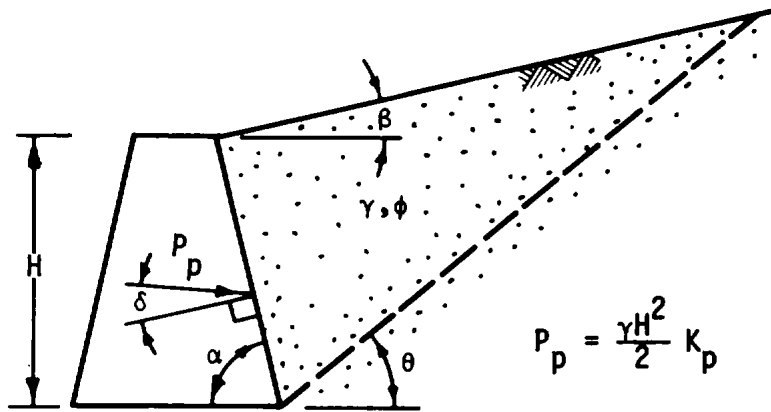

Where  $K_p = \frac{\sin^2 (\alpha - \phi)}{\sin^2 \alpha \sin(\alpha + \delta) \left[ 1 - \sqrt{\frac{\sin(\phi + \delta) \sin(\phi + \beta)}{\sin(\alpha + \delta) \sin(\alpha + \beta)}} \right]^2}$

∴ Component of  $P_p$  perpendicular to wall back is:

$$P_{pn} = P_p \cos \delta = \frac{\gamma H^2}{2} K_p \cos \delta$$

Special cases

① If  $\alpha = 90^\circ$ ,  $\beta = 0^\circ$ , then:

$$P_p = \frac{\gamma H^2}{2} K_p$$

where  $K_p = \left[ \frac{\cos \phi}{\sqrt{\cos \delta} - \sqrt{\sin(\phi + \delta) \sin \delta}} \right]^2$

② If, in addition,  $\delta = 0$ :

$$K_p = \frac{\cos^2 \phi}{(1 - \sin \phi)^2} = \frac{1 + \sin \phi}{1 - \sin \phi} = \tan^2 \left( 45 + \frac{\phi}{2} \right)$$

(Typical values for this case are given in Fig. 14-4.)

Note: Equations are unconservative and should not be used for  $\delta > \frac{\phi}{3}$ ; they are satisfactory for  $\delta \leq \frac{\phi}{3}$ .

Figure 14-3. Passive pressure of sand with planar boundaries.

**14-4. Design procedures for retaining walls.**

*a. Criteria for selecting earth pressures.*

(1) The equivalent fluid method should be used for estimating active earth pressures on retaining structures up to 20 feet high, with the addition to earth pressures resulting from backfill compaction (fig 14-8).

(2) For walls higher than 20 feet, charts, equations, or graphical solutions should be used for computing lateral earth pressures, with the addition of earth pressures resulting from backfill compaction.

(3) Use at-rest pressures for rigid retaining structures resting on rock or batter piles. Design cantilever walls founded on rock or restrained from lateral movement for at-rest pressures near the base of the wall, active pressures along the upper portions of the wall, and compaction-induced earth pressures from the top to the depth at which they no longer increase lateral

earth pressures (fig 14-8). Generally, a linear variation in earth pressure coefficients with depth may be assumed between the sections of wall.

(4) Consider passive pressures in the design if applied loads force the structure to move against the soil. Passive pressures in front of retaining walls are partially effective in resisting horizontal sliding.

*b. Overturning.* Calculate the factor of safety, FS, against overturning, defined as the ratio of resisting moments to the overturning moments. Calculate the resultant force using load diagrams shown in figure 14-1, as well as other loadings that may be applicable. Use only half of the ultimate passive resistance in calculating the safety factor. The resultant of all forces acting on the retaining wall should fall within the middle third to provide a safety factor with respect to overturning equal to or greater than 1.5.

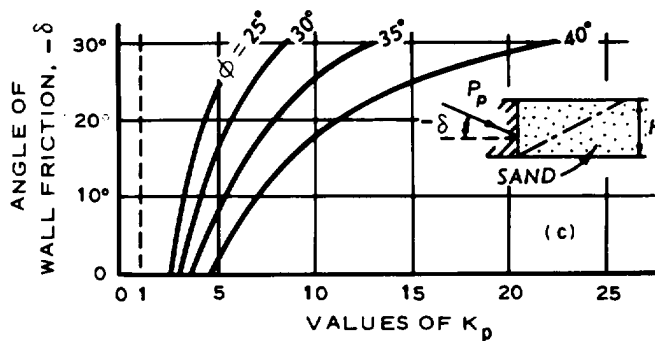
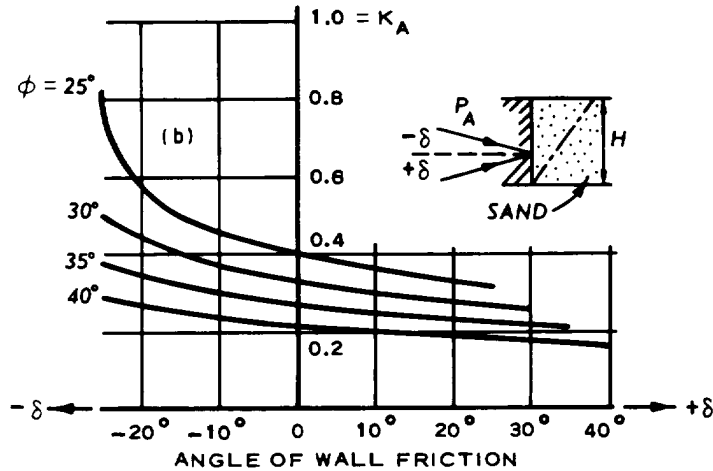

(Courtesy of R. B. Peck, W. E. Hanson, and T. H. Thornburn, *Foundation Engineering*, 1974, p 309. Reprinted by permission of John Wiley & Sons, Inc., New York.)14-5

Figure 14-4. Active and passive earth pressure coefficients according to Coulomb theory.

c. Sliding.

(1) The factor of safety against sliding, calculated as the ratio of forces resisting movement to the horizontal component of earth plus water pressure on the back wall, should be not less than 2.0. If soil in front of the toe is disturbed or loses its strength because of possible excavation, ponding, or freezing and thawing, passive resistance at the toe,  $P_p$ , should be neglected and the minimum factor of safety lowered to 1.5; but if

the potential maximum passive resistance is small, the safety factor should remain at 2.0 or higher.

(2) For high walls, determine the shearing resistance between the base of wall and soil from laboratory direct shear tests in which the adhesion between the concrete and the undisturbed soil is measured. In the absence of tests, the coefficient of friction between

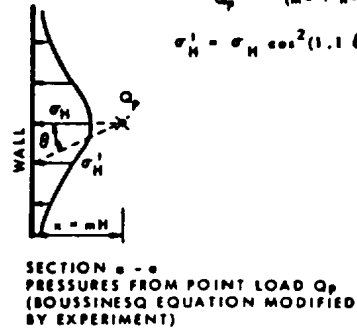
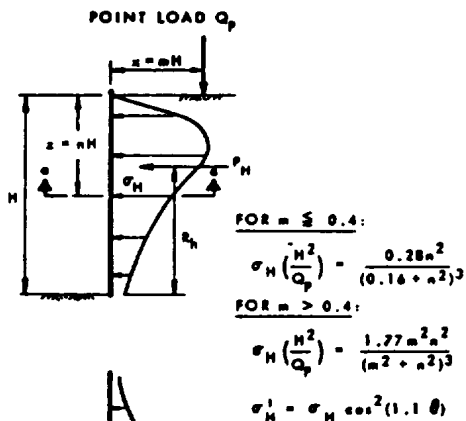
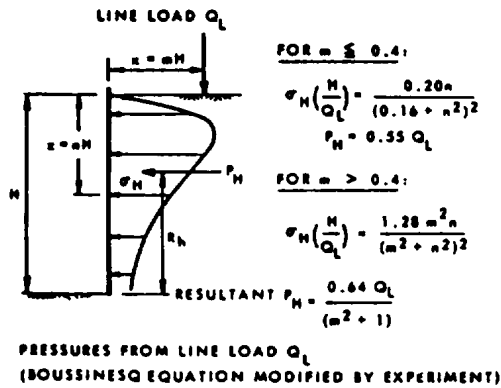
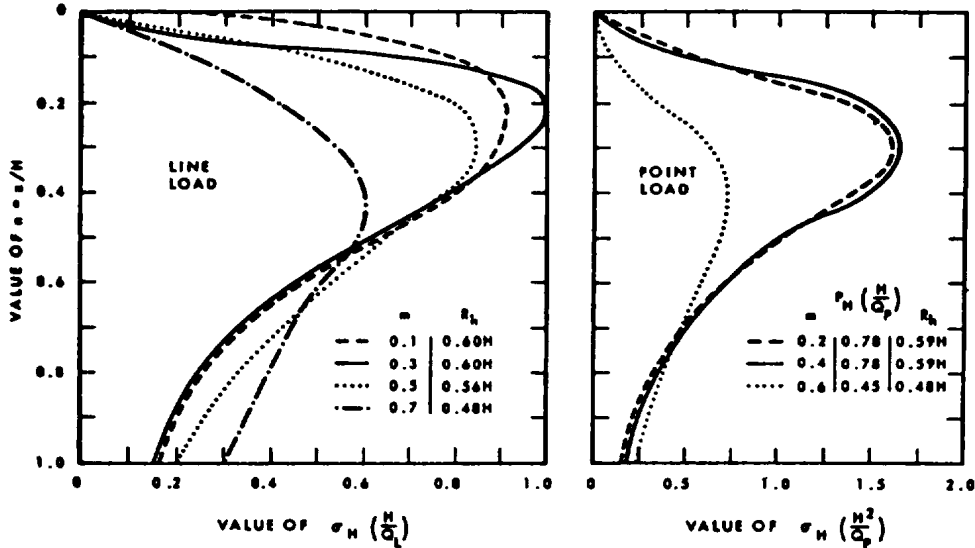

U. S. Army Corps of Engineers

Figure 14-5. Horizontal pressures on walls due to surcharge.

concrete and soil may be taken as 0.55 for coarsegrained soils without silt, 0.45 for coarserained soils with silt, and 0.35 for silt. The soil in a layer beneath the base may be weaker, and the shearing resistance between the base of wall and soil should never be assumed to exceed the soil strength. Consider maximum uplift pressures that may develop beneath the base.

(3) If the factor of safety against sliding is insufficient, increase resistance by either increasing the width of the base or lowering the base elevation. If the wall is founded on clay, the resistance against sliding should be based on  $s_u$  for short-term analysis and  $\phi'$  for long-term analysis.

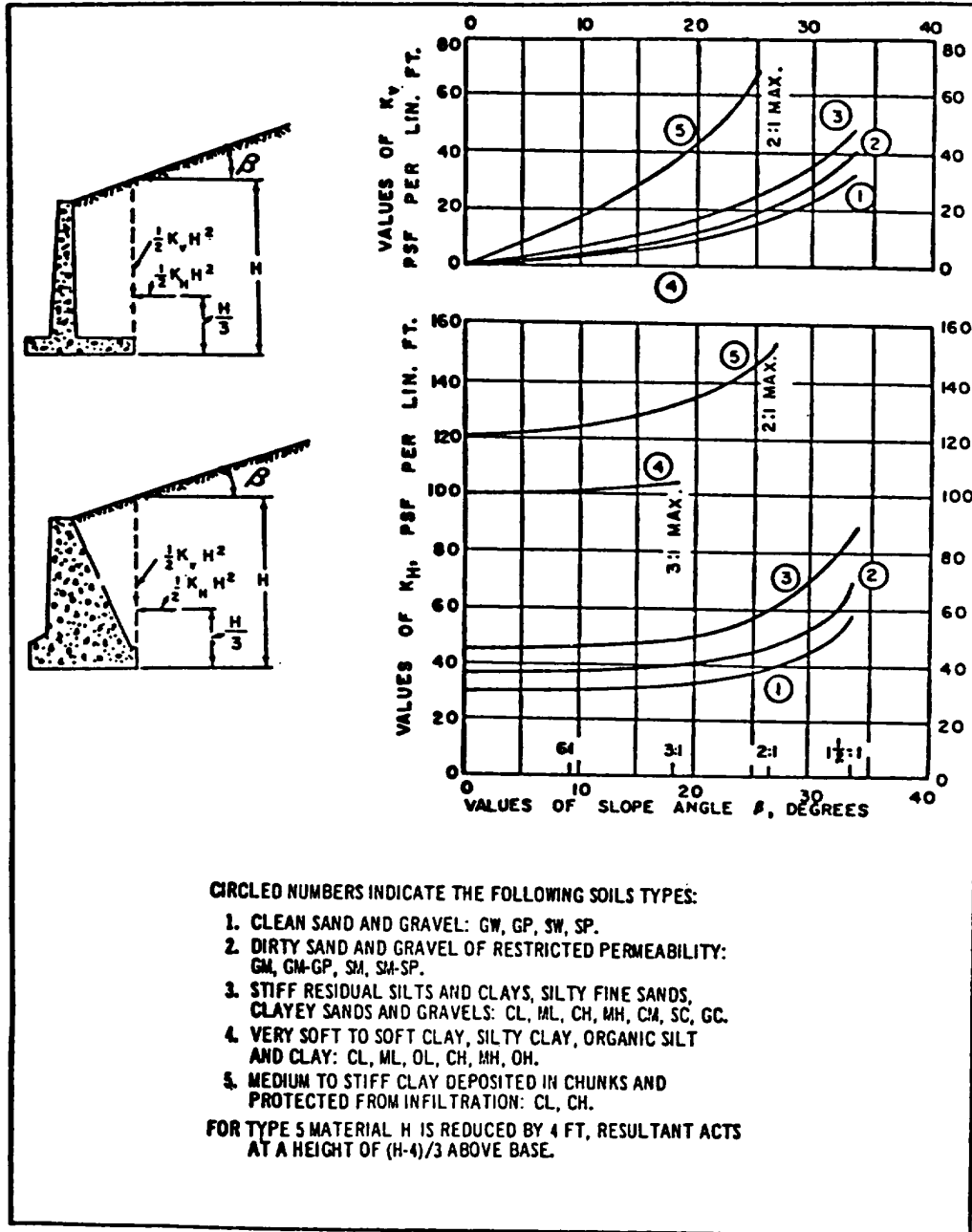

(NAVFAC DM-7)

Figure 14-6. Design loads for low retaining walls, straight slope backfill.

d. *Bearing capacity.* Calculate from the bearing capacity analysis in chapter 6. Consider local building codes or experience where applicable.

e. *Settlement and tilting.* When a high retaining wall is to be founded on compressible soils, estimate total and differential settlements using

procedures outlined in chapter 5. Reduce excessive total settlement by enlarging the base width of the wall or by using lightweight backfill material. Reduce tilting induced by differential settlement by proportioning the size of the base such that the resultant force falls close

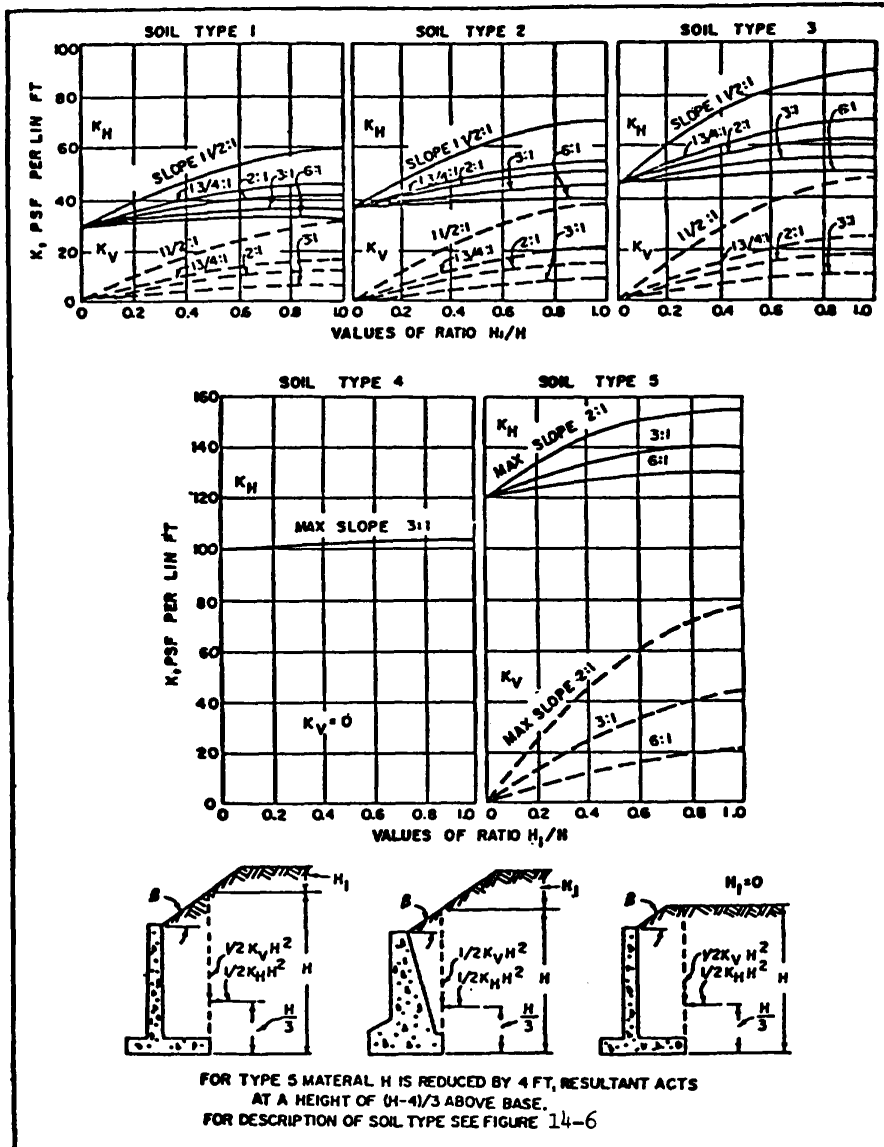

(NAVFAC DM-7)

Figure 14-7. Design loads for low retaining walls, broken slope backfill.

to the center of the base. Limit differential settlement to the amount of tilting that should not exceed 0.05H. If settlements are excessive, stabilize compressible soils by surcharge loading or a support wall on piles.

f. *Deep-seated failure.* Check the overall stability of the retaining wall against a deep-seated foundation failure using methods of analysis outlined in chapter 8. Forces considered include weight of retaining wall, weight of soil, unbalanced water pressure, equipment, and future construction. The minimum safety factor is 1.5.

g. *Use of piles.* When stability against bearing capacity failure cannot be satisfied or settlement is excessive, consider a pile foundation. Use batter piles if the horizontal thrust of the lateral earth pressure is high.

14-5. **Crib wall.** Design criteria of crib walls are presented in figure 14-9.

14-6. **Excavation support systems.** The use of steep or vertical slopes for a deep excavation is often necessitated by land area availability or economics.

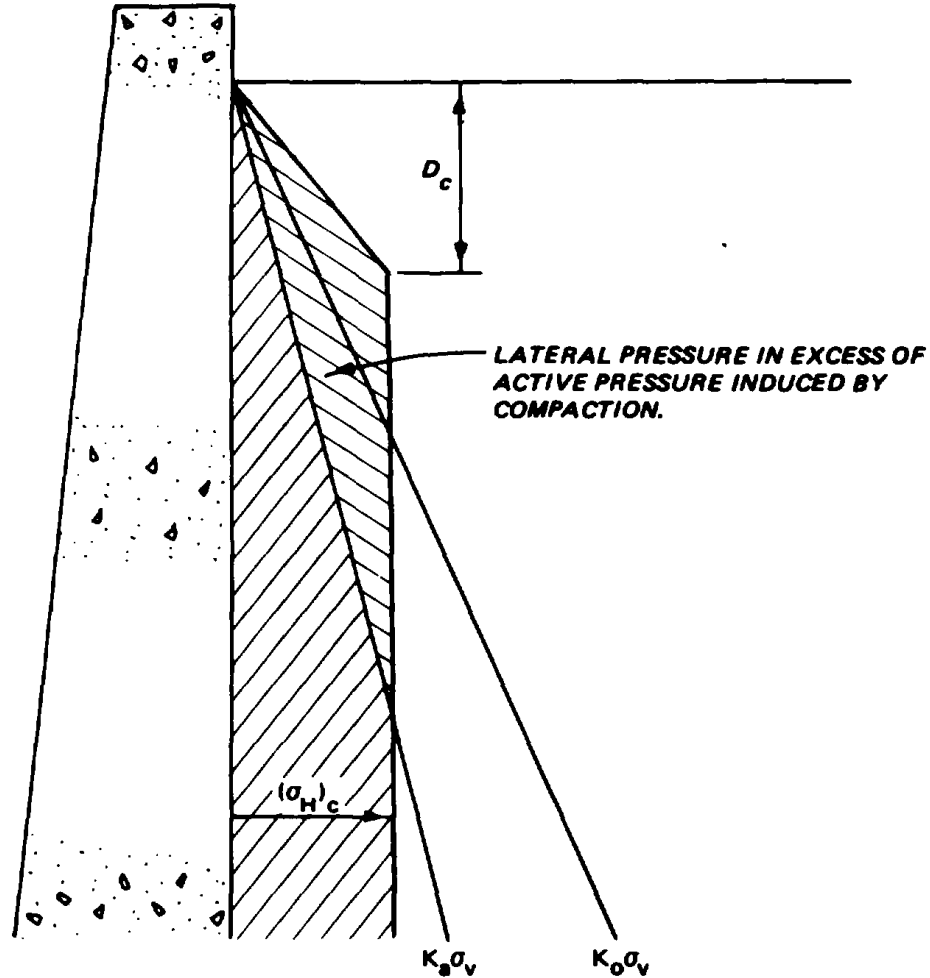

<u>COMPACTION EQUIPMENT</u>	<u>CRITICAL DEPTH, <math>D_c</math>, ft</u>	<u><math>(\sigma_H)_c</math> psf</u>
10-TON SMOOTH WHEEL ROLLER	1.9	420
3.2-TON VIBRATORY ROLLER	1.7	400
1.4-TON VIBRATORY ROLLER	1.2	260
400-KG VIBRATORY PLATE	1.5	340
120-KG VIBRATORY PLATE	1.0	240

U. S. Army Corps of Engineers

Figure 14-8. Estimates of increased pressure induced by compaction.



Such slopes are commonly supported by a cantilever wall (only for shallow excavations), a braced wall, or a tieback wall (fig 14-10). In some cases, it may be economical to mix systems, such as a free slope and a tieback wall or a tieback wall and a braced wall. Table 14-1 summarizes the wall types with their typical

properties and advantages and disadvantages. Table 14-2 lists factors for selecting wall support system for a deep excavation (>20 feet). Table 14-3 gives design parameters, such as factors of safety, heave problems, and supplemental references.

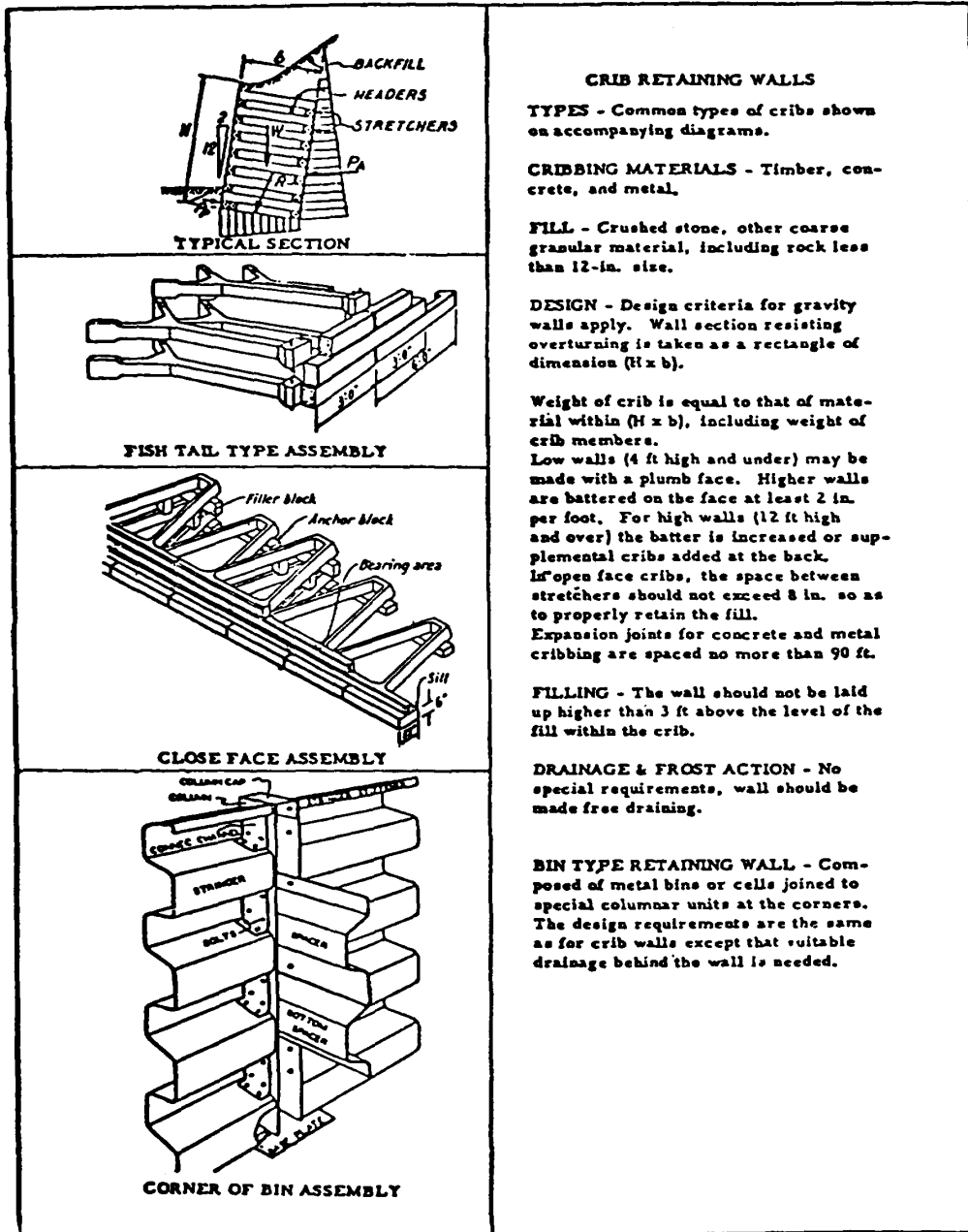

(NAVFAC DM-7)

Figure 14-9. Design criteria for crib and bin walls.

**14-7. Struted excavations.**

a. Empirical design earth pressure diagrams developed from observations are shown in figure 14-11. In soft to medium clays, a value of  $m = 1.0$  should be applied if a stiff stratum is present at or near the base of the excavation. If the soft material extends to a sufficient depth below the bottom of the excavation and significant plastic yielding occurs, a value of 0.4 should be used for

m. The degree of plastic yielding beneath an excavation is governed by the stability number  $N$  expressed as

$$N = \gamma H / s_u \quad (14-2)$$

where  $\gamma$ ,  $H$ , and  $s_u$ , are defined in figure 14-11. If  $N$  exceeds about 4,  $m < 1.0$ .

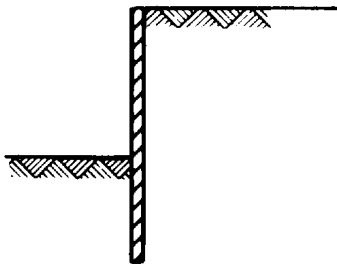

a. CANTILEVER WALL

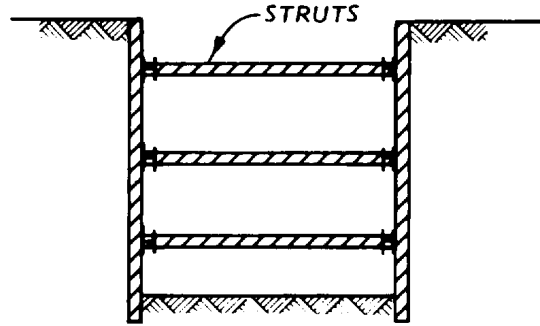

b. CROSS-LOT BRACED WALL

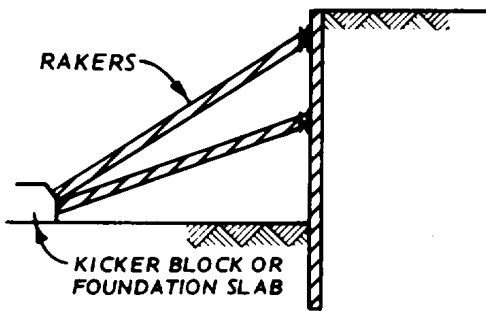

c. RAKER SYSTEM

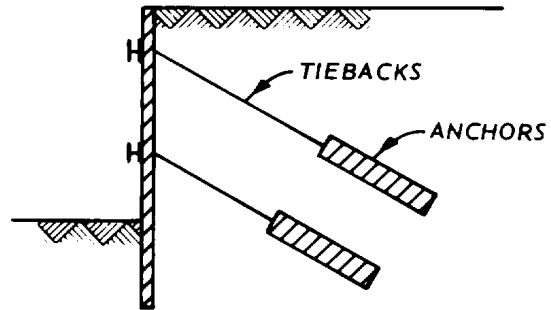

d. ANCHOR OR TIEBACK WALL

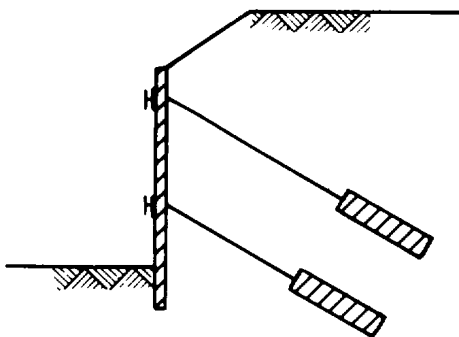

e. FREE SLOPE-TIEBACK WALL

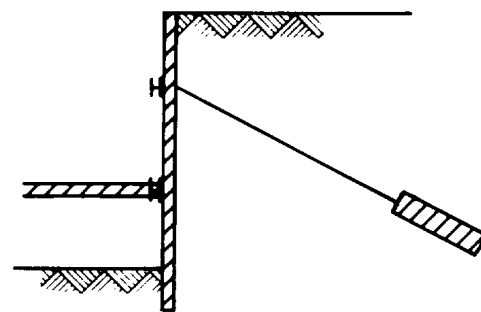

f. TIEBACK-BRACED WALL

U. S. Army Corps of Engineers

Figure 14-10. Types of support systems for excavation.

Table 14-1. Types of Walls

Name	Section	Typical EI Values per foot ksf	Advantages	Disadvantages
Steel sheeting		900-90, 000	(1) Can be impervious (2) Easy to handle and construct (3) Low initial cost	(1) Limited stiffness (2) Interlocks can be lost in hard driving or in gravelly soils
Soldier pile and lagging		2,000-120,000	(1) Easy to handle and construct (2) Low initial cost (3) Can be driven or augered	(1) Wall is pervious (2) Requires care in placement of lagging
Cast-in-place concrete slurry wall		288, 000-2, 300, 000	(1) Can be impervious (2) High stiffness (3) Can be part of permanent structure	(1) High initial cost (2) Specialty contractor required to construct (3) Extensive slurry disposal needed (4) Surface can be rough.
Precast concrete slurry		288,000-2,300,000	(1) Can be impervious (2) High stiffness (3) Can be part of permanent structure (4) Can be prestressed	(1) High initial cost (2) Specialty contractor required to construct (3) Slurry disposal needed (4) Very large and heavy members must be handled for deep systems (5) Permits some yielding of subsoils

(Continued)

Table 14-1. Types of Walls-Continued

Typical EI				
Name	Section	Values per foot ksf	Advantages	Disadvantages
Cylinder pile wall		115,000- 1,000,000	<ul style="list-style-type: none"> <li>(1) Secant piles impervious</li> <li>(2) High stiffness</li> <li>(3) Highly specialized equipment not needed for tangent piles</li> <li>(4) Slurry not needed</li> </ul>	<ul style="list-style-type: none"> <li>(1) High initial cost</li> <li>(2) Secant piles require special equipment</li> </ul>

b. For stiff-fissured clays, diagram (c) of figure 14-11 applies for any value of N. If soft clays, diagram (b) applies except when the computed maximum pressure falls below the value of the maximum pressure in diagram (c). In these cases, generally for  $N < 5$  or 6, diagram (c) is used as a lower limit. There are no design rules for stiff intact clays and for soils characterized by both  $c$  and  $\phi$  such as sandy clays, clayey sands, or cohesive silts.

c. The upper tier of bracing should always be installed near the top of the cut, although computations may indicate that it could be installed at a greater depth. Its location should not exceed  $2s_u$  below the top of the wall.

d. Unbalanced water pressures should be added to the earth pressures where the water can move freely through the soil during the life of the excavation. Buoyant unit weight is used for the soil below water. Where undrained behavior of a soil is considered to ap-

ply, the use of total unit weights in calculating earth pressures automatically accounts for the loads produced by groundwater (fig 14-11). Pressures due to the surcharge load are computed as indicated in previous sections and added to the earth and water pressures.

e. Each strut is assumed to support an area extending halfway to the adjacent strut (fig 14-11). The strut load is obtained by summing the pressure over the corresponding tributary area. Temperature effects, such as temperature increase or freezing of the retained material, may significantly increase strut loads.

f. Support is carried to the sheeting between the struts by horizontal structural members (wales). The wale members should be designed to support a uniformly distributed load equal to the maximum pressure determined from figure 14-11 times the spacing between the wales. The wales may be assumed to be simply supported (pinned) at the struts.

Table 14-2. Factors Involved in Choice of a Support System for a Deep Excavation

Requirement	Lends Itself To Use Of	Downgrades Utility Of	Comment
1. Open excavation area	Tiebacks or rakers or cantilever walls (shallow excavation)	Crosslot struts	
2. Low initial cost	Soldier pile or sheetpile walls; combined soil slope with wall	Diaphragm walls, cylinder pile walls	Depends somewhat on <u>3</u>
3. Use as part of permanent structure	Diaphragm or cylinder pile walls	Sheetpile or soldier pile walls	Diaphragm wall most common as permanent wall
4. Deep, soft clay subsurface conditions	Strutted or raker supported diaphragm or cylinder pile walls	Tiebacks, flexible walls	Tieback capacity not adequate in soft clays
5. Dense, gravelly sand	Soldier pile, diaphragm or clay subsoils	Sheetpile walls or cylinder pile	Sheetpile walls lose interlock on hard driving
6. Deep, overconsolidated clays	Struts, long tiebacks or combination tiebacks and struts (fig. 14-10)	Short tiebacks	High lateral stresses are relieved in O.C. soils and lateral movements may be large and extend deep into soil
7. Avoid dewatering	Diaphragm walls, possibly sheetpile walls in soft subsoils	Soldier pile wall	Soldier pile wall is pervious
8. Minimize movements	High preloads on stiff strutted or tied-back wall	Flexible walls	Analyze for stability of bottom of excavation
9. Wide excavation (greater than 20m wide)	Tiebacks or rakers	Crosslot struts	Tiebacks preferable except in very soft clay subsoils
10. Narrow excavation (less than 20m wide)	Crosslot struts	Tiebacks or rakers	Struts more economical but tiebacks still may be preferred to keep excavation open

Table 14-3. Design Considerations for Braced and Tieback Walls

Design Factor	Comments
1. Earth loads	For struts, select from the semiempirical diagrams (fig. 14-10); for walls and wales use lower loads - reduce by 25 percent from strut loading. Tiebacks may be designed for lower loads than struts unless preloaded to higher values to reduce movements
2. Water loads	Often greater than earth load on impervious wall. Should consider possible lower water pressures as a result of seepage through or under wall. Dewatering can be used to reduce water loads
3. Stability	Consider possible instability in any berm or exposed slope. Sliding potential beneath the wall or behind tiebacks should be evaluated. Deep seated bearing failure under weight of supported soil to be checked in soft cohesive soils (fig. 14-12)
4. Piping	Loss of ground caused by high groundwater tables and silty soils. Difficulties occur due to flow beneath wall, through bad joints in wall, or through unsealed sheetpile handling holes. Dewatering may be required.
5. Movements	Movements can be minimized through use of stiff impervious wall supported by preloaded tieback or braced system. Preloads should be at the level of load diagrams (fig. 14-11) for minimizing movements
6. Dewatering - recharge	Dewatering reduces loads on wall systems and minimizes possible loss of ground due to piping. May cause settlements and will then need to recharge outside of support system. Not applicable in clayey soils
7. Surcharge	Storage of construction materials usually carried out near wall systems. Allowance should always be made for surcharge, especially in upper members

(Continued)

Table 14-3. Design Considerations for Braced and Tieback Walls-Continued

Design Factor	Comments												
8. Preloading	Useful to remove slack from system and minimize soil movements. Preload up to the load diagram loads (fig. 14-10) to minimize movements												
9. Construction sequence	Sequence used to build wall important in loads and movements of system. Moments in walls should be checked at every major construction stage for maximum condition. Upper struts should be installed early												
10. Temperature	Struts subject to load fluctuation due to temperature loads; may be important for long struts												
11. Frost penetration	In very cold climates, frost penetration can cause significant loading on wall system. Design of upper portion of system should be conservative. Anchors may have to be heated												
12. Earthquakes	Seismic loads may be induced during earthquake. Local codes often govern												
13. Codes	For shallow excavations, codes completely specify support system. Varies from locality to locality. Consult OSHA requirements												
14. Factors of safety	<table border="1" style="width: 100%; border-collapse: collapse;"> <thead> <tr> <th style="text-align: center;">Item</th> <th style="text-align: center;">Minimum Design Factor of Safety</th> </tr> </thead> <tbody> <tr> <td>Earth Berms</td> <td style="text-align: center;">2.0</td> </tr> <tr> <td>Critical Slopes</td> <td style="text-align: center;">1.5</td> </tr> <tr> <td>Noncritical Slopes</td> <td style="text-align: center;">1.2</td> </tr> <tr> <td>Basal Heave</td> <td style="text-align: center;">1.5</td> </tr> <tr> <td>General Stability</td> <td style="text-align: center;">1.5</td> </tr> </tbody> </table>	Item	Minimum Design Factor of Safety	Earth Berms	2.0	Critical Slopes	1.5	Noncritical Slopes	1.2	Basal Heave	1.5	General Stability	1.5
	Item	Minimum Design Factor of Safety											
	Earth Berms	2.0											
	Critical Slopes	1.5											
	Noncritical Slopes	1.2											
	Basal Heave	1.5											
General Stability	1.5												

**14-8. Stability of bottom of excavation.**

a. *Piping in sand.* The base of an excavation in sand is usually stable unless an unbalanced hydrostatic head creates a "quick" condition. Among the methods to eliminate instability are dewatering, application of a surcharge load at the bottom of the excavation, and deeper penetration of the piling.

b. *Heaving in clays.* The stability against heave of the bottom of an excavation in soft clay may be evaluated from figure 14-12. If the factor of safety is less than 1.5, the piling should be extended below the base of the excavation. Heave may also occur because of

unrelieved hydrostatic pressures in a permeable layer located below the clay.

c. *Care of seepage.* Small amounts of seepage into the excavation can be controlled by pumping from sumps. Such seepage can be expected if the excavation extends below the water table into permeable soils. If the soils consist of fine sands and silts, the sumps should be routinely monitored for evidence of fines being washed from the soil by seepage. If large quantities of fine-grained materials are found in the sumps, precautionary steps should be taken to make the lagging or sheeting watertight to avoid excessive settlements adjacent to the excavation.

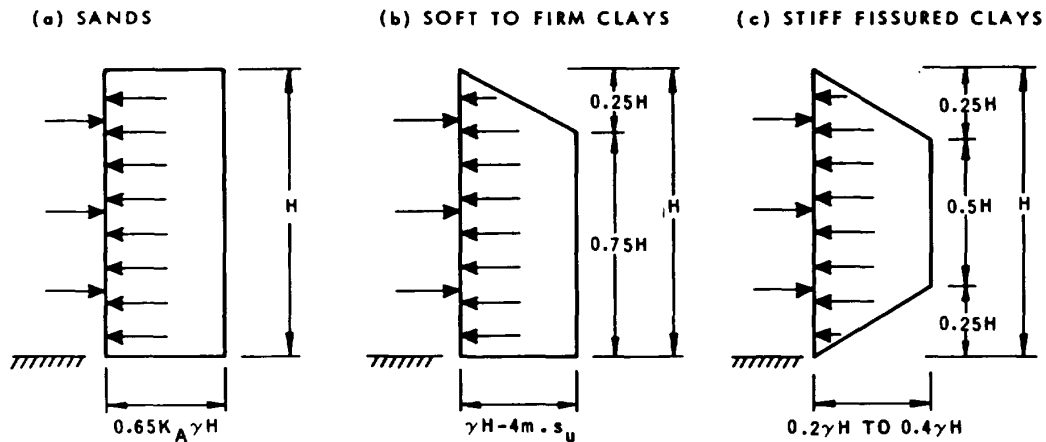

**NOTES:**

1. CHECK SYSTEM FOR PARTIAL EXCAVATION CONDITION
2. IF THE FREE WATER LEVEL IS ABOVE THE BASE OF THE EXCAVATION THE HYDROSTATIC PRESSURE MUST BE ADDED TO THE ABOVE PRESSURE DISTRIBUTION IN SANDS
3. IF SURCHARGE LOADINGS ARE PRESENT AT OR NEAR THE GROUND SURFACE THESE MUST BE INCLUDED IN THE LATERAL PRESSURE CALCULATION.
4. VALUES OF  $m$  ARE GIVEN IN PARAGRAPH 14-7.
5.  $\gamma$  = UNIT WEIGHT OF SOIL.  
 $s_u$  = UNDRAINED SHEAR STRENGTH.

U. S. Army Corps of Engineers

Figure 14-11. Pressure distribution-complete excavation.



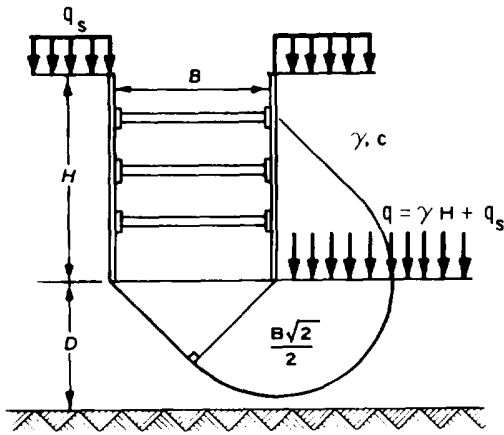

$D > 0.7B$  F.S. =  $\frac{cN_c}{q}$   $N_c$  FROM I

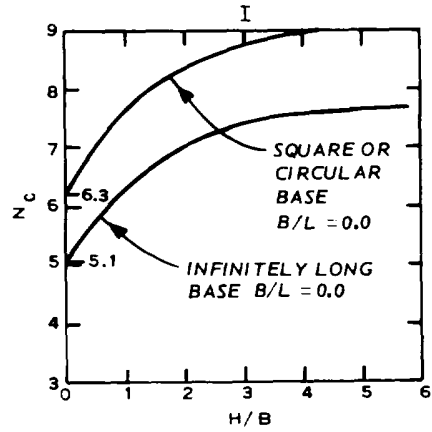

RECTANGULAR BASE  $N_c = \left(1 + 0.2 \frac{B}{L}\right) N_{c \text{ inf.}}$   
 WHERE L = LENGTH OF EXCAVATION

a.

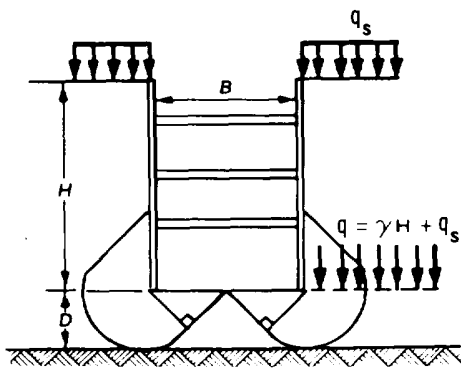

HARD BASE

$D < 0.7B$  F.S. =  $\frac{cN_c}{q}$

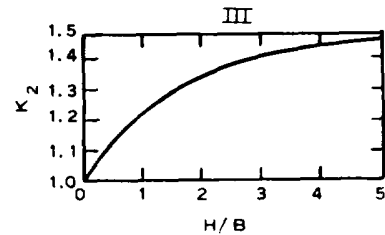
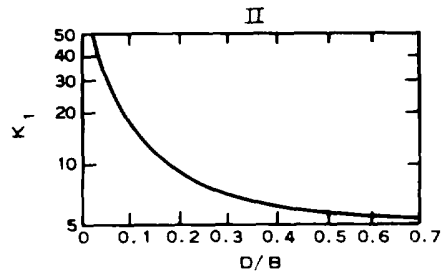

LONG EXCAVATION:

$N_{c \text{ inf.}} = f(D/B, H/3) = K_1 K_2$

RECTANGULAR EXCAVATION:

$N_c = \left(1 + 0.2 \frac{B}{L}\right) N_{c \text{ inf.}}$

b.

U. S. Army Corps of Engineers

Figure 14-12. Stability of bottom of excavation in clay.

**14-9. Anchored walls.**

a. Tiebacks have supplanted both strut and raker systems in many instances to support wide excavations. The tieback (fig 14-13) connects the wall to an anchorage located in a zone where significant soil movements do not occur. The anchorage may be in soil or rock; soft clays probably present the only condition where an anchorage in soil cannot be obtained reliably. In figure 14-13, the distance  $L_{ub}$  should extend beyond the "Rankine" zone some distance. This distance is necessary, in part, to obtain sufficient elongation in anchored length of rod  $L_a$  during jacking so that soil creep leaves sufficient elongation that the design load is retained in the tendon. After jacking, if the soil is corrosive and the excavation is open for a long time, the zone  $L_{ub}$  may be grouted. Alternatively, the length of tendon  $L_{ub}$  is painted or wrapped with a grease impregnated wrapper (prior to placing in position).

b. The tieback tendon may be either a single high-strength bar or several high-strength cables (fy on

the order of 200 to 270 kips per square inch) bunched. It is usually inclined so as to reach better bearing material, to avoid hole collapse during drilling, and to pass under utilities. Since only the horizontal component of the tendon force holds the wall, the tendon should be inclined a minimum.

c. Tieback anchorages may be drilled using continuous flight earth augers (commonly 4 to 7 inches in diameter) and may require casing to hold the hole until grout is placed in the zone  $L_a$  of figure 14-13, at which time the casing is withdrawn. Grout is commonly used under a pressure ranging from 5 to 150 pounds per square inch. Underreaming may be used to increase the anchor capacity in cohesive soil. Belling is not possible in cohesionless soils because of hole caving. Typical formulas that can be used to compute the capacity of tieback anchorages are given in figure 14-14.

d. Exact knowledge of the anchor capacity is not

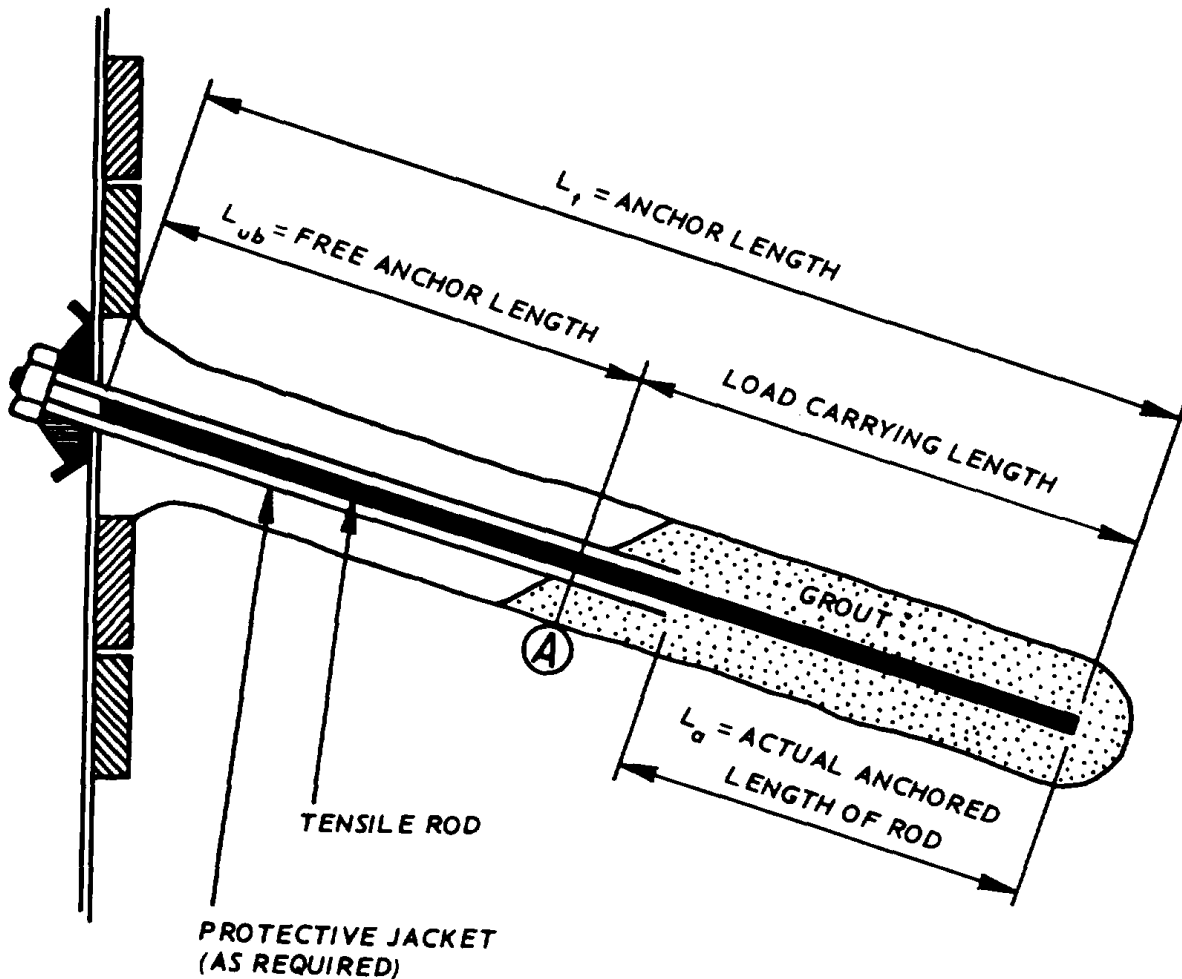

U. S. Army Corps of Engineers

Figure 14-13. Typical tieback details.

Case 1 - Straight Shaft Anchors

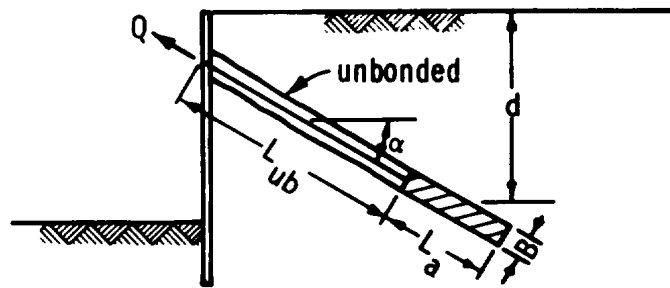

$$Q_u = \pi B (c_a + \sigma_n \tan \delta) L_a$$

$c_a$  = adhesion on shaft

$c_a = s_u$  in clay with  $s_u < 0.5$  tsf

$c_a = 0.5$  tsf in clay with  $s_u > 0.5$  tsf

$c_a = 0$  in sand

$\delta$  = angle of frictional resistance at grout-soil interface  
commonly  $\delta \cong \phi$

$B$  = diameter of hole for tremie or if hole was cased  
= diameter computed from grout volume and  $L_a$  as

$$B = \sqrt{\frac{Vg}{0.7854 L_a}}$$

$\sigma_n$  = normal stress on center of anchor; determine as per Mohr circle. If grouted anchor,  $\sigma_n$  may be higher

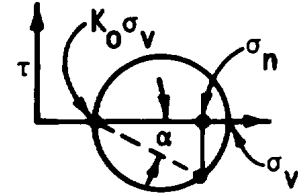

$Vg$  = volume of grout in length  $L_a$

Case 2 - Underreamed Anchor (Clays Only)

Drill case embedded to form seal

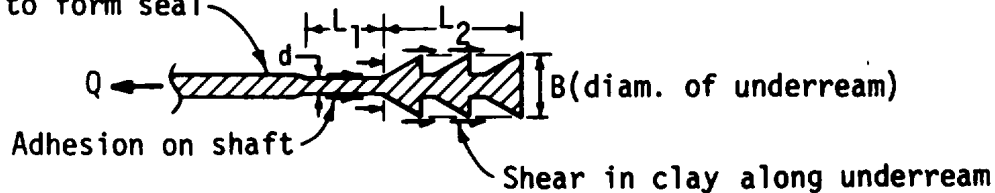

$$Q_u = \pi B L_2 s_u F_1 + \frac{\pi}{4} (B^2 - d^2) N_c s_u + \pi d L c_a$$

$F_1$  ranges from 1 to 0.75 depending upon amount of disturbance  
 $N_c = 9$  (range of 5.7 to 9 depending on depth)

needed as all the anchors are effectively "proof-tested" (about 120 to 150 percent of design load) when the tendons are tensioned for the design load. One or more anchors may be loaded to failure; however, as the cost of replacing a failed anchor is often two to three times the cost of an initial insertion, care should be taken not

to fail a large number of anchors in any-test program. If the tieback extends into the property of others, permission, and possibly a fee, will be required. The tieback tendons and anchorages should normally be left in situ after construction is completed. See table 14-3 for additional design considerations.

## CHAPTER 15

## FOUNDATIONS ON FILL AND BACKFILLING

**15-1. Types of fill.**

a. Fills include conventional compacted fills; hydraulic fills; and uncontrolled fills of soils or industrial and domestic wastes, such as ashes, slag, chemical wastes, building rubble, and refuse. Properly placed compacted fill will be more rigid and uniform and have greater strength than most natural soils. Hydraulic fills may be compacted or uncompacted and are an economical means of providing fill over large areas. Except when cohesionless materials, i.e., clean sands and gravels, are placed under controlled conditions so silty pockets are avoided and are compacted as they are placed, hydraulic fills will generally require some type of stabilization to ensure adequate foundations.

b. Uncontrolled fills are likely to provide a variable bearing capacity and result in a nonuniform settlement. They may contain injurious chemicals and, in some instances, may be chemically active and generate gases that must be conducted away from the structure. Foundations on fills of the second and third groups (and the first group if not adequately compacted) should be subjected to detailed investigations to determine their suitability for supporting a structure, or else they should be avoided. Unsuitable fills often can be adequately stabilized.

**15-2. Foundations on compacted fills.**

a. *Compacted fill beneath foundations.* Compacted fills are used beneath foundations where it is necessary to raise the grade of the structure above existing ground or to replace unsatisfactory surface soils. Fills constructed above the natural ground surface increase the load on underlying soils, causing larger settlements unless construction of the structure is postponed until fill-induced settlements have taken place. Settlements beneath a proposed fill can be computed using methods outlined in chapter 5. If computed settlements are excessive, consider surcharging and postponing construction until the expected settlement under the permanent fill loading has occurred. Extend the fill well beyond the loading area, except where the fill is placed against a cut slope. Where the fill is relatively thick and is underlain by soft materials, check its stability with respect to deep sliding. If the fill is underlain by weaker materials, found the footings on the fill unless settlement is excessive. If the fill is underlain by a stronger material, the footings may be founded on the fill or on the stronger material.

b. *Foundations partially on fill.* Where a sloping ground surface or variable foundation depths would result in supporting a foundation partially on natural soil, or rock, and partially on compacted fill, settlement analyses are required to estimate differential settlements. In general, a vertical joint in the structure should be provided, with suitable architectural treatment, at the juncture between the different segments of foundations. The subgrade beneath the portions of foundations to be supported on natural soils or rock should be undercut about 3 feet and replaced by compacted fill that is placed at the same time as the fill for the portions to be supported on thicker compacted fill.

c. *Location of borrow.* Exploratory investigations should be made to determine the suitable sources of borrow material. Laboratory tests to determine the suitability of available materials include natural water contents, compaction characteristics, grain-size distribution, Atterberg limits, shear strength, and consolidation. Typical properties of compacted materials for use in preliminary analyses are given in table 3-1. The susceptibility to frost action also should be considered in analyzing the potential behavior of fill material. The scope of laboratory testing on compacted samples depends on the size and cost of the structure, thickness and extent of the fill, and also strength and compressibility of underlying soils. Coarse-grained soils are preferred for fill; however, most fine-grained soils can be used advantageously if attention is given to drainage, compaction requirements, compaction moisture, and density control.

d. *Design of foundations on fill.* Foundations can be designed on the basis of bearing capacity and settlement calculations described in chapter 10. The settlement and bearing capacity of underlying foundation soils also should be evaluated. Practically all types of construction can be founded on compacted fills, provided the structure is designed to tolerate anticipated settlements and the fill is properly placed and compacted. Good and continuous field inspection is essential.

e. *Site preparation.* The site should be prepared by clearing and grubbing all grass, trees, shrubs, etc. Save as many trees as possible for environmental considerations. The topsoil should be stripped and stockpiled for later landscaping of fill and borrow areas. Placing and compacting fills should preferably be done when

the area is still unobstructed by footings or other construction. The adequacy of compacted fills for supporting structures is dependent chiefly on the uniformity of the compaction effort. Compaction equipment generally can be used economically and efficiently only on large areas. Adverse weather conditions may have a pronounced effect on the cost of compacted fills that are sensitive to placement moisture content, i.e., on materials having more than 10 to 20 percent finer than the No. 200 sieve, depending on gradation.

*f. Site problems.* Small building areas or congested areas where many small buildings or utility lines surround the site present difficulties in regard to maneuvering large compaction equipment. Backfilling adjacent to structures also presents difficulties, and power hand-tamping equipment must be employed, with considerable care necessary to secure uniform compaction. Procedures for backfilling around structures are discussed in TM 5-818-4 / AFM 88-5, Chapter 5.

### 15-3. Compaction requirements.

*a. General.* Guidelines for selecting compaction equipment and for establishing compaction requirements for various soil types are given in table 15-1. If fill materials have been thoroughly investigated and there is ample local experience in compacting them, it is preferable to specify details of compaction procedures, such as placement water content, lift thickness, type of equipment, and number of passes. When the source of the fill or the type of compaction equipment is not known beforehand, specifications should be based on the desired compaction result, with a specified minimum number of coverages of suitable equipment to assure uniformity of compacted densities.

*b. Compaction specifications.* For most projects the placement water content of soils sensitive to compaction moisture should be within the range of -1 to + 2 percent of optimum water content for the field compaction effort applied. Each layer is compacted to not less than the percentage of maximum density specified in table 15-2. It is generally important to specify a high degree of compaction in fills under structures to minimize settlement and to ensure stability of a structure. In addition to criteria set forth in TM 5-818-4/AFM 88-5, Chapter 5, the following factors should be considered in establishing specific requirements:

(1) The sensitivity of the structure to total and differential settlement as related to structural design is particularly characteristic of structures to be founded partly on fill and partly on natural ground.

(2) If the ability of normal compaction equipment to produce desired densities in existing or locally available materials within a reasonable range of placement water content is considered essential, special equipment should be specified.

(3) The compaction requirements for clean, cohesionless, granular materials will be generally higher than those for cohesive materials, because cohesionless materials readily consolidate, or liquify, when subjected to vibration. For structures with unusual stability requirements and settlement limitations, the minimum density requirements indicated in table 15-2 should be increased. For coarse-grained, well-graded, cohesionless soils with less than 4 percent passing the No. 200 sieve, or for poorly graded cohesionless soils with less than 10 percent, the material should be compacted at the highest practical water content, preferably saturated. Compaction by vibratory rollers generally is the most effective procedure. Experience indicates that pervious materials can be compacted to an average relative density of  $85 \pm 5$  percent with no practical difficulty. For cohesionless materials, stipulate that the fill be compacted to either a minimum density of 85 percent relative density or 95 percent of CE 55 compaction effort, whichever gives the greater density.

(4) If it is necessary to use fill material having a tendency to swell, the material should be compacted at water contents somewhat higher than optimum and to no greater density than required for stability under proposed loadings (table 15-2). The bearing capacity and settlement characteristics of the fill under these conditions should be checked by laboratory tests and analysis. Swelling clays can, in some instances, be permanently transformed into soils of lower plasticity and swelling potential by adding a small percentage of hydrated lime (chap 16).

*c. Compacted rock.* Compacted crushed rock provides an excellent foundation fill. Vibratory rollers are preferable for compacting rock. Settlement of fill under the action of the roller provides the most useful information for determining the proper loose lift thickness, number of passes, roller type, and material gradation. Compaction with a 10-ton vibratory roller is generally preferable. The rock should be kept watered at all times during compaction to obviate collapse settlement on loading and first wetting. As general criteria for construction and control testing of rock fill are not available, test fills should be employed where previous experience is inadequate and for large important rock fills.

**15-4. Placing and control of backfill.** Backfill should be placed in lifts no greater than shown in table 15-1, preferably 8 inches or less and depending on the soil and type of equipment available. No backfill should be placed that contains frozen lumps of soil, as later thawing will produce local soft spots. Backfill should not be placed on muddy, frozen, or frost-cov-

Table 15-1. A summary of Density Methods for Building Foundation

Soil Group	Soil Types	Degree of Compaction	Fill and Backfill				Deep Foundation Deposits		
			Typical Equipment and Procedures for Compaction				Field Control	Compaction Methods	Field Control
			Equipment	No. of Passes or Coverages	Comp. Lift Thick., in.	Placement Water Content			
Pervious (Free-Draining)	GW GP SW SP	90 to 95% of CE 55 maximum density  75 to 85% of relative density	Vibratory rollers and compactors	Indefinite	Indefinite	Saturate by flooding	Control samples at intervals to determine degree of compaction or relative density	None available except for near surface (to approximate depth of 5 ft) compaction by equipment and procedure shown at left	
			Rubber-tired roller <sup>(a)</sup>	2-5 coverages	12				
			Crawler-type tractor <sup>(b)</sup>	2-5 coverages	8				
			Power hand tamper <sup>(c)</sup>	Indefinite	6				
	Semicompacted	85 to 90% of CE 55 maximum density  65 to 75% of relative density	Rubber-tired roller <sup>(a)</sup>	2-5 coverages	14	Saturate by flooding	Control samples as noted above, if needed	Vibroflotation, compaction piles, sand piles, explosives  Surface compaction as noted above	
			Crawler-type tractor <sup>(b)</sup>	1-2 coverages	10				
			Power hand tamper <sup>(c)</sup>	Indefinite	8				
			Controlled routing of construction equipment	Indefinite	8-10				
Semipervious and Impervious	GM GC SM SC ML CL OL OH MH CH OH	90 to 95% of CE 55 maximum density	Rubber-tired roller <sup>(a)</sup>	2-5 coverages	8	Optimum water content based on CE 55 test with 12 blows per layer	Control samples at intervals to determine degree of compaction	(A) Surface compaction by equipment and procedures shown at left is feasible only if material is at proper water content  (B) Densification of soils is controlled by consolidation process  (a) preload fills* (b) lowering of ground-water table (c) drying * Consolidation may be accelerated by means of sand drains  Field control exercised by observation of pore pressures and surface settlements	
			Sheepsfoot roller <sup>(d)</sup>	4-8 passes	6				
			Power hand tamper <sup>(c)</sup>	Indefinite	4				
	Semicompacted	85 to 90% of CE 55 maximum density	Rubber-tired roller <sup>(a)</sup>	2-4 coverages	10	(A) Optimum water content based on CE 55 test with 7 blows per layer  (B) By observation; wet side-maximum water content at which material can satisfactorily operate, dry side-minimum water content required to bond particles and which will not result in voids or honeycombed material	(A) Control samples as noted above, if needed  (B) Field control exercised by visual inspection of action of compacting equipment		
			Sheepsfoot roller <sup>(d)</sup>	4-8 passes	8				
			Crawler-type tractor <sup>(b)</sup>	3 coverages	6				
			Power hand tamper <sup>(d)</sup>	Indefinite	6				
			Controlled routing of construction equipment	Indefinite	6-8				

Note: The above requirements will be adequate in relation to most construction. In special cases where tolerable settlements are unusually small, it may be necessary to employ additional compaction equivalent to 95 to 100% of CE 55 compaction effort. A coverage consists of one application of the wheel of a rubber-tired roller or the threads of a crawler-type tractor over each point in the area being compacted. For a sheepsfoot roller, one pass consists of one movement of a sheepsfoot roller drum over the area being compacted.

- (a) Rubber-tired rollers having a wheel load between 18,000 and 25,000 lb and a tire pressure between 80 and 100 psi.
- (b) Crawler-type tractors weighing not less than 20,000 lb and exerting a foot pressure not less than 6-1/2 psi.
- (c) Power hand tampers weighing more than 100 lb; pneumatic or operated by gasoline engine.
- (d) Sheepsfoot rollers having a foot pressure between 250 and 500 psi and tamping feet 7 to 10 in. in length with a face area between 7 and 16 sq in.

Table 15-2. Compaction Density as a Percent of CE 55 Laboratory Test Density

	CE 55 Maximum Density, %	
	Cohesive Soils	Cohesionless Soils
<u>Fill, embankment, and backfill</u>		
Under proposed structures, building slabs, steps, and paved areas	90	95 <sup>a</sup>
Under sidewalks and grassed areas	85	90
<u>Subgrade</u>		
Under building slabs, steps, and paved areas, top 12 in.	90	95
Under sidewalks, top 6 in.	85	90

<sup>a</sup> May be 85% relative density, whichever is higher.

ered ground. Methods of compaction control during construction are described in TM 5-818-4/AFM 88-5, Chapter 5.

**15-5. Fill settlements.** A fill thickness of even 3 feet is a considerable soil load, which will increase stresses to a substantial depth (approximately 2B, where B = smallest lateral dimension of the fill). Stress increases from the fill may be larger than those from structure footings placed on the fill. Use procedures outlined in chapter 10 to obtain expected settlements caused by fill loading. Many fills are of variable thickness, especially where an area is landscaped via both cutting and filling to obtain a construction site. In similar cases, attention should be given to building locations with respect to crossing cut and fill lines so that the proper type of building settlement can be designed (building may act as a cantilever, or one end tends to break off, or as a beam where the interior sags). Proper placing of reinforcing steel in the wall footings (top for cantilever action or bottom for simple beam action) may help control building cracks where settlement is inevitable; building joints can be provided at critical locations if necessary. The combined effect of structure (one- and two-story residences) and fill loading for fills up to 10 feet in thickness on sound soil and using compaction control should not produce a differential settlement of either a smooth curved hump or sag of 1 inch in 50 feet or a uniform slope of 2 inches in 50 feet.

**15-6. Hydraulic fills.** Hydraulic fills are placed on land or underwater by pumping material through a pipeline from a dredge or by bottom dumping from barges. Dredge materials vary from sands to silts and fine-grained silty clays and clays. Extensive maintenance dredging in the United States has resulted in disposal areas for dredge materials, which are

especially attractive from an economic standpoint for development purposes. Dikes are usually required to retain hydraulic fills on land and may be feasible for underwater fills. Underwater dikes may be constructed of large stones and gravel.

*a. Pervious fills.* Hydraulically placed pervious fills with less than 10 percent fines will generally be at a relative density of 50 to 60 percent but locally may be lower. Controlled placement is necessary to avoid silt concentrations. Compaction can be used to produce relative densities sufficient for foundation support (table 15-1). Existing uncompacted hydraulic fills of pervious materials in seismic areas are subject to liquefaction, and densification will be required if important structures are to be founded on such deposits. Rough estimates of relative density may be obtained using standard penetration resistance. Undisturbed borings will be required to obtain more precise evaluation of in situ density and to obtain undisturbed samples for cyclic triaxial testing, if required. For new fills, the coarsest materials economically available should be used. Unless special provisions are made for removal of fines, borrow containing more than 10 percent fines passing the No. 200 sieve should be avoided, and even then controlled placement is necessary to avoid local silt concentrations.

*b. Fine-grained fills.* Hydraulically placed overconsolidated clays excavated by suction dredges produce a fill of clay balls if fines in the washwater are permitted to run off. The slope of such fills will be extremely flat ranging from about 12 to 16H on 1V.

(1) These fills will undergo large immediate con-



solidation for about the first 6 months until the clay balls distort to close void spaces. Additional settlements for a 1-year period after this time will total about 3 to 5 percent of the fill height.

(2) Maintenance dredgings and hydraulically placed normally consolidated clays will initially be at water contents between 4 and 5 times the liquid limit. Depending on measures taken to induce surface drainage, it will take approximately 2 years before a crust is formed sufficient to support light equipment and the water content of the underlying materials approaches the liquid limit. Placing 1 to 3 feet of additional cohesionless borrow can be used to improve these areas rapidly so that they can support surcharge fills, with or without vertical sand drains to accelerate consolidation. After consolidation, substantial one- or two-story buildings and spread foundations can be used without objectionable settlement. Considerable care must be used in applying the surcharge so that the shear strength of the soil is not exceeded (i.e., use light equipment).

c. *Settlements of hydraulic fills.* If the coefficient of permeability of a hydraulic fill is less than 0.0002 foot per minute, the consolidation time for the fill will be long and prediction of the behavior of the completed fill will be difficult. For coarse-grained materials with a larger coefficient of permeability, fill consolidation and strength buildup will be relatively rapid and reasonable strength estimates can be made. Where fill and foundation soils are fine-grained with a low coefficient of permeability, piezometers should be placed both in the fill and in the underlying soil to monitor

pore pressure dissipation. It may also be necessary to place settlement plates to monitor the settlement. Depending on the thickness of the fill, settlement plates may be placed both on the underlying soil and within the fill to observe settlement rates and amounts.

d. *Compaction of hydraulic fills.* Dike-land hydraulic fills can be compacted as they are placed by use of-

(1) Driving track-type tractors back and forth across the saturated fill. (Relative densities of 70 to 80 percent can be obtained in this manner for cohesionless materials.)

(2) Other methods such as vibratory rollers, vibroflotation, terraprobng, and compaction piles (chap 16). Below water, hydraulic fills can be compacted by use of terraprobng, compaction piles, and blasting.

e. *Underwater hydraulic fills.* For structural fill placed on a dredged bottom, remove the fines dispersed in dredging by a final sweeping operation, preferably with suction dredges, before placing the fill. To prevent extremely flat slopes at the edge of a fill, avoid excessive turbulence during dumping of the fill material by placing with clamshell or by shoving off the sides of deck barges. To obtain relatively steep slopes in underwater fill, use mixed sand and gravel. With borrow containing about equal amounts of sand and gravel, underwater slopes as steep as 1V on 2H may be achieved by careful placement. Uncontrolled bottom dumping from barges through great depths of water will spread the fill over a wide area. To confine such fill, provide berms or dikes of the coarsest available material or stone on the fill perimeter.

## CHAPTER 16

## STABILIZATION OF SUBGRADE SOILS

**16-1. General.**

a. The applicability and essential features of foundation soil treatments are summarized in tables 16-1 and 16-2 and in figure 16-1. The depth of stabilization generally must be sufficient to absorb most of the foundation pressure bulb.

b. The relative benefits of vibrocompaction, vibrodisplacement compaction, and precompression increase as load intensity decreases and size of loaded area increases. Soft, cohesive soils treated in place are generally suitable only for low-intensity loadings. Soil stabilization of wet, soft soils may be accomplished by addition of lime; grout to control water flow into excavations to reduce lateral support requirements or to reduce liquefaction or settlement caused by adjacent pile driving; seepage control by electroosmosis; and temporary stabilization by freezing. The range of soil grain sizes for which each stabilization method is most applicable is shown in figure 16-1.

**16-2. Vibrocompaction.** Vibrocompaction methods (blasting, terraprobe, and vibratory rollers) can be used for rapid densification of saturated cohesionless soils (fig 16-1). The ranges of grain-size distributions suitable for treatment by vibrocompaction, as well as vibroflotation, are shown in figure 16-2. The effectiveness of these methods is greatly reduced if the percent finer than the No. 200 sieve exceeds about 20 percent or if more than about 5 percent is finer than 0.002 millimeter, primarily because the hydraulic conductivity of such materials is too low to prevent rapid drainage following liquefaction. The usefulness of these methods in partly saturated sands is limited, because the lack of an increase of pore water pressure impedes liquefaction. Lack of complete saturation is less of a restriction to use of blasting because the high-intensity shock wave accompanying detonation displaces soil, leaving depressions that later can be backfilled.

a. *Blasting.*

(1) Theoretical design procedures for densification by blasting are not available and continuous on-site supervision by experienced engineers having authority to modify procedures as required is essential if this treatment method is used. A surface heave of about 6 inches will be observed for proper charge sizes and placement depths. Surface cratering should be avoided. Charge masses of less than 4 to more than 60 pounds

have been used. The effective radius of influence for charges using (M = lb) 60 percent dynamite is as follows:

$$R = 3M^{1/3} \text{ (feet)} \quad (16-1)$$

Charge spacings of 10 to 25 feet are typical. The center of charges should be located at a depth of about two-thirds the thickness of the layer to be densified, and three to five successive detonations of several spaced charges each are likely to be more effective than a single large blast. Little densification is likely to result above about a 3-foot depth, and loosened material may remain around blast points. Firing patterns should be established to avoid the "boxing in" of pore water. Free-water escape on at least two sides is desirable.

(2) If blasting is used in partly saturated sands or loess, preflooding of the site is desirable. In one technique, blast holes about 3 to 3/2 inches in diameter are drilled to the desired depth of treatment, then small charges connected by prima cord, or simply the prima cord alone, are strung the full depth of the hole. Each hole is detonated in succession, and the resulting large diameter holes formed by lateral displacement are backfilled. A sluiced-in cohesionless backfill will densify under the action of vibrations from subsequent blasts. Finer grained backfills can be densified by tamping.

b. *Vibrating probe (terraprobe).*

(1) A 30-inch-outside-diameter, open-ended pipe pile with 3/4-inch wall thickness is suspended from a vibratory pile driver operating at 15 Hz. A probe length 10 to 15 feet greater than the soil depth to be stabilized is used. Vibrations of 7/8- to 1-inch amplitude are in a vertical mode. Probes are made at spacings of 3 to 10 feet. After sinkage to the desired depth, the probe is held for 30 to 60 seconds before extraction. The total time required per probe is typically 2 1/2 to 4 minutes. Effective treatment has been accomplished at depths of 12 to 60 feet. Areas in the range of 450 to 700 square yards may be treated per machine per 8-hour shift.

(2) Test sections about 30 to 60 feet on a side are desirable to evaluate the effectiveness and required probe spacing. The grain-size range of treated soil should fall within limits shown in figure 16-2. A square pattern is often used, with a fifth probe at the center of each square giving more effective increased densification than a reduced spacing. Saturated soil

	METHOD	PRINCIPLE	MOST SUITABLE SOIL CONDITIONS/TYPES	MAXIMUM EFFECTIVE TREATMENT DEPTH	ECONOMICAL SIZE OF TREATED AREA	SPECIAL MATERIALS REQUIRED	SPECIAL EQUIPMENT REQUIRED	PROPERTIES OF TREATED MATERIAL	SPECIAL ADVANTAGES AND LIMITATIONS	RELATIVE COSTS (1976)
VIBRO-COMPACTION	BLASTING	Shock waves and vibrations cause liquefaction, displacement, remolding	Saturated, clean sands; partly saturated sands and silts after flooding	60 ft	Small areas can be treated economically	Explosives, backfill to plug drill holes	Jetting or drilling machine	Can obtain relative densities to 70-80%; may get variable density	Rapid, inexpensive, can treat small areas; variable properties, no improvement near surface, dangerous	Low (\$0.50 \$1.00 per cu yd
	TERRAPROBE	Densification by vibration; liquefaction induced settlement under overburden	Saturated or dry clean sand	60 ft (Ineffective above 12 ft depth)	>1200 yd <sup>2</sup>	None	Vibratory pile driver and 750 mm dia open steel pipe	Can obtain Relative Densities of 80% or more	Rapid, simple, good underwater; soft underlayers may damp vibrations, difficult to penetrate, stiff overlayers, not good in partly saturated soils	Moderate \$1.50- \$3.25 per cu yd \$2.00/cu yd average
	VIBRATORY ROLLERS	Densification by vibration; liquefaction induced settlement under roller weight	Cohesionless soils	6-10 ft	Any size	None	Vibratory roller	Can obtain very high relative densities; upper few decimeters not densified	Best method for thin layers or lifts	Low
VIBRO-DISPLACEMENT COMPACTION	COMPACTION PILES	Densification by displacement of pile volume and by vibration during driving	Loose sandy soils; partly saturated clayey soils; loess	60 ft	Small to moderate	Pile material (often sand or soil plus cement mixture)	Pile driver	Can obtain high densities, good uniformity	Useful in soils with fines, uniform compaction, easy to check results; slow, limited improvement in upper 1-2 m	High
	HEAVY TAMPING (Dynamic Consolidation)	Repeated application of high intensity impacts at surface	Cohesionless soils best, other types can also be improved	50-60 ft	>4000 yd <sup>2</sup>	None	Tamper of 10-40 tons high capacity crane	Can obtain high relative densities, reasonable uniformity	Simple, rapid, suitable for some soils with fines; usable above and below water; requires control, must be away from existing structures	<Vibro- flotation
	VIBROFLOTATION	Densification by vibration and compaction of backfill material	Cohesionless soils with less than 20% fines	90 ft	>1200 yd <sup>2</sup>	Granular backfill	Vibroflot, crane	Can obtain high relative densities, good uniformity	Useful in saturated and partly saturated soils, uniformity	\$10.00- \$25.00/yd \$1.00/cu yd May be about half compaction piles or concrete piles

(Continued)

(Sheet 1 of 5)

Table 16-1. Stabilization of Soils for Foundations of Structures

	METHOD	PRINCIPLE	MOST SUITABLE SOIL CONDITIONS/TYPES	MAXIMUM EFFECTIVE TREATMENT DEPTH	ECONOMICAL SIZE OF TREATED AREA	SPECIAL MATERIALS REQUIRED	SPECIAL EQUIPMENT REQUIRED	PROPERTIES OF TREATED MATERIAL	SPECIAL ADVANTAGES AND LIMITATIONS	RELATIVE COSTS (1976)
GROUTING AND INJECTION	PARTICULATE GROUTING	Penetration grouting-fill soil pores with soil, cement, and/or clay	Medium to coarse sand and gravel	Unlimited	Small	Grout, water	Mixers, tanks, pumps, hoses	Impervious, high strength with cement grout, eliminate liquefaction danger	Low cost grouts, high strength; limited to coarse-grained soils, hard to evaluate	Lowest of the grout systems
	CHEMICAL GROUTING	Solutions of two or more chemicals react in soil pores to form a gel or a solid precipitate	Medium silts and coarser	Unlimited	Small	Grout, water	Mixers, tanks, pumps, hoses	Impervious, low to high strength, eliminate liquefaction danger	Low viscosity, controllable gel time, good water shut-off; high cost, hard to evaluate	High to very high \$30/m <sup>3</sup> min-\$80/m <sup>3</sup> typical
	PRESSURE INJECTED LIME	Lime slurry injected to shallow depths under high pressure	Expansive clays	Unlimited, but 2-3 m usual	Small	Lime, water, surfactant	Slurry tanks, agitators, injection	Lime encapsulated zones formed by channels resulting from cracks, root holes, hydraulic fracture	Rapid and economical treatment for foundation soils under light structures	\$2.50 to \$3.00/m <sup>2</sup> of ground surface area
	DISPLACEMENT GROUT	Highly viscous grout acts as radial hydraulic jack when pumped in under high pressure	Soft, fine-grained soils, foundation soils with large voids or cavities	Unlimited, but a few m usual	Small	Soil, cement, water	Batching equipment, high pressure pumps, hoses	Grout bulbs within compressed soil matrix	Good for correction of differential settlements, filling large voids; careful control required	Low material, high injection
	ELECTROKINETIC INJECTION	Stabilizing chemicals moved into soil by electro-osmosis	Saturated silts, silty clays	Unknown	Small	Chemical stabilizer	DC power supply, anodes, cathodes	Increased strength, reduced compressibility	Existing soil and structures not subjected to high pressures; no good in soil with high conductivity	Expensive

(Continued)

(Sheet 2 of 5)

Table 16-1. Stabilization of Soils for Foundations of Structures-Continued

	METHOD	PRINCIPLE	MOST SUITABLE SOIL CONDITIONS/TYPES	MAXIMUM EFFECTIVE TREATMENT DEPTH	ECONOMICAL SIZE OF TREATED AREA	SPECIAL MATERIALS REQUIRED	SPECIAL EQUIPMENT REQUIRED	PROPERTIES OF TREATED MATERIAL	SPECIAL ADVANTAGES AND LIMITATIONS	RELATIVE COSTS (1976)
PRECOMPRESSION	PRELOADING	Load is applied sufficiently in advance of construction so that compression of soft soils is completed prior to development of the site	Normally consolidated soft clays, silts, organic deposits, completed sanitary landfills	-----	>1000 m <sup>2</sup>	Earth fill or other material for loading the site; sand or gravel for drainage blanket	Earth moving equipment; large water tanks or vacuum drainage systems sometimes used; settlement markers, piezometers	Reduced water content and void ratio, increased strength	Easy, theory well developed, uniformity; requires long time (sand drains or wicks can be used to reduce consolidation time)	Low (Moderate if vertical drains are required)
	SURCHARGE FILLS	Fill in excess of that required permanently is applied to achieve a given amount of settlement in a shorter time; excess fill then removed	Normally consolidated soft clays, silts, organic deposits, completed sanitary landfills	-----	>1000 m <sup>2</sup>	Earth fill or other material for loading the site; sand or gravel for drainage blanket	Earth moving equipment; settlement markers, piezometers	Reduced water content, void ratio and compressibility; increased strength	Faster than preloading without surcharge, theory well developed; extra material handling; can use sand drains or wicks	Moderate. Sand drains cost \$3.30-\$6.60/m
	DYNAMIC CONSOLIDATION	High energy impacts compress and dissolve gas in pores to give immediate settlement; increased pore pressure gives subsequent drainage	Partly saturated fine grained soils, quaternary clays with 1-4 gas in micro bubbles	20 m	>15000-30000 m <sup>2</sup>	None	Tamper of 10-40 tons, high capacity crane	Reduced water content, void ratio and compressibility; increased strength	Faster than preloading, economical on large areas; uncertain mechanism in clays, less uniformity than preloading	<preload fills with sand drains
	ELECTRO-OSMOSIS	DC current causes water flow from anode towards cathode where it is removed	Normally consolidated silts and silty clays	10-20 m	Small	Anodes (usually re-bars or aluminum), cathodes (well points or re-bars)	DC power supply, wiring, metering systems	Reduced water content and compressibility, increased strength, electrochemical hardening	No fill loading required, can use in confined area, relatively fast; non-uniform properties between electrodes, no good in highly conductive soils	High

(Continued)

(Sheet 3 of 5)

Table 16-1. Stabilization of Soils for Foundations of Structures-Continued

	METHOD	PRINCIPLE	MOST SUITABLE SOIL CONDITIONS/TYPES	MAXIMUM EFFECTIVE TREATMENT DEPTH	ECONOMICAL SIZE OF TREATED AREA	SPECIAL MATERIALS REQUIRED	SPECIAL EQUIPMENT REQUIRED	PROPERTIES OF TREATED MATERIAL	SPECIAL ADVANTAGES AND LIMITATIONS	RELATIVE COSTS (1976)
REINFORCEMENT	MIX-IN-PLACE PILES AND WALLS	Lime, cement, or asphalt introduced through rotating auger or special in-place mixer	All soft or loose inorganic soils	>20 m	Small	Cement, lime, asphalt, or chemical stabilizer	Drill rig, rotary cutting and mixing head, additive proportioning equipment	Solidified soil piles or walls of relatively high strength	Uses native soil, reduced lateral support requirements during excavation; difficult quality control	Moderate to high
	STRIPS AND MEMBRANES	Horizontal tensile strips or membranes buried in soil under footings	All	A few m	Small	Metal or plastic strips, polyethylene, polypropylene or polyester fabrics	Excavating, earth handling, and compaction equipment	Increased bearing capacity, reduced deformations	Increased allowable bearing pressure; requires over-excavation for footings	Low to Moderate
	VIBRO-REPLACEMENT STONE COLUMNS	Hole jetted into soft, fine-grained soil and back-filled with densely compacted gravel	Soft clays and alluvial deposits	20 m	>1500 m <sup>2</sup>	Gravel or crushed rock backfill	Vibroflot, crane or Vibrocat, water	Increased bearing capacity, reduced settlements	Faster than pre-compression, avoids dewatering required for remove and replace; limited bearing capacity	Moderate to high ~\$30/m; >pile penetration
THERMAL	HEATING	Drying at low temperatures; alteration of clays at intermediate temperatures (400-600°C); fusion at high temperatures (>1000°C)	Fine-grained soils, especially partly saturated clays and silts, loess	15 m	Small	Fuel	Fuel tanks, burners, blowers	Reduced water control, plasticity, water sensitivity; increased strength	Can obtain irreversible improvements in properties; can introduce stabilizers with hot gases. Experimental	High
	FREESING	Freeze soft, wet ground to increase its strength and stiffness	All soils	Several m	Small	Refrigerant	Refrigeration system	Increased strength and stiffness; reduced permeability	No good in flowing ground water, temporary	High

(Continued)

(Sheet 4 of 5)

Table 16-1. Stabilization of Soils for Foundations of Structures-Continued

	METHOD	PRINCIPLE	MOST SUITABLE SOIL CONDITIONS/TYPES	MAXIMUM EFFECTIVE TREATMENT DEPTH	ECONOMICAL SIZE OF TREATED AREA	SPECIAL MATERIALS REQUIRED	SPECIAL EQUIPMENT REQUIRED	PROPERTIES OF TREATED MATERIAL	SPECIAL ADVANTAGES AND LIMITATIONS	RELATIVE COSTS (1976)
MISCELLANEOUS	REMOVE AND REPLACE (with or without admixtures)	Foundation soil excavated, improved by drying or admixture, and recompacted	Inorganic soils	10 m ?	Small	None, unless admixture stabilizers used	Excavating and compaction equipment, dewatering system	Increased strength and stiffness, reduced compressibility	Uniform, controlled foundation soil when replaced; may require large area dewatering	High
	MOISTURE BARRIERS	Water access to foundation soils is prevented	Expansive soils	5 m	Small	Membranes, gravel, lime, or asphalt	Excavating and trenching equipment, compaction equipment	Initial natural or as-compacted properties retained	Best for small structures; may not be 100% effective	Low to moderate
	PREWETTING	Soil is brought to estimated final water content prior to construction	Expansive soils	2-3 m	Small	Water	None	Decreased swelling potential	Low cost, best for small, light structures, may still get shrinking and swelling	Low
	STRUCTURAL FILLS (with or without admixtures)	Structural fill distributes loads to underlying soft soils	Use over soft clays or organic soils, marsh deposits	-----	Small	Sand, gravel, flyash, bottom ash, slag, expanded aggregate, clam shell or oyster shell, incinerator ash	Compaction equipment	Soft subgrade protected by structural load-bearing fill	High strength, good load distribution to underlying soft soils	Moderate to high (\$12/m <sup>3</sup> )

(Sheet 5 of 5)

U. S. Army Corps of Engineers

Table 16-1. Stabilization of Soils for Foundations of Structures-Continued

CATEGORY OF STRUCTURE	STRUCTURE	PERMISSIBLE SETTLEMENT	LOAD INTENSITY/ USUAL BEARING PRESSURE REQUIRED (tsf)	Probability of Advantageous Use of Soil Improvement Techniques		
				LOOSE COHESION- LESS SOILS	SOFT ALLUVIAL DEPOSITS	OLD, INORGANIC FILLS
OFFICE/ APARTMENT  FRAME OR LOAD- BEARING CONSTRUCTION	High rise: More than 6 stories	Small <25-50 mm	High (3+1)	High	Unlikely	Low
	Medium rise: 3-6 stories	Small <25-50 mm	Moderate (2)	High	Low	Good
	Low rise: 1-3 stories	Small <25-50 mm	Low (1-2)	High	Good	High
INDUSTRIAL	Large span w/heavy machines, cranes; process plants; power plants	Small (<25-50 mm) Differential settlement Critical	Variable/high local concentrations to >4	High	Unlikely	Low
	Framed warehouses and factories	Moderate	Low (1-2)	High	Good	High
	Covered storage, stor. rack systems, production areas	Low to moderate	Low (<2)	High	Good	High
OTHERS	Water and waste water treatment plants	Moderate Differential settlement Important	Low/<150 (<1.5)	High, if required at all	High	High
	Storage tanks	Moderate to high, but differential, may be critical	High/up to 300 (3)	High, if required at all	High	High
	Open storage areas	High	High/up to 300 (3)	High, if required at all	High	High
	Embankments and abutments	Moderate to high	High/up to 200 (2)	High, if required at all	High	High

U. S. Army Corps of Engineers

Table 16-2. Applicability of Foundation Soil Improvement for Different Structures and Soil Types (for efficient use of Shallow Foundations)



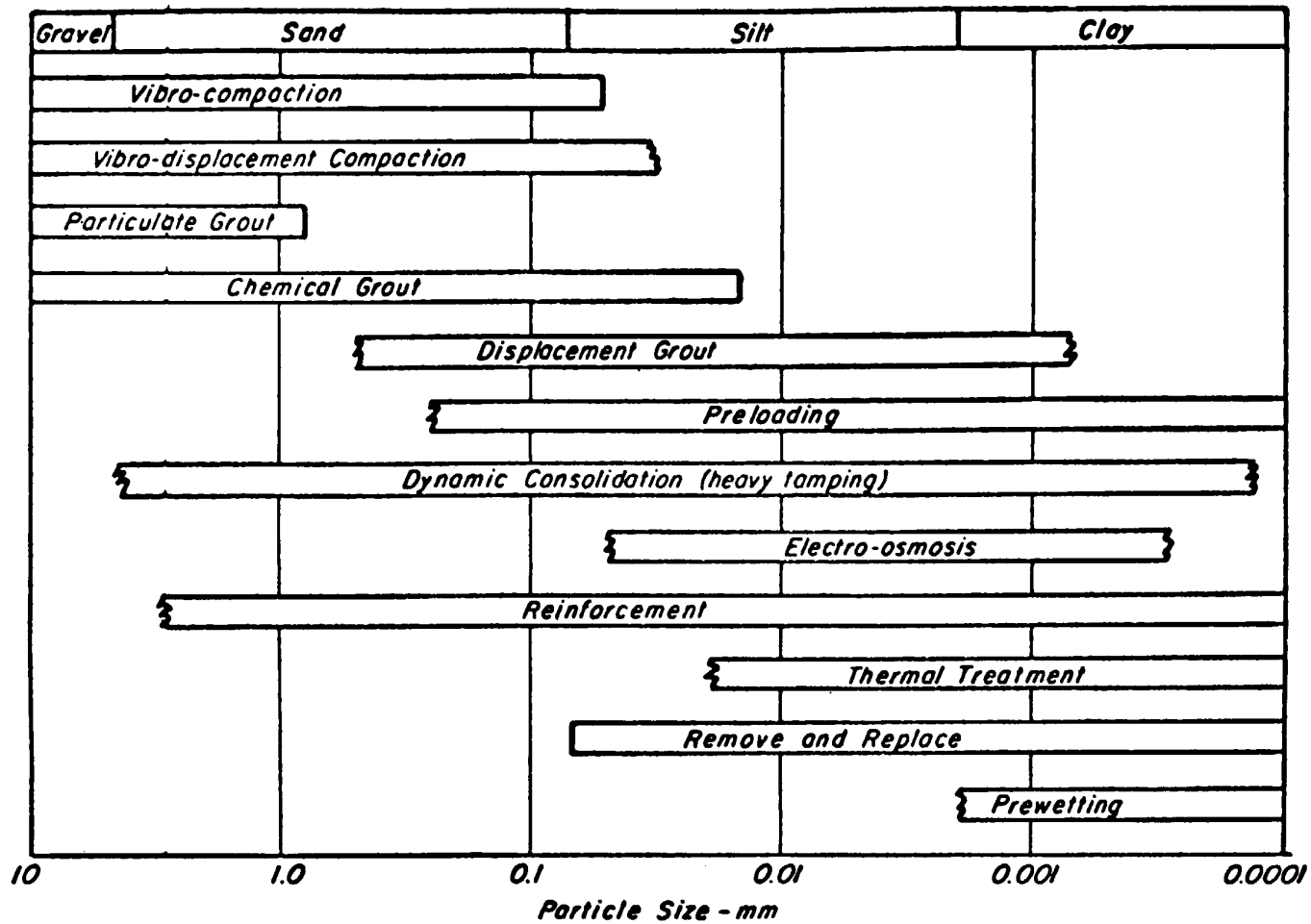

(Courtesy of J. K. Mitchell, "Innovations in Ground Stabilization," *Chicago Soil Mechanics Lecture Series, Innovations in Foundation Construction, Illinois Section, 1972*. Reprinted by permission of The American Society of Civil Engineers, New York.)

Figure 16-1. Applicable grain-size ranges for different stabilization methods.

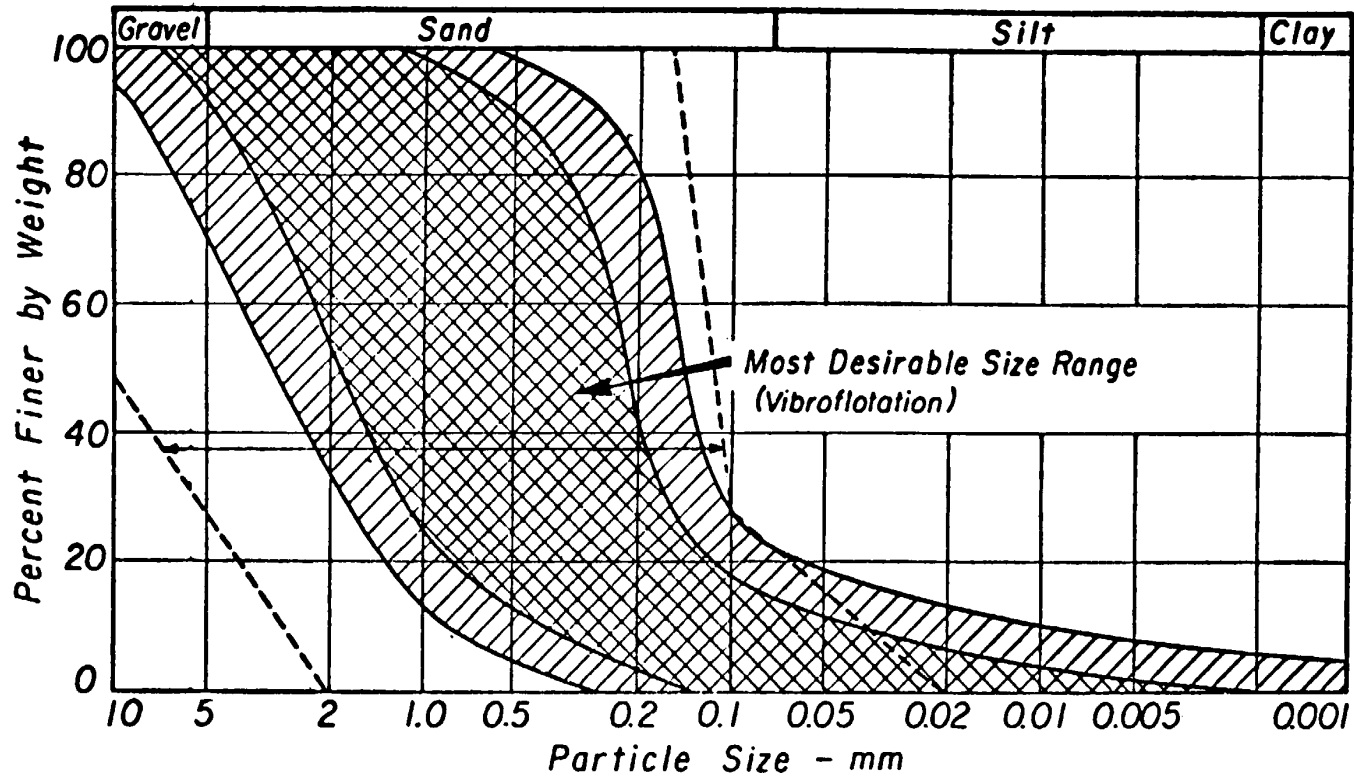

(Courtesy of J. K. Mitchell, "Innovations in Ground Stabilization," *Chicago Soil Mechanics Lecture Series, Innovations in Foundation Construction, Illinois Section*, 1972. Reprinted by permission of The American Society of Civil Engineers, New York.)

Figure 16-2. Range of particle-size distributions suitable for densification by vibrocompaction.

conditions are necessary. Underlying soft clay layers may dampen vibrations.

*c. Vibratory rollers.* Where cohesionless deposits are of limited thickness, e.g., less than 6 feet, or where cohesionless fills are being placed, vibratory rollers are likely to be the best and most economical means for achieving high density and strength. Use with flooding where a source of water is available. The effective depth of densification may be 6 feet or more for the heaviest vibratory rollers (fig 16-3a). For a fill placed in successive lifts, a density-depth distribution similar to that in figure 16-3b results. It is essential that the lift thickness, soil type, and roller type be matched. Properly matched systems can yield compacted layers at a relative density of 85 to 90 percent or more.

**16-3. Vibrodisplacement compaction.** The methods in this group are similar to those described in the preceding section except that the vibrations are supplemented by active displacement of the soil and, in the case of vibroflotation and compaction piles, by backfilling the zones from which the soil has been displaced.

*a. Compaction piles.* Partly saturated or freely draining soils can be effectively densified and strengthened by this method, which involves driving displacement piles at close spacings, usually 3 to 6 feet on centers. One effective procedure is to cap temporarily the end of a pipe pile, e.g., by a detachable plate, and drive it to the desired depth, which may be up to 60 feet. Either an impact hammer or a vibratory driver can be used. Sand or other backfill material is introduced in lifts with each lift compacted concurrently with withdrawal of the pipe pile. In this way, not only is the backfill compacted, but the compacted column has also expanded laterally below the pipe tip forming a caisson pile.

*b. Heavy tamping (dynamic consolidation).*

(1) Repeated impacts of a very heavy weight (up to 80 kips) dropped from a height of 50 to 130 feet are applied to points spaced 15 to 30 feet apart over the area to be densified. In the case of cohesionless soils, the impact energy causes liquefaction followed by settlement as water drains. Radial fissures that form around the impact points, in some soils, facilitate drainage. The method has been used successfully to treat soils both above and below the water table.

(2) The product of tamper mass and height of fall should exceed the square of the thickness of layer to be densified. A total tamping energy of 2 to 3 blows per square yard is used. Increased efficiency is obtained if the impact velocity exceeds the wave velocity in the liquefying soil. One crane and tamper can treat from 350 to 750 square yards per day. Economical use of the method in sands requires a minimum treatment area of 7500 square yards. Relative densities of 70 to 90

percent are obtained. Bearing capacity increases of 200 to 400 percent are usual for sands and marls, with a corresponding increase in deformation modulus. The cost is reported as low as one-fourth to one-third that of vibroflotation.

(3) Because of the high-amplitude, low-frequency vibrations (2-12 Hz), minimum distances should be maintained from adjacent facilities as follows:

Piles or bridge abutment	15-20 feet
Liquid storage tanks	30 feet
Reinforced concrete buildings	50 feet
Dwellings	100 feet
Computers (not isolated)	300 feet

*c. Vibroflotation.*

(1) A cylindrical penetrator about 15 inches in diameter and 6 feet long, called a vibroflot, is attached to an adapter section containing lead wires and hoses. The whole assembly is handled by a crane. A rotating eccentric weight inside the vibroflot develops a horizontal centrifugal force of about 10 tons at 1800 revolutions per minute. Total weight is about 2 tons.

(2) To sink the vibroflot to the desired treatment depth, a water jet at the tip is opened and acts in conjunction with the vibrations so that a hole can be advanced at a rate of about 3.6 feet per minute; then the bottom jet is closed, and the vibroflot is withdrawn at a rate of about 0.1 foot per minute. Newer, heavier vibroflots operating at 100 horsepower can be withdrawn at twice this rate and have a greater effective penetration depth. Concurrently, a cohesionless sand or gravel backfill is dumped in from the ground surface and densified. Backfill consumption is at a rate of about 0.7 to 2 cubic yards per square yard of surface. In partly saturated sands, water jets at the top of the vibroflot can be opened to facilitate liquefaction and densification of the surrounding ground. Liquefaction occurs to a radial distance of 1 to 2 feet from the surface of the vibroflot. Most vibroflotation applications have been to depths less than 60 feet, although depths of 90 feet have been attained successfully.

(3) A relationship between probable relative density and vibroflot hold spacings is given in figure 16-4. Newer vibroflots result in greater relative densities. Figure 16-5 shows relationships between allowable bearing pressure to limit settlements to 1 inch and vibroflot spacing. Allowable pressures for "essentially cohesionless fills" are less than for clean sand deposits, because such fills invariably contain some fines and are harder to densify.

(4) Continuous square or triangular patterns are often used over a building site. Alternatively, it may be desired to improve the soil only at the locations of individual spread footings. Patterns and spacings required for an allowable pressure of 3 tons per square foot and square footings are given in table 16-3.

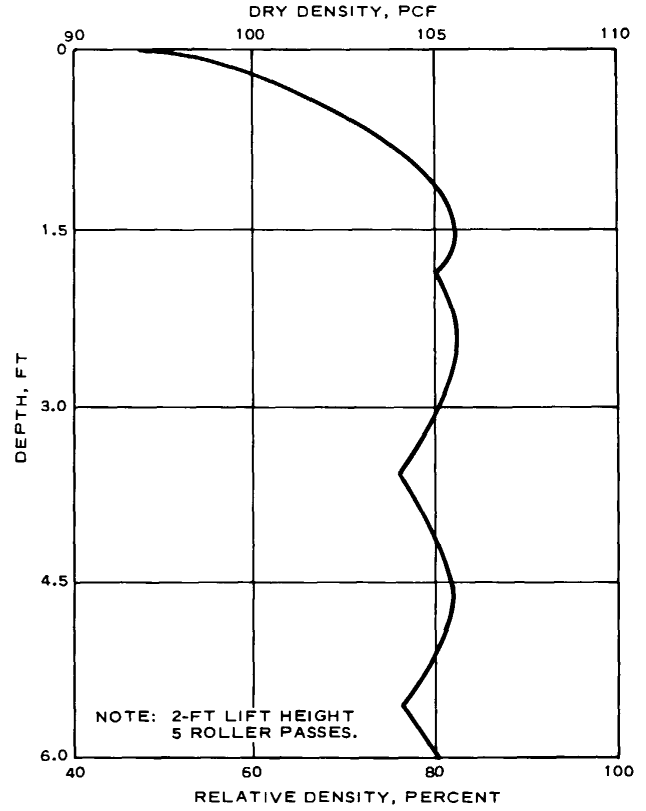
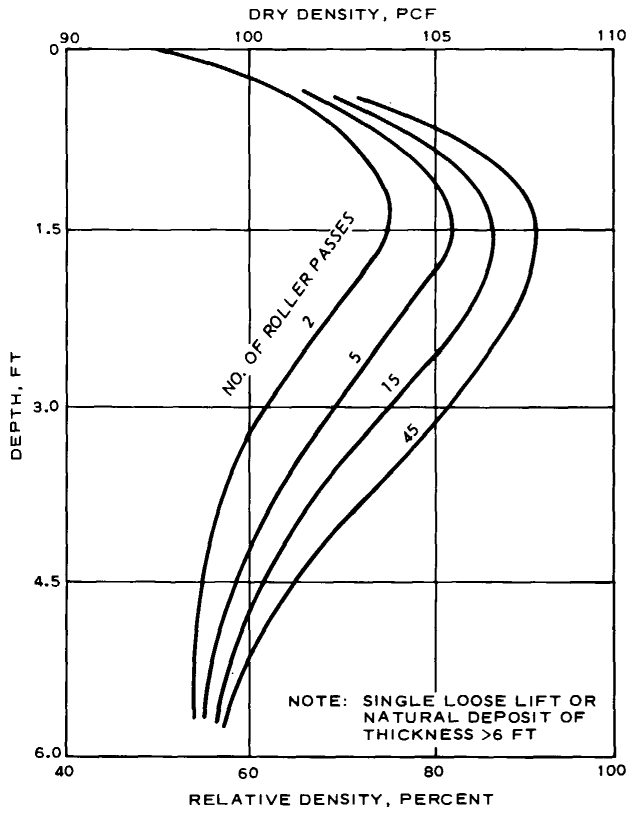

a. DENSITY VERSUS DEPTH FOR DIFFERENT NUMBERS OF ROLLER PASSES

b. DENSITY VERSUS DEPTH RELATIONSHIP FOR A SERIES OF 2-FT LIFTS

Figure 16-3. Sand densification using vibratory rollers.

**16-4. Grouting and injection.** Grouting is a high-cost soil stabilization method that can be used where there is sufficient confinement to permit required injection pressures. It is usually limited to zones of relatively small volume and to special problems. Some of the more important applications are control of groundwater during construction; void filling to prevent excessive settlement; strengthening adjacent foundation soils to protect against damage during excavation, pile driving, etc.; soil strengthening to reduce lateral support requirements; stabilization of loose sands against liquefaction; foundation underpinning; reduction of machine foundation vibrations; and filling solution voids in calcareous materials.

a. *Grout types and groutability.* Grouts can be classified as particulate or chemical. Portland cement is the most widely used particulate grouting material. Grouts composed of cement and clay are also widely used, and lime-slurry injection is finding increasing application. Because of the silt-size particles in these materials, they cannot be injected into the pores of soils finer than medium to coarse sand. For successful grouting of soils, use the following guide

$$\frac{(D_{15})_{\text{soil}}}{(D_{85})_{\text{grout}}} > 25$$

Type I portland cement, Type II portland cement, and Type III portland cement, Type III portland cement, and processed bentonite cannot be used to penetrate soils finer than 30, 40, and 60 mesh sieve sizes, respectively. Different types of grouts may be combined to both coarse- and fine-grained soils.

b. *Cement and soil-cement grouting.* See TM 5-818-6/AFM 88-32 for discussion of planning and implementation of foundation grouting with cement and soil-cement.

c. *Chemical grouting.* To penetrate the voids of finer soils, chemical grout must be used. The most common classes of chemical grouts in current use are silicates, resins, lignins, and acrylamides. The viscosity of the chemical-water solution is the major factor controlling groutability. The particle-size ranges over

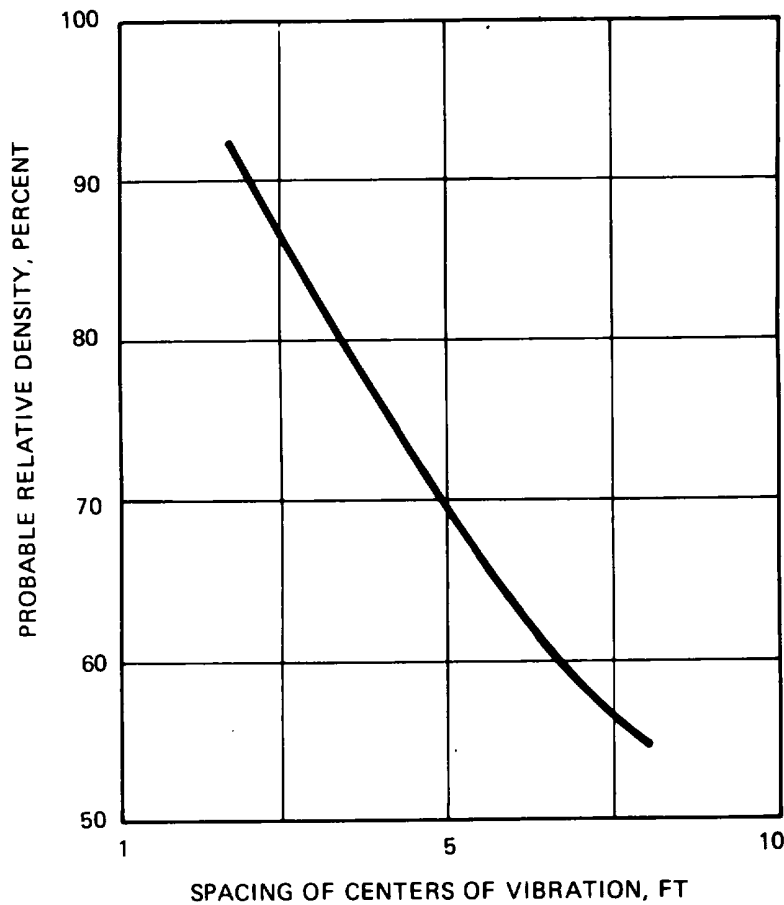

U. S. Army Corps of Engineers

Figure 16-4. Relative density as a function of vibroflot hole spacings.

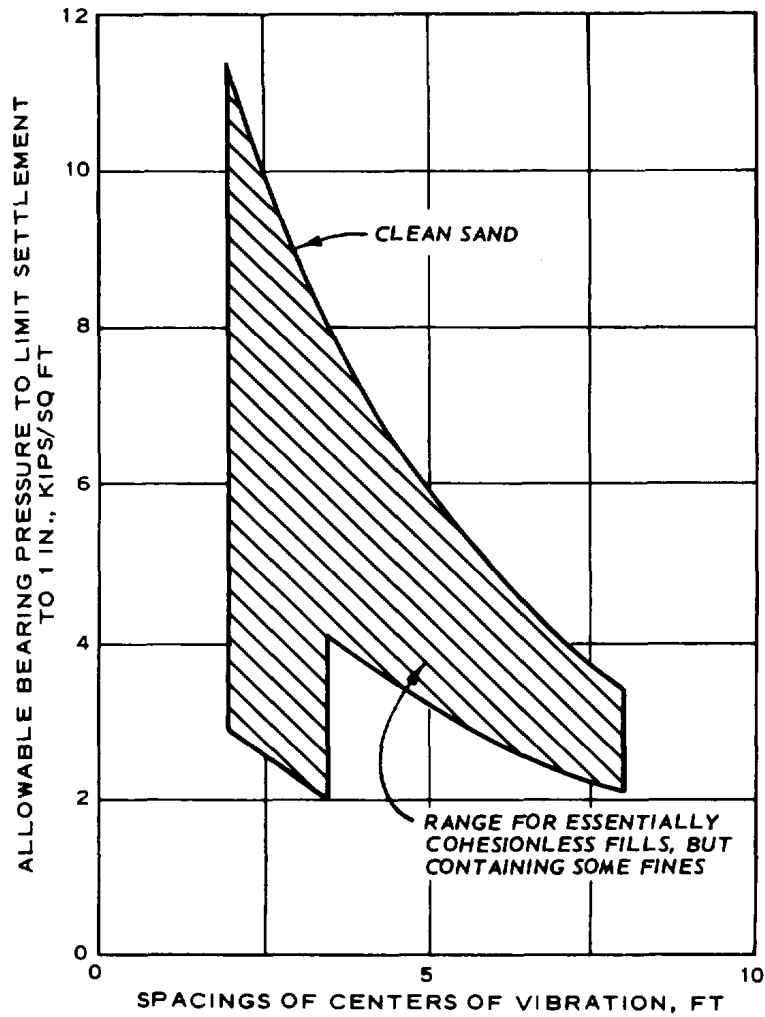

U. S. Army Corps of Engineers

Figure 16-5. Allowable bearing pressure on cohesionless soil layers stabilized by vibroflotation.

Table 16-3. Vibroflotation Patterns for Isolated Footings for an Allowable Bearing Pressure.

Square Footing Size, ft	Vibroflotation Points	Center to Center Spacing, ft	Pattern
4.0	1	---	---
4.5-5.5	2	6.0	Line
6-7	3	7.5	Triangle
7.5-9.5	4	6.0	Square
10-12	5	7.5	Square + 1 @ Center

U. S. Army Corps of Engineers

which each of these grout types is effective is shown in figure 16-6.

### 16-5. Precompression.

*a. Preloading.* Earth fill or other material is placed over the site to be stabilized in amounts sufficient to produce a stress in the soft soil equal to that anticipated from the final structures. As the time required for consolidation of the soft soil may be long (months to years), varying directly as the square of the layer thickness and inversely as the hydraulic conductivity, preloading alone is likely to be suitable only for stabilizing thin layers and with a long period of time available prior to final development of the site.

*b. Surcharge fills.* If the thickness of the fill placed for pre-loading is greater than that required to induce stresses corresponding to structure-induced stresses, the excess fill is termed a surcharge fill. Although the rate of consolidation is essentially independent of stress increase, the amount of consolidation varies approximately in proportion to the stress increase. It follows, therefore, that the preloading fill plus surcharge can cause a given amount of settlement in shorter time than can the preloading fill alone. Thus, through the use of surcharge fills, the time required for preloading can be reduced significantly.

(1) The required surcharge and loading period can be determined using conventional theories of consolidation. Both primary consolidation and most of the secondary compression settlements can be taken out in advance by surcharge fills. Secondary compression settlements may be the major part of the total settlement of highly organic deposits or old sanitary landfill sites.

(2) Because the degree of consolidation and applied stress vary with depth, it is necessary to determine if excess pore pressures will remain at any depth after surcharge removal. If so, further primary consolidation settlement under permanent loadings would occur. To avoid this occurrence, determine the duration of the surcharge loading required for points most distant from drainage boundaries.

(3) The rate and amount of preload may be controlled by the strength of the underlying soft soil. Use berms to maintain foundation stability and place fill in stages to permit the soil to gain strength from consolidation. Predictions of the rates of consolidation strength and strength gain should be checked during fill placement by means of piezometers, borings, laboratory tests, and in situ strength tests.

#### *c. Vertical drains.*

(1) The required preloading time for most soft clay deposits more than about 5 to 10 feet thick will be large. The consolidation time may be reduced by providing a shorter drainage path by installing vertical sand drains. Sand drains are typically 10 to 15 inches

in diameter and are installed at spacings of 5 to 15 feet. A sand blanket or a collector drain system is placed over the surface to facilitate drainage. Other types of drains available are special cardboard or combination plastic-cardboard drains. Provisions should be made to monitor pore pressures and settlements with time to determine when the desired degree of precompression has been obtained.

(2) Both displacement and nondisplacement methods have been used for installing sand drains. Although driven, displacement drains are less expensive than augered or "bored" nondisplacement drains; they should not be used in sensitive deposits or in stratified soils that have higher hydraulic conductivity in the horizontal than in the vertical direction. Vertical drains are not needed in fibrous organic deposits because the hydraulic conductivity of these materials is high, but they may be required in underlying soft clays.

*d. Dynamic consolidation (heavy tamping).* Densification by heavy tamping has also been reported as an effective means for improving silts and clays, with preconstruction settlements obtained about 2 to 3 times the predicted construction settlement. The time required for treatment is less than for surcharge loading with sand drains. The method is essentially the same as that used for cohesionless soils, except that more time is required. Several blows are applied at each location followed by a 1- to 4-week rest period, then the process is repeated. Several cycles may be required. In each cycle the settlement is immediate, followed by drainage of pore water. Drainage is facilitated by the radial fissures that form around impact points and by the use of horizontal and peripheral drains. Because of the necessity for a time lapse between successive cycles of heavy tamping when treating silts and clays, a minimum treatment area of 18,000 to 35,000 square yards (4 to 8 acres) is necessary for economical use of the method. This method is presently considered experimental in saturated clays.

*e. Electroosmosis.* Soil stabilization by electroosmosis may be effective and economical under the following conditions: (1) a saturated silt or silty clay soil, (2) a normally consolidated soil, and (3) a low pore water electrolyte concentration. Gas generation and drying and fissuring at the electrodes can impair the efficiency of the method and limit the magnitude of consolidation pressures that develop. Treatment results in nonuniform changes in properties between electrodes because the induced consolidation depends on the voltage, and the voltage varies between anode and cathode. Thus, reversal of electrode polarity may be desirable to achieve a more uniform stress condition. Electroosmosis may also be used to accelerate the consolidation under a preload or surcharge fill. The method is relatively expensive.

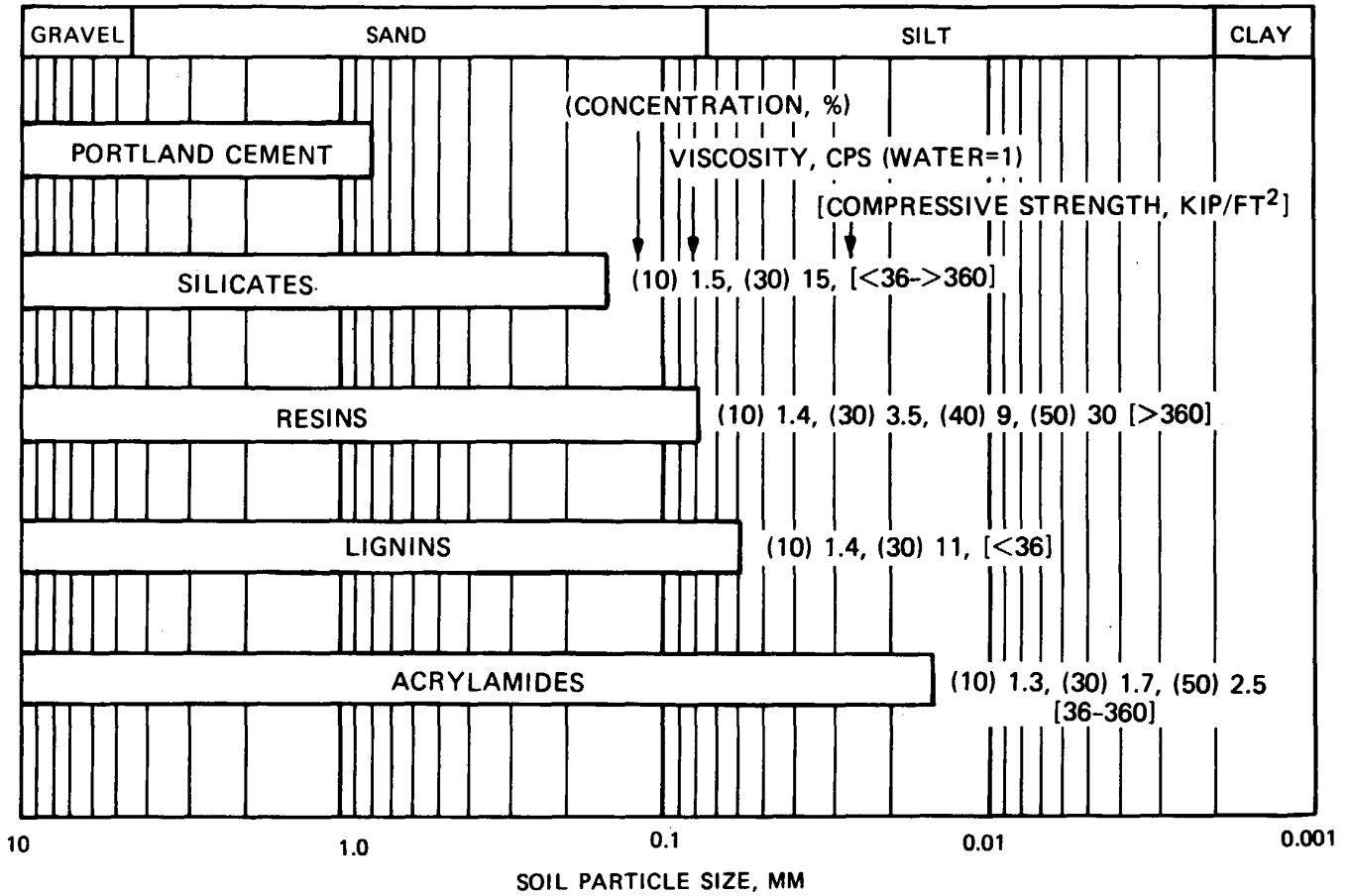

U. S. Army Corps of Engineers

Figure 16-6. Soil particle sizes suitable for different grout types and several concentrations and viscosities shown.



**16-6. Reinforcement.** The supporting capacity of soft, compressible ground may be increased and settlement reduced through use of compression reinforcement in the direction parallel to the applied stress or tensile reinforcement in planes normal to the direction of applied stress. Commonly used compression reinforcement elements include mix-in-place piles and walls. Strips and membranes are used for tensile reinforcement, with the latter sometimes used to form a moisture barrier as well.

*a. Mix-in-place piles and walls.* Several procedures are available, most of them patented or proprietary, which enable construction of soil-cement or soil-lime in situ. A special hollow rod with rotating vanes is augered into the ground to the desired depth. Simultaneously, the stabilizing admixture is introduced. The result is a pile of up to 2 feet in diameter. Cement, in amounts of 5 to 10 percent of the dry soil weight, is best for use in sandy soils. Compressive strengths in excess of 200 kips per square foot can be obtained in these materials. Lime is effective in both expansive plastic clays and in saturated soft clay. Compressive strengths of about 20 to 40 kips per square foot are to be expected in these materials. If overlapping piles are formed, a mix-in-place wall results.

*b. Vibroreplacement stone columns.* A vibroflot is used to make a cylindrical, vertical hole under its own weight by jetting to the desired depth. Then, 1/2- to 1- cubic yard coarse granular backfill, usually gravel or crushed rock 3/4 to 1 inch is dumped in, and the vibroflot is used to compact the gravel vertically and radially into the surrounding soft soil. The process of backfilling and compaction by vibration is continued until the densified stone column reaches the surface.

*c. Strips and membranes.*

(1) Low-cost, durable waterproof membranes, such as polyethylene, polypropylene asphalt, and polyester fabric asphalt, have had application as moisture barriers. At the same time, these materials have sufficient tensile strength that when used in envelope construction, such as surrounding a well-compacted, fine-grained soil, the composite structure has a greater resistance to applied loads than conventional construction with granular materials. The reason is that any deformation of the enveloped soil layer causes tension in the membrane, which in turn produces additional confinement on the soil and thus increases its resistance to further deformation.

(2) In the case of a granular soil where moisture infiltration is not likely to be detrimental to strength, horizontally bedded thin, flat metal or plastic strips can act as tensile reinforcing elements. Reinforced earth has been used mainly for earth retaining structures; however, the feasibility of using reinforced earth slabs to improve the bearing capacity of granular soil has been demonstrated.

(3) Model tests have shown that the ultimate bearing capacity can be increased by a factor of 2 to 4 for the same soil unreinforced. For these tests, the spacing between reinforcing layers was 0.3 times the footing width. Aggregate strip width was 42 percent of the length of strip footing.

*d. Thermal methods.* Thermal methods of foundation soil stabilization, freezing or heating, are complex and their costs are high.

(1) *Artificial ground freezing.* Frozen soil is far stronger and less pervious than unfrozen ground. Hence, artificial ground freezing has had application for temporary underpinning and excavation stabilization. More recent applications have been made to back-freezing soil around pile foundations in permafrost and maintenance of frozen soil under heated buildings on permafrost. Design involves two classes of problems; namely, the structural properties of the frozen ground to include the strength and the stress-strain-time behavior, and thermal considerations to include heat flow, transfer of water to ice, and design of the refrigeration system.

(2) *Heating.* Heating fine-grained soils to moderate temperatures, e.g., 1000C+, can cause drying and accompanying strength increase if subsequent rewetting is prevented. Heating to higher temperatures can result in significant permanent property improvements, including decreases in water sensitivity, swelling, and compressibility; and increases in strength. Burning of liquid or gas fuels in boreholes or injection of hot air into 6- to 9-inch-diameter boreholes can produce 4- to 7-foot-diameter strengthened zones, after continuous treatment for about 10 days. Dry or partly saturated weak clayey soils and loess are well suited for this type of treatment, which is presently regarded as experimental.

## **16-7. Miscellaneous methods.**

*a. Remove and replace.* Removal of poor soil and replacement with the same soil treated by compaction, with or without admixtures, or by a higher quality material offer an excellent opportunity for producing high-strength, relatively incompressible, uniform foundation conditions. The cost of removal and replacement of thick deposits is high because of the need for excavation and materials handling, processing, and recompaction. Occasionally, an expensive dewatering system also may be required. Excluding highly organic soils, peats and sanitary landfills, virtually any inorganic soil can be processed and treated so as to form an acceptable structural fill material.

*b. Lime treatment.* This treatment of plastic fine-

grained soils can produce high-strength, durable materials. Lime treatment levels of 3 to 8 percent by weight of dry soil are typical.

c. *Portland cement.* With treatment levels of 3 to 10 percent by dry weight, portland cement is particularly well suited for low-plasticity soils and sand soils.

d. *Stabilization using fills.*

(1) At sites underlain by soft, compressible soils and where filling is required or possible to establish the final ground elevation, load-bearing structural fills can be used to distribute the stresses from light structures. Compacted sands and gravels are well suited for this application as are fly ash, bottom ash, slag, and various lightweight aggregates, such as expanded shale, clam and oyster shell, and incinerator ash. Admixture stabilizers may be incorporated in these materials to increase their strength and stiffness.

(2) Clam and oyster shells as a structural fill material over soft marsh deposits represent a new development. The large deposits of clam and oyster or reef shells that are available in the Gulf States coastal areas can be mined and transported short distances economically. Clam shells are 1/4, to 1/2 inch in diameter; whereas, oyster shells, which are coarser and more elongated, are 2 to 4 inches in size. When dumped over soft ground, the shells interlock; if there are fines and water present, some cementation develops owing to the high calcium carbonate (>90 percent) content. In the loose state, the shell unit weight is about 63 pounds per square foot; after construction, it is about 95 pounds per square foot. Shell embankments "float" over very soft ground; whereas, conventional fills would sink out of sight. About a 5-foot-thick layer is required to be placed in a single lift. The only compaction used is from the top of the lift, so the upper several inches are more tightly knit and denser than the rest of the layer.

CHAPTER 17

DESIGN FOR EQUIPMENT VIBRATIONS AND SEISMIC LOADINGS

**17-1. Introduction.**

a. Vibrations caused by steady state or transient loads may cause settlement of soils, excessive motions of foundations or structures, or discomfort or distress to personnel. Some basic design factors for dynamic loading are treated in this section. Design of a foundation system incorporates the equipment loading, subsurface material properties, and geometrical proportions in some analytical procedure.

b. Figure 17-1 shows some limiting values of vibration criteria for machines, structures, and personnel. On this diagram, vibration characteristics are described in terms of frequency and peak amplitudes of acceleration, velocity, or displacement. Values of frequency constitute the abscissa of the diagram and peak velocity is the ordinate. Values of peak displacement are read along one set of diagonal lines and labelled in displacement (inches), and peak acceleration values are read along the other set of diagonal lines and labelled in various amounts of g, the acceleration of gravity. The shaded zones in the upper right-hand corner indicate possible structural damage to walls by steady-state vibrations. For structural safety during blasting, limit peak velocity to 2.0 inches per second and peak acceleration to 0.10g for frequencies exceeding 3 cycles per second. These limits may occasionally have to be lowered to avoid being excessively annoying to people.

c. For equipment vibrations, limiting criteria consist of a maximum velocity of 1.0 inch per second up to a frequency of about 30 cycles per second and a peak acceleration of 0.15g above this frequency. However, this upper limit is for safety only, and specific criteria must be established for each installation. Usually, operating limits of equipment are based on velocity criteria; greater than 0.5 inch per second indicates extremely rough operation and machinery should be shut down; up to 0.10 inch per second occurs for smooth, well-balanced equipment; and less than 0.01 inch per second represents very smooth operation.

d. Figure 17-1 also includes peak velocity criteria for reaction of personnel to steady-state vibrations. Peak velocities greater than 0.1 inch per second are "troublesome to persons," and peak velocities of 0.01 inch per second are just "barely noticeable to persons." It is significant that persons and machines respond to equivalent levels of vibration.

Furthermore, persons may notice vibrations that are about 1/100 of the value related to safety of structures.

**17-2. Single degree of freedom, damped, forced systems.**

a. Vibrations of foundation-soil systems can adequately be represented by simple mass-spring-dashpot systems. The model for this simple system consists of a concentrated mass, m, supported by a linear elastic spring with a spring constant, k, and a viscous damping unit (dashpot) having a damping constant, c. The system is excited by an external force, e.g.,  $Q = Q_0 \sin(\omega t)$ , in which  $Q_0$  is the amplitude of the exciting force,  $\omega = 2\pi f_0$  is the angular frequency (radians per second) with  $f_0$  the exciting frequency (cycles per second), and t is time in seconds.

b. If the model is oriented as shown in the insert in figure 17-2(a), motions will occur in the vertical or z direction only, and the system has one degree of freedom (one coordinate direction (z) is needed to describe the motion). The magnitude of dynamic vertical motion,  $A_z$ , depends upon the magnitude of the external excitation, Q, the nature of  $Q_0$ , the frequency,  $f_0$ , and the system parameters m, c, and k. These parameters are customarily combined to describe the "natural frequency" as follows:

$$f_n = \frac{1}{2\pi} \sqrt{\frac{k}{m}} \tag{17-1}$$

and the "damping ratio" as

$$D = \frac{c}{2\sqrt{km}} \tag{17-2}$$

c. Figure 17-2(a) shows the dynamic response of the system when the amplitude of the exciting force,  $Q_0$ , is constant. The abscissa of the diagram is the dimensionless ratio of exciting frequency,  $f_0$ , divided by the natural frequency,  $f_n$ , in equation (17-1). The ordinate is the dynamic magnification factor,  $M_z$ , which is the ratio of  $A_z$  to the static displacement,  $A_z = (Q_0/k)$ . Different response curves correspond to different values of D.

d. Figure 17-2(b) is the dynamic response of the system when the exciting force is generated by a rotating mass, which develops:

$$Q_0 = m_e (\bar{e}) 4\pi^2 f_0^2 \tag{17-3}$$

where

- $m_e$  = the total rotating mass
- $e$  = the eccentricity
- $f_o$  = the frequency of oscillation, cycles per second

e. The ordinate  $M_z$ . (fig 17-2(b)) relates the dynamic displacement,  $A_z$ , to  $m_e e/m$ . The peak value of the response curve is a function of the damping ratio and is given by the following expression:

$$M_{z(max)} \text{ or } M_z = \frac{1}{2D\sqrt{1-D^2}} \quad (17-4)$$

For small values of  $D$ , this expression becomes  $1/2D$ . These peak values occur at frequency ratios of

$$f_n = \sqrt{1-D^2} \quad (\text{fig. 17-2a}) \quad (17-5)$$

or

$$f_n = \frac{1}{\sqrt{1-2D^2}} \quad (\text{fig. 17-2b})$$

**17-3. Foundations on elastic soils.**

a. *Foundations on elastic half-space.* For very small deformations, assume soils to be elastic materials with properties as noted in paragraph 3-8. Therefore, theories describing the behavior of rigid foundations resting on the surface of a semi-infinite, homogeneous, isotropic elastic body have been found useful for study of the response of real footings on soils. The theoretical treatment involves a circular foundation of radius,  $r_o$ , on the surface of the ideal half-space. This foundation has six degrees of freedom: (1-3) translation in the vertical ( $z$ ) or in either of two horizontal ( $x$  and  $y$ ) directions; (4) torsional (yawing) rotation about the vertical ( $z$ ) axis; or (5-6) rocking (pitching) rotation about either of the two horizontal ( $x$  and  $y$ ) axes. These vibratory motions are illustrated in figure 17-3.

(1) A significant parameter in evaluating the dynamic response in each type of motion is the inertia reaction of the foundation. For translation, this is simply the mass,  $m = (W/g)$ ; whereas in the rotational

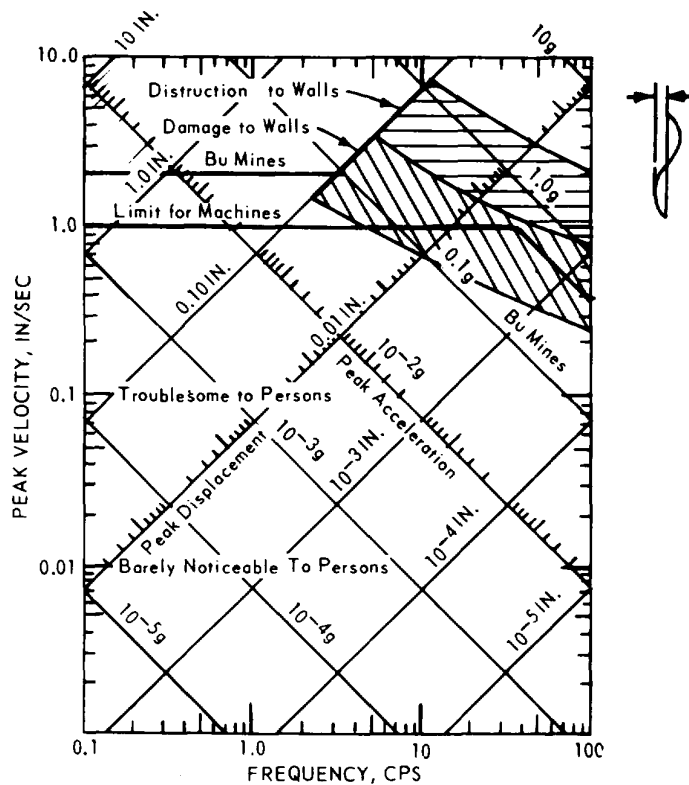

(Courtesy) of F. E. Richart, Jr., J R. Hall, Jr., and R. D. Woods, *Vibrations of Soils and Foundations*, 1970, p 316. Reprinted by permission of Prentice-Hall, Inc., Englewood Cliffs, N. J.)

Figure 17-1. Response spectra for vibrator limits.

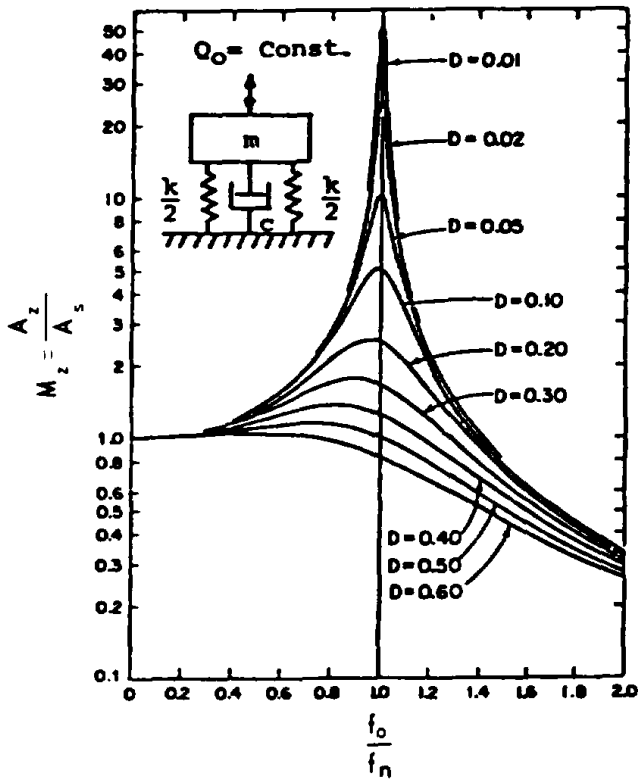

(a) CONST. FORCE AMPLITUDE EXCITATION  
 $Q = Q_o \sin \omega t$

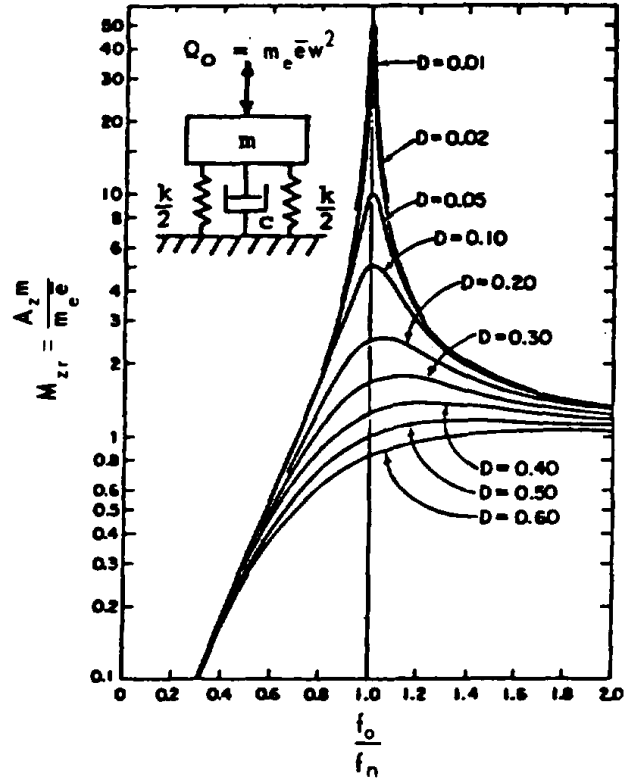

(b) ROTATING MASS EXCITATION  
 $Q = m_e \bar{\omega}^2 \sin \omega t$

(Courtesy of F. E. Richart, Jr., J. R. Hall, Jr., and R. D. Woods, *Vibrations of Soils and Foundations*, 1970, pp 383-384. Reprinted by permission of Prentice-Hall, Inc., Englewood Cliffs, N. J.)

Figure 17-2. Response curves for the single-degree-of-freedom system with viscous damping.

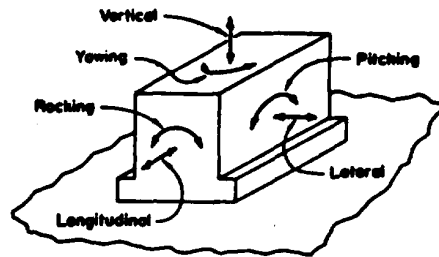

Figure 17-3. Six modes of vibration for a foundation.

U. S. Army Corps of Engineers

Figure 17-3. Six modes of vibration for a foundation.

modes of vibration, it is represented by the *mass moment of inertia* about the axis of rotation. For torsional oscillation about the vertical axis, it is designated as  $I_\theta$ ; whereas for rocking oscillation, it is  $I_\psi$ , (for rotation about the axis through a diameter of the base of the foundation). If the foundation is considered to be a right circular cylinder of radius  $r_o$ , height  $h$ , and unit weight  $\gamma$ , expressions for the mass and mass moments of inertia are as follow:

$$m = \frac{\pi r_o^2 h \gamma}{g} \quad (17-6)$$

$$I_s = \frac{\pi r_o^4 h \gamma}{2g} \quad (17-7)$$

$$I_\psi = \frac{\pi r_o^2 h \gamma}{g} \left( \frac{r_o^2}{4} + \frac{h^2}{3} \right) \quad (17-8)$$

(2) Theoretical solutions describe the motion magnification factors  $M$ , or  $M_L$ , for example, in terms of a "mass ratio"  $B_z$  and a dimensionless frequency factor  $a_o$ . Table 17-1 lists the mass ratios, damping ratios, and spring constants corresponding to vibrations of

the rigid circular footing resting on the surface of an elastic semi-infinite body for each of the modes of vibration. Introduce these quantities into equations given in paragraph 17-2 to compute resonant frequencies and amplitudes of dynamic motions. The dimensionless frequency,  $a_o$ , for all modes of vibration is given as follows:

$$a_o = \frac{2\pi f_o r_o}{V_s} = \omega r_o \sqrt{\frac{\rho}{G}} \quad (17-9)$$

The shear velocity,  $V_s$ , in the soil is discussed in paragraph 17-5.

(3) Figure 17-4 shows the variation of the damping ratio,  $D$ , with the mass ratio,  $B$ , for the four modes of vibration. Note that  $D$  is significantly lower for the rocking mode than for the vertical or horizontal translational modes. Using the expression  $M = 1/(2D)$  for the amplitude magnification factor and the appropriate  $D$ , from figure 17-4, it is obvious that  $M$ , can become large. For example, if  $B_\psi = 3$ , then  $D_\psi = 0.02$  and  $M_\psi = 1/(2 \times 0.02) = 25$ .

Table 17-1. Mass ratio, Damping Ratio, and Spring Constant for Rigid Circular Footing on the Semi-Infinite Elastic Body

Mode of Vibration	Mass (or Inertia) Ratio, $B_i$	Damping Ratio $D_i$	Spring Constant $k_i$
Vertical	$B_z = \frac{(1 - \nu)}{4} \frac{m}{\rho r_o^3}$	$D_z = \frac{0.425}{\sqrt{B_z}}$	$k_z = \frac{4Gr_o}{1 - \nu}$
Sliding	$B_x = \frac{(7 - 8\nu)m}{32(1 - \nu)\rho r_o^3}$	$D_x = \frac{0.288}{\sqrt{B_x}}$	$k_x = \frac{32(1 - \nu)}{7 - 8\nu} Gr_o$
Rocking	$B_\psi = \frac{3(1 - \nu)}{8} \frac{I_\psi}{\rho r_o^5}$	$D_\psi = \frac{0.15}{(1 + B_\psi)\sqrt{B_\psi}}$	$k_\psi = \frac{8 Gr_o^3}{3(1 - \nu)}$
Torsional	$B_\theta = \frac{I_\theta}{\rho r_o^5}$	$D_\theta = \frac{0.50}{1 + 2B_\theta}$	$k_\theta = \frac{16}{3} Gr_o^3$

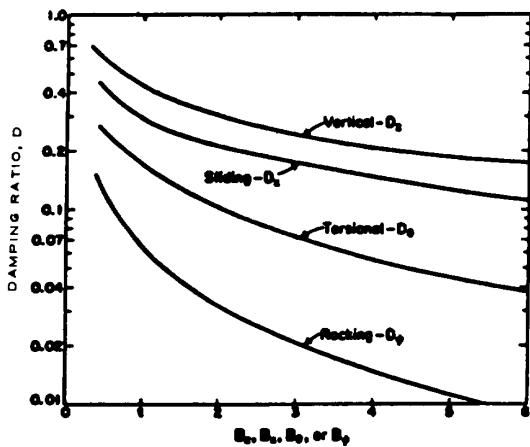

(Courtesy of F. E. Richart, Jr. J. R. Hall, Jr., and R. D. Woods, *Vibrations of Soils and Foundations*, 1970. p 226. Reprinted by permission of Prentice-Hall, Inc., Englewood Cliffs, N. J.)

Figure 17-4. Equivalent damping ratio for oscillation of rigid circular footing on elastic half-space.

b. *Effects of shape of foundation.* The theoretical solutions described above treated a rigid foundation with a circular contact surface bearing against the elastic half-space. However, foundations are usually rectangular in plan. Rectangular footings may be converted into an equivalent circular footing having a radius  $r_0$  determined by the following expressions:

For translation in z- or x-directions:

$$r_0 = \frac{\sqrt{4cd}}{\pi} \tag{17-10}$$

For rocking:

$$r_0 = 4 \sqrt{\frac{16cd^3}{3\pi}} \tag{17-11}$$

For torsion:

$$r_0 = 4 \sqrt{\frac{16cd(c^2 + d^2)}{6\pi}} \tag{17-12}$$

In equations (17-10), (17-11), and (17-12),  $2c$  is the width of the rectangular foundation (along the axis of rotation for rocking), and  $2d$  is the length of the foundation (in the plane of rotation for rocking). Two values of  $r_0$  are obtained for rocking about both x and y axes.

c. *Computations.* Figure 17-5 presents examples of computations for vertical motions (Example 1) and rocking motions (Example 2).

d. *Effect of embedment.* Embedment of foundations a distance  $d$  below the soil surface may modify the dynamic response, depending upon the soil-foundation contact and the magnitude of  $d$ . If the soil shrinks away from the vertical faces of the embedded foundation, no beneficial effects of embedment may occur. If the basic evaluation of foundation response is based on a rigid circular footing (of radius  $r_0$ ) at the surface, the effects of embedment will cause an increase

in resonant frequency and a decrease in amplitude of motion. These changes are a function of the type of motion and the embedment ratio  $d/r_0$ .

(1) For vertical vibrations, both analytical and experimental results indicate an increase in the static spring constant with an increase in embedment depth. Embedment of the circular footing a distance  $d/r_0 \leq 1.0$  produces an increase in the embedded spring constant  $k_{zd}$ , which is greater than  $k_z$  (table 17-1) by  $k_{zd}/k_z \cong (1 + 0.6 d/r_0)$ . An increase in damping also occurs, i.e.,  $D_{zd}/D_z (1 + 0.6 d/r_0)$ . These two approximate relations lead to an estimate of the reduction in amplitude of motion because of embedment from  $A_{zd} / A_z = 1 / D_{zd} / D_z \times k_{zd}/k_z$ . This amount of amplitude reduction requires complete soil adhesion at the vertical face, and test data have often indicated less effect of embedment. Test data indicate that the resonant frequency may be increased by a factor up to  $(1 + 0.25 d/r_0)$  because of embedment.

(2) The influence of embedment on coupled rocking and sliding vibrations depends on the ratio  $B_y/B_x$  (table 17-1). For  $B_y/B_x \cong 3.0$ , the increase in natural frequency due to embedment may be as much as  $(1 + 0.5 d/r_0)$ . The decrease in amplitude is strongly dependent upon the soil contact along the vertical face of the foundation, and each case should be evaluated on the basis of local soil and construction conditions.

e. *Effect of finite thickness of elastic layer.* Deposits of real soils are seldom homogeneous to significant depths; thus theoretical results based on the response of a semi-infinite elastic media must be used with caution. When soil layers are relatively thin, with respect to foundation dimensions, modifications to the theoretical half-space analyses must be included.

(1) Generally, the effect of a rigid layer underlying a single elastic layer of thickness,  $H$ , is to reduce the effective damping for a foundation vibrating at the upper surface of the elastic layer. This condition results from the reflection of wave energy from the rigid base back to the foundation and to the elastic medium surrounding the foundation. For vertical or torsional vibrations or a rigid circular foundation resting on the surface of the elastic layer, it has been established that a very large amplitude of resonant vibrations can occur if

$$\frac{V_s}{f_0} > 4H \tag{17-13}$$

In equation (17-13),  $V_s$  is the shear wave velocity in the elastic layer and  $f_0$  is the frequency of footing vibrations. When the conditions of equation (17-4) occur, the natural frequency (equation (17-1)) becomes the important design criterion because at that frequen-

EXAMPLE 1

A. FOUNDATION FOR SINGLE - CYLINDER VERTICAL COMPRESSOR

14" BORE , 9" STROKE  
450 RPM OPERATING SPEED  
UNBALANCED FORCES:

VERTICAL PRIMARY = 7720 LB.  
VERTICAL SECONDARY = 1885 LB.  
HORIZ. PRIMARY = 104 LB.  
HORIZ. SECONDARY = 0 LB.

WT. MACHINE AND MOTOR = 10900 LB.

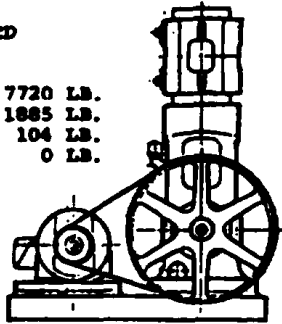

DESIGN CRITERION : SMOOTH OPERATION  
( LESS THAN 0.10 IN / SEC VELOCITY )  
AT 450 RPM THIS REQUIRES  $A_x = 0.002$  IN.

SOIL PROPERTIES:  $v_s = 680$  FT / SEC  
 $G = 11,000$  LB / IN<sup>2</sup>  
 $f' = 110$  LB / FT<sup>3</sup>  
 $\nu = 0.33$

SOLUTION :

FOR FIRST ESTIMATE OF FOUNDATION SIZE,  
DETERMINE STATIC SIZE FOR  $A_{zs} = 0.002$  IN.

$$A_{zs} = \frac{Q_o}{k_x} = 0.002" = \frac{(1-\nu) Q_o}{4 G r_o} = \frac{0.667(7720+1885)}{4 \times 11,000 \times r_o}$$

$r_o = 72.8" = 6.07$  FT FOR CIRCULAR FOUNDATION  
THEN REQUIRED AREA  $= \pi r_o^2 = 115.6$  FT<sup>2</sup>

TRY 15'x8'x3' THICK FOUNDATION BLOCK  
THEN  $A = 120$  FT<sup>2</sup> , and  $r_o = 6.18$  FT.  
WT. FOUNDATION BLOCK = 54,000 LB.  
WT. TOTAL =  $W = 64,900$  LB.

FROM TABLE 17-1:

$$B_z = \frac{(1-\nu) W}{4 f' r_o^2} = \frac{0.67 \times 64900}{4 \times 110 (6.18)^2} = 0.42$$

$$D_z = \frac{0.425}{\sqrt{B_z}} = 0.66$$

$M_x \approx 1.0$  . THUS  $A_x = A_{zs}$

$$A_{zs} = \frac{(1-\nu) Q_o}{4 G r_o} = 0.00197" , \text{ FOR } r_o = 6.18 \text{ FT.}$$

THEREFORE, THE 15'x 8'x 3' THICK CONCRETE BLOCK FOUNDATION IS SATISFACTORY

EXAMPLE 2

B. MACHINE FOUNDATION SUBJECTED TO ROCKING VIBRATIONS

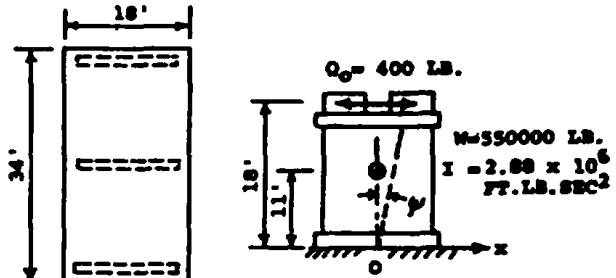

DESIGN CRITERION : 0.20 IN / SEC HORIZONTAL MOTION AT MACHINE CENTERLINE  
AT 1300 RPM THIS LIMITS  $A_x$  TO 0.0015 IN FROM COMBINED ROCKING AND SLIDING.  
(AT SLOWER SPEEDS THE ALLOWABLE  $A_x$  IS LARGER )

SOIL PROPERTIES:  $v_s = 770$  FT / SEC  
 $G = 14,000$  LB / IN<sup>2</sup>  
 $f' = 110$  LB / FT<sup>3</sup>  
 $\nu = 0.33$

HORIZONTAL TRANSLATION ONLY:

$$\text{EQUIVALENT } r_o = \sqrt{\frac{4cd}{\pi}} = \sqrt{\frac{18 \times 34}{\pi}} = 13.96 \text{ FT}$$

$$B_x = \frac{(7-8\nu) W}{32(1-\nu) \rho r_o^3} = 0.37 . \therefore M_x \approx 1.0$$

$$A_{xs} = \frac{Q_o}{k_x} = \frac{Q_o (7-8\nu)}{32 (1-\nu) G r_o} = 0.00003 \text{ IN.}$$

HORIZONTAL TRANSLATION IS NEGLIGIBLE

ROCKING ABOUT POINT O

$$\text{EQUIVALENT } r_o = \sqrt{\frac{16cd^3}{3\pi}} = \sqrt{\frac{34(18)^3}{3\pi}} = 12.04 \text{ FT}$$

$$B_y = \frac{3(1-\nu) I}{8 \rho r_o^5} = \frac{3(0.67) 2.88 \times 10^6}{8 \times \frac{110(12.04)^5}{32.2}} = 0.83$$

$$\text{THEN } D_y = \frac{0.15}{(1+B_y) \sqrt{B_y}} = 0.09 , \text{ AND FROM}$$

$$\text{EQ.17-4, } M_y = 5.6$$

THE STATIC MOMENT ABOUT O IS

$T_o = 400 \times 18 = 7200$  FT.LB. , AND THE STATIC ANGULAR DEFLECTION IS

$$\theta_s = \frac{T_o}{k_y} = \frac{7200 \times 3(0.67)}{8(14000) 144(12.04)^2} = \frac{0.51}{10^6} \text{ RAD}$$

THIS ROTATION WOULD PRODUCE A HORIZONTAL MOTION AT THE MACHINE CENTERLINE OF

$$A_{xs} = \theta_s h = \frac{0.51}{10^6} (18 \times 12) = 1.10 \times 10^{-4} \text{ IN.}$$

OR, THE DYNAMIC AMPLITUDE AT RESONANCE IS

$$A_x = M_y A_{xs} = 6.17 \times 10^{-4} \text{ IN. } < 0.0015 \text{ IN.}$$

Figure 17-5. Examples of computations for vertical and rocking motions.



cy excessive dynamic motion will occur. To restrict the dynamic oscillation to slightly larger than the static displacement, the operating frequency should be maintained at one half, or less, of the natural frequency (fig 17-2).

(2) The relative thickness (expressed by  $H/r_0$ ) also exerts an important influence on foundation response. If  $H/r_0$  is greater than about 8, the foundation on the elastic layer will have a dynamic response comparable to that for a foundation on the elastic half-space. For  $H/r_0 < 8$ , geometrical damping is reduced, and the effective spring constant is increased. The values of spring constant,  $k$ , in table 17-1 are taken as reference values, and table 17-2 indicates the increase in spring constant associated with a decrease in thickness of the elastic layer. Values of the increase in spring constants for sliding and for rocking modes of vibration will tend to fall between those given for vertical and torsion for comparable  $H/r_0$  conditions.

f. *Coupled modes of vibration.* In general, vertical and torsional vibrations can occur independently without causing rocking or sliding motions of the foundation. To accomplish these uncoupled vibrations, the line of action of the vertical force must pass through the center of gravity of the mass and the resultant soil reaction, and the exciting torque and soil reaction torque must be symmetrical about the vertical axis of rotation. Also, the center of gravity of the foundation must lie on the vertical axis of torsion.

(1) When horizontal or overturning moments act on a block foundation, both horizontal (sliding) and rocking vibrations occur. The coupling between these motions depends on the height of the center of gravity of the machine-foundation about the resultant soil reaction. Details of a coupled rocking and sliding analysis are given in the example in figure 17-6.

(2) A "lower bound" estimate of the first mode of coupled rocking and sliding vibrations can be obtained from the following:

$$\frac{1}{f_o^2} = \frac{1}{f_x^2} + \frac{1}{f_\psi^2} \tag{17-14}$$

In equation (17-14), the resonant frequencies in the sliding  $x$  and rocking  $\psi$  motions can be determined by

introducing values from table 17-1 into equations (17-1) and (17-5). (Note that equation (17-14) becomes less useful when  $D_x$  is greater than about 0.15). The first mode resonant frequency is usually most important from a design standpoint.

g. *Examples.* Figure 17-5, Example 1, illustrates a procedure for design of a foundation to support machine-producing vertical excitations. Figure 17-5, Example 2, describes the analysis of uncoupled horizontal and rocking motion for a particular foundation subjected to horizontal excitations. The design procedure of Example 1 is essentially an iterative analysis after approximate dimensions of the foundation have been established to restrict the static deflection to a value comparable to the design criterion.

(1) In figure 17-5, Example 1 shows that relatively high values of damping ratio  $D$  are developed for the vertical motion of the foundation, and Example 2 illustrates that the high damping restricts dynamic motions to values slightly larger than static displacement caused by the same force. For Example 2, establishing the static displacement at about the design limit value leads to satisfactory geometry of the foundation.

(2) Example 2 (fig 17-5) gives the foundation geometry, as well as the analysis needed to ascertain whether the design criterion is met. It is assumed that the 400-pound horizontal force is constant at all frequencies and that a simple superposition of the single-degree-of-freedom solutions for horizontal translation and rocking will be satisfactory. Because the horizontal displacement is negligible, the rocking motion dominates, with the angular rotation at resonance amounting to  $(M_\psi \times \psi_s)$  or  $A_\psi = 5.6 \times 0.51 \times 10^{-6} = 2.85 \times 10^{-6}$  radians. By converting this motion to horizontal displacement at the machine center line, it is found that the design conditions are met.

(3) In figure 17-6, the foundation of Example 2 (fig. 17-5) is analyzed as a coupled system including both rocking and sliding. The response curve for angular rotation shows a peak motion of  $A_\psi = 2.67 \times 10^{-6}$  radians, which is comparable to the value found by considering rocking alone. The coupled dynamic response of any rigid foundation, e.g., a radar tower, can

Table 17-2. Values of  $k_t/L$  for Elastic Layer ( $k$  from Table 17-1)

$H/r_0$	0.5	1.0	2.0	4.0	8.0	$\infty$
Vertical	5.0	2.2	1.47	1.23	1.10	1.0
Torsion	--	1.07	1.02	1.009	--	1.0

IN THE SKETCH REPRESENTING THE DYNAMIC MOTION OF THE FOUNDATION OF FIGURE 17-5, EXAMPLE 2, THE SUBSCRIPT "g" REFERS TO THE CENTER OF GRAVITY, AND "b" REFERS TO THE CENTER OF THE BASE.

$$x_b = x_g - h_0 \psi \quad I_b = I_g + m h_0^2$$

m = TOTAL MASS, AND I = MASS MOMENT OF INERTIA

$$c_x = D_x 2 \sqrt{k_x m} = \frac{18.4 (1-\nu)}{(7-8\nu)} r_0^2 \sqrt{\rho G}$$

$$c_\psi = D_\psi 2 \sqrt{k_\psi I} = \frac{0.80 r_0^4 \sqrt{\rho G}}{(1-\nu)(1+B_\psi)}$$

FROM EQUATION 17-2 AND VALUES FOR B<sub>1</sub>, D<sub>1</sub>, and k from TABLE 17-1

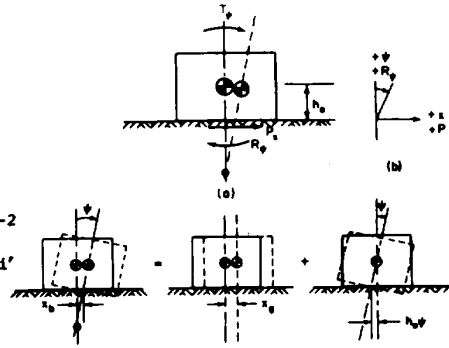

$$P_x = -c_x \dot{x}_b - k_x x_b, \quad R_\psi = -c_\psi \dot{\psi} - k_\psi \psi$$

THE EQUATION OF EQUILIBRIUM FOR HORIZONTAL TRANSLATION IS

$$m \ddot{x}_g + c_x \dot{x}_b + k_x x_b = Q_x = m \ddot{x}_b + m h_0 \ddot{\psi} + c_x \dot{x}_b + k_x x_b \quad (a)$$

AND FOR ROTATION ABOUT THE CENTER OF GRAVITY IT IS

$$I_g \ddot{\psi} + c_\psi \dot{\psi} + k_\psi \psi - c_x h_0 \dot{x}_b - k_x h_0 x_b = T_\psi, \quad \text{OR} \quad (b)$$

$$I_b \ddot{\psi} - m h_0^2 \ddot{\psi} + c_\psi \dot{\psi} + k_\psi \psi - c_x \dot{x}_b h_0 - k_x x_b h_0 = T_\psi$$

$$\text{LET } x_b = \lambda_{x1} \sin \omega t + \lambda_{x2} \cos \omega t = \lambda_x \sin(\omega t - \alpha_x) \quad (c)$$

$$\psi = \lambda_{\psi 1} \sin \omega t + \lambda_{\psi 2} \cos \omega t = \lambda_\psi \sin(\omega t - \alpha_\psi)$$

$$Q_x = Q_0 \sin \omega t \quad \text{NOTE: } \lambda_x = \sqrt{\lambda_{x1}^2 + \lambda_{x2}^2}; \tan \alpha_x = \frac{-\lambda_{x2}}{\lambda_{x1}}$$

$$T_\psi = Q_0 h \sin \omega t \quad \lambda_\psi = \sqrt{\lambda_{\psi 1}^2 + \lambda_{\psi 2}^2}; \tan \alpha_\psi = -\lambda_{\psi 2} / \lambda_{\psi 1}$$

INTRODUCING THE EXPRESSIONS (c) INTO EQUATIONS (a) AND (b) GIVE FOUR EQUATIONS WITH FOUR UNKNOWNNS (λ<sub>x1</sub>, λ<sub>x2</sub>, λ<sub>ψ1</sub>, λ<sub>ψ2</sub>), FOR EACH CHOSEN VALUE OF ω (ω = 2π-FREQUENCY). THUS A COMPUTER SOLUTION IS NEEDED. THE GRAPH BELOW SHOWS THE ROCKING RESPONSE CURVE FOR THE FOUNDATION (SEE SKETCH ABOVE AND FIGURE 17-5). THE PARAMETERS NEEDED FOR THE SOLUTION ARE NOTED BELOW.

$$Q_0 = 400 \text{ LB. (FREQUENCY INDEPENDENT)*}$$

$$h = 18 \text{ FT.}, \quad h_0 = 11 \text{ FT.}$$

$$m = \frac{550,000}{32.2} = 17,080 \text{ LB SEC}^2 / \text{FT.}$$

$$I_b = 2.88 \times 10^6 \text{ FT LB SEC}^2$$

$$r_0 = 13.96 \text{ FT (SLIDING)}$$

$$r_0 = 12.04 \text{ FT (ROCKING)}$$

$$k_x = 1.39 \times 10^8 \text{ LB / FT}$$

$$k_\psi = 1.41 \times 10^{10} \text{ FT LB / RAD}$$

$$c_x = 1.45 \times 10^6 \text{ LB SEC / FT}$$

$$c_\psi = 3.62 \times 10^7 \text{ FT LB SEC/RAD}$$

\* FOR ROTATING MASS MACHINE TYPE EXCITATION, WE WOULD INTRODUCE

$$Q_0 = m_e \bar{e} \omega^2$$

m<sub>e</sub> = eccentric mass

e = eccentric radius

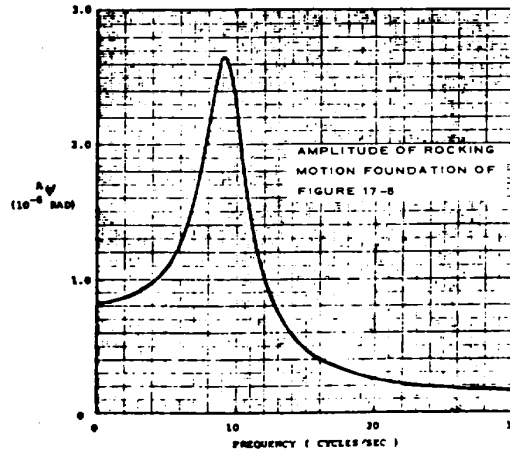

U. S. Army Corps of Engineers

Figure 17-6. Coupled rocking and sliding motion of foundation.

be evaluated by the procedure illustrated in figure 17-6.

**17-4. Wave transmission, attenuation, and isolation.** Vibrations are transmitted through soils by stress waves. For most engineering analyses, the soil may be treated as an ideal homogeneous, isotropic elastic material to determine the characteristics of the stress waves.

a. *Half-space.* Two types of body waves may be transmitted in an ideal half-space, compression (P-) waves and shear (S-) waves; at the surface of the halfspace, a third wave known as the Rayleigh (R-) wave or surface wave will be transmitted. The characteristics that distinguish these three waves are velocity, wavefront geometry, radiation damping, and particle motion. Figure 17-7 shows the characteristics of these waves as they are generated by a circular footing undergoing vertical vibration on the surface of an ideal half-space with  $\mu = 0.25$ . The distance from the footing to each wave in figure 17-7 is drawn in proportion to the velocity of each wave. The wave velocities can be computed from the following:

$\rho$

P-wave velocity:

$$v_c = \frac{\lambda + 2G}{\rho} \quad (17-15)$$

S-wave velocity:

$$v_s = \frac{G}{\rho} \quad (17-16)$$

R-wave velocity:

$$v_R = K v_s \quad (17-17)$$

where

$\lambda = \frac{2\mu G}{1-2\mu}$  and G are Lamé's constants;  $G = \frac{E}{2(1 + j)}$

$\rho = \frac{\gamma}{G}$  = mass density of soil

$\gamma$  = moist or saturated unit weight

K = constant, depending on Poisson's ratio  
 $0.87 \leq K \leq 0.98$  for  $0 \leq \mu < 0.5$

(1) The P- and S-waves propagate radially outward from the source along hemispherical wave fronts, while the R-wave propagates outward along a cylindrical wave front. All waves encounter an increasingly larger volume of material as they travel outward, thus decreasing in energy density with distance. This decrease in energy density and its accompanying decrease in displacement amplitude is called *geometrical damping* or radiation damping.

(2) The particle motions are as follows: for the P-wave, a push-pull motion in the radial direction; for the S-wave, a transverse motion normal to the radial direction; and for the R-wave, a complex motion, which varies with depth and which occurs in a vertical plane containing a radius. At the surface, R-wave particle motion describes a retrograde ellipse. The shaded zones along the wave fronts in figure 17-7 represent the

relative particle amplitude as a function of inclination from vertical.

b. *Layered media.*

(1) In a layered medium, the energy transmitted by a body wave splits into four waves at the interface between layers. Two waves are reflected back into the first medium, and two waves are transmitted or refracted into the second medium. The amplitudes and directions of all waves can be evaluated if the properties of both media and the incident angle are known. If a layer containing a lower modulus overlies a layer with a higher modulus within the half-space, another surface wave, known as a Love wave, will occur. This wave is a horizontally oriented S-wave whose velocity is between the S-wave velocity of the layer and of the underlying medium.

(2) The decay or attenuation of stress waves occurs for two reasons: geometric or radiation damping, and material or hysteretic damping. An equation including both types of damping is the following:

$$A_2 = A_1 \frac{r_1}{r_2} C \exp[-\alpha (r_2 - r_1)] \quad (17-18)$$

where

- $A_2$  = desired amplitude at distance  $r_2$
- $A_1$  = known or measured amplitude at radial distance  $r_1$ , from vibration source
- $C$  = constant, which describes geometrical damping  
 = 1 for body (P- or S-) waves  
 = 0.5 for surface or R-waves
- $\alpha$  = coefficient of attenuation, which describes material damping (values in table 17-3)

c. *Isolation.* The isolation of certain structures or zones from the effects of vibration may sometimes be necessary. In some instances, isolation can be accomplished by locating the site at a large distance from the vibration source. The required distance,  $r_2$ , is calculated from equation (17-18). In other situations, isolation may be accomplished by wave barriers. The most effective barriers are open or void zones like trenches or rows of cylindrical holes. Somewhat less effective barriers are solid or fluid-filled trenches or holes. An effective barrier must be proportioned so that its depth is at least two-thirds the wavelength of the incoming wave. The thickness of the barrier in the direction of wave travel can be as thin as practical for construction considerations. The length of the barrier perpendicular to the direction of wave travel will depend upon the size of the zone to be isolated but should be no shorter than two times the maximum plan dimension of the structure or one wavelength, whichever is greater.

**17-5. Evaluation of S-wave velocity in soils.** The key parameter in a dynamic analysis of a

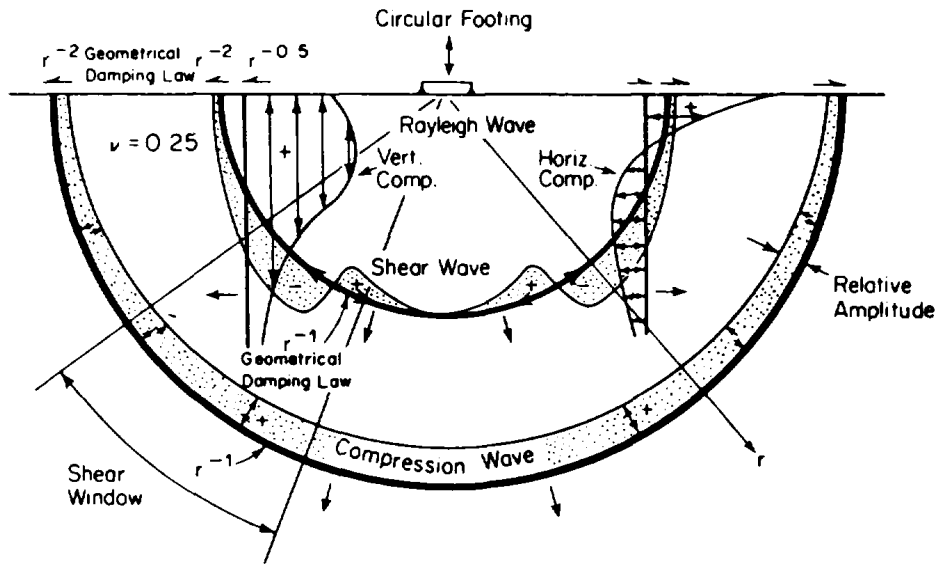

(Courtesy of F. E. Richart, Jr., J. R. Hall, Jr., and R. D. Woods. *Vibrations of Soils and Foundations*, 1970, p 91. Reprinted by permission of Prentice-Hall, Inc., Englewood Cliffs, N. J.)

Figure 17-7. Distribution of displacement waves from a circular footing on the elastic half-space.

soil-foundation system is the shear modulus,  $G$ . The shear modulus can be determined in the laboratory or estimated by empirical equations. The value of  $G$  can also be computed by the field-measured S-wave velocity and equation (17-16).

a. *Modulus at low strain levels.* The shear modulus and damping for machine vibration problems correspond to low shear-strain amplitudes of the order of 1 to 3 x 10<sup>-4</sup> percent. These properties may be determined from field measurements of the seismic

wave velocity through soil or from special cyclic laboratory tests.

b. *Field wave velocity tests.* S-wave velocity tests are preferably made in the field. Measurements are obtained by inducing a low-level seismic excitation at one location and measuring directly the time required for the induced S-wave to travel between the excitation and pickup unit. Common tests, such as uphole, downhole, or crosshole propagation, are described in geotechnical engineering literature.

Table 17-3. Attenuation Coefficients for Earth Materials

Materials		a (1/ft) @ 50 HZ <sup>a</sup>
Sand	Loose, fine	0.06
	Dense, fine	0.02
Clay	Silty (loess)	0.06
	Dense, dry	0.003
Rock	Weathered volcanic	0.02
	Competent marble	0.00004

a  $\alpha$  is a function of frequency. For other frequencies,  $f$ , compute  $\alpha_f = (f/50) \times \alpha_{50}$

(1) A problem in using seismic methods to obtain elastic properties is that any induced elastic pulse (blast, impact, etc.) develops three wave types previously discussed, i.e., P-, S-, and R-waves. Because the velocity of all seismic waves is hundreds of feet per second and the pickup unit detects all three wave pulses plus any random noise, considerable expertise is required to differentiate between the time of arrival of the wave of interest and the other waves. The R-wave is usually easier to identify (being slower, it arrives last; traveling near the surface, it contains more relative energy). Because R- and S-wave velocities are relatively close, the velocity of the R-wave is frequently used in computations for elastic properties.

(2) Because amplitudes in seismic survey are very small, the computed shear and Young's moduli are considerably larger than those obtained from conventional laboratory compression tests.

(3) The shear modulus, G, may be calculated from the S- (approximately the R-wave) wave velocity as follows:

$$G = \rho V_s^2 \tag{17-19}$$

where

$\rho$  =  $\gamma/32.2$  = mass density of soil using wet or total unit weight

$V_s$  = S-wave velocity (or R-wave), feet per second

This equation is independent of Poisson's ratio. The  $V_s$  value is taken as representative to a depth of approximately one-half wavelength. Alternatively, the shear modulus can be computed from the P-wave velocity and Poisson's ratio from:

$$G = \frac{\rho(1-2\mu)V_p^2}{2(1-\mu)} \tag{17-20}$$

The use of this equation is somewhat limited because the velocity of a P-wave in water is approximately 5000 feet per second (approximately the velocity in many soils) and Poisson's ratio must be estimated. For saturated or near saturated soils,  $\mu \approx 0.5$ . The theoretical variation of the ratio  $V_p/V_s$  with  $\mu$  is shown in figure 17-8.

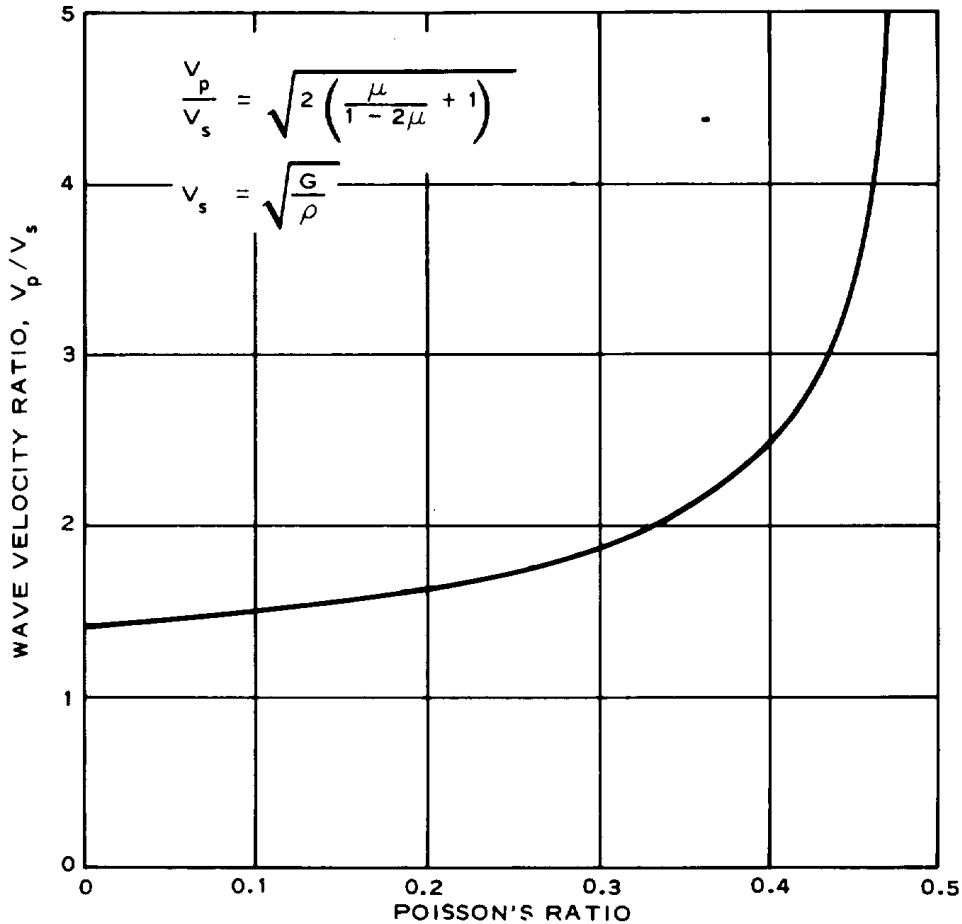

U. S. Army Corps of Engineers

Figure 17-8. Theoretical relation between shear velocity ratio  $V_p/V_s$  and Poisson's ratio.

c. *Laboratory measurement of dynamic stress-strain properties.* Low shear-strain amplitude, i.e. less than  $10^{-2}$  percent, shear modulus data may be obtained from laboratory tests and usually involve applying some type of high-frequency forced vibration to a cylindrical sample of soil and measuring an appropriate response. Some types of tests allow the intensity level of the forced vibration to be varied, thus yielding moduli at different shear strains.

(1) High strain-level excitation, i.e. 0.01 to 1.0 percent, may be achieved by low-frequency, cyclic loading triaxial compression tests on soil samples. The modulus, damping, and strain level for a particular test are calculated directly from the sample response data. The usual assumption for calculating the modulus and damping from forced cyclic loading tests on laboratory samples is that at any cyclic strain amplitude the soil behaves as a linear elastic, viscous, damped material. A typical set of results may take the form of a hysteresis loop as shown in figure 17-9. Either shear or normal stress cyclic excitation may be used. The shear modulus is calculated from the slope of the peak-to-peak secant line. The damping is computed from the area of the

hysteresis loop, and the strain level is taken as the single-amplitude (one-half the peak-to-peak amplitude or origin to peak value) cyclic strain for the condition during that cycle of the test. Note that the equations for modulus and damping shown in figure 17-9 assume the soil behaves as an equivalent elastic viscous, dampened material, which is linear within the range of strain amplitude specified. This assumption is usually made in most soil dynamics analyses because of the low-vibration amplitudes involved. If the cyclic hysteresis loops are obtained from triaxial test specimens, the resulting modulus will be the stress-strain modulus, E. If the tests involve simple shear or torsion shear such that shear stresses and strains are measured, the resulting modulus will be the shear modulus, G. In either case, the same equations apply.

(2) The shear modulus, G, can be computed from the stress strain modulus and Poisson's ratio as follows:

$$G = \frac{E}{2(1+\mu)} \tag{17-21}$$

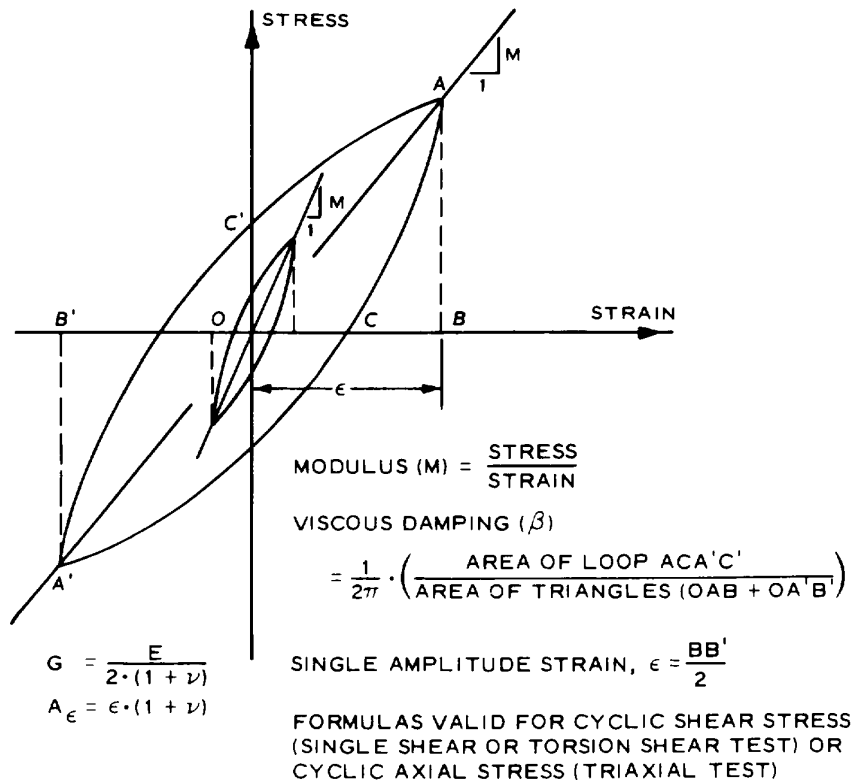

U. S. Army Corps of Engineers

Figure 17-9. Idealized cyclic stress-strain loop for soil.

The shear strain amplitude,  $A_E$ , may be computed from the axial strain amplitude,  $\epsilon$ , and Poisson's ratio as follows:

$$A_E = E(1 + \mu) \quad (17-22)$$

For the special case of saturated soils, Poisson's ratio is 0.5, which leads to the following:

$$G = E/3$$

$$A_E = 1.5\epsilon$$

d. *Correlations.*

(1) Empirical correlations from many sets of data have provided several approximate methods for estimating the S-wave velocity and shear modulus for soils corresponding to low-strain excitation. For many undisturbed cohesive soils and sands:

$$G = 1230(21973 - e)^2 (\text{OCR})^{0.5} \text{ (pounds 1 + per square inch)} \quad (17-23)$$

where

$e$  = void ratio

$\eta$  = empirical constant, which depends on the PI of cohesive soils (table 17-4). For sands,  $\text{PI} = 0$  and  $\eta = 0$ , so OCR term reduces to 1.0. For clays, the maximum value is  $\eta = 0.5$  for  $\text{PI} \geq 100$ .

$\sigma_0 = 1/3 (\sigma_1 + \sigma_2 + \sigma_3)$  = mean normal effective stress, pounds per square inch

(2) For sands and gravels, calculate the low-strain shear modulus as follows:

$$G = 1000(K_2)(\sigma_0)^{0.5} \text{ (pounds per square foot)} \quad (17-24)$$

where

$K_2$  = empirical constant (table 17-5)

=90 to 190 for dense sand, gravel, and cobbles with little clay

$\sigma_0$  = mean normal effective stress as in equation (17-23) (but in units of pounds per square foot)

(3) For cohesive soils as clays and peat, the shear modulus is related to  $S_u$  as follows:

$$G = K_2 S_u \quad (17-25)$$

For clays,  $K_2$  ranges from 1500 to 3000. For peats,  $K_2$  ranges from 150 to 160 (limited data base).

(4) In the laboratory, the shear modulus of soil increases with time even when all other variables are held constant. The rate of increase in the shear modulus is approximately linear as a function of the log of time after an initial period of about 1000 minutes. The change in shear modulus,  $\Delta G$ , divided by the shear modulus at 1000 minutes,  $G_{1000}$ , is called the normalized secondary increase. The normalized secondary increases range from nearly zero percent per log cycle for coarse sands to more than 20 percent per log for sensitive clays. For good correlation between laboratory and field measurements of shear modulus, the age of the in situ deposit must be considered, and a secondary time correction applies to the laboratory data.

e. *Damping in low strain levels.* Critical damping is defined as

$$c_c = 2 \sqrt{km} \quad (17-26)$$

where  $k$  is the spring constant of vibrating mass and  $m$  represents mass undergoing vibration (W/g). Viscous damping of all soils at low strain-level excitation is generally less than about 0.01 percent of critical damping for most soils or:

$$D = c/c_c \leq 0.05 \quad (17-27)$$

It is important to note that this equation refers only to material damping, and not to energy loss by radiation away from a vibrating foundation, which may also be conveniently expressed in terms of equivalent viscous damping. Radiation damping in machine vibration problems is a function of the geometry of the problem rather than of the physical properties of the soil.

Table 17-4. Values of Constant  $r$  Used with Equation (17-23) to Estimate Cyclic Shear Modulus at Low Strains

Plasticity Index	K
0	0
20	0.18
40	0.30
60	0.41
80	0.48
$\geq 100$	0.50

(Courtesy of O. Hardin and P. Drnevich. "Shear Modulus and Damping in Soils: Design Equations and Curves," *Journal, Soil Mechanics and Foundations Division*. Vol 98. No. SM7. 1972, pp 667-692. Reprinted by permission of American Society of Civil Engineers, New York.)

Table 17-5. Values of Constant  $K_2$  Used with Equation (17-24) to Estimate Cyclic Shear Modulus at Low Strains for Sands

$e$	$K_2$	$D_r(\%)$
0.4	70	90
0.5	60	75
0.6	51	60
0.7	45	45
0.8	39	40
0.9	33	30

(Courtesy of H. B. Seed and L. M. Idriss, "Simplified Procedures for Evaluating Liquefaction Potential," Journal, Soil Mechanics and Foundations Division Vol 97, No. SM9, 1971, pp 1249-1273. Reprinted by permission of American Society of Civil Engineers, New York.)

*f. Modulus and damping at high strain levels.*

The effect of increasingly higher strain levels is to reduce the modulus (fig 17-10) and increase the damping of the soil (fig 17-11). Shear modulus and damping values at high strains are used mainly in computer programs for analyzing the seismic response of soil under earthquake loading conditions. The various empirical relations for modulus and damping pertain to sands and soft, normally consolidated clays at low-to-medium effective confining pressures, in the range of about 100 feet or overburden. Stiff overconsolidated clays and all soils at high effective confining pressure exhibit lower values of damping and higher values of modulus, especially at high strain levels. As a maximum, the modulus and damping values for stiff or strong soils at very high effective confining pressures correspond to values pertaining to crystalline or shale-type rock.

**17-6. Settlement and liquefaction.**

*a. Settlement.* Repeated shearing strains of cohesionless soils cause particle rearrangements. When the particles move into a more compact position, settlement occurs. The amount of settlement depends on the initial density of the soil, the thickness of the stratum, and the intensity and number of repetitions of the shearing strains. Generally, cohesionless soils with relative densities ( $D_r$ ) greater than about 75 percent should not develop settlements. However, under  $10^6$  or  $10^7$  repetitions of dynamic loading, even dense sands may develop settlements amounting to 1 to 2 percent of the layer thickness. To minimize settlements that might occur under sustained dynamic loadings, the soil beneath and around the foundation may be precompacted during the construction process by vibroflotation, multiple blasting, pile driving, or vibrating rollers acting at the surface. The idea is to subject the soil to a more severe dynamic loading condition during

construction than it will sustain throughout the design operation.

*b. Liquefaction of sands.* The shearing strength of saturated cohesionless soils depends upon the effective stress acting between particles. When external forces cause the pore volume of a cohesionless soil to reduce the amount  $V$ , pore water pressures are increased during the time required to drain a volume  $V$  of water from the soil element. Consequently, pore pressure increases depend upon the time rate of change in pore volume and the drainage conditions (permeability and available drainage paths). When conditions permit the pore pressure,  $u$ , to build up to a value equal to the total stress,  $\sigma_n$ , on the failure plane, the shear strength is reduced to near zero and the mixture of soil grains and water behaves as a liquid. This condition is true liquefaction, in which the soil has little or no shearing strength and will flow as a liquid. Liquefaction or flow failure of sands involves a substantial loss of shearing strength for a sufficient length of time that large deformations of soil masses occur by flow as a heavy liquid.

*c. Liquefaction due to seismic activity.* Soil deposits that have a history of serious liquefaction problems during earthquakes include alluvial sand, aeolian sands and silts, beach sands, reclaimed land, and hydraulic fills. During initial field investigations, observations that suggest possible liquefaction problems in seismic areas include low penetration resistance; artesian heads or excess pore pressures; persistent inability to retain granular soils in sampling tubes; and any clean, fine, uniform sand below the groundwater table. The liquefaction potential of such soils for structures in seismic areas should be addressed unless they meet one of the criteria in table 17-6. In the event that



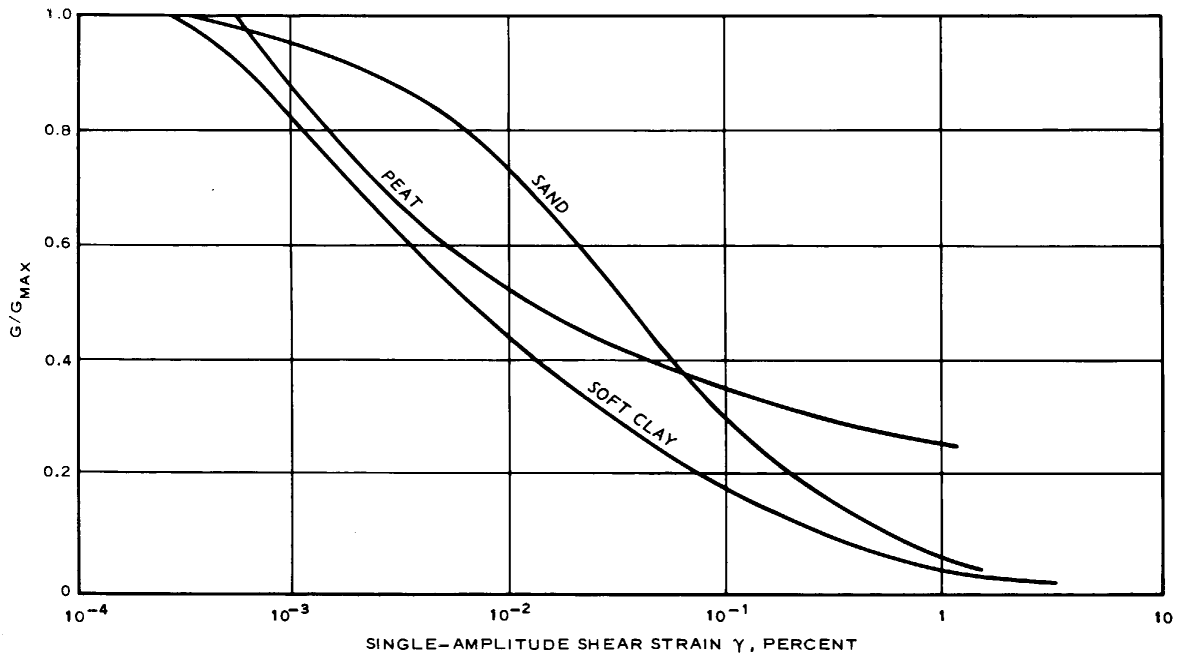

(Courtesy of H. B. Seed and L. M. Idriss, "Simplified Procedures for Evaluating Liquefaction Potential," *Journal, Soil Mechanics and Foundations Division* Vol 97, No. SM9, 1971, pp 1249-1273. Reprinted by permission of American Society of Civil Engineers, New York.)

Figure 17-10. Variation of shear modulus with cyclic strain amplitude;  $G_{max} = G$  at  $\epsilon = 1$  to  $3 \times 10^{-4}$  percent; scatter in data up to about  $\pm 0.1$  on vertical scale.

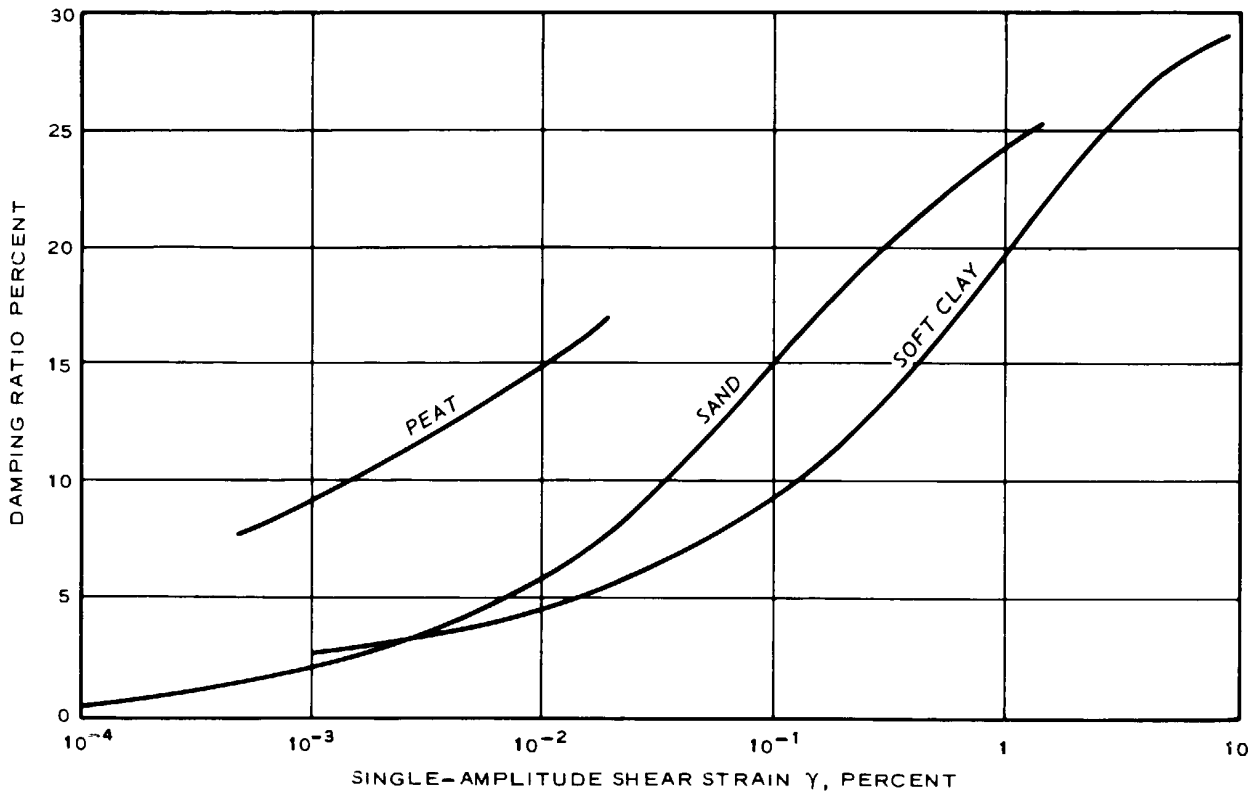

(Courtesy of H. B Seed and I. M Idriss. "Simplified Procedure for Evaluating Soil Liquefaction Potential." *Journal, Soil Mechanics and Foundations Division*. Vol 97, No. SM9. 1971, pp 1249-1273. Reprinted by permission of the American Society, of Civil Engineers. New York.)

Figure 17-11. Variation of viscous damping with cyclic strain amplitude, data scatter up to about  $\pm 50$  percent of average damping values shown for any strain.

Table 17-6. Criteria for Excluding Need for Detailed Liquefaction Analyses

- 
1. CL, CH, SC, or GC soils.
  2. GW or GP soils or materials consisting of cobbles, boulders, uniform rock fill, which have free-draining boundaries that are large enough to preclude the development of excess pore pressures.
  3. SP, SW, or SM soils which have average relative density equal to or greater than 85 percent, provided that the minimum relative density is not less than 80 percent.
  4. ML or SM soils in which the dry density is equal to or greater than 95 percent of the modified Proctor (CE 55) density.
  5. Soils of pre-Holocene age, with natural overconsolidation ratio equal to or greater than 16 and with relative density greater than 70 percent.
  6. Soils located above the highest potential groundwater table.
  7. Sands in which the "N" value is greater than three times the depth in feet, or greater than 75; provided that 75 percent of the values meet this criterion, that the minimum "N" value is not less than one times the depth in feet, that there are no consistent patterns of low values in definable zones or layers, and that the maximum particle size is not greater than 1 in. Large gravel particles may affect "N" values so that the results of the SPT are not reliable.
  8. Soils in which the shear wave velocity is equal to or greater than 2000 fps. Geophysical survey data and site geology should be reviewed in detail to verify that the possibility of included zones of lowvelocity is precluded.
  9. Soils that, in undrained cyclic triaxial tests, under isotropically consolidated, stress-controlled conditions, and with cyclic stress ratios equal to or greater than 0.45, reach 50 cycles or more with peak-to-peak cyclic strains not greater than 5 percent; provided that methods of specimen preparation and testing conform to specified guidelines.

---

Note: The criteria given above do not include a provision for exclusion of soils on the basis of grain-size distribution, and in general, grain-size distribution alone cannot be used to conclude that soils will not liquefy. Under adverse conditions nonplastic soils with a very wide range of grain sizes may be subject to liquefaction.

U. S. Army Corps of Engineers

none of the criteria is met and a more favorable site cannot be located, the material in question should be removed, remedial treatment applied as described in chapter 16, or a detailed study and analysis should be conducted to determine if liquefaction will occur.

Ground motions from earthquakes cause motions of foundations by introducing forces at the foundation-soil contact zone. Methods for estimating ground motions and their effects on the design of foundation elements are discussed in TM 5-809-10 / AFM 88-3, Chapter 13.

**17-7. Seismic effects on foundations.**

## CHAPTER 18

## FOUNDATIONS IN AREAS OF SIGNIFICANT FROST PENETRATION

**18-1. Introduction.**

a. *Types of areas.* For purposes of this manual, areas of significant frost penetration may be defined as those in which freezing temperatures occur in the ground to sufficient depth to be a significant factor in foundation design. Detailed requirements of engineering design in such areas are given in TM 5-818-2/AFM 88-6, Chapter 4, and the Arctic and Subarctic Construction series, TM 5-852-1 through 9/AFM 88-19, Chapters 1 through 9, respectively. Areas of significant frost penetration may be subdivided as follows:

(1) *Seasonal frost areas.*

(a) Significant ground freezing occurs in these areas during the winter season, but without development of permafrost.<sup>1</sup> In northern Texas, significant seasonal frost occurs about 1 year in 10. A little farther north it is experienced every year. Depth of seasonal freezing increases northward with decreasing mean annual and winter air temperatures until permafrost is encountered. With still further decrease of air temperatures, the depth of annual freezing and thawing becomes progressively thinner.

(b) The layer extending through both seasonal frost and permafrost areas in which annual freeze-thaw cycles occur is called the *annual frost zone*. In permafrost areas, it is also called the *active layer*. It is usually not more than 10 feet thick, but it may exceed 20 feet. Under conditions of natural cover in very cold permafrost areas, it may be as little as 1 foot thick. Its thickness may vary over a wide range even within a small area. Seasonal changes in soil properties in this layer are caused principally by the freezing and thawing of water contained in the soil. The water may be permanently in the annual frost zone or may be drawn into it during the freezing process and released during thawing. Seasonal changes are also produced by shrinkage and expansion caused by temperature changes.

(2) *Permafrost areas.*

(a) In these areas, perennially frozen ground is found below the annual frost zone. In North America, permafrost is found principally north of latitudes 55 to 65 degrees, although patches of permafrost are found much farther south on mountains where the

temperature conditions are sufficiently low, including some mountains in the contiguous 48 States. In areas of *continuous permafrost*, perennially frozen ground is absent only at a few widely scattered locations, as at the bottoms of rivers and lakes. In areas of *discontinuous permafrost*, permafrost is found intermittently in various degrees. There may be discontinuities in both horizontal and vertical extent. *Sporadic permafrost* is permafrost occurring in the form of scattered permafrost islands. In the coldest parts of the Arctic, the ground may be frozen as deep as 2000 feet.

(b) The geographical boundaries between zones of continuous permafrost, discontinuous permafrost, and seasonal frost without permafrost are poorly defined but are represented approximately in figure 18-1.

b. *General nature of design problems.* Generally, the design of foundations in areas of only seasonal frost follows the same procedure as where frost is insignificant or absent, except that precautions are taken to avoid winter damage from frost heave or thrust. In the spring, thaw and settlement of frost-heaved material in the annual frost zone may occur differentially, and a very wet, poorly drained ground condition with temporary but substantial loss of shear strength is typical.

(1) In permafrost areas, the same annual frost zone phenomena occur, but the presence of the underlying permafrost introduces additional potentially complex problems. In permafrost areas, heat flow from buildings is a fundamental consideration, complicating the design of all but the simplest buildings. Any change from natural conditions that results in a warming of the ground beneath a structure can result in progressive lowering of the permafrost table over a period of years that is known as degradation. If the permafrost contains ice in excess of the natural void or fissure space of the material when unfrozen, progressive downward thaw may result in extreme settlements or overlying soil and structures. This condition can be very serious because such subsidence is almost invariably differential and hence very damaging to a structure. Degradation may occur not only from building heat but also from solar heating, as under pavements, from surface water and groundwater flow, and from underground utility lines. Proper insulation will prevent degradation in some situations, but where a con

<sup>1</sup> Specialized terms relating to frozen ground areas are defined in TM 5-818-2/AFM 88-6, Chapter 4, and TM 5-852-1/AFM 88-19, Chapter 1.

tinuous source of heat is available, thaw will in most cases eventually occur.

(2) The more intense the winter cooling of the frozen layer in the annual frost zone and the more rapid the rate of frost heave, the greater the intensity of uplift forces in piles and foundation walls. The lower the temperature of permafrost, the higher the bearing capacity and adfreeze strength that can be developed, the lower the creep deformation rate under footings and in tunnels and shafts, and the faster the freeze-back of slurried piles. Dynamic response characteristics of foundations are also a function of temperature. Both

natural and manufactured construction materials experience significant linear and volumetric changes and may fracture with changes in temperature. Shrinkage cracking of flexible pavements is experienced in all cold regions. In arctic areas, patterned ground is widespread, with vertical ice wedges formed in the polygon boundaries. When underground pipes, power cables, or foundation elements cross shrinkage cracks, rupture may occur during winter contraction. During summer and fall, expansion of the warming ground may cause substantial horizontal forces if the cracks have become filled with soil or ice.

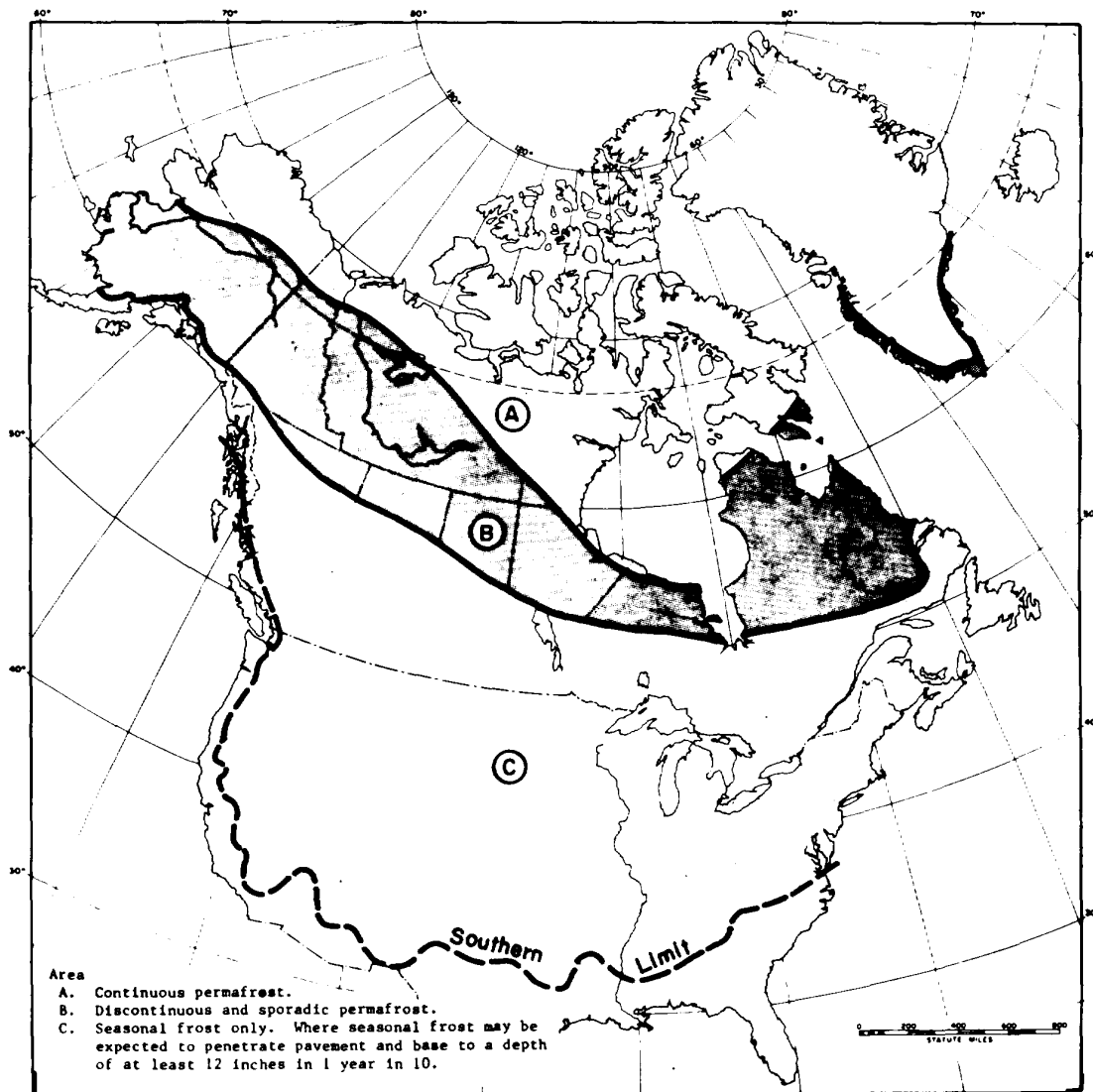

U. S. Army Corps of Engineers

Figure 18-1. Frost and permafrost in North America.

(3) Engineering problems may also arise from such factors as the difficulty of excavating and handling ground when it is frozen; soft and wet ground conditions during thaw periods; surface and subsurface drainage problems; special behavior and handling requirements for natural and manufactured materials at low temperatures and under freeze-thaw action; possible ice uplift and thrust action on foundations; condensation on cold floors; adverse conditions of weather, cost, and sometimes accessibility; in the more remote locations, limited local availability of materials, support facilities, and labor; and reduced labor efficiency at low temperatures.

(4) Progressive freezing and frost heave of foundations may also develop under refrigerated ware-houses and other facilities where sustained interior below-freezing temperatures are maintained. The design procedures and technical guidance outlined in this chapter may be adapted to the solution of these design problems.

## 18-2. Factors affecting design of foundations.

*a. Physiography and geology.* Physiographic and geologic details in the area of the proposed construction are a major factor determining the degree of difficulty that may be encountered in achieving a stable foundation. For example, pervious layers in fine-grained alluvial deposits in combination with copious groundwater supplies from adjacent higher terrain may produce very high frost-heave potential, but clean, free-draining sand and gravel terrace formations of great depth, free of excess ice, can provide virtually trouble-free foundation conditions.

*b. Temperature.* The most important factors contributing to the existence of adverse foundation conditions in seasonal frost and permafrost regions are cold air temperatures and the continual changes of temperature between summer and winter. Mean annual air temperatures usually have to be 2° to 8°F below freezing for permafrost to be present, although exceptions may be encountered both above and below this range. Ground temperatures, depths of freeze and thaw, and thickness of permafrost are the product of many variables including weather, radiation, surface conditions, exposure, snow and vegetative cover, and insulating or other special courses. The properties of earth materials that determine the depths to which freezing-and-thawing temperatures will penetrate below the ground surface under given temperature differentials over a given time are the thermal conductivity, the volumetric specific heat capacity, and the volumetric latent heat of fusion. These factors in turn vary with the type of material, density, and moisture content. Figure 18-2 shows how ground temperatures vary during the freezing season in an area of substantial seasonal freezing having a mean annual temperature of 37°F (Limestone, Maine), and figure 18-3 shows similar data

for a permafrost area having a mean annual temperature of 26°F (Fairbanks, Alaska).

(1) For the computation of seasonal freeze or thaw penetration, *freezing-and-thawing indexes* are used based upon *degree-days* relative to 32 F. For the average permanent structure, the *design indexes* should be those for the coldest winter and the warmest summer in 30 years of record. This criterion is more conservative than that used for pavements because buildings and other structures are less tolerant of movement than pavements. It is important to note that indexes found from weather records are for air about 4.5 feet above the ground; the values at ground surface, which determine freeze-and-thaw effects, are usually different, being generally smaller for freezer conditions and larger for thawing where surfaces are exposed to the sun. The *surface index*, which is the index determined for temperature immediately below the surface, is *n* times the air index, where *n* is the *correction factor*. Turf, moss, other vegetative cover, and snow will reduce the *n* value for temperatures at the soil surface in relation to air temperatures and hence give less freeze or thaw penetration for the same air freezing or thawing index. Values of *n* for a variety of conditions are given in TM 5-852-4/AFM 88-19, Chapter 4.

(2) More detailed information on indexes and their computation is presented in TM 5-852-6/AFM 88-19, Chapter 6. Maps showing distribution of index values are presented in TM 5-852-1/AFM 88-19, Chapter 1, and TM 5-818-2/AFM 88-6, Chapter 4.

*c. Foundation materials.* The foundation design decisions may be critically affected by the foundation soil, ice, and rock conditions.

### (1) Soils.

(a) The most important properties of soils affecting the performance of engineering structures under seasonal freeze-thaw action are their frost-heaving characteristics and their shear strengths on thawing. Criteria for frost susceptibility based on percentage by weight finer than 0.02 millimeter are presented in TM 5-818-2/AFM 88-6, Chapter 4. These criteria have also been developed for pavements. Heave potential at the lower limits of frost susceptibility determined by these criteria is not zero, although it is generally low to negligible from the point of view of pavement applications. Applicability of these criteria to foundation design will vary, depending upon the nature and requirements of the particular construction. Relative frost-heaving qualities of various soils are shown in TM 5-818-2/AFM 88-6, Chapter 4.

(b) Permafrost soils cover the entire range of types from very coarse, bouldery glacial drift to clays and organic soils. Strength properties of frozen soils

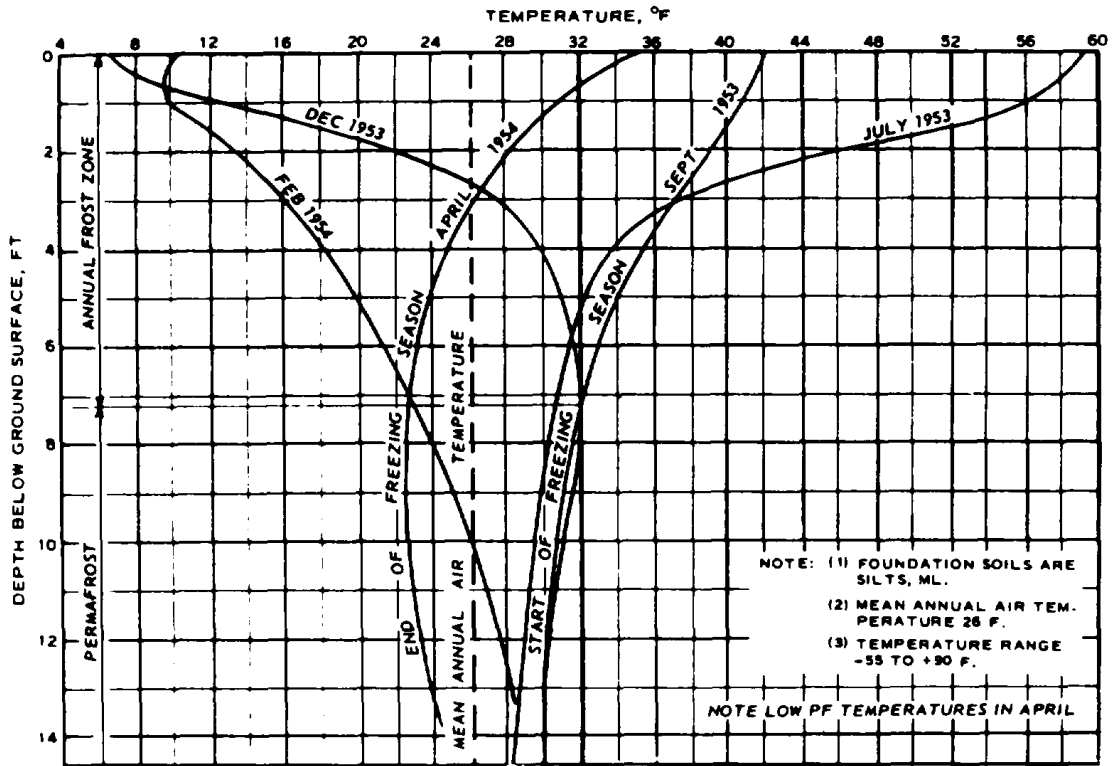

U. S. Army Corps of Engineers

Figure 18-2. Ground temperature during freezing season in Limestone, Maine.

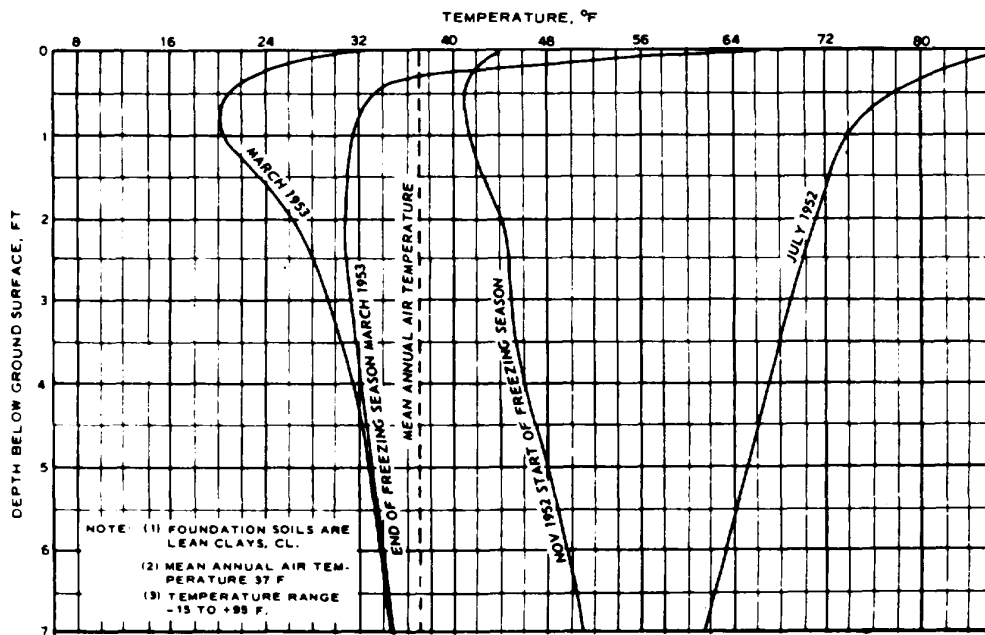

U. S. Army Corps of Engineers

Figure 18-3. Ground temperatures during freezing season in Fairbanks, Alaska.



are dependent on such variables as gradation, density, degree of saturation, ice content, unfrozen moisture content, temperature, dissolved soils, and rate of loading. Frozen soils characteristically exhibit creep at stresses as low as 5 to 10 percent of the rupture strength in rapid loading. Typical strength and creep relationships are described in TM 5-852-4/AFM 88-19, Chapter 4.

(2) *Ice.* Ice that is present in the ground in excess of the normal void space is most obvious as more or less clear lenses, veins or masses easily visible in cores, and test pits or excavations, but it may also be so uniformly distributed that it is not readily apparent to the unaided eye. In the annual frost zone, excess ice is formed by the common ice segregation process, although small amounts of ice may also originate from filling of shrinkage cracks; ice formations in this zone disappear each summer. Below the annual frost zone, excess ice in permafrost may form by the same type of ice segregation process as above, may occur as vertical ice wedges formed by a horizontal contraction-expansion process, or may be "fossil ice" buried by landslides or other events. Although most common in fine-grained soils, substantial bodies of excess ice are not uncommon in permanently frozen clean, granular deposits. The possible adverse effects of excess ice are discussed in paragraph 18-4a(2)(b).

(3) *Rock.* Bedrock subject to freezing temperatures should never be assumed problem-free in absence of positive subsurface information. In seasonal frost areas, mud seams in bedrock or concentrations of fines at or near the rock surface, in combination with the ability of fissures in the rock to supply large quantities of water for ice segregation, frequently cause severe frost heave. In permafrost areas, very substantial quantities of ice are often found in bedrock, occurring in fissures and cracks and along bedding planes.

*d. Water conditions.*

(1) If free water drawn to developing ice segregation can be easily replenished from an aquifer layer or from a water table within a few feet of the plane of freezing, heave can be large. However, if a freezing soil has no access to free water beyond that contained in voids of the soil *immediately* at or below the plane of freezing, frost heave will necessarily be limited.

(2) In permafrost areas, the supply of water available to feed growing ice lenses tends to be limited because of the presence of the underlying impermeable permafrost layer, usually at relatively shallow depths, and *maximum* heave may thus be less than under otherwise similar conditions in seasonal frost areas. However, uplift forces on structures may be higher because of lower soil temperatures and consequent higher effective tangential adfreeze strength values.

(3) The water content of soil exerts a substantial effect upon the depth of freeze or thaw penetration that will occur with a given surface freezing or thawing index. Higher moisture contents tend to

reduce penetration by increasing the volumetric latent heat of fusion as well as the volumetric specific heat capacity. While an increase in moisture also increases thermal conductivity, the effect of latent heat of fusion tends to be predominant. TM 5-852-6/AFM 88-19, Chapter 6, contains charts showing thermal conductivity relationships.

*e. Frost-heave forces and effect of surcharge.* Frost-heave forces on structures may be quite large. For some engineering construction, complete prevention of frost heave is unnecessary and uneconomical, but for most permanent structures, complete prevention is essential. Under favorable soil and foundation loading conditions, it may be possible to take advantage of the effect of surcharge to control heave. It has been demonstrated in laboratory and field experiments that the rate of frost heaving is decreased by an increase of loading on the freezing plane and that frost heaving can be completely restrained if sufficient pressure is applied. However, heave forces normal to the freezing plane may reach more than 10 tons per square foot. Detailed information on frost-heaving pressures and on the effect of surcharge is presented in TM 5-852-4/AFM 88-19, Chapter 4.

*f. Type of structure.* The type and uses of a structure affect the foundation design in frost areas as in other places. Applicable considerations are discussed in TM 5-852-4/AFM 88-19, Chapter 4.

**18-3. Site investigations.**

*a. General.* In addition to the needed site investigations and data described in the manuals for nonfrost conditions, design of foundations in areas of significant frost penetration requires special studies and data because of factors introduced by the special frost-related site conditions. Detailed site investigation procedures applicable for arctic and subarctic areas are described in TM 5-852-2/AFM 88-19, Chapter 2, and TM 5-852-4/AFM 88-19, Chapter 4, and may be adapted or reduced in scope, as appropriate, in areas of less severe winter freezing. Methods of terrain evaluation in arctic and subarctic regions are given in TM 5-852-8.

*b. Remote sensing and geophysical investigations.* These techniques are particularly valuable in selection of the specific site location, when a choice is possible. They can give clues to subsurface frozen ground conditions because of effects of ground freezing upon such factors as vegetation, land wastage, and soil and rock electrical and acoustical properties.

*c. Direct site investigations.* The number and extent of direct site explorations should be sufficient to reveal in detail the occurrence and extent of frozen

strata, permafrost and excess ice including ice wedges, moisture contents and groundwater, temperature conditions in the ground, and the characteristics and properties of frozen materials and unfrozen soil and rock.

(1) The need for investigation of bedrock requires special emphasis because of the possibilities of frost heave or ice inclusions as described in paragraph 18-2c(3). Bedrock in permafrost areas should be drilled to obtain undisturbed frozen cores whenever ice inclusions could affect the foundation design or performance.

(2) In areas of discontinuous permafrost, sites require especially careful exploration and many problems can be avoided by proper site selection. As an example, the moving of a site 50 to 100 feet from its planned position may place a structure entirely on or entirely off permafrost, in either case simplifying foundation design. A location partly on and partly off permafrost might involve an exceptionally difficult or costly design.

(3) Because frozen soils may have compressive strengths as great as that of a lean concrete and because ice in the ground may be melted by conventional drilling methods, special techniques are frequently required for subsurface exploration in frozen materials. Core drilling using refrigerated drilling fluid or air to prevent melting of ice in the cores provides specimens that are nearly completely undisturbed and can be subjected to the widest range of laboratory tests. By this procedure, soils containing particles up to boulder size and bedrock can be sampled, and ice formations can be inspected and measured. Drive sampling is feasible in frozen fine-grained soils above about 250F and is often considerably simpler, cheaper, and faster. Samples obtained by this procedure are somewhat disturbed, but they still permit ice and moisture content determinations. Test pits are very useful in many situations. For frozen soils that do not contain very many cobbles and boulders, truck-mounted power augers using tungsten carbide cutting teeth will provide excellent service where classification, gradation, and rough ice-content information will be sufficient. In both seasonal frost and permafrost areas, a saturated soil condition is common in the upper layers of soil during the thaw season, so long as there is frozen, impervious soil still underlying. Explorations attempted during the thaw season are handicapped and normally require cased boring through the thawed layer. In permafrost areas, it is frequently desirable to carry out explorations during the colder part of the year, when the annual frost zone is frozen, than during the summer.

(4) In subsurface explorations that encounter frozen soil, it is important that the boundaries of frozen and thawed zones and the amount and mode of ice occurrence be recorded. Materials encountered should be identified in accordance with the Unified Soil

Classification System (table 2-3), including the frozen soil classification system, as presented in TM 5-852-2/ AFM 88-19, Chapter 2.

(5) In seasonal frost areas, the most essential site data beyond those needed for nonfrost foundation design are the design freezing index and the soil frost-susceptibility characteristics. In permafrost areas, as described in TM 5-852-4/AFM 88-19, Chapter 4, the data requirements are considerably more complex; determination of the susceptibility of the foundation materials to settlement on thaw and of the subsurface temperatures and thermal regime will usually be the most critical special requirements. Ground temperatures are measured most commonly with copper-constantan thermocouples or with thermistors. (6) Special site investigations, such as installation and testing of test piles, or thaw-settlement tests may be required. Assessment of the excavation characteristics of frozen materials may also be a key factor in planning and design.

18-4. Foundation design.

a. *Selection of foundation type.* Only sufficient discussion of the relationships between foundation conditions and design decisions is given below to indicate the general nature of the problems and solutions. Greater detail is given in TM 5-852-4/AFM 88-19, Chapter 4.

(1) *Foundations in seasonal frost areas.*

(a) When foundation materials within the maximum depth of seasonal frost penetration consist of clean sands and gravels or other non-frost-susceptible materials that do not develop frost heave or thrust, or thaw weakening, design in seasonal frost areas may be the same as for nonfrost regions, using conventional foundations, as indicated in figure 18-4. Effect of the frost penetration on related engineering aspects, such as surface and subsurface drainage systems or underground utilities, may need special consideration. Thorough investigation should be made to confirm the nonfrost susceptibility of subgrade soils prior to design for this condition.

(b) When foundation materials within the annual frost zone are frost-susceptible, seasonal frost heave and settlement of these materials may occur. In order for ice segregation and frost heave to develop, freezing temperatures must penetrate into the ground, soil must be frost-susceptible, and adequate moisture must be available. The magnitude of seasonal heaving is dependent on such factors as rate and duration of frost penetration, soil type and effective pore size, surcharge, and degree of moisture availability. Frost heave in a freezing season may reach a foot or more in silts and some clays if there is an unlimited supply of moisture available. The frost heave may lift or tilt

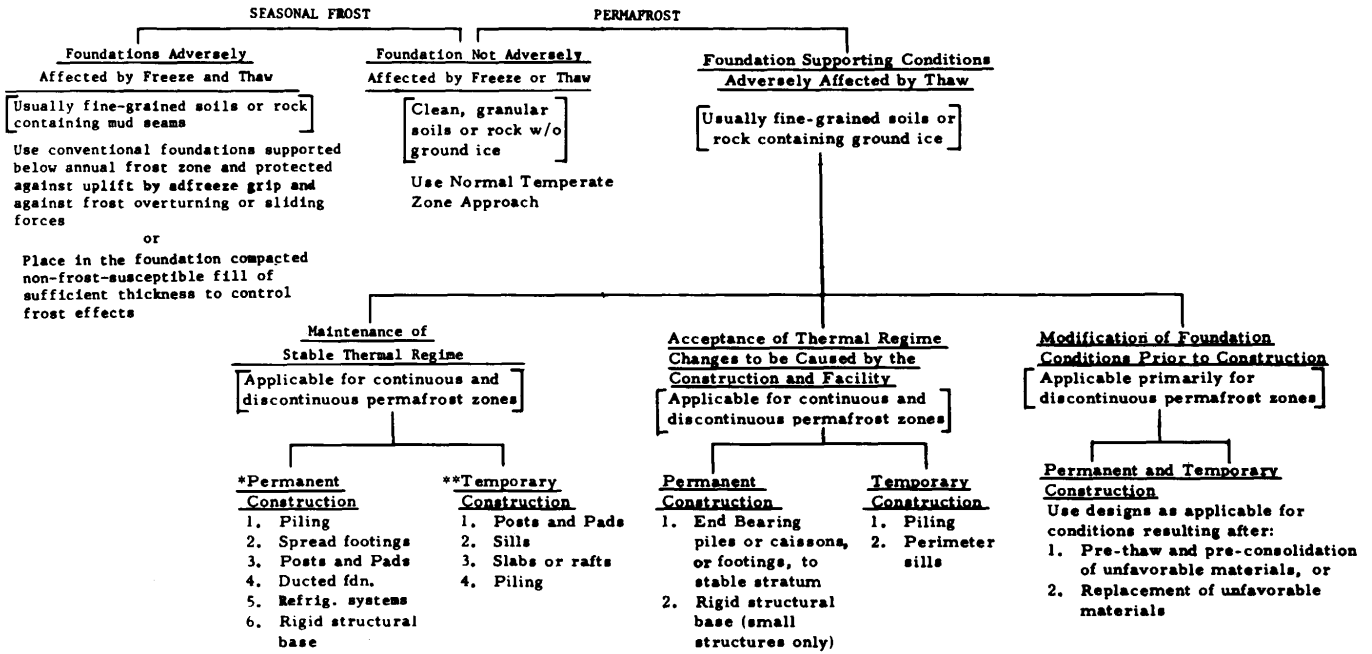

\*Permanent Construction - Construction incorporating the type and quality of materials and equipment, and details and methods of construction, which results in a building or facility suitable to serve a specific purpose over a minimum life expectancy of 25 years with normal maintenance.

\*\*Temporary Construction - Construction incorporating the type and quality of materials and equipment, and details and methods of construction, which results in a building or facility suitable to provide minimum accommodations at low first cost to serve a specific purpose for a short period of time, 5 years or less, in which the degree of maintenance is not a primary design consideration.

Figure 18-4. Design alternatives.

foundations and structures, commonly differentially, with a variety of possible consequences.

(c) When thaw occurs, the ice within the frostheaved soil is changed to water and escapes to the ground surface or into surrounding soil, allowing overlying materials and structures to settle. If the water is released by thaw more rapidly than it can be drained away or redistributed, substantial loss in soil strength occurs. In seasonal frost areas, a heaved foundation may or may not return to its before-heave elevation. Friction on lateral surface or intrusion of softened soil into the void space below the heaved foundation members may prevent full return. Successive winter seasons may produce progressive upward movement.

(d) Therefore, when the soils within the maximum depth of seasonal frost penetration are frost-susceptible, foundations in seasonal frost areas should be supported below the annual frost zone, using conventional foundation elements protected against uplift caused by adfreeze grip and against frost overturning or sliding forces, or the structure should be placed on compacted non-frost-susceptible fill designed to control frost effects (fig 18-4).

(2) *Foundations in permafrost areas.* Design on permafrost areas must cope with both the annual frost zone phenomena described in paragraph 18-4a(l) and those peculiar to permafrost.

(a) *Permafrost foundations not adversely affected by thaw.* Whenever possible, structures in permafrost areas should be located on clean, non-frost-susceptible sand or gravel deposits or rock that are free of ground ice or of excess interstitial ice, which would make the foundation susceptible to settlement on thaw. Such sites are ideal and should be sought whenever possible. Foundation design under these conditions can be basically identical with temperate zone practices, even though the materials are frozen below the foundation support level, as has been demonstrated in Corps of Engineers construction in interior Alaska. When conventional foundation designs are used for such materials, heat from the structure will gradually thaw the foundation to progressively greater depths over an indefinite period of years. In 5 years, for example, thaw may reach a depth of 40 feet. However, if the foundation materials are not susceptible to settlement on thaw, there will be no effects on the structure from such thaw. The possible effect of earthquakes or other dynamic forces after thawing should be considered.

(b) *Permafrost foundations adversely affected by thaw.* When permafrost foundation materials containing excess ice are thawed, the consequences may include differential settlement, slope instability, development of water-filled surface depressions that serve to intensify thaw, loss of strength of frostloosened foundation materials under excess moisture conditions, development of underground uncontrolled drainage channels in permafrost materials susceptible to bridging

or piping, and other detrimental effects. Often, the results may be catastrophic. For permafrost soils and rock containing excess ice, design should consider three alternatives, as indicated in figure 18-4: maintenance of stable thermal regime, acceptance of thermal regime changes, and modification of foundation conditions prior to construction. These approaches are discussed in TM 5-852-4/AFM 88-19, Chapter 4. Choice of the specific foundation type from among those indicated in figure 18-4 can be made on the basis of cost and performance requirements after the development of details to the degree needed for resolution.

b. *Foundation freeze and thaw and techniques for control.* Detailed guidance for foundation thermal computations and for methods of controlling freeze-and-thaw penetration is presented in TM 5-852-4 and TM 5-852-6/AFM 88-19, Chapters 4 and 6, respectively.

(1) *Design depth of ordinary frost penetration.*

(a) For average permanent structures, the depth of frost penetration assumed for design, for situations not affected by heat from a structure, should be that which will occur in the coldest year in 30. For a structure of a temporary nature or otherwise tolerant of some foundation movement, the depth of frost penetration in the coldest year in 10 or even that in the mean winter may be used, as may be most applicable. The design depth should preferably be based on actual measurements, or on computations if measurements are not available. When measurements are available, they will almost always need to be adjusted by computations to the equivalent of the freezing index selected as the basis for design, as measurements will seldom be available for a winter having a severity equivalent to that value.

(b) The frost penetration can be computed using the design freezing index and the detailed guidance given in TM 5-852-6/AFM 88-19, Chapter 6. For paved areas kept free of snow, approximate depths of frost penetration may be estimated from TM 5-818-2/AFM 88-6, Chapter 4, or TM 852-3/AFM 88-19, Chapter 3, entering the appropriate chart with the air freezing index directly. A chart is also presented in TM 5-852-4/AFM 88-19, Chapter 4, from which approximate depths of frost penetration may be obtained for a variety of surface conditions, using the air freezing index in combination with the appropriate surface index/air correction factor (n-factor).

(c) In the more developed parts of the cold regions, the building codes of most cities specify minimum footing depths, based on many years of local experience; these depths are invariably less than the maximum observed frost penetrations. The code

values should not be assumed to represent actual frost penetration depths. Such local code values have been selected to give generally suitable results for the *types of construction, soil moisture, density, and surface cover conditions, severity of freezing conditions, and building heating conditions* that are common in the area. Unfortunately, the code values may be inadequate or inapplicable under conditions that differ from those assumed in formulating the code, especially for unheated facilities, insulated foundations, or especially cold winters. Building codes in the Middle and North Atlantic States and Canada frequently specify minimum footing depths that range from 3 to 5 feet. If frost penetrations of this order of magnitude occur with fine silt and clay-type soils, 30 to 100 percent greater frost penetration may occur in well-drained gravels under the same conditions. With good soil data and a knowledge of local conditions, computed values for ordinary frost penetration, unaffected by building heat, may be expected to be adequately reliable, even though the freezing index may have to be estimated from weather data from nearby stations. In remote areas, measured frost depths may be entirely unavailable.

(2) *Design depth of ordinary thaw penetration.* Estimates of seasonal thaw penetration in permafrost areas should be established on the same statistical measurement bases as outlined in subparagraph a(2)(b) above for seasonal frost penetration. The air thawing index can be converted to a surface thawing index by multiplying it by the appropriate thawing-conditions n-factor from TM 5-852-4/AFM 88-19, Chapter 4. The thaw penetration can then be computed using the detailed guidance given in TM 5-852-6/AFM 88-19, Chapter 6. Approximate values of thaw penetration may also be estimated from a chart of the air thawing index versus the depth of thaw in TM 5-852-4/AFM 88-19, Chapter 4. Degradation of permafrost will result if the average annual depth of thaw penetration exceeds the average depth of frost penetration.

(3) *Thaw or freeze beneath structures.*

(a) Any change from natural conditions, which results in a warming of the ground beneath a structure, can result in progressive lowering of the permafrost table over a period of years. Heat flow from a structure into underlying ground containing permafrost can only be ignored as a factor in the long-term structural stability when the nature of the permafrost is such that no settlement or other adverse effects will result. The source of heat may be not only the building heat but also the solar radiation, underground utilities, surface water, and groundwater flow. TM 5-852-4 and TM 5-852-6/AFM 88-19, Chapters 4 and 6, respectively, provide guidance on procedures for estimating the depth of thaw under a heated building with time.

(b) The most widely employed,

effective and economical means of maintaining a stable thermal regime under a heated structure, without degradation of permafrost, is by use of a ventilated foundation. Under this scheme, provision is made for the circulation of cold water air between the insulated floor and the underlying ground. The same scheme can be used for the converse situation of a refrigerated facility supported on unfrozen ground. The simplest way of providing foundation ventilation is by providing an open space under the entire building, with the structure supported on footings or piling. For heavier floor loadings, ventilation ducts below the insulated floor may be used. Experience has shown that ventilated foundations should be so elevated, sloped, oriented, and configured as to minimize possibilities for accumulation of water, snow, ice, or soil in the ducts. Guidance in the thermal analysis of ventilated foundations, including the estimation of depths of summer thaw in supporting materials and design to assure winter refreezing, is given TM 5-852-4 and TM 5-852-6/AFM 88-19, Chapters 4 and 6, respectively.

(c) Natural or forced circulation thermal piles or refrigeration points may also be used for overall foundation cooling and control of permafrost degradation.

(4) *Foundation insulation.* Thermal insulation may be used in foundation construction in both seasonal frost and permafrost areas to control frost penetration, frost heave, and condensation, to conserve energy, to provide comfort, and to enhance the effectiveness of foundation ventilation. Unanticipated loss of effectiveness by moisture absorption must be avoided. Cellular glass should not be used where it will be subject to cyclic freezing and thawing in the presence of moisture. Insulation thicknesses and placement may be determined by the guidance given in TM 5-852-4 and TM 5-852-6/AFM 88-19, Chapters 4 and 6, respectively.

(5) *Granular mats.* In areas of significant seasonal frost and permafrost, a mat of non-frost-susceptible granular material may be used to moderate and control seasonal freeze-and-thaw effects in the foundation, to provide drainage under floor slabs, to provide stable foundation support, and to provide a dry, stable working platform for construction equipment and personnel. Seasonal freezing-and-thawing effects may be totally or partially contained within the mat. When seasonal effects are only partially contained, the magnitude of seasonal frost heave is reduced through both the surcharge effect of the mat and the reduction of frost penetration into underlying frost-susceptible soils. TM 5-852-4/AFM 88-19, Chapter 4, provides guidance in the design of mats.

(6) *Solar radiation thermal effects.* The control of summer heat input from solar radiation is very important in foundation design in permafrost areas. Correc-

tive measures that may be employed include shading, reflective paint or other surface material, and sometimes live vegetative covering. In seasonal frost areas, it may sometimes be advantageous to color critical surfaces black to gain maximum effect of solar heat in reducing winter frost problems. TM 5-852-4/AFM 88-19, Chapter 4, provides guidance on the control of solar radiation thermal effects.

*c. Control of movement and distortion.* The amount of movement and distortion that may be tolerated in the support structure must be established and the foundation must be designed to meet these criteria. Movement and distortion of the foundation may arise from seasonal upward, downward, and lateral displacements, from progressive settlement arising from degradation of permafrost or creep deflections under load, from horizontal seasonal shrinkage and expansion caused by temperature changes, and from creep, flow, or slide of material on slopes. Heave may also occur on a nonseasonal basis if there is progressive freezing in the foundation, as under a refrigerated building or storage tank. If the subsurface conditions, moisture availability, frost penetration, imposed loading, or other factors vary in the foundation area, the movements will be nonuniform. Effects on the foundation and structure may include various kinds of structural damage, jamming of doors and windows, shearing of utilities, and problems with installed equipment.

(1) *Frost-heave and thaw-settlement deformations.*

(a) Frost heave acts in the same direction as the heat flow, or perpendicular to the freezing plane. Thus, a slab on a horizontal surface will be lifted directly upward, but a vertical retaining wall may experience horizontal thrust. Foundation members, such as footings, walls, piles, and anchors, may also be gripped on their lateral surfaces and heaved by frost forces acting in tangential shear. Figure 18-5 shows an example of frost-heave forces developed in tangential shear on timber and steel pipe piles restrained against upward movement.

(b) In rivers, lakes, or coastal water bodies, foundation members to which floating ice may adhere may also be subject to important vertical forces as water levels fluctuate.

(c) Among methods that can be used to control detrimental frost action effects are placing non-frost-susceptible soils in the depth subject to freezing to avoid frost heave or thrust; providing sufficient embedment or other anchorage to resist movement under the lifting forces; providing sufficient loading on the foundation to counterbalance upward forces; isolating foundation members from heave forces; battering or tapering members within the annual frost zone to reduce effectiveness of heave grip; modifying soil frost susceptibility; in seasonal frost areas only, taking advantage of natural heat losses from the facility to

minimize adfreeze and frost heave; or cantilevering building attachments, e.g., porches and stairs, to its main foundation.

(d) In permafrost areas, movement and distortion caused by thaw of permafrost can be extreme and should be avoided by designing for full and positive thermal stability whenever the foundation would be adversely affected by thaw. If damaging thaw settlement should start, a mechanical refrigeration system may have to be installed in the foundation or a program of continual jacking may have to be adopted for leveling of the structure. Discontinuance or reduction of building heat can also be effective. Detailed guidance is given in TM 5-852-4/AFM 88-19, Chapter 4.

(2) *Creep deformation.* Only very small loads can be carried on the unconfined surface of ice-saturated frozen soil without progressive deformation. The allowable long-term loading increases greatly with depth but may be limited by unacceptable creep deformation well short of the allowable stress level determined from conventional short-term test. Present practice is to use large footings with low unit loadings; support footings on mats of well-drained non-frost-susceptible granular materials, which reduce stresses on underlying frozen materials to conservatively low values; or place foundations at sufficient depth in the ground so that creep is effectively minimized. Pile foundations are designed to not exceed sustainable adfreeze bond strengths. In all cases, analysis is based on permafrost temperature at the warmest time of the year. For cases which require estimation of foundation creep behavior, see TM 5-852-4/AFM 88-19, Chapter 4.

*d. Vibration problems and seismic effects.*

(1) Foundations supported on frozen ground may be affected by high stress-type dynamic loadings, such as shock loadings from high-yield explosions, by lower stress pulse-type loadings as from earthquakes or impacts, or by relatively low-stress, relatively low-frequency, steady-state vibrations. In general, the same procedures used for nonfrozen soil conditions are applicable to frozen soils. Design criteria are given in TM 5-809-10/AFM 88-3, Chapter 13; TM 5-856-4; TM 5-852-4/AFM 88-19, Chapter 4; and chapter 17 of this manual. These manuals also contain references to sources of data on the general behavior and properties of nonfrozen soils under dynamic load and discuss types of laboratory and field tests available. However, design criteria, test techniques, and methods of analysis are not yet firmly established for engineering problems of dynamic loading of foundations. Therefore, the Office, Chief of Engineers, ATTN: DAEN- ECE-T, WASH DC 20314, or HQUSAF/PREE, WASH DC 20332, should be notified upon initiation of design and should participate in establishing criteria and ap-

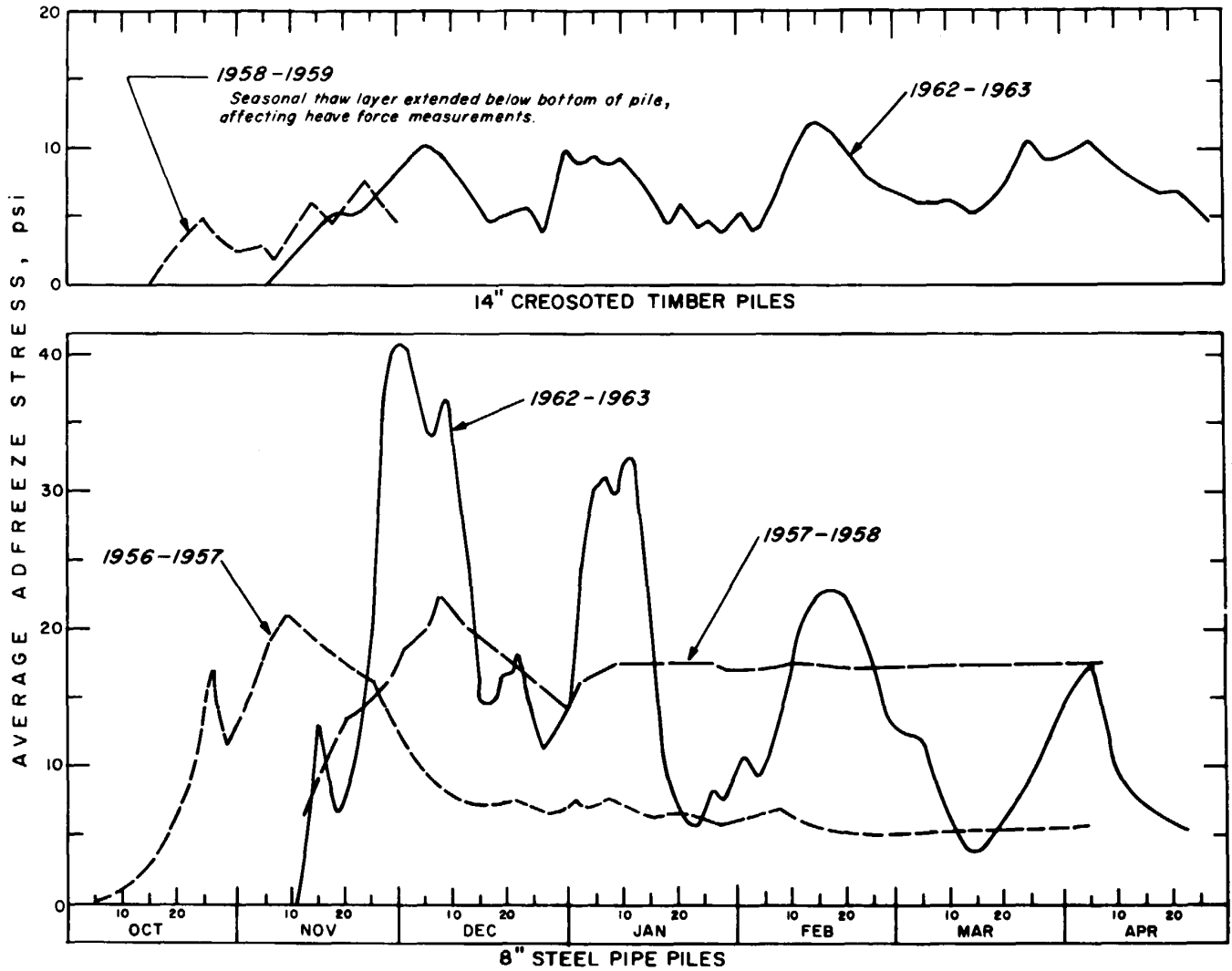

U.S. Army Corps of Engineers

**AVERAGE ADFREEZE STRESS vs TIME**

Figure 18-5. Heave force tests, average tangential adfreeze bond stress versus time, and timber and steel pipe piles placed with silt-water slurry in dry excavated holes. Piles were installed within annual frost zone only, over permafrost, to depths from ground surface of 3.6 to 6.5 feet.

proach and in planning field and laboratory tests.

(2) All design approaches require knowledge of the response characteristics of the foundation materials, frozen or nonfrozen, under the particular load involved. As dynamic loadings occur in a range of stresses, frequencies, and types (shock, pulse, steady-state vibrations, etc.), and the response of the soil varies depending upon the load characteristics, the required data must be obtained from tests that produce the same responses as the actual load. Different design criteria are used for the different types of dynamic loading, and different parameters are required. Such properties as moduli, damping ability, and velocity of propagation vary significantly with such factors as dynamic stress, strain,

frequency, temperature, and soil type and condition. TM 5-852-4/AFM 88-19, Chapter 4, discusses these properties for frozen ground.

*e. Design criteria for various specific engineering features.* In addition to the basic considerations outlined in the preceding paragraphs of this chapter, the design of foundations for frost and permafrost conditions requires application of detailed criteria for specific engineering situations. Guidance for the design of various specific features, construction consideration, and monitoring of performance of foundation is presented in TM 5-852-4/AFM 88-19, Chapter 4.



APPENDIX A

REFERENCES

**Government Publications**

**Departments of the Army, the Navy, and the Air Force**

TM 5-809-7	Pile Foundations	
TM 5-809-10/AFM 88-3,	Chap. 13	Seismic Design for Buildings
TM 5-818-2/AFM 88-6,	Chap. 4	Soils and Geology: Pavement Design for Frost Conditions
TM 5-818-4/AFM 88-5,	Chap. 5	Soils and Geology: Backfill for Subsurface Structures
TM 5-818-5/AFM 88-5,	Chap. 6	Dewatering and Groundwater Control for Deep Excavations
TM 5-818-6/AFM 88-32		Grouting Methods and Equipment
TM 5-818-7		Foundations on Expansive Soils
TM 5-824-3/AFM 88-6,	Chap. 3	Rigid Pavements for Airfields Other Than Army
TM 5-852-1/AFM 88-19,	Chap. 1	Arctic and Subarctic Construction: General Provisions
TM 5-852-2/AFM 88-19,	Chap. 2	Arctic and Subarctic Construction: Site Selection and Development
TM 5-852-3/AFM 88-19,	Chap. 3	Arctic and Subarctic Construction: Runway and Road Design
TM 5-852-4/AFM 88-19,	Chap. 4	Arctic and Subarctic Construction: Building Foundations
TM 5-852-5/AFM 88-19,	Chap. 5	Arctic and Subarctic Construction: Utilities
TM 5-852-6/AFM 88-19,	Chap. 6	Arctic and Subarctic Construction: Calculation Methods for Determination of Depths of Freeze and Thaw in Soils
TM 5-852-7/AFM 88-19,	Chap. 7	Arctic and Subarctic Construction: Surface Drainage Design for Airfields and Heliports in Arctic and Subarctic Regions
TM 5-852-8		Arctic and Subarctic Construction: Terrain Evaluation in Arctic and Subarctic Regions
TM 5-852-9/AFM 88-19,	Chap. 9	Arctic and Subarctic Construction: Buildings
TM 5-856-4		Design of Structures to Resist the Effects of Atomic Weapons: Structural Elements Subjected to Dynamic Loads
NAVFAC DM-7		Soil Mechanics, Foundations, and Earth Structures

The proponent agency of this publication is the Office of the Chief of Engineers, United States Army. Users are invited to send comments and suggested Improvements on DA Form 2028 (Recommended Changes to Publications and Blank Forms) direct to HQDA (DAEN-ECE-G), WASH DC 20314.

By Order of the Secretaries of the Army and the Air Force:

JOHN A. WICKHAM, JR.  
*General, United States Army*

Official: *Chief of Staff*  
ROBERT M. JOYCE  
*Major General, United States Army*  
*The Adjutant General*

CHARLES A. GABRIEL, *General, USAF*

Official: *Chief of Staff*  
JAMES H. DELANEY, *Colonel, USAF*  
*Director of Administration*

Distribution:

*Army:* To be distributed in accordance with DA Form 12-34B, requirements for TM 5-800 Series: Engineering and Design for Real Property Facilities.

*AirForce:* F

\*US GOVERNMENT PRINTING OFFICE 1996 - 406-421/50226

RECOMMENDED CHANGES TO EQUIPMENT TECHNICAL PUBLICATIONS



THEN... JOT DOWN THE DOPE ABOUT IT ON THIS FORM. CAREFULLY TEAR IT OUT, FOLD IT AND DROP IT IN THE MAIL!

**SOMETHING WRONG WITH THIS PUBLICATION?**

FROM: (PRINT YOUR UNIT'S COMPLETE ADDRESS)

DATE SENT

PUBLICATION NUMBER

PUBLICATION DATE

PUBLICATION TITLE

BE EXACT... PIN-POINT WHERE IT IS

PAGE NO.	PARA-GRAPH	FIGURE NO.	TABLE NO.
----------	------------	------------	-----------

IN THIS SPACE TELL WHAT IS WRONG AND WHAT SHOULD BE DONE ABOUT IT:

TEAR ALONG PERFORATED LINE

PRINTED NAME, GRADE OR TITLE, AND TELEPHONE NUMBER

SIGN HERE:

DA FORM 2028-2  
1 JUL 79

PREVIOUS EDITIONS ARE OBSOLETE.

P.S.—IF YOUR OUTFIT WANTS TO KNOW ABOUT YOUR RECOMMENDATION MAKE A CARBON COPY OF THIS AND GIVE IT TO YOUR HEADQUARTERS.

**PIN: 025929-000**