

TECHNICAL MANUAL

# SITE PLANNING AND DESIGN

## **REPRODUCTION AUTHORIZATION/RESTRICTIONS**

**This manual has been prepared by or for the Government and is public property and not subject to copyright.**

**Reprint or republications of this manual should include a credit substantially as follows:  
“Department of the Army, TM 5-803-6, Site Planning and Design, 14 October 1994.”**

TECHNICAL MANUAL

NO. 5-803-14



HEADQUARTERS  
DEPARTMENT OF THE ARMY  
WASHINGTON, DC, 14 October 1994

**SITE PLANNING AND DESIGN**

		Paragraph	Page
CHAPTER	1. INTRODUCTION		
	Purpose .....	1-1	1-1
	Scope .....	1-2	1-1
	References .....	1-3	1-1
	How to Use the Manual .....	1-4	1-1
	Design Team .....	1-5	1-1
CHAPTER	2. SITE PLANNING AND DESIGN PROCESS		
	General .....	2-1	2-1
	Goals and Objectives .....	2-2	2-1
	Relationship to the Installation Master Plan and the Installation Design Guide .....	2-3	2-1
	Site Planning and Design Process .....	2-4	2-1
CHAPTER	3. SITE PLANNING		
	General .....	3-1	3-1
	Program Analysis .....	3-2	3-1
	Site Analysis .....	3-3	3-4
	Site Verification .....	3-4	3-11
	Concept Development .....	3-5	3-14
CHAPTER	4. SITE DESIGN GUIDELINES		
	General .....	4-1	4-1
	Building Location .....	4-2	4-1
	Circulation .....	4-3	4-3
	Grading .....	4-4	4-11
	Drainage .....	4-5	4-13
	Erosion Control .....	4-6	4-15
	Climatological Conditions .....	4-7	4-15
	Utilities .....	4-8	4-17
	Lighting .....	4-9	4-18
	Physical Security .....	4-10	4-18
CHAPTER	5. SITE DESIGN		
	General .....	5-11	5-1
	Concept Development .....	5-12	5-1
	Sketch Site Plan .....	5-13	5-1
	Concept Site Plan .....	5-14	5-2
	Confined Sites .....	5-15	5-4
CHAPTER	6. DESIGN FOR ON-SITE VEHICULAR CIRCULATION AND PARKING		
	General .....	6-1	6-1
	Design Vehicles .....	6-2	6-1
	Access and Service Drives .....	6-3	6-1
	POV Parking Areas .....	6-4	6-4
	Parking Areas for Petroleum, Oil and Lubricates (POL) Vehicles .....	6-5	6-8
	Special Circulation Areas .....	6-6	6-8
	Mitigating Vehicular Impact .....	6-7	6-12
APPENDIX	A. REFERENCES		A-1
APPENDIX	B. TYPICAL SITE TRAFFIC IMPACT STUDY REPORT OUTLINE		B-1

**List of Figures**

Figure	2-1. Site Planning and Design Process.	2-2
	3-1. Functional Relationships Diagram for a Brigade.	3-3
	3-2. Functional Relationships Diagram for a Battalion Complex.	3-4
	3-3. Analysis of Off-Site Conditions.	3-6
	3-4. Slope Categories.	3-8
	3-5. Topography and Hydrology Analysis.	3-9

APPROVED FOR PUBLIC RELEASE; DISTRIBUTION IS UNLIMITED

**List of Figures (cont'd)**

Figure	3-6.	Climatic Zones in the Continental United States.	3-10
	3-7.	Visual Conditions Analysis.	3-12
	3-8.	Site Opportunities and Constraints Plan.	3-13
	3-9.	Site Plan for DA Standard Battalion Complex.	3-16
	3-10.	Spatial Relationships Diagram for a Battalion Complex. Alternative 1.	3-17
	3-11.	Spatial Relationships Diagram for a Battalion Complex. Alternative 2.	3-18
	3-12.	Spatial Relationships Diagram for a Battalion Complex. Preferred Alternative	3-19
	4-1.	Locating Building Setbacks.	4-2
	4-2.	Buildable Zone.	4-3
	4-3.	Orientation of Building Axes.	4-4
	4-4.	How Slope Orientation Affects Buildings.	4-5
	4-5.	How Prevailing Winds Affect Building Orientation.	4-5
	4-6.	Typical Circulation Flow Diagram.	4-6
	4-7.	Typical Drop-Off Areas.	4-7
	4-8.	Parking Aisle Alignment.	4-8
	4-9.	Locating a Dumpster Pad.	4-9
	4-10.	Typical Pedestrian Desire Line of Walking-Study.	4-10
	4-11.	Alternative Sidewalk Schemes.	4-10
	4-12.	Building Orientation to Topography.	4-12
	4-13.	Topographically Responsive Building Types.	4-13
	4-14.	Balancing Cut and Fill.	4-14
	4-15.	Transitioning Regraded Areas.	4-14
	4-16.	Principles of Positive Drainage.	4-15
	4-17.	Detention and Retention Ponds.	4-16
	4-18.	Methods of Erosion Control.	4-17
	5-1.	Sketch Site Plan for a Battalion Complex.	5-3
	5-2.	Concept Site Plan for a Battalion Complex.	5-5
	5-3.	Site Opportunities and Constraints Plan for a Confined Site.	5-7
	5-4.	Spatial Relationships Diagram for an Information Systems Facility. Alternative 1.	5-8
	5-5.	Spatial Relationships Diagram for an Information Systems Facility. Alternative 2.	5-9
	5-6.	Sketch Site Plan for an Information Systems Facility.	5-10
	5-7.	Concept Site Plan for an Information Systems Facility.	5-11
	6-1.	Turning Template for a POV Vehicle.	6-2
	6-2.	Sight Distances for Access Drives.	6-3
	6-3.	Minimum Throat Widths and Lengths.	6-4
	6-4.	Standard 90-Degree Parking Layout.	6-5
	6-5.	Typical Parking Islands and Medians.	6-6
	6-6.	Landscaped Area in Proportion to Paved Area.	6-7
	6-7.	Typical Grading and Drainage for a Small Parking Lot.	6-8
	6-8.	Typical Interior Grading and Drainage for a Parking Lot.	6-9
	6-9.	Typical POL Parking Area.	6-10
	6-10.	Typical Low-Volume Gate Areas.	6-11
	6-11.	Typical Drop-off Area.	6-12
	6-12.	Typical Truck Loading Area.	6-13
	6-13.	Typical Dumpster Pad Layout.	6-14
	6-14.	Typical Layout for a Drive-in Facility.	6-15
	6-15.	Motorcycle Parking.	6-16
	6-16.	Screening Parking Areas.	6-17

**List of Tables**

Table	4-1.	Standard Desirable Slopes.	4-11
	4-2.	Relative Surface Temperatures in Summer at Noon.	4-17
	6-1.	Dimensions (in Feet) for Design Vehicles (for Non-organizational Vehicle Parking.)	6-1
	6-2.	Minimum Turning Radii (in Feet) for Design Vehicles.	6-1
	6-3.	Minimum Driveway Spacing for Streets Serving More than 5,000 Vehicles per Day.	6-2
	6-4.	Minimum Sight Distances along Access Road from Access Drive to Allow Vehicle to Safely Turn Left or Right onto Road (in Feet.)	6-3

# CHAPTER 1

## INTRODUCTION

---

### 1-1. Purpose.

This manual describes the site planning and design process used to develop a project which fulfills facility requirements and creates the optimal relationship with the natural site. The manual also provides specific guidance for design of on-site vehicular circulation and parking on military installations. The manual is intended for use by those individuals given the responsibility for developing contract site plans.

### 1-2. Scope.

Site planning is the art of evaluating a site, determining an appropriate program of activity and organizing that activity on the site. Site design is the art of arranging facilities on the site in support of the desired activity. Site design shapes the site to accommodate facilities with the least negative impact to the natural environment and the greatest benefit for the users. The manual provides guidance for developing a site plan from preliminary planning through the conceptual or 35 percent design phase. The manual provides general site design guidelines. It provides criteria for design of on-site vehicular circulation and parking.

### 1-3. References.

Appendix A contains a list of references used in the manual.

### 1-4. How to Use the Manual.

*The manual focuses on the site planning and design process as it leads from program and site analyses to the preparation of a concept site plan. The manual is organized to follow the process as it would ideally occur during a project's development.*

a. Chapter 2 provides a brief overview of the site planning and design process to familiarize the user with the steps necessary to produce a complete and integrated site plan. Because the planning and design process is often segmented and interrupted within the military system, the man-

ual describes an idealized process to which all participants may refer in order to make their appropriate contributions. Chapter 2 relates the planning and design of individual sites to the larger planning and design efforts of the installation as a whole.

b. Chapter 3 addresses the planning stage of the process. It describes the preparation of program and site analyses and their initial synthesis into a concept.

b. Chapter 3 addresses the planning stage of the process. It describes the preparation of program and site analyses and their initial synthesis into a concept.

c. Chapter 4 provides general site design guidelines to be used as background for the preparation and evaluation of individual site designs.

d. Chapter 5 addresses the design stage of the process. It describes the refinement of the initial concept into sketch and concept site plans, resulting in the completion of the 35 percent design phase.

e. Chapter 6 provides specific criteria for the design of on-site vehicular circulation and parking.

### 1-5. Design Team.

An interdisciplinary team should accomplish site planning and design. This helps assure that all aspects of the man-made and natural site are properly and thoroughly considered. An interdisciplinary team is better equipped to recognize opportunities as well as constraints. It can develop designs which do not create additional problems. The interdisciplinary team should be identified at the beginning of a project so that its expertise can be applied from the outset. The makeup of the team will be determined by the functional requirements of the project. The leader of the team will be determined by the type of project. The team leader should represent the primary discipline for the project. The landscape architect may take the lead role due to the expertise and experience required for site planning and design.

## CHAPTER 2

### SITE PLANNING AND DESIGN PROCESS

---

#### 2-1. General.

The site planning and design process applies a man-made, or constructed, system upon a natural, or ecological, system. Site planning procedures, or courses of action, recognize the opportunities and constraints presented by both. Each site is unique, and the functions on each site present different problems and opportunities. Site design procedures develop specific methods to create the optimal relationship between facilities and site. The relationship among facilities, the site and its surroundings helps determine the installation's environmental and design quality.

#### 2-2. Goals and Objectives.

The goals of site planning and design are to contribute to the overall functional efficiency, conservation of resources, economic stability and quality of life of the installation. Objectives in support of these goals for individual projects are to:

- a. Ensure the project accomplishes its basic function with maximum efficiency and economy.
- b. Ensure a safe environment.
- c. Provide proper relationships with surrounding facilities.
- d. Allow for expansion.
- e. Contribute to overall project cost effectiveness.
- f. Create designs which contribute to the quality of life of soldiers and civilian personnel.
- g. Provide energy-efficient design solutions.
- h. Provide environmentally sensitive and visually pleasing design.
- i. Take full advantage of natural site amenities.

#### 2-3. Relationship to the Installation Master Plan and the Installation Design Guide.

In the military system, planning and designing individual sites are part of a larger process affecting development of the installation as a whole. Site planning and design impact and are impacted by all phases of land development including the following:

a. *Installation Master Plan.* The installation master plan provides comprehensive documentation of the existing conditions of natural, man-made and human resources. It also guides future land-use development. The information found in the master plan forms the foundation for site planning. The master plan is a mechanism for ensuring that individual projects are sited to meet

overall installation requirements. Army Regulation (AR) 210-20 and Technical Manual (TM) 5-803-1 provide additional information concerning the master plan.

b. *Department of Defense (DD) Form 1391 (FY-Military Construction Project Data) and the TM 5-800-3, Project Development Brochure (PDB).* Site selection is accomplished in the master plan procedures. DD Form 1391 and the PDB provide documentation of site selection. Preparation of these documents is the initial step in site planning. The decisions made in the documents are not easily changed. It is important to acquire as much information as possible on which to base these decisions. It is also important to consider as broadly as possible the potential needs of the user relative to the site. AR 415-15 provides additional information concerning Military Construction, Army program development.

c. *Installation Design Guide.* The installation design guide provides guidelines for creating a visually consistent, harmonious and attractive installation. TM 5-803-5 provides further information on the design guide. The design guide recommends development of a pleasant and efficient physical environment for the site by:

- (1) Defining natural site assets.
- (2) Harmonizing the natural and built environments.
- (3) Providing an efficient organization of function to land use and to vehicular circulation.
- (4) Defining a consistent architectural character.
- (5) Providing a visual theme for the site components.

d. *Installation Contacts.* Because development of individual sites affect and are affected by other areas of the installation, it is important to consult with various personnel who may contribute information and expertise. Valuable contacts may include users of surrounding facilities, traffic and transportation personnel, and security personnel.

#### 2-4. Site Planning and Design Process.

Site planning and design comprise a two-staged process. Site planning proposes a program of activity, evaluates a site, and organizes the program on the site. Site design details the program on the site, eventually resulting in final construction documents. Chapter 3 describes the procedures for site planning; chapter 5 describes the procedures

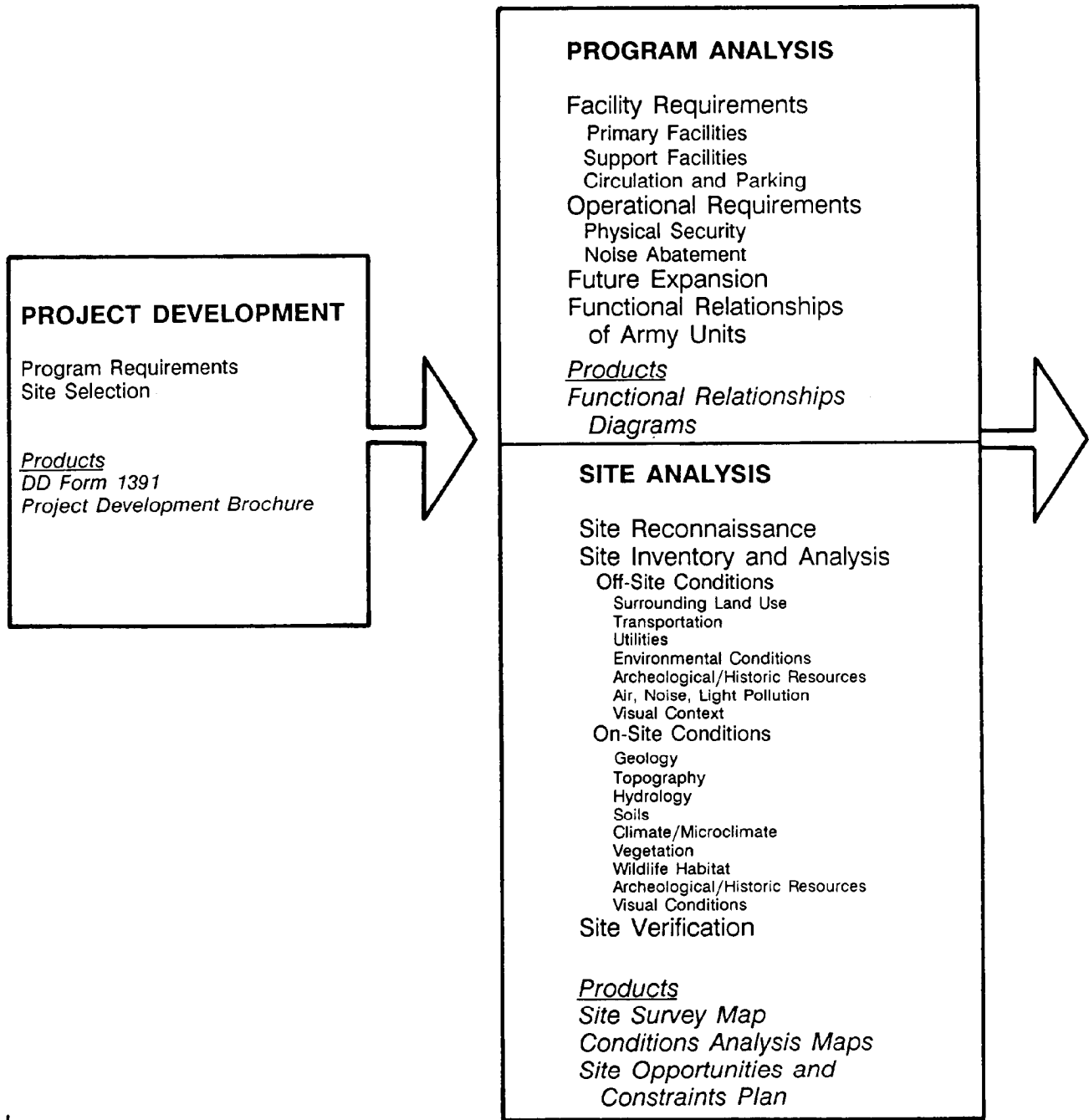

## SITE PLANNING

Figure 2-1a Site Planning and Design Process.

for site design. Planning and design are conceived as a continuous and increasingly refined process. Site planning forms the basis for site design. Therefore, site planning should produce sufficiently thorough documentation to support site design efforts. Changes in program, site, economic conditions and personnel can all interrupt the flow and delay the timing of the process. It is important to understand the process as a whole in order to

accommodate successfully the individual dynamics of a project as it progresses.

a. *The Process in the Military System.* The site planning and design process ideally provides for sequential and increasingly refined decision-making. However, as a military project progresses from the master plan to construction approval, decision-making is segmented among different locations and personnel. There may be significant

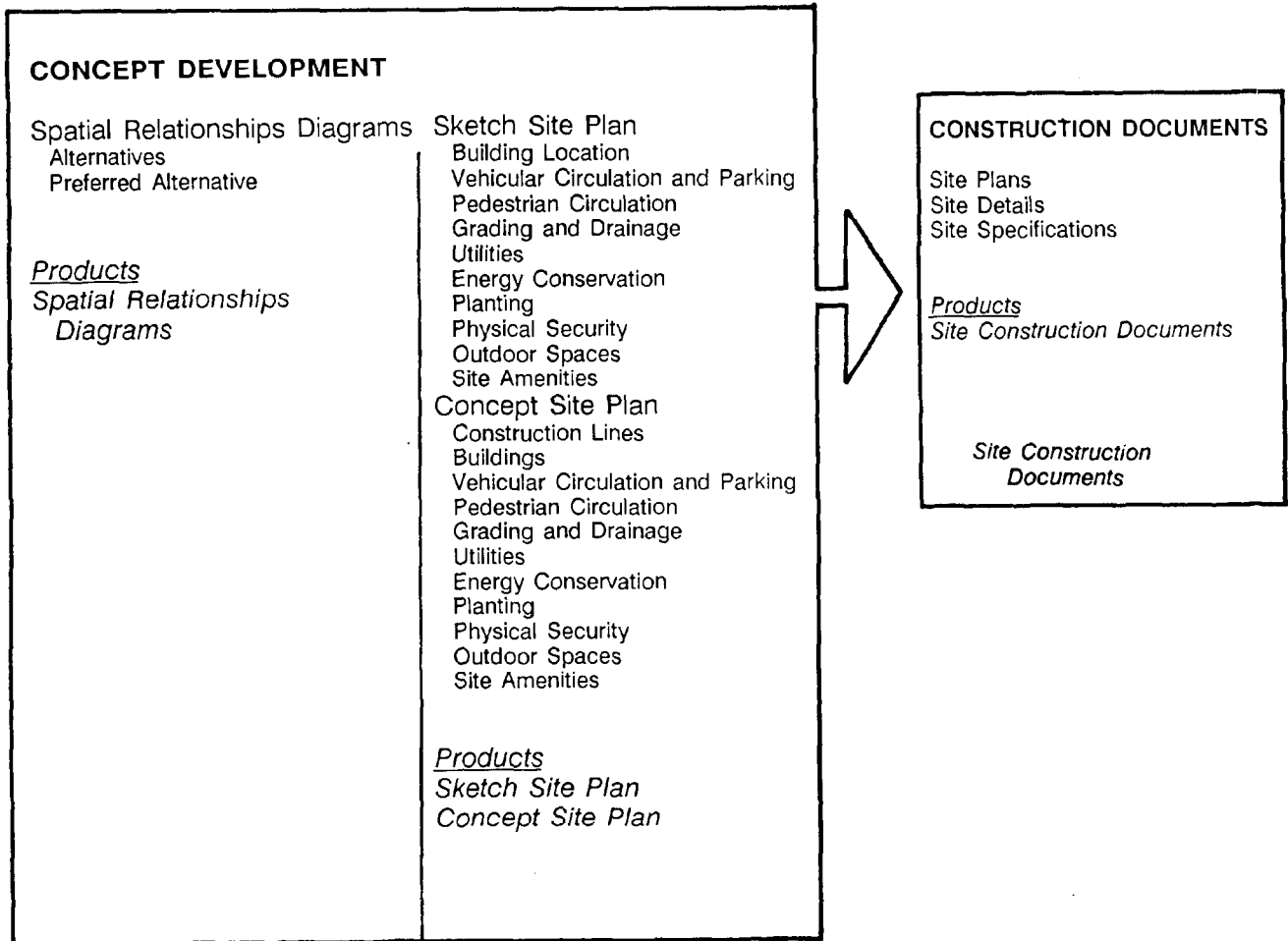

SITE DESIGN

Figure 2-1b Site Planning and Design Process.

time lag between the planning and design stages. DD Forms 1391 and PDB's are often deficient in their treatment of site concerns. They become the source of budget and design problems. At the crucial point where program and site analyses are synthesized into a concept, there may be confusion as to who should do this. Planners may view concept development as an unnecessary design exercise when accurate site data (especially, the topographic survey) is not complete or available. Subsequently, designers may view basic conceptualization as a planning function which already should have occurred. Some concept development should take place on both sides of the funding process. Involving a variety of disciplines as early as possible facilitates both planning and design. It

improves in-house communication. The multi-disciplinary approach helps avoid problems which arise from an incomplete understanding of the program and the site.

*b. Process Chart.* The problems described above may be expected when the two-staged process transitions from planning to design. Figure 2-1 diagrams a flow of planning and design tasks necessary to take a site plan from preliminary planning through 35 percent design. It also lists the subjects addressed by the tasks. The tasks are program analysis; site analysis; and concept development. Concept development includes spatial diagrams, sketch site plans, and concept site plans. The diagram indicates at the bottom of each task the resulting products. While the flow



may appear idealized in the military context, the diagram represents the tasks which must be accomplished to achieve a well-planned and designed project. Understanding the tasks helps prevent omission of critical information and ne-

glect of critical questions during site planning. It helps evaluate the quality and thoroughness of previously accomplished work. It helps align with past work and direct future efforts during site design.

## CHAPTER 3

### SITE PLANNING

---

#### 3-1. General.

##### Site planning:

- a. Determines appropriate and required activities and their functional relationships through program analysis.
- b. Evaluates the site through site analysis.
- c. Establishes the organization of activities and facilities on site through the concept development of spatial relationships diagrams.

#### 3-2. Program Analysis.

Program analysis translates user needs into physical criteria requirements for facilities. The program is the basis of the functional relationships diagram. The functional relationships diagram delineates the optimal relationship among activities and facilities. Both the user mission and project requirements will be verified by interviewing the user to determine the current status, AR 415-15 provides guidance on program analysis.

a. *User Mission.* The goals and objectives of the user mission will be reviewed. How the proposed project is intended to accomplish or support these aims will be defined. The user's specific needs will be determined for the following:

- (1) Functional requirements.
- (2) Creation of organizational efficiency and safety.
- (3) Relationship to adjacent functions.
- (4) Contribution to the quality of life of the occupants.

b. *Project Requirements.* Accurate project requirements are fundamental to organizing and locating project elements on site. Failure to anticipate true programmatic and spatial needs can create many problems. This is especially true on small or confined sites. The program and space requirements will be fully articulated beyond the primary facility or building.

(1) *Primary Facilities.* The principal functions occurring at the facility and the necessary space requirements will be determined. If applicable, the Department of the Army (DA) facility standardization program definite designs will be used. Other items to be determined include the following:

- (a) Probable points of ingress and egress and need for control.
- (b) Special architectural configurations.
- (c) Physical and visual connections to other facilities.
- (d) Desired visual presentation.

(e) Use and desired proximity of shared facilities (e.g., dining halls or headquarters buildings.)

(2) *Support Facilities.* Program and space requirements will be determined for:

(a) *Buildings.* The guidelines for primary facilities will be followed.

(b) *Utilities.* The necessary types of systems (water, sewer, electric, gas, communications, etc.) will be determined. The location and capacity of available trunk lines will be identified. Probable sizes and loads will be estimated. Potential environmental controls (e.g., Environmental Protection Agency sewage outflow standards) will be discussed. Civil, mechanical, electrical and other appropriate engineering disciplines should be consulted.

(c) *Outdoor Space.* The need for outdoor space will be established. This includes active use areas (e.g., formation grounds or outdoor classrooms), active recreation (e.g., playing fields or tennis courts), and passive recreation.

(3) *Circulation.* Both the user and the Director of Engineering and Housing (DEH) should be interviewed to obtain information and data. The user will determine the number and kinds of vehicles. Transportation and traffic engineers should also be consulted as appropriate. Military Traffic Management Command (MTMC) provides detailed information on transportation and traffic concerns. Programming for circulation will cover requirements for access and on-site circulation, estimates of the type and quantity of parking demand, evaluation of alternative modes of travel, and the need for a site traffic impact study.

(a) *Design Requirements.* The design vehicles (passenger car, delivery van, truck, tracked vehicle, etc.) expected on site will be identified and listed. Design requirements for site access and on-site vehicular circulation are usually determined by the largest design vehicle on the list. Probable service requirements such as delivery (including loading docks), maintenance, sanitation, and emergency will be identified. Probable requirements for site lighting levels will be determined. Chapter 6 provides more specific design criteria for vehicular circulation and parking.

(b) *Parking Demand.* The user will determine parking demand, or number of required parking spaces, for non-organizational or private occupancy (POW vehicles and for all other vehicles

(motorcycles, trucks, recreational vehicles, etc.). The user will determine the types of parking spaces (e.g., visitor or employee) and the number of spaces per type. The need for separation of parking areas and any locational requirements (e.g., near the facility's front entrance) will be identified. Peak (or highest) use hours for parking will be identified to determine the potential for shared parking with other facilities. Parking structures may be considered in areas of dense development, limited available land, and high parking demand (more than 500 spaces) by one or more facilities. Because structures are expensive to build and maintain, all of the above criteria should be met to make a structure economically feasible.

(c) *Alternative Travel Modes.* Because parking consumes enormous space and typically dominates the landscape setting of facilities, alternative modes of travel to the site and carpooling should be encouraged. The impact of installation transport systems (e.g., bus routes and pedestrian and bicycle paths) will be determined.

(d) *Site Traffic Impact Studies.* The need for a site traffic impact study is determined by the condition of the site's accessibility and the traffic volume projected to be added to adjacent roads. Appendix B provides an outline for a typical study report.

(4) *Physical Security.* The functional requirements of the user will determine the requirements for physical security. The Provost Marshal or Physical Security Officer will be interviewed concerning security needs. Additional help may be obtained from security engineers and/or physical security specialists. Requirements for physical security deal with protective measures to mitigate the threat from a variety of tactics. The threat is determined through a threat analysis which should be done during project planning. Physical security includes the following site considerations and needs:

(a) Facility setback from roadways, parking areas, the site perimeter, other facilities and other use areas.

(b) Proximity between primary and support facilities.

(c) Physical barriers to prevent or delay unauthorized pedestrian and vehicular access and to resist weapons and/or explosives effects.

(d) Entry control points.

(e) Visual seclusion or openness.

(5) *Noise Abatement.* The need to maintain an acceptable noise level within the primary facility or to prevent the noise level of the primary facility from impacting the surrounding area will be deter-

mined. TM 5-803-2 provides guidance in planning for noise abatement.

(6) *Future Expansion.* Planning for future expansion which is neither programmed nor prioritized in the master plan can be a problem. Often, it takes place in a casual manner, depending upon whether the user raises the possibility. The facility's potential for future expansion should be addressed. Future expansion may refer to actual physical expansion or increased usage of the primary facility. This is often difficult to predict and more difficult to estimate. A recommendation for expansion may be based on generally accepted growth trends for various user requirements. If it is anticipated, or simply desired, that the project expand at a later date, some estimate of growth should be made. Future expansion of circulation, including parking, should be considered.

c. *Functional Relationships of Army Units.* Functional relationships describe the need various activities and facilities have for mutual support. In planning, support can be operational and/or physical. Functional relationships diagrams graphically represent the necessary support. Program analysis serves as the basis for functional relationships diagrams. It relates the individual project to the larger context of the installation. It also organizes the activities and facilities within the project.

(1) *Functional Relationships for a Brigade.* Army planning is based on a series of relationships among a hierarchy of units: garrison, division, brigade and battalion. Functional relationships within one Army unit ideally should not interrupt those of another unit. However, organization of the relationships should allow for interaction and support among units as needed. A functional relationships diagram helps determine the need for such interaction and support. The diagram later helps place facilities where they can support the larger mission and helps locate shared facilities. Figure 3-1 illustrates a functional relationships diagram for a brigade.

(2) *Preparing a Functional Relationships Diagram.* Developing functional relationships is a method of organizing activities or facilities into ideal arrangements, based upon their interdependence. In site planning, this is expressed as the need for physical and/or visual connections. In turn, the connections become the basis for circulation patterns. A functional relationships diagram is a bubble diagram. It places proposed activities and/or facilities, including circulation, in the ideal arrangement for efficiency, safety and convenience. The diagram delineates the best locations for facilities in relation to each other, irrespective of site considerations. It does not consider any site

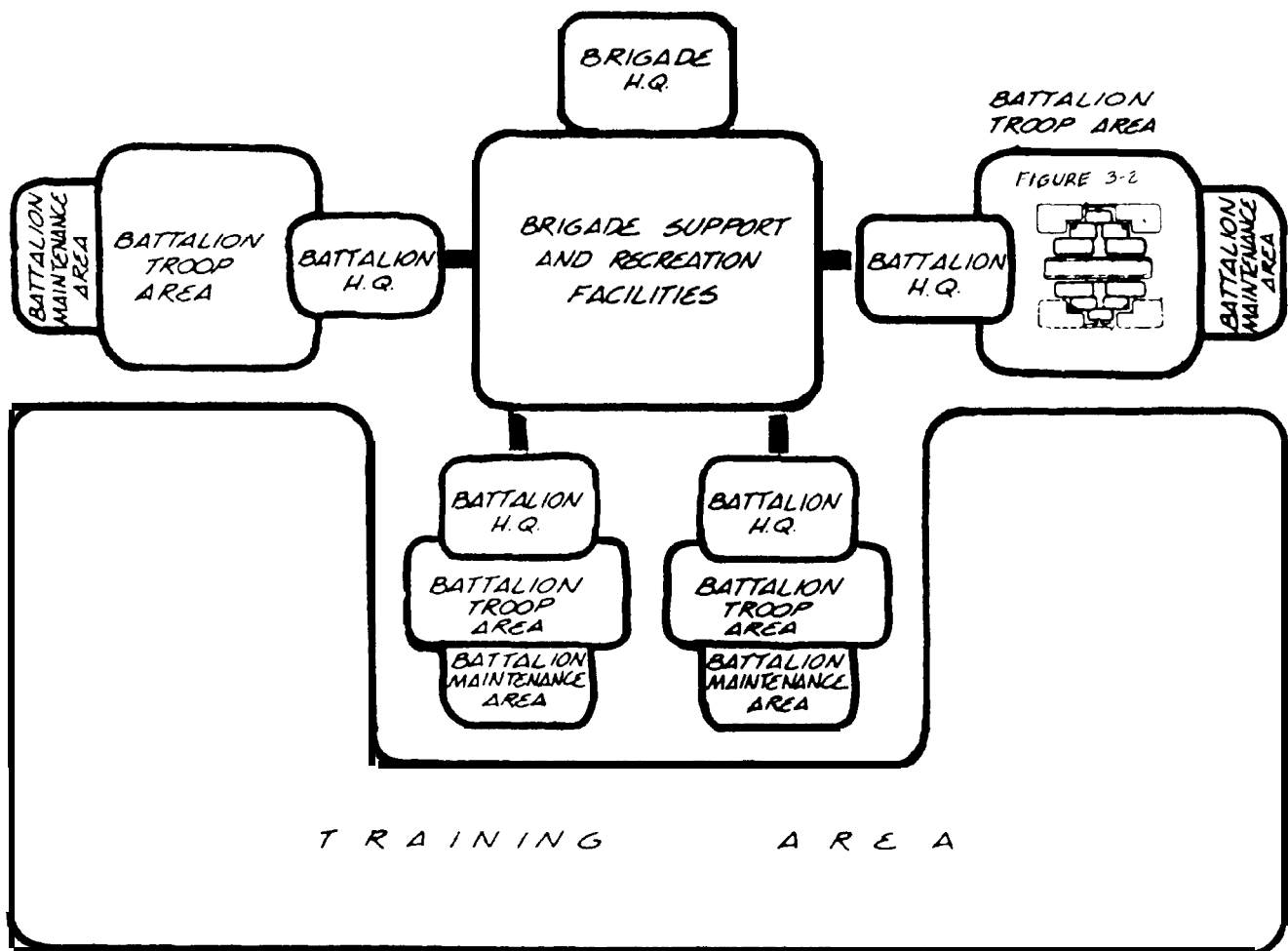

Figure 3-1. Functional Relationships Diagram for a Brigade.

but forms the basis for site design. As the number and complexity of activities and facilities increase, a variety of alternatives should be explored and compared to find the optimal arrangement. Diagrams should be drawn at an appropriate scale to accurately represent the proposed spatial requirements of the facilities and circulation. A diagram may be developed through the following steps:

(a) Delineation of the approximate square footage of the primary facility in a bubble or block.

(b) Delineation of the approximate square footage of support facilities into bubbles or blocks and their placement in relation to the primary facility.

(d) Delineation of major vehicular access and circulation with weighted lines. Arrows should be used to indicate access points and direction of traffic flow.

(d) Delineation of major pedestrian access and circulation with weighted lines and arrows.

(e) Delineation of future facilities and circulation with dashed lines.

### (3) Functional Relationships for a Battalion.

The importance of functional relationships within an Army unit is determined by operational requirements. Tabulation of Equipment units are planned for in land area by battalion size. Figure 3-2 illustrates a functional relationships diagram for a battalion complex. It shows an optimal arrangement of the areas listed below. The diagram shows both vehicular and pedestrian circulation and delineates future expansion. The functional areas of a battalion are:

(a) Battalion headquarters and classroom.

(b) Headquarters parking area.

(c) Battalion recreational facilities.

(d) Battalion maintenance area.

(e) Company administration and supply.

(f) Company service area.

(g) Company troop barracks.

(h) POV parking area.

(i) Formation area.

(j) Facilities shared with other battalions or companies.

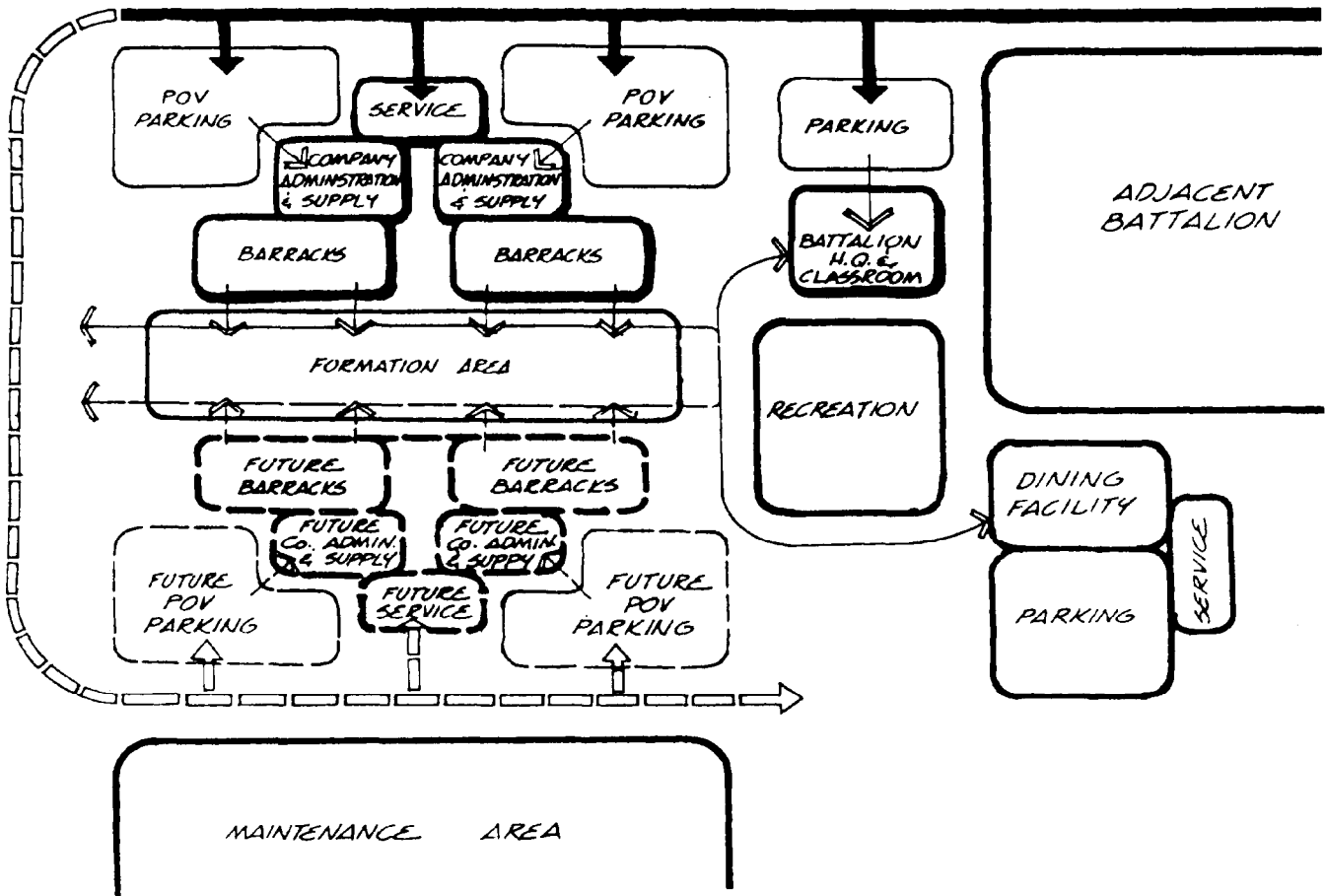

Figure 3-2. Functional Relationships Diagram for a Battalion Complex.

3-3. Site Analysis.

Site analysis inventories on- and off-site conditions and evaluates how these conditions may impact the project. The principal elements of the evaluation are translated into a written and graphic summary of opportunities and constraints. Complete documentation of the inventories and evaluation are important since they may be accomplished by personnel other than those who later do site design. A thorough site analysis is fundamental to responsive and responsible site design. It is important to understand the potential impact various site elements can have on a project. It is important to know how these elements interrelate and are impacted by changes to each other. The involvement of different disciplines, as appropriate to the site, is essential to understanding these relations and to preparing a sound analysis.

a. *Site Reconnaissance.* Site reconnaissance deals with the acquisition of site information.

(1) *Sources of Information.* Sources include installation personnel and documents, especially the installation master plan. Past project plans and reports also provide information. Site-specific

topographic and geotechnical surveys should be acquired prior to site reconnaissance.

(2) *Site Survey Map.* The topographic survey is the foundation of the site survey map. It should be acquired as soon as practical for any project. The site survey should locate all existing above and below-ground facilities and structures. It should show information about area boundaries and size, topography, water bodies, drainage patterns, utilities, roadways, vegetation and other site features. If additional information is needed, other mapping resources include aerial photographs; installation documents; and US Geological Survey (USGS), Soil Conservation Service and Federal Emergency Management Agency (FEMA) maps. FEMA maps provide information on flood plain water surface profiles and flood plain outlines.

(3) *Site Visit.* A site visit is essential to developing an accurate site analysis. No other task provides as much useful information. A site visit provides the opportunity to:

(a) Verify existing information, especially if a current topographic survey is not available.

(b) Evaluate the impact of existing on- and off-site conditions.

(c) Discover previously unknown conditions and factors.

*b. Site Inventory and Evaluation.* A site inventory documents all existing conditions, both on- and off-site. It evaluates the impact they will have on site development. The evaluation may be simply a positive or negative assessment or may be rated on a scale. The data collection procedures for master planning, as described in TM 5-803-1, provide a useful start for preparing site inventories. The site survey map serves as the base map for the inventory. The information may be compiled on one or a series of maps, depending upon the size and complexity of the site. Usually, off-site conditions are recorded on a single map at a scale which addresses sufficient area surrounding the site. On-site conditions usually require more than one map. These maps often reflect a combination of conditions which can be expected to affect each other (e.g., soils and geology, drainage and topography, or climate and vegetation). The overlay/composite method registers a series of maps to a base map, allowing one map to overlay another. This method helps visualize how various conditions impact or reinforce each other.

*c. Off-site Conditions.* Site analysis should extend beyond the project boundaries. Most off-site conditions are related to man-made features and activities. A site may be influenced by numerous factors (traffic, noise, light, visual conditions, drainage, etc.) which occur in the surrounding area. Both existing and future conditions should be considered. Figure 3-3 illustrates an analysis of off-site conditions for a candidate site for a battalion complex.

(1) *Surrounding Land Use.* Surrounding land use should be recorded on the analysis of off-site conditions map. It will be verified that the candidate site for the proposed project is located in an appropriate land use area according to the master plan. TM 5-803-8 provides further guidance on surrounding land use.

(2) *Transportation.* All existing and proposed transportation systems to and around the site will be evaluated for their accessibility. The primary and secondary roadways will be examined to determine potential access points, traffic loads and safety conditions including potential hazards. Underutilized parking areas available for shared use will be identified. Bus routes and loading zones convenient to the site will be identified. Pedestrian and bicycle paths which may be connected to project development will be identified.

(a) *Site Traffic Impact Analysis.* Site traffic impact analysis examines existing and future off-site traffic on adjacent roadways. It analyzes pro-

posed on-site traffic. The principal purpose of the analysis is to determine the proper location and design of site access. Appropriate access location and design avoids: inadequate access capacity, congestion on site or on adjacent roadways, high accident rates, and limited potential for adjusting design or operation according to changing conditions. Site access should not interfere with traffic movement on adjacent roadways. Inappropriate access location and design can create as many or more problems as the increase in traffic volume. Projects may require off-site improvements to accommodate new traffic movement and additional volume.

(b) *Site Traffic Impact Study.* A site traffic impact study should be prepared for projects located near highly congested areas, high accident locations, and sensitive neighborhoods. The need for a study may also be established using the following threshold: the project is anticipated to generate 100 or more new peak direction trips to or from the site in the hour of peak traffic on the adjacent roadway(s). A transportation plan should be prepared for facilities which can be anticipated to expand and generate more than 500 peak hour trips. (Peak refers to the greatest number of vehicles moving in a specific direction and/or at a certain time.) The plan should be prepared for the horizon year (or final year of development) if the full buildout will be significantly larger. Data regarding the direction and time of peak traffic flow may be available on the installation. Trip generation rates most often used in traffic studies can be found in the report *Parking Generation* prepared by the Institute of Transportation Engineers. Guidance for determining trip generation can be found in *Transportation and Land Development*. Because a number of variations can occur when developing trip generation data for a specific site, transportation and traffic engineers should be consulted. If a site traffic impact study is needed, *Transportation and Land Development* provides further guidance. A minimum site traffic impact study should include information about: trip generation and design-hour volumes, trip distribution and traffic assignment, existing and projected traffic volumes, capacity analysis, traffic accident analysis, and the traffic improvement plan. Appendix B provides an outline for a typical study report.

(3) *Utilities.* All utility systems which may be tapped for use will be located and their capacities indicated. If an existing system is running at or nearing its capacity, additional growth in the area may require improvements to the utility trunk line beyond the immediate site. Underground pipe-

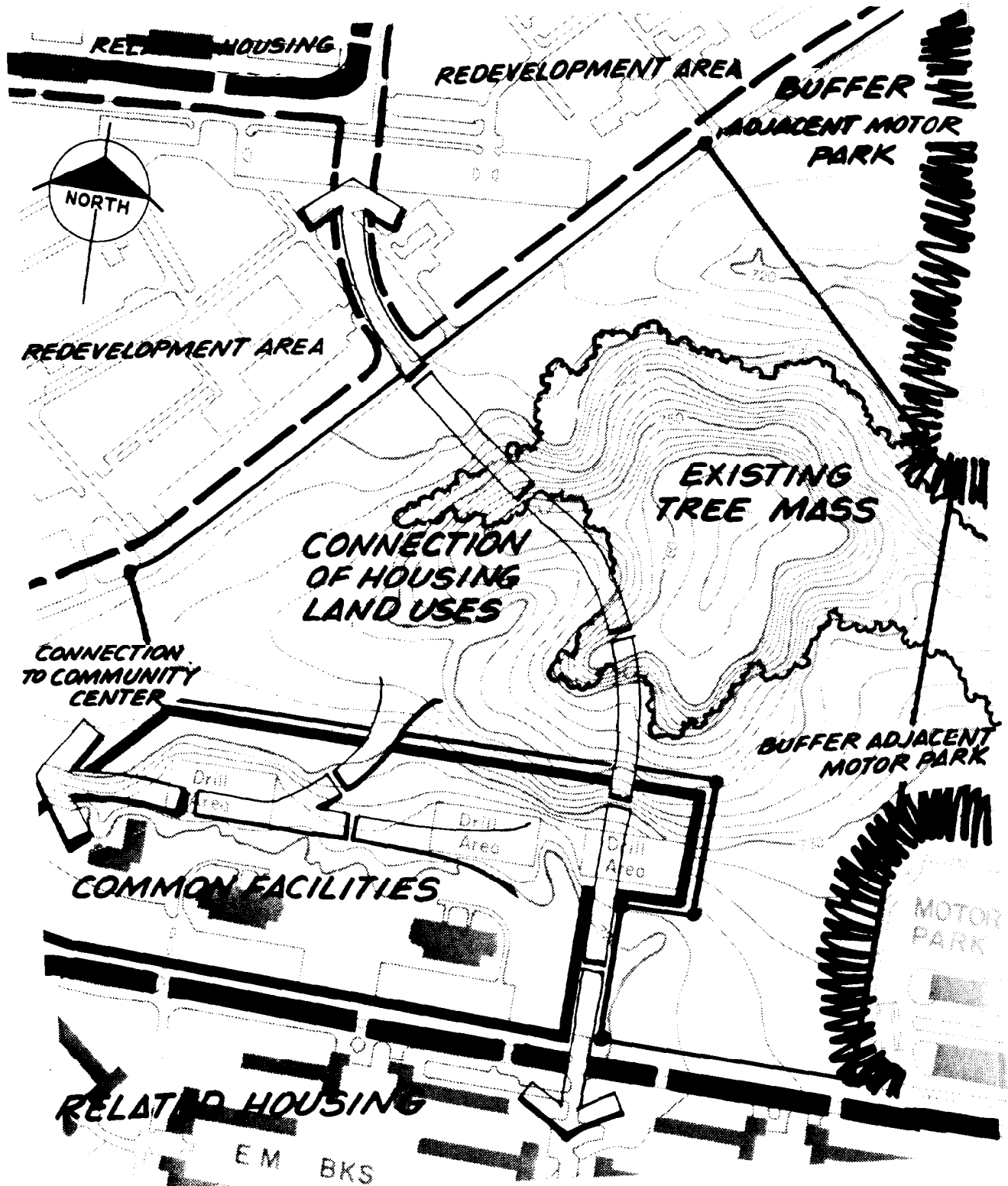

Figure 3-3. Analysis of Off-Site Conditions.

line systems (e.g., fuel oil) will be located. Information useful in evaluating utility systems is their availability and reliability and the distances from existing trunk lines to the site. Utility analyses available from DEH should be acquired. The following systems will be identified and their sizes indicated:

- (a) Water system with locations of fire hydrants near the site.
- (b) Sewer system.
- (c) Storm drainage system with invert elevations near the site.
- (d) Electrical/gas system.
- (e) Telephone system.
- (f) Other types of communication systems.

(4) *Environmental Conditions and Hazards.*

Environmental conditions and hazards near the site will be examined, beginning with a review of the environmental assessments prepared for the installation and the site. Storm drainage patterns, indicating direction of flow, will be located. Stormwater management areas which include the site will be located. Floodplain areas, wetland areas and wildlife habitat areas (especially for threatened and endangered species) will be identified. The location of buried tanks will be identified. AR 200-2 and AR 415-15 provide further guidance on determining and evaluating environmental conditions.

(5) *Historic and/or Archeological Resources.*

Archeological or historic sites protected from development will be located. Regulations governing activity near them will be identified.

(6) *Safety Hazards.* Requirements and distances necessary for fire codes, flood damage control, airfield and helicopter clear zones, and explosives safety from surrounding areas will be considered.

(7) *Physical Security.* Such physical security factors as the proximity of uncontrolled public use areas or vantage points from which standoff attacks could be launched will be considered if the threats to assets within the facility dictate concern. If the threat includes the use of explosives, the likely impact of collateral damage on nearby facilities will be considered.

(8) *Sources of Air, Noise and Light Pollution.* Immediate sources of pollution will be identified and their impact upon the site will be evaluated. Information may be found in the environmental impact assessments for the site and installation. The need and potential for achieving mitigation will be indicated.

(9) *Visual Context.* The site's viewshed (area of visual enclosure) will be located if it extends beyond the site boundaries. The degree to which

the surrounding area contributes to the site's sense of enclosure or openness, creates desirable or undesirable views from the site, contains visible scenic features, or may need to be buffered from the site's own visual condition will be defined.

*d. On-site Conditions.* On-site conditions include any existing factors which may affect development, either positively or negatively. They include both natural and man-made factors but usually emphasize the natural. Natural conditions are interwoven. Changes in one factor and location of the environment often create changes in other factors and locations. Although all detailed engineering data may not yet be available, site analysis looks for conditions which would prevent development of a facility, reduce the acceptable size or density, or create costs prohibitive to construction. Site analysis also looks for situations which can be used to reduce construction costs, reduce environmental damage, and create a more aesthetic site design.

(1) *Geology.* Geology influences the placement and design of facilities and activities on site. Typical soils data is available from the Field Operating Agency. Soil borings are required for each project. The following conditions may create problems and additional costs:

(a) Poor stability including limestone voids which do not support construction; layered deposits which must be considered before placing structures, regrading, or changing the moisture content of the soil; expansive substrates which can crack foundations, paving and other structural elements; and an unstable angle of repose which can limit regrading.

(b) Shallow depth to bedrock.

(c) Poor substrate strength which influences the size, depth and spacing of building supports and the structural grid above ground.

(d) Substrate drainage which can compound problems of slope stability and increase groundwater.

(e) Seismic factors (e.g., earthquakes and geologic faulting) which impact structural design.

(2) *Topography.* Topography will be examined to determine the various slopes on site. Slopes, to a large extent, influence the type of development and support systems a site can sustain. Slopes are usually placed in categories. The categories describe potential problems, suggest types of suitable development, and indicate the amount of grading which will accommodate development. Topographically responsive buildings accommodate steeper slopes with their size and/or structural foundation. These buildings can lessen the need for regrading. Figure 3-4 illustrates slope categories. Generally,



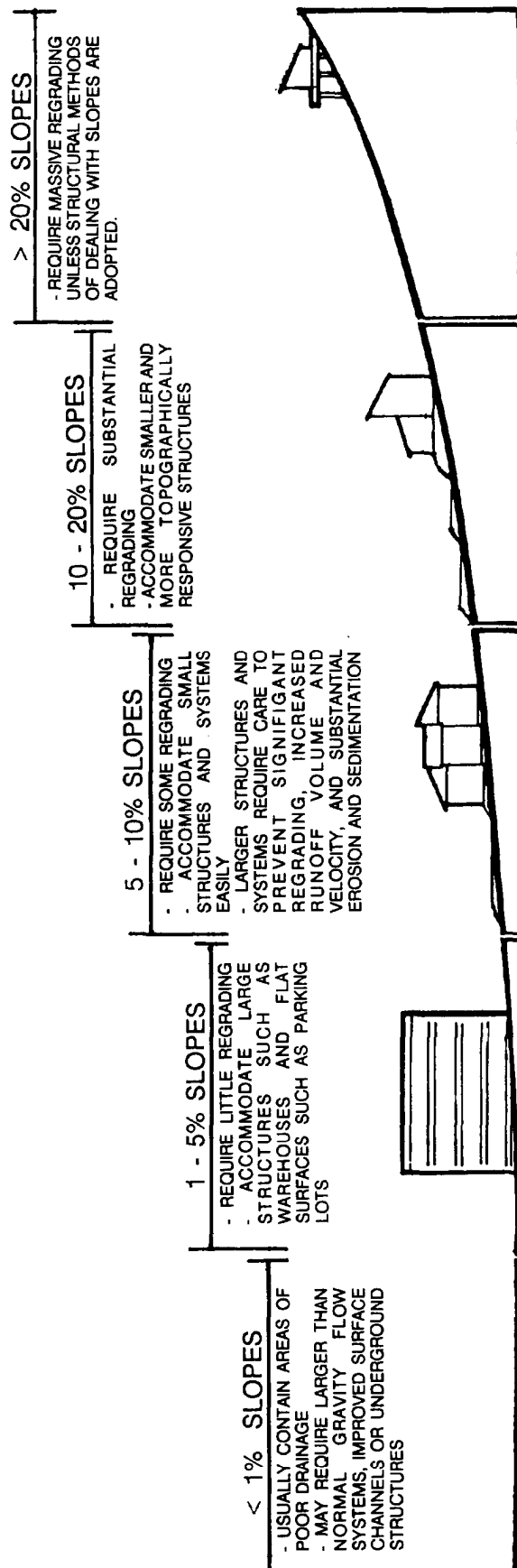

Figure 3-4. Slope Categories.

grading can be described by the following categories:

(a) *Minimal:* removing topsoil and establishing finished grade with only a minor transition between existing grade and constructed facilities.

(b) *Moderate:* requiring cuts and fills greater than one foot in more than 50% of the constructed site.

(c) *Massive:* requiring cuts deep into subsurface material and/or rock together with fills which cover the entire building or site area. The transition between existing grade and constructed facilities occurs at maximum slopes.

(3) *Hydrology.*

(a) *Subsurface.* Subsurface hydrology deals with the storage and movement of groundwater through aquifers. Subsurface information may be obtained from USGS maps. Increasingly, Federal, state and local agencies regulate the quantity and quality of water allowed to infiltrate the ground surface. Shallow, perched and fluctuating water tables can all impact development. If a site is in a groundwater recharge area, there may be restrictions upon the amount of impermeable surface and upon the minimum water quality allowed for infiltration.

(b) *Surface.* Surface hydrology, or runoff, increases as development decreases the area of infiltration. Surface conditions affecting site design are existing drainage patterns, flood plains, and man-made structures (e.g., dams or channelized drainageways.) Where soils are naturally subject to erosion and sedimentation, care may be necessary to avoid increasing slopes, concentrating runoff, or increasing impermeable surface. Development may be precluded altogether. Water bodies (e.g., ponds, lakes, streams or rivers) will be examined and evaluated. Figure 3-5 illustrates a combined topography and hydrology analysis for the candidate site for the battalion complex.

(4) *Soils.* Soil types and locations will be identified. The geotechnical investigation prepared for each project will determine the type of foundation design for buildings. Soils influence the kind of activities and location of facilities on a site. The most common soil problems affecting site development are the following:

(a) Expansive soils can cause damage to structures and paving.

(b) Unstable soils do not withstand pressure. They require foundations with a larger bearing area or foundations installed into a stable substrate.

(c) Corrosive soils can affect materials used in buildings and utility systems.

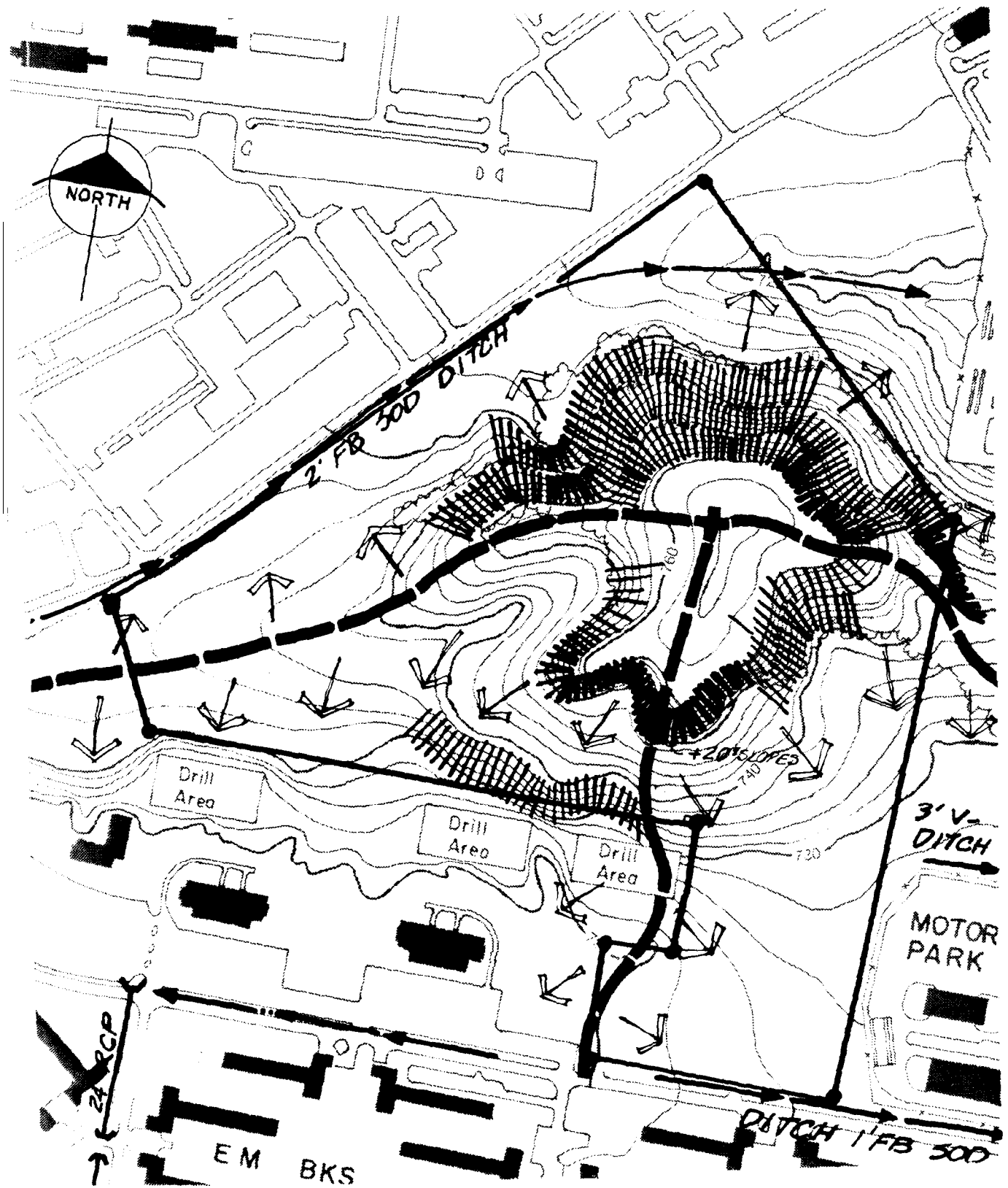

Figure 3-5. Topography and Hydrology Analysis.

(d) Impermeable soils can create poor drainage.

(e) Soils subject to wind or water erosion require maintaining existing grades, minimizing volume and velocity of runoff, and providing good surface cover.

(5) *Climate*. Climate is the weather which occurs in an area over an extended period of time. Climatic considerations are important to human comfort and energy efficiency. The following information should be obtained and evaluated: average monthly temperature range, quantity and frequency of precipitation, orientation and angle of sun at sunrise and sunset during midwinter and midsummer, and prevailing wind direction. There are found generally accepted climatic zones in the continental United States, as illustrated in figure 3-6. The general climatic considerations in these zones are:

(a) *Cool*. Long, severe winters and cool summers; ample precipitation; limited sunshine; and severe winds.

(b) *Temperate*. Weather with extreme changes from cold, snowy winters to hot, humid summers; ample precipitation; adequate sunshine; and a good deal of wind activity.

(c) *Hot arid*. Extreme fluctuations from hot to cold in daily temperatures; very limited precipitation; ample sunshine; and severe hot winds.

(d) *Hot humid*. Moderate temperatures; warm, moisture-laden air; ample sunshine; and often limited air movement.

(6) *Microclimate*. The site-specific microclimate will be evaluated by determining how the general weather conditions are influenced by such site elements as topography, vegetation and water bodies. The principal climatic variables are radiant energy, temperature, air movement and hu-

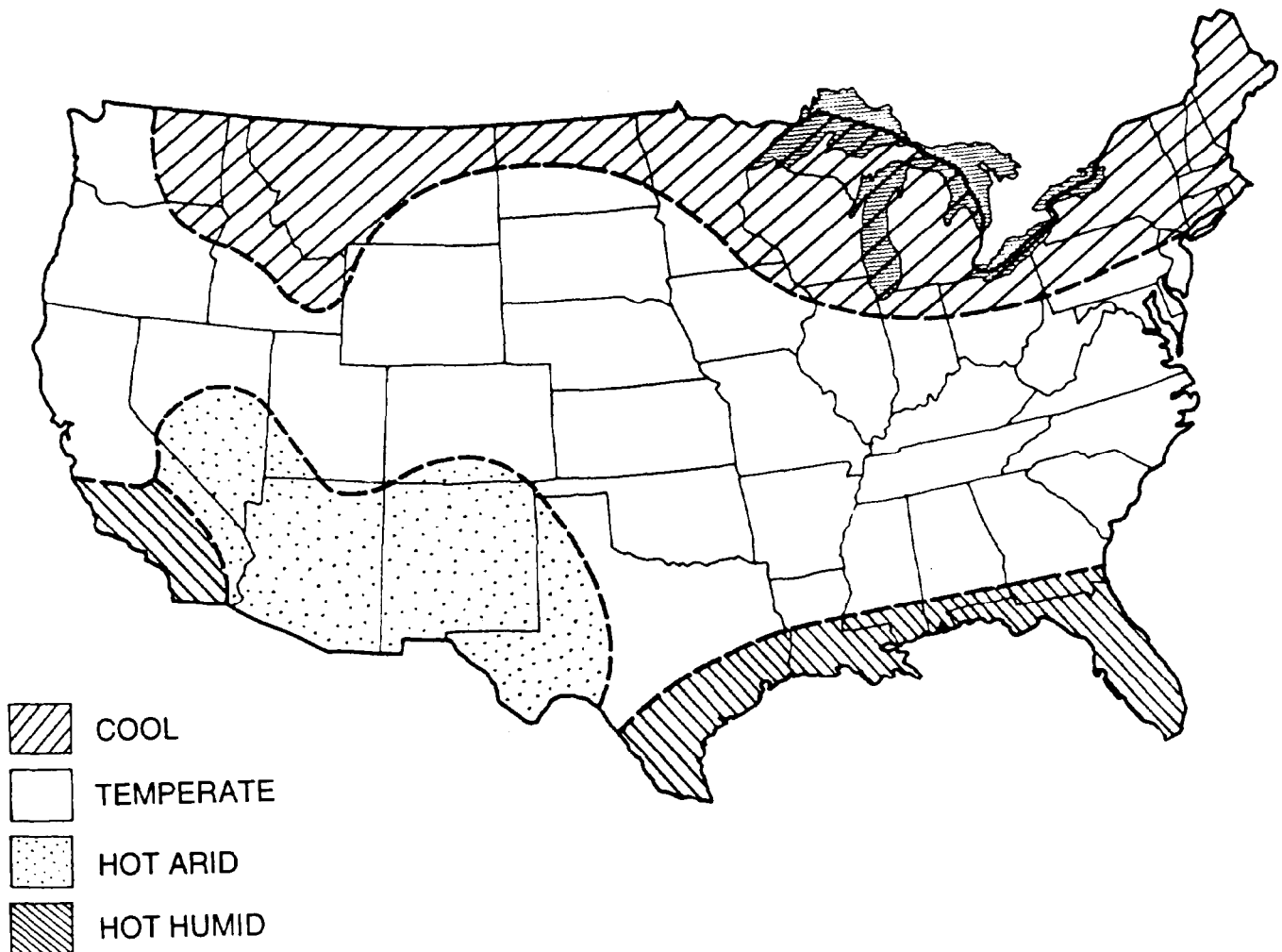

Figure 3-6. Climatic Zones in the Continental United States.

midity. The following locations should be noted for their potential impact on site development:

(a) Where topography collects cool, damp air or decreases air flow in depressed areas. This affects soil moisture and site humidity.

(b) Where slope orientation affects the amount of solar energy incident on site.

(c) Where vegetative cover causes temperature reduction, modifies wind velocity and/or prevents summer air infiltration.

(d) Where natural and man-made surfaces capture and store heat, increase heat, or cool through the evaporation process.

(e) Where climatic pockets of heat, cold, frost and fog are created by topography, vegetation, and/or walls.

(7) *Vegetation.* Vegetation can serve many purposes: climate modification, soil enrichment, wildlife sustenance, reduction of wind and water erosion, spatial definition, and creation of a pleasant physical and psychological environment. In terms of physical security, vegetation can block sightlines and provide hiding places for aggressors. On the other hand, vegetation can provide natural barriers to unwanted approaches. The site will be examined for both individual species and plant associations. A plant association includes the canopy, understory and ground cover plant material which thrive in similar soil and microclimatic conditions. Plant associations on site or nearby suggest the types of plant material which will do well when the site is developed. Useful information includes location, individual species names, size, approximate maturity, and general condition. Vegetative masses and individual specimens will be considered. It should be remembered that younger vegetation may have a greater chance of survival and more potential for long-term impact. The vegetation's ability to withstand construction activity will be determined. Possible protective measures will be considered. Federally protected wetlands are usually identified by observation of wetland plant species. Since plants on the Threatened and Endangered Species List require protection from disturbance, they will be noted.

(8) *Wildlife Habitat.* Habitat is not only the physical area but also the physical environment. Species are dependent upon vegetation and water located within an area for sustenance, cover and shelter. Changes to any element can affect habitat. Habitat(s) on site will be examined. Territorial or migratory areas and the species using them should be determined. If similar habitat where animals may move is located nearby or if these areas are saturated, it should be noted. Potential to preserve habitat without impacting human activity on site

should be noted. Potential to augment such activities as passive recreation and education should be noted. Habitat for threatened and endangered species will require protection.

(9) *Archeological and Historic Resources.* Archeological and historic resources requiring preservation and/or protection will be identified. Late discovery, especially of archeological sites, can create delays and escalate costs during construction.

(10) *Visual Conditions.* Figure 3-7 shows a visual conditions analysis for the candidate site for the battalion complex. Aspects of the visual character including the following:

(a) General geologic, topographic and vegetative character.

(b) Boundaries of the viewshed.

(c) Good and poor site-specific views and their potential for enhancement or mitigation.

(d) Special visual features such as water bodies.

e. *Site Opportunities and Constraints.* The site opportunities and constraints plan provides an overall evaluation of the site. It identifies the principal opportunities and constraints. It should be used to verify a site's adequacy for a proposed project. A key requirement for site verification is the determination that current user requirements obtained from the program analysis can be accommodated on the selected site. If the site will not accommodate the project, the installation will provide a different site. The opportunities and constraints plan addresses both on- and off-site conditions. It summarizes the relationships between various site elements. It identifies the impacts that may occur as the result of a change in one or more elements. With this plan, specific environmental objectives for site development, irrespective of any proposed activities or facilities, are determined. Such objectives may include maintaining existing drainage patterns, restricting facilities to certain slopes, and augmenting existing vegetation. When multiple candidate sites are being analyzed, the opportunities and constraints plans offer a good basis for comparison. Figure 3-8 illustrates an opportunities and constraints plan for the candidate site for the battalion complex.

#### 3-4. Site Verification.

When a site has been selected in the master plan, time and budget constraints may not allow for a thorough site analysis. In this instance, several key issues should be reviewed to verify the site's adequacy for development. Most of these issues can be recognized and, at least, preliminarily

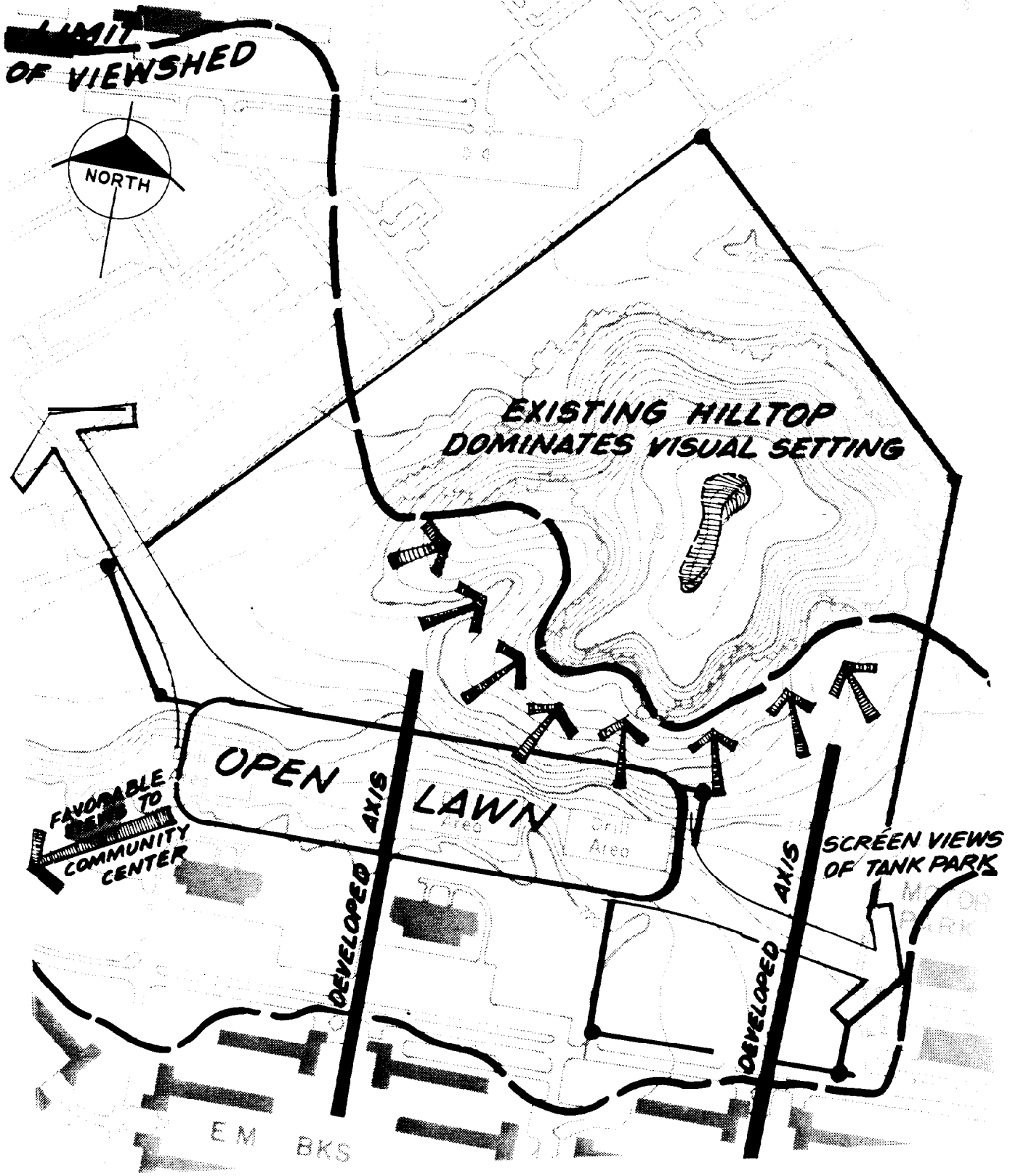

Figure 3-7. Visual Conditions Analysis.

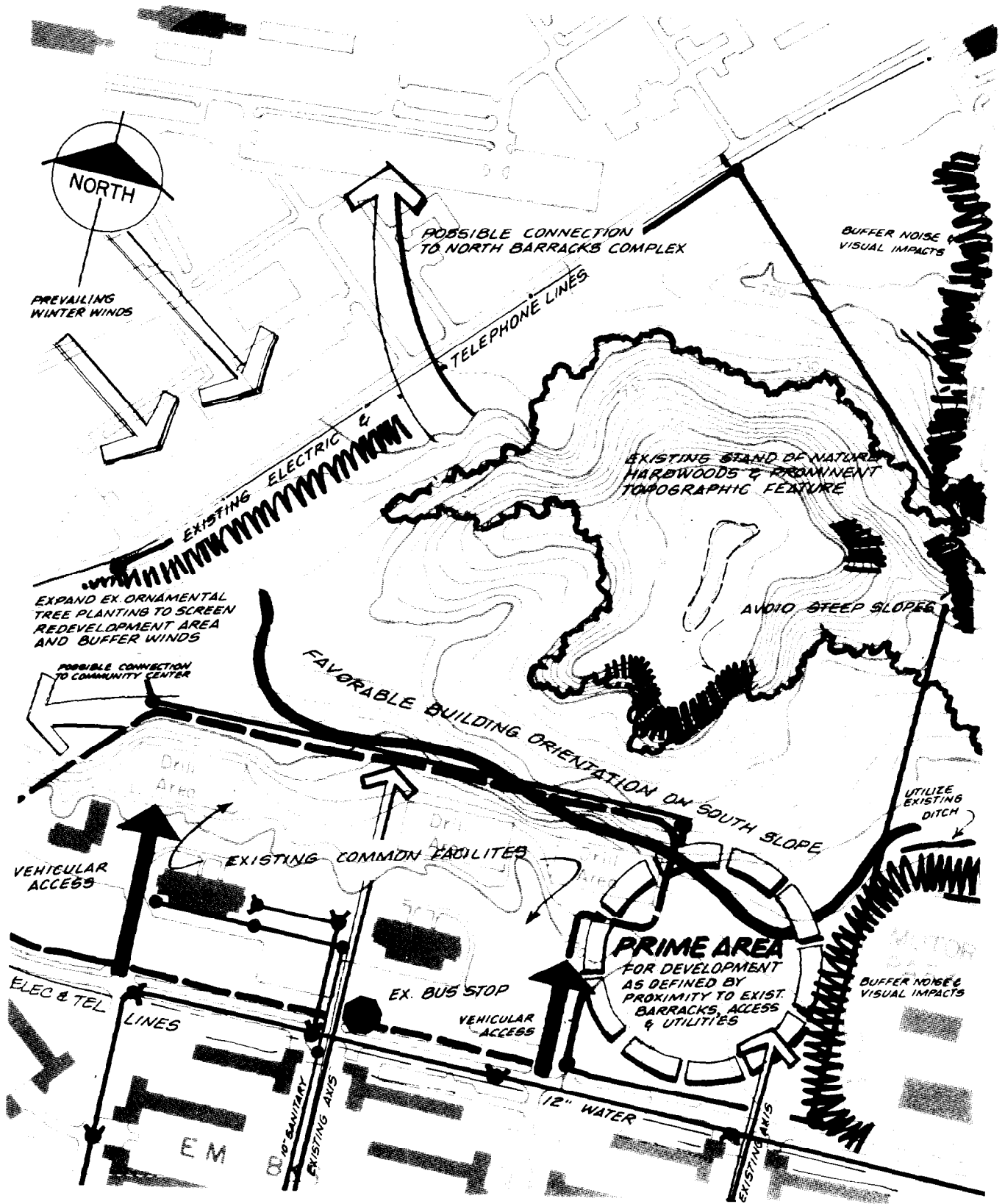

Figure 3-8. Site Opportunities and Constraints Plan.

evaluated on a site visit. The following questions can predict the most substantial problems:

*a. Inadequate Size and Shape.* Would the site with its present size and configuration meet user needs and requirements? Would it accommodate proposed facilities? Would it allow for future expansion?

*b. Poor Location and/or Accessibility.* Would the site be easily accessed without substantial improvements to or expansions of existing roadways? Would the site support, rather than interrupt, nearby facilities and activities? Would necessary and adequate utility service be available?

*c. Incompatible Surround Land Use.* Would the site be adversely impacted by surrounding activity? Would development on the site adversely impact surrounding activity? Would the site be constrained by requirements (e.g., safety clearances) of neighboring land uses?

*d. Extremely Flat or Steep Topography.* Would extremely flat slopes on site create significant drainage problems and increase construction costs? Would extremely steep slopes require substantial regrading to accommodate facilities and increase construction costs?

*e. Erosion and Sedimentation.* Is there evidence of existing erosion and/or sedimentation which may indicate both drainage and construction problems?

*f. Unstable Soils or Sinkholes.* Is there evidence of unstable soils or sinkholes which may suggest increased construction costs or preclude construction altogether?

*g. Floodplains, Wetlands and/or Standing Water?* Is the site located in a floodplain or wetland area which would preclude construction? Is there evidence of standing water which would indicate drainage problems and increased construction costs?

*h. Environmental Hazards.* Is there evidence of environmental hazards which would impact or prevent development of the site?

*i. Archeological and Historic Resources.* Is there evidence of archeological and/or historic resources which would preclude development or require costly protective measures?

*j. Threatened and Endangered Species.* Are there threatened and endangered species of plants and/or animals which would prevent development?

*k. Physical Security.* Does the site have security vulnerabilities which would prevent development or substantially increase construction costs? Security vulnerabilities include inadequate standoff distance, natural barriers, natural vantage points, location near uncontrolled areas and facilities, and

location near facilities which cannot accept collateral damage.

### 3-5. Concept Development.

Concept development is the application of a specific program to an individual site. In concept development, a series of progressively more detailed steps is taken to achieve a concept design: spatial relationships diagrams, sketch site plans, and concept site plans. As shown in figure 2-1, the work effort transitions from planning to design during this task. Planning finishes with the development of spatial relationships diagrams.

*a. General.* In each step of concept development, alternatives should be explored and evaluated to arrive at the optimal design. An awareness of the site design guidelines discussed in chapter 4 is useful during the evaluation. The size and complexity of each project will determine the level of detail necessary during concept development. However, the general procedures described below for the preparation of spatial relationships diagrams should be followed for every project.

*b. Spatial Relationships Diagrams.* Spatial relationships diagrams employ a broad-brush approach to initial concept development: the organization of activities and facilities on site. The diagrams will be used to look for the optimal fit of the program to the site. The diagrams will note potential problems and benefits, without formulating detailed responses to either. The use of correctly scaled graphics for facilities, activity areas and circulation helps to assure that there is adequate space on site for the program.

*c. User Participation.* It is important to involve representatives of the user in concept development. Spatial relationships diagrams interpret user needs into site-specific alternatives. They are an effective way to elicit user response because they help focus the user's attention upon the way site conditions will impact facilities and the way facilities will impact the site. A design charette is a useful tool at this stage. A charette is a concentrated work effort over a short period of time. It allows interaction between the user's representatives and the design team and takes maximum advantage of the multi-disciplinary approach to site planning.

*d. DA Facility Standardization Program Definite Designs.* The Army provides standard designs for many facilities. These designs will be used where applicable. A facility design may include a site plan. The plan presents an idealized design based on the functional relationships diagram and using the standard facility design. This site plan does not refer to any individual site. It should not be

applied literally to specific site development. Figure 3-9 illustrates such a site plan for a Battalion Complex.

*e. Preparation of the Spatial Relationships Diagram.* A spatial relationships diagram illustrates the application of a functional relationships diagram to an actual site. Often, various functions can be manipulated around the site and still maintain the desired relationships. Then, the critical planning determinants become the relationships between the facilities and the existing site conditions. Preparing alternatives is especially important. Alternatives provide an opportunity to look at the range of effects which will occur when the site is developed. They aid the selection of the concept which will take maximum advantage of the site while impacting it the least. Comparing alternatives may lead to the creation of a revised, preferred concept. The preferred concept may combine different aspects of the various alternatives and/or suggest new solutions. Evaluation and comparison of alternatives should be an interdisciplinary endeavor. When evaluating alternatives, it is helpful to ask the following questions and compare how the alternatives measure in response:

(1) Which alternative promotes the optimal functional relationships? Which alternative supports the functional relationships of Army units?

(2) Do the facilities, activities and circulation fit comfortably on site? Will future expansion fit comfortably on site?

(3) Can required setbacks, space standards, and buffer zones be maintained?

(4) Does circulation encourage safe, efficient movement? Is there a recognizable sequence of entry and arrival?

(5) Can an approximate finished floor elevation and access elevation at the street be set, and can reasonable grades be expected to be maintained between the two?

(6) Can existing drainage patterns be reasonably maintained?

(7) Can existing utility systems be reasonably accessed?

(8) Do the location of facilities, circulation and utilities avoid natural assets or problems (e.g., existing vegetation, drainage ditches, steep slopes or poor soils)?

(9) How do facilities, circulation and open space take advantage of the site's natural assets?

(10) What site constraints require special attention? What methods for resolution of problems are suggested?

(11) What will the design character of the facility and site be?

*f. Example Spatial Relationships Diagrams.* The following spatial relationships diagrams illustrate alternatives for a battalion complex.

(1) *Alternative 1.* Figure 3-10 illustrates alternative 1. Alternative 1 locates the complex in the prime development area identified on the site opportunities and constraints plan. It takes advantage of the close access to existing circulation and utility networks. It provides barracks facilities with convenient access to the dining hall and reasonable access to the brigade headquarters across the street. Alternative 1 develops a through access drive to troop housing areas north and south of the site. It restricts interior circulation and parking to the perimeter of the site. This allows creation of a residential character around the barracks. Alternative 1 enables active and passive recreation areas to take advantage of the wooded hillside to the north. Grading in the prime development area has already been judged reasonably simple. First-phase facilities can be accommodated with minimum cut and fill except in the area where the new roadway crosses the hillside. Barracks in the second phase will require the excavation of up to six to eight feet to create a large building pad. The facility arrangement in alternative 1 avoids interference with the existing drainage swale to the northeast. However, it requires stormsewer connection to the existing system. There is ample room for future expansion, but the proposed access drive will separate existing and future development. The access drive also separates the complex from the parade ground. Location of new utilities should consider the potential for use by future expansion. A principal concern in alternative 1 is the location of the motor pool area to the east. It will require an adequate buffer zone and screening to maintain the residential character of the barracks.

(2) *Alternative 2.* Figure 3-11 illustrates alternative 2. Alternative 2 also locates the battalion complex in the prime development area identified on the site opportunities and constraints plan. It works with the site in several ways similar to alternative 1. Alternative 2 does not develop a through access drive. As a result, adequate turnaround area must be provided for service and other large vehicles. The costs associated with developing access are expected to be lower since the access drive(s) does not have to be designed to accommodate through traffic. First-phase facilities are separated from the parade ground by the access drive. Pedestrian flow between existing and future facilities is uninterrupted. Future development is relocated further south to minimize the need for regrading. To reduce regrading and asso-



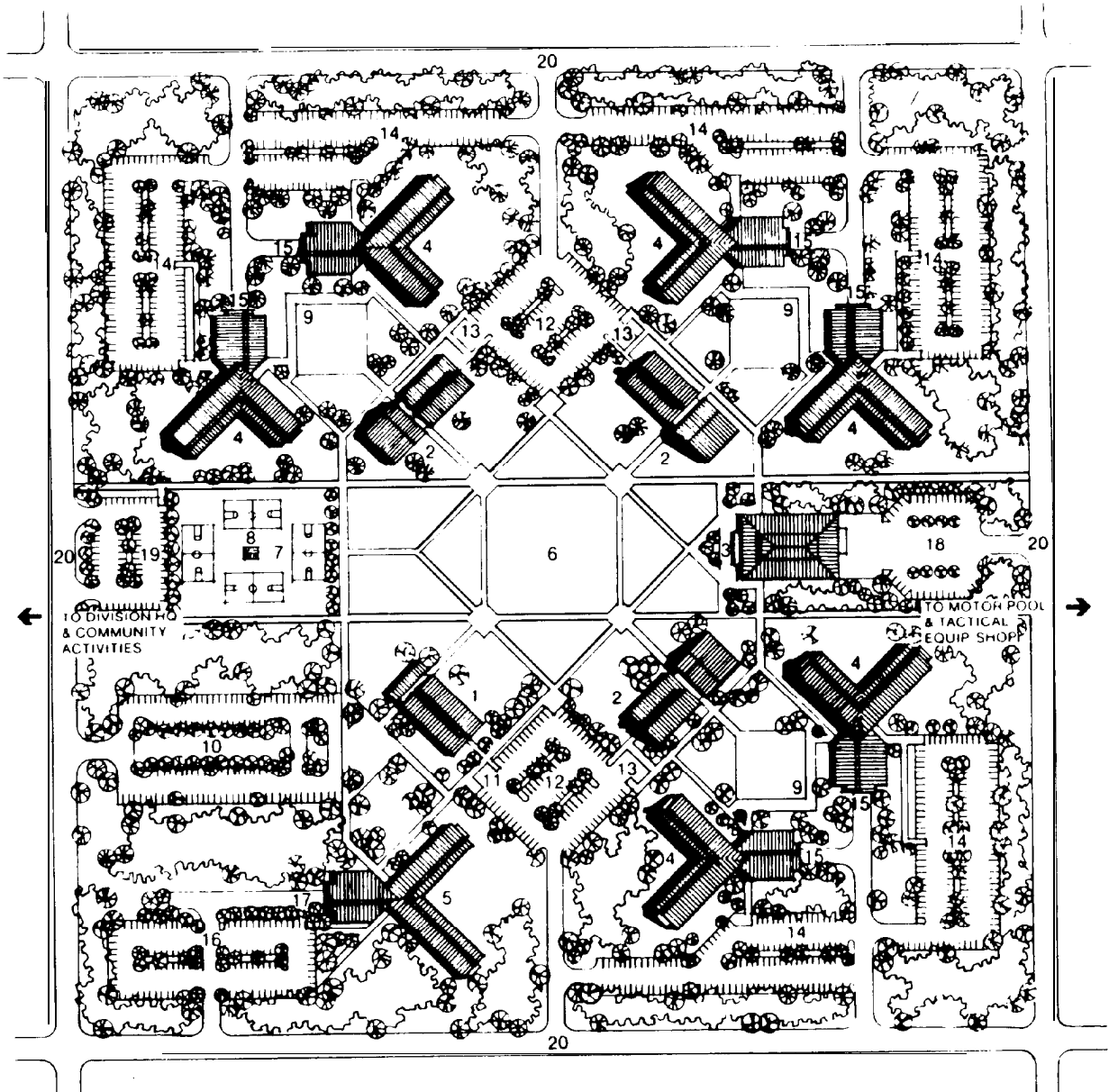

**LEGEND**

- |  |  |
|--|--|
| 1 BRIGADE HEADQUARTERS                                 | 11 BRIGADE SERVICE AREA                    |
| 2 BATTALION HQ W/CLASSROOM & L R C (MEDIUM SIZE SHOWN) | 12 BATTALION PARKING                       |
| 3 DINING FACILITY                                      | 13 BATTALION SERVICE AREA                  |
| 4 BARRACKS W/ADMIN & SUPPLY                            | 14 BARRACKS & CO ADMIN PARKING             |
| 5 HQ COMPANY BARRACKS W/ADMIN & SUPPLY                 | 15 ADMIN & SUPPLY SERVICE AREA             |
| 6 PARADE FIELD   | 16 HQ COMPANY PARKING                      |
| 7 RECREATION AREA                                      | 17 HQ ADMIN & SUPPLY SERVICE AREA          |
| 8 CONCESSION BUILDING                                  | 18 DINING SERVICE YARD & PERSONNEL PARKING |
| 9 FORMATION AREA                                       | 19 GUEST PARKING                           |
| 10 BRIGADE HQ PARKING                                  | 20 PERIMETER ROAD                          |

Figure 3-9. Site Plan for DA Standard Battalion Complex.

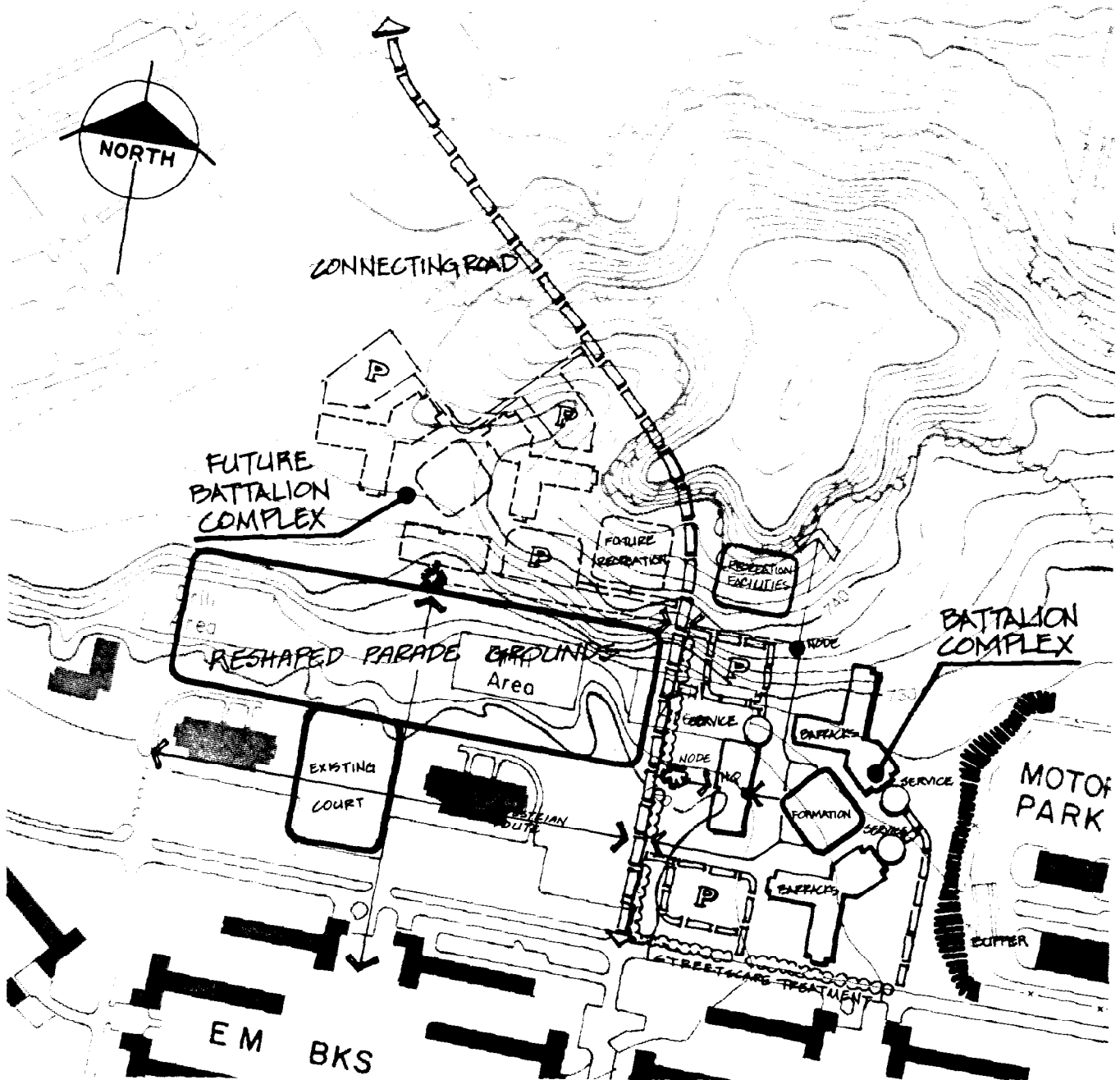

Figure 3-10. Spatial Relationships Diagram for a Battalion Complex. Alternative 1.

ciated costs, the buildings are spread slightly farther apart. This detracts from the spatial organization of the complex. Alternative 2 takes better advantage of the wooded hillside for recreational opportunities. However, it will require more careful placement and design since it encroaches upon the vegetated area. Alternative 2 does not use the hillside as effectively for energy conservation. The necessary buffering and screening of the motor pool area remains a concern.

(3) *Preferred Alternative.* Figure 3-12 illustrates a preferred alternative. The preferred alternative combines several aspects of alternatives 1 and 2 and provides a new solution for one of the site concerns. The preferred alternative again locates facilities in the prime development area. This alternative eliminates the through access drive since the costs, site disturbance, and separation of facilities it will create are evaluated as unjustifiable. The preferred alternative restricts

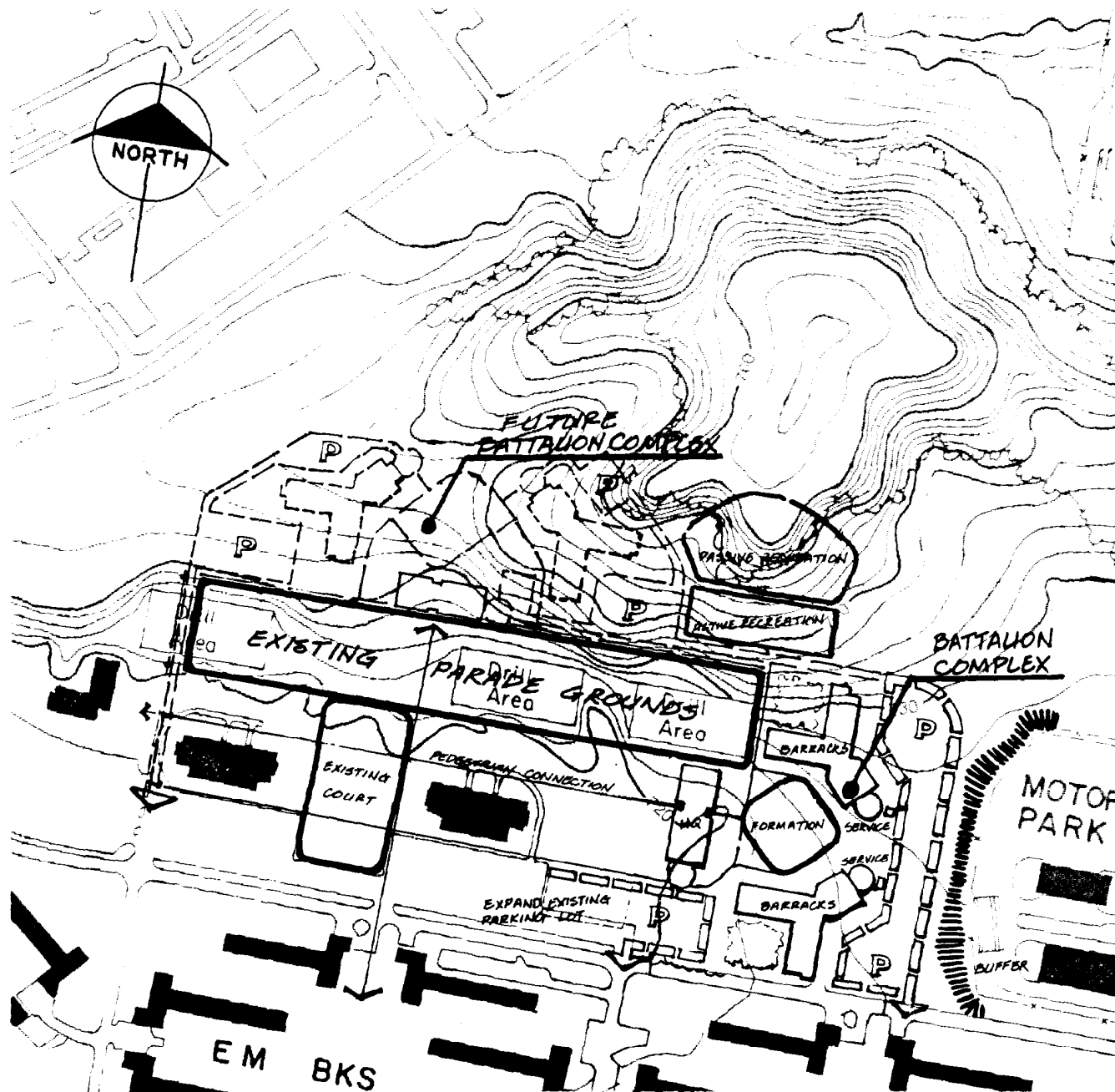

Figure 3-11. Spatial Relationships Diagram for a Battalion Complex. Alternative 2.

vehicular circulation to the perimeter of the first-phase development. It provides uninterrupted pedestrian circulation between facilities. The preferred alternative provides the opportunity to

maximize the recreational benefits to be achieved near the wooded hillside. This alternative uses the barracks parking areas to buffer the residential areas from the motor pool.

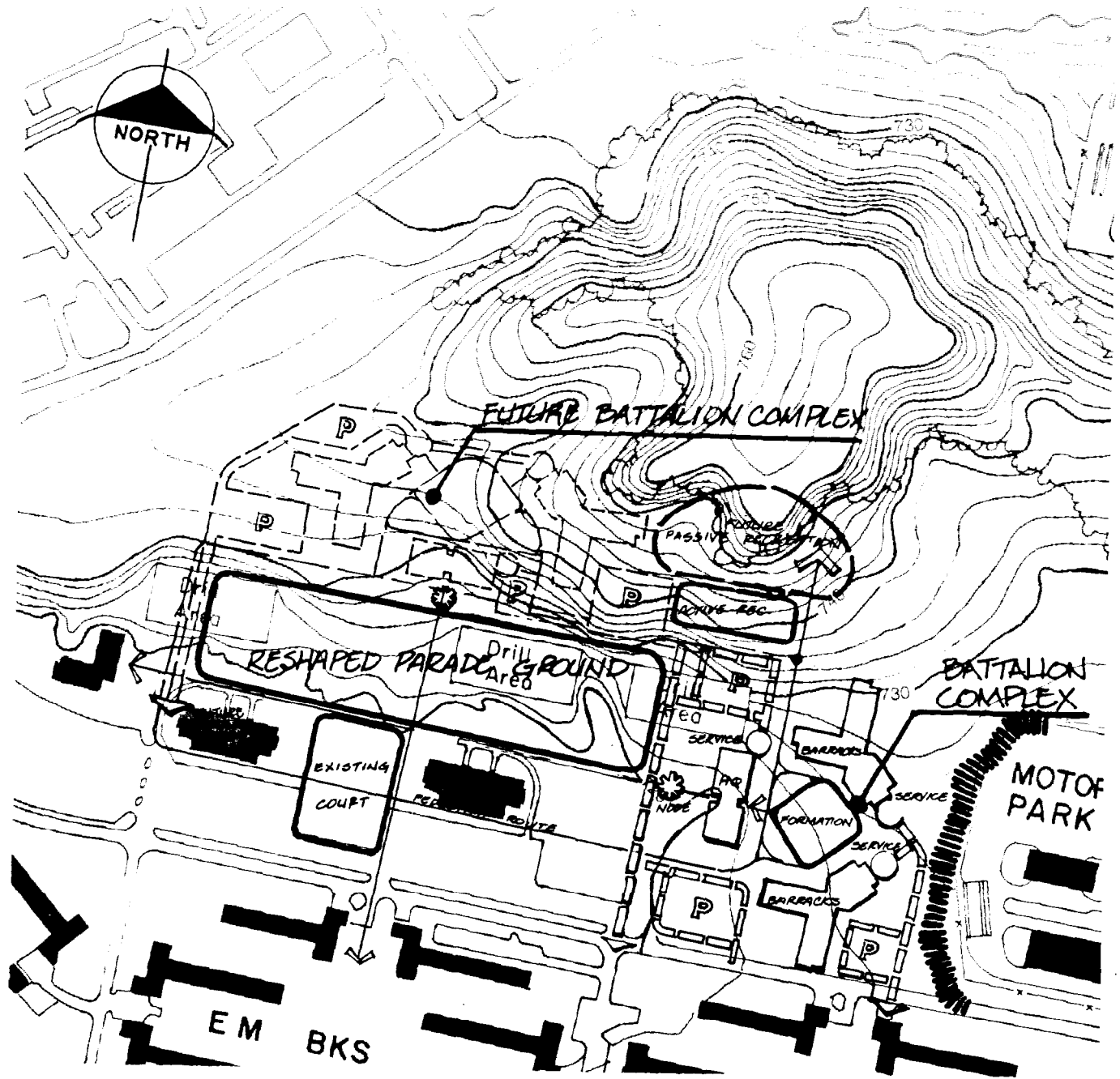

Figure 3-12. Spatial Relationships Diagram for a Battalion Complex. Preferred Alternative.

## CHAPTER 4

### SITE DESIGN GUIDELINES

---

#### 4-1. General.

This chapter addresses the treatment of various natural and man-made elements when designing a site. The objective of site design is to place facilities on site with the least disruption to the natural environment. Site design emphasizes optimal use of site elements to enhance facilities. Just as the natural environment is woven from various elements, site design interweaves natural and man-made elements to achieve the optimal condition. While demanding a comprehensive knowledge of generally accepted practice, site design requires a flexible approach to problem-solving. The following factors should be considered in site design:

- a. Siting and orienting buildings.
- b. Developing vehicular and pedestrian circulation systems.
- c. Providing adequate grading and drainage.
- d. Responding to climatological conditions.
- e. Locating utility systems.
- f. Developing lighting coverage.
- g. Providing for physical security.

#### 4-2. Building Location.

The location of the primary facility is key to a successful site design. The building is usually the most prominent single element and the center of site activity. This does not mean that it belongs in the middle of the site. Several factors influence building location. Siting effects a compromise among the following factors:

a. *Dimensional Factors.* The building dimensions or footprint, the desired proximity to other facilities, buffer zones, spacing standards, and setbacks influence building location. These distances, especially those established for safety purposes, usually must be rigidly maintained.

(1) *Buffer Zones.* Buffer zones may involve such requirements as screening or absence of vertical elements. Buffer zones maintain mandated distances for:

- (a) Runway clearances.
- (b) Noise abatement.
- (c) Security threats.
- (d) Storage of hazardous materials.

(2) *Spacing Standards.* Spacing between buildings is normally determined by their:

- (a) Functional relationships.
- (b) Fire separation requirements.
- (c) Physical security requirements.

(d) Need for future expansion of either or both facilities.

(e) Need for passive and active open space for the facility.

(3) *Setbacks.* Setbacks are the distances between buildings and property frontages, roadways, parking areas and other buildings. Building setbacks may be established by the installation design guide or by historic usage. If building setbacks have been established in an area, these setbacks should be observed. Where setbacks are not established, new buildings should be located in relationship to the surrounding structures. Figure 4-1 illustrates an implied setback area between two existing structures. A new building should normally conform and align with the front of one or other other building. It should not be placed in front of the foremost structure, behind the rear structure, or in the middle space between the two structures.

(4) *Proximity to Other Facilities.* A building's relationships to its support facilities and to other primary facilities influence its location. Proximity to access roads, existing utility lines, and other compatible functions (especially if they share facilities or have interdependent activities) also influence location. When a building is a shared facility, it should be centrally located and within a reasonable distance from all participating users. Buildings which depend upon a shared facility should acknowledge this relationship by orienting either the front building face or a doorway area towards the shared facility.

(5) *Buildable Zone.* Using the guidelines above, a development perimeter can be developed. This perimeter quickly defines a buildable zone as shown in figure 4-2.

b. *Environmental Factors.* The location and condition of such elements as geology, soils, drainage and vegetation may create areas which should be excluded from development. This further defines the buildable zone. Such areas:

- (1) Are unbuildable for structural, economic or environmental reasons.
- (2) Require protection from construction activity.
- (3) Require preservation of their natural integrity.

c. *Orientation.* Building location may be influenced by orientation for the purpose of energy conservation.

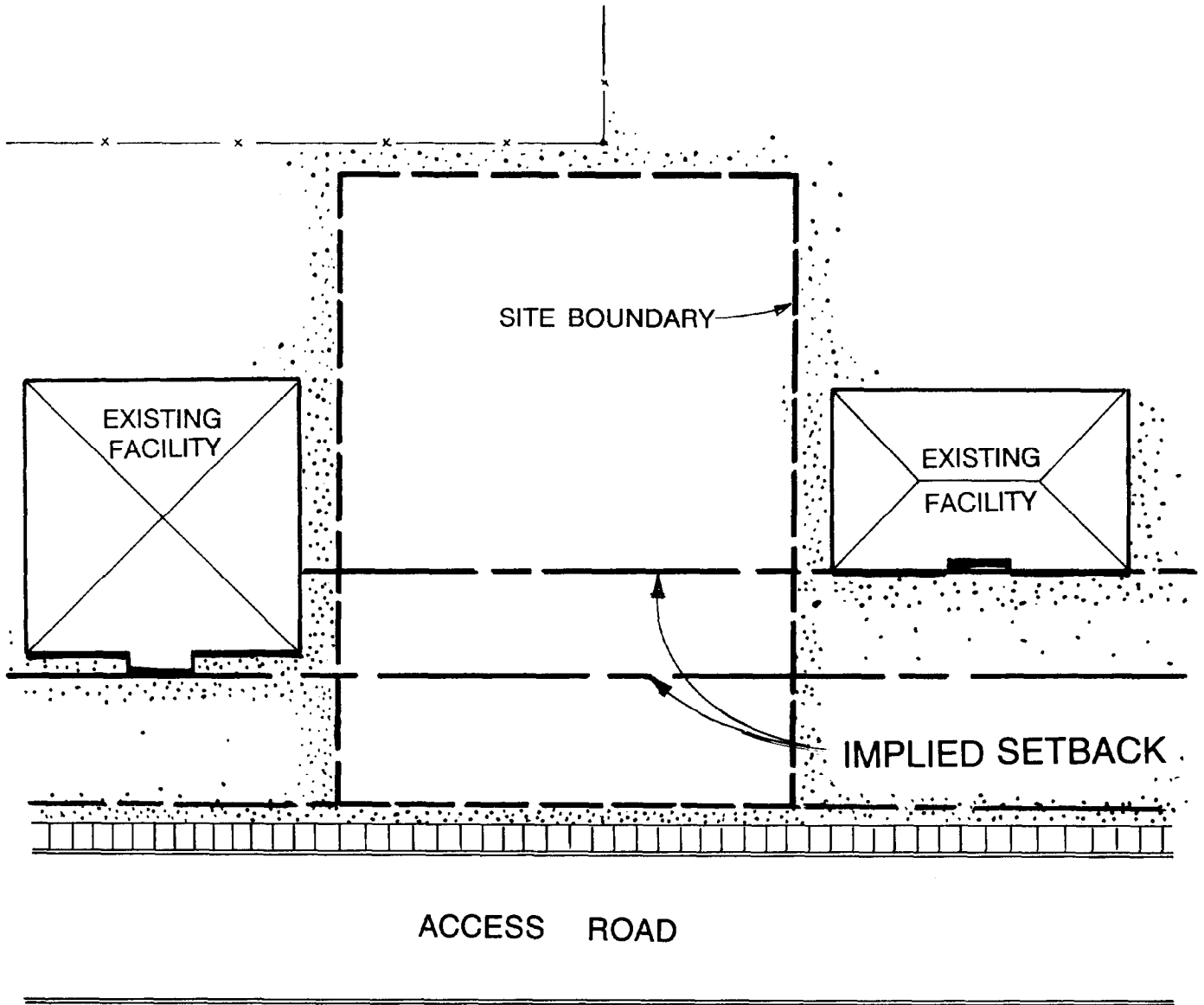

Figure 4-1. Locating Building Setbacks.

(1) *Solar.* Buildings should be oriented to take advantage of passive solar heating and cooling conditions. The solar study determines orientation. Generally, the long axis of a building is oriented along or at some angle less than 45 degrees to the east-west axis. As illustrated in figure 4-3, this orientation allows facilities to do the following:

- (a) Harvest or avoid maximum sunlight.
- (b) Be protected from northern winds.
- (c) Take advantage of east-west summer breezes.
- (d) Create shade to the south.
- (e) Locate outdoor living spaces in the more comfortable southern area.

(f) Create microclimatic pockets, as appropriate, to the east or west of the building.

(2) *Other.* Other site-specific conditions can influence building alignment. Figure 4-4 shows how slope orientation may impact the sunlight and subsequent heat a building receives. Slope orientation may increase exposure to the sun or may, in combination with structures or vegetation, create pockets of shade. Figure 4-5 illustrates how building orientation may be modified to take advantage of or reduce the impact of prevailing winds. Existing topography and vegetation can also create microclimatic pockets. These pockets alter normal weather conditions by reducing available sunlight, creating shade and reducing prevailing winds.

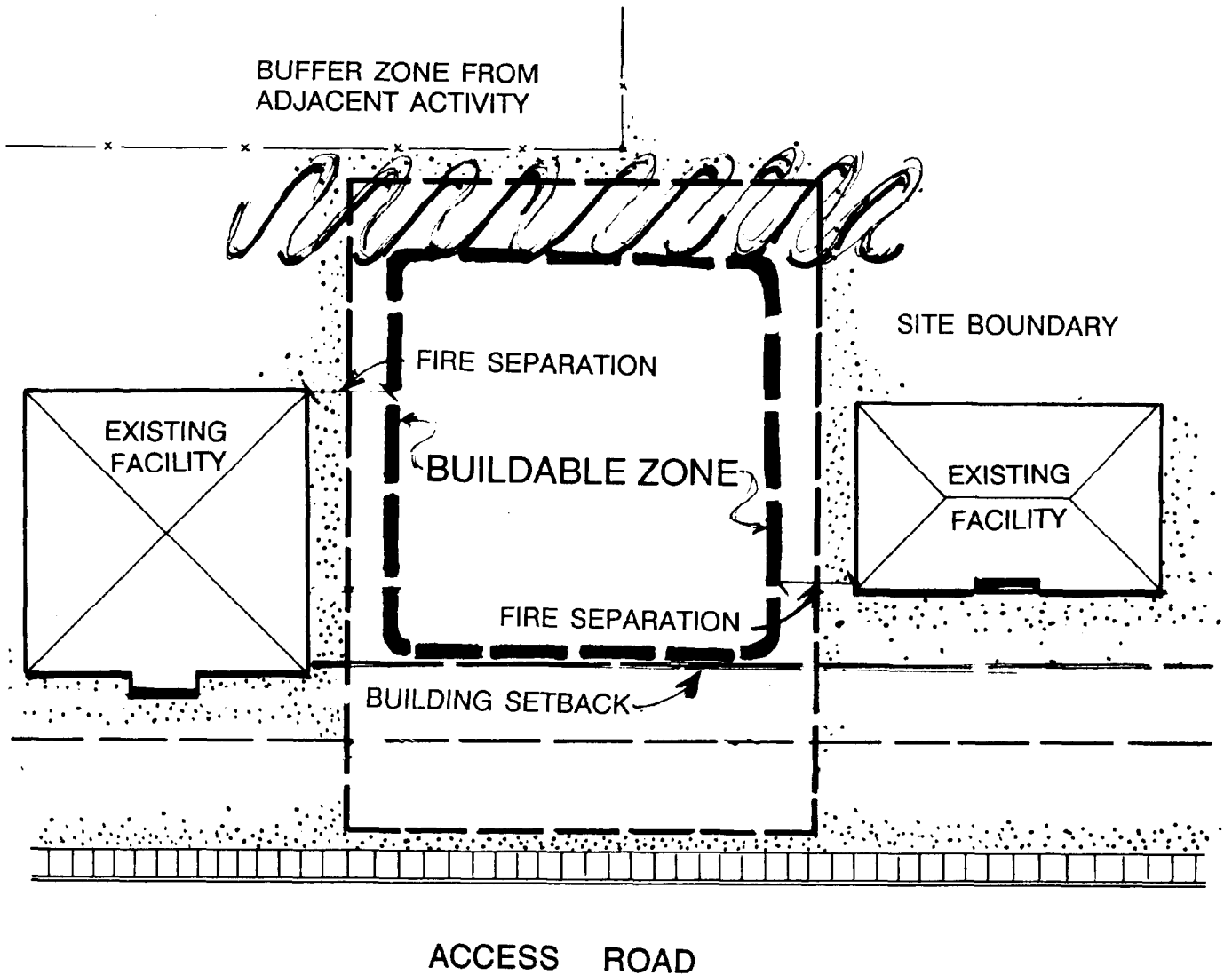

Figure 4-2. Buildable Zone.

d. *Visual Determinants.* Visual considerations for siting buildings are determined by both the user's needs and existing conditions. A building may need to be clearly visible from the access road. The user may desire a visual relationship between structures which are located within a single unit and/or service the same user group. In these circumstances, the locations of entrances are often important. Their visibility may be used to reinforce circulation. Existing conditions which can influence building location include:

- (1) Views into areas of good natural quality.
- (2) Views which can be achieved by taking advantage of higher site elevations.

(3) Visual enclosure which can be provided by existing topography and/or vegetation.

4-3. Circulation.

Circulation should promote safe, efficient movement of vehicles and pedestrians. Maintaining maximum separation of vehicles and pedestrians helps promote safety. Safe circulation systems have a perceivable hierarchy of movement, lead to a clear destination and do not interrupt other activities. MTMC provides detailed information on circulation requirements. Chapter 6 provides more specific design criteria for vehicular circulation and parking.

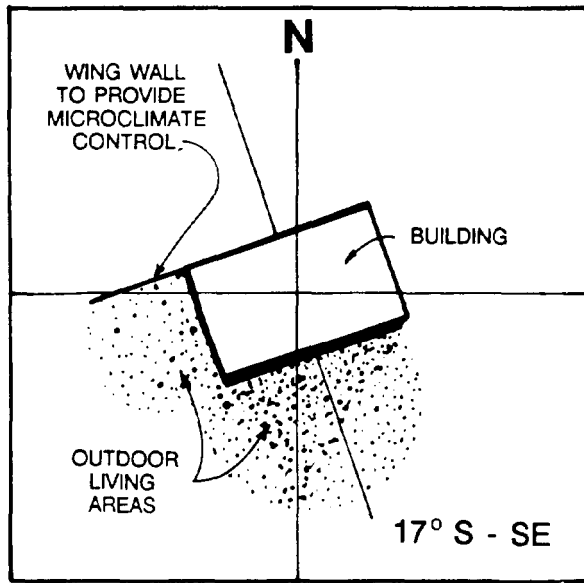

TEMPERATE REGION

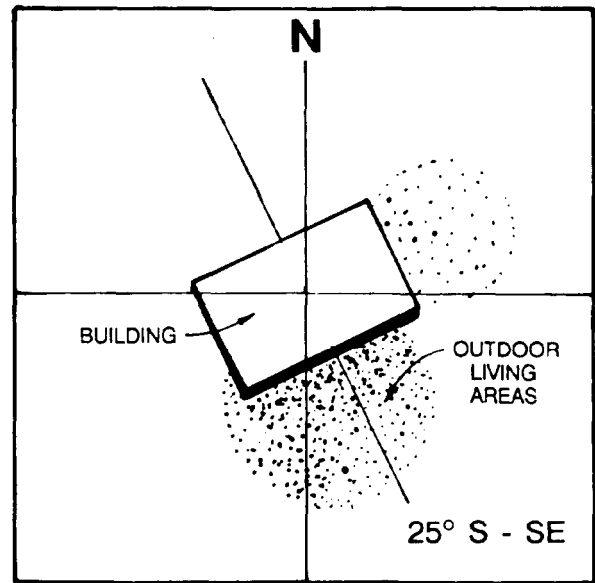

HOT ARID REGION

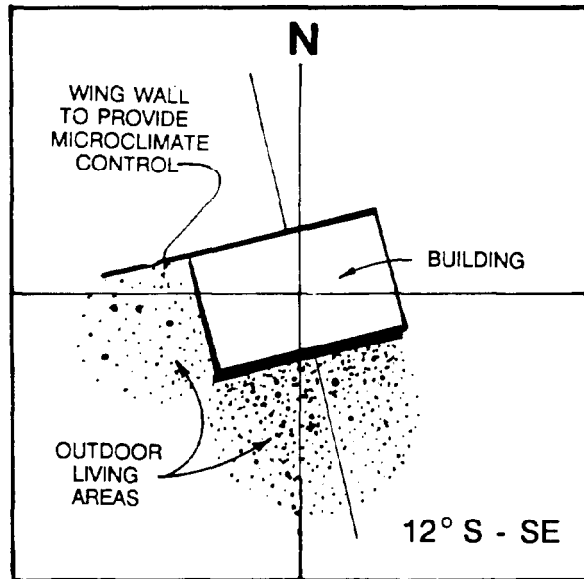

COOL REGION

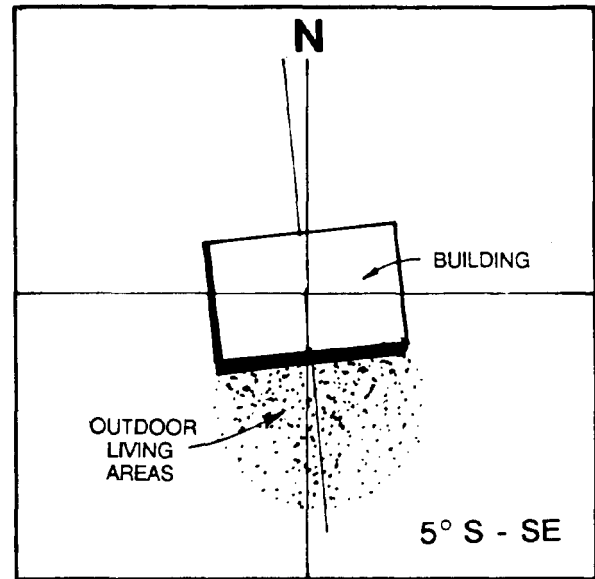

HOT HUMID REGION

Figure 4-3. Orientation of Building Ares.

a. *Vehicular Circulation.* Because of their size and type of movement, vehicular routes should be established first. The following factors should be considered.

(1) *Access.* Access should be controlled to minimize the conflicts between through traffic and vehicles entering and exiting the site. Access from the through access road should separate conflict areas by reducing the number of access drives and/or increasing the space between drives and between drives and roadway intersections. The number of drives should be limited to a two-way drive or a pair of one-way drives for each site.

Drives may be added to the site if the daily traffic volume exceeds 5,000 vehicles per day (both directions.) Drives may be added if traffic using one drive would exceed the capacity of a stop-sign-controlled intersection during the peak (highest) traffic hour. Access should reduce conflict by preventing certain maneuvers (e.g., left turns.) Access should remove turning vehicles from through traffic by providing separate paths and storage areas for turning vehicles. Access should provide the following:

(a) Physical and sight distances which allow safe entry and exit from the access road.



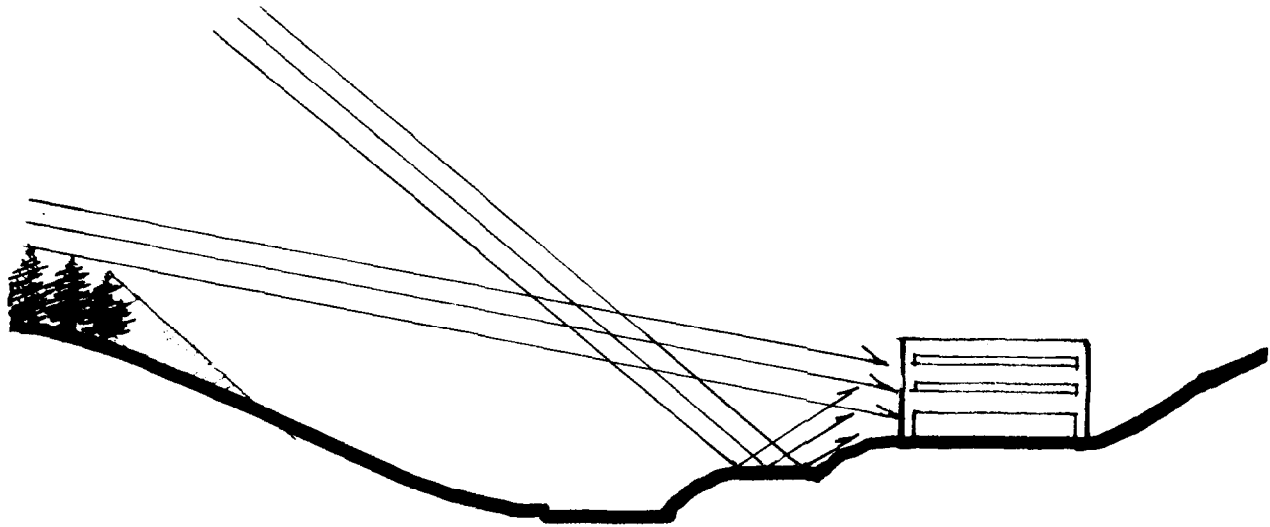

NORTH SLOPE ALLOWS NATURAL TOPOGRAPHIC AND VEGETATIVE FEATURES TO PROVIDE SHADE

SOUTH SLOPE INCREASES EXPOSURE TO REFLECTED LIGHT FROM PAVEMENTS AND DIRECT SUN AT LOW ANGLES

Figure 4-4. How Slope Orientation Affects Buildings.

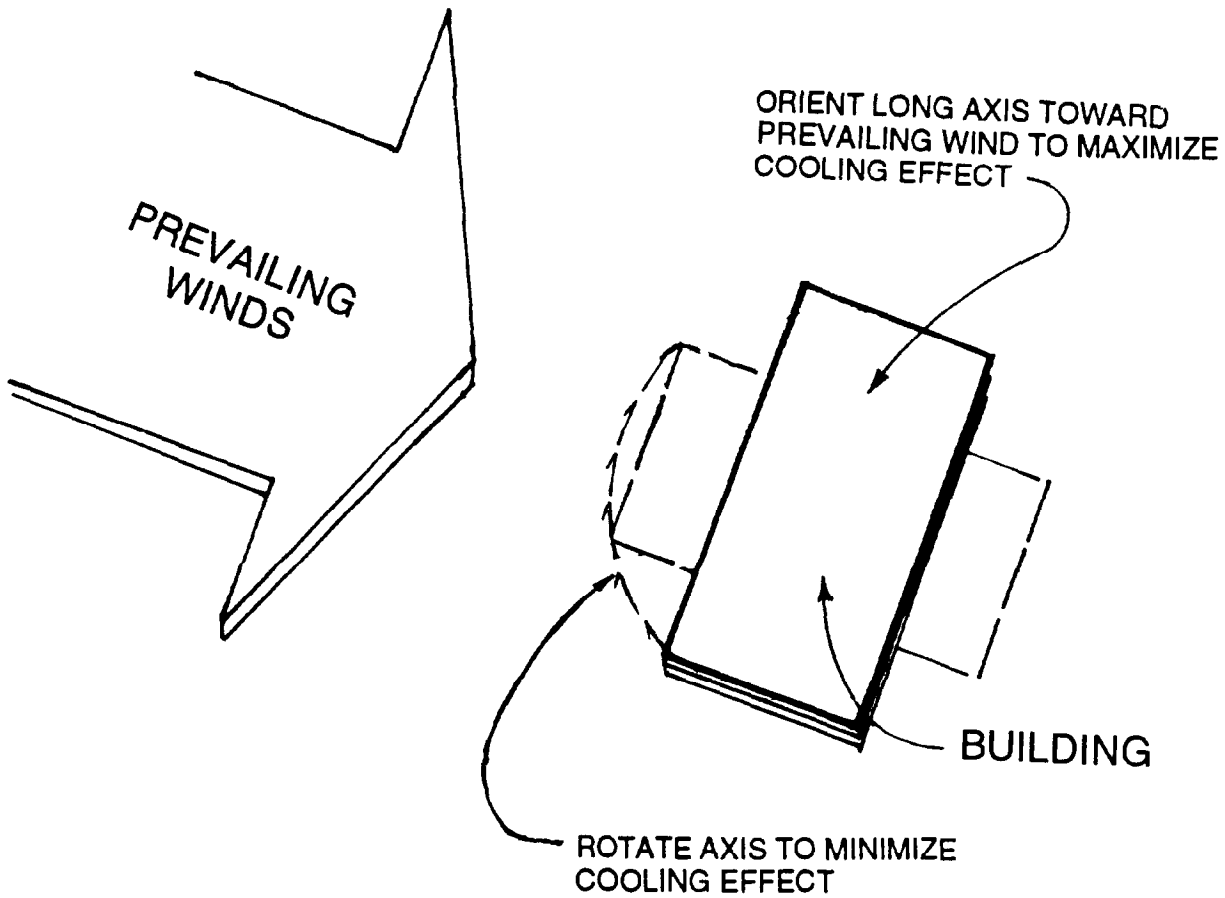

Figure 4-5. How Prevailing Winds Affect Building Orientation.

(b) Location away from any elements (e.g., building, topography or vegetation) which block or lessen sight distance.

(c) Adequate views and signage of entry to the site from the access road.

(d) Use of topography, vegetation and water to reinforce a sense of entry.

(e) Maintenance of maximum spacing between access drives occurring on the same access road.

(f) Alignment of access drives which occur across the access road from each other. If this is not possible, a separation of 75' between access drives is generally adequate.

(g) Right-angle turns from the access road onto the access drive.

(h) Depending upon the size of the project, marginal or medial channelization.

(i) Adequate throat width and length to channel vehicles into the proper lanes, discourage erratic movement and provide storage space on the access drive. This prevents vehicles which have slowed or stopped from blocking the path of vehicles entering the site.

(2) *Access Drives.* Normally, traffic enters and exits the site at the same access point or points, but not all vehicles have the same purpose or destination. Figure 4-6 illustrates a typical circulation flow diagram. Understanding traffic flow and patterns on site helps determine the location of turn-around areas, appropriate turning radii at intersections and appropriate drive widths. Different drive widths can be used for different types of

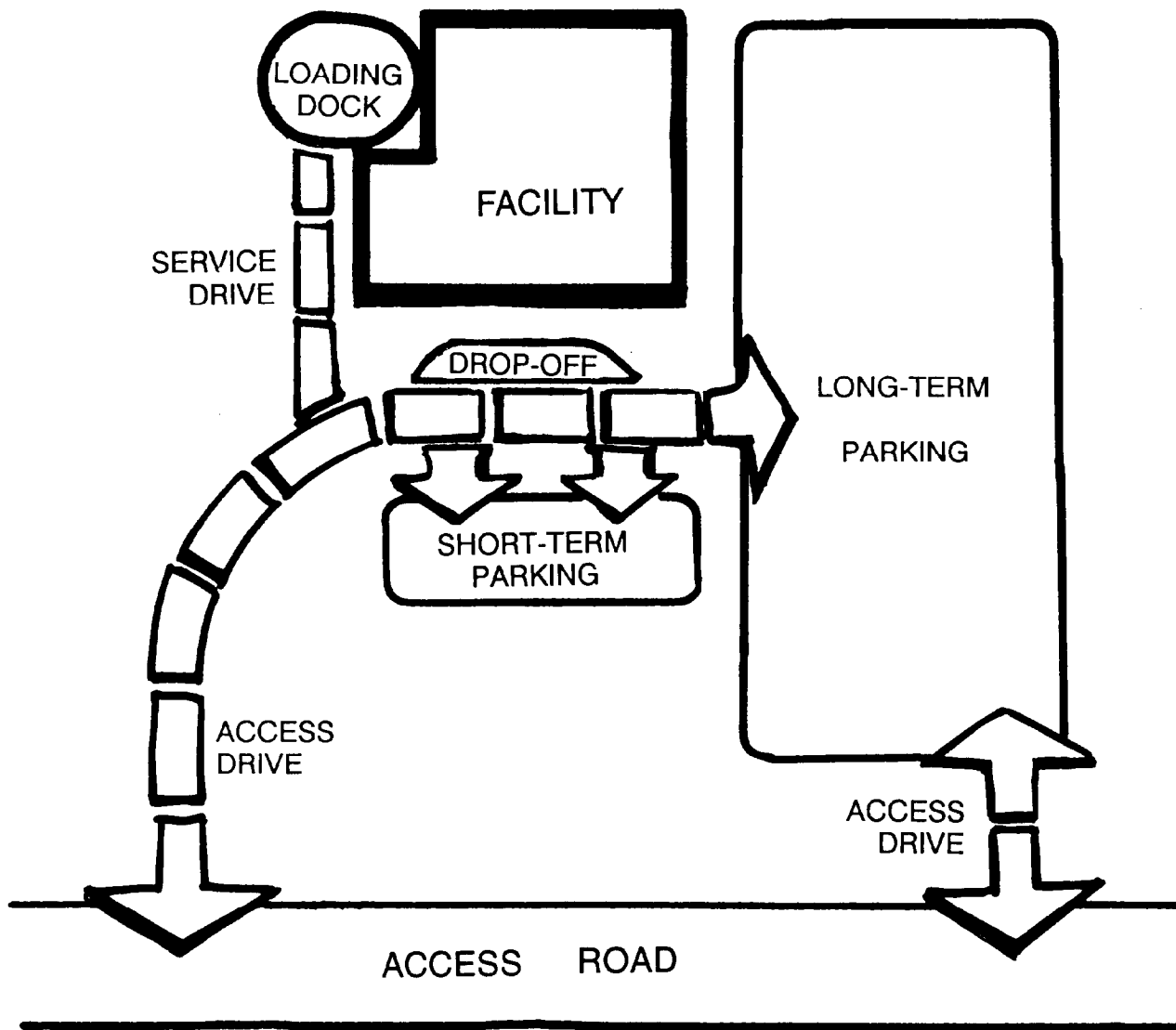

Figure 4-6. Typical Circulation Flow Diagram.

vehicles. Drives used only for service or emergency vehicles can be reduced substantially. Varying widths indicate the hierarchy of movement and reduce the amount of impermeable surface. The access drive should do the following:

(a) Take vehicles to their destination and return with minimum interference with or travel through parking areas, service areas or emergency zones.

(b) Enter and exit at the same point or on the same access road to discourage through traffic on site.

(c) Accommodate two-way traffic since one-way systems can create confusion and actually result in more vehicle movement.

(d) Promote separation of service drives from other drives.

(3) *Dropoff Areas.* Drop-off areas should be provided for office, commercial, educational and community facilities with high use. This promotes both vehicular and pedestrian traffic flow. Figure 4-7 illustrates typical drop-off areas. Drop-off areas should be:

(a) Located at or near the front of the building and apart from entries into parking lots. Buses and shuttles require a separate drop-off area located away from the building entrance.

(b) Preferably on a one-way loop to avoid confusion.

(c) Sufficient in size to avoid vehicle conflicts and stoppages of traffic flow. Where a circular turn-around is used, the circle should be sized according to the design vehicle and provided with adequate radii.

(4) *Parking.*

(a) Parking should occur in lots or structures with a limited number of entrances and exits onto the access road or drive. Entrances and exits into different lots on the same site should be aligned or separated to provide adequate sight distance. One-way systems will be discouraged because they result in extended circulation through the lots when they are at or nearing capacity.

(b) Parking should be within convenient walking distance of a building entrance. Barrier-free parking should be located within 100' of an accessible building entrance as required by "FED STD 795." Parking for high turn-over or short-term use (e.g., visitor, outpatient or delivery) should be located in a separate lot or signed and placed nearest the entrance. Usually, more distant parking areas should be maintained for employees.

(c) A minimum distance of 20' should be maintained between parking and buildings. This provides adequate separation between the facility

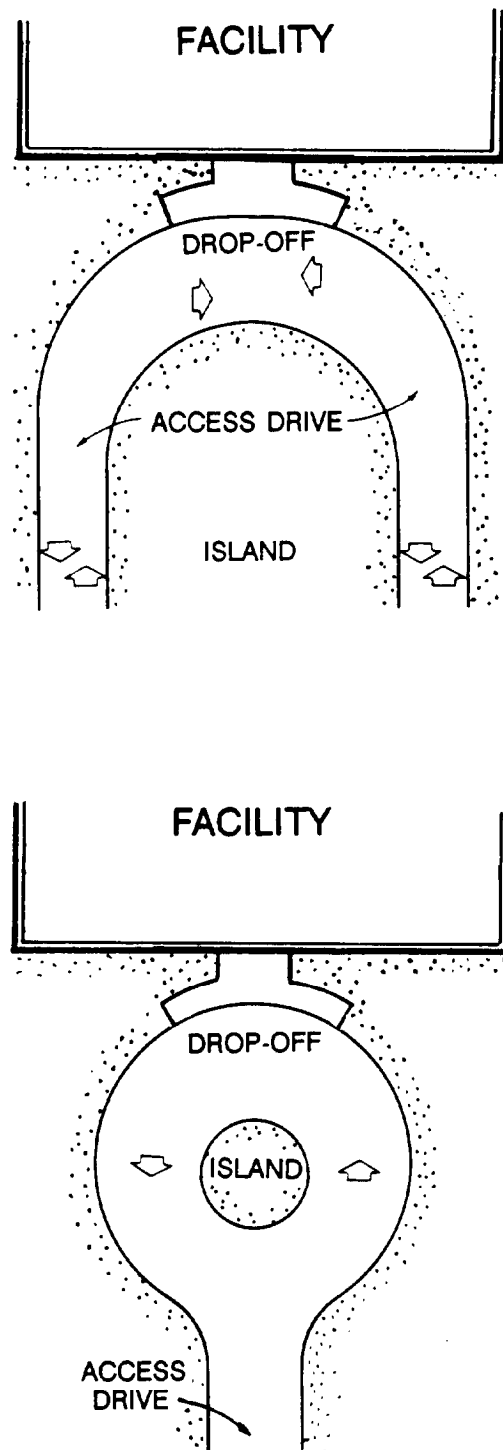
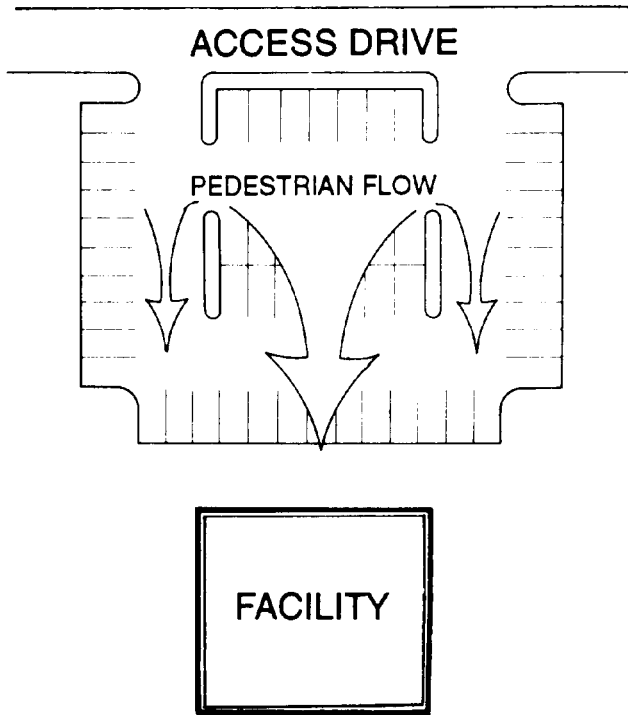

Figure 4-7. Typical Dropoff Areas.

and vehicular movement and adequate room for pedestrian movement.

(d) Parking aisles should be aligned towards the building entrance to encourage more organized pedestrian flow. This alignment limits the number of places where pedestrian traffic must cross vehicular traffic. Barrier-free parking should not require movement across vehicular circulation paths. Figure 4-8 illustrates appropriate alignment.



PARALLEL ALIGNMENT

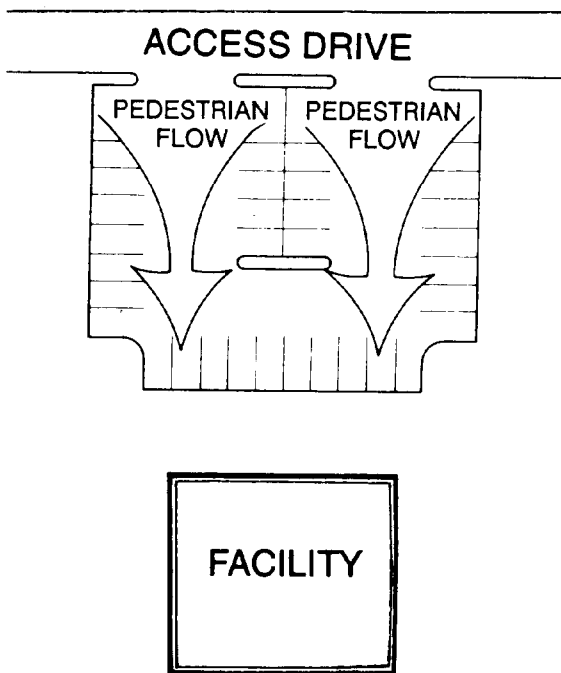

PREFERRED PERPENDICULAR ALIGNMENT

Figure 4-8. Parking Aisle Alignment.

(5) *Emergency Vehicle Access.* Direct access to a building will be provided for emergency vehicles. A separate access will be provided for ambulances. Fire truck access will be provided between buildings. This access may be provided on sidewalks or gravel paths designed for the vehicle. If a special drive is installed to accommodate emergency vehicles, it will provide sufficient room for the vehicle to turn and exit the site.

(6) *Service Vehicles.* Service vehicles can range in size from pickup trucks and vans to garbage and large delivery trucks. Service vehicles generally require larger turning radii, more room to maneuver, and holding space while deliveries or service occur. Service traffic should be separated as much as possible from the traffic flow on the access drive and in the traffic aisles of parking lots.

(a) *Sanitation Vehicles.* The circulation of sanitation vehicles is dictated by the locations of the dumpster pads. Pad locations should: provide convenient access for pedestrians taking garbage to the dumpster, provide convenient and easy access to vehicles emptying the dumpster, be in less visible areas of the site (e.g., the rear of buildings), and have sufficient room for screening with plant material, fences and/or walls. Sanitation vehicles should not have to turn around to exit the facility. When more than one dumpster location is required, it is desirable for sanitation vehicles to access each pad as part of a continuous loop. When the dumpster for a facility is located in the principal parking lot, the pad should be removed physically and visually from the building entrance and major pedestrian and vehicular circulation routes. Figure 4-9 illustrates how to locate a dumpster pad.

(b) *Delivery Vehicles.* Delivery zones should be placed in less visible areas of the site, at the rear or sides of buildings. Space requirements vary according to the type and size of vehicle and the need to access loading docks. Maneuvering room should be provided to allow trucks to back up and turn around to exit the site or to allow trucks to back up to the loading dock.

(7) *Barrier-Free Accessibility.* Barrier-free design will be in accordance with the requirements published in "FED STD 795."

b. *Pedestrian Circulation.* Pedestrian circulation involves travel routes and areas of pedestrian concentration. TM 5-822-2 provides guidance on the geometric design of walks.

(1) *Pedestrian Desire Lines.* Pedestrian circulation should be based on pedestrians' desired lines of walking between facilities. It is fairly simple to anticipate desire lines. People tend to follow the

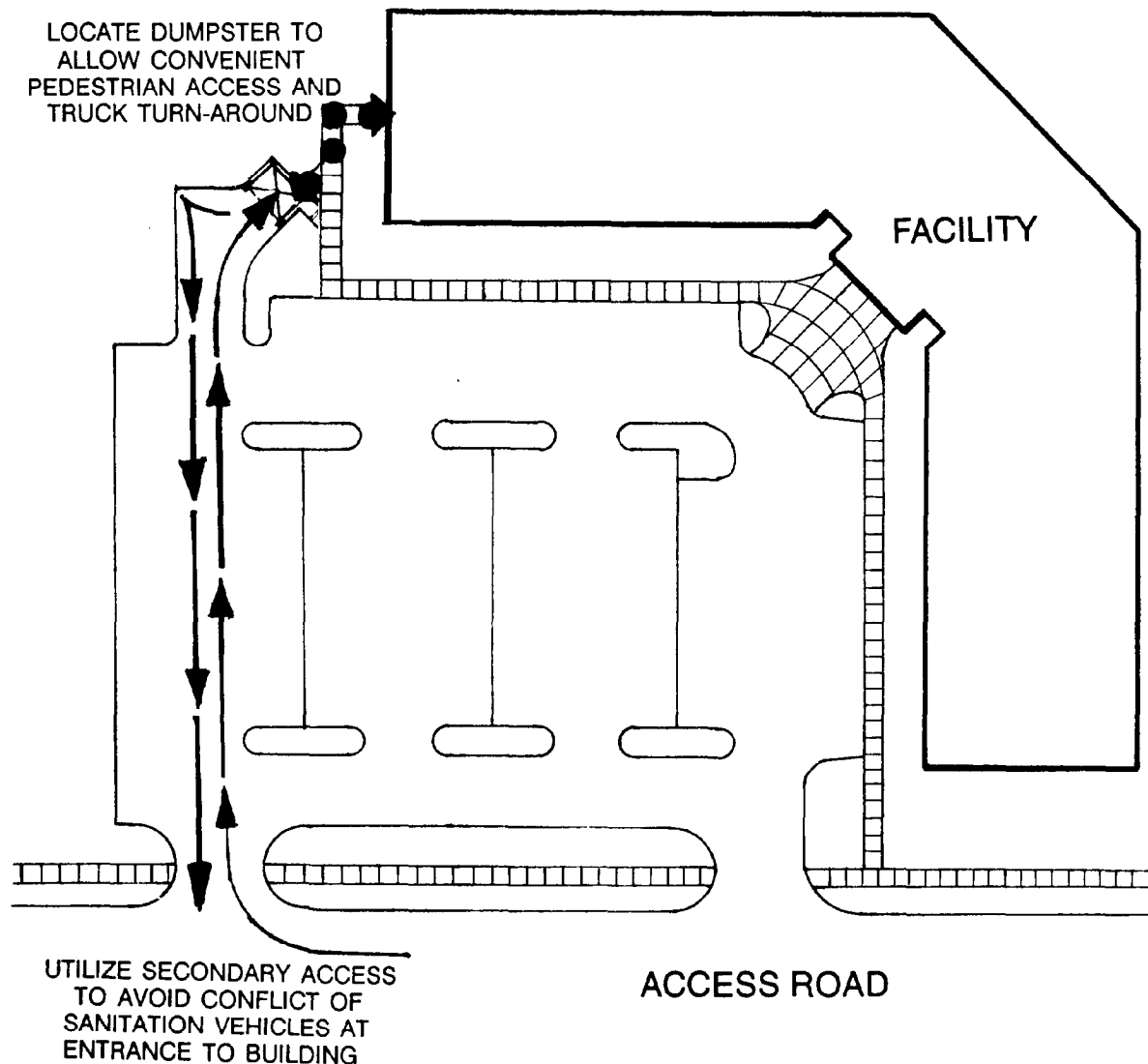

Figure 4-9. Locating a Dumpster Pad.

most direct route when walking between two points. Desire lines should be weighted to predict the most travelled routes. This prevents crisscrossing the site with sidewalks. Figure 4-10 illustrates a typical desire line study. Because people often cut corners, more generous paved area should be provided at pathway intersections. Corners should be rounded or filleted. Where pedestrians can be expected to enter and exit a building or outdoor space from all directions, it is better to concentrate on the most direct and important routes, accepting that there will be some pedestrian flow across grassed areas. Adequate reception area should be provided at the doorway.

(2) *Grid and Curvilinear Path Systems.* A grid path system tends to provide the most direct access between locations. It is appropriate in areas with a strong sense of architectural definition. A more curvilinear path system can provide reason-

ably direct access while also providing more comfortable and interesting movement than a grid system. Figure 4-11 illustrates alternative sidewalk schemes. Topography and vegetation can be used to reinforce a sense of movement and direct sightlines. Topography and vegetation are less successful if used to block movement.

(3) *Pedestrian Concentration.* As the speed of pedestrian movement slows at the points of origin and destination, the space required to accommodate movement expands. Pedestrian movement is also interrupted so that people may meet, gather, wait or sit. In areas of pedestrian concentration (e.g., building entrances, drop-offs and small outdoor spaces between buildings), the space should be developed to accommodate these needs. General design techniques include the following:

(a) Widening walkways at the points of origin and destination.

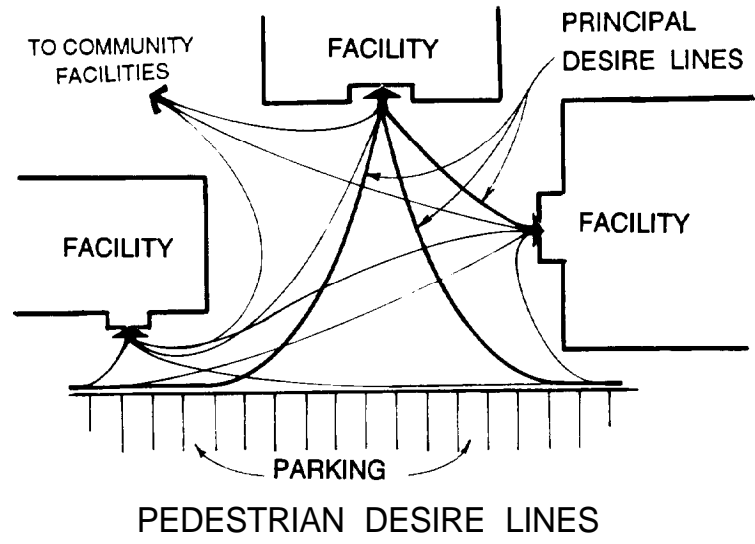

Figure 4-10. Typical Pedestrian Desire Line of Walking-Study.

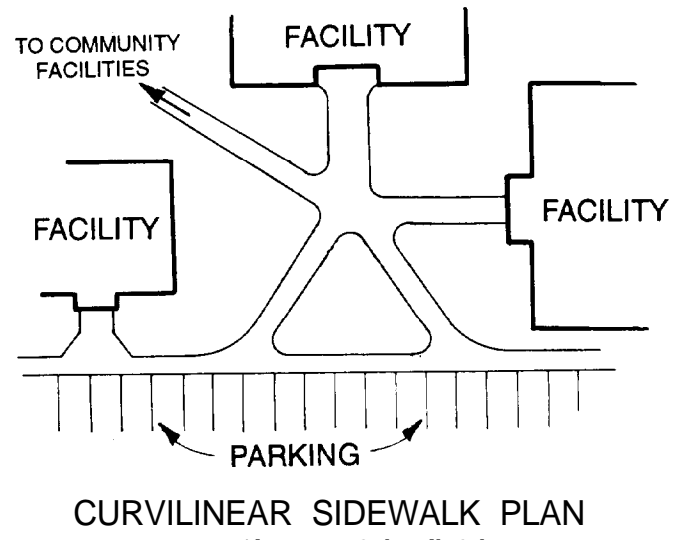
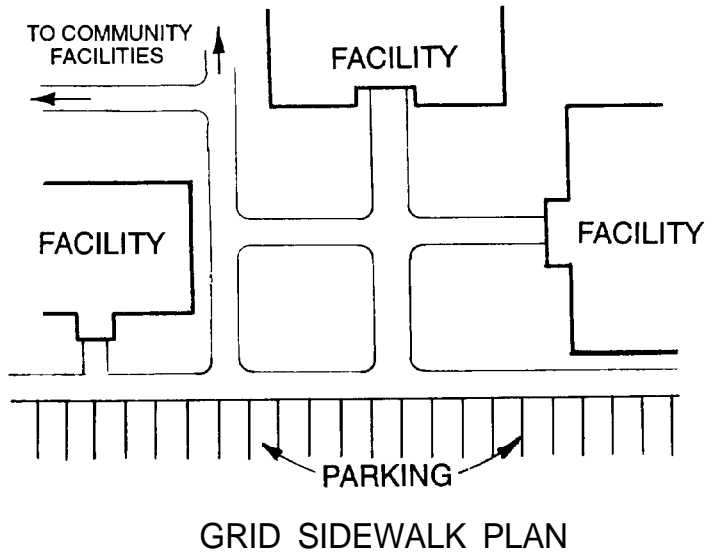

Figure 4-11. Alternative Sidewalk Schemes.

(b) Providing adequate space for people to concentrate outside of the pedestrian traffic flow.

(c) Locating areas for people to sit on the edge or outside of the pedestrian flow.

(d) Providing both shaded and sunny areas for people to congregate or sit.

(4) *Troop Formation Areas.* Installations with training facilities require walkways for troops marching in formation between classrooms, barracks, dining halls and parade grounds. These walkways should be wide enough to accommodate personnel walking four abreast. They should be hard-surface.

4-4. Grading.

a. *General.* Existing and proposed topography on site can serve many purposes including the following:

- (1) Emphasizing the prominence of facilities.
- (2) Secluding and sheltering facilities.
- (3) Helping to direct vehicular and pedestrian flows.
- (4) Managing site runoff.
- (5) Screening undesirable views or activities.
- (6) Creating a more interesting natural character.

b. *Standard Desirable Slopes.* Grading should maintain existing topography while recognizing standard gradients for various functions and activities. Table 4-1 provides standard desirable slopes for various land uses.

Table 4-1. Standard Desirable Slopes

Area Title	Maximum	Minimum
Lawn Areas	20%	1.0%
Playing Fields	4%	1.0%
Swales	10%	1.0%
Grass Banks	3:1 slope	
Ground Cover Banks	2:1 slope	
Courtyards and Entryways	2%	1.0%
Sidewalks	12%	0.5%
Barrier-Free Walks	5%	0.5%
Barrier-Free Ramps	8%	5.0%
Parking Areas	5%	1.0%
Roads and Drives	8%	0.5%

c. *Buildings.*

(1) *Siting.* Building orientation may be influenced by existing topography as well as the solar conditions determined in the solar study. Generally, the best orientation for buildings is parallel to slope. Buildings may also be located with their long axis perpendicular to grade. Even on moder-

ate slopes, this usually requires some terracing as illustrated in figure 4-12. Slab-on-grade is the most economical and, therefore, predominant building type, especially on flat sites. To balance cut and fill, these structures are often sited diagonally to the slope. Figure 4-13 illustrates the following building types which respond to steeper topographic situations.

(a) Fall-away structures locate the front of the building at one elevation, lower the grade down the sides, and locate the back of the building at a lower elevation. Fall-away buildings can be used on grades ranging from 5 to 10%.

(b) Cantilevered buildings allow existing grade to remain substantially unaltered while the building is suspended in air, supported by a vertical structure installed into the substrate. Cantilevered buildings can be used on extremely steep slopes, up to about 18%.

(c) Earth-sheltered buildings use existing or created slopes or berms to insulate the structure.

(2) *Floor Elevations.* Finished or first floor elevations of buildings will be set a minimum six inches above adjacent outdoor grade. The finished floor elevation will be set to provide positive drainage around the entire perimeter of the building. The correct setting of this elevation is critical to a good grading plan. The building must not be placed too low in relation to the rest of the site. Where outdoor entrances (e.g., basement exits), occur below finished elevation, additional provisions, such as drain inlets, will be made to provide drainage. Access and utility service should also be considered when setting the finished floor elevation.

(3) *Outside Finished Grade.* Outside finished grade should normally slope away from the building at a minimum five percent slope for approximately 10'. Where topography is too steep or space between buildings is too limited to maintain such a large area around the building, the slope of the outside finished grade can be increased. Additional drainage structures, such as yard inlets, will be provided.

d. *Circulation.* Grading for vehicular routes, pedestrian routes, and parking areas should respond to existing topography.

(1) *Vehicular Circulation.* Roads and drives should be laid out to traverse the topography as closely as possible to existing grade, within the standard grade limits. This reduces the amount of earthwork. Maximum grades are determined by the types of vehicles using the road and its design speed. Maximum grades are influenced by local weather conditions and practice. To the extent possible, the profile of a road or drive should

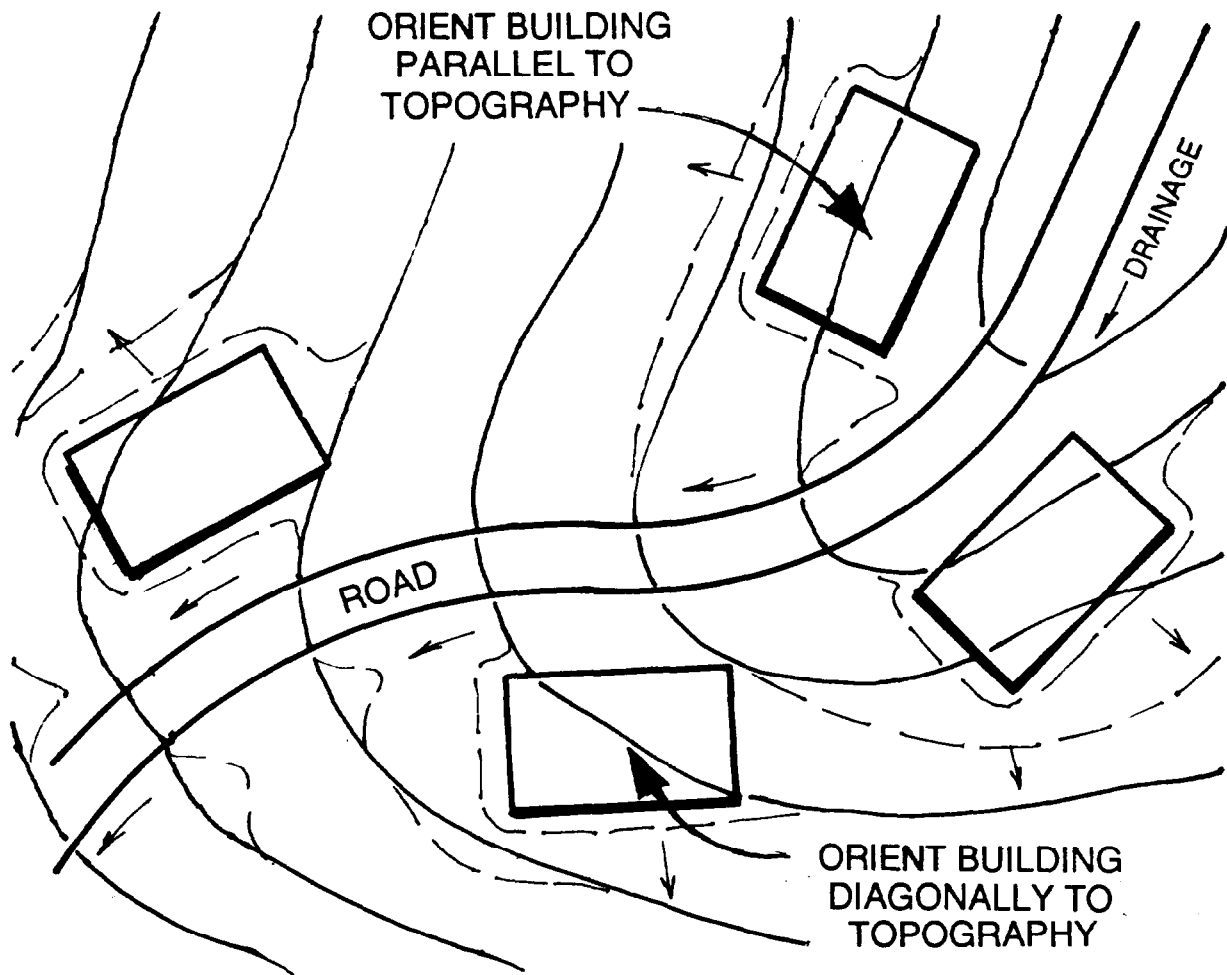

Figure 4-12. Building Orientation to Topography.

maintain a smooth grade line with gradual changes. Vertical curves should be sympathetic to and balance the severity of horizontal curves. On up or down slopes, particularly at intersections, sufficient flattening of the vertical curve should be provided to allow adequate sight distance and to avoid bumps at the crest or hidden dips. TM 5-822-2 provides additional guidance on the design of roads. Good grading for vehicular circulation should:

(a) Relate the roadway profile as closely as possible to existing topography.

(b) Allow adequate vertical and horizontal sight distances.

(c) Provide safe and smooth intersections.

(2) **Parking Areas.** A relatively constant grade should be maintained across parking areas. Slight changes in the slope interval should be made at intersections to provide a gradual transition into the main traffic flow. Changes may also be made at interior and exterior corners to direct or collect runoff. For areas laid out for 90-degree parking, 5% is the maximum desirable grade along the

aisles and 1.5% for the transverse slope. For areas laid out for 60- and 45-degree parking, 5% is the maximum desirable grade along the aisles with 1% for the transverse slope. Steeper grades create problems with opening and closing car doors and increase the potential of cars rolling.

(3) **Sidewalks.** Gradients for sidewalks can range from 0.5% to 15%. Gradients depend upon the quantity and types of pedestrians, the width of the pathway, and the surface. The normal minimum grade is 1 to 2%. Entrance areas or courtyards require a slightly steeper grade to ensure that runoff moves rapidly away from doors as well as locations where people sit or stand. Long, vertical climbs should be broken by short spans. The spans should continue upward movement at a gentler grade to reduce exertion. Ramps and steps can access steeper topography (where grades are greater than 5%) and minimize regrading. TM 5-822-2 provides additional guidance on grading walks. Grades are critical to barrier-free accessibility. Careful thought is needed to make all facilities, not just buildings, accessible. "FED STD



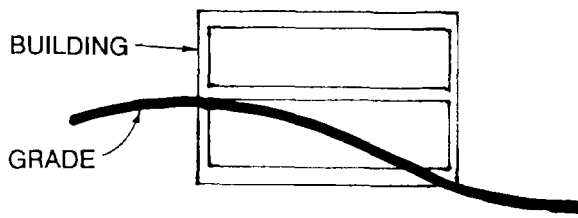

FALL AWAY BUILDINGS

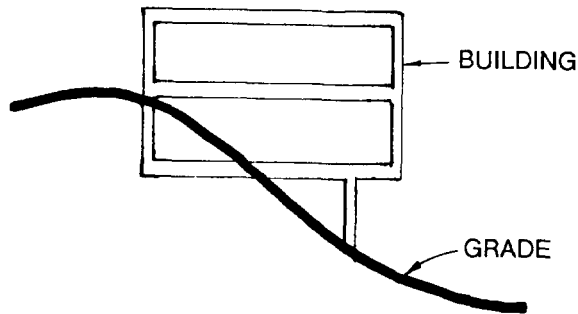

CANTILEVER OR STRUCTURED BUILDINGS

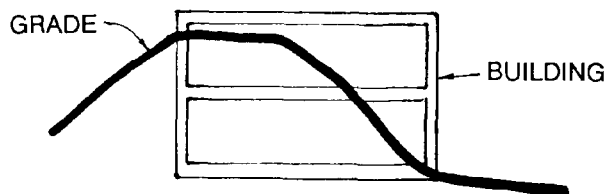

EARTH SHELTERED BUILDINGS

Figure 4-13. Topographically Responsive Building Types.

795" provides guidance on accessibility requirements. Sensitive site grading minimizes the need for architectural ramping into buildings. Such ramping creates additional costs and a less aesthetic appearance.

*e. Balance of Cut and Fill.* Site design should balance the quantity of cut and fill. Balancing cut and fill creates a more pleasing transition of the regraded areas into the natural site. It minimizes the costs of hauling in additional fill or removing and disposing of extra cut. Figure 4-14 illustrates balancing cut and fill.

*f. Transition.* Figure 4-15 illustrates how grading should be designed to accommodate proposed facilities and to effect a smooth transition from the regraded area to the existing topography. When berms or mounds are introduced into the landscape, they should give the appearance of rising

from the existing topography as opposed to being placed on the topography. The area for berms and mounds should be large enough to allow transition from the base plane, moderate slope on the sides, and room for a rounded crest. Slopes regarded to accommodate various facility requirements should:

- (1) Be sympathetic to the existing natural grade.
- (2) Return to the natural grade gradually, not abruptly.
- (3) Have their edges at the top and bottom rounded into the existing grade.

*g. Spot Elevations.* Spot elevations are important to ensure that the grading plan accomplishes its objectives. Early grading plans often show arrows to indicate desired drainage paths, but only adequate spot elevations actually determine that water will move where desired. Spot elevations are often not considered until the detailed grading documents. Early consideration should be given to spot elevations for such critical locations as doorways, intersections at access roads and drives, parking lot corners, and existing trees to be saved.

#### 4-5. Drainage.

Drainage design should create controlled conditions that help move rainfall away from facilities and activities as quickly as possible. It should maintain the rate of infiltration that exists on site. The guidelines discussed below are general in nature and refer to on-site drainage design. There is an increasing degree of civilian regulatory review of military site design projects, particularly with regard to stormwater management and sediment and erosion control for both on-site and surrounding environs. The specific criteria developed by local and state agencies should be consulted. The civil engineer and/or hydrologist on the design team should address drainage problems and solutions. TM 5-820-4 provides additional guidance on drainage design.

*a. Impervious Surface.* The placement of facilities on site automatically changes drainage conditions because it increases impervious surface. This increases the volume and velocity of water to be managed. Site design should avoid adding any unnecessary impervious surface. Generally, drainage should be evenly diffused across the site and not concentrated at one point. The site may need to be divided into more than one drainage basin or area of control to accomplish this. Where a large expanse of impervious surface (e.g., a parking lot) is required, the expanse may be broken up into smaller areas. This helps control the runoff, reduce the size of necessary drainage structures (e.g., catch basins), and avoid drainage system back-up.

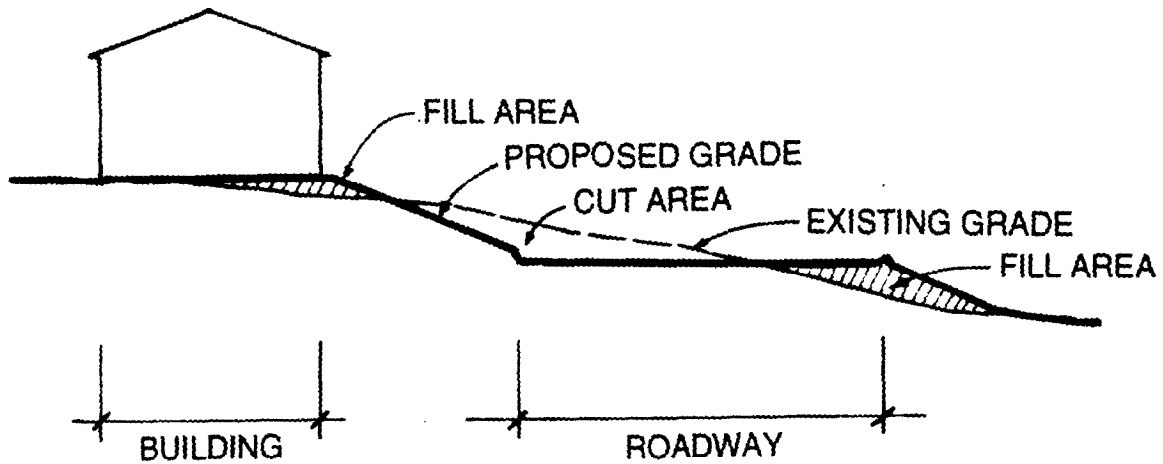

Figure 4-14. Balancing and Fill.

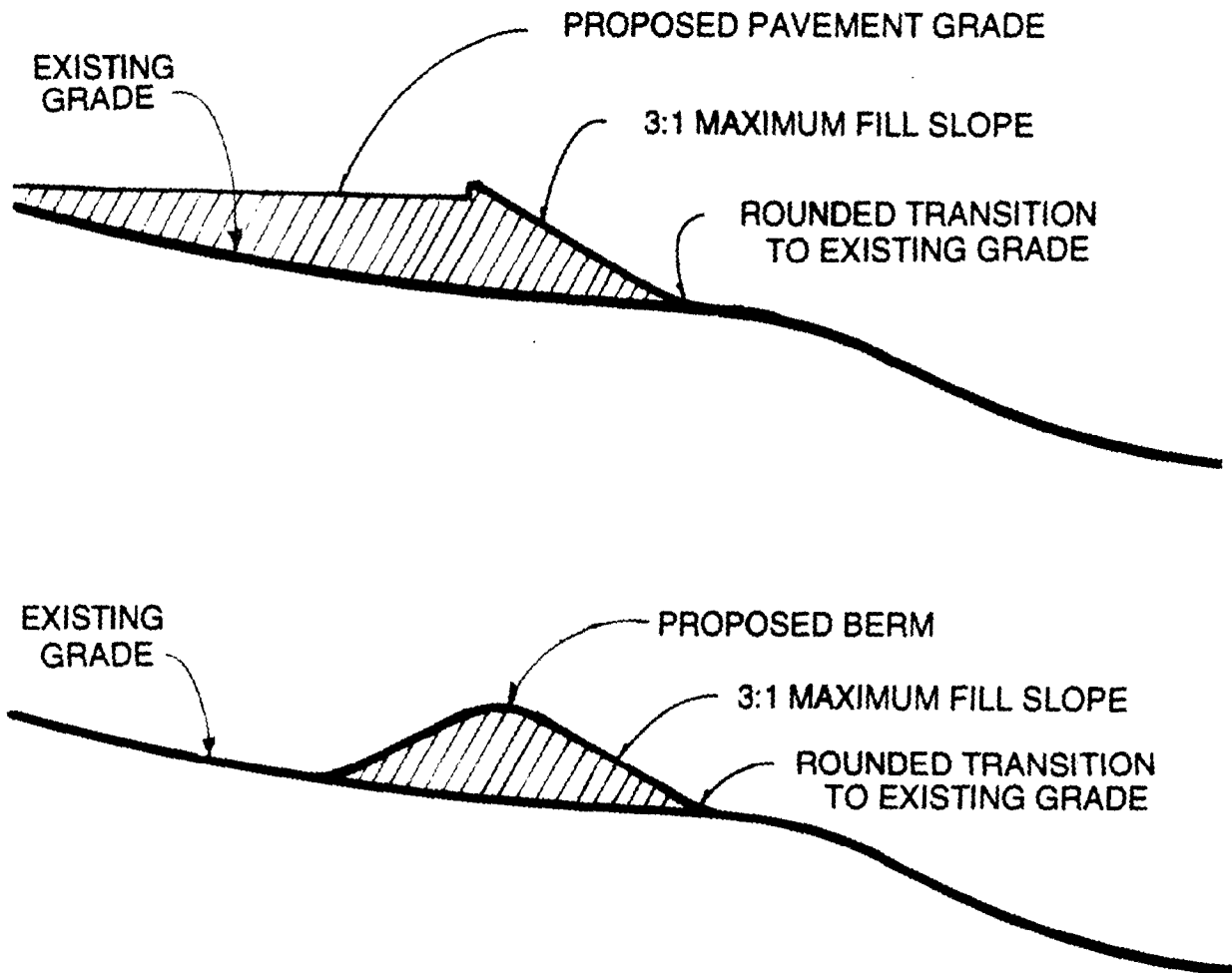

Figure 4-15. Transitioning Regraded Areas.

Islands and medians, as well as curb and gutter, can be used to control drainage within parking areas. Porous surfaces which allow limited infiltration (e.g., gravel or lock-block) should be considered.

*b. Grading.* Topography helps determine the amount, direction and rate of runoff. To the extent

existing contours can be retained, the existing drainage patterns can be maintained. Grading can be used to correct existing drainage problems. Where extremely steep slopes are contributing to rapid runoff, regrading with more moderate slopes can slow the velocity and achieve a more balanced infiltration rate.

c. *Positive Drainage.* The principles of positive drainage should be applied universally across the site. Figure 4-16 illustrates the following basic principles:

(1) Water should be moved away from structures.

(2) Water should not be allowed to pond at low points or in low areas.

(3) The finished floor elevations of buildings should be sufficiently high that if drainage structures are blocked, the water will not back up into the buildings.

d. *Drainage Control.* When drainage must be controlled, captured and redirected, both natural and mechanical methods can be used. Natural means are preferable because they are less expensive, require less maintenance, and fit more easily into the natural landscape. Swales and grassed ditches can move moderate amounts of runoff provided they observe minimum (1%) and maximum gradients. The maximum gradient is determined by the velocity of the flow and the erodibility of the soil. When a minimum slope on a grassed ditch is unattainable, paved ditches can be used on slopes as flat as 0.5%. When the quantity and speed of runoff is greater, the drainage channel can also be paved, or check dams or weirs can be introduced to slow the water's movement.

e. *Detention and Retention Ponds.* Detention ponds collect stormwater and detain it so that it can be released from the site through a control structure at a previously established rate of flow. Retention basins collect stormwater on site and retain it until it is able to infiltrate the ground or evaporate. Ponds are most commonly used during

construction when the lack of drainage systems and vegetative cover make it difficult to control stormwater flow. A pond can be converted into a permanent site feature and serve as a site amenity. Appropriate guidance for designing ponds should be obtained from local and state agencies. Figure 4-17 illustrates detention and retention ponds.

#### 4-6. Erosion Control.

Erosion occurs as the result of a lack of vegetative cover, excessively steep slopes, excessive runoff, or a combination of these factors. Erosion conditions can be improved by: reducing grades, using geotextiles, establishing or reestablishing vegetative cover, and introducing mechanical controls such as riprap and cribbing. Banks with steeper than 3:1 slopes are discouraged because they increase the rate of runoff and deter establishment of vegetative cover. If an area on site involves such steep grades, then, realistically, mechanical means of control, including retaining walls, should be explored in the original design. Otherwise, maintenance problems will persist and eventually begin to affect the site beyond the immediate problem area. Figure 4-18 illustrates methods of erosion control. The civil engineer and/or agronomist on the design team should address erosion problems and solutions.

#### 4-7. Climatological Conditions.

There are a variety of established techniques for mitigating or improving climatological conditions on site. TM 5-803-13 provides specific guidance on using plant material to deal with climatological

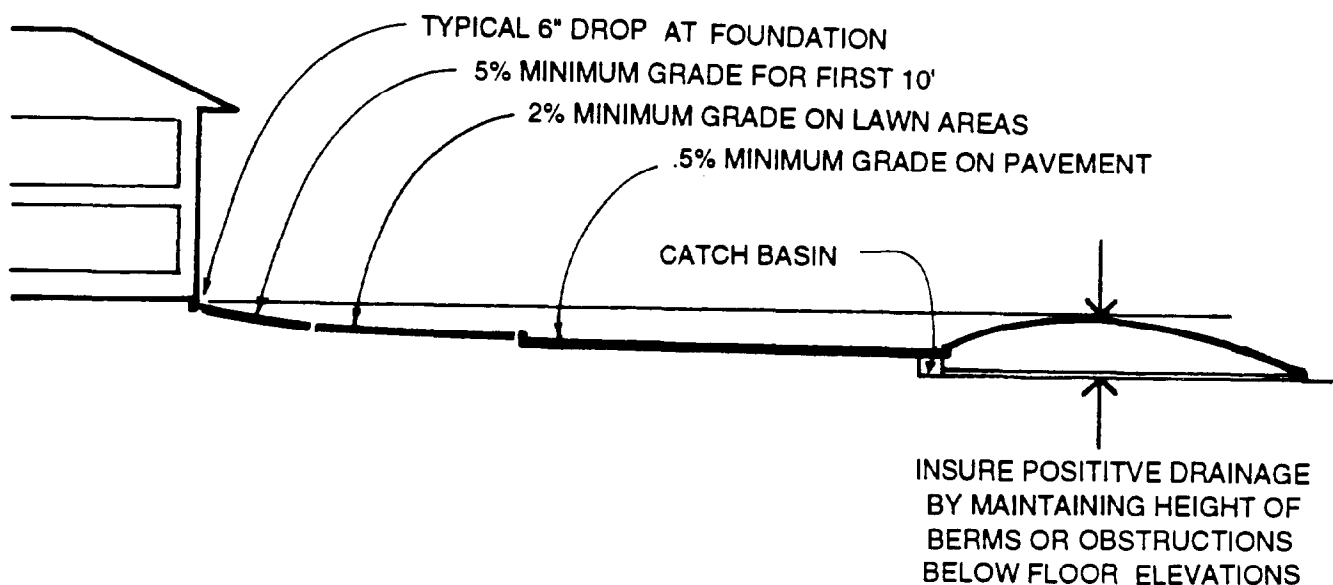

Figure 4-16. Principles of Positive Drainage.

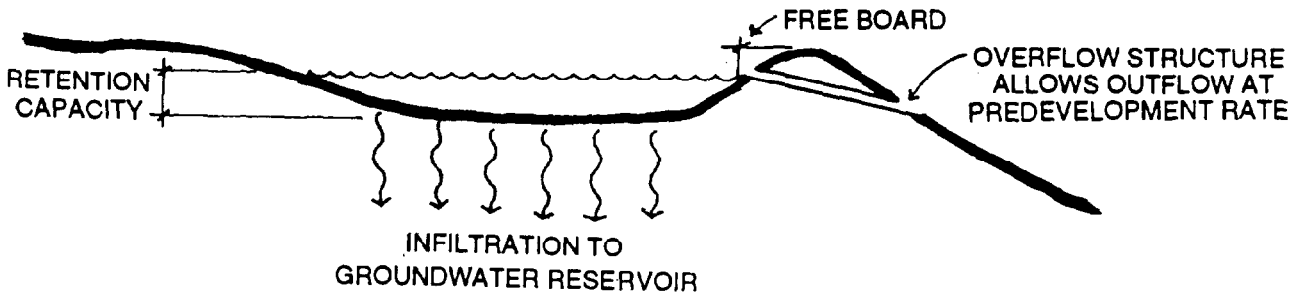
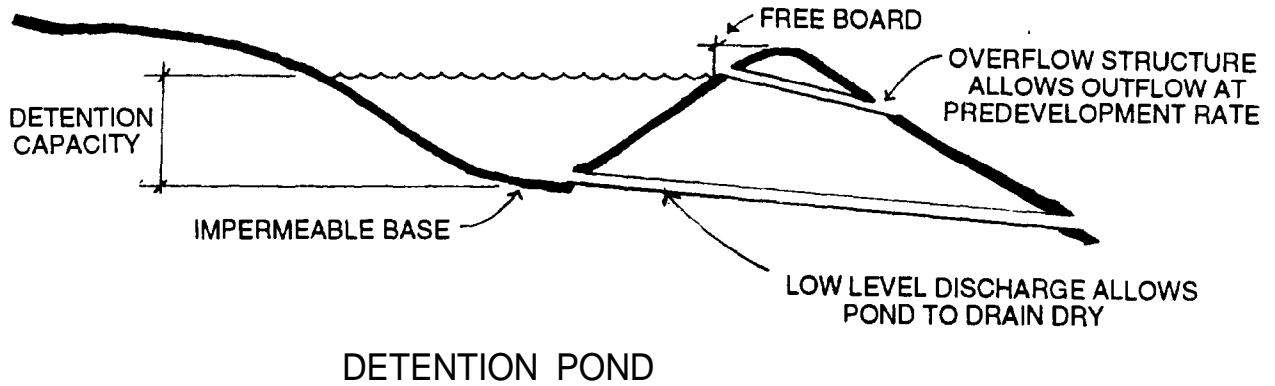

Figure 4-17 Detention and Retention Ponds.

variables. The principal components of control are architectural structures, building and pavement surfaces, topography, plant material, and water.

a. Temperature. Temperature on site is influenced by:

(1) *Building Walls*. Temperature can be increased by extending buildings and building walls

to create sun traps in the cool climate or in the temperate climate during fall and spring.

(2) *Surfaces and Colors*. Different surfaces and colors increase or decrease temperature on site by retaining more or less of the sun's rays. Table 4-2 gives some of the average temperatures produced by different surfaces.

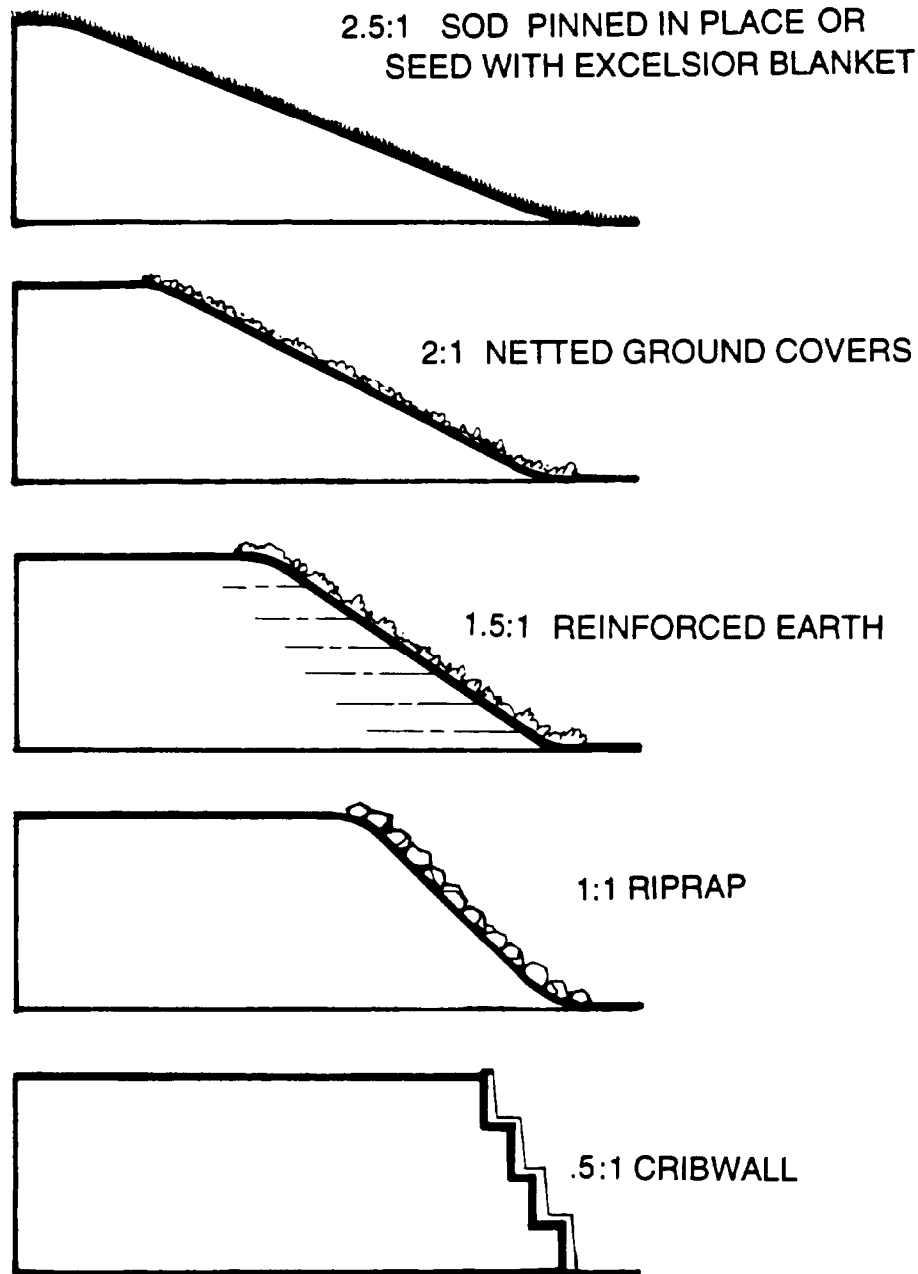

Figure 4-18. Methods of Erosion Control.

Table 4-2. Relative Surface Temperatures in Summer at Noon.

Side of Building	125 degrees reflected
Asphalt Road or Drive	125 degrees
Concrete Sidewalk	110 degrees
Unshaded Lawn	94 degrees
Shaded Lawn	88 degrees

b. *Wind.* Wind, to a large extent, determines the level of comfort which can be achieved in the cold or heat conditions found on site. In the cool climate or the temperate climate during winter, the wind chill factor can substantially lower the perceived temperature. Topography, vegetation, walls or fences can be used as windbreaks. In hot

climates and the temperate climate in summer, the goal is to maximize breezes by channelling them with topography, vegetation, walls or fences. Windbreaks can be used to minimize turbulence caused by undesirable winds.

c. *Snow.* Plant material can be used to reduce snow accumulation along walks, roads and the perimeters of parking lots and at building entrances.

4-8. Utilities.

Utility systems should minimize interruption of the natural site while meeting basic functional criteria and economizing on costs. Utilities should be placed underground to avoid conflicts with the

architectural character of the installation. Utility corridors should be used to minimize environmental disturbance and simplify maintenance. Corridors should be located as far as possible along a site's perimeter. Utility alignments should not cross a site diagonally or indiscriminately since this may necessitate future realignment of existing systems and increase the costs of future development. To simplify maintenance, utility lines should not be placed under paved areas. They may be located at the back of the roadway curb. It is extremely important to determine the potential for future expansion and to allow for upgrading the system when locating systems. The civil, sanitary, electrical, mechanical engineering and other members of the design team responsible for utilities should be consulted on questions of location and placement.

#### 4-9. Lighting.

Outdoor lighting allows such activities as driving and walking to continue at night under safe conditions. On most sites, only enough light to cover these functions is necessary. Where physical security is a concern, more lighting may be required. The electrical engineer on the design team should address lighting issues. Lighting should:

- a. Provide even coverage, avoiding areas of deep shadow between illuminated zones.
- b. Gradually increase and decrease along vehicular and pedestrian routes as traffic becomes more or less concentrated.
- c. Increase in areas of high concentration such as intersections, parking, drop-offs, steps and building entrances.
- d. Avoid light spillage into neighboring sites.
- e. Provide sufficient lighting to support visual surveillance or closed circuit television as required.

#### 4-10. Physical Security.

a. General. Site design for physical security should be developed to reduce vulnerabilities resulting from identified threats. A physical security engineer or specialist should address site design issues including:

- (1) Maintaining adequate distances from uncontrolled areas.
- (2) Limiting accessibility to the site and facilities.

(3) Maintaining adequate standoff distances between potential locations for bombs and facilities.

(4) Maintaining appropriate clear zones.

(5) Maximizing exposure on the site perimeter to allow discovery of unauthorized approaches.

(6) Minimizing exposure of personnel around the facility.

(7) Blocking sightlines from vantage points.

(8) Siting and orienting buildings to minimize adverse exposure.

(9) Providing barriers to unauthorized pedestrian and vehicle movement.

(10) Providing barriers to mitigate weapons and explosives effects.

(11) Providing exterior electronic security systems.

b. *Vehicular Access.* Where an identified threat indicates that vehicle control is necessary, access may be limited to a single or as few as possible entry control points. Vehicle control at entry control points may require a gate and/or gatehouse, vehicle barriers, or a combination of the two. Adequate room must be provided at the entry control point to permit search of vehicles without interfering with normal traffic flow. Both horizontal and vertical alignment of drives can be used to reduce speed at the entry control point. This allows more reaction time to breaches of security and may reduce the size of vehicle barriers required to stop a vehicle. The reaction time and the location of the barrier also affect whether or not there will be sufficient time to deploy a barrier in response to a threat. Access drives and parking areas may need to be separated from facilities by sufficient distance to mitigate the threat of vehicle bombs.

c. *Site Features.* In an area where there is an identified threat, topography and vegetation should not be placed on the site perimeter where they will obstruct views of surrounding areas. Topography, vegetation, water and walls can be used around a facility to slow movement towards exposed building faces, to limit exposure of personnel moving between buildings and parking areas, and to block sightlines from vantage points. Perimeter walls may be used to mitigate blast effects from an explosion but they must be carefully located with respect to the protected facility. If the wall is too far away from the facility, it may provide no benefit. If the wall is too close, it may compound the blast effects. Structural engineers will be consulted when considering the application of perimeter blast walls.

## CHAPTER 5

### SITE DESIGN

---

#### 5-1. General.

##### Site design:

a. Locates primary and support facilities on site and addresses both positive and negative site concerns which will impact development through the preparation of the sketch site plan.

b. Details facilities on site and develops specific methods for dealing with site concerns through the concept site plan.

#### 5-2. Concept Development.

Site design begins by continuing concept development through the preparation of sketch site plans and concept site plans. In each step, alternatives may be explored and evaluated to arrive at the optimal design. The site design guidelines discussed in chapter 4 should form the basis of the evaluation. The level of detail which is prepared for each step will depend on the size and complexity of the project, but the general procedures listed below should be followed for every design.

#### 5-3. Sketch Site Plan.

The sketch plan refines the preferred spatial relationships diagram. The sketch site plan shows the initial design of the facilities and site at scale. It begins to address the site in detail. Buildings, roads, parking areas, and other structural elements assume form and definition in relation to the site elements. The sketch site plan is still geographically loose, usually free-hand, but is drawn to scale.

a. *Principal Considerations.* The sketch site plan should address the following principal considerations:

(1) *Buildings.* The plan should:

(a) Define recognizable shapes for facilities.

(b) Clearly identify entrances.

(c) Establish a building orientation which addresses energy conservation needs (based on a solar study), access to other facilities, and visibility.

(d) Mass buildings to define outdoor space when there is more than one building or a new building is introduced into an area with other existing structures.

(2) *Vehicular Circulation and Parking.* The plan should:

(a) Provide the general location of the access drive.

(b) Provide the location of drives for emergency and service vehicles.

(c) Locate required gates or vehicle search areas.

(d) Separate vehicular circulation and parking.

(e) Locate parking areas and orient them towards facilities.

(f) Locate drop-off areas and/or waiting areas for buses.

(3) *Pedestrian Circulation.* The plan should:

(a) Establish pedestrian paths along anticipated desire lines.

(b) Identify expected areas of pedestrian concentration.

(c) Suggest methods of handling these areas, from widening of paths to development of courtyards.

(4) *Grading and Drainage.* The plan should:

(a) Set the initial finished floor elevations for all buildings.

(b) Identify means other than grading necessary to maintain positive drainage around the building(s).

(c) Determine approximate grades for the drives and parking areas.

(d) Identify critical elevations (e.g., low points which could produce ponding or elevations on existing trees which are to be saved.)

(e) Review existing storm drainage, including areas of sheet flow and swales, to determine if it can be maintained.

(f) Suggest methods for handling drainage if the site cannot accommodate the increased runoff.

(g) Delineate areas requiring erosion control.

(5) *Energy Conservation.* The plan should:

(a) Note climatic conditions which can be improved or enhanced.

(b) Identify potential locations for wind-breaks, shade walls, etc.

(6) *Utilities.* The plan should:

(a) Identify access points and connecting routes to existing utilities.

(b) Establish requirements for upgrading existing systems.

(7) *Physical Security.* The plan should:

(a) Locate special physical security requirements (e.g., search areas and the serpentine layout of access drives.)

(b) Roughly locate additional measures (e.g., walls or fences.)

(8) *Planting*. The plan should:

(a) Locate vegetative massing and identify its proposed functions.

(b) Locate existing plant material to be preserved.

(9) *Outdoor Space*. The plan should:

(a) Begin to provide scale and definition for outdoor spaces.

(b) Indicate the functions outdoor space will accommodate (e.g., formation grounds, travel zones, or active and passive recreation.)

(c) Size and locate facilities for active recreation (e.g., tennis or basketball courts.)

(10) *Site Amenities*. The plan should identify any critical areas which need special design consideration (e.g., site entries, courtyards or picnic areas.)

*b. Sketch Site Plan for a Battalion Complex.*

Figure 5-1 illustrates a sketch site plan for a battalion complex. It shows the initial design of the preferred alternative described in chapter 4. It addresses the concerns which were judged significant to the project in that alternative. The plan locates the buildings in an arrangement which, together with the primary vehicular and pedestrian circulation, focuses on the large open space of the formation grounds. A smaller, more enclosed private space is developed in the ell of each of the barracks units. This helps create a desirable residential character within the complex. The barracks' access drive and turnaround create a formal entrance into the complex. By focusing on the formation grounds, the turnaround visually and physically presents the complex. The barracks' access drive and turnaround allows service vehicles to enter and exit the site without moving through the parking areas. Service for the battalion headquarters building is maintained on the perimeter of its parking area. Service vehicles will not have to travel through parking aisles. Pedestrian circulation within the complex provides easy access to and from parking areas and to the game courts. There is convenient movement between the various buildings. Instead of crossing the formation grounds, the sidewalk system is used to define the area. Grading on site is designed to direct the principal drainage flow from the barracks and their parking lots toward the existing drainage culvert. The parking area behind the battalion headquarters is drained towards the existing storm system located along the access road. An extensive vegetative screen is developed between the complex and the motor pool area. Game courts are located just north of the complex where they

can conveniently serve future expansion needs. At the intersection of the access road and barracks' access drive, an area is designated for a sign and landscaping to identify the complex. The landscaping will also serve to screen the parking area behind it.

5-4. Concept Site Plan.

The concept site plan further refines and details the sketch site plan. The concept site plan is a hardline plan, at scale. It provides accurate locations, dimensions and elevations for facilities and site improvements. The level of detail achieved depends upon the level of detail supplied concerning the architecture, utilities and other elements affecting the site. The concept plan cannot resolve all potential problems, but it does attempt to recognize them. The sooner consideration is given to all factors affecting site development, the better. The concept site plan can help make design team members aware of the impacts of the individual designs before those designs become too entrenched and difficult to change. The concept site plan provides sufficient detail to serve as the basis for construction documents for the project. The concept site plan does not resolve all site problems but indicates, at a minimum, how they will be addressed and their cost implications.

*a. Principal Considerations.* The concept site plan should address the following principal considerations:

(1) *Construction Lines*. The plan should

(a) Locate critical construction lines (e.g., setbacks, easements or building spacing.)

(b) Ensure that facilities do not encroach upon any of these boundaries or zones.

(2) *Buildings*. The plan should:

(a) More precisely define the location of the building footprint.

(b) Identify all entrances, including fire exits.

(c) Further refine the outdoor space between facilities.

(3) *Vehicular Circulation and Parking*. The plan should:

(a) Provide further definition of access, service and emergency drives.

(b) Provide further definition of parking areas.

(c) Indicate appropriate turning radii to be used throughout the site.

(d) Delineate parking spaces, including barrier-free spaces, to assure the proper count.

(e) Define parking islands and medians.

(f) Further refine gate and drop-off areas to ensure that they function properly.



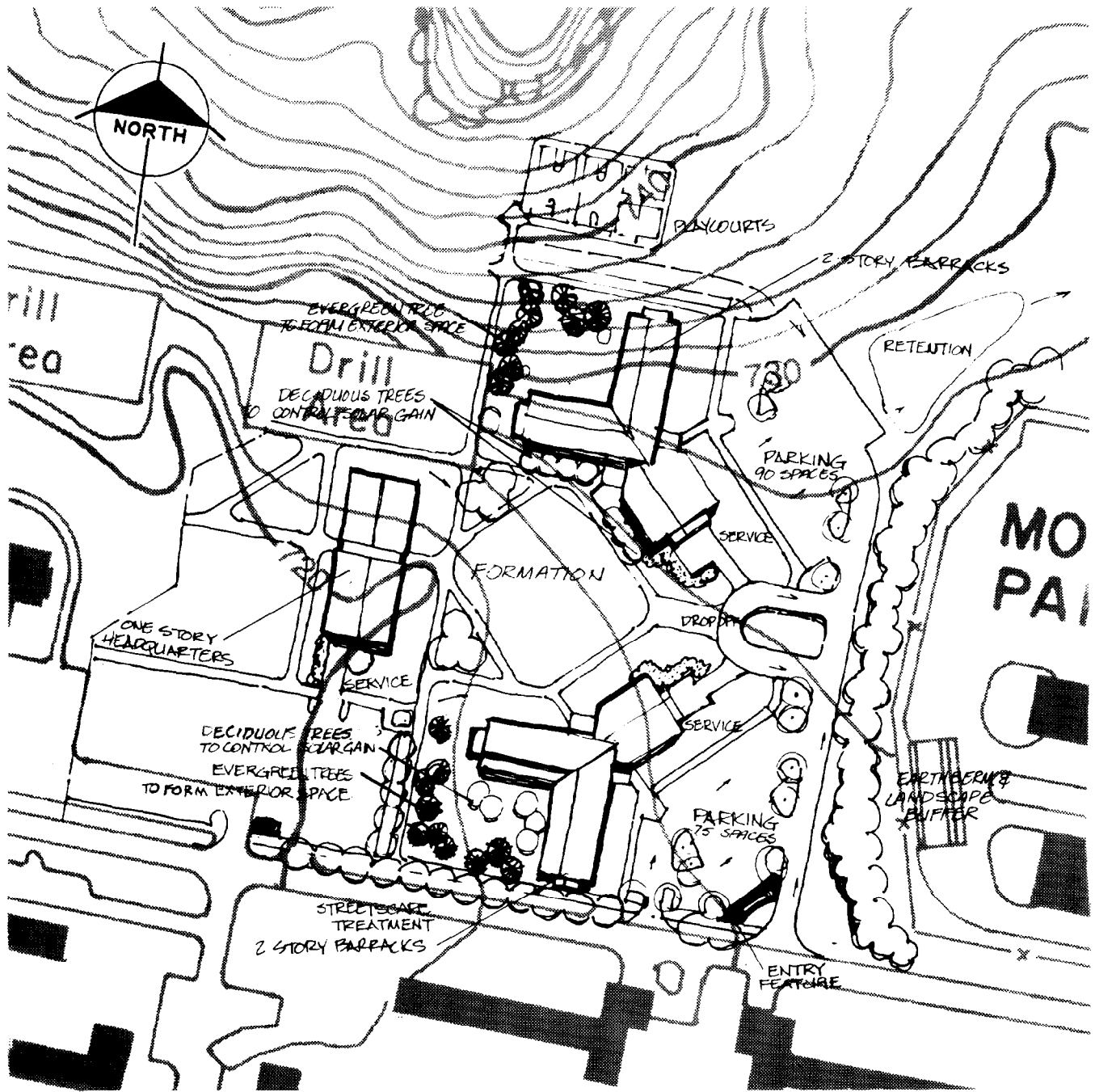

Figure 5-1. Sketch Site Plan for a Battalion Complex.

(g) Ensure that sufficient turn-around room is provided for service and emergency vehicle routes.

(h) Locate dumpster pads.

(4) *Pedestrian Circulation.* The plan should:

(a) Further refine pedestrian circulation to assure clear and convenient flow of pedestrian movement.

(b) Assure barrier-free accessibility between buildings and from barrier-free parking spaces to at least one building entrance.

(c) Note the location of any necessary ramps.

(d) Identify means of using topography and plant material to help direct pedestrian flow.

(5) *Grading and Drainage.* The plan should:

(a) Establish an overall grading concept for the site, showing proposed contours and critical elevations on roadways, in parking lots, on walkways and at building entrances.

(b) Define and locate stormwater management areas on site.

(c) Determine if curb or curb and gutter will be used to control stormwater.

(d) Locate and indicate critical elevations for other drainage facilities such as swales, paved ditches, yard drains and underground systems.

(e) Determine the need for retention or detention ponds and locate them if they are necessary.

(f) Locate and provide critical elevations for structures such as retaining walls or steps which are needed to facilitate grading conditions.

(g) Indicate methods for dealing with erosion or sediment control problems.

(6) *Energy Conservation.* The plan should further delineate means for dealing with climatic conditions.

(7) *Utilities.* The plan should:

(a) Further define the locations of utility lines.

(b) Further identify access points from the supply lines and entry points into buildings.

(c) Ensure that utility lines are not located under proposed paved areas.

(d) Ensure that utility lines are located logically for future expansion.

(8) *Lighting.* The plan should:

(a) Develop an initial lighting coverage scheme.

(b) Identify areas requiring higher lighting levels or special lighting.

(9) *Physical Security.* The plan should further refine proposed security measures.

(10) *Landscape Plantings.* The plan should:

(a) Further refine the planting scheme by broadly describing the types of vegetative massing (e.g., large deciduous trees, flowering trees, evergreen trees, shrub beds, etc.).

(b) Identify lawn areas.

(11) *Outdoor Spaces and Site Amenities.* The plan should:

(a) Further refine the design for outdoor areas.

(b) Give preliminary consideration to the location of site features (e.g., lighting, signs, fountains and site furniture.)

*b. Concept Site Plan for a Battalion Complex.* Figure 5-2 illustrates a concept site plan for a battalion complex. This plan further refines and details the sketch site plan. A more formal entry has been suggested for both the drop-off area and the battalion headquarters building. The parking areas are more fully articulated and include handicapped spaces. Landscaped medians have been added to break up the expanse of pavement. Pedestrian circulation eliminates the sidewalks which previously ran along the parking lots and

concentrates pick-up of pedestrian movement at the turnaround. Finished floor elevations have been set for the buildings. The grading concept allows barrier-free accessibility across the site. Grading will drain the barracks' parking lots into inlets which can be piped to the existing culvert. An initial scheme for lighting coverage has also been developed. The planting scheme has been further refined to: develop the sidewalk islands; substantially screen the barracks' service areas; contribute to the aesthetic quality of the open area around the formation grounds; and reduce solar gain on the south sides of the barracks' buildings.

#### 5-5. Confined Sites.

Confined sites are located in areas which are already densely developed. They present critical situations on many installations. Confined sites create interface difficulties with the surrounding area. Their constricted sizes and the more complex surrounding conditions (e.g., existing structures, circulation and utilities) place physical and cost limitations on their development. Confined sites should be approached with the same planning and design process as any other site. Confined sites raise site planning issues because candidate sites may not be appropriate to the development for which they have been selected. Site analysis should determine the suitability of confined sites and document the reasons for and against project development. Confined sites present site design problems which may require more flexibility and creativity in the solutions. The planning and design challenges associated with development of confined sites are discussed below. The description of an Information Systems Facility project addresses some of the common issues found on confined sites.

*a. Site Analysis.* Because of their locations, confined sites tend to be more greatly impacted by off-site and man-made conditions. They demand thorough and sensitive site analysis since the sites are greatly constricted from the beginning. Problems related to confined sites include the following:

(1) Inadequate size-not necessarily for the primary facility, but for support facilities.

(2) No room for future expansion.

(3) Location in the midst of incompatible land uses which might be negatively impacted by a proposed facility.

(4) Inadequate access for proposed vehicular circulation.

(5) Creation of traffic problems (e.g., congestion or accident incidence) by increasing trips to and from the site on inadequate access roads.

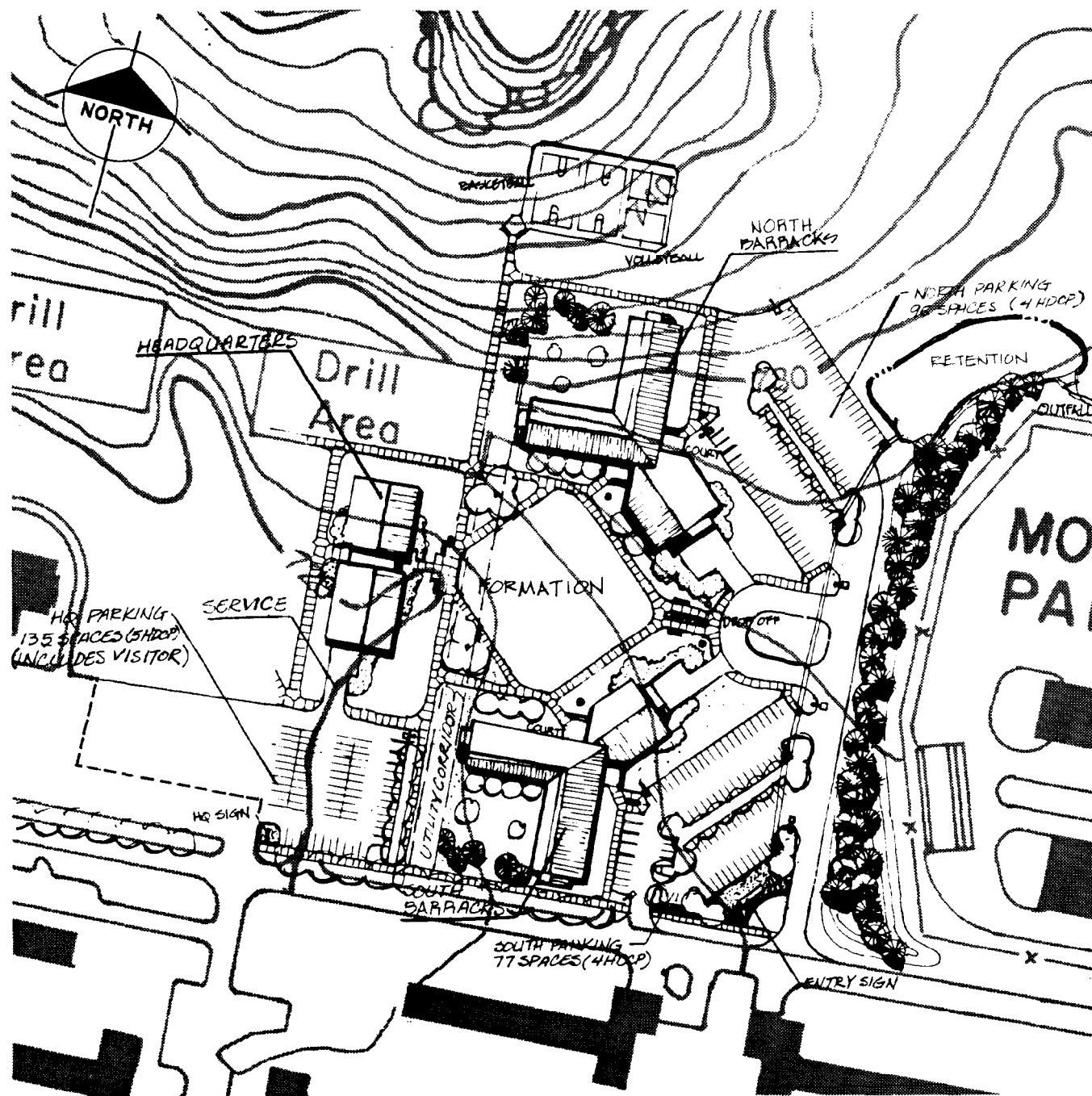

Figure 5-2. Concept Site Plan for a Battalion Complex.

(6) Encroachment upon or obliteration of previous uses for adjacent facilities (e.g., parking.)

(7) Expensive relocation or difficult siting of existing utilities.

b. *Concept Development.* Concept development uses the same procedures, or courses of action, no matter how small or large, simple or complex a project is. The same steps need to be taken and the fundamental issues addressed. A confined site is usually small and constricted. It may have room for the addition of only one building. On the surface, this may appear to be a simpler problem

with a single solution. However, there are still many variables on site (e.g., circulation, grading, utilities, etc.). These variables need to be addressed in the same methodical manner as for larger and more complex sites. On confined sites, there is literally less room for error. It can be more difficult to control problems (e.g., drainage or parking) on the site and prevent them from spilling over into the surrounding area. Some of the most common challenges on confined sites are:

(1) Maintaining setbacks and responding creatively to space constraints.

- (2) Relating new facilities to existing facilities visually and physically.
- (3) Providing access and parking.
- (4) Managing stormwater runoff.
- (5) Providing new utilities and avoiding relocation of existing utilities.
- (6) Conserving the natural environment.

c. *Planning and Design for an Information Systems Facility on a Confined Site.* An information systems facility consists of one large building with associated equipment storage, service and parking areas. The facility requires a security fence and substantial screening of the equipment storage and loading dock areas.

(1) *Site Analysis.* Figure 5-3 illustrates a site opportunities and constraints plan for an Information Systems Facility. The candidate site is a confined site and presents some of the typical problems including the following:

- (a) Irregular site configuration closely confined by surrounding facilities.
- (b) Setbacks defined by existing buildings.
- (c) High visibility to surrounding facilities.
- (d) Potential for traffic problems and confusion at entrances to the access road.

(e) Limited area for managing drainage on site.

(2) *Spatial Relationships Diagrams.*

(a) *Alternative 1.* Figure 5-4 shows the building in the prime development area identified on the site opportunities and constraints plan. The diagram simplifies vehicular circulation by sharing access with the existing bowling center. It locates the proposed parking area between the two existing lots to take advantage of existing entrances and exits. Another small parking lot is provided between the facility and the bowling center. A drop-off area is provided. Movement of service vehicles in and out of the site is accomplished on the through access drive. This decreases the space required for the loading dock. Placing the equipment storage to the side of the facility provides additional security. However, it locates an unattractive area of the facility next to the surrounding buildings.

(b) *Alternative 2.* Figure 5-5 also shows the building in the prime development area. However,

the building location establishes a better visual relationship with surrounding buildings and the access road. The site has its own entrance. This avoids confusion with the traffic into the bowling center and provides a more convenient drop-off. Service vehicle movement is direct and entirely separated from the bowling center traffic. Parking is concentrated in one lot which does feed off the existing circulation established by the bowling center. The equipment storage is placed between the two existing lots. It is still heavily screened. This location avoids the massive expanse of parking shown in alternative I. It places the storage in a more remote and easily screened section of the site, away from surrounding buildings.

(3) *Sketch Site Plan.* Figure 5-6 illustrates the initial design for alternative 2 which was judged to be the better alternative. The sketch site plan not only locates the building but also determines its relationship to the surrounding buildings. The plan places the vehicular circulation and parking to ensure that they will fit comfortably and meet the requirements for size and maneuverability. The plan articulates the limited pedestrian circulation and provides for pedestrian flow across the street to the athletic facilities. The plan locates the security fence. It also locates the planting necessary to screen both the equipment storage and loading dock. Grading for the site is minimal but must provide sufficient slope to carry drainage to the existing culvert across the access road. The plan identifies initial routes and access points to existing utilities.

(4) *Concept Site Plan.* Figure 5-7 further refines the sketch site plan. It ensures that all setback and spacing requirements around the building have been met. The plan suggests establishment of street trees along the access road and continuing this landscape treatment around the parking area to mitigate its impact. It sets the finished floor elevation for the building necessary to accommodate access to existing utility systems. It also establishes the location of the high point on the access drive necessary to ensure positive drainage on the site. The locations of inlets have been established so that stormwater can be piped off site to the existing culvert. An initial scheme for lighting coverage on site has also been developed.

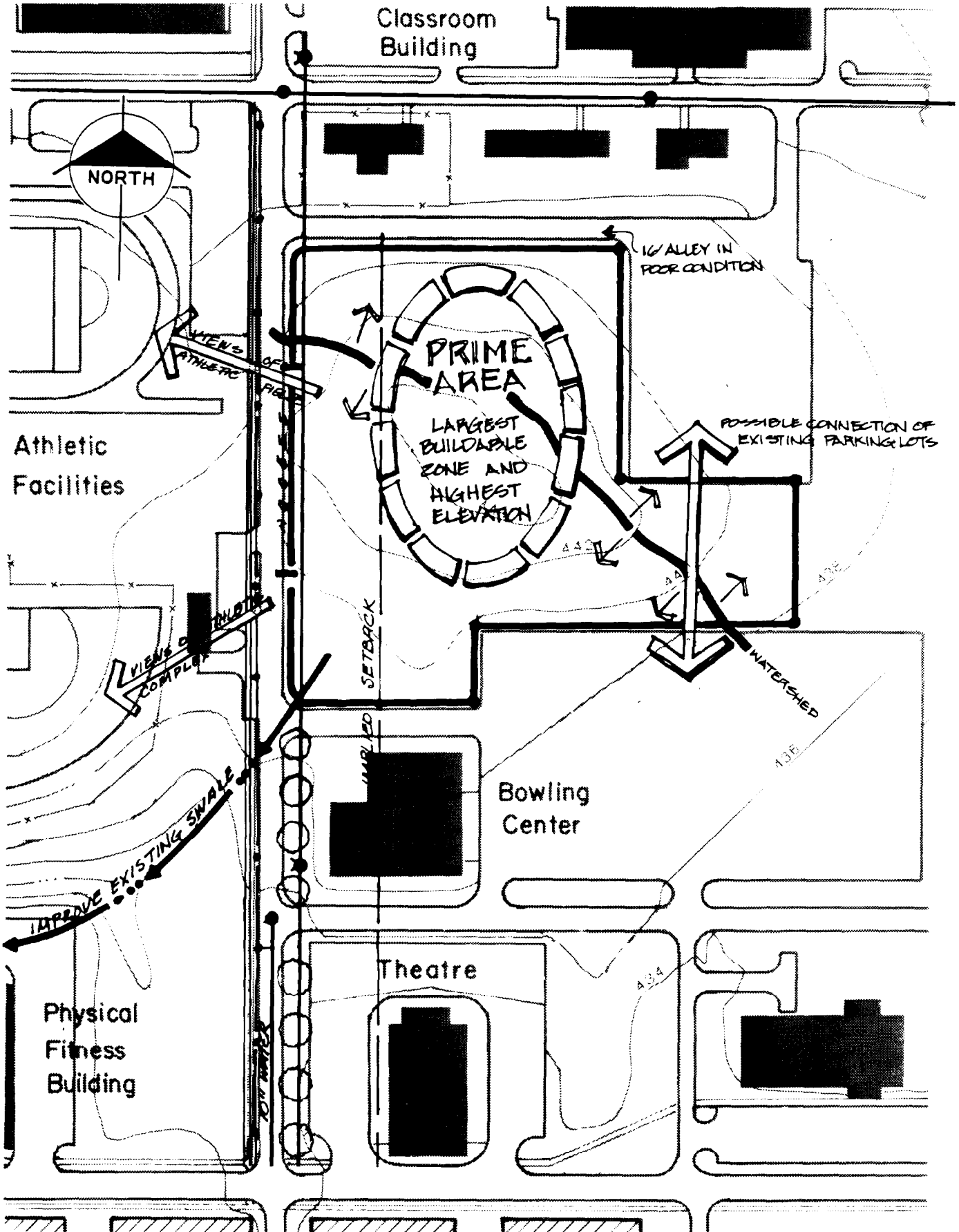

Figure 5-3. Site Opportunities and Constraints Plan for a Confined Site.

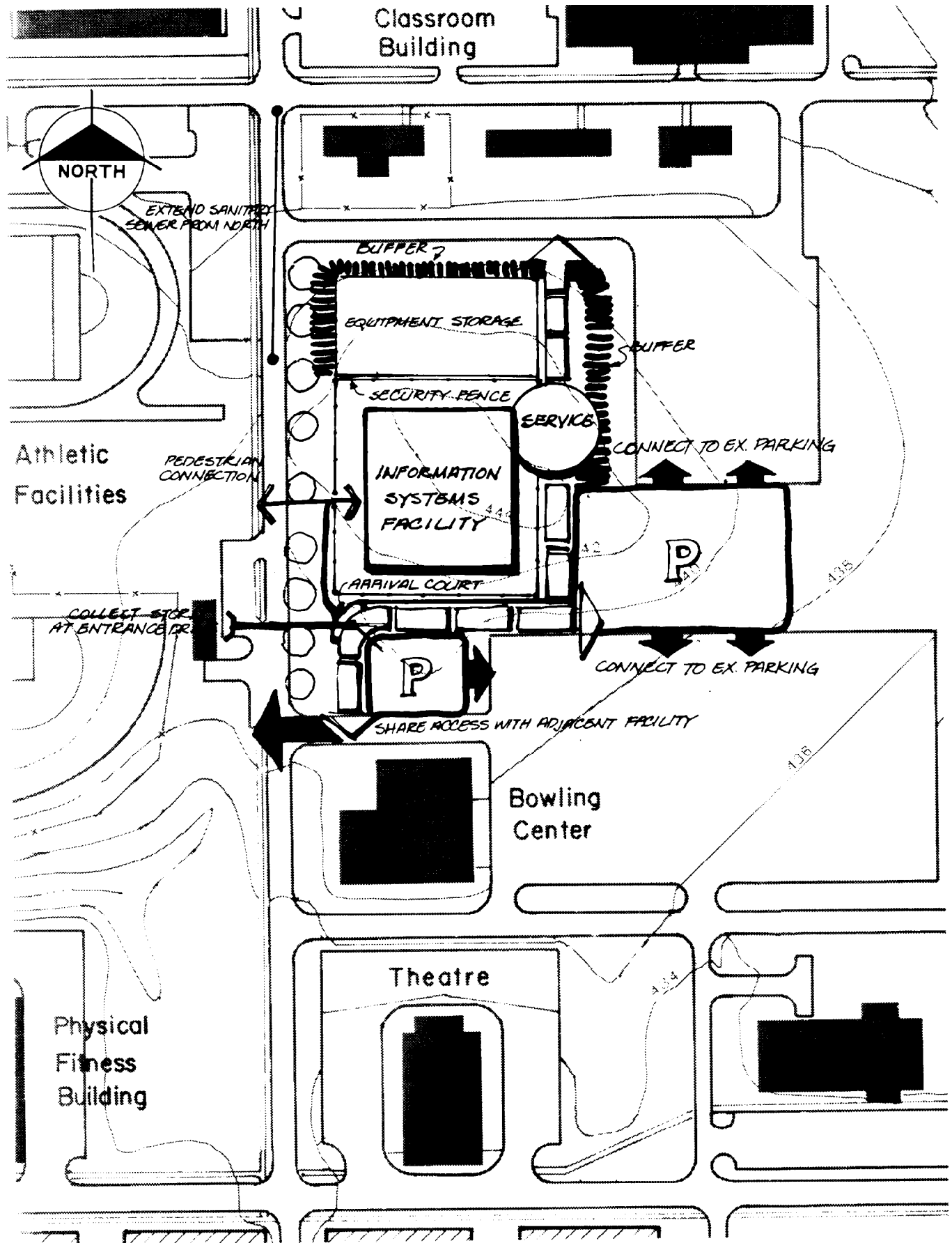

Figure 5-4. Spatial Relationships Diagram for an Information Systems Facility. Alternative 1.



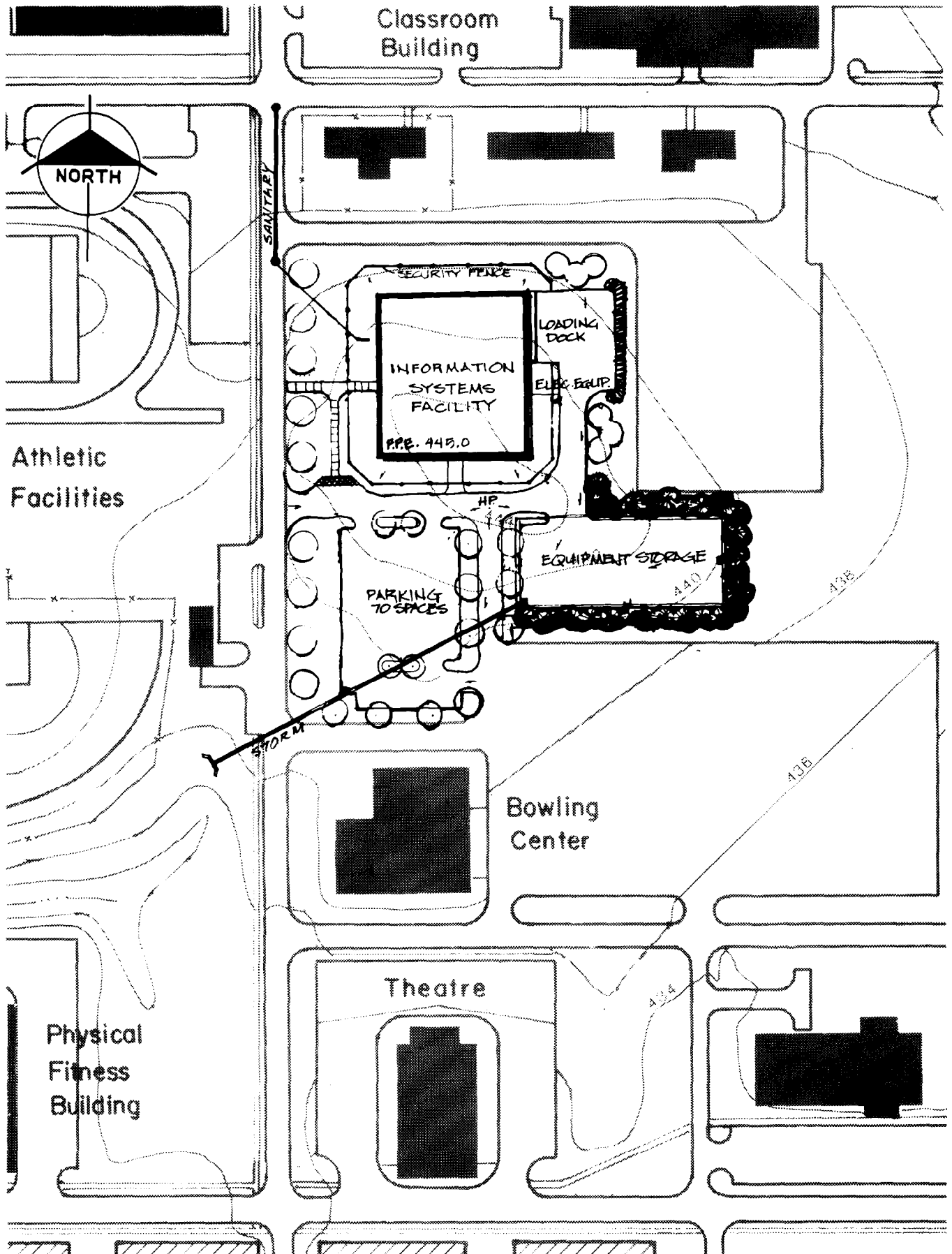

Figure 5-6. Sketch Site Plan for an Information Systems Facility.



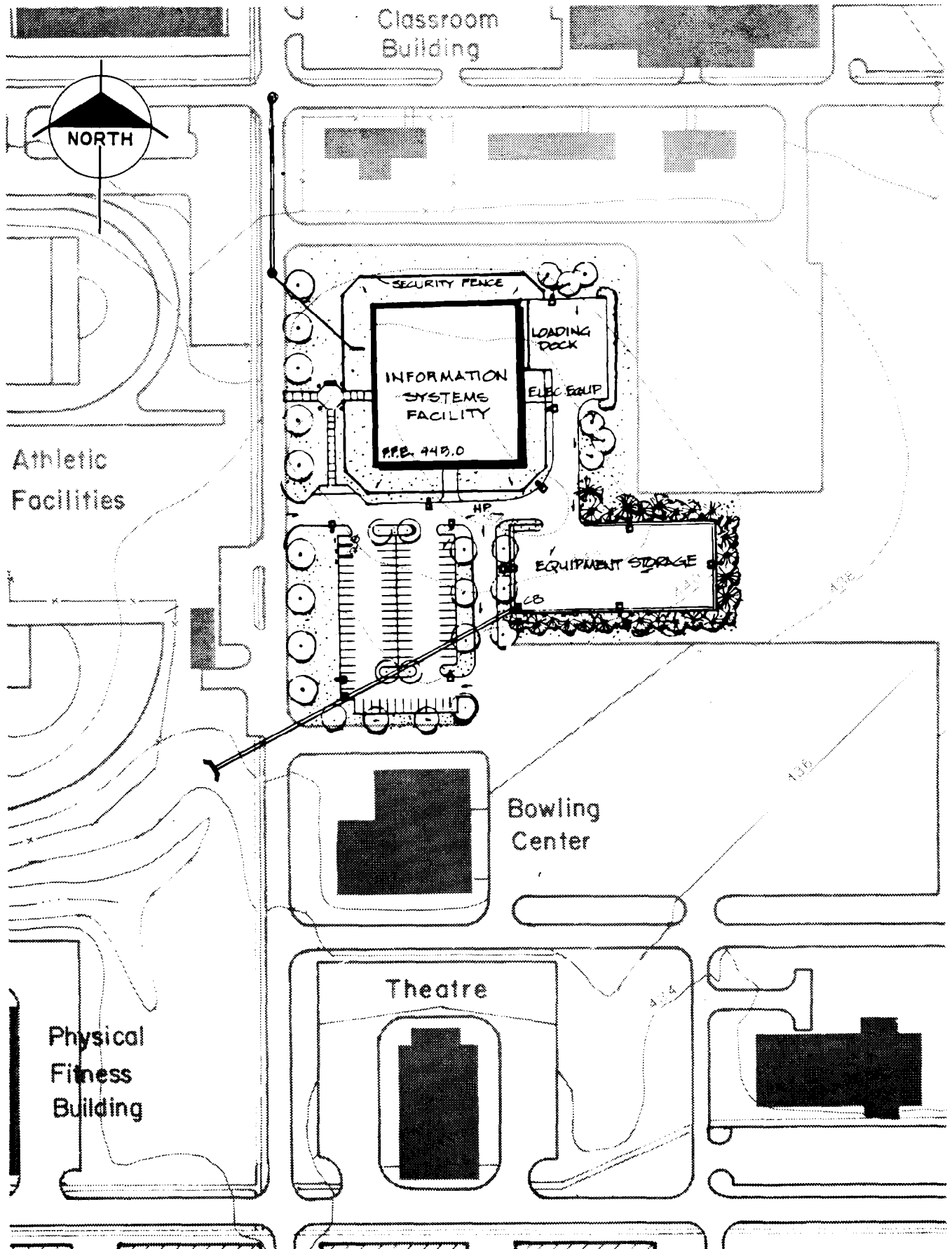

Figure 5-7. Concept Site Plan for an Information Systems Facility.

## CHAPTER 6

### DESIGN FOR ON-SITE VEHICULAR CIRCULATION AND PARKING

#### 6-1. General.

This chapter provides general guidelines and criteria, or standards, for determining the size, layout, and design of on-site vehicular circulation and parking. The chapter covers access and service drives; parking areas; and special vehicle-use areas including gateways, drop-offs, dumpsters, deliveries, and drive-in facilities. This chapter also addresses methods for mitigating the visual impact of parking and other vehicle use areas. MTMC provides detailed information on all aspects of circulation design.

#### 6-2. Design Vehicles.

A variety of vehicles can be expected on any site. These include cars, pick-up trucks, garbage trucks, delivery vans and trucks, buses, recreation vehicles, fire trucks, oversized or tracked organizational vehicles, and motorcycles. Site entrances and exits should be designed to accommodate the largest vehicle using the site. Other areas (e.g. parking lots or loading docks which have special requirements) should be designed for the largest vehicle using the area.

a. **Vehicle Dimensions and Turning Radii.** In *A Policy on Geometric Design of Highways and Streets*, the American Association of State Highway and Transportation Officials (AASHTO) places vehicles into three general classes: passenger cars, trucks, and buses/recreation vehicles. The passenger car class includes light delivery trucks such as vans and pick-ups. Table 6-1 lists dimensions for some of the more commonly found vehicles. Table 6-2 lists minimum turning radii for the same vehicles. AASHTO provides an expanded list with additional dimensions and information. For the purposes of design, the design vehicles have larger physical dimensions and larger minimum turning radii than almost all vehicles in their classes.

b. **POV Vehicles.** The AASHTO passenger car is equivalent to a non-organizational or POV vehicle. Figure 6-1 illustrates a turning template showing the turning paths and radii of a POV vehicle. AASHTO provides turning templates for the other design vehicles.

Table 6-1. Dimensions (in Feet) for Design Vehicles (for Non-organizational Vehicle Parking).

Design Vehicle (Symbol)	Width	Length	Overhang	
			Front	Rear
Passenger Car (P)	7	19	3	5
Single Unit Truck (SU)	8.5	30	4	6
Intermediate Semitrailer (WV-40)	8.5	50	4	6
Large Semitrailer (WB-50)	8.5	55	3	2
Single Unit Bus (BUS)	8.5	40	7	8
Motor Home (MH)	9	30	4	6
Motor Home & Boat Trailer (MH/B)	8	53	4	8

Table 6-2. Minimum Turning Radii (in Feet) for Design Vehicles.

Design Vehicle	Minimum Design Turning Radius	Minimum Inside Radius
Passenger Car	24	13.8
Single Unit Truck	42	27.8
Intermediate Semitrailer	40	18.9
Large Semitrailer	45	19.2
Single Unit Bus	42	24.4
Motor Home	40	26.0
Motor Home & Boat Trailer	50	35.0

#### 6-3. Access and Service Drives.

Access drives carry all vehicular traffic on site. They should be designed to accommodate the full range of vehicles. Service drives are limited to special vehicle traffic. They should be designed to accommodate the particular vehicle.

a. **Spacing.** Location of access drives should follow these spacing guidelines:

- (1) Maintain 200' or more between access drives on arterial roads. Table 6-3 provides acceptable minimum spacing if this is not possible.

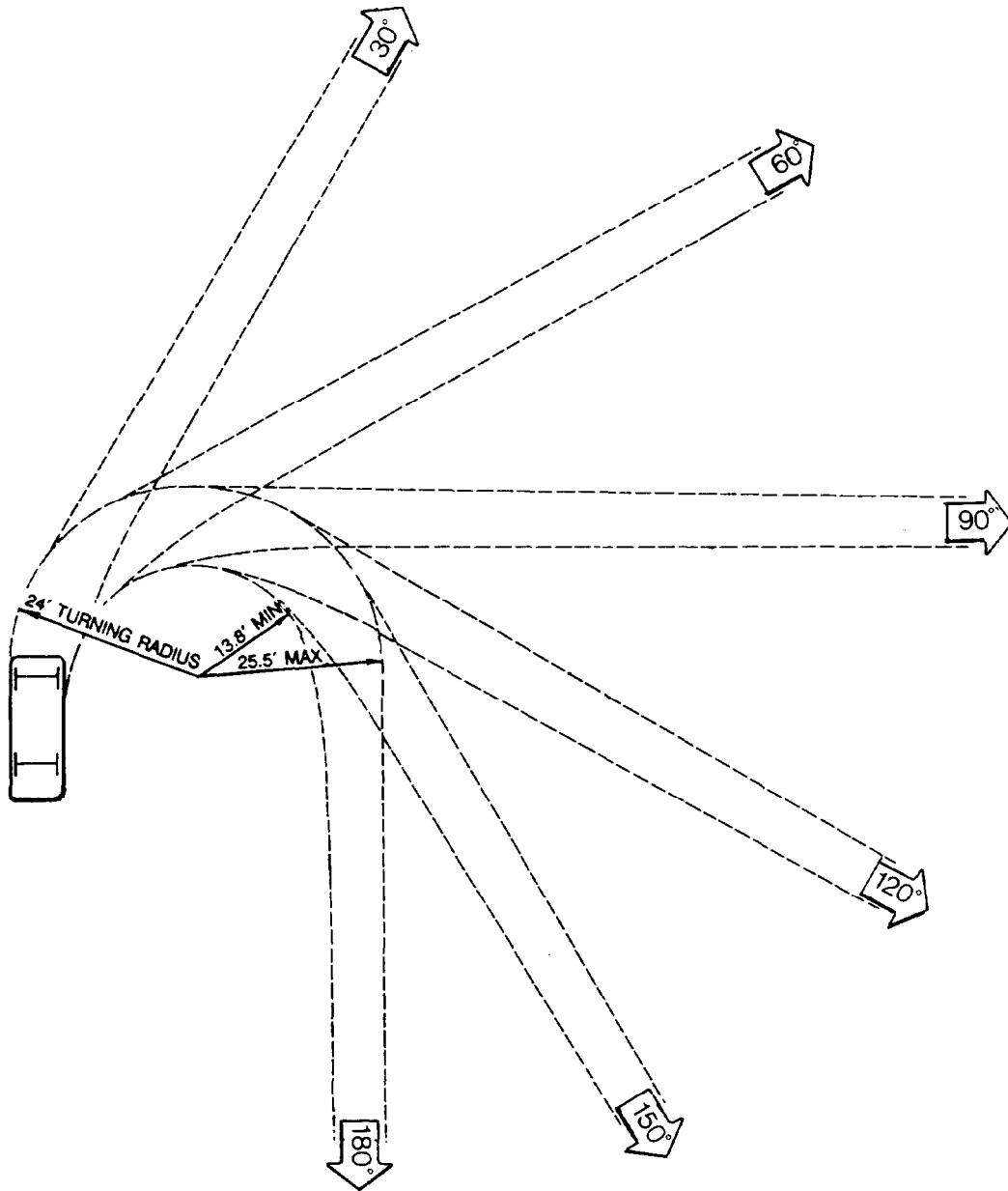

Figure 6-1. Turning Template for a POV Vehicle.

Table 6-3. Minimum Driveway Spacing for Streets Serving More than 5,000 Vehicles per Day.

Arterial Speed (mph)	Minimum Separation (ft)
20	85
25	105
30	125
35	150
40	185
45	230
50	275

(2) Maintain a minimum spacing of 1,200 to 1,500' between a signalized drive and adjacent signalized intersection. If the signalized drive is a t-intersection, 600' is an acceptable minimum spacing.

(3) Coordinate drive signals within 2,500' of adjacent signals.

(4) Maintain a minimum spacing of 35 to 50' on low-volume (5,000 vehicles per day), low-speed (30 mph) roads.

*b. Corner Clearances.* Access drives near major intersections adversely affect traffic operations. They may result in unexpected conflicts with vehicles turning at the intersection. A minimum

clearance of 50' should be maintained between access drives and major intersections. MTMC provides further guidance on recommended corner clearances.

c. *Sight Distances.* Adequate sight distance should be provided for vehicles entering and exiting the access drive. Figure 6-2 illustrates safe sight distances as determined by table 6-4. If sight distance is not adequate, the following alternatives should be considered:

- (1) Removal of sight obstructions.
- (2) Relocation of the access drive to a more favorable location along the access road.

(3) Prohibition of critical movements at the access drive.

(4) Relocation of the access drive to another access road.

d. *Left turns.* Access should limit conflict on the through road by preventing certain maneuvers (e.g., left turns.) Left turns should be prohibited under the following conditions:

- (1) Inadequate corner clearance.
- (2) Inadequate sight distance.
- (3) Inadequate driveway spacing.
- (4) Median opening too close to another median opening.

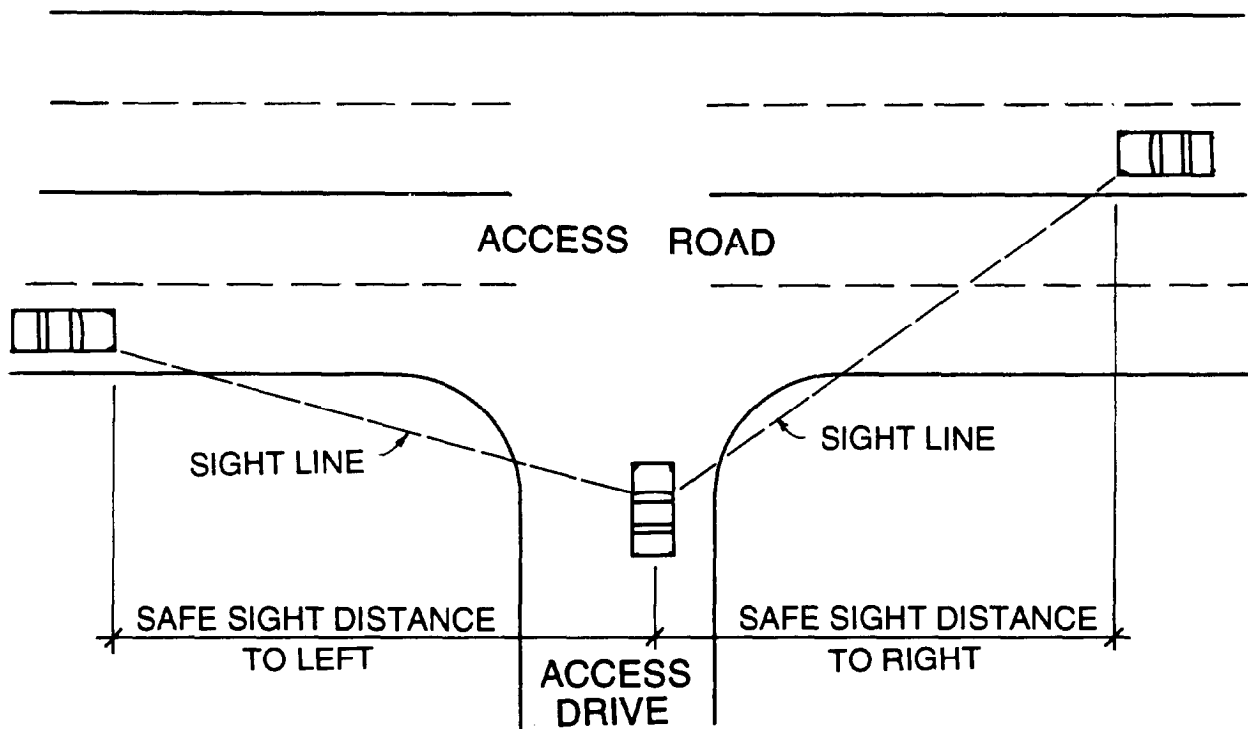

Figure 6-2. Sight Distances for Access Drives.

Table 6-4. Minimum Sight Distances along Access Road from Access Drive to Allow Vehicle to Safely Turn Left or Right onto Road (in Feet).

NOTE: Sight distances are based on the following assumptions:

- 1. Upon turning left or right when exiting the access drive, the vehicle accelerates to the operating speed of the access road without causing approaching vehicles to reduce speed by more than 10 mph.
- 2. Upon turning left when entering the access drive, the vehicle clears the near half of the access road without causing approaching vehicles to reduce speed by more than 10 mph.
- 3. Turns are 90-degree.
- 4. The access road and the access drive are on level terrain.

Operating Speed (mph)	20		30		40		50	
	Left	Right	Left	Right	Left	Right	Left	Right
Passenger Car	210	170	320	360	540	590	900	970
Truck	360	230	520	450	920	920	1510	1530

e. *Entrances.* Entrances to and from access drives should have:

- (1) Minimum turning radii for the largest vehicle expected to use the site.
- (2) A minimum 10'-wide traffic island where entry and exit lanes into the site are separated.
- (3) Minimum throat widths and lengths to accommodate incoming and outgoing traffic. Figure 6-3 illustrates throat dimensions.
- (4) Sufficient width to accommodate single- or double-lane traffic depending upon the design vehicle using the route.

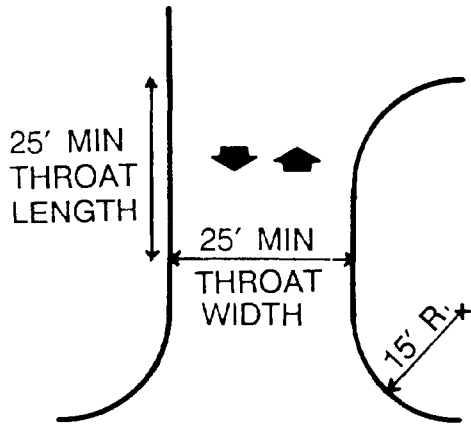

COMMERCIAL

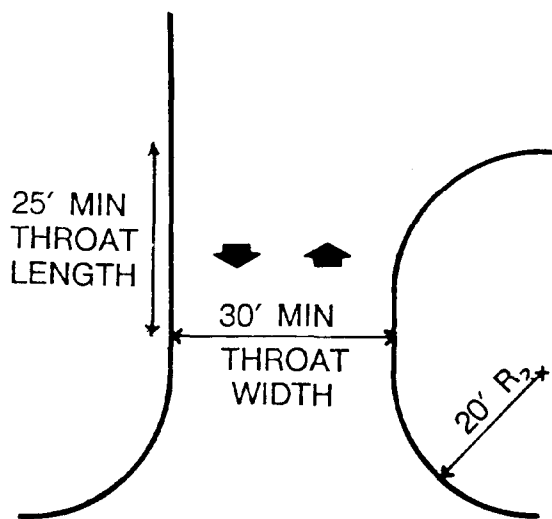

LIGHT INDUSTRIAL

Figure 6-3. Minimum Throat Widths and Lengths.

(5) A minimum 100' unobstructed sight distance for turns from parking lots and service drives onto the access drive.

f. *Grading and Drainage.* Grading for access drives should respond to the natural topography. Grading should observe commonly accepted minimum and maximum gradients for the locale. TM 5-822-2 provides additional information on the grading of drives.

g. *Pavement.* TM 5-822-5 provides guidance for the design and engineering of roadway pavements.

h. *Traffic Controls.* TM 5-822-2 and the *Manual on Uniform Traffic Control Devices for Streets and Highways* (ANSI D 6.1e) provide information on devices to control and direct traffic.

i. *Lighting.* TM 5-811-1 provides guidance on roadway lighting.

6-4. POV Parking Areas.

POV parking includes on-street parking, off-street parking lots and parking structures.

a. *On-street Parking.* On-street parking will be limited to parallel parking spaces. There should be sufficient length and width to allow comfortable movement into and out of the space. There should be sufficient width to adequately separate the parked car from traffic.

b. *Off-street Parking Lots.* Off-street parking lots are the principal means of parking on installations.

(1) *Layout.* A 90-degree parking layout is preferable. Where a fast rate of turnover is expected or where required by site limitations, a 60- or 45-degree layout with one-way aisles may be used. Figure 6-4 illustrates a standard 90-degree parking lot layout. Parking lot layout should:

- (a) Maintain two-way movement if at all possible.
- (b) Avoid dead end parking lots in all situations.
- (c) Provide more than one entrance and exit in parking lots with more than 100 parking spaces.
- (d) Provide traffic breaks in parking aisles longer than 350'.
- (e) Use compact parking spaces only if recommended by a traffic impact study.
- (f) Provide curbing or a painted line at the ends of stalls to control placement of vehicles.
- (g) Provide adequate walkway width to allow comfortable pedestrian movement in areas of bumper overhang.
- (h) Provide curb cuts for barrier-free access to sidewalks.

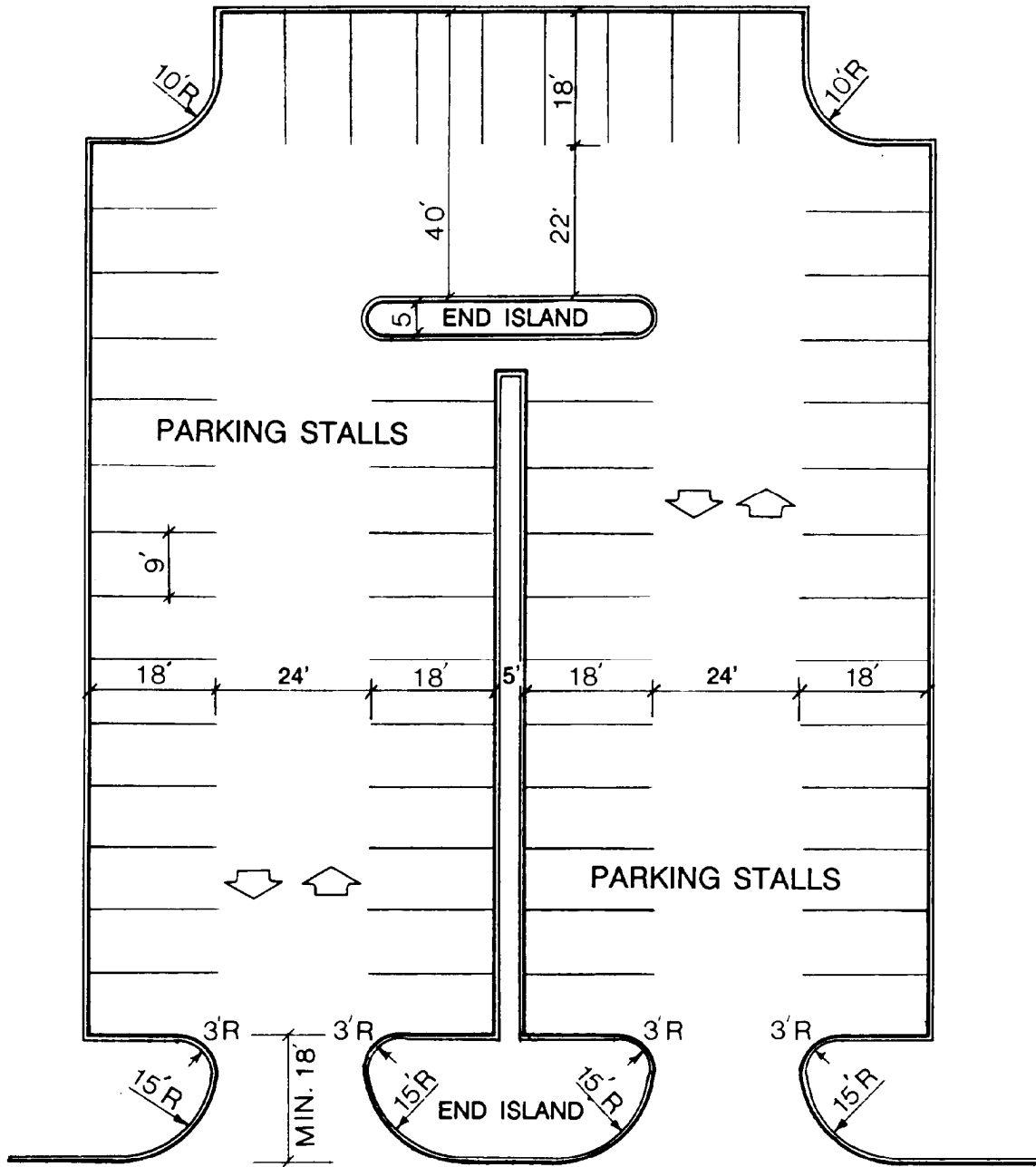

NOTE:  
 LENGTH OF STALLS WITH OVERHANG 16'  
 LENGTH OF STALLS WITHOUT OVERHANG 18'

Figure 6-4. Standard 90-Degree Parking Layout.

(i) Consider snow removal.

(2) *Islands and Medians.* Islands should be located at the ends and intersections of parking aisles. They establish turning radii for vehicular movement and protect end stalls. Turning radii should be based on the design vehicle. Turning radii should be sufficient to allow traffic movement without destroying the island and/or curbing. Figure 6-5 illustrates criteria for laying out islands and medians. Landscaped islands and/or

medians should be placed in the midst of parking lots to:

- (a) Separate different vehicles and user types.
- (b) Break up the expanse of impermeable and unshaded surface.
- (c) Provide a more pleasing visual appearance.
- (d) Preserve existing vegetation.
- (e) Consider snow removal.

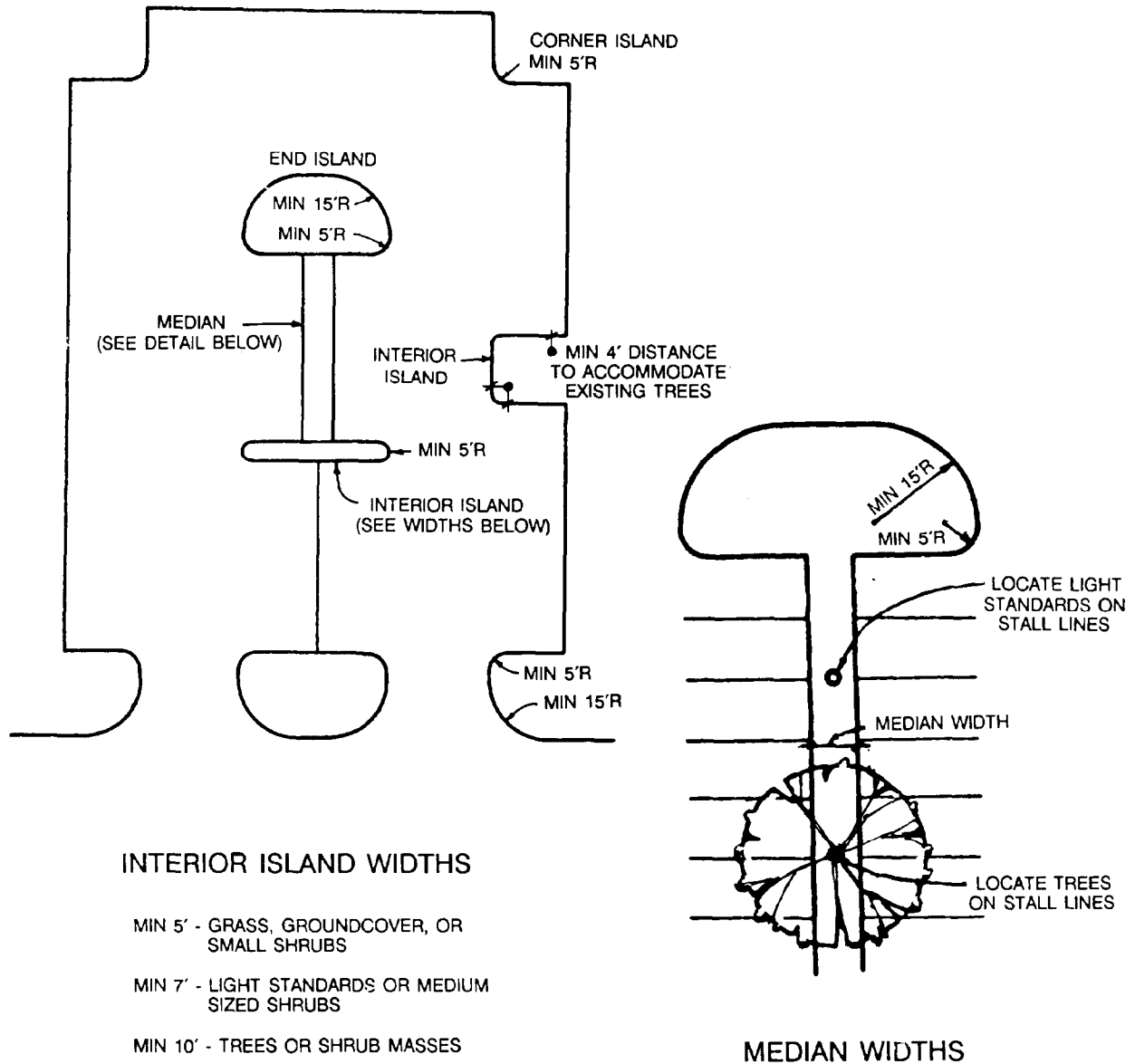

Figure 6-5. Typical Parking Islands and Medians.

(3) *Landscaping.* The landscaped area within and around a parking lot is usually based on a proportional amount of “green” space to paved area. A common minimum standard is 10% of the paved area, including planted islands, medians and perimeter areas. Figure 6-6 illustrates the areas used to attain this proportion. As a general rule, the landscaped area should be increased from the minimum standard in parking lots associated with residential land use. The standard may be decreased for commercial and industrial land uses. There should be adequate room within islands and medians to accommodate plant material and light poles. Where medians are narrow, tree trunks and

light standards should be located on the stall lines between parking spaces.

(4) *Pedestrian Use.* Islands and medians can be partially or completely paved to service pedestrian traffic. Pedestrians tend to use parking aisles, especially if medians are not generous and do not allow for comfortable movement between vehicles. Should the median be designed as a sidewalk, it should be sufficiently wide (a minimum eight feet) to allow for pedestrian movement and bumper overhang.

(5) *Grading and Drainage.* Figures 6-7 and 6-8 illustrate basic principles for grading and draining parking lots. Parking lot design should:

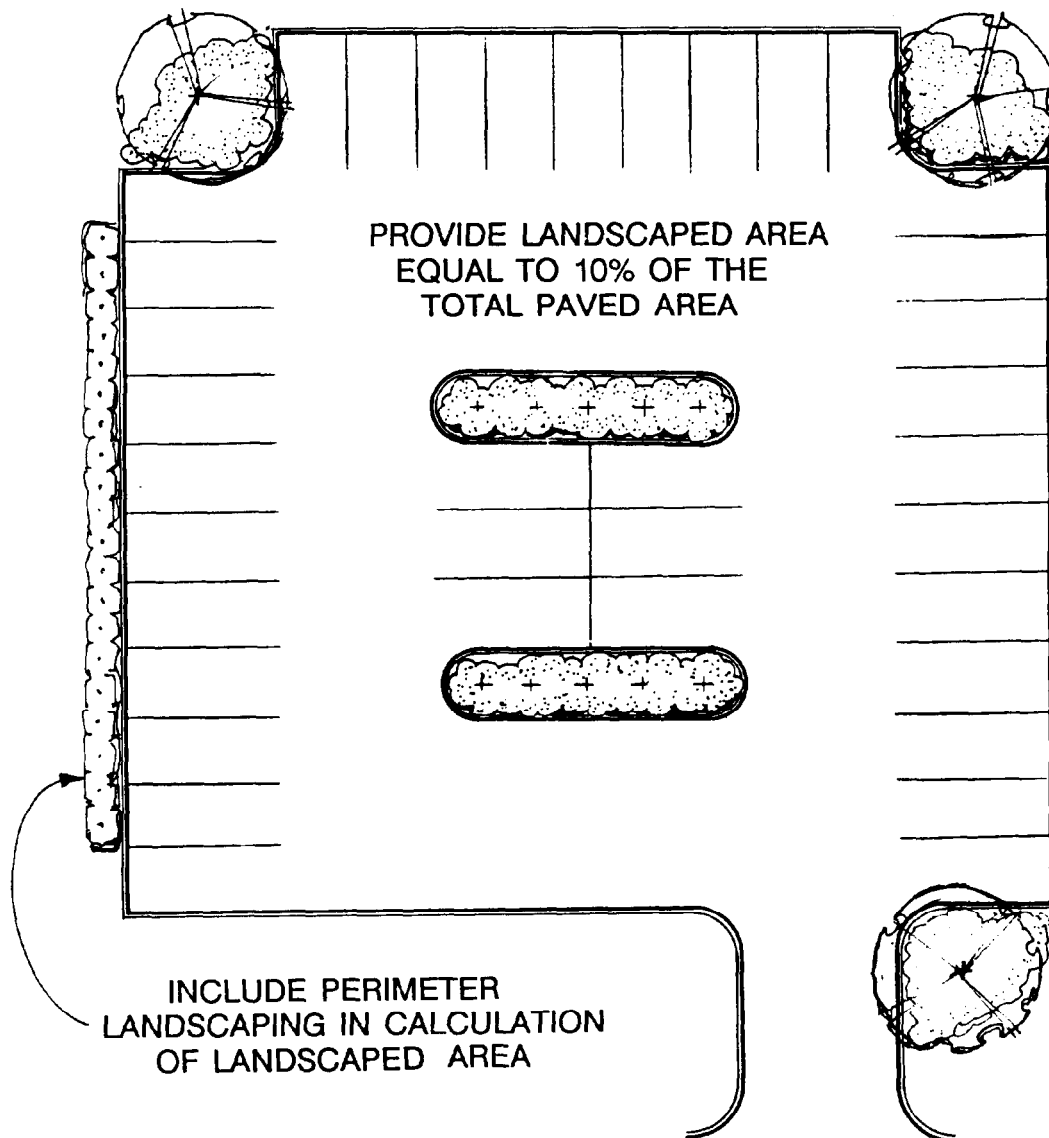

Figure 6-6. Landscaped Area in Proportion to Paved Area

(a) Maintain a relatively constant grade across the lot while providing enough slope and adequate spot elevations to properly direct drainage off the lot or to drainage inlets.

(b) Use islands and medians to accommodate topographic change between the access drive and parking areas or between different parking levels.

(c) Sheet drainage across small, flat parking lots into swales in surrounding grassed areas.

(d) Control runoff with curbing and direct it to the sides and corners of larger (more than 100 spaces) and/or steeper lots.

(e) Avoid channelling of sheet flow.

(f) Avoid ponding water.

(g) Avoid creation of an impoundment zone in the center of the lot.

(h) Never trap water in corners.

(i) Provide sufficient spot elevations to move water off the lot.

(j) Provide adequate drainage inlets to move water off the lot.

(6) *Lighting.* Parking lots should be illuminated for traffic safety and security. Uniform coverage should be provided across the lot. TM 5-811-1 provides guidance on lighting parking areas.

(7) *Pavement Marking and Signage.* The *Manual on Uniform Traffic Control Devices for Streets and Highways* (ANSI D 6.1e) provides guidance on pavement marking and signage.

*c. Parking Structures.* Parking structures may be separate buildings or built underground in conjunction with other building development. For



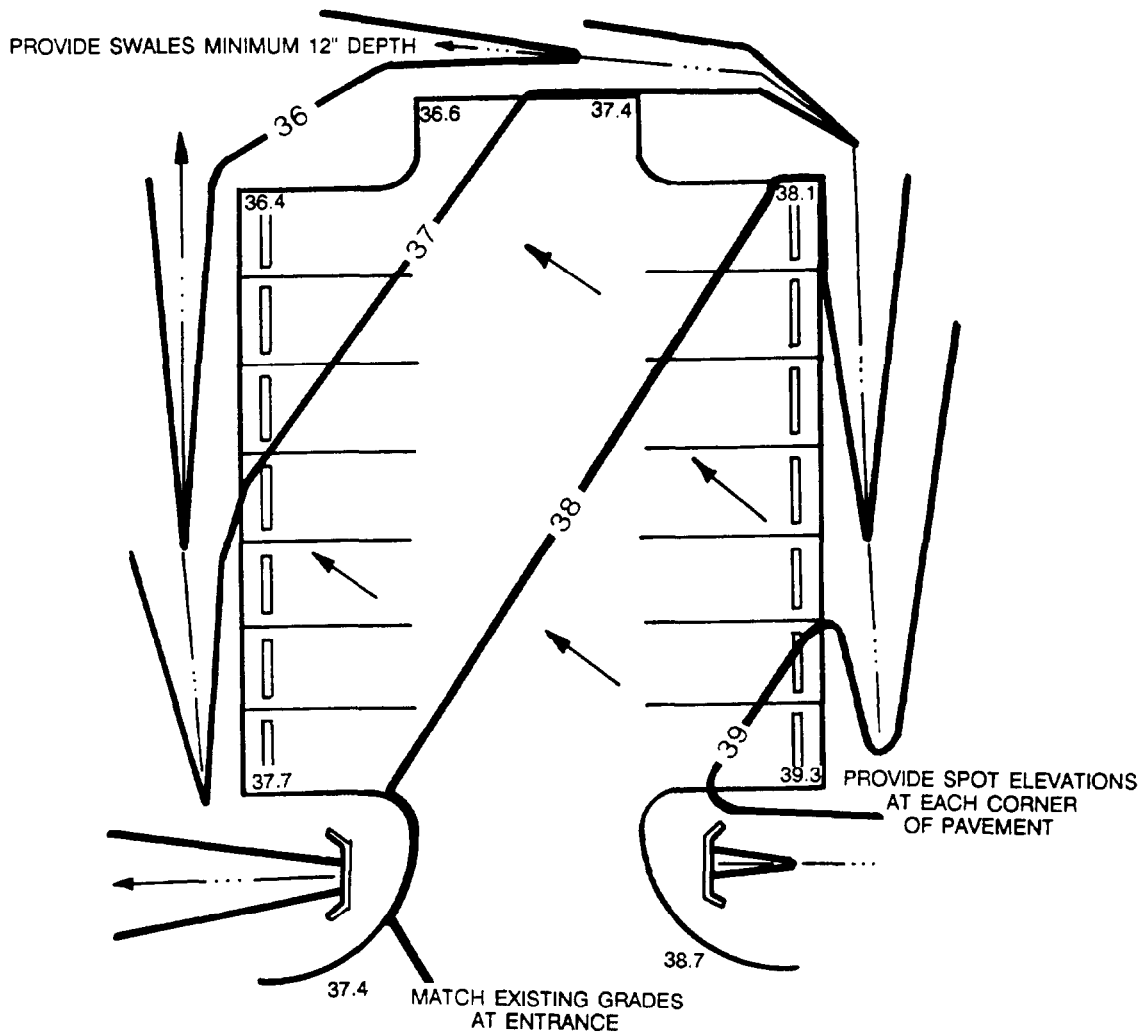

Figure 6-7. Typical Grading and Drainage for a Small Parking Lot.

underground structures providing a transition between the access road or drive which permits enough vertical height at the structure's entrance is critical to successfully incorporating the structure into the site. If the roof of the structure is to be used as a site amenity or is to incorporate recreational activity, the site designer should coordinate with the structural engineer to ensure that the roof can support the weight of such additional elements as plant material and soil. The book *Parking* provides guidance on development of parking structures.

6-5. Parking Areas for Petroleum, Oil and lubricates (POL) Vehicles.

Figure 6-9 illustrates a typical POL parking area. POL parking area design should:

a. Provide traffic flow which allows vehicles to enter the parking stall with a single turn and to exit in a continuous straightforward movement.

b. Locate stalls a minimum 100' away from motor pool shops and dispatch offices.

c. Locate stalls a minimum 300' away from non-motor pool buildings, public highways and public gathering areas.

d. Maintain a minimum 10' distance between vehicles.

e. Maintain a minimum 1% and maximum 5% gradient.

f. Provide adequate positive drainage and adequate spill containment to prevent contamination of normal storm drainage running off site.

6-6. Special Circulation Areas.

Circulation areas for other than normal automobile traffic have special requirements to make them function successfully. They require additional space to accommodate unusual traffic patterns and to provide more room, especially larger turning radii, for maneuverability.

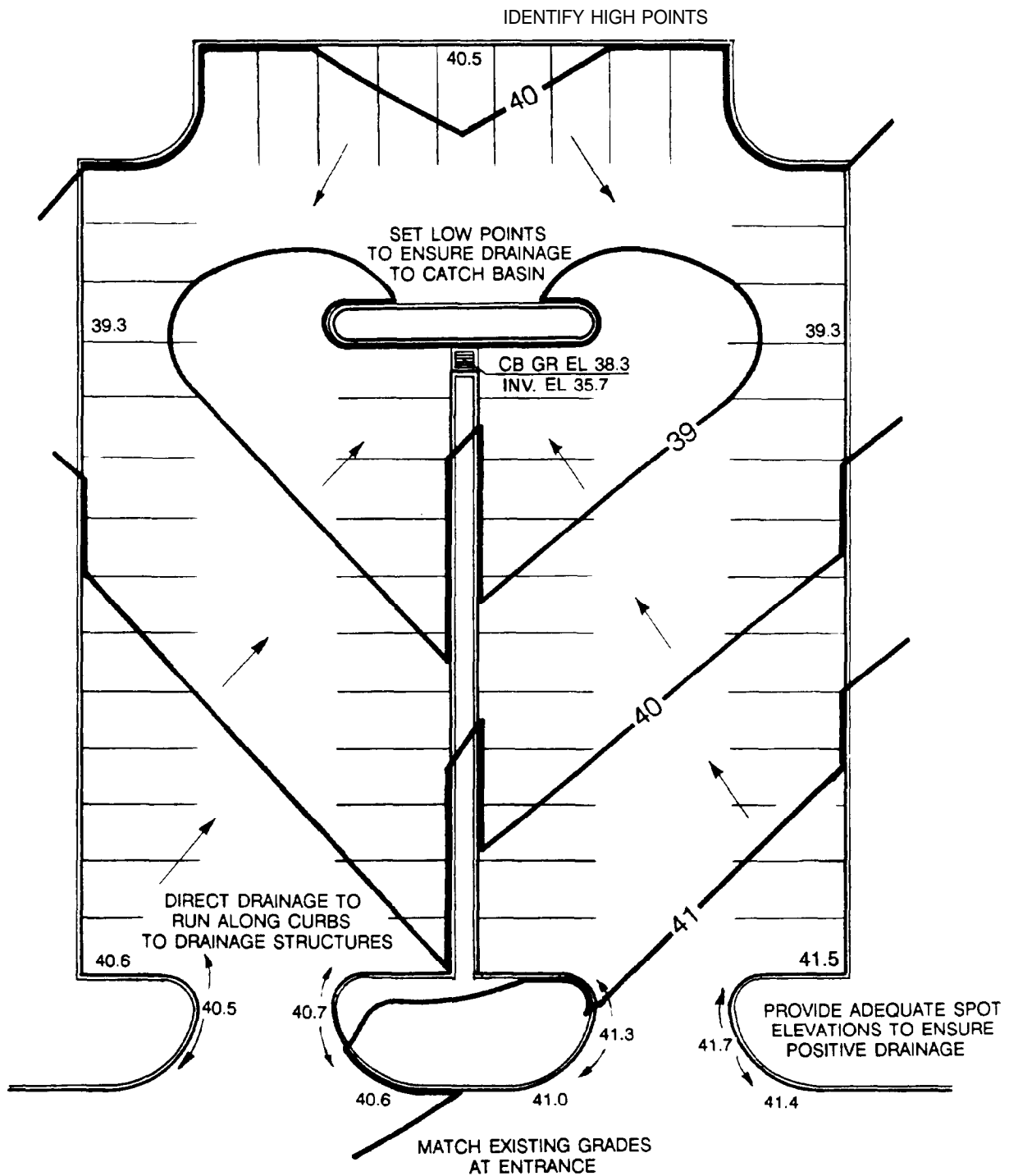

Figure 6-8. Typical Interior Grading and Drainage for a Parking Lot.

a. Gateways. Figure 6-10 illustrates typical low-volume gate areas. Design for gateways should be discussed with the Provost Marshal and coordinated with the site's physical security requirements. Design for gate areas should:

(1) Provide adequate width for a gatehouse, traffic island, travel lane and, if necessary, pull-over lane for questioning or search.

(2) Provide enough straight length on the access drive to accommodate stacking for waiting

vehicles and to allow an adequate transition zone into and out of the major traffic flow.

(3) Use curb around the traffic island to create better visibility and prevent poor drainage at the gatehouse.

b. Dropoff Areas. Figure 6-11 illustrates a typical drop-off area. Design of drop-off areas should:

(1) Provide adequate width and length to accommodate the movement of cars in and out of the flow of traffic.

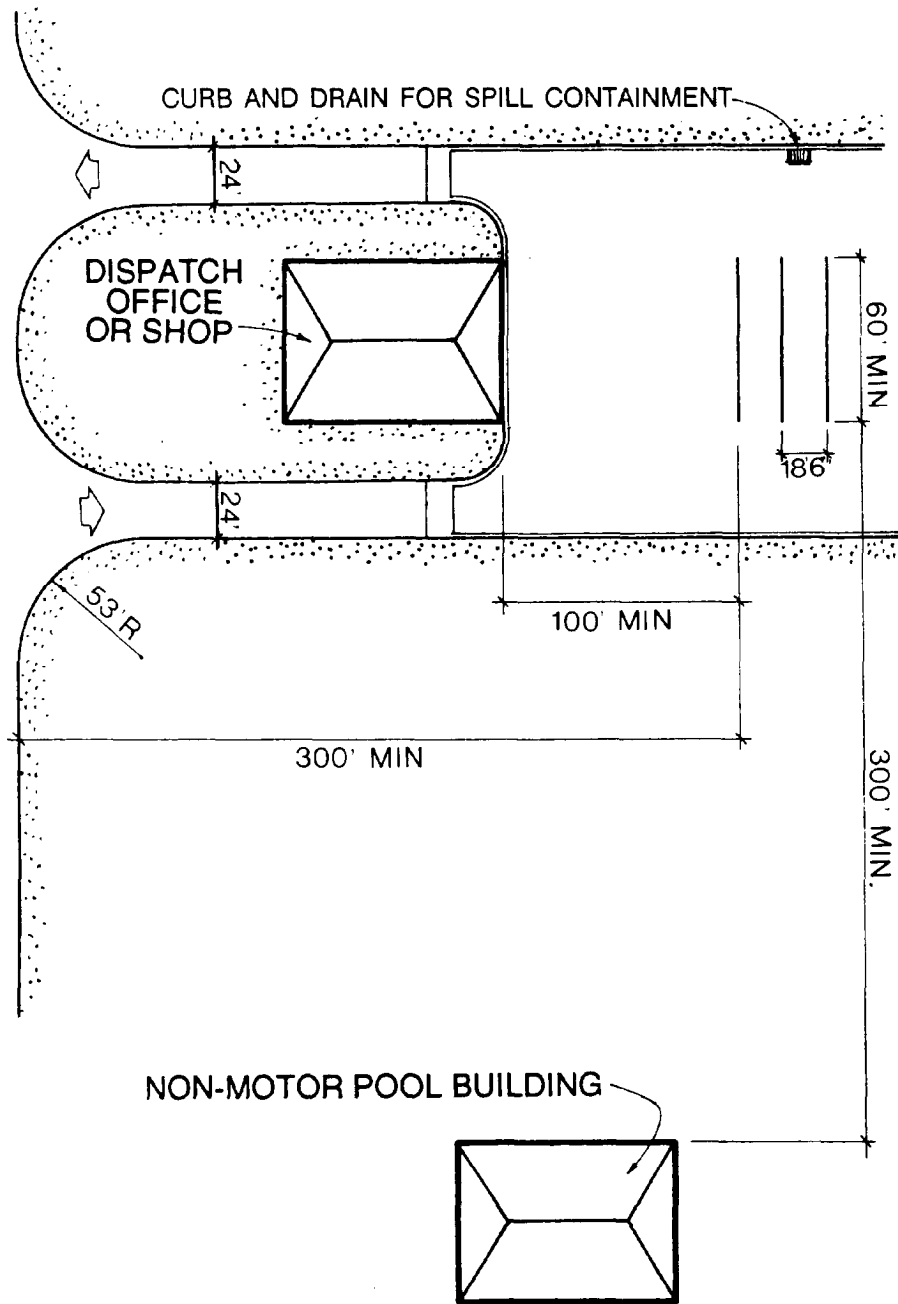

Figure 6-9. Typical POL Parking Area

(2) Provide enough width and length for vehicles to move entirely out of the traffic flow where cars and buses are using the same drop-off zone.

(3) Maintain a fairly level grade across the area.

(4) Have curb cuts for barrier-free access onto sidewalks.

c. *Delivery and Service Zones.* Delivery and service trucks can access rear or side doors in buildings. These services should not cross pedestrian traffic or take place over sidewalks. Delivery may require dock facilities which need sufficient room

to accommodate the necessary maneuvering into and out of the dock. Figure 6-12 illustrates a typical truck loading area for a single-unit truck. Design for delivery zones should:

(1) On a continuous-flow vehicular system, provide enough length to pull forward, then back into the dock, and then move forward again to exit.

(2) On a dead-end service drive, provide enough space for the necessary turning movements.

(3) Provide positive drainage away from the loading dock. This may be accommodated by a

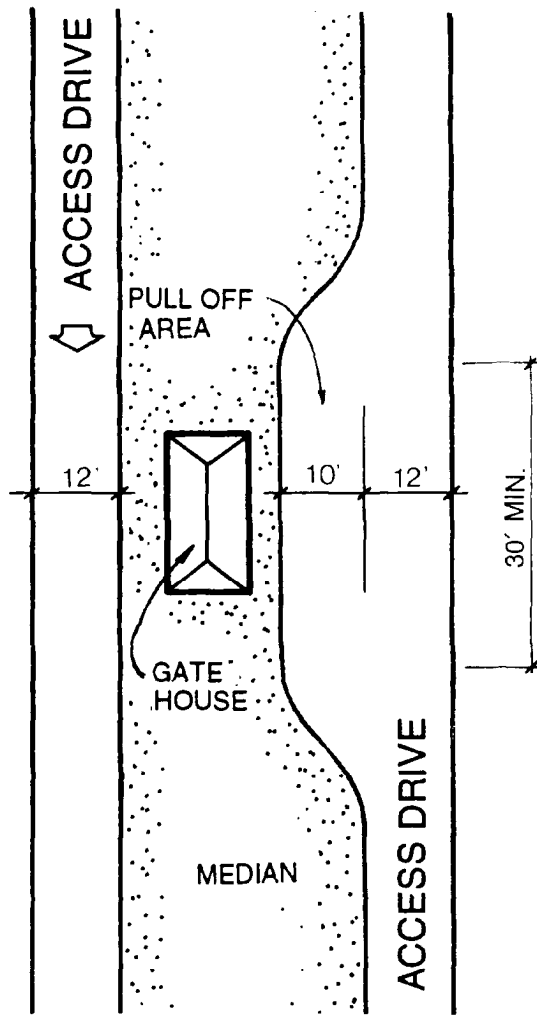

**LOW THROUGH - VOLUME INSPECTION FACILITY**

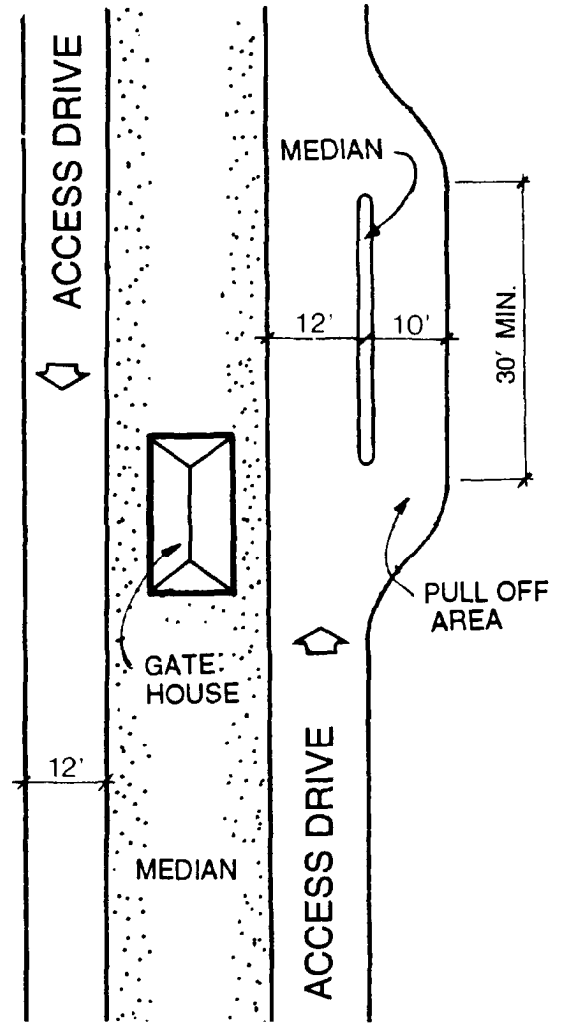

**HIGH THROUGH - VOLUME INSPECTION FACILITY**

Figure 6-10. Typical Low-volume Gate Areas.

six-inch drop across the first 20' away from the loading dock to a drainage inlet.

(4) Maintain as level a grade as possible so that trucks do not have to move uphill to the dock. The maximum standard desirable grade is 3%.

(5) Be screened with walls, fences, plant material or a combination of these.

*d. Dumpsters.* The design of trash removal areas is controlled by the size and location of the dumpster pad. Figure 6-13 illustrates a typical dumpster pad layout. Design for dumpster pads should:

(1) Allow sanitation trucks to approach the pad in a straightforward manner, align with the dumpster, reverse away from the pad and exit the site. It is preferable if trucks do not have to reverse out of the site or turn to exit the

site but can maintain a continuous forward movement.

(2) Locate dumpsters on concrete pads.

(3) Provide positive drainage away from the pad.

(4) Screen the pad with fences, walls, plant material or a combination of these.

*e. Drive-in Facilities.* Drive-in facilities, such as banks and fast-food restaurants, require careful and clear establishment of traffic patterns and a continuous traffic flow. The standard configuration for a single- or double-service position facility does not lend itself to a two-lane approach and departure design. It usually relies on some form of loop system. Figure 6-14 illustrates a typical layout for a drive-in facility. Design for drive-in facilities should:

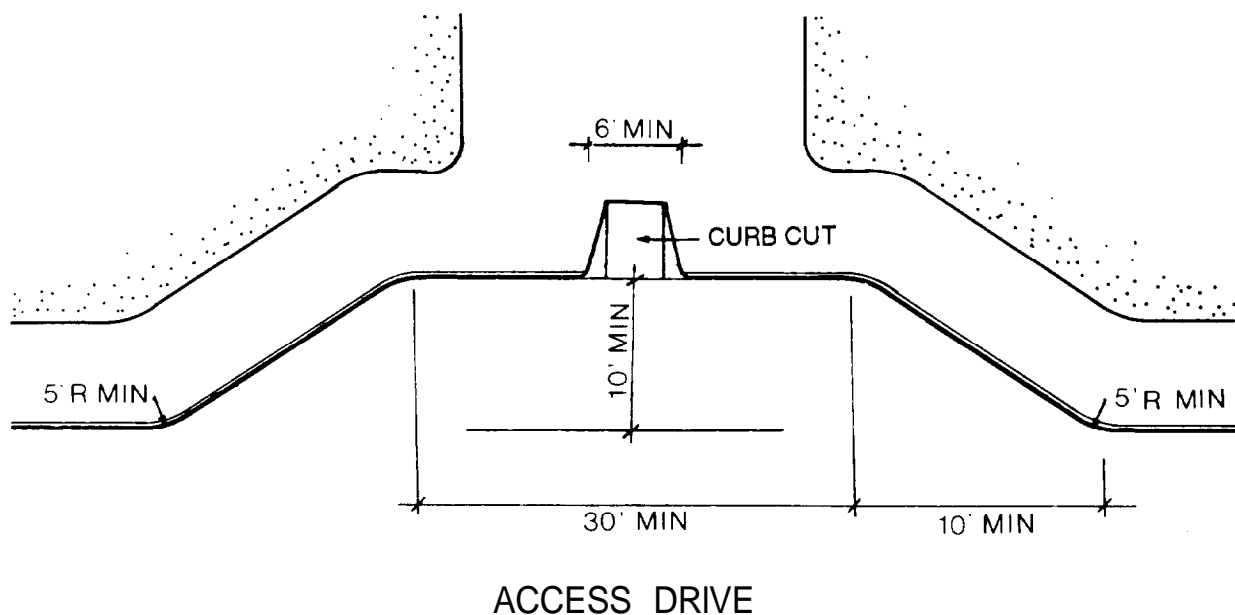

Figure 6-11. Typical Dropoff Area.

(1) Maintain traffic flow into and out of the drive-in windows while working with other on-site vehicular traffic flow including parking.

(2) Minimize interference with pedestrian traffic flow.

(3) Provide adequate stacking room in the drive-through lanes for waiting vehicles.

(4) Provide adequate stacking room on-site to prevent spillage out into access roads.

(5) Use curb and planting islands to control traffic movement.

(6) Use signs and directional arrows on the pavement to help avoid confusion.

*f. Motorcycle Parking.* Figure 6-15 illustrates a typical motorcycle parking area. Design for motorcycle parking should:

(1) Locate parking close to building entrances.

(2) Locate parking in parking lot corners.

(3) Locate parking away from low areas which catch drainage.

(4) Place parking on a concrete pad which is resistant to kick stands in warm weather.

(5) Provide adequate signage and pavement striping.

#### 6-7. Mitigating Vehicular Impact.

Because circulation and parking consume such large areas, all possible methods of mitigating their impact on site should be explored. A minimum 20' wide buffer strip should separate all parking areas from neighboring streets.

*a. Grading.* Working closely with existing topography in the placement of parking areas limits cut and fill and creates a more pleasant flow experience. Locating parking on flatter slopes also limits cut and fill. Where slopes are steeper, more than one level of parking may be used to break up the parking expanse. Locating parking structures partially underground or surrounding them with earth banks lessens their visual impact. In order to avoid the visual and lighting impact of automobiles, parking should not be placed at an elevation above the finished floor elevation of surrounding buildings.

*b. Screening.* Locating parking below the grade of neighboring streets and surrounding land uses helps mitigate its visual impact. Berms and plant material alone or in combination should be used to screen parking lots from neighboring roads and surrounding land use. Architectural screens such as walls or fences may also be used. The design of parking screens should relate to the natural or architectural character of the site as a whole. Earth berms should be designed relative to the 52" viewing height, or eye level, of a motorist. Figure 6-16 illustrates various methods of screening parking areas. It may be impractical to provide continuous screens around large parking areas. Judicious placement of berms and plant material can still break up the uninterrupted line of vehicles and significantly lessen their impact. Landscape treatment of islands and medians can also be used to break up large expanses of parking.

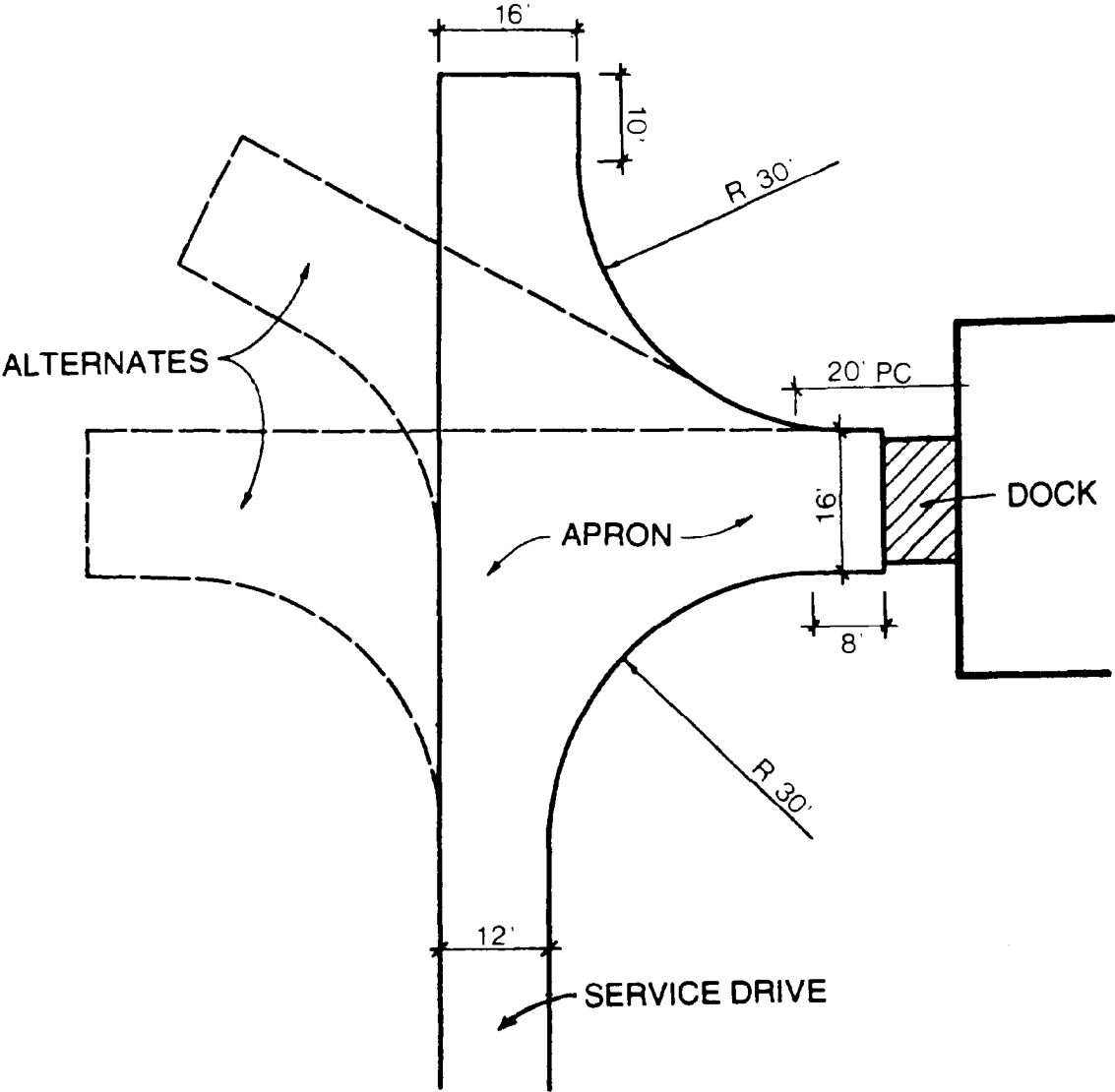

### TURN-AROUND FOR MEDIUM SIZED TRUCKS (SU)

Figure 6-12. Typical Truck Loading Area.

**DUMPSTER**  
(SEE DETAIL BELOW)

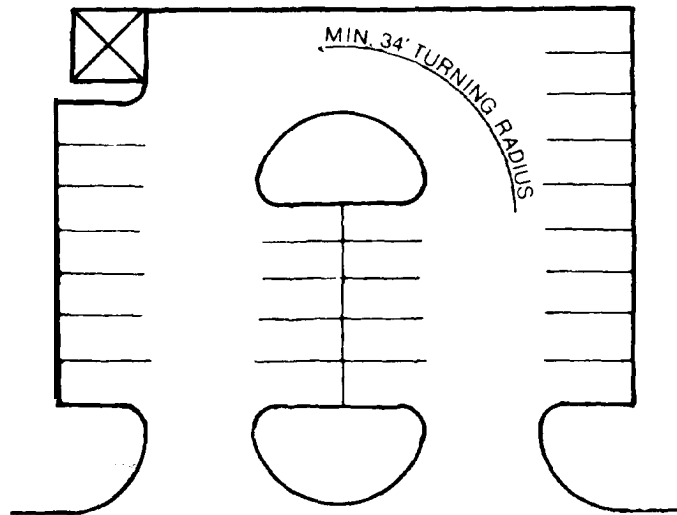

**SITE PLAN**

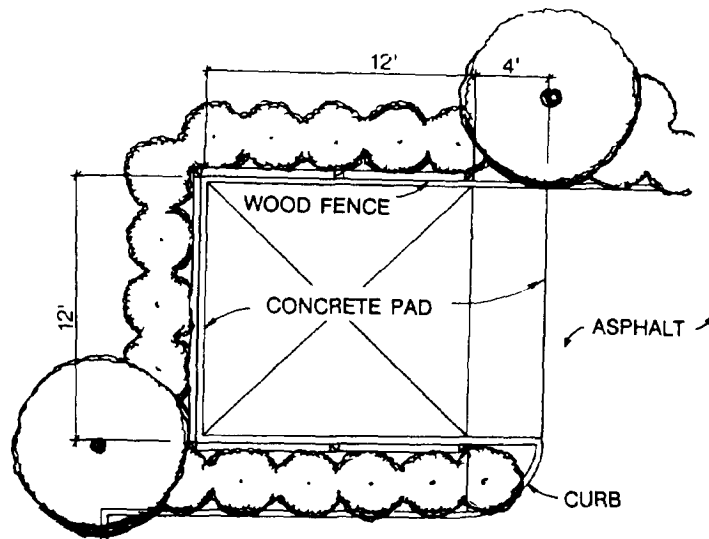

**DETAIL**

**NOTE: LENGTH OF CONCRETE PAD SHOULD BE COORDINATED WITH THE LOCAL MANAGEMENT COMPANY**

*Figure 6-13. Typical Dumpster Pad Layout.*

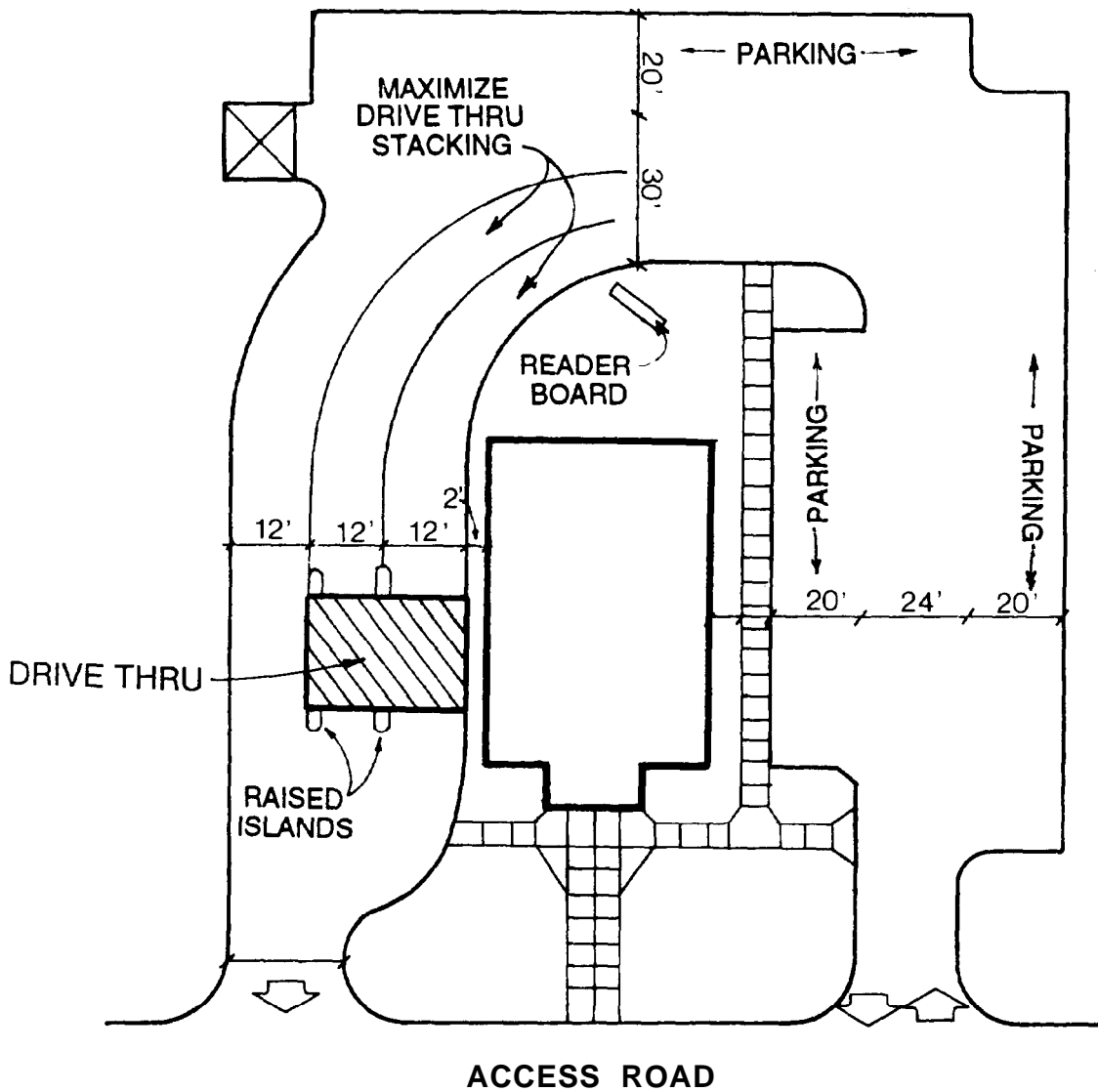

Figure 6-14. Typical Layout for a Drive-In Facility.



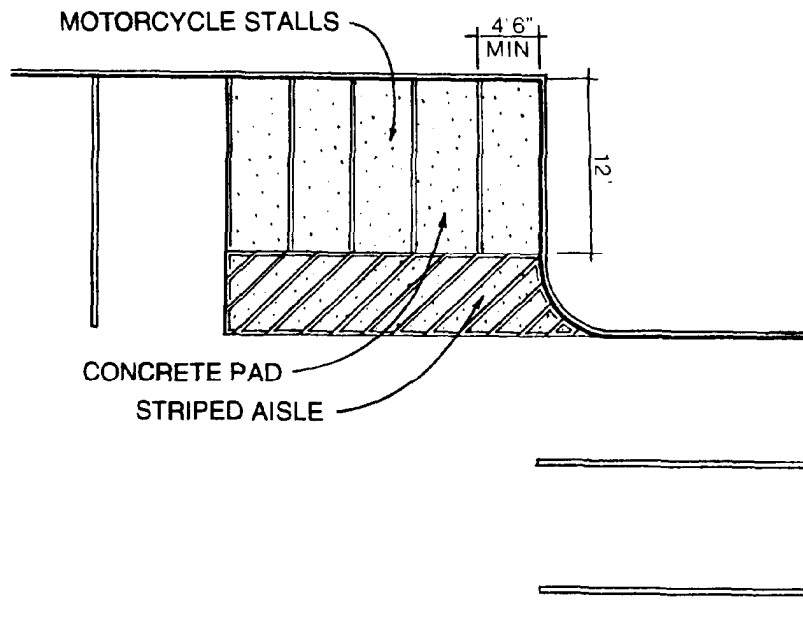

Figure 6-15. Motorcycle Parking.

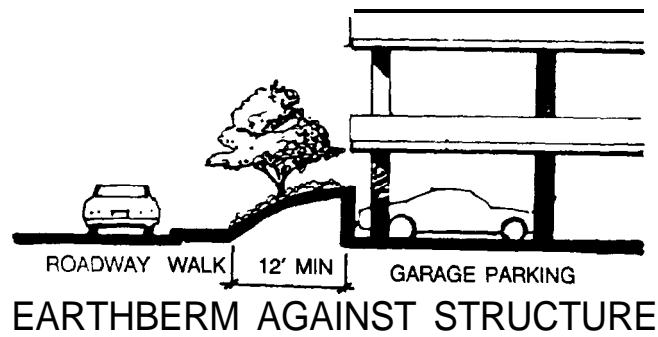
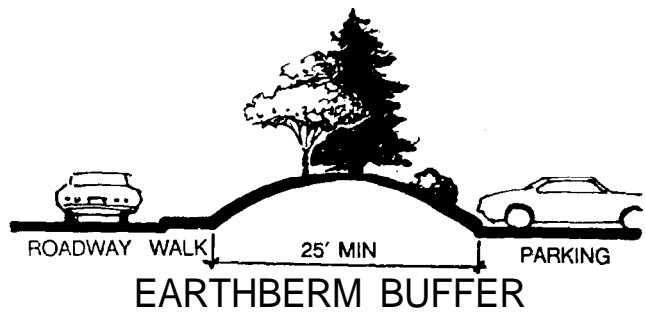
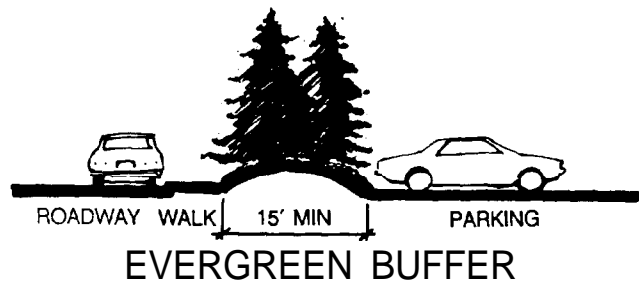

Figure 6-16. Screening Parking Areas.

## APPENDIX A

### REFERENCES

---

#### Government Publications

*Department of the Army*

AR 200-2	Environmental Effects of Army Actions
AR 210-20	Master Planning for Army Installations
AR 415-15	Military Construction, Army
TM 5-800-3	(MCA) Program Development Project Development Brochure
TM 5-803-1	Installation Master Planning
TM 5-803-2	Planning in the Noise Environment
TM 5-803-5	Installation Design
TM 5-803-8	Land Use Planning
TM 5-803-13	Landscape Design and Planting
TM 5-811-1	Electric Power Supply and Distribution
TM 5-820-4	Drainage for Areas Other than Airfields
TM 5-822-2	General Provisions and Geometric Design for Roads, Streets, Walks, and Open Storage Areas
TM 5-822-5	Engineering and Design Flexible Pavements for Roads, Streets, Walks, and Open Storage Areas

*Referenced Forms*

DD Form 1391

FY-Military Construction Project Data

*Department of Transportation, Federal Highway Administration*

ANSI D 6.1e

Manual on Uniform Traffic Control Devices for Streets and Highways (1989)

*Government Printing Office, US Government Printing Office, Washington, D.C.*

D.C.

FED STD 795

Uniform Federal Accessibility Standards

#### Nongovernment Publications

*American Association of State Highway and Transportation Officials,*

Suite 225, 444 N. Capitol Street, NW, Washington, DC 20001

A Policy on Geometric Design of Highways and Streets (1990)

*Institute of Transportation Engineers,* Suite 410, 525 School Street, SW, Washington, DC 20024-2729

Parking Generation, 2nd. edition (1987)

Stover, Vergil G., and Koepke, Frank J. *Transportation and Land Development*, Prentice-Hall, Englewood Cliffs, NJ, 1988.

Weant, Robert A., and Levinson, Herbert S., *Parking*, ENO Foundation for Transportation, PO Box 2055, Westport, CN 06880,1990.

## APPENDIX B

### TYPICAL SITE TRAFFIC IMPACT STUDY REPORT OUTLINE

---

This appendix outlines the typical information and analyses necessary to prepare a site access and circulation plan and subsequent site traffic impact study report for a proposed project.

- I. Executive Summary
  - A. Site location and study area.
  - B. Principal findings.
  - C. Recommendations.
- II. Introduction
  - A. Purpose of report and study objectives.
  - B. Site plan.
  - C. Land use and intensity.
  - D. Phasing and timing.
- III. Area Conditions
  - A. Study area.
    1. Existing land uses.
    2. Area of significant traffic impact.
    3. Anticipated future development.
  - B. Site accessibility.
    1. Area road system.
      - a. Existing.
      - b. Future.
    2. Traffic volumes and conditions.
    3. Transit service.
    4. Existing relevant transportation management programs-carpool programs and flexible duty hours.
- IV. Projected Traffic
  - A. Site traffic (each horizon year.)
  - B. Trip generation.
    1. Trip distribution.
    2. Modal (type of transport: e.g., POV vehicle, shuttle bus, POL vehicle, etc.) split.
    3. Trip assignment.
  - C. Through traffic (each horizon year.)
    1. Method of projection.
    2. Non-site traffic in study area.
      - a. Method of projection.
      - b. Trip generation.
      - c. Trip distribution.
      - d. Modal split.
      - e. Trip assignment.
    3. Through traffic.
    4. Estimated volumes.
  - D. Total traffic (each horizon year.)
- V. Traffic Analysis
  - A. Site access.
  - B. Capacity and level of service.
  - C. Traffic safety.
  - D. Traffic signals.
  - E. Site circulation and parking.
- VI. Improvement Analysis
  - A. Improvements to accommodate base traffic.
  - B. Additional improvements to accommodate site traffic.
  - C. Alternative improvements.
  - D. Status of improvements already funded, programmed or planned.
  - E. Evaluation.
- VII. Findings and Recommendations
  - A. Site accessibility.
  - B. Traffic impacts.
  - C. Need for any improvements.
- VIII. Recommendations
  - A. Site access and circulation plan.
  - B. Roadway improvements.
    1. On site.
    2. Off site.
    3. Phasing, if appropriate.
  - C. Transportation management actions.
    1. On site.
    2. Off site.
  - D. Other.

The proponent agency of this publication is the Office of the Chief of Engineers, United States Army. Users are invited to send comments and suggested improvements on DA Form 2028 (Recommended Changes to Publications and Blank Forms) to HQUSACE (CEMP-EA), WASH DC 20314-1000.

By Order of the Secretary of the Army:

GORDON R. SULLIVAN  
*General, United States Army*  
*Chief of Staff*

Official:

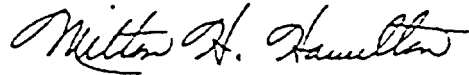

MILTON H. HAMILTON  
*Administrative Assistant to the*  
*Secretary of the Army*

DISTRIBUTION:

Army: To be distributed in accordance with DA Form 12-34-E block 4567, requirements for TM 5-803-6.