

# **POWER TOOL**

# **SAFETY IS SPECIFIC**

**GUIDELINES FOR THE  
SAFE OPERATION OF  
WIDELY USED PORTABLE  
AND STATIONARY  
POWER TOOLS**



**DANGER**



**WARNING**



**CAUTION**



Presented by the manufacturer members of the  
**power tool institute, inc.**

## NOTICE

The contents of this brochure are not meant to be, nor should they be considered, an absolute or complete presentation of the safety measures and procedures that relate to using the power tools covered. Obviously every possible application cannot be foreseen. This brochure's purpose is to highlight only some important safety and safety related information compiled from the experience of Institute members and other reliable safety oriented sources. Individual manufacturers' tool operator's manuals, shipped with tools and accessories, are recommended as a final source for proper procedures for specific tool usage.

## INTRODUCTION

Power tools are 'good friends' that require operator respect in specific ways. They must be used carefully and kept in safe operating condition, whether they are in the hands of a professional tradesman, a beginning do-it-yourselfer or a vocational student. *The demands of safety apply to all.* The material presented here is a compilation of carefully selected safe use precautions as they relate to specific electric power tool CAUTIONS, WARNINGS and DANGERS. The purpose is to highlight the safe use of specific tools that have a high potential of causing injury if ignored. The General Safety precautions and the tool-specific safety precautions offer a basis for safety. The warnings and instructions on the power tool and in its operator's manual provide the best source of safety information for the tool.

Read and understand the contents and follow the advisements of operator's manuals on each specific power tool and all related accessories. This is considered essential to the safe operation of any power tool.

### **For more information:**

The purpose of the Power Tool Institute is to educate the public as to the usefulness and importance of power tools; to encourage high standards of safety and quality control in the manufacture of power tools; and to prepare and distribute information about safe use of power tools. The following is a list of other agencies offering safety guidelines and regulations:

#### **Safety Organizations & Agencies**

National Safety Council	<a href="http://www.nsc.org">www.nsc.org</a>
Occupational Safety & Health Agency	<a href="http://www.osha.gov">www.osha.gov</a>
Underwriters Laboratories Inc.	<a href="http://www.ul.com">www.ul.com</a>
Electrical Safety Foundation International	<a href="http://www.esfi.org">www.esfi.org</a>
CSA International	<a href="http://www.csa-international.org">www.csa-international.org</a>
National Institute of Occupational Safety and Health	<a href="http://www.cdc.gov/niosh">www.cdc.gov/niosh</a>
U.S.D.A. Extension Services	<a href="http://www.csrees.usda.gov">www.csrees.usda.gov</a>
Consumer Product Safety Commission	<a href="http://www.cpsc.gov">www.cpsc.gov</a>

#### **Standards Organizations**

American National Standards Institute	<a href="http://www.ansi.org">www.ansi.org</a>
International Electrotechnical Commission	<a href="http://www.iec.ch">www.iec.ch</a>

#### **Related Industry Groups**

Compressed Air and Gas Institute	<a href="http://www.cagi.org">www.cagi.org</a>
International Staple, Nail and Tool Association	<a href="http://www.isanta.org">www.isanta.org</a>
Unified Abrasives Manufacturers' Association	<a href="http://www.uama.org">www.uama.org</a>
Outdoor Power Equipment Institute.	<a href="http://www.opei.org">www.opei.org</a>
The American Hardware Manufacturers Association	<a href="http://www.ahma.org">www.ahma.org</a>
SkillsUSA	<a href="http://www.skillsusa.org">www.skillsusa.org</a>
National Electric Contractors Association	<a href="http://www.necanet.org">www.necanet.org</a>
International Brotherhood of Electrical Workers	<a href="http://www.ibew.org">www.ibew.org</a>
National FFA Organization	<a href="http://www.ffa.org">www.ffa.org</a>

#### **Battery Recycling Information**

Portable Rechargeable Battery Association (PRBA)	<a href="http://www.prba.org">www.prba.org</a>
Rechargeable Battery Recycling Corp. (RBRC)	<a href="http://www.rbrc.org">www.rbrc.org</a>

## SAFETY PROGRAM MATERIALS

The following is a list of safety information to meet the needs of professional tradesmen, consumers, vocation students, educators and do-it-yourselfers. Visit [www.powertoolinstitute.com](http://www.powertoolinstitute.com) to order or download these materials.

### Literature

#### **“On the Job Power Tool Safety Maintenance Check List”**

A check list of 11 items including operator’s manual, cord sets and extension cords, switches, tool holding devices, guards, housings, adjustments, blades and bits, maintenance, mechanical operation and electrical safety.

#### **“Power Tool Safety”**

A cartooned brochure consisting of recommendations for the safe use of portable, stationary, lawn and garden power tools on the job or at home.

#### **“Safety Poster”**

Mr. Power Tool Safety Says “Prepare for the job, dress for the job and perform the job with SAFETY in mind!”

#### **“A Teacher’s Reference Guide to Power Tool Safety” (Includes a copy of “Safety Is Specific”)**

Provides lesson plans, student activities and quizzes, support materials, and references to additional information on each power tool category.

#### **“Safety Is Specific”**

An illustrated brochure which includes a straightforward compilation of rules and safe practices for each category of power tool use (Specific cautions, warnings and dangers). The guidelines discuss the safe operation of widely used portable and stationary tools.

### Videos

All Safety programs are available on one DVD in English or Spanish.

#### **“Power Tool Accidents — They Can Be Prevented”**

A 19-minute DVD which addresses the importance of keeping the work area safe, electrical safety, developing good personal work habits and proper tool use and care. Includes interviews with emergency room physicians, people injured while using power tools and PTI safety experts.

#### **“Circular Saw Safety”**

A 25-minute DVD which addresses the importance of keeping the work area safe, developing good personal work habits while using circular saws.

#### **“Table Saw Safety”**

A 19-minute DVD which addresses proper workspace setup, the basics of making cuts, general safety procedures and proper maintenance when using table saws.

#### **“Miter Saw Safety”**

A 15-minute DVD which addresses safety procedures when using a miter saw.

## TABLE OF CONTENTS

TOOL	PAGE	TOOL	PAGE
<b>General Safety</b>	<b>4-5</b>	<b>Impact Wrenches</b>	<b>27</b>
<b>Abrasive Cut-Off Machines and Dry-Cut Machines</b>	<b>6-7</b>	<b>Jig Saws (Saber Saws)</b>	<b>28-29</b>
<b>Accessories</b>	<b>8</b>	<b>Jointer/Planer</b>	<b>30-31</b>
<b>Band Saw (Portable and Stationary)</b>	<b>9-10</b>	<b>Metal Cutting Saws (Portable)</b>	<b>32-33</b>
<b>Circular Saws</b>	<b>11-13</b>	<b>Miter Saws</b>	<b>34-35</b>
<b>Cordless</b>	<b>14</b>	<b>Radial Arm Saws</b>	<b>36-37</b>
<b>Coring Rigs and Motors</b>	<b>15-16</b>	<b>Reciprocating Saws</b>	<b>38-39</b>
<b>Drill Presses</b>	<b>17</b>	<b>Rotary Die Grinders</b>	<b>40-41</b>
<b>Drills, Hammer-Drills, Rotary Hammers, and Hammers</b>	<b>18-19</b>	<b>Routers</b>	<b>42-43</b>
<b>Electric Chain Saws</b>	<b>20-21</b>	<b>Sanders (Stationary and Portable)</b>	<b>44-45</b>
<b>Grinders (Portable and Bench)</b>	<b>22-24</b>	<b>Shapers and Router Tables</b>	<b>46-47</b>
<b>Heat Guns</b>	<b>25-26</b>	<b>Table Saws</b>	<b>48-49</b>
		<b>Wood Lathes</b>	<b>50</b>

## General Safety

All power tools can be dangerous if both general and tool specific safety instructions are not followed carefully. General safety instructions apply to all power tools, both corded and cordless.

### Start with a Safe Work Area



Keep your work area clean and well lit. Cluttered benches and dark areas invite accidents.



Do not operate power tools in explosive atmospheres, near flammable liquids, gases, or dust. Power tools create sparks, which may ignite the dust or fumes.

- Keep bystanders, children, and visitors away when using a power tool. Distractions can cause you to lose control.



### Electricity can be Dangerous

Grounded tools (three pronged cords) must be plugged into a properly grounded installed outlet. Never remove or cut off the grounding prong or modify the plug in any way. Do not use any adapter plugs.



Double Insulated tools have a polarized plug (one blade is wider than the other.) This plug will fit into an outlet only one way. Do not change the plug in any way.



Do not use AC only rated tools with a DC power supply.



Store battery packs away from other metal objects like paper clips, coins, keys, nails, screws, or other small metal objects. These things can make a connection from one terminal to the other, shorting the battery terminals together and causing burns or fire.



- When using a power tool, don't touch grounded surfaces such as pipes, radiators, ranges and refrigerators. There is a higher risk of electric shock if your body is grounded.

### GFCI

In damp locations, only plug your tool into a Ground Fault Circuit Interrupter (GFCI). If the work area does not have a permanent GFCI on the outlet, use a plug-in GFCI. Wear rubber gloves and footwear.



Don't use or leave power tools in the rain or wet conditions.



Do not abuse the cord, carry the tool by its cord, or pull the cord to unplug it. Keep the cord away from heat, oil, sharp edges or moving parts. Replace damaged cords immediately.



Always hold the tool by the insulated gripping surfaces. Contact with hidden wiring or its own cord will make exposed metal parts of the tool "live" and shock the operator.

### Rules about Extension Cords

- When using a power tool outside, use an extension cord marked for outdoor use with "W-A" or "W". These cords are made for outdoor use.
- Extension cords with 3-prong grounding plugs must be plugged into 3-prong outlets when using grounded tools.
- Replace damaged or worn cords immediately.

### Amps

The wire gauge and length of the extension cord must be able to handle the amps of the tool. Find the Amps (A) on the tool's nameplate and use the chart to determine the necessary wire gauge for your extension cord length.

Nameplate Amps	Extension Cord Gauge Cord Length in Feet			
	25'	50'	100'	150'
0-6	18	16	16	14
6-10	18	16	14	12
10-12	16	16	14	12
12-16	14	12	Not Recommended	

### Good Personal Safety is a Must

Following good safety practices when using all power tools is a must. Make a habit of including safety in all of your activities.



Always read and understand the tool's operator's manual, tool markings and the instructions packaged with the accessory before starting any work.

- Stay alert, watch what you are doing and use common sense when using a power tool.



Do not use tools when you are tired or under the influence of drugs, alcohol, or medication.

- Dress right. Do not wear gloves, loose clothes or jewelry. Contain long hair. Loose clothes, gloves, jewelry, or long hair can be caught in moving parts.
- Keep handles dry, clean and free from oil and grease.
- Be sure the power tool's switch is OFF before plugging it in or inserting a battery pack. Do not carry tools with your finger on the switch.



Remove adjusting keys and wrenches before turning the tool ON.

- Always keep a firm footing when using power tools. Be sure you have balance and control before you start the job.



Use safety equipment. Always wear eye protection. A dust mask, non-skid safety shoes, hard hat, or hearing protection must be used when needed. The reference to “safety goggles” or “safety glasses” in product specific sections provides potential options - always refer to the tool’s operator’s manual for the specific eye protection recommended, which should be marked as complying with current national standards.

- Unplug tool/remove battery before changing accessories.



Keep hands away from rotating or moving parts.

### Do the Job Safely

- Use the power tool accessories only for the jobs for which they were designed.



Secure and support the workpiece. Use clamps and a stable work surface. Do not hold the work by hand or against your body.

- Keep guards in place and working properly.
- Do not force the tool. Use the right tool for your job. It will do the job better and safer.
- Use only accessories recommended by the tool manufacturer. Accessories that may be suitable for one tool may become hazardous when used on another tool.



Do not touch the drill bit, blade, cutter or the workpiece immediately after operation; they may be very hot and may burn you.

- If a method of dust collection is available with the power tool, it should be used to reduce the risk of dust-related hazards.

### Maintenance Keeps Tools Working Safely and Effectively

- Do not use a tool if the switch does not turn it on and off. It must be repaired.



Look at the tool before using it. Are moving parts misaligned or binding? Is anything broken? Damaged tools must be fixed before using them. Develop a maintenance schedule for your tool.

- Maintain accessories carefully. Keep blades and bits sharp and clean.
- Take your tool to be serviced by qualified repair people. Service or maintenance performed by unqualified personnel could result in a risk of injury. For example: internal wires may be misplaced or pinched, safety guard return springs may be improperly mounted.
- When servicing a tool, use only identical replacement parts. Follow instructions regarding maintenance in the tool’s operator’s manual. Use of unauthorized parts or failure to follow the maintenance instructions may create a risk of electric shock or injury.
- Clean and lubricate a tool only as directed in its operator’s manuals. Certain cleaning agents such as gasoline, carbon tetrachloride, ammonia, etc. may damage plastic parts.
- Maintain labels and nameplates. These carry important information. If unreadable or missing, contact the manufacturer for a replacement.

### When Done, Store the Tools out of Harm’s Way



To avoid accidental starting, unplug the cord, remove batteries or lock off the switch when the tool is not being used, when changing accessories, and when adjusting or cleaning tools.

- Keep tools out of the reach of children and people unfamiliar with the tools.

## Abrasive Cut-Off Machines and Dry-Cut Machines

Abrasive cut-off machines and dry-cut machines are used to cut metal. Some machines are capable of cutting masonry materials. Abrasive machines use abrasive wheels to grind through ferrous metals, while dry-cut machines use special toothed saw blades to cut through ferrous and nonferrous metals.

### Good Personal Safety is a Must

Following good safety practices when using abrasive cut-off machines and dry-cut machines is a must. Make a habit of including safety in all your activities.



Always read and understand the tool's operator's manual, tool markings and the instructions packaged with the accessory before starting any work.



Always wear safety goggles or safety glasses with side shields complying with current national standards, and a full face shield when needed.



Use the appropriate mask or respirator in dusty work conditions.

Wear proper hearing protection, as needed.

- Dress right. Do not wear gloves, loose clothes or jewelry. Contain long hair. Loose clothes, gloves, jewelry, or long hair can be caught in moving parts.
- Crowded, cluttered work areas that can cause tripping or loss of balance are particularly dangerous.
- Never alter a guard or use the tool with a guard missing. Be sure all guards are in place and working properly before each use. Do not defeat guards.

### Choose the Right Tool and Blade or Wheel

Choosing the correct tool and the proper accessory for your application can help to reduce the risk of serious injury. When used according to the manufacturer's instructions, the proper tool and accessory will do the job safer and faster.

- Do not attempt to install a toothed blade on an abrasive cut-off machine, or an abrasive wheel on a dry-cut machine. The cut-off machine's guard will only protect the user when an abrasive wheel is used, and the dry-cut machine's guard will only protect the user when a toothed blade is used. Never alter a guard or use the machine with a guard missing.



Check this carefully: Does your blade or wheel have the proper size and shape arbor hole?

Never force a blade or wheel onto an arbor or alter the size of an arbor. Do not use a blade or wheel that does not fit the arbor, as vibration may result. If the blade or wheel doesn't fit the arbor, get one that does.

- Keep the arbor and blade or wheel clean. Buildup on the surface of the arbor and blade or wheel could cause excessive friction.

### RPM

Make sure the speed marked on the blade or wheel is at least as high as the no load RPM on the tool.



Use sharp blades and wheels. Damaged or dull blades could throw teeth, posing a serious injury risk. Damaged or dull wheels can create excessive friction, causing the wheel to warp or bind. A sharp blade or wheel will tend to cut its way out of a pinching condition.

### Know your Workpiece

Take time to review your work and make sure that all necessary precautions have been taken before making a cut.

- Support long workpieces at the same height as the machine.
- Never attempt to cut materials larger than the rated capacity, as this may result in personal injury.
- Always place the workpiece securely between the vise and fence when making cuts. Never make freehand cuts. Holding the workpiece by hand is unstable and may lead to loss of control.



Never cut small workpieces that put fingers near the cutting blade or wheel.

- Never try to remove or clamp the workpiece while the blade or wheel is rotating.

### Before Cutting...

Before working with an abrasive cut-off machine or dry-cut machine, make sure the machine and its accessories are in proper working order. Failure to do so can increase your risk of injury and result in blade or wheel pinching, binding or stalling, and loss of control.

- Set the machine securely on a flat, level surface.



Before installing a blade or wheel, always check for damage. Check wheels for cracks and blade teeth for damage. Replace cracked abrasive wheels or damaged blades immediately.

- Make sure the blade has adequate blade set. Blade set provides clearance between the sides of the blade and the workpiece, thus minimizing the probability of binding. Some saw blades have hollow ground sides instead of blade set to provide clearance.

### Blade Set



- Make sure that all mounting flanges, related washers, fasteners and other mounting hardware are in good condition. Make sure this hardware is properly positioned and secured on the arbor before each use. Always use the mounting hardware supplied with the machine.



With the machine unplugged and the machine head all the way down, manually spin the blade or wheel to check for blade/wheel clearance and alignment. The blade or wheel should rotate freely and not contact the table.

- Be sure all guards are in place and working properly before each use. Do not defeat guards. If the lower guard appears loose or if it does not move to cover the blade or wheel when the head is up, take the machine to an authorized service center for repairs.

### While Cutting ...

- Do not use cutting fluids on the blade, wheel or workpiece.
- Allow the motor to reach full speed before contacting the workpiece.



Never place your body or fingers in line with the blade or wheel while cutting.

- Use only the edge (not the sides) of the abrasive wheel for cutting. Do not allow the abrasive wheel to twist or bind.
- Do not force cutting. Always start the cut gently. Do not bump or bang an abrasive wheel or blade down on the work piece to start a cut. Excessive force only causes operator fatigue, increased wear and reduced control.
- Make sure the blade or wheel contacts the center of the workpiece for the safest, most efficient cutting.
- If the blade or wheel binds or stops rotating, or the motor sounds like it is straining, release the switch immediately to reduce the risk of damage to the machine.



Never reach under the machine or workpiece. The blade is exposed under the workpiece and the guard cannot protect your body here.

- Never remove the machine from a cut while the wheel or blade is rotating. When making a partial cut, or if power is interrupted, release the switch immediately. Don't remove the machine from the workpiece until the wheel or blade has come to a complete stop.
- Release the switch immediately if the wheel or blade binds or the machine stalls.
- Turn off the machine after a cut is complete, and keep the blade or wheel away from your body until it has stopped. Be aware that blades and wheels may coast after the machine is turned off.

### When Done...



Unplug, clean and store the tool in a safe, dry place after use.

Store blades and wheels with care. Do not drop them or subject them to excessive heat, cold or humidity.

### Always Remember...

- Be alert at all times, especially during repetitive operations. Don't be tempted into carelessness due to a false sense of security. Blades are extremely unforgiving.



When cutting metals, sparks or hot fragments could cause fires or burns. Never touch a work piece until it cools. Let the blade or wheel cool properly before changing.



When starting the machine after an idle period, always let the machine run with the blade or wheel completely recessed into the guard for one full minute before making a cut. If an abrasive wheel wobbles or vibrates, discard it and replace immediately.

- To reduce the risk of injury, always unplug the machine when leaving a workstation. Lock machines in the down position before transporting or when not in use.

## Accessories

A wide variety of accessories is available for use with power tools. However, the fact that an accessory will fit a tool does not automatically mean it is safe to use with that tool. Caution must be used when selecting and using any accessory with any power tool. Using an inappropriate accessory, or the incorrect accessory, can result in serious injury.

### Good Personal Safety is a Must

Following good safety practices when using power tools and their accessories is a must. Make a habit of including safety in all your activities.



Always read and understand the tool's operator's manual, tool markings and the instructions packaged with the accessory before starting any work.

### Before Installing Accessories...



Always unplug the tool, remove the battery pack, or lock off the trigger before installing, adjusting, and changing any accessory.

### Choose the Right Tool and Accessory

Choosing the right tool and accessory for your job can reduce the risk of serious injury. When used according to the manufacturer's instructions, they will do the job safer and faster.

Only use accessories that:

- Are specifically recommended by the power tool manufacturer.
- Are right for the job.
- Have specifications that match those of the power tool (for example, speed, size, mounting and guarding requirements, power requirements, etc.). Refer to the power tool markings and operator's manual.
- Fit the power tool without modification. Accessories should not require the removal, modification or bypassing of any guard, barrier, or other safety device on the power tool, unless another means of protection is used as recommended by the tool manufacturer. If another means of protection is used, the original equipment and safety devices should be reinstalled once the accessory is removed.



## Band Saws (Portable and Stationary)

Band saws can be found in most professional tradesman and student vocational work shops. Band saws cut fast and accurately due to continuous tooth blade action and a slow moving blade, which allows for more finesse and control.

### Good Personal Safety is a Must

Following good safety practices when using band saws is a must. Make a habit of including safety in all your activities.



Always read and understand the tool's operator's manual, tool markings and the instructions packaged with the accessory before starting any work.



Always wear safety goggles or safety glasses with side shields complying with current national standards, and a full face shield when needed.



Use the appropriate mask or respirator in dusty work conditions.

Wear proper hearing protection, as needed.

- Dress right. Do not wear gloves, loose clothes or jewelry. Contain long hair. Loose clothes, gloves, jewelry, or long hair can be caught in moving parts.
- Crowded, cluttered work areas that can cause tripping or loss of balance are particularly dangerous.
- Never alter a guard or use the tool with a guard missing. Be sure all guards are in place and working properly before each use. Do not defeat guards.

### Choose the Right Tool and Blade

Choosing the correct tool and the proper accessory for your application can help to reduce the risk of serious injury. When used according to the manufacturer's instructions, the proper tool and accessory will do the job safer and faster.



Use sharp blades. Damaged or dull blades could throw teeth, posing a serious injury risk. A sharp blade will tend to cut its way out of a pinching condition.

- When installing or changing a blade, be sure the blade is aligned properly and the teeth are running in the right direction. Check blade tension regularly and carefully. This helps prevent blade breakage.
- Be sure the blade is properly seated on the pulleys of the band saw before starting.
- Use clean blades. Buildup on the surface of the blade increases blade thickness and also increases blade friction.

### Know your Workpiece

Take time to review your work and make sure that all necessary precautions have been taken before making a cut.

- Support long workpieces at the same height as the saw.



Always place the workpiece securely in a vise or clamp when making cuts. Never make freehand cuts. Holding the workpiece by hand is unstable and may lead to loss of control.

- Never try to remove or clamp the workpiece while the blade is rotating.

### Before Cutting...

Before working with a bandsaw, make sure the machine and its accessories are in proper working order. Failure to do so can increase your risk of injury and result in blade or wheel pinching, binding or stalling, and loss of control.

- Make sure the blade has adequate blade set. Blade set provides clearance between the sides of the blade and the workpiece, thus minimizing the probability of binding. Some saw blades have hollow ground sides instead of blade set to provide clearance.



- Be sure all guards are in place and working properly before each use. Do not defeat guards.
- Never attempt to cut materials larger than the rated capacity listed in the band saw operator's manual, as this may result in personal injury. Always check maximum operating speeds established for blades against band saw speed.

## Stationary Band Saw:

- Adjust the blade guard, upper blade guide, and thrust bearings so only the necessary length of the blade is exposed. The upper blade guide should just clear your workpiece. This will prevent blade breakage and assure a smooth cut.

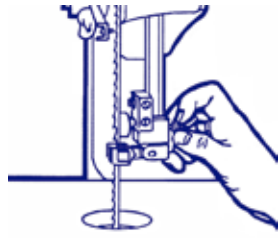

- Hold the band saw straight in the cut. Any twisting or cocking of the blade results in shorter blade life. If the blade makes a clicking sound as it passes through the workpiece, it is probably defective. Stop the saw; inspect and replace the blade if necessary.

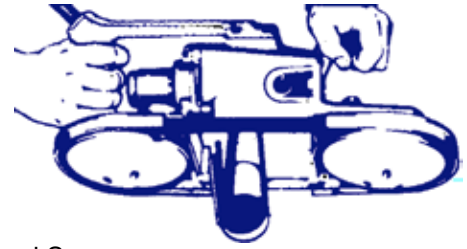

## While Cutting ...



Concentrate on what you are doing and be aware of kickback (a sudden reaction to a pinched, bound or misaligned blade). Kickback can cause an uncontrolled tool to lift up and out of the workpiece toward the operator and is the result of tool misuse and/or incorrect operating procedures or conditions. Take these specific precautions to help prevent kickback when using any type of band saw:



NEVER overreach! Always, hold the saw firmly with both hands after securing the workpiece.

- When you start the saw, allow the blade to reach full speed before the workpiece is contacted.



Be alert to the possibility of the blade binding and kickback occurring.

- Keep your hands away from all cutting edges and moving parts.



Never reach under the saw or workpiece. The blade is exposed under the workpiece and the saw guard cannot protect your body here.

- Keep hands and body away from and to the side of the blade. Contact with blade will result in serious injury.
- Never remove the saw from a cut while the blade is rotating. When making a partial cut, or if power is interrupted, release the switch immediately and don't remove the saw from the workpiece until the blade has come to a complete stop. A saw tooth could grab the workpiece, causing loss of control.
- Release the switch immediately if the blade binds or the saw stalls.
- Switch the tool off after a cut is completed, and keep the saw away from your body until the blade stops. The blade may coast for a time, posing the risk of serious cuts.
- Overheating a saw blade can cause it to warp and result in kickback. Buildup of sap on the blade, insufficient blade set, dullness, and unguided cuts, can all cause an overheated blade and kickback.

## Portable Band Saw:

- Do not bear down on the blade while cutting. The weight of the band saw will supply adequate pressure for the fastest cutting. Too much pressure will slow down the speed of the blade and reduce cutting efficiency.

## Stationary Band Saw:

- Do not make curved cuts with too small a radius for the width of blade being used. This can also cause unnecessary binding and possible blade breakage. Be attentive to thin cut-off pieces hitting the end of the slot in the table, or jamming in the slot. Use a push stick to free workpieces. Never place your fingers in line with the blade.

## When Done...



Unplug, clean and store the tool in a safe, dry place after use.

## Always Remember...

Be alert at all times, especially during repetitive operations. Don't be tempted into carelessness due to a false sense of security. Blades are extremely unforgiving.



Be aware that workpieces and other work fragments are hot and could cause fires or burns. Never touch a workpiece until it cools. Let the blade cool properly before changing.

- To reduce the risk of injury, always unplug the saw when moving from a workstation.
- Never use liquid coolants to lubricate your band saw. Liquid coolants can increase the risk of electric shock and may cause damage to the saw.
- Do not overfill the gear chamber with lubricant. Any excess pressure in the chamber will force lubricant into the motor, and may result in damage to the band saw.

## Circular Saws

Among professional tradesmen, on the farm, around the house and in the vocational shop, the circular saw is probably the most commonly used power saw and perhaps the most commonly abused. Familiarity should not lead to carelessness. The following are specific safety 'musts' when using any portable circular saw. Failure to follow these safety rules can result in serious injury.

### Good Personal Safety is a Must

Following good safety practices when using circular saws is a must. Make a habit of including safety in all your activities.



Always read and understand the tool's operator's manual, tool markings and the instructions packaged with the accessory before starting any work.



Always wear safety goggles or safety glasses with side shields complying with current national standards, and a full face shield when needed.



Use the appropriate mask or respirator in dusty work conditions.

- Wear proper hearing protection, as needed.
- Dress right. Do not wear gloves, loose clothes or jewelry. Contain long hair. Loose clothes, gloves, jewelry, or long hair can be caught in moving parts.
- Crowded, cluttered work areas that can cause tripping or loss of balance are particularly dangerous.

### Choose the Right Tool and Blade

Choosing the correct tool and the proper saw blade for your application can help to reduce the risk of serious injury. When used according to the manufacturer's instructions, the proper tool and accessory will do the job safer and faster.

- Do not use a circular saw that is too heavy for you to easily control.



Use sharp blades. Damaged or dull blades could throw teeth, posing a serious injury risk. A sharp blade will tend to cut its way out of a pinching condition.



Use the correct blade for your tool. Check this carefully: Does it have the proper size and shape arbor hole?

### RPM

Make sure the speed marked on the blade is at least as high as the no load RPM marked on the tool.

- Use clean saw blades. A buildup of pitch or sap on the surface of the saw blade increases blade thickness and also increases blade friction and the likelihood of kickback.

### Know your Workpiece

Take time to review your work and make sure that all necessary precautions have been taken before making a cut. Circular saws are used to cut a variety of materials, each having its own specific setup requirements.



Know what is behind a workpiece before you do the job. Do not cut into existing walls or other blind areas where electrical wiring, water, or gas pipes may exist. If this situation is unavoidable, disconnect all fuses/circuit breakers, and shut off any water and gas lines feeding this work site.

- Support large panels (as illustrated) so they will not pinch the blade.
- Use a straight edge or rip fence as a guide for ripping.
- Avoid cutting small workpieces that can't be properly secured, and workpieces on which the base of the saw (shoe) can not properly rest. Injury could result from small pieces being thrown back at the operator if the blade pinches and binds.

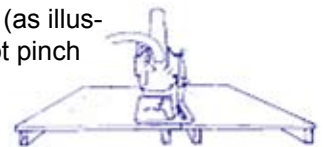

Portable circular saws are not designed for cutting logs, roots, trimming trees or shrubs.



Be very cautious of stock which is pitchy, knotty or warped. These are most likely to create pinching conditions and possible kickback.

### Before Cutting...

Before working with a circular saw, make sure the tool and its accessories are in proper working order. Failure to do so can increase your risk of injury and result in blade pinching, binding or stalling, kickback and loss of control. These situations can cause the saw to jump back at the operator and result in a serious injury.



Check blades carefully before each use for proper alignment and possible defects. Never use a bent, broken or warped saw blade.

- Make sure the blade has adequate blade set. Blade set provides clearance between the sides of the blade and the workpiece, thus minimizing the probability of binding. Some saw blades have hollow ground sides instead of blade set to provide clearance.

### Blade Set



- Be sure the blade flanges (washers) or bolt are correctly assembled on the shaft and installed in accordance with the tool manufacturer's instructions.
- Check for proper blade guard operation before each cut. Never use a tool with a guard missing. The guards should return to their normal position quickly. If a guard seems slow to return or "hangs up", repair or adjust it immediately. Never alter or defeat the guard (e.g., tying back or removing the guard).
- The lower guard should be pulled back manually only for special cuts such as "Pocket Cuts" and "Compound Cuts". Raise the lower guard using the lower guard lever. As soon as blade enters the material, release the lower guard.
- Be sure the tool switch works properly. Do not use a tool if the switch does not turn it off when returned to the off position.
- Tighten depth and bevel levers securely.



### While Cutting ...



Concentrate on what you are doing and be aware of kickback (a sudden reaction to a pinched, bound or misaligned blade). Kickback can cause an uncontrolled tool to lift up and out of the workpiece toward the operator and is the result of tool misuse and/or incorrect operating procedures or conditions. Take these specific precautions to help prevent kickback when using any type of circular saw:

Before starting a circular saw, be sure the power cord and extension cord are out of the blade path and are long enough to freely complete the cut. A sudden jerk or pull on the cord can cause loss of control of the saw and a serious accident.



Clamp workpieces securely. Check frequently to be sure clamps remain secure. A moving workpiece can cause loss of control and result in injury.



Never hold a workpiece in your hand or across your leg when sawing.



NEVER overreach! Always, hold the saw firmly with both hands after securing the workpiece.



Keep hands and body away from and to the side of the blade. Contact with blade will result in serious injury.

- Set blade depth to no more than 1/8 in. to 1/4 in. greater than the thickness of the material being cut. Less than a full tooth should be visible below the workpiece.



- Minimize blade pinching by placing the saw shoe on the clamped, supported portion of the workpiece, and allowing the cut off piece to fall away freely.
- When you start your saw allow the blade to reach full speed before contacting the workpiece.



Be alert to the possibility of the blade binding and kickback occurring. Hold the saw with two hands and position your arms to resist kickback.



If a fence or guide board is used, be certain the blade is kept parallel with it.

- Never remove the saw from a cut while the blade is rotating. When making a partial cut, or if power is interrupted, release the switch immediately and don't remove the saw from the workpiece until the blade has come to a complete stop. Removing the saw with a rotating blade could result in a saw tooth grabbing the workpiece, causing loss of control.



Never reach under the saw or workpiece. The blade is exposed under the workpiece and the saw guard cannot protect your body here.

- Release the switch immediately if the blade binds or the saw stalls.
- When restarting a saw in the workpiece, center the saw blade in the kerf and check that saw teeth are not touching the material when the saw is turned on.
- Turn off the tool after a cut is completed and keep the saw away from your body until the blade stops. The blade may coast for a time, posing the risk of serious cuts.

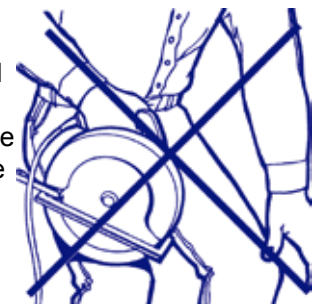

Overheating a saw blade can cause it to warp and result in kickback. Buildup of sap on the blades, insufficient blade set, dullness, and unguided cuts, can all cause an overheated blade and kickback.

## When Done...



Unplug, clean and store the tool in a safe, dry place after use.

## Always Remember...

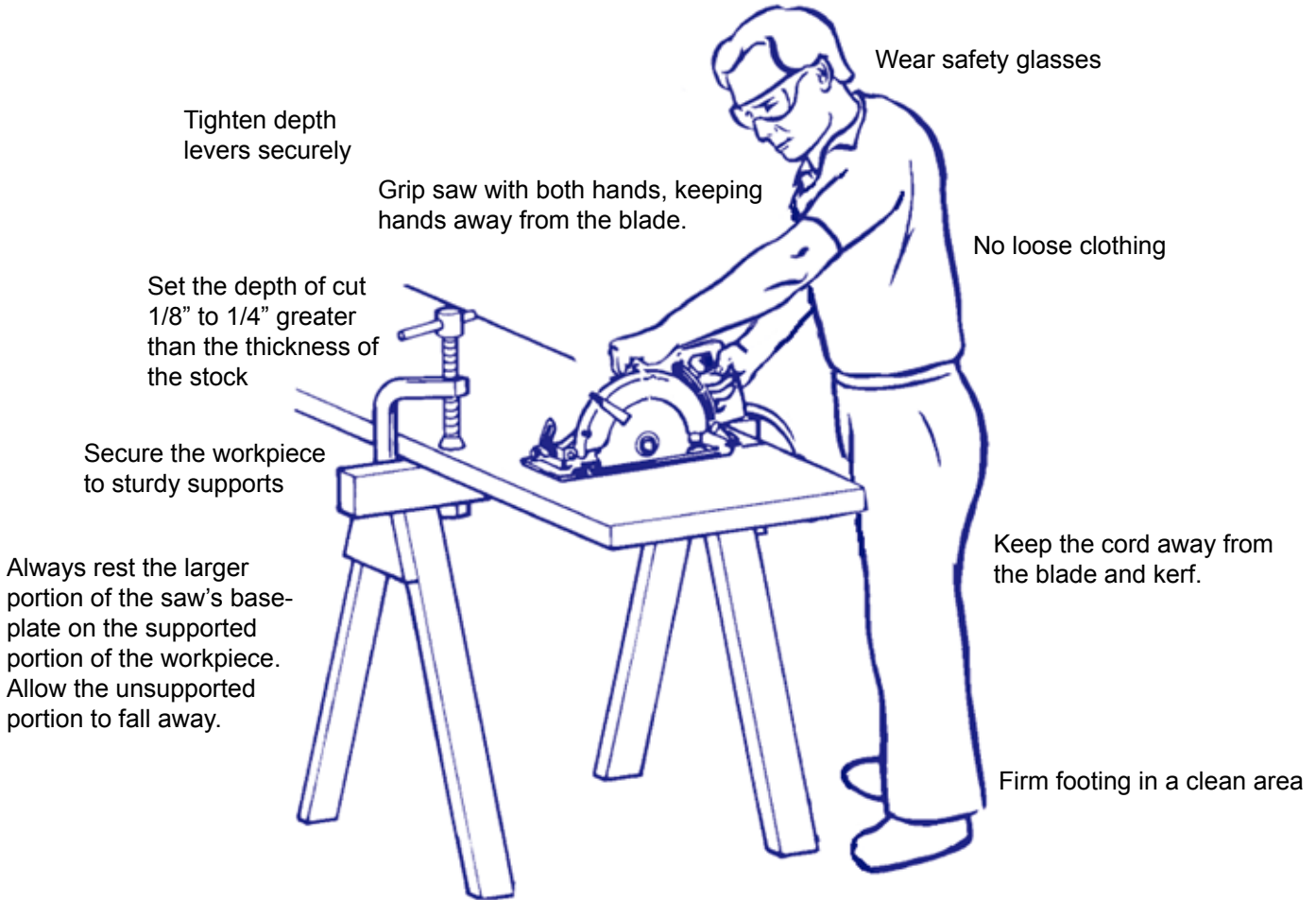

Wear safety glasses

Tighten depth levers securely

Grip saw with both hands, keeping hands away from the blade.

No loose clothing

Set the depth of cut 1/8" to 1/4" greater than the thickness of the stock

Secure the workpiece to sturdy supports

Always rest the larger portion of the saw's base-plate on the supported portion of the workpiece. Allow the unsupported portion to fall away.

Keep the cord away from the blade and kerf.

Firm footing in a clean area

## Cordless

Cordless tools get their electrical power from batteries. They demand the same respect that corded tools demand. Remember, cordless tools are very capable of causing injury if all safety precautions are not followed. Cordless tools come in many types; read and understand the section of this booklet for the type of cordless tool you are using, as well as the operator's manual provided with the tool.

### Good Personal Safety is a Must

Following good safety practices when using cordless tools is a must. Make a habit of including safety in all your activities.



Always read and understand the tool's operator's manual, tool markings and the instructions packaged with the accessory before starting any work.



Cordless tools may create sparks, so do not use them in an explosive atmosphere, near flammable liquids, gases or dust.

- To avoid accidental starting, remove batteries or lock off the switch when the tool is not being used, when changing accessories, and when adjusting or cleaning tools.
- Keep hands away from rotating or moving parts.
- Broken or abused battery packs can leak chemicals that can cause irritation or burns. If you come into contact with these chemicals, flush the area with water. If it contacts the eyes, flush with water and seek medical help.



Batteries may vent gas that can explode near a source of ignition, like a pilot light. Never use any cordless tool in the presence of open flame.



Do not place battery packs near fire or heat. The battery packs could explode.

### Choose the Right Battery Pack for the Tool

Use cordless tools only with their recommended battery packs. Other battery packs may create a risk of fire, burns, and explosions.

### Charge Battery Packs Safely

- Charge battery packs only with their recommended chargers.



Charge in a dry location.

- Do not charge near combustible materials.
- Do not use a charger or battery pack if it has been hit, dropped or damaged.
- Do not take apart the charger or battery pack. Take it to an authorized service center for all repairs.
- Keep tools, battery packs and chargers out of the reach of children and people unfamiliar with the tools.

### Maintain and Store Battery Packs Safely



Clean the contacts on the battery pack and tool with a pencil eraser if the tool isn't working at full power with a fully charged battery pack.

- Take the tool, charger, and battery to an authorized service center for all repairs. Do not attempt to repair them yourself.



Store battery packs away from other metal objects like paper clips, coins, keys, nails, screws, or other small metal objects. These things can make a connection from one terminal to the other, shorting the battery terminals together and causing burns or fire.



Store the battery pack away from extreme temperature conditions.

### Disposing of Battery Packs

Properly dispose of battery packs to help protect our environment.



Battery pack chemistries can be dangerous to the environment under certain conditions. Recycle or dispose of properly.



Refer to the instructions included with your battery pack for proper disposal/recycling of the battery packs. Local, state, or federal laws may prohibit disposal of certain batteries in ordinary trash.

- Place electrical tape over the battery pack's terminals before disposing/recycling.



Call 1-800-BATTERY for disposal information. RBRC™ Battery Recycling Seal on a battery pack indicates that the tool manufacturer has arranged for the recycling of that battery pack with the Rechargeable Battery Recycling Corporation (RBRC). At the end of your battery pack's useful life, return the battery pack to the tool manufacturer's branch office or service center or the participating retailer nearest you. For more information, visit the RBRC web site at [www.rbrc.org](http://www.rbrc.org).

Do not incinerate a battery pack or throw it into fire even if it is damaged or is completely worn out. Battery packs can explode in a fire.



Portable, hand-held drills and hammers are undoubtedly

## Coring Rigs and Motors

Portable coring rigs and motors, once considered a high-priced specialty tool, are becoming more economical and common on construction projects, as the demand for drilling larger-diameter holes through concrete, stone, asphalt, and other similar base materials has increased. Available in many sizes and capacities, these coring rigs typically use a diamond bit, and are designed for either dry or wet use. Whenever water is used near an electrical tool, it is extremely important to follow the instructions provided in the tool's operator's manual.

### Good Personal Safety is a Must

Following good safety practices when using power tools is a must. Make a habit of including safety in all your activities.



Always read and understand the tool's operator's manual, tool markings and the instructions packaged with the accessory before starting any work.



Always wear safety goggles or safety glasses with side shields complying with current national standards, and a full face shield when needed.



Use the appropriate mask or respirator in dusty work conditions.

Wear proper hearing protection, as needed.

- When coring with water, wear insulated boots and gloves.
- Dress right. Do not wear loose clothes or jewelry. Contain long hair. Loose clothes, gloves, jewelry, or long hair can be caught in moving parts.
- Crowded, cluttered work areas that can cause tripping or loss of balance are particularly dangerous.



Know what is behind a workpiece before you do the job. Do not core into existing walls or other blind areas where electrical wiring may exist. If this situation is unavoidable, disconnect all fuses or circuit breakers feeding this work site.

### Choose the Right Tool and Bit

Choosing the correct tool and the proper accessory for your application can help to reduce the risk of serious injury. When used according to the manufacturer's instructions, the proper tool and accessory will do the job safer and faster.

- Use only the size and type of coring bits recommended for your tool in the operator's manual or on the tool.

### Know your Workpiece

Take time to review your work and make sure that all necessary precautions have been taken before coring.

Securing Motor Base:

- Make sure the rig motor base is secured properly to the workpiece. An insecure rig can rotate and cause serious personal injury.
- When securing the rig base to concrete using anchors, check the operator's manual for the right size and type of anchor.
- When securing the coring rig using the vacuum pad attachment, make sure the work surface is clean and free from contaminants so a good seal is created; and verify that a minimum recommended vacuum (typically measured in "psi") is developed before coring. Check the operator's manual for any special requirements whenever using a vacuum pad.
- Do not use the vacuum for horizontal (wall) or overhead coring jobs.

**GFCI** In damp locations, only plug your tool into a Ground Fault Circuit Interrupter (GFCI). If the work area does not have a permanent GFCI on the outlet, use a plug-in GFCI. Wear rubber gloves and footwear.

## Before Coring...

Before coring with a coring rig and motor, make sure the tool and its accessories are in proper working order. Failure to do so may increase your risk of injury and may result in tool damage.

- Never core through a floor without first making sure the area below is clear of people, and that a falling core will not cause damage.
- Do not core through steel reinforcement without first consulting the project engineer to ensure that the integrity of the structure will not be damaged. Never core through tensioning cables.
- Always turn the tool off and unplug before removing a core from the bit. Make sure the carriage assembly is securely locked in place before placing your hands under the core bit.
- Before coring, compare the data on the tool nameplate with the voltage source and be sure that the voltage and frequency are compatible.
- Be sure the tool switch works properly. Do not use a tool if the switch does not turn it off when returned to the off position.

## While Coring ...

- Make sure the motor base is secured properly with either anchors or a vacuum base, depending on the type of job.
- Always keep firm footing when using coring rigs. Water may make the work area slippery. Use a collection device to keep the work area dry.
- In a binding situation, the tool will react in the opposite direction of the turning bit. When coring into the workpiece (clockwise), the rig will try to spin counterclockwise.
- Don't force the tool – Apply enough pressure to keep the bit coring smoothly. If the motor slows down, relieve the pressure. Too much pressure can damage the bit and cause you to lose control of the tool. Light pressure slows down coring and dulls the bit.
- If the bit binds in the workpiece, release the on/off switch immediately. Unplug the tool, then free the bit from the workpiece. Do not use a lock-on button in warped, pitched, knotty, or imbedded materials where binding may be more common. Do not try to free a jammed bit by starting and stopping the tool.
- If the rig shifts (moves) at all during coring, turn off the motor immediately and reposition the base of the rig.
- As you get close to breaking through the workpiece, reduce pressure and allow the bit to pass through the hole more easily.

## When Done...



Unplug, clean and store the tool in a safe, dry place after use.



## Drill Presses

Drill presses can be found in most professional and vocational work shops. Most wood or metal drilling jobs can be done quickly and accurately with a drill press, but some basic safety rules still apply.

### Good Personal Safety is a Must

Following good safety practices when using drill presses is a must. Make a habit of including safety in all your activities.



Always read and understand the tool's operator's manual, tool markings and the instructions packaged with the accessory before starting any work.



Always wear safety goggles or safety glasses with side shields complying with current national standards, and a full face shield when needed.



Use the appropriate mask or respirator in dusty work conditions.



Wear proper hearing protection, as needed.



Dress right. Do not wear gloves, loose clothes or jewelry. Contain long hair. Loose clothes, gloves, jewelry, or long hair can be caught in moving parts.

- Crowded, cluttered work areas that can cause tripping or loss of balance are particularly dangerous.
- Never alter a guard or use the tool with a guard missing. Be sure all guards are in place and working properly before each use. Do not defeat guards.

### Choose the Right Tool and Bit

Choosing the correct tool and the proper accessory for your application can help to reduce the risk of serious injury. When used according to the manufacturer's instructions, the proper tool and accessory will do the job safer and faster.



Does the bit shank fit properly into the chuck? Check the tool's operator's manual for the type of shank necessary (e.g., SDS, Hex, Round, Spline).

- Is the drill's capacity adequate for the accessory? Make sure the size of the bit is equal to or less than the capacity on the tool's nameplate.

### Know your Workpiece

Take time to review your work and make sure that all necessary precautions have been taken before drilling.



Never hold the work piece by hand. Secure the work piece with a clamp or another appropriate fixture if it is not long enough to be braced against the table column.

- Do not use bits with screw tips. These bits will pull the workpiece up from the table and start to spin, causing a serious risk of injury.

### Before Drilling...

Before working with a drill press, make sure the tool and its accessories are in proper working order. Failure to do so may increase your risk of injury and may result in binding, stalling, and loss of control. These situations may cause an accessory to break, causing an injury.

- Be sure belt guards are installed and working properly.
- Be sure the chuck is tightly secured to the spindle.



Tighten the bit securely in the chuck. Remove all chuck keys or wrenches before starting the drill. The key can be thrown at a high velocity if not removed, causing risk for injury.

- Carefully set the drill press speed for both the type of material and bit size you are using.
- Remove material or debris from the area that might be ignited by hot chips.

### When Drilling...

- To prevent the workpiece and backup material from spinning, set them against the left side of the drill support column.
- NEVER overreach! Never reach around or under the working head, or grab the chuck to stop a drill press. This can result in hand puncture or other serious injury.
- Don't force drilling. The tool will do the job better and safer at the rate for which it was intended.
- As you get close to breaking through the bottom of the workpiece, reduce pressure and allow the bit to pass through the hole easily. Set a piece of scrap wood under your workpiece to reduce splintering and to protect the bit tip.
- If the bit binds in the workpiece, release the on/off switch immediately. Unplug the tool, then free the bit from the workpiece. Do not try to free a jammed bit by starting and stopping the tool.

### When Done...



Don't touch the drill bit or cuttings. The drill bit and cuttings are hot immediately after drilling.

- Always shut off, unplug, and lock the drill press, if a lock is available, and store the key.



Store drill bits with care. Do not drop them or subject them to excessive heat, cold or humidity.

## Drills, Hammer-Drills, Rotary Hammers and Hammers

the most widely used power tools in the world. They are grouped into three general categories: drills; hammer-drills/rotary hammers; and hammers. They are used to drill holes and drive fasteners into a wide variety of materials.

### Good Personal Safety is a Must

Following good safety practices when using drills and hammers is a must. Make a habit of including safety in all your activities.



Always read and understand the tool's operator's manual, tool markings and the instructions packaged with the accessory before starting any work.



Always wear safety goggles or safety glasses with side shields complying with current national standards, and a full face shield when needed.



Use the appropriate mask or respirator in dusty work conditions.

Wear proper hearing protection, as needed.

Dress right. Do not wear gloves, loose clothes or jewelry. Contain long hair. Loose clothes, gloves, jewelry, or long hair can be caught in moving parts.

- Crowded, cluttered work areas that can cause tripping or loss of balance are particularly dangerous.

### What Type of Tool do you Have?

Using the right tool will get the job done faster and more safely.



Drills are used to create a hole with a rotating drill bit in wood, metal and plastics. Drills are rated by the maximum bit capacity of their chuck (1/2", 3/8", etc.). These tools are often well suited for driving screws.



Hammer Drills and Rotary Hammers use impacting action in combination with rotation of the specially designed "percussion bit" to drill holes in masonry materials. In the rotary mode they can also be used to drive fasteners into concrete, masonry, pavement, and similar materials. Often, these tools have different operating modes; hammering with rotary motion, rotation-only, and hammering-only.



Hammers (also called breakers, chipping hammers or percussion hammers) have a back-and-forth hammering action, without rotation. They are most often used for light-to-medium demolition or shaping of concrete, masonry, asphalt and similar materials.

### Choose the Right Tool and Bit

Choosing the correct tool and the proper accessory for your application can help to reduce the risk of serious injury. When used according to the manufacturer's instructions, the proper tool and accessory will do the job safer and faster.



Does the bit shank fit properly into the chuck? Check the tool's operator's manual for the type of shank necessary (e.g., SDS, Hex, Round, Spline).

- Is the drill's capacity adequate for the accessory? Make sure the size of the bit is equal to or less than the capacity on the tool's nameplate.

### Know your Workpiece



Know what is behind a workpiece before you do the job. Do not cut into existing walls or other blind areas where electrical wiring, water, or gas pipes may exist. If this situation is unavoidable, disconnect all fuses/circuit breakers, and shut off any water and gas lines feeding this work site.

### Before Drilling or Hammering...

Before working, make sure the tool and its accessories are in proper working order. Failure to do so may increase your risk of injury and may result in binding, stalling, and loss of control. These situations may cause the tool to twist or an accessory to break, causing an injury.

- Be sure the trigger turns the tool "on" when it is pulled and "off" when it is released. A trigger "lock-on" and lock release must also work correctly.



Check carefully for loose power cord connections and frays or damage to the cord and plug. Replace damaged tool /extension cords immediately. For grounded tools, equipped with a three-prong plug, make sure the grounding prong is in good condition.

- For tools with a chuck, be sure the chuck is tightly secured to the spindle. This is especially important on reversible type drills. The chuck could loosen and come off the drill.



Tighten the bit securely in the chuck. Remove all chuck keys or wrenches before starting the drill.

- Tighten any auxiliary (side) handles provided with the tool.

### When Drilling or Hammering...

- Firmly grasp the trigger handle and auxiliary handle (if provided) to maintain control.
- Always hold or brace the tool securely. Brace against stationary things for maximum control.
- In a binding situation, the tool will react in the opposite direction of the turning bit. When drilling into the workpiece (clockwise), the tool will try to spin counterclockwise.
- Don't force the tool— apply enough pressure to

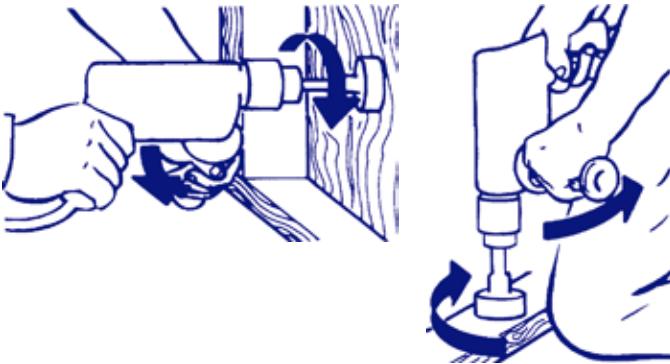
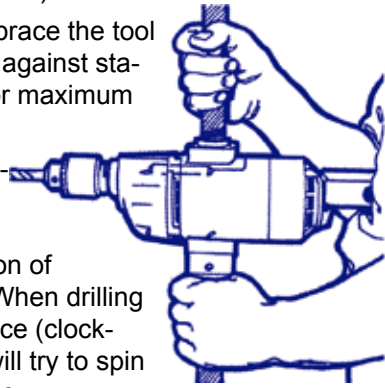

keep the bit cutting or chipping smoothly. If the motor slows down, relieve the pressure. Too much pressure can damage the bit and cause you to lose control of the tool.

- If the bit binds in the workpiece, release the trigger immediately. Unplug the tool, and then free the bit from the workpiece. Do not use a lock-on button when drilling in warped, pitched, knotty, or imbedded materials (e.g., reinforcing bars in concrete) where binding may be more common. Do not try to free a jammed bit by starting and stopping the tool.
- As you get close to breaking through the workpiece, reduce pressure and allow the bit to pass through the hole easily.
- Always keep a firm footing when using power tools. Be sure you have balance and control before you start the job.
- Remove material or debris from the area, especially if it could be ignited by hot chips or friction.

### When Done...



Unplug tool immediately after use, before removing or changing the bit and before performing any service or maintenance on the tool.



Store the tool in a dry place.

## Electric Chain Saws

An electric chain saw can be used to cut down small trees, trim and prune unwanted limbs and brush, and resize firewood and lumber. Chain saws require strict adherence to important safety practices.

### Good Personal Safety is a Must

Following good safety practices when using power tools is a must. Make a habit of including safety in all your activities.



Always read and understand the tool's operator's manual, tool markings and the instructions packaged with the accessory before starting any work.



Always wear safety goggles or safety glasses with side shields complying with current national standards, and a full face shield when needed.



Use the appropriate mask or respirator in dusty work conditions.

Wear proper hearing protection, as needed.

- Dress right. Do not wear gloves, loose clothes or jewelry. Contain long hair. Loose clothes, gloves, jewelry, or long hair can be caught in moving parts.
- Crowded, cluttered work areas that can cause tripping or loss of balance are particularly dangerous.
- Never alter a safety device or use the tool with a safety device missing. Be sure all safety devices are in place and working properly before each use. Do not defeat safety devices.

### Choose the Right Tool and Accessory

Choosing the correct tool and the proper accessory for your application can help to reduce the risk of serious injury. When used according to the manufacturer's instructions, the proper tool and accessory will do the job safer and faster.

- Use only chains specifically recommended for your tool in the operator's manual.
- Keep your chain sharp and clean from buildup of pitch or sap on the surface, which increases chain thickness and excessive chain friction.

### Know your Workpiece

Take time to review your work and make sure that all necessary precautions have been taken before making a cut.

- Don't use an electric chain saw for cutting plastics, masonry, metals or other non-wood building materials, as this may result in personal injury or damage to the tool. Cut wood and wood products only.

- Avoid cutting small pieces of material which can not be properly secured. Injury could result from small pieces being thrown back at the operator if the chain pinches and binds.



Be very cautious of workpieces that are pitchy, knotty or warped. These are most likely to create pinching conditions and possible kickback.



Know what is behind a workpiece before you do the job. Do not cut into existing walls or other blind areas where electrical wiring may exist. If this situation is unavoidable, disconnect all fuses or circuit breakers feeding this work site.

### Before Cutting...

Before cutting with a chain saw, make sure the tool and its accessories are in proper working order. Failure to do so may increase your risk of injury and may result in kickback, chain pinching, binding or stalling, and loss of control. These situations may cause the saw to jump back at the operator and can result in a serious injury.



Unplug electric chain saws when not in use, before servicing, and when changing accessories and attachments, such as the saw chain and guard.

- Do not use an electric chain saw if the switch does not turn the saw on and off. Be sure the chain stops moving when the switch is released or the brake guard (lever) is pushed forward.
- Do not operate an electric chain saw that is damaged, improperly adjusted, or is not completely and securely assembled. A handle, guard or other part that is damaged should be properly repaired or replaced by an authorized service center.
- Do not attempt to disable the chain brake. If kickback occurs, the chain brake will stop the chain immediately, and may reduce the risk of personal injury. The chain brake is engaged manually when the handle guard is pushed forward. Periodically test the brake. If the chain brake doesn't stop the chain immediately, the brake needs to be repaired by an authorized service center.
- Before use, check for the misalignment, binding or breakage of moving parts, improper saw chain tension and mounting, and any other conditions that may affect saw operation. Too much tension in the saw chain will burn the guide bar and damage the chain. Too little tension in the saw chain will allow the chain to leave the guide bar, and may cause personal injury. A new chain will stretch when used and will require readjustments later.

- Keep handles dry, clean, and free from oil and grease. Greasy, oily handles are slippery and will cause a loss of control.
- Before starting an electric chain saw, make sure the saw chain is not contacting anything. Do not cut until you have a clear work area, secure footing and a planned retreat path, if cutting down a tree.
- Do not operate an electric chain saw while in a tree unless specifically trained to do so. Improper operation of a chain saw may result in personal injury.

- Maintain a firm grip with thumbs and fingers around the chain saw handles, and your body and arms positioned to resist kickback forces. Do not cut above shoulder height.



- NEVER overreach! Keep proper footing and balance at all times.
- Use devices such as low kickback chains, guide bar nose guards, chain brakes and special guide bars that reduce the risks associated with kickback.
- Never remove the saw from a cut while the chain is rotating. When making a partial cut, or if power is interrupted, release the trigger immediately and don't remove the saw from the workpiece until the chain has come to a complete stop. A chain link could grab the workpiece, causing a loss of control.

## While Cutting ...



Concentrate on what you are doing and be aware of kickback (a sudden reaction to a pinched, bound or jammed chain). Kickback can cause an uncontrolled tool to rotate the bar toward the operator or push or pull the tool, depending on the location along the periphery of the guide bar where the jamming of the chain occurs. Kickback is the result of incorrect operating procedures or conditions. Take these specific precautions to help prevent kickback when using an electric chain saw:

- Be alert to the possibility of the blade binding and kickback occurring.
- Firmly control the chain saw when the motor is running. Do not stand in line with the guide bar in case kickback occurs.
- Be aware of rotational kickback, which may occur when the rotating chain at the nose or tip of the guide bar touches an object. This action frequently causes a fast reverse reaction, kicking the guide bar up and back, essentially rotating the chain saw towards the operator. This reaction may cause you to lose control of the saw, which could result in serious injury.



- Linear or "pinch" kickback may occur when the wood closes in and pinches the chain in the cut. Pinching the chain along the top of the guide bar may push the guide bar rapidly back toward the operator. Pinching the chain along the bottom of the guide bar may pull the guide bar rapidly away from the operator. This reaction may cause you to lose control of the saw, which could result in serious injury.



Never reach under the chain saw or workpiece. The chain is exposed under the workpiece and the saw guard cannot protect your body here.

- Release the switch immediately if the chain binds or the saw stalls.
- Turn the tool off after a cut is completed, and keep the saw away from your body until the chain stops.
- Do not force a saw chain into the material being cut. Allow the saw to reach full speed, then use a controlled motion while making the cut.
- Use extreme caution when cutting small size brush and saplings. The slender material may catch the saw chain and be whipped toward you or pull you off balance. When cutting a limb that is under tension, be alert for spring back so that you will not be struck when the wood fibers release.

## When Done...

- When storing or transporting an electric chain saw, use a scabbard or carrying case to cover the guide bar and saw chain.

## Always Remember...

- Do not operate an electric chain saw when you are tired. Be alert at all times, especially during repetitive operations. Don't be tempted into carelessness due to a false sense of security. Saw chains are extremely unforgiving.

## Grinders (Portable and Bench)

Grinders and sanders are highly versatile tools capable of accepting a variety of attachments and accessories that allow the tool to be used for grinding, sanding, polishing, wire brushing or cutting-off operations. The proper guarding and safety devices must be used with the accessories (e.g., the proper type of guard used with a certain grinding wheel).

### Good Personal Safety is a Must

Following good safety practices when using a grinder is a must. Make a habit of including safety in all your activities.



Always read and understand the tool's operator's manual, tool markings and the instructions packaged with the accessory before starting any work.



Always wear safety goggles or safety glasses with side shields complying with current national standards, and a full face shield when needed.



Use the appropriate mask or respirator in dusty work conditions.



Wear proper hearing protection, as needed.

Wear gloves and a shop apron capable of stopping small abrasive or workpiece fragments.

- Dress right. Do not wear loose clothes or jewelry. Contain long hair. Loose clothes, jewelry, or long hair can be caught in moving parts.
- Crowded, cluttered work areas that can cause tripping or loss of balance are particularly dangerous.



Do not operate the power tool near flammable materials. Sparks could ignite these materials.

### Choose the Right Tool and Accessory

Choosing the correct tool and the proper accessory for your application can help to reduce the risk of serious injury. When used according to the manufacturer's instructions, the proper tool and accessory will do the job safer and faster.



When it is recommended to use a guard with a wire brush, do not allow the wire brush to rub against the guard. The wire wheel or brush may expand in diameter due to work load and spinning.

- Wheels must be used only for their recommended jobs. For example, do not grind with the side of a cut-off wheel. It will shatter.
- The outside diameter and the thickness of your accessory must be within the capacity rating of your power tool (e.g., don't use an 8" wheel on a 7" grinder). Incorrectly sized accessories cannot be adequately guarded or controlled.

- Use the correct accessory for your tool. Check this carefully: Does it fit the spindle of the power tool. Be careful not to over-tighten the spindle nut. Too much pressure will deform the flanges and stress the wheel. Accessories with arbor holes that do not match the tool will wobble, vibrate excessively and may cause loss of control.
- Always use undamaged wheel flanges that are the correct size and shape to properly support your accessory.

### RPM

Make sure the speed marked on the accessory is at least as high as the no load RPM marked on the tool. Accessories running faster than their rated speed can fly apart.



Do not use accessories that require liquid coolant, unless your tool has been specifically designed for operations with liquid coolant. Using water or other liquid coolants may result in electrocution or shock.

Portable Grinders:

- Determine the type of tool needed for the job. Portable grinders come in various types, such as: "straight" grinders, "vertical" grinders or "angle" grinders.
- Do not use a grinder that is too heavy for you to easily control.
- When sanding, do not use excessively oversized sanding disc paper. Follow tool manufacturer's recommendations when selecting sanding paper.

### Know your Workpiece

- Avoid working on small pieces of material which can't be properly secured. Injury could result from small pieces being thrown by the spinning accessory.

Portable Grinders:



Know what is behind a workpiece before you do the job. Do not cut into existing walls or other blind areas where electrical wiring, water, or gas pipes may exist. If this situation is unavoidable, disconnect all fuses/circuit breakers, and shut off any water and gas lines feeding this work site.

## Before Grinding...

Before working with a grinder, make sure the tool and its accessories are in proper working order. Failure to do so may increase your risk of injury.

- Handle accessories carefully to prevent damage or cracking. Do not use a damaged accessory.
- Before each use, inspect
  - abrasive wheels for chips and cracks
  - backing pad for cracks, tear or excess wear
  - wire brush for loose or cracked wires.



- Test grinding wheels before mounting. Tap the wheel lightly with a nonmetallic implement such as the handle of a screwdriver. If it produces a ringing sound, it is in good condition. If it sounds dull, replace the wheel. **DO NOT USE A CRACKED WHEEL.**



- Tuck away or trim any loose portion of a polishing bonnet or its attachment strings.



After inspecting and installing an accessory, position yourself and bystanders away from the rotating accessory and run the power tool at maximum no load speed for one minute. Damaged accessories will normally break apart during this test time.

- Keep bystanders a safe distance away from the work area. Anyone entering the work area must wear personal protective equipment. Pieces of a workpiece or a broken accessory may fly away.
- Be sure the tool switch works properly. Do not use a tool if the switch does not turn it off when returned to the off position.

Portable Grinders:

- Be sure the guard is securely attached to the tool and positioned for maximum safety, so the least amount of wheel is exposed toward the operator during use.
- Position the cord away from the spinning accessory. If you lose control, the cord may be cut or snagged and your hand or arm may be pulled into the spinning accessory.



- Bench grinder wheels should be trued and dressed when worn out of round, or the surface face is clogged or worn smooth. This provides a clean sharp grinding surface and rebalancing of the wheel.



New bench grinder wheels should be balanced by dressing and truing to eliminate vibration and possible mishap. Check your operator's manual. Don't operate a grinder unless you are certain the grinder, its base and/or stand are securely mounted.

## While Grinding...



Concentrate on what you are doing and be aware of kickback (a sudden reaction to a pinched or snagged accessory). Pinching or snagging causes rapid stalling of the rotating accessory. This forces the uncontrolled power tool in the direction opposite the accessory's rotation at the point of binding. It can also cause an uncontrolled workpiece to be thrown.

- For example, when using a portable grinder, if an abrasive wheel is snagged or pinched by the workpiece, the edge of the wheel entering the pinch point can dig into the surface of the material causing the wheel to climb or kick out of the workpiece. The wheel may either jump toward or away from the operator, depending on direction of the wheel's movement at the point of pinching. Abrasive wheels may also break under these conditions.
- Kickback is the result of power tool misuse and/or incorrect operating procedures or conditions, and can be avoided by taking proper precautions.



Never place your hand near the rotating accessory. The tool may kick back.

- Use special care when working on corners, sharp edges, etc. Avoid bouncing and snagging the accessory. Corners, sharp edges or bouncing have a tendency to snag the rotating accessory and cause loss of control or kickback.



Do not attach a saw chain, woodcarving blade, or toothed saw blade. Grinders are not designed for these types of blades.

- Do not "jam" a cut-off wheel or apply excessive pressure. Do not attempt to make an excessive depth of cut.



When using wire brushes, wire bristles are thrown during ordinary operation. Do not overstress the wires by applying excessive load to the brush.

- When stopping a cut, switch off the tool and hold the tool motionless until the wheel comes to a complete stop. Never attempt to remove the cutoff wheel from the cut while the wheel is in motion.
- Do not restart the cut in the workpiece. Let the wheel reach full speed and then carefully re-enter the cut.

Portable Grinders:

- Maintain a firm grip on the power tool and position your body and arms to allow you to resist kickback forces. Always use an auxiliary (side) handle, if provided, for maximum control over kickback or a torque reaction during start-up. The operator can control torque reactions or kickback forces, if proper precautions are taken.
- Do not position your body in the area where the power tool will move if kickback occurs. Kickback will propel the tool in the direction opposite to the wheel's movement at the point of snagging.
- Support panels or any oversized workpiece to minimize the risk of wheel pinching and kickback. Large workpieces tend to sag under their own weight. Supports must be placed under the workpiece near the line of cut and near the edge of the workpiece on both sides of the wheel.
- When it is recommended to use a guard with a wire brush, do not allow the wire brush to rub against the guard. The wire wheel or brush may expand in diameter due to work load and spinning.

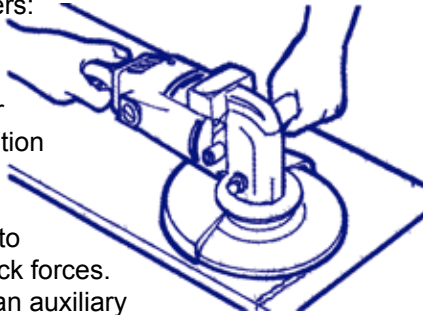

Bench Grinders:

- On bench grinders, tool rests and spark guards are adjustable to compensate for wheel wear. They must be reset when a new wheel is installed or after a wheel has been worn or dressed. The distance between the spark guard and the wheel should be within 1/16". The tool rest should be slightly below the center of the wheel with 1/8" or less clearance from the wheel. This prevents accidental jamming between tool rest and the wheel.

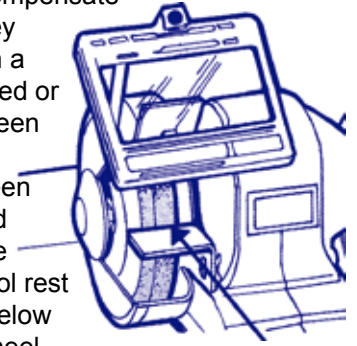

When Done...



Unplug, clean and store the tool in a safe, dry place after use.

Never lay the power tool down until the accessory has come to a complete stop. The spinning accessory may grab the surface and pull the power tool out of your control.

- Do not run the power tool while carrying it at your side. Accidental contact with the spinning accessory could snag your clothing, pulling the accessory into your body.



Regularly clean the power tool's air vents. The motor's fan will draw the dust inside the housing and excessive accumulation of powdered metal may cause electrical hazards.

- Store accessories with care. Do not drop them or subject them to excessive heat, cold or humidity.



## Heat Guns

Heat guns have a variety of uses, such as removing paint, creating bends and welding plastics, cutting Styrofoam, soldering, heat shrinking, and thawing water pipes. The extreme temperatures that make heat guns so useful also make them very dangerous.

### Good Personal Safety is a Must

Following good safety practices when using a heat gun is a must. Make a habit of including safety in all your activities.



Always read and understand the tool's operator's manual, tool markings and the instructions packaged with the accessory before starting any work.



Always wear safety goggles or safety glasses with side shields complying with current national standards, and a full face shield when needed.



Always wear the appropriate mask or respirator.



Wear proper hearing protection, as needed.

Do not point the heat gun at clothing, hair or other body parts. Do not use as a hair dryer. Heat guns can produce 1000°F (540°C) or more of flameless heat at the nozzle. Contact with the air stream will result in serious burns and personal injury.

- Dress right. Do not wear loose clothes or jewelry. Contain long hair. Loose clothes, jewelry, or long hair can contact the air stream or nozzle, causing burns or fire.
- Crowded, cluttered work areas that can cause tripping or loss of balance are particularly dangerous.

### Choose the Right Tool and Accessory

There are hundreds of nozzles and accessories for heat guns. Use only those specifically recommended by the heat gun manufacturer. Others may not fit right or be able to handle the heat generated by the heat gun.

### Know your Work Environment



Do not use near flammable liquids or in explosive atmospheres, such as near fumes, gases or dust. The flameless heat from the heat gun may ignite the dust or fumes. Remove materials or debris that may become ignited from work area.

- Hidden areas such as behind walls, ceilings, floors, soffit boards and other panels may contain flammable materials that may ignite when using the heat gun in these locations. Ignition of these materials may not be readily apparent and could result in property damage and personal injury. Check these areas before applying heat. If in doubt, use a different method.

### Before Using the Heat Gun...



Shield materials around the heated area to prevent property damage or fire. Keep a fire extinguisher nearby.

### When Using the Heat Gun...

- Always hold the heat gun by the plastic enclosure.
- Do not touch nozzle or accessory tips, or store heat gun until the nozzle has cooled to room temperature. The metal nozzle requires approximately 20 minutes to cool before it can be touched. Contact with the nozzle or accessory tip could result in personal injury. Place the heat gun in a clear area away from combustible materials while cooling to prevent materials from igniting.
- Keep heat gun moving to avoid excessive temperatures. Pausing or lingering in one spot may ignite or melt the workpiece or the material behind it.
- Do not cut off air flow by placing nozzle too close to workpiece. Keep intake vents clean and clear of obstructions. Restricting air flow may cause the heat gun to overheat.
- Place the heat gun on a stable, level surface when not hand held. Use the support pads or support stand. Place cord in a position that won't cause the heat gun to tip over.
- Do not leave the heat gun unattended while running or cooling down. It could tip, causing fire or burns.
- Do not apply airflow directly on glass. The glass may crack or shatter, resulting in property damage or personal injury.
- The proper amount of heat for each job depends on the temperature range selected, distance between the nozzle and workpiece, and the length of time heat is applied. Experiment with scrap materials and start with lowest temperature range. Be careful when working until the proper combination of heat, distance and time of application has been obtained. Use a back and forth motion when applying heat unless concentrated heat is desirable.

## When Done...



Unplug tool immediately after use, before removing or changing the nozzle and before performing any service or maintenance on the tool.



Store the tool in a dry place.

## Special Considerations for Removing Paint



Use extreme care when stripping paint. Peelings, residue and vapors of paint may contain lead, which is POISONOUS. Pre-1977 paint may contain lead and paint made before 1950 is likely to contain lead. Hand to mouth contact with

paint peelings or residue from pre-1977 paint may result in lead ingestion. Exposure to even low levels of lead can cause irreversible brain and nervous system damage. Young and unborn children are especially vulnerable to lead poisoning. **DO NOT REMOVE LEAD-BASED PAINT WITH A HEAT GUN.** Before beginning your work, determine whether the paint you are removing contains lead. A local health department or a professional who uses a paint analyzer can check the paint for lead content. **LEAD-BASED PAINT SHOULD BE REMOVED ONLY BY A PROFESSIONAL.**

- Work in a well ventilated area. If possible, move the workpiece outside. If working indoors, open windows and put an exhaust fan in a window. Be sure the fan is moving air from inside to outside. Proper ventilation will reduce the risk of inhaling chemicals found in the fumes or dust created by using a heat gun.
- Remove or protect any carpets, rugs, furniture, clothing, cooking utensils and air ducts to prevent contamination and property damage from the paint peelings. Paint scrapings may ignite if too close to the heat gun nozzle.



Keep food and drink away from work area. Wash hands, arms and face and rinse mouth after leaving the work area and before eating and drinking. Do not smoke, or chew gum or tobacco in the work area.

- Place drop cloths in the work area to catch paint scrapings. Wear protective clothing such as hats, extra work shirts and overalls. Paint scrapings may contain chemicals that are hazardous.
- Work in one room at a time. Remove furnishings or cover them and place in the center of the room. Seal doorways with drop cloths to seal work area from the rest of the building.
- Children, pregnant women, and nursing mothers should not be near work area until all work is

completed and work area is cleaned thoroughly.

- Wear a dust respirator mask or a dual filter (dust and fume) respirator mask which has been approved by the Occupational Safety and Health Administration (OSHA), the National Institute of Safety and Health (NIOSH), or the United States Bureau of Mines. These masks and replaceable filters are readily available at major hardware stores or industrial distributors. Be sure the mask fits. Beards and facial hair may keep masks from sealing properly. Change filters often. Disposable paper masks are not adequate.
- Clean up all paint scrapings and dust. Do not sweep, dry dust or vacuum; the paint dust will be thrown up into the air where it can be inhaled or contaminate other areas. Wet mop floors. Use a wet cloth to clean all walls, sills and other surfaces where paint and dust have accumulated. Use a high phosphate detergent, trisodium phosphate (TSP), or a trisodium phosphate substitute to clean and mop the work area.



Dispose of paint scrapings properly. Following each work session, place paint scrapings in a double plastic bag, close it with tape or twist ties and dispose.

- Remove protective clothing and work shoes in the work area to avoid transferring dust to other parts of the building. Wash work clothes separately. Wipe shoes off with a wet rag that is then washed with the work clothes. Wash hair and body thoroughly with soap and water.
- Crowded, cluttered work areas can cause tripping or loss of balance and are particularly dangerous.
- Never alter a guard or use the tool with a guard missing. Be sure all guards are in place and working properly before each use. Do not defeat guards.

## Impact Wrenches

Impact wrenches are used for tightening and loosening nuts and bolts, and sometimes for light drilling. The tool's high torque output is preferred to many other tools (such as a standard drill) because it minimizes torque reaction. Impact wrenches do, however, pose some risks that require your attention.

### Good Personal Safety is a Must

Following good safety practices when using power tools is a must. Make a habit of including safety in all your activities.



Always read and understand the tool's operator's manual, tool markings and the instructions packaged with the accessory before starting any work.



Always wear safety goggles or safety glasses with side shields complying with current national standards, and a full face shield when needed.



Use the appropriate mask or respirator in dusty work conditions.

Wear proper hearing protection, as needed.

- Dress right. Do not wear gloves, loose clothes or jewelry. Contain long hair. Loose clothes, gloves, jewelry, or long hair can be caught in moving parts.
- Crowded, cluttered work areas that can cause tripping or loss of balance are particularly dangerous.

### Choose the Right Tool and Accessory

Choosing the correct tool and the proper accessory for your application can help to reduce the risk of serious injury. When used according to the manufacturer's instructions, the proper tool and accessory will do the job safer and faster.

- Use only sockets that are specifically designated "impact wrench sockets". Other sockets which are made for hand tool use will not withstand impact wrench use. They are subject to premature failure, breaking and possibly causing injury.
- Always check the socket carefully for wear, cracks or damage before use.
- Other accessories for impact wrenches are available, such as chucks, drill bits and driver bits. Be sure the accessory is specifically made for your job.

### Before Impacting...

Before working with an impact wrench, make sure the tool and its accessories are in proper working order. Failure to do so may increase your risk of injury.



Know what is behind a workpiece before you do the job. Do not cut into existing walls or other blind areas where electrical wiring, water, or gas pipes may exist. If this situation is unavoidable, disconnect all fuses/circuit breakers, and shut off any water and gas lines feeding this work site.

- Always be sure you have firm footing.
- Be sure no one is below you when using the tool in high locations.



Never use a wire, soft pin or nail to hold the socket onto the square anvil of the impact wrench. If the proper retaining device on the tool is broken, have the tool repaired before use.

### While Impacting...

- NEVER overreach! For maximum control, hold the impact wrench firmly with both hands after securing the workpiece.
- Don't force the impact wrench. It will do the job better and safer at the rate for which it was intended. Always check maximum operating speeds established for sockets used on your impact wrench.
- Avoid over-impacting, particularly on small bolt sizes. Small bolts could easily be broken or the threads stripped. Over-impacting can cause early failure of fasteners or other damage, and can lead to accidents.
- On jobs where a low or critical level of torque is required, impact each fastener lightly, and then do the final tightening with a hand torque wrench. The proper torque may differ depending upon the kind or size of the bolt.

### When Done...



Unplug, clean and store the impact wrench in a safe, dry place after use.



Store sockets with care. Do not drop them or subject them to excessive heat, cold or humidity.

### Always Remember...

- To reduce the risk of injury, unplug the impact wrench before changing sockets or other accessories.
- Do not use an impact wrench in wet or damp environments.

## Jig Saws (Saber Saws)

Jig saws, also known as saber saws, are light weight and generally easy to handle. For this reason, carelessness can easily enter into tool operation.

### Good Personal Safety is a Must

Following good safety practices when using jig saws is a must. Make a habit of including safety in all your activities.



Always read and understand the tool's operator's manual, tool markings and the instructions packaged with the accessory before starting any work.



Always wear safety goggles or safety glasses with side shields complying with current national standards, and a full face shield when needed.



Use the appropriate mask or respirator in dusty work conditions.

Wear proper hearing protection, as needed.

- Dress right. Do not wear gloves, loose clothes or jewelry. Contain long hair. Loose clothes, gloves, jewelry, or long hair can be caught in moving parts.
- Crowded, cluttered work areas that can cause tripping or loss of balance are particularly dangerous.
- Never alter a guard or use the tool with a guard missing. Be sure all guards are in place and working properly before each use. Do not defeat guards.

### Choose the Right Tool and Blade

Choosing the correct tool and the proper accessory for your application can help to reduce the risk of serious injury. When used according to the manufacturer's instructions, the proper tool and accessory will do the job safer and faster.

- Unplug the tool before checking or installing blades or accessories.



Use sharp blades. Dull blades can produce excessive heat, make cutting difficult, result in forcing the saw, and possibly cause an accident.

- Make sure the blade is clean. Buildup on the surface of the blade could cause excessive friction.

### Know your Workpiece

Take time to review your work and make sure that all necessary precautions have been taken before making a cut.



Know what is behind a workpiece before you do the job. Do not cut into existing walls or other blind areas where electrical wiring may exist. If this situation is unavoidable, disconnect all fuses or circuit breakers feeding this work site.

- Support long workpieces at the same height as the saw.



Always place the workpiece securely in a vise or clamp when making cuts. Never make freehand cuts.

- Holding the workpiece by hand is unstable and may lead to loss of control.
- Never try to remove or clamp the workpiece while the blade is moving.

### Before Cutting...

Before cutting with a jig saw, make sure the tool and its accessories are in proper working order. Failure to do so may increase your risk of injury, blade pinching, binding or stalling, and loss of control. These situations may result in an injury.

- Check blades carefully before each use for proper alignment and possible defects. Never use a bent, broken or warped saw blade.
- Never attempt to cut materials larger than the rated capacity listed in the jig saw operator's manual, as this may result in personal injury.
- Never unplug the tool with the trigger locked on. Before plugging in the tool, be sure the "lock-on" switch is off. Accidental start-ups could cause injury.
- If the "lock-on" switch cannot be turned off with the trigger while the tool is running, unplug it and have it repaired by a qualified service technician.
- Be sure all guards are in place and working properly before each use. Do not defeat guards.
- Be sure all adjusting screws (knobs) and the blade clamp are tight before making a cut. Loose adjusting screws and blade clamps can cause the saw or blade to slip and loss of control may result.

- Make sure the blade has adequate blade set. Blade set provides clearance between the sides of the blade and the workpiece, thus minimizing binding. Some saw blades have hollow ground sides instead of blade set to provide clearance.

**Blade Set**



## While Cutting ...



Concentrate on what you are doing and be aware of kickback (a sudden reaction to a pinched, bound or misaligned blade). Kickback can cause an uncontrolled tool to lift up and out of the workpiece toward the operator and is the result of tool misuse and/or incorrect operating procedures or conditions. Take these specific precautions to help prevent kickback when using a jig saw:

- NEVER overreach! For maximum control, hold the saw firmly after securing the workpiece.
- Be alert to the possibility of the blade binding and kickback occurring.
- Never remove the saw from a cut while the blade is moving. When making a partial cut, or if power is interrupted, release the trigger immediately and don't remove the saw from the work piece until the blade has come to a complete stop. A saw tooth could grab the work piece, causing loss of control.



Never reach under the saw or workpiece. The blade is exposed under the work piece and the saw guard cannot protect your body here.

- Release the trigger immediately if the blade binds or the saw stalls.



Overheating a saw blade can cause it to warp and result in kickback. Buildup of sap on the blade, insufficient blade set, dullness, and unguided cuts, can all cause an overheated blade and kickback.

- When starting the cut, firmly position the saw plate/shoe on the workpiece before turning on the tool. Always keep firm contact between the plate/shoe and the workpiece. Small or thin material may flex or vibrate with the blade, causing loss of control.
- Before starting a cut, turn the tool "ON" and allow the blade to reach full speed. The saw can chatter or vibrate if the blade speed is too slow when beginning the cut and kickback may occur.



Keep your hands away from all cutting edges and moving parts. Never place your fingers in line with the blade.

- When plunge (pocket) cutting, use a blade designed for that purpose and follow the tool manufacturer's instructions.
- Pinch Points! Keep hands from between the gear housing and saw blade clamp (plunger). The reciprocating blade clamp (blade plunger) can pinch your fingers.
- Switch the tool off after a cut is completed, and keep the saw away from your body until the blade stops. The blade may coast for a time, posing the risk of serious cuts.

## When Done...



Unplug, clean and store the tool in a safe, dry place after use.

## Always Remember...

- Be alert at all times, especially during repetitive operations. Don't be tempted into carelessness due to a false sense of security. Blades are extremely unforgiving.
- To reduce the risk of injury, always unplug the saw when moving from a workstation.

## Jointer/Planer

Jointers/planers are used to resurface wood and like materials to provide a straight, smooth surface.

### Good Personal Safety is a Must

Following good safety practices when using a power tool is a must. Make a habit of including safety in all your activities.



Always read and understand the tool's operator's manual, tool markings and the instructions packaged with the accessory before starting any work.



Always wear safety goggles or safety glasses with side shields complying with current national standards, and a full face shield when needed.



Use the appropriate mask or respirator in dusty work conditions.



Wear proper hearing protection, as needed.

- Dress right. Do not wear loose clothes or jewelry. Contain long hair. Loose clothes, jewelry, or long hair can be caught in moving parts.
- Crowded, cluttered work areas that can cause tripping or loss of balance are particularly dangerous.
- Never alter a guard or use the tool with a guard missing. Be sure all guards are in place and working properly before each use. Do not defeat guards.
- Always use push blocks/sticks when jointing or beveling wood or when planing.

### Choose the Right Tool and Accessory

Choosing the correct tool and the proper accessory for your application can help to reduce the risk of serious injury. When used according to the manufacturer's instructions, the proper tool and accessory will do the job safer and faster.

- Always keep cutter blades (knives) sharp and clean of rust and pitch to avoid excessive blade friction.
- Use only cutter blades (knives) recommended by the tool manufacturer. This is extremely important for your personal safety.

- Never operate the tool without the cutter blade (knife) cover securely in position.
- Do not attempt to sharpen blades while they are installed in the cutter head unless a proper blade sharpening attachment is provided.
- Do not use cracked or damaged blades. Check blades for cracks or damage before use. Replace cracked or damaged blades immediately.
- Make sure that the blade flange fits in the arbor hole when installing the blade.

### Know your Workpiece

Take time to review your work and make sure that all necessary precautions have been taken before making a cut.



Examine the workpiece carefully before cutting. Do not joint or plane chipboard, panel board or any stock containing nails, paint or varnish.

- Be cautious of knots in wood. Knots can be thrown out of the work piece or cause kickback.
- Properly support long lengths of material to maintain control. Use work supports or stands as needed.
- Never joint or plane wood narrower than  $\frac{3}{4}$  inch or thinner than  $\frac{3}{4}$  inch. Never joint or plane wood shorter than 12 inches.



When using a portable jointer/planer, always place the workpiece on a stable workbench and secure it firmly with a clamp or vise to avoid losing control.

## Before Cutting...

Before cutting with a jointer/planer, make sure the tool and its accessories are in proper working order. Failure to do so may increase your risk of injury, and may result in tool damage.

- Obtain advice from a qualified person if you are not thoroughly familiar with the operation of this tool.
- Do not operate the tool until it is completely assembled and installed according to the manufacturer instructions.
- Check that all guards are in place and return quickly to normal rest positions. If a guard seems slow to return or “hangs up”, have it adjusted, repaired or replaced immediately. Never use a tool without a properly operating guard.
- Set up and secure blades and worktables according to the operator’s manual.
- Make sure blades are securely locked in the cutter head and that the unused portion of the blade is covered with the guard before tool use.
- Maintain proper adjustment of infeed and outfeed tables.
- Avoid awkward operations and hand positions where a sudden slip could cause a hand to move into the blade.
- Hold the tool firmly with both hands.
- Run the tool for a while without the blade pointing toward anybody. Check for vibration or wobbling that could indicate poor installation or a poorly balanced blade.
- Never reach your hands underneath the work piece while the blade is rotating.

## While Cutting ...

- Never make freehand cuts. Holding the work piece by hand is unstable and may lead to loss of control.
- Keep your hands, fingers and body away from the cutting area. Contact with a blade will cause serious injury.
- Don’t try to remove too much material in one pass. Never remove more than 1/8 inch per pass.
- Keep the exhaust port pointed away from yourself and bystanders.
- Don’t reach into the exhaust chute to unclog chips. Stop the tool and unplug it from the power source. After making sure that blade has stopped, clear the chute with something other than your bare hand.
- Always be sure that the tool is switched off and unplugged before making any adjustments.



Never feed the workpiece in the direction of cutting blade rotation. It can cause the cutter blade to grab and pull the workpiece.

- Use push blocks to hold down the work piece to protect your hands and fingers. Your hands and fingers should never pass directly over the cutter head when feeding a workpiece.

## When Done...

- When done, lock the switch in the “off” position to prevent unauthorized use.

## Metal Cutting Saws (Portable)

Hand-held metal cutting saws take chips or shavings out of metal workpieces. Metal cutting saws are not recommended for all types of metals and metal thicknesses. Refer to the saw's operator's manual for specific recommended applications.

### Good Personal Safety is a Must

Following good safety practices when using metal cutting saws is a must. Make a habit of including safety in all your activities.



Always read and understand the tool's operator's manual, tool markings and the instructions packaged with the accessory before starting any work.



Always wear safety goggles or safety glasses with side shields complying with current national standards, and a full face shield when needed.



Use the appropriate mask or respirator in dusty work conditions.



Wear proper hearing protection, as needed.



Wear gloves when handling the workpiece after the cut. The workpiece may be hot and have sharp edges.

- Dress right. Do not wear loose clothes or jewelry. Contain long hair. Loose clothes, jewelry, or long hair can be caught in moving parts.
- Crowded, cluttered work areas that can cause tripping or loss of balance are particularly dangerous.



Do not use near flammable liquids or in explosive atmospheres, near fumes, gases or dust. The hot chips or shavings and sparks may ignite the dust or fumes. Remove materials or debris that may become ignited from work area.

### Choose the Right Tool and Blade

Choosing the correct tool and the proper accessory for your application can help to reduce the risk of serious injury. When used according to the manufacturer's instructions for use, the proper tool and accessory will do the job safer and faster.

- Do not use a metal cutting saw that is too heavy for you to easily control.



Use sharp blades. Damaged or dull blades could throw teeth, posing a serious injury risk. A sharp blade will tend to cut its way out of a pinching condition.



Use the correct blade for your tool. Check this carefully: Does it have the proper size and shape arbor hole?

**RPM**

Make sure the speed marked on the blade is at least as high as the no load RPM marked on the tool.

- Never use damaged or incorrect blade flanges or bolts.



Do not use any type of abrasive cut-off wheel or dry diamond cutting blades.

### Know your Workpiece

Take time to review your work and make sure that all necessary precautions have been taken before making a cut. Metal cutting saws are used to cut a variety of materials, each having its own specific setup requirements.

- Support large panels (as illustrated) so they will not pinch the blade.
- Avoid cutting small workpieces that can't be properly secured, and workpieces on which the base of the saw (shoe) cannot properly rest. Injury could result from small pieces being thrown back at the operator if the blade pinches and binds.

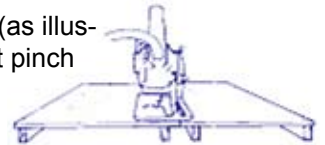

Do not use cutting oils or lubricants. Liquids can damage the saw, causing an electrical hazard.



Know what is behind a workpiece before you do the job. Do not cut into existing walls or other blind areas where electrical wiring, water, or gas pipes may exist. If this situation is unavoidable, disconnect all fuses/circuit breakers, and shut off any water and gas lines feeding this work site.

### Before Cutting...

Before cutting with a metal cutting saw, make sure the tool and its accessories are in proper working order. Failure to do so may increase your risk of injury and may result in kickback, blade pinching, binding or stalling, and loss of control. These situations may cause the saw to jump back at the operator and can result in a serious injury.



Check blades carefully before each use for proper alignment and possible defects. Never use a bent, broken or warped saw blade.

- Make sure the blade has adequate blade set. Blade set provides clearance between the sides of the blade and the workpiece, thus minimizing the probability of binding.

**Blade Set**





- Be sure the blade flanges (washers) are correctly assembled on the shaft and that the blade is properly supported.
- Check for proper blade guard operation before each cut. The guards should return to their normal position quickly. If a guard seems slow to return or “hangs up”, repair or adjust it immediately. Never alter or defeat the guard (e.g., tying back or removing the guard).
- Be sure the tool switch works properly. Do not use a tool if the switch does not turn it off when returned to the off position.
- Tighten depth levers securely.
- The lower guard should be pulled back manually only for special cuts such as “Pocket Cuts” and “Compound Cuts”. Raise the lower guard using the lower guard lever. As soon as blade enters the material, release the lower guard.

- Set blade depth to no more than 1/8 in. to 1/4 in. greater than the thickness of the material being cut.



- Minimize blade pinching by placing the saw shoe on the clamped, supported portion of the workpiece, and allowing the cut off piece to fall away freely.
- When you start your saw allow the blade to reach full speed before the workpiece is contacted.



Be alert to the possibility of the blade binding and kickback occurring.



If a fence or guard board is used, be certain the blade is kept parallel with it.

- Never remove the saw from a cut while the blade is rotating. When making a partial cut, or if power is interrupted, release the switch immediately and don't remove the saw from the workpiece until the blade has come to a complete stop. A saw tooth could grab the workpiece, causing loss of control.



Never reach under the saw or workpiece. The blade is exposed under the workpiece and the saw guard cannot protect your body here.

- Release the switch immediately if the blade binds or the saw stalls.
- Turn off the tool after a cut is completed, and keep the saw away from your body until the blade stops. The blade may coast for a time, posing the risk of serious cuts.

Overheating a saw blade can cause it to warp and result in kickback. Insufficient blade set, dullness, and unguided cuts, can all cause an overheated blade and kickback.

## While Cutting ...



Concentrate on what you are doing and be aware of kickback (a sudden reaction to a pinched, bound or misaligned blade). Kickback can cause an uncontrolled tool to lift up and out of the workpiece toward the operator and is the result of tool misuse and/or incorrect operating procedures or conditions. Take these specific precautions to help prevent kickback when using any type of metal cutting saw:

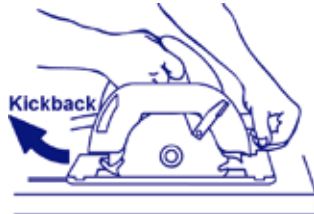

Before starting a metal cutting saw, be sure the power cord and extension cord are out of the blade path and are long enough to freely complete the cut. A sudden jerk or pull on the cord can cause loss of control of the saw and a serious accident.



Clamp workpieces securely. Check frequently to be sure clamps remain secure. A moving workpiece can cause loss of control and result in injury.

- Never hold a workpiece in your hand or across your leg when sawing.
- Do not use cutting oil. The use of cutting oil may cause a fire.



Keep hands away from cutting area and blade. Keep your second hand on other saw handle or motor housing. If both hands are holding the saw, they cannot be cut by the blade.

- NEVER overreach! For maximum control, hold the saw firmly with both hands after securing the workpiece.

## When Done...



Unplug, clean and store the tool in a safe, dry place after use.



Some metal cutting saws have chip or shaving collectors that must be emptied. Chips and shavings will be hot immediately after being cut. Wear gloves when handling. Always unplug the saw before emptying the container. Do not dispose of chips and shavings in receptacles containing flammable materials such as paper or wood. NEVER operate saw when guards and chip container are not installed. Serious injury may occur.





## Miter Saws

Miter saws are used for crosscutting, mitering or beveling wood, nonferrous metals and plastics. These saws cut through the work piece at a set miter angle. Some also can cut at both miter and a beveled angle.

### Good Personal Safety is a Must

Following good safety practices when using miter saws is a must. Make a habit of including safety in all your activities.

 Always read and understand the tool's operator's manual, tool markings and the instructions packaged with the accessory before starting any work.

 Always wear safety goggles or safety glasses with side shields complying with current national standards, and a full face shield when needed.

 Use the appropriate mask or respirator in dusty work conditions.

Wear proper hearing protection, as needed.

- Dress right. Do not wear gloves, loose clothes or jewelry. Contain long hair. Loose clothes, gloves, jewelry, or long hair can be caught in moving parts.
- Crowded, cluttered work areas that can cause tripping or loss of balance are particularly dangerous.
- Never alter a guard or use the tool with a guard missing. Be sure all guards are in place and working properly before each use. Do not defeat guards.

### Choose the Right Tool and Blade

Choosing the correct tool and the proper accessory for your application can help to reduce the risk of serious injury. When used according to the manufacturer's instructions, the proper tool and accessory will do the job safer and faster.

 Check this carefully: Does your blade have the proper size and shape arbor hole? Never force a blade onto an arbor or alter the size of an arbor. Do not use a blade that does not fit the arbor, as vibration may result. If the blade doesn't fit the arbor, get one that does.

 Use sharp blades. Damaged or dull blades could throw teeth, posing a serious injury risk. A sharp blade will tend to cut its way out of a pinching condition.

- Make sure the arbor and blade are clean. Buildup on the surface of the arbor and blade will increase excessive friction.

**RPM** Make sure the speed marked on the blade is at least as high as the no load RPM marked on the tool.

- When installing or changing a blade, match the direction of the arrow on the blade with the direction of the arrow on the tool casting to be sure you install it properly.
- Be sure the blade screw is tight to prevent slipping or loosening during use.
- Never attempt to cut materials larger than the rated capacity listed in the saw operator's manual, as this may result in personal injury.

### Know your Workpiece

Take time to review your work and make sure that all necessary precautions have been taken before making a cut.

- Support long workpieces at the same height as the saw table.
- Always place the workpiece securely on the table and against the fence when making cuts. Never make freehand cuts. Holding the workpiece by hand is unstable and may lead to loss of control.



Never cut small workpieces that would require you to put fingers near the cutting blade.



Use clamps to secure the workpiece to the table and avoid injuries

- Never try to remove or clamp the workpiece to the saw while the blade is rotating.
- Do not cut stone, brick, concrete, or ferrous metals (iron, steel, stainless steel, or alloys of these metals) with a miter saw. Particles created by cutting these materials can jam the blade guard and possibly cause personal injury.



Remove all nails from the workpiece before cutting, if present.

### Before Cutting...

Before working with a miter saw, make sure the tool and its accessories are in proper working order. Failure to do so can increase your risk of injury and result in kickback, blade pinching, binding or stalling, and loss of control.

- Set the saw securely on a flat, level surface.



Before installing a blade, always inspect it for damage. Visually check blade teeth for damage. Replace damaged blades immediately.

- Make sure the blade has adequate blade set. Blade set provides clearance between the sides of the blade and the workpiece, thus minimizing the probability of binding. Some saw blades have hollow ground sides instead of blade set to provide clearance.

#### Blade Set



- Make sure that all mounting flanges, related washers, fasteners and other mounting hardware are in good condition and are properly positioned and secured on the arbor before each use. Always use mounting hardware supplied with the saw.
- Never alter a guard or use the tool with a guard missing. Be sure all guards are in place and working properly before each use. Do not defeat guards.
- If the lower guard appears loose or if it does not move to cover the blade when the head is up, take the saw to an authorized service center for repairs. Clean the lower guard often to help visibility and movement.
- Be sure angle mechanisms are tightened securely before making a cut.



Switch the tool off after completing a cut, and keep your body away from the blade until it stops. The blade may coast for a time, posing a risk for serious cuts.



Overheating a saw blade can cause it to warp and result in kickback. Buildup of sap on the blades, insufficient blade set, dullness, and unguided cuts, can all cause an overheated blade and kickback.

### When Done...



To reduce the risk of injury, always unplug the saw when moving from a workstation. Lock miter saws in the down position before transporting or when not in use.

- Unplug, clean and store the tool in a safe, dry place after use.

### While Cutting ...



Concentrate on what you are doing and be aware of kickback (a sudden reaction to a pinched, bound or misaligned blade). Kickback can cause the head of the tool to lift up and out of the workpiece toward the operator and is the result of tool misuse and/or incorrect operating procedures or conditions. Take these specific precautions to help prevent kickback when using any type of miter saw:

- When you start your saw, allow the blade to reach full speed before the workpiece is contacted.
- Do not force cutting. Always start the cut gently. Do not bump or bang a blade down on the workpiece. Your saw will perform best at the rate for which it was designed. Excessive force only causes operator fatigue, increased wear and reduced control.
- If the blade stops rotating or if the motor sounds like it is straining, release the trigger switch immediately to reduce the risk of damage to the saw.



Be alert to the possibility of the blade binding and kickback occurring.

- Never remove the saw from a cut while the blade is rotating. When making a partial cut, or if power is interrupted, release the trigger immediately. Don't remove the saw from the workpiece until the blade has come to a complete stop. A saw tooth could grab the work piece, causing loss of control.
- Release the switch immediately if the blade binds or the saw stalls.
- Never reach under the saw blade or perform "cross handed" operation, i.e. with your left hand supporting the workpiece on the right side of the blade (or vice versa)

### Always Remember...

- Be alert at all times, especially during repetitive operations. Don't be tempted into carelessness due to a false sense of security. Blades are extremely unforgiving.

## Radial Arm Saws

Radial arm saws, because of their versatility, are widely used in home, professional, and vocational work shops. They demand a thorough understanding by the operator of all procedures.

### Good Personal Safety is a Must

Following good safety practices when using a radial arm saw is a must. Make a habit of including safety in all your activities.



Always read and understand the tool's operator's manual, tool markings and the instructions packaged with the accessory before starting any work.



Always wear safety goggles or safety glasses with side shields complying with current national standards, and a full face shield when needed.



Use the appropriate mask or respirator in dusty work conditions.

Wear proper hearing protection, as needed.

- Dress right. Do not wear gloves, loose clothes or jewelry. Contain long hair. Loose clothes, gloves, jewelry, or long hair can be caught in moving parts.
- Crowded, cluttered work areas that can cause tripping or loss of balance are particularly dangerous.
- Do not use the tool until it is completely assembled and installed according to the manufacturer's instructions. Check adjustments often.
- Never operate a radial arm saw with tools, debris or loose objects on the table.
- Never alter a guard or use the tool with a guard missing. Be sure all guards are in place and working properly before each use. Do not defeat guards.

### Choose the Right Tool and Accessory

Choosing the correct tool and the proper accessory for your application can help to reduce the risk of serious injury. When used according to the manufacturer's instructions, the proper tool and accessory will do the job safer and faster.



Use sharp, clean blades. A sharp blade will tend to cut its way out of a pinching condition. A buildup of pitch or sap on the surface of the saw blade increases blade thickness and friction.

- Use the correct blade for your tool. The saw blade should never extend beyond the saw table in any operation you perform.
- Never use a bent, broken or warped saw blade. Throw it away immediately and get a new one.
- Only use accessories specifically recommended in the tool operator's manual.

**RPM** Make sure the speed marked on the blade is at least as high as the no load RPM marked on the tool.

- Some accessories, such as a dado or molding head, require special safety precautions and equipment. Refer to the tool's operator's manual and instructions that come with the accessory.



Do not use grinding or wire brush wheels on your radial arm saw. Radial arm saws are not equipped with the proper guards to use grinding wheels or wire brush wheels.

### Know your Workpiece

Radial arm saws are used to cut a variety of materials, each having its own specific setup requirements. Take the time to review your work and make sure that all necessary precautions have been taken before making a cut.

- Do not cut wet wood. It produces higher friction against the blade. The blade will also tend to load up with wet sawdust increasing the risk of kickback.
- Cut only wood, wood-like, or plastic materials. Do not cut metal.
- Do not cut more than one piece at a time.



Be very cautious of stock which is pitchy, knotty or warped. These are most likely to create pinching conditions and possible kickback.

### Before Cutting...

Before using a radial arm saw, make sure the tool and its accessories are in proper working order. Failure to do so may increase your risk of injury and may result in kickback, blade pinching, binding or stalling, and loss of control. These situations may cause the workpiece and/or the motor and carriage to jump and can result in an injury.



Always unplug the tool before installing, adjusting, and changing any accessory.

Do not set up the work with the blade rotating. Turn off and unplug the tool before making adjustments.

- Check blades carefully before each use for proper alignment and possible defects. Never use a bent, broken or warped saw blade.



Make sure the blade is installed to rotate in the correct direction.

- Make sure the blade has adequate blade set. Blade set provides clearance between the sides of the blade and the workpiece, thus minimizing the probability of binding. Some saw blades have hollow ground sides instead of blade set to provide clearance.

#### Blade Set



- Check for proper blade guard operation before each cut. The guards should return to their normal position quickly. If a guard seems slow to return or “hangs up”, repair or adjust it immediately.
- Be sure the tool switch works properly. Do not use a tool if the switch does not turn it off when returned to the off position.
- When ripping, make sure the blade is exactly parallel to the fence. If the fence closes in toward the rear of the blade, it will tend to wedge the wood against the blade and may cause kickback.
- Anti-kickback devices should be positioned to just clear the workpiece.
- When ripping, the upper guard must be positioned to hold down the workpiece on the table. Make certain that the anti-kickback device fingers are sharp, free-moving and adjusted to stop kickback and assure proper operation. See your operator’s manual.



- Keep your radial arm saw in correct adjustment and alignment. Use only sharp accessories that were designed for your saw. Follow your operator’s manual carefully.

#### While Cutting ...



Concentrate on what you are doing and be aware of kickback (a sudden reaction when a workpiece binds between the saw blade and the fence during a ripping operation). Kickback can cause the workpiece to be thrown back toward the operator. Kickback is the result of tool misuse and/or incorrect operating procedures or conditions. Take these specific precautions to help prevent kickback when using any type of radial arm saw:

- Feeding a workpiece in the wrong direction when ripping is extremely dangerous. Follow the instructions provided with and on the saw very carefully.
- Do not release your feed pressure on a workpiece when ripping until it clears the blade.
- If a guard jams, shut off tool power and allow the blade to stop before freeing the guard.

- Position the workpiece so the cut off piece falls away from the table.
- Anti-kickback devices may not work when cutting smooth, hard surfaces. Always cut with the smooth, hard surface down, on the table.

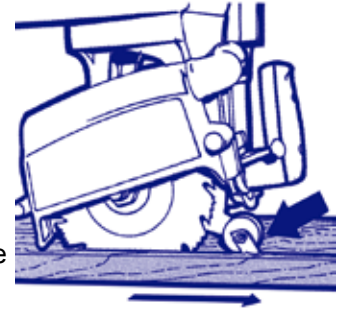

- A spreader should always be used when rip cutting. The spreader must be precisely lined up with the blade.
- For ripping short or narrow stock, always use a pushstick between the blade and the fence. Do not rip a workpiece that is shorter than the diameter of the saw blade.

- Do not cut free-hand (failing to use the fence to stabilize the workpiece.) Free-handing a workpiece can cause crooked cuts and potential kickback.

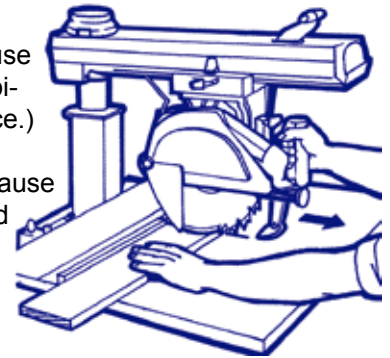

- Always hold the workpiece firmly against the fence when crosscutting. Pull the saw toward you and through the workpiece just far enough to complete the cut.
- When you start your saw allow the blade to reach full speed before contacting the workpiece.
- Avoid standing or permitting others to stand directly behind the workpiece when making a ripping cut.



Never reach near, along side, or around the saw blade. This is particularly dangerous.

Never place arms, hands or fingers in the path of the blade. This is especially dangerous during a crosscutting job.

- Hold onto the saw handle until the blade comes to a complete stop.

#### When Done...



When a crosscut job is complete, return the carriage to the full rear position behind the fence.

Unplug, clean and store the tool in a safe, dry place after use.

## Reciprocating Saws

The reciprocating saw can be used to cut metal, pipe, wood, nail-embedded wood and other materials. By design, it is a simple tool to handle. Its few demands for safe use, however, are very important.

### Good Personal Safety is a Must

Following good safety practices when using reciprocating saws is a must. Make a habit of including safety in all your activities.



Always read and understand the tool's operator's manual, tool markings and the instructions packaged with the accessory before starting any work.



Always wear safety goggles or safety glasses with side shields complying with current national standards, and a full face shield when needed.



Use the appropriate mask or respirator in dusty work conditions.

Wear proper hearing protection, as needed.

Dress right. Do not wear gloves, loose clothes or jewelry. Contain long hair. Loose clothes, gloves, jewelry, or long hair can be caught in moving parts.

- Crowded, cluttered work areas that can cause tripping or loss of balance are particularly dangerous.

### Choose the Right Tool and Blade

Choosing the correct tool and the proper accessory for your application can help to reduce the risk of serious injury. When used according to the manufacturer's instructions, the proper tool and accessory will do the job safer and faster.



Use sharp blades. Dull blades can produce excessive heat, make cutting difficult, result in forcing the saw, and possibly cause an accident.

- When changing blades, be sure the spindle and blade clamp areas are clean. Metal chips and sawdust may prevent the blade from being held securely.
- Blades can break. Use the blade and accessories recommended for the job being done. Check your operator's manual carefully about this.

- To minimize blade flexing and provide a smooth cut, use the shortest blade that will do the job but will extend beyond the workpiece throughout the stroke. Blades may shatter if they impact the work or shoe. Do not use the saw without the shoe for secure control and to avoid damage to the tool and blade.

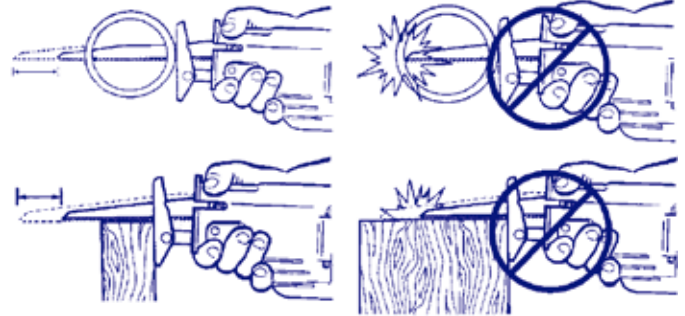

- When cutting metal, choose a blade that will allow for at least three blade teeth to be in the material at all times. Less than three teeth will result in teeth snagging and breakage. However, using blades with too fine a tooth will slow your cut.

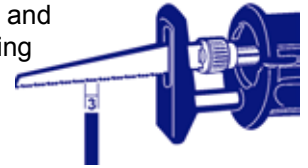

- Use clean saw blades. A buildup of pitch or sap on the surface of the saw blade increases blade thickness and blade friction.

### Know your Workpiece

Take time to review your work and make sure that all necessary precautions have been taken before making a cut. Reciprocating saws are used to cut a variety of materials, each having its own setup requirements.



Know what is behind a workpiece before you do the job. Do not cut into existing walls or other blind areas where electrical wiring, water, or gas pipes may exist. If this situation is unavoidable, disconnect all fuses/circuit breakers, and shut off any water and gas lines feeding this work site.

- Support large workpieces so they will not pinch the blade. Use a straight edge as a guide for ripping.
- Avoid cutting small workpieces that can't be properly secured, and workpieces on which the base of the saw (shoe) can not properly rest. Injury could result from small pieces being thrown at the operator if the blade pinches and binds.
- Be very cautious of stock which is pitchy, knotty

or warped. These are most likely to create pinching conditions.

- When possible, avoid cutting above shoulder height.



## Before Cutting...

Before cutting with a reciprocating saw, make sure the tool and its accessories are in proper working order. Failure to do so may increase your risk of injury, blade pinching, binding or stalling, and loss of control. These situations may result in an injury.

Unplug the saw before making any adjustments or changing the blade.



Check blades carefully before each use for proper alignment and possible defects. Never use a bent, broken or warped saw blade.

Make sure the blade has adequate blade set. Blade set provides clearance between the sides of the blade and the workpiece, thus minimizing binding.

### Blade Set



- Be sure the tool switch works properly. Do not use a tool if the switch does not turn it off when returned to the off position.
- When using a variable speed saw, use higher speeds for soft materials and lower speeds for harder materials to avoid blade damage.

## While Cutting ...

- Position yourself to maintain full control of the saw. When possible, avoid cutting above shoulder height.



Keep hands away from the blade and shoe.



Before starting, be sure the power cord and extension cord are out of the blade path and are long enough to freely complete the cut. A sudden jerk or pull on the cord can cause loss of control of the saw and a serious accident.



Clamp workpieces securely. Check frequently to be sure clamps remain secure. A moving workpiece can cause loss of control and result in injury.

- Never hold a workpiece in your hand or across your leg when sawing.
- NEVER overreach! For maximum control, hold the saw firmly with both hands after securing the workpiece.
- When you start your saw allow the blade to reach full speed before contacting the workpiece.
- Always hold the shoe of the saw firmly against the work to prevent operator injury and blade breakage. Striking the blade end against the workpiece can cause loss of control and damage to the saw.
- Be alert to the possibility of the blade binding.
- When making anything other than a through cut, allow the saw to come to a complete stop before removing the blade from the workpiece. This prevents blade breaking and possible loss of saw control.
- When plunge cutting, maintain firm contact between the saw's shoe and the workpiece. Lower the blade into the workpiece using the shoe as a pivot. Once the shoe is flat against the workpiece, begin the desired cut.
- Do not plunge cut into a metal workpiece. Instead, using a drill or chisel, make a pilot hole larger than the widest portion of the blade. Insert the blade, placing the shoe flat against the workpiece, and begin the desired cut.

## When Done...

- Switch off the tool after a cut is completed, and keep the saw away from your body until the blade stops. The blade may coast for a time, posing the risk of serious cuts.



Remember that the blade and blade clamp may be hot immediately after cutting. Avoid contact until they have cooled.



Unplug, clean and store the tool in a safe, dry place after use.

## Die Grinders

Die grinders perform a wide variety of jobs, typically in a confined space. Die grinders are a special version of end grinders to be used with mounted wheels or accessories 2" or less in diameter. Due to the small accessory diameters, die grinders are designed to work without a guard, therefore requiring a special attention while operating. You must have a thorough understanding of all procedures for each job you perform.

### Good Personal Safety is a Must

Following good safety practices when using a die grinder is a must. Make a habit of including safety in all your activities.



Always read and understand the tool's operator's manual, tool markings and the instructions packaged with the accessory before starting any work.



Always wear safety goggles or safety glasses with side shields complying with current national standards, and a full face shield when needed.



Use the appropriate mask or respirator in dusty work conditions.

Wear proper hearing protection, as needed.

- Dress right. Do not wear loose clothes or jewelry. Contain long hair. Loose clothes, jewelry, or long hair can be caught in moving parts.
- Crowded, cluttered work areas that can cause tripping or loss of balance are particularly dangerous.
- Never alter a guard or use the tool with a guard missing. Be sure all guards are in place and working properly before each use. Do not defeat guards.
- Do not operate the power tool near flammable materials. Sparks could ignite these materials.

### Choose the Right Tool and Accessory

Choosing the correct tool and the proper accessory for your application can help to reduce the risk of serious injury. When used according to the manufacturer's instructions, the proper tool and accessory will do the job safer and faster.

- Use the correct accessory for your tool. Check this carefully: Does it fit the spindle of the tool. Accessories with spindles that do not match the tool will wobble and vibrate and may cause loss of control.
- Some die grinders are designed to be used with wheel types that may require different guards. Follow the tool and accessory manufacturers' instructions for selecting guards and grinding wheels. Just because an accessory can be attached to a tool, does not mean it is safe to do so.

- Accessories must be used only for recommended jobs. For example: do not grind with the side of a cut-off wheel. It will shatter, causing a serious risk for injury.
- Be sure to properly secure all die grinder accessories that use a collet.
- Be careful not to over-tighten the spindle nut of the tool. Too much pressure will deform the flanges and stress the wheel.

### RPM

Make sure the speed marked on the accessory is at least as high as the no load RPM marked on the tool. The wrong accessory can shatter during use, possibly causing injury.

### Know your Workpiece

Take time to review your work piece and make sure that all necessary precautions have been taken before grinding.

- Use grinding wheels when working with hard materials – such as steel. Use rotary cutters for soft materials – such as aluminum, brass, copper and wood. If you use wheels on soft material, it will cause over loading, and could cause the wheel to shatter or disintegrate. Dangerous flying objects could result.



Always place the work piece securely in a vise or clamp securely. Never make freehand cuts. Holding the work piece by hand is unstable and may lead to loss of control.

- Support panels or any oversized workpiece to minimize the risk of wheel pinching and kick-back. Large workpieces tend to sag under their own weight. Supports must be placed under the workpiece near the line of cut and near the edge of the workpiece on both sides of the wheel.

### Before Grinding...

Before working with a die grinder, make sure the tool and its accessories are in proper working order. Failure to do so may increase your risk of injury.

- Be sure the switch is in the "off" position before plugging it in.
- Do not use a tool if the switch does not turn it off when returned to the "off" position after release.



Always unplug the grinder before making accessory installations.



- When installing a mounted grinding wheel, burr or cutter in the collet, keep distance between the back of the wheel and the front of the collet (overhang) at a maximum of ½ inch. This prevents spindle bending and wheel damage that could cause injury.
- Never use cracked or damaged accessories. Carefully check them before each use.
- Always check accessory for tightness on the tool before each use. A loose cutter or wheel can be thrown from the rotary grinder and can cause serious injury. If the grinder is dropped, inspect it for damage, such as a cracked accessory, broken collet, or bent mandrel. Repair or replace damaged parts to prevent further breakage and thrown objects.
- Never over-tighten a collet. It can damage the cutter or wheel.



Allow new wheels to run for a minimum of 1 minute to check for proper balancing.

- For maximum control, hold the grinder firmly with both hands.
- Always hold the accessory end of the tool away from you and co-workers to prevent possible injuries.
- Die grinders operate at high speeds. To avoid injury, be very careful not to contact the accessory end or be hit by thrown objects.
- If the die grinder vibrates during use, stop immediately and check for the grinding points. Dull grinding points could force the collet out of the tool. Replace or sharpen the grinding accessory.

### While Grinding...

- Too much pressure during use can bend or break the collet, mandrel, or accessory. If the grinder runs smoothly when not under load, but does not run smoothly under load, then too much pressure is being used.
- If the tool does not run smoothly when not under load, the accessory may be bent or out of balance. Replace the accessory.
- Never use a rotary die grinder with the cutter pointing toward you. If the grinder should slip, the accessory could cause injury.
- Never hold the workpiece by hand. Keep your hands and fingers away from the working area. Contact with the cutter or wheel will cause injury.
- When stopping a cut, switch off the tool and hold the tool motionless until the accessory comes to a complete stop. Never attempt to remove a wheel from the cut while the wheel is in motion to avoid accidental contact.

- Do not restart the cut in the work piece. Let the cutter or wheel reach full speed and then carefully re-enter the cut.

### When Done...



Unplug, clean and store the tool in a safe, dry place after use.



To avoid burns, wait before touching workpieces. Allow time to cool.

### Always Remember...

- Store tools and accessories with care. Do not drop them or subject them to excessive heat, cold or humidity.

## Routers

The widespread use of routers is based on their ability to perform an extensive range of smooth finishing and decorative cuts.

### Good Personal Safety is a Must

Following good safety practices when using routers is a must. Make a habit of including safety in all your activities.



Always read and understand the tool's operator's manual, tool markings and the instructions packaged with the accessory before starting any work.



Always wear safety goggles or safety glasses with side shields complying with current national standards, and a full face shield when needed.



Use the appropriate mask or respirator in dusty work conditions.

Wear proper hearing protection, as needed.

- Dress right. Do not wear gloves, loose clothes or jewelry. Contain long hair. Loose clothes, gloves, jewelry, or long hair can be caught in moving parts.
- Crowded, cluttered work areas that can cause tripping or loss of balance are particularly dangerous.

### Choose the Right Tool and Accessory

Choosing the correct tool and the proper accessory for your job can help to reduce the risk of serious injury. When used according to the manufacturer's instructions, the proper tool and accessory will do the job safer and faster.

**RPM** Use only those accessories with speeds rated at least as high as the no-load RPM on the tool. The wrong accessory can shatter during use, possibly causing injury.

- Never use dull or damaged bits. Sharp bits must be handled with care. Damaged bits can snap during use. Dull bits tend to over load, causing possibility of bit breakage.
- Never use bits that have a cutting diameter greater than the opening in the router base.

### Know your Workpiece

Take time to review your workpiece and make sure that all necessary precautions have been taken before cutting.



Always make sure the work surface is free from nails and other foreign objects. Cutting into a nail can cause the bit and the tool to jump and damage the bit.

- Never lay the workpiece on top of hard surfaces like concrete, stone, etc. The bit may hit the surface and cause the tool to jump up. This can be very dangerous.



Always place the workpiece securely in a vise or other recommended clamping device. Holding the work piece by hand is unstable and may lead to loss of control.

### Before Routing...

Before working with a router, make sure the tool and its accessories are in proper working order. Failure to do so may increase your risk of injury.

- After changing the bits or making any adjustments, make sure the collet nut and any other adjustment devices are securely tightened. Loose adjustment devices can unexpectedly shift, causing loss of control; loose rotating components will be violently thrown. Install router bits securely and according to the operator's manual.
- Always use the wrenches provided with the tool to make adjustments. Using the correct wrench enables a more secure grip on the tool and may prevent slipping leading to potential injury.

## While Routing...

- Never start the tool when the bit is touching the workpiece. The bit may grab the workpiece and cause loss of control. Follow the tool manufacturer's procedure for setting the depth of cut. Tighten adjustment locks. Make certain that the bit shaft is engaged in the collet at least  $\frac{1}{2}$  inch.
- Always inspect the router bit before each use and NEVER use a bit if the carbide is cracked or appears damaged in any way.
- Never use a router with the bit pointing toward you. If the router should slip, the bit could cause serious injury. Always face the bit away from your body.
- If the router does not run smoothly, the bit may be bent or out of balance. Replace the bit immediately.

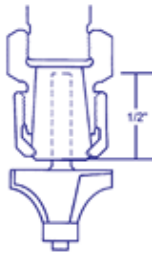

- For maximum control, hold the router firmly with both hands. The reaction torque of the motor can cause the tool to twist.



Keep your hands and fingers away from the work area. Contact with the bit will cause serious injury.

- Always feed the bit into the workpiece in the same direction as the bit rotation (same direction as the chips are being thrown). When the router is positioned between your body and the side of the routed workpiece, the direction of the router feed is to the right. If the router is positioned on the side of the workpiece away from your body the direction of the router feed is to the left.

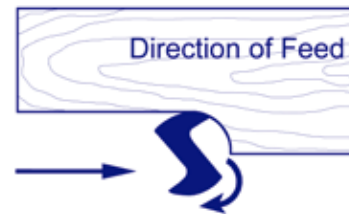

- Feeding the tool in the wrong direction causes the cutting edge of the bit to climb out of the work piece and pull the tool toward the operator, and may result in loss of control and injury. Follow the instructions provided with and on the tool very carefully.

## When Done...



Unplug, clean and store the tool in a safe, dry place after use.



Never touch the bit during or immediately after use. The bit is too hot to be touched with bare hands.

- Never lay the tool down until the motor and bit have come to a complete standstill. The spinning bit can grab a surface and pull the tool out of your control.

## Always Remember...



Store tools and bits with care. Do not drop them or subject them to excessive heat, cold or humidity.

## Sanders (Stationary and Portable)

Sanders come in wide variety of designs, such as belt sanders, drum sanders, disc sanders, random orbit sanders or pad sanders. Sanding is often a long job. For this reason, it is very important that you do not lose concentration and that your working environment is set up correctly. If you use the sander unsafely or incorrectly, you could be injured.

### Good Personal Safety is a Must

Following good safety practices when using a sander is a must. Make a habit of including safety in all your activities.



Always read and understand the tool's operator's manual, tool markings and the instructions packaged with the accessory before starting any work.



Always wear safety goggles or safety glasses with side shields complying with current national standards, and a full face shield when needed.



Use the appropriate mask or respirator in dusty work conditions. Sanding dust may affect your breathing and overcome you if you are not protected against it – particularly when working with many of the exotic (tropical) hardwoods or products containing hazardous substances.

- Wear proper hearing protection, as needed.
- Dress right. Do not wear loose clothes or jewelry. Contain long hair. Loose clothes, jewelry, or long hair can be caught in moving parts.
- Crowded, cluttered work areas that can cause tripping or loss of balance are particularly dangerous.

### Choose the Right Tool and Accessory

Choosing the correct tool and the proper accessory for your application can help to reduce the risk of serious injury. When used according to the manufacturer's instructions, the proper tool and accessory will do the job safer and faster.



Always unplug the sander before changing any accessories.

Stationary sanders may have multiple features, such as belt and disc sanding. Portable sanders are normally single feature sanders (disc, pad, or belt). Exercise caution and alertness to avoid injuries, such as skin abrasions or pinching, that can result from contacting the sanding medium or other moving parts – belts, pulleys, and arbors.

- Don't use small sanders for big jobs or large sanders for small jobs.
- Abrasive belts should be the width recommended by the manufacturer.
- Do not use excessively oversized sanding disc paper. Follow tool manufacturer's recommendations when selecting sanding paper.

### Know your Workpiece

Take time to review your workpiece and make sure that all necessary precautions have been taken before sanding.



Always support your workpiece on a stationary sander with the table or backstop.

Use jigs or fixtures to hold your workpiece in position whenever possible.

- Never hold the workpiece by hand, as this is unstable and may lead to loss of control.
- Avoid working on small pieces of material which can't be properly secured. Injury could result from small pieces being thrown by the spinning sanding pad.
- Remove material or debris from the area that might be ignited by sparks from sanding metal.
- On stationary sanders, maintain a 1/16 inch maximum clearance between the table and the sanding disc or belt.

### Before Sanding...

Before working with a sander, make sure the tool and its accessories are in proper working order. Failure to do so may increase your risk of injury.

- Adequate ventilation of your work area is very important when using any type of sander. The use of exhaust type systems or bag collection is also recommended. Dust can explode if the concentration becomes too great. Wood dust and the finishes from woodworking are very combustible.



Do not use the dust collection bag when sanding metal. Using the dust collection bag when sanding metal creates a fire hazard, which could damage the tool and lead to serious personal injury.

- Before connecting the sander to the power supply, be sure the switch and switch lock (if provided) are in the "OFF" position. If not, the sander will start immediately and could result in injury.



Keep power supply and cords from entanglement with the moving parts of the sander. Damaged cords can result in an electrical shock.

- Do not work with a faulty tracking belt sander. Stop using it until the problem is fixed.
- When adjusting the tracking of a portable belt sander, be sure that the sander is supported and positioned properly to avoid accidental contact with yourself or nearby objects.

## While Sanding...

- Always keep your body well clear of moving parts such as belts, pads and pulleys.
- Hold portable sanders firmly with both hands. Never lock a portable sander in the “ON” position when the job may require stopping the sander quickly, such as using a sanding disc on a car fender. The rotating disc could get jammed and cause injury.
- It should never be necessary to force a portable sander. The weight of the tool applies adequate pressure. Forcing too much pressure can cause stalling, overheating of the tool, burning of the workpiece, and possible kickback of the tool or workpiece.



If sander is equipped with a dust bag, empty it frequently and when you are done sanding. Spontaneous combustion may result from a mixture of some wood finishing chemicals with dust particles. Be extremely careful of dust disposal, as materials in fine dust may be explosive.

## When Done...

- When you are done sanding, switch the tool to the “OFF” position and hold the tool motionless until the sanding disc comes to a complete stop. Never try to remove sand paper while the sanding pad is still rotating.
- Never lay down the portable tool until the sanding pad or belt has come to a complete stop. The spinning pad or belt may grab a work surface and pull the tool out of your control.



Unplug, clean and store the tool in a safe, dry place after use.

## Always Remember...



With portable sanders, be careful not to expose the tool to liquids, or to use in damp, wet locations.

## Shapers and Router Tables

Shapers and router tables are used to create decorative surfaces in wood and wood like materials.

### Good Personal Safety is a Must

Following good safety practices when using a shaper or router table is a must. Make a habit of including safety in all your activities.



Always read and understand the tool's operator's manual, tool markings and the instructions packaged with the accessory before starting any work.



Always wear safety goggles or safety glasses with side shields complying with current national standards, and a full face shield when needed.



Use the appropriate mask or respirator in dusty work conditions.



Wear proper hearing protection, as needed.

Dress right. Do not wear gloves, loose clothes or jewelry. Contain long hair. Loose clothes, gloves, jewelry, or long hair can be caught in moving parts.

- Crowded, cluttered work areas that can cause tripping or loss of balance are particularly dangerous.
- Never alter a guard or use the tool with a guard missing. Be sure all guards are in place and working properly before each use. Do not defeat guards.

### Choose the Right Tool and Accessory

Choosing the correct tool and the proper accessory for your job can help to reduce the risk of serious injury. When used according to the manufacturer's instructions, the proper tool and accessory will do the job safer and faster.

- Use only the cutter recommended by the tool manufacturer. This is extremely important for your personal safety.
- Always keep cutters sharp and clean of rust and pitch to avoid excessive blade friction.
- Do not attempt to sharpen cutters while they are installed in the cutter head unless a proper sharpening attachment is provided.

### Know your Workpiece

Take time to review your workpiece and make sure that all necessary precautions have been taken before shaping.



Examine the workpiece carefully before cutting. Do not shape chipboard, panel board or any stock containing nails, paint or varnish.

- Shaping narrow materials can be hazardous. Always use fixtures, featherboards, push blocks and/or other jigs to hold down the workpiece.
- Never make freehand cuts. Holding the work piece by hand is unstable and may lead to loss of control.
- Be cautious of knots in wood. Knots can be thrown out of the workpiece or cause kickback.
- Properly support long lengths of material to maintain control. Use work supports or stands as needed.

### Before Shaping...

Before working with a shaper or router table, make sure the tool and its accessories are in proper working order. Failure to do so may increase your risk of injury.

- Obtain advice from a qualified person if you are not thoroughly familiar with the operation of this tool.
- Do not operate the tool until it is completely assembled and installed according to the manufacturer instructions.
- Check that all guards are in place and return quickly to normal rest positions. If a guard seems slow to return or "hangs up", have it adjusted, repaired or replaced immediately. Never use a tool without a properly operating guard.
- Always use the guard as recommended by the tool manufacturer.
- Set up and secure cutters and worktables according to the operator's manual.
- Make sure cutters are securely locked in the cutter head and that the unused portion of the cutters are covered by the guard before tool use.

- Maintain proper adjustments for infeed and out-feed tables.
- Adjust the fence halves so the cutter opening is more than is required to clear the cutter blade.
- Lock the fence into position after making fence adjustments.

### While Shaping...

- Avoid awkward operations and hand positions where a sudden slip could cause a hand to move into the cutter knives.
- Keep your hands, fingers and body away from the cutting area. Contact with a knife will cause serious injury.
- Never feed the workpiece in the direction of cutting blade rotation. Otherwise, the cutter blade can grab and pull the workpiece.



Always use a miter gauge and clamp for “end shaping” to maintain safe control of the work piece.

- Keep the exhaust port pointed away from yourself.
- Don't reach into the exhaust chute to unclog chips. Stop the tool and unplug it from the power source. After making sure that blade has stopped, clear the chute with something other than your bare hand.
- Never reach under the table while the tool is running to avoid personal injury.
- Always be sure that the tool is switched off and unplugged before making any adjustments.

### When Done...

- When done, lock the switch in the “off” position to prevent unauthorized use.

### Always Remember...

- Store cutters with care. Do not drop them or subject them to excessive heat, cold or humidity.

## Table Saws

Table Saws are one of the most commonly used stationary power tools in woodworking shops. To use them safely, they must be properly set up, maintained with care, and specific operating procedures must be followed to prevent accidents.

### Good Personal Safety is a Must

Following good safety practices when using table saws is a must. Make a habit of including safety in all your activities.



Always read and understand the tool's operator's manual, tool markings and the instructions packaged with the accessory before starting any work.



Always wear safety goggles or safety glasses with side shields complying with current national standards, and a full face shield when needed.



Use the appropriate mask or respirator in dusty work conditions.

Wear proper hearing protection, as needed.

- Dress right. Do not wear gloves, loose clothes or jewelry. Contain long hair. Loose clothes, gloves, jewelry, or long hair can be caught in moving parts.
- Crowded, cluttered work areas that can cause tripping or loss of balance are particularly dangerous.
- Keep the saw table clear of other tools, workpieces, and debris.
- Only use table saws that are completely assembled and secured according to their instructions. A table saw should be equipped with a rip fence, miter gage, blade guard, riving knife or spreader and anti-kickback device.
- Children and onlookers should be kept out of the work area. They may distract the operator leading to an accident.
- Never alter a guard or use the tool with a guard missing. Be sure all guards are in place and working properly before each use. Do not defeat guards.

### Choose the Right Tool and Blade

Choosing the correct tool and the proper accessory for your application can help to reduce the risk of serious injury. When used according to the manufacturer's instructions, the proper tool and accessory will do the job safer and faster.



Use sharp blades. Damaged or dull blades could throw teeth, posing a serious injury risk. A sharp blade will tend to cut its way out of a pinching condition.



Use the correct blade for your tool. Check this carefully: Does it have the proper size and shape arbor hole?

- Use the proper blade for the job. Watch out for overheating or vibrating blades.
- Use clean saw blades. A buildup of pitch or sap on the surface of the saw blade increases blade thickness and also increases blade friction.

**RPM** Make sure the speed marked on the blade is at least as high as the no load RPM marked on the tool.

### Know your Workpiece

- Use auxiliary work stand/tables to properly support and control long or wide workpieces.
- Cut only wood, wood-like, or plastic materials. Do not cut metal.
- Avoid cutting small pieces of material which cannot be properly secured. Injury could result from small pieces being thrown back at the operator if the blade pinches and binds
- Be very cautious of stock that is pitchy, knotty or warped. These are most likely to create pinching conditions and possible kickback.
- Do not cut wet wood. It produces higher friction against the blade. Also the blade tends to load up with wet sawdust, creating a greater probability of kickback.
- Anti-kickback devices may not work when cutting smooth, hard surfaces. Always cut with the smooth, hard surface down, on the table.
- Check the workpiece for nails or other foreign objects.

### Before Cutting...

Before working with a table saw, make sure the tool and its accessories are in proper working order. Failure to do so may increase your risk of injury and may result in kickback, blade pinching, binding or stalling, and loss of control. These situations may cause the workpiece to jump back at the operator that can result in an injury.



The saw should always be turned off and disconnected from its power source before making adjustments, installing accessories or making repairs.



Check blades carefully before each use for proper alignment and possible defects. Never use a bent, broken or warped saw blade.

- Make sure the blade has adequate blade set. Blade set provides clearance between the sides of the blade and the workpiece, thus minimizing the probability of binding.





- Be sure the blade flanges (washers) are clean and correctly assembled on the shaft and that the blade is properly supported.
- Check often to assure that the blade guard functions properly and returns quickly to its rest position. If a guard seems slow to return or “hangs up”, adjust, repair or replace it immediately.
- Be sure the tool switch works properly. Do not use a tool if the switch does not turn it off when returned to the off position.
- The rip fence must be parallel to the saw blade to prevent binding and possible kickback.



Make sure the blade is installed to rotate in the proper direction – towards the front of the saw.



Do not use grinding wheels, wire brushes, or abrasive wheels on a table saw.

### While Cutting ...



Concentrate on what you are doing and be aware of kickback (a sudden reaction to a pinched, bound or misaligned blade). Kickback can cause an uncontrolled workpiece to be thrown toward the operator and is the result of tool misuse and/or incorrect operating procedures or conditions. Take these specific precautions to help prevent kickback:

- Always keep the fence parallel to the blade.
- Always push the workpiece through the cut.
- Set blade height to no more than 1/8 in. to 1/4 in. greater than the thickness of the material being cut.
- Use the riving knife or the spreader for all “through-sawing” operations (where the saw blade cuts through the thickness of the workpiece).
- When using the table saw for non-through cutting operations, such as dadoing, grooving or moding, use pushsticks, pushblocks, featherboards, jigs or fixtures to keep your hands and fingers away from the saw blade.
- Do not use the fence as a cut-off stop when cross-cutting.
- Always use the miter gauge when cross-cutting, and hold the workpiece firmly against the miter gauge to assure a straight and even cut.
- When you start your saw, allow the blade to reach full speed before contacting the workpiece.



Be alert to the possibility of the blade binding and kickback occurring.

- Do not cut “freehand”. Always use the miter gauge or rip fence to ensure a straight cut.
- Use pushsticks to keep your fingers away from the saw blade for short or narrow ripping operations.
- Use featherboards to firmly hold the workpiece against the fence and table when ripping narrow stock.
- Always use a spreader /splitter for through-sawing. This prevents the kerf from closing and pinching the blade. Make sure the spreader is properly aligned with the blade.
- Always use the anti-kickback pawls /fingers. If a kickback should occur, they are designed to engage the workpiece and keep it from being thrown back toward the operator. Keep the teeth of the pawls /fingers sharp.
- Feeding work too aggressively can overheat a saw blade causing it to bind or warp and create a kickback. Buildup of sap on the blades, insufficient set, dullness, and “freehand” cuts can all result in an overheated blade.

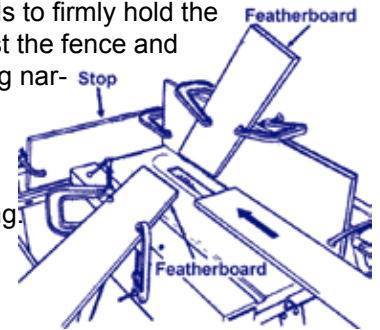

Never reach over or behind the saw. Keep arms, hands and fingers away from the blade.

- The saw blade may coast after the saw is turned off.

### When Done...

- Turn off the saw after each completed job.



When done cutting, unplug the tool and lock the switch in the “off” position to prevent unauthorized use.

Clean and store the tool in a safe, dry place after use.

## Wood Lathes

Safe, effective use of a wood lathe requires detailed study and knowledge of all procedures for using this tool.

### Good Personal Safety is a Must

Following good safety practices when using wood lathes is a must. Make a habit of including safety in all your activities.



Always read and understand the tool's operator's manual, tool markings and the instructions packaged with the accessory before starting any work.



Always wear safety goggles or safety glasses with side shields complying with current national standards, and a full face shield when needed.



Use the appropriate mask or respirator in dusty work conditions.

Wear proper hearing protection, as needed.

- Dress right. Do not wear gloves, loose clothes or jewelry. Contain long hair. Loose clothes, gloves, jewelry, or long hair can be caught in moving parts.
- Crowded, cluttered work areas that can cause tripping or loss of balance are particularly dangerous.
- Do not use the tool until it is completely assembled and installed according to the manufacturer's instructions. Check adjustments often.

### Choose the Right Tools

Choosing the correct tool and the proper accessory for your job can help to reduce the risk of serious injury. When used according to the manufacturer's instructions, the proper tool and accessory will do the job safer and faster.

- Check the operator's manual for proper speed recommendations for the intended purpose and use.
- A lathe should not be altered in any way, or set up to perform any operation not covered in the operator's manual.
- Keep accessories sharp. Dull accessories can dig into the wood, causing the workpiece to be thrown.

### Know your Workpiece

- Use only defect-free stock, without cracks, checks, knots and splits. Knots, for example, can fly out and cause serious injury.
- It is recommended that you rough out faceplate workpiece on a band saw or with hand tools before installing them on the lathe faceplate to prevent jams, slips, or thrown workpieces.
- Never remount a turned piece once it is removed from the faceplate.

### Before Cutting...

- Make certain that the belt guard or cover is in place and the workpiece is free but firmly mounted between centers. Check that all clamping devices (locks), such as on the tailstock and tool rest, are tight and that the workpiece clears the tool rest and other machine parts before operating the tool.



Do not run a lathe in the wrong direction. This can cause the turning tool to be thrown from your hands. The lathe spindle must rotate so the top of the workpiece turns toward you.

- The clearance between the workpiece and the tool rest should be only about 1/8". Rotate the workpiece by hand to be sure it clears the tool rest.

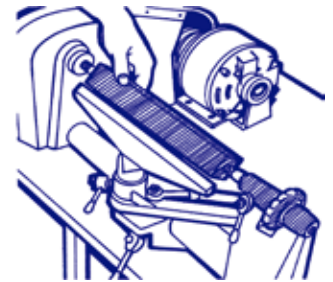

- Remove the tool rest before you sand a workpiece by hand.
- Clear the lathe bed of all objects before turning on the tool.

### While Cutting ...

- Never adjust the tool rest with the lathe turned on.

- Hold turning chisels securely on the tool rest, and hold the handle of the chisel firmly.

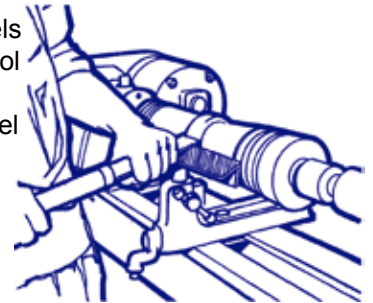

- Always use the lowest speed when starting a new workpiece.

Lathes should be operated at slow speeds until the workpiece is cylindrical. This helps avoid the possibility of an unbalanced piece jumping out at high speed and striking the operator.

- Clamp workpieces securely. Check frequently to be sure clamps remain secure. A moving workpiece can cause loss of control and result in injury.

### When Done...



Unplug the lathe and lock the switch when not in use. Make sure the switch is in the off position to prevent accidental start-up.

Clean and store the tool in a safe, dry place.



THOMAS ASSOCIATES, INC. EXECUTIVE MANAGER



1300 SUMNER AVENUE, CLEVELAND, OHIO 44115-2851 216-241-7333 FAX 216-241-0105

Revision 9/07 - 10m