

EPA/600/R-10/146  
September, 2010

# **GENERIC PROTOCOL FOR THE VERIFICATION OF BALLAST WATER TREATMENT TECHNOLOGY**

---

**Produced by**

**NSF International  
Ann Arbor, MI**

**For**

**U.S. Environmental Protection Agency  
Environmental Technology Verification Program**

**In cooperation with**

**U.S. Coast Guard  
Environmental Standards Division  
Washington, DC**

**And**

**U.S. Naval Research Laboratory  
Center for Corrosion Science and Engineering  
Washington, DC**

**ETV ✓ ETV ✓ ETV ✓**

## **NOTICE**

The U.S. Environmental Protection Agency, through its Office of Research and Development, funded and managed, or partially funded and collaborated in, the research described herein. It has been subjected to the Agency's peer and administrative review and has been approved for publication. Any opinions expressed in this report are those of the author (s) and do not necessarily reflect the views of the Agency, therefore, no official endorsement should be inferred. Any mention of trade names or commercial products does not constitute endorsement or recommendation for use.

## FOREWORD

The EPA is charged by Congress with protecting the nation's air, water, and land resources. Under a mandate of national environmental laws, the Agency strives to formulate and implement actions leading to a compatible balance between human activities and the ability of natural systems to support and nurture life. To meet this mandate, the EPA's Office of Research and Development provides data and science support that can be used to solve environmental problems and to build the scientific knowledge base needed to manage our ecological resources wisely, to understand how pollutants affect our health, and to prevent or reduce environmental risks.

The Environmental Technology Verification (ETV) Program has been established by the EPA to verify the performance characteristics of innovative environmental technology across all media and to report this objective information to permittees, buyers, and users of the technology, thus substantially accelerating the entrance of new environmental technologies into the marketplace. Verification organizations oversee and report verification activities based on testing and quality assurance protocols developed with input from major stakeholders and customer groups associated with the technology area. ETV consists of six environmental technology centers. Information about each of these centers can be found on the Internet at <http://www.epa.gov/etv>

Under a cooperative agreement, NSF International has received EPA funding to plan, coordinate, and conduct technology verification studies for the ETV "Water Quality Protection Center" and report the results to the community at large. The WQP Center's primary technology areas address surface water pollution concerns such as ship ballast water treatment, wastewater treatment, stormwater runoff treatment, confined animal feeding operations (CAFOs), and urban infrastructure rehabilitation.

## ACKNOWLEDGEMENTS

EPA and NSF acknowledge and thank those persons who participated in the preparation and review, subsequent validation, and the revision of this *Generic Protocol for Verification of Ballast Water Treatment Technologies*. Without their hard work and dedication to the project, this document would not have been possible. The original draft was prepared by Battelle, Duxbury, MA, while significant input in later drafts was provided in a multi-year effort by the Naval Research Laboratory, Key West, FL. Much input was also provided by the biological sub-group of the Ballast Water Treatment Protocol Technical Panel as well as the Technical Panel in whole.

### Revised Protocol Authors

Edward Lemieux	Naval Research Laboratory
Jonathan Grant	Battenkill Technologies, Inc.
Timothy Wier	EXCET, Inc.
Lisa Drake	Science Applications International Corporation

### NRL Technical Staff

Stephanie Robbins	Science Applications International Corporation
Kevin Burns	Science Applications International Corporation
Scott Riley	Science Applications International Corporation
Luke Davis	Science Applications International Corporation
Wayne Hyland	Azimuth Technical Consultants, Inc.
Bruce Nelson	Battenkill Technologies, Inc.
Tiffanee Donowick	Science and Engineering Technologies, Inc.
Robert Brown	Azimuth Technical Consultants, Inc.

### Original Protocol Writers

Deborah Tanis	Battelle
Carlton D. Hunt	Battelle

### NSF Staff

Thomas Stevens	Project Manager, ETV Water Quality Protection Center
----------------	------------------------------------------------------

### EPA Staff

Raymond Frederick	Project Officer, ETV Water Quality Protection Center
-------------------	------------------------------------------------------

### ETV Water Quality Protection Center – Technical Panel Participants for Current and Past Versions

Donald Anderson	Woods Hole Oceanographic Institute
Allegra Cangelosi	Northeast-Midwest Institute
Dorn Carlson	National Oceanic and Atmospheric Administration
Fred Dobbs	Old Dominion University
Richard Everett	U.S. Coast Guard

Maurya Falkner	California State Lands Commission
Richard Fredricks	Maritime Solutions, Inc.
Stephan Gollasch	GoConsult and Chairman, ICES/IOC/IMO Working Group on Ballast and Other Ship Vectors (WGBOSV)
Frank Hamons	American Association of Port Authorities
Richard Harkins	Formerly with the Lake Carriers Association, currently with Keystone Shipping Company
Penny Herring	U.S. Coast Guard R&D Center
Russell Herwig	University of Washington
Brian Howes	University of Massachusetts
James Hurley	U.S. Coast Guard R&D Center
Thomas Mackey	Hyde Marine, Inc.
Lucie Maranda	University of Rhode Island
Kathy Metcalf	Chamber of Shipping of America
Richard Mueller	Northeast Technical Services Company, Inc.
Gail Roderick	U.S. Coast Guard R&D Center
Andrew Rogerson	California State University, Fresno
Terri Sutherland	Fisheries and Oceans Canada
Mario Tamburri	University of Maryland
Fred Tsao	U.S. Navy
Thomas Waite	Florida Institute of Technology
Nick Welschmeyer	Moss Landing Marine Laboratories

## Table of Contents

Chapter 1 Introduction .....	1
1.1 The ETV Program.....	1
1.2 Objectives of Verification Testing.....	1
1.3 Purpose and Scope of the Protocol .....	2
1.4 Verification Testing Process .....	2
1.5 Policies and Program Specifications and Guidelines.....	2
Chapter 2 Responsibilities of Involved Organizations .....	3
2.1 Vendor.....	3
2.2 Testing Organization (TO).....	3
2.3 TF Owner (Owner) .....	3
2.4 Verification Organization (VO).....	4
2.5 Environmental Protection Agency (EPA).....	4
2.6 Stakeholder Advisory Group (SAG).....	4
2.7 Technology Panel.....	4
Chapter 3 Ballast Water Treatment System Capabilities and Description .....	5
3.1 Ballast Water Treatment System Definition .....	5
3.2 Technology or Treatment Performance Claims .....	5
3.3 Acceptability for Testing .....	6
3.4 Test BWTS Requirements .....	6
3.5 Operating and Maintenance (O&M) Evaluation.....	7
3.6 Biological Efficacy Evaluation with Standard Test Organisms .....	9
3.7 Calibration and Test Requirements.....	10
3.8 System Documentation Evaluation.....	10
3.9 Technical Data Package Submission .....	11
3.10 Format for the BWTS Technical Data Package.....	12
Chapter 4 Treatment Verification TQAP Development .....	14
4.1 Description of Ballast Water Treatment System .....	14
4.2 Required Elements of the TQAP .....	14
Chapter 5 Experimental Design .....	16
5.1 Test Verification Factors.....	16
5.1.1 Biological Treatment Efficacy .....	17
5.1.2 Operation and Maintenance .....	17
5.1.3 Reliability.....	17
5.1.4 Cost Factors .....	17
5.1.5 Environmental Acceptability .....	17
5.1.6 Safety Factors.....	17
5.2 Challenge Conditions.....	18
5.2.1 Challenge Water – Water Quality Characteristics .....	18
5.2.2 Challenge Water - Biological Organism Conditions .....	21
5.2.3 Challenge Water – Flow Rates and Volumes .....	22
5.3 TF Physical Configuration.....	22
5.3.1 Overall experimental configuration .....	22
5.3.2 Sampling Methodology.....	23

---

5.3.3	Test Organism & Water Quality Augmentation .....	29
5.3.4	Control & Instrumentation .....	29
5.4	Verification Testing .....	30
5.4.1	Treatment System Commissioning .....	31
5.4.2	Operation and Maintenance (O&M) Manual .....	32
5.4.3	Vendor and Test Organization Requirements .....	32
5.4.4	Toxicity Testing for Biocide Treatments .....	33
5.4.5	BE and O&M Verification Strategy: Test Duration and Coordination .....	33
5.4.6	Biological Efficacy (BE) Verification Testing .....	35
5.4.7	BE Validity Criteria .....	48
5.4.8	Alternative and Emerging Methods .....	50
5.4.9	Operation and Maintenance Verification Factor .....	51
Chapter 6	Reporting Verification Testing Results .....	57
Chapter 7	Quality Assurance/Quality Control (QA/QC) .....	58
7.1	Verification of Test Data .....	58
7.2	Project Management .....	58
7.3	Measurement and Data Acquisition .....	58
7.4	Assessment .....	59
Chapter 8	Data Management, Analysis and Presentation .....	60
8.1	Data Management .....	60
8.2	Data Analysis and Presentation .....	60
Chapter 9	Environmental, Health, and Safety Plan .....	61
References	.....	62
Appendix A	Quality Assurance Project Plan .....	65
Appendix B	Approach for Evaluating standard Test Organisms .....	70
Appendix C	Report on Discharge Sampling .....	96

## List of Tables

Table 1. Acceptable Variations for Frequency and Voltage.....	7
Table 2. Recommended Standard Test Organisms for Bench-Scale Testing .....	10
Table 3. Water Quality Challenge Matrix for Verification Testing.....	19
Table 4. Minimum Criteria for Challenge Water Total Living Populations.....	22
Table 5. Accuracy and Precision Requirements for Potential Sensors .....	24
Table 6. Likely Treatment Sequences and Applications Inherent to Ballast Operations .....	31
Table 7. Criteria for Concentrations of Living Organisms in Control Tank Discharge .....	34
Table 8. Core and Potential Auxiliary Parameter and Measurement Techniques .....	36
Table 9. Sample Volumes, Containers and Processing.....	38
Table 10. Recommendation for Water Quality Sample Analysis Methods.....	39
Table 11. Data Quality Objectives for Water Quality Samples.....	40
Table 12. Density Confidence Intervals for Poisson Distributions Using the Chi-Square Statistic .....	43
Table 13. Sample Volume Required Relative to Treatment Standards–Organisms $\geq 50 \mu\text{m}$ .....	44
Table 14. Sample Volume Required Relative to Treatment Standards Organisms $\geq 10 \mu\text{m}$ and $< 50 \mu\text{m}$ .....	44
Table 15. Challenge Test Validation Criteria by Location .....	50

## List of Figures

Figure 1. Sampling design example for in-tank treatment.....	26
Figure 2. Sampling design example for in-line treatment.....	27



## GLOSSARY OF TERMS

**Accuracy:** The degree of agreement between an observed value and an accepted reference value, including a combination of random error (precision) and systematic error (bias) components that are due to sampling and analytical operations (EPA, 1992).

**Ambient Populations:** The biological organisms, including bacteria, protists, and zooplankton that are naturally occurring in the water at the TF location.

**Ballast Water Treatment System (or System):** Prefabricated, commercial-ready, treatment systems designed to remove, kill or inactivate (prior to discharge) organisms in ballast water. The entirety of a vendor's ballast water treatment product will be used to achieve the vendor claims for treatment efficacy or operational performance, and includes all components, in an integrated fashion.

**Bias:** The systematic or persistent distortion of a measurement process that causes errors in one direction.

**Challenge Water:** Water supplied to a treatment system under test. Challenge water must meet specified ranges for living organism densities and water quality parameters and is used to assess the efficacy of the treatment equipment under full-scale operational conditions.

**Comparability:** The measure of the confidence with which one data set can be compared to another.

**Completeness:** The amount of data collected as compared to the amount needed to ensure that the uncertainty or error is within acceptable limits.

**Core Parameters:** The measurements that are required as part of the ETV verification.

**Cyst:** The dormant cell or resting stage of microalgae, heterotrophic protists, and metazoans, including but not limited to cysts of dinoflagellates, spores of diatoms, cysts of heterotrophic protists, and cysts of rotifers.

**Effluent:** The treated discharge water produced by a ballast water treatment system.

**Equipment:** The ballast water treatment system, defined as either a package or a modular system, which is tested in the Verification Testing Program.

**ETV Testing:** Testing of a technology under the EPA Environmental Technology Verification Program following provisions of an established protocol and/or TQAP, with the final outcome being a Verification Report, containing all findings of the test, and a Verification Statement, signed by the US EPA and the Verification Organization (VO).

**In-Line Treatment:** A treatment system or technology used to treat ballast water during normal flow of ballast during uplift or discharge.

**In-Tank Treatment:** A treatment system or technology used to treat ballast water during the time that it resides in the ballast tanks. This may involve treatment steps during uptake.

**Mean Time Between Failure (MTBF):** The predicted elapsed time between inherent failures of a system during operation. MTBF can be calculated as the arithmetic mean (average) time between failures of a system. The MTBF is typically part of a model that assumes the failed system is immediately repaired (zero elapsed time), as a part of a renewal process. This is in contrast to the mean time to failure (MTTF), which measures average time to system failure with the modeling assumption that the failed system is not repaired.

**Normally distributed data:** Data that meet the following criteria: the data forms a bell shaped curve when plotted as a graph, the mean is at the center of the distribution on the graph, the curve is symmetrical about the mean, the mean equals the median, and the data are clustered around the middle of the curve with very few values more than three standard deviations away from the mean on either side.

**Owner:** The owner of a test site used for verification testing of a ballast water treatment system.

**Performance Data:** Removal efficacy and effluent concentration data for core and supplemental parameters for a given set of Challenge conditions.

**Precision:** The degree to which a set of observations or measurements of the same property, obtained under similar conditions, conform to themselves. Precision is usually expressed as standard deviation, variance, or range, in either absolute or relative terms (NELAC, 1998).

**Protocol:** A written document that clearly states the objectives, goals, scope, and procedures for the study of a particular group of similar technologies. A protocol shall be used for reference during vendor participation in the verification testing program.

**Proxy Measurement:** A parameter used in lieu of another measurement (i.e., chlorophyll *a* as a bulk measure of phytoplankton).

**Quality Assurance Project Plan (QAPP):** A written document that describes the implementation of quality assurance and quality control activities during the life cycle of the project (also see Test/quality assurance plan).

**Representativeness:** The degree to which data accurately and precisely represent a characteristic of a population.

**Sensitivity:** The capability of a test method or instrument to discriminate between different levels (e.g., concentrations) of a variable of interest.

**Stakeholder Advisory Group (SAG):** A group overseen by a Verification Organization (VO) consisting of representatives from verification customer groups, technology developers and vendors, the consulting engineer sector, the finance and export communities, and government permittees and regulators.

**Standard Operating Procedure (SOP):** A written document containing specific instructions and protocols to ensure that quality assurance requirements are maintained.

**Standard Test Organisms:** Biological organisms of known types and abundance that have been previously evaluated for their level of resistance to physical and/or chemical stressors representing ballast water technology. The organisms are added to the challenge water during testing of ballast water treatment technologies to determine treatment system effectiveness.

**Start-Up:** The period between the time the ballast water treatment system is activated and when stable operating conditions are achieved.

**Stable Operation:** The time interval following a start-up period that the ballast water treatment system performs consistently within the range of vendor-specified operating conditions.

**Supplemental Parameters:** A measurement taken that is specific to a particular treatment and augments the results of the core parameter measurements.

**Technical Panel:** A group comprised of a subset of stakeholders and other individuals with a technical expertise in various ballast water issues, such as fresh water and marine biologists, environmental scientists, engineers, and ship architects.

**Test Cycle:** One fill/discharge cycle (including appropriate holding periods) designed to gather data on treatment efficiency.

**Test Facility:** A site that provides the necessary infrastructure, systems and personnel to complete the verification testing described in this protocol. The facility may be part of the Testing Organization or may be independent from the Testing Organization, but in any case shall be totally independent from technology vendors testing at their site.

**Test/Quality Assurance Plan (TQAP):** Also called a Quality Assurance Project Plan (QAPP), this is a written document that describes the procedures for conducting a test or study according to the verification protocol requirements for the application of a particular ballast water treatment system at a particular site. At a minimum, the TQAP shall include detailed instructions for sample and data collection, sample handling and preservation, precision, accuracy, goals, and quality assurance and quality control requirements relevant to the particular site.

**Testing Organization (TO):** An organization qualified to conduct studies and testing of ballast water treatment technologies in accordance with protocols and TQAPs.

**Upset Conditions:** Deviation or exception from normal or vendor-defined operating conditions, for example, system faults or hardware failures.

**Vendor:** A business that manufactures, assembles, or sells ballast water treatment technologies.

**Verification:** The establishment of evidence on the performance of a ballast water treatment system under specific conditions, following a predetermined study protocol(s) and TQAP(s).

**Verification Organization (VO):** The party responsible for overseeing TQAP development, overseeing testing activities in conjunction with the Testing Organization, and overseeing the development and approval of the Verification Report and Verification Statement for the ballast water treatment system. Within the ETV Program, verification organizations are the managers and operators of the various technology centers under cooperative agreements with the EPA.

**Verification Report:** A detailed report on the testing results of a particular technology according to an approved Test /Quality Assurance Plan and conducted under the ETV Program. The report is typically prepared by the TO and contains a description of the test facility, photographs of technology being tested methods and procedures, presentation of analyzed data including all QA/QC data obtained during the test. Appendices include raw data sets and lab audit information, TQAP, O&M Manual and other relevant information. Both the verification report and verification statement are publically available on the ETV Program’s web site and NSF’s web site .

**Verification Statement:** An executive summary of the verification report, usually 4-6 pages in length which is signed by EPA and the verification organization.. The verification statement is intended to be used by the vendor for sales and marketing purposes.

**Verification Test:** A complete test of a treatment system, following a well defined TQAP which includes enumeration of ambient and test populations in the challenge water to determine the efficacy of the technology. Also see ETV Testing.

**Viable:** According to the IMO G8 guidelines, “organisms and any life stages thereof that are living”.

## Abbreviations and Acronyms

<b>ATP</b>	Adenosine triphosphate
<b>BE</b>	Biological efficacy
<b>BWTS</b>	Ballast water treatment system(s)
<b>CT</b>	Concentration-time relationship (curve) demonstrating the relationship between concentration and time that achieves desired treatment effect.
<b>m<sup>3</sup></b>	Cubic meter
<b>CFR</b>	Code of Federal Regulations
<b>DOC</b>	Dissolved organic carbon
<b>DOM</b>	Dissolved organic matter
<b>EPA</b>	U.S. Environmental Protection Agency
<b>ETV</b>	Environmental Technology Verification
<b>FRU</b>	Field replaceable unit
<b>µg/L</b>	Micrograms per liter
<b>mgd</b>	Million gallons per day
<b>mg/L</b>	Milligrams per liter
<b>MAWP</b>	Maximum allowable working pressure
<b>MM</b>	Mineral matter
<b>MOA</b>	Memorandum of agreement
<b>MSDS</b>	Material safety data sheets
<b>MTBF</b>	Mean time between failures
<b>NRL</b>	U.S. Naval Research Laboratory
<b>NSF</b>	NSF International (formerly National Sanitation Foundation)
<b>NTU</b>	Nephelometric turbidity unit

<b>O&amp;M</b>	Operations and maintenance
<b>OSHA</b>	Occupational Safety and Health Administration
<b>Owner</b>	TF owner, if different from the Testing Organization (TO)
<b>POM</b>	Particulate organic material
<b>PSU</b>	Practical salinity units
<b>QA</b>	Quality assurance
<b>QAPP</b>	Quality assurance project plan
<b>QC</b>	Quality control
<b>QMP</b>	Quality management plan
<b>SAG</b>	Stakeholder Advisory Group
<b>SOP</b>	Standard operating procedure
<b>STO</b>	Standard test organism
<b>TF</b>	Test Facility
<b>TO</b>	Testing Organization
<b>TQAP</b>	Test/quality assurance plan
<b>TSS</b>	Total suspended solids
<b>USCG</b>	U.S. Coast Guard
<b>VO</b>	Verification Organization
<b>WQPC</b>	Water Quality Protection Center

---

# Chapter 1

## Introduction

### **1.1 The ETV Program**

The U.S. Environmental Protection Agency (EPA) established the Environmental Technology Verification (ETV) Program in 1995. The goal of the ETV Program is to promote environmental protection by accelerating the development and commercialization of improved and more cost-efficient environmental technologies through third-party verification, performance reporting, and information dissemination. The ETV Program neither certifies nor endorses environmental technologies, but rather provides objective, high-quality, peer-reviewed performance data that can be utilized by customer groups and regulators when selecting, permitting, or certifying the use of environmental technology. The ETV Program's Water Quality Protection Center (WQPC) addresses technologies to protect surface and ground water from chemical or biological contamination and conducts performance verifications of technologies resulting in comprehensive reports that are publically available on the ETV Program web site. Further information on the ETV Program can be obtained at <http://www.epa.gov/etv>.

Through a formal Memorandum of Agreement (MOA) signed in 2001, the U.S. Coast Guard (USCG) and EPA formed a partnership to develop procedures for evaluating the performance of ballast water treatment systems (BWTS). The partnership also provided the Coast Guard a pathway to begin the development of technical procedures for approving BWTSs for installation on ships. EPA's interest includes the ecological, economic and public health impacts of ballast water discharges. Ballast water treatment is viewed as an important step in mitigating the proliferation of aquatic invasive species in U.S. coastal waters and the Great Lakes.

### **1.2 Objectives of Verification Testing**

The objective of ETV ballast water treatment technology testing is to evaluate the performance characteristics of commercial-ready treatment technologies with regard to specific verification factors, including biological treatment performance, predictability/reliability, cost, environmental acceptability, and safety. Given the variety of ship and ballast tank types, and potential treatment system configurations, this protocol addresses the use of a land-based testing facility (TF) rather than shipboard testing, to provide controlled conditions for verifying treatment performance. Land-based BWTS verification testing will be conducted in a manner providing information that is comparable to the maximum practical extent, to ensure that consumers and other stakeholders can make informed choices in selecting appropriate ballast water treatment technology for shipboard installations.

It is believed that ballast water treatment systems performing well under the controlled but challenging conditions specified in this protocol at land-based testing facilities will have a reasonable chance of performing as well in a shipboard installation. However, because of the various designs used in ship ballasting systems and the water quality conditions encountered by vessels in seaports around the world, any assumptions of shipboard technology performance

based solely on land-based testing results should be avoided. Thorough evaluation of ballast water treatment technology must also include shipboard trials to monitor biological performance and other ship-related verification factors over an extended period of time. The U.S. Coast Guard's Environmental Standards Division [http://www.uscg.mil/environmental\\_standards/](http://www.uscg.mil/environmental_standards/) should be contacted for information concerning procedures for shipboard testing of ballast water treatment technologies.

### **1.3 Purpose and Scope of the Protocol**

The parties involved with ETV testing, including vendors, testing organizations, testing site owners, and verification organizations, can use the information provided in this protocol as guidance for BWTS verification testing. This protocol provides guidance on the necessary elements of verification testing including: technology acceptability; vendor provided specifications and information; and test/quality assurance plan (TQAP) development and content. The protocol is intended for verification testing of entire BWTSs, not individual component technologies that could be combined to form a system. The systems addressed by the protocol could be in many configurations, such as treatment on uplift or discharge, treatment in-transit (in-tank), or combinations of these options.

Periodic review and revision of protocols is a critical aspect of the ETV Program. As such, this protocol will be reviewed periodically and revised as necessary. These efforts will keep the protocol scientifically and functionally up to date.

### **1.4 Verification Testing Process**

Verification testing is a three-step process, consisting of planning, verification, and data assessment/reporting phases. The planning phase includes development of standardized challenge conditions and the specific experimental design as it will be applied to the testing of the vendor's BWTS. A site and treatment system-specific TQAP are prepared during the planning phase in accordance with the guidance provided in Chapter 4 of this protocol. The BWTS vendor, Testing Organization (TO), and Verification Organization (VO) collaborate on the planning phase documents. The verification phase involves the testing of the BWTS by the TO under the conditions and standard operating procedures specified in the TQAP. In the data assessment and reporting phase, data are processed and analyzed by the TO, who prepares the draft verification report and verification statement. The VO is responsible for QA review of the data generated during the testing and coordination of the finalization of the verification report and statement.

### **1.5 Policies and Program Guidelines**

Treatment system verification testing will be conducted in accordance with an approved TQAP (for test specific activities) and with the policies and guidelines set forth by an established Quality Management Plan (QMP) for the testing facility. Examples of ETV Center QMPs and quality assurance plan documents for other testing activities can be viewed on the ETV Program's web site. EPA also provides guidance documents for preparing QMPs and quality assurance project plans (QAPPs) at <http://www.epa.gov/quality>



---

## Chapter 2

### Responsibilities of Involved Organizations

Verification testing will involve several organizations with responsibilities divided among them. These organizations may include the vendor of the treatment system, the TO (TO), the Test Facility (TF) owner, the Verification Organization (VO), EPA, and sometimes the Technology Panel and Stakeholder Advisory Group.

#### **2.1 Vendor**

The vendor of the ballast water treatment system will apply to the VO for verification testing. The vendor must provide the VO and TO verification testing objectives and any existing relevant performance data, along with the information required in Chapter 3. This information will be considered during the development of the TQAP, which will be reviewed and approved by the vendor. The vendor will provide a complete System along with any relevant operation and maintenance manuals. Additionally, the vendor will be responsible for assuring proper installation and set up of the equipment at the test site, training of TO personnel on BWTS operation, and confirmation of the system's proper operation prior to commissioning and commencement of maintenance or treatment efficacy testing. It is strongly recommended that the vendor inspect the installation and operation of the system prior to the initiation of the testing. The vendor will be available for logistical and technical support as required during the planning and verification phases, but will not be directly involved in the testing. The vendor will also be responsible for reviewing the verification report and statement generated from the TO.

#### **2.2 Testing Organization (TO)**

The TO is responsible for preparing the TQAP and working with the vendor and VO to assure EPA approval of the TQAP, conducting the verification testing and all aspects of test data management, and may be responsible for preparing drafts and final versions of the verification report and verification statement. The TO is also responsible for coordinating all personnel and testing activities, operating the vendor's equipment as specified in the equipment operations and maintenance manual(s), and evaluating and reporting on the performance of the equipment. Maintaining security for testing activities and site safety for all personnel is also the responsibility of the TO.

#### **2.3 TF Owner (Owner)**

If different from the TO, the Owner of the verification TF may provide logistical and technical support during planning and verification phases, as agreed upon by the TO, vendor, and Owner. The Owner must notify the TO of any logistical or operational developments that may affect the verification testing process and results.

---

## **2.4 Verification Organization (VO)**

The VO is responsible for the technical and administrative operation of the ETV Program's Water Quality Protection Center and all verification activities conducted on behalf of the ETV Program. The VO is responsible for overseeing the development and approval of the TQAP, and collaborating with the TO to administer testing activities at the TF. The VO is also responsible for reviewing, revising and submitting the Verification Report and Statement to the EPA project officer for final QA and technical review. The Report and Statement are typically drafted by the TO, but they may be drafted by the VO or a contractor to the VO. The VO is also responsible for initiating and coordinating periodic review and revision of this protocol.

## **2.5 Environmental Protection Agency (EPA)**

The EPA Office of Research and Development (ORD), through the National Risk Management Research Laboratory (NRMRL) in Cincinnati, Ohio oversees the Environmental Technology Assessment, Verification and Outcomes Staff (ETAVOS) where the ETV Program is headquartered. The ETV Program's Water Quality Protection Center is managed administratively from ETAVOS. The Project Officer (PO) for the WQPC is assigned to the Water Supply and Water Resources Division, Urban Watershed Management Branch. The Project Officer is responsible for administrative and technical management of the cooperative agreement with the VO. The PO is also responsible for obtaining EPA reviews of TQAPs for BWTS verification testing, the verification report and statement generated from the testing, and for assuring that the report and statement are posted on the EPA/ETV web site. EPA is also responsible for coordinating review and approval of revisions that may be proposed to this protocol.

## **2.6 Stakeholder Advisory Group (SAG)**

Stakeholder Advisory Groups (SAGs) are established in each of the ETV Program's six Centers, and consist of representatives from verification customer groups, such as buyers and users of technology, developers and vendors, the consulting engineering sector, the finance and export communities, and government regulators. The SAGs support generic verification protocol development, prioritizing the types of technologies to be verified, and defining and conducting outreach activities appropriate to the technology area and customer groups. In addition, the SAGs may review WQPC-specific procedures and selected ETV verification reports emerging from the ETV WQPC and serve as information conduits to the particular constituencies that each member represents. The Ballast Water SAG, of the WQPC, is charged with addressing ballast water treatment technologies.

## **2.7 Technology Panel**

The Technology Panel is comprised of a subset of stakeholders and other individuals with technical expertise in ballast water and environmental technology issues. Scientists, engineers, technology vendors, naval architects, and regulators supported the development of this Verification Protocol as participating panel members. In the future, the Technology Panel may be responsible for reviewing TQAPs and verification reports and statements. The Panel will also play a key role in working with the VO in reviewing and revising this protocol as needed.

## Chapter 3

# Ballast Water Treatment System Capabilities and Description

### **3.1 Ballast Water Treatment System Definition**

For the purposes of this verification testing program, ballast water treatment systems (BWTS) are defined as:

*Prefabricated, commercial-ready, treatment systems designed to remove, kill or inactivate (prior to discharge) organisms in ballast water. This includes all components, in an integrated fashion, required for shipboard operation.*

Note that it is understood that many of the proposed regulatory discharge standards, and in fact the desired effect of BWTSs, is that these technologies should render organisms unviable or incapable of reproduction. In other words, to “kill, remove or inactivate” is technically unnecessary when the objective is to eliminate the organism’s capability for reproduction. However, as the introduction of “viability” as a measure of efficacy significantly complicates the Protocol and test methods, and since “kill, remove or inactivate” is a conservative approach, the latter has been adopted as the measure of biological efficacy in this Protocol.

This definition includes both in-line (systems that treat the flow of ballast water either on uplift or discharge) and in-tank systems (systems that treat ballast water during the time it resides in the ballast tanks). Typically, BWTSs treat an average design flow between 1.4 – 17 m<sup>3</sup> per minute (370 – 4,490 gpm) or a total tank volume within a range of 20 – 14,500 m<sup>3</sup> (5,280 – 3,830,000 US gal).

Systems that will be tested under this program will be capable of treating the entire discharge or ballast water volume for biological organisms, either through a one-step treatment process or through multi-step treatment processes, and will be capable of treating a wide range of source water typical of ballast uplifted from fresh, coastal, estuarine and/or marine origins. These technologies may be biological, physical, or chemical in nature or a combination of any or all of the technologies. Treatment systems, or components of systems, that provide only partial treatment of the discharge are excluded from verification testing.

### **3.2 Technology or Treatment Performance Claims**

The vendor will supply a statement of treatment performance claims for the treatment or technology. Discharge water quality specifications should reference current EPA regulations or recommendations for shore discharge standards. The statement should include, as a minimum:

- Quantitative measures of biological treatment efficacy expressed as a concentration upon discharge for a range of biological size groups as defined in Section 0; minimum reporting parameters are specifically detailed in Section 5.4.6;
- Quantitative measures of operational performance requirements to achieve the biological treatment performance stated above; these should include, as a minimum, the allowable

and treatable flow rate range and water quality (dissolved and particulate matter concentration and particulate size range, salinity, water temperature, turbidity and dissolved oxygen content);

- Treatment capabilities over the anticipated range of maritime environmental conditions must be identified by the vendor; the effects of extremes in temperature, turbidity, biomass density, or other environmental conditions that may impact the treatment system must be noted where these may cause variations in Vendor performance specifications;
- Quantify the concentration of disinfection residuals, by-products and toxicity for relevant systems;
- The required operational and maintenance conditions (operator time, power requirements, chemical consumption requirements, reliability, etc.) to achieve the biological performance under a range of source water conditions typical to fresh, coastal, estuarine, and marine ballast water (water conditions are detailed in Section 0); and
- The projected mean-time between failure (MTBF) for the technology given the operation and maintenance schedules provided for the technology.

### **3.3 Acceptability for Testing**

The treatment system must meet the definition of a BWTS and all existing environmental regulatory requirements for operation and treatment byproduct discharge (including EPA Registration under FIFRA for any antimicrobial chemical used in the system as active substances). The system must be safe for the crew to operate and be compatible with other shipboard systems as defined by marine equipment certification procedures by the American Bureau of Shipping (ABS), or Det Norske Veritas (DNV). Only complete treatment systems will be accepted for verification testing. Moreover, it is anticipated that a BWTS will have undergone bench-scale testing with standard test organisms (STO) to validate treatment efficacy under controlled laboratory conditions prior to the full scale standardized testing within the ETV Program.

The VO has the right to reject a proposed system that does not satisfy the definition of a BWTS in Section 3.1. A proposed treatment system may also be denied acceptance to the verification testing program if, for technical or logistical reasons, it cannot be accommodated at the TF or its use will result in non-compliance with the discharge requirements for the TF.

### **3.4 Test Requirements for BWTS**

All piping, valves and fittings shall comply with regulations and marine industry standards as contained in applicable sections of 46 CFR Subchapter F. Pressure piping shall be fitted with relief valves set not to exceed maximum allowable working pressure (MAWP).

Electrical and electronic components in alternating current (AC) systems must be capable of operating satisfactorily under normally occurring variations in voltage and frequency. Unless otherwise stated, the variations from the rated value may be taken from Table 1. Direct current (DC) system devices must be capable of operating satisfactorily at minus 15% voltage. Conductors, power supply, and over-current protection shall be provided in accordance with 46 CFR Subchapter J and appropriate marine industry standards.

**Table 1. Acceptable Variations for Frequency and Voltage**

<b>Quantity in Operations</b>	<b>Permanent Variation</b>	<b>Transient Variation</b>
Frequency	±5%	±10% (5 s)
Voltage	+6%, -10%	±20% (1.5 s)

Operating conditions and tolerances for TO supplies of water pressure and flow, power conditions, air pressure and flow, or any other requirements specific to the BWTS must be clearly identified in system documentation.

System design should provide for appropriate lift and/or hoist points during installation. Center of gravity, no step areas and other installation specific information should be clearly identified. Any areas presenting a hazard to personnel during installation, checkout, and operation should be visibly marked.

Recommendations to ensure post-installation operator access to maintenance ports, access panels, and field replaceable units (FRUs) should be clearly identified in an installation guide with appropriate layout diagrams.

### **3.5 Operating and Maintenance (O&M) Evaluation**

The BWTS will be evaluated during the testing to determine if the system is:

- Designed and constructed to ensure that user access is restricted to essential controls for normal operation of the system;
- If access beyond these controls is available for emergency maintenance and temporary repair, and requires the breaking of security (lockout) seals or activation of another device indicating an entry to the equipment;
- Provides capability for efficient maintenance and repair operations and provides a high mean-time between failures (MTBF);
- If minor and major maintenance schedules, pre-requisite training, level of effort, and recommended spares/supplies are detailed in the appropriate sections of the O&M manual;
- If adequate documentation, including drawings, diagrams and instructions necessary for routine maintenance, troubleshooting, and repairs, are provided;
- Designed to ensure any potential exposure to hazards or hazardous materials that are involved in the maintenance or operation of the equipment are minimized;
- If explicit warning labels identifying the hazard are installed in accordance with OSHA and/or other appropriate federal regulations;
- If procedures for working with stated hazards are clearly identified in the operating instructions;

- If by-product, disposable component, or field replaceable unit (FRU) that presents a safety or environmental hazard are explicitly identified, along with procedures for material handling and disposal according to relevant regulations; and
- If the vendor provides technical support for this system via phone and internet, including contact information for both methods.

The BWTS operation and control capability will be evaluated to determine the following:

- The control system ensures that services needed for the proper operation of the BWTS are provided through automatic arrangements and operators are promptly alerted when conditions warrant human intervention;
- The operator is able to control all BWTS functions through a single control unit;
- The control unit automatically monitors and adjusts optimal treatment dosages or intensities, or other aspects of the BWTS, and/or provides control signals to the ballast water system of the vessel to properly provide the necessary treatment;
- The control unit provides a continuous self-monitoring function when the BWTS is in operation;
- The control unit includes a tamper-proof or tamper-evident recording device, located in a position easily accessible to the person in charge of the BWTS, that provides the operator the parameters listed below during ballast water treatment while continuously logging the data:
  - Proper functioning and status of all the services needed for the operation of the BWTS;
  - All parameters necessary to ensure the proper operation of the BWTS;
  - Status of the valves present in the BWTS, including those leading to overboard discharge;
  - Total quantity of ballast water treated;
  - Ballast water treatment rates;
  - Alarm conditions;
  - Date and time of start and end of the treatment operation;
  - Ballast operation monitored (upload, discharge);
  - Calibration and maintenance events;
  - Other system events of interest;
  - Relevant and necessary measurement information required for control and monitoring operation of the BWTS;
  - Meter and sensor accuracy to measure the suite of parameters appropriate and necessary for control of the BWTS, representing the actual value of the parameters being monitored within 10% despite the presence of contaminants normally expected in ballast water and the operational environment of the BWTS;
  - Diagnostics to enable the local operator to check the functioning of the electrical and electronic circuitry, as well as the calibration of meters and sensors according to the manufacturer's specifications;
  - An emergency manual override function to be used in the event of failure of the control unit;

- Audio and visual alarms and a recording in the event there is discharge of any effluent or a component failure whenever the control unit is not fully operational; and
- The capability to print reports and logged data, as applicable, or stored electronically with printout capability, upon the following events:
  - the BWTS is started
  - the BWTS is stopped
  - an alarm condition develops
  - normal conditions are restored
  - manual override is engaged
- In case of a single failure compromising the proper operation of the BWTS, audible and visual alarm signals are given in all stations from which ballast water operations are controlled, including, but not limited to, the following conditions:
  - Power failure to the BWTS or any subsystem;
  - Failure of any sensor, meter, or recording device;
  - Hazardous condition detected by control system; and
  - Operation outside set points of the BWTS for proper treatment.

### **3.6 Biological Efficacy Evaluation with Standard Test Organism**

Standard test organisms (STOs) shall be used in bench-scale tests to mimic and assess the efficacy of the ballast water treatment system. Such tests occur in the laboratory prior to full-scale testing. Recommended STOs are identified in Table 2 along with the recommended densities to be added to the experimental water in the laboratory experiments.

The viability of STOs used in bench-scale tests should be determined with the following parameters: using one organism from each size class listed in Table 2, treating the STOs in conditions identical to the ballast water treatment system being tested (e.g., 18 ppm of sodium hypochlorite) and following the experimental replication and use of controls as well as the guidance for synthetic water preparation described in Anderson et al. (2008, which is included in Appendix B of this document; e.g., tests are run in quadruplicate for bacteria and protists and run at least in triplicate for zooplankton). If STOs are cultured rather than purchased from a vendor, the methods described in Anderson et al. (2008) should be followed. Bench-scale tests may be completed by the test facility or another organization; results should be included in the Technical Data Package (Section I.8, Test Results/Qualification Data) that is submitted to the TO following full-scale testing.

If the STOs identified in Table 2 are unsuitable for use, alternatives may be considered and utilized with completion of validation experimentation and the concurrence of the VO. Test facilities wishing to replace any of the recommended STOs with other organisms should conduct sufficient experimentation and provide evidence indicating a broad resistance to treatments as outlined by Anderson, et al. (2008). The Anderson research identified the recommended standard test organisms as a function of biological functional group and salinity. Similar methods, as described in Appendix B, should be used by the TF to determine replacements for those STOs.

**Table 2. Recommended Standard Test Organisms for Bench-Scale Testing**

Size Class	Marine/Brackish Water	Fresh Water	Minimum Concentration <sup>1</sup>
Zooplankton	<i>Artemia franciscana</i>	<i>Ostracod</i>	10 <sup>5</sup> organisms/m <sup>3</sup>
Protists	<i>Tetraselmis sp.</i>	<i>Green microalgae</i>	10 <sup>3</sup> organisms/mL
Bacteria	<i>Geobacillus sp.</i>	<i>Geobacillus sp.</i>	10 <sup>3</sup> organisms/mL

<sup>1</sup> The volumes of water used in the laboratory do not have to match those in the table, but the concentration of organisms should be equivalent (e.g., 10<sup>2</sup> zooplankton/l is acceptable for 10<sup>5</sup> zooplankton/m<sup>3</sup>).

### **3.7 Calibration and Test Requirements**

The BWTS will be evaluated during the testing to determine if the system provides:

- Diagnostic routines and procedures to maintain accuracy of measured process parameters, including:
  - The degree to which diagnostics are automated;
  - If self test routines are incorporated as part of the control unit;
  - If the manufacturer specified appropriate diagnostic intervals; and
  - If the diagnostics confirm that parameters are within specifications or that calibration is required.
- Diagnostics for fault checking, system maintenance and repair;
- Automated diagnostics that also may be manually initiated by the operator;
- Diagnostics that isolate faults down to field replaceable units (FRUs);
- If the accuracy of the system components that take measurements are verifiable according to the manufacturer's instructions; and
- If only the manufacturer or persons authorized by the manufacturer do the accuracy checks.

### **3.8 System Documentation Evaluation**

The documentation provided for the BWTS will be evaluated during verification to determine if the specifications provide detailed requirements and tolerances for the following system parameters:

- Ballast water turbidity, pressure, temperature and flow rate ranges (include any other applicable criteria);
- Electrical power requirements;
- Air/pneumatic pressure and flow rate ranges;
- Weight;
- Dimensions;
- Environmental limitations (e.g., ambient temperature);
- Treatment limitations;
- Safety hazards; and



- The vendor provided list of procedures for unpacking and verifying contents of shipped items.

The documentation of the installation procedures and requirements in the installation guide will be evaluated to determine if:

- All areas of mechanical, electrical, hydraulic, pneumatic, and any other interface requirements are addressed;
- Time estimates in man-hours provided for installation procedures are appropriate;
- If applicable standards are referenced and special precautions and hazards identified; and
- Appropriate diagrams, photographs and/or assembly drawings detail footprints, attachment points, interfaces, and any referenced components or subassemblies.

The adequacy of the O&M manual(s) provided with the system will be evaluated during the verification. If not included in the O&M manual, ancillary documentation provided with the BWTS will be evaluated for the detail provided for the following items:

- Piping and instrumentation diagrams;
- Electrical schematics and wiring diagrams;
- Photographs;
- Guides for diagnostics and troubleshooting;
- Parts lists; and
- Operator training – minimal additional special training required to operate the system (identified and supplied).

### **3.9 Technical Data Package Submission**

A technical data package must be submitted to the TO by the Vendor of a BWTS to be considered for verification. Vendor-specific performance claims should be identified along with relevant existing performance data.

The information in the technical data package should demonstrate that the treatment processes are well characterized and the equipment is designed to meet specific ballast water treatment performance criteria at the intended operational scale. Photographs with appropriate reference scales should be included. The data package shall also document operational and maintenance requirements and conditions. At a minimum, the technical documentation provided by the Vendor should address the items identified in the format outline in Section 3.9.

Much of the required information will likely be available in the Vendor O&M manual(s), which are part of the required documentation. The information presented in an O&M manual will, however, vary by vendor. To be considered for verification testing under this protocol, vendors are required to submit a technical documentation package. This allows each vendor the opportunity to incorporate those data most appropriate to the content topic. In addition to the technical data package and the O&M manual(s), vendors may also provide ancillary reference information through any combination of manuals, product literature, and electronic files. Any

ancillary information or proprietary information must be clearly identified as such, and the intended purpose/relevance of providing the information must be clearly stated.

While not required for verification, but likely to be part of a submittal for regulatory compliance, the manufacturer may provide certifications or quality assurance documentation for all vendor QA/QC and factory testing that occurs during the manufacture of the equipment. If provided, relevant standards traceability data should also be provided.

### **3.10 Format for the BWTS Technical Data Package**

- A Cover Page
- B Table of Contents
- C General Description & Capabilities (Marketing and technical specifications, and other items below)
  - C.1 System volume, weight, power & mechanical interface requirements
  - C.2 Vendor performance objectives (vendor should describe primary and non-primary objectives of ETV testing, i.e., verification testing, or full scale evaluations)
- D Target operating environments and conditions
  - D.1 General Features
  - D.2 Permitting and Certifications
  - D.3 Scalability (no specified requirement – please address range of applicable ballast system volumes and rates for the described treatment system)
- E Installation Requirements and Instructions
  - E.1 Hydraulic and mechanical connections
  - E.2 Electrical connections to mains
  - E.3 Hazard locations
  - E.4 Other special installation criteria / handling
  - E.5 Considerations for maintenance / consumables / repair
  - E.6 Shipping and delivery considerations (no specified requirement – vendor should describe ability / methods to transport treatment system)
  - E.7 Interfacing for performance monitoring, alarms & controls (no specified requirement – vendor should describe available options)
- F Operating and Maintenance Instructions
  - F.1 Operating and Maintenance Manual (may provide as standalone document(s), but – any references in the text of the technical data package to the separate O&M manual must/should be specific to page and paragraph.)
  - F.2 Training Materials
  - F.3 Repairs and Troubleshooting
  - F.4 Recommended Spares (and sources)
  - F.5 Safety Precautions and Issues
  - F.6 Environmental Hazards and Issues, Including By-Products
  - F.7 Expendables, Materials Handling, and Waste Disposal
  - F.8 Technical Support contact information
- G System Performance Specifications

- G.1 Discharge water quality
- G.2 Treatment capabilities vs. environmental conditions
- G.3 Control features and capabilities
- G.4 Factory testing criteria and procedures (for entire system and ancillary equipment)
- G.5 Human operator requirements (special skills or training required to operate the system)
- G.6 Data Storage
- G.7 Automated capabilities
- G.8 Alarms and safety capabilities
- H Calibration and System Test Procedures
  - H.1 Diagnostics
  - H.2 Quality assurance during operation
  - H.3 Calibration schedules and procedures
- I Detailed Description of System Operation
  - I.1 Theory, processing and principles of operation (no specified performance requirement – vendor should provide background on how and why treatment system works, including explanation of any environmental limiting factors)
  - I.2 Selection of materials used in fabrication
  - I.3 Design considerations for marine applications
  - I.4 Ancillary Documentation Package (this section is for documentation not referenced elsewhere)
  - I.5 Reference drawings and photographs
  - I.6 Materials / parts lists
  - I.7 Certifications (such as American Bureau of Shipping certifications)
  - I.8 Test Results / Qualification Data (no specified requirements – this should be results of vendor and/or independent testing of system performance)

---

## Chapter 4

# Treatment Verification TQAP Development

### **4.1 Description of Ballast Water Treatment System**

Each ballast water treatment verification test will be completed following a written TQAP. From the vendor-supplied treatment system documentation submitted as outlined in Chapter 3, the TQAP should include those materials, data, and information that are necessary to describe the treatment system's principle of operation, physical properties, installation and commissioning, startup and operation, data collection, required actions during upset conditions and necessary consumables. These may include, but are not limited to:

- Vendor treatment and operation claims as identified in Section 3.2
- Engineering description
- Process description including performance ranges and expectations
- Discharge characteristics
- Footprint
- Photographs
- TO physical and electrical interfaces
- Safety and Environmental Hazards and Precautions

### **4.2 Required Elements of the TQAP**

The TQAP will detail test objectives, specific test procedures (including sample and data collection, sample handling, analysis and preservation) and quality control and assurance requirements (including measures of precision, accuracy, comparability, and representativeness). The experimental approach for the ballast water treatment test, treatment system start-up, and verification procedures will be presented. The TQAP will include a summary description of the standardized water quality and biological challenge conditions established by the experimental configuration as described in Section 5.3. The TQAP will summarize how the challenge conditions will be implemented at the TF relative to the ballast water treatment system being tested. Any modifications or supplements to the treatment verification protocols will be defined and discussed in the Plan. The TQAP will also address quality assurance/quality control (QA/QC) requirements, data handling and presentation, and environmental, health, and safety issues.

The TO, with input from the vendor, is responsible for preparing the TQAP. If the vendor desires data from ETV testing to be made available for type approval or other regulatory purposes, the data required should be clearly identified in the TQAP. The VO shall review and coordinate the approval of the TQAP prior to the start of verification testing.

The TQAP shall include:

- Title page/approval page with all project participants
- Table of contents
- Project description and treatment performance objectives
- Project organization and personnel responsibilities
- TF description
- Treatment system description
- Experimental design (including installation/start-up plan)
- Challenge water conditions and preparation (including TF standard operating procedures (SOPs) for preparation)
- Sampling and analysis plan including sampling and analytical procedures
- Data management, analysis and reporting
- Environmental, health and safety plan
- References
- Appendices
  - Quality Assurance Project Plan (QAPP)
  - Vendor operation and maintenance manual

Content requirements for the QAPP are discussed in more detail in Appendix A.

---

## Chapter 5

### Experimental Design

The primary purpose of ETV verification of BWTSs is to verify the biological treatment performance according to an established protocol and specified challenge conditions identified in an approved TQAP. Other factors pertinent to the treatment system's performance will also be evaluated, including engineering and environmental metrics. To enable purchasers and other stakeholders to make informed choices in selecting appropriate treatment systems, land-based verification testing conducted in accordance with this protocol is intended to provide comparable data sets for each technology or system to the maximum extent practical. Standardized challenge conditions included in this protocol address both water quality and the biological organism concentrations used to evaluate treatment performance. Key water quality challenge conditions are standardized under this protocol because the effectiveness of various treatment processes may be influenced by certain water quality characteristics (e.g., salinity, turbidity, color, etc.). Moreover, the natural environment (as would be encountered during shipboard BWTS performance testing) has a large range of conditions, which may or may not provide adequate information on a system's ability to perform in accordance with the Vendor's specifications under non-ideal water quality conditions. Therefore, non-ideal water quality conditions form the basis for challenging the treatment systems under this land-based verification testing protocol. To this end, the protocol also includes the requirement for vendors to produce BWTS test data using STOs at an appropriate scale in a controlled environment, and verification testing using robust ambient species during full-scale tests to measure biological treatment efficacy.

The general objectives of the verification testing are to:

- Provide a comprehensive set of water quality and biological challenge conditions against which treatment effectiveness can be quantitatively evaluated.
- Develop adequate data to document system performance against the verification factors.

The requirements for testing are described in the following sections, which provide guidance on the four key elements of the protocol: 1) verification factors, 2) water quality and biological challenge conditions, 3) the TF experimental configuration, and 4) verification testing, including commissioning of the equipment and the measurement programs required under this protocol. Variations in the protocol for specific treatment system types (e.g., in-line treatment versus in-tank treatments) are also described.

#### **5.1 Verification Factors**

All treatment systems will be verified according to the following factors:

- Biological treatment efficacy
- Operation and maintenance
- Reliability
- Cost factors

- Environmental acceptability
- Safety

### **5.1.1 Biological Treatment Efficacy**

Biological treatment efficacy is defined as the removal, inactivation, or death of organisms and will be measured in terms of the concentration of selected organism size classes in the treated discharge. Additional measures of efficacy may include measurements in terms of removal efficiency (e.g., a percentage reduction of organisms present at uptake), against a threshold (e.g., a water quality standard), or in relation of treatment vs. control discharge concentrations. The measurement program required by the protocol evaluates the primary treatment efficacy criteria by measuring the quantity of living organisms in both the challenge water and the treated discharge.

### **5.1.2 Operation and Maintenance**

Operation and maintenance includes the labor expertise, equipment, and consumables required to operate the system to achieve the stated performance goals and objectives. The quantitative indicators to be considered during verification are described in detail in Section 5.4.9.1.

### **5.1.3 Reliability**

Reliability is a statistical measure of the number of failures (either qualitative or quantitative) per known quantity of test cycles. This is described in greater detail in Section 5.4.9.8.

### **5.1.4 Cost Factors**

Cost factors include only those factors that can be verified, such as labor hours to operate and maintain the system, expendable material, such as filter cartridges, and pounds or gallons of chemicals consumed by the treatment system. Data is collected in units, to which unit prices, which are likely to vary from location to location, can be applied to determine costs. These are discussed further in Section 5.4.9.2.9.

### **5.1.5 Environmental Acceptability**

Environmental acceptability assesses ballast water quality following treatment for factors other than the abundance and viability of organisms. For example, this will determine if the treated water meets acceptable water quality characteristics for such measures as dissolved oxygen, temperature, treatment residuals, pH, etc. This is discussed in further detail in Section 5.4.4.

### **5.1.6 Safety Factors**

Safety factors include any treatment-specific considerations that may pose a threat to the safety of the operator or shipboard operations. These are not intended to be comprehensive in nature, which is best evaluated by Classification Societies, such as the American Bureau of Shipping, but are included as observations that can be made during the verification testing. Further discussion of these observations are discussed in Section 5.4.9.2.11.

Performance test results will be reported using standard ETV formats to make certain the reported information among treatment technologies tested is comparable. Flexibility is permissible to ensure reporting for a specific treatment system type is appropriate and accurate.

Some information supplied by vendors may not be verified under the protocol. This information may be included in the verification test report and clearly identified as non-verified information. Vendor-provided information may include shipboard compatibility (e.g., corrosion resistance, system weight, system volume including clearances needed to perform maintenance and replace vital components, and compatibility with other common shipboard systems such as operational flow rates). Submission and reporting requirements for non-verified, Vendor-supplied information is included under Chapter 3.

## **5.2 Challenge Conditions**

This protocol recognizes that land-based testing cannot fully replicate actual treatment system performance onboard ship. However, land-based verification testing can provide sufficient information to verify the expected performance of treatment in the shipboard environment. It is understood that all treatment technologies will face a range of physical/chemical water quality conditions and biological organisms when operated onboard a ship. Therefore, each treatment system's performance will be verified using a set of standard challenge conditions. This protocol defines the following objectives for the challenge conditions:

- To verify a treatment system's performance using a set of challenging, but not rare, water quality conditions representative of the natural environment.
- To verify removal or kill of bacteria, protists, and zooplankton using ambient organisms as defined by size classes and analytical techniques that identify living quantities for these organisms.

The standard challenge conditions are specified using two groups of factors that must be addressed to properly challenge treatment technologies: water quality and living organisms. The requirements for each group are presented in the following sections.

### **5.2.1 Challenge Water – Water Quality Characteristics**

Since water quality conditions in ports and harbors around the world vary greatly, treatment systems may encounter a wide range of conditions. Also, certain water quality conditions may interfere with the ability of some treatment processes. It is therefore critical to evaluate the effectiveness of a treatment system under water quality conditions that are challenging to the technology being tested. Simulating all potential water quality conditions in a land-based testing design would be prohibitively expensive<sup>1</sup> and not essential for verifying the performance of a treatment system. Because water quality parameters that can interfere with various treatments are generally understood and few in number (e.g., salinity, turbidity, organic matter either as dissolved or particulate forms), the number of water quality metrics that must be explicitly included in the protocol can be limited. This protocol defines three possible challenge conditions that represent some of the more challenging, natural conditions that may be encountered by

---

<sup>1</sup> Similarly, shipboard testing of all potential water quality conditions will require extensive logistics to move a treatment system to a matrix of natural conditions, as well as investment in methods and protocols by which the treatment effectiveness is established using natural populations of organisms.



ballast water treatment systems. Challenge water quality characteristics to be used during testing events are presented in Table 3.

**Table 3. Water Quality Challenge Matrix for Verification Testing**

<b>Water Types</b>	<b>Minimum Water Characteristics</b>
Fresh (Salinity <1 PSU)	DOM: 6 mg/L as DOC POM: 4 mg/L as POC
Brackish (Salinity 10-20 PSU)	MM: 20 mg/L TSS = POM + MM: 24 mg/L
Marine (Salinity 28-36 PSU)	Temperature: 4 – 35 °C

Another basic premise in the design for this protocol is that ballast water treatment systems are designed to function effectively in the full range of water quality characteristics that will be encountered under shipboard operational conditions. By challenging the treatment systems with these conditions, it is assumed treatment will be effective under less demanding conditions. Challenge waters have been tailored to a minimum set of water quality conditions that may be achieved either through naturally occurring conditions or through augmentation, if appropriate, and validated by the TF. The challenge conditions are specified for three possible levels of salinity, <1, 10 to 20, and 28 to 36 PSU (practical salinity units), and water quality characteristics problematic for the range of technologies being developed to treat ballast water, namely, suspended solids and dissolved organic matter (DOM).<sup>2</sup>

Suspended solid material that can interfere with treatment effectiveness is composed of several types of particles, which can be of biological or mineral origin, specifically clay and silt. The water quality challenge conditions defined by the solids content of the matrix include particulate organic matter (POM) and mineral matter (MM). These two types of particles are both present in natural waters at a range of concentrations and size distributions. Therefore, both forms are included in the challenge conditions to address issues of particulate removal and turbidity, which can interfere with transmission of UV light or other treatment processes.

Various forms of dissolved chemicals and compounds, particularly organic material, can directly affect the efficiency of some treatment processes. Dissolved organic matter (DOM) and dissolved organic carbon (DOC) are two terms used to describe this component of natural water.

<sup>2</sup> The protocol does not explicitly call for verification at a series of temperatures, even though some treatments may have strong temperature dependence or may include temperature manipulation as part of the treatment procedure. Rather than include temperature as a controlled water quality condition, which can have significant cost implications for the TF, accurate and continuous monitoring of the source and treated water temperatures is required for all test cycles. If temperature manipulations are to be included, the Test Plan will include protocols for these manipulations. Temperature challenges should be addressed in shipboard testing, and in bench-scale tests of treatment process.

DOM/DOC often contains many chromophores that contribute substantially to the color of the water, another potential interference for treatments. Thus, the color of a water and DOM/DOC concentration are often interrelated.

The measurement methods for evaluating the status of the challenge water quality conditions are described in Section 5.4.6. They include standard analytical methods to document the concentration of total suspended solids, particulate organic matter or dissolved organic matter, and methods that indirectly measure these parameters (e.g., turbidity measured by electronic/optical measurement such as nephelometry (NTUs) or transmissometry (beam attenuation) or fluorescence (color /DOM)).

Standardization of the water quality conditions for the verification testing requires a consistent set of source water (e.g., fresh or marine water), as well as the use of well-characterized organic matter and mineral matter. The TF will be responsible for providing these materials and ensuring the water quality conditions are as described under this protocol. The water quality test conditions will be standardized for salinity, particulate organic matter, mineral matter, and dissolved organic matter as described in the following sections:

#### 5.2.1.1 Salinity

Natural water of less than 1 PSU will be used for fresh water conditions, while natural seawater will be used for marine conditions. Testing at multiple salinities at a given TF should only be conducted if there are natural water sources with the differing salinities (e.g., fresh and brackish waters). Artificial modification of the salinity of the waters should be used only if it can be demonstrated that the concentrations, diversity and condition of organism populations required in Section 5.2.2 will not be impacted by adjustment of the salinity.

#### 5.2.1.2 Particulate and Dissolved Organic Matter

In the case of POM, if the natural waters have insufficient concentrations, the TO may augment them through the addition of humic material (e.g., Micromate humates [Mesa Verde Resources, Placitas, New Mexico]). Other sources include particulate carbon from sources such as ground up seaweed or plankton detritus. DOM can be very difficult to adjust or augment if the natural waters have insufficient content. There has been some success using *Camellia sinensis* (decaffeinated iced tea mix) to augment natural DOM content, but a TF must assess the effect of additives on the ambient and test organisms (if used) before using.

#### 5.2.1.3 Mineral Matter (MM) – Clays and Silts

Mineral particles in the size range typically found in coastal and estuarine waters are readily obtained from commercial sources and will be used as the source of the mineral matter. A study of sediment size in ballast tanks suggests that particles are mostly fine grained (less than 63 µm) and most vessels contain <10% sand (F. Dobbs, Pers. Com.). Thus, addition of the commercially available clay minerals (with a majority of particles in the 10 to 50 µm size) addresses the objective of having a prescribed level of non-biological particles as part of the water quality challenge conditions. Specifically, ISO 12103-1, A3 MEDIUM TEST DUST and ISO 12103-1, A4 COARSE TEST DUST can be used for this purpose. As these particles will tend to settle out over time within the augmentation storage vessels, the test protocols must include a means of

maintaining any sediments in a homogeneous suspension prior to addition of the challenge water (e.g., continuous mixing of the sediment augmentation tank).

The TO should verify that, whatever source of augmentation or delivery system is used, the addition of that material should minimize to the extent possible biocidal or growth stimulant response to the ambient organisms. The TF will be responsible for preparing the challenge water, documenting the challenge conditions, and validating that the conditions are maintained at the treatment system or control entry point. Challenge waters will be prepared under standard operating procedures developed by the TF. The TQAP will include these SOPs and describe any planned deviations from the SOPs.

#### *5.2.1.4 Challenge Water – Water Quality Deviations*

In some cases, a specific ballast water treatment system may be unable to operate with all of the prescribed challenge water quality conditions as specified in Table 3. This may be either due to mechanistic limitations of the technology (e.g., electrolytic chlorination (without brine addition) is inoperable in fresh water) or by design (e.g., scale). In such cases, deviations may be permitted provided that significantly challenging and realistic conditions are identified and justified by the TO, and that the VO approves the deviation. In no case, however, shall the total number of test cycles be reduced. All deviations will be specified in the verification report as limiting conditions of the technology.

### **5.2.2 Challenge Water – Biological Organism Conditions**

The death or removal of living aquatic organisms is central to the need to treat ballast water. To ensure proper evaluation of a BWTS's performance, the effects on biological organisms living in the challenge water will be measured for each treatment system tested. Biological efficacy will be evaluated as function of a system's ability to kill or remove organisms that are naturally occurring and represent the more robust ambient populations at the test site.

#### *5.2.2.1 Organism Concentrations*

A minimum total input concentration of living organisms, by size class, is defined in Table 3. The two larger size classes must contain at least 5 different species from at least 3 phyla/divisions. Challenge water meeting these criteria shall be demonstrated for each test cycle at 1) the influent point of the control tank and 2) immediately prior to the point of treatment for systems that treat upon uptake or at the treatment tank influent point for systems that treat either wholly in-tank or upon discharge.

**Table 4. Minimum Criteria for Challenge Water Total Living Populations**

<b>Organism Size Class</b> <sup>1</sup>	<b>Total Concentration</b>	<b>Diversity</b>
<b>≥ 50 μm</b>	10 <sup>5</sup> organisms/m <sup>3</sup>	5 species across 3 phyla
<b>≥ 10 μm and &lt; 50μm</b>	10 <sup>3</sup> organisms/mL	5 species across 3 phyla
<b>&lt;10 μm</b>	10 <sup>3</sup> /mL as culturable aerobic heterotrophic bacteria <sup>2</sup>	n/a <sup>3</sup>

<sup>1</sup> Size is determined by the maximum dimension on the smallest axis.

<sup>2</sup> Note it is assumed that the effects on culturable aerobic heterotrophic bacteria will be indicative of the effects on all bacteria.

<sup>3</sup> Diversity of bacteria by species or phyla is not applicable, and there is no diversity requirement for this size class.

## 5.2.3 Challenge Water – Flow Rates and Volumes

### 5.2.3.1 Flow Rate

Treatment tests will evaluate equipment at operational flow rates defined by the vendor’s O&M manual. The TF shall be capable of providing flow rates of at least 200 m<sup>3</sup> per hour (880 gallons per minute) and an available volume per test cycle of at least 400 m<sup>3</sup>. The TF shall provide sufficient challenge water volume to meet these requirements, and the TQAP will identify the rates that will be tested.

### 5.2.3.2 Volume

A minimum of 200 m<sup>3</sup> shall be processed in each BE test cycle. The recommended minimum volume for in-tank testing is 200 m<sup>3</sup> (~52,800 gallons). The TF shall provide test and control ballast tank configurations of at least 200 m<sup>3</sup>. Larger volumes may be used depending on vendor specifications and availability of tanks at the TF.

## 5.3 Test Facility Physical Configuration

### 5.3.1 Overall experimental configuration

As a minimum, the TF should encompass four components: (1) fluid delivery capacity, (2) a control tank and piping system, (3) a treatment tank and piping system, and (4) a discharge collection tank and post-test treatment system. The fluid delivery systems include pumps, piping, flow distribution controls, flow rate controls and relevant instrumentation to support the challenge water requirements described in Section 5.2. The control tank shall be utilized to hold untreated challenge water for each biological efficacy test cycle. The treatment tank will be utilized to hold all test water subject to the BWTS during the test cycle. Both tanks shall be a minimum of 200 m<sup>3</sup> and suitably constructed to hold such volumes for at least one day. The tank drains shall be located, to the extent possible, to minimize the retention of water following discharge. Tank intake and discharge piping, fittings and relative configurations shall be identical or the equivalent as validated by the TO. Finally, the discharge tank may be necessary if the TF is required to post-treat on-site the control and treated challenge or test waters to remove added inorganic and organic matter, disinfection by-products, or other regulated

substances prior to discharge back to the environment. The discharge tank should be of sufficient volume to store at least 200 m<sup>3</sup>, but preferably large enough to store the cumulative volume of the control and treatment tank.

There are multiple potential locations of ballast water treatment systems when used onboard vessels. The TF must be arranged to support testing of systems, which operate at uptake, discharge, in-tank or a combination of these. Examples of the arrangement for in-tank and in-line treatment are shown in Figures 1 and 2. As shown, the test configuration includes a flow-splitter such that challenge or test water is provided to both the control and treated legs simultaneously. Note that in such an arrangement, the fluid pumping capacity of the TF would be a minimum of 400 m<sup>3</sup>/hr. A sequential fill configuration may also be allowable, in which the treatment and control are filled or drained sequentially. The latter may result in reduced pump capacity needs (but still requires a minimum pump capacity of 200 m<sup>3</sup> per hour), less overall logistic complexity, and reduced piping through the dual use of sampling apparatus, feed and discharge plumbing, instrumentation and so on. In either case, the TF shall validate, to the satisfaction of the VO, that significant differences between treatment and control lines in biological and physical responses are minimal, and that there is no cross contamination by dual use of the site infrastructure.

### 5.3.2 Sampling Methodology

Several types of samples are to be acquired during the verification testing of a ballast water treatment system. During biological efficacy tests, discrete samples for water quality and biological enumeration shall be acquired over the course of the test on a time averaged basis. A minimum volume of 3 m<sup>3</sup> shall be collected per location. *In situ* instrumentation to monitor water quality and physiochemical parameters are also included. All sampling is assumed to be in-line, whether discrete or *in situ*. Characterization of ambient waters may require discrete grab samples, as described in Table 8

#### 5.3.2.1 Sampling Locations

Required sample locations for various treatment scenarios are shown in Figures 1 and 2; samples should be collected according to one of these test designs, unless otherwise accepted by the VO in the TQAP. Samples (data) from the challenge water must be obtained, in accordance with the guidance in Section 5.3.2.4, immediately prior to water entry to the control tank, and immediately before entry to the BWTS (in-line treatment) or the ballast tank in the case of in-tank treatments (if demonstrated as representative of the control and challenge water, a single sample collected ahead of the splitter shown in Figures 1 and 2). For in-line BWTSs, samples of treated water must be collected (1) immediately following the treatment system and (2) following the holding tank at the end of the one-day hold time. For in-tank treatments, samples of treated water must be collected from the ballast tank discharge following the vendor-defined contact period. Further definition of hold times is described in Section 5.4.5. Systems that incorporate treatment at multiple locations (e.g., upon uptake and discharge) will only require sampling after the final stage of treatment. Sampling locations for the control tanks and BWTS must exactly mimic the treatment tanks and system. Finally, in-tank sampling (e.g., via plankton net tows) shall not be utilized for the purposes of verifying biological efficacy, as this method may not result in representative samples. The exact locations, frequency, and methods to be used to collect the samples must be defined in the TQAP.

### 5.3.2.2 Sample Collection Requirements – Frequency

Continuously recording *in situ* sensors (as available and feasible) may be used to measure water quality and proxy parameters during verification testing. Description of the sensors, how they operate, and how they are calibrated shall be included in the TQAP. Minimum instrument performance requirements are provided in Table 5. Discrete samples for water quality characterization will also be obtained during verification testing as discussed above, and they will be collected at the time biological verification samples are collected. A higher frequency of collection for discrete samples may be used if additional samples for calibrating the sensors are necessary. The sample collection requirements and frequency of obtaining samples from the control tanks and piping system will identically match those of the treatment tanks and system. The appropriate frequency of discrete sample collections made in lieu of *in situ* sensing shall be described in the TQAP.

**Table 5. Accuracy and Precision Requirements for Potential Sensors**

Sensor	Reporting Units	Range	Accuracy	Precision
Temperature	°C	0 to 30	0.1	0.01
Conductivity (salinity)	MS/cm	0.5 to 65	0.1	0.01
Transmissometer (20-cm)	per m	0 to 40	0.20	0.01
Dissolved oxygen	mg/L	0 to 20	0.10	0.05
Fluorometer	µg/L	0.03 to 75	50% of reading <sup>1</sup>	0.01

<sup>1</sup> When compared to wet chemistry results.

### 5.3.2.3 Sample Replication

Verification testing will include replication only in analysis. Sample collection replicates are based on the time integrated sample volumes collected during the test cycle (see examples shown in Figures 1 and 2). These sample volumes form the minimum sample collection replication required during each test cycle. Each of the integrated sample tanks will be sub sampled for the Core parameters, which are discussed later. The TQAP will describe each type of analytical replication planned, including acceptable ranges of variability.

### 5.3.2.4 In-line Sampling for Biological Efficacy

To obtain an accurate measurement of the organism concentration at the sample location, the installation of an isokinetic sampling facility at each of these locations is recommended. Isokinetic sampling is primarily intended for the sampling of water mixtures with secondary immiscible phases (i.e., sand or oil) in which there are substantial density differentials. In such conditions, convergence and divergence from sampling ports is of significant concern. Since most organisms are relatively neutrally buoyant, true isokinetic sampling is likely unnecessary for testing ballast water treatment systems. Nonetheless, the mathematics related to isokinetic sampling are deemed useful for describing and specifying appropriate sampling geometries. Isokinetic sampling is necessary to ensure that a sample contains the same proportions of the various flowing constituents as the flow stream being sampled. During isokinetic sampling the

sampling device does not alter the profile or velocity of the flowing stream at the moment or point at which the sample is separated from the main flow stream. To achieve isokinetic sampling conditions, a sampler is designed to separate a subsection of the total flow-stream in a manner that does not encourage or discourage water entry other than that which is otherwise in the cross-section of the sampler opening. In other words, flow streams in the main flow of the pipe should not diverge or converge as they approach the opening of the sampler.

Recommendations for the design and installation of appropriate sampling facilities are given below. In any case, validation of the Test Facilities configuration should include verification that the chosen sampling design, geometry and installation result in representative samples and minimize organism mortality as a result of sample acquisition.

#### *5.3.2.5 Design of In-line Sampling Apparatus*

Through computational fluid dynamics modeling, it has been shown that the isokinetic diameter calculation can provide guidance for sizing of sample ports for sampling of organisms (Richard et al., 2008). Simulations showed that flow transitions from the main stream were best for sample port diameters between 1.5 and 2.0 times the isokinetic diameter. Ports sized in this range had smooth transitions and pressure profiles that allowed for direct sampling without the need of a pump to induce sample collection. The isokinetic sample port diameter should therefore be determined generally according to the equation:

$$D_{iso} = D_m \sqrt{\frac{Q_{iso}}{Q_m}}$$

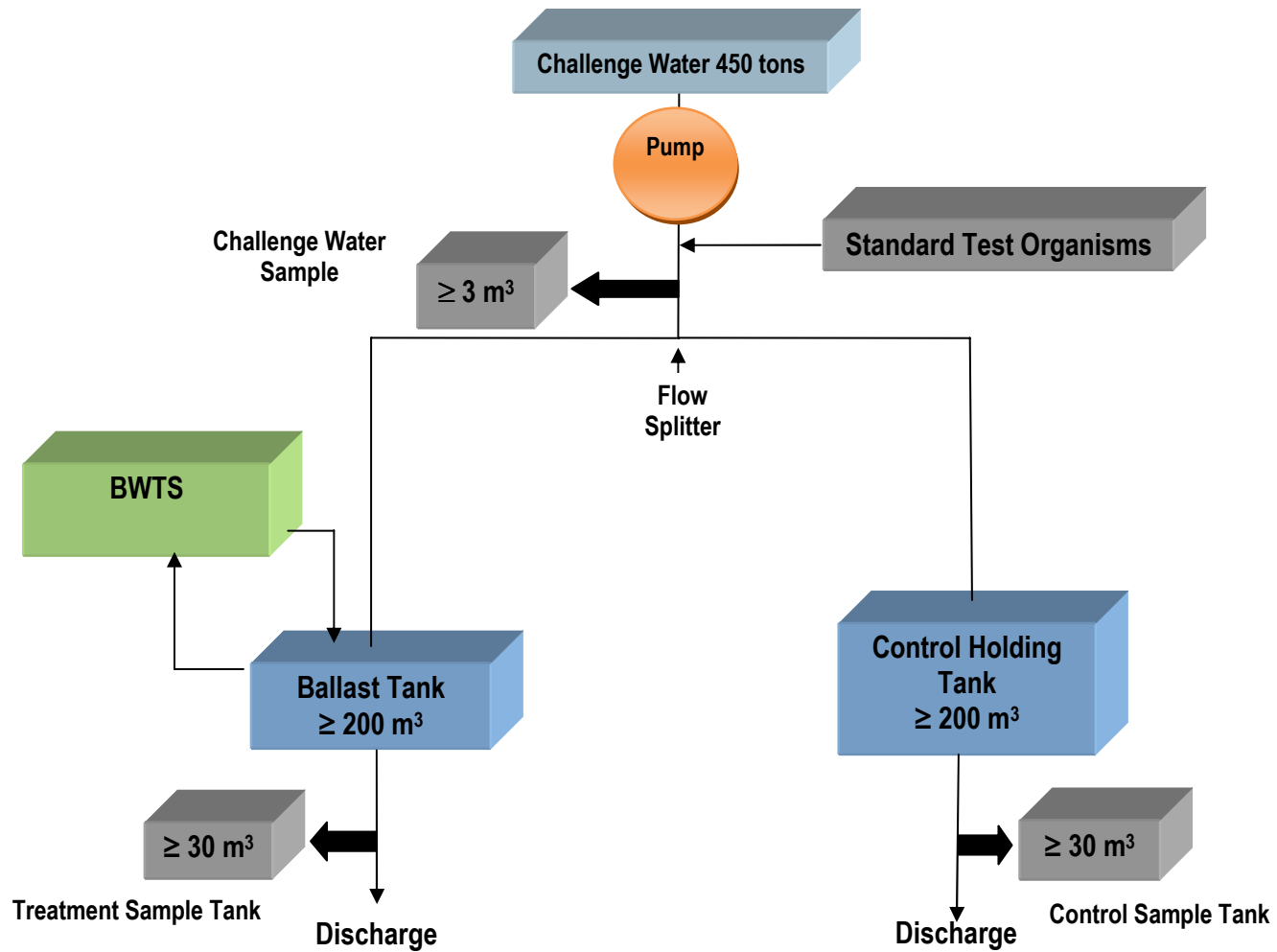

Figure 1. Sampling design example for in-tank treatment.



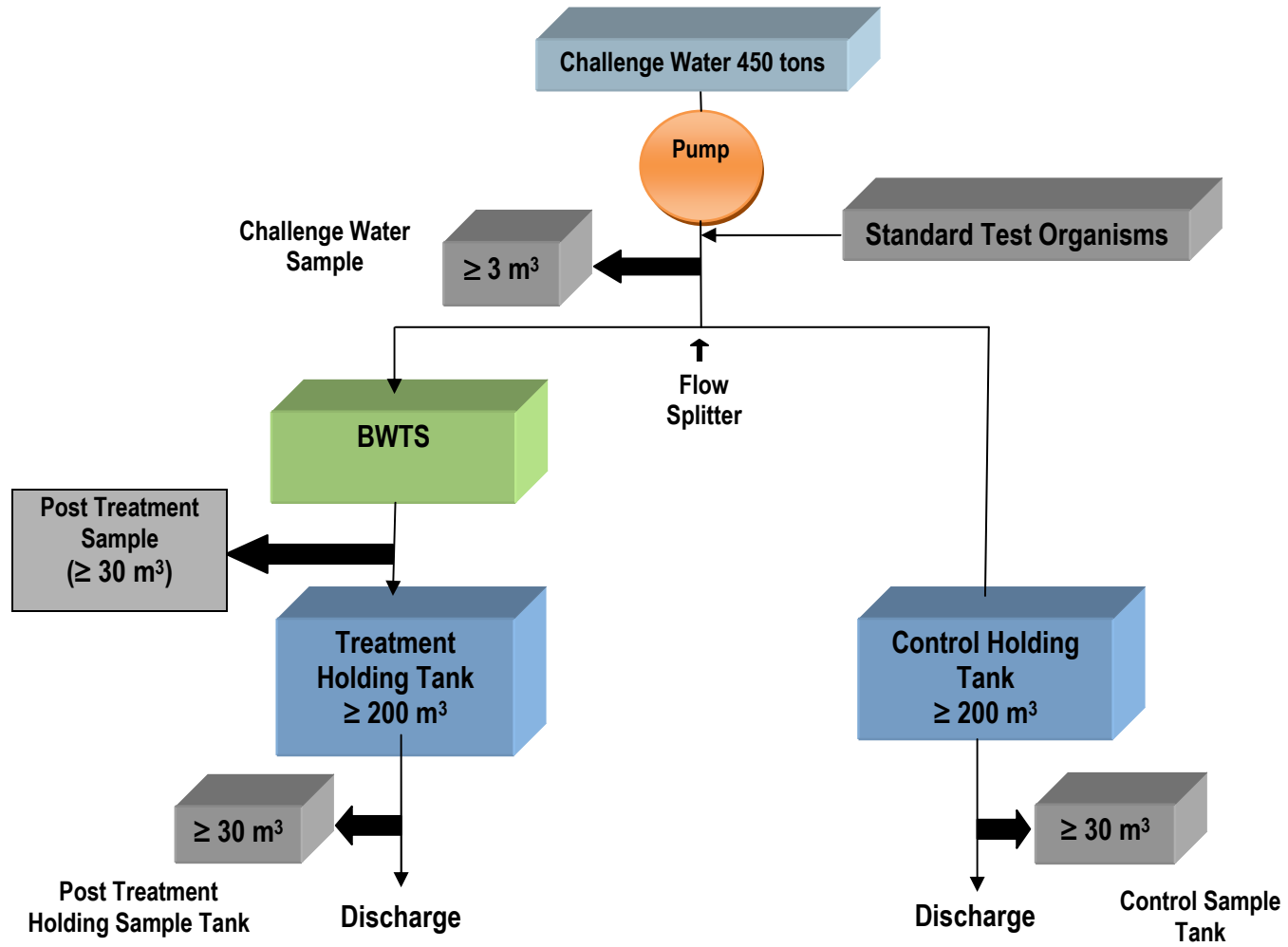

Figure 2. Sampling design example for in-line treatment.

where  $D_{iso}$  and  $D_m$  are the diameters of the sample port opening and the main flow in the line to be sampled, respectively; and  $Q_{iso}$  and  $Q_m$  represent the respective volumetric flow rates through the two pipes. It is recommended that sample port size be based on the combination of maximum sample flow rate and minimum ballast flow rate that yields the largest isokinetic diameter.

The opening of the sampling pipe should be chamfered to provide a smooth and gradual transition between the inside and outside pipe diameters. The length of the straight sample pipe facing into the flow can vary, but it should not usually be less than one diameter of the sampling pipe. The sampling port should be oriented such that the opening is facing upstream and its entrance leg flow is parallel to the direction of main pipe flow and concentric to the larger pipe, which may require sampling pipes to be “L” shaped with an upstream facing leg, if installed along a straight section of discharge pipe.

The need to be able to service the sample pipe is important and should be considered, taking safety into consideration. Therefore, the sampling pipe should be retrievable either manually or mechanically, or it must be in a system that can be isolated. Because of the potential for the opening and interior of the sample pipe to become occluded by biological or inorganic fouling, it is recommended that samplers be designed to be closable at the opening, removed between sampling intervals, or be easily cleaned prior to sampling.

The sample pipe and all associated parts of the sampler that come into contact or near proximity with the system piping should be constructed of galvanically compatible materials and generally corrosion resistant. Any corrosion of the sampling system will affect sample flow rates and potentially sample representativeness.

If flow control of the sample flow rate is required, ball, gate, and butterfly valve types should be avoided as they may cause significant shear forces, which may result in organism mortality. For flow control, it is recommended that diaphragm valves or similar valve types be used to minimize sharp velocity transitions. For flow distribution, ball valves may be utilized only if they are either fully open or fully closed.

When sampling is conducted on the discharge of a tank through the use of a pump (i.e., a non-gravity drain) and the sample port is located upstream of the pump, it may not be possible to draw an adequately sized sample since the line will be under suction with a variable hydrostatic pressure head. Therefore, maintenance of a time-averaged sample flow requires the sample to be drawn from the discharge utilizing a pump. In such cases, a diaphragm pump is recommended to minimize pump-induced organism mortality during sampling.

#### *5.3.2.6 Installation of an In-line Sample Point*

The sample taken should be removed from the main pipeline at a location where the flowing stream at the sample point is representative of the contents of the stream. The sample port entrance should be placed at a point where the flow in the main pipe is fully mixed and fully developed.

The sampling point should be installed in a straight part of the system piping and the sampling fixture should be positioned such that a representative sample of ballast water is taken. It is

recommended that the position of the sample point be determined using methods such as computational fluid dynamics.

#### *5.3.2.7 Operation of an In-line Sample Points*

In-line biological samples will be collected on a time-integrated basis such that a composite sample of the entire period of uptake or discharge is acquired. The sample flow rate should be appropriately controlled to maintain an even distribution of samples acquisition over that time period.

### **5.3.3 Test Organism & Water Quality Augmentation**

Where the addition of organisms for the augmentation of ambient organisms) is required for biological efficacy testing, a method for the injection or addition of organisms to the challenge water must be provided. Similarly, water quality parameters that require adjustment from the ambient conditions to the requisite challenge water properties will require some type of injection process. Various means are available to inject or add organisms to the challenge water, for instance, by a batch method to a large, discrete source volume or by injection into the flow stream. In any case, the following requirements are applicable:

- Any organism addition or injection method must minimize, to the extent possible, organism mortality as a result of its addition/injection mechanism.
- The method must result in a well-mixed and uniform distribution, spatially and temporally, of organisms within the challenge water and at its introduction at the point of treatment or tank intake.
- The concentration of living test (if used) organisms at the point of treatment or tank intake must conform to the requirements given in Section 5.2.2.
- The point of addition or injection must be situated such that the flow is well mixed at the subsequent point from which the first discrete sample is acquired to ensure a representative sample is obtained; inclusion of substantial pipe lengths and/or a static mixer may need to be considered.
- All methods for the injection or addition of organisms must be validated by the TF to meet the above requirements.

For water quality additions, for example sediments or dissolved organics, the addition should occur far enough upstream from the point of water quality sampling to ensure that the sample is well mixed. Furthermore, the apparatus used for addition should minimize the system related mortality on ambient and test organisms, to the extent possible.

### **5.3.4 Control & Instrumentation**

The testing described throughout this protocol is complex and logistically challenging. Moreover, since these tests are designed to provide a repeatable and accurate verification of treatment system performance, it is important to ensure that each phase and measurement is conducted with a high degree of reliability, repeatability, and accuracy. The verification testing process is further complicated by the inclusion of biological organisms and related measurements, which result in a variety of design and timing complexities. As a result, it is recommended that the TF include a typical supervisory control and data acquisition (SCADA)

system to support the many operations and data acquisition tasks associated with this testing. A typical SCADA system provides the TF with the ability to: 1) provide automatic control of pumps, valves and sub-systems to maintain operational set points; 2) acquire and archive all events, data and conditions; 3) provide controllable process control algorithms which improve system efficiency, safety and repeatability; and 4) provide facility- and treatment-system diagnostics during commissioning, testing, and upset conditions. Instituting such a system can be expected to improve measurements, quality assurance, standardized reporting, and reduce labor and analysis time.

Whether a SCADA system is utilized or not, the TF should include within its QAPP a discussion of how the instrumentation associated with TF operation, process control (either manual or automatic), and condition monitoring of the verification tests shall be operated, maintained and calibrated. Also, as a minimum, the TF shall include sufficient instrumentation and condition monitoring such that a substantive record is established which verifies that 1) challenge conditions were obtained and maintained, 2) the treatment system was operated in accordance with the Vendor's requirements and 3) no system or environmental effects occurred to perturb the verification test or treatment system operation. The test instrumentation and test operating procedures shall be documented in the TQAP.

#### **5.4 Verification Testing**

Verification testing will be separated into three distinct phases, 1) treatment system commissioning, 2) biological efficacy (BE) tests, and 3) operating and maintenance (O&M) tests. Commissioning tests are intended to validate, prior to the commencement of either BE or O&M tests, that the treatment system is installed correctly and operating in accordance with the vendor's requirements. A minimum of three BE tests shall be completed at each of two salinities selected by the vendor (the vendor may complete testing at all three salinities if desired) and with all of the challenge conditions specified in Section 5.2 to assess and verify the biological efficacy of the treatment system under pre-established conditions. O&M testing shall be conducted with ambient source water conditions, with the intention of operating the system with realistic physical conditions, to assess the systems engineering performance.

Ballast water treatment system performance, operating conditions, and certain O&M criteria will be recorded and monitored during verification testing by the TO. Results will be presented in the verification report, described in Chapter 6. The factors to be verified during ballast water treatment system verification testing include: biological treatment performance, operation and maintenance, predictability/reliability, cost factors, environmental acceptability, and safety.

Any of several treatment sequences may be used by a particular treatment system (see Table 6), including in-line treatment (during ballasting or deballasting), in-tank treatment, or a combination of the two. The stage in the ballasting cycle at which treatment is applied may also vary. This verification testing protocol accounts for these through flexibility in the TF and Verification TQAP. The guidance in the following section provides the basic test requirements and rationale for inclusion in the TQAP that will provide details specific to the treatment system and its operation. The final verification report shall document the system sequence(s) completed during testing.

**Table 6. Likely Treatment Sequences and Applications Inherent to Ballast Operations**

Sequence Number	Ballast Operation Application
1	Treatment applied during ballasting/ No treatment during deballasting.
2	Treatment applied during ballasting/ Treatment applied during deballasting.
3	No treatment applied during ballasting/ Treatment applied during deballasting.
4	No treatment applied during ballasting/ Treatment applied during transit/ No treatment during deballasting.
5	No treatment applied during ballasting/ Treatment applied during transit/ treatment during deballasting.
6	Treatment applied during ballasting/ Treatment applied during transit/ No treatment applied during deballasting.
7	Treatment applied during ballasting/ Treatment applied during transit/ Treatment applied during deballasting.

The over-arching objectives of the verification testing (including all phases) are to:

- Evaluate the treatment performance of the ballast water treatment system relative to the removal or kill of ambient and test organisms (if used), operating under vendor-specified conditions;
- Evaluate the treatment system O&M criteria;
- Determine and record cost factor data; and
- Record and document test conditions, observations, and results.

Other testing objectives may be defined by the vendor and included in the TQAP. The requirements for verification testing are described in the following sections and must be addressed in the TQAP.

#### **5.4.1 Treatment System Commissioning**

The TQAP shall describe all the tests and start-up requirements required to validate that the treatment system is installed correctly and operating in accordance with the vendor's requirements. The objectives of the commissioning are to:

- Install and start the ballast water treatment system in accordance with the vendor O&M manual;
- Reach stable operating conditions;
- Make modifications as needed to ensure stable operations under TF condition; and
- Record and document all installation and start-up conditions, observations and results.

The treatment system shall be installed at the TF according to the vendor instructions included in the TQAP. Ideally, this phase of the verification will include close coordination between the vendor and TO to quickly resolve discrepancies or malfunctions. Commissioning tests may include small-scale tests of various vendor sub-systems or components, validation of treatment system integration into the TF (e.g., a leak test or communication tests), or any other vendor-required installation tests that may be expected during a shipboard installation. However, at least one valid, full-scale verification test cycle, meeting all of the requisite challenge conditions, should be conducted successfully by the TO without vendor assistance. While the challenge conditions are to be employed during commissioning tests, it is not necessary to conduct a complete suite of analytical measurements to assess biological treatment efficacy.

A successful commissioning is defined as one in which (1) all TF requirements and conditions defined by the challenge conditions were met and (2) all components of the treatment system operated in accordance with the vendor requirements. Subsequent BE and O&M verification testing cannot commence until commissioning is successfully completed and agreed upon by the TO and vendor. The verification report should document all of the small-scale, component-level tests conducted and their results, any treatment system or TF deficiencies or failures, and their successful resolution. Finally, the verification report should document in detail the challenge conditions during the full-scale commissioning verification test cycle.

#### **5.4.2 Operation and Maintenance (O&M) Manual**

The O&M manual shall be incorporated into the TQAP and will be essential to the development of the monitoring and maintenance plan incorporated in the TQAP. The vendor shall identify factors that affect the operation of the BWTS, including any warm up or other requirements that must be completed to achieve operational stability. The vendor's O&M manual shall specify what constitutes stable operating conditions for the BWTS, factors that may affect operating conditions, and any adjustments required to reach or to maintain a stable operating condition. Adjustments made in the operating conditions will be presented in the final verification report.

#### **5.4.3 Vendor and TO Requirements**

An installation/start-up plan shall be prepared and included as part of the TQAP. The TO shall conduct start-up procedures for the BWTS in accordance with the installation/start-up plan and with the vendor O&M manual. At the end of the start-up period, the TO will assess whether the BWTS is in a stable operating state, as specified in the O&M manual, and the vendor will certify in writing that the system is installed and operating as intended. If the operation is stable, the verification testing can begin. If not, start-up procedures will be repeated no more than two additional times. If the BWTS does not achieve stable operating conditions after three start-up cycles, the TO, in conjunction with the vendor, will review the start-up work plan for applicability and determine where adjustments and modifications are required. In any case, the TO will have the option of concluding or postponing further testing at the conclusion of three failed start-up cycles.

The vendor will identify any additional equipment, system maintenance, changes to operating conditions, or other modifications needed to ensure effective BWTS operation and to attain or maintain stable operational conditions.

#### **5.4.4 Toxicity Testing for Biocide Treatments**

The Federal Insecticide, Fungicide, and Rodenticide Act (FIFRA), as amended, requires registration by the U.S. Environmental Protection Agency (EPA) of pesticides sold or used in the United States, which includes biocide products that might be used in BWTSs. The vendor is required to provide information regarding FIFRA registration of any biocide to be used in their BWTS.

The residual toxicity in the discharge from BWTSs employing a biocide is of concern to the TF (as part of the TF's NPDES permit requirements), as well as for the environmental acceptability of the treated ballast water from the BWTS in use. Toxicity testing of the water following treatment and hold time, as appropriate, shall be conducted during the commissioning phase of the verification testing according to the toxicity methods cited in Section 5.4.7.5. If the post-treatment effluent passes the toxicity tests, then verification testing can proceed. If, however, the effluent fails the toxicity test, verification testing shall not be initiated, and further toxicity tests shall be required. The vendor shall be allowed no more than two additional attempts to pass the toxicity tests within 30 days of the initial test. This may require modifications to the approach for verifying the technology in the TQAP or other investigations to understand the toxicity response. In the event a TF's NPDES permit requires a toxicity evaluation of the treated waters at the end of each test with the addition of a biocide, or if the vendor requests additional toxicity testing during the verification, the TQAP shall address the additional testing.

#### **5.4.5 BE and O&M Verification Strategy: Test Duration and Coordination**

A minimum of three valid BE tests, described in detail below, are required for each salinity regime (defined in Section 5.2.1) under which the treatment system is verified. At a minimum, testing at two salinity conditions shall be conducted. In addition, O&M testing of the treatment system shall distribute testing of a minimum treated volume of 10,000 m<sup>3</sup> amongst the BE test cycles. These O&M test cycles are equivalent to ~50 hours of operation at 200 m<sup>3</sup> per hr (or ~65 hours of operation at 150 m<sup>3</sup> per hr). Upon completion of the commissioning verification tests, the next verification test shall be a BE test cycle. This sequence allows the testing to validate operation of a new unit prior to substantial operational testing. For example, for the case in which 6 BE test cycles will be conducted, each BE test cycle should be separated by 2,000 m<sup>3</sup> in O&M testing. This approach also involves a substantial duration for the testing period and associated range of ambient water conditions over this time.

During actual shipboard operation, ballasting procedures may occur over time periods ranging from minutes to hours. For each in-line treatment BE or O&M verification cycle, a minimum operational period of one (1) hour is required, although this may be extended if flow rates are reduced from 200 m<sup>3</sup>/hr.

In addition to the uptake time, a minimum 1-day holding time within both the treatment and control tank is required for each BE test cycle to simulate the time that water would reside in a ballast tank. Thus, the duration of each test cycle will be defined by the operational approach used by the treatment system. The holding time of the required BE test cycles may be extended if the vendor requires such time as part of the BWTS or process.

The holding time included in this protocol is intended to provide a conservative assessment of the BWTS's ability to treat ballast water according to the vendor's claims. For in-tank treatment with additional in-line treatment during ballast water discharge, the duration will be equal to in-tank treatment requirements and the deballasting time. Regardless, subsequent to the one-day tank holding time, the control tank discharge must exhibit a minimum concentration of living organisms, as defined in Table 7. These criteria are necessary, in addition to the input challenge conditions, to constitute a valid BE test cycle. These control tank discharge concentrations are intended to make certain that treatment efficacy measurements attributed to the BWTS in any given BE test cycle are not the result of natural or non-treatment system related effects.

**Table 7. Criteria for Concentrations of Living Organisms in Control Tank Discharge**

Organism Size Class	Minimum Concentration
$\geq 50 \mu\text{m}$	100 organisms/m <sup>3</sup>
$\geq 10 \mu\text{m}$ and $< 50\mu\text{m}$	100 organisms/mL
$< 10 \mu\text{m}$	5 x 10 <sup>2</sup> /mL as culturable aerobic heterotrophic bacteria

Shorter or longer tank hold times may be utilized but must be justified in the TQAP. Justifications for shorter tank hold times may include an inability to sustain organism populations in the control tank to achieve the requirements in Table 7 because of natural mortality. In such cases, tank hold times may be shortened, as appropriate and agreed upon, such that an adequate assessment of the BWTS treatment efficacy may be made.

For in-tank treatments, test duration will include the minimum contact time the vendor prescribes for effective treatment, but not less than a cumulative one-day holding time for each of the required BE test cycles. As with the in-line approach, testing of the BWTS without active ingredients may be run in parallel with the challenge test to reduce the overall duration of the verification test. Modifications may be made according to vendor-specified requirements for treatment, but they must be justified in the TQAP. For example, if holding water for a specified time after the treatment's minimum contact time is required by the vendor, that time interval would be added to each verification test incorporating challenge organisms. For combinations of in-tank and in-line treatment, test duration will be equal to treatment time (in-line plus in-tank).

The O&M test cycles will provide data on the system's operation and support the assessment of non-biological verification factors. In the case of in-tank treatment approaches, particularly those using biocides or other chemical/physical means of achieving treatment, the TQAP may elect to operate the BWTS during O&M cycle either eliminating or reducing dosage of the active agent (i.e., to verify the electro/mechanical aspects of the BWTS). In some cases, it may be possible to use inert substances in place of treatment chemicals to reduce the need for conditioning prior to discharge back to the environment. Any such substitution must mimic the operation of the BWTS when using treatment chemicals and must be agreed to by the VO.



### 5.4.6 Biological Efficacy (BE) Verification Testing

As discussed above, a minimum of three BE test cycles per salinity regime will be conducted; each having a minimum tank holding time of one-day and having input challenge conditions as described in Section 5.2. The BE verification test cycles are intended to measure the efficacy with which the treatment system removes or kills organisms under challenging conditions. The remainder of this section provides the detailed description of test parameters, measurements, and analyses related to assessing biological efficacy and monitoring challenge water conditions. Due to the nature of the verification tests, a set of core and auxiliary measurement parameters will apply to each BE verification test. Core and auxiliary parameters, sampling location, and sample/measurement approach are shown in Table 8. Core parameters are those that are required during each BE test cycle and are the minimum measurements required to verify treatment efficacy and the validity of the BE test cycle. Auxiliary parameters are: (1) useful indicators of core parameters, (2) required by the vendor or VO, or (3) otherwise advisable to assess test validity or treatment efficacy. Guidance on sampling methods, sample volumes, sample container type, preservation method, and maximum holding time for each parameter is shown in Table 9. Although the maximum holding times are listed, all analyses should be conducted as soon as possible,

The TO, in conjunction with the TF and the vendor, will assess the use of continuous, *in situ* (inline) biological or other process measurements during verification testing. Any selected methods must be described and justified in the TQAP and approved for use by the VO.

The TO shall present a detailed schedule for verification test sample collection and analytical methods in the TQAP. At a minimum, the TQAP shall contain the scheduled sample collection times (expressed as time from start of test), parameters for testing, number of replicates, and number of control samples.

#### 5.4.6.1 Water Quality Parameters & Analysis

Water quality samples shall be collected as described in Section 5.3.2.1 and defined in the TQAP, with the volumes described in Table 9. Note that some analyses, following methods described in Table 10, must be performed within 6 hours of the sample collection. In cases where water quality samples can be stored for appropriate time periods, TO logistics may warrant outsourcing of water quality analyses to an independent, qualified laboratory, with agreement by the VO. Reliable, continuously recording *in situ* sensors are available for temperature, salinity, dissolved oxygen, chlorophyll *a*, and turbidity. Such sensors may, with VO approval, be used to measure water quality parameters during verification testing. Discrete analytical samples shall be collected to provide test-specific verification or calibration of the sensor data and to allow comparison of sensor data to vendor-supplied information as appropriate. Sensor maintenance and calibration shall be described in the test site operating procedures and the TQAP. Data quality objectives for quality control and quality assurance purposes are provided in Table 11. These data quality objectives and the related QA/QC measures should be discussed in the QAPP of the TQAP as described in Appendix A.

**Table 8. Core and Potential Auxiliary Parameter and Measurement Techniques**

Parameter	Measurement Class	Sample Location and Approach <sup>1,2</sup>	
		Challenge Water	Post Treatment
Temperature	Core	<i>In situ</i> , continuous	<i>In situ</i> , continuous
Salinity	Core	<i>In situ</i> or Discrete grab	<i>In situ</i> or Discrete grab
Total suspended solids	Core	Discrete grab	Discrete grab
Particulate organic matter	Core	Discrete grab	Discrete grab
Dissolved organic matter	Core	<i>In situ</i> , continuous, discrete	<i>In situ</i> , continuous, discrete
Dissolved oxygen	Core	<i>In situ</i> , discrete	<i>In situ</i> , discrete
pH	Core	<i>In situ</i> , continuous	<i>In situ</i> , continuous
Ambient Organism Concentration	Core	Discrete	Discrete
Ballast System Flow Rate	Core	<i>In situ</i> , continuous	<i>In situ</i> , continuous
Ballast System Pressure	Core	<i>In situ</i> , continuous	<i>In situ</i> , continuous
Sampling Flow Rates	Core	<i>In situ</i> , continuous	<i>In situ</i> , continuous
Chlorophyll <i>a</i> (biomass)	Core	<i>In situ</i> , continuous	<i>In situ</i> , continuous
Dissolved nutrients (N, P, Si)	Auxiliary	NA	Discrete
Turbidity	Auxiliary	<i>In situ</i> , continuous	<i>In situ</i> , continuous
ATP (living material)	Auxiliary	Continuous as available	Continuous as available

<sup>1</sup> *In Situ* = in-line or in-tank measurements; Discrete Grab = an acquired sample for analysis at a specific place and time; Continuous = measurement is continuous throughout the period of operation at some defined rate.

<sup>2</sup> The frequency and means for calibrating and validating performance of *in situ* monitoring devices must be addressed in the TQAP.

Discrete samples for determination of total suspended solids, particulate organic matter (as carbon, POM), total dissolved organic matter (as carbon, DOC), and nutrient concentrations shall

be collected appropriate to the tests being conducted. The concentration of mineral matter may be determined as the difference between the total suspended solids and the particulate organic matter concentration (mass per liter basis). In addition, when appropriate, samples should be acquired or measurements made *in situ* to measure residual toxicity or the concentration of chemical residuals or disinfection by-products. Guidance for such measurements and sample collection are highly dependent on the chemicals of interest or in use; a qualified laboratory should be consulted for the appropriate handling and measurement methods.

The analytical methods must be applied within defined holding times (Table ) after appropriate preservation, per industry standard procedures. Where available, US EPA, *Standard Methods* or other methods (i.e., ASTM) approved by the VO will be used to quantify each parameter. If standardized methods are not available, the sampling and analytical methods to be used shall be documented in the TQAP. These methods will follow accepted scientific practices and be accepted by the VO.

#### 5.4.6.2 Biological Parameters

Biological samples will be collected using methods and techniques appropriate to the size class and anticipated concentration being measured. The samples for biological analyses will be acquired from each of the time integrated sample volumes acquired during the test cycle. The TO will ensure that the contents of the integrated sample collection tanks have been thoroughly mixed to ensure homogeneity prior to sub-sampling.

The abundance of living ambient and test organisms (if used) will be quantified in (1) the uptake challenge water just prior to treatment and entry into control tank, (2) the discharge of the control tank after the appropriate hold time, (3) the discharge following an in-line BWTS and (4) the discharge from the holding tank (for both types of treatment) of treated water after the appropriate holding time. In the case of the control and treated discharge, biological samples will be retrieved from a point upstream of any pumps or significant components which could be expected to affect organism mortality or sample representativeness.

**Table 9. Sample Volumes, Containers and Processing**

	Parameter	Min. Sample Volume (mL) <sup>1</sup>	Sample Containers <sup>3</sup>	Processing/ Preservation <sup>3</sup>	Maximum Holding Time
Core Parameters	Electronic <i>in situ</i> data (Temperature, pH, Salinity, etc.) <sup>2</sup>	NA	NA	Maintain digital archive.	NA
	Total suspended solids	100	250 mL HDPE or glass	Process immediately or store at 4°C.	1 week
	Dissolved organic carbon	25	40-mL glass vial	Pass sample through a GF/F; freeze filtrate until analysis.	28 days
	Particulate organic carbon	500	Whatman GF/F in foil	Pass through a GF/F; freeze filter until analysis.	28 days
	Dissolved oxygen	300	300 mL glass BOD bottle	Fix per Oudot et al. (1988); titrate 2-24 h later.	24 hours
	Phytoplankton Enumeration (Live/Dead Analysis) <sup>4</sup>	3 m <sup>3</sup> concentrated to 1000 mL	Dark 1000-mL HDPE bottle	No preservation; stain with Fluorescein Diacetate and CMFDA as described in the protocol	Process immediately
	Zooplankton Enumeration (Live/Dead Analysis) Low Concentration/Discharge	3 m <sup>3</sup> concentrated to 1000 mL	1 L flask	No preservation; Sub-sample into well plate (20 1-mL wells observed). Observe with dissecting microscope and probe organisms to determine live/dead status. Fix with Lugol's solution for total counts.	Process immediately
	Bacteria	1000	1 L sterile HDPE	Plate on appropriate media.	Process immediately.
Auxiliary Parameters	Dissolved inorganic nutrients	40	60-mL polyethylene bottle	Pass through a Nuclepore™ (Whatman Inc., Piscataway, NJ) membrane filter; freeze filtrate until analysis.	28 days
	Chlorophyll <i>a</i> and phaeopigments	400	Whatman GF/F in foil	Pass through GF/F; fix with a saturated MgCO <sub>3</sub> solution; freeze filter until analysis.	4 weeks

GF/F: pre-ashed glass fiber filter.

<sup>1</sup> Volume processed for analysis; volumes are quantitative.

<sup>2</sup> Conductivity, temperature, pressure, dissolved oxygen, chlorophyll *a* fluorescence, transmissometry.

<sup>3</sup> Name brand items (e.g., Nuclepore™, Whatman™) may be substituted with comparable items from a different manufacturer.

<sup>4</sup> Dinoflagellate methods are under development.

**Table 10. Recommendation for Water Quality Sample Analysis Methods**

<b>Parameter</b>	<b>Units</b>	<b>Instrument</b>	<b>Method/Reference</b>
<b>Dissolved ammonium</b>	μM	Autoanalyzer	APHA Standard Method No. 4500-NH3 / 20 <sup>th</sup> edition EPA Method No. 349.0 <a href="http://www.epa.gov/nerlcwww/m349_0.pdf">http://www.epa.gov/nerlcwww/m349_0.pdf</a>
<b>Dissolved inorganic nitrate and inorganic nitrite</b>	μM	Autoanalyzer	ESS Method No. 220.3 <a href="http://www.epa.gov/glnpo/lmmb/methods/methd220.pdf">http://www.epa.gov/glnpo/lmmb/methods/methd220.pdf</a> APHA Standard Method Nos. 4500-NO2-B and 4500-NO3-F, 19 <sup>th</sup> edition EPA Method No. 353.4 <a href="http://www.epa.gov/nerlcwww/m353_4.pdf">http://www.epa.gov/nerlcwww/m353_4.pdf</a>
<b>Dissolved inorganic phosphate</b>	μM	Autoanalyzer	ESS Method No. 310.1 <a href="http://www.epa.gov/glnpo/lmmb/methods/methd310.pdf">http://www.epa.gov/glnpo/lmmb/methods/methd310.pdf</a> EPA Method No. 365.5 <a href="http://www.epa.gov/nerlcwww/m365_5.pdf">http://www.epa.gov/nerlcwww/m365_5.pdf</a>
<b>Dissolved inorganic silicate</b>	μM	Autoanalyzer	EPA Method 366.0 <a href="http://www.epa.gov/nerlcwww/m366_0.pdf">http://www.epa.gov/nerlcwww/m366_0.pdf</a>
<b>Dissolved organic carbon</b>	μM	Carbon Analyzer	APHA Standard Method No. 5310-C, 20 <sup>th</sup> edition ASTM Method Nos. D6317, D2579, D4129, D4839, D513-02 and D5790  LMMB Method No. 096 <a href="http://www.epa.gov/glnpo/lmmb/methods/docanal2.pdf">http://www.epa.gov/glnpo/lmmb/methods/docanal2.pdf</a>  LMMB Method No. 014 <a href="http://www.epa.gov/glnpo/lmmb/methods/pocdoc2.pdf">http://www.epa.gov/glnpo/lmmb/methods/pocdoc2.pdf</a> EPA Method No. 440.0 <a href="http://www.epa.gov/nerlcwww/m440_0.pdf">http://www.epa.gov/nerlcwww/m440_0.pdf</a>
<b>Particulate organic matter</b>	μM	Carbon analyzer or CHN Analyzer	LMMB Method No. 097 <a href="http://www.epa.gov/glnpo/lmmb/methods/pocanal2.pdf">http://www.epa.gov/glnpo/lmmb/methods/pocanal2.pdf</a> APHA Standard Method No. 5310-C, 20 <sup>th</sup> edition LMMB Method No. 014 <a href="http://www.epa.gov/glnpo/lmmb/methods/pocdoc2.pdf">http://www.epa.gov/glnpo/lmmb/methods/pocdoc2.pdf</a> EPA Method No. 440.0 <a href="http://www.epa.gov/nerlcwww/m440_0.pdf">http://www.epa.gov/nerlcwww/m440_0.pdf</a>
<b>Chlorophyll a/phaeopigments</b>	μg/L	Fluorometer	EPA Method 445.0 <a href="http://www.epa.gov/nerlcwww/m445_0.pdf">http://www.epa.gov/nerlcwww/m445_0.pdf</a> EPA Method No. 446.0 <a href="http://www.epa.gov/nerlcwww/m446_0.pdf">http://www.epa.gov/nerlcwww/m446_0.pdf</a> EPA Method 447.0 <a href="http://www.epa.gov/nerlcwww/m447_0.pdf">http://www.epa.gov/nerlcwww/m447_0.pdf</a> ASTM Method No. 3731-87 (1998)
<b>Total suspended solids</b>	Mg/L	5-place balance	ESS Method No. 340.2 (LMMB Method No. 065) <a href="http://www.epa.gov/glnpo/lmmb/methods/methd340.pdf">http://www.epa.gov/glnpo/lmmb/methods/methd340.pdf</a> APHA Standard Method No. 2540D (1998) EPA Method 160.2 <a href="http://www.epa.gov/region09/qa/pdfs/160_2.pdf">http://www.epa.gov/region09/qa/pdfs/160_2.pdf</a>
<b>Dissolved oxygen</b>	Mg/L	Radiometer TitraLab	EPA Method No. 360.1 (Probe Method) APHA Standard Method No. 4500-OG (Probe Method)

**Table 11. Data Quality Objectives for Water Quality Samples**

<b>Core Parameter</b>	<b>Frequency of QC Sample Collection</b>	<b>Method Detection Limit</b>	<b>Data Quality Indicator Type/Acceptance Criteria</b>
Dissolved nutrients	<u>Procedural blank</u> Two (2) per treatment cycle <u>Sample replicates</u> Three (3) sample replicates per treatment cycle	Ammonia and silica 0.02 µM Nitrate, nitrite, phosphate 0.01 µM	<u>Procedural blank</u> <5 times MDL <sup>1</sup> <u>Sample replicates</u> ≤2% PD <sup>2</sup>
Total suspended solids (DI water and seawater)	<u>Procedural blank</u> Two (2) per treatment cycle <u>Sample replicates</u> Three (3) sample replicates per treatment cycle	0.1 mg/L	<u>Procedural blank</u> <5 times MDL <u>Sample replicates</u> <10% RPD <sup>3</sup>
DOC	<u>Procedural blank</u> Two (2) per treatment cycle <u>Sample replicates</u> Three (3) sample replicates per treatment cycle	20 µM	<u>Procedural blank</u> ≤15% PD <u>Sample replicates</u> ≤10% RPD
POM	<u>Procedural blank</u> Two (2) per treatment cycle <u>Sample replicates</u> Three (3) sample replicates per treatment cycle	5.5 µM	<u>Procedural blank</u> ≤15% PD <u>Sample replicates</u> ≤10% RPD
Chlorophyll <i>a</i> /phaeophytin	<u>Procedural blank</u> Two (2) per treatment cycle <u>Sample replicates</u> Three (3) sample replicates per treatment cycle	0.02 µg/L	<u>Procedural blank</u> ≤5% PD <u>Sample replicates</u> ≤15% RPD
Dissolved oxygen	<u>Procedural blank</u> NA <u>Sample replicates</u> Three (3) sample replicates per treatment cycle		<u>Procedural blank</u> NA <u>Sample replicates</u> ≤5% CV <sup>4</sup>

<sup>1</sup> MDL = method detection limit.

<sup>2</sup> Percent Difference (PD) = [(true concentration – measured concentration)/true concentration] × 100%.

<sup>3</sup> Relative Percent Difference (RPD) = {[absolute value (replicate 1 – replicate 2)]/[(replicate 1 + replicate 2)/2]} × 100.

<sup>4</sup> Filter blanks used for QC purposes only.

#### 5.4.6.3 Sample Volumes & Data Quality

Samples from the discharges of successful treatments will likely have low concentrations of organisms. Enumeration of the organisms from these samples (determined from 20 one-mL subsamples from a concentrated whole water sample, as described below) is represented by the Poisson distribution, and therefore the cumulative or total count is the key test statistic (Lemieux et al., 2008b). Further, a chi-square transformation can be utilized to approximate the confidence intervals.

Assuming, for organisms  $\geq 50 \mu\text{m}$ , that the desired minimum precision is that the upper bound of the chi-square statistic should not exceed twice the observed mean (this corresponds to a coefficient of variation of 40%), a count of 6 organisms is required.<sup>3</sup>

The volume required to successfully count 6 organisms is dependent on the whole water sample volume, concentration factor, number of sub-samples counted, and the target concentration. Table 12 provides the resultant upper bounds, based on the Poisson distribution for a 95% confidence interval from the chi-square transformation for a variety of sample volumes at a concentration factor of 3000 (3 m<sup>3</sup> concentrated to 1 L) assuming 20 subsamples of 1 mL. Given these assumptions, 30 m<sup>3</sup> must be sampled to enumerate 10 organisms/m<sup>3</sup>, with the desired level of precision given above. **The total sample volume may be reduced accordingly if: the concentration factor is increased, the confidence limit is lowered (e.g., from 95% to 90%), or the volume of subsample analyzed is increased (e.g., from 20 mL to 40 mL).** If the latter is done, the TF should conduct validation experiments to ensure counting accuracy is high (e.g., using microbeads as described in Lemieux et al. (2010), which is found in Appendix C). It is the responsibility of the Testing Organization to justify any changes to the volumes suggested in Table 12. As discussed previously, sample replication is unnecessary as the Poisson distribution pools the data to improve the measurement precision and assumes the organisms to be randomly distributed. **Note that this approach would not be appropriate if samples are not continuously acquired on a time-averaged basis.**

In any case, sample size should be selected relative to the targeted concentration and to provide the level of precision required to supply a 95% upper confidence limit which is (1) no more than twice the observed mean and (2) does not exceed the targeted concentration or as otherwise defined by the TO. Examples are provided in Table 13 for standards for organisms larger than 50  $\mu\text{m}$  compared to standards that are currently proposed or considered domestically and internationally. The chart provides the volume of sample required assuming that the entire sample is concentrated to 1 L and 6 organisms are counted. N is the number of samples analyzed, with each sample dispensed into a well plate and having 20 one-mL subsamples observed.

A similar approach for organisms  $\geq 10 \mu\text{m}$  and  $< 50 \mu\text{m}$  may be applied; however, the targeted concentrations are considerably denser, and the anticipated total counts can be expected to be

---

<sup>3</sup> Mathematically, that relationship can be represented as follows: coefficient of variation = standard deviation/mean. For the Poisson distribution, the variance = (standard deviation)<sup>2</sup> = mean, thus substituting the critical value of the mean, 6, gives a coefficient of variation =  $6^{0.5}/6 \approx 40\%$ .

higher. The Poisson distribution assumption still applies, and a more stringent level of precision may be applied. Specifically, if the desired level of precision is set at a coefficient of variation of 10% or the upper confidence limit is not more than approximately 20% of the estimated density, then the volumes given in Table 14 result. These volumes are the required whole water sample volume to be concentrated to 1 L as a function of the number of 1 mL sub-samples (N).

#### *5.4.6.4 Zooplankton Enumeration*

Time integrated in-line sample volumes should be concentrated at the time of sampling using 35  $\mu\text{m}$  mesh plankton nets (50  $\mu\text{m}$  in the diagonal). The concentrated contents of the cod-end should be rinsed into a flask. The volume capacity of the flask will be dependent on the organism density of the sample but typically requires a range of 1 to 4 L capacity. Fresh, artificial seawater, filtered seawater, or freshwater, as appropriate, should be added to maintain oxygen levels for the living organisms to be counted. If the initial sample has a low concentration of zooplankton, the sample may need to be further concentrated before analysis. In this instance, the sample should be concentrated using 35  $\mu\text{m}$  mesh.



1 **Table 12. Density Confidence Intervals for Poisson Distributions Using the Chi-Square Statistic**

2

**Scaled Densities and Confidence Intervals**  
*(Assumes whole water sample volume is concentrated to 1L, with analysis of 20 one-mL subsamples from the concentrate)*

<b>Count Data</b>													
<b>Whole Water Sample Volume (V) =</b>				<b><u>V = 1 m<sup>3</sup></u></b>		<b><u>V = 3 m<sup>3</sup></u></b>		<b><u>V = 10 m<sup>3</sup></u></b>		<b><u>V = 30 m<sup>3</sup></u></b>		<b><u>V = 60 m<sup>3</sup></u></b>	
<b>Organism Count</b>	<b>95% Upper Bound</b>	<b>Upper Bound / Count</b>	<b>Upper Bound / Count</b>	<b>Mean Density (m<sup>-3</sup>)</b>	<b>95% Upper Bound (m<sup>-3</sup>)</b>	<b>Mean Density (m<sup>-3</sup>)</b>	<b>95% Upper Bound (m<sup>-3</sup>)</b>	<b>Mean Density (m<sup>-3</sup>)</b>	<b>95% Upper Bound (m<sup>-3</sup>)</b>	<b>Mean Density (m<sup>-3</sup>)</b>	<b>95% Upper Bound (m<sup>-3</sup>)</b>	<b>Mean Density (m<sup>-3</sup>)</b>	<b>95% Upper Bound (m<sup>-3</sup>)</b>
0	3.00			0	150	0	50	0	15	0	5	0	2.5
1	4.74	4.74		50	237	17	79	5	24	2	8	1	4.0
2	6.30	3.15		100	315	33	105	10	31	3	10	2	5.2
3	7.75	2.58		150	388	50	129	15	39	5	13	3	6.5
4	9.15	2.29		200	458	67	153	20	46	7	15	3	7.6
5	10.51	2.10		250	526	83	175	25	53	8	18	4	8.8
6	<b>11.84</b>	<b>1.97</b>		<b>300</b>	<b>592</b>	<b>100</b>	<b>197</b>	<b>30</b>	<b>59</b>	<b>10</b>	<b>20</b>	<b>5</b>	<b>9.9</b>
7	13.15	1.88		350	657	117	219	35	66	12	22	6	11.0
8	14.43	1.80		400	722	133	241	40	72	13	24	7	12.0
9	15.71	1.75		450	785	150	262	45	79	15	26	8	13.1
10	16.96	1.70		500	848	167	283	50	85	17	28	8	14.1
11	18.21	1.66		550	910	183	303	55	91	18	30	9	15.2
12	19.44	1.62		600	972	200	324	60	97	20	32	10	16.2
13	20.67	1.59		650	1033	217	344	65	103	22	34	11	17.2
14	21.89	1.56		700	1094	233	365	70	109	23	36	12	18.2
15	23.10	1.54		750	1155	250	385	75	115	25	38	13	19.2
16	24.30	1.52		800	1215	267	405	80	122	27	41	13	20.3
17	25.50	1.50		850	1275	283	425	85	127	28	42	14	21.2
18	26.69	1.48		900	1335	300	445	90	133	30	44	15	22.2
19	27.88	1.47		950	1394	317	465	95	139	32	46	16	23.2
20	29.06	1.45		1000	1453	333	484	100	145	33	48	17	24.2

**Table 13. Sample Volume Required Relative to Treatment Standards—Organisms  $\geq 50 \mu\text{m}$**

Concentration (individuals/m <sup>3</sup> )	N = 1	3	5
	Sample Volume Required (m <sup>3</sup> ) <sup>1</sup>		
0.01	60,000	20,000	12,000
0.1	6000	2000	1200
1	600	200	120
10	60	20	12

<sup>1</sup> Assumes the entire volume is concentrated to 1 L, 20 1-mL subsamples are analyzed, and the desired precision is the 95% Confidence Interval of the Poisson distribution = 2 times the observed mean and not greater than the Standard Limit.

**Table 14. Sample Volume Required Relative to Treatment Standards Organisms  $\geq 10 \mu\text{m}$  and  $< 50 \mu\text{m}$**

Concentration (individuals/mL)	N <sup>1</sup> = 2	3	4
	Sample Volume Required (L) <sup>2</sup>		
0.01	6000	4000	3000
0.1	600	400	300
1	60	40	30
10	6	4	3

<sup>1</sup> The number of 1 mL sub-samples analyzed.

<sup>2</sup> Assumes the entire volume is concentrated to 1 L and the desired precision is that CV is not greater than 10%.

Subsamples should be analyzed immediately, and as analysis proceeds, the original sample should be held at ambient water temperature. Previous work has shown zooplankton die-off occurs in the sample after a hold time of 6 hours. The appropriate maximum hold time should be validated at each test facility so that the detectable zooplankton mortality over the hold time does not exceed 5%.

Subsamples should be extracted using 5-mL serological, graduated pipettes with an Eppendorf pipette helper (or a similarly accurate instrument that can effectively capture swimming zooplankton). Subsamples should then be examined in multi-well plates, Bogorov chambers, Sedgewick Rafter Counting Chambers, or counting wheels. The subsample should be dispensed into the counting chamber while still allowing for the addition of a narcotizing agent. In addition, the counting chamber volume should be shallow enough to allow for adequate focusing on the organisms during analysis. All direct counts should be done using counting chambers placed under a stereo or compound microscope at magnifications ranging from 10 $\times$  to 40 $\times$ .

Lugol's iodine solution should be used as a euthanizing and preservation agent. It should be noted that this agent works particularly well on the standard test organism *Artemia* spp. And for ambient organisms that have chitinous exoskeletons. It has been documented, however, that

Lugol's can have distorting effects on the preservation of some marine organisms, particularly if their bodies lack chitin or other types of hard body structure. Given the choices of preservation or euthanizing agents available, additional validation is advised when different zooplankton are present in samples, or when dealing with organisms found at specific TFs, to determine which fixative(s) work best in preserving the zooplankton concentrations for total direct counts.

In samples from challenge water or a control tank, the zooplankton should first be examined to count the number of dead organisms, defined by a lack of visible movement during an observation time of at least ten seconds. Unmoving but intact zooplankton may be living, so they are gently touched with the point of a fine dissecting needle or probe to elicit movement. Given that each dead organism is monitored for at least 10 seconds for visible movement, viability measurements could be lengthy for samples with dense concentrations of dead organisms, thereby increasing the potential for sample bias due to sample degradation.

Once the number of dead organisms has been tallied, the organisms within the wells should be killed and/or preserved (to eliminate motion of the live organisms) and total counts obtained. Live counts will then be calculated from the difference using the equation: Total # – # Dead = # Live. Because samples collected following treatment are expected to have few living organisms, the living organisms can be enumerated directly.

Note that samples collected to verify challenge conditions are met may require taxonomic identification of dominant organisms.

#### *5.4.6.5 Organisms $\geq 10 \mu\text{m}$ and $\leq 50 \mu\text{m}$ (nominally protists)*

Laboratory concentration of this size of organisms in the whole water sample can be accomplished by gently passing the sample through a sieve with mesh  $\leq 10 \mu\text{m}$  in the diagonal. Care should be taken to gently sieve organisms to ensure they are not killed in the process. Techniques and standardized methods for the enumeration and viability analyses of protists remain an active area of investigation. This protocol recommends use a combination of two vital stains: Fluorescein Diacetate (FDA, Molecular Probes-Invitrogen Carlsbad, CA) and 5-chloromethylfluorescein diacetate (CMFDA, CellTracker™ Green; Molecular Probes-Invitrogen Carlsbad, CA). When non-specific esterases in living cells cleave the stains, the resultant molecules fluoresce green when excited with a blue light (e.g., Selvin et al., 1988; www.invitrogen.com).

This method utilizes manual epifluorescence microscopy to evaluate samples: FDA (final concentration  $5 \mu\text{M}$ ) and CMFDA (final concentration  $2.5 \mu\text{M}$ ) are added to a 1 mL sample that is incubated in the dark for 10 minutes, the sample is loaded into a Sedgewick Rafter Counting Chamber, and it is examined under epifluorescence using a Fluorescein Isothiocyanate (FITC) narrow pass filter cube (e.g., excitation 465-495 nm, dichroic mirror wavelength 505 nm, barrier filter 515-555 nm; Drake et al., 2010). Samples should be examined for a maximum of 20 minutes because the signal fades as stain leaks from the cell. If a cell is labeled by either FDA or CMFDA (as exhibited by a characteristic fluorescent green color) or moves, or both, it is scored as viable. A photomicrograph should be taken of any such cells under fluorescent and brightfield (white light) illumination to create a visual record of viable cells.

Research on the dual staining method at four locations (including marine and estuarine sites) in the U.S. has shown the method to yield variable degrees of false positives (Type I error) from as little as 3% to nearly 40% (Steinberg et al., 2010). Thus, before Tos use the dual staining method or any other alternative method, it is necessary that it undergo on-site validation by preparing, examining, and analyzing ambient samples that are killed (i.e., negative controls).<sup>4</sup> From the perspective of environmental protection, this type of error is conservative, as it overestimates the number of viable organisms. In contrast, Type II errors (false negatives) underestimate the number of viable organisms. Encouragingly, the Type II error rate was uniformly low across all study sites: 0% in three locations and 1% at the remaining two locations (Steinberg et al., 2010). Nonetheless, the Type II error rate should also be determined during initial site validation of this method or alternative method validation on a seasonal basis, and as part of the on-going QA program.<sup>5</sup>

The advantages of using manual microscopy with vital stains are: (1) the instrumentation required is available in most research laboratories, (2) the cost of materials is low, (3) sample incubation times are relatively short, (4) the protocol is straightforward, and (5) results can be generated fairly rapidly. The disadvantages of this method are that it takes several hours (4-5 hours) to completely characterize the subsamples within a sample, and unless the microscope is equipped with a camera (which is recommended), there is no archive of the data collected. Additionally, manual counts are subject to errors from operator-specific biases as well as from fatigue effects during extended observation periods.

Within this size class fall dormant cells or resting stages exhibited across a broad phylogenetic range of microalgae, heterotrophic protists, and metazoans (e.g., Marret and Zonneveld, 2003; Matsuoka and Fukuyo, 2000). To encompass this group, the term ‘cysts’ is used, which includes but is not limited to cysts of dinoflagellates, spores of diatoms, cysts of heterotrophic protists, and cysts of rotifers. Notably, spores of bacteria and fungi are not included; they are smaller in minimum dimension than the lower limit of the size class considered here (10  $\mu\text{m}$ ).

With focus on dinoflagellates alone, many authors (e.g., Dobbs and Rogerson, 2005; Doblin and Dobbs, 2006; and references in both) have made the point that cysts in ships’ ballast water represent robust ecological hazards. Given their resistance to physiological stress, killing cysts may be the best, i.e., most stringent, test of ballast-water technologies. If cysts can be killed, then there is excellent reason to assume vegetative cells or non-resting stages will also be killed. But because of their low metabolic state and relative impermeability to stains, it may be difficult to assess the viability of cysts on an individual basis without painstaking, cultural analyses, which, if possible at all, may require weeks or months to complete. At present, no rapid, reliable

---

<sup>4</sup> For example, heat-killed, negative control samples are prepared by placing ambient water samples in a 50 °C water bath. Once the sample temperature reached 50 °C, it is held in the bath for an additional 10 minutes (Drake et al., 2010; Steinberg et al., 2010). The sample is cooled to room temperature before being stained. Organisms should not show a green, fluorescent signal after heat killing; those that do fluoresce represent false positives and indicate the Type I error associated with the dual-stain method.

<sup>5</sup> One approach is to collect ambient protists and place them in one of four categories based on an organism’s fluorescence signal and movement: (1) fluorescent and moving, (2) fluorescent and non-moving, (3) non-fluorescent and moving, and (4) non-fluorescent and non-moving (Drake et al., 2010; Steinberg et al., 2010). Organisms binned as non-fluorescent and moving are obviously viable, but the combination of stains fails to indicate viability, representing the Type II (false negative) error.

method to determine cysts' viability is in widespread use, and the FDA-CMFDA method has yielded variable results with dinoflagellates and cyst-like objects. This protocol allows for additional techniques for plankton assemblages to be developed (Section 5.4.8); should a method reliably indicating cyst viability become available, it is assumed that it would allow all viable organisms within the □rotest size class to be enumerated.

#### 5.4.6.7 Organisms <10 µm

Bacteria samples should not need to be concentrated from the whole water sample prior to analysis. Sample analysis will be conducted according to standard microbial techniques. Multiple bacterial growth media will be used to assess the effectiveness of a treatment for bacteria<sup>6</sup>. Use of multiple types of media enables measurement of the response of different portions of the ambient bacterial community<sup>7</sup>. The minimum number of media used will include two general-purpose (1 marine, 1 nutrient agar) media for culturable aerobic heterotrophic bacteria. Other media may be added during the development of the TQAP. The rationale and methods will be described in the TQAP.

For culturable, aerobic, heterotrophic bacteria, 1 mL samples should be diluted in a 10-fold dilution series in sterile Phosphate Buffered Saline (PBS) or sterile ambient water. Next, 100 µl of each appropriate dilution should be spread onto the media recommended in the protocol, with triplicate plates for each dilution. Plates should be incubated at 25 °C and monitored during the incubation time to ensure overgrowth does not occur. Colonies should be monitored and counted after 5 days (or after 3-5 days, if colony overgrowth appears imminent on all plates) and recorded as colony forming units (CFUs) per 100 mL of sample water.

For *E. coli* samples, USEPA Method 1603 should be used: 1mL, 10 mL and 100 mL water samples should be passed through 0.45 µm membranes, which should be placed on modified thermo-tolerant *E. coli* agar (mTEC) plates (Becton Dickson, Sparks, MD). Plates should be incubated at 35 ± 0.5°C for 2 hours to allow for cell wall repair. Next, plates should be incubated at 44.5°C in a waterbath for 22-24 hours. Total red and magenta colonies should be scored and data reported as *E. coli* colonies per 100 mL of sample water. Alternatively, an IDEXX Colilert kit (Westbrook, ME) can be used according to the manufacturer's protocol.

For *Enterococci* samples, a modified version of USEPA Method 1106.1 should be used: 10 mL and 100 mL water samples should be passed through 0.45 µm membranes, the membranes transferred onto mEnterococcus agar (mEA) plates, and the plates incubated at 35 ± 2°C for 24 hours. Membranes with light and dark red colonies should be transferred to bile esculin agar (BEA) plates, which should be incubated for 4 hours at 35 ± 2°C. After incubation, colonies with black halos should be scored and data reported as *Enterococci* per 100 mL. Alternatively, an IDEXX Enterolert kit (Westbrook, ME) can be used according to the manufacturer's protocol.

Toxigenic *Vibrio cholerae* densities should be determined by a DNA colony blot hybridization method that detects *ctxA* gene (Huq et al., 2006). Briefly, colonies are grown on TCBS agar,

---

<sup>6</sup> The suggested media for marine water include 2216 Marine Agar and salt-modified R2A agar; media for fresh water species may include Plate Count Agar and Nutrient broth (plus agar (15 g/L)).

<sup>7</sup> Note it is assumed that if all culturable bacteria are killed, all non-culturable bacteria are also killed.

purified, and inoculated with 2.5% yeast extract and nalidixic acid and fixed after incubation overnight. Viable *V. cholerae* O1 and O139 cells are enumerated using a direct-fluorescent antibody kit (New Horizons Diagnostics; Columbia, MD) for serogroups O1 and O139 using monoclonal antibodies tagged with fluorescein isothiocyanate (FITC) under an epifluorescence microscope.

Appropriate controls (e.g., heat to remove vegetative cells for tests using resting stages or spores) for microbial plates will be used throughout the verification testing. Steps will also be taken to ensure the action of any treatment (e.g., a biocide) is stopped at the time of sample collection (i.e., treatment does not continue after sample collection). Any steps and controls used to verify the effectiveness of a neutralizer will be described and justified in the TQAP.

#### 5.4.6.8 Auxiliary Parameters

Sampling and analysis of supplemental parameters may be required depending on vendor-specified information. For example, a vendor may define an additional treatment effectiveness based on removal of fecal coliform bacteria or other microorganisms of public health concern. In such cases, the TO, with VO acceptance, will determine the appropriate supplemental parameters, based on vendor-specific information, and shall determine sampling and analysis requirements for inclusion in the sample collection schedule in the TQAP.

### 5.4.7 BE Validity Criteria

At the conclusion of each BE verification test cycle, the TO should verify that all criteria necessary for a valid BE test were established and maintained, as appropriate. As a minimum, the test validity criteria should consist of: (1) operational parameters that demonstrate the requisite volumes were transferred and sampled and Vendor-specified flows, pressures, or other validation criteria were maintained, (2) water quality challenge conditions for uptake and discharge waters, including any toxicity sampling as required by the TQAP, were met, and (3) biological challenge conditions for ambient organism concentration and diversity in treatment and control samples were met. Note that the vendor-specified validation criteria should be limited to operational parameters; that is, the criteria should be employed to ensure the system was operated correctly and in accordance with the provided training and O&M manual. Parameters that document a system failure under proper usage do not invalidate a test. The types and locations for measurements in each category are summarized in Table 15, and requisite criteria are discussed by category.

Each of the measurement criteria and its valid ranges are to be documented by the TO in the TQAP. The declared ranges should accommodate variability of ambient source water conditions as well as possible ranges for ambient organisms in challenge water. The declared range of valid conditions also indicates the degree to which the TO can control the test parameters. Following each individual test, the TO will produce a test validation matrix that summarizes valid ranges (from the TQAP) and corresponding mean values obtained during the test. Any significant deviations from the mean noted during the testing shall be discussed in the verification report.

#### 5.4.7.1 Uptake Operations

The ETV protocol provides minimum requirements for volume and flow in Section 5.2.3, with final ranges for volume, pressure and flow to be identified in the TQAP by the TO and the vendor. For all water transfers, the minimum volume is 200 m<sup>3</sup>, and the minimum sample collection volume associated with each transfer is 3 m<sup>3</sup>. Acceptable ranges for sample collection volumes, pressures, and flows are also to be identified in the TQAP. The test validation matrix should provide the valid ranges and the resulting mean values to verify if valid, in-range conditions were met over the duration of the test at the locations specified in Table 16.

#### 5.4.7.2 Water Quality Conditions

Minimum water quality conditions for BE tests are provided in Table 3 for dissolved and particulate organics, mineral matter, total suspended solids, and temperature for the two salinity ranges. The TO, in conjunction with the vendor, will declare valid test ranges for these and other relevant water quality parameters of interest (e.g., pH, DO, etc.) in the TQAP and provide a list of the valid ranges and mean results for each test in the test validation matrix. If there is reason to measure these parameters in the discharge waters as well, these measurements should also be presented.

#### 5.4.7.3 Biological Diversity and Concentrations

Table 3 presented requirements for biological challenge conditions to include a minimum of 5 species from 3 separate phyla across the three requisite size classes. This specification refers to populations at the point of treatment and entry to the control tank. Valid population densities and diversity ranges for ambient organisms should be defined by the TO in the TQAP. These ranges are envisioned to be fairly broad to accommodate variations in ambient populations and dominant species over the duration of the ETV testing. The anticipated ranges and the measured mean values for the sampled populations are to be presented in the test validation matrix.

Organism population densities and diversity are also to be measured in the discharge samples for both treated and control waters, where minimum living concentrations are required in the control discharge as noted in Table 7. These criteria are given by totals for each size class and should be shown in the test validation matrix with results broken out for the dominant 5 species present in each size class.

#### 5.4.7.4 Biological Treatment Efficacy Determination

Treatment efficacy will be determined by the measurement of living ambient organism concentrations in the treatment discharge for the three size classes identified in Table 3.

#### 5.4.7.5 Toxicity Test for Biocide Treatments

Toxicity tests conducted during the start-up for treatments involving biocides in marine and brackish waters will be selected from the following:

Inland Silverside, *Menidia beryllina*, Larval Survival and Growth ([EPA Method 1006.0](http://www.epa.gov/OST/WET/disk1/ctm13.pdf)):  
<http://www.epa.gov/OST/WET/disk1/ctm13.pdf>)

**Table 15. Challenge Test Validation Criteria by Location**

Parameter	Control Sample Tank	Treatment Sample Tank	Control Tank	Treatment Tank	Control Discharge Sample Tank	Treatment Discharge Sample Tank
<i>Ballasting Operations</i>						
Volume	×	×	×	×	×	×
Pressure	×	×	×	×	×	×
Flow	×	×	×	×	×	×
Vendor-specified parameters				×		
<i>Water Quality Conditions</i>						
Temperature, Salinity, pH, DO (can monitor source waters)	×	×				
Total Suspended Solids (TSS)	×	×			×	×
Dissolved Organic Carbon (DOC)	×	×			×	×
Particulate Organic Material (POM)	×	×			×	×
Mineral Matter (MM)	×	×			×	×
Environmental Contaminants						×
<i>Biological Diversity and Concentrations</i>						
Ambient organisms/m <sup>3</sup> ; ≥ 50µm (live/dead)	×	×			×	×
Ambient organisms/mL; ≥ 10 and < 50µm (live/dead)	×	×			×	×
Ambient organisms/mL; < 10 µm (live/dead)	×	×			×	×

Sea Urchin, *Arbacia punctulata*, Fertilization Test (EPA METHOD 1008.0:  
<http://www.epa.gov/OST/WET/disk1/ctm15.pdf>)

Mysid Acute Toxicity Test ([EPA OPPTS Method 850.1035](http://www.epa.gov/opptsfrs/OPPTS_Harmonized/850_Ecological_Effects_Test_Guidelines/Drafts/850-1035.pdf):  
[http://www.epa.gov/opptsfrs/OPPTS\\_Harmonized/850\\_Ecological\\_Effects\\_Test\\_Guidelines/Drafts/850-1035.pdf](http://www.epa.gov/opptsfrs/OPPTS_Harmonized/850_Ecological_Effects_Test_Guidelines/Drafts/850-1035.pdf))

Additional guidance can be found in ASTM (1996a, 1996b) and Klemm, et al. (1994). Tests and species selected for toxicity testing during commissioning will be specified in the TQAP in accordance with the salinity ranges identified for testing.

#### 5.4.8 Alternative and Emerging Methods

New methods for analysis and enumeration of living plankton communities are being developed to meet the relatively complex and demanding needs of ballast water treatment system testing. These methods include, but are not limited to, rapid analytical measurements, vital stains and dyes, and molecular probes. The inclusion or substitution of these techniques to those described above is acceptable. However, at a minimum the method(s) selected for any given size class



should provide a quantitative measurement of the concentration of living organisms. If non-standard methods are selected, they should be validated by the TO to the satisfaction of the VO.

#### **5.4.9 Operation and Maintenance Verification Factor**

The operation and maintenance (O&M) of the ballast water treatment system will be verified. The verification has been designed as a minimum volume requirement, allowing sufficient time to verify operation and maintenance of the ballast water treatment system. It is anticipated that O&M testing commences in between BE test cycles to ensure some equipment run-time occurs prior to each BE verification test. In this manner, any changes in treatment efficacy due to equipment operation over time may be observed.

The TO is responsible for monitoring and maintaining the system, in accordance with the Vendor's O&M manual, throughout the testing to ensure stable operating conditions (as mutually agreed to by the vendor) and proper operating effectiveness. All system components will be monitored for proper operation throughout the test period. All maintenance activity completed during the verification testing shall be documented for inclusion in the verification report.

All required monitoring and maintenance activities should be coordinated with the TO in advance of verification testing, and detailed in a monitoring and maintenance plan included in the TQAP. The monitoring and maintenance plan shall address the following requirements, as applicable:

- A monitoring and maintenance schedule for the testing period (as shipboard systems are generally designed to require minimal regular maintenance, visual inspections by the operator may be all that is required);
- Equipment and component calibration methods and frequencies;
- Monitoring and maintenance activities and procedures shall be described and documentation forms provided – maintenance documentation forms must identify the TF, date and time, describe the work performed, observations of the treatment system, and results of the work; and
- Operating characteristics and vendor-specified ranges required for proper operating conditions shall be described (e.g., system temperature, flows entering and exiting the system, power levels).

Other information that must be addressed in the TQAP includes:

- Monitoring requirements to ensure a proper operating environment;
- Continuous on-line O&M monitoring requirements, as specified by the vendor; and
- Credentials of all personnel involved in operating, monitoring and maintaining the treatment system.

All monitoring and maintenance documentation must be maintained in a written record at the TF and will be included in the verification report.

To help address predictability and reliability verification factors, qualitative and quantitative O&M performance indicators will be evaluated. The means and methods to evaluate or quantify

O&M performance indicators shall be included in the TQAP and described in a schedule for collecting this information.

#### *5.4.9.1 Qualitative O&M Performance Indicators*

Qualitative O&M performance indicators will include, but are not limited to:

#### *5.4.9.2 Visual Observations*

Visual inspections of the treated ballast water quality (e.g., turbidity, color) and treatment system conditions (e.g., foaming, floating material, settled solids) will be performed at each maintenance or monitoring event. Visual observations will also include the inspection of the treatment system prior to, during and following each test cycle for equipment and process failures, corrosion, leaks, impediments of flow (entering or exiting the system) and any other system issues that could impact performance. Specific visual indicators shall be defined in the TQAP.

#### *5.4.9.3 Operability*

Observations regarding the ease of start-up and operation during testing and the ease of monitoring system performance shall be noted and recorded.

#### *5.4.9.4 O&M Manual*

The TO shall evaluate the usefulness and quality of the O&M manual, and a written report on the evaluation shall be prepared.

#### *5.4.9.5 Operator Skills*

The level of operator expertise required to operate and maintain the treatment system shall be noted and compared with that indicated by the vendor.

#### *5.4.9.6 System Accessibility*

The ease of access and required clearances for system operation and required maintenance shall be noted.

#### *5.4.9.7 Quantitative O&M Performance Indicators*

Quantitative O&M performance indicators shall include, but are not limited to:

#### *5.4.9.8 Time demand*

Personnel time required to start-up, shutdown, operate, and maintain the treatment system shall be recorded in the monitoring and maintenance log.

#### *5.4.9.9 Residual*

Volumes of residual materials, (e.g., solids removed via filtration systems, etc.), mass generation rates, and concentrations shall be determined during verification testing. Results will be recorded in m<sup>3</sup>, gallons or pounds per m<sup>3</sup>, or gallons of water treated, as appropriate. Factors related to the disposal of residuals (such as storage requirements and handling hazards) shall also be addressed.

#### *5.4.9.10 Chemical Use*

Usage rates and concentrations of any chemicals (e.g., biocides) used as part of the treatment system and its operation during verification testing (per test cycle) will be measured and recorded. Results shall be reported for residuals and possible by-products.

#### *5.4.9.11 Power consumption*

The power consumed per test cycle by the treatment system will be monitored and recorded (e.g., kWh per m<sup>3</sup> of water treated shall be calculated for use in cost factors below). The peak electrical load at system start-up will also be monitored and recorded as will fluctuations in consumption during test cycles.

#### *5.4.9.12 Other Consumables*

The use of any other consumables, such as filter cartridges, shall be monitored, documented, and reported.

#### *5.4.9.13 Supplemental Parameters*

Depending on vendor claims, supplemental monitoring, maintenance, and O&M performance indicators may be required. These will be described, along with requirements for performance monitoring, in the TQAP.

#### *5.4.9.14 Upset Conditions*

Upset conditions are those events or occurrences outside the operating parameters defined in the TQAP that result in either malfunctioning of the equipment, exception from normal operating conditions, or conditions causing alarms that indicate the system is producing or discharging treated water that exceeds the stated set points or limits for effective treatment. The cause of upset conditions may be due to conditions at the TF or the technology. These events may include both events in which the system is operating within the manufacturer's specifications and those that are within specification but do not result in adequate treatment. The TO shall notify the vendor and the VO immediately when an upset condition is identified. The TO shall correct the upset condition as soon as possible to bring the treatment system back on line. For unusual upset conditions, the TO will work with the vendor to identify and correct the problem. The occurrence of all upset conditions, the causes, the results, and the means to correct the upset shall be documented at the time of the occurrence and shall be described in the verification report.

As sampling is continuous over the course of the test, any upset conditions during the test need to be noted and a post-test review conducted to determine their cause and assess the impact on test results. (This task will be done by the TO and approved by the VO.) This review will determine where inclusion of these data is appropriate for performance assessment and the statistical analysis presented in the verification report. If the cause of an upset condition cannot be determined or the condition cannot be qualified as a true upset, then the sampling results shall be used in the statistical analysis for the verification report.

#### *5.4.9.15 Reliability*

The mechanical reliability of the technology will be determined by comparing the Vendor projected mean-time between failure (MTBF) with the maintenance events observed during testing. The comparison will be reported in the verification report.

The reliability of the treatment system to achieve treatment will be determined by (1) the number of instances where the treatment system or technology does not achieve the stated performance goal per the total number of test cycles, and (2) the standard deviation of the mean for biological performance data (e.g., percent removal).

Reliability performance measures will take into consideration any vendor provided information that assists in the projection of the performance such as CT (concentration-time) disinfection information or power/energy curves. Any adjustments made to the system, outside of the vendor-specified operation and maintenance claims, to achieve the performance goals will be noted in the maintenance log and specified in the verification report.

Specific performance reliability indicators along with the planned methods for evaluating and reporting them will be identified in the TQAP.

#### *5.4.9.16 Cost Factors*

Verified cost factors will include the following as applicable:

##### *5.4.9.17 Power consumption*

Power consumption will be reported as total kWh necessary to operate all equipment to achieve desired biological treatment performance.

##### *5.4.9.18 Consumable or expendable materials*

Amounts of all consumables or expendables, including chemicals or other items required for treatment, shall be itemized and reported.

##### *5.4.9.19 Replacement parts used during normal maintenance*

The number of replacement parts will be itemized and reported. Any unanticipated replacement of parts will be specified separately.

##### *5.4.9.20 Labor time to start-up, operate, and maintain the treatment system*

The total number of hours for each activity will be recorded and reported.

##### *5.4.9.21 By-product or waste materials produced*

By-products that require treatment or disposal will be reported as an expression of total volume treated or disposed.

#### *5.4.9.22 Environmental Acceptability*

Two performance indicators will determine the environmental acceptability of a treatment system: water quality and treatment residuals.

The data used to evaluate the environmental acceptability of a system will be taken from the water quality data collected at the point of discharge as detailed in Section 5.3.2. These data will include but may not be limited to the following parameters:

- Temperature
- pH
- Salinity
- Total suspended solids
- Particulate organic matter
- Dissolved organic matter
- Dissolved oxygen
- Dissolved nutrients
- Biochemical oxygen demand
- Biological efficacy

The results of these tests at the point of discharge will be compared to the range of expected natural conditions and reported in the verification report.

Additional analytical parameters will be included as necessary for reporting on any residual material that may result from treatment; for example residual biocides and disinfection byproducts. The additional parameters, the potential impact to the environment, and the analytical methods will be detailed in the TQAP

It will be the responsibility of the TF to obtain NPDES discharge permits and to ensure that discharge is within permitted limits. Additionally, toxicity testing of any biocide treatment will be conducted, as discussed under Section 5.4.4. Verification testing will not begin unless the results of the toxicity tests are acceptable.

#### 5.4.9.23 Safety

Safety is of concern during the operation of any equipment or machinery and during the use of potential hazardous materials, but it is of particular concern while on board ship, where staff is limited and access to land based emergency infrastructure is unavailable. Therefore, the safety of the treatment system will be evaluated during verification testing.

The performance indicators for this verification factor will be technology specific, but, to the extent possible, required indicators shall include:

- Listing of all dangerous or hazardous materials, including submittal of Material Safety Data Sheets (MSDS);
- Potential to compromise the normal ship ballasting or deballasting cycle (i.e., impediment of flow);
- Visual indicators of potential threats to shipboard operations, such as exposed or improper housing of power cables, structural stability of the system, external temperatures of the treatment system, and any other treatment-specific factors that may pose a threat to the operator or compromise the safety of ship operations; and

- Review of the vendor provided O&M manual for adequacy of cautions and guidance on ways to minimize the potential for, and directives to mitigate, a hazardous situation.

The method for evaluating these and other items identified by the TO in reviewing the technology documentation shall be described in the TQAP.

## Chapter 6

# Reporting Verification Testing Results

Deviations from this protocol or any TQAP prepared for BWTS testing shall be described in the verification report, which shall include supporting documentation that provided the basis for acceptance of the deviations. All testing results will be presented in the report, including all data regarding challenge conditions, results of verification testing for all verification factors, and any vendor supplied data or information. A summary verification statement will also be prepared.

The outline for the report shall include:

- Verification Statement
- Executive Summary
- Introduction and Background
- Description of the Treatment System or System
- Experimental Design (including a description of all deviations from the protocol and the basis for accepting the deviations)
- Description of Challenge Conditions
- Methods and Procedures
- Results and Discussion
- Verification Testing Operation and Monitoring QA/QC

Appendices:

- TQAP
- BE Test Validation Matrix
- Vendor-supplied Operation and Maintenance Manual
- Data Generated During Testing
- QA/QC Records
- Maintenance Logs
- Any other records maintained during testing, such as chain of custody forms
- Any other information provided by the Vendor, which may be of use to the stakeholder community

Upon completion of the draft report the VO, the vendor, and the TF QA manager will review the document and supporting data, and provide comment. The comments will be addressed or stricken with approval of all parties and the final report will be submitted to NSF International (ETV Water Quality Protection Center partner) and EPA for QA and technical review. The final verification report and statement will be processed for clearance and posted on the ETV Program's web site.

## Chapter 7

### Quality Assurance/Quality Control (QA/QC)

To ensure the quality and integrity of data gathered during testing activities, a Quality Assurance Project Plan (QAPP) will be prepared by the TO and included as part of the TQAP. The QAPP will describe the project scope, management, procedures for measurements and data acquisition, project assessment and oversight, and data validation and usability assessments necessary to meet the project goals. The written document will communicate all decisions related to project design and completion to the project team so work is performed according to written specifications. The generic format for a QAPP is included in Appendix A. EPA also provides guidance in preparing quality management plans, QAPPs and other quality management documents on their web site: <http://www.epa.gov/quality>.

#### **7.1 Project Management**

The QAPP will list all project participants and clearly define their roles and responsibilities. In addition, this section will describe project scheduling, data quality objectives, training and certification requirements (as applicable), and required documentation. The information included in this section will ensure that all participants understand the scope of the study and their explicit roles. Due to the complexity of testing in accordance with these protocols, it is advisable that each test cycle be preceded by a briefing or meeting in which the TF personnel critically review the plan of action, test operation, and conduct so they are familiar with the TQAP and their responsibilities. It is further recommended that this briefing or review be accompanied by a standardized test form that identifies the specific, quantitative set points and objectives that may be actively used throughout the test cycle to identify or record specific events, measurements or alarms. The consolidated and completed test form from each cycle should be included in an Appendix of the test report.

#### **7.2 Measurement and Data Acquisition**

A detailed description of the experimental design and its components will be included in the QAPP. Specific requirements with regard to use, maintenance, and calibration of equipment, analytical procedures, chain-of-custody procedures, sample collection, data management and documentation, records management, project scheduling, experimental design assumptions, and disclosure of non-standard techniques or equipment will be discussed.

#### **7.3 Verification of Test Data**

The data quality objective process will be used to develop the QAPP and establish the locations, types and numbers of samples to be collected, the quality control samples (duplicates, blanks, spikes, etc.) required for both field and laboratory samples, and will establish the data quality criteria and measures of acceptability that are appropriate for the project. The TQAP will also detail a corrective action plan to describe actions to be taken if acceptance criteria for accuracy, precision and completeness are not met.



#### **7.4 Assessment**

The effectiveness of QA/QC will be monitored through assessments of general and project-specific activities. The QAPP will include detailed information on the types of assessments to be utilized (e.g., management, technical, and/or quality assurance assessments), appropriate response actions, reporting requirements, and assessment and reporting authority. To increase facility-to-facility and test-to-test comparisons, and TF internal QA/QC, standardized spiked and blank samples shall be incorporated into the sample analysis procedures. Spikes may be accomplished using inert objects such as stained, killed organisms or microbeads of appropriate size for the specific analyses. The methods to be used for spiked and blank samples shall be described in the QAPP.

## **Chapter 8**

### **Data Management, Analysis and Presentation**

#### **8.1 Data Management**

Any data collected during testing activities must be capable of withstanding challenges to its validity, accuracy, and legibility. Data will be recorded in standardized formats and in accordance with the following minimum requirements:

- Data are entered directly, promptly, and legibly;
- Hand-entered data are recorded legibly in ink; all original data records include, as appropriate, a description of the data collected, the unit, the unique sample identification, the name of the person collecting the data, and the date and time of data collection;
- Any changes to the original entry do not obscure the original entry, document the reason for the change, and are initialed and dated by the person making the change;
- All deviations from the QAPP must be documented in writing, and approved by the TO; documentation and communication include an assessment of the impact the deviation has on data quality; and
- Data in electronic format shall be included in a commercially available program for word processing, spreadsheet calculations, database processing, or commercial software developed especially for the data collection and processing on a specific hardware instrument or piece of equipment; backup of computer databases should be performed on a daily basis, if possible.

Project-specific data management requirements, including the types of data to be collected and managed and how they will subsequently be reported, shall be defined in the data handling section of the TQAP. QA/QC activities for data management will be described in the QAPP and included in the TQAP.

#### **8.2 Data Analysis and Presentation**

Hand-recorded data gathered during verification testing will be entered into electronic format (a spreadsheet or other database product capable of performing graphical and simple statistical analyses). Following reduction, data will be presented in a graphical, tabular, or other logical format and accompanied by a detailed discussion to be included in the verification report.

Treatment effectiveness will be calculated for each size class of ambient organisms as concentration per unit volume in the discharge and may be related to relevant standards as identified by the vendor or the vendor's claims. In addition, viability data will be reported for STOs used in bench-scale experiments. Additional measures or comparisons may also be used to assess treatment efficacy, including percent organism removal by size class, or as a comparison of treated discharge to the control tank discharge. All methods will be described in the TQAP. The treatment effectiveness will be discussed in the verification test report with raw data included as an appendix.

## Chapter 9

### Environmental, Health, and Safety Plan

The TO shall develop an Environmental, Health, and Safety (EHS) Plan to be included in the TQAP. The EHS Plan shall identify all environmental concerns and potential hazards associated with the verification testing process and the TF, as well as the required measures to prevent exposure to the identified hazards. The TO shall be responsible for informing all personnel at the test site, including employees, contractors, and visitors, of the potential hazards and safety measures to be employed at the test site. The EHS plan shall address the following issues, as applicable:

- Permitting requirements for equipment operation, effluent discharge, and waste disposal;
- Biological, chemical, mechanical, electrical, and other hazards;
- Environmental hazards will be defined in accordance with local, state and federal regulations;
- Handling, storage, and disposal of all biological material and chemicals associated with the testing;
- Safeguards and protocols to prevent the accidental release to the environment of any non-ambient organisms if used in the test process; protocols of the form supplied in Part II ANS Task Force ANS Research Evaluation Protocol are recommended ([http://www.anstaskforce.gov/Documents/Research\\_Evaluation\\_Protocol\\_ANSTF.pdf](http://www.anstaskforce.gov/Documents/Research_Evaluation_Protocol_ANSTF.pdf));
- Material Safety Data Sheets (MSDS);
- Conformance with the local electrical code;
- Conformance with the local plumbing code;
- Ventilation of equipment, trailers, or buildings housing equipment, if gases generated by the equipment could present a safety hazard;
- Confined space entry hazards;
- Fire safety; and
- Emergency contacts for 911, the nearest hospital (provide directions), local fire department, the site manager, and all other important contacts.

Any other environmental, health, or safety issues specific to the test location or ballast water treatment system to be tested must be addressed. A copy of the EHS plan, including all MSDS, shall be maintained and readily accessible at the test site. A one-page summary of emergency contacts shall be placed inside a clear plastic cover and kept at the verification-testing unit.

## References

- Anderson, A., J. Cordell, F. Dobbs, R. Herwig, and A. Rogerson. 2008. Screening of Surrogate Species for Ballast Water Treatment. Final Report to NSF International, Ann Arbor, MI.
- ASTM. 1996a. Standard Guide for Conducting Acute Toxicity Tests Starting with Embryos of Four Species of Saltwater Bivalve Mollusks. *In* Annual Book of ASTM Standards, Section 11, Water and Environmental Technology, Volume 11.05 (724-94), West Conshohocken, PA.
- ASTM. 1996b. Standard Guide for Conducting Acute Toxicity Tests with Echinoid Larvae, *In* Annual Book of ASTM Standards, Section 11, Water and Environmental Technology, Volume 11.05 (E1563-95). West Conshohocken, PA.
- Dobbs, F.C., and A. Rogerson. 2005. Ridding ships' ballast water of microorganisms. *Environ. Sci. Technol.* **39**: 259A-264A.
- Doblin, M.A., and F.C. Dobbs. 2006. Setting a size-exclusion limit to remove toxic dinoflagellate cysts in ships' ballast water. *Mar. Pollut. Bull.* **52**: 259-263.
- Drake, L.A., M.K. Steinberg, S.H. Robbins, S.C. Riley, B.N. Nelson, and E.J. Lemieux. 2010. Development of a method to determine the viability of organisms  $\geq 10 \mu\text{m}$  and  $< 50 \mu\text{m}$  (nominally protists) in ships' ballast water: a combination of two vital, fluorescent stains. NRL Letter Report 6130/1011, Washington, D.C.
- Garthright, W.E. 1993. Bias in the logarithm of microbial density estimates from serial dilutions. *Biometrical Journal* **35**: 299-314.
- Huq, A., C.A. Grim, R.R. Colwell, G.B. Nair. 2006. Detection, Isolation, and Identification of *Vibrio cholerae* from the Environment. *Current Protocols in Microbiology*: 6A.5
- Klemm, D.J., G.E. Morrison, T.J. Norberg-King, W.H. Peltier, and M.A. Heber. 1994. Short-Term Methods for Estimating the Chronic Toxicity of Effluents and Receiving Waters to Marine and Estuarine Organisms (Second Edition) EPA/600/4-91/003, Washington, DC.
- Lemieux, E.J., T.P. Wier, M.K. Steinberg, S.H. Robbins, S.C. Riley, E.C. Schrack, W.B. Hyland, J.F. Grant, C.S. Moser, and L.A. Drake. 2010. Design and preliminary use of a commercial filter skid to capture organisms  $\geq 50 \mu\text{m}$  in minimum dimension (nominally zooplankton) for evaluating ships' ballast water management systems at land-based test facilities. NRL Letter Report 6130/1029, Washington, DC.
- Lemieux, E.J., J. Grant, T. Wier, S. Robbins, S. Riley, W. Hyland, L. Davis, T. Donowick, B. Stringham, W.J. Kinee, B. Brown, and R. Everett. 2008a. Pilot Environmental Technology Verification (ETV) Test Report of the Severn Trent DeNora BalPure™ Ballast Water Treatment System, NRL Letter Report 6130/6098, Washington, DC.

- Lemieux, E.J., S. Robbins, K. Burns, S. Ratcliff, and P. Herring. 2008b. Evaluation of Representative Sampling for Rare Populations using Microbeads. Report No. CG-D-03-09, United States Coast Guard Research and Development Center, Groton, CT.
- Marret, F., and K.A.F. Zonneveld. 2003. Atlas of modern organic-walled dinoflagellate cyst distribution. *Rev. Palaeobot. Palynol.* **125**: 1-200.
- Matsuoka, K., and Y. Fukuyo. 2000. Technical Guide for Modern Dinoflagellate Cyst Study. [http://dinos.anesc.u-tokyo.ac.jp/technical\\_guide/main.pdf](http://dinos.anesc.u-tokyo.ac.jp/technical_guide/main.pdf).
- Oudot C., R. Gerard, P. Morin, and I. Gningue. 1988. Precise shipboard determination of dissolved oxygen (Winkler procedure) for productivity studies with a commercial system. *Limnol. Oceanogr.* **33**: 146–150.
- Richard, R.V., J.F. Grant, and E.J. Lemieux. 2008. Analysis of Ballast Water Sampling Port Designs Using Computational Fluid Dynamics. Report No. CG-D-01-08. US Coast Guard Research and Development Center, Groton, CT.
- Selvin, R., B. Reguera, I. Bravo, and C.M. Yentsch. 1988. Use of Fluorescein Diacetate (FDA) as a single-cell probe of metabolic activity in dinoflagellates cultures. *Biol. Oceanogr.* **6**: 505-511.
- Steinberg, M.K., S.C. Riley, E.J. Lemieux, and L.A. Drake. 2010. Mult-site Validation of a Method to Determine the Viability of Organisms  $\geq 10 \mu\text{m}$  and  $< 50 \mu\text{m}$  (Nominally Protists) in Ships' Ballast Water Using Two Vital, Fluorescent Stains. Letter Report No. 6130/1016, Published by the US Naval Research laboratory, Washington, D.C.

## **Appendix A: Quality Assurance Project Plan Outline**

## Quality Assurance Project Plan

A Quality Assurance Project Plan (QAPP) shall be prepared as part of the TQAP for evaluating the performance of ballast water treatment technologies. Information on preparing QAPPs is provided on the EPA web site: <http://www.epa.gov/quality>. The generic format for QAPPs include:

### A.1 Project Descriptions, Objectives and Organization

- The purpose of the study shall be clearly stated.
- The processes to be evaluated will be described.
- The TF, apparatus and technology set-up will be fully described.
- Project objectives shall be clearly stated and identified as being primary or non-primary.
- Responsibilities of all project participants shall be identified. Key personnel and their organizations shall be identified, along with the designation of responsibilities for planning, coordination, sample collection, measurements (i.e., analytical, physical, and process), data reduction, data validation (independent of data generation), data analysis, report preparation, and quality assurance.

### A.2 Experimental Approach

- Technology installation and shakedown procedures will be identified.
- Technology startup procedures will be identified. Startup will comprise a number of tasks to implement and check operating and sampling protocols. Tasks will include establishing feed makeup (including and procedures for challenge water preparation) and performing calibration checks on monitoring systems, identifying sampling and monitoring points and identifying the types of samples to be collected.
- Physical, analytical or chemical measurements to be taken during the study will be provided. Examples include flow rates, pH, salinity, total suspended solids, particulate organic matter, dissolved organic matter, dissolved oxygen, dissolved nutrients, biochemical oxygen demand, biological organisms, O&M performance indicators, etc.
- Sampling and monitoring points for each test unit and the type of sample to be collected (grab or composite) will be identified.
- The frequency of sampling and monitoring as well as the number of samples required will be provided. This includes the number of samples needed to meet QA/QC objectives.
- Planned approach for evaluation objectives (data analysis). This will include formulas, units, and definition of terms and statistical analyses to be performed in the analysis of the data. Example graphical relationships will be provided.
- Demobilization of the technology, including scheduling and site restoration requirements, will be described.

### A.3 Sampling Procedures

- Whenever applicable or necessary to achieve project objectives, the method used to establish steady-state conditions shall be described.

- Each sampling/monitoring procedure to be used shall be described in detail or referenced. If compositing or splitting samples is required, those procedures shall be described.
- Sampling or monitoring procedures shall be appropriate for the matrix or analyte being tested.
- If sampling/monitoring equipment is used to collect critical measurement data (e.g., used to calculate the final concentration of a critical parameter), the QAPP shall describe how and at what frequency the sampling equipment is calibrated.
- If sampling/monitoring equipment is used to collect critical measurement data, the QAPP shall describe how cross-contamination between samples is avoided.
- When representativeness is essential for meeting a primary project objective, the QAPP shall include a discussion of the procedures to be used to assure that representative samples are collected.
- A list of sample quantities to be collected, and the sample amount required for each analysis, including QC sample analysis, shall be specified in the QAPP.
- Containers used for sample collection for each sample type shall be described in the QAPP.
- Sample preservation methods (e.g., refrigeration, acidification, etc.) and holding times shall be described in the QAPP.
- A sample of the chain of custody form to be used during testing shall be provided, including records of times and other critical parameters such as storage temperatures, light condition, etc.

#### **A.4 Testing and Measurement Protocols**

- Each measurement method to be used shall be described in detail or referenced in the QAPP. Modifications to EPA-approved or similarly validated methods shall be specified.
- For unproven methods, the QAPP shall provide evidence that the proposed method is capable of achieving the desired performance.
- For measurements that require a calibrated system, the QAPP shall include specific calibration procedures, and the procedures for verifying both initial and continuing calibrations (including frequency and acceptance criteria, and corrective actions to be performed if acceptance criteria are not met).

#### **A.5 QA/QC Checks**

##### **A.5.1 Data Quality Indicators**

- Statistical analyses shall be carried out on data obtained for all performance measurements. As part of the assessment of data quality, six data quality indicators (DQIs) can be used to interpret the degree of acceptability or utility of the data. At a minimum, the QAPP shall include a protocol for assessing the following DQIs, and acceptable limits and criteria for each of these indicators: representativeness, accuracy, precision, bias, comparability, and completeness.
- The TO shall determine acceptable values or qualitative descriptors for all DQIs in advance of verification testing as part of the experimental design. The assessment of data quality will require specific field and laboratory procedures to determine the data quality indicators. All details of DQI selection and values shall be documented in the QAPP.



### A.5.1.1 Representativeness

Representativeness refers to the degree to which the data accurately and precisely represent the conditions or characteristics of the parameter represented by the data. In this testing, representativeness will be ensured by executing consistent verification procedures. Representativeness will also be ensured by using each method at its optimum capability to provide results that represent the most accurate and precise measurement it is capable of achieving. For equipment operating data, representativeness entails collecting a sufficient quantity of data during operation to be able to detect a change in operations.

### A.5.1.2 Accuracy

For water quality analyses, accuracy refers to the difference between a sample result and the reference or true value for the sample. Loss of accuracy can be caused by such processes as errors in standards preparation, equipment calibrations, loss of target analyte in the extraction process, interferences, and systematic or carryover contamination from one sample to the next. Loss of accuracy for microbial species can be caused by such factors as error in dilution or concentration of microbiological organisms, systematic or carryover contamination from one sample to the next, improper enumeration techniques, etc. The TO shall discuss the applicable ways of determining the accuracy of the chemical and microbiological sampling and analytical techniques in the TQAP.

For equipment operating parameters, accuracy refers to the difference between the reported operating condition and the actual operating condition. For water flow, accuracy may be the difference between the reported flow indicated by a flow meter and the flow as actually measured on the basis of known volumes of water and carefully defined times. Meters and gauges must be checked periodically for accuracy, and when proven dependable over time, the time interval between accuracy checks can be increased. In the TQAP, the TO shall discuss the applicable ways of determining the accuracy of the operational conditions and procedures.

From an analytical perspective, accuracy represents the deviation of the analytical value from the known value. Since true values are never known in the field, accuracy measurements are made on the analysis of QC samples analyzed with field samples. QC samples for analysis shall be prepared with laboratory control samples, matrix spikes, and spike duplicates. It is recommended for verification testing that the TQAP includes laboratory performance of one matrix spike for determination of sample recoveries. Recoveries for spiked samples are calculated in the following manner:

$$\% \text{ Recovery} = \frac{100(SSR - SR)}{SA} \quad (A-1)$$

where: SSR = spiked sample result  
SR = sample result  
SA = spike amount added

Recoveries for laboratory control samples are calculated as follows:

$$\% \text{ Recovery} = \frac{100(\text{foundconcentration})}{\text{trueconcentration}} \quad (\text{A-2})$$

For acceptable analytical accuracy under the verification testing program, the recoveries reported during analysis of the verification testing samples must be within control limits, where control limits are defined as the mean recovery plus or minus three times the standard deviation.

#### A.5.1.3 Precision

Precision refers to the degree of mutual agreement among individual measurements and provides an estimate of random error. Analytical precision is a measure of how far an individual measurement may be from the mean of replicate measurements. The standard deviation and the relative standard deviation recorded from sample analyses may be reported as a means to quantify sample precision. The coefficient of variation (CV) may be calculated in the following manner:

$$\% \text{ CV} = \frac{S(100)}{X_{\text{average}}} \quad (\text{A-3})$$

where: S = standard deviation

$X_{\text{average}}$  = the arithmetic mean of the recovery values

Standard Deviation is calculated as follows:

$$\text{Standard Deviation} = \sqrt{\frac{(X_i - X)^2}{n-1}} \quad (\text{A-4})$$

where:  $X_i$  = the individual recovery values

X = the arithmetic mean of the recovery values

n = the number of determinations

The QAPP shall list and define all other QC checks and/or procedures (e.g., detection limits determination, blanks, spikes, surrogates, controls, etc.) used for the project.

For each specified QC check or procedure, required frequencies, associated acceptance criteria, and corrective actions to be performed if acceptance criteria are not met shall be included in the QAPP.

### A.6 Data Reporting, Data Reduction, and Data Validation

- The reporting requirements (e.g., units) for each measurement and matrix shall be identified in the QAPP.
- Data reduction procedures specific to the project shall be described, including calculations and equations.

- The data validation procedures used to ensure the reporting of accurate project data to internal and external clients should be described.
- The expected product document that will be prepared shall be specified.

### **A.7 Assessments**

Whenever applicable, the QAPP shall identify all audits (i.e., both technical system audits [TSAs] and performance evaluations [PEs]) to be performed, who will perform these audits, and who will receive the audit reports.

### **A.8 References**

References shall be provided in the QAPP in the body of the text as appropriate.

## **Appendix B: Anderson, et al. Approach for Evaluation of Standard Test Organisms**

**Taken From:**

**Final Report  
To NSF International  
For  
Contract No 03/06/394**

**Woods Hole Oceanographic Institute  
Woods Hole, MA 02543**

**“Screening of Surrogate Species for  
Ballast Water Treatment”**

**3 July, 2008**

## MATERIALS AND METHODS

### Common Methods

#### Synthetic Water Preparation

The freshwater and seawater used in these experiments were prepared in each PI's lab using synthetic solutions for uniform consistency and replication purposes. The seawater for these experiments was prepared by dissolving Instant Ocean<sup>®</sup> salts in Milli-Q or equivalent deionized water to achieve the desired salinity. Freshwater was prepared either as WC medium (Guillard, 1975) (for heterotrophic protists and phytoplankton) or according to the EPA's recommended aquatic toxicology testing protocol for freshwater organisms (<http://www.epa.gov/waterscience/WET/disk2/>) (for bacteria and zooplankton). Freshwater and seawater were prepared using Milli-Q water or equivalent water (bacteria and zooplankton only) and was filtered through glass fiber filters (marine zooplankton) or filter-sterilized (all other taxa and water combinations) before use. Additional details are found in the taxon-specific methods sections.

#### Treatments

The treatments, their associated vendors, dose, and literature citation are summarized in Table 1. Phase I tests separately involved thermal, glutaraldehyde, and hypochlorite treatments. All other treatments were administered in Phase II tests. The methods common to all taxa tested are provided in the text following the table. Please note there occasionally were deviations from the specific concentrations or times listed here, and those deviations, as well as other specific methods, are given in the taxon-specific section of the Materials and Methods. In particular, the data sets for the zooplankton species are more extensive than for the other three taxa.

***Thermal treatment:*** Regardless of the organisms or the volume of the experimental container in which they were held, the thermal treatment was begun by immersing the container into a water bath (accurate to  $\pm 0.5^\circ\text{C}$ ) heated to the test temperatures ( $35^\circ$ ,  $40^\circ$ ,  $45^\circ$ , and  $50^\circ\text{C}$ ). Timing of the treatment began once the water in the container reached the criterion temperature. After 4 hours (bacteria and zooplankton) or 8 hours (heterotrophic protists and phytoplankton) of treatment, viability was assessed. Controls consisted of vessels containing organisms held for the same time at room temperature.

***Chlorine (sodium hypochlorite):*** Household bleach (UltraClorox<sup>®</sup> Regular Bleach) has a concentration of 6.0% sodium hypochlorite. Appropriate volumes were added to generate four experimental concentrations of sodium hypochlorite (0.25, 0.5, 1.0, and 2.0 mg/L). Additional concentrations were tested in the zooplankton study; see details in the taxon-specific section. After 24 hours of exposure, viability was assessed. Control vessels containing organisms were not treated with hypochlorite, but were held for the same time at room temperature.

**Table 1. Summary of treatment and experimental conditions.**

Treatment	Vendor or source	Concentration or Intensity	Exposure time	References
Thermal treatment	Water bath	35°, 40°, 45°, 50° C	4 hours or 8 hours	Hallegraeff et al. 1997; Rigby et al. 1999
Chlorine (sodium hypochlorite)	Chlorox bleach	Aqueous solution of sodium hypochlorite. Final concs. of 0.25, 0.5, 1.0, 2.0 mg/L	24 hours	Sano et al. 2004; Bolch and Hallegraeff 1993
Chlorine dioxide (Ecochlor™)	Ecochlor, Inc.	Final concs. of 1, 2, 4, 6 ppm	24 hours	T. Perlich, Ecochlor, Inc. (pers. comm., 19 & 20 Oct. 2004)
Glutaraldehyde	Fisher Scientific	Final concs. of 50, 100, 500 and 1000 mg/L	24 hours	Sano et al. 2003
UV light	UV collimator designed and built by Dr. E. "Chip" Blatchley, Purdue University	UV light (256 nm) at 10, 25, 50, 100 mJ/cm <sup>2</sup>	Dose independent of exposure time between c. 30 sec. to 2 min.	Azanza et al. 2001; Montani et al. 1995; Sutherland et al. 2001; Sutherland et al. 2003
Ozone	Enaly OZX-300U or Clear Water Tech UV-275	Total initial residual oxidant (TRO) level of 0.25, 0.5, 1.0, and 2.0 mg Br <sub>2</sub> /L in seawater	24 hours after achieving initial level of TRO	Hoigné 1998; Langlais et al. 1991; Cooper et al. 2002
Hydrogen peroxide	Local drugstore	Final concs. of 0.5, 1, 10 and 20 ppm	24 hours after achieving initial conc.	Kuzirian et al. 2001
Deoxygenation	BBL GasPak System™	Anoxia (0 mg/L oxygen)	24, 48, 72 hours	Tamburri et al. 2002; P. D. McNulty, NEI Treatment Systems, Inc. (pers. comm., 27 Oct. 2004)
SeaKleen®	Vitamar, Inc.	0.25, 0.5, 1.0, 2.0 mg/L active ingredient	24 hours	Cutler et al. 2003; Sano et al. 2004
PeraClean® Ocean	Degussa AG	Final concs. of 50, 100, 200 and 400 ppm	24 hours	<a href="http://dmses.dot.gov/docimages/pdf81/175321_web.pdf">http://dmses.dot.gov/docimages/pdf81/175321_web.pdf</a>

Note: NB SeaKleen® was tested only with zooplankton species and *Geobacillus stearothermophilus*, as it was not provided by its manufacturer for general distribution to the PIs.

**Chlorine dioxide (Ecochlor™):** Species were tested against four concentrations (1.0, 2.0, 4.0, and 6.0 ppm) of chlorine dioxide (Ecochlor™). Reagents were provided by Ecochlor, Inc. (Acton, MA). A concentrated stock solution (3,000 ppm) was prepared as per manufacturer directions by dissolving the two-part reagent into one liter of distilled water. This stock was maintained in the refrigerator in a glass bottle until required. To make working solutions, appropriate volumes were added to either WC or sterile artificial seawater to generate the four experimental concentrations listed above. Additional concentrations were tested in the

zooplankton study; see details in the taxon-specific section. Treatment times were 24 hours in all cases, during which time experimental and control organisms were incubated at room temperature. After 24 hours, viability was assessed.

**Glutaraldehyde:** Glutaraldehyde (Fisher Scientific, Cat. No. G151-1 or for the zooplankton and bacteria studies, 25% solution from Sigma Chemical Company) was used at concentrations of 50, 100, 500, and 1000 mg/L in either artificial seawater or WC medium. Additional concentrations were tested in the zooplankton study; see details in the taxon-specific section. Controls consisted of organisms incubated in all ways the same, save the addition of glutaraldehyde. After 24 hours of treatment at room temperature, the viability of the organisms was determined.

**Ultraviolet light:** This treatment utilized a collimator built by Dr. E. “Chip” Blatchley, Purdue University, which has a 256 nm UV bulb to provide controlled dosages of UV light onto the test surface. Different dosages were delivered by varying the length of time organisms were exposed. The protocols employed were developed by Drs. Russell Herwig and Adelaide Rhodes (University of Washington). The test organisms and medium were transferred into disposable 50 mm diameter petri dishes, which were positioned ca. 1 cm beneath the end of the collimator. Dosages used for zooplankton, protists, and phytoplankton were: 10 mJ/cm<sup>2</sup> (72 seconds); 25 mJ/cm<sup>2</sup> (180 seconds); 50 mJ/cm<sup>2</sup> (360 seconds); and 100 mJ/cm<sup>2</sup> (720 seconds). Similar dosages were used for bacteria but since these experiments were performed later in the contract period and following extensive usage of the same UV lamp, the exposure time needed to be slightly increased to achieve the similar doses. The doses (time of exposure) for the bacteria were: 10 mJ/cm<sup>2</sup> (80 seconds); 25 mJ/cm<sup>2</sup> (200 seconds); 50 mJ/cm<sup>2</sup> (400 seconds); and 100 mJ/cm<sup>2</sup> (800 seconds). Additional higher dosages were tested in the zooplankton study since some of the species were tolerant of 100 mJ/cm<sup>2</sup>; see details in the taxon-specific section. During the UV exposure, organisms suspended in freshwater or seawater in the petri dishes were stirred with a small magnetic stir bar to ensure equal exposure of all organisms placed in the dish. The control exposures were conducted in the same way, but the UV light was not turned on.

**Ozone:** Ozone (O<sub>3</sub>) is a gas that is also an oxidizing biocide. It is commonly used for the disinfection of freshwater and seawater, such as in drinking water, freshwater and seawater aquaria. Ozone can be generated in a corona-discharge tube by passing an electrical current through an atmosphere that is enriched in oxygen. A variety of commercial ozone generators are available, but we decided to use a small inexpensive unit that could generate ozone for bench-scale experiments. We chose the Enaly (<http://www.ozone.enaly.com/>, Shanghai, China) OZX-300 U unit with air dryer and built-in aerator.

We calibrated the unit using synthetic seawater and freshwater (R. Herwig and A Rhodes, University of Washington). To calibrate the instrument, ozone was bubbled into test water for various times, and Total Residual Oxidant (TRO) levels were measured for seawater and the ozone concentrations were measured for freshwater. Ozone in freshwater is toxic by direct contact with the organism. In seawater, ozone quickly reacts with bromide ions (Br<sup>-</sup>) to form bromines, compounds that are long lasting disinfectants. In freshwater, this transformation does not occur. The concentration of bromines was measured using the DPD (N,N-diethyl-*p*-

phenylenediamine) colorimetric test (Hach DREL/2010 spectrophotometer with the DPD Total Chlorine Powder Pillows (US EPA Method 8016), Hach Company, Loveland, CO). Using a calibration curve (Figure 2), the times required to achieve the desired concentration of ozone were calculated. A similar procedure was used to calibrate freshwater ozone concentrations. We directly measured ozone concentrations in freshwater at various times using a Hach DREL/ 2010 spectrophotometer with Ozone Accuvac ampoules that measure the formation of indigo (US EPA Method 8311). The freshwater ozone test was difficult to perform because of the rapid disappearance of ozone, so we repeated the calibration three times (Figure 3).

To expose the zooplankton, phytoplankton, and protists to ozone, we placed the test organisms in 500 ml of seawater or freshwater, inserted the airstone provided by the manufacturer (Enaly) into the liquid, and let the generator run for the required time. Ozone testing with bacteria followed a slightly different protocol because small volumes of liquid were treated. For freshwater testing, ozone was produced using the Enaly ozone generator. The UV-275 (ClearWater Tech, LLC, San Luis Obispo, California), which produces ozone using UV light, was used for testing seawater conditions, because the Enaly generator produced ozone too rapidly.

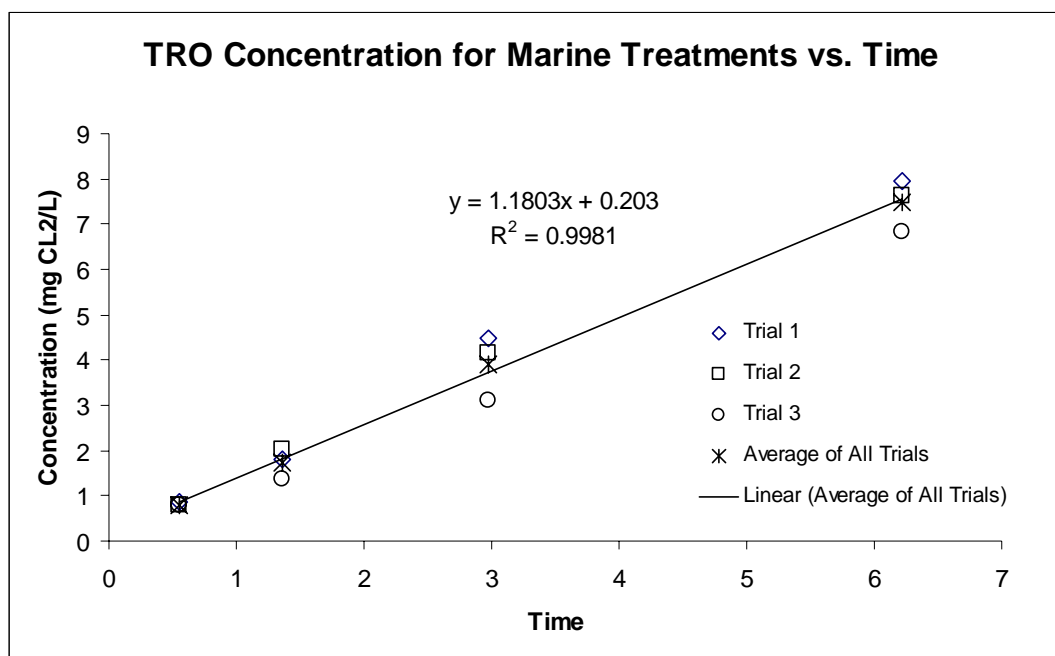

**Figure 2. TRO concentrations (measured as mg Cl<sub>2</sub>/L) for synthetic seawater treated with ozone versus time using the Enaly ozone generator.**



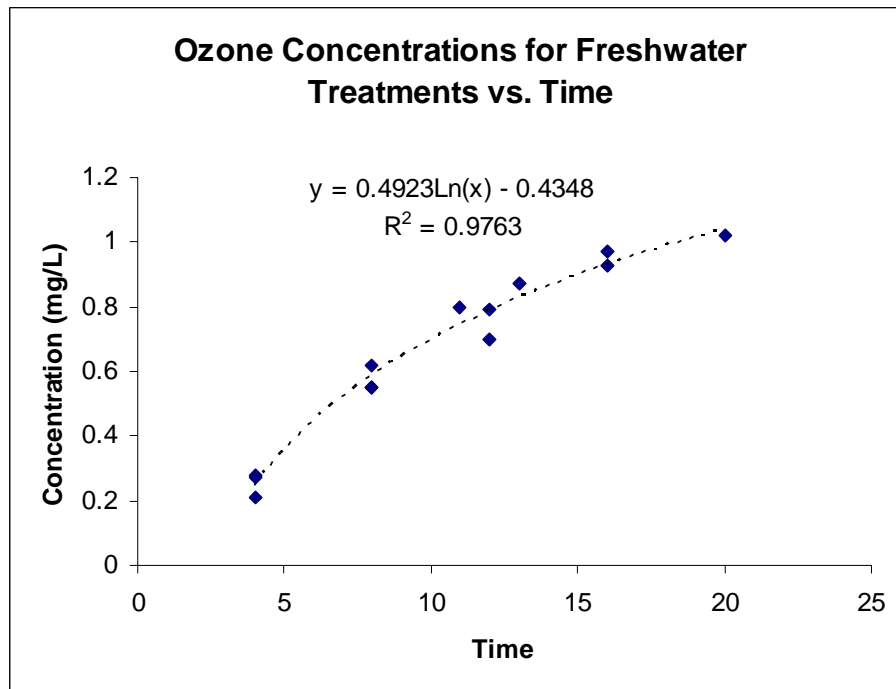
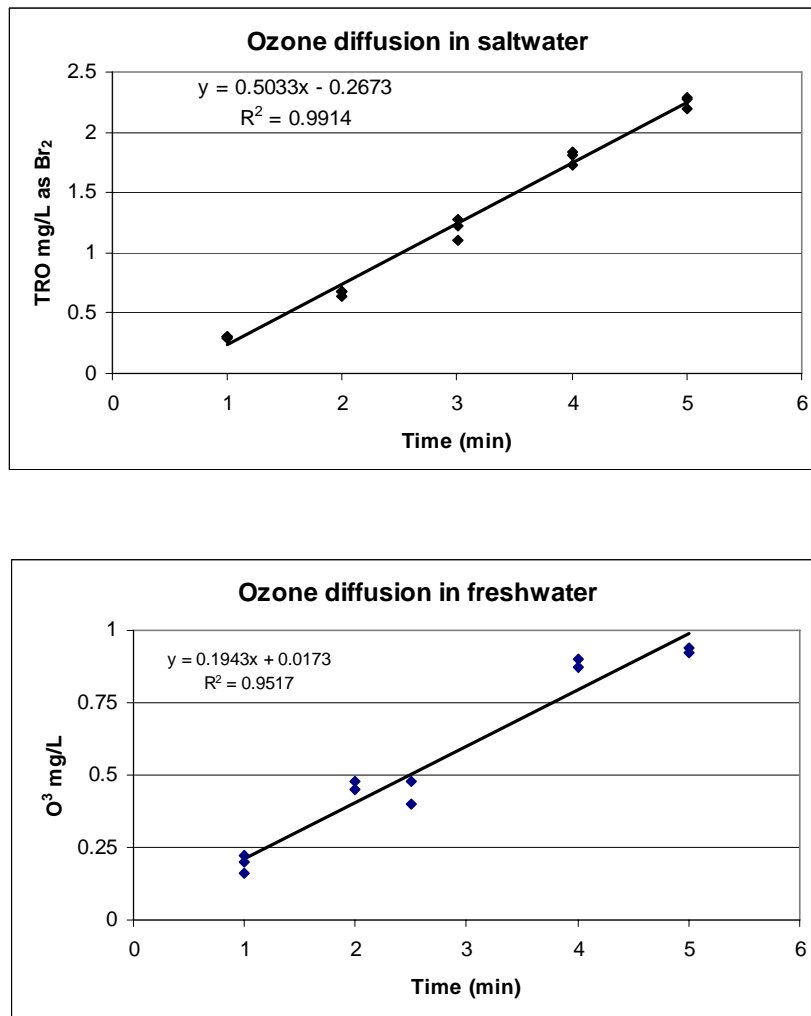

**Figure 3. Ozone concentrations for freshwater versus time using the Enaly ozone generator.**

Exposure times for each experimental run were based on a standard curve of ozone concentrations versus time (Figure 4) (Russell Herwig and Jake Perrins, University of Washington). Containers holding test bacteria were injected with ozone to four experimental TRO concentrations (0.25, 0.50, 1.0, and 2.0 mg Br<sub>2</sub>/L). Following exposure, organisms were held for 24 hours at room temperature, after which their viability was determined. Controls were similarly treated, but ozone was not injected into the test containers. Additional ozone concentrations were tested in the zooplankton study; see details in the taxon-specific section.

**Hydrogen Peroxide:** Hydrogen peroxide (3%) was purchased locally at drug stores by the PIs. Only unopened bottles were used to make treatment solutions. Appropriate volumes were added to either WC or sterile artificial seawater to generate four experimental concentrations of hydrogen peroxide (0.5, 1.0, 10.0, and 20.0 ppm). Additional concentrations were tested in the bacteria and zooplankton studies; see details in the taxon-specific section. All treatments lasted 24 hours at room temperature. Viability was assessed thereafter.

**Deoxygenation:** The deoxygenation tests used a BBL™ GasPak™ anaerobic system (Becton Dickinson, Becton Drive, Franklin Lakes, NJ 07417). The GasPak™ system is self-contained and produces anaerobic conditions when used with hydrogen and CO<sub>2</sub> generating GasPak™ envelopes (BD# 271040). Test organisms and media were placed in Petri dishes and the dishes placed in the chamber, together with GasPak™ dry anaerobic test strips (BD # 271051). The strips were monitored for color change when conditions became anaerobic, approximately 2 hours after activation. The containers were sealed to prevent infiltration of any oxygen over the time course of the experiment, and treatments lasted 24, 48, and 72 hours at room temperature.



**Figure 4. Ozone standard curves used to test bacteria in seawater and freshwater.** (For seawater, bromine was measured as TRO. For freshwater, ozone was directly measured.)

Experimental controls consisted of containers not exposed to anaerobic conditions for same time periods. After treatment, the viability of the organisms was determined.

**SeaKleen®** (zooplankton and *Geobacillus stearothermophilus* only): As mentioned earlier, Vitamar, Inc. chose not to distribute SeaKleen® to the PIs. The zooplankton and bacteria investigators, however, had some material remaining from previous work and were able to perform a series of experiments. See the taxon-specific methods for details.

**PeraClean® Ocean:** The manufacturer of PeraClean® (Degussa Corporation, 379 Interpace Parkway Parsippany, NJ 07054) supplied the product, certified to contain 15.4% peracetic acid and 14.2% hydrogen peroxide. PeraClean® volumes were added either to WC or sterile artificial seawater to generate four experimental concentrations (50, 100, 200, and 400 ppm). Treatment

times were 24 hours in all cases and tubes were incubated at room temperature. Controls consisted of containers identical in all ways save the addition of PeraClean® Ocean.

### **Experimental Replication and Controls**

Each combination of treatment level and species tested were run in quadruplicate, as were the controls, for the bacteria, heterotrophic protists, and phytoplankton. Zooplankton experimental combinations were replicated at least three times. In any case where high mortality (defined as >20%) was determined for the controls, the experiment was repeated until controls achieved an acceptable level of survival.

### **Viability Determinations**

For the potential surrogate species studied here, viability was determined either through an assessment of their growth potential or in the case of zooplankton species, their ability to move or respond to mechanical stimulation. Thus, two different approaches were followed, one culture-based and the other behavioral.

Bacterial viability was determined based on the ability of the species to grow on agar plates comprised of a standard general or selective bacteriological medium. This classic technique yields so-called “colony-forming units” (CFUs) that can be pointed to and counted. Effectiveness of a treatment was expressed as the log-scale mortality in the treatment relative to the control.

Viability of both heterotrophic protists and phytoplankton was assessed using the “most probable number” (MPN) method (Thronsdon 1978), also known as the “extinction dilution method” of Imai et al. (1984). The MPN data yield an estimate of the abundance of cells (or cysts) capable of dividing (or germinating and dividing). It is important to understand the dormancy and excystment characteristics of the species being investigated if this method is to be used, since cysts sometimes will not germinate, but are nevertheless viable in the long term.

Briefly, the MPN counting method begins with pipetting medium into a set of tubes, one set for each of the four replicate tubes of organisms (experimental or control). The inoculum volume added to each MPN tube differs by a factor of 10. After mixing, samples of the MPN series are then transferred to multiwell plates and following an appropriate incubation period, wells are examined by inverted microscopy to determine cell viability. The number of positive scores (i.e., the presence of viable cells in a well) is entered into a Most Probable Number program (Blodgett, 2003) to determine the number of organisms per ml. Percent survival is calculated by comparing the MPN from the treated samples with the MPN of the control after incubation. We emphasize this MPN technique is suitable for pure cultures of heterotrophic protists or phytoplankton, but is not a useful tool for mixed cultures.

To assess viability of zooplankton following treatment, animals were placed in a counting wheel and examined under at least 10× magnification to determine their survival (indicated by motion) or mortality (lack of movement after a few seconds of observation or prodding with a wire pointer).

## **Bacteria Methods**

### **General**

The Phase I assessment utilized two Gram negative pathogen-indicator organisms, *Enterococcus avium* (ATCC 14025) and *Vibrio cholerae* (ATCC 14033), and two Gram positive spore-forming organisms, *Geobacillus stearothermophilus* (ATCC 7953), and *Bacillus subtilis* (ATCC 6633). *E. avium* and *V. cholerae* were purchased from the American Type Culture Collection (ATCC) (www.atcc.org) as freeze dried pellets of cells. *G. stearothermophilus* and *B. subtilis* were purchased as spores from SGM Biotech, Inc. (www.sgmbiotech.com). Spores of these species are also available from other commercial sources. Spore suspensions from these and other bacterial species are commonly used for disinfection experiments and the testing of disinfectants, so the suspensions are routinely available. Phase II experiments were conducted solely with *G. stearothermophilus*, based on its superior performance (as a potential surrogate species) in Phase I of the investigation. *G. stearothermophilus* is a thermophilic bacteria that has a recommended incubation temperature of 55° C.

At the beginning of an experiment, sterile containers (test tubes or petri dishes) were inoculated with a live bacterial culture or spore suspension to achieve a final concentration of  $10^4$  to  $10^5$  cells/mL. Two methods were used to provide this concentration. In the first, freeze-dried pellets of *E. avium* and *V. cholerae* were rehydrated and streaked onto agar media, as suggested by ATCC, and incubated for 24 hours at 37° C. Colonies were harvested with a sterile inoculating loop, and plated onto general purpose agar media, Trypticase Soy Broth Agar for *E. avium*, and Nutrient Agar for *V. cholerae*. To collect cells for the surrogate challenge tests following a 24 hr incubation, colonies on the agar media were harvested with a sterile inoculating loop and suspended in Phosphate Buffered Saline (PBS). The cell suspensions were placed in a spectrophotometer and the cell concentration was determined by measuring the absorbance at 450 nm. An absorbance of 0.05 was equivalent to a concentration of  $10^6$  cells/mL. The bacteria suspension was then distributed into sample containers to yield a final concentration of  $10^4$  to  $10^5$  cells/mL.

In the second method, *G. stearothermophilus* and *B. subtilis* spore suspensions were purchased at the vendor-reported spore concentrations of  $10^7$  and  $10^8$  spores/mL. Spores were diluted to an estimated  $10^6$  spores/mL in PBS. An aliquot of the PBS spore suspension was then added to the sample containers to have a final concentration of  $10^4$  spores/mL.

In either case, to ensure uniform bacteria distribution among replicate treatments and controls, all bacterial cell and spore aliquots were removed from the same intermediate PBS suspension for use in a specific surrogate test. The stressor was added or applied after bacteria were diluted into the synthetic freshwater or seawater in the sample containers. The total experimental volume (after bacterial cell or spore, and stressor addition) was 10.0 mL for experiments conducted in 16 × 125 mm screw-capped test tubes, and 5.0 mL for the two experiments (UV and anaerobic treatment) conducted in 50 mm diameter sterile plastic petri dishes.

After treatment, culturable bacteria were enumerated as colony forming units (CFU) using the agar spread-plate method. Petri dishes (100 mm diameter) containing agar medium were

inoculated directly with a 0.1 mL ( $10^{-1}$  dilution) aliquot from the treatment or control sample, which was spread evenly over the agar surface using a sterile, bent-glass rod. Nutrient Agar was used to enumerate *G. stearothermophilus*, *B. subtilis*, and *V. cholerae* cells, and Trypticase Soy Broth Agar (TSBA) was used to enumerate *E. avium*. Two serial dilutions ( $10^{-2}$  and  $10^{-3}$  dilutions) were prepared as necessary to ensure an accurate count when the number of culturable bacteria was greater than 200 to 300 CFU per inoculated petri dish on the  $10^{-1}$  dilution. The spread-plate samples were inoculated in triplicate (three plates per dilution) and incubated in the dark for 24 hours. Petri plates for *E. avium*, *V. cholerae*, and *B. subtilis* were incubated at 37° C, and *G. stearothermophilus* plates were incubated at 55° C in a dry incubator. After incubation, bacterial colonies were counted and the data were reported as CFU/mL.

### **Thermal Treatment (Phase I)**

As described in “Common Methods”. Following treatment, bacteria were enumerated (as above) after the incubation period.

### **Biocide Treatments (Phase I and II)**

Biocides (sodium hypochlorite, chlorine, chlorine dioxide (Ecochlor™), glutaraldehyde, hydrogen peroxide, Seakleen®, and PeraClean® Ocean—all except ozone, see below) were added to test tubes as aqueous solutions, and were prepared from liquid or solid stocks using deionized water. Biocide stocks were prepared at ten times their final concentrations. A volume of 1.0-mL of the stock solution was added to treatment test tubes containing 9.0 mL of the bacteria or spore suspension in synthetic freshwater or seawater, resulting in the desired final biocide concentration. Control test tubes received 1.0 mL of deionized water in place of the treatment solution. After addition of the biocide, treatment and control test samples were mixed with a vortexer and held in the dark at room temperature for 24 hours. Bacteria were enumerated (as above) following this incubation period.

### **Ultraviolet Light Treatment (Phase II)**

The UV treatment tests were performed as described in “Common Methods”. Specifically for bacteria, UV treatment was conducted by putting 5.0-mL samples containing  $10^4$  bacterial cells or spores/mL in 50 mm sterile plastic petri dishes, and placing the dish, with the lid removed, under the collimated UV beam. Bacteria in the dish were gently stirred with a small clean magnetic stir bar during treatment. After the treatment, the petri dishes were covered with the plastic lid, and held in the dark at room temperature for 24 hours before enumerating culturable bacteria by counting colonies on the inoculated media.

### **Ozone Treatment (Phase II)**

Prior to ozone treatment, 1.00-L volumes of synthetic seawater and freshwater were filter sterilized and amended with bacteria or spores to achieve a final concentration of  $10^4$  cells/mL. Fifty (50.0) mL of these bacterial suspensions were placed into sterile, 500-mL graduated glass cylinders using a sterile pipet, and ozonated for the required time to achieve the target ozone dose or Total Residual Oxidant (TRO) level. The graduated cylinder reduced the water volume

necessary to submerge the air stone diffuser and allowed for a tall water column, which increased ozone absorption efficiency. After treatment, a 10-mL aliquot of ozonated water was transferred from the graduated cylinder into a screw-cap test tube and held in the dark at room temperature for 24 hours. Control samples (also 10 mL) were taken from the original 1.00-L volume of the bacteria-amended water, and held in the dark at room temperature for 24 hours. Viable bacteria remaining in both control and treatment test tubes after 24 hours were plated on agar media. Viable organisms were reported as CFUs.

## **Deoxygenation Treatment (Phase II)**

The deoxygenation treatment was generally performed as described in “Common Methods”. Specifically for bacteria, 5.0-mL samples containing  $10^4$  bacterial cells or spores/mL of a given species were placed in 50 mm sterile plastic petri dishes. The combination of the small sample volume and its placement in a petri dish yielded a large surface area for the sample, reducing the time required to achieve anoxic conditions. Petri dishes were placed inside a BD BBL GasPak<sup>®</sup> Jar and held for 48 hours in the dark at room temperature. The 5.0 mL control samples containing  $10^4$  bacteria cells/mL also were placed in 50 mm plastic petri dishes and held in the dark, not under anaerobic conditions, at room temperature for 48 hours. After 48 hours, petri dishes were removed from the dark and the GasPak<sup>®</sup> jars. Plates were agitated before removing an aliquot for plating, incubation, and enumeration of culturable bacteria.

## **Heterotrophic Protist Methods**

### **Sources of Organisms**

*Acanthamoeba* sp. was obtained from stocks maintained by the Oceanographic Center (OC) of Nova Southeastern University (NSU). This strain was originally isolated from soil adjacent to Hollywood beach, Florida. *Chilomonas* sp. was purchased from Carolina Biological Supply. *Rhynchomonas* sp. was isolated from mangrove water in the vicinity of the OC of NSU. Axenic *Tetrahymena pyriformis* were purchased from the American Type Culture Collection (ATCC, Maryland, USA) and *Vannella anglica* and *Vanella platypodia* from the Culture Collection of Algae and Protozoa (CCAP, Dunstaffnage, UK). *Uronema* sp. was isolated from a beach in Oregon by A. Hartz.

### **Culture Methods**

The seven heterotrophic protists tested (Figure 5) were cultured and maintained in various media formulations as summarized in Table 2. The freshwater amoebae, *Acanthamoeba* sp. and *Vannella platypodia*, were cultured on non-nutrient agar plates (NNAS) streaked with *E. coli* as a food source. In the case of the acanthamoebae, when food was depleted cyst formation was induced; a typical Petri dish generated ca. 10 million cysts within one week. The freshwater flagellate *Chilomonas* sp. was cultured in amoeba saline (AS) with an added sterile rice grain. Nutrients leaching from the rice stimulated attendant bacteria in the culture to grow and provided prey for this bacterivorous protist. The freshwater ciliate *Tetrahymena pyriformis* was maintained in axenic culture in tubes of proteose peptone yeast (PPY) medium. The marine flagellate

*Rhynchomonas* sp. and the ciliate *Uronema* sp. were cultured in filtered sterile seawater seeded with rice grains (again to stimulate the growth of bacterial prey). The saltwater amoeba *Vannella anglica* was cultured on malt yeast agar plates made with 75% seawater (MY75S). All cultures were incubated at 21°C and subcultured weekly to maintain healthy, exponentially growing stocks. The one exception was *Acanthamoeba* sp., which survived well in encysted form. This amoeba was cultured every three weeks.

NNAS was made by dissolving 15 g non-nutrient agar in 1 L amoeba saline. AS was prepared from five stock solutions: NaCl, 1.20 g/100 mL; CaCl<sub>2</sub>, 0.04 g/100 mL; MgSO<sub>4</sub>, 0.04 g/100 mL; Na<sub>2</sub>HPO<sub>4</sub>, 1.42 g/100 mL; KH<sub>2</sub>PO<sub>4</sub>, 1.36 g/100 mL. Ten (10) mL of each stock solution was added to 950 mL dH<sub>2</sub>O. PPY was made with proteose peptone (20.0 g), yeast extract (2.5 g), and dH<sub>2</sub>O (1 L). MY75S comprised sterile filtered natural seawater (750 mL), dH<sub>2</sub>O (250 mL), malt extract (0.1 g), yeast extract (0.1 g), and bacteriological agar (15.0g).

**Table 3. Growth media used for the routine cultivation of surrogate protists.**

Surrogate	Growth Conditions
1 <i>Acanthamoeba</i> sp. cysts	NNAS agar seeded with <i>E. coli</i>
2 <i>Chilomonas</i> sp.	Amoeba saline enriched with rice grains
3 <i>Rhynchomonas</i> sp.	Filtered sterile seawater enriched with rice grains
4 <i>Tetrahymena pyriformis</i>	PPY
5 <i>Uronema</i> sp.	Filtered sterile seawater enriched with rice grains
6 <i>Vannella anglica</i>	MY75S
7 <i>Vannella platypodia</i>	NNAS agar seeded with <i>E. coli</i>

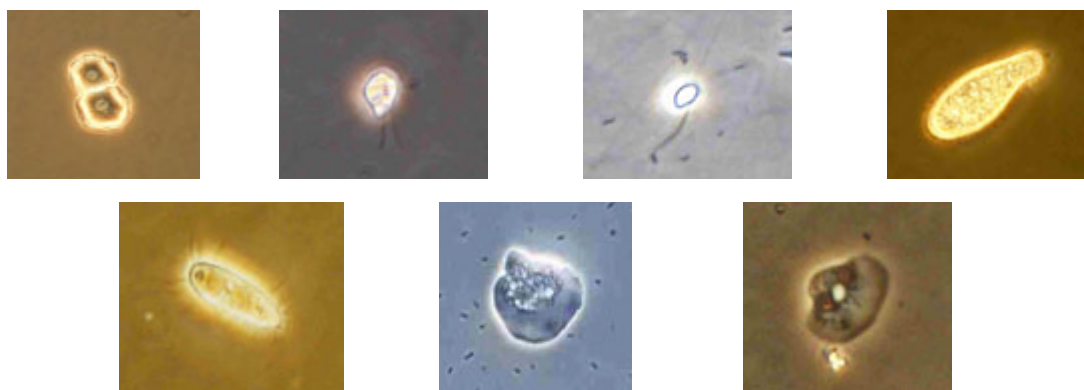

**Figure 5. Photomicrographs of heterotrophic protists used for Phase I testing.** (Top row, left to right: *Acanthamoeba* sp. cysts, freshwater, 15-18 µm; *Chilomonas* sp., freshwater, 13-15 µm; *Rhynchomonas* sp., marine, 4-7 µm; *Tetrahymena pyriformis*, freshwater, 60 µm; Bottom row, left to right: *Uronema* sp., marine, 24 µm; *Vannella anglica*, marine, 21-24 µm; *Vannella platypodia*, freshwater, 16-21 µm. For Phase II testing, only *Acanthamoeba* sp. cysts, *T. pyriformis*, and *Uronema* sp. were used.)

## Thermal Treatment (Phase I)

Six protozoan species plus *Acanthamoeba* sp. cysts were tested against four temperature stressors, 35°, 40°, 45°, and 50° C. Three of the trophic protists were freshwater and the others were marine. The acanthamoebae cysts were from a freshwater source, however these cysts are unaffected by marine conditions and previous work has shown that trophs even replicate in seawater (Booton et al., 2004). In all cases, the treatment time was 8 hours at the experimental temperature. Each experimental run was tested in quadruplicate. The organisms were transferred to a sterile tube (16 mL) with either 10 mL artificial seawater (Instant Ocean<sup>®</sup>, Aquarium Systems, Mentor, OH), in the case of the marine protists, or 10 ml WC medium (Table 3). To concentrate organisms, cells were either washed off agar plates into the respective medium or rinsed from the base of Petri dishes after pouring off excess medium. *Tetrahymena pyriformis* were maintained in axenic PPY medium. Prior to experimentation, cells were pipetted into amoeba saline and centrifuged three times (3 min at 3000 rpm) to concentrate and wash cells free of this organically rich medium. *Acanthamoeba* sp. cysts were tested in both artificial seawater (SW *Acanthamoeba*) and WC medium (FW *Acanthamoeba*). In all cases, densities of cells in the experimental tubes was sufficient to allow reliable enumeration but not so excessive as to promote interference between cells. The tubes were immersed in a water bath to maintain the correct incubation temperature (+/- 0.1°C). After the 8 hours incubation, the number of viable organisms was determined using an MPN method (see “Common Methods” above and next paragraph as well). For each experimental run, a control set of 4 tubes was set up to ensure that cells remained viable over the experimental period. The controls were kept with the minimum of bacteria (to limit cell replication) in either artificial seawater or WC medium. Incubation was at 21° C, a temperature chosen to optimize the survival of the protozoa.

**Table 3. Preparation of inorganic medium WC.**

1. Prepare 7 Stock Solutions:
  - a. NaNO<sub>3</sub>: 85.01 g/L
  - b. CaCl<sub>2</sub>· 2H<sub>2</sub>O: 36.76 g/L
  - c. K<sub>2</sub>HPO<sub>4</sub>: 8.71 g/L
  - d. MgSO<sub>4</sub>· 7H<sub>2</sub>O 36.97 g/L
  - e. Na<sub>2</sub>O<sub>3</sub>Si· 9H<sub>2</sub>O 14.21 g/L
  - f. NaHCO<sub>3</sub> 12.6 g/L
  - g. Trace Metal Mix
 

MnCl <sub>2</sub> · 4H <sub>2</sub> O	0.18 g/L
ZnSO <sub>4</sub> · 7H <sub>2</sub> O	0.022 g/L
(NH <sub>4</sub> ) <sub>6</sub> Mo <sub>7</sub> O <sub>24</sub> · 4 H <sub>2</sub> O	0.0046 g/L
CoCl <sub>2</sub> · 6H <sub>2</sub> O	0.012 g/L
CvSO <sub>4</sub> · 5H <sub>2</sub> O	0.01 g/L
H <sub>3</sub> BO <sub>3</sub>	0.006 g/L
2. Add 1 mL of each of the 7 stock solutions to 993 mL diH<sub>2</sub>O



The most probable number (MPN) counting method was used to count the number of protozoa after treatment (in the experimental tubes and the control tubes). For each tube, medium was pipetted into a set of MPN tubes containing either amoeba saline or filtered, sterilized seawater (depending on whether the cells were freshwater or marine). The inoculum volume added to each MPN tube differed by a factor of 10. One set of MPN tubes were inoculated with 10 mL of water, 1 mL of water, 0.1 mL of water and 0.01 mL of water. A separate MPN series was set up for each of the 4 replicate experimental or control tubes. The MPN tubes were sub-sampled after briefly vortexing (5 sec) to ensure thorough mixing of cells. Nine replicate aliquots of each tube (20 µl) were added to 1 ml of amoeba saline (or sterile filtered seawater, as appropriate) held in nine wells of a 24 well tissue culture plate and incubated at 21°C. To promote excystment and growth of surviving cysts, nutrients were added to stimulate bacterial prey. Two 2 µL Bacto Casitone medium (Difco) was added to each well. After 1, 3, and 5 days, wells were examined by inverted microscopy to detect the presence or absence of a population of growing protozoa.

The number of positive scores were entered into a Most Probable Number (MPN) program (Blodgett, 2003) to determine the number of organisms per ml. Percent survival was calculated by comparing the MPN from the treated samples with the MPN of the control after incubation. Statistical analyses were performed on the MPN data using single-factor ANOVA and the Tukey-Kramer procedure for determining difference in mean. Data was analyzed using the PHStat2 add-in for Microsoft Excel (Version 10, Prentice Hall, 2001).

### **Chlorine (sodium hypochlorite) Treatment (Phase I)**

Household bleach was added to either amoeba saline or sterile artificial seawater to generate the four experimental concentrations of sodium hypochlorite. The organisms were transferred to a sterile tube (16 mL) containing either 10 mL artificial seawater, in the case of the marine protists, or 10 mL WC medium for freshwater protists. After 24 hours at room temperature, the number of surviving organisms was determined using the MPN method.

### **Glutaraldehyde Treatment (Phase I)**

As described in “Common Methods”. After 24 hours of treatment, the viability of the organisms was determined using the MPN method.

### **Chlorine Dioxide (Ecochlor™) Treatment (Phase II)**

Three heterotrophic protists (*Acanthamoeba* sp. cysts, *Tetrahymena pyriformis*, and *Uronema* sp.) were selected for Phase II testing based on the results of the Phase I tests. These three species were easy to culture in large numbers, were robust during harvesting, and grew out rapidly in the MPN counting protocols. Moreover, they were easy to observe under the microscope when scoring positive or negative growth.

The three species were tested against four concentrations of chlorine dioxide (Ecochlor™). The organisms were transferred to a sterile tube (16 mL) containing either 10 mL artificial seawater 32 ppt (Instant Ocean®, Aquarium Systems, Mentor, OH), in the case of the marine protists, or 10 mL WC medium for freshwater protists.

To concentrate *Acanthamoeba* sp. cysts, cells were harvested off agar plates by scraping the surface with Falcon™ Cell Scrapers. Cysts were decanted into 100 mL of WC medium. *Tetrahymena pyriformis* was maintained in axenic protease peptone and yeast (PPY) medium. Prior to experimentation, cells were pipetted into WC medium and centrifuged three times for three minutes at 3000 rpm to concentrate and wash. *Uronema* sp. was harvested from Petri dishes by washing cells into 100 mL of artificial seawater. In all cases, densities of cells in the experimental tubes was sufficient to allow reliable enumeration but not so excessive to promote interference between cells.

After 24 hours incubation, the number of viable organisms was determined using the MPN method described above. For each experimental run, a control set of 4 tubes was set up to ensure that cells remained viable over the experimental period. Like the experimental runs, the controls were kept with the minimum of bacteria (to limit cell replication) in either artificial seawater or WC medium. Incubation was 24 hours at 21°C, a temperature chosen to optimize the survival of the protozoa.

The enrichment of surviving cells was similar to protocols used in Phase I with a few minor modifications. For the ciliates *Tetrahymena pyriformis* and *Uronema* sp., 20 µL aliquots were inoculated into nine wells of a 24 well tissue culture plate containing 1 ml of appropriate media enriched with the prey bacterium *E. coli*. Plates were incubated at 21°C for 7 days. *Acanthamoeba* sp. cysts were inoculated (20 µL aliquots) onto non-nutrient agar plates (NNAS) streaked with *E. coli* prey. After 7 days, agar plates were examined by dissecting microscopy with transmitted light to detect the presence or absence of a population of growing amoebae. The number of positive scores were entered into a Most Probable Number (MPN) program (Blodgett, 2003) and percent survival was calculated by comparing the MPN from the treated samples with the MPN of the controls after incubation.

### **PeraClean® Ocean Treatment (Phase II)**

As described in “Common Methods”. PeraClean® Ocean volumes were added to either WC or sterile artificial seawater to generate four experimental concentrations. The organisms were transferred to sterile tubes (16 mL), each containing 10 mL of the experimental (or control) media. After 24 hours the number of surviving organisms was determined using the MPN method.

### **Hydrogen Peroxide Treatment (Phase II)**

As described in “Common Methods”. After 24 hours of treatment, the viability of the organisms was determined using the MPN method.

### **Ultraviolet Light Treatment (Phase II)**

The test organisms were transferred into sterile 60x15 mm polystyrene Petri dishes along with 10 mL of appropriate media. The dish was positioned 1 cm beneath the end of the collimator box and dosages were delivered as indicated in “Common Methods”. After exposure, medium and

organisms were transferred to sterile 16 mL glass tubes for 24 hours incubation at room temperature, after which viability of the organisms was determined using the MPN method.

### **Ozone Treatment (Phase II)**

Generally as described in “Common Methods.” The test organisms contained in 500 mL of appropriate medium were placed in 500 mL glass media bottles. Holes were drilled in bottle lids to accommodate tubing leading to an airstone that was used to deliver the ozone. Ozone was injected into marine media for 9, 18, 35, and 90 secs to generate four experimental concentrations of ozone (0.25, 0.50, 1.0, and 2.0 mg Br<sub>2</sub>/L). Since ozone reaction chemistry differs in freshwater and seawater (see “Common Methods”), only three experimental concentrations could be achieved in the case of the freshwater treatments. Here, ozone was injected into WC media for 4, 8, and 16 minutes to generate the different experimental concentrations of ozone (0.25, 0.50, and 1.0 mg Br<sub>2</sub>/L).

After treatment exposure, suspensions were transferred to sterile 16 mL glass tubes for 24 hours incubation at room temperature. Each treatment, including controls, was replicated 4 times. After 24 hours of treatment, the viability of the organisms was determined using the MPN method.

### **Deoxygenation Treatment (Phase II)**

Generally as described in “Common Methods.” Test organisms were transferred to sterile 100 × 15 mm polystyrene Petri dishes along with 10 mL of appropriate media and dishes were placed in the GasPak® chamber. Each treatment, including controls, was replicated 4 times. After 24 hours of treatment, the viability of the organisms was determined using the MPN method.

## **Phytoplankton Methods**

### **Phase I**

Phase I experiments testing the impact of hypochlorite, glutaraldehyde, and thermal stressors were conducted on eight phytoplankton species of which five were marine forms [*Chlorella* sp. (CCMP256), *Chaetoceros affinis* (CCMP158), *Skeletonema costatum* (CCMP780), *Scrippsiella trochoidea* (CCMP1599), *Scrippsiella lachrymosa* (both vegetative and cyst forms, clone: B10-1)] and four were freshwater forms [*Prymnesium parvum* (CMS204), *Microcystis aeruginosa* (UTEX B 2672) and *Fragilaria crotensis* (UTCC269)]. The marine species were cultured in modified f/2 medium with or without silicate (Guillard and Ryther 1962), where Na<sub>2</sub>SeO<sub>3</sub> has been added to a final concentration of 10<sup>-8</sup> M and the concentration of CuSO<sub>4</sub>·5H<sub>2</sub>O has been reduced to the same level. For culture upkeep, the medium was prepared in autoclaved, 0.2 μm filtered natural seawater. The freshwater species were grown in WC medium (Guillard, 1975) made with Milli-Q water. All cultures were maintained at 20°C on a 14:10h light: dark cycle (ca. 200 μmol photons·m<sup>-2</sup>·sec<sup>-1</sup> irradiance provided by cool white fluorescent bulbs). All marine culture experiments were conducted in f/2 medium made with sterile filtered Instant Ocean® water adjusted to a salinity of 32 as the base.

Sterile, disposable polystyrene tubes (17 × 100 mm) filled with 7 mL of mid-exponential growth phase culture were used for all experiments except for the UV light and deoxygenation trials, for which sterile, polystyrene Petri dishes (50 × 11 mm) containing 5 mL of culture were used.

The thermal trial tubes were supported on floating racks and incubated in separate water baths adjusted to the criterion temperatures. After 8 hours, the cultures were transferred to room temperature and individually pipetted into 96 well tissue culture plates for most probable number (MPN) determinations. Phytoplankton species were exposed to the other Phase I treatments, glutaraldehyde and hypochlorite, for 24 hours at room temperature, then pipetted into culture plates preparatory to MPN determinations.

For MPN estimates, each well of the tissue culture plate was filled with 270 µL of f/2 medium, with the exception of wells in row H, which were loaded with 300 µL of treatment culture (6 replicate wells per replicate treatment tube). 30 µL of the culture from row H wells were then serially diluted into the wells above using a 12 position multi-channel pipette so that a final dilution series ranging from 10<sup>-0</sup> to 10<sup>-7</sup> was achieved. The plates were sealed with tape around the perimeter to minimize evaporative loss, incubated at 20°C and monitored after 21 days with an inverted microscope at 100× to determine cell viability. A gridded tally sheet was scored with the results and the data were entered into a most probable number calculator Excel spreadsheet (Dr. R. Blodgett, Division of Mathematics, FDA/CFSAN) to derive the MPN for the experiment.

## Phase II

Based on the results of the Phase I trials, 3 species, *S. lachrymosa* cysts (B10-1), *Chaetoceros affinis* (CCMP158), and *Chlorella* sp. (CCMP256) were advanced for Phase II testing. Experiments with chlorine dioxide (Ecochlor™), hydrogen peroxide, and Peraclean® Ocean were conducted in the same manner described for the glutaraldehyde and hypochlorite Phase I trials.

For the UV light exposures, 5 mL of culture was loaded into a 50 mm diameter polystyrene Petri dish and exposed, uncovered, to the collimator UV light. Samples were then transferred into disposable 15 mL centrifuge tubes so that the samples could be mixed well prior to MPN dilutions.

For the deoxygenation treatment, 5 mL samples were pipetted into Petri dishes, which were placed on a perforated plastic support within a glass desiccator. Four desiccators in total were used – 1 each for the 12, 24, 48, and 72 hour incubations. Two BD BBL™ GasPak sachets, clipped onto the support in an upright position, were then activated within each desiccator per the manufacturer's protocol. The desiccators were covered with the airtight lid and were closely monitored until duplicate indicator strips revealed that anaerobic conditions were achieved. This event marked the “time 0” for the experiments. At the termination of the incubation time, the indicator strips were again checked to ensure that anaerobic conditions had persisted through the course of the incubation. The Petri dish culture contents were then transferred into disposable 15 mL centrifuge tubes as above for MPN dilutions.

## **Zooplankton Methods**

### **Species Selection**

We obtained and isolated representative species from the list of organisms provided by the ETV Technical Panel and suggested in the “Request for Proposals” (Table 4). This list was developed with the understanding that in some cases, species might not be obtainable and the final list would substitute equivalent taxa more readily available in the Pacific Northwest. For example, the European harpacticoid copepod species, *Tisbe battagliai*, was replaced with a common and abundant *Tisbe* species of the Pacific Northwest, *Tisbe* cf. *furcata*.

After collecting or purchasing the organisms, cultures were established using a standardized protocol based on EPA recommendations and refined to accommodate the large number of organisms being screened. Many of the suggested organisms were not easy to obtain or to culture to the numbers required for bench-top testing, so the list was augmented with organisms either easily obtained from the field in the Pacific Northwest region or ordered from a reputable provider of live organisms (Table 5a,b). We verified species identifications of all purchased species. In the course of the project, we screened 35 species distributed among 12 major taxa as potential surrogate species: copepods (17 species); cladocerans (7); rotifers (4); amphipod (1); barnacle (1); isopod (1); branchiopod (1); annelid (1); abalone (1); and insect (1).

Three criteria were used in the Phase I testing to reduce the list of surrogates for Phase II tests: performance in the preliminary trials; ability to culture the organisms to high enough densities for future full-scale testing in experimental ballast water tanks; and ability to determine the efficacy of the treatments, i.e., the organisms’ viability, using a microscope. Application of these three criteria allowed us to narrow the list of potential surrogates to four marine and three freshwater zooplankton species representing three marine classes (one branchiopod, two copepods, and one annelid) and three freshwater classes (one cladoceran, one copepod, and one ostracod) (Table 6). These seven species were used in the Phase II trials.

**Table 4. Potential surrogate zooplankton species identified by the ETV program and related studies.**

Fresh Water	Marine Water
<i>Daphnia pulex</i> (resting)	<i>Acartia hudsonica</i> (warm – resting)
<i>Daphnia magna</i>	<i>Acartia tonsa</i> (cold – resting)
<i>Brachionus calyciflorus</i> (resting)	<i>Brachionus calyciflorus</i> (adult)
<i>Culex</i> (insect larvae)	<i>Tisbe battagliai</i> (adult)
<i>Diaptomus pallidus</i> (adult)	<i>Nitokra lacustris</i>
<i>Ceriodaphnia lacustris</i> (adult)	<i>Artemia</i>
	Mussel larvae

**Table 5a. Potential surrogate zooplankton species ordered from commercial sources or provided by other researchers.**

<b>Organism and Type</b>	<b>Acquisition Procedure</b>	<b>Experimental Status</b>
<b>Harpacticoid copepods</b>		
<i>Tisbe</i> sp. cf. <i>furcata</i> (CA)	Essential Live Feeds, WA	Phase I
<i>Nitokra lacustris</i>	Essential Live Feeds, WA	Phase I & II
<b>Calanoid copepods</b>		
<i>Acartia tonsa</i>	Algagen, LLC, in Vero Beach, FL	Phase I
<b>Cyclopoid copepods</b>		
<i>Acanthocyclops robustus</i>	Carolina Biological Supply, NC	Phase I
<i>Macrocyclops albidus</i>	Essential Live Feeds, WA	Phase I & II
<b>Cladocerans</b>		
<i>Daphnia pulex</i>	Carolina Biological Supply, NC	Phase I
<i>Daphnia magna</i>	Frieda Taub's Lab, UW	Phase I
<i>Ceriodaphnia dubia</i>	Carolina Biological Supply, NC	Phase I
<i>Chydorus sphaericus</i> *	Carolina Biological Supply, NC	Phase I & II
<i>Moina</i> sp.	Florida Aquafarms, FL	Rejected for experimentation; very low densities in culture.
<b>Mollusks</b>		
<i>Red Abalone</i>	Carolyn Friedman's Lab, UW	Phase I
<b>Rotifers</b>		
<i>Brachionus plicatilis</i>	Carolina Biological Supply, NC	Phase I
<i>Brachionus calyciflorus</i>	Florida Aquafarms, FL	Phase I
<i>Philodina citrine</i>	Carolina Biological Supply, NC	Rejected for experimentation because it is not easy to filter intact for observation.
<i>Lecane monostyla</i>	Carolina Biological Supply, NC	Rejected for experimentation because it is not easy to filter intact for observation.
<b>Branchiopods</b>		
<i>Artemia salina</i>	Brine Shrimp Direct	Phase I & II
<b>Ostracods</b>		
Ostracod sp.*	Carolina Biological Supply, NC	Phase I & II
<b>Annelids</b>		
<i>Nereis virens</i>	Sea Bait Ltd., Maine	Phase I & II
<b>Mosquito larvae</b>		
<i>Culex</i> sp.	Florida Aquafarms, FL	Phase I

\*While these organisms were started from cultures from Carolina Biological Supply, these were not the organisms ordered. They were contaminants in with the *D. pulex*.

**Table 5b. Potential surrogate zooplankton species collected by the University of Washington ballast water team.**

<b>Organism and Type</b>	<b>Acquisition Procedure</b>	<b>Experimental Status</b>
<b>Harpacticoid copepods</b>		
<i>Tigriopus californicus</i>	Deception Pass State Park, WA. April, 2005	Phase I & II
<i>Tisbe</i> sp. Washington	Field sampling at NOAA Fisheries Manchester Research Station, WA. April, 2005	Rejected for experimentation because needs to be kept at 10 degrees C.
<i>Harpacticus uniremis</i>	NOAA Fisheries Manchester Research Station, WA. April, 2005	Rejected for experimentation due to length of life cycle and univoltine reproduction limit the culture of this species throughout the year
<i>Mesochra</i> sp.	Jakle's Lagoon, San Juan Island, June, 2005	Rejected for experimentation due to low densities in culture, and because three harpacticoid copepods were already available for testing.
<b>Calanoid copepods</b>		
<i>Eurytemora affinis</i>	Columbia River sampling. April, 2005	Rejected for experimentation due to extremely low densities in culture.
<i>Eurytemora americana</i>	Jakle's Lagoon on San Juan Island, June, 2005	Phase I
<i>Calanus pacificus</i>	NOAA Fisheries Manchester Research Station, WA. April, 2005	Rejected for experimentation because it Could not be kept alive on the variety of diets available
<i>Acartia hudsonica</i>	Jakle's Lagoon on San Juan Island, June, 2005	Rejected for experimentation due to extremely low densities in culture.
<i>Diaptomus nevadensis</i>	Soap Lake, WA. August, 2005.	Rejected for experimentation because it Could not be kept alive on the variety of diets available
<i>Diaptomus</i> sp.	Collected from Lake Washington, October 2005	Phase I
<b>Cyclopoid copepods</b>		
<i>Corycaeus anglicus</i>	NOAA Fisheries Manchester Research Station, WA. April, 2005	Rejected for experimentation because it did not adapt easily to the laboratory conditions
<b>Cladoceran</b>		
<i>Bosmina longirostris</i>	Lake Washington sampling, October, 2005	Phase I
<i>Daphnia villosa</i>	Soap Lake, WA, August 2005	Rejected for experimentation because it could not be kept acclimated to full strength salinity or freshwater.
<b>Cirripedia</b>		
Cirripedia larvae	Columbia River sampling. April, 2005	Rejected because it is not easy to culture nor is it available commercially

Organism and Type	Acquisition Procedure	Experimental Status
<b>Amphipods</b>		
<i>Eogammarus confervicolus</i>	Duwamish River Estuary, WA. April, 2005	Rejected for experimentation due to extremely low densities in culture.
<b>Isopods</b>		
<i>Gnorimosphaeroma</i> sp.	Duwamish River Estuary, WA. April, 2005	Rejected for experimentation due to extremely low densities in culture.

**Table 6. Zooplankton species used in Phase II treatments.**

Fresh Water	Marine Water
<i>Macrocyclops albidus</i> (copepod) <i>Chydorus sphaericus</i> (cladocerans) ostracod sp.	<i>Artemia salina</i> (branchiopod) <i>Tigriopus californicus</i> (copepod) <i>Nitokra lacustris</i> (copepod) <i>Nereis virens</i> (annelid)

### Culture Conditions

Organisms were acclimated to standard laboratory conditions by placing them in an incubator held at 20°C with a 12 hours light-12 hours dark photoperiod. Depending on the densities achievable, organisms were kept either in 1 L of media in a half-gallon glass jar, or in a 150 mL vented tissue culture flask. For regular maintenance, animals were screened and placed in fresh culture media biweekly. (Twenty-four hours before experiments, animals were placed in fresh media and allowed to evacuate their guts.) All cultures were kept in batch conditions, meaning that no aeration was provided and all animals were manually filtered when the culture media was changed.

Marine organisms were fed a combination of the live algae *Tetraselmis suecica*, freeze-dried phytoplankton (Phytoplankton™, Two Little Fishies, FL), and powdered fish food (Boyd's Vita-diet, Boyd Enterprises, FL) on a weekly basis. Freshwater animals were provided with the live alga *Scenedesmus* sp., freeze-dried phytoplankton (Phytoplankton™, Two Little Fishies, FL), and powdered fish food (Boyd's Vita-diet, Boyd Enterprises, FL) on the same schedule. The same media was used for the experiments and the maintenance conditions, with the exception two commercial products added to the freshwater maintenance media: Kent Marine R/O Right powdered formula (a mixture of major salts of sodium, magnesium, calcium, and potassium; Kent Marine, WI) and Kent Freshwater Essential liquid (a mixture of essential trace minerals to reproduce natural freshwater; Kent Marine, WI). Organisms were held up to one year using these techniques.

### Experimental Conditions and Methods

The experiments for zooplankton differed from those for phytoplankton, where the dilution media required the presence of nutrients to determine whether the organisms were affected by the treatments and not starvation. An elevated level of nutrients was not required to keep the



animals alive in the zooplankton trials. The seawater comprised filter-sterilized artificial seawater (Instant Ocean®) without nutrient supplementation. Salts were dissolved in glass fiber-filtered reverse osmosis water to a salinity of 30.

For freshwater organisms, the test medium consisted of filter-sterilized (glass fiber-filtered) reverse osmosis water with a testing medium based on the EPA's recommended aquatic toxicology testing dilution protocols for freshwater organisms. Depending on the sensitivity of the organisms, one of two EPA protocols was utilized to prepare the dilution water for testing (see <http://www.epa.gov/waterscience/WET/disk2/>). In the toxicity-test methods, synthetic water is referred to as diluted mineral water (DMW).

Whether seawater or fresh, the pH of test water was adjusted to match the culture conditions of the organism to be tested. Water was used within 7 days of preparation.

Freshwater and marine experiments were conducted at room temperature in containers of volumes appropriate to the size of the organisms being tested. Except for the thermal treatments, which were terminated directly after 4 hours of exposure to the target temperature, and the deoxygenation treatments, which were terminated after 48 hours in the degassing units, percent survivals were determined after 24 hours in the dark. Biocides were treated as instantaneous stressors, but the time of exposure to the treatment stressors for the ozone and UV treatments varied based on desired exposure levels. Table 7 provides detailed information on the source, concentration, and exposure time.

Because so many zooplankton species were resistant to the levels originally proposed for this project, many of them were tested at higher levels or concentrations to provide a basis for comparison with the performance of other zooplankton.

Phase I testing identified the seven most promising organisms among the different classes to be tested (Table 7). Only the organisms listed in Table 6 were carried forward into Phase II testing.

**Table 7. Zooplankton treatments (proposed and realized) and experimental conditions.**

Treatment stressor	Vendor or source	Concentration or Intensity	Test volume	Actual Conditions and Exposure Times
Thermal treatment	Water bath	35°, 40°, 45°, 50°C	150 mL or 1 L	35°, 40°, 45° for 4 hours
Chlorine (sodium hypochlorite)	Chlorox bleach	Aqueous solution of sodium hypochlorite. Final concs. of 0.25, 0.5, 1.0, 2.0 mg/L	150 mL or 1 L	Final conc. of 1, 2, 4, 8 mg/L for 24 hours
Chlorine dioxide (Ecochlor™)	Ecochlor, Inc.	Final concs. of 1, 2, 4, 6 ppm	150 mL	Final conc. of 1, 2, 4, 8 and 16 ppm for 24 hours
Glutaraldehyde	Fisher Scientific	Final concs. of 50, 100, 500 and 1000 mg/L	150 mL	Final conc. of 50, 100, 200, 400, 800, 1200 and 1600 mg/L for 24 hours
UV light	UV collimator designed and built by Dr. E. “Chip” Blatchley, Purdue Univ.	UV light (256 nm) at 10, 25, 50, 100 mJ/cm <sup>2</sup>	50 mL	Final exposures of 50, 100, 200, and 400 mJ/cm <sup>2</sup> – dose depends on exposure time
Ozone	<b>Aquatic Eco-Systems, UV-type, 2.4 g with air. Connected to tubing and an air stone.</b>	Total initial residual oxidant (TRO) level of 0.25, 0.5, 1.0, and 2.0 mg Br <sub>2</sub> /L	0.5 L	Final exposure of 0.5 and 1 mg Br L <sup>-1</sup> for FW and 1, 2, 4, and 8 mg Br L <sup>-1</sup> residual oxidant level for Marine for 24 hours after achieving initial level of TRO
Hydrogen peroxide	Fisher Scientific	Final concs. Of 0.5, 1, 10, and 20 ppm	150 mL	Final conc. of 10, 20, 40, 80, 160, and 320 ppm for 24 hours after achieving initial concentration
Deoxygenation	<b>Sparge with N<sub>2</sub> (95%) and CO<sub>2</sub> (5%) mixture, at levels to reduce pH to 5.5, then seal container.</b>	Anoxia (0 mg/L oxygen)	50 mL	48 hours after achieving anoxia
SeaKleen®	Vitamar, Inc.	0.25, 0.5, 1.0, 2.0 mg/L active ingredient	150 mL	Final conc. of 1, 2, 4, 8, and 16 mg/L for 24 hours
PeraClean® Ocean	Degussa AG	Final concs. of 50, 100, 200, and 400 ppm	150 mL	Final concs. of 50, 100, 200, and 400 ppm

Note: Entries in **bold** indicate alterations from the originally proposed protocol (see Table 2 of this report).

## **Thermal Treatment (Phase I)**

For zooplankton, only three temperatures were tested, 35°, 40°, and 45°C. Regardless of organism and volume of culture container (150 mL of medium in 200 mL beakers or 1 L of medium in half-gallon glass jars), the test container was filled either with artificial seawater or freshwater medium and the test organisms were screened and added. After 4 hours of treatment in the dark, the viability of organisms was immediately assessed. Controls were incubated simultaneously at room temperature in the dark.

In the case of 1 L treatments, animals were recollected by passing the test medium twice through a 20µm Nitex filter screen. As this method proved to be inefficient in recollecting soft-bodied organisms such as rotifers or animals which disintegrated due to the treatment, we switched to 150 mL treatments in 200 mL beakers, which enabled us to count organisms without having to recollect them on a filter screen. Animals were placed in a counting wheel and examined under at least 10x magnification to determine survival (indicated by motion) or mortality (lack of movement after a few seconds of observation or prodding with a wire pointer).

## **Biocide Treatments (Phase I and II)**

Biocide (sodium hypochlorite, glutaraldehyde, chlorine dioxide (Ecochlor™), SeaKleen®, PeraClean® Ocean, hydrogen peroxide) experiments with zooplankton were conducted in microcosms of non-reactive materials, incubated at natural ambient temperatures in the dark for 24 hours. At least 20 animals were placed in the microcosms and tested at various doses of the treatments with a no-treatment control. Since variability was low in biocide treatments, three replicates at each dosage level were adequate for comparison. Experimental controls consisted of organisms held either in artificial seawater or freshwater medium for 24 hours in the dark. All treatments were analyzed for survival and mortality after 24 hours.

When the originally proposed doses of biocides were not sufficient to kill more than 50% of treatment organisms, dosages were increased until 50% mortality (or more) was obtained or until the dose of biocide reached more than 100 times the maximum dose originally proposed. Details about individual biocides follow.

### **Chlorine (sodium hypochlorite)**

As described in “Common Methods”. At the start of the experiment and after 24 h, the level of total residual oxidant (TRO) was measured using a Hach Kit 2010.

### **Glutaraldehyde**

As described in “Common Methods”, except that organisms were exposed to a wider range of glutaraldehyde concentrations: 50, 100, 200, 400, 800, 1200 and 1600 mg/L (Table 7).

### **Chlorine dioxide (Ecochlor™)**

As described in “Common Methods”, except that organisms were exposed to a wider range of chlorine dioxide concentrations: 1, 2, 4, 8, and 16 ppm (Table 7).

### **SeaKleen®**

An organic biocide, SeaKleen® is available in several formulations and concentrations from the manufacturer. We examined the sensitivity of prospective surrogate organisms to a wetttable powder that contains 85% active ingredient. Fresh stock solutions were prepared from the powder before each series of trials. SeaKleen® was tested at 1, 2, 4, 8, and 16 mg/L of the active ingredient (Table 7).

### **PeraClean® Ocean**

As described in “Common Methods”.

### **Hydrogen peroxide**

As described in “Common Methods”, except that organisms were exposed to a wider range of hydrogen peroxide concentrations: 10, 20, 40, 80, 160, and 320 ppm (Table 7).

### **Ultraviolet Light Treatment (Phase II)**

Generally as described in “Common Methods”, except that organisms were exposed to a greater range of exposures: 50, 100, 200, and 400 mJ/cm<sup>2</sup> (Table 7). A small polystyrene petri dish (60 × 15 mm, Falcon) containing the test organisms and less than 0.5 cm of medium was placed beneath the collimator light beam. We determined there was no significant production of heat generated by the lamp. Organisms were generally checked for mortality only once, 24 hours after exposure. When no mortality was observed, we occasionally held onto samples for further analysis at 48 and 72 hours. Four replicates were conducted for each combination of treatment level and species.

### **Ozone Treatment (Phase II)**

Generally as described in “Common Methods”. To expose zooplankton to ozone, we placed them in one half liter of media, placed the air stone in the media, and let the generator run for the predetermined periods. In the case of the marine treatments, times were adjusted if exposure level was less than anticipated. We were not able to do this for the freshwater experiments. A lid through which the ozone delivery hose was fitted was placed on freshwater containers to ensure maximum contact between the organisms and ozone for each 24 hour experiment. After treatment, we replaced the hose-fitted lid with a sealed lid. All treatment jars were placed in the dark for 24 hours before analyzing organism survival.

## **Deoxygenation Treatment (Phase II)**

Generally as described in “Common Methods”, except that only a 48 hours treatment was run. At least 20 organisms from each taxon being tested were placed in a small polystyrene petri dish (60 × 15 mm, Falcon), and the dish itself was placed inside the BD BBL GasPak® Jar System.

**Appendix C: Design and Preliminary Use of a Commercial Filter  
Skid to Capture Organisms  $\geq 50 \mu\text{m}$  in Minimum Dimension  
(Nominally Zooplankton) for Evaluating Ships' Ballast Water  
Management Systems at Land-based Test Facilities**

**REPORT DOCUMENTATION PAGE**

*Form Approved  
OMB No. 0704-0188*

The public reporting burden for this collection of information is estimated to average 1 hour per response, including the time for reviewing instructions, searching existing data sources, gathering and maintaining the data needed, and completing and reviewing the collection of information. Send comments regarding this burden estimate or any other aspect of this collection of information, including suggestions for reducing the burden, to Department of Defense, Washington Headquarters Services, Directorate for Information Operations and Reports (0704-0188), 1215 Jefferson Davis Highway, Suite 1204, Arlington, VA 22202-4302. Respondents should be aware that notwithstanding any other provision of law, no person shall be subject to any penalty for failing to comply with a collection of information if it does not display a currently valid OMB control number.

**PLEASE DO NOT RETURN YOUR FORM TO THE ABOVE ADDRESS.**

<b>1. REPORT DATE (DD-MM-YYYY)</b> 22-06-2010	<b>2. REPORT TYPE</b> NRL Letter Report	<b>3. DATES COVERED (From - To)</b> March 2009-April 2010
--------------------------------------------------	--------------------------------------------	--------------------------------------------------------------

<b>4. TITLE AND SUBTITLE</b> Design and Preliminary Use of a Commercial Filter Skid to Capture Organisms ≥ 50 µm in Minimum Dimension (Nominally Zooplankton) for Evaluating Ships' Ballast Water Management Systems at Land-Based Test Facilities	<b>5a. CONTRACT NUMBER</b>
	<b>5b. GRANT NUMBER</b>
	<b>5c. PROGRAM ELEMENT NUMBER</b>

<b>6. AUTHOR(S)</b> Edward J. Lemieux, Code 6130, NRL, DC, Lisa A. Drake, SAIC, Key West, FL, Stephanie H. Robbins, SAIC, Key West, FL, Mia K. Steinberg, Code 6130, NRL, DC, Scott C. Riley, SAIC, Key West, FL, Elizabeth C. Schrack, University of Virginia, Charlottesville, VA, Wayne B. Hyland, Azimuth Technical Consultants, Key West, FL, Jonathan F. Grant, Battenkill Technologies, Inc., Manchester Center, VT, Cameron S. Moser, EXCET, Inc., Key West, FL, Tim P. Wier, EXCET, Inc., Seattle, WA	<b>5d. PROJECT NUMBER</b>
	<b>5e. TASK NUMBER</b>
	<b>5f. WORK UNIT NUMBER</b>

<b>7. PERFORMING ORGANIZATION NAME(S) AND ADDRESS(ES)</b> US Naval Research Laboratory 4555 Overlook Ave., SW Washington, DC 20375	<b>8. PERFORMING ORGANIZATION REPORT NUMBER</b> 6130/1029
---------------------------------------------------------------------------------------------------------------------------------------------	--------------------------------------------------------------

<b>9. SPONSORING/MONITORING AGENCY NAME(S) AND ADDRESS(ES)</b> United States Coast Guard Environmental Standards Division (CG-5224) 2100 2nd Street, S.W. Washington, DC 20593	<b>10. SPONSOR/MONITOR'S ACRONYM(S)</b> USCG
	<b>11. SPONSOR/MONITOR'S REPORT NUMBER(S)</b>

**12. DISTRIBUTION/AVAILABILITY STATEMENT**  
Distribution Statement A: Approved for public release, distribution is unlimited.

**13. SUPPLEMENTARY NOTES**

**14. ABSTRACT**  
International and national standards dictating the number of living organisms discharged in ships' ballast water are in the process of being enacted. Developing a method to accurately determine whether how many organisms are present in treated water (e.g., with sparse concentrations of organisms) with statistical confidence requires large volume (e.g., > 10 m<sup>3</sup>) are concentrated and examined. Here, we describe efforts to (1) develop and validate a procedure for retaining organisms > 50 µm in minimum dimension (nominally zooplankton) in large volumes of water used for testing ballast water management systems, (2) design and build the equipment to do so, and (3) validate the equipment. Importantly, zooplankton needed to be kept alive and minimally affected by filtering and handling, since ballast water discharge standards prescribe the number of viable (living) organisms.

**15. SUBJECT TERMS**

<b>16. SECURITY CLASSIFICATION OF:</b>			<b>17. LIMITATION OF ABSTRACT</b> Unclassified	<b>18. NUMBER OF PAGES</b> 46	<b>19a. NAME OF RESPONSIBLE PERSON</b> Edward Lemieux
<b>a. REPORT</b> U	<b>b. ABSTRACT</b> U	<b>c. THIS PAGE</b> U			<b>19b. TELEPHONE NUMBER (Include area code)</b> 202-404-2123



DEPARTMENT OF THE NAVY  
NAVAL RESEARCH LABORATORY  
4555 OVERLOOK AVE SW  
WASHINGTON DC 20375-5320

IN REPLY REFER TO  
3900  
Ser 6130/1029  
22 June 2010

From: Commanding Officer, Naval Research Laboratory  
To: Commandant, United States Coast Guard (CG-3PSO-4, R. Everett)

Subj: DESIGN AND PRELIMINARY USE OF A COMMERCIAL FILTER SKID TO CAPTURE ORGANISMS  $\geq 50 \mu\text{M}$  IN MINIMUM DIMENSION (NOMINALLY ZOOPLANKTON) FOR EVALUATING SHIPS' BALLAST WATER MANAGEMENT SYSTEMS AT LAND-BASED TEST FACILITIES

Encl: (1) Two copies of subject report

1. Enclosure (1), entitled "Design and Preliminary Use of a Commercial Filter Skid to Capture Organisms  $\geq 50 \mu\text{m}$  in Minimum Dimension (Nominally Zooplankton) for Evaluating Ships' Ballast Water Management Systems at Land-Based Test Facilities" describes the design, construction, preliminary trials using a filter skid built of commercially available products to filter ballast water for zooplankton.

2. This work was sponsored by and guidance provided by the United States Coast Guard.

3. The NRL points of contact are Lisa Drake, Code 6136, 305-293-4215, e-mail: lisa.drake.ctr@nrl.navy.mil and Edward Lemieux, Code 6130, 240-475-6918, e-mail: edward.lemieux@nrl.navy.mil.

  
WARREN W. SCHULTZ  
By direction



6130/1029  
21 JUN 2010



**Naval Research Laboratory**  
4555 Overlook Ave, S.W.  
Washington, DC 20375-5320



**Center for Corrosion**

---

---

## **Design and Preliminary Use of a Commercial Filter Skid to Capture Organisms $\geq 50 \mu\text{m}$ in Minimum Dimension (Nominally Zooplankton) for Evaluating Ships' Ballast Water Management Systems at Land-Based Test Facilities**

Edward J. Lemieux, Code 6130, NRL, DC  
Lisa A. Drake, SAIC, Key West, FL  
Stephanie H. Robbins, SAIC, Key West, FL  
Mia K. Steinberg, Code 6130, NRL, DC  
Scott C. Riley, SAIC, Key West, FL  
Elizabeth C. Schrack, University of Virginia, Charlottesville, VA  
Wayne B. Hyland, Azimuth Technical Consultants, Key West, FL  
Jonathan F. Grant, Battenkill Technologies, Inc., Manchester Center, VT  
Cameron S. Moser, EXCET, Inc., Key West, FL  
Tim P. Wier, EXCET, Inc., Seattle, WA

**DISTRIBUTION STATEMENT A. Approved for public release, distribution is unlimited.**

Encl (1) to NRL Ltr  
3900  
6130/1029

## Table of Contents

1	Introduction.....	1
2	Objectives .....	2
3	Experimental Approach .....	2
3.1	Ballast Water Treatment Test Facility (BWTF) Description .....	2
3.2	Microbeads.....	3
3.2.1	Microbead Disintegration .....	4
3.2.2	Method of Microbead Counting.....	4
3.2.3	Intercalibration.....	5
3.3	Filter Bags.....	6
3.3.1	Filter Bags Field Trials—Water Flow Rate .....	7
3.3.2	Filter Bags—Laboratory and Field Validation with Microbeads .....	7
3.3.3	Filter Bags—Seams .....	8
3.3.4	Filter Bags—Toxicity of Sealant on the Seams .....	8
3.4	Filter Skid.....	9
3.4.1	Filter Skid Requirements .....	9
3.4.2	Toxic Effects of Stainless Steel Filter Housings.....	9
3.4.3	Comparison of Zooplankton in the Ballast Tank vs. the Filter Skid .....	10
3.4.4	Effect of Crowding on Ambient Zooplankton .....	11
4	Results.....	11
4.1	Microbeads.....	11
4.1.1	Microbead Disintegration .....	11
4.1.2	Method of Microbead Counting.....	11
4.1.3	Intercalibration.....	12
4.2	Filter Bags.....	12
4.2.1	Filter Bag Field Trials—Water Flow Rate.....	12
4.2.2	Filter Bags—Field and Laboratory Validation Using Microbeads.....	13
4.2.3	Filter Bags—Seams .....	15
4.2.4	Filter Bags—Toxicity of Sealant on the Seams.....	15
4.3	Filter Skid.....	16
4.3.1	Filter Skid Design .....	16
4.3.2	Filtration Area of Filter Skid vs. Plankton Net.....	22
4.3.3	Flow Velocity through the Filter Skid vs. Plankton Net.....	22
4.3.4	Toxic Effects of Stainless Steel Filter Housings.....	24
4.3.5	Comparison of Zooplankton in the Ballast Tank vs. the Filter Skid .....	25
4.3.6	Effect of Crowding on Ambient Zooplankton .....	25
5	Discussion.....	25
6	Acknowledgements.....	26
7	References.....	26
	Appendix 1.....	28
	Appendix 2.....	29
	Appendix 3.....	30
	Appendix 4.....	31
	Appendix 5.....	32
	Appendix 6.....	38
	Appendix 7.....	40

Appendix 8.....	41
Appendix 9.....	41

**Table of Figures**

Figure 1. Two 41 cm long filter bags in Hayward housing arranged in series; water entered the system via the green hose at the top of the left-hand housing. ....	6
Figure 2. Recovery after microbeads were counted using the ‘dry’ and ‘wet’ methods. Orange bars represent dry trials, and blue bars represent wet trials; numbers above bars indicate the percent microbead recovery; letters on the x-axis labels indicate the researcher’s initials. ....	12
Figure 3. Recovery efficiency of microbeads in laboratory trials using 25 µm filter bags (FB). Blue, red, and green bars represent 50 µm, 100 µm, and 150 µm microbeads, respectively. ....	13
Figure 4. Recovery efficiency of microbeads in field trials. Unless noted, filter bags’ mesh was 25 µm. Blue, red, and green bars represent 50 µm, 100 µm, and 150 µm microbeads, respectively. * = a notable amount of green algae was collected in filter bags. ....	14
Figure 5. Recovery efficiency of 50 µm microbeads in laboratory and field trials conducted after improvements were made to the microbead protocol. Numbers in parentheses represent replicates; FB = filter bag. ....	15
Figure 6. Filter skid design for flow-through sampling of discharged ballast water. ....	16
Figure 7. Eaton Topline™ filter housing. ....	17
Figure 8. Nylon monofilament mesh filter bag secured in an Eaton Topline™ filter housing. ..	18
Figure 9. Plan view of the prototype filter skid at NRLKW. Blue arrow shows water entering the filter skid; yellow arrow shows water exiting the skid. ....	18
Figure 10. Yamada NDP-80 Air diaphragm pump as installed. ....	20
Figure 11. Pressure drop of filter skid vs. flow rate (figure from Eaton Filtration, LLC). ....	21
Figure 12. Flow velocity model for water flow through an Eaton Topline™ Filter Housing at 50 gpm, entering though the top of the housing and exiting at the bottom. ....	23
Figure 13. Flow velocity model illustration for water flow through an Eaton Topline™ Filter Housing at 25 gpm, entering though the top of the housing and exiting at the bottom. ....	24

# 1 Introduction

In 2004, the International Maritime Organization adopted the International Convention for the Control and Management of Ships' Ballast Water and Sediments, which establishes standards for ballast water discharge and the performance of ballast water management systems (IMO, 2004). Among the criteria for ballast water discharge is the density of organisms  $\geq 50 \mu\text{m}$  (nominally zooplankton), which is set at  $< 10$  viable organisms  $\text{m}^{-3}$ . This numerical standard, intended to prevent, minimize and ultimately eliminate the risks to the environment, human health, property and resources arising from the transfer of harmful aquatic organisms and pathogens', is also proposed by the US Coast Guard (2009).

Because the probability of finding a living zooplankter in a water sample meeting the proposed discharge standard follows a Poisson distribution (Lemieux et al., 2008b), the key test statistic is the number of organisms counted. With respect to land-based and shipboard testing of ballast water management systems, accurate enumeration of organisms in ballast tanks depends on several factors: the volume of water sampled, the volume of sample analyzed (e.g., the entire sample or a sub-sample), the level of desired precision, and the relevant discharge standard (e.g.,  $< 10$  viable organisms  $\text{m}^{-3}$  or  $< 0.1 \text{ m}^{-3}$ ). Previous work at the Naval Research Laboratory in Key West (NRLKW) has shown for a  $3 \text{ m}^3$  zooplankton sample treated by a ballast water management system and concentrated to a volume of 1 l, only a 20 ml subsample of the concentrate could be evaluated before zooplankton in the subsample died because they were held in artificial conditions in the laboratory (i.e., concentrated and gently aerated in a flask; Lemieux et al., 2008a). If only 20 ml of a concentrated sample can be evaluated, the required sample volume is large. For example, to know with 95% confidence a ballast tank contains  $< 10$  living zooplankters  $\text{m}^{-3}$ , a sample volume of  $60 \text{ m}^3$  would need to be concentrated to 1 l and a 20 ml subsample examined (Lemieux et al., in review). Several factors affect the statistics; if a larger volume of subsample (or the entire concentrated sample) could be analyzed, the sample volume concentrated to 1 l would decrease accordingly. Nonetheless, given the work at NRLKW and other test facilities, it appears large sample volumes—at least  $10 \text{ m}^3$ —will need to be concentrated and evaluated.

The large volumes result in two challenges: adverse effects on organisms filtered through a fine mesh must be minimized, and the size of the individual nets or filters must be manageable (the latter is especially relevant for shipboard testing). Traditionally, marine scientists capture organisms by filtering water through a plankton net. Alternatively, a set of filter bags enclosed in individual housings—a configuration commonly used in water-treatment facilities—can be employed. An argument can be made that filter bags are superior to a plankton net for ballast water testing because filter assemblies do not require a mechanism to lift them from a tank to collect samples. Additionally, the filter bags are enclosed in a housing, so they are less vulnerable to inclement weather than plankton nets.

## 2 Objectives

The objectives of this work were to (1) develop and validate a procedure for retaining organisms  $\geq 50 \mu\text{m}$  in minimum dimension (nominally zooplankton) in large volumes of water used for testing ballast water management systems, (2) design and build the equipment to do so, and (3) validate the equipment. Importantly, zooplankton needed to be kept alive and minimally affected by filtering and handling, since the ballast water discharge standard prescribes the number of *viable* (living) organisms (IMO, 2005).

## 3 Experimental Approach

All laboratory and field experiments were conducted at the Ballast Water Treatment Test Facility (BWTF) at NRLKW. An initial field experiment compared the recovery of zooplankton proxies (red,  $50 \mu\text{m}$  diameter microbeads) between a plankton net and two filter bags enclosed in individual filter housings. After microbeads were added to the net or filter bag, ambient seawater was pumped through them, and the filtrand of each was examined for the presence of microbeads (see Appendix 1 for experimental details). Although NRLKW is surrounded by oligotrophic seawater with relatively low levels of plankton, debris, or colored dissolved organic matter, the samples were clouded with material so it was difficult to see the microbeads. Recovery efficiency of the microbeads was very low (Appendix 1; 25 and 28% from the plankton net and filter bags, respectively).

To address this outcome, trials using microbeads were conducted in the laboratory using filter bags or sieves. The initial laboratory trials also yielded low microbead recovery efficiencies, so a number of improvements was made to the experimental approach (e.g., as described in sections 3.2 and 3.3.3 below). Next, field trials were conducted using fresh water and filter bags.

Considering the initial field trial with a plankton net—and taking into account previous experiences at NRLKW—it was concluded using plankton nets to process the large volumes of water required to evaluate treated water at land-based testing facilities would not be feasible. Nets are cumbersome, prone to tearing, open to the atmosphere and thus vulnerable to wind and weather, and difficult to configure in a flow-through sampling apparatus suitable for large volumes. In response, engineers at NRLKW designed and built a filter skid containing multiple filter bags, each enclosed in a stainless steel housing. Here, we describe preliminary trials to evaluate the retention efficiency of filter bags using microbeads, the design and construction of the filter skid, and initial validation trials.

### **3.1 Ballast Water Treatment Test Facility (BWTF) Description**

As part of the United States Environmental Protection Agency's Environmental Technology Verification (ETV) program and in partnership with the U.S. Coast Guard, a BWTF was established at NRLKW, where research is conducted to provide technical guidance for the ETV's Generic Protocol for the Verification of Ballast Water Treatment Technologies (Lemieux et al.,

in review). The BWTF is located on Fleming Key at Trumbo Point Annex, Naval Air Station Key West, FL. As part of the Naval Research Laboratory's Center for Corrosion Science and Engineering, it functions as a scientific test platform for the standardized assessment of technologies designed to reduce or eliminate aquatic nuisance species in shipboard ballast water.

If land-based test facilities incorporate a standard set of challenge conditions, then comparable and defensible results are generated. To that end, the BWTF is designed to conduct experiments and develop methods to inform the ETV verification protocol and thereby has a fully instrumented seawater storage and transfer system that replicates the volumes, flows, and pressures typical of ballast water systems on marine vessels. The BWTF pumps can provide flow rates up to  $5110 \text{ l min}^{-1}$  (1350 gpm), and on-site tanks include a  $382 \text{ m}^3$  (101,000 gal) ballast tank, a  $151 \text{ m}^3$  (40,000 gal) ballast test tank, and a  $394 \text{ m}^3$  (104,000 gal) discharge tank. The facility provides for the injection of specified test organisms as well as the means to monitor test conditions, conduct sampling, and analyze samples in the laboratory. All water from experiments is treated prior to final discharge to remove all added challenge components and any by-products of any treatment systems tested. To accommodate yet undefined and unidentified technologies, the system can be reconfigured to accommodate treatment systems at uplift, in-tank, or discharge locations in the flow path.

Control of all systems and instrumentation is provided by the Honeywell Plantscape Industrial Control and Automation system (Honeywell, Morris Township, NJ), which has been customized by engineers at NRLKW to provide BWTF-specific data acquisition, operational control, and system monitoring with alarm and interlock functionality. The industrial control hardware consists of standalone control panels with programmable logic controllers, relays, and analog-to-digital converters connected to a redundant computer server system to log all actions and data. A computer in a control room adjacent to the ballast tanks with five displays provides the primary operator interface to control of the BWTF. This control system provides a series of graphical control screens from which the operator can select and view the overall system with key parameters displayed.

### ***3.2 Microbeads***

The proxies used for zooplankton were red, ChromoSphere-T NIST Certified microspheres (Microgenics Corporation, Fremont, CA). Depending on the trial, one or two sizes of microbeads were used: with a nominal diameter of  $49 \mu\text{m}$  ( $\text{CV} = 7.8\%$ ),  $96 \mu\text{m}$  ( $\text{CV} = 7.8\%$ ) or  $150\text{-}\mu\text{m} \pm 3.6 \mu\text{m}$  ( $\text{CV} = 6\%$ ). All microbeads were composed of a cross-linked polystyrene divinylbenzene copolymer. Microbeads were counted in 15 ml Bogorov counting chambers or 1-ml Sedgewick Rafter counting chambers using an Olympus SZH10 dissecting microscope, a Nikon AZ100 Multizoom microscope, or a Nikon Eclipse TS100 inverted microscope.

Usually, microbeads were counted the day before an experiment and placed in a beaker with Type II water ( $5\text{-}\mu\text{m}$  filtered and treated by reverse osmosis and deionization). The contents of the beaker were poured into the plankton net, filter bag, or sieve with care to minimize splashing and loss of microbeads. Initial trials used 600 microbeads to approximate a discharge volume of  $60 \text{ m}^3$  meeting the IMO zooplankton discharge standard ( $10 \text{ zooplankton m}^{-3} \times 60 \text{ m}^3 = 600$

microbeads); subsequent trials typically used 100 or 200 microbeads (which allowed more trials to be run, as less time was spent counting microbeads). In all cases, the beaker containing the microbeads was rinsed 3-5 times with Type II water, and the beaker and wash water were examined for microbeads that may have adhered to the beaker wall.

At the end of laboratory trials or field runs, the sieve or filter bags were rinsed with Type II water or artificial seawater (Instant Ocean®; Aquarium Systems, Inc., Mentor OH) into beakers. Subsamples of approximately 15 ml were pipetted into Bogorov counting chambers. Two researchers counted subsamples until the entire volume of each beaker was counted. Additionally, surfaces that touched the sample were examined for microbeads: beakers, pipet tips, and funnels.

For each Bogorov chamber analyzed, counts were made by a researcher until two subsequent counts agreed. In most experiments, two researchers examined at least one of the Bogorov Chambers to ensure counts were the same. If the final count differed between the researchers, which was rare (approximately 20% of the time), it differed by one or two microbeads. Because it was assumed microbeads were much more likely to be undercounted than over counted, the highest number was used in the final tally.

### **3.2.1 Microbead Disintegration**

When the initial recovery rates were low in field and laboratory trials, it seemed unlikely, but possible, the microbeads dissolved in seawater or Type II water. An assay was conducted: in separate wells of a 12-well plate, 10 50- $\mu\text{m}$  microbeads and 10 150  $\mu\text{m}$  microbeads were dispensed into 5 ml of filtered seawater (0.22  $\mu\text{m}$ ), and ten microbeads of each size class were dispensed into 5 ml of Type II water. The four wells were covered and placed on a laboratory bench for 7 days, and then microbeads in each well were counted.

### **3.2.2 Method of Microbead Counting**

The microbead recovery efficiency was low in initial trials using 50  $\mu\text{m}$  diameter microbeads in field and laboratory experiments, which was surprising, as the microbeads had been accounted for in all possible places: the filtrate, filtrant (material retained in the filter bag), residue in the beaker that initially held the microbeads, and residue in the pipette used to dispense samples. Given this unbalance, it seemed possible the method for initially counting microbeads to add to filter bags, sieves, or plankton nets was somehow undercounting them. Until this point, the microbeads had been counted 'dry', that is, a sterile pipette tip was dipped into the bottle containing the microbeads to deliver a pile of microbeads to a gridded Sedgewick Rafter (SR) counting chamber, which did not have water on it. After the microbeads were counted, the SR was gently rinsed with Type II water from a squirt bottle into a beaker, and the beaker's contents were poured into a filter bag or sieve for an experiment. To ensure the SR did not have any remaining microbeads, it was placed on a Kim wipe and examined under the microscope. Perhaps rinsing the dry microbeads into a beaker caused them to be dispersed into the air rather than the beaker.

Addressing this hypothesis, recovery efficiency of 100 50- $\mu\text{m}$  microbeads was determined in 5 trials with ‘dry’ counting and 4 trials with ‘wet’ counting. In the latter method, a pipette tip was dipped into the bottle containing the microbeads and tapped into a drop of Type II water on a SR slide to remove the microbeads from the pipette tip. The water did not touch the edge of the slide, nor was a cover slip used. After the microbeads were dispensed (dry or wet) into the SR, they were counted and rinsed from the SR with a squirt bottle containing Type II water into a beaker. To determine that 100 microbeads were, in fact, delivered to the beaker, its contents were pipetted into Bogorov chambers and counted. When the entire sample was counted, the pipette and beaker were examined for any residual microbeads. For each trial, the name of the scientist counting the microbeads was recorded to determine if the poor recovery was attributable to a given researcher.

### 3.2.3 Intercalibration

To ensure all microbeads were counted, an intercalibration exercise was conducted in which two observers counted the same 15 ml sample dispensed in a Bogorov counting tray. Four trays (each with a different sample from the filter bag) were counted by each observer, and then each tray was recounted by each observer. An additional 10 trays (each with a different sample from the filter bag) were counted by both observers, for a total of 18. Although the seawater used for the experiment had been filtered, debris (sediment and plankton) was present in the samples. Thus, extra care was required to find the microbeads, and each tray took approximately 45 min to examine.

To determine the difference between observers the mean of the observers’ counts for a single tray was determined, and the percent difference for each observer’s count was calculated as follows:

Equation 1. Calculation to determine percent difference between microbead counts.

$$\frac{|\text{Mean of Counts} - \text{Observer 1 Count}|}{\text{Mean of Counts} \times 100}$$

Because there were two observers, the percent difference was the same for each observer for each tray counted.

In a separate trial, one observer dispensed 15 ml of sample from the first filter bag and counted it five times. Each time, she shook the tray before counting to determine if the movement of debris and microbeads resulted in a different microbead count.



### 3.3 Filter Bags

In laboratory trials using microbeads, nylon filter bags (18 cm [7"] in diameter at the top and 41 cm [16"] long) with various mesh sizes (100  $\mu\text{m}$ , 50  $\mu\text{m}$ , 25  $\mu\text{m}$ , or 10  $\mu\text{m}$ ) were used singly (Universal Filters, Inc., Asbury Park, NJ). In some cases, sieves (20 cm [8"] in diameter) with 25  $\mu\text{m}$  and 10  $\mu\text{m}$  nylon mesh were used in lieu of filter bags to test recovery in a very straightforward way (i.e., from a flat surface free of seams and dimples found in filter bags).

In field trials, filter bags 18 cm (7") in diameter and 41 cm (16") long were placed in filter housings arranged in series. A variety of mesh sizes was used: 25  $\mu\text{m}$ , 35  $\mu\text{m}$ , 50  $\mu\text{m}$ , 100  $\mu\text{m}$ . Each filter bag was enclosed in a fiberglass filter housing (Hayward Flow Control Systems, Clemmons, NC) containing a polypropylene filter basket (Figure 1). Flow and pressure were monitored using a paddle wheel flow sensor downstream of the second housing and with three pressure sensors (one before and after the first housing and one after the second housing; all sensors were manufactured by GF Signet, El Monte, CA). Flow was controlled manually using a 5 cm (2") diaphragm valve at the bottom of the right-hand filter housing (Figure 1, black handle). Ambient seawater was taken up by a 30-hp, horizontal centrifugal pump, passed through a 15 cm (6"), polyvinyl chloride (PVC) line, passed through a manifold, and delivered to the Hayward units by a 5 cm (2"), reinforced PVC plastic hose. Freshwater was added to a 3-m<sup>3</sup> storage tank using a hose and pumped to the Hayward units through a 5 cm (2"), reinforced PVC plastic hose.



Figure 1. Two 41 cm long filter bags in Hayward housing arranged in series; water entered the system via the green hose at the top of the left-hand housing.

Early field trials employed filter bags with 25- $\mu\text{m}$  mesh. Later trials used filter bags with 35  $\mu\text{m}$  mesh, because it better approximated the mesh size used by researchers at test facilities in the US and abroad (37  $\mu\text{m}$ ) and was available in commercially manufactured filter bags. To capture organisms in the  $\geq 50 \mu\text{m}$  size class, the IMO Convention (2004) states the hypotenuse of the

mesh must be no longer than 50  $\mu\text{m}$ ; that requirement is met using 35  $\mu\text{m}$  mesh (hypotenuse = 49.5  $\mu\text{m}$ ).

When microbeads were used as proxies for zooplankton, immediately prior to the trial, they were rinsed into a filter bag placed in the second filter housing in series (downstream of a housing with a filter bag used as a prefilter). The cover of the second filter housing was removed, and the housing had been filled with freshwater. After the cover was secured on the filter housing and the air bled from the housing using a valve on its cover, water was pumped through the system. The filter bags were retrieved and the microbeads counted from the filter bag to which the microbeads had been added and from the filter bag downstream of it. Often, a filter bag was used as a prefilter upstream of the filter bag containing the microbeads to remove plankton, sediment, and detritus.

### **3.3.1 Filter Bags Field Trials—Water Flow Rate**

To determine the appropriate mesh size for filter bags arranged in series and the appropriate water flow rate through them, five trials were run. The flow rates varied (25 gpm, 125 gpm, 150 gpm), as did the filter bags' mesh sizes (25  $\mu\text{m}$ , 50  $\mu\text{m}$ , 100  $\mu\text{m}$ ). The differential pressure between filter housings was monitored, and whether the filter bags clogged was noted.

### **3.3.2 Filter Bags—Laboratory and Field Validation with Microbeads**

In laboratory trials, microbeads were counted using a Sedgewick Rafter counting chamber in the wet or dry manner, rinsed into a beaker with Type II water, and the beaker's contents gently rinsed into a filter bag or onto a sieve. The material retained on the filter bag or sieve was rinsed with Type II water into a beaker, and its contents were transferred with a serological pipet into Bogorov counting chambers. The recovery efficiency of 50  $\mu\text{m}$  microbeads was low in the first laboratory (and field) trials, so 150  $\mu\text{m}$  and 100  $\mu\text{m}$  microbeads were added to experiments because their large size rendered them easier to find, thus they served as quasi-positive controls. The following parameters were recorded to account for any biases: type of filter bag (plastic-topped vs. felt-topped), the glue used to seal the seams, how the seams were glued (e.g., once on the inside and once on the outside), the method of counting, and the filter bag number (to record the number of uses).

After initial field trials with ambient seawater yielded low microbead recovery efficiencies, freshwater was used exclusively in the field. One 25- $\mu\text{m}$  filter bag was placed in each of three Hayward filter housings arranged in series (with the pressure and flow sensors described above). A filter bag served as a prefilter to remove debris from the water; a known number of microbeads in a beaker was rinsed with Type II water into the second filter bag in series. After approximately 3785 liters (1000 gal) was pumped through the system at a flow rate of 25 gpm, the second and third filter bags were removed, rinsed with Type II water, and the material retained in the bags was rinsed into a beaker, pipette into Bogorov counting chambers, and examined for microbeads. The filter bags' seams used in field trials were sealed with 3M® 5200: 25  $\mu\text{m}$  filter bags were sealed twice on the inside. To reduce handling time, the 35  $\mu\text{m}$

filter bags were sealed once on the inside with twice as much sealant typically used for the 25  $\mu\text{m}$  filter bags; a laboratory trial showed 100% recovery of 50  $\mu\text{m}$  microbeads.

In laboratory and field trials, the filter bags' seams, the beakers, and pipettes were examined for residual microbeads.

### 3.3.3 Filter Bags—Seams

After initial experiments showed a low recovery efficiency of microbeads, it was discovered that the holes at the seams were much greater than the nominal mesh size, and it was hypothesized the microbeads passed through the filter bags via the holes. A survey of filter bag manufacturers showed bags with heat-welded seams were available, which would ameliorate the problem, but bags were available only in microfilament or polypropylene felt material. Neither was appropriate, as organisms could not be retrieved from these surfaces.

Closing off the bags' seams with a marine sealant was a viable solution, as long as the cured sealant was malleable, not tacky (so it would not trap zooplankton), and non-toxic to marine organisms over the short time they would be sequestered in the filter bags during sampling (approximately 2 h). Seven sealants were evaluated: Marine Goop® (Eclectic Products, Inc., Eugene, OR), INSTANT Adhesive (GC™ Electronics, Rockford, IL), Weld-On PVC 717™ Plastic Pipe Cement (IPS Corporation, Gardena, CA), 2-part epoxy (John C. Dolph Company, Monmouth Junction, NJ), white 3M™ Marine Fast Cure 5200 Adhesive Sealant (3M, St. Paul, MN), and Elmer's® No-Wrinke Rubber Cement (Elmer's Products, Inc., Columbus, OH).

Using a 41 cm (16") long filter bag with 10  $\mu\text{m}$  mesh, each adhesive was applied in approximately 5-cm long sections the outside and inside of the bags, and the adhesives cured for 36 h (longer than any of the recommended curing times).

### 3.3.4 Filter Bags—Toxicity of Sealant on the Seams

To test if zooplankton were killed by brief exposure to the filter bags' sealant (3M™ 5200, chosen after the trial described in section 3.3.3), bioassay experiments were conducted with brine shrimp *Artemia franciscana* (previously used at NRLKW as a standard test organism) and subsequently with ambient zooplankton (copepods). Cysts of *A. franciscana* were purchased from a vendor (Brine Shrimp Direct, Ogden, UT) and incubated in 5- $\mu\text{m}$ -filtered, aerated artificial seawater (salinity = 36) for 24 h in 25°C with a 12:12 light:dark cycle under fluorescent bulbs (72  $\mu\text{M}$  Einsteins  $\text{m}^{-2} \text{s}^{-1}$ ). Hatched nauplii approximately 12 h old and 300 - 400  $\mu\text{m}$  long were removed from the culture in 1 ml aliquots and dispensed into each of eight Petri dishes (47 mm diameter) with 10 ml of 0.22  $\mu\text{m}$ -filtered seawater. Next, the dishes were examined using a dissecting microscope to ensure all *A. franciscana* were living (determined by movement), which was the case. Four Petri dishes served as controls, and to the remaining four, a strip (approximately 4 cm x 1 cm) of 25  $\mu\text{m}$ , nylon filter bag with a bead of sealant (approximately 3 cm x 0.5 cm) that had been cured for 24 h was added.

Petri dishes were arranged haphazardly on a shelf in the incubator (described above) for 2 h, the estimated amount of time zooplankton would be sequestered in a filter bag during collection. After the incubation, the number of dead *A. franciscana* was counted. If an organism was not moving, it was gently prodded with a probe, and if it did not move within 10 s, it was scored as dead. Following the tally, all samples were fixed with Lugol's iodine solution, the total number of *A. franciscana* counted, and the number of living organisms determined by subtraction.

The trial was repeated with ambient copepods, which were concentrated from a seawater hose onto a 31- $\mu\text{m}$  sieve. Copepods of all-life history stages ( $\geq 50 \mu\text{m}$  in minimum dimension) were removed from the sample individually using a pipet. To each of eight Petri dishes (47 mm diameter) containing 10 ml of 0.22  $\mu\text{m}$  filtered seawater, 20 copepods were added. Four dishes served as controls, and strips of mesh with sealant were added to the other four Petri dishes (treatment). Dishes were examined to ensure all copepods were living (they were), and dishes were arranged haphazardly on a shelf in the incubator and incubated for 2 h at the settings from the previous trial. Following incubation, the number of dead copepods was counted and preserved as above. Statistics were calculated with SigmaPlot® v. 11 (Systat Software Inc., San Jose, CA).

### **3.4 Filter Skid**

#### **3.4.1 Filter Skid Requirements**

The filter skid was designed with several considerations in mind: first, it was desirable to construct an apparatus using common, commercially available products so the skid could be replicated easily at other test facilities and did not require special fabrication techniques. Second, the prototype was developed to eliminate large, cumbersome plankton nets currently used by test facilities, so it needed to have nets in self-contained filter housings. Third, the apparatus was designed so it might be accommodated in future shipboard sampling programs, e.g., a small footprint was required. Because the skid would be used with seawater, the materials needed to withstand a corrosive environment (e.g., stainless steel or PVC). Both the cost and availability of corrosion-resistant metals were considered. Grade 316 stainless steel was chosen for the filter housings, and PVC was chosen for the piping.

#### **3.4.2 Toxic Effects of Stainless Steel Filter Housings**

A bioassay test was conducted to determine if the brine shrimp *Artemia franciscana* or ambient zooplankton would die from exposure to stainless steel filter housing. Cysts of *A. franciscana* were hatched as in section 3.3.4, and 3 1-ml subsamples of 12-h old Nauplii (300 - 400  $\mu\text{m}$  long) were removed from the culture and evaluated qualitatively using a dissecting microscope. If a nauplius was not moving, it was gently prodded with a probe, and if it did not move within 10 s, it was scored as dead. All nauplii (70 - 77 per subsample) were living. Two ml aliquots of the culture were dispensed into each of five 1000 ml beakers containing 800 ml of 0.45  $\mu\text{m}$ -filtered seawater.

Ambient zooplankton (primarily copepods) were concentrated from a seawater hose onto a 37- $\mu\text{m}$  sieve. The filtrand was suspended in 0.45  $\mu\text{m}$ -filtered seawater. A 1 ml sample was removed and zooplankton ( $\geq 50 \mu\text{m}$  in minimum dimension) were qualitatively assessed: 1 was dead, 6-10 were living. Four-ml aliquots of the sample were placed into each of the five beakers.

Two beakers served as controls, with only seawater, *A. franciscana*, and ambient zooplankton. To the remaining three beakers, 10 washers (grade 316 stainless steel, 1.9 mm thick, and 38.1 mm in diameter with a hole in the center 15.8 mm in diameter) were added. Their surface area (SA) in the beaker was calculated to equal the SA:volume ratio of water in a filter skid housing.

Beakers were arranged haphazardly on a shelf and covered with a black tray in the incubator for 2.5 h, the estimated amount of time zooplankton would be sequestered in a stainless steel filter housing during collection. After the incubation, the washers were removed from the treatment beakers using forceps, and the contents of each beaker were gently poured through a 37  $\mu\text{m}$  sieve, the filtrand rinsed with filtered seawater into a beaker, and the entire volume transferred to a Petri dish. The number of dead *A. franciscana* and zooplankton were counted. Following the tally, all samples were fixed with Lugol's iodine solution, the total number of organisms counted, and the number of living organisms determined by subtraction.

### **3.4.3 Comparison of Zooplankton in the Ballast Tank vs. the Filter Skid**

In a preliminary experiment to determine if collecting zooplankton (copepods) using the filter skid killed them, the percentage of living, ambient copepods was quantified after they were pumped into a ballast tank at NRLKW, and that number was compared to the percentage of living zooplankton collected in the filter bags in the skid as the tank was drained. The ballast tank was filled with 219  $\text{m}^3$  (57,775 gal) of ambient seawater at a flow rate of 3834  $\text{l min}^{-1}$  (1013 gpm), and immediately afterwards, a vertical plankton tow was taken in the tank using a 25  $\mu\text{m}$  mesh, 0.75 m mouth diameter, nylon plankton net. Originally, a quantitative sample was to be collected, but when the Niskin bottle used to collect the sample broke, a qualitative plankton tow was taken instead. The net was rinsed with ambient seawater and its contents suspended in filtered seawater (0.22  $\mu\text{m}$ ) and diluted 10x with filtered seawater. After the container was sealed and gently inverted 3x, 2 subsamples were removed and evaluated in Bogorov counting chambers. The number of dead copepods (nauplii; copepodites and adults) was counted, the samples fixed in Lugol's iodine solution, and the number of living copepods determined by subtraction.

The water was held in the ballast tank for two hours (as the net tow was analyzed) and then drained at flow rate of 3834  $\text{l min}^{-1}$  (1013 gpm), with 65  $\text{m}^3$  (17226 gal) diverted to flow through the filter skid at a rate of 454  $\text{l min}^{-1}$  (120 gpm), with 114  $\text{l min}^{-1}$  (30 gpm) through each of the 8 housings containing filter bags (all flows are approximate averages). The first two filter housings in the filter skid were empty (except for the metal liners with 3 mm holes); the 8 housings downstream each held a 25- $\mu\text{m}$  filter bag with the seams glued twice on the inside with 3M® 5200 sealant. After the drain operation, filter bags were removed from the housings, rinsed with ambient seawater, and their filtrands consolidated into a 2 l graduated cylinder. The cylinder was gently inverted 5x, and, using 10 ml serological pipettes, three researchers each

immediately and simultaneously took a 10 ml sample from the center of the cylinder and dispensed their samples into a 50 ml centrifuge tube. The inversion was repeated, and the researchers took a 5-ml sample and placed it into their centrifuge tube, bringing each tube's volume to 15 ml. This process was undertaken to ensure subsamples were representative of the sample in the 2 l graduated cylinder. Due to the high concentrations of plankton, sediment, and debris, it was necessary to dilute the samples 10x using filtered seawater before they were analyzed in the same manner as the samples from the plankton tow.

#### **3.4.4 Effect of Crowding on Ambient Zooplankton**

The effect of crowding during sampling was evaluated by comparing (1) a sample simulating a parcel of water 60 m<sup>3</sup> meeting the zooplankton discharge standard (10 living organisms m<sup>-3</sup>) and concentrated during sampling to a volume of 1 l (= 600 zooplankters l<sup>-1</sup>) to (2) a control sample with a much lower concentration of zooplankton (10 l<sup>-1</sup>). Six hundred or ten copepods (*Acartia tonsa*, purchased from LiveCopepods.com, Seattle, WA; salinity = 33.5), were manually counted and added to a beaker containing 1 l of artificial seawater (salinity = 34). Beakers were placed in an incubator set at 25°C and illuminated by fluorescent bulbs (72 μM Einsteins m<sup>-2</sup> s<sup>-1</sup>), gently aerated, and incubated for 4 h. Previous work at NRLKW has shown die-off occurs in samples held longer than six h (Riley et al., 2006), so the zooplankton handling time and incubation time was a total of 6 h. After incubation, the copepods were recovered from the beakers using a 50-μm sieve. The dead *A. tonsa* were counted. Next, the samples were fixed with Lugol's iodine solution, the total number of copepods counted, and the number of living copepods was determined by subtraction. Because the sample handling time was too long to prepare and analyze replicate samples in a single day, the experiment was repeated the following day. In that trial, only 572 *Acartia tonsa* were available, so 28 brine shrimp (*Artemia franciscana*) were added to bring the treatment beaker's total zooplankton count to 600. Because no *A. franciscana* were added to the control sample, the survival was determined only for *A. tonsa* in both treatments.

## **4 Results**

### **4.1 Microbeads**

#### **4.1.1 Microbead Disintegration**

The counts of microbeads (10 50 μm microbeads and 10 150 μm microbeads) at the start of the trial and 7 days later were the same in both the filtered seawater and the Type II water (data not shown). Therefore, microbeads did not disintegrate on the time scales used for trials.

#### **4.1.2 Method of Microbead Counting**

The nine trials comparing dry to wet counting of microbeads showed the wet method to be superior (Figure 2). In only one of five trials using the dry method, microbead recovery was ≥ 90%; however, in all four trials using the wet method, microbead recovery was ≥ 90%. No bias

was attributed to any researchers, as all three researchers achieved both good and poor recovery. Henceforth, microbeads were counted only in the wet manner.

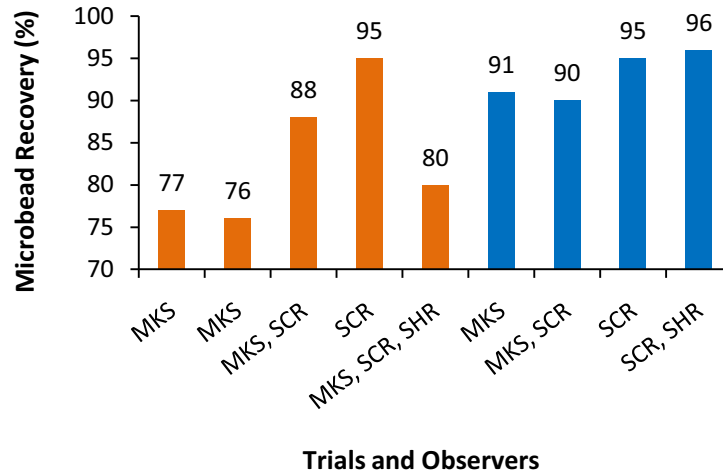

Figure 2. Recovery after microbeads were counted using the ‘dry’ and ‘wet’ methods. Orange bars represent dry trials, and blue bars represent wet trials; numbers above bars indicate the percent microbead recovery; letters on the x-axis labels indicate the researcher’s initials.

### 4.1.3 Intercalibration

When 18 Bogorov trays with a seawater sample were counted by two observers to determine the difference from the mean of the counts, the grand mean was 12% (SD = 14%; data not shown). When one observer counted the same tray with a seawater sample five times, the number of microbeads counted varied over three-fold: 5, 5, 4, 2, 7 microbeads.

The intercalibration showed good agreement between observers, but because different counts resulted when a sample with seawater (and corresponding debris) was counted repeatedly, it was necessary to conduct validation trials—in both the laboratory and the field—using freshwater, so microbeads would be visible.

## 4.2 Filter Bags

### 4.2.1 Filter Bag Field Trials—Water Flow Rate

The filter bags clogged immediately in the first trials, which were conducted at relatively high flow rates (e.g., 150 gpm; Appendix 2). Subsequent trials showed a flow rate of 25 gpm allowed sustained flow with low pressure differentials across filter bags having relatively small mesh sizes (50  $\mu$ m or 25  $\mu$ m). In subsequent trials, the flow rate was set at 25 gpm. With the

Hayward units, a 5 cm (2”) hose supplied water to the system; at 25 gpm, water flowing through the pipe would travel at 0.78 m s<sup>-1</sup> (1.7 mph).

### 4.2.2 Filter Bags—Field and Laboratory Validation Using Microbeads

Recovery efficiencies of 50 µm microbeads in the laboratory ranged from 41% - 84% when the microbeads were counted in the wet fashion and the filter bags’ seams were unglued or glued insufficiently with Marine Goop® (Figure 3). Usually, no microbeads were found in the filtrate; on one occasion, 7 microbeads were found (100 were added to the filter bag; recovery efficiencies exclude microbeads found in the filtrate). Recovery of the 50-µm microbeads generally improved after the microbeads were counted in the wet fashion and the seams were glued more thoroughly. When 3M 5200® was used, recovery efficiency of the smallest microbeads ranged from 82% - 110% (mean = 94%). The larger two size classes showed excellent recovery efficiencies, at least 95%, with one exception (87%, Trial 21). A laboratory trial using 50 µm microbeads in a 50 µm filter bag with seams glued twice on the inside with 3M 5200® sealant yielded a 20% recovery efficiency (data excluded from Figure 3).

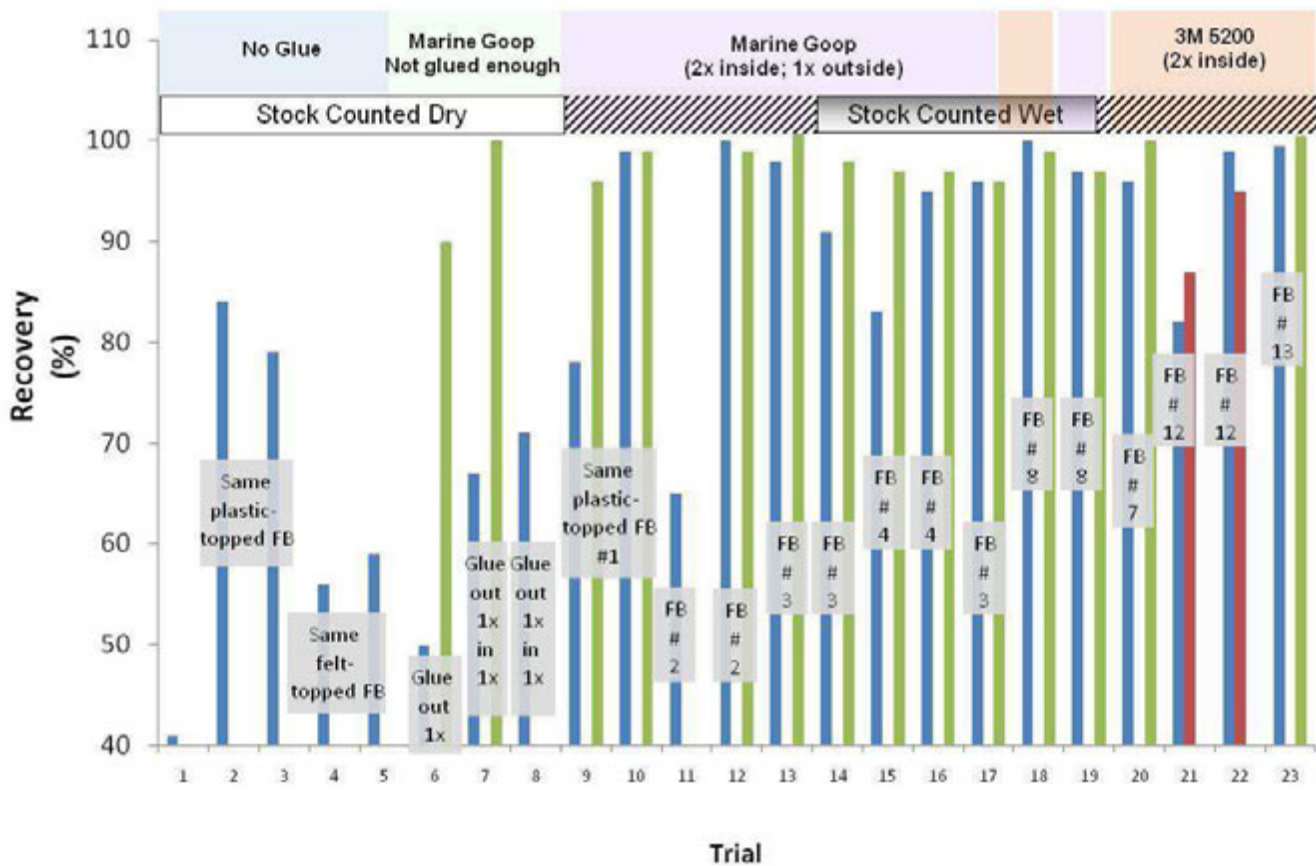

Figure 3. Recovery efficiency of microbeads in laboratory trials using 25 µm filter bags (FB). Blue, red, and green bars represent 50 µm, 100 µm, and 150 µm microbeads, respectively.



Although the tank that acted as a freshwater reservoir for field trials was cleaned beforehand, a small amount of green algae from the tank and the piping in the system was collected and concentrated in the filter bags (Figure 4, Trial 1; all trials except the first one had a 25- $\mu\text{m}$  filter bag placed upstream to filter material from the water). During sample analysis, removing algae from one Bogorov counting chamber with many microbeads and re-counting it led to a 20% increase in the number of microbeads recovered (Trial 7). The little bit of algae in the samples, it seems, obscured the 50  $\mu\text{m}$  microbeads, making recoveries appear to be low even though microbeads were likely captured in the filter bags. The tank was rigorously scrubbed to remove algae, and the experiment was repeated with 200 50  $\mu\text{m}$  and 200 150  $\mu\text{m}$  microbeads. The results were better: 93% and 100% recovery efficiency (50  $\mu\text{m}$  and 150  $\mu\text{m}$  microbeads, respectively); there was noticeably less algae in the sample than in previous experiments. Subsequent trials with very clean tanks showed recovery efficiencies  $> 87\%$  of 50  $\mu\text{m}$  microbeads. Recovery efficiency of larger (100  $\mu\text{m}$  and 150  $\mu\text{m}$ ) microbeads prior to trial 7 ranged from 74% to 101% (the latter represents a counting error or a microbead leftover from a previous trial, although filter bags were examined for residual microbeads on a dissecting microscope prior to each trial). Following Trial 7, efficiencies were  $> 99\%$ . In all trials, nearly all of the microbeads were recovered from the filter bag to which they had been added; in one instance, 13 microbeads were found in the filter bag downstream of it.

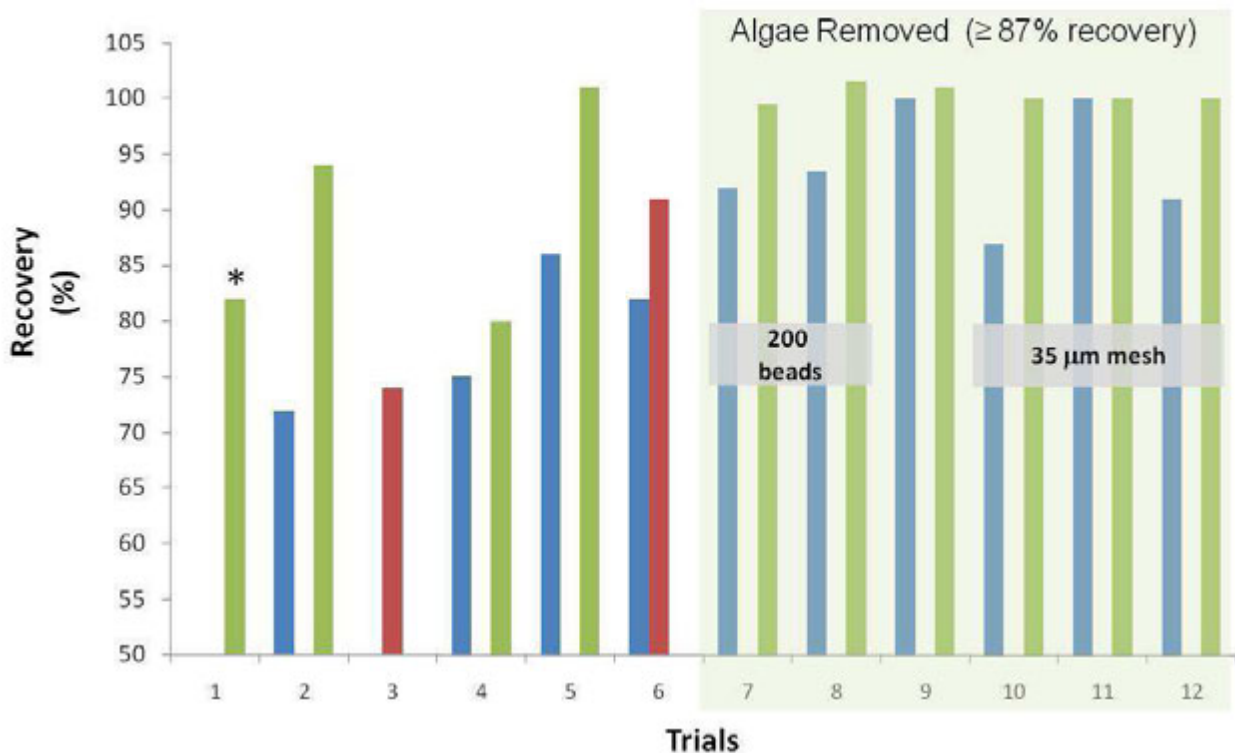

Figure 4. Recovery efficiency of microbeads in field trials. Unless noted, filter bags' mesh was 25  $\mu\text{m}$ . Blue, red, and green bars represent 50  $\mu\text{m}$ , 100  $\mu\text{m}$ , and 150  $\mu\text{m}$  microbeads, respectively. \* = a notable amount of green algae was collected in filter bags.

Because microbead recovery efficiencies increased after improvements were made to the protocol for trials in the laboratory (i.e., counting using the wet method and sealing the filter bags' seams) and the field (i.e., removing algae from the reservoirs used to hold freshwater), the data collected after improvements were compiled to give a true picture of microbead recovery (Figure 5). With the exception of the laboratory trial using 50  $\mu\text{m}$  microbeads in a 50- $\mu\text{m}$  filter bag, the average recovery efficiency was  $\geq 89\%$ .

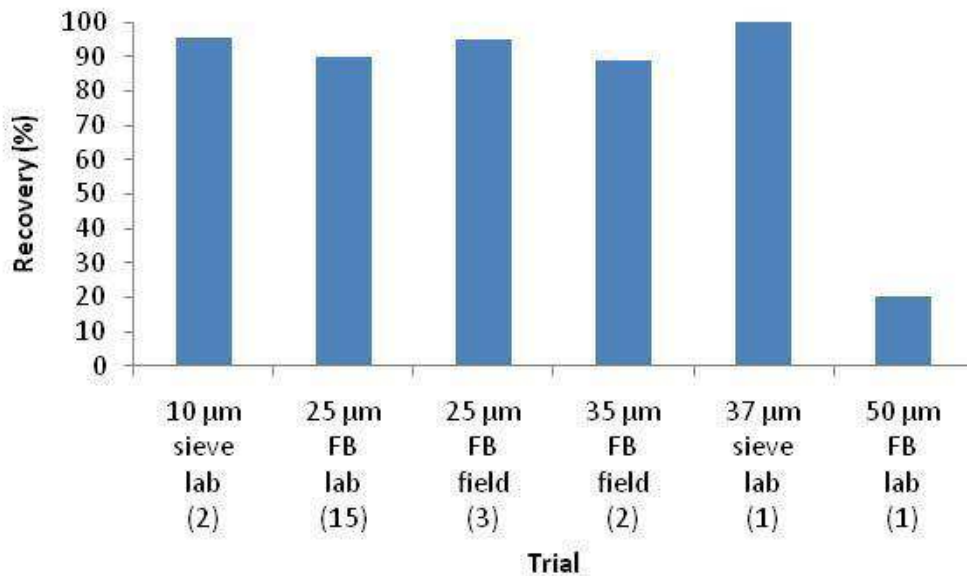

Figure 5. Recovery efficiency of 50  $\mu\text{m}$  microbeads in laboratory and field trials conducted after improvements were made to the microbead protocol. Numbers in parentheses represent replicates; FB = filter bag.

### 4.2.3 Filter Bags—Seams

Of the seven sealants examined, Marine Goop® appeared best for sealing the filter bags' seams because it was the most pliable but not sticky. After being used in field tests, however, the clear sealant began to flake apart, allowing microbeads to become trapped in the sealant and potentially uncovering the relatively large holes along the bags' seams. 3M™ 5200 was re-evaluated, and after using it in a field trial and noticing no breakdown, it was used in all subsequent experiments. Like Marine Goop, it was also pliable but not sticky, and it was white, so red microbeads were visible along the seams.

### 4.2.4 Filter Bags—Toxicity of Sealant on the Seams

There was no apparent, negative effect of the 3M™ 5200 sealant on *Artemia franciscana* or ambient copepods. In both trials, in all replicates, the percentage of living organisms was at least

90% (Appendix 3). In the *Artemia franciscana* experiment, because the data were not distributed normally, a Mann-Whitney Rank Sum Tests was used, and no significant difference was found ( $p = 0.49$ ). In the copepod experiment, a t-test showed no significant difference between treatment and control groups ( $p = 0.54$ ). When all of the *A. franciscana* results (from both control and treatment groups) were averaged into a grand mean and compared to the grand mean of the copepod results, the numbers were nearly identical (98.3% and 98.1%, respectively).

### 4.3 Filter Skid

#### 4.3.1 Filter Skid Design

After investigating commercially available filtration devices, the Eaton Topline™ Type II housing (Eaton Filtration, LLC, Iselin, NJ) was chosen. To capture zooplankton effectively in large volumes of water, the filter skid was designed with 10 cylindrical filter housings, each containing a metal filter basket with holes 3 mm (0.12”) in diameter (Figure 6; schematic in Appendix 4 and operations manual in Appendix 5). As water entered the skid, it was split to flow into one of two prefilters, which contained no filter bags, but the metal filter baskets served as prefilters to collect large organisms, sediment, and rust flakes from the ballast tank. Following each prefilter, water flow was split again, into two filter housings, thus evenly distributing the water flow between the housings and reducing the filtration load for each filter by a factor of four. Each of the four housings was followed by another filter housing, which was intended to capture anything organisms that may have gone through the first set of housings. All filter housings, excluding the prefilters, contained a filter bag designed to capture all organisms greater than 50- $\mu\text{m}$  minimum dimension in each experiment. A key feature of the Eaton design is the tight seal among the filter bag, housing, and housing cover.

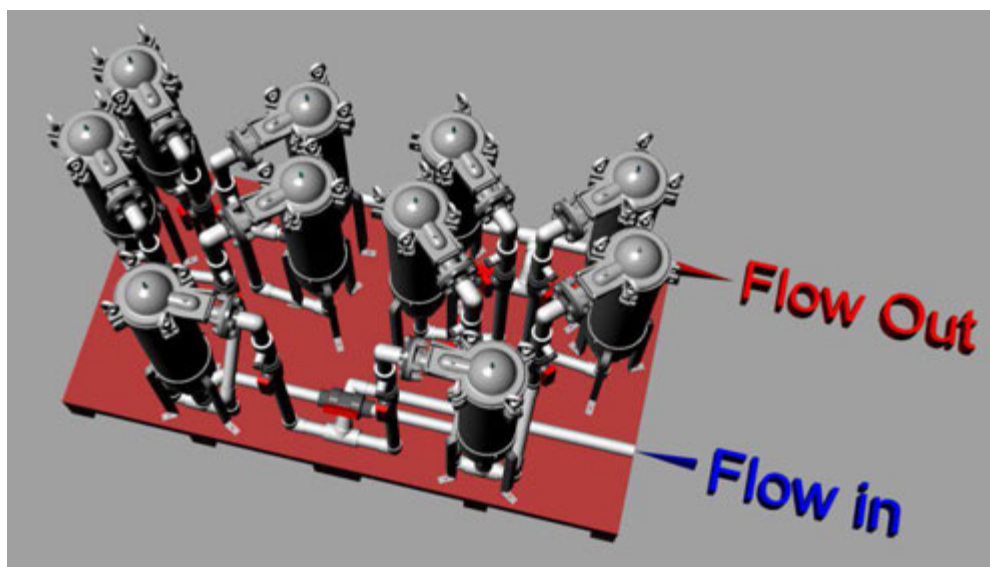

Figure 6. Filter skid design for flow-through sampling of discharged ballast water.

#### 4.3.1.1 Filter Housings

The cylindrical Eaton Topline™ bag filter housings, constructed of corrosion-resistant 316 stainless steel, had dimensions of 18 cm (7") diameter x 91 cm (36") long (Figure 7; drawing created using SolidWorks 2010 3D Design Software, Concord, MA). The height and orientation of the housings could be varied using their support legs.



Figure 7. Eaton Topline™ filter housing.

Water entered the side of the housing through a 5 cm (2") flanged connection and flowed over the top of the filter bag, sealing it in place. This design resulted in a minimal volume of unfiltered liquid (i.e., between the housing's lid and the top of the filter bag) and provided optimum sealing of the filter bag so a minimal amount of water bypassed the filter bag. Although each of the Eaton Topline™ filter housings are manufactured for a maximum flow rate of  $681 \text{ l m}^{-1}$  (180 gpm) and  $10,500 \text{ g cm}^{-2}$  (150 pounds per square inch, psi) maximum pressure, the filter skid was designed so each of the housings would realize approximately  $95 \text{ l min}^{-1}$  (25 gpm) during normal operation (see section 3.3.1 for rationale). Additionally, the manufacturer's operation instructions indicated low-flow conditions lead to good filtration results. By splitting the flow four ways, it was possible to slow velocity through the skid by a factor of four.

A main component of the filter skid is the filter bags that were snapped into place in the eight filter housings after the two prefilters. The material of the filter bags was chosen to (1) mimic the filtration efficiency of plankton nets, which are commonly used by test facilities, and (2) capture organisms and allow them to be gently removed from the filter bag surface without increasing mortality. Felt, microfiber, and monofilament meshes were considered, and nylon monofilament filter bags best met the criteria (Eaton part number BNMO35P2P, Figure 8; the filter bag's polypropylene ring is snapped into place at the top of the filter housing. The 3 mm holes in the metal liner are visible through the filter bag's mesh).





Figure 8. Nylon monofilament mesh filter bag secured in an Eaton Toplevel™ filter housing.

#### 4.3.1.2 Piping, Valves, and Diaphragm Pump

All piping between the filter housings was 5 cm (2") diameter, Schedule 40, PVC (Spears® Manufacturing Company, Sylmar, CA), with glued fittings (Figure 9). Piping was connected to the filter housings using 5 cm (2") diameter 68 kg (150 lb) Van Stone flanges with ethylene propylene diene Monomer (M-class) rubber (EPDM) gaskets.



Figure 9. Plan view of the prototype filter skid at NRLKW. Blue arrow shows water entering the filter skid; yellow arrow shows water exiting the skid.

To allow filter housings to be individually isolated, 5 cm (2") diameter valves were fitted to the inlet and outlet of each filter housing (Spears® Manufacturing Company, model Compact 2000 ball valves). Because all isolation valves were left in the 100% open position during operation, they did not add shear forces to the organisms during sampling.

At the base of every filter housing, a threaded 1.3 cm (0.5") diameter PVC ball valve (Spears® Manufacturing Company) was installed to serve as a drain valve. The valves remained closed during filtration operations but were opened at the end of a run to drain the filter housings from the bottom. In this manner, filter bags were removed from the housings without the bottoms of the filter bags floating upwards and potentially losing part of the sample.

A threaded, 0.64 cm (0.25") diameter PVC ball valve was installed atop of each filter housing, and it was used to manually bleed air trapped within the housings prior to use. This important safety feature prevented air from being trapped within filter housings and potentially building to several times greater than atmospheric pressure. This feature allowed the system operator to know when the filter housings were full of water (i.e., water exits the valves), thereby ensuring the filter bags were wet prior to sampling.

A Yamada NDP-80 8 cm (3") diaphragm pump (Yamada® America, Inc., Arlington Heights, IL) was installed to draw a sample from the discharge line exiting the ballast tank into the filter skid (Figure 10). The pump was needed because the discharge line was under suction (as water was pumped to a discharge tank for filtration prior to discharge into ambient waters); therefore, to collect a representative sample of the line, a diaphragm pump was been installed. It was constructed of polypropylene with an EPDM rubber diaphragm in contact with the water passing through the pump. Previous testing by engineers at NRLKW on various pump types on organism mortality has shown diaphragm pumps to be the superior choice (Riley et al., 2009). Although it was capable of flowing at a rate of 220 gpm, the pump was set at 100 gpm and operated by compressed air supplied from a portable Sullair® 185SCFM air compressor (Michigan City, IN). A time-averaged sample was removed from the discharge line from the ballast tank to the line into the filter skid using a tee; an isokinetic sample port was not necessary, as the sample volume was greater than 10% of the tank volume (i.e., 60 m<sup>3</sup> of 200 m<sup>3</sup>; Richard et al., 2008).



Figure 10. Yamada NDP-80 Air diaphragm pump as installed.

#### **4.3.1.3 Pressure Drop Calculations vs. Flow Rate**

Maintaining a low pressure drop across a filter bag is critical because it reduces the chances organisms are killed during sampling, and it enhances filtration efficiency and increases the service life of the filter bag, thus reducing the operating cost of the system. During the design phase, the filter skid was analyzed to determine where the bulk of the friction losses occurred. Data for the filter housings and filter bags were available from the manufacturer (Figure 11). The analysis was completed using data from 25  $\mu\text{m}$  filter bags, since data for 35  $\mu\text{m}$  nylon monofilament filter bags were unavailable. As expected, the pressure drop increased as the flow rate increased. At a flow rate of  $95 \text{ l min}^{-1}$  (25 gpm), the pressure drop across an individual housing with a 25  $\mu\text{m}$  nylon monofilament bag was slight, approximately  $35 \text{ g cm}^{-2}$  (0.5 psi). It is anticipated the pressure drop would be a bit smaller using a 35- $\mu\text{m}$  filter bag.

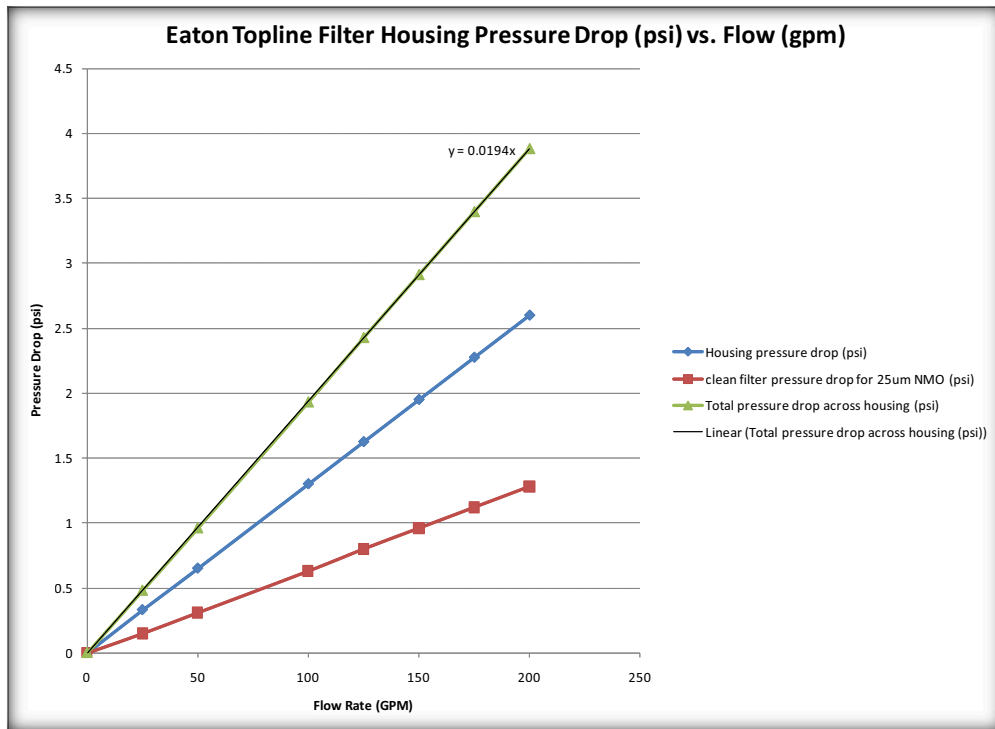

Figure 11. Pressure drop of filter skid vs. flow rate (figure from Eaton Filtration, LLC).

Because the skid was designed with a small footprint, there were several elbows and fittings, as well as flow direction changes, which contributed to the pressure drop across the skid. When all pressure changes were calculated, the pressure drop across the entire skid was  $631 \text{ g cm}^{-2}$  (9 psi) at  $379 \text{ l min}^{-1}$  (100 gpm; calculations not shown).

#### 4.3.1.4 Flow Rate, Flow Control, and Volume Measurement through the Filter Skid

The flow rate was monitored using a GF Signet 2551 Magmeter, which was situated on the inlet line to the skid using a saddle fitting. The total volume sampled was calculated from a totalizer installed downstream of the skid that used the electrical signal generated by the Magmeter to calculate the total volume by multiplying the flow rate by time and summing it over the entire test run. Because the sampling was a continuous operation, rather than a batch process, the totalizer was used to sum the flow rate. Flow was controlled through the filter skid using a linear, pneumatic-actuated, 7 cm (3") diameter diaphragm valve. In turn, valve position was controlled using Proportional, Integral, Derivative (PID) feedback control via Honeywell controls logic based on the Magmeter reading to maintain a flow of 100 gpm through the skid.



#### **4.3.1.5 Cost and Weight of the Filter Skid**

When the cost of the materials and labor to build the filter skid was tabulated, the total cost of the prototype was \$19,851, and it took approximately 60 hours to construct it (Appendix 6).

The skid was analyzed to determine its weight with and without water. Using the respective weight of each of the skid's components from the manufacturer's literature, the weight of the skid without water was estimated to be 228 kg (503 lb); when seawater is contained in all of the housings and the piping system, the total weight of the skid was an estimated 556 kg (1225 lb).

#### **4.3.2 Filtration Area of Filter Skid vs. Plankton Net**

The effective surface area of the filter skid was compared to that of typical plankton net. The effective surface area of a single filter bag within the filter skid was  $0.43 \text{ m}^2$  (calculations not shown). Because the sample flow was split into four filter housings in parallel, the effective surface area is four times the surface area of one housing, or  $1.70 \text{ m}^2$ . The surface area could easily be increased by increasing the number of filter housings arranged in parallel.

In the past, a Sea-Gear Model 9000 Plankton Net with a mouth opening of 60 cm and a length to mouth ratio of 3:1 was used at NRLKW (Sea-Gear Corporation, Melbourne, FL). Its surface area was  $1.72 \text{ m}^2$ , nearly identical to the filter skid (calculations not shown).

#### **4.3.3 Flow Velocity through the Filter Skid vs. Plankton Net**

The filter skid was designed to obtain discharge water samples at a volumetric water flow rate of 100 gpm, and the flow through the skid was plumbed to split into a set of pre-filters at a volumetric flow rate of 50 gpm. After the two pre-filters, the flow split again to flow into a set of four filter housings that contained  $35\mu\text{m}$  filter bags to capture organisms  $\geq 50 \mu\text{m}$ . The volumetric flow rate to these four housings was 25 gpm. The flow velocity of the water as it flows through the pre-filters and filters was calculated and compared to velocities encountered in theoretical, horizontal plankton tows using plankton nets.

##### **4.3.3.1 Flow Velocity through Two Prefilters (No Filter Bags)**

Water was supplied to the filter housings through a 5 cm (2") inner diameter PVC pipe. The flow velocity of the water entering the pre-filter housings is  $1.55 \text{ m s}^{-1}$  (3.5 mph) (Appendix 7, Equation 1).

As the water enters the filter housing, the flow velocity is reduced because the cross sectional area increases from the 5 cm (2") pipe to the 18 cm (7") housing (Figure 12; model created using SolidWorks). Correspondingly, the flow velocity decreases from  $1.55 \text{ m s}^{-1}$  (3.47 mph) to  $0.51 \text{ m s}^{-1}$  (1.13 mph; Appendix 7 Equation 2). As the water leaves the housing, the flow velocity returns to  $1.55 \text{ m s}^{-1}$  (3.47 mph).

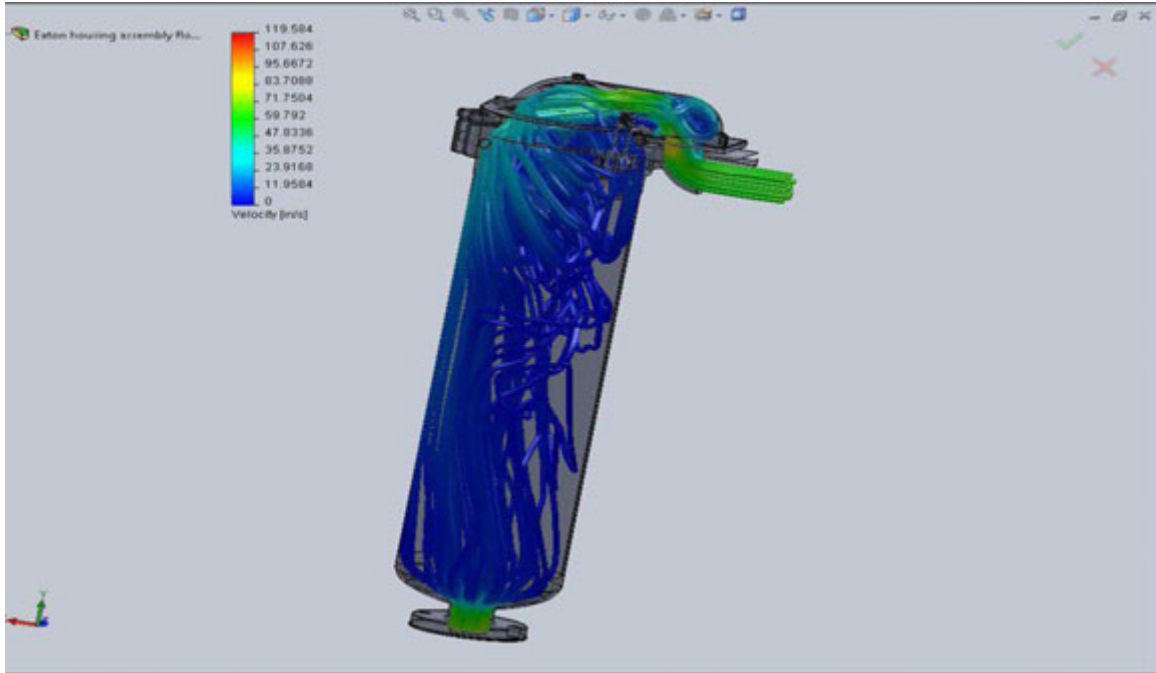

Figure 12. Flow velocity model for water flow through an Eaton Topline™ Filter Housing at 50 gpm, entering through the top of the housing and exiting at the bottom.

#### 4.3.3.2 Flow Velocity through Housings with Filter Bags

Downstream of the pre-filters, the water flow split to enter the next four housings, which contained filter bags. The volumetric flow rate to each of these filter housings is 25 gpm. The flow velocity entering these filters is  $0.77 \text{ m s}^{-1}$  (1.7 mph; Appendix 7, Equation ).

As seen in the first set of pre-filters, as the water enters into the housing, the flow velocity decreases because the cross sectional area increases from 5 cm to 18 cm (2" to 7", Figure 13). Here, the flow velocity slows from  $0.77 \text{ m s}^{-1}$  (1.72 mph) to  $0.25 \text{ m s}^{-1}$  (0.56 mph; the velocity of the water when contacting the filter bags; Appendix 7, Equation 4). As the water leaves the housing, it returns to  $0.77 \text{ m s}^{-1}$ .

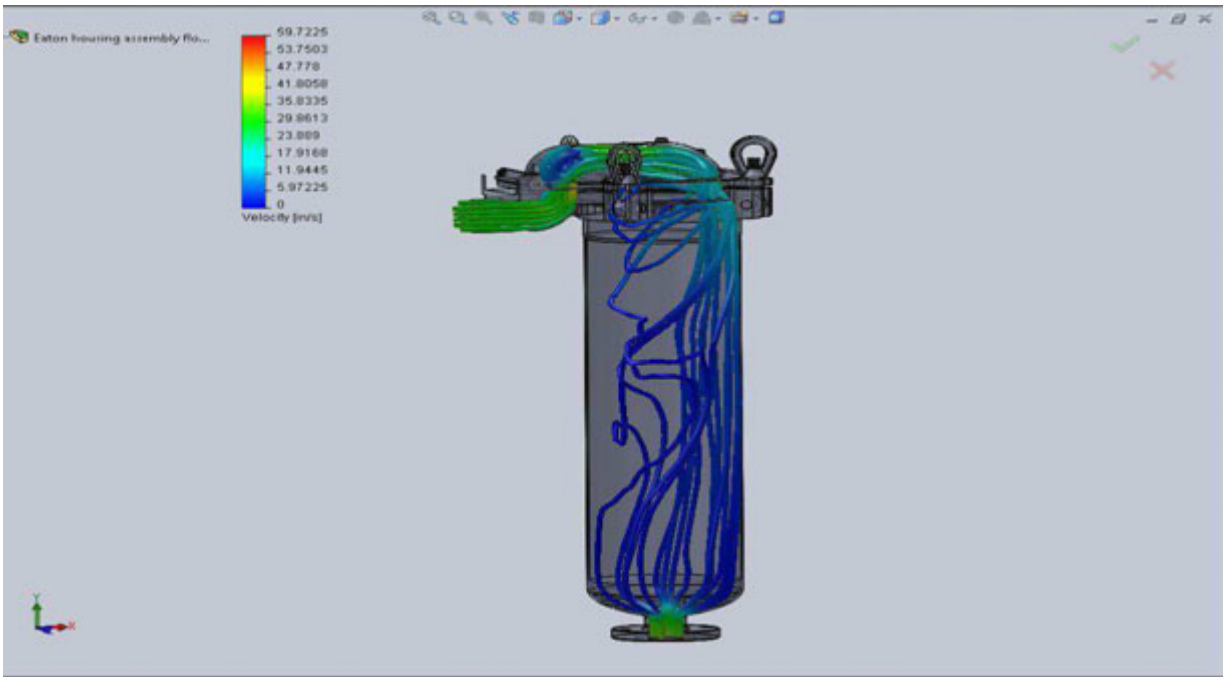

Figure 13. Flow velocity model illustration for water flow through an Eaton Topline™ Filter Housing at 25 gpm, entering though the top of the housing and exiting at the bottom.

#### 4.3.3.3 Flow Velocity through a Plankton Net

The flow velocity of water entering a plankton net as it is towed behind a boat was calculated. For this example, it was assumed the velocity of the boat during sampling was  $0.51 - 3.1 \text{ m s}^{-1}$  (1 - 6 kts; e.g., Aron, 1965), the mouth diameter of the net was 1 m, and the exit diameter near the cod end was 10 cm. Because of its conical shape, the net tends to concentrate organisms strained from the water sample in the cod end and uses surface filtration to separate organisms and particles  $\geq 35 \mu\text{m}$ . The entrance velocities of the water entering the plankton net for speeds 1 kt, 2 kts, and 6 kts are  $0.51 \text{ m s}^{-1}$ ,  $1.03 \text{ m s}^{-1}$ , and  $3.1 \text{ m s}^{-1}$ , respectively. The velocity of water entering the filtration housings in the filter skid ( $0.77 \text{ m s}^{-1}$ , Appendix 7, Equation ) is similar to a horizontal plankton tow between  $0.51 \text{ m s}^{-1} - 1.03 \text{ m s}^{-1}$  (1 - 2 kts).

#### 4.3.4 Toxic Effects of Stainless Steel Filter Housings

Stainless steel did not induce mortality on 12-hour old *Artemia franciscana* nauplii or ambient zooplankton ( $\geq 50\mu\text{m}$ ) over a 2.5 h exposure time, as there was no significant difference between the percentage of living organism in the control and treatment groups (Appendix 8; t-test  $p = 0.59$  for *A. franciscana*,  $p = 0.33$  for zooplankton). Although the grand mean from all *A. franciscana* measurements (both control and treatment groups) was greater than the grand mean

from all ambient zooplankton (99.1% vs. 87.8%), there was no statistical difference between them (Mann-Whitney Rank Sum Test,  $p = 0.15$ ).

#### **4.3.5 Comparison of Zooplankton in the Ballast Tank vs. the Filter Skid**

A sample collected using a plankton net tow from a ballast tank holding 200 m<sup>3</sup> of ambient seawater was compared to a time-averaged, 60-m<sup>3</sup> sample collected as the tank was drained. The percentage of living zooplankton was nearly identical (Appendix 9). The mean percentage of living copepod nauplii was 98.3% and 97.8% (plankton tow and filter skid, respectively), and for copepod adults and copepodites, it was 84.2% and 83.7% (plankton tow and filter skid, respectively).

#### **4.3.6 Effect of Crowding on Ambient Zooplankton**

When approximately 600 copepods (*Acartia tonsa*) or 10 copepods were added to 1 l of artificial seawater and incubated for 4h, the percentage of living copepods was > 90% in each treatment for both trials: 98.0% and 100% (600, 10 *A. tonsa*) and 97.5% and 90% (600, 10 *A. tonsa*; data not shown).

## **5 Discussion**

A filter skid was successfully designed to sample large volumes of water to determine if its zooplankton concentration meets a ballast water discharge standard of < 10 organisms m<sup>-3</sup>. Using off-the-shelf components, it was built to meet the requirements of having a low water-flow rate, self-contained nets, and a small footprint. Calculations of the filtration surface area and flow velocity show the skid is comparable to a standard plankton net, and the number of filter housings in the skid could be increased to allow more surface area. The trade off, of course, is a greater handling time of the sample, as more filter bags would require rinsing.

Initial trials using zooplankton proxies (microbeads 50 µm in diameter) to validate filter bags' efficiencies revealed issues that were addressed: the method for counting microbeads was improved, the filter bags' seams were sealed to prevent microbeads from slipping through the holes, and the small amount of algae found in holding tanks used in freshwater field trials was removed to ensure all microbeads were visible within samples. The latter point illustrates the importance of employing fluorescent stains or movement or both to quantify zooplankton. Otherwise, zooplankton may be undercounted when small organisms are obscured by dead organisms, sediment, and debris in samples. Although not addressed in this study, the same is true of the protist (≥ 10 µm and < 50 µm) size class. In the end, microbeads approximating the lower end of the zooplankton size class could be recovered from filter bags in field and laboratory trials with good efficiency, ≥ 87%.

To address concerns that the sealant used to fuse the filter bags' seams and the stainless steel of the filter housings may be toxic to plankton as they are sequestered (albeit for a short time) in the

filter bags within the housings, short-term toxicity tests were conducted. Both toxicity tests exposed the test organism *Artemia franciscana* and ambient zooplankters to the potential toxicant. No immediate or apparent negative effect on the crustaceans was evident. In each instance, no significant difference between treatment or control groups was detected.

Validating nets' or filters' retention efficiencies is, as far as we know, an uncommon practice, both in oceanographic research in general, and in ballast water treatment testing specifically. Regarding the latter case, it seems especially relevant given the potential for fines to be levied when ballast water management systems exceed a discharge standard. Microbeads are not a perfect proxy for living organisms, which may be squeezed through a net more readily than polystyrene spheres. The microbeads do, however, represent a good metric, as they can be purchased at the lower size class (e.g., with a diameter of 50  $\mu\text{m}$ ) and have no spines or setae to cling to a net or filter. A logical—and necessary—next step is to compare retention efficiencies of natural aquatic communities between the filter skid and plankton nets. Those trials are underway at NRLKW.

## 6 Acknowledgements

William 'BJ' Kinee and Barron Stringham helped construct the filter skid and run field trials, and we are grateful for their assistance. We appreciate and acknowledge the support of the US Coast Guard Environmental Standards Division (CG-5224) for funding this research.

## 7 References

Aron W, Ahlstrom EH, Bary BMcK, Bé AWH, Clarke WD (1965) Towing characteristics of plankton sampling gear. *Limnol Oceanogr* 3:33-340

Federal Register (2009) Standards for Living Organisms in Ships' Ballast Water Discharged in U.S. Waters; Draft Programmatic Environmental Impact Statement, Proposed Rule and Notice, 74 FR 44631-44672 (28 August 2009). National Archives and Records Administration, Washington, DC

International Maritime Organization (2004) Convention BWM/CONF/36 'International Convention for the Control and Management of Ships' Ballast Water and Sediments, 2004'

International Maritime Organization (2005) Resolution MEPC.125(53) 'Guidelines for Approval of Ballast Water Management Systems (G8)'

Lemieux EJ, Grant J, Wier T, Drake L, Robbins S, Burns K. In review. Generic Protocol for the Verification of Ballast Water Treatment Technologies, Version 4.2. Submitted to the EPA Environmental Technology Verification Program

Lemieux, EJ, Grant J, Wier T, Robbins S, Riley S, Hyland W, Davis L, Donowick T, Stringham B, Kinee WJ, Brown B, Everett R (2008a) Pilot Environmental Technology Verification

(ETV) Test Report of the Severn Trent DeNora BalPure™ Ballast Water Treatment System, NRL Letter Report 6130/6098, Washington, DC

Lemieux EJ, Robbins S, Burns K, Ratcliff S, Herring P (2008b) Evaluation of Representative Sampling for Rare Populations using Microbeads. Report No. CG-D-03-09, United States Coast Guard Research and Development Center, Groton, CT

Richard RV, Grant JF, Lemieux EJ (2008) Analysis of Ballast Water Sampling Port Designs using Computational Fluid Dynamics. Report No. CG-D-01-08 issued by the US Coast Guard Research and Development Center, Groton, CT

Riley SC, Grant JF, Lemieux EJ, Robbins SH, Hyland WB (2006) Biological in-tank sampling and sample degradation for standardized ballast water treatment technology sampling. Abstract in the Proc 14<sup>th</sup> International Conference on Aquatic Invasive Species, Key Biscayne, FL

Riley SC, Lemieux EJ, Grant JF, Robbins SH, Hyland WB, Davis LE (2009) Validation of biological methods for full-scale treatment testing. Abstract in Proc 16<sup>th</sup> International Conference on Aquatic Invasive Species, Montreal, Quebec, Canada

## Appendix 1

Data from initial field trials conducted at NRLKW comparing microbead recovery efficiency between a plankton net and filter bags arranged in series.

Type of Filtration	Parameter			
	Mesh size	Dimensions	Flow rate (gpm)	Number of 50 µm-diameter microbeads recovered <sup>a</sup>
Plankton net	35 µm net with two filter bags in series as prefilters: 50 µm (first in series) and 25 µm (second) <sup>b</sup>	99 cm (39") diameter at the top and 162 cm (64") long	100	150/600 (25%)
Filter bags (2 in series)	100 µm (first) and 25 µm mesh (second)	18 cm (7") diameter at the top and 41 (16") cm long	25	168/600 (28%)

<sup>a</sup>The 600 microbeads, in Type II water in a beaker, were gently poured into the cod cup of the plankton net or the first filter bag in series. Afterwards, the beaker was examined for residual microbeads, and in both cases, 0 were found.

<sup>b</sup>A previous trial conducted with ambient seawater pumped through the plankton net with no prefilters in place yielded a sample so loaded with debris and sediment that it would have taken days to analyze all of it. In the 8% of sample analyzed, 1 microbead (of 600 added) was found. All subsequent trials used prefilters with ambient seawater (as was the case for data in this table) or freshwater.

## Appendix 2

Results of preliminary trials to determine the appropriate flow rate through the filter bags to allow maximum flow and minimum clogging.

Mesh in first bag in series ( $\mu\text{m}$ )*	Mesh in second bag in series ( $\mu\text{m}$ )	Flow rate ( $\text{l min}^{-1}$ ) (gpm)	Duration of the run (min)	Outcome
25	25	568 (150)	9	The bags clogged and water flow nearly stopped almost immediately; a total of 87 gal (330 l) flowed
50	50	474 (125)	46	The bags clogged, pressure differential between filter housings increased (P1 = 5.3 psi, P2 = 19.1, P3 = 59.4 at the end of the run), and the flow rate slowed to 62.1 gpm; 3312 gal (12,550 l) flowed
100	25	95 (25)	64	The pressure differential remained slight (P1 = 64.8 psi, P2 = 63.9, P3 = 64.3 at 53 min); 1485 gal (5627 l) flowed with little clogging of bags
50	25	95 (25)	80	The pressure differential remained slight (P1 = 65.2 psi, P2 = 63.9, P3 = 64.3 at 70 min); 1460 gal (5533 l) flowed with little clogging of bags
25	25	95 (25)	72	The pressure differential remained slight (P1 = 64.5, P2 = 63.2, P3 = 63.3); 1833 gal (6946 l) flowed with little clogging of bags

\*All experiments were conducted using Hayward Filtration units with 41-cm long filter bags.



### Appendix 3

Data from toxicity tests evaluating the effect of 3M™ 5200 sealant on brine shrimp *Artemia franciscana* (top table) and ambient zooplankton (bottom table) after two hours of exposure time.

Replicate	Live Af	Total Af	% living Af
C1*	78	79	98.7
C2	60	60	100.0
C3	43	43	100.0
C4	48	48	100.0
T1	49	54	90.7
T2	56	56	100.0
T3	50	50	100.0
T4	66	68	97.1

\*C = control group, T = treatment group, Af = *Artemia franciscana*, cultured brine shrimp.

Replicate	Live copepods (≥ 50 µm)	Total copepods (≥ 50 µm)	% living copepods
C1*	20	20	100.0
C2	19	20	95.0
C3	19	20	95.0
C4	20	20	100.0
T1	20	20	100.0
T2	19	20	95.0
T3	19	19	100.0
T4	20	20	100.0

\*C = control group, T = treatment group

# Appendix 4

Eaton Filter Skid drawing with dimensions.

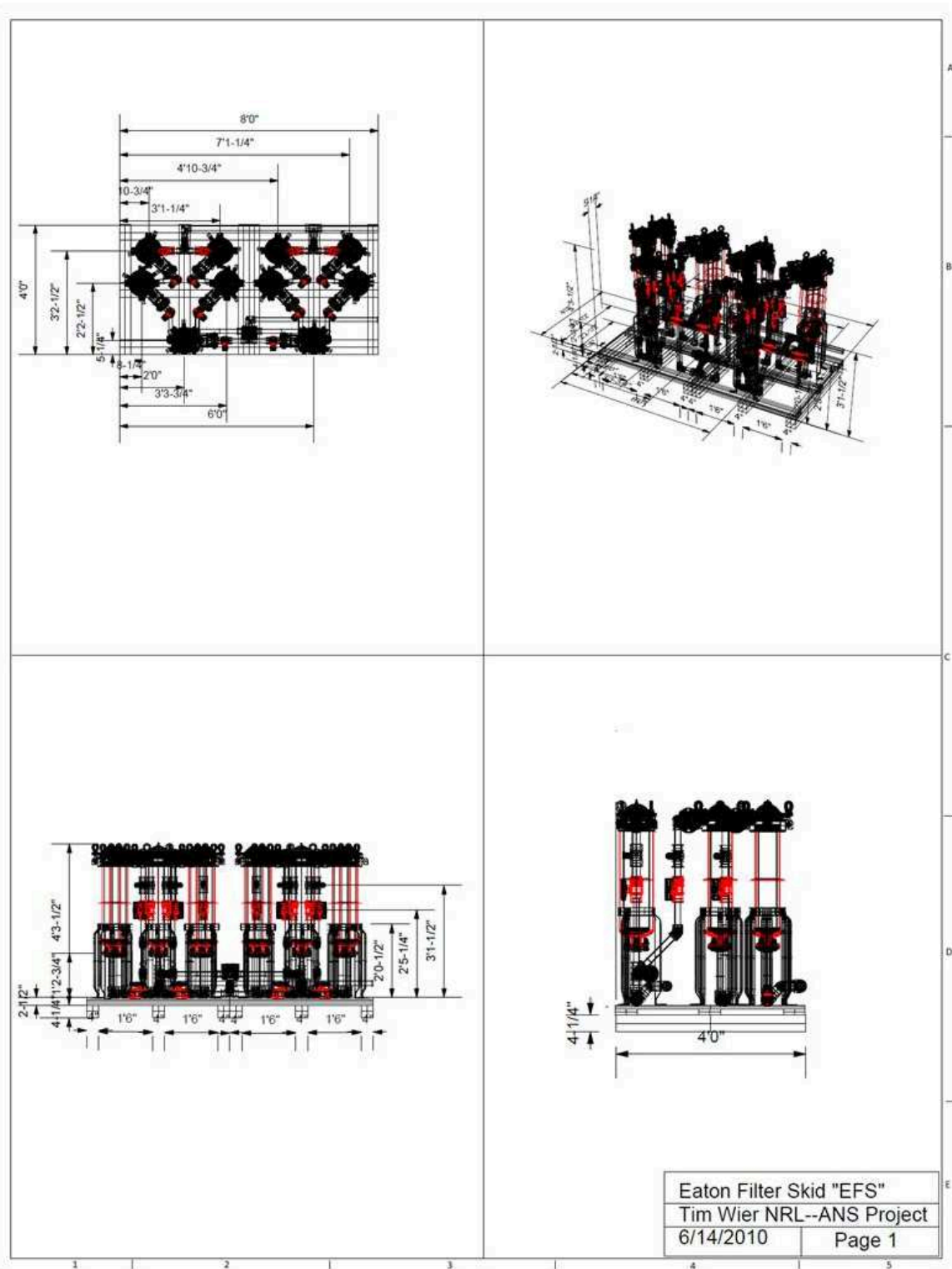

## Appendix 5

Eaton Filter Skid operations manual.

These instructions are specific to operations using the Eaton Filter Skid (EFS, shown in Figure 1) and performed at the Naval Research Laboratory ballast water treatment test facility (BWTTF) in Key West, Florida. The procedures typically used in trials with the EFS are broadly categorized into preparation, operation, and shutdown.

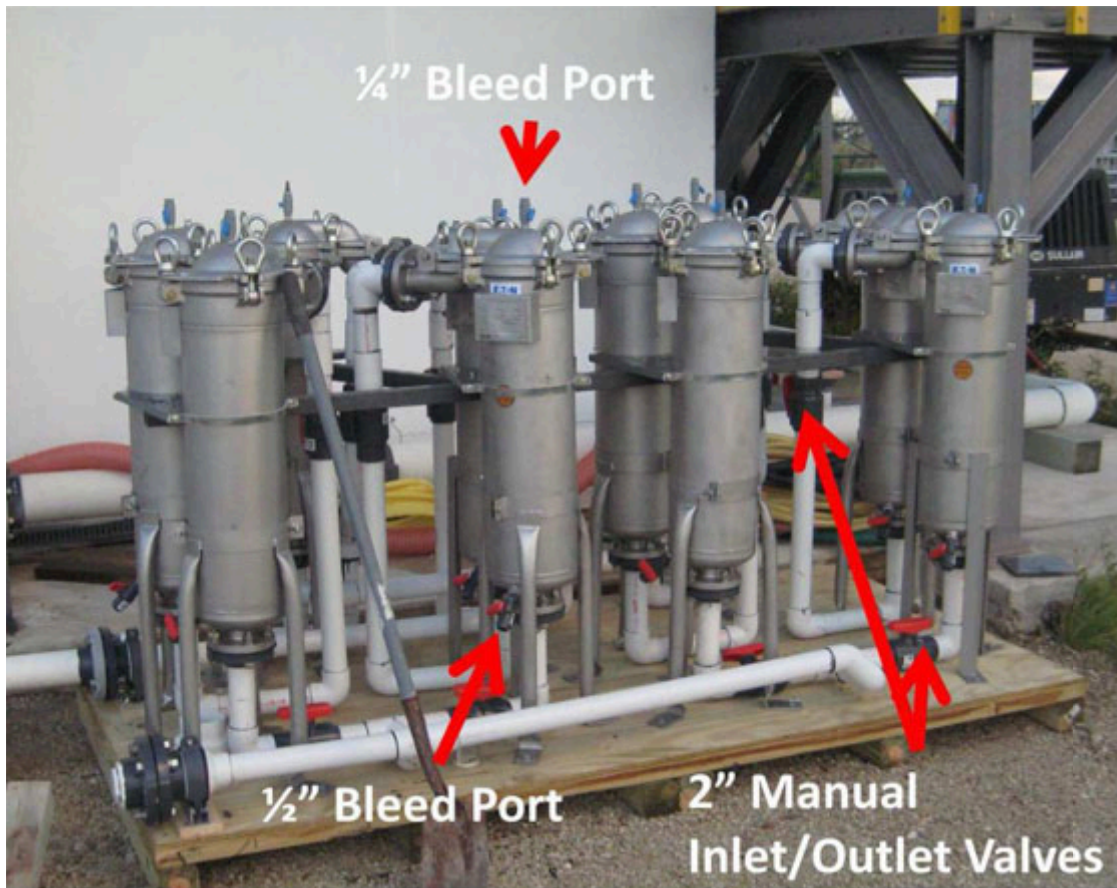
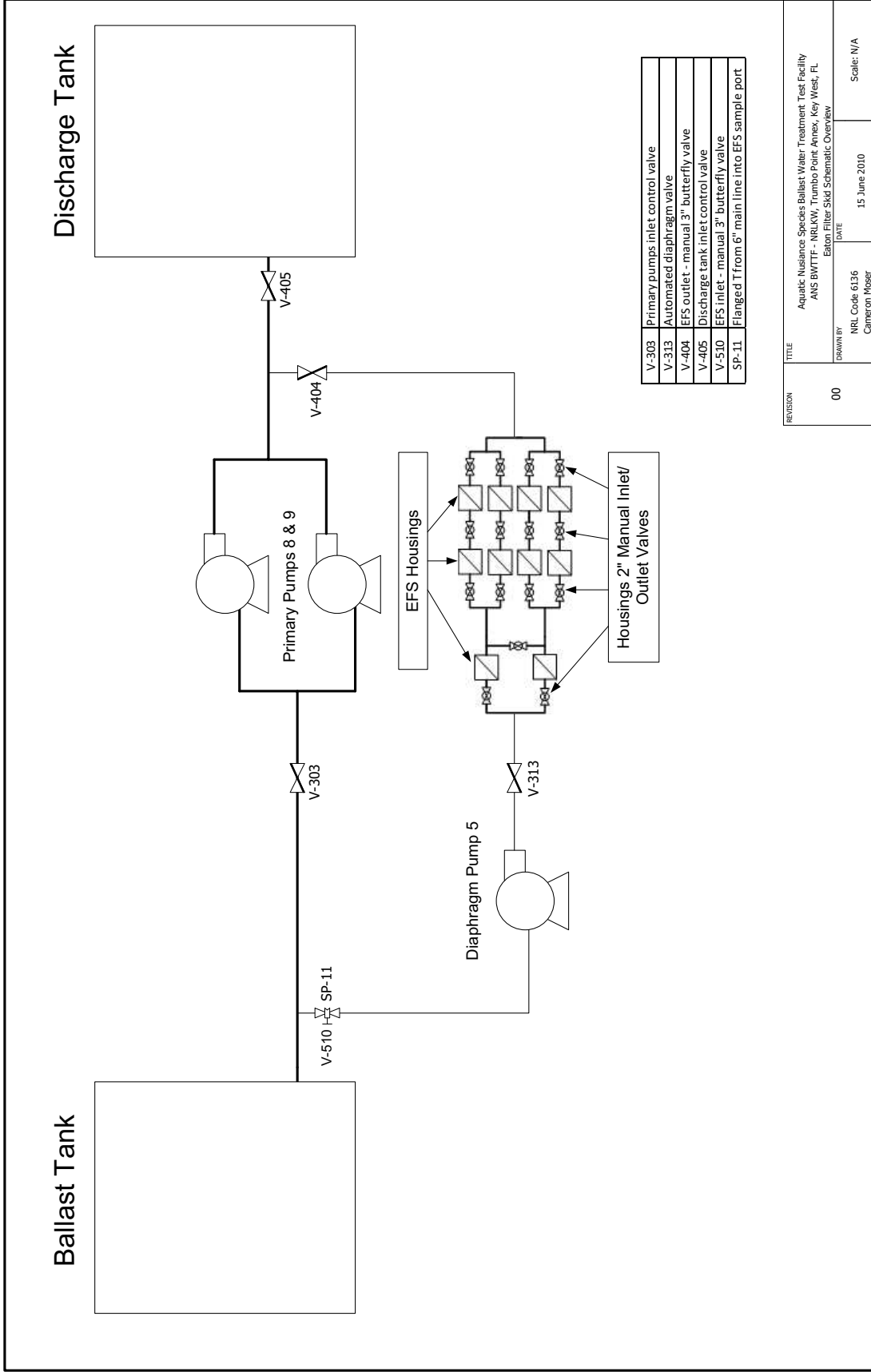

Figure 1. Eaton Filter Skid showing air bleed and drain ports and housing manual inlet and outlet ball valves.

Only a trained system operator shall perform operations specified in this document; improper setup or operation can jeopardize personnel safety or damage equipment.

### Preparation

1. Verify there is sufficient capacity in the discharge tank to receive the entire volume of water contained in the ballast tank.
2. Isolate the EFS by closing the manual 3" butterfly inlet and outlet valves (Figure 2, Valves 510 and 404, respectively), which are upstream and downstream of the EFS.



REVISION	TITLE	DATE	SCALE
00	Aquatic Nuisance Species Ballast Water Treatment Test Facility ANS BWTF - NRLKW, Trumbo Point Annex, Key West, FL Eaton Filter Skid Schematic Overview	15 June 2010	Scale: N/A
	DRAWN BY		
	NRL Code 6136		
	Carneron Moser		

Figure 2. Eaton Filter Skid piping and instrumentation diagram.

- Close 1/2" drain port valves on each of the individual Eaton Topline™ filter housings at their posterior ends (Figure 1 and Figure 3, balloon 5).

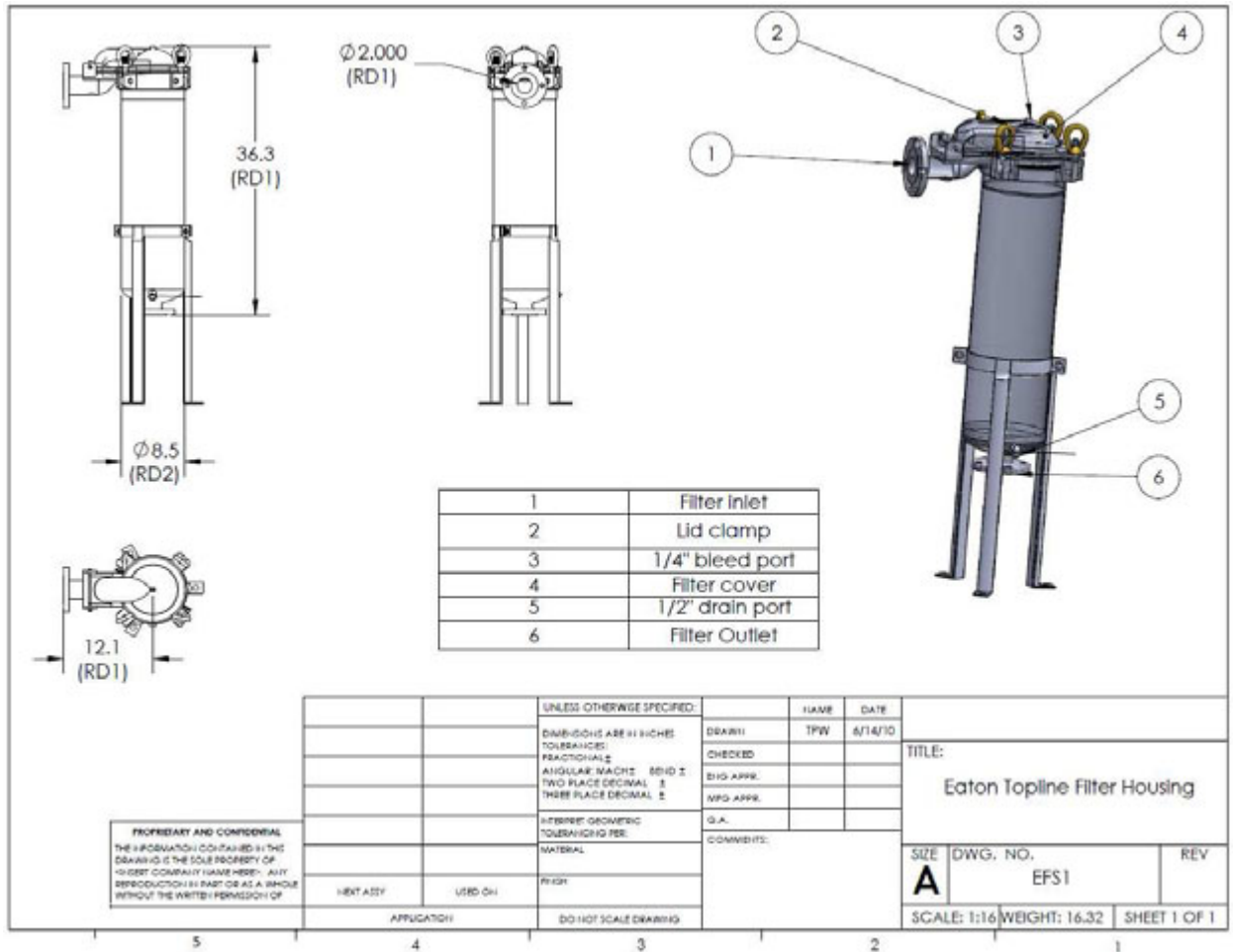

Figure 3. Eaton Topline™ Filter Housing used in the Eaton Filter Skid.

- Open each housing by unscrewing the four lid clamps at the anterior end and lifting the hinged lid by its handle (Figure 1 or Figure 3, balloon 2).
- Install a filter bag in each of the filter housings (Figure 4). The filter bag will slide into the housing, and the top plastic ring of the filter bag should seat into the top of the housing. Take care when installing the filter bags to prevent their ripping on sharp edges during installation.
- Fill each of the housings from the top using a hose with running seawater. Filter the seawater by placing the end of the hose in a 25- $\mu$ m mesh filter bag and directing the water that passes through the filter bag into all filter housings.
- Close each of the individual filter housings by ensuring O-rings are in the proper position, which is determined by ensuring each O-ring lies flat in its designated circular slot (Figure 4). Shut the lid and re-tighten the four lid clamps.



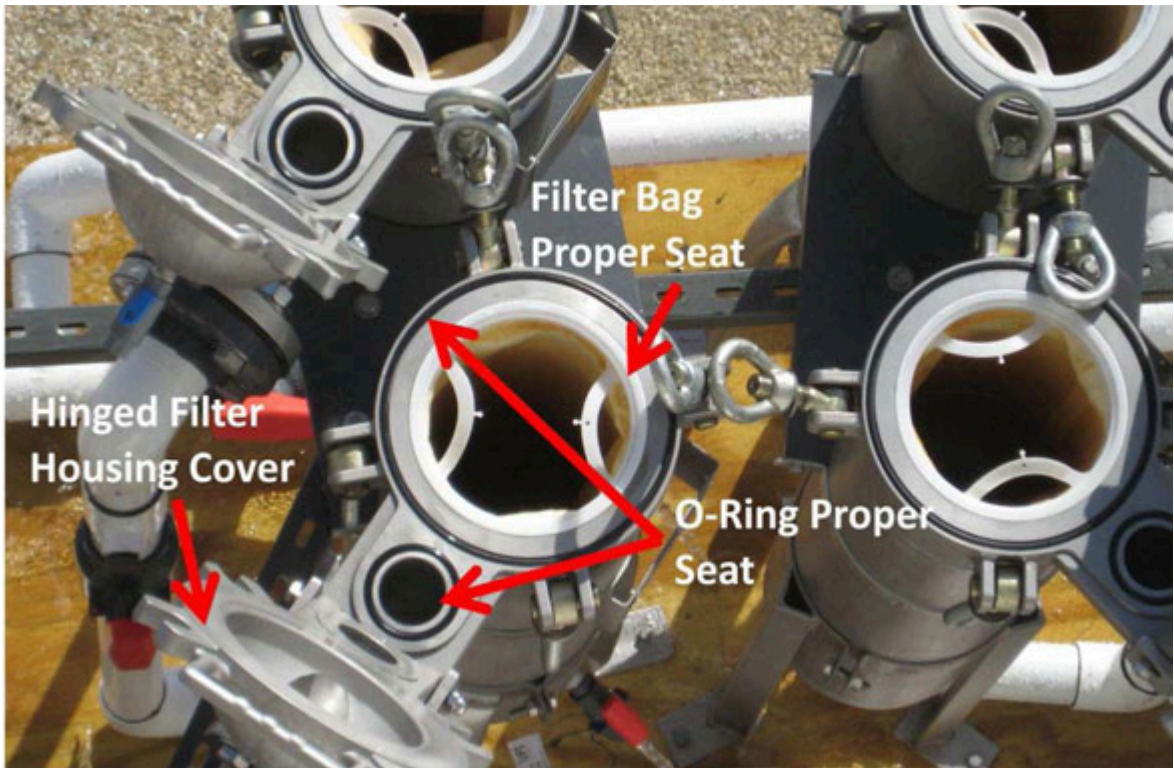

Figure 4. Filter housing with cover open and filter bag installed; O-rings are properly seated.

8. Open ¼" bleed port valves at the anterior end of each housing (Figure 3, balloon 3).
9. Open all manual and control valves to create a flow path from the ballast tank to the discharge tank with an exception of the EFS and discharge tank inlets, which are to remain *closed*.
10. The EFS draws flow from sample port 11 (Figure 2, SP-11) which connects to the main 6" ballast tank discharge line by a T fitting. Slowly open the EFS inlet valve to approximately 50% until water under head pressure from the ballast tank generates a steady stream flowing from the open ¼" filter housing bleed ports, indicating a full prime is achieved.
  - a. At this point, if a housing lid is not properly sealed, a leak (due to a loose lid clamp or unaligned O-ring) will be apparent. This situation must be remedied by closing the EFS inlet valve, isolating the leaking housings at their individual inlets and outlets by closing 2" valves (Figures 1 and 2), and then correcting the issue.
  - b. Re-open housing inlet and outlet valves then repeat step 8.
11. Throttle back the manual EFS inlet valve until the flow in step 10 is reduced to a minimum, then close all bleed port valves.
12. Open the EFS inlet valve completely. Pressure from the ballast tank will equalize throughout the system upstream of the discharge tank inlet valve such that opening it would invoke flow, i.e., this valve should be the last obstacle preventing head pressure from the ballast tank from causing a gravity-induced flow into the discharge tank.
13. Check the fuel level for portable air compressor to ensure there is an ample amount for the desired run time.

14. Hook up the  $\frac{3}{4}$ " air hose from the diaphragm pump to the portable air compressor. The  $\frac{3}{4}$ " air hose has Chicago-type twist-lock fittings. These fittings should align and mate correctly.
15. The diaphragm pump, powered from high-pressure air generated by the compressor, feeds into and is controlled binarily using an electrically actuated solenoid valve located toward the top end of the pump. Ensure the power plug from the solenoid valve is plugged into a power receptacle near the diaphragm pump.
16. Start the compressor and then open the corresponding manual valves that feed air to the diaphragm pump (Figure 2, Diaphragm Pump).
17. At the BWTTF in Key West, a Honeywell Plantscape Control and Automation system is integrated such that all switches, sensors, and machinery send inputs and receive outputs from a programmable logic controller that can be monitored, operated, and controlled from a human-machine interface (HMI) in a centralized control room. Using an identical or similar system is required to enter proper parameters for desired pressure and ballast tank discharge and EFS sampling flow set points into control operation input fields in the HMI. Depending on the location of the controlling flow meter, the set point should be adjusted to account for sampling flow to achieve total desired flow, e.g., if the primary pumps are controlled using a flow meter upstream from where sampling flow rejoins main flow; the set point should be the total designed flow minus the sampling flow.

#### Operation

1. Partially open the inlet control valve to the discharge tank (Figure 2, Valve 405) using the HMI; verify that flow is initialized from the ballast tank to the discharge tank.  
**Note:** If little or no flow observed, an issue needs further investigation by the system operator. Causes may include valves set in an improper position, an inoperable flow meter, or a higher level of water in the discharge tank than the ballast tank.
2. Begin the diaphragm pump and sampling automation from the HMI by clicking `_Start` under the appropriate control operations. Pumps and valves will actuate to achieve desired set points.
3. Continually monitor EFS pressure and flow to ensure filter bags do not clog; pressure should not exceed 30 pounds per square inch.

#### Shutdown

1. As head pressure from the ballast tank decreases, the primary pumps (Figure 2, Pumps 8 and 9) will start to overpower the suction from the diaphragm pump drawing water from the sample port (Figure 2, SP-11). This situation must be prevented by closely monitoring EFS flow as the ballast tank level becomes low (relative to the total flow and tank dimensions, i.e., approximately 10 minutes remaining at the current flow rate and remaining volume) until it suddenly begins to decrease dramatically. At this point:
  - a. Shut down the primary pumps (Figure 2).
  - b. Close the primary pumps' inlet control valve (Figure 2, Valve 303) to isolate all flow through EFS.
  - c. Open the control valve to the discharge tank inlet to 100% (Figure 2, Valve 405).
  - d. Normal flow through EFS should be restored and stable.

2. Depending on tank dimensions, flow will continue for a period until it again begins to decrease drastically. At this point:
  - a. Close the automated diaphragm valve (Figure 2, Valve 313) at the outlet of the diaphragm pump.
  - b. Immediately shut down the diaphragm pump.
  - c. Immediately isolate EFS from the system by closing the six 2" ball valves at the farthest upstream and downstream filter inlets and outlets (Figure 5).

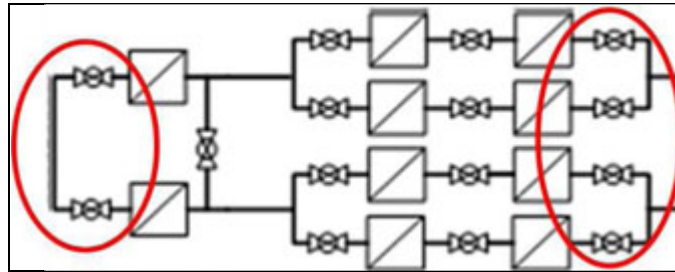

Figure 5. Ball valves (in red circles) closed immediately after the diaphragm pump is shut down.

3. Isolate the remaining housings by closing all 2" ball valves.
4. Release pressure at the posterior end 1/2" drain valves such that flow channels through the filters and out through the drain valves.
5. Once pressure releases, open the 1/4" bleed valves at the top of the housings. The remaining water will drain onto the ground until no more water exits the housings.
6. Open the lid of each housing by unscrewing lid clamps and lifting at the handle.

The filter bags are ready for extraction.



## Appendix 6

Eaton Filter Skid bill of materials and calculation of weight.

	Equipment	Quantity	Cost	Total Cost
<b>Filter Housing</b>	Eaton 316SS Topline™ Housing	10	\$1,707.00	\$17,070.00
<b>Filter Bags</b>	Filter Specialist Incorporated 35µm size 2 NMO 35 with plastic snap rings	10	\$20.43	\$204.30
<b>PVC Piping and Fittings</b>	2" Spears van stone flange socket style	28	\$7.59	\$212.52
	PVC/EPDM COMPACT B VLV 2" S	14	\$50.51	\$707.14
	2" schedule 40 socket Tees	10	\$1.50	\$15.00
	2" x 2" x 3/4" reducing TEE Soc x Soc x FIPT schedule 40	20	\$2.50	\$49.95
	2" Soc x Soc schedule 40 ELL	30	\$1.22	\$36.45
	3/4" plug	20	\$0.52	\$10.35
	PVC/EPDM COMPACT B VLV 1/2" S	12	\$14.18	\$170.10
	3" Spears van stone flange socket style	10	\$12.95	\$129.54
	3" Soc x Soc schedule 40 ELL	10	\$4.42	\$44.18
	Low-Pressure PVC Ball Valve 1/2" NPT Female, White (Same as 4876K11)	10	\$5.96	\$59.60
	Thk-Wall Dk Gray PVC Thrd-One-End Pipe Nipple 1/2" Pipe Size, 2" Length, Schedule 80	20	\$1.21	\$24.20

	<b>Equipment</b>	<b>Quantity</b>	<b>Cost</b>	<b>Total Cost</b>
<b>Wood Skid</b>	4x8 treated plywood 3/4"	2	\$32.00	\$64.00
	2x6 treated 8' board	3	\$5.50	\$16.50
	4x4 treated 8' board	2	\$9.50	\$19.00
	Wood Screws	40	\$0.10	\$4.00
<b>Stainless hardware</b>	5/8-11x3" 316 stainless steel hex cap screw partially threaded	100	\$4.32	\$432.00
	5/8-11 316 Stainless steel hex cap nut	22	\$8.00	\$176.00
	Type 316 SS Type A SAE Flat Washer 5/8" Screw Size, 1-5/16" OD, .07"-.13" Thick, Packs of 10	20	\$8.54	\$170.80
	Type 316 Stainless Steel Split Lock Washer 5/8" Screw Size, 1.08" OD, .15" min Thick, Packs of 10	12	\$5.37	\$64.44
	Type 316 Stainless Steel Hex Head Cap Screw 5/8"-11 Thread, 3-1/4" Length, Packs of 1	10	\$4.69	\$46.90
<b>Cam-Lock Fittings</b>	Aluminum Cam-and-Groove Hose Coupling Plug, PFA Adapter, 3 Coupling Size, 3" Pipe Size	2	\$62.30	\$124.60
<b>Cost of Equipment Components</b>				<b>\$19,851.57</b>
<b>Labor</b>	Hours to build skid per design drawing	80	\$150.00	\$12,000.00
<b>Total Discharge Skid Cost</b>				<b>\$19,851.57</b>

## Appendix 7

Calculations of flow velocity in the filter skid and during a hypothetical plankton tow.

Equation 1. Flow velocity calculation for 50 gpm in a 5 cm (2") diameter pipe.

$$\begin{aligned} \text{Flow Velocity} \left( \frac{ft}{sec} \right) &= \frac{\text{Volumetric Flow Rate}}{\text{Cross Sectional Area}} = \frac{(50 \frac{gal}{min}) * 0.133 \left( \frac{ft^3}{gal} \right) * 144 \left( \frac{in^2}{ft^2} \right)}{\left( 60 \left( \frac{sec}{min} \right) * \pi * \left( \frac{2in}{2} \right)^2 \right)} \\ &= 5.08 \left( \frac{ft}{sec} \right) * 0.3048 \left( \frac{m}{ft} \right) = \mathbf{1.55 \left( \frac{m}{sec} \right)} \end{aligned}$$

Equation 2. Flow velocity calculation for 50 gpm in an 18 cm (7") diameter filter housing.

$$\begin{aligned} \text{Flow Velocity} \left( \frac{ft}{sec} \right) &= \frac{\text{Volumetric Flow Rate}}{\text{Cross Sectional Area}} = \frac{(50 \frac{gal}{min}) * 0.133 \left( \frac{ft^3}{gal} \right) * 144 \left( \frac{in^2}{ft^2} \right)}{\left( 60 \left( \frac{sec}{min} \right) * \pi * \left( \frac{3.5in}{2} \right)^2 \right)} \\ &= 1.66 \left( \frac{ft}{sec} \right) * 0.3048 \left( \frac{m}{ft} \right) = \mathbf{0.51 \left( \frac{m}{sec} \right)} \end{aligned}$$

Equation 3. Flow velocity calculation for 25-gpm flow in a 5 cm (2") diameter pipe.

$$\begin{aligned} \text{Flow Velocity} \left( \frac{ft}{sec} \right) &= \frac{\text{Volumetric Flow Rate}}{\text{Cross Sectional Area}} = \frac{(25 \frac{gal}{min}) * 0.133 \left( \frac{ft^3}{gal} \right) * 144 \left( \frac{in^2}{ft^2} \right)}{\left( 60 \left( \frac{sec}{min} \right) * \pi * \left( \frac{2in}{2} \right)^2 \right)} \\ &= 2.54 \left( \frac{ft}{sec} \right) * 0.3048 \left( \frac{m}{ft} \right) = \mathbf{0.77 \left( \frac{m}{sec} \right)} \end{aligned}$$

Equation 4. Flow velocity calculation for 25-gpm flow in an 18 cm (7") diameter filter housing.

$$\begin{aligned} \text{Flow Velocity} \left( \frac{ft}{sec} \right) &= \frac{\text{Volumetric Flow Rate}}{\text{Cross Sectional Area}} = \frac{(25 \frac{gal}{min}) * 0.133 \left( \frac{ft^3}{gal} \right) * 144 \left( \frac{in^2}{ft^2} \right)}{\left( 60 \left( \frac{sec}{min} \right) * \pi * \left( \frac{3.5in}{2} \right)^2 \right)} \\ &= .83 \left( \frac{ft}{sec} \right) * 0.3048 \left( \frac{m}{ft} \right) = \mathbf{0.25 \left( \frac{m}{sec} \right)} \end{aligned}$$

## Appendix 8

Results of toxicity tests evaluating the effect of stainless steel on brine shrimp *Artemia franciscana* and ambient zooplankton for 2.5 h of exposure.

Replicate	Live Af	Total Af	% living Af	Live zoopl (≥ 50 μm)	Total zoopl (≥ 50 μm)	% living zoopl
C1*	264	265	99.6	34	38	89.5
C2	262	267	98.1	15	20	75.0
T1	353	354	99.7	34	38	89.5
T2	229	232	98.7	28	33	84.9
T3	348	350	99.4	30	30	100

\* C = control group, T = treatment group, Af = *Artemia franciscana*; zoopl = ambient zooplankton ≥ 50 μm.

## Appendix 9

Results of the comparison between living copepods in the ballast tank and the filter skid.

Replicate	Live nauplii	Total nauplii	% living nauplii	Live A + C	Total A + C	% living A + C
PT1*	83	86	96.5	39	43	90.7
PT2	104	104	100	28	36	77.8
FS1	293	299	98	79	97	81.4
FS2	279	286	97.6	98	114	86

\* PT = plankton tow; FS = filter skid; A + C = adult and copepodite stages. All copepods were ≥ 50 μm in minimum dimension.