

THE HYPERSONIC REVOLUTION

Case Studies in the History of Hypersonic Technology

Volume III

**The Quest for the Orbital Jet:
The National Aero-Space Plane Program
(1983-1995)**

**By
Dr. Larry Schweikart**

**Air Force History and Museums Program
Bolling AFB, DC 20332-1111
1998**

About This Series

The Hypersonic Revolution began as a study effort while I was Director of the Special Staff Office at the Aeronautical Systems Division of Air Force Systems Command (ASD, now the Aeronautical Systems Center of Air Force Materiel Command) at Wright-Patterson Air Force Base in 1986. At that time, coinciding with vigorous interest in developing what were then termed “Transatmospheric Vehicles” (TAV), I was convinced that the hypersonics field needed a solid grounding in its own history. Accordingly, I assembled and edited a two-volume group of studies by leading experts and authorities who had written on the major programs, and these were locally published by ASD in 1987. I planned a third volume as well, on the then-ongoing National Aero-Space Plane effort (NASP, which became the X-30 program), but recognized that it would have to be completed at a later date. Reaction to the first two volumes was immediate and strongly positive, as *The Hypersonic Revolution* constituted the first compilation of case studies on hypersonic technology ever assembled. It quickly became a much sought-after reference, and, I am gratified to say, has remained so to the present day, despite an obvious need to be brought more up-to-date.

That updating is at least partially addressed by the third volume, only now ready for publication. Understandably, it had a lengthier history for, after all, the X-30 NASP program itself was just unfolding. During my tenure at ASD, the leadership of the NASP joint program office (Brig. Gen. Kenneth Staten, who first established the JPO, and then his successor Dr. Robert Barthelemy) were both keenly interested in the history of hypersonics and strongly supportive of ensuring that the history of the NASP was appropriately documented. As a long-time student of high-speed flight in general and hypersonics in particular, I found their attitude and support most encouraging. In 1987 I left to teach at the Army War College on a one-year visiting professorship, and, the following year, joined Headquarters Air Force Systems Command, effectively ending any opportunity I might have had to continue at that time with the history of hypersonic flight (though I later briefly returned to the field while serving as a senior

issues and policy analyst in the Secretary of the Air Force's Staff Group during the exciting and productive tenure of Secretary Donald Rice).

But we were all fortunate that, at this time, another player entered the scene: Dr. Larry Schweikart of the University of Dayton. Schweikart, a distinguished student of national defense acquisition policy and programs, already knew Dr. Barthelemy, and exhibited keen interest in pursuing the history of NASP. Very quickly, the NASP Joint Program Office supported a contract for his research; ultimately, it proved long and, at times, tortuous; Schweikart was unflagging in his research and tenacity to get at the story. Thus, the third volume became a reality a decade after he began his work. Rather than publish the third volume as a "stand alone" work, the completion of this third volume now offers an opportunity to reissue the first two volumes as well, giving the aerospace community an opportunity to have a set of case studies in hypersonics even as once again there is rising interest in the subject.

It is worth noting that, since the time the first two volumes of *The Hypersonic Revolution* appeared, much more information has come to light regarding certain technology areas and activities, particularly (1) air-breathing propulsion development, and (2) the hypersonic and lifting reentry activities of the former Soviet Union. Accordingly, Volume II now has been given a short section on propulsion (added to the editor's introduction of the NASA HRE scramjet case study), and an appendix on Soviet hypersonics (added to the Epilogue) Further, I have added an introductory essay, "Whither Hypersonics?" briefly tracing and summarizing some of the recent history as well as the current state of hypersonic projects and work, so as to enable readers to place these volumes within a broader and more relevant context.

Dr. Richard P. Hallion

The Air Force Historian
HQ USAF/HO
500 Duncan Avenue, Box 94
Bolling AFB, DC 20332-1111

Introduction

Groucho Marx once said that 80% of success was just showing up. In a program with such lofty goals as sending a jet aircraft into orbit, one might hope to define success in more demanding terms. Yet in many ways, the National Aerospace Plane (NASP) program, which originated in the early 1980s with the intention of designing and fabricating a jet aircraft that could fly fast enough to attain orbital velocity, is considered a success by many of the participants.¹ They contend that by “showing up,” NASP survived long enough to produce what many deem critical technologies for hypersonic flight (that is, speeds above Mach 5, or roughly 3600 miles per hour), and it reinvigorated an interest in aerospace that was somewhat dormant (and certainly underfunded) at the National Aeronautics and Space Administration (NASA).

But NASP found itself in a world of troubles not long after contracts went out to major aircraft and propulsion companies in 1986. The technical challenges far exceeded what many had expected, and the funding arrangements and political support---thought to be solidified by a variety of administrative and political mechanisms---simply did not stand up to the routine, but merciless, Washington infighting. Even the major sponsors, NASA and the U.S. Air Force, hardly agreed on what the program was *really* about or what the “product” should be.

Many prominent voices within NASA saw an aerospace program as a way to “push” technology (a phrase adopted within the NASP program and wielded by NASP program manager

¹The term “National Aerospace Plane” became the generally accepted name of the program in the popular press and even many scholarly publications, although the official title was National Aero-Space Plane (making it NASP instead of “NAP”). To avoid confusion with the vast majority of popular works, I will use National Aerospace Plane without the hyphen and capital “s”.

Robert Barthelemy on a constant basis). Various groups within the Air Force saw the program almost exclusively as a means to build and fly a hypersonic vehicle for the purpose of getting operational high-speed aircraft onto the runways as soon as possible. Somewhere in between stood those who saw NASP as a “cover” for more extensive hypersonic research and base technology development. Yet others envisioned Mach 10 reconnaissance aircraft taking to the skies before the year 2000. Thus, for a variety of reasons, often contradictory in nature, a large segment of the research and development (R&D) community, NASA, the Air Force, Navy, and even new agencies such as the Strategic Defense Initiative Office championed the program because it promised to try to produce a research aircraft---thus advancing the hypersonic technology base---that would nevertheless address and answer questions about hypersonic flight. As some in the “research group” saw it, NASP needed to fabricate and fly an aircraft *in order to obtain* the very research data that was demanded. Others in the research community, however, were satisfied that the immediate objective of the program, namely to build and fly a hypersonic aircraft, was actually impossible but was still desirable as a way to force-feed technologies into the “right” questions.

To fly the aircraft, however, meant focusing as closely as possible on the research mission. That became especially clear after the original projected aircraft weight of 50,000 lbs. proved a fantasy, at which point the decades-old struggle of aircraft designers to increase thrust and decrease drag required that the NASP jettison as much weight as possible. But decreasing the operational appeal of the aircraft specifically eroded support from the “user” or “ops” community, most notably the Air Force commands that had both the political clout and the budgets to sustain a program of the level NASP was rapidly becoming. At the same time,

technical hurdles slowed parts of the program (although others ran on, or ahead of, schedule) and consumed more resources. The inability to muster or maintain consistent, unwavering support from either the research community on the one hand---represented by parts of NASA, the Defense Science Board, the RAND Corporation, and other scientists---or the user community on the other---especially the Air Force's Strategic Air Command and Space Command left a broad but severely thin middle range of supporters. When extremes usually carried the day for a particular program in Washington by increasing the profile of a program through its vocal advocates, the inability of the NASP program to generate extreme support among any of its participants sealed its doom. By late 1992, when attempts to reconfigure the program into less expensive alternative technology demonstrations failed, "RIP" had been carved into the headstone of the Aerospace Plane.

Yet Groucho's observation has some application to NASP. The program advanced technology along a broad spectrum of fronts and across several disciplines, including creation and application of Computational Fluid Dynamics codes for predicting airflows and combustion results; fabrication of exotic and advanced materials; practical and theoretical work in scramjet engine flowpath performance; production, use and storage of hydrogen-based fuels; and investigations into then-popular "Japanese-style" in management approaches. Program managers tried to ensure that NASP technology, once developed, was force-fed into American industry---and not just aerospace but autos, medical instruments, computers, and dozens of other applications. Many of those technologies had little relation to space launch, including artificial hip joints, computer hard drives, and new heat-resistant materials for autos. "Just showing up" indeed had produced dramatic breakthroughs and consistent, comprehensive advances in

aerospace. What the program did not produce was a hypersonic airplane, and that is the story of NASP.

Acknowledgments

This history originated in the mid-1980s when Richard Hallion, now Chief of Air Force History, contemplated additions or updates to his two-volume study of hypersonic flight, *The Hypersonic Revolution*. Hallion, aware that he could not write a third volume as he had originally intended, which was to cover NASP, discussed options with NASP program manager Robert Barthelemy, and prepared an outline, along with significant questions the volume might answer. Given the promise of NASP, as well as its challenges, Barthelemy agreed that management of such a potentially important program should be documented, especially as it would break ground at almost every level. If NASP actually made it to the runway---let alone into orbit---it could constitute a technological breakthrough on the magnitude of Whitney's cotton gin or have the economic impact of Ford's Model T, even though the complex NASP X-30 aircraft in no way resembled those earlier inventions of relatively (even for the time) simple design. Barthelemy was optimistic, but nevertheless recognized that there was a good chance that NASP might never fly---let alone fly into orbit---and that documenting failure was as important as recording success.

Barthelemy and I met through a mutual friend at the University of Dayton, where I was team-teaching a course with Prof. John Heitmann on the history of military uses of technology and the relationships between economics, technology, and warfare. I also had co-authored a history of the Trident submarine program, and although Trident was a production-line weapon

and not a R&D program, it still employed vastly new and even revolutionary technology. Barthelemy liked the policy analysis used in tracing the history of Trident program management, and assigned the history to me as a subcontractor to Science Applications International Corporations (SAIC). Yet even after the decisions were made to contract me to write the program management document, it took more than a year before the contractual vehicles could be arranged. The fact that the simple act of hiring a historian for the program took a year suggested to me at the outset that this was no “fast track” or “skunk works” project; and it shed light on the difficulties of making major changes in such a government program, when thousands of contracts and millions of dollars are at stake. (I had conducted other corporate histories for multimillion-dollar companies on the authority and signature of a single executive, and begun work within weeks of concluding an agreement!)

While it was Hallion and Barthelemy who started the history project, on the Air Force side within the Joint Program Office, Col. Ted Wierzbowski, a former test pilot for the X-29 “forward swept wing” aircraft and Barthelemy’s right-hand man for his entire tenure at NASP, who provided consistent support and contacts. In consultation with Barthelemy and Wierzbowski, I determined that to be useful the NASP history would have to tell the entire story of the program, including not only the internal technical developments and management decisions, but also a comprehensive analysis of external events, political developments, policy debates, and trends that shaped the program. As a result, the document had two main purposes: it was to record program decisions for the purpose of providing a clear set of “lessons learned” in the process of managing the X-30 program; and it was to provide, where necessary, reference for internal questions about the details that escaped traditional types of government documentation.

The first objective often ran counter to traditional Air Force-prepared histories and their methodologies (though not so much with NASA histories), which focused narrowly on units and organization. I conducted extensive interviews with NASA, Air Force, and Navy participants, as well as with all of the contractors. In addition, I sought external analysis from scholars, writers, intellectuals, and policymakers on topics that touched on NASP, including people with expertise in trade, technology, space, and defense. Other non-traditional approaches included obtaining measures of corporate financial performance, and incorporating that data into analysis of industry trends. Meeting both the first and the second objective, of course, required attention to documents, attitudes, and unwritten views that the minutes of staff meetings and e-mail memos would not contain. The details that explained why certain policies emerged, or how management reached specific decisions, often became so politically sensitive that the history, which Barthelemy once hoped might become a handbook briefing for all personnel new to the program, had to be held in restricted access.

At the conclusion of the program the Joint Program Office wanted a summary of the larger history that it could share with personnel but also which would get wider circulation with its lessons learned that might have applicability to other programs. That summary history (approximately 90 pages) was delivered to SAIC, then to the Joint Program Office in October 1994. Still, no one had trimmed down the sixteen volumes of management history that I also had delivered. At that point, Roger Launius of the NASA History Office entered the picture. NASA was interested in such a book if it incorporated the substantial role NASA had played in the project. Thus, I embarked on new research at the NASA Langley archives and conducted a new round of interviews with NASA participants. The result, I think, is a work that treats the program

as the truly joint program that it was and focuses as much on NASA and its role as it does the Air Force. Moreover, the NASA research revealed that the tensions I had identified among the contractors and the Air Force as to what the NASP mission really was, and thus, what the aircraft designs needed to emphasize, not only existed in NASA but included other variants that I had not seen on the military side of the program. In short, I found a program riddled with contradictions and mutually exclusive goals---all of which were well-justified by their supporters based on whether one was looking at the program from a political, operational, or research perspective.

I have sought to illuminate lessons that could be transferred easily to other programs. I also have attempted to record lessons specific to a hypersonics program, with an eye toward informing those successors who ultimately will build a single-stage-to-orbit airbreathing vehicle. And it is clear that eventually this nation, or one of our economic competitors will do exactly that. Thus, while some of the narrative may be specific to NASP, much of it will contain lessons that could be applied to any major program. It is my hope that the readers of this history will not only be from NASA and the Air force, but also from the ranks of private contractors, government agencies, entrepreneurs, and other areas.

For all of this, I have the men and women of the NASP program to thank, for they all gave generously of their time and file cabinets. Many people contributed to this volume but must remain anonymous (even today). Where I am free to give credit by name, I do so cheerfully. Col. Wierzbanski not only provided meticulous files, maintained over the last few years by Debbie Yates, but also took time to explain the most difficult technical and flight details to me. He held distinct opinions about piloted flight and the potential of NASP, but always insisted that I get “the other side of the story” and went out of his way to make sure I contacted the appropriate

people. Robert Williams, the first NASP program manager at the Defense Advanced Research Projects Agency, explained without reservation the stresses on the program in its formative stages. He had a controversial career, no doubt in part because he was totally committed to the concept of an orbital jet. It is safe to say that no two people in the world wanted to see NASP work more than Wierzbanski and Williams. Barry Waldman, the NASP National Contractor Team program manager at the National Program Office, provided me with the contractor's view. Like Ted, Barry always urged me to compare his interpretations with those of others in the team and the government. Once my NASA site research started, Beth Quinto at Langley, who had "inherited" much of the NASP data and documentation, ensured that I had interview time with NASA participants and made available to me un-processed documents from her own extensive NASP files. When Beth could not provide the necessary contact, Roger Launius or my editor, Steve Garber, could.

At NASA, thanks to Vince Rausch, Bill Piland, Richard Tyson, Richard Truly, and Raymond Colladay for interview time. Sharon Stack of NASA Langley also discussed the program with me. Sandra Keemer of the NASA Langley Technical Library provided documents from the NASP history section. Other NASA employees, located at the JPO, also extended their full cooperation and made documents available, including Jim Arrington, Richard Culpepper, and Howard Wright. Among the Air Force JPO members generously supplied background information, documentation, and, when necessary, technical explanations, that made this history possible, I'd like to thank Chuck Anderson, Lt. Col. Rod Earehart (ranks listed are always the last held by the officer at the time of his or her association with the program), Lt. Col. Rick Roach, Lt. Col. Scott Parks, Col. Ken Griffin, Bill Imfeld, Terry Ronald, Tom Richmond, Col.

John Fuller, Col. George Matthews, Terry Kasten, Lt. Col. Dan Heale, Lt. Col. Bill Seward, Victory Dorrian, Maj. Dan McCorry, Len Pohlar, and Berwin Kock. In addition, many of those individuals contributed to the overall intellectual debates that shaped this work. At SAIC, John Kleperis, then Adrian Dinardo supervised my work on this project. At the Santa Fe Institute, Bruce Abell refined my thinking on several aspects about access to space. To those and many others who helped me during my time at NASP, thank you. At the University of Dayton, I am deeply indebted to Cynthia Thomas and Linda McKinley for their office support, as well as to Larry Flockerzie and the History Department, which provided copy and printing support. Frederick Cedoz, a former student, contributed to the quality of the manuscript through his excellent editing. Needless to say, the concepts, conclusions, and errors that remain are mine alone.

Finally, it says a great deal about the Air Force that it was willing to document the program so thoroughly, and about NASA that it was willing to publish a book about a program that literally never got off the ground. The self-examination that a history of such an experience requires testifies to both organizations' commitment to improving their quality.

Larry Schweikart

Springboro, Ohio

November, 1997

Table of Contents

Chapter 1: A Jet into Orbit?	
Program Direction: Entering the Quagmire of Strategic and Technical Tradeoffs	3
Space Economics and the Promise of Low-Cost to Orbit	9
What was NASP--or, what was NASP suppose to be?	11
Origins of the Aerospace Plane	13
NASP Phase I: Copper Canyon and DARPA, 1981-1984	19
The Memorandum of Agreement, 1985	32
Early Internal Contradictions in NASP	35
Policy Questions of the NASP Program	37
Chapter 2: Trapped Inside the Tension Box	
Program Management Organization	47
Differing Visions of the Program: Early Fissures	52
The NASP Tension Box	56
Unequal Partners: SDIO and the Navy	66
Program Funding Projections	69
Williams and Staten: “Mr. Outside” and “Mr. Inside”	71
NASP Management: the Early Months	75
Chapter 3: The Contractors Come In	
Contractor Selection and the Exclusion of DuPont	84

	xii
Corporate “Contributions:” The Ante to Play in the NASP “Game”	86
Structure of the American Aerospace Industry: Implications for NASP	88
NASP Contractors and Corporate “Contribution”	91
Airframe Companies: Funding, Commitments, and Early Designs	92
Propulsion Contractors: Funding, Commitments, Technology	99
Early Management Difficulties at NASA	106
Managing the Contractors’ Work: the “Tech Mat” Effort	110
Government as its Own Contractor	112
Materials and Management	119
The 1987 Downselection: Boeing, Lockheed, General Electric are Eliminated	124
 Chapter 4: New Leaders, New Directors	
Forming the National Contractor Team	163
Managing NASP at the Contractor Tea: Government-Industry “Work Buckets”	171
Reorganizing the JPO for the Managing the National Contractor Team	172
Early Contractor Operations	174
 Chapter 5: Team Formation and “Incremental” Politics	
The NASP Cost Estimate	183
Stairways to Heaven: The “Incremental” Approach to SSTO	189
Design Developments and Weight Growth in the X-30	199
Team Progress and the Interim Award Fee	202
Technical Progress Toward X-30 Fabrication	203

	xiii
Technical Reality, Schedules, and Budgets, 1991-1992	206
The Incremental Approach Becomes the “Two-Aircraft” Approach	208
Management and Technology at the NPO	211
Chapter 6: The Battle of Ideas	
The Applications Directorate: Building User Support for NASP	232
“Pioneering New Frontiers:” The “New” NASP Image	238
The War for Enthusiasm: Promoting NASP in the Popular Press	246
“Technology Transition” and Program Hopes	249
NASP, Technology, and “Industrial Policy”	253
Continued Expansion of the NASP Bureaucracy	256
Concerns About NASP on Capitol Hill	259
Technical Advances Continue--Would They Be Enough?	261
Chapter 7: Hypersonic Hopes, Deferred Dreams	
The Research Plan, Budgets, and Schedules	280
Testing and Flying a Scramjet	283
Technical Advances and Test Facilities, 1992	299
Pressures to Internationalize NASP	303
HYFLITE I and II, Reprise	307
Attrition and Talent Deletion at NASP	311
Chapter 8: The Final Tally	
“Team” Operations in NASP: Strengths and Weaknesses	336

	xiv
The Integrated Aircraft vs. The Research Mission	338
Revolutionary Management in NASP?	347

List of Figures/Illustrations

Fig. 1.1, "Trajectory Comparison"	11
Fig. 1.2, "Blended Engine Airframe Propulsion System"	11
Fig. 1.3, "Key Aero-Space Plane Technologies"	12
Fig. 1.4, "Active Cooling"	12
Fig. 1.5, "NASP Geneology"	16
Fig. 1.6, "du Pont NASP Design (1983)"	23
Fig. 1.7, "History of NASP-Related Hypersonic Efforts"	29
Fig. 2.1, "NASP Management Structure (1987)"	48
Fig. 2.2, "NASP Steering Group"	48
Fig. 2.3, "NASP Joint Program Office (JPO), 1986"	49
Fig. 2.4, "NASP 'Tension Box' Potential Program Outcomes"	56
Fig. 2.5, "Planned NASP Budget Allocations"	69
Fig. 2.6, "Materials Requirements"	76
Fig. 3.1, "Federal, Private, and Total R&D, 1953-84 (Constant 1972 \$, Millions)"	89
Fig. 3.2, "Sources of Funds for Basic Research by Sector, 1953, 1960, and 1965-84 (\$ Millions)"	90
Fig. 3.3, "R&D Investment in Aerospace 1945-1982 (1972 \$ Millions)"	90
Fig. 3.4, "Company and Federal Funding of Industrial R&D for Selected Industries, 1971 and 1981"	90

Fig. 3.5, "Composition of R&D Expenditures in Aircraft, 1945-69 (Nominal \$, Millions)"	90
Fig. 3.6, "Annual Aeronautical Industry R&D Funds By Aircraft Component (in \$ Millions)"	90
Fig. 3.7, "Measures of Financial Performance: Major U.S. Aerospace Companies, FY 1990"	91
Fig. 3.8, "Contractor Contributions (\$M)"	92
Fig. 3.9, "Contractor Contributions by "TEAM" (\$ Millions)"	92
Fig. 3.10, "Financial Comparison of NASP Airframers, 1985-1988"	93
Fig. 3.11, "Financial Comparison of NASP Propulsion Contractors, 1985-1988"	93
Fig. 3.12, "NASP as a % of Military, Commercial & Aerospace Sales for Airframers (1986)"	95
Fig. 3.13, "Impact of HSCT Introduction on Worldwide Aircraft Financing"	96
Fig. 3.14, "GD/Convair Hypersonic Transport"	128
Fig. 4.1, "U.S. Aircraft Related Industries as a Percent of World Export Share, 1971 and 1985"	146
Fig. 4.2, "Research and Development by Sector"	147
Fig. 4.3, "Federal Government Receipts and Outlays"	150
Fig. 4.4, "Composite of Federal Outlays"	150
Fig. 4.5, "Military Spending"	151
Fig. 4.6, "Revised Program Budget"	162
Fig. 4.7, "NASP Funding Profiles (\$ Millions)"	163
Fig. 4.8, "National Aero-Space Plane Team"	170
Fig. 4.9, "NASP NPO Organization, 1990"	172
Fig. 4.10, "NASP National Team Organization Concept ('Work Buckets')"	173

Fig. 4.11, “NPO Bucket Responsibilities”	173
Fig. 4.12, “NAM Projects Directorate, 1991”	173
Fig. 5.1, “Funding History for the NASP Program, Requested and Actual Funding, 1986-1994 (In Millions of Current \$)”	182
Fig. 5.2, “NASP Program Funding”	183
Fig. 5.3, “NASP Funding Requests (FY 90-92, in \$M)”	183
Fig. 5.4, “NASP Phase 3 Planning”	187
Fig. 5.5, “Incremental Approach”	190
Fig. 5.6, “X-30 Options Study Results (Mach #/Size)”	191
Fig. 5.7, “Exit Criteria”	193
Fig. 5.8, “NASP Composite Design”	196
Fig. 5.9, “NASP Contractor Weight Comparison (1988)”	199
Fig. 5.10, “Material Breakout by Major Sections by Weight”	213
Fig. 5.11, “Airframe Manufacturing Flow”	213
Fig. 5.12, “‘Major Mate’ and ‘Final Assembly’”	213
Fig. 5.13, “Airframe Integration Facilities”	213
Fig. 5.14, “Comparison of Alternative Program Options Presented in January 1992 to the NASP Steering Group”	219
Fig. 5.15, “NASP Organization by Functional Review, 1992”	223
Fig. 6.1, “NDV Response Times from East Coast Basing”	234
Fig. 6.2, “NDV Response Times from West Coast Basing”	234
Fig. 6.3, “NDV Cost Effectiveness”	234

Fig. 6.4, "Existing Vehicles"	234
Fig. 6.5, "NASP-derived Vehicle Capability is Achievable by the late 1990s"	236
Fig. 6.6, "Aerospace Planes: the Global Competition"	239
Fig. 6.7, "Japanese National Aerospace Laboratory Spaceplane Budgets"	239
Fig. 6.8, "Costs and Market Value of Military Hyper-Velocity Vehicle Notional Fleet"	240
Fig. 6.9, "Discounted Life-Cycle Costs of Space Transportation Options"	243
Fig. 6.10, "Scenario Comparisons"	247
Fig. 6.11, "NASP Ground Support System Concept"	265
Fig. 7.1, "NASP Funding Decrease vs. Schedule Increase"	282
Fig. 7.2, "Potential Hypersonic Aircraft"	285
Fig. 7.3, "Options Discussed at Sept/Oct 1992 Strategy Meeting"	288
Fig. 7.4, "Phase 3 X-30X Solution Space"	288
Fig. 7.5, "Technology Evolution to Airbreathing Hypersonic Air-Space Craft"	294
Fig. 7.6, "Titanium Matrix Composites Technology Development Test Articles"	301
Fig. 7.7, "Military Space Budgets, 1980s"	303
Fig. 7.8, "Satellite Manufacturing, by Contractor, 1972-1996"	303
Fig. 7.9, "Commercial Launch Market"	304
Fig. 7.10, "Real Investment in Plants & Equipment"	304
Fig. 7.11, "Manufacturing Productivity"	304
Fig. 7.12, "Gross Domestic Product Per Capita in Market Prices"	304
Fig. 7.13, "The Big Difference in Drawdowns"	312
Fig. 7.14, "Phase 2 Schedule, 1994"	313

Fig. 8.1, "Traditional Perceptions of Layers of Program Support"	344
Fig. 8.2, "Layers of Consensus/Constituency Building"	344
Fig. 8.3, "Political History 1988 & Before (DARPA)"	345
Fig. 8.4, "Political History, 1989 (AFSC)"	345
Fig. 8.5, "Political History, 1990-1991 (SAF/AQ)"	345
Fig. 8.6, "Political History, 1993 (NIO)"	345
Fig. 8.7, "Award Fees, Periods 1-7"	347

Chapter I: A Jet Into Orbit?

THE QUEST FOR an orbital jet has enthralled aircraft designers since the 1960s, if not earlier.¹ Not until the 1980s, however, did the nation apparently have the technology and the budget to make a sustained effort at producing a jet aircraft capable of attaining speeds necessary to reach orbits. Indeed, the intellectual and engineering base for hypersonics---that is, speeds above Mach 5 (3600 miles per hour)---in the private sector had been confined to a defense contractor's ghetto, with work in that area going to support other projects in a peripheral sense. On the government side, the majority of research in hypersonics remained a quiet, ongoing process in the labs of the National Aeronautics and Space Administration (NASA). Relatively suddenly, however, the enthusiasm for the possibility of hypersonic flight reemerged in the late 1970s and early 1980s. In a short span of time, several existing programs in NASA and the Air Force were given new life following a series of conceptual studies undertaken by the Defense Advance Research Projects Administration (DARPA). From those efforts emerged the National Aerospace Plane (NASP) program.¹

NASP had the ambitious, and, in retrospect, unattainable goal of using a scramjet-powered aircraft to reach speeds of 18,000 miles per hour (Mach 25) and boosting itself into orbit without a rocket assist. The absence of rocket boosters, or stages, led to the use of the phrase "single-stage-to-orbit" to describe the NASP mission. Initially pursued as a secret, or "black," program under DARPA, NASP expanded into a high-visibility public national project that enjoyed the endorsement of President Ronald Reagan in the mid-1980s. By the late 1980s,

its funding profile had it on a course to reach an annual expenditure of \$1 billion, which would be used to construct two X-30 aircraft, one of which would fly into orbit. Then, just as suddenly as the budgets expanded, program funding peaked in 1989 at \$320 million, the nation and policymakers appeared to lose interest, technology advances came more slowly. Budgets dried up, and cutbacks forced an endless series of program “restructures,” which only delayed technical advances still further. Official last rites were performed on the program in 1995 when the Department of Defense relegated it to a \$20 million-a-year laboratory “project.” But NASP had acquired its terminal illness several years earlier, and, indeed, some would argue that the contradictory goals and strategy NASP had, when it was first conceptualized, condemned it to be stillborn.

At one time or another, both of the chief sponsors---NASA and the Air Force---sought to unload the program. After Reagan left office, the only prominent political champion of NASP in the government, Vice President Dan Quayle, was committed to NASP only on the grounds that it remained a single-stage-to-orbit (SSTO) vehicle. Yet by that time, even the most enthusiastic program advocates considered that goals unattainable under the 1989 revised a program schedule that Quayle had approved and supported through the National Space Council, even if those budgets had remained firm. But the budgets for NASP were seldom firm, and shortfalls in the early parts of the program had ensured that NASP would have to make a steady retreat from its SSTO focus. At that point, the program managers and contractors were between a Scylla of inadequate budgets that could not sustain the integrated aircraft program and the Charybdis of support based solely on maintaining exactly such an integrated aircraft program. Robert Barthelemy, the NASP program manager throughout much of the budget turmoil, attempted to

conceal the increasing likelihood that the X-30 could not come close to orbit without dramatically increased resources, a few technological breakthroughs, and a little luck. Instead, he fought a campaign to restructure the program around technical and budget reality. Given the political climate of the day, program management chose to concentrate resources on only the most critical technologies, especially the scramjet---at increasingly smaller scales and far lower speeds than that necessary for orbit---in hopes that a breakthrough demonstration and mastery of key scramjet performances would revive flagging organizational support within NASA and the Air Force and, perhaps, even energize the political base. Moreover, those restructured tests were aimed at muting a stream of criticism from the scientific and technical community, especially that part of it engaged in oversight of government science and technology programs, whose positive recommendations seldom could “sell” a program but whose negative appraisals were the kisses of death, often providing the professional rationale for political actions.

Program Direction: Entering the Quagmire of Strategic and Technical Tradeoffs

NASP supporters, especially the first program manager, Robert Williams, and his superior at DARPA after 1983, Raymond Colladay of NASA, had made deliberate political calculations at the outset that such piecemeal technological demonstrations would fail to generate support, and therefore had pursued an advance across a broad front of technology as opposed to a concentrated effort in a few key areas. In retrospect, many argued that a more rational plan would have emphasized important technical demonstrations during the early phases of a broad program. It was especially critical to “fly something, fly anything” on a routine basis during the life of the

program to maintain political, organizational, and public interest, many argued. Even from the purely technical view, making targeted gains in areas fundamental to achieving the larger goal of attaining orbits with an air-breathing vehicle seemed reasonable and necessary.

Whatever the merits of a broad-based program of technical development, many of the DARPA, NASA, and contractor advocates of hypersonics worried that anything less than a full commitment to an orbital vehicle would result in little other than a backwater lab operation. Getting the nation behind hypersonics demanded some **glamorization**, and even more: it required putting a little “hype” in hypersonics. Mobilizing the political support necessary for the program, they concluded, demanded more than boring flight tests of scramjets on rockets or unromantic boundary layer transition experiments. Williams and others were convinced that, ultimately, it required more than merely flying a scramjet-powered aircraft: the only concept capable of galvanizing large resources was a full-scale commitment to SSTO. As Colladay phrased it, without the vehicle there would be no “forcing function” causing the technology to mature.² The strategy worked to an extent: a number of technologies did mature faster than a “non-forced” time line would have predicted (although, as will be discussed later, that concept itself is disputed by scholars of technology development and by economists interested in the costs of shifting resources from market-driven demand to government-driven demand). Regardless of the success of “pushing” the technology in a number of areas, however, the scramjet performance stood out as an unyielding hurdle. Thus, by the time Barthelemy and the contractors butted up against the slow pace and swelling cost of technical advance, combined with falling budgets, the only choice was to scale back the goals from achieving an orbital flight to demonstration of critical technologies. But to politicians and to those scientific advisors less familiar with the

technical challenges of hypersonic flight---not to mention the general public---the tactical withdrawals of the early 1990s looked suspiciously like abandonment of the SSTO mission, which, in the short term, they certainly were. Meanwhile, each time NASP program managers reconfigured the research goals to meet the shrinking budgets, or investigated reducing the scale of the vehicles or the top speed of the scramjet, new and additional investments of time and resources were required simply to reconfigure existing schedules and tests. Money spent on government-required documentation, such as environmental impact statements for basing facilities not yet funded or built, was needed desperately in the scramjet research. Toward the end of the program, merely analyzing potential reconfigurations based on a variety of budget scenarios absorbed the majority of the Joint Program Office's time and effort. The smallest change, such as a budget reduction of a few million dollars, carried its own extremely expensive costs, such as elimination of planned test facilities or delay in developing critical materials, which rippled through the program to cause still other schedule and cost revisions, further absorbing management's time. Moreover, little new technical work could be commissioned, because of the complete uncertainty over program direction. As a result, after approximately 1990, program management found itself constantly reacting, constantly behind, with each "new" program strategy trailing actual funding trends. In its final years, NASP was reduced to a series of scramjet flight tests in which scramjet engines were to be accelerated to high Mach numbers and then turned on for a matter of seconds to determine if the engines could generate thrust sufficient to overcome drag---the basic aerodynamic principle. It represented an astounding reversal of technical priorities, in that in more traditional programs, such tests would have been the first order of business.

On the surface, then, the NASP program would appear to the casual observer to be a failure---though not an exceptionally costly one by the standards of such boondoggles as fusion reactors, the supercollider, the Super Sonic Transport, or other large-scale research projects.³ Yet NASP attempted far more than most recent research projects, by comparison dwarfing the narrow goals of the X-15---or, in pure technical complexity---even the Apollo missions.⁴ Many of the high-profile technology programs, such as Apollo, relied on a vast base of existing experience and demanded little in the way of revolutionary technology. NASP, on the other hand, required fantastic and dynamic breakthroughs in virtually every element of the aircraft and its support systems. Certainly some innovations occurred due to cost pressures, which often force unusual or unorthodox responses within project management. Perhaps the most radical response was the formation of a contractor “team,” in which, as a precursor of many modern weapons programs, the five primary NASP contractors (three airframe and two propulsion companies) in 1990 agreed to join together into a single contractor entity, dividing the work and profits while sharing their technology from the previous, competitive phase. That team formation---whether planned from the outset (as some suggested) or a desperate reaction to retain the major players in the aerospace industrial base (according to others)---marked the apex of the NASP program, and reflected the lengths to which the government and the contractors would go to sustain the X-30. By that time, however, NASP already had started to come apart due to its own contradictions and the intransigence of the technology.

Long before budgets started to slip, the NASP program took dramatic steps to create a technology base capable of producing a hypersonic aircraft capable of flying at sustained high speeds. NASP, for example, utilized the NASA research centers as contractors, demanding of

them “work packages” that had to be performed at cost and on time---a novel concept, some have suggested, for government researchers. Government-contractor relationships also took new forms, as the government found itself simultaneously an employee as a part of the work packages and a manager as a program office. When early internal government reviews found that the progress in a variety of technologies occurred too slowly to support the NASP program, management launched an immediate assault on specific technologies through a maturation process called “Tech Mat.” Later, when materials had not evolved as fast as hoped, the NASP office ordered a similar crash program to develop necessary materials. Both Tech Mat and the materials program were hailed as great successes, even by NASP critics.

Finally, anyone who thinks of NASP as a failure might examine any number of continuing NASA and/or Air Force programs, including Hyper-X, the X-33, and HiTech, all of which constitutes sub-components of the original NASP program, and which are attempting to demonstrate in smaller bites what NASP intended to swallow. Work on hypersonics has not disappeared, and in some ways has even expanded. Dozens of government programs benefited from the technology developed by NASP, especially from the materials developed for the aerospace plane. The private sector received scores of advanced products, such as a new computer hard drive materials and artificial hip joints, that streamed out of the NASP labs.

Nevertheless, the ultimate fact is that the National aerospace Plane never flew, and indeed, no X-30 was even built. Many insiders noted that the most impressive piece of hardware built and tested in the program’s history was a fuel tank. By the time NASP died in the mid-1990s, the contractors’ scramjets could not power any aircraft, even of a subspace variety, at any speed over the drag of a vehicle, let alone propel a half-million-pound vehicle into orbit. From

that perspective, the NASP program certainly was an abysmal failure. Indeed, in retrospect, its failure seemed inevitable, so much so that some critics suggested that NASP was never intended to fly, only to provide public “cover” for a secret reconnaissance aircraft called *Aurora*.⁵

The cynical view, however, fails to take into account either the unknowns of research and the tremendous potential offered by SSTO aircraft. It also ignores the human element, in which people make decisions based not only on existing evidence and experience but also on the basis of personal optimism, and even faith and hope. American business history overflows with the stories of entrepreneurs who saw railroads where none existed, or who had a vision of personal computers at a time when giant supercomputers dominated markets.⁶ America embarked on the mission to create an air-breathing orbital aircraft on the basis of a little science, perhaps a little more experience, but mostly on faith and optimism. A key difference between those who saw beyond the technical challenges, who might loosely be called “entrepreneurs,” and those of a more pure technical and scientific orientation, or the “engineers,” also manifested itself many times during the program’s history. The two groups clashed, with the “entrepreneurs” arguing that the “engineers” had no vision, and the “engineers” claiming that the “entrepreneurs” ignored technical realities. Frequently the “entrepreneurs” in the program sought to go beyond what the numbers told them, but pure imagination proved a weak defense against the unrelenting data of the “engineers.” Yet even the most pessimistic of the technologists did not find any theoretical reason a scramjet-powered aircraft could not attain orbit, and many of them agreed that the right mixes of technologies, aircraft designs, and integration could still produce an orbital jet.

Space Economics and the Promise of Low-Cost to Orbit

Most important, the inability of the NASP program to put a jet into orbit did not in any way diminish the phenomenal potential that SSTO aircraft represented, and that potential remains to be tapped. Space launch economics differs little from the economics associated with other, earlier transportation systems. All economies of scale rely on taking advantage of fixed costs---that is, those costs that are already invested and do not change with factor inputs or outputs. With the railroads, the fixed costs consisted of the track, locomotives and cars, and stations. Fuel and personnel varied according to the amount of freight or passengers handled. A space launch was similar in that the fixed cost of the rocket and support systems stayed the same whether a 10-lb. Package or a two-ton satellite was placed into orbit. Unlike the railroads, however, the space transportation system lost its “locomotive”---the multistage rocket---with every trip. A reusable vehicle, whether a recoverable rocket or an aircraft that could land, stood to ensure quantum savings in space launches.⁷ But rockets also carried a substantial element of risk unknown to even the earliest railroads. No single train accident ever destroyed all of the track in the line, and even a large-scale disaster, such as a collapsing trestle or a collision of two trains, only stopped service on part of the route, and then only temporarily. In stark contrast, each space launch entailed numerous potentially catastrophic failures that could cost clients millions of dollars in losses and even shut down the entire launch infrastructure itself (as occurred with the *Challenger* disaster and the Shuttle fleet). Consequently, customers who planned to use the nation’s launch apparatus had to invest heavily in costly insurance, while the manufacturers of both the launch systems and the objects placed into orbit had to build in extensive and expensive redundancies.

Once an object made it to orbit, another launch to replace a malfunctioning satellite was a long way off. All of those redundancies drove the costs of a space launch to unimaginable levels, perhaps far higher comparatively than outfitting major overseas expeditions in the time of Columbus.

Reducing the cost of a space launch thus required making launch systems reusable and, as a side effect, making them more expendable. That did not mean that, after investing billions of dollars in a NASP-type vehicle, it was expected to crash, but only that as the space launch frequency increased, the relative value of a single mission decreased. Perhaps, then, a more fitting model for the economics of space transportation architecture might be that of a fort, a wagon train, and a railroad. The space station is analogous to a fort or trading post, established in a distant and unfriendly territory. Initially, wagon trains might be assembled to deliver supplies and also bring in settlers. Each wagon train represented a major investment, taking months to organize. Its destruction by the forces of nature or at the hands of hostile natives not only marked the end of that particular mission, but also could spell doom for the outpost it was scheduled to resupply and relieve. The railroad, on the other hand, provided a permanent link, even though trains only arrived periodically, and the destruction of a single train could be overcome at relatively low cost, and in a relatively short time, so that the fort itself was not imperiled. Thus, freight and passenger costs fell.

Anyone watching a Shuttle launch should be struck by its similarity to the outfitting of a wagon train, from the celebrations that accompany its departure to the publicity surrounding its arrival back home. In contrast, a genuine routine space launch will be characterized by a complete lack of attention and emotion after a successful launch, the way no one cheers when an

airliner departs, and few people celebrate the fact that their cars start when they turn their ignition keys.

More than the quantified savings, though, a routine space launch promised to open new areas of commercial activity by making it cheap enough to experiment with space-based businesses. At that point, unforeseen and unpredicted users of space launch architecture would appear, much as the computer spawned the unforeseen \$6 billion computer gaming industry, and new, unforeseen users would force launch costs down still further. To the “entrepreneurs” in the NASP program, the aerospace plane spoke exactly to those hopes.

What was NASP—or, what was NASP supposed to be?

Briefly, the NASP story technically began in DARPA. As conceived, NASP was a fully integrated aircraft program that proposed to design and build two X-30 research aircraft, at least one of which was to achieve orbits by flying in a single stage through the atmosphere (see Fig. 1.1, "Trajectory Comparison") at speeds up to 18,500 miles per hour (Mach 25).⁸ At that point the aircraft would obtain orbit, making it a true SSTO, system (in contrast to the Space Shuttle, which is essentially a three-stage to orbit system). The X-30 would utilize a multi cycle engine system, beginning with a low-speed subsonic propulsion unit, switching to a mid-speed ramjet, then finally converting to a supersonic combustion ramjet (scramjet), with the progression from one system to another occurring in flight. The scramjet's unique properties required that the aircraft itself become part of the engine intake and exhaust, and thus the X-30 design featured an integrated fore body (see Fig. 1.2, "Blended Engine Airframe Propulsion System") and aft

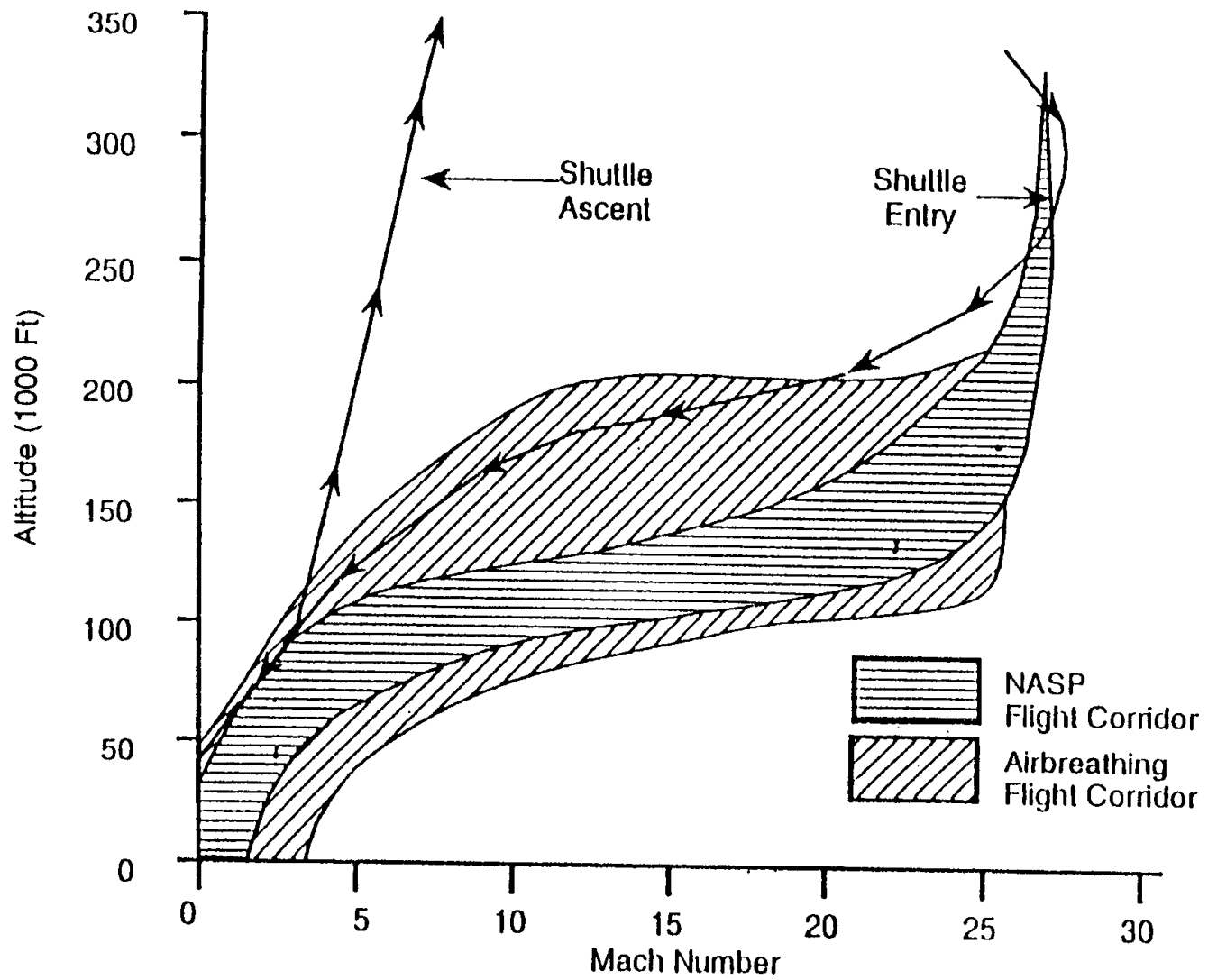

Fig. 1.1, "Trajectory Comparison"

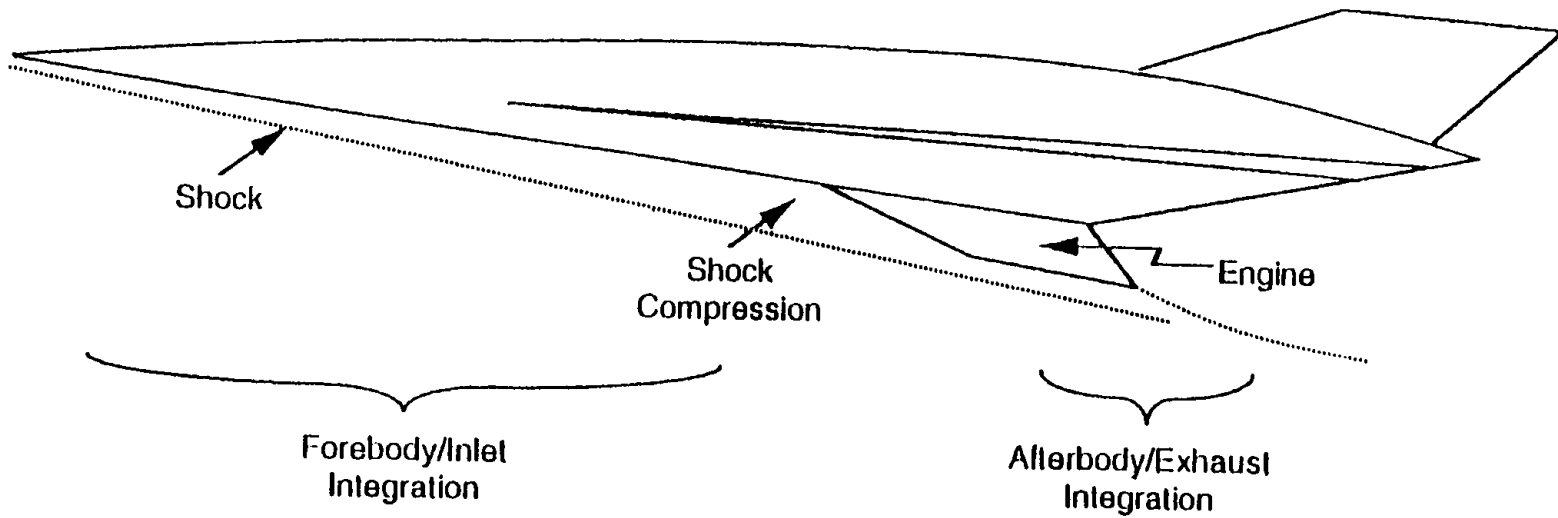

Fig. 1.2, "Blended Engine Airframe Propulsion System" n

section that acted as a giant exhaust. Merely producing a functioning aircraft of that type represented no small challenge: but NASP demanded far more to achieve the orbital flight capability it promised. In addition to the scramjet, the X-30 would require breakthroughs in several key technologies (see Fig. 1.3, “Key Aero-Space Plane Technologies”), such as developing advanced and exotic materials, creating and validating computational fluid dynamics (CFD) computer codes of unprecedented sophistication, defeating the fantastic heat of atmospheric flight at high speeds and reentry through revolutionary methods cooling (including using the aircraft’s own super-cold fuel to circulate through the wings, body and engine), avionics, and pioneering methods of making, transporting, storing, pumping, and burning its unusual fuel.

Unlike traditional rocket-powered orbital craft, NASP would use the very oxygen it flew through as part of the fuel, which would in turn require it to fly through the atmosphere for prolonged periods, thus generating tremendous heat and stress on the aircraft and engine. The solution, as X-30 engineers saw it, was to find a cold fuel that could mix with oxygen, and thus perform two tasks simultaneously---fuel the engine and cool the structure. For that, they chose an almost-frozen version of liquid hydrogen, called “slush,” to circulate throughout the craft (see Fig. 1.4, "Active Cooling").

Most important, all of those new technologies and concepts had to be developed simultaneously. The program had to "push" the technology---a concept that many economists dismiss as not cost efficient---but even that required innovation. Program management ultimately adopted new management structures and eventually implemented an innovative "team" approach among the contractors. Any one of those many technical or managerial challenges would have

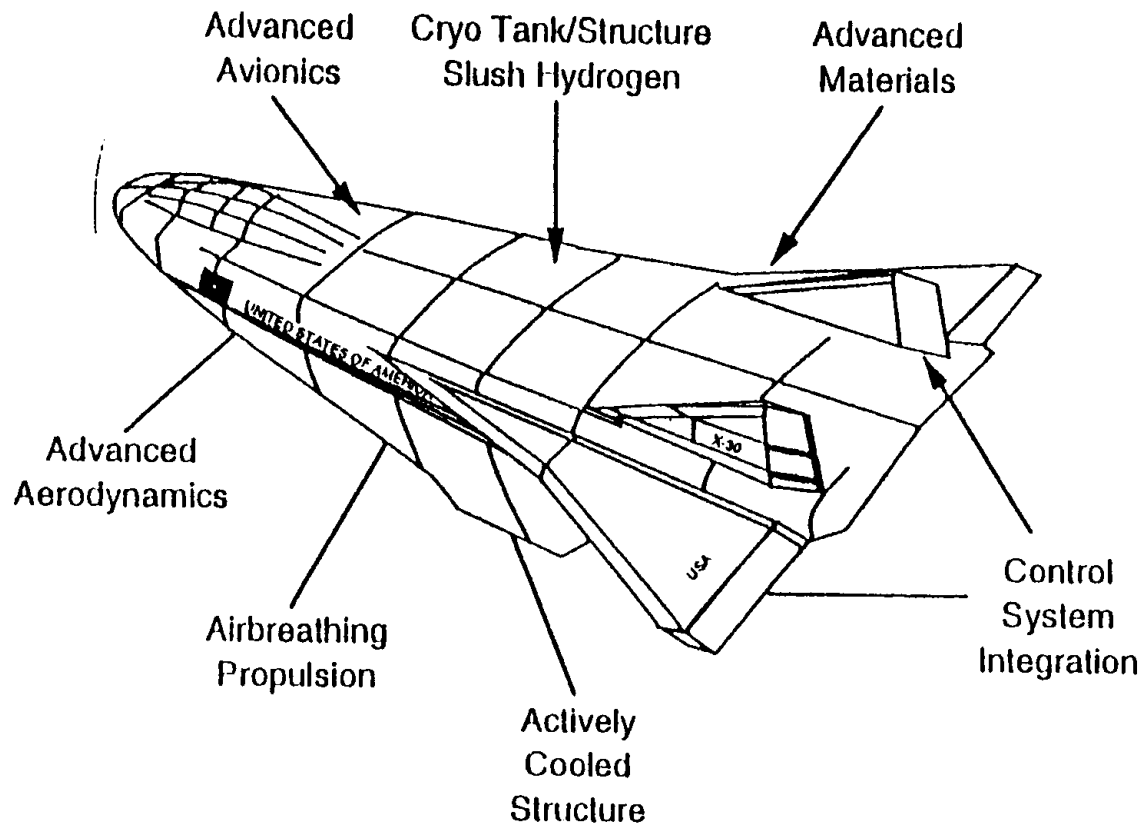

Fig. 1.3, "Key Aero-Space Plane Technologies"

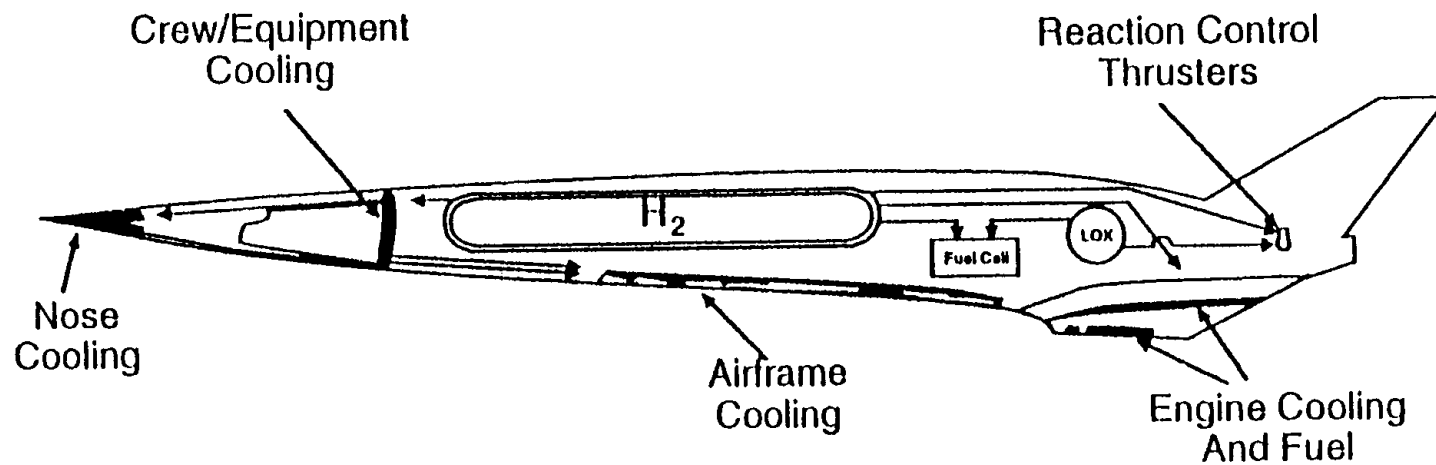

Fig. 1.4, "Active Cooling"

absorbed the resources and attention of most typical research and development (R&D) programs: NASP to succeed, had to conquer all of them, virtually simultaneously.

Origins of the Aerospace Plane

After World War II, while rocket propulsion took a substantial lead in propelling objects and people into space, many engineers and pilots sustained a vision of flying an airplane to the outer reaches of the atmosphere, giving way only at the edge of space to rockets.⁹ Concepts of scramjets had been well known in aviation circles since the 1950s.⁶ Researchers at Lewis Research Center had examined scramjet combustion, and in September 1958 R.J. Weber and J.S. MacKay of Lewis published *An Analysis of Ramjets Using Supersonic Combustion* for the National Advisory Council On Aeronautics (NACA).⁷

From 1959 to 1961, the Air Force worked on an “aerospace plane” that would combine an airbreathing engine with a rocket for orbit, while the U.S. Navy, working with the “Bumblebee” group at Johns Hopkins University Applied Science Laboratory (JHU/AHL) worked on the TALOS missile to develop a jet-propelled antiaircraft missile with supersonic speed.⁸ TALOS used a ramjet to push the missile to supersonic speeds for surface-to-surface warfare within a 60 nautical mile range. A second missile, called TRITON, never got off the drawing board because of the success of a solid-fuel missile, the Polaris. Gradually the Navy came to view airbreathing missiles as competitors for funds with its solid fuel missiles, and thus eliminated funding as the latter proved technically sounder than anticipated.⁹ Nevertheless, one of the “Bumblebee” researchers, Fred S. Billig, had been part of a project to develop an External

Ramjet (ERJ), which so impressed Adm. Levering Smith of Naval Sea Systems Command that he continued to fund hypersonic research secretly out of his Polaris funds. With that funding, Billig performed calculations for inlets up to Mach 28. Indeed, in December 1960, John Hopkins University/Applied Physics Laboratory (JHU/APL) submitted a proposal to the Bureau of Naval Weapons for a hyperonsonic ramjet test facility that would investigate the feasibility of hypersonic propulsion between Mach 5 and Mach 29 “by means of an airbreathing engine which burns hydrogen or other suitable fuels . . . in a supersonic flow field.”¹⁰

NASA’s scramjet efforts included ongoing work at Ames Research Center that, among other studies, performed tests on a General Dynamics/Convair hypersonic transport to explore tradeoffs involved in hypersonic civil transportation. Those studies produced a preferred configuration that utilized a Mach 6 turboramjet-powered aircraft with a range beyond that of supersonic transports of the era. The aircraft featured a blended body (meaning that the engine was not attached on a nacelle, but was integrated into the aircraft) and used liquid hydrogen, and looked remarkably like the design that emerged from Tony du Pont more than fifteen years later. Ames was home to other contractor studies during this time, including a Lockheed investigation that examined costs and performance of airbreathing hypersonic flight vs. rocket-powered flight. Lockheed’s two studies investigated both ramjets and scramjets.¹¹ One of the most significant efforts in high-speed flight at NASA emerged from plans to flight test a ramjet on the X-15 in 1963. That led in 1964 to the Hypersonic Research Engine Project (HRE) at Langley Research Center.¹² Marquardt, General Electric, and Garrett AiResearch all joined in a first-phase project, with AiResearch selected to actually build the ramjet. However, the costs for a flight test rose too high, and the effort was divided into an engine flight test and a ground support test in 1966.

HRE work showed potential for scramjet propulsion that used hydrogen as both a fuel and a liquid coolant; provided engine component data that indicated the feasibility of the inlet diffusion process and for combustion of fuel at supersonic speeds; and nozzle efficiency data. However, no full-scale scramjet engine data existed, and indeed the HRE hoped to provide data on scramjet performance between Mach 4 and Mach 8, concluding with test results at Mach 5, 6, and 7. Taken together, the widespread scramjet studies suggested that internal scramjet thrust performance was demonstrated, but only at the lab level. Researchers were a long way from examining the numerous and extensive effects on the engine and propulsion system caused by scramjet combustion, especially that of heat on engine performance. Moreover, traditional pod-type configurations of engines mounted to wings simply proved impractical, and the scramjet tests showed that the engines barely overcame their own drag. (HRE tests on the X-15 failed to produce a suitable flight test, as one X-15 flight ended when an engine mount burned and the dummy engine plummeted into the desert.)

Meanwhile, in 1968, NASA Langley's Hypersonic Propulsion Branch started an effort to improve scramjet performance and to address other problematic areas related to the scramjets through a series of inlet and combustor tests. Among the test articles, Langley had two single-module scramjet engines, roughly capable of capturing an intake area of 8" x 6 1/4" of air, that underwent testing at Mach 4 and Mach 7. The performance of those engines suggested that scramjets could indeed generate thrust over drag. An internal design study on an integrated scramjet followed, in 1972, and, under Robert A. Jones, head of the Hypersonic Propulsion Branch, in 1975, work started on a flight test effort that would utilize an X-24 aircraft derivative that would have flown under scramjet power at Mach 6. The result was the Langley Integrated

Scramjet (Copper Engine) installed in test facilities at Langley in 1976, with a second model engine (Nickel) tested up to Mach 4 through 1978. Tests at General Applied Science Laboratory (GASL) had examined scramjet performance as high as Mach 7 by that time.

Of course, actual flight tests involving pilots got more publicity than lab work or flight tests of equipment, and they, too, contributed to the understanding of high-speed flight and its demands on aircraft systems. As early as 1947, when Chuck Yeager flew the Bell X-1, named the “Glamorous Glennis” after his wife, past the then-magical and foreboding wall, the sound barrier (see Fig. 1.5, “NASP Genealogy”), the romance of human-controlled aircraft that could perform exceptional feats offered the potential for substantial public relations gains. The pilot in the cockpit underscored the memorable phrase from the book and successful film, *The Right Stuff*: “no Buck Rogers, no bucks,” and, according to some, wedded aeronautic and space exploration to manned flight to an unnecessary degree, a phenomena Alex Roland has called the “tyranny of manned spaceflight.”¹³ Within a few years, however, flying above Mach 1 (approximately 750 miles per hour at sea level, or the point at which one “broke” the sound barrier) no longer constituted much of an accomplishment. Yeager tripled his speed in 1954 with the X-2, and between 1959 and 1968, the rocket-powered X-15 experimental aircraft (with a total operating gross weight of 33,000 lbs.) reached speeds of Mach 6.7, or more than 4000 miles per hour. It appeared that high-speed flight would require rockets, but the early rockets proved temperamental and prone to explosions. Worse, the nature of the fuel and the preparations demanded to launch a rocket all combined to make rocket-propelled flight less than routine by any stretch of the imagination.

Continual expansion of the flight envelope by jets, however, combined with the promise

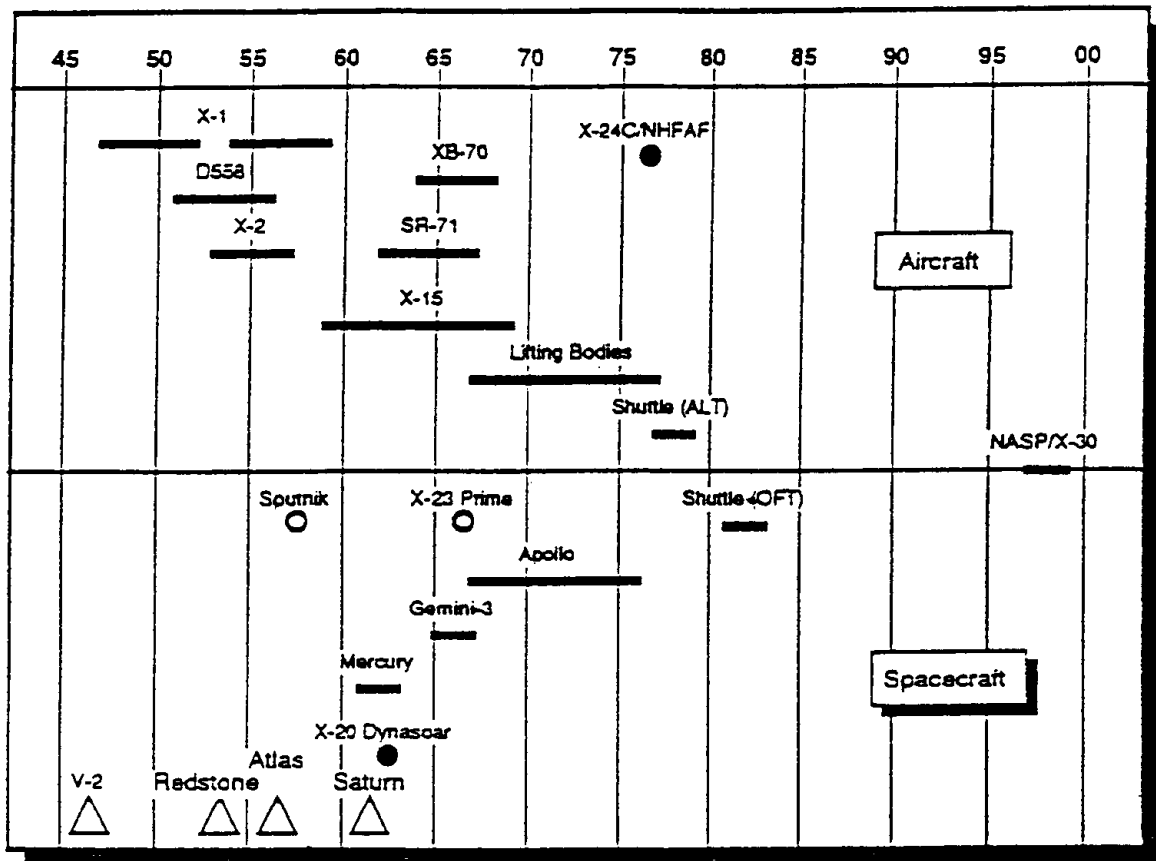

Fig. 1.5, "NASP Geneology"

of airplane-like operations, repeatedly beckoned designers to examine orbital vehicles that could operate more like airplanes than rockets. In the early 1960s, work on an Air Force lifting body called the Dynasoar showed promise, but was canceled before it could "fly" into orbit. By the 1970s, though, the advances in scramjets lured researchers to continue to examine ways to mate a scramjet propulsion system with a lifting-body aircraft to attain orbital velocity. In 1977, a joint NASA/USAF planing project proposed to fund a Mach 7 research aircraft to "explore propulsion, aerodynamics, and structure technologies," but the project "lack[ed] a defined mission" (other than pure research) and was not funded.¹⁴ Virtually all of the substantial advances made with scramjets at that time represented a tiny allocation of overall NASA, military, and civilian aerospace allocations. Navy programs emphasized scramjet experiments on anti-missile or anti-aircraft weapons, while the Air Force concentrated more on lifting body design and ramjets, which offered more of an immediate payoff. NASA, the natural home of scramjet research, had generated exceptional public good will with the Apollo flights, and had invested that "enthusiasm capital" into the Space Shuttle program, winning support on the premise that the Shuttle would provide the essential routine space transportation system needed to build a space station, then use the space station for deep space missions. Eventually, the space station became a source of heated controversy, mainly because of its budget, but also because it would draw resources away from transportation systems needed to keep it operational and useful in a practical sense.¹⁵ As early as 1975, NASA started to explore replacement vehicles for the Shuttle, essentially admitting that the Shuttle was not the routine space transportation system it had originally been touted as being.¹⁶

Meanwhile, NASA analysts, mostly based at Langley, examined two general approaches

to achieving a routine space transportation system. The first, a two-stage-to-orbit system, looked at the possibility of using a scramjet to power an aircraft from Mach 6 to Mach 10. A second, emphasizing single-stage-to-orbit (SSTO), analyzed the possibility of using a vertically-launched rocket. Interestingly, the central selling point of NASP was that it combined the scramjet of the first system with the SSTO goal of the second.¹⁷

Individual contractors had done some work in aerospace vehicles during that time. Boeing, for example, in 1978 had presented a study to the Air Force's Space Division for a reusable aerospace vehicle (RASV) that was an SSTO system. Space Division's RASV interest overlapped the trans-atmospheric vehicle studies going on then at ASD, but neither effort was sufficient to keep much of a private contractor base in hypersonics at work. As the Shuttles soaked up a growing amount of contractor resources, engineers were transferred from hypersonics work during the early 1970s.

By the time NASP was born, the dispersion of contractor expertise alone constituted a substantial hurdle for the program. One of the first tasks of Program Manager Robert Williams was to call a meeting in 1986 of all the contractors for the purpose of sharing with them what data on hypersonics the government already had in its possession. As the contractors went back to their corporate bases, they started to look up all of the employees that had worked on the older programs, and dig up all of the buried reports, which constituted an exercise in "technological archeology," as one contractor called it.¹⁸ Not only had the private sector seen its base of expertise in hypersonics erode, the government labs had witnessed a steady exodus of engineers and technicians out of hypersonic work. Raymond Colladay, the Deputy Associate Administrator of Research and Technology at NASA in 1983, expressed concern about the "vanishing

capability” in computational fluid dynamics, advanced materials, and other hypersonic-related technologies, noting that “there was nothing there to attract talent.”¹⁹

Up to that time, a central problem inherent in scramjet work was that no wind tunnels even existed to test engines that produced high Mach numbers. Depending on the size of the test item, most wind tunnels could not produce test conditions above Mach 6, with some capable of being modified to attain Mach 8 for extremely short periods of time (often less than a few seconds), and on extremely small scales. One obvious, but expensive, option was to built wind tunnels to test small scramjets. But researchers expressed serious reservations about the data they might obtain from such tests, and more than a few thought that the margin of error in scaling up to full size aircraft any results gained from test articles only inches long, and run for only a few seconds, was at best inapplicable and at worst dangerous. Over the next decade, but especially during the formative stages of NASP, the scaling-up issue dominated the debate over whether to attempt wind tunnel tests or flight tests. In a 1985 interview, H. Lee Beach, head of the NASA Langley Hypersonic Propulsion Branch, observed that “expansion of the size of the engine led to drag that the thrust could not overcome,” and thus posed a significant problem.²⁰ Many, if not most, had concluded that the only way to really test a scramjet-powered aircraft was to build one and fly it, allowing the aircraft to become its own wind tunnel.

NASP Phase I: Copper Canyon and DARPA, 1981-1984

In the early 1980s, several forces coalesced to accelerate the hypersonic scramjet work at NASA by focusing it on a specific aircraft. First, DARPA had conducted several studies on hypersonic

missiles for the U.S. Navy, including particularly influential work by Norris Krone who, in 1981, was the Director of DARPA's Air Vehicle Technology Office. Krone's work brought him into contact with another DARPA manager, Robert Williams, who had just arrived to head the Tactical Technical Office and who had worked with the Navy at the David Taylor Naval Ship Research and Development Center in Bethesda, Maryland. Williams' background included the X-wing, which was an experimental aircraft designed to take off and hover like a helicopter and to fly like a fixed-wing jet. Williams saw an opportunity to apply Krone's hypersonic missile work to aircraft, and thus attended a 1981 meeting with an aerospace designer, Tony du Pont, who had his own small aerospace company, described as essentially a computer research firm. du Pont had specialized in engine cycle studies, but found time to develop some of his own designs. Among du Pont's contracts was some work from NASA to design a multi-cycle engine that combined a jet and a rocket. The DARPA management---Krone, Williams, and Tony Tether---were so impressed that they gave du Pont a \$30,000 contract for computer studies of engine cycles.²¹

A second impetus for a hypersonic research aircraft came from the Air Force. Gen. Lawrence Skantze at Aeronautical Systems Division (ASD) at Wright Patterson Air Force Base in Dayton, Ohio. Skantze, in 1979, had ordered a study of post-Shuttle vehicles by the experimental research directorate (XR). When Skantze became Commander of Air Force Systems Command (AFSC), the Trans-Atmospheric Vehicle (TAV) program still operated on a slim budget. In his new capacity, Skantze, on January 9, 1982, literally on a handwritten note, ordered the ASD planning staff to study advanced space vehicles that could serve as a follow on to the Space Shuttle under the auspices of the existing TAV program. Unlike some of the NASA

work, the TAV project did not concern itself specifically with any propulsion scheme, but instead emphasized aircraft design.²²

In August 1982, the Air Force invited more than 200 participants to an aerospace/hypersonics conference at WPAFB. According to Vince Rausch, then a major and director of the XR section of ASD, the number of people and organizations that attended that conference was “surprising,” and demonstrated a “high level of interest” in TAVs.²³ More important to Rausch, while the TAV study itself had not expressed a preference for airbreathing propulsion, most of the discussion centered on airplanes, not rockets. Skantze’s successor, Lt. Gen. Thomas McMullen, authorized an even broader study, conducted by the ASD Deputy for Development Planning, Stanley Tremaine (who had actually coined the term “TAV”). The first part of Tremaine’s study sought to determine the feasibility of building such aerospace vehicles, and in May 1983 ASD awarded a contract to Battelle Columbus Laboratories in Columbus, Ohio, which concluded in December 1983.

From that time until August, 1984, when the by-then NASP program had entered its Phase 2, Battelle’s work had included input from the Strategic Air Command, the Tactical Air Command, Air Force Space Command, and other potential aerospace plane users. According to Richard Hallion, who documented the history of hypersonics up to 1985, at the time of the Copper Canyon Phase 2 decision point, the “TAV had grown into a major Air Force Study effort, already characterized by overtones of growing into a Department of Defense-wide and even inter-agency study effort as well.”²⁴ By December 1984, ASD’s Deputy for Development and Planning established the TAV project office and named Rausch the first director, and thus, whereas Air Force Space Division might have been the more logical residence for a space-

oriented program, and ultimately, for NASP, ASD---the operational and production-oriented command within the Air Force, retained control over it. Space Command had displayed a lack of interest in ASD studies on space vehicles, seeing them as primarily manned aircraft. Although Space Command proceeded with a variety of studies on its own involving NASP-type vehicles, and although Williams made his first briefing on NASP to Gen. Robert Harres of Space Command, the “ops” side of the Air Force interested in production-line strategic and tactical aircraft became the supporting agency for NASP.

While the Air Force work continued, the truly seminal study for the entire project, performed by du Pont, originated with a NASA contract. Thus, the efforts of NASA, the Navy, the Air Force, and DARPA all came together when DARPA’s management examined the results of du Pont’s NASA study.²⁵ Williams, a deeply religious visionary whose fertile imagination effortlessly linked the most intricate recent breakthroughs in mathematics to plans for futuristic orbital cities, became particularly enthusiastic, sensing the opportunity to shift an entire regime from carbon-based fuels to hydrogen.²⁶ He immediately jumped from the technical details of du Pont’s design to the vast promise it held for space travel. Williams even made the intellectual leap from a hydrogen-based plane to the prospects for hydrogen-powered aircraft overthrowing the tyranny of fossil fuels. He received permission to supervise du Pont in a more specific study of engine cycles as they related to generating orbital velocity within a model. Du Pont’s computer studies ultimately got the numbers to work, or “to close” in aeronautical terminology. The du Pont computer model demonstrated that a scramjet-powered aircraft could generate sufficient thrust over drag to attain orbit without rocket boost for a 50,000-lb. aircraft. Du Pont’s study eventually went on to form the government baseline for an aerospace plane, if for no other reason

than he was the first (and virtually the only one) to make the numbers work. But du Pont also had hit upon the key to an efficient scramjet engine, in that the aircraft itself had to function as an inlet and exhaust, reportedly giving Williams a plexiglas model of a turbo-ramjet and explaining the critical integration of the aircraft body and the engine (see Fig. 1.6, “du Pont NASP Design, 1983”).

The implications of du Pont’s demonstration were nothing short of revolutionary: if true “airplane-like” operations could be achieved, the turnaround time for space launches---even if the payloads were markedly smaller---could be reduced at geometric rates from those of the Space Shuttle and other large rocket-powered launches. As NASA’s Ming Tang later observed, “The benefit of using the combined cycle air-breathing propulsion engine . . . was more operational flexibility, and an order-order-of-magnitude [sic] reduction in vehicle gross weight and cost, compared to a rocket-powered vehicle for the same payload weight.”²⁷ A genuine emergency response lift capability also could be attained for the first time in space history, making it possible to rescue astronauts or cargoes that experienced trouble on the flight. Routinization of space launch, in turn, promised to yield what economists call “social savings” at exponential levels---that is, the generation of new and unforeseen opportunities for economic activities simply by having access to daily or weekly orbital flight. Just as the railroads produced unexpected multiplier effects in land sales, farming, tourism, travel, freight shipping, iron production, lumbering, and dozens of other enterprises, so too could airplane-like space operations make possible new space-based satellite and communications activities, science missions, and even tourism of the degree once predicted by science fiction writers. Most important, routine space flight would produce economic and business spinoffs not yet perceived

NASP

- duPONT SUPPLIED GOVERNMENT BASELINE DESIGN 1983

- 50,000 POUND TOGW CLASS

- EXISTING MATERIALS

- NICKEL ALLOYS
- GRAPHITE COMPOSITE TANK
- CARBON LEADING EDGES

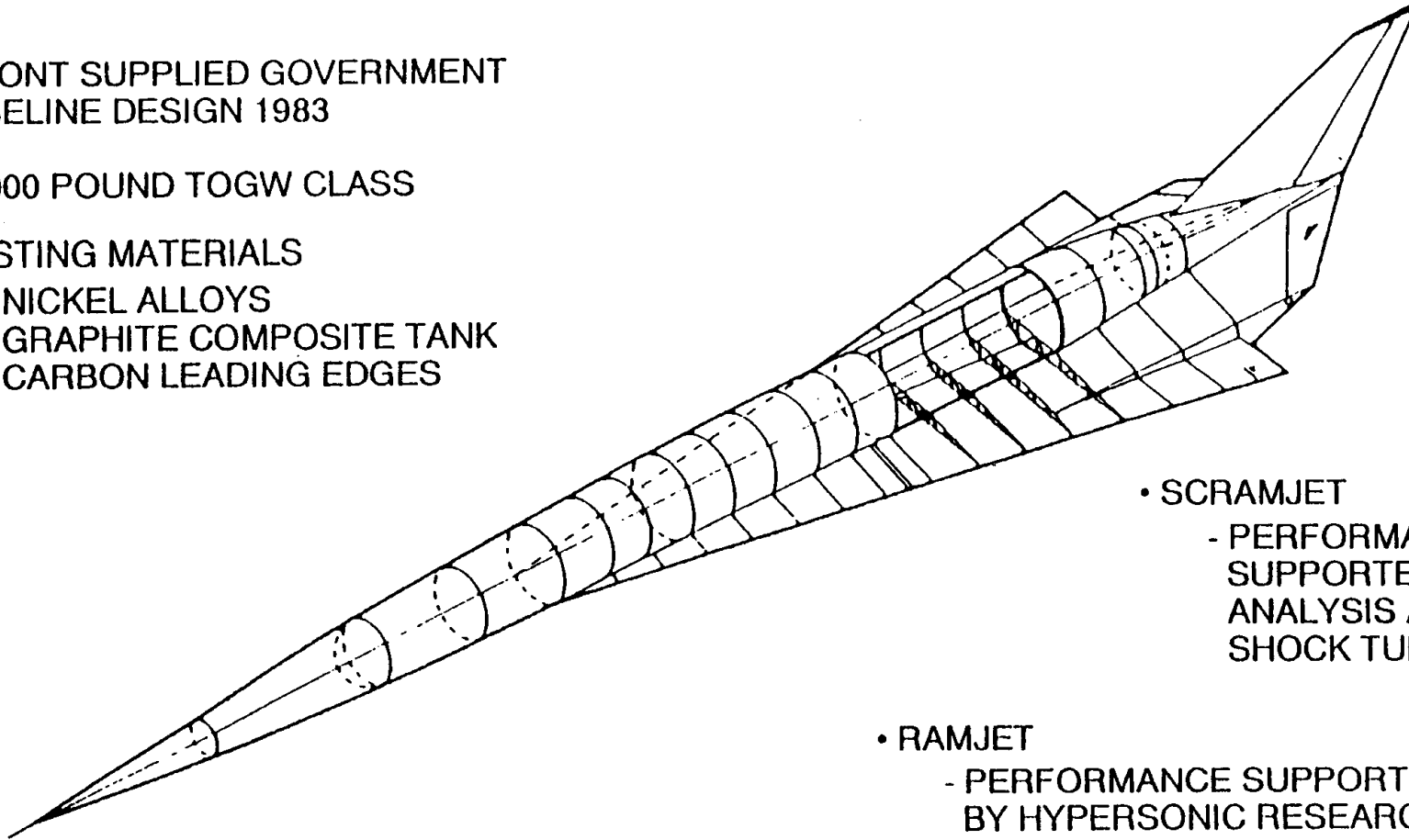

- SCRAMJET

- PERFORMANCE SUPPORTED BY ANALYSIS AND SHOCK TUNNEL

- RAMJET

- PERFORMANCE SUPPORTED BY HYPERSONIC RESEARCH ENGINE TEST DATA

- ACCELERATION ENGINE

- U.S. PATENT ISSUED TO A. duPONT
- PERFORMANCE VERIFIED BY GASL AND PW TESTS

- DRAG LEVEL VERIFIED

- NASA WIND TUNNEL TESTS
- BOEING SUPPLIED MODEL

or anticipated. All of that, Williams appreciated.

Williams accepted du Pont's computer models as evidence that a hypersonic scramjet-powered aircraft would work, but the models rested on a number of highly questionable assumptions, optimistic interpretation of results, and convenient omissions. The 1983 du Pont design for an experimental, scramjet-powered aircraft, again, seen in Fig. 1.6, had no landing gear, a wing structure that ran through the center liquid hydrogen propellant tank---which itself was to be a weight/support-bearing structure---and no room for error or size/weight growth (called "margin") in any calculation. Moreover, the study was based on the assumption of a takeoff speed that exceeded 300 miles per hour, requiring an exceptional performance from the non-scramjet cycles of the engine and a highly unconventional airstrip. Using more traditional measures, researchers tasked to replicate du Pont's results could not do so. As Bill Piland, the NASA director for NASP within the DARPA office, later recalled, no other study---whether NASA's internal work or the other independent studies done by contractors on du Pont's data---could duplicate his results. Piland, therefore, saw his own job within the DARPA office as one of, in essence, keeping Williams honest about claims he might make based on du Pont's paper.²⁸

The du Pont design called for engine combustors of a specific size and shape: any larger and the combustion chambers would require internal injection struts (that also served as a source of support for the engine walls) that du Pont claimed disrupt airflow and reduce combustion efficiency; any smaller and the chambers would not burn all the fuel. Inherent in the design from the outset, then, was the implicit assumption that the aircraft could not serve as a prototype for any other aircraft, because the engine size could not change, but rather that the aircraft, to work, would have to conform almost exactly to du Pont's specifications. Williams, however, when he

touted the design to his superiors, then to Capitol Hill, dismissed such assertions and assured everyone that the design could be "scaled-up" at a later date. That was partly political bluster and partly Williams' typical overconfidence. He had been briefed extensively on the scale-up problems, and used that data to support his claim that only a full-scale aircraft would provide the necessary "flying wind tunnel" to test the data. But that was a problem, Williams thought, he could solve at a later date. Get the support for the aircraft was the name of the game.

Williams also emphasized a second point about the du Pont concept that resonated with most of the hypersonics community at that time, namely that *only* an integrated system could test the scramjet by actually using the aircraft and engine system as a flying test bed. Vince Rausch, who worked on the Air Force's TAV program at the time, recalled that "Most people thought you needed to do a full-scale scramjet, and we [only learned later] we could use a smaller scale."²⁹ Certainly no wind tunnels existed that could come close to producing the Mach 25 conditions needed to evaluate orbital capability in the near future, so Williams had a powerful argument for construction of an integrated aircraft at the outset.³⁰ It is important to reiterate that two factors stood as obstacles to work on scramjets only: first, the du Pont design had required the complementary effects of the fore body and aft section of the aircraft to generate the proper intake and exhaust conditions, and second, the absence of test facilities meant that even *if* a scramjet was built, there would be few ways to test it. In short, Williams and others argued that it was as inexpensive and quick to build an entire test aircraft as it was to develop a system piecemeal.

Although a relatively low-level DARPA manager in charge of several other projects at the time, Williams also had an intuitive sense of political reality, and understood that an *airplane*

that flew would have a much greater chance of obtaining funding support from Congress and public enthusiasm than a test article that sat on an engine stand. From both a technical and political standpoint, then, there were powerful reasons in 1983 to press for an entire “X” series aircraft rather than for a scramjet development program.

But such an approach meant that other essential elements related to the aircraft also would have to be funded and developed simultaneously, including fuel storage, pilot training, flight test plans, runway and hanger construction or modification, tracking and rescue capabilities, and, at each step of the way, environmental impact and safety evaluations and ongoing test facilities for components. As the cost aspects of those peripheral but critical components of the program became known, they would have overwhelmed the budgets even if the aircraft’s costs had not. Just as optimism clouded some of the technical evaluations of the du Pont design, the programmatic obstacles were not considered insurmountable because, as Rausch recalled “There was a hope that NASP would be cheaper, better, faster---this was before such things as Environmental Impact Statements were a big issue.”³¹

The Pentagon had sped some programs through a “fast track” that minimized red tape, contractual details, and other barriers to rapid development, and many within the program thought they had assurances from the Department of Defense that at the proper time a full-blown X-30 program would receive such advantages. Likewise, at the contractor level, aircraft such as the SR-71 *Blackbird* went from blueprints to flight test in short order due to the efforts of the Lockheed “skunk works,” which insulated and isolated the development team under the authority of the government, who gave the company a relative free hand to operate with its budget as it saw fit. Daily management of the contractor was kept to a minimum in such cases.

In the political arena, optimism also had seeped into the program through Dana Rohrabacher, speech writer for Reagan and later a California Congressman, who had coined the phrase "Orient Express." According to Adm. Richard Truly, who became the NASA Administrator in 1986, Rohrabacher became transfixed with the potential of three-hour flight times to the Orient, and tended to ignore the numerous qualifiers that Truly and others would use when discussing the technology. Rohrabacher and other NASP supporters on Capitol Hill accepted hypersonic flight as a "fairly easy thing to do," without appreciating the tremendous challenges and incremental nature of the advances associated with the program.³² Truly was convinced that the technical difficulties the program later encountered only exasperated some of the Hill support, where the problems had been seen as minimal, and that the budgets may have suffered because appropriate progress was not made.

Thus, optimism crept in along at least two, and possibly three, separate paths---the technical and the managerial, and perhaps even the political---with the effects of one supposedly caroming off the other to accelerate development even further. The history of American business and technology was replete with examples to show that it was possible to achieve such gains. The question was, would they apply to a hypersonic aircraft?

Several questions arise, though, as to why the program---which originated with the du Pont NASA contracts in the early 1980s and which represented a continuation of work carried on almost exclusively at NASA during the previous two decades---wound up under DARPA. It was especially curious in that a November 1984 report by the Office of the Administrator of Science and Technology (OAST), evaluating the existing state of research and assessing the facilities for hypersonics, concluded that the "ongoing national program in hypersonics is primarily within

NASA”³³ Some NASA sources implied that they favored expanding the technical base, but thought the technology to build an actual airplane did not yet exist. Allowing DARPA to draw funds from the Pentagon to advance the technology, while sheltering NASA from a solo effort to fly an aircraft, made perfect sense from that perspective. But it also suggested that many within NASA did not think it feasible to build such an aerospace plane, and “went along” as a means to gain better understanding of hypersonic data. But others within NASA were firmly committed to building the aircraft, and thought it entirely “within technology’s grasp to do such an airplane.” Richard Truly, for one, flatly stated “if I thought we were not going to try to get an airplane out of [NASP] I wouldn’t have done the program.”³⁴

The most plausible explanation of the ultimate location of NASP in DARPA was that Robert Williams simply took over---he embraced the concept wholeheartedly. He took the du Pont work to his superiors at DARPA, who expressed excitement about the potential. DARPA approved a broader program of further testing of the du Pont design under a secret phase of the program called Copper Canyon, started in 1983. Copper Canyon’s main work took place at Battelle Columbus Laboratories in Columbus, Ohio, coincident with Battelle’s existing Air Force TAV contract. The DARPA project also involved Lockheed, Boeing, Rockwell, and General Dynamics to conduct airframe studies, while McDonnell Douglas, excited about the concept of a hypersonic aircraft, submitted its own additional independent TAV concept to the Air Force at no cost to the government. In November 1983, the Air Force held a TAV review at Wright Patterson Air Force Base (WPAFB), and two months later an independent panel commissioned in November arrived at a consensus that hypersonic flight was feasible and a spaceplane program was worth pursuing.³⁵ By January 1984, the reports from the attendees suggested that, despite du

Pont's optimism, hypersonic flight was feasible; the early du Pont studies did not violate any laws of physics; and the potential return from a hypersonic aircraft was well worth the investment. From 1984 to 1986, Marquardt and GASL worked to replicate du Pont's engine study, while Boeing, Lockheed, and General Dynamics received approximately \$100,000 each for airframe studies.

Initially, none of the contractors could replicate du Pont's claim that the design would close and attain orbital velocity. After early failures to confirm the du Pont design at GASL and Marquardt, DARPA contracted two premier jet engine companies, General Electric and Pratt & Whitney, to support the work by the other contractors.³⁶ All of the contractors found that the du Pont design lacked any resemblance to a working aircraft. It had no room for the normal weight growth that occurs as engineers actually calculate the numbers of nuts and bolts, and the quantities of metals and wire, needed to fly. It had no landing gear. It had virtually none of the required flight safety equipment that any test aircraft would have to contain. The wing, which ran through the fuel tank, would require exceptional resistance to *both* extreme heat and cold, as it would be simultaneously subject to the freezing temperatures inside the tank and the superheated leading edge temperatures. There were no maneuvering rockets for the aircraft once it reached space. As the string of frustrating failures to replicate the experiments rolled in, DARPA finally received a report from GASL that it had validated the du Pont orbital claim.³⁷ Other contractors, having struggled with the design, expressed doubts about the confirmation; nevertheless, the promise of a Mach 25 vehicle and the opportunity to break the shackles of rocket-powered spaceflight were substantial enough to lead DARPA to support further research and development under Williams' direction (see Fig. 1.7, "History of NASP-Related Hypersonic Efforts"). He

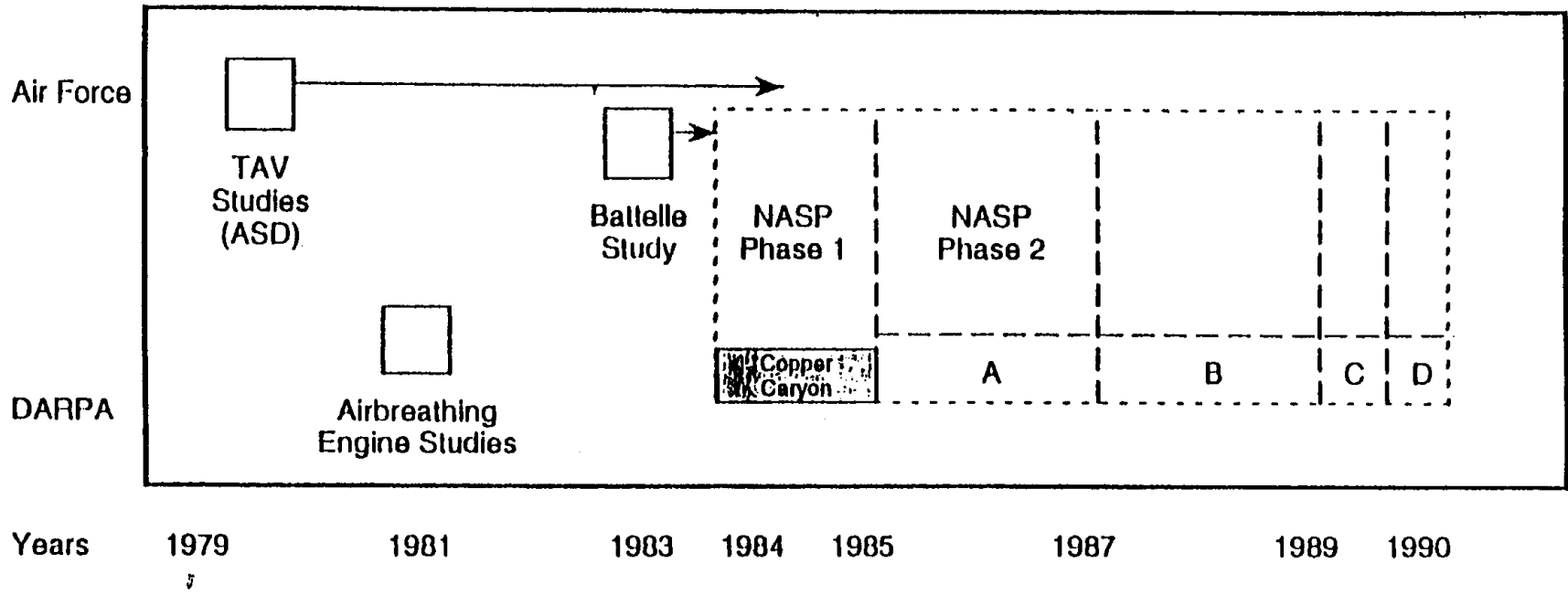

Fig. 1.7, "History of NASP-Related Hypersonic Efforts"

quickly contracted with SAIC to form an outside advisory group to monitor the program. The “Wizards,” as that group was called, consisted of academic and government specialists in aerospace, propulsion, and technology, and ensured that the program did not pursue too many blind alleys, essentially performing a function later handled by the Defense Science Board. Even the “Wizards” expressed concern about the du Pont claims.

Vince Rausch noted that the contractors supported the decision to move ahead with an aircraft program despite their reservations about the du Pont results because, while they “realized Williams was overly optimistic,” the general feeling was “there’s a pony in the pile”---that du Pont had something, and even if his design did not prove satisfactory, it appeared that a scramjet might just be capable of powering an aircraft to high Mach numbers.³⁸ As Rausch noted, the most promising of those technologies was not the scramjet itself, but CFD, the wondrous computer codes that would allow researchers at computer terminals to simulate in a realistic manner the aerodynamic, heat, and fuel mixing and combustion effects of flight at hypersonic speeds. Many supporters thought at the time that if CFD came along quickly enough, many of the inadequacies of the du Pont design could be overcome through efficiency improvements or even, if necessary, completely new designs. But the du Pont aircraft offered a testbed for the computer codes.

Others supported using the du Pont design for entirely different reasons. NASA’s Colladay, while having a “fundamental disagreement with du Pont over the technical base to do an aerospace plane,” nevertheless embraced it because “the du Pont vehicle forced the right technologies to be worked. A different vehicle concept would not have offered more.”³⁹ Colladay spoke for an influential group, mostly within NASA, that saw the product of the NASP program as the technology itself, not necessarily an orbital jet. They counted the incremental, and

occasionally substantial---but from a public relations standpoint, boring---technical advances as victories, even while other participants, mostly within the operations-oriented Air Force, saw their timetable for flight and their window of opportunity for gaining public support slipping away despite the technical gains. For those holding Colladay's position, NASP could succeed even if it never flew, while for those with the Air Force/Williams perspective, NASP could succeed *only* if it flew.

But even those who detected "a pony in the pile" knew that the goal of producing an orbital jet represented a daunting task. Single-stage-to-orbit demanded that the engine alone would have to consist of three separate cycles: a low-speed system to get the aircraft to Mach 2-3, ramjets to kick in at Mach 3-5, and the scramjet to engage after that. The airframe, which had to be configured so as to become an integral part of the engine, had to demonstrate airflow efficiency, durability at high speeds and superheated temperatures, and advanced avionics and controllability at hypersonic speeds. But a study by SAIC on the potential military applications of a hypersonic vehicle, delivered in June 1985, affirmed the payoffs possible with a high-Mach number aircraft.⁴⁰ At the point that DARPA approved a continuation of the work, it reconfigured the program in three phases, breaking the work down into airframe development and propulsion. Copper Canyon was designated "Phase 1," while the subsequent period of technology maturation, hardware fabrication, and ground test constituted "Phase 2." Contracts would be given to several competitors in propulsion systems and airframes. At the end of Phase 2, if the government concluded that, based on the competitive designs and test work, the technology had matured to the point that it was feasible to build and test an aircraft, fabrication and the flight test would occur under Phase 3. A separate Phase 3 contract would be issued, presumably to the

"winner" of the Phase 2 competition.

The Memorandum of Agreement, 1985

Williams knew the life cycle of typical programs depended entirely on institutional support, funding, and political connections, not necessarily on returns on investment. He undertook to fashion an ironclad arrangement that would de-politicize the program by building a base of support across several armed service branches and NASA and DARPA. Williams crafted a Memorandum of Agreement in 1985 that united NASA, DARPA, the Air Force, the Navy, and another potentially important future user, the Strategic Defense Initiative Office (SDIO) to jointly sponsor and pay for the program. DARPA would manage the secret program, with Williams as the program manager.⁴¹ James Fletcher signed the final, official revised Memorandum of Understanding [MOU] for NASA and Richard Cheney signed it for the DoD in 1988.⁴² The MOU stated that the objective of the program was “to develop, and then demonstrate in an experimental flight vehicle, the requisite technologies to permit the Nation to develop both military and civil vehicles capable of operating at sustained hypersonic speeds within the atmosphere and/or as space launch vehicles with the capability of delivering payloads into orbit.”⁴³ Clearly while the program was “a technology program,” it was to “provide the basis for hypersonic flight vehicles, and the objective in the documentation, to reiterate, was never to expand, enhance, or otherwise merely improve the technological status of hypersonics but to build and fly an airplane.

Although managed out of Williams’ DARPA office, NASP had full-time representatives

from other organizations: Bill Piland (NASA), Col. Len Vernamonte (USAF), and Commander Bob Kraft (USN). Only the Office of the Strategic Defense Initiative did not have a full-time representative in the DARPA office (nor, later, at WPAFB). In addition to those key people, George Baum, a DARPA consultant familiar with the hypersonic missile work done earlier, also kept a desk in the DARPA/NASP office. Originally, NASA had assigned Robert Jones, a veteran of hypersonic work, to the DARPA office, but at the last minute Piland, who formerly worked in Space Systems Division on orbital vehicles, received the nod. Piland saw his task primarily as keeping Williams grounded in technical reality. A harsh critic of the du Pont design, Piland expressed strong skepticism that the aerospace plane could fly, and thought that even his superior at NASA in the program, Ray Colladay, had become too enamored with the SSTD concept. Yet Colladay maintained that all along he saw his own role as “reigning in” Williams---providing a “counterweight” to Williams’ claims. NASA, Colladay said, was the “technical conscience” of the program.⁴⁴ If indeed so much concern existed that Williams had (in the term most often used to describe his efforts) “oversold” the program, it is understandable that NASA would seek a buffer between itself and NASP, and that buffer was DARPA.

Under the MOU, the DoD had responsibility for overall management, but NASA had the lead responsibility for civil applications and an “integral role in the overall program.”⁴⁵ Ironically, one of the chief areas of confusion of authority came not from the NASA/DoD responsibilities, but from a “NASP Inter-Agency Office (NIO) reporting directly to the Assistant Secretary of the Air Force For Acquisition [which was] responsible for coordination and oversight of policy, budgetary, program progress, congressional and public affairs, and other matters, as required [emphasis added].”⁴⁶ NIO eventually assumed an increasing amount of

control over the program, making it conform to the policy view of whatever NIO director happened to be staffing the office at the time, and worse, to whatever perceptions about NASP and/or the space program in general were fashionable in Washington at the time. Thus, while the MOU made clear that the original intent of the program was for the “DoD [to be] responsible for overall program management . . . [and] Within the DoD, the Air Force has . . . the overall responsibility for the NASP program,” with a Steering Group to “provide policy, guidance, and broad programmatic Direction” with “issue resolution authority,” the door was left open enough for NIO that it could later expand its authority beyond all boundaries intended by the signers of the MOU.⁴⁷

Williams, of course, had little concern for the subsequent program organization as he prepared to oversee the DARPA phases of the program. By keeping the program under DARPA’s control in its early stages, Williams hoped to retain the research and development (R&D) emphasis. By keeping it classified program, he hoped to eliminate any potentially negative publicity, especially during the difficult times when the technology was first being seriously tested, and during which time there would be any number of expected failures. By pulling in NASA, the Air Force, the Navy, and SDIO, he hoped to avoid inter-service and civilian/military controversies that he knew would afflict a program run purely by either NASA or the Air Force. He reasoned that NASA and each service participant (including DARPA) would have reason to maintain support for the program before Congress. Moreover, by dividing the burden among five participants, no one service or office would have so much tied up in the program that it could participate and stay on the team for only a relatively small contribution.

To underscore the unity that Williams hoped to build, in December 1985 all other

designations for the program were dropped in favor of the new title, National Aero-Space Plane (NASP), although the aircraft itself would still have the research designation of X-30. (In the popular press, the hyphen and capitalization of “Space” were dropped, and therefore the style in this work will reflect the name as popularly used, “National Aerospace Plane.”) Officially, NASP was born, but solving the daunting challenge of hypersonic flight still remained.

Early Internal Contradictions in NASP

NASP contained enough internal contradictions, though, to doom any program. By basing the program on a government baseline---the du Pont vehicle---that virtually no one could validate, Williams had ensured that any contractors *other* than du Pont (whose tiny firm was incapable of actually building an aircraft) would approach the project with the utmost skepticism, showing why the du Pont design could not work rather than seeking to make it fly. Worse, from the outset the original du Pont concept was left with no advocates within the program other than Williams. Put another way, the contractors and the government abandoned the very design upon which the program was “sold.” It should be reiterated that while some had supported the du Pont study as a means to “push” the technology, that distinction was never perceived by members of Congress voting on NASP funds or by the Reagan administration. Information regarding the aircraft and its benefits became so garbled that Reagan referred to NASP indirectly in a major televised speech, calling it the “Orient Express,” and telling the public that it would be a high-speed commercial aircraft capable of taking passengers from Los Angeles to Tokyo in two hours! Meanwhile, many proponents of NASP outside the technical community thought they were

supporting a genuine SSTO aircraft program, which, indeed, Williams himself thought he was advocating. In short, there was some misrepresentation by members of the technical community who wanted an aerospace plane program as a way to get to the hypersonic technology questions, while the public perception of the NASP program---regardless of the qualifiers used in Congressional or other presentations---was that NASP was engaged in building a specific research airplane.

Certainly the contractors approached the program as producing an aircraft---their own particular aircraft. Some have suggested that the contractors had no faith in the du Pont design, but supported NASP merely as a means to maintain their employment base.⁴⁸ But that view ignores two key realities of the contractors. First, they invested millions of dollars of their own money, regardless of how one chooses to calculate their investment, in the program before any decision had been made either to have a “downselection” (i.e., eliminate some competitors) or to form a national team. As discussed in the subsequent chapter, the extent of those investments was dramatic and correlated closely with the government’s perceptions of the company’s performance in the program. McDonnell Douglas could just as easily have put its people to work on an existing program if it was going to invest its own money, and certainly did not need a new program for that purpose. Second, as the contractor personnel made clear, engineers and technicians had to be recruited for NASP, and pulled off existing work. Another set of tensions immediately entered, though, when the government chose to issue competitive contracts to five airframe companies and two---later, three---propulsion contractors. Resources were divided eight ways, on different approaches and designs (and nine, if du Pont’s original was included), while the contractors all rather quickly departed from the du Pont concept, for a variety of reasons

discussed in the following chapter, meaning that the diffusion of resources increased at a time when the technology demanded the focusing of resources.

These internal contradictions represented some---but by no means all---of the internal tensions characteristic of almost any joint program, especially when elements as disparate as NASA, the U.S. Navy, and the Air Force are involved. Once the contractors came into the program, however, and once the NASP program entered the budgetary and policy arena of Washington, numerous other strains appeared. Many of those will be the focus of the next chapter, but suffice it to say that from its birth, the NASP program was racked by perhaps unparalleled tensions. Despite those unique obstacles, however, the program offers important “lessons learned” for other joint programs, for assessing different contract vehicles, and for evaluating the performance of various government and market incentives on research and development projects.

Policy Questions of the NASP Program

NASP, with its intricate network of support, its interest in maintaining several contractors in hypersonics research, its formidable challenges in virtually every technical area, and its political and budgetary strategies, offers an excellent case study for those interested in research and development, “big science,” civilian-military relations, NASA’s role in aeronautics, and in American corporate and business history. Each of those questions could generate its own book-length analysis, and therefore this history will examine only some of the major issues.

*What is the role of NASA and the DoD in space and civilian aerospace policy?

Specifically, how did NASP---ostensibly a NASA-originated contract that might have produced a compliment to, or substitute for, the Space Shuttle---become a program dominated politically and managed by the Air Force? If Congress wanted NASA to play a bigger role, as it indicated on several occasions, and if the Air Force wanted to cut its NASP commitment, as it indicated on several occasions, why did NASP nevertheless begin and end its life in the Pentagon?

*To what degree did the promise and potential of technology override evidence about the actual performance of the technology? Specifically, how and why did Williams, Colladay, and others minimize or appear to minimize the difficulties in hypersonic flight overall, and ignore or overlook the failures of the du Pont baseline design in particular? Did the political requirements to generate excitement “on the Hill” and to inspire enthusiasm within the American public justify selling an entire integrated aircraft program on the basis of the sketchiest of projections of cost and technical capability? Did the promise of building a technical base surmount the stated purpose of the program? Indeed, in what different ways did the participants interpret the real goal of the NASP program? Finally, were there genuine expectations that technical breakthroughs were ripe---ready to yield a cornucopia of dramatic new technologies that would have “feedback” effects and improve the efficiency and capabilities of still other technologies? Based on *what the participants knew then*, did their strategies and actions appear reasonable and justifiable?

*How do bureaucracies, both government and contractors, respond when either technology proves intractable or when budgets fall? Particularly, how do research and scientific bureaucracies react in those situations, when so much of actual technical progress depended on long-term testing and formulation of research plans? In that respect, how do private sector and market-driven firms differ from government-sponsored activity? How did the Joint Program

Office seek to attain the mission goal of SSTO in the face of such difficulties? In what ways did revisions of research plans, facilities construction, and even the “shotgun wedding” of the contractors into a national contractor team reflect the pressures of budgets, without which the program might have had other options or made other choices?

*To what extent did different cultures of the science-oriented NASA and the operations-oriented Pentagon and the science-oriented NASA conflict in the NASP program? How did the two seek to minimize those differences, and in what ways did those dissimilarities produce discord, and in other ways generate solutions to technical and/or management problems? How did NASA incorporate more traditional market-driven approaches to technical progress under NASP?

In short, this work takes as its central question, “What were the management lessons of NASP?” Phrased another way, “Under other conditions, and with a different approach, would the X-30 have flown?” Perhaps so, perhaps not. The key to learning lessons from the aerospace plane program, however, lies in understanding what the participants thought at the time they faced their eventful decisions. Using that perspective, one could rephrase the question as: “Was NASP successful even though it did not fly?”

CHAPTER 1 NOTES

1 . No single published work exists covering the entire history of NASP. For published work on parts of the NASP history, see Larry Schweikart, "Hypersonic Hopes: Planning for NASP, 1982-1990," Air Power History, Spring 1994, pp. 36-48 and "Managing a Program Revolutionary Technology, American Style: The National Aero-Space Plane," Essays in Economic and Business History, XII (1994), pp. 118-132, and "From Team to Team: Revolutionary Management Structures in the National Aero-Space Plane Program, 1982-1990," in Proceedings of the 1991 Acquisition Research Symposium, vol. 2 (Washington, D.C.: Defense Systems Management Association, 1991); John D. Moteff, "The National Aero-Space Plane Program: A Brief History," CRS Report for Congress (Washington, D.C.: Congressional Research Service and the Library of Congress, February 17, 1988), 88-146 SPR and update, January 2, 1991 DARPA was renamed "Advanced Research Projects Administration," or ARPA, under the Clinton administration. There is, however, a detailed history of the NASP, written by the author (though not identified as such in the document) submitted to the National Aerospace Plane Program Office, March 31, 1995, through Science Applications International Corporation, called "National Aero-Space Plane (NASP) Advanced Technology Impacts," Final Report, Program Management Document, contract #F33657-90-2195/DO 0009. This document was based extensively on papers, memos, reports, and briefings from the program office, NASA, the Air Force, and the contractors, as well as other internal government agencies, and will be cited hereafter as "National Aero-Space Plane (NASP) Advanced Technology Impacts." Specific documents cited therein, which subsequently may have been moved or removed, nevertheless can be acquired through the Freedom of Information Act. Nevertheless, I have attempted to support each internally-cited document with interview material or other public materials. A similar document, prepared for the program by the author, and delivered to SAIC, under the same contract number, has the name "National Aero-Space Plane (NASP) Advanced Technology Impacts, Final Report, Program Management Document, Managing the NASP: Major Accomplishments and Lessons Learned," March 31, 1995.

2 . Interview with Raymond Colladay, August 15, 1997.

3 . Among those viewing NASP as a boondoggle, see Stephen W. Korthals-Altes, "Will the Aerospace Plane Work?" Technology Review, January 1987, pp. 43-51; Linda Cohen, Susan Edelman, and Roger G. Noll, "The National Aero-Space Plane: An American Technological

Long Shot, Japanese Style," American Economic Review, May 1991, pp. 50-53; and Linda Cohen and Roger Noll, eds., The Technology Pork Barrel (Washington: Brookings Institution, 1991).

4 . On the X-15, see "Development of the X-15 Research Aircraft, 1954-1959," Supplemental Volume 111, History of Wright Air Development Center, History Office, Aeronautical Systems Division, (n.d., circa 1959).

5 . See Roy Harris, Jr., "Evidence Points to Secret U.S. Spy Plane," Wall Street Journal, December 4, 1992; Bill Sweetman, "Out of the Black: Secret Mach 6 Spy Plane," Popular Science, March 1993, 56-6-, 62-63, and 98-100; Keith Rogers, "Budget for Hypersonic Spy Plan Rivals Nevada Test Site," Las Vegas Review-Journal/Sun, December 5, 1993; Stuart Brown, "Searching for the Secrets of Groom Lake," Popular Science, March 1994, 52-59, 84-85; and Federation of American Scientists, "Secrecy and Government Bulletin," January 1994, as well as the FAS web site on the world wide web. John Pike, of FAS, when contacted by the author and told of the fact that in six years there was no evidence of any sort on any internal document to lend credence to the "Aurora" theory, agreed to re-think the issue and promised a rebuttal page dedicated to my arguments in the FAS "Bulletin."

6 . Many sources discuss the environment for technical change and innovation, and examine the difficulties that existing institutions or firms have in making significant breakthroughs. See Burton Klein, Dynamic Economics (Cambridge, Mass.: Harvard University Press, 1977); Larry Schweikart, The Entrepreneurial Adventure (Ft. Worth, Texas: Harcourt Brace, forthcoming); George Gilder, The Spirit of Enterprise (New York: Simon and Schuster, 1984), Microcosm: The Quantum Revolution in Economics and Technology (New York: Simon and Schuster, 1989), and his "The Revitalization of Everything: The Law of the Microcosm," Harvard Business Review, March/April 1988, 49-61, and "The Message of the Microcosm," The American Spectator, December 1987, 16-19.

7 . George Keyworth and Bruce Abell, "Making Space Launch Routine," Technology Review, October 1990, 25-31; John M. Logsdon and Ray A. Williamson, "U.S. Access to Space," Scientific American, 20 (March 1989),34-40.

8 . Lt. Col. Ted Wierzbanski, "The Challenge of the X-30 Flight Test," paper presented to AIAA First National Aero-Space Plane Conference, July 20-21, 1989, Dayton, OH; William Piland, "Technology Challenges for the National Aero-Space Plane," paper presented to the 38th International Astronautical Congress, October 14, 1989, Brighton, United Kingdom; Carl Sypniewski, "The NASP Challenge: Technical Breakthrough," paper presented to AIAA First National Aero-Space Plane Conference, July 20-21, 1989, Dayton, OH.

9 . Much of the historical data for this section relies on an internal NASA paper by E.A. Mackley, "Historical Aspects of NASA Scramjet Technology Development," 1984, "NASP Historical File, 1984-1985," NASA Langley Technical Library, Langley, VA.

7. Richard Hallion, ed., The Hypersonic Revolution, vol. II: Eight Case Studies in the History of Hypersonic Technology from Scramjet to the National Aero-Space Plane (Dayton, OH: Special Staff Office, Aeronautical Systems Division, Wright Patterson Air Force Base, 1987). Management Document for the National Aero-Space Plane, #7226(2)163269F, December 4, 1989. Most primary source documents for this study were accumulated from 1988 to 1995 when the author wrote a history of the NASP program. References to those documents indicate locations at Wright Patterson Air Force Base (WPAFB) in Dayton, OH, or in Col. Ted Wierzbanski's files at the National Program Office (NPO) in Palmdale, California, and in some cases represent the last known location of those papers during processing. Since 1995, when the program was terminated, Col. Wierzbanski has donated most of his papers, which included the unclassified documents cited here, to the Air Force Flight Test Center (AFFTC) History Office, Edwards Air Force Base, California. Although they remain unprocessed, they retain the same filing system as referenced in this book, and are accessible to the public.

NASP, though officially ended, still enjoyed some life on a much smaller scale after 1995 in the form of three separate programs, "HYPER-X," a program managed at NASA Langley, the X-33 program managed by NASA, and HyTech, a technology study of alternate fuels and hypersonic engines run out of WPAFB. Much of the documentation remains at the defunct NASP JPO office, Building 52, WPAFB, Dayton, OH. The majority of available NASP material, however, has been relocated to NASA Langley for processing in the Technical Library. While many of the official program documents have been processed, several semi-tractor trailers containing the contractors' data have yet to be processed at Langley. In addition, Beth Quinto, who was the long-time secretary for NASA/NASP at Langley, has several unprocessed boxes of files containing NASP material, some of which is cited here. Therefore, as a check for accuracy, I attempted to secure an interview source for virtually every documented citation---processed or unprocessed---in this study.

7 . H.E. Gilreath, "Beginning of Hypersonic Ramjet Research at APL," Technical Digest of the Johns Hopkins University, January 1991.

8 . Ibid.

9 . Interview with Fred Billig, November 28, 1990.

10 . Ralph Gibson to Weldon Worth, Bureau of Naval Weapons Representative, proposal, December 30, 1960, Fred Billig's personal files.

11 . Tom Gregory, "Hypersonic Aircraft Studies and Tests at Ames Research Center from 1963 to 1974," paper presented to the National Aero-Space Plane Symposium, May 20-22, 1986, in author's possession.

- 12 . James R. Hansen, Spaceflight Revolution: NASA Langley Research Center from Sputnik to Apollo (Washington, D.C.: National Aeronautics and Space Administration, 1995), and, with Fred E. weick, Engineer in Charge: A History of the Langley Aeronautical Laboratory, 1917-1958 (Washington, D.C.: Smithsonian Institution, 1987).
- 13 . See Alex Roland's unpublished manuscript, "The Tyranny of Manned Spaceflight," 1987, produced for the Twentieth Century Fund, which then refused to publish it due to an inability to gain consensus among the Fund's management about the book's controversial slant and conclusions.
- 14 . "National Aerospace Plane Program Management Plan," November 22, 1982, History Office, Aeronautical Systems Division [ASD], WPAFB, 3.
- 15 . On the space station, see Howard E. McCurdy, The Space Station Decision: Incremental Politics and Technological Choice (Baltimore: Johns Hopkins University Press, 1990).
- 16 . Numerous works on the Shuttle program exist, with many analyses appearing after the *Challenger* disaster. See Dennis R. Jenkins, Space Shuttle: The History of Developing the National Space Transportation System: The Beginning Through STS-50 (Marcelene, Missouri: Walsworth Publishing Company, 1992); Roger D. Launius, "NASA and the Decision to Build the Space Shuttle, 1969-1972," The Historian, Autumn 1994, 17-34; John Logsdon, "The Space Shuttle Program: A Policy Failure?" Science, 232 (May 30, 1986), 1099-1105, and his "The Space Shuttle Decision: Technology and Political Choice," Journal of Contemporary Business, 7 (1978); Steve Blakely, "The U.S. Space Program: Air Force Blue or NASA White?" Journal of Defense and Diplomacy, 5 (1987), 22-27; Joseph Trento, Prescription for Disaster: From the Glory of Apollo to the Betrayal of the Shuttle (New York: Crown, 1987); Diane Vaughn, The Challenger Launch Decision: Risky Technology, Culture, and Deviance at Nasa (Chicago: University of Chicago Press, 1996); and Stephen M. Cobaugh, "Space Shuttle: The First Decade," Space Age Times, May/June 1991, reprinted in Space Exploration: Opposing Viewpoints (San Diego, California: Greenhaven Press, 1992).
- 17 . R.L. Chase and M.H. Tang, "A History of the NASP Program from the Formation of the Joint Program Office to the Termination of the HySTP Scramjet Performance Demonstration Program," paper presented to the Sixth International Aerospace Planes and Technologies Conference, April 3-7, 1995, (AIAA# 95-6031), 2.
- 18 . Interview with John Steurer, McDonnell Douglas, July 10, 1989. Also interviewed at MD were Hershel Sams and Ed Will.
- 19 . Interview with Raymond Colladay, August 15, 1997.
- 20 . Interview with H. Lee Beach, October 10, 1985, in "NASP Historical File, 1984-1985," NASA Langley Technical Library.

- 21 . Much of the material for this section comes from interviews with Robert Williams, especially July 18, 1989, but other dates as well, and Tony du Pont, October 24, 1989. The story is romanticized somewhat by Trish Gilmartin, "Bob Williams: Aggressive Nature Sets Him Apart From Government Managers," Defense News, October 1989, and by Tom A. Heppenheimer, "The Hypersonic World of Robert Williams," Smithsonian Air & Space, February/March 1988, 52-55. George Baum, Williams' associate as an independent contractor during that period, was also present at most interviews to confirm Williams' recollections.
- 22 . Interviews with Lt. Col. Vince Rausch, July 18, 1989, and July 16, 1997. Summaries of other interviews were provided to the author by Brenda Foreman, for her course at the University of Southern California, "The Political Process in System Architecture Design," 1992. Foreman's notes, including interviews with Williams and Lawrence Skanze, confirm this interpretation.
- 23 . Interview with Rausch, July 18, 1989.
- 24 . Hallion, Hypersonic Revolution, vol. II, 1340.
- 25 . Interviews with Williams, various dates, 1989-1994.
- 26 . Virtually all interview subjects familiar with Williams expressed an appreciation for his abilities in this respect. Williams provided a published example of his visionary nature in "Forces for Change and the Future of Hypersonic Flight in the 21st Century," address before the First International Conference on Hypersonic Flight in the 21st Century, September 20-23, 1988, Grand Forks, North Dakota, in author's possession.
- 27 . Chase and Tang, "History of the NASP Program,"2.
- 28 . Interview with Bill Piland, July 18, 1997.
- 29 . Interview with Vince Rausch, July 17, 1997.
- 30 . Interviews with Robert Williams, various dates, 1989-1994; interview with George Baum and Robert Williams, July 18, 1989; interviews with Robert Barthelemy, various dates, 1988-1995; T.A. Heppenheimer, "The Hypersonic World of Robert Williams," Air & Space, February/March 1988, pp. 52-55; Craig Covault, "Aero-Space Plane Leading U.S. Hypersonic Research," Aviation Week & Space Technology [henceforth called Aviation Week], February 27, 1989, pp. 18-19; and Glenn Emery, "Faster Than the Speed of Sound? You Bet," Washington Times, October 12, 1988.
- 31 . Interview with Rausch, July 17, 1997.
- 32 . Interview with Adm. Richard Truly, September 5, 1997.

- 33 . "A Focused Hypersonic Research Program," Office of Aeronautics and Space Technology, November 1984, 6.
- 34 . Interview with Truly, September 5, 1997.
- 35 . In addition to aforementioned sources, material for this section comes from interviews with Gen. Kenneth Staten, July 17, 1989; Col. Vincent Rausch, July 18, 1989; Hallion, Hypersonic Revolution, II:1341; and material from Gen. Lawrence Skanze taken from Brenda Forman, "The Political Process in System Architecture Design," notes for course at the University of Southern California, Fall 1992, author's files.
- 36 . Interview with Tom Donahue, General Electric NASP Program Manager, July 5, 1989.
- 37 . The crucial GASL study was dissected in several closely held government studies, including numerous NASA studies, as well as independent review boards. None of them agreed with the duPont/GASL findings.
- 38 . Interview with Rausch, July 17, 1997.
- 39 . Interview with Colladay, August 15, 1997.
- 40 . "Weekly Activity Report," January 16, February 5, Robert Barthelemy's files, NASP collection, WPAFB History Office.
- 41 . Undersecretary of Defense (R&E) to Assistant Secretary of the Air Force (Research, Development, and Logistics), Director DARPA, Assistant Secretary of the Navy (Research, Engineering, and Systems), and Director, SDIO, memo of understanding, December 2, 1985; "Memorandum of Understanding Between the DOD and NASA for the Conduct of the National Aero-Space Plane Program," June 18, 1986, Joint Program Office (JPO) files, WPAFB History Office.
- 42 . "Memorandum of Understanding Between the Department of Defense and the National Aeronautics and Space Administration for the Conduct of the National Aero-Space Plane Program," (revision B), 1988, in NASP files, NASA Langley Technical Library.
- 43 . "Memorandum of Understanding," 1.
- 44 . These comments come from interviews with Colladay, August 15, 1997, and Piland, July 18, 1997.
- 45 . "Memorandum of Understanding," 2.
- 46 . "Memorandum of Understanding," 2.

47. "Memorandum of Understanding," 1-2.

48. Bill Piland, for example, made this argument in interviews with the author.

CHAPTER 2: Trapped Inside the Tension Box

OPERATING ANY JOINT program poses a number of challenges, but one seeking to incorporate civilian and military---and within the military, two service branches, a research agency, and a newly-formed office struggling with its own identity---offered more than a few opportunities for miscommunication and differing program visions. Although the Undersecretary of the Air Force for Research and Engineering, Donald Hicks, had formalized the consensus that Robert Williams had built over the previous two years by issuing a memorandum approving NASP as a “joint Air Force/DARPA/Navy/SDIO/NASA technology demonstration effort” in October 1985, getting an equitable commitment from each was difficult to measure and carry out.¹ Nevertheless, Williams and the program managers expected that the formation of the Joint Program Office (JPO), headquartered at Wright Patterson Air Force Base (WPAFB) would provide a central location for the participants to integrate their potentially competing concepts. Within the JPO, the management team itself reflected the attempt to provide each participant with equitable work and authority.

Program Management Organization

As outlined in the MOU and subsequent arrangements between NASA and the DoD, management for the NASP program allowed oversight by both NASA and the Pentagon through the NASP Steering Group, a body consisting of the DARPA director (Colladay---who had

moved to DARPA from NASA), the SDIO director (James Abrahamson), the Associate Administrator (Office of Science and Technology) for NASA (Williams Ballhaus, Jr.), the Assistant Secretary of the Navy for Research, Engineering, and Systems (Thomas Faught, Jr.); Director of Defense Research and Engineering (Donald Duncan); the Deputy Undersecretary of Defense for Research and Advanced Technology (Killburn); the Assistant Secretary of Defense for Acquisition and Logistics (John J. Welch); the Assistant Secretary of the Air Force for Acquisition and Logistics, and the Undersecretary of Defense for Acquisition (Robert Costello, who chaired the meetings). The vice-chairman was the Associate Administrator (OAST) for NASA, and the president's Director of Science and Technology Policy, William Graham, attended as an honorary member. DARPA ran the program on a daily basis, specifically through its own Program Manager for NASP in Washington (Robert Williams). Within Williams' NASP program office were representatives of NASA (Bill Piland), the Air Force (Col. Len Vernamonte), and the Navy (Commander Bob Kraft). Meanwhile, at the Joint Program Office, located at Wright Patterson Air Force Base in Dayton, Ohio, the JPO program manager, Brig. Gen. Kenneth Staten operated with assistance from his deputy program managers from NASA, the Air Force, and the Navy (see Fig. 2.1, "NASP Management Structure, 1986" and Fig. 2.2, "DoD/NASA National Aerospace Plane Phase 2 Organization, 1987"). Not only did the JPO office under Staten supervise the contractors, but it also had responsibility for implementing the technology development programs, conducting future application studies, and planning the flight vehicle program.² Management's responsibilities at the JPO included developing a plan to implement the project containing goals and objectives, schedules, milestones, and a work breakdown structure. The JPO also was charged with preparing a Technology Maturation Plan, a

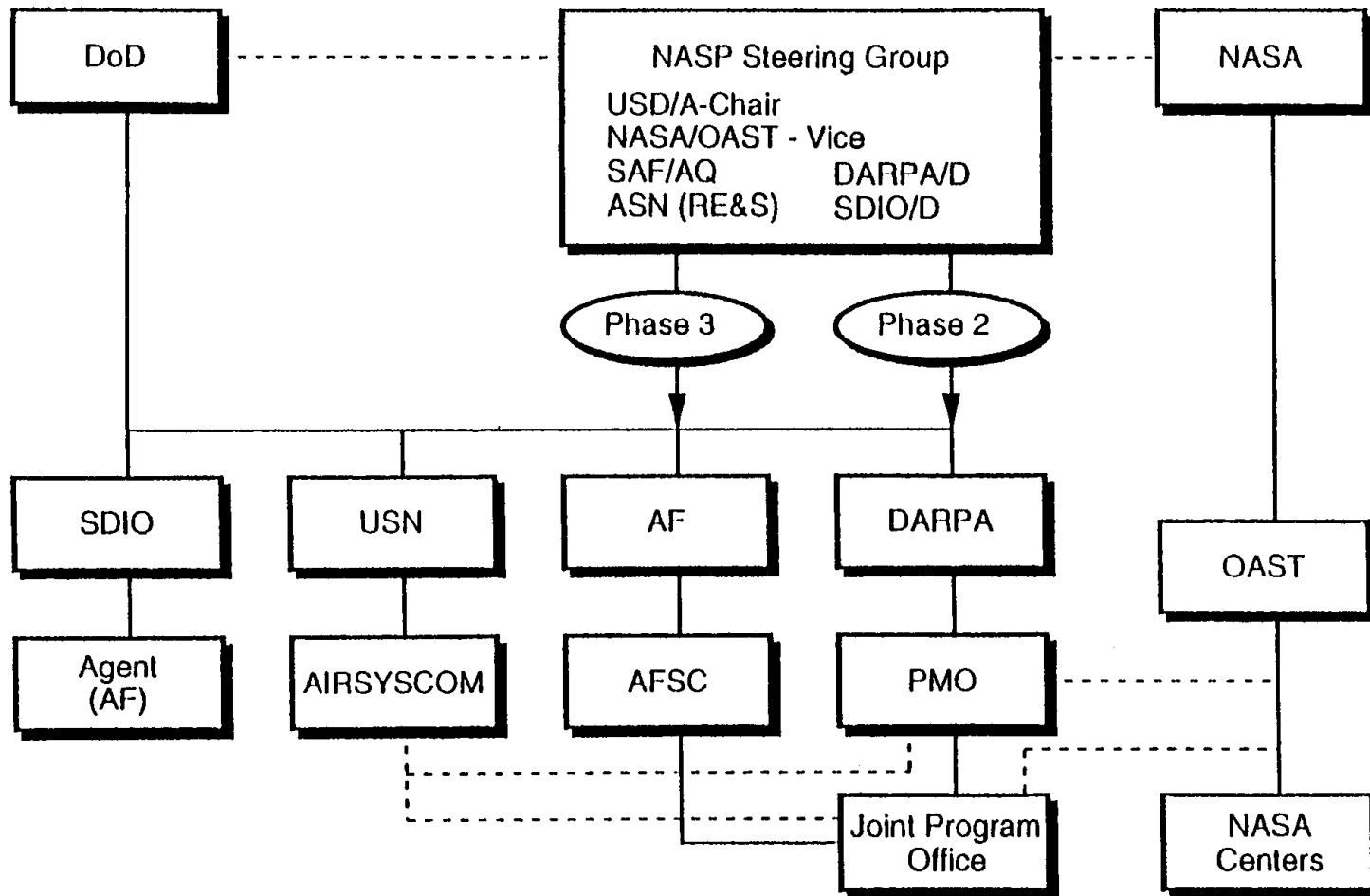

Fig. 2.1, "NASP Management Structure (1987)"

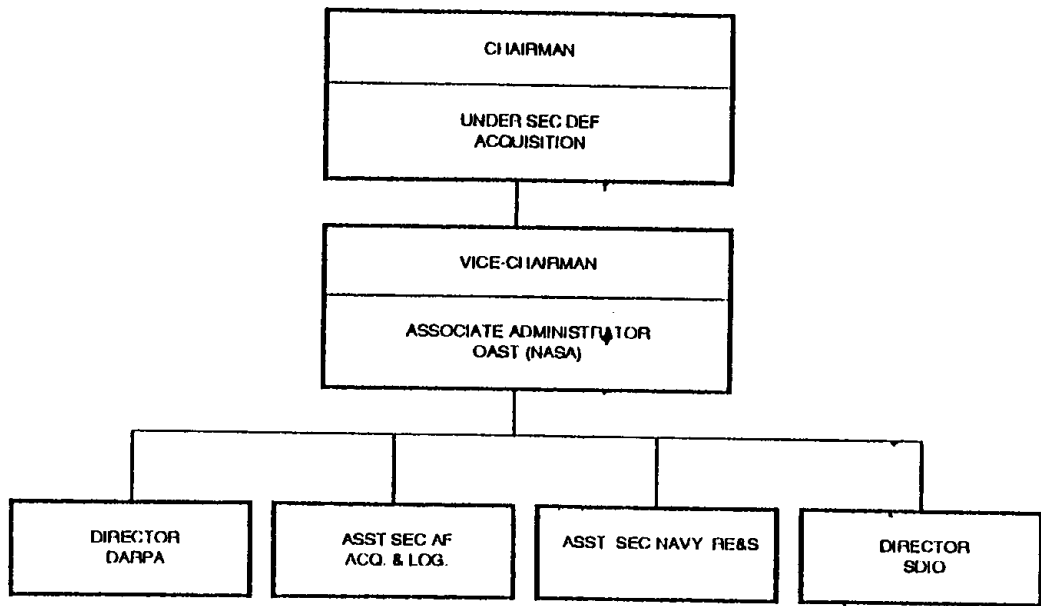

Fig. 2.2, "NASP Steering Group"

NASP program test plan, and annual operating budgets. On a daily basis, the JPO oversaw the airframe and propulsion contracts, directed the technology maturation activities, planned for the flight test programs, and conducted future applications studies for civil and military needs.³

To accomplish those tasks, the JPO utilized seven directors who reported to Staten: airframe development, propulsion development; vehicle integration; technology maturation; planning; systems engineering; and program support. Within a year, “planning” had become “experimental vehicle planning” and “systems engineering” had become “systems applications.” In accordance with the creation of the NASP JPO, the program manager and all deputies located full time at WPAFB. The office received technical and management support from DARPA, but on a functional level it reported to Gen. Bernard Randolph of Air Force Systems Command. Initially, Staten’s Air Force deputy was Col. J. Ruttner, while the NASA deputy and director of technology was Bob Jones out of the Langley hypersonics program (although he was replaced almost immediately by Howard Wright from Langley and the technology maturation tasks handed to Joe Watts, also of Langley); the director of vehicle integration was Col. Vince Rausch; and the directors of propulsion development and airframe development were both Air Force personnel, Chuck Anderson and Frank Boensch, respectively. Capt. Stuart Schmitt of the U.S. Navy was the director for planning (see Fig. 2.3, “NASP Joint Program Office, 1986”). A director from one service branch or NASA was to have as his deputy someone from a different service branch or NASA (with the exception of the program support director) to preserve the joint nature of the program and to foster communication and innovation. Instead of competing against each other, the participants were to work for a common purpose

Many of the early slots intended to go to NASA went to Air Force personnel, often by

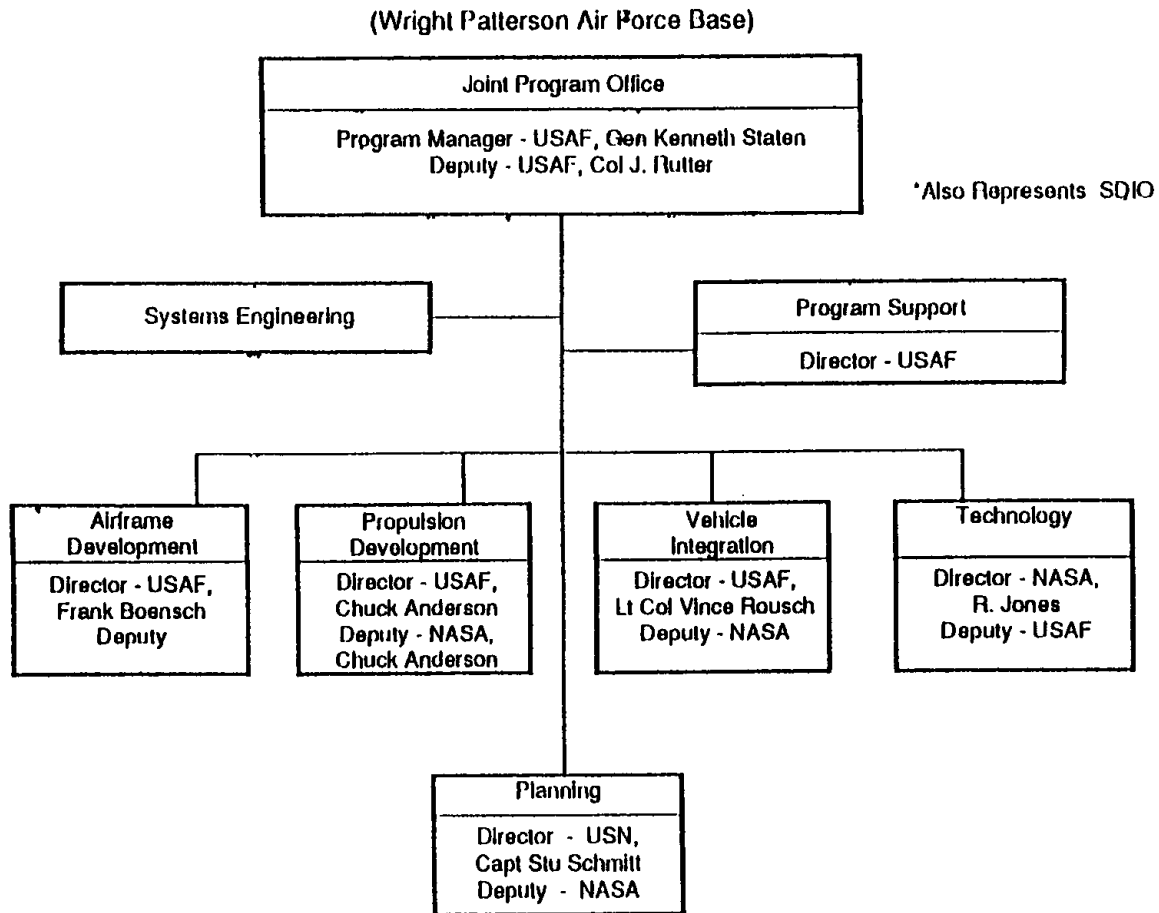

Fig. 2.3, "NASP Joint Program Office (JPO), 1986"

default. By March, 1986 NASA had only one staff member in house, and only four more had arrived by June, a number that only equalled that of the U.S. Navy in a JPO of approximately 40.⁴ Tom Gregory, who came from NASA's Ames Research Center suggested that NASA "moved slowly" when asked to staff the positions.⁵ Staten was more blunt: "The Air Force staffed the positions while NASA expressed no interest."⁶ To the Air Force, the apparent lack of concern about the JPO staffing meant that NASA did not care about NASP, but the NASA personnel took a different view of life at the JPO. As Vince Rausch---then a Lt. Colonel in the Air Force and later a NASA employee---explained, the JPO was "away from the flagpole The real work [as NASA personnel saw it] was at the research centers, not at Wright Patterson."⁷ Even when it came to policy matters, NASA people viewed the "political focus of NASA as always NIO and the Office of Aeronautics" in Washington.⁸ Many talented people eventually went to the JPO, but in several cases their abilities lay in technical areas, and not, in essence, in the political advocacy work demanded by the JPO. One NASA official, on condition of anonymity, flatly stated that NASA Langley "sent three extremely capable people to the JPO and it ruined them." The different perceptions of the JPO positions, and the enthusiasm with which they were filled, however, would later prove damaging, as would the split between the Air Force continually trying to direct program policy from Dayton and NASA coordinating activities through the NASP Washington office. Attaining more of a NASA influence comprised one reason for the 1988 internal reorganization, although the primary force for reorganizing the structure was the lack of coordination and communication between the airframe and propulsion directorates.

Among its other management functions, the NASP JPO focused on providing a

technology readiness assessment to serve as the basis for the Phase 3 decision by the Sterring Group. That report had to include several vehicle configurations; the estimated performance goals, flight envelope, and research objectives; a program cost estimate and schedule; and a recommendation of the best vehicle based on the above considerations.⁹

Management at the JPO moved quickly to get the project underway. In early March 1986, Staten reported that “Major progress had been made in establishing the JPO core.”¹⁰ He noted that the JPO had reached 21 people that month, and made clear his intention to “centralize control and put management attention on what is currently a disjointed process.”¹¹ He noted, however, that a major challenge remained getting the four to six program/project managers on duty. At the same time, he received briefings or had discussions with SAC and Air Force SPACECOM on the topic, and concluded that he had “full commitment” from both commands, and that both were “urging us on.”¹²

On April 7, the JPO awarded airframe contracts to Boeing, General Dynamics, Lockheed, McDonnell Douglas, and Rockwell International to pursue configuration development against a set of goals to lead to a downselection.¹³ It also awarded two propulsion contracts to GE and P&W. Three months later, a third propulsion contractor, Rocketdyne, agreed to participate at its own cost. Rocketdyne had the luxury of ignoring the Du Pont design because it came in on “its own nickel,” and was free to develop a propulsion design of its own apart from the government baseline.¹⁴

Despite progress in getting the contracts out, staffing the JPO, and organizing the office, Staten admitted that “due to more immediate problems, I have thought only in broad terms about how to approach the systems applications studies and mission analysis of the NASP vehicles.”¹⁵

That lack of attention to missions, reflected in the fact that the JPO did not have a director dedicated to examining applications until Col. John Fuller arrived in October, cost NASP in its assessment and strategy for developing support at the JPO level and for making its missions clear to the user commands and to NASA's potential clients. It also fed the growing tensions caused by differing visions of the program.

Differing Visions of the Program: Early Fissures

Even before personnel started to arrive at WPAFB, the aerospace plane had inherited several contradictory and occasionally completely incompatible sets of characteristics originating from differing visions of the program's goals and missions. To generate enthusiasm and support for the concept, Williams had to sell the aerospace plane as a complete, integrated program. That meant that NASP would feature a full-functioning, piloted aircraft, complete with fuel production and delivery systems; an thorough flight-test plan, including environmental protection and safety controls; and deliver a prototype vehicle that could be scaled-up for production.

Unseen, however, a second important priority lay buried in the program. During the 1960s and 1970s, the government had focused almost obsessively with cost control in weapons programs. From Robert McNamara's experiment with a multi-service fighter, to the introduction of the M-16, to numerous review panels and dozens of "reforms," the Pentagon sought to hold down costs. Rising real costs of weapons contributed to that need for control, but so did negative publicity about \$500 hammers and \$1500 toilet seats. Less understood by the public, or by the media, was the fact that in any potential conflict with the Soviet Union or the Warsaw Pact

nations, the U.S. and its allies would be severely outnumbered. That drove the service branches, particularly the “fast response” branches like the Air Force and Navy, to stress absolute maximum performance in weapons (which carried a higher price tag) as opposed to less impressive performance at a much lower cost. The U.S. Army aptly characterized its position in Europe during this time with a battle plan informally called “Fight Outnumbered and Win.” Aware of this issue, the military services tried to control costs through contractor competition, with the assumption that competitive contracts would force prices down.

In any program, then, a long-term view of the cost of procuring operational equipment necessitated that the government ask the question, “Will there be sufficient industrial base to build this weapon when it is needed?” Most research programs would not entertain such a question, let alone seek to address it within the research and development phase. But Robert Williams hoped to deal with the high costs of producing NASP-Derived Vehicles (NDVs) by considering operational cost issues within the X-30 program itself. As a strategy to ensure the government that several contractors had the capability to bid for NDV production, Williams planned to encourage as much competition as possible within the NASP program. “Keeping the contractors competitive” thus became an underlying goal of the entire program, and it shaped contractor relations as much as their performances on technical matters. Eventually, the focus on maintaining the contractor base in the hypersonics industry played a crucial role in the decision to form a NASP contractor team.¹⁶

That fact, widely acknowledged within the program but seldom mentioned in public, added to the reality that the NASP program was spectacularly ambitious in almost every aspect.¹⁷ Even without the tensions heaped on the program by the necessity to maintain a competitive

contractor base over a period of several years, NASP faced an immense challenge merely in focusing and integrating the different approaches of scientists, engineers, and program managers; of finding cohesion between the research and the operational demands of the major sponsors; and of trying to sustain political support for a flight program long before the technical issues even involved in the engine had been solved. From the outset the program was pulled in several opposite directions. An early NASA memo confirmed the divisions that had appeared, arguing that the program was “structured, budgeted and managed as if key technologies are in hand and only design decisions remain,” and that there was an “Emphasis on supportability, maintainability, reliability even before feasibility is established.”¹⁸

Putting together the science/research culture of NASA with the operationally-oriented service branches involved trying to mesh substantially different ways of approaching a research program. Even within NASA or the services, however, balancing the different approaches of scientists, engineers, and production-line program managers constituted a substantial feat. In typical programs, scientists at some point turn the work over to the engineers, who then turn them over to program managers. NASP researchers, however, had to invent and engineer at the same time, because the project proceeded on a schedule of force-fed technology that virtually demanded weekly advances in computational fluid dynamics, materials, and propulsion/airflow design. Combining the efforts of the scientists and engineers simultaneously was difficult. As Gen. Kenneth Staten, the first Air Force NASP project manager put it, the scientists were “broad,” while the engineers, “narrow.”¹⁹ Scientists worked in an “invention mode,” examining a universe of ideas, while engineers constantly sought to define and constrain the existing parameters to solve problems. Civilian and military program managers tended to work in yet a

third mode, wanting answers to scientific and technical problems, but on a schedule and within a budget.

Within NASA, other sources of resistance to NASP appeared. Although NASP was a research program, its ambitious goal of flying an aircraft---and, after the “Orient Express” speech, a high-profile aircraft at that---put it in direct competition (at least in the eyes of some legislators and space enthusiasts) with established programs like the Shuttle and more traditional rocket technologies. Operational programs such as the Shuttle commanded huge numbers of people, with a single Shuttle launch requiring more than 12,000 technicians at the site itself (6000 specifically assigned to the Shuttle and another 6000 working in ongoing security, maintenance, ground control, etc.). Behind the scenes, thousands more provided technical support in telemetry, communications, rescue, and Shuttle-related work at other locations. If NASP fulfilled its promise of genuinely routine horizontal SSTO, estimates of the numbers of personnel needed to conduct a launch were a fraction of those needed for the Shuttle. While hardly a 747, a NASP nevertheless was anticipated to resemble a standard aircraft in its ground and control personnel demands, perhaps with a total crew numbering in the dozens. The NASP JPO itself, while admittedly a research organization, was dwarfed by the gigantic rocket programs at NASA. In 1987, the program had fewer than 100 personnel at the JPO, and perhaps less than 1000 full-time employees working on it at any given time. The issue was not that NASP was a research program and that the Shuttle was an operational, ongoing, deeply entrenched program, but that in a contest for scarce resources, the political weight of programs such as the Shuttle easily overwhelmed the impressive, but ultimately puny, lobbying base for the aerospace plane.

At a deeper level, a functional aerospace plane presented a real threat to the thousands of NASA and contractor personnel whose jobs depended on rocket technology. NASA's support of the aerospace plane in the face of the potential internal resistance on that basis alone would have been difficult to maintain as NASP grew, much as the submariners in the U.S. Navy constantly struggled against the battleship and carrier admirals. Deliberately committing to a path that makes the skills and jobs of large segments of your workforce obsolete is a tough sell even when, in the case of the advantages of airplanes over battleships in the 1930s, and submarines over carriers in the 1970s, the technology is well proven and difficult to deny. In the case of NASP, the technology was not proven at all, and already had an army of skeptics. Had the program possessed an extremely clear mission focus---one to which all or most of the participants endorsed and agreed to---it might have had enough to overcome such institutional barriers that virtually any new technology must defeat. Unfortunately, NASP suffered from a variety of viruses that infected the mission goal, from loose translation of the planning documents to different visions of the final product. Those viruses produced a constant internal tension that kept NASP in a weakened condition throughout its short life.

The NASP Tension Box

Most of the tensions that diffused the energies of the program stemmed from the varied interpretations of what NASP was supposed to be. Those different outcomes are captured in Fig. 2.4, "NASP Tension Box: Potential Program Outcomes." It is important to note that these options represented *results* of the NASP program broadly defined as viewed by all the

NASP "Tension Box"
Potential Program
Outcomes

Research

Operations

Military

NASA/Civ

<p>1</p> <p>SSTO →</p> <p>X-30 →</p> <p>DATA to support positive phase 3 decision.</p>	<p>2</p> <p>SSTO →</p> <p>X-30 →</p> <p>S-30 →</p> <p>NDVs</p>
<p>3</p> <p>MACH 12-15 →</p> <p>DATA</p>	<p>4</p> <p>SSTO → Cargo lifter Hypersonic spinoffs for Space Shuttle, ALS, Space Rescue, Space Station support</p> <p>Mach 4 cruiser Federal Express cargo plane Low cost cargo orbit "Orient Express"</p>

Fig. 2.4, "NASP 'Tension Box' Potential Program Outcomes"

participants, including contractors and political supporters outside of the narrow team of internal players within the Joint Program Office (JPO), NASA, and the Air Force. But each option had, or was supposed to have (as was the case of the civilian operations box) its supporters in the JPO. As Staten noted, the controversial box 4 in Fig. 2.4, which contained the much-derided “Orient Express” Mach 10 passenger aircraft, had hardly any support within the JPO because the NASA personnel, who were instructed to study the civilian uses of a hypersonic spaceplane, never completed the job.²⁰ And while the most vigorous civilian supporters of hypersonic craft with commercial uses indeed remained outside the official program itself, their arguments, especially those related to the benefits of advancing the U.S. aerospace industry either directly or indirectly coming from NASP, took on increasing force in 1989 when program management sought ways to emphasize the non-military uses of NASP.²¹

The tensions that strained at the program emerged at a meeting of the DARPA Aero-Space Plane Senior Review Panel (a panel formed to advise the management team) on October 10, 1985. While the discussion centered on approaches to funding during the DARPA-managed portion of the program through transition to the Air Force, in the process it defined the final vehicle it wanted to develop. The panel “strongly supported” the need for an experimental flight test vehicle (represented in box 1, Fig. 2.4).²² But since the military supporters agreed that NASP would lead to NDVs of some type---as Williams made clear in the drive to keep several contractors competitive during the R&D phase---represented in box 2 of Fig. 2.4, a fundamental conflict was internalized early in the conceptualization of the NASP program. Moreover, even if the operational/research differences could be minimized, substantial disagreement surfaced over the number of the steps involved in reaching that goal, and whether the program should include

such diverse interim goals as building a non-SSTO airplane; making a smaller-scale vehicle that, when scaled up would be a prototype for the “operational NASP” or NDVs (called the “S-30s); or building the SSTO research vehicle that would demonstrate the technology “leading to” an S-30 or NDVs of completely different size, structure, and mission capability. In contrast, critics charged that the Du Pont aircraft had virtually no capability to prove anything except that one particular design could achieve SSTO.

If Williams was correct in maintaining that only the Du Pont “strutless” combustor would work, the design had no promise whatsoever for scaling up to an operational vehicle, and its data would be of extremely limited use. Initially, most participants agreed that the X-30 would not be a prototype vehicle or an “S-30,” but how far it should go in the direction of a prototype generated strong differences of opinion. Within the Air Force, those disagreements centered on timing, defining how soon the aircraft needed to prove certain critical new materials; whether the program should build a ‘low-tech’ version for testing problems up to Mach 12, and incorporate newer materials into a second “real thing” aircraft; and other such thorny questions. (Ironically, Du Pont had claimed that his design made use of “existing” materials, making it all the more difficult to think that it could make orbit, especially given the advances on a geometric scale in making lightweight materials that the program later made, and *still* struggled with weight issues!) Later, as the program developed, the considerable latitude provided by the Program Management Plan (PMP) allowed serious differences in interpretation to emerge. This formed the “research/ops” tension in Fig. 2.4, boxes 1 and 2. Since the differences stemmed from interpretations of the documents, and ultimately, the mission, clashes within NASP resembled the bitter splits that developed within the early Christian church over what, to outsiders, appeared

to be minor details. In fact, such minor details constituted the very identity of the project and defined its mission. Ultimately, those “minor details” determined to what degree the program could obtain funding.

One major area of disagreement involved whether to attempt to provide simultaneously for all the components of an aircraft system, including hydrogen fuels, avionics, pilot protection and escape, flight test plans, environmental impact statements, hazardous fuels and noise abatement programs, or to tackle the major technological obstacles somewhat independently, mastering, say, the scramjet first, then the materials, and so on. As a Langley memo made explicit, “Program advocacy material has presented a variety of goals: 1) Single stage to orbit, 2) Low cost delivery of payload to [Low Earth Orbit], 3) Long duration hypersonic cruise (interceptor, cruise, transport), 4) Experimental vehicle for hypersonic research.”²³ Officially, SSTO remained a “primary goal,” but unofficially items 3 and 4 were “considered sufficient” for justifying the program and “many feel that 1 and 2 *are not feasible or even a serious requirement*” (emphasis added).²⁴ Yet the authors of such memos apparently ignored the fact that the program had gained programmatic, administrative, and congressional support on the basis that it could provide an aircraft capable of SSTO. The idea that SSTO was not a “serious requirement” constituted an astounding internal position, considering that the program had originated specifically due to the advantages offered by SSTO.

Such comments reopened the philosophical debate that Williams thought he had closed. Since no wind tunnel existed that could provide data above Mach 8, the program had to develop the entire aircraft to test the scramjet. Although most proponents agreed the scramjet itself was the major hurdle, many of the scramjet issues might be finessed with better CFD, more heat-

resistant materials, or more efficient airframe design. Proponents of the “integrated aircraft” view maintained that advances in materials could reduce aircraft weight, lower the thrust requirements; or that improved forebody design would increase inlet efficiencies, thus enhancing the scramjet. If fuels could be refined, an improved fuel could generate more thrust, just as high-octane gas is better than regular.

Yet even within the “integrated aircraft” proponents, one group favored taking smaller, incremental steps as the quickest way to produce the integrated vehicle, while those with experience in more traditional aircraft production emphasized making an aircraft that was as close as possible to the final NDV or S-30 concept in order to save time during the transition from research aircraft to operational airplane. Each of those views---the “research” and the “ops” interpretations---brought a different and incompatible approach to Phase 3 fabrication and test. “Research” advocates argued that most of the critical data needed to actually fabricate the SSTO vehicle could have been drawn from flight testing in the Mach 8-15 range. Materials available at the time might have sufficed temporarily to test either static articles or a non-SSTO plane, while the team continued research on newer and more exotic materials. (Consider an example from drag racing: if the goal is to test the car’s engine for a 1/4-mile shakedown run, the car might not need its fiberglass hood or side panels, and might use heavier metal components in order to get the engine down the track for a test. But for actual competition, the driver would want the car as light as possible.) In the case of NASP, a less-capable aircraft was acceptable to obtain certain data. But if SSTO served as the driving criteria, certain testing would demand entirely new materials for the wing, fuselage, cryogenic tank, and even engine components, and the program would have to ensure that all those advances materials came to maturity at roughly the same

time.

Both the advocates of individual technology emphasis and the proponents of the “full-aircraft” integrated system held fundamentally different views of how to package the program in the political arena, either to Congress or the public. SSTO offered radical new capabilities, far different from anything the nation possessed at the time, but merely flying faster, say, to Mach 12, “didn’t give you anything useful,” as Herschel Sams, the NASP program manager at McDonnell Douglas put it.²⁵ Data from Mach 12 “didn’t tell you anything about the real problems of SSTO, which were totally outside the Mach 12-15 research envelope,” he maintained. SSTO provided a goal---a galvanizing quest around which the contractors, the users, and even the nation, could rally. In contrast, achieving a higher speed, even if it produced important data that researchers could use to confidently design an SSTO aircraft, lacked public appeal and some of the long-term spinoffs that allowed proponents to sell the program to legislators. Another way of viewing the SSTO objective is to compare the X-15 flights, which most people would not have watched even had the media technology been available, to the Apollo moon landing, which few people missed.

Compounding the differences between the “ops” and the “research” groups, the “ops” side (especially those in the Air Force and Navy) harbored a traditional suspicion of the technicians that researchers could content themselves with data for its own sake. Colladay, for one, confirmed that such a view existed within NASP. Justified or not, the perception was widespread among contractors and within certain elements of the JPO that many of the researchers supported the operational SSTO vehicle half-heartedly, using the program to acquire ever-growing piles of data that lacked actual application. Even though the competing groups

debated their views with intensity, yet generally treated the opposing camps with respect and good humor, fundamentally divergent approaches toward the program had appeared from NASP's inception.

Within NASA, the different interpretations took a somewhat different twist, as seen in the "CIV/NASA" boxes 3-4 in Fig. 2.4. As study results and test data started to roll in, many in NASA (and a few in the Air Force) contended that indeed the predictive tools necessary to make rational estimates of performance did not require SSTO, or even reaching Mach 25 (orbital velocity), but instead those predictive tools might be available at a much lower level, possibly Mach 10-12. If the program could merely get an aircraft to operate at Mach 12, it could be scaled up from that point to an orbital vehicle. While many physics barriers existed to scale up such a vehicle, many argued that the data gathered at Mach 12 would be sufficient to overcome any remaining obstacles specific to the flight regime above Mach 12.

Many in NASA off the record admitted that they would have no problem if the X-30 was never built, and that the data was the goal. Thus, a split developed between the JPO NASA contingent, loyal to the SSTO mission, and some at the NASA Centers, who viewed NASP as an interesting but flawed program that they could use for their own purposes. Several NASA administrators, including Fletcher, Truly, and former administrator James Webb, issued strong endorsements of the program. But within NASA, NASP represented a tiny fish competing in an ocean of larger predators, including the space station, the Advanced Manned Launch System, the Hubble Space Telescope, and the Shuttle program, as well as hundreds of ongoing programs at the Field Centers. Further compounding all the existing fissures in NASP support, the "ops" side of NASA needed data it could use on its Hypersonic Civilian Transport (HSCT), seen in Fig. 2.4,

box 4, while the commercial civilian users---express delivery companies, civilian space users with small payloads, and, down the line, aircraft manufacturers and airlines---were drawn to the “Orient Express” Mach 3-4 hypersonic passenger and cargo jet.

To reiterate, few in NASA saw the aerospace plane in the context of an “Orient Express.” Indeed, the fact that the research elements of NASA so strongly supported NASP (for whatever reason) indicated that the “ops”-oriented groups in NASA were already involved in other space launch systems. Somewhat naturally, then, the Air Force’s interpretation of the missions for the aerospace plane tended to dominate the early discussions, a point made even more emphatic when the one contractor with a primarily civilian customer base, Boeing, was eliminated in the 1986 downselection, removing the potentially strongest voice for an HSCT or “Orient Express” outcome for the program. Ironically, by the time the program had to fight for its existence in 1989, the supporters revived the arguments about civilian benefits, enhanced trade resulting from advances in the aerospace technology base, and spinoffs when briefing cabinet secretaries, congressional staffers, and important allies among civilian lobbyists.

Consequently, two primary sets of tensions embedded themselves in the program at its origin: the civilian/military tension and the research/operations tension. They remained dormant for a brief period, but at some point they would resurface to damage program support. Why, then, did the Plan, which was the mechanism by which the program shaped its direction and defined its mission, allow room for so many different interpretations? Robert Williams accepted blame for the “big tent philosophy,” and even admitted that he practiced a policy of “tolerat[ing] apparent ambiguity” about the program’s goals to keep options open and foster creativity.”²⁶ Depending on his audience, Williams in briefings emphasized totally different potential program outcomes

and substantially different qualities of the NASP hypersonic vehicle. It was exactly that flexibility that allowed Reagan to advocate sincerely an “Orient Express” while the contractors thought they were building an orbital jet and the researchers satisfied themselves that they were expanding the technology base.

Even the most talented politicians, however, have trouble maintaining their support from groups with conflicting goals, and Williams, despite his bent for politics, could not pull it off for long. Pitfalls awaited at almost every turn. For example, the Plan provided for “assessing the utility” of vehicles and operational characteristics that the new technologies allowed, including both military and civilian space transportation and military and civil atmospheric vehicles. That opened the door for Williams and others to emphasize the operational aspects of the program. But when the operational and payload issues seemed to grow, Williams “just backed off and said ‘we’ll just carry people’ [i.e., only pilots]. All we wanted to do was to get the technology proven.”²⁷ Indeed, the Phase 2 goals included providing utility assessments of potential applications before committing to the flight vehicle itself. In the course of the program, the interpretation of this objective played a critical role in shaping the overall direction. And certainly the objective itself allowed a great deal of latitude: it could be interpreted as to make experimental vehicles essentially prototypes for the NDVs. In that respect, “assessing the utility” could be seen as a mandate for a craft that would resemble an NDV in most of its important characteristics, especially size, weight, propulsion, and operational characteristics. Others argued that “assessing the utility” merely meant proving the technology, not actually demonstrating SSTO in a flight.

In the flush of the program’s early enthusiasm, many of the disturbing tensions that

would later prove damaging seemed to disappear. The Plan and its subordinate document, the Program Management Document (PMD) left plenty of running room for management to allow NASP to evolve as the directors saw fit (with the approval of the Steering Group). At that stage, some in the JPO argued, the program needed to focus immediately on operational vehicles. In order to marshal top level DoD (“four star”) support, they contended, the program needed to show clear progress toward developing useable military vehicles---fighters, bombers, or reconnaissance aircraft---that it could reproduce on a cost-effective basis in quantity. Thus, some wanted NASP to emphasize and even tout the close connection to the NDVs.

In fact, the Plan only mentioned follow-on systems in an oblique way, stating that the studies conducted as part of Phase 2 were to identify “specific applications of the technologies for future military and civil purposes” and “consider a broad range of military and civil space transportation systems as well as military and civil space transportation vehicles.”²⁸ Williams, with assistance from his principal advisors, had drawn up the Plan to reflect the open-ended concepts of the program, but the strategy of shaping exactly what the Plan meant fell to the program managers, first, Williams and Staten, then later, Barthelemy.

Stripped of its varied implications, the Plan emphasized the central focus of the program to fabricate the X-30 aircraft. Few disputed that, including the “techies” who wanted NASP mainly as a means to broaden and enhance the hypersonic technology base. Controversy arose when various interests in and around the program tried to determine *what else* the documents said or implied. The greatest divisions came over the extent to which the documents committed the program to support follow-on vehicles. For those who suggested that the Plan and the PMD contained clear direction on NDV development, their approach toward the NASP research

aircraft led them in one direction. Others interpreted the documentation as making NASP a self-contained research program that would end and hand the technology off to other programs.

Unequal Partners: SDIO and the Navy

Adding to the research/ops tensions and the disagreements over what the Plan contained, the various sponsors of the program had different needs, which made the joint nature of the program more fragile still. Initially, all the participants willingly and enthusiastically signed on to the program: as Vince Rausch noted, “nobody poked anybody in the chest and said ‘you will participate.’”²⁹ (Indeed, for a brief period, an almost frantic rush to get on board NASP ensued, with the prevailing attitude that the aerospace plane was the program of the future, and any contractor or agency not tied into it would be left out.) After successfully gaining admission to NASP, however, many of the members found a final product or a timetable that ultimately would not fit their needs, and in that regard some of the participants started to lose interest almost from the outset.

SDIO’s role in NASP illustrated how a participant could have specific demands for an aerospace plane, and therefore explain the initial interest, and yet show how external factors could shape its subsequent level of participation in the program. A somewhat late arrival to NASP, the Strategic Defense Initiative (SDI), had itself only recently come into existence. SDI stemmed from a March 1983 speech by Reagan in which the president urged the nation’s scientific and technical community to search for a missile defense. Without specifying any single approach, advances in such areas as particle-beam weapons, lasers, and traditional anti-missiles

led Reagan to conclude that an effective multi-tiered defense shield could be constructed that would eliminate---or at least greatly reduce---the threat of Soviet ballistic missiles. Contrary to what the critics of “Star Wars” (as they dubbed SDI) claimed, Reagan---nor any of the program’s major supporters---never claimed that it could be 100% effective in destroying missiles, but rather that it would drive up the technical demands placed on ballistic missiles, and subsequently the weight and cost of each, that defeating the missile defenses would prove either impractical or unaffordable. Moreover, the advocates of “High Frontier” (as the proponents called the system) noted that even if it was only 20% successful, the need to overwhelm the defenses would demand that the attacker increase his barrage in *quantum* numbers.³⁰

One of the most serious challenges to the space-based aspects of SDI defenses was that of lifting sufficient hardware into orbit to construct the necessary number of satellites. Critics erred by factors of five, ten, and even twenty in their claims of what the SDI satellites would weigh, but even the proponents agreed that an unprecedented level of orbital launch capability would be demanded by a space-based defense. Thus, SDIO became an interested---and potentially important---partner in the aerospace plane, and added support to the commercial sector seeking low-cost access to space.

Unfortunately for NASP, the SDI program itself had suffered schedule setbacks and budget reductions. It never had a clear focus of establishing any particular system (either satellite lasers or ground-based missiles), but rather was a general technology development program that explored many potential missile defenses. George Baum, a consultant to the Copper Canyon phase of NASP and a close confidant of Robert Williams during that period of the aerospace plane’s life, recalled that “before the stretchouts [of SDI in 1987 and 1989], SDIO had definite

uses for NASP, but the window of usefulness vanished when the program was delayed.”³¹ Those within NASP supporting a broad program of technological advance had only to look at SDI to see the dangers of failing to provide a clear-cut product from the research, a point that tended to strengthen Williams’ emphasis on producing an aircraft.

The Navy, on the other hand, had spawned Williams’ original interest in hypersonic flight, and had several vague and generic uses for hypersonic aircraft, ranging from reconnaissance to adapting the scramjet technology back to missiles. Once again, however, the lack of a clear utility for a particular vehicle deeply eroded the Navy’s interest, especially after the budget downturns forced elimination of such strongly supported programs as the new attack aircraft, upgrades to the F-18 and F-14, and, in shipbuilding, reductions in the submarine forces. The demands on other systems, and the highly specialized contributions of NASP to the Navy mission (it certainly could not be carrier based, for example) meant that more than any other participant, the U.S. Navy was forced at an early stage to choose between NASP and other, more immediate, programs. In FY88, the separate budget lines of SDIO, the Air Force, DARPA, and the U.S. Navy were combined into a single DoD budget line, at which time it became impossible to formally track SDIO and the Navy’s commitment to the program, but it is fair to say that by that time both had withdrawn their support. A skeleton Navy contingent remained at the JPO; no SDIO personnel ever located at WPAFB; and SDIO even started to search for other, more near-term, launch delivery systems for its space-based technology.

Program Funding Projections

If the Navy and SDIO had maintained their levels of commitment according to the original funding plan, both would have steadily increased their contributions to the program. As seen in Fig. 2.5, "Planned NASA Budget Allocations," the Navy's commitment to NASP was slated to grow from \$6 million in FY86 to \$105 million in FY89, while SDIO was projected to increase its level of support from \$9 million to \$130 million over the same period. NASA would increase its support of the program from \$16 million to \$95 million. While that represented a significant sum, there is some evidence that NASA originally intended to put up half of all program costs. At a DARPA meeting in October and November, 1985, Bob Jones of Langley reported that the participants "assumed significant NASA support," that NASA would have the lead in several areas, and that more than half the total over a four-year period (or \$150 million) would come from NASA.³² By the time the budgets were finalized, however, while NASA still maintained a genuine commitment to NASP, the budget made clear that DoD constituted the most important source of NASP funding, and that within DoD, the Air Force was the single most important player. Air Force spending on NASP by FY89 was to reach \$170 million---almost double that of NASA's revised spending levels for that year---and the DoD total of \$445 represented a commitment four times greater than the space agency's. As early as July 25, 1985, six congressmen drafted a letter to James Beggs of NASA urging NASA to increase its funding of hypersonics.³³

Even at that, NASP was grossly underfunded. A draft of "Propulsion Technology Maturation Plan," produced by the government/contractor teams on, appropriately enough,

(\$M)

Source	Phase II				Phase III				Total
	FY 86	FY 87	FY 88	FY 89	FY 90	FY 91	FY 92	FY 93	
DOD									
DARPA	20	60	80	40	40	0	0	0	240
Air Force	10	34	86	170	250	240	160	85	1035
Navy	6	26	53	105	165	115	40	10	520
SDIO	9	30	66	130	230	145	55	20	685
Total DOD	45	150	285	445	685	500	255	115	2480
NASA									
R&T Base	(16)	(17)	(18)	(20)	(20)	(20)	(21)	(22)	(154)
Phase II		(45)	(56)	(50)	(34)	(22)	(--)	(--)	(207)
Phase III				(25)	(106)	(78)	(24)	(3)	(236)
Totals	61	212	359	540	845	620	300	140	3077

Fig. 2.5, "Planned NASP Budget Allocations"

Halloween, 1985 (with the handwritten comment “first priority,” indicating that propulsion received preference over airframe in funding issues) allocated a scant \$39 million for the basic scramjet research, including engine test facilities and fabrication of two engines.³⁴ The total amount going to the three propulsion contractors during the Phase 2 design validation phase was \$360 million, meaning that the three propulsion contractors, working on one of the most challenging problems in aerospace propulsion history, anticipated tackling the problem for approximately \$25 million a year each.

The early, unrealistically low funding projections resulted from the original Du Pont cost estimates of \$5 billion for the orbital aircraft; but also from the unfamiliarity with the technology and the unanticipated additional costs that every new program faces. As discovered during the cost estimating of the Trident submarine program, which used some revolutionary but little radical technology, new cost considerations appeared constantly during the process of engineering.³⁵ As an October/November 1985 memo by key NASA Langley NASP leaders concluded, “Its [sic] too early to accurately determine funding and schedules” and “Funding for this plan is not clear.”³⁶

Indeed, the way in which NASA headquarters funded NASP itself constituted a source of friction. First, in most cases, the research centers saw their existing hypersonics budgets simply rolled into NASP---no actual new money was provided by NASA. Not only did center money already going to hypersonics make up the new NASA NASP budget, but Ray Colladay, the Associate Administrator for Aerospace and Space Technology, ordered some transfers of funds from non-hypersonic programs, including auxiliary propulsion for TAVs to NASP.³⁷ Although the centers complied, they did so grudgingly. As Lee Beach noted that the letter did not assume

that focused hypersonic work on NASP would be under Langley, but rather “assumed that the discipline divisions would manage the programs.”³⁸ Others within NASA maintained that reallocating money from the centers for new projects was “business as usual,” or that the transfers had less to do with NASP and more to do with other recent funding shifts that had resulted in the dilution of a particular center’s budget as it carried the brunt of funding for a particular project. Nevertheless, for several years, many NASA personnel continued to express resentment that the Space Agency had not created new funding priorities for hypersonics but had merely rearranged and repackaged existing commitments. In fact, in a presentation for OAST Management Control on priorities for the FY87 aeronautics program, under a category called “Major Needs and Opportunities,” NASP was not split out as a separate budget item, although NASP-related technical work was identified.³⁹ The NASA/contractor meetings that occurred from October 28 to November 1, 1985 reiterated that NASA needed “its *own* plan for support of this program (emphasis in original),” and raised again the key question: “How much NASA money will actually be used to direct this program?”⁴⁰

Williams and Staten: “Mr. Outside” and “Mr. Inside”

While NASA sorted out its funding assignments, the JPO began operations. Program documentation may have defined Williams’ role and that of the JPO directors, but it could not specifically delineate the practical division of labor between Washington and the JPO when it came to interaction between the JPO and the contractors, or the contractors and Washington. By all accounts, Williams was the program evangelist, considered “indispensable” according to

dozens of early participants. Bill Piland, upon arriving at the DARPA NASP office, found Williams on the phone until 5 o'clock every day, building support for the program. Only after "normal" business hours did Williams get to the daily technical issues that had arisen.⁴¹

Williams' working of the telephones paid off by producing a base of support in Washington and around the nation, although he tended to tell different constituents what he thought they needed to hear. Insiders recalled that he handled briefings with consummate skill, according to one person in attendance at the briefings who wished to remain anonymous, "saying exactly the right things, turning the questions in just the right manner" to deliver the appropriate message.⁴²

Although Williams was a scientist by training, he had natural political abilities, especially when it came to framing issues in the best possible light. But both Williams and Barthelemy noted that DARPA managers by nature practice ambiguity, and promoting a program by obscuring certain unpleasant details is nothing new in Washington. Such was true of almost any successful program manager in the service branches as well. As long as NASP remained a small, DARPA program, Williams had that luxury.

Ironically, Williams himself viewed Aeronautical Systems Division Commander, Gen. Lawrence Skantze, as the prime mover. "Skantze," he said, "was probably the single most important individual in getting the program started. DARPA was going to have the technology program anyway, but Skantze brought the Air Force in on full afterburner."⁴³ Skantze pulled the right levers within the Air Force, but to get the X-30 out of the laboratories required support from "non-players" who were influential in the aerospace community, especially those with a voice in Washington. Such a peripheral, but important, individual was Jack Kerrebrock, Associate Dean of Engineering at MIT. He found Williams' initial sales pitch intriguing, recalling that the

scientific community appreciated the “imaginary component” in the notion of the “Orient Express” or hydrogen-powered civilian aircraft, but recalled that what attracted serious interest from outside researchers was the opportunity to do work on hypersonic problems. “That,” he observed, “produced a sort of symbiosis between the wild-eyed politicians and the real engineers . . . an odd sort of coalition.”⁴⁴ But Kerrebrock was wrong in that there were scarcely any “wild-eyed politicians” who were enraptured with hypersonic flight---chiefly only Dana Rohrabacher, and then, thanks to his influence, Reagan and later Vice President Dan Quayle expressed special interest in the program---and their attention, in general, was lamented by program officials who always thought it diversionary from the real goals of the program. As Adm. Richard Truly, the NASA Administrator noted, “the ‘Orient Express’ speech, in my opinion, was both the beginning and the end of NASP because it generated interest in the program, but made the problems of hypersonic flight appear too easy.”⁴⁵ Indeed, the challenge of selling NASP to potential users lay in making the final vehicle appear close enough to reality to support, but far enough away in terms of its technical difficulty to demand extreme patience.

It was assumed by most NASP participants that since Williams was in Washington, and Staten at the program office, that daily technical work would be overseen by “Mr. Inside”---Staten---and that the lobbying and support-building activities would fall to “Mr. Outside,” Williams. Staten certainly had no interest in entering the policy arena, nor did he possess any real authority to do so. The contractors liked Staten, seeing him as “decisive,” which Staten (by rank and personality) was. Nevertheless, Staten’s decisions had little to do with the strategic issues Williams dealt with daily, thus seldom demanding that he be controversial. Staten’s assignment, though roughly average in length by Air Force standards, proved too brief for NASP, which

thrived under his continuity. Even Staten, though had difficulty smoothing over relations between the companies and the DARPA program manager. Had neither of them left or been reassigned, both the nature of their roles and their personalities would have produced a fissure.

Trouble appeared when Williams, concerned that the contractors were abandoning the Du Pont design, tried to refocus them on the baseline. At that point, Williams began to blur the roles between the Washington and Dayton offices, and Staten found that he had to “go around fixing problems with the contractors” after Williams’ visits with them.⁴⁶ Contractors interviewed for the program, who refused to go on record, complained that Williams constantly told them “how to design the airplane.” Williams remained steadfast that the propulsion contractors in particular had, through their designs, abandoned the lynchpin of the Du Pont scramjet, the “strutless” injector. The contractors equally steadfastly maintained that the Du Pont injector would not work as intended, and that new approaches were needed. Regardless of any substance of Williams’ arguments may have had, his relationship with the contractors tended to erode the original concept of having a Washington-based advocate/consensus builder and an on-the-scenes program manager.

Yet criticisms of Williams during this time must be tempered. At least some evidence suggests that Williams’ grasp of the technology was far deeper than most contractors and many at NASA wanted to believe. Pratt & Whitney’s NASP manager, Carl Sypneiwski, for example, recalled Williams from the outset “picked up something he didn’t like [about the P&W design], and brought the matter of the injector up at every meeting, claiming that there would be pressure and themal problems.”⁴⁷ Sypneiwski proudly pointed out that P&W had proved Williams wrong--yet the fact that Williams had been close enough to identifying a real problem was borne out by

the fact that it took P&W “substantial amounts of time and money” on testing the issue. Had Williams’ understanding been as shallow as charged, his criticisms of the designs could have been dismissed with little effort. Still, Williams continued to tell the contractors “how to design the airplane,” a practice that alienated most of the contractor participants.

The failure of the “Mr. Inside/Mr. Outside” arrangement meant that any future NASP program manager had to possess sufficient technical competence to oversee the technological development, and at the same time wield political and policy skills to maintain administration, congressional, and public support for the program. It therefore demanded a manager who could delegate technical tasks to contractors and JPO directors during the long periods away from the JPO demanded for lobbying and building program support.

NASP Management: the Early Months

Great progress had occurred since Du Pont first walked into Williams’ office. Over a period of several years, a number of disparate, uncoordinated hypersonic efforts had been gradually funneled into two foci, DARPA in Washington and the Air Force at WPAFB. The establishment of the JPO not only centralized the program but streamlined all its activities, including design studies, technical support, and management. It united and reinvigorated the technological base for hypersonics, especially air-breathing SSTO craft, which had deteriorated. Gathering all those data bases, especially CFD, which in many ways could compensate for the absence of wind tunnels capable of testing at high Mach speeds, comprised the first task facing program management. CFD had only recently emerged as a powerful research tool, and along with the

propulsion technology and materials needed for advanced spacecraft, posed a serious management challenge. Those technologies would have to come on line at precisely the exact time as they would be needed, and if not, the entire program could stall. Thus, management had the daunting task of starting a “race” with several different technologies “running” at different paces, but with the necessity of having everyone reach the finish line together.

Almost immediately, the program and those charged with its oversight realized that the technological progress in some areas was going to come more slowly than expected. Congress took note of that development and reduced FY87 funding to \$167 million. As a result, in December, the Steering Group restructured the program by delaying all milestones four months, extending airframe and concept designs. The new schedule called for preliminary design reviews in early 1987.⁴⁸

Materials raised particular concerns about timely development. In many ways, despite the fact that the integrated design and scramjet operation stood as daunting challenges, virtually every aspect of the technology---including performance, temperature and pressure sustainability, and weight savings---depended in some way on the timely arrival of a wide array of new materials. NASP research into a variety of new materials, including the heat tiles on the Space Shuttle, found that substantially new materials took an average of 10-15 years to develop, but NASP assumed that the program could get its critical new materials on line in five years (see Fig. 2.6, “Materials Requirements”).⁴⁹ Internal DoD reviews expressed concern that the program would pass critical decision points before needed data became available. The CFD codes, especially, had to develop quickly or they could not be used to influence the engine competition downselection process.

Time-Temperature Requirements For Oxidation-Resistant Materials In Aerospace Propulsion Systems

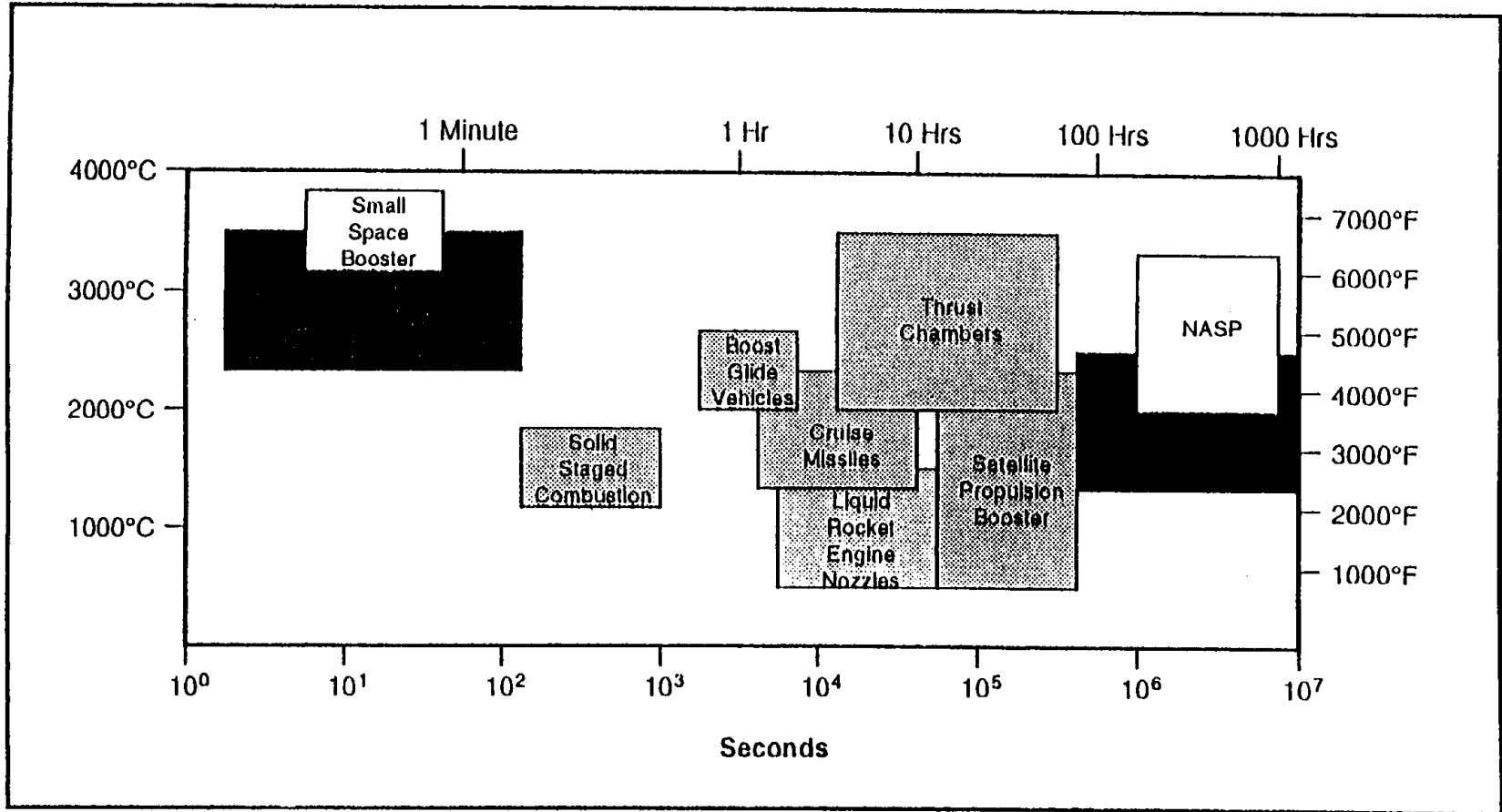

Fig. 26, "Materials Requirements"

Concerns about the materials frequently failed to recognize that many of the “radical” new materials had been around for a decade. They either lacked the right application, or they cost a great deal. NASP solved both problems by creating a market. Often overlooked when critics raised the issue of materials development were the materials requirements of the original Du Pont design---all material commonly used at the time, and nothing exotic.

“Technology push” was a necessity, however, if NASP was to succeed in bringing together all the various elements of the program when they were needed. And the program responded---indeed often anticipated---criticisms from the Defense Science Board, the General Accounting Office, or other oversight agencies when it came to accelerating technological development of critical components or materials. Staten played no small role in organizing the materials effort at the JPO. On the other hand, Williams, the person who had the most expertise to offer when it came to radical technologies, intruded himself consistently into the technical areas of the program.

The introduction of the contractors into the process provided new opportunities for improvement in the design, but also offered new challenges in that still other “visions” of NASP competed with those already present. They lost no time abandoning the Du Pont design as unworkable, unrealistic in its projected thrust, weights, and airframe performance, and generally unattainable. Their appearance, however, served to move the real action in the program from Washington to the contractor sites. There, eight companies charged with making the Du Pont design fly, working independently and competitively, concluded that they could not. They each quietly, but unanimously, rejected the government baseline and began to design, in essence, their own vehicles. Unfortunately for the NASP program, the major sponsors---NASA, the Air Force,

and especially DARPA---had supported the program based on the claims for Du Pont's aircraft.

NOTES Chapter II

1. Undersecretary of Defense (R&E) to Assistant Secretary of the Air Force (Research, Development, and Logistics), Director DARPA, Assistant Secretary of the Navy (Research, Engineering, and Systems), and Director SDIO, memo dated December 2, 1985, in Wierzbanski's files, AFFTC History Office, Edwards AFB.
2. "National Aerospace Plane Program Management Plan," November 28, 1986, 25, Aeronautical Systems Division, WPAFB History Office.
3. "Program Management Plan," 25-29.
4. "National Aero-Space Plane Program Review," March 17, 1986, Tom Richmond's files, Bldg. 53, WPAFB.
5. Interview with Tom Gregory of the JPO, July 12, 1990.
6. Interview with Staten, July 17, 1989.
7. Interview with Rausch, July 17, 1997.
8. Interview with Rausch, July 17, 1997.
9. "Program Management Plan," 31-32.
10. Weekly Activity Report, March 6, 1986, Barthelemy's files, WPAFB History Office.
11. Weekly Activity Report, March 27, 1986, *ibid.*
12. Weekly Activity Report, March 6, 1986, *ibid.*
13. Weekly Activity Report, April 10, 1986, *ibid.*
14. Weekly Activity Report, June 5, 1986, *ibid.*
15. Weekly Activity Report, March 6, 1986.
16. On the environment in which the contractors operated at this time, see Jacques Gansler, The Defense Industry (Cambridge, Mass.: MIT Press, 1980) and his Affording Defense (Cambridge, Mass.: MIT Press, 1989); and David C. Mowery and Nathan Rosenberg, Technology and the Pursuit of Economic Growth (Cambridge: Cambridge University Press, 1989). Material for the sections dealing with the contractors came from interviews with JPO personnel who managed the contracts, specifically Lt. Col. Rodney Earehart, Maj. Dennis Minor, Lt. Col. Ken Griffen, Lt. Col. Rick Roach, Lt. Col. Scott Parks, Maj. Tim Roberts, and contracts chief Tom Richmond, as well as Frank Boensch and Col. Ted Wierzbanski, all of whom were interviewed on numerous

occasions.

17. Virtually all of those involved in the program considered it extremely ambitious, although not an impossible challenge. In addition to the JPO personnel mentioned above, other sources include an interview with Boeing's Tom Cornell, August 29, 1989; NASA's Bill Piland, July 18, 1997; Chuck Anderson at the JPO, February 27, 1990; and Bruce Abell, then of the Hudson Institute, March 13, 1990. Also see, Stephen W. Korthals-Altes, "Will the Aerospace Plane Work?" Technology Review (January 1987), 43-51.
18. These observations are found in a 1986 memo, "Overall Program Direction and Balance," in "Steering Committee, 11/19/86," NASA Langley Technical Library.
19. Interview with Gen. Kenneth Staten, July 17, 1989.
20. Interview with Staten, July 17, 1989.
21. See, for example, the briefing prepared by McDonnell Douglas, presented by the JPO to the United States Space Council, called "National Aerospace Plane: Pioneering New Frontiers," June 1989, in author's possession.
22. "Weekly Activity Report," October 10, 1989, Robert Barthelemy's files, WPAFB History Office.
23. "Overall Program Direction and Balance," in "'Steering Committee, 11/19/86," NASA Langley Technical Library.
24. "Overall Program Direction and Balance," *ibid.*
25. Interview with Herschel Sams, July 10, 1989.
26. Interview with Robert Williams, July 18, 1989.
27. Interview with Williams, July 18, 1989.
28. "Program Management Plan," 8.
29. Interview with then Lt. Col. Vince Rausch, July 18 1989.
30. Larry Schweikart and D. Douglas Dagleish, "What You Don't Know About SDI," Dayton Engineer, part I, July 1988, 1, 4, 8, 11, and part II, August 1988, 1,4, and their "Why the Soviets Really Fear SDI," National Defense, 52, December 1987, 64-69; Missile Defense in the 1990's (Washington:George C. Marshall Institute, 1987); Office of Technology Assessment, Strategic Defenses: Two Reports (Princeton: Princeton University Press, 1986); John Tirman, ed., The Fallacy of Star Wars (New York, Vintage, 1984); Robert Jastrow, "The War Against 'Star Wars'," Commentary, 78, December 1984), 19-25; Donald R. Baucom, The Origins of SDI,

- 1944-1983 (Lawrence, Kansas: University of Kansas Press, 1992); and Jay Wink, On the Brink (New York: Simon and Schuster, 1996).
31. Interview with George Baum, July 18, 1989.
 32. Notes of DARPA meeting, October 28-November 1, 1985, Bob Jones' papers, NASA Langley Technical Library.
 33. Caspar Weinberger to James Beggs, Associate NASA Administrator (position?), July 25, 1985.
 34. See "Propulsion Technology Maturation Plan," October 31, 1985, Bob Jones' Papers, NASA Langley Technical Library.
 35. Dagleish and Schweikart, Trident, ch. 3-4, passim.
 36. "Comments on 10/28-11/1 Meeting," October 31, 1985, Bob Jones' papers, NASA Langley Technical Library.
 37. Ray Colladay to NASA Centers, June 26, 1985, NASP Historical File, NASA Langley Technical Library.
 38. Colladay to Centers for Distribution, June 26, 1985, with letter attached from Neil Saunders, July 19, 1997, and note from Lee Beach, July 31, 1985, NASP Historical File, NASA Langley Technical Library.
 39. Lee Beach, "FY87 Aeronautics Program and Guideline Definition," presented to OAST Management Control, November 7, 1985, NASA Langley Technical Library.
 40. "Comments on 10/28-11/1 Meeting," October 31, 1985, Bob Jones' papers, NASA Langley Technical Library.
 41. Interview with Piland, July 18, 1997.
 42. Comments by numerous anonymous NASP personnel with access to the early briefings support these statements.
 43. Interviews with Williams, various dates, and Williams' similar comments in interviews with Brenda Forman, "The Political Process in System Architecture," notes in author's possession.
 44. Kerrebrock interview with Forman in "Political Process in System Architecture," notes in author's possession.
 45. Interview with Truly, September 5, 1997.

46. Interview with Staten, July 17, 1989.
47. Interview with Sypneiwski, October 9, 1989; interview with Staten, July 17, 1989; and confirmation by interviews with Williams, Baum, Rausch, and other sources.
48. Weekly Activity Report, February 4, 1987, Barthelemy's files, WPAFB History Office.
49. "Defense Science Board Task Force Propulsion Sub-Panel Review of Tech Mat," March 6, 1987, Barthelemy's files; Joe Watts, memo, March 12, 1987, *ibid.*, WPAFB History Office.

Chapter 3: The Contractors Come In

JUST AS THE NASP concept demanded unique and original solutions to the challenge of attaining orbit, so too did the contractual and management approaches for the program require innovation and originality. NASP was neither a standard procurement for a production line aircraft, nor was it a typical R&D aircraft meant to test narrow propositions, with data to be applied in totally different aircraft at a later date. Instead, largely because of its exceptional cost compared to traditional aircraft of the X-15 variety, the X-30 was to serve both as the research aircraft *and* as the prototype for SSTO vehicles (NDVs). As a result, program management had to balance the need to obtain useable data with a practical emphasis on operational characteristics.

Very few people inside DARPA or the Air Force actually anticipated that the X-30 would serve as a prototype without major operational modifications. Nevertheless, the single greatest concern about the aircraft, namely the scramjet performance, had to be tied inseparably to the size of the airframe that the engine had to propel into orbit. Thus, at an early date, program management found itself immersed in questions about “scaling up”---possibly the most important argument in favor of building an entire aircraft system. More important, however, was the breadth of the goals established under Copper Canyon: SSTO with onboard landing gear; horizontal takeoff and land; and so on. Increasingly, the “test vehicle” had to demonstrate an exceptional number of operational characteristics.

Yet by 1986, few people inside or outside of the program suspected which of the conflicting sets of requirements (research or operations) would predominate in NASP. Williams himself did not know, and specifically had allowed for the possibility that *any* of several

“NASPs” might surface during the development process, establishing itself as the “winner.” But on other issues, Williams had a much clearer view. He knew, for example, that the cost and technical challenges in the aircraft would demand more expertise and talent in the area of hypersonics than any one aerospace company possessed. He also suspected that long-term funding required political and corporate support from many aerospace firms, not just one or two. Unlike the SR-71, designed and build almost entirely by Lockheed, no one contractor had the resources to build an X-30. Finally, he decided that the man who designed the X-30, Tony Du Pont, would be the last person to get a contract to build it.¹

Contractor Selection and the Exclusion of du Pont

Du Pont’s small aerospace company had little lobbying capability in Washington and certainly lacked a track record of, say, Rockwell International. It was really a computer aerospace design operation, unable to build or test hardware. Although Williams personally concluded that the du Pont design could reach orbit, he recognized that getting NASP in the air demanded far more engineering talent and probably corporate dollars than du Pont was capable of providing. Nevertheless, the most significant “road not taken” during the entire NASP program remains the fact that the program “froze out” du Pont from participating in the development and production process. At no time do the documents show even a discussion of having du Pont work as a “B Team,” developing an alternative design that might later offer a counter to existing work. It proved a costly mistake, because du Pont would not disappear, nor could the contractors ignore him---as much as they tried. Even to depart from his baseline required that contractors ask a

number of questions about how he intended certain parts to interact. That meant that the program had to keep him on a consultant's salary, providing him an entry to become little more than a program gadfly. Once the aerospace companies finally departed almost entirely from his concepts---and once the weights grew, the budgets exploded, and the schedules slipped---congressional friends of du Pont reintroduced him into the mix through legislation to develop a spaceplane based on his "5-year, \$5 billion, 50,000-lb. vehicle." Convinced that NASP had gotten away from the simple, stripped-down design du Pont had supposedly validated as reaching orbit, supporters sought to rescue NASP by returning it to the point at which it started. That legislation died, but not before du Pont had received yet another consulting contract to examine the contractors' designs (which he completely rejected anyway). In short, the commitment to du Pont's idea, on the one hand, combined with the rejection of him and his company, on the other, condemned NASP to providing du Pont with a highly visible, full-time pulpit from which to criticize the program without in any way binding him to actually improving the performance or the design---all funded by the taxpayer. It was the worst of all possible worlds, in that he had no specific deliverables other than opinion.

Williams appreciated the difficulties, suspecting that the corporate giants would not remain loyal to the government baseline, which represented, as one NASP insider termed it, a "caffeinated" version of the du Pont aircraft, increased by some 40,000-50,000 lbs for fuel allowance and performance risk allowance, which the JPO lumped together under the term "margin." The contractors probably, Williams anticipated, would depart from the baseline, even if it were viable, due to pressures to develop their "own" successful designs. Yet at the same time, Williams knew that NASP desperately needed the companies' funds, their lobbying

support, and their pool of talent and design expertise.

The way in which Williams envisioned the contracting process also ensured du Pont would be absent. When DARPA prepared to let the contracts on NASP, Williams considered two scenarios. In one scenario, companies would compete to validate their designs for the two X-30 aircraft, with a single airframe company and engine contractor selected for the final, cost-plus award based on the performance of their respective designs up to that point. As of 1986, when the contracts went out, the award amount was undetermined, but most contractors and government participants estimated it would be between \$3-5 billion. The profits from that award, however, would not recoup all the investments the companies had made to get NASP, but rather would place the winners in a position to get the real prize, the contracts for the NDVs. With the learning curve advantages over the losers in the X-30 competition, the winners could anticipate the much more lucrative NDV business, which could run into the range of \$20-30 billion. That strategy, however, ran counter to one of DARPA's goals---to prepare multiple American aerospace contractors for competition in a new generation of hypersonic aircraft.

A second scenario would have had the companies engage in some sort of cooperative research during the R&D phase in which they build the X-30 as a team, then have the government open the competition for the NDVs to the companies, which would enter that phase of the competition on an equal footing. Williams, again looking far into the future, wanted the government to reap the benefits of having the lowest cost available from a competition between several qualified NDV-capable companies.

Corporate “Contributions:” the Ante to Play in the NASP “Game”

A central component of the NASP budget planning, never reflected in the government funding, involved contractor “contributions,” or R&D funds that the aerospace companies would invest in the NASP project on their own. The government, of course, hoped that through such investments the contractors would take NASP even more seriously, and such contributions offset potential government expenditures in a number of areas, thereby in reality greatly increasing the NASP budget. As a somewhat perverse incentive to convince the contractors to invest in NASP, the government issued fixed-price contracts for Phase 2, that is, contracts in which the amount to be paid was limited. Such contracts were typical for production line equipment, such as tanks, destroyers, or aircraft, in which the government and contractor both knew in advance the cost of building the item, but for research and development projects---especially when the unknown technological challenges were as substantial as with NASP---it was common to issue a “cost-plus” contract in which the contractor received a percentage profit over and above the costs of manufacturing the item.² With the cost fixed---but confronted with a substantial number of research “unknowns”---the government anticipated that if the contractors wanted to participate, they would assume the shortfall.

Both the technical difficulty and the relatively modest state of existing knowledge on hypersonics ensured that the contractors could not possibly come close to winning the award without major investments up front. Merely developing the CFD base would soak up millions of dollars, and the trial and error with materials could consume the remaining contract funds. But if the contractors wanted to have a chance at the NDV contracts, they had to develop the experience

base by joining NASP, whatever the ante. Some companies based their decisions not only on potential NDV contracts, but on potential spinoffs of NASP technology to other applications within their firm. Lockheed, for example, had a long history of manufacturing fighter aircraft, and hoped to use NASP CFD codes and materials for existing fighter programs. Other companies found themselves eliminated almost immediately. Grumman had experienced so many cutbacks in its other aircraft programs that it simply had no funds to invest in a long-term project like NASP. Aerospace giant Martin Marietta had not made many production-line aircraft in years, instead focusing on missiles. Still others, such as Phase 1 engine participants Aerojet and Marquardt, had not performed their Phase 1 work impressively enough to warrant Phase 2 consideration. Instead, the competition involved Boeing, General Dynamics (GD), Lockheed, Rockwell (RI), and McDonnell Douglas (MD) on the airframe side, and General Electric (GE) and Pratt & Whitney (P&W) among engine contractors.

On April 7, 1986, the program let fixed price contracts to those seven companies for Phase 2 of the NASP program (and soon Rocketdyne joined as an unfunded competitor, working exclusively on its own money). The approach taken by each company reflected its broader corporate strategy, which in turn dictated its design and performance.³

Structure of the American Aerospace Industry: Implications for NASP

An understanding of those corporate strategies that shaped NASP on the commercial side requires a brief digression into the structure of the American commercial and military aircraft

industry as it stood in 1986. In that year, aerospace sales totaled \$105 billion (including missiles), or more than 2% of U.S. GNP. Of that amount, sales of military and civilian aircraft and engines exceeded \$55 billion. Aerospace constituted the largest single category of American manufactured exports at almost \$20 billion.⁴

Investment in R&D by the aircraft industry came to 17.4% of net sales in 1985, an amount second only to the electronics industry. Over the years, the industry's R&D drew heavily on technological developments in other industries, wherein a network of self-sustaining support webs increased demand by increasing availability of a technology. Multiplying the beneficial effects of broad-based research, a phenomena called "vicinities effects" could increase the rewards for several companies working on a related technology, even if they worked independently.⁵ Technological improvements had come at a rapid clip, increasing thrust per pound by more than 50% in 20 years. Such technology developments needed to occur in an industry where high fixed costs of design and development were defrayed over long periods of time. The costs of developing new aircraft could consume huge sums: Boeing's 767 development exceeded \$1.5 billion. But the efforts paid off, as seen in one measure of productivity, seats multiplied by cruising speed, which shot up by 211,000 seats for the Boeing 747 by 1983 alone.⁶

David Mowery and Nathan Rosenberg, who studied R&D costs across several industries, concluded that the "transportation of 1983 volume of passenger traffic with 1939 technology would cost nearly \$24 billion (in 1972 dollars), rather than current costs of more than \$5.8 billion . . . [suggesting] innovation in commercial aircraft during 1939-1983 reduced the cost of [air passenger travel] by more than 75%."⁷ Much of that gain can be attributed to federal and private R&D expenditures (see Fig. 3.1, "Federal, Private, and Total R&D, 1953-1984"), with private

Year	Total	Federal	Private	% Federal
1953	8,702	4,675	4,027	53.7
1954	9,456	5,247	4,209	55.7
1955	10,121	5,473	4,648	54.1
1956	13,296	7,714	5,582	58.0
1957	15,034	9,397	5,637	62.5
1958	16,214	10,262	5,952	63.3
1959	18,303	11,917	6,386	65.1
1960	19,693	12,725	6,968	64.6
1961	20,664	13,351	7,313	64.6
1962	21,820	14,048	7,772	64.4
1963	23,829	15,651	8,178	65.7
1964	25,930	17,241	8,689	66.5
1965	26,896	17,443	9,453	64.8
1966	28,442	18,180	10,262	63.9
1967	29,241	18,176	11,065	62.2
1968	29,833	18,108	11,725	60.7
1969	29,586	17,209	12,377	58.2
1970	28,617	16,316	12,297	57.0
1971	27,814	15,615	12,199	56.1
1972	28,477	15,808	12,669	55.5
1973	29,147	15,594	13,553	53.5
1974	28,736	14,826	13,910	51.6
1975	28,153	14,537	13,616	51.6
1976	29,510	15,072	14,438	51.1
1977	30,506	15,382	15,124	50.4
1978	32,002	15,878	16,124	49.6
1979	33,612	16,407	17,205	48.8
1980	35,133	16,541	18,592	47.1
1981	36,859	17,124	19,735	46.5
1982	38,742	17,841	20,901	46.1
1983 (est.)	40,568	18,622	21,946	45.9
1984 (est.)	42,951	19,577	23,374	45.6

Source: David C. Mowery and Nathan Rosenberg, *Technology and the Pursuit of Economic Growth* (Cambridge: Cambridge University Press, 1989), p. 126.

Fig. 3.1, "Federal, Private, and Total R&D, 1953-84 (Constant 1972 \$, Millions)"

R&D growing steadily since 1964. In particular, industry's share of funds for basic research expanded, exceeding that of universities and other non-profit institutions put together (see Fig. 3.2, "Sources of Funds for Basic Research by Sector, 1953, 1960, and 1965-84"). Industry-financed R&D in aerospace continued to expand, with R&D expenditures in aircraft and missiles surpassing total investments in any other category between 1971 and 1981 (see Fig. 3.3, "R&D Investment in Aerospace, 1945-1982" and Fig. 3.4, "Company and Federal Funding of Industrial R&D for Selected Industries, 1971-1981"). Annual R&D in industry rose by more than 220% in real terms (that is, after adjusted for inflation), while NASA funding grew over the same period.

Industry-financed R&D came to \$17.4 billion, roughly 15% of all R&D, which accounted for more than 30% of all R&D in the nation from 1945 to 1982. Notable successes appeared as a result of that investment, including much of the design for the Boeing 707, which underscored the fact that most industry R&D investment went toward applied research (more than 1/3) and not toward basic research, with less than 10% of industry investment and 1% of total aircraft R&D comprising basic research (see Fig. 3.5, "Composition of R&D Expenditures in Aircraft, 1945-1969"). Instead, most of the funding went toward applied research in airframes, with the share of airframe research absorbing and increasing share of aeronautical R&D during that period, consuming resources previously dedicated to engines (see Fig. 3.6, "Annual Aeronautical Industry R&D Funds by Aircraft Component"). Not surprisingly, the NASP airframe contractors not only dominated the funding emphasis, but eventually shaped the entire direction of the research agenda.

Investment for new research in the aerospace industry could come from one of three major funding sources: capital investment from profits (which could be reimbursable on

Year	Total	Federal Gov.	Industry	Universities and Colleges	Other Nonprofit Institutions
1953	441	251	153	10	27
1960	1,197	715	342	72	68
1965	2,555	1,809	461	164	121
1966	2,814	1,978	510	197	129
1967	3,056	2,201	492	223	140
1968	3,296	2,336	535	276	149
1969	3,441	2,441	540	298	162
1970	3,549	2,489	528	350	182
1971	3,672	2,529	547	400	196
1972	3,829	2,633	563	415	218
1973	3,946	2,709	605	408	224
1974	4,239	2,912	651	432	244
1975	4,608	3,139	705	478	286
1976	4,977	3,436	769	475	297
1977	5,537	3,823	850	527	337
1978	6,392	4,445	964	605	378
1979	7,257	4,044	1,091	711	411
1980	8,039	5,559	1,265	805	460
1981	9,217	6,236	1,585	909	487
1982	9,886	6,588	1,805	983	510
1983 (est.)	10,610	6,970	2,025	1,075	540
1984 (est.)	11,850	7,775	2,270	1,220	585

Source: David C. Mowery and Nathan Rosenberg, *Technology and the Pursuit of Economic Growth* (Cambridge: Cambridge University Press, 1989), p. T31.

Figure 3.2 Sources Of Funds For Basic Research By Sector, 1953, 1960, And 1965-84 (\$ Millions)

Year	NACA/NASA	Federal Civil Aeronautics R&D (Incl. NASA)	Military R&D	Total Federal R&D	Industry- Financed R&D
1945	79.16	81.79	820.58	902.37	60.69
1946	84.28	86.56	952.16	1,038.72	63.78
1947	60.61	62.63	705.05	767.68	74.75
1948	79.25	83.02	683.02	766.04	90.57
1949	100.95	104.76	788.57	893.33	133.33
1950	97.01	111.94	822.76	934.70	169.78
1951	108.58	127.85	1,185.64	1,313.49	287.22
1952	195.16	219.34	1,884.28	2,103.63	478.41
1953	129.25	170.07	2,574.83	2,744.90	576.53
1954	92.44	134.45	2,793.28	2,927.73	576.47
1955	77.30	123.36	2,587.17	2,710.53	526.32
1956	81.21	160.83	2,562.10	2,722.93	562.10
1957	77.04	200.31	2,654.85	2,855.16	604.01
1958	68.18	201.52	2,780.30	2,981.82	539.39
1959	71.01	224.85	2,569.53	2,794.38	501.48
1960	46.58	216.89	2,196.51	2,413.39	478.89
1961	56.28	220.78	2,295.82	2,516.59	441.56
1962	62.32	152.97	2,286.12	2,439.09	430.59
1963	92.05	200.84	2,776.85	2,977.68	325.36
1964	115.38	192.31	2,663.46	2,855.77	417.58
1965	137.10	205.65	2,505.38	2,711.02	474.46
1966	143.23	329.43	2,621.09	2,950.52	579.43
1967	169.41	453.86	2,441.21	2,895.07	714.29
1968	207.27	326.06	2,429.09	2,755.15	815.76
1969	248.85	398.62	2,111.75	2,510.37	701.61
1970	217.72	263.68	2,410.96	2,674.63	678.76
1971	218.75	294.79	2,282.44	2,577.23	536.10
1972	236.00	331.00	2,429.60	2,760.60	513.40
1973	296.12	367.08	2,082.63	2,449.71	419.73
1974	241.53	305.82	1,800.81	2,106.63	378.16
1975	249.60	308.43	1,571.56	1,879.99	306.81
1976	245.65	309.90	1,779.50	2,089.40	344.46
1977	270.00	336.43	1,953.17	2,289.60	376.83
1978	291.33	354.00	2,338.99	2,692.99	515.68
1979	317.63	373.32	1,936.97	2,310.29	624.23
1980	313.90	367.15	1,933.35	2,300.50	688.00
1981	268.92	323.11	2,021.81	2,344.92	733.81
1982	248.79	287.85	2,102.72	2,390.57	732.14
Cumulative R&D	6,095.85	9,013.21	77,335.93	86,349.14	17,493.47

Source: David C. Mowery and Nathan Rosenberg, *Technology and the Pursuit of Economic Growth* (Cambridge: Cambridge University Press, 1989), p. 126

Fig. 3.3, "R&D Investment in Aerospace 1945-1982 (1972 \$ Millions)"

Industry	Total		Federal		Company	
	1971	1981	1971	1981	1971	1981
	Current \$, Millions					
Total	18320	51830	7666	16468	10654	35362
Chemical And Allied Products	1832	5325	184	383	1648	4942
Industrial Chemicals	1009	2553	159	367	850	2186
Drugs And Medicines And Other Chemicals	823	2770	25	20	798	2756
Petroleum Refining And Extraction	505	1920	17	140	488	1777
Rubber Products	239	800	69	190	221	616
Primary Metals	272	889	6	182	266	707
Ferrous Metals And Products	144	560	2	140	142	414
Nonferrous Metals And Products	128	330	4	40	124	293
Fabricated Metal Products	242	638	11	80	230	558
Nonelectrical Machinery	1860	6800	315	739	1545	6061
Electrical Machinery	4389	10466	2258	3962	2131	6502
Communication Equipment And Electronic Components	2731	6396	1479	2167	1252	4228
Motor Vehicles And Other Transportation Equipment	1768	5089	309	704	1461	4381
Aircraft And Missiles	4881	11702	3864	8501	1017	3201
Professional And Scientific Instruments	746	3685	164	638	583	3047
Scientific And Mechanical Measuring Instruments	133	1680	14	40	120	1285
Optical, Surgical, Photographic, And Other Instruments	612	2000	150	240	463	1762
All Other Manufacturing Industries	2889	8325	395	963	2494	7368
Nonmanufacturing Industries	704	2080	452	880	252	1199

Source: David C. Mowery and Nathan Rosenberg, *Technology and the Pursuit of Economic Growth* (Cambridge: Cambridge University Press, 1989), p. 141.

Figure 3.4 Company And Federal Funding Of Industrial R&D
For Selected Industries, 1971 And 1981

	Industry-Financed Basic Research	Military-Funded Basic Research	Federally Funded Nonmilitary Basic Research	Total Basic Research	Industry-Funded Applied Research	Military-Funded Applied Research	Federally Funded Nonmilitary Applied Research	Total Applied Research	Industry-Funded Development	Military-Funded Development	Federally Funded Nonmilitary Development	Total Development
1945	2	15	5	22	20	41	6	67	18	238	20	276
1946	2	19	6	27	25	55	7	87	22	323	25	370
1947	3	16	5	24	33	44	6	83	29	261	20	310
1948	4	16	7	27	42	46	8	96	37	265	29	331
1949	6	18	9	33	62	50	10	122	56	292	36	384
1950	9	18	9	36	86	51	10	147	76	292	46	414
1951	17	25	11	53	170	70	12	252	153	406	51	610
1952	29	40	19	88	286	111	21	418	257	645	91	993
1953	35	57	13	105	353	181	14	528	317	930	69	1,316
1954	35	65	9	109	354	101	10	545	319	1,051	56	1,426
1955	33	61	8	102	332	173	9	514	298	996	66	1,360
1956	36	63	9	108	356	175	10	541	319	1,013	89	1,421
1957	39	67	9	115	387	188	10	585	298	1,087	84	1,518
1958	36	74	8	118	358	206	9	573	319	1,196	97	1,615
1959	32	70	8	110	329	198	9	536	347	1,150	108	1,555
1960	31	61	5	97	310	170	6	486	322	988	118	1,384
1961	30	65	7	102	300	182	7	489	297	1,051	70	1,390
1962	30	66	6	102	303	183	15	501	278	1,064	84	1,420
1963	29	85	11	125	290	238	28	556	269	1,375	100	1,733
1964	30	82	14	126	301	229	29	559	272	1,330	92	1,693
1965	33	78	17	128	329	217	35	581	258	1,265	96	1,656
1966	41	81	19	141	406	227	23	656	365	1,338	211	1,914
1967	51	73	23	147	509	204	27	740	457	1,202	309	1,968
1968	58	76	29	163	577	211	33	821	519	1,236	207	1,962
1969	53	70	37	160	533	195	43	771	480	1,129	266	1,875

Source: David C. Mowery and Nathan Rosenberg, *Technology and the Pursuit of Economic Growth* (Cambridge: Cambridge University Press, 1989), Table 7.3, p. 187.

Figure 3.5 Composition of R&D Expenditures in Aircraft, 1945-69 (Nominal \$, Millions)

Fiscal Year	Airframe	Engine	Avionics	Total
1945	118	66	79	263
1946	153	85	102	340
1947	138	76	91	305
1948	148	82	99	329
1949	184	102	123	409
1950	212	117	141	470
1951	332	184	221	737
1952	550	306	366	1,222
1953	716	397	477	1,590
1954	759	422	505	1,686
1955	715	397	476	1,588
1956	749	416	499	1,664
1957	815	453	543	1,811
1958	834	463	556	1,853
1959	795	441	530	1,766
1960	711	395	473	1,579
1961	730	406	486	1,622
1962	729	405	485	1,619
1963	852	473	568	1,893
1964	843	468	562	1,873
1965	845	469	563	1,877
1966	982	546	655	2,183
1967	1,056	587	703	2,349
1968	1,098	610	733	2,441
1969	1,026	570	685	2,281

Source: David C. Mowery and Nathan Rosenberg, *Technology and the Pursuit of Economic Growth* (Cambridge: Cambridge University Press, 1989), Table 7.4, p. 189.

Fig. 3.6, "Annual Aeronautical Industry R&D Funds By Aircraft Component (in \$ Millions)"

“IRAD”), which was reimbursable conditional to government approval. IRAD, an invention of Secretary of Defense Robert S. McNamara (secretary from 1961-1968), represented an attempt by the government to encourage contractors to put aside R&D funds for projects of their own choosing, and at the same time permit a form of competition from companies that found themselves excluded on a particular contract. For example, if a company lost a bid to build a stealth fighter aircraft, it could on its own invest IRAD funds to maintain competition in stealth production at a later date. Under IRAD requirements, each government contract carries a stipulation that a contractor set aside a small amount of the total contract (1-2%) for R&D. But the contractor may use those funds on R&D for a project other than the one under the contract. Of course, the larger the company’s contract base, the greater its IRAD available.

NASP Contractors and Corporate “Contributions”

This framework permits an assessment of the contractor contributions on NASP, which in many ways reflected the companies’ financial positions as they entered the program (see Fig. 3.7, “Measures of Financial Performance: Major U.S. Aerospace Companies, FY1990”). Boeing and United Technologies (Pratt & Whitney’s parent company) stood well ahead of most other competitors in annual sales and net income. McDonnell Douglas, while seeing its sales increase, had a lower net income, but higher stock price than most of the other competitors. Only General Dynamics had lost money in the 1990 fiscal year, although Lockheed had shown little sales

AEROSPACE	Exch	Fiscal Year	Yearly Sales	% Change	Net Income	% Change	Earnings Per Share	Book Value Per Share	Cash Flow Per Share	Common Shares	Quarterly Dividend	Return On		Capital Spending	S&P Bond Rating
												Equity	Assets		
Boeing Co. (BA)	NYSE	12/90	27595.0	36.1	1385.0	105.2	4.01	20.30	5.62	344	1.00	19.9	9.5	1586.0	AA
United Technologies Corp. (UTX)	NYSE	12/90	21549.5	10.3	750.6	6.9	5.91	44.10	12.51	121	1.80	14.0	4.7	1200.4	AA-
McDonnell Douglas Corp. (MD)	NYSE	12/90	16246.0	11.4	275.0	NM	7.99	91.75	23.12	38	1.40	7.8	1.8	NA	BBB
Allied Signal Inc. (ALD)	NYSE	12/90	12343.0	3.4	462.0	-12.5	3.35	25.10	6.79	135	1.80	13.7	4.4	675.0	A-
General Dynamics Corp. (GD)	NYSE	12/90	10173.0	1.3	-639.0	NM	-13.86	36.24	-14.82	42	1.00	-4.3	-9.7	321.0	A-
Lockheed Corp. (LK)	NYSE	12/90	9958.0	0.7	335.0	5483.3	5.30	36.54	11.12	63	1.90	14.5	4.9	340.0	A
Martin Marietta Corp. (ML)	NYSE	12/90	6125.9	5.7	327.6	6.7	6.52	31.53	10.18	49	1.50	21.3	9.1	212.1	A+
Northrop Corp. (NOC)	NYSE	12/90	5489.8	4.6	210.4	NM	4.48	22.00	10.46	47	1.20	20.4	6.8	121.2	NA
Grumman Corp. (GO)	NYSE	12/90	4041.3	13.6	85.6	27.2	2.48	26.45	4.94	33	1.00	9.9	3.5	49.7	BBB-

Source: Aviation Week & Space Technology, May 27, 1991

Figure 3.7 Measures Of Financial Performance: Major U.S. Aerospace Companies, FY 1990

growth, and Grumman had a low earnings per share. The NASP contractors' "contributions" to the program appear in Fig. 3.8, "Contractor Contributions, FY86-FY90"). For the purposes of this study, the "Profits" category best indicates a company's commitment to the program, because it represented the company's investment, not the government's. These figures suggest that MD contributed more of its own money to NASP than any other contractor, roughly double the contributions of RI or Rocketdyne, its subsidiary, combined, and about 40% greater than that of GD. Some "double counting" of contributions from RI and Rocketdyne occurred, and allowing for that RI's investment from profits in the program represented the smallest of any airframe manufacturer except those downselected in 1987. (Even then, pro-rated as if it had remained in the program, Boeing's contributions would have nearly equaled those of RI.)

Looked at another way, in FY89 and FY90, RI's contributions stood at about one-third of those of GD, and both MD and GD exceeded RI's investment in NASP by almost \$10 million each. On the other hand, when all of RI's investments were considered, including those reimbursable costs, they surpassed any single contractor and nearly equaled the combined total of the other two airframe companies. When the RI/Rockedyne "team" investment was compared to a MD/P&W team investment, the latter exceeded the RI investment (see Fig. 3.9, "Contractor Contributions by 'Team'[\$million]").

Airframe Companies: Funding, Commitments, and Early Designs

Measuring the individual contractor's commitment to the program constituted only one of the challenges facing government managers as they attempted to determine exactly who "was

Contractor		FY86 ^①	FY87	FY88	FY89	FY90	Total	Contractor Total
General Dynamics	Profits	0.0	4.0	1.3	16.2	13.8	35.3	107.0
	NBF	8.1	6.7	10.7	10.0	14.0	49.5	
	Cap Invest	0.0	0.9	3.6	11.5	6.2	22.2	
McDonnell Douglas	Profits	3.6	12.2	14.0	18.5	10.1	58.4	200.0
	NBF	5.9	8.3	15.3	17.5	20.3	67.3	
	Cap Invest	16.7	2.9	3.5	3.7	47.5	74.3	
Rockwell International ^②	Profits	0.0	4.5	4.1	4.8	4.8	18.2	191.1
	NBF	8.0	10.3	11.8	16.4	20.8	67.3	
	Cap Invest	0.0	① 50.6	5.1	8.8	10.0	74.5	
	Suppliers	0	0	1.7	6.3	4.3	12.3	
	Science CT	0	1.1	5.8	6.1	5.8	18.8	
Pratt & Whitney (United Technologies)	Profits	0.9	1.1	4.5	4.0	TBD	10.5	104.8
	NBF	4.7	4.3	1.8	4.4	1.0	16.2	
	Cap Invest	9.9	41.1	23.1	4.0	TBD	78.1	
Rocketdyne ^②	Profits	0.0	① 0.0	2.4	3.7	5.1	11.2	96.3
	NBF	0.0	① 6.5	3.5	5.0	10.7	25.7	
	Cap Invest	0.0	① 30.0	7.2	14.6	7.6	59.4	
Boeing	Profits	5.6					5.6	30.9
	NBF	16.0					16.0	
	Cap Invest	9.3					9.3	
Lockheed	Profits	3.7					3.7	39.7
	NBF	0.0					0.0	
	Cap Invest	36.0					36.0	
General Electric	Profits							36.0
	NBF							
	Cap Invest	36.0					36.0	
Totals:		164.4	184.5	119.4	155.5	182.0	805.8	

① FY86 and prior

② includes some duplicate corporate contribution

Figure 3.8 Contractor Contributions (\$M)

Source ?

NASP Contractor Data
supplied to Author

"Team"	From Profits	Total Contribution
General Dynamics/ Pratt & Whitney (United Technologies)	45.8	211.8
McDonnell Douglas/ Pratt & Whitney (United Technologies)	68.7	304.8
Rockwell International/ Rocketdyne	19.4	287.4
General Dynamics/ Rocketdyne	46.5	203.3
McDonnell Douglas/ Rocketdyne	69.6	296.3
Rockwell/ Pratt & Whitney	28.7	295.9

Source: NASP office figures from Figure 3.1

Figure 3.9 Contractor Contributions by Team (\$ Millions)

serious” about NASP. MD, for example, had universally impressed all of the government directors as focused as much on the NASP contract as on any future NDV work. MD had participated in the Phase 1 study at Battelle, and had a store of knowledge on hypersonics in the person of senior scientist Paul Czysz from his work on TAVs in the 1960s. Czysz became MD’s technical leader when the company joined the Copper Canyon effort in 1984.

MD gave NASP top-level management support, often voiced publically by Sandy McDonnell, the chairman, who personally visited Williams on several occasions to express his interest in NASP. Internally, the MD NASP program reported to McDonnell with no product division in between, and the NASP program manager (first, Joe Waldner, and, after 1987, Herschel Sams) had the authority to pick people from any division. That authority carried with it the ability to tap IRAD money from different programs, and it also illustrated the support that NASP had inside McDonnell Douglas. The company put in more money from profits than any other contractor and more funds total than any other contractor, with profit contributions surpassing those of RI and GD combined (see Fig. 3.10, “Financial Comparison of NASP Airframers, 1985-1988,” and Fig. 3.11, “Financial Comparison of NASP Propulsion Contractors, 1985-1988”).

That was not to say that MD did not have programs competing for funds and talent, with its NASP investment representing less than 5% of new business funds and other large programs such as the Advanced Tactical Fighter (ATF) were vying for corporate attention and money. Indeed, although no public data exists on MD’s investment in ATF---a competition it lost--- estimates drawn from team contributions to the fighter program suggest that MD put more than half its invested profits into ATF. And at the very time that NASP commanded internal MD

	(1) Total Assets (\$ Billions)				(2) Net Earnings Per Share (\$)				(3) R&D (\$ Millions)				(4) ❶ NASP Contribution From Profits (Thru FY90 \$ Millions)	(5) Total Contractor NASP Contribution (\$ Millions)	(6) ❷ NASP % Of R&D	(7) ❸ ❹ NASP Contribution From Profits As A % Of Total Assets	(8) ❺ Total NASP Contribution As % Of Total Assets
	1985	1986	1987	1988	1985	1986	1987	1988	1985	1986	1987	1988					
McDonnell Douglas	8.5	9.4	10.6	11.8	8.6	6.0	7.7	9.1	423	505	648	610	58.4	200.0	.09	.004	.016
Rockwell International ❷	7.3	7.7	8.7	9.2	4.0	4.1	2.2	3.0	367	360 ❻	430	450 ❻	18.2 ❷ ❸	287.4	.040	.001	.031
General Dynamics	4.3	5.1	5.5	6.1	9.1	(1.2)	10.2	9.0	230	300	339	413	35.3	107.0	.08	.005	.017
Boeing ❸	9.1	10.9	12.5	12.6	3.7	4.2	3.1	4.0	409	757	824	751	5.6	30.9	.007	.0005	.002
Lockheed ❸	4.8	5.9	6.3	6.6	6.1	6.1	6.6	7.3	425	484	546	536	3.7	39.7	.006	.0006	.006

Source: Corporate annual reports and reports to U.S. Congress.

❶ represents contributions from profits

❷ Includes some duplicate corporate contributions

❸ NASP contributions from profits through FY88, R&D through calendar year 1988 or last year of NASP participation if downselected

❹ downselected in 1986

❺ estimate based on previous year

❻ total assets given represent last year of NASP participation

❼ Includes Rockotdyne

Figure 3.10 Financial Comparison Of NASP Airframers, 1985-1988

	(1) Total Assets (\$ Billions)				(2) Net Earnings Per Share (\$)				(3) R&D (\$ Millions)				(4) ① NASP Contribution From Profits (Thru FY90 \$ Millions)	(5) Total Contractor NASP Contribution (\$ Millions)	(6) ③ NASP % Of R&D	(7) ④ NASP Contribution From Profits As A % Of Total Assets	(8) ④ Total NASP Contribution As % Of Total Assets
	1985	1986	1987	1988	1985	1986	1987	1988	1985	1986	1987	1988					
Pratt & Whitney (United Technologies)	10.5	11.0	11.9	12.7	4.7	.07	4.5	5.0	⑤	⑤	⑤	⑤	10.5	104.8	⑤	.0008	.008
Rocketdyne ⑥	7.3	7.7	8.7	9.2	4.0	4.1	2.2	3.0	367 ⑤	360 ⑤	430 ⑤	450 ⑤	11.2 ① ⑤	96.3	.040	.001	.017
General Electric ⑦	15.4 ②	34.4	38.3	41.2	2.5	2.7	3.2	3.7	260	260	260	260 ④	0	36.0	0	0	.001

Source: Corporate annual reports and contractor reports to U.S. Congress, 1985-1988.

- ① represents contributions from profits
- ② average current assets, GE subsidiary
- ③ 5 year average based on 1988 annual report information
(includes all subsidiaries, such as NBC, RCA, GE Commercial & GEFS)
- ④ total assets represent last year of NASP participation
- ⑤ includes Rockwell International
- ⑥ NASP contributions from profits through FY 88, R&D through calendar year 1988
- ⑦ downselected in 1986
- ⑧ data not available

Figure 3.11 Financial Comparison Of NASP Propulsion Contractors, 1985-1988.

funds, the company was attempting to wean itself from an over reliance on defense contracts: by 1992 MD had climbed to the position of the world's largest defense contractor while paring its defense revenues 3%, yet for much of the 1980s the company carried high debt to equity ratios and, in a massive 1990 restructuring, MD laid off 22,000 employees.⁸ MD saw in NASP opportunities both for continued profitable military contracts and for expanding its civilian/non-defense work. Thus, MD's investment in NASP as a share of assets dwarfed that of its competitors, with MD being four times higher.

Other contractors' commitment to the program, while significant, was more difficult to measure. The contributions of RI and its subsidiary, Rocketdyne, while technically separate, nevertheless legitimately could be combined. When all of RI's investments were taken into account, its total contributions, including many that were reimbursable, exceeded those of any other single contractor and nearly equaled the combined total investment of the other two airframe companies. But most observers expected the propulsion companies to stand on their own, and anticipated that their contributions would equal those of the airframe contractors. From that perspective, a RI/Rocketdyne "team" did not compare favorably with several other combinations, including MD/P&W or MD/Rocketdyne. More important, when measured by investments from profits, all other arrangements surpassed the RI team.

RI had excellent credentials, however, extending from its work on the Space Shuttle. Although the Shuttle was a rocket program, Curt Wiler, the deputy program manager for NASP at RI observed that hypersonics was "the next step in the aerospace industry and represented 20-30 years of business in the future."⁹ On the other hand, RI's expertise---especially RI's---lay in rockets, not airbreathing vehicles. While that gave it some fresh approaches, it also limited the

company's overall view of the profitability of hypersonics.¹⁰ Its initial design was the "accelerator-type" that relied on a sleek shape that emphasized maximum thrust but reduced lift.

GD had a reputation as the nation's premier defense contractor across a broad spectrum of weapons, including submarines, tanks, and combat aircraft.¹¹ The company built up a substantial knowledge base during the Dyna-Soar program in the 1960s through Bob Widmer, the Chief of Engineering at GD in Fort Worth, Texas. But the company had seen its efforts in hypersonics wane, much to the dismay of engineers such as Armand Chaput, who were the driving forces behind GD's participation in NASP. Fred Kelly, the deputy program manager for NASP at GD in 1989, recalled that Widmer convinced management to join the program in order to "put itself in position to be a hypersonic competitor in the 21st Century."¹² GD made a strong commitment to NASP, with its contributions from profits almost twice those of RI, but the investment from "New Business Funds" trailed RI's by almost \$20 million and total GD investment barely exceeded half of MD's. The early GD design resembled the "accelerator type" of vehicle under development at Boeing, but after a round of initial studies, GD abandoned that shape for a "waverider" concept that relied on aerodynamic lines that were coincident with particular flow fields at certain hypersonic points, maximizing a critical scramjet performance condition. Although not as flexible as other designs, a waverider could be superior at particular points.

Two other companies received Phase 2 contracts but quickly decided that they could not match the ante set by MD and RI. Boeing, awash in aircraft contracts for civilian airliners, needed the program less than anyone else (see Fig. 3.12, "NASP as a % of Military, Commercial & Aerospace Sales for Airframers [1986]"). Its corporate strategists did perceive a role for

	(1) Military Sales (\$ Millions)				(2) Commercial Sales (\$ Millions)				(3) Aerospace (\$ Millions)				(4) Total (\$ Millions)				(5) NASP Investment As % Of Military Sales	(6) NASP Investment As % Of Commercial Sales	(7) NASP Investment As % Of Aerospace Sales	(8) NASP Investment As % Of Total Sales
	1985	1986	1987	1988	1985	1986	1987	1988	1985	1986	1987	1988	1985	1986	1987	1988				
McDonnell Douglas	5,907	5,888	5,925	6,070	2,896	3,681	3,977	4,077	1,661	2,013	2,146	2,368	10,544	11,582	12,048	13,315	.001	.002	.004	.0007
General Dynamics	2,114	2,671	3,199	⑤	162	577 ^①	457 ^①	453 ^①	2,359	2,329	2,475	5,901 ^②	4,635	5,577 ^①	5,921 ^①	5,901 ^{①②}	⑥	.004	.03	.002
Rockwell International	5,281	5,425	4,986	3,836 ^①	143	167	114	113	5,309	5,545	5,073	3,971	10,733	11,137	10,173	7,919	.001	.040	.001	.0006
Boeing	3,973	4,882	3,979	3,668	8,893	9,820	9,827	11,369	1,219	1,126	1,063	1,457	14,085	15,828	14,869	16,494	.001	.0005	.004	.0003
Lockheed	3,627	4,113	4,357	3,446	4,130	4,389	4,586	3,728	4,982 ^①	5,086	5,225	5,411	12,739	13,588	14,168	12,589	.0008	.0008	.0006	.0002

① Includes acquisition of Cessna Aircraft

② Includes military sales

③ Includes electronics sales

④ Indicates "sales to U.S. Government"

⑤ last year in program

⑥ figures reflect 1987 data (1988 data not available)

Figure 3.12 NASP As A % Of Military, Commercial & Aerospace Sales For Airframers (1986)

hypersonics in their company *if* hypersonic travel had a genuine commercial future---a promise that was not guaranteed by existing evidence but which had potential (see Fig. 3.13, “Impact of HSCT Introduction on Worldwide Aircraft Financing”). Boeing’s NASP program had to report through numerous channels within the Boeing divisions. The company never brought the same amount of money to the table that other participants did, and therefore Boeing started the program with only half of the personnel it needed. Boeing’s primary configuration, which was almost a duplicate of the government baseline (or, as Boeing would argue, the baseline was a duplicate of it!) was labeled a “distinct “wing-body” design that relied on wings for lifting surfaces. Yet early in the program, Boeing shifted its support to an “accelerator-type” aircraft in which the engine completely encircled the vehicle. Both Boeing and Langley data had suggested that a cone shape might provide the best airflow, and the difficulties with the baseline vehicle led the company to adopt the unique “accelerator” design (and, at an early stage, GD considered this design as well). Yet Boeing had a number of technical and managerial problems, as indicated in the 3d Quarterly Technical Review from 1987. The NASA Langley team reviewing the Boeing work concluded that Boeing “has done a great deal of work but did not feel a necessity to explain [its] methods [and the Boeing team members] have yet to put their concepts together into a whole airplane.”¹³ What initially looked good in the studies proved far more difficult to design in real terms: the cone proved several times longer than any other design, and one anonymous director recalled “It was huge, even by the standards of the other airframers.” On top of all those deficiencies, the design’s circular engine required propulsion control beyond the realm of any known system.

Boeing in many ways actually led the contractors in understanding the data: according to

	In The Year			In The Period
	2005	2015	2025	2001 - 2025
Worldwide Commercial Aircraft Deliveries				
Total	828	962	1240	23,341
HSCT	25	60	100	1,300
HSCT%	3	6.2	8.0	5.6
Value Of Aircraft Delivered (\$ Billions)				
Total	\$54.6	72.6	126.8	1815.2
HSCT	7.5	21.9	44.6	500.0
HSCT%	13.7	30.1	35.2	27.5
HSCT% Of Total	4.6	11.3	14.4	8.7

Source: *Aviation Week & Space Technology*, November 21, 1988, p. 56.

Figure 3.13 Impact Of HSCT Introduction On Worldwide Aircraft Financing

Robert Williams, Boeing “beat the studies to death.”¹⁴ As in other contractor’s locations, Boeing’s engineers had started to keep two sets of data, one on the du Pont design they did not believe in and a second on a new design of their own in which they had more faith. That duality reflected in part the necessity for the contractors to serve two masters, Williams---who insisted the du Pont design would work---and Staten, who had to deliver a working airplane regardless of the design.

Among the airframe contractors, Lockheed also made a relatively small investment in NASP. Of all the contractors, Lockheed had the best reputation for turning out “high tech” and radical airplanes from its secret “skunk works” program, including the F-117 Stealth fighter and the famous SR-71 “Blackbird” spy plane. Such programs, however, had little in common with NASP. In those cases, the aircraft, despite radical advances in some technologies, represented tightly focused programs to produce a known quantity for a specific mission. The F-117’s mission was clear from the outset, for example. But with NASP, the mission was ill-defined at best, and most of the sentiment in the program rested with development of a data-gathering research aircraft first, *then* moving to production line vehicles. The rewards for Lockheed lay much further down the road than the company wanted.

Nevertheless, Lockheed attempted to design the aircraft it wanted, then convince the government that the Lockheed design was the appropriate approach. It began with a lifting body concept much like MD’s, relying on the vehicle fuselage to provide substantial amount of lift. There, however, the Lockheed engineers departed from the focus on integrating the airframe and the propulsion system, putting the engines on the sides of the vehicle, rather than the bottom, abandoning much of the integrated airframe/propulsion concept. In its drive to develop a

mission-capable airplane as soon as possible, Lockheed's engineers built in operational characteristics that drove up weights (with a correlated increase in projected costs). Lockheed's approach, while in some ways quite sensible, repelled government managers, who viewed it as "corporate arrogance." In essence, Lockheed adopted an attitude quite consistent with its earlier "skunk works" projects---an attitude expressed by one Lockheed employee who wished to remain anonymous: "give us the money, leave us alone, and you'll get your damn airplane." But with NASP and its multiple sponsors, not to mention the scientific and technical skepticism that surrounded scramjet engines and hypersonics, such an approach was not practical in 1986.

Government attempts to prepare configuration parametrics through a broad, generic data base that might apply to all of the vehicles proved futile, because the contractors resisted sharing data that might provide an advantage to competitors. A 1996 Langley review of the program concluded that other factors also contributed to the difficulties in improving the vehicle design. "High level company representation to Government program management on this issue," it noted, "resulted in an aerodynamics technology development plan that was supposed to meet designer needs but ended up with very weak configuration parametrics."¹⁵ Ironically, this concern over the possibility that a competitor might gain an edge so dominated Boeing that it would not support proposed parametric studies by the government on the baseline vehicle, which meant that Boeing "never made any serious attempt to perform such parametrics on [its] own."¹⁶ Moreover, all the contractors knew that whatever data might emerge from the parametric studies, it would not be available in time to help *their designs* win the competition. Thus, all the contractors tended to eliminate "all but the most basic of technologies from the Government program and gain control of those funds to bolster their in-house design efforts."¹⁷

Propulsion Contractors: Funding, Commitments, Technology

Propulsion companies that received contracts in April 1986 included GE and P&W, the two traditional powers in jet engine manufacturing, and naturals to be considered for the scramjet work. RI's subsidiary, Rocketdyne, saw great potential for hypersonic propulsion, especially if the parent company received the airframe contract for the X-30 aircraft itself. Consequently, Rocketdyne offered to participate on its own funding without a fixed-price contract (but with rights to all the government furnished data available to the other contractors), and it joined the program in July 1986. Committing \$6 million of its own money to the project, Rocketdyne found itself in the position of having considerably more freedom than the other competitors because it was not bound by the same rules that constrained P&W and GE.

Originally, both GE and P&W had substantial commitments for other projects, and planned to have their vice presidents tell the government in a joint statement that their participation in NASP would be impossible.¹⁸ (Such evidence by the companies refutes claims by some associated with NASP that the contractors supported a design they knew would not work merely to keep a workforce employed: clearly the two engine competitors had more than enough to keep their workforces busy). At the last minute, P&W reconsidered, and in keeping with the government's goal of maintaining competition, more pressure was exerted on GE to join the program. Work by other Phase 1 participants, including Marquardt and Aerojet, had proven unsatisfactory, and Williams in particular did not want to have the government in the position of relying on a sole source engine contractor for follow-on NDVs. After he and other government representatives convinced GE to participate in NASP, the company invested \$36 million as a

capital investment, but contributed no new business funds or profits. Quickly, GE turned adversarial, and some NASP directors thought the company was downright hostile, toward the program. GE's estimates on the thrust of its propulsion designs always fell below projections, to which the company maintained that it---and only it---was "honest" with the data.

In any program involving radical jumps in technology, a tension will emerge between those who interpret data pessimistically (they would say, "realistically") and those who interpret data optimistically. Pessimists usually claim that no other conclusion is justified by existing evidence, emphasizing the present data. Optimists generally interpret data in light of its direction---its "trendline"---and on the basis of future developments that might change the effect of the existing data. Both groups genuinely believed that they were interpreting data fairly and honestly, but each used data for different purposes: pessimists to show that something is not possible, optimists to show that it is. Any successful enterprise needs the correct mix of both, because pessimists would kill almost all programs and optimists would never find any program that would not work if not given enough time and/or money. R&D programs tend to need more optimists, while production programs need more of the pragmatic types.

The development challenge for NASP especially required a number of optimists because so many problems could be solved through the benefits of integration. Additional thrust, for example, might be provided by improvements on the airframe side by widening the lower part of the airframe, expanding the intake. But GE focused rather narrowly on the engine itself, and did not work well with the airframe companies. Indeed, GE denied access to its data to the airframers, providing answers only to specific questions---usually through a third party, the government director. Quickly GE wore out its welcome, and more than a few in the program

asserted that the government kept the engine maker in NASP only as a prod to improve P&W's performance.

P&W, meanwhile, failed to take advantage of the situation offered by its stumbling competitor. The previously noted running feud with Williams had immersed P&W in difficulties of its own making. Although P&W had indicated its eagerness to participate in NASP from the outset, calling NASP critical to the "21st century space delivery system," the company had a number of early problems with its design, most notably with the size of the combustion box. Eventually, the company worked through the design flaws in the combustor on its own, only to butt heads with Williams over the injector. Interestingly, Langley's Lee Beach confirmed Williams' concerns about the changes in the du Pont design, stating in a 1985 interview that one early problem was that expansion of the size of the engine led to drag that the thrust could not overcome. A strut had been introduced to "allow you to globally distribute the fuel," he noted, but did not add Williams' and du Pont's concern that the strut *itself* altered the geometry and performance of the engine.¹⁹ After the company successfully defended itself against Williams' concerns, an independent evaluator, Applied Physics Lab, contracted in 1986 to assess the progress of the propulsion companies, concluded that P&W was "following a sound [engine design] philosophy."²⁰ In October, a visit to P&W's Florida headquarters by JPO directors, found the team enthusiastic and highly motivated, whereas by comparison the JPO reported a week later that GE had slipped three months behind schedule in its first two tasks.²¹ By April 1987, P&W refined its combustor design and obtained a 5% improvement in combustor efficiency, indicating to Staten that "we have 'turned the corner' in the propulsion design process."²²

P&W used a variable geometry engine that featured (in somewhat simplistic terms) an

inlet similar to a window that expanded and contracted to permit larger or smaller amounts of air into the inlet, depending on the speed. At lower speeds, the inlet would be at its largest, while at higher speeds, when the need for compression was greater, the inlet would contract, forcing air through at a higher rate of compression. The concept was innovative; but the mechanics of getting an engine with so many moving parts to function correctly---not to mention seal properly---at 18,000 miles per hour was far too advanced for American aerospace technology in the 1980s. By comparison, Rocketdyne focused immediately on the high speed challenges, reasoning that if it could solve the Mach 18-25 problems it could handle the lower-end phenomena more easily.

Rocketdyne's addition to the competition not only added new approaches but also sharpened the efforts of GE and P&W. In March 1987, for example, Staten reported that "several months ago I sensed very little competitive motivation within General Electric or Pratt & Whitney. That deficiency has been corrected by Rocketdyne's significant technical progress."²³ GE, in particular, suddenly realized that it no longer was assured of a contract, but by that time GE found itself so far behind the other companies that it could not catch up. Thus, by the summer of 1986, five airframe contractors and three propulsion companies built test, items, refined designs, and ran extensive studies on the data they obtained through computational fluid dynamics (CFD). While progress on those designs continued at the eight locations, challenges of a different sort had emerged at the JPO. DARPA had determined that ten major technical risks stood in the way of achieving orbit with an airbreathing vehicle:

- *Scramjet performance

- *Nozzle performance

- *Inlet performance
- *Advanced materials
- *Computational fluid dynamics code calibration
- *Low speed propulsion system
- *Control system integration
- *Cryo tank and structure construction and/or mating
- *Actively cooled structure

Most observers agreed that the scramjet performance surpassed all others as the “showstopper,” yet all of the scramjet and airframe designs also depended on advanced materials coming on line in time to enhance progress in all other areas, even scramjets. Indeed, materials advances were key, because they affected two critical factors in the design and performance of the engines, the weight of the aircraft and the ability of leading edges and engine parts to endure extreme temperatures.

Despite those realities, by 1986, NASA Langley had completed its baseline assessment and the picture was not pretty. A Langley-generated memo on “Overall Program Direction and Balance” concluded that “Feasibility has yet to be demonstrated in several key areas: 1) high speed propulsion, 2) materials & structure to meet required fuel fraction, 3) cryogenic storage, 4) high speed aerodynamics---transition, heat transfer, etc.”²⁴

In 1986, another NASA memo, called “Fundamental Issues for NASP,” presented what was an apparent internal consensus at Langley regarding key elements of the program.²⁵ Contained in “Steering Committee, 1986” folders, the memo---which had no specific author’s name attached---provided background material for the NASA information that percolated up to

the Steering Committee. It noted that although the contractors had the primary design responsibility, they operated with existing technology, which was only three years' worth of new technology development.²⁶ NASA correctly argued that "all technology efforts . . . must directly support design efforts of [the] contractors," but that there was a "disconnect" between the program goals/objectives and the state of the technology.²⁷ Technical issues, which had become schedule driven, resulted in contractors and government teams "afraid to speak with honesty; i.e., any hint of necessity for new technology believed to be program-threatening by Williams and Staten."²⁸ The result, the Langley memo suggested, was a "much-reduced role for NASA." Ironically, NASA argued that the contractors were "clearly confused" as to what the NASP primary mission was. But such an assertion by Langley staff suggested just the opposite---that NASA was divided over whether the program was to develop technology or fly an aircraft. The contractors, with the exception of Boeing and Lockheed, which were eliminated, had a fairly clear conception of what the program wanted, and what they were to do. For NASA, "program management remains [a] critical concern," with a failure (as of 1986) to address the integration of the airframe and propulsion system. The program was "under-utilizing [the] talents and capabilities of [the] government team---particularly NASA."²⁹ Once again, NASA personnel raised the issue of contractor "advisors," and lamented what they saw as du Pont and others having "replaced" the government experts as key program advisors. And, again, Williams was lambasted as engaging in "micro-management," for which he was blamed for generating "an amazing amount of negative feeling towards the program in the NASA technical community."³⁰

Some of the criticisms in the memos ignored basic limitations on government managers, who could not even prohibit a contractor from duplicating another contractor's failed experiment

or from copying a seriously flawed plan. Thus, when critics charged that there was a lack of integration between the airframe companies and the engine companies, a certain amount of direction could be counted against the proprietary nature of information. Although the government had access to all the information, providing one contractor's results to another constituted a breach of contract. Likewise, carping about the "failure to establish a Security Guide," reflected a lack of appreciation for the bigger picture. At that very time, Williams was deliberately foot dragging in preparing the security guide for political reasons---to blunt the reports of the Defense Science Board's internal review (discussed below). In short, the criticisms of Williams, especially at NASA, probably captured the sense of the employees, yet may have been unfair given the hidden agendas that Williams had to control in order to perpetuate the program.³¹

NASA reviewers later charged that "Unrealistic (and inflexible) program schedules set up by the Government [i.e., DARPA] were the root cause of shallow technology and minimal innovation on more than one occasion."³² Du Pont's design had utilized an "acceptable (not necessarily optimum) level of existing technology," which created a perception within the program that "when significant technological deficiencies were uncovered . . . program management was unable (or unwilling) to adjust even though parallel technology development was recognized and funded as an integral part of the program."³³ Yet the NASA team concluded that this perception stemmed from a "genuine fear" that any suggestion to extend the program to develop technology would "cause its immediate demise."³⁴ That, of course, was exactly the situation with the ill-fated "X-30X" option that Barthelemy supported in the 1991-1992 period.

Early Management Difficulties at NASA

As the JPO organized to manage the contractors' activities, it had to do more than employ and assign the best available talent to a management task. There was a matter of a joint/multi-agency program, which required delicate balancing of responsibilities and personnel. At first, however, with the delay in staffing JPO positions by NASA, the Steering Group, in its early reviews, concluded that NASP "looked too much like an Air Force program," and insisted that NASA get more deeply involved.³⁵ Only by October 1986 could Gregory Peck of Langley report that the "Joint Program Office . . . [is] staffed up and beginning to be a real project office."³⁶

The memo also reported that "NASA's interactions in [the] program are fragmented and uncoordinated with strong negative implications to our image," and that there existed "competition from other centers."³⁷ At Langley, ostensibly the "lead" center on hypersonics, a number of difficulties had arisen, including the fact that the team was spread out in different locations and that "foot-dragging" had caused a morale problem and complicated NASA's image. The report to the Steering Committee concluded that there was a "critical need to close ranks" at NASA.³⁸ Some of NASA's difficulties arose out of the dual nature of its NASP charter, which, like that of the JPO, included providing support to the JPO's Chief Engineer "(i.e., help make the Government a smart buyer)" and, at the same time, "help guide technology development," a task that included identifying highest technology payoffs.³⁹

Another early management challenge, which would remain with the program until the end, involved the dual role played by NASA, part manager, part customer. Like the Air Force, NASA found itself charged with producing some of the work and, at the same time, with

managing that work. Such a position that threatened to compromise objectivity: after all, how could Langley both advocate its own technological advances while searching for the best deal for the government? After formation of the contractor team, in 1990, the National Program Office would attempt to deal with these conflicts through “work buckets,” in which NASA centers were charged with supplying work as part of the team, then with managing certain tasks in a management matrix. The problem of self-evaluation, though, remained substantial.

NASA also remained as divided as ever over the program’s objectives---both what they were (in Williams’ mind, on any given day) and what NASA participants thought they were---as seen in the 1986 Langley memo that had argued that SSTO was “not a feasible or even a serious requirement” for the program.⁴⁰ The NASA technical teams had “‘played ball’ but many recommendations . . . have not been followed, and the teams cannot touch ‘fenced’ activities.”⁴¹ When NASA in the same memo asked the Steering Committee, “Is technology advancement a goal?” it meant “Is base technological development the goal of the NASP program?” which, clearly, it was not.

Standing like a shadow over the NASA and contractor work, Tony du Pont’s baseline vehicle design had opened the door for du Pont himself to remain active in the program as a contracted advisor. NASA officials questioned why other “second-tier” contractors were not given the same access to the program (with the answer, most likely, that *their* designs were not providing the starting point for NASP), and feared that he might have an undue influence on Williams. Concerns over du Pont’s role revived the debate about whether the du Pont design was a “pump primer” for new ideas, or whether it was expected to serve as a genuine baseline for relatively minor improvements.

NASA, and at least one of the contractors, Boeing, viewed it as the former. NASA's Bob Jones, who worked with Williams as his deputy in the DARPA program office as NASP got under way, explained the role of the baseline as a starting point to "force the contractors to look at things."⁴² GASL and Marquardt did not have the capability to validate the du Pont design, he maintained, and Jones insisted that Williams involve GE and P&W. Without help, though, none of the companies "could go SSTO," and therefore the baseline was provided as a way to get the contractors on the same starting point.⁴³ But since NASA, apparently, had little faith in the du Pont design, did that mean that the government was providing the contractors the "wrong" answer as a way to get them to find the "right" answer? Jones admitted that, indeed, in an odd sort of way, that was the situation. Meanwhile, in 1986, Langley reported that it had closure on the conical vehicle design it had worked on, and attempted to convince Williams and Colladay of its merits. But Colladay, according to Bill Piland, proved unreceptive. "Ray [Colladay] was in a 'sell' mode [for du Pont design] and may not have appreciated the differences" between du Pont's paper designs and Williams' claims.⁴⁴ (That seems unlikely, given that Colladay himself commented that Williams "didn't let physics get in the way" of promoting the du Pont design.)⁴⁵

But not only did the Williams, then later, the JPO, view NASA's independent design activities as "undesirable" or "questionable," the much-lauded conical design developed by Langley, when adopted by Boeing, was one of the first eliminated from further consideration due to significant weaknesses involving the engine and aerodynamic control.⁴⁶ As a NASA-contracted summary of the program, written in 1996, concluded, "The Government conical configuration was not proving to be a viable candidate while significant NASP resources were still being devoted to it."⁴⁷ Moreover, other NASA documents, especially the "Copper Canyon

Research Aircraft Airframe Technology Development Plan” (1985) contained a vehicle schematic that looked nothing like either the du Pont “baseline” or the Langley/Boeing conical vehicle.⁴⁸ In short, there was certainly no consensus, even at Langley, on the quintessential design for an SSTO aerospace plane. Nevertheless, in 1987, the program suspended all configuration testing on the baseline vehicle because the “conical configuration was not proving to be a viable candidate . . . [and] no remaining contractor had a concept similar enough to warrant refinement”⁴⁹ After formation of the national contractor team, the government anticipated that the team would establish its own composite configuration, which it did. The NASA reviewers concluded that “On the surface such action seems appropriate and warranted, but, as it turns out, probably the most complex and versatile powered model for transonic/supersonic propulsion integration analysis that ever existed throughout the life of the Program was essentially thrown away and never tested.”⁵⁰ Perhaps. Yet the inability or unwillingness of five airframe contractors to commit to such a design---not to mention their *joint* reluctance to endorse the concept---suggests that the government researchers were of one opinion and private industry of another.

Debate over the independent design only illustrated deeper divisions between the participants on the interpretation of roles, with DARPA, the Air Force, and the contractors seeing NASA as a support agency, and NASA seeing itself as a design driver. Langley technical personnel argued that the “government has systems analysis expertise and technical experience to define [the] technology program,” and that “Contractor inputs should do no more than fine tune” NASA’s work.⁵¹ That, however, certainly did not reflect the view of Williams, Staten, or the contractors, who saw it as *their* job to develop the design, and indeed, expected *NASA to fine*

tune the technology! The research vs. ops tension that had plagued NASP from the beginning again surfaced, with NASA complaining that there was a “question whether design oriented contractors should be dictating technology.”⁵² Such comments again reflected the NASA approach, which was to conduct all the base technology first, but missed the essential mission of NASP, which was to build and fly an aircraft, and *then, in the process*, prove the technology. Indeed, at Langley in particular the emphasis seemed less on improving the contractors’ designs than on insinuating into the discussion NASA’s own vehicle.

Managing the Contractors’ Work: the “Tech Mat” Effort

As of 1986, NASA’s pipeline to the JPO came through three Langley representatives: Howard Wright, Richard Culpepper, and Joe Watts. Wright, the NASA principal deputy program director, had overall authority for the technology development and reported directly to Staten. Watts had assumed the position of Director of Technology, and directed much of the early effort that later came to be known as the Technology Maturation Plan, or “Tech Mat.” Culpepper served as the NASA headquarters liaison to WPAFB. Tom Gregory, from Ames Research Center, soon joined the team as Director of Airframe Development. Thus, NASA not only held key technology positions within the JPO, but also directed the airframe work.

Everyone at the Air Force and NASA recognized, though, that the most pressing managerial task would be to focus all the disparate efforts at the contractor sites, the NASA research centers, the government labs, and at the JPO into a coherent plan that prioritized the technology and avoided duplication, while ensuring that necessary tasks were accomplished.

With the rapid maturation of technology across scores of areas, and with work dispersed among hundreds of sites, the temptation existed for individual centers or groups of contractor researchers to pursue their special interests---"play in their sandboxes," in the words of NASP materials guru, Terry Ronald.⁵³ The JPO had to make certain that each task fit with all the other tasks in such a way that the overall technology for the X-30 advanced.

Management used an innovative program called the Technology Maturation Plan to coordinate all the technology activities. In May 1986, the JPO established seven "Tech Mat" teams on structures, aerodynamics, high speed propulsion, low speed propulsion, materials, CFD, and flight systems. In addition, the JPO organized three special task forces that Watts oversaw on CFD code validation, inlets, and nozzles. Watts supervised an effort that wrote the first Tech Mat Plan, with extensive assistance from Wright, Ronald, and their teams. From May to December 1986, the labs and contractors identified and defined the key technological work that needed to be done. Official approval of Tech Mat finally came in December 1986, several months after it had been operating.

Tech Mat focused on more than 100 separate research tasks conducted by NASA and the military labs, prioritizing the tasks into three major categories. Category one constituted those technologies necessary to achieving the program's technical goals. For example, propulsion-related Tech Mat tasks in this category covered shock tunnel experiments, inlet/forebody aerodynamic and performance tests, and scramjet data base, to name a few. The second category involved those tasks that stood to reduce costs, improve performance, or shorten the schedule in Phase 2, but in and of themselves did not have a direct impact on actual program goals. Tasks in that category included ice prevention concepts, low speed inlet performance, and

primary/secondary inlet controls. Finally, a third category included technologies that would benefit the program or enhance vehicle design, but were not necessary to performance *per se*. The program categorized stability and control data base, low speed aerodynamics, and inlet/airframe interactions in the third category.⁵⁴ Each major objective had its tasks subdivided into one of those three groups.

The technical teams prepared and submitted regular progress reports to the JPO Director of Technology Maturation, while Richard Culpepper developed a reporting system for the tasks that served the JPO until Tech Mat officially ended in early 1991. Reports came in the form of technical memoranda (the standard data report, made uniform by Culpepper's system), contractors' reports, and conference proceedings, as well as oral presentations at meetings and reviews.⁵⁵ One source of difficulty arose out of the categorization of the Tech Mat items, however. DARPA and NASA found that they disagreed over which technology products should be classified for national security purposes, and which areas should remain open. In April 1986, the DoD and NASA signed a Memorandum of Understanding that stipulated which of the technology elements of NASP were to be classified.

Government as its Own Contractor

Tech Mat tasks represented the government's side of the work process, separate from the contractor's work. Those tasks went overwhelmingly to the NASA research centers in the form of government work packages (GWPs), that required NASA to deliver specific finished pieces of technology by a specific time. The goal, according to Richard Tyson, who supervised all the

GWPs at Ames, Langley, and Dryden Research Centers, was to “get the government to respond like contractors.”⁵⁶ Like its counterparts in the Air Force, NASA personnel found themselves simultaneously involved in both “management” and “labor.” As part of the NASP team, the NASA managers and researchers played the role of supervisors, evaluating and directing the work of the contractors. But through the GWPs, NASA had a labor function as a technical supplier in which the researchers played the role of contractor employees. The task designation itself reflected these differing roles. “Task 2.3/GASL/NASA/NASA” represented the “major category” (2, which was the “aero/prop/tech maturation category”), the “work breakdown system element number” (3), the “performer” (GASL), the “government technical lead” (NASA), and the “technical lead contracting agent” (NASA).

For the first time in the memory of many NASA researchers, the researchers found themselves with deadlines and strict budgets, and, most importantly, deliverable products that other elements upon which other elements of the program depended. According to Tyson, the center directors put “#1 priority on NASP,” and Langley alone had five high-level managers in charge of GWPs, who in turn assigned leaders in each technical area who were “aggressive and ambitious.”⁵⁷ In addition, the centers supplemented the NASP budget with their own computer funds for CFD work. While some complained that the JPO and the contractors gave NASA the “tough jobs,” the work nevertheless aligned well with NASA’s expertise and facilities. When the program ended, NASA produced an extensive study of its work packages, and reported that they had worked extremely well: GWP #1, which was an aerodynamics configuration for the later-developed “202” X-30 configuration, was, according to Tyson, “one of the most efficient work packages ever, coming in at under \$1 million.”⁵⁸ Tyson contended that the work packages placed

a new, but productive, pressure on NASA researchers to get the tasks done. He suggested that it introduced a type of “market force” into the NASA work, with successful results. Later, Vince Rausch could claim with pride that NASA “delivered on its work packages in a timely fashion and was a big player in the program reviews.”⁵⁹

Nevertheless, some practices by the NASA centers had the appearance of resistance to program direction. Some of that stemmed from earlier NASA projects, such as the National Transonic Facility, that consumed up to half of a center’s engineering resources. A series of small contracts, which piled up, could result in a facility incrementally swallowed up by a project. Therefore, Lewis Research Center, for example, only submitted large GWPs for NASP and refused smaller technical items, all of which looked to the JPO like recalcitrance. Worse, the flight centers wanted “nothing to do with the program.”⁶⁰ Once the NASP work left the area of the research centers, NASA personnel had to assume “uncomfortable” roles as “project guys,” and, according to Tyson at least, “shaping internal policy ‘killed’ two of our best guys,” leaving them disillusioned and depressed.⁶¹ Perhaps the greatest source of dissent between the contractors and NASA, however, involved a certain arrogance on the part of the space agency that it was, as Colladay boasted, “the technical conscience of the program.”⁶² The view that NASA “insisted on technically grounded truth” implied that the contractors lacked integrity---a more subtly-phrased variant of the oft-repeated charge against weapons producers that they deliberately turned out shoddy products---and that only the government was capable of “technically grounded truth.”⁶³

From the time that the contractors were included, NASP technology assumed a certain inertia that defied either progress in specific technical areas. For example, six contractor-endorsed aerodynamics technology concerns---aerothermodynamics, boundary layer transition,

code validation, facilities, instrumentation, and propulsion/airframe integration---would not normally have been included as part of a traditional aircraft development program. Accordingly, the program based its funding projections on the six “unusual” NASP aerodynamics technologies, which accounted for 80% of the aerodynamics funding in Tech Mat.⁶⁴ However, once those six areas dominated projections, they took on a life of their own, dominating independent contractor reviews and Tech Mat prioritization. That, in turn, meant that “any technology in any discipline other than vehicle design that was perceived to require five years or more development time was initially ruled unsuitable for consideration . . . [and] all technologies requiring more than three years to develop were always under threat and were first considered for deletion.”⁶⁵ Attitudes changed after schedule slippage and after various technical reviews reiterated the degree to which technology had to advance for NASP to work.

In addition to the Tech Mat tasks handled by the government, the contractors’ technical work had been assigned under the original seven fixed price contracts. In addition to the work contracted, the contractors also submitted a group of priced options in their original proposals, but which the government had not funded under the original contracts because they were not called for in the Requests for Proposals (RFPs). Despite the fact that they had proposed much of the work, the contractors had little control over the tasks that NASA had not received but which they had been given. Their loss of control over their own contracts came in part because they had pushed the work down to a lower level of smaller firms.

Tech Mat represented an innovative approach to “forcing” technical maturation, and, practically, to seeing that all the technical needs of the aircraft were in place for the Phase 3 decision. Nevertheless, Williams’ supervisors at DARPA and in the DoD grew concerned that

the program had not addressed the technology issues---a criticism it had heard frequently from NASA. In late 1985, DARPA conducted an in-house review of the NASP technology, directed by Victor Reis. Reis's committee noted a number of shortcomings, but especially criticized the Phase 1 work on materials, maintaining that "the material[s] requirements for the X-30 clearly exceeded the state-of-art in 1985."⁶⁶ The committee determined that NASP had to make two major breakthroughs, first by developing several new types of materials in the time frame for the program, and second to accelerate the transition and utilization of materials technology "by a factor of two from normal practice."⁶⁷ Reis's group recommended formation of a task force similar to that of Tech Mat, and also urged the program to commit more funds to materials. Subsequently, NASP increased its investment in materials development to a total of \$150 million over three years.

Even as Williams put the Tech Mat plan into operation, the program's overall management suffered its first serious attack. DoD, which considered the Reis committee report the work of an "in-house" DARPA group, wanted an independent assessment of the progress in hypersonic technology under the program. In late 1986, DoD's Defense Science Board (DSB) chartered a Task Force on NASP headed by Joseph Shea to "evaluate the degree with the technology base can support the decision to transition NASP into Phase 3, detailed design, fabrication, and flight test"⁶⁸ The task force held four meetings at WPAFB in which the overall program was reviewed, in addition to four sub-panel meetings on specific technologies and one three-day meeting with the contractors. On January 7 and 8, 1987, the DSB task force assessed the entire program at DARPA, and from then until June the group continued to gather data in individual reviews. Oral briefings on its conclusions started in late summer, and they

were not positive.

At the outset, many in NASP had expressed concern over the membership of the DSB task force. Some of the members, although respected in their fields, had not kept up with the recent developments in materials. In the case of NASP, where advances came on a weekly basis, being even slightly less up to date could detrimentally affect a review. Williams found the oral presentations extremely harsh, and contended that the criticisms raised about the program quickly worked their way back to Capitol Hill and the ears of staffers with an inclination to terminate the program.

Williams flew into action to counter the report. First, convinced that many of the conclusions were unsupported by the actual data, he sought to stifle release of some “facts” by maintaining that they were classified. That bought him time to get the “truth” out---at least, what he believed to be the correct data. His approach proved successful: the government indeed withheld much of the report for some time on security grounds. Next, Williams unleashed a “truth squad” of contractors, who delivered informational briefings to any and all legislators Williams could line up, especially any who had received a negative briefing from a staffer based on the DSB report.

Williams stood on solid ground with his concern that the DSB report contained dated studies, flawed data, or otherwise unreliable research derived from some of the earliest program tests and developments. Since that time, the contractors had made adjustments on their own, examined new approaches, and, in some cases, discontinued their efforts along certain paths altogether. On other fronts, the JPO already had addressed shortcomings that the report identified. For example, the DSB criticized the program for having to overcome too many

technological unknowns, which it did. But those “unknowns” identified in the report were already being addressed through the Tech Mat plan, and both Williams and Staten had anticipated such criticisms from the outset of the programs. Staten even went further to address the materials development problem, which the earlier internal DARPA review also had raised. In June 1987, just as the DSB had concluded its official investigative work, Staten met with Terry Ronald, who had come to NASP from Wright Labs, and asked “What will it take to solve the materials challenge? How long will it take to get a plan into place?”⁶⁹ From June to October 1987, Ronald created a Material Planning Task Force to “define a roadmap for the development, manufacture, and fabrication of NASP materials.”⁷⁰ That team studied the problem, set up workshops, brought in consultants, and prepared a plan, which Ronald delivered on October 15. The team identified three classes of material that the program needed to develop: titanium aluminides and titanium aluminide metal matrix composites; carbon-carbon composites; and “Advanced Metal Matrix Composites” (AMMC-1 and AMMC-2), an unclassified term used to describe the then-classified and since declassified combination of graphite fiber (AMMC-1) and silicon carbide fiber (AMMC-2) in a beryllium matrix. The team estimated that research and development of those materials would cost \$100 million, while scaling up and fabricating the components could take up to \$500 million.⁷¹ Those figures represented substantial amounts, given that the FY87 NASP budget *total* was \$212 million, while the FY88 budget was \$359 million.

Ronald’s team concluded that with materials claiming so much of the budget, the entire NASP community would have to work on a cooperative basis instead of in a competitive mode when it came to materials development. Otherwise, the members reasoned, no contractor would

make enough progress to have a viable design. Staten and Williams agreed, and they advocated a new approach to the materials problem.

The contractors, however, already had come to the same conclusion and had started work on a plan of their own, initiated by Robert Gulcher of RI and Joe Waldner of MD.⁷² That plan had lacked government funding in 1986, but after the DSB report and Ronald's team made their recommendations, the contractor plan was revived under Gulcher and Hershel Sams, Waldner's replacement at MD. Gulcher and Sams set down governing principles of a consortium for materials, which would be jointly managed and established through an associate contractor arrangement to avoid antitrust laws.⁷³ Soon all five major contractors (that still remained after the 1987 downselection) had joined the consortium, which went into operation in March 1988, although some aspects of the joint materials work already had started.

Materials and Management

Organizationally, the materials consortium, known as the NASP Materials and Structures Augmentation Program, or NASP MASAP, fell under the authority of Howard Wright's Tech Mat program.⁷⁴ The contractors pooled the \$150 million in augmented materials funds they received (with some materials funded separately and in parallel under Tech Mat). Overall materials funds from MASAP or otherwise came to \$193 million from FY86-FY89---some distance from \$500 million, but a substantial commitment to a specific technological challenge. Although the government eventually added \$150 million, in FY88, the first year of the consortium, the government only had put in \$9 million, so the contractors were at risk of using

up their own funds if the consortium did the work. In its operation, the consortium worked as follows: each contractor took the lead for a key class of materials, with each participating in the development activities for all materials, and each participating in the development activities for all materials and each contributing and sharing its IRAD and corporate research in its respective areas. RI, for example, took the lead in titanium aluminides (TiAl), and it took TiAl orders from all the other contractors, placed a single order, with a single set of specifications agreed to by all participants, and saw to the distribution of the order. By 1989, the consortium had 129 subcontracts out to materials suppliers.⁷⁵

Why didn't DARPA emphasize materials development in Phase 1 and the earliest parts of Phase 2? In part, the original du Pont design incorporated materials then available. Only at the last minute in his design process did du Pont switch to a host of materials not yet developed in order to "close" his design (i.e., show that the thrust of the engines would get the aircraft into orbit). As GD's Bill Garver noted, "There was no materials development in the basic contracts because Tony du Pont said the materials already existed."⁷⁶ Since the 1950s, work on a variety of heat-resistant materials had proceeded, but at a slow pace. Despite the fact that "the sustained interest in [hypersonic flight]" seemed to create a ready market and the "profound revolution in flight structures," namely the onset of the composite era, had occurred during the 1970s, a surprising absence of work had occurred in advanced structure and materials.⁷⁷ Materials in the 1970s, however, witnessed the onset of the composite revolution, wherein scientists had made breakthroughs in polymer matrix composites, aluminum and titanium alloys, superalloys, and carbon-carbon composites. Developing such materials and actually using them in flight operations constituted entirely separate matters. Metal alloys may have special characteristics

when dry or wet, hot or cold, polished, welded, or drilled.

Reis's committee had warned that materials could not be developed quickly enough to benefit NASP. "Development of new materials," the Reis report stated, "including scaled up production facilities is estimated to take twelve to fifteen years."⁷⁸ NASP, of course, was not isolated when it came to the development of many of these materials. Earlier policy decisions in the American aerospace community, such as the decision in 1971 not to build an American version of the SuperSonic Transport (SST) *Concorde* had slowed down advanced aerospace materials work, but the Space Shuttle had regained some of the momentum in materials work, including the use of carbon-carbon composites and advanced thermal materials in its ceramic tiles. Such new materials already had proven extremely effective at saving weight, and one study comparing aluminum body flaps covered with tiles to similar panel made of carbon-carbon showed weight savings of 830 lbs. on the panels.

Advances in composites and breakthroughs in lightweight materials made more feasible the likelihood of overcoming other technical challenges, particularly the engine inlets and the cryogenic tank. One key concept of NASP was to utilize liquid hydrogen as a fuel to mix with the air. Liquid hydrogen essentially, which would be stored at freezing temperatures, would be pumped throughout the aircraft's body as a coolant. That process would both heat the hydrogen, making it easier to burn when it reached the engines, and simultaneously cool the rest of the aircraft. Storing the dense liquid required a large tank that would take up most of the aircraft's interior body. Although program management had not yet decided on the best design---a separate interior tank or a tank that would be fully integrated with the body (in essence a part of the aircraft) that would bear some of the flight loads---the tank materials would have to be able to

sustain freezing temperatures (-423 degrees F) on the interior and very hot temperatures (+2000 degrees F or higher) on the outside of the vehicle. Early proposals for a cryogenic tank included a “titanium multi wall approach . . . and a superalloy honeycomb concept.”⁷⁹

Engine inlets comprised another area where advances in materials could provide dramatic improvements in performance. The more durable the part was, the less volume and size it required in the engine. With a hypersonic engine, relatively insignificant intrusions into the airflow could have major consequences, and reducing the size of injectors or other parts was crucial.

Thanks to the NASP MASAP program, advances came much more rapidly than most observers thought possible. By 1990, significant advances had occurred in titanium aluminides, titanium aluminide metal matrix composites, and coated carbon-carbon composites. Other materials also had shown promise, including copper niobium alloys and high conductivity graphite copper. Hudson Institute researcher Bruce Abell summarized the effect on materials development as follows: “In three years we’ve gone from materials that have potential to materials that have application. A number of materials problems have yielded elegantly.”⁸⁰

In fact, by 1990 government and contractor labs had fabricated large titanium aluminide panels, tested to approximate vehicle operating conditions, and the contractors had fabricated and tested titanium aluminide composite pieces as well. The extensive work with TiAl actually had shown it to be less useful than hoped, and had caused the program to return to work with more monolithic materials. But even a negative finding on a material’s use constituted important additions to the knowledge base. Many of those who oversaw the program had to be reminded constantly that, in R&D, “no” was an answer, too.

Williams successfully had tied up the DSB report until 1988, and although when it finally circulated it contained the same conclusions, by that time most of the assertions were out of date. For example, the DSB document stated that “although the Technology Maturation Plan is a good start, it is far short of what will be required to enable the NASP program to enter Phase 3 on the present schedule with any degree of acceptable risk.”⁸¹ Specifically, the hypersonic speed tests of scramjet performance, supported by CFD work, revealed “much-less-than-expected high speed performance due primarily to faulty propulsion-airframe integration.”⁸²

Meanwhile, the Tech Mat plan that Williams, Wright, and Watts set into motion continued evolving to address arising technological challenges. Among the advances that allowed the JPO to direct funds to other areas, most notably engine design and materials, Tech Mat had funded tests of a transpiration cooled cowl lip at Calspan; initiated a task to demonstrate non-intrusive diagnostic techniques in a pulse facility at Queensland University in Australia; and at the same time Tech Mat cut back activities already being conducted by the contractors, especially hypersonic inlet design.⁸³

If the government’s lab work under the Tech Mat plans dealt with a myriad of small but critical technologies needed to make the entire system work, the central design and development activity occurred at the contractor sites and NASA Langley. Through 1986 and 1987, the three engine companies and the five airframe companies had pursued designs that would (the government hoped) validate the du Pont concept. Within a year, each contractor independently had concluded that the du Pont concept was unworkable. As just one small example of the flaws of the original concept, the contractors (and, independently, the government) discovered that the integrated tank, which in du Pont’s design had the wing run all the way through it, could not

sustain the temperature variations transmitted by the hot wing with any existing material. Du Pont's engine never came close to producing the necessary combustion, requiring larger inlets, and, in turn, requiring struts to support the inlet, thereby interrupting the critical flow and affecting combustion further. Moreover, each contractor rapidly was coming to the conclusion that there existed an "unexpected adverse ground effect" for this class of vehicle, which required the program to employ a "quick and dirty" investigation to pinpoint the causes and solutions.⁸⁴ Once again, an unknown factor had arisen to consume program resources.

The 1987 Downselection: Boeing, Lockheed, General Electric are Eliminated

Restraining technical progress, NASP budgets had not kept to original predictions, and the program found it impossible to spread resources among eight contractors, even though one, Rocketdyne, participated on its own funds. Thus, faced with abandoning the du Pont design and with finding some way to pare down the contractors, in 1987 Williams and Staten, based on the results of program reviews, eliminated Boeing, Lockheed, and GE from the program. Some have suggested that the JPO at WPAFB made the final determination on eliminating certain contractors, but Staten flatly noted "Bob Williams made the call on the downselect."⁸⁵ NASA cheered the action. Indeed, as early as 1985, NASA Langley had supported a "Need [to] downselect ASAP," not only because of the multiple airframe/engine combinations but also because "Downselect pressures are leading companies to tell the JPO and [Program Management Office, i.e., Williams] what they want to hear, [namely] that key technologies are in hand."⁸⁶ NASA contended that the companies, in their quest to appear further along than their

competitors, had overstated the technical capabilities of their engines, airframe designs, and/or materials, and that a downselection process would introduce more technical honesty into NASP.

Williams, though, had operated under several “bigger picture” concerns. First and foremost, as former NASA/NASP program manager Robert Jones explained, “Williams knew that he had to maintain a large lobbying base for the program to keep it alive, and that required the big contractors.”⁸⁷ Jones, who worked just down the hall from Williams in the first year of the program, noted that Williams understood the substantial budgets that would be required to sustain a hypersonic aircraft program, and intended to spread the contracts out so as to build a base of support. That, in turn, reinforced the unstated program goal of keeping the large aircraft companies competitive for the NDV contracts. There were also technical reasons, though, for maintaining several large contractors: Williams viewed NASP’s technical questions as yielding most rapidly to multiple paths of inquiry, and argued that the more numerous and varied the approaches to a problem, the more likely the program would hit upon an innovative answer. Gen. Skantze, a major supporter of the program, told Williams that he agreed with the multiple approaches strategy: “We wanted revolution, not evolution.”⁸⁸

All of those agendas surfaced in the selection of engine contractors. The original pair of propulsion investigators in the pre- and early-Copper Canyon studies, Marquardt, Aerojet, and GASL, had neither the expertise nor the political clout of the large companies, GE and P&W. But even after GE and P&W came into the program, with their engine designs of the more traditional variety, Rocketdyne also was admitted, partly because it was spending its own money, but also because its design proposed inlets significantly differing from the other two contractors. Moreover, Rocketdyne had focused on high end speeds while the others had concentrated more

on low speed cycles. Williams hoped to offset each company's weakness with another's strength, and by 1988 the program reported that the scramjet tests had yielded "remarkable insights" into the scramjet combustion process.⁸⁹ The Rocketdyne concept, according to the Weekly Progress Reports, "has demonstrated the potential that had been hoped for," which brought the goals of the NASP program "an important step closer."⁹⁰ An update to the National Space Council (created in 1989) stated that "Understanding and development of the ramjet and scramjet engines for NASP experimental vehicles is progressing on schedule."⁹¹

Yet what appeared to researchers to be "remarkable insights" and "important steps" in scramjet development remained, in the broad context, to be small, incremental steps. Moreover, NASA researchers had correctly predicted that the contractors had not dealt with the extensive levels of related technologies needed to produce a flying aircraft. The unprecedented levels of integration between airframe and engine, for example, caused a relatively minor change in a single area to affect the entire design. Neither traditional propulsion nor airframe contractors---who were used to "bolting on" an engine nacelle to a wing, or, at worst, installing it in the rear of an aircraft---ever had dealt with the extreme interaction between airframe and propulsion. With each new tweak, the contractors found that they had to add redundancy, support, or cooling, each of which added weight to the engine. No one could successfully demonstrate that the seals in the engine would work, or that the injector "teeth" would not melt off in such high temperatures, although materials continued to improve repeatedly in testing. An infinitesimal design change could rearrange all the airflow characteristics in the combustor, forcing a new round of trade studies to see if the gains exceeded the costs. Engineers eventually added a process called "external burning," wherein uncombusted fuel leaving the nozzle was subjected to a second

round of combustion outside the engine for additional thrust. But even after such improvements, the contractors remained far from demonstrating thrust over drag. Consequently, engine companies hoped that advances in airframe design could provide inlet and exhaust performance improvements to make their engine designs better, while the airframe companies increasingly hoped that the engine companies would bail out their heavier designs.

Airframe contractors seemed to fight the weight issues more than the propulsion companies. Weight had constituted a major part of the decision to downselect Boeing, which ironically had abandoned its first design and adopted a NASA/Langley “look alike” conical vehicle. As the cylindrical aircraft got heavier and longer, no engine could come close to achieving sufficient propulsion for it. (Researchers also found there were immense control problems associated with the “360-degree engine” needed on the conical design. Another casualty of obesity, the Lockheed design, never attempted to incorporate new materials, but instead developed its concept on existing materials. Lockheed also made no pretext of subscribing to the integrated demands of the aircraft, instead designing two huge engines mounted to the side of its aircraft. To compensate for the rising weights, Lockheed turned to a du Pont-like quick-fix of having a set of wheels that dropped off after takeoff, much like the sled designs of early ramjets, with the landing accomplished “glider-style” on the aircraft’s belly. It is worth noting that after the “downselection” (the government’s term for eliminating contractors), neither the Boeing cone or the Lockheed side-mounted engine concepts appeared in any form in any of the remaining designs, suggesting that after the researchers investigated the integration effects more fully, neither offered much hope for achieving orbit.

Indeed, there is some question as to how deeply even the Langley researchers were

committed to the conical design. An October, 1985 “Copper Canyon Research Aircraft: Airframe Technology Development Plan” proposed a schematic of a “generic vehicle” that had a pointed nose and a flat forebody for compression; multiple engines integrated on the bottom of the aircraft, and a wide delta wing, looking like a B-58 “Hustler” bomber without the engine pods!⁹² Virtually all of the critical problems identified in the paper, which represented a strategic approach to the Copper Canyon effort, utilized the “lifting body” design instead of *either* the long, thin du Pont design or the earlier Langley (and, later, Boeing) conical shape, although a design for a GD/Convair hypersonic transport at about that time looked closer to the du Pont concept than other efforts (see Fig. 3.14, “GD/Convair Hypersonic Transport”).

Beyond the specific shape of the aircraft, two alternative design strategies appeared. In the first, the “pure” vehicle would utilize airbreathing engines to Mach 25 and use the momentum of 18,500 miles per hour to reach orbit. A second approach, however, assumed that since the aircraft would need at least maneuvering rockets for space, a rocket was an intrinsic part of the design, and therefore it might be engaged at some point before orbit, supplementing the orbital boost of the engines.

MD supported the second strategy, which quickly provided a “safety net” for the lack of orbital thrust from the engines or for performance from the airframe. It soon lulled some of the MD researchers into the attitude: “If the design does not achieve orbit with the scramjet, just turn on the rocket a little earlier.” MD’s strategy, however, did offer a substantial advantage in that both the airframe company and the engine companies could focus on a much smaller range of scramjet performance---say, to Mach 15 or even lower. That, in turn, brought MD increasingly closer to the P&W engine design, which emphasized low-end performance and thrust, but which

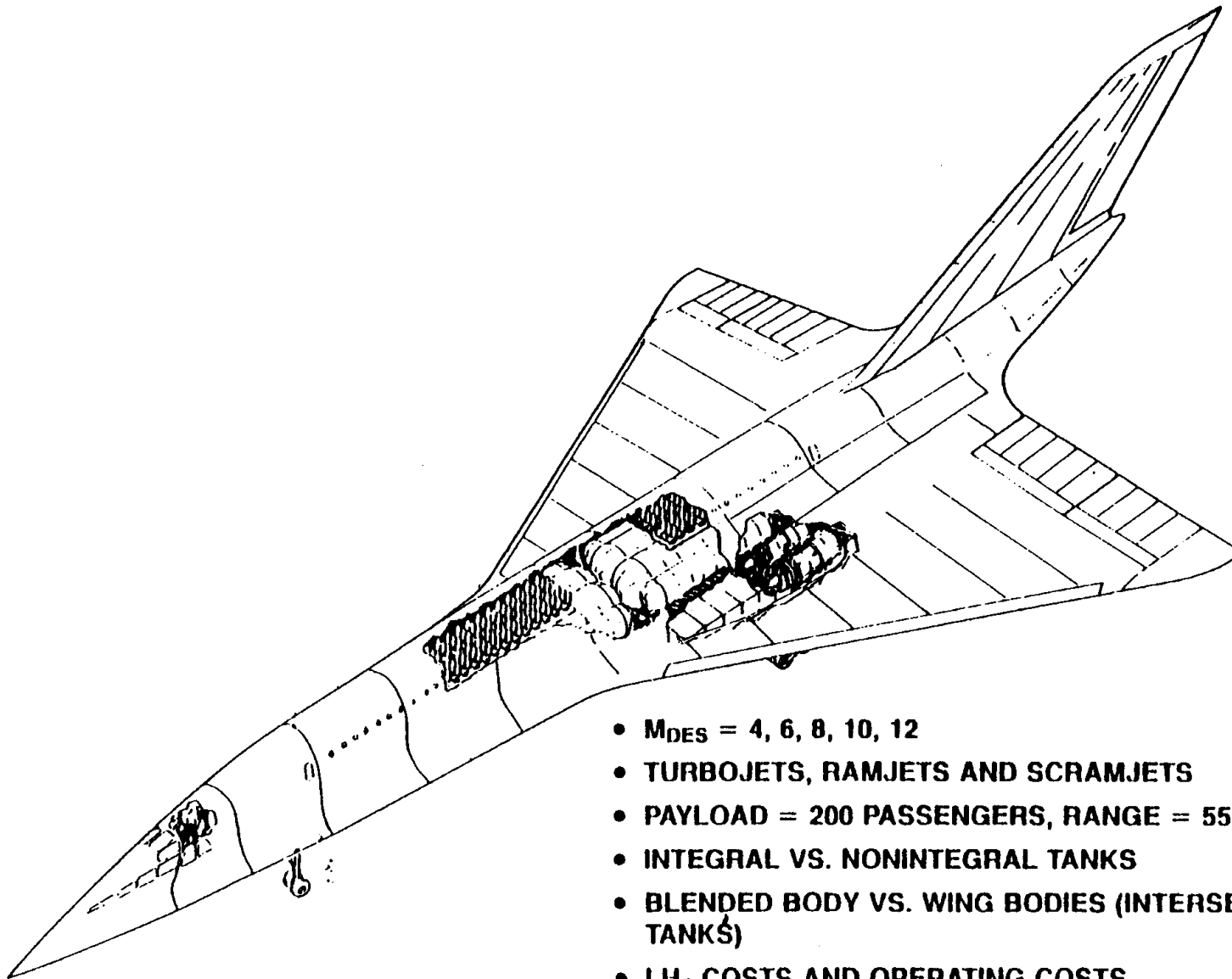

- $M_{DES} = 4, 6, 8, 10, 12$
- TURBOJETS, RAMJETS AND SCRAMJETS
- PAYLOAD = 200 PASSENGERS, RANGE = 5500 n. mi.
- INTEGRAL VS. NONINTEGRAL TANKS
- BLENDED BODY VS. WING BODIES (INTERSECTING TANKS)
- LH_2 COSTS AND OPERATING COSTS

Fig. 3.14, "GD/Convair Hypersonic Transport"

lacked the top end characteristics of the Rocketdyne engine.

More important for the MD design than the early commitment to a rocket boost, in early 1987 the MD engineers discovered a phenomena later tabbed the “magic 2-D flow,” which in actual design took the form of a “shovel nose” on the aircraft. By optimal shaping of the nose into a broad, flat forebody, MD turned the nose into a leading edge that could deliver maximum two-dimensional airflow into the engine. Because MD settled on that design so early---and committed itself to it---the company explored a single particular approach more deeply than the competitors could investigate theirs. In the early stages of the competition, therefore, it frequently appeared to government analysts that MD was “further along” in its design than the other companies. Yet in retrospect, the MD design also was headed toward an early plateau because it had excluded many other options that its competitors chose to examine.

In contrast to MD, RI/Rocketdyne had both assumed that SSTO using a scramjet constituted a non-negotiable element in the program. (Company officials repeatedly claimed that the two companies operated separately during this period, but the similarities in design emphasis call that into question). RI/Rocketdyne thus positioned themselves to achieve the best high-end performance and the lowest drag vehicle possible. More critically, Rocketdyne had to squeeze more out of the scramjet than anyone else, prodding RI into achieving the lowest drag possible in its airframe. Whereas the MD vehicle was wide and flat, with twin tails and completely moveable wings to maximize aerodynamic attitude at all ends of the spectrum, Rocketdyne’s corporate parent, airframe manufacturer RI, chose a sleek, single-tail design. Its obsession with scramjet performance translated into a similar obsession with weight, and drove RI toward an over-reliance on new materials, including several that were still in the development stages, such

as gamma titanium aluminide. "Gamma," as the engineers called it, soon showed brittleness and poor interaction with the liquid hydrogen molecules in the fuel tank. The JPO urged (but could not require) RI to drop its assumption that gamma would be available, but as late as 1990 RI still remained wedded to gamma as a key material.

GD had gone through several design variations, including a drooping "waverider." The multiple studies performed by GD greatly benefitted the government, which used GD's data to evaluate the claims of the other companies in whose claims it had greater faith. GD's vehicle had a vertical single "shark fin" stabilizer toward the front of the aircraft and featured retractable forward canards, but despite those and other efforts to stabilize the "waverider," the design proved refractory. After a February 1989 technical review by NASA and Air Force technical staff, which contained sharp criticism of the GD vehicle's stability, the company added still more wing area and sharpened the nose, causing it to look more like the RI aircraft and less like MD's "shovel nose." The redesign also required GD to adopt a rocket boost at a lower Mach number than it had anticipated, while the new interpolation pushed GD toward the P&W engine as a propulsion mate. GD had produced one truly revolutionary feature, however: it had created an integrated fuel tank capable of sustaining primary fuselage structural bending loads in a similar way as its old Atlas rocket tanks (and resembling the du Pont design of a structure-bearing fuel tank).

By late 1987, all of the contractors' designs had proceeded far enough that the JPO concluded that the use of a rocket to attain orbit in some boost capacity was virtually assured. No contractor had come close to producing even "theorized" thrust capable of pushing an aircraft to more than 18,000 miles per hour. Perhaps more important, the five contractors independently and unanimously had concluded that du Pont's design lacked credibility---and even the

“downselected” companies had rejected it! In 1985 and 1986, NASA Langley had conducted still other separate studies on the du Pont baseline and found it did not have orbital potential, even after the improvements made at the several previous technical reviews. Taken together, the work of the independent contractors, NASA, and the Air Force all pointed to one unmistakable conclusion: whatever positive impact that du Pont’s design may have had in reinvigorating hypersonic research, the real-world X-30 would bear little resemblance to the design that started it all.

The contractors also had struggled with a problem less politically thorny, but no less technically daunting. Since the X-30 was to be a piloted aircraft, it required some type of pilot visibility. A variety of electronic systems were proposed, such as heads-up displays, televisions, and even a periscope, but the test community raised concerns about each system. One JPO document noted, “from the very beginning of X-30 design, there has been a reluctance on the part of the NASP engineering community to provide direct visibility (windows) for the pilots due to the additional structure (weight) windows might induce . . . and the potential additional cost . . . [of] cooling them.”⁹³

Having a human in the aircraft had been settled as a design fact for the X-30, but the issue did not disappear. Critics frequently charged that unmanned aircraft could perform the tests just as effectively and more cheaply than piloted aircraft, and would not require any of the safety redundancies and/or pilot rescue provisions that added weight. Further weight savings, they argued, could be gained by removing comfort systems needed by pilots, allowing the design to shed still more weight. Col. Ted Wierzbanski, who had experience in the X-29 program, had come to the JPO specifically because of his test pilot experience. He led the charge for a piloted

aircraft.⁹⁴ He and the Planning Directorate's Terry Kasten argued in a 1990 paper that robotic vehicles certainly did not guarantee either lighter weight or lower cost; that remotely piloted vehicles had as many safety and performance concerns as piloted aircraft; and that the flexibility gained by having humans on board would be invaluable to a research aircraft. Recovery of the X-30 from orbit, Wierzbanski and Kasten argued, demanded a reliable control and guidance system that would have to safely return and X-30 from space under a wide spectrum of threats and unpredictable occurrences. Wierzbanski and Kasten submitted projections that showed, in the long run, humans in the cockpit would be cheaper than relying on robots.

Safety concerns related to the human pilot increased dramatically the performance of a wide variety of components. The DSB required hydraulic pumps, for example, that could provide pressure far beyond what even the most conservative NASP engineers and pilots thought necessary for safety. Some of the most difficult safety problems would come in the area of ejection and/or compartmental detachment. Some expected the X-30 to have an entire crew module that would eject, similar to that of a B-1 bomber, or break off, like that on the Shuttle. But a module proved unfeasible, and although engineers turned to more traditional ejection measures, the thought of a pilot exiting an aircraft going 15,000 miles per hour lacked an appreciation for reality.

Crew comfort played into such issues as cooling the aircraft. How hot can the airplane get and not fry the crew? Human requirements exceeded those of machines or electronics, driving up weight and cost still further. An interior that might allow hardened, shielded electronics to function might not be sufficient for pilots.

Such concerns irked some who thought the R&D mission was a rationale to introduce

another manned system into production, and exacerbated the already serious divisions between the research and “ops” elements in NASP. NASA used them to temporarily deflect criticisms from its on lack of agreement on what NASP was, and to rail against the “fighter jock” mentality of the Air Force, while posturing itself as the objective voice of reason that could introduce cost savings into the program by advocating smaller, pilotless vehicles. But NASP planned for pilots anyway, and the designs soon included windows for optical visibility and open seat/pressure suit combinations for high-altitude/high pressure survival and ejection.⁹⁵

By 1988, then, the contractors had arrived at their fundamental NASP designs, based only loosely on the government baseline and, in most elements, departing from the du Pont concept drastically. Extensive work had been done on materials, propulsion, airframe design, CFD coding, slush hydrogen fuel, and cryogenic fuel transfer and combustion. And, as the program gained visibility, it profited from a willingness of the national technical community to help. A NASA review document noted that “when new or unforeseen challenges arose, the national technical community . . . was considered a resource to be drawn upon. Coercion to participate was unnecessary. It was an exciting and challenging program”⁹⁶ Progress in the technical areas came at the expense of a streamlined management structure. The JPO’s organization, intended as a sleek “skunk works,” had spread into a multi-layered office that looked like a typical Air Force procurement program office rather than a cutting-edge revolutionary hotbed of ideas. NASA benefitted most of all from the introduction of schedule and cost pressures, and responded with quality “deliverables.” But the contractors, accustomed to vast, bureaucratic approaches to procurement, had not moved as quickly. The government found that after a year and a half of contractor work, no single design combination appeared to generate the thrust

necessary to achieve orbit.

Worse, the available resources were being eaten up at an astounding rate with the competing designs. The program could not afford the luxury of funding five different solutions to the SSTO problem. Williams had extracted as much as could be hoped from the separate design approaches of the contractors: he had his innovation and revolution. Now, he had to make choices of evolution---to pick a design and commit to it. But neither Williams nor Staten would be around for the next phase of NASP, and the choices would fall to others.

Chapter 3 Notes

1. Interview with Tony du Pont, October 24, 1989.
2. Material on acquisition and procurement practices in DoD (with applications to NASA) appears in Jacques Gansler, The Defense Industry (Cambridge: MIT Press, 1980), Affording Defense (Cambridge: MIT Press, 1989), and "How the Pentagon Buys Fruitcake," Air Force Magazine, June 1989, 94-97.
3. Materials for these sections relies heavily on interviews with Lt. Col. Rodney Earehart, Maj. Dennis Minor, Lt. Col. Ken Griffen, Lt. Col. Rick Roach, Lt. Col. Scott Parks, who managed the contracts for the airframe and engine companies; Maj. Tim Roberts, Col. Ted Wierzbowski, Tom Richmond, and Frank Boensch, all of whom were involved in the contracting process with the companies. [all ranks given as of the date the individuals managed the contracts].
4. David C. Mowery and Nathan Rosenberg, Technology and the Pursuit of Economic Growth (Cambridge: Cambridge University Press, 1989), 169-170 and chapter 7, passim.
5. Herman C. Quirmback, "The Diffusion of New Technology in the Marketplace for Innovation," RAND Journal of Economics, Spring 1986, 33333-47, and Jennifer Reinganum, "Market Structure and the Diffusion of New Technology," Bell Journal of Economics, 12 (1981), 618-24 and her "Dynamic Games of Innovation," Journal of Economic Theory, 25 (1981), 21-41. The literature on the relationship between technology, research, and economic growth is extensive. See Nathan Rosenberg, "Science, Invention and Economic Growth," The Economic Journal (March 1974), 90-108; F.M. Scherer, Innovation and Growth: Schumpeterial Perspectives (Cambridge: MIT Press, 1984); Ronald J. Terleckyj, Effects of R&D on the Productivity Growth of Industries: An Exploratory Study (Washington, D.C.: National Planning Association, 1974); Adam B. Jaffe, "Demand and Supply Influences in R&D Intensity and Productivity Growth," Review of Economics and Statistics, August 1988, 431-437 and his "Technological Opportunity and Spillovers of R&D: Evidence from Firms' Patents, Profits, and Market Value," American Economic Review, December 1986, 984-1001; Jeffrey I. Bernstein and M. Isaq Nadiri, "Interindustry R&D Spillovers, Rates of Return, and Production in High-Tech Industries," National Bureau of Economic Research Working Paper #22554, April 1988; Timothy F. Bresnahan, "Measuring the Spillovers from Technical Advance: Mainframe Computers in Financial Services," American Economic Review, December 1986, 742-745; Zvi Griliches, "Issues in Assessing the Contribution of Research and Development to Economic Growth," Bell Journal of Economics, December 1985, 217-223.
6. Mowery and Rosenberg, Technology and the Pursuit of Economic Growth, table 7.1 (175).

7. Mowery and Rosenberg, Technology and the Pursuit of Economic Growth, 176.
8. The history of McDonnell Douglas's financial difficulties appears in a series of articles in Defense News. See Barbara Mmouyal, "McDonnell Douglas Corp. Looks Inward for Outward Improvement," September 18, 1989; Philip Finnegan, "McDonnell Douglas Pegs Fortunes on Success of Commercial Ventures," June 17, 1991 and his "Production Work Propels McDonnell Douglas to No. 1," July 20-28, 1992 and "U.S. Firms Face Uphill Fight in Diversification," July 20-28, 1992. Company histories exist, but do not cover events after 1979. See Rene Francillon, McDonnell Douglas Aircraft Since 1920 (London: Putnam, 1979), and Douglas J. Ingells, The McDonnell Douglas Story (Fallbrook, CA: Aero Publishers, 1979).
9. Interview with Curt Wiler, RI, July 11, 1989.
10. No comprehensive corporate history of Rockwell exists, although studies of program such as the Space Shuttle are extensive. Material on Rockwell and Rocketdyne comes from interviews with Fred Peinemann and Barry J. Waldman, July 12, 1989, and from earlier company work on the Navaho. See John Simmons, "The Navaho Lineage," in Threshold: An Engineering Journal of Power Technology (Rockwell International, December 1987), 17-23.
11. Information on General Dynamics comes from Roger Franklin, The Defender: The Story of General Dynamics (New York: Harper and Row, 1986); Jacob Goodwin, Brotherhood of Arms: General Dynamics and the Business of Defending America (New York: Times Books, 1985); and interviews with Fred Kelly, GD NASP deputy program manager, July 6, 1989.
12. Interview with Fred Kelly, July 6, 1989.
13. "3d Quarterly Technical Review, March 1987," in "NASP Historical Files, 1987," NASA Langley Technical Library.
14. Interview with Robert Williams, July 18, 1989.
15. C.L.W. Edwards and D.E. McIver, "Executive Summary of Aerodynamics Technology for the National Aero-Space Plane Program," February 1996, 12, in author's possession.
16. Edwards and McIver, "Executive Summary," 14.
17. Edwards and McIver, "Executive Summary," 14.
18. This information is based on interviews with company personnel, especially Carl Sypniewski of P&W (October 9, 1989) and Tom Donahue of GE (July 5, 1989). There is no single history of the GE aircraft engine program. Some information appears in Robert W. Drewes, The Air Force and the Great Engine War (Washington, D.C.: National Defense University Press, 1987). On P&W, see Partners in Defense: Twenty-five Years in Florida (n.p.: Pratt & Whitney and United Technologies, 1983) and The Pratt & Whitney Story (n.p.: Pratt & Whitney and United Aircraft

- Corporation, 1950), copies of company manuscripts provided by P&W.
19. Interview with Lee Beach, October 10, 1985, in "NASP Historical File, 1984-1985," NASA Langley Technical Library.
 20. Weekly Activity Report, August 14, 1986, Barthelemy's files, WPAFB History Office.
 21. Weekly Activity Report, August 14, 1986, Barthelemy's files, WPAFB History Office.
 22. Weekly Activity Report, April 2, 1987, Barthelemy's files, WPAFB History Office.
 23. Weekly Activity Report, March 25, 1987, Barthelemy's files, WPAFB History Office.
 24. "Overall Program Direction and Balance," in "Steering Committee, 11/19/86," NASA Langley Technical Library.
 25. "Fundamental Issues for NASP [n.d., circa 1986]," in "Steering Committee, 11/19/86," NASA Langley Technical Library. The author of this appears to be Pete Peterson, but there is no specific information validating this.
 26. "Fundamental Issues for NASP," 1986, in *ibid.*
 27. "Fundamental Issues for NASP," *ibid.*
 28. "Fundamental Issues for NASP," *ibid.*
 29. "Fundamental Issues for NASP," *ibid.*
 30. "Fundamental Issues for NASP," *ibid.*
 31. Interview with Robert Jones, October 10, 1997. Jones disputed the notion that Williams was a "micro manager," arguing that he only tried to "hold the contractors to the baseline." However, Jones also suggested that while Williams was extremely bright, his insightful criticisms of the P&W design "probably came from George Baum," who acted as his technical advisor.
 32. Edwards and McIver, "Executive Summary," 14.
 33. Edwards and McIver, "Executive Summary," 14.
 34. Edwards and McIver, "Executive Summary," 14.
 35. Interview with Tom Gregory, Ames Research Center and Director of Airframe Development, NASP, June 12, 1990.
 36. "Langley Aero-Space Plane Program, Presentation [by Gregory Peck] for Langley Aero-Space Plane Program Steering Committee," October 17, 1986, in "Steering Committee,

- 11/19/86," NASA Langley Technical Library.
37. "Langley Aero-Space Plane Program," *ibid.*
38. "Langley Aero-Space Plane Program," *ibid.*
39. Edwards and McIver, "Executive Summary," 14.
40. "Overall Program Direction and Balance," 1986, in "Steering Committee, 11/19/86," *ibid.*
41. "Overall Program Direction and Balance," *ibid.*
42. Interview with Robert Jones, NASP Program Director for NASP, October 10, 1997.
43. Interview with Robert Jones, October 10, 1997.
44. Interview with Bill Piland, July 18, 1997.
45. Interview with Raymond Colladay, August 15, 1997.
46. "Conceptual Studies Status," October 17, 1986, in "Steering Committee, 11/19/86." The discussion of the JPO's analysis of the Boeing design appears later in this chapter.
47. Edwards and McIver, "Executive Summary," 18.
48. "Copper Canyon Research Aircraft: Airframe Technology Development Plan," October 1985, in Robert Jones' files, NASA Langley Technical Library.
49. Edwards and McIver, "Executive Summary," 18.
50. Edwards and McIver, "Executive Summary," 18.
51. "Overall Program Direction and Balance," in *ibid.*
52. "Overall Program Direction and Balance," *ibid.*
53. Interview with Terry Ronald, NASP Materials Directorate, various dates, 1989-1995.
54. "National Aero-Space Plane, Program Technology Maturation Plan, Version "A," December 1986, in Terry Ronald's files, Hy-Step Program Office, WPAFB.
55. Interviews with Richard Culpepper, June 20, 1991 and other dates, and interviews with Terry Ronald, various dates.
56. Interview with Richard Tyson, July 18, 1997.

57. Interview with Richard Tyson, July 18, 1997.
58. Interview with Richard Tyson, July 18, 1997.
59. Interview with Vince Rausch, July 17, 1997.
60. Interview with Richard Tyson, July 18, 1997.
61. Interview with Richard Tyson, July 18, 1997.
62. Interview with Raymond Colladay, August 15, 1997.
63. Such a view dominated debates over the Trident and *Los Angeles*-class submarines in the 1970s, for example. See Dalglish and Schweikart, Trident, chapter 6, *passim*, as well as McNaugher, M-16 Controversy, and Alain C. Enthoven and K. Wayne Smith, How Much is Enough? Shaping the Defense Program, 1961-1969 (New York: Harper & Row, 1971).
64. Edwards and McIver, "Executive Summary," 8.
65. Edwards and McIver, "Executive Summary," 8.
66. References to this report appear in a 1990 document, "NASP Technology Status," March 1, 1990, in Wierzbanski's files, AFFTC History Office, Edwards Air Force. No copies of the original report itself were made available.
67. "NASP Technology Status," *ibid*.
68. Joseph F. Shea to Robert R. Everett, April 25, 1988, cover letter to the "Report of the Defense Science Board," copy in author's files.
69. Interview with Terry Ronald, Materials Directorate, NASP JPO, April 10, 1990.
70. "National Aero-Space Plane Program Technology Maturation Plan," Version B, 1987, Terry Ronald's files, HyStep Program Office, WPAFB.
71. "National Aero-Space Plane Program Technology Maturation Plan," Version B, 1987, *ibid*.
72. Interview with Robert Gulcher, July 11, 1989.
73. Curt Wiler of RI maintained that under "business as usual" defense contracting laws such a consortium never could have occurred. Interview with Curt Wiler, July 11, 1989.
74. Interview with Howard Wright, May 31, 1989.
75. Interviews with Ronald, Wright, Gulcher, Sams, various dates.

76. Interview with Bill Garver, July 6, 1989.
77. Hallion, Hypersonic Revolution . . . vol. II, 1352.
78. "Report of the Defense Science Board Task Force on the National Aero-Space Plane (NASP)," September 1988, 13, in author's files. This report, although dated 1988, was completed in early 1987 and briefed in Washington. Robert Williams successfully delayed further distribution and dissemination of it because he deemed parts of it too critical of the program.
79. "Report of the Defense Science Board," 13, 53.
80. Interview with Bruce Abell, Hudson Institute (since that time he has joined the Santa Fe Institute), March 13, 1990.
81. "Report of the Defense Science Board," 7.
82. Edwards and McIver, "Executive Summary," 8.
83. See the "National Aero-Space Plane Program Technology Maturation Plan, Version B, change 1," May 1988, and "Version C, change 1," August 1989, Terry Ronald's files, HyStep Program Office, WPAFB.
84. Edwards and McIver, "Executive Summary," 8.
85. Interview with Staten, July 10, 1989.
86. "Overall Program Management and Balance."
87. Interview with Robert Jones, October 10, 1997.
88. Skantze was quoted by Williams, but his sentiments were corroborated in research by Deborah Foreman in her class materials.
89. Interview with Chuck Anderson, JPO Integration Directorate, February 27, 1990.
90. Weekly Activity Reports, April 21, 1988 and January 5, 1989, Barthelemy's files, WPAFB History Office.
91. Weekly Activity Report, January 5, 1989, *ibid*.
92. "Copper Canyon Research Aircraft: Airframe Technology Development Plan," October 1985, in "Robert L. Jones Files," NASA Langley Technical Library.
93. Col. Ted Wierzbanski and Maj. Dan McCorry, "The NASP Program: An Update," File 15-63, Wierzbanski's files, AFFTC History Office, Edwards Air Force Base.

94. Col. Ted Wierzbowski and Terry Kasten, "Manned vs. Unmanned: the Implications to NASP," AIAA Paper #90-5265, paper presented to the AIAA Second International Aerospace Planes Conference, October 29-31, 1990.
95. Wierzbowski and Maj. Dan McCorry, "The NASP Program: an Update," in Wierzbowski's files, File 15-63, AFFTC History Office, Edwards Air Force Base.
96. Edwards and McIver, "Executive Summary," 36.

Chapter 4 New Leaders, New Directions

BUDGET AND TECHNICAL realities had taken their toll on the NASP program by 1988. One of the earliest signs that SSTO technology still had not completely arrived was the increased use of the term "challenge" in papers presented by those involved in NASP.¹ In response, NASA, especially some of the Langley contingent, had joined with Williams to design a strategy that would push the technology at a faster rate than normal, thus bringing the needed breakthroughs that would, in turn, yield a working aircraft. Such a concept was not new, certainly: the Manhattan Project during World War II was the model for "force-feeding" technology in such a way that it matured ahead of schedule. Wartime imperatives, though, allowed the government to ignore budgets for the most part.

NASP, in contrast, had to operate under a relatively austere budget structure.

Nevertheless, Williams, Ray Colladay, and others in the program accepted the notion that proper focus could speed up technological development timetables. Williams favored encouraging multiple technological options in the hope that one would hit on the right design. He wanted differences between the contractors' designs, and he wanted them specializing in specific aspects of the aircraft and engine. Although he realized that maintaining several design options would increase costs, Williams thought that with such a strategy a dramatic breakthroughs might result, lowering the ultimate cost.

The contractors, on the other hand, had much different objectives. They were not involved for the sake of pure research, and the only measure of success they ultimately could

accept was a winning contract award. It mattered little to them if they won the contract because they had pushed a particular technology further than anyone else, or whether they simply had the best combination of total technologies---none spectacular. It was a competition, and in the most narrow sense, winning the award, *not* getting a vehicle to orbit, was their most pressing concern. Of course, the government managers understood that, and it was their job to ensure that the winning company did all the things necessary to mesh the government's goal with that of the contractors to get a design into orbit.

By 1988, however, the JPO had split into two camps with regard to the best strategy for advancing the technology. One group, supported strongly by NASA and the Air Force "traditionalists," favored a continued, standard competition toward an award, in which only one airframe manufacturer and one propulsion company would survive. The program would then focus all its energies on making those winning designs as efficient as possible. Such a strategy evoked predictable responses from the companies, based on where they perceived they stood in the competition up to that point, with MD and P&W (both of which thought they had the respective "lead" in the competition in their fields) favoring a down selection as soon as possible. More important was the implication that a standard down selection held for the technology, because it gave companies that could "close" their designs (i.e., achieve orbital velocity) the edge, *regardless* of the method they used to achieve that closure. A company had an incentive to consider a bigger rocket booster, for example, allowing it to operate with less efficiency out of either the scramjet or the airframe models. But that negated the central mission---both operationally and technologically---of the NASP program, which was to put an scramjet-powered vehicle into orbit.

Those in the JPO favoring the winner-take-all approach had legitimate arguments for the strategy. First, the approach was uncontroversial, and would have little trouble meeting standard reviews, such as those of the DoD's Acquisition Strategy Panels. It was familiar, and almost everyone who had ever worked on a procurement program had engaged in a winner-take-all process at some point. From a technology standpoint, the strategy allowed the program to settle into a design very rapidly, and to seek efficiencies on a known quantity. However, the most important merits of this strategy involved intangibles, such as political support and public perceptions. By finalizing a design early, the program could start fabricating and testing parts with specific design objectives in mind, thereby producing results that could be used to generate support among lawmakers. Most important, the program could fly something relatively quickly, even though early versions of the X-30s would not come close to reaching orbital velocity, the psychological and visual effects of an aircraft taking off, flying, and landing was worth immeasurable votes and dollars on Capitol Hill.

A second group inside the JPO, and among some contractors, advocated forming a joint venture or cooperative arrangement among all the participants. Obviously, those companies that trailed in the competition embraced such an approach, for it provided a way to keep them active in the hypersonic work. Proponents of the "team" strategy argued that by pooling all the talent and ideas of the contractors, the government could get the best results from each. It could, for example, gain the advantages of GD's tank design as well as the benefits of the MD "shovel nose." At the same time, proponents argued, the program could gain cost savings by eliminating redundancies at every contractor location---five sets of reports and forms for every decision or item; paying five management staffs; and so on.

The discussions over competitive strategy emerged gradually during a period in which politicians and American industry itself had started to discuss competitiveness in terms of "industrial policy."² In the early 1980s, a growing number of academics and policy writers, largely associated with the Democratic Party, criticized President Ronald Reagan for his policies of "deregulation" and, they charged, *laissez-faire* for business. The result, they argued, was that the United States had lost the technological lead to the Japanese in electronics, steel, and automobiles and was on the verge of losing it in aerospace and computers---two areas critical to American security.³ (Japan had its own, much smaller, version of the NASP program in projects called HOPE, an aerospace plane, and HIMES, which raised no small concerns within the JPO.) Critics maintained that the expanding trade deficit with Japan only represented one aspect of America's continued economic weakness compared to the Japanese. In particular, the industrial policy advocates wanted the U.S. to fund the High Definition Television (HDTV), which, they claimed, would be the next generation of television electronics. But by 1997, after the Japanese had HDTV broadcasts running for seven years---while the United States manufacturers still had not decided on a format---Japan's early focus on analog technology has proven to be inferior to virtually all of the American designs.⁴ As one Tokyo-based media analyst noted, "It's ironic Japan has always gone one step further with Western advances But here you have a case where Japan has pumped all kinds of effort and investment into analog HDTV, only to have the West take that technology a step further with digital, making the [Japanese] analog system obsolete."⁵ In November 1997, headlines blared "Japan's banks 'in a danger zone,'" saddled with a quarter of a trillion dollars worth of bad loans---many of them made to particular industries at the insistence of the government.⁶ Even Federal Reserve Chairman Alan Greenspan noted that

the Asian weaknesses were due, ultimately, to the earlier “industrial policy” interventions by the government.

Even at the time, some of the industry policy concerns lacked credibility. Great Britain, not Japan, remained by far the major trading partner with the U.S., and only in the 1990s did the Japanese surge past the Netherlands into third place among all American trading partners. The Japanese record of success with government-backed industry was slim, and virtually all of the industries where the Japanese had gained market share from the U.S.---autos, steel, electronics, copiers---Japan had generated more competitors, not fewer, and some of the most successful of all, such as Honda, had no government support whatsoever. Indeed, Honda met with resistance from the Japanese government at every step of the way.⁷ In retrospect, with the Japanese markets collapsing in the 1990s, the Japanese government virtually admitted that its policy of supporting industries or bailing out others was a mistake. Its message to struggling companies to fend for themselves essentially discredited the “industrial policy” arguments. Yet, in the 1980s, when American steel and autos were still fighting to recapture their market share, aerospace companies could play on fears of European and Asian nations taking over another market to generate support for government assistance.

Indeed, the aerospace industry representatives planned a strategy for expanded government support if the advocates of an “industrial policy” triumphed. By pointing to its slightly declining share of all U.S. exports, aerospace lobbyists maintained that the industry needed government “protection” (see Fig. 4.1, “U.S. Aircraft Related Industries as a Percent of World Export Share, 1971 and 1985”). They also could point to the fact that U.S. private sector R&D spending was lower than major economic competitors, and that total national R&D in non-

Industry	Total Share Of World Exports		Export Value (\$ b)		Import Value (\$ b)		Share Of Total U.S. Exports	
	1971	1985	1971	1985	1971	1985	1971	1985
Aircraft	77.5	79.4*	2.552	8.823	.79	1.80	5.9	4.1
Aircraft Parts	49.3	67.4	.852	.383	.25	.09	2.0	0.18
Aircraft Gas, Jet Turbines	36.8	62.8	.381	1.229	.03	1.25	0.9	0.58
Transistors, Values	32.7	56.6	.480	5.674	.25		1.1	2.66
Aircraft Engines And Motor Parts		41.6		2.451		1.202		1.15

* Includes Helicopters

Michael E. Porter, The Competitive Advantage Of Nations (New York: Free Press., 1990), Tables 7-2 (p. 285), 9-2 (p. 509)

Figure 4.1 U.S. Aircraft Related Industries
As A Percent Of World Export Share, 1971 And 1985

defense areas as a percent of all R&D fell well below that of Japan and West Germany (see Fig. 4.2, "Research and Development by Sector"). However, the single statistic of a declining export share was about the only weakness that the industry could claim: between 1971 and 1985, U.S. aircraft industry's share of total world exports rose by almost 2% and the export value grew more than three-fold.⁸ Likewise, aircraft parts, gas, jet turbines, transistors, and values all rose sharply, in export value and world export share. In a widely heralded, massive study of international competitive positions of the major nations, Michael Porter, who grouped similar industries in "clusters" for analysis, indeed reported lower rates of increase for the American transportation competitive cluster (when compared to Korea or Japan). Nevertheless, the overall size of the "cluster" remained impressive, and, despite a lower rate of increase, *overall growth* in the U.S. transportation "cluster" continued to increase.

When it came to aerospace, though, even otherwise erstwhile "free-market" contractor personnel involved in NASP tended to gravitate toward the view that government had to play a role in advancing U.S. industrial interests. Most notably, even Williams, who in his papers had indicated an appreciation for the tremendous power of markets and a disdain for the failures of Marxism, nevertheless subscribed to the position that national direction from government in industrial policy had produced bountiful rewards in Japan.⁹

When examining specific evidence in the defense industry, however, the case for reducing competition by forming teams or a consortium grew somewhat thin. In an analysis of several international teams, multi-service teams, and industrial teams, Jacques Gansler of The Applied Science Corporation (TASC) concluded that "these programs historically have been *unsuccessful* in achieving the promised economic advantages"¹⁰ A GAO report that

Nation	% Of National R&D Spending By Private Sector	% Of National R&D Spending By Government	% Of Government R&D On Defense	% Of Total National R&D On Non-Defense
West Germany (1987 Figures)	59.1	40.9	12.5	94.8
Japan (1986 Figures)	78.8	21.2	3.5	99.9
U.S. (1986 Figures)	53.5	46.5	68.1	68.3

Source: Michael E. Porter, The Competitive Advantage Of Nations. (York: Free Press, 1990), Table 12.1, p. 633.

Fig. 4.2, "Research and Development by Sector"

identified "a successful joint program as one which has brought about a substantial harmonization in fielded systems, satisfied participating services, and realized actual savings," concluded that "by these measures, no success [has] been achieved so far."¹¹

Nevertheless, defense procurement differed from, say, buying television sets, and competition, while long heralded as the holy grail of defense procurement, too had shown less than spectacular results. Michael Beltrano's case study of the Sparrow AIM-7F missile showed that "the dual source competition actually *lost* money; that is, the total recurring price for the two producers . . . was \$88 million, or 13 percent higher than it would have been if the initial source, Raytheon, had produced the entire quantity"¹² In the highly competitive ship repair business, of 75 fixed price contracts investigated by the General Accounting Office (GAO), all 75 cost more than contract price by an average of 63 percent.¹³ Finally, evidence from the U.S. Navy's 688 *Los Angeles* class submarine program, wherein a second competitor was brought in to lower costs, suggests that the second competitor raised its prices upon entry rather than first lowering its prices.¹⁴

Whether or not a faith in competition for defense procurement in general was justified is questionable. In the case of NASP most of those in management positions thought some element of corporate competition in the program was needed, especially if the optimistic view that NASP would lead to NDVs came to pass. Matters were somewhat more complex than that, however. NASP strategy for competition involved more than the X-30 contracts themselves, as already noted: Williams wanted to ensure that the government qualify several aerospace companies for hypersonic work in such a way that the government would have several competitors for NDV contracts in the future. In addition, Williams needed to maintain a large corporate lobbying base

for the program, and could not afford to eliminate any of the competitors on that basis alone.¹⁵

At the same time that issues of competitiveness and industrial policy percolated into the national debate, budget deficits derived from excessive annual spending by the government forced dramatic reductions in the DoD (as well as throughout government). NASP almost immediately felt the effect of those cutbacks. Williams had gone to great lengths to maintain budget support through his five-way MOA. Even years after he left the program he called the agreement "my greatest accomplishment" and spoke with pride about the arrangement under which "no member could reduce funding without the other four members' approval."¹⁶ But in the spring of 1987, several factors swirled around the budget that no manager could have predicted, nor could any agreement have insulated the program from those forces. First, the fact that NASP money had to come from five independent budget lines---four within DoD (Air Force, DARPA, Navy, and SDIO) and one from NASA. It was a system that begged for streamlining. DoD suggested combining the lines into a single budget, arguing that it consumed more time and effort than it should, and that consolidation of the four lines into one would make it easier to track. Consolidation, in turn, raised other problems, some of which Williams had hoped to avoid. If DARPA became the single budget source for NASP---even with "contributions" from the Air Force and NASA---then NASP would dominate a small DARPA budget. As Williams put it, if the DARPA budget took a hit, the NASP line "was protected and everything else [in DARPA's budget] was out."¹⁷ While DARPA reconsidered its exposure as the lead management agency for NASP, the Air Force continued to express a strong interest in acquiring it. Gen. Lawrence Welch of Strategic Air Command (SAC) had once offered to put up to \$500 million into NASP if SAC could control the program, and the Air Force, as Williams recalled, "wanted it badly."¹⁸ At the

same time, the Secretary of Defense Caspar Weinberger decided to supplement the budgets of the services from the Office of Secretary of Defense general budget. All those factors inexorably moved to combine the various budget lines under the single Air Force line.

Williams feared that moving NASP under the umbrella of the Air Force would cost the program political support. Already, however, many of the participants in Williams' "greatest accomplishment" had started to withdraw their support. SDIO, for example, despite its desperate need for low-cost, rapid turnaround access to space, had to lobby for other more immediate elements of its program. By 1987, SDIO had turned its focus almost entirely from NASP and to other systems that might potentially come on line sooner. None of the participants officially could pull out; but when it came time to prioritize before congressional committees, however, the Navy and SDIO seldom mentioned NASP, and NASA's commitment, while strong and possible on track to expand, nevertheless remained well down the pecking order behind the Space Station, the Shuttle, and a dozen other projects.

In 1980, Ronald Reagan had won the presidency on the basis of his campaign pledge to restore the nation's defenses and to cut taxes. By 1988, the tax cuts, contrary to popular impressions, had led to revenue increases, with revenues eventually rising by 30% (see Fig. 4.3, "Federal Government Receipts and Outlays").¹⁹ But government spending---for non-defense programs---rose by more than 50%.²⁰ Economic historians hardly disagree that spending rose faster than revenues, but it is irrefutable that revenues did rise. Critics sought to blame defense spending for the deficits, yet military spending scarcely moved during the decade (see Fig. 4.4, "Composite of Federal Outlays"). Moreover, in reality the deficits were not historically high, and as a share of GNP the 1980s deficits were not exceptionally higher than those run from 1977-

Federal Government Receipts And Outlays

(As Percentage Of GNP)

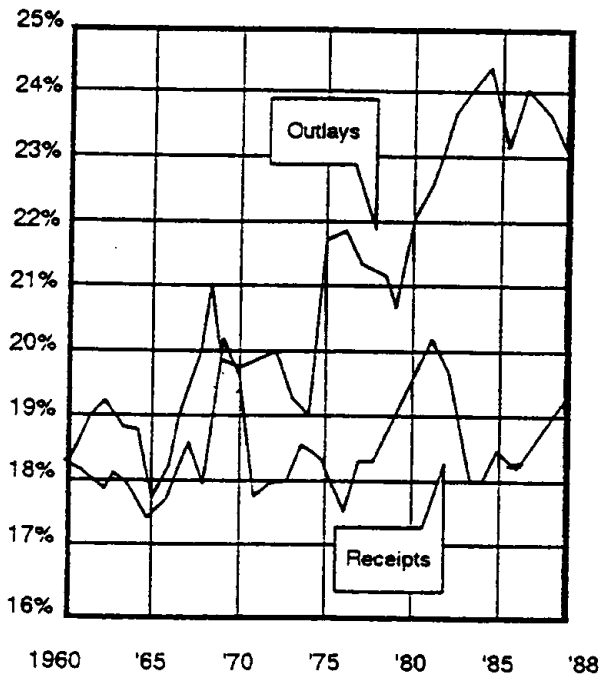

Source: Office of Management and Budget
specific document? date?

Fig. 4.3, "Federal Government Receipts and Outlays"

Composition Of Federal Outlays

(As Percentage Of GNP)

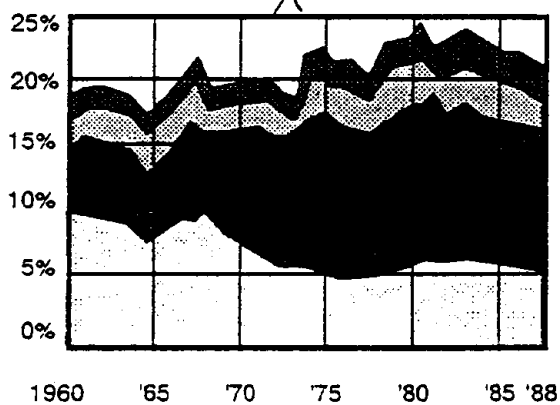
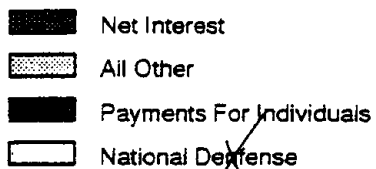

Source: Office of Management and Budget

date? sp. document?

Fig. 4.4, "Composite of Federal Outlays"

1980.²¹ Nevertheless, deficits constituted a political issue, and the Pentagon and the space program offered tempting targets for budget cuts. Again, it bears repeating that the evidence available then, and confirmed later, suggested that the defense budget had only risen less than 1% as a share of GNP in the mid-1980s, while transfers and social spending rose by as much as 5% (again, see Fig. 4.4 and Fig. 4.5, "Military Spending").²² But media headlines of the "trillion-dollar defense budget," along with exaggerated or misleading stories of the "\$1800 toilets," prompted congress increasingly to look to defense cuts as a way to reduce deficits. DoD searched for "non-essential" programs to cut, and NASP kept coming up on the non-essential list more than its proponents would have liked, because R&D was viewed as less critical than procuring operational weapons and personnel costs..

Although NASP sailed through its first year as a public program (i.e., out of the "black"), in the preparation for the FY88 budget, the program encountered resistance from Congress. Williams remained the chief spokesman and drew most of the important briefing assignments for NASP in Washington. His efforts as the primary "briefer" became even more exaggerated in late 1987 when, through a series of accidents of history, the Steering Group all but disappeared temporarily. In the fall of 1987, Secretary of Defense Caspar Weinberger resigned, and his replacement, Frank Carlucci, barely moved into his offices when he received a summons from Reagan to accompany the president to Geneva for arms limitations talks. Thus, Carlucci was "out of pocket" during crucial votes in the House and Senate that involved the DoD budget. NASP had requested \$236 million, but the House Appropriations Committee appropriated \$211 million, while the Senate Appropriations Committee cut even deeper, appropriated only \$113 million. If the Senate version stood, the program could expect \$123 million less than it requested, a level

Military Spending

(As Percent Of The GNP)

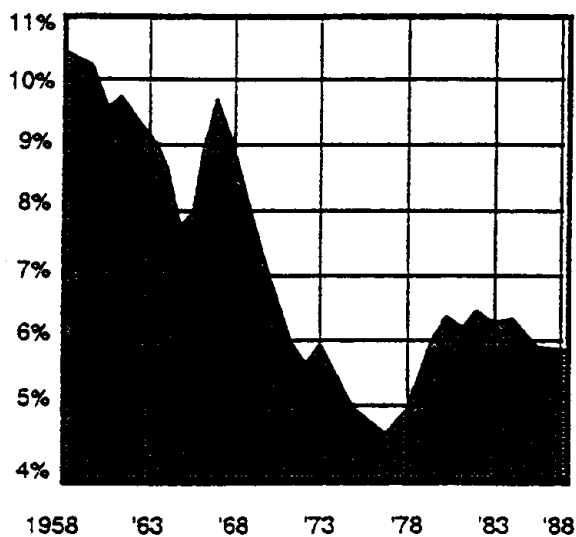

Note: Figures for 1988 and 1989 are estimated

Source: Office of Management and Budget

sp document? date?

Fig. 4.5, "Military Spending"

that would have threatened the program's existence and terminated most of the contracts.

Without the Secretary of Defense available to lobby for the program, the task fell to the Undersecretary for Defense Acquisition (USDA), but he also was in Geneva, and *his* replacement, Cliff Duncan, the Undersecretary for Defense Research and Engineering, still awaited congressional confirmation of his appointment. Those circumstances alone portended a short life for NASP. Other factors added to the threat: in January 1987, a former NASA consultant Stephan Korthals-Altes published an article in *Technology Review* called "Will the Aerospace Plane Work?" The article emphasized that the technology was unproven and that government had underestimated the costs.²³

Meanwhile, the critical Defense Science Board report, which Williams had stalled successfully for almost a year, finally was printed in September 1988. Oral briefings of the report had occurred during the summer, often generating results far different than what the board members expected. Secretary of the Air Force Pete Aldridge, for example, found the briefing so loaded with technical errors that, according to one eyewitness, Aldridge "threw [DSB task force leader Joseph] Shea out of his office" when the DSB concluded its report, instructing Shea not to bring him such faulty data again.²⁴ The DSB report went well beyond criticizing the technology, and impugned Williams' management of the program, charging that his claims about NASP technology were "unrealistic and optimistic."²⁵

Repeatedly Williams and Gen. Skantze, among others, tried to minimize the damage done by the DSB report by explaining to staffers hostile to NASP that the program was less interested in arriving at a configuration than it was devising a conceptual focus for hypersonic technologies that would result in SSTO---exactly the opposite of what the program was indeed doing,

although the “technology development” then under way could be cast in such a light. To repeat, Williams had generated initial support for the program on the promise of a flying aircraft configuration. Yet at the same time, the Langley personnel warned that the program was overly focused on configuration without a sufficient data base.²⁶ These confusions, in part, derived from different interpretations about timing and ultimate objectives vs. nearer-term goals. Individuals in the test community well knew that the *first* X-30 did not have to reach orbit, and that the last X-30 might vary significantly from earlier versions as the tests yielded their data. But Shea already had told influential members of the administration, such as George Keyworth, the president's science advisor, that Williams claimed to be able to produce a 50,000 lb. gross takeoff weight vehicle that could put 2500 lbs. in orbit by 1990. While admitting Williams' tendency to put an optimistic spin on the technology, it is highly unlikely the DARPA manager ever made such a claim: even the original du Pont design had no operational capability, and was intended for design focus only. It seems much more reasonable that Williams touted the potential of the 50,000-lbs. design as a basis for eventually putting payloads in orbit, and that Shea left out the qualifiers when he summarized the claims.²⁷ It is also possible that Williams downplayed the qualifiers. In his exuberance, Williams easily leaped from the “here and now” to the future, without noting that the future he spoke of was decades away, instead expecting listeners to make the necessary distinctions.

Program officials and contractors found themselves in the incredible position of having to admit that they had not addressed materials, even though they had. Shea's focus on materials, which was a problem area that the program had attacked, was unfortunate when there were plenty of genuine concerns about other elements of the program---and to concede that NASP had to

aggressively pursue materials development. Therefore program management "admitted" that it was behind in materials, even though it already had resolved---or, at least, had set up mechanisms to resolve---many of the most pressing challenges in materials through Tech Mat and the early stages of NASP MASAP. Meanwhile, the DSB, satisfied that it had acted as the "technical conscience" for NASP by condemning the slow progress in materials, largely ignored the more serious lack of progress in the scramjet design and thrust-to-drag ratios.

Meanwhile, in December 1986, Scott Pace of the RAND Corporation delivered a report called "National Aerospace Plane Program: Principal Assumptions, Findings, and Policy Options."²⁸ Pace stated that "major uncertainties" existed in the rate of technical progress, cost projections, and potential applications. He recommended that NASA increase its responsibility for NASP, especially for sub-orbital, atmospheric flight, while at the same time "hedge" NASP by expanding other space transportation work.²⁹ Combined with the DSB report, the negative impact of the RAND study provided plenty of ammunition to opponents of the SSTO program.

At the same time during the autumn and early winter of 1987, the holes in the advocacy chain of command grew worse when several of Reagan's administrative team resigned amidst the Iran-Contra allegations. Increasingly, a crucial Senate committee vote on NASP---which stood to reduce the funding by more than \$100 million---came down to the influence wielded by Sen. Ted Stevens of Alaska. Williams grew desperate when he could not arrange a briefing with Stevens. He was unaware that William Graham, Jr., Reagan's new science advisor who had replaced Keyworth, already had internally countered much of the DSB report in the White House over the previous month and had met with Stevens about NASP. Graham had supported the program and, concurrently, Stevens had received a visit from Rep. William Chappelle of North Carolina,

another NASP supporter on the appropriations subcommittee. Chappelle had met with Williams and asked for a "bottom line" to keep the program in business. Williams and the contractors agreed that they could keep the major research functions intact for about \$211 million, a cut of \$23 million off the original request. Chappelle convinced Stevens to agree to the \$211 million figure as well.

All of this occurred without Williams' knowledge, perhaps because by that time Williams had dedicated an increasing amount of attention and energy to running the technical aspects of the program. The developments roughly coincided with Staten's replacement at Wright Pat with Robert Barthelemy, and the transition no doubt absorbed much of Williams' time and energy. Or, as others suggested, the problem was more under control than he thought: as a mid-level DARPA manager (in the scheme of things, a relatively "low man on the totem pole" despite the nature of the program), he had not been brought into the "high strategy" between Stevens and Chappelle, nor did they perceive the potential reductions in the NASP budget as being as critical as did Williams, and thus they saw no reason to keep him informed of what was, to them, "chump change" in a gigantic DoD budget. In the fall of 1987, Williams' frustration peaked when he staged an "end run" around the chain of command by writing a letter to White House chief of staff Howard Baker explaining the program's difficulties. That letter went through Pentagon channels downward until it arrived on the desk of Williams' superior at DARPA, Cliff Duncan. The outraged Duncan removed Williams as the NASP program manager (but surprised many familiar with the situation by not firing him altogether). Williams' dismissal coincided with other important changes in the program.

In November 1987, as the budget battles heated up and as Williams became mired in his

self-created morass, the new AFSC commander, Gen. Bernard Randolph, reassigned Staten on a normal rotation and replaced him as NASP project manager at WPAFB with a civilian (Senior Executive Service, or “SES” grade equivalent to a general), Robert Barthelemy, who had come over from his position as technical director at Wright Labs. From November 1987 through February 1988, Barthelemy managed the JPO as Williams' subordinate, all the while anticipating that eventually the Air Force would gain control of the program because of its size. Under the original plan, DARPA expected to turn control of the program over to either the Air Force or NASA at the Phase 3 go-ahead point; but the Williams developments, the transfer of authority from Staten to Barthelemy, and the continued exposure of the DARPA budget made early 1988 a more suitable time. Thus, in February 1988, DARPA officially turned NASP over to the Air Force, and suddenly Barthelemy had to do the jobs of both Williams and Staten.

Barthelemy, though, came to the program with a considerable amount of respect from NASA. He was a “lab guy,” and was assumed to understand the technology on a much deeper level than either Williams or Staten. Colladay, calling “Bart” a “NASA kind of guy,” characterizing him as a “solid program manager---well grounded in the technical challenges.”³⁰ Barthelemy “got [NASP] to start running like a program,” Colladay noted. Unlike managers who had come of age during the 1950s, Barthelemy embraced a philosophy of management that had gained popularity in the early 1980s when American industry, reeling from blows delivered by the Japanese, sought to reestablish itself. The Japanese had made exceptional strides in quality control, per capita output, and labor/management relations. American businesses eagerly copied Japanese management practices, based on how-to manuals such as *Theory Z*. One of the most popular concepts in the new management theory involved the notion that Japan's Ministry of

Trade and Information (MITI) had forged a successful business/government "team" relationship; that government had picked "winning" new technologies and industries in which to invest; and that Japanese managers did not operate in a hierarchical structure but managed by consensus. In fact, while it is true for some companies that the business government alliance is much stronger in Japan, for others government is an impediment.³¹ As for the idea that Japanese managers gain total cooperation before they make decisions, much of that was a western perception of deference that masked a less rigid---but not less real---hierarchy of management.

Nevertheless, Barthelemy wanted to pursue both the "team" aspect of Japanese management strategy and the internal consensus decision-making structure. After his appointment in November, he started to examine ways to change the JPO internally, and to investigate ways that the contractors might pool their efforts. In fact, the program already had started a number of team arrangements or processes under different names. The materials consortium, for example, acted as a joint venture. More relevant to the type of data sharing and true team design approach that Barthelemy had in mind were the arrangements made at the outset of Phase 2 between the airframe and propulsion contractors to share relevant design data with each other. That exchange was necessary, of course, if the engine companies were to have any assessment of the performance they could expect from the airframe designs, and vice versa. In essence, the contractors themselves had paired up into six parallel "teams": MD/P & W; MD/Rocketdyne; GD/P & W; GD/Rocketdyne; RI/P & W; and RI/Rocketdyne. Though those "teams" resembled traditional prime/sub relationships more closely than they did joint ventures, and while they did not have any common or unified management or technology sharing schemes, they did provide networks by which the companies could exchange design information.

Yet a third type of team had been formed, by MD, in anticipation of a contract award. In a last-minute attempt to convince the government to make a final down selection, MD had contracted Aerojet, Martin Marietta, Honeywell, Harris, and others to augment its design and fabrication if it won the Phase 3 award.

The contractors' views on team formation only represented part of the equation. The government still had to conclude that the competitiveness it once had encouraged was no longer desirable---and not all in the JPO had reached that conclusion. Barthelemy appreciated the different views within the JPO for the necessity of competition, with some preferring the competitiveness between the companies in both the R&D and procurement stages, others accepting a team arrangement during R&D but preferring to have the procurement phase competitive, and a third group willing to have a team in both Phase 2 and 3, with competitiveness issues left for production-line items such as the NDVs well into the future.³²

Nevertheless, when Barthelemy took over as NASP Program Manager in February 1988, he had decided that the only way to conserve the resources that would be needed for the big-ticket items, such as scramjet research and testing, was through forming a team and settling on a single design that included the best of all the contractors' ideas. In that way, Barthelemy also could sustain the political base created by Williams, keeping all the major players active and, equally important, informed on the technology so that they would be able to compete for NDVs in the future. He received support in June at the Steering Group meeting by the Group's chairman, Robert Costello, who called the "current zero-sum competition . . . an inefficient use of resources."³³ Costello noted that the designs had started to converge anyway, and that competition had served its purpose in advancing the technology. Although cautious, Costello

tasked the JPO with developing a plan for restructuring the program based on a team option.

With the Steering Group's blessing, Barthelemy, true to his commitment to a consensus management style, sought to lead the contractors to a voluntary arrangement. He ran into trouble, however, as many companies interpreted his efforts as his personal preference, not government policy. During the summer of 1988, Barthelemy held meetings with the chief executive officers of all five companies, and received assurances from each that they favored teaming in principle and approved of a joint venture during Phase 3. Again, however, that depended on where each company thought it stood in the competition.

Once MD formed its own team with Aerojet and the other subcontractors, GD and RI grew alarmed and met with JPO personnel to advance the status of team formation. Slowly, they explored ways to merge their efforts, culminating in a March 1989 Memorandum of Agreement.³⁴ Called by RI the "first step in the Government's realization for a National Team," the two contractors agreed to conduct a joint design and development study "using their selected common configuration to bring it to the same level of maturity that existed in their separate designs [as of February 1989]."³⁵ They also agreed to make joint R&D status reports; submit a program schedule approved by each; and submit presentations materials following a joint review. The JPO hoped that MD might join in the agreement, but MD refused to participate.

Several potential obstacles loomed ahead for the GD/RI agreement itself. First, anticipating legal problems involving anti-trust suits that might arise out of the team, the JPO had developed a point paper in April 1989 for a pending legal review. In May, Tom Richmond, the head of the contracts directorate in the JPO, submitted a request for a legal opinion on teaming, especially as it involved anti-trust issues.³⁶ Second, the rapid approach of the June 1990 Aircraft

Development Review meant that any team would not have enough time to create a unique design; rather, they would have to refine an existing configuration. To encourage MD to join, the Memorandum of Understanding (MOU) that supplanted the MOA set a deadline of July 15, 1989 as the last point that the St. Louis-based company could enter the team on an equal basis. After that, MD only could join as a 20% participant.³⁷

Throughout the summer, the engine contractors prepared for the Test Module Review (TMR), which to many directors provided a natural point to pull the airframe contractors into a team. Under one plan, called the "natural selection approach," the government would ask the airframe companies to "find someone to dance with."³⁸ That should "engender a furious bidding activity among all the participants."³⁹ However, most directors inside the JPO thought that such a plan would result with two teams still in competition, not one. By August, the JPO had reached an agreement that even if the airframe companies could not be "teamed,"---the JPO tended to utilize the noun team as a verb---the engine contractors' efforts should be consolidated, at least achieving the goal of centralizing the scramjet work. Thus, when the Request for Proposals (RFPs) went out in November 1988 in accordance with the revised program schedule (discussed below), they included a provision for combining the efforts of the engine contractors.

Uniting the airframe and propulsion companies into what, for the purposes of the program, was a single contractor entity required a clear definition of all the relationships between the contractors themselves, as well as between the newly-formed "company" and the government. The most important of the details to be worked out was that of determining the team leader, including both the "lead" company and the individual who would speak for all of the contractors. Lead companies in most aircraft production programs generally came from

airframe companies, because traditionally engines represented "bolt-on" technology. Clearly that did not apply in the case of NASP, with its thoroughly integrated system. Yet most observers thought that one of the airframe companies, probably MD, would lead any team that the government might form. The contractors also shared a second assumption about the team leader, namely that the government would make its selection of a lead company based on technical merit.

All of this occurred against a backdrop of turmoil in the program during the summer of 1989. Throughout late 1988, the program had assessed its status if the Democrat, Michael Dukakis, won the presidency in November, and developed a strategy to maintain support in a new administration. But assuming that a Republican administration under George Bush would change little in its attitude toward NASP from that of the Reagan administration, the JPO put little effort into anticipating changes under Bush, a mistake that almost proved fatal. Bush's Secretary of Defense, Richard Cheney, based on a recommendation from Pentagon analyst David Chu, canceled all DoD funding for NASP in the late spring of 1989, deleting the line from the preliminary budget. Most NASP personnel familiar with Chu maintained off the record that he had nothing against NASP in particular, but disliked research programs funded out of the Pentagon's suddenly-shrinking budget. Whether he had made similar recommendations to Cheney's predecessor, Caspar Weinberger, and been overridden, is unknown, but Cheney, who was new on the job, deferred to the advice of the established analysts like Chu. Essentially Cheney's decision killed the program, for although NASA still had a small amount of money specifically dedicated to NASP, the program would not survive on the NASA funds alone.

Rescuing NASP took a monumental effort, and constituted Barthelemy's most serious

management challenge. The JPO in conjunction with the contractors frantically developed a new strategy that emphasized the technological advances already made by the program; the "spinoffs" those technologies had created and the potential for future spinoffs; and the contribution of an aerospace plane program in America's trade competitiveness in the aerospace and transportation industries. An all-out briefing blitz hit the Pentagon, but also sought new areas of support in the Departments of Commerce and Transportation. Most important, Barthelemy, through channels, reached a new supporter, Vice President Dan Quayle. As a senator, Quayle had received several NASP briefings related to his position on defense committees. He saw the issue of low-cost access to space as important for national security reasons more than purely economic benefits. When elected as Bush's Vice President, Quayle chaired the National Space Council, a new agency created by presidential order on April 20, 1989, and thus he enthusiastically welcomed the decisions on NASP, which DoD had just bobbled. Putting NASP on the Space Council's agenda provided a way for the Bush administration to make Quayle look good and take the focus off Cheney's decision. In Quayle, NASP had a champion in a position of real authority for the first time in its history. Quayle contacted Cheney immediately and persuaded him to put in a \$100 million placeholder in the budget until the Space Council could review the program over the following two months.

Quayle's support led the Space Council to recommend reinstating the program with a 2 ½ year schedule slip and a reduced annual budget to \$254 million (\$127 million each from DoD and NASA). That represented an amount \$96 million below the requested funding, but in theory guaranteed funds in the out years to ensure that the program could plan with some stability (see Fig. 4.6, "Revised Program Budget, 1990"). So strong was Quayle's role in reviving the program

Area	FY89	FY90	FY91	FY92	FY93 Thru 1/93
Airframe	45	35	40	40	10
Engine	110	80	90	100	20
Materials	70	50	60	60	20
Testing	20	30	25	35	25
Tech Mat	55	30	47	55	20
Focused Technology	5	14			
Support	15	15	15	15	5
Total	320	254	277	305	100

Fig. 4.6, "Revised Program Budget"

that, according to one source in attendance at the Space Council meeting, it went ahead "as if it were a done deal." The rearrangement of the schedule placed the Phase 3 decision point in January 1993, relieving some of the pressure on any contractor team to arrive at a design in 1990. Indeed, the Preliminary Design Review was pushed back to after the Phase 3 decision point after the schedule slip. Funding levels between NASA and the DoD, shown in Fig. 4.7 ("Funding Profiles"), reflect the original anticipated funding from DoD and the reductions made inside the Pentagon (the "J Panel" line).

Forming the National Contractor Team

With the program rescued and funding stabilized, the directors at the JPO started to consider team formation strategy. Two distinct approaches emerged. One team approach resembled the traditional prime/sub arrangement in which one contractor would oversee the efforts of other participants; would receive a larger share of the contract (and work); and would dominate the design. A second approach involved forming a multiple member team led by a prime contractor based on a competitive Phase 3 source selection. That required the government to issue a Request for Proposal that would require the companies propose a team approach in their offer. Over the summer of 1989, the government refined its options in the two categories, carefully keeping the selection of a *configuration* separate from selection of a team or contractor for Phase 3.⁴⁰

Finally, the government arrived at the position advocated by Barthelemy all along: a single contractor team would be formed and would collectively select a configuration.

	FY90	FY91	FY92	FY93	FY94	FY95	FY96	FY97
DoD	194	158	233	522(a)	680(a)	781(a)	795(a)	824(a)
"J Panel"	194	158	233(b)	330(b)	390(b)	470(b)	540(b)	580(b)
NASA Share	60	119	72(b)	82.5(b)	97.5(b)	117.5(b)	135(b)	145(b)
Actual Total	254	277	305	412.5	487.5	587.5	675	725

Source: Col. Wierzbowski's Files, G-136, Bldg. 39, WPAFB.

(a) Represents The Highest Reasonable Number DoD Thought It Could Get

(b) Assumes 80/20 DoD/NASP Split

Fig. 4.7, "NASP Funding Profiles (\$ Millions)"

Barthelemy claimed that the JPO directors had reached their team formation strategy on their own, but more than a few thought that the formation of a team had been a foregone conclusion from the time Barthelemy took over as program manager.

At an October 1989 meeting, the Steering Group gave its endorsement to the JPO's proposal to form a team, and four days later the JPO named a committee to generate an RFP that the contractors could only satisfy with a consortium arrangement in which they investigated ways to pursue the composite configuration. By the end of November, the JPO drafted its contractor team formation principles, which it transmitted to the contractors for review in early December. Within a week, all contractors had responded favorably, and at the December Acquisition Strategy Panel (ASP) meeting, the team formation strategy won further support. The ASP even went so far as charging the JPO with issuing an RFP that could *only* be satisfied with a team proposal.

Approval by the ASP did not solve the potential anti-trust violations, however. In late 1989, a member of the Defense Contract Audit Agency, who had conducted audits of several teams or joint ventures, briefed members of the JPO on his findings. He pointed to the Light Helicopter Experimental (LHX) program as the most successful team/joint venture program he had examined, and one that met the approval of the government's anti-trust divisions. Consequently, Lt. Col. Rodney Earehart and Lt. Col. Rick Roach arranged to meet on January 25, 1990 with members of the LHX program to discuss the team formation concepts. The LHX team was so well integrated that, according to an auditor, "it was impossible to tell for whom a particular employee worked" in the program.⁴¹ As a result of their visit to the LHX program, the NASP managers adopted some of the specific language and special documentation of that

helicopter team to their own contract.

Increasingly, by late December the last barrier to team formation was the selection of an individual and company to lead the team. The contractors---even the recalcitrant ones---realized that a team would leave them fully involved in the program and, although it might make some of their competitors stronger, a team would at least ensure that each company was ready for the NDV competition. But the issue of team leader involved additional money to the corporate “parent” to run the program, and, more importantly, expanded influence when it came to configuration selection and definition. In Barthelemy's view, the proper selection of a leader involved other issues as well. He looked not so much at the company whose design had matured the most---a point that others might take as indicative of the best “leader” or leading company---rather, he sought an individual who could truly forge a national team and who could work with all the contractors. In short, Barthelemy wanted a person, not a program.

He did not exclude an individual from a propulsion contractor from leading the team, and, conversely, he had disqualified in his own mind several individuals from airframe companies for what he perceived was their inability to get other airframe companies to cooperate. Thus, he had made his personal choice long before January 1991, when the JPO notified the contractors of the result of the ASP that virtually ensured team formation. On January 4, 1990, the contractor program managers met with Barthelemy in West Palm Beach, Florida, and expected him to name a team leader. Instead, Barthelemy spoke on "global issues" and guided the group to get the teaming arrangement in place. The contractors informed him that they could agree on all issues except the leader, and that two names continued to surface, Hershel Sams of MD and Barry Waldman of Rocketdyne. Inside the JPO, however, there was a quiet understanding that

Barthelemy would not brook Sams becoming the team leader, not because Sams personally was deficient, but because for a number of reasons, he epitomized the shortcomings of the MD program that seemed to offer little hope for a merging of ideas. It was, some thought, a type of “design imperialism” by MD, and as such ran counter to the goals Barthelemy sought to attain through consensus.

Thus, the government directors agreed that the contractors had to name their own leader, and that it could not appear as though the first important decision of the team came from the JPO. Barthelemy did not give any specific direction to the contractors, but they knew his views. As they continued to meet throughout January, the corporate heads signed the Interim Teaming Agreement (ITA) at the same time that the government released its new Program Management Document extending the program and containing the Phase 2 exit criteria and Phase 3 entrance criteria. The CEOs scheduled a follow-up meeting for January 22 and concluded that they would institute the team agreement as much as possible, even if they had not agreed on an individual leader at that time. Since the CEOs had requested Barthelemy's input, he planned to attend the meeting and reveal his preference. On January 21, Barthelemy telephoned Rockwell's CEO, Sam Iocabellis, to inform him that he had selected Rocketdyne's Waldman as his choice, but that Waldman needed out of the engine company to make the selection more palatable. Could Iocabellis "promote" Waldman to the corporate level? Iocabellis said he could, and the following day, Barthelemy explained to the CEOs his rationale for preferring Waldman, aiming his pitch specifically at MD, which, due its position as the owner of the most advanced design, stood to lose the most. Nevertheless, the MD officials perceived that they had to stay in the program, and could not do it except as a team member; and their choice, Sams, was unacceptable to the other

companies. Reluctantly, MD agreed to Waldman. After the officers affixed their signatures to the path-breaking teaming document, Barthelemy gave what he termed a "come to Jesus" talk in which he asked if any of the CEOs, in light of the tough competition through which they had just passed, would be unable to give Waldman their full support. None voiced any objections. The NASP contractor team was formed.

Certainly, however, many at the lower levels of the contractors and in the aerospace community in general were stunned. Not only had the leader come from a propulsion company, it was not the company whose design was most thoroughly developed. Some sarcastically argued that the progress in the Rocketdyne program hardly qualified Waldman to lead everyone else. But members of the JPO appreciated the fact that Rocketdyne had tried to "handle the really tough problems," especially the high end, as Lt. Col. Rick Roach observed.⁴² The Rocketdyne project manager in the JPO, Lt. Col. Scott Parks pointed out that the high speed engine that finally ended up in the aircraft in all likelihood would be the Rocketdyne design, and that the company's design in no way had peaked, whereas most thought that the P&W design, if left alone, did not have far to go.⁴³ It also had not hurt that Rocketdyne had "played on its own money," signaling its commitment to SSTO when others drank at the government trough. Most important in the selection of Waldman, however, was an intangible: Barthelemy simply had an excellent working relationship with Waldman that he lacked with some of the other managers. The two agreed fundamentally on NASP as a test of the so-called "Japanese style" management, and Waldman, like Barthelemy, was highly interested in innovative management styles.⁴⁴ He had previous experience with a team, working with AVCO and Rocketdyne on a laser project for the Air Force Weapons Lab. (There was, of course, considerable skepticism over how effectively

“Japanese-style” management worked, especially on American programs, and subsequent research has shown that it enjoyed only marginal, temporary success.)⁴⁵ But more than specific management style or experience, Barthelemy wanted an “engine guy” running the program to avoid some of the political pitfalls that might afflict a manager from an airframe company, and, at the same time, he had a suspicion that Waldman could extract full participation from everyone involved.⁴⁶ As Col. Wierzbanski put it, the team manager had to be adept at “herding cats.”

Waldman knew that the previous four years of competition had created barriers and deep attachments within individual companies toward their own house proprietary designs. Even before the January 22 meeting, Waldman had prepared a plan of action called the “First 30 Days,” which he distributed to the CEOs and the government after his selection was announced at the meeting.⁴⁷ He established task teams aimed at delivering products, scheduled the briefings, selected a staff, and organized the travel. After one week, the contractors would meet at a single site and make direct, “no-bull” presentations that were to be non-evaluative toward other designs but were to put the company’s “best foot forward.”⁴⁸ Waldman carefully rotated sites among the companies, and, at the end of six weeks, the team would be ready to brief the government’s program managers.

His preliminary survey of the situation in January 1990 led Waldman to conclude that the team leader had to distribute a great deal of information in a short amount of time, and to focus the technology, airframe, and propulsion teams on specific goals. Within a week, he had an advisory group that included representatives of all the major contractors. He also found some unexpected challenges. When naming his office staff, for example, he wanted to select from the most talented people at each NASP contractor. But the most talented were not always the highest

ranking individuals, and Waldman had to balance the need for talented subordinates and advisors with corporate politics.

In a related sense, the very corporate cultures of the companies---the way they reported data, the way they handled pay vouchers and travel, and innumerable other details---varied widely. Some areas could be changed with minimal disturbance at the home site; but others required fundamentally different ways of doing business. In the latter cases, Waldman had to identify those areas where he had some influence and those he had no real prospect of changing. And each question relied to some extent on the final location of the team headquarters, because the most optimal way to develop a team was to isolate the members at a single location, thus not allowing each contractor to run its own NASP program within the confines of the team. Nevertheless, Waldman moved the temporary headquarters of the team to Rockwell's Seal Beach facility. Although that resulted in some grumbling from employees of other contractors, most necessary members made the move. On the other hand, the Seal Beach location itself was not the final site, as the aircraft would have to be built at or near Edwards Air Force Base northeast of Los Angeles. Thus, one more relocation would be needed---a factor that shaped the thinking of employees already contemplating a move for the program and their own careers.

Technological differences between the contractors presented the stiffest challenge, in that the companies had pursued substantially different designs. The team could not mate a GD tail to an MD fuselage, with a hybrid P&W/Rocketdyne engine strapped on, because the aircraft was much too integrated for that. Instead, Waldman realized almost immediately, the team would have to develop an all-new composite configuration. To do that, the team needed to reassess the program mission and philosophy, reopening the "tension box" that Williams had at least partially

locked. In the course of discussions, the contractor team leadership concluded that the X-30 needed to demonstrate the technology for SSTO; to establish the technology and data base for hypersonic flight (including the development required for SSTO capability); and to demonstrate the technology for hypersonic flight. The philosophy also included a commitment to "fully capable NDVs."⁴⁹ It carefully avoided including a requirement that the X-30 itself go to orbit or be orbital capable.

Even before the team could grapple with the pressing technical issues, it lacked official standing until the arrangement received formal approval from Assistant Secretary of the Air Force Jack Welch. When the team concept was proposed to the Air Force, Welch's superior, John Betti, already had approved teaming in principle in a number of comments directed to program management. The JPO fully expected to have "fast track" approval by February 15. Welch, however, surprised the program by delaying his response. Not only did approval not arrive, but attempts to prod Welch's office into action elicited no response. As Barthelemy commented, the plan to form a team "disappeared into a black hole."⁵⁰ Eventually, NASA Deputy Administrator and NASP proponent J.R. Thompson provided the stimulus that moved Welch. At a May 11 meeting, Thompson brought up the team arrangement, then suggested that he would see Betti and would pass along Welch's support, if Welch would supply him with a memo. On May 22, Betti gave his approval, and the announcement in the *Washington Times* stated that NASA and the DoD had "approved a unique plan by [the five prime contractors] to put aside rivalries and work on the National Aero-Space Plane as a team."⁵¹ The National Aero-Space Plane Team organization thus formed an entirely new contractor entity that reported directly to the JPO (see Fig. 4.8, "National Aero-Space Plane Team").

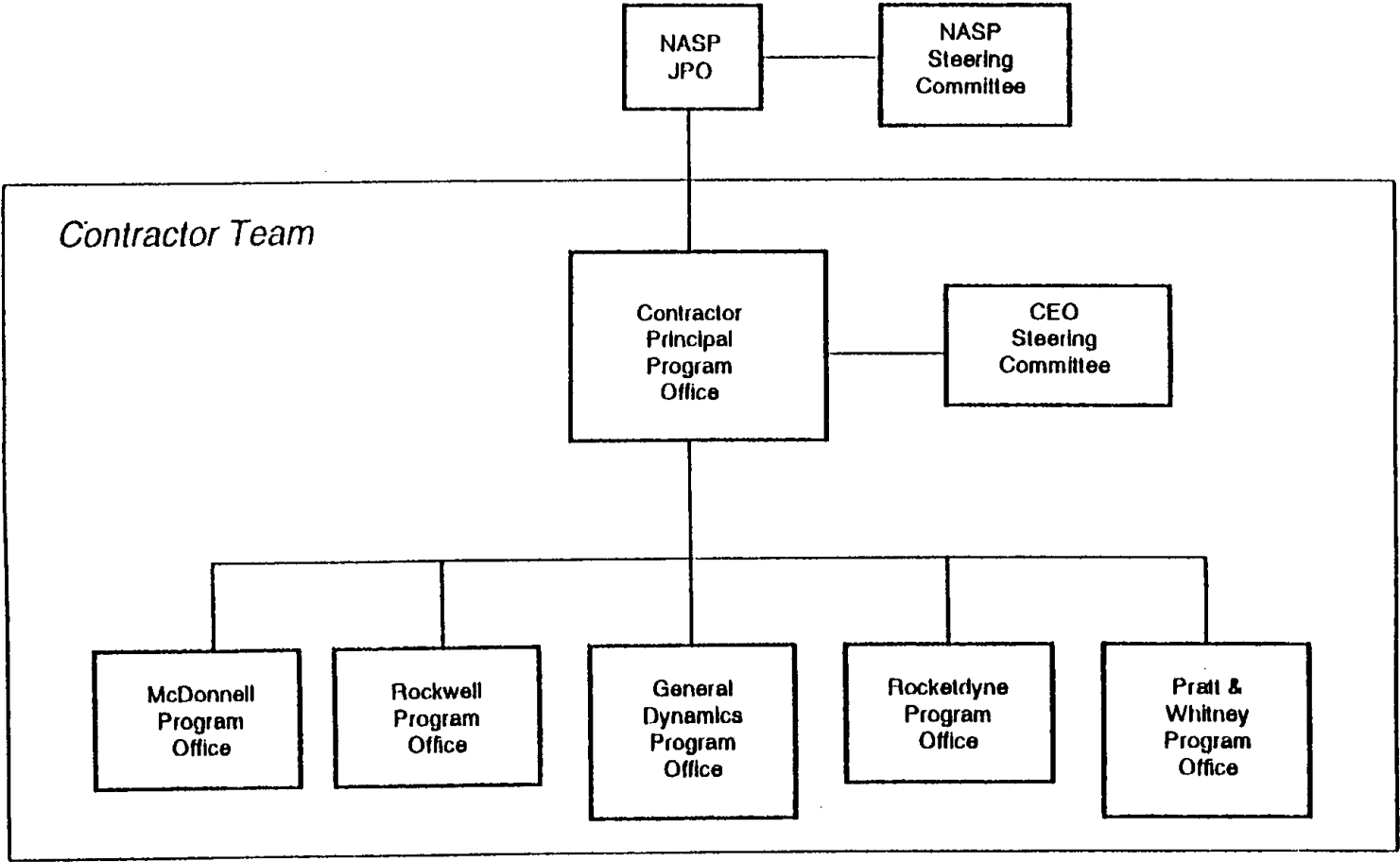

Fig. 4.8, "National Aero-Space Plane Team"

Managing NASP at the Contractor Team: Government-Industry “Work Buckets”

Meanwhile, to the extent that he could, Waldman continued to try to forge a team as far as possible within the limits of the law. He had scheduled a series of philosophy discussions that used as an organizing tool a key group of facilitator charts. Those charts, which addressed such issues as utility, enhancements, and design drivers. What, for example, did the aircraft have to develop, and by when? What technologies would be useful, but not critical, and when would those be incorporated most easily? The real significance of the facilitator charts, however, was that it gave Waldman and the JPO a way to organize the unmanageable matrix of options and designs to a much smaller number of issues through choices that excluded other options. For example, if the group decided against a rocket as a substantial contributor to the orbital boost, then it had to direct the design toward low drag and to emphasize the top end air breathing component.

At the same time as those high level philosophy groups started to meet, several other teams were created, including a plans team, a development and operations team, and a business team to work out the problems involved in proprietary data, antitrust concerns, and so on. During that period, however, the contractors carefully avoided discussions of technical data, which they could not exchange until the government approved the team formation.

Waldman could not risk further delays associated with waiting for official approval before laying the groundwork for effective team organization. Therefore, even without the government’s “official” sanction, he proceeded in the faith that it would soon come. To reinforce his new position as program leader, Rocketdyne transferred Waldman to a new corporate entity,

called division 840. The new unit was known as the National Program Office, or NPO, and each contractor provided personnel for the major staff positions (see Fig. 4.9, "NASP NPO Organization, 1990"). In the area of business management, however, Waldman selected his colleague, Gerry Gullick, formerly the business manager for Rocketdyne, who assumed the position of Deputy Program Director/Business Manager for Administration. All other positions were distributed relatively evenly among the contractors.

Reorganizing the JPO for the Managing the National Contractor Team

Just as Waldman could not wait for official word before preparing for the team formation, neither could the JPO delay reorganizing itself for managing the new structure. One major change involved the contract: under the competitive arrangement, the government had to supervise a fixed price contract, but the teaming agreement required a new cost-plus contract. As the government feared, that meant that contractor "contributions" dried up almost immediately, partly because no one wanted to support more of the team than anyone else, but also because the contractors' risk now was covered. They stood to gain a specified award above their costs.⁵²

A second change saw the government move from strictly a management position to one of manager/participant---a role the NASA centers had played all along. As a JPO document pointed out, the JPO needed to "recognize we are participants with the contractor, not just evaluators."⁵³ The JPO noted that the time had come to "employ the good ideas in hand, not emphasize the search for new ideas," and at the same time the government operations needed to shrink and become more streamlined.⁵⁴ In reality, the JPO had grown from roughly 25 people in

NASP NPO Organization, 1990

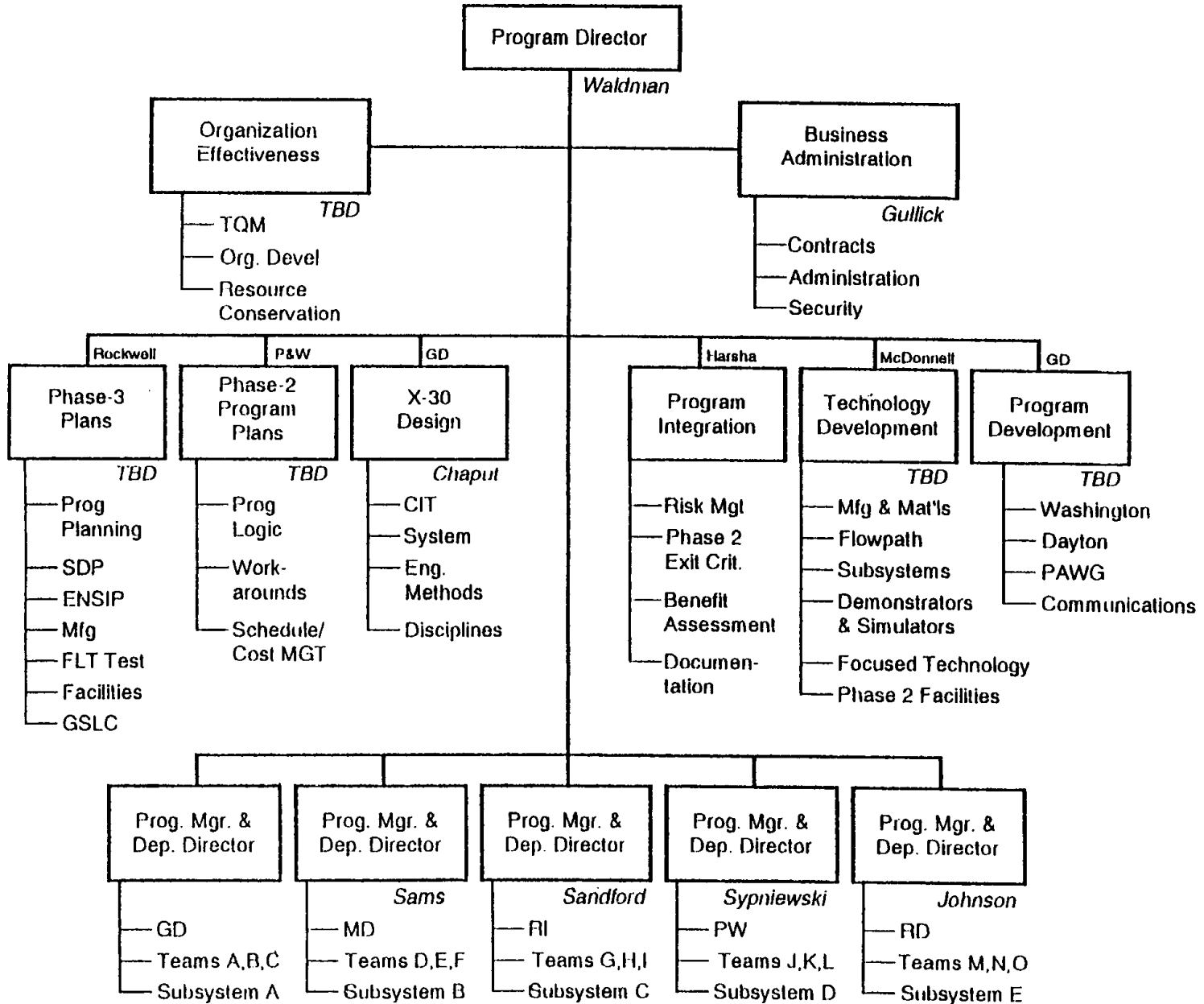

1986 to more than 125 by 1990, with plans to expand still further. Ironically, that expansion, seen as a positive indicator of health in other programs, did not bode well for NASP: if Barthelemy, Wierzbanski, and others in the JPO had at one time envisioned a "skunk works," that vision had all but evaporated by the time the contractors formed the team.

Reorganizing the JPO to match its new role in the program worked hand-in-glove with Waldman's management system at the NPO. The two meshed through a matrix management system common to Air Force projects that placed all the different corporate employees, as well as the government employees, who worked on a single aircraft function into a single management unit, called a "work bucket" that contained several related technology tasks (see Fig. 4.10, "NASP National Team Organization Concept"). With each work bucket responsibility went a budget. All work buckets then were divided among the five contractors, a process that proved difficult because it required not only dividing work along lines of expertise, but it involved a political balancing act to keep all the contractors happy and relatively even in their amounts of work (see Fig. 4.11, "NPO Bucket Responsibilities"), while at the JPO the NAM Projects Directorate was reconfigured to manage the award fees of the contractor buckets (see Fig. 4.12, "NAM Projects Directorate, 1991"). The GWPs assigned earlier to NASA were maintained, but reconfigured to fit the work bucket organization.

Meanwhile, all of a contractor's work remained under the oversight of the company's program manager. For example, if GD had responsibility for the fuel tank, it managed all elements of tank design, fabrication, and test, supervising the work of employees from the other contractors as well as some government personnel. But the GD program manager maintained a corporate responsibility for all GD's work, including other functions than the fuel tank. At the

NASP National Team Organization Concept

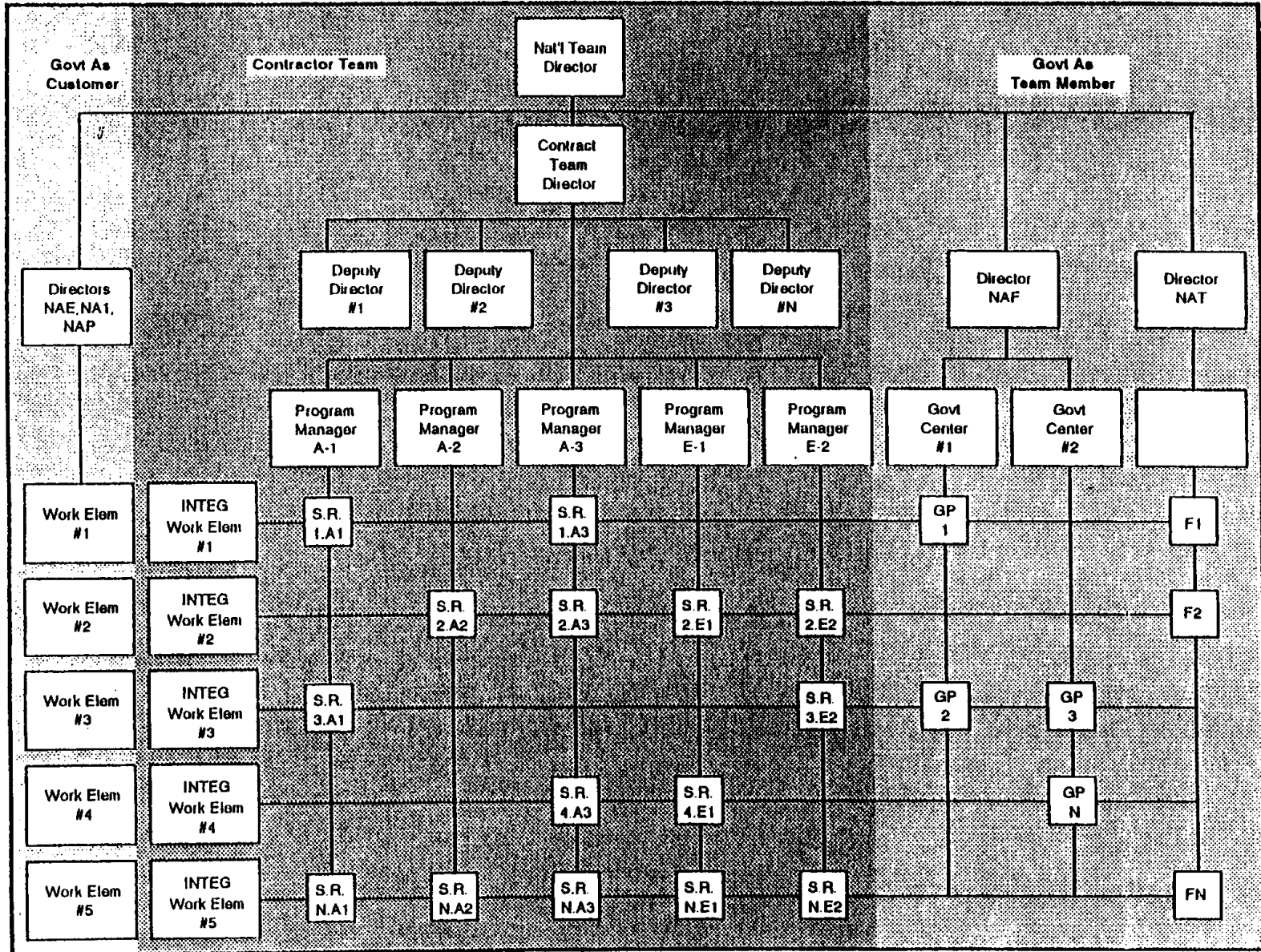

<p style="text-align: center;"><u>NPO: Waldman</u></p> <p>1130 Vehicle Design Chaput</p> <p>4420 Government Test Facility (GSACE) Stringer</p> <p>5110 Advance Program Planning Stringer</p> <p>5210 System Engineering Chaput</p> <p>5310 Program Management Gullick</p> <p>5410 System Application Studies Harsha</p>	<p style="text-align: center;"><u>SPSI: Sypniewski</u></p> <p>1520 X30 Flowpath & Control Gantz</p> <p>1540 XDE Flowpath & Control Faulkner</p> <p>1550 Flowpath & Control Technology Egan</p> <p>1570 Integrate Flowpath Design/Fab/Test Faulkner</p> <p>4410 Contractor Test Facility Faulkner</p>
<p style="text-align: center;"><u>GD: Barlow</u></p> <p>1210 Airframe Design Integration Law</p> <p>1240 Cryogenic Tank Ring</p> <p>1250 Thermal Protection System Thomas</p> <p>1260 Active Cooling Structure Kygar</p>	<p style="text-align: center;"><u>NAA: Sandford</u></p> <p>1310 Subsystems Chandler</p> <p>1410 VMS Aldana</p> <p>1270 Wing/Fuselage Component Henn</p>
<p style="text-align: center;"><u>MD: Eills</u></p> <p>1220 Fuselage Design Coyle</p> <p>1230 Fuselage Shell Coyle</p> <p>4110 Wind Tunnel Test Elsworth</p>	<p style="text-align: center;"><u>RD: Johnson</u></p> <p>1510 X30 System Integration Ratekin</p> <p>1530 SDC System Integration Ratekin</p> <p>1560 Systems Technology Treinen</p> <p>1580 Property Materials Technology Faklor</p>

Fig. 4.11, "NPO Bucket Responsibilities"

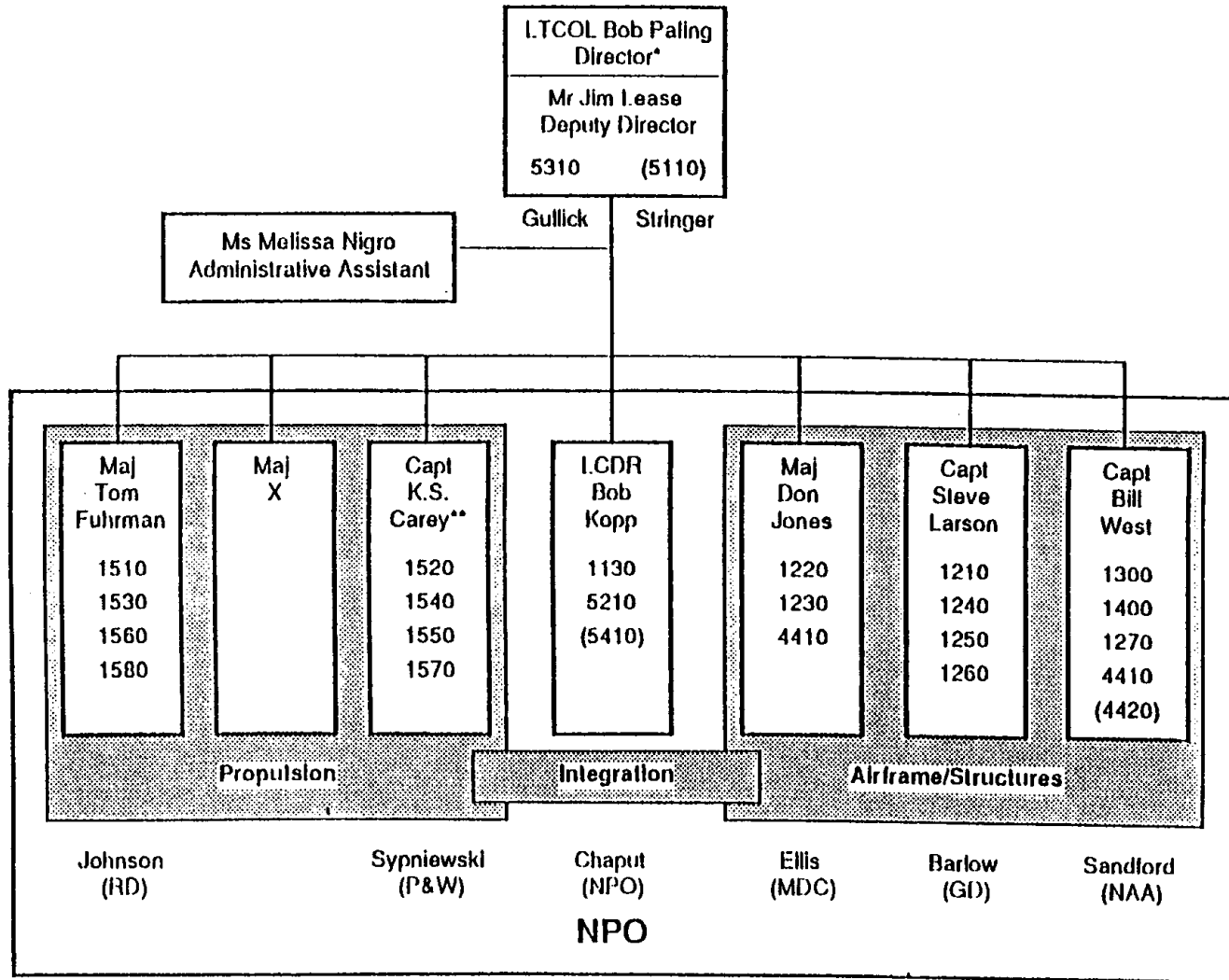

* Award Fee ARB Lead Member

** Award Fee ARB Administrator (1st Period)

Fig. 4.12, "NAM Projects Directorate, 1991"

same time, the government personnel reported functionally to their bucket leaders, but overall had to answer to their government superiors. The weakness of the work bucket structure came through the dual responsibility roles of the program managers to their tasks, on the one hand, and their corporate employer on the other. Even the most open-minded of managers had to consider their own company's position and concerns when solving tasks, and the tendency was for a GD manager, at least initially, to respond to a problem with GD experience and answers. Waldman sought to offset that natural bias with balance on the teams and relentless internal reviews by other company personnel, but his authority over employees from other companies remained limited in a number of ways. Ultimately, the engineers had to remain loyal to their companies.

Overall government management of the project demanded more of a permanent presence with the team than was occurring with the quarterly reviews and the steady stream of JPO visitors to the contractor sites. Consequently, Barthelemy formed a detachment (Det 5) of the JPO led by Wierzbowski and Berwin Kock to relocate at Seal Beach.

Early Contractor Operations

The contractor teams over the summer---even prior to final approval---had agreed upon the technology budget and the division of work and funds among the contractors. They met in Dayton with the JPO in May 1990, and although minor differences over amounts spent on certain areas surfaced, the government and the contractors ended those meetings with a mutually acceptable plan to manage the new NASP team. By that time, the contractor team had started to be viewed as a single contractor entity, and frequently was referred to as "the contractor."

According to the schedule the JPO and NPO laid out, the team planned to deliver a Phase 2D (the "D" designation indicated the post-team contract) proposal by March 1991, with a composite configuration submitted by the fall of 1991.

Those deadlines pressured Waldman into his first mistake. He had a rule not to consider a design in the early stages but instead to conduct new studies. The configuration group was permitted to consider design, and the chief engineers had delegated the work back to the very people who had the most riding on the success of their particular design. Not surprisingly, the chief engineers reported back to Waldman with the exact designs offered by RI, GD, and MD. Waldman and his managers learned a lesson: they could not go back and argue old designs, but had to get the participants in the team to attach themselves to a new configuration.

Despite those difficulties, the government directors were impressed with the cooperation they observed. JPO chief engineer Bill Imfeld approved of "how well [they] had integrated their work already," and Barthelemy and Wierzbanski, with few reservations, spoke favorably of the revolutionary management experiment that the program had undertaken.⁵⁵ It appeared that with the September 1990 ASP, which gave the new management strategy a go-ahead, the NASP would soon be on the runway.

Chapter 4 Notes

- 1 . By 1989, for example, which allowed adequate lag time for papers to be written and reviewed, titles included "Technology Challenges for the National Aero-Space Plane," by William Piland (paper presented to the 38th International Astronautical Congress, Brighton, United Kingdom, October 14, 1989); "The NASP Challenge: Technical Breakthrough," by Carl Sypniewski," paper presented to the AIAA First National Aero-Space Conference, Dayton, OH, July 20-21, 1989; and "The Challenge of the X-30 Test Flight," by Ted Wierzbowski, paper presented to *ibid*.
- 2 . The literature on the industrial policy debate is extensive. A partial history appears in Otis L. Graham, Losing Time: the Industrial Policy Debate (Cambridge: Harvard University Press, 1992), although this source omits some of the strongest critics of industrial policy strategies. A more balanced account, although not so much a synthesis as a debate, is the "Opposing Viewpoints" pamphlet, "Is America Falling Behind in Technology?" (Greenhaven Press, 1990). Specific sources included Henry R. Nau, The Myth of America's Decline (New York: Oxford, 1990); Karl Zinmeister, "MITI Mouse," Policy Review, Spring 1993, pp. 28-35; Bill Clinton and Albert Gore, "Technology: the Engine of Economic Growth," September 21, 1992, in William G. Wills, Jr. and Richard E. Bradshaw, "A Report on Science and Technology in the Clinton Administration: Recommendations for Transition Planning," November 1992, in Adrian Denardo's files, Science Applications International Corporation (SAIC), Dayton, OH; Robert B. Reich, The Work of Nations (New York: Vintage, 1992); Ira C. Magaziner and Mark Patinkin, The Silent War: Inside Global Battles that are Shaping America's Future (New York: Random House, 1989); Ira C. Magaziner and Robert B. Reich, Minding America's Business: the Decline and Rise of the American Economy (New York: Times Books, 1987); Clyde V. Prestowitz, Jr., Trading Places: How We Allowed Japan to Take the Lead (New York: Basic Books, 1988); Lester Thurow, The Zero-Sum Society (New York: Basic Books, 1980); Stephen Cohen and John Zysman, Manufacturing Matters: the Myth of the Post-Industrial Economy (New York: Basic Books, 1987); George Gilder, Wealth and Poverty (New York: Basic Books, 1981), and his Microcosm: the Quantum Revolution in Economics and Technology (New York: Simon and Schuster, 1989); and Michael E. Porter, The Competitive Advantage of Nations (New York: Free Press, 1990).
- 3 . See particularly Prestowitz, Trading Places, and Magaziner and Patinkin, The Silent War.
- 4 . Greg Wiegand, "Japan Might Slide to Second as the U.S. Advances Digital Technology," USA Today, November 17, 1997.
- 5 . Mark Simonds, quoted in Wiegand, "Japan," *ibid*.
- 6 . Rich Miller, "Japan's Banks 'In a Danger Zone,' Analysts Warn," USA Today, *ibid*.

- 7 . My textbook, "The Entrepreneurial Adventure," (Ft. Worth, Texas: Harcourt-Brace, forthcoming), traces these developments in the final three chapters. On the effectiveness of Japan's Ministry of International Trade and Industry (MITI), see Scott Callon, Divided Sun: MITI and the Breakkdown of Japanese High-Tech Industrial Policy, 1975-1993 (Stanford: Stanford University Press, 1995).
- 8 . See table 7-2 and 9-2 in Porter, Competitive Advantage of Nations, pp. 285 and 509, respectively.
- 9 . Robert Williams, "Forces for Change and the Future of Hypersonic Flight in the 21st Century," address before the First International Conference on Hypersonic Flight in the 21st Century, September 20-23, 1988, Grand Forks, North Dakota.
- 10 . Jacques Gansler, "International Arms Collaboration," unpublished paper presented at Harvard University, November 8, 1989, p. 1, in author's possession and available from TASC.
- 11 . General Accounting Office, "Joint Major System Acquisition: An Allusive Strategy," May 1983, cited in Gansler, "International Arms Collaboration," p. 5.
- 12 . Michael L. Beltrano, "A Case Study of the Sparrow AIM-7F," Program Manager, September-October, 1985, pp. 28-35; Donald L. Pilling, Competition in Defense Procurement (Washington: The Brookings Institution, 1989); Robert W. Drewes, The Air Force and the Great Engine War (Washington, D.C.: Defense University Press, 1987).
- 13 . Fred Hiatt, "Chronic Abuses Found in Navy Repair Program," Washington Post, February 11, 1986.
- 14 . D. Douglas Dalglish and Larry Schweikart, Trident (Carbondale, IL: Southern Illinois University Press, 1984).
- 15 . Interview with Robert Jones, October 10, 1997.
- 16 . Interviews with Williams, July 18, 1989 and various informal phone conversations.
- 17 . Ibid.
- 18 . Ibid.
- 19 . See Paul Craig Roberts, "What Everyone 'Knows' About Reaganomics," Commentary, February 1991, pp. 25-30.
- 20 . "Historical Tables, Budget of the United States Government, Fiscal Year 1990," in Budget of the United States Government (Washington, D.C.: Government Printing Office, 1990), chart 3 and 5.

- 21 . Data taken from Historical Statistics of the United States, adjusted for inflation and taken as a share of GNP by the author, presented in "Entrepreneurial Adventure," ch. 13. Robert Eisner, The Misunderstood Economy: What Counts and How to Count It (Boston: Harvard Business School Press, 1994).
- 22 . These issues are reviewed in a number of economic history textbooks, and developed in an abbreviated version in my textbook, "The Entrepreneurial Adventure," ch. 13-14.
23. Stephan Korthals-Altes, "Will the Aerospace Plane Work?" Technology Review, January 1987, pp. 43-51.
- 24 . Interview with Col. Tom Bishop, December 5, 1989.
- 25 . Interview with Col. Tom Bishop, December 5, 1989.
- 26 . See C.L. Edwards and D.E. McIver, "Executive Summary of Aerodynamics Technology for the National Aero-Space Plane," February 1996, in author's possession provided by NASA Langley. See also Lee Beach's presentation to Raymond Colladay, "Impact of the National Aero-Space Plane Program on Langley Hypersonics," August 28, 1986, in "Pete's Charts for HQ," NASA Langley Technical Library.
27. These discussions were reported by several anonymous individuals with close proximity to Keyworth, Williams, and Shea.
- 28 . Scott Pace/RAND Corporation, "National Aerospace Plane Program: Principal Assumptions, Findings, and Policy Options," December 1986, in File N87-25990, NASA Langley Technical Library.
- 29 . Pace, "National Aerospace Plane Program."
- 30 . Interview with Raymond Colladay, August 15, 1997.
31. A thorough discussion of the false perception of MITI's successes appears in "MITI Mouse," and is developed in detail by Gilder in Microcosm.
32. The different views on team formation within the JPO were explored in the Acquisition Strategy Meeting, March 25, 1988. See the "Memo for the Record, Minutes of the Acquisition Strategy Meeting on 25 Mar[ch] [19]88, in NAK files, cited in "National Aero-Space Plane (NASP) Advanced Technology Impacts," 6.6-6.7. Other information came from interviews with the principal directors and contractors.
33. Draft minutes of the Third NASP Steering Group Meeting, June 3, 1988, in 15-125, Wierzbanski's files, AFFTC History Office, Edwards Air Force Base.

34. Memorandum of Understanding, March 23, 1989, in NAK files [Tom Richmond's files], JPO, WPAFB, cited in "National Aero-Space Plane (NASP) Advanced Technology Impacts," 6.7. Also see Fred Kelly, Jr. to National Aero-Space Plane (NASP), May 25, 1989 and C.D. Wiler to Air Force Systems Command National Aerospace Plane Program Office, May 25, 1989, cited in *ibid.*

35. C.D. Wiler to Air Force Systems Command, National Aerospace Plane, May 25, 1989, in NAK's files [Tom Richmond's files], JPO, WPAFB, cited in "National Aero-Space Plane (NASP) Advanced Technology Impacts," 6.7.

36. Tom Richmond to AFCLC/JANS, Request for Legal Opinion, NASP Airframe Teaming, May 11, 1989, cited in *ibid.* When the response to Richmond's request finally arrived, in July 1990, it generally approved the RI/GD team, but added the caveat that "Approval by the Department of Defense is not, in itself, a defense to antitrust violations." It also found that the two contractors would still have to complete their original design concepts. The main concern involved MD: "We believe there is substantial potential that the third airframer, who has elected not to participate in this arrangement, may have grounds to protest the proposed change [and] would pursue legal remedies." See "NASP" memo in Richmond's files out of AFC/LCI, July 1990, no file number, cited in *ibid.*

37. "NASP Team," Tom Richmond's files, cited in *ibid.*

38. *Ibid.*

39. *Ibid.*

40. Several documents illustrated the JPO's evolution on teaming issues during the summer, including Chuck Anderson and Ed Graber, "Thoughts on a top Level Game Plan," July 1989, in Tom Richmond's files; "Objectives of Teaming Strategy," n.d. [circa summer, 1989], *ibid.*; "NASP Acquisition Strategy," September 19, 1989, in *ibid.*; and "Phase 3 Program Alternatives," Summer 1989, all cited in "National Aero-Space Plane (NASP) Advanced Technology Impacts," 6.9-6.11.

41. Interview with Lt. Col. Rodney Earehart, May 14, 1991; "Trip Report," January 29, 1990, in NAM files; "Summary of the LHX Team," *ibid.*; U.S. Army, "After Action Report, Lessons Learned (One Year Into Contract), 'Industry Perspective,'" January 21, 1987, *ibid.*; and interview with Mark Schneider, Contracting Representative, LHX program, May 22 1991, cited in "National Aero-Space Plane (NASP) Advanced Technology Impacts, 6.19.

42. Interviews with Lt. Col. Rick Roach, various dates 1989-1990.

43. Interviews with Lt. Col. Scott Parks, various dates, 1989-1990.

44. Interview with Barry Waldman, July 12, 1989.

45. "Re-engineering Not a Roaring Success," Dayton Daily News, January 28, 1996.
46. Interview with Barthelemy, April 12, 1990.
47. "The First 30 Days, Plan-of-Action," January 20, 1990, from Barry Waldman's files, in author's possession.
48. Ibid.; interviews with Waldman, August 9-14, 1990.
49. "Program Philosophy Discussion Draft," April 6, 1990, in Waldman's files.
50. Interview with Barthelemy, April 12, 1990.
51. "Five Firms form Unique Partnership on Aero-Space Plane," Washington Times, May 25, 1990.
52. The advantages and disadvantages of both types of contracts are discussed in the sources given in notes 6-9 of this chapter.
53. "JPO Management Meeting: the Current Situation and What It Means to JPO Management," January 25, 1990, in Wierzbanski's files, 15-179, AFFTC History Office, Edwards Air Force Base.
54. Ibid.
55. Interview with Bill Imfeld, JPO Chief Engineer, April 9, 1991; interviews with Waldman, August 9-14, 1990.

Chapter 5: Team Formation and “Incremental” Politics

AT THE VERY TIME that the NASP contractors appeared to settle into a comfort level with the team concept and operation, and at a time when the program apparently had a champion at the highest level in the administration in the person of Dan Quayle, the threads of support for NASP started to unravel. The drama of pulling the competing companies into a joint venture had occurred against a backdrop of larger, more significant trends in the world balance of power, rippling through both NASA and the DoD. Individually, any one of those multiple factors could have sunk NASP; taken together, a project with the price tag of the aerospace plane did not have a prayer.

On November 9, 1989, five days after a million people marched in protest in East Berlin, the Berlin Wall came down, signaling the demise of the Soviet bloc and, ultimately, the end of the Cold War. But already military budgets had come under attack for being extravagant--- despite the fact that during the "Reagan buildup" defense spending barely reached 6% of GNP, or less than a percent higher than the lean Carter years and far below the Johnson/Nixon Vietnam-era budgets or the Kennedy defense budgets. Comparatively, despite the presence of vocal critics who decried military spending, the military growth in the 1980s represented scarcely a blip on the nation's budgetary history, and even by 1995 real growth in the defense budget compared to 1955 *totaled* less than 12% in real dollars, compared to real growth in the science and technology budgets of just under 4000% and of federal health support of 16,000%!¹ Under the Bush administration, the armed services had been told to expect further reductions, and money that had flowed somewhat freely six years earlier dried up. Long-term forecasts for the Air Force told the

systems commanders to prepare for a 30% reduction in budget. In such a case, Air Force support for NASP was a luxury, even if it approached its advertised price of \$5 billion.

A second development eroded support for NASP more directly. For more than a decade, the nation had drifted in its space policy. Committed to a space station---whose characteristics and capabilities, and thus, price tag, also shifted endlessly---NASA lacked a reliable lift capability to build such a facility in any kind of cost-effective manner.² The Space Shuttle had proved long before that it was incapable of quick launch, easy turnaround, and, ultimately, low-cost access to space. Both NASA and the Air Force had systems capable of launching heavy payloads into orbit, but those systems either were expensive or required long preparations to launch. Other advanced systems were not yet on the production line.³ Worse, the 1986 *Challenger* disaster grounded the shuttle fleet for almost two years, leaving the field open to France's *Ariane*. The lack of space launch merely reflected a deeper problem, namely that NASA had lost the public's good will and support for expensive space missions. Certainly few people had the same excitement for space exploration in the mid-1980s that they had in the 1960s.

Such obstacles could have been overcome if NASP had been relatively cheap, but even at original projections it was not. Worse, the original projections seriously understated the cost of two X-30 aircraft and their ground and test support systems. But even before realistic costs of the program had become well known either at DoD or in Congress, funding had started to fade. As seen in Fig. 5.1, "Funding History of the NASP Program, Requested and Actual Funding, 1986-1994," by 1991 funding levels that had increased at a steady rate over a five-year period suddenly decreased for two straight years. Moreover, congress steadily decreased the authorized levels

FY	Request		Actual		Total	
	DoD	NASA	DoD	NASA	Request	Actual
1986	45	16	45	16	61	61
1987	150	62	110	62	212	172
1988	236	74	183	71	310	254
1989	245	104	231	89	349	320
1990	127	127	194	60	254	254
1991	158	119	163	95	277	258
1992	232	72	200	5	304	205
1993	183	80	150	0	263	140*
1994	43	80	40	20	123	60
1995	45	22	-	-	67	-

* Indicates Subsequent Special Adjustments To The Budget
 Source: NASP Program, NAP files

Fig. 5.1, "Funding History for the NASP Program, Requested and Actual Funding, 1986-1994 (In Millions of Current \$)"

from the requested levels, and by FY93 the program would not have regained its *original* 1986 planned funding profile. Although the Space Council's reinstated mark of \$254 million in FY90 saved the program, actual funding levels quickly fell below the Council's proposed funding (see Fig. 5.2, "NASP Program Funding Profile") and represented a serious shortfall from the original funding trend of \$427 million by 1990. Neither the original Bush budget nor the revised Bush budget of July 1989 even approximated what Reagan had proposed, with the entire difference attributable to the declines in DoD funding (see Fig. 5.3, "NASP Funding Requests [FY 90-92]").

The NASP Cost Estimate

Much of the erosion of NASP budgets can be attributed to a general "trimming" effect going on within the Air Force, combined with the relative long-term benefits of hypersonic aircraft. Clearly, no operational hypersonic vehicle would fly before the turn of the millennia. A more substantial concern in NASA and the Air Force involved the ultimate cost to put the X-30 into orbit, assuming the technology could be pushed. Program management realized that the figure of \$5 billion, though used in 1982 or 1983, had stuck as a benchmark. When the program was created, a \$5 billion-to-flight-cost was pure fantasy, but as late as 1987, the JPO still did not know how much a real, flying X-30 would cost. In part, there was a genuine reluctance within the JPO to avoid coming to grips with the cost. Directors tried to use the excuse that either the technology was not yet developed (which was true) or that it was changing too fast to evaluate (which, strictly speaking, also was true), yet neither fact was relevant to the unwillingness to

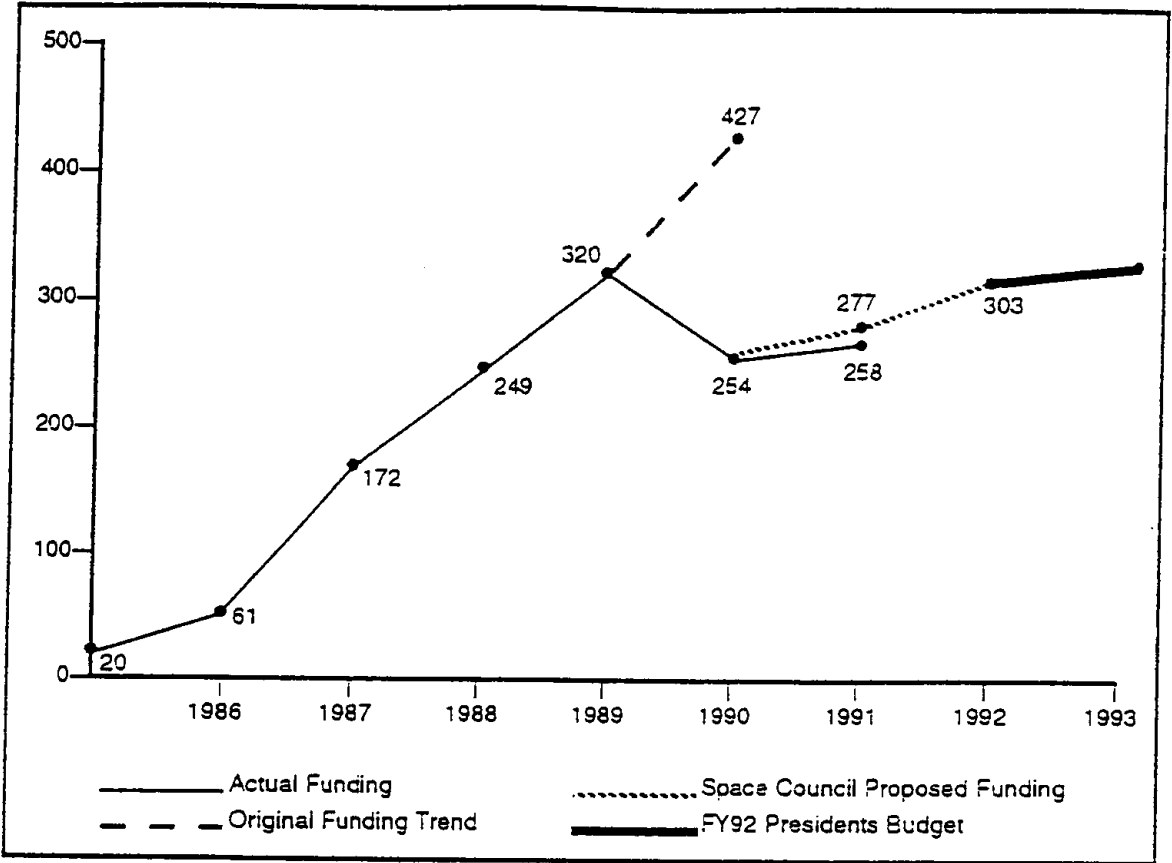

Source: NASP Joint Program Office

Fig. 5.2, "NASP Program Funding"

	FY 90		FY 91		FY 92		Total	
	DoD	NASA	DoD	NASA	DoD	NASA	DoD	NASA
Reagan	300	127	390	119	420	78	1110	324
Bush (April 1989)	100	127	0	119	0	78	100	324
Bush (July 1989)	127	127	158	119	233	72	518	324

Source: Office Of Management And Budget

Fig. 5.3, "NASP Funding Requests (FY 90-92, in \$M)"

produce a cost estimate. In truth, the JPO knew that the cost would exceed Du Pont's unrealistic figures by at least a factor of three, and possibly five (i.e., \$15-25 billion). Still, pressure came from several quarters to develop a reliable cost estimate, and thus from April to August 1987 the directors undertook to develop a cost estimating relationship database for the X-30.

Typically, the procedures involved in such a cost estimating exercise use known, existing program costs for individual items (such as a hydraulic pump, or a wing panel), then are adjusted for materials costs for anticipated newer materials. At each stage, the costs involve labor and fabrication, but often do not include investment in new machinery to manufacture such parts, assuming that a contractor will make that investment. The further a program gets from known or operational systems, and the higher the level of exotic materials utilized, the more difficult it is to arrive at a reliable estimate. Imagine, for example, trying to estimate the costs to build a house that would have features no existing house has, using wood that no one has yet discovered, with tools that no one has yet invented! Engineers often can envision a way "to get there from here," but often identifying where "there" is proves more troublesome.

Consider the case of a relatively non-revolutionary program, the U.S. Navy's Trident submarine program. It used existing materials and incorporated state-of-the-art technology, but employed (for the American submarine program) never-before-used manufacturing and fabrication techniques. The submarine hulls, for example, were continuously welded in a giant circular weld by huge welding towers, compared to older welding methods where steel plates were welded to a skeleton. Difficulties in estimating the costs of using that new technology brought the Tridents in at about \$400 million over budget, although virtually no cost growth in the program occurred---nor were any major modifications needed---after the first Trident took to

sea in 1982.⁴

Tridents certainly did not represent "revolutionary" technology---and a more appropriate example to NASP would have been one of building a Trident when no previous submarines capable of diving past 100 feet deep even existed. Nevertheless, the Trident program had to estimate its costs at the time of congressional approval based on the fact that only 15 percent of the final designs were complete.⁵ That compared with a NASP program that had virtually *no* final reliable designs in 1986---only du Pont's "validated" 50,000-lb. aircraft. By late 1987, when the JPO attempted to estimate costs, virtually all involved in the NASP program had jettisoned du Pont's design.

Pulling the data together in the April 1987 cost estimating relationship (CER) exercise, the JPO working group, including Ming Tang and Tom Galloway of NASA; Col. Wierzbanski, Maj. Gus Bell, Maj. Ken Griffin, and Frank Boensch, and three other Aeronautical System Division representatives, Dick Stalder, Bert Shields, and Jim Westrich from the Air Force; Bill Woodbury and Rick Caggiano of the USN; and contractor participants identified three major points of emphasis in their work. First, any cost working group would "provide a baseline for trade studies . . . [for] low cost access to space."⁶ Second, the group's cost estimate would identify areas of cost risk, voids, areas needing management attention, and methodologies. Third, the cost estimate would support DoD programming and budgeting procedures. Maj. Bell headed the final team of six Air Force representatives and four representatives from the U.S. Navy's Naval Air Systems Command.⁷ The team scoured the records of other systems that had relevance to NASP: experimental aircraft such as the SB-70 and the X-15, as well as operational systems such as the SR-71 and the B-1. Other data came

from the Space Shuttle, although the team thought that its costs might be less applicable because it was further removed than, say, the SR-71, from traditional airbreathing systems. Team members spent time in the field interviewing government researchers and private contractors as well as using cost data from reports. By August 1987, the team had a cost figure to forward to Williams: \$14 billion (1986 dollars), not counting facilities needed to fabricate materials; not counting the \$1.319 billion already spent during Phase 1 and part of Phase 2; and not counting the \$800 million the contractors put in from their own funds during the first part of Phase 1. Finally, no costs from follow-on NDVs were included.⁸

Despite what appeared to any uninitiated observers as a shocking figure well out of line with the original du Pont estimate of \$5 billion, the JPO thought the \$14 billion number represented an overestimate of actual costs, for several reasons. First, the "bottoms up" estimating method---a commonly-used and legitimate approach---nevertheless resulted in counting several items or work packages more than once. Analysts examined individual parts' costs or processes' costs, without consideration of overall redundancies or savings effects. A fuel pump system that might make use of an auxiliary pump to increase its pressure, for example, had to be evaluated as though it had to generate all its own pressure, and supply all of its own tubes and hookups, even though those same tubes and hookups might be accounted for under other items. Duplication of materials was a certainty without a sense of how sections would fit together. More important, independent systems had to perform at levels of top reliability, void of the backup of the entire system. Consequently, analysis concluded that weight savings would drastically shift costs downward as improvements in some areas---say, subsystems---produced savings across the board.

In addition, the JPO knew that historically costs specifically related to technology did tend to fall, even in the early stages of technology maturation. As scientists and engineers took advantage of the learning curve, costs could fall on a number of fronts, even before a program reached production. The Sidewinder missile offers an example of this trend: by FY62 the per-unit production cost had fallen to one-seventh the FY55 level.⁹ And it was possible that further savings might not occur until well along in the program: Burton Klein, in his study of military development projects in the 1950s, concluded that "sharp improvements in [cost performance] estimates begin to occur only after the [item] is in test."¹⁰ On the other hand, historically, advances in one area often led to cost increases in unexpected areas. Jet fuel consumption, which had fallen from .9 pound of fuel per hour-pound of thrust in 1950 to .6 in 1968, would have led to the conclusion that consumption rates, and thus costs would have fallen further with the introduction of turbofans in the late 1960s. While indeed fuel consumption fell, maintenance costs rose by 100 percent per pound of thrust per year.¹¹

Nothing was done with the cost estimates until March 1988 when Barthelemy assumed his duties as program manager. He ordered a second CER exercise that lasted until January 1989. Concurrently, the contractors embarked on their own costs for their System Development Plans (see Fig. 5.4, "NASP Phase 3 Planning Process"). The JPO's cost team included members from Aeronautical Systems Division (ASD), the comptrollers office, JPO members, and consultants from The Applied Science Corporation (TASC). Beginning in July, the contractors developed the ground rules and assumptions for their reports. Although they did not represent complete costs for NASP systems, they provided a starting point for a Phase 3 cost estimate. MD submitted an estimate of \$6.6 billion for an airframe using the P&W engine, and \$7.1 billion for an aircraft

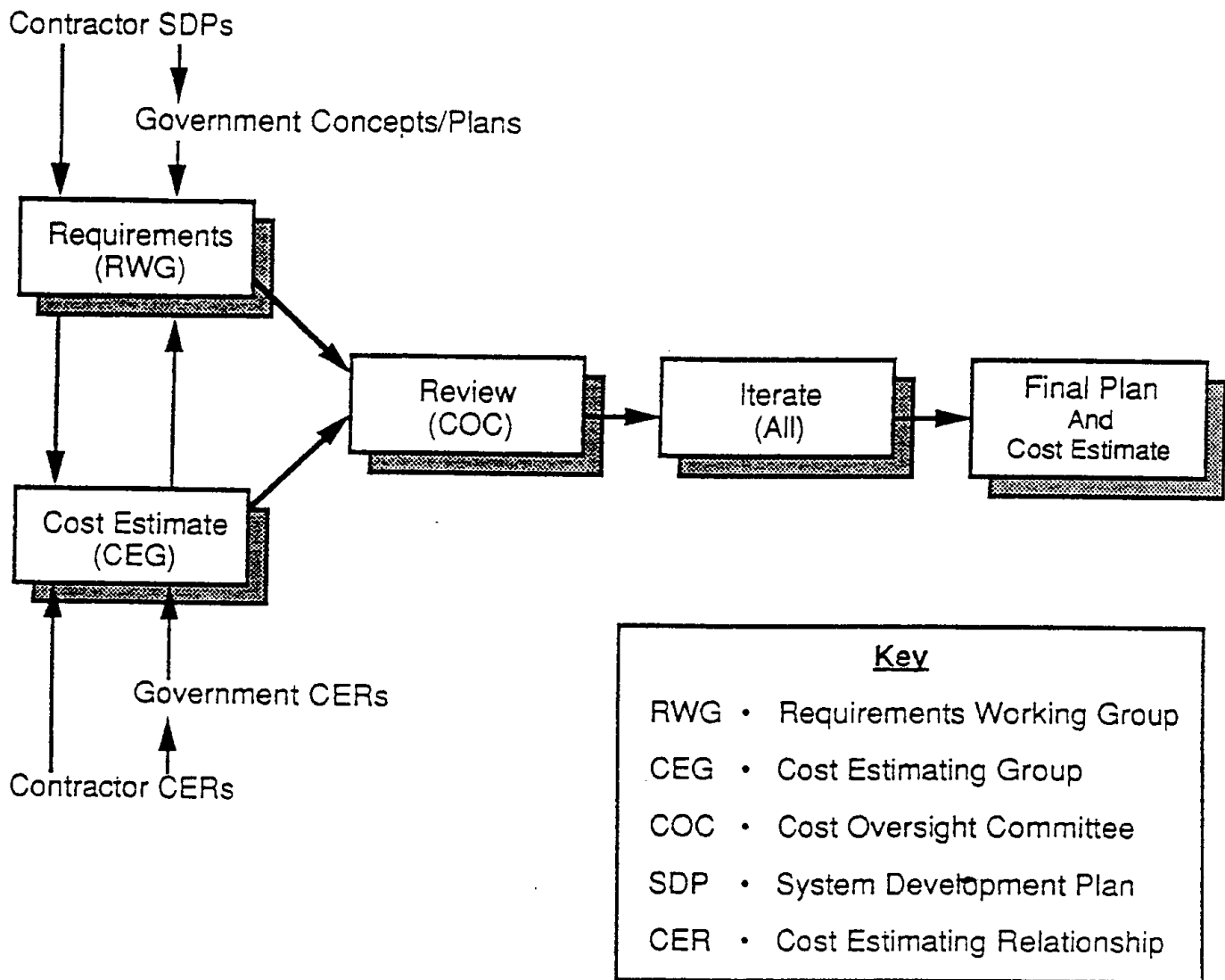

Fig. 5.4, "NASP Phase 3 Planning"

using the Rocketdyne engine, based on a total effort of 15 million man-hours. RI put its Phase 3 costs at \$5.1 billion with the Rocketdyne engine. GD not only provided an estimate for the research aircraft of \$5.9 billion, but included an estimate for a larger payload aircraft---the so-called "4X" NASP (i.e., an aircraft with an operational capability)---of \$8.3 billion.¹²

The government's effort blended the estimates of the contractors with its own estimates and the refinements added by TASC. In October 1988 the JPO proposed a cost management plan. The JPO claimed that it did not produce "a number" (defined as an estimate) but instead identified a "target" of \$12.5 billion for a "4X" vehicle, plus a risk cushion of \$3.63 billion for a total "target" of \$16.13 billion. JPO directors planned to meet regularly to evaluate the inputs and to refine them based on comparisons to other programs. The series of working group meetings would lead to a number of initiatives to reduce cost, and a long-term estimate was due by November 1988. A Requirements Working Group (RWG) in February 1989 then undertook a strategy called the "cost estimate attack," in which it would march through 13 topic areas and find ways to reduce the costs. With a "target" of \$16.13 billion, clearly a great deal of room existed to "attack" the costs!

Nevertheless, early RWG meetings achieved dramatic savings for the program on paper. For example, the RWG brought down a \$489 million training and mission support estimate to \$242 million by reducing systems engineering personnel, using a contractor facility's simulator to work hardware/software, and by letting NASA provide data the costs of which the program otherwise would have to absorb. Similarly, the March 17 RWG meeting trimmed another \$97 million from avionics and software.

Progress on the budget/cost "attack" came to a screeching halt in the late Spring 1989,

however, when Cheney canceled the program. All efforts in the program focused on survival, and no one could make any kind of cost estimate without a baseline. At the same time, contractor representatives in Washington started to hear rumblings that the NASP program cost should not exceed a total of \$4 billion or it would risk losing political support. Unfortunately, the program already had approached \$3 billion well before it even completed Phase 2. That made cost presentations for NASP all but impossible.

Meanwhile, the cost analyses by the contractors, which were made public, confused matters further. GD, for example, produced an estimate for a follow-on NDV program that listed "procurement of *five* spaceplanes [*italics added*]" at \$4.8 billion.¹³ Regardless of the specific dollar amount associated with NASP in Washington, however, even the most ardent NASP supporters admitted privately by 1989 that putting an X-30 into orbit would substantially exceed the \$5 billion du Pont figure, and program management struggled to find a way to keep the "selling price" below \$10 billion. Based on their own analysis, however, and that of the contractors, the survival of NASP depended on management finding a way to keep advancing to the goal of SSTO while understanding that the NASP program as structured and funded could not build even one aircraft capable of attaining orbit.

Stairways to Heaven: The "Incremental Approach" to SSTO

Quietly, then, the JPO adopted what it called "the incremental approach," whereby existing technology would be used to achieve certain milestones, with advanced technology brought in at specified increments. Only the second aircraft would be capable of SSTO flight

under that incremental approach (see Fig. 5.5, “Incremental Approach”). Most important, the program could get "hardware" flying in order to assuage the worries of those who feared they were pouring good money after bad.

Vince Rausch had attempted to institute the “incremental approach” early in the program’s history. He had located some rocket boosters to attempt a small experiment, and had, in his mind, “convinced the program to proceed based on ground test to Mach 8, use of CFD from Mach 8-15, and then the air test to account for performance above Mach 15.”¹⁴ But the small rocket booster experiment quietly was dropped---Rausch received little actual support---and the people in the program he “convinced” apparently became quickly “unconvinced.” Ultimately, Rausch’s position was vindicated and the program increasingly drifted to subscale, lower Mach-number aircraft, and he could note in 1997 that “One lesson we learned: you can scale down.”¹⁵

Adoption of an incremental method also helped solve a rift that had appeared between NASA and the Air Force about the pace of testing and the approach to SSTO. Many in NASA for years had argued that a Mach 15 vehicle would yield most of the data needed to make reasonable predictions about the SSTO demands. Having a non-SSTO first vehicle provided time to apply data gained in lower Mach number flights to the orbital aircraft, and tended to satisfy those in NASA who had contended that the most important goal of the program was to expand the base technology for hypersonics.

In mid-1989, the JPO requested that the contractors submit their best estimates as to the size aircraft they needed to build and the speed it needed to attain in order for the companies to have confidence in their predictive tools that they could proceed to SSTO. Had the contractors all

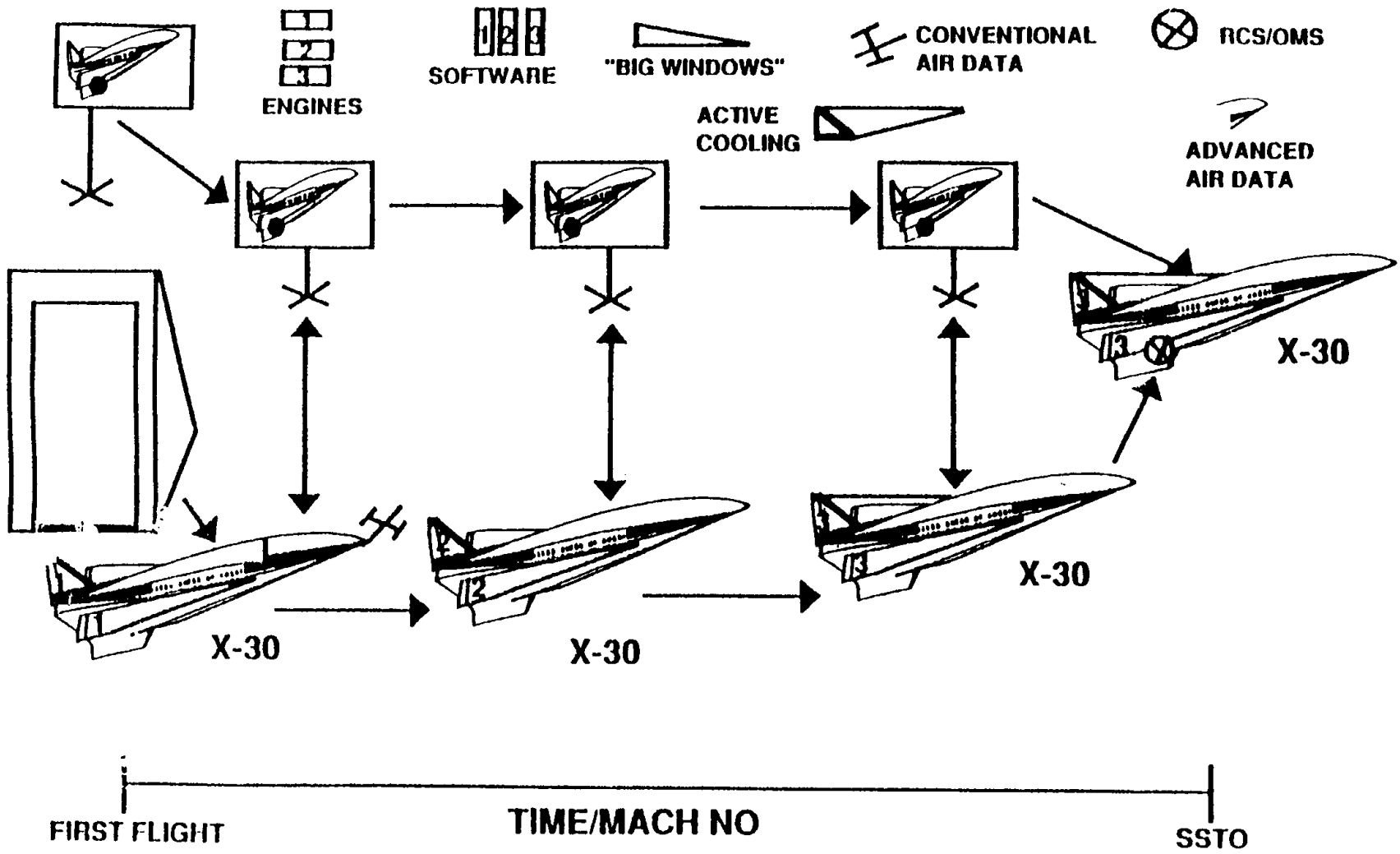

Fig. 5.5, "Incremental Approach"

replied that they could make reliable predictions about SSTO performance based on, say, a 30% size vehicle that only reached Mach 15, then presumably the program was prepared to build a Mach 15, 30% scale aircraft. At least, program management would have had ammunition to claim that validation methods had improved, CFD codes had become more reliable, and so on, allowing Barthelemy to maintain that placing the X-30 into orbit no longer was necessary to prove that the tools existed. However, in their study of options to the X-30, all of the contractors maintained that they needed almost a full-scale aircraft traveling at above Mach 20 to ensure reliable predictive tools (see Fig. 5.6, “X-30 Options Study Results [Mach #/Size]”). Any hope of building a subscale X-30 vanished with those reports.

Contrary to the hopes of many in the program, and at NASA Langley in particular, the further the contractors had gotten into the designs, the *less* confident they had gotten in predicting general performance from specific data points. Whereas Colladay and others had expected that unraveling the basics of hypersonic airflow and combustion would open new worlds of understanding high speed Mach flight, the contractors discovered that uncertainties existed at many data points, and worse, that the uncertainties changed. Nevertheless, the unsustainable cost of building the SSTO vehicle mitigated against the original NASP goals of building two aircraft, one of which would be SSTO capable, and pressured the contractors to accept the incremental strategy.

Prioritizing the technical work had to emphasize the evolution of a safe, robust operable flight test in a minimum weight vehicle. Engine design prioritization emphasized high speed first, then work on low speed, then finally, if resources allowed, mid speed. Airframe design had to start with the flowpath definition, then tailor the airframe and engine to the necessary

	GD	MD	RI	Government
Propulsion	18/0.9	15/1	25/1	15/0.9-1
Structures/ Materials	18/0.9	15/1	25/0.7	8-15/1
Aerothermo	18/0.9	15/1	25/0.7	15-18/1
Controls	16/0.9	25/1	25/0.7	15-25/1

Source : File G-159, Lt. 61. Wierzbanski's Files, Building 39, WPAFB
 * 1=4 x Payload

Fig. 5.6, "X-30 Options Study Results (Mach #/Size)"

flowpath. The contractor team, of course, would decide the configuration.¹⁶ In the summer of 1990, as the team had started its informal meetings, the program briefed the Steering Committee on the incremental approach and received the committee's blessing.

By that time, the JPO knew that anticipated savings from team formation that Barthelemy and others had counted on to reduce some of the program costs had not appeared. Even if they ever came, such savings would be well in the future. Consequently, the program started to strip away everything from ground support to test activities that did not directly and immediately contribute to getting the first X-30 off the ground. But that, too, had been stretched out still further into the future, first with the Space Council's 2 1/2 year schedule slip, then with the nine-month lag related to teaming. By 1991, the program struggled to show any kind of first flight before the year 2000, and the SSTO flight already had slipped to the year 2002. While a politician might get some mileage out of local NASP work, only a handful of districts got enough work that a politician could make political capital out of NASP. Meanwhile, the contributions to science as far as the public was concerned languished somewhere near that of the supercollider. The delays---which NASA, DoD, and virtually all of the outside advisors had applauded, actually further eroded NASP support on Capitol Hill. Only later did many in the program admit that flying something---anything---even if the aircraft did not come close to orbit, would have generated immense political capital.

Most of the influential people in the program---Barthelemy, Waldman, Wierzbanski---shared the opinion that the flight of an X-30 airplane, even if it was at low speeds for short distances, would be a huge psychological bonus. Repeated budget cuts, schedule stretches, and general instability had taken their toll, however, and with the adoption of the incremental

approach over a longer time frame, the program had opted for higher overall costs traded off against an earlier first flight by an X-30 aircraft. That did not solve the issue of what kind of aircraft the government (particularly the Air Force) thought it was buying. The program still did not have a reliable cost estimate---how could it when the baselines and schedules shifted like sands---nor did it have clear political guidance as to whether it had to have one aircraft or two, full scale or subscale, SSTO or not. In short, by 1991 the NASP program was flailing about, desperate for guidance as to what Washington expected and would fund. But the legislators and bureaucrats who shaped the nation's budgets, not to mention the Air Force and NASA themselves, were divided on what they wanted.

Inside the JPO, that confusion translated into a steady stream of "options" briefings, laying out (often with considerable bluntness) the schedule and cost of different program options. Privately, the JPO hoped that the Steering Group, the Air Force, and Congress would see that the original plan of building two full-size aircraft and taking one of them to orbit was too costly and time-consuming. Barthelemy and Wierzbanski in particular wanted to receive direction to focus the program on a subscale, non-SSTO aircraft that would fly to Mach 15 and produce the data necessary to build a follow-on SSTO-capable airplane. That strategy demanded that the Washington community back off from the SSTO mission of NASP and redefine NASP only as needing to "prove the technologies" needed to reach orbit, not actually reach orbit. Accordingly, the JPO gradually shifted its focus from entering Phase 3 to one of exiting Phase 2---in other words, defining exactly the requirements a vehicle design would need to meet to ensure a positive Phase 3 decision. That allowed, for example, program management to set both a "goal" and a "threshold" for gross weight, type of fuel, and other operating conditions (see Fig. 5.7,

	Goal	Threshold
Total Operating Gross Weight With Margin	325,000	425,000
Margin Percent Of TOGW	30	30
TOGW Without Margin	250,000	325,000
Fuel	Slush H ₂	LH ₂
Reusable Structural Design Life	Per SOW	Complete Envelope +255,580
Materials Available	No Vehicle Upgrade To Achieve TOGW Or Life	Secondary Aircraft Structure And/Or Replacement Engine Upgrade To Meet TOGW And/Or Life

Source: File G-171, Col. Wierzbowski's Files, Bldg. 39, WPAFB

Fig. 5.7, "Exit Criteria"

“Exit Criteria”). In that way, the program could claim to be on target (by meeting the threshold) for “exiting Phase 2” and still fall considerably short of the requirements to ensure a successful SSTO program for Phase 3. It did permit the JPO to clarify more clearly what still needed to be accomplished by the contractors, but it had the appearance to outsiders of playing definition games.

NASA, meanwhile, had started to reconsider its own commitment to NASP. The agency's long-term, overarching project, the Space Station Freedom, had itself developed budget overruns, and the once-predicted price tag of \$8 billion was neither accurate nor supportable.¹⁷ A fundamental problem still plagued NASA---one for which the aerospace plane originally had been conceived to solve---in that NASA had no routine space transportation system. The Shuttle fleet depended on the vicissitudes of weather, and each vehicle took months of preparation before a launch. Asked one member of the JPO, “If this [shuttle] system really was routine, do you think you’d see people cheer and cry every time one goes up?” Indeed, the launch of each shuttle orbiter more resembled the launch of the *Queen Mary* more than a delivery truck leaving the warehouse (as proponents of the shuttle once had likened it). Increasingly, Congress sought to make NASA commit or abandon NASP: it put language in the FY91 funding that tied the total amount that the Air Force could commit to the amount provided by NASA.

While the JPO attempted to provide options with a budget that Washington would find acceptable, and while NASA struggled to maintain its funding commitment, the contractors had quietly arrived at a composite configuration.¹⁸ In June 1990, the contractor philosophy meetings had produced a guidance document for the configuration process. That document recognized that “none of the present configurations are best” and that the new baseline vehicle had to be “clearly

superior" to any previous design."¹⁹ The configuration strategy already had accepted the incremental approach, and contained restrictions against changing primary engine or airframe materials, the overall dimension of the final engine, or pursue duplicate programs for subsystems. Total gross weight had to include a 30% margin, but remained to be determined, although the threshold for exiting Phase 2 was a hefty 425,000 lbs. The aircraft could utilize an independent rocket system, but had to retain emphasis on the airbreathing system for the main propulsion. All materials had to meet the schedule based on an initial 1997 first flight, and orbital flight by 1999. Use of slush hydrogen, a baseline for the composite configuration, was not a requirement on the non-orbital flights. Finally, the aircraft had to be controllable with and without powered flight.²⁰

Most important of all, planning documents reflected the conclusion that management had to make fundamental design decisions soon on a number of fronts. But the contractors found that in many cases their designs were so incompatible that they had little common ground. Indeed, the "dirty little secret" of the team agreement had started to surface, namely that the contractor costs never fell, and the savings from duplication and "triplication" (a favorite JPO term) never materialized. As Vince Rausch noted, "The contractor team costs were too high, and we never got the overhead down."²¹ But, he noted, the necessity for future competition (which Rausch had traced to Assistant Secretary of Defense John Betti, who had presided over the ASP) had "led to inefficiencies in the team."

Regardless of whether immediate savings from the team appeared, design improvements were appreciable. Waldman and Barthelemy agreed that the flat forebody of the MD and GD designs was the best place to start; and that decision set parameters for drag, lift, and other factors. And the program did see some benefits to the team formation: Berwin Kock, the

Associate Deputy for Phase 3 Planning sent the JPO a message that "some of the synergism hoped for is becoming realized. The process used to get to this [design] decision appears to have worked well---it resulted in a win/win environment for the companies and individuals involved."²² Unable simply to merge many points in the design, Waldman, with the support of the JPO, opted for a vehicle that had many of the characteristics of the MD design. By October 1, 1990, the team agreed to those preliminary decisions (see Fig. 5.8, "X-30 Composite Configuration"). Thus, ironically, Waldman's first major decision as team leader had been to select a competitor's design, or, at least, the major elements of it.

Other companies' work also found its way into the design, however, a fact that Waldman hoped would allow each company to call the composite configuration its own.²³ The contractors, however, often saw things differently. Engine configuration, which had to combine two engines tailored to entirely different speed regimes, finally resulted in a flowpath called the "01" P & W-based flowpath with Rocketdyne technology transfused, and the "03" that was a Rocketdyne flowpath with P & W technology. Since combined teams worked on each, and since the JPO gave each team a list of the designs' deficiencies, the decision shifted from parochial company designs to competing team designs.

Ultimately, the engineers settled on the "01" design, but even more simplified than originally presented. Although the engine resembled a P & W design, it contained significant amounts of Rocketdyne's concept and technology. The team also arrived at a three-engine baseline, although each engine had to stand alone as a unit, including pumps, valves, flowpaths, and structures. Establishing ten selection criteria for the engine, the team presented an initial version of the engine to the NPO in December 1990, marking the first totally integrated plan

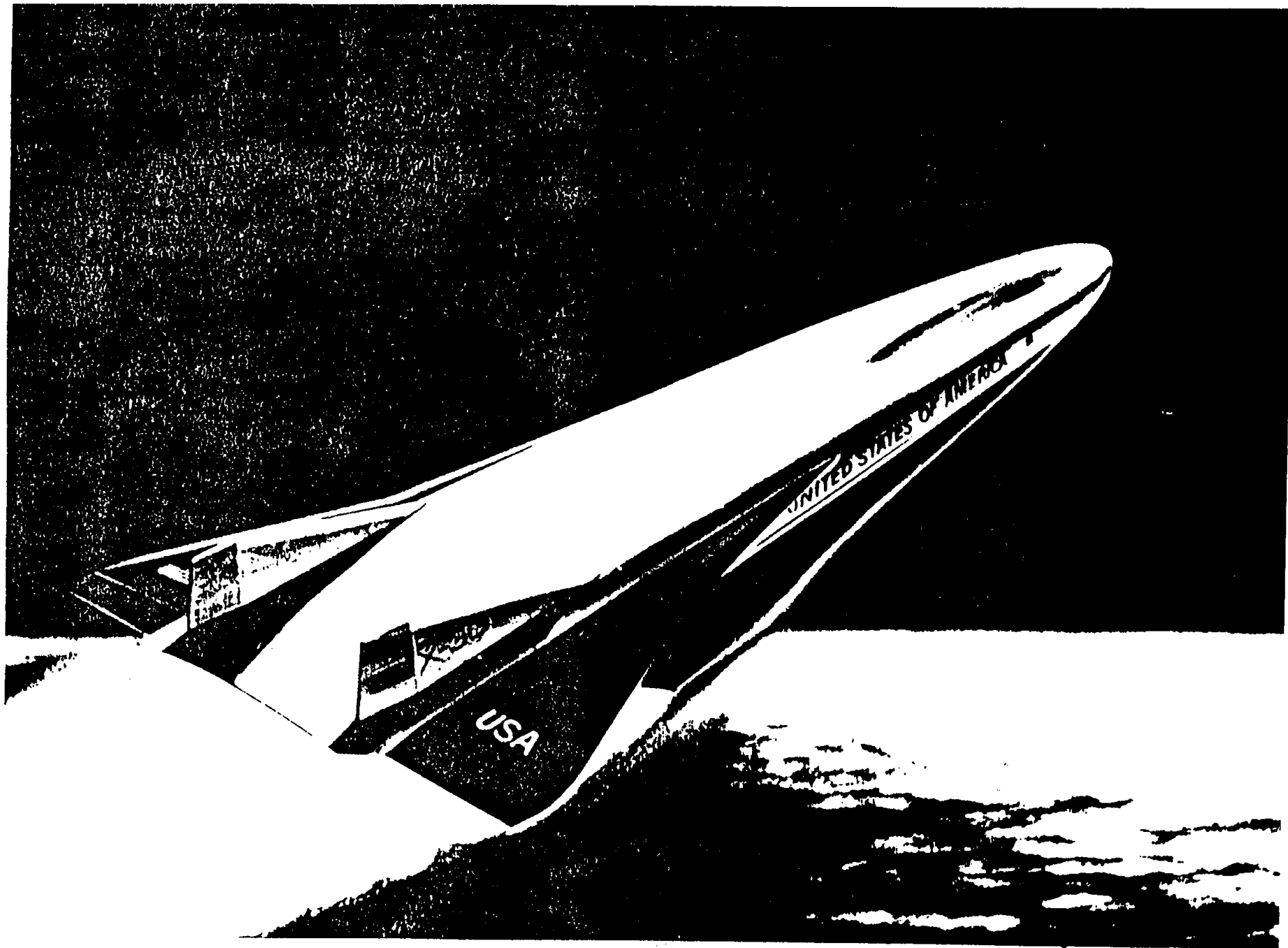

F-59 USA-19

prepared by the team. Despite its flaws, the engine plan stimulated a number of questions about ground rules and real requirements, and most insiders admitted that the hybrid engine surpassed either of the two company-specific designs. More important, the engine team had grown close, and Waldman had ceased to receive phone calls from each contractor about the other.

Success in arriving at a team design, however, had not come without cost: JPO engineers estimated that the program may have lost a year's worth of technical and design refinement. No one doubted that, in hindsight had the program simply selected the front running engine and airframe companies in 1989 and refined the designs, the NASP would have been much further along in its development. The central question remained, however, whether any *one* design, no matter how refined, could have made it to orbit. Barthelemy had his doubts, indicating that each existing configuration had serious deficiencies. But other setbacks had occurred with teaming, some less visible than the schedule slippage. Each company lost talented employees who did not want to work in a cooperative situation: according to the JPO's Chief Flight Systems Engineer, Dick Dyer, "People did not have confidence in [other contractors' designs and] systems."²⁴ Dyer thought the technological benefits of teaming were "minimal," and others in the JPO, while less direct, implied that the program had not gained as much as hoped by team formation.²⁵

During the design process, many hoped to attain benefits from team formation that exceeded the narrow design schedule. By making the contractor a part of the process, the NPO knew the budget numbers and status as well as the government. It did no good to try to gain "position," for the budgets were apparent to everyone. Instead, the contractor had to work with the government to arrive at the most manageable and attractive program. In addition, it is doubtful that any contractor would have put in further financial contributions on its own after its

competitors were eliminated. Consequently, though some claimed that the government had benefitted from the competitive stage to the extent that the companies had subsidized the research, it was unlikely that the government was ever going to see continued investment on the part of the winning company after the downselection, and therefore it is equally as unlikely that Uncle Sam lost further contractor investments by forming a team. Indeed, the feature that encouraged the contractors to invest in the first place was the relatively high payoff of winning the X-30 contract and the advantages such a contract gave the winner in the bids for NDVs, all working through the vehicle of a fixed-price contract. But based on the cost fluctuations of the NASP, it is entirely likely that the NDVs would have been "cost-plus," and therefore the government never anticipated seeing any savings on that part of the program anyway

The work on the composite configuration had started long before the contractor team had a new contract, which did not arrive until January 30, 1991, when the JPO awarded the new contract to the "NASP National Contractor Team." Signed by the CEOs or executive vice presidents of all five companies, the contract held the contractors all "jointly and severally" liable for performance. Payment could not exceed \$502.6 million for Phase 2D, the restructured contract that completed Phase 2. The team, however, had to meet performance exit criteria established by the JPO to obtain the award, and it was unlikely that the team would attain 100 percent of the contract in the first few fee periods. Among the deliverable work or items in the contract, a Phase 2D technological effort, data, software, special studies and test articles were considered the most important.

Design Developments and Weight Growth in the X-30

By March 1991, the engineering team reached a decision on the X-30's structure, with the central question involving the integrated tank from the GD design and the MD non-integrated tank. Although the integrated tank had to withstand wider fluctuations in thermodynamic temperatures and pressures, the contractor team concluded that it should plan on using an integrated tank. The tank discussions soon were overshadowed, however, by rapidly rising weights throughout every element of the vehicle. As early as 1988, every one of the airframe contractors, and even the government's own revised "baseline" design, was heavier than the du Pont/DARPA baseline (see Fig. 5.9, "1988 Contractor X-30 Weight Comparison"). With the exception of the government revised baseline, which came in at approximately 80,000 lbs. total gross weight, the contractor estimates differed dramatically from the du Pont/DARPA vehicle weight of 50,000 lbs. For example, RI approached 200,000 lbs. in weight, while the heaviest airframe, Lockheed, soared near 350,000 lbs., all of which represented estimates made before test instrumentation and margin were added. Nevertheless, the JPO not only hoped for weight savings from the contractor team's refined designs, but *expected it*.

One factor that had allowed the du Pont design to appear so light was the absence of any margin for error, especially in fuel capacity, but also throughout the working systems. In other words, du Pont assumed a vehicle that would reach orbit on its last drop of fuel, and one in which there would be absolutely no inefficiencies in any system whatsoever---no clogged lines, no sticky joints, no malfunctioning valves or combustors. Or, more bluntly, du Pont assumed a completely idealistic and unrealistic, even perfect, aircraft. Addressing such issues was a primary

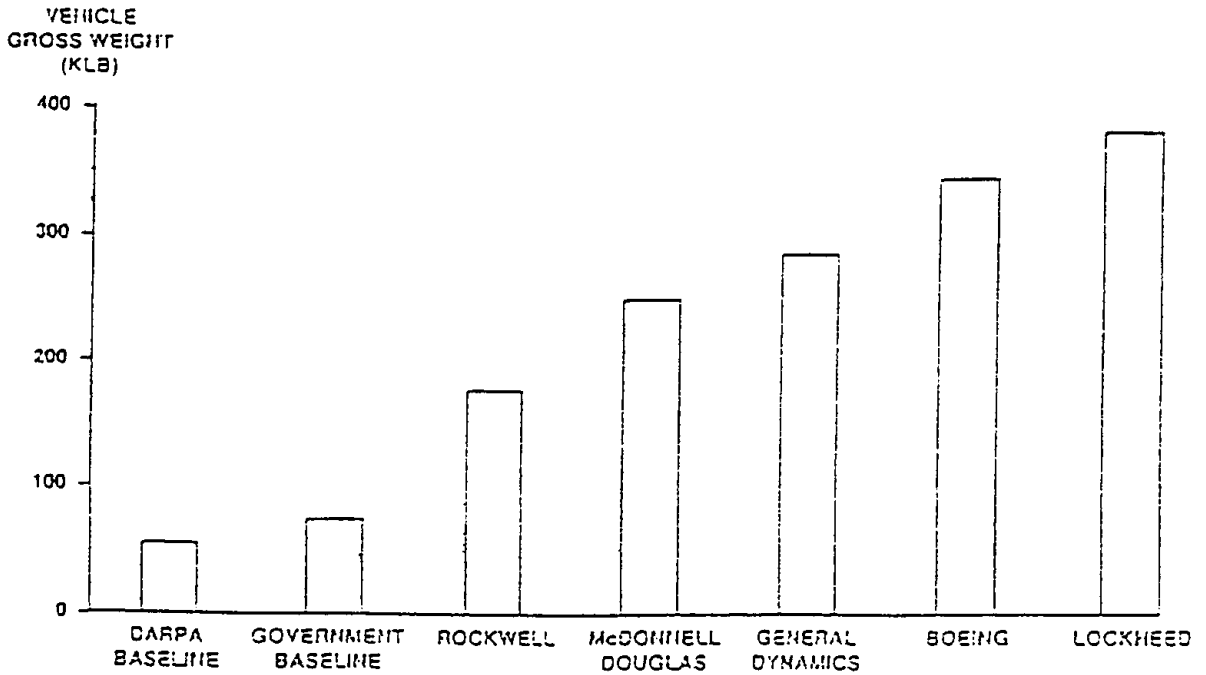

Fig. 5.9, "NASP Contractor Weight Comparison (1988)"

Source: R.L. Chase and M.H. Tung, "A History of the NITSP Program from the Formation of the Joint Program Office to the Termination of the HYSTP Scramjet Performance Demonstration Program," AIAA Sixth International Aerospace Planes and Hypersonics Technologies Conference, 1995 (AIAA-95-6031), 6.

function of the contractors, then later, the NPO. Working independently, each group in the NPO had built in extra margin. When combined, the cumulative design combination was so heavy that Waldman labeled it "a dog," while Barthelemy called it a "pig." Both Waldman and Barthelemy knew that the weight estimation measures were first attempts, and were vastly overblown, they nevertheless wanted to avoid having to acknowledge that weights had soared far above the unrealistic 50,000-lbs touted by Williams. Concerned that that outside sources might get word of the "pig" design, the NPO immediately tasked Chief Engineer Armand Chaput to assign weight allocations to each unit, and to remove all margin from the aircraft. The weights improved, and by February 1992 Waldman reported that the team was "in the ball park" on weight, with most of the estimates coming in at 500,000 lbs.²⁶ Indeed, the JPO's chief engineer, Bill Imfeld, thought that the "zero margin" approach might result in an aircraft below the weight goal, but that the reality of materials would finally push weight back up, if only slightly above original projections.²⁷

By 1990, the weight growth had so concerned the congressional supporters that \$2 million was authorized in the FY91 budget for DARPA to conduct an independent NASP configuration study.²⁸ DARPA contracted none other than du Pont Aerospace to "reconcile" the NASP team configuration with the government baseline vehicle "insofar as vehicle take-off gross weight . . . is concerned." Du Pont's supporters in Congress had, in the opinion of many NASP insiders, lobbied heavily for years to get back into the program, yet according to a NASA internal review of the du Pont paper, "We in fact have found little evidence that du Pont Aerospace has reacted to the technical findings surfaced by the NASP program during the past few years."²⁹ Du Pont had gotten his weights down, according to the NASA reviewers, by skimping on design

fidelity and by using an “overly optimistic” estimate of engine and vehicle performance. Despite the fact that the government design had soared to more than ten times that of the original du Pont projection, NASA pointed out that the high levels of integration meant that a slight negative change in *any* performance parameter had cascading effects on weight throughout the entire system. RI’s design, for example, could have saved 50% of its weight if the original du Pont estimates were used. Yet the government researchers found that, with then-current materials, even the original du Pont baseline design would increase to 110,000 lbs., and, the evaluation concluded, still would not make orbit. The review cited more than a dozen areas that the du Pont design either had ignored or miscalculated, including “trim drag;” nozzle drag; failure to include weights associated with “detailed designs,” including hinges, fairings, and joints; weight allowances for avionics and subsystems; and others. Drag issues alone caused weights to soar. NASA concluded that “Based on comprehensive JPO assessment of prior evaluations of the duPont Aerospace [design], plus our own JPO comparisons of the . . . NASP contractor design and analysis . . . the overwhelming evidence is that a 50,000 lb. [SSTO aircraft] is not viable and is lacking in credibility.”³⁰

The NASA review of du Pont’s “reconciliation” document represented only the most recent technical denunciation on the design that started the NASP program. Despite the harsh and unequivocal language in the review, du Pont still could sustain important support on Capitol Hill. He would return.

Team Progress and the Interim Award Fee

In April 1991, the team ended its first nine months together. During that time, it had given birth to a vehicle design, forged a unique operating and management structure, and successfully planned its transition from a group of competitors to a single entity. At the point of the first Interim Award Fee---the first real evaluation of the team---the team had performed at the levels of "Very Good," an assessment that indicated the JPO's appreciation of the difficulties of team formation. The JPO expressed its satisfaction on a number of issues, but made it clear that the first set of test plans had not been specific enough, nor had they measured as the JPO wanted. On the other hand, as one member of the JPO put it, the directors sent a message to the contractors that "You're teamed now. There's no excuse. We should get good test plans from here on out." Still, Waldman had insisted that the JPO "Be honest," and the JPO, while praising the efforts of the team, expected greater aggressiveness to regain the momentum lost in the team formation process.

Under the surface of the Interim Award Fee, though, both the JPO and NPO grew increasingly concerned about aircraft weight. Bearing in mind that the original du Pont aircraft was a 50,000-lb-fantasy., the composite configurations' weight estimates nevertheless had soared into the equally fantastic heights of 800,000 lbs., depending on the data used to estimate the weight. Armand Chaput, who had undertaken the task of getting the weight out of the first composite design, had set a goal of 300,000 lbs. for a "zero margin" aircraft, meaning that there would be no extra fuel for reaching orbit, conducting any last-minute maneuvers, or adding safety levels to the minimal performance goals. Engineering groups at the NPO and JPO set more

attainable weight targets of 425,000 lbs., but still admitted that given the schedule, such a goal remained out of reach. Barthelemy looked at the weight more philosophically: "A goal is a goal--designs can change if they are too ambitious. And you should have ambitious designs, otherwise, what is there to work toward?"

Neither the contractors nor the JPO conceded the weight issue, and work continued on shaping the body and the auxiliary wings, and on reconfiguring the landing gear doors. Perhaps more important, weights on the first vehicle using the incremental approach might have little relationship to weights on the SSTO aircraft. The incremental approach stressed using existing materials and technologies (as much as possible) in the first aircraft, then modifying the second. By the time the contractors were ready to start fabrication on the second aircraft, however, work on lighter materials and components might reach fruition; and at the same time, redundancies in the system would be identified.

Technical Progress Toward X-30 Fabrication

Aside from the weight---which became a crucial issue---the team made steady and impressive technical progress. In May 1991, the team started design of the deliverable hardware for the thermal protection system, and MD completed its first test series on the integrated fuselage tank.³¹ Among the advances made in June, the team conducted a concept validation of an advanced heat exchanger unit, introduction of which could save 700 lbs. in items such as turbo pumps and gas generators related to the Life Support System.³² Slush hydrogen production commenced the second week in June, and marked one of the first tangible products of the

program that could be carried over into Phase 3 exactly as it stood.³³

The most critical technology issue, however, remained engine performance. Although the JPO representatives at the NPO assessed the "engine development plan [as] about right," virtually no work had occurred on the low speed system.³⁴ An integrated scramjet had been tested to Mach 8, and wind tunnels were available for use, with conceptual design configurations tested to Mach 10. One of the most important test articles, the P&W one-sixth scale scramjet, accomplished more than 170 runs totaling 90 minutes of test time from simulated speeds of Mach 4 to Mach 7. Rocketdyne had tested a quarter scale engine to speeds of Mach 7 at NASA Langley. Meanwhile, combustion data on X-30 type injectors was obtained at a simulated flight Mach number of 10 at the CALSPAN 96" shock tunnel in Buffalo, New York. That testing involved relatively large scale (50% size) sectors of the combustor and nozzle. During 1991, the CALSPAN facility and the engine model were both upgraded to allow testing from Mach 8 through Mach 16.

Inlet performance tests required large scale facilities that did not exist when the NASP program started. As the program invested in those facilities, inlet tests at NASA Lewis Research Center demonstrated the feasibility of a high performance configuration. During 1990, NASP two- and three- dimensional inlet concepts also were tested successfully at Mach 10 and Mach 14. Further testing of other candidate inlets continued during 1991, which resulted in a high degree of confidence in CFD analysis that would be used to predict propulsion performance at other points in the program.

Progress occurred in testing the integrated fuel tank, which met a critical milestone in January 1990 when the tank, filled with liquid hydrogen, sustained structural temperatures to -

300 degrees F. Curved titanium matrix composite fuselage panels had been spot-welded successfully, and the tank was integrated into the fuselage section with no difficulties. A large scale cryogenic tank was scheduled for assembly in late 1993, with its structural test to occur in mid-1994.

Propulsion-related advances included progress in the nozzle applications of CFD. Code-to-code comparisons, which would provide the basis for code-to-experiment comparisons in late 1992, were slated for early 1992. Likewise, slush hydrogen technology also had moved along on schedule, with a system operation demonstration scheduled for October of 1992. The CFD plan had solidified, and NASA researchers especially found that their predictions based on CFD programs matched actual test performance. In some ways, CFD code validation came along even faster than hoped at the outset of the program, a factor that encouraged NASA and JPO officials to support the “incremental approach” with even more enthusiasm.

The contractor had completed a number of tests in the area of materials. Subsequent technology tasks included developing a coating for combustors, inlets, and nozzles. Where damage to the coating had developed, the contractor had started to assess the damages. Overall, the program's tests had developed confidence in a hot fuselage structure and had demonstrated a large-scale tank system. Engine systems had shown the importance of emphasizing the integration in the engines, and had revealed some weaknesses in the structures. Vehicle subsystems would continue to stress the use of existing subsystems and would accept a compromise for lower weight or performance if it meant lower cost. The program planned to use existing rockets, reducing the need for expenditures to develop new rockets. Measured against the exit criteria, the first design cycle achieved an important milestone by arriving at a concept

selection. The size of the vehicle would accelerate that design maturity. Engine component performance had proven encouraging, although unlocking the puzzles of a fully integrated engine remained a challenge. Structures approached a point where the engineers could validate them; materials progress had come more slowly and the Quarterly Technical Review suggested that the program might require "conventional materials," even if it had to obtain them at a price in increased weight or reduced performance.

Based on the technical progress, planning sessions at the JPO and NPO led to a strategy of freezing the design as soon as possible; working to ensure that vehicle #1 had sufficient design margin; having the design team focus on the SSTO vehicle; and tasking a "trade study team" to develop a "technically smart" incremental program. The incremental development strategy involved featuring common items between vehicle #1 (approximately Mach 15 or higher capable) and the second vehicle (SSTO capable). Although no one wanted to use the term, the first vehicle gradually received the appellation "X-30A." In that manifestation, a liquid oxygen system would replace the low-speed system, use existing subsystems, and provide hard points or plumbing for "strap ons." The second vehicle (or, as some people called it, the "X-30B") would feature the SSTO engine, optimized active cooling, and improved subsystems.³⁵

Technical Reality, Schedules, and Budgets, 1991-1992

Without any doubt, the hypersonic technology base had improved a hundred-fold since the program's inception. In some cases, such as the fuel tank and some wing panels, fabrication had taken place and the program had tested actual articles. Substantial advances had occurred in

the entire engine cycle. But for all the progress in inlets and combustor design, fuel tanks and CFD codes, materials and liquid hydrogen fuel, during 1991 a sinking reality started to settle in with the contractors and the government: the scramjet was nowhere near to the necessary performance that the X-30 would require, and still far from where it was anticipated to be in 1986. That grim admission showed up first in the constantly revised schedules that pushed back first flight from the mid-1990s to the late-1990s and---most predicted---a more realistic first flight date of 2005 or later. In June 1991, for example, the JPO and NPO held an integration meeting and the subsequent schedules that skipped back and forth across FAX machines contained "unofficial" first flight dates of 2001-2002. Politically, flying after the turn of the millennium left NASP unsupportable. Few serious Washington players wanted to back any program which had its first visible payoffs 15 years in the future. Consequently, the NPO refused to concede that late a date, and with considerable juggling, managed to move a first flight date forward to 1999. But attaining even that flight date required an excessive amount of program funding to be spent in the early part of the schedule, essentially "front loading" the budget with money the program certainly didn't have.

Such a schedule conflicted with a second perceived political risk, namely a single year budget of no more than \$1 billion. Internally, the Washington NASP contingents considered \$1 billion in a year to be what one director referred to as the "scream level," pitting the multi-year schedule against the single year budget ceilings. Other budget realities combined to make the picture even more foreboding: with each year added to the schedule, and with each dollar spent later rather than sooner, inflation threatened to push up the total allocations still further.

Increasingly, the JPO rested its hope on the contractor team, looking to the NPO to

redeem part of the schedule through substantial cost reductions in management efficiencies.

Waldman touted the team's cooperation and ability to coalesce, and in some areas the contractors had made great strides in working together. On the other hand, even Waldman admitted that the "ability of the companies to take responsibility for each other's work," a key component of the division of labor, remained a "mixed bag."³⁶ Barthelemy questioned whether the "bucket" approach had actually reduced accountability and efficiency, and Vince Rausch more bluntly noted that the "contractors never operated as a team."³⁷

Perhaps more damaging to the idea that the team organization could achieve major gains in making up lost time, the NPO suffered from indecisiveness when Waldman was not present, with the management structure having holes in the chain of command. Waldman had proven irreplaceable; but when he was out of the office, the JPO and contractors alike argued that no one remained who had decision-making authority. Although NPO reorganizations finally corrected that shortcoming, the contractor team came nowhere near the "skunk works" model that the JPO had once hoped to achieve.

The Incremental Approach Becomes the "Two-Aircraft" Approach

As a remedy for almost all of the schedule and budget problems, the JPO increasingly had started to advocate a different program from the two full-scale-aircraft SSTO program. During its many "options" studies, the program looked at combinations of a subscale, non-SSTO aircraft with a full scale SSTO second aircraft; a non-SSTO aircraft, proceeding directly to NDVs; or a full scale, non-SSTO aircraft followed by an SSTO vehicle. The essence of those studies

involved identifying a mid-point aircraft that the program could afford to build and fly. While, in some cases, falling well short of SSTO speeds or performance, nevertheless would validate many of the technologies necessary for SSTO. Such an interim vehicle would be subscale (most design estimates suggested a one-third aircraft), and would focus on the Mach 12-15 flight regime. In all likelihood, the interim aircraft would be remotely piloted, perhaps launched from a B-52.

Some, including NASA's Bill Piland, disputed that the program could learn much at all from lower-speed Mach flights. "How a scramjet works above Mach 10 was the issue," he noted, and the physics of gaining each additional number of Mach speed demanded exponentially greater performance from the scramjet engine.³⁸ Piland had long advocated focusing the research on a non-SSTO, Mach 8-9 scramjet powered aircraft.

Without abandoning the goal of SSTO, NASP program management ultimately endorsed the subscale, Mach 12-15 stepping-stone aircraft, which it labeled the "X-30X." It represented a design substantially similar to the X-30, but scaled down. Rather than three engines, the X-30X would feature two. Otherwise, the aircraft would need the extensive net of support facilities---almost as many as demanded by the SSTO variant, including laboratories, aircraft storage and construction sites, fuel handling and processing facilities, and test and tracking networks. In all likelihood, those costs would push even an X-30X option close to the "scream levels" that the JPO had to avoid.

NASP management, including Barthelemy, Wierzbanski, Waldman, and, at NASA, the new NASA Administrator Richard Truly (1989-1992) and veteran Langley people at the JPO, such as Jim Arrington, all came to the same conclusion. A set of inflexible restraints had made it impossible for the program to live within the emerging budget levels. Such a requirement, then,

in practical terms dictated a number of other requirements, including multiple aircraft, total systems (ground/air/space) installations and control, and, especially, safety and performance margin. Any one of those corollary requirements would have exceeded the \$1 billion annual spending "scream level." Taken together, the costs---as the JPO well knew by then---had risen so far beyond what du Pont and Williams had predicted that program management simply could not present briefings to officials in the Air Force, NASA, or Congress that contained the expenditures that the JPO had projected.

Ironically, Richard Truly, the NASA Administrator during this time, put the du Pont and Williams claims for NASP in a slightly different context. "Congress underfunded the program from the outset," Truly argued, "because Williams had made the technology sound easy to achieve."³⁹ "The program was kicked off as a fairly easy thing to do," he recalled, "when in fact it was one of the hardest technical challenges I've ever encountered."

Regardless of the immediate result on budgets, the long-term impact of the commitment to SSTO had boxed the program into a corner. Thus, on several occasions between 1990 and 1992, the JPO sought to finesse the barrier of SSTO demonstration by subtly changing the language to read "demonstrate the technologies necessary" for SSTO. A "demonstration" of that type could come any number of ways. For example, the program could hold several smaller demonstrations of individual technologies, such as slush hydrogen production, storage, and operation. Or, more crucial to the program, a demonstration of a subscale scramjet could be performed using missiles to launch the scramjet to predetermined altitude, then have a powered flight. The key concept involved the fact that demonstrating technologies could yield a level of confidence in a final integrated aircraft.

In short, the JPO had shifted its ground by trying to accomplish the mission without building and flying an entire aircraft system, in essence abandoning the principle that had resulted in such divisions among the sponsors several years earlier. Whatever hope the original founders of NASP held, the goal of actually flying a manned aircraft from a runway into orbit, given even optimistic estimations of the dollars available, had become a distant dream. By early 1992, proponents of NASP, including those in NASA and the Air Force who wanted to keep it alive to move closer to that dream, realized that the best they could hope for was funding of a set of steady, incremental tests of the technology well short of flying an X-30.

Management and Technology at the NPO

The program did have a strong position with which to argue for funding of that nature: technology had advanced consistently at the NPO and the NASA labs, although somewhat slower than everyone had anticipated. Even Waldman had underestimated the difficulties of getting the engine companies to cooperate in their tasks and by March 1992, he concluded that "the engine companies do not work well managing each other's efforts."⁴⁰ Fundamental differences in philosophy continued to fray at the edges of the relationship. P&W, long an airline engine manufacturer, thought in terms of large production runs of 100-500 items. That philosophy brought an emphasis on reliability and mass production. Rocketdyne, on the other hand, defined a high production run as 30 units, making the company emphasize performance.

To his credit, Waldman realized the "work bucket" concept did not function with the engine companies, and between 1992 and 1993 he restructured the work into single company

buckets run by each contractor, with integration issues handle through a single integration bucket authority.⁴¹ P&W led the flowpath work, and not surprisingly the NASP flowpath started to look like the P&W flowpath. Rocketdyne worked the physics and the systems.

Airframe activity worked better in the bucket structure, although a number of accounting and information transfer glitches still remained. Each contractor took responsibility for his bucket tasks, but all contractors had to have a presence on each task to "know what was going on . . ."⁴² The "work buckets" (or, in government terminology, Government Work Packages or GWPs) had more stringent requirements than previously had been imposed on the contractors.⁴³ A NASA review in 1996, commenting on the GWPs, concluded "From the contractor's perspective/point-of-view, the GWP process was considered innovative and successful However, from a Government technical community point-of-view, the cost, scheduling, and technology successes of the GWPs . . . at times came at the expense of other critical non-NASP research and were, for the most part, achieved in spite of JPO/NPO management structures rather than because of them."⁴⁴ To the JPO, the multiple contractor management structure in place before team formation implied redundancy and, in the JPO buzz phrase, "triplication." Waldman bowed to the JPO's criticisms on that matter and switched from a functional organization to an end item organization, wherein one contractor had responsibility for the entire bucket in accounting and management structure as well as work distribution.

All of the reorganizations slowed, but did not stop, technical progress. By 1991 the contractor team had settled on the Titanium Matrix Composite (TMC) as the most important material to use in fabricating the airframe. The lower thermal toleration of TMC required an outer layer of carbon-carbon composites for thermal protection. Titanium Matrix Composites in

the center of the aircraft's structure still represented the largest target for weight savings, although the propulsion system constituted an exceptionally heavy element of the aircraft compared to other, traditional aircraft (see Fig. 5.10, "Material Breakout by Major Sections by Weight"). Adding another layer drove the weights up, and that, in turn, led the NPO to reconsider the design. Toward the end of 1992, the NPO created a "reassessment team" to review virtually all the design assumptions. "We needed to make sure we weren't in love with our own design," Waldman noted.⁴⁵ Armand Chaput headed the team, although he had a number of preconceptions and had his own stake in the composite configuration, whose design he directed. Eventually, the reassessment team arrived at what became known as the "02" configuration, which remained the contractor configuration to the end of the program. To keep the reassessment team on its toes, the NPO engaged the services of Johns Hopkins University researcher and hypersonics pioneer Fred Billig and the ever-present Tony du Pont. Berwin Kock coordinated the efforts of the two teams.

By that time, the program had prepared intricate plans for actually manufacturing and assembling the X-30 aircraft (see Fig. 5.11, "Airframe Manufacturing Flow," and 5.12, "Major Mate and Final Assembly"). At that time, anyone still uncertain about the complexity of the program doubtless understood the highly dependent and interrelated nature of the subcomponent work, the materials advances, and the necessity for advanced welding and fitting techniques. Nevertheless, due to other pressures, little attention had been directed toward the actual assembly methods, with only a few panels tested and even fewer hinges and fittings subjected to operational stresses. More important, the facilities to assemble and integrate the vehicle had substantial lead times (see Fig. 5.13, "Airframe Integration Facilities"), making them extremely sensitive to schedule changes.

	FWD	Center	AFT	Wing	Tail	Body Flap	Total
	(%)	(%)	(%)	(%)	(%)	(%)	(%)
Structure	5.295	27.923	16.915	5.109	1.661	1.386	58.289
TMC	1.397	10.243	6.002	3.832	1.246	0.922	23.642
TI	0.728	3.858	2.795				7.382
C/C	0.964	3.326	1.012	0.766	0.249	0.308	6.626
C/SIC-Lockalloy		0.421	3.012	0.511	0.166		4.111
GR/EP		3.076	2.126				5.202
AL/LI		0.649	0.427				1.076
Insulation	0.302	1.328	0.983			0.103	2.717
Other	1.903	5.021	0.557			0.053	7.534
Subsystem	3.563	7.294	3.078				13.935
Propulsion		25.767	2.009				27.776
Weight Empty	8.858	60.984	22.003	5.109	1.661	1.386	100.000

Fig. 5.10, "Material Breakout by Major Sections by Weight"

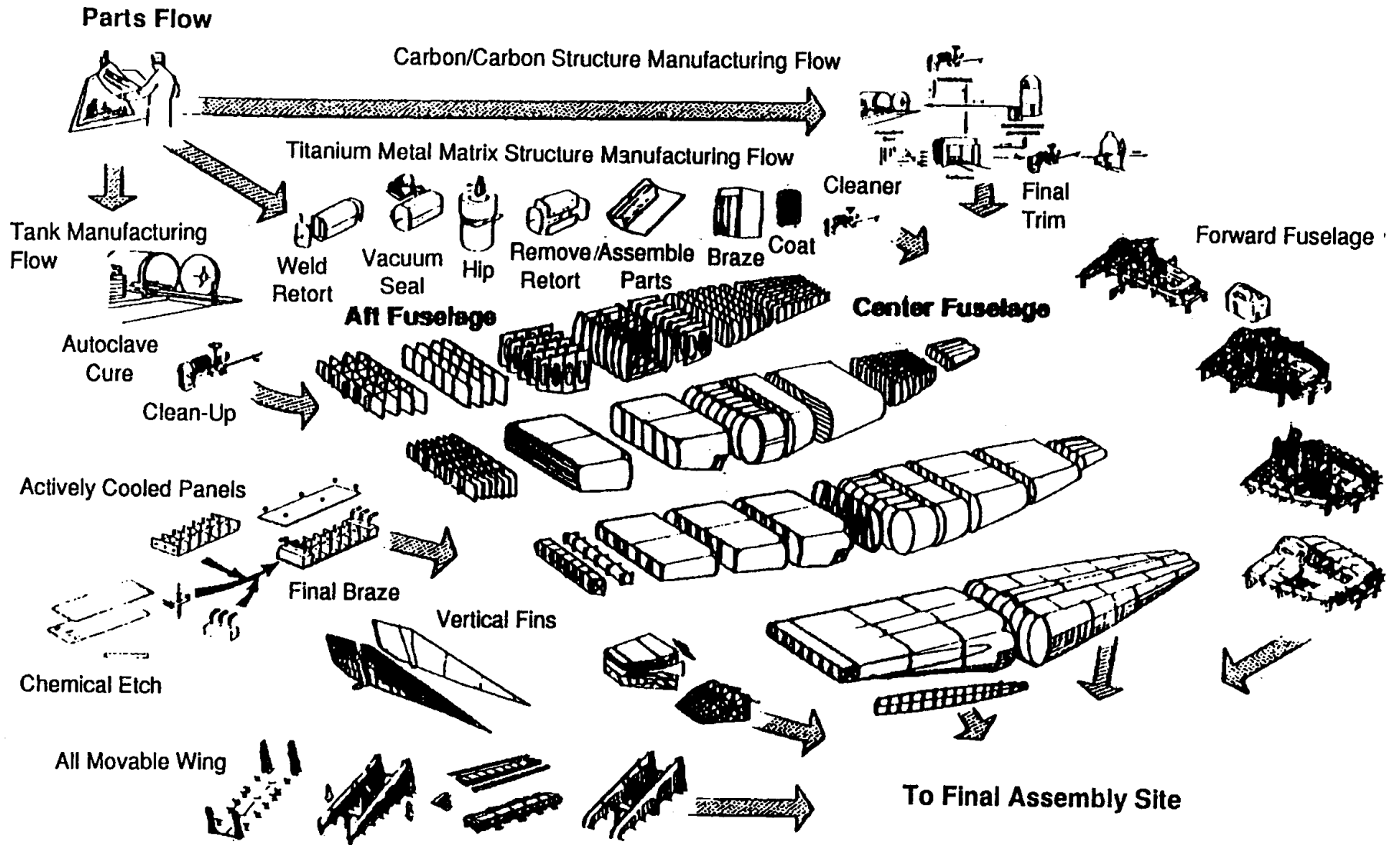

Fig. 5.11, "Airframe Manufacturing Flow"

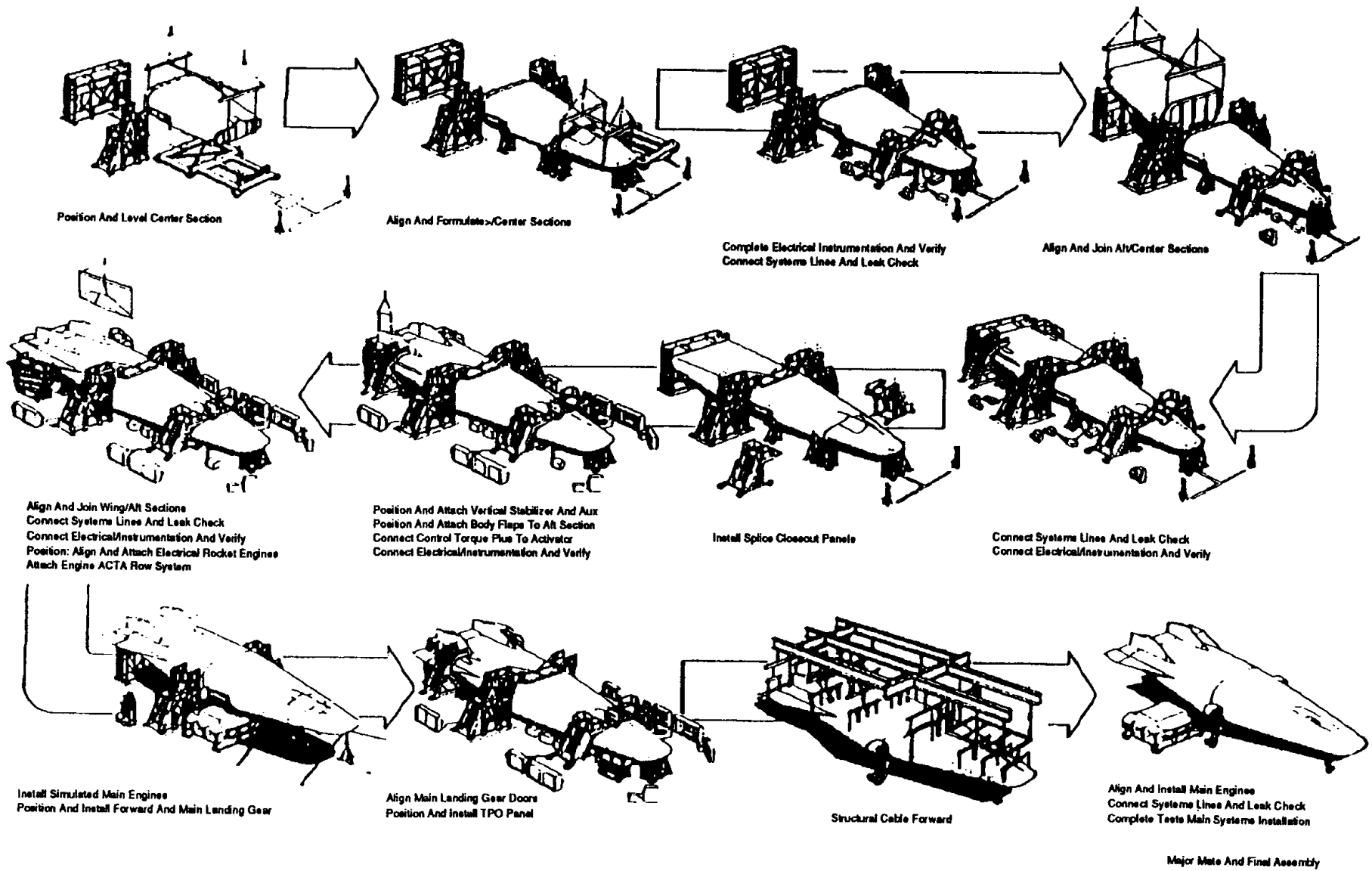

Fig. 5.12 "'Major Mate' and 'Final Assembly'"

Function Of Facility	Location	Area Sq Ft	Requirements	Facility Lead Time	Need Date
Carbon-Carbon Parts Fab	GD/ATCD/NAA	175K	Add. 15K Sq Ft Warehousing Lease Autoclave Size & Quality Control Requests Key.	30 Mos.	4Q 95
Graphite/Epoxy Processing	TBD	20K	Farm-Out Parts In Excess Of 15' x 50'. Autoclave	30 Mos.	4Q 96
Graphite/Epoxy Tank Parts Fab	TBD	130K	Add. 15K Sq Ft Warehousing Lease Autoclaves, Bonding Oven, Press & Leak Ok. Mobile Automated Ultrasonic Scan	18 Mos.	2Q 96
Titanium Metal Matrix Parts Fab	Textron	105K	Add. 25K Sq Ft Warehousing Lease. Expand From 20.	24 Mos.	2Q 96
Actively Cooled Panel Parts Fab	TBD	30K	1/3 Air Conditioned Clean Room	18 Mos.	3Q 94
Forward Fuselage Mfg	NAA	75K	Need Jigs, Fixtures, Crane. Toxic Environment	24 Mos.	1Q 97
Center Fuselage Mfg	MDC	75K	Need Jigs, Fixtures, Crane. Toxic Environment	24 Mos.	4Q 96
Aft Fuselage Mfg	GD	75K	Need Jigs, Fixtures, Crane. Toxic Environment	24 Mos.	4Q 96
Full Airframe Proof & Cable	EAFB	10K	LH2 & Load 20,000 Gal	24 Mos.	1Q 02
Full AF GVT & Crye Checkout	EAFB	16K	LH2 (50K Gal LH2 - 300K Gal LH2)	24 Mos.	2Q 00
Cir/All Fuselage Test	PMD/EAFB	5K	LH2 Heat & Load (30,000 LH2)	24 Mos.	2Q 99
Fwd/ Cir Fuselage Test	DFRF	2.5K	LH2 Heat & Load (20,000 LH2). At Site WVL	24 Mos.	2Q 99
Fwd Tank Proof Test	DLHSTF	2.5K	LH2	24 Mos.	2Q 99
Wing Heat & Load Test	WRL	2.5K	All Site DFFF	24 Mos.	4Q 97
Mfg Final Assy Test Facility	PMD/EAFB	139K	Assy, Insulation Installation, QA	24 Mos.	4Q 97
Major Assy (MOC)	PMD/EAFB	75K		24 Mos.	4Q 97
Major Assy (GD)	PMD/EAFB	75K		24 Mos.	4Q 97

Fig. 5.13, "Airframe Integration Facilities"

In the midst of the design evolution process, Congress started to cut the defense budgets. Between FY94 and FY96, NASP expected to lose \$345 million of its projected funding. Most of the cuts would hit the airframe, but virtually all activities would be hit: management would take a 25% cut; JPO activities a 50% cut; and all flight test experiments were eliminated. Even after those stiff actions, the JPO expected to have to cut \$12 million more to meet budget. Testing on the integrated fuel tank stopped in May, and the test article was removed and dismantled. MD made plans for disposition of the tank, symbolically a crushing blow given the fact that the fuel tank represented the largest single test item completed to that point. Test facilities themselves suffered. Testing at Marquardt was terminated in April 1992 and moved to Langley. Both Marquardt and Aerojet saw entire sections of work disappearing, and Aerojet had only a single contract remaining to complete a test rig for the program. Aerojet had a contract to create a High Heat Flux test facility to house the High Heat Flux test rig to test NASP actively cooled panels. With that contract gone, once Aerojet finished its work on the existing test rig it no longer would have any role in NASP.⁴⁶ Those cancellations, ended the participation of two of the original companies to analyze the du Pont design.

Closing some of the test facilities forced the JPO to make a deeper level of difficult decisions. Construction of test facilities required considerable time and advanced funding. One of the major benefits of the program to date had been the appearance of numerous hypersonic test facilities that dramatically expanded the nation's ability to conduct research at high Mach speeds. Indeed, as of 1991, Len Pohlar, the JPO civilian in charge of developing the facilities funding, explained "the facilities are ready to go, just waiting the 'go'" even as fundamental changes were occurring in the program that would establish different requirements (and, thus, establish

different needs for test facilities).⁴⁷ Different vehicle requirements could, for example, determine the pressure or flow levels that different engine test facilities might need to achieve.

The main facilities, the Aero Propulsion System Test Facility (ASTF) and the Engine Test Facilities (ETFs, at Aerojet and Marquardt) stood by, waiting to proceed. It took a year and a half from the time that they received authority to proceed until they would have their first actual test facilities ready. Thus, the first test date depended on that decision. Worse, the uncertainty over whether the program could get by with one aircraft or if it needed two had a crucial impact on facilities planning. A two vehicle program would need test facilities sooner, and they might not be available if delayed even slightly. Facilities budgets also represented a pool of funds that other groups in the program might see as "available" if it appeared they would not be used immediately. Once a facility closed, however, it was extremely costly to reopen or, in the worst case, rebuild altogether. Moreover, the schedule damage was virtually unrecoverable. JPO test directors had the difficult task of having to fund and build facilities that the program might not need, on the one hand, or possibly not funding critical facilities if the program took an abrupt turn, as it had in the past. In either case, the facilities development had to be perfectly in sync with the development of the aircraft, or one would sit idle until the other was ready.⁴⁸

Another factor started to affect costs by 1992. The JPO had developed its research plan, a critical document that established what technologies had to be measured and with what instruments.⁴⁹ In the narrow sense, any measurement instrument would add weight for itself and reduce weight that could be allocated to performance or margin. In a broader sense, however, the research plan forced the JPO to re-evaluate its entire schedule and strategy. If the most important research topic was performance and operability for SSTO, the program had to focus its design,

production, and test activities in such a way as to obtain data for SSTO performance. But the research team had to prepare for different program realities (such as a non-SSTO vehicle). The JPO had to determine whether it could obtain reliable data necessary for SSTO design at lower Mach levels. Again, though, a discrepancy in the program's documentation that had become imbedded at the outset was revived during the research plan discussion. The NASP had to attain orbit by flying through all flight regimes, if only for a few seconds. The research plan stated that the "propulsion system performance and operability must be defined and documented for all flight regimes."⁵⁰ But the phrase "all flight regimes" could be interpreted as only up to, say, Mach 15 if the research team determined that Mach 15 represented the last distinct flight regime in the vehicle's mission. It did not necessarily mean that the program had to *obtain data* at Mach 25; rather it had to show only that the Mach 15 data was reliable for predicting performance at Mach 25.

Determining what the program should research, then, depended entirely on what the program *was*, and by 1992 the program changed on a weekly basis to adapt to the ever-changing political shifts. Instrumentation again played a role at that point, because the engineers would have to take the necessary test instrumentation into account when completing their designs. If, say, a strain gage added weight to a design or reduced its performance, then the engineers would have to compensate for that *before* the final design, not after. But the engineers could not keep changing the requirements, instrumentation, and design infinitely, regardless of the politics.

Politics could not be ignored, of course. By December 1991, NASP funding stood at \$205 million for the FY92 budget. At that time the program operated under several mutually exclusive constraints: a \$1 billion funding level, first flight before the turn of the century, and a

demonstration of SSTO capability. A November 1991 briefing noted that "No program can satisfy all constraints simultaneously."⁵¹

Worse, NASA had promised to reprogram funding that was left flexible by Congress. According to *Aviation Week*, congressmen pressed NASA administrator Richard Truly to reprogram \$35 million of that flexible funding by Christmas, but most observers expected a sum closer to \$15 million to be reprogrammed.⁵² In fact, the program did not count on any significant reprogramming of NASA funds.

NASA's delays in reprogramming funds sounded alarm bells in Congress. On November 26, 1991 George E. Brown, Jr., the chairman of the House Committee on Science, Space, & Technology, and Robert Walker the leading minority member, as well as several other members wrote Vice President Dan Quayle expressing their concern over the NASP program's future. They urged Quayle, as chairman of the National Space Council, to "ensure that the NASP program is a well-coordinated effort," and to "encourage NASA to use the transfer authority provided in HR1988 to get NASP back on track."⁵³ Similar letters went to NASA Administrator Richard H. Truly from the committee and from one of its members, Dana Rohrabacher of California.⁵⁴ Rohrabacher urged that the Vice President, as chairman of the National Space Council, "hold Admiral Truly's feet to the fire and hold him to what he expressed to you in his October . . . letter on NASP."⁵⁵ Rohrabacher and Truly were not on the best of terms, with the former admiral considering the congressman one of those who had bought into the notion that NASP technology was "easy."⁵⁶

In a November 1992 point paper prepared by Don Dix, of the Office of the Secretary of Defense, Research and Engineering (Research and Advanced Technology/Engineering

Technology), for the Space Council, the schedule and funding effects of NASA's recalcitrance were spelled out clearly.⁵⁷ Continued reductions by NASA directly affected the schedule, which by 1992 did not anticipate the end of Phase 2 until well after FY93. Worse, Congress had inserted language into the appropriations bills that limited the Air Force's funding levels to no more than twice that of NASA to try to force NASA to assume more of the burden. Thus, if NASA reduced its commitment by \$10 million, the net effect was a \$30 million program cut. For the first time, in 1992, DOD admitted to higher Phase 3 costs than stated in the past, estimating the Phase 3 cost as "likely to exceed \$10 billion for an SSTO vehicle."⁵⁸ A tug of war over NASA funds ensued, with the Space Council urging NASA to reprogram money for NASP and the House Appropriations Committee ordering that the funds be spent as programmed, namely, not for NASP. Had NASA genuinely wanted to move the money, Truly could have found any number of ways to do so.

Meanwhile, in preparation for the upcoming Steering Group meeting, the JPO had arranged a program briefing at the NPO for Don Dix. Wielding influence beyond his title, Dix served as the watchdog of NASP and the primary interface between NIO and Aeronautic Systems Command (ASD). A technical guru and program critic---Dix would argue that his job required him to act as a skeptic---he worked for Victor Reis, the head of DDR&E and himself a former NASP critic during his days as chairman of DARPA committee that investigated NASP. DOD had expanded the role of the research side, and specifically had increased the influence of DDR&E in budget debates. Thus, Dix's visit gave the program an opportunity to convince a skeptic in an important position, and a position that grew more influential daily, of the merits of NASP.

By all accounts, the briefing was accurate and open, recounting all of the program's weaknesses as well as strengths. Although Dix agreed that a non-SSTO Phase 3 was an option, it was clear that he viewed NASP as a standard procurement program, and that he expected the aircraft to contain operational elements. It represented the view of the program abandoned in 1986 by the JPO at the direction of the Steering Group, NASA, and the DOD. It also stood in sharp contrast to the consistent guidance the program had received from the Office of the Secretary of the Air Force, the Space Council, and members of Congress.

By the time of the Dix visit, the "Options" group had arrived at five alternative programs that represented refinements of the two ("A" and "B") scenarios originally developed based around two similar aircraft approaches with the second including more margin and robustness, as well as more weight (see Fig. 5.14, "Comparison of Alternative Program Options Presented to the NASP Steering Group [January 1992]"). For the first time, however, a subscale, non-SSTO option was briefed. Each of the five options included a risk assessment, with the two-aircraft program with full-scale SSTO aircraft representing the most risky and costly of the options. Despite warnings that the program could not exceed the "scream level" of \$1 billion per year, all of them rose above that level in their peak year funding, and the heavier version came in at \$1 billion *every* year, peaking at \$2 billion in a single year.⁵⁹

The "Options" paper came at a time when most of the personnel in the JPO and NPO were away during the "down time" at Christmas. Management had to make a number of decisions at that time because of the upcoming January QTR, and also because language Congress put in the funding bills had made it clear that NASA and DoD had to put in real money, and not placeholders, as frequently had been done in the past. Without having any

(Billions of Then Year Dollars)

Option	Number of Vehicles	Size of Vehicle	Conduct SSTO Flight Test?	Flight Test Dates		Project Costs
				First	SSTO	
Baseline	Two	Full Scale	Yes	2000	2003	\$13.2 - 15.1 *
1	One	Full Scale	Yes	2000	2002	12.5
2	One	Full Scale	No	1999		10.3
3	One	Subscale	No	1999		8.5

*Variation in projected cost for baseline program due to difference in projected weight.

Fig. 5.14, "Comparison of Alternative Program Options Presented in January 1992 to the NASP Steering Group"

specific direction on which option to pursue (aside from the ongoing program as outlined in the 1986 PMD), management devised a three year budget request of \$350, \$425, and \$500 million (1992 dollars) that would allow NASP to continue work by focusing on critical technology tasks that would be appropriate for any one of the options. If the funding held, the strategy called for complete engine preliminary design, construction or preparation of engine test facilities, the test of a structurally correct full scale flow path (including potential flight experiments), completion of other tests in support of engine design, completion of airframe/ground support system preliminary design, and test of some airframe development items with final materials.⁶⁰

When the estimated costs (\$1-2 billion per year) reached the members of the Space Council and Steering Group over the holidays in 1991, word quickly came back to the JPO that no support existed for those levels of funding. Rather, several sources suggested reducing the program to \$200 million per year simply for hypersonic research. But the JPO and program advocates did not think that was feasible, and that Congress would cancel the program if it reached such low levels.

Meanwhile, budget cuts had forced the restructuring of Phase 2D activities, reducing design effort by 30 percent in FY92, pushing work in subsystems and vehicle management systems to a "marginal level." In areas related to technology, the restructure eliminated the large scale tank effort, fuselage structures efforts, simulator work, turbomachinery development, and slush activity. All airframe design-related work in the government work packages (the government-furnished labor) was delayed or canceled, as well as government activity at the Titanium Metal Matrix Composites plant. Overall, five work efforts were canceled, 18 postponed, and 16 reduced, leaving 46 basically intact.⁶¹

Increasing frustration had settled in at the JPO and NPO. The Dix visit left the program's management with the realization that DoD leadership still held diverse views about the very direction of NASP. Barthelemy and Waldman concluded that they could not discern which option DoD favored, and they also knew that Dix would offer no support. Further reinforcement of those views came in December when Col. Jim Beale, the National Space Council aide to Mark Albrecht, the executive secretary for the Space Council (and the central conduit to Quayle), reported on a meeting with Undersecretary of the Air Force Jack Welch that DoD did not want to select any of the five options as the basis for a Phase 3 decision to proceed; and accordingly the Space Council itself decided "not to decide." In essence, NASP continued down the same road to oblivion.

Barthelemy, Waldman, and other NASP officials tried to perceive any long-range strategy on the part of the Air Force, other than purely budgeting issues, that might be driving the "non-decisions." One theory involved a scenario that had NASP "preserved" until the Air Force again could afford it. According to that theory, by 1992, the B-2 bomber and the F-22 fighter programs, plus many other expensive items, had taken cuts or seen caps imposed on overall procurement levels. Some officials even discussed taking the F-22 only as far as full scale development, not into production. Although no immediate budget savings would accrue, by FY94 or FY95, the Air Force would have money to invest in R&D at higher levels. Thus, just keeping NASP afloat would maintain the aerospace plane until later fiscal years when more R&D money would be available.

The historical precedents for such visionary budget manipulations, however, are few. In Washington, "once cut, always cut" had provided the logic behind "zero-based budgeting," where

every year an agency would *begin* its request from what it had received the year before, then add new amounts for inflation or new activities. No bureaucrat ever was rewarded for achieving great cost savings. As a result of the pensiveness with which lawmakers avoided the NASP numbers, the program hesitated to present anything other than absolutely defensible final cost estimates. Consequently, NASP's program control kept the cost numbers so tightly held that not even NASP engineering could get them. A certain justification existed for that mentality: even the best estimates relied on numbers based on what Congress would give the program if it funded the program fully, and had little relationship to less-than-optimum funding levels.

Quite the contrary to visionary leadership had proved the rule with NASP: despite the efforts of Williams, Barthlemy, and, to a lesser degree, Quayle, NASP had careened along with little real Washington leadership. Neither the Steering Group nor the Space Council could implement tough, technical decisions that could redirect the program along the lines that it needed to go. Meanwhile, neither NASA or the Air Force could commit to the program in a way that revealed much confidence in the X-30. Once the costs were known---and all the leadership bodies should have demanded an accurate cost estimate by 1989 instead of accepting the \$3-5 billion figure left over from the du Pont days---or once the weaknesses in the scramjet technology at the propulsion companies became apparent, NASP needed clear direction to implement an incremental strategy.

The program's difficulty in developing such a strategy can in part be traced to Vice President Quayle and the Space Council. Quayle's support proved a two-edged sword. While he was critical in maintaining the program, his insistence that it remain an SSTO program in its current manifestation effectively killed the X-30.⁶² The Steering Group, NASA, and the Air

Force, however, all had the responsibility of informing Quayle that bridges were needed to SSTO; and that the technology (not to mention the money) did not exist at that time to fly the X-30 into orbit. Another level of confusion came from the joint-program nature of NASP, which subjected it to pressures from more than a dozen agencies or offices in the government---some under the guise of “policy/guidance,” some within the context of “oversight/advocacy,” and still others under the auspices of “execution/technology management.” While the NASP organizational chart may have appeared typical on the surface, when the implications of the different functional review groups is considered, it stood worlds apart from other supposedly “high-tech” weapons programs like Trident or the B-1 (see Fig. 5.15, “NASP Organization by Functional Review, 1992”).

Part of the failure to brief Quayle fully on the costs and technical limitations occurred because the mid-level of management within NASA and the Air Force, particularly the Washington contingent, constantly feared that giving accurate cost information would be suicidal. Ironically, just the opposite may have occurred: the inability of the program to provide accurate costs early may have alienated many otherwise undecided staffers and legislators. Consequently, word traveled from the White House that the program had to remain wedded to SSTO, while information that could have flowed upward to modify that position never reached the right ears. One other option existed, however. The numerous government oversight bodies, working from the inside, and the dozens of technical and popular journals from the outside, gradually started to unearth data on the technology and the costs. Supporters and opponents, within the agencies and in the public arena, started an opinion war. If victorious in that war, NASP supporters still had a chance to reshape the program around feasible technical goals that

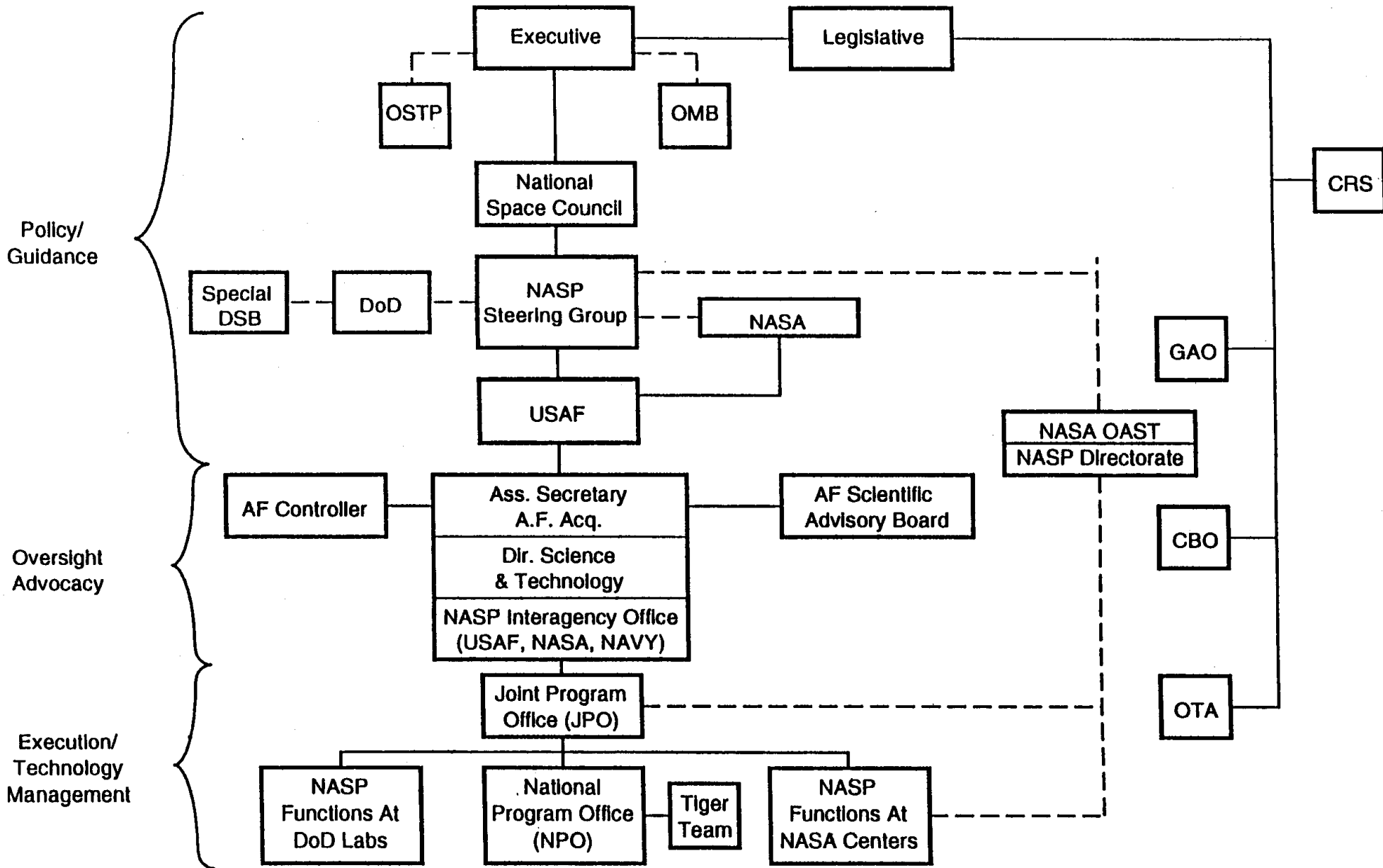

Fig. 5.15, "NASP Organization by Functional Review, 1992"

Congress would fund.

Chapter 5 NOTES

- 1 . “Growth in the Federal Budget,” table in National Review, December 25, 1995, 21, citing “Budget of the U.S. Government, FY1996 Historical Tables.”
- 2 . A superb study of the Space Station and its woes appears in Howard E. McCurdy, The Space Station Decision: Incremental Politics and Technical Choice (Baltimore, MD.: Johns Hopkins University Press, 1990).
- 3 . See Roger D. Launius, "NASA and the Decision to Build the Space Shuttle, 1969-72," The Historian, Autumn 1994, pp. 17-33. Ironically, the shuttle suffered from many of the same problems that beset the thinking about NASP. Because the shuttle had to offer low development costs and low operational costs, the design featured a series of compromises. According to the historian of the program, a series of debates about the goals and demands of the program led to "a compromise that most could tolerate, but none fully endorsed" (p. 18). Diane Vaughn, in The Challenger Launch Decision: Risky Technology, Culture, and Deviance at NASA (Chicago: University of Chicago Press, 1996), discusses the *Challenger* disaster in detail.
- 4 . D. Douglas Dalgleish and Larry Schweikart, Trident (Carbondale, IL.: Southern Illinois University Press, 1984). For a look at procurement across a number of systems, see Thomas L. McNaugher, New Weapons, Old Politics: America's Military Procurement Muddle (Washington: The Brookings Institution, 1989), p. 44; and for specific cost estimating problems, see David Montgomery, "How the A-12 Went Down," Air Force Magazine, April 1991, pp. 44-48; Dagnija Sterste-Perkins, B-2 Strategic Bomber: Issue Brief (Washington: Congressional Research Service, 1990), IB#90156; Bill Sweetman, Stealth Bomber, Invisible War Plane, Black (Osceola, WI: Motor Books, 1989).
- 5 . Dalgleish and Schweikart, Trident, ch. 3, passim. Also see their "Trident Revolutionizes Submarine Building," National Defense, October 1986, pp. 42-48.
- 6 . “National Aero-Space Plane (NASP) Advanced Technology Impacts,” 8.9.
- 7 . Interview with Maj. Gus Bell, November 13, 1990, and interview with Carl Conley, February 28, 1991.
- 8 . These figures were tightly controlled inside the JPO, but were contained in "NASP Program Cost Estimate," n.d., a copy of which was in Col. Wierzbanski's files and cited in the author's "National Aero-Space Plane (NASP) Advanced Technology Impacts," 8.8-8.15. Subsequent directors in NASP program control, contracts, and even the program manager's office refused to acknowledge the existence of those binders, maintaining that since the "estimate" was never made public or officially sent to Congress, it really was not an estimate, but rather just a "guess."

9. Michael J. Fitzpatrick, "A Case Study in Weapons Acquisition: the Sidewinder Air-to-Air Missile," Journal of International Affairs, Summer 1985, pp. 175-190.
10. Burton Klein, "Policy Issues Involved in the Conduct of Military Development Programs," in Edwin Mansfield, ed., Defense, Science, and Public Policy (New York: W. W. Norton, 1968), p. 103.
11. Nathan Rosenberg, Inside the Black Box: Technology and Economics (Cambridge: Cambridge University Press, 1982), p. 128.
12. "NASP Phase 3 System Development Plan, IV---Cost," McDonnell Douglas Corporation, June 30, 1989; "National Aero-Space Plane System Development Plan (SDP), Status Report," 1989, Rockwell International; and "National Aero-Space Plane (NASP) Program, X-30 Phase III Research and Development, Preliminary System Development Plan for the X-30," vol. 4, General Dynamics Corporation, all in NAM files, JPO, cited in "National Aero-Space Plane (NASP) Advanced Technology Impacts," 8.8-8.15.
13. General Dynamics Corporation, Future Roles for Hyper-Velocity Vehicles (Fort Worth, TX: General Dynamics, 1990), p. 12.
14. Interview with Vince Rausch, July 17, 1997.
15. Interview with Rausch, July 17, 1997.
16. "Configuration Team Engine Contractor Interim Technical Flight Test Engine Operability Evaluation," January 18, 1980, no file number, in Wierzbanski's files, AFFTC, Edwards Air Force Base.
17. See McCurdy, Space Station Decision, passim.
18. Stanley W. Kandebo, "Lifting Body Concept Selected for National Aero-Space Plane," Aviation Week, October 8, 1990, 26, and his "Lifting Body Design is Key to Single-Stage-to-Orbit," Aviation Week, October 29, 1990, pp. 36-37.
19. "NASP Program Guidance," June 20, 1990, in Barry Waldman's files, RI, Palmdale, CA. These have since been relocated to Rocketdyne's files deposited with NASA Langley in large semi-trailers containing all the contractors' material, all of which remains unprocessed as of this writing.
20. "NASP Program Guidance."
21. Interview with Vince Rausch, July 17, 1997.

- 22 . "Weekly Activity Report," September 17-21, 1990, in Wierzbanski's files, 15-198, AFFTC, Edwards Air Force Base.
- 23 . Interview with Barry Waldman, September 3, 1991.
- 24 . Interview with Dick Dyer, June 4, 1991. Other material for this section came from interviews on several dates with JPO Chief Engineers Bill Imfeld and Dave Morton.
- 25 . Interview with Dyer.
- 26 . Interviews with Waldman and Barthelemy, various dates.
- 27 . Interview with Bill Imfeld, April 9, 1991.
- 28 . FAX copy of "Comparison of Current NASP Configuration to DARPA Government Baseline Vehicle (GBV) Concept," with cover letter from H. Lee Beach, Jr. to Lana Couch, July 26, 1991, in Beth Quinto's files, 1002-C, "SAO Outgoing Correspondence, (92)," NASA Langley. These files were unprocessed as of this writing.
- 29 . "Comparison of Current NASP Configuration," 3.
- 30 . "Comparison of Current NASP Configuration," 9.
31. Weekly Activity Report, May 21, 1991, in Wierzbanski's files, AFFTC, Edwards Air Force Base.
32. Weekly Activity Report, May 21, 1991, June 5, 1991, in Wierzbanski's files, AFFTC, Edwards Air Force.
33. Detachment 5, Weekly Activity Report, June 14, 1991, in Wierzbanski's files, AFFTC, Edwards Air Force Base.
34. Detachment 5, Weekly Activity Report, June 21, in Wierzbanski's files, AFFTC, Edwards Air Force Base.
35. These and other technology developments were detailed in the July Quarterly Technical Review, July 31, 1991, in Wierzbanski's files, AFFTC, Edwards Air Force.
36. Interview with Barry Waldman, September 3, 1991.
33. Interview with Vince Rausch, July 17, 1997.
34. Interview with Bill Piland, July 18, 1997.

35. Interview with Richard Truly, September 5, 1997.
40. Interview with Waldman, March 3, 1992.
41. "Teaming Agreement Stresses Equality Among Five NASP Prime Contractors," Aviation Week, October 29, 1990, 38-39.
42. Interview with Waldman, March 3, 1992.
43. Edwards and McIver, "Executive Summary," 56.
44. Edwards and McIver, "Executive Summary," 56.
45. Interview with Waldman, March 3, ;1992.
46. These and other decisions related to the test facilities are found in "Decision Summary Memorandum, CDE/SX21/Engine Program Management Review Splinter Session," March 26, 1992, in NAM files; R.J. Budica to Robert Barthelemy, March 27, 1992, in NAX files; J.R. Thompson to the NASA Administrator, November 8, 1991, copy in author's files; and "NASP Directors' Decision Summary," April 7, 1992, in NAT files, all files in NASP Papers, WPAFB, and cited in "National Aero-Space Plane (NASP) Advanced Technology Impacts," ch. 11 and passim.
47. Interview with Len Pohlar, October 17, 1991.
48. Interview with Len Pohlar, October 17, 1991.
49. "National Aerospace Plane, Phase 3 Research Plan," Version 3, September 1, 1991, in NAX files, NASP Papers, WPAFB, cited in "National Aero-Space Plane (NASP) Advanced Technology Impacts," 11.5.
50. "Phase 3 Research Plan."
51. "NASP Phase 3 Planning Status," November 14, 1991, in Wierzbanski's files, AFFTC, Edwards Air Force Base.
52. Stanley W. Kandebo, "X-30 Political and Funding Turmoil Causes Program Delays, Staff Cuts," Aviation Week & Space Technology, December 16-23, 1991, p. 24.
53. George E. Brown, Jr., et. al. to J. Danforth Quayle, November 26, 1991, copy in NAR files, NASP Papers, WPAFB, cited in "National Aero-Space Plane (NASP) Advanced Technology Impacts," 11.8.
54. George E. Brown, Jr., et. al. to Richard H. Truly, November 26, 1991, in NAR files, NASP Papers, WPAFB, cited in *ibid*.

55. Dana Rohrabacher to J. Danforth Quayle, November 18, 1991, copy in NAR files, NASP Papers, WPAFB, cited in *ibid*.
49. Interview with Truly, September 5, 1997.
57. [Don Dix, R&AT/ET], "Background Paper: National Aero-Space Plane (NASP) Program," November 21, 1992, in NAR files, NASP Papers, WPAFB, cited in "National Aero-Space Plane (NASP): Advanced Technology Impacts," 11.8.
58. [Dix], "Background Paper."
59. This material all appeared in the "Summary 'Quick Look'" provided to Dix by the JPO and contained here as Fig. 5.1.
60. "NASP Phase 3 Planning Status," in Wierzbanski's files, AFFTC, Edwards Air Force Base.
61. Quarterly Technical Review, January 6, 1992, NASA Langley Technical Library.
62. The space shuttle had ironic similarities to NASP. President Richard Nixon had appointed a Space Task Group in 1969 to make recommendations on space policy under the chairmanship of his vice president, Spiro Agnew. See Launius, "NASA and the Decision to Build the Space Shuttle," p. 21.

Chapter 6: The Battle of Ideas

POLITICAL LEVERAGE AND financial support for public programs are the manifestations of the public's support for large-scale undertakings. Whether the activity is a war or construction of a national highway system, if it is popular the public will eventually register its opinion through Congress, and generally that support will take the form of appropriations. No "big science" or large-scale engineering feat, including the Panama Canal, had captured the imagination of the American public like the Apollo moon landing. By the late 1970s, although it was declining steadily, space exploration still held a special place in the hearts of the citizenry. The problem, however, had been to capitalize on the enthusiasm of Apollo by finding other missions that stirred national emotions. Unfortunately for NASA, Apollo derived from a special combination of factors not likely to appear again in the near future. The Cold War had provided military and national security reasons for "beating the Russians" to the moon, while the science involved in the project fell within the near-term capabilities that the U.S. had at the time, and while representing a stretch, was by no means "revolutionary." Going to the moon also embodied the fulfillment of dreams of writers and visionaries held for decades, if not centuries, and thus spoke to the imagination of most Americans---indeed, many people of the world. Finally, the evolutionary nature of the project allowed for highly public displays of "progress," with each Mercury, Gemini, then Apollo launch lasting longer, going further, and pressing closer toward the mark of a moon landing. In short, Apollo benefitted from unique circumstances that have not, and likely will not, grace other "big science" projects.

Science, in fact, is hardly glamorous. Hoopla surrounding such breakthroughs as calf cloning, or the hype associated with the pseudo-science of “cold fusion” will push scientists into the public eye, but only temporarily. Even then, the mistaken assumption is that the breakthrough came in the form of a “Eureka/Aha!” moment of brilliance rather than after years of painstakingly meticulous, and usually dull, repetitive work. But that, after all, is the “real” science: millions of small steps, by people who seldom get credit. But such also is human nature, with its yearning for “important” events, in which the arrival of the railroad brought out the crowds, while laying the track elicited a yawn.

Yet an important part of the NASP mission was exactly that---to lay the track. The Space Shuttle, although touted as offering "cost effective, routine access to space," by the late 1990s had yet to come close to attaining routine launches.¹ NASP held out that potential, but first it had to demonstrate its ability to fly aircraft into orbit. That aspect of the program did promise great excitement and enthusiasm, along the lines of the X-15 flights. Unfortunately for NASP, getting to the flight tests represented a long-term process of technology development that was invisible most of the time and boring when it made news. More important, once the program shifted its focus---however slightly---to the incremental approach, large, exciting breakthroughs would be even more infrequent.

Consequently, winning the battle of ideas was crucial for NASP, which had to keep the program before the public and to elicit the popular support for the long-term technology development process of an incremental nature. If media treatment contained a steady stream of criticism of the program, or pessimism in its goals, or, worse still, skepticism over the appropriateness of space exploration in general, NASP could not sustain the momentum

necessary to achieve fabrication and flight of any system. Thus, the program's attempt to explain what its mission was; how the aircraft would work; and, most important, how it benefitted and would benefit the citizenry as a whole constituted a key element of the JPO's activities.

The Applications Directorate: Building User Support for NASP

Within the JPO, the Applications Directorate (NAR) served as the focal point for most activity that analyzed and explained the value of NASP (either as an aircraft or as individual pieces of technology) to the public and to Congress. NAR itself had evolved somewhat late as a unit in the JPO. Not until Col. John Fuller came to NAR from Strategic Air Command in October 1986 did the directorate have real clout. Gen. Staten himself had admitted pushing applications onto the back burner "due to more immediate problems."² Fuller's appointment indicated exactly where the Air Force thought NASP and NDV applications resided---in Strategic Air Command---and NAR quickly geared up to emphasize the operational characteristics of an X-30 research airplane. Maj. Jess Sponable, Fuller's subordinate, recalled that as NAR members started to assemble briefings, they often refrained from approaching some of the "heavy hitters" in the user community because they did not have anything to show them, "and Fuller could not just go in there empty handed."³

Still, for years NAR operated below the office of the program manager, Robert Williams, who made little use of the Applications Directorate, a point that conflicts with those who charged that Williams had "oversold" the program and its utility. If Williams saw NASP as an operational program, he would have reinforced the NAR mission. Instead, Williams insulated the

NASP JPO from the need to develop support on its own because of the five way MOA that he thought would force the agencies to advocate NASP independently. The more significant issue in Williams' mind, however, was that Air Force operational missions would take NASP away from its research focus, and might drive up the weights.

NAR made extensive use of internal studies of NDV applications provided by the government and by the contractors. The earliest NASP studies had originated in the TAV studies ordered by Gen. Lawrence Skantze, and in AFSPACECOM's studies on the Manned Atmospheric Vehicles (MAVs). NAR also used contractor studies, as well as NASA extrapolations, to assess the impact in the civilian sector, although that aspect of NASP was relegated well below more traditional military applications. By 1988, NAR had a well-developed body of evidence on the effects of NDVs on the costs of access to space. It also had a number of classified briefings on the military benefits of aircraft that could attain orbit and/or fly at hypersonic speeds. Those two streams of NDV benefits were developed into briefings, awaiting only an audience. When Barthelemy took over as program manager in early 1989, he tasked Fuller to revive his contacts at SAC, SPACECOM, and other Air Force commands. Specifically, Barthelemy told Fuller to get the commands on board, and gave NAR "the green light to brief as wide an audience as possible" on the potential of the aerospace plane.⁴ Suddenly, everyone wanted to hear about NASP's potential utility, and, as Fuller recalled, "we had to turn down briefings."⁵

Several versions of the briefings existed, but they all emphasized the vast improvement in response time made possible by hypersonic aircraft (as opposed to, say, satellite launch or aircraft launched from carriers at sea). A Mach 10 NDV could reach Germany 15 minutes after

launch, pass over the Soviet Union in 20 minutes, and cross the southern expanses of the Indian Ocean in 45 minutes (see Figure. 6.1, "NDV Response Times from an East Coast Basing" and Figure. 6.2, "NDV Response Times from a West Coast Basing"). Of course, the faster, the better: a Mach 10 aircraft could reach critical geographic points faster than a Mach 6 aircraft. NAR did not mention, however, that response time assumed that fully fueled aircraft could be maintained on runways, waiting "on alert." In reality, even the famous SR-71 "Blackbird" aircraft required considerable lead time to fly. An NDV could reach a geographic spot much faster than any existing aircraft launched from the same position, but would not necessarily reach a location faster than other systems already in place, such as carrier groups or satellites.

Most of NAR's emphasis was on space-related applications of NDVs. NAR's approach rested on early studies that compared X-30 payload capacity-to-cost to that of the shuttle. Whereas shuttle payloads of 65,000 lbs. cost between \$3000-4300/lb. to put into orbit (\$175-300 million per flight, of which 4 percent came from fuel costs), NDV costs were projected at \$140/lb., or \$1-9 million per flight (see Figure 6.3, "NDV Cost Effectiveness").⁶ Existing space systems were too expensive, the JPO argued, citing the high-end Shuttle payload cost-per-pound of \$4300, the Titan IV (\$2700), or other systems as vastly more costly than the estimated cost-per-pound of NDV payloads (see Fig. 6.4, "Existing Vehicles"), which the JPO had estimated based on projected costs of the NASP.

NASP, of course, was not an NDV. As a research aircraft, many envisioned the X-30 strictly as a data-gathering vehicle. The user interest, however, centered on the X-30 having---or demonstrating---some operational capability---and to do so it had to have some similarity to an operational aircraft, including a cargo door, the ability to go into space, return to the atmosphere,

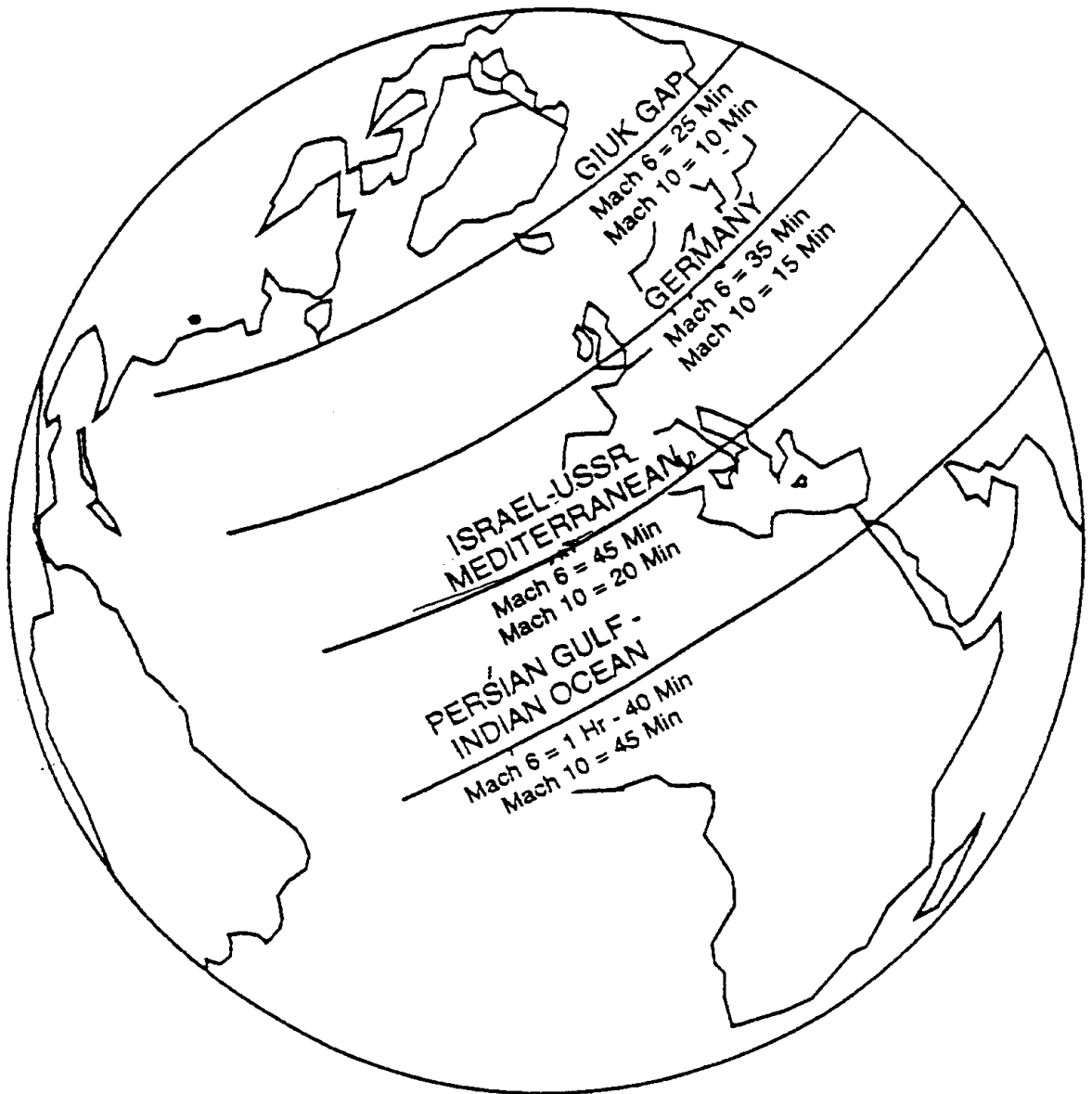

Source: Author's Computations; NAR; *100,000 ft Altitude

Fig. 6.1, "NDV Response Times from East Coast Basing"



Fig. 6.2, "NDV Response Times from West Coast Basing"

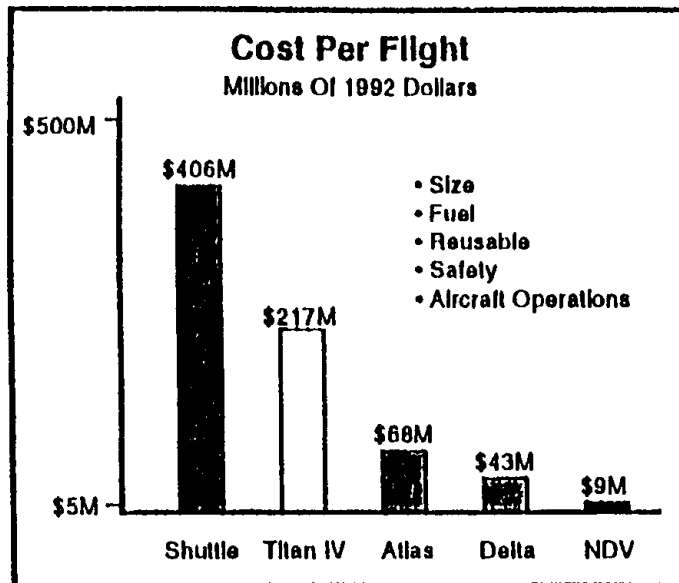

Source: NASP Joint Program Office Estimates

Fig. 6.3, "NDV Cost Effectiveness"





Systems Characteristics	 STS	 TITAN IV	 DELTA II	 ATLAS II	 PEGASUS  SSLV
Performance	5K	39-52K	11K	14-20K	1-3K
Reliability (Historical)	.976	.952	.961	.934	.98?
Capacity (Flts/Yr)	8-12	12-14	10-12	6-8	?
Cost					
Fixed \$/Yr	1988M	263M	61M	16M	?
Variable \$/Fit	48M	122M	34M	38M	10-20M
\$/Lb	4300	2700	3600	2900	10000-6700

Fig. 6.4, "Existing Vehicles"

Source: "Space Transportation Options And Launch Architecture Comparisons"

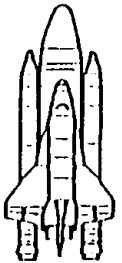
Study by Air Force Space Command 1990 AAR files,
 cited in 'National Aero-Space Plane (NASP) Advanced
 Technology Impacts,' 7.10.

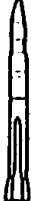
then “pop up” to space again, and, some suggested, a sustained lower-speed flight capability. Any one of those “wish list” items could add billions of dollars to the X-30, even *assuming* they could be accomplished technically. But the pressure to include them in planning led the JPO to consider expanding the payload capacity of the X-30 (known in briefings as the "4X" vehicle). The briefings also would emphasize delivering payloads to polar orbits as well as easterly orbits. In addition, the JPO gave some consideration to a "go around" capability, in which an aircraft coming in for a landing could pull up, go around, and return for another descent in the event of a problem. The “go around” capability---a characteristic of airplanes but not the Shuttle---by itself drove up weights by 50,000 to 100,000 lbs. and would have added billions of dollars to the price tag. When all the operational characteristics were combined, they made the X-30 a vastly different airplane than the research vehicle described in the PMD.

Whatever support the operational capabilities gained for the program within the Air Force, it cost NASP in its relationship with NASA, which continued to emphasize the data-gathering value of the aircraft, not to mention the opposition of the vocal group of dissidents who still maintained that the program did not even have to attempt SSTO to successfully explore the hypersonic challenges. One anonymous contractor observed after one utility briefing that “NASA could care less if the X-30 ever flew . . . as long as the data from the program was good.”

Another Air Force source overheard a NASA official after a briefing on costs and utility by NAR commenting that “the program is a success even if the X-30 never flies.” Factions within the JPO itself appeared, favoring either an operational version or a more traditional research aircraft. If a subscale or slower version of the SSTO full-size X-30 could have demonstrated the necessary capabilities, the differences between the two groups might have been less pronounced. But to

generate the immediate support NASP needed, program planners had to derive from the anticipated mission of the X-30 itself, not NDVs, and the mission had to drive the X-30 design, not vice versa. Put another way, the challenges for a NDV would not be significantly more than for NASP; but the difficulty in moving from Mach 12 to NASP was substantial. So the contractors concluded that little could be gained from “merely” going mach 12. Thus, when the contractors returned from their 1990 "Options" study with the conclusion that nothing short of a full scale, Mach 25 aircraft would demonstrate SSTO for an NDV, the program finally seemed to be forced to define once and for all its mission.

As far as possible, however, the JPO continued to try to find room for both concepts. On the matter of payload, for example, a larger aircraft offered critical advantages related to "margin" for error and additional fuel capacity, and advocates of that aircraft argued that in early flights the “payload” simply could consist of added fuel to reach orbit. From the standpoint of cost-effective planning, it also made sense for the research aircraft to resemble as closely as possible the operational follow-on aircraft. Wierzbanski and other directors with a test-pilot frame of reference argued that it might be possible to provide the equivalent of a cargo door, or its weight, by including enough “margin,” which would enhance flight safety. At the same time, NAR embarked on establishing tentative schedules for an overlapping program that would encapsulate "Phase 4," with planning for the NDVs overlapping Phase 3 work.⁷ NAR anticipated that first flight of an NDV could occur as early as eight months after the last originally scheduled X-30 test flight (See Fig. 6.5 “NASP Derived Vehicle Capability is Achievable by the Late 1990s”). McDonnell Douglas even went so far as to provide charts suggesting that the experience gained on the learning curve would reduce the time to build NDVs after producing an X-30.

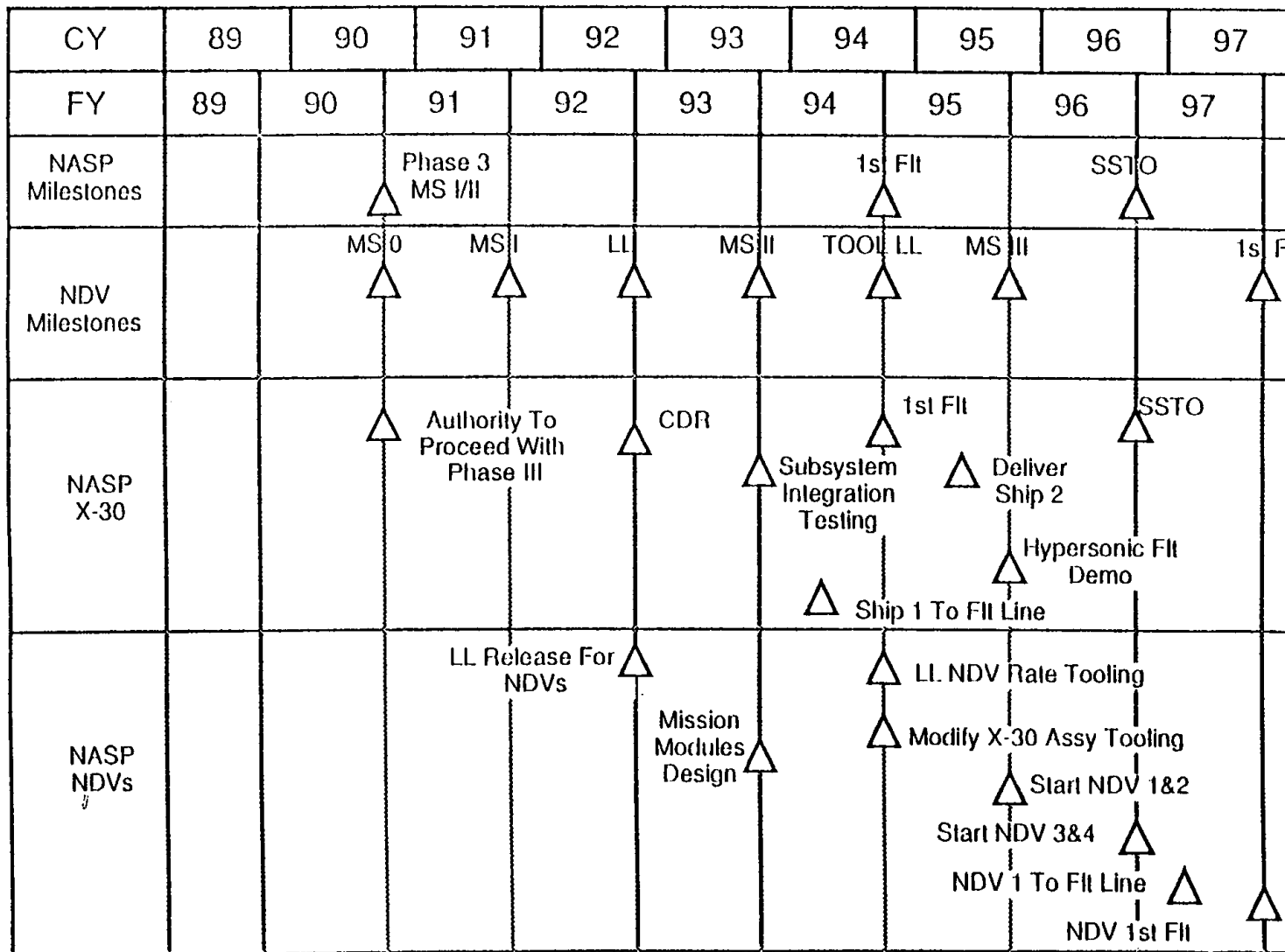

Fig. 6.5, "NASP-derived Vehicle Capability is Achievable by the late 1990s"

Source: "Schedules," Maj. Sponable's Files, NAR, Bldg. 91, WPAFB

The infatuation with operational capability had positive results insofar as it made NASP less dependent on the scramjet, and thus brought down the performance needed by both the engine and the integrated features of the aircraft. Maneuverability in space required a rocket; and most observers thought some kind of rocket "punch" would be necessary for the last surge into orbit. Thus, at every opportunity the users urged simply expanding the size of the rocket. Each time the rocket's role grew, the technical difficulties facing NASP shrank somewhat. However, the more the design relied on a rocket, the less it could achieve lower cost, quicker turnaround, and more routine flight, and the more it started to look like other systems. So whatever benefits the program gained in its scheduling and support by the Air Force, it lost in its higher payload costs and similarity to existing space transportation. Nevertheless, NAR, under Fuller, continued to emphasize risk reduction for the purpose of getting something operational as soon as possible, even at lower levels of performance. He contended that "lowering the risk and delivering a more near-term operationally capable system must be the goal of this program---not a 'High Risk,' Experimental Research Vehicle . . . [f]urther described as a vehicle to 'meet the challenge,' 'flying wind tunnel,' and 'see if we can gather the data'"⁸ That approach, Fuller argued, was not only wrong strategically, but ran counter to the Air Force's mission: "If you are a member of the Air Force, military or civilian [,] and you are not moving this program toward operational capability as rapidly as possible, then you've lost your purpose."⁹

Fuller's view had predominated between 1987 and 1989, at least at the JPO. After Barthelemy took over, Fuller elicited the envy of many, who thought he "had Bart's ear." Barthelemy admitted that he had enthusiastically embraced what he called the "four-star" strategy of cultivating military users.¹⁰ Abruptly, however, Cheney's cancellation of NASP

forced Barthelemy to reexamine the user strategy. He concluded that it had been unwise to rest the program's fate solely in the hands of the Air Force, and he looked to firm up support from NASA while gaining new support at the Departments of Transportation and Commerce. The strategy of emphasizing applications had failed to develop the appropriate support for the program, especially at SAC, which repeatedly supported its B-2 bombers at the expense of other programs. (Ironically, in 1990, congress all but killed the B-2 production, slashing the total number to be procured from 132 to around 15). Barthelemy recognized the error in the "user" strategy, for which he took full responsibility: "we've been forced to fundamentally re-evaluate what we are developing, and for whom."¹¹ yet for a period of days at the JPO, a time of mourning set in. Cheney's action temporarily paralyzed NASP management. But Barthelemy and the others soon shook it off, and they quickly met with the contractors to develop an entirely new "pitch" for NASP. In doing so, the relative influence inside the JPO of NAR rapidly declined, with Building 91, where NAR was housed, likened to "a morgue" by others in the program. Shortly thereafter, the most forceful advocate of the military user strategy in the JPO, Col. Fuller, departed for SAC in Omaha, replaced by Col. George Matthews. But like the JPO, NAR soon found a new sense of purpose, and mobilized a new briefing strategy.

"Pioneering New Frontiers": The "New" NASP Image

The new briefing, assembled with significant assistance from the contractors, aimed at the growing portion of the Washington community that saw the U.S. balance of trade position eroding.¹² One bar graph, for example, focused on the "disturbing trends" in which the U.S. had

lost position in the world market in jet transport (down from 91% to 65%), while another decried the shift since 1986 in nine of 17 industrial areas, without mentioning the fact that the U.S. held two-thirds of the world's software market, or that it controlled almost 75% of the world's hard disk market. The briefing did note that aerospace had surpassed chemicals as the top performer in U.S. foreign trade (\$17 billion vs. \$6.2 billion), while at the same time generating a trade surplus that hovered at \$10-12 billion. However, the briefings pointed out, other countries had started to make inroads into the jet transport market and into space launch. "We can't afford to lose another market," the briefing charts warned. Certainly the aircraft manufacturers encouraged such attitudes, and they viewed the subsidies given the European Airbus as "unfair competition." At the same time, the bar graphs hardly mentioned the fact that most of the aerospace market involved military sales, anti-aircraft guns, missiles, and other weapons, often sold to Third World nations.

Warning that other nations recognized the market potential of hypersonic aircraft, the briefings noted that competitive efforts such as Japan's "Hope" and its unmanned aerospace plane, the West German "Sanger," the British "HOTOL," the French "Hermes," not to mention the Soviets' efforts, all threatened to cut into American space dominance (see Fig. 6.6, "Aerospace Planes, the Global Competition"). Targeting the Japanese, especially, the briefings observed that "Japanese Space Planning is All Encompassing," including meteorological satellites, communications broadcasting systems, data relay satellites, rockets, orbital vehicles, and even a space station. Between 1987 and 1991 (as seen in Fig. 6.7, "Japanese National Aerospace Laboratory Spaceplane Budgets"), Japan spent \$40 million (U.S. dollars) in facilities, and \$15 million in R&D in its spaceplane project. Estimates for 1993-1999 placed Japanese

Aerospace Plane Characteristics	U.S.	U.K.	Germany	Japan
Air-Breathing Engine Speed Limit (Mach Speeds)	15-20	5	4-4.7	6-12
Air-Breathing Upper Altitude Limit (Feet; 1st Stage Only)	150,000	85,000	85,000	120,000
Highest Temperatures To Withstand (°F)	5,000	2,700	2,000	4,000
Anticipated First Test Flight	1997	2000	2005	2006
Use Of SCRAMJET	Yes	No	No	Yes
Use Of Active Cooling System	Yes	No	No	Yes
Hypersonic Cruise Capability	Yes	No	Yes (1st Stage Only)	Yes
Single Stage To Orbit	Yes	Yes	No	Yes
Powered Landing Capability	Yes	No	Yes (1st Stage Only)	Yes

Source: Congressional Research Service

Fig. 6.6, "Aerospace Planes: the Global Competition"

Fiscal Year	R&D	Facilities
1987	0.64	1.24
1988	2.25	2.91
1989	3.26	8.47
1990	4.01	12.98
1991	4.60	14.24
1992 (est.)	4.94	22.77
1993-99 (est.)	155.40	32.55 (1993)

Source: Stanley W. Kandebo, "Japanese Making Rapid Strides in Hypersonic Technologies," *Aviation Week and Space Technology*, December 16-23, 1991, p. 61.

- * In million of U.S. dollars. Does not include monies spent by other government agencies or by private industry.

Fig. 6.7, "Japanese National Aerospace Laboratory Spaceplane Budgets"

hypersonic budgets at \$155 million in R&D and another \$54 million in facilities at the Japanese National Aerospace Laboratory alone, not counting private industry's investments.

A second element of the new strategy emphasized technology spinoffs, from uses for new materials to civilian applications of CFD codes. That strategy, while in its infancy, eventually provided some of the most tangible results of the NASP program by featuring artificial hip joints, computer hard drives, new heat resistant materials, and other physical artifacts of NASP technology. Over 1000 technologies stood to benefit from advances in the aerospace plane program. One study, cited by NAR, estimated the impact of the NASP on the U.S. economy at \$26 billion by 1999, with the program creating 65,000 jobs and \$6.5 billion in tax revenues.¹³ A 1990 General Dynamics study of a military "notional fleet" of NDVs, including six orbital aircraft, 100 strategic and tactical bombers, and another 130 vehicles based on shore or on carriers could, the contractor argued, be purchased for just under \$92 billion, or less than the cost of 50 B-2 bombers (see Fig. 6.8, "Costs and Market Value of Military High Velocity Vehicle Notional Fleet").

The most important aspect in the new effort to garner support retained the earlier emphasis on low cost access to space, but with a new focus on civilian rather than military payloads. In sharp contrast to the utility originally considered by such users as the Strategic Air Command, which emphasized response time and high-speed atmospheric flight, with orbital payload delivery an important, but secondary issue, the new "low-cost-to-orbit" orientation emphasized the payload savings offered by NASP. NASP initially had aimed at a cost-per-pound of \$150, but by the time the program shifted its emphasis, the numbers had grown substantially, occasionally by a factor of four. Even so, then-current systems only could lower costs from

	No. Built	HVV Type	(1) O&S/ Flight	(2) Unit Fly Away	(3) Mission Factor	(4) Unit Mission Fly Away	(5) Type Mkt Value	(6) R&D	(7) Unit Procurement	(8) Fleet Mission Acquisition
Orbital	6	Space	\$1.3M	\$1181M	1.1	\$1299M	\$6.1B	Sunk Cost	\$1624M	\$7.6B
Aerial Recce	10	Small	\$0.4M	\$ 374M	1.1	\$ 411M	\$2.9B	\$7.3B	\$ 573M	\$4.76B
Shore-Based Navy	30	Small			1.3	\$ 486M	\$2.3B		\$ 606M	\$14.7B
Continental Air Def.	25	Small			1.3	\$ 486M	\$7.2B		\$ 608M	\$11.8B
Strategic Bomber	50	Large	\$1.2M	\$ 701M	1.5	\$1052M	\$26.9B	\$16.4B	\$1315M	\$41.8B
Tactical Bomber	50	Large			1.5	\$1052M	\$26.9B		\$1315M	\$41.8B
Carrier Navy	60	Carrier	\$1.2M	\$ 302M	1.5	\$ 453M	\$13.3B	\$7.3B	\$ 302M	\$23.9B
TOTAL MARKET VALUE							\$91.6B			

* This model is expected to be essentially similar to the spaceplane developed for the space transportation role. The only significant R&D required will be for sensors, which are accounted for in the missionization factor.

Source: *Future Roles for Hyper-Velocity Vehicles* (Fort Worth, TX: General Dynamics Corp, 1990), p. 19.

Fig. 6.8, "Costs and Market Value of Military Hyper-Velocity Vehicle Notional Fleet"

\$5000/lb. (at 5 million lbs. launched) to \$2000/lb. by increasing payload to orbit to 15 million lbs. The Shuttle had to charge \$155 million to achieve full cost recovery.¹⁴ NASP could support 50% of the mass of the nation's satellite launches---as much as 20 million lbs. In that vein, proponents frequently likened NASP to clipper ships, early automobiles, or early airplanes, all of which not only made travel to existing markets easier and cheaper, but opened new markets as well.

Not only would NASP carry out existing civilian missions, but the low-cost offered by the aerospace plane would generate new and unforeseen market activity in space. Unfortunately, the JPO was on its strongest ground historically with that concept, but the most difficult to "prove" quantitatively. Proponents argued that current satellites were heavy and expensive due to the need for redundant systems because, with space launch so infrequent, the satellite had to be totally reliable when in orbit. Routine and rapid access to space, as provided by NDVs, would permit rapid repair of systems, meaning that they could be lighter and less redundant. Satellite designers would start to focus on smaller systems, making them lighter still. Eventually, given frequent enough launches, modular systems could be put into orbit. Similar developments had occurred in the world of computers, where smaller sizes consistently lowered costs.¹⁵

The Applications Directorate and the contractors carefully noted that other countries had recognized the value of hypersonic aircraft. Japan had an aerospace plane on the drawing boards; Britain had its HOTOL and France its Hermes in the design phase; and Germany had its Sanger two-stage-to-orbit aircraft in the early concept validation phase. Foreign systems promised large payloads, with the Sanger having up to 33,000 lbs. available. Unfortunately for foreign competitors, none had a chance of flying before the year 2000.¹⁶

The shift away from the military user strategy apparently had vindicated Robert Williams and the NASA Langley contingent, who all along had expressed concern that the program would fail if it became tied too strongly to the Air Force. Politically, Barthelemy admitted, "we've been forced to fundamentally re-evaluate what we are developing, and for whom."¹⁷ At the same time, the program attempted to broaden its application to what it previously considered competitor programs, such as rocket vehicles and/or rocket/ramjet aircraft.

Shortly after the new strategy was implemented, and after the Space Council had rescued NASP, the Air Force's Space Command (AFSPACECOM) undertook an assessment of existing space launch architecture (again, see Fig. 6.4, "Existing Vehicles"). Four deficiencies stood out: responsiveness, resiliency, capacity, and assured access. A comparison of existing vehicles revealed that the flights per year of *all* systems came to 48 (using the most optimistic number), while NDV estimates had envisioned 50 NDV missions a year. General Dynamics even had a mission model that assumed 112 NDV flights per year.¹⁸ The AFSPACECOM study identified lost market share of commercial traffic as a major deficiency of the existing fleet. All U.S. commercial launches had used the Space Shuttle, but delays and failures in the shuttle fleet launch schedule threatened to make their payloads obsolete. Most important of all, NDVs offered rapid response and flexibility. The most frequently cited scenario was: what if something happens to a shuttle crew and they cannot return to Earth? At present they would die, but with NDVs the nation could expect to rescue them. Even in non-crisis situations, NASP promised turnaround time of 9 days, compared to the turnaround time of 51 days with a Delta rocket or 180 days of a shuttle.

In 1990, the Office of Technology Assessment (OTA), produced a study of space

transportation options (see Fig. 6.9, "Discounted Life-Cycle Costs of Space Transportation Options). NASP and NDVs were conspicuously missing. OTA set a target of reducing space transportation costs to \$3000-10,000 per lb. for low earth orbit, compared to the anticipated NDV cost of \$500-1000. The study concluded that a mixture of systems, including rockets and Shuttles, would provide the best cost effectiveness for space launch. A 1991 study by the Department of Transportation, though, revealed that NDVs would produce the lowest cost per flight, by far, than competitor systems.

NAR found the AFSPACECOM study extremely encouraging, and even found a silver lining around the OTA report. NASP technologies could improve near-term systems, such as the shuttle and rocket systems, while at the same time offering a longer term solution to some of the serious deficiencies in the fleet. The aerospace plane could provide an important remedy to the civilian launch weaknesses in the American fleet. Well above those advantages, however, if space exploration continued, NDVs could capture a large percentage of the mass of the lunar and Mars missions. No scenario showed NASP to be the answer to the nation's launch deficiencies, but several options scenarios in the AFSPACECOM study showed that any option would benefit with NASP included in place of other, competitor systems.

Vice President Quayle's action to rescue the program in 1989, and the ensuing two-and-a-half year extension, seemed to validate the new strategy. Equally important, it seemed to give the program time to develop the new civilian-oriented user base to a sufficient degree that the program would be safe. NAR continued, therefore, to work the "space launch/civilian user" emphasis. In May 1990, using data from AFSPACECOM's Space Transportation Study and NASA, NAR compiled a national mission model showing that NDVs could accommodate 40-

Mixed fleet options

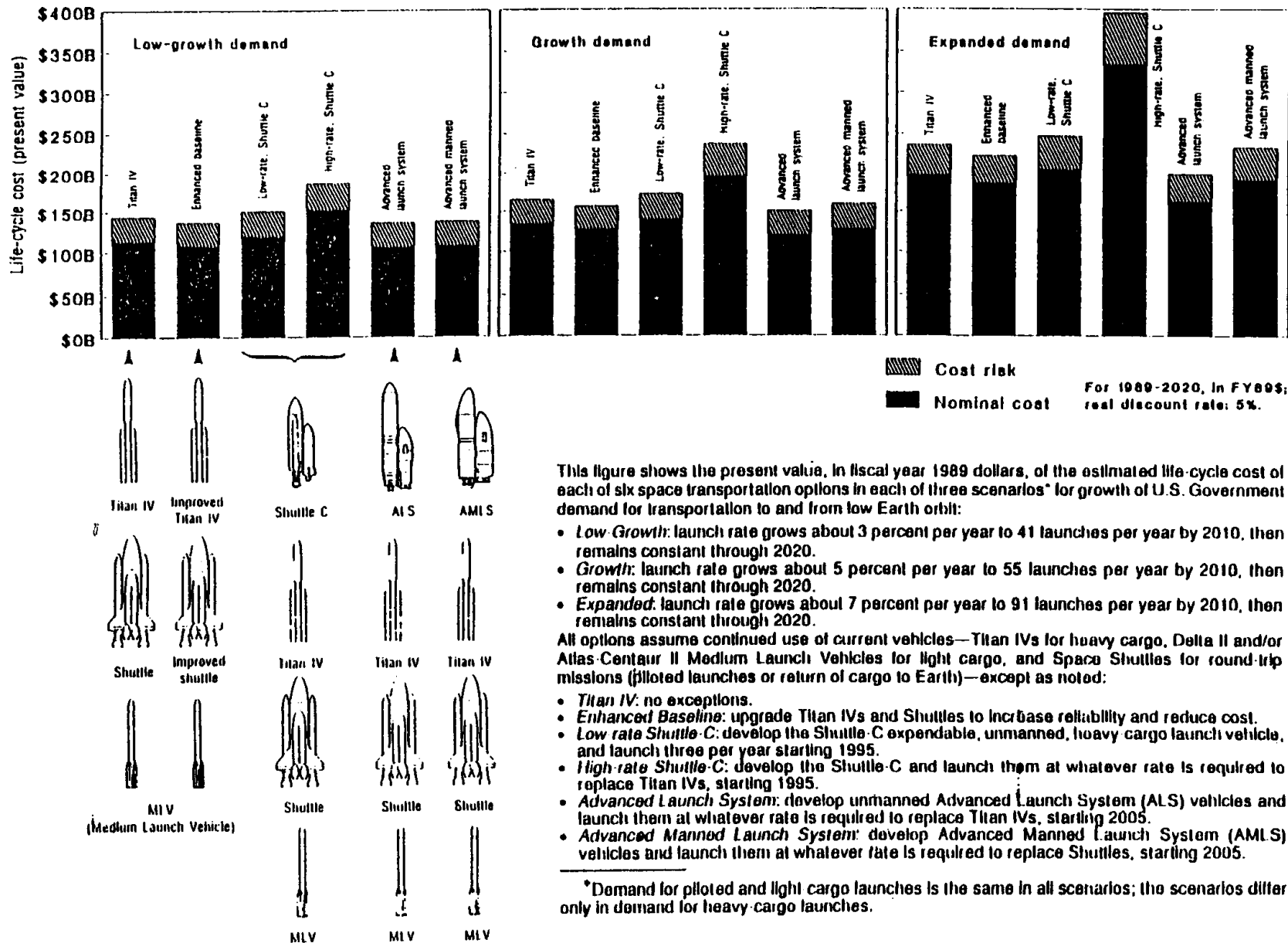

Source: Office Of Technology Assessment, 1990

Fig. 6.9, "Discounted Life-Cycle Costs of Space Transportation Options"

60% of anticipated DoD space launches and 80-90 percent of civil launches. The NAR study also estimated costs of a four-vehicle NDV fleet at \$13 billion, and of a nine aircraft fleet at \$30 billion. Those numbers did not reflect the cost of completing the X-30 program and test flight. Yet even with such eye-popping numbers, the cost savings of NDVs over other systems under investigation ranged from substantial to overwhelming.

Internal studies such as NAR's would have had trouble generating support merely on the face of the exceptional cost projections. But criticisms from inside the Air Force gained momentum from several commissioned research projects by the RAND corporation, a well-respected think tank used by DOD, but one that had its own set of biases. RAND, for example, repeatedly supported the use of rockets over air-breathing systems, and tended to favor unmanned systems over piloted aircraft. In a 1989 analysis called "Comparison of Launch Systems for Space Support Missions," RAND researchers identified six space support missions, ranging from "single satellite insertion" to "space station crew replacement/rescue," proposing a set of desirable launch system characteristics that might be embodied in a particular system.¹⁹ Although the study concluded that NDVs emerged as "the best *manned* launcher across a spectrum of scenarios ranging from peacetime to nuclear war," it left considerable room for reconsideration of unmanned launch systems. Overall, RAND recommended a two-stage concept similar to the German Sanger aerospace vehicle. The RAND study contained numerous hedges, however, with the most obvious being the frequent use of "maybe" to describe the necessity of having human pilots. In one scenario, some 25% of the categories invoked the nebulous "maybe."

By supporting a two-stage Sanger concept, RAND revived an approach to orbit that the

American hypersonic community had abandoned years earlier as too expensive. Indeed, one of the major advantages the NASP managers thought the U.S. had over its German competitors was that NASP was a single-stage-to-orbit system. Two stages burdened the technical community with all of the problems of *both* rockets and airbreathing vehicles, and the high-speed scramjet technology that stifled the X-30's development still would have presented a formidable hurdle. For example, a two-stage aircraft would have to reach at least Mach 8 to deliver a second, rocket-powered craft into orbit. NASP engineers had concluded much earlier that if they could breach the Mach 10-12 barrier, they would have solved the single greatest challenge.

RAND, then, in one report had dredged up not only the single-stage vs. two-stage debate, but had again brought up the manned-vs.-unmanned issue. And more than a few in the JPO were sympathetic to different sides of each position. Added to the conflicting study results, yet another dilemma had appeared by 1990 that had its roots in both the manned/unmanned debate and the stage debate. Competitor systems such as those identified by RAND promised or had the potential for more near term payoffs than NDVs, although at far less performance and ultimate cost savings. But they threatened to dissipate political support, technology focus, and program impetus. As one NAR director commented, "To get user support for airbreathing SSTO we needed to show near term operability, and that meant rockets. But extensive use of rockets, or a variety of other risk-reducing paths we could take tended to undercut the very case for NASP. It was a Catch-22: to get NASP we needed rockets, but if we had rockets [some argued] we didn't need NASP."²⁰

The War for Enthusiasm: Promoting NASP in the Popular Press

When the reconsideration of key NASP assumptions started to occur, the program relaxed its efforts to develop user support. Users were reluctant to commit to an undefined technology, especially when the range of options seemed to grow with each new report. Consequently NASP developed a second, somewhat separate push to interest a different group of users in NASP spinoff technology. Although extremely difficult to "sell" as a concept to users, legislators, or the public, the potential for spinoffs to emerge out of a revolutionary technology such as NASP were immense. As with earlier technology breakthroughs, however, NASP was dependent on many other related technologies coming of age at the same time, and it was not altogether clear to anyone that those other technologies either were in place or affordable. Economist Paul David has observed that certain components of a system may resist change if problems with other, compatible parts have not yet been resolved.²¹ Joel Mokyr called this the "Leonardo Problem," and noted "gadgets and devices can be conceived that are known to be possible, but cannot be built efficiently because supporting technologies are lacking. Energy generation without long-term environmental damage and superfast long distance travel are among the technological bottlenecks of our age."²²

The technology spinoff efforts, which utilized Science Applications International Corporation (SAIC) as the primary focal point, involved two major thrusts. First, SAIC gathered data from a half-dozen authors, researchers, econometricians, and space enthusiasts on potential and probable returns to the nation from an active NDV program. Those studies went beyond some of the earlier number-crunching activities in that they enlisted the efforts of visionaries

such as Harry Stine and Paul Hans who imagined a host of scenarios that might develop with NDV access to space. They also anticipated the economic impact of potential spinoff technology, such as better artificial hip joints or tennis racquets made from NASP-developed materials.²³

SAIC collected three major studies that projected NASP\NDV benefits to the nation's GNP. DRIMcGraw-Hill produced a study that concluded that by the year 2010 NASP\NDV benefits to the economy could exceed \$140 billion; and another study found that as early as eleven years after the project's initiation (2001, according to the year in the study, the program's additions to the GNP would exceed costs).²⁴ In addition to the SAIC-commissioned studies, several government or contractor employees produced independent studies touting the returns to technology of an aerospace plane fleet.²⁵ Another study, by Paul Bierly, S. Basheer Ahmed, and Ed Dupnick of Princeton Economic Research, used the Standard Industrial Code to generate an "incident matrix" that offered "candidate sectors" for NASP-related technology. The Princeton research group developed a technology model that defined national R&D expenditures for various sectors, then established a baseline productivity estimate for the non-NASP case to establish a relationship between national R&D expenditures and economic productivity *sans* NASP technology. Using five scenarios---for example, one in which U.S. exports increased, one in which they decreased, etc.---the results showed increases over the "non-NASP" American economy of \$29 billion to almost \$60 billion (see Fig. 6.10, "Scenario Comparisons"). Most studies of that type were little more than exercises in partisan wishful thinking, often containing little solid data. And with the exception of the work by DRIMcGraw-Hill, Hannigan, and the Princeton Economic Research group study, none of them would have stood up to any kind of scholarly peer review. Nevertheless, the exercises did capture an important point about NASP

	Cumulative Increase In U.S. GNP (billion 77\$)	Cumulative Increase In U.S. Exports (billion 77\$)	Average Annual Increase In Employment (thousands)
Scenario I	49.1	12.5	34.7
Scenario II	10.3	9.8	4.0
Scenario III	59.9	24.2	38.6
Scenario IV	58.0	22.3	35.6
Scenario V	50.7	13.1	35.2
Scenario VI	29.8	9.8	21.9
Scenario VII	29.3	9.3	21.6

Source: Paul Beirly, S. Basheer Ahmed, and Ed Dupnick, "A Macroeconomic Assessment of Hypersonic Technology," Report prepared by Princeton Economic Research, Inc. January 15, 1992, p. 407

Fig. 6.10, "Scenario Comparisons"

that the media had missed completely, namely the fabulous potential for new and unique businesses to bloom once a nation gained routine access to space.

Tapping into the public's imagination as it involved space had helped forge support for the Apollo programs, and despite tireless efforts by the JPO and the NASP contractors, the X-30 had never triggered that same element of fantasy in the general population. Part of the blame could be laid at the feet of the JPO, in that its public relations strategy had focused less on the civilian public and more on, first, the Air Force, then, later, the space community. Hoping to get the same class of intelligensia that had written wistfully about the moon landings, then, as Tom Wolfe's *The Right Stuff* did, capture the emotions of average Americans, the JPO paid only marginal attention to cultivating support among the editorialists and think-tank writers. While that group did not make policy directly, it formed a significant link between the opinion-shaping media and legislators on one end and with the folksy, television and radio hosts that reached out to the informed populace on the other. Only by 1990 did the JPO start to extend feelers into the ranks of faculty at university institutes, and to writers in the policy oriented media outlets such as *Foreign Affairs*, *National Review*, *The New Republic*, or *Atlantic Monthly*. NASP had gone unmentioned in such think tanks as the Heritage Foundation and the Brookings Institution. Predictably, end-of-the-spectrum publications, such as the *CATO Journal* or *The Nation*, ignored NASP entirely. In other periodicals and journals that one would have expected to find interest, including *U.S. Naval Institute Proceedings*, *ISIS*, and *Technology and Culture*, mentions of NASP were non-existent. Occasionally newspapers such as the *New York Times* or the *Wall Street Journal* did feature pieces on NASP in specific or hydrogen-based flight in general, and the trade weeklies *Aviation Week & Space Technology* and *Space News*, plus the partisan *Air*

Force Magazine, devoted regular coverage to the program.²⁶ But the press as a whole and the policy-oriented periodicals in particular rarely reported on NASP.

The most positive piece, and the most likely one to reach a wide general audience, appeared in *Popular Science*.²⁷ A somewhat less favorable column touching on NASP was written by Warren Brookes in the *Washington Times*.²⁸ Eventually, a minor debate graced the pages of *Technology Review*, and *Defense News* carried a regular exchange on the program.²⁹

“Technology Transition” and Program Hopes

Unable to gain a foothold in the popular press or intellectual policy journals, the program had to create a demand for NASP-related products through businesses. More than ever, by 1990 the program emphasized technology spinoffs, and gained some of its best publicity in local papers and trade magazines related to specific small technological advances provided by the program. Theoretically, the JPO was on solid ground arguing that “spinoffs” would occur, and would have an impact on ordinary Americans. Indeed, historical evidence existed to show that an investment in sophisticated technology---even quite specialized---had lucrative returns in other markets, and for years NASA had based much of its promotional material on the relationships of space exploration to everyday life.³⁰ Unfortunately for NASP, the historical record also showed that many technologies had unanticipated uses, far removed from their original intent and untouched by “marketing” approaches. Few people perceived that radar, for example, would have its largest market as a domestic cooking appliance; or that simulators would find their most widespread use in video games. Other products, such as aluminum or private business jets,

appeared only after the government invested considerable money. Clearly "technology transfer," as the process was called, occurred, but even specialists in technology and business applications could not identify how government technologies actually came to be transferred to the private sector.

Whenever NAR attempted to quantify and publicize the potential benefits of an aerospace plane program, the numbers---always an informed guess---were challenged. Projections by Russell Hannigan based on relating NASP technologies to specific areas in the U.S. industrial code yielded an impact to the U.S. economy of \$26.2 billion by 1999, accounting for 65,000 new jobs, or by Harry Stine that predicted costs falling in areas such as popsicles came under fire at a 1991 conference on NASP.³¹ One critic called such numbers "hyperbole of the worst sort These are the same things people said would result from the [Space] Shuttle."³² Yet shortly after the conference, a Washington-based newspaper, *Washington Technology*, stirred controversy over possible cuts in the NASP budget when it ran an article called "NASP: Herald of Great Upheaval, Payloads Put Into Low Earth Orbit at 1/10 the Cost."³³

Technology transfer at NASP took on a life of its own, and engaged some of the most respected analysts in the nation. Michael Porter, the Harvard expert on competitiveness in industries, argued in the case of NASP that "technology transfer requires a strategy---it doesn't just happen."³⁴ NAR indeed had a strategy. NASP created a technology data base upon which users could draw, then it targeted Air Force Reservists, many of whom had their own businesses outside their monthly duties for the Air Force, to receive technology transfer (or technology "transition" as the NASP program often called it). The program found that it could expose NASP technology on a fairly broad basis using the Reservists. Another component of the transfer

strategy focused on industrial meetings whose members might have an interest in NASP-related technology. NAR worked with the Society of Automotive Engineers and the Society of Manufacturing Engineers to spread further the benefits of NASP technology in the private sector. The JPO also established a training program at universities to enhance research and education in hypersonics. In FY86 and FY87, NASP funded programs at Stanford, SUNY Buffalo, the University of Texas, University of South Carolina, Ohio State University, and North Carolina State University.³⁵

Few doubt whether “spillovers” occur in R&D, and a substantial technical literature exists on the subject of “technology diffusion.” Yet whether or not the government has effectively facilitated technology transfer remains a matter of disagreement. According to a 1986 report on patents that have emerged from federal laboratories, the nation employs 185,000 scientists and engineers and spends close to \$20 billion annually in its labs, yet only about 1500 of the nation’s 30,000 patents originate in federal labs.³⁶ If the research is commercially valuable, the conclusion must be that little technology transfer from the government to industry has occurred. At least one critic has argued that the “lack of interest by the private sector can be traced to the inability of government to efficiently promote and market government-developed technologies and the negative perception held by industrial managers of the relevance and/or potential value of technology developed in federal laboratories.”³⁷ Part of the problem with technology transfer from government to the private sector, as SAIC learned, was that the process is extremely sophisticated and difficult to control. Frederick Scherer, for example, has noted that the airline industry has specifically benefitted from federal defense R&D spillovers; and N.E. Terleckyj identified spillovers to and from “similar” industries---those sharing the same market--

-and also “other” industries that have little in common.³⁸ Economist Adam Jaffe has even found that spillovers positively affect firms outside the initial firm’s “cluster.”³⁹ Other studies confirm that spillover effects exist, and that they are probably underestimated.⁴⁰ Nevertheless, the research indicates that the effects of federal R&D tend to benefit an industry as a whole, not particular firms, and Zvi Griliches found the rate of return lower in industries that had high levels of federal R&D support.⁴¹ After a Chase Econometrics report claimed very high rates of return for spillovers from NASA R&D (40%, or twice that of all other R&D), both Griliches and N.E. Terleckj found substantial weaknesses in the report, and Terleckyj even concluded, from the same data, that the most productive inputs came from private investment in R&D.⁴² When the GAO evaluated a NASA attempt to get private industry interested in financing seven NASA-originated project, it failed in six cases “because the projects were too far along or there was not a commercial market for them,” according to *Aviation Week’s* report of the GAO report.⁴³ The efforts that “flopped,” according to the report, included advanced solid rocket motors, a weightless training pool, telerobotic systems, and scientific instruments for unmanned space probes. All the projects were extremely specific---always a poor characteristic for technology transfer candidates---and rather than no commercial market existing, the truth of the examples was that no business perceived a market for the technologies at the time.

One last caveat accompanied the technology transfer efforts. Studies found that the behavior of the participants was critical to spreading the benefits of technologies, in that collusive behavior tended to stifle technical diffusion, while competitive behavior tended to enhance it.⁴⁴

Edwin Mansfield has discovered that whether a deliberate attempt to “get the technology

out” is made or not, information concerning development decisions is in the hands of rivals in 12-18 months, suggesting that technology diffusion occurs regardless of whether it is being “pushed” or “contained.”⁴⁵ Processing and operating information leaks out even more rapidly. Thus, the NASP technology diffusion effort may have been both effective and redundant at the same time.

NASP, Technology, and “Industrial Policy”

Two problems faced the program's efforts to generate support for NASP through successes in technology transfer. First, evidence has shown that most technical breakthroughs come from smaller companies, and usually not a company that is considered the leader in the field. It was not the slide-rule manufacturers who fielded the next generation of calculators, but Texas Instruments; not IBM that pioneered the personal computer but Apple; and not Apple or IBM that first created a video game market, but a toy manufacturer called Atari; and not Kodak that developed the first color camera, but Edwin Land and Polaroid. Perhaps more telling, the government virtually missed the computer chip revolution, pouring untold millions into vacuum tube technology. Nor did the telephone giant AT&T create the cellular phone market. Burton Klein, in his book *Dynamic Economics*, pointed out that *none* of the top fifty American technological breakthroughs of the twentieth century came from the established leader in the field.⁴⁶ Reaching the lowest level of the entrepreneurs with the benefits of NASP involved more than creating a data base: entrepreneurs had to be "linked up" specifically with the technology that best suited their needs. Was it cost effective for the government to try to do that?

Taken to a logical extreme, such arguments as Klein raised even called into question the early decision to exclude du Pont Aerospace from competing. Indeed, Dick and Burt Rutan of Scale Composites, the successful designers of idiosyncratic but record-setting *Voyager* aircraft, argued that the best way to achieve SSTO was to offer a national prize available to anyone who met a few, demonstrable goals. Heralding back to the days of explorers and achievers, such as Robert E. Peary, who generated most of his funds from private supporters for his expeditions or Charles Lindbergh---all to receive either societal or national prizes---the Rutans argued that the most cost-effective way of attaining orbit with an air-breathing vehicle would be through such a prize. It had to be of sufficient worth to induce participation, though, and they suggested that a \$3 billion price for first SSTO reusable vehicle would produce the technology that the nation needed. Critics, however, quickly rejected such notions with references to the technological base, arguing that such “stunts” would not “prove” the technology. Once again, NASP was faced with multiple missions of attaining a performance goal and spreading the technical base.

A second, and even more serious, question than that of the cost-effectiveness of government intervention in diffusing technology involved the critical need to have the credit for technical breakthroughs go to NASP, and quickly! Not only did the program have to identify entrepreneurs who could attribute their success to the NASP “spinoff” technology, but the program had to “re-package” those “satisfied customers” quickly enough that they could contribute toward building political support. Ultimately, it proved a losing proposition. Even if NASP specifically received credit for private adaptation of a technology---a dubious proposition---the time within which an entrepreneur could apply the technology, see its benefits, and respond politically by writing or calling a legislator was so long that NASP could not hope to benefit.

The technology diffusion elements of the NASP program proved to be the most significant in actual applied technology. But the political returns to the program were minimal at best, and at worst the entire process absorbed effort and energy that could have gone to problems on the X-30 aircraft itself. NAR's technology transfer effort, which accurately boasted of important adaptations of NASP technology by private companies within a short time, was indeed a limited success insofar as it connected government research to the corporate world outside of the aerospace industry. But that in itself cost the program support from fiscal conservatives in Washington who supported strong national defense, but who opposed what they saw as "corporate welfare."

In yet another ironic setback, the fruits of the technology diffusion program started to appear at roughly the same time a national debate erupted in the policy journals and on media television and radio shows about the desirability of a national "industrial policy."⁴⁷ Two central questions emerged from that national debate: "Should the U.S. attempt to have an "industrial policy" at all?" and, "What should the role of DOD be in such a policy?"

Critics of the Pentagon long had charged that the U.S. had an industrial policy carried out by the Department of Defense, and that it was not as efficient as Japan's MITI when it came to advancing commercial technologies. Popular authors such as Robert Reich, Lester Thurow, John Kenneth Galbraith, and David Halberstam extolled the necessity for federal direction of industrial policy. Most of them encouraged the federal government to support efforts such as High Definition Television (HDTV), touted as the next generation of video technology. Ira Magaziner, in his co-authored book called *The Silent War*, used the European Airbus as an example of foreign governments directing industrial policy in the aerospace industry to their

advantage and at the expense of American commercial airline manufacturers, such as Boeing and MD.⁴⁸

Opponents of government-directed industrial policy pointed out that MITI had as many failures as it had successes, and that the United States had captured the critical software market in computers. The opponents' best evidence against having the government "pick winners and losers" was HDTV itself. By 1992, the Japanese companies directed by MITI were mired in HDTV technology that had not proven itself, while American companies, mostly without government subsidies, had struck on a successful design that the Japanese eventually adopted.

But the voices calling for industrial policy were numerous and the spokesmen highly visible. Congressman Richard Gephardt (D-MO) and Governor Bill Clinton of Arkansas (who was later elected President of the United States) both made strong public statements during the political campaigns of 1992 in favor of an industrial policy disassociated with DOD. Even President George Bush embraced elements of a commercial industrial policy by chartering a "Council on Competitiveness," which to a great extent searched for ways to distribute federal benefits to American corporations. It was inevitable that space policy was drawn into the competitiveness debate.⁴⁹

Continued Expansion of the NASP Bureaucracy

Given the personal philosophies of both Barthelemy and Waldman that approved of a government/business "team," and a widespread attitude among the aerospace contractors that the federal government had a duty to enhance their competitiveness, it was entirely predictable that

NASP would extend itself into areas such as technology transition.⁵⁰ Yet the entire technology spinoff effort within the JPO illustrated one of the underlying problems of the program: it had grown too big to adapt quickly or change directions quietly. By 1992, for example, the NASP JPO had more than 100 personnel with a near-term target of 150. That number represented a small staff compared to large production aircraft programs such as the B-2 bomber (400-500 people in its program office) or the F-16 fighter (400 in its System Project Office), but when measured against the less-sophisticated research aircraft programs, such as the X-29, with its 18 people, NASP was bloated. Even then, ASD considered the X-30 JPO understaffed, and in 1991 instructed Barthelemy that 150 was the minimum number that the NASP office should have for maximum efficiency.⁵¹

Those changes placed NASP light years from the “skunk works” program management team envisioned by Barthelemy and Wierzbanski---a lean, slimmed-down management structure staffed by eager, entrepreneurial officers and administrators. However, few programs in history had achieved the advantages of the “skunk works.” Indeed, as Kelly Johnson, the “creator” of the “skunk works,” asked, “If the Skunk Works is so successful . . . why doesn’t everybody do it [?] Not even other divisions at Lockheed? . . . I believe industrial management does not want to use our type of operation because fewer people are required; therefore the profit is less [since] profit is a function of the number of people on a program.”⁵² Johnson, though, ignored another reason that few programs achieve a “skunk works” status: the government has to yield direct management responsibility and trust the contractor to deliver a product. Lockheed has performed beyond expectations, but could the same have been said, in 1986, of Marquardt or Aerojet, or even GE? Indeed, a likely outcome of turning the propulsion program over to, say,

GE, might have been that all the money would have been spent and GE's engineers would say, "We can't do it." More important, the government's numerous mandates for oversight of everything from workers' protection to affirmative action hiring in federal contracts means that a program must have clear national priority before Uncle Sam will turn control over to a private business.

The NASP bureaucracy expanded in exactly those federally-mandated areas, with additional areas of management employed to direct such activities as the Environmental Impact Statement, the safety of fuel systems, and the Air Force's new Total Quality Management initiative made the JPO increasingly less flexible, and shaped it more like a typical production program. Two other changes associated with the growth of management occurred, as well. First, as more personnel were added, they increasingly came from the ranks of captains and majors. The early JPO under Barthelemy had been exceptionally "top-heavy," featuring several full colonels, a number of lieutenant colonels, and Barthelemy (an SES, or Senior Executive Service, the civilian equivalent of a general officer). Moreover, each man and woman was selected for experience in research aircraft, especially unique systems. The expansion of the JPO dramatically reduced the proportion of senior officers and civilians in management. That had a second, related effect: most of the replacements for reassignments and most of the new personnel did not come from R&D programs. Instead, they brought to the program, as one anonymous JPO director called it, a "production line mentality."

Concerns About NASP on Capitol Hill

The effects of burdens on both the technological innovation and the budget that such bureaucratic growth inevitably causes started to appear internally within NASP by 1990 or 1991. Externally, however, they remained hidden to legislators and policymakers, who saw only that the aerospace plane program looked a great deal different than the \$5 billion, 50,000-lb. du Pont aircraft that had won funding initially. Instead, members of Congress expressed concern about NASA contributing more equitably to the program, and about the failure of the program to capture the imagination of the public by stating clearly the value that NASP and NDVs offered. In the 1990 hearings before the several House subcommittees, representatives sharply questioned witnesses about their enthusiasm for the program. Oklahoma Congressman Dave McCurdy asked NASA witnesses if they were "going to 'lobby' for the program."⁵³ Congressman Jon Kyl (R-AZ) wanted an indication if "the partners are willing to have a 'true' love arrangement and each allocate [a] fair share of monies."⁵⁴ Representative Dana Rohrabacher of California, a long-time NASP supporter, expressed the sentiments of many on the panels when he stated that he was "overwhelmed with the lack of conviction shown on this program."⁵⁵ Congress wanted the program to publicize the potential of NASP and NDVs more than it had, and Rohrabacher accused the Bush administration of having a "DC-3 mentality" in the space age.⁵⁶

Yet NASP managers continued to operate under the assumption that a full disclosure of the anticipated costs of the Phase 3 part of the program would result in immediate termination, and, they could rationalize, no complete, reliable cost estimate existed. Therefore, they could say with honesty that "no one knows" what the program would cost---and they could legitimately

point out that no cost estimate was possible as long as Congress, NASA, and the Air Force continued to vacillate in budget commitments. To reiterate, program management, despite failing to deliver the “whole truth” to Congress or its sponsoring agencies, nevertheless was prevented from *preparing any reliable cost estimate by the fact that no sooner did a working group inside the JPO arrive at an estimated cost for a future activity, test, or package of work than the budget and schedule made it instantly obsolete!* Furthermore, despite the pleas of supporters such as Rohrabacher, who insisted that NASP act with greater boldness, program management had heard even more forcefully through indirect channels that it had to operate under a total program cost ceiling and an annual ceiling in the minds of most legislators. (The source most often cited at the JPO for these “boundaries” was Ming Tang at NIO, who, technically, worked for the JPO.) Unfortunately, as questions about the technology status and cost grew more central to the issue of the program's survival, accurate assessments of each were more needed than ever before.

In hopes of providing at least some outside, independent estimate of the status of NASP, in 1991, Congress instructed the General Accounting Office (GAO) to conduct another investigation of the program similar to the one it performed in 1988. The 1991-92 GAO investigation (never really concluded, because the GAO extended its investigation indefinitely) stood out as potentially the most positive and favorable of the internal reports that the program had received. Unfortunately, what essentially became an “executive summaries” circulated internally in Washington, but it lacked the impact of the earlier report and hardly offset the damage done by the DSB report years before.⁵⁷ Compared to the several previous government investigations of the program, the GAO report positively glowed, and, based on the earlier levels of criticism generated by government reports, program officials had confidence that the it could

rejuvenate support for NASP in Congress by reassuring the members as to the costs and/or technological status of the aerospace plane.

Technical Advances Continue---Would They Be Enough?

In fact, the technology had made great leaps forward since 1986. One of the most important areas of technical progress had occurred in materials, where titanium alloys, especially Beta 21S, had so impressed program engineers that it was used as the baseline for the fuselage material.⁵⁸ Terry Ronald, the JPO materials leader, labeled Beta 21S "a pleasant surprise."⁵⁹ Another material, in which the program once placed great hope---titanium aluminides, with their capacity to withstand temperatures of up to 1700 degrees F---failed to develop as a fuselage material, but still had great potential for use in leading wing edges and critical heat areas. Program materials experts focused their efforts in particular on reinforcing titanium aluminides with fibers such as silicon carbide. When fabricated in a foil/fiber/foil consolidation, they had proven successful as structural shapes for large airframe components that use multi-ply panels and included cross-plyed fiber layers and tapered cross sections.

A second material, developed for aerospace use largely by NASP, was the carbon-carbon composite, which had exceptional potential for use as a light, heat-resistant shell covering. Carbon-carbon presented a challenge in that high temperature environment caused oxidation problems, but when augmented by a protective coating, carbon-carbon could survive high temperatures, but not "NASP-type" temperatures.

Conservative estimates of the heat demands on the aircraft required that the X-30 sustain

temperatures in the range of 2800 degrees F. Optimistic projections of active hydrogen cooling allowed for the cooling system to reduce temperatures by 1000 degrees, meaning that materials had to sustain at least 1500 degrees "on their own." Most NASP engineers thought that they could develop and produce materials that could sustain such heat, and especially if carbon-carbon could be reinforced with heavier materials (such as silicon carbide-reinforce silicon carbide (SiC/SiC) and carbon-reinforced silicon carbide (C/SiC) in critical leading edge areas of the X-30.

Temperature demands of the engine area posed a much tougher challenge for NASP engineers. Since hot gas would shoot through the engine in a fraction of a second, and that gas had to combust at as high a temperature as possible, all the materials in the engine---injectors, sidewalls, fasteners, and hinges---all had to be cooled actively. The path of that coolant would be critical. One path had the coolant flowing through the combustor first (the hottest section), then to the inlet, then finally to the exhaust, allowing the hydrogen to be at its coldest when it arrived at the most heat-intense part of the flowpath. However, whereas that path had considerable benefits for *cooling*, it was the least efficient path for combustion, as cold fuel does not burn as efficiently as hot fuel. A second flowpath essentially reversed the circuit, sending the coolant to the inlet first, and delivering it to the combustor last, a path that provided for optimal combustion, but inefficient cooling.

Dilemmas within the engine flowpath and cooling systems underscored the tremendous degree of integration in the X-30. A change in one area forced changes across the board. For example, the choice of materials dictated the weight of the vehicle, but it also affected the coolant flowpath, and thus combustor efficiency, and even the aircraft's trajectory. Changing the

trajectory by a small degree could reduce the level of efficiency required in the engine, but also could permit the use of lower-weight materials, offsetting decreases in thrust. With materials weight in the structure constituting half the total aircraft weight, any savings in weight achieved through materials improvements could be substantial across all areas.

By 1991, the program had done a great deal of testing on materials, especially in the form of hydrogen tank tests. The hydrogen tank represented the single largest component on the aircraft, and both GD and MD had developed tanks tested under a spectrum of pressures and temperatures while loaded with hydrogen, and the tanks had performed as predicted.

Another area of technical challenge, slush hydrogen manufacture and transportation, had progressed even more rapidly than the materials. Slush characteristics had been identified, and slush itself had been stored and transported distances appropriate for use on the X-30. Some pumping of slush also had occurred.⁶⁰

In still yet another area, expansion and improvement of hypersonic test facilities, again NASP had made significant advances. NASA's Lee Beach, writing to Barthelemy in June 1992, noted that "Significant progress is being made toward providing the facility capability needed to address scramjet performance and CFD code anchoring data in ground simulations at speeds greater than Mach 12."⁶¹ Beach specifically pointed to the improvements in the HYPULSE expansion tube at the General Applied Science Labs and at the 16" shock tunnel at NASA Ames.

Advances in slush hydrogen, materials, and test facilities, however, could not offset the slow pace of work on the scramjet. Program engineers had managed to demonstrate combustor efficiency within 10% of its goal, and completed a subscale test of the integrated engine (which represented the first two iterations of the post-team design). But virtually no demonstration of

active cooling of engine parts had occurred, and the technology in engine structures still lagged. The JPO attempted to use the award fee money made available in the contract as incentive---and the NPO consistently received a high percentage of the award fee, indicating good and continually improving levels of effort---but in reality contractor engineers were not capable of much more effort. Eventually Waldman gained some efficiencies through a relocation of the propulsion directors of Rocketdyne and P&W at the NPO, but the directors increasingly resigned themselves to finding a way to gain improvements in the airframe, reduce weight, or change the trajectory as a means to "make do" with the existing scramjet performance. The ultimate symbol of their resignation, however, was the increased emphasis on a rocket in earlier stages of the flight to achieve orbital velocity.

Despite concern about the scramjet's performance, the integrated schedule demanded that work continue on all peripheral areas required by an X-30 aircraft flight test, including preparation of an Environmental Impact Statement to cover ground test and operations of the aircraft and to assess the impact of the flight test. The program had chosen Edwards Air Force Base in California for the origination of the flight tests. Early test plans called for the X-30 to fly east from Edwards, make a large loop, and return to Edwards. As the flight test program unfolded, the loops eventually would extend to the Atlantic Ocean. Ultimately, the X-30 would attempt its orbital flight. Environmental issues related to the flight test emphasized two major areas, sonic boom effects and potential ozone depletion effects of the scramjet exhaust.⁶² Program test pilots had identified the flight patterns that would have minimal sonic boom effects on people or animals, and most observers were satisfied that no significant problem would emerge related to the aircraft breaking the sound barrier during the flight test.

Potential ozone damage by the scramjet exhaust was assessed as extremely minimal, if any existed at all. Indeed, directors working on the environmental effects had grown so confident that no ill effects would occur that in 1992 DoD solicited several Small Business Innovation Research (SBIR) Program proposals to examine ways that NASP might *replete* the ozone layer as it flew. Most of the SBIR proposals sought to fine-tune the chemical mixture of the exhaust. But one innovative approach suggested using an electric discharge process to charge the exhaust and form ozone out of the water molecules given off by the scramjet's combustion process, and another similarly sought to use electric fusion to generate electron beams.⁶³ The winning proposal, however, sought to stimulate ozone enhancement through catalysts added to the combustion or exhaust process.⁶⁴ Nevertheless, until the program had identified an ozone-repletion technology it favored, the early test flights of the X-30 would cause an infinitesimal and virtually unmeasurable level of ozone depletion. By 1992, neither critics nor supporters of NASP could find enough in the environmental elements of the program to use as evidence for or against their points.

Another area in which the integrated plan required immediate action was in the development of facility and process to manufacture and assemble the X-30 aircraft. The JPO had chosen Rockwell's Plant 42 at Palmdale, California, directly across from the B-2 test aircraft hangers (see Fig. 6.11, "NASP Ground Support System [GSS] Concept"). Palmdale offered proximity to Edwards, making transportation of the finished product easy, and with the major aircraft contractors located in Los Angeles, just an hour away, the location provided quick access to expertise that might be needed throughout the process.

If all the critical areas of NASP technology had yielded to steady breakthroughs, as had

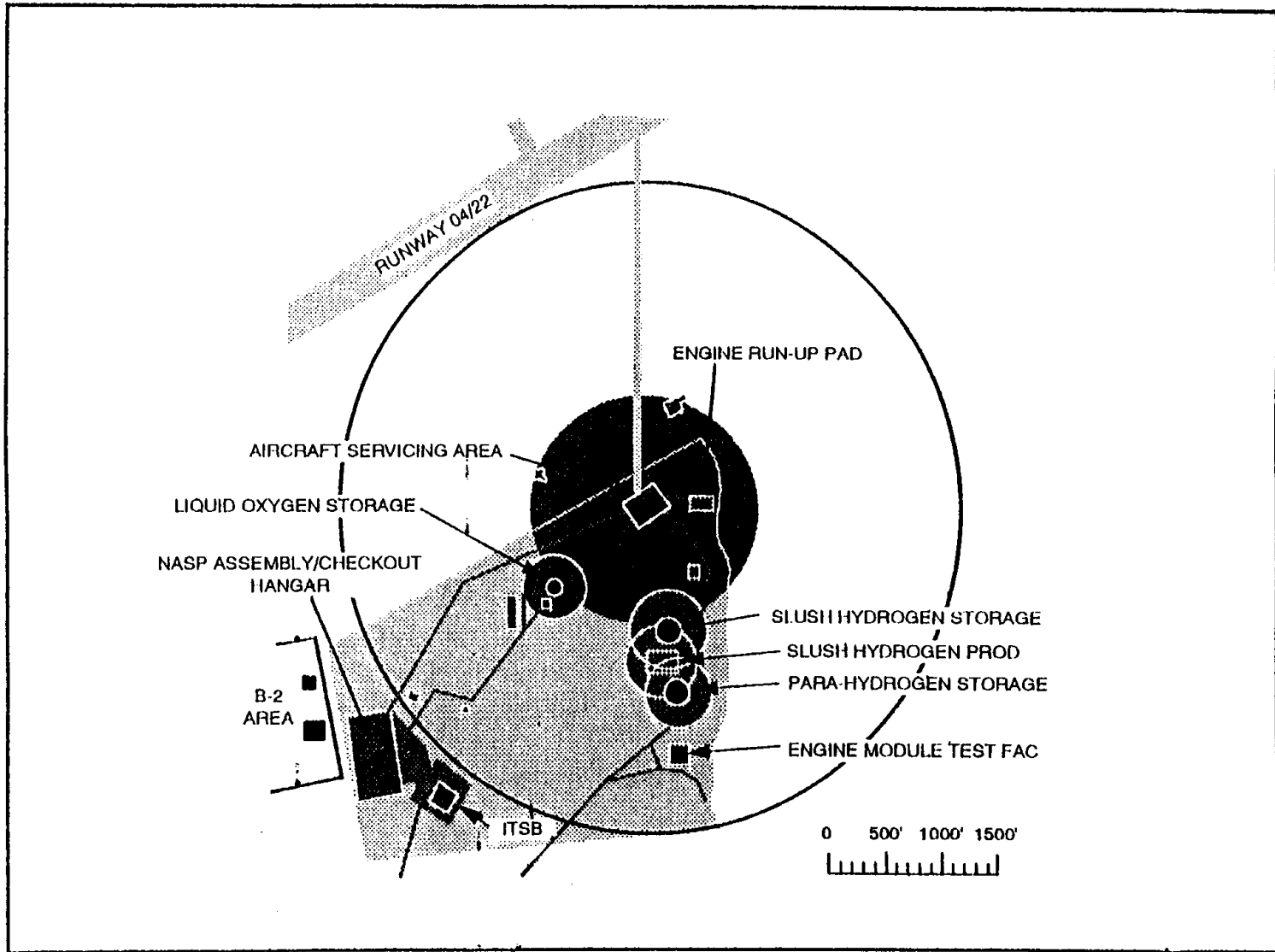

Fig. 6.11, "NASP Ground Support System Concept"

occurred in materials and slush hydrogen, such planning would have represented sensible steps for the program to take at that time. But when the slow, incremental gains in scramjet propulsion combined with the concerns about the effectiveness of actively cooling leading edges and the engine, using precious resources for environmental impact statements of tests that might never take place seemed poorly targeted.

Critics, of course, had grabbed onto the slow progress of scramjet to attack NASP. In February 1992, RAND Corporation, of Santa Monica, at the direction of Maj. Gen. Albert L. Logan, Director of Plans, DCS/Plans and Operations, produced a study called "The National Aerospace Plane (NASP): Development Issues for Follow-On Systems."⁶⁵ RAND had a history of opposition to SSTO in general and NASP in particular, and the conclusions of that study were not surprising. RAND's conclusions, however, were guaranteed to arrive at the top levels of the Air Force, because Secretary of the Air Force Donald Rice had worked at RAND and had strong connections there. Given the study's title, it was ironic that it hardly touched on "follow-on systems" at all. Instead, the RAND report emphasized that a two-stage-to-orbit configuration as having "much to commend it" as a "strong contender" for the NASP project. RAND criticized CFD progress, claiming that the "state of the art will not allow CFD to serve as a self-contained design tool for NASP and is not likely to do so over the next ten years even with a program of testing, experimentation, and analysis to narrow the major hypersonic aerodynamic and combustion uncertainties." That position was similarly ironic because CFD had made great strides, so much so that by 1992 virtually all of the CFD prediction codes that had been compared to actual test results had been validated. RAND was correct to suggest that no aircraft system could "prove" SSTO using CFD---only flight could do that---but was entirely off the

mark to suggest that CFD could not perform the tasks for which the NASP researchers had intended it to perform. Indeed, by 1992, CFD code validation had come far enough that virtually everyone inside the program had concluded that a Mach 12-15 vehicle was feasible because the engineers could use CFD to predict performance above Mach 15 enough to begin designing the aircraft for flight above Mach 15.

Elsewhere in its report, RAND stumbled upon more accurate analysis. The report found that NASP had no single overriding mission (a point that program management had arrived at years earlier), but could conduct so many different missions as to make it valuable. The two-stage-to-orbit concept had undergone extensive study at a number of levels, and in almost every case SSTO offered greater potential. Two-stage-to-orbit represented evolutionary change, which NASP could have achieved at almost any point by utilizing the rocket earlier in the orbital mission. Critics missed the entire point that NASP was revolutionary change, which never came easy. Looking at the early automobiles, which could only travel a few miles an hour, arguments could have been made that they offered no great improvement over the stagecoaches and covered wagons. Had the first car, in order to receive financing, been required to go 200 miles per hour, certainly no one would have produced a car. In the same way, the single greatest handicap under which NASP operated by 1992 was the orbital requirement, because the program could have put a non-orbital vehicle in the air at almost any time to start gathering data.

Barthelemy and the JPO leadership recognized that, given the advances in CFD, the budget reductions, and the slow pace of scramjet work, the SSTO mission that once was thought necessary to obtaining high Mach data now stood in the way of obtaining that data. The program desperately needed to start flying something on both a practical technical level---to start

answering questions that still could not be answered on computers, but which could be addressed by lower-Mach number flight---and on a political level to generate enthusiasm and reassure budget-makers that they were not throwing good money after bad. Increasingly after 1991, the JPO emphasized options to the X-30, either in the form of a subscale aircraft or as a non-SSTO Mach 15 aircraft---exactly the kinds of options that had (for good reason at the time) been discounted in the early 1980s! At the April 1992 Quarterly Technical Review (QTR), program management briefed NASA and Air Force representatives, outlining proposals to scale down program goals by offering options that included further testing and deferring fabrication of any entire aircraft.⁶⁶ Publications such as *Space News* reacted to those suggestions by commenting, "Finally, a Realistic NASP Plan."⁶⁷

Still, those options never received support from the Air Force or, after 1989, from the White House, which surprised no one. But shockingly, resistance also came from Ming Tang, the NASA official who headed the NASP NIO office in Washington. As shown later, that office had gradually assumed authority for policy making, expanding its domain from its original charter of sharing information. Ming Tang declined interviews for this manuscript, but sources close to NIO contend that Tang had information that any deviation from the SSTO mission would unravel the political support from the White House. Such an explanation for blocking less ambitious modifications to the flight schedule and immediate NASP mission is understandable, and Tang certainly may have operated on the assumption that changes in the program would lose Quayle's support. However, the immediate weak point for NASP was not Quayle, who already had accomplished as much as he could (and, given the marginal influence of other Vice Presidents, far more than anyone expected of the "Veep"). Rather, NASP needed to shore up

congressional support, and Congress increasingly was demanding evidence of progress.

In that regard, some NASP supporters indeed also feared that any retreat from the SSTO mission would cost the program dearly in Congress and in public support. Still others saw SSTO as a point of honor, to which the program had originally committed itself and received funding. Therefore, anything less than that would violate the "contract" between those who originally "sold" the program and those who funded it. Had the key policy decisions as to the wisdom of holding fast to SSTO been made by the Steering Group, after full input from the JPO, or even been debated within the Space Council, NASP may well have survived. Instead, they were developed by NIO based on perceptions NIO had about what would, and would not, elicit support.

The April 1992 QTR further increased tensions between NIO and the JPO in other ways. For years, the program had stated its costs in 1986 dollars, which always reduced the total. Recognizing that Congress had insisted on more accurate information with which to review the program, the JPO had attempted to start presenting all costs in briefings as current year dollars (i.e., 1992 costs in 1992 dollars, 1993 costs in projected 1993 dollars, etc.). That would have made out-year totals much higher than previously stated, but much more accurate. Several individuals in the JPO lobbied to "get everything up front" so there could not be an accusation that the program had hidden its real costs. (It had, of course, delayed releasing the early cost-estimate numbers of \$11.5 billion, and had never prepared a reliable total cost estimate). As a result, the QTR placed the costs of FY93, FY94, and FY95 of \$382-\$479-\$582 million dollars instead of the numbers circulated in public of \$350-\$425-\$500 million. Once again, however, NIO, fearing political fallout, insisted that the JPO convert the numbers back to the 1992 dollars,

and the JPO complied. Only later did the program learn that it was to receive actual funding in 1992 dollars without inflation adjustments for the out years. The technically honest attempt to "tell the truth" about program costs was rewarded by a sleight of hand that left the program with a net loss of close to \$170 million.

After six years, the program had found itself increasingly confined by its own somewhat contradictory mission requirements, rising costs, and technology that refused to be "pushed" in some areas. No one problem inherently threatened NASP, but when combined, they placed the program in a hopeless position. It could not achieve more rapid technical progress without higher funding; it could not maintain the current technical effort and conduct an SSTO mission before the year 2000; and it was prohibited from abandoning, *even in the near term*, the SSTO mission requirement. For all its success, the X-30 program was on a collision course with either time or money.

And for all of NAR's efforts to find a single champion---a bureaucratic residence that would adopt NASP, the program was no closer in 1992 to having a single, clear, reliable sponsor than it was in 1986. As an insightful article in *Spaceflight* explained, the primary reason DoD did not back NASP is "because NASP has no mission [and is] a technology development programme not in search of a mission but in search of a home."⁶⁸ Despite Robert Williams' remarkable five-way agreement; despite Barthelemy and Fuller's energetic attempts to generate Air Force support at SAC and AFSPACECOM; and despite the door-to-door sales of NASP to the Departments of Commerce and Transportation; and despite the directed effort at creating a unique network of NASP technology spinoff distribution points, the aerospace plane remained, as *Spaceflight* aptly put it, "An American Orphan."

Chapter 6 Notes

1. Roger D. Launius, "NASA and the Decision to Build the Space Shuttle, 1969-72," The Historian, Autumn 1994, pp. 17-34 (quotation on p. 17).
2. Weekly Activity Report, March 6, 1986, in NA files, cited in "National Aero-Space Plane (NASP) Advanced Technology Impacts," 7.2.
3. Interviews with Maj. Jess Sponable, various dates, 1990.
4. Interview with Col. John Fuller, February 1, 1990.
5. Interview with Col. John Fuller, February 1, 1990.
6. National Aero-Space Plane Status Report, February 1988, in NAR files, cited in "National Aero-Space Plane (NASP) Advanced Technology Impacts," 7.3.
7. A number of documents covered these developments, including "Major Milestones During NASP Phase 3," "NASP and NDV Notional Development Schedule," and "NDVs must be Reflected in the Current FYDP if Initial IOC is to Occur in the Late 1990s," all in NAR files, cited in "National Aero-Space Plane (NASP) Advanced Technology Impacts," 7.4.
8. Maj. Jess Sponable to Col. [John] Fuller and All Directors, memo, May 10, 1989, Maj. Sponable's files, NAR, cited in "National Aero-Space Plane (NASP) Advanced Technology Impacts," 7.6. Fuller's comments come from handwritten notes on the memos.
9. Interview with Col. John Fuller, February 1, 1990.
10. Interviews with Robert Barthelemy, various dates 1989.
11. Robert Barthelemy to Maj. Gen. Robert R. Rankine, Space Systems Division, January 11, 1990, Maj. Sponable's files, NAR, cited in "National Aero-Space Plane (NASP) Advanced Technology Impacts," 7.9.
12. See "Pioneering New Frontiers: Developing National Assets, Supporting National Interests," 1989, in author's possession. This briefing was assembled in large part by General Dynamics.
13. Russell Hannigan, "The NASP Derived Vehicle Launch Architecture Economic Assessment, IHRI Presentation, August 1990, and Paul Bierly, S. Basheer Ahmed, and Ed Dupnick, "A Microeconomic Assessment of Hypersonic Technology," Princeton Economic Associates, January 15, 1992, NAR files, both contained similar estimates. These documents, prepared for NAR, are cited in "National Aero-space Plane (NASP) Advanced Technology

- Impacts," 7.15-7.17.
- 14 . Heppenheimer, Countdown, 321.
- 15 . See George Gilder, Microcosm: The Quantum Revolution in Economics and Technology (New York: Simon and Schuster, 1989).
- 16 . Material on foreign aerospace planes appears in Stanley W. Kandebo, "Japanese Making Rapid Strides in Hypersonic Technologies," Aviation Week, December 16-23, 1991, p. 60; "Japanese Plan Aero-Space Plane Test Vehicle, International Prototype," *Ibid.*, August 10, 1990, pp. 83-90; "Japan Will Initiate Research On Supersonic-Hypersonic Transport," *ibid.*, November 21, 1988, p. 61; Jeffrey Leorovitz, "Europeans to Reorganize Hermes Management Setup," *ibid.*, July 9, 1990; Stanley W. Kandebo, "Aerospace Partners Close to Launching Scramjet Propulsion Program," *ibid.*, p. 64; "ESA Formulates Proposal for Scaled-Down Space Plan," *ibid.*, pp. 69-70; Craig Couvalt, "Saenger Aero-Space Plan Gains Increased Support in Europe," *ibid.*, July 10, 1989, p. 18; Carol A. Shifrin, "British Aerospace, Soviets to Study Launching HOTOL from AN-225," Aviation Week, September 10, 1990, p. 23; Stanley W. Kandebo, "Germans Define Mach 6-Class Vehicle to Air Saenger First-Stage Development," *ibid.*; H. Kuczera, "Saenger: An Advanced Space Transport System for Europe," in the proceedings of the First International Conference on Hypersonic Flight in the 21st Century, Grand Forks, North Dakota, University of North Dakota, September 1988 and, with Helmuth Hauk, "The German Hypersonics Technology Programme," AIAA paper #92-5002; R.C. Parkinson and E. Webb, "The Status of Aerospaceplane Research in the U.K.," AIAA paper #92-5004; and Tatsuo Yamanaka, "Overview of Japanese Aerospace Plane," AIAA paper #92-5021.
- 17 . Robert Barthelemy to Gen. Robert Rankine, January 16, 1990, in "Schedules," in NAR files, cited in "National Aero-Space Plane (NASP) Advanced Technology Impacts," 7.9.
- 18 . Future Roles for Hyper-Velocity Vehicles (Fort Worth, TX: General Dynamics Corporation, 1990), p. 12.
- 19 . T.B. Garber and E.D. Harris, "Comparison of Launch Systems for Space Support Missions," RAND Corporation, December 1989.
- 20 . Interviews with Maj. Jess Sponable, various dates, 1990.
- 21 . Paul A. David, Technical Choice, Innovation, and Economic Growth (Cambridge: Cambridge University Press, 1975); "Clio and the Economics of QWERTY," American Economic Review, May 1985, pp. 332-337; and his "Understanding the Economics of QWERTY: The Necessity of History," in William N. Porter, ed., Economic History and the Modern Economist (Oxford: Basil and Blackwell, 1986).

22 . Joel Mokyr, The Lever of Riches (New York: Oxford University Press, 1990), p. 146. A somewhat more specific explanation of innovation and risk appears in Jack A. Goldstone, "Cultural Orthodoxy, Risk, and Innovation: the Divergence of East and West in the Early Modern World," Sociological Theory, V (1987), pp. 119-137. Goldstone argues that innovation only occurred when social and cultural conditions allowed tolerance and diversity, which encouraged risk.

23 . Harry Stine and Paul Hans, "Economic Considerations of Hypersonic Vehicles and Spaceplanes," AIAA Paper #90-5267.

24 . "Summary of DRIMcGraw-Hill Presentation," in Wierzbanski's files; Francis J. Cronin and Patricia M. McGovern, "An Analysis of the National Benefit of NASP/NDV Expenditures: 1990 through 2010," January 23, 1990, in *ibid.*; and Russell Hannigan, "The NASP Derived Vehicle Launch Architecture Economic Assessment," IHRI Presentation, August 1990. One of the most thorough studies was by Paul Bierly, S. Basheer Ahmed, and Ed Dupnick, "A Macroeconomic Assessment of Hypersonic Technology," report prepared by Princeton Economic Associates, January 15, 1992, in NAR files. All of these are cited in "National Aero-Space Plane (NASP) Advanced Technology Impacts," 7.15-7.17.

25 . See, for example, D. Froning, W. Gaubatz, and George Matthews, "NASP: Enabling New Space Launch Options," AIAA Paper #90-5263; Terry Kasten, "NASP: Enabling a Twenty-First Century Vision," AIAA Paper #90-5241 and his "NASP: Enabling a New Space Launch Architecture," AIAA Paper #90-3833; Robert Koenig, "Space Transportation and Payload Integration," AIAA Paper #90-5272; and K. Gaffney and N. Krumm, "NASP Derived Vehicles--Assured and Flexible Access to Space in the 21st Century," AIAA Paper #90-5253.

26 . Among the few published works on the X-30 program were William Welling, "Spaceplane," International Combat Arms, January 1989, pp. 66-73, 92; Malcolm W. Browne, "Clean Hydrogen Beckons Aviation Engineers," New York Times, May 24, 1988; Glenn Emery, "Faster Than the Speed of Sound? You Bet," Washington Times, October 12, 1988; Craig Covault, "Aero-Space Plane Leading U.S. Hypersonic Research," Aviation Week & Space Technology, March 7 1988, pp. 36-43; John Rhea, "Fly By Light," Air Force Magazine, March 1988, pp. 98-103; "Blue Sky: Plane of the Future would Fly into Orbit, Cross the U.S. in an Hour," Wall Street Journal, June 19, 1989; James W. Canan, "Technology Hits the Cost Barrier," Air Force Magazine, May 1989, pp. 38-42. As an example of how the debate needed to involve NASP, but did not, see J. Anthony Daniel, "Capital Takes to Space," The American Spectator, October 1988, pp. 14-16. Several pieces by the author---the first published with an internal perspective of the program---started to appear in 1991, including "From Team to Team: Revolutionary Management Structures in the National Aero-Space Plane," Proceedings of the 1991 Acquisition Research Symposium, vol. 2 (Washington, D.C.: Defense Systems Management Association, 1991); "Aerospace Asia," Journal of East Asian Affairs, Summer 1992, pp. 504-28; "Managing a Revolutionary Technology, American Style: The National Aero-Space Plane," in Edwin Perkins, ed., Business and Economic History, 12 (1994), 118-132;

- "Hypersonic Hopes: Planning for NASP, 1982-1990," Air Power History, Spring 1994, pp. 36-48; and "Space Plane Challenges Science's Full Spectrum," National Defense, December 1993, pp. 32-33.
- 27 . Stuart F. Brown, "X-30: Out of this World in a Scramjet," Popular Science, November 1991, pp. 70-75, 106-110.
- 28 . Warren Brookes, "Spacey Policy Swamp," Washington Times, May 29, 1991.
- 29 . Stephen W. Korthals-Altes, "Will the Aerospace Plane Work?" Technology Review, January 1987, pp. 43-51; George A. Keyworth and Bruce R. Abell, "How to Make Space Launch Routine," *ibid.*, October 1990, pp. 25-31; David Webb, "The Perils of NASP Mismanagement," Defense News, January 15-21, 1990, pp. 23-24; "Space Council Should Fuel NASP," *ibid.*, April 24, 1989; "Finally a Realistic NASP Plan," *ibid.*, p. 14.
- 30 . See, for example, "Space Program Benefits," NASA brochure available through Centralized Technical Services Group, P.O. Box 8757, Baltimore/Washington International Airport, Maryland 21240. Among the benefits claimed by the brochure as resulting from the space program, it listed anti-corrosion paint, breathing systems for firefighters, and insulin infusion pump, a reading machine for the blind, a vehicle controller for the handicapped, water recycling, weather forecasting, advanced wheelchairs, dental braces, laser heart surgery, and scratch resistant sunglasses!
- 31 . Russell J. Hannigan, "The NASP Derived Vehicle Launch Architecture Economic Assessment," IHRI Presentation, August 1990, in author's files.
- 32 . Comments found in the edited proceedings of "American Aerospace in the 21st Century: the Role of NASP," produced by the U.S. Space Foundation, Colorado Springs, CO., 1991.
- 33 . Gene Koprowski, "NASP: Herald of Great Upheaval, Payloads Put Into Low Earth Orbit at 1/10 the Cost," Washington Technology, May 30, 1991.
- 34 . Interview with Michael Porter, March 19, 1991.
- 35 . Cited in NASP Historical File, 1986-1987, no file number, NASA Langley Technical Library.
- 36 . E.J. Soderstrom and B.M. Winchell, "Patent Policy Changes Stimulating Commercial Application of Federal R&D," Research Management, May 1986.
- 37 . Joseph W. Lee, "The Improvement of Technology Transfer from Government Laboratories to industry," unpublished paper presented at the 15th Annual Technology Transfer Society Meeting, June 26-28, 1990, 1-2.

- 38 . F.M. Scherer, Innovation and Growth: Schumpeterian Perspectives (Cambridge, Mass.: MIT Press, 1984), 52; N.E. Terleckyj, Effects of R&D on the Productivity Growth of Industries: An Exploratory Study (Washington, D.C.: National Planning Association, 1979) and "Direct and Indirect Effects of Industrial Research and Development on the Productivity Growth Industries," in J.W. Kendrick and B. Vaccara, eds., New Developments in Productivity Measurement, Washington, D.C., Studies in Income and Wealth, vol. 41.
- 39 . Adam B. Jaffe, "Demand and Supply Influences in R&D Intensity and Productivity Growth," Review of Economics and Statistics, August 1988, 431-437 (quotation on 431).
- 40 . See Jaffe, "Technological Opportunity and Spillovers of R&D: Evidence from Firms' Patents, Profits, and Market Value," American Economic Review, 76, December 1986, 984-1001; Jeffrey I. Bernstein and M. Isaq Nadiri, "Interindustry R&D Spillovers, Rates of Return, and Production in High-Tech Industries," National Bureau of Economic Research Working Paper, #2554, April 1988; Timothy F. Bresnahan, "Measuring the Spillovers from Technical Advance: Mainframe Computers in Financial Services," American Economic Review, 76, September 1986, 742-755; and Zvi Griliches, "Issues in Assessing the Contribution of Research and Development to Productivity Growth," Bell Journal of Economics, 10, Spring 1979, 92-116.
- 41 . Griliches, "Issues," 108.
- 42 . Griliches, "Issues," 112 and Terleckyj, "Direct and Indirect Effects," *passim*.
- 43 . "Commercial Flops," Aviation Week, October 8, 1990, 19.
- 44 . Herman C. Quirmbach, "The Diffusion of New Technology and the Market for Innovation," RAND Journal of Economics, 17, Spring 1986, 33-47; Jennifer F. Reinganum, "Market Structure and the Diffusion of New Technology," Bell Journal of Economics, 12, 1981, 618-624 and her "Dynamic Games of Innovation," Journal of Economic Theory, 25, 1981, 21-42.
- 45 . Edwin Mansfield, "How Rapidly Does New Industrial Technology Leak Out?" Journal of Industrial Economics, 34, December 1985, 217-223.
- 46 . Burton Klein, Dynamic Economics (Cambridge, MA: Harvard University Press, 1977).
- 47 . Among the sources relevant to that debate, cited earlier, are Reich, The Work of Nations; Gilder, Microcosm and his The Spirit of Enterprise (New York: Simon and Schuster, 1984); and especially Graham, Losing Time. Other sources include Clyde V. Prestowitz, Jr., Trading Places: How We Allowed Japan to Take the Lead (New York: Basic Books, 1988); Stephen Cohen and John Zysman, Manufacturing Matters: the Myth of the Post-Industrial Economy (New York: Basic Books, 1987); Michael G. Borrus, Competing for Control: America's Stake in Microelectronics (Cambridge, MA: Ballinger Publishing Co., 1988); David Soergel, "DoD

Policy Fosters Arms Monopolies," Defense News, June 10, 1991, p. 32; Rick Tumlinson, "Scrap the Socialist Model," Space News, May 13-15, 1991. A slightly different interpretation appears in Jacques S. Gansler, "Needed: a U.S. Industrial Policy," International Security, Fall 1987, pp. 45-62. The symposium on NASP sponsored by the U.S. Space Foundation in 1991, "American Aerospace in the 21st Century: the Role of the National Aero-Space Plane," included a panel dedicated to exactly this topic. Copies of the proceedings of this symposium are available from the U.S. Space Foundation, Colorado Springs, Colorado. For a discussion of the numerous "misses" by government planners and unpredicted "hits" by entrepreneurs, see Schweikart, "Entrepreneurial Adventure," passim.

48 . Even if one accepted that the Airbus was a success---a highly debatable point, given that no one knows if the Airbus consortium ever could operate without subsidies---it is difficult to see how Airbus hurt Boeing. By the early 1990s, when Airbus supposedly was capturing market share from American companies, Boeing had more orders for commercial aircraft than it could fill. MD, in contrast, never had developed an economical competitor to the Boeing 757s or 767s.

49 . See Mark Albrecht, "Space Promotes Competitiveness," Space News, March 29-April 4, 1993, p. 17, and Brenda Forman, "Not a Tool for Competitiveness," *ibid.*

50 .

For examples that the contractors shared the notion that the federal government should play a role in enhancing competitiveness in the aerospace industry, see Harry A. Scott, "National Aerospace Plane Program Overview," Rockwell International briefing, n.d., in author's possession, and Armand J. Chaput, "21st Century Aerospace: the 20th Century Challenge," General Dynamics briefing, n.d., in author's possession. Both briefings were prepared for presentation, ultimately, to the National Space Council, but variations of those briefings were used at numerous contractor presentations to legislators, DOD officials, and public groups. Also see Nathan A. Krumm, T.J. Kent, and W.T. Sconyers, "Government on the Critical Path: A Case History of Teaming on the National Aero-Space Plane Program," Fort Worth, Texas, General Dynamics, 1992, in author's possession. In addition, those attitudes were expressed repeatedly in contractor interviews, 1988-1995.

51 . "ASD/CY SPO Reorganization/Restructure," September 3, 1991, in Barthelemy's files, cited in "National Aero-Space Plane (NASP) Advanced Technology Impacts," 10.6.

52 . C.L. (Kelly) Johnson, "The Skunk Works," in F.E.C. Culick, ed., Guggenheim Aeronautical Laboratory at the California Institute of Technology (San Francisco: San Francisco Press, 1983), 55-64.

53 . National Aero-Space Plane Hearing Summary, U.S. House of Representatives, March 13, 1990.

- 54 . National Aero-Space Plane Hearing Summary, U.S. House of Representatives, March 13, 1997.
- 55 . National Aero-Space Plane Hearing Summary, U.S. House of Representatives, March 13, 1997.
- 56 . National Aero-Space Plane Hearing Summary, U.S. House of Representatives, March 13, 1997.
- 57 . Nancy R. Kingsbury, "National Aero-Space Plane: Key Issues Facing the Program," Washington, D.C., General Accounting Office, March 31, 1992.
- 58 . Interview with Terry Ronald, December 19, 1991; Terry Ronald, "Structural Materials for NASP," AIAA paper #91-5101.
- 59 . Interview with Terry Ronald, December 19, 1991.
- 60 . Interview with Bill Imfeld, January 9, 1992.
- 61 . Lee Beach to Robert Barthelemy, June 4, 1992, in "Outgoing Correspondence," folder 1002, Beth Quinto's files, NASA Langley.
- 62 . Capt. Helmut Reda, "NASP and the Environment," AIAA paper #91-5051.
- 63 . On the effects of NASP on the ozone in general, see Center for Remote Sensing, "Potential of Ozone Enhancement in Relation to Supersonic Flights," SBIR #AF92-181, 1992; Aeronautical Technology Associates, "Hypervelocity Vehicle Atmospheric Ozone Enhancement," SBIR #AF92-181, 1992. For the electric discharge proposal, see J.C. Miller & Assoc., Inc., "Ozone Enhancement: A Solution to a Significant Global Problem," SBIR #AF92-181, 1992, and also Energy/Matter Conversion Corporation, "Ozone Generation by Advance Electric Fusion Aerospace Propulsion," SBIR #92-181, 1992. All SBIRs were stored in Capt. Helmut Reda's files, NAX, Bldg. 52, WPAFB, cited in "National Aero-Space Plane (NASP) Advanced Technology Impacts," 11.16.
- 64 . Suman Ganguly, "Potential for Ozone Enhancement in Relation to Supersonic Flights," SBIR #AF92-181, 1992, cited in "National Aero-Space Plane (NASP) Advanced Technology Impacts," 12.13..
- 65 . Bruno Augenstein and E.D. Harris, "The National Aerospace Plane (NASP): Development Issues for the Follow-On Vehicle, Executive Summary," RAND Report R-3878/1-AF, 1992, cited in "National Aero-Space Plane (NASP) Advanced Technology Impacts," 12.8 The Air Force provided a copy of this for my examination, but attempts to obtain an independent copy from RAND have proven unsuccessful.

- 66 . Interview with Bill Imfeld, May 13, 1992.
- 67 . "Finally, a Realistic NASP Plan," Space News, April 20-26, 1992, pp. 1, 20.
- 68 . Joan Johnson-Freese and Roger Handberg, "NASP as an American Orphan: Bureaucratic Politics and the Development of Hypersonic Flight," Spaceflight, April 1991, 134-137.

Chapter 7: Hypersonic Hopes, Deferred Dreams

ONCE A WEEK, usually on a Tuesday, all the directors at the JPO met for a strategy briefing and general session of information exchange. Barthelemy presided over those meetings, unless a specific unit in the JPO had a pre-arranged topic to present. They were open for anyone's comments, and items under discussion spanned the spectrum from office letterhead to recent materials tests. With the exceptions of the brief period in 1989 when DoD "killed" the program and occasional budget votes, the focus of the weekly meetings for the first five years of the program had been moving the technology of the NASP program closer to the goal of SSTO. After 1992, however, that focus shifted heavily to identifying ways to keep some level of hypersonic effort going.

Aware that they had to propose a less expensive alternative to the existing cost estimates for the SSTO X-30 program, and equally attuned to the tough sledding the scramjet engineers had encountered, the NASP managers had expended considerable amounts of time and energy to arrive at several levels of options. By 1992, the JPO had presented those options to the Steering Group, the National Space Council, and virtually anyone else who would listen. By all accounts, the program begged for guidance. Yet none was forthcoming.

Among the various options the JPO had developed to stifle criticism that the technology did not support approval of Phase 3 (the fabrication and flight test of the X-30), one variant would split Phase 3 into an introductory "Phase 3A," or a "risk-reduction phase. A crucial element of the 3A concept was the performance of several flight missions that would validate

parts of the scramjet engine. Moreover, the program struggled to find a way to fly something---anything---to demonstrate that NASP was more than a "laboratory sandbox," as Terry Ronald called such exercises.

The Research Plan, Budgets, and Schedules

With each new variation, however, the central purpose of the SSTO mission became further obscured. As originally proposed, the X-30 would fly into orbit to provide the data necessary to build a fleet of NDVs. Reliable data---not only attaining orbit---constituted the real *product* of the NASP program. Researchers must know in advance of building and flying an aircraft what kind of data they need to obtain, and the aircraft must be designed with the data in mind. Every time the directors developed an optional aircraft with different capabilities, however, it demanded a totally new research plan. Thus, by 1992 the order had been inverted entirely: instead of designing an aircraft with the data as the objective, management had to tailor the data to be gained to whatever aircraft "option" emerged.

Of perhaps more immediate concern to the engineers, obtaining data required instrumentation, for which the program had to plan in its designs. Any instrumentation added weight, and when Armand Chaput's *ad hoc* "weights" contractor team struggled to shave pounds from the design, the JPO's research group (NAX) fought to have weight put back in the form of instrumentation.¹ NAX had actively fought to have the research agenda taken seriously during the design process, which to that point had not occurred. In 1991, Lt. Col. Ken Griffen had formed a research program development committee, which included John Rohde (NASA Lewis),

John Hicks (NASA Ames), Joe Watts (NASA Langley), Tom Sieron of Wright Labs, Paul Waltrup (the Navy representative at JHU/APL), Dave Richardson (AFFTC), Armand Chaput (NPO), and Dick Dyer of the JPO's engineering directorate. The members shared a complete lack of enthusiasm for the process, noting that the program seemed committed to building a demonstration---not a research---vehicle, and many complained that they had little support from the JPO and NPO engineering and design staff. Griffen, so disgusted by the inattention to research activities, transferred out of NASP in December 1991, but not before he generated a memo in which he observed that the customer of the X-30 was not the government *per se* but the engineering community that would design government NDVs based on the X-30 data.² Even before Griffen departed, his strong lobbying to have management pay more attention to research issues already had started to pay off, supported at NASA by Deputy Administrator and vocal NASP advocate, J.R. Thompson.

NASA had created a NASP project office at each of the centers in 1990 "to promote and coordinate" the space agency's work. The project offices had duties that ranged from co-managing the "NASP flight test planning and support activities" with the Air Force at Edwards Air Force Flight Test Center, to coordinating and "maintaining cognizance of tasks" performed at each center for NASP, including facilities support and NASP work packages, and engaging in advocacy issues for NASP.³ Thompson had recommended coordination of all the NASP activities at the NASA research centers before he left his position, and in the spring of 1992, NASA formed a Flight Research Office (FRO) in the spring of 1992 for coordinating and formulating the research plan at the centers.

No amount of coordination, however, could counterbalance the continual funding turmoil

that kept the JPO in a constant state of reviewing options. Indeed, as groups such as NAX worked overtime to prepare research plans and program work requirements, each new variant made the documents obsolete as soon as they appeared. And the continued evolution of options was dictated by the unrelenting budget reductions.

During the budget processes in the summer, 1992, the program had anticipated receiving more than \$200 million from DoD. (The original request had been for \$263 million.) Several "hits" later, NASP found itself with \$150 million and official language in the appropriations and authorizations bills that limited DoD's funding of NASP in the future to an amount twice that of NASA. NASA Administrator Dan Goldin made it clear that NASA would not contribute more than \$75 million in any year, making the maximum NASP could get \$225 million. To appreciate how far NASP had fallen, its 1989 funding profile had projected 1990 funding of \$427 million, and continued growth towards \$1 billion annually by the mid-1990s. Indeed, the president's FY92 budget request had attempted to recapture some of that momentum by requesting \$303 million.⁴ And, with each budget decrease, the schedule slipped still more, adding more cost to the program (see Fig. 7.1, "NASP Program Funding Decrease vs. Schedule Increases").

Consequently, the program's top management concluded that it could neither support a non-SSTO demonstration/data-gathering X-plane, nor could it fly an aircraft into orbit. Certainly it could not hope to achieve orbital flight in the 20th century; and *most* certainly little could be done for under \$200 million a year except flight tests of subscale articles. Early in 1992 program managers again made the rounds to NASA and DOD officials, explaining the costs and the hardships under which the program already had labored.

Ironically, at almost the same time, the old nemesis of the program, the DSB, had

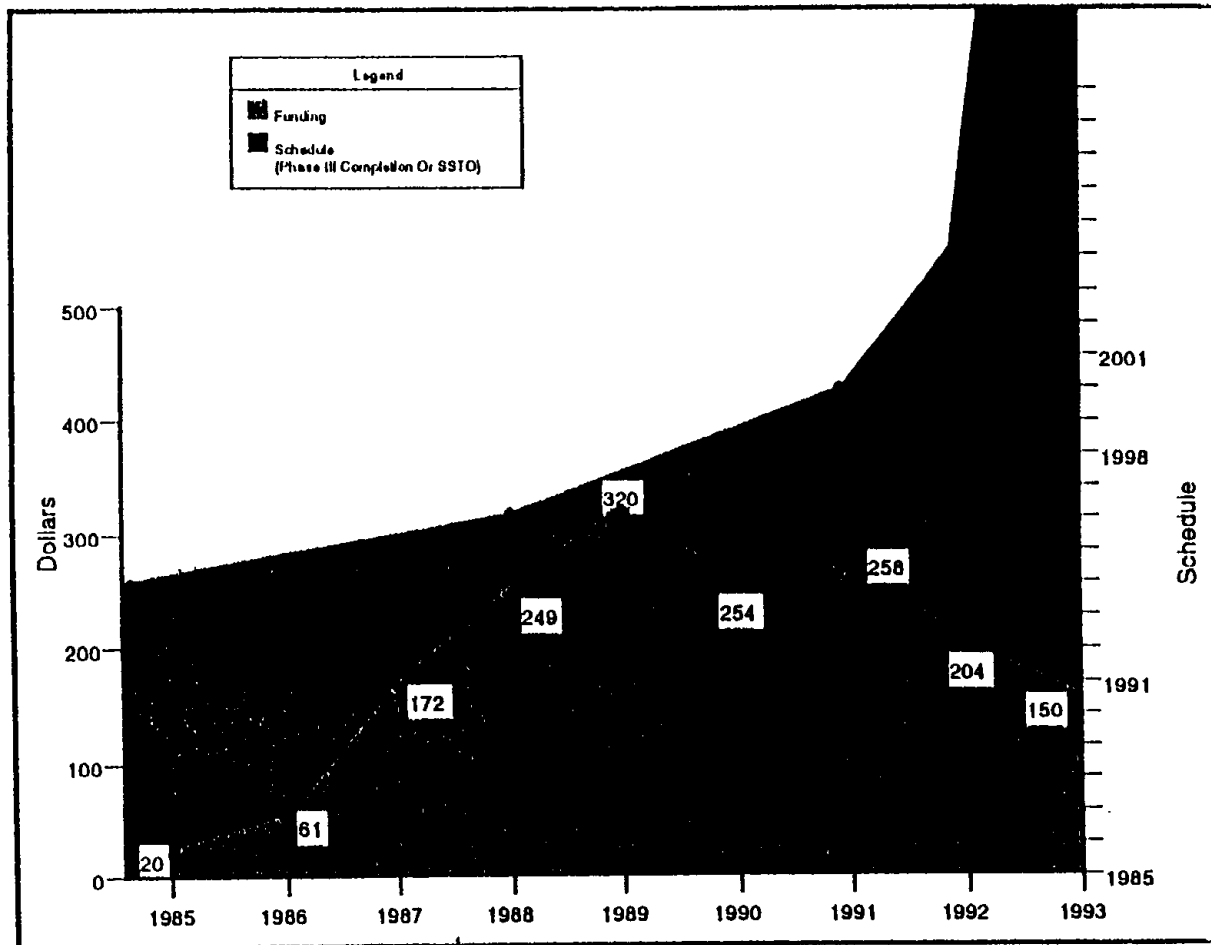

Source: NASP Joint Program Office, GAO

Fig. 7.1, "NASP Funding Decrease vs. Schedule Increase"

concluded an investigation that offered a solution. Like its predecessor report in the Williams era, the 1992 DSB report was briefed in Washington orally long before it appeared in print. The report found a high degree of technological progress in a number of areas, but it also concluded that in the high risk area of propulsion, the technology demanded much more intensive testing. That conclusion fit well with the numerous subscale options and scramjet flight tests that the program had recommended, but which as of then had yet to receive a blessing from any official agency. Concurrent to the DSB briefings, a NASA Dryden group, operating in relative secrecy, had investigated the possibilities of testing a subscale aircraft---perhaps a variant of the "X-30X" concept earlier considered by the JPO---using an SR-71 as a staging aircraft. Ultimately, that concept proved of little use when engineers could not find a way to increase the SR-71's 17,000-lb. carrying capability---which was well under the weight of even a subscale research aircraft.

Testing and Flying a Scramjet

Between the suggestions of the DSB and the internal NASA studies, a number of similar solutions started to coalesce, all of which featured a subscale aircraft or scramjet test and all of which essentially abandoned SSTO as any sort of immediate goal. It marked a vindication of sorts for Vince Rausch, who had attempted unsuccessfully to stage just such an experiment in the first year of the program. Nevertheless, such an option still ran counter to the prevailing philosophy within DoD. Even that philosophy started to change in mid-1992, however, when one of the major advocates of holding fast to SSTO, Assistant Secretary of the Air Force Jack Welch, retired. Although the program still lacked formal approval of a dramatic change in its immediate

mission, the JPO started to prepare a new strategy based on the DSB's recommendations, convinced that such a shift would find a warm acceptance in DOD and NASA.

In August 1992 the program delivered its new "vision." It proposed to reduce airframe and technology development efforts, and to refocus all resources on an engine/flowpath demonstration that would comprise one-third of the risk reduction effort. A large scale combustor ground test would be accompanied by an one-third engine/flowpath flight test. The DSB also had recommended addressing critical boundary-layer transition issues (wherein the air pressure and other aerodynamic factors change drastically as the aircraft moves from one layer of the atmosphere to another), but the JPO concluded that it would need additional resources to conduct those tests after FY97.⁵

Certainly the new strategy marked a sea change in the program's approach to achieving an orbital vehicle; but it still projected funding of \$225 million in FY93 and FY94, \$275 million in FY95, and as much as \$300 million in FY97. Those were optimistic assumptions that even then might have been high by \$75-100 million per year. Nevertheless, the overall strategy received support from the Air Force. On August 11, 1992, in a briefing by Jim Mattice of the Secretary of the Air Force's Acquisition Office to Air Force Secretary Donald Rice, Mattice summarized the DSB briefings and noted that the revised program strategy was consistent with the DSB's recommendations. Rice agreed, and even questioned why only a vision of SSTO was considered previously without alternatives. Barthelemy and the program's management finally had achieved what they had determined was necessary more than a year earlier.

To those outside the program, however, the funding reductions and retreat from SSTO made it appear that "the blood was in the water," as one director put it. One JPO briefing even

warned, "The vultures are circling." In September, NASA Administrator Goldin, in an off-the-cuff remark to the *Antelope Valley News*, indicated that he favored an alternative to NASP.⁶ He suggested using the High Altitude Launch Option (HALO), proposed by NASA Ames and Dryden Flight Research Facility, to launch a research vehicle from an SR-71 at Mach 3.⁷ Such a vehicle would have little relevance for the data needed to fly to orbit. It would, however, have increased the data base for another NASP alternative offered by Boeing, the High Speed Civil Transport (HSCT). Like other contractors disassociated with NASP, Boeing saw an opportunity to reintroduce itself into the high-speed technology race with the HSCT, and sought subsidies in Washington by playing on the same "industrial policy" arguments used (so far) successfully by the NASP program (see Fig. 8.13, "Impact of HSCT Introduction on Worldwide Aircraft Financing"). Boeing's new entry into the hypersonic field alarmed the Space Council, which saw the HSCT as a potential drain on NASP funds.⁸ The Boeing proposal revived yet again the two-stage-to-orbit concept, and required NASP to devote time and resources to demonstrate how the two concepts differed fundamentally. Ultimately, NASP NAR director Terry Kasten, who had requested the internal study, visited Boeing to discuss potential areas of common technology use. NAR recommended that each program continue independently, but Kasten agreed to a certain measure of commonality to the extent that he could, while making it clear that the HSCT could not replace NASP, and a new round of NDV studies appeared to counter the notion that NASP was a "space-only" vehicle (see Fig. 7.2, "Potential Hypersonic Aircraft").

Goldin's remarks surprised many in NASA. Just two months earlier, Lana Couch had forcefully argued in a presentation to Goldin that NASP depended on NASA's support, and that a risk reduction phase would address many of the Administrator's concerns.⁹ In addition, NASA

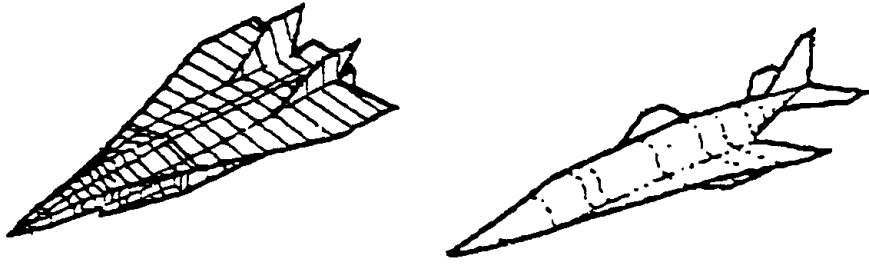

Characteristics	Tactical Fighter-Bomber	Military/Commercial Transport
Mach Number	4.0	5.0
Radius/Range (NM) - Carrier Based - Land Based	500 1,000	5,000 - 6,500
Relative TOGW	0.33	2.5
Engine Type	Turbojet/Turbo (Fan) Ramjet	Turbojet/Turbo (Fan) Ramjet
Fuel Type	Advanced JP	Advanced JP or Dual JP/Hydrogen

"Ramjet Powered" Vehicle Characteristics

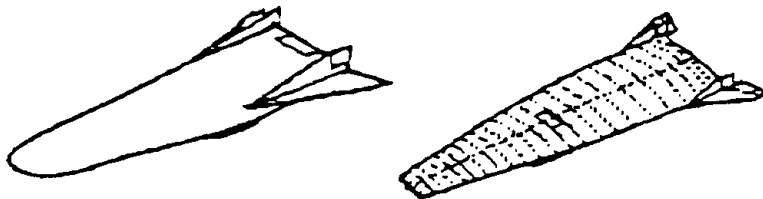

Characteristics	Single-Stage-to-Orbit Operational (SSTO)	Mach 10 Long Range Cruiser
Mach Number	20+	10
Radius/Range (NM)	Orbital	10,000
Relative TOGW	1.2	1.0
Engine Type	Low Speed System + Ram/Scramjet	Turbo (Fan) Ramjet + Scramjet
Fuel Type	Liquid/Slush Hydrogen + Oxygen	Liquid/Slush Hydrogen

"Scramjet Powered" Vehicle Characteristics

Fig. 7.2 "Potential Hypersonic Aircraft"

had continued to deliver its work packages and to support the program institutionally. Goldin's comment was not policy, nor, when pressed, did Goldin indicate that he wanted to abandon NASP. Still, for a program already teetering, and one with congressional supporters "jumping ship" routinely, Goldin's comment may have pushed NASP over the edge, and opened the door further for competitors to try to lay claim to NASP money.

One of the most formidable of the competitor systems to NASP came in the form of a rocket SSTO project sponsored by SDIO, a former NASP "team" member.¹⁰ Developed by McDonnell Douglas' rocket division, the "Delta Clipper," as the DC-X was named, was heralded as the "DC-3 of space."¹¹ As it neared completion of its \$15 million design and concept validation stage and approached its testing cycle in the spring of 1993, the DC-X appeared to offer yet another "quick fix" to routine space travel. Despite considerable publicity given the DC-X, it contained little in the way of new or revolutionary technology. It was designed to use its navigation equipment to hover over a landing area, at which time it sprouted four legs for a "soft" touchdown, similar to the lunar landing vehicle. Like the HCST, the DC-X constituted less of a threat to scramjet technology than it did a siphon on the already-diminishing pool of funds available for aerospace research. NASP management hoped that its new strategy would take the luster off such systems as the DC-X; but more important the program hoped to cement new support in all levels of the Washington community with its new approach.¹²

The transition to a scramjet development project promised substantial upheaval among the contractors and to force significant restructuring at the NPO. Whereas three of the five contractors were airframe contractors, suddenly two-thirds of the work was going to go to the two propulsion companies. Waldman accomplished most of the restructuring at the NPO by

parceling out to the airframe companies as much propulsion-related work as they could handle. Reductions, however, were inevitable, in overall numbers and, proportionally within the ranks of the airframe firms. Anticipating a program restructure with a substantial emphasis on propulsion, over the summer of 1992 the contractors held an exercise to reallocate a budget of \$175 million (to the contractor, not allowing for JPO costs or government operations). The program managers from the five contractors prioritized all the technical activity, and eliminating many items in the Government Work Packages, some of which the JPO restored. Those, after all, had been well performed by the NASA centers and helped solidify NASA's commitment to the program. When the final budget of \$150 million was released, the contractors had to make further cuts.

During those exercises, the government made a decision to retain the contractor team and to allow the NPO to let it shrink as the contractors chose. Some government directors had considered looking for "volunteers" to leave the team, and thus reduce the number of ways the NPO would have to divide the budget. That approach, however, would have required a new contract, as each contractor had a legal commitment to the team. Issuing such a contract could take a year, which the program did not have, and "would kill the team," as Waldman noted.¹³

By August 1992, after Secretary Rice gave his informal approval to the new program strategy, Barthelemy, Waldman, Wierzbowski, NASA's Jim Arrington from the JPO, and contractor representatives discussed a new "marketing strategy," (although Ming Tang of NIO only arrived at the end of the discussions). The participants agreed that setting a new, clear vision of the program and establishing a mission that the program could achieve was critical.¹⁴ One mission that all accepted unequivocally was that of minimizing the time between an SSTO X-30 and follow-on vehicles. SSTO, the group added, was "too high risk," and the program office

concluded.¹⁵ (Lana Couch at Langley, who spearheaded much of the NASA centers' technical hypersonic work, had already agreed to---and supported in writing---such a position in her June 1992 letter to Goldin.) Other than that mission, the X-30 options remained open, and the participants weighted a number of factors, including "affordability," "doability," "satisfied customer/sellable," "exciting/sexy," and so on (see Fig. 7.3, "Options Discussed at Sept/Oct 1992 Strategy Meeting").

Instead of actually attaining orbit, the new version of NASP would "enable" (the key word in all the briefings after that point) SSTO by performing a series of incremental steps, the most important of which was the subscale scramjet flight test. But even if the flight tests proved successful, that did not obviate the need for a prototype vehicle or a full-scale X-plane. Indeed, even with subscale scramjet flight tests, a subscale X-30 (the X-30X option discussed in earlier meetings) still would probably be needed. No matter how the JPO structured tests, the X-30X variant looked increasingly important (see Fig. 7.4, "Phase 3 X-30X Solution Space").

Nevertheless, for any new incremental step in the program, NASP had to gain support on the grounds that the restructured tasks could bridge the gap between ground test and an orbital X-30, but at the same time politics demanded that the new strategy could eliminate the need for an SSTO aircraft, as the original X-30 had been intended.

That discrepancy irked some members of Congress, especially in the House Committee on Space, Science and Technology, chaired by Congressman George Brown (D-CA), which held hearings in September 1992 as a preliminary to introduce legislation in FY94 calling for a \$5 billion, 50,000-lb. SSTO aircraft to be available in five years. Those numbers represented the exact parameters that du Pont had used when he claimed he could attain orbital velocity with a

Program Strategy Options	Affordable 5 (A)	Doable 5 (B)	Sellable Satisfy Customer 5 (C)	Exciting Sexy 3 (D)	Internally Supported 3 (E)	Reasonable Timeframe 3 (F)	Easily Describable Goals 2 (G)	Meets Goal 5 (H)	All Criteria
(1) SSTO/X-30	1	3	0	9	3	7	9	9	140
(2) NASP-Focused Technology	9 (Ass 100M/yr)	9	3	1	1	0	3	3	132
(3) Risk Reduction Component Flt Tst	8 (Ass 200M/yr)	8	4	3	1	1	5	4	145
(4) International #1	3 (Ass 700M/yr)	3	1	8	3	7	7	9	148
Flight Research Vehicles T.O. Orbit Prop.									
(5) Air Yes Self	1 (Ass 15M/yr)	3	0	8	3	8	8	8	133
(6) Air No Self	4 (Ass 600M/yr)	5	5	7	5	8	7	5	169
(7) Air No Exp	5 (Ass 450M/yr)	7	5	7	7	9	7	5	193
(8) Gnd No Self	3 (Ass 700M/yr)	4	5	8	4	8	7	5	159

Fig. 7.3, "Options Discussed at Sept/Oct 1992 Strategy Meeting"

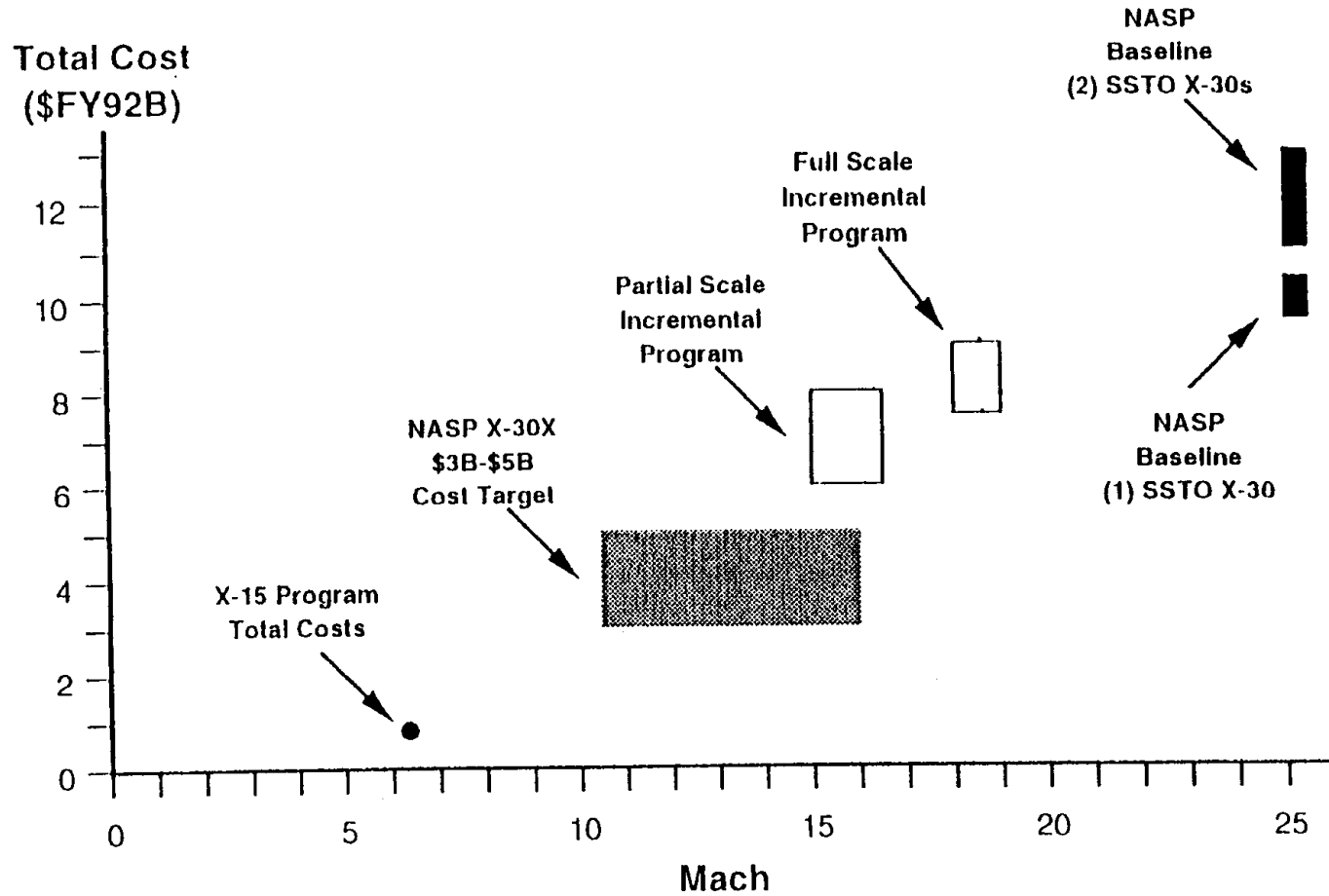

Fig. 7.4, "Phase 3 X-30X Solution Space"

scramjet in 1984 and 1985, and were the basis for the FY91-FY92 NASA review of the government baseline vehicle that had found it vastly optimistic in its weight estimations and, even when examined in the most favorable conditions, completely incapable of reaching orbit. Nevertheless, the du Pont vehicle still lived, and Brown's committee not only called du Pont to explain what was wrong with NASP, but virtually anyone else with an ax to grind against the aerospace plane program.

Witnesses called before the committee looked like a "who's who" of NASP detractors, including representatives of two contractors who had negative associations with the program. Robert Budica came from Kaiser Marquardt Corporation, for example, whose contracts for tests the NASP program had just terminated. Henry Lopez represented Allied Signal, a company that had sought to participate in NASP but had never received any contracts. Each company had a great deal to gain from a "new look" hypersonic program that excluded the existing NASP contractors. But no one had more to gain than, Tony du Pont and it was clear that the program's strategy of retaining du Pont as a consultant for several years---in Lyndon Johnson's words, "have him inside the tent pissing out, rather than outside pissing in"---had proven a failure.

Quite naturally, most of the witnesses Brown called thought NASP was headed in the wrong direction. Du Pont criticized weight growth and diffusion of resources in the program, and argued that studies done on his design in 1991 produced engine efficiencies that would "reduce the gross weight of the X-30 by a factor of three," even though his own design was inaccurate by a factor of two, not counting "minor" pieces of hardware such as wheels, flanges, or hinges, or a realistic amount of fuel¹⁶ Du Pont also claimed it was possible to get close to the original low weight of 50,000 lbs. by returning to a low drag design, and maintained that "the engine and

airplane design [he prepared] for DARPA in 1983 outperform[ed] what has been put on the table by the NASP Team after spending \$2 billion."¹⁷ Equally critical testimony came from Budica, who charged that "it is now eight years after the Copper Canyon program . . . and I don't believe we are one step closer to flying anything."¹⁸ He claimed that all of the breakthroughs identified as emanating from the NASP program were invented or tested in the 1960s or 1970s, except for the "innovative" cooling system and the cryogenic heat exchangers that his own company, Kaiser Marquardt, developed. Henry Lopez, the third critic called by the committee, concluded that the NASP "propulsion system is frothed with problems, and the vehicle has grown [to the point that] I do not believe the NASP program will achieve closure in a reasonable design."¹⁹

Congressman Brown had hoped to use the hearings to build support for funding a "classic" NASP---the du Pont airplane, or, as Brown called it in committee, a "5-5-50" package of five years, \$5 billion, and an aircraft weight of 50,000-lbs. In reality, such an aircraft was more of a "NASP Lite"---devoid of real fuel allowances, landing gear, avionics and other essential systems. But few took the "NASP Lite/ 5-5-50 concept" seriously, and nothing came of the proposal. More disturbing was a comment by Congressman Dana Rohrabacher (R-CA), a committee member and a long-time supporter of the NASP program, who stated that he was "flabbergasted by the lack of leadership" on NASP. "There doesn't seem to be anyone who can make decisions," he concluded, in an obvious slap at the Steering Group and a direct criticism of Barthelemy.²⁰ Yet Rohrabacher, in NASP Administrator Richard Truly's assessment, had bought into the notion that NASP technology, and SSTO flight, was "easy," and no one had ever disabused him of that idea.²¹

The hearings by Brown's committee did not accomplish their goal of reviving the du

Pont design, and for good reason. During 1991 and 1992, to make absolutely certain that they had not missed anything in the du Pont design that would validate it, the NASP directors, DARPA, and the program's engineers themselves all conducted another round of evaluations on the du Pont configuration. By 1992, the results of those studies had appeared, and without exception they identified glaring weaknesses du Pont's design.

Among the numerous problems, the evaluators concluded that the design as given contained mistakes raising its weight to more than 63,000 lbs.; that the propulsion efficiencies did not correlate with the data given; that the GASL "validations" in 1986 had included tests that utilized nozzles much longer than those in the design; that the moveable inlet would not work; that du Pont underestimated the fuel needed by at least 13 percent, driving up weights further; that the weights were drastically *understated*; that nozzle efficiencies were vastly *overstated*; and many other such problems. None of those problems touched on the more obvious deficiencies, such as the absence of landing gear, crew safety equipment, or instrumentation for research. In addition, separate studies done at NASA Langley in 1985 and 1986 had concluded that the du Pont aircraft did not have orbital potential even with major improvements. At least eight independent analyses of the du Pont design had been conducted since 1986 and all eight reached the same conclusion---the airplane could not come close to achieving orbit.

But the hearings had magnified the lack of advocacy and direction at the top levels of NASP management, a great deal of which was explained by the exceptional turnover within the Steering Group in 1991 and 1992. Yet that only constituted part of the burden under which NASP had labored since Robert Williams had created the five-way Memorandum of Agreement. NASP simply had too many different constituencies to please. In 1991, Col Wierzbanski

mused what a "real" organizational chart would look like if all the different layers of reporting were symbolized, and if all the different organizations that NASP had to satisfy were identified. Working with the author, Wierzbanowski produced Fig. 5.15, "NASP Organization by Functional Review (1992)." Nowhere more did the absence of a "champion" or reliable sponsor make itself felt than in a system where dozens of oversight and or guidance bodies, such as the General Accounting Office, the Congressional Budget Office, the Defense Science Board, and many others had constant review authority.

A clear example of that review authority in operation arose in the December 1992 General Accounting Office report, a document that NASP leadership contributed to over the summer, and one the directors anticipated due to the relatively favorable report by the GAO in 1988. Instead, the program got a cold bath of negativism.²² The report emphasized the schedule slippage of 25 percent of the critical tests---without mentioning that much of the slippage ensued from budget reductions---and pointed out that the vehicle was too heavy, a fact deeply appreciated in the JPO and NPO. As a consequence of its investigation over the summer, in November the GAO located a person inside the JPO for an undetermined period. That act alone indicated that the government saw NASP as "on the block," due to the cost of locating an individual inside such a small program.

Support for NASP had been so inconsistent, the investigations so discordant, and the advocacy so uncertain, that unusual, and outright weird, stories started to surface. The most oft-repeated involved a "super secret spy plane" that the United States had developed to replace the SR-71, which recently had been retired from active duty. Sources as reliable as the *Wall Street Journal* reported the existence of such an aircraft, as did less erudite publications like *Popular*

Science.²³ Called the *Aurora*, the spy plane supposedly drew heavily from NASP technology, and the Federation of American Scientists went so far as to allege that the *Aurora's* budget was "'hidden in plain sight' within the National Aero-Space Plane . . . project."²⁴ Subsequent reports of an "Aurora" appeared in the *Las Vegas Review-Journal/Sun* in December 1993, followed by another blast from the Federation of American Scientists, whose publication "Secrecy and Government Bulletin" repeated the nostrum that "the National Aero-Space Plane program may well have served as a cover for [Aurora], supporting particularly the development of new materials. Having served its purpose, NASP will gracefully fade away."²⁵ In March, *Popular Science* again featured the *Aurora*, in an article called "Searching for the Secrets of Groom Lake."²⁶ The top secret project supposedly consumed \$1-2 billion during the period that NASP was slated to receive roughly the same amount, but did not.

As bizarre as the *Aurora* story seemed, it had a certain logic to it. According to the theory, the spy plane came into service in the mid-1980s, as the SR-71s were retired. NASP not only could have passed along important technology, but the original schedule for operational capability of NDVs had them available by the late 1990s, at a time the *Aurora* itself would have grown somewhat obsolete. On the surface, scramjet technology used in NASP would seem appropriate for a Mach 6 aircraft. More than a few NASP personnel expressed concern---even as early as 1989---that the program "had all the characteristics of a 'front' program." Most of those sentiments arose from their perception that a "real" program would not suffer from budget fluctuations in the way NASP did.

In reality, most of the NASP work had occurred on the high end of the scramjet's performance spectrum. Indeed, after the 1989 restructure, less emphasis was placed on the low-

speed system, and after the 1992 restructure the low-speed system work was dropped almost entirely. Little of the engine testing that remained would transpire in the Mach 6 range. More important, if DOD "saved" NASP as a front for "Aurora" in 1990 and 1992, why did Secretary of Defense Cheney cancel the program in 1989? Certainly NASP had an unusual budget history. But it did not look quite as odd when compared to other systems that had funding turmoil, such as the B-2 bomber.²⁷

Strange reports and the presence of the GAO did not seem to affect the mood inside the JPO by late 1992, which, for the first time in a year, was optimistic. For the first time since team formation, the program worked toward a near-term, attainable goal of creating a scaled-down version of NASP that Congress could afford to fund. The program's personnel suddenly displayed new energy as they reconfigured NASP into a flight test scramjet instead of an integrated aircraft program. At the November 1992 QTR, the JPO made its first public presentation of the revised program. Barthelemy explained that the program had to "bridge the gap" between SSTO and a non-SSTO vehicle (which he continued to call the X-30X, despite some consternation over that term in Washington). The program laid out a technology evolution to reach SSTO through a number of incremental steps---arguably steps that should have been established in 1986 (see Fig. 7.5, "Technology Evolution to Airbreathing Hypersonic Air-Space Craft"). Several test projects would follow, with the most important near-term tests consisting of scramjets flown aboard Minuteman II missiles to gather data on combustion and thrust.

A new project name, HYFLITE (for *HY*personic *F*light *T*est *E*xperiments), characterized the fact that the JPO wanted an entirely new approach to the scramjet experiments. Col. Ted Wierzbanski headed the project, and Barthelemy instructed him to keep the management team

CY 95 96 97 98 99 00 01 02 03 04 05 06 07 08 09 10 11 12

POSSIBLE APPLICATION

NASP PROGRAM

SDR

PDR

CDR

FF

SDR

PDR

CDR

FF



BOUNDARY LAYER FLT. TEST

MMI LAUNCH
MACH 15
ENGINE SHROUD
2 FLIGHTS

TEST OBJECTIVES

- B.L. CHARAC.
- B.L. CONTROL
- FLOWPATH INTEGRATION
- INSTRUM. VAL.

SCRAM FLT. TEST

MMI LAUNCH
MACH 14 - 17
CDE SIZED ENGINE
LIH2 FUEL
3 FLIGHTS

TEST OBJECTIVES

- HIGH MACH SCRAM PERF.
- LOX AUG. CHARAC.
- INJECTOR EFFICIENCY
- INLET/NOZZLE EFFICIENCY
- COMBUSTOR MIXING
- MATERIALS DEMO
- ACTIVE/PASSIVE COOLING

HYPERSONIC RESEARCH AIRCRAFT (HRA)

HYPERSONIC RESEARCH AIRCRAFT

747 AIR LAUNCHED
MACH 12 - 16
2 LARGE SCALE ENGINES
- VARIABLE GEOMETRY
- LIH2 FUEL
MODIFIED RL-10 ASSIST
- LO2 FUEL
SUBSYSTEMS AS REQUIRED

TEST OBJECTIVES

- AIR LAUNCH TEST
- HIGH MACH SCRAM PERF.
- LOX AUG. CHARAC.
- RAM/SCRAM TRANSITION
- UNSTART
- POWER EFFECTS
- THERMAL SURVIVAL
- VMS
- PILOT WORKLOAD & VISIBILITY
- EMERGENCY PROCEDURES

POSSIBLE HRA UPGRADE

HRA UPGRADE

TEST OBJECTIVES

- LSS PERF.
- LINEAR ROCKETS
- BASE BURNING
- SLUSH H2
- MATERIALS
- EMERGENCY PROCEDURES

PROTOTYPE SSTD ACFT (YS - 30)

HORIZONTAL TAKEOFF
ORBITAL
LSS
LINEAR ROCKET
SLUSH H2 FUEL
ORBITAL SYSTEMS
MARGIN FOR PAYLOAD

TEST OBJECTIVES

- AIRBREATHING PERF.
- SLUSH H2 OPS
- ROCKET PERF.
- LSS OPS AND PERF.
- LOX AUG.
- THERMAL SURVIVABILITY
- UNSTART RECOVERY
- AC PERF. AND FLT. QUALITIES
- TRAJECTORY OPTIMIZATION
- ORBITAL MANEUVERING
- PAYLOAD OPS SYSTEM OPS
- GROUND OPS
- EMERGENCY PROCEDURES
- SUPPORTABILITY TESTS

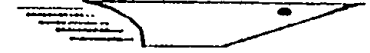

S - 30

OTHER POSSIBLE APPLICATIONS:

- TWO STAGE TO ORBIT
- HYPERSONIC CRUISE
- COMMERCIAL ACFT

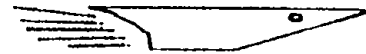

YS - 30

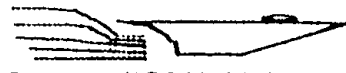

NASP PROGRAM

EVOLUTIONARY VEHICLE

Fig. 75, "Technology Evolution to Airbreathing Hypersonic Air-Space Craft"

small: "If you can run this project with four people, go ahead," Barthelemy said.²⁸ Many in the JPO thought they had received a second chance at developing a "skunk works" atmosphere. That goal remained illusory. Wierzbanski soon found himself enmeshed in a network of relationships with the Ballistic Missile Office, a new contractor, TRW, and another division of Rockwell, Rockwell Autonetics, in order to coordinate the launch of Minuteman IIs.²⁹ Nevertheless, the contractor and the HYFLITE project office moved extremely rapidly, and even had a manufacturing flow plan for the test vehicle ready before December 1992. Wierzbanski's early projections put HYFLITE costs at \$200-300 million total.

At the same time---late 1992---the NASP office continued to plan for an X-30X or a similar vehicle, with a total cost in the \$3-5 billion range.³⁰ The program estimated that the first X-30X would require \$3 billion, and the aircraft would fly in the Mach 12-15 range to demonstrate high-speed capability and gather data on boundary layer transition. Unlike the original X-30, the X-30X would not have a low-speed system or a rocket, and would need a carrier aircraft, such as a B-52, for air launch. Other alternative launch modes were considered, however, including turbojets or ground launched rocket boosters.

The change within the JPO and NPO was remarkable during the HYFLITE/X-30X restructure. Barthelemy found himself so excited by the prospect of flying a scramjet in the near future that he sought to put "another \$25 million of the FY93 money if the program had gotten [the original \$175 million request], but I could not take \$25 million out of the \$150 million we got."³¹ Directors who had grown pessimistic over several years, confronted by the reality that without interim steps the X-30 could not attain orbit suddenly found themselves energized. The euphoria did not last long.

Revised budgets coming from Washington already had left NASP with only \$150 million, compared to the \$175 million it had anticipated. Congress, still struggling to push NASA into the central sponsorship role of the program, already had prohibited DoD from spending more than twice that of NASA on the program, the FY93 Conference Committee added still other stipulations, one of which directed that only half the appropriated funds be obligated until the Secretary of Defense certified that NASA had committed sufficient funds to complete the technology assessment phase. In other words, until NASA actually provided the money for its share of the program, NASP was limited to \$75 million.³²

Those restrictions constituted small waves next to the tsunami that struck the program in late 1992. The Steering Group had been scheduled to meet on December 12, 1992 when a word of a December 8 news story resulted in turmoil in Washington. Maj. David Thurston, in the Air Force Public Relations Office, told a reporter that NASP had abandoned the goal of takeoff from a runway and stated that "the bottom line is that [NASP] is going to be a suborbital craft."³³ Barthelemy, in Washington to brief Allen Bromley, the president's science advisor, learned that Bromley had reported the changes informally to the Space Council. Vice President Dan Quayle, who unreservedly had supported the X-30, took the abrupt change as an insult, and worse, as a retreat from a program to which management had previously agreed. Thus, Air Force Secretary Donald Rice changed directions 180 degrees, and on December 11 made a statement that the Air Force would "not walk away from the goal of reaching orbit" with the X-30.³⁴ Indeed, the program was instructed not to mention the X-30X concept in any of its briefings.

Once again the program was saddled to SSTO without any means to get there. Rice had expressed the concern that HYFLITE was too far removed from an X-airplane, and yet another

bridge was needed. Consequently, the program developed HYFLITE III, which would utilize a Minuteman missile to launch an accelerator that could demonstrate thrust over drag---not merely that the scramjet could generate thrust. HYFLITE III carried a steep price tag, especially for the few data points it promised: \$1.5 billion. Even after HYFLITE III, however, there was still no conclusive evidence that the program could leap directly to a prototype aircraft. HYFLITE III had all the disadvantages of high cost and limited data, and none of the advantages of other HYFLITE interim steps. Management scrambled to put together yet another "revised strategy," this time with HYFLITE III as the interim measure, and presented that approach at the March 1993 QTR. Barthelemy received explicit instructions from NIO in Washington not to mention the X-30X in the QTR. Thus, the program was left in the position where the SSTO X-30 would have no support in Congress, and the program was not permitted to propose anything *short* of an SSTO X-30.³⁵ To the members of the JPO, that not only appeared to contradict recent specific instructions they had received from the Air Force, but it also represented a repudiation of the agreement they all (contractors, Air Force, NASA) had apparently reached at the September/October 1992 meetings.

The program had another blow to absorb: Barthelemy announced his reassignment to ASC/YT (Training) at the QTR---a substantial promotion personally, but conceptually a step down from what many only a few years earlier considered to be the "cutting edge" program. Prior to his departure, Barthelemy contacted Bill Heiser at the Air Force Academy to request that Heiser organize and head a review of the NASP airbreathing propulsion technology program. Heiser's group, known in the past as the "Greybeards," planned to examine all the airbreathing technology issues, but by the time they met, HYFLITE was their chief concern.³⁶

When management and contractors met at the March QTR, they found few senior Air Force officials. Virtually all of the upper-level civilian Pentagon leadership was absent, and newly-inaugurated President Bill Clinton had disbanded the National Space Council. He also soon renamed DARPA the “Advanced Projects Research Agency,” taking it in the direction of “industrial policy.” Other than Secretary of Defense Les Aspin (who soon resigned), and one civilian assistant secretary, none of the other ten undersecretary positions had yet been nominated, let alone confirmed. Clinton had not yet nominated a Secretary of the Air Force. NASA Administrator Goldin appeared briefly, then departed, leaving the director of the NASA Langley Center to hear the briefing. In a setting eerily reminiscent of the 1988 Williams debacle, the links in the chain of command came nowhere near going to the top within the ranks of NASP’s sponsors. Once again, NASP was the orphan.

Little in the March QTR differed from the November QTR except HYFLITE III. The briefing detailed the integration between HYFLITE I and II, and the new elements. HYFLITE I and II would provide data on boundary layer transition (inlet and forebody), propulsion performance (high speed thrust demonstrator) and structural weight (thermal loads); the ongoing SSTO technologies would advance research on propulsion at mid-speed levels and improve subsystems and structural weights; and HYFLITE III would demonstrate integrated propulsion performance at high speed and stability and controllability in a “free flyer.” By the end of the HYFLITE program, NASP officials estimated that they would have met 50 percent of their research objectives for scramjet performance in aerothermal loads validation; just under 50 percent for boundary layer and CFD validation for local flow; about 25 percent of the scramjet in areas of operability and performance; 20 percent of engine mode integration; and 40 percent of

overall engine/airframe integration. If indeed the program met all those estimates, it would constitute a significant stage in the incremental approach to SSTO. Following the QTR, NASP received approval to continue with HYFLITE I and II, but the decision on HYFLITE III was still pending.

Technical Advances and Test Facilities, 1992

Once again, the program awaited political decisions while technical progress proceeded. During the winter, 1992, slush hydrogen fuel tests commenced to quantify the performance and operating characteristics of liquid hydrogen under a variety of conditions. Specifically, the program sought to determine if it could make and transfer slush, and whether goal concentrations of solid/liquid fractions could be sustained during transportation and pumping. By December 1992, the program had conducted more than 300 tests on slush, and despite the failure of an occasional pump or instrument, management expressed confidence that slush could be manufactured, stored, transported, and pumped for use in hypersonic aircraft.³⁷

Scramjet combustor arc testing continued at NASA Ames simulating Mach 10-12 flight conditions, with each of 20 tests supplying 20 seconds of steady state data. The tests used two different scramjet injectors under investigation by the NPO fuel injector design team. In the first series, the injectors were of the "flush wall" variety, while a second set utilized intrusive injectors. Combustor performance tests of fuel mixing at Mach 8, 10, 12, 14, and 16 continued at the CALSPAN V facility to compare with the Ames data.³⁸ But the most important of the engine-related projects was the completion of drawings for the 30 percent scale integrated engine to be

tested at NASA Langley, the Concept Demonstrator Engine. By March 1993, all but a few parts of the engine were in production. At the same time, CFD data had started to arrive from tests on the inlets at low-, mid-, and high-speeds. The high speed data confirmed the CFD predictions, but the low- and mid-speed data did not fit the CFD predictions. Nevertheless, that did not alarm NASP engineers, because, as they pointed out, they had not used their most sophisticated CFD tools available. "Normally," JPO Chief Engineer Bill Imfeld explained, "you don't use your most sophisticated CFD on every test---it's too expensive, for one thing."³⁹ Engineers also hoped to find a level of reliable CFD analysis that resided well below the most complete tests.

In other areas of propulsion, however, progress had ground to a halt, mostly due to funding. Work on the Low Speed System had slowed due to the emphasis on the scramjet. Proof of concept issues on the Low Speed System, such as the catalyst, still presented significant technical challenges---perhaps more difficult than the scramjet. But since the program knew that early test vehicles could be air-launched or assisted to higher Mach speeds with a rocket boost, the Low Speed System comprised an element of the propulsion system that could be ignored temporarily. On the other hand, although testing on external burning slowed, the program had concluded that it represented a plausible technique to improve overall vehicle performance. The JPO had spent more than \$3 million on external burning from FY93 to FY94, and still needed to determine the exact placement of the flameholder. Along with slush, however, external burning provided a glowing success story for the program.

Only slightly behind advances in slush and external burning came materials progress, thanks to the "jump start" the materials consortium had provided. Titanium Matrix Composites technology constituted the area of most significant progress, with the test articles, including wing

attachment fittings, highly loaded joints, side shear panels, and other articles made from the composites tested (see Fig. 7.6, “T[itanium] M[atrix] C[omposites] Technology Development Test Articles”). Articles representing all sections of the X-30 were tested in 1992, including a successful test of the Lightly Loaded Splice Subcomponent, which reached 100 percent of design limit. A carbon-carbon panel and T-sections also withstood elevated temperatures, while a NARLOY-Z cooled panel sub-element, using helium as a coolant, underwent testing up to 550 degrees F, and by March 1993 engineers had raised the temperature/load level to 750 degrees F. Other testing of full panels or small panel elements occurred across a broad range of materials planned for use in the X-30, with progress in almost every case. Testing for Beta 21S titanium matrix composites halted when the instrumentation at the test facility suffered damage, underscoring the delicate balance that the program had to obtain between developing materials and cultivating the proper instrumentation to measure the technology. New strain gages were prepared, and those instruments met all expectations, allowing the program to plan a series of re-tests. At the same time, NASP invested in a metal matrix composites manufacturing facility in Lowell, Massachusetts, at Textron Specialty Materials. Planned for full operational capability in July 1993, that facility was expected to produce 4 x 8-ft. panels for the airframe skin.⁴⁰

Faced with declining resources, however, support for facilities such as the Lowell plant came at the expense of other parts of the program. Airframe manufacturers, who had taken significant reductions in their work, nevertheless often obtained new tasks as support for the propulsion contractors. But in the area of highly-specialized test facilities, created specifically for high Mach number tests, no alternative work existed. They simply had to shut down.

That constituted a major loss to the nation, because prior to NASP, no test facilities

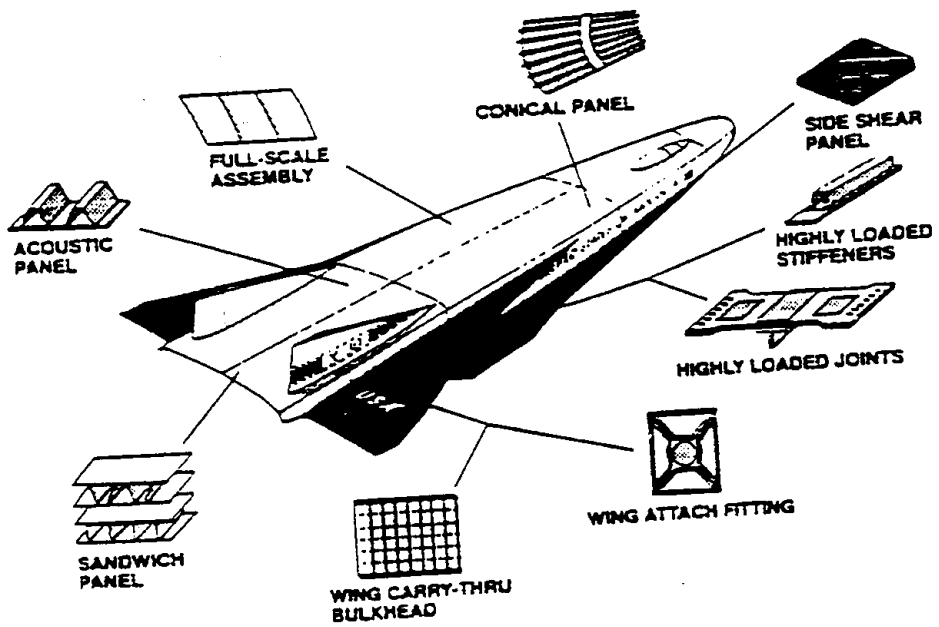

Fig. 7.6, "Titanium Matrix Composites Technology Development Test Articles"

existed for measuring speeds above Mach 16. When the program originally expected to build and test an X-30 aircraft, it ordered construction---or, in the case of existing facilities, refurbishing and enhancing---of a massive network of test buildings, tunnels, and instruments. The program spent nearly \$100 million on test facility development. NASP upgraded and created instrumentation systems for the Naval Surface Warfare Center at Greenbelt, Maryland, giving it the capability to test up to Mach 18.

Two of the most significant facilities, however, were created expressly for the purpose of testing NASP scramjet engines. Both Kaiser Marquardt and Aerojet had started test rig work early in the program. Kaiser Marquardt received a contract in May 1985 to provide a unique engine test capability to accommodate a full-scale engine module for testing across a range of extreme conditions. The Engine Test Facility, as it was known, experienced several failures during tests, and had to be shut down in August 1989. Although the contractor completed authorized repairs, program officials concluded by 1992 they no longer could support the ETF, and decided to move testing of the concept demonstrator engine to NASA Langley.⁴¹ Aerojet, which received its contract in 1986, had to construct a unit capable of testing a full-scale engine module, capable of Mach 8, at extreme conditions. Like the ETF, the Aerojet facility found itself out of work when the government transferred all concept demonstrator engine tasks to NASA Langley.⁴²

Closing some of the test facilities represented a serious loss to the American hypersonic research community, but it was only one of a number of measures the program utilized to reduce costs and save the core scramjet research. With each retrenchment, new budgetary pressures appeared. For example, in the FY93 budget, the Air Force found that it had a shortfall of \$722

million related to rising medical expenses. It assessed every budget line, and the "hit" on NASP came to \$5.1 million, which the program took from the Rocketdyne Low Speed System effort, terminating it. In addition, HYFLITE I and II would be extended. Such constant turmoil led management to consider an avenue once thought taboo: international cooperation on NASP, parallel to the international space station effort.

Pressures to Internationalize NASP

To appreciate the level of consternation that accompanied any discussion of international cooperation, it is worth reviewing the primary emphasis placed on *repelling* international competitors that the program had used before the Space Council in 1989 and thereafter. The market for satellite and other orbital payload launches had grown dramatically in the 1980s, actually enhancing the early arguments made by the program for the utility of NDVs (see Figure 7.7, "Military Space Budgets, 1980"). By 1990, the U.S. military space budget had risen 55%, far outstripping Japan's growth and eclipsed over a 4-year period--- in rate of growth only---by France's Ministry of Defense. The twelve European Community nations combined only spent one-twelfth the American level. Moreover, U.S. satellite manufacturing contractors dominated satellite manufacturing (see Figure 7.8, "Satellite Manufacturing by Contractor [1972-1996]). American manufacturers held 72% of the market, with two of the American companies, Hughes and General Electric, holding three times more market value in satellites projected for the period 1990-1996 than their nearest competitor. Even the Europeans admitted that Hughes and GE had "pulled away from the competition and appear likely to pace the market in the 1990s."⁴³

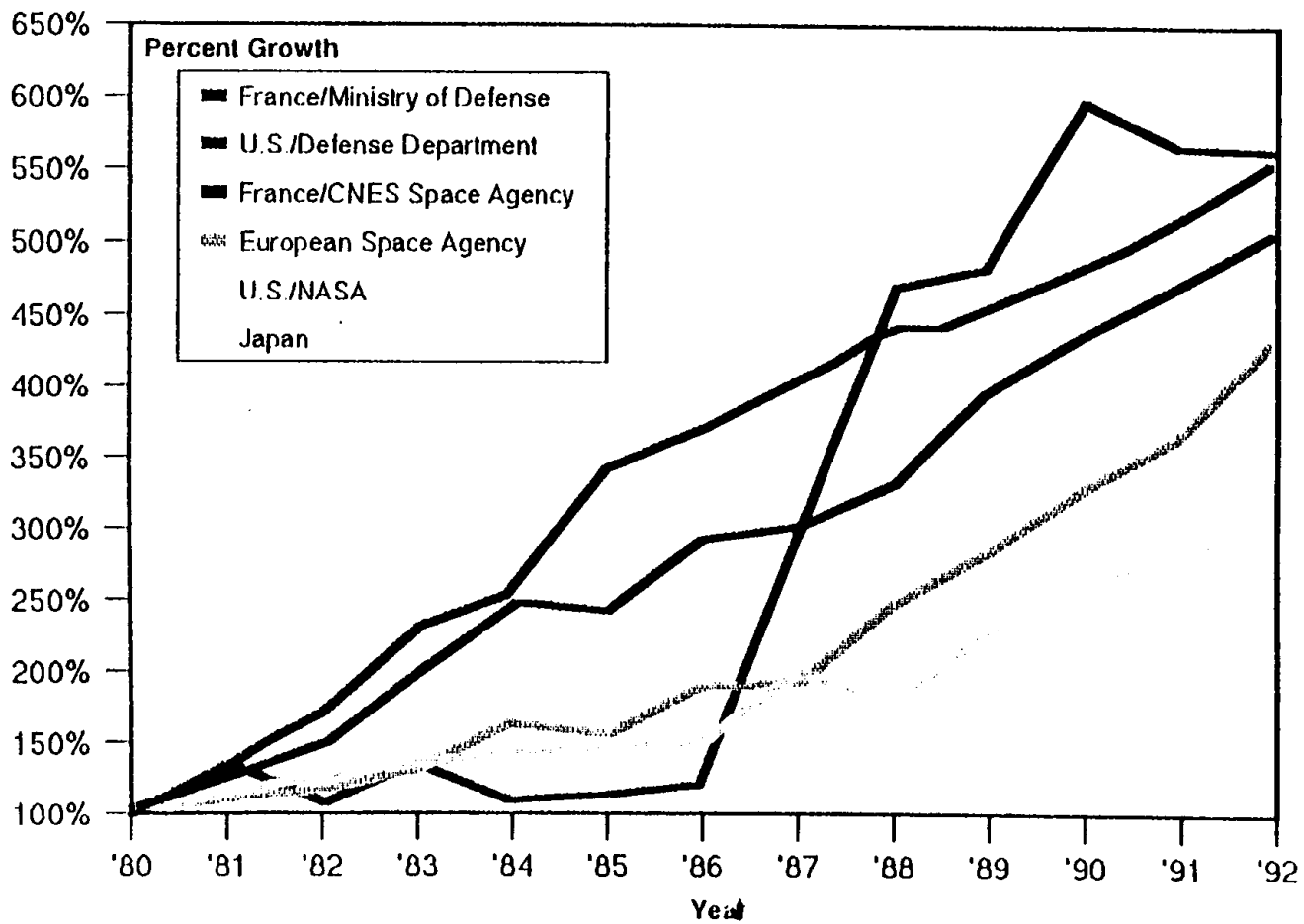

Source: Space News, 1/25 - 1/31, 1993, p. 7

Fig. . . , "Military Space Budgets, 1980s"

	1972-79	1980-89	1990-96*
Number of satellites	37	99	125
Market value in billions of 1992 dollars	2	6.39	10.40
United States	100%	69.7%	72.3%
Hughes Aircraft	87.1%	27.7%	30.0%
General Electric	12.9%	16.8%	26.6%
Space Systems/Loral	0.0%	18.9%	9.9%
TRW	0.0%	6.3%	4.3%
Fairchild	0.0%	0.0%	1.0%
CTA	0.0%	0.0%	0.5%
Europe	0.0%	23.5%	25.1%
Matra	0.0%	4.4%	9.8%
Aerospatiale	0.0%	5.2%	8.2%
British Aerospace	0.0%	8.2%	3.3%
Alenia	0.0%	0.9%	2.5%
Deutsch Aerospace	0.0%	4.8%	1.3%
Canada	0.0%	3.8%	1.4%
Japan	0.0%	3.0%	1.2%
*Includes firm contracts for future launches			

Source: Space News January 25-31, 1993, p. 7

Fig. 7.8, "Satellite Manufacturing, by Contractor, 1972-1996"

America's space industry remained so dominant that in September 1993, European officials stepped up efforts to block "a threat of American domination of the future market or mobile satellite communications."⁴⁴

In stark contrast, American programs, including NASP and the DC-X program, labored to show that the American space launch business was in decline (see Fig. 7.9, "Commercial Launch Market"). Those sentiments were repeated by the du Pont/Lopez/Budica group that testified before Congressman Brown's committee, although, obviously, for partisan reasons of those individual companies. Nevertheless, NASP management saw an opportunity in the period 1989-1993 to play upon fears that the U.S. industrial base---and particularly the aerospace industry---needed help from the government to overcome foreign competitors, and briefings by the program made use of trendlines showing erosion in the American industrial base.

That strategy seemed all the more applicable when Bill Clinton became President. He appointed Laura Tyson, long an advocate of "industrial policy," as head of the Council of Economic Advisors. Robert Reich and Ira Magaziner also received important appointments within the new administration.⁴⁵ Clinton had run on the claim that the U.S. economy was the worst in the last 30 years, and during the campaign had set the stage for a government directed industrial policy. He drew support from the U.S. Council on Competitiveness (a "fair trade" group). New studies appeared purporting to show that the U.S. had fallen behind in real investment (see Fig. 7.10, "Real Investment in Plants & Equipment"), manufacturing productivity (Fig. 7.11, "Manufacturing Productivity"), and even gross domestic product, or GDP (Fig. 7.12, "GDP Per Capita in Market Prices"). Such claims measured, in the case of manufacturing, a single year, or did not account for labor inputs, in which nations such as Japan

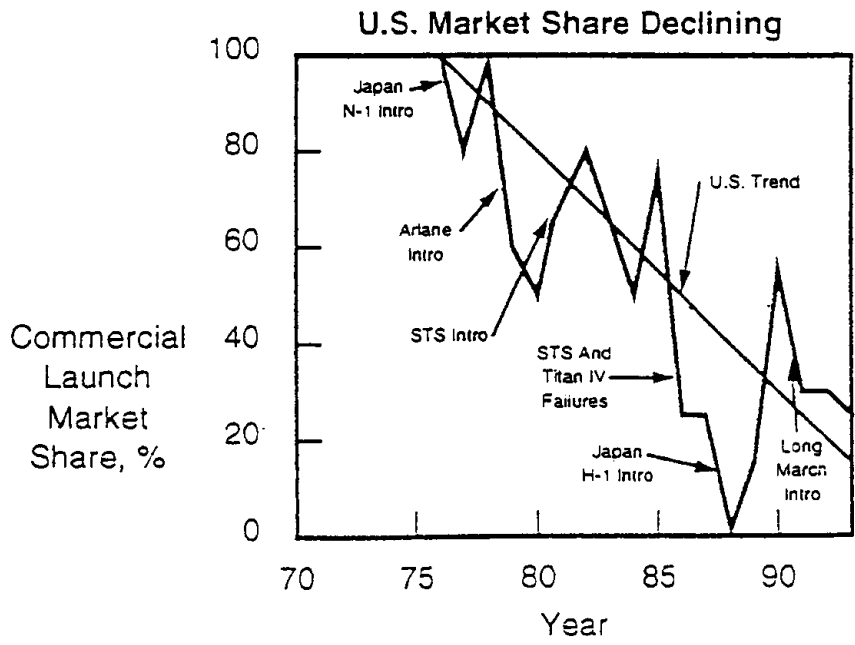
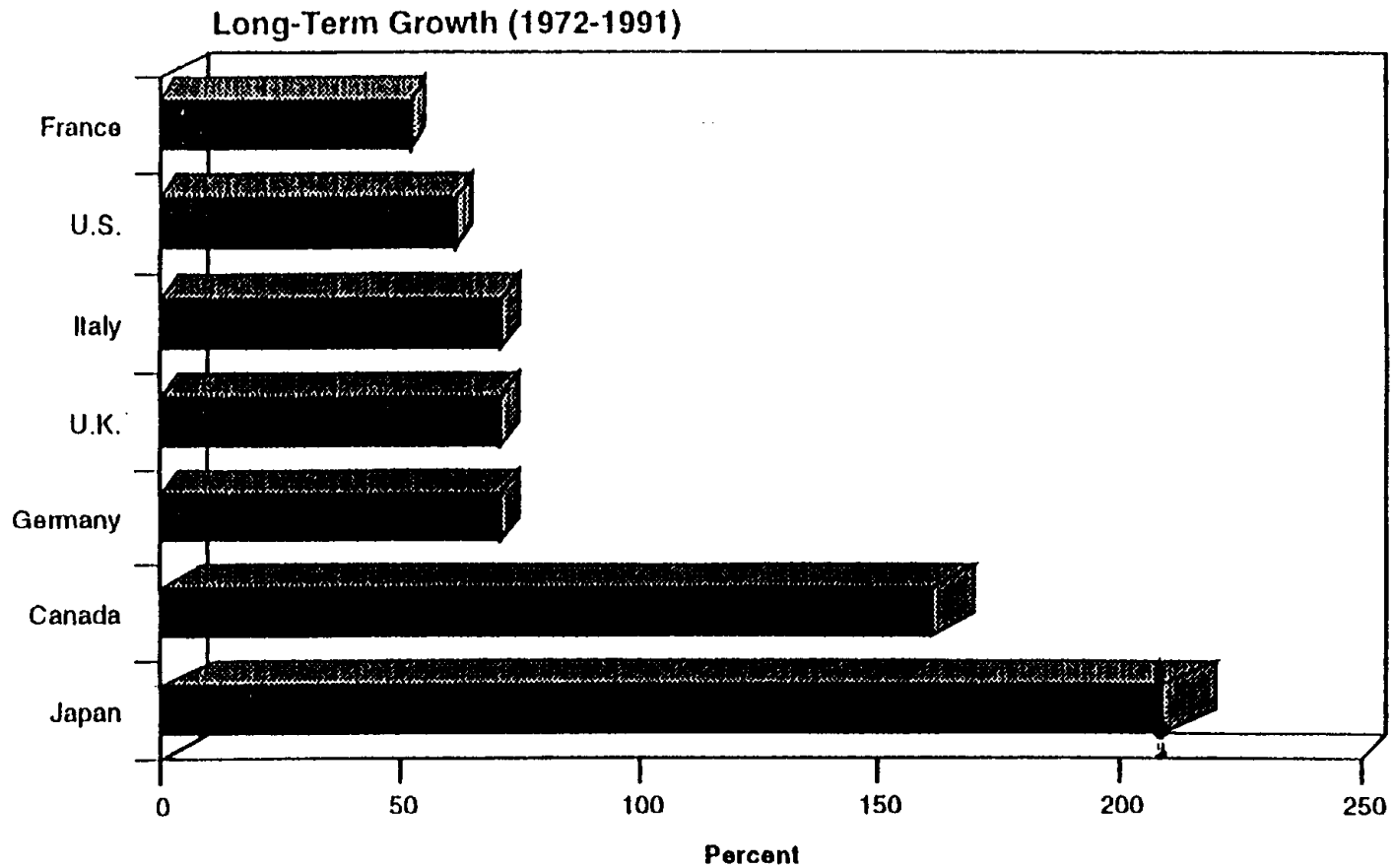
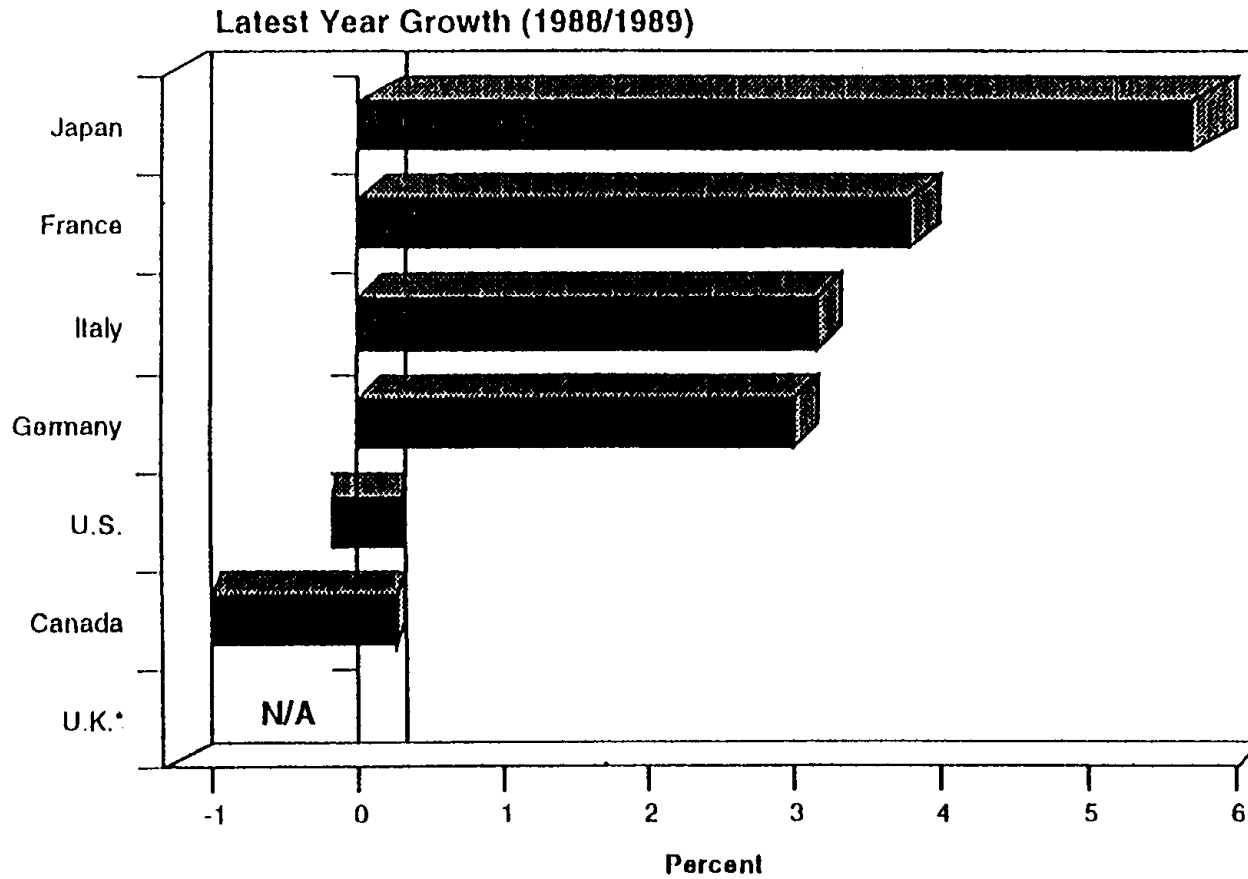

Fig. 7.9, "Commercial Launch Market"



Source: Council on Competitiveness
Focus, 1/93, p.7

Fig. 7.10, "Real Investment in Plants & Equipment"



* The latest year for which the U.K. data is available is 1987

Source: Council on Competitiveness
Focus 1/93, p. 4

Fig. 7.1j, "Manufacturing Productivity"

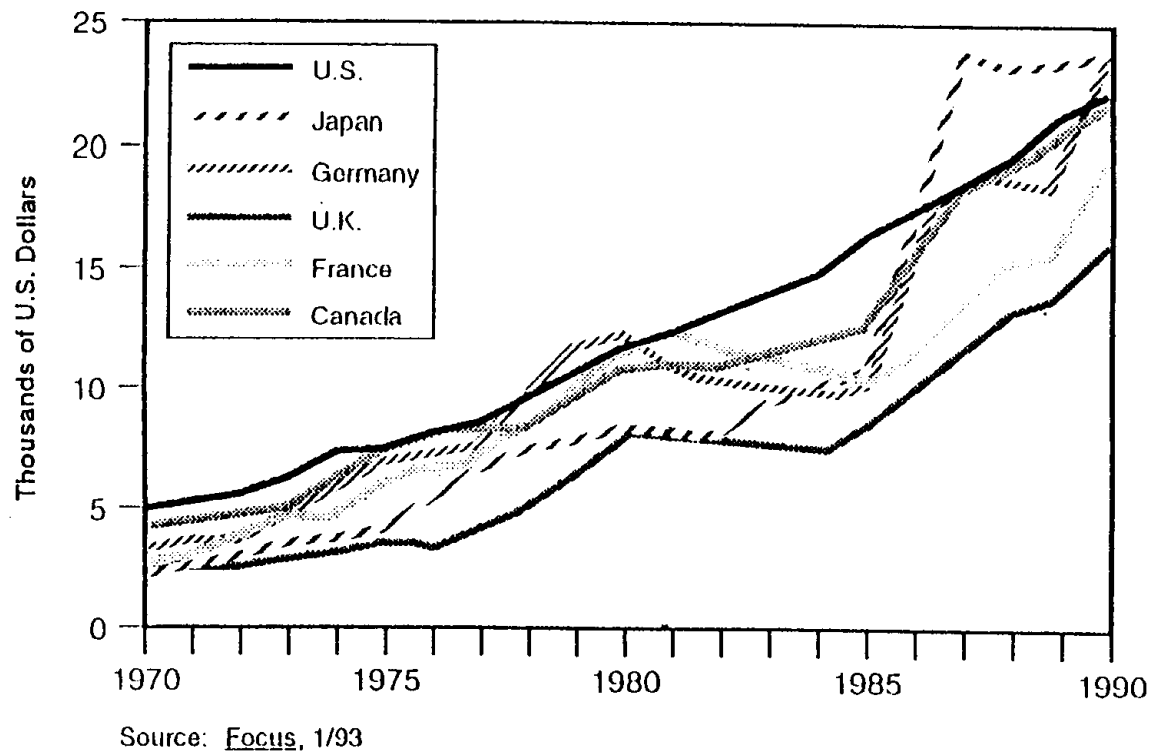

Fig. 7.12, "Gross Domestic Product Per Capita in Market Prices"

and the “Seven Dragons” expanded only by adding labor, not through productivity increases.⁴⁶ And indeed, some of the assertions may have been valid if viewed in the narrow context of a year or two’s performance. But between 1980 and the time Clinton took office, the European Union nations had not produced a single net new job, while the U.S. created more than 20 million; and American assets in single industries totaled more than the GNP of many entire nations; and that Japan experienced a dramatic short-term burst at the expense of long-term solvency, which became apparent in 1996 and 1997 as its securities markets and businesses collapsed under a tidal wave of speculation and debt.⁴⁷ Again, however, planners at the time saw only success in strategies that followed the European and Japanese examples. Paul Tsongas, who lost to Clinton in the primaries, argued “industrial policy is what Japan has It is what we must have as well [to compete],” while the vocal Ross Perot, running as a third-party candidate, agreed: “You’ve got to target the industries of the future. If you study MITI in Japan, it works.”⁴⁸ Corporate America, always open to government support, agreed. Jerry Sanders, the Chief Executive Officer of Advanced Micro Devices, said the “government of Japan has acted The United States, too, must act The United States needs an industrial policy.”⁴⁹ Both the *Harvard Business Review* and *Business Week* ran surveys or feature stories favorable to industrial policy. In a March 1993 editorial for *Defense News*, William Taft IV, the former deputy secretary of Defense under Reagan argued that government “must take the lead” in formulating an industrial strategy.⁵⁰

All of that occurred during a time of stagnation in the European economies. But MITI’s record---frequently cited as the “model”---was one of costly miscalculations and incredible shortsightedness. In 1953, MITI refused permission to a small company called Sony to buy

transistor-manufacturing rights from Western Electric, instead directing resources to the steel industry. By the 1980s, Japanese blast furnaces had fallen idle, laying off 50,000 steelworkers in what economist Paul Krugman called “the success that never was.”⁵¹ Meanwhile, revolutionary American competitors, made lean and innovative by several years of free-market downsizing, led the world in steel productivity. NUCOR, a company that made steel from junk, had the lowest management-to-employee relationship in the entire industry, with levels of profitability among the highest. MITI rejected overtures from a small lawn-mower/motorcycle company to enter the auto business, but in 1992, without government assistance, Honda was the only Japanese auto company not losing money in America. Japan’s emphasis on shipbuilding led to the creation of the world’s largest shipyards at the peak of a world glut in shipping, leading the government to preside over a 75% reduction in the industry.⁵² Even in aerospace, Japanese Air Lines remained one of the highest-cost carriers in the world, while in the U.S. annually the most profitable and fastest growing airlines included Southwest, which certainly had no government subsidies.

Ironically, by late 1992, as the industrial policy debates peaked, the budget pressures on NASP forced the program had to explore partnerships with the very nations it sought to outdistance in economic growth. In addition, the impetus to form international teams or consortia also came from foreign governments and contractors, which, for all of NASP's troubles, had not achieved nearly the same advances in technology as had the X-30 program. Even after forming a Future European Space Transportation Investigation Programme (FESTIP), the Europeans lagged behind the U.S. effort.⁵³ Consequently, at the December 1992 AIAA meeting in Florida, European participants pressed enthusiastically for an international effort. Although the keynote address by John Swihart, an American, was a clarion call to “explore, build, and utilize [space]

jointly," subsequent speakers, such as Hans Pfeffer of Germany expressed a willingness to form a committee at that very meeting for the purposes of getting such an effort underway.⁵⁴ Another American, USAF Capt. Matthew Bille presented a paper proposing an international NASP-type vehicle called the *Athena*.⁵⁵ Other evidence indicated that the Europeans had started to court Russia, and in November 1992, France and Russia had cooperated on a flight test of a scramjet from a launch site in Kazakhstan and might expand that relationship.⁵⁶

Barthelemy admitted that the program might be able to utilize foreign efforts without "giving up the farm," and noted that the French and Russian work in particular could be valuable for NASP.⁵⁷ He mused that there might be a way to "keep the Phase 2D research in the U.S. and pursue scramjet research on an international basis."⁵⁸ However, he well understood that NASP had sold itself as "preserving the U.S. aerospace industrial base" for years, and that any deviation from that line might cost the program substantial support. As of 1992, however, the program could not even talk to foreign representatives about purchasing data that could benefit NASP, because the NASP security program, which DoD still controlled tightly, did not permit it. Many, however, remained convinced that the budget reductions of the 1990s required an international effort: "the only way we can do it is to . . . work with [the French and the Russians]," one NASP supporter said.⁵⁹ Otherwise, developing a space plane would be "hellaciously expensive."⁶⁰

HYFLITE I and II, Reprise

NASP, after briefly flirting with internationalization, thus returned to its HYFLITE I and II program, with the fate of HYFLITE III still undetermined. Following the departure of Robert

Barthelemy in March 1993, the interim program manager, Col. Phil Bruce, continued to prepare for a HYFLITE-oriented budget and organization. Already problems had appeared with the HYFLITE I concept. Program engineers had decided to use a Minuteman II missile over a number of alternative launch systems. The HYFLITE I test unit would be a wedge-shaped article simulating the X-30's forebody, and would be designed to determine boundary layer transition. HYFLITE II's test article would also be wedge-shaped, and would incorporate the engine flowpath to determine inlet operability and airflow characteristics, as well as demonstrate scramjet performance (although it would not necessarily have to prove that the scramjet could produce sufficient thrust---only that it would produce some thrust!). The wedge-shaped articles, however, had to be covered with a shroud that would blow off when the test started, causing controllability problems and causing a slight delay in obtaining data. Engineers also struggled with the problem of getting a ballistic missile, designed for an arc trajectory, into a flatter trajectory simulating a NASP flight regime.

Overcoming those obstacles required additional funding, and merely the "fleshing out" of the program's numbers, once the technology was better understood, increased costs. Original budget estimates for HYFLITE I and II, for example, had come in at \$135 million total; but when the JPO's program control directorate (NAP) conducted a detailed assessment of the costs, it arrived at a figure of \$579.8 million! And, once again, Washington advocates had proceeded on the basis of the first cost "guess," without waiting for a realistic cost estimate. But the more serious cost predicament involved HYFLITE III, where Berwin Kock, at the JPO's on-site detachment, "Det. 5" at Palmdale, had just arrived at a projection of \$1.4 billion. Kock's was an engineering estimate---not a complete program cost projection---and thus the JPO and the NASP

Washington Office, NIO, received that number with considerable concern. Using the HYFLITE I and II cost estimating "history" as a basis, they could envision a HYFLITE III cost of \$4-5 billion, ironically the "original" cost of the Du Pont vehicle in 1986.

Wierzbanski and Waldman dismissed such outlandish estimates, and even thought the HYFLITE I and II estimates prepared by NAP were unrealistic. For example, NAP's cost estimates on aluminum, Wierzbanski argued, "were way above what HYFLITE needed--- something like \$135 million for aluminum alone! [NAP] had the HYFLITE 6-ft. engine fairing priced at \$6 million a copy. That's more than two Cessna Citations!"⁶¹ NAP mandated a cost reserve of \$200 million, or more than the entire projected cost of the entire program.

Over the summer of 1993, while the HYFLITE office worked on technology and budget issues, the quest continued to identify an appropriate follow-on to HYFLITE I and II. Congress, led by Brown's committee, issued instructions to NASA and DoD to conduct a six-month study on a hypersonic research vehicle to fly in the Mach 12-15 range, essentially requesting information on the X-30X that the program had been prohibited from briefing in March! Brown's committee heard testimony from the "Greybeards" group formed by Barthelemy before his reassignment. William Heiser, Fred Billig, and others appeared before the committee to deliver a message the committee had not heard often. Heiser stated that in "perfect hindsight" the difficulty of the SSTO task was underestimated and that a "rigid adherence to SSTO as the only option" had contributed to the program's problems.⁶² Heiser pointed out that the program had adopted a management structure more appropriate to acquisition practices than R&D---a point Wierzbanski, among other, made vociferously---and that "unusual levels of management turbulence due to changing program direction and funding" had contributed to the challenge.⁶³

Another "Greybeard," and scramjet pioneer, Fred Billig, praised NASP as having "provided the technical base which will permit proceeding to the development of an X-airplane" although ignoring the fact that NASP was created specifically to develop such an airplane.⁶⁴ The group strongly supported the HYFLITE experiments, but recommended that it not dominate NASP funding. The members also urged that some resources continued towards basic SSTO technology.

Until HYFLITE III, or some variant of an X-30X, received approval, the program had near-term goals but little else to argue for its continuation. Recent briefings in Washington had wandered, searching for a way to integrate the "new" NASP in bigger picture national strategy. That, however, opened the door for a variety of claims. Increasingly, NIO exerted greater control over the program and its message, and in June 1993 NIO instructed the JPO that NIO maintained final approval over any travel to Washington. Moreover, NIO insisted that "no one is to speak for the program with Washington individuals, without NIO coordination."⁶⁵

That did not deflect the increasing criticisms of the top management at NASP---not Williams, Barthelemy, or the JPO---but the Steering Group and NIO. The drumbeat continued in June with the publication of the GAO report, entitled "National Aero-Space Plane: A Need for Program Direction and Funding Decisions," which stated flatly that "Neither the Office of Science and Technology Policy, the Steering Group, nor DoD has provided clear direction on what the program's future efforts and objectives should be."⁶⁶ Surprising some observers, the GAO agreed with contractor officials who "cited funding instability as the single most disruptive factor that hindered the execution of Phase 2"⁶⁷ For the first time, a review body singled out mismanagement above the JPO level for many of the program's problems. And, reviewing past

positive support for the program, the GAO pointed out that Vice President Dan Quayle and the National Space Council had played a prominent role in providing that direction. GAO's report, however, did not specifically criticize the Steering Group, NASA, or the Air Force for failing at innumerable points to deal with the internal contradictions of the SSTO/"ops" mission and the research imperatives; or the unstated goal of maintaining the aerospace contractors vs. advancing a single design to conserve resources; or the failed strategy of attempting to maintain several "sponsors" through the joint program when no one sponsor had ever surfaced as the program's champion; or the program's deficiencies when it came to developing a consistent source of congressional and administrative support related to its refusal or inability to "fly hardware."

Attrition and Talent Deletion at NASP

No one doubted that the JPO had lost its autonomy after Barthelemy left. Changes in the real management power of the JPO made an impression on the contractors, where Waldman called the diminution of authority "profound." Between 1989 and 1993, the program lost dozens of key personnel, including many people who had shaped the critical technology efforts, such as Frank Boensch and Ken Griffin, or program specialists like Tom Richmond, Carl Conley, and Col. George Matthews. Chief Engineer Bill Imfeld left in July 1993; Wierzbanski and Berwin Kock had long ago moved to the NPO; and even a new layer of younger civilians and officers, who had an intimate knowledge of the research aims of the program, such as Peter Erbland, Maj. Dan McCorry, Capt. Steve Mattern, and Lt. Col. Robert Paling, soon departed. By the summer of 1993, the JPO had lost the best of its "brains trust."⁶⁸ Many abandoned the program because the

appeal of being involved in the first airplane to orbit simply no longer existed. NASP would not go into space, many thought, any time during their careers, much less their assignment on the project. Still others had left out of frustration when they sensed that no matter what plans the JPO or NPO came up with, NIO would override them. The countless strategic development sessions that directors had invested thousands of hours into had resulted in virtually nothing tangible. Yet others concluded that better career opportunities would pass them by if they remained at a shrinking program.

Budget pressures continued over the summer. DoD suffered from a drawdown related to the end of the Cold War, as well as from a general anxiety about the continued deficits. Despite the impression, fostered by the aerospace industry in particular, that the post-Cold War drawdown was exceptional, the 1989-1993 reductions hardly compared to the post-World War II and Korea restructuring, and fell slightly below that of the Vietnam War (see Fig. 7.13, "The Big Difference in Drawdowns").⁶⁹ Moreover, the differences between the "peak" and the "valley" was lower than in earlier eras. A "Defense Conversion Commission," charged with "converting" defense industries into civilian production, received \$1.8 billion from Congress to assist communities and industries affected by defense cuts, and not surprisingly when NASP contractor representatives in Washington made their appeals for funds, they once again emphasized technology transition and the industrial base. The deficit debate, which had arisen only in the 1980s as a criticism of the Reagan Administration's tax cuts, continued to dominate Congressional rhetoric, but until the Republicans gained control of the House and the Senate in 1994, the reality of budget cuts only reached to DoD.⁷⁰

For NASP, any further cuts threatened to put the program below "life support" level.

Period		Peak		Valley		Difference		Average Annual Drop
		Year	Amount	Year	Amount	Years	Amount	
Military Outlays In Billions Of 1993 Dollars	World War II	1945	885.7	1948	80.4	3	805.3	268.40
	Korea	1953	390.7	1956	284.5	3	106.2	35.40
	Vietnam	1968	371.2	1977	219.1	9	152.1	16.90
	Current	1989	353.6	1997	256.9	8	96.7	12.10
Military Outlays As A Percent Of Gross Domestic Product	World War II	1944	39.3	1948	3.7	4	35.6	8.90
	Korea	1953	14.5	1956	10.2	3	4.3	1.43
	Vietnam	1968	9.6	1978	4.8	10	4.8	0.48
	Current	1986	6.5	1997	3.6	11	2.9	0.26

Reference: Air Force Magazine, March 1993

13
Fig. 7.. "The Big Difference in Drawdowns"

Waldman admitted that the minimum the NPO could continue to exist on, and make technical progress, was \$125 million. After a number of mark-ups in the House and Senate on the FY94 budget resulted in several committees giving NASP a "0" mark. As the budget process dragged on throughout the Fall of 1993, many individuals inside the JPO admitted that they thought the program was in a termination mode. The final FY94 Air Force budget confirmed their suspicions: the request was for \$94 million, which, if augmented by NASA's \$20 million, the program still would find itself with \$114 million, or \$9 million less than the amount considered "minimum." But DoD further cut the Air Force request to \$43 million, an amount that, even when combined with NASA's \$20 million, the final amount, according to one director, "barely kept the lights on."

Congress also instructed the Air Force to wrap up all Phase 2D activities and terminate the National Aero-Space Plane program while continuing to explore basic hypersonic vehicle research including HYFLITE. Accordingly, the NASP program started to produce transition schedules (see Fig. 7.14, "Phase 2 Schedule, 1994). According to the conference report language, NASP should "be phased out in an orderly fashion in Fiscal Year 1994."⁷¹ The conferees noted that the nation could not afford to pursue an X-plane development program, but encouraged investment in hypersonic research. But HYFLITE could not be funded for a \$60 million annual budget and have any resources for any other hypersonic technology research. Even in the most stripped-down circumstances, different factions in NASP continued to differ over whether base hypersonic technology research or demonstrating operational hardware mattered most.

Once again, the lack of direction from above continued to afflict the program. The budget could not provide for the most basic---indeed, unrealistic---HYFLITE project; but no one offered

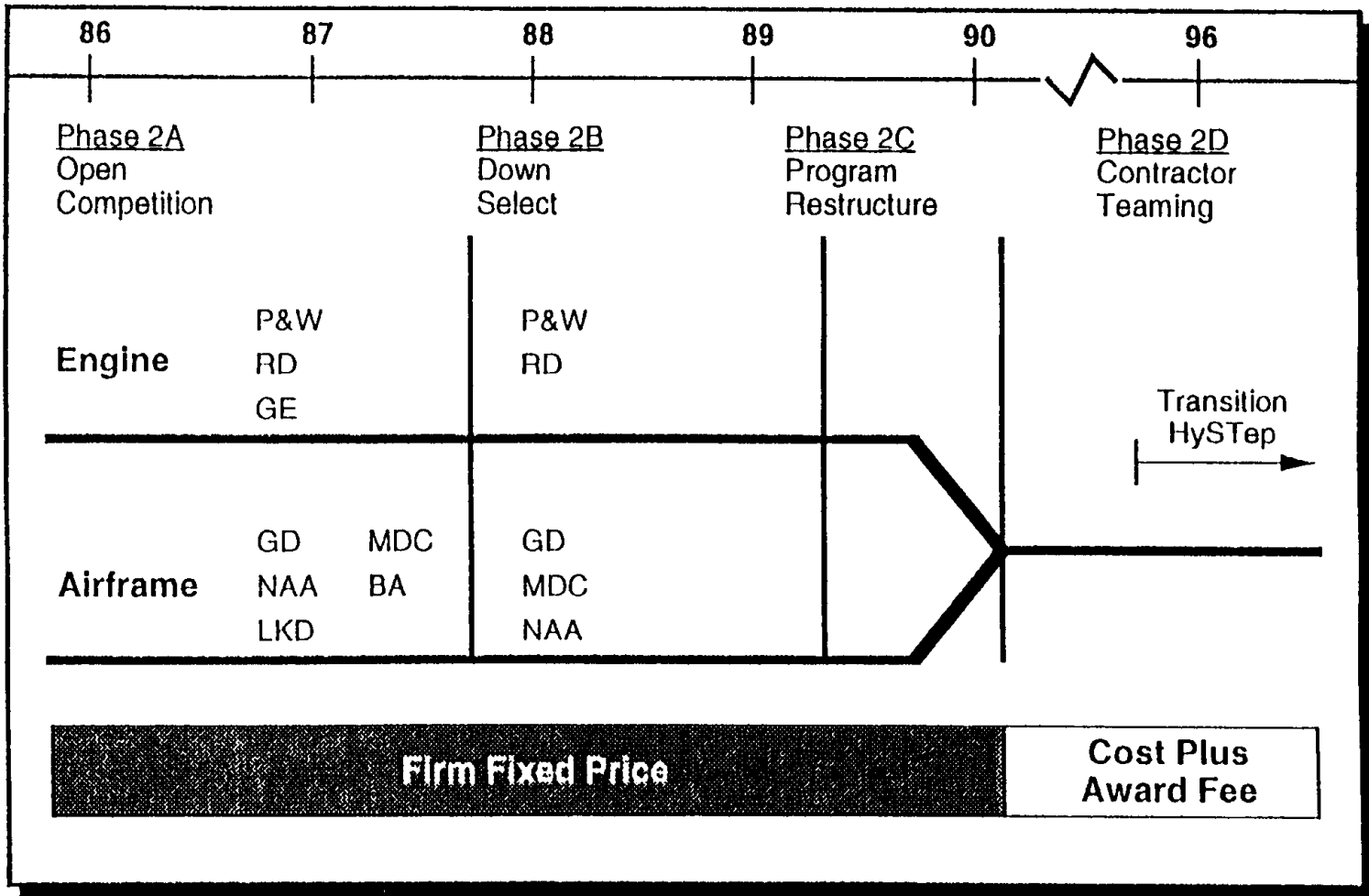

Fig. 7.1¹⁸ "Phase 2 Schedule, 1994"

2.14

any clear alternative to the scramjet demonstrations. As in the past, leadership came from the JPO and the NPO. Berwin Kock, who replaced the retired Col. Ted Wierzbanski, headed the new effort to abandon the boundary layer research and concentrate on the single most important issue---will the scramjet work?⁷² The new derivation of HYFLITE with a "scramjet only" focus would be called "HySTP" (*Hypersonic Scramjet Technology Project*). Funded at \$300 million, HySTP would attempt to test a 25% scale scramjet in the Mach 12-15 range using a Minuteman or Peacekeeper as a booster.⁷³

The JPO presented its new, revised strategic plan to the Acquisition Strategy Panel for the last time in May 1994.⁷⁴ It proposed to launch a small scale--but not subscale---scramjet to obtain "point" data. In other words, the JPO planned to see if a scramjet, any scramjet, would work. The data would not necessarily translate to an X-30 engine, and might not even be valid for a scaled-up scramjet of any type. It would, however, provide some additional flight data. Program engineers defined the key parameter as determining whether or not a scramjet could produce "useful" thrust from combustion beyond the mere expulsion of hydrogen. The JPO considered implementing a new contractor arrangement, perhaps handing out a contract to one of the existing propulsion companies, or could continue the contract with the team. Overall, the ASP approved of the JPO's strategic plan.⁷⁵

Based on a recommendation from the Air Staff, the Air Force budgeted \$450 million over the subsequent five years to support HySTP. For FY95, HySTP was to receive \$60 million from the Air Force and \$30 million from NASA. (Those amounts eventually were cut to \$45 million for the Air Force and \$22.5 million from NASA.) More important, the Air Staff allowed NASP to let a contract on December 1, 1994 to the existing National Contractor Team and otherwise

make the transition from NASP. It appeared that hypersonic technology finally had a reliable funding base.

Half way around the globe, however, U.S. involvement in Somalia placed an "off-budget" burden on DoD. Under normal circumstances, DoD would request more money from Congress to cover such operations, but having just run a campaign on budget issues, and having already boasted that it had brought the Pentagon into line with budget realities, the Clinton administration could not suddenly admit that its projections were wrong. Instead, to cover the Somali operations, the Pentagon had to "tax" other, existing programs. DoD targeted NASP/HySTP for a contribution of \$40 million a year from FY96 to FY2000, but, aware that such a sum would devastate the program, the Office of the Secretary of Defense already had identified another source from which to draw NASP/HySTP's contribution. DoD was confident that it had covered the shortfalls, and planned to proceed with NASP/HySTP as indicated by the \$45 million budget that HySTP received for FY95 (NASA would commit \$22.5 million). The Air Force's \$45 million, and the \$67 million total, represented full funding from the Air Force. However, Congress only released \$10 million pending testimony before the House of Secretary of the Air Force Shiela Widnall that the Air Force indeed was committed to NASP, and thus planned to provide full funding in the period FY96-FY2000.⁷⁶

Before Widnall met with legislators on HySTP, the Secretary of Defense levied a second "tax" that dried up supplemental funds intended for HySTP's earlier contribution. After searching for alternative funds, the Air Force Secretary's Office determined that no other funds were available for HySTP and the contract was terminated. Ending the contract at that point---having already let the contract---cost the government \$10 million.

In its Future Year Defense Plan, the Air Force retained \$20 million a year over the period FY95-FY2000 for generic hypersonic research. That research was to be moved to Wright Labs by May 1995, with an emphasis on further verification of NASP technology through HySTP. Two major changes from the earlier proposed HySTP program emerged: 1) the research program would work on hydrocarbon fueled scramjets, and 2) the program would work in the Mach 8 to 10 range vs. Mach 15. Even with the new fuel, the scramjet design would remain close to that of the slush engine.

NASA continued hypersonic work by establishing the "Hyper-X" program to demonstrate scramjet technologies.⁷⁷ In Phase I of the program, operated jointly by Langley and Dryden centers, four 12-ft.-long pilotless aircraft would fly up to 10 times the speed of sound (7200 mph) to demonstrate the operation of a scramjet engine. The aircraft would utilize air launch of a booster rocket from a B-52 at 40,000 feet, and shortly thereafter the Hyper-X vehicle would separate, turning on the scramjet engine for approximately five seconds of operation to demonstrate forward thrust. Then, the vehicle would go into 10-15 minutes of glide to collect hypersonic aerodynamic data. NASA anticipated that the five-year program would cost \$150 million.

As for NASP, the last rites were administered at a figurative "wake" in early 1995, held by program veterans from NASA, the Air Force, and the contractors who over the program's life had worked so hard to put a jet into orbit. Barthelemy attended, giving the eulogy. The National Program Office in Palmdale closed in January 1995, at which time Waldman transferred back to other Rockwell assignments. All contractor facilities related to NASP were to be closed out by June 1995, at which time all final reports were due. Robert Williams, the "father of NASP," had

left DARPA for other government duties. As of 1997, neither Tony du Pont's aircraft design nor any other jet-powered aircraft has achieved orbit.

NOTES: Chapter 7

- 1 . "National Aero-Space Plane Phase 3 Research Plan," version 3, September 1, 1991, in NAX files, cited in "National Aero-Space Plane (NASP) Advanced Technology Impacts," 11.5 ; Ken Griffin, "Dr. B[arthelemy] and Col. Helt, sub: Business Relationship between the JPO and the NPO," n.d., circa fall 1990, in Wierzbanski's files, AFFTC, Edwards AFB; and interviews with Maj. Kevin Brown, June 19, 1992 and Peter Erbland, June 30, 1992.
- 2 . Lt. Col. Ken Griffen to Robert Barthelemy and Col. Helt, "Business Relationship Between JPO and NPO," memo, n.d., circa fall 1990, File 15-202, Wierzbanski's files, AFFTC, Edwards Air Force Base.
- 3 . Dale Compton to Staff, Ames Research Center, October 10, 1990, (no folder number) in Wierzbanski's files, AFFTC, Edwards Air Force Base.
- 4 . John D. Moteff, "National Aero-Space Plane," Congressional Research Service, IB89128, January 1991, pp. 3-6.
- 5 . "NASP Budget What-If Point Paper, "August 4, 1992, NAP files.
- 6 . Ronald Shinkman, "Goldin Backs Alternatives to Hypersonic Plane," Antelope Valley News, September 4, 1992.
- 7 . William Scott, "NASA Ames Proposal Could Challenge NASP," Aviation Week & Space Technology, September 14, 1992, p. 27.
- 8 . "Point Paper on Potential Commonality Between the National Aero-Space Plane and the High Speed Civil Transport (HSCT)," August 14, 1992, NAR files. Shortly thereafter, in the Fall, 1993, Lockheed announced a "linear plugged nozzle" propulsion system combined with a lifting body design to lift 40,000 lbs. into low-Earth orbit. See Ben Ianotta and Neil Munro, "Spy Satellite Firms Seek U.S. Industrial Policy," Defense News, August 30-September 5, 1993, pp. 3, 28.
- 9 . Lana Couch presentation to Daniel L. Goldin, June 18, 1992 in folder 1002-B, "1992," Beth Quinto's files, NASA Langley.
- 10 . Leonard David, "Unorthodox New DC-X Rocket REady for First Tests," Space News, January 11-17, 1993, p. 10; Maj. Jess Sponable, "Single Stage Rocket Technology," Program Review, March 1993, in NAR files, cited in "National Aero-Space Plane (NASP) Advanced Technology Impacts," 14.10. Sponable had worked in the NASP office under Col. Fuller in 1988-89.
- 11 . A. Royce Dalby, "The Delta Clipper," Ad Astra, October 1991, 22-26 (quotation on 22).

12 . Although the DC-X completed its first flight test in August 1993, it had experienced numerous delays brought about by weather, technical problems, and even the visit of the Pope. The flight test elicited more criticism than it did support. According to one observer, it "looked like something out of one of those 'B' horror movies, and didn't prove anything." Maj. William West of NAR said of the DC-X flights, "Apollo did that stuff 20 years ago but [the DC-X program officials] held their demonstration and got Congress to allocate millions of dollars" (Interview with Maj. William West, October 12, 1993). Other observers in the September 20-26 edition of Space News were less generous. One said "the corporate marketing guys thought the Delta Clipper ought to win a national prize. If you make a list of all the things you've got to do go get to orbit in a single stage, the DC-X has almost none of them" (p. 17). "You can fly higher than this thing in a Cessna," he added.

13 . Interview with Barry Waldman, October 5, 1992.

14 . "NASP Program Strategy," August 22-26, Detachment 5 files, Plant 42, Palmdale, cited in "National Aero-Space Plane (NASP) Advanced Technology Impacts," 13.8.

15 . Ibid.

16 . Tony du Pont, "Testimony Before the House committee on Space, Science, and Technology," September 29, 1992.

17 . Ibid.

18 . Robert Budica, *ibid.*

19 . Henry Lopez, *ibid.*

20 . "National Aero-Space Plane (NASP)," [Hearings] House Space, Science, and technology Committee, September 29, 1992, pp. 3, 20.

21 . Interview with Richard Truly, September 5, 1997.

22 . General Accounting Office, "National Aero-Space Plane: Restructuring Future Research and Development Efforts" (Washington: General Accounting Office, 1992), NSIAD-93-71.

23 . Roy Harris, Jr., "Evidence Points to Secret U.S. Spy Plane," Wall Street Journal, December 4, 1992; Bill Sweetman, "Out of the Black: Secret Mach 6 Spy Plane," Popular Science, March 1993, pp. 56-60, 62-63, and 98-100.

24 . Sweetman, "Out of the Black," p. 62. In e-mail correspondence with the author, a spokesman for the Federation of American Scientists, when confronted with information that no one in NASP ever noted any evidence whatsoever that suggested that Aurora existed, agreed to reconsider FAS's statements.

25. Keith Rogers, "Budget for Hypersonic Spy Plane Rivals Nevada Test Site," Las Vegas Review-Journal/Sun, December 5, 1993, and his "'Spy' Turns Focus on Buffer Area," *ibid.*; Federation of American Scientists, "Secrecy and Government Bulletin," January 1994, p. 1.
26. Stuart Brown, "Searching for the Secrets of Groom Lake," Popular Science, March 1994, pp. 84-85.
27. On the B-2, see Michael Brown, Flying Blind: the Politics of the U.S. Strategic Bomber Program (Ithaca, NY: Cornell University Press, 1992).
28. Interview with Robert Barthelemy, November 17, 1992.
29. "HYFLITE Briefing," November 20, 1992, Col. Wierzbanski's files, AFFTC, Edwards Air Force Base.
30. "X-30X Concept Evaluation Study," in "Det. 5 files," Wierzbanski's files, AFFTC, Edwards Air Force Base.
31. Interview with Robert Barthelemy, November 17, 1992.
32. Quarterly Technical Review, November 20, 1992, NASP Historical Files, NASA Langley Technical Library.
33. Copy of wire service story, E-mail, December 8, 1992. Ostensibly, this story appeared in the Los Angeles Times, but the Washington community learned of it through E-mail.
34. E-mail to Col. Phil Bruce, December 11, 1992. Critics would claim that RAND had struck again, and that Rice's "RANDian" tendencies placed NASP in a hopeless position.
35. Interview with Robert Barthelemy, March 16, 1993.
36. William H. Heiser to Col. Phil Bruce, June 4, 1993, "Airbreathing Propulsion Specialists Report," in Wierzbanski's files, AFFTC, Edwards Air Force Base.
37. Chuck Anderson to JPO/FOG/3-Ltr Division Chiefs, e-mail, November 30 and December 31, 1992; Interview with Bill Imfeld, January 12, 1993; Interview with Steve Van Horn, January 12, 1993.
38. Chuck Anderson to JPO/FOG/3-Ltr Division Chiefs, "Preliminary Activity Report," March 23, 1993; Imfeld interview.
39. Interview with Imfeld.

- 40 . Chuck Anderson, to JPO/FOG/3-Ltr Division Chiefs, e-mail, December 31, 1992.
- 41 . Capt. John Oliver, "Historical Background on Marquardt Company," memo to the author, January 1993.
- 42 . Capt. John Oliver, "Historical Background on Aerojet Engine Test Facility," memo to the author, February 22, 1993.
- 43 . Peter deSelding, "Study Finds U.S. Builders are at Top of Market," Space News, January 25-31, 1993, p. 7.
- 44 . Peter deSelding, "Europeans Fear U.S. Monopoly in New Market," *ibid.*, September 1993, p. 1.
- 45 . Tyson argued for an American activist policy that would generate "significant knowledge and technological spillovers for the entire economy" through a national industrial policy. See "The State of U.S. Manufacturing," National Center for Manufacturing Sciences, FOCUS, January 1993, p. 1. Yet those calls came shortly after the Federal Reserve Board had published a new study showing that "labor productivity in U.S. manufacturing soared in the 1980s [growing] at an annual average of 5 percent . . ." See Charles Steindel, "Manufacturing Productivity and High-Tech Investment," Federal Reserve Bank of New York Quarterly Review, Summer 1992, p. 39. An excellent overview of the debate appears in the "Opposing Viewpoints" pamphlets from Greenhaven Press, "Is America Falling Behind in Technology?" (1990), which includes essays by Reich, Charles Ferguson, George Gilder, Robert Mossbacher, and several others. Otis Graham's book, Losing Time: The Industrial Policy Debate (Cambridge: Harvard University Press, 1992), is less useful and often contradictory, as when he criticizes a military-dominated national industrial strategy, yet cites as a "success" of industrial policy the federal armories in the 19th century! Also see David Hounshell, From the American System to Mass Production: 1800-1932 (Baltimore: Johns Hopkins University Press, 1984).
- 46 . See Schweikart, "The Entrepreneurial Adventure," ch. 12-14 on these issues.
- 47 . These statistics are discussed in Gilder, Wealth & Poverty, *passim*; in Schweikart, "The Entrepreneurial Adventure," ch. 13-14; and in several columns in the Wall Street Journal and Washington Post, by James K. Glassman, cited extensively in Schweikart, "Entrepreneurial Adventure." Also see the entire issue of American Enterprise magazine, _____.
- 48 . Both men are quoted in Karl Zinmeister, "MITI Mouse," Policy Review, Spring 1993, 28-35 (quotations on 30).
- 49 . Quoted in Zinmeister, "MITI Mouse," 30.

- 50 . William Taft IV, "Government Must Take the Lead," Defense News, March 22-28, 1993, 20.
- 51 . Quoted in Zinneister, "MITI Mouse," 31.
- 52 . Mark Albrecht, "Space Promotes Competitiveness," Space News, March 29-April 4, 1993, 17.
- 53 . "Hypersonics: a Non-Issue at Grenada," European Space Report, November 16, 1992, p. 5.
- 54 . John Swihart, "Keynote Address: Advanced Technology Demonstrators, Prototypes, and Hypersonic Flight," AIAA keynote address, AIAA Forth Annual International Aerospace Planes Conference, December 1-4, 1992; Hans Pfeffer, "The Actions of the European Space Agency to Prepare for Future Space Transportations Systems, the FESTIP Programme," AIAA paper #92-5003.
- 55 . J. Gabrynowicz, John Graham, Matthew Bille, and Deborah Bille, "The Case for International Cooperation on Hypersonic Technology Development," AIAA paper #92-5000.
- 56 . Front Office Shared Account to JPO-Everyone, "Scramjet Flight Test," e-mail, December 4, 1992; Peter deSelding, "Russians Seek French Francs for Engine Test," Space News, October 18-24, 1993.
- 57 . Interview with Robert Barthelemy, January 20, 1993.
- 58 . Ibid.
- 59 . deSelding, "Russians Seek French Francs," quoting David Webb.
- 60 . Ibid.
- 61 . Interview with Col. Ted Wierzbanowski, June 1, 1993; interview with Barry Waldman, *ibid.*
- 62 . William H. Heiser, Testimony Before the House Committee on Science, Space, and Technology, May 5, 1993.
- 63 . Ibid.
- 64 . Fred Billig, *ibid.*
- 65 . Col. Phil Bruce, e-mail, June 23, 1993.

- 66 . General Accounting Office, "National Aero-Space Plane: A Need for Program Direction and Funding Decisions," Washington, D.C.: General Accounting Office, June 1993, p. 4.
- 67 . Ibid.
- 68 . Internal workings of the JPO had started to conform to an Air Force initiative called "Total Quality" control, or "TQ." Although ostensibly derived from American industry, TQ had all the earmarks of "make-work" for the 1990s, and of the type of processes put in place during peacetime for a war-fighting force. It consumed considerable amounts of time for meetings, and every unit in the JPO had to participate. There were numerous "off-sites" that focused on "processes." In reality, the emphasis on TQ represented the erosion of individuals' authority and responsibility. As one anonymous official noted, "There was a time when any of the project managers could solve a problem with a phone call to the contractor or trip to the contractor location. That can't happen anymore." Another noted, "If you trust your people, you know they can perform without all these 'processes'."
- 69 . Bruce Auster, "A Few Swords Along With the Plowshares," Air Force Magazine, March 1993, pp. 63-65, (see the chart in this article in particular).
- 70 . A concise summary of the economy, taxation, and budgets appears in Schweikart, "The Entrepreneurial Adventure," chapters 13-14, *passim*.
- 71 . "DoD Conference Report Language FY94 Authorization Conference," Barry Waldman's files, NPO, cited in "National Aero-Space Plane (NASP): Advanced Technology Impacts," 16.1.
- 72 . Interview with Berwin Kock, January 4, 1993.
- 73 . "Program Management Directive for National Aero-Space Plane," n.d. (circa 1994).
- 74 . "NASP Strategic Plan," February 31, 1994.
- 75 . Interview with Terry Kasten, March 7 1995; interview with Col. Stephen Heaps, June 9, 1994.
- 76 . Interview with Terry Kasten, March 7, 1995.
- 77 . "NASA 'Hyper-X' Program Established," NASA Facts, FS-1997-03-26-LaRC, April 1997.

Chapter 8: The Final Tally

IF WOODY ALLEN was correct, NASP should be able to list some achievements simply by "showing up," and indeed it could. Technical progress in the NASP program, 1986-1994, was significant. A brief survey of the most important technical achievements included the following:

- *The inlet and combustor was tested to Mach 18, a feat never performed before.

- *Small scale scramjets were tested to Mach 18.

- *Large scale ramjets were tested to Mach 8.

- *Large scale scramjets were tested to Mach 16.

- *The program developed advanced, non-intrusive, high-speed combustor diagnostics.

- *Engineers directly measured skin friction and nozzle thrust up to Mach 14.

- *Testing at Kirtland AFB and NASA Langley proved that the program could develop leading edges capable of surviving under the conditions that approached flight.

- *CFD analysis methods were developed, validated, and utilized to make predictions and

analyze actual test data.

*The contractor team developed a "lifting body" composite design with a rounded nose that provided the basis for an SSTO aircraft design.

*The program made exceptional advances in materials, including carbon-carbon composites, titanium alloys, advanced metal matrix composites, copper niobium, and beryllium fiber materials.

*Slush hydrogen production, transfer, storage, and transportation was demonstrated.

*The contractors developed and tested the "2D" integrated fuel tank.

*The program funded a number of new hypersonic test facilities, including several wind tunnels capable of high Mach tests. Of special significance was the construction of the United States' first free piston driven shock tube. Modification of existing test facilities gave the nation the capability to test large scale engines to Mach 8.

*Program engineers developed and installed a number of new test instruments capable of measuring pressure and heat in a variety of materials and components.

*Five competing contractors forged a unique team arrangement in which they shared all data, design, production, and award fees.

*For the first time, researchers directly measured thrust above Mach 8, whereas previously they had to infer it from pressure measurements.

*The JPO engineers estimated that uncertainty in the X-30 design's transition onset was reduced to 50% of what it was prior to team formation.

Those efforts, as well as many others documented and placed in government and data bases as part of NASP's final contractual commitments, constituted the real legacy of NASP.¹ They advanced the knowledge base in hypersonics by quantum measures. Often overlooked---but critically important---the program also had shown what would *not* work. "No" was as important an answer in many cases as "yes." Indeed, the program's earliest "no" was that the du Pont design could not reach orbit. Despite funding turmoil, the program accomplished those achievements on a timetable roughly equivalent to that of the YF-12, the X-15, or the X-3.²

The airframe/engine integration research also yielded two designs that, if not adequate in their ability to attain orbital velocity (in simulations), at least served as the basis for future spaceplane work. A 1996 summary of the NASP program's aerodynamics technology by NASA's C.L. Edwards and Duncan McIver concluded that "most of the NASP concepts had some very good (and often innovative) aerodynamic characteristics, but very few (if any) were anywhere near their optimum."³ That occurred, in their opinion, for several reasons, including a lack of data early in the program, data sets that were sequestered due to the competition, and adverse impacts of the program schedule. The authors concluded that a "golden (or is it 'Goldin') opportunity exists to provide an aerodynamics technology base . . . which is much more

comprehensive than that experienced by the NASP and suitable to launch any future hypersonic airbreathing vehicle program.”⁴ Conditions were ripe in 1996 to reinvigorate such a program, the authors argued, because the test hardware had been preserved and the hypersonic test facilities, instrumentation, and expertise were at their peak. They urged using a reconfigured government baseline vehicle, but suggested also that “minor configuration modifications to the NASP ‘teaming’ concept (C202)” would also provide a useful starting design.⁵ Most important, the authors urged the development of firm “anchor points” of data that could be used for further CFD code calibration, and recommended substantial further research into boundary layer transition work and external burning as a means to increase the performance of the designs dramatically.

Political reality, however, argues against the program suggested by the Langley analysts. As maintained here repeatedly, “no Buck Rogers, no bucks” has been a working maxim of space activity and funding. That is not an endorsement specifically of putting humans into every space mission, but rather must be considered in the broader context: without a romantic and exciting reason to commit large amounts of funding to space, it will remain well down the list of national priorities.

As to the larger questions that surrounded NASP, some answers seem clearer than others. To the question, “Can technology can be ‘pushed’ or focused by government?” the answer is a qualified “yes.” No one has questioned seriously the notion that government could focus technology if it spent enough money or invested enough research hours. Both the Panama Canal and the Manhattan project showed that government investment could be effective under certain conditions. But with NASP, program advocates, contractors, and legislators eager to show their support for space and defense frequently ignored the maxim that every dollar invested by

government is a dollar *not* invested by the private. Would the contractors, for example, have invested hundreds of millions of dollars in “contributions” to hypersonic research if the NASP or NDV contracts had not existed as a reward? Almost certainly not: the fact that they had not done so prior to NASP is a good indicator that, whatever the rewards of hypersonic flight, expenditures on such research could be put to better use other places in the aerospace industry. The difficulty, of course, is that no one knows exactly how, or where, such money might have been spent. It might have gone to develop more efficient traditional airframes; or toward less exotic fuels, such as those tested in the HySTP program; and possibly even to hypersonic research. Was the nation better off that it had “pushed” hypersonic technology at the possible expense of safer commercial aircraft? Or cheaper fuels? Or other types of privately-funded space activities?

One thing is certain: the aerospace companies would have invested their nearly \$1 billion in “contributions to the NASP program somewhere. It may have been in other technologies, or it may have been in improving efficiencies across the spectrum of their companies, or it could have even been by installing new computer networks that might, in the long run, have facilitated the CFD work that NASP relied on so heavily. Alternate “investment” might have come in the form of higher wages to employees, or higher profit shares to stockholders, which in turn could have other unforeseen results, such as improving productivity or stimulating further investment in the companies. To state that government spending in technology is required because companies would not invest in a particular technology assumes that the item or science project in question is measurably more useful to American society than the generic, invisible uses of such funds would be. And that returns the argument to utility and demonstrability: a science project, to elicit and

maintain public support, must not only be useful, but it must be shown to be useful in the near term.

Advocates of government-sponsored research argue that private industries will not undertake large-scale science projects on their own. They may be correct, yet repeatedly the private sector has come up with alternate ways to achieve goals that, to “big-science” advocates, seem to have only a government-initiated solution. One clear example again comes from Burt Rutan, the co-developer of the *Voyager* aircraft that flew non-stop around the world. In May 1996, Peter Diamandis of Angel Technologies, in St. Louis, Missouri, announced a \$10 million prize---the “X Prize”---for the first individual or company to design and build a vehicle that can carry one person 62 miles above the Earth and return safely, performing the feat twice in two weeks.⁶ Rutan, who had made a similar suggestion made to NASP management 10 years earlier, was considered a leading contender in the competition. After all, the \$25,000 Orteig prize led businessmen from St. Louis to raise the funds to support Charles Lindbergh’s transatlantic flight in 1927. In the case of the X-prize, most of the competitors planned to spend at least \$10 million and some as much as \$80 million to win the contest, with the goal of boosting commercial space opportunities. As Diamandis noted, “the best way to predict the future is to create it yourself,” while Rutan, who planned to use a two-stage-to-space strategy, observed, “I’d like to think people would someday look back and ask . . . with all the billions we’ve spent at NASA, why didn’t [NASA] bring spaceflight to the common man 20 years earlier?”⁷ Both Diamandis and Rutan should know the answer to that question, in that the private sector has never had the incentive to engage in spaceflight because the government has provided the service at taxpayer expense. Peter Drucker developed a rule of technology that states that for a new technology to

drive out an existing technology, it must be 10 times more productive. The same, to an extent, is true of private sector incentives where government subsidies are involved: the returns from private investment must be significantly more than marginal, or investors will perceive that the risk outweighs the return.

Aside from occasional breakthroughs, such as that offered by a “space prize,” the typical advance of the marketplace has occurred through remarkable marginal advances---by millions of miniature technical revolutions that simultaneously and spontaneously combine to yield dramatic and more highly visible scientific advances. Again, returning to the example of the automobile, it took far more than a determined craftsman named Henry Ford to provide affordable, independent transportation in America and the world. A vast number of incremental advances---in oil refining by John Rockefeller, in advanced steel chassis (thanks to Andrew Carnegie), in creating vulcanized rubber, just to name a few---to make possible any car, let alone Ford’s. Government did play a role, with state and local governments financing the critical asphalt pathways on which the new vehicles traveled---but again, largely doing so through bond issues to the private sector. Those, in turn, were made possible in large extent by securities pioneers, such as Jay Cooke in the 1860s and Charles E. Merrill in the 1920s, both of whom channeled securities sales to the “common man.” From the vantage point of 1860, the transportation system, on both the ground and in the air, that existed in the 1920s was simply beyond imagination, yet each of the individual elements that made autos and aircraft possible---oil refining, advances in rubber vulcanization, steel manufacturing, bicycle and gear technology (not to mention quantum advances in tool manufacturing and management efficiencies)---all had originated around the time of the Civil War, if not before.

For the technology---any technology---to take root and grow, the “vicinities effects” must not only be present but also mature. Computers were invented in the 1950s, and the silicon chip and modem were available by the early 1960s. So why did no thriving internet, built on PCs appear? Why was America still 15-20 years from a genuine “computer revolution?” The simple reason, again, lay in the absences of the complementary technologies. Steve Jobs and Steve Wozniak had not created the personal computer; Bill Gates had yet to develop an operating system that facilitated personal computer use; MCI had yet to force the telephone industry into the modern era of fiber optical wires capable of transmitting fantastic amounts of data in milliseconds; and an army of “net nuts” had yet to figure out how to make money at home from their computers. By the 1990s, the real revolution had only started (the “telecosm” as George Gilder calls it in his many articles in *Forbes ASAP*) and despite the homage paid to Bill Gates, the telecosm has exploded geometrically, pushing Metcalf’s law (that any “*n*” number of computers linked together yields “*n squared*” connections) to unimagined limits.⁸ Advocates of government aerospace research will argue that an aircraft, particularly one as ambitious as NASP, is a much larger project with a stratospheric price tag that bears no relation to the largely privatized computer networks of Gilder’s telecosm.

Is it? Consider, for a moment, the direction that the developers of the ENIAC computer or the experts in computing merely 25 years ago saw as the future of the computer: increasingly larger “Cray-type” supercomputers. After all, the history of most technology up to that point had been that greater power output, and thus, economies of scale, come from larger machines. A Chevy 427 produced more power than a 350; an 18" naval gun delivered more deadly ordnance than a 12" gun; and so on. (Such is still the case in rocketry and space: so far, generating more

power requires larger engines). However, the computer ran counter to all existing laws of economies of scale. Within one generation after the advent of the silicon chip, computers work faster and more efficiently the smaller they become. Not only have personal computers surged ahead of the behemoth Crays in almost every area of use, but, when linked together, PCS have consistently outperformed the supercomputers in tests and chess matches. Moreover, no single computer can begin to approximate the information capacity of the internet. As to size, the computing networks in place easily approach a trillion dollars in value, and the top 15 computer companies had more than \$15 billion in assets *before the stock market surge of the 1990s*. In short, it is both bad science and bad business to underestimate the power of the private sector to accomplish large science projects. The market tends to determine utility for itself, then address it in ways that even the best-considered government programs seldom envision.

Indeed, the difficulty with government attempting to “push” technology in a particular area---as NASP clearly demonstrated---is that for all the expertise and talent available to the government, it still cannot accurately assess or predict the future maturation of technologies. NASP pioneers, such as Lee Beach, Robert Jones, Robert Williams, and Tony du Pont all identified *some* of the critical areas, and most of them correctly targeted the scramjet as the most recalcitrant technology. Yet none of them guessed that liquid hydrogen or CFD would yield so rapidly; or that many---but not all---of the materials would prove worthy. Further, even experienced aircraft designers landed well off target when initially estimating weights, and simply failed to include weight growth in such areas as wiring, hinges, and joints. Fewer still would have predicted (or at least, at an early stage, planned for the reality) that a fully function NASP would require 18 *miles* of wires and cables. Moreover, not one person at the outset of the

program who agreed to interviews for this history admitted to anticipating the *non-technical*, and often apparently unrelated, factors that soaked up program time and resources, such as the concerns about ozone depletion, environmental impact statements, or safety and hazard assessments related to the fuel and the aircraft. The Air Force apparently did not calculate the internal institutional burdens of such programs as the Air Force's Total Quality Management program, which, although designed to improve productivity, in reality consumed resources and turned productive staff into paper-shufflers.

These issues suggest that the traditional justification of big-science programs, namely for national security purposes, remain the strongest, but that to be effective, a case must be made that the item in question has a defense utility. That was exactly Barthelemy's original, but failed, strategy for NASP, suggesting that, like the supercollider, NASP would always have stood on a weak foundation without the support of the Strategic Air Command or other user communities in the Air Force from whom Robert Williams tried to shield the program.

Once government projects shed the mantle of having national security reasons for existing, it becomes difficult to justify them in a direct comparison with private sector efficiencies. Consequently, a better measure of government investment than comparing it to the private sector is to ask, "compared to other *government* investments, did this program show a reasonable return?" Clearly NASP advanced technologies on a number of fronts, often far faster than predicted. In the area of materials, for example, new classes of materials and composite either were developed outright, or moved from the laboratory into production-capable situations. NASP compressed the materials development time from 15 years, where it had been when the DSB first criticized the program, to approximately five years. Moreover, NASP effectively

transferred many of those materials to the private sector in previously unmatched levels.

Scramjet technology probably was "pushed" equally rapidly, but the nature of the advances---namely laboratory tests and CFD analysis---made the gains less visible. On the other hand, test results and CFD analysis are more easily transferred to the private sector than might have occurred with a single piece of technology, such as a scramjet engine. NASP contributed more to the private sector by supplying information that companies could apply on their own than if it actually had flown subscale or smaller scramjet test items for smaller sets of data.

Slush hydrogen proved a viable alternative fuel for hydrogen-based aircraft. Slush handling and storage proved achievable, and constituted a major accomplishment for the program. Validation and improvement of CFD technology not only promised exceptional dividends to the Air Force and civilian aerospace contractors, but also offered potential uses for the Navy in its research on submarine design.

Numerous other examples exist wherein the program moved technology from the government to the private sector, which constituted the first, and most significant tangible products of the aerospace plane program. However, all assessments of such "successes" must be tempered with the understanding that any government "transition" of information or technology represents a non-market transaction, and regardless of intentions, distortions will occur. For example, the formation of a team of former competitors meant that less viable designs or corporate strategies were mixed in with more competent approaches or better plans. Likewise, the transfer of a government-developed material suggests that private companies chose not to make that same investment in the material, presumably because of market forces. It is not unreasonable to suggest that, had no Space Shuttle or NASP come along, private companies

would find the returns of space launch sufficient to attempt other---but perhaps radically different---launch technologies. In the same vein consider the Panama Canal: in the absence of government funding for the canal, private companies might have developed an exceptionally efficient land transportation system, including better or faster railroads, or more reliable and faster ships. NASP successfully united government and industry for a particular goal; but any such union comes at a price to private enterprise as a whole, and the enthusiasm for great accomplishments---either by NASA, the Air Force, or any other government institution---needs to constantly take such losses into account.

One drawback of “big science” is that it develops a culture in which even unorthodox thought starts to have a certain orthodoxy. In the case of NASP, the very budgets and contracts to the airframe companies, based on the government baseline, channeled the approaches in certain directions. Future high-risk programs, therefore, might at least keep open the possibility that a second “Blue Team” budget line be established to allow an “outsider” with a significantly radical approach to compete. In doing so, the government might well get a du Pont or a Rutan; it might get a Preston Tucker, a Howard Hughes, or a Andrew Jackson Higgins---all of whom had exceptional ideas that yielded prototypes, but little in the way of operational products; or it might get a Walt Disney, a Bill Gates, or a Henry Ford. At the very least, such a “Blue Team” budget would have, in the case of NASP, completely defused the criticisms of several congressional committees and the steady erosion produced by those who thought the contractor team’s design was completely wrong. Some in the program argued that NASP had competition---among the airframe and engine contractors---and yet they would be missing the point that the competition was not over approaches to achieve SSTO but over which variant of a particular, government-

endorsed design would have been the likely candidate to reach orbit. As Jacques Gansler, in his classic article, "How the Pentagon Buys Fruitcake," points out, the necessity of having measurable, deliverable products often reaches the point of absurdity, to the extent that people in the Pentagon actually count nuts and cherries in fruitcakes. NASP showed that ambitious programs demand multiple approaches, and not merely multiple variations of a single answer.

"Team" Operations in NASP: Strengths and Weaknesses

A second aspect of NASP that made it unique was its interservice/interagency national "team." Robert Williams had sought to insulate NASP from the vicissitudes of the budget cycle by providing the program with several "partners" to form what he saw as a stable constituency. However, by diluting "ownership" of the program, the five-way Memorandum of Understanding may have weakened support for NASP in the long run.

Williams thought that he had "locked" the Navy, DARPA, the Air Force, NASA, and SDIO into a long-term commitment to the program. The fact that DARPA initiated the action and oversaw the organization of the program should have aroused some skepticism. Compared to the Air Force, the Navy, or NASA, DARPA was a small unit---a tail trying to wag several dogs. It also was an agency involved in largely secret studies, yet DARPA supervised a large-scale, visible, "national" program. Those organizational factors alone should have warned Williams and others not to rely on the various "partners," and certainly not while DARPA remained in charge.

Moreover, there was little in the historical experience of such multi-service initiatives to suggest that any project with so many players could satisfy them all. (The TFX comes to mind as

an example of how difficult it is to satisfy different services with the same aircraft.)⁹ With so many government agencies and service branches involved, any one of them could withdraw at any time under the rationale that its departure alone could not damage the program. The DoD understood that dilemma---and the problem of having DARPA head the NASP effort---when it combined the budget lines under that of the U.S. Air Force.

Even that move did not have the desired effect, however. In essence, the program became less of a "team" of several agencies and more of a partnership program between NASA and the Air Force, thus losing much of its claim to be a "national" program. Moreover, the USAF could argue that if NASP was a national effort, then the Air Force should not have to shoulder so much of the burden within DoD. Rather, a separate budget line in the Pentagon should have been created, as many in NASP contended for years. With a separate NASP line, as Barthelemy often argued, Congress would have to specifically vote on the aerospace plane. But by keeping it in the DoD and NASA budgets, congressional advocates and opponents both shunted the burden of defending or eliminating the program on the NASA Administrator and the Secretary of the Air Force. NASP never received the support of the operational commands, which many contend "run" the Air Force, and NASA's early funding of the program by reallocating existing hypersonic resources---but providing little in the way of reallocations from *other existing programs*---should have served as a warning that NASP was desirable, but not viewed as essential to NASA's future. Nor did Congress assume its responsibility: not even Rohrabacher or other Congressional supporters ever attempted to provide NASP with its own line.

The Integrated Aircraft vs. the Research Mission

A third issue surrounding the aerospace plane involved the decision at an early point to pursue an integrated aircraft and ground system, replete with all the trappings of a production line aircraft. Again, that emerged out of the acceptance of the widely-held view that only by flying a scramjet-powered aircraft could the program attain the necessary data on hypersonic flight, aerodynamics, and combustion to achieve orbit. That, in turn, had rested on the view (which was supportable at the time) that neither wind tunnel test facilities nor computational fluid dynamics would be available or reliable enough to ground test key parts of the system. As a result, NASP had to fund and develop fuel storage facilities, ground safety and high explosive handling guidelines, an entire flight test plan, environmental impact statements for aircraft and facilities, and a myriad of other features not normally needed for “research” programs but necessary for operational vehicles. Yet the NASP mission was to gather data, and as such needed to include test instrumentation (which also drove up weights) and required a full research plan. With each technical setback related to scramjet performance, airframe performance, or weights, the temptation grew even stronger to eliminate test equipment or skimp on the research plan “just to see if we can get this to fly,” as one director put it. At that point, the entire *raison d’etre* of NASP disappeared, and the program essentially had committed itself to an operable vehicle first and a research vehicle second.

DARPA proceeded into a program for an integrated aircraft system, complete with ground support, new fuels, new materials, a radical new engine concept, and a unique airframe design, using untested validation techniques on the basis of *one set* of validation studies from

GASL. Those studies---the only ones ever done that Williams claimed validated Tony du Pont's design that it could attain orbital velocity---were refuted on numerous occasions. NASA researchers had produced several highly critical reviews of the du Pont design, yet it appeared that those studies were not given equal weight. The implications for the program were extraordinary in that by starting with the du Pont concept and the goal of SSTO, NASP immediately became a full-scale R&D aircraft program, with development required for all the related support infrastructure. Even while the program had not validated the scramjet engine, it had to focus personnel, funds, and effort on such areas as environmental impact studies, slush hydrogen fuel characterization, crew safety and cockpit design, and instrumentation for an aircraft might never fly.

In addition, by pursuing the du Pont design as a baseline, the government lost opportunities to examine other strategies, even to the same SSTO mission. In retrospect, HySTP would have made an excellent "phase 1," followed by HYFLITE I and II, then perhaps an X-30X, then ultimately a full-size X-30 capable of attempting the orbital mission. NASP followed that path exactly in the reverse order. A scramjet-oriented program would not have diverted funds to ground safety, or crew comfort. Instead, it could have addressed the problem of the scramjet first.

In fact, even at the time Williams decided to move forward with du Pont's aircraft as the baseline, the criticisms of that design were numerous and serious. His assumptions about weight, scramjet performance, fuel margin, not to mention the absence of landing gear and instrumentation, all demanded more rigorous attention from DARPA and the Air Force. Du Pont's design proved so unfeasible that every one of the airframe contractors, including those

eliminated in the 1987 downselection, abandoned it within a year after the program let contracts. Such a universal inability to recreate the du Pont test data should have sent warning signals to all relevant officials. Nevertheless, DARPA's commitment at the outset to five airframe contractors and only two engine companies (later expanded to three by Rocketdyne's addition) illustrated the unwavering commitment to the integrated aircraft system approach, and the virtual rejection of an incremental strategy based on developing the scramjet first. It also shockingly revealed the political factors driving the program, in that five airframe companies had far more lobbying capability and clout in Washington than did a pair of engine contractors. That in turn, as commented on by the NASA "Executive Summary," had the effect of focusing an inordinate amount of resources on the airframe to the exclusion of other technical work, and especially to the exclusion of critical long-term base technology.¹⁰ Williams gambled that the combined political weight of the aerospace companies, especially if Boeing remained involved, could sustain the program while the technology came along, in essence endorsing airframe work to maintain support for other technical tasks later, even though those tasks represented work that might have been more imperative at that time to the program's survival.

The program maintained, correctly, that some of the problems with scramjet propulsion only became evident after extensive design development. "We didn't know that we didn't know," was an accurate description of the learning process that NASP engineers went through. However, the return to scramjet testing in HySTP did not depart significantly from the types of testing that the program could have pursued in 1987 or 1988. Efforts to introduce an "incremental approach" were introduced in 1990 and earlier, but by that time even those incremental efforts had to be based on an entire integrated aircraft.

Not only was the commitment to an entire aircraft system premature technically, it also resulted in political weaknesses. Money spent on some technologies, such as airframe and CFD, often proved beneficial to the scramjet work. But the long-term diversion of resources from the key technical problem of the scramjet proved politically damaging to NASP. By attempting to develop so many technologies simultaneously, the program committed itself to a distant goal of an integrated aircraft at the expense of near-term demonstrations of flying hardware. "In hindsight," one source later admitted, "we probably should have flown something sooner." Vince Rausch admitted disappointment that the program would not fund his suggested "strap-on" rocket tests early in its history. One factor that contributed to the inattention to staging public demonstrations came from the fact that in its initial stages NASP was a secret program. By the time it came "out of the black," it seldom was in the public eye, and was never covered by the mainstream media in a way that it appeared to be "making progress." But program management failed to present the program in such a way that attracted any attention: there were no high profile tests, flights, or demonstrations (some called these "stunts") that maintained public interest and support. Nevertheless, as public and congressional response to the DC-X's unimpressive demonstrations suggested, even the most simple technology demonstrations could excite the public. With the exception of the integrated fuel tank, the X-30 program never produced the kind of hardware that worked in flight---hardware that could provide tangible evidence of progress upon which lawmakers could base their votes for program funding. Without hardware and flights, the program found itself relying on computer code results, trade studies on designs, and imaginative---but unsupportable---"benefits" analyses to win funding votes.

Williams, DARPA, and the early supporters at NASA and the Air Force have to shoulder

most of the blame for allowing the aerospace plane to focus solely on SSTO as opposed to a structured, incremental approach. Their motivations varied, with some at NASA genuinely thinking that CFD and wind tunnels could not provide the needed data. Others, however, admitted that they never believed in the SSTO mission, and only used NASP as a stepping stone to expand the technical base. Still others tended to gloss over considerable technical difficulties in attaining orbit to focus on the NDVs and other operational hypersonic vehicles, thus minimizing the work that remained to be done.

Nevertheless, much of the blame for the dilemma in which NASP found itself, especially after 1987, can be laid at the feet of the Steering Group, which never actively redirected the NASP mission. Intended as both an advocacy body and a source of direction for the program, the Steering Group proved to be neither. Personnel rotation accounted for much of the impotence of the Steering Group. The constant shifting of personnel meant that even if the members had been “up to speed” on NASP, no individual remained long enough to become a program champion. Moreover, the officials in the group itself never defined their role with any clarity. One of the most amazing stories about NASP is the devolution of the power of the Steering Group, which had become virtually invisible by 1991. After that year, the JPO, and, later, the NPO, paid scant attention to what the Steering Group might say, but dedicated exceptional effort and energy towards determining what NIO might say. The shift away from the Steering Group represented an amazing contradiction to typical Washington bureaucratic organizations, which rarely if ever voluntarily yield authority or resources to subordinate bureaucracies. But the Steering Group, partly through its constant state of flux, and partly because after 1988 it made few key strategic decisions, lost influence nonetheless. After 1989, the continual shakeups at the Pentagon or in

NASA left the group little more than a body of substitutes or vacant chairs.

At any time, the Steering Group could have insisted on the incremental approach, demanded redirected funding, or made other dramatic changes. Part of its inability to do so again reflected the difficulties of running a multi-partner program, especially when differences exist as to the mission among some of the participants. The Air Force's budget lines depended on one set of congressional supporters; but NASA's often depended on another. Thus the Steering Group members themselves could maintain no clear sense of direction, and, legitimately, also had to rely on the technical analysis delivered by the JPO. Much like the foreman of the factory, who set the noon whistle by the clock in the window of a watch shop, without knowing that the store owner set his clock to the noon whistle of the factory, the Steering Group and the JPO looked to each other for guidance.

Under those conditions, no organization could issue adequate direction. More important for NASP than the direction, however, the Steering Group did not provide the voice of advocacy that the program desperately needed. Indeed, Vice President Dan Quayle came as close to a "champion" in Washington as the program ever had. But whereas the Vice President's opportunities for support were limited, a NASA administrator with NASP as a key agenda item, or a vocal four-star general might have been able to carry the program. No such personality emerged. Adm. Truly, who expressed his deep commitment to NASP before being named NASA Administrator, unfortunately had to rebuild the Shuttle program and restore morale at the agency during his tenure. Other programs dominated the agenda for Air Force Space Command, and Strategic Air Command needed a space system that could come on line faster than could NASP, even if the technology matured.

Part of the problem of eliciting support came from the disparity between the perceived ways that programs gain support and the real layers of consensus building. As seen in Fig. 8.1, “Traditional Perceptions of Layers of Program Support,” a widely held perception is that the public “demands” a program, leading to media support, which generates issues that allow candidates to get elected, resulting in policy enactment. Henry Nau, however, has questioned this, offering a much different view, in which leaders identify and advocate positions, naming special committees and panels, thus engaging academics and institutions, whose research spreads to the media, which then generates public interest and support (see Fig. 8.2, “Layers of Consensus/Constituency Building”). Again, in the case of NASP, it never had the national leader who made it a priority.

Although after 1989, the National Space Council actually assumed much of the advocacy role that many had hoped the Steering Group would adopt. But the Space Council had charge over space policy, not just NASP, and thus its ability to tout NASP specifically was not as strong as what the Steering Group potentially possessed. Finally, the program lost the Space Council's voice when the Clinton Administration dissolved it as a holdover from the Bush Administration.

Without that source of direction, NASP program managers had to walk a fine line between meeting the SSTO mission statement and operating in the reality of the technology and budget. When Robert Barthelemy assumed the position of program manager in 1988, he noted that it might be difficult to build an X-30 that could attain SSTO without incremental steps. On several occasions, the NASP program attempted to subtly de-scale the mission to accommodate incremental flight tests short of SSTO. One such attempt, the X-30X option, was emphatically rejected by the Washington NASP office, NIO, on the grounds that the administration held firm

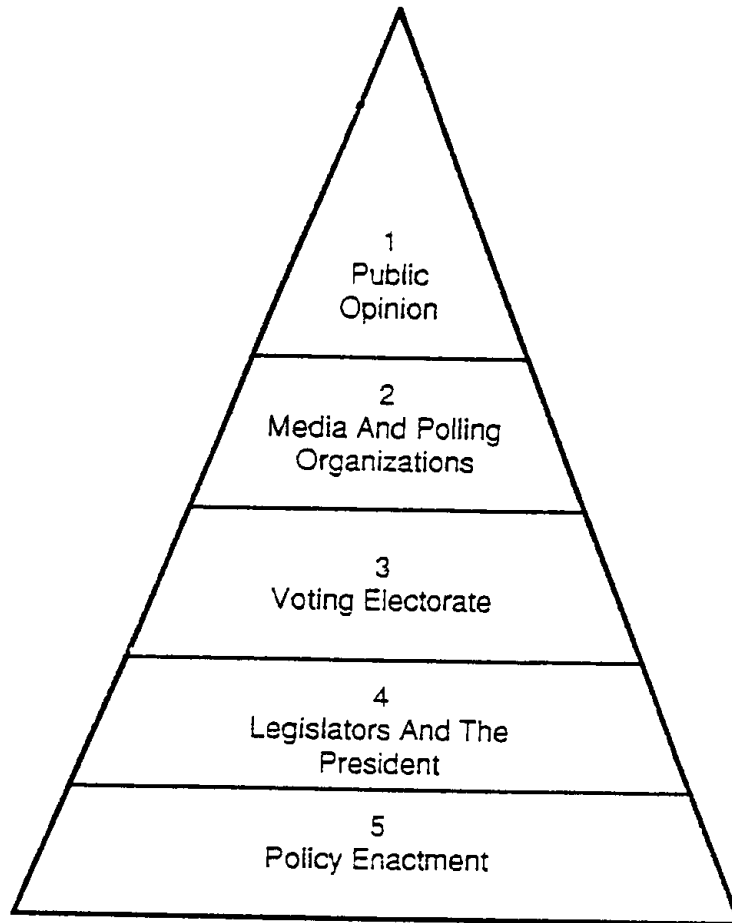

Explanation Of Layers

1. Public Opinion Is Formed On An Issue
2. The Media And Polling Organizations Express That Opinion
3. The Voters Express Their Wishes
4. Legislators And The President Respond To Those Wishes
5. Policy Enactment Follows, Based On The Wishes Of The Electorate

Fig. 8.1, "Traditional Perceptions of Layers of Program Support"

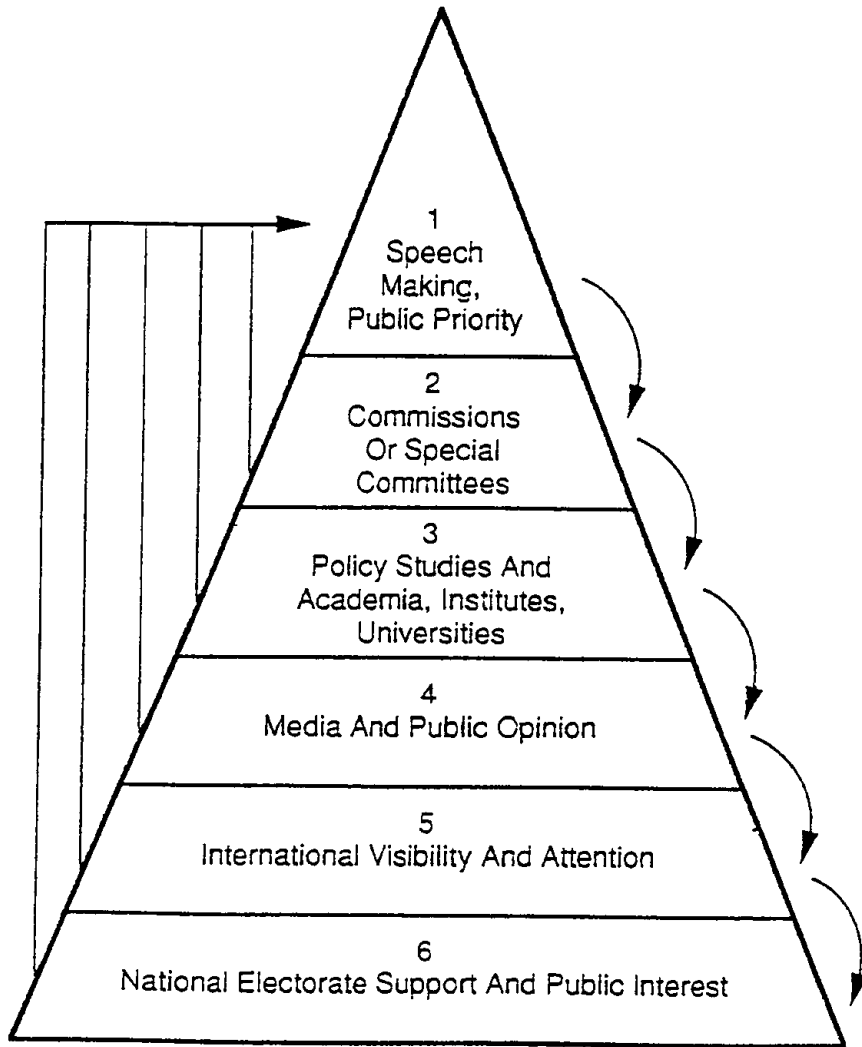

Source: Adapted From Table 1-6, In Henry R. Nau, The Myth Of America's Decline (New York: Oxford University Press, 1990)

Fig. 8.2, "Layers of Concensus/Constituency Building"

Fig. 8.2

Explanation of Layers and Examples

1. A national figure, preferably the president or vice president, advocates a policy goal in public speeches as a national priority. (Ex. President Ronald Reagan identifies the Aerospace Plane as the "Orient Express," or President George Bush, in numerous speeches, includes the NASP as a national priority in making space more accessible.)
2. Specialized panels convened to review the program, suggest improvements, help resolve issues outside the policy context of the program's immediate bureaucratic relationships. (Ex. The National Space Council endorses the Aerospace Plane program.)
3. Policy studies institutes, think tanks, and academics publish papers about the program, bringing it increasingly into the public eye, especially among the "informed electorate." (Ex. The Brookings Institution papers on homelessness, the trade deficit, or various weapons procurement programs.)
4. Includes media, polling organizations, and the "advocacy press," such as partisan magazines and newspapers. (Ex. National Review or Atlantic Monthly would do an article on America's space policy, in which it would mention NASP.)
5. International study groups, projects, symposia, commissions, all lend further credibility and inevitability to the program. (Ex. International

conferences on Acid Rain, leading to U.S. domestic legislation, or AIAA panels that include international developments in hypersonics.)

6. The public itself comes to view the program as either worthy or undeserving of support, making its wishes known to legislators. If the project is deemed worthy of support, the public itself becomes a source of advocacy. (Ex. The national enthusiasm for the Apollo program, or the resistance by the public to the SST project.)

to the orbital mission goal. From 1989 to 1993, the JPO conducted dozens of "options" studies trying to reconcile the SSTO goal with existing budgets and technology---an impossible task. Management thus had to press for the development of technology as quickly as possible, hope for a breakthrough, and realize that the major technical demands of the program cost far more than the nation wanted to commit.

A series of organizational charts, focusing on the political influences on the program, show the changing role of the Steering Group and NIO. In Fig. 8.3, "Political History 1988 & Before (DARPA)," the Steering Group's recommendations went primarily through DARPA, which had direct access to congress and, at the same time, to the JPO. After the Air Force took over the program, DARPA no longer had any direct access to either, reporting on its part of the program through DoD, then to the Air Force, which ran the program through Air Force Systems Command (see Fig. 8.4, "Political History, 1989 [AFSC]"). In 1990, however, the Secretary of the Air Force and Air Force Headquarters began to act directly on the program, by-passing Air Force Systems Command (see Fig. 8.5, "Political History, 1990-1991 [SAF/AQ]"). Note that, at that point, NIO remained only the "liaison to Congress." By 1993, however, the Secretary of the Air Force began to use NIO as its messenger for the program, endowing NIO with policy powers it never before held (see Fig. 8.6, "Political History, 1993 [NIO]"). Perhaps the most significant aspect of all the political history charts is the absence of any direct control over the program by NASA. Never did NASA have direct authority over NASP except through the Steering Group and/or through the leverage it had in funding.

And that leads to yet another "rule" that NASP did not obey: R&D aircraft (or other systems, for that matter) must have the full administrative and budgetary support of either NASA

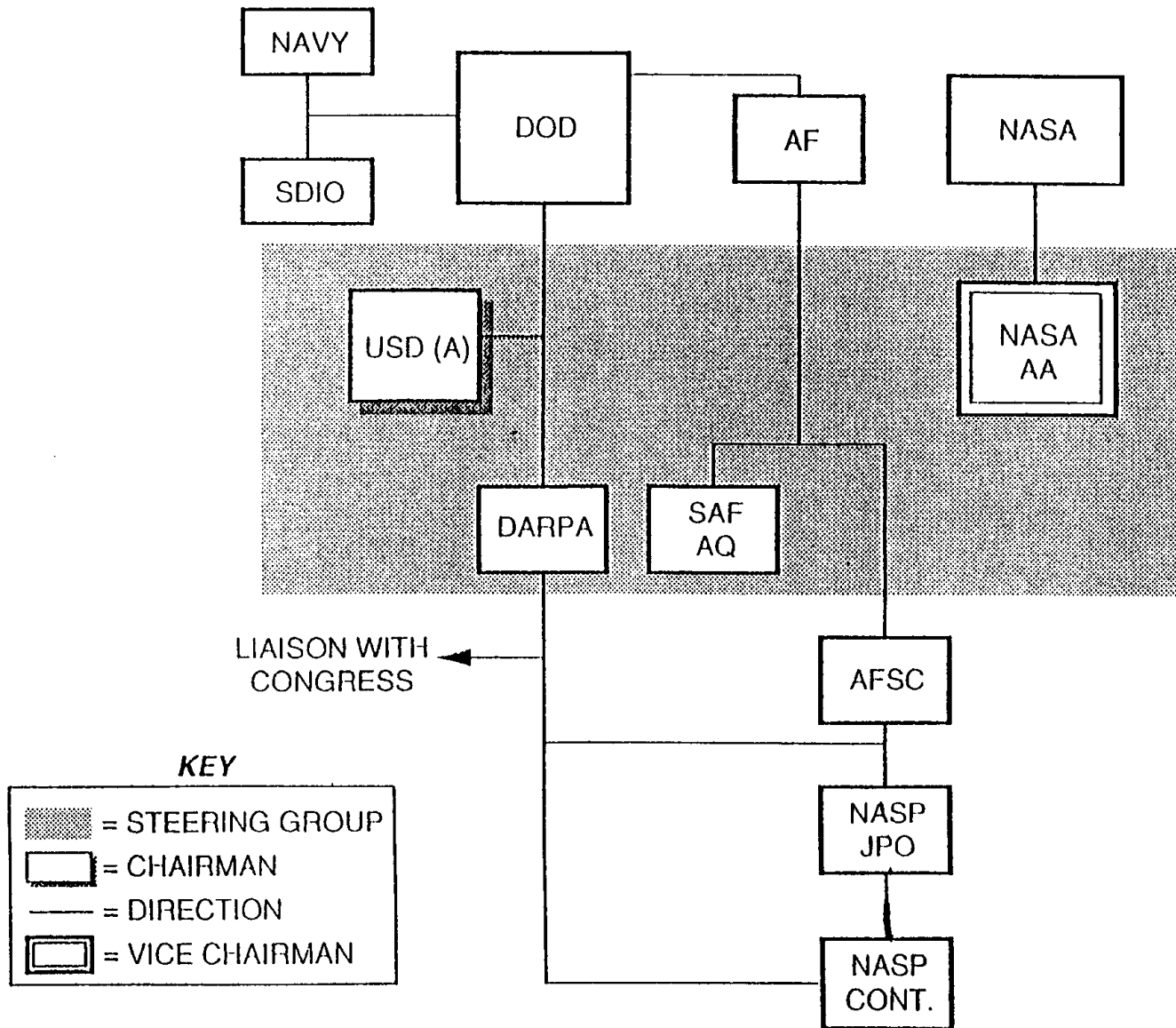

Fig. 8.3, "Political History 1988 & Before (DARPA)"

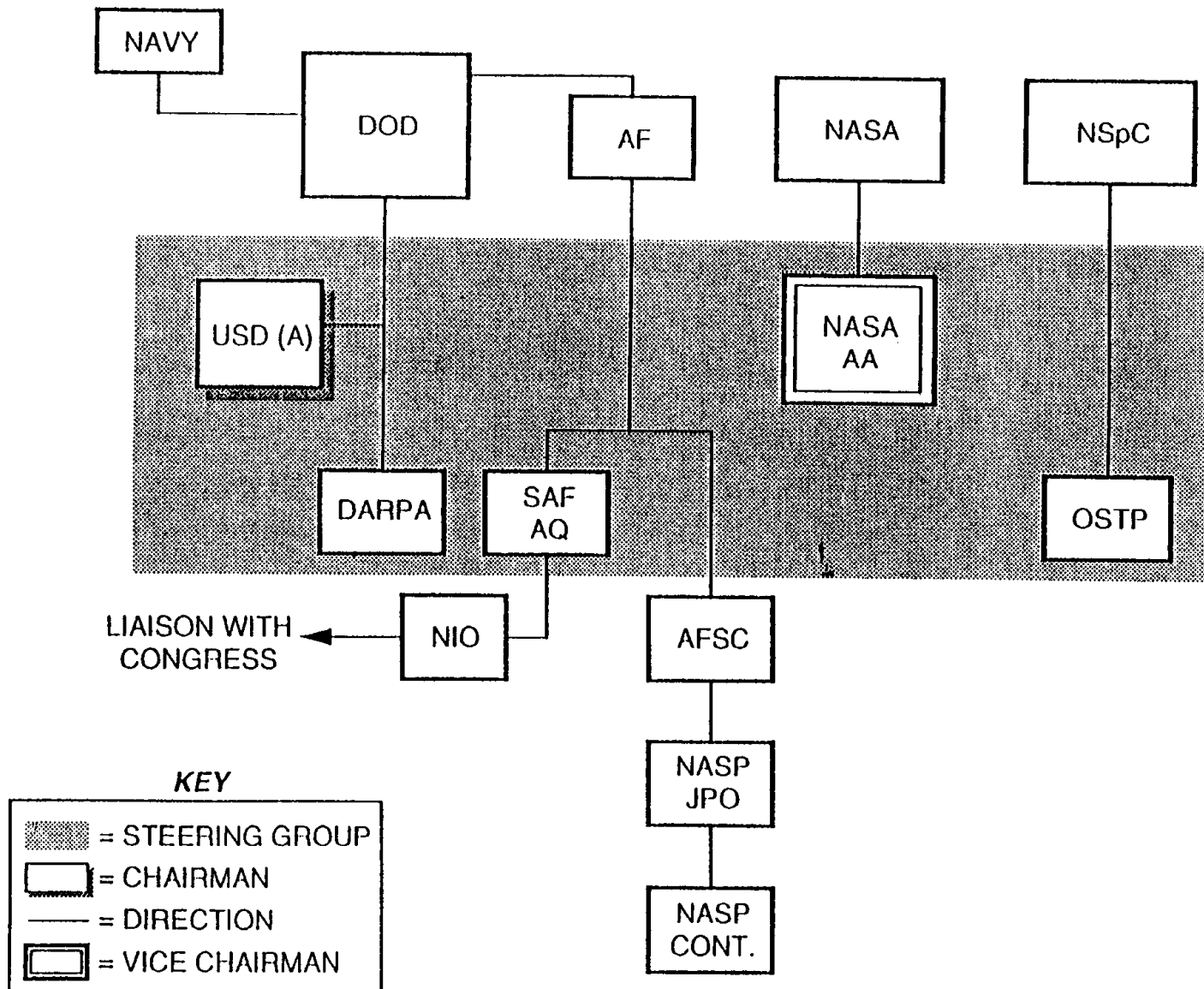

Fig. 8.4, "Political History, 1989 (AFSC)"

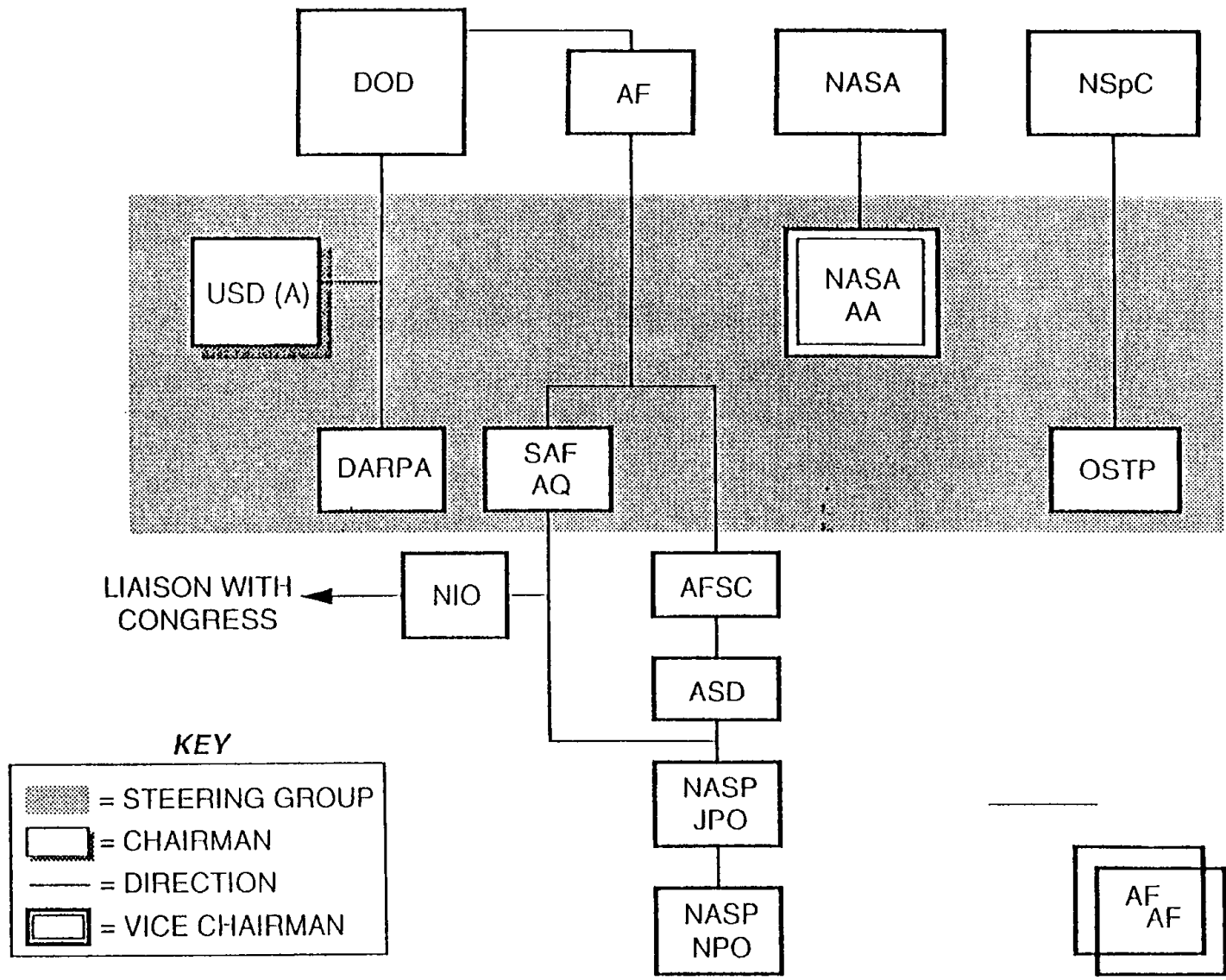

Fig. 8.5, "Political History, 1990-1991 (SAF/AQ)"

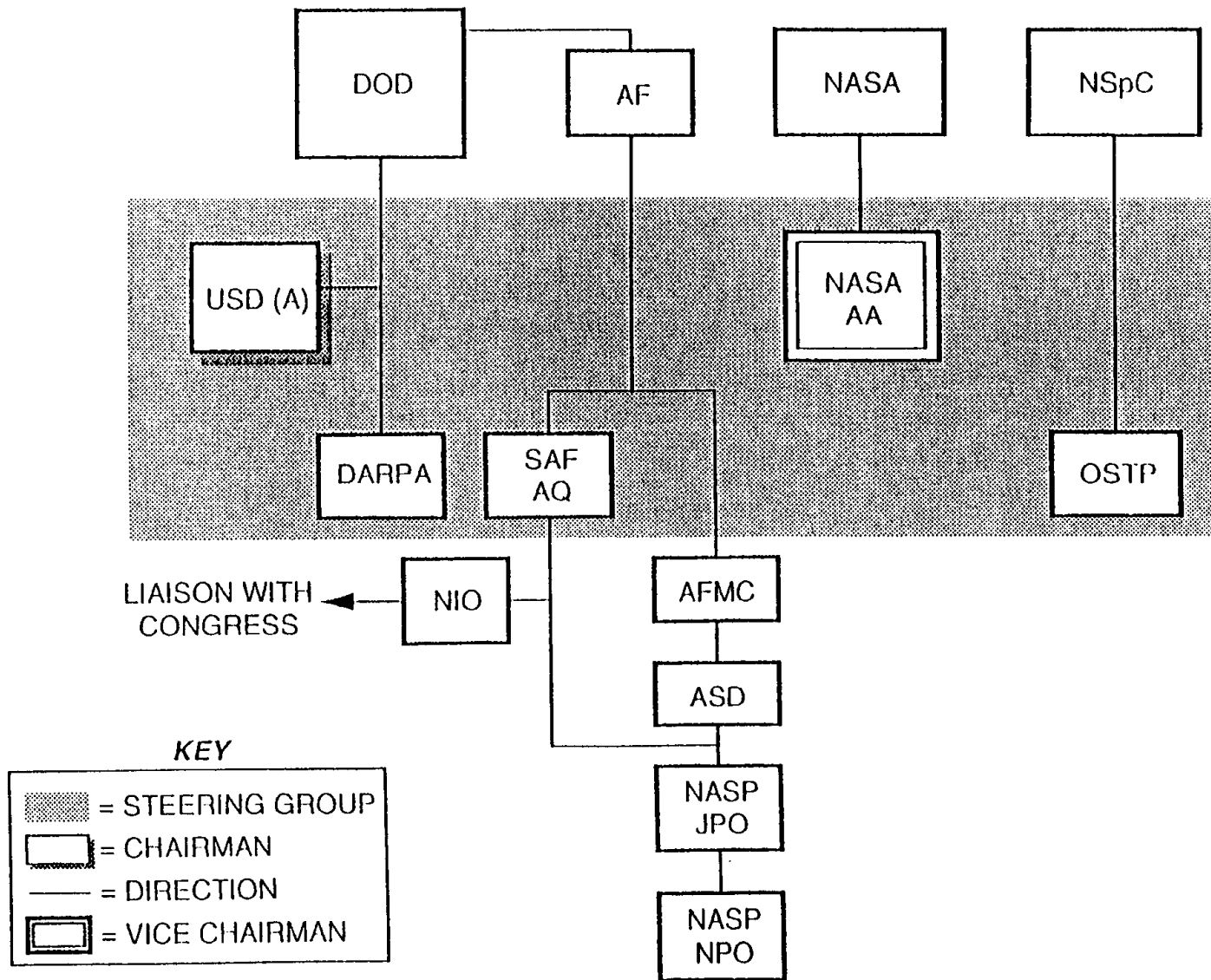

Fig. 8.6, "Political History, 1993 (NIO)"

as a scientific and/or space agency, or a service branch as a "user." The long term nature of "payoffs" from R&D programs make them undesirable to fund in the near term. For any R&D aircraft, the support from the users, such as the Air Force and Navy, is directly related to the length of time required to translate the research into a production line aircraft. NASA might appear to be a more likely candidate for funding long-term R&D aircraft, but NASA has seemed preoccupied with the Space Station---a questionable strategy given the absence of routine launchers of the type NASP promised! Without the immediate returns to service commands through applications, NASP never obtained the "four star" support necessary to survive in that no major command ever made NASP its first priority.

NASA might have been able to take the lead in NASP, but only under much different circumstances. The division of research into centers allowed for divergent approaches to hypersonic research to appear---which is good for basic research, but can be limiting when trying to produce a single aircraft. NASA's tragic distraction with the *Challenger* consumed attention and resources on the Shuttle program that otherwise might have been available for other projects, including NASP. NASA Deputy Administrators, such as J.R. Thompson, delivered consistent and vocal support, yet the slow staffing of the JPO by NASA, the early perceptions by contractors and Air Force personnel that NASA was dragging its feet, and the internal divisions over the feasibility of the mission all eroded NASA's influence. Perhaps an early "purge" of naysayers---no matter how credible their arguments---might have allowed NASA, by the late 1980s, to take control of the aerospace plane. But by then it was almost too late to reshape the program strategy to focus on the scramjet.

Revolutionary Management in NASP?

What about the claims for a revolutionary management style along the lines of the Japanese? The new management structures promised by NASP and pursued by Barthelemy and Waldman proved innovative, and just as NASP was terminated the contractor team had started to take advantage of the "learning curve." By all accounts of government engineers, the composite design had more positive features than any single contractor's design, and had little, if any, discernable additional cost to the government. Yet the NASA-sponsored program review in 1996 found the "most meaningful configuration parametrics" would be based on the NASP government baseline, not the most advanced NASP contractor "teaming" concept (C202).¹¹ The contractor design, while a reasonable approach that was not discounted, was not viewed by the research reviewers as the most favorable jumping-off point to start a new program.

As seen in the award fees, which represented JPO evaluations of the contractor team's work, most deficiencies in contractor performance were associated with the repeated restructurings due to budget cuts, not an inherent weakness of the team (see Fig. 8.7, "Award Fee, Periods 1-7"). The contractors consistently earned above 80% of the total fee (excluding a special second award fee judgment that contained a rollover clause into period 3 if the contractors met certain requirements). In addition, the government's managers seemed well in tune with their contractor counterparts, and friction remained minimal. The award fees indicated that the contractor team performed consistently at a very high level. Team performance, however, relied on a certain critical mass and a sufficient level of funding that the team could maintain its economies of scale at the NPO. When budgets started to fall, the comparative

Fee Period	Pt 1 (% Avail)	Pt 1 (% Awarded)	Pt 2 (% Avail)	Pt 2 (% Awarded)	Total \$ Available	% Of Total Fee	% Of Total Fee Awarded	Total \$ Awarded
1	80	81	20	81	\$6.865	13.5	81	5.005 _A
2	65	75*	35	81.3	\$10.809	21.3	77*	8.825 _B
3 ^{tt}	60	82	40	98.6	\$5.903	10.5	88.6	5.653 _C
4	74	84	26	92	\$5.985	13.9	86.7	5.189
5	72	85.5	28	94.8	\$5.160	13.9	89.5***	4.618
6	40	88.5	60	91.4	\$5.160 _D	13.9	90.3	4.698
7	85	87.1	14	82.7	\$1.375 _E	13.9	88	1.21
						**100%	TBD	TBD

* Up To 6 Percent Of Pt 1 Money Rolled Over Leaving Final Amount/Percentage Awarded TBD, On Totalling Up To 81%

** All Numbers Rounded Off

*** Determining Official Increased Award By 1.4% (\$71,745.00)

^{tt} Award Fee Periods Changed For Contract Restructure

A. 10% Of Award Fee Pool (685K) Moved To Period 2 To Match A Change In Part 2 Milestone

B. Includes 70% Of Fee Moved From Period 1 (479K) And Rolled 422K Into Period 3

C. Includes Award Of 422K Rolled Over From Period 2

D. Estimated To Be Determined Finally After Award Of Restructured 2D Contract

E. Will Be Determined After Award Of Restructured 2D Contract

Fig. 8.7, "Award Fees, Periods 1-7"

advantage of the team also diminished. More significantly as the program lost funding, the contractors (and the government) quietly withdrew their more talented personnel for other programs.

Perhaps the most significant of the lessons related to "teaming" involved the conditions and timing of team formation: both government and business agreed that a team would be stronger if the impetus for teaming came from the contractors themselves rather than the government. Participants also agreed that it would have been more effective if a team approach had been in place from the outset, rather than having the companies compete for four years, then attempt to meld the competitors together. Even though the contractors and the government expressed satisfaction that the companies finally had reached the point that they could work together effectively, competition---especially in the technical designs---left scars that required intensive amounts of team building exercises to allay, and consumed much of Waldman's time to solve. Formation of a team at an earlier stage might have avoided those problems.

Neither the competitive mode nor the team attained the "skunk works" goal, and indeed as the program matured, it grew in personnel and complexity. The contractor team expanded as well. Yet many in NASP longed for a "skunk works" atmosphere, where decisions could be implemented more quickly and where "red tape" was cut. Instead, NASP became increasingly bureaucratic and inflexible. One of the reasons for that inflexibility was that as the program aged, many of the most senior officers and civilians departed, replaced by more junior officers and civilians. That reflected in part a normal transition from a research program to an operational or production-line program. But it also illustrated the diminishing appeal of serving at the JPO. When the aerospace plane program first started, it attracted the "best and brightest," from

engineers to test pilots, and its appeal allowed the program to select from qualified senior officers and civilians. At that time, few budget constraints existed on personnel. But by the 1990s, the program no longer offered the opportunity for high profile, career-enhancing promotions, while at the same time the JPO hardly wanted to use its precious resources on salaries when it desperately needed technical progress. Meanwhile, the original research-oriented group gave way to officers and civilians more familiar with production line aircraft. Those forces both eroded NASP's clout and diminished its research vision.

Ironically, as NASP lay on life support in 1993, the organization was bureaucratically more complex than it had been in 1988, when it was larger budgetarily and in number of personnel. As some critics expected, team formation did not reduce the bureaucracy, and may have expanded it; and the attempts to institute progressive management had fallen prey to bureaucratic inertia within the Air Force and the contractors. No “skunk works” had come close to emerging, exactly because the multi-organizational joint program arrangement, then the team formation, had demanded that the program be responsible to multiple layers of supervisors, several agencies, the DoD, NASA, DARPA, the Space Council, and many other administrative layers. Likewise, on the corporate side, the NPO merely added another layer on top of existing corporate bureaucracies, and lacked any authority to eliminate such buffers at the home locations.

If the NASP program taught any single lesson, it was that whatever the project, and whatever the management system, to succeed in obtaining public support it must appeal to Americans on the basis of imagination and vision, not economics and marginal technical achievement. Unfortunately, such a conclusion raises questions about the technical approach of a big-science project like NASP, where even the NASA review team concluded that future

configuration advances will “likely be evolutionary (i.e., research based on research) rather than revolutionary (i.e., a predetermined ‘shot-gun’ approach).”¹² Although indeed the soundest, and most rapid, technical advances may come from such a strategy, sustaining either political interest or public enthusiasm for such widespread “research based on research” is difficult at best and impossible at worst. Apollo generated such support and enthusiasm precisely because people could see their science in action, and their tax dollars at work. Anything less visible is likely to fail if it seeks substantial funding.

NASP counted on its promised incredible reductions in the cost of putting payloads into orbit to generate appeal. Yet that promise never excited the public, for two central reasons. First, NASP never flew anything. To capture the public's imagination, an aircraft of space program must *fly* something, and a ship program must *sail* something. Second, NASP never linked itself to any particular vision for being in space in the first place. Program advocates had intended it to have the same impact as Ford's auto; but the perception viewed it as a dragster in an age when autos were commonplace, merely seeking higher speeds. While orbital costs may have constituted the most important economic reason for pursuing SSTO, the program failed to create a Peary, reaching for the Pole, or an Armstrong stepping on the Moon.

Ultimately, possibly no argument for an X-30 would have maintained political support for the program in the 1980s. The demise of the Soviet "evil empire," the concerns about deficits, and the tragic disappointment associated with the *Challenger* and the media attention devoted to the troubles of the Hubble telescope, soured many Americans on space and its expense. The Mars Pathfinder photos of the 1997 recaptured only a fraction of the good will that NASA had lost since the first Shuttle missions. Yet even the Martian pictures tended to be received among the

American public with a degree of sterility and nonchalance associated with the announcement of a new version of Windows. By the 1990s, neither NASA nor the Air Force had come close to recapturing the thrill of space exploration that had existed in the 1960s. Robert Williams, for all his weaknesses, temporarily had found a way to recapture that imagination with his vision of NASP. It was that type of talent that the National Aero-Space Plane needed at higher levels than DARPA, only multiplied many times over. Nevertheless, Williams, du Pont, and the NASP pioneers in NASA and the Air Force demonstrated, if only fleetingly, that Americans still responded to the promise of space and the possibilities of routine space travel. While NASP failed to capitalize on that promise, the technology remains and has continued to advance. The hypersonic hopes of putting a jet into orbit may, as of the late 1990s, merely be in the same formative stages as the dawn of the automobile age in the 1890s or the emergence of the computer age in the 1960s. When---not if---the first jet eventually does go into orbit, it will have the same revolutionary effect on society and the world.

NOTES: Chapter 8

- 1 . Archivists, working under Defense Information and Technology Conservation guidelines, stored significant amounts of technical information on computer discs during the final months of the aerospace plane program.
- 2 . See "Program Milestones and Historical Benchmarks," chart prepared by the author .
- 3 . Edwards and McIver, "Executive Summary," 74.
- 4 . Edwards and McIver, "Executive Summary," 74.
- 5 . Edwards and McIver, "Executive Summary," 74.
- 6 . Paul Hoversten, "\$10M Prize Launches Space Race," USA Today, December 1, 1997.
- 7 . Both Diamandis and Rutan quoted in "\$10M Prize."
- 8 . George Gilder, "Metcalf's Law and Legacy," on <http://forbes.com/asap/gilder/telecosm>, first published in Forbes ASAP, September 13, 1993.
- 9 . Robert Coulam, Illusions of Choice: The F-111 and the Problems of Weapons Acquisition Reform (Princeton, N.J.: Princeton University Press, 1977).
- 10 . Edwards and McIver, "Executive Summary," 8, 14.
- 11 . Edwards and McIver, "Executive Summary," 74.
- 12 . Edwards and McIver, "Executive Summary," 74.

APPENDIX A

Acronyms and Terms

AFSC (Air Force Systems Command), the Air Force organization under which NASP worked, and the parent organization of ASC. During the course of the NASP program, the Air Force merged AFSC with Air Force Logistics Command to form ASC (Aeronautical Systems Command)

ASD (Aeronautical Systems Division), the Air Force organization under which NASP worked through AFSC (Air Force Systems Command)

AMMC-1 and AMMC-2 (Advanced Metal Matrix Composites) was the cleared or unclassified term for classified materials, which later were declassified, and included materials with Beryllium fibers.

APL (Applied Physics Laboratory at Johns Hopkins University), an early NASP technology test center.

ASP (Acquisition Strategy Panel), is a board in the procurement process that examines the strategy for obtaining and producing a particular weapon that is in development.

Carbon-Carbon was a composite material used in the NASP airframe.

CDE (Concept Demonstrator Engine), a subscale scramjet test article

CFD (Computational Fluid Dynamics) is the term for computer recreations of aerospace (and underwater) fluid, or stream, movements. Essential for the NASP program to calculate scramjet and airframe performance at hypersonic speeds.

“Copper Canyon” was the term for NASP while it was a classified DARPA program.

CRAD (Corporate Research & Development), or funds invested by companies in research and development projects

DARPA (Defense Advanced Research Projects Agency), now just “Advanced Research Projects Agency,” or ARPA, had the responsibility for developing innovative and even radical new weapons. After a certain period of development, if the weapon proved feasible, it was transferred to a service branch.

DSB (Defense Science Board), was charged with evaluating science and technology projects inside the Defense Department.

DoD (Department of Defense), also referred to as the Pentagon

DRAM (Dynamic Random Access Memory) computer chips

DDR&E (Deputy Director for Research and Engineering), a directorate in the Pentagon

ETF (Engine Test Facility)

FESTIP (Future European Space Transportation Investigation Programme), a European space consortium

FRO (Flight Research Office), a NASA office

FY (Fiscal Year---October to October)

GAO (General Accounting Office), the office that originated two NASP evaluations for the government

GASL (General Applied Science Laboratory), a source of early NASP technology tests.

GD (General Dynamics, Fort Worth, Texas and since merged with Lockheed), an airframe company

GE (General Electric), an engine manufacturer

Government baseline vehicle was the Du Pont design with some “margin” or fuel capacity added.

GWPs (Government Work Packages) were the arrangements of government work after the formation of the contractor team, mostly performed at the NASA centers.

HALO (High Altitude Launch Option)

HDTV (High Definition Television)

HRE (Hypersonic Research Engine), a Langley research center-developed ramjet.

HOPE (Japan’s aerospace plane)

HOTOL (Britain’s aerospace plane)

HSCT (Hypersonic Civilian Transport), a Boeing concept for a hypersonic passenger aircraft.

HYFLITE I, II, and III (Hypersonic Flight Test Experiments I, II, and III) were a series of planned hyperonic flight tests of a scramjet that ultimately were not funded.

Hypersonics (air speeds above Mach 5, or five times the speed of sound [roughly 3600 miles per hour])

Hyper-X, NASA's follow-on to the defunct NASP program that planned to test scramjets.

HySTP (Hypersonic Scramjet Technology Program) was a proposed scaled-down series of scramjet tests that eventually became HyTech (Hypersonic Technology Program) after the NASP was cancelled.

INCOLOY 909, a NASP-developed nickel steel alloy

INCOLNEL 909, a NASP-developed nickel steel alloy

JHU (Johns Hopkins University), a source of academic support for NASP tests

JPO (Joint Program Office), located at Wright Patterson Air Force Base, was the management office for the NASP program.

LHX (Light Helicopter Experimental), a U.S. Army-developed helicopter that used a consortium or "team" approach and served as a model for NASP

MD (McDonnell Douglas), an aerospace contractor

MITI (Ministry of International Trade and Industry), Japan's agency for "industrial policy."

MOA (Memorandum of Agreement), the 1985 agreement among NASP support agents that included DARPA, the Air Force, NASA, SDIO, and the U.S. Navy, later replaced by a similar document, the Memorandum of Understanding (MOU).

NA (NASP Directorates)

NAE (NASP Engineering Directorate)

NAK (NASP Contracts Directorate)

NAR (the NASP applications directorate at the JPO)

NARLOY-Z patented nickel alloy

NASA (National Aeronautics and Space Administration), generally called the "space agency"

NASP MASAP (NASP Materials As Soon As Possible), the NASP program to “force feed” materials development.

NAX (the NASP research directorate at the JPO, but also labeled “plans”a in some organizational charts)

NASA (National Aeronautics and Space Administration), the major partner in NASP with the Air Force.

NDVs (NASP-derived Vehicles) were the planned follow-on, operational hypersonic aircraft.

NIO (the NASP Interagency Office) the NASP information directorate in Washington

NPO (National [Team] Program Office), located first at Seal Beach, then Palmdale, California, this was the office of the National Team of contractors working on the NASP.

OAST (Office of the Administrator of Science and Technology for NASA)

OMB (Office of Management and Budget)

OSTP (Office of Science and Technology Planning)

“Orient Express” was the name given to a variant of NDVs resulting from NASP that Pres. Ronald Reagan used in his state of the union message in 1986.

PMD (Program Management Document), the guiding “mission statement” of a program.

P&W (Pratt & Whitney), a NASP engine contractor

QTR (Quarterly Technical Review), the reviews of the NASP program by NASA and DoD management that occurred four times a year

R&D (research and development)

RASV (Reusable Aerospace Vehicle), an Air Force program that was a forerunner of NASP

RDT&E (Research, Development, Test, & Evaluation)

RI (Rockwell International), a NASP airframe contractor and prime contractor for the Space Shuttle

RWG (Requirements Working Group), internal JPO committees that sought to clarify requirements to meet various milestones or schedules

SAC (Strategic Air Command), an early potential Air Force “user” of NASP

SAIC (Science Applications International Corporation), a contractor that provided support to the NASP program, especially in applications and technology transfer.

Sanger (the German aerospace plane)

Scramjet (Supersonic Combustion Ramjet), an engine designed to work at speeds above Mach 5 or roughly 3600 miles per hour.

SDIO (Strategic Defense Initiative Office), better known as the “Star Wars” office, and a NASP participant

“Slush” referred to frozen, slushy hydrogen fuel.

Space Council (also known as the National Space Council), established under Pres. George Bush and chaired by Vice President Dan Quayle, this was to prioritize programs related to space and to develop a coherent policy.

SSTO (Single-Stage-to-Orbit) was the concept in which an aircraft could attain orbit without rocket boosters (i.e., a single stage).

Steering Group, the NASP oversight body consisting of representatives of the Defense Department and NASA

TASC (The Applied Science Group), a defense contractor specializing in analysis

TAV (Trans-Atmospheric Vehicle), a research program that provided early Air Force support for NASP.

Technology Transfer was the term given to the process of moving technology in the NASP program to private sector uses.

TMP (Technology Management Plan, or “Tech Mat”) was the NASP program’s strategy for allocating resources for a number of critical technology areas.

Tech Mat (see TMP)

USAF (United States Air Force)

USDR&E (Undersecretary of Defense for Research and Engineering)

WPAFB (Wright Patterson Air Force Base), in Dayton, Ohio

X-30, the specific aircraft designation for NASP airplanes.

APPENDIX B

NASP Timeline

1947 X-1 flight breaks sound barrier

1957 *Sputnik* launched into orbit

1959 X-15 high speed/high altitude flight tests begin

1962 SR-71 *Blackbird* begins flight tests

1963 *Dynasoar* program conceptual studies initiated, starting lifting body aerospace plane work

1964 Hypersonic Research Engine (HRE) work started at NASA Langley Research Center

1966 X-23A Orbital Lifting Body aircraft flight tests begin

1968 NASA Langley Hypersonic Propulsion Branch engages in scramjet inlet and combustor tests

1970 Space Shuttle design and technology development begins

1975 NASA initiates studies on “follow-on” vehicles to the Space Shuttle

1979 Air Force orders studies on Trans Atmospheric Vehicles

1981 Space Shuttle’s first orbital flight

1982 Aeronautical Systems Division of the US Air Force begins studies on space vehicles based on the TAV studies that could provide follow-on aircraft to the Space Shuttle

1983 Battelle conducts a study on aerospace vehicles for the Air Force

1983 Tony Du Pont engages in studies for the NASA on scramjet engine cycles, which are then brought to the attention of Robert Williams and Robert Cooper at DARPA

1983 DARPA begins the Copper Canyon program what will evolve into the National Aerospace Plane program

1984-1986 DARPA contracts with several aerospace companies to review and validate the Du Pont studies

June 1985 Based on early results of the studies, DARPA orders an extension of Copper Canyon work, and reconfigures the program into three “phases,” in which Copper Canyon work already done became “Phase I,” a period of technology maturation would be “Phase 2,” and fabrication of an X-30 aircraft would be “Phase 3.”

1985 Memorandum of Agreement signed between the Department of Defense and NASA to provide funds and support for an aerospace plane program using the government baseline---a modified Du Pont design---as the starting point. NASP Joint Program Office established at Wright Patterson Air Force Base in Dayton, Ohio

1985 DARPA conducts and in-house review of NASP, concluding that key materials exceeded the state-of-the-art

December 1985 The program adopts the name “National Aero-Space Plane (NASP)”

February 1986 President Ronald Reagan uses the term “Orient Express” in referring to research supporting NASP-type vehicles, but does not call NASP the “Orient Express”

April 1986 The NASP program lets contracts to five airframe companies and two propulsion companies, and shortly thereafter a third propulsion company offers to participate on its own funding

1986 NASP Steering Group formed; NASA Langley completes assessment of the government baseline vehicle, recommending substantial advances in the technology prior to continuing with configuration; the Department of Defense combines the individual budget lines for NASP from the Navy, SDIO, DARPA, and the Air Force, into a single line

May 1986 The Joint Program Office establishes seven technology maturation (“Tech Mat”) teams to advance critical technologies

December 1986 Congressional reductions in funding for FY87 force Steering Group to restructure the program by delaying all milestones 4 months

January 1987 The Defense Science Board releases the results of its investigation into NASP, recommending that the program develop several types of new materials and substantially increase the maturation process of technology. Robert Williams successfully ties up public release of the report.

February 1987 The Department of Defense announces plans for a 3-phase NASP program based on the 1985 DARPA plan

April 1987 Joint Program Office undertakes a cost estimate of NASP

June-October 1987 The Joint Program Office creates a Materials Task Force to accelerate work on materials, resulting in the formation of NASP MASAP (NASP Materials As Soon As Possible)

August 1987 NASP cost estimate delivered: \$14 billion, at minimum, and not counting already-invested funds or contractor “contributions,” to put an X-30 into orbit

1987 Program eliminates Boeing, Lockheed, and General Electric from further competition

1987 Contractor work on the scramjets and airframe suggest that a rocket assist would be required to attain orbital velocity

November 1987 Robert Barthelemy replaces Gen. Kenneth Staten as the project manager at Wright Patterson Air Force Base

December 1987-February 1988 Robert Williams is removed as Program Director following protests of budget cuts

February 1988 DARPA turns program management of NASP over to the Air Force, which names Barthelemy as Program Manager; Barthelemy adopts a “user” strategy of emphasizing the utility of NASP-derived vehicles to the Air Force

Spring 1988 The NASP program examines possible team formation or “pairings” of contractor designs

November 1988 Requests for Proposals go out to the five contractors in the program that stipulate that they must submit a proposals that adhere to the “team” concept

1988 Defense Science Board report finally released. By then, the program has materials rapidly advancing; the General Accounting Office releases a “mixed” report on NASP.

Spring 1989 Secretary of Defense Richard Cheney deletes NASP funding for the FY90 budget; Barthelemy abandons the “user” strategy and focuses on “low-cost to orbit/technical spinoffs” strategy

1989 Air Force Space Command assesses space launch architecture, which provided a positive review of NASP potential

October 1989 Steering Group endorses contractor team formation

1989 Joint Program Office advances several “trial balloons” for an “incremental approach to SSTO by building and flying subscale or sub-Mach 15 vehicles

January 1990 Contractor program managers meet in West Palm Beach and name Barry Waldman as the contractor team leader; sign Interim Teaming Agreement; JPO agrees to deliver a new contract (the 2D contract, to cover the time under Phase 2 that was to fall under the operation of the team); work started on a composite contractor design

April 20, 1990 National Space Council created to coordinate space activities and launch strategies

Summer 1990 The Space Council, led by Vice President Dan Quayle, recommends reinstating NASP funding, but extending the schedule by 2 ½ years to allow maturation of the technology; NASP Joint Program Office nears peak size of 150 personnel

1990 Schedule slippage puts first flight at or after the year 2000; SSTO flight at 2002; vehicle weights at the contractor sites, then contractor team location, grow

1990 DARPA authorized to conduct an independent NASP study with Du Pont Aerospace

January 1991 National Contractor Team delivers composite configuration design

1991 Joint Program Office develops “X-30X” 1/3 scale, Mach 10-15 alternative NASP vehicle as a part of the incremental strategy

November 1991 Congressional subcommittees hold hearings on NASP; urge NASA to transfer funds to accelerate the NASP effort

December 1991 The Joint Program Office “Options” group delivers several scenarios to the Air Force, NASA, and Congress

1992 Further budget cuts force JPO to terminate several subcontracts, cut staff, and close test facilities; a second General Accounting Office report issued that provided a favorable review of NASP; scramjet work at NASA obtains reliable data for Mach 12

February 1992 RAND Corporation issues a report critical of NASP

April 1992 Quarterly Technical Review emphasizes low-Mach number flights and subscale vehicles; NIO orders the Joint Program Office to cancel or delete all references to a “X-30X” non-SSTO aerospace plane

1992 Defense Science Board conducts another review that recommends subscale, low-Mach number vehicles as an incremental approach; Air Force reviews X-30X option

August 1992 NASP program engages in a “risk reduction effort” to test a flying scramjet under the name HYFLITE and revives X-30X program outline

September 1992 NASA Administrator Dan Goldin suggests that he favors an alternative to NASP; Congress conducts hearings on a "5-5-50" program alternative based on the original Du Pont design

1992 NASP Joint Program Office agrees to conduct another round of evaluations of the Du Pont design, and again concludes it had insurmountable problems

March 1993 Robert Barthelemy transferred from NASP; Col. Phil Bruce becomes interim NASP program manager

Summer 1993 Congressional "marks" on Defense Department budget result in further NASP cuts; Congress orders program to terminate the NASP program by FY94 and to continue work on HYFLITE

1993 Program develops a "scramjet only" version of HYFLITE called HySTP, using a Peacekeeper missile to propel the scramjet to Mach 15 for flight tests

May 1994 Joint Program Office presents its new, revised strategy to the Acquisition Strategy Panel, which grants approval. HySTP to be funded in FY 95.

1994 The U.S. Air Force determines that no further funds will be spent on HySTP and cancels the contract, reallocating \$20 million to a new HySTP research program run under Wright Labs; NASA continues hypersonic work on hypersonics with the "Hyper-X" program to test scramjets on booster rockets

1995 NASP participants and former employees stage a "wake" for the program

1993-1995 McDonnell Douglas develops and tests its DC-X Delta Clipper SSTO rocket design

1995 Stories surface of an *Aurora* high-speed/high-altitude aircraft