

Emergency Vehicle Operator Course (Ambulance)

National Standard Curriculum



Instructor's Guide

1995

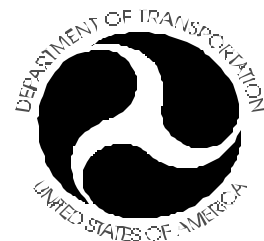

PREFACE

The U.S. Department of Transportation (DOT), National Highway Traffic Safety Administration (NHTSA) has the responsibility for the development of training courses that are responsive to the guidelines established by the Highway Safety Act of 1966 (amended). One of the most compelling highway safety justifications for an Emergency Vehicle Operators Course is that such a course would reduce the incidence of emergency vehicle collisions. In 1978, NHTSA developed the: Training Program for Operation of Emergency Vehicles: A National Standard Curriculum (EVOC). Vehicle technology and ambulance design have moved rapidly since 1978. In order for DOT curricula to be responsive to the constituency it must serve, curricula must be accurate, current, and assure that effective adult learning techniques are utilized.

The 1978 edition of the EVOC course has been revised to the Emergency Vehicle Operator Course (Ambulance): National Standard Curriculum, to ensure that it is accurate, current, and that it incorporates adult learning strategies. The revised curriculum will address only emergency vehicle operations as they relate to the operation of ambulances. The new course is recommended for anyone who operates an ambulance. The revised curriculum is appropriate for either rural or urban operations. The curriculum is made up of an instructor guide and participant manual which allow for the inclusion of local and State laws and organizational operation procedures. The revised curriculum will consist of three modules. Module A is approximately sixteen hours of classroom teaching. Module B allows participants to practice ambulance operator skills on a driving range and includes a driving range practice checklist. Module C is designed to provide an on-the-job performance assessment of the skills learned in the course through the use of an on-the-job checklist.

The Emergency Vehicle Operator Course (Ambulance) curriculum provides the knowledge and skill practice necessary for individuals to learn how to safely operate all types of ambulances.

ACKNOWLEDGEMENT

Star Mountain, Inc. of Alexandria, Virginia was selected to revise the EVOC. They were charged with developing a user friendly curriculum geared to adult learners that could be utilized by the States in their efforts to standardize ambulance operation training. Star Mountain utilized a NHTSA sponsored Curriculum Development Group (CDG) representing five major Emergency Medical Service organizations. The CDG was actively involved in the design and review of the revised curriculum. NHTSA gratefully acknowledges the contributions of the CDG members and the organizations they represented.

Curriculum Development Group (CDG)

National Council of State EMS Training Coordinators
Representative: Gail A. Stewart, EMT-P

American Society for Testing and Materials
Representative: James A. Lawrence, RN, EMT-P

National Association of State EMS Directors
Representative: Dan Manz, EMT-D

National Association of Emergency Medical Technicians
Representative: Patrick Moore, EMT-I

American Ambulance Association
Representative: Bill Leonard

Organizations Visited

Star Mountain visited the following organizations to collect information on ambulance operations. The information was used to prepare the working documents for the CDG meeting. NHTSA greatly appreciated the full cooperation of these organizations.

District of Columbia Fire Department Training Academy

Virginia Association of Volunteer Rescue Squads, Inc.
Forest View Rescue, Chesterfield, Virginia
Volunteer Rescue Squad, Madison County, Virginia

Maryland Institute of Emergency Medical Services
Community Rescue Service, Inc. Hagerstown, Maryland
Fire Training Academy, Anne Arundel County, Maryland

Federal Agencies

General Services Administration. M.L. Globerman, Chief, Vehicle Engineering Branch was very helpful in reviewing the curriculum involving the ambulance specifications. He also provided expert advice on the Federal Specification for Ambulances, Emergency Medical Care Surface Vehicles, KKK-A-1822C.

United States Fire Administration. William J. Troup provided numerous documents and contributed to the discussions about the overall curriculum development.

Individuals

Many individuals contributed by providing comments and ideas for the revision of the curriculum. The dedicated people doing the job as paid and volunteer Emergency Medical Technicians, Paramedics and Ambulance Operators were an inspiration for this program.

PILOT TESTS

Pennsylvania and Florida were selected to support the pilot testing because both require training for ambulance operators. Star Mountain conducted instructor training at the County of Bucks in Pennsylvania for rural operations and Randle-Eastern Ambulance Service, Inc., an American Medical Response, Inc. company in Miami, Florida for urban operations.

Joseph W. Schmider, Director, Department of Emergency Health Services, County of Bucks, coordinated the instructor training and conduct of the course by the recently trained instructors. Because most of the participants in Bucks County were volunteers, the course was conducted over two weekends.

Robert W. Trinkleback, CSP, Corporate Director of Safety and Health coordinated the American Medical Response participation. Captain Robert R. Crowel, Director, Safety/Risk Management at Randle-Eastern coordinated the instructor training and conduct of the course during three days of training.

The instructors did an excellent job of integrating the state, local and organizational requirements into the curriculum. The participant and instructor evaluations of the course were excellent. NHTSA appreciated the outstanding support at both of these organizations.

ORGANIZING YOUR INSTRUCTOR GUIDE

It is recommended that each user obtain separator sheets with tabs to separate the modules, lessons within each module, and the appendixes. You will need separators labeled A, B, and C for the Modules. Module A has 10 lessons and the Appendixes go from A to K. Adding the separators with tabs will make it easier to use the instructor guide.

TABLE OF CONTENTS

| | Page |
|--|------|
| Instructions to Instructors..... | |
| MODULE A | |
| Lesson 1 - Introduction to the National Standard Curriculum for Ambulance Operators..... | 1-1 |
| Lesson 2 - Legal Aspects of Ambulance Operations..... | 2-1 |
| Lesson 3 - Communication and Reporting Rules and Responsibilities..... | 3-1 |
| Lesson 4 - Ambulance Types and Operation..... | 4-1 |
| Lesson 5 - Ambulance Inspection, Maintenance, and Repair..... | 5-1 |
| Lesson 6 - Navigation and Route Planning..... | 6-1 |
| Lesson 7 - Basic Maneuvers and Normal Operating Situations..... | 7-1 |
| Lesson 8 - Operations in Emergency Mode and Unusual Situations..... | 8.1 |
| Lesson 9 - Safety; Special Considerations | 9-1 |
| Lesson 10 - The Run..... | 10-1 |
| MODULE B | |
| Ambulance Operation: Demonstration and Practice..... | 1 |
| MODULE C | |
| Ambulance Operator Internship: Guidelines for Additional On-The-Job Training and Documentation..... | 1 |

APPENDIXES

| | |
|--|---|
| Appendix A - Area Motor Vehicle Operation Guidelines..... | A |
| Appendix B - Interpreting Hand Signals..... | B |
| Appendix C - Sample Checklist: Quick Check..... | C |
| Appendix D - Sample Checklist: Full Check..... | D |
| Appendix E - Sample Work Request..... | E |
| Appendix F - Glossary..... | F |
| Appendix G - References..... | G |
| Appendix I - Test / Answer Key..... | I |
| Appendix J - Adult Learning and Presentation Techniques..... | J |
| Appendix K - Training Supplement for Managers..... | K |

INSTRUCTIONS TO INSTRUCTORS

COURSE OVERVIEW

The Emergency Vehicle Operator Course (Ambulance): National Standard Curriculum is a training program that can be used in a variety of settings and organizations to meet ambulance operator training needs. The course consists of three training sections--

- ! Module A, a classroom based training course
- ! Module B, driving range practice exercises
- ! Module C, on-the-job training checklists

COURSE GOAL

The goal of the course is to provide participants with the skills and knowledge necessary to operate their ambulances so that the vehicle, equipment, crew, and patients will be delivered safely and efficiently and the safety of the public will be assured during all phases of the delivery of Emergency Medical Service involving the ambulance.

PREPARATION

Before you deliver the course for the first time, take time to read the Instructor Guide and the Participant Manual and become familiar with the course materials.



In each lesson, areas where local policies and procedures should be added and addressed are indicated with an ambulance icon. You should gather and prepare that instruction before delivering the course.

It is also recommended that before presenting the course, you take a ride in an ambulance--as a patient--to better understand the needs of patients relating to ambulance operation. You may also recommend, during the course, that each participant also rides in an ambulance--as a patient--to see how the operation of the ambulance affects patient comfort.

HOW TO USE

Adding local information and examples--including your policies, procedures, etc.--makes this course a valuable reference tool for participants later on the job. During presentation of the course materials, stress National Highway Traffic Safety Administration (NHTSA) recommendations for safety and training--don't exceed posted speed limits, communicate in plain English, continue to learn, and develop local reference libraries.

TRAINING METHODS/MATERIALS

Module A

Module A, approximately 16 hours of classroom-based training, is designed to train participants in the operation of an ambulance in both nonemergency and emergency modes.

Instructor Guide

The Instructor Guide (IG) is a scripted, visually-oriented document intended to be used by instructors familiar with the subject matter. The IG provides detailed text for presenting the lesson content. The two-column format provides a left column display of icons prompting you to perform instructional activities, such as--



show an overhead transparency,



conduct a question and answer session, or



provide local policies and procedures.

The Instructor Guide also includes a Glossary, References, overhead transparencies, and an end-of-module test and answer key. Appendix J is a brief refresher in adult education and presentation techniques.

Participant Manual

The Participant Manual (PM) parallels the IG and includes the content for each lesson. The PM is designed to be personalized with notes, and notetaking space is provided. In addition, space is provided for adding local policies and procedures as they are discussed in the lesson. All content on which the participant may be tested is included. The PM also includes reduced size copies of all overheads used in the course so participants do not have to copy information as it is displayed on the overhead projector in the classroom. The PM also includes a Glossary and a list of References.

Recommended Equipment

The following equipment is recommended for presentation of Module A:

- ! overhead projector (to show transparencies)
- ! projection screen or wall space to project overhead transparencies
- ! flipchart and markers
- ! comfortable seating and writing space for each participant
- ! lectern or instructor table

Additional Module A Training Activities

Additional hands-on training activities may be added to Module A where time, facilities, and equipment are available. The Instructor Guide indicates where the activities, suggested below, may be added.

| Lesson | Additional Activity | Resources Required/Advance Preparation |
|---------------|---|---|
| Lesson 1 | Have participants ride in an ambulance as a patient. | Ambulance, operator |
| Lesson 2 | None | |
| Lesson 3 | Practice sending and receiving messages using local equipment. | Radio equipment |
| Lesson 4 | Have photographs of the ambulances used in your area available to pass around or posted on the walls. You may also write to the manufacturers of your ambulance types for brochures. | Photographs and manufacturer's brochures |
| | Take the participants to the ambulance(s) and go over configuration. | Ambulance |
| | Take the participants to the ambulance(s) and locate the gross weight information for the ambulance(s). | Ambulance |
| | Take the participants to the ambulance(s) and locate payload capacity information for the ambulance(s). | Ambulance |
| Lesson 5 | Have participants conduct an inspection. | Ambulance, checklists |
| Lesson 6 | None | |
| Lesson 7 | None | |
| Lesson 8 | None | |
| Lesson 9 | None | |
| Lesson 10 | Have students go through the steps in a run--prerun, operations, postrun. | Ambulance, driving range |

Module B

Module B is designed to allow participants to practice ambulance operator skills on a driving range and includes driving range practice checklists.

Required Equipment

The following equipment is required for presentation of Module B:

Physical Setting

- ! Ambulance
- ! Driving range (one that is not used for pursuit-type driving) or other location, such as a large, open parking lot, where trainers can set up a driving range with cones and other markers or tape

Trainers

- ! Two (minimum) or more -- one trainer for every three participants

Vehicles

- ! Two (minimum) or more -- one ambulance for every three participants, of similar type that trainees will drive for their unit

Supplies

- ! 50 cones plus tape for marking driving courses

Module C

The on-the-job checklists are designed to provide a performance assessment of the skills learned in this course.

Recommended Equipment

The following equipment is required for presentation of Module C:

- ! Ambulance
- ! On-the-job checklists

TRAINING METHODS/MATERIALS FOR ALL MODULES

If the appropriate facilities are available--driving range, vehicles, etc.--Module B exercises may be performed by participants after the Module A classroom instruction. The Instructor Guide indicates where practices may be incorporated in the training program.

PARTICIPANT EVALUATION/QUALIFICATION

Evaluation

Module A contains a brief multiple-choice test covering the content of Module A. Evaluation of participant performance will be conducted using the test and answer key provided in the Instructor Guide.

Module B contains checklists for performance-based evaluation of driving techniques as demonstrated on a driving range. Evaluation requires the participant to actually perform a given task or activity in a training environment (for example, a driving range). You will assess performance by observing the participant performing the task and recording whether it was performed satisfactorily using a GO/NO GO checklist.

Module C contains checklists for performance-based evaluation of driving techniques as demonstrated while at work. Performance-based evaluation requires the participant to actually perform a given task or activity on the job. The instructor/coach assesses performance by observing the participant performing the task and recording whether it was performed satisfactorily using a GO/NO GO checklist.

Qualifications

Each state should define the requirements for ambulance operator qualification. Satisfactory completion of this course and any local training should qualify individual's as an ambulance operator. Individuals should be presented with a certificate.

Each state and organization should use an appropriate certificate. When appropriate, the certificate should indicate that the course met the National Standard Curriculum requirements for Emergency Vehicles Operators (Ambulance) A Sample Certificate is shown in Module C. This is only a sample.





SUMMARY

After preparation--reading the training materials, previewing the training facilities--you will be ready to conduct the course.

| | |
|----------------------------------|--|
| COURSE: | EMERGENCY VEHICLE OPERATOR COURSE (AMBULANCE): NATIONAL STANDARD CURRICULUM |
| MODULE A: | Ambulance Operation: The Basics |
| LESSON 1: | Introduction to the DOT National Standard Curriculum for Ambulance Operators |
| LENGTH: | 1 Hour |
| COURSE GOAL: | To provide ambulance operators with knowledge and skills to operate their vehicles so that vehicle, equipment, crew, and patients will be delivered safely and efficiently, and the safety of the public will be assured during all phases of the delivery of Emergency Medical Services (EMS) involving the ambulance |
| MODULE GOAL: | To provide ambulance operators with the knowledge required to safely and efficiently operate an ambulance in both nonemergency and emergency modes |
| LESSON GOAL: | To introduce the course by describing its organization and schedule and reviewing course materials |
| PERFORMANCE OBJECTIVE(S): | ! Identify ambulance operator selection requirements |
| INSTRUCTIONAL | Participant Manual |

AIDS:

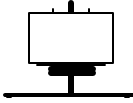
Handout

| ICON LEGEND (Those used in this lesson are highlighted) | | | | | |
|---|---|----------------------------|---|---|---|
|  |  | Q & A |  |  |  |
| Appendix | Show Overhead | Question and Answer Period | Use Flipchart | Ask Question | Local Requirements |



1. This Course Provides
2. Icon Legend
3. Ambulance Operator Selection

INSTRUCTIONAL EQUIPMENT:

Overhead projector and screen
Transparencies
Handout

Training Tips for: Lesson 1: Introduction to the National Standard Curriculum for Ambulance Operators

- Tip 1. As the instructor for this lesson you will need to discuss the highlights of each lesson. Review each lesson guide and the participant manual until you are comfortable with your knowledge about the lessons. Make notes in your instructor guide about the points you want to make about each lesson.
- Tip 2. Review each of the Appendices and be as comfortable with them as you are with the other information about each lesson.
- Tip 3. If the participants don't know each other, provide a 5"x8" white card and have them write their name on it and put it at the front of their table or desk. This will let the participants get to know each other's name and just as important you can now call on them by name to answer questions.
- Tip 4. Coordinate with the person responsible for the training and be sure that you have a written schedule for the course and that each participant has a copy.
- Tip 5. If you have a good example of a real job description for an ambulance operator, bring it to class. Discuss how the description should cover the job requirements. How do you deal with lifting requirements? How many pounds does an operator or EMT have to lift to qualify for the job?
- Tip 6. Get copies of the state statutes that deal with the operation of emergency vehicles. Have a copy of the individual licensing requirements. Don't guess at the statutes. Provide each participant with the pertinent sections of the statute. Are there any unusual local requirements?

| Instructor Notes | Presentation |
|--|--|
| | INTRODUCTION |
| | Welcome to the Emergency Vehicle Operator Course for ambulance operators. |
| Introduce yourself and give a brief explanation of your experience and qualifications as an ambulance operator/ instructor. | Let me introduce myself. |
| | Participant Introductions |
| Have participants introduce themselves. Have them give their name; their organization; their experience, if any; length of service; and any other information that will help make this a positive learning experience. | Let's all get to know each other. |
| | COURSE OVERVIEW |
| | We all know that ambulance operators are dedicated professionals who want to know the best way to do their job. That's why you're here for training. |

| Instructor Notes | Presentation |
|------------------|--|
| | In this course you will learn about-- |
| | ! legal aspects of ambulance operation, including appropriate vehicle procedures based upon federal, state, local, and organization regulations; due regard; true emergencies; negligence; abandonment; good Samaritan provisions; and patient's rights. |
| | ! communications responsibilities for receiving and sending radio messages and for interpreting hand signals |
| | ! ambulance types and operation, including general guidelines about weight restrictions and operation for each type |
| | ! ambulance readiness, including inspection, maintenance, and repair |
| | ! navigation and route planning, including selecting the safest route to the emergency scene and the medical facility |
| | ! normal and high-risk driving situations and the appropriate driving skills for situations from routine traffic to hazardous weather and traffic conditions |
| | ! safety considerations for ensuring safety of passengers, patients and their family, the ambulance, and the crew |

Instructor Notes

Presentation

We all know that there is a big difference in learning about ambulance driving in a classroom and learning on the job, at the scene of a major crash, with injured patients and other emergency vehicles on the scene. This course provides all those learning opportunities.

MODULE OVERVIEWS



1: This Course Provides

THIS COURSE PROVIDES

Knowledge

Practice

Performance

This course will provide the following:

First: the **knowledge** you need to operate your vehicle safely and efficiently. This information is contained in Module A.

Second: recommendations and methods for **practice**. This

| Instructor Notes | Presentation |
|------------------|--|
| | information is contained in Module B. |
| | Third: methods for evaluating your performance on the job. This information is contained in Module C. |
| | Module A provides learning evaluation using a brief multiple choice test on the information we cover during this class. |
| | Module B provides a series of checklists that you will be evaluated on while driving on a protected range. |
| | And Module C provides a series of checklists that can be used by your supervisors to provide you with feedback on your performance of ambulance operator duties on the job. |
| | This course will not cover pursuit driving or high-speed operation of an ambulance. The U.S. Department of Transportation recommends operating at or below the posted speed limits and getting to the scene safely. |
| | Once you have your ambulance at the scene and patient care begins, the chances are that the patient will survive. |
| | You will also learn that with the patient on board you want to provide the smoothest ride possible in a nonemergency mode. Statistics show that if the patient gets to the medical facility within one hour, the chances of surviving are greater than 90 percent. |
| | Relationship to Other NHTSA Courses |

Instructor Notes

Presentation

This course is part of the National Standard Curricula being developed or revised by the National Highway Traffic Safety Administration (NHTSA) for EMS providers. That curriculum includes training for bystanders, for first responders, for Emergency Medical Technicians (EMT-B, EMT-I, and EMT-P), for dispatchers, and EMS Instructors.

Schedule

Our schedule for this course is one of many configurations for the three modules I have described. Some of our colleagues will be taking the course in three full days, while others will have one or two hours of training at a time over a longer period. We have arranged the schedule to meet the needs and availability of our operators, trainers, and facilities.



This is our training schedule--

Hand out and discuss printed schedule of training for Modules A and B. Include timeframe for completing Module C on the job.

TRAINING MATERIALS

You have been given a Participant Manual. Turn to Lesson 1,

Instructor Notes

Presentation

Page 1 now. You will see that each lesson begins with information pages that let you know--

! the name of the lesson

! the learning goals of the lesson

! the objectives (that is, what you can expect to learn during the lesson)

! appendix items that go with the lesson

! "actions" you might perform during the lesson. (Look at the icon legend on page 2. For example, you might take notes, respond to a question, or look at an appendix item.)



2: Icon Legend

Instructor Notes

Presentation

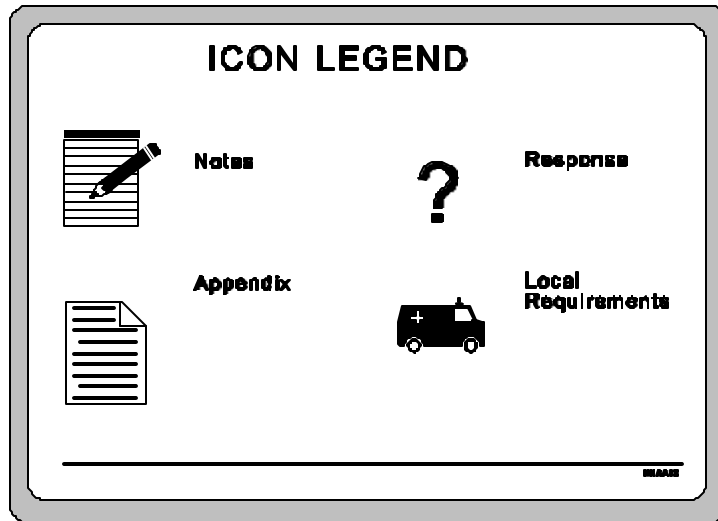

The last icon, LOCAL REQUIREMENTS, shows that in this lesson you will be provided with additional information about some policy or procedure unique to your organization.

When we finish this course, you will have a useful reference that you can take back to the job and refer to whenever you have questions.

Appendixes/References/Glossary

We have included some very important information at the back of your participant manual. The appendixes include these items for your use:

! motor vehicle operation guidelines for our area

| Instructor Notes | Presentation | |
|------------------|--------------|---|
| | ! | hand signals for use by ground spotters |
| | ! | sample checklists for the quick check and full check of the ambulance |
| | ! | sample vehicle repair work requests |
| | ! | a glossary that defines terms used in these training materials and on your job |
| | ! | list of references used for this course |
| | ! | additional references if you want further background |
| | | Your organization should have a reference library of materials for your refresher training and on-the-job training. |
| | | WHO THIS COURSE IS FOR |
| | | This course is designed for ALL ambulance operators whether they-- |
| | ! | are new hires or experienced operators who want refresher training |

Instructor Notes

Presentation

! work in large cities or small towns

! belong to paid professional or volunteer organizations



3: Ambulance Operator Selection

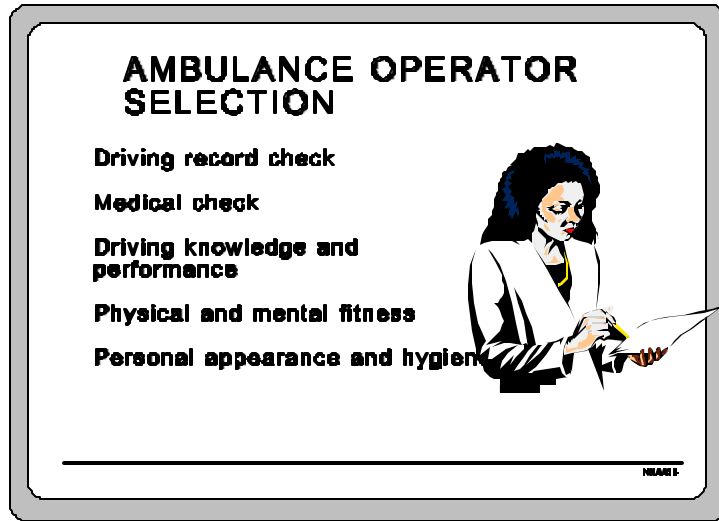

HOW YOU GOT TO BE AN AMBULANCE OPERATOR

Ambulance operators are selected based on their qualifications to perform the duties for responding to emergency calls and safely transporting patients to medical facilities. Authorization of ambulance operators must always be based on Bona Fide Occupational Qualifications (BFOQ) for the task of ambulance operation.

Before you were hired, your overall qualifications were reviewed. This review may have included driving record checks, medical checks, and vocational tests.

Instructor Notes

Presentation

A curriculum development group representing the major EMS professional organizations has assisted in developing this course. They support the following recommendations for driving checks, medical check, driving knowledge and performance evaluation, and physical fitness.



Our organization has the following selection qualifications:

Driving Checks



Driving record checks and license checks should be preconditions to hiring or acceptance into an EMS organization.

State Motor Vehicle Record Check



A review of state motor vehicle records for the previous three years should have been conducted when you were first hired.

This review should have been checked for any speeding, careless or reckless driving, driving under the influence of alcohol or other mind-altering substances, or moving violations.

Motor Vehicle Accident Check

| Instructor Notes | Presentation |
|---|---|
| | <p>Your driving record should have been checked for any accidents you have had in the previous five years.</p> |
|  | <p>Our organization requires these driving record checks:</p> |
| <p>Discuss driving record checks.</p> | |
| | <p>License Check</p> |
| | <p>Your driver's license should have been checked to make sure that you are licensed and qualified to operate the class of vehicle you will be driving.</p> |
|  | <p>Our organization requires these licensing checks--</p> |
| <p>Discuss licensing check.</p> | |
| | <p>Medical Check</p> |
| | <p>A licensed physician determines if someone is physically able to perform the job of ambulance operator under all conditions. The medical exam should reveal no medical or physical condition</p> |

| Instructor Notes | Presentation |
|------------------|--|
| | which would prove detrimental to operating an ambulance. |
| | The examination identifies drivers who may be impaired by-- |
| | - loss of consciousness |
| | - cardiovascular disease |
| | - neurological/neurovascular disorder |
| | - mental illness |
| | - substance abuse/dependency |
| | - insulin-dependent diabetes |
| | - rheumatic, arthritic, orthopedic, muscular, neuromuscular, or vascular disease which interferes with the ability to control and operate a motor vehicle |
| | The presence of a medical condition alone may not indicate an impaired operator. However, it can identify an area to consider when determining a person's medical fitness to operate an ambulance. |
| | Our organization requires these initial medical checks and |

| Instructor Notes | Presentation |
|--|--|
|  | physical qualifications: |
| | Driving Knowledge and Performance |
| | <p>You should also pass this ambulance operator course written test and driving test. That should be followed by a period of on-the-job training to evaluate your performance under actual job conditions. Following successful completion of the written test, the driving test, the on-the-job evaluation, and any local requirements, your supervisor should consider you a qualified ambulance operator.</p> |
|  | Our local guidelines and policy for testing are-- |
| | Operator Qualification |
| | <p>In addition to the initial driving and medical checks you may have taken to qualify as an ambulance operator, you should maintain your qualifications by--</p> |
| | ! keeping your license up-to-date and valid |
| | ! reporting any violation you receive when driving your personal vehicle |
| | ! remaining physically and mentally fit |

| Instructor Notes | Presentation |
|------------------|---|
| | <p>! participating in training when available</p> |
| | <p>Licensing</p> |
| | <p>An operator with an expired state driving license is no use to the organization. Remember to renew your license before the expiration date. Keep abreast of changes in licensing requirements.</p> |
| | <p>Physical and Mental Fitness</p> |
| | <p>Your physical and mental condition affects the daily performance of your job. You are expected to be mentally and physically fit for every run.</p> |
| | <p>Your physical fitness may be affected by your health and the amount of rest you are getting. For example--</p> |
| | <p>! If you have the flu, you may not be at your best and alert.</p> |
| | <p>! A shoulder injury may affect your ability to maneuver your vehicle.</p> |
| | <p>! Over-the-counter medications may make you sleepy.</p> |
| | <p>! Lack of sleep can make your response time slower.</p> |

Instructor Notes

Presentation



Discuss physical fitness policy. Are annual physicals required? How do operators report when they are not in condition to drive?

If you are not in good physical condition it is better not to drive.

Our organization's physical fitness policy includes--

Having a good attitude is the best influence on doing a good job.

Your **mental fitness** may be affected by a lack of concentration or the use of alcohol or drugs.

If you are worried about a sick family member, money problems, or problems concerning children, you may be distracted and not perform at your best. It is better not to drive until you are better able to concentrate.

You can be distracted when you are angry about something. If you are angry, you may lose patience and take risks you normally wouldn't consider. Calm down before driving.

It is illegal to drink and drive. Don't drink at all when you may have to drive.

| Instructor Notes | Presentation |
|------------------|--|
| | <p>Illegal drugs are never acceptable, under any circumstances, and should never be used while on or off duty.</p> |
| | <p>You need to consider your physical and mental condition every time you go on a run to ensure your safety and the safety of your crew and patients.</p> |
| | <p>Personal Appearance and Hygiene</p> |
| | <p>While not exactly a part of physical and mental fitness, your physical appearance and hygiene have a lot to do with how well you perform your job duties.</p> |
| | <p>A professional physical appearance builds confidence in patients and other civilians that you might need to direct. Your professional bearing will be a credit to your organization.</p> |
| | <p>Secondly, your personal hygiene and patient handling precautions are required to prevent the spread of infection. If you get sick, you will not be of much use to your organization.</p> |
| | <p>Professional appearance relates not only to your person but also to your equipment. Clean, properly stowed equipment makes your task--driving the ambulance and transporting patients--safer and easier, and makes the results more positive.</p> |
| | <p>Participation in Training</p> |





| Instructor Notes | Presentation |
|------------------|---|
| | <p>After you have been selected to be an ambulance operator, your most important task is to improve your job performance at every opportunity. Training programs like this one are a part of that experience.</p> |
| | <p>Often this is the beginning of several years of training. Many of you will be required to complete the EMT-BASIC within a certain time. Many of you already may be qualified EMTs.</p> |
| | <p>The ambulance crew should strive to become as qualified as possible within their organization. When possible, all crew members should be working to become paramedics operating advanced life support-equipped ambulances.</p> |
| | <p>SUMMARY</p> |
| | <p>Ambulance operators are selected based on their qualifications to perform the duties required of them.</p> |
| | <p>A driving record check and license check is a precondition to hiring.</p> |
| | <p>A medical evaluation should be required to determine physical ability to perform the job under all conditions.</p> |
| | <p>You should pass this ambulance operator course written test and driving test, then pass the on-the-job driving evaluation.</p> |

| Instructor Notes | Presentation |
|------------------|---|
| | You are expected to be mentally and physically fit for every run. |
| | Your personal appearance and hygiene have a lot to do with how well you perform your job. |
| | You're here because you have an important job to do, driving an ambulance, and this training course will offer you the training designed for all aspects of that job. |
| | The training will be presented in the classroom, behind the wheel, and on the job. When you have successfully completed all three modules, met all local and state requirements and recommend by your supervisor you should be considered a qualified ambulance operator. |

| | |
|------------------|---|
| COURSE: | EMERGENCY VEHICLE OPERATOR COURSE (AMBULANCE): NATIONAL STANDARD CURRICULUM |
| MODULE A: | Ambulance Operation: The Basics |
| LESSON 2: | Legal Aspects of Ambulance Operation |
| LENGTH: | 1.5 Hours |

COURSE GOAL: To provide ambulance operators with the knowledge and skills to operate their vehicles so that their vehicle, equipment, crew, and patients will be delivered safely and efficiently and the safety of the

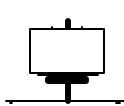
| | |
|----------------------------------|---|
| | public will be assured during all phases of the delivery of Emergency Medical Services (EMS) involving the ambulance |
| MODULE GOAL: | To provide ambulance operators with the knowledge and skills to safely and efficiently operate an ambulance in both nonemergency and emergency modes |
| LESSON GOAL: | To provide participants with knowledge of the federal, state, and local laws and of how to apply the laws when operating an ambulance |
| PERFORMANCE OBJECTIVE(S): | <ul style="list-style-type: none"> ! Identify types of laws that apply to ambulance operation ! Identify how specific laws apply to ambulance operation |
| INSTRUCTIONAL AIDS: | |

| ICON LEGEND (Those used in this lesson are highlighted) | | | | | |
|---|---|---|---|---|---|
|  |  |  |  |  |  |
| Appendix | Show Overhead | Question and Answer Period | Use Flipchart | Ask Question | Local Requirements |



1. Types of Regulations
2. Policies Working Together
3. Due Regard for Safety
4. True Emergency Situation
5. Negligence
6. Abandonment
7. Good Samaritan Provision
8. Patient's Rights

**INSTRUCTIONAL
EQUIPMENT:**

Overhead projector and screen
Transparencies
Flipchart and markers

APPENDIX:

Appendix A, Job Aid - Area Motor Vehicle Operation Guidelines

Training Tips for: Lesson 2: Legal Aspects of Ambulance Operations

- Tip 1. Use the forms in Appendix A. Get copies of the state and local statutes, county and city ordinances and regulations. Give each participant a copy.
- Tip 2. Develop examples that are appropriate for your organization. Don't leave any doubt as to what is right or wrong. If possible get an attorney or law enforcement official to assist you with preparing the examples for your organization. They could also help in presenting the lesson.
- Tip 3. For most organizations, when in doubt call the dispatcher.
- Tip 4. It may be possible to get some audio tape from the 911 operations center that would have real examples of ambulance crews asking the dispatcher for advice about a specific incident or reporting their actions.

Instructor Notes

Presentation

INTRODUCTION

As an ambulance operator, you are responsible for the safe and efficient transportation of your patients and crew. At the same time, you must look out for the safety of the public. The very nature of your job requires you to work with others during a time of crisis and with this comes certain risks. You need to be aware that at all times while performing your job, you are being held "legally accountable" for your actions.

This lesson highlights some of the legal aspects--laws, issues, and guidelines--surrounding the performance of your duties.

DEFINING THE LAW

Let's first talk about some of the types of regulations covering emergency vehicle operation and how the regulations guide the decisions you make while performing your job.

Types of Regulations

There are several types of regulations that tell us how to conduct emergency vehicle operation. These regulations are for all types of emergency vehicles including ambulances.



1: Types of Regulations

Instructor Notes

Presentation

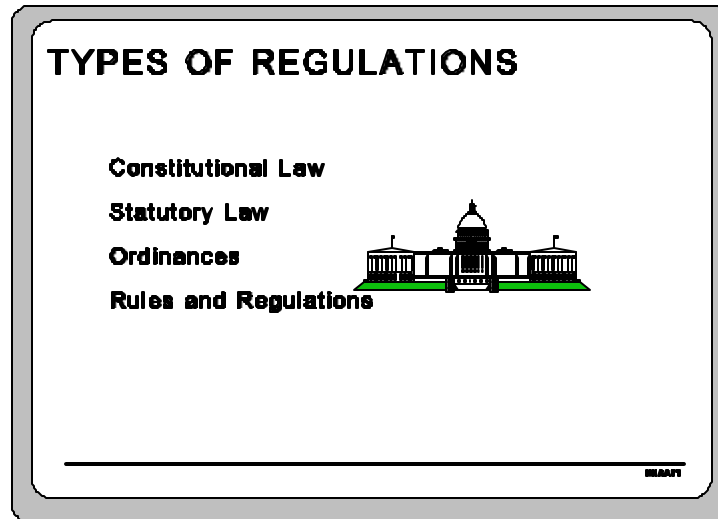

Constitutional laws come from the U.S. Constitution. The Constitution guarantees the rights of the individual. These laws explain patients' rights before, during, and after transport.

Statutory laws come from legislative acts. Each state has laws or statutes that tell us how to operate emergency vehicles. The laws vary from state to state. For example, the state Motor Vehicle Code for each state tells us laws about traffic regulations. The code may dictate exceptions to these laws for ambulance operators, such as special procedures for proceeding through red traffic lights or parking in a no parking zone.

Ordinances are guidelines enacted by a governing municipal body or its agent. These guidelines usually include city or county codes. For example, in some cities, the use of bright headlights is not permitted.

Rules and regulations are guidelines enacted by an agency that

Instructor Notes

Presentation

have the force of law. The rules and regulations are intended to provide more information about statutory laws. These are often referred to as the organizational policies and procedures or Standard Operating Procedures (SOP). For example, an organization may have specific guidelines about when to use sirens.

Understanding the Regulations

There are things about emergency vehicle operation laws that you need to know. You need to know how the laws work and when you are exempt from doing what the law says to do.

With so many regulations telling us how to operate emergency vehicles, you must know which law applies in a given situation. You may feel like there may be a conflict of policy about how you do your job. Here are some suggested guidelines for EMS ambulance operators:

All organizational policy should incorporate the principles of state laws, local ordinances, rules, and regulations into guidelines for the ambulance operator.



2: Policies Working Together

Instructor Notes

Presentation

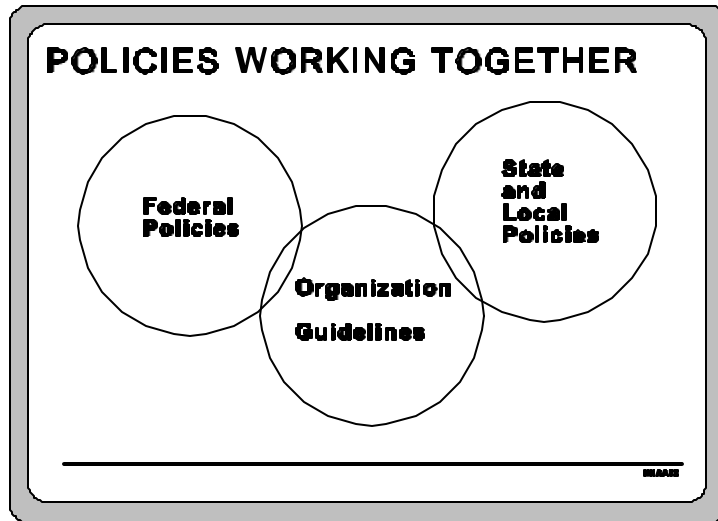

This means that all organizational policies and procedures should include and must not contradict federal, state, and local laws concerning the ambulance operation under all conditions. Your organization's policies may be formal or informal, but all policies should be in writing. This can provide protection from liability issues. As an operator, you must know your organization's policies.



Let's see what some of the local policies are concerning ambulance operation. We will discuss what makes up these policies in more detail later in the lesson.



List local organization SOPs and other guidelines

| Instructor Notes | Presentation |
|------------------|---|
| | <p>There are times when you will be exempt from certain guidelines listed in the regulations. As part of your job, you are required to make decisions concerning the operation of your vehicle. Good training provides you with the knowledge and ability to make appropriate decisions when faced with an emergency situation. Knowing ahead of time what the law says does not apply in the situation is important. Keep the following <u>three</u> principles in mind when approaching the idea of exemptions:</p> |
| | <ol style="list-style-type: none"><li data-bbox="505 814 1403 919">1. Ambulance operators are subject to all traffic regulations unless a specific exemption is made in the state or local statutes. |
| | <ol style="list-style-type: none"><li data-bbox="505 1010 1292 1041">2. Exemptions are legal only in the emergency mode. |
| | <ol style="list-style-type: none"><li data-bbox="505 1125 1398 1192">3. Even with an exemption, operators can be found criminally or civilly liable if involved in a crash. |
| | <p>Some examples of exemptions to laws include proceeding through red lights/stop signs at controlled intersections, parking in a no parking zone, or violating traffic flow and turning procedures.</p> |
| Q&A | <p>What is meant by "specific exemption"?</p> |
| | <p><i>[Answer: A specific exemption is a statement which appears in the statutes and specifies an exception to the rule such as: "The operator of an authorized emergency vehicle may park in a no parking zone as long as the operator does not endanger life or</i></p> |

| Instructor Notes | Presentation |
|--|---|
| | <p><i>property."]</i></p> |
| | <p>Scenario</p> |
| <p>Have the participants read the scenario and write their response. Discuss responses as a group.</p> | <p>Let's apply what we have just learned about the types of laws and exemptions to the laws.</p> |
| | <p>Your state has a specific exemption for emergency vehicles proceeding through an intersection with a red signal light or stop sign. The exemption reads, "Emergency vehicles may proceed through an intersection with a red light signal or stop sign if the vehicle is brought to a complete stop, proper clearance is observed, and the vehicle proceeds through the intersection with caution."</p> |
| | <p>During a run, you are following behind another emergency vehicle responding to an emergency call. You are approaching the intersection when you notice a red light. The other emergency vehicle stops, checks to see the intersection is clear, and then proceeds through the intersection. You then follow right behind the other vehicle through the light. Was your action within the law? Why?</p> |
| | <p><i>[Answer: No. Even though the first vehicle did meet the requirements of the law, your vehicle must also come to a complete stop, check for proper clearance, and then proceed with caution. No two emergency vehicles may proceed through the intersection at one time.]</i></p> |

Instructor Notes

Presentation

State and local laws and statutes may be different in your state. Revise the example if your state laws are different.

INTERPRETING THE LAW

Next, let's look at specific laws and how to interpret those laws to see what things you, as an operator, could be held legally liable for as well as what your patients' rights are during the medical transport.

Law of Due Regard

All patients and crew members have the right to know that while being entrusted in your care, you are exercising "due regard" for their safety. If ever a crash should occur while you are operating an ambulance, the courts will judge your actions according to this principle.



3: Due Regard for Safety

Instructor Notes

Presentation

"DUE REGARD" FOR SAFETY

**A reasonably careful person,
performing similar duties and
under similar circumstances,
would act in the same manner.**



Deciding whether an ambulance operator has exercised "due regard" for the safety of others is always based on a specific set of circumstances. Certain rules, however, should act as guidelines for your actions. Always keep these points in mind when thinking about the Law of Due Regard and the safety of others.

Ask yourself these questions:

- ! Am I responding like others would in the same situation?
- ! Am I giving enough notice of my vehicle's approach to allow other motorists and pedestrians to clear a path and protect themselves?

[Notice is given by using appropriate signaling equipment (i.e., lights and siren) in accordance with

| Instructor Notes | Presentation |
|---|---|
| | <p><i>statutes. Enough is difficult to define. If motorists have the windows up or the heater or air conditioner and radio on, it may take them a long time to respond.]</i></p> |
| | <p>! Am I using the signaling equipment appropriately? Is it necessary to use it? Can motorists and pedestrians hear and see my signals?</p> |
| | <p>! Am I using extreme caution? I must never travel at a speed that does not permit complete control of my vehicle.</p> |
| <p>Cite other examples as appropriate. Solicit participant input.</p> | <p>Examples:</p> |
| | <p>No regard for safety - When returning to the station at the end of a run, an ambulance proceeds through a red light after slowing to 10 MPH. This situation indicates the operator had no regard for safety of others. No true emergency exists and the operator is violating a traffic law.</p> |
| | <p>Due regard for safety - While enroute to an emergency, the ambulance lights are flashing, the siren is on, and the ambulance is traveling within posted speed limits. The ambulance approaches an intersection with a red light, stops, checks for other motorists, and proceeds through the light. In this case an emergency exists, and the correct procedures were followed to ensure the safety of others.</p> |
| | <p>True Emergency Situation</p> |

Instructor Notes

Presentation

Others also will judge your liability in a situation by determining whether or not the situation involved a "true emergency."



4: True Emergency Situation

"TRUE EMERGENCY" SITUATION

Involves high probability of death or serious injury to an individual and action by operator may reduce seriousness of the situation.

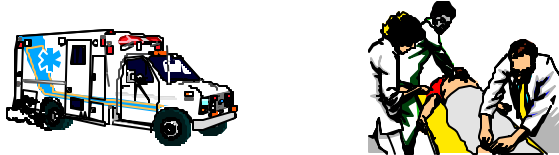

EMSS

In some situations, others--not you--will decide whether or not a true emergency exists. However, even in emergency situations, you are still responsible for operating your vehicle in a safe manner.

Situations where others determine the "nature of the emergency" include--

! code system calls

! information from a dispatcher (example: While enroute to an emergency, the status of the emergency may

| Instructor Notes | Presentation |
|--|--|
| | change--from emergency to nonemergency--and this information is relayed to you by the dispatcher.) |
| | ! affiliated emergency service operator requests (example: Another emergency service may ask for your assistance because their service cannot handle the emergency.) |
| | ! medical facility physician's decision |
| | Hopefully, situations where you must decide what is a true emergency are the exception rather than the rule. However, if faced with these situations, keep these points in mind. |
| | Ask yourself these questions: |
| | ! Is there a high probability of death or serious injury to the patient? |
| | ! Will my actions reduce the seriousness of the incident? |
| Cite other examples as appropriate. Solicit participant input. | Examples: |
| | True Emergency - A dispatcher reports that an individual, who is highly allergic to bees, is stung by a bee. |
| | Nonemergency - An individual breaks a leg at a county |

Instructor Notes

Presentation

fairgrounds and the emergency medical crew is transporting the patient to a hospital.

Negligence

You may also be held liable in a court of law if you were in some way careless while performing your duties as an ambulance operator.



5: Negligence

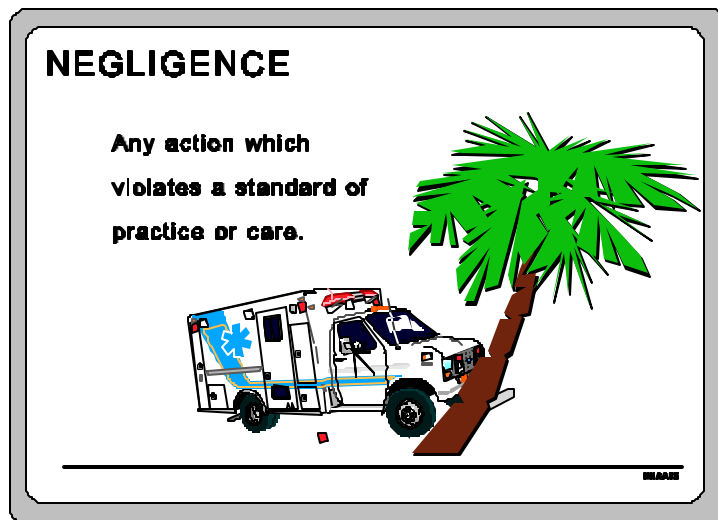

What this means is that as an operator something you SHOULD HAVE done was not done or was done incorrectly. As a direct result, a person was injured or killed or property was damaged. No court can replace lives, but they can attempt to compensate the injured or their families with money.

In a lawsuit involving negligence, proving operator negligence is difficult. It must be proven that the negligence was willfully done.

| Instructor Notes | Presentation |
|--|--|
| | <p>Certain facts must be established in the case. To avoid being caught in a negligence issue, keep the following in mind.</p> |
| | <p>Ask yourself these questions:</p> |
| | <p>! Do I have a "duty to act" toward the other person?</p> |
| | <p>! What must I do to avoid a "breach of duty?" (For example, you must not fail to respond.)</p> |
| | <p>! How can I avoid the other person suffering injury or loss because of my duty? (The actual cause of the other person's injury or loss must be a direct result of breach of duty, such as a violation of a traffic regulation.)</p> |
| <p>Cite other case examples as appropriate. Solicit participant input.</p> | <p>Case Examples:</p> |
| | <p>Example 1 - An ambulance was transporting a young girl with an injured arm to the hospital when it crashed with another vehicle. The operator of the ambulance was at fault. The crash caused an additional injury to the child. The operator could be found negligent.</p> |
| | <p>Example 2 - An ambulance inspection was done and the operator noted in writing that the tire had a problem. A run was called in and the operator drove the vehicle knowing the tire was bad. During the run, the operator was involved in a crash as a result of the bad tire. The operator could be found negligent.</p> |

Instructor Notes

Presentation



Our state and local policies on negligence include--

Abandonment



Another area that you need to be "legally" concerned with is abandonment.



6: Abandonment

ABANDONMENT

Act of refusing to transfer or terminating transportation prior to being relieved by other qualified health care provider.



Once you begin to help someone having a medical emergency or someone who is injured, you have legally initiated a patient/provider contract. This means that you must continue the responsibility for the patient's care until you have transported the patient to another medical provider of equal or higher qualifications.

| Instructor Notes | Presentation |
|--|--|
| | <p>This idea exists to make sure that the required care is completed. Also, it exists to avoid situations in which someone else does not stop to provide transportation thinking you are taking responsibility for the patient and will stay with the patient until another provider is reached.</p> |
| | <p>Each state views abandonment differently. You need to know your state's rules and how you can be held liable regarding this issue. An instance that could be viewed as abandonment would be not responding to a call or failing to complete a run.</p> |
|  | <p>Your state and local policies on abandonment include--</p> |
| | <p>Good Samaritan Provision</p> |
| | <p>As part of the EMS team, you need to be aware that there are "Good Samaritan" provisions in the law applying to emergency operation and care.</p> |
|  <p>7: Good Samaritan Provision</p> | |

Instructor Notes

Presentation

GOOD SAMARITAN PROVISION

**Protects person who gives aid
at the scene of an emergency
from liability for additional
damage or injury.**



Example: A person stops to help a crash victim who is trapped underneath a vehicle. The person who stops to help would not be liable for any cuts or bruises the victim sustains while removing the victim from the vehicle.

These provisions provide immunity to liability in cases in which you rendered care or were unable to render care. Most of the time the law will grant immunity from liability if the rescuer acts in good faith. Each state varies in regard to the issue of immunity. In some states, Good Samaritan provisions do not apply to volunteer ambulance crews. These states have determined that because the volunteers are acting as agents of an emergency response organization, the public can rightly expect a certain level of competence and training.



Our state and local Good Samaritan provisions include--

Ensure that all
participants

Instructor Notes

Presentation

understand the Good Samaritan provisions.

Patient Rights

As part of the EMS team, you need to know the rights of patients during a medical emergency transport. Patients have certain rights before, during, and after transport. You need to be aware of these rights so you do not become legally liable for violating the rights of the patient. Each state has specific laws regarding patient rights. Let's first take a general look at a few of these rights and what they mean.



8: Patient's Rights

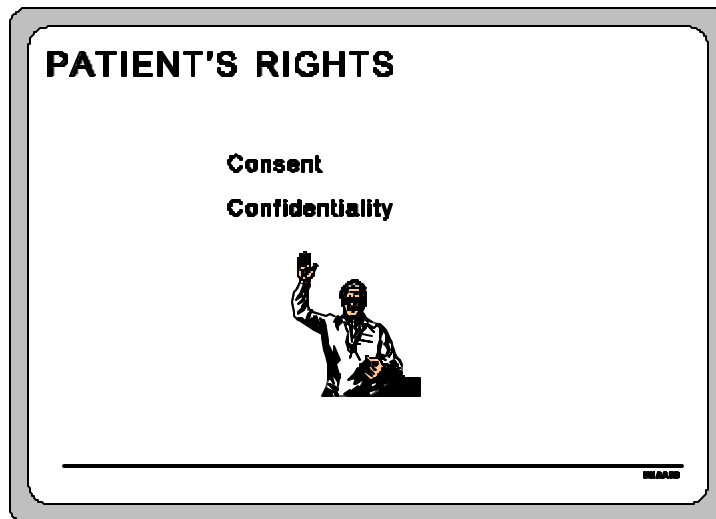

The consent to perform medical treatment is either actual consent, when patients are conscious and mentally competent, OR implied consent when the patients are unconscious or for other reasons unable to give you their actual consent.

| Instructor Notes | Presentation |
|------------------|---|
| | <p>Adults who are conscious and mentally competent have the RIGHT TO REFUSE CARE! This refusal may be either informed or implied.</p> |
| | <p>When dealing with patient consent, let's discuss a few guidelines you and the rest of the EMS team must follow.</p> |
| | <p>! Respect the patient's right to refusal--do not restrain patients who have refused treatment, demand they be treated, or argue with them concerning the treatment. (Example: The victim has a bump on the head and you feel the victim should be checked for a possible concussion. You cannot force treatment on the victim.)</p> |
| | <p>! Have someone witness that your EMS team has offered care and the patient refused. (Example: Law enforcement officers make excellent witnesses.)</p> |
| | <p>! Document that your EMS team offered care and the patient refused. Report immediately to dispatcher the refusal of care.</p> |
| | <p>Even though many states do not have specific laws governing confidentiality and EMS care, you must as a team prevent the intentional invasion of a person's privacy. Confidentiality applies not only to cases of physical injury but also to cases involving possible infectious diseases, illnesses, and emotional and psychological emergencies. In some states, legal action can be brought against you if this patient right is violated.</p> |
| | <p>In dealing with patient confidentiality, let's discuss a few</p> |

| Instructor Notes | Presentation |
|---|---|
| | guidelines that you and the rest of the EMS team must follow. |
| | <p>! Do not speak to the press, your family, friends, or other members of the public about the service provided. (Refer to your organization's policies on speaking to the press. Most organizations have a spokesperson for the group who handles these matters.)</p> |
| | <p>! Do not relate specifics about what a patient may have said, who the person was or was with, anything unusual about the patient's behavior, or any descriptions of personal appearance. (Be careful of what you say on the radio because people could be listening to your radio communications!)</p> |
|  | Your state and local policies regarding patient's rights include-- |
| | Other Legal Liability Issues |
| | As part of the EMS team, you have other responsibilities during the medical emergency service operation that may carry legal implications if carried out in an inappropriate manner. |
| | Other things your team must consider include-- |
| | <p>! responsibility for passenger possessions</p> |

| Instructor Notes | Presentation |
|---|--|
| | ! failure to report crashes or using improper reporting procedures (must follow state guidelines) |
| | ! exceeding load capacity of the vehicle (must follow vehicle weight restrictions) |
| Tell participants that they will cover Ambulance Inspection, Maintenance and Repair later in this course. | ! failure to conduct/record vehicle inspections |
| | ! failure to provide training (must not operate any vehicle that operator has not completed operator training) |
| | ! failure to maintain training records |
| | ! failure to maintain written records of safety meetings |
| | Scenarios |
| Have participants read each scenario and write their responses. Discuss responses as a group. | Let's consider some situations you may encounter as an ambulance operator. Think about what we just discussed about operator liability and patient's rights. |
| | Scenario 1: You are returning from a run when a car pulls up beside you while you are stopped at a traffic light. The individual |

| Instructor Notes | Presentation |
|------------------|--|
| | <p>informs you that a three-vehicle crash has just occurred on the nearby interstate. No other emergency vehicles are at the scene. The individual informs you that several of the victims are trapped in the cars. The severity of the injuries is unknown. Is this a true emergency situation? Why?</p> |
| | <p><i>[Answer: This is a true emergency. Because so little information is known about the injuries or about any other circumstances, the operator must assume a true emergency. In this case, the operator is determining the "nature of the emergency." Always call the dispatcher to tell them about the situation and get instructions.]</i></p> |
| | <p>Scenario 2: Your ambulance is traveling the wrong way down a one-way street while enroute to a fire at a large apartment complex where people are reported injured. You are using all signaling equipment. Are you observing "due regard"? Why?</p> |
| | <p><i>[Answer: YES, because a true emergency does exist. The ambulance operator is complying with the statute (using signaling equipment) while violating the normal direction of movement (wrong way--one way street). Without more information to indicate why traveling the wrong way down this street might be unsafe, it would seem that the operator is exercising due regard.]</i></p> |
| | <p>Scenario 3: A dispatcher reports that a man phoned requesting help. The man is hysterical and the dispatcher can not determine the extent of the injuries. You respond in an emergency mode. In route, you receive a call from the dispatcher. He reports the man has calmed down and the man thinks his son may have broken his ankle; there is some pain and swelling. Is this a true emergency situation? Why?</p> |

Instructor Notes

Presentation

[Answer: Most likely NO. Even though the call started as a true emergency, the dispatcher changed the nature of the emergency during the run. Unless local policy dictates otherwise, a broken bone is generally not considered a threat to human life.]

IDENTIFYING SPECIFIC AND LOCAL MOTOR VEHICLE OPERATION LAWS



Appendix A: Area Motor Vehicle Operation Guidelines

All states have statutes governing the operation of motor vehicles. It is important that you understand the statutes dealing with operating an ambulance. We will now go over some traffic regulations for our state and local area that apply to emergency vehicles.

Refer to the handout in the Appendix. Follow the instructions listed in the Appendix.

Q & A

Legal issues surrounding ambulance operation is a serious subject. You can be sued. However, knowing the laws makes a difference and helps you to act "legally smart." Do you have any other questions concerning legal issues?

Allow participants time for questions. Research questions if uncertain about





| Instructor Notes | Presentation |
|------------------|--|
| answers. | |
| | SUMMARY |
| | In defining the law, we learned that-- |
| | ! federal, state, and local guidelines dictate Emergency Vehicle Operation |
| | ! organizational requirements must incorporate and not contradict federal, state, or local requirements |
| | ! there are certain situations where the ambulance operator may be exempt from the regulations--know the exemptions for your state |
| | In interpreting the law, we learned that-- |
| | ! operators must exercise due regard for the safety of all patients and passengers |
| | ! operators should not operate under emergency response conditions unless a true emergency exists |
| | ! operators need to "think safety" to avoid negligence charges |

| Instructor Notes | Presentation |
|------------------|--|
| | ! operators have an obligation to continue providing care until relieved by other care providers once the operator begins the patient/provider relationship |
| | ! operators need to know about the "Good Samaritan" provisions and how they affect them |
| | ! patients have rights such as consent and confidentiality in medical emergency situations |
| | By knowing specific state and local laws, you can protect yourself against liability situations and can act appropriately when faced with emergency medical situations in your area. |

| | |
|----------------------------------|--|
| COURSE: | EMERGENCY VEHICLE OPERATOR COURSE (AMBULANCE): NATIONAL STANDARD CURRICULUM |
| MODULE A: | Ambulance Operation: The Basics |
| LESSON 3: | Communication and Reporting Roles and Responsibilities |
| LENGTH: | 1.5 Hours |
| COURSE GOAL: | To provide ambulance operators with the knowledge and skills to operate their vehicles so that their vehicle, equipment, crew, and patients will be delivered safely and efficiently and the safety of the public will be assured during all phases of the delivery of EMS involving the ambulance |
| MODULE GOAL: | To provide ambulance operators with the knowledge required to safely and efficiently operate an ambulance in both nonemergency and emergency modes |
| LESSON GOAL: | To provide participants with knowledge of the communication roles and responsibilities and protocols for receiving and sending messages |
| PERFORMANCE OBJECTIVE(S): | <ul style="list-style-type: none">! Identify communication roles and responsibilities! Identify communication guidelines for receiving messages! Identify communication guidelines for sending messages |

INSTRUCTIONAL AIDS:

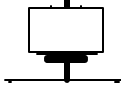
ICON LEGEND
(Those used in this lesson are highlighted)

| | | | | | |
|--|---|----------------------------|---|--|---|
|  |  | Q & A |  |  |  |
| Appendix | Show Overhead | Question and Answer Period | Use Flipchart | Ask Question | Local Requirements |



1. Operator Reporting Requirements
2. Critical Operator Information
3. Radio frequencies
4. Composing Messages
5. Plain English
6. Broadcasting Techniques

INSTRUCTIONAL EQUIPMENT:

Overhead projector and screen
Transparencies
Flipchart and markers

APPENDIX:

Appendix B, Interpreting Hand Signals

Training Tips for: Lesson 3: Communication and Reporting Roles and Responsibilities

- Tip 1. Prepare a diagram on an overhead transparency to show how the communications system works in your area. Who do I need to talk with? Describe how you communicate with other emergency crews in your area and the adjacent areas.
- Tip 2. Get several examples of transmissions on the 911 net on audio tape and use them in class to demonstrate both good and bad examples of communications. Look for the use of jargon and slang and discourage unneeded phrases such as "Be advised".
- Tip 3. Practice using the hand signals in Appendix B before you have the participants practice in class.

| Instructor Notes | Presentation |
|------------------|--|
| | INTRODUCTION |
| | In this lesson we will discuss your responsibilities for routine communication during a run. |
| | Communication is an important part of your vehicle operation role. When you communicate, you tell others where you are and where you're going during a run. This helps dispatchers and other responders to do their jobs and take related actions. |
| | COMMUNICATION RESPONSIBILITIES |
| | You, the ambulance operator, and the entire EMS crew are responsible for routine communications at many points in a run. |
| | Together you must operate as a team, and all team members have tasks that they perform for every situation they are faced with. |
| | Knowing these tasks and what to expect from each other will make your job easier. |
| | The routine reporting points for the ambulance crew are-- |
| | ! prerun |
| | ! when dispatched on a run |

| Instructor Notes | Presentation |
|------------------|---|
| | ! upon scene arrival |
| | ! at the scene to give an update/overview/situation report |
| | \$ before scene departure |
| | ! enroute to the medical facility |
| | ! after arriving at the medical facility |
| | ! when headed back to the station |
| | <p>Emergency Medical Technician (EMT) Communication Responsibility</p> |
| | <p>The EMT in the passenger seat is responsible for communication when the operator is driving. The EMT communicates with the dispatcher, the medical facility, and other agencies.</p> |
| | <p>During the most critical phase of the run--getting to the scene--it is important for the operator to focus on operating the ambulance. The EMT in the passenger seat does the communicating.</p> |

| Instructor Notes | Presentation |
|---|--|
| Navigation will be covered in Lesson 6. | The EMT in the passenger seat should also write down the information you are receiving and direct you to the scene. We will further discuss navigation later in the course. |
| | Unless it is absolutely necessary, do not communicate on the radio and operate the ambulance at the same time. |
| | Dispatcher Responsibility |
| | The dispatcher is another key member of the EMS communication team. The dispatcher coordinates all calls for an agency. |
| | The dispatcher's specific responsibilities vary across locations. Often the dispatcher receives calls for emergency services and determines which crew will handle the call. The dispatcher will alert EMS and may alert additional assistance such as law enforcement, the fire department, heavy rescue, and harbor patrol. Some of these units may be from the same department. |
| | The dispatcher may coordinate with other services responding to an incident. |
| | Operator's Communication Responsibility |
| | Your first responsibility is for safe and efficient operation of the vehicle. |

Instructor Notes

Presentation



1: Operator Reporting Requirements

Comprehensive Inspection and Maintenance Programs

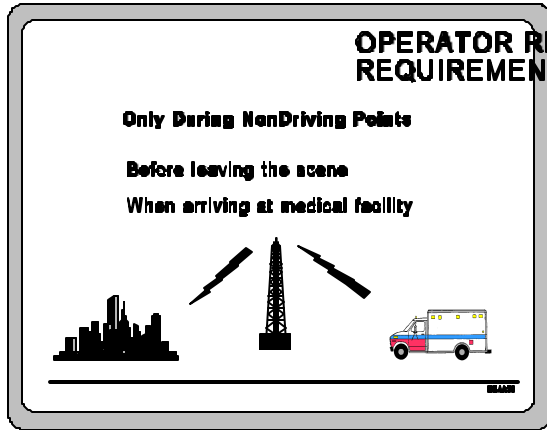

You, the operator, must report to the dispatcher at these points in your run:

! before leaving the scene for the medical facility

! after arriving at the medical facility

(Note to Remember: the EMT generally reports before leaving the station.)

Communicating to the dispatcher at these two points lets the dispatcher follow your movements and coordinate with others as necessary.

Report Before Leaving the Scene

| Instructor Notes | Presentation |
|------------------|---|
| | <p>When you are ready to leave the scene for the medical facility, you will call the dispatcher. Report that you are leaving and proceeding to the medical facility.</p> |
| | <p>The EMT in the patient compartment will establish communication with the hospital, if necessary, to report on the patient's condition and talk with the physicians.</p> |
| | <p>Reporting when you are ready to leave the scene enroute to the medical facility allows you to get information to plan the route you should take from the scene to that facility.</p> |
| | <p>This is information that may not have been available from dispatch before you started your ambulance run because it is fast changing situation. For example, sometimes you will not know which medical facility you will drive to until your EMT diagnoses the medical situation at the scene.</p> |
| | <p>Or if you are in an urban area, you will need information about fast-changing traffic congestion or incidents that could affect your drive from the scene to the medical facility. Also, during severe weather conditions, for example, you may need up-to-the-minute information about ice, snow, flooding, or other hazards on the roads you will drive to the medical facility.</p> |
| | <p>You or your crew should report to dispatch any hazardous condition you find, such as traffic or route problems. This allows the dispatcher to describe up-to-the-minute route conditions for other emergency vehicles as needed.</p> |
| | <p>Report When You Arrive at the Medical Facility</p> |

| Instructor Notes | Presentation |
|--|---|
| | <p>Reporting after you arrive at the medical facility lets the dispatcher know that your crew and vehicle will soon be ready to respond to another service call.</p> |
| | <p>Other Possible Reporting Situations</p> |
| | <p>Tell the dispatcher whenever you are leaving the vehicle. This is important for those of you who do not carry a portable radio when away from your vehicle at a scene. Reporting when leaving the vehicle saves the dispatcher time searching for you.</p> |
|  | <p>Your ambulance operators are required to report at these points during a run:</p> |
| <p>Describe all local operator reporting requirements for <u>when</u> to report. Guidelines for <u>how</u> to report are a later topic in this lesson.</p> | |
| <p>Q&A</p> | <p>When do you, the operator, report to the dispatcher?</p> |

| Instructor Notes | Presentation |
|---|--|
| Ask several participants to answer. If their responses differ, resolve the difference. | <p><i>[Answer: Before you leave the scene for a medical facility and after you arrive at the medical facility.</i></p> <p><i>It's also a good idea to report whenever you leave the ambulance.]</i></p> |
| | RECEIVING MESSAGES |
| | <p>Messages you receive may be for a run from the station or for another run after you have delivered a patient to the medical facility and before returning to the station.</p> |
| | Critical Items to Know for Every Run |
| | <p>The EMT will generally receive the initial service call from the dispatcher and give the information to you, the operator. All information should be recorded on log sheets by the receiving member of your crew.</p> |
| | <p>Be sure you know the following information before starting a run.</p> |
|  2: Critical Operator Information | |

Instructor Notes

Presentation

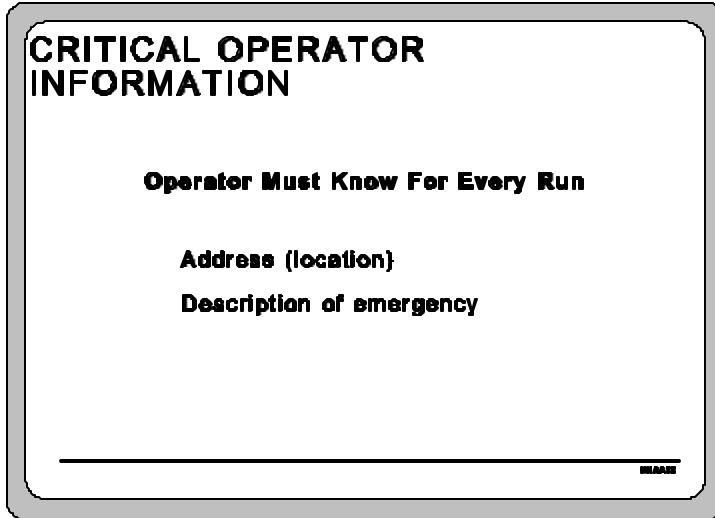

Know the Location

As the operator, the key information you must have is the address or location of the emergency.

You must have the specific location of the emergency to be able to plan your route. Get locator information such as street or highway, house number, nearest intersection and milepost markers. Or get exact directions. Directions may vary from "the Jackson farm" for rural situations to "15th and Main Streets, Northwest" for urban locations.

Know exactly where you are going before you depart.



What kinds of location information do you need in your area to get to any scene?

| Instructor Notes | Presentation |
|---|---|
| <p>Encourage discussion of details of your locality. For example, if yours is a metropolitan area operators may need street name and other designator (15th Street West), house or building number.</p> | |
| <p>If in a suburban or rural area, an operator may need mileposts, nearest intersection, or distance from major landmarks.</p> | |
| | Description of the Emergency |
| | <p>You also will need a description of the emergency. This information will vary greatly based on local practices and who called the operations center. The information known before you arrive at the scene may even be incorrect, especially if given by someone under great stress from an incident.</p> <p>It is even possible that your operations center may give only general information to discourage the tendency to take driving risks in life threatening situations.</p> |

Instructor Notes

Presentation

However, some communities may give response priority as standard information. Sometimes the response priority is given in code.

If possible, you and your crew should know what is involved in the emergency. For example, are vehicles involved? What kind are they and how large are they? You should also know the type of injury, number of patients, and known hazards at the scene, such as downed power lines and/or hazardous materials.

Also, it will help you to know if other units are responding. Some organizations have a standard response that includes fire apparatus, police, and crash trucks. Other organizations will only have multiple responding units when conditions at the scene are known to require them.

If you know others are responding, you can anticipate other emergency vehicles on the route. They may be behind you. Or they may be approaching an intersection at the same time you are. While you will always be alert for all other vehicles on the road, it is helpful to know if other emergency vehicles are responding.

Locally we have these guidelines for information that will be given for every ambulance run:

| Instructor Notes | Presentation |
|---|---|
|  <p>Describe standard information that dispatchers will give.</p> <p>If your jurisdiction uses response priority codes, give the operators a written list of the codes and their meanings.</p> | |
| | |
| | |
| | Review Receiving Messages |
| | Before you leave on a run, you need to have the following information communicated from the dispatcher: |
| | ! address (location) and other identification to help you find the scene |
| | ! description of the emergency |

Instructor Notes

Presentation

Q&A

Are there any questions about the communication you will receive?

Encourage discussion and answer the questions. If you are not sure of the correct answer, get the answers between class sessions and bring them to the class at a later time.

SENDING MESSAGES

We've talked about when you need to report while on a run and what information you need to get before you depart on a run. Now we'll talk about how to report or communicate using the equipment in the ambulance you will drive.

This part covers communication on the radio, the most common type of equipment in use.

Radio Communication Frequencies



3: Radio Frequencies

Instructor Notes

Presentation

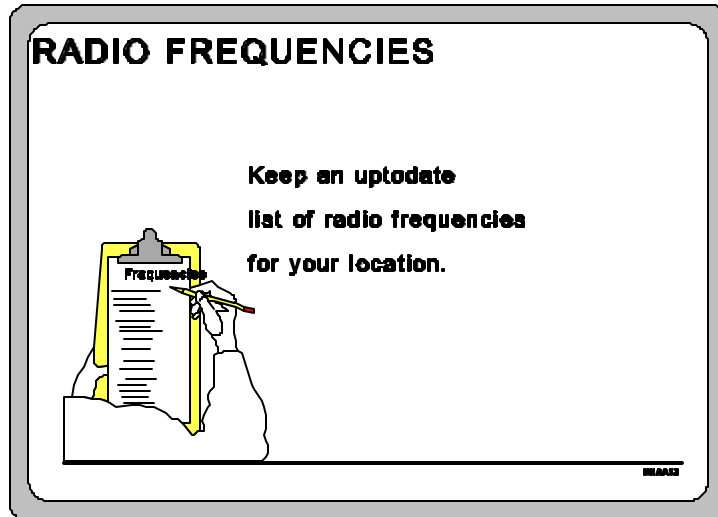

You will need to know the frequencies for the various agencies you will communicate with on a variety of runs. There will usually be one frequency that will be the control frequency. All emergency vehicles can send and receive information from the dispatcher on that frequency.

The EMS, law enforcement agencies, and fire departments often have another frequency to communicate with their own organization.

If you respond to calls to assist other organizations in different cities or counties, those other cities and counties will probably have different frequencies. You will need to know how to communicate with them.

When you respond to an emergency involving several different organizations you need to know how to communicate with the organization that is in charge at the scene. If you don't have the correct frequencies, your operations center can relay information

| Instructor Notes | Presentation |
|---|--|
| | to you. |
| | <p>Some ambulances may have three or more radios that can receive and transmit on different frequencies. Some of these radios will have a switch that will allow you to select a different frequency on the same radio. The ambulance can become a confusing place with several radios all going at the same time.</p> |
| | Communication Security |
| | <p>Most radio transmissions can be heard by anyone who has a radio with the emergency frequency. You must have a policy that protects individual's privacy.</p> |
| | <p>Keeping security in mind, you must limit your transmission to only that which is necessary. Never joke about a situation.</p> |
| | <p>Remember that anyone can listen to the conversation.</p> |
| | What to Say and How to Say It |
|  4: Composing Messages | |

Instructor Notes

Presentation

COMPOSING MESSAGES

Plan

Identify person called, then calling unit

Be brief

Use plain English

Pronounce words clearly

Spell phonetically

Repeat directions



Before you pick up the microphone or other communication device, collect your thoughts and decide what you need to say. It has to be brief.

Your messages to the dispatcher need to include certain information and be presented the same way each time. Messages generally begin with the designation of the unit being called, followed by the designation of the calling unit. You must identify who you are calling, then identify your unit. You are not required to identify yourself by name.

For example, if you are unit 42 calling the dispatcher, you will begin "Dispatch, unit four two."

Brief message formats can be developed locally for routine reports. If you use the same format every time, you will be less likely to forget anything or give too much information.

Instructor Notes

Presentation



5: Plain English

"PLAIN ENGLISH" MESSAGES

**Examples
Use instead of**

Affirmative Yes

Negative No

Five zero Fifty

One five Fifteen

EMERGENCY

The standard language should be plain English, free of codes wherever possible.

Choose words that can be easily understood. For example, "affirmative" is easier to understand than "yes."

Do not use filler words such as "Uh" and "well."

Give numbers in singular form, such as "five-oh" for fifty and "one five" for fifteen so that they cannot be confused. Route 495 is given as "route four nine five." Always pronounce the number "0" as zero.

Many organizations like to use ten codes to reduce air time and identify specific situations or events. However, codes can be misunderstood, especially if you are communicating with some other organization that doesn't use the codes. Numerous organizations are moving away from ten codes and are using

| Instructor Notes | Presentation |
|------------------|--|
| | plain language instead. |
| | Plain language is less likely to cause confusion. Use codes only if they are a requirement of your organization and you are sure the person receiving your communication knows the codes. |
| | Pronounce words clearly and crisply. Speak as clearly as possible and without emotion so you will be understood. Speaking crisply means saying words in full, like "going" instead of "goin'." |
| | Phonetic Alphabet |
| | It is often hard to understand what is being received or transmitted, particularly when reception is poor. For example, we know that similar street names, like "Henry" and Emery," cause confusion. |
| | Your organization should pick one of the phonetic alphabets and use them when needed. The following is the standard phonetic alphabet adopted by the Department of Transportation-- |
| | A - ALFA |
| | B - BRAVO |
| | C - CHARLIE |
| | D - DELTA |

| Instructor Notes | Presentation |
|------------------|--------------|
| | E - ECHO |
| | F - FOXTROT |
| | G - GOLF |
| | H - HOTEL |
| | I - INDIA |
| | J - JULIETT |
| | K - KILO |
| | L - LIMA |
| | M - MIKE |
| | N - NOVEMBER |
| | O - OSCAR |
| | P - PAPA |
| | Q - QUEBEC |

| Instructor Notes | Presentation |
|------------------|--|
| | R - ROMEO |
| | S - SIERRA |
| | T - TANGO |
| | U - UNIFORM |
| | V - VICTOR |
| | W - WHISKEY |
| | X - X-RAY |
| | Y - YANKEE |
| | Z - ZULU |
| | <p>How do you use it? You use it when you are having trouble getting someone to understand or when you can't understand. For example, to spell "Smythe" Street say this:</p> |
| | <p>"Smythe Street: Sierra Mike Yankee Tango Hotel Echo. Smythe."</p> |
| | <p>Repeat all of the directions to be sure that you have them right.</p> |

Instructor Notes

Presentation

Q&A

What are some examples of names or words that can be easily misunderstood over a radio or telephone?

Some examples of words or names that may be misunderstood are "McDonald," and "McDowell," and "Fourth" and "Fort."
Ask participants for examples of real names from your area that can be misunderstood.

Ask one or two participants to spell phonetically two of the examples given by the class.

How to Use the Radio Equipment



6: Broadcasting Techniques

Instructor Notes

Presentation

BROADCASTING TECHNIQUES

Listen

Depress microphone key

Talk with mouth close to microphone

Clear frequency

These are rules to remember when using a radio:

- ! Listen to the frequency to be sure it is clear traffic. If others are talking, wait for them to sign off before using the frequency.
- ! Press the microphone transmit key for a half second before speaking. If you're too quick to begin talking, your first word or syllable may be cut off.
- ! Keep your mouth close to the microphone, no more than 1-1/2 inches away.
- ! Clear the frequency when you finish. The word "out" is a standard way to signal the end of a radio transmission. Example: Unit 43 out.

Instructor Notes

Presentation

Review Sending Messages

Remember, when sending messages--

- ! plan your message
- ! identify unit being called, then your own unit
- ! use brief formats
- ! use plain English where possible
- ! pronounce words clearly
- ! spell names phonetically
- ! repeat all directions

When using a radio--

- ! listen for a clear frequency
- ! depress the key and hold
- ! keep your mouth close to microphone to speak
- ! clear the frequency



You use this kind of equipment in our locality--

Do you use pagers?
radios? cellular
telephones? other
equipment?

Show samples of
equipment used in
your locality.

Instructor Notes

Presentation



This is how our local equipment is different from using a radio--

If pagers are used, tell the operators what to do when they receive a call on the pager. Do they make a radio or telephone call to acknowledge? Or do your pagers allow for one-way voice communication?

Ask participants if they can describe differences between a radio and your local equipment. For example, if you use cellular telephones, you or the other party can interject a comment in a transmission. When using a radio, whoever has the transmit key pressed cannot hear another talk.

If you use pagers for voice transmission, tell participants how to do that.

To send messages using our equipment, you need to do the following:

| Instructor Notes | Presentation |
|--|--|
| | Practice Composing and Sending Messages |
| Use local procedures when possible. | We are going to practice communication. I need two volunteers, one to take the part of a dispatcher and one to be an ambulance operator. |
| | Please listen carefully to what these volunteers say and how they say it. Be ready to discuss the good and not so good points they show. |
| Provide two radio microphones for each participant in this demonstration, if possible. Ask two participants to read the script, one reading the operator part and another reading the dispatcher part. | <p>SCRIPT 1:</p> <p>Operator: "Dispatch, Unit Four Two." Dispatcher: "Unit Four Two, dispatch. Ready to copy." Operator: "Unit Four Two on scene." Dispatcher: "Copy Four Two." Operator: "Four Two changing to hospital frequency." Dispatcher: "Copy Four Two. Out"</p> |
| Q & A | What was done right in that demonstration? |
|  | <p><i>[Answer (points that should have been made):</i></p> <ul style="list-style-type: none"> <i>! identified unit being called then the operator's own unit</i> <i>! used brief statements</i> <i>! used plain English]</i> |
| | What was wrong in that demonstration? |

Instructor Notes

Presentation

Q&A

If participants do not respond, probe further by asking:

Did the operator do the following--

Identify the unit being called, then the operator's own unit?

Keep his or her mouth close to the mike to speak?

Repeat all directions?

Use brief statements?

Use plain English?

Ask two more participants to read the second script.

SCRIPT 2:

Operator: "This is Unit four two calling the dispatcher. Come in, dispatcher."

Dispatcher: "Unit four two, this is your dispatcher. Ready to copy."

Operator: "Unit four two is on the scene at Henry Street and Fourth Avenue."

Dispatcher: "Copy four two."

Operator: "This is Unit four two changing to hospital frequency."

Dispatcher: "Copy four two. Out."

Q&A

What was right with this demonstration?

What was wrong with that demonstration?

Instructor Notes

Presentation

[Answer (points that should have been made):

Operator did not do these:

- ! identify unit being called first, then their own unit*
- ! be brief*
- ! use plain English*
- ! spell names phonetically]*

Describe other right or wrong practices that you observed.

INTERPRETING HAND SIGNALS



Appendix B:

Interpreting Hand Signals

Another kind of communication that an ambulance operator must understand is the method of signaling that a ground guide will do. Turn to Appendix B for a description of recommended hand signals that should be adopted by you and your crew who serve as your ground guides for backing and other driving situations. Your organization should adopt a system of hand signals such as this.

Note: Lesson 7 discusses backing up with the help of a ground guide using agreed-upon hand signals.

SUMMARY

| Instructor Notes | Presentation |
|------------------|--|
| | <p>Your first responsibility is operating the ambulance. The EMT in the passenger seat communicates when you are driving.</p> |
| | <p>The dispatcher coordinates calls for an agency. Dispatcher's specific responsibilities vary.</p> |
| | <p>The operator usually communicates with the dispatcher at only these two points in your ambulance run:</p> <ul style="list-style-type: none">! before leaving the scene for the medical facility! after arriving at the medical facility |
| | <p>When beginning a run you must have the address or location of the emergency and a description of the emergency.</p> |
| | <p>You should keep in your ambulance at all times an up-to-date list of radio frequencies for your locality.</p> |
| | <p>Limit your radio transmission to only that which is necessary. Anyone can listen to your conversation.</p> |
| | <p>To send a message--</p> <ul style="list-style-type: none">! plan messages before you talk! identify the person called and the calling unit! be brief! use plain English! pronounce words clearly! spell confusing names phonetically! repeat directions |

| Instructor Notes | Presentation |
|------------------|--|
| | When using radio equipment-- ! listen ! depress microphone key ! talk with mouth close to microphone ! clear the frequency |
| | Learn to recognize standard hand signals from your ground guide. |





| | |
|------------------|---|
| COURSE: | EMERGENCY VEHICLE OPERATOR COURSE (AMBULANCE): NATIONAL STANDARD CURRICULUM |
| MODULE A: | Ambulance Operation: The Basics |
| LESSON 4: | Ambulance Types and Operation |
| LENGTH: | .5 Hours (May require longer if additional activities are performed) |

| | |
|---------------------|---|
| COURSE GOAL: | To provide ambulance operators with knowledge and skills to operate their vehicles so that their vehicle, equipment, crew, and patients will be delivered safely and efficiently and the safety of the public will be assured during all phases of the delivery of the Emergency Medical Services (EMS) involving the ambulance |
| MODULE GOAL: | To provide ambulance operators with the knowledge required to safely and efficiently operate an ambulance in both non-emergency and emergency modes |
| LESSON GOAL: | To provide participants with knowledge of ambulance types, weight restrictions, and operation |

PERFORMANCE OBJECTIVE(S):

- Identify the types of ambulances
- Identify how size and weight affects the operation and control of an ambulance

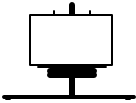
INSTRUCTIONAL AIDS:

| ICON LEGEND (Those used in this lesson are highlighted) | | | | | |
|--|--|----------------------------|--|--|--|
|  |  | Q & A |  |  |  |
| Appendix | Show Overhead | Question and Answer Period | Use Flipchart | Ask Question | Local Requirements |



1. Star of Life
2. Type I Ambulance
3. Type II Ambulance
4. Type III Ambulance
5. Size
6. Weight

**INSTRUCTIONAL
EQUIPMENT:**

Overhead projector and screen
Transparencies

Training Tips for: Lesson 4: Ambulance Types and Operation

- Tip 1. Get a copy of the Federal Specification for Ambulances, KKK-A-1822C. Know the information in this specification and in particular what the differences are between each type of ambulance. The KKK specification has been revised and 1822D will be available in 1995.
- Tip 2. Make every effort to have an ambulance of each type available. You may want to coordinate presenting this lesson on the same day as Lesson 5 on Inspections. Both classes are much better if you have the ambulances.
- Tip 3. If you get the ambulances, be sure that they represent the examples you want to show. A participant may drive one to the class that is used more for administrative runs and it may not be a good example.

| Instructor Notes | Presentation |
|---|---|
| | INTRODUCTION |
| | <p>In this lesson we'll talk about ambulance types and operation. Ambulance types vary according to location, but there are general guidelines about weight restrictions and operation that you need to know. In addition, we'll cover the specifics of the ambulances that we use here in your area.</p> |
| <p>ADDITIONAL ACTIVITY:</p> <p>Have photographs of the ambulances used in your area available to pass around or posted on the walls.</p> <p>You may also write to the manufacturers of your ambulance types for brochures.</p> | AMBULANCE TYPES |
| | <p>The KKK-A-1822C Federal Specification standards, published by the General Services Administration (GSA), recognize three types of ambulances--Type I, Type II, and Type III.</p> |
| | <p>The "Star of Life" emblem may be displayed on the ambulance when the manufacturer certifies to the purchaser that the ambulance, it's components and equipment meet or exceed the tests in the KKK specification. This emblem certifies that the ambulance meets minimum specifications and passed certain</p> |

Instructor Notes

Presentation

tests, as well as design, performance, equipment, and appearance requirements.



1: Star of Life

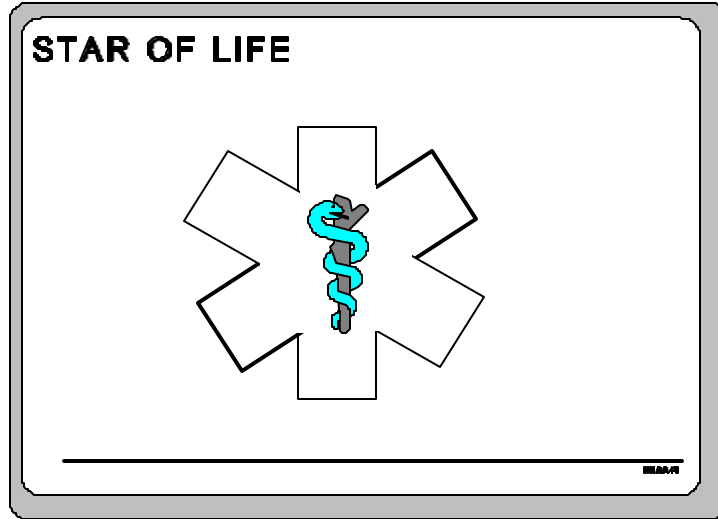

If students have an interest in the specific "Star of Life" standards, refer them to the KKK-A-1822C, "Federal Specification For Ambulances" document distributed by the GSA.

In this lesson we will only discuss the body types, service capability, classes, and weight restrictions of these three types of ambulances.

If your area has only one type of ambulance you may go on to the description of that type. It is

Instructor Notes

Presentation

recommended that participants be familiar with all three types.

Type I Ambulance



2: Type I Ambulance

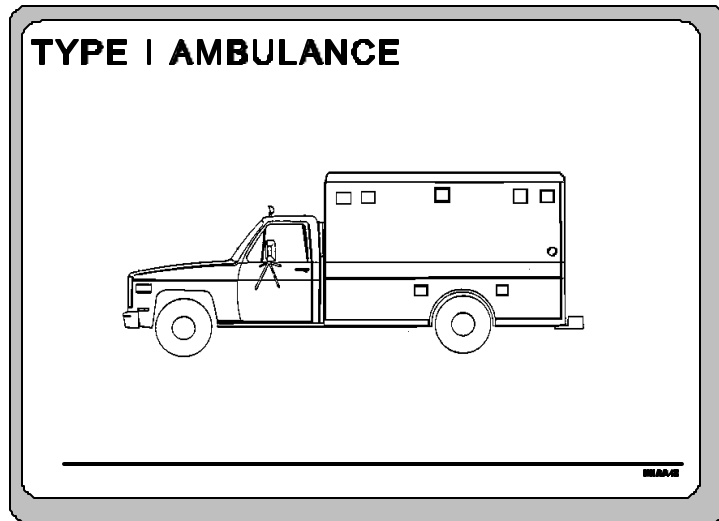

Body type: Conventional Truck, Cab-Chassis with Modular Body Ambulance

Service Capacity: Basic Life Support (BLS) or Advanced Life Support (ALS)

Classes: Class 1 - Two-Rear-Wheel Drive or Class 2 - Four-Wheel Drive

Instructor Notes

Presentation

Type II Ambulance



3: Type II Ambulance

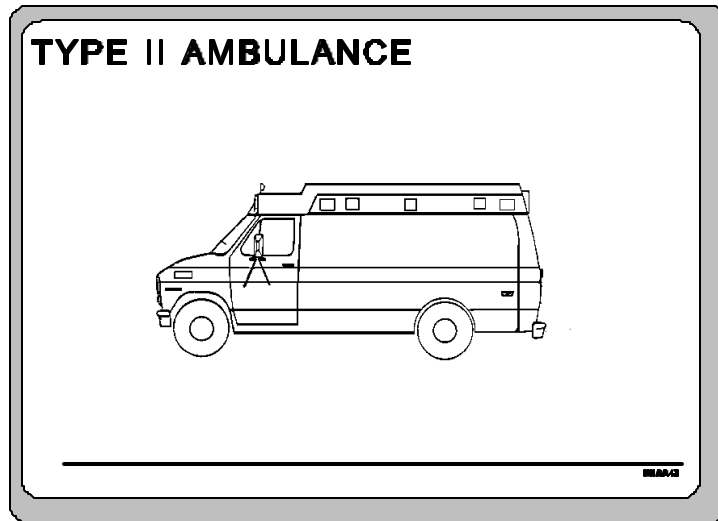

Body type: Standard Van, Integral Cab-Body Ambulance

Service Capacity: Basic Life Support (BLS) or Limited Advanced Life Support (ALS)

Classes: Class 1 - Two-Rear-Wheel Drive or Class 2 - Four-Wheel Drive

Type III Ambulance



Instructor Notes

Presentation

4: Type III Ambulance

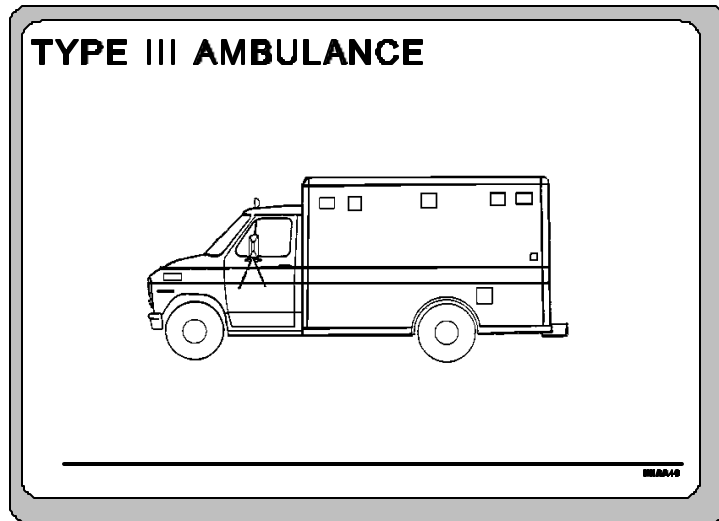

Body type: Cutaway Van, Cab-Chassis with Integral or Containerized Modular Body Ambulance

Service Capacity: Basic Life Support (BLS) or Advanced Life Support (ALS)

Classes: Class 1 - Two-Rear-Wheel Drive or Class 2 - Four-Wheel Drive



Your organization uses the following type(s) of ambulances:

ADDITIONAL
ACTIVITY:

If you are

| Instructor Notes | Presentation |
|--|---|
| <p>presenting this training where ambulances are available, this is an opportunity to take the participants to the ambulance(s) and go over configuration.</p> | |
| <p>Point out the equipment that the ambulance carries, and how it is stowed and secured.</p> | |
| <p>Demonstrate the operation of the emergency lights and equipment.</p> | |
| <p>If more than one ambulance type is used, point out the differences.</p> | |
| | <p>If you usually operate the same type of ambulance, you will get to know all of the operating equipment and how to use it in a variety of situations.</p> |
| | <p>If you might be assigned to drive a type of ambulance you have never driven before, have your supervisor (or another qualified operator) give you an orientation to the new ambulance. You should have an opportunity to PRACTICE driving a new ambulance type and pass a written and performance test before you operate the ambulance.</p> |

| Instructor Notes | Presentation |
|--|---|
| | Weight Restrictions |
| | No matter what type of ambulance you drive, you must know your ambulance's weight restrictions in order to operate safely during all driving conditions. |
|  | When an ambulance arrives at your facility from the manufacturer it is labeled with a gross weight. You can usually find this information on the weight/payload certification sticker mounted on the body in a conspicuous location. |
| <p>ADDITIONAL ACTIVITY:</p> <p>If you are presenting this training where ambulances are available, this is an opportunity to take the participants to the ambulance(s) and locate the gross weight information for the ambulance(s).</p> | |
| | The payload capacity is part of gross weight and represents the MAXIMUM safe weight of your emergency equipment, crew, and patients. This capacity has already been determined at your facility and should be displayed on the ambulance. The payload capacity is part of gross weight and represents the MAXIMUM safe weight of your emergency equipment, crew, and patients. This capacity has already been determined at your facility and should be displayed on the ambulance. |

Instructor Notes

Presentation

ADDITIONAL
ACTIVITY:

If you are presenting this training where ambulances are available, this is an opportunity to take the participants to the ambulance(s) and locate payload capacity information for the ambulance(s).



Payload capacity information is found in:

The payload capacity is used to determine--after considering equipment weight--how many crew members and patients it is safe to transport. By the way, the national standard for determining the weight of one person is 175 pounds per person.



With a crew of _____
our ambulances can safely carry _____ pounds
or _____ patients.

What are the weight/patient restrictions with only the ambulance operator and an EMT as crew?

| Instructor Notes | Presentation |
|---|---|
|  <p>What are the weight/patient restrictions with one operator and two EMTs as crew?</p> | <p>With a crew of _____ our ambulances can safely carry _____ pounds or _____ patients.</p> |
| | <p>Each ambulance organization should have a current loading plan in the ambulance log book. The loading plan should have the current payload, i.e., how much the ambulance can carry.</p> |
| | <p>The loading plan should distribute the weight of the patient, crew, and equipment evenly. Too much weight in one location can change the handling characteristics of the ambulance.</p> |
| | <p>As equipment is added to the ambulance, the new weight should be figured and the loading plan updated. Remember that for each piece of equipment added, the patient and passenger weight that can be safely carried decreases.</p> |
| | <p>Knowing how many people you can carry and keeping an accurate loading plan will help you decide how to load your ambulance.</p> |
| | <p>Just because you have seats available does not mean that you can load a patient or passenger into each one.</p> |
| | <p>And just because your ambulance is designed to carry only two</p> |

| Instructor Notes | Presentation |
|------------------|---|
| | <p>patients does not mean that you leave a third patient at a crash scene rather than loading them.</p> |
| | <p>Two children might actually equal one adult person. Remember that an average weight of 175 pounds is used to calculate passenger and patient capacity.</p> |
| | <p>The most important thing for you to know and remember about ambulance types and weight restrictions is HOW MANY PATIENTS AND PASSENGERS YOU CAN SAFELY TRANSPORT.</p> |
| | <p>Your good judgment is needed. If you are the only ambulance at a crash scene, you may have to load more weight than ideally recommended. If you know that your ambulance is overweight, you can adjust your driving to accommodate the situation.</p> |
| | <p>OPERATION</p> |
| | <p>Besides the limitations put on you by the weight restrictions of your ambulance, there is a difference between driving a car and driving an ambulance. These differences make an ambulance harder to drive than a car. You need to know these differences and understand how they affect your ability to operate the ambulance safely.</p> |
| | <p>Size</p> |
| | <p>An ambulance is larger than a standard car. It is wider, longer, and taller which makes it harder to maneuver. The ambulance's width and length affects turning; its height means you must be</p> |

Instructor Notes

Presentation

aware of height clearances (for example, parking garages, bridges or overpasses, covered entrances).



5: Size

Differences Affect Maneuvers

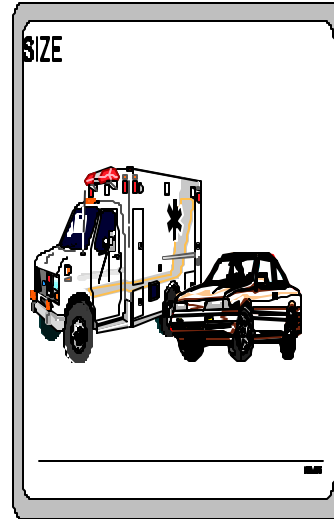

Q & A

What other problems can the size of your ambulance cause?



In your area, what are some specific places where we have to exercise extra caution because of the size of our ambulances?

Weight

An ambulance may weigh more than a car. This is important to remember because it takes longer to accelerate and brake.

Instructor Notes

Presentation

When pulling out into traffic, for example, an ambulance will not move out as quickly as a car. When braking, you will need more room to come to a complete stop.



6: Weight

Differences Affect Accelerating
and Braking

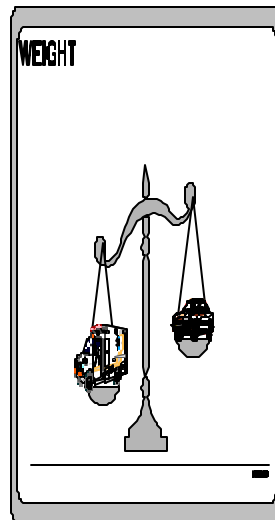
**Visibility**





Because of an ambulance's size and style, there are blind spots that can block your view of objects and vehicles around you. You must rely heavily on your side view mirrors since a rear view mirror is not always available.

Even when a rear view mirror is provided, it may not be as usable as you would like. Rear view mirrors are mostly useless even in Type II ambulances. Activities in the patient compartment may block your view out of the back of the ambulance. Plan on using your side mirrors only.

| Instructor Notes | Presentation |
|--|---|
| | This is why you should ALWAYS use a ground guide when backing up. |
| Q&A | What are some other situations when your vision might be blocked? What can you do about it? |
| Allow participants to discuss some other visibility concerns and provide them with possible solutions. | <i>[Answers: Night and reduced visibility; when the crew consists only of you and the EMT and the EMT is with a patient, you must check out the area behind your ambulance before backing up; accident scenes are always confusing, even after you clear behind the ambulance, back slowly and watch both mirrors; confined areas at the medical facility for ambulances]</i> |
| | SUMMARY |
| | There are three KKK-recognized types of ambulances--Type I, Type II, and Type III. |
| | Weight restrictions of the ambulance type determines the maximum number of crew and patients you can safely carry. |
| | All ambulance types require extra caution when driving because of their size, weight, and visibility. |

| | |
|----------------------------------|---|
| COURSE: | EMERGENCY VEHICLE OPERATOR COURSE (AMBULANCE): NATIONAL STANDARD CURRICULUM |
| MODULE A: | Ambulance Operation: The Basics |
| LESSON 5: | Vehicle Inspection, Maintenance, and Repair |
| LENGTH: | 2 to 3 Hours |
| COURSE GOAL: | To provide ambulance operators with the knowledge and skills to operate their vehicles so that their vehicle, equipment, crew, and patients will be delivered safely and efficiently and the safety of the public will be assured during all phases of the delivery of the Emergency Medical Services (EMS) involving the ambulance |
| MODULE GOAL: | To provide ambulance operators with the knowledge required to safely and efficiently operate an ambulance in both nonemergency and emergency modes |
| LESSON GOAL: | To provide participants with knowledge of ambulance operator responsibilities for vehicle inspections and maintenance |
| PERFORMANCE OBJECTIVE(S): | <ul style="list-style-type: none"> ! Select from a list the operator's responsibilities for vehicle inspection ! Select from a list the operator's responsibilities for vehicle maintenance and repair |

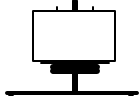
INSTRUCTIONAL AIDS:

| ICON LEGEND (Those used in this lesson are highlighted) | | | | | |
|---|---|---|---|---|---|
|  |  |  |  |  |  |
| Appendix | Show Overhead | Question and Answer Period | Use Flipchart | Ask Question | Local Requirements |



1. Safe Operating Condition
2. Mechanical Systems
3. Systematic Inspections
4. Recommended Inspection Schedule
5. Inspection Types
6. Sample Checklist: Quick Check
7. Inspection Sequence
8. Operator Negligence
9. Preventive Maintenance
10. Operator Maintenance Responsibilities
11. Decision Aid for Vehicle Malfunctions While in Service

INSTRUCTIONAL

Overhead projector and screen
Transparencies

EQUIPMENT:

Ambulance (recommended, but not required)

APPENDIX:

C: Sample Checklist: Quick Check
D: Sample Checklist: Full Check
E: Sample Work Request

Lesson 5: Vehicle Inspection, Maintenance and Repair

- Tip 1. Spend some time with the maintenance officer of your organization or local ambulance organizations. Discuss with them the problem areas that you can cover in the lesson that will help do a better job in the organization.
- Tip 2. Get copies of the inspection forms being used by local organizations and compare them with the sample forms in Appendixes C and D.
- Tip 3. Organizations vary in how the crew reports maintenance problems. Look at the sample work request form in Appendix E.
- Tip 4. The forms provided for this lesson are samples and each organization should develop their own form. Emphasize that if the inspection is not recorded in some form, it will be difficult to prove that it did take place.
- Tip 5. Find out some of the maintenance problems that would put an ambulance out of service. Who decides that the ambulance should be put out of service? Does every one in the organization know how to contact the supervisors if they are not present? Does the Standard Operating Procedure (SOP) cover maintenance procedures? If possible have copies of the SOP to show the participants.
- Tip 6. Every area has some severe weather conditions that will affect ambulance operations. Make a list of the weather conditions that can affect the operation and maintenance of ambulances in your area. Discuss these conditions and how operators can best deal with them.
- Tip 7. If possible have an ambulance available to demonstrate how to conduct and record a quick and full check. If this is not possible when you conduct the class, try to get each participant to conduct these inspections at the practice driving range during Module B.

| Instructor Notes | Presentation |
|---|--|
| | INTRODUCTION |
| | Normal ambulance operation puts great demands on the vehicle. If your ambulance breaks down during a run, lives may be endangered. In addition, you may be held legally responsible for any preventable mechanical failures that lead to accidents or loss of life. |
| | One of your most important responsibilities as an ambulance operator is checking the condition of your vehicle and deciding if it is in safe operating condition and ready for a run. |
| | When you place a vehicle in service by taking it out on a run, you are assuming personal responsibility for its operating condition. |
| Q&A | How can you ensure that your ambulance is in a safe operating condition? |
|  1: Safe Operating Condition | |

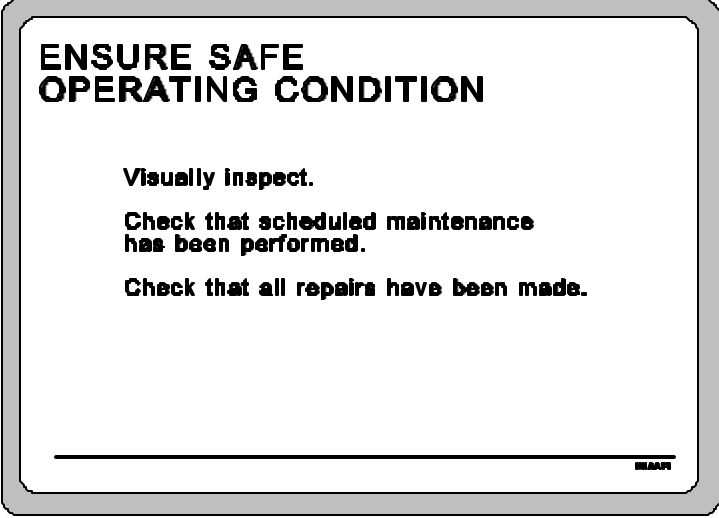
| Instructor Notes | Presentation |
|------------------|---|
| |  |
| | By-- |
| | ! inspecting the vehicle according to established procedures |
| | ! checking that all scheduled maintenance has been performed |
| | ! checking that all needed repairs have been made |
| | If a vehicle is NOT in a safe operating condition, you, as the operator have the responsibility to take the vehicle out of service until the problems have been fixed. |

**Instructor
Notes**

Presentation

In this lesson we'll discuss how **you** can make sure that appropriate inspection, maintenance, and repairs have been performed--before you decide whether or not to place your ambulance in service. The information presented will apply, in general, to all EMS organizations.

Your organization may have different policies and procedures than those presented, and we will discuss those differences throughout the lesson.

MAJOR MECHANICAL SYSTEMS



2: Mechanical
Systems

MAJOR MECHANICAL SYSTEMS

- Engine/drive train**
- Cooling system**
- Braking system**
- Electrical system/auxiliary power**
- Environmental control systems**
- Support equipment**

_____ MEAS

Before we begin talking about inspecting your vehicle, let's quickly go over its major mechanical systems, such as engines, drive

| Instructor Notes | Presentation |
|--|--|
| | <p>trains, and cooling systems. Since most ambulances are specialized bodies added to truck frames, there are many similarities between different makes and models.</p> |
| | <h3 data-bbox="505 667 781 705">Engine/Drive Train</h3> |
| | <p>The weight of the vehicle and its installed auxiliary systems require most ambulances to have a large engine, either diesel or gasoline powered. To provide the smoothest ride possible, these powerplants are most often connected to automatic transmissions.</p> |
|  <p data-bbox="217 1220 451 1436">Briefly describe engine/transmission combinations. Select a typical engine and transmission for future reference.</p> | <p>Your supervisor will discuss the specific engine/transmission combination of the ambulance you will be operating. For our discussions, we will use a ____ engine and ____ transmission.</p> |
| | <h3 data-bbox="505 1520 745 1558">Cooling System</h3> |
| | <p>Heavy duty vehicles, such as ambulances, require heavy duty engine cooling systems. It is critical that you check the fluid level of the cooling system every day, especially in hot weather. Remember to follow the correct procedures for your vehicle. Severe burns can be the result of doing this check wrong.</p> |

| Instructor Notes | Presentation |
|---|--|
| | <p>Transmission fluid cooling systems are installed in many ambulances to maintain proper operating temperatures and to help prevent breakdown of the transmission fluid.</p> |
| | <p>Braking System</p> |
| | <p>There are two types of brake systems in use today. The older, drum-type brakes are still used extensively in trucks. Many of the newer vehicles use the more reliable disc brakes. These two types are often used together, with the disc brakes installed on the front wheels, where most of the braking effort occurs, and drum brakes on the rear. Anti-lock braking systems are now available from some truck manufacturers and are especially efficient on snow and ice.</p> |
|  <p>Briefly describe installed brake systems.</p> | <p>Brake systems on our vehicles are--</p> |
| | <p>Electrical System/Auxiliary Power</p> |
| | <p>With the additional demand of emergency lighting systems, sirens, and installed medical support systems, the electrical system is a vital component of your ambulance. These heavy-duty systems require careful attention and monitoring to ensure that they retain peak efficiency.</p> |

| Instructor Notes | Presentation |
|---|--|
| | <p>To provide electrical power while parked, without drawing from the ambulance's battery(ies), many units have auxiliary power systems installed. An auxiliary power system is a small, engine-powered generator, such as a portable generator. It is independent of the ambulance's electrical system and is used during heavy electrical load conditions. Auxiliary power systems are normally mounted in the rear of the ambulance and are used to power the lights and basic life support equipment while parked.</p> |
| | <p>Most ambulances are equipped with a DC to AC inverter to provide AC power. The inverter provides a constant 115 volt AC power source for onboard AC systems. The patient compartment has AC outlets for using AC systems. Some of your lighting is also powered by AC. The crew will select AC power when needed to supply certain systems in the ambulance. When they activate the inverter a red light indicator will be illuminated. Your supervisor will cover the operation of the inverter when you get your orientation on the ambulance that you will be driving. For more information about inverters and AC power supplies, check with your maintenance supervisor and consult the General Services Administration Federal Specification for Ambulances, KKK-A-1822C.</p> |
|  <p>Describe the auxiliary power systems in use, and which vehicles have and which do not have them.</p> | <p>Your vehicles have (do not have) auxiliary power systems.</p> |

| Instructor Notes | Presentation |
|---|---|
| <p>ADDITIONAL ACTIVITY: If an ambulance is available, demonstrate the location, operation, and use of the auxiliary power system.</p> | |
| | <p>Environmental Control Systems</p> |
| | <p>Environmental control systems are the heating and air conditioning systems. Some vehicles may have separate units for the cab and the patient compartment.</p> |
| | <p>Support Equipment</p> |
| | <p>All ambulances have similar basic medical support equipment installed by the manufacturer. Each organization then customizes its vehicles with additional equipment, often outfitting vehicles to meet specific requirements. So, not all vehicles will carry the same equipment.</p> |
| | <p>When the typical ambulance leaves the factory, it is designed to carry a driver and an EMT at 175 lbs. each, two patients at 175 lbs. each, and the following medical support equipment:</p> <ul style="list-style-type: none"> ! main and portable oxygen bottles ! stretchers, cots, and patient handling equipment ! portable, removable medical devices |

| Instructor Notes | Presentation |
|--|--|
| | <ul style="list-style-type: none">! durable and disposable medical items! optional vehicle equipment such as battery charger, inverter, or auxiliary power unit! communications equipment! extrication and rescue equipment |
|  <p>Briefly describe the support equipment installed in each ambulance.</p> | <p>In addition to this equipment, carry the following equipment in your vehicles:</p> |
| <p>ADDITIONAL ACTIVITY: If an ambulance is available, identify and demonstrate the proper storage of the support equipment carried in the ambulance.</p> | |
| | <p>As the operator, you will be responsible for inspecting your vehicle and for properly operating its mechanical systems. You may also be responsible for providing routine servicing and preventive maintenance for each system and its components.</p> |

**Instructor
Notes**

Presentation



Describe the maintenance/repair function of your organization.

For other maintenance and repairs, you will--

VEHICLE INSPECTION

The most important way to check the operating condition of your vehicle is to inspect it regularly and to document the results of those inspections.



3: Systematic Inspections

**SYSTEMATIC VEHICLE
INSPECTIONS**

- Find and report problems.**
- Track preventive maintenance.**
- Document vehicle condition.**

| Instructor Notes | Presentation |
|------------------|---|
| | <p>By conducting regular, systematic vehicle inspections, you are able to--</p> |
| | <p>! find and report problems that need to be fixed</p> |
| | <p>! keep track of preventive maintenance requirements</p> |
| | <p>! document the overall condition of the vehicle</p> |
| | <p>You will evaluate the results of your inspection before deciding whether or not to place the vehicle into service.</p> |
| | <h3>Inspection Standards</h3> |
| | <p>The ASTM Standard Guide for Training Emergency Medical Services Ambulance Operators inspection standards were used to develop the inspection procedures presented in this lesson and may be adopted in whole or in part by your organization. These standards provide a minimum acceptable level of vehicle inspection.</p> |
| | <h3>Inspection Methodology</h3> |
| | <p>To ensure that vehicle inspections are consistent, thorough, and accurate, each EMS organization develops specific vehicle inspection procedures and checklists to meet its needs. The completed checklists are then kept on file and are used to</p> |

| Instructor Notes | Presentation |
|--|--|
| | <p>document the condition of the vehicles. We will look at examples of these procedures and checklists later in the lesson.</p> |
| | <p>Importance of Maintaining Records</p> |
| | <p>If an emergency vehicle is involved in a crash, and there is the possibility that a mechanical malfunction was the cause, the courts would be very interested in reviewing the maintenance records of the ambulance. If the operating organization knew in advance of the malfunction and continued to operate the vehicle, it may be found negligent and held liable for all damages resulting from the crash.</p> |
| | <p>Maintenance organizations must be able to document in writing the servicing, maintenance, and repair of their vehicles and equipment. A good general guideline for documenting inspections and maintenance actions is: "If it's not in writing, it did not happen."</p> |
| | <p>Inspection Schedule</p> |
| | <p>The schedule below is a <u>recommendation</u> and may be different from the one used in your organization. Whether you inspect by number of runs per week, by hours of operation, or by specific days of the week, the important thing is that you inspect according to a specific schedule and that you strictly stick to that schedule.</p> |
|  <p>4: Recommended</p> | |

**Instructor
Notes**

Presentation

Inspection
Schedule

| RECOMMENDED INSPECTION SCHEDULE | | |
|--|-----------------------|-----------------------|
| RUNS PER WEEK | FULL CHECK | QUICK CHECK |
| 1 | Every 96 hours | Every 24 hours |
| 2 | Every 72 hours | Every 24 hours |
| 4 | Every 48 hours | Every 24 hours |
| 6 | Every 24 hours | Every 12 hours |
| 8 | Every 24 hours | Every 8 hours |

An organization's inspection schedule is determined by a number of factors, including vehicle age and mileage, insurance requirements, and past experience.



Our organization's inspection schedule is--

Q&A

How are our inspection procedures different from the recommended procedures?

**Instructor
Notes**

Presentation

Inspection Types



5: Inspection Types

VEHICLE INSPECTIONS

Quick check for systems to check most often.



Full check for all systems checked without special equipment or facilities.

© 2008

There are two types of vehicle inspections recommended for ambulances:

- ! The **Quick Check** covers those systems that should be checked most often.

- ! The **Full Check** covers all vehicle systems that can be checked without special equipment or facilities.



| Instructor Notes | Presentation |
|---|--|
| | <p>QUICK CHECK</p> |
| | <p>Checklist</p> |
| | <p>Let's look at a sample checklist for the Quick Check.</p> |
| <p></p> <p>Appendix C</p> <p>Sample Checklist: Quick Check</p> | <p>Turn to Appendix C, the Sample Checklist for the Quick Check.</p> |
| <p></p> <p>6: Sample Checklist: Quick Check</p> | <div data-bbox="558 1304 1276 1814" style="border: 2px solid gray; padding: 10px;"> <p style="text-align: center;">SAMPLE CHECKLIST</p>  </div> |

| Instructor Notes | Presentation |
|------------------|---|
| | Your organization's checklist may not look exactly like this one, and it may include different items arranged in a different order. |
| | We'll cover the recommended inspection checklist items before identifying our local differences. |
| | Look at the top of the page. The first things you should fill out are the unit or ambulance number, the station where it is located, and the date and time of the inspection. This important information is included because the form may be reviewed by someone not from your organization and at a much later date. You may not be present to explain your entries. |
| | Notice the instructions in the block at the top of the page. When you conduct the inspection, you should-- |
| | <p>! inspect each item and place a check mark in the column labelled OK if there are no problems. By checking off an item as OK, you verify that you (1) inspected it and, (2) found no problems with it.</p> |
| | <p>! fix any problems found, if you are capable <u>and</u> authorized to do so, and document that you did so in the Work Completed block, OR file a work request for the problem(s) found</p> |
| | Note that any starred (*) problems must be fixed before the vehicle is placed in service. |

| Instructor Notes | Presentation |
|--|---|
| | <p>! decide whether or not to place the vehicle in service and document your decision by circling the appropriate word in the printed statement above your signature</p> |
| | <p>! sign and date the checklist</p> |
| | <p>This is how you document that you have properly completed the inspection; according to your judgement, the vehicle <u>is</u> or <u>is not</u> in safe operating condition.</p> |
| | <p>Remember that all starred (*) problems <u>must be fixed</u> before the ambulance is placed in service.</p> |
| | <p>Checklist Format</p> |
| <p>On the overhead "The Sample Checklist" (#6), point out the ambulance diagram.</p> | <p>Ambulance Diagram</p> |
| | <p>This diagram shows the eight areas that you will inspect.</p> |
| | <p>Inspection Sequence</p> |

| Instructor Notes | Presentation |
|---|--|
| | <p>Notice that the inspection is divided into specific areas of the ambulance. You will have several items to inspect in each area. The sequence is designed so that you inspect all the listed items in one area before moving clockwise around the vehicle to the next area. Because all the items to be inspected are listed by area, there is less chance that you will forget an item that was called out in a previous area.</p> |
| | <p>For example, if, in area three, you were directed to "inspect the tires," you would have to either break off your inspection of the left front of the vehicle and inspect all four tires, or you would have to hope that you didn't forget to inspect the other three tires as you continued around the ambulance. Your organization's checklist may be organized differently.</p> |
| | <p style="text-align: center;">Area Rows</p> |
| <p>On the overhead, point out the rows that show the Areas which correspond to the numbers on the diagram.</p> | <p>These are the areas that you will check and in the recommended sequence.</p> |
| | <p style="text-align: center;">Items Column</p> |
| <p>On the overhead, point out the column titled Items.</p> | <p>These are the items that you will check in each area.</p> |

| Instructor Notes | Presentation |
|---|---|
| | Check Column |
| <p>On the overhead, point out the column titled Check.</p> | <p>For each item listed, this is what you are to check. As we walk through the checklist, I will tell you what is meant by each check you are to perform.</p> |
| | Problem Column |
| <p>On the overhead, point out the column titled Problem.</p> | <p>In this area, briefly describe any problems discovered. If you think the problem makes the vehicle unserviceable, put a star (*) to the left of the description of the problem. These starred items (*) must be corrected before placing the vehicle in service.</p> |
| | <p>NOTE: Some organizations may have a list of problems which make a vehicle unserviceable. If in doubt about a problem, consult the list or contact maintenance.</p> |
|  | <p>Our organization has (does not have) such a list. It is located--</p> |
| | <p>A single problem without a star may not keep you from placing the vehicle in service. However, if there are multiple problems,</p> |

| Instructor Notes | Presentation |
|--|---|
| | <p>consider how the overall operation of the vehicle is affected and whether the combination of problems should keep the vehicle out of service.</p> |
| | <p>Example 1: Suppose a vehicle you have inspected has one cracked turn signal lens and a slow oil leak. Depending on organization guidelines and other circumstances, you may or may not place the vehicle in service. Before making your decision, you may want to talk to a supervisor and/or maintenance.</p> |
|  | <p>Our organization would handle this example by--</p> |
| | <p>Example 2: One organization might let a vehicle go on a run with a broken windshield wiper on a clear day; another organization might take the vehicle out of service. In either case, the problem should be documented and the repairs made as soon as possible.</p> |
|  | <p>Our organization would handle this example by--</p> |
| | <p>OK Column</p> |

| Instructor Notes | Presentation |
|--|--|
| On the overhead, point out the column titled OK . | Check here if there are no problems in the area inspected OR if you found a problem and have fixed the problem yourself. |
| | Work Request Column |
| On the overhead, point out the column titled Work Request . | If you find a problem and <u>are not able</u> or <u>are not authorized</u> to fix it yourself, file a work request with your maintenance organization. |
| | Work Completed/Other Remarks Column |
| On the overhead, point out the column titled Work Completed/Other Remarks . | Organization policies and procedures will tell you which specific items you are authorized to service or repair yourself. Note all work you did and any other information about the problem. |
| | Preparation |
| | To prepare for performing the Quick Check, you need to do three things: |
| | ! Arrange for another crew member to help you check the lights. |
| | ! Place wheel chocks where you can quickly retrieve them if |

| Instructor Notes | Presentation |
|--|---|
| | required. |
| | ! Get a blank checklist and fill out the administrative information. |
| | Inspection Sequence |
|  <p>7: Inspection Sequence</p> | <div style="border: 2px solid gray; padding: 10px; text-align: center;"> <p>INSPECTION SEQUENCE</p> <ol style="list-style-type: none"> 1. Overall appearance 2. Operator compartment 3. Exterior: operator's side 4. Exterior: front 5. Engine compartment 6. Exterior: passenger's side 7. Patient compartment 8. Exterior: rear </div> |
| <p>Point out the main phases of the inspection by number on the overhead.</p> | <p>There are eight specific areas to be checked during the quick check inspection. They are--</p> |
| | <p>1) Overall Appearance</p> |

| Instructor Notes | Presentation |
|--|--|
| | |
| | 2) Operator Compartment |
| | 3) Exterior: Operator's Side |
| | 4) Exterior: Front |
| | 5) Engine Compartment |
| | 6) Exterior: Passenger's Side |
| | 7) Patient Compartment |
| | 8) Exterior: Rear |
| | When we cover the Full Check, you will see that we use these same eight areas. We just cover more items and in greater detail during the Full Check. |
| ADDITIONAL ACTIVITY: If an ambulance is available, perform a Quick Check. Identify installed equipment and demonstrate how to check each item. | |

| Instructor Notes | Presentation |
|--|--|
| <p>NOTE: The participants will each perform a Quick Check and a Full Check during Modules B and C.</p> | |
| <p>Point to area 1 on the overhead. Refer participants to the Sample Checklist: Quick Check in Appendix C.</p> | <p>1) Overall Appearance</p> |
| | <p>! Check vehicle cleanliness.</p> |
| | <p>Your overall appearance to the public as a professional organization is enhanced by a clean, well-maintained vehicle.</p> |
| | <p>! Check general vehicle condition.</p> |
| | <p>Is the vehicle sitting level?</p> |
| | <p>Are there any puddles or other signs of visible fluid leaks?</p> |
| | <p>Are there any signs of new, unreported body damage?</p> |
| <p>Point to area 2 on the overhead.</p> | <p>2) Operator Compartment</p> |

| Instructor Notes | Presentation |
|------------------|--|
| | ! Check the vehicle log. |
| | The most recently completed Full Check and Quick Check checklists should be in the log, along with blank copies of the run report and a complete inventory list of installed equipment. |
| | ! Check for stowage of items. |
| | ! Be sure switches for lights and communication equipment are in the "off" position. |
| | ! Adjust the seat, seat belt, and side view mirrors. |
| | ! Release the hood latch. |
| | ! Turn the key to the ON position and check the fuel gauge. |
| | Each organization has specific procedures for refueling. An urban organization that makes several short runs each day may elect to refuel at the end of each day or when the quantity drops below 1/2 full. But a rural organization that only makes a few runs each week may refuel after each run because runs of 40-100 miles are common and fuel may not be readily available. |

| Instructor Notes | Presentation |
|--|--|
| | <p>Routine refueling should occur when the fuel level is between 1/2 and 3/4 empty. Follow your organization's procedures for refueling.</p> |
|  | <p>Your organization uses the following refueling procedures:</p> |
| <p>Point to area 3 on the overhead.</p> | <p>3) Exterior Walk-around: Operator's Side</p> |
| | <p>! Check left outside mirror bracket for general condition.</p> |
| | <p>! Check left side window for general condition.</p> |
| | <p>! Check left side of windshield and left wiper for general condition.</p> |
| | <p>! Check the left front wheel and tire for general condition.</p> |
| | <p>! Check the tire for a properly inflated appearance, but do not check tire pressure.</p> |
| | <p>! Check left front fender for general condition.</p> |

| Instructor Notes | Presentation |
|----------------------------------|--|
| Point to area 4 on the overhead. | 4) Exterior Walk-around: Front |
| | ! Inspect front of vehicle and grill for general condition. |
| | Remove any obstructions to the grill, radiator, or lights. |
| | ! Visually check condition of headlights and turn signals. |
| | ! Visually check condition of emergency lights from the front. |
| Point to area 5 on the overhead. | 5) Engine Compartment |
| | ! Open hood and visually check engine for signs of leaks. |
| | ! Visually check condition of belts. |
| | ! Visually check condition of battery(ies). |
| | ! Check levels of engine oil, windshield washer fluid, and cooling system. |

| Instructor Notes | Presentation |
|--|---|
| | Check coolant level at overflow reservoir; do <u>not</u> remove radiator cap to check. |
| | Replenish fluids according to local organization's requirements. |
|  | Always replenish the engine oil when it is one quart low. In addition, our fluid replenishment requirements are-- |
| | ! Close the hood and ensure that it is latched. |
| Point to area 6 on the overhead. | 6) Exterior Walk-around: Passenger's Side |
| | ! Check right front fender for general condition. |
| | ! Check the right front wheel and tire for general condition. |
| | ! Check the tire for a properly inflated appearance, but do not check tire pressure. |
| | ! Check right side of windshield, right wiper for general condition. |

| Instructor Notes | Presentation |
|----------------------------------|--|
| | ! Check right side window for general condition. |
| | ! Check right outside mirror bracket for general condition. |
| | ! Check right rear fender for general condition. |
| | ! Check the right rear wheel and tire for general condition. |
| | ! Check the tire for a properly inflated appearance, but do not check tire pressure. |
| Point to area 7 on the overhead. | 7) Patient Compartment |
| | ! Open rear doors and visually check general condition of patient compartment. |
| | Check that all equipment is properly secured. |
| | Verify that no new equipment that may change vehicle weight has been added to patient compartment. |
| | ! Close rear doors and ensure that they are properly latched. |

| Instructor Notes | Presentation |
|----------------------------------|--|
| Point to area 8 on the overhead. | 8) Exterior Walk-around: Rear |
| | ! Visually check the condition of emergency lights from the rear. |
| | ! Visually check the condition of rear lights and turn signals. |
| | ! Visually check the condition of external flood lights, if installed. |
| | ! Check the left rear fender for general condition. |
| | ! Check the left rear wheel and tire for general condition. |
| | ! Check the tire for a properly inflated appearance, but do not check tire pressure. |
| | This completes the items on the quick check. When you finish the check, decide whether or not to place the vehicle into service and sign and date the form. Place your completed checklist into the vehicle log. |
| | NOTE: If your organization requires an operational check of the communications and emergency warning equipment, perform those checks after |

| Instructor Notes | Presentation |
|---|---|
| | completing the visual inspection. |
| | To conduct operational checks-- |
| | ! start the vehicle and drive it outdoors |
| | ! check the communications equipment, following local procedures |
| | ! operate and have the other crew member check the emergency lights |
| | ! check the siren, following local procedures |
| | ! secure the communications and emergency equipment and return the vehicle to its parking space |
|  | Our organization requires (does not require) operational checks of the communications and emergency warning equipment. The local procedures are-- |

| Instructor Notes | Presentation |
|--|---|
| <p>Q & A</p> | <p>Are there any questions on the Quick Check?</p> |
| | <p>FULL CHECK</p> |
| <p></p> <p>Appendix D</p> <p>Sample Checklist:</p> <p>Full Check</p> | <p>Now, let's look at Appendix D for a Sample Checklist for the Full Check.</p> |
| <p>Point out the following:</p> | <p>Notice that the same headings are used on both checklists. The Full Check includes additional items and should be adapted to meet each organization's requirements.</p> |
| | <p>Both checklists follow the same basic clockwise rotation around the vehicle to ensure a systematic inspection.</p> |
| <p>Give the participants five minutes to review the Full Check checklist.</p> | <p>Since this checklist is similar to the Quick Check checklist, we are not going to go over it item by item. Take the next five minutes to look over the list and then I will answer any questions you may have.</p> |

| Instructor Notes | Presentation |
|---|---|
| Q&A | Are there any questions? |
|  | Your organization requires that you perform the following vehicle maintenance checks before you place a vehicle in service-- |
|  | How is your organization's checklist different from the recommended checklist for the Quick/Full Check? |
| | <i>Example: One organization might require that at least 1/2 tank of fuel be on board before a run; another might require 3/4 tank.</i> |
| | Negligence Related to Inspection |
| | An operator might be judged to be negligent with regard to vehicle inspection for two main reasons: |

**Instructor
Notes**

Presentation



8: Operator
Negligence

OPERATOR NEGLIGENCE

Failing to inspect a vehicle thoroughly in accordance with organization's requirements.

Knowingly operating an unsafe vehicle.

BLANK

! failing to inspect a vehicle thoroughly according to the organization's requirements

! knowingly operating a vehicle with a problem that should have caused it to be taken out of service

Negligence: Case study

The following case study will give you an example of negligence related to vehicle inspection. While you read it, think about the operator's role in the situation.

Background: A crew was taking a patient to a hospital in the next county. The ambulance maintenance log, which contains

| Instructor Notes | Presentation |
|--|--|
| | <p>information about previous inspections and work requested and completed, was kept in a room upstairs from the vehicle. The crew was in a hurry, so they did not review the log before they left, contrary to the organization's procedures. They also did not to perform a Quick Check.</p> |
| | <p>Midway through the trip, the oil pressure warning light came on, and the engine temperature rose. The crew pulled over and called for a replacement vehicle.</p> |
| | <p>Investigation: The follow-up inquiry included a review of the ambulance maintenance log. The two most recent vehicle checks each noted a slow oil leak. The maintenance log contained a note to the operator to check the oil level before each trip. The log showed that repairs were scheduled for the following Monday, when the regular mechanic returned from vacation.</p> |
| <p>Allow enough time for participants to finish reading.</p> | |
| <p>Q&A</p> | <p>How might the <u>operator</u> be judged negligent in this situation?</p> |
| | <p><i>[Answer: The operator did not follow established procedures to make sure that the vehicle was in safe operating condition.]</i></p> |
| | <p>How might the <u>organization</u> also be found at fault?</p> |

Instructor

Presentation

Notes

Q&A

[Answer: ! for not having an effective system to inform the operator of problems
! for not making repairs promptly]

Refusing to Drive an Unsafe Vehicle

You should never operate a vehicle that is not in safe operating condition. While this seems pretty basic, faced with a medical emergency, some drivers might feel pressured to take an unsafe vehicle.

A Federal program, the Injury/Illness Prevention Program (IIP), supports an operator's right to refuse to drive an unsafe vehicle.

Guidelines for this program are available from the Occupational Safety and Health Administration (OSHA).





In our organization these guidelines are located--

To review, what three things should you know before you decide

| Instructor Notes | Presentation |
|---------------------|---|
| Q&A | that your vehicle is ready for service? |
| | <i>[Answer: That the vehicle has been inspected according to established procedures, that all scheduled maintenance has been performed, and that all needed repairs have been made]</i> |
| Q&A | How do you decide whether a vehicle is in safe operating condition? |
| | <i>[Answer: Personally inspect the vehicle and look at the most recent inspection and maintenance records]</i> |
| | OPERATOR RESPONSIBILITY FOR VEHICLE MAINTENANCE |
| | Vehicle maintenance is a critical part of an effective emergency medical response organization. If vehicles are not ready to respond to a service call, or if they break down during a run, the organization cannot transport patients effectively. |
| | We're going to discuss some general characteristics of a good maintenance program and then describe the operator's role in vehicle maintenance. |

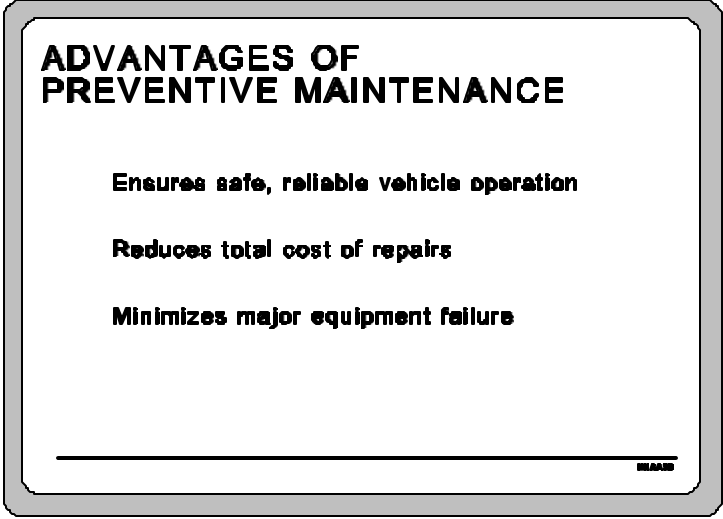
| Instructor Notes | Presentation |
|------------------|--|
| | Comprehensive Maintenance Programs |
| | A comprehensive maintenance program anticipates the need for maintenance and completes it <u>before</u> a failure occurs and repairs are needed. |
| | Comprehensive Inspection and Maintenance Programs |
| | A comprehensive program-- |
| | ! uses information from regular inspections to identify maintenance that may be needed |
| | Regular inspections, including those performed by the operator, can provide an indication that maintenance is needed. We've already discussed your role in performing maintenance inspections. |
| | ! documents all inspections, work requests, and work completed |
| | We've said it before, but it's worth repeating: "If it's not in writing, it did not happen." |
| | ! includes preventive maintenance |

| Instructor Notes | Presentation |
|---|---|
| | <p>Preventive maintenance is maintenance performed according to the manufacturer's suggested schedule. It may include additional items identified by the organization.</p> |
| | <p>Preventive maintenance focuses on preventing the most likely vehicle malfunctions by replacing parts or making adjustments before a failure occurs.</p> |
| | <p>Advantages of Preventive Maintenance</p> |
|  <p>9: Preventive Maintenance</p> |  <p>ADVANTAGES OF PREVENTIVE MAINTENANCE</p> <ul style="list-style-type: none">Ensures safe, reliable vehicle operationReduces total cost of repairsMinimizes major equipment failure |
| | <p>Preventive maintenance relies on fixing minor problems before they become major ones. It has several important advantages over repairing equipment when it breaks:</p> |

| Instructor Notes | Presentation |
|---|---|
| | ! It ensures safe, reliable vehicle operation. |
| | |
| | ! It reduces the total cost of repairs. |
| | |
| | ! It minimizes major equipment failure. |
|  <p>Briefly describe your organization's preventive maintenance program:</p> <p>! How long program has been in place</p> <p>! Any benefits realized</p> | <p>Your organization's preventive maintenance program--</p> |
| | |
| | Operator Responsibilities for Maintenance |
| | |
| | You are an important part of the maintenance program. |
|  | |

**Instructor
Notes**

10: Operator
Maintenance
Responsibilities

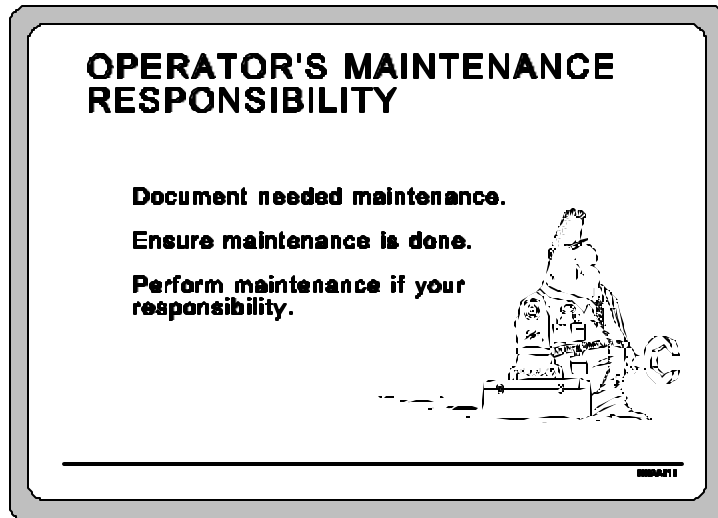

Presentation





Your primary responsibilities for maintenance are--

- ! to document any needed maintenance you find
- ! to make sure needed maintenance has been completed before you place the vehicle in service
- ! to perform any maintenance for which your organization makes you responsible



You will document needed maintenance on your inspection checklist or other form as required by your organization.

| Instructor Notes | Presentation |
|--|--|
| | <p>Before you place your vehicle in service, you will <u>make sure needed maintenance has been completed</u> following your organization's procedures. We will talk about the forms used to do this in a moment.</p> |
| | <p>Performing Maintenance</p> |
|  | <p>In our organization the operator is responsible for these maintenance items--</p> |
| | <p>Work Requests</p> |
| | <p>A work request tells maintenance the work that is needed on a vehicle. When maintenance finishes the work, they record on the form the work performed, tests run, and the results of their efforts.</p> |
|  | <p>Turn to Appendix E, the Sample Work Request.</p> |
| <p>Appendix E: Sample Work Request</p> | |

| Instructor Notes | Presentation |
|---|--|
| | <p>As you can see, this work request covers those problems that you find during an inspection as well as routine preventive maintenance.</p> |
| | <p>An organization may or may not use a work request to track maintenance and repairs.</p> |
|  | <p>Our organization uses (does not use) a work request. The procedures are--</p> |
| | <h3>Vehicle Maintenance Logs</h3> |
| | <p>Information from the inspection checklists and work requests are written into a vehicle maintenance log.</p> |
| | <p>The vehicle maintenance log is a vehicle's central record--</p> |
| | <p>! to list all maintenance needed and done, including routine maintenance and problems identified by inspections</p> |
| | <p>! to support the preventive maintenance program</p> |

| Instructor Notes | Presentation |
|--|---|
| | <p>! to document that the vehicle has been properly maintained</p> |
| | <p>Vehicle maintenance log pages are usually organized into binders and saved in an inspection file for use by a maintenance supervisor or manager.</p> |
|  | <p>Our organization uses this system to request and track maintenance and repairs:</p> |
| | <p>Review</p> |
| | <p>To determine whether the vehicle is in safe operating condition, you must know whether required maintenance has been performed.</p> |
| | <p>You must understand your organization's maintenance program in order to know your vehicle's maintenance status.</p> |
| | <p>OPERATOR'S RESPONSIBILITIES FOR VEHICLE REPAIRS</p> |

| Instructor Notes | Presentation |
|------------------|--|
| | Your primary responsibilities for repairs are-- |
| | ! to document any needed repairs you find during an inspection or during a run |
| | ! to make sure needed repairs have been completed before you place the vehicle in service |
| | ! to make any repairs for which your organization makes you responsible |
| | You will <u>document needed repairs</u> on your inspection checklist or other form as required by your organization. |
| | Before you place your vehicle in service, you will <u>make sure needed repairs have been completed</u> following your organization's procedures. |
| | Making Repairs |
| | In some organizations, operators make a variety of repairs to their vehicles. In others, the operator is responsible for only minimal repairs. |
| | You should only perform repairs for which you are trained and authorized . |

| Instructor Notes | Presentation |
|---|---|
|  Describe local organization policies and procedures related to repairs. | <p>In our organization, the operator is expected to be trained and authorized to make these repairs:</p> |
| | <p>Malfunctions During a Run</p> |
| | <p>There may be a time when, in spite of all precautions, your vehicle breaks down during a run.</p> |
| | <p>When this happens, you should think your situation through carefully before you take action. You should also <u>use</u> communications to give you more options.</p> |
| | <p>Proper patient care should always be your first consideration.</p> |
| | <p>This decision aid will help you to focus on the most important information and make the correct decision about what action to take.</p> |
|  11: Decision Aid for Vehicle | |

| Instructor Notes | Presentation |
|-------------------------------|---|
| Malfunctions While in Service | <div data-bbox="558 510 1276 1020" style="border: 1px solid black; padding: 10px;"><p>VEHICLE MALFUNCTIONS DURING RUN</p><p>Are you trained and authorized to make repair?</p><p>Is a backup readily available?</p><p>How quickly can you make repair?</p><p>What is patient's condition?</p><p>Can vehicle's electrical system meet demand?</p><hr/><p style="text-align: right;"><small>MMAR1</small></p></div> |
| | <p style="text-align: center;">Decision Aid for Vehicle Malfunctions During a Run</p> |
| | <p>! Are you trained and authorized to make the repair?</p> |
| | <p>The operator should be both <u>trained</u> and <u>authorized</u> to make any repair. If you <u>should not</u> fix the problem yourself, call for help.</p> |
| | <p>! Is a backup readily available?</p> |
| | <p><u>Use your communication system</u> to inform dispatch of your situation and to find out if a backup is available. Develop a plan before you start any repair, in case the repair fails.</p> |

| Instructor Notes | Presentation |
|------------------|---|
| | <p>If you are operating outside your normal service area, you may need to coordinate with an organization based in that service area.</p> |
| | <p>! How quickly can you make the repair?</p> |
| | <p>Can you make the repair in less time than it takes for the backup to arrive?</p> |
| | <p>! What is the patient's condition?</p> |
| | <p>Is the patient stable, or has the medical technician decided that the patient must get to a medical facility as soon as possible?</p> |
| | <p>! Can the vehicle's electrical system meet the demands made on it during the repair?</p> |
| | <p>If a long stay at the scene has depleted the system, you may need a backup vehicle even if you can make the repair.</p> |
| | <p>This decision aid applies for any vehicle problem during a run.</p> |
| | <p>Your organization's policies and procedures may also discuss what to do when a malfunction occurs.</p> |

| Instructor Notes | Presentation |
|---|---|
|  | <p>Our organization policies and procedures for malfunctions are--</p> |
| | <p>Repairs You May Make on the Spot</p> |
| | <p>An operator is generally expected or allowed to make only the most minor repairs during a run. For example--</p> |
| | <p>! change a flat tire</p> |
| | <p>! use duct tape to make temporary repairs to a broken radiator hose (usually the upper radiator hose)</p> |
|  | <p>Our organization trains and authorizes operators to make these repairs during a run:</p> |
| | |

| Instructor Notes | Presentation |
|--|--|
| | Problems That May Allow You to Drive the Vehicle Safely |
| | You may find yourself in a situation where your vehicle has malfunctioned but is still driveable. |
| | For example, an ambulance with a power steering belt failure can be driven carefully with compensation for the lack of power steering. |
| | Your decision about whether you continue to drive the vehicle should be based on your organization's policies and procedures. |
| | You may be required to inform a supervisor of the situation instead of making the decision yourself. |
|  | Our organization policies and procedures about driving malfunctioning vehicles are-- |
| | Review |
| | You are responsible for documenting any needed repairs you find during an inspection or a run. |





| Instructor Notes | Presentation |
|---|---|
| | <p>Before you place a vehicle in service, make sure that needed repairs have been completed.</p> |
| | <p>You and your organization should have a strategy for dealing with vehicle malfunctions during a run.</p> |
| | <p>Practice: Vehicle Malfunction Decision-Making</p> |
| <p>Q&A</p> | <p>Suppose that you have just loaded a stable patient into your vehicle a few miles from your usual station. Before leaving the scene, you notice that the left rear tire is flat.</p> |
| | <p>What should you think through in deciding whether to change the tire or call for help?</p> |
| | <p><i>[Answer 1: If your organization doesn't allow you to make repairs, or if you haven't been trained to change the tire, your first action would be to call a repair service.]</i></p> |
| | <p><i>[Answer 2: A backup might also be assigned to keep the patient from having to wait while you change the tire, even though the patient is stable.]</i></p> |
|  | <p>How our organization's guidelines would affect this decision:</p> |

| Instructor Notes | Presentation |
|------------------|---|
| Q & A | What procedure does our organization use to place a vehicle in service? |
| | SUMMARY |
| | You should inspect your vehicle to decide whether it is in safe operating condition or whether it should not be driven. |
| | You may be found negligent for driving a vehicle that is not in safe operating condition. |
| | When you place your vehicle in service, you should indicate that the vehicle is in safe operating condition. |
| | To determine whether the vehicle is in safe operating condition, you must know whether required maintenance has been performed. |
| | You must understand your organization's maintenance program in order to know your vehicle's maintenance status. |
| | You are responsible for documenting any needed repairs you find during an inspection or during a run. |

| Instructor Notes | Presentation |
|-----------------------------|--|
| | Before you place a vehicle in service, make sure that needed repairs have been completed. |
| | You and your organization should have a strategy for dealing with vehicle malfunctions during a run. |

| | |
|----------------------------------|---|
| COURSE: | EMERGENCY VEHICLE OPERATOR COURSE (AMBULANCE): NATIONAL STANDARD CURRICULUM |
| MODULE A: | Ambulance Operation: The Basics |
| LESSON 6: | Navigation and Route Planning |
| LENGTH: | 2 Hours |
| COURSE GOAL: | To provide ambulance operators with the knowledge and skills to operate their vehicles so that their vehicle, equipment, crew, and patients will be delivered safely and efficiently and the safety of the public will be assured during all phases of the delivery of the Emergency Medical Services (EMS) involving the ambulance |
| MODULE GOAL: | To provide ambulance operators with the knowledge required to safely and efficiently operate an ambulance in both nonemergency and emergency modes |
| LESSON GOAL: | To provide participants with knowledge of strategies used to select the safest route to the emergency scene |
| PERFORMANCE OBJECTIVE(S): | <ul style="list-style-type: none"> Identify those factors used for route planning |
| INSTRUCTIONAL | |

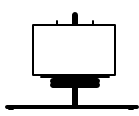
AIDS:

| ICON LEGEND (Those used in this lesson are highlighted) | | | | | |
|---|---|---|---|---|---|
|  |  |  |  |  |  |
| Appendix | Show Overhead | Question and Answer Period | Use Flipchart | Ask Question | Local Requirements |



1. Route Planning
2. Choose Routes
3. Know Your Area
4. Vehicle Clearance

INSTRUCTIONAL EQUIPMENT:

Overhead projector and screen
 Transparencies
 Flipchart and markers
 Handouts (optional)

Lesson 6: Navigation and Route Planning

- Tip 1. Find out how ambulance organizations in your area learn about special events, street construction projects and other activities that would affect route planning. Prepare an information sheet for each participant.
- Tip 2. Navigation at night and during inclement weather is more difficult. Prepare an overhead transparency that highlights the conditions and how to deal with them.
- Tip 4. Emphasize the need to have the crew work as a team with the person in the right seat primarily responsible for navigation to the scene.
- Tip 5. Take time to prepare the exercise on page 6-15. It is an excellent technique to get participants involved in the exercise and for you to check how well they are learning the material.

| Instructor Notes | Presentation |
|------------------|---|
| | INTRODUCTION |
| | <p>Route selection is a key decision for both urban and rural area driving. Each time you prepare to leave for a run, you must decide on a route that is quick and avoids potential hazards or delays.</p> |
| | <p>This lesson presents general information you need to help you decide which route to take to an emergency scene. We'll go over necessary procedures for route selection.</p> |
| | ROUTE SELECTION: PROCEDURES |
| | <p>Effective route selection considers procedures such as route planning, predetermined routes, and operator familiarization.</p> |
| | Route Planning |
| | <p>Safety is the most important factor when driving to the scene. You must have a route plan if you want to get to the emergency scene quickly and carefully.</p> |
| | <p>Route planning involves learning the geographic and local conditions, individual characteristics of the area, and your organization's procedures to map out the most efficient route to the emergency scene.</p> |

Instructor Notes

Presentation



1: Route Planning

ROUTE PLANNING

Primary Goals of Route Planning Are To

minimize travel time

minimize crash exposure

allow operator to focus attention on driving

avoid environmental and construction hazards

in order to arrive at the emergency scene in most efficient way.

EMMART

Geographic and Local Conditions

When you plan a route, think about the geographic and local conditions affecting the roads you will be using.

Be aware of and prepare yourself for the conditions in the type of area you will be driving in.

Q&A

Special considerations must be made when planning a route in a rural area. What conditions could you expect in a rural area?

Encourage discussion.

Instructor Notes

Presentation

[Answer: While driving in rural conditions, you may have to drive on two-lane, dirt or gravel roads that are poorly marked.]

Street and road signs in rural areas may be limited, and directions are often given in reference to buildings, gas stations, race tracks, or other past or present landmarks. Farms are commonly referenced since farm names never change.

When responding to an emergency in a rural area, the distance you drive is usually greater. The road conditions may not always be known, and the police may not even get a call.

When you head out to the emergency scene, communicate with dispatch or directly with the first responder. In rural areas, a first responder may get to the scene before the ambulance. The first responder will have information about the patient, road, and weather conditions.



2: Choose Routes

Instructor Notes

Presentation

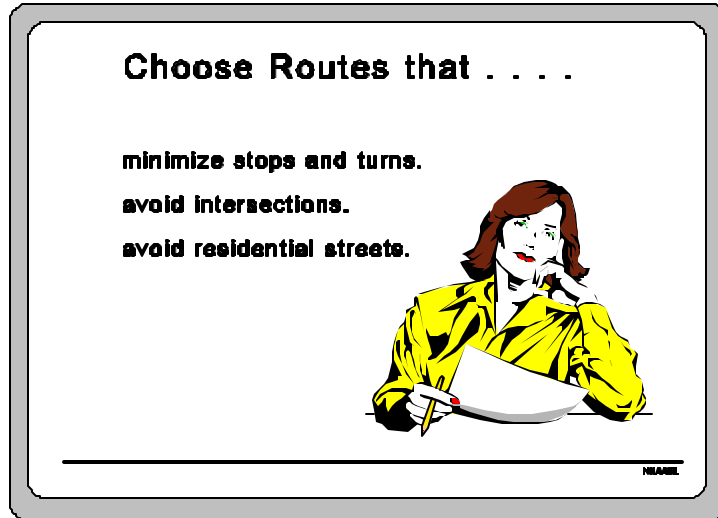

Plan ahead so you don't waste time on a run. Make sure you stay within the speed limit! Choose routes that--

! minimize stops and turns

! avoid intersections

! avoid residential streets--the posted speed limits will be slower; you must be careful of pets, children, cars backing out, and so on

Organization Procedures

| Instructor Notes | Presentation |
|--|--|
| | <p>A variety of resources can be used to help you with route planning. Each organization should have a procedure for updating special events, road conditions, and other factors on a daily basis.</p> |
| | <p>Your shift supervisor should conduct a briefing at the shift change. This briefing should cover any special events, route problems, personnel assignments, and so on.</p> |
|  <p>Provide guidance on local resources available. Possible resources include detailed maps, the Opticom System, helicopter assistance, and automatic vehicle locators.</p> | <p>Our local procedures include--</p> |
| | <p>Predetermined Route Procedures</p> |
| | <p>Predetermined routes are standard response routes that are prepared in advance. These routes have been selected to avoid potential problems.</p> |
| | <p>Routes should be developed and maintained by your organization or coordinated with other emergency services in the area.</p> |

| Instructor Notes | Presentation |
|------------------|--|
| | Route planning includes the best way to get to the emergency scene AND the best way to get from the scene to the medical facility. |
| | On the way to the emergency scene, you and your crew should communicate and navigate the route together. It is a good idea to have at least one experienced person on your crew who knows the area. |
| | After you pick up the patient and are on the way to the medical facility, the EMT will be busy caring for the patient and will not be able to help you navigate. |
| | Make sure you know the route from the scene to the medical facility before the EMT begins attending to the patient. |
| | Follow your organization's standard procedures so any two members can work together and understand what to do. |
| | Take every opportunity to practice communicating as a crew. Example: operator calls out road conditions, RR crossing, other bumps on the route. EMT in patient compartment calls out what they are doing to alert the ambulance operator. The operator should tell the EMT in the patient compartment of any conditions that will limit medical attention. |
| | A good time to practice is during a practice run or when you are returning from the medical facility and are returning to your station. |

| Instructor Notes | Presentation |
|------------------|--|
| | Primary and Alternate Routes |
| | When planning routes, primary and alternate routes should be identified. |
| | Alternate routes must be available in case of bad road conditions, weather, or other situations that effect primary routes. |
| | Navigation at night can be difficult, especially if you can't see the street signs, hazards, or other problems. Communicate as a team and follow your organization's standard procedure for giving directions. |
| | To make it easier to choose an alternate route, map out the local areas commonly used and refer to these maps when deciding which way to go to the scene. |
| | ! Use a grid system to show any short cuts, one-way streets, expressways, and so on. |
| | ! Add useful information that is not included on the map, such as dirt roads, dangerous intersections, very steep grades, roads or lanes on roads that change direction according to the time of day. |
| | Our local procedure for primary and alternate routes includes-- |

Instructor Notes

Presentation



Provide guidance on the local procedure used.

Operator Familiarization



3: Know Your Area

KNOW YOUR AREA

- Primary and alternate routes**
- New construction**
- Local landmarks or reference points**
- Traffic flow changes**



© 2011

Operator familiarization involves your awareness of daily route information, procedures to identify local information, height restrictions, and map reading.

When you get a call from dispatch, you are responsible for

| Instructor Notes | Presentation |
|---|---|
| | knowing how to get to the scene safely and without taking unnecessary risks. If you don't know the streets and the area you'll be driving the ambulance in, you could easily get lost. |
| | Daily Route Information |
| | Become familiar with your area to prevent getting lost. |
| | ! Review the primary and alternate routes you usually drive. |
| | ! Find out if there are new developments and buildings under construction. |
| | ! If you are in an area with limited road and street signs, learn the local references, such as buildings, farms, gas stations, and so on. |
| | ! Review and learn about different activities that may effect the traffic flow of your route each day. |
| Q&A | Your area has buildings that you need to pay particular attention to everyday. Can you think of types of buildings that may have scheduled activities in which you need to be aware of? |
|  | <i>[Answer: Schools, hospitals, auditoriums, concert halls, stadiums, factories, churches, shopping centers, downtown work</i> |

| Instructor Notes | Presentation |
|--|--|
| List the participants' answers on the flipchart. Add any buildings from the given answer if they were not mentioned. | <i>areas]</i> |
| | Keep in mind the approximate busy times for the buildings we just listed. Expect delays in high traffic building areas during these times: |
| | ! beginning and end of normal work and school day |
| | ! shift-change times for large factories, hospitals, and so on |
| | Your daily route can be effected by the weather and other environmental reasons: |
| | ! emergency snow routes |
| | ! roads closed due to flooding |
| | Watch for changes in the condition of local roads and streets. Just think how uncomfortable it would be to ride in the back of the ambulance, while injured, and go over a pothole or a huge bump in the road! |

| Instructor Notes | Presentation |
|---|--|
| Road conditions and driving will be covered in greater detail in Lessons 7 and 8. | Be aware of the following conditions of local roads and streets: |
| | ! damage, potholes, badly rutted roads |
| | ! expressway utilization policies during rush hour or construction |
| | ! detours, closed roads |
| | ! speed bumps, dips, bumps |
| | ! areas of standing water |
| | Dispatch can help when it is absolutely necessary; however, it is your responsibility to know the conditions of the area before you leave. |
| | Procedures to Identify Local Information |
| Q&A | How could you find out about different activities in the area that may affect your route? |

Instructor Notes

Presentation



Write participant responses on a flipchart or blackboard.

[Answer: Refer to your organization's bulletin board or computer for special considerations and information. You can also get information from department bulletins, newspapers, TV, radio, and school calendars.]

Height Restrictions

Q & A

When would ambulance height be important in route planning?

[Answer: You should know the height of your ambulance (including the warning lights) in case you must go through or under a height-restricted area. There could be a bridge, tunnel, or parking ramp on your route.]

Just a reminder that many fast food drive-through areas have a height restriction. Don't leave your light bar and antennas in the drive-through!

Keep the height posted in the vehicle where you can quickly see it during the run. The dashboard or visor would be good places to post the vehicle height.



4: Vehicle Clearance

Instructor Notes

Presentation

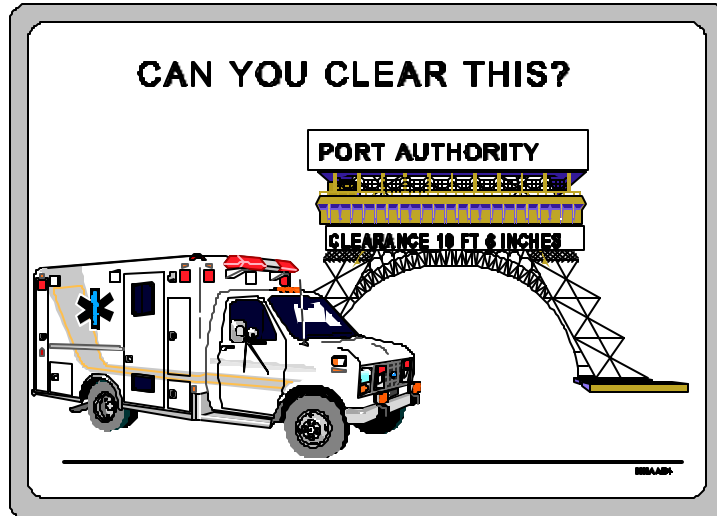

Q&A

If you and your partner were on your way back to the station after a run and had to pass under this overpass, could your vehicle pass under this height obstacle?

How to Read a Map

Additional Activity:

Factors to consider when planning your route:

Obtain and select a section of a local map that the participants will be familiar with. Prepare a list of factors that must be considered when

| Instructor Notes | Presentation |
|---|--|
| planning a route. | |
| Make enough copies of the map and factors to consider for all participants. | |
| | Use a local map to plan a route from an emergency site to your local medical facility. Use the names of real roads, streets, and buildings. |
| | ! Indicate the road or street where the entrance to your local medical facility is located. <i>[Example: The entrance to the hospital is on Main Street.]</i> |
| | ! Indicate the road or street where the entrance to the emergency site is located. <i>[Example: The entrance to the mall is on Oak Road.]</i> |
| | ! List any special conditions, street closings, detours, and other factors that would effect the route to the emergency site. <i>[Examples: Highcliff Road is closed in the area of River Park. Oak Road is a heavily-traveled road with several schools on it. It is 4:30 p.m.]</i> |
| | Now you're going to have a chance to practice the skills you just learned about route planning. Choose a partner and use the factors on the handout to plan a route together. |

| Instructor Notes | Presentation |
|--|--|
| | You have 20 minutes to plan a route. |
| Pair the participants. Give them 20 minutes to plan a route. | |
| Q&A Discuss the activity with the class. | Does anyone want to share the route you and your partner planned? |
| Q&A | Why is route planning important? |
| | <i>[Answer: To get to the emergency scene quickly and safely.]</i> |
| Q&A | When you plan a route, what factors should be considered? |
| | <i>[Answer: Geographic and local conditions]</i> |
| Q&A | Why must alternate routes be available? |
| | |

Instructor Notes

Presentation

[Answer: Bad weather or road conditions that may effect the primary route.]

Q & A

What do you need to be familiar with so you can get to the emergency scene quickly and carefully?

[Answer: Daily route information, procedures to identify this information, ambulance height, and how to read a map.]

SUMMARY

Route selection is necessary for you to get to the scene quickly and carefully. Route planning, predetermined route procedures, and operator familiarization all contribute to effective route selection.

Choose a route to arrive at the emergency in the most efficient way. Minimize travel time, minimize crash exposure, and allow the operator to focus attention on driving.

When planning a route--

! consider geographic and local conditions

! utilize your organization's procedures

| Instructor Notes | Presentation |
|------------------|--|
| | Use predetermined routes to avoid potential problems on the road. |
| | If primary routes are not in good condition, use alternate routes. |
| | You should be familiar with-- |
| | ! daily route information |
| | ! procedures to identify local information |
| | ! height restrictions |
| | ! how to read a map |





| | |
|------------------|--|
| COURSE: | EMERGENCY VEHICLE OPERATOR COURSE (AMBULANCE): NATIONAL STANDARD CURRICULUM |
| MODULE A: | Ambulance Operations: The Basics |
| LESSON 7: | Basic Maneuvers and Normal Operating Situations |
| LENGTH: | 3 Hours |

| | |
|----------------------------------|---|
| COURSE GOAL: | To provide ambulance operators with the knowledge and skills to operate their vehicles so that their vehicle, equipment, crew, and patients will be delivered safely and efficiently and the safety of the public will be assured during all phases of the delivery of the Emergency Medical Services (EMS) involving the ambulance |
| MODULE GOAL: | To provide ambulance operators with the knowledge required to safely and efficiently operate an ambulance in both nonemergency and emergency modes |
| LESSON GOAL: | To provide participants with knowledge of how to operate an ambulance in order to improve the safety and quality of ride for an ambulance patient |
| PERFORMANCE OBJECTIVE(S): | <ul style="list-style-type: none"> ! Identify five road construction and engineering factors affecting ambulance control and ride quality for an ambulance patient ! Identify driving skills that affect the ride quality for an |

ambulance patient

- ! Identify things an operator must do to maintain a safety cushion around the ambulance
- ! For each basic driving maneuver listed, select the recommended procedure to be followed when driving an ambulance

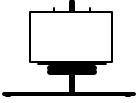
INSTRUCTIONAL AIDS:

| ICON LEGEND (Those used in this lesson are highlighted) | | | | | |
|---|---|---|---|---|---|
|  |  |  |  |  |  |
| Appendix | Show Overhead | Question and Answer Period | Use Flipchart | Ask Question | Local Requirements |

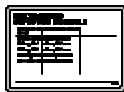

1. Road Surfaces
2. Road Conditions (1 of 2)
3. Road Conditions (2 of 2)
4. Fright

5. Centrifugal Force
6. Stopping Distance
7. 2-4-12 Rule
8. Practice
9. Defensive Driving
10. Safety Cushion
11. Communicate
12. Basic Maneuvers
13. Braking and Stopping
14. Making Lane Changes
15. Passing-two-Lane
16. Pass Stopped Traffic
17. Backing
18. Perpendicular Parking
19. Angle Parking
20. L/R Turns
21. U-Turn
22. Back-Around



**INSTRUCTIONAL
EQUIPMENT:**

Overhead projector and screen
Transparencies
Flipchart and markers

Training Tips for: Lesson 7: Basic Maneuvers and Normal Operating Situations

- Tip 1. Prepare a list of areas that represent the types of road surfaces, bridges and unusual conditions discussed in the lesson. Take pictures of these areas and have them available in class. Better yet, use a video camera to get some videotape of these areas. Play the videotape in class and discuss the particular condition.
- Tip 2. Model cars and ambulances can be used very effectively to demonstrate all of the ambulance maneuvers. Use a large poster board or other surface to draw out streets, intersections and other areas. Masking tape or other types of tape can be used on surfaces such as a vinyl tablecloth to lay out the areas. Let each participant practice maneuvering the ambulance in different situations such as making a U-turn, parking and backing. This type of exercise was used with excellent success during both pilot tests.

| Instructor Notes | Presentation |
|--|---|
| | INTRODUCTION |
| | When you have a medical team and a patient in the back of your ambulance, they are counting on you to get them safely to the hospital without making the patient's condition any worse than it already is. |
| | I would like to challenge you to learn to drive so that they are able to forget that they are in a moving vehicle. |
| If participants rode in an ambulance as part of the Course introduction in Lesson 1, review their experiences. | During the next few hours, we are going to cover those items that you need to think about and practice while driving your ambulance. These are the basic maneuvers and normal driving situations that you face every day and which influence how well you are able to meet the challenge. |
| | ROAD CONSTRUCTION AND ENGINEERING |
| | Road Surfaces |
| | We will begin by discussing the various road surfaces you drive |

| Instructor Notes | Presentation |
|--|---|
| | <p>on. While the road surface greatly influences the quality of the ride, you can't control it or change it. You must learn how to adjust your driving to match the road conditions.</p> |
| <h1>Q&A</h1> | <p>When roads are built, the engineers plan each road to handle different kinds of traffic, and they use different materials to build each road. What types of road surfaces do you have to drive on?</p> |
|  <p>Write participant responses on a flipchart or blackboard.</p> | |
| <p>If participants do not mention each of these, add them to the list.</p> | <p><i>[Answer: Asphalt, concrete, dirt/gravel]</i></p> |
|  <p>1: Road Surfaces</p> | |

Instructor Notes

Presentation

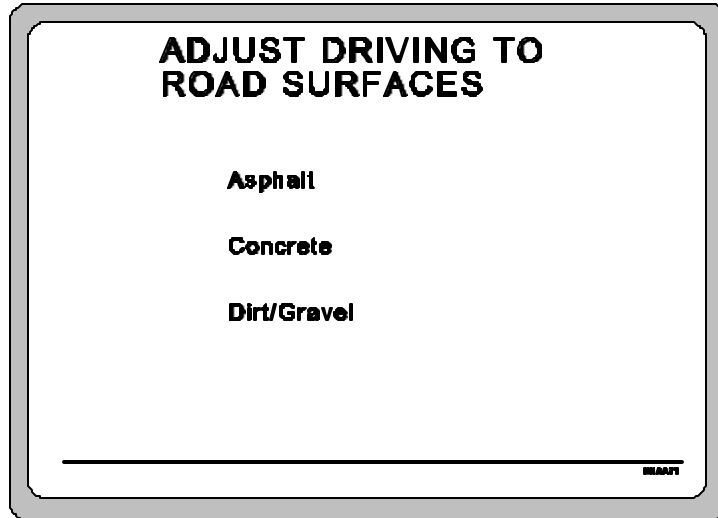

Asphalt

Asphalt is not as durable as some other common surfaces and requires repair more often. Repairs normally consist of patching the surface with more asphalt material or with tar to fill in cracks. These patches then create bumps in the road.

Asphalt is at its worst during the hot summer months. When it's very hot, the oils used to make asphalt bleed to the surface, making it slick, especially when it rains.

An asphalt roadway can also become wavy with heavy use during extremely hot days. Not only is that very uncomfortable to ride over, but you do not have full control of your ambulance since your tires are in contact with the road only half the time.

| Instructor Notes | Presentation |
|------------------|---|
| | Concrete |
| | During hot weather, concrete expands and may break up at its joints, leaving a hole in the surface. |
| | Concrete also settles more than other road surfaces. As the earth under it settles, the concrete sections develop severe dips, causing the ambulance to bounce heavily between dips. |
| | Concrete road surfaces also glaze over very quickly in freezing conditions, much more so than asphalt. |
| | Dirt/Gravel |
| | Dirt and gravel roads are tricky to drive on if you're not used to them. Because of the irregular shape, size, and weight of the stones, they move about easily. This movement can cause a vehicle to go out of control with only a slight action by the operator. Braking on gravel can cause a vehicle to slide easily. |
| | When following another vehicle on dirt and gravel roads, stay back to increase visibility and to avoid flying stones. |
| | Transitions Between Surface Types |
| | One of the most dangerous areas of a road surface is that area |

Instructor Notes

Presentation

where the surface changes from one type to another, such as from hard surface to gravel. When this happens, you must change your driving style before moving onto the gravel road or you could easily lose control of your ambulance.

Road Conditions

Q&A

Now, besides the type of road surface, what road conditions do you think might affect your ride?

Encourage discussion.



Write participant responses on a flipchart or blackboard.

If participants do not mention each of these, add them to the list.

[Answer: bumps, mud, potholes, animals, tree limbs, bridges and ramps, corners, water drainage, roadside engineering]



2: Road Conditions
(1 of 2)

Instructor Notes

Presentation

**ADJUST DRIVING FOR
ROAD CONDITIONS (1 of 2)**

Bumps

Mud

Potholes

Animals, Tree limbs

EMMAZE

Bumps

Q&A

Let's talk about bumps. How do you know when you are approaching a bump in the road?

[Answer: watch other cars bounce, road signs]

One of the easiest ways to see a bump in the road ahead is to watch the vehicles ahead of you bounce as they hit the bump. This gives you time to slow the ambulance and lessen the effects of the bump.

Another way to see bumps is to look at the road surface itself. A

| Instructor Notes | Presentation |
|--|---|
| | <p>clear path in the center of the roadway followed by a dark spot indicates a large dip or bump in the road. When vehicles hit the bump, loose oil and debris under the car fall off, creating the dark spot.</p> |
| | Mud |
| | <p>Mud on the roadway causes problems, first by creating a slick surface, and second, by filling the tread pattern of the tire and making the reaction ability of the tire very slow.</p> |
| | Potholes |
| Q & A | <p>Let's talk about one of the biggest dangers in the road surface-- potholes. Does anyone have any pothole horror stories?</p> |
| <p>Allow participants to share experiences for a few minutes to provide a sense of how important the topic is.</p> | |
| | <p>Potholes are holes in the road surface, sometimes at the joint of a concrete road or, more commonly, where a asphalt surface has failed. Potholes cannot be easily fixed and keep returning, getting wider and deeper each time they reappear.</p> |

| Instructor Notes | Presentation |
|------------------|---|
| | <p>Potholes give us two problems. First, they can destroy the ambulance's tires or suspension system. Second, they can cause you to lose control as one corner of the ambulance drops into the hole and the ambulance frame twists. Both problems cause hardship for the medical personnel and increase the discomfort of your patient.</p> |
| | <p>During your prerun route planning, be sure that you select roads known to be free of potholes. And, if you discover potholes during your run, pass this information on to the dispatcher so that the route information can be updated.</p> |
| | <p>The best way to handle a pothole is to try to drive around it.</p> |
| | <p>If you must drive through a pothole--</p> |
| | <p>! release your brakes just as you get to the pothole</p> |
| | <p>If you hit a pothole with your brakes on, your front tire can actually stop as you cross the leading edge of the pothole. By the time you get to the other side, the wheel is no longer turning and the impact can tear the tire apart.</p> |
| | <p>! hit the pothole squarely, rather than on the side of the tire</p> |
| | <p>The face of the tire can take considerably more impact than the sidewall.</p> |

Instructor Notes

Presentation

Animals, Tree Limbs, and Miscellaneous Objects

Another problem you will encounter wherever you drive is objects in the road. These could be animals, tree limbs, or dropped debris. Everyone's natural reaction is to swerve to avoid hitting objects in the road, but this often causes more problems than the object itself. Instead of swerving--

! if it is a small object, hit the object head-on

Do not cause a larger collision by swerving into another lane or oncoming traffic.

! if it is a large animal or object, maintain control of your vehicle and attempt to avoid a head-on collision



3: Road Conditions
(2 of 2)

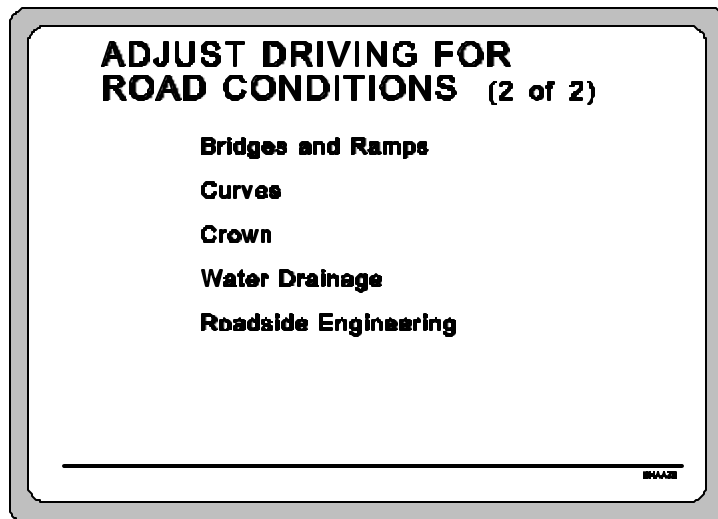

| Instructor Notes | Presentation |
|------------------|---|
| | Bridges and Ramps |
| | Bridges and ramps can cause control problems if you are not accustomed to driving on them. |
| | Bridges often have an open metal grating over the main expanse of the bridge. When the ambulance's tires cross this grating, the tire tread tries to align itself with the grating, causing the wheels to jump and jerk. The best way to handle the grating is to slow while approaching the bridge and then hold the steering wheel firmly in both hands. There will still be some jerking of the wheel, but you should be able to control it by using both hands. |
| | Bridges and ramps often have a reinforced concrete bed, which will freeze before the roadway on either side. This is because, as the temperature drops, the cold air circulates around the concrete bed of the bridge or ramp and the concrete becomes cold faster than the roadway that is built on the warmer ground. Use caution when driving on bridges and ramps during freezing temperatures. |
| | Curves |
| | When highway engineers design a new roadway, they use the natural contour of the land. Most of the time, they can reform the land slightly and create comfortable roads. Sometimes, they can't. In hilly or mountainous areas, following the land's natural contour often results with roads designed with deep or multiple curves. |

Instructor Notes

Presentation

What this means to you is that you can never take a curve for granted. You must enter a curve carefully, following the posted recommended speed limit for the curve, and watch how the curve changes as you continue. If it gets tighter, you must slow down even more to retain control of your ambulance.

Banking

Most curves that are created for today's highways are banked to help you maintain speed while going through the turn. This was not always true in the early days of road building when speed was not a problem. If a roadway is built so that the inside of the curve is lower than the outside edge, then it is banked properly. If the inside edge is level with or higher than the outside edge, you will have to slow down to complete the curve.

Posted speed limits

The speed limits posted at the beginning of most curves is the recommended speed that allows you to safely continue through the curve. This speed is often lower than the prevailing highway speed because of the amount of banking or because the curve is a compound curve.

Crown

Older roads and those in areas that receive a lot of rain often have a crown in the middle of the road. When a road has a crown, the center of the road is higher than both edges. Since the

| Instructor Notes | Presentation |
|--|--|
| | <p>crowns is normally not very high, it does not pose a problem on a straight road. But in a corner, the crown acts like improper banking and works against the vehicle going around the corner. Again, you must slow down to retain control of your ambulance.</p> |
| | <p>Water Drainage</p> |
| | <p>Road crowns are essential for good water drainage during rainy periods. When water drains quickly from the road surface, the danger of hydroplaning is reduced. Some concrete roads accomplish drainage by cutting grooves into the road surface.</p> |
| | <p>Hopefully, the water will drain completely away from the road, thus eliminating the dangers of hydroplaning and possibly losing control of your vehicle. You must look ahead and remain clear of areas of standing water and water collected alongside the roadway.</p> |
| | <p>Roadside Engineering</p> |
| | <p>Roadside engineering consists of all the signs, guardrails, and barriers along the roadway. These include your speed limit, no passing, and intersection signs, and the safety barriers beside deep ditches or bridges.</p> |
| <p>Q&A</p> <p>Encourage</p> | <p>How could roadside engineering effect the quality of ride you give your patient?</p> |

| Instructor Notes | Presentation |
|------------------|--|
| discussion. | <i>[Answer: warn of hazards, limit the escape route in case of problems, tell what other drivers may or may not be doing, etc.]</i> |
| Q&A | To review, are you more likely to have control problems going from concrete to gravel, or from gravel to concrete? <i>[Answer: Concrete to gravel]</i> |
| Q&A | If you are driving down a highway with very little traffic and in your lane ahead, you notice a dark spot in the middle of your lane, what would that indicate and what would you do? <i>[Answer: A bump in the road. Slow slightly.]</i> |
| Q&A | Okay, now you are driving through a hilly area after picking up a teen-aged boy with a broken leg. It has been raining heavily, and there is a lot of traffic on the road. Up ahead, it looks like some mud has slid from someone's yard onto the roadway. What is the problem and what would you do? <i>[Answer: Mud on the road will be slick and will get into the tire treads and I could lose control. I would slow down and try to steer around the mud.]</i> |

| Instructor Notes | Presentation |
|------------------|--|
| Q&A | Just before you get to the mud, a small tree branch falls into the roadway in front of you. What would you do? |
| | <i>[Answer: Slow, and since there is other traffic, hit the branch.]</i> |
| Q&A | What problems might you have on asphalt in August when the temperature is 101 degrees? |
| | <i>[Answer: Oil on the surface, rough surface]</i> |
| Q&A | As you round a curve in the highway at 50 mph, with a patient on board, you see a deep pothole in the right tire track on your side of the highway. You firmly press your brakes to slow, but realize that you cannot change lanes and are going to hit the pothole. What should you would do? |
| | <i>[Answer: Release the brakes as I get to the pothole and hit the pothole squarely with the tire.]</i> |
| Q&A | It's night and you come over a hill. In your lane stands a full-grown deer looking at you. There is a car coming toward you in the other lane and there is a deep ditch on your right. What should you do? |
| | <i>[Answer: Try to hit the deer a glancing blow without hitting the oncoming car or going into the ditch.]</i> |

Instructor Notes

Presentation

Q&A

Are there any questions on road construction or things in the road?

DRIVING SKILLS THAT INFLUENCE THE QUALITY OF THE PATIENT'S RIDE

Let's now talk about some of the driving skills which influence the quality of the patient's ride. These are the skills that will permit you to meet my challenge of driving so that the medical team and the patient forget that they are in a moving vehicle.

Adverse Effects on Patient When Riding in an Ambulance

Q&A

What would be some of the adverse effects of riding in an ambulance? First, consider the patient.

Ask participants to relate personal experiences where the ride quality had a positive or negative effect on the patient.

[Answer: Pain, fright, increase in severity of the problem]

Instructor Notes

Presentation



4: Fright

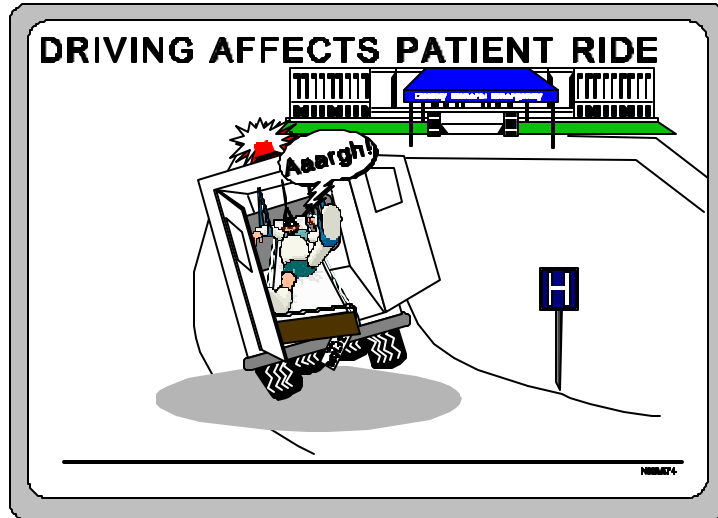

Both sick and injured patients may feel nauseated. When you place them on the stretcher and put them into the ambulance head first, they may become even more nauseated from motion sickness. If the ride you provide is not smooth and comfortable, their nausea may increase and they may vomit, causing further complications for your medical crew.

Also, patients will tense their muscles to counteract the pitching forces encountered in turns and while braking and accelerating. When patients have broken bones or internal injuries, the muscle contractions will aggravate their condition.

Adverse Effects on Medical Team When Riding in an Ambulance

And, how about adverse effects on the medical team?

Instructor Notes

Presentation

Q&A

Ask participants to relate personal experiences where ride quality had a positive or negative effect on the medical team.

[Answer: Problems treating the patient because of having to hold on and by having medical instruments and equipment moving around, problems handling a terrified patient.]

Patient care cannot continue if your medical team has to hold on. Patient care must continue uninterrupted while enroute to the hospital.

Several basic and advanced life support skills are difficult to perform in a moving ambulance, no matter how smoothly it is driven. These skills are impossible if the ambulance is bouncing and swaying as it is driven down the road. For example, studies have demonstrated that CPR is best performed in a moving ambulance that is being driven at speeds below 25 mph and not being driven in the emergency mode.

How Driving Skills Influence the Quality of the Patient's Ride

There are four main driving skills that we are going to talk about.

| Instructor Notes | Presentation |
|---|---|
| | They are cornering, braking, accelerating, and maintaining appropriate speed. |
| | Ambulance Suspension System |
| | <p>First, let's review how an ambulance is constructed. Like most cars and trucks, the ambulance is a body that is attached to the engine and wheels with a suspension system. The suspension system is designed to do two things. First, it is designed to keep all four wheels firmly on the ground, no matter what the surface is like, so that you can steer, brake, and accelerate. And second, it is designed to isolate the body and its occupants from the bouncing of the wheels when they hit bumps and uneven road surfaces.</p> |
| | <p>Because of the way the suspension system is designed, when you speed up, brake, or take corners, the body leans. You have all felt the body lean when you brake hard or go around a corner too fast. Because an ambulance is a heavy vehicle and crammed full of equipment, it has a stiff suspension and the amount of lean is not great, but it must still be taken into account when driving.</p> |
| | Cornering |
|  5: Centrifugal Force | |

Instructor Notes

Presentation

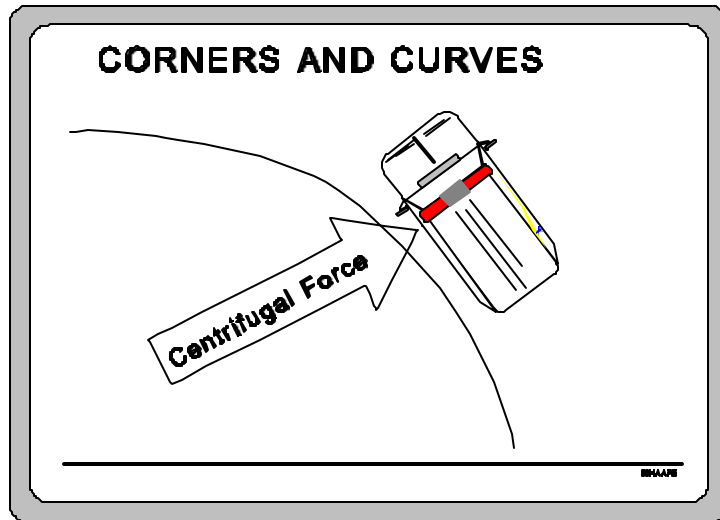

There is a force that must be considered when going around a corner or a curve. That force is called centrifugal force, and it throws a body toward the outside of a curve as the vehicle goes around the curve. You have all felt it even if you didn't know what it was called.

For example, if you travel down the highway at 55 mph and enter a curve to the left, you feel yourself being pushed toward the right side of the vehicle. You naturally lean to the left to counteract this push. That works fine for the passengers sitting upright in the seats.

But the patient strapped to the stretcher can't lean. And the medical team can't lean, and their equipment can't lean. So you, as the operator, have to reduce the force that they feel. And you reduce the force by slowing down and making smooth turns so that they can balance and stay balanced throughout the turn.

| Instructor Notes | Presentation |
|---|---|
| | Braking |
| | <p>Body lean is a very important factor when you brake or when you accelerate. When you brake hard, the nose of the ambulance drops downward and all the weight of the ambulance, and its occupants, shifts toward the front. When you accelerate hard, just the reverse happens. Everything shifts toward the back.</p> |
| | <p>Just like when cornering, body lean is not a big problem for you because you are sitting upright in a seat with your seat belt on. But the medical team and the patient aren't so lucky. They are forced to lean forward and backward as you brake hard and then accelerate. And they can't see what's coming so that they can brace themselves. You have to protect them by braking no harder than necessary and by accelerating smoothly and steadily.</p> |
| | <p>When braking, you must take two factors into consideration: reaction time and braking time</p> |
|  <p>6: Stopping Distance</p> | |

Instructor Notes

Presentation

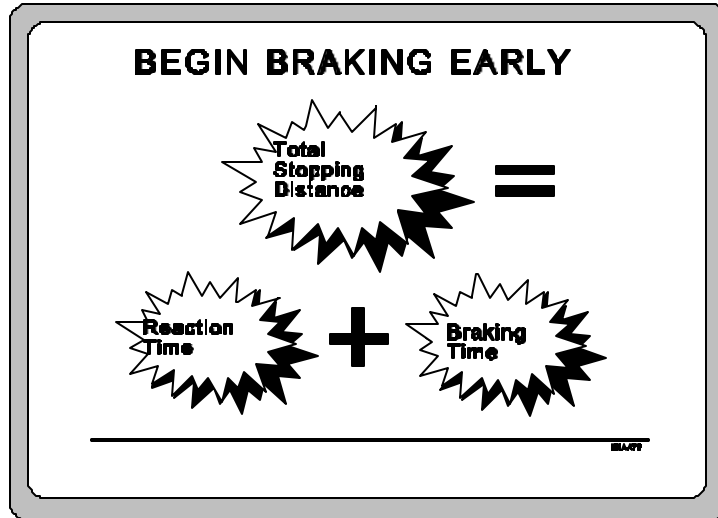

Reaction time is a combination of the time it takes you to see and understand that you will have to brake and to actually move your foot to the brake pedal.

Braking time is the time it takes your brakes to bring the ambulance to a complete stop.

Total stopping distance, then, is equal to the reaction time plus the braking time.

Training can reduce reaction time. When the brain is under stress, as it is when you recognize a problem ahead, the body will react the way it was trained to react.

In Lesson 1 we talked about factors that can affect your reaction

Instructor Notes

Presentation

time--illness (e.g., cold, flu), a physical injury that could affect your ability to maneuver the ambulance, medication(s), and lack of sleep.

All of these factors influence your reaction time and ultimately determine if you will be able to stop in the time (distance) available. You need a way to maximize the time and distance available for braking by placing your ambulance in the safest position.

2-4-12 Rule



7: 2-4-12 Rule

2 4 12 Rule

2 second interval below 55 mph
4 second interval above 55 mph
12 second visual lead time

One recommended way to calculate where you should place your ambulance is called the 2-4-12 rule. It permits you to see what is happening well ahead of your ambulance and to take action early. The 2-4-12 rule says--

| Instructor Notes | Presentation |
|------------------|--|
| | <p>! maintain a 2 second interval between your ambulance and the vehicle ahead for speeds below 55 mph</p> |
| | <p>! increase the following distance to 4 seconds when speeds get above 55 mph to allow for increased stopping distances at higher speeds</p> |
| | <p>! give yourself a 12 second visual lead time. In other words, look ahead for possible hazards and alternate paths of travel should an emergency arise</p> |
| | <p>Use your 12-second visual lead time to constantly make speed and position adjustments. Simplify your choices as much as possible. Don't tackle more hazards than you absolutely have to.</p> |
| | <p>For example, if you are looking 12 seconds ahead, you will see the traffic light almost a block away turn red. You are able to respond by removing your foot from the accelerator and begin slowing early. Then by smoothly applying the brakes, you can bring the ambulance to a stop without having to slam on the brakes. When traffic clears and you can proceed forward, you can gently release the brakes and begin to accelerate at a steady pace. As you continue to look ahead, you begin slowing for that next corner and make a smooth turn that doesn't throw the patient from one side to the other.</p> |

| Instructor Notes | Presentation |
|--|--|
| | <p>Look ahead, see what is happening all around you, and begin your actions early. Your driving will improve and you will begin providing a smooth ride for your crew and your patient.</p> |
| | <p>Accelerating</p> |
| | <p>To reduce body lean and strain on the patient and the medical team, accelerate smoothly and steadily.</p> |
| | <p>Steadily does not mean to push the accelerator down quickly and hold it there. Instead, you can provide a more comfortable ride by using a smooth, slow rate of acceleration.</p> |
| | <p>This method requires that initially you apply a feather-touch to the accelerator and then continue to move the accelerator pedal downward gradually but steadily. As you approach the desired speed, hold the accelerator still for a moment. Begin to ease up on the accelerator to the point where you are using just enough engine power to maintain the selected speed.</p> |
|  <p>8: Practice</p> | |

Instructor Notes

Presentation

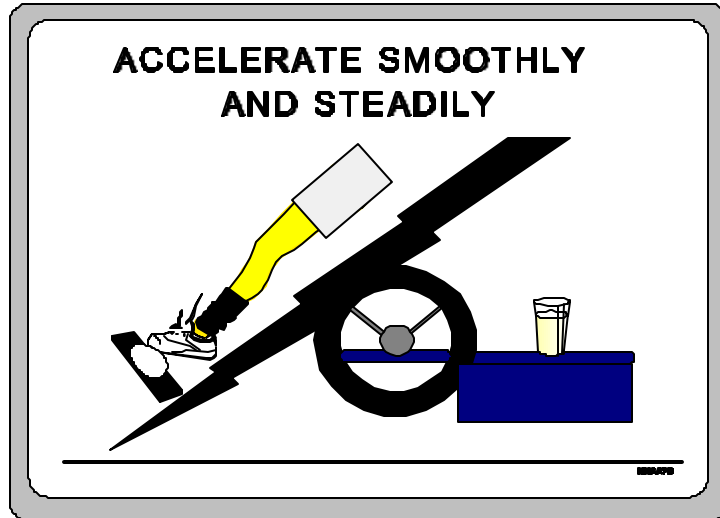

To practice, you can do two things. First, pretend there is a raw egg between your right foot and the accelerator pedal. Try not to break the egg. The second thing is something you should practice but not do on a run. Place a half-full glass of water on the dash and try to accelerate (and brake and take corners) without spilling any of the water.

Speed

Q&A

If two ambulances are going down the same road, one at 55 mph and one at 35 mph, which one do you think is providing the smoother ride?

[Answer: The one at 35 mph]

| Instructor Notes | Presentation |
|---|--|
| | <p>Of course, the ambulance doing 35 mph is providing a smoother ride. High speed makes the ride rougher than lower speed does. The faster an ambulance goes, the more it bounces. Each turn of the steering wheel throws the ambulance harder from side to side.</p> |
|  <p>Provide guidance on local speed regulations.</p> | <p>Our local regulations concerning speed include--</p> |
| | <p>High speed normally makes the patient's ride so much worse that it is actually detrimental to the patient, not beneficial. You may get to the hospital faster, but you may have made the patient's injuries worse just from the bouncing. And the medical team hasn't been able to work because they had to hold on to counteract the effects of a less than smooth ride.</p> |
| | <p>Most patients are stabilized and on life support, if necessary, before the ambulance leaves the emergency scene. Therefore, speed is not as necessary when transporting the patient to the medical facility.</p> |
| | <p>So, slow down for curves and corners and take them smoothly. Brake smoothly and no more than is required. Accelerate smoothly and steadily and go no faster than necessary.</p> |
| | <p>To review, the driving skills we want to improve are involved in</p> |

Instructor Notes

Presentation

Q&A

what four phases of driving?

[Answer: Cornering, braking, accelerating, and speed]

Q&A

And what's the best way to improve these driving skills?

[Answer: Practice and look ahead of the ambulance]

Q&A

Total stopping distance equals what?

[Answer: Reaction time plus the braking time]

There is a delicate balance between the operator, the machine, and the environment:

! The machine, your ambulance, is the most reliable and is responsible for only one percent of crashes.

! The environment is constantly changing and is responsible for approximately ten percent of the crashes.

| Instructor Notes | Presentation |
|---|--|
| | <p>! That leaves you, the operator. The operator is responsible for a large percent of ambulance crashes. The operator is also responsible for the successful merging of the three-part relationship.</p> |
| | <p>Preventable Collisions</p> |
| | <p>Most collisions are preventable. Think about that for a moment. Most collisions are preventable.</p> |
| | <p>The key to preventing collisions is called situational awareness. This means that you must be constantly aware of your situation by remaining alert at all times, knowing what's going on all around the ambulance, and driving defensively. There is no time to relax while driving. To begin talking about situational awareness, let's discuss defensive driving.</p> |
| | <p>Defensive Driving</p> |
| <p>Q&A</p> | <p>Could someone please give me a definition of defensive driving?</p> |
| <p> 9: Defensive Driving</p> | |

Instructor Notes

Presentation

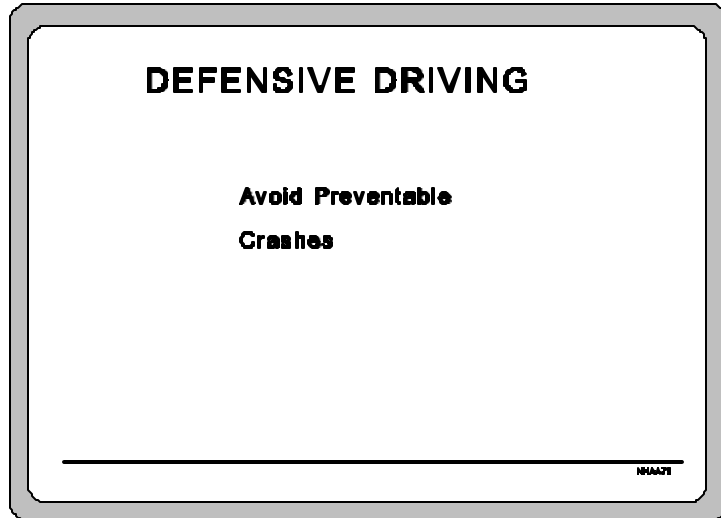



Defensive driving means doing everything reasonably possible to avoid being involved in a preventable crash, regardless of what the law is, what the other driver does, or adverse driving conditions.

Defensive driving requires continual exercise of good judgment and good driving habits with an awareness that all other drivers cannot be relied upon to drive properly and safely.

When you are driving an ambulance, you are operating a lethal weapon on a crowded, public roadway. You have to expect the unexpected and be prepared to act. Have a plan of action at all times. Remember, you have the final responsibility for your safety and that of your passengers.

Maintaining a Safety Cushion

| Instructor Notes | Presentation |
|---|--|
| <p>Q&A</p> <p>Encourage discussion.</p> | <p>The next thing we want to discuss is "Maintaining a Safety Cushion." What do you think we mean when we say "maintaining a safety cushion?"</p> |
| <p></p> <p>Write participant responses on a flipchart or blackboard.</p> | |
| <p>If participants do not mention each of these, add them to the list.</p> | <p><i>[Answer: Driving so that you position your vehicle in relation to other vehicles and possible hazards so that you have a cushion of empty space completely surrounding your ambulance]</i></p> |
| <p></p> <p>10: Safety Cushion</p> | |

Instructor Notes

Presentation

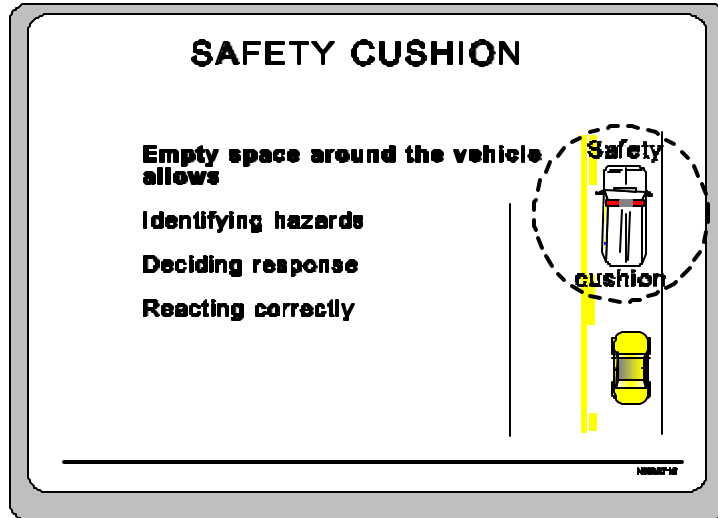

You want to allow enough room around the ambulance so that you can identify possible hazards, decide on a course of action, and react by either bringing the ambulance to a controlled stop or maneuvering to avoid the hazard.

Q&A

Why would you want to maintain a safety cushion of empty space around the ambulance?

Encourage discussion.

[Answer: Prevent crashes, have an escape route]

In a road emergency, you don't want to get boxed in without an escape route. Maintaining a safety cushion around your

| Instructor Notes | Presentation |
|------------------|--|
| | ambulance reduces your chances of being involved in a crash. |
| | Obviously, the safest position for the ambulance is as far away from any possible collision hazard as you can be. It's easy to be involved in a crash with the vehicles in front, beside, and behind you. |
| Q&A | Why should you be concerned about vehicles behind you? |
| | <i>[Answer: Tailgaters, multiple responding units]</i> |
| | Tailgaters |
| | Let's discuss tailgaters first. Tailgaters are people who follow too closely behind the vehicle in front of them. Normally, they are so close that if you have to stop suddenly, they don't have time to stop or prevent running into the back of your ambulance. |
| | Don't allow other drivers to tailgate you. Use any method to make them pass or fall back. If necessary, slow and pull to the right of your lane to encourage them to pass. Tailgaters are safer for you if they are tailgating the vehicle in front of you. You at least can see them and plan your action if they run into the other vehicle. |
| | Multiple Responding Units |

Instructor Notes

Presentation

Q & A

Why would multiple responding units be a problem behind your ambulance?

Encourage discussion.

[Answer: Trying to get to the same place at the same time; other motorists only expect one emergency vehicle and may pull into them or you]

Emergency units responding along the same route should maintain 300 to 400 feet of distance between them. To make sure the other motorists know there is more than one emergency unit in the area, use a different siren tone than the vehicle ahead of you. Change tones at intersections and allow your siren to partially wind down prior to the intersection so that both you and the other motorists will be alerted that there are multiple emergency vehicles in the area.



Local regulations regarding multiple responding units include--

Provide guidance on local regulations on multiple responding units.

Communication

Instructor Notes

Presentation

And finally, to get the maximum advantage from proper positioning, your safety cushion, and defensive driving, you must communicate with other drivers.

Q&A

How can you, when driving the ambulance, communicate with other drivers?

Encourage discussion

[Answer: Communicate through nonverbal signals such as lights, horn, eye contact, hand signals, emergency lights, and sirens. Make your intentions known to other drivers. Watch other drivers to foresee what their intentions are.]



11: Communicate

COMMUNICATION WITH OTHER DRIVERS

- Lights**
- Horn**
- Eye contact**
- Hand signals**
- Siren**

EMERGENCY

Instructor Notes

Presentation

Remember: always expect the unexpected from the other drivers. Don't assume that they see or hear you. And even if they do see and hear you, don't assume that they will give you the right of way.

PRE-CRASH PLANNING

Sometimes a crash is going to happen, even though you have done everything you could to avoid it. You need to plan ahead for that situation and think about how you are going to handle it.

Now, three things to do to reduce the effects of a crash.

First, keep the doors locked. A locked door will withstand many times more strain in a crash than an unlocked door. You won't fly out of a locked door, and you are generally better off staying inside your vehicle during an crash rather than being thrown from it.

Second, always wear your seat belt. It's the best protection you have in a collision.



Our local regulations for seat belt use include--

Provide guidance on local regulations for seat belt use.

| Instructor Notes | Presentation |
|------------------|---|
| | <p>And, third, good housecleaning habits also can prevent serious injury. Keep loose items, such as clipboards, secured. Properly secure your equipment to reduce the number of potential missiles inside your ambulance.</p> |
| | <p>PREPARING FOR THE INEVITABLE CRASH</p> |
| | <p>Your first priority is to protect yourself and your passengers from death or injury. The next priority is to reduce vehicle damage. But remember, you and your crew are more important than your vehicle.</p> |
| | <p>The key to surviving an inevitable crash is to REDUCE. First, reduce the speed of the impact. The lower the speed, the lower the energy levels involved and the lower the probability of death or serious injury.</p> |
| | <p>Next, reduce the angle of impact. Try for a glancing blow rather than a direct blow, such as a head-on collision.</p> |
| | <p>Third, reduce the size and hardness of the object you are going to hit. For instance, if you are going to leave the road, try to steer into a grassy field instead of trees, or into small saplings and bushes rather than into larger trees.</p> |
| | <p>If you are absolutely sure that you are going to strike something, try to hit it with the part of the ambulance the furthest from you--the right front or right rear--even if it places your passengers in greater jeopardy. Remember, only the operator can control the</p> |

Instructor Notes

Presentation

ambulance after the initial impact. You may still need to steer the ambulance to reduce injury and damage, not only to yourself, but to others.

Q&A

If I notice that I have a tailgater riding my bumper, what should I try to do?

[Answer: Encourage the tailgater to pass by slowing and pulling to the right of my lane. If you failed to brief the patient's family, it could be them. Stop and brief them, telling them to follow at a safe distance. If tailgating ever becomes dangerous, call law enforcement to assist.]

Q&A

Why do I want to maintain a safety cushion around my ambulance?

[Answer: Prevent crashes, have an escape route]

Q&A

In order to prevent crashes, how can I communicate with other drivers?

[Answer: Lights, horn, eye contact, hand signals, emergency lights, and sirens]

BASIC MANEUVERS

Instructor Notes

Presentation



12: Basic Maneuvers

BASIC MANEUVERS

- Braking & Stopping**
- Making Lane Changes**
- Passing**
- Backing**
- Parking**
- Turning**

MANA/11

Now that you know how to avoid crashes, let's talk about the basic maneuvers that you will use every day. We've already talked once about braking and stopping, but there are a couple of more things about braking and stopping that are important.



13: Braking and Stopping

Instructor Notes

Presentation

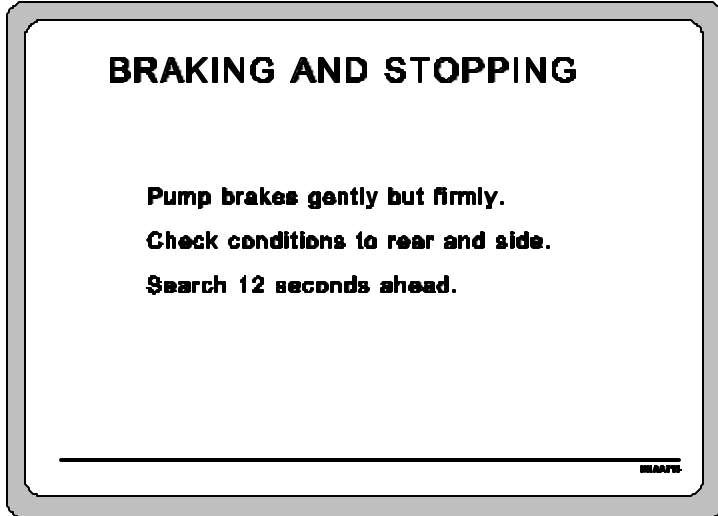

Braking and Stopping

Braking is very effective in stopping your ambulance if it is done properly, but it can be hazardous if you do it improperly. If you apply too much pressure and lock the brakes, the wheels will skid and you will lose steering control. If all four wheels skid, the rear end of the ambulance may slide to the side and you will lose control of the vehicle. To avoid these problems, you must keep the wheels turning.

Apply pressure on the brake pedal with the upper half of the right foot, preferably with the heel contacting the floor. Try to pivot on the heel for greater sensitivity on the pedal. This involves fewer leg muscles and reduces unwanted "pumping" or "lock-up" of the brakes.

Instructor Notes

Presentation

In a straight line, the most efficient way to brake to a stop on any surface is by gently but firmly pumping the brakes. Braking, when properly done, involves firmly pressing the brakes to the point before lockup, then gently releasing them so that there is a minimum amount of front-end weight change and bounce. The main point is to never lock-up the brakes.

Avoid staring at the front hood of the ambulance while braking. Check the conditions to the rear to avoid being hit from behind. Check conditions to the side in an effort to find an escape route. Search 12 seconds ahead to see if the conditions which forced your braking actions have changed.

Making Lane Changes



14: Making Lane Changes

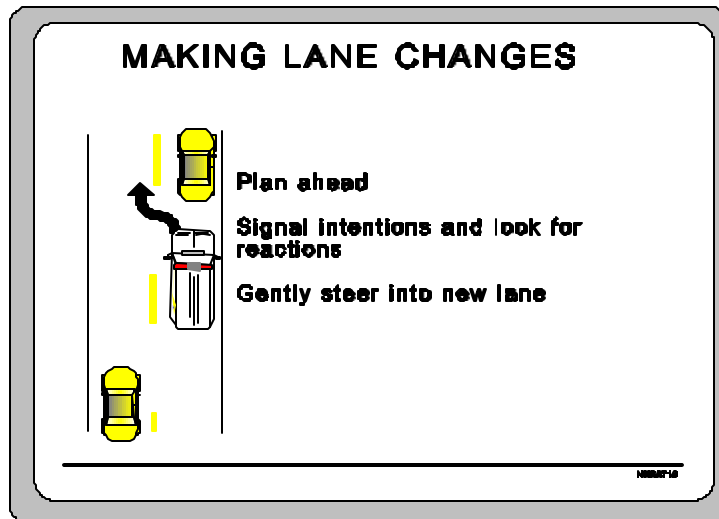

When making lane changes on a multilane road, you must plan

| Instructor Notes | Presentation |
|------------------|--|
| | <p>ahead. Using the 12-second method we spoke of earlier, plan your lane change well in advance. Signal your intentions and look for reactions from the other drivers. If the new lane remains clear, gently steer into the new lane and continue straight ahead. A properly executed lane change should be smooth, and your passengers should never feel the change in the position of the ambulance.</p> |
| | <p>When changing lanes for passing on multilane highways--</p> |
| | <p>! check other lanes for problems and a clear path</p> |
| | <p>! check your mirrors to find an opening in the adjacent lane</p> |
| | <p>! signal your intentions by having the signal lever in the "on" position for at least three seconds before changing lanes</p> |
| | <p>! check your blind spot by making a quick glance over your shoulder in the direction the vehicle is to travel</p> |
| | <p>! slightly turn the wheel for a smooth, gradual, accurate movement</p> |
| | <p>! control your speed with a slight increase in speed, if required.</p> |

Instructor Notes

Presentation

! time vehicle arrival into the adjacent lane to avoid interfering with other traffic

Passing

Passing on two-lane roads



15: Passing-two-Lane

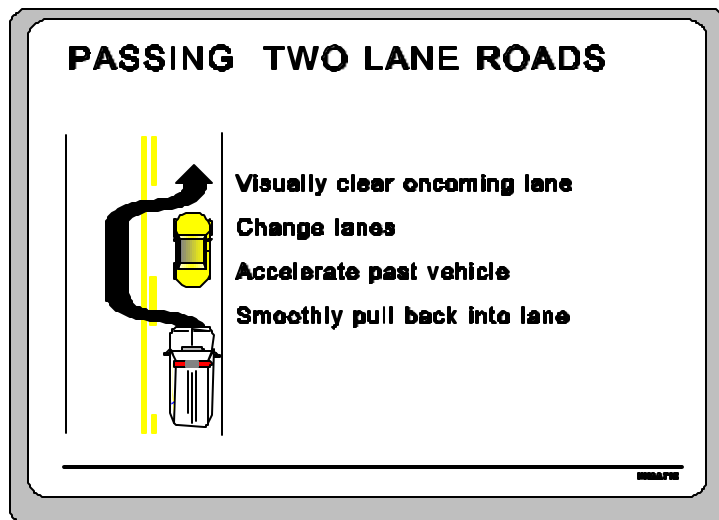

When on two-lane roads, you will sometimes have to pass a slower vehicle ahead. If the vehicle refuses to pull over or if there is no space beside the road for it to pull over, then you will have to plan and execute a pass.

Passing on a two-lane road is a very dangerous maneuver because, for several moments, you are in the lane of approaching traffic. Your closing speed on the

Instructor Notes

Presentation

approaching vehicle is the total of your speed and their speed. When passing at 55 mph, your vehicle and the oncoming vehicle will be about 1/2 mile closer at the end of the passing maneuver than when you started. You have to ask yourself whether you have the space and if the risk is worth the few seconds saved.

To pass a slower vehicle on a two-lane road, you must visually clear the oncoming lane, change lanes, accelerate past the slower vehicle, and smoothly pull back into your lane in just a matter of a few seconds.

Passing Stopped Traffic



16: Pass Stopped Traffic

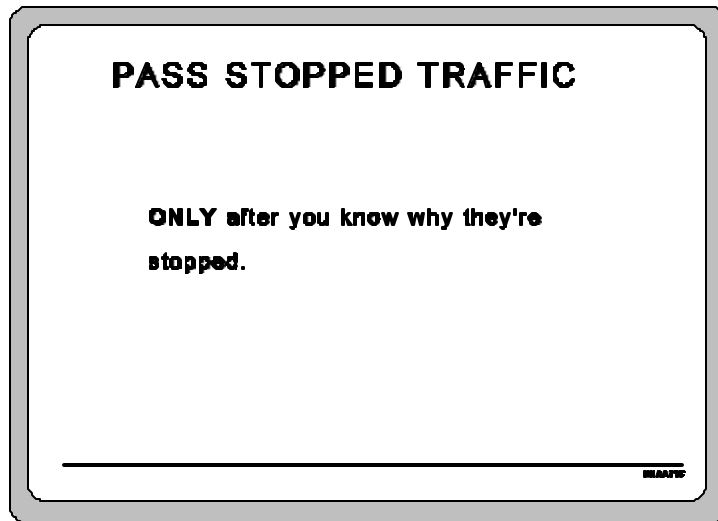

Attempting to pass stopped traffic is a hazardous situation. You should pass stopped traffic only when you are able to

Instructor Notes

Presentation

determine the reason for their stopping. While you are passing stopped traffic, part of your escape route has been eliminated. If oncoming traffic suddenly appears or one of the stopped drivers suddenly pulls in front of you, you may have nowhere to go.

Backing



17: Backing

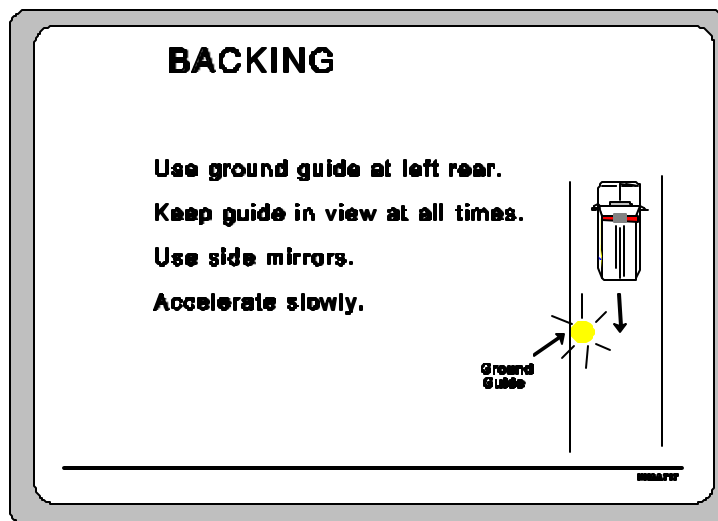

You might be surprised to learn that Childs and Ptacnik, in *Emergency Ambulance Driving*, report that backing accidents account for 85 percent of all single-vehicle crashes involving ambulances. This is normally a very slow maneuver, but remember that the area directly behind the ambulance is not visible to the operator. If backing is going to be necessary, it is best to do the backing when you first arrive at the scene.

| Instructor Notes | Presentation |
|------------------|--|
| | <p>You should always use a ground guide positioned at the left rear of the ambulance to help. Position the guide so that you can see him or her in your side view mirrors and so that the guide can see all the obstacles behind the ambulance. Use agreed-on hand signals and, if there is any confusion, stop and clear up the confusion before continuing. When backing, you will either back in a straight line or make turns while backing. For straight line backing--</p> |
| | <p>! position your body so that you can properly use the side view mirrors</p> |
| | <p>! position both hands on the wheel, either at ten and two o'clock or at nine and three o'clock</p> |
| | <p>! make sure that you have a clear view to the rear</p> |
| | <p>! begin to accelerate slowly</p> |
| | <p>! keep hand movement on the steering wheel to a minimum</p> |
| | <p>For turning while backing--</p> |
| | <p>! position your body so that you can properly use the side view mirrors</p> |
| | <p>! position both hands on the wheel, either at ten and two</p> |

| Instructor Notes | Presentation |
|---|--|
| | o'clock or at nine and three o'clock |
| | ! frequently check the front corners of the vehicle--remember that, as you turn, it is the front end that moves sideways |
| | ! begin to accelerate slowly |
| | ! turn the steering wheel while maintaining firm control, always keeping your hands on the wheel |
| | ! maintain speed control; in close quarters, creep the vehicle |
| | Parking |
| | Correct parking of the ambulance prevents it from being hit by other vehicles at the scene of a crash or at the hospital. Parking in an urban setting is the toughest parking problem. You have to search for a place to park and then squeeze your ambulance into a tight space while trying to keep from impeding other traffic or getting your ambulance hit by other vehicles. |
|  <p>Provide guidance on local policy on parking at crash sites and hospitals</p> | Our local policy on parking at crash sites and hospitals is-- |

Instructor Notes

Presentation

Perpendicular or Stall Parking



18: Perpendicular Parking

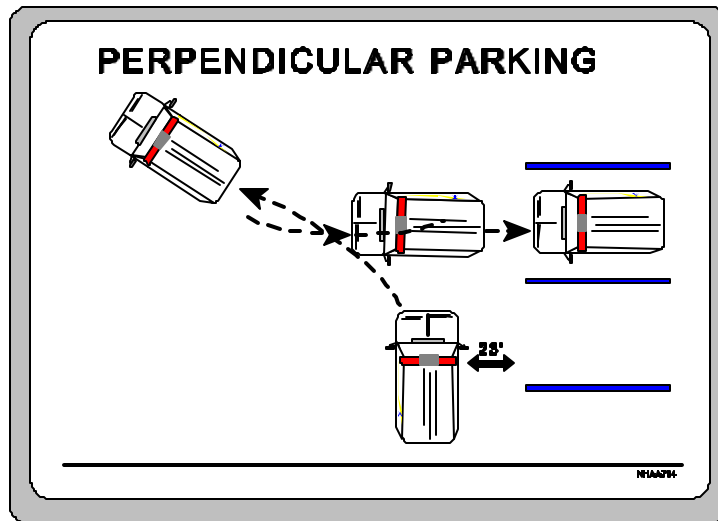

Backing into a perpendicular parking space is highly recommended. You can get into and out of a tighter area than if you parked forward in. When a vehicle is backed into a space, the operator is able to move it quicker in case of an emergency. To park in a perpendicular space--

- ! use a ground guide
- ! position the ambulance two to three feet from the parked vehicles on your right

| Instructor Notes | Presentation |
|------------------|---|
| | ! stop the ambulance when the operator's body appears to be lined up with the center of the parking space |
| | ! select a 45 degree target--use the left corner post blind spot of the windshield as a target guide |
| | ! creep forward while rapidly turning the steering wheels--check for traffic. Aim for the 45 degree target. Set the tires straight. |
| | ! shift into reverse |
| | ! line your vehicle up with the space and, looking over your right shoulder, aim the vehicle for the space |
| | ! back to the rear pivot point |
| | ! creep backward and turn the steering wheel |
| | ! get the vehicle straight in the space |
| | ! creep backward and straighten the wheels |
| | ! back to the rear parking line |

Instructor Notes

Presentation

Angle Parking



19: Angle Parking

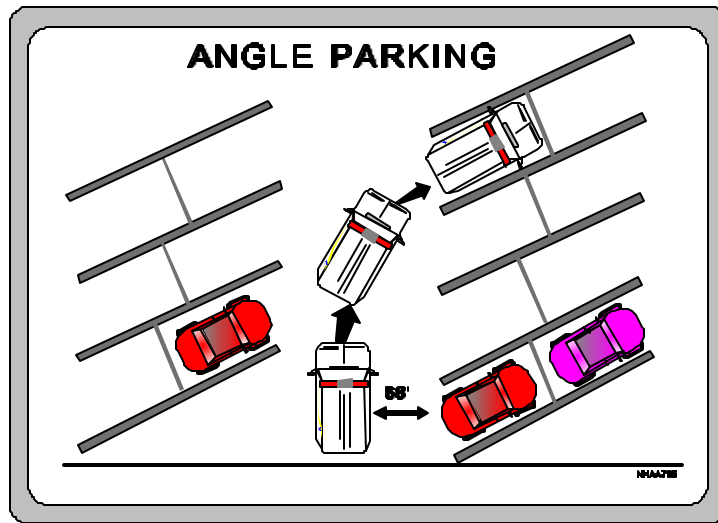

Angle parking is used when there are 30 to 45 degree angle parking spaces. This type of parking is designed for head-in parking. To park in an angled space--

- ! before parking, check the side view mirrors and check the parking space
- ! position the ambulance at least six to eight feet away from the side of the parked vehicles
- ! see the center of the space without your line of sight

| Instructor Notes | Presentation |
|------------------|--|
| | curving across the parking line |
| | ! creep forward and turn the wheel |
| | ! line up with target in center of space |
| | ! straighten the wheels |
| | ! stop at front parking line |
| | To back out of the angle parking space-- |
| | ! use a ground guide |
| | ! back slowly |
| | ! check the traffic as you back up |
| | ! check all corners of the vehicle |
| | ! clear the fender of the car on the left, then turn the steering wheel hard |
| | ! straighten the wheels |

Instructor Notes

Presentation

! shift to drive and move forward

Turning

There are several turning maneuvers that we will cover. The simplest turns are the right and left corners.

Q&A

On two-way streets, which takes more time and space to accomplish, a right turn or a left turn at a corner?



20: L/R Turns

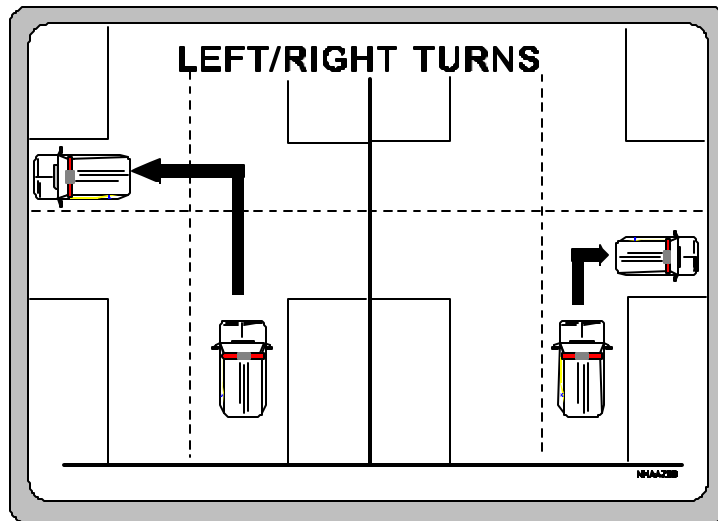

[Answer: Left turn]

Instructor Notes

Presentation

Q & A

In a left turn, you must cross the near lane before turning into the travel lane. You are exposed in the intersection longer than when making a right turn. You must give oncoming traffic more time. What is another difference when making a left turn than when making a right turn?

[Answer: You are involved with traffic from both directions.]

The U-turn also leaves your vehicle exposed to both oncoming and ongoing traffic.



21: U-Turn

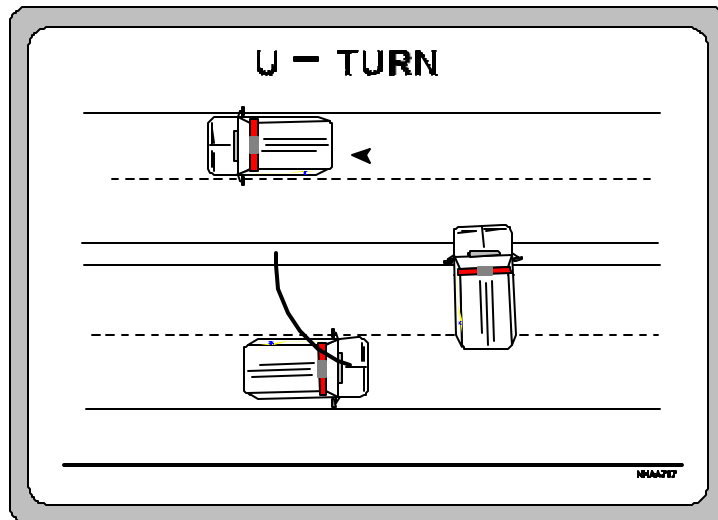

To make a U-turn on a road without a median strip--

| Instructor Notes | Presentation |
|------------------|--|
| | ! slow the ambulance |
| | ! pull to the extreme right of lane or onto the shoulder |
| | ! check traffic in both directions |
| | ! signal your intent to turn |
| | ! turn steering wheel hard in the direction of the turn |
| | ! when traffic is clear in both directions, move forward and complete the turn as quickly as possible |
| | ! do not accelerate until after the turn is completed |
| | ! and if the turn cannot be completed in one motion, back only as far as necessary for completion of the turnabout |
| | To turn around by using the right side of the roadway or by backing into a driveway requires a two-lane roadway. |



22: Back-Around

Instructor Notes

Presentation

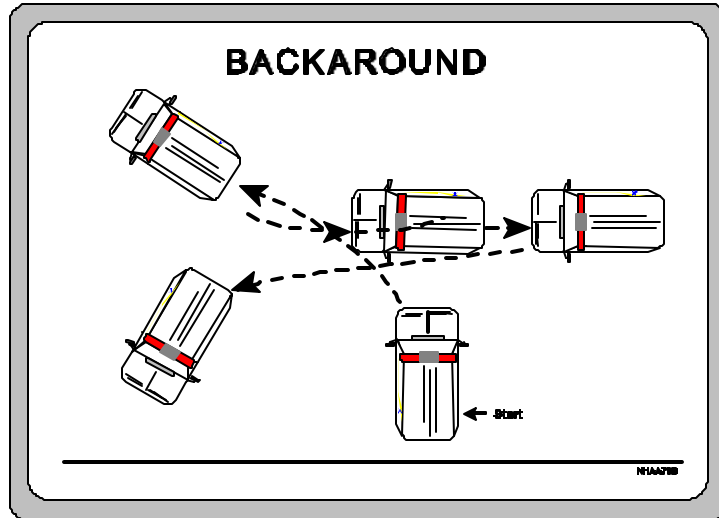

To complete such a backaround--

- ! use a two-lane roadway
- ! use the same method as backing into a perpendicular parking space
- ! check roadway for traffic before and during the maneuver
- ! avoid driving head-in into a driveway, as this reduces maneuverability when exiting the driveway

| Instructor Notes | Presentation |
|--|---|
| | <p>Urban Driving</p> |
| | <p>Urban driving can be one of the most challenging experiences an operator will face. In urban traffic, your ambulance is surrounded by others being driven closer together than is considered safe. Traffic is constantly changing speed, some traffic may be stopped, and vehicles are entering and exiting the traffic flow from all directions.</p> |
|  <p>Provide guidance on specific areas of concern in local urban area, including agreements when entering other jurisdictions.</p> | <p>Our local regulations about urban driving include--</p> |
| | <p>Obviously, you must be at your peak of alertness to safely drive in heavy urban traffic. In order for ambulance operators to drive a safe emergency response in heavy urban traffic, they must first understand and be able to drive routinely in heavy traffic. Urban driving requires that the operator be observant and learn to fit well within traffic.</p> |
| | <p>When operating in congested city traffic, there are usually a lot of things happening. It is most helpful to have a second pair of eyes assist you. Since the most critical part of your run is getting to the</p> |

| Instructor Notes | Presentation |
|------------------|--|
| | <p>patient and your primary duty is to drive the ambulance safely, have the EMT sit in the passenger seat to help navigate and watch the traffic.</p> |
| | <p>The EMT may also use the radio to request alternate routes from dispatch should you run into stopped traffic or unforecasted road repairs.</p> |
| | <p>When it is not possible to have two people in the cab of the ambulance, such as on the way to the medical facility, slow down and always look twice. This is critical when proceeding through busy intersections.</p> |
| | <p>Large buildings will limit visibility at intersections. Large buildings also limit the range of your siren and confuse people about which direction the siren is coming. Your siren may get lost in all the other city noises unless you change modes often, such as from wail to yelp.</p> |
| | <p>In urban settings--</p> |
| | <p>! be alert for traffic entering the roadway from alleys, parking lots, driveways, and intersections</p> |
| | <p>! be alert for children playing in the streets, people exiting delivery vehicles, drivers opening doors to exit parked vehicles, bicyclists, and pedestrians at school crossings and crosswalks</p> |

Instructor Notes

Presentation

In the next lesson, we will discuss one of the most dangerous areas where you will drive--the controlled intersection--and the recommended procedures that have been established to get you safely through the intersection.

Rural Driving



Provide guidance on specific areas of concern in local rural areas, including agreements when entering other jurisdictions.

Our local regulations about rural driving include--

- ! Be alert for loose livestock and pets.
- ! Be alert for bicyclists, school buses, and children waiting for buses.
- ! At the higher speeds of driving in rural areas, drivers may have their windows up and the radio on and will not be able to hear the siren until you are close to them.
- ! Be alert for slow-moving vehicles, such as tractors, farm equipment, trucks, and horses and buggies.

| Instructor Notes | Presentation |
|---|--|
| | Two-lane Highway Driving |
| | <p>Two-lane highways are dangerous because it is difficult to maneuver around other vehicles, making you contend with slower traffic. Do not take unwarranted chances in the hopes of getting to your destination faster. Studies have shown that the chances taken are not worth the few seconds saved by passing a slower vehicle.</p> |
|  <p>Provide any local regulations concerning two-lane highway driving.</p> | <p>Our local regulations concerning two-lane highway driving include--</p> |
| | <p>Remain calm and patient and allow the other drivers sufficient time to slow and pull over so that you may pass without endangering yourself, your passengers, or the other drivers.</p> |
| | Highway/interstate Highway Driving |
| | <p>The special challenges of highway or interstate driving are directly related to the increased number of vehicles on the road and the increased speed of those vehicles.</p> |
| | <p>Our local regulations about interstate highway driving include--</p> |

Instructor Notes

Presentation



Provide any local regulations concerning interstate highway driving.

Use the 12-second rule to constantly read the subtle changes that occur in traffic. This includes vehicle brake lights, vehicles maneuvering for an exit, or a line of vehicles entering the highway. Always try to be at least two steps ahead of the other drivers on the road and three steps ahead of traffic.

Prerun route planning, which is covered in Lesson 6, means not only picking a route but knowing the route, including the corners where you will turn and the exits you will take off the interstate road. Sudden moves, such as quickly changing lanes to get to an approaching exit or the reflex to brake after you miss an exit, are the cause of many interstate crashes. Know the exit you're supposed to take by at least one exit preceding it.

Be aware of how other drivers may respond to the emergency vehicle. Abrupt lane changes or stops by other drivers are especially hazardous in crowded and fast moving traffic.

When exiting an interstate roadway, maintain your present speed until your ambulance is completely off the interstate. Use the exit ramp for decelerating. Obviously, some common sense comes into play here. If it's rush hour and the ramp is congested, you don't want to be tracking at 55 mph! If you are looking 12

| Instructor Notes | Presentation |
|------------------|--|
| | <p>seconds ahead, you will see the congestion and plan your highway exit accordingly. Also, shorter ramps will require a greater rate of deceleration, so be aware of this.</p> |
| | <p>When entering an interstate roadway, use the entrance ramp to accelerate to the speed of traffic. Once on the interstate, progress lane by lane to the extreme left or "fast" lane. The siren should be in the yelp mode when making lane changes as this promotes vehicle recognition.</p> |
| | <p>Use extreme caution while on the interstate. Most people mean well and are really trying to clear the path for your vehicle. A little patience will help keep you in good stead with the public and out of potential crash situations.</p> |
| Q&A | <p>Let's review basic driving maneuvers. About how much distance must there be between my vehicle and an oncoming vehicle if I want to pass a slower vehicle at 55 mph on a two-lane road?</p> |
| | <p><i>[Answer: More than one-half mile]</i></p> |
| Q&A | <p>The best way to back the ambulance is with the aid of what?</p> |
| | <p><i>[Answer: A ground guide]</i></p> |
| | <p>Why don't I want to lock the brakes in an emergency situation?</p> |

Instructor Notes

Presentation

Q&A

[Answer: I will lose control of the ambulance because I can no longer steer]

Q&A

Perpendicular parking is best performed by which: backing in or driving forward into the spot?

[Answer: Backing in]

Q&A

The 12-second rule should only be used on the highway because you can't see 12 seconds ahead when driving in a city. True or false, and why?

[Answer: False. The 12-second rule should be followed at all times when driving]

SUMMARY

Road construction and engineering factors affect ambulance control and quality of ride. Some of the factors to be considered are--

! different types of road surfaces

| Instructor Notes | Presentation |
|------------------|--|
| | ! |
| | ! the transition between road surfaces |
| | ! |
| | ! road conditions |
| | ! |
| | ! design of curves |
| | ! |
| | ! road crown |
| | ! |
| | ! water drainage |
| | ! |
| | ! roadside engineering |
| | |
| | The four driving skills which effect the quality of ride are-- |
| | ! |
| | ! cornering |
| | ! |
| | ! braking |
| | ! |
| | ! accelerating |
| | ! |
| | ! maintaining appropriate speed |

| Instructor Notes | Presentation |
|------------------|--|
| | Ambulance operators maintain a safety cushion around the ambulance to prevent crashes. They can do so by-- |
| | ! encouraging tailgaters to pass |
| | ! making the public aware of the existence of multiple responding units |
| | ! driving defensively |
| | ! communicating with the other drivers on the road |
| | Basic maneuvers the ambulance operator performs every day include-- |
| | ! braking and stopping |
| | ! making lane changes |
| | ! passing on two lane roads and passing stopped traffic |
| | ! backing |
| | ! parking |

Instructor Notes

Presentation

! turning

You must be accomplished in driving on all road types and for all road conditions that you may encounter in your area.

| | |
|----------------------------------|---|
| COURSE: | EMERGENCY VEHICLE OPERATOR COURSE (AMBULANCE): NATIONAL STANDARD CURRICULUM |
| MODULE A: | Ambulance Operation: The Basics |
| LESSON 8: | Operations in Emergency Mode and Unusual Situations |
| LENGTH: | 3.0 Hours |
| COURSE GOAL: | To provide ambulance operators with the knowledge and skills to operate their vehicles so that their vehicle, equipment, crew, and patients will be delivered safely and efficiently and the safety of the public will be assured during all phases of the delivery of the Emergency Medical Services (EMS) involving the ambulance |
| MODULE GOAL: | To provide ambulance operators with the knowledge required to safely and efficiently operate an ambulance in both non-emergency and emergency modes |
| LESSON GOAL: | To provide participants with knowledge of how to operate an ambulance under emergency driving and other high risk driving situations in order to reduce ambulance crashes |
| PERFORMANCE OBJECTIVE(S): | <ul style="list-style-type: none"> ! For each emergency driving situation presented, select the recommended procedure to be followed when driving an ambulance ! Identify the problem(s) associated with each adverse driving |





condition listed

- ! For each adverse driving condition listed, select the recommended procedure to be followed when driving an ambulance
- ! For each driving scenario listed, select the recommended crash avoidance technique to be followed when driving an ambulance
- ! For each driving scenario listed, select the recommended vehicle recovery technique to be followed when driving an ambulance

INSTRUCTIONAL AIDS:

ICON LEGEND

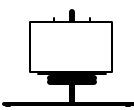
(Those used in this lesson are highlighted)

| | | | | | |
|--|---|---|---|--|---|
|  |  |  |  |  |  |
| Appendix | Show Overhead | Question and Answer Period | Use Flipchart | Ask Question | Local Requirements |



1. Emergency Driving

2. Emergency Signaling Devices
3. Response
4. Speed Limits
5. Danger
6. Due Regard
7. National Voluntary Consensus Standards 1
8. National Voluntary Consensus Standards 2
9. National Voluntary Consensus Standards 3
10. Driving Against Traffic
11. Adverse Conditions
12. Traction
13. To Improve Traction
14. Vision
15. Night Driving
16. Rain and Fog
17. Compensating for Poor Visibility
18. Compensating for Poor Visibility
19. Crash Avoidance
20. Avoid a Crash
21. Off-Road Recovery
22. Vehicle Malfunctions
23. Pulling Off the Road

**INSTRUCTIONAL
EQUIPMENT:**

Flipchart and markers
Transparencies
Overhead projector and screen

Training Tips for: Lesson 8: Operations in Emergency Mode and Unusual Situations

- Tip 1. You will need to incorporate your local procedures and policies into this lesson. Hopefully, they will be the same as those policies in the lesson but when they are not you must describe the local policy to the participants. If different organizations are represented in the class or some of the participants don't belong to an organization, you will need to stress that they must learn and comply with the local policies.
- Tip 2. Get copies of the state statutes and local ordinances that describe how to respond in an emergency mode. These should have been covered in Lesson 2 but it is worth reviewing them in this lesson.
- Tip 3. Make an audio tape of the different audio warning devices to demonstrate the siren, wail, yelp, and air horns.
- Tip 4. You will need to alert the operators that they will probably respond to many calls as one of several emergency vehicles. They should review the organization Standard Operating Procedures on how to be a member of this emergency team.

| Instructor Notes | Presentation |
|--|---|
| | INTRODUCTION |
| | <p>We have already discussed what we called "normal" driving. What we talked about should have been called "normal for an ambulance."</p> |
| | <p>Each emergency you respond to will be unique. The weather conditions will change, the nature of the response will change, and the traffic conditions will change. All this change can easily lead to you and your ambulance being involved in a traffic crash.</p> |
| | <p>During this lesson, we are going to discuss how to drive your ambulance in the emergency mode and in varying weather and traffic conditions and still be able to avoid crashes.</p> |
| | <p>Once you have the patient, healthcare has started, and you should normally drive to the healthcare facility in a nonemergency mode. The siren and other audio signaling devices only cause the patient more concern and are rarely justified.</p> |
| | EMERGENCY DRIVING |
| <p>Q&A</p> <p>Ask interactive question; encourage</p> | <p>How would you define "emergency driving"?</p> |

Instructor Notes

Presentation

discussion.

Refer back to Appendix A which should outline your state's Motor Vehicle Code

The emergency mode of ambulance operation is specifically defined by each individual state and refers to the use of emergency vehicles, equipment, and operations. Emergency driving, in general, is defined as using clearly defined procedures in the operation of an ambulance when responding to a medical emergency, including the use of emergency signaling devices, such as lights and siren.



1: Emergency Driving

EMERGENCY DRIVING

Using clearly defined procedures in the operation of an ambulance when responding to a medical emergency, including the use of emergency signaling devices, such as lights and siren.

Emergency ambulance driving and high-speed driving are two distinctly different activities. You may think that high-speed driving is required in your desperate attempt to save a life. However, high-speed driving is dangerous for the patient, the crew, and everyone else on the road.

Instructor Notes

Presentation

Refer to Appendix A

When responding to a medical emergency, follow the state statutes concerning speed, but it is best to stay within the posted speed limit.

Emergency Signaling Devices



2: Emergency Signaling Devices

EMERGENCY SIGNALING DEVICES (LIGHTS & SIREN)

Notify other drivers that an emergency vehicle is approaching

Request that other drivers yield the right of way to the ambulance

Emergency signaling devices (lights and siren) are used during emergency driving for two reasons:

! to notify other drivers that an emergency vehicle is approaching

! to request that the other drivers yield the right of way to the ambulance

| Instructor Notes | Presentation |
|------------------|--|
| | <p>Did everyone catch that last part? You have to ask for the right of way; you cannot demand it.</p> |
| | <p>Other Drivers' Response to Emergency Driving</p> |
| | <p>Most drivers will yield the right of way to an ambulance if--</p> |
| | <ul style="list-style-type: none">! they realize the ambulance is there |
| | <ul style="list-style-type: none">! they have sufficient time to make a decision as to what to do |
| | <ul style="list-style-type: none">! they have sufficient time and space to carry out that decision |
| | <p>Even during an emergency response, there is time for courtesy. If you take the time to let a motorist make a rational decision as to how to help you, you will arrive at your destination quickly and safely. It takes a panicked driver longer to overcome his panic and react properly than it would if he wasn't frightened by the blaring siren of an ambulance behind him.</p> |
| | <p>The use of the emergency lights and siren cannot guarantee safe, clear passage. While most drivers will yield the right of way, some won't be able to see and/or hear the ambulance because of visibility restrictions in their vehicle or because of other noise or radio interference. And some drivers, even though they see and</p> |

Instructor Notes

Presentation

hear the ambulance, will refuse to yield the right of way. You must be prepared to respond to them.

The use of lights and siren actually increases your danger of a crash. Other drivers are suddenly placed under stress when they look in their rear view mirrors and see an approaching ambulance with lights and siren on. People under stress do not always act as you would expect. If you give them plenty of warning and approach them with reasonable speed, you give them time to react and, if needed, you give yourself time to counteract any inappropriate response they might make.

Response Time



3: Response

RESPONSE

Run to ambulance =

Greater adrenalin rush =

Greater tension =

GREATER PROBLEMS!

While there is a need to respond to an emergency as quickly and efficiently as possible, some time-saving methods can have

| Instructor Notes | Presentation |
|------------------|---|
| | <p>harmful effects and, in the majority of cases, the few minutes saved will probably not matter. Even in those rare cases where minutes matter, the time saved does not justify exposing the public to the jeopardy of a high-speed run by your ambulance.</p> |
| | <p>Speed Limits</p> |
| | <p>Speed limits are based on the quality of the road and the normal traffic conditions. Traffic conditions do not remain normal when an ambulance approaches. First, the ambulance is larger than most of the vehicles on the road. Second, it has emergency lights flashing and siren wailing. And third, most vehicles are trying to get out of the way of the ambulance. It is very dangerous for you to think that you can go faster than the posted speed limits and not become involved in a crash.</p> |
| | <p>A study by the Society of Automotive Engineers indicates that sirens warn pedestrians and the drivers of vehicles traveling in the same direction and ahead of the ambulance. Sirens <u>do not</u> give sufficient warning to drivers of vehicles approaching head on, or traveling on converging roads.</p> |
| | <p>The difficulty in projecting the siren sound around corners in urban areas, or ahead of ambulances traveling at higher speeds in rural areas, can cause the warning time to be too short to allow other drivers to yield the right-of-way.</p> |
| | <p>In a rural environment, a person in a closed car proceeding at 55 miles per hour (mph), with the radio playing, may not be aware of a penetrating electronic siren (wail) until it is as close as 33 feet away. In city traffic, a driver with the car windows open and no</p> |

Instructor Notes

Presentation

radio playing might not detect the siren more than 123 feet away.

The effectiveness of the siren warning system to vehicles on crossroads is only about one-third of that for a vehicle straight ahead of the siren and traveling in the same direction.

You can still drive quickly, but you must do so within the speed that the road and traffic conditions will safely allow and not count on your lights and siren providing a clear path ahead.



4: Speed Limits



Even when operating in the emergency mode, follow the state statutes concerning speed, but it is best to stay within the posted speed limit.

The local regulations governing the use of lights and siren are--

Instructor Notes

Presentation



Provide local criteria for use of lights and siren.



If appropriate, provide local regulations which authorize exceeding posted speed limits.

[Select the statement which applies]

You are never authorized to exceed the published speed limit --
OR -- The local regulations authorize you to exceed the posted speed limit under the following circumstances--

Controlled Intersection Procedure

Q & A

What is a "controlled intersection?"

[Answer: An intersection with traffic control equipment, such as pavement markings, stop or yield signs, or traffic lights]

Dangers



5: Danger

Instructor Notes

Presentation

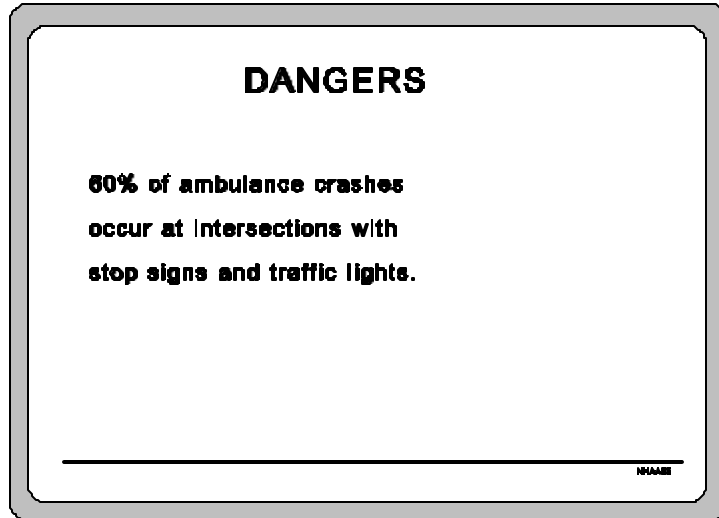

The New York State Department of Health reported in the "Ambulance Accident Prevention Seminar" that 60 percent of ambulance crashes occur at intersections with stop signs or traffic lights.

Q&A

Ask interactive question, encourage discussion

If the intersection is controlled, why would ambulances have so many crashes?

[Possible answers: ambulance driver running red light, other drivers running red light while trying to get out of the way of the ambulance, crossing vehicles not seeing approaching]

Instructor Notes

Presentation

ambulance]

Q & A

At an intersection controlled with traffic lights, who has the right of way, the approaching ambulance or the cars with the green light?

[Answer: The cars with the green light]

Reinforce: The lights and siren do not automatically grant the right of way to the ambulance.

Remember, by using the emergency lights and siren, the ambulance driver is asking the other drivers to yield the right of way to the ambulance. Until they grant the ambulance the right of way, you cannot proceed.

Due Regard

As we discussed in the lesson on legal aspects, one of the laws that applies to ambulance crashes, especially when they occur at controlled intersections, is the Law of Due Regard.



6: Due Regard

Instructor Notes

Presentation

LAW OF DUE REGARD

**A reasonably careful person,
performing similar duties and
under similar circumstances,
would act in the same manner.**

The Law of Due Regard says that "a reasonably careful person, performing similar duties and under similar circumstances, would act in the same manner."

This means that you must drive your ambulance with due regard for the safety of your passengers and patients, and all other persons and drivers using the streets, highways, and freeways, and to protect them from the consequences of your actions when operating your ambulance.

As you can see, due regard is not a hard and fast rule, such as "the speed limit is 55 mph." Instead, it requires that the courts look at each crash and determine if the ambulance operator was abiding by the law of due regard at the time a traffic crash occurred. To do so, they must get answers to questions like the following:

| Instructor Notes | Presentation |
|------------------|--|
| | <p>! Was it necessary to use the emergency warning system under the circumstances of the call you were responding to and the medical condition of the patient you were transporting?</p> |
| | <p>! Did the ambulance operator give enough warning of the vehicle's approach to allow other motorists and pedestrians to clear the way for the ambulance?</p> |
| | <p>! Was the emergency warning system activated and operating prior to the crash?</p> |
| | <p>! Was the ambulance operator using the emergency warning system in the manner for which the system was designed to be used?</p> |
| | <p>! Was the operator of the ambulance operating the vehicle at a speed greater than necessary to allow the complete control of the ambulance in relation to traffic, road, and weather conditions?</p> |
| | <p>As you can see, your performance as the operator is going to be closely looked at in relation to the nature of the emergency and the traffic, road, and weather conditions. With a law such as this, rules cannot be written that cover all situations.</p> |
| | <p>The National Voluntary Consensus Standard</p> |

Instructor Notes

Presentation

The standards have used the ASTM guideline as a reference. The standards for controlled intersection management during emergency response mode are--



7: National Voluntary Consensus Standards 1

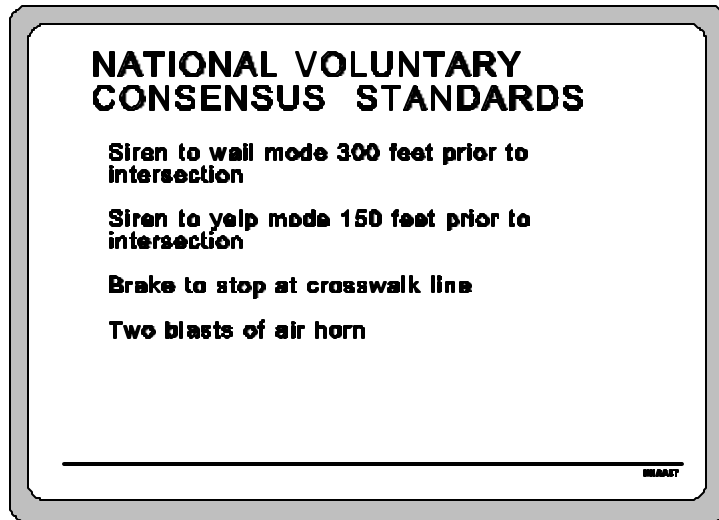

! The siren should be in the wail mode 300 feet prior to the intersection.

! Switch the siren to the yelp mode 150 feet prior to the intersection.

! Remove your foot from the accelerator to cover the brake pedal and allow compression to slow the vehicle. Start applying the brake to bring the ambulance to a complete stop at the crosswalk line.

Instructor Notes

Presentation

- ! If the ambulance has an air-driven airhorn, give two short blasts on the airhorn.



8: National Voluntary Consensus Standards 2

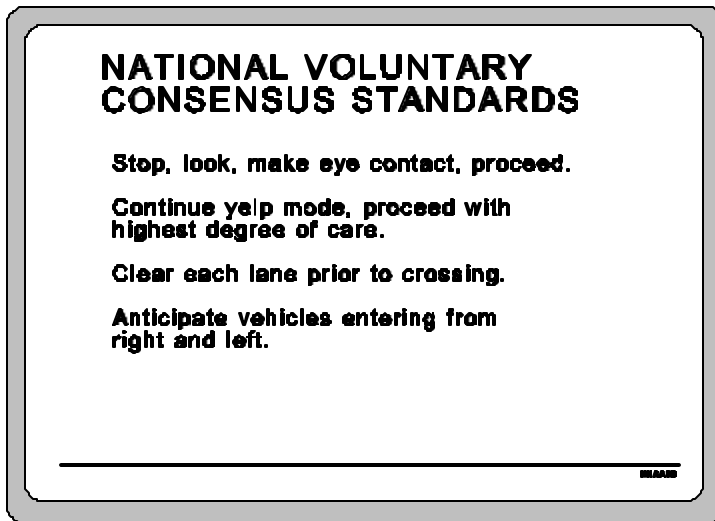

- ! **Make a complete stop.** Look to the left, look to the immediate front, look to the right, and then again to the left. You may then proceed through the intersection under 10 mph if traffic is stopped in all lanes to the left, in front of and to the right of the ambulance. After you have made eye contact with all stopped vehicle drivers, you may proceed through the intersection exercising the highest degree of care.

- ! Continue with the siren in yelp mode and proceed through the intersection exercising the highest degree of care.

Instructor Notes

Presentation

! When there are vacant lanes to the left or right, you must complete the previous steps of clearing each lane of traffic prior to crossing that lane.

! You should expect that any vacant lane to your left or right may become occupied by another vehicle which did not see or hear the ambulance's warning systems.



9: National
Voluntary
Consensus
Standards 3

**NATIONAL VOLUNTARY
CONSENSUS STANDARDS**

Anticipate multiple responding units.



Avoid passing stopped vehicles on the right.



**Turn right after drivers on the right are aware
of ambulance.**

**Anticipate left turns in front of ambulance by
oncoming traffic.**

Beware of other intersection hazards.

! You should be aware that other emergency vehicles may be approaching the same intersection that you have taken control of. You should not enter the intersection until the other vehicles have stopped or proceeded through the intersection.

| Instructor Notes | Presentation |
|--|--|
| | <p>! You should avoid passing stopped vehicles on their right.</p> |
| | <p>! You should turn right at the intersection only after all vehicles have stopped and drivers on the right are aware of the ambulance.</p> |
| | <p>! You should expect that any vehicles in front may make an unexpected left turn in front of the ambulance after it has started to enter the intersection.</p> |
| | <p>! You must be aware of other hazards at the intersection, for example, pedestrians, road hazards, defective traffic control systems.</p> |
|  <p>Provide local rules for driving the ambulance through controlled intersections.</p> | <p>The local rules for driving through controlled intersections are:</p> |
|  <p>Diagram "typical" intersections in the local area and demonstrate crossing the intersection.</p> | <p>A typical intersection that you will see looks like--</p> <p>To cross this intersection--</p> |

| Instructor Notes | Presentation |
|---|--|
|  <p>Diagram known dangerous intersections and demonstrate crossing these intersections</p> | <p>We have some dangerous intersections. The first (second, third, etc.) looks like this--</p> <p>To cross this intersection--</p> |
| | <p>Driving Against Traffic</p> <p>Occasionally, ambulance drivers try to save time by driving in traffic against the normal flow of traffic. This is seldom recommended, however, there are times when it may be necessary.</p> |
|  <p>10: Driving Against Traffic</p> | |

Instructor Notes

Presentation

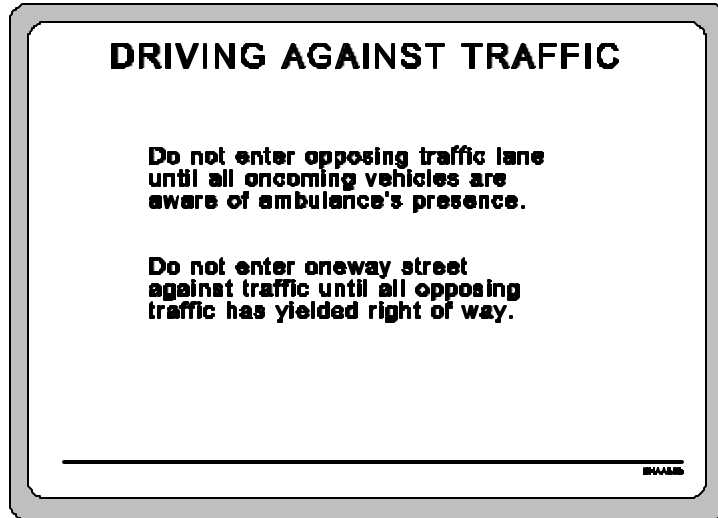

On a multilane highway, do not enter an opposing traffic lane until it is safe to do so and all other oncoming vehicles are aware of the ambulance's presence.

Similarly, do not enter a one-way street against traffic until all opposing traffic is aware of the ambulance's presence and has yielded the right of way.



Provide local criteria for driving against traffic.

Our state and local criteria for driving against traffic includes--

| Instructor Notes | Presentation |
|------------------|---|
| Q&A | There are two reasons why we use emergency signaling devices. What are they? |
| | <i>[Answer: Notify other drivers of approach of ambulance, request other drivers yield right of way to ambulance]</i> |
| Q&A | You are in the emergency response mode and are driving to the scene of a multiple-car crash. The weather conditions are good, traffic is light, and the speed limit is 55 mph. What is the maximum speed you may drive? |
| | <i>[Answer: 55 mph, unless modified by local regulations. If other than 55 mph, give the correct maximum speed and reinforce by stating local regulations.]</i> |
| Q&A | Three hundred feet prior to approaching a controlled intersection, your siren should be in which mode? And, 150 feet prior to the intersection, change the siren to which mode? |
| | <i>[Answer: Wail, yelp]</i> |
| Q&A | Prior to entering a one-way street against traffic, what must you do? |
| | <i>[Answer: Confirm that all opposing traffic is aware of the ambulance's presence and has yielded the right of way]</i> |

Instructor Notes

Presentation

Q&A

After coming to a complete stop for a red light at a controlled intersection, what must the operator do prior to proceeding through the intersection?

[Answer: Look left, look forward, look right, look left again. Make eye contact with all stopped vehicle drivers]

ADVERSE CONDITIONS

As we begin talking about the adverse driving conditions you will face, I want to repeat a couple of items from the previous lesson.

First, remember that one of your goals is to provide a smooth, uneventful ride for your patient, not the fastest ride possible. Commercial aircraft pilots face the same goal as they fly through all types of weather conditions. Since you can't change the weather conditions, you must learn how to adjust your driving style to the existing conditions.

And second, remember that smooth driving keeps the ambulance balanced. Remember, in the lesson on ambulance characteristics and weight, we said that when an ambulance is balanced, its weight is distributed evenly to all four wheels, the suspension is stable, and steering and braking are most effective.



11: Adverse

Instructor Notes

Presentation

Conditions

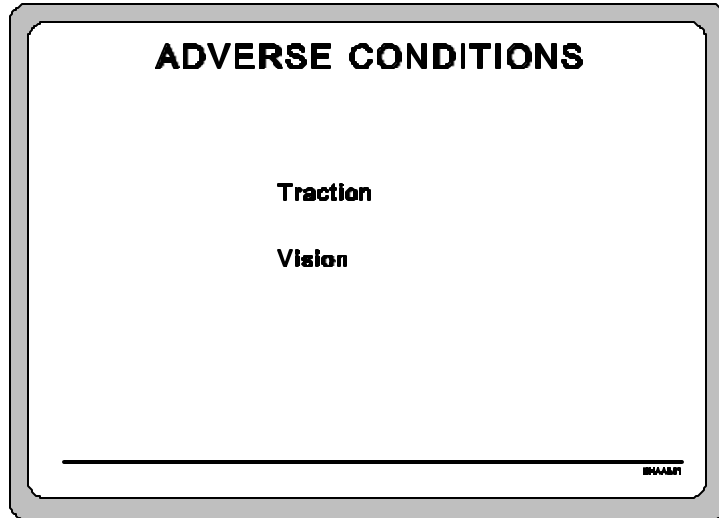

The two types of adverse conditions we are going to discuss affect--

! Traction

! Vision

Conditions Affecting Traction



12: Traction

Instructor Notes

Presentation

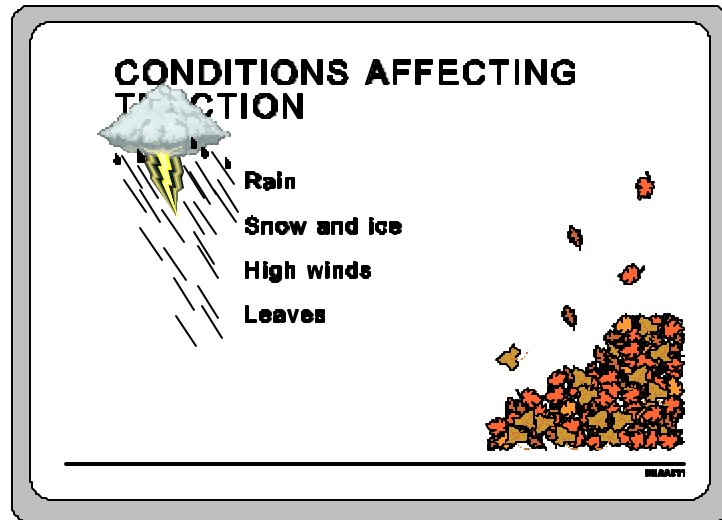

Rain

Rain affects traction in three ways:

- ! When it rains, a layer of water forms over the road. As a rolling tire moves over this layer of water, it loses contact with the road surface. This is called hydroplaning. Hydroplaning is especially dangerous because you lose steering and braking control. As little as 1/16 of an inch of water on the road surface can cause hydroplaning.
- ! Driving through large areas of water can affect brake performance because the brakes become wet and less effective. In older vehicles, splashing water can short out the vehicle's electrical system and can stall the engine.

| Instructor Notes | Presentation |
|------------------|---|
| | <p>! If the water is concentrated on one portion of the road and only one side of the vehicle goes through the water, the vehicle will tend to pull in that direction. The force of the pull is dependent on the depth of the water and the speed of the vehicle.</p> |
| | <p>By understanding the effects of rain and by taking the following precautions, you can lessen the effects of the rain and standing water:</p> |
| | <p>! Slow down before hitting water. This will lessen the splashing and reduce the effects of hydroplaning, giving you more control of your vehicle.</p> |
| | <p>! Gently apply your brakes for a few moments as you exit the deeper puddles to heat the brake shoes and dry them. Until the brakes are dry, you will notice that it takes more foot pressure to stop the ambulance.</p> |
| | <p>Snow and Ice</p> |
| | <p>Snow and ice form an extremely slick barrier between your tires and the roadway. Extreme caution must be taken when driving on snow and ice to avoid sliding when turning, braking, and accelerating.</p> |
| | <p>Remember that in cold weather, bridges and shaded roadways freeze first. Often this freezing is nearly invisible and all bridges</p> |

| Instructor Notes | Presentation |
|------------------|---|
| | and shaded areas must be approached with caution. |
| | When driving through deep snow, proceed slowly and shift into a lower gear before entering the snow and attempt to keep the ambulance moving through the snow. |
| | High Winds |
| | Although the ambulance is a heavy vehicle, it is tall, and the large flat-sided body acts like a sail, making the ambulance very susceptible to the effects of the wind. |
| | Cross-winds can blow the vehicle off the road or across the center line, particularly in curves and corners and especially when it's raining, snowing, or icy and traction with the road is already reduced. |
| | Wind shifts occur as you pass buildings, travel through an underpass, or pass large trucks. These shifts toss the ambulance first one way and then another. Reduced speed will lessen the effects of these wind shifts. |
| | Leaves |
| | Wet leaves on the roadway can become as slick as ice or snow. If you cannot avoid driving through areas of wet leaves, slow down and treat them as you would a large patch of ice. |

Instructor Notes

Presentation



13: To Improve Traction

To Improve Traction . . .

Reduce speed
Steer, brake, accelerate smoothly

EMMATE

Increasing Traction with Traction Devices

When it starts to rain, you cannot pull to the side of the road and put on a set of "anti-hydroplaning" or "wet-leaf" tires. Reduced speed and smooth steering, braking, and acceleration are all you can do to retain control of your vehicle.

However, during the winter months, there are traction devices that can be installed on or carried in the ambulance.

Snow Tires

Organizations located in areas where it snows often and where the snow remains for weeks at a time often install snow tires in the fall and remove them in the spring. Snow tires have a tread

Instructor Notes

Presentation

pattern that is different than normal highway tires. This open, deeply grooved tread pattern increases the tire's grip on the snow and is designed to clean itself as the tire rotates.

Chains

Chains are convenient in that they can be carried in the vehicle and installed by the operator when needed. Chains bite into the snow or ice and greatly increase traction. When using chains, you must reduce your speed to keep them from banging against the ambulance. Since chains will dig into asphalt surfaces as they do into ice, they should be removed before driving on bare roads, if possible.



14: Vision

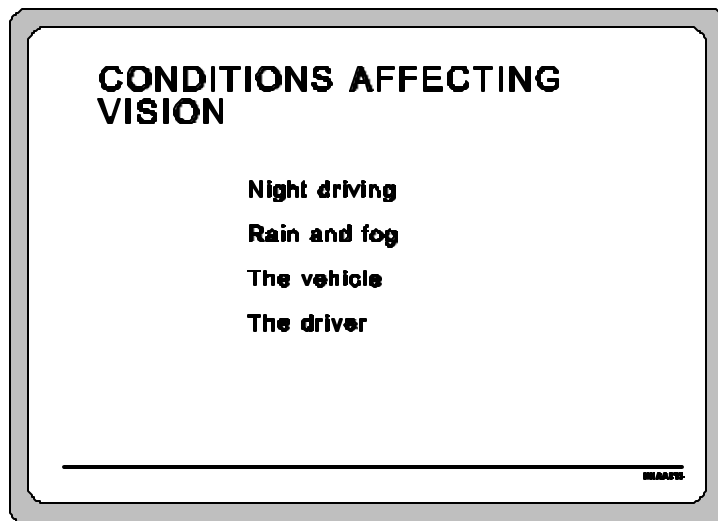

Conditions Affecting Vision

| Instructor Notes | Presentation |
|------------------|--|
| | <p>Your vision can be affected in three ways. First, the environment may give you problems. Second, your vehicle and the way you care for it may affect the way you are able to see things. And finally, your physical condition and preparation for duty will affect your eye's ability to see.</p> |
| | <p>Driving at Night</p> |
| | <p>Even under the best of weather conditions, visibility is decreased at night. Because there is less light, your eyes work differently, and you see things differently than in the daytime.</p> |
| | <p>Because of the way your eyes are designed, you have a small blind spot right in the center of where you look, or right in the center of your field of vision. During the daytime, this is not a big problem because different parts of your eyes are at work and you have lots of light. At night, this small blind spot comes into play because it may hide small, poorly lit objects if you look directly at them or try to stare at them. To compensate, you must constantly scan the different parts of the area ahead.</p> |
| | <p>Some other problems you encounter when driving at night:</p> |
| | <p>! Darkness conceals hazards and you must make decisions based on incomplete information.</p> |
| | <p>! It is more difficult to judge the speed and position of another vehicle because you do not have distinct</p> |

| Instructor Notes | Presentation |
|--|--|
| | shadows and other objects as reference points. |
| | ! Your peripheral vision is reduced if you smoke. This makes it more difficult to judge the speed and position of other vehicles, especially at night. |
| | ! Adequate highway lighting is limited. |
| | ! Glare from roadside lighting and oncoming vehicle headlights impair your visibility. |
| | Night Driving Techniques |
| | Even with these problems, driving at night is possible and, with careful attention, does not have to be dangerous. A few night driving techniques will help: |
|  | |
| 15: Night Driving | |

Instructor Notes

Presentation

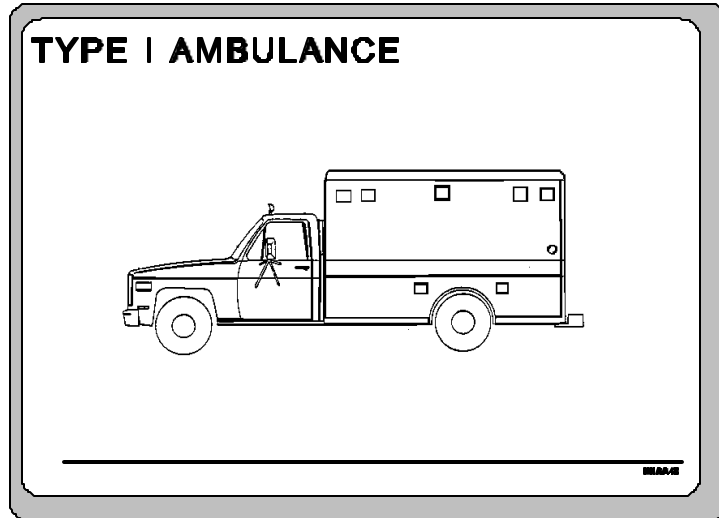

! Keep dash and panel lights dim for better vision, but always have enough light to read the speedometer.

! Reduce speed so that you can stop within the visible distance.

Remember, the act of braking begins with the recognition that something ahead requires that you slow or stop. You can't begin stopping if you can't see ahead, so drive within the range of your headlights.

By driving within the range of your headlights, you are able to begin braking as soon as your headlights reveal an object. When you overdrive the range of your headlights, you may not see the object in time to stop.

| Instructor Notes | Presentation |
|------------------|---|
| | <p>! Increase sight distance by keeping the headlights clean and properly aimed and the windshield clean.</p> |
| | <p>! Watch beyond the headlights on or near the roadway for slow-moving or unlighted vehicles, curves, T-intersections, road obstructions or defects, trains, pedestrians, and animals.</p> |
| | <p>! Keep your eyes moving so that your blind spot does not hide objects ahead.</p> |
| | <p>Maintaining Night Vision</p> |
| | <p>There are several things you can do to increase your ability to see at night:</p> |
| | <p>! Don't move immediately from a brightly-lit room to a dark vehicle and begin driving.</p> |
| | <p>Give your eyes a chance to adjust to the darkness.</p> |
| | <p>! Avoid looking directly into glaring headlights of oncoming vehicles.</p> |
| | <p>The human eye takes about seven seconds to fully recover from being blinded by a bright light. At 60 mph, your</p> |

Instructor Notes

Presentation

ambulance would travel 616 feet in seven seconds.

! Don't smoke.

! Don't wear sunglasses at night.

Rain and Fog

Rain and fog affect visibility in two ways:



16: Rain and Fog

RAIN AND FOG

- Reduce visibility**
- Reduce warning capability**
- Create glare**



EMERGENCY

! Reduced visibility

| Instructor Notes | Presentation |
|------------------------------|---|
| | <p>Rain and fog shorten the distance you can see. In addition, other vehicles on the roadway may splash water and mud onto your windshield and headlights. Fog also reduces the range of the siren. Your visibility and warning capabilities are reduced.</p> |
| | <p>! Glare</p> |
| | <p>The sun and your headlights will reflect off the many drops of moisture in the air with both rain and fog. Not only is the random light reflected back into your eyes, but a large portion of the light from your headlights is reflected and never reaches the roadway.</p> |
| | <p>Emergency lights, including strobes, are especially prone to reflect off of fog and mist.</p> |
| | <p>Use caution in checking outside mirrors when it is raining. Rain can distort or obliterate the images in your mirrors.</p> |
| | <p>The Vehicle</p> |
| <p>Q&A</p> | <p>How can your vision be affected by the vehicle?</p> |
| <p>Encourage discussion.</p> | <p><i>[Answer: If the vehicle is dirty and you don't take time to ensure that it is prepared for duty, you will not be able to see properly,</i></p> |

| Instructor Notes | Presentation |
|------------------|---|
| | <i>especially under adverse weather conditions.]</i> |
| | Windshield/Wipers |
| | <p>If your windshield is cracked or broken, the light rays are scattered improperly and your vision will be obstructed. Have broken or cracked windshields fixed or replaced, and keep your windshield clean and your wipers operative so that you may clean the windshield. Don't let dead bugs and trash accumulate under the wipers.</p> |
| | Visors |
| | <p>Use the visors mounted above the windshield to prevent looking directly into the sun. Move the visors to the side to reduce glare and the hypnotic effect of the sun flashing through trees as you drive down the road.</p> |
| | Bug Screens |
| | <p>Plastic bug screens mounted on the front of the hood are very effective in deflecting bugs, and even light rain and snow, up and over the windshield.</p> |
| | Headlights |
| | <p>Keep your headlights clean and operative to provide maximum lighting at night and in adverse weather conditions.</p> |

| Instructor Notes | Presentation |
|---|---|
| Side View Mirrors | Keep your side view mirrors clean and properly adjusted so that you are able to see down both sides of the vehicle. If necessary, adjust a mirror slightly to prevent glare when the sun is behind you. |
| Q&A | The Driver |
| Encourage discussion. | What things might you do that affect your own vision? |
| | <i>[Answers: Not get enough sleep, move from lighted area to dark area, look into the glare of lights, use alcohol or drugs, smoke]</i> |
| ? 17: Compensating for Poor Visibility | Compensating for Visibility Problems |

Instructor Notes

Presentation

**ENSURE SAFE
OPERATING CONDITION**

Visually inspect.

**Check that scheduled maintenance
has been performed.**

Check that all repairs have been made.

There are several things that you can do to compensate for visibility problems. We have already discussed a few specific items, but here are a few more general ones:

! Prepare yourself.

Get enough sleep and do not drink alcohol before going on duty. Smoking also reduces your night vision.

! Turn on low beam headlights and the wipers, if needed.

Never drive with only the parking lights on. As their name implies, they are for use when the vehicle is parked, not when you are driving it.

Instructor Notes

Presentation

And, if the conditions are such that you need to use your wipers, turn on your headlights.

! Watch for slow moving and stopped vehicles.

! Check the side view mirrors frequently for vehicles approaching quickly from the rear.



18: Compensating for Poor Visibility

COMPENSATING FOR POOR VISIBILITY (2 of 2)

- Be alert for fog.**
- Drive slowly, but keep moving.**
- Increase safety cushion.**
- Pull over and park.**

! Be alert for patches of fog in valleys and low-lying areas.

! Drive slowly, but keep moving.

| Instructor Notes | Presentation |
|------------------|---|
| | <p>! If conditions are too bad to continue, pull over as far as possible, stop, leave lights on, and activate hazard lights.</p> |
| | <p>Do not create another emergency by continuing at all costs.</p> |
| Q&A | <p>Hydroplaning occurs when it rains and a layer of water forms between the tire and the road surface. Why is hydroplaning dangerous?</p> |
| | <p><i>[Answer: You lose steering and braking control.]</i></p> |
| Q&A | <p>After it has rained and there are puddles of standing water, how can you reduce the effects of hydroplaning?</p> |
| | <p><i>[Answer: Slow down before hitting the puddle.]</i></p> |
| Q&A | <p>What is the problem associated with high cross-winds?</p> |
| | <p><i>[Answer: They can blow the vehicle off the road or across the center line.]</i></p> |
| | <p>While on a run at night, you remember from this course that your</p> |

Instructor Notes

Presentation

Q&A

eyes work differently and that you have a blind spot in the center of your field of vision. What do you do to compensate for this blind spot?

[Answer: Constantly scan the different parts of the area ahead.]

Q&A

What things improve your night vision?

[Answer: Do not move immediately from a brightly-lit room to a dark vehicle and begin driving, avoid looking directly into glaring headlights of on-coming vehicles, don't smoke, and do not wear sunglasses at night]

CRASH AVOIDANCE TECHNIQUES

Q&A

What do you think I mean when I say "crash avoidance"?

Encourage discussion.

[Answer: Driving to keep the ambulance out of a situation where a crash is unavoidable]



19: Crash

Instructor Notes

Presentation

Avoidance

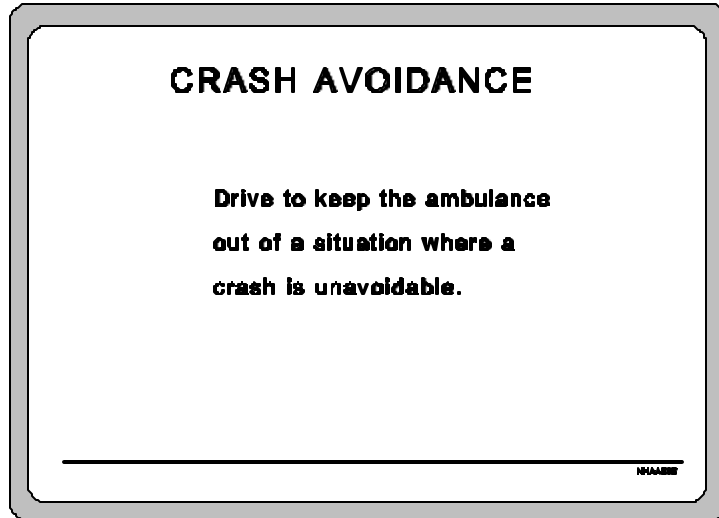

Justification

In *Emergency Ambulance Driving*, Childs and Ptacnik point out that one in four drivers will be involved in a major motor vehicle crash. Ambulance drivers are not left out of that statistic just because they are driving a big vehicle equipped with flashing lights and screaming sirens.

Crashes don't have to be caused by you. In their panic to get out of your way, other drivers may cause a crash that eventually involves your vehicle.

Techniques

A crash's severity can almost always be lessened if the operator

Instructor Notes

Presentation

continues to drive the ambulance. When faced with an impending crash, most drivers panic. They either slam on the brakes and grip the steering wheel until the crash is over, or they close their eyes and hope for the best.

These drivers have stopped driving and are doing nothing to help lessen the severity of the crash.

Plan Ahead to Avoid a Crash

Planning ahead for a crash does two things. It physically prepares your vehicle for the effects of a crash. And, it prepares you mentally by making you think about avoiding the crash.

Securing Your Equipment

Because of the quantity of equipment you carry and the fact that much of the equipment will be in use while traveling, when you are involved in a crash, you will have many missile hazards to contend with. The more items that can be stored in cabinets or tied down, the fewer things there will be flying forward during a crash.

Check your ambulance for items that may come loose and doors or drawers that may open. Try to find ways to fasten them so that they remain closed or tied down when not in use.

| Instructor Notes | Presentation |
|------------------|---|
| | <p>Use padding to cushion sharp corners and prevent injury.</p> |
| | <p>Wear Seat Belts</p> |
| | <p>Always wear your seat belts and have your passengers wear theirs.</p> |
| | <p>Keep the patient belted to the stretcher and the stretcher secured to the chassis.</p> |
| | <p>Mentally Prepare Yourself</p> |
| | <p>While driving down the road, plan your escape route from every situation around you. Think about how you will avoid a crash if it happened in front of you, or to the right or left, or even right behind you.</p> |
| | <p>Decide which item to hit if a crash is unavoidable. You have two choices, but always hit at an angle rather than head-on. Sideswiping a parked car is preferable to colliding with one head-on. Choose to hit items that will absorb the impact rather than solid objects. It is better to hit a telephone pole than a concrete bridge abutment.</p> |
| | <p>Maintain Rear and Side Space Cushion</p> |
| | <p>The further other vehicles are from your ambulance, the more difficult it is to be involved in a crash with them.</p> |

Instructor Notes

Presentation

Back With a Ground Guide

Use all the help you can to avoid backing into other vehicles or items on the ground. Back with a ground guide.

Multiple Responding Units/Multiple Agency Response

Anticipate other units responding to the same emergency, or to other emergencies in the vicinity. Look out for their lights. Change the volume of your siren so that you can hear the sirens of other units.

Clearing a Controlled Intersection

We've talked about how to cross controlled intersections. Just think that there is a crash hidden in the next intersection and you must eliminate it before crossing the intersection.

Any of the other drivers might be in control of the crash. You can eliminate some of them just by warning them of your approach with your lights and sirens. You can eliminate others by slowing and stopping before they have a chance to start the crash.

Instructor Notes

Presentation

But, the only way that you can eliminate all of the other drivers from the crash is to look each in the eye and see that they have acknowledged your presence and have agreed to yield the right of way to you.

Then, and only then, are you safe to proceed toward the next intersection. Or are you? Is there another driver hidden behind that truck beside you or around the corner? Always be alert and never get careless.



20: Avoid a Crash

TO AVOID A CRASH

Brake smoothly, firmly

Accelerate smoothly

Turn to avoid

EMERGENCY

Sometimes, despite all the planning you can do, crashes are going to happen. Faced with the certainty of a crash, there are three things a driver can do: brake, accelerate, or turn to avoid it or lessen the impact.

Braking

Instructor Notes

Presentation

Braking is the normal reaction of most drivers when faced with a crash.

Remember that braking takes time and distance to be effective. If brakes are required, apply them smoothly and firmly. Do not lock the brakes. With locked brakes, you lose steering control and braking distances are increased.

Acceleration

If, when crossing an intersection, you realize that you are about to be hit from the side or rear, you may be able to avoid a crash by accelerating as smoothly and rapidly as possible without spinning the wheels.

Steering Out of the Way

There are many times where steering out of the way is the only way to avoid a crash. To do so, the vehicle must be moved sideways as far as required and as quickly as possible to clear the hazard. You may be afraid that the ambulance will tip over, but this is seldom the case since most vehicles will slide before tipping. Even if you only partially clear the object, you will hit it with a glancing blow instead of head-on.

Steering quickly to avoid a crash cannot be done if you must move your hands on the steering wheel. Practice driving with your hands at the ten and two o'clock or nine

| Instructor Notes | Presentation |
|------------------|--|
| | and three o'clock positions so that you are always prepared to execute a smooth, but rapid, turn. |
| Q&A | What are some of the things you can do to mentally prepare yourself to avoid a crash? |
| | <i>[Answer: Plan your escape route, maintain rear and side space cushions, back with a ground guide, recognize that there may be multiple responding units, safely clear a controlled intersection]</i> |
| Q&A | Sometimes, despite all the planning you do, crashes happen. Faced with the certainty of a crash, there are three things a driver can do. What are they? |
| | <i>[Answer: Brake, accelerate, turn to avoid]</i> |
| Q&A | As you are moving through a controlled intersection, you suddenly notice a car moving rapidly toward you from your left side. What is probably the best way to avoid a crash? |
| | <i>[Answer: Accelerate]</i> |
| Q&A | You are driving down the interstate in the left lane doing 55 mph. All the traffic has been responsive to your lights and siren and have moved into the right lane. Suddenly, a car ahead pulls from the right lane into your lane right in front of you. What two things can you do to avoid the crash? |

Instructor Notes

Presentation

[Answer: Brake and steer to the left to avoid the car]

Q&A

You have been parked at the crash scene for 20 minutes. As you get ready to leave, you notice that other vehicles have blocked you from driving forward. Prior to backing out of your parking spot, what should you do to help you avoid colliding with equipment behind your ambulance?

[Answer: Use a ground guide while backing]

VEHICLE RECOVERY TECHNIQUES

Sometimes, you may be able to avoid a crash by driving off the road, or, for some reason you have driven off the road and need to recover by returning to the road without causing a crash. At other times, you may have a vehicle malfunction and you need to respond to the malfunction and then safely pull off the road.

Running Off the Road Recovery Techniques



21: Off-Road Recovery

Instructor Notes

Presentation

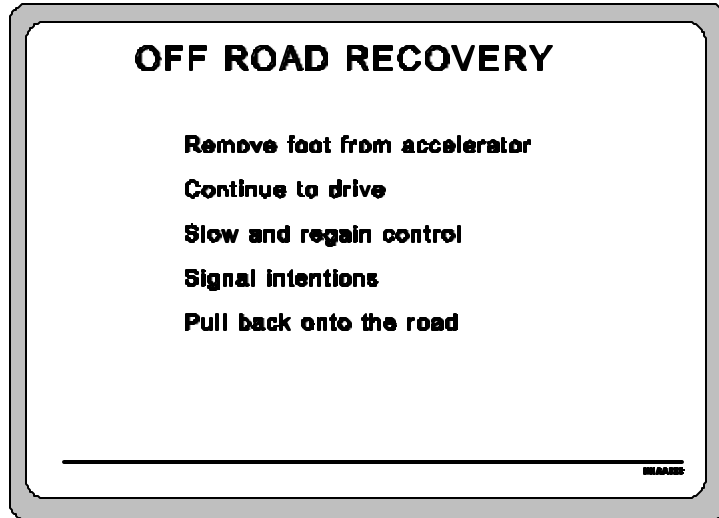

Initial Reaction

The most common reaction when leaving the road surface is to quickly try to get back onto the road. This reaction frequently causes a head-on crash because you overcorrect and cross the center line into the oncoming lane.

Control

To avoid over-correcting, immediately remove your foot from the accelerator and continue to drive the ambulance. Do not brake heavily or you may be pulled further from the road. If no obstacles are directly ahead, continue to slow and regain steering control in preparation for pulling back onto the road.

Instructor Notes

Presentation

Pulling Back Onto the Road

Check your side view mirrors and signal drivers behind you that you plan to return to the road. Smoothly turn the steering wheel and drive back onto the road.

In the event an additional hazard (such as a pole or guard rail) is directly ahead on the shoulder of the road, you may have to drive immediately back onto the road, even though you may not be fully prepared.

To do so, smoothly turn the steering wheel toward the road and then immediately straighten it as the front tire makes contact with the edge of the roadway. The brief period between the steering input and the resulting action should allow the rear tire to also climb onto the road. This rapid maneuver will allow the steering to be corrected before the ambulance is driven into oncoming traffic.

Responding to Vehicle Malfunction



22: Vehicle Malfunctions

Instructor Notes

Presentation



When you experience a vehicle malfunction, you must respond to the malfunction and then move the ambulance out of the flow of traffic.

Tire Blowout

Tire blowout seldom occurs with today's tires. A blowout occurs when the tire is damaged to such an extent that it instantly deflates, often disintegrating in the process. If a front tire blows out, the vehicle immediately swerves in the direction of the destroyed tire, causing the operator to whip the steering wheel in the opposite direction. If a rear tire is involved, the back of the vehicle sways back and forth, making it difficult for the operator to maintain control.

In either situation, hold the steering wheel firmly and steer enough

| Instructor Notes | Presentation |
|------------------|---|
| | <p>to maintain your lane position. Ease off the accelerator, but do not brake. Rapid deceleration or braking may make steering control more difficult.</p> |
| | <p>Once speed has been reduced to the point where you can steer, slowly begin braking, signal your intentions, and move off to the side of the road.</p> |
| | <p>Brake Failure</p> |
| | <p>Brake failure seldom occurs in today's vehicles. If brake failure occurs, try the brakes again. If pumping the brakes does not work, shift into a lower gear and use the engine to brake. Carefully apply the parking brakes. The parking brakes only work on the rear brakes and stopping distances will be much longer. Continue to steer and maneuver to where you can safely leave the road.</p> |
| | <p>If brake failure occurs while going down a hill and engine braking and use of the parking brake are not effective, you may have to sideswipe parked cars, guard rails, small trees, or dirt banks to slow sufficiently.</p> |
| | <p>Steering Failure</p> |
| | <p>Today's ambulances are equipped with power steering. In these vehicles, steering failure occurs whenever the engine quits. It may also occur if all power steering fluid is lost. In either case, the ambulance can still be steered, but it will take more physical strength since the operator has to overcome the failure of the</p> |

| Instructor Notes | Presentation |
|------------------|--|
| | hydraulic system. |
| | If steering failure occurs, slow the vehicle and pull off the road. Do not brake heavily in case the vehicle pulls to one side; you do not have the strength to overcome this extra force. |
| | Stuck Accelerator |
| | The seemingly obvious solution to a stuck accelerator is to turn off the ignition. In today's vehicles, you cannot do this or you will lose your power steering, power brakes, and possibly lock the steering wheel. |
| | The best response in today's vehicles is to shift the transmission into neutral and get the vehicle off the road and stopped as quickly as possible. Understand though, that once the resistance of the drive train is released by the transmission, the engine will rev up quickly. If the engine is not shut off quickly, it will probably fail, resulting in the loss of steering control and brakes. |
| | Released Hood |
| | While this may sound comical, it is very serious. If the hood releases and breaks your vision, try to find a small gap through which you can look at the base of the hood and pull the ambulance off the road. If all forward visibility is blocked, quickly get your head out the side window and drive the vehicle to the side of the road and stop. |

Instructor Notes

Presentation

Techniques for Pulling Off the Road



23: Pulling Off the Road

PULLING OFF THE ROAD

- Plan exit**
- Signal intentions**
- Brake smoothly, firmly**
- Park out of traffic path**

_____ EMERGENCY

Once you have responded to the immediate threat of the vehicle malfunction, you still have to get the ambulance safely off the roadway and parked where further damage will not occur.

Planning

Plan your exit with the time available. Signal your intentions and use the first available parking area.

Braking

| Instructor Notes | Presentation |
|-----------------------|---|
| | <p>Most vehicle malfunctions require rapid deceleration. Remove your foot from the accelerator and begin smooth, firm braking. You may have to release some of the braking pressure if it becomes difficult to control the steering. Continue to drive the ambulance and do not just jam on the brakes.</p> |
| | <p>Parking</p> |
| | <p>Once you have driven off the roadway, stop the ambulance where it will not be hit by other traffic. Turn on your emergency flashers and turn of your emergency lights and siren.</p> |
| <p>Q&A</p> | <p>As you are taking a patient to the medical facility, you hit a deep pothole and your left front tire blows out. How should you recover?</p> |
| | <p><i>[Answer: Hold the steering wheel firmly and steer to maintain your lane position, ease off the accelerator, slowly begin braking, signal your intentions, and move off to the side of the road]</i></p> |
| <p>Q&A</p> | <p>After stopping and visually clearing a controlled intersection, you accelerate normally and begin a right turn toward the medical facility. You notice that it is taking a lot of effort to turn the steering wheel. What is the probable failure and what do you do to recover?</p> |
| | <p><i>[Answer: Steering failure. Steer around the corner, slow, and</i></p> |

Instructor Notes

Presentation

pull to the side of the road]

Q & A

You are on a run in the country on a two lane asphalt road and notice that the farm tractor coming toward you is wider than normal and is crowding the center line. As you pull to the right to avoid hitting the tractor, your right wheels run off the hard surface onto the soft shoulder and you feel the ambulance pull hard to the right. What should you do to recover?

[Answer: Remove your foot from the accelerator and continue to drive the ambulance. After regaining steering control, pull back onto the road without crossing the center line]

Q & A

If, in the previous situation, you saw a car parked on the edge of the road just ahead of where you came off the road, what procedures would you use to quickly pull back onto the road?

[Answer: Smoothly turn the steering wheel toward the road and then immediately straighten it as the front tire makes contact with the edge of the roadway. The brief period between the steering input and the resulting action should allow the rear tire to also climb onto the road.]

SUMMARY

To review, when you are in the emergency mode of ambulance driving, you are using emergency signaling devices while responding to a medical emergency. Emergency driving is not a clearance to engage in high-speed driving, which puts everyone





| Instructor Notes | Presentation |
|------------------|--|
| | <p>on the road in serious jeopardy. Safe, controlled driving will normally get you to the emergency scene and the medical facility without endangering you, your crew, or the patient.</p> |
| | <p>Emergency signaling devices are used during emergency driving for two reasons:</p> |
| | <p>! to notify other drivers that an emergency vehicle is approaching</p> |
| | <p>! to request that the other drivers yield the right of way to the ambulance</p> |
| | <p>When approaching other drivers with your lights and siren on, always expect the unexpected.</p> |
| | <p>Even when operating in the emergency mode, there is no reason for you to ever exceed the posted speed limit.</p> |
| | <p>The controlled intersection is the most dangerous part of any run you make. You must approach each intersection slowly and carefully and thoroughly ensure that you have the right of way before proceeding through the intersection.</p> |
| | <p>Adverse weather conditions affect your traction and your vision. To improve your traction, slow down. Remember that wet leaves on the roadway are just as slick as snow and ice. To improve your vision, make sure your windshield and mirrors are clean and that you are well rested and not under the influence of drugs or</p> |

| Instructor Notes | Presentation |
|------------------|---|
| | alcohol. |
| | Before a crash occurs, you can prepare your ambulance so that your equipment does not become missile hazards. You can prepare yourself mentally by thinking about your escape paths and, when faced with two choices, selecting the one that minimizes injury and damage. |
| | When faced with an impending crash, you can sometimes brake, accelerate, or steer to avoid the crash. |
| | Most vehicle malfunctions require that you slow, continue to maintain control of the ambulance through careful steering and braking, and exit the roadway. |
| | The Law of Due Regard puts the burden on you, the operator, to ensure that your actions are necessary and appropriate for the situation. |
| Q&A | Are there any further questions? |

| | |
|----------------------------------|---|
| COURSE: | EMERGENCY VEHICLE OPERATOR COURSE (AMBULANCE): NATIONAL STANDARD CURRICULUM |
| MODULE A: | Ambulance Operations: The Basics |
| LESSON 9: | Safety: Special Considerations |
| LENGTH: | 1.5 Hours |
| COURSE GOAL: | To provide ambulance operators with the knowledge and skills to operate their vehicles so that their vehicle, equipment, crew, and patients will be delivered safely and efficiently and the safety of the public will be assured during all phases of the delivery of the Emergency Medical Services (EMS) involving the ambulance |
| MODULE GOAL: | To provide ambulance operators with the knowledge required to safely and efficiently operate an ambulance in both nonemergency and emergency modes |
| LESSON GOAL: | To provide participants with knowledge of safety requirements and how to comply with them while operating the ambulance |
| PERFORMANCE OBJECTIVE(S): | <ul style="list-style-type: none"> • Identify obligations for ensuring passenger safety • Identify responsibilities for ensuring safety of the patient's |

| | |
|--|--|
| | <p>family</p> <ul style="list-style-type: none"> • Identify activities for protecting the vehicle and crew at the scene • Identify requirements for handling ambulance fires |
|--|--|

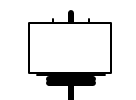
INSTRUCTIONAL AIDS:

| ICON LEGEND (Those used in this lesson are highlighted) | | | | | |
|---|---|---|---|---|---|
|  |  |  |  |  |  |
| Appendix | Show Overhead | Question and Answer Period | Use Flipchart | Ask Question | Local Requirements |

| | |
|--|--|
| |  <ol style="list-style-type: none"> 1. Ambulance Operator 2. Responsibility for Families 3. Potential Dangers 4. HAZMAT |
|--|--|

5. Fire
6. Crowd
7. Violent Act
8. Power Lines
9. Vehicle Placement
10. Diagram 1
11. Diagram 2
12. Diagram 3
13. Diagram 4
14. Diagram 5
15. Flares
16. Flare Placement
17. Warning Triangles
18. Placement of Triangles

**INSTRUCTIONAL
EQUIPMENT:**

Overhead projector and screen
Transparencies
Paper-based scenarios

Training Tips for: Lesson 9: Safety: Special Considerations

- Tip 1. This lesson covers how to respond to a variety of potentially dangerous situations that could threaten the safety of the ambulance crew. The ambulance crew is motivated to save lives but it will not help anyone if the crew is harmed in a crash and cannot do their job. You need to develop a series of scenarios that are locally oriented that clearly explain the expected action by the crew in each situation. It will also be important for you to have copies of organizational Standard Operating Procedures that describe what to do in each of these situations.
- Tip 2. The model vehicles used in lesson 8 can be used very effectively to demonstrate how to position your ambulance at the scene. Have each participant work with the models to show how to position the ambulance as the single emergency vehicle and when other emergency vehicles must be positioned to do their jobs.
- Tip 3. This is a good time to talk about the protective clothing that the crew should wear during the day and at night. Discuss protecting the scene and the crew.

Instructor Notes

Presentation

INTRODUCTION

The safety of the passengers, crew, and vehicle are your responsibility. This lesson will provide you with the information you need to protect them from potential dangers.

PASSENGER SAFETY



1: Ambulance Operator

AMBULANCE OPERATORS

Are responsible for safety of:
passengers
crew
vehicle

As the ambulance operator, you are responsible for the safety of all passengers in the vehicle. This includes making sure restraints are being used properly, that all equipment and other objects have been secured, and that only safe behavior is tolerated within the vehicle.

| Instructor Notes | Presentation |
|------------------|--|
| | Restraints |
| | <p>All passengers--the crew, patients, and operator--must wear a seat belt when the vehicle is motion. If a child is transported as a nonpatient passenger, you should properly restrain the child in a safety seat. All patients must be secured at all times when the vehicle is in motion.</p> |
| | <p>Only the medical technician is exempt from wearing restraints and <u>only</u> when attending to the patient in the patient compartment. This should be the exception and not the norm. Typically the patient is stabilized before transport, so the need for patient care should be minimal during transport.</p> |
| | Secure Equipment |
| | <p>Secure all equipment in the operator and patient compartments to prevent an injury if the vehicle has to suddenly stop or swerve. When leaving the scene, all equipment used on the scene should be secured in the vehicle. This includes such things as clipboards, portable radios, and flashlights. If any of the patient's personal effects are being transported, be sure they are properly secured.</p> |
| | Unsafe Behavior |
| | <p>While the vehicle is in motion, if you notice unsafe behavior in the ambulance, it is your responsibility to stop it. If someone is interfering with patient care or vehicle operation, demand that it</p> |

Instructor Notes

Presentation

stops. If necessary, pull the vehicle over until the unsafe behavior has stopped. Do not allow unsafe behavior to threaten patient care or passenger safety.

Q&A

Who must wear restraints?

[Answer: All passengers, including the crew and the patient, must wear safety restraints.

- ! patient--safely secured to the stretcher*
- ! crew and passengers--wear seat belts*
- ! exception--if a crew member is providing medical care to the patient]*

Q&A

Why should all equipment be secure?

[Answer: To protect all passengers, including the crew and patient, from being struck if the vehicle has to make a sudden stop or turn.]

Q&A

What are some examples of unsafe behavior?

- [Answer:*
- ! interfering with patient care*

Instructor Notes

Presentation

! *interfering with vehicle operation]*

Q & A

What should you do if you notice unsafe behavior in the vehicle?

[Answer: Demand that it stops; if necessary, pull over and insist the unsafe behavior is stopped immediately.]

PATIENT'S FAMILY



2: Responsibility for Families

RESPONSIBILITY FOR FAMILIES OF PATIENTS

May include:

- transporting
- ensuring safety
- communicating information

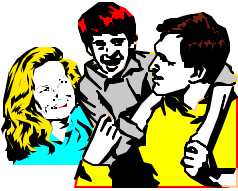

© 2011 AHA

Often the family of a patient will be at the emergency scene. Your responsibilities to the family may include transporting them, ensuring their safety, and communicating certain information to

Instructor Notes

Presentation

them.



As a matter of policy, some emergency services forbid family members or other passengers from riding in the ambulance. If this is the case in your service, you may omit "When to Transport."

When to Transport

Most of the time it is better for the family, or others involved, to go to the hospital in a different vehicle. Do not feel obliged to transport the patient's family. Check with dispatch or standard operating procedures for sources of other vehicles. Riding in another vehicle prevents them from seeing patient treatment which may be alarming to them. Also, having their own vehicle provides a way home for the family and the patient. However, sometimes it will be necessary for a family member to travel in the ambulance.

In the following situations it may be appropriate for a nonpatient passenger to ride in the ambulance to the medical facility:

! If the patient is in psychological crisis, it may be comforting

| Instructor Notes | Presentation |
|---|--|
| | to have a family member travel along. |
| | ! If the patient is a child, it may be comforting to have a parent travel as well. |
| | ! If the family member is very upset, it may be dangerous to have that person drive to the hospital. |
| | ! If the patient speaks limited English, the medical technician may need a translator. |
| | ! If the patient is the parent, there may be no one else to care for the child. |
| | ! The family member has no other means of transportation. |
| | Once it is decided that a family member will be riding in the ambulance, you must ensure that person's safety. |
|  <p>As a matter of policy, some emergency services forbid family members or other passengers from riding in the ambulance. If this is the case in your</p> | |

| Instructor Notes | Presentation |
|--|--|
| <p>service, you may omit "Safety as Passengers."</p> | <p>Safety As Passengers</p> |
| | <p>When family members or other nonpatient passengers are transported, you should consider the ambulance's weight restrictions discussed in Lesson 4.</p> |
| | <p>You also need to tell the passenger where to sit and make sure that the seat belts have been fastened properly before you move the vehicle. In addition, if the nonpatient passenger is a child, you will need to use a car seat. In most cases the nonpatient passenger should ride in the front seat with the operator. This prevents them from interfering with the medical technician. In some circumstances, it may be better to have the passenger ride in the back with the patient.</p> |
| | <p>You may want to reassure the family member that the emergency is over. If appropriate, explain that because care is being given by your partner, and the patient has stabilized, emergency driving is not necessary, and in fact may be harmful to the patient.</p> |
| | <p>Guidelines for Following the Ambulance</p> |
| | <p>If a family member is going to the medical facility in another vehicle, explain where you will be taking the patient and why you will or will not be using the emergency warning devices. This will help to calm any anxiety. If you will be transporting in the emergency mode, be sure to tell the family NOT to try to follow the</p> |

| Instructor Notes | Presentation |
|---|---|
| | ambulance. Tell them they must obey all traffic laws. This may save a life. |
| | If the family does not know the area or where the medical facility is, briefly give them directions. If you won't be transporting in emergency mode, suggest that they follow you to the medical facility. |
| | Showing courtesy to the family members of the patient will help relieve a patient's concerns about the family. |
| <p data-bbox="240 932 402 1024">Q&A</p> <p data-bbox="215 1073 448 1262">You may eliminate this question if local policy forbids transporting nonpatient passengers.</p> | <p data-bbox="501 989 1318 1058">When is it appropriate to transport members of the patient's family?</p> |
| | <p data-bbox="501 1350 625 1381"><i>[Answer:</i></p> <ul data-bbox="501 1388 1409 1827" style="list-style-type: none"><li data-bbox="501 1388 1328 1465"><i>! If the patient is in psychological crisis, it may be comforting to have a family member travel along.</i><li data-bbox="501 1472 1344 1549"><i>! If the patient is a child, it may be comforting to have a parent travel along.</i><li data-bbox="501 1556 1382 1633"><i>! If the family member is very upset, it may be dangerous to have them drive to the hospital.</i><li data-bbox="501 1640 1409 1717"><i>! If the patient speaks limited English, the medical provider may need a translator.</i><li data-bbox="501 1724 1360 1801"><i>! If the patient is the parent, there may be no one else to care for the child.</i><li data-bbox="501 1808 1206 1827"><i>! The family member has no other means of</i> |

Instructor Notes

Presentation

transportation.]

Q&A

You may eliminate this question if local policy forbids transporting nonpatient passengers.

What should you do to ensure the safety of a family member traveling in the ambulance?

[Answer:

- ! Assign them a place to sit.*
- ! Ensure they are safely restrained.*
- ! Keep them out of the medical technician's way.]*

Q&A

What information should you give a family member who is traveling to the medical facility in another vehicle?

[Answer:

- ! Tell them to obey all traffic laws.*
- ! Explain the mode you will be traveling in and why.*
- ! Explain which medical facility you will be going to.*
- ! Give them directions, if necessary.]*

SAFETY ON SCENE

To ensure the safety of the crew and ambulance while on scene, you need to be cautious and look for dangers when approaching

Instructor Notes

Presentation

the scene. You will also need to be aware of the presence of other emergency vehicles/services as well as the problems improper placement of the ambulance can create. In addition, you should know the correct way to use warning devices to protect the crew, patient, and vehicle from danger while at the scene.

Potential Dangers

Protect the ambulance and crew from potential dangers. A crew member or ambulance disabled by a danger on the scene will hinder patient care, the primary goal of the ambulance crew. Potential dangers you may encounter include--



3: Potential Dangers

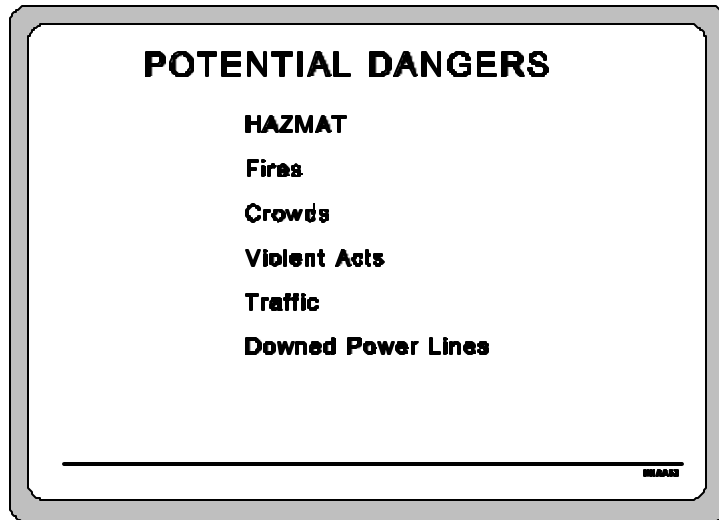

Hazardous Materials (HAZMAT)

Instructor Notes

Presentation

Signs of HAZMAT dangers may include spills, fumes, and noxious gases. Be especially aware of hazardous materials when you are responding to a tractor-trailer crash, train derailment, industrial incident, and certain farm incidents. Properly trained and equipped personnel should assess the scene before you enter a possible HAZMAT area. Call for the help you need. Do not risk the health and safety of your crew or contamination of your vehicle by being reckless.



4: HAZMAT

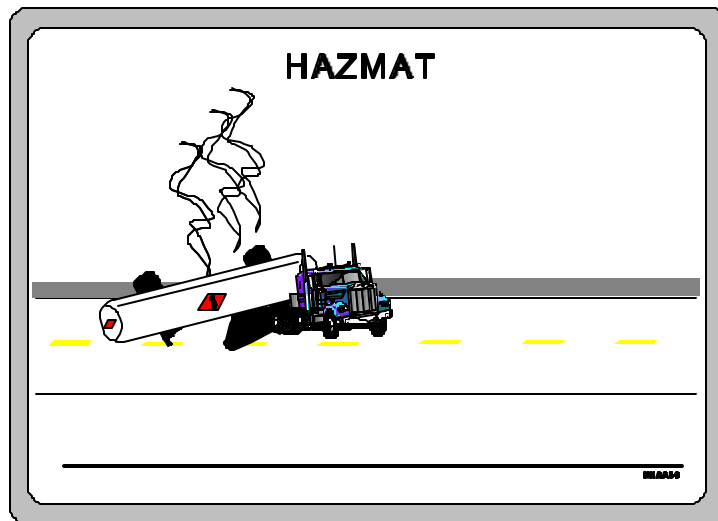

Present the standard operating procedures for responding to HAZMAT calls.

The standard operating procedures for responding to HAZMAT calls are--

Fires

Instructor Notes

Presentation

Approach the scene of a fire very slowly. Avoid driving into a wet area; the liquid may be flammable. Also avoid driving over hoses. If smoke clouds are present, be cautious; they may contain lethal, toxic gases. Coordinate your efforts with fire fighters, but allow the trained fire fighters to fight the fire. Call for help if you need it.



5: Fire

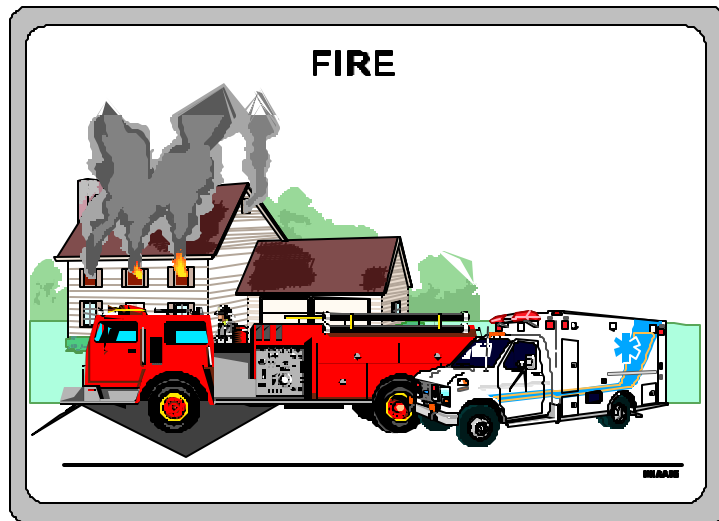

Crowds

When approaching a scene where a crowd has gathered, use extreme caution. People, recognizing you as "help," may run to the ambulance in a panicked state, placing themselves in danger. Crowds can also become hostile to EMS operators. Be sure you are safe. When in doubt, wait on the law enforcement officers to arrive. Allow law enforcement or a scene commander to control crowds. If necessary, call for help.

Instructor Notes

Presentation



6: Crowd

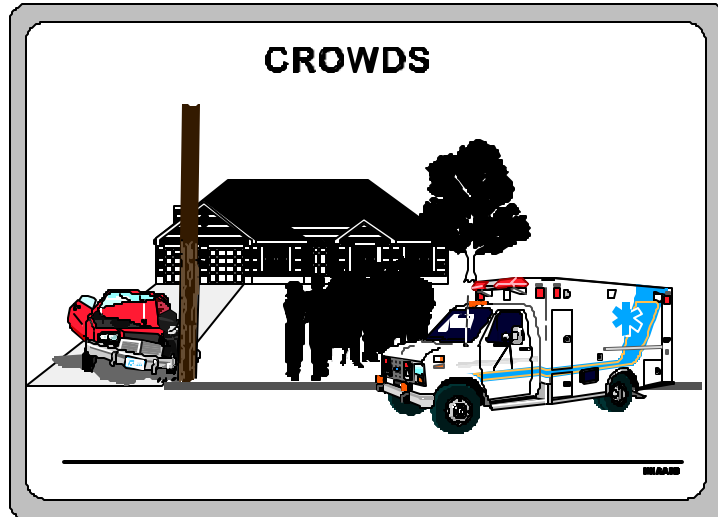

Violent Acts

There may be times when an emergency call concerns a violent situation. Let law enforcement personnel deal with violent or hostile persons and do not hesitate to call for help if needed. Make sure that the vehicle remains secure and attended and out of range of gun fire and other violence. Work closely with the law enforcement officer to safely treat and load patients in the ambulance.



7: Violent Act

Instructor Notes

Presentation

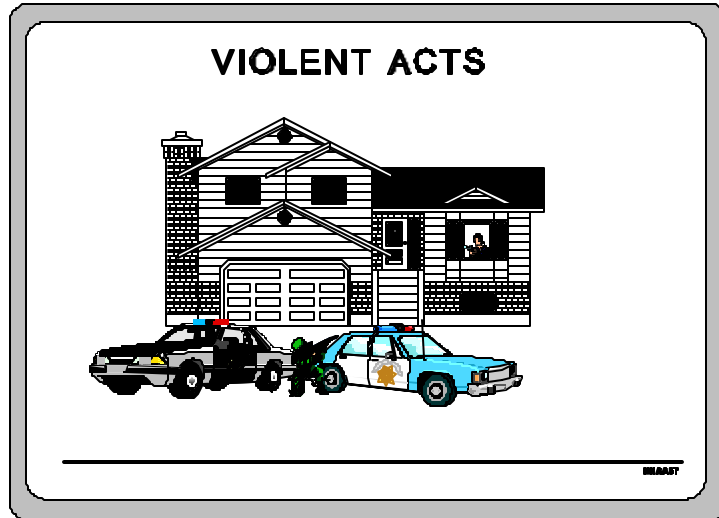

Traffic

The ambulance must be parked away from the flow of traffic in order to protect the crew, patient, and vehicle. (Vehicle placement will be discussed later in this lesson.) Remember that curious drivers often pay more attention to the incident than to their driving. If a reckless motorist disables your ambulance, then you will be unable to transport the patient. Allow law enforcement personnel or scene commander to divert traffic. If needed, call for help. The standard operating procedures will provide guidance if you are the only one on the scene.



Present standard operating procedures for

The standard operating procedures for diverting traffic are--

Instructor Notes

Presentation

diverting traffic.

Downed Power Lines

Power lines that are down or hanging precariously are very dangerous; only trained personnel should try to remove them. Do NOT touch power lines. A danger zone should be made so that everyone at the scene realizes the danger. Power lines may arc and jump, so make the safety zone far enough away for protection.



8: Power Lines

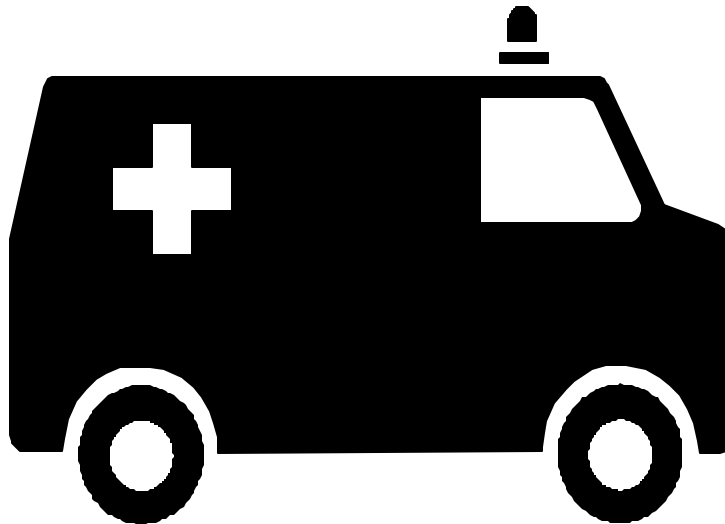

Read the following scenarios. Have the class discuss their decisions. Ensure that they reacted correctly to

Break up into groups of two or three. Read each of the following scenarios and discuss how you should react to each. Have someone write down your answers. When you are finished, we will discuss your answers as a class.

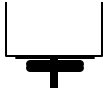
| Instructor Notes | Presentation |
|--|---|
| each situation. (To save time you may want to assign one scenario to each group, then have them discuss their scenarios and decisions with the whole class.) | |
| | Scenario 1 |
| Q&A | You are approaching an emergency scene where the injuries have been caused by a gang fight. You are first to arrive on the scene. What should you do? |
| | <i>[Answer: Don't be a victim. Make a judgment call of situation safety. If necessary, stay at a safe distance until law enforcement personnel have arrived and secured the scene. Call for law enforcement assistance if necessary.]</i> |
| | Scenario 2 |
|  | You are approaching an emergency scene where a large crowd has formed. What should you do? |
| | <i>[Answer: Be careful to avoid causing injury to someone who may run up to the vehicle. Request help from law enforcement personnel if it is not being provided.]</i> |

Instructor Notes

Presentation

Scenario 3

Q&A

You are approaching an emergency scene where a tanker truck with a HAZMAT symbol has been in a wreck. What should you do?

[Answer: Stay at a safe distance until a person trained in hazardous materials has declared the area safe to enter. Follow standard operating procedures. Call for help if needed.]

Vehicle Placement

When you arrive at the emergency scene, your first instinct may be to park the vehicle in the first available open area and leave it to assist with patient care. This practice may lead to more problems and delays because access to the ambulance and equipment may become dangerous and/or lengthy. There are four issues to consider for vehicle placement at the emergency scene. They are--safety, traffic flow, ease of departure, distance from patient.



9: Vehicle Placement

Instructor Notes

Presentation

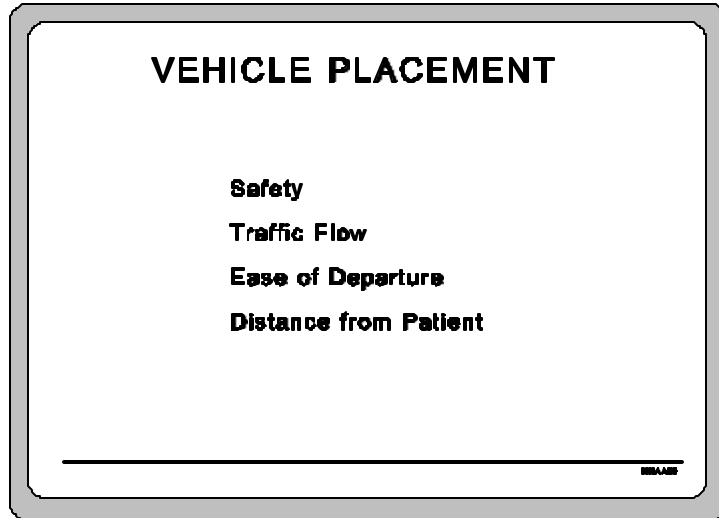

Safety

Safety includes not only the safety of the ambulance but also the safety of the crew. Ambulance and crew safety can be affected by restricted access to the ambulance, using the ambulance for scene protection, and various danger zones.

Access

The safety of the crew when accessing the vehicle and the equipment housed in the vehicle is an important consideration for vehicle placement. If one or two sides of the vehicle are along the flow of traffic it will be dangerous for crew members to get to the materials needed for patient care. Park where access to all compartments is out of dangerous traffic flow. Be aware of obstacles such

| Instructor Notes | Presentation |
|---|--|
| | <p>as guard rails and bushes which may restrict access to parts of the vehicle if you park too close to them.</p> |
| | <p>Scene Protection</p> <p>To keep the vehicle out of traffic flow, it should not be used for scene protection. The ambulance is needed for patient transport and carries essential patient care equipment. If it is damaged, patient transportation and care may be compromised. Therefore, the ambulance should not be used as the sacrificial barrier. A police or fire vehicle would be a better choice (if available.) Follow standard operating procedures for the situation, whether you are first on the scene or one of many responders. Call for help if necessary.</p> |
|  <p>Present standard operating procedures for scene protection.</p> | <p>The standard operating procedures for scene protection are--</p> |
| | <p>Danger Zones</p> <p>If the emergency is a fire, HAZMAT, or other such incident, park the ambulance far enough away to protect the crew and the patient. Don't park near damaged vehicles, because they might catch fire and explode. In the case of a vehicle wreck, park at least 50 feet away from the wreckage. This will protect the ambulance from broken glass and debris from the wreckage. Also be aware of any</p> |

| Instructor Notes | Presentation |
|------------------|--|
| | <p>fuel leaking from wrecked vehicles. The scene commander should direct you to a location, preferably upwind to protect everyone from noxious fumes and smoke. In addition, avoid parking the vehicle where it will be an obstacle to other emergency personnel.</p> |
| | <p>Traffic Flow</p> |
| | <p>The ambulance should be parked so that it does not block traffic. An emergency scene presents plenty of distractions for motorists without the ambulance becoming another one. In addition, if an ambulance is parked in such a way that it's causing traffic problems, then at least one side of the vehicle is unsafe for access by the crew.</p> |
| | <p>However, there may be times when you must place the vehicle amidst traffic flow. When responding to an emergency in a business district, you may need to double-park or otherwise inconvenience motorists. Unfortunately, this often can't be avoided, because the first priority should be patient care.</p> |
| | <p>Ease of Departure</p> |
| | <p>Park the vehicle in a position which provides for an easy departure and in the direction of the medical facility. Avoid having to back into traffic or steer around obstacles once the patient has been loaded.</p> |
| | <p>When responding to a home, it may be better to park in the street rather than a driveway. This is especially true if the house is near</p> |

| Instructor Notes | Presentation |
|---|---|
| | <p>the street, or if the driveway is steep or narrow. Parking on the street will prevent having to back into or out of a driveway. This can be difficult and dangerous on residential streets due to the presence of children, pets, and obstacles like bushes and parked cars.</p> |
| | <p>Distance from Patient</p> |
| | <p>Unfortunately, the need to be near to the patient frequently overrides the first three issues--safety, traffic flow, and ease of departure.</p> |
| | <p>The primary goal of the ambulance crew is patient care. The patient care equipment is stored in the ambulance, and the patient will most likely be transported in the ambulance. Therefore, the back doors of the ambulance should be placed close to the patient. However, don't park so close that fumes from the engine overcome the crew or the patient.</p> |
| | <p>The key to protecting the vehicle and crew is to think ahead about the consequences of your actions. Before parking the ambulance, remember to consider each of these factors--</p> <ul style="list-style-type: none"> ! safety ! traffic flow ! ease of departure ! distance from patient. |
| <p>Have the groups discuss their decisions as a class. Ensure that they reacted correctly to each</p> | <p>For each of the following diagrams, we will discuss the advantages and disadvantages of the parking configuration. Break up into groups of two or three. Look at each diagram and discuss the advantages and disadvantages. Have someone write down your answers. When you are finished, we will discuss</p> |

Instructor Notes

Presentation

situation. (To save time you may want to assign one diagram to each group, then have them discuss their diagrams and decisions with the whole class.) Possible answers have been provided for each diagram.

your answers as a class.

Diagram 1



10: Diagram 1

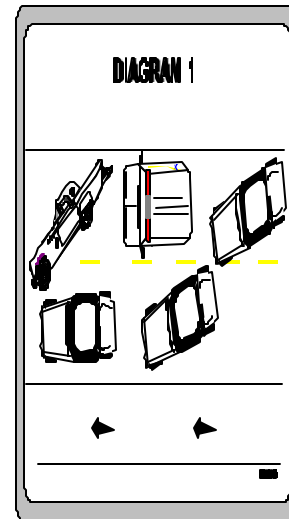

Traffic Sign

Q & A

What are the possible advantages of this parking configuration?

Instructor Notes

Presentation

[Answer:

- ! The vehicle won't additionally restrict traffic.*
- ! When the medical facility is in the direction that the ambulance is facing, this may be easiest for leaving the scene.*
- ! This may be the only alternative if the road is completely blocked by the emergency scene.*
- ! If the scene is on the left side of the road, this may be the most protected area.]*

Q & A

What are the possible disadvantages of this parking configuration?

[Answer:

- ! If the accident is on the right side of the road, the ambulance becomes the barrier vehicle.*
- ! The patient loading area is exposed to oncoming traffic.*
- ! The rear of the ambulance is farther from the patient than necessary.*
- ! One side of the ambulance is exposed to traffic, making access dangerous.]*

Diagram 2



11: Diagram 2

Instructor Notes

Presentation

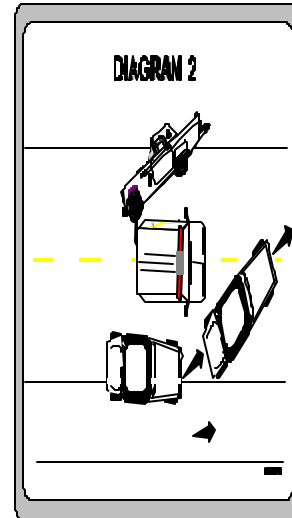

Q&A

What are the possible advantages of this parking configuration?

[Answer: Departure does not require backing.]

Q&A

What are the possible disadvantages of this parking configuration?

*[Answer:
! The ambulance severely restricts traffic.
! One side of the ambulance is inaccessible.]*

Instructor Notes

Presentation

Diagram 3



12: Diagram 3

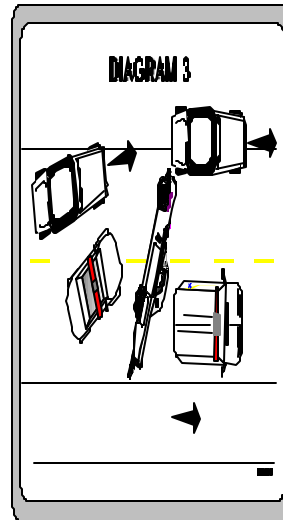

Traffic flow

Q & A

What are the possible advantages of this parking configuration?

[Answer:

- ! Access around the ambulance is not restricted.*
- ! Traffic is not further restricted.*
- ! The patient loading area is close to the scene.*
- ! Departure does not require backing or maneuvering around other vehicles.*
- ! A barrier vehicle is present.]*

What are the possible disadvantages of this parking

Instructor Notes

Presentation

Q&A

configuration?

[Answer: If the wreck blocks the whole road, this is not possible.]

Diagram 4



13: Diagram 4

Q&A

What are the possible advantages of this parking configuration?

[Answer: Easy to access if approaching from opposite direction.]

Instructor Notes

Presentation

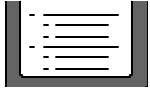

What are the possible disadvantages of this parking configuration?

[Answer:

- ! The crew has to cross the median and possibly a lane of traffic.*
- ! Equipment is difficult to access.*
- ! Loading the patient will be difficult.*
- ! The ambulance will cause more traffic problems for opposing traffic.]*

Diagram 5



14: Diagram 5

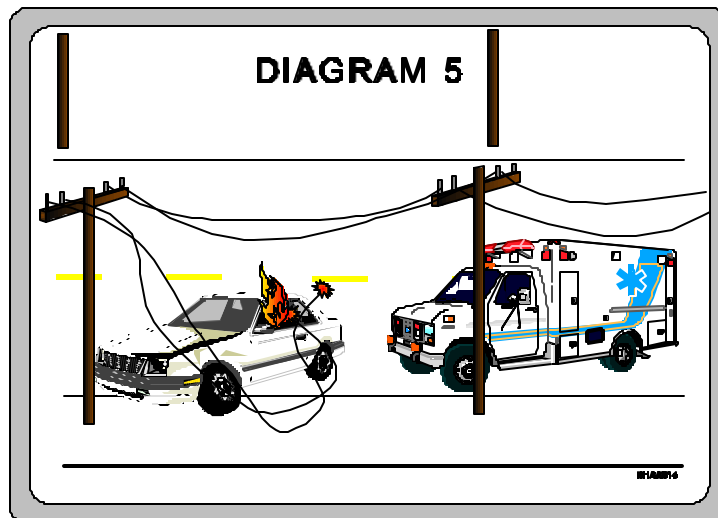

Instructor Notes

Presentation

Q&A

What is wrong with this picture?

[Answer:

! The ambulance is next to a burning car.

! Power lines are dangling overhead.

Warning Devices

A number of warning devices are available to help protect the ambulance at the scene. Warning devices should be placed to define the accident scene and mark temporary traffic lanes. Although placement of such devices isn't your primary responsibility, there may be a time when the ambulance is first to arrive on the scene. You will likely have to do some scene protection. In such cases, you may want to distribute the devices to a bystander with some brief instructions for use and placement.



Present the standard operating procedures for use of warning devices.

The standard operating procedures for using warning devices are--

There are several choices of warning devices which serve various purposes for protecting the scene. Flares and warning triangles are generally placed on the ground, whereas cyalumes (hand-held chemical light sticks), flashlights, and vests are held or worn by someone to warn others of the potential danger.

Instructor Notes

Presentation

Flares

A flare is a stick made of combustible material which burns brightly for a certain length of time. A flare may not burn long enough for the situation. If the flare is not long enough for the incident, lay a flare on the ground and place the head of a second flare, with the cap removed, on the base of the first flare. The first flare will ignite the second flare. Don't put flares where they'll be extinguished or washed away by washdown hoses.



15: Flares

Be very careful when igniting a flare. They burn at very high temperatures and drip when burning. Follow the manufacturer's instructions for igniting the flare. Never light the flare inside a vehicle. Don't use flares if combustible liquids or vapors are present. Don't place flares near dry vegetation.

Instructor Notes

Presentation

Q&A

What are the precautions for using flares?

[Answer:

- ! Be sure nothing flammable is around the flare (fumes, liquids, dry vegetation).*
- ! Be aware that flares are extremely hot.*
- ! Follow the manufacturer's instructions for igniting the flare.*
- ! Never light the flare inside a vehicle.*
- ! A flare may not burn long enough for the situation - a precaution?*
- ! Never place a flare at an accident scene where gas, oil, and other flammable fluids can drain to the flare.]*

When an emergency scene is limited to one side of the roadway, one flare should be placed alongside the scene; a second flare should be placed about 150 to 200 feet towards approaching traffic; the third flare should be placed about 300 feet from the scene. If the emergency scene is on a two-lane road, you may want to place an additional flare 100-150 feet in front of the scene to warn oncoming traffic of the danger. In some cases you may find it necessary to place more flares in order to protect the scene.



16: Flare Placement

Instructor Notes

Presentation

Q & A

What are some situations which may require the use of more warning devices?

[Answer:

- ! poor weather conditions*
- ! scene is around the curve in a road*
- ! large volume of traffic*
- ! poor road surface]*

An easy and efficient way to estimate the distance for flare placement is to count your steps as you walk quickly. The average pace is slightly more than two feet. For example, 50 paces is approximately 100 feet.

Instructor Notes

Presentation

Warning Triangles

The large reflective orange-red triangles are effective warning devices and are much safer than flares. They are especially useful when combustible materials are present or when you are unsure of the dangers present. In addition, you do not need to be concerned about the length of time you will be using them.



17: Warning Triangles

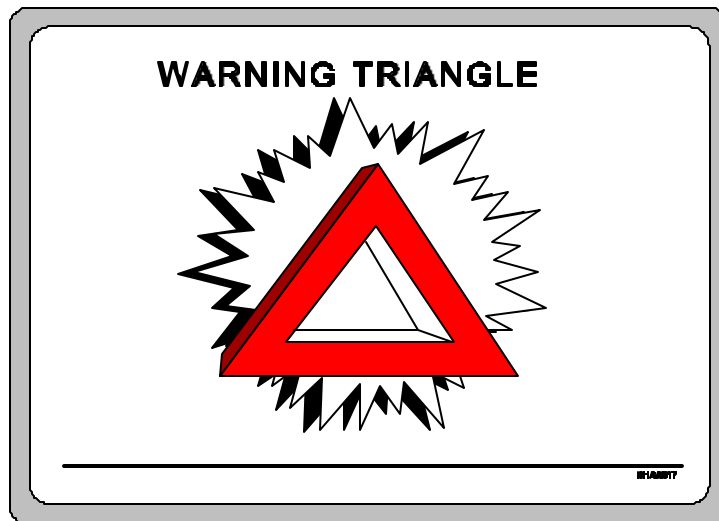

Warning triangles can be placed in the same configuration as flares.



18: Placement of Triangles

Instructor Notes

Presentation

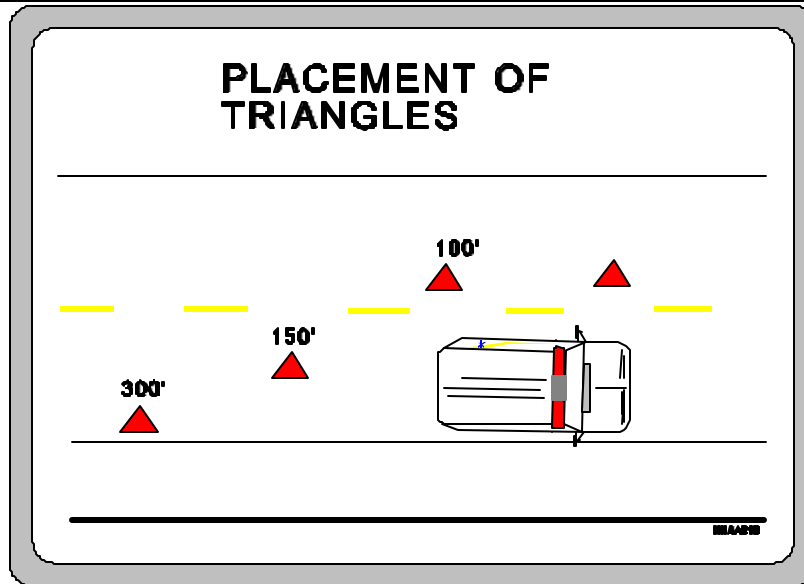

Flashlights/Cyalumes

Flashlights/cyalumes can be used to warn people of a potential danger, but they should not be relied upon. These tools depend on someone holding and waving them to be effective, therefore, they tie up a precious resource, emergency care providers. These devices may be given to a bystander with instructions on how they should be used. Anyone using these to warn traffic should also be given a safety vest to increase visibility and safety.

Safety Vests

Safety vests are made of reflective material and are worn by someone who wants to be more visible. They are often used by someone who is working in a potentially dangerous area, near the flow of traffic.

Instructor Notes

Presentation

Q&A

What are the types of warning devices available to you?

[Answer:

- ! flares*
- ! reflective triangles*
- ! cyalumes/flashlights*
- ! reflective safety vests]*

AMBULANCE FIRES

In the event of a fire in the ambulance or the potential for fire due to a crash involving the ambulance, you are responsible for ensuring the safety of the passengers and crew. If a fire in the ambulance is detected, you should safely pull off the road and order the evacuation of the vehicle. (Refer to Lesson 8 for safe procedures for pulling off of the road.) Be sure to take necessary equipment for patient care and protection from the weather.





If the ambulance is involved in a crash, reduce the possibility for fire by shutting of the engine, any unnecessary electrical power, and oxygen/air tanks.

The ambulance should have at least two fire extinguishers aboard, one in the operator compartment and one in the patient compartment. If trained, you may want to attempt to extinguish a fire in the ambulance. Fire fighting should be left to trained individuals. Call for help if necessary.

| Instructor Notes | Presentation |
|------------------|--|
| | SUMMARY |
| | The safety of all passengers is your responsibility when operating the ambulance. |
| | You are responsible for encouraging safe behavior by the patient's family if they will be traveling to the medical facility. |
| | Once at the scene, you are responsible for ensuring that it is safe for the vehicle and crew to enter the area. |
| | You are responsible for parking the ambulance so it does not cause a risk for the crew or vehicle. |
| | You are responsible for the safety of all passengers and crew if there is an ambulance fire. |

| | |
|----------------------------------|---|
| COURSE: | EMERGENCY VEHICLE OPERATOR COURSE (AMBULANCE): NATIONAL STANDARD CURRICULUM |
| MODULE A: | Ambulance Operations: The Basics |
| LESSON 10: | The Run |
| LENGTH: | 1 Hour |
| COURSE GOAL: | To provide ambulance operators with the knowledge and skills to operate their vehicles so that their vehicle, equipment, crew, and patients will be delivered safely and efficiently and the safety of the public will be assured during all phases of the delivery of the Emergency Medical Services (EMS) involving the ambulance |
| MODULE GOAL: | To provide ambulance operators with the knowledge required to safely and efficiently operate an ambulance in both non-emergency and emergency modes |
| LESSON GOAL: | To provide participants with knowledge on how to plan and carry out a successful run |
| PERFORMANCE OBJECTIVE(S): | <ul style="list-style-type: none"> • Identify prerun activities • Identify operational activities • Identify postrun activities |

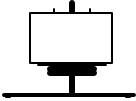
INSTRUCTIONAL AIDS:

| ICON LEGEND (Those used in this lesson are highlighted) | | | | | |
|---|---|----------------------------|---|---|---|
|  |  | Q & A |  |  |  |
| Appendix | Show Overhead | Question and Answer Period | Use Flipchart | Ask Question | Local Requirements |



1. Operator Readiness
2. Inspecting Ambulance
3. Intersection
4. Clearing Controlled Intersection
5. Clearing Controlled Intersection
6. Cautions
7. Difficult Situation(1)
8. Downed Power Lines
9. Crowds
10. Parking Safety
11. Predeparture
12. Fright
13. Bumpy Road
14. Postrun

**INSTRUCTIONAL
EQUIPMENT:**

Overhead projector and screen
Transparencies
Flipchart and markers

Training Tips for: Lesson 10: The Run

- Tip 1. Use this lesson as a review of Module A. This lesson may be less than an hour if the previous two lessons were presented during the same day. You need to add the local examples and leave no doubt as to the correct procedures.

Instructor Notes

Presentation

INTRODUCTION

We've covered a lot of information in this course so far. You have learned about--

- ! legal issues affecting ambulance operations
- ! the basics of communications
- ! vehicle types and dynamics
- ! making sure your vehicle is ready for a run
- ! making sure you and the crew are ready for a run
- ! driving techniques for normal situations
- ! recognizing and driving in high-risk situations
- ! safety considerations during the run.

Now let's put it all together as it would happen on a typical run. A run has three phases--prerun, operations, and postrun.

The prerun phase typically consists of--

- ! ensuring that you and the crew are ready
- ! ensuring that your ambulance is ready
- ! knowing primary and alternate routes

The operations phase typically consist of--

- ! leaving for the scene
- ! driving to the scene
- ! emergency scene operations
- ! transporting the patient
- ! operations at the medical facility

During the postrun phase you get your ambulance resupplied,

| Instructor Notes | Presentation |
|--|---|
| | cleaned, and decontaminated, if needed, and ready to make the next run. |
| <p>This lesson is an interactive scenario. Read each portion of the scenario out loud. Then ask the participants to answer the questions associated with it. Discuss the answers with the group.</p> | <p>Listen to each part of the scenario. For each question think about how you would react and why. We will discuss the situation and your responses as a group.</p> |
| | SCENARIO |
| | <p>You and several others are arriving at the station to begin your shift. While you are settling in, you find out one of the crew only had an hour of sleep because of a sick child.</p> |
| Q&A | <p>What should you do?</p> |
|  <p>Have participants discuss answers. Write answers on a flipchart.</p> | <p><i>[Answer: Talk to the shift supervisor about requiring the person to get some rest or take the day off, because their tiredness and preoccupation with the child's illness could lead to costly mistakes.]</i></p> |

Instructor Notes

Presentation

Q & A

Why should you be concerned with another crew member's state of mind?



Have participants discuss answers. Write answers on a flipchart.

[Answer: Physical and mental condition affects daily performance, and these things can affect physical and mental states--

- ! health*
- ! alcohol*
- ! drugs*
- ! sleepiness*
- ! anger*
- ! preoccupation]*



1: Operator Readiness



The supervisor has handled the problem of the tired EMT by

| Instructor Notes | Presentation |
|--|---|
| | <p>making him get some sleep and bringing someone as a replacement. You have made sure the crew is ready to go on a run. You check the bulletin board for any important information which may affect a run today. The shift supervisor provides a briefing on the current conditions in your area which may affect operations on your shift. There is construction on Main Street with one lane blocked; there is a baseball game at the stadium; and there is a possibility of thunderstorms in the afternoon.</p> |
| <p>Q&A</p> | <p>How will such conditions affect operations during a shift?</p> |
| <p></p> <p>Have participants discuss answers. Write answers on a flipchart</p> | <p><i>[Answer: The conditions impact the use of primary or alternate routes to:</i></p> <ul style="list-style-type: none"> <i>! find most direct and quickest route</i> <i>! minimize stops and turns</i> <i>! avoid busy high-traffic intersections</i> <i>! avoid residential streets (pets, children, cars backing out, and so on)]</i> |
| | <p>After the briefing, the supervisor tells you to check the ambulances. Ambulance A is still on a run, so you do a quick check or full check of ambulance B at the station. Ambulance A returns from the run, but it is a mess.</p> |
| <p>Q&A</p> | <p>What should you do to prepare ambulance A for another run?</p> |

Instructor Notes

Presentation



Have participants discuss answers. Write answers on a flipchart.

[Answer: Inspect, resupply, and decontaminate the ambulance to ensure vehicle readiness]



2: Inspecting Ambulance

INSPECTING AMBULANCE





You inspect the ambulance while another crew member checks the patient compartment. You notice that the brake lights on the back of the ambulance are not working.

Q&A

What should you do?

[Answer: Put ambulance out-of-service; follow local procedures]

| Instructor Notes | Presentation |
|--|---|
|  Have participants discuss answers. Write answers on a flipchart. | <p><i>for having it repaired.]</i></p> |
| | <p>Ambulance A has been repaired and returned to you. You inspect it again and it passes with flying colors. You report to your supervisor that you and your ambulance are ready to go when needed.</p> |
| | <p>A true emergency call comes in from dispatch. You are to respond to an injury on one of the town's busiest roads. Dispatch gives you the location.</p> |
| | <p>You and the crew get ready to leave.</p> |
| <h1>Q&A</h1> | <p>What should you do before you move the ambulance?</p> |
|  Have participants discuss answers. Write answers on a flipchart | <p><i>[Answer: Notify dispatch you will be responding; check around the ambulance for obstacles.</i></p> |
| | <p>You have left the station in an emergency response mode and are on your way to the scene, using your predetermined primary route.</p> |

Instructor Notes

Presentation

You are driving as smoothly as possible, while obeying all traffic laws.

Q&A

Dispatch tells you there's flooding on one of the roads on your planned route. What do you do?



Have participants discuss answers. Write answers on a flipchart.

[Answer: Follow the preselected alternate route.]

You have successfully navigated around the flooding but now have to clear a major controlled intersection before reaching the scene.



3: Intersection

Instructor Notes

Presentation

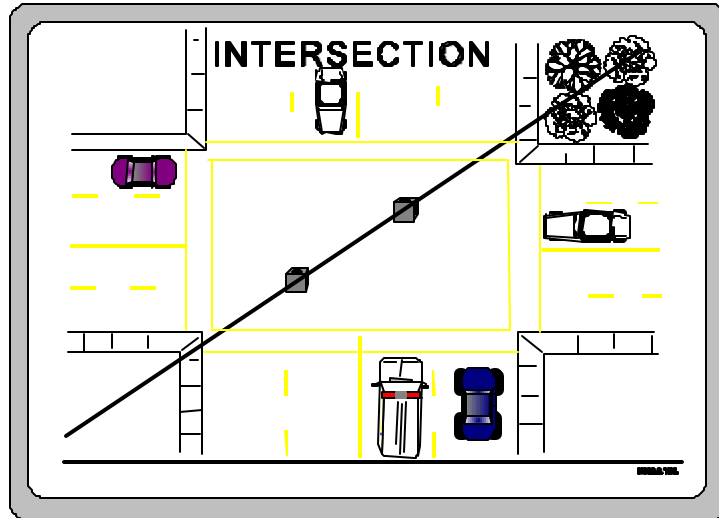

Q&A

How would you clear this controlled intersection?



Have participants discuss answers. Write answers on a flipchart. These are all steps in the process. If the students do not get all of them, show the transparencies.

[Answer:

! *At 300 feet prior to the intersection, the siren should be in the wail mode.]*

! *At 150 feet prior to the intersection, activate the yelp*

| Instructor Notes | Presentation |
|------------------|---|
| | <i>mode of the siren.</i> |
| | <i>! Remove foot from the accelerator to cover the brake pedal and allow compression to slow the ambulance, then start to apply the brake to bring the ambulance to a complete stop at the crosswalk line.</i> |
| | <i>! Give two short blasts on the airhorn.</i> |
| | <i>! Look to the left, look to the immediate front, look to the right, and then again to the left, then proceed through the intersection under 10 mph if traffic is stopped in all lanes to the left, in front of, and to the right of the ambulance.</i> |
| | <i>! After making eye contact with all stopped vehicle drivers, proceed, exercising the highest degree of care, through the intersection.</i> |
| | <i>! Continue the siren yelp mode activation as you proceed.</i> |
| | <i>! When there are vacant lanes to the left or right, complete the previous steps of clearing each lane of traffic prior to crossing that lane.</i> |
| | <i>! Anticipate that any vacant lane to the left or right may become occupied by another vehicle which did not see or hear the ambulance's warning systems.</i> |

| Instructor Notes | Presentation |
|--|--|
| | <p><i>! Be aware that other emergency vehicles may be approaching the same intersection that the operator has taken control of. Do not enter the intersection until the other vehicles have stopped or proceeded through the intersection.</i></p> |
| | <p><i>! Avoid passing stopped vehicles on the right.</i></p> |
| | <p><i>! Anticipate that any vehicles in front may make an unexpected left turn in front of the ambulance after it has started to enter the intersection.</i></p> |
| | <p><i>! Be aware of other hazards at the intersection, e.g., pedestrians, road hazards, and defective traffic control systems.]</i></p> |
|  <p>4: Clearing Controlled Intersection</p> | |

Instructor Notes

Presentation

CLEARING CONTROLLED INTERSECTION (1 OF 2)

- Siren to wail 300 feet before**
- Yelp 150 feet before**
- Remove foot from accelerator**
- Start braking**
- Two blasts airhorn**

EMSRM



5: Clearing Controlled Intersection

CLEARING CONTROLLED INTERSECTION (2 OF 2)

- Look left, front, right, and left**
- Make eye contact all drivers**
- When all clear, proceed under 10 mph**
- Continue yelp through intersection**

EMSRM

Instructor Notes

Presentation



6: Cautions

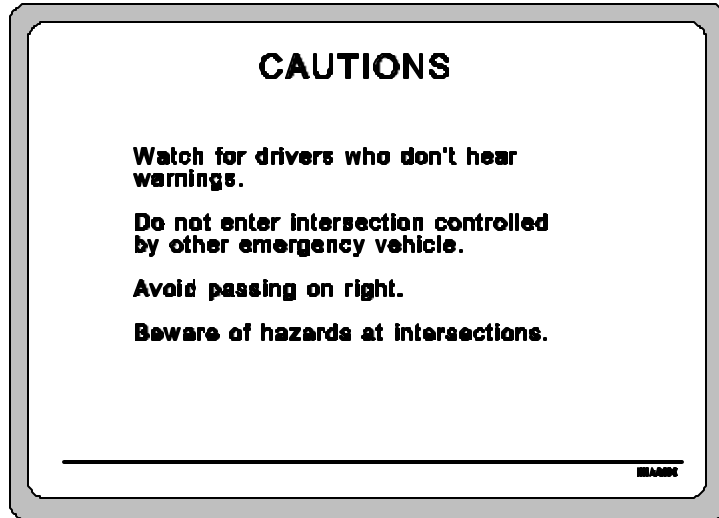

You have successfully cleared the intersection with no problems. You are traveling on a two-lane road at about 40 mph. You are going north. The opposing lane is clear. There are buildings and a sidewalk along the right side of the road. Suddenly a car backs out of a hidden driveway into your path, 50 yards in front of you. The driver can't see you because of the building. (If you drive in a rural area, change the scenario to a deer that runs into your path, 50 yards in front of you.)



7: Difficult Situation(1)

Instructor Notes

Presentation

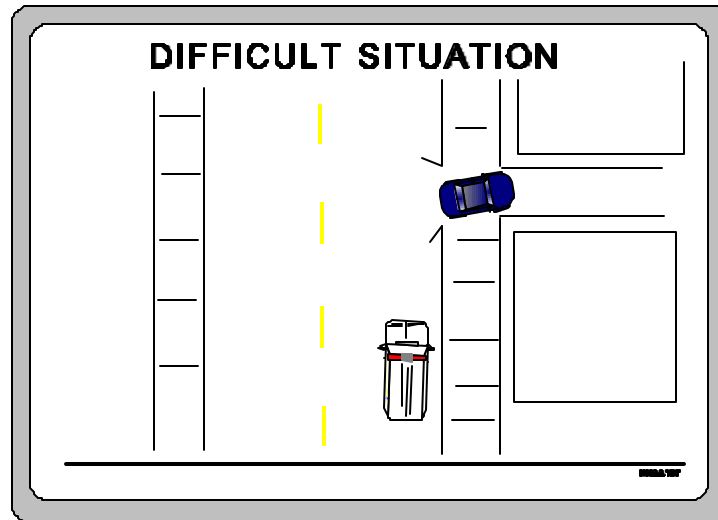

Q&A

How would you avoid a crash?



Have participants discuss answers. Write answers on a flipchart.

[Answer:

- !** *Slow down or stop.*
- !** *Blow the horn or use the siren.*
- !** *Steer around the car to the left or steer around the deer.]*

That was close. But you made it without any problems. You are now approaching the scene of the emergency.

Q&A

What would you do if there are already other emergency vehicles and personnel on the scene?

Instructor Notes

Presentation



Have participants discuss answers. Write answers on a flipchart.

[Answer:

- ! Follow their directions because they have already assessed the scene.*
- ! Notify your dispatcher.*
- ! Check in with the senior EMT on the scene unless told to return to your station.]*

Q&A

What if you are the first to arrive at the scene? What should you be looking for to protect the ambulance and crew?



Have participants discuss answers. Write answers on a flipchart.

[Answer:

- ! fire*
- ! hazardous materials*
- ! violent persons*
- ! crowds*
- ! downed power lines*
- ! traffic]*

Q&A

What should you do if you detect downed power lines?



8: Downed Power Lines

Instructor Notes

Presentation

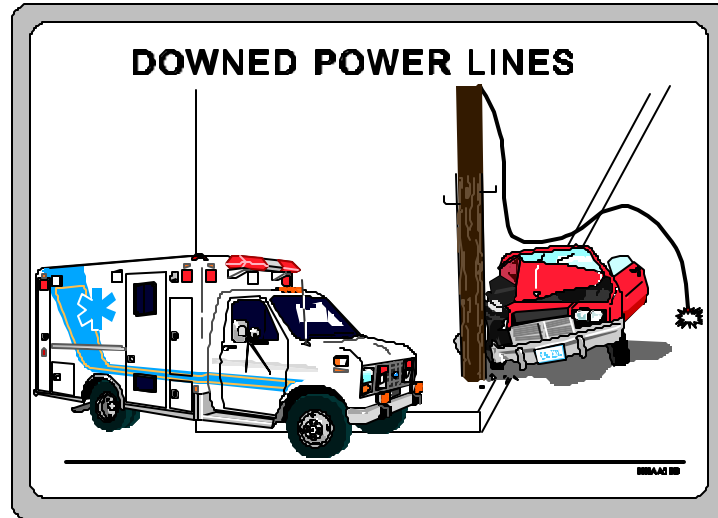

Have participants discuss answers. Write answers on a flipchart.

[Answer:

- ! Do not touch them.*
- ! Notify dispatch to get the power company to the scene.*
- ! Set up a safety zone around the wires.]*

Q&A

What should you do if you find a large crowd?



9: Crowds

Instructor Notes

Presentation

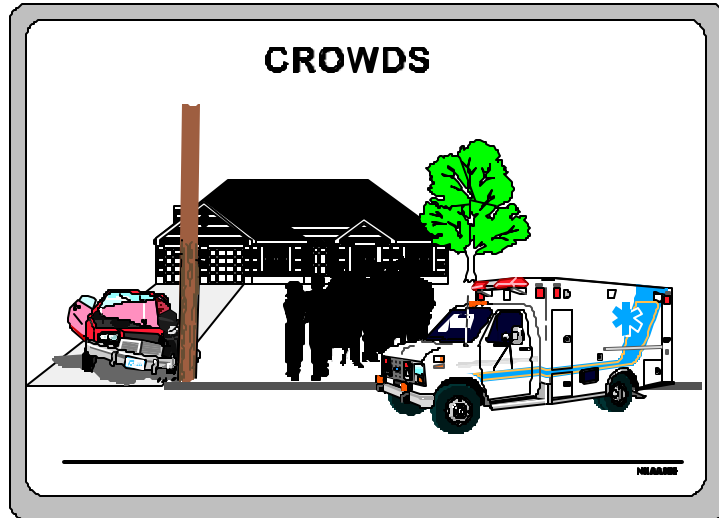

Have participants discuss answers. Write answers on a flipchart.

[Answer:

- ! Drive slowly to avoid causing injury.*
- ! Call for help to control the crowd.*
- ! Have the EMT get out and clear a path.]*

Q&A

You are going to park now. What should you consider before parking the ambulance?



10: Parking Safety

Instructor Notes

Presentation

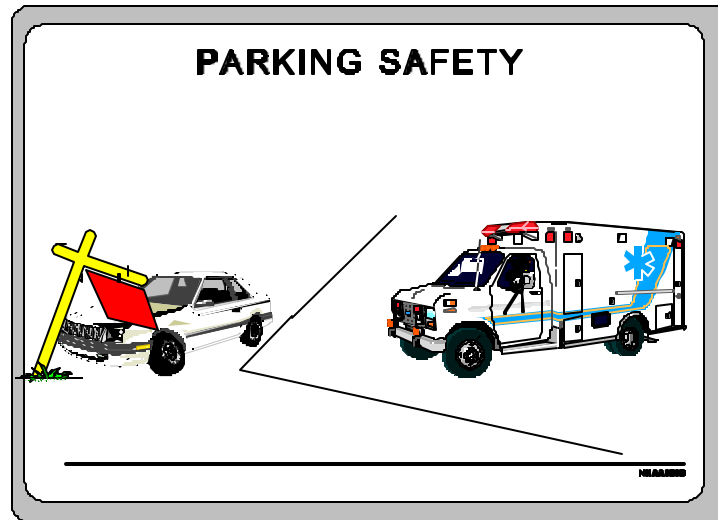

Have participants discuss answers. Write answers on a flipchart.

[Answer:

- ! safety (access, scene protection, danger zones)*
- ! traffic flow*
- ! distance from patient*
- ! ease of departure*
- ! directions received from other emergency personnel]*

Q&A

You have chosen the best possible place to park your ambulance. What should you do now, before assisting with patient care, to ensure that the ambulance will remain operational?



Have participants discuss answers. Write answers on a flipchart.

[Answer: (depends on local procedures given in Lesson 9)]

Instructor Notes

Presentation

The crew is preparing to transport the patient. The patient has been loaded into the ambulance.

Q&A

What steps should you take before moving the ambulance?



Have participants discuss answers. Write answers on a flipchart.

[Answer:

- ! Ensure all supplies are secured in the ambulance.*
- ! Ask the EMT for the patient destination (local policy).*
- ! Ask the EMT for the mode of transport (emergency/non-emergency).*
- ! Check around the ambulance for obstacles.*
- ! Tell the family the destination (if applicable).*
- ! Notify dispatch of the departure.]*



11: Predeparture

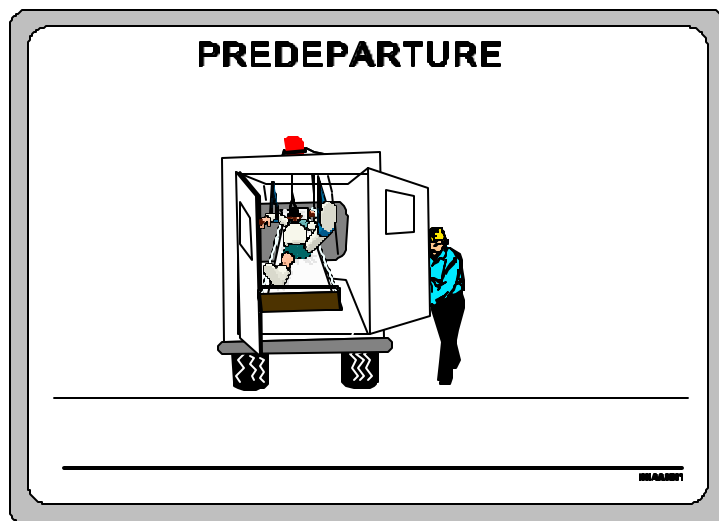

Instructor Notes

Presentation

You are on your way to the medical facility.

Q&A

What should you remember about transporting the patient?



Have participants discuss answers. Write answers on a flipchart.

*[Answer: Traveling in the back of the ambulance--
! can be frightening, painful, and sickening for the patient
! can be difficult for the crew to provide patient care
! requires the ambulance be driven smoothly and carefully]*



12: Fright

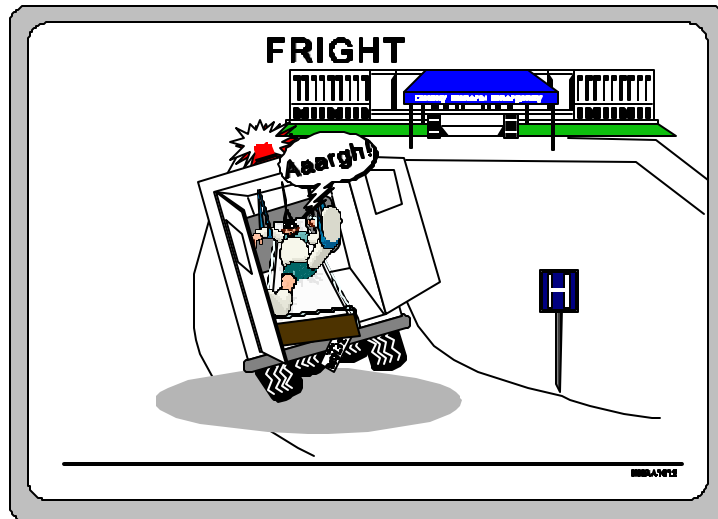

You are about to travel over a very bumpy section of road.

Instructor Notes

Presentation

Q&A

What should you do?



13: Bumpy Road

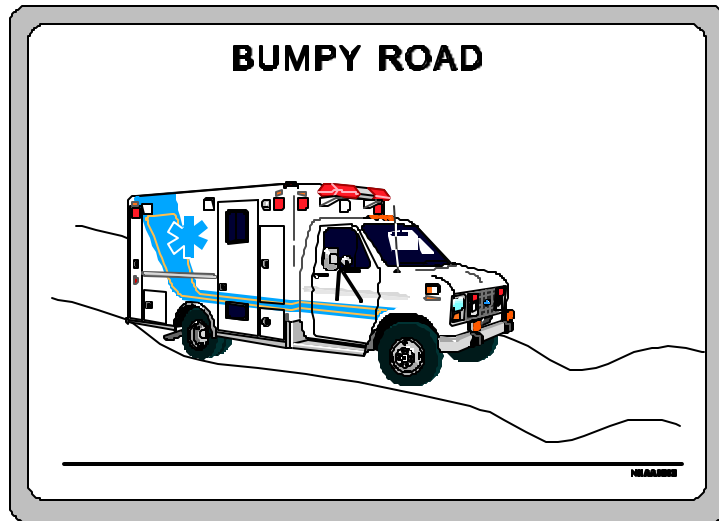

Have participants discuss answers. Write answers on a flipchart.

[Answer: Tell the EMT of the upcoming bumpy road. Maneuver around the bumps as carefully and as smoothly as possible.]

You have arrived at the medical facility and have parked the ambulance near the doors of the building for patient unloading.

What should you do?

Instructor Notes

Presentation

Q&A



Have participants discuss answers. Write answers on a flipchart.

[Answer:

- ! Turn off the engine while unloading the patient.
- ! Leave the lights on in the patient compartment until the patient is unloaded.
- ! Assist with patient unloading.]

The patient has been released into the care of the medical facility.



14: Postrun

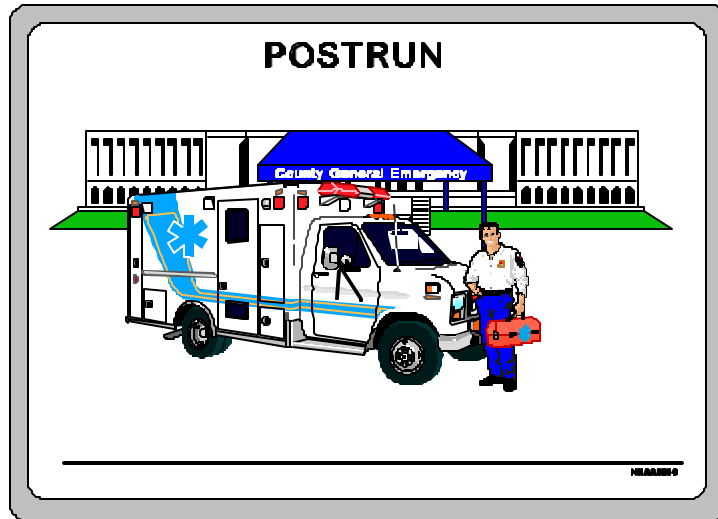

Q&A

What should you do to get the ambulance ready for the next run?

Instructor Notes

Presentation



Have participants discuss answers. Write answers on a flipchart.

[Answer:

- ! Decontaminate the patient compartment.*
- ! Replace any supplies used or left with the patient at the medical facility.*
- ! Refuel the ambulance.*
- ! Notify dispatch when you are back in service.]*

SUMMARY

Additional Exercise

If time permits, have the participants practice team skills such as navigating to the scene and communicating with the EMT in the patient compartment. Go on a practice run or role play a practice run. Have one participant get into the patient compartment and the other in the operators compartment of an ambulance. Have the driver comment on what is occurring--approaching a railroad track, turning right. Make

An ambulance crew must operate as a team with each person performing individual skills.

| Instructor Notes | Presentation |
|---|--|
| sure they each understand the communications. | The three phases of a typical run are-- |
| | 1. prerun |
| | 2. operational activities |
| | 3. postrun |
| | Prerun includes ensuring operator readiness, ensuring vehicle readiness, and route familiarization. |
| | The components of the operations phase include departing for the scene, driving to the scene, emergency scene operations, transporting the patient, and operations at the medical facility. |
| | The postrun phase includes any activities you did not perform in any other phase which prepares you or the ambulance for the next run. |
| | You now have the knowledge needed to be a safe and efficient ambulance operator. However, you still need to develop the skills necessary to operate the ambulance safely. The next section of this course provides you with the opportunity to observe and then practice the skills you will need to operate the |

Instructor Notes

Presentation

ambulance safely and efficiently. Then you will be provided with checklists for on-the-job evaluation of your job performance.

MODULE B

AMBULANCE OPERATION: DEMONSTRATION AND PRACTICE

MODULE GOAL

The goal of this module is to provide ambulance operators with the skills to safely and efficiently operate an ambulance.

MODULE OVERVIEW

It is important that the participant be able to identify those situations that result in a high number of ambulance crashes. Crash prevention requires that the operator learn the appropriate procedures and develop low-risk habits.

Ambulance operators often are involved in crashes at intersections, when backing, parking at the medical facility, turning around, and changing lanes. The exercises in Module B are designed for participants to learn how to perform each of these maneuvers safely.

The participants will be able to inspect and operate an ambulance on a driving range prior to operating in a job environment. Module C describes the on-the-job training where all the skills and knowledge from Modules A and B will be used to perform the job.

MODULE EXERCISES

There are ten exercises in this module. The order in which these exercises are conducted may be modified.

| | <u>Page</u> |
|------------------------|-------------|
| The Serpentine | 7 |
| Diminishing Clearance | 11 |
| Braking While Turning | 15 |
| Straight Line Braking | 19 |
| J-Turn | 23 |
| Three-Point Turn | 27 |
| Right Side Road Turn | 31 |
| Left Side Road Turn | 35 |
| Slow Speed Lane Change | 39 |

Perpendicular Parking, Back In and Drive Out 43

HOW TO CONDUCT EXERCISES

The exercises are conducted using the concept of performance-oriented training. This concept is very simple and is success oriented. The following steps explain how to implement this concept. The sample of the interaction with the participant will give you an idea of the type of coaching that instructors can use. It is not meant to be a script, but an example. Each instructor should be willing to explain, demonstrate, and coach before evaluating a participant. For some exercises, there can be value-added training by having additional participants in the ambulance playing the role of the patient on the stretcher and the Emergency Medical Technician in the patient compartment.

Keep the instruction success oriented. Most people learn to drive an automobile and never drive anything else. All the participants must be allowed to practice until they can meet the evaluation standard. There may be a rare case when it is agreed that the participant's progress is too slow and that the participant should not continue in the operator training.

Follow these procedures for each exercise:

1. Explain to the participant what is to be accomplished and the acceptable performance standard.

The instructor explains the task: In this backing exercise you will use a ground guide to back in your lane until the guide gives you the signal to stop. In doing this task you will need to back slowly following the guide's direction and staying in the lane marked with the cones. Acceptable performance will be when you can do this without hitting any cones. Talk with the ground guide to be sure that you both understand the hand and arm signals. Let me demonstrate this task and give you some tips on using the mirrors when backing.

2. Demonstrate the procedure to the participant.

The instructor explains the task: The first thing you need to do is to be sure that you and the ground guide can communicate using the correct hand and arm signals. Let's get the guide up here and discuss with her exactly why it is important to stand at the left rear corner of the ambulance where she can be seen and discuss which signals we will use for backing. Now that we know how to communicate, I will get in the operator's seat and adjust my seat and mirror. I want you to sit in the passenger's seat and adjust the mirror on that side for me. I am now ready to start backing so I will wave at the ground guide to let her know to begin. OK, I check both mirrors and see in my left mirror that the guide is motioning me straight back. I keep both hands on the wheel and smoothly start backing with only enough speed to keep going backward. I will make no quick moves turning. It's best to stop and pull forward rather than go out of the lane. Keep the guide in sight at all times; if you lose sight of the guide, stop immediately and

Don't continue until you can see the guide again. Keep checking both mirrors. Remember, the guide is keeping you clear on the left side only; you must check your right mirror. The guide will also let you know when to begin stopping and when to stop completely. The instructor discusses and demonstrates each phase of the backing and how to use the mirrors and obey the ground guide. Ask the participants if they understand the procedure. If they do, pull forward and have them explain each part of the task. If they don't understand the procedure, discuss it with them to clear up any misunderstanding and then demonstrate the task again.

3. Coach the participants as they practice the task.

The instructor should discuss the task with the participant and be satisfied that the participant understands the procedure. The instructor now gets into the passenger seat and has the participant tell him what he is going to do before he does it. Each step of the task is done slowly and safely until the participant demonstrates the proper procedure. The instructor comments to improve the participant's performance but must not over-prompt. When the instructor is satisfied that the participant can perform the task safely, the instructor exits the ambulance and allows the participant to practice.

4. Have the participant practice the procedure.

The decision to turn the ambulance over to the participant to practice alone is based on demonstrated performance during the coaching phase and on the instructor's judgment. The practice session must follow the procedures precisely. The instructor is not in the ambulance but is in a position to comment on the performance and stop any potentially unsafe act. The participants practice until they believe that they are performing to the standard. Practice time will vary based on the participant's experience and abilities. The participants notify the instructor when they are ready to be evaluated on the task.

5. Evaluate the participant's performance of each procedure.

The instructor reviews the evaluation sheet with the participant and begins the evaluation. If the participant's performance meets the evaluation standard, he moves on to the next task. If the participant fails to meet the standard, the instructor has the participant continue to practice or provides some coaching and conducts another evaluation. This process is repeated until the participant meets the standard or until it is agreed that the training required for the participant to meet the standard will be excessive and not in the best interest of the participant or the organization.

MODULE EXERCISE SHEETS

Each module exercise contains three sheets.

The first sheet shows a *diagram of the exercise* as it is laid out on the course. It shows the dimensions of the exercise and where the traffic cones will be placed. For the driving range, some of these cones may be changed somewhat, and these changes should be pointed out to participants prior to conducting the exercise.

The second sheet provides *general exercise information*, such as the purpose of the exercise, how it is to be performed, and some of the things the participant and instructor will be doing during the exercise.

The third sheet is an *evaluation rating form* the instructor uses when testing the performance of the exercise. Remember, the participants shouldn't be evaluated until they have had a chance to practice and have told the instructor that they are ready.

The rows of boxes are a guide to the number of practices that a participant may need to achieve the standard. However, most participants should achieve the standard on their first attempt if they have practiced sufficiently. Put a check mark in the box for satisfactory performance of the task. Leave the box blank for unsatisfactory performance. These sheets will become a part of the participant's training record.

TRAINING AMBULANCES

The ambulances used during Module B should be those that the participant will operate when on the job. If this is not possible, similar models should be used and the differences pointed out to the participant. Each ambulance should be in safe working condition, but may have discrepancies and require servicing or repair to add realism to the training. Those used on the driving range must be fully equipped and mechanically sound with high quality tires and fully functional safety and communication equipment.

If more than one ambulance will be used on the course, communication must be established between the vehicles to prevent accidents.

THE COURSE

Any half-mile or greater stretch of straight, four-lane roadway that can be closed off, or abandoned airport runways, may be used. The dimensions of the exercises used in this module may be altered to provide the most training in the space available.

Your organization may have a permanent range that is used for emergency vehicle operator training. Permanent ranges may or may not provide enough space to set up all of the exercises. This may also be the case if a vacant

field or parking lot is used to set up the course. Instructors should evaluate each location and adjust the exercises to the available area. Enough space should be available to set up several exercises with enough space between each exercise area to operate safely.

Planning the training before the participants arrive at the course will save time and confusion. Each participant should be scheduled in advance, and the training manager must decide if concurrent training at the range should be scheduled.

There should be one instructor per ambulance and for each two or three participants. Fifty to 100 orange traffic cones, 18 to 28 inches in height, will be required for each exercise.

DRIVING SPEED

All driving exercises are designed for the participant to learn the control and handling of the ambulance, not its speed capabilities. Each exercise should be run slowly at first and the speed gradually increased as the participant's proficiency improves. None of the exercises is designed to be run at highway speeds.

USE OF GROUND GUIDES

The use of ground guides should be stressed to the participant as the recommended method of backing an ambulance and operating in a congested area such as a crash scene. However, during the initial backing exercises, the participant must learn to use the mirrors; the exercise should first be performed using the mirrors only. Once the participant is able to use the mirrors to back successfully while turning in both directions and stop at a designated point, the ground guide should be added for all subsequent backing maneuvers. The advantages of using the ground guide should be stressed to the participant as this important asset is added. The hand signals discussed in lesson 3 should be demonstrated by the instructor and the participant, and the ground guide should have a chance to practice them, using the mirrors, prior to practicing backing the ambulance with the ground guide.

RANGE RULES

There are several rules that must be followed at all times while on the driving range unless otherwise told to disregard or a particular exercise.

- No food or drinks in ambulances.
- No smoking in ambulances.
- No alcoholic beverages on the driving range.

- ! Seat belts shall be worn at all times.
- ! Do not exceed speed limits established locally at any time on the range.
- ! Unsafe vehicles will not be allowed on the range.
- ! Report all equipment malfunctions immediately.
- ! Ambulance operators must have a state automobile or higher driver's license before operating on the range.
- ! Follow directions of the instructors at all times.

These are sample rules. Each organization should develop a list of local rules that will be appropriate for their course. The course rules should be discussed with all participants before they arrive at the course.

EVALUATING THE PARTICIPANT

The participants either pass or fail the exercise based on their ability to perform the maneuver as outlined on the evaluation tool. We strongly encourage a positive, "let me help you succeed" attitude by all instructors and evaluators. If a participant does have difficulty with a certain aspect of the exercise, it is usually more beneficial to recommend additional practice in this area rather than to "fail" the participant.

If a participant does not meet the standard for an exercise, the instructor must decide if additional coaching, practice, or both will be necessary for the participant to achieve the standard. Each exercise should have a locally developed standard based on the actual exercise layout and type ambulance used. Time should not be a part of the standard. A sample standard: Without hitting a cone, move the ambulance forward so that the front bumper is within 12 inches.

CONCURRENT TRAINING

The training manager should decide how many participants go to the course. The size of the course, number of ambulances and instructors available for training, and other factors can limit the number of participants that can be accommodated in a training session. If participants will be idle, the training manager should consider establishing concurrent training stations. These stations could provide additional training on a variety of subjects such as vehicle inspections, communications, and emergency procedures. The concurrent training can be conducted by a participant or by an instructor.

SERPENTINE COURSE

Full stop

Begin braking

Begin to decelerate

Maintain steady speed

Accelerate smoothly

Begin from a standstill

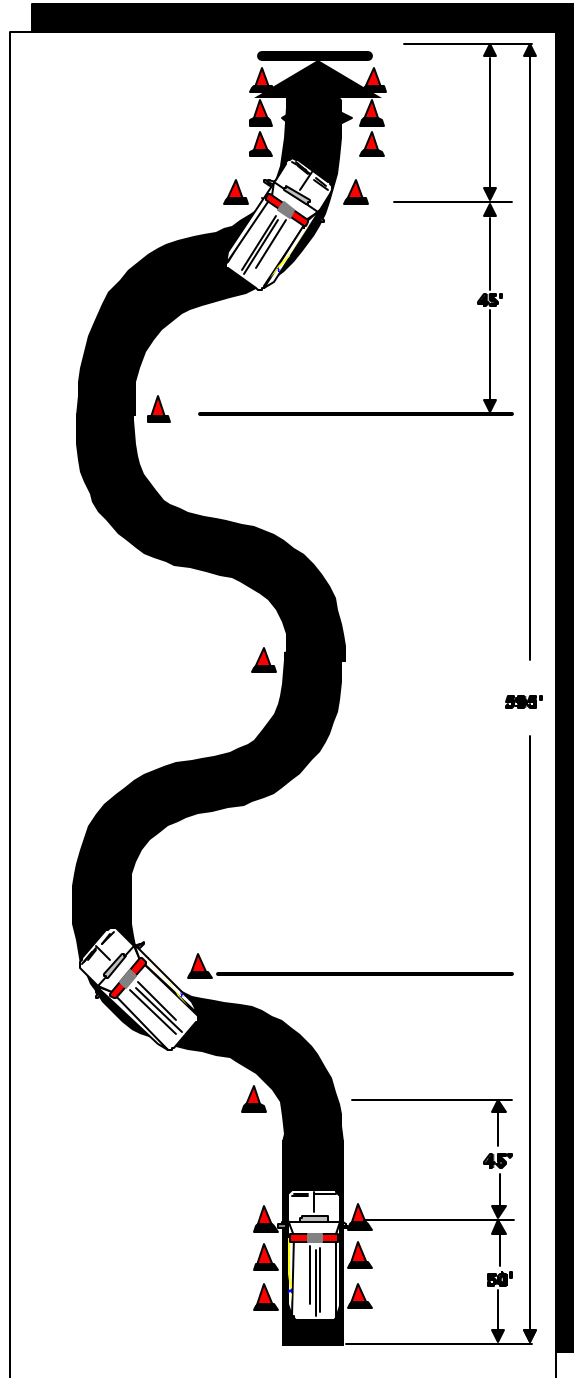

COURSE REQUIREMENTS

595' x 70'

Requires 20 traffic cones

Serpentine

Purpose:

To develop the basic skills of coordinating acceleration, timing of steering movements, and the use of the 9 - 3 hand position. It also develops the ability to judge the relationship of fixed objects to the vehicle.

This exercise does not simulate a real world situation. It develops the skills for use in other exercises and gives the participant the opportunity to become familiar with how the vehicle handles and to build confidence. It should be taught before exercises using the 9 - 3 hand position.

Procedure:

Begin from a standstill and accelerate smoothly. Maintain steady speed on course. Begin braking at the assigned point and bring ambulance to a full stop at the stop line.

Instructor:

1. Explains purpose of exercise and key factors of the exercise.
2. Demonstrates exercise at moderate speed.
3. Demonstrates exercise at required speed.

Participant:

1. Assumes proper driving position; seat, mirrors, seat belt.
2. Accelerates smoothly.
3. Negotiates the course smoothly.
4. Keeps steering movements constant and even.
5. Maintains 9 - 3 hand position.
6. Maintains constant speed throughout the course once assigned speed is reached.
7. Passes closely to the cones.
8. Brakes smoothly to a full stop.

Serpentine Exercise Rating

Participant's name _____ Date _____ Vehicle make/number _____

| | | <u>Practice Exercises</u> | | | |
|----|--|---------------------------|---|---|---|
| | | 1 | 2 | 3 | 4 |
| A. | Accelerated smoothly | G | G | G | G |
| B. | Maintained required speed..... | G | G | G | G |
| C. | 9-3 hand position..... | | G | G | G |
| D. | Maintained constant speed..... | G | G | G | G |
| E. | Steering control..... | | G | G | G |
| F. | Accelerator, steering coordination.... | G | G | G | G |
| G. | Foot movement | | G | G | G |
| H. | Use of brakes..... | | G | G | G |

Number of cones hit _____

Reaction time was adequate. YES NO

Vehicle remained under control at all time. YES NO

Describe negative actions or attitudes.

Failed to complete exercise because _____

All requirements were met. YES NO

GENERAL REMARKS:

Instructor's signature _____ Date _____

I have seen the completed form and have been given an explanation of my performance and rating.

Participant's signature _____ Date _____

THIS PAGE INTENTIONALLY LEFT BLANK.

DIMINISHING CLEARANCE

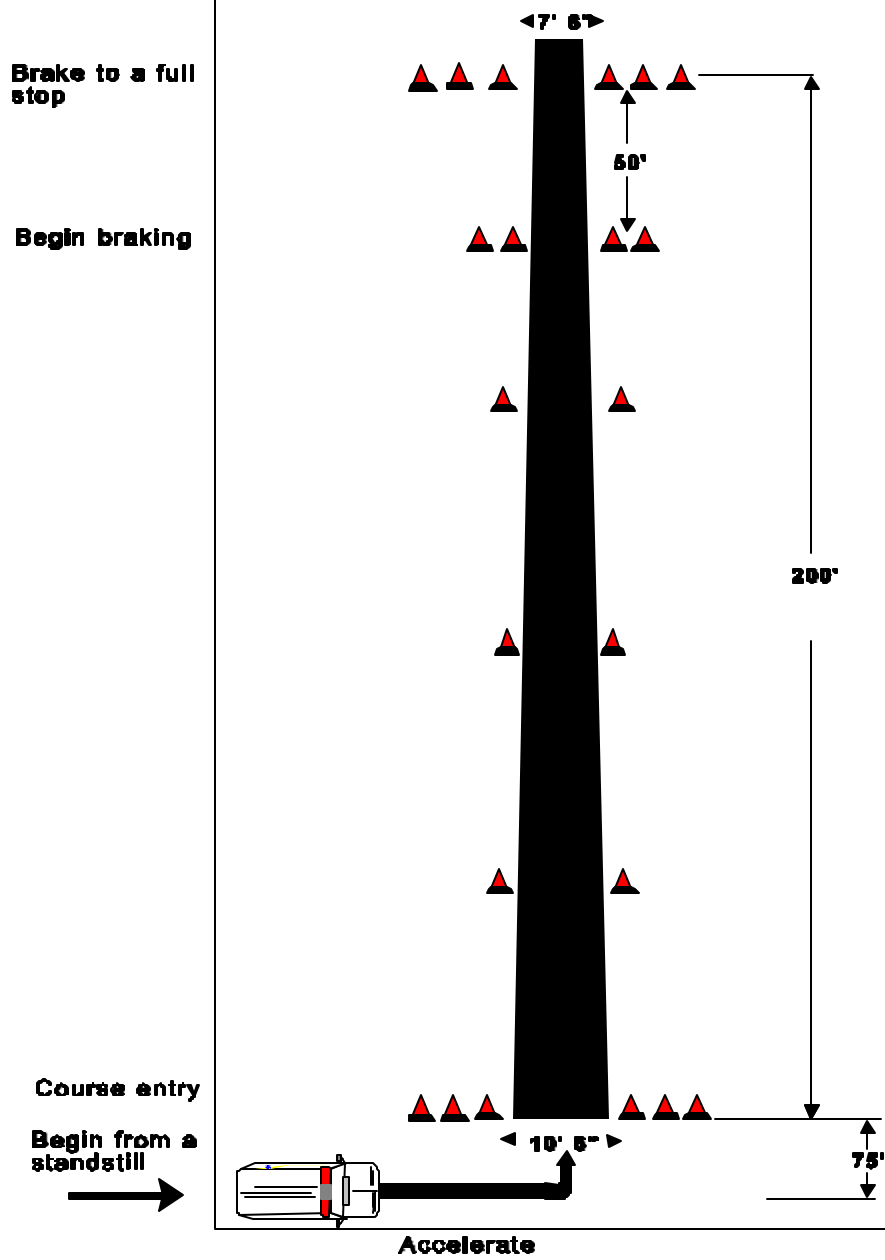

Diminishing Clearance

Purpose:

To give the operator the sensation of driving in a street that starts out at 10 ft. 6 inches and ends up at 7 ft. 6 inches. Judges the operator's ability to perceive change in dimension while driving forward and to use mirrors while backing.

Procedure:

Begin from a standstill facing perpendicular to the course. Accelerate and turn to enter the course. Maintain a steady speed while on the course. Keep the ambulance on the centerline of the course and begin braking at the assigned point to bring the ambulance to a full stop at the stop line. The distance over or behind the stop line will be recorded. Ambulance will then be backed full length of course and stopped at course entry points.

Instructor:

1. Explains purpose of exercise and key factors of the exercise.
2. Demonstrates exercise at slow speed.
3. Demonstrates exercise at required speed.

USE A GROUND GUIDE WHEN BACKING

Participant:

1. Assumes proper driving position; seat, mirrors, seat belt.
2. Accelerates smoothly.
3. Negotiates the course smoothly.
4. Keeps steering movements constant and even.
5. Maintains 9 - 3 hand position.
6. Maintains constant speed throughout the course.
7. Maintains ambulance on course centerline.
8. Brakes smoothly to a full stop.
9. Uses mirrors while backing.
10. Accelerates smoothly in reverse and maintains slow steady speed while in reverse.
11. Brakes smoothly to full stop at course entry point.

Diminishing Clearance Exercise Rating

Participant's name _____ Date _____ Vehicle make/number _____

Practice Exercises

1 2 3 4

| | | | | | | | |
|----|--|---|---|---|---|---|---------|
| A. | Accelerated smoothly | G | G | G | G | | |
| B. | Maintained required speed..... | G | G | G | G | | |
| C. | 9-3 hand position..... | | | G | G | G | G |
| D. | Maintained constant speed..... | G | G | G | G | | |
| E. | Steering control..... | | | G | G | G | G |
| F. | Accelerator, steering coordination.... | G | G | G | G | | |
| G. | Maintained centerline position..... | G | G | G | G | | |
| H. | Foot movement | | | G | G | G | G |
| I. | . Use of brakes..... | | | | | G | G G G G |
| J. | . Use of mirrors..... | | | | | G | G G G G |

Number of cones hit _____

Reaction time was adequate. YES NO

Vehicle remained under control at all time. YES NO

Distance OVER/BEHIND stop line _____

Describe negative actions or attitudes.

Failed to complete exercise because _____

All requirements were met. YES NO

GENERAL REMARKS:

Instructor's signature _____ Date _____

I have seen the completed form and have been given an explanation of my performance and rating.

Participant's signature _____ Date _____

THIS PAGE INTENTIONALLY LEFT BLANK.

BRAKING WHILE TURNING

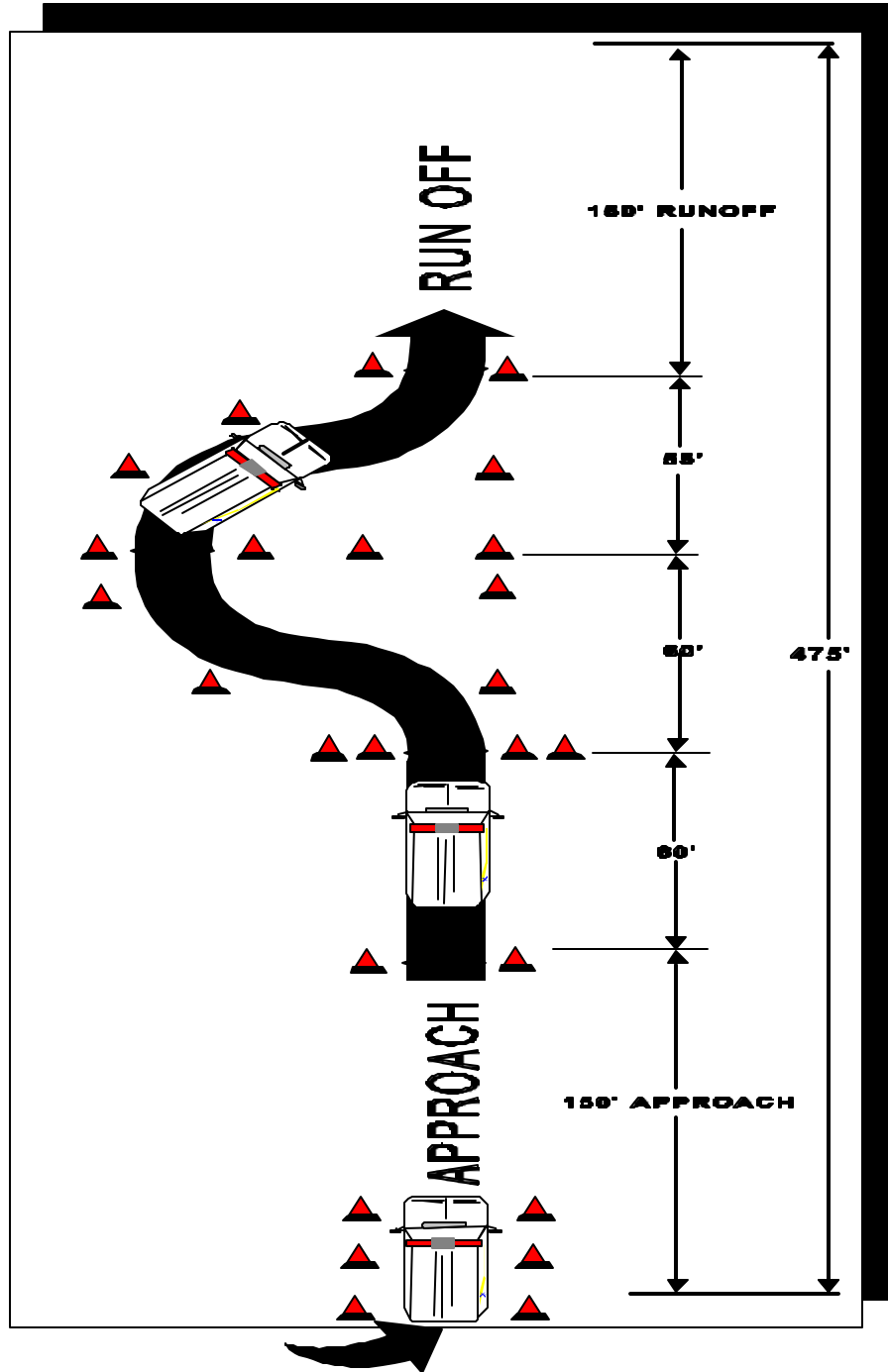

Braking While Turning

Purpose:

To develop skill in achieving and maintaining maximum braking pressure while controlling the direction of the vehicle.

Procedure:

Enter course at selected speed. At brake cue cones, begin maximum braking. Steer through course while braking. Do not lock brakes.

Instructor:

1. Explains purpose of exercise and key factors of the exercise.
2. Demonstrates exercise at moderate speed.
3. Demonstrates exercise at required speed.

Participant:

1. Assumes proper driving position; seat, mirrors, seat belt.
2. Enters course at speed determined by instructor.
3. Negotiates the course smoothly.
4. Maintains 9 - 3 hand position.
5. Exits the course at the direction of the instructor.

Braking While Turning Exercise Rating

Participant's name _____ Date _____ Vehicle make/number _____

| | | <u>Practice Exercises</u> | | | |
|----|--|---------------------------|---|---|---|
| | | 1 | 2 | 3 | 4 |
| A. | Entered course correctly | G | G | G | G |
| B. | Maintained required speed..... | G | G | G | G |
| C. | 9 - 3 hand position..... | | G | G | G |
| D. | Controlled acceleration..... | G | G | G | G |
| E. | Steering control..... | | G | G | G |
| F. | Accelerator, steering coordination.... | G | G | G | G |
| G. | Smooth acceleration..... | | G | G | G |
| H. | Foot movement | | G | G | G |
| I. | Use of brakes..... | | | G | G |

Number of cones hit _____

Reaction time was adequate. YES NO

Vehicle remained under control at all time. YES NO

Describe negative actions or attitudes.

Failed to complete exercise because _____

All requirements were met. YES NO

GENERAL REMARKS:

Instructor's signature _____ Date _____

I have seen the completed form and have been given an explanation of my performance and rating.

Participant's signature _____ Date _____

THIS PAGE INTENTIONALLY LEFT BLANK.

STRAIGHT LINE BRAKING

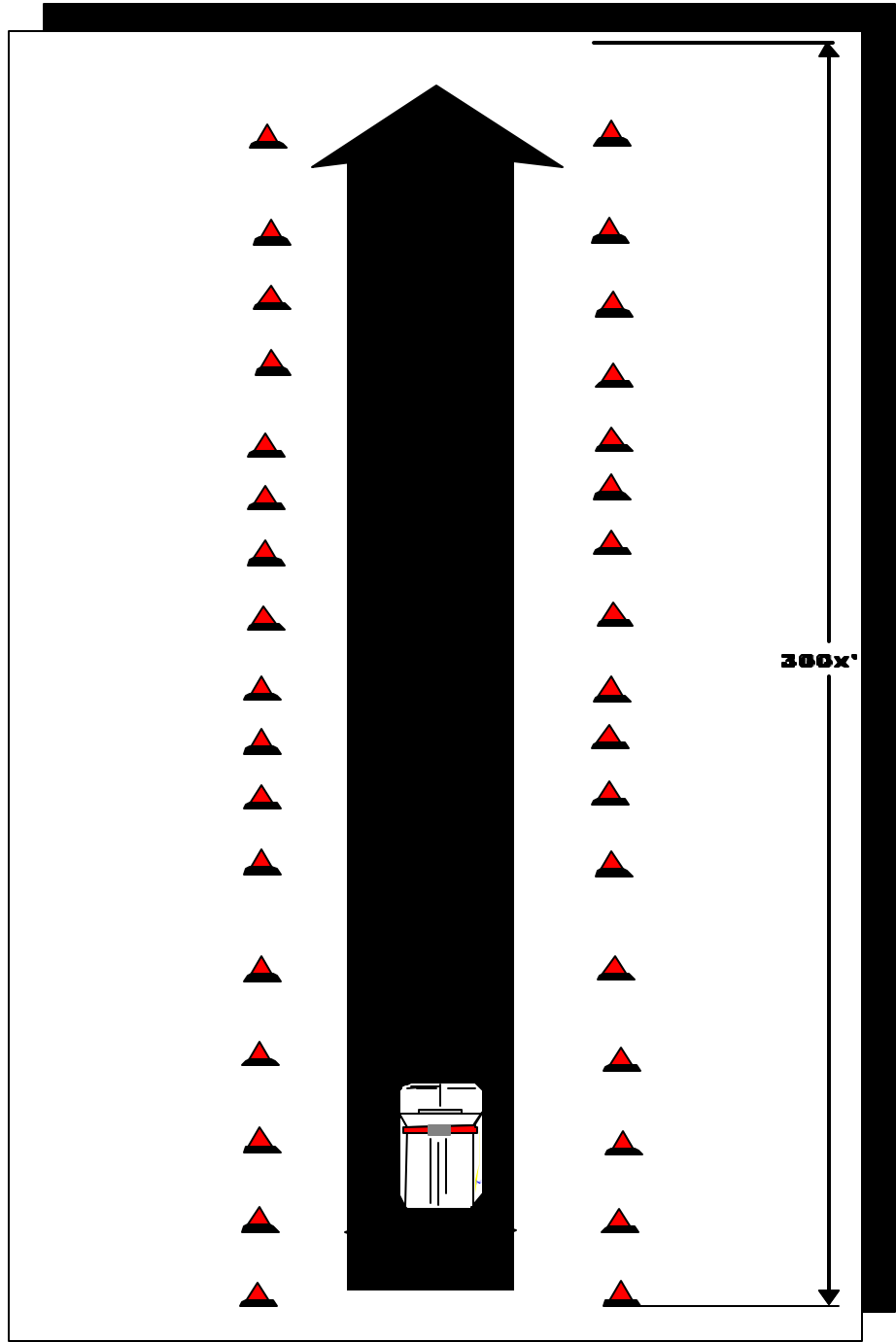

Straight Line Braking

Purpose:

To teach operator to brake quickly and smoothly on demand. Combines reaction time, smooth braking, and steering skills.

Procedure:

Enter course at selected speed. At instructor command, quickly bring ambulance to smooth, full stop. Maintain straight direction and stop without locking brakes.

Instructor:

1. Explains purpose of exercise and key factors of the exercise.
2. Demonstrates exercise at moderate speed.
3. Demonstrates exercise at required speed.

Participant:

1. Assumes proper driving position; seat, mirrors, seat belt.
2. Enters course at speed determined by instructor.
3. Negotiates the course smoothly.
4. Keeps steering movements constant and even.
5. Maintains 9 - 3 hand position.
6. Maintains constant speed throughout the course.
7. Passes closely to the cones.
8. Brakes smoothly on instructor command without locking brakes.

Straight Line Braking Exercise Rating

Participant's name _____ Date _____ Vehicle make/number _____

| | | <u>Practice Exercises</u> | | | |
|----|--|---------------------------|---|---|---------|
| | | 1 | 2 | 3 | 4 |
| A. | Entered course correctly | G | G | G | G |
| B. | Maintained required speed..... | G | G | G | G |
| C. | 9 - 3 hand position..... | | G | G | G G |
| D. | Controlled acceleration..... | G | G | G | G |
| E. | Steering control..... | | G | G | G G |
| F. | Accelerator, steering coordination.... | G | G | G | G |
| G. | Smooth acceleration..... | | G | G | G G |
| H. | Foot movement | | G | G | G G |
| I. | Use of brakes..... | | | G | G G G G |

Number of cones hit _____

Reaction time was adequate. YES NO

Vehicle remained under control at all time. YES NO

Describe negative actions or attitudes.

Failed to complete exercise because _____

All requirements were met. YES NO

GENERAL REMARKS:

Instructor's signature _____ Date _____

I have seen the completed form and have been given an explanation of my performance and rating.

Participant's signature _____ Date _____

THIS PAGE INTENTIONALLY LEFT BLANK.

UTURN

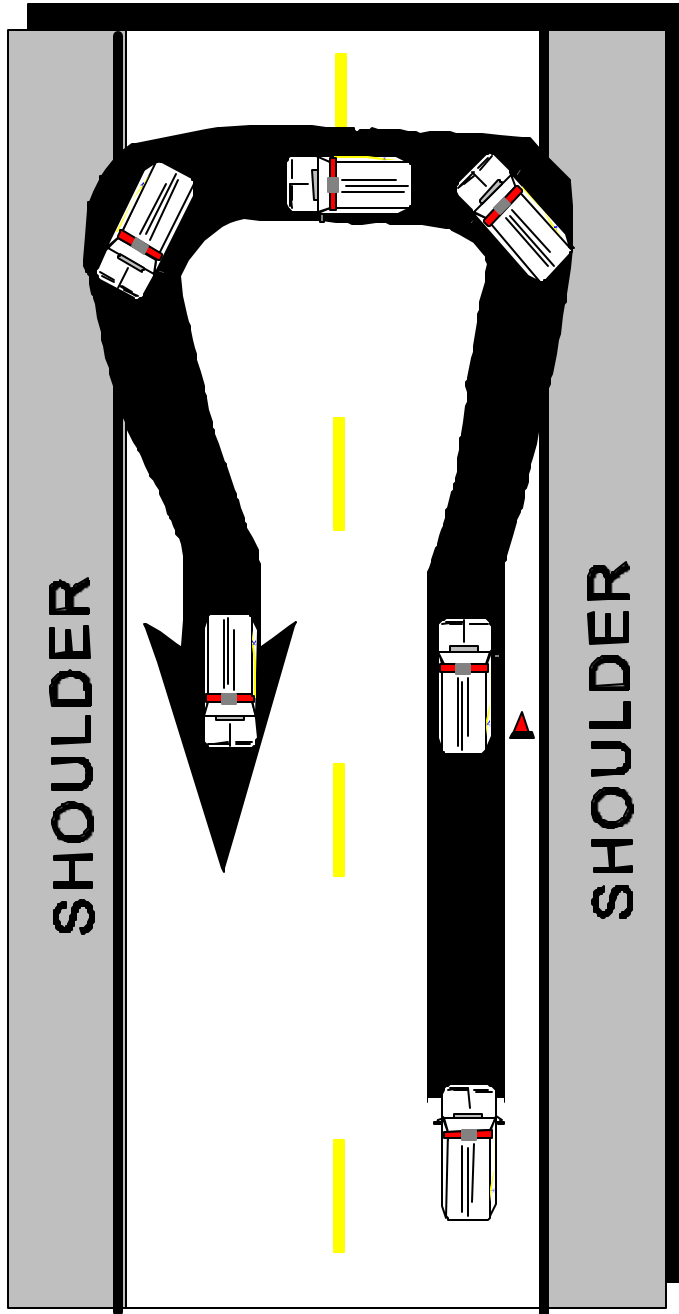

COURSE REQUIREMENTS

Use tape or paint to simulate two lane roadway

For longer ambulances, add width to shoulder

U-Turn

Purpose:

To develop the coordination of acceleration, turning, judgment of road width, and signaling.

Procedure:

Enter course and begin braking. Signal, check mirrors, and begin turn. Use shoulder areas to complete turn in one motion.

Instructor:

1. Explains purpose of exercise and key factors of the exercise.
2. Demonstrates exercise at moderate speed.
3. Demonstrates exercise at required speed.

Participant:

1. Assumes proper driving position; seat, mirrors, seat belt.
2. Enters course at speed determined by instructor.
3. Signals for a right turn at least 100 feet in advance.
4. Pauses momentarily to check for oncoming traffic.
5. Follows through with the counter clockwise turn.
6. Avoids situations with considerable cross traffic or pedestrians.
7. Crosses minimum number of traffic lanes (considerably safer).
8. Negotiates the course smoothly.
9. Keeps steering movements constant and even.
10. Maintains 9 - 3 hand position.
11. Exits the course at the direction of the instructor.

J-Turn Exercise Rating

Participant's name _____ Date _____ Vehicle make/number _____

| | | <u>Practice Exercises</u> | | | |
|----|--|---------------------------|---|---|---|
| | | 1 | 2 | 3 | 4 |
| A. | Entered course correctly | G | G | G | G |
| B. | Maintained required speed..... | G | G | G | G |
| C. | 9 - 3 hand position..... | | G | G | G |
| D. | Controlled acceleration..... | G | G | G | G |
| E. | Steering control..... | | G | G | G |
| F. | Accelerator, steering coordination.... | G | G | G | G |
| G. | Smooth acceleration..... | | G | G | G |
| H. | Foot movement | | G | G | G |
| I. | . Use of brakes..... | | | G | G |
| J. | . Signaled intention..... | | | G | G |
| K. | Checked mirror..... | G | G | G | G |
| L. | Turned head..... | G | G | G | G |

Number of cones hit _____

Reaction time was adequate. YES NO

Vehicle remained under control at all time. YES NO

Describe negative actions or attitudes.

Failed to complete exercise because _____

All requirements were met. YES NO

GENERAL REMARKS:

Instructor's signature _____ Date _____

I have seen the completed form and have been given an explanation of my performance and rating.

Exercises

Participant's signature _____ Date _____

THIS PAGE INTENTIONALLY LEFT BLANK.

Three-Point Turn

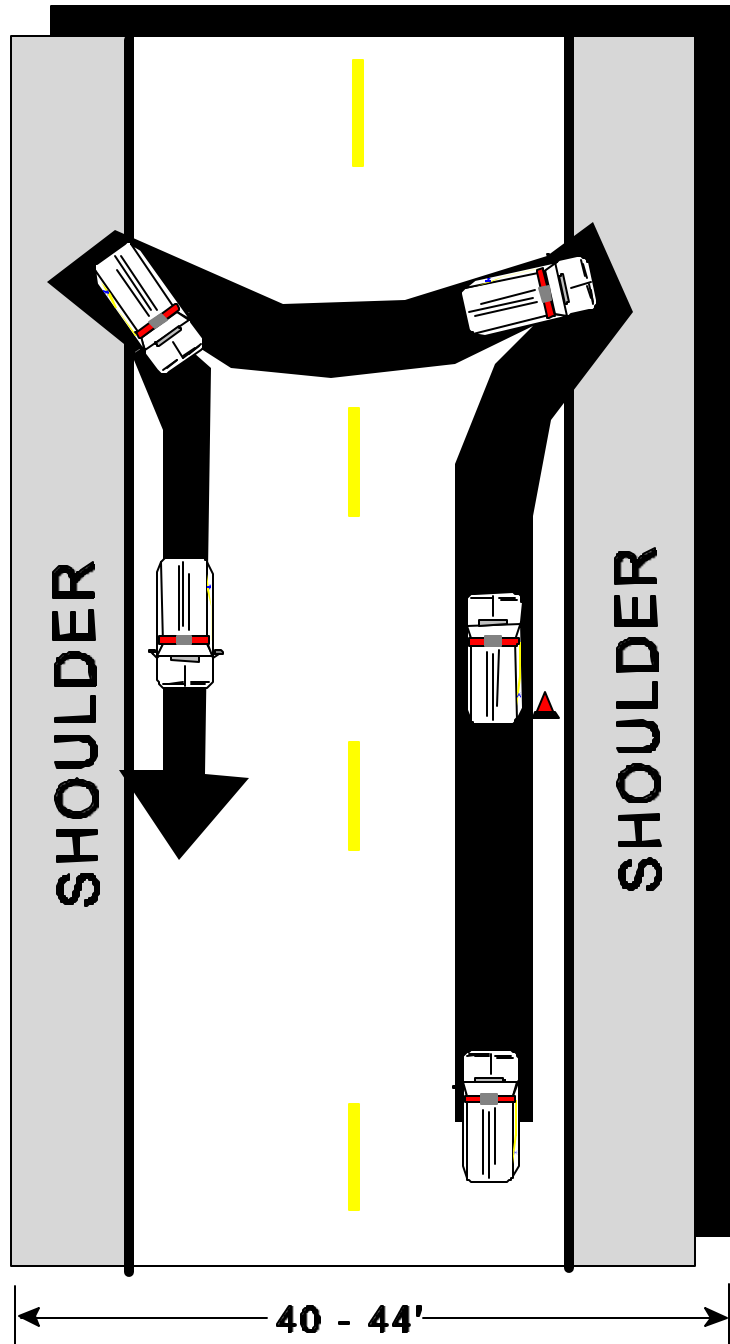

COURSE REQUIREMENTS

Use tape or paint to simulate two-lane roadway

Three-Point Turn

Purpose:

To develop the coordination of acceleration, turning, judgment of road width, and signaling.

Procedure:

Check traffic. When clear, brake and turn to come to stop with front wheels on right shoulder. Begin backing and turning steering wheel to left. Stop when rear wheels are on left shoulder. Steer to the right and begin to accelerate. Move into right lane and continue forward.

Instructor:

1. Explains purpose of exercise and key factors of the exercise.
2. Demonstrates exercise at moderate speed.
3. Demonstrates exercise at required speed.

Participant:

1. Assumes proper driving position; seat, mirrors, seat belt.
2. Enters course at speed determined by instructor.
3. Checks rear traffic and signals for a stop at least 100 feet in advance.
4. Brings vehicle to a stop at approximately a 15-degree angle from the center of the road.
5. Begins backing turning the wheel slowly for the first 5 feet.
5. Steers counter clockwise until rear wheels barely hit the shoulder.
7. Moves forward into the right lane.
8. Negotiates the course smoothly.
9. Keeps steering movements constant and even.
0. Maintains 9 - 3 hand position.
1. Exits the course at the direction of the instructor.

Three-Point Turn Exercise Rating

Participant's name _____ Date _____ Vehicle make/number _____

| | | <u>Practice Exercises</u> | | | | | |
|----|--|---------------------------|---|---|---|---|---|
| | | 1 | 2 | 3 | 4 | | |
| A. | Entered course correctly | G | G | G | G | | |
| B. | Maintained required speed..... | G | G | G | G | | |
| C. | 9 - 3 hand position (going forward). | G | G | G | G | | |
| D. | Controlled acceleration..... | G | G | G | G | | |
| E. | Steering control..... | | G | G | G | G | |
| F. | Accelerator, steering coordination.... | G | G | G | G | | |
| G. | Smooth acceleration..... | | G | G | G | G | |
| H. | Foot movement..... | | G | G | G | G | |
| I. | . Use of brakes..... | | | G | G | G | G |
| J. | . Signaled intention..... | | | G | G | G | G |
| K. | Checked mirror..... | | G | G | G | G | |
| L. | Turned head..... | | G | G | G | G | |

Number of cones hit _____

Reaction time was adequate. YES NO

Vehicle remained under control at all time. YES NO

Describe negative actions or attitudes.

Failed to complete exercise because _____

All requirements were met. YES NO

GENERAL REMARKS:

Instructor's signature _____ Date _____

I have seen the completed form and have been given an explanation of my performance and rating.

Participant's signature _____ Date _____

THIS PAGE INTENTIONALLY LEFT BLANK.

RIGHTSIDE ROAD TURN

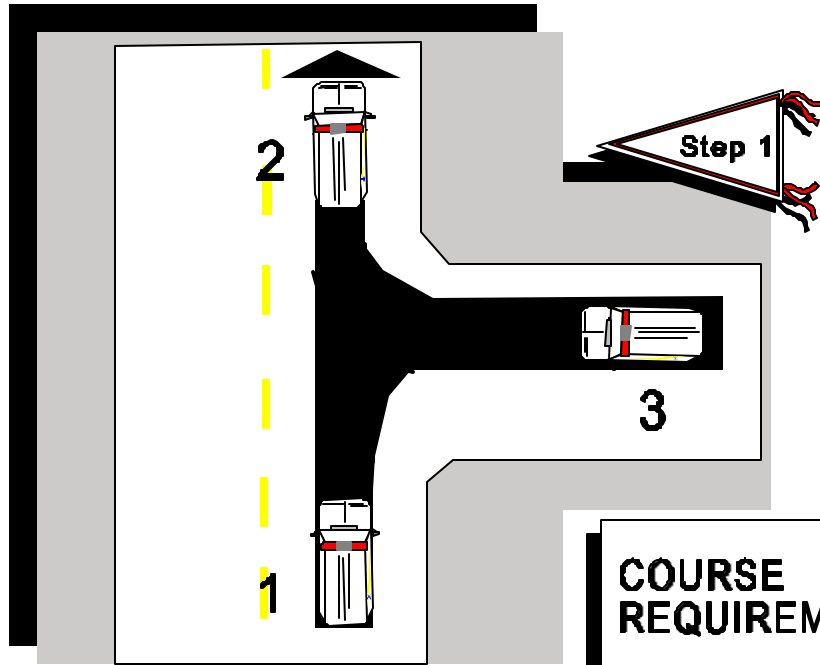

COURSE REQUIREMENTS

Set up exercise to simulate local roadway dimensions
Requires 50 traffic cones

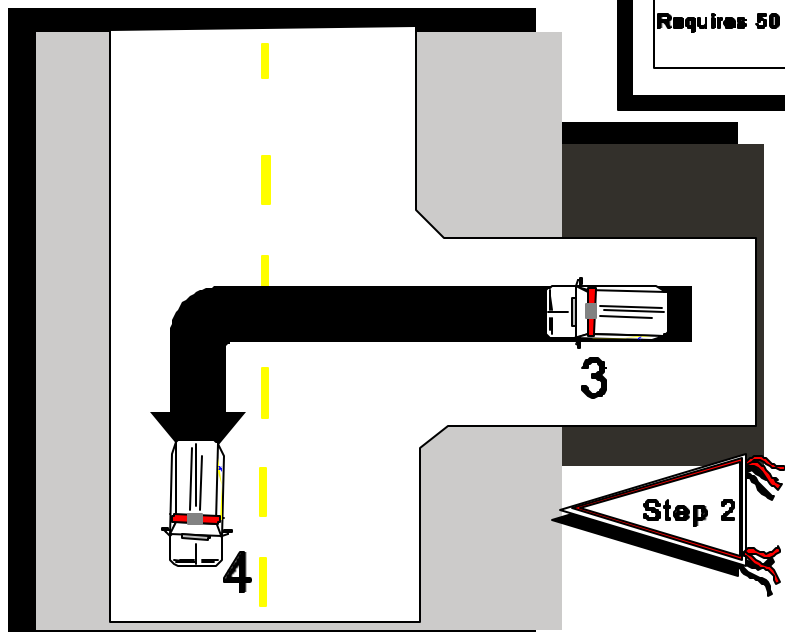

Right Side Road Turn

Purpose:

To develop the skill of coordinating turning, braking, signaling, and making traffic observations.

Procedure:

Enter course, slow, and stop just past side road. Back into side road. Stop with front bumper clear of roadway. Check traffic, signal, and pull into opposite lane. Accelerate and exit course.

Instructor:

1. Explains purpose of exercise and key factors of the exercise.
2. Demonstrates exercise at moderate speed.
3. Demonstrates exercise at required speed.

Participant:

1. Assumes proper driving position; seat, mirrors, seat belt.
2. Enters course at speed determined by instructor.
3. Selects side road, checks rear traffic, and signals for a stop at least 100 feet in advance.
4. Keeps close to right edge of road and brings vehicle to a stop approximately 10 feet past the side road.
5. Allows traffic from the rear to pass.
6. Looks over the right shoulder and rechecks traffic.
7. Backs into the side road on the right.
8. Checks traffic in both directions, signals for left turn and re-enters the roadway.
9. Negotiates the course smoothly.
10. Keeps steering movements constant and even.
11. Maintains 9 - 3 hand position.
12. Exits the course at the direction of the instructor.

Right Side Road Turn Exercise Rating

Participant's name _____ Date _____ Vehicle make/number _____

Practice Exercises

1 2 3 4

| | | | | | | | | | |
|----|--|---|---|---|---|---|---|---|---|
| A. | Entered course correctly..... | G | G | G | G | | | | |
| B. | Maintained required speed..... | G | G | G | G | | | | |
| C. | 9 - 3 hand position (going forward).. | G | G | G | G | | | | |
| D. | Controlled acceleration..... | G | G | G | G | | | | |
| E. | Steering control..... | | | G | G | G | G | | |
| F. | Accelerator, steering coordination.... | G | G | G | G | | | | |
| G. | Smooth acceleration..... | | | G | G | G | G | | |
| H. | Foot movement..... | | | G | G | G | G | | |
| I. | . Use of brakes..... | | | | | | | G | G |
| J. | . Signaled intention..... | | | | | | | G | G |
| K. | Checked mirror..... | | | G | G | G | G | | |
| L. | Turned head..... | | | G | G | G | G | | |

Number of cones hit _____

Reaction time was adequate. YES NO

Vehicle remained under control at all time. YES NO

Describe negative actions or attitudes.

Failed to complete exercise because _____

All requirements were met. YES NO

GENERAL REMARKS:

Instructor's signature _____ Date _____

I have seen the completed form and have been given an explanation of my performance and rating.

Exercises

Participant's signature _____ Date _____

THIS PAGE INTENTIONALLY LEFT BLANK.

LEFTSIDE ROAD TURN

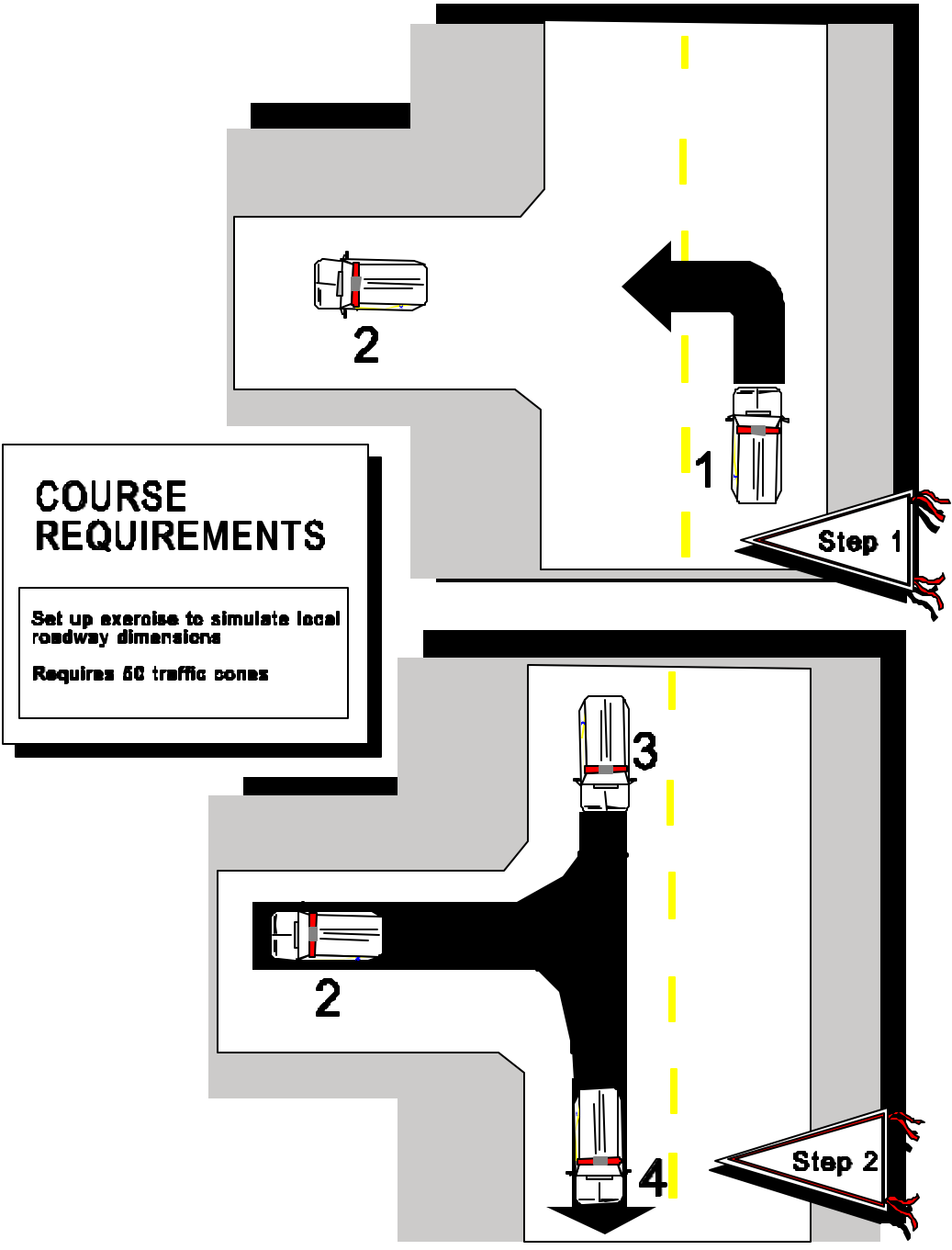

Left Side Road Turn

Purpose:

To develop the skill of coordinating turning, braking, signaling, and making traffic observations

Procedure:

Enter course, slow, and signal for left turn. Check traffic and turn left into side road. Stop with rear bumper clear of roadway. Check traffic and back into lane. Stop. Accelerate forward and exit course.

Instructor:

1. Explains purpose of exercise and key factors of the exercise.
2. Demonstrates exercise at moderate speed.
3. Demonstrates exercise at required speed.

Participant:

1. Assumes proper driving position; seat, mirrors, seat belt.
2. Enters course at speed determined by instructor.
3. Selects side road, checks rear traffic, and signals for a turn at least 100 feet in advance.
4. Keeps to the right of the centerline and stops approximately 20 feet from roadway.
5. Checks traffic and proceeds ahead.
5. Moves forward.
7. Negotiates the course smoothly.
8. Keeps steering movements constant and even.
9. Maintains 9 - 3 hand position.
0. Exits the course at the direction of the instructor.

Left Side Road Turn Exercise Rating

Participant's name _____ Date _____ Vehicle make/number _____

| | | <u>Practice Exercises</u> | | | | | |
|----|--|---------------------------|---|---|---|---|---|
| | | 1 | 2 | 3 | 4 | | |
| A. | Entered course correctly | G | G | G | G | | |
| B. | Maintained required speed..... | G | G | G | G | | |
| C. | 9 - 3 hand position (going forward). | G | G | G | G | | |
| D. | Controlled acceleration..... | G | G | G | G | | |
| E. | Steering control..... | | G | G | G | G | |
| F. | Accelerator, steering coordination.... | G | G | G | G | | |
| G. | Smooth acceleration..... | | G | G | G | G | |
| H. | Foot movement..... | | G | G | G | G | |
| I. | . Use of brakes..... | | | G | G | G | G |
| J. | . Signaled intention..... | | | G | G | G | G |
| K. | Checked mirror..... | G | G | G | G | | |
| L. | Turned head..... | G | G | G | G | | |

Number of cones hit _____

Reaction time was adequate. YES NO

Vehicle remained under control at all time. YES NO

Describe negative actions or attitudes.

Failed to complete exercise because _____

All requirements were met. YES NO

GENERAL REMARKS:

Instructor's signature _____ Date _____

I have seen the completed form and have been given an explanation of my performance and rating.

Participant's signature _____ Date _____

THIS PAGE INTENTIONALLY LEFT BLANK.

SLOW SPEED LANE CHANGE

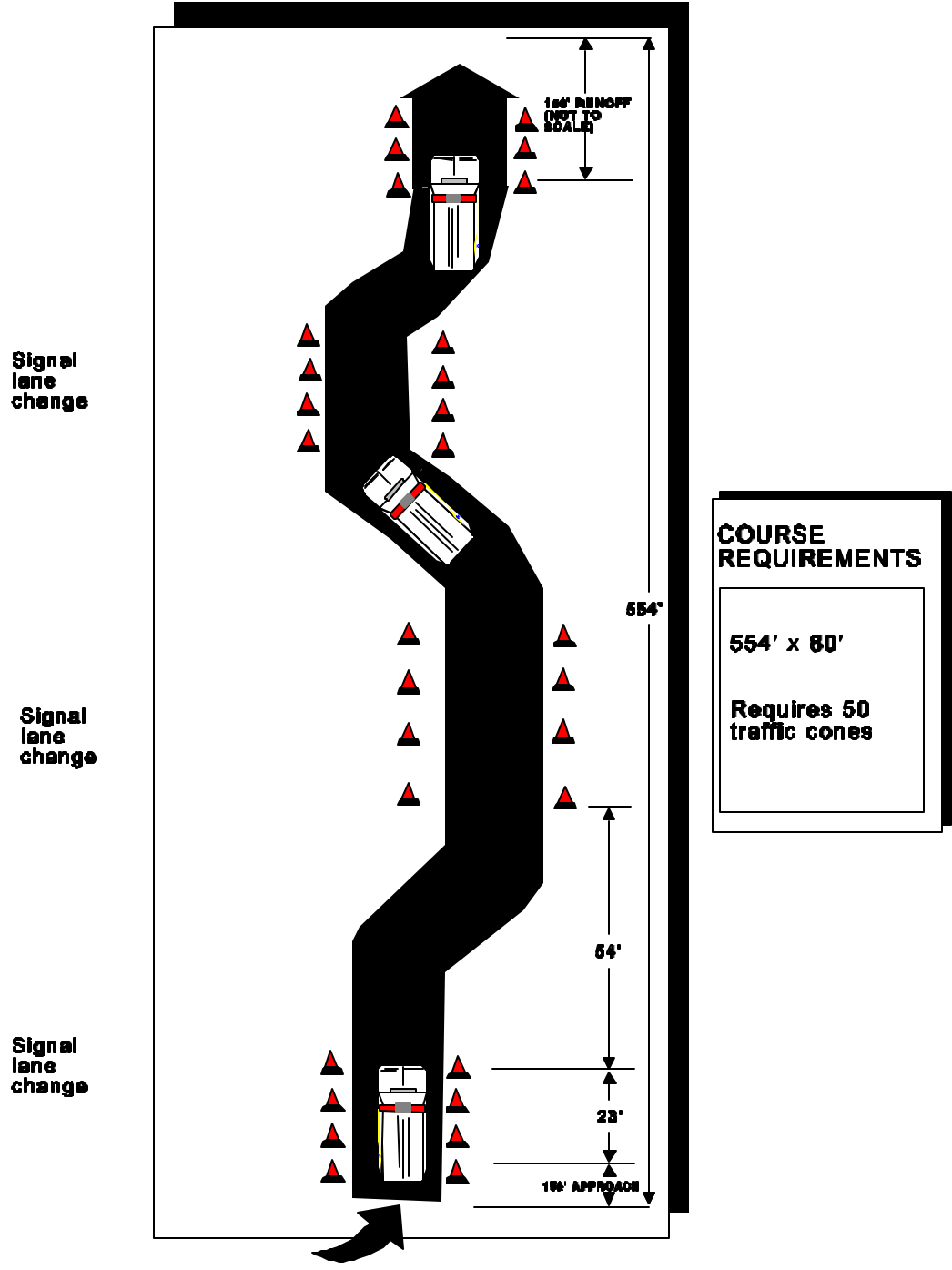

Slow Speed Lane Change

Purpose:

To develop confidence in controlling the vehicle and to experience vehicle stability. The exercise assists in developing coordination of steering and acceleration as well as the recognition of the relationship of fixed objects with respect to the vehicle.

Procedure:

Enter course at selected speed. Maintain speed as lane changes are made. Signal for turn when first entering lanes, change lanes, change signal for opposite lane change.

Instructor:

1. Explains purpose of exercise and key factors of the exercise.
2. Demonstrates exercise at moderate speed.
3. Demonstrates exercise at required speed.

Participant:

1. Assumes proper driving position; seat, mirrors, seat belt.
2. Enters course at speed determined by instructor.
3. Negotiates the course smoothly.
4. Keeps steering movements constant and even.
5. Maintains 9 - 3 hand position.
6. Maintains constant speed throughout the course.
7. Does not use brakes.
8. Passes closely to the cones.
9. Exits the course at the direction of the instructor.

Slow Speed Lane Change Exercise Rating

Participant's name _____ Date _____ Vehicle make/number _____

| | | <u>Practice Exercises</u> | | | |
|----|--|---------------------------|---|---|---------|
| | | 1 | 2 | 3 | 4 |
| A. | Entered course correctly | G | G | G | G |
| B. | Maintained required speed..... | G | G | G | G |
| C. | 9 - 3 hand position..... | | G | G | G G |
| D. | Controlled acceleration..... | G | G | G | G |
| E. | Steering control..... | | G | G | G G |
| F. | Counter steering..... | | G | G | G G |
| G. | Accelerator, steering coordination.... | G | G | G | G |
| H. | Checked mirrors..... | | G | G | G G |
| I. | . Turned head..... | | | G | G G G G |
| J. | . Foot movement..... | | | G | G G G G |
| K. | Use of brakes..... | G | G | G | G |

Number of cones hit _____

Reaction time was adequate. YES NO

Vehicle remained under control at all time. YES NO

Describe negative actions or attitudes.

Failed to complete exercise because _____

All requirements were met. YES NO

GENERAL REMARKS:

Instructor's signature _____ Date _____

I have seen the completed form and have been given an explanation of my performance and rating.

Participant's signature _____ Date _____

THIS PAGE INTENTIONALLY LEFT BLANK.

PERPENDICULAR PARKING (BACKING)

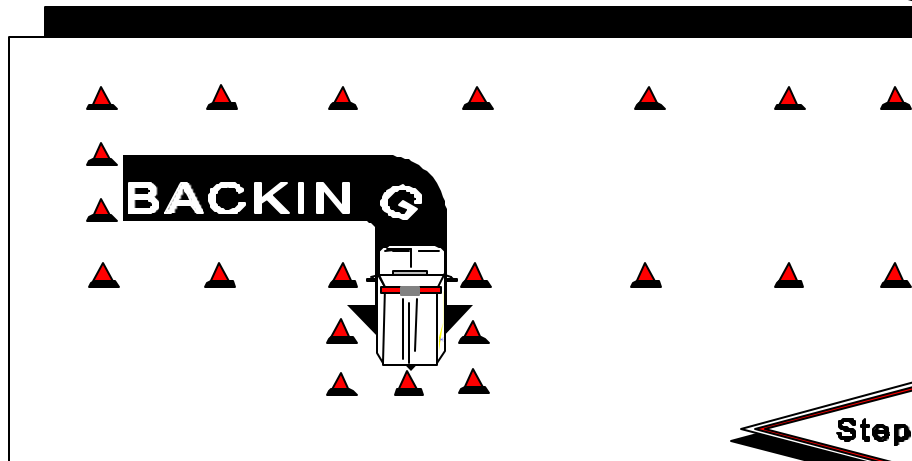
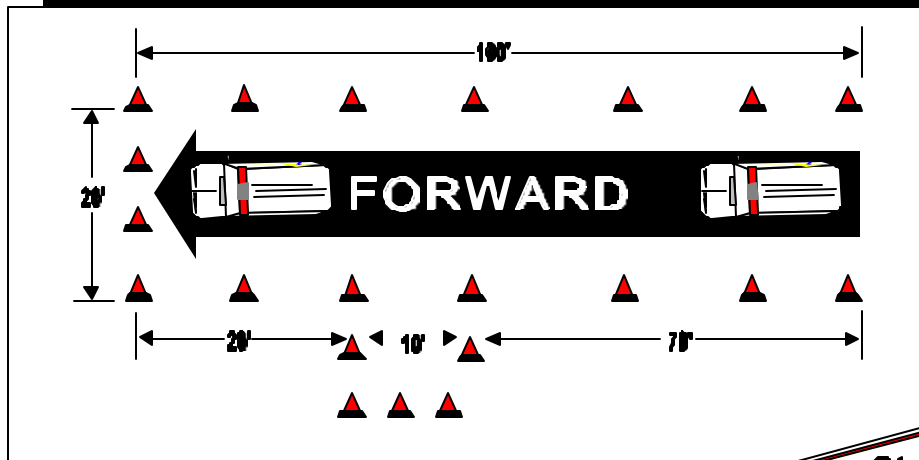

COURSE REQUIREMENTS

Set up cones to simulate local medical facility parking spaces

Option: Use vehicles to create parking space

Perpendicular Parking, Back In and Drive Out

Purpose:

To develop skill in backing a vehicle into a stall controlling front end swing and recognizing the relationship of the vehicle to fixed objects. Develops use of mirrors and use of ground guide and mirrors.

Procedure:

Drive forward at steady speed. Brake to stop at forward cone line. Back into space while turning. Stop at cone line. Maintain centerline of parking space. First tries to be conducted using mirrors only. Add ground guide for subsequent tries.

Instructor:

1. Explains purpose of exercise and key factors of the exercise.
2. Demonstrates exercise at moderate speed.
3. Demonstrates exercise at required speed.

Participant:

1. Assumes proper driving position; seat, mirrors, seat belt.
2. Enters course at speed determined by instructor.
3. Drives the vehicle beyond the stall, which is perpendicular to the road.
4. Backs the vehicle into the center of the stall.
5. Drives forward using the 9 - 3 steering method.
6. Turns into designated parking space using hand-over-hand or shuffle steering.
7. Centers vehicle in parking space.
8. Drives out, turning steering wheel to the desired direction selected.
9. Makes final adjustments and drives forward.
10. Exits course at direction of instructor.
11. Uses ground guide and proper hand signals.

Perpendicular Parking Exercise Rating Back In and Drive Out

Participant's name _____ Date _____ Vehicle make/number _____

Practice Exercises

1 2 3 4

| | | | | | |
|----|--|---|---|---|---|
| A. | Controlled acceleration..... | G | G | G | G |
| B. | Coordination of steering and braking.... | G | G | G | G |
| C. | Foot movement..... | G | G | G | G |
| D. | Use of ground guide..... | G | G | G | G |
| E. | Use of proper hand signals..... | G | G | G | G |

Number of cones hit _____

Reaction time was adequate. YES NO

Vehicle remained under control at all time. YES NO

Task was completed in one sequence of movements. YES NO

Vehicle was 12 inches or less from curb. YES NO

Describe negative actions or attitudes.

Failed to complete exercise because _____

All requirements were met. YES NO

GENERAL REMARKS:

Instructor's signature _____ Date _____

I have seen the completed form and have been given an explanation of my performance and rating.

Participant's signature _____ Date _____

THIS PAGE INTENTIONALLY LEFT BLANK.

MODULE C

AMBULANCE OPERATOR INTERNSHIP: GUIDELINES FOR ADDITIONAL ON-THE-JOB TRAINING AND DOCUMENTATION

MODULE GOAL

The goal of this module is to provide ambulance operators with the skills to safely and efficiently operate an ambulance while performing on-the-job training (OJT) runs.

MODULE OVERVIEW

This module builds on the knowledge and skills the participant learned in Modules A and B. The participant will now begin a series of supervised on-the-job training sessions. This training is necessary because there are operational tasks that cannot be evaluated in other than an operational setting. A participant may do an excellent job on the driving course but not be able to cope with an emergency response, traffic congestion, and navigating to different medical facilities. This is the final phase of the training to qualify as an ambulance operator. Organizational training managers should assign participants to partners who are qualified to coach and evaluate their performance. The training should never stop. There is always something to learn or practice to maintain a professional level of performance.

ORIENTATION

The training manager should assign an experienced person to conduct an orientation for the participant. This should include a complete discussion of the traffic situation in the operational area and practice runs without patients to the medical facilities. If there are any particular areas the organization responds to frequently, the reason for the responses should be explained and the best routes identified. Navigation training should begin and continue so that the participant can find the medical facilities from any location in the operational area. Throughout the OJT, the training manager should monitor the progress of the participants by discussing their progress with them, and the supervisor, and by reviewing the checklists. When the performance standard has been achieved in each phase of the OJT, the participants should be told and the entries made to their training records.

Each ambulance crew should continue training by practicing during every opportunity. They should also critique each run to review what they did that could be improved and to determine how the next run could be better.

If you have a busy organization that makes many runs daily, the OJT period may be completed in a few days. In less busy organizations, the training may take weeks. Try to get all training completed as soon as possible. It is certainly appropriate to schedule practice runs to evaluate the participant.

CHECKLIST ORGANIZATION

Each of the checklists listed below covers a related group of tasks that must be performed by ambulance operators.

Checklists

Ambulance Familiarization
Ambulance Inspection, Maintenance, and Repair
Normal and High Risk Operating Situations
Operational Driving

Beside each task statement on the checklist is a series of boxes. The number of boxes signifies a projected number of times the participant might need to perform the task to the standard under supervision on an actual run. Some participants may perform to the standard on the first run, and this should be indicated. Space is included on each checklist for the evaluator's comments. These comments provide a running narrative of the participant's progress. The checklist should be filled out at the end of each run and the participant immediately debriefed on performance results with suggestions for improvement. Completed checklists become a valuable training record, and they are placed in the participant's permanent training record.

Depending on the tasks performed during each supervised run, the evaluator may be able to sign off task accomplishment on more than one checklist, and is encouraged to do so.

HOW TO USE THE CHECKLISTS

The checklists are designed to record how the participants did their job in an operational setting or simulated practice.

In an operational setting, the type of run will not be known until the ambulance is dispatched and the run is completed. During this time the crew must focus on doing the job. When the run is completed, the supervising crew member (evaluator) gets a copy of the checklist most appropriate for the type of run completed. In most cases, all of the tasks on the checklist will not be performed on a single run. The evaluator and the participant should go over

he run in private. If there are no private areas at the station, go back to the ambulance and use it as your "training room."

There are several techniques that can be used to conduct the evaluation. It's always best to let the participants know if their performance was satisfactory or not. A broad statement can be made, such as, "That was a good run, and I was pleased with the way you did your job" and 1) "Let's review the run and see if there are areas that we can do better next time," or 2) "We need to review a couple of areas where we had some close calls."

Start at the beginning and cover all aspects. Reinforce the correct performance and coach them on those areas where they can improve. Always keep your comments positive.

Complete the checklist for the areas that you observed and make any comments that you feel are appropriate. If the participant has a weak area or strong area of performance, it is a good idea to note that on the checklist. This is particularly helpful when there will be different evaluators for the participant. Sign the checklist and show it to the participant and have the participant sign it. Put the checklist in the area designated by your supervisor. Repeat this process after every run.

When you believe that a participant has demonstrated satisfactory performance for a task, put a check mark in the box. Leaving a box blank means the participant did not perform the task or was not observed by an evaluator when he did perform the task.

The organization training manager or supervisor should review all checklists and discuss the participant's progress with the evaluators.

The designated authority to issue operator certificates should be notified when the participant has demonstrated satisfactory performance in all tasks. A certificate of completion should be issued to the participant immediately, at an appropriate ceremony.

THE EVALUATOR

The evaluator should be the training supervisor or a person qualified to evaluate the participant's performance during actual runs. As with the driving range training in Module B, all evaluators are encouraged to maintain a positive, "let me help you succeed" attitude. If a participant does have difficulty with a certain aspect of ambulance operations, it is usually more beneficial to recommend additional practice in that area rather than eliminate the person as an operator. The evaluator's input and recommendations are invaluable in keeping a participant motivated and progressing during his final phase of training.

THIS PAGE INTENTIONALLY LEFT BLANK.

Ambulance Familiarization Checklist

| Participant's name | Date | Vehicle make/number | | |
|-----------------------------------|--|---------------------|---|-----|
| A. Ambulance description (verbal) | | 1 | 2 | 3 |
| 1. | Ambulance class..... | G | G | G |
| 2. | Engine/transmission type..... | | G | G G |
| 3. | Height..... | G | G | G |
| 4. | Basic weight and load capacity..... | | G | G G |
| 5. | Installed emergency lights, sirens, horns..... | G | G | G |
| 6. | Installed life support equipment..... | | G | G G |
| 7. | Other..... | G | G | G |

Comments:

| | | | | |
|-------------------------------|---|---|---|-----|
| B. Use of installed equipment | | 1 | 2 | 3 |
| 1. | Auxiliary power unit..... | G | G | G |
| 2. | On-scene floodlights..... | G | G | G |
| 3. | Emergency lights, sirens, horns..... | | G | G G |
| 4. | Operator compartment controls and switches. | G | G | G |
| 5. | Other..... | | G | G G |

Comments:

All requirements have been met. YES NO

Instructor's signature _____ Date _____

I have seen the completed checklist and have been given an explanation of my performance.

Participant's signature _____ Date _____

THIS PAGE INTENTIONALLY LEFT BLANK.

Ambulance Inspection, Maintenance, and Repair Checklist

| Participant's name | Date | Vehicle make/number | | | |
|--------------------|--|---------------------|---|---|---|
| A. Quick check | | 1 | 2 | 3 | 4 |
| 1. | Use of checklist..... | G | G | G | G |
| 2. | Documentation of discrepancies..... | G | G | G | G |
| 3. | Completion of Work Request..... | G | G | G | G |
| 4. | Appropriate vehicle in-service decision..... | G | G | G | G |
| 5. | Recordkeeping..... | G | G | G | G |

Comments:

| | | | | | |
|---------------|--|---|---|---|---|
| B. Full check | | 1 | 2 | 3 | 4 |
| 1. | Use of checklist..... | G | G | G | G |
| 2. | Documentation of discrepancies..... | G | G | G | G |
| 3. | Completion of Work Request..... | G | G | G | G |
| 4. | Appropriate vehicle in-service decision..... | G | G | G | G |
| 5. | Recordkeeping..... | G | G | G | G |

Comments:

| | | | | |
|---------------------------|---|---|---|---|
| C. Maintenance and repair | | 1 | 2 | 3 |
| 1. | Use of Work Request..... | G | G | G |
| 2. | Preventive maintenance program..... | G | G | G |
| 3. | Maintenance and repair follow-up..... | G | G | G |
| 4. | Maintenance procedures for enroute malfunctions | G | G | G |

Comments:

All requirements have been met. YES NO

Instructor's signature _____ Date _____

I have seen the completed checklist and have been given an explanation of my performance.

Participant's signature _____ Date _____

THIS PAGE INTENTIONALLY LEFT BLANK.

Normal and High Risk Situations Checklist

| Participant's name | Date | Vehicle make/number |
|--|--|---------------------|
| A. Ambulance operation under normal conditions | | 1 2 3 4 5 |
| 1. | Road surfaces--asphalt, concrete, gravel, transition | G G G |
| 2. | Road surfaces--bumps, mud, potholes, misc. objects | G G G |
| 3. | Road construction--bridges, ramps, curves | G G G |
| 4. | Cornering skills..... | G G G G |
| 5. | Braking skills..... | G G G G |
| 6. | Accelerating skills..... | G G G G |
| 7. | Speed control..... | G G G G |
| 8. | Lane changes..... | G G G G |
| 9. | Passing other vehicles..... | G G G G |
| 10. | Backing--uses ground guide..... | G G G G G |
| 11. | Parking..... | G G G G |
| 12. | Turning around..... | G G G G |
| 13. | Operating on two-lane roads..... | G G G |
| 14. | Operating on interstate highways..... | G G G |
| 15. | Overall ambulance control..... | G G G G |
| 16. | Use of lights and turn signals..... | G G G G |
| 17. | Use of mirrors..... | G G G G |

Comments:

| | | |
|---|--|-----------|
| B. Ambulance operation under high risk conditions | | 1 2 3 4 5 |
| 1. | Use of lights and siren..... | G G G G G |
| 2. | Compliance with state and local regulations for emergency vehicles..... | G G G G G |
| 3. | Adherence to speed limits..... | G G G G G |
| 4. | Maintains safety cushion..... | G G G G G |
| 5. | Use of 2-4-12 Rule..... | G G G G G |
| 6. | Drives defensively..... | G G G G G |
| 7. | Response to potential crash situations..... | G G G |

Checklists

- | | | |
|-----|---|-----------|
| 8. | Communicates with other drivers..... | G G G G G |
| 9. | Performs pre-crash planning..... | G G G G G |
| 10. | Controlled intersections | |
| | a. Use of lights and siren..... | G G G G G |
| | b. Approaches intersection cautiously | G G G G G |
| | c. Communicates with other drivers.. | G G G G G |
| | d. Looks to clear all other traffic..... | G G G G G |
| | e. Anticipates reactions of other drivers | G G G G G |
| | f. Moves through intersections with caution..... | G G G G G |
| 11. | Compliance with Law of Due Regard..... | G G G G G |
| 12. | Driving against traffic..... | G G G |
| 13. | Adverse weather | |
| | a. Preparation of ambulance..... | G G G G |
| | b. Response to visibility problems.... | G G G G |
| | c. Response to traction problems..... | G G G G |
| | d. Response to high winds..... | G G G G |
| 14. | Night driving | |
| | a. Maintains night vision capabilities. | G G G G |
| | b. Use of headlights..... | G G G G |
| | c. Ambulance control at night..... | G G G G |
| 15. | Response when ambulance runs off the edge of the road..... | G G G |
| 16. | Response to enroute malfunctions | |
| | a. Control of ambulance..... | G G G |
| | b. Pulling off the road and parking... | G G G |
| | c. Maintenance performed..... | G G G |

Comments:

All requirements have been met. YES NO

Instructor's signature _____ Date _____ I have seen the completed checklist and have been

iven an explanation of my performance.

Participant's signature _____ Date _____

Operational Driving Checklist

| | | |
|--------------------|------|---------------------|
| Participant's name | Date | Vehicle make/number |
|--------------------|------|---------------------|

A. Pre-run phase

| | 1 | 2 | 3 |
|---|---|---|-------|
| 1. Ensures personal and crew readiness..... | | | G G G |
| 2. Ensures readiness of ambulance..... | | | G G G |
| 3. Plans primary and alternate routes..... | | | G G G |

Comments:

B. Operations phase

| | 1 | 2 | 3 |
|--|---|---|-------|
| 1. Completes departure procedures..... | | | G G G |
| 2. Operation of ambulance enroute to the scene | G | G | G |
| 3. Assists EMT at the scene..... | | | G G G |
| 4. Performs required emergency scene operations | G | G | G |
| 5. Operation of ambulance enroute to medical facility..... | | | G G G |
| 6. Performs required operations at the medical facility..... | G | G | G |

Comments:

C. Use of radio

1 2 3

- | | | | | | | | |
|----|------------------------------------|---|---|---|---|---|---|
| 1. | Operation and test..... | | | | G | G | G |
| 2. | Frequency selection..... | | | | G | G | G |
| 3. | Security..... | G | G | G | | | |
| 4. | Required calls..... | G | G | G | | | |
| 5. | Complete and concise messages..... | | | | G | G | G |
| 6. | Use of phonetic alphabet..... | | | | G | G | G |

Comments:

- | | | | | | | | |
|--------------------------|--|---|---|---|---|---|---|
| D. Verbal communications | | 1 | 2 | 3 | | | |
| 1. | With EMT enroute to scene..... | | | | G | G | G |
| 2. | With individuals at the scene..... | | | | G | G | G |
| 3. | With EMT enroute medical facility..... | | | | G | G | G |

Comments:

- | | | | | | | | |
|-------------------|--|---|---|---|---|---|---|
| E. Post-run phase | | 1 | 2 | 3 | | | |
| 1. | Resupplies ambulance..... | G | G | G | | | |
| 2. | Cleans and decontaminates ambulance..... | | | | G | G | G |
| 3. | Prepares ambulance for next run..... | | | | G | G | G |

Comments:

All requirements have been met. YES NO

Checklists

Instructor's signature _____ Date _____

I have seen the completed checklist and have been given an explanation of my performance.

Participant's signature _____ Date _____



Certificate of Completion

Presented to

Name

For successful completion of the
Emergency Vehicle Operator Course (Ambulance) Trainer Training

Agency Conducting Course

Course Director

City and State

Date Course Completed

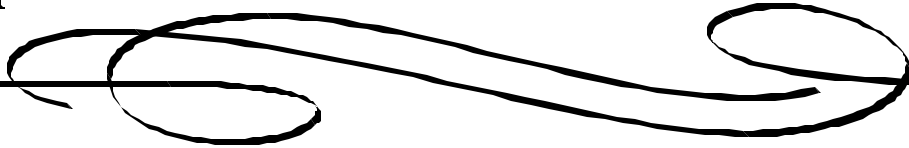
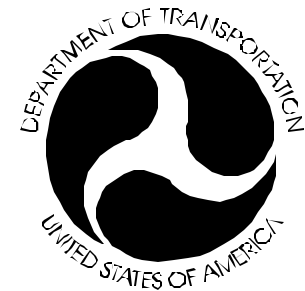



Certificate of Completion

Presented to

Name

For successful completion of the
Emergency Vehicle Operator Course (Ambulance)

Agency Conducting Course

Course Director

City and State

Date Course Completed

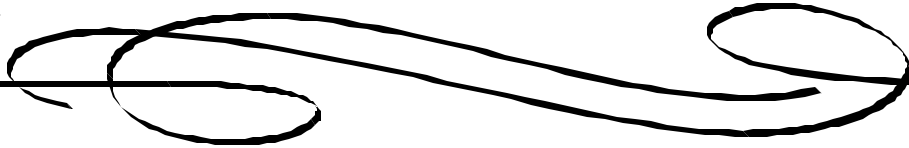

Appendix A

Area Motor Vehicle Operations Guidelines

AREA MOTOR VEHICLE OPERATION GUIDELINES

Instructions for Preparing the Form:

(TO BE COMPLETED PRIOR TO THE TRAINING SESSION)

1. Locate the blank forms on the following pages. These forms will be used to record state statutes and local policies on emergency vehicle operation.
2. Obtain a copy of your state's Motor Vehicle Code and local ordinances and departmental policies that relate to the topics listed on the form.
3. Put the name of your state in the blank at the top of the form.
4. Fill out the state statute information for the topics listed on the forms using the state statute reference material. Look at the example provided with the forms to see the kind of information required.
5. Use the blank space provided on the forms if your state statutes address other topics that are not listed.
6. Leave the local policy and ordinance column blank. Participants will be completing this information.
7. Make enough copies for participants.

Directions for Using the Form:

(DURING THE TRAINING SESSION)

1. Distribute copies of the forms to the participants which you prepared prior to class highlighting your state's statutes.
2. Discuss each topic listed on the form pertaining to the state statute.
3. Discuss the corresponding local policies (if applicable) pertaining to the topic. Have participants complete the information on the local policies in the appropriate column.

EXAMPLE

RELEVANT STATE STATUTES

Motor Vehicle Code, State of _____

| Topic | Local Policy/Ordinance |
|--|------------------------|
| <p><u>Definition of Emergency Vehicle</u></p> <p>Ch. 1, Sec 1-104</p> <p>Such fire department vehicles, police vehicles and ambulances as are publicly owned, and such other publicly or privately owned vehicles as are designated by the commissioner (or other appropriate state official)...</p> | |
| <p><u>Proceeding past red lights and stop signals</u></p> <p>Ch. 11, Sec. 11-106, (b) 2.</p> <p>The operator of an authorized emergency vehicle must stop at a red signal or stop sign, check for other motorists, and then proceed with caution when intersection is clear.</p> | |
| <p><u>Recognized warning devices</u></p> <p>Ch. 12, Sec. 12-218, (a).</p> | |

| | |
|--|--|
| <p>Every authorized emergency vehicle shall, in addition to any other equipment and distinctive markings required by this act, be equipped with a siren exhaust whistle or bell capable of giving an audible signal.</p> | |
|--|--|

RELEVANT STATE STATUTES

Motor Vehicle Code, State of _____

| Topic | Local Policy/Ordinance |
|--|------------------------|
| <u>Definition of Emergency Vehicle</u> | |
| <u>Proceeding past red lights and stop signals</u> | |
| <u>Recognized warning devices</u> | |

| | |
|--|--|
| | |
|--|--|

| RELEVANT STATE STATUTES | |
|--|------------------------|
| Motor Vehicle Code, State of _____ | |
| Topic | Local Policy/Ordinance |
| <u>Violating traffic flow and turn regulations</u> | |
| <u>Passing</u> | |
| <u>Parking at the scene of an emergency</u> | |

| | |
|--|--|
| | |
|--|--|

RELEVANT STATE STATUTES

Motor Vehicle Code, State of _____

| Topic | Local Policy/Ordinance |
|--------------------------------------|------------------------|
| <u>Exceeding posted speed limits</u> | |
| <u>Definition of an emergency</u> | |
| | |

| | |
|--|--|
| | |
|--|--|

| RELEVANT STATE STATUTES | |
|---|------------------------|
| Motor Vehicle Code, State of _____ | |
| Topic | Local Policy/Ordinance |
| | |
| | |

| | |
|--|--|
| | |
| | |

Appendix B

Interpreting Hand Signals

Signal No. 1 Come Ahead

Day

Extend arms in front of your body, palms facing up. Move arms toward your body, bending at the elbows.

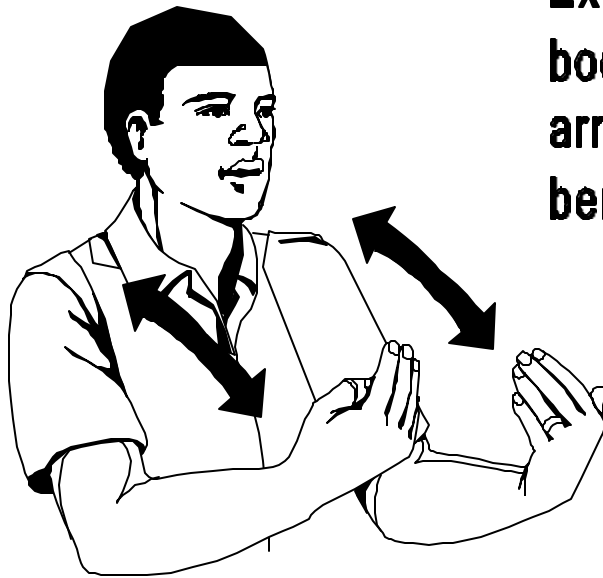

Night

When using conventional flashlights, direct lights forward.

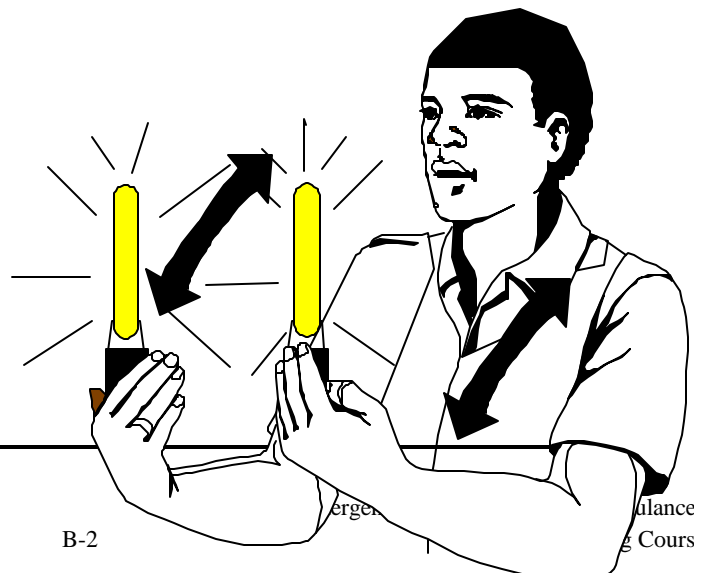

Signal No. 2 Slow Down

Day

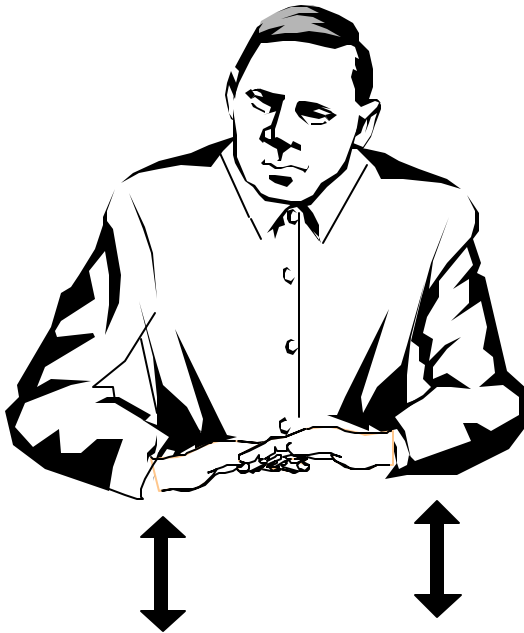

Turn palms facing downward with thumbs toward your body at waist level. Move hands down and up.

Night

When using conventional flashlights, direct lights forward.

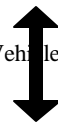
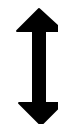

Signal No. 3 Stop or Halt

Day

Extend right arm forward with palm facing outward.

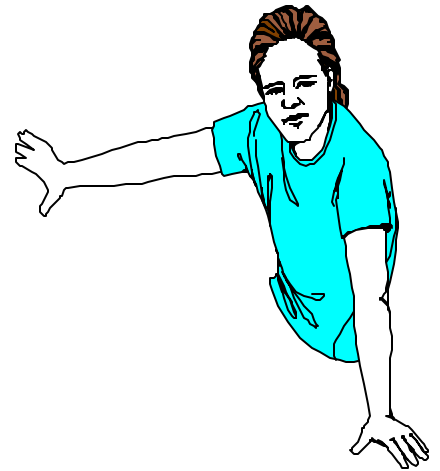

Night

Light in right hand pointed upward, blinking. When using conventional flashlights, direct light in right hand forward, blinking.

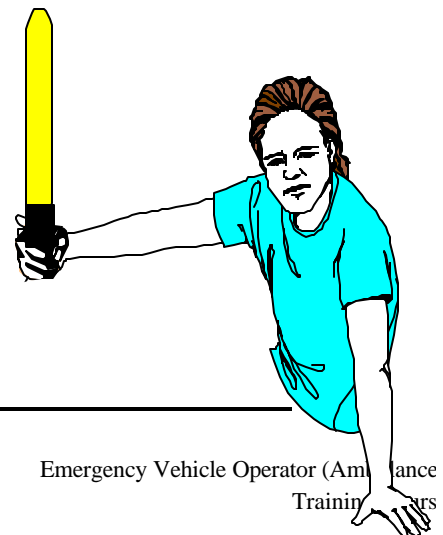

Signal No. 4 Move in Reverse

Day

Extend both arms in front of you, palm facing forward. Move hands forward and back.

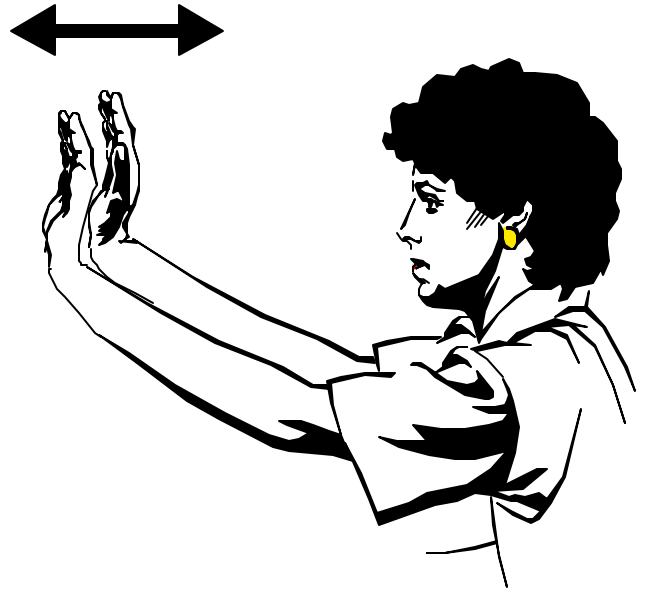

Night

When using conventional flashlights, direct lights forward.

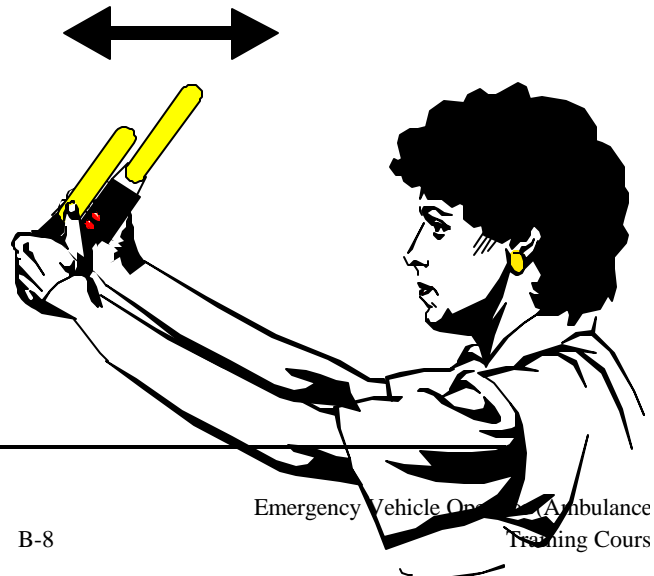

Signal No. 5 Turn Left

Day

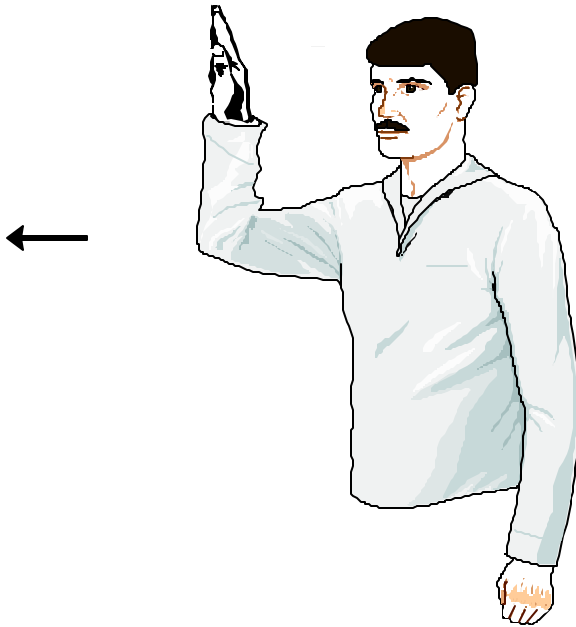

Facing the vehicle, raise right arm to your side, bending at the elbow. Face palm outward and move hand to your right.

Night

When using conventional flashlights, direct light in right hand forward.

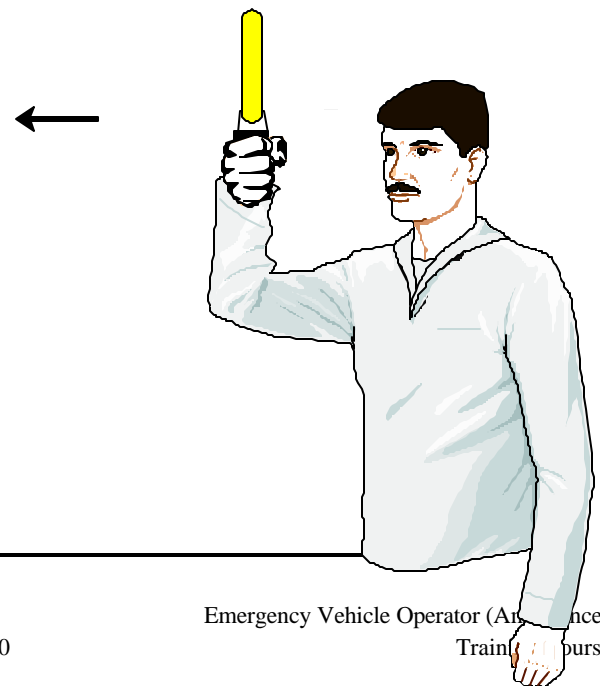

Signal No. 6 Turn Right

Day

Facing the vehicle, raise left arm to your side bending at the elbow. Face palm outward and move hand to your left.

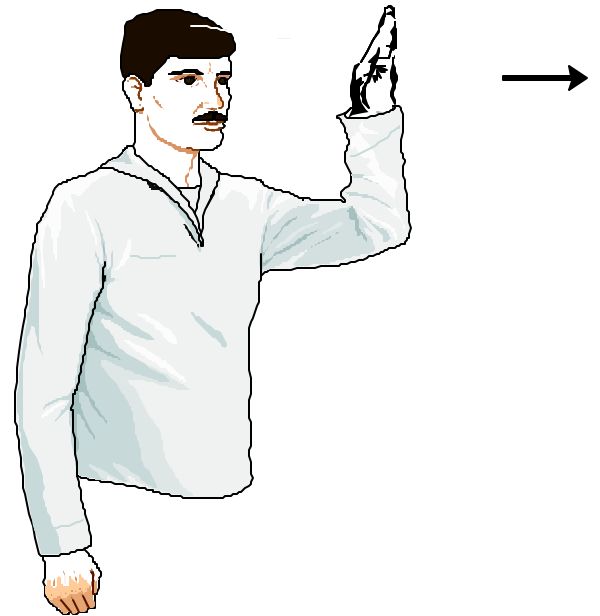

Night

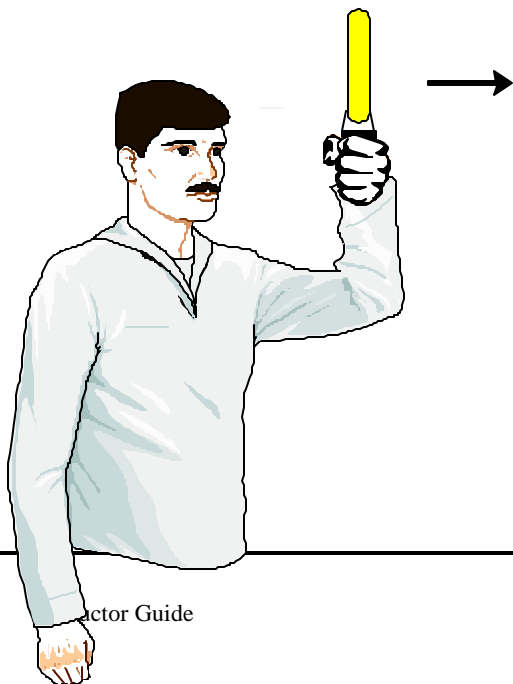

When using conventional flashlights, direct light in left hand forward.

Signal No. 7 Turn Off Engine

Day

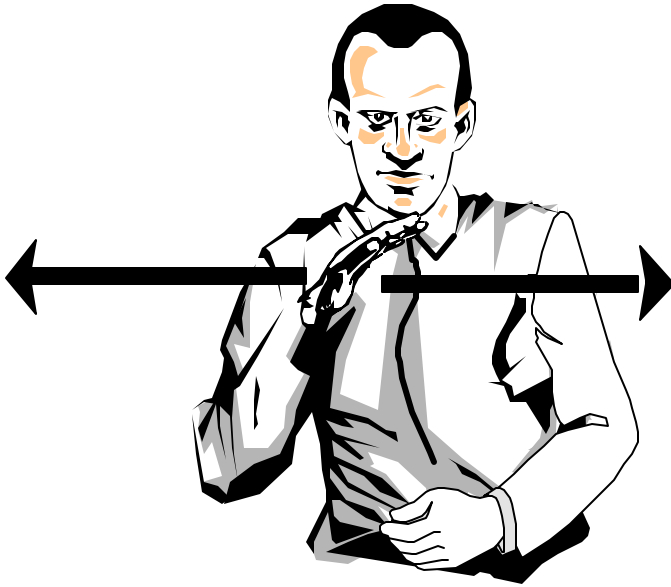

Place right hand above chest level, with elbow at your side, and palm facing downward. Move hand from right to left.

Night

When using conventional flashlights, direct light in right hand forward.

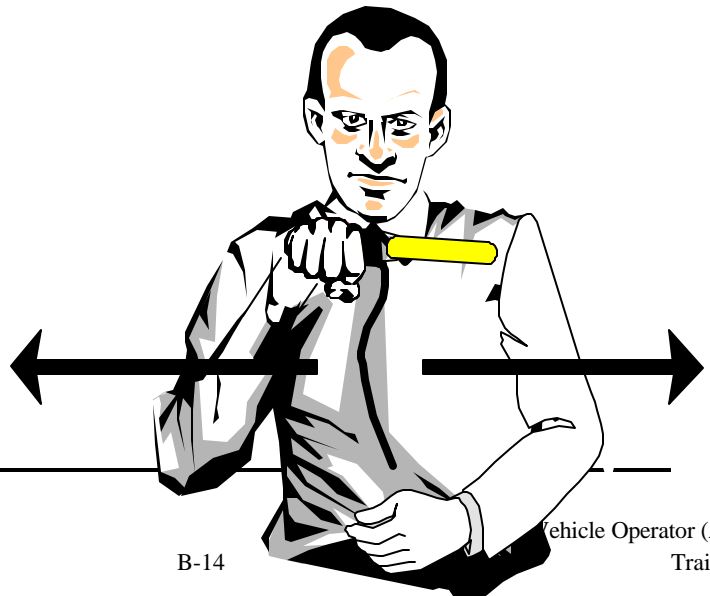

Signal No. 8 Increase Speed



Extend right arm above you with a closed fist, palm forward. Move arm up down and up in front of your body.

Night



When using conventional flashlights, direct light in right hand forward.



Signal No. 9 Start Engines

Day

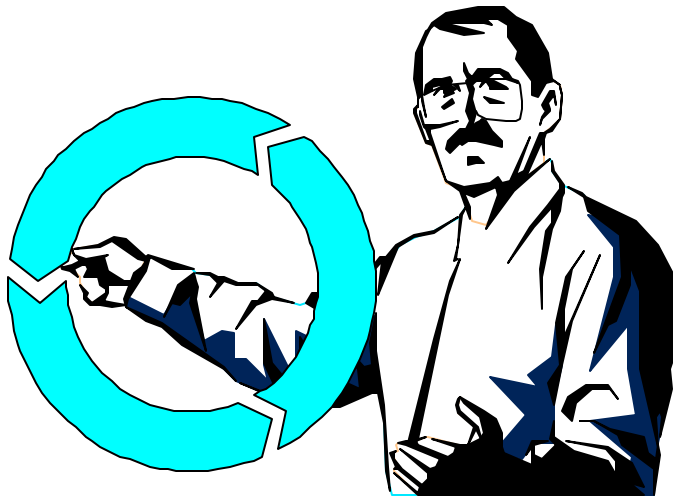

Circle your right arm clockwise in front of your body.

Night

When using conventional flashlights, direct light in right hand forward.

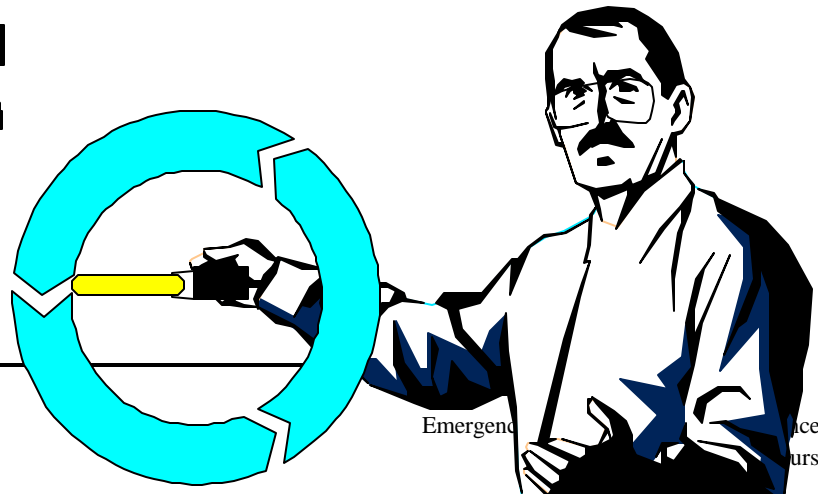

Signal No. 10 As You Were

Day

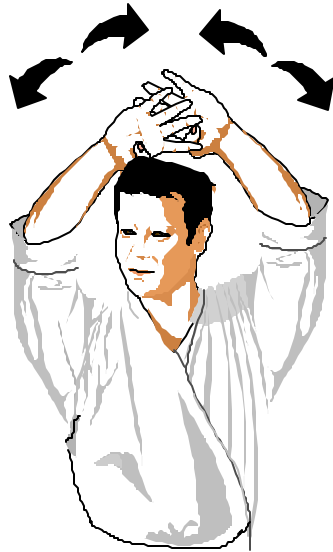

**Extend arms above your head;
cross and uncross your hands
at the wrists.**

Night



**When using conventional
flashlights, direct lights
forward.**

Signal No. 11 Attention

Day



Extend right arm above you, palm facing outward. Wave hand right and left above your head.

Night

When using conventional flashlights, direct light in right hand forward.



Appendix C

Sample Checklist: Quick Check

SAMPLE CHECKLIST: QUICK CHECK

UNIT NUMBER: _____ STATION: _____ DATE: _____ TIME: _____

Instructions: ! Inspect each item and check ✓ OK if there are no problems.
 ! If you find a problem, fix it and list repairs under Work Completed, OR file work request.
 ! Decide whether or not to place the vehicle in service. Sign and date the checklist.
 ! Any starred (*) problem must be fixed before the ambulance is placed in service.

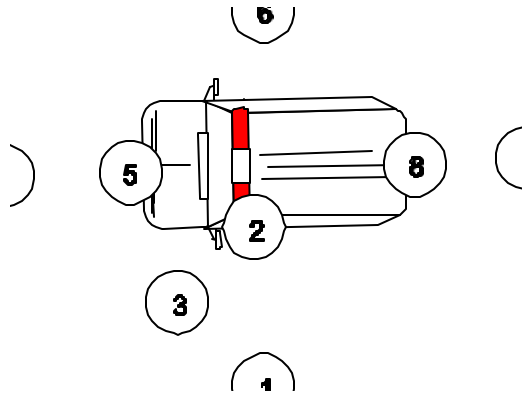

- 1) Overall Appearance
- 2) Operator Compartment
- 3) Exterior: Operator's Side
- 4) Exterior: Front
- 5) Engine Compartment
- 6) Exterior: Passenger's Side
- 7) Exterior: Rear
- 8) Patient Compartment

| Items | Check | Problem | OK ✓ | Work Request ✓ | Work Completed/ Other Remarks |
|---------------------------------|-------------------|---------|---------|----------------------|-------------------------------------|
| OVERALL APPEARANCE (1) | | | | | |
| Vehicle | Cleanliness | | | | |
| | General Condition | | | | |
| OPERATOR COMPARTMENT (2) | | | | | |
| Interior | Items Properly | | | | |

| Items | Check | Problem | OK ✓ | Work Request ✓ | Work Completed/ Other Remarks |
|---------------------------------------|--|---------|---------|----------------------|-------------------------------------|
| | Stowed | | | | |
| Vehicle Log | Previous Inspection Forms, Blank Run Forms | | | | |
| Lights and Communication Equipment | Switches "OFF" | | | | |
| Seat, Belt, Mirrors | Adjust | | | | |
| Hood Latch | Release | | | | |
| Fuel Gauge | Check Fuel Quantity | | | | |
| EXTERIOR: OPERATOR'S SIDE (3) | | | | | |
| Mirror Bracket | Condition | | | | |
| Side Window | Condition | | | | |
| Windshield/Wiper | Condition | | | | |
| Front Wheel/Tire | Condition, Inflation | | | | |
| Front Fender | Condition | | | | |
| EXTERIOR: FRONT (4) | | | | | |
| Hood, Bumper, Grill | Condition, Remove Debris | | | | |
| Antennas | Condition | | | | |
| Headlights, Turn Signals | Lens Condition | | | | |
| Emergency Lights | Lens Condition | | | | |
| ENGINE COMPARTMENT (5) | | | | | |
| Engine | Signs of Leaks | | | | |

| Items | Check | Problem | OK ✓ | Work Request ✓ | Work Completed/ Other Remarks |
|--|----------------------|---------|---------|----------------------|-------------------------------------|
| Belts | Condition | | | | |
| Battery(ies) | Condition | | | | |
| Fluids (Engine, Transmission, Cooling System, Windshield Washer) | Levels | | | | |
| Hood | Latched | | | | |
| EXTERIOR: PASSENGER'S SIDE (6) | | | | | |
| Front Fender | Condition | | | | |
| Front Wheel/Tire | Condition, Inflation | | | | |
| Windshield/Wiper | Condition | | | | |
| Side Window | Condition | | | | |
| Mirror Bracket | Condition | | | | |
| Rear Fender | Condition | | | | |
| Rear Wheel/Tire | Condition, Inflation | | | | |
| PATIENT COMPARTMENT (7) | | | | | |
| General | Condition | | | | |
| Doors | Latched | | | | |
| EXTERIOR: REAR (8) | | | | | |
| Emergency Lights | Lens Condition | | | | |
| Lights/Turn Signals | Lens Condition | | | | |
| Flood Lights | Lens Condition | | | | |

| Items | Check | Problem | OK ✓ | Work Request ✓ | Work Completed/ Other Remarks |
|-----------------|----------------------|---------|---------|----------------------|-------------------------------------|
| Rear Fender | Condition | | | | |
| Rear Wheel/Tire | Condition, Inflation | | | | |

I have completed the above inspection. This vehicle should / should not be placed into service.

NAME: _____ DATE: _____

Appendix D

Sample Checklist: Full Check

SAMPLE CHECKLIST: FULL CHECK

UNIT NUMBER: _____ STATION: _____ DATE: _____ TIME: _____

Instructions: ! Inspect each item and check ✓ OK if there are no problems.
 ! If you find a problem, fix it and list repairs under Work Completed, OR file work request.
 ! Decide whether or not to place the vehicle in service. Sign and date the checklist.
 ! Any starred (*) problem must be fixed before the ambulance is placed in service.

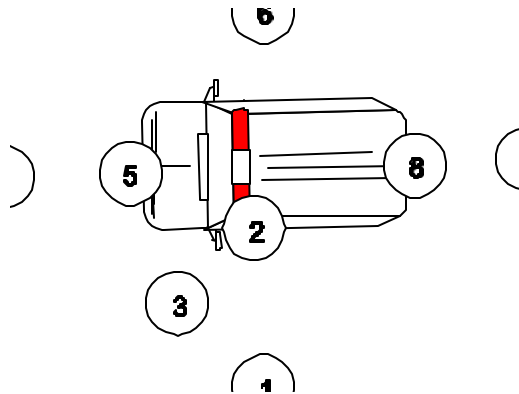

- 1) Overall Appearance
- 2) Operator Compartment
- 3) Exterior: Operator's Side
- 4) Exterior: Front
- 5) Engine Compartment
- 6) Exterior: Passenger's Side
- 7) Exterior: Rear
- 8) Patient Compartment

| Items | Check | Problem | OK ✓ | Work Request ✓ | Work Completed/Oth er Remarks |
|-------------------------------|-------------------|---------|---------|----------------------|-------------------------------------|
| OVERALL APPEARANCE (1) | | | | | |
| Vehicle | Cleanliness | | | | |
| | Body Lean/Balance | | | | |
| | Leaks | | | | |
| | Damage | | | | |
| | Paint | | | | |

| Items | Check | Problem | OK ✓ | Work Request ✓ | Work Completed/Oth er Remarks |
|--|---|---------|---------|----------------------|-------------------------------------|
| | General Condition | | | | |
| OPERATOR COMPARTMENT (2) | | | | | |
| Interior | Items Properly Stowed | | | | |
| Vehicle Log | Previous Inspection Forms, Blank Run Forms | | | | |
| DMV Registration, Inspection, Insurance Card | On Board | | | | |
| Flashlight/lantern | On Board | | | | |
| Maps | On Board | | | | |
| Emergency Brake | Adjustment, Operation | | | | |
| Lights (Check With Guide) | Condition, Lens, Operation, Then "OFF" | | | | |
| Headlights | | | | | |
| Parking Lights | | | | | |
| Turn Signals | | | | | |
| Clearance Lights | | | | | |
| Hazard Lights | | | | | |
| Emergency Lights | | | | | |
| Spot Lights | | | | | |
| Flood Lights | | | | | |

| Items | Check | Problem | OK ✓ | Work Request ✓ | Work Completed/Oth er Remarks |
|---|-----------------------|---------|---------|----------------------|-------------------------------------|
| Tail Lights | | | | | |
| Brake Lights | | | | | |
| Back Up Lights | | | | | |
| Rear Step Lights | | | | | |
| License Plate Lights | | | | | |
| Side Lights | | | | | |
| Interior Lights | | | | | |
| Dash Lights | | | | | |
| Radio Equipment | Operation, Then "OFF" | | | | |
| PA System | Operation, Then "OFF" | | | | |
| Vehicle Locator System | Operation, Then "OFF" | | | | |
| Vehicle Data Terminal | Operation, Then "OFF" | | | | |
| Seats | Condition, Adjust | | | | |
| Seat Belts | Condition, Adjust | | | | |
| Mirrors | Condition, Adjust | | | | |
| Air Horn | Operation | | | | |
| Siren | Operation, All Modes | | | | |
| Gauges (Check After Starting Engine) | Operation, Readings | | | | |
| Electrical Charging | | | | | |

| Items | Check | Problem | OK ✓ | Work Request ✓ | Work Completed/Oth er Remarks |
|--------------------------------------|---|---------|---------|----------------------|-------------------------------------|
| System | | | | | |
| Auxiliary Generator/Inverter | | | | | |
| Brakes | | | | | |
| Fuel | | | | | |
| Oil Pressure | | | | | |
| Tachometer | | | | | |
| Engine Temperature | | | | | |
| Windshield Washer | | | | | |
| Windshield Wipers | | | | | |
| Hood Latch | Release | | | | |
| EXTERIOR: OPERATOR'S SIDE (3) | | | | | |
| Door | Condition, Alignment | | | | |
| Mirror Bracket | Condition | | | | |
| Side Window | Condition | | | | |
| Windshield/Wiper | Condition | | | | |
| Front Wheel | Condition, Lug Nut Tightness | | | | |
| Tire | Condition, Tire Inflation Reading, Tread Depth | | | | |
| Front Fender | Condition | | | | |
| EXTERIOR: FRONT (4) | | | | | |

| Items | Check | Problem | OK ✓ | Work Request ✓ | Work Completed/Oth er Remarks |
|--|---|---------|---------|----------------------|-------------------------------------|
| Hood, Bumper, Grill | Condition, Remove Debris | | | | |
| Antennas | Condition | | | | |
| ENGINE COMPARTMENT (5) | | | | | |
| Engine | Signs of Leaks | | | | |
| Belts | Condition, Tension | | | | |
| Battery(ies) | Condition, Water Level, Hydrometer Check, Terminals, Cables | | | | |
| Fluids (Engine, Transmission, Cooling System, Windshield Washer, Brakes, Power- Steering) | Condition, Levels | | | | |
| Hoses/Lines | Condition | | | | |
| Hood | Latched | | | | |
| EXTERIOR: PASSENGER'S SIDE (6) | | | | | |
| Front Fender | Condition | | | | |
| Front Wheel | Condition, Lug Nut Tightness | | | | |
| Tire | Condition, Tire Inflation Reading, Tread Depth | | | | |
| Windshield and Wiper | Condition | | | | |
| Side Window | Condition | | | | |

| Items | Check | Problem | OK ✓ | Work Request ✓ | Work Completed/Oth er Remarks |
|--------------------------------|---|---------|---------|----------------------|-------------------------------------|
| Mirror Bracket | Condition | | | | |
| Door | Condition, Alignment | | | | |
| Rear Fender | Condition | | | | |
| Rear Wheel | Condition, Lug Nut Tightness | | | | |
| Tire | Condition, Tire Inflation Reading, Tread Depth | | | | |
| PATIENT COMPARTMENT (7) | | | | | |
| General | Condition, Equipment Stowed | | | | |
| Fire Extinguishers | Quantity, Charge Level, Inspection Date | | | | |
| Battery Jumper Cables | On Board | | | | |
| Road Flares | Quantity On Board | | | | |
| Medical Equipment | Inventory, Properly Stowed | | | | |
| Doors | Latched | | | | |
| EXTERIOR: REAR (8) | | | | | |
| Emergency Lights | Lens Condition | | | | |
| Lights and Turn Signals | Lens Condition | | | | |
| Flood Lights | Lens Condition | | | | |
| Rear Fender | Condition | | | | |

| Items | Check | Problem | OK ✓ | Work Request ✓ | Work Completed/Oth er Remarks |
|-------------------|---|---------|---------|----------------------|-------------------------------------|
| Rear Wheel | Condition, Lug Nut Tightness | | | | |
| Tire | Condition, Tire Inflation Reading, Tread Depth | | | | |
| Spare Tire, Tools | Condition, On Board | | | | |

I have completed the above inspection. This vehicle should / should not be placed into service.

NAME: _____ DATE: _____

Appendix E
Sample Work Request

SAMPLE WORK REQUEST

| | | | | | | | | | |
|-------------------------------|--------|---------|------|--------------------|---------------------|-------------------------|----------------|----------------|------------|
| COMPANY NAME | | | | | WORK REQUEST NUMBER | | | | |
| UNIT # | LIC. # | MILEAGE | TIME | TIME IN: | TIME OUT: | | | | |
| | | | | WORK PERFORMED | | | | | |
| REPORTED PROBLEMS: | | | | WORK PERFORMED | | MECHANIC'S SIGNATURE | LABOR HOURS | HOURLY COST | LABOR COST |
| 1: | | | | | | | | | |
| 2: | | | | | | | | | |
| 3: | | | | | | | | | |
| 4: | | | | | | | | | |
| SIGNATURE OF OPERATOR | | | DATE | PARTS AND SUPPLIES | | | | | |
| | | | | DESCRIPTION | | | PART # | COST | |
| OFF DUTY PHONE #: | | | | | | | | | |
| ON EMERGENCY RUN __ YES __ NO | | | | | | | | | |
| PREVENTIVE MAINTENANCE | | | | | | | | | |

| | | | | |
|--|---|---|--------------------------|------------|
| INTERIOR CLEANED | Y | N | | |
| EXTERIOR CLEANED | Y | N | | |
| BRAKES CHECKED | Y | N | | |
| TIRES CHECKED | Y | N | LABOR TOTAL | |
| BATTERY(IES) CHECKED | Y | N | PARTS AND SUPPLIES TOTAL | |
| EMERGENCY SIGNALING EQUIPMENT CHECKED | Y | N | | TOTAL COST |

Appendix F

Glossary

Source: *"Standard Guide for Scope of Performance of Emergency Medical Services Ambulance Operations."* ASTM, F1517, April 1994.

| Term | Definition |
|--|--|
| ambulance operations | the efficient delivery of the ambulance, equipment, crew, passengers and patients, during all phases of the delivery of EMS involving the ambulance, at all times exercising the highest degree of care for the safety of the public |
| ambulance service provider | a person, company, corporation, or political entity responsible for operation, maintenance and/or policy making regarding emergency vehicle operations |
| Bona Fide Occupational Qualification (BFOQ) | the skills and knowledge relevant to the performance of a specific task |
| departure check | the visual check of the vehicle and surrounding area ensuring that equipment and supplies have been retrieved and properly stored and that all compartment doors are secured |
| egress check | the visual check of the vehicle and surrounding area prior to operating the ambulance |
| emergency mode | as defined by individual state statues that refer to emergency vehicles, equipment and operations |
| full check | a comprehensive and systematic evaluation of the ambulance at specified intervals, including documentation of the inspection, deficiencies, and corrective actions |
| operator | a person who operates or assists with the operation of an ambulance |
| prerun | all aspects of assuring response readiness |

| Term | Definition |
|--------------------|--|
| postrun | the managed return of the ambulance and operators to optimal pre-run readiness |
| quick check | an abbreviated version of the full check, focusing on the major operational functions of the vehicle |

Appendix G

References

The following references were used in course development--

- American Society for Testing and Materials. *Standard Guide for Performance of Emergency Medical Services Ambulance Operators*. Atlanta Draft. 20 April, 1993.
- American Society for Testing and Materials. *Standard Guide for Training Emergency Medical Services Ambulance Operators*. Las Vegas Draft #4. 11-13 February, 1994.
- AzStar Center for Safety & Risk Management Operator/Driver Instructor Course. AzStar Casualty Co. Version IV. August 1991.
- Childs, B., and D. Ptacnik. *Emergency Ambulance Driving*. Englewood Cliffs, NJ: Prentice Hall, 1986.
- Driver Marine Division. *Vehicle Dynamics*. Glynco, GA:Federal Law Enforcement Training Center.
- Emergency Medical Services Program. *Ambulance Accident Prevention Seminar*. New York State Department of Health.
- Grant, H.D. R.H. Murray, and J.D. Bergeron. *Brady Emergency Care*. 5th ed. Englewood Cliffs, NJ: Prentice Hall, 1990.
- Klein, M.E. *Emergency Vehicle Operator's Course*. Apopka, FL: Florida Central Educational Clinic, 1993.
- Minnesota Dept. of Public Safety. *Emergency Vehicle Driving Program*. St. Paul: Minnesota Technical College System.
- United States. Dept. of Transportation, National Highway Traffic Safety Administration. *Training Program for Operation of Emergency Vehicles*.
- United States. General Services Administration, Federal Supply Service. *KKK-A-1822C Federal Specification for Ambulances*. Washington: Federal Supply Service, 1 January 1990.

Other Recommended Reference Materials

FEDERAL

National Safety Council. *Coaching the Emergency Vehicle Operator*. Princeton, NJ:FLI Learning Systems, Inc. 1991.

United States. Dept. of Transportation, National Highway Traffic Safety Administration. *Emergency Vehicle Operator Courses & Materials*. March 1992.

United States. Dept. of Transportation, National Highway Traffic Safety Administration. *Emergency Medical Services: First Responder Training Course* (formerly titled: Crash Injury Management for Traffic Law Enforcement Officers). Washington, D.C.

United States. Federal Emergency Management Agency, United States Fire Administration. *Emergency Preparedness U.S.A. Course*. HS-2. September 1992.

United States. Federal Emergency Management Agency, United States Fire Administration. *Emergency Vehicle Driver Training*. FA-110. September 1991.

STATE

Office of Advisory Council. *Driver Training Manual*. Phoenix, AZ:Arizona Law Enforcement Advisory Council. August 1989

Texas Dept. of Transportation. *Emergency Medical Service Driver Instructor Course - Volumes I & II*. Law Enforcement and Security Training Division, Texas Engineering Extension Service, Texas A & M University. 1992

Texas Dept. of Transportation. *Emergency Medical Service Driving Range Technician Course Curriculum*. Law Enforcement and Security Training Division, Texas Engineering Extension Service, Texas A & M University. 1992

Texas Dept. of Transportation. *Emergency Medical Service Emergency Vehicle Operator Course*

Curriculum. Law Enforcement and Security Training Division, Texas Engineering Extension Service, Texas A & M University. 1994

Commonwealth of Virginia. *Emergency Vehicle Operator's Curriculum Guide - Instructor & Student Manuals.* Virginia Association of Volunteer Rescue Squads Inc. and Commonwealth of Virginia Fire Programs/Fire Services Board.

Minnesota Technical College System. *Emergency Vehicle Driving Program.* St. Paul, MN:Fire Departments & EMS Ambulance Services. 1993

Indiana Emergency Medical Services. *Certified Driver.* Indianapolis, IN:Indiana Emergency Medical Services Commission.

OTHER

OPERATOR STANDARDS/REQUIREMENTS/TESTING

Commercial Driver Testing and Licensing Standards:Final Rule. 49 CFR 391. Federal Register.

Qualification of Drivers: Final Rule. 49 CFR 383. Federal Register.

United States. Dept. of the Army. *Prehospital Emergency Care & Transportation.*

Army Ambulance Requirements. HSC Pamphlet 40-7-18. 21 July, 1992.

United States. Dept. of Transportation, National Highway Traffic Safety Administration.

Functional Aspects of Driver Impairment: A Guide for State Medical Advisory Boards.

United States. Dept. of Transportation, National Highway Traffic Safety Administration.

Screening for Driver Limitation. October 1976.

United States. Dept. of Transportation, National Highway Traffic Safety Administration. *Status*

of Medical Review in Driver Licensing: Policies, Programs & Standards. March 1992

GENERAL INFORMATION/TRAINING HINTS

Clawson, J.J. "The Maximal Response Disease: 'Red Lights and Siren' Syndrome in Priority

Dispatching". *Journal of Emergency Medical Services.* January 1987.

Clawson, J.J. and R.L. Martin. "Modern Priority Dispatch." *Emergency Training.* January 1990.

Emergency Medical Response Task Force (J.J. Clawson et al.) "Use of Warning Lights and Siren

in Emergency Medical Vehicle Response and Patient Transport." *Prehospital and Disaster Medicine.* Vol. 9, No. 2.

April-June 1994.

Federal Emergency Management Agency, Emergency Management Institute. *Catalog of*

Activities 1993-1994. Emmitsburg, MD.

Federal Emergency Management Agency, United States Fire Administration. *Alive on Arrival.*

Washington, DC. August 1992

Federal Emergency Management Agency, United States Fire Administration. *Federal Agencies*

in EMS. Washington, DC. August 1993

Federal Emergency Management Agency, United States Fire Administration. *Resources on Fire & Emergency Medical Services (EMS)*. September 1993.

Pirrallo, R.G. "Fatal Ambulance Crashes During Emergency & Non-Emergency Operation." *Emergency Training*.

Virginia Association of Volunteer Rescue Squads, Inc. *Training Brochure*. 13 October 1993.

SURVEYS & ANALYSES

Pirrallo, R.G. and R.A. Swor. "Characteristics of Fatal Ambulance Crashes During Emergency and Non-emergency Operation." *Prehospital and Disaster Medicine*. Vol. 9, No. 2. April-June 1994.

Saunders, C.E. and C.J. Heye. "Ambulance Collisions in an Urban Environment." *Prehospital and Disaster Medicine*. Vol. 9, No. 2. April-June 1994.

United States Fire Administration. *Survey of Fire Apparatus Driver Training Programs*. Arlington, VA:TriData Corporation. October 1991.

United States. Dept. of Transportation, National Highway Traffic Safety Administration. *Emergency Medical Services - 1990 and Beyond*. Washington, DC. October 1990.

Appendix H

Overhead Transparencies



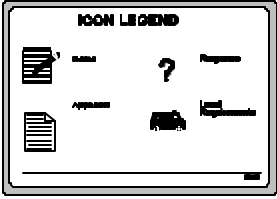

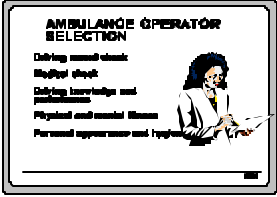

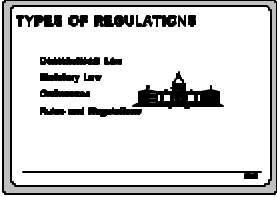

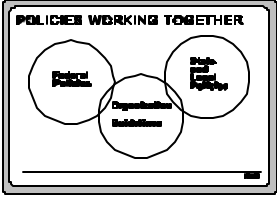



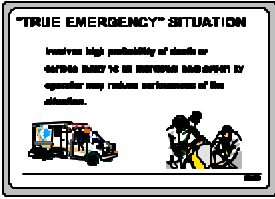



ABANDONMENT
Act of refusing to transfer or
transfer responsibility
plus to being refused by other
qualified health care provider.



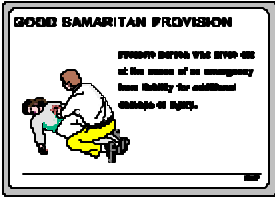





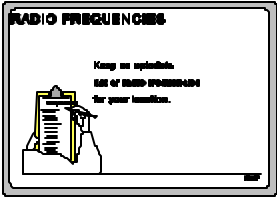

| |
|--|
| CRITICAL OPERATOR INFORMATION |
| Operator Name, State, Per. No. (if any) |
| APPROXIMATE |
| Classification of emergency |
| _____ |



COMPOSED MESSAGE

Plan
Identify person called, time calling and
to whom

Use plain English
Personnel usually already
know plan
Repeat directions



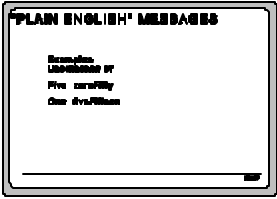

BROADCASTING TECHNIQUES

LEARNING

- Explain microphone use
- Talk with mouth close to microphone
- Check frequency

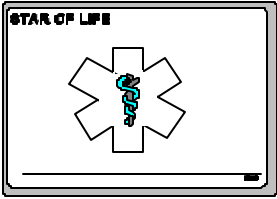

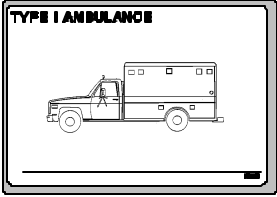

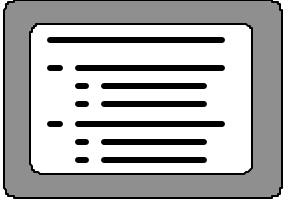





Emergency Vehicle

App

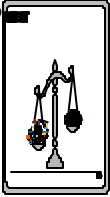

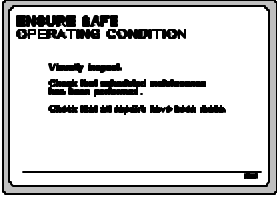

MAJOR MECHANICAL SYSTEMS

Lighting system

Braking system

Steering system

EXHAUST SYSTEMS

Environmental control systems

Support equipment

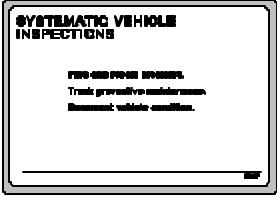

| RECOMMENDED INSPECTION SCHEDULE | |
|---------------------------------|-------------------|
| Pre-trip | Before every trip |
| Weekly | Once per week |
| Monthly | Once per month |
| Quarterly | Once per quarter |
| Annually | Once per year |

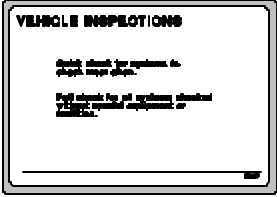

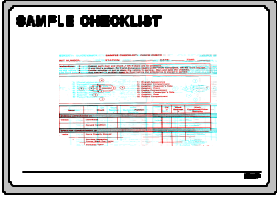

| INSPECTION SEQUENCE | |
|-------------------------|--|
| 1. Visual inspection | |
| 2. Operator equipment | |
| 3. Driver's equipment | |
| 4. Driver's seat | |
| 5. Driver's compartment | |
| 6. Driver's compartment | |
| 7. Driver's compartment | |
| 8. Driver's compartment | |

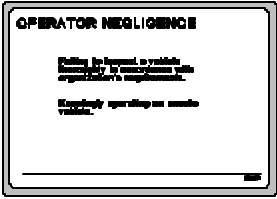

ADVANTAGES OF PREVENTIVE MAINTENANCE

- Ensure safe, reliable vehicle operation
- Reduce total cost of repairs
- Minimize major equipment failure



VEHICLE MALFUNCTIONS DURING RUN

Are you trained and authorized to make repairs?
Is a backup readily available?
How quickly did you arrive on-scene?
What is patient's condition?
Can vehicle's electrical system meet demands?

ROUTE PLANNING

Primary Goals of Route Planning Are To:

- minimize travel time
- minimize road exposure
- allow egress to clear routes as desired
- avoid environmental and residential hazards
- to arrive at scene of the emergency scene in least amount of time.



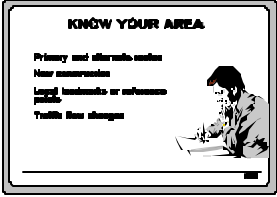



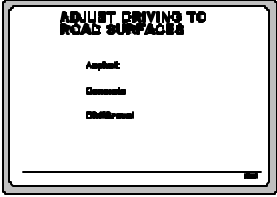

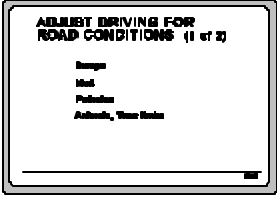

COMPOSING MESSAGE

- Plan
- Identify person called, time calling and: 911/912
- Use plain English
- Personnel needs clearly
- Speak clearly
- Repeat directions



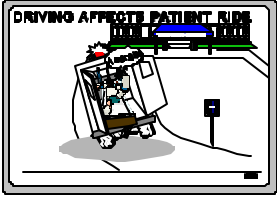

Emergency Vehicle

App

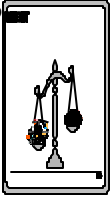

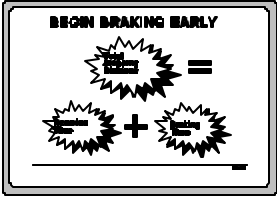

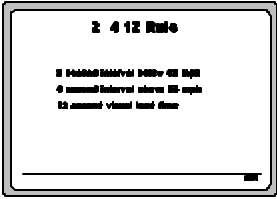

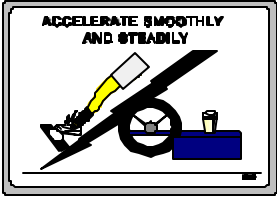



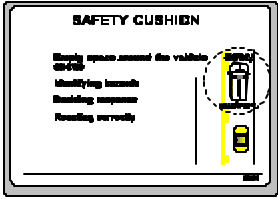

**COMMUNICATION WITH
OTHER DRIVERS**

- Light
- Horn
- Eye Contact
- Hand Signals
- Blame

| |
|------------------------|
| BASIC MANEUVERS |
| Braking & Stopping |
| Making Lane Changes |
| Passing |
| Backing |
| Parking |
| Turning |

BRAKING AND STOPPING

Pump brakes gently but firmly.
Check conditions in rear and side.
Watch 10 seconds ahead.

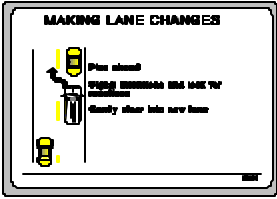

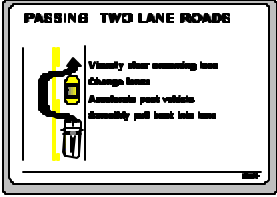



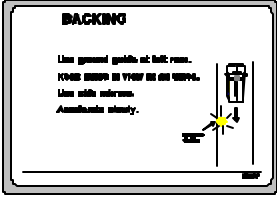

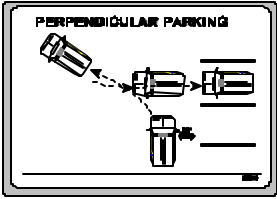

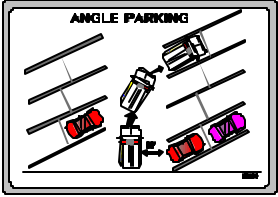

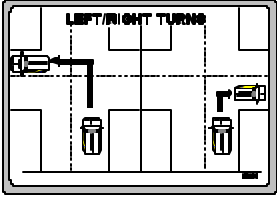

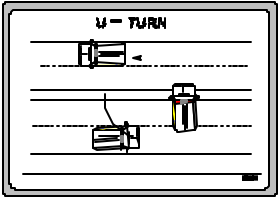

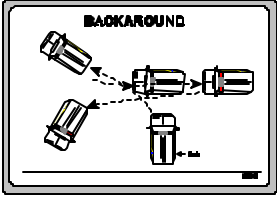









| | |
|---|---|
|  | Emergency Vehicle Operator Course (Ambulance) National Standard Curriculum 2018 Edition 2018 |
|  | Emergency Vehicle Operator Course (Fire/Rescue) National Standard Curriculum 2018 Edition 2018 |
|  | Emergency Vehicle Operator Course (Law Enforcement) National Standard Curriculum 2018 Edition 2018 |
|  | Emergency Vehicle Operator Course (Public Safety) National Standard Curriculum 2018 Edition 2018 |
|  | Emergency Vehicle Operator Course (Public Safety) National Standard Curriculum 2018 Edition 2018 |
|  | Emergency Vehicle Operator Course (Public Safety) National Standard Curriculum 2018 Edition 2018 |
|  | |
|  | |

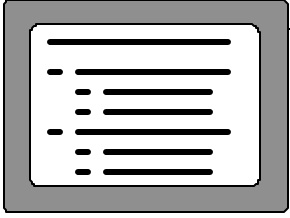

INSPECTION SEQUENCE

1. Visual appearance
2. Operator compartment
3. Driver's: operator's side
4. Driver's: front
5. Right compartment
6. Driver's: passenger's side
7. Patient compartment
8. Exterior view



**Emergency Vehicle Operator
Course (Ambulance)**

Appendix

National Standard Curriculum



**Instructor Guide
1995**



National Standard Curriculum



**Participant Manual
1998**



Appendix I
Test/Answer Key

MODULE A TEST

Ambulance Operation: The Basics

DIRECTIONS: Read each test item. Select the response which best answers the question or completes the statement.

1. Driving to an emergency scene, the ambulance operator approaches a controlled intersection with a red light. The operator stops at the red light, checks for clearance, and then proceeds through the light with caution. Which law is the operator complying with?
 - A. True Emergency
 - B. Negligence
 - C. Abandonment
 - D. Due Regard for Safety

2. An ambulance operator just arrived at the scene of a medical emergency. Which of the following describes the appropriate communication action the operator should take?
 - A. No radio report required
 - B. Dispatch, Unit 42; we've arrived at the scene
 - C. Dispatch, 42; our 10-20 is the accident scene
 - D. Harry, you there? This is Bob; uh! we're here; we'll call when we leave.

3. What would be the effect of putting too many people into the ambulance?
 - A. If maximum payload is exceeded, the operator will have to prepare a written report on the circumstances
 - B. Would increase momentum which would make stopping vehicle more difficult
 - C. Would have no effect as long as the EMT has sufficient room to continue basic life

support on the patient

D. Would have no effect because ambulance engine has sufficient horsepower

4. Which inspections and maintenance is the Ambulance Operator responsible for performing?

A. Operator not responsible for inspecting or maintaining vehicle

B. Full check and preventive maintenance

C. Quick check, full check, and maintenance for which the operator has been trained and authorized to perform

D. Quick check and that maintenance which is required during a run

5. A multi-car crash has been reported. The primary consideration in selecting a route to the scene is--

A. speed

B. safety

C. directions given by reporting party

D. destination medical facility

6. When driving defensively and following the 2-4-12 rule, the operator will--

A. be confident that all other drivers see the light and hear the siren and grant the operator the right of way

B. maintain safety cushion around ambulance and drive 12 seconds ahead of the vehicle

C. maintain 12 second spacing behind vehicle in front

D. maintain two car lengths between the ambulance and the car ahead when in the city and four car lengths when on a interstate highway

7. While operating the ambulance on a run in the country on a two lane asphalt road, the operator sees an oncoming vehicle which is over the center line. To avoid a crash, the operator pulls the vehicle to the right and the wheels run off the hard surface onto the soft shoulder. The vehicle pulls hard to the right. What should the operator do to recover?
- A. Pull off highway and stop; enter highway when traffic is clear
 - B. Turn steering wheel quickly to left to re-enter highway
 - C. Brake firmly and re-enter highway by turning left
 - D. Slow down but continue to operate vehicle; pull back onto highway after regaining steering control
8. While operating the ambulance through a controlled intersection, the operator notices a car moving rapidly towards the ambulance from the left side. What is probably the best way to avoid a crash?
- A. Accelerate quickly
 - B. Brake hard
 - C. Turn hard to left
 - D. Turn hard to right
9. An ambulance operator picked up a patient and the patient's spouse. During the trip to the medical facility, the spouse is standing and interfering with the care of the patient. The

ambulance operator should--

- A. continue driving; conduct of patient and passenger is the responsibility of the EMT
- B. stop and forcibly remove the spouse from the ambulance
- C. direct spouse to sit down and fasten safety belt
- D. direct EMT to sedate spouse

MODULE A TEST - ANSWER KEY

Ambulance Operation: The Basics

1. Driving to an emergency scene, the ambulance operator approaches a controlled intersection with a red light. The operator stops at the red light, checks for clearance, and then proceeds through the light with caution. Which law is the operator complying with?
 - A. True Emergency
 - B. Negligence
 - C. Abandonment
 - D. Due Regard for Safety***

2. An ambulance operator just arrived at the scene of a medical emergency. Which of the following describes the appropriate communication action the operator should take?
 - A. No radio report required
 - B. Dispatch, Unit 42; we've arrived at the scene***
 - C. Dispatch, 42; our 10-20 is the accident scene
 - D. Harry, you there? This is Bob; uh! we're here; we'll call when we leave

3. What would be the effect of putting too many people into the ambulance?
 - A. If maximum payload is exceeded, the operator will have to prepare a written report on the circumstances
 - B. Would increase momentum which would make stopping vehicle more difficult***
 - C. Would have no effect as long as the EMT has sufficient room to continue basic life support on the patient

- D. Would have no effect because ambulance engine has sufficient horsepower

4. Which inspections and maintenance is the Ambulance Operator responsible for performing?
- A. Operator not responsible for inspecting or maintaining vehicle
 - B. Full check and preventive maintenance
 - C. Quick check, full check, and maintenance for which the operator has been trained and authorized to perform***
 - D. Quick check and that maintenance which is required during a run
5. A multi-car crash has been reported. The primary consideration in selecting a route to the scene is--
- A. speed
 - B. safety***
 - C. directions given by reporting party
 - D. destination medical facility
6. When driving defensively and following the 2-4-12 rule, the operator will--
- A. be confident that all other drivers see the light and hear the siren and grant the operator the right of way
 - B. maintain safety cushion around ambulance and drive 12 seconds ahead of the vehicle***
 - C. maintain 12 second spacing behind vehicle in front
 - D. maintain two car lengths between the ambulance and the car ahead when in the city and four car lengths when on a interstate highway

7. While operating the ambulance on a run in the country on a two lane asphalt road, the operator sees an oncoming vehicle which is over the center line. To avoid a crash, the operator pulls the vehicle to the right and the wheels run off the hard surface onto the soft shoulder. The vehicle pulls hard to the right. What should the operator do to recover?
- A. Pull off highway and stop; enter highway when traffic is clear
 - B. Turn steering wheel quickly to left to re-enter highway
 - C. Brake firmly and re-enter highway by turning left
 - D. **Slow down but continue to operate vehicle; pull back onto highway after regaining steering control***
8. While operating the ambulance through a controlled intersection, the operator notices a car moving rapidly towards the ambulance from the left side. What is probably the best way to avoid a crash?
- A. **Accelerate quickly***
 - B. Brake hard
 - C. Turn hard to left
 - D. Turn hard to right
9. An ambulance operator picked up a patient and the patient's spouse. During the trip to the medical facility, the spouse is standing and interfering with the care of the patient. The ambulance operator should--
- A. continue driving; conduct of patient and passenger is the responsibility of the EMT

Appendixes

- B. stop and forcibly remove the spouse from the ambulance
- C. direct spouse to sit down and fasten safety belt***
- D. direct EMT to sedate spouse

Appendix J
Adult Learning
and
Presentation Techniques

N

OPE:

This appendix is not intended to re
Transportation. National Highway

PRINCIPLES OF ADULT LEARNING

Motivating Adult Learners

Adults need a reason to learn. They seek learning experiences that are applicable to their situation.

Adults seek learning experiences which directly relate to their lives. Once convinced that change is a certainty, adults are willing to engage in learning experiences before, after, or even during the actual life-change event, especially if the learning will help them cope better with the change.

Self-esteem and pleasure are strong secondary motivators for engaging in new learning experiences.

Curriculum Design for Adult Learners

Adults prefer single-concept, single-theory courses that focus on how to apply that concept to relevant problems. They tend to be less interested in survey courses. The *Emergency Vehicle Operator Course (Ambulance): National Standard Curriculum* focuses on one major concept--how to safely operate an ambulance.

If they are going to keep and use the new information, adults need to be able to integrate new ideas with what they already know. Information that conflicts with what is already held to be true, thus forcing a reevaluation of the old material, must be presented and integrated more slowly.

Working with Adult Learners in the Classroom

The learning environment must be physically and psychologically comfortable. Long periods of sitting, long lectures, and the absence of practical opportunities can cause lack of attention. The *Emergency Vehicle Operator Course (Ambulance): National Standard Curriculum* takes into account such factors by varying the instructional technique. You will control elements as lighting and air conditioning.

Adults have something real to lose in a training situation. Their self-esteem and ego are at risk when they try a new behavior in front of peers and colleagues. Following the guidelines for giving effective feedback can help participants maintain self-esteem while learning new skills or knowledge.

Adults have expectations, and it is critical to take time to clarify and to articulate all expectations before getting into course content. Learners and trainers must understand the objectives and the goals of the course. Each lesson contains the course goal, module goal, lesson goal, and performance objectives.

One key to the instructor role is time management. The instructor must balance the presentation of new material, debate, discussion, sharing of relevant trainee experiences, and time. The instructor is responsible for ensuring that all questions are answered, that the complete course contents are taught, and that learning proceeds in an orderly manner. Each lesson of the *Emergency Vehicle Operator Course (Ambulance): National Standard Curriculum* contains a recommended amount of time to spend on each lesson. Within the lessons, however, each instructor needs to make time checks to ensure, for instance, that about a third of a three hour-lesson is covered each hour of class time.

Instructional Methods/Learning Styles

Some adults learn best with visual stimuli (e.g., pictures, slides, video). Others learn best through auditory stimuli (e.g., spoken word, audio tapes). All adult learners learn best by doing. Training needs to account for these different learning styles. A combination of these styles is employed in this course, ranging from classroom presentation and discussion to behind-the-wheel practice.

PRESENTATION METHODS

Instructors should use a variety of presentation methods to satisfy different learning styles. The following presentation methods are those used in the *Emergency Vehicle Operator Course (Ambulance): National Standard Curriculum*.

Instructor Presentation/Discussion

This course has been designed with a large amount of activity, since adults learn best by "doing." Module A, even though it is developed for the classroom to teach what operators need to know, is intended to be highly interactive. All lessons in Module A of the Ambulance Operator course contain a verbal presentation by the instructor. This is useful for disseminating large amounts of material in a relatively short time. It assures that all present people receive the same information. Although the Instructor Guide is fully scripted, it is critical that instructors prepare the presentation and not read it verbatim. Adults do not want to be read to, although they will accept some reading of key points (and this is an acceptable instructional technique). It is accompanied by transparencies to hold participant interest, and discussion to increase participation. It is used to teach material the participants need to

know.

Performance-Oriented Training

Performance-oriented training is a method involving--

- ! demonstration by the instructor of the procedure to the participant.
- ! coaching by the instructor as the participants practice the skill.
- ! participants practicing the skill until they feel they are performing to the standard.

In this course, the Module B exercises use performance-oriented training to teach the driving skills.

Scenarios

Scenarios allow the student to apply what they've learned by reading a situation that needs some kind of response by an ambulance operator. Students are given time to consider the answer, sometimes independently, sometimes in small groups.

On-the-Job Checklists

On-the Job Checklists provide performance assessment in the work environment. They can guide a participant to demonstrate knowledge and skills in the job environment while being supervised and evaluated by an experienced individual. In the Ambulance Course, Module C provides a means of continuing evaluation and improvement for ambulance operators.

PUBLIC SPEAKING SKILLS

Effective Public Speaking Skills

Instructors can improve their training effectiveness by using good public speaking skills. Effective public speaking skills include--

- ! eye contact
 - use to establish credibility/confidence/rapport
 - look directly at eyes
 - look at whole audience
- ! body movement
 - vary position (move from "base")
 - keep confident stance/posture
 - make purposeful movements
- ! facial expression
 - use variety
 - be animated
 - smile often

Appendixes

- show emotion

! voice

- use variety
- allow silence/pauses
- vary pace
- vary volume
- accent and emphasize points
- enunciate clearly

! gestures

- be purposeful
- vary gestures
- act natural and spontaneous

! advanced preparation

Suggestions for Overcoming Fear of Public Speaking

Speaking before a group can be stressful. To overcome a fear of speaking before a group you should be well prepared. By following these guidelines prior to and during the training presentation, you can reduce anxiety associated with presentations.

Logistics

- ! Check the facilities and audio-visual equipment in advance.
- ! Have a spare projector bulb on hand.
- ! Make sure that handouts and transparencies are prepared in advance.
- ! Keep transparencies in 3-ring binder to keep them in order.

! Dress comfortably and appropriately.

Preparation

! Know the material well (e.g., be alert).

! Practice your presentation (e.g., conduct a "dress rehearsal" and possibly practice in front of a mirror).

! Do not plan to read to the class except for occasional emphasis.

! Anticipate potential problems and prepare responses.

! Obtain information about the group in advance. Know your audience.

! Prepare to be physically and psychologically alert.

! Introduce yourself to individual group members in advance.

! Practice responses to tough questions or situations.

In-Class

! Concentrate on helping the participants learn.

! Use involvement techniques (e.g., participation).

! Learn participants' names and use them.

- ! Use eye contact to establish rapport.

- ! Convince yourself to relax (e.g., breathe deeply, meditate, talk to yourself).

- ! Use your own style.
- ! Use your own words.

- ! Put yourself in the audience's shoes.

- ! Assume the audience is on your side. They are there to learn and believe that you know more than they do.

- ! Provide an overview of the presentation when you start (state the end objectives).

- ! Accept some fears as being good (energizing stress vs. destructive stress).

- ! Identify your fears, categorize them as controllable or uncontrollable, and confront them.

- ! Give special emphasis to the first 5 minutes of your presentation; be extra prepared for the start of your presentation as this is when you establish credibility.

- ! Imagine yourself as a good speaker (and enjoy reaping the benefits of a self-fulfilling prophecy).

- ! Do not be afraid to answer a question with "I don't know" and get back to the individual with an answer. Make note of the question and answer for future use.

FACILITATION TECHNIQUES

There are several techniques for facilitating adult learning that go beyond basic public speaking skills. These techniques include using introductions and icebreakers, employing active listening techniques, asking questions, and giving feedback. In addition, there are several techniques for controlling problem participants and engaging non-participants.

Introductions and Icebreakers

Introductions and icebreakers are used to gain attention and to motivate the participants. Some approaches for introducing a lesson include--

- ! State the purpose of the lesson.

- ! Review the lesson objectives. Relating the objectives to the future work assignments will make the learning more meaningful to the participants.

- ! Relate the topic to previously covered content.

- ! State the topics that will be covered in the lesson.

- ! Share a personal experience. Using real life examples demonstrates how the knowledge can be used.

- ! Use humor, such as a funny incident or relevant cartoon.

- ! Use an icebreaker exercise or a game. These techniques can be used to acquaint participants with one another, to reduce tension, to focus the group's efforts, and to build relationships among class members.

Active Listening Techniques

Active listening includes both verbal and non-verbal communication. To communicate effectively, trainers must master both techniques. Non-verbal communication techniques include--

- ! facing the participants
- ! maintaining eye contact
- ! moving among the participants; leaning toward the speaker
- ! avoiding distracting behaviors.

Effective verbal communication involves confirming your understanding of what has been said. This can be done by rephrasing what the participant has said. For example, the instructor might respond by saying--

"So what you are saying is..."

OR

"What I am hearing is that..."

Asking Effective Questions

By asking effective questions, instructors can clarify and confirm what has been said and determine the participant's level of understanding. Questions are given in your instructor guide and always have the Q&A icon. The expected answers are shown in italics. Ask questions of the entire group or target questions to individual learners. Vary your question format and avoid "yes/no" or closed-ended questions.

When participants respond to the question or ask one, repeat the question or answer to make sure that everyone heard. This helps to reinforce concepts. For example--

"Allison's question was..."

OR

"Joe's answer was..."

When participants have questions or are only partially correct in their answers, ask for help from the rest of the class. Remember to provide positive reinforcement after participants respond. For example--

"That's right, Chris."

OR

"Good idea, Maria. Thanks."

Guidelines for Giving Feedback

Feedback is an important part of the learning process because it--

! tells whether responses or performance are correct, allowing participants to make the necessary adjustments to their behavior

makes learning more interesting.

For feedback to be effective, there are several guidelines to be followed. Read the following example. As each guideline is presented, note in the example where that guideline has been followed.

"Joe, your U-Turn was good. I know it is difficult the first time, but you did a good job of following the basic steps, including signaling, pausing to check for traffic and maintaining the 9-3 hand position. However, smooth out your steering the next time you try the U-turn."

! Direct the comments to the individual and clearly address the person.

"Joe,"

! Maintain and enhance self-esteem. Build confidence.

"your U-Turn was good"

! Point out what was done correctly.

"following the basic steps"

! Be specific. Describe exact behavior. Give descriptive rather than evaluative feedback. Give specific rather than general feedback.

"including signaling, pausing to check for traffic and maintaining the 9-3 hand position"

! Offer alternative positive behavior. Suggest other ways for doing the same task.

"However, smooth out your steering the next time."

Techniques to Control Problem Participants and Engage Non-Participants

The Over-Participant

If you have a person who wants to participate too much (e.g., someone who talks too much, a "babbler"), thank the participant for his/her contribution, then ask others for comments. For example:

"Thank you, Chris. What do the rest of you think?"

The Non-Participant

The reasons for "under-participating" are often not clear. Non-verbal behavior may provide a clue.

If the participant appears shy, ask questions to the group. Make eye contact with the participant, and try to gauge when he/she is ready to join in.

If the participant appears bored, try to ask questions that might relate to the individual's interests or areas of expertise. You may want to direct questions to the individual so that the group can benefit from his/her experience.

If the participant is not cooperative, try creating a team-like atmosphere. Explain the value of working together in the group. You might want to begin by using an icebreaker geared toward teamwork.

The Anti-Participant

If the participant continuously objects and disrupts the group, acknowledge the individual and ask for reactions from other participants. For example:

"Thank you for your contribution, Mark. What do the rest of you think?"

If the participant digresses, remind him/her of the primary topic. Ask if you can post that idea for later discussion, or ask if the group, as a whole, would like to change topics. For example:

"Our topic now is _____. May I post your idea so we can come back to that later?"

OR

"Our topic now is _____. Does the group want to return to our original topic? Or should we consider this other issue? Do we have consensus?"

If several participants have a side conversation, pause and then ask if they would like to offer an example to the group.

Alternative approaches to handling participants who continuously disrupt the group include the following:

! *Establish "Ground Rules."* At the beginning of the presentation, have the class brainstorm a list of "rules" which are not to be broken during this class. For example, the class may want a "No interrupting" rule. It is important to ensure that all of the rules posted were

created from class consensus. This will gain their acceptance of the Ground Rules. If, at any time, the class wishes to add a rule that was not originally included, feel free to stop the class long enough to revise the list of rules. This list should be posted in a location visible to the entire class.

An extension of the "Ground Rules" would be to have the class also develop a punishment for those who persistently violate the Ground Rules. For example, a punishment may be that it will cost violators a quarter (\$.25) every time they break a rule.

! *Create a "Parking Lot."* Basically, this is a list of "heated" questions or issues which may arise during your presentation and produce "active" class discussion that will take more time to resolve than the time scheduled. After the discussion has become sidetracked from the original topic, the instructor simply interrupts with a sentence like: "This is obviously a point of concern. Why don't we put it in the parking lot (usually a piece of newsprint), and finish this discussion at the end of the lesson?" This approach allows the instructor an opportunity to either "derail" a conversation which is not productive to the current topic, or postpone resolution to an issue which is important to the participants, though not directly relevant to the topic at hand.

! *Suggest a one-on-one discussion after the presentation.* This approach may be used when disruption is caused by one member of the class. Most of the time, the discussion will never take place because the person will not remember what the issue was about.

Techniques for Showing Overheads

Several procedures can help instructors use overhead transparencies most effectively. The following are helpful:

- ! Arrange the room, projector, screen, and your position so that all participants can view the complete projected picture without obstruction. Practice and test this before classes begin.

- ! Show the overhead for a brief period, talk about it, then remove the overhead so that participants are not distracted from hearing new material.

Techniques for Flip Charts

If the instructor is right handed, the flip chart stand should be placed so that he or she can stand at the left of the chart and write. This allows participants to see what is being written rather than having to wait until the writer moves away. As with all classroom logistics, test the location of your flip chart stands and be sure all participants can see it.

Never talk while looking at the chart. When discussing something on a flip chart, be sure you are making eye contact with the participants rather than the chart.

LOGISTICS

A training session can be affected by a large number of factors. Concerns such as site reservations, lighting and heating, noise, supplies, and equipment can cause an otherwise excellent training program to fail. Giving adequate time and consideration to the logistics of a training session can eliminate many of the possible "glitches" that can occur in training.

The configuration of the furniture in the classroom can impact the effectiveness of the training delivery. When planning a training

program, keep in mind the mobility of the furniture in the classroom.

REVIEW

Incorporating adult learning principles into training involves--

- ! providing a reason to learn in order to motivate adult learners
- ! designing a relevant, interactive curriculum
- ! creating a comfortable, "safe" environment for adults in the classroom
- ! incorporating a variety of instructional strategies to accommodate different learning styles

Using a variety of presentation methods is most effective for teaching specific content and/or processes to satisfy different learning styles. Presentation methods in the ambulance operator course include--

- ! instructor presentation/discussion
- ! team exercises
- ! case studies
- ! drill/practice exercises

Instructors can improve their training effectiveness by using public speaking skills. Public speaking skills involve--

- ! eye contact
- ! body movement
- ! facial expression
- ! voice
- ! gestures
- ! avoiding crutch words or phrases
- ! being prepared

Facilitation techniques can be used to enhance learning, control problem participants and engage non-participants. These techniques involve--

- ! introductions and icebreakers
- ! active listening techniques
- ! asking effective questions
- ! feedback

Extensive research has been done to study characteristics of adult learners. Ideas that have been widely accepted fall into four main categories: 1) motivating adult learners, 2) designing curriculum for adult learners, 3) working with adult learners in the classroom, and 4) teaching instructional methods/learning styles.

A trainer's instructional methods are the keys to successful teaching. Depending on the material to be taught, one or more methods may be used at a time. Various methods are employed in the *Emergency Vehicle Operator Course (Ambulance): National Standard Curriculum*.

When speaking before a group, you should be aware of both verbal and non-verbal communication, such as voice, body movements,

eye contact, and facial expression. To overcome nervousness, you should prepare by reviewing the material, coordinating the logistics, and checking the equipment.

Questioning techniques, active listening skills, introductions and icebreakers, and effective feedback can help instructors facilitate the learning process. These techniques can also be used when dealing with problem participants or engaging non-participants. Thorough planning and preparation for training can help a training session run smoothly.

REFERENCES

U.S. Department of Transportation, National Highway Traffic Safety Administration. (1994)

Emergency Vehicle Operator Course (Ambulance): National Standard Curriculum. Washington, D.C.

U.S. Department of Transportation, National Highway Traffic Safety Administration. (1986)

Emergency Medical Services Instructor Training Program, a National Standard Curriculum, Washington, D.C.

U.S. Environmental Protection Agency. (1993). *Worker Protection Inspection Course:*

Train-the-Trainer. Washington, D.C. June 1981.

30 Things We Know for Sure About Adult Learning. Training, pp. 45-52.

Appendix K
Training Supplement for Managers

TABLE OF CONTENTS

1. PURPOSE 3

2. BACKGROUND..... 3

3. CURRENT AND FUTURE ACTIONS..... 4

4. SELECTING PERSONNEL TO BE AMBULANCE OPERATORS 5

5. INSTRUCTOR SELECTION QUALIFICATIONS..... 6

6. PLANNING FOR CONDUCTING TRAINING 7

7. TRAINING RECORDS..... 10

8. REFRESHER TRAINING..... 11

9. STANDARD OPERATING PROCEDURES (SOP)..... 12

10. REFERENCES 12

11. SUMMARY 12

Enclosures..... 14

 Ambulance Familiarization Checklist..... 15

 Ambulance Inspection, Maintenance, and Repair Checklist..... 17

Normal and High Risk Situations Checklist..... 19

Operational Driving Checklist..... 21

1. PURPOSE

The purpose of this supplement is to provide managers with information they can use to review how their organization is planning, conducting and managing their training and related Emergency Medical Service (EMS) operations.

The information represents lessons learned and suggestions and recommendations collected during discussions with senior EMS managers and personnel.

2. BACKGROUND

When the Department of Transportation (DOT), National Highway Traffic Safety Administration (NHTSA) scheduled the *Emergency Vehicle Operator Course (Ambulance): National Standard Curriculum* for revision, it established some very important guidelines as shown below:

- Develop a course that can be conducted by Urban and Rural Emergency Medical Service Organizations.

- Establish a small, highly qualified Curriculum Development Group (CDG) to help with the course design and review all course materials.

- Visit several EMS organizations and conduct a job and task analysis to define what ambulance operators needs to know to do their job.

- Let the job and task analysis determine the length of the course.

- Use the performance oriented training concept:
 - Explain the task to be performed
 - Describe the standard for satisfactory performance
 - Demonstrate the task
 - Coach the participant
 - Allow practice until the participant feels that they can pass the test
 - Administer the test.

- Provide enough material in the instructor guides so that the lessons can be presented with minimum additional references. Develop manuals that can be retained by each participant and used as a reference after the training has been completed.

- Allow ample opportunity for insertion of the state and local laws and organizational procedures.

This guidance has been followed and it is reflected in the *Emergency Vehicle Operator Course (EVOC) (Ambulance)* materials.

3. CURRENT AND FUTURE ACTIONS

During the development of the EVOC course materials, other areas were identified and considered for inclusion in the course or assigned to another project. Some of the more significant areas are:

- Emergency Response Procedures

- The Department of Transportation recommends observing the posted speed limit during an emergency response

- Stop and clear every controlled intersection

- Use a ground guide when backing.

- Establish an Ambulance Operator Training Program. During the collection of information about training programs, there were many examples of states and EMS organizations that do little or no training. NHTSA is continuing coordination with State EMS offices to encourage each state to implement the training and certification of ambulance operators.

-Operator and Patient Compartment Designs. The safe and efficient operation and quality of patient care is often influenced by how well these compartments are designed. The Federal Interagency Committee for Emergency Medical Services (FICEMS) has established a subcommittee to recommend performance standards and specifications for designing the patient and operator compartments. The goal of this subcommittee is to recommend standards that manufacturers can follow to improve the operational efficiency and safety of both compartments.

- Training Technology. NHTSA has continued to assess how training can be made available by a variety of media. On-going projects are evaluating Distance Learning which uses one way and two way, interactive television. This course and other NHTSA courses are available in paper format. This course will also be available on CD-ROM. NHTSA is supporting and sponsoring other projects that are assessing the future use of other training media such as interactive compact disk, video disk, computer-based training, multimedia training, computer bulletin board systems

and computer managed training systems.

4. SELECTING PERSONNEL TO BE AMBULANCE OPERATORS

Each EMS organization must establish a policy for selecting personnel to be ambulance operators. The following paragraphs discuss three of the most important areas that should be considered when selecting volunteers or job applicants to be ambulance operators.

i. Individual Prerequisites

-- Drivers License Check

-- Vehicle Accident Check

-- Medical Examination

-- Physical Standards.

Training managers should be closely involved in establishing the prerequisites and selecting volunteers and job applicants for their organization.

ii. Job Descriptions. Every organization should have a well defined job description for every job in the organization. These job descriptions should comply with federal and state guidelines. The job description should include:

-- Educational requirements

- EMT Qualifications

- Physical Requirements

- Description of duties and functions.

As manager, you may want to establish a small group to help you review or develop job descriptions for your organization. It is also a good idea to have someone in the community or your organization who is qualified in this area to review the job descriptions. This review should verify that you have complied with all federal and state employment requirements, the American Disabilities Act and any local or organizational procedures. A solid job description defines the prerequisites, duties and functions they are expected to perform.

- iii. Non EMT Qualified Ambulance Operators. Many organizations allow personnel to operate an ambulance without being EMT qualified. This could cause a variety of problems because the ambulance crew usually has only two people. More often than not, the operator is required to assist the EMT with medical care. If the operator has not received the necessary training they might attempt to provide care when they are not qualified. Equally important is that they must know how to protect themselves from bloodborne pathogens and other communicable diseases, how to lift a stretcher without injuring themselves and many other tasks. Each organization must decide if they will use operators who are not EMT qualified. When organizations use non-EMT qualified operators they should have a separate job description that limits their duties.

5. INSTRUCTOR SELECTION QUALIFICATIONS

Managers should select instructors who:

-
- Will do the best job

 - Are fully qualified ambulance operators

 - Are state and/or Organizational Qualified EVOC Instructors

 - Have two years experience in EMS, and

 - Are well qualified in specific lessons.

Managers should identify guest speakers with special expertise to assist with specific lessons, such as a local attorney for lesson 2, Legal Aspects of Ambulance Operations, or the manager of the 9-1-1 operations on lesson 3, Communications and Reporting Roles and Responsibilities.

Each organization should have several instructors who can tailor and present the lessons. When your organization does not have enough qualified instructors, check with other EMS organizations to get help until your organization can obtain personnel qualified as instructors. State and County EMS Directors are a good source for helping organizations identify instructors and other organizations that are conducting the training programs.

6. PLANNING FOR CONDUCTING TRAINING

- Module A of the *Emergency Vehicle Operator Course* is about 16 hours of classroom instruction. The time is variable because each organization must add information specific to its state and organization. Module A covers the basic knowledge required for ambulance operators, such as the legal aspects of ambulance operations, communications, ambulance types, operational

readiness, ambulance dynamics, safety considerations and a final lesson that simulate a complete run.

- Module B is for learning the basic driving skills and uses the performance-oriented training concept. Using this concept, the instructor explains to each participant the task to be performed and the performance standard, demonstrates how to perform the task, and allows a participant during practice. The participants practice until they believe they can pass. Finally the instructor administers the performance test using a go/no go scoring system. The number of hours required for Module B will vary based on the participant's ability.

- Managers should plan the training to ensure that they make the best use of the participants time.

Here are some areas that should be considered when planning training. These can be used as a checklist to plan the training program for your organization.

- ! Tailor course materials for local use

- ! Incorporate state and local information in the instructor guides

- ! Establish a training council

A small training council (less than 5 people) can be very productive in selecting the topics and providing the state and local references. This council can recommend innovative instructional methods and strategies for presenting the lessons. There are numerous innovative techniques being used to help participants learn how to safely operate ambulances.

During the NHTSA Train-the-Trainer course, an instructor in Bucks County, PA used small model cars and ambulances to demonstrate how to park an ambulance at the scene of a multiple car crash on a busy highway. He used a large piece of posterboard to draw out the highway and even made some poles with power lines parallel to the highway. During the exercise each student had an opportunity to "drive" the model ambulance to the scene and park it in a location based on the situation given to them by the instructor. During one exercise, a power line was cut and fell on one of the model vehicles involved in the crash. This was very effective training and all of the participants agreed that they had learned from the exercise. A training council of experienced managers and instructors can add many ideas and examples of how to enrich the training.

! Determine the Resources Required to Support the Training. The resources may vary greatly but there are some resources that must be available to meet the minimum instructional requirements. Instructor guides should suggest the minimum resources to support each lesson. Managers may become very involved in providing or coordinating actions and resources such as:

- Classroom Furnishings

- Table space for each participant to write, use manuals and other references

- A comfortable chair

- Chalkboard and/or Flipchart

- Audio visual equipment

- Classroom Facilities and Location

Appendixes

- Reasonable Access to Restrooms

- Quiet area with minimum distractions

- Temperature controls

- Outdoor Training Facilities

- Coordinate the use of outdoor space

- Inform city and county organizations and the media of scheduled outdoor training when appropriate

- Visit the training sites

- Traffic Cones and other Markings. Some EMS organizations may not have enough traffic cones or be in a position to buy the 50 cones suggested. When this is the case, it is time to turn again to the Training Council to help identify other sources for the cones or substitute marking devices. Volunteer organizations typically conduct training on the weekends. Consider these actions when you are having trouble getting enough cones or markers to support your training:
 - Borrow from construction companies, power companies, the telephone company and municipal organizations.

 - Make markers using cardboard and tape or just boxes that you can weight down to keep them from blowing away.

- Scheduling. Managers should schedule the ambulance operator training to accommodate their operational requirements. Here are some suggestions for scheduling training:
 - Check the availability of instructors and classroom facilities
 - Schedule as far in advance as possible
- Inform all potential participants of any prerequisites, fees and other requirements for enrolling in the course
 - Always assign two qualified instructors.
 - Support Materials. Each organization is responsible for providing the instructor guides and participant manuals. Instructors should have their guide tailored to the state and local requirements well in advance of their first presentation. The organizations should also provide the participant manual to each participant in a 3-ring binder. This will become a permanent reference.

Checklists should be used to record participant performance during practical exercises. Managers should provide the checklists to the instructors. Instructors should assemble all of the materials for conducting the training several days before the training is scheduled. Check all of your materials during normal office hours. It may not be possible to get to the copy machine at 10 am on Sunday morning to reproduce checklists.

7. TRAINING RECORDS

Establishing and maintaining training records is an essential part of every EMS operation. There are several reasons to maintain a record for each individual. The first is to ensure that personnel have successfully completed

all required initial training and maintain their proficiency by completing mandatory refresher training.

Another very important reason for maintaining training records is to substantiate that an individual was properly trained and qualified in all job related tasks. If an operator is involved in a crash, it is very likely that the organization and individual will become involved in an investigation that could result in legal action. If the individual operating the ambulance when it was involved in a crash was properly trained and this training was recorded it could be helpful to the organization and individual. If there is no recorded training, it could be very difficult to prove the qualifications of the individual.

Well organized and conducted training could be very beneficial when negotiating the insurance costs for the organization. While most insurance companies want to see three or more years of crash history to establish rates, a well managed training program will be considered. Most important is that good training will reduce the number of crashes and the injuries to EMS and other personnel.

Many counties, cities and towns are self insured and rarely go to court to settle litigation. It is not unusual to reach an out of court settlement rather than risk the bad publicity surrounding an ambulance crash. For self insured organizations, the rewards for good training can be immediate with fewer crashes, injuries and less litigation.

Ambulance operations are only one area of the overall training requirement for EMS personnel. Each member of the organization must have an individual training record. This record should have the following features:

- Personal Data

-- Full, correct name

-- Home address

-- Home and work telephone numbers

-- Person to be notified in an emergency

- Education and Training

-- Educational level, such as 12 years, High School Graduate

-- Other educational institutions such as community colleges, colleges and universities attended with the degree or certification attained

-- EMS courses completed and date

-- Certifications, such as *Emergency Vehicle Operator Course (Ambulance): National Standard Curriculum* completed November 4, 1994

-- Refresher training required and date of expiration of present certification

When available, the record should include a copy of the document certifying or acknowledging the successful completion of the course or training event.

- On-the-Job Training (OJT). Checklists, such as the examples in the inclosure, should be used to document OJT and maintained in the individuals training record. A separate listing should be maintained of each checklist. This listing is an inventory of the checklists and is a quick reference for training managers and supervisors.

8. REFRESHER TRAINING

The material in the instructor guide is appropriate for conducting refresher training. Supervisors can tailor the material for specific individuals or develop a standard refresher training course for all operators. Refresher training should be conducted at least every two years.

Ambulance operators who are active on a weekly basis will probably need to have about four hours of classroom training. Operators who are less active may need two additional hours on the operational procedures. Refresher training should focus on those lessons where changes have occurred.

It is not recommended that ambulance operator receive refresher training in "Cone Type" driving exercises. These exercises are for learning and demonstrating basic operator skills. The suggested method for ambulance operation practical driving refresher training is the use of scheduled evaluations by supervisors. These evaluations should be scheduled by having supervisors assigned to respond to actual runs with the operator who will be evaluated. The operator should know well in advance of the dates when they will be evaluated and who will do the evaluation. The checklists provided in Module C can be used for recording the evaluations. The evaluator should have the opportunity to observe the operator in enough situations to provide a complete evaluation of the majority of the required tasks. When the evaluator has completed the evaluation, they should brief the operator on the results, recommend any corrective actions and submit the report to the operators supervisor. Copies of the evaluation forms are included in this supplement.

9. STANDARD OPERATING PROCEDURES (SOP)

Standard Operating Procedures are used to describe the administrative and operational procedures for the organization. When you want to know how to do something, you should be able to look in your SOP and find out how it is done. What are the uniform procedures? How do I clear an intersection when responding in an emergency mode? How do I get a quart of oil? Where do I get traffic information? These are only a few samples

of the many subjects that should be in an SOP.

Organizational SOPs are generally coordinated with other emergency response organizations to clarify roles and responsibilities for individuals and organizations.

SOPs are valuable references and are often reproduced in pocket size versions so that EMS personnel can carry a copy with them at all times. When in doubt - check the SOP. If your organization operates one ambulance or 100 ambulances, you should have an SOP. If your organization has no SOP, make it a priority to develop one as soon as possible. You may not have to start with a blank sheet of paper. Don't hesitate to call other EMS organizations and ask them for a copy of their SOP.

10. REFERENCES

The *Emergency Vehicle Operator Course (Ambulance): National Standard Curriculum* and other NHTSA courses were designed to be a reference. Each of these courses has a list of other references. Every organization should have reference materials available at each EMS facility and readily available to their EMS personnel.

There are also a variety of professional magazines and journals that provide industry information for the EMS profession.

11. SUMMARY

There are few things more rewarding than seeing people learn and acquire new job skills. How much they learn is often a direct result of how well the training was planned and conducted. Managers can ensure that all phases of the training are implemented within the limits of their resources and imagination.

There is an overriding factor to training that will determine the organizational effectiveness and that is the management philosophy and attitude. The professionalism of an organization can be assessed very quickly when you see how the personnel are dressed, the condition of their equipment and facilities and enthusiasm of the personnel. Managers set the example for every phase of the operation and training. Enthusiastic, professional managers spread this attitude to all members of the organization.

Enclosures

These are examples of the On-The-Job Training Checklists used in the *Emergency Vehicle Operator Course (Ambulance): National Standard Curriculum*.

Organizations can revise these checklists to meet local requirements.

Ambulance Familiarization Checklist

| Participant's name | Date | Vehicle make/number |
|---|------|---------------------|
| A. Ambulance description (verbal) | | 1 2 3 |
| 1. Ambulance class..... | | G G G |
| 2. Engine/transmission type..... | | G G G |
| 3. Height..... | | G G G |
| 4. Basic weight and load capacity..... | | G G G |
| 5. Installed emergency lights, sirens, horns..... | | G G G |
| 6. Installed life support equipment..... | | G G G |
| 7. Other..... | | G G G |

Comments:

| | | |
|--|--|-------|
| B. Use of installed equipment | | 1 2 3 |
| 1. Auxiliary power unit..... | | G G G |
| 2. On-scene floodlights..... | | G G G |
| 3. Emergency lights, sirens, horns..... | | G G G |
| 4. Operator compartment controls and switches. | | G G G |
| 5. Other..... | | G G G |

Comments:

All requirements have been met. YES NO

Instructor's signature _____ Date _____

I have seen the completed checklist and have been given an explanation of my performance.

Participant's signature _____ Date _____

THIS PAGE INTENTIONALLY LEFT BLANK.

Ambulance Inspection, Maintenance, and Repair Checklist

| Participant's name | Date | Vehicle make/number |
|--------------------|--|---------------------|
| A. Quick check | | 1 2 3 4 |
| 1. | Use of checklist..... | G G G G |
| 2. | Documentation of discrepancies..... | G G G G |
| 3. | Completion of Work Request..... | G G G G |
| 4. | Appropriate vehicle in-service decision..... | G G G G |
| 5. | Recordkeeping..... | G G G G |

Comments:

| | | |
|---------------|--|---------|
| B. Full check | | 1 2 3 4 |
| 1. | Use of checklist..... | G G G G |
| 2. | Documentation of discrepancies..... | G G G G |
| 3. | Completion of Work Request..... | G G G G |
| 4. | Appropriate vehicle in-service decision..... | G G G G |
| 5. | Recordkeeping..... | G G G G |

Comments:

| | | |
|---------------------------|---|-------|
| C. Maintenance and repair | | 1 2 3 |
| 1. | Use of Work Request..... | G G G |
| 2. | Preventive maintenance program..... | G G G |
| 3. | Maintenance and repair follow-up..... | G G G |
| 4. | Maintenance procedures for enroute malfunctions | G G G |

Comments:

All requirements have been met. YES NO

Instructor's signature _____ Date _____

I have seen the completed checklist and have been given an explanation of my performance.

Participant's signature _____ Date _____

THIS PAGE INTENTIONALLY LEFT BLANK.

Normal and High Risk Situations Checklist

| Participant's name | Date | Vehicle make/number |
|--|--|---------------------|
| A. Ambulance operation under normal conditions | | 1 2 3 4 5 |
| 1. | Road surfaces--asphalt, concrete, gravel, transition | G G G |
| 2. | Road surfaces--bumps, mud, potholes, misc. objects | G G G |
| 3. | Road construction--bridges, ramps, curves | G G G |
| 4. | Cornering skills..... | G G G G |
| 5. | Braking skills..... | G G G G |
| 6. | Accelerating skills..... | G G G G |
| 7. | Speed control..... | G G G G |
| 8. | Lane changes..... | G G G G |
| 9. | Passing other vehicles..... | G G G G |
| 10. | Backing--uses ground guide..... | G G G G G |
| 11. | Parking..... | G G G G |
| 12. | Turning around..... | G G G G |
| 13. | Operating on two-lane roads..... | G G G |
| 14. | Operating on interstate highways..... | G G G |
| 15. | Overall ambulance control..... | G G G G |
| 16. | Use of lights and turn signals..... | G G G G |
| 17. | Use of mirrors..... | G G G G |

Comments:

| | | |
|---|--|-----------|
| B. Ambulance operation under high risk conditions | | 1 2 3 4 5 |
| 1. | Use of lights and siren..... | G G G G G |
| 2. | Compliance with state and local regulations for emergency vehicles..... | G G G G G |
| 3. | Adherence to speed limits..... | G G G G G |
| 4. | Maintains safety cushion..... | G G G G G |
| 5. | Use of 2-4-12 Rule..... | G G G G G |
| 6. | Drives defensively..... | G G G G G |
| 7. | Response to potential crash situations..... | G G G |
| 8. | Communicates with other drivers..... | G G G G G |

-
- 9. Performs pre-crash planning..... G G G G G

 - 10. Controlled intersections
 - a. Use of lights and siren..... G G G G G
 - b. Approaches intersection cautiously G G G G G
 - c. Communicates with other drivers.. G G G G G
 - d. Looks to clear all other traffic.... G G G G G
 - e. Anticipates reactions of other drivers G G G G G
 - f. Moves through intersections with caution..... G G G G G

 - 11. Compliance with Law of Due Regard..... G G G G G

 - 12. Driving against traffic..... G G G

 - 13. Adverse weather
 - a. Preparation of ambulance..... G G G G
 - b. Response to visibility problems.... G G G G
 - c. Response to traction problems..... G G G G
 - d. Response to high winds..... G G G G

 - 14. Night driving
 - a. Maintains night vision capabilities. G G G G
 - b. Use of headlights..... G G G G
 - c. Ambulance control at night..... G G G G

 - 15. Response when ambulance runs off the edge of the road..... G G G

 - 16. Response to enroute malfunctions
 - a. Control of ambulance..... G G G
 - b. Pulling off the road and parking... G G G
 - c. Maintenance performed..... G G G

Comments:

All requirements have been met. YES NO

Instructor's signature _____ Date _____ I have seen the completed checklist and have been given an explanation of my performance.

Participant's signature _____ Date _____

Operational Driving Checklist

| | | |
|--------------------|------|---------------------|
| Participant's name | Date | Vehicle make/number |
|--------------------|------|---------------------|

A. Pre-run phase

1 2 3

- | | | | | |
|----|--|---|---|---|
| 1. | Ensures personal and crew readiness..... | G | G | G |
| 2. | Ensures readiness of ambulance..... | G | G | G |
| 3. | Plans primary and alternate routes..... | G | G | G |

Comments:

B. Operations phase

1 2 3

- | | | | | |
|----|---|---|---|---|
| 1. | Completes departure procedures..... | G | G | G |
| 2. | Operation of ambulance enroute to the scene | G | G | G |
| 3. | Assists EMT at the scene..... | G | G | G |
| 4. | Performs required emergency scene operations | G | G | G |
| 5. | Operation of ambulance enroute to medical facility..... | G | G | G |
| 6. | Performs required operations at the medical facility..... | G | G | G |

Comments:

C. Use of radio

1 2 3

- | | | | | |
|----|------------------------------------|---|---|---|
| 1. | Operation and test..... | G | G | G |
| 2. | Frequency selection..... | G | G | G |
| 3. | Security..... | G | G | G |
| 4. | Required calls..... | G | G | G |
| 5. | Complete and concise messages..... | G | G | G |
| 6. | Use of phonetic alphabet..... | G | G | G |

Comments:

| D. Verbal communications | 1 | 2 | 3 |
|---|---|---|-------|
| 1. With EMT enroute to scene..... | | | G G G |
| 2. With individuals at the scene..... | | | G G G |
| 3. With EMT enroute medical facility..... | | | G G G |

Comments:

| E. Post-run phase | 1 | 2 | 3 |
|---|---|---|-------|
| 1. Resupplies ambulance..... | G | G | G |
| 2. Cleans and decontaminates ambulance..... | | | G G G |
| 3. Prepares ambulance for next run..... | | | G G G |

Comments:

All requirements have been met. YES NO

Instructor's signature _____ Date _____

I have seen the completed checklist and have been given an explanation of my performance.

Participant's signature _____ Date _____