



ADMINISTRATION AND
MANAGEMENT

OFFICE OF THE SECRETARY OF DEFENSE
1950 DEFENSE PENTAGON
WASHINGTON, DC 20301-1950

JUL 10 2006

MEMORANDUM FOR: SEE DISTRIBUTION

SUBJECT: Compliance with Executive Order 13392

Reference: Department of Defense Freedom of Information Act (FOIA) Improvement Plan for Executive Order (EO) 13392, Improving Agency Disclosure of Information, June 14, 2006

The Department submitted the attached plan (Tab A) to the Attorney General and to the Director, Office of Management and Budget on June 14, 2006. The intent of this plan is to improve the FOIA process and to reduce FOIA backlogs in accordance with EO 13392.

In order to accomplish this goal, the Defense Freedom of Information Policy Office (DFOIPO) will periodically send out memoranda to your Component Chief FOIA Public Liaison Officer requesting information to support plan implementation. The first of these memos was sent out June 29, 2006, and is attached for your information (Tab B). This memo seeks input on the optimal organizational placement of FOIA Offices. It also requests manning data to determine the staffing shortfalls in FOIA Offices that routinely contend with FOIA case backlogs. Our intent is to capture the costs to significantly reduce FOIA backlogs for submission in the FY08 budget cycle.

As the DoD Agency Chief FOIA Officer, I am fully committed to the goals set forth in the DoD plan. I ask that you provide your Component Chief FOIA Public Liaison Officer the necessary support to implement the plan within your Component and to improve your FOIA Program.

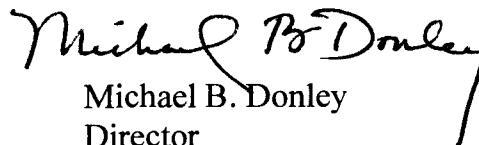
Michael B. Donley
Director

Attachments:
As stated



DISTRIBUTION:

**INSPECTOR GENERAL OF THE DEPARTMENT OF DEFENSE
DIRECTOR, DEFENSE COMMISSARY AGENCY
DIRECTOR, DEFENSE CONTRACT AUDIT AGENCY
DIRECTOR, DEFENSE CONTRACT MANAGEMENT AGENCY
DIRECTOR, DEFENSE FINANCE AND ACCOUNTING SERVICE
DIRECTOR, DEFENSE INFORMATION SYSTEMS AGENCY
DIRECTOR, DEFENSE INTELLIGENCE AGENCY
DIRECTOR, DEFENSE LOGISTICS AGENCY
DIRECTOR, DEFENSE SECURITY SERVICE
DIRECTOR, DEFENSE THREAT REDUCTION AGENCY
DIRECTOR, NATIONAL GEOSPATIAL-INTELLIGENCE AGENCY
DIRECTOR, NATIONAL RECONNAISSANCE OFFICE
DIRECTOR, NATIONAL SECURITY AGENCY/CENTRAL SECURITY SERVICE
ADMINISTRATIVE ASSISTANTS TO THE MILITARY DEPARTMENTS**



OFFICE OF THE SECRETARY OF DEFENSE
1950 DEFENSE PENTAGON
WASHINGTON, DC 20301-1950

14 JUN 2006

ADMINISTRATION AND
MANAGEMENT

MEMORANDUM FOR ATTORNEY GENERAL
DIRECTOR, OFFICE OF MANAGEMENT AND BUDGET

SUBJECT: Department of Defense (DoD) Freedom of Information Act (FOIA)
Improvement Plan for Executive Order (EO) 13392, Improving Agency
Disclosure of Information

On behalf of the Secretary of Defense and as DoD Chief FOIA Officer, I hereby submit the attached DoD FOIA Improvement Plan in compliance with EO 13392. The structure of this Plan follows the outline provided by the Department of Justice in implementing guidance published April 27, 2006.

DoD has considered EO 13392 a significant and long overdue opportunity to improve the FOIA Program. The internal FOIA Review was thorough and forthright, as evidenced by the depth and breadth of the Information Collection Plan and the substantive analysis of findings and observations. The remarkable response rate of over 90% to the FOIA Office survey reveals a FOIA workforce across DoD that is keenly interested in the FOIA process and genuinely intent on contributing to its improvement.

The FOIA Review confirmed with empirical evidence what had been intuitive to veteran FOIA managers:

- Customer responsiveness is generally good
- FOIA staff members are knowledgeable and motivated
- FOIA Office processes are sound but lack adequate IT support
- Backlogs are in FOIA Offices that manage volume and the more complex cases
- Inadequate FOIA staffing is a prime cause of backlogs
- Senior organizational leaders generally do not understand nor appreciate the FOIA process or the impact of untimely responses
- Job series and grade structures for FOIA staff members are nonstandard throughout DoD
- FOIA Websites need standards to better serve the public
- FOIA training is required at all levels
- Increased funding for FOIA operations is essential to the reduction of backlog

The DoD Improvement Plan concentrates on the following areas: organizational structure and manning; training; technology; and resources/backlogs – all selected based on their importance to the FOIA process. It is the Department's goal to execute the Improvement Plan as expeditiously as possible, within available resources.

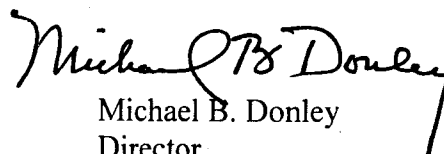
Michael B. Donley
Director

Attachment:
As stated





**Department of Defense
Freedom of Information Act
Executive Order 13392 Improvement Plan
June 14, 2006**

**Department of Defense
Freedom of Information Policy Office
1155 Defense Pentagon
Washington, D.C. 20301-1155**

Table of Contents

	<u>Page</u>
Executive Summary	iii
Part A – The DoD FOIA Program and Implementation of Executive Order (EO) 13392, Improving Agency Disclosure of Information	1
A.1. Introduction	1
A.2. Areas of Consideration for DoD FOIA Review	2
Part B – Areas Selected for Review	2
B.1. DoD FOIA Office Survey	2
B.2. DoD Component Chief Public Liaison Officer Survey	3
Part C – Results of Review	3
C.1. Information Collection Plan	3
C.2. FOIA Office Survey Population	4
C.3. FOIA Staff Demographics	4
C.4. FOIA Office Survey Findings and Observations – Information Source #1	4
C.5. DoD Component Chief Public Liaison Officer Findings and Observations – Information Source #2	7
C.6. Senior DFOIPO Findings and Observations – Information Source #3	10
Part D – Areas Chosen For Improvement	11
D.1. Organizational Structure and Manning	11
D.2. Training	11
D.3. Technology	11
D.4. Resources/Backlogs	11
Part E – Plans for Selected Improvement Areas	11
E.1. Name: Organizational Structure and Manning	11
Objective 1: Optimal organizational placement of FOIA Offices	11
Objective 2: Standardized job series and GS levels for FOIA Personnel	12
Objective 3: Establish standards within DoD for contracting FOIA functions	13

E.2.	Name: Training	14
	Objective 1: Develop DoD FOIA resident training program	14
	Objective 2: Develop a DoD FOIA online training capability within a newly created DFOIPO Website	15
E.3.	Name: Technology	15
	Objective 1: Analyze FOIA software for expanded use in streamlining DoD FOIA processes	15
	Objective 2: Standardize DoD FOIA Websites to enable better public access	16
	Objective 3: Conduct a feasibility study for a DoD-wide electronic network to expedite FOIA processing	17
E.4.	Resources/Backlog	18
	Objective 1: Determine manpower required to reduce backlogs in FOIA Offices that have backlogs over 50 requests	18
	Objective 2: Fund additional FOIA personnel staffing required to reduce backlogs in FY 08 and beyond	18
Part F – Grouping of Improvement Areas		19
	F.1. Areas anticipated to be completed by December 31, 2006	19
	F.2. Areas anticipated to be completed by December 31, 2007	20
	F.3. Areas anticipated to be completed after December 31, 2007	20
Part G – Summary		21
TABS:		
	A. Executive Order 13392 – Improving Agency Disclosure of Information, December 14, 2005	
	B. Deputy Secretary of Defense Memorandum, Executive Order (EO) 13392 on the Freedom of Information Act (FOIA), January 11, 2006	
	C. Director of Administration and Management Memorandum, Executive Order 13392 on the Freedom of Information Act (FOIA) – DoD Implementation, February 1, 2006	
	D. Chief Defense Freedom of Information Policy Office Memorandum, DoD Implementation of Executive Order 13392 on the Freedom of Information Act (FOIA), February 10, 2006	
	E. Department of Defense Freedom of Information Act Program Survey	
	F. Chief Defense Freedom of Information Policy Office Memorandum, Executive Order 13392 – Review of DoD FOIA Program, March 24, 2006	
	G. Department of Defense Freedom of Information Act (FOIA) Program Study, May 19, 2006	

Executive Summary

Department of Defense (DoD) Freedom of Information Act (FOIA) Improvement Plan for Executive Order (EO) 13392, Improving Agency Disclosure of Information

The review of FOIA operations within DoD has been thorough and comprehensive. The findings and observations have been drawn from survey data received from over 500 FOIA Offices DoD-wide. Additionally, DoD Component Chief Public Liaison Officers from 16 major headquarters and senior FOIA managers from the Defense Freedom of Information Policy Office (DFOIPO) also provided their perspectives on backlogs, customer service, adequacy of resources, FOIA Websites, and more.

The FOIA Review, supported by this highly effective Information Collection Plan, confirmed the following areas within DoD need improvement: organizational structure and manning; training; technology; and resources/backlogs.

Organizational structure and manning is an improvement area that will focus on the optimal placement of FOIA Offices to assure their visibility and support by senior leaders. This improvement area will also include the development of standardized job series and grade levels to better sustain the FOIA workforce. Standards for contracting FOIA functions are also an issue to address to assure a balance is maintained between the requirement for inherently governmental positions in FOIA management and the prudent use of skilled contractor personnel.

Training is a key improvement area that concentrates on the development of both resident and online FOIA training opportunities. This training is intended not only for FOIA Office staff, but also for their senior leaders and supporting legal advisors – a need frequently documented in survey responses.

Technology, the third DoD FOIA improvement area, will address the expanded use of FOIA software to streamline the process. Technology will also encompass the standardization of FOIA Websites within DoD to better enable public access. Also within this improvement area is the long-term objective to develop an electronic document control system that will serve FOIA applications on a DoD enterprise network.

These three improvement areas have been selected based on their overall impact on the FOIA. They primarily focus on the fundamentals of an effective FOIA process – a supported organizational structure; a well trained workforce; and the technological tools to enhance the effort. These three improvement areas are the critical enablers of the FOIA process.

The fourth area of improvement more narrowly targets backlog – a principal objective of EO 13392 – and the resources necessary to reduce it. Within DoD, elimination of backlog is not an attainable objective due to the extraordinary complexity of many FOIA requests for voluminous documents from multiple Component sources. Because defense issues routinely include the equities from other Federal Agencies, referrals consume considerable time. Additionally, the special handling given to the volume of highly classified documents responsive

to FOIA requests also adds time to the process. However, a measurable reduction of backlog is an attainable objective.

FOIA Office survey data established that the backlog issues in DoD are confined to a relatively small number of FOIA Offices. Approximately 48 DoD FOIA Offices (9%) reported a backlog greater than 50 cases. These FOIA Offices provided a strong survey response that they were not adequately funded or staffed. There is no backlog problem in the majority of smaller DoD Offices routinely processing a manageable number of FOIA requests. Survey data also showed that 58% of the backlog is at the headquarters level (28 of the 48 backlogged offices).

The DoD Improvement Plan will aggressively identify those FOIA Offices with backlogs greater than 50 cases; will determine the manpower required (Federal civilians and/or contractors) to significantly reduce the backlog; and will seek the necessary funding to provide this additional staffing.

The DoD FOIA Improvement Plan is ambitious, and the accomplishment of some objectives requires additional manpower and/or funding. The changes in policy and procedures reflected in this Plan will be institutionalized in the DoD Directives, Instructions, and Regulations that govern this program.



**Department of Defense
Freedom of Information Act
Executive Order 13392 Improvement Plan
June 14, 2006**

“Unique location in Baghdad, Iraq. Mail processing slow, slow IT [information technology] connections, lack of fax capability and ground transportation is dangerous.”

– One respondent’s answer to the Department of Defense (DoD) Freedom of Information Act (FOIA) survey item: “Please indicate the obstacles that impede FOIA processing.”

Part A – The DoD FOIA Program and Implementation of Executive Order (EO) 13392, Improving Agency Disclosure of Information

A.1. Introduction. DoD administers the largest, globally decentralized FOIA Program in the Federal Government. In fiscal year 2005, DoD completed 78,775 FOIA requests at an estimated cost of \$47,876,973. FOIA litigation related activities added another \$2,180,360 in estimated FOIA costs. The requests made to DoD encompass the most complex legal and administrative issues associated with the FOIA, to include the processing of significant amounts of classified information.

Of the 78,775 FOIA requests completed by DoD, the number of total grants (requesters received what they requested) was 36,587 (46%). The number of requests for information partially released was 15,307 (19%), and the total denials were 1,765 (2%). The remaining 25,116 (33%) requests were closed for other reasons, such as no responsive records were found and/or referrals were made to another appropriate agency. The FOIA exemption employed most often within DoD to deny information to requesters was Exemption 6, personal privacy. This exemption was used to deny information 10,327 times.

A stated objective of EO 13392 (TAB A) is for each Federal Agency to examine ways to eliminate or reduce FOIA backlog. Within DoD, elimination is not an attainable objective due to the extraordinary complexity of many FOIA requests for voluminous documents from multiple

Component sources. Because defense issues routinely include the equities from other Federal Agencies, referrals consume considerable time. Additionally, the special handling given to the volume of highly classified documents responsive to FOIA requests also adds time to the process. However, a measurable reduction of backlog is an attainable objective as this FOIA Review and Plan will explain.

DoD Components, consisting of the Military Departments, Joint Staff, Combatant Commands, and the Defense Agencies and Field Activities, are responsible for establishing and maintaining their own FOIA programs. Effective upon the publication of EO 13392, the Defense Freedom of Information Policy Office (DFOIPO) was established to serve as the responsible action office for the DoD Agency Chief FOIA Officer (ACFO) to implement the provisions of EO 13392 throughout the Department. The DFOIPO provides FOIA policy guidance to all of DoD and it oversees the Office of the Secretary of Defense (OSD) FOIA Office, which processes FOIA requests for the OSD and the Joint Staff (OSD/JS).

Following designation as DoD ACFO (TAB B), the Director of Administration and Management issued EO 13392 implementation guidance to DoD Components (TAB C). DoD Components were tasked to establish FOIA Public Liaisons and FOIA Service Centers. On February 10, 2006, the DFOIPO gave further guidance on the implementation of the EO, identified specific focus areas concerning the FOIA to be evaluated, and initiated a survey instrument to be used to collect data for the DoD FOIA Review (TAB D).

A.2. Areas of Consideration for DoD FOIA Review. As reflected in the February 10, 2006, DFOIPO memorandum, the areas of FOIA operations within DoD that were initially considered for review were:

- Current FOIA processes to identify reasons for Component FOIA Office backlogs
- Customer service practices by which the Component FOIA Office assists and informs the public on their respective FOIA processes
- Current IT systems and software used for FOIA processing
- Current resources committed to FOIA operations (funding, manpower, facilities, IT support, etc.)
- Component use of Websites to make information available to the public in compliance with 5 U.S.C. 552(a)(2)
- Component recommendations to resolve shortfalls identified above

Part B – Areas Selected for Review

B.1. DoD FOIA Office Survey. DFOIPO contracted a recognized specialist in the administration of Federal Agency surveys to develop and administer a unique survey that would capture data from FOIA managers and action officers at all levels within DoD. The contractor interviewed DFOIPO personnel and other key DoD FOIA managers to obtain information on the FOIA process. This comprehensive survey (TAB E) was sent electronically to over 600 FOIA Offices throughout DoD. The survey instrument was designed to address the specific FOIA areas identified in the February 10, 2006 DFOIPO memorandum. As reflected in the survey, these areas were:

- Identification of methods of communication with requesters
- Identification of methods of FOIA request tracking/control
- Primary redaction methods
- Percentages of requests associated with Initial Request categories
- The impact on backlog of various categories of processing time
- The current backlog in the office of the respondent
- The average number of initial requests received by the respondent's office per year
- Job satisfaction issues including perceived expertise and understanding of FOIA
- Resources, including personnel, equipment, and IT support available to respondent
- Respondent's perception of leadership, teamwork, and cooperation
- Level of customer service from respondent's office
- Obstacles impeding timely FOIA processing
- Respondent's recommendations to improve the FOIA process
- Position levels of FOIA staff in respondent's office
- Type of FOIA training received (if any) within respondent's office during the year
- Identification of DoD Component

B.2. DoD Component Chief Public Liaison Officer Survey. In addition to the survey, the DFOIPO queried the newly designated DoD Component Chief Public Liaison Officers to provide their managerial perspectives in a headquarters level assessment separate from the FOIA Office survey. As reflected in a March 24, 2006 DFOIPO memorandum (TAB F), DoD Chief Public Liaison Officers were asked to provide their perspectives on:

- Causes of FOIA backlogs
- FOIA customer service practices and managerial oversight
- IT available to support FOIA processing
- Current resources committed to FOIA processing
- Component compliance with Website requirements and applications
- Component vision for a FOIA process that meets the objectives of EO 13392

Part C -- Results of Review

C.1. Information Collection Plan. The DFOIPO developed an Information Collection Plan consisting of three separate feedback sources to conduct the DoD FOIA Review. The three primary sources were:

- The FOIA Office survey that was conducted by the contractors. These results were statistically significant with an estimated 90% response rate; 548 from an estimated 600 FOIA Offices responded. Additionally, the validity of the responses was high based on the remarkably high response rate and the quality of responses to open-ended questions.

- The input from DoD Component Chief Public Liaison Officers proved valuable from the perspective of DoD Component headquarters, often reinforcing the findings and observations from the FOIA Office survey responses. This narrowly focused data collection was also statistically significant with 16 of 17 Components responding.
- The invaluable experience of senior DFOIPO managers in administering the DoD FOIA Program; a combined total of 112 years experience in FOIA processing, customer service, policy, appeals, and litigation.

C.2. FOIA Office Survey Population. The survey was designed to solicit information from one staff member from each DoD FOIA Office, although the responses often reflect data on multiple staff members from the same FOIA Office. To be specific, there were 548 FOIA Office respondents to the survey out of an estimated total potential population of 600 FOIA Offices, with individual data provided from over 1200 military, civilian, and contract personnel performing FOIA functions. The contractors who administered the survey indicated that this survey generated an extraordinarily high response rate, a likely reflection of the high level of interest from DoD personnel who process FOIA actions. In addition to receiving revealing responses from the specific questions posed in the survey, a significant amount of relevant information was also collected from the analysis of responses to open-ended questions that prompted candid comments, recommendations, and insights.

C.3. FOIA Staff Demographics. The survey included a question on the grade levels of FOIA personnel. Of the 900 civilian personnel processing FOIA requests, 171 (19%) are levels of GS-1 to GS-7; 312 (35%) are GS-8 to GS-11; and 417 (46%) are GS-12 and above. There were 35 different civil service job series reported by the respondents. The survey shows that DoD personnel receive training in varied ways, but 23.6% indicated that they had never received any FOIA training in the FOIA.

Contractors involved in the processing of FOIA requests play a small but increasingly more important role within DoD. Although only 7.4% of the FOIA staff positions were identified as contract personnel, the use of contractors in processing FOIA requests has grown. In some DoD locations, such as the OSD FOIA Office, contract personnel provide over half the FOIA workforce.

C.4. FOIA Office Survey Findings and Observations – Information Source #1.

- The complete Program Study Report of survey findings is at TAB G. The findings are divided into three study areas: demographics, general results, and organizational climate. It also provides an analysis that compares these three study areas. A targeted analysis for two specific demographic groups was conducted for those FOIA Offices reporting more than 100 requests processed annually (128 or 23% of respondents), and those FOIA Offices reporting a backlog greater than 50 (48 or 9% of respondents). Despite their relatively small percentage of all 548 FOIA Offices, these two groups work the majority of DoD FOIA requests. Based on this observation, it was determined that an

organizational climate analysis of these two groups would be valuable in determining their perspectives on customer focus, job mastery, cooperation/teamwork, and available resources. The Program Study Report contains more detailed statistical analyses of the survey data than are summarized in this DoD FOIA Review.

- The organizational placement of FOIA Offices varies greatly within DoD. This inconsistency substantiates that FOIA Offices are sometimes placed within an organizational structure that can lead to a lack of emphasis on the FOIA program, or result in FOIA Offices not receiving adequate oversight or legal support. Survey data supported this finding. One of the lowest scoring survey questions on the strongly agree – strongly disagree scale was “*This office's FOIA staff is adequate for FOIA processing.*”
- The survey indicated high scores for DoD personnel in the area of communication with requesters. An average of 80% of respondents answered that they routinely accomplished the following actions: “*Acknowledgement of request receipt; Notification of request referral; Point of contact and telephone number provided; Resolve fees before processing the request; Interim communication at approximately 20 working days*”; and “*Requesters advised when they will receive a response.*” These positive responses were anticipated because DoD has established effective methods of communicating with requesters, and FOIA personnel routinely contact requesters to try to resolve problems and to better define requests.
- DoD uses a variety of methods to track and control FOIA requests. 57% most often use a manual or paper system with only 21% of the respondents currently using specialized FOIA software. 80% of the offices surveyed accept FOIA requests electronically. Only 54% reported having a specific telephone number available for FOIA inquiries and only 46% said there was a FOIA Website dedicated for their activity or location. Questions on methods of redaction revealed that the overwhelming majority (81%) of respondents still use manual redaction methods and are not using redaction software currently available in the commercial market.
- A recurring theme throughout the survey comments indicates FOIA Officers believe they are not adequately supported by their senior leadership, and the organizational climate scores for specific target groups indicate this lack of support is a contributing factor to large backlogs. Even though these comments on leader support were primarily from installation/activity level respondents within the Services, they did come from all levels throughout DoD. One respondent stated: “[not] having management’s support makes it very hard to get the OPRs [Offices of Primary Responsibility] to respond in a timely manner,” while another said, “Something needs to be done through the chain of command to management explaining the importance of this program ... [Make] the FOIA program a special interest item so commanders can brief their people that processing a FOIA is

vitaly important. If we lead from the head down there won't be as many problems." When we review these comments with climate scores from the survey, we note the following:

- Concerning the survey item "*The leadership of this activity supports the FOIA program,*" the total population of respondents strongly agreed with this item and rated it highly. However, the scores for the two chosen target groups, those with volume (number of FOIA requests received annually) greater than 100 and those with backlogs greater than 50 cases, rated this item lower.
- A more in-depth study of these scores for the target groups reveals more telling statistics. For the survey item "*Other offices involved in FOIA processing cooperate to achieve FOIA program goals,*" the target groups scored in the high range. For the item "*This office receives timely responses from offices tasked for record search and review,*" the scores associated with this item were in the medium to low range; meaning few responding FOIA Offices agreed with the statement. These comments and statistics appear to show a direct correlation between senior leader support for the FOIA Program and large backlogs.
- Two conclusions can be drawn here, particularly from FOIA Offices with large backlogs: 1 – DoD officials who are tasked by FOIA Offices to process requests need FOIA awareness training; and 2 – the senior staff at all levels of DoD must be made aware of the importance of the FOIA and need to emphasize this within their organizations, especially to the office of primary responsibility (OPR) charged to search and review FOIA requests.
- Questions concerning the processing of requests revealed that searches for documents are required 68.3% of the time, and that a thorough response is received by the due date 62.8% of the time. These statistics indicate that a high frequency of time-consuming searches for responsive documents is a primary reason for FOIA Offices failing to respond within the statutory 20-day time period and, subsequently, is a prime cause of case backlog. Note that most searches and reviews are required to be conducted by OPRs outside of the FOIA Offices.
- The issue of FOIA backlog is a primary concern of EO 13392. DoD routinely compiles backlog statistics for the Annual FOIA Report submitted to the Department of Justice, and DoD awareness and concern for FOIA backlog is well documented. The DoD review for the EO revealed that the Components with the biggest backlogs, as expected, are the ones that have the most resource concerns. While this is not a surprise, the data from the survey establishes that the backlog issues in DoD are confined to a relatively small number of FOIA Offices. Approximately 48 DoD FOIA Offices (9%) reported a backlog greater than 50 cases. These FOIA Offices provided a strong survey response that they were not

adequately funded or staffed. There is no backlog problem in the majority of smaller DoD Offices routinely processing a manageable number of FOIA requests. Survey data also showed that 58% of the backlog is at the headquarters level (28 of the 48 backlogged offices).

- A standard part of most professionally administered surveys is the measurement of job satisfaction. DoD was especially interested in these measurements because of a perceived high level of turnover of FOIA Staff. However, the job satisfaction climate reported by DoD FOIA Office personnel was rated high on the survey's strongly agree – strongly disagree scale. No differences were observed in job satisfaction ratings between the headquarters, intermediate and installation/activity levels. The areas comprising job satisfaction included job mastery, available resources, cooperation/teamwork, and customer focus. When the job satisfaction data was analyzed, DoD FOIA Offices having the larger backlogs, not surprisingly, were the ones that had the lower job satisfaction ratings. The deficient areas most often cited by these FOIA Offices with the higher backlogs are adequate resources and proper training. Specifically, budget allocations were given the lowest score out of any climate assessment question in the survey. The next lowest deficient areas were adequate numbers of FOIA personnel and administrative support. Interestingly, those FOIA Offices with the largest backlogs scored highest on the following climate items: *“This FOIA office is responsive to customer inquiries; The FOIA staff in this office understands their FOIA roles and responsibilities”*; and *“The FOIA staff in this office has the expertise and judgment required for FOIA processing.”* Collectively, these measures indicate FOIA Offices, despite their backlog, have a high level of job satisfaction, as defined by the variables of job competence and responsiveness.

C.5. DoD Component Chief Public Liaison Officer Findings and Observations – Information Source # 2

- Findings from DoD Chief Public Liaison Officers mirror many of those from the FOIA Office survey. The Chief Public Liaison Officers stated that effective FOIA processes are in place, and responsive customer service has generally been established enabling requesters to obtain information about their requests.
- Inadequate resources dominate the concerns presented by the Chief Public Liaison Officers. One Chief Public Liaison Officer stated: “Backlogs are prevalent in large organizations that lack adequate personnel resources to process requests.” The overall tone of their responses was that FOIA personnel are doing the best they can in a Federal Agency that in recent years has had budget cuts that have affected their FOIA Programs.
- DoD Chief Public Liaisons agree with the findings of the survey that backlogs exist in the FOIA Offices that have the most resource concerns. These concerns were succinctly stated by two Components: “Many FOIA Offices throughout...have backlogs due primarily to lack of resources” and “The

personnel and financial resources committed to FOIA...are inadequate.” One Component noted that resource concerns are not new: “In the early years, there were only one or two case officers assigned to process all requests...” Another Chief Public Liaison stated: “During the past six years, the...FOIA staff was cut from six to three... employees,” and that their office “could meet the criteria of Executive Order 13392 as well as the FOIA by tripling the number of ...employees on its FOIA staff and supplementing them with 10 contractor employees...” Other factors affecting backlogs voiced by the Chief Public Liaison Offices include failure of record custodians to provide timely responses to FOIA Offices and review time required by their staff attorneys. Comments about time consuming reviews from attorneys included: “Review by command attorneys takes time because of their other commitments,” and “sending all FOIA actions to the servicing legal office causes a bottle-neck affect and timeliness of review decreases exponentially.”

- Most FOIA Offices within DoD already have established effective customer practices consistent with the provisions of EO 13392. Many FOIA Offices within DoD were set up years ago and have reputations for excellent relationships with FOIA requesters. One Component Chief Public Liaison Officer stated, “Many FOIA positions...have established customer service as a standard that is evaluated when preparing annual performance appraisals.” Another observed, “The ...FOIA office places a high value on being responsive to FOIA requesters. The ...Chief of FOI...frequently contacts requesters telephonically or via email so that ambiguous requests can be clarified.” This spirit of customer service prevalent within DoD was summed up in this quote from another Chief Public Liaison Officer, “...[our FOIA Office] has always worked closely with the requester community to meet their needs. We frequently contact requesters by phone to discuss their cases, helping them to clarify, helping them to focus/narrow their requests, and/or explaining the FOIA process.”
- Conversely, survey questions on managerial oversight revealed that emphasis needs to be placed on FOIA programs in some DoD Components. One Chief Public Liaison Officer said, “FOIA doesn’t receive the support it should from immediate supervisors and top management...FOIA Officers have complained that they are not allowed to attend FOIA training due to budget constraints...Some have complained about poor service from their office of counsel.” Other DoD Components reported no problems with management oversight as reflected by one Chief Public Liaison Officer who indicated, “We enjoy autonomy in managing our program based on our reputation...”
- Although some DoD Components have purchased or developed FOIA time-saving redaction or other FOIA software programs, most do not have modern IT solutions for FOIA. As one DoD Component stated, “At this point ... [our Component] does not have any information technology programs to support our FOIA processing...due to lack of funding... [and] still does not have any supporting information technology software to process and track FOIA requests.”

Some Components indicated they would like to purchase FOIA software but cannot due to budget concerns within their IT departments. In general, because of IT budget concerns and the requirement that redaction software pass security standards, some Chief Public Liaison Officers point out that IT support for FOIA is problematic. One Component stated, “We have no redaction software. Previously, software was tested...but would not pass the security side of the house...All redaction is done with [an]X-Acto knife by the FOIA officer.” Another Public Liaison Officer agreed saying, “We lack the necessary software to perform electronic redactions...we are reliant upon them [supporting IT staff] to test and approve software packages for deployment...It is over two years and we are still awaiting approval...”

- The comments from the Chief Public Liaison Officers on resource issues parallel their comments concerning FOIA backlog. Their subjective input, when combined with the survey data, reinforces the finding that most of the FOIA resource concerns in DoD are from the FOIA Offices with the highest backlogs. Chief Public Liaison Officers drew on their experience and illuminated other unique concerns regarding resources such as, “...it is extremely difficult to recruit at the General Schedule (GS) 11/12 grades,” and “...FOIA is a very specialized area and FOIA trained candidates are not easy to find...Finding candidates who understand the intricacies and relationships...are difficult to find.” These comments demonstrate the difficulty in finding and retaining the uniquely qualified personnel essential to successful FOIA Offices. Some Chief Public Liaison Officers believe that senior management is sympathetic to FOIA resource issues, but funding for FOIA is perceived to be a low priority.
- DoD Chief Public Liaison Officers expressed differing opinions on compliance by their FOIA Offices with Website requirements. This is due to DoD’s decentralized FOIA Program and a lack of DoD wide standards. Many Components thought their FOIA Office web applications were current and adequate. Others indicated that there was work to be done in making more information available to the public on FOIA Office Websites. Those Chief Public Liaison Officers who agree that FOIA Websites need improvement cite as contributing factors a lack of dedicated resources and a misunderstanding on the part of some senior managers on what is required to be put on FOIA Websites.
- DoD Chief Public Liaison Officers were asked to give their visions for a more effective FOIA process within their Component. As expected, additional resources was the principal outcome hoped for in the implementation of EO 13392. Additional resources would be used to address backlogs and provide even better customer service. As one Component states, “However, this is an unlikely scenario in the near future.” The responses to this question indicated that the Chief Public Liaison Officers are realistic about where FOIA Offices stand within Component funding priorities.

- The Chief Public Liaison Officers would also like to see the FOIA Offices better located within their organizations to facilitate higher visibility commensurate with the importance of their FOIA Programs. Some of the Public Liaison Officers also expressed the desire to see standardized job series and grades for FOIA personnel to provide for potential advancement in a professional FOIA career field. They also want to see a certification program for FOIA Officers to improve their professional standing.

C.6. Senior DFOIPO Findings and Observations – Information Source #3

- The DFOIPO senior staff agrees the issue of resources dedicated to processing FOIA requests is a major concern within DoD.
- The DFOIPO staff has observed an increase in litigation resulting from untimely responses to FOIA requests, which can be traced to DoD Component backlogs. Although the survey found only 9% of DoD FOIA Offices report a backlog of more than 50 cases, those same offices are more likely to be engaged in costly and time-consuming FOIA litigation as a result of the backlog.
- The DFOIPO staff has heard many comments over the years concerning the placement of the FOIA function within DoD Component organizational structures. Although evidence indicates this is a problem in all categories of DoD Component, it is especially problematic at the installation/ activity level. When the FOIA function is subordinated within an activity at a level far removed from the senior leadership, the results are often detrimental to the efficient functioning of the FOIA Program.
- Frequently, the position descriptions of FOIA staff personnel are insufficient to adequately reflect their responsibility and authority. DFOIPO has observed that this deficiency significantly impairs the ability to increase the grade level of the FOIA position commensurate with responsibility and authority. This is a concern at all levels throughout the Department.
- The issue of employing contractors to process FOIA requests has become a more prevalent issue in recent years. Because FOIA is an inherently governmental function, outsourcing this function must be controlled. Because FOIA Officers often exercise judgment in determining releasability of documents, the assessment of fees, and expedited processing, FOIA Officer positions can not be outsourced and must be filled by Federal employees in an inherently governmental position.
- Consistent with the responses from DoD Chief Public Liaisons, the DFOIPO recognizes a legal review of all FOIA actions prior to final disposition often increases FOIA processing time and backlogs. It is recognized that legal reviews are necessary in many cases; however, because DoD attorneys, both civilian and military, are already overburdened with more pressing legal issues, their FOIA case load is often given a low priority.

Part D – Areas Chosen For Improvement

The DoD FOIA Program is a decentralized effort with many and varied DoD Component organizations, missions, functions, and locations. The results of the review undertaken in accordance with EO 13392 reveal many positives about the DoD Program. There are, however, areas that require improvement. Of the many subject areas reviewed, the FOIA areas selected by DoD as areas for improvement are:

D.1. Organizational Structure and Manning

- Optimal organizational placement of FOIA Offices
- Standardized job series and GS levels
- Standards for contracting of FOIA functions

D.2. Training

- Resident FOIA training
- Online FOIA training

D.3. Technology

- Use of FOIA software to streamline processing
- Enhanced FOIA Websites to increase public knowledge
- A DoD wide electronic network to expedite FOIA processing

D.4. Resources/Backlogs

- Focus on specific FOIA Offices where problems exist
- Increased personnel resources to help reduce backlogs

Part E – Plans for Selected Improvement Areas

E.1. Name: Organizational Structure and Manning

- **Objective 1: Optimal organizational placement of FOIA Offices** – Provide guidance to DoD Components on the optimal organizational placement of FOIA Offices. The survey revealed that DoD FOIA Offices are placed within a variety of different organizational elements. In some instances, FOIA Offices are within a functional organization like IT systems and services that are unrelated to the FOIA mission. This occurs at all levels of DoD. The goal is to determine where the FOIA Offices are currently placed and to establish consistent standards within the Department to maximize the effectiveness of all FOIA Offices. The intent is to raise the visibility and level of importance of the FOIA Office to more effectively garner senior leader support.

- **Steps to be taken:**
 - Survey DoD Components to determine where FOIA Offices are currently placed and to solicit recommendations for optimal placement in their organizational structures
 - Analyze DoD Component responses
 - Develop a DoD proposal for optimum FOIA Office placement at all DoD levels

- **Milestones:**
 - Jun 30, 2006 – DoD Components requested to provide recommendations for the optimum organizational placement of their FOIA Offices; response due Aug 15, 2006
 - Sep 15, 2006 – DFOIPO memo published recommending where DoD Components should place their FOIA Offices
 - Jan 15, 2007 – DoD Components provide initial progress reports on implementation and quarterly thereafter
 - Dec 2007 – DoD Components implement changes to organizational structure

- **Means of measuring success/outcomes:**
 - DoD Components implement organizational changes
 - FOIA Offices are more visible and effective

- **Objective 2: Standardized job series and GS levels for FOIA personnel** – The review revealed a multitude of job series for DoD FOIA personnel that may be affecting their job advancement opportunities and professional training and development. Additionally, the review suggests that there are DoD civilian personnel performing critical FOIA functions at improperly low grade levels. One objective is to establish a standard job series for FOIA personnel within DoD and work towards the establishment of an Office of Personnel Management (OPM) career field for FOIA personnel across all Federal Agencies. Another objective is to standardize grade levels of DoD FOIA personnel. To support these goals, a standardization of position descriptions within DoD is warranted.

- **Steps to be taken:**
 - DoD Components recommend one single job series for civilian FOIA personnel, and to offer recommendations on standardizing grade levels for civilian personnel in the FOIA job series
 - DFOIPO publishes recommended wording to be used within the position descriptions of DoD FOIA personnel
 - With the assistance of the Human Resources Directorate (HRD) of Washington Headquarters Services, DFOIPO attempts to establish a specific job series for FOIA personnel within DoD
 - DFOIPO establishes recommended standard grade levels for DoD personnel processing FOIA requests

- Once these standards are established within DoD, DFOIPO works with HRD and OPM to establish standards for job series and grade levels for FOIA personnel government wide
- **Milestones:**
 - Jul 14, 2006 – DoD Components requested to provide input and recommendations on job series and grade levels for FOIA personnel; responses due Oct 30, 2006
 - Sep 15, 2006 – DFOIPO publishes standard position descriptions for DoD FOIA personnel
 - Feb 2007 – DFOIPO establishes specific job series and designates grade levels for DoD FOIA personnel
 - Mar 2007 – DFOIPO coordinates with HRD and OPM to standardize grade levels and job series for FOIA personnel government wide
- **Means of measuring success/outcomes:**
 - Establishment of standard job series for FOIA personnel within DoD
 - Establishment of standard grade levels for DoD FOIA personnel
 - Standard position descriptions of FOIA personnel that accurately reflect the responsibility and authority required of the FOIA function
 - DoD FOIA personnel transitioned into common job series at appropriate grade levels
 - Long range – Establishment by OPM of a government wide FOIA Career Field with centralized oversight of professional development and staffing standards.
- **Objective 3: Establish standards within DoD for contracting FOIA functions –**
The review has shown that contractors currently support FOIA Offices within some DoD Components. The objective is to establish standards within DoD on what FOIA functions are inherently governmental, thus exempt from outsourcing.
- **Steps to be taken:**
 - DoD Components advise DFOIPO on what FOIA Offices have contract support and which have outsourced their entire FOIA function due to an A-76 review
 - DFOIPO obtains legal review of inherently governmental determinations
 - DFOIPO publishes guidance defining the limits of outsourcing the FOIA function
- **Milestones:**
 - Aug 4, 2006 – DoD Components survey their use of contractors and document any A-76 outsourcing of FOIA functions; responses due Oct 30, 2006
 - Oct 16, 2006 – DFOIPO obtains legal review on the applicability of outsourcing an activity's FOIA responsibility

- Dec 15, 2006 – DFOIPO issues standards for contracting FOIA operations in DoD
- **Means of measuring success/outcomes:**
 - Number of DoD Components that report information by due date
 - No outsourcing of FOIA functions within DoD that includes inherently governmental positions; potential increase in outsourcing of other non-inherently governmental positions

E.2. Name: Training

- **Objective 1: Develop DoD FOIA resident training program** – According to the survey, only 76.7% of FOIA personnel have received any FOIA training. Additionally, comments provided by the survey respondents indicate their senior leaders and staff attorneys lack an understanding of the requirements of the FOIA. The goal is to develop plans for resident training to include a FOIA Officer Certification Program. Funding sources for this training development will also be addressed.
- **Steps to be taken:**
 - DFOIPO and the Component Chief Public Liaison Officers develop plans to conduct resident training for the FOIA workforce, senior leaders, and staff attorneys on a biennial basis
 - Military Departments requested to determine the feasibility of adding/increasing FOIA training to the curriculum at Service Judge Advocate General Schools
 - DFOIPO develops a FOIA Officer Certification Program built on completion of training and service in a FOIA position
- **Milestones:**
 - Jul 17, 2006 – DoD Components requested to identify their resident training requirements and their plans to provide this training; responses due by November 24, 2006
 - Jul 17, 2006 – Military Services requested to study the feasibility of adding/increasing FOIA training to JAG school curriculum; responses due by October 16, 2006
 - Dec 15, 2006 – Concept for FOIA Officer Certification Program approved; implementation pending deployment of FOIA training
- **Means of measuring success/outcomes:**
 - FOIA Officers attend FOIA training on a regular basis; the percentage of FOIA Officers trained to be tracked as a performance metric
 - DoD attorneys, both military and civilian, have a fundamental knowledge of the FOIA; the percentage trained to be tracked as a performance metric

- Senior leaders have a better understanding and appreciation for their FOIA Programs; the percentage trained to be tracked as a performance metric
- A DoD FOIA Officer Certification Program is implemented concurrent with deployment of a DoD FOIA training plan
- **Objective 2: Develop a DoD FOIA online training capability within a newly created DFOIPO Website** – A comprehensive online DoD FOIA training capability designed to reinforce resident training will keep DoD FOIA personnel current as well as provide a starting point for incoming personnel. The product, to be contracted, would provide basic and advanced training as well as to serve as an additional vehicle for DoD FOIA personnel to receive guidance from DFOIPO on policy matters and to get technical responses to specific policy or procedural questions.
- **Steps to be taken:**
 - FOIA online training capability submitted in the FY 08 budget
 - Process online training contract
 - DFOIPO works with contractor to establish content of training modules
 - Establish final training modules on DFOIPO Website
- **Milestones:**
 - Aug, 2006 – Budget submission to OSD for FOIA online training
 - Mar, 2007 – Submit bid to contract for the FOIA online project
 - Sep, 2007 – Contract awarded; development of training modules begins
 - Jul, 2008 – Online training modules established on FOIA Website
- **Means of measuring success/outcomes:**
 - FY08 budget proposal approved to establish DoD online training project
 - Contract awarded to establish online training in FY 08
 - FOIA online training modules are established on DFOIPO Website
 - Access to online training Website measured to assure ever increasing use

E.3. Name: Technology

- **Objective 1: Analyze FOIA software for expanded use in streamlining DoD FOIA processes** – Provide guidance to Components on options available for FOIA software and electronic redaction solutions and improve the FOIA-IT funding/procurement process. The survey revealed that only 19% of FOIA Offices within DoD are currently utilizing FOIA software suites or redaction modules. The goal is to make all DoD Components aware of electronic options available to them and encourage their purchase and use if FOIA workload warrants the expense. Additionally, DoD Components report difficulty purchasing FOIA software, thus requiring review and improvement of current IT budget/procurement processes that support FOIA operations.

- **Steps to be taken:**
 - Conduct a FOIA software use and applicability study; document FOIA software applications currently in use in DoD FOIA Offices; determine potential applications for future use
 - Provide guidance to Components on options available for FOIA software and electronic redaction solutions to include expected system performance standards and vendor identification
 - Establish security standards within DoD for redaction software
 - Establish liaison with DoD IT funding and procurement agents to examine IT budgeting/procurement processes; to eliminate budgetary impediments; to facilitate procurement of FOIA software; and to implement FOIA software policies within DoD

- **Milestones:**
 - Jul 14, 2006 – FOIA software standards, commercial options, and vendors defined
 - Aug 22, 2006 – DoD Components conduct an internal FOIA software use and applicability study; responses due October 2, 2006
 - Jun, 2007 – Complete review of IT budgeting/procurement process that supports FOIA
 - Sep, 2007 – Establish security standards within DoD for FOIA software
 - Oct, 2007 – Implement policy within DoD to facilitate purchase of FOIA software

- **Means of measuring success/outcomes:**
 - DoD Components have an understanding of the performance standards expected from FOIA software and the products that are available
 - Under Secretary of Defense for Intelligence establishes standards for redaction software
 - DoD Component studies received by DFOIPO by due date
 - DoD Components better understand and manage their budgeting/procurement processes to purchase FOIA software
 - Long Range – Increase in the number of DoD Components using FOIA software

- **Objective 2: Standardize DoD FOIA Websites to enable better public access –** Develop a DFOIPO Website as a platform for online training, promulgation of policy and procedures, other FOIA network communications, and customer service feedback. Develop and implement a policy for standardizing DoD Component Websites. Currently, DoD FOIA Websites are inconsistent in fulfilling the requirements set forth in the 1996 Electronic Freedom of Information Act amendments. The goal is to implement policy across DoD, to standardize DoD FOIA Websites, and to enable better public access.

- **Steps to be taken:**
 - Establish DFOIPO Website
 - Establish standards for all DoD Websites
 - Issue standards to DoD Components to improve FOIA Websites
 - Monitor progress of improvements to DoD Websites

- **Milestones:**
 - Aug 31, 2006 – Establish DFOIPO Website
 - Sep 22, 2006 – Publish standards for improving DoD Websites
 - Jan 31, 2007 – Complete DoD improvements to Websites; continue to monitor

- **Means of measuring success/outcomes:**
 - DFOIPO Website functional by Aug 31, 2006 with links established to all DoD Component FOIA Websites
 - Increase in percentage of DoD Components having FOIA Websites
 - Increase in percentage of DoD Components posting frequently requested documents and providing pertinent information to the public

- **Objective 3: Conduct a feasibility study for a DoD wide electronic network to expedite FOIA processing** – There is no existing IT network that links DFOIPO with all DoD Components and their FOIA Offices capable of transmitting both unclassified and classified materials responsive to FOIA requests. Additionally, there is no existing network for DoD FOIA Offices to refer classified FOIA requests to all other Federal Agencies with equities in the materials. Throughout DoD and the other Federal Agencies there are some FOIA Offices equipped with classified SIPRNET email systems that serve the purpose, but these capabilities are rare. In most situations, classified FOIA cases are either hand-carried or mailed, an inefficient and time-consuming process. The long-term intent is an electronic document control system that will serve FOIA applications on a DoD enterprise network. The pace of developing such a DoD enterprise network will be driven by many considerations to include cost, technology, and applications other than FOIA.

- **Steps to be taken:**
 - Form an integrated processing team (IPT) from Component FOIA and IT staffs
 - IPT determine the requirements for this system
 - IPT examines IT systems that will support the requirements
 - IPT documents findings in feasibility study to include cost considerations
 - DFOIPO makes recommendations to ACFO on system procurement and deployment
 - If approved and funded, DoD electronic FOIA network established

- **Milestones:**
 - Oct, 2006 – Form IPT

- Jun, 2007 – IPT completes feasibility study
- Jul, 2007 – Decision brief to ACFO
- Aug, 2007 – If approved, submit funding for FY 09
- **Means of measuring success/outcomes:**
 - A DoD wide electronic FOIA network is determined to be feasible
 - The network is approved and funded
 - The network is established

E.4. Resources/Backlog

- **Objective 1: Determine manpower required to reduce backlogs in FOIA Offices that have backlogs over 50 requests** – One of the key points of the survey was the correlation between FOIA Offices with backlogs over 50 requests and FOIA Offices believed to have adequate manpower resources. Since the survey indicated backlog and resource concerns within DoD appear to be concentrated within FOIA Offices with backlogs over 50, these specific offices must be identified for further analysis and targeting of potential manpower resource allocations.
- **Steps to be taken:**
 - DoD Components identify FOIA Offices with routine backlogs over 50 requests
 - DFOIPO evaluates information
 - Targeted FOIA Offices are identified and discourse begins with DoD Components on levels of resources provided these FOIA Offices
 - Increased staffing plan developed for targeted FOIA Offices
- **Milestones:**
 - Jul 14, 2006 – DFOIPO requests DoD Components identify FOIA Offices with routine backlogs of over 50; response due Aug 1, 2006
 - Aug 15, 2006 – Increased staffing plan developed for targeted FOIA Offices
- **Means of measuring success/outcomes:**
 - The number of FOIA Offices identified as having backlogs of over 50 parallels the number identified on the survey – a validation of survey findings
 - FOIA Offices with backlogs over 50 are targeted for further analysis to determine specific resource requirements
 - Increased manpower staffing plan developed for FY 08 funding consideration
- **Objective 2: Fund additional FOIA personnel staffing required to reduce backlogs in FY 08 and beyond** – The DoD FOIA Review for EO 13392 has clearly revealed FOIA personnel shortages in FOIA Offices with backlogs. In the absence of specific appropriations from Congress for FOIA, budgeting for additional FOIA personnel within DoD must be included in the FY 08 (and beyond) planning cycle. Accordingly, DFOIPO and the OSD FOIA Office requested additional resources in

the FY 08 budget. To comply with the provisions of the EO, specific budgeting for FOIA resources must also be accomplished by DoD Components for their FOIA Offices with backlogs over 50.

- **Steps to be taken:**
 - DFOIPO/OSD FOIA Office submits FY 08 budget request
 - FY 08 funding sought for DoD wide increased manpower staffing to include consideration of both Federal civilian and contractor personnel.

- **Milestones:**
 - Jun, 2006 – DFOIPO/OSD FOIA Office submits FY 08 budget requirements
 - Aug 15, 2006 – Funding request submitted for increased staffing plan developed for targeted FOIA Offices
 - Mar, 2007 – If funded, hiring process begins for new FOIA personnel within DFOIPO and OSD FOIA Office
 - FY 08 – If funded, increased FOIA staffing across DoD

- **Means of measuring success/outcomes:**
 - The FY 08 budget approved for OSD FOIA operations to include increased staffing for DFOIPO to implement this Improvement Plan
 - The FY 08 budget approved for DoD wide increased manpower staffing plan
 - New FOIA personnel are hired in DFOIPO/OSD FOIA Office
 - FOIA Offices that routinely have backlogs over 50 are adequately staffed commensurate with FOIA workload
 - Long Term – FOIA backlogs are significantly reduced

Part F – Grouping of Improvement Areas

F.1. – Areas anticipated to be completed by December 31, 2006

- **Organizational Structure and Manning**
 - DFOIPO issues standards for contracting FOIA operations in DoD
 - Manpower requirements (GS and contractor) submitted for funding in FY 08

- **Training**
 - FOIA resident training requirements are documented
 - FOIA online training capability submitted in the FY 08 budget
 - Concept approved for a DoD FOIA Officer Certification Program

- **Technology**
 - DFOIPO Website functional and links established to all DoD Component FOIA Websites
 - Significant increase in the percentage of DoD Components having FOIA Websites designed to standard

- **Resources/Backlog**
 - Increased manpower staffing plan for DFOIPO/OSD FOIA Office developed for FY 08 funding
 - Increased manpower staffing plan for DoD Component FOIA Offices developed for FY 08 funding

F.2. – Areas anticipated to be completed by December 31, 2007

- **Organizational Structure and Manning**
 - DoD Components implement organizational changes, where necessary, regarding placement of FOIA Offices
 - Establishment of standard job series for DoD FOIA personnel
 - Establishment of standard grade levels for DoD FOIA personnel
 - Standard position descriptions documented and effective for FOIA personnel that accurately reflect the responsibility and authority required of the FOIA function
- **Training**
 - A DoD FOIA Officer Certification Program is implemented concurrent with deployment of the DoD FOIA training plan
- **Technology**
 - DoD Components have an understanding of the performance standards expected from FOIA software and the products that are available
 - DoD Components better understand and manage their budgeting/procurement processes to purchase FOIA software
 - Increase in percentage of DoD Components posting frequently requested documents and providing pertinent information to the public
 - Feasibility determined for a DoD wide electronic FOIA network
- **Resources/Backlog**
 - If funded, new FOIA hiring process begins (Oct-Dec 07) to augment DFOIPO to implement this FOIA Improvement Plan
 - If funded, new FOIA hiring process begins (Oct-Dec 07) to reduce backlogs in targeted DoD FOIA Offices

F.3. – Areas anticipated to be completed after December 31, 2007

- **Organizational Structure and Manning**
 - Establishment by OPM of a government wide FOIA Career Program with centralized oversight of professional development and staffing standards
 - DoD FOIA personnel transitioned into common job series at appropriate grade levels
- **Training**
 - Online training modules established

- FOIA Officers attend resident FOIA training on a biennial basis; the percentage of FOIA Officers trained increases
- DoD attorneys attend resident FOIA training on a biennial basis; the percentage of attorneys trained increases
- Senior leaders attend resident FOIA training on a biennial basis; the percentage of senior leaders trained increases
- **Technology**
 - Increase in the number of DoD Components using FOIA software
 - If feasible, approved, and funded, a DoD wide electronic FOIA network to be implemented
- **Resources/Backlog**
 - DFOIPO is adequately staffed to successfully implement the long-term objectives of this Improvement Plan and EO 13392
 - FOIA Offices that routinely have backlogs over 50 are adequately resourced commensurate with FOIA workload
 - FOIA backlogs are significantly reduced

Part G – Summary

The FOIA Review, supported by a comprehensive and highly effective Information Collection Plan, confirmed the following areas within DoD need improvement: organizational structure and manning; training; technology; and resources/backlogs. The Improvement Plan is ambitious, and the accomplishment of some objectives requires additional manpower and/or funding. The changes in policy and procedures reflected in this FOIA Improvement Plan will be institutionalized in the DoD Directives, Instructions, and Regulations that govern this program.

TAB A



Federal Register

**Monday,
December 19, 2005**

Part V

The President

**Executive Order 13392—Improving
Agency Disclosure of Information**

Presidential Documents

Title 3—

Executive Order 13392 of December 14, 2005

The President

Improving Agency Disclosure of Information

By the authority vested in me as President by the Constitution and the laws of the United States of America, and to ensure appropriate agency disclosure of information, and consistent with the goals of section 552 of title 5, United States Code, it is hereby ordered as follows:

Section 1. *Policy.*

(a) The effective functioning of our constitutional democracy depends upon the participation in public life of a citizenry that is well informed. For nearly four decades, the Freedom of Information Act (FOIA) has provided an important means through which the public can obtain information regarding the activities of Federal agencies. Under the FOIA, the public can obtain records from any Federal agency, subject to the exemptions enacted by the Congress to protect information that must be held in confidence for the Government to function effectively or for other purposes.

(b) FOIA requesters are seeking a service from the Federal Government and should be treated as such. Accordingly, in responding to a FOIA request, agencies shall respond courteously and appropriately. Moreover, agencies shall provide FOIA requesters, and the public in general, with citizen-centered ways to learn about the FOIA process, about agency records that are publicly available (e.g., on the agency's website), and about the status of a person's FOIA request and appropriate information about the agency's response.

(c) Agency FOIA operations shall be both results-oriented and produce results. Accordingly, agencies shall process requests under the FOIA in an efficient and appropriate manner and achieve tangible, measurable improvements in FOIA processing. When an agency's FOIA program does not produce such results, it should be reformed, consistent with available resources appropriated by the Congress and applicable law, to increase efficiency and better reflect the policy goals and objectives of this order.

(d) A citizen-centered and results-oriented approach will improve service and performance, thereby strengthening compliance with the FOIA, and will help avoid disputes and related litigation.

Sec. 2. *Agency Chief FOIA Officers.*

(a) *Designation.* The head of each agency shall designate within 30 days of the date of this order a senior official of such agency (at the Assistant Secretary or equivalent level), to serve as the Chief FOIA Officer of that agency. The head of the agency shall promptly notify the Director of the Office of Management and Budget (OMB Director) and the Attorney General of such designation and of any changes thereafter in such designation.

(b) *General Duties.* The Chief FOIA Officer of each agency shall, subject to the authority of the head of the agency:

(i) have agency-wide responsibility for efficient and appropriate compliance with the FOIA;

(ii) monitor FOIA implementation throughout the agency, including through the use of meetings with the public to the extent deemed appropriate by the agency's Chief FOIA Officer, and keep the head of the agency, the chief legal officer of the agency, and the Attorney General appropriately informed of the agency's performance in implementing the FOIA, including the extent to which the agency meets the milestones

in the agency's plan under section 3(b) of this order and training and reporting standards established consistent with applicable law and this order;

(iii) recommend to the head of the agency such adjustments to agency practices, policies, personnel, and funding as may be necessary to carry out the policy set forth in section 1 of this order;

(iv) review and report, through the head of the agency, at such times and in such formats as the Attorney General may direct, on the agency's performance in implementing the FOIA; and

(v) facilitate public understanding of the purposes of the FOIA's statutory exemptions by including concise descriptions of the exemptions in both the agency's FOIA handbook issued under section 552(g) of title 5, United States Code, and the agency's annual FOIA report, and by providing an overview, where appropriate, of certain general categories of agency records to which those exemptions apply.

(c) *FOIA Requester Service Center and FOIA Public Liaisons.* In order to ensure appropriate communication with FOIA requesters:

(i) Each agency shall establish one or more FOIA Requester Service Centers (Center), as appropriate, which shall serve as the first place that a FOIA requester can contact to seek information concerning the status of the person's FOIA request and appropriate information about the agency's FOIA response. The Center shall include appropriate staff to receive and respond to inquiries from FOIA requesters;

(ii) The agency Chief FOIA Officer shall designate one or more agency officials, as appropriate, as FOIA Public Liaisons, who may serve in the Center or who may serve in a separate office. FOIA Public Liaisons shall serve as supervisory officials to whom a FOIA requester can raise concerns about the service the FOIA requester has received from the Center, following an initial response from the Center staff. FOIA Public Liaisons shall seek to ensure a service-oriented response to FOIA requests and FOIA-related inquiries. For example, the FOIA Public Liaison shall assist, as appropriate, in reducing delays, increasing transparency and understanding of the status of requests, and resolving disputes. FOIA Public Liaisons shall report to the agency Chief FOIA Officer on their activities and shall perform their duties consistent with applicable law and agency regulations;

(iii) In addition to the services to FOIA requesters provided by the Center and FOIA Public Liaisons, the agency Chief FOIA Officer shall also consider what other FOIA-related assistance to the public should appropriately be provided by the agency;

(iv) In establishing the Centers and designating FOIA Public Liaisons, the agency shall use, as appropriate, existing agency staff and resources. A Center shall have appropriate staff to receive and respond to inquiries from FOIA requesters;

(v) As determined by the agency Chief FOIA Officer, in consultation with the FOIA Public Liaisons, each agency shall post appropriate information about its Center or Centers on the agency's website, including contact information for its FOIA Public Liaisons. In the case of an agency without a website, the agency shall publish the information on the Firstgov.gov website or, in the case of any agency with neither a website nor the capability to post on the Firstgov.gov website, in the **Federal Register**; and

(vi) The agency Chief FOIA Officer shall ensure that the agency has in place a method (or methods), including through the use of the Center, to receive and respond promptly and appropriately to inquiries from FOIA requesters about the status of their requests. The Chief FOIA Officer shall

also consider, in consultation with the FOIA Public Liaisons, as appropriate, whether the agency's implementation of other means (such as tracking numbers for requests, or an agency telephone or Internet hotline) would be appropriate for responding to status inquiries.

Sec. 3. Review, Plan, and Report.

(a) *Review.* Each agency's Chief FOIA Officer shall conduct a review of the agency's FOIA operations to determine whether agency practices are consistent with the policies set forth in section 1 of this order. In conducting this review, the Chief FOIA Officer shall:

(i) evaluate, with reference to numerical and statistical benchmarks where appropriate, the agency's administration of the FOIA, including the agency's expenditure of resources on FOIA compliance and the extent to which, if any, requests for records have not been responded to within the statutory time limit (backlog);

(ii) review the processes and practices by which the agency assists and informs the public regarding the FOIA process;

(iii) examine the agency's:

(A) use of information technology in responding to FOIA requests, including without limitation the tracking of FOIA requests and communication with requesters;

(B) practices with respect to requests for expedited processing; and

(C) implementation of multi-track processing if used by such agency;

(iv) review the agency's policies and practices relating to the availability of public information through websites and other means, including the use of websites to make available the records described in section 552(a)(2) of title 5, United States Code; and

(v) identify ways to eliminate or reduce its FOIA backlog, consistent with available resources and taking into consideration the volume and complexity of the FOIA requests pending with the agency.

(b) *Plan.*

(i) Each agency's Chief FOIA Officer shall develop, in consultation as appropriate with the staff of the agency (including the FOIA Public Liaisons), the Attorney General, and the OMB Director, an agency-specific plan to ensure that the agency's administration of the FOIA is in accordance with applicable law and the policies set forth in section 1 of this order. The plan, which shall be submitted to the head of the agency for approval, shall address the agency's implementation of the FOIA during fiscal years 2006 and 2007.

(ii) The plan shall include specific activities that the agency will implement to eliminate or reduce the agency's FOIA backlog, including (as applicable) changes that will make the processing of FOIA requests more streamlined and effective, as well as increased reliance on the dissemination of records that can be made available to the public through a website or other means that do not require the public to make a request for the records under the FOIA.

(iii) The plan shall also include activities to increase public awareness of FOIA processing, including as appropriate, expanded use of the agency's Center and its FOIA Public Liaisons.

(iv) The plan shall also include, taking appropriate account of the resources available to the agency and the mission of the agency, concrete milestones, with specific timetables and outcomes to be achieved, by which the head of the agency, after consultation with the OMB Director, shall measure and evaluate the agency's success in the implementation of the plan.

(c) *Agency Reports to the Attorney General and OMB Director.*

(i) The head of each agency shall submit a report, no later than 6 months from the date of this order, to the Attorney General and the OMB Director that summarizes the results of the review under section 3(a) of this order and encloses a copy of the agency's plan under section 3(b) of this order.

The agency shall publish a copy of the agency's report on the agency's website or, in the case of an agency without a website, on the Firstgov.gov website, or, in the case of any agency with neither a website nor the capability to publish on the Firstgov.gov website, in the **Federal Register**.

(ii) The head of each agency shall include in the agency's annual FOIA reports for fiscal years 2006 and 2007 a report on the agency's development and implementation of its plan under section 3(b) of this order and on the agency's performance in meeting the milestones set forth in that plan, consistent with any related guidelines the Attorney General may issue under section 552(e) of title 5, United States Code.

(iii) If the agency does not meet a milestone in its plan, the head of the agency shall:

(A) identify this deficiency in the annual FOIA report to the Attorney General;

(B) explain in the annual report the reasons for the agency's failure to meet the milestone;

(C) outline in the annual report the steps that the agency has already taken, and will be taking, to address the deficiency; and

(D) report this deficiency to the President's Management Council.

Sec. 4. Attorney General.

(a) *Report.* The Attorney General, using the reports submitted by the agencies under subsection 3(c)(i) of this order and the information submitted by agencies in their annual FOIA reports for fiscal year 2005, shall submit to the President, no later than 10 months from the date of this order, a report on agency FOIA implementation. The Attorney General shall consult the OMB Director in the preparation of the report and shall include in the report appropriate recommendations on administrative or other agency actions for continued agency dissemination and release of public information. The Attorney General shall thereafter submit two further annual reports, by June 1, 2007, and June 1, 2008, that provide the President with an update on the agencies' implementation of the FOIA and of their plans under section 3(b) of this order.

(b) *Guidance.* The Attorney General shall issue such instructions and guidance to the heads of departments and agencies as may be appropriate to implement sections 3(b) and 3(c) of this order.

Sec. 5. OMB Director. The OMB Director may issue such instructions to the heads of agencies as are necessary to implement this order, other than sections 3(b) and 3(c) of this order.

Sec. 6. Definitions. As used in this order:

(a) the term "agency" has the same meaning as the term "agency" under section 552(f)(1) of title 5, United States Code; and

(b) the term "record" has the same meaning as the term "record" under section 552(f)(2) of title 5, United States Code.

Sec. 7. General Provisions.

(a) The agency reviews under section 3(a) of this order and agency plans under section 3(b) of this order shall be conducted and developed in accordance with applicable law and applicable guidance issued by the President, the Attorney General, and the OMB Director, including the laws and guidance regarding information technology and the dissemination of information.

(b) This order:

(i) shall be implemented in a manner consistent with applicable law and subject to the availability of appropriations;

(ii) shall not be construed to impair or otherwise affect the functions of the OMB Director relating to budget, legislative, or administrative proposals; and

(iii) is intended only to improve the internal management of the executive branch and is not intended to, and does not, create any right or benefit,

substantive or procedural, enforceable at law or in equity by a party against the United States, its departments, agencies, instrumentalities, or entities, its officers or employees, or any other person.

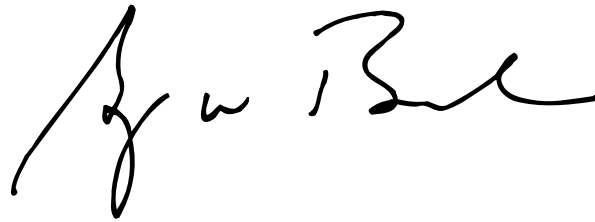
A handwritten signature in black ink, appearing to read "G. W. Bush". The signature is fluid and cursive, with a large initial "G" and a distinct "W" and "B".

THE WHITE HOUSE,
December 14, 2005.

[FR Doc. 05-24255
Filed 12-15-05; 8:45 am]
Billing code 3195-01-P

TAB B



DEPUTY SECRETARY OF DEFENSE
1010 DEFENSE PENTAGON
WASHINGTON, DC 20301-1010

JAN 11 2006

MEMORANDUM FOR SECRETARIES OF THE MILITARY DEPARTMENTS
CHAIRMAN OF THE JOINT CHIEFS OF STAFF
UNDER SECRETARIES OF DEFENSE
ASSISTANT SECRETARIES OF DEFENSE
GENERAL COUNSEL OF THE DEPARTMENT OF DEFENSE
DIRECTOR, OPERATIONAL TEST AND EVALUATION
INSPECTOR GENERAL OF THE DEPARTMENT OF DEFENSE
ASSISTANTS TO THE SECRETARY OF DEFENSE
DIRECTOR, ADMINISTRATION AND MANAGEMENT
DIRECTOR, PROGRAM ANALYSIS AND EVALUATION
DIRECTOR, NET ASSESSMENT
DIRECTOR, FORCE TRANSFORMATION
DIRECTORS OF THE DEFENSE AGENCIES
DIRECTORS OF THE DOD FIELD ACTIVITIES

SUBJECT: Executive Order (EO) 13392 on the Freedom of Information Act (FOIA)

On December 14, 2005, the President signed the attached EO, "Improving Agency Disclosure of Information," that emphasizes a new citizen centered and results oriented focus on agency Freedom of Information Act (FOIA) programs. The EO directs that the head of each agency shall designate a senior official at the Assistant Secretary or equivalent level to serve as the Chief FOIA Officer. Accordingly, the Director, Administration and Management (DA&M) is designated as the Chief FOIA Officer for the Department.

In his capacity as the DoD Chief FOIA Officer, the DA&M will issue guidance to ensure that the Department complies with the spirit and intent of the EO. The DA&M will oversee the efforts of the DoD Components to establish FOIA Requester Service Centers and FOIA Public Liaisons, both described in the attached EO. He will also lead the development of a DoD plan establishing goals to improve FOIA processing and to reduce or eliminate FOIA case backlogs.

In accordance with the provisions of the EO, DoD Components shall commit adequate resources to FOIA Requester Service Centers and FOIA Public Liaisons. Forthcoming guidance from the DA&M will provide the DoD Components a concept plan for implementing the EO and the opportunity to indicate requirements for additional necessary resources.

Attachment:
As Stated



OSD 00001-06



Federal Register

**Monday,
December 19, 2005**

Part V

The President

**Executive Order 13392—Improving
Agency Disclosure of Information**

Presidential Documents

Title 3—**Executive Order 13392 of December 14, 2005****The President****Improving Agency Disclosure of Information**

By the authority vested in me as President by the Constitution and the laws of the United States of America, and to ensure appropriate agency disclosure of information, and consistent with the goals of section 552 of title 5, United States Code, it is hereby ordered as follows:

Section 1. Policy.

(a) The effective functioning of our constitutional democracy depends upon the participation in public life of a citizenry that is well informed. For nearly four decades, the Freedom of Information Act (FOIA) has provided an important means through which the public can obtain information regarding the activities of Federal agencies. Under the FOIA, the public can obtain records from any Federal agency, subject to the exemptions enacted by the Congress to protect information that must be held in confidence for the Government to function effectively or for other purposes.

(b) FOIA requesters are seeking a service from the Federal Government and should be treated as such. Accordingly, in responding to a FOIA request, agencies shall respond courteously and appropriately. Moreover, agencies shall provide FOIA requesters, and the public in general, with citizen-centered ways to learn about the FOIA process, about agency records that are publicly available (e.g., on the agency's website), and about the status of a person's FOIA request and appropriate information about the agency's response.

(c) Agency FOIA operations shall be both results-oriented and produce results. Accordingly, agencies shall process requests under the FOIA in an efficient and appropriate manner and achieve tangible, measurable improvements in FOIA processing. When an agency's FOIA program does not produce such results, it should be reformed, consistent with available resources appropriated by the Congress and applicable law, to increase efficiency and better reflect the policy goals and objectives of this order.

(d) A citizen-centered and results-oriented approach will improve service and performance, thereby strengthening compliance with the FOIA, and will help avoid disputes and related litigation.

Sec. 2. Agency Chief FOIA Officers.

(a) *Designation.* The head of each agency shall designate within 30 days of the date of this order a senior official of such agency (at the Assistant Secretary or equivalent level), to serve as the Chief FOIA Officer of that agency. The head of the agency shall promptly notify the Director of the Office of Management and Budget (OMB Director) and the Attorney General of such designation and of any changes thereafter in such designation.

(b) *General Duties.* The Chief FOIA Officer of each agency shall, subject to the authority of the head of the agency:

(i) have agency-wide responsibility for efficient and appropriate compliance with the FOIA;

(ii) monitor FOIA implementation throughout the agency, including through the use of meetings with the public to the extent deemed appropriate by the agency's Chief FOIA Officer, and keep the head of the agency, the chief legal officer of the agency, and the Attorney General appropriately informed of the agency's performance in implementing the FOIA, including the extent to which the agency meets the milestones

in the agency's plan under section 3(b) of this order and training and reporting standards established consistent with applicable law and this order;

(iii) recommend to the head of the agency such adjustments to agency practices, policies, personnel, and funding as may be necessary to carry out the policy set forth in section 1 of this order;

(iv) review and report, through the head of the agency, at such times and in such formats as the Attorney General may direct, on the agency's performance in implementing the FOIA; and

(v) facilitate public understanding of the purposes of the FOIA's statutory exemptions by including concise descriptions of the exemptions in both the agency's FOIA handbook issued under section 552(g) of title 5, United States Code, and the agency's annual FOIA report, and by providing an overview, where appropriate, of certain general categories of agency records to which those exemptions apply.

(c) *FOIA Requester Service Center and FOIA Public Liaisons.* In order to ensure appropriate communication with FOIA requesters:

(i) Each agency shall establish one or more FOIA Requester Service Centers (Center), as appropriate, which shall serve as the first place that a FOIA requester can contact to seek information concerning the status of the person's FOIA request and appropriate information about the agency's FOIA response. The Center shall include appropriate staff to receive and respond to inquiries from FOIA requesters;

(ii) The agency Chief FOIA Officer shall designate one or more agency officials, as appropriate, as FOIA Public Liaisons, who may serve in the Center or who may serve in a separate office. FOIA Public Liaisons shall serve as supervisory officials to whom a FOIA requester can raise concerns about the service the FOIA requester has received from the Center, following an initial response from the Center staff. FOIA Public Liaisons shall seek to ensure a service-oriented response to FOIA requests and FOIA-related inquiries. For example, the FOIA Public Liaison shall assist, as appropriate, in reducing delays, increasing transparency and understanding of the status of requests, and resolving disputes. FOIA Public Liaisons shall report to the agency Chief FOIA Officer on their activities and shall perform their duties consistent with applicable law and agency regulations;

(iii) In addition to the services to FOIA requesters provided by the Center and FOIA Public Liaisons, the agency Chief FOIA Officer shall also consider what other FOIA-related assistance to the public should appropriately be provided by the agency;

(iv) In establishing the Centers and designating FOIA Public Liaisons, the agency shall use, as appropriate, existing agency staff and resources. A Center shall have appropriate staff to receive and respond to inquiries from FOIA requesters;

(v) As determined by the agency Chief FOIA Officer, in consultation with the FOIA Public Liaisons, each agency shall post appropriate information about its Center or Centers on the agency's website, including contact information for its FOIA Public Liaisons. In the case of an agency without a website, the agency shall publish the information on the Firstgov.gov website or, in the case of any agency with neither a website nor the capability to post on the Firstgov.gov website, in the **Federal Register**; and

(vi) The agency Chief FOIA Officer shall ensure that the agency has in place a method (or methods), including through the use of the Center, to receive and respond promptly and appropriately to inquiries from FOIA requesters about the status of their requests. The Chief FOIA Officer shall

also consider, in consultation with the FOIA Public Liaisons, as appropriate, whether the agency's implementation of other means (such as tracking numbers for requests, or an agency telephone or Internet hotline) would be appropriate for responding to status inquiries.

Sec. 3. Review, Plan, and Report.

(a) *Review.* Each agency's Chief FOIA Officer shall conduct a review of the agency's FOIA operations to determine whether agency practices are consistent with the policies set forth in section 1 of this order. In conducting this review, the Chief FOIA Officer shall:

(i) evaluate, with reference to numerical and statistical benchmarks where appropriate, the agency's administration of the FOIA, including the agency's expenditure of resources on FOIA compliance and the extent to which, if any, requests for records have not been responded to within the statutory time limit (backlog);

(ii) review the processes and practices by which the agency assists and informs the public regarding the FOIA process;

(iii) examine the agency's:

(A) use of information technology in responding to FOIA requests, including without limitation the tracking of FOIA requests and communication with requesters;

(B) practices with respect to requests for expedited processing; and

(C) implementation of multi-track processing if used by such agency;

(iv) review the agency's policies and practices relating to the availability of public information through websites and other means, including the use of websites to make available the records described in section 552(a)(2) of title 5, United States Code; and

(v) identify ways to eliminate or reduce its FOIA backlog, consistent with available resources and taking into consideration the volume and complexity of the FOIA requests pending with the agency.

(b) *Plan.*

(i) Each agency's Chief FOIA Officer shall develop, in consultation as appropriate with the staff of the agency (including the FOIA Public Liaisons), the Attorney General, and the OMB Director, an agency-specific plan to ensure that the agency's administration of the FOIA is in accordance with applicable law and the policies set forth in section 1 of this order. The plan, which shall be submitted to the head of the agency for approval, shall address the agency's implementation of the FOIA during fiscal years 2006 and 2007.

(ii) The plan shall include specific activities that the agency will implement to eliminate or reduce the agency's FOIA backlog, including (as applicable) changes that will make the processing of FOIA requests more streamlined and effective, as well as increased reliance on the dissemination of records that can be made available to the public through a website or other means that do not require the public to make a request for the records under the FOIA.

(iii) The plan shall also include activities to increase public awareness of FOIA processing, including as appropriate, expanded use of the agency's Center and its FOIA Public Liaisons.

(iv) The plan shall also include, taking appropriate account of the resources available to the agency and the mission of the agency, concrete milestones, with specific timetables and outcomes to be achieved, by which the head of the agency, after consultation with the OMB Director, shall measure and evaluate the agency's success in the implementation of the plan.

(c) *Agency Reports to the Attorney General and OMB Director.*

(i) The head of each agency shall submit a report, no later than 6 months from the date of this order, to the Attorney General and the OMB Director that summarizes the results of the review under section 3(a) of this order and encloses a copy of the agency's plan under section 3(b) of this order.

The agency shall publish a copy of the agency's report on the agency's website or, in the case of an agency without a website, on the Firstgov.gov website, or, in the case of any agency with neither a website nor the capability to publish on the Firstgov.gov website, in the **Federal Register**.

(ii) The head of each agency shall include in the agency's annual FOIA reports for fiscal years 2006 and 2007 a report on the agency's development and implementation of its plan under section 3(b) of this order and on the agency's performance in meeting the milestones set forth in that plan, consistent with any related guidelines the Attorney General may issue under section 552(e) of title 5, United States Code.

(iii) If the agency does not meet a milestone in its plan, the head of the agency shall:

(A) identify this deficiency in the annual FOIA report to the Attorney General;

(B) explain in the annual report the reasons for the agency's failure to meet the milestone;

(C) outline in the annual report the steps that the agency has already taken, and will be taking, to address the deficiency; and

(D) report this deficiency to the President's Management Council.

Sec. 4. Attorney General.

(a) *Report.* The Attorney General, using the reports submitted by the agencies under subsection 3(c)(i) of this order and the information submitted by agencies in their annual FOIA reports for fiscal year 2005, shall submit to the President, no later than 10 months from the date of this order, a report on agency FOIA implementation. The Attorney General shall consult the OMB Director in the preparation of the report and shall include in the report appropriate recommendations on administrative or other agency actions for continued agency dissemination and release of public information. The Attorney General shall thereafter submit two further annual reports, by June 1, 2007, and June 1, 2008, that provide the President with an update on the agencies' implementation of the FOIA and of their plans under section 3(b) of this order.

(b) *Guidance.* The Attorney General shall issue such instructions and guidance to the heads of departments and agencies as may be appropriate to implement sections 3(b) and 3(c) of this order.

Sec. 5. OMB Director. The OMB Director may issue such instructions to the heads of agencies as are necessary to implement this order, other than sections 3(b) and 3(c) of this order.

Sec. 6. Definitions. As used in this order:

(a) the term "agency" has the same meaning as the term "agency" under section 552(f)(1) of title 5, United States Code; and

(b) the term "record" has the same meaning as the term "record" under section 552(f)(2) of title 5, United States Code.

Sec. 7. General Provisions.

(a) The agency reviews under section 3(a) of this order and agency plans under section 3(b) of this order shall be conducted and developed in accordance with applicable law and applicable guidance issued by the President, the Attorney General, and the OMB Director, including the laws and guidance regarding information technology and the dissemination of information.

(b) This order:

(i) shall be implemented in a manner consistent with applicable law and subject to the availability of appropriations;

(ii) shall not be construed to impair or otherwise affect the functions of the OMB Director relating to budget, legislative, or administrative proposals; and

(iii) is intended only to improve the internal management of the executive branch and is not intended to, and does not, create any right or benefit,

substantive or procedural, enforceable at law or in equity by a party against the United States, its departments, agencies, instrumentalities, or entities, its officers or employees, or any other person.

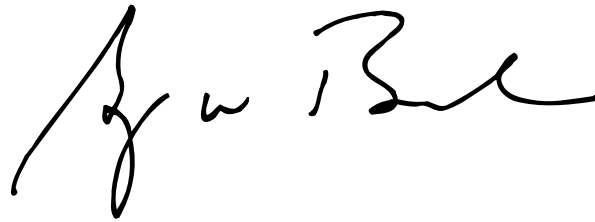
A handwritten signature in black ink, appearing to read "G. W. Bush". The signature is fluid and cursive, with a large initial "G" and a distinct "W" and "B".

THE WHITE HOUSE,
December 14, 2005.

[FR Doc. 05-24255
Filed 12-15-05; 8:45 am]
Billing code 3195-01-P

TAB C



ADMINISTRATION AND
MANAGEMENT

OFFICE OF THE SECRETARY OF DEFENSE
1950 DEFENSE PENTAGON
WASHINGTON, DC 20301-1950

FEB 1 2006

**MEMORANDUM FOR SECRETARIES OF THE MILITARY DEPARTMENTS
CHAIRMAN OF THE JOINT CHIEFS OF STAFF
UNDER SECRETARIES OF DEFENSE
ASSISTANT SECRETARIES OF DEFENSE
GENERAL COUNSEL OF THE DEPARTMENT OF DEFENSE
DIRECTOR, OPERATIONAL TEST AND EVALUATION
INSPECTOR GENERAL OF THE DEPARTMENT OF DEFENSE
ASSISTANTS TO THE SECRETARY OF DEFENSE
DIRECTOR, ADMINISTRATION AND MANAGEMENT
DIRECTOR, PROGRAM ANALYSIS AND EVALUATION
DIRECTOR, NET ASSESSMENT
DIRECTOR, FORCE TRANSFORMATION
DIRECTORS OF THE DEFENSE AGENCIES
DIRECTORS OF THE DOD FIELD ACTIVITIES**

**SUBJECT: Executive Order (EO) 13392 on the Freedom of Information Act (FOIA) – DoD
Implementation**

On December 19, 2005, the President signed EO 13392, "Improving Agency Disclosure of Information." EO 13392 sets new standards for Federal Agency FOIA programs by ordering that agencies emphasize a new citizen-centered approach to the FOIA with a results-oriented focus.

The first requirement of EO 13392 is for agency heads to name an Agency Chief FOIA Officer (ACFO) at the Assistant Secretary or equivalent level. On January 11, 2006, the Deputy Secretary of Defense signed the memorandum at attachment 1 designating the Director, Administration and Management (DA&M) as the ACFO for the DoD. As ACFO, I have designated the Defense Freedom of Information Policy Office (DFOIPO), a DA&M staff element, as the responsible action agent to implement the provisions of EO 13392 throughout DoD.

To comply with the provisions of the EO, DoD Components must ensure that proper procedures are established and adequate resources are applied to their FOIA programs. Recent heightened interest in the FOIA from the public, the media, watchdog organizations, and the Congress has resulted in the need for the Federal Agencies to re-examine their FOIA programs. EO 13392 is a reflection of this elevated visibility and interest. Historically, DoD Component FOIA programs have been under-emphasized, resulting in inadequate staffing and funding. EO 13392 requires DoD Components place a higher degree of senior leader oversight on their respective FOIA programs.

The EO requires Federal Agencies take specific steps to complete implementation. These steps are to:

OSD 01711-06



- Establish FOIA Requester Service Centers;
- Establish FOIA Public Liaisons;
- Conduct a thorough review of agency FOIA operations with focus on eliminating or reducing FOIA backlog;
- Develop an agency plan to improve FOIA operations and to eliminate or reduce FOIA backlog; and to
- Submit a report to the Attorney General and Director, Office of Management and Budget (OMB) summarizing the results of the agency review. This report will also include a copy of the agency's plan.

Within DoD, implementation of the EO will be conducted in three phases:

- Phase I: Establish a FOIA organizational structure and increase public awareness;
- Phase II: Review current FOIA operations; develop a plan for improvement; and report results; and
- Phase III: Improve FOIA services and eliminate or reduce backlog.

FOIA Requester Service Centers. In accordance with section 2(c)(i) of the EO, all DoD Components shall establish one or more FOIA Requester Service Centers to serve as initial points of contact for FOIA requesters to receive status updates and any appropriate information about their requests. It is recognized that many Components already have established FOIA Offices that could be redesignated as FOIA Requester Service Centers. In accordance with the EO, FOIA requesters shall be treated as customers seeking a service from their Federal Government. Therefore, FOIA Requester Service Centers shall have the ability to locate the current status of any requests within their purview and to respond professionally to requesters in need of assistance.

DoD Components shall have their respective Requester Service Centers designated and operational by March 1, 2006. Complete address listings for Requester Service Centers will be provided to the DFOIPO. The DFOIPO will provide specific guidance concerning this reporting requirement.

FOIA Public Liaisons. Section 2(c)(ii) of the EO requires the ACFO to designate FOIA Public Liaisons who shall serve as supervisory officials to whom requesters can raise concerns about the service received from the FOIA Requester Service Centers. Individuals named as FOIA Public Liaisons shall be in addition to and separate from FOIA Requester Service Center personnel. The number of FOIA Public Liaisons, as well as the option for larger DoD Components to designate Chief FOIA Public Liaisons, is at the discretion of individual DoD Components. Chief FOIA Public Liaisons would provide supervisory oversight essential for large Components with geographically dispersed subordinate elements. It is envisioned that each DoD Component cited at attachment 2 will designate a Chief FOIA Public Liaison to represent FOIA services from a Component perspective. Additional Chief FOIA Public Liaisons within the Component are optional and would be determined by organizational size, structure, and dispersion. FOIA Public Liaisons may serve in a FOIA Requester Service Center or another location, shall report via FOIA technical channels to the ACFO, and should be at a grade level commensurate with the importance of the position. The Component Chief FOIA Public Liaison

positions at attachment 2 should be staffed no lower than GS-15/O6-Colonel/Captain level. DoD Components shall ensure that personnel with appropriate FOIA knowledge and expertise be designated as FOIA Public Liaisons. It would be appropriate, therefore, to designate the existing DoD Component FOIA policy positions as FOIA Public Liaisons concurrent with an appropriate billet upgrade to reflect the new duties and increased responsibilities prescribed in EO 13392.

DoD Components shall submit their appointments for Component Chief FOIA Public Liaison positions complete with grade/rank, duty title, and contact information to the DFOIPO by March 1, 2006. The ACFO will designate each in writing to formalize the structure at attachment 2 in accordance with the intent of the EO. Component Chief FOIA Public Liaisons will similarly designate in writing FOIA Public Liaisons throughout the Component organization. The Office of the Secretary of Defense, the Joint Staff, the Combatant Commands, and selected DoD Field Activities will be served by the OSD FOIA Public Liaison as reflected at attachment 2. Therefore, these Components are not tasked to appoint FOIA Public Liaisons. Because public awareness is a principal objective of the EO, contact information for the networks of FOIA Public Liaisons and Requester Service Centers shall be posted to organizational web sites immediately following official designation.

Review, Plan and Report. Section 3 of the EO requires the ACFO to conduct a review of current Component FOIA operations and to develop an agency-specific plan to ensure that the agency's administration of the FOIA is consistent with applicable law and the EO. The Secretary of Defense will submit a summary of this review and the agency plan to the Attorney General and the OMB Director by June 14, 2006. The DFOIPO will lead the DoD FOIA review and development of the plan. DoD Component support is essential to both efforts. DoD Components shall conduct extensive internal reviews of their respective FOIA programs and will submit their reviews to the DFOIPO by May 1, 2006. Development of the DoD plan will be a collaborative effort, and Component Chief FOIA Public Liaisons will be principal points of contact.

By February 10, 2006, the DFOIPO will provide additional information concerning the required format and instructions for all DoD Component obligations specified in this EO implementation memorandum.

This is an important endeavor and I look forward to working with the Component Chief FOIA Public Liaisons in establishing a DoD network of professional FOIA Public Liaisons and Requester Service Centers trained and motivated to provide better service to the public.

My point of contact for this initiative is Mr. Will Kammer, Chief, DFOIPO. He can be contacted at 703-696-4495.

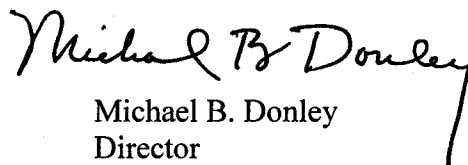
Michael B. Donley
Director

Attachments:
As stated

Attachment

1



DEPUTY SECRETARY OF DEFENSE
1010 DEFENSE PENTAGON
WASHINGTON, DC 20301-1010

JAN 11 2006

MEMORANDUM FOR SECRETARIES OF THE MILITARY DEPARTMENTS
CHAIRMAN OF THE JOINT CHIEFS OF STAFF
UNDER SECRETARIES OF DEFENSE
ASSISTANT SECRETARIES OF DEFENSE
GENERAL COUNSEL OF THE DEPARTMENT OF DEFENSE
DIRECTOR, OPERATIONAL TEST AND EVALUATION
INSPECTOR GENERAL OF THE DEPARTMENT OF DEFENSE
ASSISTANTS TO THE SECRETARY OF DEFENSE
DIRECTOR, ADMINISTRATION AND MANAGEMENT
DIRECTOR, PROGRAM ANALYSIS AND EVALUATION
DIRECTOR, NET ASSESSMENT
DIRECTOR, FORCE TRANSFORMATION
DIRECTORS OF THE DEFENSE AGENCIES
DIRECTORS OF THE DOD FIELD ACTIVITIES

SUBJECT: Executive Order (EO) 13392 on the Freedom of Information Act (FOIA)

On December 14, 2005, the President signed the attached EO, "Improving Agency Disclosure of Information," that emphasizes a new citizen centered and results oriented focus on agency Freedom of Information Act (FOIA) programs. The EO directs that the head of each agency shall designate a senior official at the Assistant Secretary or equivalent level to serve as the Chief FOIA Officer. Accordingly, the Director, Administration and Management (DA&M) is designated as the Chief FOIA Officer for the Department.

In his capacity as the DoD Chief FOIA Officer, the DA&M will issue guidance to ensure that the Department complies with the spirit and intent of the EO. The DA&M will oversee the efforts of the DoD Components to establish FOIA Requester Service Centers and FOIA Public Liaisons, both described in the attached EO. He will also lead the development of a DoD plan establishing goals to improve FOIA processing and to reduce or eliminate FOIA case backlogs.

In accordance with the provisions of the EO, DoD Components shall commit adequate resources to FOIA Requester Service Centers and FOIA Public Liaisons. Forthcoming guidance from the DA&M will provide the DoD Components a concept plan for implementing the EO and the opportunity to indicate requirements for additional necessary resources.

Attachment:
As Stated



OSD 00001-06



Federal Register

Monday,
December 19, 2005

Part V

The President

Executive Order 13392—Improving
Agency Disclosure of Information

Presidential Documents

Title 3—

Executive Order 13392 of December 14, 2005

The President

Improving Agency Disclosure of Information

By the authority vested in me as President by the Constitution and the laws of the United States of America, and to ensure appropriate agency disclosure of information, and consistent with the goals of section 552 of title 5, United States Code, it is hereby ordered as follows:

Section 1. Policy.

(a) The effective functioning of our constitutional democracy depends upon the participation in public life of a citizenry that is well informed. For nearly four decades, the Freedom of Information Act (FOIA) has provided an important means through which the public can obtain information regarding the activities of Federal agencies. Under the FOIA, the public can obtain records from any Federal agency, subject to the exemptions enacted by the Congress to protect information that must be held in confidence for the Government to function effectively or for other purposes.

(b) FOIA requesters are seeking a service from the Federal Government and should be treated as such. Accordingly, in responding to a FOIA request, agencies shall respond courteously and appropriately. Moreover, agencies shall provide FOIA requesters, and the public in general, with citizen-centered ways to learn about the FOIA process, about agency records that are publicly available (e.g., on the agency's website), and about the status of a person's FOIA request and appropriate information about the agency's response.

(c) Agency FOIA operations shall be both results-oriented and produce results. Accordingly, agencies shall process requests under the FOIA in an efficient and appropriate manner and achieve tangible, measurable improvements in FOIA processing. When an agency's FOIA program does not produce such results, it should be reformed, consistent with available resources appropriated by the Congress and applicable law, to increase efficiency and better reflect the policy goals and objectives of this order.

(d) A citizen-centered and results-oriented approach will improve service and performance, thereby strengthening compliance with the FOIA, and will help avoid disputes and related litigation.

Sec. 2. Agency Chief FOIA Officers.

(a) *Designation.* The head of each agency shall designate within 30 days of the date of this order a senior official of such agency (at the Assistant Secretary or equivalent level), to serve as the Chief FOIA Officer of that agency. The head of the agency shall promptly notify the Director of the Office of Management and Budget (OMB Director) and the Attorney General of such designation and of any changes thereafter in such designation.

(b) *General Duties.* The Chief FOIA Officer of each agency shall, subject to the authority of the head of the agency:

(i) have agency-wide responsibility for efficient and appropriate compliance with the FOIA;

(ii) monitor FOIA implementation throughout the agency, including through the use of meetings with the public to the extent deemed appropriate by the agency's Chief FOIA Officer, and keep the head of the agency, the chief legal officer of the agency, and the Attorney General appropriately informed of the agency's performance in implementing the FOIA, including the extent to which the agency meets the milestones

in the agency's plan under section 3(b) of this order and training and reporting standards established consistent with applicable law and this order;

(iii) recommend to the head of the agency such adjustments to agency practices, policies, personnel, and funding as may be necessary to carry out the policy set forth in section 1 of this order;

(iv) review and report, through the head of the agency, at such times and in such formats as the Attorney General may direct, on the agency's performance in implementing the FOIA; and

(v) facilitate public understanding of the purposes of the FOIA's statutory exemptions by including concise descriptions of the exemptions in both the agency's FOIA handbook issued under section 552(g) of title 5, United States Code, and the agency's annual FOIA report, and by providing an overview, where appropriate, of certain general categories of agency records to which those exemptions apply.

(c) *FOIA Requester Service Center and FOIA Public Liaisons.* In order to ensure appropriate communication with FOIA requesters:

(i) Each agency shall establish one or more FOIA Requester Service Centers (Center), as appropriate, which shall serve as the first place that a FOIA requester can contact to seek information concerning the status of the person's FOIA request and appropriate information about the agency's FOIA response. The Center shall include appropriate staff to receive and respond to inquiries from FOIA requesters;

(ii) The agency Chief FOIA Officer shall designate one or more agency officials, as appropriate, as FOIA Public Liaisons, who may serve in the Center or who may serve in a separate office. FOIA Public Liaisons shall serve as supervisory officials to whom a FOIA requester can raise concerns about the service the FOIA requester has received from the Center, following an initial response from the Center staff. FOIA Public Liaisons shall seek to ensure a service-oriented response to FOIA requests and FOIA-related inquiries. For example, the FOIA Public Liaison shall assist, as appropriate, in reducing delays, increasing transparency and understanding of the status of requests, and resolving disputes. FOIA Public Liaisons shall report to the agency Chief FOIA Officer on their activities and shall perform their duties consistent with applicable law and agency regulations;

(iii) In addition to the services to FOIA requesters provided by the Center and FOIA Public Liaisons, the agency Chief FOIA Officer shall also consider what other FOIA-related assistance to the public should appropriately be provided by the agency;

(iv) In establishing the Centers and designating FOIA Public Liaisons, the agency shall use, as appropriate, existing agency staff and resources. A Center shall have appropriate staff to receive and respond to inquiries from FOIA requesters;

(v) As determined by the agency Chief FOIA Officer, in consultation with the FOIA Public Liaisons, each agency shall post appropriate information about its Center or Centers on the agency's website, including contact information for its FOIA Public Liaisons. In the case of an agency without a website, the agency shall publish the information on the Firstgov.gov website or, in the case of any agency with neither a website nor the capability to post on the Firstgov.gov website, in the **Federal Register**; and

(vi) The agency Chief FOIA Officer shall ensure that the agency has in place a method (or methods), including through the use of the Center, to receive and respond promptly and appropriately to inquiries from FOIA requesters about the status of their requests. The Chief FOIA Officer shall

also consider, in consultation with the FOIA Public Liaisons, as appropriate, whether the agency's implementation of other means (such as tracking numbers for requests, or an agency telephone or Internet hotline) would be appropriate for responding to status inquiries.

Sec. 3. Review, Plan, and Report.

(a) *Review.* Each agency's Chief FOIA Officer shall conduct a review of the agency's FOIA operations to determine whether agency practices are consistent with the policies set forth in section 1 of this order. In conducting this review, the Chief FOIA Officer shall:

(i) evaluate, with reference to numerical and statistical benchmarks where appropriate, the agency's administration of the FOIA, including the agency's expenditure of resources on FOIA compliance and the extent to which, if any, requests for records have not been responded to within the statutory time limit (backlog);

(ii) review the processes and practices by which the agency assists and informs the public regarding the FOIA process;

(iii) examine the agency's:

(A) use of information technology in responding to FOIA requests, including without limitation the tracking of FOIA requests and communication with requesters;

(B) practices with respect to requests for expedited processing; and

(C) implementation of multi-track processing if used by such agency;

(iv) review the agency's policies and practices relating to the availability of public information through websites and other means, including the use of websites to make available the records described in section 552(a)(2) of title 5, United States Code; and

(v) identify ways to eliminate or reduce its FOIA backlog, consistent with available resources and taking into consideration the volume and complexity of the FOIA requests pending with the agency.

(b) *Plan.*

(i) Each agency's Chief FOIA Officer shall develop, in consultation as appropriate with the staff of the agency (including the FOIA Public Liaisons), the Attorney General, and the OMB Director, an agency-specific plan to ensure that the agency's administration of the FOIA is in accordance with applicable law and the policies set forth in section 1 of this order. The plan, which shall be submitted to the head of the agency for approval, shall address the agency's implementation of the FOIA during fiscal years 2006 and 2007.

(ii) The plan shall include specific activities that the agency will implement to eliminate or reduce the agency's FOIA backlog, including (as applicable) changes that will make the processing of FOIA requests more streamlined and effective, as well as increased reliance on the dissemination of records that can be made available to the public through a website or other means that do not require the public to make a request for the records under the FOIA.

(iii) The plan shall also include activities to increase public awareness of FOIA processing, including as appropriate, expanded use of the agency's Center and its FOIA Public Liaisons.

(iv) The plan shall also include, taking appropriate account of the resources available to the agency and the mission of the agency, concrete milestones, with specific timetables and outcomes to be achieved, by which the head of the agency, after consultation with the OMB Director, shall measure and evaluate the agency's success in the implementation of the plan.

(c) *Agency Reports to the Attorney General and OMB Director.*

(i) The head of each agency shall submit a report, no later than 6 months from the date of this order, to the Attorney General and the OMB Director that summarizes the results of the review under section 3(a) of this order and encloses a copy of the agency's plan under section 3(b) of this order.

The agency shall publish a copy of the agency's report on the agency's website or, in the case of an agency without a website, on the Firstgov.gov website, or, in the case of any agency with neither a website nor the capability to publish on the Firstgov.gov website, in the **Federal Register**.

(ii) The head of each agency shall include in the agency's annual FOIA reports for fiscal years 2006 and 2007 a report on the agency's development and implementation of its plan under section 3(b) of this order and on the agency's performance in meeting the milestones set forth in that plan, consistent with any related guidelines the Attorney General may issue under section 552(e) of title 5, United States Code.

(iii) If the agency does not meet a milestone in its plan, the head of the agency shall:

(A) identify this deficiency in the annual FOIA report to the Attorney General;

(B) explain in the annual report the reasons for the agency's failure to meet the milestone;

(C) outline in the annual report the steps that the agency has already taken, and will be taking, to address the deficiency; and

(D) report this deficiency to the President's Management Council.

Sec. 4. Attorney General.

(a) *Report.* The Attorney General, using the reports submitted by the agencies under subsection 3(c)(i) of this order and the information submitted by agencies in their annual FOIA reports for fiscal year 2005, shall submit to the President, no later than 10 months from the date of this order, a report on agency FOIA implementation. The Attorney General shall consult the OMB Director in the preparation of the report and shall include in the report appropriate recommendations on administrative or other agency actions for continued agency dissemination and release of public information. The Attorney General shall thereafter submit two further annual reports, by June 1, 2007, and June 1, 2008, that provide the President with an update on the agencies' implementation of the FOIA and of their plans under section 3(b) of this order.

(b) *Guidance.* The Attorney General shall issue such instructions and guidance to the heads of departments and agencies as may be appropriate to implement sections 3(b) and 3(c) of this order.

Sec. 5. OMB Director. The OMB Director may issue such instructions to the heads of agencies as are necessary to implement this order, other than sections 3(b) and 3(c) of this order.

Sec. 6. Definitions. As used in this order:

(a) the term "agency" has the same meaning as the term "agency" under section 552(f)(1) of title 5, United States Code; and

(b) the term "record" has the same meaning as the term "record" under section 552(f)(2) of title 5, United States Code.

Sec. 7. General Provisions.

(a) The agency reviews under section 3(a) of this order and agency plans under section 3(b) of this order shall be conducted and developed in accordance with applicable law and applicable guidance issued by the President, the Attorney General, and the OMB Director, including the laws and guidance regarding information technology and the dissemination of information.

(b) This order:

(i) shall be implemented in a manner consistent with applicable law and subject to the availability of appropriations;

(ii) shall not be construed to impair or otherwise affect the functions of the OMB Director relating to budget, legislative, or administrative proposals; and

(iii) is intended only to improve the internal management of the executive branch and is not intended to, and does not, create any right or benefit,

substantive or procedural, enforceable at law or in equity by a party against the United States, its departments, agencies, instrumentalities, or entities, its officers or employees, or any other person.

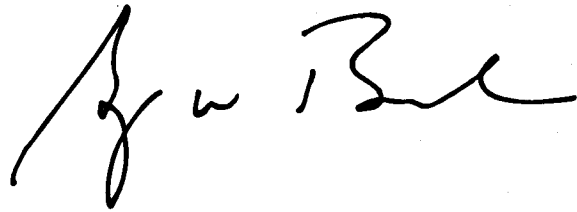
A handwritten signature in black ink, appearing to read "G. W. Bush". The signature is fluid and cursive, with a large initial "G" and a distinct "W" and "B".

THE WHITE HOUSE,
December 14, 2005.

[FR Doc. 05-24255
Filed 12-15-05; 8:45 am]
Billing code 3195-01-P

Attachment

2

DoD Component FOIA Chief Public Liaisons

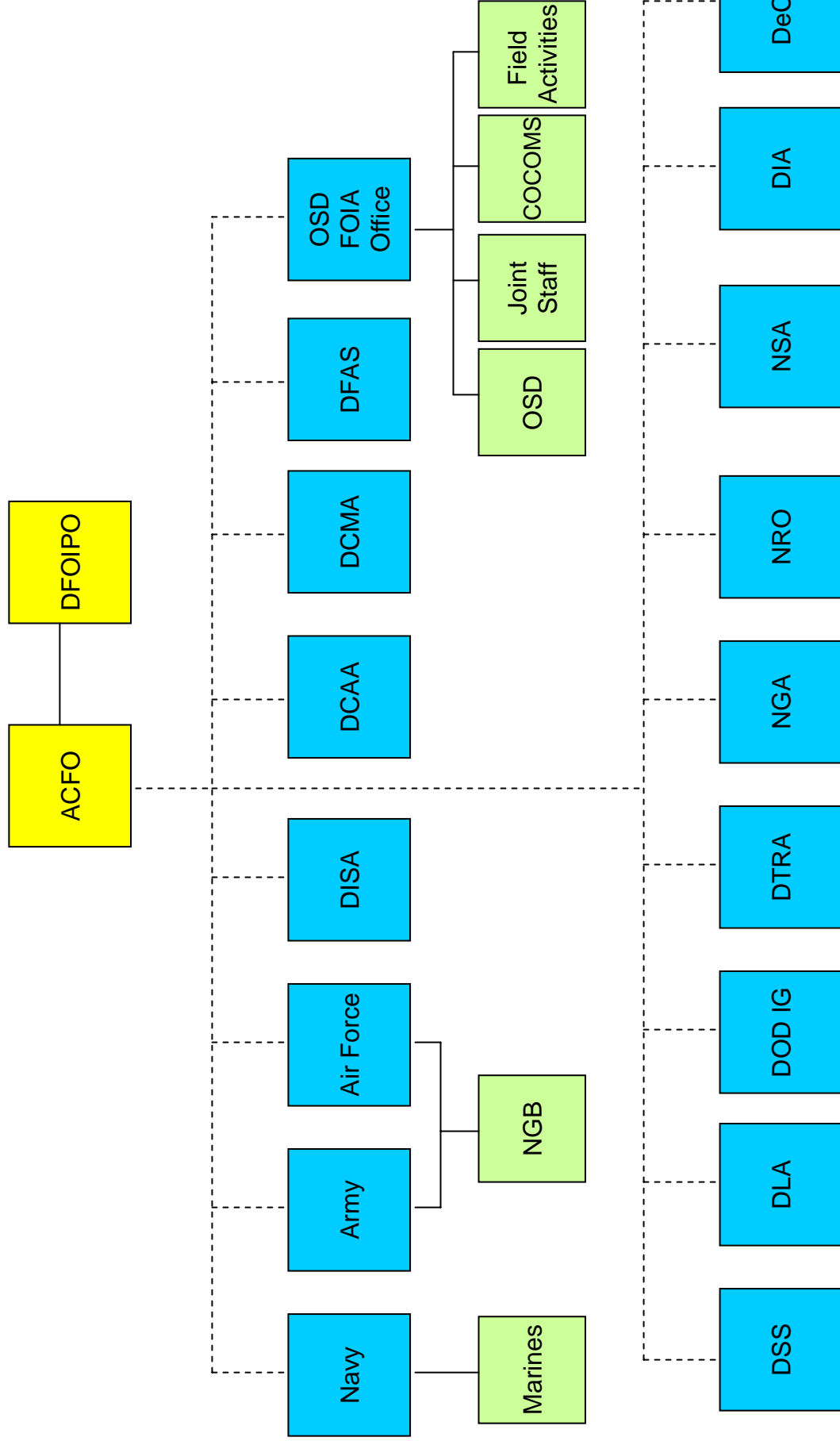

— DoD Component Chief FOIA Public Liaisons

— FOIA Supported Organizations

TAB D



ADMINISTRATION AND
MANAGEMENT

OFFICE OF THE SECRETARY OF DEFENSE
1950 DEFENSE PENTAGON
WASHINGTON, DC 20301-1950

10 FEB 2006

MEMORANDUM FOR SECRETARIES OF THE MILITARY DEPARTMENTS
COMMANDERS OF THE COMBATANT COMMANDS
INSPECTOR GENERAL OF THE DEPARTMENT OF DEFENSE
DIRECTORS OF THE DEFENSE AGENCIES
DIRECTORS OF DOD FIELD ACTIVITIES

Subject: DoD Implementation of Executive Order 13392 on the Freedom of Information Act (FOIA)

Reference: Director of Administration and Management, Executive Order (EO) 13392 on the Freedom of Information Act (FOIA) – DoD Implementation, February 1, 2006

The referenced Director of Administration and Management (DA&M) memorandum provides guidance to DoD Components concerning the implementation of EO 13392, and it designates the Defense Freedom of Information Policy Office (DFOIPO) as the principal action agent to coordinate this significant project. As attachment 1 indicates, the DFOIPO has been established within the DA&M and is staffed with senior FOIA experts who understand DoD Component FOIA operations.

The referenced memorandum further states that the DFOIPO would provide additional information concerning the Review, Plan, and Report Phases of implementation cited in the EO. Therefore, this first DFOIPO communication provides initial instruction for the completion of DoD Component reviews of their FOIA operations to determine if practices are consistent with the standards of service prescribed in the EO. In order for the DoD to meet milestone dates specified in the EO, Components shall conduct extensive internal reviews of their FOIA programs and will submit the results of these reviews to the DFOIPO by May 1, 2006. Attachment 2 lists the specific DoD Components, Combatant Commands, Agencies and Activities required to conduct these reviews. The Freedom of Information Division, Washington Headquarters Services, will conduct the review of the Office of the Secretary of Defense and the Joint Staff.

Section 3 (a) of the EO details the specific areas of FOIA operations that DoD Components must evaluate and review in order to meet the goals of the EO. These specific focus areas are summarized below:

- Review of current FOIA processes to determine reasons for agency backlogs.
- Review of customer service practices by which the Component assists and informs the public on their respective FOIA processes.
- Review of current information technology (IT) systems used for FOIA processing.



- Review of current resources committed to FOIA operations (funding, manpower, facilities, IT support, etc.).
- Review of the Component's use of websites to make information available to the public in compliance with 5 U.S.C. § 552(a)(2).
- Recommendations to improve shortfalls identified above.

To assist in the systematic collection of information from FOIA offices throughout the DoD, DFOIPO is developing a common survey instrument guided by the focus areas listed above. This survey will enable DoD Components to collect essential data on FOIA operations and will facilitate the analysis and review prescribed in the EO. This survey will contain core questions and will encourage the addition of Component unique data requirements. DFOIPO will distribute the FOIA data survey instrument with instructions on its use. The intent is to produce a candid analysis and review of Component FOIA operations at both the managerial and customer service levels. Components will consolidate reviews from subordinate elements and will submit an overall review that will help build the total DoD review. These reviews will serve as the foundation for the required plan to improve FOIA operations throughout the DoD. Most significantly, these reviews will identify the resources that would be required to meet the provisions for better customer service set forth in the EO. Capturing that resource requirement is essential to the DoD review, plan, and report that go forward.

DFOIPO will create a single DoD review and plan for the DA&M in his role as Chief Agency FOIA Officer to submit to the Secretary of Defense for approval. The plan will address the DoD implementation of the EO during fiscal years 2006 and 2007, and will include specific activities that the DoD will implement to reduce or eliminate the FOIA backlog. In turn, the Secretary of Defense will submit this plan, along with a report summarizing the DoD review, to the Attorney General and the OMB Director by June 14, 2006. The Attorney General will subsequently submit a combined report to the President by October 14, 2006.

We look forward to working with you in improving the FOIA service provided by the DoD to the public.



Will Kammer
Chief
Defense Freedom of Information Policy Office

Attachments:
As stated



ADMINISTRATION AND
MANAGEMENT

OFFICE OF THE SECRETARY OF DEFENSE
1950 DEFENSE PENTAGON
WASHINGTON, DC 20301-1950

January 31, 2006

MEMORANDUM FOR CHIEF, FREEDOM OF INFORMATION DIVISION

SUBJECT: Appointment of Personnel to the Defense Freedom of Information Policy Office

Effective January 25, 2006, the following personnel assigned to the Freedom of Information Division, Executive Services Directorate, are appointed to serve concurrently in the Defense Freedom of Information Policy Office (DFOIPO) in the positions indicated:

<u>Employee</u>	<u>DFOIPO Position</u>
William T. Kammer	Chief
James P. Hogan	Deputy Chief
David W. Maier	Policy Officer
Michael A. Black	Information Management Officer

The DFOIPO, a staff element under the Director of Administration and Management (DA&M), assists in administering Freedom of Information Act (FOIA) policy throughout the DoD. The DFOIPO is the designated action agent for the DA&M in his role as the DoD Chief FOIA Officer under the provisions of Executive Order 13392.

Michael B. Donley
Director

cc:
DoD General Counsel
DoD Component FOIA Offices
Dir, WHS
Dir, ESD
Dir, HRD
Mr. James P. Hogan
Mr. David W. Maier
Mr. Michael A. Black



Attachment 2

Required Reviews of FOIA Operations

Office of the Secretary of Defense/Joint Staff
Department of the Army
Department of the Navy
Department of the Air Force
Defense Contract Audit Agency
Defense Contract Management Agency
Defense Finance and Accounting Service
Defense Information Systems Agency
Defense Intelligence Agency
Defense Logistics Agency
Defense Threat Reduction Agency
National Reconnaissance Office
Defense Security Service
National Geospatial-Intelligence Agency
National Security Agency
Office of the Inspector General of the DoD
Defense Commissary Agency
National Guard Bureau
U.S. Marine Corps
U.S. Central Command
U.S. European Command
U.S. Joint Forces Command
U.S. Northern Command
U.S. Pacific Command
U.S. Southern Command
U.S. Special Operations Command
U.S. Strategic Command
DoD Education Activity
TRICARE Management Activity
Defense Technical Information Center

T A B L E



DEPARTMENT OF DEFENSE Freedom of Information Act Program Survey

Your participation is requested to complete this survey about the FOIA Program at your office location.

The survey is part of the response to Executive Order 13392, which calls for a review of FOIA processes. The results will be used to formulate recommendations to improve the FOIA Program.

This survey is **Voluntary** and **Anonymous**, and responses are **Confidential**. The data will go directly to and will be analyzed by an external contractor. The demographic items at the end of the survey are used for macro level comparative analysis, and do not identify offices or activities.

In addition to survey items, please take time to include your comments and recommendations about any issue addressed in the survey. Please be candid in your survey responses.

To ensure that your input is included in the analyses, please complete the survey by **April 17, 2006**. Thank you for your participation.

[Press here to fill out the SURVEY](#)

FOIA Program Survey

The items below refer to FOIA requests received and processed in your FOIA office:

Communication with requesters - Please check all activities performed by your FOIA office:

- Acknowledgement of request receipt.
- Notification of request referral.
- Point of contact and telephone number provided.
- Resolve fees before processing the request.
- Interim communication at approximately 20 working days.
- Requesters advised when they will receive a response.

FOIA Tracking/Control - Please check all that apply:

- Manual (paper)
- Microsoft Excel or other spreadsheet
- Microsoft Access or other database
- Specialized FOIA software (FOIA Xpress, FACTS, etc.)
- Web or Server based processing system
- Multitrack processing system

E-FOIA - Please check all that apply to this office:

- Accept FOIA requests electronically
- FOIA website for this activity/location/installation
- Link to a DoD FOIA website (agency, component, etc.)
- Telephone number on your website for FOIA related inquires
- Link to FOIA handbook

Primary redaction method in your office - Please check one:

- Manual (marker, etc.)
- Generic software (Adobe Acrobat, MS Word, etc.)
- Specialized redaction software (RedactXpress, Redax, etc.)

Request Processing - Please estimate the percent of requests that fall in each category below:

- % Requester contacted to clarify the request, fees, and/or scope.
- % Responsive record(s) are maintained in your office - tasking to other offices not required.
- % Search required.
- % Thorough response received from tasked office(s) by the due date.
- % No redaction required.
- % Expedited requests that demonstrate a **compelling need**.

Processing Time - Please rank order the following according to impact on your backlog.
1 = greatest impact, 5 = least impact.

- Request screening, logging, and assignment.
- Record search/retrieval.

19.	Customer feedback is used to improve FOIA products and services.	<input type="radio"/>	<input type="radio"/>	<input type="radio"/>	<input type="radio"/>	<input type="radio"/>	<input type="radio"/>
20.	Documents electronically available to the public are kept current.	<input type="radio"/>	<input type="radio"/>	<input type="radio"/>	<input type="radio"/>	<input type="radio"/>	<input type="radio"/>

Please indicate the key obstacles that impede FOIA processing.

Please offer your recommendations to improve the FOIA program.

Position Levels of FOIA Staff in this office - Please indicate the number of employees in each level:

<input type="text"/> GS-1 to GS-7	<input type="text"/> E-1 to E-6
<input type="text"/> GS-8 to GS-11	<input type="text"/> E-7 to E-9
<input type="text"/> GS-12 and above	<input type="text"/> O1 to O3
<input type="text"/> Contractor or other adjunct personnel	<input type="text"/> O4 and above

Job Series of FOIA Staff in this office - Please check all that apply:

<input type="checkbox"/> 0086	<input type="checkbox"/> 0675
<input type="checkbox"/> 0301	<input type="checkbox"/> 0905
<input type="checkbox"/> 0303	<input type="checkbox"/> 0950
<input type="checkbox"/> 0340	<input type="checkbox"/> 0986
<input type="checkbox"/> 0342	<input type="checkbox"/> 1102
<input type="checkbox"/> 0343	<input type="checkbox"/> Other - please specify: <input type="text"/>

Training of FOIA Staff in this office - Please indicate the number trained in each category within the past year:

<input type="text"/> On-the-job training
<input type="text"/> Formal FOIA training course/conference by external source (DOJ, ASAP, USDA, etc.)
<input type="text"/> Formal FOIA training conducted by DoD
<input type="text"/> Formal FOIA training conducted at your location

Hierarchical Level - Please indicate the level of this activity within your component command structure:

Headquarters for your component
 Intermediate (major command, etc.)
 Unit (installation, etc.)

Please select your DoD Component

Department of the Army
 Department of the Navy/USMC
 Department of the Air Force
 Unified Combatant Commands
 Other DoD Agency or Field Activity

19.	Customer feedback is used to improve FOIA products and services.	<input type="radio"/>	<input type="radio"/>	<input type="radio"/>	<input type="radio"/>	<input type="radio"/>	<input type="radio"/>
20.	Documents electronically available to the public are kept current.	<input type="radio"/>	<input type="radio"/>	<input type="radio"/>	<input type="radio"/>	<input type="radio"/>	<input type="radio"/>

Please indicate the key obstacles that impede FOIA processing.

Please offer your recommendations to improve the FOIA program.

Position Levels of FOIA Staff in this office - Please indicate the number of employees in each level:

<input type="text"/> GS-1 to GS-7	<input type="text"/> E-1 to E-6
<input type="text"/> GS-8 to GS-11	<input type="text" value="115"/> E-7 to E-9
<input type="text"/> GS-12 and above	<input type="text"/> O1 to O3
<input type="text"/> Contractor or other adjunct personnel	<input type="text"/> O4 and above

Job Series of FOIA Staff in this office - Please check all that apply:

<input type="checkbox"/> 0086	<input type="checkbox"/> 0675
<input type="checkbox"/> 0301	<input type="checkbox"/> 0905
<input type="checkbox"/> 0303	<input type="checkbox"/> 0950
<input type="checkbox"/> 0340	<input type="checkbox"/> 0986
<input type="checkbox"/> 0342	<input type="checkbox"/> 1102
<input type="checkbox"/> 0343	<input type="checkbox"/> Other - please specify: <input type="text"/>

Training of FOIA Staff in this office - Please indicate the number trained in each category within the past year:

<input type="text"/> On-the-job training
<input type="text"/> Formal FOIA training course/conference by external source (DOJ, ASAP, USDA, etc.)
<input type="text"/> Formal FOIA training conducted by DoD
<input type="text"/> Formal FOIA training conducted at your location

Hierarchical Level - Please indicate the level of this activity within your component command structure:

Headquarters for your component
 Intermediate (major command, etc.)
 Unit (installation, etc.)

Please select your DoD Component

Department of the Army
 Department of the Navy/USMC
 Department of the Air Force
 Unified Combatant Commands
 Other DoD Agency or Field Activity

FOIA Program Survey

The items below refer to FOIA requests received and processed in your FOIA office:

Communication with requesters - Please check all activities performed by your FOIA office:

- Acknowledgement of request receipt.
- Notification of request referral.
- Point of contact and telephone number provided.
- Resolve fees before processing the request.
- Interim communication at approximately 20 working days.
- Requesters advised when they will receive a response.

FOIA Tracking/Control - Please check all that apply:

- Manual (paper)
- Microsoft Excel or other spreadsheet
- Microsoft Access or other database
- Specialized FOIA software (FOIA Xpress, FACTS, etc.)
- Web or Server based processing system
- Multitrack processing system

E-FOIA - Please check all that apply to this office:

- Accept FOIA requests electronically
- FOIA website for this activity/location/installation
- Link to a DoD FOIA website (agency, component, etc.)
- Telephone number on your website for FOIA related inquiries
- Link to FOIA handbook

Primary redaction method in your office - Please check one:

- Manual (marker, etc.)
- Generic software (Adobe Acrobat, MS Word, etc.)
- Specialized redaction software (RedactXpress, Redax, etc.)

Request Processing - Please estimate the percent of requests that fall in each category below:

- % Requester contacted to clarify the request, fees, and/or scope.
- % Responsive record(s) are maintained in your office - tasking to other offices not required.
- % Search required.
- % Thorough response received from tasked office(s) by the due date.
- % No redaction required.
- % Expedited requests that demonstrate a **compelling need**.

Processing Time - Please rank order the following according to impact on your backlog.

1 = greatest impact, 5 = least impact.

- Request screening, logging, and assignment.
- Record search/retrieval.

TAB F



ADMINISTRATION AND
MANAGEMENT

OFFICE OF THE SECRETARY OF DEFENSE
1950 DEFENSE PENTAGON
WASHINGTON, DC 20301-1950

24 MAR 2006

MEMORANDUM FOR DOD COMPONENT FOIA CHIEF PUBLIC LIAISON OFFICERS

Subject: Executive Order 13392 - Review of DoD FOIA Program

On March 16, 2006, I sent out a memorandum launching the DoD FOIA survey that will be used to develop the DoD FOIA review and plan in accordance with Executive Order 13392. We anticipate receiving valuable feedback from the FOIA offices at all levels of the DoD.

To further assist us in the development of our review and plan, we are asking you as FOIA Chief Public Liaison Officers to provide us with your managerial perspectives on the FOIA process within your DoD Component. You are asked to provide us with a more unique insight into the administration of your FOIA programs at the headquarters level. Your top-of-the-system assessments will provide us with valuable information to supplement the data we receive from the surveys.

In order to capture as much information as possible, we are leaving this assessment open-ended and, accordingly, we are not supplying questions in survey form. In your assessment, we ask that you address the following six areas that will form the core structure of the DoD review and plan:

- FOIA backlogs – a top down assessment of causes and needed improvements
- FOIA customer service practices and managerial oversight
- Information technology to support FOIA processing – what you have, what is needed, and what can be provided from the Component headquarters
- Resources committed to FOIA processing – funding, manpower, facilities, IT support, etc., to include comment on shortfalls that impede process improvement
- Component compliance with 5 U.S.C. § 552 (a)(2) to make information available to the public, with specific comment regarding website applications
- Your vision for a FOIA process that achieves the objectives of EO 13392

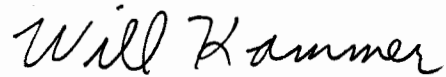

In addition to identifying areas that need help, we are hoping you can provide success stories that can be included in our plan. In order to receive, review, and analyze your responses within a compressed time schedule, we ask that you provide your assessment by April 24, 2006 to David Maier. He can be contacted at 703-696-4689 / DSN 426-4689 or by email at david.maier@whs.mil.

A handwritten signature in cursive script that reads "Will Kammer".

Will Kammer
Chief
Defense Freedom of Information Policy Office

TAB G

DEPARTMENT OF DEFENSE



Freedom of Information Act (FOIA) Program Study

Office of the Secretary of Defense
Quality Management Office
Washington, DC



Interaction Research Institute, Inc.

Inquiries regarding this study or the results contained herein
may be referred to:

Interaction Research Institute, Inc.

4428 Rockcrest Drive
Fairfax, Virginia 22032

Voice : (703) 978-0313

Email : iriinc@aol.com

Website : www.irism.com



DEPARTMENT OF DEFENSE Freedom of Information Act (FOIA) Program Study

TABLE OF CONTENTS

[Executive Summary](#)

[Chapter One. Introduction](#)

[Chapter Two. Demographics](#)

[Chapter Three. General Results](#)

[Chapter Four. Organizational Climate](#)

[Chapter Five. Comparison Groups](#)

[Chapter Six. Analysis of Target Groups](#)

[Appendix A. FOIA Program Study Detailed Analysis by DoD Component & Hierarchical Level](#)

[- Table A.1: Communication with Requesters](#)

[- Table A.2: FOIA Tracking/Control](#)

[- Table A.3: E-FOIA Capability in Office/Activity](#)

[- Table A.4: Request Processing](#)

[- Table A.5: Climate Item Scores](#)

[Appendix B. DoD FOIA Program Survey](#)

Executive Summary

The *Freedom of Information Act (FOIA)* is a federal statute (5 U.S.C. § 552) that establishes the public's right to request existing records from Federal government agencies. Enacted in 1966, the Freedom of Information Act was the first law to establish an effective legal right of access to government information. The statute was amended by the *Electronic Freedom of Information Act Amendments of 1996*. This legislation established annual reporting and E-FOIA requirements, and extended the legal response period from 10 to 20 working days.

Executive Order 13392 was issued by President Bush on Dec 14, 2005. The Executive Order (EO) establishes procedures for a more citizen-centered and results-oriented approach, and requires a review of each agency's FOIA operations to assess compliance with FOIA legislation and identify ways to eliminate or reduce FOIA backlog. The EO also directs that each agency submit a plan of specific activities that will be implemented to improve customer service and eliminate or reduce backlog.

The *DoD Freedom of Information Act Program Study* was conducted in April 2006 to provide information for the review required by Executive Order 13392. The study included a survey of FOIA processes and organizational climate. The results will be used to formulate recommendations to improve the DoD FOIA Program.

Interaction Research Institute, Inc. (IRI) designed and constructed the customized web-based survey for all DoD FOIA activities. IRI reviewed pertinent handbooks and regulations and conducted *Critical Incident Interviews* with FOIA professionals in order to customize the survey to reflect the unique terminology and issues associated with DoD FOIA processing.

Due to its size and complexity, the Department of Defense's FOIA program is decentralized among the DoD components, which operate their own FOIA offices and respond directly to the public for their own records. The target audience of the study was the primary FOIA officer within each DoD activity that receives and processes FOIA requests. The survey was completed by over 80% (548) of the DoD FOIA activities.

The study results reveal excellent customer focus, cooperation, and teamwork within FOIA offices. The study also disclosed the following improvement opportunities:

- Access to and training of all FOIA staff members
- E-FOIA compliance
- Support of the FOIA program within each command/activity/installation
- Software to facilitate redaction
- Standardization of FOIA Job Series and Grade/Rank position levels

Detailed analysis of FOIA staff training disclosed that FOIA personnel in the offices with the greatest FOIA workload are better prepared for FOIA duties. However, there are some employees at all levels who are not sufficiently trained. This indicates that a DoD-wide training initiative is required to ensure that all FOIA staff members receive the training needed to perform their jobs effectively.

A targeted analysis of DoD FOIA offices with large request volumes and backlogs reveal that backlog has a much greater impact on resource requirements than request volume. Offices/activities with a large request volume do not report insufficient resources, unless they also have a large backlog.

These findings indicate that a targeted approach is required to reduce FOIA backlog - to provide additional resources (personnel and budget) to offices that are accumulating a large backlog. Short-term options include resource redistribution or targeted Tiger Teams.

Introduction

Executive Order 13392 directs each agency to submit a plan of specific activities that will be implemented to improve customer service and eliminate or reduce backlog. The *DoD FOIA Program Survey* was developed and conducted by *Interaction Research Institute, Inc (IRI)* as a means to solicit information and feedback about the FOIA program from those involved in daily FOIA processing. The survey instrument can be viewed in [Appendix B](#).

The *DoD FOIA Program Survey* was administered through a web-based form. Invitations to complete the survey were emailed to the target population with a link to the survey cover page. Responses were transmitted directly to IRI for analysis. Response to the survey was anonymous and voluntary on the employee's part. No respondent identifying information was obtained or recorded into the database.

Demographics

Over 80 percent (548) of the DoD FOIA offices completed the survey. Tables 2.1 and 2.2 show the demographic characteristics of the respondents.

**Table 2.1
DoD Component**

DoD Component	Number	Percent
Department of the Army	137	25.0
Department of the Navy/USMC	190	34.7
Department of the Air Force	141	25.7
Unified Combatant Command	7	1.3
Other DoD Agency or Field Activity	49	8.9
Not Indicated	24	4.4
Total	548	100.0

**Table 2.2
Hierarchical Level**

Hierarchical Level	Number	Percent
Headquarters for component	124	22.6
Intermediate (major command, etc.)	109	19.9
Unit (installation, etc.)	288	52.6
Not Indicated	27	4.9
Total	548	100.0

Table 2.3 displays the sample used for comparative analyses of results by DoD Component and Hierarchical Level. Due to the small sample size, the *Unified Combatant Command* respondents were included in the *Other DoD* group. This table does not include respondents that did not indicate their component or hierarchical level

**Table 2.3
Sample for Comparative Analysis by Component & Hierarchical Level**

Hierarchical Level	AF	Army	Navy	Other DoD	TOT
Headquarters for component	28	27	42	27	124
Intermediate (major command, etc.)	16	21	59	13	109
Unit (installation, etc.)	96	88	88	16	288
TOTAL	140	136	189	56	521

Respondents were asked to input the number of employees in their office within specified Grade/Rank levels. Table 2.4 depicts the number and percent of FOIA staff within each Grade/Rank level. Detailed analysis of the 171 employees below GS-8 revealed that 46 work in a Headquarters activity, 28 within an intermediate activity, and 97 at a unit/installation activity.

**Table 2.4
FOIA Staff Position Levels**

Position Level	Number	Percent
GS-1 to GS-7	171	13.9
GS-8 to GS-11	312	25.3
GS-12 and above	417	33.9
Contractor or adjunct personnel	91	7.4
E-1 to E-6	87	7.1
E-7 to E-9	45	3.7
O1 to O3	55	4.5
O4 and above	52	4.2
Total	1230	100.0

The survey asked respondents to indicate the Job Series of staff members at their location. Table 2.5 shows the series represented, and the number of offices/activities that reported at least one FOIA staff member with the position description for that series.

**Table 2.5
Job Series of FOIA Staff Members**

Series	Description	Count
0343	Management & Program Analysis	117
0905	General Attorney	100
0950	Paralegal Specialist	77
0301	Miscellaneous Administration & Program	62
0344	Program Assistant	54
0986	Legal Assistance	30
0303	Miscellaneous Clerk & Assistant	23
0342	Support Services Administration	15
1102	Contracting	12
0132	Intelligence	6
0201	Human Resources Management	6
0318	Secretary	6
0341	Administrative Officer	6
2210	Information Technology Management	5
0080	Security Administration	4
0326	Office Automation Clerical & Assistance	3
0335	Computer Clerk & Assistant	3
0511	Auditing	3
1106	Procurement Clerical & Technician	3
1801	General Inspection, Investigation & Compliance	3
0086	Security Clerical & Assistance	2
1420	Archivist	2
0111	Economist	1
0180	Psychology	1
0309	Correspondence Clerk	1
0669	Medical Records Administration	1
1035	Public Affairs	1
1082	Writing & Editing	1
1083	Technical Writing & Editing	1
1105	Purchasing	1
1222	Patent Attorney	1
1412	Technical Information Service	1

1550	Computer Science	1
1654	Printing Services	1
1802	Compliance Inspection & Support	1

Table 2.6 shows the number and percent of FOIA staff that received the specified types of training within the past year. The denominator to compute the percentages (1186) includes the number of FOIA staff members reported by those respondents that entered a number (e.g., 0, 1, 2) in at least one of the types of training.

**Table 2.6
Training of FOIA Staff**

Training of FOIA Staff	Number	Percent
On-the-job training	604	50.9%
Formal FOIA training conducted by external source	359	30.3%
Formal FOIA training conducted by DoD	172	14.5%
Formal FOIA training conducted at your location	159	13.4%
No formal FOIA training	280	23.6%
No training of any type	109	9.2%

General Results

Table 3.1 through 3.3 displays the number and percent of respondents who checked the checkbox indicating that the activities are executed within their FOIA office. The denominator to compute the percents is all respondents that completed this set of questions (541). Table 3.1 shows the number and percent of respondents that checked each type of communication with requesters.

Table 3.1
Communication with Requesters

Type of Communication	Number	Percent
Acknowledgement of request receipt	451	83%
Notification of request referral	481	89%
Point of contact and telephone number provided	494	91%
Resolve fees before processing the request	404	75%
Interim communication at approximately 20 working days	427	79%
Requesters advised when they will receive a response	380	70%

Table 3.2 displays the number and percent of respondents who checked each tracking/control mechanism.

Table 3.2
FOIA Tracing/Control

Tracking/Control Method	Number	Percent
Manual (paper)	307	57%
Microsoft Excel or other spreadsheet	238	44%
Microsoft Access or other database	129	24%
Specialized FOIA software	111	21%
Web or Server based processing system	106	20%
Multi-track processing system	97	18%

Table 3.3 displays the number and percent of respondents who checked that their office/activity has the specified E-FOIA capabilities.

Table 3.3
E-FOIA Capabilities at Office/Activity

E-FOIA at Activity/Location	Number	Percent
Accept FOIA requests electronically	433	80%
FOIA website for this activity/location	249	46%
Link to a DoD FOIA website	244	45%
Telephone number for FOIA inquiries	291	54%
Link to FOIA handbook	193	36%
Neither website nor link to website	234	43%

Table 3.4 shows the primary redaction method used in the FOIA offices that responded to the survey.

**Table 3.4
Primary Redaction Method**

Redaction Method	Number	Percent
Manual	446	81.8
Generic Redaction Software	41	7.5
Specialized Redaction Software	38	6.9
Not Indicated	21	4.5
Total	548	100.0

Respondents estimated the percent of requests in their office within each category below. Table 3.5 displays the average percent of requests for each category.

**Table 3.5
Request Processing - Estimated Percent of Requests**

Category	Percent
Requester contacted to clarify request, fees, and/or scope	22.6%
Responsive records maintained in your office	30.0 %
Search required	67.8%
Thorough response received by tasked office by due date	62.8%
No redaction required	37.5%
Expedited requests that demonstrate a compelling need	6.2%

Survey respondents were asked to rank order the five major FOIA processing steps according to impact on backlog. The results were converted to a 0-100 scale. A step would receive a score of 100 if all respondents indicated that the step had the greatest effect on backlog. Figure 3.1 shows that *the Compilation, redaction and final response preparation* and *Record Search/Retrieval* steps have the greatest impact on backlog.

Figure 3.1
FOIA Process Steps in Rank Order
According to Impact on Backlog

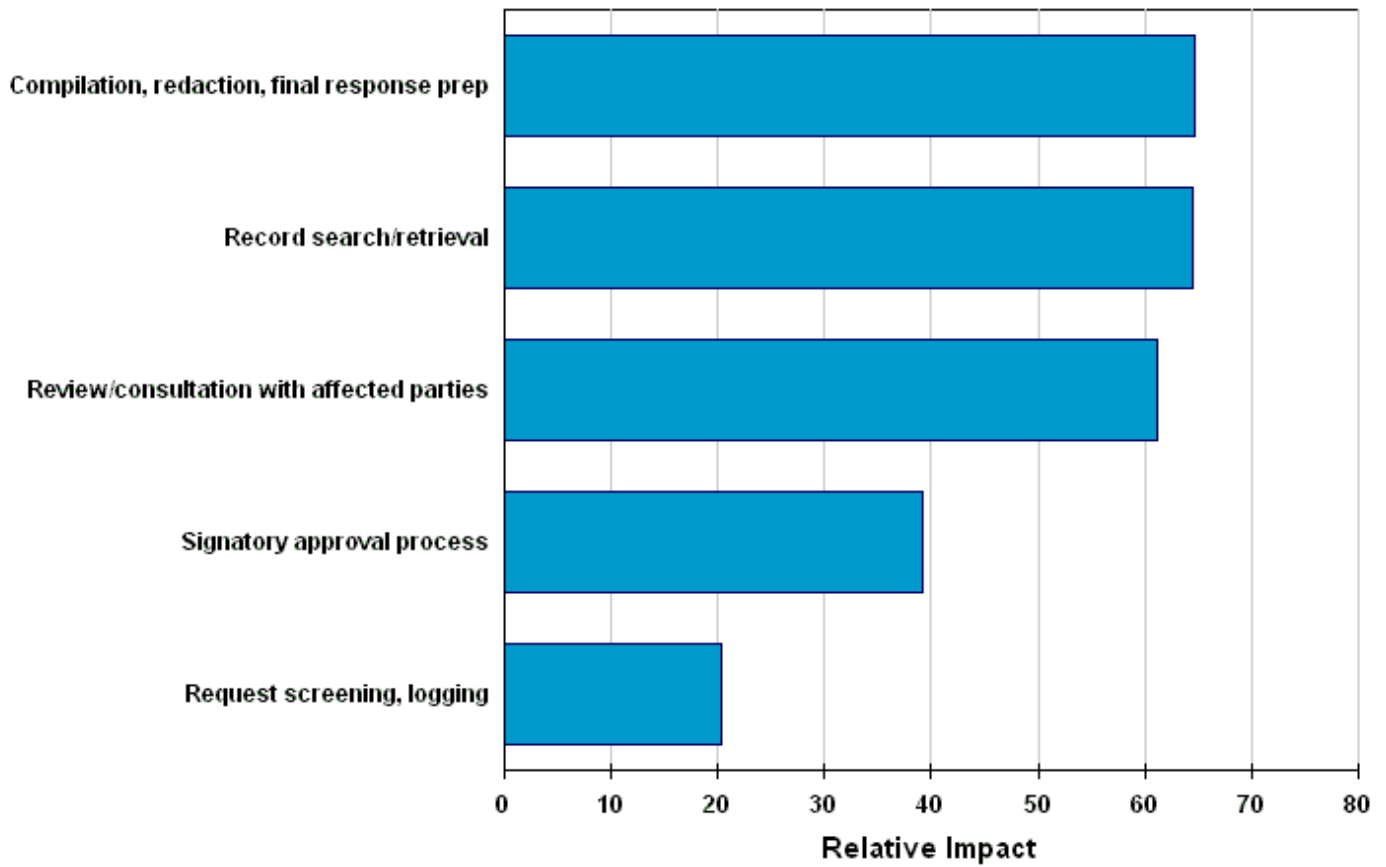

Figure 3.2 displays the distribution of backlog (number of pending requests). The Frequency represents the number of FOIA offices. Figure 3.2 shows that almost 180 offices had no backlog whatsoever at the time of the survey.

Figure 3.2
FOIA Backlog Distribution

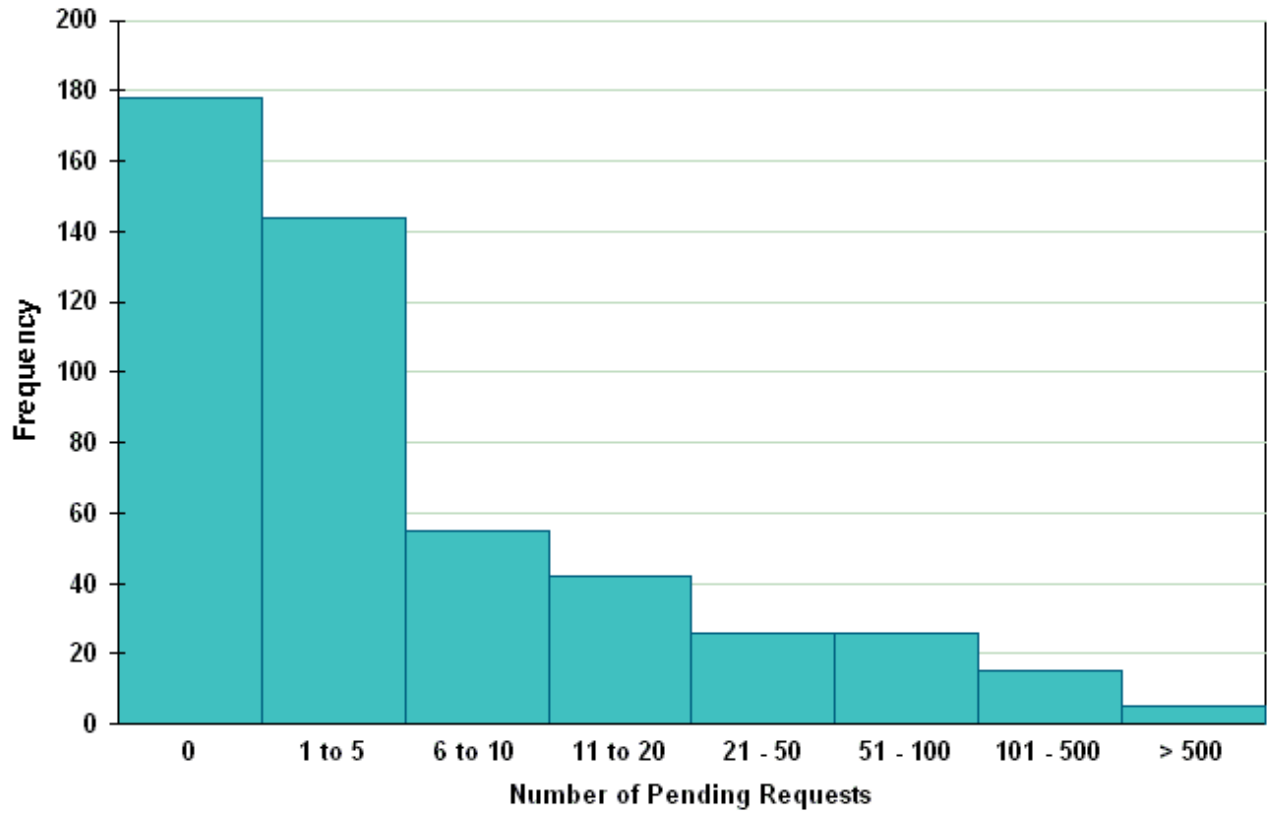
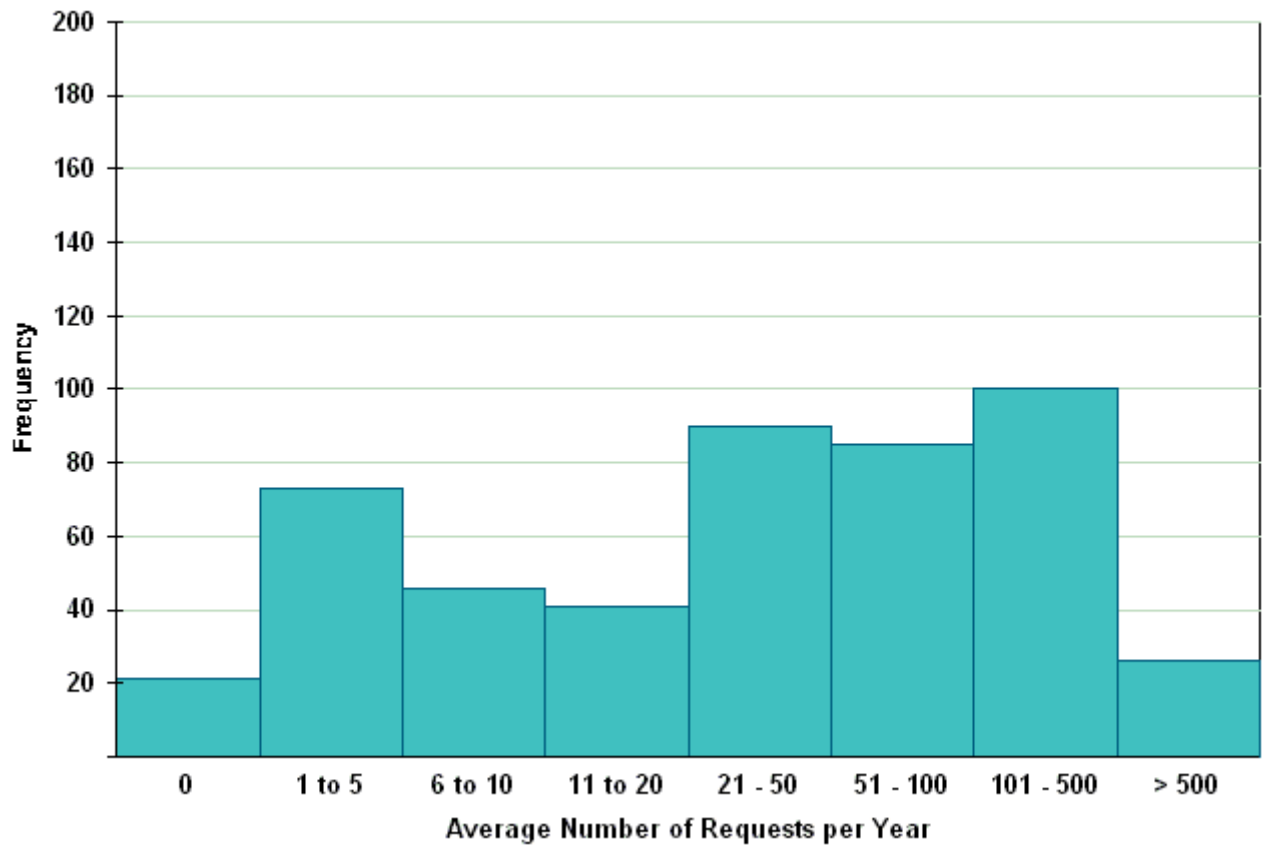

Figure 3.3 displays the distribution of the average number of FOIA requests received per year. It shows that 128 offices reported request volumes greater than 100 per year.

Figure 3.3
FOIA Request Volume Distribution



Organizational Climate

The *organizational climate* section of the survey assessed respondent perceptions about their work environment. Organizational climate items measure concerns, conditions, and issues that provide diagnostic insight into the motivational level of the work force. This information is useful for management to direct activity toward improvement. The following categories of assessment comprise the organizational climate section.

Organizational Climate Categories

Job Mastery	:	Development of and competence in required skills.
Resources	:	Adequacy of resources for FOIA processing at respondent location.
Cooperation & Teamwork	:	Coordination, collaboration and cooperation within and between groups involved in FOIA processing.
Customer Focus	:	Customer orientation and perceived satisfaction.

Each category consists of several relevant item statements representing key issues and conditions about FOIA processing in their office. Respondents were asked to make judgments about each statement along a five point scale shown in the table below.

Response Alternatives

Value	Description
5	Strongly agree
4	Agree
3	Neither agree nor disagree
2	Disagree
1	Strongly disagree
N	Not applicable or don't know

Organizational climate scores were converted to a 0-100 scale for ease of interpretation. Each score represents the percent of the total possible score. The overall score (Climate Quotient) is **71.0**. The Mean Score and Grade Level interpretation below (derived using empirical data and the Normal Curve model) shows that the Climate Quotient is in the *Excellent* range.

Mean Score and Grade Level

Mean Score	Grade	Performance
68 - 80+	A	Excellent
56 - 68	B	Good
44 - 56	C	Fair
< 44	D	Poor

The scores for the four organizational climate categories are displayed in rank order in Figure 4.1, and in sequential order in Table 4.1.

**Figure 4.1
DoD FOIA Climate Category Scores**

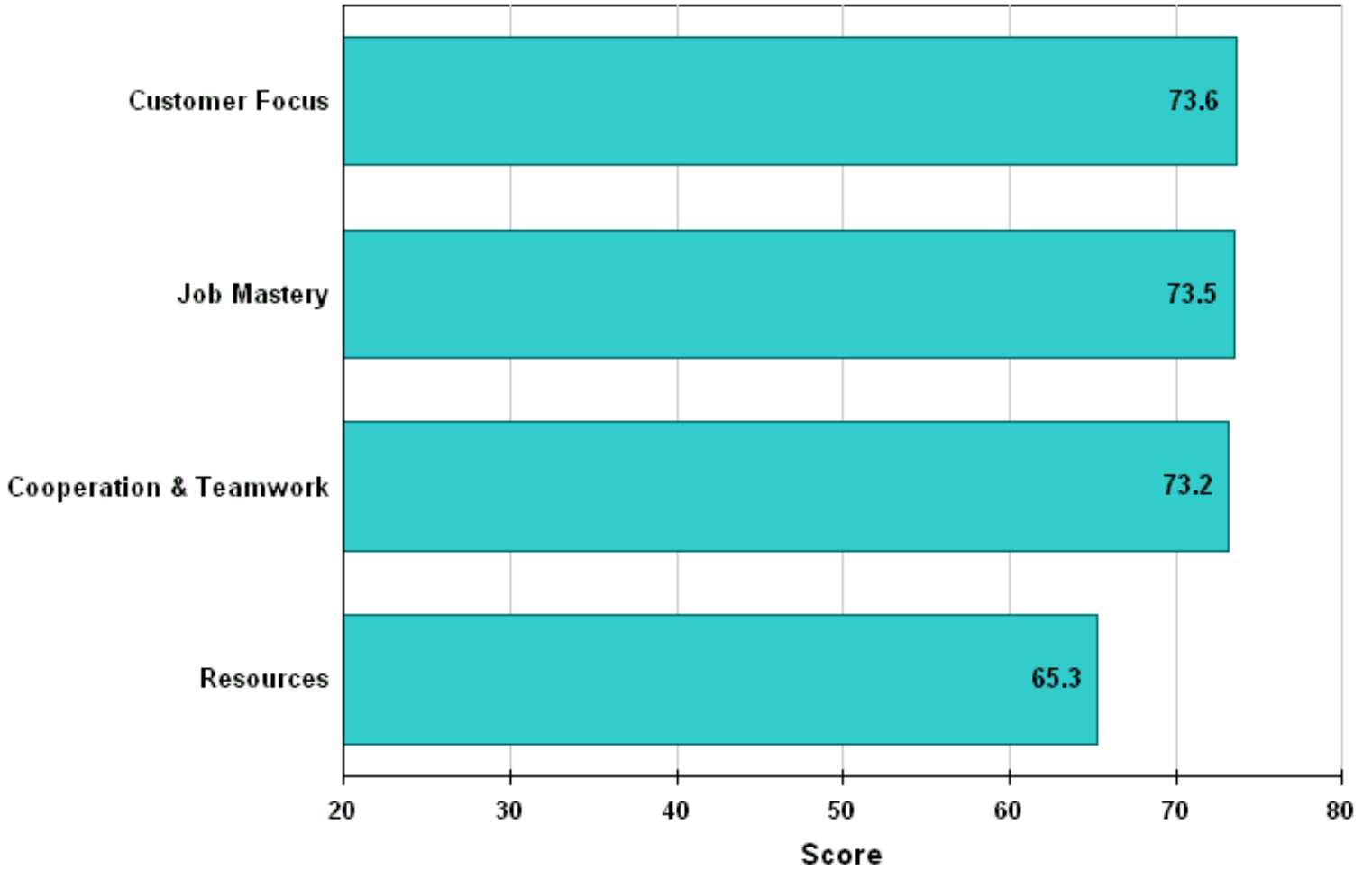

**Table 4.1
Category Scores**

Category	Score
Job Mastery	73.5
Resources	65.3
Cooperation & Teamwork	73.2
Customer Focus	73.6
Climate Quotient	71.0

Table 4.2 displays the category and item scores. This table reveals that the low score for the Resources category is attributable to *FOIA staff, administrative support, and budget allocations*.

**Table 4.2
Climate Category & Item Scores**

No.	Category/Item	Score
Job Mastery - The FOIA staff in this office:		73.5
1	Receive the training needed to perform their jobs effectively.	65.6
2	Have the expertise and judgment required for FOIA processing.	76.6
3	Understand their FOIA roles and responsibilities.	81.1
4	Have Position Descriptions that specify FOIA duties.	70.6
Resources - The following resources are adequate for FOIA processing in this office:		65.3
5	Office equipment (scanner, fax, etc.).	75.5
6	Office materials and supplies.	79.8
7	FOIA staff (full and part time personnel).	58.9
8	Administrative support.	59.7
9	IT support (software, help desk, etc.).	63.6
10	Budget allocations.	53.0
Cooperation and Teamwork		73.2
11	There is a spirit of cooperation and teamwork within this FOIA office.	79.4
12	Other offices involved in FOIA processing cooperate to achieve FOIA program goals.	69.3
13	This office receives timely responses from offices tasked for record search and review.	63.7
14	Affected parties (e.g., Legal Counsel, IDA, SME's) respect the advice and decisions from this FOIA office.	76.0
15	The leadership of this activity supports the FOIA program.	75.2
16	This office receives timely updates on the FOIA program from your component's FOIA Policy Office.	75.9
Customer (Requester) Focus		73.6
17	FOIA processes are designed to meet customer needs.	77.1
18	This FOIA office is responsive to customer inquiries.	85.2
19	Customer feedback is used to improve FOIA products and services.	65.3
20	Documents electronically available to the public are kept current.	64.2
Climate Quotient		71.0

Comparison Groups

The Demographic segment of the *DoD FOIA Program Survey* included items to indicate the *DoD Component* and the *Hierarchical Level* of the reporting office. Table 5.1 displays the sample used for comparative analyses of results by DoD component and hierarchical level. This table does not include respondents that did not indicate their component and/or hierarchical level.

Due to the small sample sizes within the cells, a difference of 10 points or greater is needed for statistical significance. Statistical significance indicates that the differences among groups are most likely attributable to an underlying cause, rather than to sampling variation.

Table 5.1
Sample for Comparative Analysis by Component & Hierarchical Level

Hierarchical Level	AF	Army	Navy	Other DoD	TOT
Headquarters for component	28	27	42	27	124
Intermediate (major command, etc.)	16	21	59	13	109
Unit (installation, etc.)	96	88	88	16	288
TOTAL	140	136	189	56	521

Table 5.2 shows that there are no significant differences in the overall Climate Quotient by Component or Hierarchical Level.

Table 5.2
Climate Quotient by Component & Hierarchical Level

Hierarchical Level	AF	Army	Navy	Other DoD	TOTAL
Headquarters for component	67.5	72.7	73.6	69.4	71.1
Intermediate (major command, etc.)	68.9	68.4	79.7	72.9	70.7
Unit (installation, etc.)	74.0	71.0	67.4	62.8	70.3
TOTAL	71.8	70.6	70.3	68.3	71.0

[Appendix A](#) displays the FOIA Program Survey items by DoD Component and Hierarchical Level. Although most of the differences are not statistically significant, the following findings are noteworthy.

- The *headquarters* level and the Other DoD component (comprised of DoD agencies, field activities, and combatant commands) report the highest percentage of FOIA staff that received training within the past year. These groups also exhibit the highest scores for the climate item: *The FOIA staff in this office receive the training needed to perform their job effectively.*
- The Army reports a higher percentage of offices that use a multi-track processing system.
- The Air Force and Other DoD component exhibit higher percentages for E-FOIA compliance.
- The Navy exhibits the highest scores for *timeliness of response from offices tasked for search and review.*
- The *Headquarters* level of the Other DoD component exhibits significantly lower scores regarding sufficient *Staff and Budget allocations.*

Analyses of Target Groups

A targeted analysis was conducted to compare findings for groups that process a large volume of requests and/or have a large backlog. Climate item scores were computed for two target groups:

- **Request Volume > 100:** FOIA offices that reported processing more than 100 requests per year (128 respondents).
- **Backlog > 50:** FOIA offices that reported a backlog greater than 50 (48 respondents). This group includes six offices that either did not report the number of requests, or reported a request volume slightly less than 100.

A demographic analysis of the **Request Volume > 100** group disclosed that less than one third (31%) reported backlogs greater than 50, and 30% reported backlogs less than 10. Table 1 shows the DoD component and hierarchical level of this group.

Table 6.1
Request Volume >100 Target Group by Component and Hierarchical Level

Hierarchical Level	AF	Army	Navy	Other DoD	TOTAL
Headquarters for component	6	11	12	17	46
Intermediate (major command, etc.)	3	5	13	4	25
Unit (installation, etc.)	14	26	11	6	57
TOTAL	23	42	36	27	128

Table 6.2 shows the distribution of the offices that reported backlogs greater than 50. Most of this group (42 of the 48) also process more than 100 requests per year.

Table 6.2
Backlog >50 Target Group by Component and Hierarchical Level

Hierarchical Level	AF	Army	Navy	Other DoD	TOTAL
Headquarters for component	3	11	4	10	28
Intermediate (major command, etc.)	0	3	2	2	7
Unit (installation, etc.)	2	6	4	1	13
TOTAL	5	20	10	13	48

Table 6.3 displays the Climate Item scores for the two target groups and the Non-Target group (the remainder of the respondents).

**Table 6.3
Climate Item Scores for Target and Non-Target Groups**

No.	Item	Volume > 100	Backlog > 50	Non Target
1	The FOIA staff in this office receive the training needed to perform their jobs effectively.	74.4	80.2	62.3
2	The FOIA staff in this office have the expertise and judgment required for FOIA processing.	83.2	81.8	74.1
3	The FOIA staff in this office understand their FOIA roles and responsibilities.	88.1	85.9	78.3
4	The FOIA staff in this office have Position Descriptions that specify FOIA duties.	79.7	79.7	66.9
5	Our office equipment is adequate for FOIA processing.	72.9	76.0	76.2
6	This office's office materials and supplies are adequate for FOIA processing.	79.1	80.9	79.7
7	The FOIA staff in this office is adequate for FOIA processing.	52.8	40.6	60.7
8	This office's Administrative support is adequate for FOIA processing.	51.2	46.4	62.7
9	This office's IT support is adequate for FOIA processing.	59.9	62.2	64.7
10	This office's budget allocations are adequate for FOIA processing.	45.3	40.3	55.8
11	There is a spirit of cooperation and teamwork within this FOIA office.	82.3	80.3	77.9
12	Other offices involved in FOIA processing cooperate to achieve FOIA program goals.	65.3	65.4	70.9
13	This office receives timely responses from offices tasked for record search and review.	55.9	51.0	67.2
14	Affected parties (e.g., Legal Counsel, IDA, SME's) respect the advice and decisions from this FOIA office.	77.2	74.0	75.5
15	The leadership of this activity supports the FOIA program.	71.4	68.6	76.3
16	This office receives timely updates on the FOIA program from your component's FOIA Policy Office.	76.6	78.6	75.7
17	FOIA processes are designed to meet customer needs.	80.1	76.6	75.9
18	This FOIA office is responsive to customer inquiries.	87.7	86.5	84.1
19	Customer feedback is used to improve FOIA products and services.	68.0	65.2	63.9
20	Documents electronically available to the public are kept current.	61.2	50.6	65.4

Table 6.3 reveals that perceptions regarding most of the issues are similar for the three groups. The difference (disparity) in scores for the group with a large request volume is not as great as for the group with a large backlog. The **Backlog > 50** group displays substantially lower scores for the following items, ranked in descending order according to the amount of disparity.

- The FOIA staff in this office is adequate for FOIA processing.
- This office's Administrative support is adequate for FOIA processing.
- This office receives timely responses from offices tasked for record search and review.
- This office's budget allocations are adequate for FOIA processing.
- Documents electronically available to the public are kept current.
- The leadership of this activity supports the FOIA program.

The **Backlog > 50** group exhibits a score **20** points less than the **Non-Target** group for Item 7 regarding *FOIA staffing*. Scores for this and other *Resources* items were computed for two subsets of the **Request Volume > 100** group; (1) offices with backlogs > 50, and (2) offices with backlogs < 50. The analysis revealed that scores for the **Request Volume > 100** offices with a backlog < 50 are approximately equivalent to those of the Non-Target group. Therefore, backlog has a much greater impact on resource requirements than request volume.

Table 6.3 also displays higher scores for all the Job Mastery items for both target groups:

- The FOIA staff in this office receive the training needed to perform their jobs effectively.
- The FOIA staff in this office have Position Descriptions that specify FOIA duties.

- The FOIA staff in this office understand their FOIA roles and responsibilities.
- The FOIA staff in this office have the expertise and judgment required for FOIA processing.

FOIA Training

The FOIA Program Survey included two questions to assess training: (1) the *number of FOIA staff members that received training within the past year*, and (2) whether *FOIA personnel receive sufficient training to perform their jobs effectively*.

Detailed analysis found that insufficient training is more prevalent in offices that process a small number of requests. However, ten of the **Request Volume > 100** offices reported that none of their FOIA personnel had received training within the past year .

Comparative analysis of the *Climate* items disclosed that offices with large request volumes and backlogs have significantly higher scores regarding *Receiving training needed to perform their jobs effectively*, and *Position Descriptions that specify FOIA duties*.

These findings indicate that FOIA personnel in the offices with the greatest FOIA workload are better prepared for FOIA duties, but across the board improvement is warranted. Therefore, a systemic approach is required to address the content, logistical, and budgetary challenges to provide relevant training to all FOIA personnel.

[Table of Contents](#)

[Table A.1: Communication with Requesters](#)

[Table A.2: FOIA Tracking/Control](#)

[Table A.3: E-FOIA Capability at Office/Activity](#)

[Table A.4: Request Processing](#)

[Table A.5: Climate Item Scores by Component & Hierarchical Level](#)



Table A.1
Communication with Requesters

C1 - Acknowledgement of request receipt					
Hierarchical Level	AF	Army	Navy	Oth DoD	TOTAL
Headquarters for component	92.9%	96.3%	90.5%	88.9%	91.9%
Intermediate (major command, etc.)	81.3%	71.4%	86.4%	92.3%	83.5%
Unit (installation, etc.)	79.2%	72.7%	84.1%	81.3%	78.8%
TOTAL	82.1%	77.2%	86.2%	87.5%	82.9%
C2 - Notification of Request Referral					
Hierarchical Level	AF	Army	Navy	Oth DoD	TOTAL
Headquarters for component	96.4%	100.0%	88.1%	92.6%	93.5%
Intermediate (major command, etc.)	100.0%	76.2%	88.1%	76.9%	86.2%
Unit (installation, etc.)	89.6%	90.9%	83.0%	75.0%	87.2%
TOTAL	92.1%	90.4%	85.7%	83.9%	88.5%
C3 - POC & telephone number provided					
Hierarchical Level	AF	Army	Navy	Oth DoD	TOTAL
Headquarters for component	92.9%	96.3%	97.6%	100.0%	96.8%
Intermediate (major command, etc.)	87.5%	76.2%	89.8%	92.3%	87.2%
Unit (installation, etc.)	89.6%	90.9%	89.8%	87.5%	89.9%
TOTAL	90.0%	89.7%	91.5%	94.6%	91.0%
C4 - Resolve fees before processing the request					
Hierarchical Level	AF	Army	Navy	Oth DoD	TOTAL
Headquarters for component	78.6%	70.4%	71.4%	88.9%	76.6%
Intermediate (major command, etc.)	87.5%	61.9%	76.3%	84.6%	76.1%
Unit (installation, etc.)	72.9%	84.1%	65.9%	68.8%	74.0%
TOTAL	75.7%	77.9%	70.4%	82.1%	75.0%
C5 - Interim communication at approximately 20 working days					
Hierarchical Level	AF	Army	Navy	Oth DoD	TOTAL

Headquarters for component	96.4%	74.1%	66.7%	66.7%	75.0%
Intermediate (major command, etc.)	87.5%	71.4%	71.2%	84.6%	75.2%
Unit (installation, etc.)	87.5%	87.5%	71.6%	75.0%	81.9%
TOTAL	89.3%	82.4%	70.4%	73.2%	78.9%

C6 - Requesters advised when they will receive a response

Hierarchical Level	AF	Army	Navy	Oth DoD	TOTAL
Headquarters for component	82.1%	74.1%	76.2%	59.3%	73.4%
Intermediate (major command, etc.)	81.3%	61.9%	69.5%	61.5%	68.8%
Unit (installation, etc.)	76.0%	69.3%	65.9%	56.3%	69.8%
TOTAL	77.9%	69.1%	69.3%	58.9%	70.4%



**Table A.2
FOIA Tracking/Control**

T1 - Manual Tracking					
Hierarchical Level	AF	Army	Navy	Oth DoD	TOTAL
Headquarters for component	67.9%	55.6%	47.6%	40.7%	52.4%
Intermediate (major command, etc.)	37.5%	42.9%	66.1%	23.1%	52.3%
Unit (installation, etc.)	57.3%	53.4%	69.3%	62.5%	60.1%
TOTAL	57.1%	52.2%	63.5%	42.9%	56.6%
T2 - Microsoft Excel or other spreadsheet					
Hierarchical Level	AF	Army	Navy	Oth DoD	TOTAL
Headquarters for component	64.3%	44.4%	47.6%	55.6%	52.4%
Intermediate (major command, etc.)	62.5%	28.6%	39.0%	69.2%	44.0%
Unit (installation, etc.)	47.9%	26.1%	42.0%	50.0%	39.6%
TOTAL	52.9%	30.1%	42.3%	57.1%	43.6%
T3 - Microsoft Access or other database					
Hierarchical Level	AF	Army	Navy	Oth DoD	TOTAL
Headquarters for component	28.6%	29.6%	28.6%	40.7%	31.5%
Intermediate (major command, etc.)	50.0%	19.0%	23.7%	30.8%	27.5%
Unit (installation, etc.)	19.8%	33.0%	10.2%	12.5%	20.5%
TOTAL	25.0%	30.1%	18.5%	30.4%	24.4%
T4 - Specialized FOIA software					
Hierarchical Level	AF	Army	Navy	Oth DoD	TOTAL
Headquarters for component	0.0%	66.7%	11.9%	37.0%	26.6%
Intermediate (major command, etc.)	6.3%	61.9%	5.1%	23.1%	18.3%
Unit (installation, etc.)	9.4%	38.6%	3.4%	43.8%	18.4%

TOTAL	7.1%	47.8%	5.8%	35.7%	20.6%
T5 - Web or Server based processing system					
Hierarchical Level	AF	Army	Navy	Oth DoD	TOTAL
Headquarters for component	14.3%	25.9%	14.3%	18.5%	17.7%
Intermediate (major command, etc.)	12.5%	19.0%	6.8%	0.0%	9.2%
Unit (installation, etc.)	11.5%	48.9%	13.6%	18.8%	24.0%
TOTAL	12.1%	39.7%	11.6%	14.3%	19.5%
T6 - Multi-track Processing System					
Hierarchical Level	AF	Army	Navy	Oth DoD	TOTAL
Headquarters for component	17.9%	25.9%	14.3%	33.3%	21.8%
Intermediate (major command, etc.)	18.8%	9.5%	10.2%	23.1%	12.8%
Unit (installation, etc.)	7.3%	45.5%	4.5%	6.3%	18.1%
TOTAL	10.7%	36.0%	8.5%	23.2%	17.9%



**Table A.3
E-FOIA Capability at Office/Activity**

E-1 Accept FOIA Requests Electronically					
Hierarchical Level	AF	Army	Navy	Other DoD	TOTAL
Headquarters for component	78.6%	70.4%	83.3%	100.0%	83.1%
Intermediate (major command, etc.)	100.0%	85.7%	76.3%	84.6%	82.6%
Unit (installation, etc.)	82.3%	84.1%	68.2%	81.3%	78.5%
TOTAL	83.6%	81.6%	74.1%	91.1%	80.4%
E2 - FOIA Website Percentage					
Hierarchical Level	AF	Army	Navy	Other DoD	TOTAL
Headquarters for component	75.0%	33.3%	50.0%	85.2%	59.7%
Intermediate (major command, etc.)	100.0%	9.5%	30.5%	69.2%	41.3%
Unit (installation, etc.)	71.9%	33.0%	18.2%	56.3%	42.7%
TOTAL	75.7%	29.4%	29.1%	73.2%	46.4%
E3 - Link to FOIA Website Percentage					
Hierarchical Level	AF	Army	Navy	Other DoD	TOTAL
Headquarters for component	67.9%	29.6%	61.9%	77.8%	59.7%
Intermediate (major command, etc.)	68.8%	14.3%	37.3%	76.9%	42.2%
Unit (installation, etc.)	55.2%	20.5%	34.1%	56.3%	38.2%
TOTAL	59.3%	21.3%	41.3%	71.4%	44.5%
E4 - Telephone number on website for FOIA related inquiries					
Hierarchical Level	AF	Army	Navy	Other DoD	TOTAL

Headquarters for component	71.4%	37.0%	64.3%	96.3%	66.9%
Intermediate (major command, etc.)	93.8%	38.1%	40.7%	92.3%	54.1%
Unit (installation, etc.)	68.8%	43.2%	31.8%	56.3%	49.0%
TOTAL	72.1%	41.2%	41.8%	83.9%	54.3%

E5 - Link to FOIA Handbook

Hierarchical Level	AF	Army	Navy	Other DoD	TOTAL
Headquarters for component	60.7%	22.2%	42.9%	74.1%	49.2%
Intermediate (major command, etc.)	81.3%	14.3%	25.4%	76.9%	37.6%
Unit (installation, etc.)	54.2%	21.6%	18.2%	37.5%	32.3%
TOTAL	58.6%	20.6%	25.9%	64.3%	36.4%



**Table A.4
Request Processing - Estimated Percentage of Requests**

P1 - Requester contacted to clarify request, fees, and/or scope					
Hierarchical Level	AF	Army	Navy	Oth DoD	TOTAL
Headquarters for component	25.6%	11.9%	20.2%	25.7%	21.0%
Intermediate (major command, etc.)	10.7%	34.4%	21.9%	24.2%	23.0%
Unit (installation, etc.)	22.1%	23.0%	24.2%	20.5%	23.0%
TOTAL	22.4%	22.7%	22.5%	24.0%	22.6%
P2 - Responsive records maintained in your office					
Hierarchical Level	AF	Army	Navy	Oth DoD	TOTAL
Headquarters for component	39.0%	15.8%	37.0%	6.4%	26.1%
Intermediate (major command, etc.)	18.2%	41.7%	49.3%	20.3%	39.7%
Unit (installation, etc.)	21.1%	25.0%	35.7%	47.2%	28.5%
TOTAL	24.7%	25.3%	40.5%	20.3%	30.4%
P3 - Search required					
Hierarchical Level	AF	Army	Navy	Oth DoD	TOTAL
Headquarters for component	61.5%	67.6%	63.5%	80.7%	57.8%
Intermediate (major command, etc.)	63.3%	76.5%	70.8%	85.8%	60.8%
Unit (installation, etc.)	66.5%	73.6%	55.3%	86.4%	66.1%
TOTAL	64.5%	73.0%	62.2%	83.6%	68.3%
P4 - Thorough response received from tasked office by due date					
Hierarchical Level	AF	Army	Navy	Oth DoD	TOTAL
Headquarters for component	62.7%	43.7%	68.0%	51.2%	57.8%
Intermediate (major command, etc.)	73.9%	59.1%	59.3%	57.6%	60.8%
Unit (installation, etc.)	61.6%	70.4%	67.7%	54.2%	66.1%

TOTAL	63.5%	63.7%	65.3%	53.7%	62.8%
P5 - No redaction required					
Hierarchical Level	AF	Army	Navy	Oth DoD	TOTAL
Headquarters for component	36.5%	28.5%	23.0%	25.2%	27.8%
Intermediate (major command, etc.)	40.1%	56.8%	28.4%	37.0%	36.2%
Unit (installation, etc.)	45.4%	53.7%	30.9%	52.5%	44.0%
TOTAL	42.7%	49.3%	28.2%	35.2%	37.5%
P6 - Expedited requests that demonstrate a compelling need					
Hierarchical Level	AF	Army	Navy	Oth DoD	TOTAL
Headquarters for component	1.7%	4.8%	7.6%	2.6%	4.5%
Intermediate (major command, etc.)	2.9%	6.3%	8.8%	3.5%	6.7%
Unit (installation, etc.)	5.9%	6.5%	8.2%	1.9%	6.6%
TOTAL	5.4%	6.2%	8.2%	2.7%	6.2%



**Table A.5
Climate Item Scores by Component & Hierarchical Level**

Q1 - The FOIA staff in this office receive the training needed to perform their jobs effectively.					
Hierarchical Level	AF	Army	Navy	Other DoD	TOTAL
Headquarters for component	64.3	66.7	72.0	90.7	73.2
Intermediate (major command, etc.)	85.9	60.0	65.1	71.2	68.0
Unit (installation, etc.)	55.6	66.5	62.2	60.9	61.3
TOTAL	61.2	65.1	65.3	77.7	65.6
Q2 - The FOIA staff in this office have the expertise and judgment required for FOIA processing.					
Hierarchical Level	AF	Army	Navy	Other DoD	TOTAL
Headquarters for component	74.1	70.4	79.2	88.9	78.2
Intermediate (major command, etc.)	89.1	78.8	72.9	76.9	76.9
Unit (installation, etc.)	74.7	82.8	71.9	65.6	75.8
TOTAL	76.4	79.4	73.8	79.5	76.6
Q3 - The FOIA staff in this office understand their roles and responsibilities.					
Hierarchical Level	AF	Army	Navy	Other DoD	TOTAL
Headquarters for component	78.6	77.8	81.5	92.6	82.5
Intermediate (major command, etc.)	89.1	85.7	76.7	86.5	81.4
Unit (installation, etc.)	79.0	85.9	77.6	71.9	80.3
TOTAL	80.2	84.0	78.2	85.3	81.1
Q4 - The FOIA staff in this office have Position Descriptions that specify FOIA duties.					
Hierarchical Level	AF	Army	Navy	Other DoD	TOTAL
Headquarters for component	70.2	63.0	71.2	83.3	71.8
Intermediate (major command, etc.)	89.1	70.2	60.2	76.9	68.8
Unit (installation, etc.)	65.9	80.5	67.5	61.7	70.8

TOTAL	69.5	74.8	66.1	75.9	70.6
-------	------	------	------	------	------

Q5 - Our office equipment is adequate for FOIA processing.

Hierarchical Level	AF	Army	Navy	Other DoD	TOTAL
Headquarters for component	75.9	75.9	73.8	76.9	75.4
Intermediate (major command, etc.)	81.3	79.8	72.0	75.0	75.2
Unit (installation, etc.)	71.5	79.9	75.6	70.3	75.3
TOTAL	73.5	79.0	74.2	74.6	75.5

Q6 - Our office materials and supplies are adequate for FOIA processing.

Hierarchical Level	AF	Army	Navy	Other DoD	TOTAL
Headquarters for component	77.7	71.3	81.1	85.2	79.1
Intermediate (major command, etc.)	87.5	82.1	78.0	88.5	81.4
Unit (installation, etc.)	76.3	82.2	79.7	75.0	79.1
TOTAL	78.1	80.0	79.5	83.0	79.8

Q7 - Our FOIA staff is adequate for FOIA processing.

Hierarchical Level	AF	Army	Navy	Other DoD	TOTAL
Headquarters for component	60.7	53.7	60.6	39.8	54.5
Intermediate (major command, etc.)	70.3	52.4	55.1	71.2	58.7
Unit (installation, etc.)	57.0	65.6	60.7	54.7	60.7
TOTAL	59.6	61.1	59.1	51.3	58.9

Q8 - Our Administrative support is adequate for FOIA processing.

Hierarchical Level	AF	Army	Navy	Other DoD	TOTAL
Headquarters for component	67.6	56.5	62.8	37.0	56.8
Intermediate (major command, etc.)	66.1	52.4	54.7	67.3	57.2
Unit (installation, etc.)	55.4	65.1	67.3	45.3	61.5
TOTAL	59.4	61.3	62.4	46.4	59.7

Q9 - Our IT support is adequate for FOIA processing.

Hierarchical Level	AF	Army	Navy	Other DoD	TOTAL
Headquarters for component	66.1	69.4	59.8	50.9	61.4
Intermediate (major command, etc.)	73.4	67.5	51.3	63.5	59.1
Unit (installation, etc.)	62.6	72.4	64.0	59.4	65.9
TOTAL	64.9	70.9	59.2	56.3	63.6

Q10 - Our budget allocations adequate for FOIA processing.

Hierarchical Level	AF	Army	Navy	Other DoD	TOTAL
Headquarters for component	59.0	55.4	54.1	27.0	49.3
Intermediate (major command, etc.)	55.0	50.0	52.6	68.2	54.1
Unit (installation, etc.)	48.3	57.0	58.3	48.3	53.9
TOTAL	51.2	55.5	55.5	42.2	53.0

Q11 - There is a spirit of cooperation and teamwork within this FOIA office.

Hierarchical Level	AF	Army	Navy	Other DoD	TOTAL
Headquarters for component	79.6	70.2	78.0	90.4	79.3
Intermediate (major command, etc.)	86.7	77.4	81.9	82.7	81.8

Unit (installation, etc.)	77.0	80.8	78.7	75.0	78.6
TOTAL	78.9	78.1	79.7	84.1	79.4

Q12 - Other offices involved in FOIA processing cooperate to achieve FOIA program goals.

Hierarchical Level	AF	Army	Navy	Other DoD	TOTAL
Headquarters for component	77.7	73.1	70.8	60.6	70.7
Intermediate (major command, etc.)	68.8	62.5	72.3	69.2	69.5
Unit (installation, etc.)	63.8	66.1	77.8	59.4	68.4
TOTAL	67.5	66.9	74.4	62.3	69.3

Q13 - This office receives timely responses from offices tasked for record search and review.

Hierarchical Level	AF	Army	Navy	Other DoD	TOTAL
Headquarters for component	75.9	60.2	72.6	42.6	64.1
Intermediate (major command, etc.)	65.0	58.8	64.7	73.1	64.7
Unit (installation, etc.)	56.4	62.2	73.1	51.6	62.8
TOTAL	61.8	61.3	70.4	52.2	63.7

Q14 - Affected parties respect the advice and decisions from this FOIA office.

Hierarchical Level	AF	Army	Navy	Other DoD	TOTAL
Headquarters for component	78.6	72.1	82.1	71.3	76.7
Intermediate (major command, etc.)	85.9	76.3	76.8	73.1	77.6
Unit (installation, etc.)	70.9	78.9	75.9	71.9	75.0
TOTAL	74.6	76.9	77.6	71.9	76.0

Q15 - The leadership of this activity supports the FOIA program.

Hierarchical Level	AF	Army	Navy	Other DoD	TOTAL
Headquarters for component	80.4	70.4	76.8	65.4	73.8
Intermediate (major command, etc.)	82.8	73.8	79.4	75.0	78.3
Unit (installation, etc.)	70.1	77.6	80.0	57.8	74.7
TOTAL	73.9	75.6	79.1	65.5	75.2

Q16 - This office receives timely updates on the FOIA program from your component's FOIA Policy Office.

Hierarchical Level	AF	Army	Navy	Other DoD	TOTAL
Headquarters for component	76.8	64.8	84.1	91.7	79.9
Intermediate (major command, etc.)	70.0	73.8	75.9	75.0	74.5
Unit (installation, etc.)	69.8	76.7	78.4	73.4	74.7
TOTAL	71.5	73.5	78.8	82.6	75.9

Q17 - FOIA processes are designed to meet customer needs.

Hierarchical Level	AF	Army	Navy	Other DoD	TOTAL
Headquarters for component	79.5	77.8	78.0	79.6	78.7
Intermediate (major command, etc.)	89.1	69.0	75.4	67.3	75.2
Unit (installation, etc.)	75.5	82.1	76.2	59.4	76.9
TOTAL	78.1	79.2	76.5	71.0	77.1

Q18 - This FOIA office is responsive to customer inquiries.

Hierarchical Level	AF	Army	Navy	Other DoD	TOTAL
Headquarters for component	86.6	78.7	86.3	88.0	85.1

Intermediate (major command, etc.)	95.0	86.3	80.4	84.6	84.1
Unit (installation, etc.)	86.8	88.2	83.5	75.0	85.6
TOTAL	87.8	85.9	83.3	83.5	85.2
Q19 - Customer feedback is used to improve FOIA products and services.					
Hierarchical Level	AF	Army	Navy	Other DoD	TOTAL
Headquarters for component	66.7	62.0	62.2	66.3	64.0
Intermediate (major command, etc.)	80.8	57.9	67.7	55.8	65.9
Unit (installation, etc.)	65.8	69.6	62.2	56.7	65.4
TOTAL	67.9	66.1	64.1	61.1	65.3
Q20 - Documents electronically available to the public are kept current.					
Hierarchical Level	AF	Army	Navy	Other DoD	TOTAL
Headquarters for component	77.4	57.6	62.1	58.3	63.4
Intermediate (major command, etc.)	83.9	56.7	61.3	57.7	63.7
Unit (installation, etc.)	67.7	67.9	58.5	59.4	64.7
TOTAL	71.4	63.9	60.2	58.5	64.2

[Table of Contents](#) : [Top of Page](#)

FOIA Program Survey

The items below refer to FOIA requests received and processed in your FOIA office:

Communication with requesters - *Please check all activities performed by your FOIA office:*

- Acknowledgement of request receipt.
- Notification of request referral.
- Point of contact and telephone number provided.
- Resolve fees before processing the request.
- Interim communication at approximately 20 working days.
- Requesters advised when they will receive a response.

FOIA Tracking/Control - *Please check all that apply:*

- Manual (paper)
- Microsoft Excel or other spreadsheet
- Microsoft Access or other database
- Specialized FOIA software (FOIA Xpress, FACTS, etc.)
- Web or Server based processing system
- Multitrack processing system

E-FOIA - *Please check all that apply to this office:*

- Accept FOIA requests electronically
- FOIA website for this activity/location/installation
- Link to a DoD FOIA website (agency, component, etc.)
- Telephone number on your website for FOIA related inquires
- Link to FOIA handbook

Primary redaction method in your office - *Please check one:*

- Manual (marker, etc.)
- Generic software (Adobe Acrobat, MS Word, etc.)
- Specialized redaction software (RedactXpress, Redax, etc.)

Request Processing - *Please estimate the percent of requests that fall in each category below:*

- Requester contacted to clarify the request, fees, and/or scope.
- Responsive record(s) are maintained in your office - tasking to other offices not required.
- Search required.
- Thorough response received from tasked office(s) by the due date.
- No redaction required.
- Expedited requests that demonstrate a **compelling need**.

Processing Time - *Please rank order the following according to impact on your backlog. 1 = greatest impact, 5 = least impact.*

- Request screening, logging, and assignment.
- Record search/retrieval.
- Review/consultation with affected parties (Subject Matter Experts, other Federal Agencies, etc.).
- Compilation, redaction, and final response preparation.
- Signatory approval process (IDA, legal review, Public Affairs, chain of command, etc.)

Current Backlog - Please input the number of initial requests pending (open cases) in this FOIA office.

Initial Requests - Please input the average number of initial requests received by this FOIA office per year.

For each statement below, please mark the circle that most closely represents this FOIA office:

#	Job Mastery - <i>The FOIA staff in this office:</i>	Strongly Agree	Agree	Neither agree nor disagree	Disagree	Strongly Disagree	NA or don't know
1.	Receive the training needed to perform their jobs effectively.						
2.	Have the expertise and judgment required for FOIA processing.						
3.	Understand their FOIA roles and responsibilities.						
4.	Have Position Descriptions that specify FOIA duties.						

#	Resources - <i>The following resources are adequate for FOIA processing in this office:</i>	Strongly Agree	Agree	Neither agree nor disagree	Disagree	Strongly Disagree	NA or don't know
5.	Office equipment (scanner, fax, etc.).						
6.	Office materials and supplies.						
7.	FOIA staff (full and part time personnel).						
8.	Administrative support.						
9.	IT support (software, help desk, etc.).						
10.	Budget allocations.						

#	Cooperation and Teamwork	Strongly Agree	Agree	Neither agree nor disagree	Disagree	Strongly Disagree	NA or don't know
11.	There is a spirit of cooperation and teamwork within this FOIA office.						
12.	Other offices involved in FOIA processing cooperate to achieve FOIA program goals.						
13.	This office receives timely responses from offices tasked for record search and review.						
14.	Affected parties (e.g., Legal Counsel, IDA, SME's) respect the advice and decisions from this FOIA office.						
15.	The leadership of this activity supports the FOIA program.						
16.	This office receives timely updates on the FOIA program from your component's FOIA Policy Office.						

#	Customer (Requester) Focus	Strongly Agree	Agree	Neither agree nor disagree	Disagree	Strongly Disagree	NA or don't know
17.	FOIA processes are designed to meet customer needs.						
18.	This FOIA office is responsive to customer inquiries.						
19.	Customer feedback is used to improve FOIA products and services.						
20.	Documents electronically available to the public are kept current.						

Please indicate the key obstacles that impede FOIA processing.

Please offer your recommendations to improve the FOIA program.

Position Levels of FOIA Staff in this office - *Please indicate the number of employees in each level:*

GS-1 to GS-7	E-1 to E-6
GS-8 to GS-11	E-7 to E-9
GS-12 and above	O1 to O3
Contractor or other adjunct personnel	O4 and above

Job Series of FOIA Staff in this office - *Please check all that apply:*

0086	0675
0301	0905
0303	0950
0340	0986
0342	1102
0343	Other - please specify:

Training of FOIA Staff in this office - *Please indicate the number trained in each category within the past year:*

- On-the-job training
- Formal FOIA training course/conference by external source (DOJ, ASAP, USDA, etc.)
- Formal FOIA training conducted by DoD
- Formal FOIA training conducted at your location

Hierarchical Level - *Please indicate the level of this activity within your component command structure:*

- Headquarters for your component
- Intermediate (major command, etc.)
- Unit (installation, etc.)

Please select your DoD Component

- Department of the Army
- Department of the Navy/USMC
- Department of the Air Force
- Unified Combatant Commands
- Other DoD Agency or Field Activity

RCS DD-DA&M(OT)2234



ADMINISTRATION AND
MANAGEMENT

OFFICE OF THE SECRETARY OF DEFENSE
1950 DEFENSE PENTAGON
WASHINGTON, DC 20301-1950

29 JUN 2006

MEMORANDUM FOR: DOD CHIEF FOIA PUBLIC LIAISONS

SUBJECT: Executive Order (EO) 13392 Data Collection Requirement # 1

Reference: Department of Defense Freedom of Information Act (FOIA) Improvement Plan for Executive Order 13392, Improving Agency Disclosure of Information, June 14, 2006

The Department of Defense (DoD) has submitted the agency-wide Plan addressing FOIA improvements in accordance with EO 13392. The provisions of the EO require "concrete milestones" and "specific timetables" associated with agency goals. This request for data collection from DoD Components is the first step towards implementing the DoD Plan. In accordance with the referenced Plan, the Defense Freedom of Information Policy Office (DFOIPO) requests your input in three areas. Specifically, this memo requires your input to Part E.1 Objective 1 and Part E.4 Objectives 1 and 2.

E.1. Organizational Structure and Manning – Objective 1: Optimal organizational placement of FOIA Offices. In order to accomplish DoD's goals of greater visibility and importance of the FOIA program, we request that you survey FOIA Offices within your Component to determine where they are placed organizationally and make recommendations regarding their optimal placement within the organization. For each headquarters, intermediate and installation/activity level FOIA Office, identify the location of the FOIA Office within that element (i.e. legal counsel, administration and management, records administration, etc.) and indicate if the Office is placed in the best location organizationally to maximize visibility and processing of FOIA requests. If not, indicate in your response where you suggest such offices should be placed organizationally.

DFOIPO realizes that the Military Departments will have unique challenges with this objective because of the large number of FOIA Offices and the lack of standardization of their placement; however, because the goal is standardization, we would like to obtain as much information as practicable. Your input to DFOIPO is requested by **August 15, 2006**.

E.4. Resources/Backlog – Objective 1: Determine manpower required to reduce backlogs in FOIA Offices that routinely have backlogs over 50 requests. For any FOIA Offices within your Component that routinely have a backlog of over 50 pending FOIA requests, please provide the following information: Name and office



equivalents currently assigned to work FOIA cases (civilian, military and contractor); the number of cases received during FY 05; the number of cases processed during FY 05; and the number of additional employees that would be required to decrease their backlog by 10% or more each year for three years beginning in FY 08. Your input is requested by **August 15, 2006**.

E.4. Resources/Backlog – Objective 2: Fund additional FOIA personnel staffing required to reduce backlogs in FY 08 and beyond. In conjunction with E.4. Objective 1 cited above, requests you provide the cost estimate required to fund the additional personnel billets and any information technology or other support to meet the backlog reduction goal. Please include in this estimate all expenses incurred as a result of the increased staffing, such as additional office space requirements, software licenses, cost of contractors, and any other justifiable expense. Your input for this objective is requested by **August 15, 2006**. Please note, this objective only applies to those offices that routinely have backlogs of over 50 pending cases.

A format for this data collection will be provided by separate correspondence by July 7, 2006.

Questions regarding this memo should be directed to David Maier, Defense Freedom of Information Policy Office, at 703-696-4695.



Will Kammer
Chief
Defense Freedom of Information Policy Office