

Grays Harbor County
All Hazards Guide

Emergency
Management
2009-2010

**Hazards Most
Likely to Hit
This Region**

**How to Protect
Your Family
and Property**

Featuring

**Emergency
Services &
Response**

**Neighbors
Helping
Each Other**



Developed by



**Grays Harbor County
Emergency Management**



**Washington State Military Department
Emergency Management**



**National Tsunami Hazard
Mitigation Program**

**Disaster Proofing
Your Business**
Strategies That Work

OFFICE OF
COUNTY COMMISSIONERS

TERRY L. WILLIS
FIRST DISTRICT
MIKE WILSON
SECOND DISTRICT
ALBERT A. CARTER
THIRD DISTRICT
DONNA CATON
ADMINISTRATIVE ASSISTANT/
CLERK OF THE BOARD



1854
STATE OF WASHINGTON

100 West Broadway, Suite #1
MONTESANO, WASHINGTON 98563
PHONE (360) 249-3731
FAX (360) 249-3783

July 21, 2009

Dear Local Residents and Visitors,

Grays Harbor has always been a location blessed with weather that usually would be referred to as "mild", but the last few years have found us dealing with natural conditions that, at times, have taxed our abilities to cope. Although weather forecasters are becoming better at giving the public advanced warning of potentially disastrous weather conditions, we see that they are not always able to give us the full picture. The strong windstorms and flooding in the last few winters are examples of how quickly conditions can change and how disastrous the results can be.

In addition to heavy wind and rainstorms, the Northwest is vulnerable to earthquakes, tsunamis and forest fires. It is important that we keep ourselves aware of what we should do if caught in one of these natural occurrences.

So the Commissioners would suggest that you read this All Hazards Guide being brought to you by the Washington State Emergency Management Department that will provide possible answers to questions that we all might have when finding ourselves in inclement weather or catastrophic conditions. This guide could be very important if you and your family are to be prepared to respond to these natural or man-made events.

Please take the time to read the information and keep a copy handy so it will be available to you in the future. Our best weapon in dealing with these situations is a plan of response to deal with whatever Mother Nature throws our way.

Thank You,

Mike Wilson
Chairman, Grays Harbor County Commissioners

A LETTER FROM
**GRAYS HARBOR
 COUNTY SHERIFF**

Dear Grays Harbor County Residents and Visitors:

One of the most precious things in life is our family yet each year natural or man-made disasters take family members from us. For almost 100 years the Boy Scouts have said, be prepared. Nowhere is that more true than in planning for disaster. A few minutes of your time in reading the *Grays Harbor County All Hazard Guide* may help save your life or a family member's life. This comprehensive hazard guide discusses what you should do when disaster strikes.

Do you know how to turn off the gas to your home? Do you know how to turn off the water? Do you know what emergency supplies your family must have to survive during a disaster? In a large scale disaster it will take time, perhaps days, to mobilize resources to provide food, shelter and medical care to our community. Ask yourself these questions: *If disaster strikes am I prepared? Do I have a Disaster Supply Kit that will see me through until help arrives?* During the initial stages of a disaster we need to be able to help ourselves, our families, and our neighbors. We cannot count on emergency responders to reach us quickly. What will you do if help is a long time in coming?

The responsibility for protecting ourselves and our families falls first upon us. This guide will assist you to be prepared *throughout* the course of a disaster. This guide has a lot of excellent information that will help you learn about what to do if a tsunami, earthquake or some other disaster should strike.

Please read this *Grays Harbor County All Hazard Guide* and use it as a resource when preparing for your safety. It is up to each of us to keep our families and loved ones safe.

Sincerely,
MICHAEL J. WHELAN, Sheriff
 Director of Emergency Management
 Grays Harbor County

TABLE OF CONTENTS

Disaster events in Grays Harbor County

What to do before disaster strikes	4
Directory of disaster preparedness organizations and assistance	4
Grays Harbor EMD is here to help.	5

Preparing for disasters

NOAA All Hazards Weather Radio	5
Map Your Neighborhood (MYN).	6
Grays Harbor County Auxiliary Emergency Communications (AEC).	7
Community Emergency Response Teams (CERT)	7
Prepare a 72-hour disaster supply kit	8
Out-of-area contact and medical needs cards	9
Getting medicine during a public health emergency.	9
Disaster planning for people with disabilities.	10
Prepare your home: Earthquakes strike without warning.	11
Prepare in a Year (PIY)	12
Prepare your vehicle for emergencies	13
All Hazards Alert Broadcast (AHAB) system	14

Disaster events

Tsunami — Head for high ground immediately.	15
Grays Harbor County tsunami evacuation routes.	16-17
Minimizing flood damage	18
Mold clean up after a flood.	19
Helping children cope with trauma	20
When earthquake strikes: Drop, cover and hold	21
Severe winter storms	22
Power outages	22
Landslides	23
Windstorms	24
Wildfires	24
How to avoid and survive rip currents	25
Hazardous chemical emergencies	26
How to shelter-in-place.	27

Disaster tips for quicker recovery

Securing water heaters	28
Turning off utilities.	28
Purifying water for household use.	29
Preparing for pets and livestock	29
Business continuity planning	30

Disaster resource directory — back cover

Cover photo: Sheriff Deputy Brad Johnson patrols the Wishkah floodwaters along with Deputy Mike Osgood and rescued resident Kermit Lantz. Photo by Keith Fouts

Publication produced by Lee Doyle, Communication by Design,
 360-709-9028

DISASTER EVENTS IN GRAYS HARBOR COUNTY

The 2005 Grays Harbor County Hazard Mitigation Plan identifies natural hazards that have the greatest potential to adversely affect people, environment, economy, and property in Grays Harbor County. The table below shows the greatest natural hazards.

Potential Hazards in Grays Harbor County

Flood
Earthquake
Wind Storm (Severe Storm)
Tsunami
Winter Storm (Severe Storm)
Hazardous Materials Incident
Landslide

The study selected these natural hazards through a rigorous review process that considered scientific data, history of occurrences, damage reports, and potential impacts to people.

In addition to these state-identified natural hazards, Grays Harbor County expanded severe storms to include winter storms, and added volcano and wildland fires to its Hazard Identification and Vulnerability Assessment (HIVA) due to local concerns of the impacts caused by these natural hazards to life and property within the recent past. The addition of hazardous material incidents to the HIVA, too, reflects community caution over

the extensive presence of hazardous materials in the county used in manufacturing processes as well as the potential for it to significantly impact life and property in the event of an accident. The table shows the rank of the hazards according to the assessment.

This All Hazards Guide provides a step-by-step approach to disaster preparedness by walking the reader through where to get information about local emergency plans, how to prepare for hazards that affect their local area, and how to develop and maintain an emergency communications plan and disaster supplies kit. Some of the primary subjects addressed in this

guide are floods, earthquakes, storms, tsunamis and wildfires.

Other topics covered include evacuation, emergency public shelters, caring for animals before and during disasters, information specific to people with disabilities, and much more.

The All Hazards Guide also provides in-depth information on specific hazards including what to do before, during, and after each hazard.

The main reason to use this guide is to help protect people and their households in the event of an emergency. Through applying what is learned in this guide, readers can take the necessary steps to be ready when an event occurs.

WHAT TO DO BEFORE DISASTER STRIKES



Disasters disrupt hundreds of thousands of lives every year. Each disaster has lasting effects — people are seriously injured, some are killed, and property damage runs into the billions of dollars. Being prepared and understanding what to do can reduce fear, anxiety and losses that accompany disasters. You should know how to prepare for emergency situations. This guide can help. Remember, your safety depends on the actions you take before disaster strikes.

In any situation, staying calm is the most important factor in getting through the crisis. Being able to think clearly,

focusing on immediate needs, knowing what to do and when to do it will help you and your family. The emotional toll that disaster brings can sometimes be equal to the devastation of the financial strains of damage and loss of home, business or personal property. Keep in mind that children, the elderly and people with special needs also may need your help — your ability to remain calm will help them remain calm.

Consider sharing this guide with family and friends. It contains useful information that can help neighborhoods develop community-wide plans to lessen the impacts of emergencies.

Directory of Disaster Preparedness Organizations and Assistance

Grays Harbor County Department of Public Services Division of Emergency & Risk Management

Web: www.co.grays-harbor.wa.us/info/DEM/index.htm
Phone: (360) 249-3911
Fax: (360) 249-3805
E-mail: ghcdem@co.grays-harbor.wa.us
Office hours: M-F 8:00-5:00

Community Emergency Response Team (CERT) www.citizen corps.gov/cert/about.shtm

Map Your Neighborhood (MYN)
www.emd.wa.gov/myn/index.shtml

NOAA Weather Radio All Hazards
www.nws.noaa.gov/nwr/

National Tsunami Hazard Mitigation Program
<http://nthmp.tsunami.gov/>

Washington State Emergency Management
www.emd.wa.gov

Prepare now

During large scale disasters or emergency situations, local responders may not be able to reach you. **You should prepare to be on your own for at least 72 hours after a disaster.**

GRAYS HARBOR EMD IS HERE TO HELP

The Division of Emergency Management (DEM) is responsible for developing and maintaining a countywide infrastructure for emergency/disaster mitigation, preparedness, response and recovery.

We do this through a multi-jurisdictional organization, which includes the cities of Aberdeen, Cosmopolis, Elma, Hoquiam, McCleary, Montesano, Oakville, Ocean Shores, Westport, and the

Quinalt Indian Nation. County departments and 15 fire districts are also a part of this organization.

The Grays Harbor DEM is responsible for maintaining the Emergency Operations Center (EOC) in a constant state of readiness. During a countywide disaster, the EOC becomes the hub of information gathering and dissemination, strategic decision-making, resource allocation and incident coordination. Representatives from

law enforcement, fire services and public health, environmental health, emergency management service, as well as other organizations from throughout the county work together to coordinate the response.

The Grays Harbor County All Hazards Mitigation Plan 2005-2010 guides county government in how to work with citizens, other local governments and the private sector in reducing the threat of disaster

events to life and property before they happen. The plan establishes a series of goals, objectives and mitigation actions for the County to accomplish. Mitigation actions are taken to reduce loss of life and property damage due to disasters.

Additional information

To learn more about the Grays Harbor County All Hazards Mitigation Plan, please visit www.co.grays-harbor.wa.us/info/DEM/Planning.htm

INSTANT ALERTS FOR ALL EMERGENCIES

NOAA All Hazards Weather Radio



NOAA Weather Radio is a service of the National Oceanic and Atmospheric Administration. Known as the “Voice of the National Weather Service,” Northwest Weather Services

provides continuous broadcast of the latest weather information. Recorded weather messages are repeated every four to six minutes and routinely revised every one to three hours. If necessary, they can be repeated more frequently.

Stations operate seven days a week, 24 hours a day, with broadcasts specifically tailored to the weather needs of the listening area. The area is usually within 40 miles of the transmitter.

Broadcasts of earthquake events, tsunami and flood warnings, AMBER Alerts for child abductions, chemical spill messages and many other notifications, in addition to routine weather observations and forecasts, make NOAA Weather Radio broadcasts critical for every home, business and public area. Both local and state emergency management offices strongly recommend that all households obtain a NOAA Weather Radio.

Most weather radios have an alert feature, which activates an alarm and turns on the radio when severe weather threatens. This provides listeners critical, potentially life-saving messages. It also provides quick notification about approaching threats, such as tsunamis, to schools, hospitals, nursing homes or businesses, giving them extra time to evacuate to safety.

Weather radios that receive the NOAA Weather Radio All Hazards

signal are available at many electronic retail stores, marine supply stores, mail order catalogs and the Internet. Prices vary by model and options, but typically range between \$20 and \$80. Receivers carrying the NOAA Weather Radio logo meet certain performance criteria, including Specific Area Message Encoding (SAME) and a battery backup. Features of a NOAA Weather Radio include:

- **Tone alarm:** Special tones precede the initial broadcast of all emergency announcements regarding immediate weather threats and civil emergency messages to gain a listener’s attention. These tones will also activate radios that are on alert mode, yet silent. This feature is especially crucial when tsunamis or other events occur at night when most people are sound asleep.
- **Size:** Units are small (about the size of a clock radio) and require little space on a counter, desk or nightstand. They travel easily (vacations, relocations) and will use the signal from a nearby transmitter.
- **Battery backup:** Ensures continued service during a loss of electricity, which can disable the warning capabilities of television and the Internet.
- **Customization:** Most models featuring SAME technology can be programmed to sound only selected alerts for specific areas — in essence, blocking undesired messages, especially those that apply outside the local area.
- **Special needs accessories:** Many radios allow customization for devices for the hearing or visually impaired, such as strobe lights, pagers, or bed shakers.

Radio Alert Signals

GRAYS HARBOR COUNTY

Transmitter	SAME No.*	Frequency	Call Sign
Mount Octopus	053027	162.425	KX127

GRAYS HARBOR AND PACIFIC COUNTY

Astoria	053027	162.400	KEC91
Olympia	053027	162.475	WXM62

* NWR Specific Area Message Encoding (SAME)

COMMUNITIES ALWAYS DO BETTER TOGETHER

Map Your Neighborhood (MYN)

Map Your Neighborhood (MYN) is a program developed by the state Emergency Management Division and made available through local emergency management offices. Implementing the MYN program assists communities to become disaster ready by building and strengthening disaster readiness among neighbors. In a disaster, the most immediate source of help are neighbors living nearby.

Disasters are major events that can strike anywhere and at any time. In a disaster, traditional 9-1-1 and First Responder capabilities such as fire, police, medics, and utility personnel may be overwhelmed and unable to immediately assist individuals.

Neighbors that have established response procedures and organized their resources are more effective in their response to a disaster and have an increased capacity to be self-sufficient for the first 72 hours after a disaster.

The MYN program addresses the important actions of disaster recovery at a neighborhood level. It includes:

- The first nine steps to take immediately following disaster to secure your home and to protect your neighborhood.
- Identifies the skills and equipment each neighbor has that are useful in an effective disaster response.
- Creates a neighborhood map that identifies homes and shows the locations of each natural gas meter and propane tank to help eliminate the threat of fires.

- Creates procedures to check on neighbors vulnerable to injury and trauma, including the elderly, those with disability, and children who may be home alone at certain hours of the day.

For information about starting a MYN program, contact Grays Harbor EMD, e-mail ghcdem@co.grays-harbor.wa.us, phone, (360)

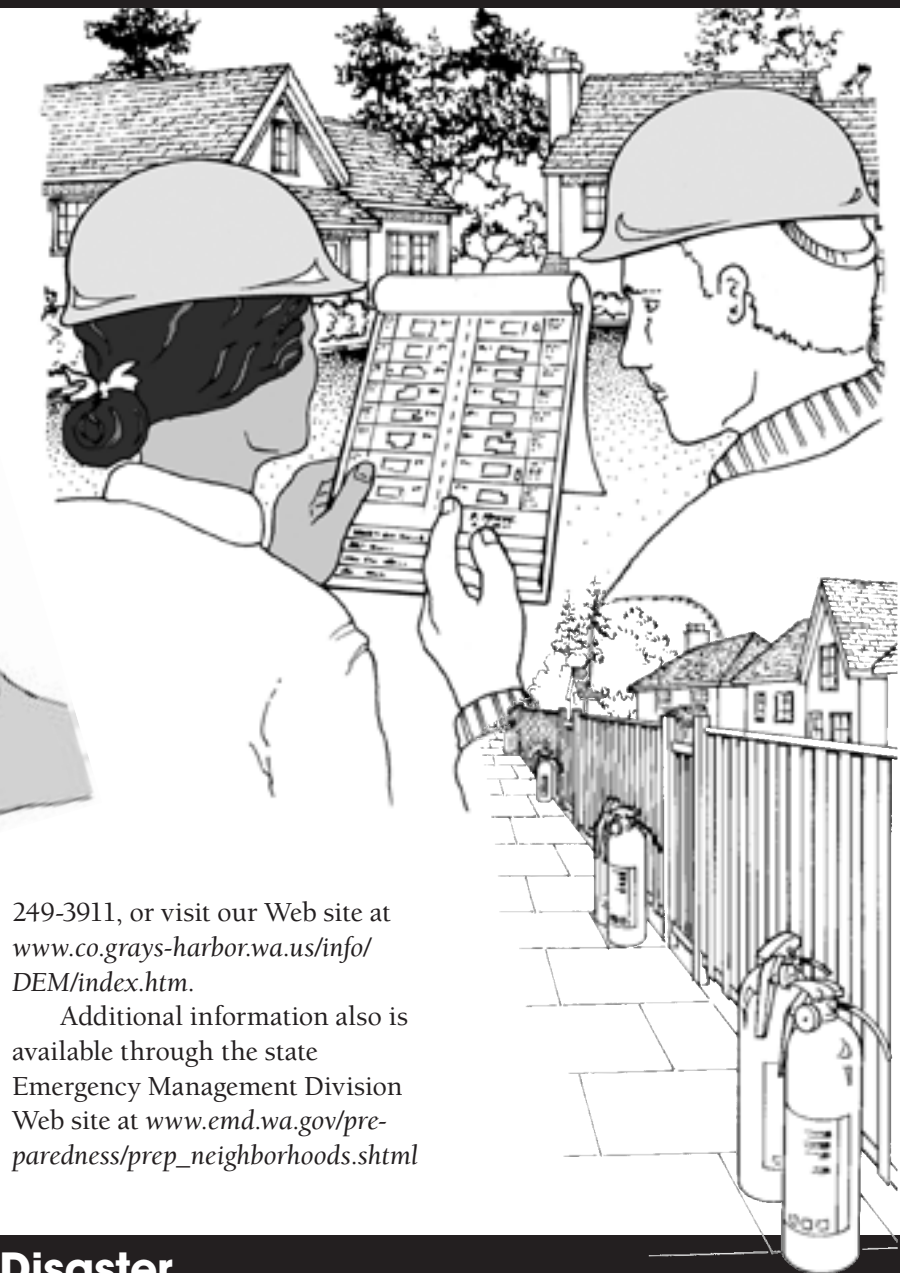

249-3911, or visit our Web site at www.co.grays-harbor.wa.us/info/DEM/index.htm.

Additional information also is available through the state Emergency Management Division Web site at www.emd.wa.gov/preparedness/prep_neighborhoods.shtml

During a Disaster

Ensure your safety first

Immediately, following a disaster, your first concern is your family's health and safety. You need to consider possible safety issues and monitor family health and well-being.

Aiding the injured

Check for injuries. Do not attempt to move seriously injured persons unless they are in immediate danger of death or further injury. If you must move an uncon-

scious person, first stabilize the neck and back, then call for help immediately.

If the victim is not breathing, carefully position the victim for artificial respiration, clear the airway, and commence mouth-to-mouth resuscitation.

Maintain body temperature with blankets. Be sure the victim does not become overheated.

Never try to feed liquids to an unconscious person.

Health precautions

Be aware of exhaustion. Don't try to do too much at once. Set priorities and pace yourself. Get enough rest.

Drink plenty of clean water. Eat well. Wear sturdy work boots and gloves.

Wash your hands thoroughly with soap and clean water often when working in debris.

Safety Issues

Be aware of new safety issues created by the disaster. Watch for washed out roads, contaminated buildings, contaminated water, gas leaks, broken glass, damaged electrical wiring, and slippery floors.

Inform local authorities about health and safety issues, including chemical spills, downed power lines, washed out roads, smoldering insulation, and dead animals.

WHEN NORMAL MEANS OF COMMUNICATION FAIL

Grays Harbor County Auxiliary Emergency Communications (AEC)

Grays Harbor Auxiliary Emergency Communications (AEC) provides communications support to all emergency response agencies of Grays Harbor County including the Grays Harbor County Department of Emergency Management (DEM) and other multi-jurisdictional Emergency Operations Centers and shelters. This includes using equipment and frequencies beyond the traditional boundaries of Amateur Radio on any authorized radio, which may be connected with the on-going emergency. This support may involve the use of telephone, cellular, computer, Internet, e-mail, packet/Factor systems and in-office support of those managing the event.

While AEC is rooted in the Amateur Radio Emergency Service and Radio Amateur Civil Emergency Service programs, changes in communication technology and the requirements needed by public safety organizations require operators to be trained in communication areas other than operations on a

Public partnership with citizen volunteers

AEC recruits volunteer who wish to serve their community by committing to AEC practices, its goals and to perform as professional communicators.



selected frequency of a single service.

The Grays Harbor Department of Emergency Management manages the AEC program and trains its personnel to be more than just operators of radios on a “call if you need me” basis. AEC mem-

bers strive to be professional communicators who work as non-paid staff with the DEM to respond to the Emergency Operations Center or to any location necessary to maintain or enhance communications for the duration of an emergency. AEC is dedicated to working

in partnership with the public-safety community to excel in the ability to provide professional emergency communications resources and services.

Auxiliary Emergency Communications members can respond with their personal equipment to set up communications most anywhere in the county and support the DEM radio room in Montesano, which has communications capabilities on all Amateur Radio bands as well as law enforcement, fire, marine, air, transportation, PUD and state emergency frequencies.

AEC encourages its members to first take care of themselves, family and neighbors during an emergency, but then to help the larger community. AEC recruits communicators who wish to serve their community by committing to AEC and its goals and to perform as professional communicators.

Additional information:
www.wwa-district3-ares.org/grays_harbor/index.html

VOLUNTEERS ARE VITAL LINKS TO DISASTER RESPONSE

Community Emergency Response Teams

The Community Emergency Response Team (CERT) Program is a well defined program that educates people about disaster preparedness for hazards that may impact their area and trains them in basic disaster response skills, such as fire safety, light search and rescue, team organization, and disaster medical operations.

Using the training learned in the classroom and during exercises, CERT members can assist others in

their neighborhood or workplace following an event when professional responders are not immediately available to help. CERT members also are encouraged to support emergency response agencies by taking a more active role in



emergency preparedness projects in their community.

CERT is about readiness, people helping people, rescuer safety, and doing the greatest good for the greatest number. CERT is a positive and realistic approach to emergency

and disaster situations where citizens will be on their own and their actions can make a difference.

Through training, citizens can manage utilities and put out small fires, provide basic medical aid, search for and rescue victims safely, and organize themselves and spontaneous volunteers to be effective.

Contact the Grays Harbor County EMD for more information about CERT training opportunities.

CREATE YOUR PERSONAL SAFETY KIT

Prepare a 72-Hour Disaster Supply Kit

Sanitation

The lack of sanitation facilities after a major disaster can quickly create problems unless basic guidelines are followed.

- If water lines are damaged, or if damage is suspected, do not flush the toilet.
- Avoid digging holes in the ground to bury or place human waste. Untreated sewage can pollute ground water, and promote the spread of disease.
- To effectively manage human waste, store a large supply of heavy-duty plastic bags, twist ties, disinfectant and toilet paper.
- An effective and convenient disinfectant is a solution of one-part liquid bleach to ten-parts water. Do not use dry bleach — it is caustic and not safe for this type of use.
- If the toilet cannot be flushed, it can still be used. For some people, using the toilet is less stressful than using other containers. To use the toilet in this situation, remove all water from the bowl, and line the bowl with a heavy-duty plastic bag. After use, add a small amount of deodorant or disinfectant to the plastic bag, securely tie the bag, and dispose of it in a large trash can with a tight fitting lid. This trash container also can be lined with a sturdy trash bag to control odor. Eventually the local refuse system will provide a means to dispose of these bags.
- Portable camp toilets, medium-sized trash cans, or sturdy buckets lined with heavy-duty plastic bags can be used as temporary toilets.
- Maintain a supply of large zip lock plastic bags, toilet paper, and newspapers at work and in the car for emergency use. Packages of waste can be wrapped in newspaper for future disposal.

First responders may not be able to reach you immediately after a disaster.

You may be on your own for hours, even days, after disaster strikes. You should be prepared to take care of yourself and your family for at least three days. Store a kit at home, at work and at each child's school or daycare facility.

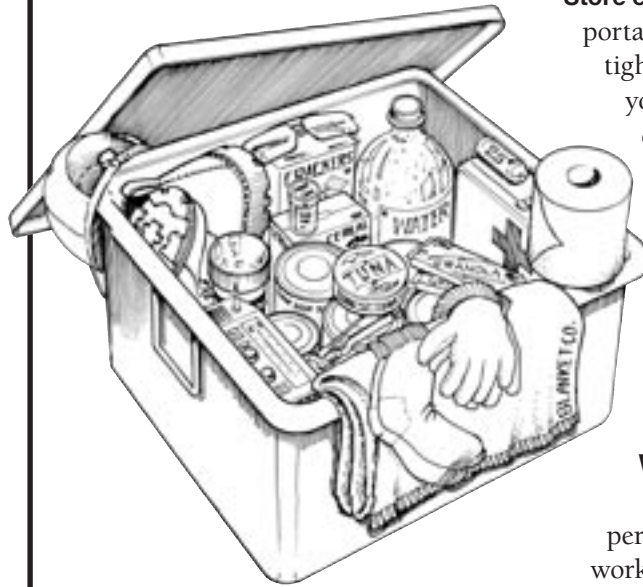

Store emergency supplies in something that is portable and easily carried, like a plastic tub with a tight-fitting lid. In the event of fire or rapid evacuation, you'll appreciate having more than just the clothes on your back.

The container should be able to withstand moisture, insects, and some abuse should it be dropped or during an earthquake. Several smaller tubs may be easier to carry.

Locate your supplies kit as close to your primary house exit as possible. You may have to leave your home quickly, or find it in the dark or after the upheaval of an earthquake.

Water

Keep at least a three-day supply of water for each person in your household. Two-liter soda pop bottles work well. That means six two-liter bottles per person.

Emergency supplies

- Dry or canned food and drinking water for each person
- Can opener
- First aid supplies and first aid book
- Copies of important documents, such as birth certificates, licenses and insurance policies
- Special needs items for family members, such as infant formula, eyeglasses and medications
- A change of clothing
- Sturdy shoes
- Sleeping bag or blanket
- Battery powered radio and batteries
- Flashlight and extra batteries
- Whistle
- Waterproof matches
- Toys, books, puzzles, games
- Extra house keys and car keys
- List of contact names and phone numbers
- Food, water and supplies for pets
- Coins for phones

Comfort

- Gloves for clearing debris
- Tent

Cooking supplies

- Barbecue, camp stove
- Fuel for cooking, such as charcoal or camp stove fuel
- Plastic knives, forks, spoons
- Paper plates and cups
- Paper towels
- Heavy-duty aluminum foil

Sanitation supplies

- Large plastic bags for trash, water protection
- Large trash cans
- Bar soap and liquid detergent
- Shampoo
- Toothpaste and toothbrushes
- Feminine and infant supplies
- Toilet paper
- Household bleach with no additives, and eyedropper (for purifying drinking water)
- Newspaper — to wrap garbage and waste

Tools

- Ax, shovel, broom
- Crescent wrench for turning off gas
- Screwdriver, pliers, hammer
- Coil of one-half inch rope
- Plastic tape and sheeting
- Knife or razor blades
- Garden hose for siphoning and fire fighting

REACHING OUT TO CONNECT WITH LOVED ONES

Out-of-Area Contact and Medical Needs Cards

If you are separated from your loved ones when disaster strikes, you will need a way to find out where they are. The stress of the event may make it difficult to remember even routine information, like phone numbers. Every household member should have an out-of-area contact card in a wallet, purse or backpack at all times.

Things to do before disaster strikes

- Ask an out-of-area family member or friend to be your contact person. This person should live at least 100 miles away from you. It may be difficult to make local calls because large numbers of people may be using the phone lines at the same time. However, you should be able to make long distance calls.
- Make small cards with the contact person's name and phone number for all family members to carry in their wallets, purses or backpacks. Take coins inside the wallet card to pay for use of public telephones.

- Keep a phone that does not require electricity. Cordless phones use electricity — if the power is out, they will not work!

Contacting loved ones after disasters

- All household members should call the out-of-area contact. The contact person will collect information about each family member, where they are and how to contact them.
- You may be able to send text messages to your loved ones on your cell phone.
- Make sure the handsets to your phones are hung up — during events such as earthquakes handsets can get knocked off their bases. When large numbers of phones are off-the-hook, local phone service may stop working correctly.
- You should be able to use a pay phone if your home phone does not work. Pay phones are part of the emergency services network, and are a priority to be restored to service. Tape the coins needed to use a pay phone to your out-of-area contact card.

Out-of-area wallet contact card

Make copies of this card for all family members. Have each person add your family's contact information and place the cards in their wallet or purse. Cut out the card

image below, fold over to fit into a wallet.

Prepare a wallet card similar to this out-of-area contact card that lists all medications and medical needs for each member of your household.

Cut out this card, make copies for household members.

<p align="center">OUT OF AREA CONTACT PERSON</p> <p>WHY? Local phone systems may be shut down in a disaster. However, you frequently can place a long-distance call.</p> <p>_____</p> <p>Name of person out of area (print):</p> <p>_____</p> <p>Phone number with area code:</p> <p>_____</p> <p>Cell number with area code:</p> <p>TIP: You may be able to text message your loved ones on your cell phone. Keep these messages short.</p>
<p align="center">PRINT EXACT LOCATION, NAME, PHONE NUMBER</p> <p>_____</p> <p>Disaster meeting place if I cannot return home</p> <p>_____</p> <p>Meeting place in case of house fire</p> <p>_____</p> <p>In case of LOCAL emergency, contact</p> <p>_____</p>

Place completed card in wallet or purse.

Getting Medicine During a Public Health Emergency

The Strategic National Stockpile (SNS) is a federal government program that provides medication and medical supplies to states during an emergency.

In the event of a disaster, outbreak or attack, our Governor will ask the federal government to send SNS shipments to Washington. Supplies can be delivered to any state within 12 hours of the request.

Depending on the type of emergency, the SNS will deliver antibiotics, chemical antidotes, antitoxins

or other medical or surgical items. Additional drugs and/or medical supplies can be supplied within the following 24 to 36 hours.

When SNS shipments are received, Washington State emergency response workers will immediately deliver the supplies and medications directly to the communities that need them.

Medication centers will be located in large public buildings in several geographic areas to minimize the amount of time people

need to travel to reach them.

Local public health agencies will announce when medication centers will open, where to find them, how to get there, what to bring and what to expect. You will be able to get this important information from sources that include television and radio news, newspapers, state and local public health and emergency management Web sites, and community, civic and religious organizations.

Grays Harbor County DEM will determine the location of medication centers in their areas.

If medication centers are opened to distribute medicine from the SNS in an emergency, there will be no charge to the public. Trained staff will be available to assist you at the medication center. The process will be simple. Depending on the type of emergency, one person may be able to pick up medications for a household or group.

TIPS FOR PEOPLE WITH SPECIAL NEEDS

Disaster Planning for People With Disabilities

Visually impaired

- If you use a cane, keep extras in strategic, consistent and secured locations at work, home, school and volunteer site.
- Keep a spare cane in your emergency kit.
- If you have some vision, place security lights in each room to light paths of travel. These lights plug into electric wall outlets and light up automatically if there is a loss of power.
- Store high-powered flashlights with wide beams and extra batteries.
- Plan for losing the auditory clues you usually rely on after a major disaster.
- Service animals may become confused, frightened or disoriented during and after a disaster. Keep them confined or securely leashed or harnessed. Be prepared to use alternative ways to negotiate your environment.
- If helpful, mark emergency supplies with large print, fluorescent tape or Braille.
- Anchor special equipment and large pieces of furniture such as computers and shelving. Create a computer back-up system for important data and store it off site.

Hard of hearing

- Store hearing aid(s) where you can easily find them after a disaster. You could keep them in a container by your bedside and attach the container to a nightstand or bedpost using a string or Velcro.
- Store extra batteries for hearing aids and implants. If possible, store an extra hearing aid with your emergency supplies.

- Keep your pager, captioned telephone and other communication equipment charged.
- Maintain batteries and store extras for your TTY and other communications equipment. Check the owner's manual for proper battery maintenance.
- Know how to communicate with emergency personnel if there is no interpreter or if you don't have your hearing aids. Store paper and pens for this purpose.
- Consider carrying a pre-printed copy of important messages with you, such as: "I use American Sign Language (ASL) and need an ASL interpreter." "I do not write or read English." "If you make announcements, I will need to have them written or signed."
- If possible, get a battery-operated television that has a decoder chip for access to signed or captioned emergency reports.
- Determine which broadcasting systems will provide continuous captioned and/or signed news.
- Install smoke alarms that give signals that can be both seen and heard. At least one smoke alarm should be battery operated.

People with special medical needs

- Always have at least a three-day supply of all your medications and medical supplies.
- Store your medications in one location in their original containers.
- Have a list of all of your medications: name of medication, dose, frequency, and the name of the prescribing doctor.
- Check with your medical supply company regarding a back-up

power source such as a battery or generator for medical equipment.

- If you use oxygen, have an emergency supply (enough for at least a three-day period).
- Oxygen tanks should be securely braced so they do not fall over.
- If you use breathing equipment, have a three-day supply or more of tubing, solutions and medications.
- Know if your infusion pump has battery back-up, and how long it would last in an emergency. Ask your care provider about manual infusion techniques in case of a power outage.
- Have written operating instructions attached to all equipment.
- Keep a bag packed at all times that contains a three day supply of medications, copies of vital papers such as insurance cards and power of attorney.

Physical disabilities

- Store emergency supplies in a pack or backpack attached to a walker, wheelchair or scooter.
- Store needed mobility aids (canes, crutches, walkers, wheelchairs) close to you in a consistent, convenient and secured location. Keep extra aids in several locations, if possible.
- Keep a pair of heavy gloves in your supply kit to use while wheeling or making your way over glass or debris.
- If you use a motorized wheelchair, consider having an extra battery available. A car battery can be substituted for a wheelchair battery. Check with your vendor to see if you can charge batteries by connecting jumper cables to a vehicle battery or by connecting batteries to a con-

verter that plugs into your vehicle's cigarette lighter.

- If possible, choose puncture-proof tires for your mobile chair, or keep a patch kit to repair flat tires.
- Store a lightweight manual wheelchair, if available.
- Make sure furniture is secured so that it doesn't block the pathways you normally travel.
- If you spend time above the first floor of a building, practice using alternative methods of evacuation. Enlist the help of your personal support network.
- If you cannot use stairs, discuss lifting and carrying techniques that will be safe for you
- It is very important to discuss the safest way to transport you if you need to be carried, and alert helpers to any areas of vulnerability. For example, the traditional "firefighter's carry" may be hazardous for some people with respiratory weakness.
- Be prepared to give helpers brief instructions on the best way to move you.

People who can help

- Know who can walk to your home to assist you if no other means of transportation is available.
- Discuss your disaster plans with your home healthcare provider.
- Ask your local fire department if they keep a list of people with special medical needs; ask to be included if they do.
- Keep a phone contact list handy of people who can help.

PREPARING FOR DISASTERS WILL SAVE LIVES, AVOID ECONOMIC HARDSHIPS

Prepare Your Home: Earthquakes Strike Without Warning

Preparing your household for earthquakes should include a thorough hunt for potential hazards throughout your home. The illustration below highlights common hazards in most homes. These hazards also represent the greatest economic impact resulting from disasters.

Reducing stress

A disaster plan should include life-critical actions, life saving training, and advance plans to enable you to respond to all types of emergencies and potential physical injuries and hazards.

Life-critical actions

Learn how to: Drop, cover, and hold. Signal for help if you are trapped somewhere. Teach children and adults to use an emergency whistle or to knock three times repeatedly if trapped. Rescuers

searching collapsed buildings will be listening for sounds.

Life saving training

Consider training in first aid, CPR, how to use a fire extinguisher, how to shut off gas, water, and electricity.

Financial plan

You should store your family's documents, such as insurance policies, deeds, property records, birth certificates, and other important papers, in a safe place away from your home (e.g., safety deposit box). Make copies for your Disaster Supplies Kit.

Consider saving money in an emergency savings account that could be used in any crisis.

Practice Drop, Cover and Hold

It's important to know where you should go for protection when your house starts to shake. By planning and practicing what to do before an earthquake occurs, you can condition yourself and your family to react correctly and spontaneously when the first jolt or shaking is felt. Each family member should know safe spots in each room. Throughout the year, hold surprise drills. Be prepared to deal with what you may experience after an earthquake.

Safe spots: The best places to be are under or beside heavy pieces of furniture, such as a sofa, desk or

sturdy table; and against inside walls. Reinforce this knowledge by physically placing yourself in the safe locations during your practice sessions. This is especially important for children.

Danger spots: Stay away from windows, hanging objects, mirrors, fireplaces, and tall, unsecured pieces of furniture.

When you feel the ground shake, take cover under a sturdy desk, table, or bench and hold on to the desk or table leg and move with it. This will ensure that the desk or table stays above you. Hold on until the earthquake shaking stops.

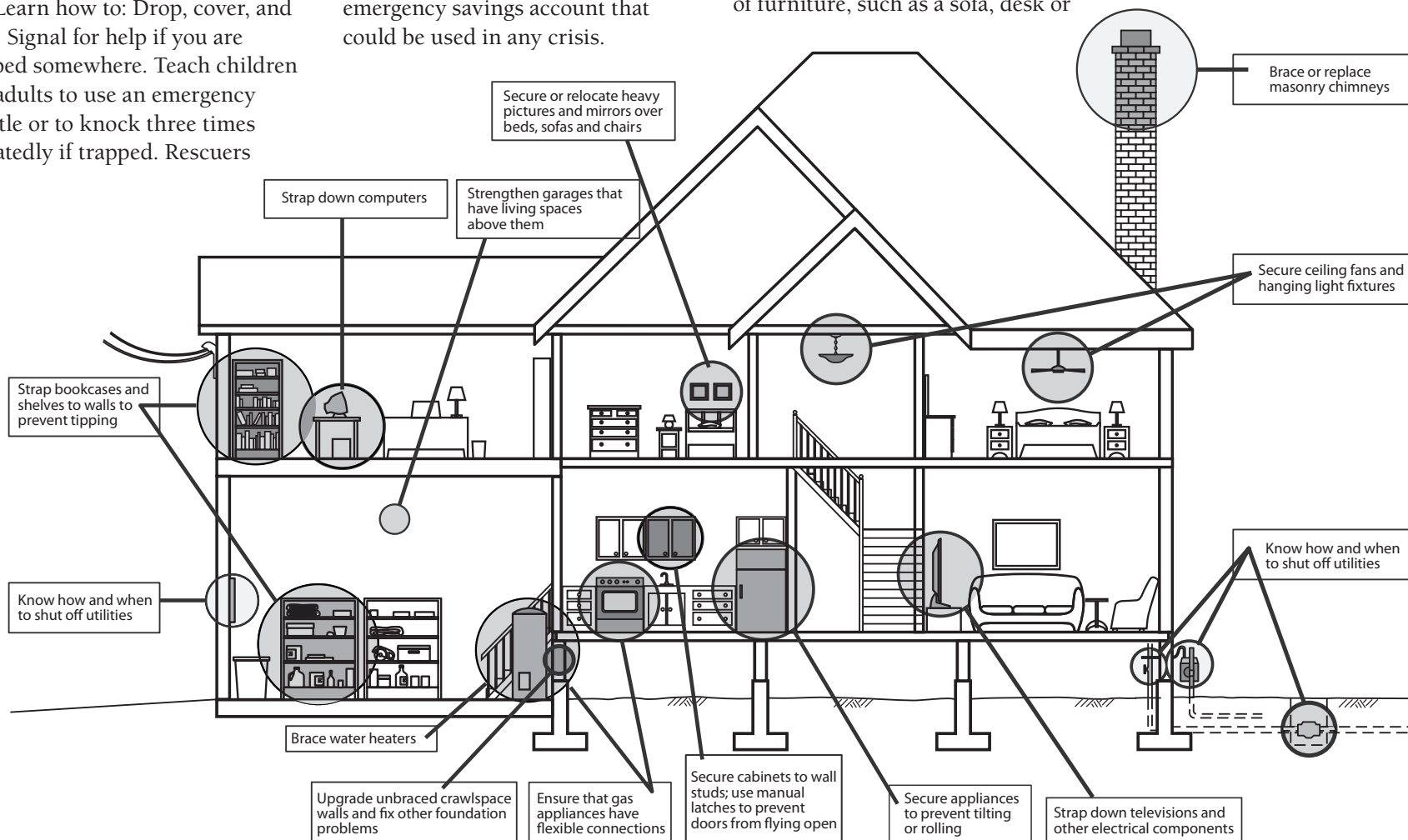

For more information on safeguarding your home, visit www.emd.wa.gov/preparedness/prep_home.shtml

PREPARE YOUR HOUSEHOLD FOR EMERGENCIES

Prepare in a Year (PIY)

We tend to think that a disaster will never happen near where we live. We tend to believe our families will never be in harm's way. Unfortunately, recent history has proven that Washington state routinely experiences major disasters with severe winter storms, floods, and extended power outages affecting hundreds of thousands of people and causing major damage to property.

Many of the steps outlined in this publication were developed as a year long activity in the Prepare in a Year (PIY) Program. Some of these activities can be completed in a relatively short period of time, and others might take longer. You can mark each month of your calendar for an activity.

Feel free to contact the Grays Harbor County Emergency Management office if you have questions about any of these action steps. Call (360) 249-3911 for help anytime.

Steps to disaster readiness

1. Developing an action plan page 10: Earthquake page 9, Tsunami page 13, or Chemical Release page 24.
2. Creating an out-of-area contact plan. See page 9.
3. Water — how to store, maintain, and purify, page 29..
4. Preparing a 72-hour disaster kit: A comprehensive approach to gathering and maintaining emergency supplies. See page 8.
5. Securing important documents.
6. Extended event supplies: This exercise addresses preparing for events that last several days or more. Topics include cooking equipment, shelter, food refrigeration and potential loss, sanitation, and pets.



7. Safety supplies stored under the bed ready for use day or night.
8. Practicing utility safety: Inspecting for safety.
9. Earthquake Drop, Cover and Hold. see page 21.
10. Practicing fire safety and fire extinguishers: Be smart.
11. How to Shelter-in-Place: How to create a safe room in your home, see age 27.
12. Home hazard hunt.

Prepare in a Year Program

This action program outlines how each household can become disaster resilient in one year. Prepare in a Year makes the most of your limited time, but generates the greatest measure of safety for your family by taking just one hour a month to complete each step.

Choosing comfort over inconvenience

Coping with the impact of a disaster is never fun. However, planning alternative ways to take

care of your needs can reduce much of the inconvenience and discomfort the disaster causes.

At first glance, the list may seem totally overwhelming. At second glance, you'll find that you probably already have many the items.

Organizing the supplies in such a way that they are readily available when you most need them will provide comfort and security.

Quick checklist

- Know how to contact your children at their school or daycare, and how to pick them up after a disaster. Let the school know if someone else is authorized to pick them up. Keep your child's emergency release card current.
- Know where the nearest fire and police stations are located.
- Learn your community's warning signals, what they sound like and what you should do when you hear them.
- Learn first aid and CPR. Have a

first aid kit, a first aid manual and extra medicine for family members.

- Keep a small amount of cash available. If the power is out, ATM machines won't work.
- If you have family members who don't speak English, prepare emergency cards in English with their names, addresses and information about medications or allergies.
- During an emergency, keep calm and take time to think. Give assistance where needed.
- Use the telephone for emergency calls only.
- If you are ordered to evacuate, take your emergency kit and follow official directions to a safe place or temporary shelter.

After the emergency or disaster is over

- Use caution in entering damaged buildings and homes.
- Stay away from damaged electrical wires and wet appliances.
- Check food and water supplies for contamination.
- Conduct earthquake and fire drills every six months.
- Make sure family members know all the possible ways to get out of your home. Keep all exits clear.
- Make sure all family members agree on an emergency plan. Give emergency information to babysitters or other caregivers.
- If government disaster assistance is available, the news media will announce where to go to apply.

To learn more:

Visit www.emd.wa.gov/preparedness/prepare_year.shtml

BECAUSE YOU NEVER KNOW WHERE THE ROAD WILL TAKE YOU

Prepare Your Vehicle for Emergencies

When planning for emergencies, don't forget your vehicle. Make sure your car, truck or van is in good working order, and keep an emergency supply kit handy.

Get your vehicle ready

- Keep an emergency supply kit in your vehicle.
- Prepare to be on your own for at least 24 hours.
- Write the date on all food and water stored in your kit. Replace items every six months.
- Keep food items in airtight plastic bags inside your kit.



Emergency supplies for your vehicle

- One gallon of water per person. Store water in large soft-drink containers. Avoid containers that will decompose or break, such as milk cartons or glass bottles.
- Emergency food. Avoid foods that will make you thirsty. Choose whole grain cereals and foods with high liquid content. Include food for infants and others with special diets.
- Small shovel, jumper cables, tow chain
- Road flare
- Battery-operated radio/extra batteries
- Flashlight and extra batteries



- ABC-type fire extinguisher
- Plastic storage bags
- Cash and change for phones
- A supply of vital medications
- Sturdy shoes, socks, work gloves
- Rain gear, whistle
- Mylar blankets, plastic tarps
- Matches in a waterproof box
- Latex gloves (at least 2 pair)
- Map of area (to locate shelters)
- Compass
- Games and books for kids
- Pet supplies
- Toilet paper, towelettes

- Feminine/personal hygiene items
- Infant diapers and wipes

Driving in difficult conditions

- Drive with your headlights on.
- Fill the fuel tank before entering open country. Stop to fill up long before the tank begins to run low.
- Don't try to out-drive the conditions.
- Start early. Remember the posted speed limits are for dry pavement.

- Leave plenty of room to stop.
- Brake carefully. It takes more time to stop in adverse conditions.
- Look farther ahead in traffic than you normally do to gain extra time to safely react to situations.
- Drive cautiously near trucks. Avoid cutting quickly in front of them.

Winter driving

- Be prepared with good winter tires, chains, a scraper, and a bag of sand for traction on ice.
- Carry extra winter clothing — the first rule of winter comfort and survival is to stay dry.
- Don't use cruise control in wintry conditions. A brief touch of your brakes to deactivate the cruise control feature can cause you to lose control of your vehicle.
- Remember: A four-wheel drive vehicle can lose traction on ice just as easily as a two-wheel drive vehicle.
- Make sure your car is in good working condition.

Check these:

- Ignition system
- Fuel system
- Belts
- Fluid levels
- Brakes
- Exhaust system
- Battery
- Antifreeze
- Wiper blades
- Washer fluid
- Tire tread/pressure
- Defroster
- Proper grade oil
- Cooling system
- Lights

TSUNAMI EMERGENCY ALERTS FOR COASTAL COMMUNITIES

All-Hazard Alert Broadcast (AHAB) System

Washington State Emergency Management Division developed multiple pole-mounted sirens that are located throughout Washington state's coast and inland water ways.

This alert system provides several features, including:

- Satellite activation from the 24/7 State Emergency Operations Center.
- Radio activation by local Emergency Management Agency.
- Modular speaker with 360-degree coverage.
- Ability to provide voice and tone alerts.
- Digital voice messages may be played or the siren may be used as a public address system.
- An intense blue light for the hearing impaired, which can also cut through fog and is visible from a long distance.

EAS alerts reaches all media communication

The Federal Communications Commission (FCC) designed the Emergency Alert System (EAS) so officials can quickly send out important emergency information targeted to a specific area. EAS replaced the Emergency Broadcast System. After conducting extensive tests of competing technologies, the FCC ruled that the EAS would be a digital-based automated system and use coding protocols similar to NOAA Weather Radio (NWR) Specific Area Message Encoding (SAME).

EAS sends out alerts not just to broadcast media but also to cable television, satellites, pagers, Direct Broadcast Satellite, High Definition Television, and Video Dial Tone. EAS also accounts for the needs of special populations such as the deaf

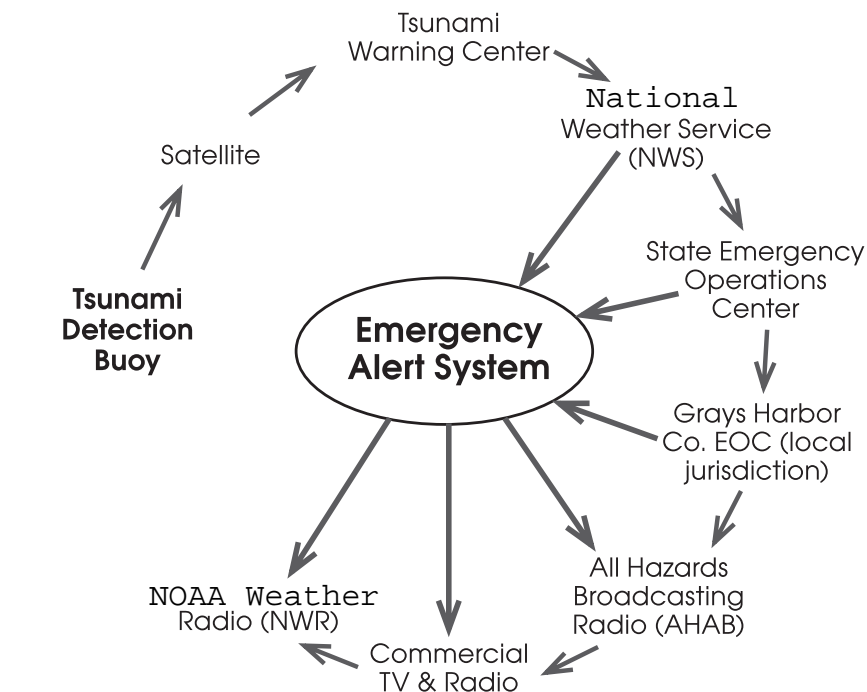

and those with special language requirements.

FCC rules also require broadcasters to monitor at least two independent sources for emergency information, ensuring that emergency information is received and delivered to viewers and listeners.

Activation of AHAB Sirens

Washington State is a member of the National Tsunami Hazard Mitigation Program (NTHMP). The program works to ensure tsunami warning information is as accurate as possible using real-time data through deep ocean tsunami detection devices. Real-time data provides the West Coast/Alaska Warning Center with quick and reliable information to determine whether an earthquake has generated a tsunami.

If a tsunami is generated, the tsunami detectors send data via satellite to the Tsunami Warning Centers. In turn, a message is generated via the NOAA Weather Wire Service to the National Weather

Service offices and State Emergency Operations Center. A message is then sent by Emergency Alert System to NOAA Weather Radios that are located in businesses, homes, TV, and Radios. The message is also sent via satellite to the AHAB sirens on beach heads or high traffic areas to warn of a pending tsunami. Through this cycle, dissemination of a warning can be obtained rapidly and effectively.

For more information about NOAA's deep ocean tsunami detection devices, visit www.ndbc.noaa.gov/.

AHAB siren alerts

During a routine **TEST** of the system, the siren will play the Westminster Chimes. A voice message, shown below, will follow the test chimes:

Voice TEST Message: "The following is a test of the siren system. It is only a test. This is a test of the siren warning system. If this had been a real emergency you should tune in to your local radio station or listen to

this system for further instructions. This was only a test."

To hear the test chime, visit the Web site www.emd.wa.gov/hazards/prog_ahab.shtml

Upon the issuance of a **TSUNAMI WARNING**, the siren will play a wail sound and a voice message will follow the siren. The following voice message will be used:

Voice Warning Message: "This is NOT a Test. A tsunami warning has been issued for the coastal areas of Washington. A tsunami can cause dangerous flooding. If you are in a low coastal area, you are at risk and must move to higher ground or inland now. Do not return until directed to do so. Tune into your local radio station for additional information. This is NOT a test a tsunami warning has been issued for the coastal areas of Washington move to higher ground or inland now." (Wail)

Know when to evacuate

- If you feel the ground shake, evacuate inland or to high ground immediately! A wave as high as 20 feet could reach many coastal areas within 30 minutes of the quake.
- If you notice a sudden drop or rise in sea level, move to high ground or inland immediately.
- If you are inside and hear a broadcast or NOAA Weather Radio alert; or if you are outside and hear an AHAB siren follow the instructions provided.
- **Remember** - the first wave is often not the largest; successive waves may be spaced many minutes apart and continue to arrive for several hours. Return only after emergency officials say it is safe to do so.

DANGER FROM THE SEA

Tsunami — Head for High Ground Immediately

Tsunamis (pronounced soo-ná-meas), also known as seismic sea waves (mistakenly called “tidal waves”), are a series of enormous waves created by an underwater disturbance such as an earthquake, landslide, volcanic eruption, or meteorite. A tsunami can move hundreds of miles per hour in the open ocean and smash into land with waves as high as 30 feet or more.

From the area where the tsunami originates, waves travel outward in all directions. Once the wave approaches the shore, it builds in height. The topography of the coastline and the ocean floor will influence the size of the wave.

There may be more than one wave and the succeeding one may be larger than the one before. That is why a small tsunami at one beach can be a giant wave a few miles away.

All tsunamis are potentially dangerous, even though they may not damage every coastline they strike. A tsunami can strike anywhere along most of the U.S. coastline. The most destructive tsunamis have occurred along the coasts of California, Oregon, Washington, Alaska, and Hawaii.

Earthquake-induced movement of the ocean floor most often generates tsunamis. If a major earthquake or landslide occurs close to shore, the first wave could reach the beach in a few minutes, even before a warning is issued. Areas are at greater risk if they are less than 25 feet above sea level and within a mile of the shoreline. Tsunami waves and the receding water are very destructive to structures in the run-up zone. Other hazards include flooding, contamination of drinking water, and fires from gas lines or ruptured tanks.



Know these terms

Familiarize yourself with these terms to help identify a tsunami hazard:

Advisory — An earthquake has occurred in the Pacific basin, which might generate a tsunami.

Watch — A tsunami was or may have been generated, but is at least two hours travel time to the area in Watch status.

Warning — A tsunami was, or may have been generated, which could cause damage; therefore, people in the warned area are strongly advised to evacuate.

Information Statement — Issued to inform emergency management officials and the public that an event has occurred at a distant location. In most cases, statements are issued to indicate there is no threat from an event, and to prevent unnecessary evacuations.

Tsunami alerts

- Listen to your radio, NOAA Weather Radio, or TV for updates on the watch.

- Know well in advance what your safest evacuation route will be.
- Local officials will determine appropriate actions such as closing beaches, evacuating people, repositioning ships, etc.
- Move to higher ground or inland immediately. If no higher ground is near, go to upper levels of reinforced buildings.
- Wait for the “All Clear” before you return to the beach or to your home.

There are two sources of tsunami for Washington coastal waters — a distant source and a local source

A **local source** - if you feel the ground shake for several minutes, head for higher ground immediately. The earthquake is your warning of a potential tsunami. A noticeable rapid rise or fall in coastal waters is also a sign that a tsunami is approaching.

A **distant source** - The perimeter of the Pacific Ocean Basin, nicknamed the Ring of Fire, has a number of earthquake sources that can produce strong earthquakes of 7.0 magnitude or greater. During the 20th century, there were three 9.0 magnitude or greater quakes, the last was the 1964 Alaskan quake of 9.2 magnitude that produced a tsunami throughout the Pacific Basin. These kind of earthquakes permit a lead time of hours before their subsequent tsunami reaches the Washington coastline. Tsunamis from distant locations like Japan or Chile will take over 10 hours to get here, while from Alaska, only three to six hours.

What to do at the beach

- Immediately head for higher ground; do not wait for a warning if:
 - The ground shakes.
 - You hear a siren.
 - The ocean recedes dramatically from the shoreline.

Follow the tsunami evacuation signs

- Tsunami evacuation route signs have been placed along coastal roadways to indicate the direction inland or to higher ground. In some places, there may be more than one route to safer areas. These routes may be marked with several signs showing additional options for evacuation. You should know the evacuation routes for your area.



GRAYS HARBOR COUNTY TSUNAMI EVACUATION ROUTES

Copalis Beach / Ocean City



Oyuhut / Ocean Shores



GRAYS HARBOR COUNTY TSUNAMI EVACUATION ROUTES

Hoquiam / Aberdeen

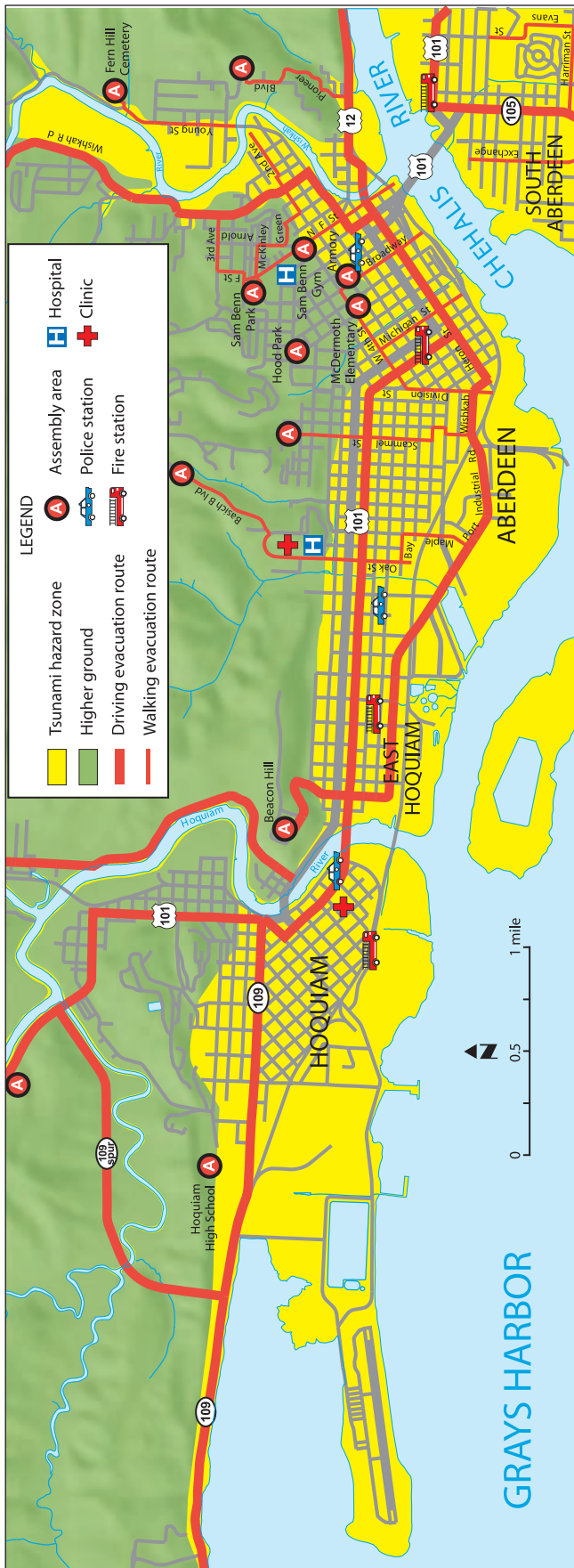

South Aberdeen / Cosmopolis



Westport / Grayland



FLOODING IS A THREAT IN GRAYS HARBOR COUNTY

Minimizing Flood Damage

Floods are one of the most common hazards in Grays Harbor County. Flood effects can be local, impacting a neighborhood or community, or very large, affecting the entire region.

Be aware of flood hazards no matter where you live, but especially if you live in a low-lying area, near water or downstream from a dam or water reserve. Even very small streams, gullies, creeks, culverts, or low-lying ground that appears harmless in dry weather can flood.

Before a flood

- Avoid building in a floodplain unless you elevate and reinforce your home.
- Elevate the furnace, water heater, and electric panel if susceptible to flooding.
- Install “check valves” in sewer traps to prevent flood water from backing up into the drains of your home.
- Construct barriers (levees, beams, floodwalls) to stop floodwater from entering the building.
- Seal walls in basements with waterproofing compounds to avoid damage.

During a flood

- Listen to your weather radio or television for information.
- Be aware that flash flooding can occur. If there is any possibility of a flash flood, move immediately to higher ground. Do not wait for instructions to move.

If you must prepare to evacuate

- Secure your home. If you have time, bring in outdoor furniture.

Move essential items to an upper floor.

- Turn off utilities at the main switches or valves if instructed to do so. Disconnect electrical appliances. Do not touch electrical equipment if you are wet or standing in water.
- Do not walk through moving water. Six inches of moving water can make you fall. If you have to walk in water, walk where the water is not moving. Use a stick to check the firmness of the ground in front of you.

- Avoid moving water.
- Be aware of areas where floodwaters have receded. Roads may have weakened and could collapse under the weight of a car.
- Stay away from downed power lines, and report them to the power company.
- Stay out of any building if it is surrounded by floodwaters.
- Use extreme caution when entering buildings; there may be hidden damage, particularly in foundations.



After a flood

- Listen for news reports to learn whether the community’s water supply is safe to drink.
- Avoid floodwaters; water may be contaminated by oil, gasoline, or raw sewage. Water may also be electrically charged from underground or downed power lines.
- Return home only when authorities indicate it is safe.
- Service damaged septic tanks, cesspools, pits, and leaching systems as soon as possible. Damaged sewage systems are serious health hazards.
- Clean and disinfect everything that got wet. Mud left from floodwater can contain sewage and chemicals.

Driving flood facts

- Six inches of water will reach the bottom of most passenger cars causing loss of control and possible stalling.
- A foot of water will float many vehicles. There is no tire friction once water has lifted the vehicle off the road.
- Two feet of moving water can carry away most vehicles including sport utility vehicles (SUVs) and pick-ups.
- Nearly half of all flood fatalities are vehicle related.
- Do not drive into flooded areas. If floodwaters rise around your car, abandon the car and move to higher ground if you can do so safely. You and the vehicle can be quickly swept away.
- Barricades are put up for your protection. Do not attempt to bypass them. Turn around and go another way!

Flood insurance

- FEMA manages the National Flood Insurance Program, which makes federally-backed flood insurance available in communities that agree to adopt and enforce floodplain management ordinances to reduce future flood damage.
- Flood insurance is available in most communities through insurance agents.
- There is a 30-day waiting period before flood insurance goes into effect, so don’t delay.
- Flood insurance is available whether the building is in or out of the identified flood-prone area.

For more information

www.floodsmart.com/

ACT FAST! MOLD QUICKLY DAMAGES HOMES

Mold Clean Up After A Flood

During a flood cleanup, the indoor air quality in your home or office may appear to be the least of your problems. However, failure to remove contaminated materials and to reduce moisture and humidity can present serious long term health risks. Standing water and wet materials are a breeding ground for microorganisms, such as viruses, bacteria, and mold. They can cause disease, trigger allergic reactions, and continue to damage materials long after the flood.

Remove standing water

Standing water is a breeding ground for microorganisms, which can become airborne and be inhaled. Where floodwater contains sewage or decaying animal carcasses, infectious disease is of concern. Even when flooding is due to rainwater, the growth of microorganisms can cause allergic reactions in sensitive individuals. For these health reasons, and to lessen structural damage, all standing water should be removed as quickly as possible.

Dry out your home

Floodwaters affect a home three ways:

1. The water damages materials. Wallboard will disintegrate if it remains wet too long; wood can swell, warp, or rot; electrical parts can short out, malfunction, and cause fires or shock.
2. Mud, silt, and unknown contaminants in the water not only get everything dirty; they also create a health hazard.
3. Dampness promotes the growth of mildew, a mold or fungus that can grow on everything.

The following steps work on all three of these problems. It is very

important that they be followed in order.

Lower the humidity.

Everything will dry more quickly and clean more easily if you can reduce the humidity in the home. There are five ways to lower the humidity and stop the rot and mildew. But you'll have to delay using some methods if you have no electricity.

Open up the house. If the humidity outside is lower than indoors, and if the weather permits, open all the doors and windows to exchange the moist indoor air for drier outdoor air. Your body will tell if the humidity is lower outdoors. If the sun is out, it should be drier outside. On the other hand, when temperatures drop at night, an open home is warmer and will draw moisture indoors. At night and other times when the humidity is higher outdoors, close up the house.

Open closet and cabinet doors. Remove drawers to allow air circulation. Drawers may stick because of swelling. Don't try to force them. Speed drying by opening up the back of the cabinet to let the air circulate. You will probably be able to remove the drawers as the cabinet dries out.

Use fans. Fans help move the air and dry out your home. Do not use central air conditioning or the furnace blower if the ducts were under water. They will blow out dirty air, which might contain contaminants from the sediment left in the ductwork. Clean or hose out the ducts first.

Run dehumidifiers. Dehumidifiers and window air conditioners will reduce the moisture, especially in closed up areas.

Use desiccants. Desiccants (materials that absorb moisture) are

very useful in drying closets or other enclosed areas where air cannot move through. Desiccants like those listed below are usually available at hardware, grocery, or drug stores.

- **Chemical dehumidifier packs** used for drying boats and damp closets.
- **Cat litter made of clay.**
- **Calcium chloride pellets** used for melting ice in the winter. Hang pellets in a pillowcase, nylon stocking, or other porous bag. Put a bucket underneath to catch dripping water. Close the area being dried. Be careful. Calcium chloride can burn your skin. It will make the air salty, so do not use near computers or other delicate equipment.

Be patient. Drying your home could take several weeks. Until your home is reasonably dry, damage caused by mildew and decay will continue. The musty odor will remain forever if the home is not thoroughly dried out well.

Discard wet materials

It can be difficult to throw away items with sentimental value. However, keeping certain items that were soaked by water may be unhealthy. Some materials tend to absorb and keep water more than others. In general, materials that are wet and cannot be thoroughly cleaned and dried within 24-48 hours should be discarded, as they can remain a source of microbial growth.

Steps to Cleaning Mold from Building Interiors

Use protection

Wear goggles, gloves, and breathing protection while working in the area. For large consolidated areas of mold growth, you should wear an Occupational Safety and Health Administration (OSHA) approved particle mask.

Seal the area

Seal off area from the rest of your home. Cover heat registers or ventilation ducts/grills. Open a window before you start to clean up.

Remove items

Remove all your furnishings to a mold-free area. Clean the surrounding moldy area then follow cleaning directions below for the items you removed and the new space.

Bag moldy trash

Bag all moldy materials and tie off the top of the bag. Bring them outdoors and place in your garbage container right away.

Scrub hard surfaces

First wash with a mild detergent solution, such as laundry detergent and warm water. Allow to dry.

Last step

Apply a borate-based detergent solution and don't rinse. This will help prevent mold from growing again. A borate-based laundry or dishwasher detergent has "borate" listed on the ingredients label.

Clean and wash

Give the rest of the entire area a good cleaning, vacuum floors, and wash any exposed bedding or clothing.

Monitor

Check regularly to make sure mold has not returned to the clean-up area.

CREATE POSITIVE RECOVERY FOR CHILDREN

Helping Children Cope with Trauma

It's important to remember some children may never show distress, while others may not give evidence of being upset for several weeks or even months after an emergency. Other children may not show a change in behavior, but may still need your help.

Children who experience an initial traumatic event before they are 11 years old are three times more likely to develop psychological symptoms than those who experience their first trauma later. Children are able to cope better with a traumatic event if parents and other adults support and help them with their experiences. Help should start as soon as possible after the event.

Children may exhibit the following behaviors after a disaster

- Become afraid of wind, rain or sudden loud noises.
- Be afraid the event will reoccur. Want to stay close to parents.
- Be upset over the loss of a favorite toy or possession that is important to them.
- Change from being quiet and obedient to loud and aggressive, or change from being outgoing to shy and afraid.
- Develop night-time fears (fear of the dark or sleeping alone).
- Lose trust in adults. (After all, their adults were not able to control the disaster.)
- Revert to younger behavior (bed-wetting, thumb-sucking).
- Feel they caused the disaster because of something they said or did.
- Have symptoms of illness, such as headaches, vomiting or fever.
- Worry about where they and their family will live.
- Talk with children about how they are feeling. Assure them that it's okay to have those feelings.
- Help children learn to use words that express their feelings, such as "happy," "sad," or "angry."
- Children should not be expected to be brave or tough. Tell them it's okay to cry.
- Don't give children more information than they can handle about the disaster.
- Assure fearful children you will be there to care for them; consistently reassure them.
- Go back to former routines as soon as possible. Maintain a regular schedule for the children.
- Let children have some control, such as choosing clothing or what meal to have for dinner.
- Help your children learn to trust adults again by keeping promises you make.
- Help your children regain faith in the future by making plans.
- Get needed health care as soon as possible.
- Spend extra time with your children at bedtime.
- Make sure children eat healthy meals and get enough rest.
- Allow special privileges for a short period of time, such as leaving the light on when they go to bed.
- Find ways to emphasize to your children that you love them.
- Allow children time to grieve losses.
- Develop positive anniversary activities to commemorate the event. These may bring tears, but they are also a time to celebrate survival and the ability to get back to a normal life.
- Re-establish contact with extended family.

Things parents can do to help their children

- Reassure children that the disaster was not their fault.

Create and Use Support Networks to Help Parents and Children



Parents help their children when they take steps to understand and manage their own feelings and ways of coping. They can do this by building and using social support systems of family, friends, community organizations, or other resources that work for that family.

Parents can build their own unique social support systems so that in an emergency situation or when a disaster strikes, they can be supported and helped to manage their reactions. As a result, parents will be more emotionally available to their children and better able to

support them. Parents are almost always the best source of support for children in difficult times. But to support their children, parents need to attend to their own needs and have a plan for their own support.

Preparing for disaster helps everyone in the family accept the fact that disasters do happen, and provides an opportunity to identify and collect the resources needed to meet basic needs after disaster. Preparation helps; when people feel prepared, they cope better and so do children.

WASHINGTON IS EARTHQUAKE COUNTRY

When Earthquake Strikes: Drop, Cover and Hold

Resist the urge to run. For your greatest safety during an earthquake, when you feel the ground start to shake, “**Drop, Cover and Hold.**” Running may put you in danger of falling trees, breaking windows, or collapsing buildings.

What to do during an earthquake

- When you feel an earthquake, **DROP** and **COVER** under a desk or sturdy table. **HOLD** that position until the ground stops shaking. Stay away from windows and objects like bookcases that could fall. Hold on to the legs of the desk or table. If it moves, move with it. Do not run — stay where you are. “**Drop, Cover and Hold.**”

Be prepared for an earthquake

- Anchor appliances and tall heavy furniture that might fall. Put latches on cabinet doors to keep contents from spilling out. See page 11.
- Establish an “out-of-area” contact and keep the phone numbers handy. This is the person family members will call if you are separated. See page 9.
- Have a place at home where emergency supplies are kept and tell others where it is.

During an earthquake

If you are indoors:

- Stay inside. Move under a desk or sturdy table and hold on to it. If it moves, move with it. Stay away from windows, bookcases, refrigerators, heavy mirrors, hanging plants and other objects that could fall. Do not go outside until the shaking stops.



- In buildings, the greatest danger exists directly outside buildings, at exits, and alongside exterior walls. Many fatalities occur when people run outside of buildings only to be killed by falling debris.
- If you are in a crowded store or public place, do not rush for an exit. Move away from display shelves holding objects that could fall on you, and “drop, cover and hold.”
- If you are in a theater or stadium, stay in your seat, protect your head with your arms or get under the seat. Do not leave until the shaking stops.

If you are outdoors:

- Move to a clear area away from trees, signs, buildings or downed electrical wires and poles.

If a table or desk is not available, tuck in close to a sturdy piece of furniture during an earthquake



If you are in a downtown area:

- If you are on a sidewalk near a tall building, get into a building’s doorway or lobby to protect yourself from falling bricks, glass and other debris.

If you are driving:

- When driving, an earthquake will feel like all four tires have blown out.
- Slowly pull over to the side of the road and stop. Avoid overpasses, power lines and other hazards. Stay inside the vehicle until the shaking stops.

If you are in a wheelchair:

- Stay in it. Move to safe cover if possible, lock your wheels and protect your head with your arms.

After the earthquake

- If you were evacuated, wait until you are told it is safe before returning home.
- Be careful entering buildings. Stay away from downed power lines.
- Check yourself and those around you for injuries.
- Be prepared for aftershocks.
- Use the phone only to report a life-threatening emergency.
- Do not drive unnecessarily.
- If you smell gas or hear a hissing sound — open a window and leave the building. Shut off the main gas valve outside.
- Check on neighbors, particularly elderly or disabled persons.
- Try to contact your out-of-area phone contact.
- Listen to your radio for reports from officials.

SEVERE COLD WEATHER: THE DECEPTIVE KILLER

Severe Winter Storms

Why talk about winter weather? Each year, dozens of people die due to exposure to cold. Add to that number, vehicle accidents and fatalities, fires due to dangerous use of heaters and other winter weather fatalities and you have a significant threat.

A major winter storm can last for several days and be accompanied by high winds, freezing rain or sleet, heavy snowfall and cold temperatures. People can become trapped at home or in a car, without utilities or other assistance.

Attempting to walk for help in a winter storm can be a deadly decision. Avoid physical exertion when outdoors during severe cold weather.

Listen to NOAA Weather Radio

- **Outlook:** Winter storm conditions are possible in the next 2-5 days.

Injuries related to cold

- 50% happen to people over 60 years old.
- More than 75% happen to males.
- About 20% occur in the home.

- **Watch:** Winter storm conditions are possible within the next 36-48 hours.
- **Warning:** Life-threatening severe winter conditions have begun or will begin within 24 hours.
- **Advisory:** Winter weather conditions are expected to cause significant inconveniences and may be hazardous.

What to do before a winter storm threatens

You can avoid the dangers and discomfort by preparing before winter weather arrives.

- Prepare to survive on your own for at least 3 days. Gather warm clothing, several days' supply of water, medicines, and food that needs no cooking or refrigeration.

- Keep fire extinguishers on hand, and make sure your household knows how to use them.

Frostbite is damage to body tissue caused by extreme cold. Frostbite causes a loss of feeling and a white or pale appearance in extremities, such as fingers, toes, ear lobes or the tip of the nose. If symptoms are detected, get medical help immediately! If you must wait for help, slowly rewarm affected areas. However, if the person is also showing signs of hypothermia, warm the body core before the extremities.

Hypothermia is a condition brought on when the body temperature drops below 95°F. It can kill. For those who survive, there are likely to be lasting kidney, liver and pancreas problems. Warning signs

include uncontrollable shivering, memory loss, disorientation, incoherence, slurred speech, drowsiness and apparent exhaustion.

If Medical Care Is Not Available, warm the person slowly, starting with the body core. Improperly warming the body will drive cold blood from the extremities to the heart, leading to heart failure. If necessary, use your body heat to help. Get the person into dry clothing and wrap in a warm blanket covering the head and neck. Do not give the person alcohol, drugs, coffee or any hot beverage or food.

Wind Chill is not the actual temperature but rather how wind and cold feel on exposed skin. As the wind increases, heat is carried away from the body at an accelerated rate, driving down the body temperature. Animals are also affected by wind chill; however, cars, plants and other objects are not.

Power Outages

Many power outages come at times of weather extremes or accompany various disasters. When the power is out, safety becomes a major concern. The following information is meant to help you when the lights go out.

- Have an alternate heat source and supply of fuel.
- Consider installing a grinder pump to keep sewage flowing out of your home. Grinder pumps work like a household garbage disposal, but on a larger scale. It grinds up wastewater produced in your home (i.e. toilet use, shower, washing machine, etc.) and pumps it into the public sewer system.



- Consider purchasing a generator, especially if someone in the house requires life-sustaining electricity-dependent equipment.

- Register life-sustaining equipment with your utility company and fire department.
- If power is out in the neighborhood, disconnect all electrical heaters and appliances to protect the motors from possible low voltage damage.
- Unplug computers and other voltage-sensitive equipment to protect them against possible surges when the power is restored.
- Keep your refrigerator and freezer doors closed. With doors closed, a fully loaded freezer can keep foods frozen for two days.

- Use battery-operated flashlights or glow sticks for alternative lighting, and a wind-up clock in your disaster supplies kit.
- If you use a kerosene heater, gas lantern or stove inside the house, maintain ventilation to avoid a build up of toxic fumes.
- If your power is out, leave one light switch in the on position to alert you when services are restored.
- Have a corded telephone available; remember that cordless phones will not work when the power is out.
- Conserve water, especially if you are on a well.

LOCAL HISTORY PREDICTS FUTURE LANDSLIDES

Landslides

The term landslide covers a wide range of ground movement. Landslides vary in size and can travel at a rate of a few inches per month to many feet per second depending on slope, type of materials and moisture content.

Landslides are caused by a combination of geology, topography, and weather and commonly occur with other disasters such as an earthquake or flood. Determining the probability of landslide events is difficult because so many factors can contribute to the cause of a ground failure (*Grays Harbor County Hazard Mitigation Plan*).

Landslides in the county are normally associated with intense or prolonged rain. Another is wave or stream action with bank undercutting during periods of intense precipitation. Earthquakes of a magnitude of 4.0 or greater can also induce landslides on susceptible slopes.

The areas most vulnerable to landslide in the county are the slopes of the Olympic range, the coastal shoreline, and the Highway 101 corridor. It should be noted that landslides might occur on a moderate slope anywhere in the county if soils become saturated.

Generally landslides in the county will develop at the base or top of a steep cut slope; on developed hillsides or coastal bluffs; from activities that disturb slopes such as construction, road building and logging; and on old existing landslides. Other factors inducing landslides can be poorly located septic systems which contribute to slope unsuitability, areas where surface water is channeled along roads and below culverts, water leakage from utilities, vegetation removal and paths or trails down a bluff leading to beach access.



Characteristics of landslides in Grays Harbor County

- Steep and/or unstable slopes
- Heavy precipitation, rain or snowmelt, or an earthquake of 4.0+
- Soils near to saturation
- Saturated bluffs undercut by waves
- Erosion on river or stream banks
- Flooding

Before a landslide

- A geologist or the county planning department may have specific information on areas vulnerable to landslides. Consult a professional geotechnical expert for advice on corrective measures you can take.
- Plan at least two evacuation routes since roads may become blocked or closed.

Insurance

- Mudflow is covered by flood insurance policies from the National Flood Insurance Program. Flood insurance can be purchased through a local insurance agency.

Minimize home hazards

- Remember: If you build walls to divert debris flow and the flow

lands on a neighbor's property, you may be liable for damages.

- Plant ground cover on slopes to stabilize the land, and build retaining walls.
- Build channels or deflection walls to direct the flow around buildings.

Learn to recognize the landslide warning signs

- Doors or windows begin to stick or jam for the first time.
- New cracks appear in plaster, tile, brick or foundations.
- Outside walls, walks or stairs begin pulling away from the building.
- Slowly developing, widening cracks appear on the ground or on paved areas.
- Underground utility lines break.
- Bulging ground appears at the base of a slope.
- Water breaks through the ground surface.
- Fences, retaining walls, utility poles or trees tilt or move.
- You hear a faint rumbling sound that increases in volume as the landslide nears. The ground slopes downward in one specific

direction and may begin shifting in that direction under your feet.

During a landslide

IF INSIDE A BUILDING:

- Stay inside.
- Take cover under a desk, table, or other piece of sturdy furniture.

IF OUTDOORS:

- Run to the nearest high ground in a direction away from the path.
- If rocks and other debris are approaching, run for the nearest shelter such as a group of trees or a building.
- If escape is not possible, curl into a tight ball and protect your head.

AFTER A LANDSLIDE

- Remember that flooding may occur after a mudflow or a landslide.
- Stay away from the slide area; there may be danger of additional slides.
- Check for injured and trapped persons near the slide area. Give first aid.
- Remember to help your neighbors who may require special assistance: infants, elderly people, and people with disabilities.
- Listen to a battery-operated radio or television for emergency information.
- Check for damaged utility lines.
- Check the building foundation, chimney, and surrounding land for damage.
- Replant damaged ground as soon as possible. Erosion caused by loss of ground cover can lead to flash flooding.

HIGH WINDS THREATEN GRAYS HARBOR COUNTY

Windstorms

Although the Pacific Northwest escapes the threat of hurricanes, the region is no stranger to strong, damaging winds. Each fall and winter season, several Pacific low pressure systems impact the Pacific Northwest, producing strong winds to 60 mph, and causing some power outages and property damage. About once every decade, storms with powerful winds of 70 mph or more pound the region, producing significant property damage.

High winds are a serious threat in Grays Harbor County from October through March. It is estimated that there is a significant chance of an occurrence of at least one damaging wind event every year in Grays Harbor County (*Grays Harbor County Hazard Mitigation*

Plan). Historic records from 1900 to 1989 of windstorms in Grays Harbor County show winds ranging from 60 mph to 100 mph or more. History shows that being prepared is your best source of prevention.

Facts about windstorms

- Falling trees or blowing debris cause most fatalities, and also cause severe damage to buildings and vehicles.
- Power pole and line damage cause widespread power outage.
- Failure of roof cover and structures can lead to additional damage and entry of wind and rain into the house.
- Garage doors are the weakest link in the outer structure of a house. Failure at this point has a domino effect.
- Exterior load-bearing walls of buildings can fail resulting in the collapse of the roof.
- Weathered, loose window frames are exceptionally vulnerable.
- Office buildings are generally structurally sound, but broken windows cause injuries inside and outside the building.
- Bus stop shelters and light metal buildings where people seek shelter are vulnerable and could collapse, resulting in significant injuries and fatalities.

What to do before a windstorm

- Purchase a NOAA Weather Radio to stay informed about pending storms.
- Contact vendors to know the proper use of home generators.

- Find out who in your area might need special assistance, specifically the elderly, disabled, or non-English speaking neighbors.
- Be familiar with evacuation routes.
- Know what emergency plans are in place at your workplace, school and daycare center.
- Conduct a home safety evaluation, including the garage door, and nearby trees.
- If you have an electric garage door opener, locate the manual override.
- Prepare and maintain a 72-hour disaster supply kit (see page 8).
- Call 9-1-1 only in life-threatening situations. Avoid making local telephone calls.

Wildfires

Wildland fires are fires caused by nature or humans that result in the uncontrolled destruction of forests, brush, field crops, grasslands, and real and personal property.

Short-term loss caused by a wildland fire can include the destruction of timber, wildlife habitat, scenic vistas, and watersheds; vulnerability to flooding increases due to the destruction of watersheds. Long-term effects include smaller timber harvests, reduced access to recreational areas, and destruction of community infrastructure.

The actions you take now can help save lives and help prevent or reduce damage caused by wildfires.

What to do before a wildfire

- Have an evacuation plan. If you must evacuate, know where you

are going and the possible routes to get there.

- Create a “fire safety zone” near your home. This is an area cleared of all flammable materials into which you can escape in the event the fire surrounds you.
- Make emergency plans for your pets and livestock.
- Listen to local radio and television stations, or a NOAA Weather Radio, for information about fire threats in your area.
- Clearly mark all driveways with names/addresses. Remove firewood, shrubs and other combustibles near your home.
- Always call your local fire department before burning. Be careful when cooking outdoors or using gas-powered equipment.

When wildfire threatens

- Remain calm. Listen to the radio and television for fire reports and evacuation information. Follow the advice given by authorities. (However, if you feel threatened, do not wait to leave.)
- Phone/tell your family and friends you may need to evacuate and let them know where you are going. Use your out-of-area contact card.
- Put on protective clothing to protect your body, face and lungs.
- Prepare a note to post at your home that tells when you left and where you are going.
- Set up a ladder, garden hoses and sprinklers on the roof. To conserve water, wait until the embers start falling.

If advised to evacuate, do so immediately

- If there is time, close all windows, vents and doors, and remove lightweight curtains.
- Shut off gas utilities.
- Post your prepared note on main entrance.
- Lock your doors.
- Choose a route away from fire hazards. Drive with your lights on and watch for emergency vehicles.
- If your evacuation routes are burning—go to your designated “safety zone.”
- Do not attempt to re-enter the area until firefighters have declared it safe.

RIP CURRENTS CAN BE KILLERS

How to Avoid and Survive Rip Currents

Rip currents are powerful, channeled currents of water flowing away from shore. They typically extend from the shoreline, through the surf zone, and past the line of breaking waves. Rip currents can occur at any beach with breaking waves.

Learn how to swim! If caught in a rip current, how you respond could make the difference between life and death. The time you take to understand rip currents can help you protect yourself and your loved ones when visiting the beaches.

Why rip currents form

As waves travel from deep to shallow water, they will break near the shoreline. When waves break strongly in some locations and weakly in others, this can cause circulation cells which are seen as rip currents: narrow, fast-moving belts of water traveling offshore.

Why rip currents are dangerous

Rip currents are the leading surf hazard for all beachgoers. They are particularly dangerous for weak or non-swimmers. Rip current speeds are typically 1-2 feet per second. However, speeds as high as 8 feet per second have been measured — this is faster than an Olympic swimmer can sprint! Thus, rip currents can sweep even the strongest swimmer out to sea.

When rip currents form

Rip currents can be found on many surf beaches every day. Under most tide and sea conditions the speeds are relatively slow. However, under certain wave, tide, and beach profile conditions the speeds can quickly increase to become dangerous to anyone entering the surf. The strength and speed of a rip current will likely increase as wave height

and wave period increase. They are most likely to be dangerous during high surf conditions as the wave height and wave period increase.

Where rip currents form

Rip currents most typically form at low spots or breaks in sandbars, and also near structures such as groins, jetties and piers. Rip currents can be very narrow or extend in widths to hundreds of yards. The seaward pull of rip currents varies: sometimes the rip current ends just beyond the line of breaking waves, but sometimes rip currents continue to push hundreds of yards offshore.

Rip Current Myth

A rip current is a horizontal current. Rip currents do not pull people under the water — they pull people away from shore. Drowning deaths occur when people pulled offshore are unable to keep themselves afloat and swim to shore. This may be due to any combination of fear, panic, exhaustion, or lack of swimming skills.

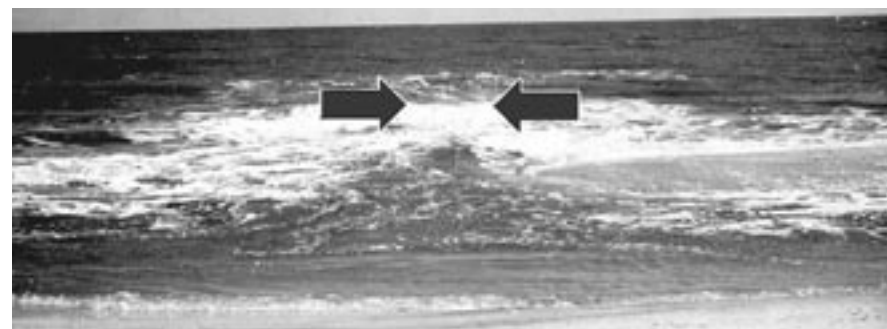

How to avoid and survive rip currents:



When at the beach

- Whenever possible, swim at a lifeguard-protected beach.
- Never swim alone.
- Learn how to swim in the surf. It's not the same as swimming in a pool or lake.
- Be cautious at all times, especially when swimming at unguarded beaches. If in doubt, don't go out.
- Obey all instructions and orders from lifeguards. Lifeguards are trained to identify potential hazards. Ask a lifeguard about the conditions before entering the water. This is part of their job.

- Stay at least 100 feet away from piers and jetties. Permanent rip currents often exist along side these structures.
- Consider using polarized sunglasses when at the beach. They will help you to spot signatures of rip currents by cutting down glare and reflected sunlight off the ocean's surface.
- Pay especially close attention to children and elderly when at the beach. Even in shallow water, wave action can cause loss of footing.

If caught in a rip current

Remain calm to conserve energy and think clearly.

- Never fight against the current. Think of it like a treadmill that cannot be turned off, which you need to step to the side of.
- Swim out of the current in a direction following the shoreline. When out of the current, swim at an angle — away from the current — towards shore.
- If you are unable to swim out of the rip current, float or calmly tread water. When out of the current, swim towards shore.
- If you are still unable to reach shore, draw attention to yourself by waving your arm and yelling for help.
- If you see someone in trouble, don't become a victim too. Get help from a lifeguard. If a lifeguard is not available, have someone call 9-1-1.
- Throw the rip current victim something that floats — a lifejacket, a cooler, an inflatable ball. Yell instructions on how to escape.

LEARN ABOUT CHEMICAL HAZARDS IN YOUR AREA

Hazardous Chemical Emergencies

A chemical emergency arises when chemicals are intentionally or unintentionally used or handled improperly. Some chemicals that are safe, and even helpful in small amounts, can be dangerous in larger quantities, and there is the remote possibility that under some conditions they can be extremely harmful.

Major chemical emergencies

A major chemical emergency is an accident that releases a hazardous amount of a chemical into the environment. Accidents can happen underground, on railroad tracks or highways, and at manufacturing plants. These accidents sometimes result in a fire or explosion, but many times you cannot see or smell anything unusual.

Planning for major chemical emergencies

- Contact the Grays Harbor Emergency Management office for information on hazardous materials in this area.
- Find out evacuation plans for your workplace and your children's schools. Know where you or your children may be taken in the event of a major chemical emergency.
- Develop an evacuation plan for home and your workplace. Everyone in your family should know where to go if they have to leave.
- Learn about industry and community warning signals. Use a NOAA Weather Radio with a tone-alert feature to be aware of warnings while you are indoors.
- Involving your children in preparing for disasters is the best way to help them endure disasters. Because they will know what to do, their fears will



be reduced and they will gain a sense of control.

What to do during a major chemical emergency

- You will be notified of a major chemical emergency by the authorities. If you hear a siren or other warning signal, turn on a radio or television for information.
- You will be told the following:
 - The type of health hazard.
 - The area affected.
 - How to protect yourself.
 - Evacuation routes (if necessary).
 - Shelter locations.
 - Type and location of medical facilities.
 - The phone numbers to call if you need extra help.
- Turn on your radio or television to learn if your community will be affected. If necessary, you will be given specific instructions for your particular situation.
- Strictly follow instructions of emergency officials. Your life could depend on it.
- Call 9-1-1 only for a possible life-threatening emergency. Telephone lines are frequently overwhelmed in disaster situations, and need to be clear for emergency calls to get through.
- Follow local instructions concerning the safety of food and water. Contaminated food or water can cause illness.
- Clean up and dispose of debris carefully. Follow instructions

from emergency officials concerning cleanup methods.

How to evacuate

If you are told to evacuate immediately, take your Disaster Supplies Kit. Take only the essentials, and leave your home quickly. Follow the route authorities recommend. Don't take shortcuts, they may be blocked or expose you to dangerous chemicals. Following the advice of local authorities is your safest choice.

- Stay calm, listen carefully, and follow all instructions.
- Listen to your radio to make sure the evacuation order applies to you. Local officials may call for evacuation in specific areas at greatest risk.
- Do not assume that a shelter will have everything you need. While shelters provide a safe place to stay, take your own specialty items for infants and individuals on restricted diets.
- Close and lock your windows and doors.
- Check neighbors to make sure they have been notified, and offer help to disabled or older persons.
- Take only one vehicle to the evacuation site. Traffic may be very heavy and parking at a shelter may be limited.
- Close your car windows, air vents, and turn off the heater and air conditioner.
- For your safety, follow the exact route you are told to take. Shortcuts may put you in the path of danger.
- Return home only when authorities say it is safe.

WAITING TO CREATE A DISASTER PLAN COULD BE A DEADLY DECISION

How to Shelter-in-Place

If a chemical accident happens, authorities will instruct people to either seek shelter where they are and seal the premises (shelter-in-place), or evacuate immediately. If ordered to remain in your home, office or school, follow these directions to “shelter-in-place.”

How to shelter-in-place

- Dampen towels and place over the cracks under doors.
- Cut plastic sheeting to fit over the windows and vents. Secure the plastic with duct tape.

- Tape around the door.
- Turn on the radio.
- Don't air out or leave your sealed shelter until you are told to do so.

Remember

- If ordered to evacuate, do so immediately and carefully follow directions. Do not wander about; know where you are going and how to get there.
- Avoiding chemical exposure should be your primary goal. Leaving your sheltered area to

rescue or assist victims can be a deadly decision.

- In a chemical emergency, there is very little an untrained volunteer can do to help victims. Stay in your sheltered area until authorities say it is safe to come out.
- If you were outside before taking shelter and think you may have been exposed to a chemical agent, there are several things you can do. If you are in a sealed shelter, take off at least your outer clothes, put them in a plastic bag and seal the bag. If

water is available, wash or take a cool to warm (not hot) shower, using lots of soap and water. Do not put the soap in your eyes, just lots of water. If you leave the area, tell emergency responders or medical staff at your destination you may have been exposed. Tell the emergency responders about the sealed bag so that they can arrange for its safe removal after the emergency.

- If you have symptoms of exposure, call 9-1-1 immediately and follow their instructions.

Follow these directions to “Shelter-in-Place”



Go indoors immediately.



Close all windows and doors.



Turn off ventilation systems (heating and air-conditioning, and fireplace dampers).



Go into a room with the fewest doors and windows and seal the room.



Turn on your radio for information.



Stay in the room until told by the authorities that it is safe to come out.

STRAPPING WATER HEATERS AND TURNING OFF UTILITIES

Securing Water Heaters

Securing your water heater is critical for two very important reasons: Water heaters that are damaged during an earthquake pose the greatest threat of fire; and, fresh water after a disaster may be as close as your water heater — provided, it remains upright.

You can protect this valuable resource by securing your water heater to the wall studs.

First, use heavy-gauge metal strapping

Experts modified the procedure for strapping water heaters following the 1989 Loma Prieta and 1994 Northridge earthquakes. Prior to this, a single strap of plumbers' tape was commonly used. Because so many tanks burst through this strapping, experts now recommend:

1. Secure both the top and the bottom, rather than just the top or just the middle, of the tank.
2. Use heavy-gauge metal strapping rather than plumbers' tape.

3. Replace all copper and metal piping with flexible natural gas and water line connectors.

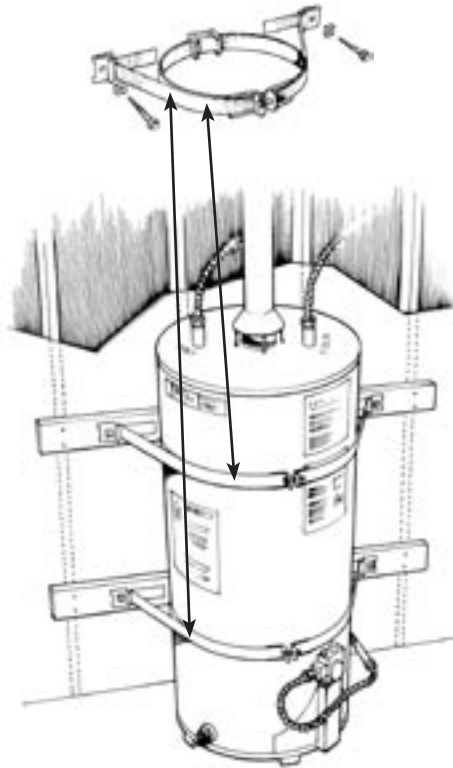

Second, secure tank top and bottom

- Commercially available strapping kits make this a relatively easy process. These can be found in many hardware stores. These kits come complete with the strapping, lag screws, washers, spacers and tension bolts.
- You can also choose to assemble the strapping materials yourself using heavy-gauge metal straps and 3-inch lag screws.
- To prevent the tank from tipping backwards, there should be very little space between it and the wall. If there is more than 1 or 2 inches, attach a wooden block to the wall with long lag screws.
- Wrap the heavy-gauge metal strapping 1-1/2 times around the tank. Start by placing the strapping at the back of the tank. Bring it to the front and then take it back to the wall.

- Secure this strapping to the wall studs or the wood block using several 1/4-inch x 3-inch or longer lag screws with oversized washers.
- If you are securing it directly into concrete, use 1/4-inch expansion bolts in place of the screws.

An emergency source of water

- Water can easily be accessed by connecting a garden hose to the drain spout, and by opening a faucet somewhere in the house.
- Make sure the electricity or natural gas is off before opening the drain.

For additional information:

www.emd.wa.gov/preparedness/prepare_personal_prep_video_index.shtml

Turning Off Utilities

When disaster strikes, it often affects one or more of the utilities in your home. It is important to know where the main controls are located, and when and how to turn them off.

Electricity

- Locate your main electrical switch or fuse panel, and learn how to turn off the electrical power system.
- If a generator is used as a backup power supply, remember to follow the manufacturer's instructions. Connect lights and appliances directly to the generator and not to the electrical system.

Water

- Turn off water at the main meter or at the water main leading into the house. This will prevent contaminated water from entering your water heater and plumbing.
- Turn off the valve — turn to the right. This will require a special valve wrench, available from a hardware store. Make sure you have the tool readily available.

Sewer system

- Make sure your sewer system is functioning properly before using it. This will prevent the contamination of your home, and the drinking water supply.

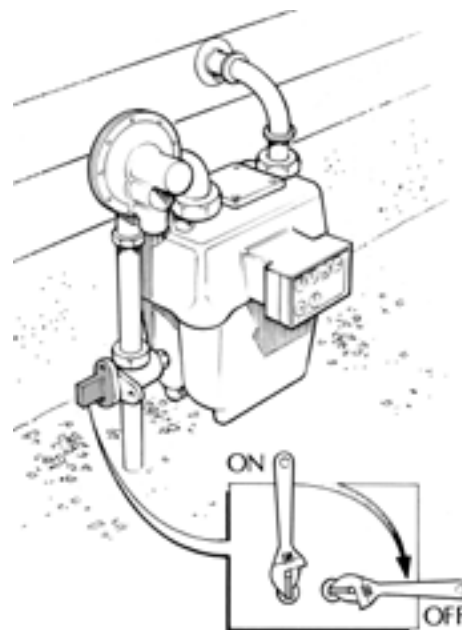

Gas meter (illustration left)

- Have a wrench immediately available for turning off the gas supply.
- If you smell natural or propane gas, evacuate immediately and leave the area. Go to where you no longer smell gas. Do not use matches, lighters or open flame appliances. Do not operate electrical switches because sparks could ignite gas causing an explosion.
- Shut off gas only if you smell gas or hear a hissing noise. Contact the gas company to turn the gas back on.

THE VALUE OF WATER TO OUR LIVES

Purifying Water for Household Use

The treatments described below work only in situations here the water is unsafe because of the presence of bacteria or viruses. If you suspect the water is unsafe because of chemicals, oils, poisonous substances, sewage, or other contaminants, **do not use the water for drinking.**

Storing water safely

- Store one gallon of water per person per day. Store at least a three-day supply of water per person.
- Collect the water from a safe supply.
- Thoroughly washed plastic containers such as soft drink bottles are best.
- Seal water containers tightly, label with date, and store in a cool, dark place.
- Replace water every six months.

- Never reuse a container that contained toxic materials such as pesticides, solvents, chemicals, oil or antifreeze.

Water purification

The two best ways to treat water are: boiling and adding bleach. If tap water is unsafe because of surface water contamination (from floods, streams or lakes), boiling is the best method.

- Cloudy water should be filtered before boiling or adding bleach.
- Filter water using coffee filters, paper towels, cheese cloth or a cotton plug in a funnel.

Boiling is the safest way to purify water

- Bring the water to a rolling boil for 3-5 minutes. Let the water cool before drinking.
- If boiling is not possible, treat water by adding liquid house-

Treating Water with a 5-6 Percent Liquid Chlorine Bleach Solution		
Volume of Water to be Treated	Treating Clear/Cloudy Water: Amount of Bleach to Add	Treating Very Cold, or Surface Water: Amount of Bleach to Add
1 quart/1 liter	3 drops	5 drops
1/2 gallon/2 quarts/2 liters	5 drops	10 drops
1 gallon	1/8 tsp	1/4 tsp
5 gallons	1/2 tsp	1 tsp
10 gallons	1 tsp	2 tsp

Washington State Dept. of Health

- hold bleach, such as Clorox™ or Purex™. Household bleach is typically between 5% and 6% chlorine. Avoid using bleaches that contain perfumes, dyes and other additives.
- Place the water (filtered, if necessary) in a clean container. Add the amount of bleach according to the table below.
- Mix thoroughly and allow to stand for at least 30 minutes

before using (60 minutes if the water is cloudy or very cold).

An emergency source of drinking water

- Water can easily be accessed by connecting a garden hose to the drain spout, and by opening a faucet somewhere in the house.
- Make sure the electricity or natural gas is off before opening the drain.

Preparing for Pets and Livestock

Consider your pets when planning for emergencies. Know where to take your pets in an emergency and remember their needs when creating your family disaster kit.

Before the disaster

- Find a safe place for your pets to stay. Emergency pet shelters, animal control shelters, or veterinary clinics are all possible choices. Some hotels and motels may allow you to bring pets; others may suspend their “no pet” rules during an emergency.
- Make sure your pets wear current ID tags all the time.
- Make sure your pet’s vaccinations are current. Pet shelters may require proof of vaccines.

- Store pet supplies in sturdy easy-to-carry containers, including water, food, medications, and first-aid kit.
- Keep pets in the house as emergency situations develop so you can locate them.

If you evacuate, take your pets

- If it’s not safe for you to stay in the disaster area, it’s not safe for your pets. Don’t leave animals inside your home, chained or roaming loose.
- If you leave, take your pet even if you think you’ll be able to come home in just a few hours. Leave early — if you wait for an evacuation order, you may be told to leave your pets behind.

Emergency supply kit for pets

- Sturdy leashes and harnesses. A secure carrier large enough for your pet to stand comfortably, turn around and lie down. Add blankets or towels for bedding.
- Photos to help identify lost pets and prove ownership.
- Food and water for at least seven days for each pet.
- Bowls, cat litter and litter box, and a manual can opener.
- Information on feeding schedules, medical conditions, behavior problems, and the name and number of your veterinarian.
- Pet beds and toys, if you can easily take them.

Plan for livestock

- Post emergency contact numbers at your barn and on your pasture fence.
- Make an animal kit with leads, halters, first aid kits, and quieting hoods for easy transport. Keep feed at a separate location that could be air-dropped if the animals become stranded.
- Have sufficient transportation available for all your livestock. Train your livestock to board the vehicles.
- Form agreements with neighbors to help each other during disasters. Know organizations that are prepared to rescue and house livestock.

HELPING YOUR BUSINESS REBOUND SUCCESSFULLY FROM A DISASTER

Business Continuity Planning

Getting back to business after a disaster depends on preparedness planning done today. Both small and large business owners invest a tremendous amount of time, money and resources to make their ventures successful, and yet, while the importance of emergency planning may seem self-evident, it may get put on the back burner in the face of more immediate concerns. An estimated 25 percent of businesses do not reopen following a major disaster, according to the Institute for Business and Home Safety.

Building a continuity plan and taking proactive steps toward preparedness will reduce this risk, protect stakeholder's interests, and ensure continuation of services.

Plan ahead for the unexpected disaster

It's critical to protect your business by identifying potential risks from natural and man-made disasters. Be pessimistic – this is definitely a case of planning for the worst and hoping for the best.

Here are some suggestions if you are at risk for the following disasters:

Flooding

- Most standard insurance policies do not cover flood damage and the resulting loss of income. Check with your insurance agent to ensure adequate protection.
- Reduce damage and ease clean up by building with flood-resistant materials.
- Consider working with a licensed contractor to raise electrical and HVAC systems above the 100 year flood level mark.
- Keep computers, electronics, and important files raised off the floor.

- Consider working with a licensed plumber to install a backflow valve to prevent sewage backup.

Earthquake

- Refer to Grays Harbor County building officials to ensure that your facility is up to code.
- Use natural gas lines with flexible connections and automatic shut-off valves.
- Use flexible water lines and/or couplings to toilets, sinks, and in sprinkler systems.
- Secure equipment, including computers, to the floor or walls to prevent tipping.
- Make sure anything with a drawer or door, like filing cabinets, has latches with a manual release.

Severe weather storms

- Assign one person to be responsible for monitoring weather alerts.
- Establish interior locations for employees to gather. Bathrooms, corners, and short hallways are safest.
- Keep a supply of non-perishable food, drinking water, and blankets in a shelter area.
- Have a method of notifying employees concerning work status before and after the storm.
- Put masking tape over windows to reduce the risk of flying glass.
- Consider evacuating vehicles in advance of a storm. Put them in a garage or keep them outside, away from trees or other potential falling objects.
- Bring outside signage, furniture, and decorations inside.
- Unplug all equipment and turn off the gas, electricity, and water.

Wildfires

- Maintain a 30-foot “combustible-free” zone around your facility. Remove any trees and combustible material, such as brush. Keep grass mowed and irrigated.
- Remove damaged or diseased limbs from nearby trees.
- Carefully consider the use of flame-resistant building materials when building or renovating.
- Keep the roof and gutters clear of debris.
- Attach non-flammable, fine-gauge screening over all chimneys.

Business essentials

Create an all-inclusive disaster plan, update it regularly, and keep a copy at an off-site location. Meet regularly with your insurance agent to ensure you have adequate coverage and knowledge of how to quickly file a claim. Here is a helpful list:

EMPLOYEES:

- Develop and practice emergency plans with your employees.
- Identify an internal shelter in the event that authorities tell you to “shelter in place.”
- Establish a single spokesperson to speak to the media and public.
- Document each employee's function and emergency contact information.
- Decide who is in charge when managers are unavailable.
- Create a phone tree and designate who will initiate the communication process.

CUSTOMERS:

- Keep a copy of your customer records off-site.
- Have an alternate worksite from which to communicate to customers during recovery.

SUPPLIERS:

- Maintain a contact list of all your suppliers. Find out how they plan to supply you if the supplier experiences a disaster.
- Maintain a list of alternate suppliers.

EQUIPMENT:

- Maintain an inventory of all equipment.
- Keep a equipment maintenance schedule, and contact lists of manufacturer and service providers.

PROPERTY:

- Make sure your facility meets all local building and fire codes.
- Know where utility shutoffs are located and how to operate them.

RECORDS:

- Document all processes that make your business run from answering the phones, to tracking finances, to distributing your product or service.
- Develop a schedule for backing up all computer records.
- Keep current copies of all paper and computer files off-site.

Make a disaster supply kit

- Weather alert radio and battery-operated radio and batteries
- Water
- Non-perishable food
- First aid kit
- Flashlights
- Tarps
- Cleaning supplies
- Gloves (rubber and leather)
- Plastic bags
- Camera (to document damage)
- Tool kit
- Duct tape
- Blankets

For additional information:

www.emd.wa.gov/preparedness/prep_business.shtml

WE CAN'T HIDE FROM NATURE... BUT WE ALL CAN BE PREPARED.

We're gearing up for the next printing of the *Grays Harbor County All Hazards Guide!* We invite you to become a sponsoring partner of this very popular publication. Your advertisement will be read by the entire Grays Harbor County residential and business community.

**HELP US BUILD A COMMUNITY SAFETY
NET WHILE BUILDING AWARENESS OF
YOUR ORGANIZATION!**



**To plan your community outreach sponsorship,
please contact**

Charles Wallace
Deputy Director Emergency Management
Sheriff's Office, Grays Harbor County

Email: CWallace@co.grays-harbor.wa.us

Phone 360-249-3911

Grays Harbor County Important Phone Numbers

Place this list of important phone numbers where all members of your household can quickly refer to it.

GRAYS HARBOR COUNTY EMERGENCY MANAGEMENT

Phone 360-249-3911
 Fax 360-249-3805
 Email ghcdem@co.grays-harbor.wa.us
 Web site www.co.grays-harbor.wa.us/info/DEM
 Grays Harbor Emergency Management Twitter: GHCDDEM

Environmental Health

Phone 360-249-4413
 FAX 360-249-3203
 Web site www.co.grays-harbor.wa.us/info/pub_svcs/envhealth.html
 Email ehd@co.grays-harbor.wa.us

Public Health and Social Services

800-464-7277 (toll-free in Grays Harbor County)
 Phone 360-532-8631
 Fax 360-533-6272

County Fire Marshal

Phone 360-249-5579
 Fax 360-249-3203

Planning and Building

Phone 360-249-5579
 Fax 360-249-3203

Public Works

Phone 360-249-4222
 Fax 360-249-2153

Utilities and Development

Phone 360-249-4222
 Fax 360-249-3203
 Email UDD@co.grays-harbor.wa.us

POLICE, FIRE OR MEDICAL EMERGENCY 911

911 NON-EMERGENCY 533-8765

CRISIS CLINIC 532-4357

COUNTY COMMISSIONER OFFICE 249-3731

COUNTY CORONER 532-2322

COUNTY HEALTH DEPARTMENT 532-8631

FIRE MARSHAL 249-5579

GRAYS HARBOR EMERGENCY MEDICAL SERVICE 532-2067

PUD HOTLINE 537-3721

SHERIFF BUSINESS 249-3711

STATE PATROL 800-283-7808

WASHINGTON STATE EMERGENCY MANAGEMENT DIVISION

Phone 253-512-7000
www.emd.wa.gov

MAP YOUR NEIGHBORHOOD (MYN)

www.emd.wa.gov/myn/index.shtml

RED CROSS

Mount Rainier Chapter, Tacoma
 Phone: 360-249-2341
 Fax: 360-249-2356
 24-Hour phone: 360-507-0021
 Web site www.rainier-redcross.org
 For information about Red Cross emergency shelters:
 Phone 1-866-438-4636

ONLINE ACCESS TO DISASTER INFORMATION AND RESOURCES

Web site www.DisasterAssistance.gov

ONLINE DISASTER RESOURCE INFORMATION IN WASHINGTON STATE

Web site <http://access.wa.gov>

FEDERAL EMERGENCY MANAGEMENT AGENCY (FEMA)

Federal Regional Center
 425-487-4600
 Web site www.fema.gov

COMMUNITY EMERGENCY RESPONSE TEAM (CERT)

Web site www.citizencorps.gov/cert/about.shtm

NOAA WEATHER RADIO ALL HAZARDS

Web site www.nws.noaa.gov/nwr/

NATIONAL TSUNAMI HAZARD MITIGATION PROGRAM

Web site <http://nthmp.tsunami.gov>

FLOODSMART INSURANCE

Web site www.floodsmart.com

Print your out-of-area phone contact numbers here:
