

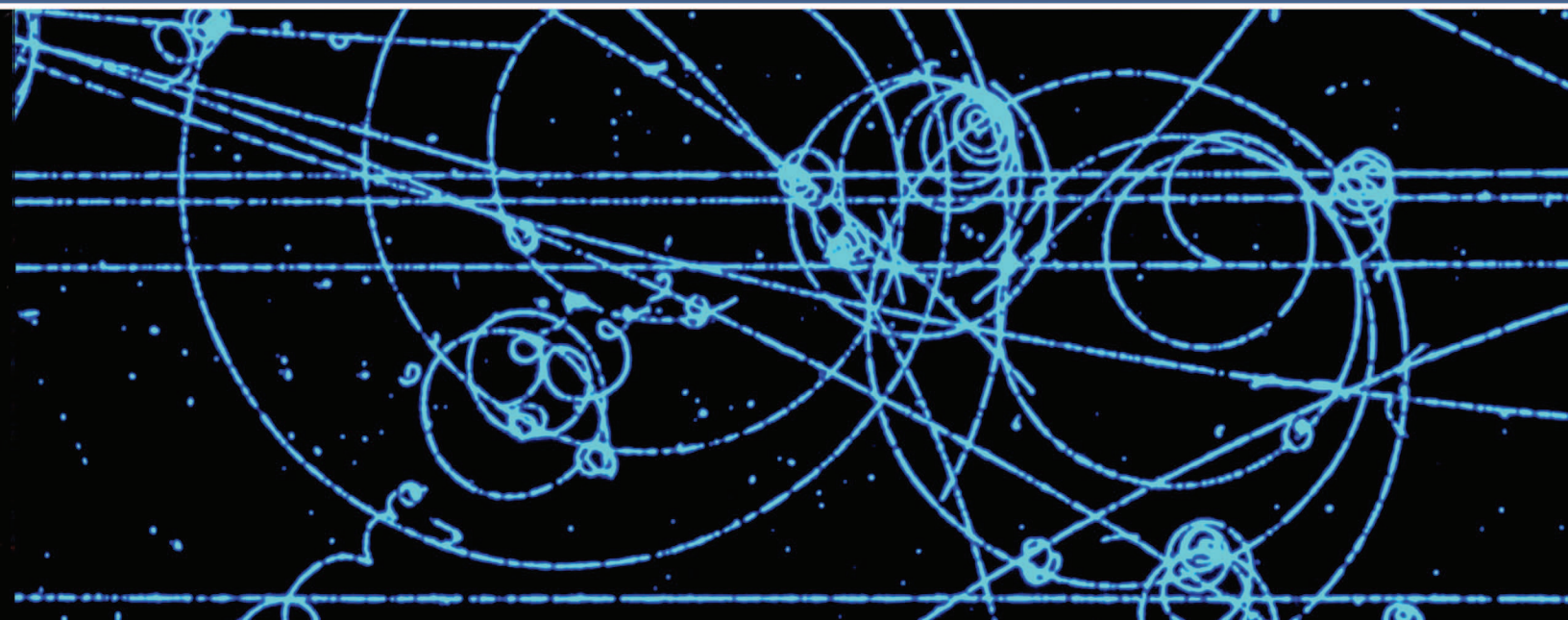

A 21ST CENTURY FRONTIER FOR DISCOVERY
THE PHYSICS OF THE UNIVERSE

**A STRATEGIC PLAN FOR FEDERAL RESEARCH
AT THE INTERSECTION OF
PHYSICS AND ASTRONOMY**



About the National Science and Technology Council

The National Science and Technology Council (NSTC) was established by Executive Order on November 23, 1993. This cabinet-level council is the principle means by which the President coordinates science, space, and technology policies across the Federal Government. NSTC acts as a virtual agency for science and technology to coordinate diverse paths of the Federal research and development enterprise.

An important objective of the NSTC is the establishment of clear national goals for Federal science and technology investments in areas ranging from information technologies and health research to improving transportation systems and strengthening fundamental research. The Council prepares research and development strategies that are coordinated across the Federal agencies to form a comprehensive investment package aimed at accomplishing multiple national goals.

Please call the NSTC Executive Secretariat at 202-456-6101 to obtain additional information regarding the NSTC, or see http://www.ostp.gov/nstc/html/NSTC_Home.html.

About the Office of Science and Technology Policy

The Office of Science and Technology Policy (OSTP) was established by the National Science and Technology Policy, Organization and Priorities Act of 1976. OSTP's responsibilities include advising the President in policy formulation and budget development on all questions in which S&T are important elements; articulating the President's S&T policies and programs; and fostering strong partnerships among Federal, state and local governments, and the scientific communities in industry and academe.

For additional copies and further information, contact the Office of Science and Technology Policy at (202) 395-7347 (voice), (202) 456-6027 (fax) or see our web site at www.ostp.gov.

About this Report

In this report the Interagency Working Group on the Physics of the Universe responds to the National Research Council's (NRC) 2002 report, *Connecting Quarks with the Cosmos: Eleven Science Questions for the New Century*. The Physics of the Universe group examines the status of the Federal government's current investments aimed at answering the eleven questions in the NRC report. Based upon that assessment, the group prioritized the new facilities needed to advance understanding in each of these areas. Consistent with a goal of the President's Management Agenda to manage Federal R&D investments as a portfolio of interconnected activities, this report lays out a plan for exciting discovery at the intersection of physics and astronomy.

A 21st Century Frontier of Discovery: The Physics of the Universe

**A Strategic Plan for Federal Research
at the Intersection of Physics and Astronomy**



A Report of the Interagency Working Group
on the Physics of the Universe

**National Science and Technology Council
Committee on Science**

February 2004

Contents

Summary	4
Summary of Recommendations	5
A Federal Research Program on the Physics of the Universe	6
R&D Investment Criteria	7
Programmatic Priorities	9
Prioritized Findings and Recommendations	12
The Opportunity: Eleven Science Questions for the New Century	18
Question 1. What is Dark Matter?	20
Question 2. What is the Nature of Dark Energy?	23
Question 3. How Did the Universe Begin?	25
Question 4. Did Einstein Have the Last Word on Gravity?	29
Question 5. What Are the Masses of the Neutrinos and How Have They Shaped the Evolution of the Universe?	31
Question 6. How Do Cosmic Accelerators Work and What Are They Accelerating?	34
Question 7. Are Protons Unstable?	39
Question 8. What Are the New States of Matter at Exceedingly High Density and Temperature?	41
Question 9. Are There Additional Space-Time Dimensions?	43
Question 10. How Were the Elements from Iron to Uranium Made?	45
Question 11. Is a New Theory of Matter and Light Needed at the Highest Energies?	48
Appendix I. Agency Research Practices and Approaches	49
Appendix II. Technical Glossary	55
Appendix III. Acronyms	62
References	64
Interagency Working Group on the Physics of the Universe	65



*We shall not cease from exploration
And the end of all our exploring
Will be to arrive where we started
And know the place for the first time. . . .*

T. S. Eliot

EXECUTIVE OFFICE OF THE PRESIDENT
OFFICE OF SCIENCE AND TECHNOLOGY POLICY
WASHINGTON, D.C. 20502

February 2004

Dear Colleague,

During the past 25 years, we have witnessed tremendous growth in our understanding of the universe - how it came to be and its ultimate fate. Highly successful models of the elementary particles of nature and the large-scale structure and evolution of the universe have been developed and tested with amazing precision. We have also made surprising recent discoveries using particle detectors deep underground, along with space-based probes such as the Hubble Space Telescope and the Wilkinson Microwave Anisotropy Probe. These results indicate that the "standard" models of particle physics and cosmology may not be complete.

As we enter the 21st Century, we have arrived at a special time in our quest to understand the universe. Just as it appeared that we were about to tie up the loose ends of our understanding of matter, space, and time, these new discoveries have revealed a challenging incompleteness in our picture of nature. Scientists have now established that 95% of the universe is made of forms of matter and energy that we do not understand. The next discoveries will have disproportionate impact on our understanding of nature.

To realize many of these discoveries, it will be necessary to bring together the science of the very large – astronomy – with the science of the very small - particle physics. No longer can one view the study of particle physics and deep space astronomy as separate and distinct. Their futures and goals are now strongly intertwined.

The accompanying report provides a Federal cross-agency strategic plan for discovery at this intersection of physics and astronomy. This plan was developed by the National Science and Technology Council, Committee on Science's Interagency Working Group (IWG) on the Physics of the Universe. The IWG was chartered to develop a Federal response to the 2002 National Research Council Report entitled "Connecting Quarks with the Cosmos: Eleven Science Questions for the New Century." The IWG activities captured in this report represent a new approach for coordinating and prioritizing research programs across the government to explore an emerging scientific frontier.

Sincerely,



John H. Marburger, III
Director, Office of Science and Technology Policy
Science Advisor to the President

Summary

The Interagency Working Group on the Physics of the Universe (IWG) presents its conclusions on the actions necessary to implement the recommendations of *Connecting Quarks with the Cosmos: Eleven Science Questions for the New Century*, a 2002 report of the National Research Council.

The opportunity to gather important new knowledge in cosmology, astronomy and fundamental physics stems from recent discoveries which suggest that the basic properties of the universe as a whole may be intimately related to the science of the very smallest known things. The properties of stars and galaxies, the existence and behavior of black holes, and the way that the universe changes with time may be connected to the physics that governs elementary particles such as quarks and other constituents of atoms.

The IWG was chartered by the National Science and Technology Council's Committee on Science to examine the investments required in this new area of scientific research, and to develop priorities for further action. The agencies of the Committee on Science agreed that coordination would enable them to provide the most beneficial results from such investments. The IWG members include representatives from the Department of Energy (DOE), the National Aeronautics and Space Administration (NASA), the National Science Foundation (NSF), the Office of Science and Technology Policy (OSTP), and the Office of Management and Budget (OMB).

As shown in the list of recommendations on the facing page, the immediate priority is heavily weighted toward the investigation of "Dark Energy," a recently discovered phenomenon that is causing the universe to expand at a greater and greater rate, contrary to the general belief of cosmologists and astronomers as recently as 1998. Dark Energy, when it is adequately explored and explained, is expected to have strong implications for fundamental physics and perhaps the nature of gravity, as well as for the nature, history and potential fate of the universe. The IWG recommends three highest priority investigations of Dark Energy by means of space and ground-based astronomy, which should be enabled by coordinated activities of the agencies.

Also ready for immediate investment are certain new approaches to the study of Dark Matter, Neutrinos, and Proton Decay, which involve physics experiments in underground and other ground-based laboratories. This work, joining the efforts of two agencies, can illuminate the mysterious "Dark Matter," which composes the vast majority of all matter in existence, but whose detailed nature is completely unknown to science. New and upgraded work on the nature of gravity, through massive, high speed computations, as well as ground-based and space observatories, is also ready for immediate investment. New studies of gravity even bear on the possible existence of higher dimensions, once thought to be purely the realm of science fiction, but now considered seriously by physicists.

Further in the future, to be spelled out in jointly formulated roadmaps by the agencies, are new departures in the study of the heavy elements and nuclear astrophysics, the birth of the universe, high density and high temperature physics, and high energy cosmic ray physics. In each area, coordinated planning at the roadmap stage is essential to maximize the return on the Nation's investment.

The IWG focused its work on the large-scale projects needed to support research activities aimed at understanding the physics of the universe. These are essential elements of a research program, have the most significant budget and policy implications, and require joint planning to ensure that the Nation develops the facilities and programs required to answer the most pressing questions without duplication or gaps. The IWG recognizes that concomitant investments in theory, simulation, data archiving, and user groups are essential to reaching the fundamental objective of understanding the physics of the universe and expects the participating agencies to respond to these requirements in an appropriate way.

Each revolution in physics, such as the respective discoveries and subsequent explanations of electromagnetism, radioactivity, and nuclear forces, has produced far-reaching social and industrial consequences that were largely unanticipated. It is possible that the new physics in *Connecting Quarks with the Cosmos*, when explored and comprehended, will likewise repay our initial investments in exploratory research.

Summary of Recommendations

Ready for Immediate Investment and Direction Known

Dark Energy

- * NASA and DOE will develop a Joint Dark Energy Mission (JDEM). This mission would best serve the scientific community if launched by the middle of the next decade. Studies of approaches to the JDEM mission undertaken now will identify the best methodology.
- * A high-priority independent approach to place constraints on the nature of Dark Energy will be made by studying the weak lensing produced by Dark Matter. This is a scientific goal of the ground-based Large-aperture Synoptic Survey Telescope (LSST). Significant technology investments to enable the LSST are required, and NSF and DOE will begin technology development of detectors, optical testing, and software algorithms leading to possible construction with first operations in 2012. NASA will contribute their expertise as appropriate.
- * Another priority method to constrain Dark Energy will be to use clusters of galaxies observed by ground-based Cosmic Microwave Background (CMB) and space-based X-ray observations. A coordinated NSF and NASA effort using this technique will provide independent verification and increase the precision of the overall measurements.

Dark Matter, Neutrinos, and Proton Decay

- * NSF will be the lead agency for concept development for an underground facility. NSF will develop a roadmap for underground science by the end of 2004.
- * NSF and DOE will work together to identify a core suite of physics experiments. This will include research and development needs for specific experiments, associated technology needs, physical specifications, and preliminary cost estimates.

Gravity

- * NSF, NASA, and DOE will strengthen numerical relativity research in order to more accurately simulate the sources of gravitational waves.
- * The timely upgrade of Laser Interferometer Gravitational wave Observatory (LIGO) and execution of the Laser Interferometer Space Antenna (LISA) mission are necessary to open this powerful new window on the universe and create the new field of gravitational wave astronomy.

Next Steps for Future Investments

Origin of Heavy Elements

- * DOE and NSF will generate a scientific roadmap for the proposed Rare Isotope Accelerator (RIA) in the context of existing and planned nuclear physics facilities worldwide.
- * DOE and NSF will develop a roadmap that lays out the major components of a national nuclear astrophysics program, including major scientific objectives and milestones, required hardware and facility investments, and an optimization of large-scale simulation efforts.

Birth of the Universe Using Cosmic Microwave Background

- * The three agencies will work together to develop by 2005 a roadmap for decisive measurements of both types of CMB polarization. The roadmap will address needed technology development and ground-based, balloon-based, and space-based CMB polarization measurements.

High Density and Temperature Physics

- * In order to develop a balanced, comprehensive program, NSF will work with DOE, NIST, and NASA to develop a science driven roadmap that lays out the major components of a national High Energy Density Physics (HEDP) program, including major scientific objectives and milestones and recommended facility modifications and upgrades.
- * NNSA will add a high energy high-intensity laser capability to at least one of its major compression facilities in order to observe and characterize the dynamic behavior of high-energy-density matter.
- * DOE and NSF will develop a scientific roadmap for the luminosity upgrade of the The Relativistic Heavy Ion Collider (RHIC) in order to maximize the scientific impact of RHIC on High Energy Density (HED) physics.

A Federal Research Program on the Physics of the Universe

“Consistent with the President’s Management Agenda, it is imperative that, where appropriate, federal R&D investments be managed as a portfolio of potentially interconnected activities to optimize scientific discovery through interagency coordination of related research areas.”

— Fiscal Year 2005 OSTP/OMB Budget Guidance Memorandum

To many, research at the forefront of the physical sciences can appear as a bewildering array of seemingly unrelated activities. Astronomers want to understand the behavior of the entire range of objects in the universe from planets to stars to galaxies. Cosmologists are striving to explain how the universe itself is structured and evolved. Particle and nuclear physicists are toiling to understand the behavior of subatomic particles that have only fleeting existences in our laboratories. The tools used in each of these fields are highly specialized and appear wildly different from one another. Ground- and space-based telescopes actively search the skies. Powerful accelerators and colliders create particles, the most short-lived of which we detect only indirectly. Subterranean detectors sit passively looking for particles streaming in from space. Despite all these differences, there is an order to the investments the Federal Government has made in these fields and their tools. In the *Connecting Quarks with the Cosmos* report, the National Research Council (NRC) defined a new frontier through a series of eleven questions and clearly explained the intellectual unity of seemingly disparate fields.

In this report, we show how our current suite of projects maps onto those eleven questions, and we plot a path to coordinate our future investments in major projects most effectively. In compiling a list of the currently funded research activities aimed at addressing the eleven science questions, we found that more often than not projects were funded by multiple agencies, evidence of a high degree of joint project execution. The important and missing element was the development of processes for joint planning across the government and the need to look more broadly at the Federal investments in science. It was clear that from both the scientific and the business perspective, Federal research programs in this area require better coordination, and we must begin to broaden our scope of interaction. We find that, on the one hand, a lack of cross-agency planning introduces inefficiency in execution of projects by not capitalizing on the expertise wherever it exists across the government. On the other hand, we find that a lack of planning can potentially introduce imbalance in investments in relevant research activities or populate

budget requests with low priority activities. The efforts of the IWG seek to avoid these fates.

Consistent with the President’s Management Agenda, the IWG explicitly developed a prioritization process to set major goals. These goals are driven by the scientific opportunities, independent of agency. The IWG fashioned a strategic plan that establishes a broadly coordinated program with clear priorities and objectives. These objectives serve as the basis for assignments of action to each of the participating agencies. As a result, all of the objectives are actionable and can be converted into specific target activities and specific assignments. This enables the concentration of effort and resources to the highest priority activities.

In the following sections we present the rationale for the development of the specific set of recommendations for a Federal research program on the understanding of the Physics of the Universe.

In the R&D Investment Criteria section, we discuss how this report was based upon the principles embodied in the R&D Investment Criteria of the President’s Management Agenda. In *The Opportunity: Eleven Science Questions for the New Century*, the IWG examines the status of the Federal Government’s current investments aimed at answering the NRC’s eleven questions.

We then made the hard choices to prioritize the new facilities needed to make further progress in answering these eleven questions. The Programmatic Priorities section makes explicit this analysis and explains our criteria. The Prioritized Findings and Recommendations section gives details and the elements of the strategic plan.

As an aid to the reader, we have included several appendices. Because each of the programs has developed according to its own traditions, we felt it important to acknowledge and explain in the Appendix on Agency Research Practices and Approaches how the different programs participating in the IWG manage and evaluate their programs. Often the difficulties of interagency cooperation are traceable to these differences. We also provide a brief technical glossary and a list of acronyms.

R&D Investment Criteria

President George W. Bush has made improving the management of government programs one of his highest priorities. Consistent with the President's Management Agenda, related R&D activities need to be managed more effectively across the government through careful interagency coordination and planning of related research programs.

Concurrent with the release of the Fiscal Year 2002 budget request, the Administration issued the President's Management Agenda that called for a number of government-wide and more targeted management reforms. One of these targeted management initiatives announced the development of R&D Investment Criteria that *"will better focus the government's research programs on performance... Applied research programs will be better focused on achieving well-defined practical outcomes. Basic research programs will better target improving the quality and relevance of their research. These investment criteria will promote our nation's leadership in important science and technology areas."*

In their FY 2005 Interagency Research and Development Priorities Memorandum (the "OSTP/OMB Priorities Memo"), OSTP and OMB issued R&D Investment Criteria aimed at improving R&D program management and effectiveness.

The Criteria

There are three primary R&D Investment Criteria—Relevance, Quality, and Performance. Each has a prospective and a retrospective component. A prospective component describes actions that programs must take prior to requesting or allocating research funds. A retrospective component describes actions programs must take to evaluate the results of their research investments. The criteria are briefly described below. This report provides, in part, the information requested by the R&D Investment Criteria and suggests other appropriate venues for obtaining other requested information as described below.

Relevance: The R&D Investment Criteria require programs to articulate why an investment is important, relevant, and appropriate. Agencies are asked to explain the methods they use to define program direction to ensure relevance and set priorities.

They should also explain the methods they use to retrospectively evaluate program design and relevance by periodically reviewing the results of research investments already made. Specifically:

- * Programs must have complete plans, with clear goals and priorities.
- * Programs must articulate their potential benefits.
- * Programs must document their relevance to specific Presidential priorities to receive special consideration.
- * Program relevance to the needs of the Nation, to fields of S&T, and to program "customers" must be assessed through prospective external review.
- * Program relevance to the needs of the Nation, to fields of S&T, and to program "customers" must be assessed periodically through retrospective external review.

The IWG documents how a subset of research investments at the DOE, NASA, and NSF capitalize upon the scientific opportunities at the intersection of physics and astronomy. Our analysis builds upon NASA's Beyond Einstein program plan and multiple NRC and Federal Advisory Committees reports and strategic plans. This report as well as NASA's Beyond Einstein program plan responds directly to the assessment of scientific opportunity provided in the NRC report, *Connecting Quarks with the Cosmos: Eleven Science Questions for the New Century*.

Projects included within the scope of the Physics of the Universe plan were required to align specifically with and be motivated primarily by at least one of the eleven questions. A larger number of important projects were examined but were not included within the scope of the Physics of the Universe program because they did not pass the alignment and motivation test. These latter investments are justified based upon other needs of the Nation, other fields of science and technology, or program "customers." The IWG undertook a prioritization of potential investments. The discussion of this prioritization is found in the Recommendations section.

Quality: The R&D Investment Criteria require programs to justify how funds will be allocated to ensure the highest quality R&D. Agencies are asked to explain the methods they use to prospectively review and award funds. They should also explain the methods they use to retrospectively review the quality of research investments already made. Specifically:

- * Programs allocating funds through means other than a competitive, merit-based process must justify funding methods and document how quality is maintained.
- * Program quality must be assessed periodically through retrospective expert review.

This report does not address the details whereby agencies select and award research funds. The retrospective quality and relevance of the collected investments that fall within the Physics of the Universe program should be periodically evaluated. The IWG expects that an appropriately constituted interagency advisory committee will be charged with the periodic review of the quality and relevance of investments made within the scope of the Physics of the Universe program. This interagency advisory committee would presumably require input or inclusion of representatives from the Federal advisory committees that advise the individual programs.

It is important to note that review by such a body does not preclude review by any agency advisory body or external review bodies. In fact, performance assessments by these other advisory bodies—High Energy Physics Advisory Panel (HEPAP), the Nuclear Sciences Advisory Committee (NSAC), and the Structure and Evolution of the Universe Subcommittee (SEUS) among others—remain essential for the evaluation of individual program portfolios, each of which contains elements not included within the scope of the Physics of the Universe program.

Performance: The R&D Investment Criteria require programs to monitor and document how well an investment is performing. Agencies are asked to explain the methods they use to manage program inputs and prospectively set output performance measures. They should also be able to retrospectively demonstrate performance. Specifically:

- * Programs may be required to track and report relevant program inputs annually.

- * Programs must define appropriate output and outcome measures, schedules, and decision points.
- * Program performance must be retrospectively documented annually.

Performance can be documented for various phases of the projects within the scope of this report. During the R&D phase of major projects, program managers should identify the technical issues that require resolution prior to a decision to build. Progress towards resolving these technical issues can be reported. During the construction phase of these projects, earned value methods can be used to track and report cost, scope and schedule performance. Well-developed methods exist within the agencies to review the performance of ongoing construction projects. The results of these reviews need to be better communicated to oversight bodies such as OMB and OSTP.

During the operations phase of these projects, performance metrics necessarily have two components: (1) low-level, easily reportable, almost “mechanical” tracking of countable things such as scheduled operating time (e.g., fraction of time beam delivered or time shutter actually open), and (2) periodic retrospective expert review of a mission’s or facility’s scientific impact. An exclusive focus on the easily reported metrics can miss the fundamental issue of whether a facility is achieving the scientific purposes for which it was built. An exclusive focus on the retrospective expert review can leave questions about the efficient and effective use of public resources unanswered.

Nearly all of the facilities included in this report are used for experiments that run for more than one year. The duration of the experiments is usually governed by the statistics required to establish a discovery or differentiate among competing theoretical models. After an initial period of learning how to operate a new unique facility, “low-level” metrics should be developed and reported that demonstrate the experiment is making progress towards accumulating the required number of events or observations necessary to achieve statistical significance, should nature behave as predicted. Discovery-oriented programs should be judged on whether they advanced our understanding of the world, not whether nature conforms exactly to our beliefs.

Programmatic Priorities

Based upon an assessment of the current suite of existing facilities and the opportunities with the greatest potential for scientific advancement, the IWG has developed prioritized findings and recommendations for programmatic investment to advance the opportunities identified in *Connecting Quarks with the Cosmos*. These priorities represent the next steps for the Nation and will need to be revisited on a regular basis as changes such as available funds, scientific advances, and our technological readiness to make significant progress change with time.

Setting Priorities:

Step 1: Prioritize the Questions

There are varying levels of activity and investment currently being expended to answer each of the eleven questions. Moving forward, future investments should be aimed at strategically positioning the U.S. scientific community to address those issues. To maximize the probability that the United States will be strategically positioned, the highest priority new investments need to be identified. This is never an easy task but one that is vital when resources are limited.

The IWG based its prioritization of the eleven questions upon an assessment of each question's fit to the following criteria:

- Current potential for scientific advancement
- The timeliness or urgency of each question
- The technical readiness of projects necessary to advance the science of each question
- Existence of gaps in the overall suite of projects addressing the question.

Those questions classified as the lowest current priority for new investment are typically those where the IWG believes the United States is adequately invested at the present time. Exploitation of existing facilities and those under construction is of utmost importance in the Physics of the Universe program; however, they are not the focus of this prioritization exercise. For example, there are a number of particle accelerators and colliders operating today where a search for extra dimensions can proceed in tandem with other experiments. No

specialized facility is as yet required to advance the search for extra dimensions. The prioritized questions are shown in the left column of Table I.

Step 2: Identifying Potential Activities

The foundation for the development of a coherent set of recommendations from the IWG was a broad set of reports from the National Research Council, reports from the DOE-NSF advisory committees HEPAP and NSAC, and strategic plans from NASA Space Science and DOE Office of Science. This suite of reports served as the reference source for the IWG to identify projects and activities already recommended by the scientific community that can contribute directly to answering the eleven questions. In this way, the recommendations of the IWG remain consistent with the advice and recommendations from the scientific community and align with the mission and goals of the individual agencies. A list of the source reports used by the IWG is given in Table II.

Step 3: Grouping of Related Elements

The next step was to sort the eleven questions based upon common programmatic needs or themes. For example, some experiments investigating Dark Matter, neutrinos, and proton decay will have a common need for deep underground laboratory space. Using the prioritized ranking of the scientific questions, the IWG then applied the additional criterion:

- Programmatic readiness to proceed.

The IWG examined whether the plans and proposed facilities were reasonably well developed and determined whether a path forward could be identified. Programmatic readiness was assessed upon the basis of whether a project had been identified, whether the science case for such a project has been made, and whether R&D on a project is underway.

Where it could not be determined that a path forward was known, the IWG recommends that additional road-mapping of future investments is required. Applying this additional criterion naturally stratified the recommendations into two categories: those program areas where the direction or path forward is known programmatically, and those where further study is required or where current facilities or facilities under

Table I. IWG Prioritization

Quarks with the Cosmos Question	Programmatic Investment Priority
Ready for Immediate Investment Dark Energy Dark Matter Gravity Neutrinos	Direction Known Dark Energy Dark Matter, Neutrinos, & Proton Decay Gravity
Further Planning and/or R&D Needed High Density & Temperature Physics Origin of Heavy Elements Proton Decay The Big Bang	Roadmap Future Investments or Exploit Existing Facilities Origin of Heavy Elements Birth of the Universe using Cosmic Microwave Background High Density & Temperature Physics High Energy Cosmic Ray Physics
Ideas Needed or Investment Adequate Cosmic Accelerators Extra Dimensions New Theories of Light and Matter	

required or where current facilities or facilities under construction adequately address opportunities. The programmatic investment priority is given in the right hand column of Table I.

It should be noted that the dynamical nature of the science at this interface, especially at this time of great discovery, requires that the efforts of this suite of activities be reexamined on a periodic basis. The recommendations given here should be viewed as the direction that each program within this portfolio

needs to move now, with the understanding that major discoveries have the potential to change our analysis. It is also expected that the IWG will continue to develop priorities and work to develop joint planning processes that seek to manage the activities within this area as a single government-wide program. In other words, our portfolio of activities will need to evolve to remain relevant to the changing frontier of science.

The absence of explicit discussion of the other essential aspects of successful programs—such as university

Table II. Source Reports for the Interagency Working Group on the Physics of the Universe

<p>NRC Reports</p> <p><i>Connecting Quarks with the Cosmos: Eleven Science Questions for the New Century</i> <i>Neutrinos: New Windows on the World</i> <i>High Energy Density Physics: The X-games of Contemporary Science</i> <i>Astronomy and Astrophysics in the New Millennium</i></p>
<p>Federal Advisory Committee Reports</p> <p><i>The Science Ahead, The Way to Discovery: The High Energy Physics Advisory Panel Long Range Plan</i> <i>Opportunities in Nuclear Science: A Long-Range Plan for the Next Decade</i></p>
<p>Agency Strategic Plans</p> <p><i>NASA: Beyond Einstein: From the Big Bang to Black Holes</i> <i>NASA: Space Science Enterprise Strategy</i> <i>DOE: Facilities for the Future of Science: A Twenty Year Outlook</i></p>



With Mt. Erebus as a backdrop, personnel inflate the 1 million m³ (28 million cubic foot) balloon which will carry the BOOMERANG telescope on its 10 day trip around the Antarctic continent. In order to make its exquisitely sensitive measurements, BOOMERANG was lifted above 99% of the atmosphere to an altitude of 35km (120,000 ft). Primary support for the BOOMERANG project came from NSF and NASA in the United States; the Italian Space Agency, Italian Antarctic Research Programme and the University of Rome La Sapienza in Italy; and the Particle Physics and Astronomy Research Council in the United Kingdom. The Department of Energy's National Energy Research Scientific Computing Center provided supercomputing support in the United States. (Photo credit – Phil Mauskopf, University of Wales)

research groups, education and outreach programs, theory, or scientific simulation capabilities—is purposeful. We have decided to do so because decisions whether to fund the particular projects discussed herein have the most significant budget and policy implications. Maximizing the scientific return in any program requires that such essential elements must be considered within the context of the program execution plans. In particular, the development of large instruments and facilities requires concomitant investment in user groups, theory, simulation, and data archival activities. These other program elements are necessary for the success of every major facility. Without attention to and support for such elements, the value of each facility is compromised. The investment in these areas should be taken as implicit within this plan and we have therefore assumed that

such elements are built into each major program as necessary supporting elements. No project plan can be considered complete without plans to address all essential aspects, including, but not limited to, support for university groups, education, outreach, theory, and scientific computation.

Prioritized Findings and Recommendations

The recommendations are grouped thematically and presented in priority order for future investment. Within each theme, only those projects and activities that most directly address the theme are included. In developing the recommendations for investment the IWG sought to clearly identify the steward and major participating agencies responsible for developing coordinated investments and program plans.

Theme 1: Dark Energy

There are at least three methods to study Dark Energy. The most direct and precise approach is to continue to use type Ia supernovae as standard candles to map the expansion of the universe. A dedicated wide-field-of-view space-based telescope can provide a much larger number of precisely measured supernovae over the necessary large distance range.

The DOE is funding R&D for a space-based Dark Energy mission.

NASA, as part of its proposed Beyond Einstein program, has identified a focused mission to study Dark Energy. NASA has begun mission concept studies, with the goal of determining the optimum space-based approach to reveal the nature of Dark Energy.

The phenomenon of weak gravitational lensing can be used to construct mass maps over a large range of distances and, hence, look-back times, to directly measure the evolution of mass clustering over about half the age of the universe. Understanding the evolution of the aggregation of matter (both dark and baryonic) via application of this “3-D mass tomography” can place strong constraints on the nature of the Dark Energy. The telescope must have both a large field of view and very high sensitivity to faint objects—two of the design goals for the Large-aperture Synoptic Survey Telescope (LSST).

The number of clusters of galaxies as a function of cosmic time is another sensitive Dark Energy probe. The Sunyaev-Zeldovich (SZ) effect—that is, the scattering of Cosmic Microwave Background (CMB) photons by electrons that are responsible for X-ray emission from a galaxy cluster can be used to both find clusters in CMB surveys and, combined with X-ray

measurements by, for example, Constellation-X, used to accurately determine the cluster distance. X-ray surveys of the sky are another powerful means to find clusters over a large distance range.

Findings

- * The evidence for Dark Energy is now overwhelming. To make further progress on understanding the underlying physics of this phenomenon requires new capabilities and a concerted multi-agency approach.
- * Multiple, complementary, and independent approaches are necessary for a complete understanding of Dark Energy. A dedicated space-based experiment to precisely measure the nature of the Dark Energy and its evolution over the history of the universe is a critical centerpiece to this program.

Recommendations

- * NASA and DOE will develop a Joint Dark Energy Mission (JDEM). This mission would best serve the scientific community if launched by the middle of the next decade. Studies of approaches to the JDEM mission undertaken now will identify the best methodology.
- * A high-priority independent approach to place constraints on the nature of Dark Energy will be made by studying the weak lensing produced by Dark Matter. This is a scientific goal of the LSST. Significant technology investments to enable the LSST are required, and NSF and DOE will begin technology development of detectors, optical testing and software algorithms leading to possible construction with first operations in 2012. NASA will contribute their expertise as appropriate.
- * Another priority method to constrain Dark Energy will be to use clusters of galaxies observed by ground-based CMB and space-based X-ray observations. A coordinated NSF and NASA effort using this technique will provide independent verification and increase the precision of the overall measurements.

Theme 2: Dark Matter, Neutrinos, and Proton Decay

Questions about the nature of Dark Matter, the mass of the neutrino, and the stability of the proton have at their heart the question of the completeness of the Standard Model of Particle Physics with concomitant implications as to the large-scale structure and evolution of the universe. The direct detection of Dark Matter, searching for the predicted decay of the proton, and determining the absolute mass of the neutrino all require an environment that is free of the background of cosmic rays, which would overwhelm the signals of interest.

The most suitable environment for many of the experiments is deep underground, where the surface layers of the earth itself provide the necessary overburden for shielding. In addition, significant savings could be gained since many experimental detectors could be used for multiple scientific purposes. There are several underground facilities available today such as the Soudan Mine in Minnesota, Sudbury Neutrino Observatory (SNO) near Ontario, Canada, the Gran Sasso in Italy, the Kamioka mine in Japan and the Waste Isolation Pilot Plant (WIPP) facility in New Mexico. Several other potential sites are currently being explored, as well.

The next generation of proton decay experiments does not require extreme depths, but does require very large volumes of water, and hence, laboratory space. The next generation proton decay detectors would need a mass approaching the equivalent of a megaton of water. Such detectors have a “dual use” and could also serve as neutrino detectors for long-baseline neutrino oscillation studies and simultaneously allow the study of neutrino bursts from supernovae.

The most sensitive experiments require very large overburden of rock, while the proton decay experiments require laboratory space with large volume. Taken as a whole, there exists a synergistic case for the development of a laboratory facility with a significant overburden of rock to shield the experiments from the continual flux of cosmic rays coming from space. Consideration of the requirements of future generations of experiments further strengthens the justification for creation of such a deep underground infrastructure. There are several other areas that have similar infrastructure needs, including biology, geology,

and engineering. These are beyond the scope of this report but should be considered within the context of any suite of underground experiments.

In addition to neutrino experiments using atmospheric neutrinos detected by deep underground detectors, it is important to use known sources of neutrinos for detailed studies of their properties. Neutrinos from particle accelerators can be aimed at nearby above-ground detectors or be used for distant long-baseline underground experiments. Neutrinos from other known sources such as nuclear reactors or the Sun can be studied in detail using underground or ground level detectors.

Due to the unknown nature of Dark Matter, a multi-pronged approach for the next generation of experiments is needed. In addition to direct searches of Dark Matter candidates using deep underground detectors, it is important to use ground-level specialized detectors and ground- and space-based telescopes to search directly for other types of Dark Matter candidates or for gamma rays or neutrinos resulting from Dark Matter annihilation. A possible scenario is that an underground experiment would be the first to detect a Dark Matter candidate. It would then be necessary to use a next-generation particle accelerator to verify its existence and determine its properties, including the determination of whether it could indeed account for the approximately 23% of the energy-matter content of the universe.

Findings

- * The science case for the pursuit of these goals is compelling. The detailed planning of a national deep underground laboratory and the attendant scientific experiments is still at an early stage.

Recommendations

- * NSF will be the lead agency for concept development for an underground facility. NSF will develop a roadmap for underground science by the end of 2004.
- * NSF and DOE will work together to identify a core suite of physics experiments. This will include research and development needs for specific experiments, associated technology needs, physical specifications, and preliminary cost estimates.

Theme 3: Gravity

Two key predictions of General Relativity gravitational radiation from moving, interacting masses and the existence of Black Holes.

The effort to detect gravitational waves is a primary objective of major projects at both NSF and NASA: the ground-based Laser Interferometer Gravitational-wave Observatory (LIGO) and the space-based Laser Interferometer Space Antenna (LISA). LIGO and LISA are complementary in that they view differing frequency bands of the gravitational wave spectra produced by a variety of cosmic sources. The growing NASA LISA effort builds upon the gravitational wave community built up by the NSF LIGO efforts over the past two decades.

The proof that Black Holes exist has come from a combination of space- and ground-based observations. NASA's Chandra X-ray Observatory has demonstrated that Black Holes are commonplace in the universe.

Constellation-X (Con-X) will provide a two-order-of-magnitude increase in capability for X-ray spectroscopy of cosmic sources and, in doing so, enable observation of the effects of gravity in the strong-field limit near the horizons of supermassive Black Holes.

Findings

- * LIGO, LISA, and Constellation-X together provide a powerful and complementary suite of tools aimed at the discovery of gravitational waves and exploration of the physics of strong gravitational fields around Black Holes. This has significantly strengthened the gravitational physics community.
- * The upgrade of LIGO to achieve a thousand times more coverage of the cosmos is expected to detect significant numbers of merging stellar mass neutron stars and Black Holes, and the core collapse of stars.
- * Source signal simulations using numerical relativity is essential to predict, identify, and interpret the gravitational wave signals from the large variety of sources to be detected by LIGO and LISA.

Recommendations

- * NSF, NASA, and DOE will strengthen numerical relativity research in order to more accurately simulate the sources of gravitational waves.
- * The timely upgrade of LIGO and execution of the LISA mission are necessary to open this powerful new window on the universe and create the new field of gravitational wave astronomy.

Theme 4: Origin of Heavy Elements

The approach to understanding the origin and role of the heavy elements in the cosmos involves advances on several fronts including astronomical observations of nucleosynthesis signatures in all spectral regions, studies of the abundances of elements in stars and supernovae, large-scale computer simulations for better theoretical interpretation of nuclear processes, and the measurement of the properties of exotic nuclei.

Looking forward, the proposed Rare Isotope Accelerator (RIA) will be able to specify, control, and vary precisely the number of protons and neutrons in nuclei in order to study not only the properties of individual nuclei, but also the evolution of these properties across the nuclear chart. The goal of is to achieve a comprehensive, unified theory of nuclear structure across the entire landscape of ordinary and exotic nuclei, leading to a detailed understanding of the processes that led to production of heavy elements. The temperatures and particle densities in stellar objects and in cataclysmic stellar explosions provide an ideal environment to generate the heavy elements, whose decay results in the gamma ray emission lines that have been observed with astrophysics observatories such as the Compton Gamma Ray Observatory and INTERNATIONAL Gamma Ray Astrophysics Laboratory (INTEGRAL).

Large-scale computing simulations are, and will continue to be, a vital component in this astrophysics arena. Programs such as SCiDAC (Scientific Discovery through Advanced Computing) that are supported by multi-disciplinary sciences in DOE have been successful in making significant advances in understanding supernovae explosions through coordinated laboratory and university efforts. Increasing interagency emphasis on high-end computing and cyber-infrastructure is poised to further strengthen this effort.

Findings

- * Existing accelerator facilities with rare isotope beams will over the next few years provide important information that will advance our knowledge of the nucleosynthesis of the lighter chemical elements, but a next generation facility will be needed to access the nuclear reactions involving the heavier elements.
- * Large-scale astrophysics simulation efforts have recently been organized and initiated with the long-term goals of reproducing the dynamics of astrophysics events such as supernovae explosions.

Recommendations

- * DOE and NSF will generate a scientific roadmap for the proposed Rare Isotope Accelerator (RIA) in the context of existing and planned nuclear physics facilities worldwide.
- * DOE and NSF will develop a roadmap that lays out the major components of a national nuclear astrophysics program, including major scientific objectives and milestones, required hardware and facility investments, and an optimization of large-scale simulation efforts.

Theme 5: Birth of the Universe Using Cosmic Microwave Background

Measurement of the portion of the polarization of the Cosmic Microwave Background (CMB) that was caused by primordial gravitational waves offers great promise for understanding the inflationary period of the universe. The polarization signal due to primordial gravitational waves is expected to be at least 100 times fainter than the already-detected polarization signal caused by early universe density fluctuations.

NASA, as part of its proposed Einstein Probes missions, has identified a focused mission to study inflation. NASA has undertaken mission concept studies to identify promising methodologies for a space-based Inflation Probe and to identify the necessary technologies for development.

Measuring this faint polarization signal represents a significant technical challenge, and a substantial detector technology development effort is required before a space-based mission can be implemented.

Ground-based and balloon-borne observations are necessary to provide experience with different detection schemes (particularly on how to guard against false polarization signals) and will provide more information about galactic foregrounds. A coordinated program of laboratory research, ground-based and balloon-borne observations, and finally a space-based mission dedicated to CMB polarization will be required to get the very best sensitivity to this important signature (and probe) of inflation.

DOE, NSF, and NASA support detector technology development for submillimeter and microwave detectors through their ongoing R&D programs. In the near term, ground-based studies from appropriate sites and balloon-borne studies from Antarctica will be required to prove the detector technology and to study the galactic foreground, as well as to exploit CMB radiation polarization as a probe of the universe.

Findings

- * Successive studies of the CMB with improved experimental sensitivity have revealed an increasingly clearer picture of the universe when it was 380,000 years old. The temperature fluctuations in the CMB data have been used to precisely determine the cosmological parameters that define our universe.
- * A future space-based measurement of the curl of the polarization field of the CMB holds the promise of detecting the signal of inflation and providing tests of the various inflation models that have been proposed.
- * Ground-based and balloon-borne experiments provide initial data to advance and constrain cosmological models, and play a key role in developing detectors and techniques for space-based CMB polarization measurements. The current Antarctic facilities are inadequate for future long-duration balloon missions.

Recommendations

- * The three agencies will work together to develop by 2005 a roadmap for decisive measurements of both types of CMB polarization. The roadmap will address needed technology development and ground-based, balloon-based, and space-based CMB polarization measurements.

Theme 6: High Density and Temperature Physics in the Laboratory

High Energy Density Physics (HEDP) in the laboratory can be used to explore fundamental physical processes that occur under extreme high energy density, and this provides a direct probe of the conditions found in exotic locations in the universe. These cosmic locations range from supernovae and stellar atmospheres of nearby stars to the first moments of the birth of the universe. Laboratory measurements are also essential to interpreting many space- and ground-based astronomical observations. The study of matter under extreme conditions represents the opportunity to explore new physical regimes in many fields, including plasma physics, nuclear physics, materials science and condensed matter physics, atomic and molecular physics, fluid dynamics and magneto-hydrodynamics.

Such experimental regimes are now becoming increasingly accessible with the development of major new and upgraded facilities, such as the National Nuclear Security Administration's Omega, Z, and National Ignition Facility (NIF), and continuing advances in the development of laser and pulsed power systems suitable for university laboratory settings. Continuing rapid advances in laser technology and the resulting availability of compact, high-intensity laser sources are major factors in making this exciting and rapidly changing field accessible to university researchers.

Another opportunity to study matter at high energy and density exists at the Relativistic Heavy Ion Collider (RHIC) which was designed to create and study the quark-gluon plasma (QGP), a state of matter that existed during the first moments of the birth of the universe. RHIC probes the evolution of the QGP in the High-Energy-Density environment formed when two massive nuclei collide. An increase in beam luminosity would enable even more detailed studies of the QGP, thus completing a comprehensive characterization of this new state of matter and gaining new insight into the early phases of the universe.

Interpretation of the complex and exotic collective phenomena occurring in matter at extreme conditions requires high-end computation to provide numerical simulations needed to interpret the experiments.

Findings

- * HEDP is an emerging field that provides crucial measurements that are relevant to interpreting astrophysical observations of the universe. The field has great promise that should be better coordinated across the various Federal agencies to capitalize on the emerging opportunities.

Recommendations

- * In order to develop a balanced, comprehensive program, NSF will work with DOE, NIST, and NASA to develop a science driven roadmap that lays out the major components of a national HEDP program, including major scientific objectives and milestones and recommended facility modifications and upgrades.
- * NNSA will add a high energy high-intensity laser capability to at least one of its major compression facilities in order to observe and characterize the dynamic behavior of high-energy-density matter.
- * DOE and NSF will develop a scientific roadmap for the luminosity upgrade of RHIC in order to maximize the scientific impact of RHIC on HED physics.

Theme 7: High Energy Cosmic Ray Physics

In order to fully understand the production and acceleration mechanisms, a complementary and coordinated suite of experiments on the ground and in space is necessary. The current approach includes ground-based and space-based detectors under consideration by all three agencies. It is important that the current program be completed as planned. The current suite of detectors under construction includes the Gamma Ray Large Area Space Telescope (GLAST) and the Very Energetic Radiation Imaging Telescope Array System (VERITAS) which will operate in complementary energy ranges.

The ground-based Pierre Auger cosmic ray detector array is under construction in the Mendoza Province of Argentina. DOE and NSF collaborate on this experiment, along with several foreign partners. Due to the economic situation in Argentina, funding for the Pierre Auger array may be compromised. A similar

array in the northern hemisphere has been discussed. The consideration of the science case for this array will take place after the initial data from the Auger array is analyzed.

ICE CUBE is a cubic kilometer array to study high energy neutrinos that is currently under construction at the South Pole. It is being developed with support from NSF and international partners. Ice Cube will offer a new approach to studying very high energy cosmic rays and associated acceleration processes.

Findings

- * DOE, NSF, and NASA are developing a coordinated broad program of ground-, balloon-, and space-based facilities to study the highest energy messengers from the universe and the particle acceleration processes that produce them.

Recommendations

- * DOE and NSF will work together to ensure that the Pierre Auger southern array is completed and will jointly review the results from the Auger array after the first full year of operations in order to consider plans for a possible northern array.

The Opportunity: Eleven Science Questions for the New Century

“The answers to these questions strain the limits of human ingenuity, but the questions themselves are crystalline in their clarity and simplicity . . .”

How did the universe come to appear as it does today? What is it made of? What is its fate? These easy-to-ask questions are not so simple to answer. Recent discoveries have led scientists to conclude that 95% of our universe is composed of matter and energy that has no earthly resemblance. The stuff we are made of makes up merely five percent of the universe! Dark Matter, matter or particles that we cannot see, makes up 25% of our universe. Astronomers, looking at the details of the motion of galaxies, have demonstrated its existence conclusively. Dark Energy, a mysterious energy field that is pushing the universe apart at an accelerating rate, comprises 70% of our universe. The existence of Dark Matter and Dark Energy are astronomical discoveries. The elucidation of their properties is the domain of particle physics. In order to unravel the mystery, the two will need to work together.

The questions "What is Dark Matter?" and "What is Dark Energy?" are only two of the driving questions at this intersection.

But, as if this were not enough, not only have we discovered that the universe is comprised largely of particles and fields we don't understand, but we also have an unsatisfying inability to explain how nature produced much of what we do see on an everyday basis. To date, there is not a good explanation for how the heavy elements—things such as copper, tin, silver, or gold—came to be. They exist on earth, and we infer their existence in the light emitted from stars, but we are unable to understand how they were formed.

At the other extreme, in the study of the nature of elementary particles, physicists have speculated that there must exist additional space-time dimensions that

The Eleven Questions Identified by the *Connecting Quarks with the Cosmos* Report

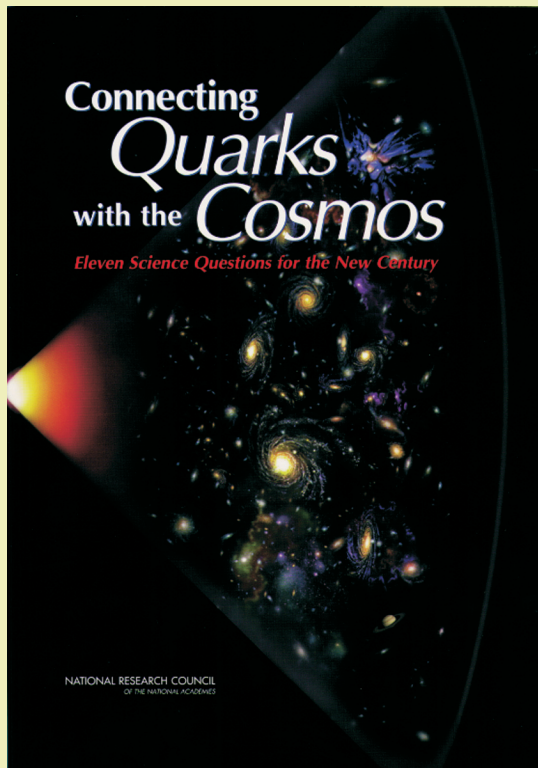

1. What is Dark Matter?
2. What is the Nature of Dark Energy?
3. How Did the Universe Begin?
4. Did Einstein Have the Last Word on Gravity?
5. What are the Masses of the Neutrinos and How Have They Shaped the Evolution of the Universe?
6. How do Cosmic Accelerators Work and What are They Accelerating?
7. Are Protons Unstable?
8. What Are the New States of Matter at Exceedingly High Density and Temperature?
9. Are There Additional Space-Time Dimensions?
10. How Were the Elements from Iron to Uranium Made?
11. Is a New Theory of Light and Matter Needed at the Highest Energies?

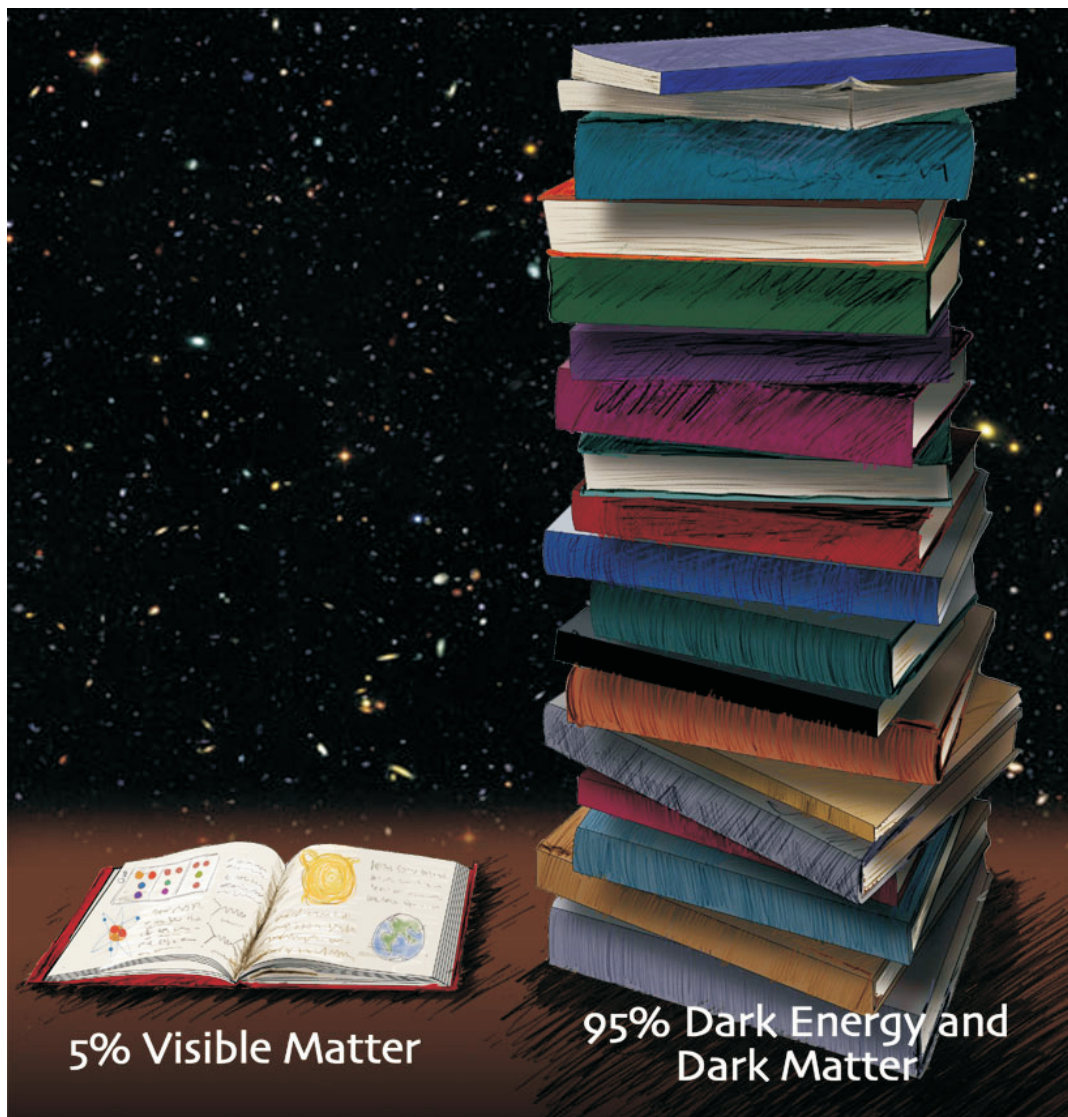

The composition of the universe is now believed to be made of 5% visible matter and 95% dark energy and dark matter (figure courtesy of Stanford Linear Accelerator Center)

are, as yet, undetected. If extra dimensions exist, the effects would most probably be felt on the largest scales of the universe, and would have played an integral part in the formation of the universe at its earliest stages. Effects would also be evident in experiments that study the nature of elementary particles. Astronomers and physicists will need to work together to search for their existence and understand their effects.

The most ubiquitous force of nature, gravity, remains an enigma. The theory of gravitation, embodied in Einstein's theory of General Relativity, is the least tested of the modern theories of physics. The only tests of the theory to date come from measuring only very tiny differences from the predictions of Newton's laws. Yet this theory is the basis for our model of the large-scale structure and evolution of the universe, and there are much more profound predictions that are now

within our reach experimentally. The detailed studies of the nature of black hole and the measurements of gravitational radiation will provide the first true tests of General Relativity.

In the 2002 National Research Council report entitled *Connecting Quarks with the Cosmos: Eleven Science Questions for the New Century*, a new frontier for discovery at the intersection of physics and astronomy was clearly presented. The eleven science questions are simple and clear, yet "among them are the most profound questions that human beings have ever posed about the cosmos." The answers to these questions have profound implications about our understanding of our world, the universe, and how it came to be and its ultimate fate.

Question 1. What is Dark Matter?

“Astronomers have shown that the objects in the universe from galaxies a million times smaller than ours to the largest clusters of galaxies are held together by a form of matter that is not what we are made of and that gives off no light. This matter probably consists of one or more as-yet-undiscovered elementary particles, and aggregations of it produce the gravitational pull leading to the formation of galaxies and large-scale structures in the universe. At the same time these particles may be streaming through our Earth-bound laboratories.”

Scientific Significance: One of the most important scientific questions at the beginning of the 21st Century is “What is Dark Matter?” Dark Matter—matter that neither emits nor absorbs light and that interacts very weakly with ordinary matter—holds the universe together. Its nature is a complete mystery. Despite the wondrous advances of science over the last century, we have yet to identify the majority component of the matter in the universe. The working hypothesis is that it is composed of elementary particles left over from the Big Bang that created the universe. The leading candidates for the Dark Matter are new particles whose

existence is predicted by theories that go beyond the Standard Model of Particle Physics. Showing that one or more of these particles comprise the Dark Matter not only would answer a key question in cosmology, but also would shed new light on the fundamental forces and particles of nature. Note that this section will focus approaches to detect so-called “cold Dark Matter,” which means that particles of this type are not moving at great speeds. Other approaches to both cold and hot Dark Matter are described in later sections on neutrinos and the Cosmic Microwave Background (CMB) radiation.

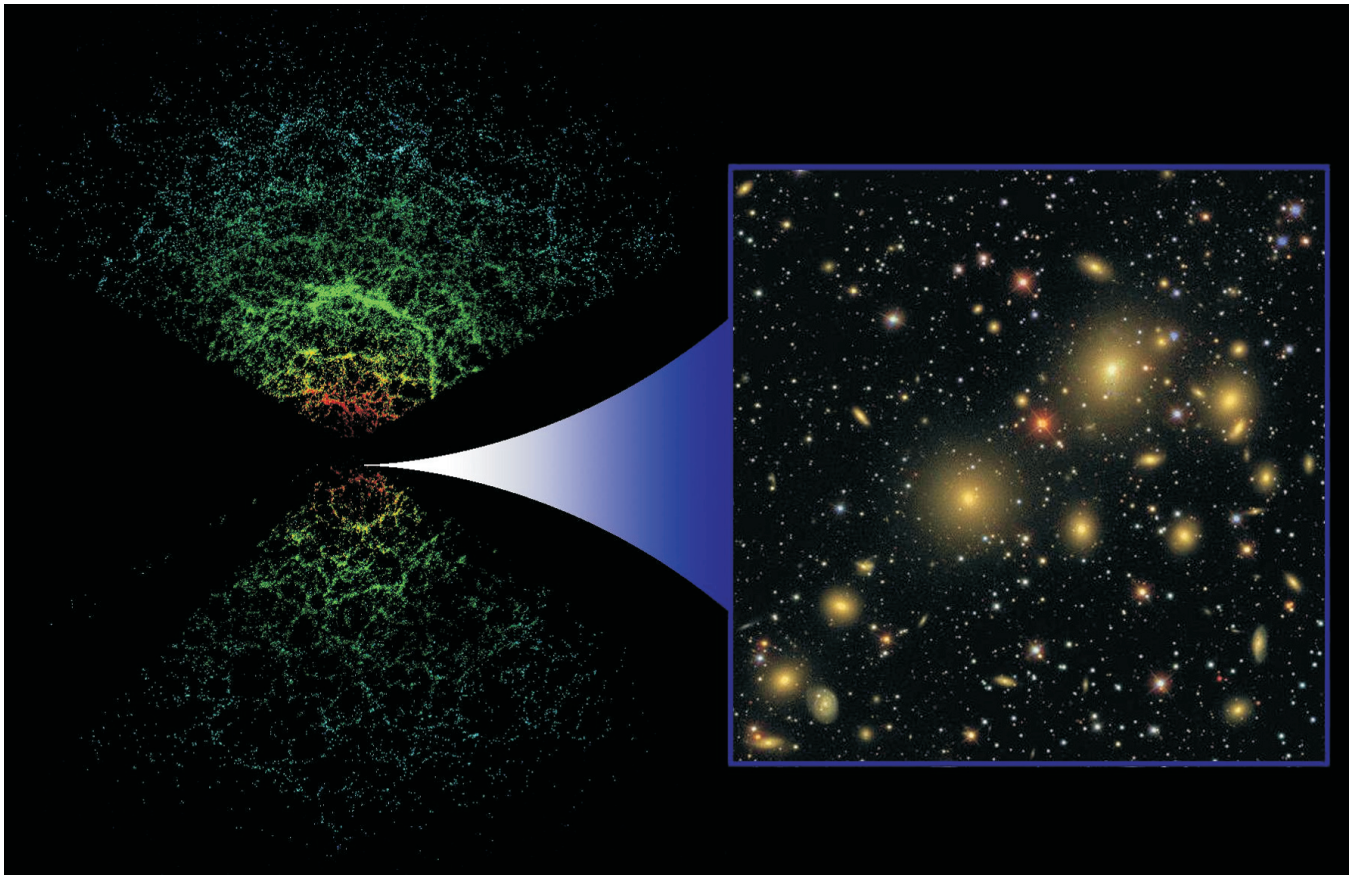

The Sloan Digital Sky Survey (SDSS) is two separate surveys in one: galaxies are identified in 2D images (right), then have their distance determined from their spectrum to create a two-billion lightyears deep 3D map (left) where each galaxy is shown as a single point, the color representing the luminosity—this shows only these 66,976 out of 205,443 galaxies in the map that lie near the plane of Earth’s equator.

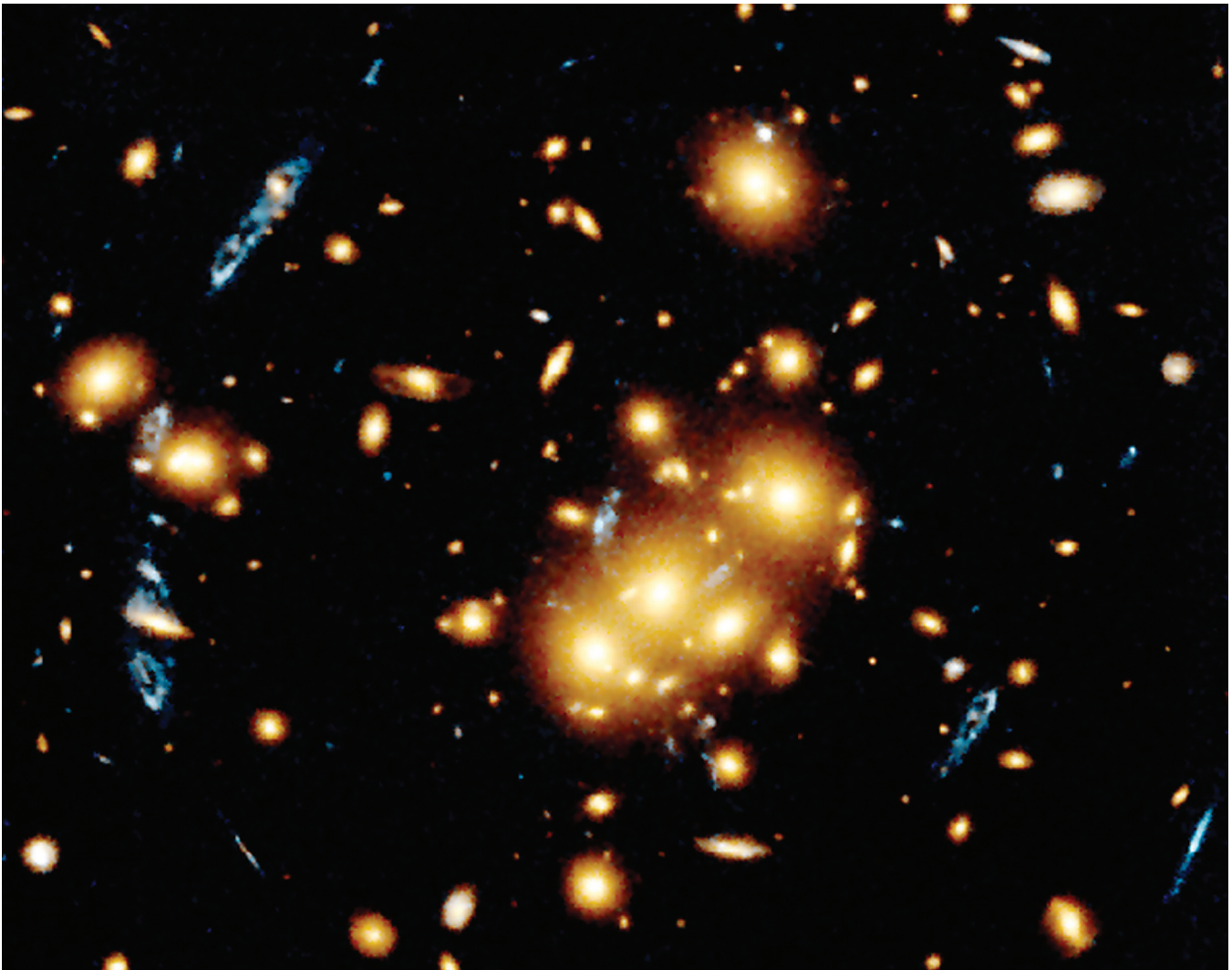

The ring of distorted images of a galaxy is the result of “gravitational lensing” by a cluster of galaxies between it and us. Studying the distortions gives valuable information about the distribution of dark, unseen matter in the cluster. The ring, a prediction of General Relativity, is called an “Einstein Ring.” Credit: NASA/Hubble Space Telescope (HST)

Measurement Methods: There are four strategies for studying (cold) Dark Matter.

1) Astronomical observations can detect its presence through the dynamical studies of the motions of stars, galaxies, and X-ray emitting hot gas in clusters of galaxies. These have provided the first convincing evidence for the existence of Dark Matter and can be used to trace its location and properties. For example, a large mass of Dark Matter can distort the image of more distant astronomical objects by gravitational lensing, a consequence of the distortion of space-time predicted by Einstein’s general theory of relativity. Gravitational lensing can be studied by means of astronomical surveys over large parts of the sky.

2) The direct detection of Dark Matter particles is possible through highly specialized detectors designed to detect directly the extremely weak signal of a rare

Dark Matter interaction with a massive detector, coupled with strong suppression of background signals that could overwhelm the signal of interest. This normally requires placing a Dark Matter detector deep underground in order to shield it from cosmic rays that would confound the search for Dark Matter. One can also search for Dark Matter candidates that should have been produced in the Big Bang using high-Q tunable microwave cavities in a magnetic field. The next generation experiments will use Superconducting Quantum Interference Device (SQUID) amplifiers.

3) Gamma rays or neutrinos resulting from annihilation of Dark Matter particles by their antimatter counterparts may be detected by astronomical telescopes. This process may take place in the core of the Sun or surrounding the center of the Galaxy, where Dark Matter and anti-Dark Matter might be concentrated by strong gravitational fields.

<i>Project Name</i>	<i>Steward</i>	<i>Participating Agencies</i>	<i>Scientific Approach</i>	<i>Status</i>
<i>Sloan Digital Sky Survey</i>	Sloan Foundation (Private)	DOE - High Energy Physics NSF - Astronomy NASA - Space Science	Study large scale distribution of matter (e.g., galaxies in the universe)	Ongoing Project
<i>Cryogenic Dark Matter Search (CDMS)</i>	DOE - High Energy Physics	NSF - Physics NSF - Astronomy	Direct detection of Dark Matter particles	Ongoing Project

4) One can also try to create Dark Matter particles by colliding particles of ordinary matter in high-energy particle accelerators. It is possible that Dark Matter may be comprised of exotic forms of matter that lie just beyond the reach of existing accelerators. The lowest-energy particles from the theory of “supersymmetry” are candidates.

Current Projects: The ground-based Sloan Digital Sky Survey (SDSS) continues to collect data on the large-scale distribution of galaxies and quasars, which can be used to investigate the amount and effects of Dark Matter in the universe.
(<http://www.sdss.org/sdss.html>)

The Cryogenic Dark Matter Search (CDMS) and its follow-on, CDMS-II, aim to measure the energy imparted to detector nuclei through collisions of Dark Matter particles and atoms in the crystals of highly sensitive detectors.
(<http://cdms.berkeley.edu/experiment.html>)

In addition to these focused projects, the creation of potential Dark Matter particles is one of the goals of the study of particle physics at the world’s highest energy accelerators, for example at the Tevatron at Fermilab and the soon to be completed Large Hadron Collider at the Center for European Nuclear Research (CERN). Further, astronomical telescopes are capable of providing studies of the effects of Dark Matter. These include the Hubble Space Telescope and ground-based telescopes, such as the Keck Telescope, which can detect the dynamical effects of Dark Matter, and GLAST and VERITAS, which will be able to detect gamma rays resulting from annihilation of Dark Matter particles.

Question 2. What is the Nature of Dark Energy?

“Recent measurements indicate that the expansion of the universe is speeding up rather than slowing down. This conclusion goes against the fundamental idea that gravity is always attractive. This discovery calls for the presence of a form of energy, dubbed “Dark Energy,” whose gravity is repulsive and whose nature determines the destiny of our universe.”

Scientific Significance: Two independent lines of evidence indicate the presence of a new form of energy pervading the universe that accounts for over two-thirds of the contents of the universe. This “Dark Energy” is causing the expansion of the universe to speed up, rather than to slow down, as was previously expected. Resolving the nature of Dark Energy is one of the most pressing questions facing both physics and cosmology and will no doubt lead to progress in our fundamental understanding of both.

Measurement Methods: There are at least three methods to investigate Dark Energy.

Because of Dark Energy’s diffuse nature, the best methods to probe its properties rely upon its effect on the expansion rate of the universe and how it influenced the formation of large-scale structure, the web of galaxies and clusters we see today. The use of

distant, or high-redshift, supernovae (redshift 0.5-1.8) as a cosmic ruler led to the discovery of the cosmic expansion speed-up. Such supernovae have great promise for shedding light on the nature of the Dark Energy. Realizing this promise will require a new class of wide-field telescopes to discover and follow up thousands of supernovae, as well as independent analysis of type Ia supernovae to better establish the degree to which they are standard candles.

Independent measurements of the Cosmic Microwave Background (CMB), the afterglow of the birth of the universe, also indicates the presence of an exotic form of energy pervading the universe.

The evolution of galaxy clusters provides an independent probe of Dark Energy. Clusters can be detected out to redshifts as large as 2 or 3 through X-ray surveys, through large-area radio and millimeter-

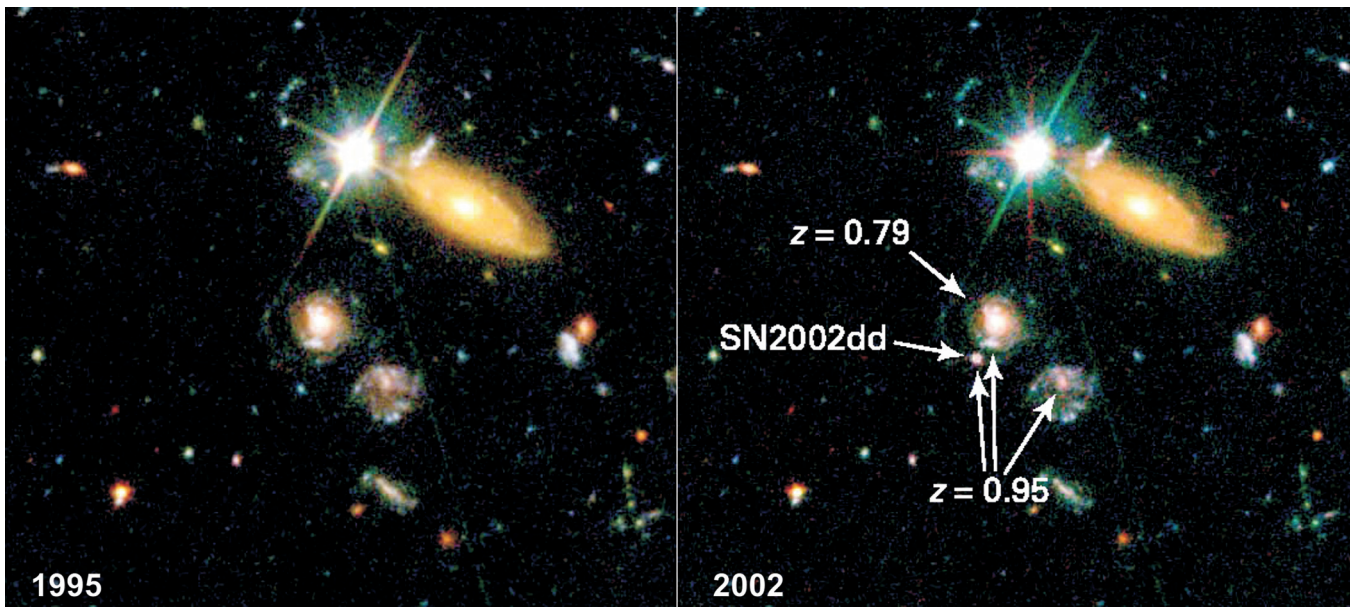

[Left] - A Hubble Space Telescope image of a portion of the Hubble Deep Field North as originally photographed in 1995 with the Wide Field Planetary Camera 2 (WFPC2). [Right] - A composite image of the same field as imaged by Hubble’s Advanced Camera for Surveys (ACS), combined with the original WFPC2 image. The ACS observations were made in May and June 2002. The red spot is the glow of a very distant supernova captured exploding in the field. The supernova is estimated to be eight billion light-years away. The supernova appears deep red in this composite image because it was photographed by the ACS at far-red wavelengths. Distant supernovae are used by astronomers to fill in the blank region where the universe’s rate of expansion switched from deceleration due to gravity to acceleration due to the repulsive force of “Dark Energy.”

<i>Project Name</i>	<i>Steward</i>	<i>Participating Agencies</i>	<i>Scientific Approach</i>	<i>Status</i>
<i>SPT</i>	NSF - Office of Polar Programs		Sunyaev-Zel'dovich Effect	Under Construction
<i>ACT</i>	NSF - Astronomy	NSF - Physics	Sunyaev-Zel'dovich Effect	Under Construction

wave surveys using a technique known as the Sunyaev-Zel'dovich (SZ) Effect, and through gravitational lensing. Con-X, for example, will be able to determine the redshifts and masses of the clusters.

Counts of galaxy clusters, high-redshift supernovae, weak-gravitational lensing, and the Cosmic Microwave Background (see Question 3) all provide complementary information about the existence and properties of Dark Energy.

Current Projects: There are many ongoing studies of Type Ia supernovae using existing facilities such as the Hubble Space Telescope (HST) and telescopes at the Cerro Tololo Inter-American Observatory and Keck Observatories. These will provide additional measurements of a few hundred supernovae.

There are two ground-based telescope projects under construction that use the Sunyaev-Zel'dovich effect technique. The 8m South Pole Telescope (SPT) will perform a large-scale survey for distant galaxy clusters to study Dark Energy through the SZ effect.

(<http://astro.uchicago.edu/spt/>)

The Atacama Cosmology Telescope (ACT) will do a large-area survey of the sky to map out the formation of cosmic structure over a wide range of redshift. Among its goals is to find and study galaxy clusters using the SZ effect.

(<http://www.hep.upenn.edu/~angelica/act/index.html>)

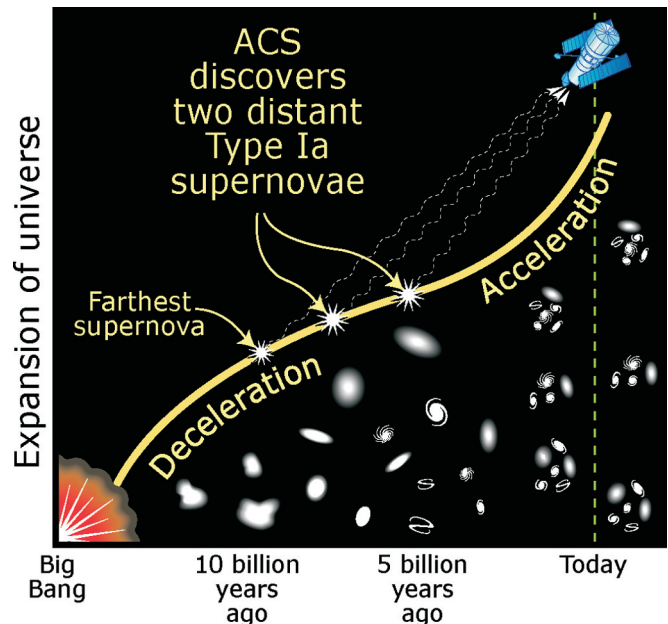

This graph plots the size of the universe over time as measured by the Hubble telescope observations of exploding stars, called supernovae, at various distances from Earth. Hubble's study of exploding stars several light-years from Earth [white objects at far right of curve] set the stage for observations of more distant supernovas [white objects at far left of curve].

Supernovae are used to map the expansion of the universe—the rate at which galaxies are moving apart. Several exploding stars discovered four years ago provided evidence that the cosmos was accelerating. These objects looked dimmer than expected because they were hurling away from Earth at faster speeds. The faraway supernova at far left, residing 10 billion light-years from Earth, appears brighter than astronomers predicted. This finding indicates that the supernova is so far away it existed at a time when the cosmos was slowing down.

Question 3. How Did the Universe Begin?

“There is evidence that during its earliest moments the universe underwent a tremendous burst of additional expansion, known as inflation, so that the largest objects in the universe had their origins in subatomic quantum fuzz. The underlying physical cause of this inflation is a mystery.”

Scientific Significance: An amazing chain of events was unleashed by the Big Bang, culminating today some 13.7 billion years later in molecules, life, planets, and everything we see around us. One of the great successes of cosmology over the past two decades has been the development and initial testing of the “inflationary paradigm,” which provides an explanation for the large size and uniformity of the universe as well as the origin of the lumpiness that led to galaxies and clusters of galaxies—that is, how the universe evolved from a primeval fog to pristine hierarchy.

The inflationary paradigm, describing how the universe expanded from an atomic scale to a visible scale in a fraction of a second, is supported by observations of tiny fluctuations in the intensity of the Cosmic Microwave Background (CMB) radiation, the afterglow of the birth of the universe.

Measurement Methods: Space-based, balloon-based, and ground-based observations of the CMB provide the most direct probe of the Big Bang. The recent Wilkinson Microwave Anisotropy Probe (WMAP) results have elevated this field to a new level by using

high quality CMB data to derive the cosmological parameters that define our universe.

The measurements of the CMB detail a radiation source of unusual and remarkable features. The CMB radiation is isotropic on both large and small angular scales to a higher degree than any other source in the universe and exhibits only little in the way of polarization. The spectrum of the CMB is well characterized as an ideal blackbody, or thermal, source with only minor deviations. In short, the CMB radiation exhibits all of the characteristics of what one would expect from a simple model for the remnant of a homogeneous and structureless primeval explosion.

CMB polarization (the degree to which light waves are aligned) holds the promise of revealing unique features of the early universe, for specific phenomena will polarize light—for example, magnetic

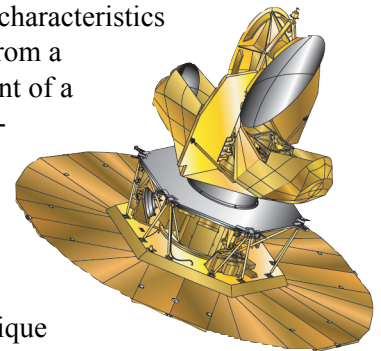

NASA's WMAP satellite.

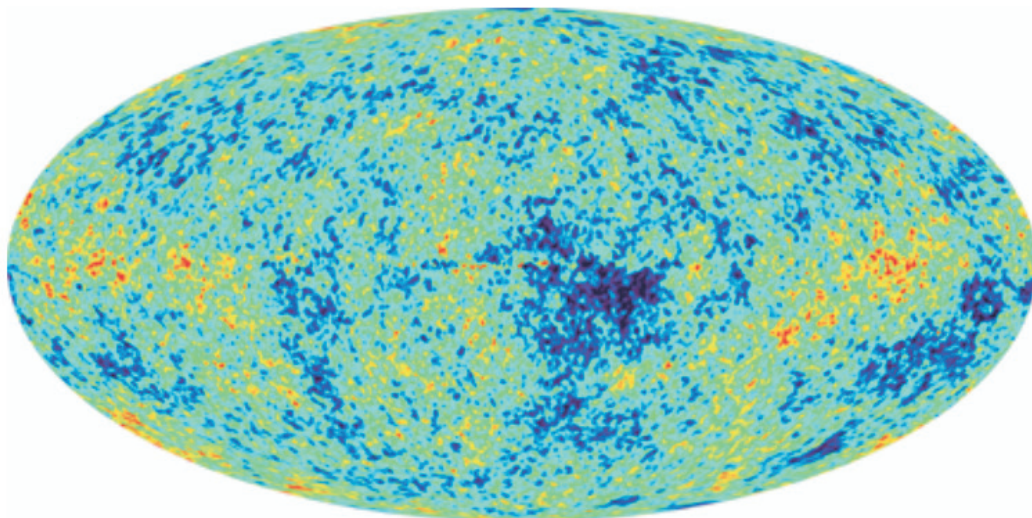

The Wilkinson Microwave Anisotropy Probe captured this image of the infant universe, light that was emitted 380,000 years after the Big Bang. The light has been stretched in wavelength, by the expansion of the universe, from the visible to the microwave.
Credit: NASA/WMAP.

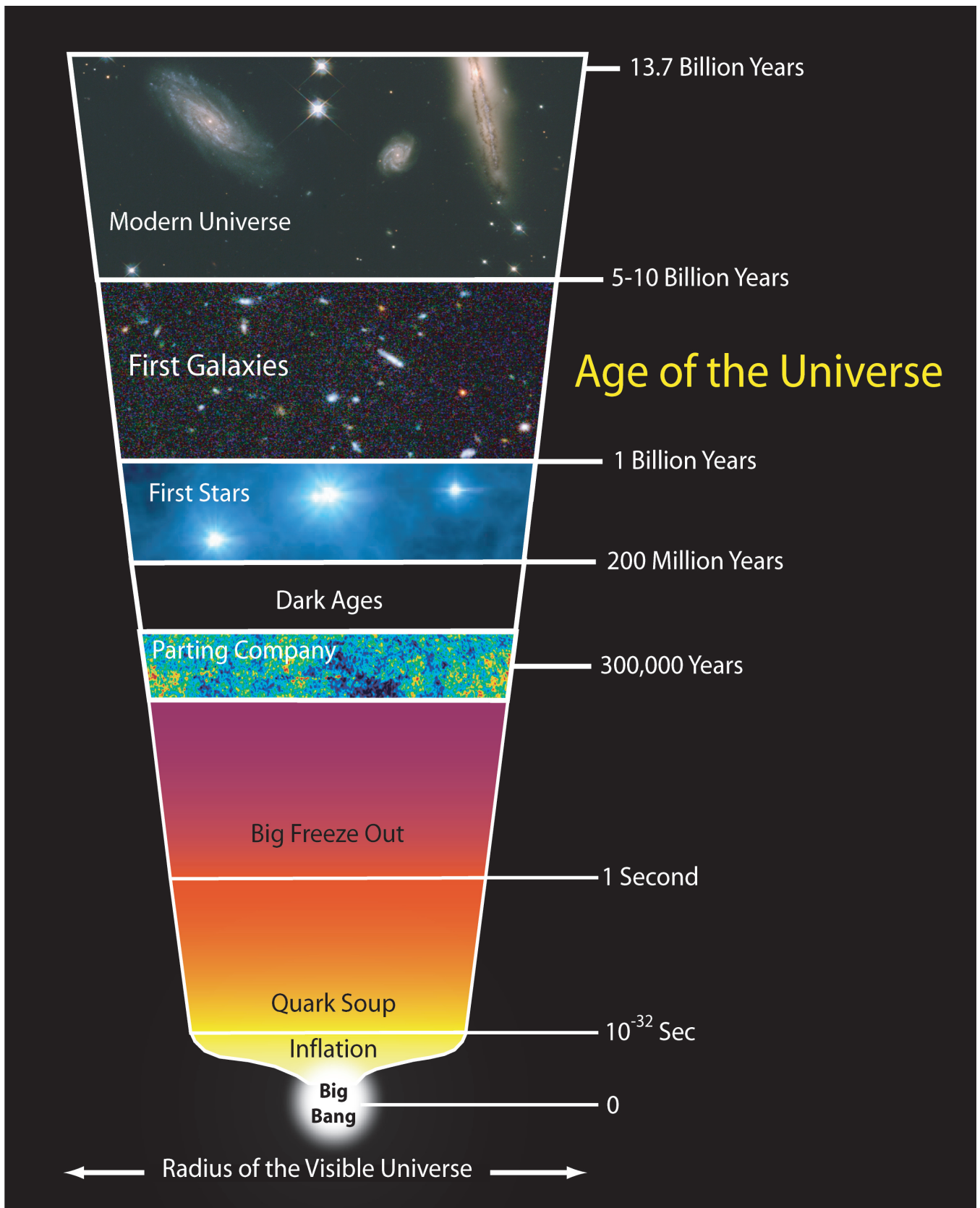

Age of the Universe

The figure indicates some major periods in our history: the mysterious "Planck era" at the earliest time (not shown); a period of inflation at the neck of the goblet that explains the uniformity we see today; a time at which the strong, weak and electromagnetic forces stop being equal (not shown); a period when the excess of particles over anti-particles came about (nor shown); the time, three minutes, when the nuclei of the light elements were made; the time, 380,000 years from the recent WMAP results, at which electrons were captured by nuclei and the universe became transparent to light because there were no charged particles to get in its way; the period of galaxy formation; and here we are today — a time to solve ageless mysteries.

<i>Project Name</i>	<i>Steward</i>	<i>Participating Agencies</i>	<i>Scientific Approach</i>	<i>Status</i>
<i>Degree Angular Scale Interferometer (DASI)</i>	NSF - Office of Polar Programs		Instrument at South Pole to measure temperature and polarization anisotropy of CMB radiation	Ongoing Project
<i>Wilkinson Microwave Anisotropy Map (WMAP)</i>	NASA - Office of Space Science		Space mission to map temperature fluctuations in the CMB radiation	Ongoing Project
<i>Cosmic Background Imager (CBI)</i>	NSF - Astronomy		Instrument in Atacama Desert to measure polarization anisotropy of CMB	Ongoing Project
<i>Planck</i>	European Space Agency	NASA - Office of Space Science	Space mission to image the temperature fluctuations in the CMB radiation	Under Construction

fields, electron scattering, or gravitational radiation. This polarization has been detected convincingly in a small region of the sky using the Degree Angular Scale Interferometer (DASI) telescope at the South Pole. The observation of the linear polarization of the CMB by WMAP has revealed that the first stars turned on only 200 million years after the birth of the universe. This is just a start. Measuring the curl of the CMB polarization with increased sensitivity may reveal the signature of gravitational waves produced during the inflationary epoch. This is a difficult measurement, but the payoff is great: Measuring the CMB polarization in essence triples the information we can obtain about the earliest moments, and it exploits the full information available in this most important relic of the early universe. The long-range goal of polarization studies is to detect the consequences of gravitational waves produced during the inflationary epoch. This campaign will be carried out with polarization sensitive CMB detectors on the ground, aboard balloons, and in space.

Current Projects: There are currently two on-going projects. The Degree Angular Scale Interferometer (DASI) is a 13-element interferometer designed to measure temperature and polarization anisotropy of the CMB radiation over a large range of scales with high sensitivity. The instrument operates from the NSF Amundsen-Scott South Pole station. (<http://astro.uchicago.edu/dasi/>)

WMAP is the highly successful Wilkinson Microwave Anisotropy Probe, a space mission that is mapping the temperature fluctuations in the cosmic microwave background with unprecedented sensitivity. The

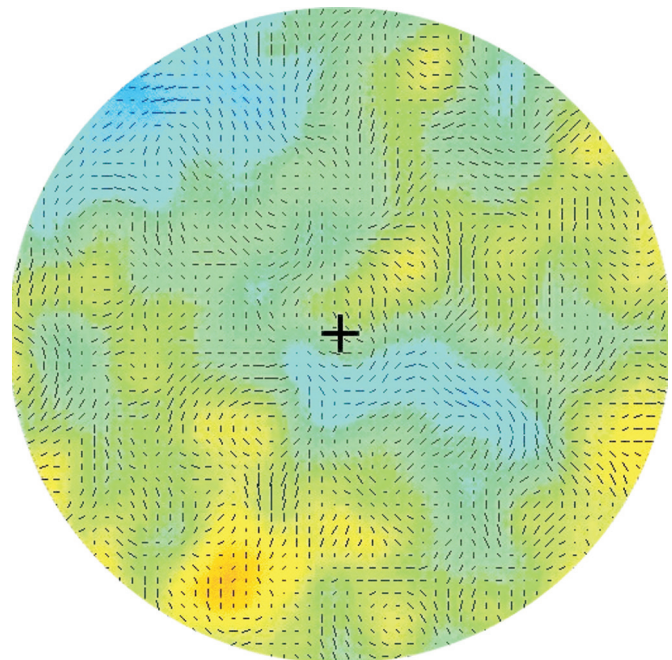

This simulation of the CMB shows the curl of the polarization field by gravitational waves as long as the universe.

WMAP maps are being used to accurately establish the age of the universe, to measure the composition of the universe, and to determine the epoch of the first star formation.

(<http://map.gsfc.nasa.gov/>)

The Cosmic Background Imager (CBI) is a special-purpose radio telescope consisting of 13 1-meter diameter elements and is designed to study the polarization anisotropy of the Cosmic Microwave Background. The CBI has produced the highest resolution images of the CMB to date, showing



DASI is a 13-element interferometer designed to measure temperature and polarization anisotropy of the Cosmic Microwave Background (CMB) Radiation over a large range of scales with high sensitivity. The instrument operates from the NSF Amundsen-Scott South Pole station. Funding for DASI comes from the NSF Office of Polar Programs. The Center for Cosmological Physics (CfCP) provides additional support at the University of Chicago. (Photo Credit – John Yamasaki and the DASI Collaboration, 2002)

fluctuations corresponding to the seeds of present day clusters of galaxies.

Planck is a European Space Agency mission that is planned for a 2007 launch. Planck will image the anisotropies of the cosmic microwave background with high sensitivity and spatial resolution. Planck will map temperature fluctuations in the cosmic microwave background over a broad wavelength band with unprecedented spatial resolution. Planck will place fundamental constraints on models for the origin and evolution of large scale structure in the universe.
(<http://astro.estec.esa.nl/SA-general/Projects/Planck/>)

Question 4. Did Einstein Have the Last Word on Gravity?

“Black Holes are ubiquitous in the universe, and their intense gravity can be explored. The effects of strong gravity in the early universe have observable consequences. Einstein’s theory should work as well in these situations as it does in the solar system. A complete theory of gravity should incorporate quantum effects — Einstein’s theory of gravity does not — or explain why they are not relevant.”

Scientific Significance: Of the four known fundamental forces (electromagnetic, weak, strong, and gravitational), the gravitational force is the most enigmatic. Whereas the electromagnetic, weak, and strong forces are well defined by quantum mechanics, gravity is the odd man out. It is by far the weakest force, yet it holds galaxies together, ignites the fusion reaction in stars, and curves space within Black Holes so severely that light is trapped.

Einstein tackled gravity in his theory of General Relativity, which predicts ripples in space-time called gravitational radiation and also Black Holes, which are purely defined by gravity. Studying gravity at its most extreme—close to the event horizon, a Black Hole’s border of no return, and in the creation of gravitational waves—provides the best test of General Relativity and a better understanding of gravity.

Although the universe should be filled with gravitational waves from a host of cataclysmic cosmic phenomena, including Black Holes, we have never detected a gravitational wave and measured its waveform. For this reason, gravitational wave

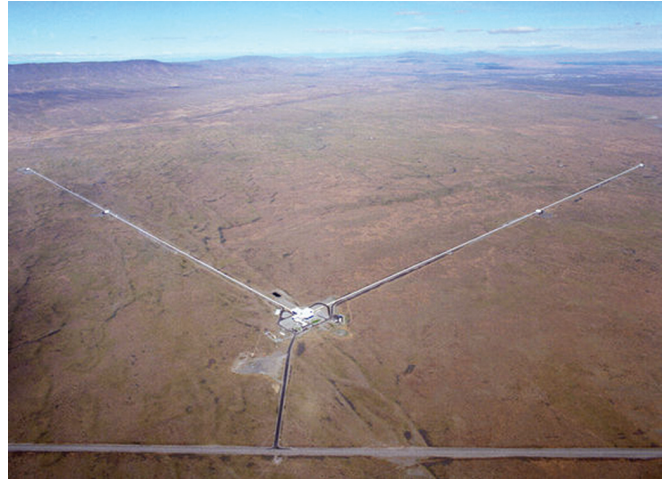

The LIGO facility in Hanford, WA.

detection has become a compelling frontier of physics with its origins in the theory of General Relativity, created by Albert Einstein early in 1915. Gravitational waves, when detected, will be a radically new messenger from the cosmos. Such waves are produced before light is generated in phenomena such as star explosions or Black Hole mergers and, unlike light, can penetrate through the thickest of “fogs” surrounding these cataclysmic events.

Measurement Methods: There are at least eight approaches to gravitational physics and gravitational wave astronomy: resonant bar detectors, large interferometer detectors, mapping of radiation from near the event horizons of Black Holes, precision laboratory measurements at distances below a millimeter, laboratory and space tests of the equivalence principle, lunar laser ranging experiments, numerical relativity, and formal theory, including string theory and other approaches to quantum gravity. In addition, such approaches as the measurement of

Black Holes are ubiquitous in the universe as demonstrated by the Chandra X-ray Observatory. All of the X-ray sources seen in this 12-day exposure, the deepest X-ray image of the universe ever taken, are powered by Black Holes at the cores of active galaxies and quasars. Many of them can be seen only with an X-ray telescope because they are shrouded by dust and invisible to optical telescopes

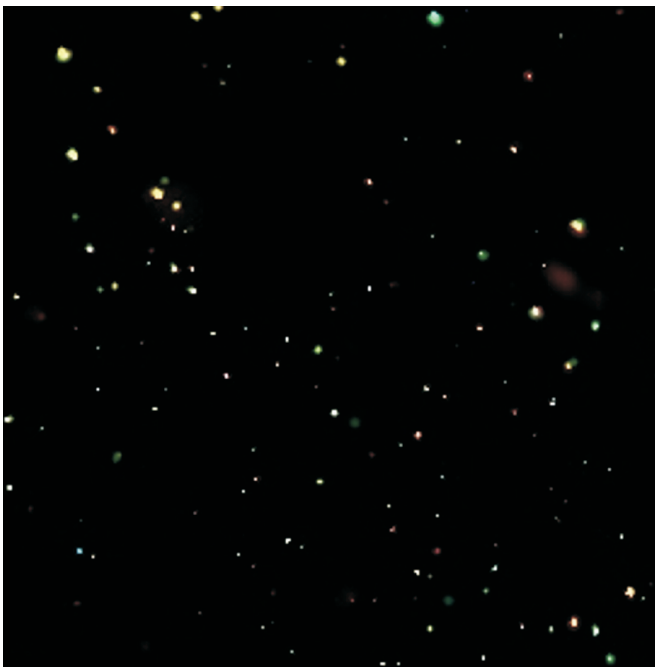

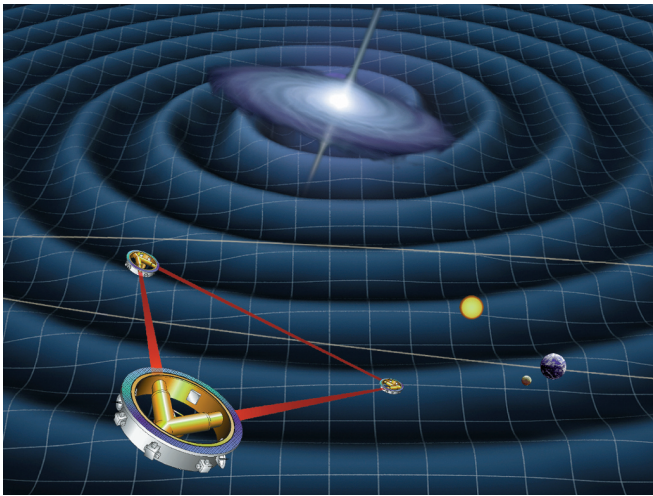

The detection of gravitational wave in the next decade would not only confirm one of the most basic prediction of Einstein's Theory of General Relativity, but also provide a new window on the universe.

CMB polarization (see last section) and astronomical observation of neutron star binaries (produced the first indication of gravitational radiation) are relevant.

The frontiers of gravitational wave science are now defined by: the interferometric approaches on the ground (Laser Interferometer Gravitational wave Observatory, LIGO) and in space (Laser Interferometry Space Antenna, LISA); laboratory measurements in the micron range; planned missions to map matter near the event horizon of Black Holes (Constellation-X); numerical relativity to compute wave forms of gravitational waves to be measured; and formal theory to better understand gravity as part of a unified theory of fundamental forces. LIGO has just begun its search for gravity waves, and its upgrade to increase its coverage of the universe by a factor of 1000 has just been proposed. LISA and Constellation-X, missions proposed in the President's FY 2004 budget, will study Black Holes in great detail.

Interpretation of these data requires substantial advances in our understanding of photo-ionized plasmas and their X-ray emissions. Laboratory high-energy-density facilities are needed to develop the

required understanding of the plasma physics in the vicinity of Black Holes. Furthermore, the accretion disks around Black Holes may be radiation-dominated plasmas, in which the energy density of the radiation exceeds that of the matter. High-energy-density plasma devices will contribute to the understanding of this exotic state of matter (see under Question 8).

Current Projects: LIGO is the Laser Interferometer Gravitational-wave Observatory, a facility dedicated to the detection of cosmic gravitational waves and the measurement of these waves for scientific research. It consists of two widely separated installations, at Hanford, WA, and at Livingston, LA, operated in unison as a single observatory. LIGO searches for waves of higher frequency, compared to LISA. (<http://www.ligo.caltech.edu/>)

GPB is Gravity Probe B, an orbiting gyroscope that is planned for launch, is sensitive enough to directly detect two predictions of Einstein's theory of General Relativity: the geodetic effect (the warping of space-time due to the Earth's mass) and frame dragging (the twisting of space-time due to the rotation of the Earth). (<http://einstein.stanford.edu/>)

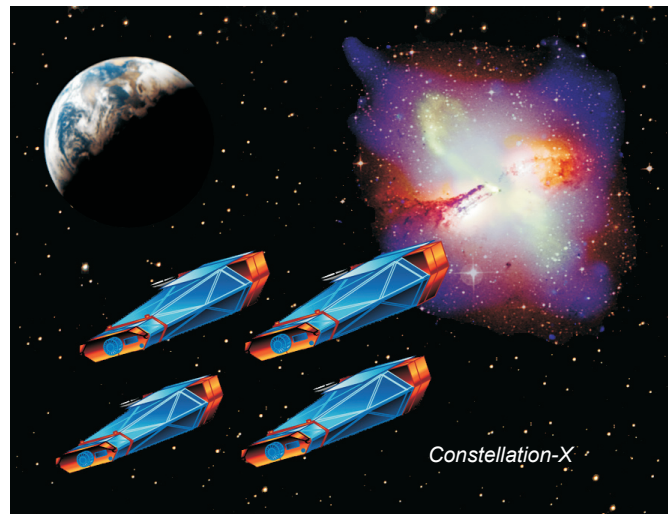

The Constellation-X Observatory will investigate black holes, Einstein's theory of General Relativity, galaxy formation, the evolution of the universe on the largest scales, the recycling of matter and energy, and the nature of "dark matter."

<i>Project Name</i>	<i>Steward</i>	<i>Participating Agencies</i>	<i>Scientific Approach</i>	<i>Status</i>
<i>Laser Interferometer Gravitational wave Observatory (LIGO)</i>	NSF - Physics	International collaboration with eight countries	Detect gravitational waves directly using laser interferometers	Ongoing Project
<i>Gravity Probe B</i>	NASA - Office of Space Science		Gravity measurements using a gyroscope in space	Under Construction

Question 5. What Are the Masses of the Neutrinos and How Have They Shaped the Evolution of the Universe?

“Cosmology tells us that neutrinos must be abundantly present in the universe today. Physicists have found evidence that they have a small mass, which implies that cosmic neutrinos account for as much mass as do stars. The pattern of neutrino masses can reveal much about how Nature’s forces are unified and how the elements in the periodic table were made.”

Scientific Significance: Among the many actors in the areas of elementary particle physics and messengers from the cosmos, neutrinos have recently taken center stage. One of the most significant observations in years has been that neutrinos can oscillate, or change, from one type to another as they travel. There are two main reasons why this is important: first, the fact that neutrinos oscillate means that they have mass. This mass is small, but the overwhelming preponderance of neutrinos in the universe means that a significant amount of Dark Matter is in the form of neutrinos traveling essentially at the speed of light (hot Dark Matter). Second, neutrinos are not “supposed” to have mass in the Standard Model of Particle Physics, so

herein lies a hint at the next higher level of theoretical understanding. Oscillation has begun a whole new scientific thrust to understand the properties of the neutrino “sector,” much like the campaign in the last twenty years or so in the quark sector. New questions are arising. What is the degree of charge-parity (CP) violation in the neutrino sector? (CP violation may explain why there is more matter than antimatter.) Are neutrinos their own antiparticles? Are there unknown types of neutrinos, such as sterile neutrinos? Neutrinos also pass through the universe mostly unaffected, so that they are useful messengers from distant cosmic citizens. This characteristic will be discussed in connection with the next question.



MINOS Far Detector in Soudan, MN. The mural on the wall was painted by a local artist to represent the physics of neutrinos.

<i>Project Name</i>	<i>Steward</i>	<i>Participating Agencies</i>	<i>Scientific Approach</i>	<i>Status</i>
<i>SuperK</i>	Japan	DOE - High Energy Physics	Large volume Cherenkov Detector for proton decay, neutrino studies	Ongoing Project
<i>K2K</i>	Japan	DOE - High Energy Physics	Neutrino beam to SuperK detector to detect neutrino oscillations	Ongoing Project
<i>SNO</i>	Canada	DOE - Nuclear Physics, High Energy Physics	Large volume Cherenkov Detector to study solar and astrophysical neutrinos	Ongoing Project
<i>KamLAND</i>	Japan	DOE - High Energy Physics and Nuclear Physics	Large volume scintillation detector to look at antineutrinos from reactors	Ongoing Project
<i>MiniBooNE</i>	DOE - High Energy Physics	NSF - Physics DOE - Nuclear Physics, NNSA	Large detector that searches for neutrino oscillations using Fermilab accelerator	Ongoing Project
<i>NUMI/MINOS</i>	DOE - High Energy Physics	NSF - Physics DOE - NNSA	Study neutrino oscillations using neutrino beam from the Fermilab Main Injector	Under Construction
<i>BOREXino</i>	Italy	NSF - Physics and Astronomy	Study solar neutrinos using a large scintillation detector	Under Construction

Measurement Methods: One characteristic defines all experimental approaches for detecting and studying neutrinos: neutrinos interact only very weakly with matter. They can pass through the earth, the Sun, and whole galaxies unscathed. However, they do interact through the “weak interaction,” occasionally striking, for example, one proton out of trillions upon trillions traveling through thousands of miles of solid earth. Such a collision can be detected, often as a flash of light, if the detector volume is large enough and the background counts in the detector are low enough. Basically, this requires very large detectors (kilotons to gigatons of detector medium, such as water or ice) and a location well shielded from cosmic rays, usually deep underground.

These difficulties are mitigated when one knows when and from where the neutrinos are coming—for example, from pulsed sources such as accelerators or from known continuous sources such as the Sun. Long baseline experiments involving neutrinos from accelerators can do with less shielding from cosmic rays, but multiple uses of the large detectors is gained when they are placed deep underground. As for the issue of the absolute mass of the neutrinos, understanding this requires not detecting incoming neutrinos, but rather the observation of neutrino-less double beta decay, a very weak process occurring in selected nuclei, and the endpoint spectrum of tritium

beta decay. Neutrino-less double beta decay is an extremely weak process that requires placement of the detector very deep underground. Tritium beta decay experiments require construction of very large and precise electron spectrometers.

Current Projects: The Super Kamiokande (SuperK) experiment is located in an underground mine in Japan and consists of a huge water tank to search for proton decay and neutrino interactions. The first evidence for a non-zero neutrino mass was obtained by SuperK in 1998 and operations are continuing. (<http://www-sk.icrr.u-tokyo.ac.jp/doc/sk/index.html>)

K2K is a Long-baseline Neutrino Oscillation Experiment from the High Energy Accelerator Research Organization (KEK) accelerator laboratory in Japan to the SuperK detector. (<http://neutrino.kek.jp/>)

SNO is the Sudbury Neutrino Observatory, which searches for neutrino flavor oscillations due to their having mass. Initial results from SNO in combination with SuperK results led to the determination that neutrinos have mass and will require a revision of the Standard Model of Particle Physics. Subsequent measurements by SNO alone confirmed the Bahcall Standard Solar Model of fusion reactions in the Sun for the Sun's production of neutrinos and the results of the original solar neutrino experiment of Ray Davis

and colleagues on solar neutrino oscillations. The 2002 Nobel Prize in Physics was awarded to Davis and Koshiba for their pioneering work in this field. (<http://www.sno.phy.queensu.ca/>)

The Kamioka Liquid scintillator Anti-Neutrino Detector (KamLAND) experiment in Japan measures the anti-neutrino flux from reactors in Japan and Korea to investigate neutrino oscillations. It also has sensitivity to detect low energy solar neutrinos. (<http://kamland.lbl.gov/>)

MiniBooNE is a neutrino experiment at Fermilab that takes a beam of muon neutrinos from the booster accelerator and looks for electron neutrinos in the MiniBooNE detector. (<http://www-boone.fnal.gov/>)

The NUMI/MINOS project, under construction, will use a beam of protons from the Fermilab Main Injector to produce neutrinos aimed at an underground mine in Minnesota. There are two detectors, one at Fermilab and one in the mine, which will observe and measure neutrino oscillations. (<http://www-numi.fnal.gov/>)

BOREXino is a new solar neutrino experiment under construction designed to detect low-energy solar neutrinos, in real time, using 300 tons of liquid scintillator in an unsegmented detector. The detector is located in the Gran Sasso underground laboratory in Italy. (<http://pupgg.princeton.edu/~borexino/welcome.html>)

Question 6. How Do Cosmic Accelerators Work and What Are They Accelerating?

“Physicists have detected an amazing variety of energetic phenomena in the universe, including beams of particles of unexpectedly high energy but of unknown origin. In laboratory accelerators, we can produce beams of energetic particles, but the energy of these cosmic beams far exceeds any energies produced on Earth.”

Scientific Significance: The observation of particles in the universe with unexpectedly high energy raises several basic questions. What are the particles? Where are their sources? How did they achieve such high energies—up to billions of times more energetic than those generated in the most powerful laboratory accelerators? These are likely atomic and subatomic particles moving essentially at light speed, each carrying the kinetic energy of a major league baseball pitch. Their existence might point to new physics.

Acceleration of particles to high energy is a characteristic feature of many energetic astrophysical sources, ranging from solar flares and interplanetary shocks to galactic supernova explosions, to distant active galaxies powered by accretion onto massive Black Holes, and to gamma ray bursters. Accelerated particles from space are called cosmic rays. It remains unproven just which structures contribute to such acceleration and whether the acceleration mechanisms actually work as hypothesized. Cosmic rays are



Seen in this Hubble telescope image is a black-hole-powered jet of electrons and other sub-atomic particles traveling at nearly the speed of light. The monstrous black hole at the center of galaxy M87 has swallowed up matter equal to two billion times our Sun's mass.

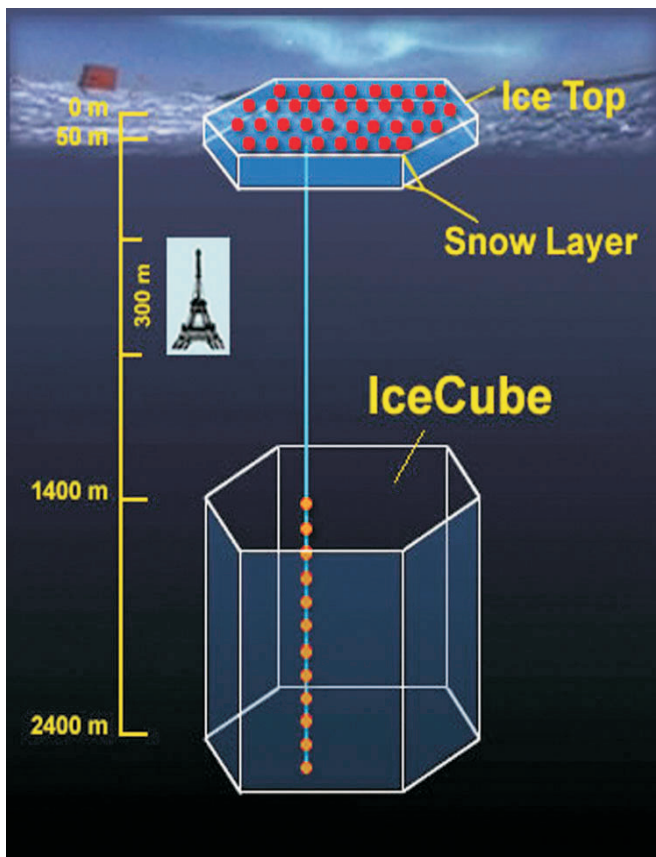

Schematic layout of the IceCube high energy neutrino observatory located at the South Pole Station (90 degrees south). A cubic kilometer of deep ice instrumented with 4800 optical modules (red circles) will detect Cherenkov light generated by the passage of muons and other charged particles produced when high energy neutrinos interact in or near the fiducial volume.

charged particles, and their paths are influenced by magnetic fields throughout the universe.

The signature of cosmic accelerators is that the accelerated electrons, protons, and heavier ions have a distribution of energies that extends far above the thermal distribution of particles in the source. It is the extreme energy that makes this population of naturally occurring particles of great interest, together with the fact that their energy density appears to be comparable to that of the thermal gas and magnetic fields in their sources. Primary cosmic ray electrons, protons, and nuclei can produce secondary photons (often in the form of a gamma ray) and neutrinos in or near the sources, which then propagate over large distances through the universe undeflected by the magnetic fields that obscure the origins of their charged progenitors. Photons are produced by electrons, protons, or nuclei, while neutrinos are produced only by the decays of protons and nuclei. The proportions of the various types of particles, secondary and primary, thus reflect the nature of their sources. A unified approach to

the problem therefore requires observations of the gamma rays and neutrinos as well as the cosmic rays themselves.

Measurement Methods: There are many ways observe cosmic accelerations at work in the universe including measurements of high-energy cosmic rays, gamma rays, and neutrinos. They include ground-based and space-based detectors.

Observations of nature also need to be supplemented with laboratory studies of plasma environments and mechanism that are believed to be involved. This can be accomplished through several means. First, the collective injection and acceleration of particles can now be studied in university-center-scale facilities, and this requires coherent planning by the agencies that support this community. Second, clever use of ultra-intense lasers will aid in the modification of particle distributions by means of relativistic collective plasma phenomena. Third, the effects of plasma interactions on the behavior of ultra-relativistic particles can now be studied using modern particle accelerators. In each case, theoretical and computational efforts will be needed to address the fundamental physics involved.

Current Projects: The Antarctic Muon and Neutrino Detector Array (AMANDA) is a unique telescope designed to detect energetic neutrinos from cosmic sources. The telescope consists of 19 strings of optical modules buried 1 to 1.5 miles beneath the ice surface of the geographic South Pole. Cherenkov light from fast-moving muons (cosmic rays) is converted to electrical signals by the photomultiplier tubes within each optical module.

(<http://amanda.uci.edu/>)

IceCube is a one-cubic-kilometer international high energy neutrino observatory being built and installed in the clear deep ice below the South Pole Station. IceCube will open unexplored bands for astronomy, including the PeV (10^{15} eV) energy region, where the universe is opaque to high energy gamma rays originating from beyond the edge of our own galaxy, and where cosmic rays do not carry directional information because of their deflection by magnetic fields.

(<http://icecube.wisc.edu/>)

The High Resolution Fly's Eye (HiRes) is a two-station, air fluorescence observatory in Utah for measuring the energy spectrum, composition, and



Artists concept of GLAST telescope which will map the high energy gamma ray sky. The major instrument is a collaboration between DOE and NASA with four international partners. Planned launch date is 2007.

<i>Project Name</i>	<i>Steward</i>	<i>Participating Agencies</i>	<i>Scientific Approach</i>	<i>Status</i>
AMANDA	NSF - Office of Polar Programs	DOE - High Energy Physics NSF - Physics Major International Participation	Under-ice telescope to detect energetic neutrinos	Ongoing Project
HiRes	NSF - Physics		Ground-based observatory to measure the composition and energy of high energy cosmic rays	Ongoing Project
SPASE	NSF - Office of Polar Programs		Large area array to measure very energetic particles (> 50 TeV)	Ongoing Project
MILAGRO	NSF - Physics	DOE - High Energy Physics, NNSA	Ground-based observatory to detect high energy gamma rays	Ongoing Project
Pierre Auger	International	DOE - High Energy Physics NSF - Physics NSF - Astronomy	Large area array to detect high energy cosmic rays	Under Construction
GLAST	NASA - Office of Space Science	DOE - High Energy Physics International	Space-based mission to measure high energy gamma rays	Under Construction
AMS	DOE - High Energy Physics	NASA - Office of Biological and Physical Research Major international participation	Magnetic spectrometer on the International Space Station to search for Dark Matter and anti-matter	Under Construction
ICECUBE	NSF - Office of Polar Programs	NSF - Physics International participation	Under-ice observatory to measure astrophysical neutrinos	Under Construction
VERITAS	NSF - Astronomy	DOE - High Energy Physics NSF - Physics Smithsonian	Ground-based array to detect gamma rays in the range 40 GeV to 50 TeV	Under Construction

arrival direction anisotropy of ultra-high energy (>10¹⁷ eV) cosmic rays.

(<http://hires.physics.utah.edu/>)

The South Pole Air Shower Experiment (SPASE) is a large-area air shower array established at the geographic South Pole for the detection of cosmic rays with primary energies above 50 TeV.

(<http://www.bartol.udel.edu/spase/>)

MILAGRO is the Multiple Institution Los Alamos Gamma Ray Observatory. MILAGRO looks at TeV energy photons from active galactic nuclei and gamma ray bursts, which gives insight into high energy

processes such as those in Black Hole accretion disks. (<http://www.lanl.gov/milagro/index.shtml>)

The ground-based Pierre Auger observatory is under construction and now collecting data with an engineering array. This observatory will detect and study ultra high energy cosmic rays (UHECR) using a very large array of detectors in Argentina. (<http://www.auger.org/>)

The Alpha Magnetic Spectrometer (AMS) will study the properties and origin of cosmic particles and nuclei, including antimatter and Dark Matter in the unique environment of space. AMS is scheduled to be

deployed for a three-year mission on the International Space Station in 2007.

(http://ams.cern.ch/AMS/ams_homepage.html)

GLAST is the Gamma ray Large Area Space Telescope, a particle detector in space planned for a 2007 launch. GLAST will map the high energy gamma ray sky to study the mechanisms of particle acceleration in extreme astrophysical environments. Radiation of such magnitude can only be generated under extreme conditions, therefore GLAST will focus on studying the most energetic objects and phenomena in the universe such as how Black Holes, notorious for pulling matter in, can accelerate jets of gas outward at fantastic speeds. It will also search for Dark Matter candidate particles.

(<http://glast.gsfc.nasa.gov/>)

The Very Energetic Radiation Imaging Telescope Array System (VERITAS) is a ground-based array which has recently started construction. The array of four 12m imaging telescopes will detect atmospheric Cherenkov radiation in the range 50 GeV to 50 TeV.

(<http://veritas.sao.arizona.edu/>)

Question 7. Are Protons Unstable?

“The matter of which we are made is the tiny residue of the annihilation of matter and antimatter that emerged from the earliest universe in not-quite-equal amounts. The existence of this tiny imbalance may be tied to a hypothesized instability of protons, the simplest form of matter, and to a slight preference for the formation of matter over antimatter built into the laws of physics.”

Scientific Significance: One of the simplest and most profound questions in science is whether or not the proton, the building block of atoms, has a finite lifetime and will eventually decay. Unified theories of elementary particles and fields, which have had great success explaining the behavior of subatomic and nuclear particles, predict that the proton cannot be stable. This is one of the most generic and most testable predictions of grand unification: the proton must ultimately decay. The implication is that even hydrogen, the majority constituent of the universe, has a finite lifetime. In addition, observations of proton decay would provide us with a unique window to view physics at truly short distances—the proton is less than

10^{-30} cm in size. In order to probe this time scale in an accelerator experiment, energies greater than 10^{25} eV would be required; this is one trillion times greater than planned terrestrial accelerators and ten thousand times greater than the highest energy cosmic rays. The physics of proton decay is also related to the excess of matter over antimatter in the universe. Detection of proton decay will provide a missing link in our theories of grand unification.

Measurement Methods: Theories predict that the average lifetime of protons is greater than 10^{35} years. The universe is only 13.7 billion (1.37×10^{10}) years old, so most protons will not decay until the universe

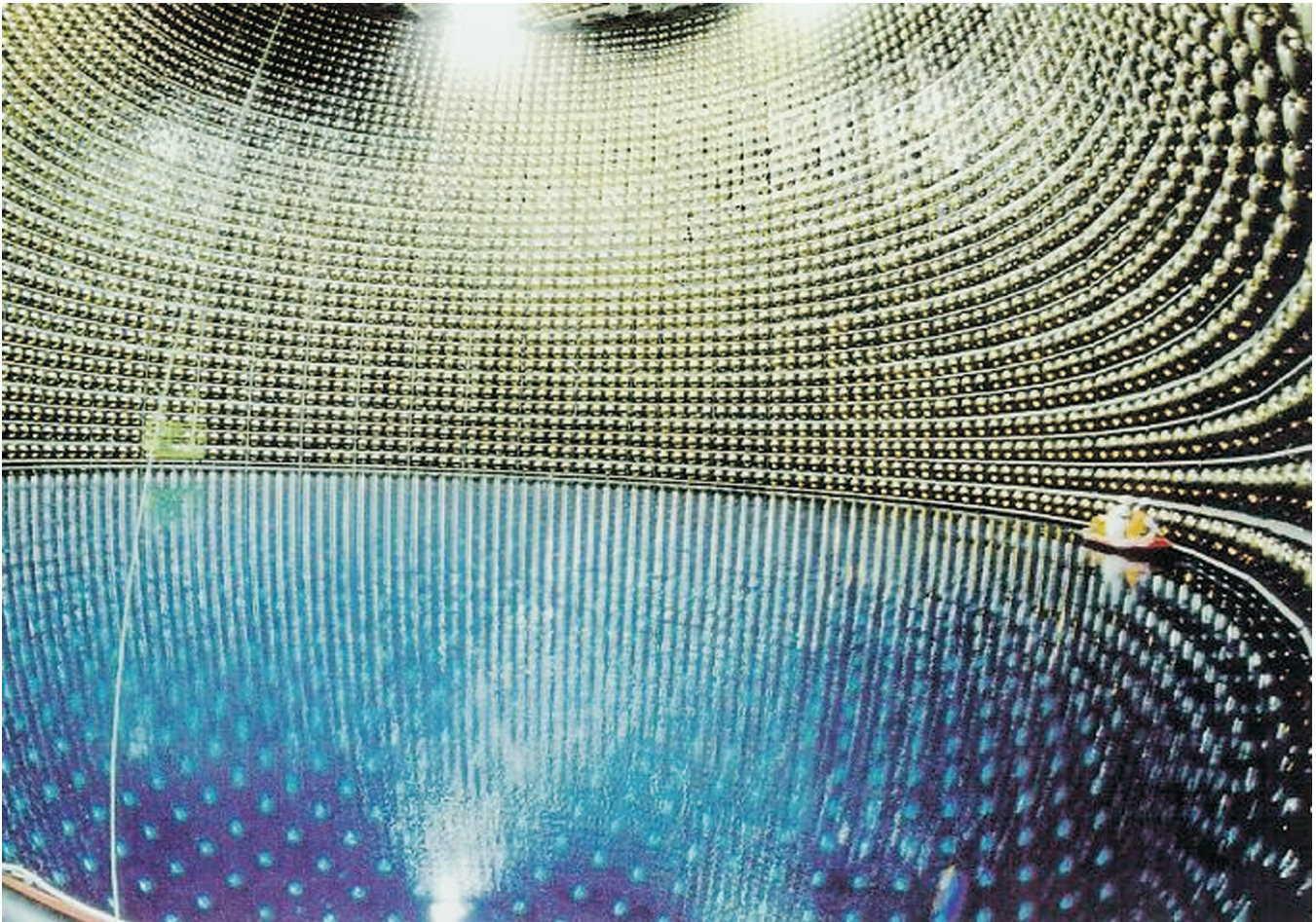

The inside of the SuperK tank before filling.

<i>Project Name</i>	<i>Steward</i>	<i>Participating Agencies</i>	<i>Scientific Approach</i>	<i>Status</i>
<i>SuperK</i>	Japan	DOE - High Energy Physics	Large volume Cherenkov Detector for proton decay, neutrino studies	Ongoing Project

is ten million billion billion times older than it is now. Since the event being sought is so rare, it is necessary to observe a large number of protons with minimum background noise. This requires observing a megaton of water in an underground laboratory with an ultra-clean detector. Such experiments can also accommodate an extensive neutrino physics program that could study neutrinos from the next nearby supernova, terrestrial accelerators, and other cosmic sources. The lack of observed decays among the protons observed in experiments to date sets the average proton lifetime at greater than 10^{32} to 10^{33} years. The next generation of proton decay experiments should provide the first detected proton decay if theories are correct.

Current Projects: The detection of proton decay is being pursued in the large volume detectors used for neutrino studies. For example, the Super Kamiokande (SuperK) experiment located in an underground mine in Japan consists of a huge water tank to search for proton decay and neutrino interactions. The first evidence for a non-zero neutrino mass was obtained by SuperK in 1998 and operations are continuing. (<http://www-sk.icrr.u-tokyo.ac.jp/doc/sk/index.html>)

Question 8. What Are the New States of Matter at Exceedingly High Density and Temperature?

“The theory of how protons and neutrons form the atomic nuclei of the chemical elements is well developed. At higher densities, neutrons and protons may “dissolve” into an undifferentiated “soup” of quarks and gluons, which can be probed in heavy-ion accelerators. Still higher densities and temperature occur and can be probed in neutron stars and the early universe.”

Scientific Significance: One of the most fruitful strategies to advance the frontiers of science is to push observation into unexplored territory. One such territory is the realm of extreme conditions of temperature and pressure in macroscopic systems. Here we are speaking of extreme plasma conditions, a topic that lies solidly at the intersection of physics and astronomy. Examples in astronomy are found in the study of compact objects such as neutron stars or Black Holes and their accretion disk systems.

Matter at high density has been studied for several decades using accelerators to attempt to create the elusive matter that is thought to have existed during the early universe: the quark-gluon plasma. At normal temperatures and densities, nuclear matter contains individual protons and neutrons that are made up of three quarks, “glued” or bound together by gluons. At extremely high temperatures, however, such as those that existed in the early universe immediately after the Big Bang, quarks and gluons are liberated and form a quark-gluon plasma. This plasma may also exist today in the cores of neutron stars, which capture matter at extreme densities.

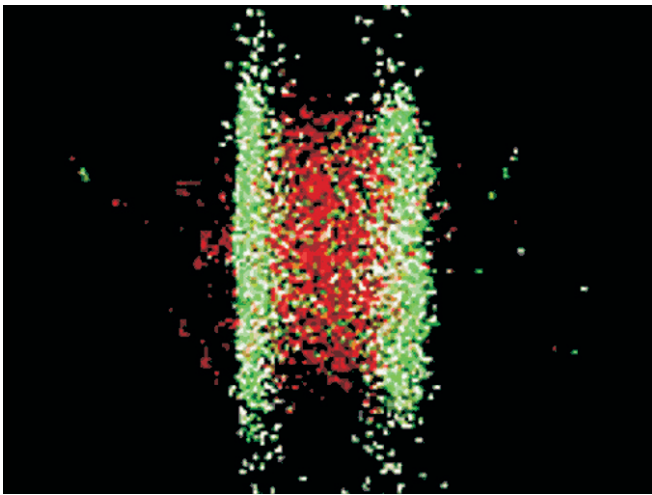

Computer simulation of the collision of two gold ions at an energy of 200 billion electron volts (200 GeV).



Relativistic Heavy Ion Collider (RHIC) at Brookhaven National Laboratory. The machine itself is enclosed in a tunnel, 12 feet under the ground. Inside two tubes, ion bunches race around RHIC's 2.4-mile ring in opposite directions.

Yet another approach to this basic question about exotic states of matter is represented by the rapidly growing field of high-energy-density (HED) physics. Its roots are in such fields as fusion energy, particle and nuclear physics, laser science, and astrophysics. But the potential intellectual connections and synergies have not been exploited, nor has a robust academic community developed to infuse new ideas and talent into the many vital applications and intellectual frontiers intertwined with the study of high-energy-density physics. Also included in the scope of this science question are related questions of turbulence, novel states of matter, and other manifestations of emergent behavior in complex systems. Taken together, studies of such complex phenomena in the laboratory and by theoretical and computational means will provide the essential intellectual ferment to understand the astrophysical phenomena outlined above.

Measurement Methods: Several approaches to high-energy-density physics have sprung up in various programs and communities. The approaches include astrophysical observations, accelerator physics, laser physics, magnetically confined plasmas, z-pinch, high

<i>Project Name</i>	<i>Steward</i>	<i>Participating Agencies</i>	<i>Scientific Approach</i>	<i>Status</i>
<i>RHIC</i>	DOE - Nuclear Physics	NSF - Physics DOE - NNSA International	Heavy ion collisions creates primordial matter in the laboratory	Ongoing Project
<i>RXTE</i>	NASA - Office of Space Science		Space-based mission to observe extreme states of matter through X-ray emission	Ongoing Project

energy density laser-drivers, numerical simulation, and advanced diagnostics, often in combination with one another.

For decades, accelerators have been used to probe the physics of the universe, unveiling bits of knowledge about the behavior of matter that existed in the early universe that bring us closer to understanding how the universe began. Large heavy-ion accelerators are used to collide heavy nuclei together at ultra-relativistic energies to create the hot, dense matter. Initial results have provided tantalizing indications that a quark-gluon plasma with fascinating properties can be produced in these collisions. This direction of work will shed light on the processes that governed the early universe.

The emerging field of high-energy-density plasma physics also has much to offer to this question. Such plasmas will increasingly prove able to produce

extreme conditions that are directly relevant to astrophysical phenomena. For example, new ultra-intense lasers and next-generation laser-driven plasma devices can be used to generate plasma conditions with ultrastrong magnetic fields relevant to neutron star atmospheres. Furthermore, it is believed that compact objects also at times involve radiation-dominated plasmas, a topic that will be addressable with laboratory-based facilities in the near future. The National Nuclear Security Administration within the Department of Energy is currently constructing the National Ignition Facility (NIF) for the purpose of achieving inertial confinement fusion (ICF) ignition in the laboratory. This facility, and the current ICF facilities; Z at Sandia National Laboratories and Omega at the University of Rochester, are able to compress and heat matter to conditions relevant to astrophysical environments. Creating these conditions in the laboratory in a controlled manner, contributes to the interpretation and understanding of a variety of high energy density astrophysical phenomena such as supernovae, stellar atmospheres, neutron stars, etc.

Current Projects: Beams of atomic nuclei at the Relativistic Heavy Ion Collider (RHIC) at Brookhaven National Laboratory are collided to recreate brief, tiny samples of quark-gluon plasma, the matter that existed in the early stages of the universe.

(<http://www.bnl.gov/rhic/>)

RXTE is the Rossi X-ray Timing Explorer, a space mission that studies compact objects such as white dwarfs and neutron stars through the temporal and spectral variability of their X-ray emission. Light curves of neutron stars obtained with RXTE are being used to constrain the equation of state for nuclear matter in degenerate stars. The mass to radius ratio of neutron stars, for example, may determine if such environments are hot and dense enough to possess the quark-gluon plasma.

(<http://rxte.gsfc.nasa.gov/>)



NASA's Rossi X-ray Timing Explorer, which was launched December 30, 1995.

Question 9. Are There Additional Space-Time Dimensions?

“In trying to extend Einstein’s theory and to understand the quantum nature of gravity, particle physicists have posited the existence of space-time dimensions beyond those that we know. Their existence could have implications for the birth and evolution of the universe, could affect the interactions of the fundamental particles, and could alter the force of gravity at short distances.”

Scientific Significance: There are only a handful of examples of new, scientific ideas that have the power to change our basic view of the universe. The roundness of the Earth was a big paradigm change that emerged. Copernicus and others recognized the heliocentric nature of the solar system. The expansion of the universe and its origin in a Big Bang were revolutionary scientific ideas. Another scientific speculation of that magnitude is that the universe

may exist in more than the three spatial and one time dimensions that we are familiar with.

This idea is expressed in so-called string theory, which suggests that the universe is expressed in up to eleven dimensions, all but four of which are tightly rolled up so that they are not evident to our senses. This sounds bizarre, but it has the potential to explain long-standing scientific puzzles, such as the weakness of the



When magnifying matter, the fundamental constituents appear to be point-like. But if we were able to magnify even more, what would they look like? String theory presents a possibility to unify particle physics with gravity provided that the particles are string-like at a lengthscale of 10^{-33} m.

–Martin Lübcke, Uppsala University

gravitational force relative to the other forces. It is also possible that cosmic acceleration is not caused by Dark Energy but is rather due to a breakdown of General Relativity on the larger scales. A new law of gravity may emerge from string theory. These issues are grand challenges at the frontiers of physics; and they underlie some of the deep mysteries of the cosmos.

Measurement Methods: The existence of extra dimensions or degrees of freedom are postulated to have several possible experimental signatures. One of the key elements to these tests for extra dimensions is their coupling to gravitational phenomena. The energy at which this coupling occurs is not well defined theoretically, however.

Several experimental approaches that could signal extra dimensions are lunar laser ranging experiments and “equivalence principle” experiments. Equivalence principle experiments are precision laboratory-scale experiments that search for deviations from predictions from a $1/r^2$ law dependence of the gravitational attraction between two objects. String theory models predict a deviation from the $1/r^2$ law, but the level of deviations has not been worked out.

Lunar Laser “ranging,” or distance measurements, with a factor of ten improved precision, also look for small deviations in the gravitational force between objects, but on a much larger scale. Ranging to spacecraft in

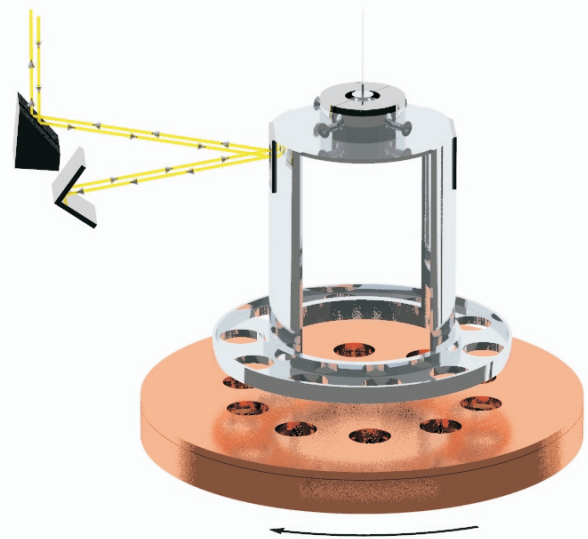

Schematic Drawing of the Eöt-Wash Short-range Experiment. The University of Washington Eöt-Wash group recently measured the strength of gravity at a distance of less than 0.2 millimeter and found no deviation in the gravitational pull from that predicted by Newton's inverse-square law.

orbit around Mars also has the potential to provide the required precision. Such deviations, the prediction of string theory, would signal a deviation from the predictions of general relativity at the largest scales.

Another way that evidence for extra dimensions may be found is by looking for their signature in high energy particle collisions produced by particle accelerators. If the energy of particle collisions can be made high enough, the production of a “graviton,” the force carrier of gravity, could provide signatures of the existence of extra dimensions. The signature would be missing energy in a collision.

Finally, the theory that underlies many of the predictions of extra space-time dimension is string theory. Further theoretical developments in this area are vital to the development of dedicated and well-focused experimental efforts in the search for extra dimensions.

Current Projects: No dedicated current projects.

The search for extra dimensions is an important goal of experiments using the highest energy particle accelerators, such as the Fermilab TeVatron and the Large Hadron Collider (LHC), which is under construction. Accelerator searches for extra dimensions are not done with dedicated experiments, though, but rather can be done in conjunction with the analysis of data being collected.

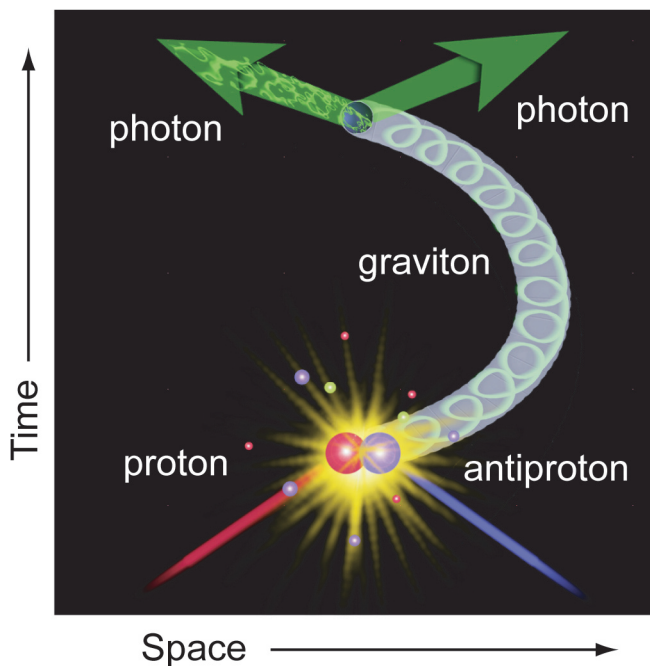

Artist's conception of a graviton being produced in a high energy proton antiproton collision and moving off into an extra dimension.

Question 10. How Were the Elements from Iron to Uranium Made?

“Scientists’ understanding of the production of elements up to iron in stars and supernovae is fairly complete. The precise origin of the heavier elements from iron to uranium remains a mystery.”

Scientific Significance: While we have a relatively good understanding of the origin of elements lighter than iron, important details in the production of elements from iron to uranium remain a puzzle. Picture the periodic table. The existence of every element with

an atomic number higher than iron—such as silver and gold—presents a mystery.

A sequence of rapid neutron captures by nuclei, known as the r-process (where r is for rapid), is

Researchers using an Oak Ridge National Laboratory supercomputer have found that the organized flow beneath the outgoing shock wave in a supernova explosion persists in three dimensions. This fluid flow develops beneath the shock and, when coupled to nuclear and neutrino interactions, is believed to lead to the explosion. The enormous energies that this generates creates an environment where elements of life are synthesized.

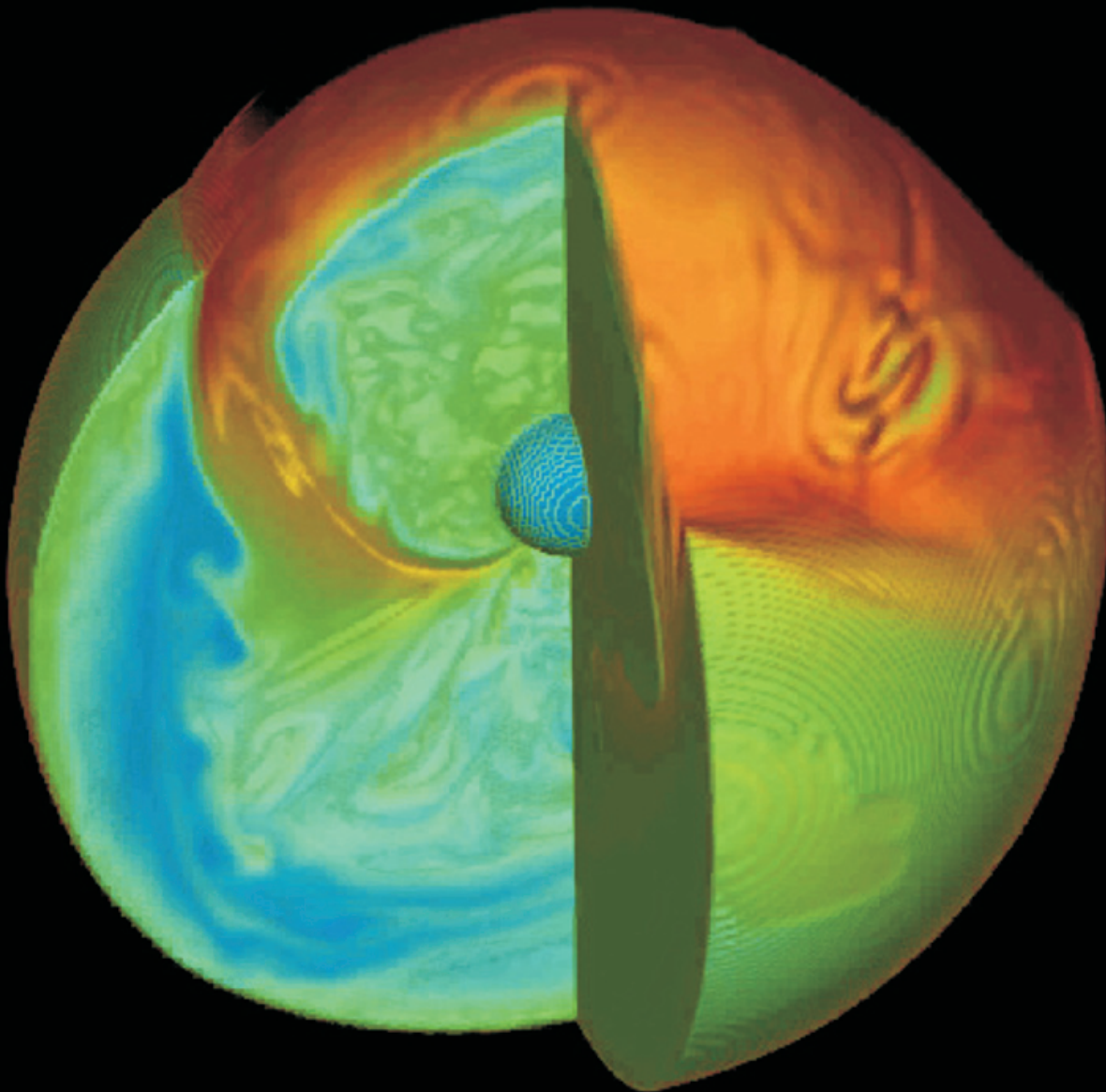

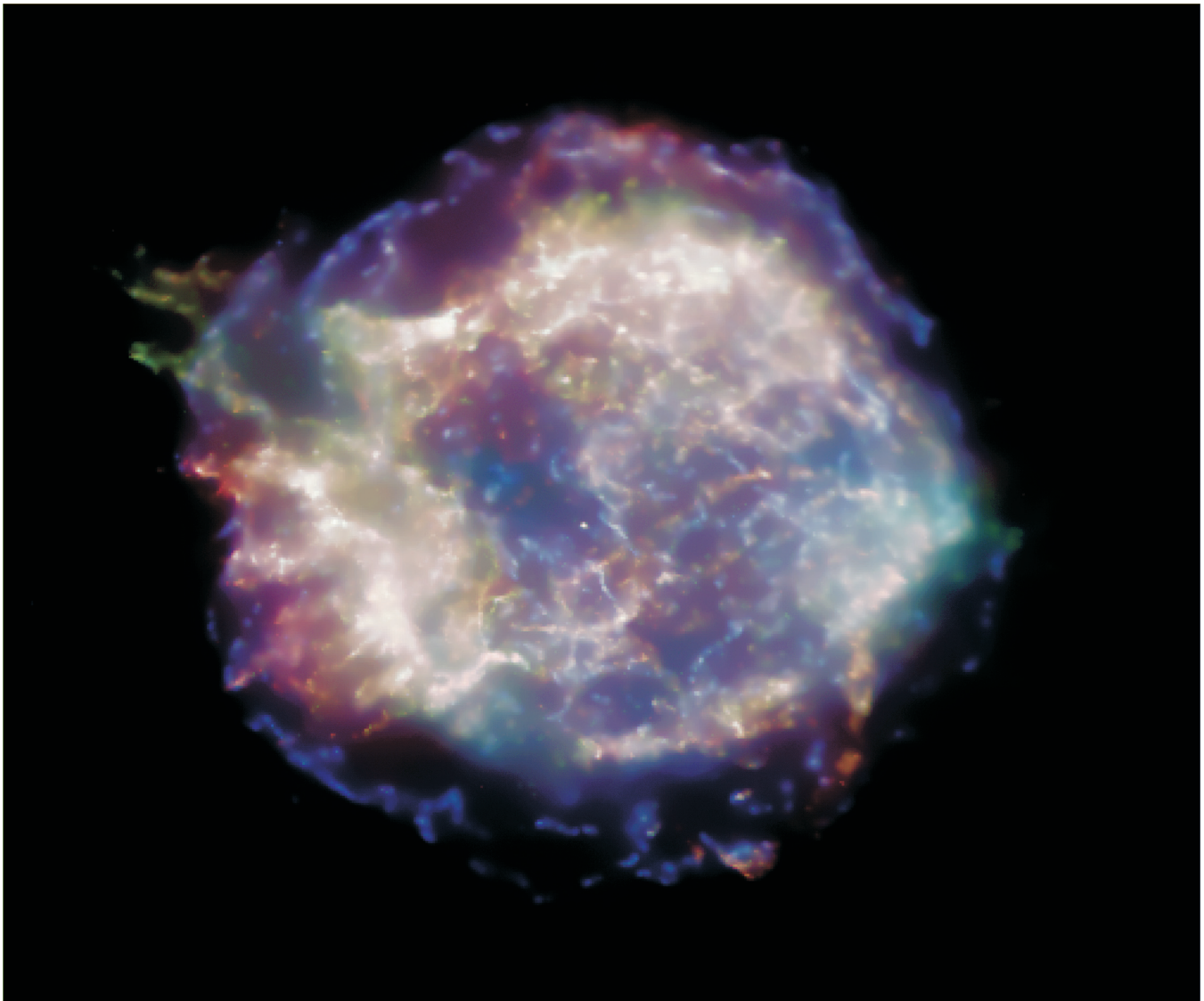

This image of the Cas A supernova remnant shows remarkable structure in the debris of a gigantic stellar explosion, as well as an enigmatic source in the center, which could be a rapidly spinning neutron star or black hole. The low, medium, and higher X-ray energies of the Chandra X-ray Observatory data are shown as red, green, and blue, respectively.

clearly involved, as may be seen from the observed abundances of the various elements. Supernova explosions, neutron-star mergers, or gamma ray bursters are possible locales for this process. Tremendous forces must fuse lighter elements into heavier ones. But our incomplete understanding of these events leaves the question open.

Measurement Methods: There are four methods to determine the origin of heavy elements: accelerator-based studies of rare isotopes, studies of high-energy-density plasmas, astrophysical observations of X-rays and gamma rays, and theory and simulations.

The creation of exotic nuclei with accelerators enables the study of nuclei at the limits of stability. Almost all the relevant r-process nuclei could be accessible

for study in a suitably designed two-stage acceleration facility that produces isotopes and re-accelerates them. Such an accelerator is being designed and would provide the capability for producing the beams of short-lived nuclei needed for an understanding of the synthesis of nuclei observed in the universe.

Laboratory studies of high-energy-density plasmas come into play in providing new knowledge concerning the complex plasma physics in supernovae, in providing input data for simulations, and for validating simulations. The dynamics of plasma hydrodynamic turbulence in particular is a substantial intellectual challenge. It has been demonstrated that experiments can be done in the laboratory that can simulate the strong-shock-driven turbulent hydrodynamics of a supernova explosion. It will also be possible to

<i>Project Name</i>	<i>Steward</i>	<i>Participating Agencies</i>	<i>Scientific Approach</i>	<i>Status</i>
HRIBF, LBNL 88-inch Cyclotron, ATLAS	DOE - Nuclear Physics	DOE - NNSA	Accelerator facilities to study interactions in nuclear matter	Ongoing Project
NSCL	NSF - Physics	DOE - Nuclear Physics, NNSA	Rare isotope research facility	Ongoing Project

replicate supernova remnant dynamics by scaled radiative shock dynamics experiments.

For the outputs, sensitive high energy X-ray and gamma ray space experiments will allow us to observe the decays of newly formed elements soon after supernova explosions and other major astrophysical events. Comparison of these observations with the outputs of simulations can constrain the theoretical models for explosions. Better measurements of abundances of certain heavy elements in cosmic rays may also provide useful constraints.

Simulating the processes involved in the initiation, evolution, and aftermath of supernovae is central to understanding the existence and distribution of elements in the cosmos. This includes computing the complex chain of nuclear reactions, the dynamics of the multistage explosion process that take place during a supernova, and the complex interstellar dynamics that govern the injection of supernova debris into interstellar space. Taken together, the interdependent set of approaches outlined above can provide an understanding of the processes by which the elements of the periodic table were generated and dispersed in the cosmos.

Current Projects: Low-energy nuclear physics facilities such as the Holifield Radioactive Ion Beam Facility (HRIBF) (<http://www.phy.ornl.gov/hribf/hribf.html>), the Lawrence Berkeley National Laboratory LBNL 88” Cyclotron (<http://www.lbl.gov/nsd/user88/index.html>) and the Argonne Tandem Linac Accelerator System (ATLAS) (<http://www.phy.anl.gov/atlas/index.html>) study interactions in nuclear matter like those that occur in neutron stars and those that create the nuclei of most atomic elements inside stars and supernovae and investigate new regions of nuclear structure.

The National Superconducting Cyclotron Laboratory (NSCL) is a rare isotope research facility at Michigan State University, conducting research in fundamental nuclear science, nuclear astrophysics, and accelerator physics. NSCL operates two coupled superconducting cyclotrons: the K500, the first cyclotron to use superconducting magnets, and the K1200, the highest energy continuous nuclear beam accelerator in the world. (<http://www.nscl.msu.edu/>)

In addition to these focused projects, some X-ray and gamma ray space observatories have sufficient sensitivity and spectroscopic capability to be capable of observing the spectral signatures of newly formed elements soon after supernova explosions and other nucleosynthesis events. These include the Chandra X-ray Observatory and the European Space Agency’s XMM-Newton and INTEGRAL observatories.

Question 11. Is a New Theory of Matter and Light Needed at the Highest Energies?

“Matter and radiation in the laboratory appear to be extraordinarily well described by the laws of quantum mechanics, electromagnetism and their unification as quantum electrodynamics. The universe presents us with places and objects, such as neutron stars and the sources of gamma ray bursts, where the energies are far more extreme than anything we can reproduce on Earth in order to test these basic theories.”

Scientific significance: As we have seen in many of the scientific questions discussed above, processes occurring in the cosmos provide a unique opportunity to study physical conditions that cannot be realized in laboratories on earth. Yet another example involves the theory of matter and light at extremely high electromagnetic fields.

Quantum electrodynamics (QED) is a highly successful, quantitative quantum theory of the electromagnetic interactions of photons and matter. It makes predictions that have been tested with great precision in regimes accessible to laboratory study. In particular, it has been tested in static magnetic fields as large as roughly 10^5 gauss (G), a hundred thousand times stronger than the earth’s magnetic field. However, ever since the discovery of pulsars, it has been known that fields as large as 10^{12} G, seven orders-of-magnitude larger, are commonly found on the surfaces of neutron stars.

More recently it has been concluded that a subset of neutron stars, called “magnetars,” have magnetic field strengths in the range 10^{14} to 10^{15} G, well above the QED “critical” field, where the kinetic energy of an electron spiraling in the magnetic field exceeds its rest mass energy. QED should still hold above this critical field, but the physics is quite different from what is normally considered. For example, when an X-ray propagates through vacuum endowed with a strong magnetic field, QED predicts that electron-positron pairs will be created in such a way that the emergent X-ray radiation will become polarized. It may therefore be possible to observe QED at work in magnetars by observing X-ray polarization and mapping out the neutron star magnetic field.

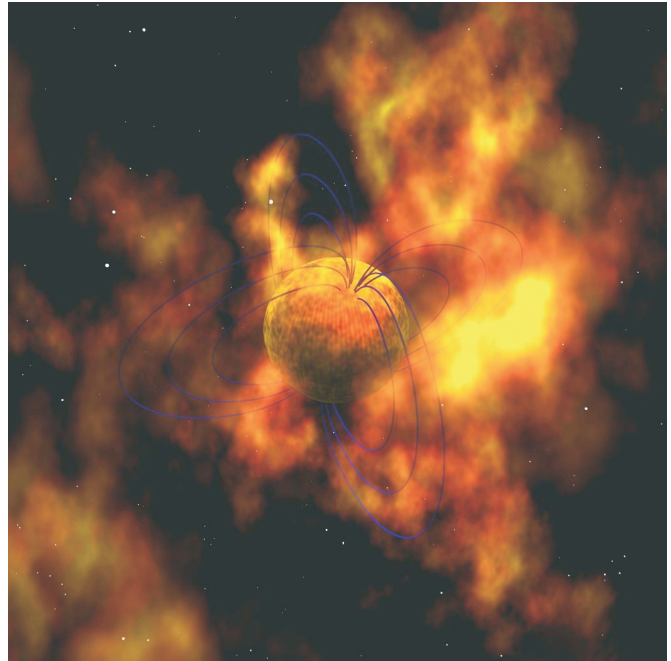

Concept image of what a magnetar might look like. The thin blue lines are renderings of the superstrong magnetic field lines of this kind of star.

Measurement Methods: To carry out such observations will require sensitive X-ray instruments capable of measuring polarization, which are being developed for X-ray synchrotron facilities and for space-based observatories.

Current Projects: None.

Appendix I. Agency Research Practices and Approaches

The three primary agencies supporting research at the intersection of physics and astronomy—DOE, NASA, and NSF—each have different cultures and characteristics that derive from their missions. These differences among the agencies in terms of organizational structures, program management, and planning processes impact the interactions among the agencies and the ease with which they will implement the various recommendations contained within this report.

Organizational Structures

Department of Energy, Office of Science: The Office of Science is the third largest business line within the Department of Energy, a cabinet-level agency. The Office of Science sponsors fundamental research into the nature of matter and energy as well as basic research that furthers the security, environmental clean-up, and energy technology missions of the Department of Energy. To carry out its basic research mission, the Office of Science designs, constructs, and operates an extensive suite of large scientific user facilities for the benefit of the nation's public and private research enterprise. These facilities include particle accelerators and colliders, X-ray synchrotron light sources, neutron sources, electron microscopes, genome sequencing facilities, atmospheric measurement facilities, and supercomputers. Large, long-term multidisciplinary research teams are the primary vehicle through which the Office of Science achieves its scientific objectives. The Office of Science's approach to conducting research is strongly influenced by the origins of DOE's precursor agencies, the Atomic Energy Commission and the Energy Research & Development Administration, which date to the Manhattan Project. DOE teams are most often centered at one of the Department's National Laboratories and almost always include university-based researchers. International collaborations on multi-year experiments are common.

Two of the Office's six major programs—High Energy Physics and Nuclear Physics—sponsor the majority of the DOE research within the scope of the Physics of the Universe program.

The mission of the High Energy Physics (HEP) program is to explore the fundamental nature of matter,

energy, space, and time. The core of the program centers on investigations of elementary particles and the interactions between them, thereby underpinning and advancing DOE missions and objectives through the development of key cutting-edge technologies and trained manpower. The major tools used are high energy particle accelerators.

The DOE HEP program provides about 90 percent of the federal support for high energy physics research in the United States, with NSF providing most of the rest. The program involves over 2,450 researchers at over 100 universities in 36 states, Washington, D.C., and Puerto Rico, as well as eight laboratories located in five states. The program supports two major accelerator user facilities in the United States: the Tevatron proton-antiproton collider at Fermilab in Illinois, and the B-factory electron-positron collider at SLAC in California.

The HEP program sponsors proposal-driven university research as an integral part of the HEP program. Reviews of the progress and plans of the individual university groups is obtained through community mail-in peer review, peer-review panels, and through site visits by program managers in the HEP program office. Specialized programs using competitive peer review include an Outstanding Junior Investigators Award for new tenure-track faculty members, the Advanced Detector Research Award, and the Linear Collider Detector Research and Development Award.

The DOE Nuclear Physics (NP) program aims to understand the composition, structure, and properties of atomic nuclei, the processes of nuclear astrophysics and the nature of the cosmos. Today, its reach extends from the quarks and gluons that form the substructure of the once-elementary protons and neutrons, to the most dramatic of cosmic events-supernovae.

The DOE NP program provides about 90 percent of the federal support for fundamental nuclear physics research in the nation. The program involves over 1,900 researchers and students at over 100 U.S. academic, Federal, and private sector institutions. The program funds research activities at over 85 academic institutions located in 35 states and at seven DOE Laboratories in six states.

In FY 2003, the DOE NP program supported five accelerator facilities at national user laboratories in the United States: RHIC, CEBAF, HRIBF, the 88-inch Cyclotron, and ATLAS. University researchers play a critical role in the nation's nuclear physics research effort and in the training of graduate students; the DOE NP program supports approximately two-thirds of the nation's university researchers and graduate students doing fundamental nuclear physics research. The grants program is proposal-driven and funds the best and brightest of those ideas submitted in response to grant solicitation notices. The program supports five university-based accelerator facilities, each providing unique capabilities and excellent hands-on training for the next generation of scientists.

The Office of Science's Fusion Energy Sciences (FES) program supports advances in plasma and fusion science to develop the knowledge base needed for an economically and environmentally attractive fusion energy source. FES pursues this goal through an integrated program of research based in U.S. universities, industry, and national laboratories, augmented by a broad program of international collaboration. As part of this effort, a growing effort in high-energy-density physics research is pursued. This is primarily as an outgrowth of research on Inertial Fusion Energy which relies on high energy beams or lasers as possible compressive drivers. FES has also provided the fundamental university training for the majority of the scientists engaged in plasma-based high energy density physics research.

Department of Energy, National Nuclear Security Administration: The NNSA's Inertial Confinement Fusion Ignition and High Yield program supports research at the intersection of physics and astronomy as a result of their primary interest in exploiting high-energy-density physics for nuclear weapons research. This program supports research using inertially-confined plasmas that contribute to the Physics of the Universe program in unique ways. Many of the measurements that may be made at these unique experimental facilities cannot be obtained in any other way and are crucial for the interpretation of observational data collected by DOE, NSF, and NASA. The NNSA recognizes the capability of its ICF facilities to address a number of interesting science questions outside of its mission, and therefore as a policy, NNSA provides a certain fraction, up to 15%, of the experimental time available on these facilities for users outside of the NNSA laboratories.

National Aeronautics and Space Administration:

The Office of Space Science (OSS) is the largest research enterprise within NASA, an independent Executive Branch agency. The OSS develops and mounts space missions to explore the universe and search for life. These space missions are the primary vehicle through which the Office of Space Science achieves its scientific and educational objectives. NASA organizes its space science activities around "science themes," where long-term science goals are used to drive a series of missions. The Structure and Evolution of the Universe (SEU) theme overlaps the goals of the *Connecting Quarks with the Cosmos* report. The Beyond Einstein Initiative, part of the President's FY2004 budget proposal, looks to address key questions relevant to this report, in particular: What powered the Big Bang? What happens at the edge of a Black Hole? What is Dark Energy?

NASA operates nine field centers and one federally-funded research and development center (Jet Propulsion Laboratory), which manage the implementation of most missions and support their operation. The Goddard Space Flight Center and Jet Propulsion Laboratory have responsibility to manage the implementation of OSS missions. The agency uses a structured and transparent project management process that employs full-time project managers, regular milestone reviews, and budgeting of contingency reserves. In addition NASA provides competitively selected grants to enable research based on the data generated by the missions and to develop the technology necessary to undertake future missions. The supporting research and technology development is carried out both in NASA centers and by investigators in universities and other laboratories.

Mission planning is comprehensive and encompasses technology development, conceptual design, instrument and spacecraft development, integration and test, launch, in-orbit mission operations, data collection and distribution, and research and data analysis. NASA supports a number of national data centers to archive and distribute the publicly accessible data generated by missions. The Explorer program provides a number of smaller missions that address the *Connecting Quarks with the Cosmos* science theme (e.g., WMAP). These are competitively selected small- and medium-sized scientist-led missions that are selected via an open competitive selection process. The largest missions are selected via the Agency's strategic planning process, using science priorities set by the National Academy

of Sciences decadal survey of Astronomy and Astrophysics. For these large facilities, instruments and science teams are selected via a competitive process.

National Science Foundation: The National Science Foundation is an independent Executive Branch agency that funds research and education in science and engineering. It does this through grants, contracts, and cooperative agreements to more than 2,000 colleges, universities, and other research and/or education institutions in all parts of the United States. The Foundation accounts for about 20 percent of federal support to academic institutions for basic research. It receives policy guidance from the National Science Board.

Each year, NSF receives approximately 40,000 new or renewal support proposals for research, graduate, and postdoctoral fellowships, and math/science/engineering education projects; it makes approximately 10,000 new awards. These typically go to universities, colleges, academic consortia, nonprofit institutions, and small businesses.

Management of NSF's research and education activities is divided among National Research Centers, major facilities in physics and astronomy, certain oceanographic vessels, and Antarctic research stations.

The management of the program is divided into seven directorates and several cross-cutting divisions and offices. The grants program at NSF is administered by individual discipline scientists and it funds the best ideas generated by the university-based research community, as judged by competitive peer review. Research grants are funded separately and independently from facility construction and operations. Project development and operations are conducted by outside entities—usually academic consortia or individual universities. The typical user who has been awarded observing time on a telescope through a competitive peer review process may also apply to NSF for a grant to carry out the research. The Foundation's approach to conducting research is strongly influenced by the ideas espoused by Vannevar Bush.

The Mathematical and Physical Sciences (MPS) Directorate is the largest directorate within the Foundation. Two of MPS's divisions—Astronomical Sciences and Physics—sponsor the majority of NSF

research within the scope of the Physics of the Universe program. The Astronomical Sciences Division in the Mathematical and Physical Sciences Directorate has primary federal responsibility for ground-based astronomy and astrophysics research, including optical/infrared, solar, and radio astronomy. NSF also supports ground-based planetary astronomy. The Physics Division is also a significant source of support for astrophysics research, including particle and nuclear astrophysics, gravitational physics, and theory. It is important to note that significant sources of research support for astronomy and astrophysics research are spread broadly across NSF. The Office of Polar Programs supports several astrophysical experiments in Antarctica. Solar research at NSF is supported by both the Astronomical Sciences Division and the Division of Atmospheric Sciences in the Geosciences Directorate.

Program Management

Department of Energy: Within the Department of Energy, well-specified program and project management strategies are implemented for the acquisition of capital assets. Extensive independent reviews of the Technical, Cost, Schedule, and Management aspects of a project are held at each phase of the construction. In addition, there are reviews at several key points by an external independent review team. The planning and construction process of projects normally has four phases. Pre-conceptual phase activities take place before a project is formally defined and include identifying ideas, making preliminary evaluations of their feasibility, and documenting the need for the project. Costs in the pre-conceptual phase do not accrue to the total project cost. In the conceptual phase, technical and project requirements are defined and estimated resources are identified; conceptual design may not commence until a successful Mission Need Independent Project Review.

In the conceptual phase of the project, a conceptual design report and the project execution plan are prepared, both of which are critical in setting the preliminary scope, cost, and schedule baselines. Costs for the conceptual phase of the project are included in the total project cost. The execution phase begins after a successful review of the conceptual design and includes design and construction of the project and the transition to start-up and acceptance. Baseline scope, costs, and schedules are firmly established in a review process after a preliminary engineering phase and prior

to the construction start. A closeout decision may be made at any time during the life of a project.

Generally by the time of the closeout phase, the project has been completed and turned over for operations. Closeout can also be the termination of an incomplete project or the retirement of a facility at the end of its life cycle. The progress in a project is tracked through monthly reports, quarterly reviews, and annual independent reviews. During the operations phase of an experiment, the progress and plans are reviewed by the appropriate advisory panels as well as through the yearly laboratory reviews.

National Aeronautics and Space Administration:

Within NASA, missions or projects are significant activities that have defined goals, objectives, requirements, life-cycle costs, a beginning, and an end. A NASA mission includes Formulation, Approval, Implementation, and Evaluation, and is divided into phases. Formulation consists of the concept study (Phase A) and the definition/preliminary design (Phase B). Approval is the process for transitioning from formulation into implementation, which can include a non-advocate review, a confirmation review with the appropriate Enterprise Associate Administrator, and the approval of a program commitment agreement (PCA) by the Agency Program Management Council and the Administrator. Implementation consists of detailed design and development (Phase C), integration, test, and launch operations extending through in-orbit checkout (Phase D), and mission operations and data analysis including analysis, publication, and public release of data (Phase E). The Evaluation process is not a separate phase but is the ongoing independent review and assessment of the project's status during both Formulation and Implementation.

The PCA sets the requirements for the mission as well as the cost and schedule commitments. Costs considered are life-cycle costs through prime mission. To the maximum extent practical, competitive solicitations are used to select participants in a mission including the science team and the industry team. A mission may be terminated at any time for failure to meet the commitments in the PCA. Following the completion of the prime mission, and resources permitting, an extended mission may be approved through the Senior Review, a competitive peer review.

National Science Foundation: Planning and construction of major facilities by NSF are governed by the Foundation-wide "Facilities Management and Oversight Guide." The Major Research Equipment and Facilities Construction (MREFC) account is an agency-wide capital asset account. It provides funding for the establishment of major science and engineering infrastructure, with costs ranging from several tens to hundreds of millions of dollars. LIGO and its proposed upgrade, as well as the proposed LSST and underground laboratory activities, are subject to this process.

To be eligible for consideration for MREFC funding, projects must: represent an exceptional opportunity that enables research and education essential to the nation's science and engineering enterprise, with a broad base of support in the relevant community or communities; ensure that the awardee provides a strong project management structure that is appropriate to the size and complexity of the project, including clear lines of communication and authority; and have undergone a thorough external review, including high-level assessment of scientific and engineering research merit, broader impacts (e.g., integrating research and education), technical and engineering feasibility, opportunities for interagency and/or international collaboration and cost sharing, and relevant management issues and accuracy of cost, schedule, and contingency estimates, including projected operating costs.

Planning proceeds through a defined, staged process that provides early visibility of projects to NSF management and to the National Science Board while the project matures from concepts developed within the scientific community to a funded activity. Appropriate management structures, oversight mechanisms, and lifecycle costing are instituted early in the planning and become part of the overall decision package presented to the National Science Board.

Projects at a smaller scale and elements of R&D preparatory to construction phases for large facilities may be handled directly through the programs of the divisions and offices for which they are most appropriate. Examples of such activities described above include preliminary work relevant to the proposed LSST, the Pierre Auger observatory, and VERITAS.

Program Planning: Federal Advisory Committee Act (FACA) Committees

Department of Energy: To ensure that resources are allocated to the most scientifically promising research, the Department of Energy and its national user facilities actively seek external input using a variety of advisory bodies and directly obtain advice through the federally chartered Nuclear Sciences Advisory Committee (NSAC), the High Energy Physics Advisory Panel (HEPAP) and Federal Advisory Committee Act (FACA) committees associated with other Offices.

NSAC provides advice to the Department of Energy and the National Science Foundation on a continuing basis regarding the direction and management of the national basic nuclear sciences research program. NSAC regularly conducts reviews of university and national laboratory facilities to assess their scientific productivity, major components of the Office's research program, and evaluates the scientific case for new facilities.

One of the most important functions of NSAC is development of long-range plans that express community-wide priorities for the upcoming decade of nuclear physics research. NSAC, on a rotating schedule, reviews the major elements of the nuclear physics program. These reviews examine scientific progress in each program element against the previous long-range plan, assess the scientific opportunities, and recommend reordering of priorities based upon existing budget profiles. Facility directors seek advice from Program Advisory Committees (PACs) to determine the allocation of scarce scientific resources, the available beam time, and to evaluate and plan their programs.

The High Energy Physics program is guided by the federally chartered High Energy Physics Advisory Panel (HEPAP), which reports both to the DOE and NSF. This panel, made up of leading members of the community, gathers information from the scientific community and provides advice on the direction and management of the field. The HEPAP panel meets at least three times per year and reviews scientific progress, assesses opportunities and the case for new facilities and projects, taking into account funding projections and program priorities. An important function of HEPAP is the development of long-range plans that reflect the community-wide priorities and future planning, through specially chartered subpanels.

Recommendations on including a project in the HEP program are made to HEPAP by the advisory panels described below, taking into account scientific merit, impact on the program, funding availability and program priorities. The Particle Physics Project Prioritization Panel (P5) is a subpanel that meets as needed to provide advice on prioritizing particular projects. The laboratory director's assess their own current programs and recommend plans for the future via Program Advisory Committees (PAC), which include in-house and independent members. The Scientific Assessment Group for Experimental Non-Accelerator Physics (SAGENAP) panel, made up of expert members of the community, usually meets yearly to provide advice on the scientific merit of proposed projects not using the major accelerator facilities. Additional information regarding program planning and scientific opportunities is provided by specially chartered panels, such as the National Research Council's Committee on Physics of the Universe which produced the *Connecting Quarks with the Cosmos* report. The newly established FACA committee, the Astronomy and Astrophysics Advisory Committee (AAAC), designed to provide advice to NSF and NASA, will also provide guidance to DOE on areas where the programs overlap.

A Committee of Visitors to review the management practices of the Nuclear Physics program and the High Energy Physics program will be appointed under the guidance of NSAC and HEPAP. In particular, they will look at the decision process for awarding grants and supporting laboratory research groups, facility operations, and construction projects.

National Aeronautics and Space Administration: The NASA Office of Space Science maintains the federally chartered Space Science Advisory Committee under the auspices of the NASA Advisory Council; the chair of the Space Science Advisory Committee is a member of the NASA Advisory Council. The Space Science Advisory Committee gathers input from the external scientific community on mission priorities, strategic planning, and ongoing activities. It has subcommittees corresponding to the space science theme areas defined by the NASA strategic plan. Researchers selected broadly from the scientific community constitute the membership of the various subcommittees.

The Structure and Evolution of the Universe Subcommittee advises NASA on science areas relevant

to the physics of the universe, including cosmology, Dark Energy, gravity, and the use of the universe as a laboratory for fundamental physics.

The Office of Space Science strategic planning process is based on roadmaps for each of the space science theme areas, and it feeds into NASA's agency-wide planning process. The Space Science Advisory Committee oversees the creation of the Space Science Strategy, takes into account the National Research Council's decadal reviews of astronomy and astrophysics and other reports, and seeks NRC review of its strategy. The Structure and Evolution of the Universe Subcommittee oversees the development of the Structure and Evolution of the Universe Roadmap through a roadmap working group. The roadmap working group provided advice for activities and priorities within the Beyond Einstein Initiative. These priorities are incorporated in both the Space Science Strategy and the NASA Strategic Plan.

National Science Foundation: Planning processes at the National Science Foundation receive significant attention by the National Science Board and the FACA advisory committees for Mathematical and Physical Sciences and the Office of Polar Programs. The newly chartered Astronomy and Astrophysics Advisory Committee provides advice in this specific area to both NSF and NASA, with emphasis on areas of overlap and complementarity. An expansion of the membership of this committee has added an interface to DOE-sponsored research in astronomy and astrophysics, which will be a material aid to the program discussed here. All these advisory groups are guided by the National Research Council's decadal reviews of astronomy and astrophysics, a community-based planning process that has been in place for four decades. The NRC study *Connecting Quarks with the Cosmos* has provided specific input to planning in this area. In addition, the Division of Physics draws relevant input and advice through its participation with the High Energy Physics Advisory Panel (HEPAP) and the Nuclear Science Advisory Committee (NSAC), both co-sponsored with DOE.

Appendix II. Technical Glossary

Accelerating Expansion: the surprising fact that the expansion of the universe is accelerating, not decelerating. This can be seen in the study of distant supernovae, whose light appears dimmer than expected because the region of the explosion and our region of space are moving apart faster than expected.

Accretion: accumulation of dust and gas on larger bodies such as stars and planets. The combined effects of gravity and rotation often force the accreting material into an orbiting *accretion disk*.

Antiparticle: an elementary particle that has mass and some other properties identical to a given particle but has still other properties, such as charge, reversed. For example, the positron with positive charge is the antiparticle of the electron, which has negative charge but is otherwise the same. When an antiparticle and a particle meet they annihilate each other, producing lighter particles and the release of energy.

Axion: a Dark Matter candidate. This particle is postulated to explain why *charge parity* (CP) invariance holds in the strong interactions but not the weak. It would be a very light particle with a rest energy of only a fraction of an *electron volt*. Axions might have been created in large numbers, at rest, in the early universe.

Baryon: a strongly interacting particle made of three quarks. The proton for example is made of two up quarks and one down quark. (See *quark*.)

Big Bang: a theory of cosmology in which the expansion of the universe is presumed to have begun with a primeval explosion. It is supported by observed expansion of the universe, observed cosmic background radiation (see *CMB*), and agreement with observations of the calculation of the primordial abundances of light elements produced (See *Energy generation*).

Black Hole: a region of space where the gravitational pull is so strong that, classically, no light can escape. A Black Hole can form when a massive star undergoes gravitational collapse.

Boson: a particle whose intrinsic angular momentum is measured in integer units (see Spin). Examples are

the photon and the gluon. Particles associated with all fundamental interactions (forces) are bosons.

Charge Parity (CP) Invariance: used to explain the excess of matter over antimatter. This refers to a property of reaction rates being the same if each particle is changed to its antiparticle and the process is reflected in a mirror. This is known not to hold for some weak interactions. And it is required not to hold for some interactions in order to explain why all matter and antimatter, created in equal amounts, didn't annihilate after the Big Bang.

Cherenkov Radiation Detector: a detector to measure the speed, energy and direction of a particle. Light travels more slowly in material such as water than in a vacuum. A high energy particle passing through such a medium, with a speed greater than the speed of light in that medium, will radiate. The radiation forms a cone expanding outward similar to the shock pattern of a supersonic airplane. Observing it permits determining the direction of the particle and its energy.

Color: a property of quarks and gluons analogous to electric charge. Just as a particle with positive electric charge can join with a particle with negative charge to form an electrically neutral pair, a color neutral particle can be made of a quark-antiquark pair. It is not related to usual use of the word "color". Quarks come in three colors; gluons in eight shades. Color is "confined," that is colored particles are never observed directly.

Cosmic microwave background (CMB) radiation: residual light from the Big Bang that we see today. The wavelength is now expanded (or cooled or lowered in energy) to the microwave range. If the universe once was very hot, then electrons could not bind to protons to form a neutral hydrogen atom, the main constituent of the universe. This dissociation must have produced radiation. When the expanding universe became cool enough, the electrons must have found the protons and made neutral atomic hydrogen, at which point the radiation could travel without further interaction. "Cool enough" must have occurred about 380,000 years into the expansion. The wavelength of this light is now in the *microwave* region. This microwave background was detected in the 1960s. It is phenomenally regular. It looks the same, to about one

part in a hundred thousand, from all directions. This regularity is a major mystery whose explanation may be *inflation*. Although the CMB is nearly uniform, there are tiny fluctuations in its temperature due to variations in the density of the early universe. These tiny fluctuations grew to form galaxies.

Cosmic rays: protons, nuclei of heavy atoms, and possibly other particles that have been accelerated to high energies by astrophysical processes in the universe and impinge upon Earth.

Cosmological constant (Λ): a possible term in Einstein's equations of General Relativity. It can be interpreted as the energy density associated with the *vacuum* (empty space).

Cosmological Principle: the assumption that, if considered in large enough units, the universe is the same everywhere (homogeneous) and in all directions (isotropic).

Cosmology: the astrophysical study of the history, structure, and dynamics of the universe.

Dark Energy: a net energy associated with the vacuum (empty space) suggested by recent astronomical observations of type Ia supernovae. A large enough positive vacuum *potential energy* leads to a gravitational repulsion, making the expansion of the universe accelerate, whereas particles, even massless ones, possess gravitational attraction making it decelerate. A positive potential energy could be a constant in time or could be due to a varying *quintessence* field originating from high energy physics.

Dark Matter: form of matter that does not emit enough light or other electromagnetic radiation for it to be directly observable. We see many clusters of galaxies that appear to be gravitationally bound, but, if we count up the mass in their stars, the cluster doesn't have enough ordinary matter to be gravitationally bound. We also see a few stars orbiting around the bright parts of galaxies, but going faster than the visible matter of the galaxy would imply. Additionally, gravitational lensing (see *gravitational lensing*) indicates more mass than is visible in many clusters. Finally, we know, from the amount of deuterium (heavy hydrogen) left over from primordial helium production (see *energy generation*) that this matter cannot be made of protons and neutrons. These astronomy discoveries have sparked major laboratory and theory efforts to discover

new elementary particles that could constitute the Dark Matter and to determine how the *Standard Model of Particle Physics* must be modified to fit them in. About 25% of the total matter-energy budget in the universe is believed to be of this type. Hot Dark Matter (particles moving at near light speed) is not considered tenable; warm Dark Matter (particles recently slowed by the expansion of the universe) is also considered unlikely.

Doppler Effect: phenomenon in which an observer receives sound and light from bodies moving away with lower frequency and longer wavelength than emitted (see *redshift*) and from bodies moving toward the observer with higher frequency and shorter wavelength. The shift (fractional change) in frequency, or the Doppler effect, increases as the speed of the body increases.

Double beta decay: a nuclear decay process in which two electrons are emitted. It is "doubly weak" and devilishly difficult to observe, but could be rich in information

Dust: micron and submicron-sized solid particles (dust grains) which account for roughly 1% of the mass of the space between stars and which obscure visible light. "Grey dust" would have a distribution in particles size such as to affect all wavelengths of light equally.

Electromagnetic radiation: radiation consisting of electric and magnetic fields vibrating with a characteristic wavelength or frequency. Long wavelengths (low frequencies) correspond to radio radiation; intermediate wavelengths, to millimeter and infrared radiation; short wavelengths (high frequencies), to visible and ultraviolet light; and extremely short wavelengths, to X rays and gamma rays. Most astronomical observations measure some form of electromagnetic radiation.

Electron Volt (eV): measure of the energy of an elementary particle. The 120 volts provided by a U.S. wall plug would permit accelerating an electron to 120 eV of (kinetic) energy. Today's electron accelerators permit accelerating electrons to hundreds of MeV (a million electron volts). Protons can be accelerated to a trillion eV (TeV). Xrays are in the kilo eV range (keV).

Energy Generation: processes by which light from the sun, supernovae, and formation of the light elements in the early universe occur. In nuclear fusion light nuclei, at high temperatures and pressures, combine

to form heavier and more tightly bound nuclei. Stars, for most of their lives, change hydrogen to helium, thereby releasing energy in the form of visible light and neutrinos. When it runs out of hydrogen, a single, not too massive star will become a slowly cooling *white dwarf*. But about half the stars are in pairs, or binary systems. A binary white dwarf will get additional hydrogen from its neighbor and make more helium. When it has made just enough, it burns helium to heavier elements explosively making a bright supernova of type Ia. Assuming that “just enough” is the same for nearby Ia supernovae as it is for far away ones, these provide the *standard candles* (supernovae of known intrinsic brightness) that showed the expansion of the universe is accelerating. Stars of masses many times that of the Sun suffer a different fate. For them, the core runs out of hydrogen before the outside does and starts to shrink under its own weight. This increases the density in the core sufficiently that neutrinos are produced copiously and help blow off a lot of the outer parts (type II supernova). The remaining matter then continues collapsing. For a sufficiently massive star, there is no known mechanism to stop the collapse and a Black Hole results. In the early universe, at about one second into the Big Bang, there were about six times as many protons as neutrons, with the neutrons slowly decaying (see *quantum field theory*). At about three minutes, the temperature cooled to the point that neutron plus proton can make heavy hydrogen (deuterium) that isn't knocked apart before it is burned to helium. We get the right answer for the observed ratio of helium to hydrogen and a permissible range for the ratio of protons to cosmic background photons from primordial deuterium measurements.

Equivalence principle: a fundamental principle of General Relativity, one of whose consequences is that all objects (and light) fall in a gravitational field in the same way independent of their internal structure or other properties.

Event Horizon: the surface surrounding a Black Hole. It is like the “roach motel,” allowing matter or signals to flow in but not out.

Expanding Universe: a natural solution of the equations of Einstein's theory of *General Relativity*. Only in the 20th century did we learn that stars are collected together into large collections, called galaxies, and that the galaxies are all moving away from us—with the ones further away moving faster. It is the *redshift*

(see also *special relativity*) that makes it clear that the further away the galaxy, the faster it is receding. If you had a movie of the expansion of the universe and ran the movie backward, you would see the universe getting denser and denser (and hotter and hotter because the wavelength of photons would be getting shorter implying higher frequency which, in turn means more energy). Running it forward is the *Big Bang*. If the universe expanded from a much hotter and denser state, there should be some observable “relics.” There are: the *cosmic microwave background*, the ratio of primordial helium to hydrogen (see *energy generation*) and possibly, *inflation*.

Family: a grouping of *fermion* particles. When grouped by their properties fermions (leptons and quarks) naturally fall into pairs of doublets know as families or generations. At present three families are known. All ordinary matter is made up of the leptons and quarks in the first family. i.e., the electron, electron neutrino, up quark, and down quark.

Fermion: particles that have intrinsic angular momentum (see *Spin*) measured in half integer ($1/2$, $3/2$, ...) units. As a consequence of this peculiar angular momentum, fermions obey a rule called the *Pauli Exclusion Principle*, which states that no two fermions can exist in the same state at the same time and place. This rule affects the properties of ordinary matter. Quarks, electrons, neutrinos, protons, and neutrons are fermions.

Field: mathematical specification of some property at every point in some space. Example 1: Earth surface temperature field—temperature at every point on the surface of the Earth. Example 2: Electric field at every point in spacetime. Example 3: Electron field at every point in spacetime. The *quantum* of the electric (electromagnetic) field is the photon; the quantum of the electron field is the electron. See *quantum field theory*.

Gamma rays: the most energetic form of electromagnetic radiation, with wavelength much shorter than X rays. *Gamma ray bursts* are transient intense bursts of gamma radiation lasting only a few seconds.

General Relativity: the theory of gravitation developed by Albert Einstein in which gravity is the result of curved geometry of space and time. General Relativity treats observers with relative accelerations, notes that you can't tell the difference between being accelerated

(say, up) and gravity pulling you (down), and it relates the very geometry of space to the distribution of mass and energy in it. Mass and energy make space curved, giving rise to such important effects as the bending of light passing near massive objects—which permits *gravitational lensing*,” tomography by distant light sources of galaxy clusters between us and the source—as well as Black Holes, regions of such high mass density that not even light can escape.

Gluon: a massless particle that carries the strong force. Quarks interact via exchange of gluons. (Also see *color*.)

Grand Unification: see *Unification*.

Gravitational lensing: a consequence of Einstein’s theory of *General Relativity* is that the path of light rays can be bent by the presence of matter. Astronomers have observed that the light from a distant galaxy or quasar can be “lensed” by the matter in, say, an intervening galaxy to form multiple and often distorted images of the background object.

Graviton: the as yet undetected massless *quantum* particle that carries the gravitational force.

Hadron: Particle with strong interactions: see Standard Model. Hadrons are either mesons (*bosons*) or baryons (*fermions*).

Inflation: a period of accelerated expansion in the first very small fraction of a second of the *Big Bang*. This is postulated, inter alia, to explain why the cosmic microwave background radiation (see *CMB*) from different directions is so similar. Einstein’s equations of *General Relativity* tell us how fast the universe expands given the energy per unit volume. If that energy were always due to matter or radiation, the origin of the microwave background radiation coming from one direction would never be within the light travel distance of that coming from a direction off by a few degrees. How could the distribution of radiation by wavelength be the same to within one part in a hundred thousand? The leading contender for the explanation is that there was a period in the very early universe when the *potential energy* of some slowly varying *field* dominated the energy content, and expansion accelerated exponentially so that the entire visible universe is descended from a single, *really* small region. If this picture is correct, slight *quantum fluctuations* in the inflation field grew into today’s galaxies.

Interferometer: an instrument in which the electromagnetic radiation from a celestial object along two different paths is collected and then brought together to form an interference pattern of alternating bright and dark bands.

Ionization: the process of an atom losing one or more electrons.

Isotope: forms of an element in which the nuclei have the same number of protons but different numbers of neutrons.

Kinetic Energy: energy of motion of a particle; energy associated with time and space variations of a field.

Leptons: fundamental particles of matter, such as electrons and neutrinos. Quarks (with strong interactions) and leptons (without them) are the two building blocks of familiar matter. There are three *families*, each with a pair of quarks and a pair of leptons, in the *Standard Model*.

Light: see Electromagnetic radiation.

Light Curve: the light intensity from an object as a function of time. This is a big piece of the available information in understanding what is happening in the object.

Light year: distance light travels in a year (about 10 trillion kilometers or 6 trillion miles).

Meson: unstable, integer-spin particle made of a quark-antiquark pair. Mesons do not exist in ordinary matter. They have been seen in the laboratory and *cosmic rays*. An example is the pion.

Microwave: see Electromagnetic Radiation.

Neutrino: a very light particle emitted in the process of radioactive decay. It is a lepton. A sterile neutrino would be one that is not paired up with one of the three charged leptons in the standard model. In a neutrino oscillation, a neutrino of one type (electron, muon, tau) changes into a neutrino of another type. A Majorana neutrino would be one that is its own *antiparticle*.

Neutron star: a supernova remnant of low enough mass not to collapse to a Black Hole but of sufficiently high density and pressure that its atoms have been crushed until the nuclei merged and most of the electrons squeezed onto the protons. This releases neutrinos and forms a neutron-rich material. This imploded

core contains about the mass of the Sun in less than a trillionth of the Sun's volume.

Photon: a quantum of electromagnetic energy; the massless particle that carries the electromagnetic force.

Pauli Exclusion Principle: see *fermion*.

Polarization: the nonrandom distribution of electric field direction among the photons in a beam of electromagnetic radiation. The electric field of a photon beam is always perpendicular to the beam direction. If it is some percentage along some particular perpendicular direction it is said to be that percentage "linearly polarized" along that direction.

Potential Energy: energy stored in the position of a particle (e.g., near another particle of the same charge) or, for a *field*, stored in the interaction of that field with itself or other fields.

Pulsar: a spinning *neutron star* that emits radiation in a beam. The sweeping action of the beams causes the object to pulse regularly when viewed by an observer, just as with a lighthouse.

Quantum: a discrete unit used to describe particles on the atomic or smaller scale. For example light energy (light waves) exists in discrete quantum units called photons.

Quantum Field Theory: a theory that allows reliable calculations of weak and electromagnetic interactions. Each particle is associated with a mathematical *field*. The math permits calculating rates for processes. When you shake a charged particle, a photon, the quantum of light, is emitted. The nucleus of an atom, made of protons and neutrons, is held together by a "strong force." When you shake a neutron or a proton, a pion is emitted. In addition to the strong and electromagnetic forces, there is a weak force that is responsible for decay of unstable particles, including the neutron, which if taken from a nucleus, decays in about 10 minutes into a proton, an electron, and a neutral *neutrino*. We know the force is weak because 10 minutes is so long on an atomic time scale. If you shake a weakly-interacting particle, you get W and/or Z bosons emitted. We thus have three forces, strong, weak, and electromagnetic. The strong interactions are more complicated. Indeed, protons, neutrons, pi mesons, and other strongly interacting particles turn out to be made of more elementary particles called quarks, held together by forces whose quanta are called gluons

in a way too complicated for us to have yet devised a satisfactory calculus. Gravity is in even worse shape. Quantum gravity is complicated by gravity itself being a source for gravitons and is plagued by calculational infinities—currently.

Quantum Fluctuation: a spontaneous fluctuation of energy in a volume of space. It is a consequence of the *uncertainty principle* which allows the brief formation of *virtual* particle pairs (one of matter and one of antimatter). In the very earliest fractions of a second of the *Big Bang*, fluctuations in space occurred and after the likely period of rapid expansion (see *inflation*), remained as irregularities in space. From these seeds eventually grew the structures in the universe such as galaxies.

Quantum mechanics: a mathematical framework for describing physics at atomic and smaller length scales, where energy exists in discrete "quantum" units. A planet, with the right speed, can orbit a star at any distance from the star; a continuum of energies is possible. However electrons, in an atom, can only be in discrete energy states. Among the many effects that follow from this quantization is *spectroscopy*. After an atom is excited to a higher energy state, it will return to a lower one by emitting a photon, light, of a specific wavelength (specific energy difference implies specific light frequency which implies specific light wavelength). The wavelength depends on the element to which the atom belongs. This effect allows chemical analysis of stars and galaxies far, far away.

Quark: a fundamental constituent of ordinary matter. Protons and neutrons are made of three quarks bound very tightly by the strong force carried by gluons. There are six "flavors" or kinds of quarks called up, down, charm, strange, top and bottom. They are distinguished by properties such as charge and mass.

Quark-Gluon Plasma: matter at sufficiently high temperature and density that atoms are dissociated into electrons and nuclei; nuclei are dissociated into protons and neutrons; and protons and neutrons are dissociated into quarks and gluons. This was the case before about a ten thousandth of a second into the Big Bang.

Quintessence: name given to field models proposed as possible explanations for the accelerating expansion of the universe. A small, but non-zero, uniform quintessence field permeating all space and only decreasing in time extremely slowly could produce an effective, time-dependent cosmic energy density

accompanied by a sufficiently negative pressure to cause the observed acceleration of the expansion of the universe.

Redshift: (1) the Doppler redshift is a shift toward longer wavelengths of spectral lines in the radiation emitted by an object caused by relative motion of the emitting object away from the observer: (2) the gravitational redshift is a shift to longer wavelengths of spectral lines emitted by a body in a gravitational field when viewed by an observer in a weaker gravitational field.

Rest Energy: energy stored in the mass of a particle at rest. If the particle decays, the energies of the decay products must add up to the rest energy of the decaying particle.

Spectroscopy: the technique whereby light is broken up into its constituent colors by a prism or other device. Different chemical elements can be distinguished by the different color lines, or spectral lines, they emit when their atoms are excited. See *quantum mechanics*.

Special Relativity: Einstein's theory of spacetime structure to account for the fact that the speed of light is a universal constant and does not depend on the relative motion between the observer and the light source. The principle of special relativity is that two different observers, moving with constant relative velocity find the same speed for a light signal. This implies that their clocks and length measurements will disagree in just such a way as to ensure agreement on the speed of light. An important effect for astronomy is that light from a source moving away from you appears more red, i.e., appears shifted to longer wavelength.

Spin: intrinsic angular momentum of quantum particles. All particles are grouped into those that have spin given in half integer units (*fermions*) or in whole integer units (*bosons*).

Standard candle: any luminous celestial object of a type which is more or less constant (from object to object) in absolute magnitude (intrinsic brightness). It can be used to gauge distances, because the further away it is, the fainter it will appear.

Standard Model of Cosmology: the current understanding that the universe is expanding and has been ever since a state of very high density and temperature. See *Big Bang*.

Standard Model of Particle Physics: the model of fundamental particles and interactions presenting all the observed particles and their processes through the strong, weak, and electromagnetic interactions of quarks and leptons. It explains the forces that hold atoms and nuclei together or lead to their decay. More than three decades of theoretical and experimental effort went into establishing it. The Standard Model has three *families* (and three *colors*). The first family consists of the “up quark,” the “down quark,” the electron, and the electron neutrino. Up and down have strong, weak, and electromagnetic interactions (mediated by gluons, the photon, and the W and Z, respectively); the electron has weak and electromagnetic, and the neutrino has just the weak. The electron and neutrino are termed *leptons*. There are two additional families of more massive quarks and leptons. The quarks of each family come in three *colors*. The gluons come in eight shades and bind the quarks into observable particles that are “color neutral” (just as you can make white light out of the primary colors). This binding (color confinement) means the strong gluon force must be quite strong indeed, explaining why we are having so much trouble computing strong interactions of observable particles. There is a kind of mixing of the three families of quarks. We are also just in the process of discovering “mixing” of the three families of neutrinos and small, but non-zero, neutrino masses. This mixing explains a problem we have had since the mid 60s—not seeing enough neutrinos coming from the Sun, which gets its energy from changing four protons into a helium nucleus, neutrinos, and photons. We have some ideas about *unification* of the three forces at high energies, but can't yet fit gravity into the schemes.

String theory: a highly mathematical and not easily tested theory that appears to resolve the incompatibility between General Relativity and quantum mechanics and to unify them.

Sunyaev-Zeldovich Effect: a method of using a hot cloud of ionized hydrogen gas as a standard candle. Scattering of the CMB photons off the energetic electrons in the cloud distorts the CMB coming from the direction of the cloud. Collisions of the energetic electrons make X rays. Combining observations of both permits deducing the size, intrinsic X-ray brightness and distance of the cloud.

Supernova: catastrophic stellar explosion in which so much energy is released that the supernova alone can

outshine for weeks an entire galaxy of billions of stars. The mechanism of explosion depends on which of two types of supernova it is. A type II supernova explosion signals the death of a massive star that has run out of nuclear fuel. The core collapses, and either a neutron star remains or a Black Hole is produced. A type Ia supernova is an explosion of a smaller star that is being fed fuel from a companion star. Type Ia supernovae are important standard candles because they explode at about the same mass with about the same brightness.

Supersymmetry (SUSY): a space-time symmetry that would imply the existence of partners to all elementary particles, with quantum spins of one-half a unit higher or lower.

Ultra High Energy Cosmic Rays (UHECRs): particles coming from outside our galaxy with energies more than a million times those that our highest-energy accelerators can produce. These are telling us something about astrophysical processes, but we don't yet know what. Cosmic rays, mostly protons, impinge on the earth from all directions. There are fewer at higher energies, but, at high enough energies, they must lose energy by interacting with the cosmic microwave background—unless they are produced relatively close to us (not too many galaxies away). We are seeing too many ultra high energy ones that shouldn't get here, 50 or so over several decades with current and past detectors. The new Pierre Auger detector will start seeing perhaps 1,000 per year in a few years, permitting detailed study of such properties as distribution in energy and direction.

Uncertainty Principle: principle that is not possible to know with unlimited precision both the position and momentum of a particle.

Unification: idea that the strong, weak, electromagnetic, and gravitational interactions are different aspects of a single universal interaction, which would be seen at extremely high energies. An example of this kind of approach is the unification of electricity and magnetism by Maxwell in 1865 into one theory of electromagnetism. In the late 1960s, electromagnetism and the weak interactions were successfully unified and in the 1970s, *Grand Unification* theory extended the idea to the strong interactions.

Vacuum: space empty of particles and radiation. A perfect vacuum would contain no atoms or molecules. There is no reason why a perfect vacuum should have zero energy; recent observations can be explained by a

very small: (1) constant vacuum energy or (2) *potential energy* of a *quintessence* field.

Virtual: name given to an elementary particle that exists only for an extremely brief instant as an intermediary in a process. The particle is “exchanged” in an interaction but cannot be directly observed because its energy is less than its *rest energy*. Such particles are thought to pop in and out of existence for a brief moment, but are not freely propagating and cannot be observed.

Weak force: one of the four fundamental forces, which also include strong force, electromagnetism, and gravity. The weak force causes radioactive decay.

White dwarf: a very small star in an advanced state of stellar evolution. A white dwarf is created when the star finally exhausts its possible sources of fuel for thermonuclear fusion. The star collapses under its own gravity. But the collapse is stopped by the *Pauli Exclusion Principle* among its electrons. White dwarfs are typically about the size of the earth. The Sun will become a white dwarf in about five billion years.

Appendix III. Acronyms

AAAC: Astronomy and Astrophysics Advisory Committee

ACS: Advanced Camera for Surveys instrument on the Hubble Space Telescope

ACT: Atacama Cosmology Telescope

AMANDA: Antarctic Muon And Neutrino Detector Array

AMS: Alpha Magnetic Spectrometer experiment

ATLAS: Argonne Tandem Linac Accelerator System

BOREXino: A Real Time Detector for Low Energy Solar Neutrinos at the National Laboratory of Gran Sasso, Italy

CBI: Cosmic Background Imager

CDMS II: The Cryogenic Dark Matter Search II experiment

CEBAF: Colliding Electron Beam Accelerator Facility

CERN: European Laboratory for Particle Physics

CMB: Cosmic Microwave Background radiation

Con-X: The Constellation X-ray Observatory

CP: charge-parity symmetry

DASI: The Degree Angular Scale Interferometer

DOE: The Department of Energy

ESA: European Space Agency

EUSO: Extreme Universe Space Observatory

eV: Electron volt

FACA: Federal Advisory Committee Act

Fermilab (or FNAL): Fermi National Accelerator Laboratory

FES: Office of Fusion Energy Science

GLAST: Gamma-ray Large Area Space Telescope

GPB: Gravity Probe B

HED: High Energy Density

HEDP: High Energy Density Physics

HEP: High Energy Physics

HEPAP: High Energy Physics Advisory Panel

HiRes: High Resolution Fly's Eye project

HRIBF: Holifield Radioactive Ion Beam Facility

HST: Hubble Space Telescope

IceCube: Under-ice telescope at the South Pole

ICF: Inertial Confinement Fusion

INTEGRAL: INTERNATIONAL Gamma Ray Astrophysics Laboratory

IWG: Interagency Working Group

JDEM: Joint Dark Energy Mission

K2K: From KEK to Kamioka long baseline neutrino oscillation experiment

KamLAND: Kamioka Liquid scintillator Anti-Neutrino Detector

KEK: Japanese abbreviation for High Energy Accelerator Research Organization

LBNL: Lawrence Berkeley National Laboratory

LHC: Large Hadron Collider

LIGO: Laser Interferometer Gravitational wave Observatory

LISA: Laser Interferometer Space Antenna

LSST: Large-aperture Synoptic Survey Telescope

MILAGRO: Multiple Institution Los Alamos Gamma Ray Observatory

MiniBooNE: Mini Booster Neutrino Experiment

MPS: NSF's Math and Physical Science Directorate

MREFC: NSF's Major Research Equipment and Facilities Construction account

NAS: National Academy of Science

NASA: National Aeronautics and Space Administration

NIF: National Ignition Facility

NIST: National Institute of Standards and Technology

NNSA: National Nuclear Security Administration

NP: DOE's Office of Nuclear Physics

NRC: National Research Council

NSAC: Nuclear Sciences Advisory Committee

NSCL: National Superconducting Cyclotron Laboratory at Michigan State University

NSF: National Science Foundation

NSTC: National Science and Technology Council

NUMI/MINOS: Neutrinos at the Main Injector/Main Injector Neutrino Oscillation Search

OMB: Office of Management and Budget

OPP: NSF Office of Polar Programs

ORNL: Oak Ridge National Laboratory

OSS: NASA Office of Space Science

OSTP: Office of Science and Technology Policy

P5: Particle Physics Project Prioritization Panel

PAC: Program Advisory Committee

PCA: Program Commitment Agreement

Pierre Auger: High energy cosmic ray detector array

QED: Quantum Electro-Dynamics

QGP: Quark Gluon Plasma

R&D: Research and Development

RHIC: The Relativistic Heavy Ion Collider

RIA: Rare Isotope Accelerator

RXTE: Rossi X-Ray Timing Explorer

S&T: Science and Technology

SAGENAP: Scientific Assessment Group for Experimental Non-Accelerator Physics

SciDAC: Scientific Discovery through Advanced Computing

SDSS: The Sloan Digital Sky Survey

SEU: NASA's Structure and Evolution of the Universe theme

SEUS: The NASA Structure and Evolution of the Universe Subcommittee

SLAC: Stanford Linear Accelerator Center

Sne Ia: type Ia supernovae

SNO: Sudbury Neutrino Observatory

SPASE: South Pole Air Shower Experiment

SPT: South Pole Telescope

SQUID: Superconducting QUantum Interference Device

Super-K: Super Kamiokande experiment

SZ: Sunyaev-Zel'dovich

TeV: trillion electron volts

TeVatron: Proton antiproton collider at Fermilab

UHECR: Ultra High Energy Cosmic Rays

VERITAS: The Very Energetic Radiation Imaging Telescope Array System

WFPC2: Hubble Space Telescope Wide Field and Planetary Camera 2

WIPP: Waste Isolation Pilot Plant

WMAP: Wilkinson Microwave Anisotropy Probe

XMM-Newton: Not technically an acronym, XMM-

References

Department of Energy, *Facilities for the Future of Science: A Twenty Year Outlook*, 2003.

High Energy Physics Advisory Panel Sub Panel on Long Range Planning, *The Science Ahead, The Way to Discovery*, Department of Energy, 2002.

National Aeronautics and Space Administration, *Space Science Enterprise Strategy*, 2003.

National Research Council, *Connecting Quarks with the Cosmos: Eleven Science Questions for a New Century*, National Academies Press, Washington, D.C. 2003.

National Research Council, *Neutrinos and Beyond: New Windows on Nature*, National Academies Press, Washington, D.C. 2003.

National Research Council, *High Energy Density Physics: The X-Games of Contemporary Science*, National Academies Press, Washington, D.C. 2003.

National Research Council, *Astronomy and Astrophysics in the New Millennium*, National Academies Press, Washington, D.C. 2001.

Nuclear Science Advisory Committee, *Opportunities in Nuclear Science: A Long Range Plan for the Next Decade*, Department of Energy, 2002.

Office of Management and Budget, *The President's Management Agenda*, Executive Office of the President, Washington, DC: 2001.

Office of Science and Technology Policy and the Office of Management and Budget, *FY 2005 Interagency Research and Development Priorities Memorandum*, Executive Office of the President, Washington, DC: June 5, 2003.

Structure and Evolution of the Universe Roadmap Team, *Beyond Einstein: From the Big Bang to Black Holes*, National Aeronautics and Space Administration, 2003.

NSTC Committee on Science

Co-Chairs: **Kathie Olsen**, Office of Science & Technology Policy
Elias Zerhouni, National Institutes of Health,
Department of Health & Human Services
Rita Colwell, National Science Foundation

Interagency Working Group on the Physics of the Universe

Co-Chairs: **Anne Kinney**, National Aeronautics & Space Administration
Joseph Dehmer, National Science Foundation
Peter Rosen, Department of Energy

Exec. Secretary: **Nicholas White**, National Aeronautics & Space Administration

OSTP Patrick Looney
Assistant Director, Physical Science
and Engineering
Office of Science and Technology Policy
Executive Office of the President
Washington, DC 20502
Telephone: 202-456-6125
FAX: 202-456-6027
Email: jlooney@ostp.eop.gov

Michael Holland
Senior Policy Analyst
Office of Science and Technology Policy
Executive Office of the President
Washington, D.C. 20502
Telephone: 202-456-6069
FAX: 202-456-6027
Email: mholland@ostp.eop.gov

NASA Paul Hertz
Senior Scientist for Astronomy and Physics
Astronomy and Physics Division
Office of Space Science
National Aeronautics and Space Administration
Code SZ
300 E Street, SW
Washington, DC 20546-0001
Telephone: 202-358-0986
FAX: 202-358-3096
Email: paul.hertz@nasa.gov

Anne L. Kinney
Director
Astronomy and Physics Division
Office of Space Science
National Aeronautics and Space Administration
Code SZ
300 E Street, SW
Washington, DC 20546-0001
Telephone: 202-358-2150
FAX: 202-358-3096
Email: anne.l.kinney@nasa.gov

Michael Salamon
Discipline Scientist for Fundamental Physics
Astronomy and Physics Division
Office of Space Science
National Aeronautics and Space Administration
Code SZ
300 E Street, SW
Washington, DC 20546-0001
Telephone: 202-358-0441
FAX: 202-358-3096
Email: michael.h.salamon@nasa.gov

Vigdor Teplitz
Chief
University Programs
NASA Goddard Space Flight Center
Code 600
Greenbelt, MD 20771
Telephone: 301-286-2363
Email: Vic.Teplitz@nasa.gov

NASA Nicholas White

Chief, Laboratory for High Energy Astrophysics
NASA Goddard Space Flight Center
Code 660
Greenbelt, MD 20771
Telephone: 301-286-8664
FAX: 301-286-
Email: Nicholas.E.White@nasa.gov

NSF Laura P. Bautz

Senior Staff Associate
Division of Physics
National Science Foundation
4201 Wilson Blvd., Room 1015
Arlington, VA 22230
Telephone: 703-292-7211
FAX: 703-292-9078
Email: lbautz@nsf.gov

G. W. Van Citters

Director, Division of Astronomical Sciences
National Science Foundation
Arlington, VA 22230
Telephone: 703-292-4908
Email: gvancitt@nsf.gov

Eileen D. Friel

Executive Officer, Division of Astronomical Sciences
National Science Foundation
Arlington, VA 22230
Telephone: 703-292-4895
Email: efriel@nsf.gov

Joseph L. Dehmer

Director
Division of Physics
National Science Foundation
4201 Wilson Blvd., Room 1015
Arlington, VA 22230
Telephone: 703-292-7370
FAX: 703-292-9078
Email: jdehmer@nsf.gov

DOE Christopher Keane

Director
Division of Secondaries and Inertial Fusion
U.S. Department of Energy
NA-113.1/Forrestal Building
1000 Independence Ave. SW
Washington, DC 20585
Telephone: 202-586-0852
FAX: 202-586-8005
Email: chris.keane@nnsa.doe.gov

Ronald McKnight

Senior Advisor for Inertial Fusion Energy
Office of Fusion Energy Sciences
SC-55/Germantown Building
U.S. Department of Energy
100 Independence Avenue, SW
Washington, D.C. 20585-1290

Dennis Kovar

Associate Director
Office of Nuclear Physics
Office of Science
U.S. Department of Energy
SC-90/Germantown Building
1000 Independence Avenue, S.W.
Washington, DC 20585-1290
Telephone: 301-903-3613
FAX: 301-903-3833
Email: dennis.kovar@science.doe.gov

John O'Fallon

Executive Assistant for International
and Interagency Programs
Office of High Energy Physics
Office of Science
U.S. Department of Energy
SC-20/Germantown Building
1000 Independence Avenue, S.W.
Washington, DC 20585-1290
Telephone: 301-903-8468
FAX: 301-903-2597
Email: john.ofallon@science.doe.gov

DOE

S. Peter Rosen

Senior Manager for Research Policy
Office of Science
U.S. Department of Energy
7B084, Forrestal Building
1000 Independence Avenue, S.W.
Washington, DC 20585
Telephone: 202-586-3673
FAX: 202-586-4120
Email: peter.rosen@science.doe.gov

Ralph Schneider

U.S. Department of Energy
NA-113/Forrestal Building
1000 Independence Ave. SW
Washington, DC 20585
Telephone: 202-586-0837
FAX: 202-586-8005
Email: Ralph.Schneider@nnsa.doe.gov

Jehanne Simon-Gillo

Program Manager for Facilities
and Instrumentation
Office of Nuclear Physics
Office of Science
U.S. Department of Energy
SC-90/Germantown Building
1000 Independence Avenue, S.W.
Washington, DC 20585-1290
Telephone: 301-903-1455
FAX: 301-903-3833
Email: jehanne.simon-gillo@science.doe.gov

Robin Staffin

Associate Director
Office of High Energy Physics
Office of Science
U.S. Department of Energy
SC-20/Germantown Building
1000 Independence Avenue, S.W.
Washington, DC 20585-1290
Telephone: 301-903-3624
FAX: 301-903-2597
Email: robin.staffin@science.doe.gov

Kathleen Turner

Program Manager
Office of High Energy Physics
Office of Science
U.S. Department of Energy
SC-20/Germantown Building
1000 Independence Avenue, S.W.
Washington, DC 20585-1290
Telephone: 301-903-1759
FAX: 301-903-2597
Email: kathy.turner@science.doe.gov

John Willis

Director, Research Division
Office of Fusion Energy Sciences
Office of Science
U.S. Department of Energy
SC-50/Germantown Building
1000 Independence Avenue, S.W.
Washington, DC 20585-1290
Telephone: 301-903-4095
FAX: 301-903-4716
Email: jwillis@fusion.doe.gov

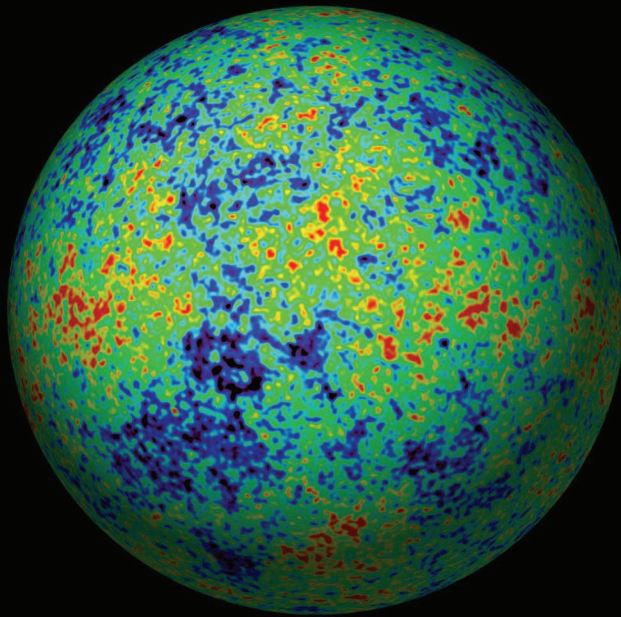

**NATIONAL SCIENCE AND TECHNOLOGY COUNCIL
COMMITTEE ON SCIENCE
INTERAGENCY WORKING GROUP
ON THE PHYSICS OF THE UNIVERSE**

