



**THE COLUMBIA RIVER SYSTEM  
INSIDE STORY**



# THE COLUMBIA RIVER SYSTEM INSIDE STORY

SECOND EDITION

FEDERAL COLUMBIA RIVER POWER SYSTEM

BONNEVILLE POWER ADMINISTRATION

U.S. BUREAU OF RECLAMATION

U.S. ARMY CORPS OF ENGINEERS

Published April 2001

This publication is an updated version of the original prepared for the System Operation Review, a joint project of the U.S. Bureau of Reclamation, U.S. Army Corps of Engineers, and Bonneville Power Administration.

Photo Credits: U.S. Bureau of Reclamation  
U.S. Army Corps of Engineers  
Bonneville Power Administration  
Northwest Power Planning Council  
Philip W. Thor  
Robin Cody

If you have comments or questions, please contact:

**Bonneville Power Administration**  
**1-503-230-3000**  
**P.O. Box 3621**  
**Portland, Oregon 97208-3621**

**U.S. Army Corps of Engineers, NWD**  
**1-503-808-3710**  
**P.O. Box 2870**  
**Portland, Oregon 97208-2870**

**U.S. Bureau of Reclamation**  
**1-208-378-5021**  
**1150 N. Curtis Road, Suite 100**  
**Boise, Idaho 83706-1234**



Printed on recycled paper

## TABLE OF CONTENTS

<b>I. Introduction</b>	<b>2</b>
<b>II. The Columbia River System</b>	<b>4</b>
A. The Basin	4
B. Uses of the River System	6
C. The Dams and Water Projects	9
D. The Coordinated Columbia River System	16
<b>III. The Agencies and the Operating Agreements</b>	<b>18</b>
A. The Forecasters	18
B. Project Owner/ Operators & Affiliated Agencies	18
C. The NMFS Regional Implementation Forum	20
D. The Operating Agreements and Guidelines	21
<b>IV. System Operation – The Big Picture</b>	<b>26</b>
A. Hydrology of the Basin	26
B. The Drivers of System Operations	27
C. Overview of System Operations	27
<b>V. Multiple Uses of the System</b>	<b>32</b>
A. Flood Control	33
B. Fish and Wildlife	38
C. Power Generation	45
D. Navigation	52
E. Irrigation	53
F. Recreation	55
G. Water Supply and Water Quality	55
H. Cultural Resources	56
<b>VI. System Planning &amp; Operations</b>	<b>58</b>
A. Current Operating Strategy	58
B. The PNCA Planning Process	60
C. In-Season Management for Salmon	63
D. Real-Time Operations	64
E. System Operation: In Action	66
<b>VII. Conclusion</b>	<b>70</b>
<b>Appendix A</b>	
Pacific Northwest Hydro Projects	72
<b>Appendix B</b>	
Glossary	74
<b>Appendix C</b>	
Acronyms and Abbreviations	76
<b>Appendix D</b>	
Reference List	78



# I. Introduction

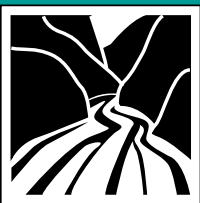

*Celilo Falls, shown here, was a Native American fishing site before The Dalles Dam was built. The Federal government is working to encourage more tribal involvement in planning and operating decisions.*

The Columbia River is one of the greatest natural resources in the western United States. The river and its tributaries touch the lives of nearly every resident of the Pacific Northwest—from fostering world-famous Pacific salmon to supplying clean natural fuel for 50 to 65 percent of the region’s electrical generation.

Since early in the 20th century, public and private agencies have labored to capture the benefits of this dynamic river. Today, dozens of major water resource

projects throughout the region are fed by the waters of the Columbia Basin river



*Federal water projects, including Lower Granite Dam on the Snake River, were constructed on the Columbia River and its tributaries from the 1930s to the mid-1970s.*

system. Through cooperative efforts, floods that periodically threaten development near the river can be controlled.

This publication presents a detailed explanation of the planning and operation of the multiple-use dams and reservoirs of the Columbia River system. It describes the river system, those who operate and use it, the agreements and policies that guide system operations, and annual planning for multiple-use operation. A glossary

and a reference list can be found at the end of this document.

The Inside Story was originally written for the participants in a multiyear environmental study of river operations called the Columbia River System Operation Review (SOR). The SOR was conducted jointly by the U.S. Army Corps of Engineers (Corps), the U.S. Bureau of Reclamation (Reclamation), and the Bonneville Power Administration (BPA). In 1995, as a result of actions under the Endangered Species Act (ESA) and the SOR, the three Federal agencies formally adopted an operating strategy for the river system that supports the recovery of Columbia River Basin fish listed under the ESA.

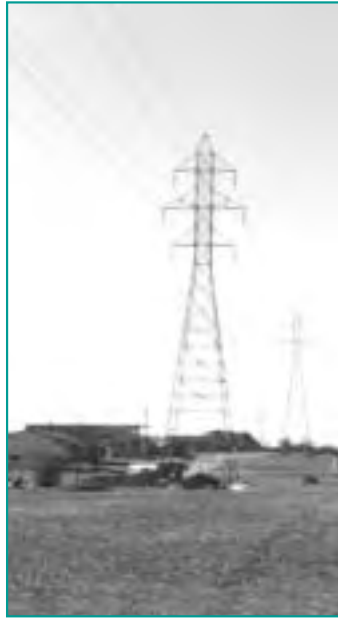

*Electricity generated on the river powers homes and businesses throughout the Northwest.*

The strategy incorporated the recommendations of the National Marine Fisheries Service (NMFS) and the U.S. Fish and Wildlife Service

(USFWS) to recover several stocks of Snake River salmon and the Kootenai River white sturgeon. The SOR provided the environmental analysis of the ESA strategy and led to renewal of the Pacific Northwest Coordination Agreement (PNCA) and other agreements related to the Columbia River Treaty (Treaty) between the United States and Canada. These complex contracts are explained in the following pages.

If you have questions or comments about the Columbia River system, we invite you to contact one of the agencies at the addresses and phone numbers on the inside front cover of this publication.



*An operating strategy was developed that supports recovery of Columbia Basin fish listed under the Endangered Species Act, as well as other, non-listed species.*



*The river and its reservoirs provide countless recreational opportunities for residents and visitors to the Northwest.*

## II. The Columbia River System

### A. The Basin

The Columbia River is the predominant river in the Pacific Northwest. It is the 15th longest river in North America and carries the sixth largest volume of runoff. The river and its tributaries are the region's dominant water system. The system drains 567,000 square kilometers (219,000 square miles) in seven western U.S. states: Washington, Oregon, Idaho, Montana, Wyoming, Nevada,

and Utah. In addition, the Columbia River Basin drainage covers 102,300 square kilometers (39,500 square miles) in British Columbia, Canada.

The Columbia River originates at Columbia Lake on the west slope of British Columbia's Rocky Mountains. It flows from Canada into the United States and eventually becomes the border between Oregon and Washington. The river is 1,954 kilometers (1,214 miles) long, and it

empties into the Pacific Ocean near Astoria, Oregon.

The Rocky Mountains to the east and north, the Cascade Range on the west, and the Great Basin to the south are the principal boundaries of the Columbia River Basin. Within the drainage, there are numerous sub-basins formed by tributaries of the mainstem river. The major tributaries in the United States are the Kootenai, the Flathead/Pend Oreille, the Snake, and the Willamette.

**The Highs and Lows of Streamflows.** On average, about 25 percent of the Columbia River flow comes from Canada. Before any mainstem dams were built, natural instantaneous streamflow at the border ranged from as low as 396 cubic meters per second ( $m^3/s$ ) (14,000 cubic feet per second (cfs)) to as high as 15,575  $m^3/s$  (550,000 cfs). This enormous variation in flow is seasonal. Most of the annual precipitation in the Columbia River Basin occurs in the winter with the largest share falling in the mountains as snow. The moisture that is stored during the winter in the snowpack is released in the spring and early summer, and about 60 percent of the natural runoff in the basin occurs during May, June, and July.

### The Columbia River Uses

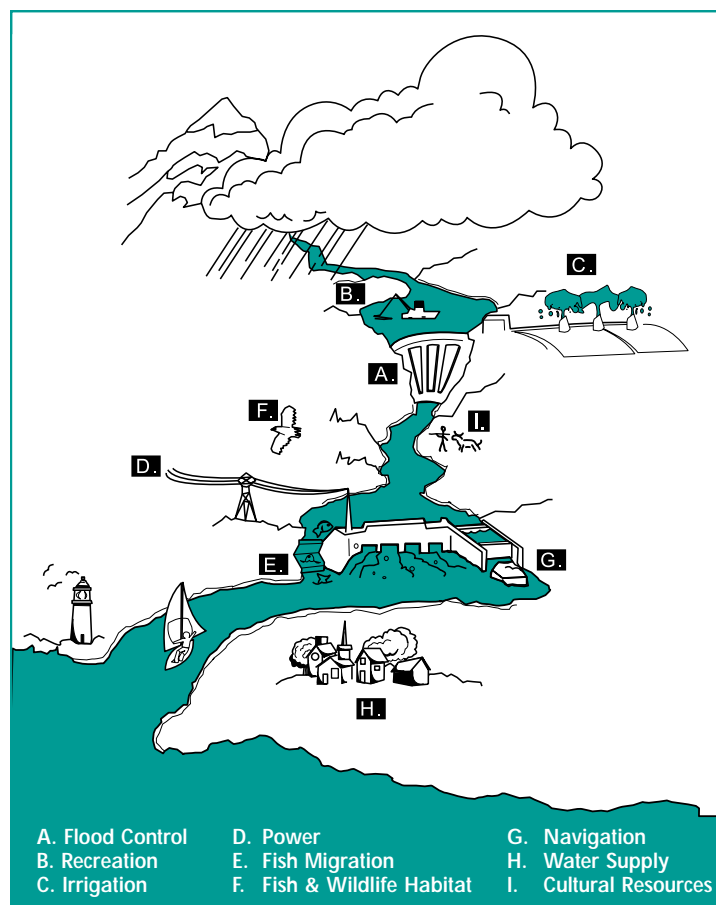

The people of the Northwest use the Columbia River in nine primary ways. The water projects make up a multiple-use system.

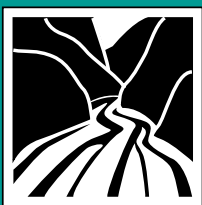

## The Columbia River Basin

### Major Federal Dams

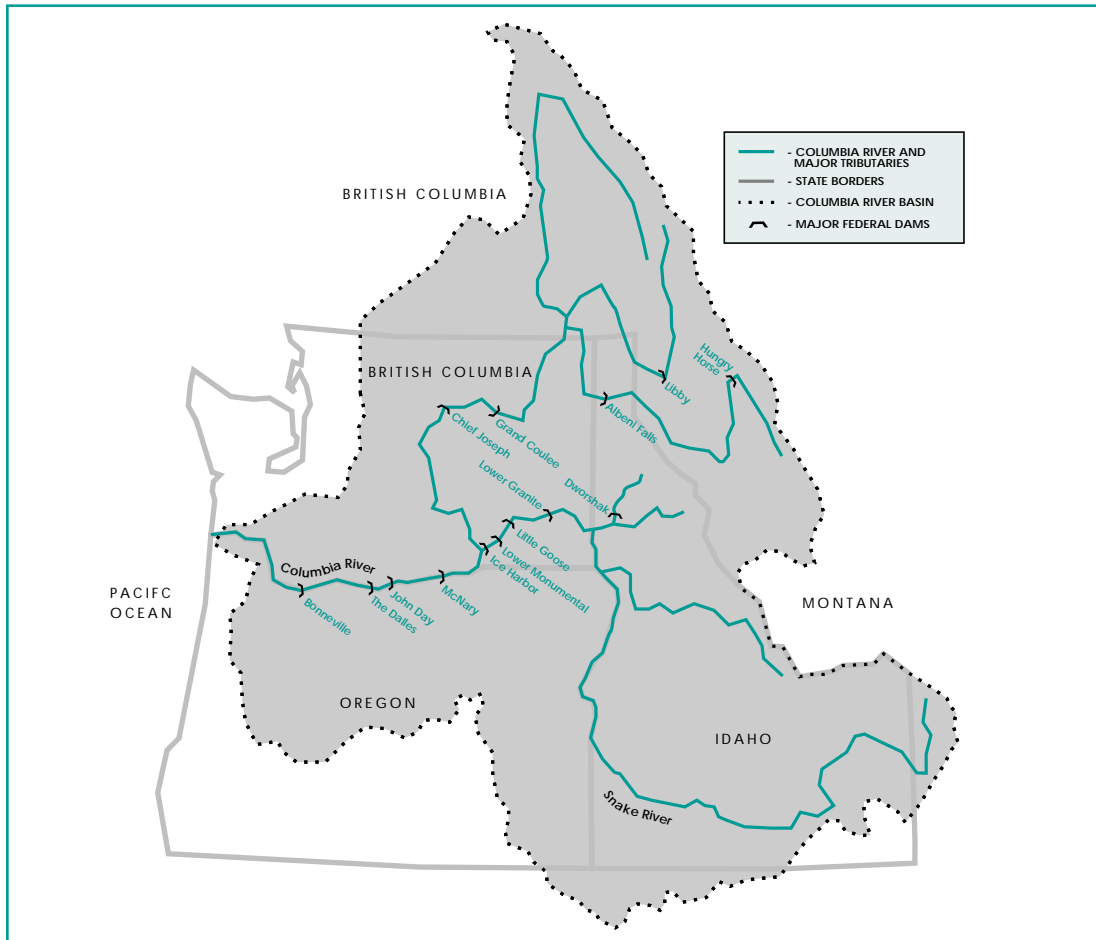

*Today, dozens of major water resource projects throughout the region are fed by the Columbia River.*

**Runoff:** That part of precipitation, snowmelt, or irrigation water that runs off the land into streams or other surface water.

**Streamflow:** Streamflow refers to the rate and volume of water flowing in various sections of the river. Streamflow records are compiled from measurements taken at particular points on the river, such as The Dalles, Oregon.

The Columbia drains 258,500 square miles in the United States and Canada.

The Columbia River has an average annual runoff at its mouth of about 244 billion cubic meters (198 million acre-feet) (average year-round flows of 7,787 m<sup>3</sup>/s (275,000 cfs)), making it second only to the Missouri-Mississippi River system in the United States in runoff. The Canadian portion of the basin generally contributes about 62 billion cubic meters (50.2 million

acre-feet) annually.

For operational purposes, runoff is usually measured at The Dalles, Oregon. Here the annual average is 165 billion cubic meters (134 million acre-feet) (average year-round flows of 5,038 m<sup>3</sup>/s (177,900 cfs)).

Beginning in 1909, the Columbia River has been harnessed for the benefit of the U.S. Pacific Northwest and the Canadian Pacific

Southwest. Federal agencies have built 29 major dams on the river and its tributaries. Dozens of larger non-Federal projects, and hundreds of small impoundments, have been developed as well. These dams provide flood control, irrigation, navigation, and recreation benefits. In addition, they form one of the largest hydroelectric systems in the world.

**Major Dams:** Large hydro-electric projects developed by Federal agencies within the Pacific Northwest. Twenty-nine major dams are in the Columbia River Basin. Two dams are in the Rogue River Basin. A total of 31 dams comprise the Federal Power System.

**Acre-feet:** A common measure of the volume of water in the river system. It is the amount of water it takes to cover one acre to a depth of one foot.



## Columbia River Streamflows

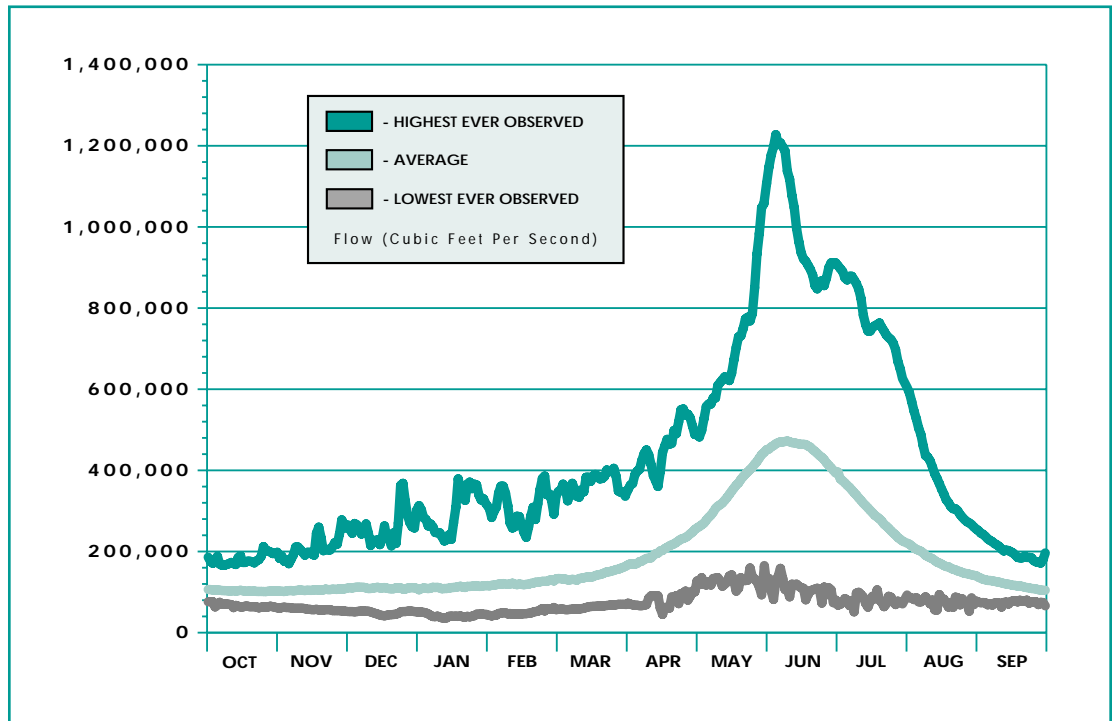

Flow on the Columbia River is generally measured at The Dalles, Oregon. Historic records show an annual pattern, with peak flows in late spring.

Columbia River dams provide flood control, irrigation, navigation, power generation, and recreation benefits to the Northwest.

### B. Uses of the River System

There are nine primary uses of the Columbia River system.

- **Flood control.**

Because the Columbia River's flow varies so widely, the river is subject to severe floods. Controlling the damaging floodwaters was one of the original purposes for many of the dams on the river. Flood control remains a high priority for system operations during high runoff years.

- **Fish migration.** The Columbia River is famous for its salmon runs. Federal dams in the lower Columbia and Snake rivers have **fish ladders** to help adult **anadromous fish** migrate upstream. Bypass systems have been installed to help juvenile smolts in their

downstream migration. More work is under way to enhance fish passage.

Indian tribes and commercial and sport anglers share the salmon and steelhead harvest in the river. Nearly 401,000 kilograms (900,000 pounds) of steelhead trout and chinook, coho, chum, and sockeye salmon were caught in 1998. Fish hatcheries are an important part of the river system. Some stocks of Columbia Basin



Barges travel up and down the river, transporting fuel, fertilizers, and agricultural products.

salmon and sturgeon fall under the protection of the ESA, and this has become an important factor in how the hydro system is operated.

- **Fish and wildlife habitat.** The Columbia Basin is alive with wildlife and both resident and migrating fish. State and Federal laws require protection of the habitat that supports these animals. The region has spent hundreds of millions of dollars restoring and protecting habitat. The investments include programs to reestablish wetlands, control erosion of streambanks, purchase sensitive wildlife tracts, and acquire harvest rights for old growth timber to protect habitat.

- **Electric power generation.** The hydroelectric dams on Columbia Basin rivers have a maximum

**Fish Ladder:** A series of stair-step pools that enables salmon to get past the dams. Swimming from pool to pool, salmon work their way up the ladder to the top where they continue upriver.

**Anadromous Fish:** Fish, such as salmon and steelhead trout, that hatch in freshwater, migrate to and mature in the ocean, and return to freshwater as adults to spawn.

## BPA Transmission Grid

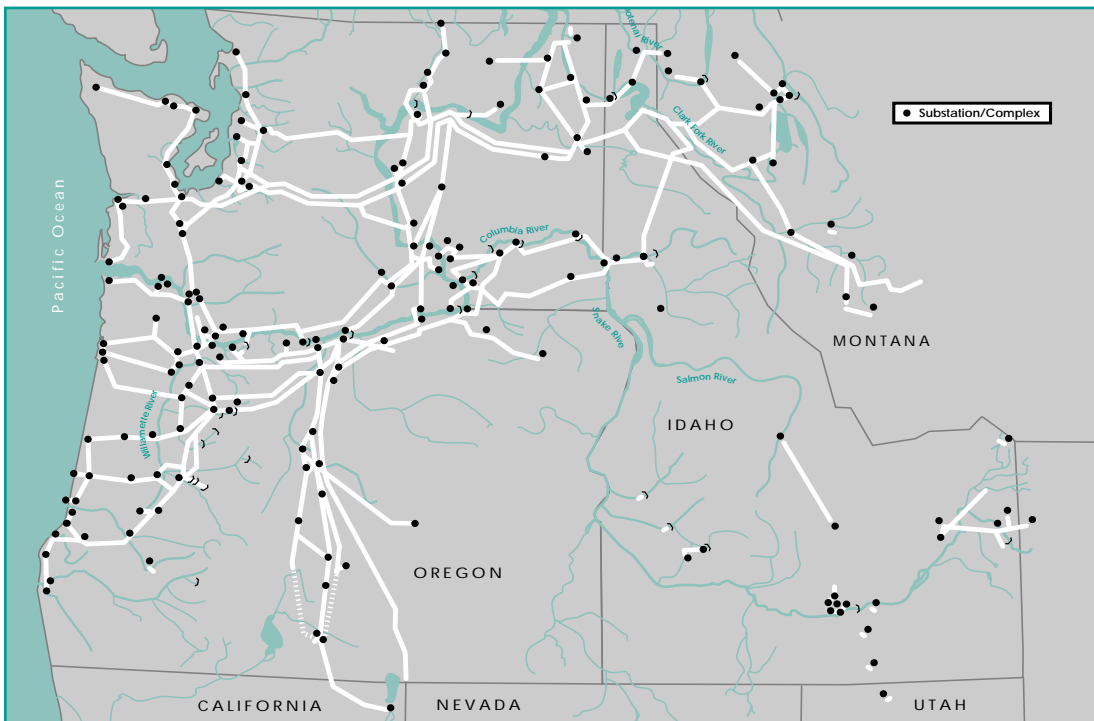

Power is delivered to cities around the region over a network of transmission lines. The BPA transmission grid interconnects with Canada to the north and California to the south.

*Over 900,000 pounds of steelhead trout and salmon were harvested in 1998.*

nameplate capacity of about 22,500 megawatts and produced in 1998 an average of about 12,000 megawatts of electricity. The dams are the foundation of the Northwest's power supply. Power lines originate at generators at the dams and extend outward to utility customers throughout the region and beyond. The transmission grid in the Northwest is interconnected with Canada to the north, with California to the south, and with Utah and other states to the south and east. Power produced at dams in the Northwest serves customers locally and thousands of kilometers away.

• **Navigation.** The Columbia and Snake rivers can be navigated as far upstream as Richland, Washington, and Lewiston, Idaho, 748 kilometers (465

miles) from the Pacific Ocean. Four Federal dams on the mainstem of the Columbia River—Bonneville, The Dalles, John Day, and McNary—have navigation locks through which boats and barges can pass. Locks at Ice Harbor, Lower Monumental, Little Goose, and Lower Granite dams on the lower Snake River also accommodate river traffic.

• **Irrigation.** Six percent of the Columbia Basin's



Marinas and boat launches give recreational boaters ready access to the reservoirs.

water (measured at its mouth; 9 percent of flows at The Dalles) is diverted for agriculture. Growers in arid parts of eastern Washington, northeastern Oregon, and southern Idaho depend on this water to produce wheat, corn, potatoes, peas, alfalfa, apples, grapes, and a vast assortment of other crops.

• **Recreation.** The rivers and lakes in the Columbia Basin attract boaters, sport anglers, swimmers, hunters, hikers and campers throughout the year. Thousands of sightseers visit the river and the projects. The wind in the Columbia River Gorge has made the area a world-class destination for windsurfers.

• **Water supply and quality.** The Columbia River system supplies water

**Megawatts:** A measure of electrical power equal to one million watts. Megawatts delivered over an hour are measured in megawatt-hours.

**Transmission Grid:** The network of high-voltage transmission lines that serves the region, carrying power from generating plants to cities.

## Columbia Basin Fish Facilities

*Indian cultures have existed in the basin up to 10,000 years.*

Name	Location	Type	In-Service Date	Managing Agency
Beaver Creek	Washington	Hatchery	1957	Wash. Fish & Wildlife
Big Creek	Oregon	Hatchery	1941	Oregon Fish & Wildlife
Bonneville Dam	Oregon-Washington	Ladders/Screens	1938/1998	Corps of Engineers
Bonneville Hatchery	Oregon	Hatchery	1909	Oregon Fish & Wildlife
Carson	Washington	Hatchery	1938	U.S. Fish & Wildlife
Cascade	Oregon	Hatchery	1959	Oregon Fish & Wildlife
Chelan	Washington	Hatchery	1965	Wash. Fish & Wildlife
Clackamas	Oregon	Hatchery	1979	Oregon Fish & Wildlife
Clearwater	Idaho	Hatchery	1987	Idaho Fish & Game
Cowlitz	Washington	Hatchery	1967	Wash. Fish & Wildlife
Dworshak	Idaho	Hatchery	1982	U.S. Fish & Wildlife
Eagle Creek	Oregon	Hatchery	1956	U.S. Fish & Wildlife
Eastbank	Washington	Hatchery	1989	Wash. Fish & Wildlife
Elokomin	Washington	Hatchery	1954	Wash. Fish & Wildlife
Entiat	Washington	Hatchery	1941	U.S. Fish & Wildlife
Entist	Washington	Hatchery	1941	U.S. Fish & Wildlife
Fallert	Washington	Hatchery	1895	Wash. Fish & Wildlife
Gnat Creek	Oregon	Hatchery	1989	Oregon Fish & Wildlife
Greys River	Washington	Hatchery	1961	Wash. Fish & Wildlife
Hagerman	Idaho	Hatchery	1933	U.S. Fish & Wildlife
Ice Harbor	Washington	Ladder/Screens	1961	Corps of Engineers
Irrigon	Oregon	Hatchery	1985	Oregon Fish & Wildlife
John Day Dam	Oregon-Washington	Ladders/Screens	1968/1999	Corps of Engineers
Kalama	Washington	Hatchery	1958	Wash. Fish & Wildlife
Klaskanine	Oregon	Hatchery	1911	Oregon Fish & Wildlife
Klickitat	Washington	Hatchery	1940	Wash. Fish & Wildlife
Kooskia	Idaho	Hatchery	1969	U.S. Fish & Wildlife
Leaberg	Oregon	Hatchery	1953	Oregon Fish & Wildlife
Leavenworth	Washington	Hatchery	1940	U.S. Fish & Wildlife
Lewis River	Washington	Hatchery	1979**	Wash. Fish & Wildlife
Little Goose Dam	Washington	Ladder/Screens	1970/1997	Corps of Engineers
Little White Salmon	Washington	Hatchery	1896	U.S. Fish & Wildlife
Looking Glass	Idaho	Hatchery	1982	Idaho Fish & Game
Lost Creek	Oregon	Hatchery	1973	Oregon Fish & Wildlife
Lower Granite Dam	Washington	Ladder/Screens	1975/1996	Corps of Engineers
Lower Monumental Dam	Washington	Ladder/Screens	1969	Corps of Engineers
Lyons Ferry	Washington	Hatchery	1983	Wash. Fish & Wildlife
Magic Valley	Idaho	Hatchery	1986	Idaho Fish & Game
Marion Forks	Oregon	Hatchery	1950	Oregon Fish & Wildlife
McCall	Idaho	Hatchery	1981	Idaho Fish & Game
McKenzie	Oregon	Hatchery	1902	Oregon Fish & Wildlife
McNary Dam	Oregon-Washington	Ladders/Screens	1953/1997	Corps of Engineers
Merwin Dam	Washington	Hatchery	1993	Wash. Fish & Wildlife
Methow	Washington	Hatchery	1992	Wash. Fish & Wildlife
Niagara Springs	Idaho	Hatchery	n.d.	Idaho Fish & Game
North Toutle	Washington	Hatchery	1985**	Wash. Fish & Wildlife
Oak Springs	Oregon	Hatchery	n.d.	Oregon Fish & Wildlife
Oxbow	Oregon	Hatchery	1913	Oregon Fish & Wildlife
Pahsimeroi	Idaho	Hatchery	1969	Idaho Fish & Game
Priest Rapids	Washington	Hatchery	n.d.	Wash. Fish & Wildlife
Rapid River	Idaho	Hatchery	1940	Idaho Fish & Game
Ringold	Washington	Hatchery	n.d.	Wash. Fish & Wildlife
Roaring River	Oregon	Hatchery	1924	Oregon Fish & Wildlife
Round Butte	Oregon	Hatchery	n.d.	Oregon Fish & Wildlife
Sandy	Oregon	Hatchery	1951	Oregon Fish & Wildlife
Sawtooth	Idaho	Hatchery	1984	Idaho Fish & Wildlife
South Santiam	Oregon	Hatchery	1923	Oregon Fish & Wildlife
Skamania	Washington	Hatchery	1956	Wash. Fish & Wildlife
Spring Creek	Oregon	Hatchery	1901	U.S. Fish & Wildlife
The Dalles Dam	Oregon-Washington	Ladders	1957	Corps of Engineers
Turtle Rock	Washington	Hatchery	n.d.	Wash. Fish & Wildlife
Umatilla	Oregon	Hatchery	1991	Oregon Fish & Wildlife
Vancouver	Washington	Hatchery	1930	Wash. Fish & Wildlife
Wallowa	Oregon	Hatchery	1985*	Oregon Fish & Wildlife
Warm Springs	Oregon	Hatchery	1978	U.S. Fish & Wildlife
Washougal	Washington	Hatchery	1959	Wash. Fish & Wildlife
Wells	Washington	Hatchery	n.d.	Wash. Fish & Wildlife
Willamette	Oregon	Hatchery	1955	Oregon Fish & Wildlife
Willard	Washington	Hatchery	1952	U.S. Fish & Wildlife
Winthrop	Washington	Hatchery	1940	U.S. Fish & Wildlife

\* Hatchery built in 1920, modified in 1985

\*\* Total rebuild n.d., Date unavailable

*The region's fish and wildlife planners have recognized the importance of fish by calling for construction of fish facilities.*

to numerous municipalities and industries. While municipal and industrial uses do not consume a significant portion of the river's water, these withdrawals are considered in system operations. Of particular importance to

these users is maintaining the high quality of Columbia River water so that it continues to provide an attractive source of supply for municipal and industrial purposes.

### • Cultural Resources.

The prehistory of human

beings in the Columbia River Basin spans thousands of years. Indian cultures may have existed in the basin perhaps 10,000 years ago, and the European and American influence began in the late 1600s and early 1700s. Because operations

## Storage and Run-of-River Projects

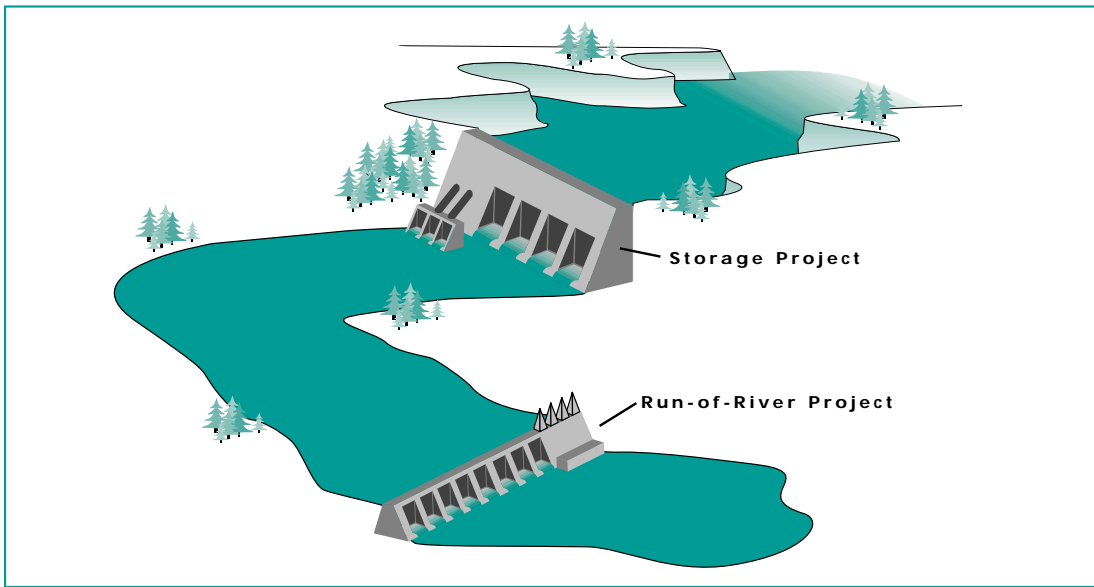

Storage projects are important for regulating river flow to serve multiple uses; run-of-river projects are primarily for navigation and power generation.

*Storage reservoirs help adjust the river's natural flow to meet the various needs of water users.*

of the hydro system affect historic and cultural sites, the Federal agencies adopted a Record of Decision in the SOR that acknowledges the potential for adverse effects and addresses long-term protection and preservation of significant cultural resources.

### C. The Dams and Water Projects

The dams of the Columbia River and its tributaries fall into two major categories: storage reservoirs and run-of-river projects. It is important to understand the difference between the two types.

#### **Storage Reservoirs.**

The main purpose of storage reservoirs is to adjust the river's natural flow patterns to conform more closely to water and energy-demand uses and to provide flood control. Water from rain and snowmelt is put into storage until it is needed.

Water flowing into the system is at its peak during the spring snowmelt, and there is more water than is needed for power production, irrigation, and some other uses. Reservoirs capture a small portion of the runoff. Traditionally, they have held the water until the late summer, fall, and winter. In the past several years, salmon recovery has become a key factor in operating the reservoirs. Depending upon overall water conditions, some of the runoff is stored and some is released to speed migrating juvenile salmon on their journey to the ocean.

The top priority for operating storage dams is to shape the heavy spring and summer snowmelt runoffs to help prevent flooding. In the fall and winter when streamflows would ordinarily be low, water is gradually released from the reservoirs for many river uses. Reservoir levels at

storage projects vary greatly during normal river operations. There is a significant difference between a storage reservoir when it is full and when it is down to its lowest operating level (i.e., vertical distance). For example, Hungry Horse operates over a range of 68.3 meters (224 feet); Libby, 52.4 meters (172 feet); Dworshak, 47.2 meters (155 feet); and Grand Coulee, 25 meters (82 feet).

Storage is the key to the operation of a multiple-use river system. The total water storage in the Columbia River system is 67.8 billion cubic meters (55 million acre-feet), of which 51.8 billion cubic meters (42 million acre-feet) are available for coordinated operation. Surprisingly, this storage represents only about 30 percent of an average year's runoff at The Dalles. By comparison, dams on the Missouri River system hold two to three times its annual runoff. While there is storage

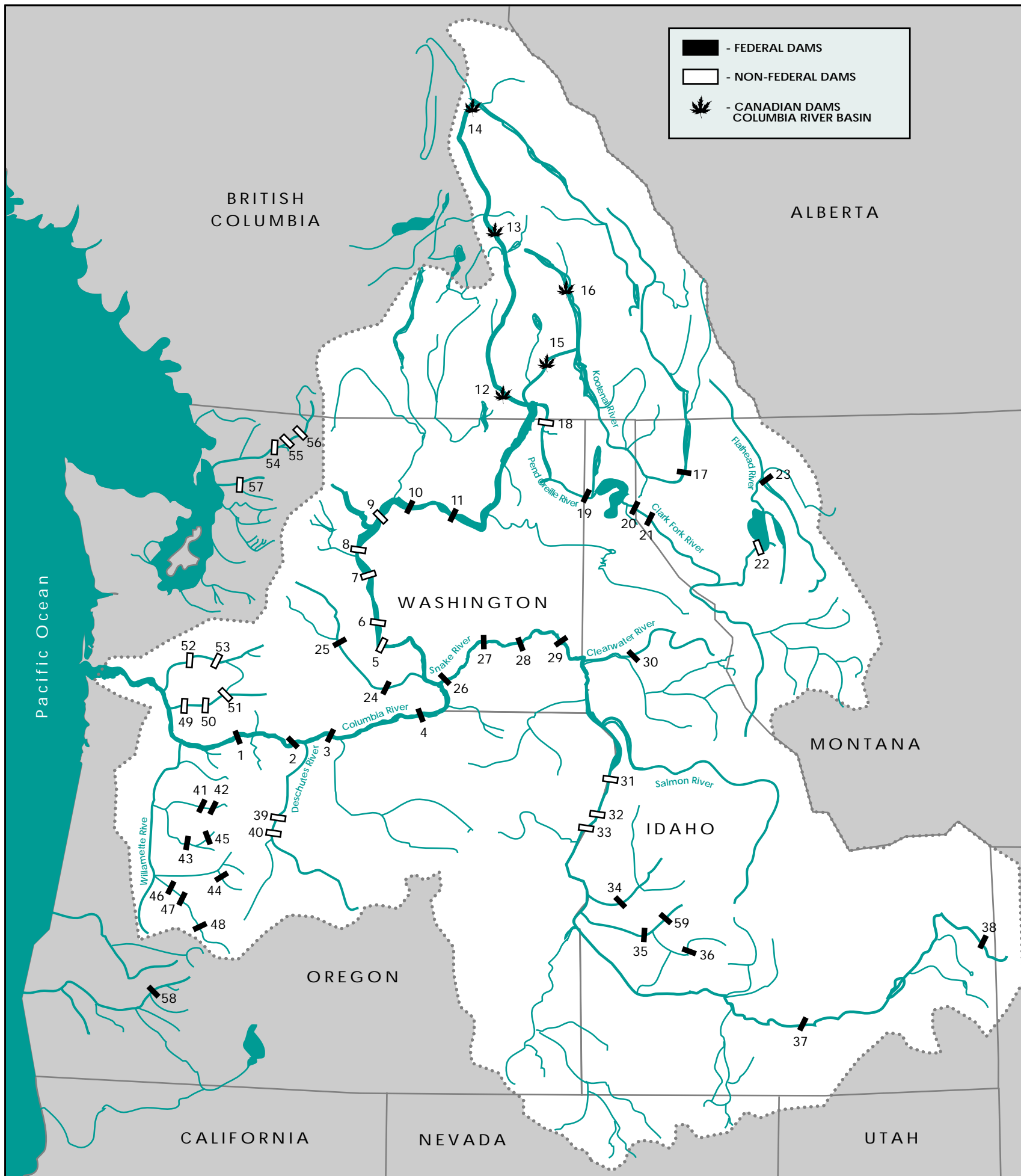

# Major Northwest Dams

The dams on this map generally represent the largest projects and those that have a significant role in river system management. A complete list of projects in the basin can be found in Appendix A. Acronyms and abbreviations are defined on page 76.

- |  |   |  |
|--|---|--|
| <ol style="list-style-type: none"> <li>1. <b>BONNEVILLE</b><br/>Columbia River, USACE</li> <li>2. <b>THE DALLES</b><br/>Columbia River, USACE</li> <li>3. <b>JOHN DAY</b><br/>Columbia River, USACE</li> <li>4. <b>McNARY</b><br/>Columbia River, USACE</li> <li>5. <b>PRIEST RAPIDS</b><br/>Columbia River, Grant Co. PUD</li> <li>6. <b>WANAPUM</b><br/>Columbia River, Grant Co. PUD</li> <li>7. <b>ROCK ISLAND</b><br/>Columbia River, Chelan Co. PUD</li> <li>8. <b>ROCKY BEACH</b><br/>Columbia River, Chelan Co. PUD</li> <li>9. <b>WELLS</b><br/>Columbia River, Douglas Co. PUD</li> <li>10. <b>CHIEF JOSEPH</b><br/>Columbia River, USACE</li> <li>11. <b>GRAND COULEE</b><br/>Columbia River, USBR</li> <li>12. <b>KEENLEYSIDE</b><br/>Columbia River, BC Hydro</li> <li>13. <b>REVELSTOKE</b><br/>Columbia River, BC Hydro</li> <li>14. <b>MICA</b><br/>Columbia River, BC Hydro</li> <li>15. <b>CORRA LINN</b><br/>Kootenay River, W. Kootenay</li> <li>16. <b>DUNCAN</b><br/>Duncan River, BC Hydro</li> <li>17. <b>LIBBY</b><br/>Kootenai River, USACE</li> <li>18. <b>BOUNDARY</b><br/>Pend Oreille River, SCL</li> <li>19. <b>ALBENI FALLS</b><br/>Pend Oreille River, USACE</li> <li>20. <b>CABINET GORGE</b><br/>Clark Fork River, WWP</li> </ol> | <ol style="list-style-type: none"> <li>21. <b>NOXON RAPIDS</b><br/>Clark Fork River, WWP</li> <li>22. <b>KERR</b><br/>Flathead River, MPC</li> <li>23. <b>HUNGRY HORSE</b><br/>Flathead River, USBR</li> <li>24. <b>CHANDLER</b><br/>Yakima River, USBR</li> <li>25. <b>ROZA</b><br/>Yakima River, USBR</li> <li>26. <b>ICE HARBOR</b><br/>Snake River, USACE</li> <li>27. <b>LOWER MONUMENTAL</b><br/>Snake River, USACE</li> <li>28. <b>LITTLE GOOSE</b><br/>Snake River, USACE</li> <li>29. <b>LOWER GRANITE</b><br/>Snake River, USACE</li> <li>30. <b>DWORSHAK</b><br/>N.F. Clearwater River, USACE</li> <li>31. <b>HELLS CANYON</b><br/>Snake River, IP</li> <li>32. <b>OXBOW</b><br/>Snake River, IP</li> <li>33. <b>BROWNLEE</b><br/>Snake River, IP</li> <li>34. <b>BLACK CANYON</b><br/>Payette River, USBR</li> <li>35. <b>BOISE RIVER DIVERSION</b><br/>Boise River, USBR</li> <li>36. <b>ANDERSON RANCH</b><br/>Boise River, USBR</li> <li>37. <b>MINIDOKA</b><br/>Snake River, USBR</li> <li>38. <b>PALISADES</b><br/>Snake River, USBR</li> <li>39. <b>PELTON</b><br/>Deschutes River, PGE</li> <li>40. <b>ROUND BUTTE</b><br/>Deschutes River, PGE</li> </ol> | <ol style="list-style-type: none"> <li>41. <b>BIG CLIFF</b><br/>N. Santiam River, USACE</li> <li>42. <b>DETROIT</b><br/>N. Santiam River, USACE</li> <li>43. <b>FOSTER</b><br/>S. Santiam River, USACE</li> <li>44. <b>COUGAR</b><br/>McKenzie River, USACE</li> <li>45. <b>GREEN PETER</b><br/>M. Santiam River, USACE</li> <li>46. <b>DEXTER</b><br/>Willamette River, USACE</li> <li>47. <b>LOOKOUT POINT</b><br/>Willamette River, USACE</li> <li>48. <b>HILLS CREEK</b><br/>Willamette River, USACE</li> <li>49. <b>MERWIN</b><br/>Lewis River, PP&amp;L</li> <li>50. <b>YALE</b><br/>Lewis River, PP&amp;L</li> <li>51. <b>SWIFT</b><br/>Lewis River, PP&amp;L</li> <li>52. <b>MAYFIELD</b><br/>Cowlitz River, TCL</li> <li>53. <b>MOSSYROCK</b><br/>Cowlitz River, TCL</li> <li>54. <b>GORGE</b><br/>Skagit River, SCL</li> <li>55. <b>DIABLO</b><br/>Skagit River, SCL</li> <li>56. <b>ROSS</b><br/>Skagit River, SCL</li> <li>57. <b>CULMBACK</b><br/>Sultan River, Snohomish Co. PUD</li> <li>58. <b>LOST CREEK</b><br/>Rogue River, USACE</li> <li>59. <b>LUCKY PEAK</b><br/>Boise River, USACE</li> <li>60. <b>GREEN SPRINGS</b><br/>Emigrant Creek, USBR</li> </ol> |
|--|---|--|

## Columbia River Runoff and Storage Compared to the Colorado and Missouri Rivers

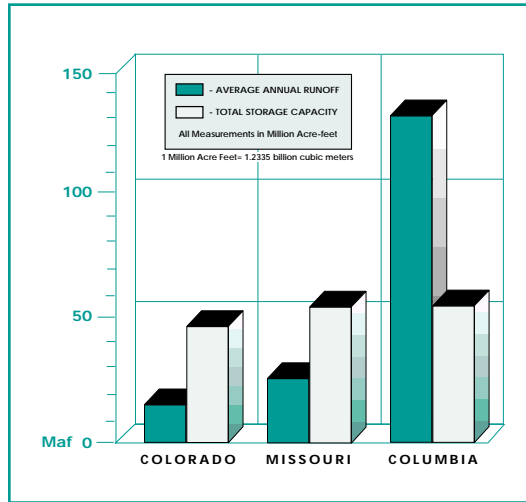

The Columbia River is unique in having more annual runoff than storage capacity.

The Columbia River has high runoff and a small amount of storage compared to two other large river systems, the Colorado and Missouri.

## Columbia River System Storage Space

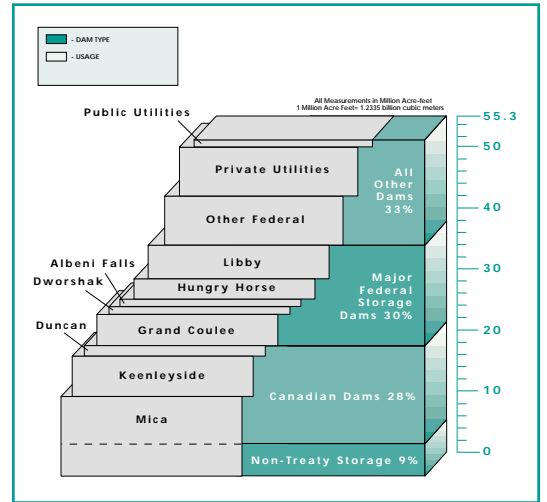

A few key reservoirs, including three in Canada and five in the U.S., hold most of the storage in the Columbia River Basin.

on the Columbia River, there is not the degree of control that exists on the Missouri and Colorado River systems, thus giving the Columbia a more natural runoff shape.

It should be noted that reservoirs west of the Cascade Mountains are operated differently than those in the interior Northwest, because most of

the winter precipitation on the west side falls as rain. At these projects, reservoirs are lowered during the late summer and fall to provide space in case of heavy

## Canadian and U.S. Storage

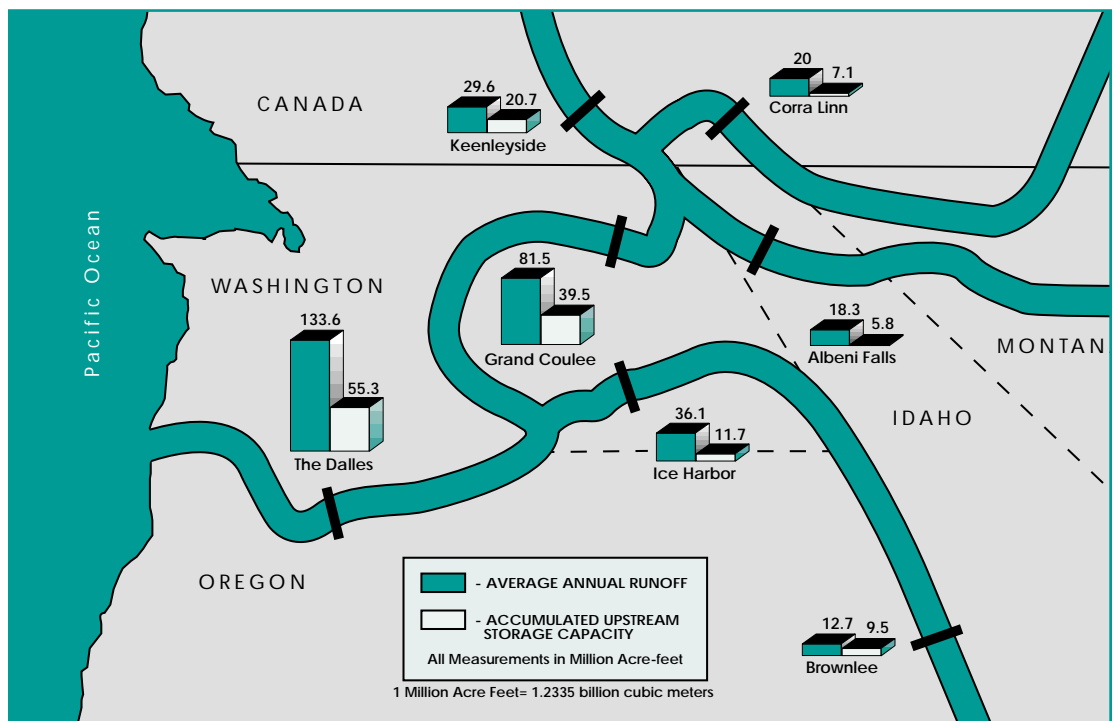

Storage at all projects on the major tributaries and the mainstem Columbia River totals 67.8 billion cubic meters (55.3 million acre-feet). As this diagram shows, most storage has been developed on the upper Columbia system; only about 8 percent of the capacity is in the lower Columbia River below its junction with the Snake River.

## The Columbia Basin and Minidoka Projects

The Columbia Basin Project, which began in the late 1930s, uses water that is diverted from Roosevelt Lake behind Grand Coulee Dam to irrigate crops. Water is drawn from Roosevelt Lake by giant pumps and lifted into Banks Lake, which was formed by damming both ends of a natural geologic formation called the Grand Coulee. The water then flows through a system of tunnels and canals to irrigate croplands many kilometers away. The project currently provides water to over 271,000 hectares (670,000 acres) and had the potential to

be expanded to 445,000 hectares (1.1 million acres).

The Minidoka Project consists of six storage dams and reservoirs and two diversion dams. Four of the facilities are on the upper Snake River in Idaho, and two reservoirs—Jackson Lake and Grassy Lake—are in Wyoming. The project dates back to 1909. American Falls Dam, which backs up the largest of the reservoirs, was built in 1927. Thousands of kilometers of distribution canals in the Minidoka Project provide irrigation service to more than 445,000 hectares (1.1 million acres) of farmland.

*Water from irrigation projects nurtures crops many miles away.*

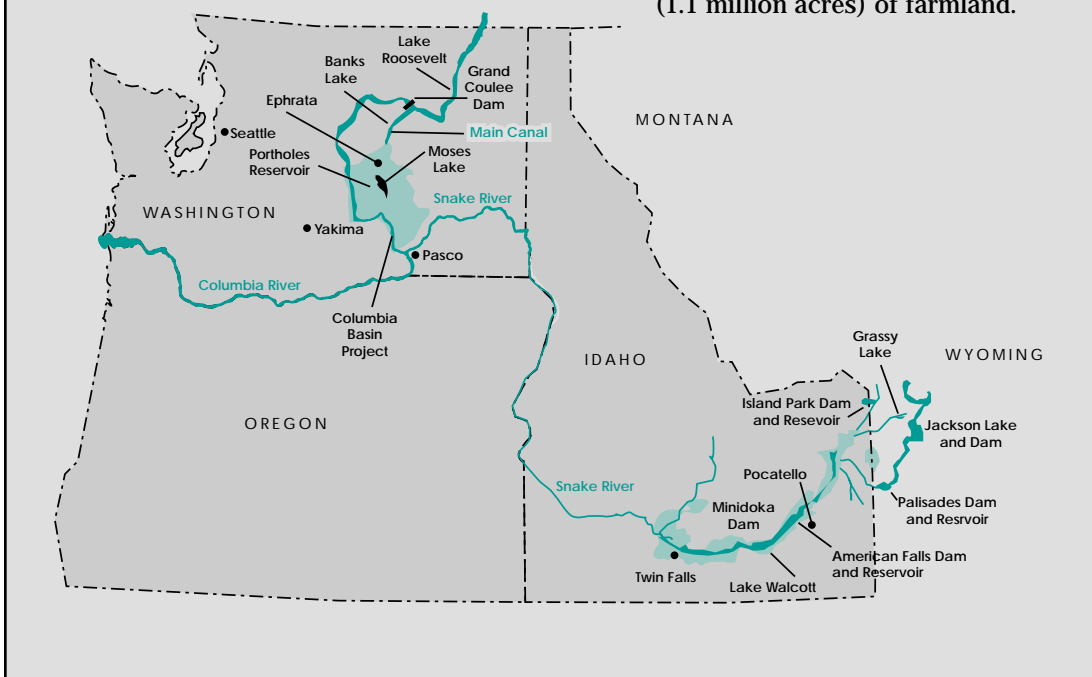

winter rains which can melt snow and cause flooding. If space is used to control flooding, the water may be released immediately afterwards to regain space for controlling future floods.

### **Run-of-River Projects.**

These projects have limited storage and were developed primarily for navigation and hydropower generation. All run-of-river projects provide hydraulic head for power generation, and many also give sufficient water depth over rapids and

other obstacles to permit barge navigation. Run-of-river projects pass water at the dam at nearly the same rate it enters the reservoir. Water that backs up behind run-of-river projects is referred to as pondage. Water levels behind these projects vary only three to five feet in normal operations.

Diversion projects may be either storage reservoirs or run-of-river projects. They include irrigation canals and pumping systems that take water from the

river and its reservoirs to nourish crops. These projects, such as Reclamation's massive Columbia Basin and Minidoka irrigation projects, have turned hundreds of thousands of hectares of arid land into productive farmland. Some of the water that is diverted for irrigation eventually finds its way back into the river downstream; the rest re-enters the hydrologic cycle through evaporation and transpiration from plants.

# Major Federal Columbia River Hydroelectric Projects

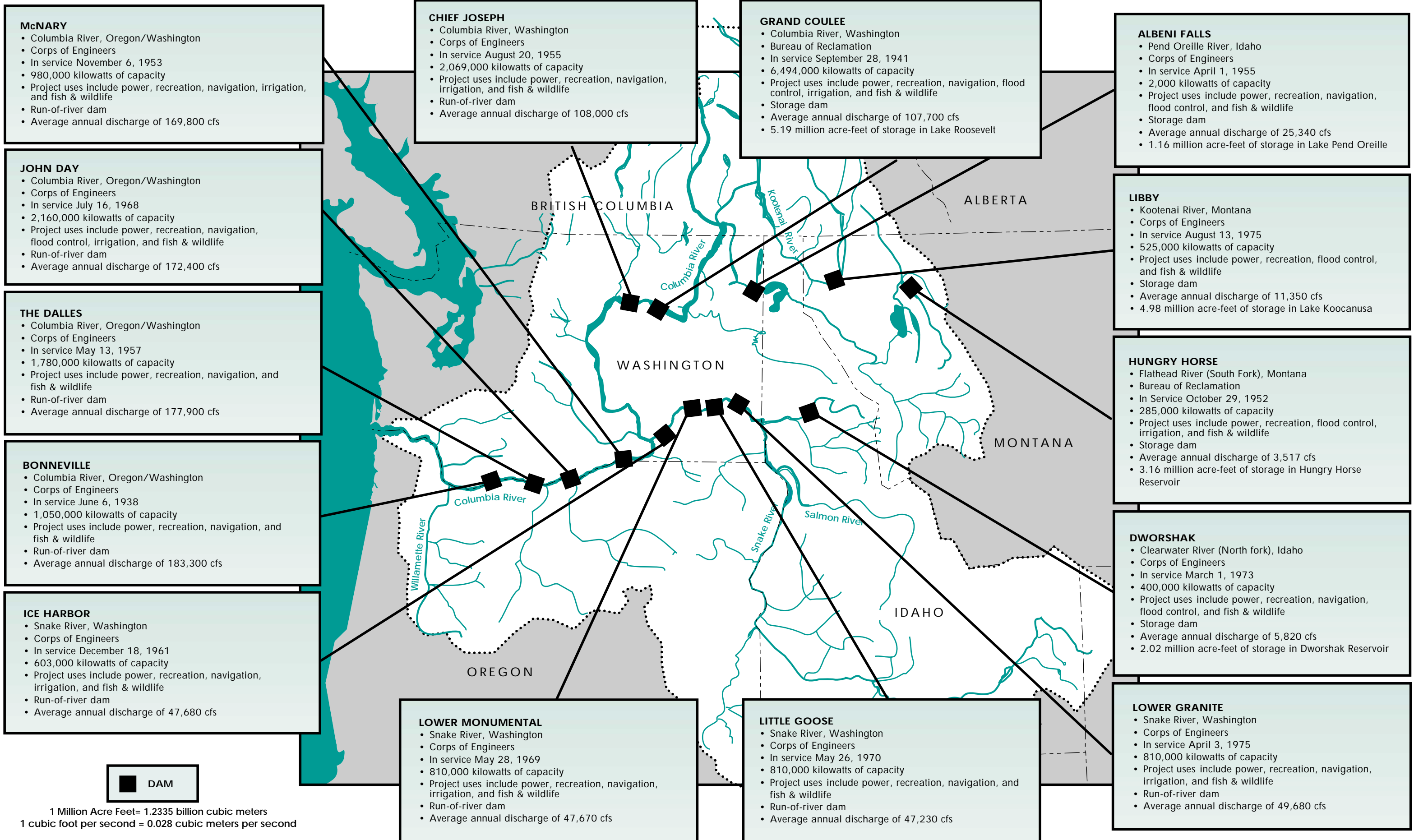



## D. The Coordinated Columbia River System

Operations on the Columbia River must take into account diverse interests and a broad spectrum of agencies and river users. This fact demands an integrated approach to planning and operations among the projects. This is known as “coordination.”

The Coordinated Columbia River System refers to projects operated under several separate arrangements: the Pacific Northwest Coordination Agreement (PNCA), the Columbia River Treaty, Federal flood control statutes, and several environmental and fish and wildlife statutes. In general, the planning and operations described throughout this document refer to the Coordinated Columbia River System.

Of the 31 hydro projects that make up the Federal Columbia River Power System (FCRPS), there are 14 large-scale **multipurpose facilities** located in the interior of the basin that play a key role in coordinated operations. Along with dams and reservoirs at these sites, there are:

- navigation channels and locks;
- hydroelectric power plants;
- high-voltage power lines and substations;
- boat launches;

*Coordination increases the benefits the river provides.*

**Multipurpose Facilities:** The Columbia River and the reservoir system are used for many purposes or uses. Projects that were authorized to serve a variety of purposes are referred to as “multipurpose.”



*The complex operation at each dam and its effect on other projects on the river make coordination essential. Coordinated planning and operations maximize benefits.*

- fish ladders, spillways, downstream bypass and collection facilities, and hatcheries;
- irrigation diversions and pumps;
- parks and recreation facilities;
- lands that are dedicated to the projects;
- areas set aside to replace wildlife habitat; and
- cultural resource protection areas

Additionally, there are a number of Federal projects, such as those in the Willamette sub-basin west of the Cascade Mountains, which operate more independently. In system planning terms, the Willamette projects are referred to as “hydro independents” because they are not coordinated as part of the PNCA. The output at these projects is used in meeting the region’s electricity demand, but the way they are operated and the water



*Planning accounts for water removed from the river system to irrigate crops.*



*Fourteen Federal multipurpose projects are the key to coordinated operations*

*The maintenance of major equipment is also considered in planning for coordinated river operations.*

they store is not factored into the region's coordinated planning scenarios.

Of the 14 Federal projects that are coordinated under the PNCA, five are storage dams. They are Libby, Hungry Horse, Albeni Falls, Grand Coulee, and Dworshak. The combined storage in the reservoirs behind these dams is about 19.7 billion cubic meters (16 million acre-feet). Three Canadian dams also included in coordinated planning—Mica, Duncan,

and Keenleyside—add another 25.3 billion cubic meters (20.5 million acre-



*A fish counter tallies the number of fish that pass up the ladder at each dam. Fish protection figures prominently in all operating decisions.*

feet) of storage. These eight projects are particularly beneficial because they are strategically located in the middle and upper basin to capture runoff for later release to control flood events and augment downstream flows.

The remaining nine projects are run-of-river dams. They are Bonneville, Chief Joseph, Ice Harbor, John Day, Little Goose, Lower Granite, Lower Monumental, McNary, and The Dalles.



### III. The Agencies and the Operating Agreements



#### A. The Forecasters

It all starts with the water cycle—evaporation, condensation, precipitation, and runoff. Sophisticated forecasts of weather and water conditions in the Columbia River Basin each year make it possible to manage the coordinated system for maximum benefit. There are two general types of forecasts required: water supply forecasts, which predict the volume of runoff expected over a given time period; and rate-of-flow forecasts, which predict streamflows. Several organizations have a role in collecting and analyzing information that goes into these forecasts. Among them are:

- U.S. Army Corps of Engineers (Corps);
- U.S. Bureau of Reclamation (Reclamation);
- British Columbia Hydro and Power Authority (BC Hydro);
- Columbia River Forecasting Service;
- National Weather Service's Northwest River Forecast Center;
- U.S. Geological Survey;
- Natural Resources Conservation Service (formerly U.S. Soil Conservation Service);
- Columbia River Water Management Group; and
- Northwest Power Pool.



*Water from snowmelt and rainfall is the essential ingredient in all river operations. The depth and water content of the winter snowpack are used to forecast the volume of spring runoff.*

#### B. Project Owner/Operators and Affiliated Agencies

The Corps and Reclamation planned, designed, constructed, and currently own and operate the Federal water projects in the Northwest. The BPA markets and distributes the power produced by the projects. Together, the three agencies for ESA biological opinion purposes are called “action agencies.”

**U.S. Army Corps of Engineers.** The Corps operates 12 of the 14 major Federal projects in the Columbia River Basin and thus has a key role in

coordinating multiple-purpose use of the system. It also shares responsibility with BPA and B.C. Hydro in determining operation of Columbia River Treaty reservoirs. The Corps is responsible for flood control operations at all reservoirs in the basin both in the U.S. and Canada. In addition, the Corps has constructed and maintains all navigation channels to accommodate barges and other river traffic, as well as providing operations to accommodate irrigators, recreators, and fish and wildlife needs.

**U.S. Bureau of Reclamation.** Reclamation operates Grand Coulee and Hungry Horse Dams, the two other major Federal

storage projects in the basin. Because of its size and key location, Grand Coulee Dam plays a prominent role in the coordinated operation of the Columbia River system. Reclamation also operates numerous water resource projects throughout the Columbia Basin, which provide irrigation, power, and other uses, particularly in the Upper Snake River Basin.

**Irrigation Districts.** Irrigation districts also operate and maintain water resource facilities in the basin, such as storage and diversion dams, pumping plants, and canal and pipeline distribution systems. Some irrigation district facilities are privately owned, and some were constructed by Reclamation and are operated by the districts under contract.

**Public and Private Utilities.** Public utility districts, municipal utilities, and investor-owned utility companies also own and operate dams and generating projects in the Coordinated Columbia River System. Three public utility districts own five mid-Columbia dams—Wells, Rocky Reach, Rock Island, Wanapum, and Priest Rapids. These owners plan and coordinate their operations with the Federal agencies.

**British Columbia Hydro and Power Authority.**

B.C. Hydro is a Canadian member of the reservoir management team. This Canadian **Crown Corporation** controls projects on the upper Columbia River in Canada that provide storage for flood control and power generation. These large-scale projects contain over one-third of the storage on the system and are operated under the Columbia River Treaty for the joint benefit of Canada and the United States. B.C. Hydro also contracts for coordination with owners of smaller Canadian dams on tributaries of the Columbia River, such as the Columbia Power Corporation, Columbia Basin Trust, West Kootenay Power and Light, and Cominco.

**Other Agencies.** Other agencies act in a regulatory or advisory capacity to Columbia Basin project operators. They include: the Federal Energy Regulatory Commission (FERC), a Federal agency responsible for regulating the interstate activities of the nation's electric and natural gas utilities and non-Federal hydroelectric power producers; the U.S. Department of State, which interacts with its Canadian agency counterpart on Treaty matters; NMFS; USFWS; and the U.S. Environmental Protection

Agency (EPA). State water resource agencies enforce water rights laws and control how much water is withdrawn from streams and reservoirs for irrigation, municipal and industrial water supply, and other purposes.

**Bonneville Power Administration.** BPA was created in 1937 as a part of the U.S. Department of Interior. In 1977, it became a part of the newly created Department of Energy. Owning no dams, the agency is charged with marketing the power generated at the Federal dams on the Columbia River and its tributaries and some other generating plants, to wholesale power customers, primarily public and private utilities and direct service industries. BPA has the obligation to pay for the Federal Hydro system on behalf of Corps and Reclamation.

BPA built and operates over 25,000 kilometers (16,000 miles) of transmission lines that deliver electricity. Federal law requires BPA to give **priority rights** to electricity produced at the Federal dams to publicly owned utilities and to entities in the U.S. Pacific Northwest. Under the 1980 Northwest Power Planning and Conservation Act (the Act), BPA is also required to fund certain

**Crown Corporation:** Canadian Federally or provincially owned organization. U.S. examples would be the Postal Service or Amtrak.

*Many agencies and organizations have a stake in river management.*

**Priority Rights:** Publicly owned entities have priority over private entities to purchase the power generated at Federal projects. This priority right, granted by Federal law, is called "preference;" public and cooperative utilities that purchase power from BPA are called "preference customers."

**Operating Requirements:** These are the limits within which a reservoir or dam must be operated. Some requirements are established by Congress when a project is authorized; others evolve with operating experience.

*Dynamic policies govern planning and operations.*

fish and wildlife mitigation programs. For power purposes, the Corps, Reclamation, and BPA collectively are sometimes referred to as the FCRPS (Federal Columbia River Power System).

The Corps and Reclamation develop **operating requirements** for all the non-power uses at their projects, and, within these limits, BPA schedules and dispatches power. System operation requires continuous communication and coordination among the three agencies and with other utilities that own generation resources, market power, and are interconnected by transmission facilities.

### C. The NMFS Regional Implementation Forum

As described later in the Fish and Wildlife section of Chapter V, NMFS, a Federal agency of the U.S. Department of Commerce, is charged with developing recovery plans for species of ocean-going fish listed under the ESA. The USFWS, part of the U.S. Department of the Interior, is responsible for ESA listed resident fish and terrestrial animals.

The NMFS Regional Implementation Forum resulted from the biological opinion issued by NMFS in 1995, adjusted in 1998, and



*The Natural Resources Conservation Service performs snow course surveys to collect data about the annual snowpack. The measurements are analyzed and translated along with other data into forecasts of the volume of runoff that can be anticipated in the Columbia River system.*

replaced in 2000, which set measures for how annual hydropower operations should be carried out so that they do not jeopardize listed species. USFWS also issued biological opinions in 1995 and 2000, which addressed resident fish.

The Forum provides for regional discussion and decisions on the operation and configuration of the FCRPS. The Implementation Team and the Executive Committee, which constitute the NMFS Forum, are charged with implementing the requirements of the biological opinions. There are several additional teams that work under the direction of the Implementation Team. These include the Technical Management Team, Water Quality Team, and System Configuration Team.

**Technical Management Team (TMT).** The TMT is an interagency technical group responsible for making in-season recommendations

on dam and reservoir operations to optimize passage conditions for juvenile and adult anadromous fish. The TMT consists of representatives from NMFS, USFWS, Reclamation, the Corps, BPA, EPA, National Weather Service, state agencies, and Indian nations.

The TMT operates year-round. It develops a water management plan each year based on the annual runoff forecast. If necessary,

the TMT meets weekly during the anadromous juvenile fish migration season (April - September) to conduct in-season management activities and make recommendations for implementing the plan. The “salmon managers,” representatives of state, tribal, and Federal agencies with anadromous fish responsibilities, provide biological information on salmon numbers, migration, and timing to the group at large. The USFWS and others provide information on other fish and wildlife resources.

Using this information, the TMT makes weekly operating recommendations to the action agencies—the Corps, Reclamation, and BPA. TMT recommendations are made by consensus when possible. If consensus is not reached, issues are elevated to the Implementation Team.

**Implementation Team (IT).** The Implementation Team consists of policy-

level managers from the Federal and State agencies and tribal sovereigns that are represented on the TMT. One of the Implementation Team's jobs is to resolve policy issues on which the TMT cannot reach agreement.

**Water Quality Team (WQT).** The WQT is composed of scientists and technical-level analysts drawn together to explore ways to reduce the total dissolved gas levels and water temperatures harmful to fish and wildlife in the Basin. This team's ultimate goals are to identify the sources of dissolved gas and high temperatures in the Basin's rivers at different times of the year and to recommend strategies to improve water quality for the benefit of fish and wildlife.

**System Configuration Team (SCT).** The SCT reviews the physical make-up of the hydroelectric system in the Basin—dams, fish screens and ladders, spill deflectors (“flip lips”), and other structures—to determine what the optimal system would look like that incorporates all the needs of the system. It meets regularly to prioritize capital expenditures on system configuration facilities for improving fish passage.

**State Fish and Wildlife Agencies.** These agencies are responsible for managing and protecting fish and wildlife populations in each of the Northwest states. They participate in the NMFS Forum and share responsibility to protect fish and

wildlife in the Columbia River Basin.

#### **Indian Nations.**

Indian nations have historic and treaty rights to take fish from the Columbia River and its tributaries. They carry out fish and wildlife resource management programs and have participated in a variety of forums in the past (for example, the “three sovereigns”—the Federal and state governments and Indian nations) that have discussed long-term institutional arrangements for making river governance decisions.

**River Users.** There are also dozens of agencies, organizations, and coalitions that use the river and its resources or have an interest in the way the river system is managed. Their opinions on Columbia River water management issues are diverse, and representatives from many of these groups participate in public hearings, meetings, and other forums that address river operations.

## **D. The Operating Agreements and Guidelines**

Planning and operations on the Coordinated Columbia River System are guided by a complex and interrelated set of laws, treaties, agreements, and guidelines. While some of the laws have been in effect for many decades, the governing policies are dynamic, and important additions have

been made in recent years.

Prior to construction, Congress specified the major intended uses in the **authorizing legislation** for each Federal hydro project. Most were authorized for one or more purposes, including flood control, navigation, irrigation, and power production. However, the laws seldom contain explicit provisions for operating individual projects or for their coordinated operation within the total system.

The Corps and Reclamation are responsible for deciding how to operate their projects based on requirements of the biological opinions, recommendations from the NMFS Forum, principles of multiple-use operation, their agency charters, operating experience, and public concerns. The Federal agencies and other project operators have developed principles and agreements among themselves; some are in formal contracts, and some are informal.

Among the laws and agreements that have a direct bearing on system operation are the following:

**Endangered Species Act.** The ESA is a Federal law that protects threatened or endangered species of plants and animals. Several species of fish that live in the Columbia and Snake rivers have been listed for protection under the ESA (see Fish and Wildlife section, Chapter V).

**Authorizing Legislation:** Congress must approve the construction of all Federal water projects. The legislation that authorizes the project spells out its purposes, the agency in charge of construction and operation, and the terms of financing under which it will be built, operated, and repaid.

*The NMFS Forum has a dramatic influence on system operations.*

**Flip Lips:** A structural device that redirects water as it comes over the spillway of a dam. Flip lips reduce deep plunging of water into the pool below; this keeps the water from becoming supersaturated with nitrogen. Fish are naturally attracted to the rapidly moving water at the base of the dam but can suffer from gas bubble disease when the water is supersaturated with gas.

**International Joint Commission (IJC):** The IJC also serves as an arbitration body under the Columbia River Treaty.

## *The Endangered Species Act has dramatically changed system planning and river operations.*

**Flood Control:** Streamflows in the Columbia River Basin can now be managed to keep water below damaging flood levels in most years. This level of flood control is possible because storage reservoirs on the river can capture and store heavy runoff as it happens.

**Flow:** Agencies have agreed to increase flows at certain times and at certain places to aid migrating fish.

**Reservoir Drawdown:** The water levels in a reservoir can be lowered, or drawn down, by releases from the dam. These drawdowns have the effect of speeding up the water that flows through a reservoir by decreasing its cross-sectional area.



*Mica Dam, shown here under construction, is one of three Canadian projects that are among the most recent major projects built on the river system. They have greatly increased the ability to control streamflows.*

As a result of the ESA, a biological opinion issued by NMFS in 1995 mandated changes in Columbia Basin system operations to emphasize salmon recovery. This biological opinion was supplemented in 1998 and replaced in 2000. A second biological opinion for the Kootenai River in Montana, issued by the USFWS in 1995 and replaced in 2000, outlined operations to protect sturgeon initially, and later, other species like bull trout. Various measures to protect these fish have been implemented, such as increased and more carefully timed **flow**, increased spill, and **reservoir drawdowns**, and others are under study, such as habitat and hatchery measures.

**National Environmental Policy Act.** The 1969 National Environmental Policy Act (NEPA) requires environmental scrutiny of actions proposed by Federal agencies. Under NEPA, an environmental assessment, a finding of no significant impact (FONSI), or an

environmental impact statement (EIS) must be prepared, and public hearings held, for any proposed action that might affect the environment. Significant modifications of existing operations fall under the provisions of NEPA. The 1995 SOR was a programmatic environmental analysis conducted in accordance with NEPA requirements on the operation of the FCRPS.

**Columbia River Treaty.** The Columbia River Treaty between the United States and Canada, signed in 1961 and put into effect in 1964, grew from the recommendations of an International Engineering Board. This



*Parties to the Coordination Agreement have developed and use a variety of computer modeling techniques to plan for upcoming power production and to guide system operation.*

Board was appointed by the **International Joint Commission** established by the 1909 Boundary Waters Treaty and studied whether an extension of the use of the Columbia River would be practical and in the interests of both nations. Concurrent with the Commission's study, the Corps began updating its master plan for development on the Columbia River. Both efforts indicated that additional storage on the upper reaches of the river would be of joint benefit for flood control and power production.

The Treaty required building three storage reservoirs in Canada (Mica, Hugh Keenleyside, and Duncan) and the option to build a fourth (Libby) in the United States. The Canadian reservoirs built and operated under the Treaty represent almost half the water storage on the Coordinated Columbia River System.

The Treaty dams added much needed **flood control** along the entire river. They also made it possible to deliver flood control more reliably and to "firm up" nonfirm energy. The benefits of the projects were divided

between the two nations in related agreements. The Treaty does not specify an end date. Instead, either country has the option, with 10 years' notice, to terminate the Treaty after September 2024.

### Pacific Northwest Coordination Agreement.

The Columbia River Treaty inspired the Pacific Northwest Coordination Agreement (PNCA, or Coordination Agreement). It is a complex agreement for planned operation among the [Federal project operators](#) and hydroelectric generating utilities of the Pacific Northwest. It was originally signed in 1964, with an expiration date of 2003.

The Coordination Agreement calls for annual planning, which must accommodate all the authorized purposes of the Columbia River hydro projects. It establishes processes that coordinate the use of planned Canadian storage operations with Federal and non-Federal project operations in the Northwest. The Coordination Agreement enables the region's power producers to optimize system reliability and power production after

## Storage Allocation at Mica Dam

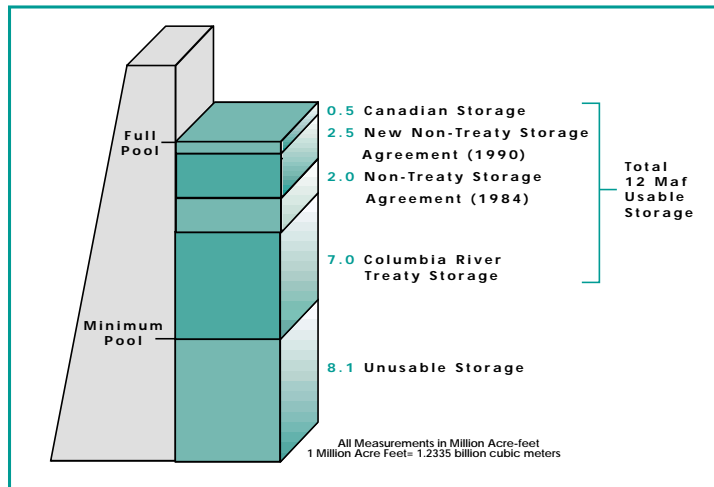

The Columbia River Treaty and subsequent storage agreements govern how water held behind Canadian dams will be used. Mica Dam, the largest of the Treaty storage projects, is located near the headwaters of the Columbia and plays a pivotal role in storage operations.

giving priority to non-power objectives. It recognizes project and system requirements that are frequently changing to serve multiple river uses. Individual project owners set the requirements for using their own reservoirs.

All Coordination Agreement parties coordinate to meet multiple-use system requirements. Power generation, which is planned under terms of the agreement, complies with these requirements. The Coordination Agreement planning process, which establishes day-to-day power operations and

associated transactions, is discussed in Chapter VI.

After extensive negotiations among all parties and completion of the SOR environmental impact analysis, the revised Coordination Agreement completed in 1997 was submitted to FERC for extension through 2024 and supplemented with a new set of operating procedures. The 1997 Coordination Agreement is quite similar to the 1964 agreement. It retains a coordinated planning process and provides for improved accommodation of non-power requirements.

*The Coordination Agreement calls for annual planning of reservoir operations.*

**Federal Project Operators:** The U.S. Army Corps of Engineers and the U.S. Bureau of Reclamation operate Federal water projects in the Columbia River system and are known as the project operators.

### Parties to the 1997 Pacific Northwest Coordination Agreement

- **Federal Agencies:** BPA, Corps, and Reclamation.
- **Investor-owned Utilities:** Enron/Portland General Electric, Scottish Power/PacifiCorp, Puget Sound Energy, Avista, and Montana Power.
- **Municipal Utilities:** Seattle City Light, Tacoma City Light, and Eugene Water & Electric Board.
- **Public Utility Districts:** Grant County PUD\*, Chelan County PUD\*, Douglas County PUD\*, Pend Oreille County PUD, and Cowlitz County PUD (\* mid-Columbia PUDs).
- **Private Company:** Colockum Transmission Company, a subsidiary of Aluminum Company of America (ALCOA).



## **Columbia Storage Power Exchange and the Canadian Entitlement Allocation Agreements.**

Water released from reservoirs in Canada increases production of power at dams in the United States. The Columbia River Treaty divides power benefits from the Canadian Treaty dams equally between Canada and the United States.

Canada sold its share of the power for the first 30 years of project operation. Forty-one utilities in the United States formed the Columbia Storage Power Exchange (CSPE) to purchase the Canadian power benefits as each Canadian dam became operational, beginning in 1968. **CSPE utilities** receive Canadian power from BPA and the three mid-Columbia public utility districts with projects on the mainstem Columbia River.

The Canadian Entitlement Allocation Agreements are contracts that divide the Treaty's power benefits and obligations among the non-Federal beneficiaries in the United States. There are five Canadian Entitlement Allocation Agreements, one for each of the five public utility district-owned dams on the mid-Columbia. These dams are Wells, owned by Douglas County PUD; Rocky Reach and Rock Island, owned by Chelan County PUD; and Wanapum and Priest Rapids, owned by Grant County PUD.

These agreements determined how much power each of the five utilities must

*Allocation agreements divide the power benefits and obligations among U.S. parties.*

**CSPE Utilities:** The Columbia Storage Power Exchange is made up of four private utilities and 37 public utilities in the Northwest. In 1968, these utilities purchased Canada's downstream power benefits for 30 years with tax-exempt revenue bonds.



*The Northwest Power Planning Council is responsible for preparing a Fish and Wildlife Program to protect, mitigate, and enhance the Columbia River Basin's anadromous fish, resident fish, and wildlife. The program was adopted in November 1982, and amended in 1984, 1987, 1994, and 1995.*

generate from Canadian flows for delivery to the CSPE utilities. The agreements were set to expire beginning in 1998.

In 1997, BPA, after negotiations with the mid-Columbia PUD project owners and completion of the SOR, adopted a new set of allocation agreements, the Canadian Entitlement Allocation Extension Agreements. These distribute the obligation for returning the Canadian Entitlement between the downstream Federal and non-Federal parties that benefit from the upstream Canadian Treaty storage dams. These agreements allocate 72.5 percent of the power generation to the Federal hydro projects, and 27.5 percent to non-Federal (mid-Columbia) hydro projects.

The new Canadian Entitlement Allocation Extension Agreements began to replace the existing Entitlement Agreements when the first portion of the

Canadian Entitlement power was returned to Canada in 1998. The Canadian Entitlement is delivered to points on the border between Canada and the United States, near Blaine, Washington, and Nelway, British Columbia, as a default. Following a 1999 exchange of diplomatic notes between Canada and the United States, the Canadian Entitlement owner—the Government of British Columbia—may elect to dispose of Canadian Entitlement power directly in the United States. The new agreements extend to 2024 since the United States' obligation to return the Canadian Entitlement continues to at least September 2024.

**Non-Treaty Storage Agreement.** In 1984, BPA and B.C. Hydro signed a 10-year agreement to coordinate the use of an additional amount of the water stored in the reservoir behind Mica Dam in southeastern British Columbia.

Since the use of this storage space was for power production not covered in the Columbia River Treaty, the agreement is referred to as the “Non-Treaty Storage Agreement.”

The two agencies agreed in 1990 to expand the Non-Treaty Storage Agreement and extend it until 2003. The new agreement more than doubled the amount of water storage covered previously, from 2.5 billion cubic meters (2 million acre-feet) to 5.6 billion cubic meters (4.5 million acre-feet). BPA and B.C. Hydro equally share the power-generating benefits represented by this storage.

In addition to BPA and B.C. Hydro, the owners of the five non-Federal mid-Columbia hydroelectric projects and their power purchasers are interested parties to the Non-Treaty Storage Agreement and share its obligations and benefits. BPA completed a companion agreement with these owners, and with many of the utilities that purchase power from these projects, because the hydropower benefits represented by the Non-Treaty Storage Agreement depend on the cooperation of the mid-Columbia dam operators.

BPA, B.C. Hydro, and Mid-Columbia parties have re-opened negotiations on both Non-Treaty Storage Agreements to determine if there are sufficient benefits to these parties to continue the agreements past 2003.

**Tribal Treaties and Executive Orders.** Indian

treaties are contractual agreements between sovereign tribal nations and the United States Government. Under the treaties, tribes ceded lands to the Federal government in return for reservation land and a number of guaranteed rights. There are 13 Federally recognized Indian tribes in the Columbia River Basin. The original treaty councils were held in 1855. After that time, other reservations were created by executive order. The treaties and the



*Some wild fish runs are so depleted that they have been declared threatened or endangered under Federal law.*

executive orders are the basis for recognizing Indian lands, ceded lands, and usual and accustomed fishing sites. Tribes retain privileges to hunt, fish, gather wild subsistence foods, and pasture livestock on ceded lands.

Subsequent interpretation of the treaties has identified a **trust responsibility** between Indian nations and the Federal government. The trust responsibilities obligate the government to provide services that protect and enhance Indian lands and resources, which includes the need to maintain harvestable stocks of anadromous fish.

**Pacific Northwest Electric Power Planning and Conservation Act of 1980.** Congress passed the Act on December 5, 1980. This law created an eight-member Northwest Power Planning Council. The governors of the four Northwest states—Idaho, Montana, Oregon, and Washington—each appoint two members. The council is entrusted with adopting a Fish and Wildlife Program for the Columbia Basin, which contains a number

*The Act called for a Fish and Wildlife Program.*

of goals for restoring and protecting fish populations, and with encouraging a vigorous energy conservation program. The Fish and Wildlife Program has led to changes in how the Coordinated Columbia River System is operated. The council also prepares a 20-year Regional Electric Power and Conservation Plan, which is designed to ensure the Pacific Northwest will have an adequate, efficient, economical, and reliable electricity supply. The council periodically updates both plans.



**Trust Responsibility:** The Federal Government is obligated as a consequence of treaties to provide those services required to protect and enhance Indian lands, resources, and self-government, and to include social and economic programs necessary to raise the standard of living and social well-being of the Indian people.

## IV. System Operation – The Big Picture



*Libby Dam, completed in 1975, is the key to controlling high spring runoff on the Kootenai River in Montana.*

### A. Hydrology of the Basin

The climate in the Columbia River Basin ranges from a moist, mild maritime condition near the mouth of the river to a near desert climate in some of the inland valleys. The Cascade Mountain Range separates the coast from the interior of the basin and has a strong influence on the climate of both areas.

There are two important runoff patterns in the basin: the snowmelt runoff in the

interior east of the Cascade Mountain Range, and the rainfall runoff of the coastal drainages west of the Cascades. In both areas, most of the precipitation occurs during the winter months.

East of the Cascades, most of the precipitation falls as snow in the mountains. Snow accumulates and water is held in the snowpack until temperatures rise in the spring. Streamflows begin to rise in mid-April, reaching a **peak flow** during May or early June. Fluctuations in streamflow

are caused by variations in sunlight and air temperature. Occasionally, spring and summer rainfall adds to the runoff.

West of the Cascades, winter storms tend to bring rain rather than snow. River levels can rise within hours during major storms. Peak flows near the mouth of the Willamette sub-basin, which drains over 28,500 square kilometers (11,000 square miles), can occur within a few days of large rainstorms, with upstream points flooding within hours of a major storm.

Most of the runoff occurs in the winter, from November through March, but moderate streamflows continue through the spring and early summer fed by precipitation, snowmelt from high areas, and groundwater outflows.

## B. The Drivers of System Operations

Historically, the three primary authorized purposes of the reservoir system in the Columbia River Basin have been flood control, power generation, and navigation. The Columbia River Treaty recognizes only power and flood control. Power generation operations are generally compatible with flood control requirements. The primary goal of flood control is to reduce high streamflows during the spring to protect areas below dams, such as the intensively developed reach of the Columbia River below Bonneville Dam.

Over the past several years, the need to maintain high flows to aid the migration of juvenile salmon and steelhead from spring through fall has taken on an heightened significance in determining operations. The system operating strategy adopted by the Federal agencies in 1995

is geared toward protecting endangered and threatened species of fish and managing operations in-season to respond to water conditions while recognizing the need for flood control and power generation operations. Reservoir operations today also attempt to balance the needs of migrating salmon and steelhead with the needs of **resident fish** that live in the reservoirs and riverine sections year-round.

The major migration of salmon and steelhead, both upstream and down, occurs during the spring, summer, and early fall. To improve juvenile fish survival, changes were made in the operation of both run-of-river projects and at upstream storage reservoirs during the migration season. NMFS has established flow objectives on the Snake and Columbia rivers aimed specifically at optimizing survival for Snake River sockeye, Snake River spring/summer chinook, Snake River fall chinook, and several other non-listed anadromous fish. When natural flows recede, reservoir operators release water from storage to attempt to meet these river passage objectives.

The demand for water from the reservoirs for power generation occurs throughout the year. However, it reaches a peak in the winter when Pacific

Northwest homes and businesses need heating. **Demand** for power in the Pacific Northwest is lowest in summer (with a concurrent higher California/Inland Southwest load as a result of cooling needs). Thus, from the standpoint of power generation to serve Northwest loads, the objective of reservoir operation is to store snowmelt runoff in the spring and early summer for release from storage in the fall and winter when streamflows are lower and demand is higher.

Today, system operations are driven primarily by a blend of flood control, fish migration, and power production needs.

## C. Overview of System Operations

All major dams and reservoirs in the Columbia River system are operated in coordination with one another to maximize the benefits provided by the storage reservoirs. The information below pertains to the Federal reservoirs located east of the Cascade Mountains that drive coordinated operations.

**Reservoirs in a Nutshell.** In the late spring and summer, the snowpack melts and the reservoirs fill. Water is released as

**Demand:** The amount of power being used at any given time. Demand in the Northwest is seasonal, with the highest use in the winter for heating and the lowest in the summer when temperatures are warmer.

*Flood control is a vital function of the reservoir system.*

**Resident Fish:** Fish that are permanent inhabitants of a water body. Resident fish include trout, bass, and perch.

**Drafting:** The process of releasing water from storage in a reservoir. Operators begin drafting reservoirs—through turbines or over the spillway of a dam—to lower the level for a number of reasons, including flood control or downstream flows for fish or power generation.

*Rule curves specify reservoir levels by month to meet project purposes.*

**Snowpack:** The accumulation of snow in the mountains that builds up during the late fall and winter.

**Rule Curves:** Water levels, represented graphically as curves, that guide reservoir operations.

necessary throughout the spring and summer to augment flows for fish migration, with an eye on keeping reservoirs full enough to enhance recreation and maintain resident fish habitat. Some drawdown of reservoir storage also occurs in the summer for irrigation, water supply, and power generation.

When temperatures and streamflows begin to drop in the fall, reservoir **drafting** for power generation increases. Recreational use of the lakes and reservoirs is decreasing at this time of year, as are irrigation withdrawals. Drawdown in the fall also creates storage space for winter flood control.

The system is drafted throughout the winter for power generation and to provide flood control space for spring snowmelt. In the early spring, the reservoirs are at their lowest elevation. Streamflows from snowmelt typically begin to increase significantly about mid-April and reach a peak in May or June. A portion of the resulting high flows is stored to reduce flood danger downriver and to augment flows later in the fish migration season.

**Rule Curves.** Reservoirs are operated according to guidelines called **rule curve** and for nonpower constraints. Rule curves specify reservoir water levels that are desirable for each month and provide guidance in meeting project purposes. They assure that adequate space is available for flood control, that there is water



*Most of the water in the Columbia River system is stored naturally as snow until spring temperatures melt it and begin the seasonal runoff.*

to protect migrating fish and to meet electric power demand, and that elevations do not drop to levels that are harmful for resident fish and wildlife.

System operators develop rule curves at the start of each operating year and update them as the year progresses and more information on **snowpack** and streamflow becomes available. Each reservoir has several sets of curves. Some curves set a maximum elevation, while others set a minimum. The curves are used to operate individual reservoirs as well as the total coordinated reservoir system.

**Three Seasons of Operation.** The operating year for flood control and power production of the Columbia River system can be divided into three seasons:

**September through December.** In the fixed drawdown season, reservoirs are operated according to predetermined rule curves because volume runoff forecasts based on the snowpack are not available until January. The goal in this period is to be sure that reservoirs reach specific

elevations by the end of December. Additionally during this period, flows are managed at Bonneville Dam to enhance chum salmon spawning and rearing below the project. This operation extends into the next season, concluding around March.

**January into April.** In the variable drawdown season, operation of the reservoirs is guided by the volume runoff forecasts. Reservoirs are drafted during this period to provide flood control space and to produce power. Water must be available in the reservoirs early in April to meet the operating requirements of juvenile fish migration.

**April through August.** In the refill season, reservoirs are operated to meet flow objectives at the Corps' dams at Lower Granite on the Snake River and McNary on the Columbia River. The flow objectives were established to enhance the survival of endangered species of chum, sockeye, chinook salmon, and steelhead as they migrate to the sea. Operations for flood control continue as needed and power is generated, with

## Three Seasons of Reservoir Operation

September through December

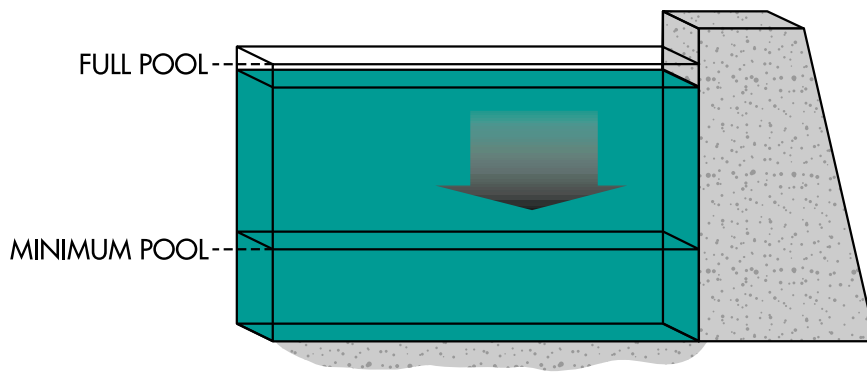

**Fixed Drawdown:** during the late summer and fall when the volume of the next spring runoff is unknown, reservoir operations are guided by fixed rule curves that follow historical patterns.

January into April

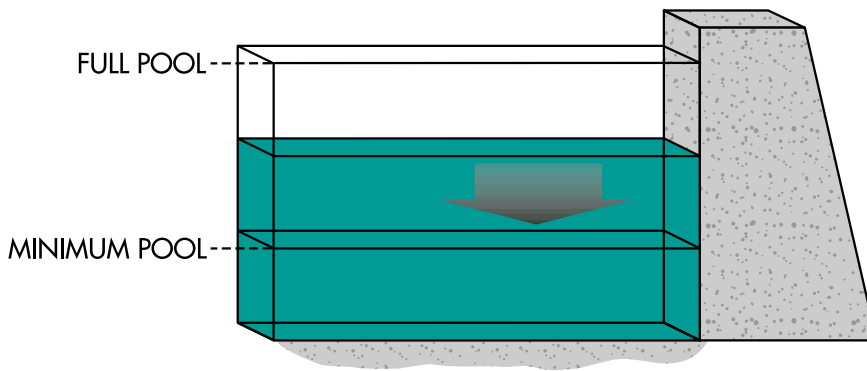

**Variable Drawdown:** Spring runoff forecasts are available beginning in January. They are the basis for rule curves that guide operations through the runoff and refill season.

April through August

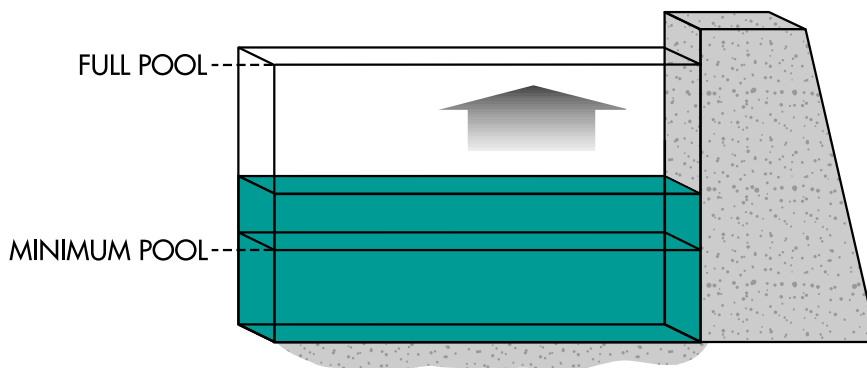

**Refill Season:** Operators focus on capturing enough runoff to refill reservoirs by the end of July. When runoff is low, reservoirs may not refill and future operations are partially shaped by how low reservoir levels are on July 31.

*Reservoirs are operated seasonally based in part on historical runoff patterns.*

*Streamflow studies are made before each new operating year.*

some restrictions on the amount of water that can be put through turbines as opposed to over spillways.

The spring flow targets go into effect April 3 on the Snake and April 10 on the Columbia. They are followed by summer objectives on June 21 and July 1, respectively. Operators try to begin July with the reservoirs full so summer flows can be augmented through August without severe impacts on recreation or resident fish habitat. There are draft limits at each reservoir to protect and balance these other uses.

Before each new operating year begins in August, streamflow studies are made to derive the rule

curves for the multipurpose operation of the dams on the river. Once the basic operating guidelines are set, actual operation of the system is based on meeting several related but sometimes conflicting objectives:

- Providing adequate flood storage space for control of the spring runoff.



*Forecasts of high runoff mean reservoirs must be drafted during the winter so there is adequate space to control flood waters in the spring.*

- Accommodating in-season management of fish passage, spawning, and stranding while providing flows to aid juvenile migration downstream and managing water quality.
- Maintaining a high probability that reservoirs will refill to meet recreation needs and provide water for next year's power and fish operations.
- Preserving and enhancing habitat for resident fish.
- Optimizing power generation within the requirements necessary to meet other objectives.



*Indicators, like this one at Libby Dam, are used to gauge the water level at each reservoir. Efforts are made to refill the reservoirs every year. Runoff is usually adequate to refill reservoirs about three out of every four years.*



When runoff is high, BPA markets extra power to customers within and outside the region.

*Historical patterns are well established, but there is always uncertainty about future runoff.*

Because natural streamflows are typically very low in the late summer and fall and because of the uncertainty regarding future runoff, reservoir operation in August through December typically follows operating curves quite closely. Sometimes more rain causes temporarily higher flows in the fall. This water can be used to produce **nonfirm energy**, increase spawning habitat for chum and chinook salmon, or left in storage for future use. If abundant water is available from January through March, the water will be stored for flow augmentation to the

extent the need for flood control space will allow. Power is produced for nonfirm energy markets as water is released to make space in reservoirs for flood control.



**Nonfirm Energy:** Energy planners separate energy from the hydro system into firm and nonfirm. Firm energy is produced on a guaranteed basis with critical water conditions. Nonfirm energy is the energy that can be generated with water that is available in excess of what is needed for firm energy generation.



## V. Multiple Uses of the System

Operation of the Columbia River system must take into account operating requirements that exist for each project. Almost all operating requirements are defined in terms of river flow or water surface elevation (lake or downstream). Operating requirements for project flows include minimum instantaneous discharge, minimum daily discharge, and maximum hourly and daily rates of change. Operating requirements for reservoir elevations include minimum and maximum reservoir levels, downstream water surface elevations, and maximum hourly and daily rates of change.

Operating requirements can be either site specific or systemwide. Most are site specific, meaning they apply to only one project or one location on the river. When a water project is designed, operating requirements that relate to the physical features and functions of a dam and its surrounding environment are often defined. For example, a requirement may specify the lowest allowable reservoir elevation for a project for use

## Operating Requirements at Grand Coulee

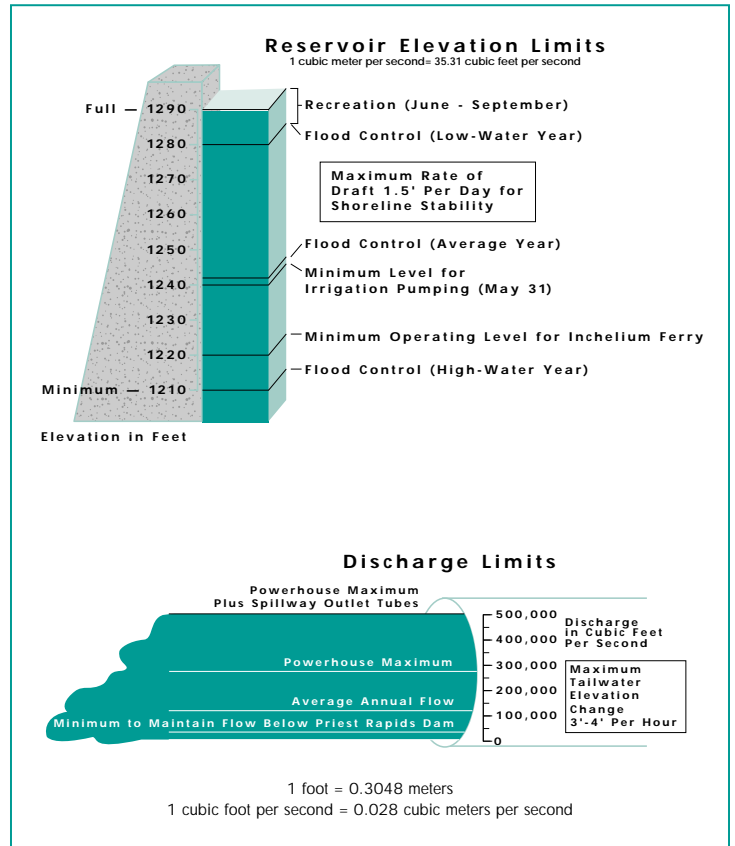

There are many operating requirements for each Federal project. The requirements at Grand Coulee specify reservoir elevations and discharge limits which operators must follow.

of a boat ramp or to accommodate wildlife concerns. Sometimes requirements are included in the authorizing legislation for Federal projects or in the FERC operating license for non-Federal projects. Systemwide requirements affect more than one project.

Sometimes a project's limits and requirements are defined after it is authorized. For example, at Dworshak Dam, a "prime steelhead harvest season" was established for a 45-day period beginning October 1. The requirement (set after the project was authorized but

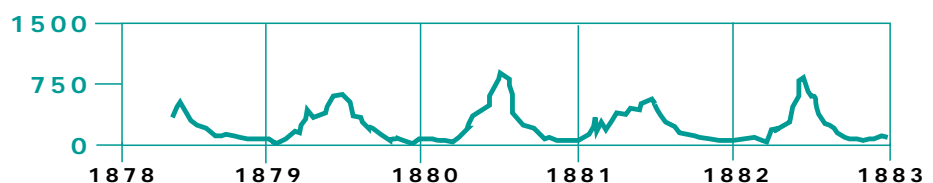
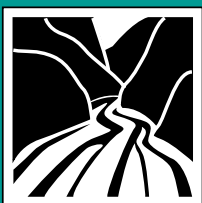

before it was built) increased public support for the project because it provided for a period of nearly natural streamflows below the dam for steelhead fishing. New requirements also are developed through studies and discussions with the public and other agencies. In the following pages, the categories of operating requirements that must be factored into Columbia River system planning and operation each year are described in detail.

## A. Flood Control

The Pacific Northwest has two principal flood seasons. November through March is the rain-produced flood period. These floods occur most frequently on streams west of the Cascade Mountains.

May through July is the snowmelt flood period. East of the Cascades, snowmelt floods dominate the runoff pattern for the Columbia Basin. The most serious snowmelt floods

develop when extended periods of warmer weather combine with a large accumulation of winter snow. The worst floods result when heavy rains fall during a heavy snowmelt.

Flood damage potential is greatest in the lower Columbia from the Portland-Vancouver area to the mouth of the river. This area suffers winter rainfall floods from the Willamette River as well as snowmelt floods from the Columbia, and it is the most highly

*Most snowmelt runoff in the basin occurs from May through July.*



*Snowmelt often causes streams and rivers to overflow their banks.*

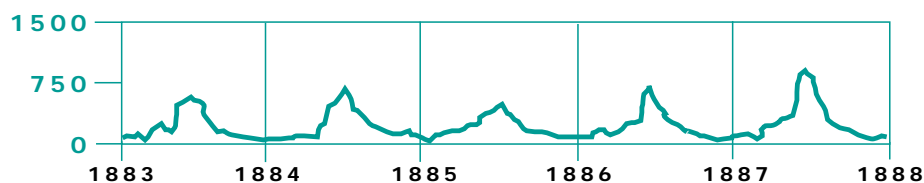

The Columbia River historical runoff record, as measured at The Dalles, Oregon, is depicted on the hydrograph that begins at the bottom of this page and continues throughout this chapter. The flow is shown in thousands of cubic feet per second.

Snowmelt and rainfall can combine to produce devastating floods.



The Columbia River community of Vanport, Oregon, was destroyed by a flood in 1948. It was never rebuilt. The frequency of damaging floods on the lower river can now be reduced by reservoir operations upstream.

**Kootenai and Kootenay:** The name of a Northwest Indian tribe which has been used to name rivers, waterfalls, and lakes in the region. The spelling varies between Kootenay (Canada) and Kootenai (U.S.).

**Levees, Flood Walls, & Bank Protection:** A levee is a raised embankment built to keep out flood waters. Flood walls, such as the concrete seawall along the Willamette River in downtown Portland, are barriers constructed to hold out high water. The soil on river banks is protected from erosion in a variety of ways. River grasses and trees are cultivated in some areas, and fine mesh screens are laid on banks in other areas to keep soil in place. Rock revetments are also used to protect against fast moving streams or vigorous wave action.

developed and populated reach of the river. Flood damage in the past has also occurred along the Flathead River near Kalispell, Montana; the **Kootenai** River between Bonners Ferry, Idaho, and **Kootenay** Lake; the Pend Oreille River below Albeni Falls; the Columbia River near Kennewick-Pasco-Richland, Washington; and the lower Clearwater River near Lewiston, Idaho. Although many streams in the basin remain uncontrolled, reservoirs on the major rivers reduce flood damage in most of these areas.

**Organizing for Flood Control.** Early efforts to

control floods in the region were organized locally in places subject to frequent damage. Levees and floodwalls were built to protect flood-prone areas along the lower Columbia River and elsewhere.

After the tragic flood of 1948 that destroyed Vanport, Oregon, the Corps developed a multiple-use reservoir storage plan for the Columbia River Basin with flood control as a major objective. This plan has evolved over the years with the projects authorized by the Columbia River Treaty bringing the system up to the desired level of protection.

Presently, up to 49 billion cubic meters (39.7 million acre-feet) of storage space can be made available for flood control from the Coordinated Columbia River System, including 25.3 billion cubic meters (20.5 million acre-feet) at the three Canadian Treaty projects. This reservoir storage is supplemented by a system of local **levees, floodwalls, and bank protection**. In addition, many areas have adopted measures such as flood plain regulations, land use regulation, and improved land treatment practices to minimize flood damage potential.

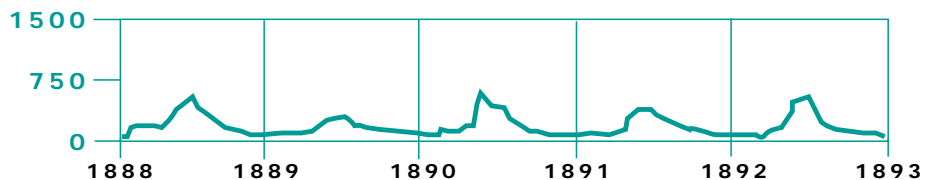

## Flood Control

**Operation.** Floods occur when rivers overflow their banks. The objective of any flood control operation is to capture enough runoff in reservoirs to keep streamflows from reaching damaging levels. Timing is critical. Filling of storage reservoirs must be timed so flows are reduced the most when runoff is highest.

In many parts of the country, floods can occur in any season, so flood control space must be available year-round. In the Columbia River Basin, however, flood flows are limited to two periods: rain-induced floods in the winter, and snowmelt floods in the spring and early summer. Furthermore, the

magnitude of the greater source of potential—snowmelt—can be predicted several months in advance with fairly high accuracy.

As a result, **flood control storage space** in Columbia River reservoirs is made available only during those months when flood risk exists, and the amount of space needed depends on how much runoff is expected. This situation makes it possible to use reservoir space for storing water for fish flows, hydropower, irrigation, recreation, and other purposes during periods when there is little or no flood risk, and to use the space jointly for flood control and the other purposes during the flood

season. This concept of joint-use storage is practiced for the reservoirs of the Coordinated Columbia River System.

**Operating Objectives.** Flood control operation has two objectives: operating the total reservoir system to minimize damaging flows on the lower Columbia River, and operating individual reservoirs to minimize damage to local areas.

The first objective—system flood control—reduces peak flows on the lower Columbia. Streamflow measured at The Dalles, Oregon, is the control point for this operation. The flow objective varies depending on the runoff forecast. In years of low to moderate

**Flood Control Storage Space:** The space that is provided in a storage reservoir to allow for the capture of runoff that could otherwise cause flood damage.

*Timing is critical to keep rivers from overflowing their banks.*



Flood control operations reduce the probability of property damage by capturing excess runoff in reservoirs and releasing it over time.

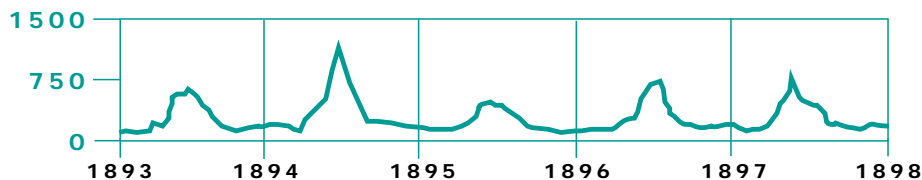

The reservoir system is operated in most years to limit peak flows to 450,000 cubic feet per second at The Dalles, Oregon



Levee systems provide another method of flood protection. There are over 20 levee systems in the lower Columbia River, and, in high water years, they add another layer of security for residents in flood prone areas.

runoff, the reservoir system can be operated to limit peak flows to a maximum of 12,743 m<sup>3</sup>/s (450,000 cfs) at The Dalles, the level above which damage begins to occur in areas not protected by levees.

There are over 20 levee systems along the lower Columbia with varying protection capabilities. Some are designed to sustain flows of 22,653 m<sup>3</sup>/s (800,000 cfs) or more. Others can fail at flows as low as 16,990 m<sup>3</sup>/s (600,000 cfs), which is considered the “major damage” threshold for the lower Columbia.

Control to this level can be accomplished in high runoff years using a combination of space in U.S. reservoirs and the 10.4 billion cubic meters (8.4 million acre-feet) of Canadian Treaty storage

that is available at no additional cost beyond the original lump sum payment. To control very large floods, the United States may choose to pay for additional storage in Canadian reservoirs.

The second objective—controlling local floods—requires consideration in both winter and spring. Each reservoir’s fall and winter drawdown schedule is designed to provide space for controlling local rainfall floods as well as snowmelt floods. Generally, during spring floods, storage of runoff for system control provides protection for local areas as well.

**Flood Control Rule Curves.** Also called Upper Rule Curves, these limits specify the amount of storage that must be evacuated

during the fall and winter to meet the objectives outlined above. These curves indicate the minimum reservoir elevation that must be maintained. The elevation defined by the curve depends on the magnitude of the flood threat at that particular time.

Flood control rule curves have a fixed component, which usually defines operation during September through December, when less predictable rainfall floods occur. Evacuation of reservoirs begins in this period to ensure that space will be available when needed to control floods. Since snowpacks are just beginning to build during this period, runoff forecasts are not available, so the curve is based on a statistical analysis of historical events.

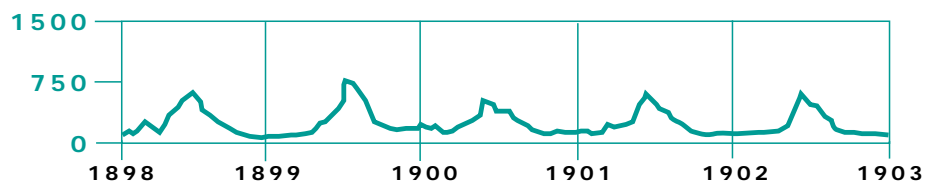

The variable component of flood control rule curves defines operation from January through April. In January, forecasts of seasonal volume runoff become available. This allows the variable portion of each project's flood control rule curve to be defined. It is based on the runoff volume expected to occur and thus indicates the amount of reservoir storage space needed to control floods for the rest of the **operating year**.

The flood control rule curve is developed using the project's **storage reservation diagram**, which specifies the amount of storage required to protect against a wide

range of runoff forecasts. The flood control curves are updated monthly as revised forecasts become available.

**Flood Control During Refill.** From April through July, reservoirs are allowed to refill gradually, at a rate that maintains downstream flows at acceptable levels. To guide this operation, the Corps uses a computer model to simulate reservoir operation on a daily basis in response to forecasted runoff. In moderate to high runoff years, careful monitoring is required to ensure that damaging flows do not occur.

In other years, cool

weather and other conditions result in reduced runoff, so the potential for flood conditions is never realized. In those years, considerations such as refill requirements, water releases for fish, and power generation opportunities heavily influence refill operation.

**Actual Operation.** Flood control rule curves define the minimum amount of storage space that must be provided at each project to meet system and local flood control needs. Prior to requirements contained in the biological opinions, actual reservoir levels tended to be somewhere between the flood control

*Flood control rule curves are updated as runoff forecasts become available.*

**Operating Year:** Detailed operations are planned over a 12-month period. The operating year begins on August 1 and ends on July 31.

## Typical Storage Reservation Diagram

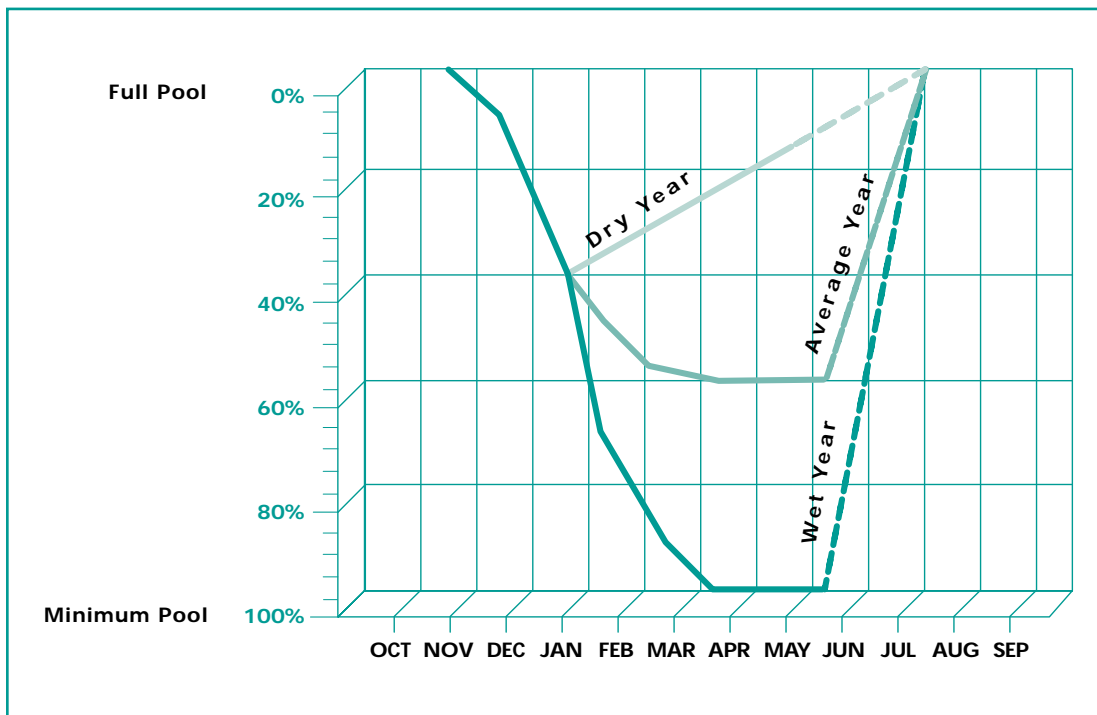

Each storage reservoir has its own storage reservation diagram, which shows the pool levels that need to be maintained given various runoff predictions.

**Storage Reservation Diagram:** Each storage reservoir has its own storage reservation diagram, which shows the pool levels that need to be maintained given various runoff predictions.

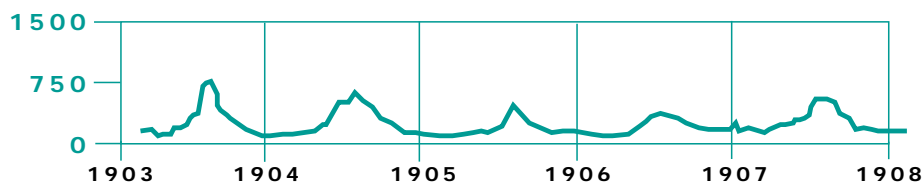



Ratepayer-funded hatcheries put millions of salmon smolts into the river each year. This practice augments the natural fish stocks that have declined rapidly in recent years.

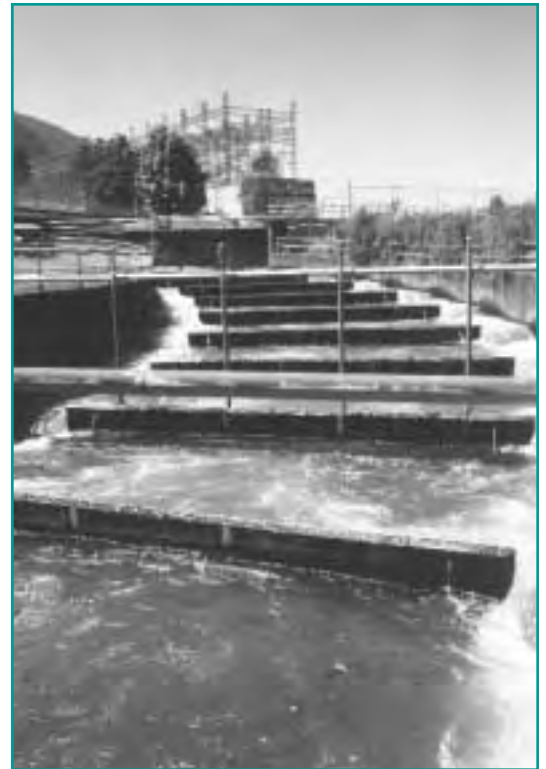

All Federal dams on the lower Columbia and lower Snake rivers have fish ladders similar to this one to aid fish migrating up the river.

Rushing water attracts fish to fish ladder entrances.

rule curves and the somewhat lower limits established for power generation. Since the biological opinions, the levels tend to follow flood control curves. The rule curves for power generation are described in section C.

## B. Fish and Wildlife

The Columbia River Basin is world renowned for its salmon and steelhead, two types of anadromous fish. A number of factors related to human activity have contributed to the decline of anadromous fish runs in the basin. Irrigation, timber harvesting, commercial fishing, mining, pollution, construction of structures in the river, flood control, and other factors have taken a toll on the once abundant fish populations.

Engineers and planners recognized that dams block the upstream passage of

adult fish. Before construction began, they designed measures to reduce this effect at many of the projects. Fish

ladders were built at middle and lower Columbia and lower Snake river dams. Operators enhance passage by providing rushing water near the fish ladder entrances to attract migrating adults.

Dams can also impede the migration of juvenile fish downstream. Juveniles can be killed when they pass through turbines, and they can be subject to predation in reservoirs. Beginning in the early 1980s, the Northwest Power Planning Council's Fish and Wildlife Program called for building bypass facilities to aid juvenile migration, constructing more fish

hatcheries, improving habitat, and screening irrigation diversions. Other measures, such as a "water budget" to help "flush" juvenile fish down the river and a spill agreement to move fish over dams, were also implemented.

Despite over a decade of effort, some stocks of fish reached such alarmingly low levels during the decade of the 1990s that they were declared endangered or threatened under Federal law. In response to the ESA listings, the Corps and Reclamation have implemented major changes in the way their projects are

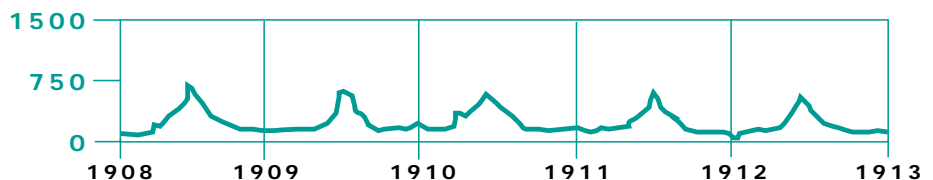

operated. Anadromous fish recovery now has a higher priority than ever before in system planning and operations.

**ESA Listings.** In the early 1990s, NMFS determined that, without ESA protection, Snake River sockeye salmon, and spring, summer, and fall chinook were likely to become extinct. The sockeye, poisoned during the 1960s and 1970s by an Idaho state agency as “trash fish,” were declared endangered in 1991. The chinook were listed as threatened in 1992 and were reclassified as endangered in 1995. According to NMFS, the populations of Snake

River spring and summer chinook have fallen to 5 percent of their historical abundance. Only 350 Snake River fall chinook returned to spawn in 1995, and one lone sockeye returned to Idaho’s Redfish Lake in 1994.

NMFS concluded that the impacts of the FCRPS jeopardize the continued existence of the Snake River salmon. The Federal operating agencies worked with NMFS to develop operations that would avoid jeopardy. These operations were set out in NMFS’ 1995 biological opinion. In 1996, after completing the SOR, the Corps, Reclamation, and BPA adopted an operating

strategy for the hydro system that was based on the 1995 biological opinion and aimed to operate the river to optimize fish survival and recover endangered salmon.

On May 14, 1998, NMFS issued a supplemental biological opinion which responded to new listings for Snake River steelhead (threatened), Upper Columbia River steelhead (endangered), and Lower Columbia River steelhead (threatened). The operating strategy was similar to the 1996 strategy but continues to evolve to optimize species’ survival and recovery. A new biological opinion was issued in

*Bypass facilities aid downstream migration of juvenile fish.*



Screens are placed at the entrance to irrigation canals to keep fish from being diverted into channels that carry water away from the river.

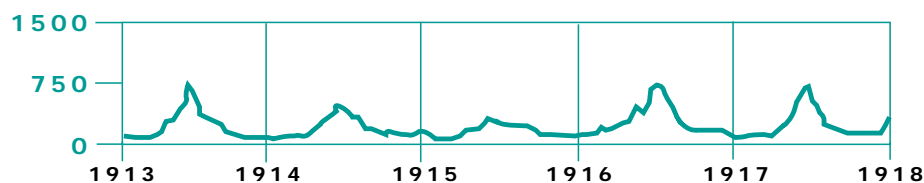



## Anadromous Fish Flow Objectives

*Flow augmentation provides higher flows to aid migrating fish.*

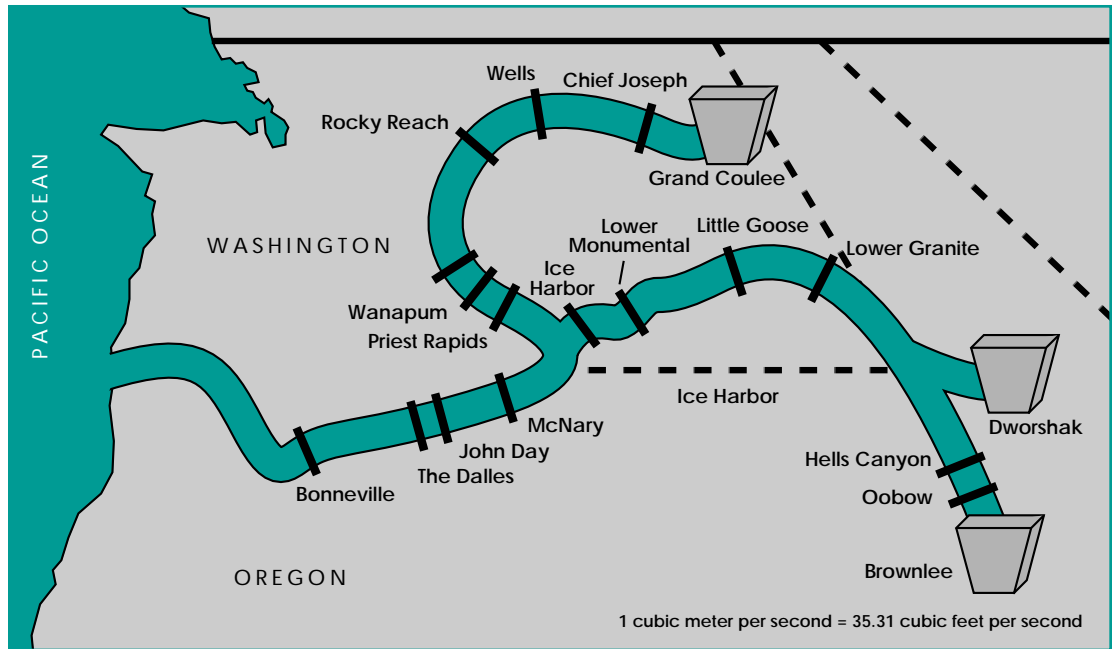

The Water Budget, begun in 1982, and subsequently replaced with flow augmentation, provided additional flow in the spring to move juvenile salmon downriver to the ocean. Some of the water was stored at upstream projects on the Snake and Columbia rivers until it was requested.

December 2000. The operating requirements are similar to the 1995 NMFS opinion with changes to improve anadromous fish passage through the hydro system. The new opinion also covers habitat, hatchery, and harvest activities.

The objective of the system operations in the spring is to restore the effects of a spring **freshet** to move migrating salmon **smolts** rapidly past the dams and out to the ocean. Flow objectives are the way operators assure that the volume of water in the river is adequate to speed the fish along. The biological opinion sets a flow objective for Lower

Granite Dam on the Snake River and for Priest Rapids and McNary dams on the Columbia. If natural runoff is inadequate to meet the objectives at these measuring points, water is released from storage reservoirs to augment flows. In order to protect other parts of the ecosystem, as well as resident fish and wildlife, there are limits on how much reservoirs will be drafted.

The biological opinion gives a range in which flow objectives are set, depending upon the runoff forecast. The objectives are expressed in thousands of cubic feet per second (kcf), and there are objectives for

both the spring and summer seasons. On April 3, fish migration operations begin on the lower Snake; seven days later the Priest Rapids objective of 135 kcf becomes effective through June 30. On April 10, fish operations begin on the rest of the Columbia. The spring flow objective is in force until June 20 on the Snake, at which time a summer target goes into effect. On the Columbia, the spring objective is in effect until June 30, and the summer objective takes effect on July 1.

Another aspect of the operating strategy concerns spill. Flows keep the fish

**Freshet:** The heavy runoff that occurs in the river when streams are at their peak flows with spring snowmelt. Before the dams were built, these freshets moved spring juvenile salmon quickly downriver.

**Smolt:** A juvenile salmon or steelhead migrating to the ocean and undergoing physiological changes to adapt its body from a freshwater to a saltwater environment.

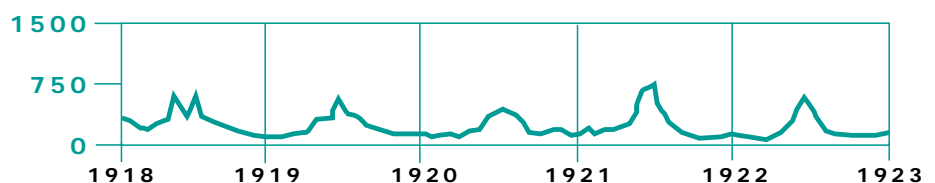

moving, and spill helps steer them away from generating units. The original biological opinion recommended that a target of 80 percent smolt passage via non-turbine routes unless the **dissolved gas level** in the water became too high. Now, the goal is to move as many fish as possible via non-turbine routes. This means the majority of fish must go through collection and bypass systems or be

passed over the spillway. Seven Corps projects have been equipped with bypass facilities: Bonneville, John Day, McNary, Little Goose, Lower Granite, Lower Monumental, and Ice Harbor. These divert juvenile fish away from turbine intakes and into special conduits or sluiceways where they can either be bypassed around the dam or collected at four sites for transport downstream—Lower Granite,

Little Goose, Lower Monumental, and McNary.

In order to provide the flows and **spill** called for in the biological opinion, the operating agencies attempt to store water through the winter for the fish migration season. The reservoirs begin the season fuller than they would have under the old operating guidelines that gave power production a higher priority in system operations. Additionally, storage is tempered by the need to provide flows for chum salmon during late fall and winter.

**Transportation.** The Corps operates an extensive program for transporting smolts past the dams. An experimental barging program was begun in the early 1970s because of the problems with cumulative impacts of gas supersaturation, turbine mortality, and predators on the juvenile fish moving through the reservoirs and past the projects. Specially constructed barges or tank trucks are used to move the fish from collector dams to release sites below Bonneville Dam. Four lower Snake and Columbia river dams (Lower Granite, Little Goose, Lower Monumental, and McNary) have juvenile collection and transport facilities; however, in-season operations under the biological opinion

**Spill:** Water released from a dam over the spillway instead of being directed into the turbines.

**Dissolved Gas Level:** As falling water hits the river surface, it drags in air as it plunges. With increasing water pressure, this air dissolves into the water and increases the levels of pre-existing dissolved gases.

*When water is spilled, fish are drawn over the spillways and away from turbines.*



The fall chinook spawning grounds at Vernita Bar upstream from the Tri-Cities, Washington, are protected by a special agreement known as the Vernita Bar Agreement.

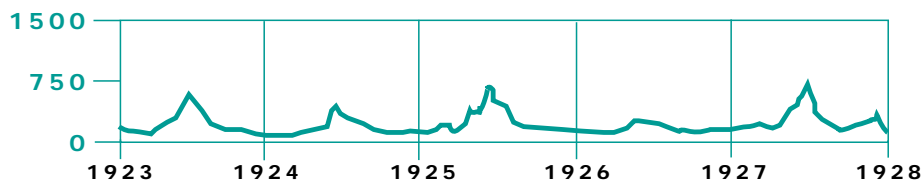

## Dam Cross-sections Showing Various Pathways for Fish

The region is committed to protecting dwindling salmon stocks.

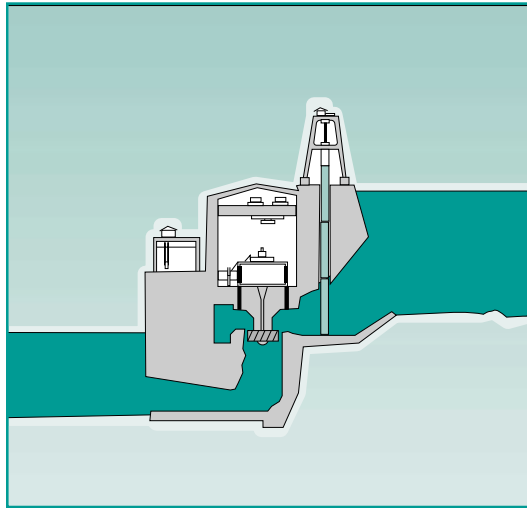

This cross-section of a typical run-of-river dam shows the water intake (penstock), the turbine generator which is spun by the falling water, and the water outlet (tailrace).

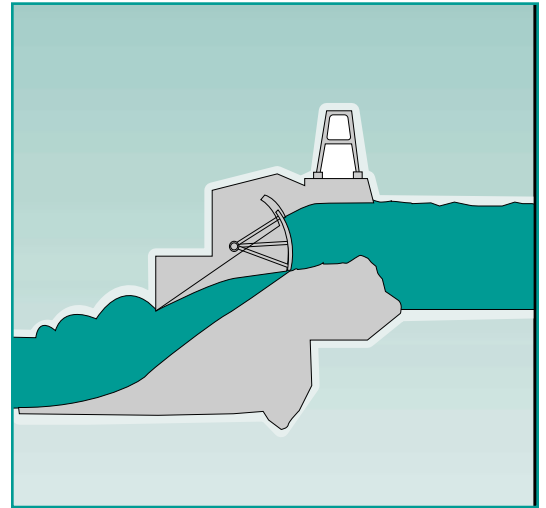

The spillway is the overflow structure on the dam where water passes over and down a concrete chute. The amount of water passing over the spillway is controlled through gates.

determine which will be used and how many fish will be transported.

Research over the years has resulted in many improvements to barging. A constant supply of fresh water pumped into the barge directly from the river provides fish with homing cues they will need later as returning adults. The number and type of fish that can be safely carried is factored into the operation. The barges are equipped with aeration chambers that remove supersaturated gases from the water.

**Operations to Recover Sturgeon and Bull Trout.** The Kootenai River white sturgeon, which lives in Canada's Kootenay Lake but travels upriver into the U.S.

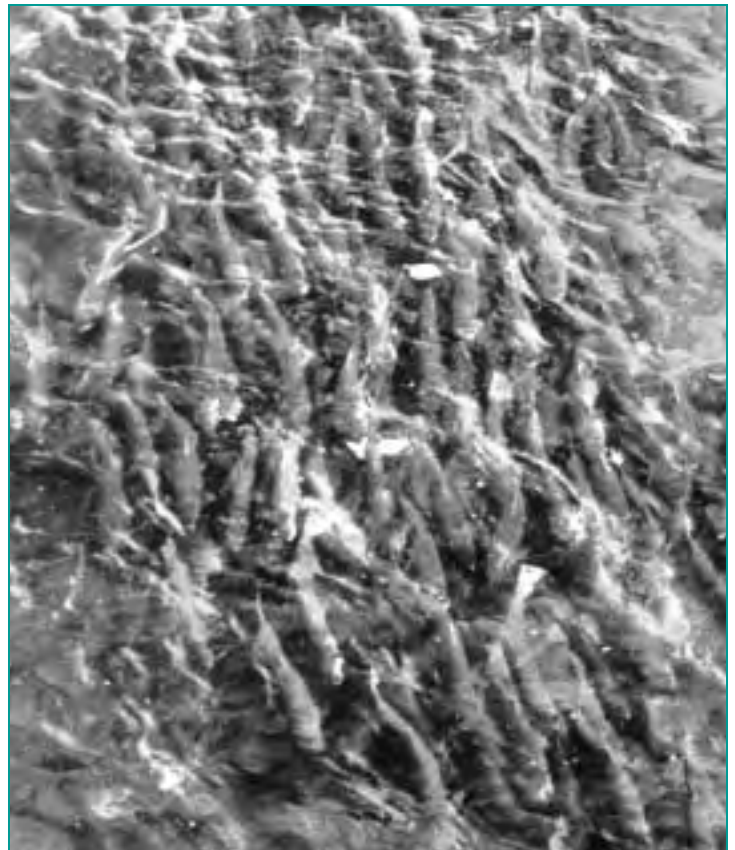

With the attention on wild salmon stocks, river managers and others in the region are exploring new methods for improving juvenile salmon migration.

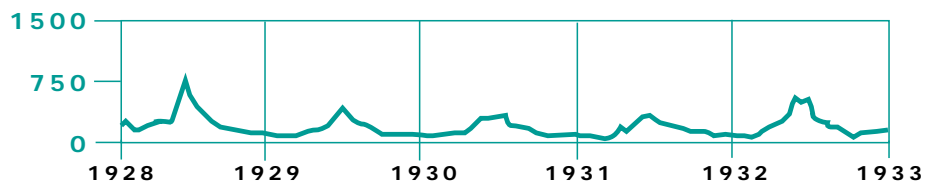

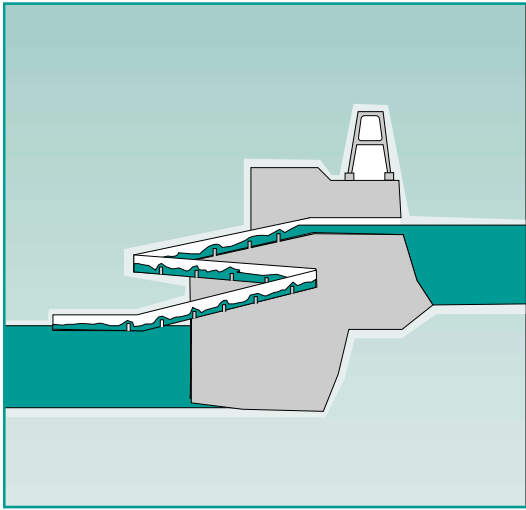

Fish ladders are a series of gradual steps that enable fish to swim around or over a dam. Ladders are in place at all Federal projects on the lower Columbia and lower Snake rivers.

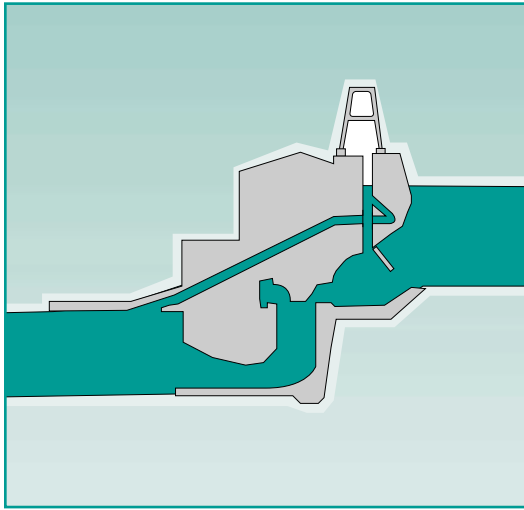

Bypass systems are pathways made up of pipes and conduits that carry juvenile fish that enter the penstocks away from turbines and around a dam. In some cases, bypasses guide fish to collection points where they are loaded into barges or trucks and transported downstream below other dams.

*Left uncontrolled, northern pikeminnow will dine heavily on juvenile salmon.*

to spawn, has also been declared endangered. The USFWS listed the sturgeon in 1994, citing Libby Dam as the most significant factor in the species' decline. In 1995, the Corps began operating the reservoir at Libby Dam according to the USFWS biological opinion for white sturgeon. The objective is to regulate the flows at Libby during the spring and summer to release water at an appropriate temperature and provide an adequate volume of flow downriver to the sturgeon's spawning grounds to meet its biological needs.

Bull trout are a threatened species in the Columbia River Basin. One measure being implemented to assist their recovery is to

provide flows of 255 m<sup>3</sup>/s (9,000 cfs) from the Libby project at Bonners Ferry during their summer spawning period.

**Vernita Bar Agreement.** In the past, operators of Federal projects had informally cooperated to ensure lower flows over Vernita Bar during the fall spawning period and higher flows in the winter while eggs are incubating. The 1988 Vernita Bar Agreement made formal the efforts by Grant County PUD, BPA, and others to deliver flows needed to encourage and protect salmon spawning at this location.

Under the agreement signed in 1988, operators provide certain flow levels from fall to early spring to

protect and preserve salmon spawning and hatching at Vernita Bar below Priest Rapids Dam. This is the largest fall chinook salmon spawning area on the mainstem of the Columbia River.

An agreement is under development to reduce stranding of juvenile salmon along the Hanford Reach of the Columbia River. If water levels drop off rapidly after a rainstorm, snowmelt, or a change in project operations upstream, salmon can become trapped in pools no longer connected to the river. Without any means to return to the river, the trapped fish die as pool temperatures rise and the dissolved oxygen is exhausted.

**Fall Chinook Salmon:** This salmon stock returns from the ocean in late summer and early fall to head upriver to its spawning grounds, distinguishing it from other stocks which migrate in different seasons.

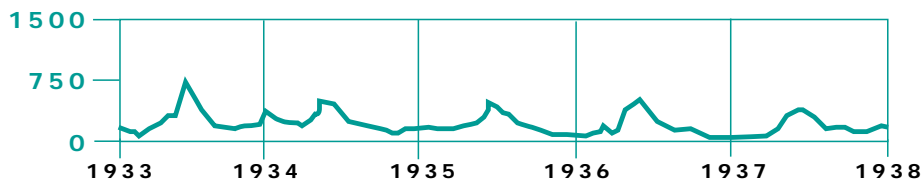

*There are special operating requirements at some projects to protect native fish and waterfowl habitat.*

## Life Cycle of Columbia River Anadromous Fish

Salmon are anadromous fish, which means they are born in freshwater, migrate downstream to the ocean where they spend most of their lives in saltwater, and then return to freshwater to reproduce (spawn). Both salmon and steelhead are strongly affected by the natural ups and downs of river flows that occur with the changes of seasons.

Salmon hatch in freshwater gravel beds of the Columbia River and its tributaries. About 50 days after eggs are laid, embryonic fish called alevins emerge. Alevins live on nutrients stored in their yolk sac until they grow large enough (about 2 centimeters (cm) (1 inch)) to emerge as young fish, or fry, that eat insects and organic matter. They quickly grow to 8 to 10 cm (3 to 4 inches) before seeking sheltered spots in freshwater streams to spend the winter.

As winter ends, their bodies begin changing to adapt to seawater, and the young salmon and steelhead, now called smolts, are ready to begin their migration down the tributaries to the Columbia River and out to sea. Most of the young fish migrate out of the river during spring and early summer when natural water flows are highest. Once they arrive in the ocean, a trip that can take a month or two, the fish feed—and are fed upon—voraciously as they grow into adults. Many are caught or eaten by native predators during the two to five years the salmon spend in the ocean.

Fish that have grown to maturity and survive the many dangers and predators at sea then begin their long return journey. They undergo another set of physiological changes to allow them to return to freshwater and swim up the river. Most adults return to the same streams and tributaries where they were spawned, guided by complex homing instincts.

Once they arrive, the adult fish pair up and spawn, releasing and fertilizing their eggs. Female fish cover their nests (called redds) with gravel from the streambed. Adult salmon die after spawning, but some steelhead survive and return to the ocean to restart the cycle.

### Controlling Predation and Fish-Killing Gases.

BPA began a project to control **northern pikeminnow**, a prime predator of juvenile fish, in 1990. Commercial and sport anglers are paid a bounty for each adult northern pikeminnow, caught and turned in at a northern pikeminnow check station.

Action agencies are also working to solve the problem of nitrogen supersaturation. When water is spilled that would otherwise

go through turbines, large amounts of air become trapped in the water. This water, which is supersaturated with



Many species of waterfowl, such as Canada geese, rely on the banks of the Columbia River and its tributaries for food and nesting.

dissolved gases (principally nitrogen), can damage and, if exposure time is high, even kill fish. Flow deflectors (flip lips) have been installed on the spillways at most of the Corps' dams to reduce the plunge of water into the basin below.

Project operators also work with fisheries agencies to reduce nitrogen supersaturation with "spill transfers." Supersaturation and spill are reduced and power generation is increased at one project where gas

**Northern Pikeminnow:** A giant member of the minnow family, the northern pikeminnow (formerly known as squaw-fish) is native to the Columbia River and its tributaries. Studies show a northern pikeminnow can eat up to 15 young salmon a day.

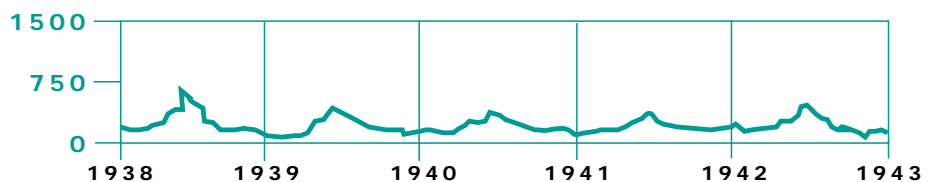

entrainment is a problem to migrating fish. Power generation is decreased and spill increased at another project where fish have already migrated. The total outflows at both projects remain constant. Research on the effects of gas supersaturation on fish life is continuing so additional measures to reduce this problem can be found.

**Nurturing the Natives.**

Rivers and reservoirs are also home to native freshwater fish that do not migrate to the sea. These are resident fish, such as trout, sturgeon, and kokanee. System operators monitor water levels in the reservoirs to protect the shallow spawning habitat of resident fish.

In the early spring, when geese and pelicans are selecting their nesting

sites, special operating requirements are put into effect at certain projects to keep them from building nests in areas that may later be inundated. For example, a reservoir level is raised every three days to keep geese from nesting too low on the bank of the John Day and McNary reservoirs. Other wildlife protection measures are included in the council's Fish and Wildlife Program.

**C. Power Generation**

Falling water is the 'fuel' for power-generating turbines at the dams. Hydropower supplies approximately 60 to 70 percent of the electricity in the Northwest. It is also exported by BPA and the region's generating utilities

when it is surplus to their needs. The balance of the region's electricity comes from thermal resources, primarily nuclear, coal-fired, and gas-fired plants.

Hydropower operations are based on a determination of how much firm energy the system can generate. In most years, there is enough water in the system to produce additional energy, called nonfirm or secondary energy.

**Striking the Balance between Fish and Power.**

Streamflows in the region do not follow the same pattern as electric energy use. Customers in the Northwest use more electricity in the winter than in the summer. The Columbia River, however, is driven by snowmelt, with high runoff in the late spring and early summer. Natural flows are low in the fall and

*Hydropower generation is the backbone of the region's electricity supply.*



Energy Northwest's Columbia Generating Station, at Hanford, Washington, is one of the Northwest's large thermal generating plants. With the hydro system extensively developed, the region has turned to thermal generation to serve the growing load. Thermal resources now supply about 30 to 40 percent of the region's electricity.

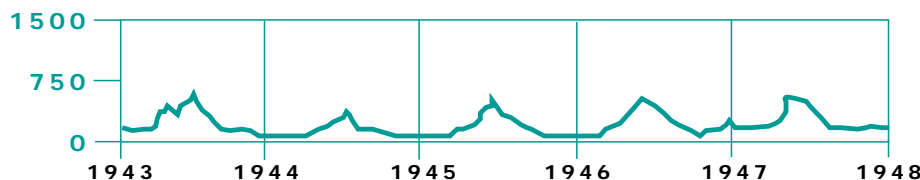

*Nuclear and coal-fired power plants and combustion turbines add to the Northwest's generating resources.*

## Speaking the Power Planners' Language

Planners categorize power according to a number of factors, such as whether generation can be guaranteed under various circumstances and whether the energy is surplus to the needs of Northwest customers. Some common terms are defined below.

**Capacity and Energy:** Capacity refers to the maximum amount of power a generator can produce or a power line can carry at any instant. A generator with a capacity of 100 megawatts can produce that amount of power when needed. However, it may rarely be run at full capacity. The same is true of an automobile engine with 350 horsepower; it can produce that maximum horsepower but is not often required to do so. Excess capacity makes it possible to meet upswings or peaks in utility system load. Energy is the actual measure of generation or consumption over time. One kilowatt-hour is 1,000 watts of energy provided for one hour. Both a 100-watt light bulb burning for 10 hours and a 1,000-watt hair dryer running for one hour result in the consumption of one kilowatt-hour.

**Seasonal Firm and Nonfirm Energy:** These are terms planners use to distinguish generation that is guaranteed—given the region's worst historical water conditions—from generation that depends upon better than worst-case streamflows. Firm energy is available even if the lowest recorded streamflows recur; nonfirm energy can be produced when streamflows are better than worst case, which is usually what happens. Nonfirm is also called secondary energy, and, in the developing marketplace, its delivery is almost as certain as firm energy.

**Firm surplus and firm deficit:** These terms refer to supply and demand conditions. BPA has a firm surplus when the amount of energy the system can produce on a firm basis exceeds anticipated demand from BPA's customers. There is a firm deficit when the anticipated demand exceeds the firm energy that the system can produce.

winter, when demand for power is high.

Storage reservoirs can be operated to at least partially correct the discrepancy between seasonal runoff and power demand. Storage reservoirs hold energy—in the form of water—until system operators determine it can be released for various system needs.

Under the current operating strategy, operation of the reservoirs is adjusted to match the needs of the ESA-listed fish species.

Conflicts between power generation and fish are generally resolved in favor of the fish. Only flood control takes absolute precedence over fish.

The current operating strategy requires increased water storage in the fall and winter and increased flows and spill during the spring and summer to benefit migrating juvenile salmon. This creates more of a mismatch between streamflows and generation than occurred with operating strategies in

the past. The result is more water for fish but a decline in annual hydropower generation and, therefore, reduced revenue from power sales. With lower winter flows and higher spring and summer flows, BPA is likely to need to purchase power more often during high load periods in the winter and to have surplus power to sell in the spring and summer. BPA replaces this power through power purchases or the acquisition of new resources.

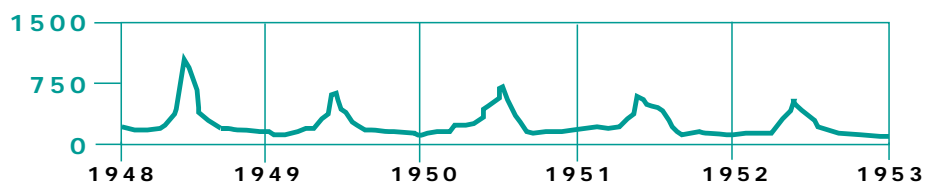

## 42-Month Critical Period

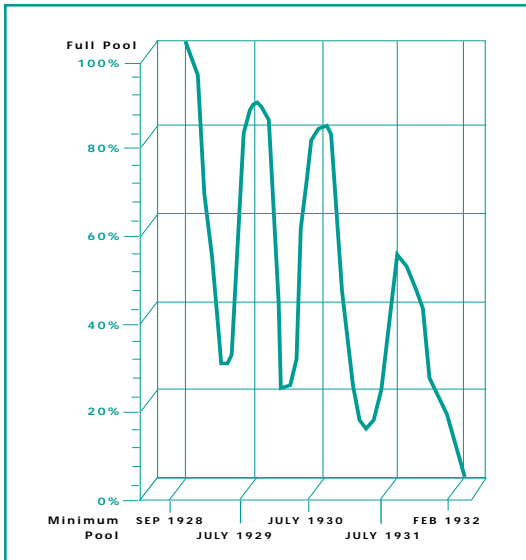

This graph illustrates the reservoir levels for a typical project if the lowest recorded runoff condition in the region were repeated. Under critical-period operation, a reservoir is operated to optimize power production while being drafted from full to empty over 42 months.

## 12-Month Critical Period

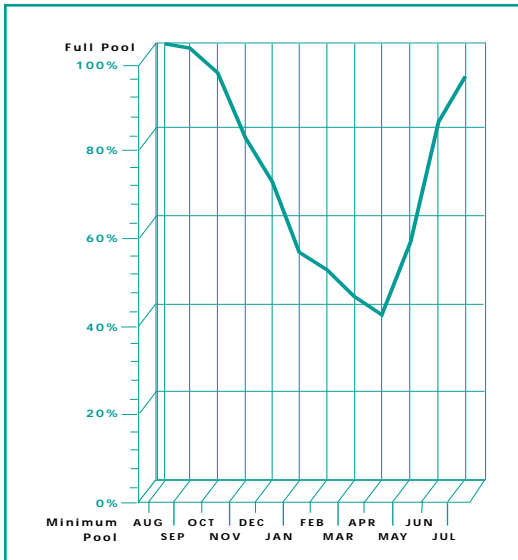

After the 1995 biological opinion the Federal system reverted to a one-year critical period (the four-year critical period came about with the construction of the Canadian Treaty projects). Here, "empty" is a relative term not meaning dry, but rather dropping below 40% of full (flood control rule curve at the end of April). The actual draft period would be 8 months, September through April, under 1937 water conditions.

*Power operations are planned according to the worst water conditions.*

**Northwest Thermal Plants.** In the U.S. Pacific Northwest, there is one operating commercial nuclear plant: the Columbia Generating Station (formerly WNP-2) at Hanford, Washington, owned and operated by Energy Northwest (formerly the Washington Public Power Supply System). The region's coal plants include Enron/Portland General Electric's plant at Boardman, Oregon; the Centralia, Washington plant operated by Scottish Power/PacifiCorp; and the four-unit Colstrip facility in Montana. There are also several natural gas and oil-fired **combustion turbines** in the region that are used periodically during high demand.

Hydroelectric generating plants can be quickly and easily ramped up and down to produce more or less electricity at any given time. As a result, these plants historically followed the ups and downs in demand very efficiently and were the key to meeting peak power loads before fish requirements limited them. Large thermal plants are not so flexible and are not easily switched on and off. They are called baseload plants since they function best when meeting a constant, stable load, 24 hours a day, week in and week out. Newer gas-fired turbines have been called upon to pick up peaking loads.

**Critical Period Planning.** On the Coordinated Columbia River System, a multi-layered planning system for power generation has evolved, based on the possibility that the lowest historical streamflow conditions could recur in the future. System planners call this worst-case sequence of water years the "critical period."

Critical period planning is essentially a **reliability standard** that defines how much hydro system energy should be considered firm, or guaranteed. It serves as a basis for determining how much non-hydro power will be needed to meet expected energy loads in the region. This power could come from

**Reliability Standard:** Just as there are reliability standards for electrical appliances, there are standards for entire electrical supply systems. The standards are set in a way that ensures electricity will be delivered reliably, or without interruption.

**Combustion Turbines:** This type of generation uses some form of combustible fuel to power turbines, similar to aircraft engines, which in turn spin generators. Combustion turbines (or CTs, as they are commonly called) can burn either gas or oil, depending upon availability and cost of the supply. CTs are often used in the Northwest to meet peak winter heating loads because they can be switched on quickly and easily.

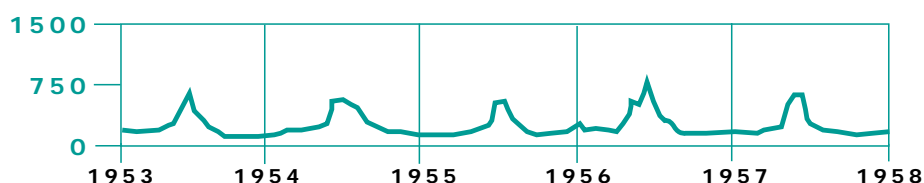



*The worst water conditions in the basin occurred during the years of 1928 to 1932.*

thermal plants in the region or from power purchases.

In the past, the critical period has been determined each year by analyzing a 60-year streamflow record and isolating the portion that would produce the least amount of energy, with all reservoirs drafted from full to empty. Reservoirs were assumed to be full at the beginning of the critical period and drawn down to their lowest operating levels by the end.

Before the biological opinions were issued, the critical period was usually based on the 42-month interval from September 1, 1928, through February 29, 1932, which was referred to as the “four-year critical period.” In general, critical period

planning and the resulting coordination allowed for more power generation than if operations were established on a 12-month cycle.

The biological opinions have introduced a variety of nonpower requirements that have to be accommodated into the critical period planning process. The amount of storage available for power production has been reduced, and, as a result, the amount of firm power the system can produce has decreased because reservoirs cannot be drafted as deep. The current mix of power and nonpower requirements has led to the use of a one-year critical period (August 1, 1936 through July 31, 1937), instead of a four-year critical period.

**Operating Rule Curves for Power Operation.** A set of operating guidelines, or rules, called “operating rule curves” is developed annually to guide reservoir operations for power production. These rule curves result from numerous studies of historical water conditions. The rule curves determine whether water can be used for producing firm or nonfirm energy.

The planning and operating year for power production is August 1 through July 31. The PNCA Coordinating Group, made up of BPA, the Corps, Reclamation, and public and private utilities in the U.S. Northwest and western Canada, administers planning and operations under the Coordination Agreement. Each year, the Northwest Power Pool Study Group constructs numerous rule curves for reservoir operations for the upcoming operating year to be used by the Coordinating Group.

In the fixed drawdown period—from September through December—before the year’s runoff forecast is available, hydro system operation is guided by three fixed rule curves. These are the flood control rule curve, the critical rule curve, and the assured refill curve. After runoff forecasts are available, during the variable drawdown and fish

### Critical Rule Curves for a Typical Columbia River Reservoir

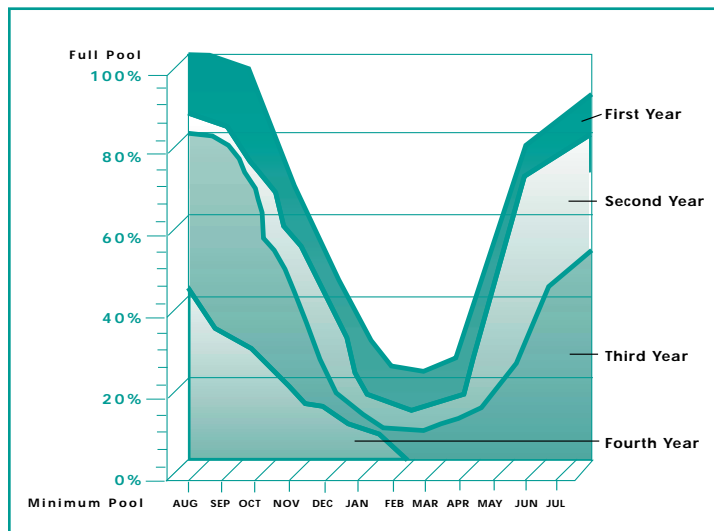

*This graph separates the critical period rule curve into four operating years. Water levels on July 31 influence which of the rule curves operators will follow in drafting reservoirs over the coming year.*

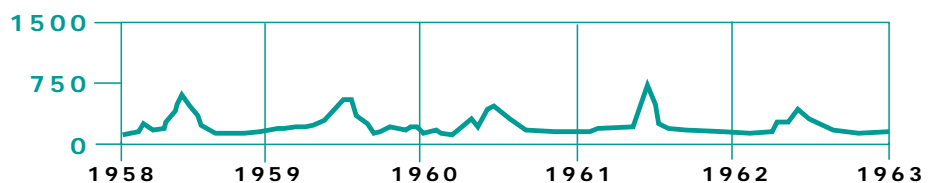

## Deregulation Means Changes for BPA and All Utilities

The electricity industry in the United States is in the midst of a significant restructuring to promote more competition. In 1996, the four Northwest governors appointed a 20-member committee to consider changes in the institutional structure of the region's electric utility industry. The Comprehensive Review of the Northwest Energy System aimed to protect the region's natural resources and distribute the costs and benefits of a more competitive marketplace equitably while assuring the region of an adequate, efficient, economical, and reliable power system.

The Comprehensive Review Steering Committee met throughout 1996 and produced a series of recommendations for restructuring the Northwest electricity industry. Early in 1997, the governors appointed a four-member Northwest Energy Review Transition Board to oversee implementation of the recommendations of the Comprehensive Review.

**Transmission.** BPA has separated its transmission business from its power sales business to conform to recommendations from the Comprehensive Review and national open-access transmission directives from FERC, as interpreted by U.S. Department of Energy officials. BPA is participating in discussions aimed at creating one regional transmission operator (RTO) for all the Pacific Northwest's transmission facilities.

**Federal Power Subscription Process.** BPA has long-term firm power sales contracts with over 120 utilities, including municipalities, public utility districts, and rural cooperatives. The agency also sells firm power directly to some Federal agencies and some of the region's largest industries, including aluminum smelters. These companies are called direct service industries or DSIs. The Northwest's publicly owned utilities have first call on power produced at Federal hydro projects, a principle known as preference.

As deregulated wholesale energy markets become a reality, BPA's customers have a greater number of power suppliers from which to choose. To meet the challenges of the competitive market while still providing stability to BPA, its customers, and the U.S. Treasury, the Comprehensive Review recommended that the region develop a subscription-based system for marketing the electricity produced by the Federal system.

BPA and its customers have worked together to develop the terms and conditions of the subscription relationship. Subscription will guide the process for disposition of Federal power after BPA's existing contracts expire in September 2001. Its outcome will determine the types of long-term contracts BPA and its customers will have in the future.

*The planning process yields rule curves to guide reservoir operations.*

migration periods (January through August), reservoir operations may be guided by one more rule curve called the variable energy content curve. This curve cannot be lower than the flood control rule curve, under the current

operating strategy.

**Flood Control Rule Curve (FCRC).** The flood control rule curve specifies the level of reservoir drawdown required to ensure adequate flood control space. Under the

biological opinions, storage reservoirs are managed to provide specified percentages of confidence of refill to flood control levels by April 10 of each year.

**Critical Rule Curves.** Critical rule curves specify

**Flood Control Rule Curve:** The curve is also called the upper rule curve. It sets the amount of storage space that must be maintained in a reservoir to reduce damaging flood conditions downriver.

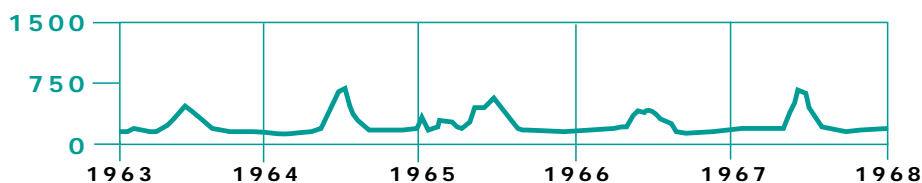

The variable energy content curve limits the amount of nonfirm energy that can be produced.

### Flood Control Rule Curve

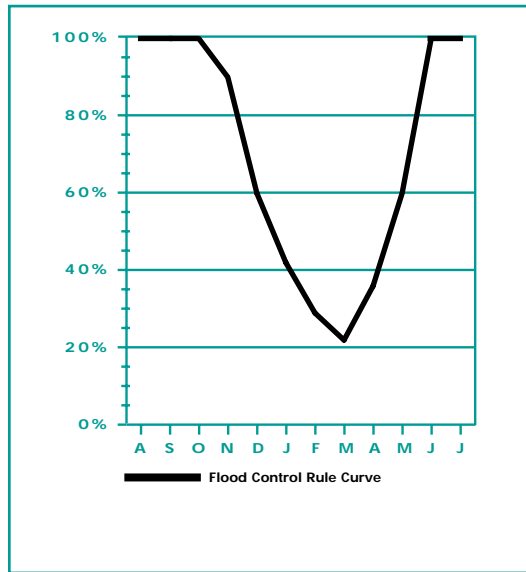

The flood control rule curve defines the drawdown required to assure adequate space is available in the reservoir to regulate the predicted runoff for the year without causing flooding downstream.

### Critical Rule Curve with Flood Control Rule Curve

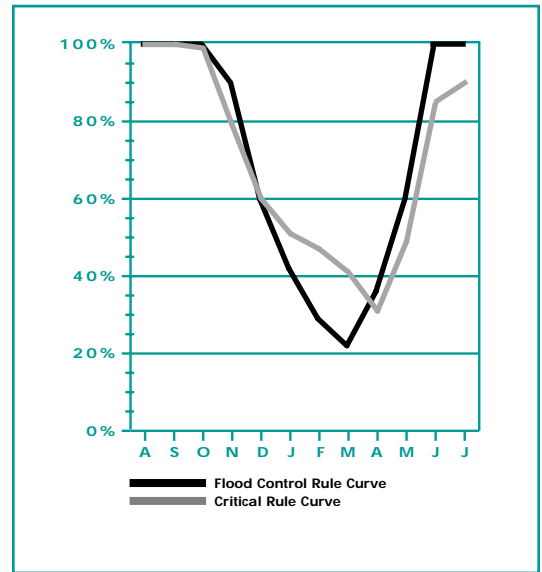

The critical rule curve defines the reservoir elevations that must be maintained to ensure that firm hydro energy requirements can be met under the most adverse streamflows on record.

reservoir elevations that must be maintained on a monthly basis to ensure that firm hydro energy requirements can be met even if there is a reoccurrence of the worst historical streamflow conditions. In the past, during the planning process, a critical rule curve was derived for each of the four years in the critical period. These were called Critical Rule Curves 1, 2, 3, and 4.

If reservoirs in the system began an operating year full, the rule curve used to guide actual drawdown that year was usually Critical Rule Curve 1. If reservoirs began the operating year less than full, or if streamflows were lower than those in the

critical period then the second-, third-, or fourth-year critical rule curve would guide operations during the year, depending on how low the reservoirs and streamflows actually were. Operation with Critical Rule Curve 2, 3, or 4 is known as proportional draft. It means that each reservoir is operated the same distance proportionally (expressed in feet of elevation) between the guiding critical rule curves.

With the one-year critical period currently being used, reservoirs are assumed to start the operating year less than full, due to summer flow augmentation for fish, and to be drawn down no lower than flood control

levels, as specified in the biological opinions, by the following spring. Reservoirs are not drafted as deeply as they were when a four-year critical period was being used. Thus, under current operations, the critical rule curve will not be lower than the flood control rule curve, which ensures that the maximum amount of stored water is available for fish flows every season.

**Assured Refill Curve (ARC).** The assured refill curve is used to limit reservoir draft for energy production before the year's runoff forecasts are known to assure there is a high probability of refill by July. The ARC concept is still used

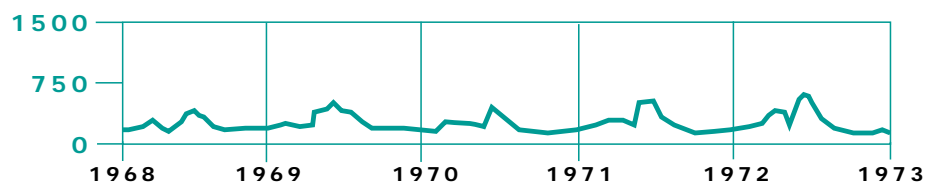

## Assured Refill Curve

with Flood Control & Critical Rule Curve

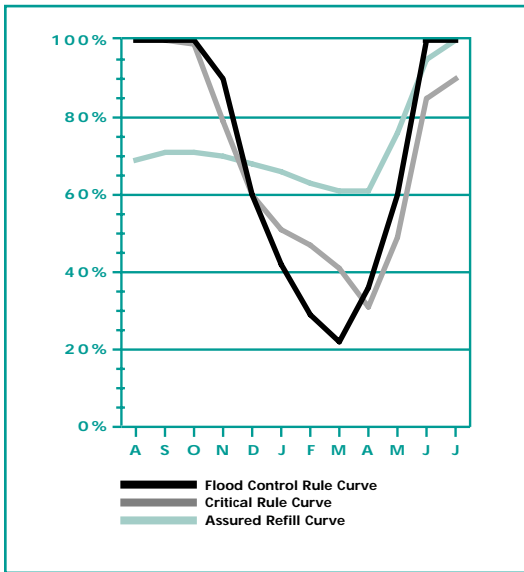

The assured refill curve is based on the Coordination Agreement refill test.

## Variable Energy Content Curve

with Flood Control Rule Curve, Critical Rule Curve & Assured Refill Curve

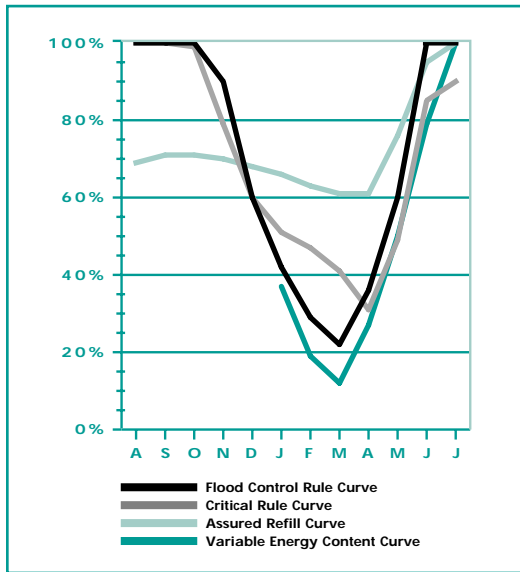

The variable energy content curve, which guides nonfirm energy generation, is usually the lowest of the four curves during the winter and early spring and is based on predicted runoff for the year.

*Reservoirs are operated seasonally based in part on historical runoff patterns.*

in Coordination Agreement planning, but, as a practical matter, it has been superseded in current operations by the biological opinions, which require that reservoirs achieve flood control elevations by mid-April. In other words, the priority is on having as much water as possible in the reservoirs in the spring to aid fish migration while still having adequate flood control space.

**Energy Content Curve (ECC).** The energy content curve, also known as the operating rule curve, defines the level of draw-down for producing nonfirm energy. The ECC is the higher of the critical rule curve and the assured refill curve; it must be at or below

the flood control rule curve.

From January through the remainder of the operating year, when actual streamflow data and runoff forecasts are known, a new **draft limit** for nonfirm energy production at each reservoir is calculated regularly. If the latest snowpack and precipitation measurements show that the ECC can be lowered, this new draft limit is known as the variable energy content curve.

**Variable Energy Content Curve (VECC).** The variable energy content curve shows how much water must remain in each reservoir to create a 95 percent probability of refill by July 31. The first runoff forecast is made in early

January, the beginning of the variable drawdown period. A new forecast is produced every month from January through August and is used to calculate a new VECC. When it is lower than the energy content curve, the VECC is used to limit the draft on reservoirs to produce nonfirm energy. Operators may draft below the VECC to meet firm hydroelectric energy requirements.

The ECC and VECC concepts continue to be used in Coordination Agreement planning. However, under current ESA-driven operations, reservoirs are not generally drafted below the flood control rule curve.

**Draft Limits:** The lowest level to which a reservoir can be drawn down. The limit is based on rule curves that are calculated on both historic and current streamflow data.

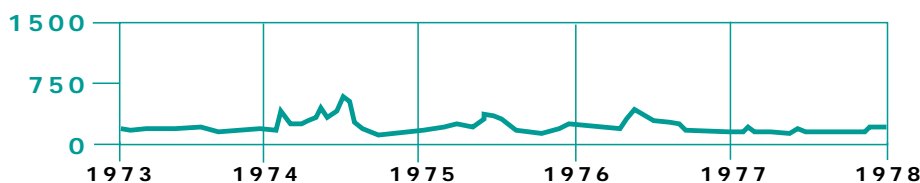

*The river provides transportation for agricultural products from the interior basin.*

## BPA Power Sales Take Many Forms

**Out-of-Region Sales, Exchanges, and Purchases.** Intertie transmission lines connect BPA's high-voltage grid with California and, from there, with utilities throughout the western United States. Other lines add eastern Montana, British Columbia, and Alberta to the interconnected grid. Power sales and trades between regions reduce electricity costs and the need for new power plants at both ends of the lines. BPA's 25,000 circuit-kilometer (16,000 circuit-mile) transmission grid is the backbone of power transfers within and passing through the Northwest.

BPA has bought power from as far away as Texas to meet power peaks in winter storms. It stores water in Canadian reservoirs as an energy reserve to draw on in a power crunch. BPA swaps spare capacity and surplus hydroelectric power in the spring for winter energy from California. All of these actions increase the Northwest's energy supply without requiring new resources. BPA sells power outside the Northwest only when the power is surplus to regional needs.

**Surplus Power Sales.** BPA may have firm surplus power to sell each spring and early summer from water sent downstream to help migrating salmon. BPA has entered into several long-term extraregional sales or exchange contracts for power excess to Northwest needs.

In 1995, Congress gave BPA greater flexibility to market surplus power outside the Northwest. Previous energy call-back requirements of 60 days' notice were removed. BPA can now sell this power for up to seven years. The legislation also gave BPA greater flexibility to do business with power marketers, load aggregators, and brokers.

**Short-term Trading.** In the new competitive power market, utilities are seeking more short-term energy sales and are making deals at a faster pace. BPA is an active player in this market. In 1995, BPA set up an electricity "trading floor" where it does short-term commodity-type trading. The trading floor brings together current West Coast electricity market conditions, up-to-the-minute hydro and power system status, and short-term weather and streamflow projections to develop a daily marketing strategy. Deals that previously took hours or days are closed in minutes.

**DSI Sales.** BPA, under its current rate schedule, serves with firm energy just under 1500 MW of the direct service industries' 3000 MW total load. This service is fixed through the year 2006, at which time the allocation of firm resources among BPA's customers may be reviewed. The remainder of the DSI loads is served through purchases the DSI's themselves make in the marketplace.

## D. Navigation

Construction of dams greatly improved conditions for navigation on the lower Columbia and Snake rivers, and river traffic has been extended and increased with the completion of each

dam. The Columbia-Snake Inland Waterway from the Pacific Ocean to Lewiston, Idaho, has been developed in two segments. The first is the 12.2-meter-deep (40 feet) open river channel for ocean-going vessels, which extends 171

kilometers (106 miles) from the ocean to Portland, Oregon, and Vancouver, Washington. The second is the 4.3-meter-deep (14 feet) barge channel that extends 578 kilometers (359 miles) from Vancouver to Lewiston.

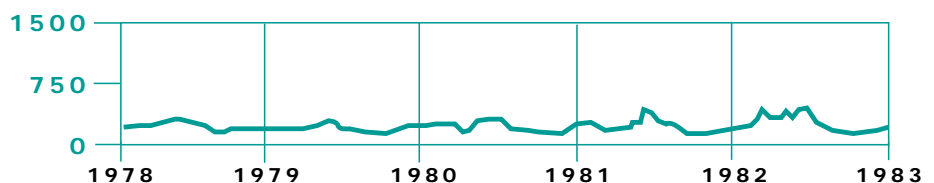

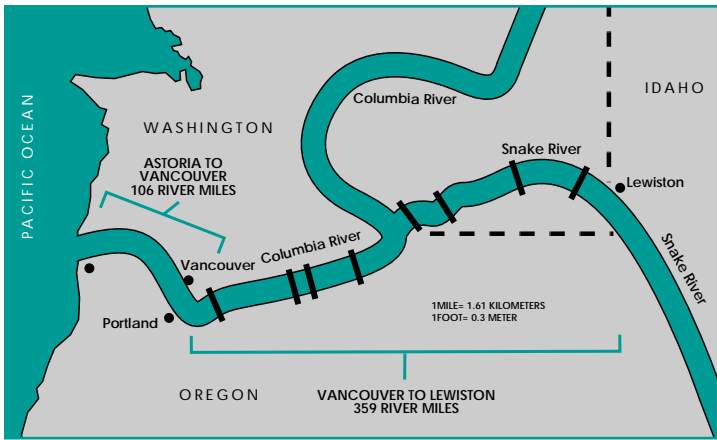

A 40-foot-deep channel accommodates large ships 106 miles inland on the Columbia River to Vancouver, Washington. A combination of dams, locks, and dredging keeps a channel of 14 feet open to Lewiston, Idaho, on the Snake River, an additional 359 miles upriver.

Navigation above Bonneville Dam is made possible by the Corps' eight-dam complex of locks and reservoirs from Bonneville through Lower Granite Dam to Lewiston, Idaho. The channel accommodates shallow-draft tugs, barges, log rafts, and recreational boats, and connects the agricultural interior basin with deep-water ports on the lower Columbia and Snake rivers.

**Meeting Navigation Needs.** Barges and other traffic plying the Columbia and Snake rivers need minimum water depths to navigate successfully. Unlike other uses, navigation has depth requirements that do not vary with the seasons. Corps operators must regulate water releases and maintain reservoir levels to provide minimum navigation depths behind the dams all year.

Operating requirements for navigation are based on the waterway's two segments. In the first segment, the river channel from the ocean to Vancouver, Washington, navigation requirements are satisfied by natural river flows without special releases. Periodic dredging maintains the channel depth to support navigation even at normal low flows.

In the second segment, the barge channel to Lewiston, the Corps has established maximum and minimum reservoir elevations to maintain the authorized channel depth. Thus, navigation requirements are fully met within the flexibility provided under normal system operation.

## E. Irrigation

Irrigation has brought agricultural prosperity to vast arid areas of the

Northwest. About 2.95 million hectares (7.3 million acres) are irrigated in the Columbia River Basin. Of this, 2.9 million hectares (7.1 million acres) are in the United States, and 0.1 million hectares (0.2 million acres) are in Canada. Besides agriculture, these figures cover irrigated lands in urban use, forest nurseries and seed orchards, recreation sites, and other non-agricultural uses. Irrigation uses approximately 6 percent of total annual Columbia Basin flow, or about 9 percent of annual flows past The Dalles. Much of this water eventually finds its way back into the rivers as irrigation return flows, although the returns are not "credited" against the original withdrawal figures.

Water releases for irrigation are scheduled on a local basis, not as a centralized system function.



Irrigation projects supply water for a variety of crops, including orchards, nursery stock, and wheat. Many agricultural products grown in the Northwest are exported to other parts of the country and abroad and return significant economic benefit to the region.

*The Columbia and its tributaries provide a vital source of water for farmland in the U.S. and Canada.*

**Locks:** The key to inland navigation on the Columbia-Snake River Waterway, locks raise and lower ships between pools on the river, i.e., from below a dam to the pool above it. On the trip from the ocean to Lewiston, Idaho, vessels travel from sea level through eight locks to an elevation of over 700 feet.

**Dredging:** The Corps regularly removes sediment from the river bottom to keep the channel at the proper depth for navigation. The continual moving and shifting of sediment makes dredging an ongoing activity.

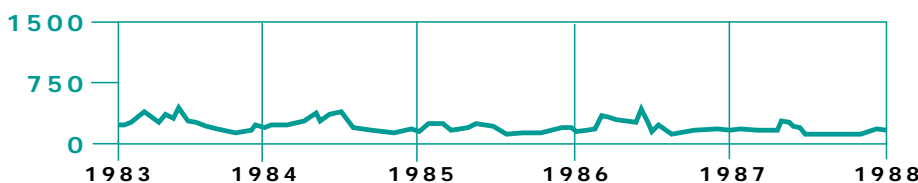

## Major Irrigation Areas in the Columbia River Basin

*When natural streamflows are inadequate, water is released from reservoirs to supply irrigators.*



Water from the Columbia River system irrigates about 2.95 million hectares (7.3 million acres) of farmland; major areas are shown shaded on this map.

Reclamation, local irrigation districts, and water companies operate most of the irrigation reservoirs in the Columbia River system.

These projects are generally operated to benefit local water users. The effect on the overall water supply from individual projects is relatively minor. But the combined impact on the river system is important. Storing water in reservoirs to meet irrigation demands alters river flows for other uses. The effects are much larger proportionally on some tributaries, such as the Snake River, than on

the mainstem Columbia.

All of these effects are accounted for in the annual studies used to guide the operation of the Columbia River system. Operating requirements for irrigation aim to have the reservoirs capture and hold as much runoff as possible during the fall, winter, and early spring.

### **The Growing Season.**

In the early part of the irrigation season, demands for water are often met by diverting natural streamflows. When natural streamflows are no longer adequate, the reservoirs are

drafted to supply irrigation water. Releases continue throughout the growing season, which usually ends in September. During the winter, some projects release water for resident fish, minimum streamflows, and livestock watering. Many of the reservoirs that were originally constructed primarily for irrigation are being operated to satisfy flood control, power, recreation, and other purposes.

Since water conditions vary greatly from year to year, demands for irrigation water also vary, as does the ability to refill the storage space in reservoirs. It is usually desirable to hold unused irrigation water in a reservoir from one year to the next to help meet demands in subsequent low-water years.

Holding water from one year to the next depends on the available storage and competing uses for that storage. In some years, for example, water cannot be held over because it has to be evacuated for flood control.

When dry conditions persist over several years, there may not be enough water to meet all irrigation demands. In such cases, supplies to some users may be curtailed, depending on their water rights and storage rights, as determined by state water resource agencies.

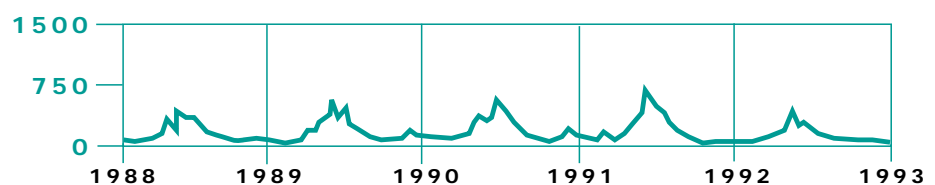

## F. Recreation

Recreation facilities are available at many locations in the Columbia River Basin. Recreation was identified as a project purpose when many of the dams were built, and it has become increasingly important. It was often a key selling point to win local support for the construction of a dam. The public uses the water projects for fishing, swimming, waterskiing, windsurfing, picnicking, camping, rafting, boating, and sightseeing.

Recreational use of the lakes behind the dams occurs throughout the year but mostly in the summer and early fall. The goal of operators frequently is to keep the lakes as full and stable as possible without jeopardizing other project uses.

Normal power generation and flood control operations are often compatible with recreational needs at the lakes during the summer. If runoff is low or delayed, if there are unexpected shutdowns of thermal power plants, or if forecasts prove wrong, lake levels may have to be drawn down to provide water for power generation to meet regional loads or to provide fish flow augmentation for part or all of the summer. If flood control space must be



Recreational use of the Columbia River is increasing as the region's population grows and more visitors are drawn to the Northwest every year. Hood River, Oregon, in the Columbia River Gorge, is known around the world as a 'Mecca' for windsurfers.

provided in storage reservoirs in June to protect against a late runoff, refill could be delayed until July or early August.

Outflows from dams affect recreation activities in the river reaches below them. The amount of flow and the rate at which it changes play a large part in the success of activities such as fishing, rafting, or swimming. Reservoir operators often provide certain flows at the request of organizers of special recreational events. During certain recreation seasons, there are limits on flow amounts and hourly changes to flows and reservoir elevations.

## G. Water Supply & Water Quality

Use of reservoir storage to meet municipal and industrial water supply needs

is of relatively minor consequence in the Columbia River system. The Columbia River does supply water to some cities and industries by diversion, but these diversions are small and have little measurable impact on system operation.

The quality of water in the Columbia River is generally very good, but there are some exceptions. Pesticide runoff in areas of heavy agriculture jeopardizes wildlife populations. Changes in reservoir operation to alleviate water quality problems are minor compared to operational changes to meet other needs. Nevertheless, there are certain water quality requirements in the tributaries and on the mainstem Columbia River that must be included in the multipurpose goals of the system.

In the tributaries,

*The public uses the projects for fishing, watersports, picnicking, camping, and sightseeing.*

**Diversions:** Refers to taking water out of the river channel for municipal, industrial, or agricultural use. Water is diverted by pumping directly from the river or by filling canals.

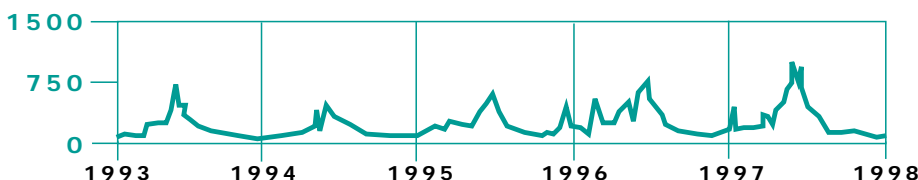





*Water from the Columbia River quenches the thirst of many residents in the region. Unlike many other rivers, it remains an excellent source of domestic water supply.*

*Water quality must be high to sustain aquatic life and recreation.*

**Temperature Control:** The Corps and Reclamation have installed equipment at some dams that can regulate the temperature of water released from the reservoirs. This allows water temperature downstream in the river to be controlled. Temperature control is achieved by drawing water from different elevations in a reservoir. Cold water is drawn from deep in the reservoir; warm water is drawn from near the surface.

streamflows from reservoir projects must be adequate to maintain water quality requirements for aquatic life, as well as for municipal or industrial use and for water recreation. Minimum outflow requirements are specified for each project based on downstream conditions. Sometimes requirements vary with the seasons.

On the mainstem, spilling water over the dams to facilitate juvenile fish passage or to pass flows in excess of the powerhouse capacity can increase dissolved gas saturation to lethal levels for fish. Most of the reservoir control challenge is to minimize spill through upstream flow regulation and installation and operation of dissolved gas abatement structures on the dam spillways.

**Adjusting Water Temperatures.** Because of its impacts on fish and

aquatic life, water temperature is an important consideration in project operation. In winter, stored water can be warmer than natural flows. In summer, the sun heats up surface waters in the reservoirs while the natural streams are often much cooler. The outlets at the storage dams generally are located in such a way that they draw water from the lower levels. As a result, water released from the reservoirs is at a different temperature than in the open river. This water temperature difference can harm or benefit fish downstream of the dams.

To provide **temperature control** that benefits fish, the Corps has installed multilevel withdrawal gates at Libby and Dworshak Dams, as has Reclamation at Hungry Horse. The gates can be operated to supply water at any temperature available within the range of temperatures in the reservoirs.

## H. Cultural Resources

Cultural resources are found throughout the Columbia River system. A significant amount of the scientific information about cultural resources comes from archeological studies associated with construction of the Federal dams in the basin. This information is,

however, incomplete in two significant ways. First, there is not a comprehensive understanding of the context of cultural resources as viewed by Native Americans (see box on page 57). Second, not all project lands have been surveyed for cultural resources nor have all those identified been evaluated.

Archeologists have identified prehistoric sites in the basin that date back over 10,000 years. In contrast, European and American settlements began to appear about 300 years ago. Native American sites include pit-house villages and seasonal camps, sweat lodges, fishing stations, storage pits, burial grounds, petroglyphs, and rock cairns. The historic sites attributed to Europeans and Americans include fur trade camps, homesteads, mines, and ferry landings.

Fluctuating water levels and shoreline erosion have the potential to damage or destroy significant cultural resources at the reservoirs. The National Historic Preservation Act requires Federal agencies to take into account these effects and to develop ways to address them. One such device is a Programmatic Agreement to guide the creation of a Historic Preservation Management Plan for each reservoir, currently under development.

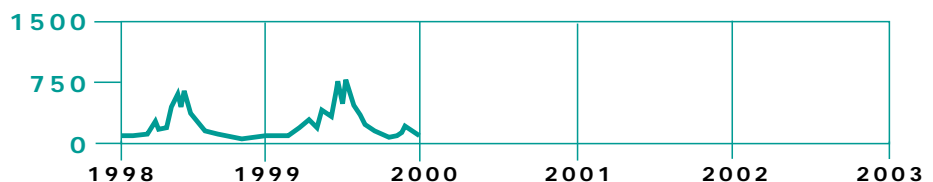

These plans identify significant cultural resources; approaches to resource protection, preservation, and treatment; and research designs for data recovery. They also provide for site monitoring, public education and interpretation of cultural materials, and the long-term curation of recovered artifacts and information. The management plans address issues required by other relevant legislation, including enforcement of the Archeological Resources Protection Act, provisions of the Native American Graves Protection and Repatriation Act, and the American Indian Religious Freedom Act.

The academic and legal definitions of cultural resources tend to focus on tangible evidence, such as sites and artifacts. Many Native Americans find these definitions too narrow. They view their entire heritage, and their spiritual relation-

ship to the earth and natural resources as a cultural resource. The Federal agencies committed through the System Operation Review

to work with the Native Americans to ensure that their perspective is a part of future cultural resource activities.



*Native Americans view their heritage and spiritual relationship to nature as a culture resource.*

## The Sacredness of the Natural World

Native Americans have traditionally conducted their lives based on the belief that there is a close physical and spiritual interrelationship between humans and nature. This relationship extends from time immemorial to the present and continues infinitely into the future. Native Americans do not assume that humans are superior to animals or other aspects of nature. They view human existence as an integral part of the natural and spiritual world. All that exists is alive and sacred, and land, rock, water, air, animals, and humans occupy unique roles in the universe. Life is seen as a process of maintaining a balance with the rest of the world, and failure to respect the proper place of all things in the natural world could upset this balance and destroy it.

Native Americans deeply respect tribal elders as the ones who traditionally preserve and transmit cultural information and language to the younger generation. The main body of cultural knowledge contained in tribal traditions and practices is unwritten, and the process of teaching it to future generations depends on a personal relationship between elders and the younger tribal members. This knowledge is sacred and cannot be given to just anyone who asks for it. From the traditional tribal perspective, elders are the primary and most authoritative source of cultural information.

## VI. System Planning & Operations



### A. Current Operating Strategy

The current system operating strategy for the Federal Columbia River Power System reflects the following priorities:

- Supporting the recovery of ESA-listed fish species by storing water during the fall and winter to increase spring and summer flows for fish.
- Protecting other resources by managing the detrimental effects caused by operations for ESA-listed species. This includes establishing minimum summer reservoir levels. The Corps' flood control operations are unchanged.
- Producing power.

The Federal agency project operators now conduct river operations year-round in accordance with the biological opinions issued under the ESA. Federal reservoirs must be operated during the winter in a way that will leave them full enough in the spring and summer to provide flows for migrating salmon. Water must be released from storage in an attempt to meet streamflow objectives



*Coordination allows generators to plan routine maintenance at individual plants, such as Bonneville Dam, without disrupting their ability to serve load.*

at Lower Granite Dam on the Snake River, and at Priest Rapids and McNary Dams on the Columbia River, based on runoff forecasts. The four Federal projects on the lower Snake River are drawn down to their minimum operating pools during the spring and summer, and John Day reservoir is operated at an elevation of 79.9 meters (262 feet), plus or minus 0.15 meter (one-half foot) from August 20 through September 30.

Prior to 1998, water was required to be released over the spillways at Federal projects in the system in an effort to achieve an 80 percent **fish passage efficiency**. The aim was for

80 percent of the smolts to pass the projects over the spillways and through bypass systems, avoiding the turbines. Current requirements set forth in the 2000 biological opinion are to maximize smolt passage around turbines via spill and bypass systems. Spill can be limited, if necessary, to prevent total dissolved gas from building up in the water, a condition which can harm fish.

Fish transportation is an important feature of the current strategy. In high-flow years, more fish are passed with spill and fewer fish transported. In low-flow years, when there is less water to spill, more fish are transported.

The current strategy imposes draft limits at Hungry Horse, Libby, Grand Coulee, and Dworshak to

protect resident fish and recreation. Libby Dam must be operated to enhance conditions for

Kootenai River white sturgeon and bull trout; that is, water is released to enhance spawning.

**Fish Passage Efficiency:** The percentage of the total number of fish that pass a dam without going through the turbine units.

## Current Operating Strategy Requirements

The operating requirements Federal project operators adopted as a result of biological opinions, can be summarized as follows:

- Manage reservoir operations during the fall and winter to achieve a high confidence of refill to flood control elevations by early spring of each year to maximize the water available for flow augmentation and spill while providing late fall and winter flow for chum salmon spawning and rearing below Bonneville Dam.
- Provide flow augmentation in the Columbia and Snake rivers and manage these flows during the fish migration season according to decisions from the in-season management (technical, policy) teams.
- Release the stored flow augmentation water during the migration season in a manner that strives toward specified flow objectives measured at Lower Granite and McNary projects and, during the spring, at Priest Rapids. During the fall and winter, release stored water for chum and fall chinook salmon.
- Manage spill at mainstem projects to improve fish passage efficiency (non-turbine fish passage) up to specified levels of total dissolved gas. Many projects are spilling up to the maximum of 120 percent of total dissolved gas.
- Transport all juvenile anadromous fish collected at the lower Snake River collector projects during the spring and summer and from McNary Dam in the summer, or as otherwise directed through regional in-season management decisions.
- Operate lower Snake River reservoirs within a limited range of 0.3 meters (one foot) from early April through August each year.
- Operate John Day reservoir at an elevation of 79.9 meters (262 feet), plus or minus 0.45 meter (one and one-half feet) from mid-April through September each year.
- Seek to refill storage reservoirs by the end of June to maximize summer flow augmentation.
- Operate turbines within 1 percent of peak efficiency during the juvenile and adult fish migration seasons, defined as March 15 through October 31 in the Columbia River and March 15 through November 30 in the Snake River.
- Operate Libby Dam to provide flows for Kootenai River white sturgeon and bull trout, and restrict daily flow changes to minimize downstream effects.
- Manage reservoir elevations at storage projects to minimize detrimental effects on resident fish, wildlife, and recreational facilities. Summer draft objectives are to be met at Hungry Horse, Libby, Grand Coulee, Banks Lake, and Dworshak projects while attempting to meet flow objectives for juvenile salmon migration.

*Coordinated planning yields rule curves that guide operations at each project.*

*The Coordination Agreement planning studies assume the coordinated system has a single owner.*

While the biological opinions and current operating strategy spell out general operating guidelines, the agencies also follow the concept of “adaptive management” in the operation of the Columbia River system. Adaptive management allows river managers to learn from actual experience and adapt the resulting operating principles or actions to what is expected to be best for fish. Periodic review may result in course corrections to be put into place based on new information from monitoring, research studies, or other sources.

## **B. The PNCA Planning Process**

Pacific Northwest Coordination Agreement annual planning is done to factor in all uses of the system such as the requirements of the biological opinions; this annual planning process allows for different owners to coordinate generation so that the system can produce as much power as possible within the operational constraints for nonpower purposes.

The Coordination Agreement annual planning process begins each February. Planning gives the operating agencies the ability to look at a variety of potential reservoir and runoff conditions. Computer models simulate the system’s ability to meet reservoir operating requirements and assess the power supply impact of various scenarios on the system.

**Exchange Power:** Utilities frequently swap power with one another to use their resources more efficiently. Rather than sell excess power, Utility A may loan it to Utility B. Utility A will take equivalent power back, for example, when it must shut a generator down for maintenance.



*Generating resources can be used most efficiently when utilities coordinate and cooperate with one another. Close coordination is essential between operators of dams adjacent to one another on a river reach.*

**The Columbia River Treaty.** The Columbia River Treaty requires the United States (the Corps’ Division Engineer and BPA’s Administrator, acting as the U.S. Entity) and Canada (B.C. Hydro acting as the Canadian Entity) to prepare an Assured Operating Plan and a Detailed Operating Plan each year. The Assured Operating Plan dictates how Treaty storage will be operated six years in advance. The plan is developed to meet the flood control and power objectives of the Treaty, the only recognized purposes for project operation when the Treaty was signed, and to define with an associated document the amount of Canadian Entitlement to be returned for that year. The Detailed Operating Plan addresses operations over the next 12 months.

The Assured Operating Plan and the Detailed Operating Plan are the basis for the operating rule curves for the Treaty projects in

Canada. The two plans are factored into the annual plan developed by parties to the Coordination Agreement because releases of water from the Canadian storage reservoirs are crucial for coordinated system planning in the United States.

**The Pacific Northwest Coordination Agreement.** Operation of water storage for power generation is coordinated through the PNCA. This Agreement among the major generating utilities of the region provides for planned electric power operation during the operating year. The Coordination Agreement gives nonpower requirements priority over power needs.

Coordinating system operations through annual planning provides many advantages. It enables utilities to **exchange power** and to help each other when planned shutdowns of transmission lines or turbines occur. Utilities can take advantage of their differences in streamflows,

loads, generation, and maintenance schedules to share resources. Coordination also lets utilities operate hydro and thermal resources more efficiently.

**The Synchronized Concept.** An important point to understand about the Coordination Agreement is that the **planning studies** are made as if the total coordinated system had a single owner, although actual operations must reflect individual utility's needs. If all projects in the system belonged to a single utility, the owner would synchronize operations to maximize power production. Coordinated planning attempts to duplicate that hypothetical situation. The Coordination Agreement contains a number of provisions, some of which are described below, to make the synchronized concept work on a day-to-day basis, while still meeting the deregulating requirements of FERC's orders.

The **Northwest Power Pool Study Group** in Portland Oregon, performs the Coordination Agreement studies. The products of the planning process are rule curves and estimates of the amount of firm energy that can be produced by each project for each month of the critical period.

Development of the annual operating plan begins in February and is completed in July of every year. By February 1 prior to each operating year, parties to the Coordination Agreement provide study data to the

Northwest Power Pool. Each reservoir owner submits multiple-use operating requirements that must be accommodated in the resulting plan. Utility parties also submit forecasts of their electricity loads, the output of their non-hydro generating resources, and planned **maintenance outages** for both hydro and thermal resources. The resources include any contracts a utility has for firm power purchases or exchanges.

Coordination Agreement planning and operating studies must accept and accommodate nonpower requirements. Whenever a nonpower requirement can be implemented by a single reservoir owner, that owner includes it in the data submittal to the annual planning process. If



*Coordinated planning and operation is essential to meet multiple needs, including agriculture through irrigation.*

coordination between two or more owners is needed, they are to make the arrangements, and when the coordination of many is needed, parties to the

Coordination Agreement must work out a way to meet nonpower requirements. Once the data are submitted, studies are conducted to identify the critical period.

**Firm Energy Load Carrying Capability.** Assuming critical period conditions, the next step in coordinated planning is determining Firm Energy Load Carrying Capability (FELCC) for the system as a whole and for each Coordination Agreement party. The firm energy load carrying capability of each plant, each individual utility system, and the coordinated system as a whole is the amount of energy each is capable of producing during the critical period after nonpower requirements have been accommodated. It is the amount of energy the

*The Actual Energy Regulation meshes all requirements throughout the operating year.*

**Planning Studies:** Computer studies model the impacts of alternative operations. Modelers may examine spill levels, potential changes in the weather, moveable maintenance outages, and many other factors to determine the optimal operation for all concerned.

**Maintenance Outage:** All generating plants, hydro and thermal, require routine maintenance. Utilities generally schedule maintenance outages during periods when energy demand is low or hydro supplies are high. For example, Energy Northwest may shut down its Columbia Generating Station nuclear plant for maintenance, or for economics, in the spring when runoff levels are high.

**Northwest Power Pool Study Group:** This organization, headquartered in Portland, Oregon, collects operating data from the utilities and conducts regulation studies under the Pacific Northwest Coordination Agreement.

system and individual parties could produce if streamflows were as low as they were in the critical period.

FELCC is also the amount of energy that the

*In low water years, draft is distributed equally among all reservoirs.*

**Preliminary Regulation:** A computer study that develops a set of rule curves that guide project operation under terms of the Coordination Agreement.

**Streamflow Records:** For over 100 years, water resource managers in the Northwest have maintained records on the seasonal volume and rate of flow in the Columbia River. These historical records are of profound importance to planning system operations each year.



*Operators work around the clock to meet load with the best combination of resources.*

system may be called on to produce on a firm, or guaranteed, basis during actual operations. The system and individual parties' FELCC may or may not be sufficient to meet power loads in the region. If it is insufficient, utilities with a firm deficit must seek other sources of power.

**The Preliminary Regulation.** Once the critical period studies have been conducted, the Coordination Agreement parties have their first estimates of the amount and distribution, month by month, of their FELCC. This initial step is called the **Preliminary Regulation.**

Parties review the Preliminary Regulation and adjust their data submittals before a Modified Regulation is produced. The Modified Regulation is then fine-tuned to make sure the hydro system is used to its fullest potential. Part of this fine-tuning includes determining interchange energy obligations and shifting and shaping FELCC (see boxes).

After adjustments to FELCC have been made, the Final Regulation is published. It provides each party to the Coordination Agreement with critical rule

curves and FELCC for each month in the critical period.

The final analysis made in developing the annual operating plan is the Coordination Agreement refill test conducted by the Corps. It simulates how the hydro system would operate under the runoff conditions in each of 60 years of **streamflow records.** This analysis determines whether the energy content curves are constructed in a way that does not threaten the coordinated system's ability to generate its firm energy capability under historic streamflow conditions.

## Interchange Energy

The concept of "interchange" is fundamental to the Coordination Agreement. Interchange energy assures all parties an equal ability to serve their firm loads.

Each party to the Coordination Agreement is expected to use its own resources to supply its own firm energy load carrying capability (FELCC) over the critical period. At any time, however, a party may not be able to produce enough energy to meet its FELCC. That party has a right to request the deficiency from other parties with resource capabilities that exceed their FELCC. Parties with excess FELCC are obligated to supply all or part of that excess energy to parties that need it. Energy transferred in this way is called interchange energy.

## Shifting and Shaping FELCC

In preparing the annual plan, some utilities can make changes to reservoir operations to match generation more closely with loads or to optimize sales of surplus FELCC, as long as nonpower requirements have been satisfied. This process is referred to as “shifting and shaping FELCC.”

Shifting and shaping moves surplus or deficit FELCC from one period to another during the year to increase the FELCC’s value or to more closely match load variations. Shifting and shaping FELCC may reduce the coordinated system’s overall capabilities somewhat, but the energy is more valuable because it is produced at a time when natural streamflows are lower. These shifting and shaping changes are limited to those that do not threaten the basic concept of operating as a single system to meet a single load.

## C. In-Season Management for Salmon

In-season management coordinates system operation during the fish migration season. That’s when decisions have to be made about how water in the system will be moved on a weekly basis. It is the job of the Technical Management Team, first discussed in Section III.C., to advise the Federal project operators on operations that optimize passage conditions for anadromous and resident fish.

The TMT, established by the 1995 biological opinion, originally had three periods of operation: pre-season planning, in-season management, and post-season reviews. With the additional requirements of the 2000 biological opinion, the TMT now operates year-round. It generally meets on a weekly basis.

Each year prior to the start of the spring fish migration and once some information about expected

water conditions is known, a Water Management Plan is developed by the operating agencies and coordinated through the TMT. The Water Management Plan is a part of the larger Implementation Plan, which the operating agencies must prepare as a result of the current biological opinion. The Water Management Plan describes measures that are desired to optimize passage conditions for juvenile and adult anadromous salmonids. It covers all aspects of operations of the FCRPS, including turbine outages, power generation schedules, water temperature control, spill, total dissolved gas management, and



*With its huge storage capability and five non-Federal mid-Columbia dams downstream, operation at Grand Coulee Dam plays an integral role in the Coordination Agreement’s interchange energy transactions.*

special operations for research and other uses.

The TMT considers a variety of factors in preparing the plan, such as the location, timing, and passage indices of listed and non-listed juvenile salmon and how to match flows and spill to actual fish migration within the parameters of the biological opinions. The plan focuses on implementation of the current biological opinions, the Northwest Power Planning Council’s Fish and Wildlife Program, state and tribal plans and programs, and other relevant operational requirements.

The Water Management Plan summarizes final water supply forecasts and discusses the outlook for meeting flow objectives in the upcoming year based on monthly computer simulations of flows. It also sets forth flood control requirements at each project and addresses total dissolved gas management, fish transportation, and special operations for research. The plan specifically addresses spring operations

*Hydro projects in the same river reach are coordinated on an hourly basis.*



*Operations vary in accordance with water conditions. 1997-98 was an average year.*



*While each operating year is different, lessons from the past can be valuable in guiding operations in the future.*

(April-June), summer operations (July-August), and fall/winter operations (September-March).

During the anadromous fish migration season, the salmon managers (NMFS and state and tribal fishery managers) provide biological information on salmon to the TMT. The USFWS provides information on other fish and wildlife resources. Data provided to the TMT at its in-season meetings also include: reservoir status, streamflow forecasts, the results of biological monitoring, juvenile fish passage indices, adult fish counts, white sturgeon movement, status of fish transportation, and the results of dissolved gas and water temperature monitoring.

Using this data and the National Weather Service River Forecast Center's streamflow forecast for the Columbia River Basin, the

TMT recommends FCRPS operations for the following week. If forecasts indicate that flows will not meet the objectives recommended in the biological opinions, the TMT may consider whether to recommend lower summer reservoir elevations to allow for more drafting to meet flow objectives or whether to establish alternative flow objectives. The TMT takes into account runoff conditions and fish movements, as well as the impact achieving flow objectives will have on reservoir operations, particularly the ability to achieve flow objectives in the future.

Fish numbers and migration timing are used as indicators to adjust flow measures within the season, particularly in low-flow years. The TMT may recommend curtailing or extending the use of available flow-augmentation water at the end of the season, depending on

the numbers of fish and the status of fish migration. Flow levels can be adjusted at any time, based on biological factors as well. The TMT makes recommendations to the Corps, Reclamation, and BPA each week, and the agencies then make their decisions about the following week's operations.

The Corps' in-season decisions on the timing and amount of releases for salmon and sturgeon, spill, and fish transportation are based on the recommendations of the TMT, which monitors and evaluates the shaping of available water based on real-time flow and biological information. In coordination with NMFS and the USFWS, the Corps may operate differently for approved research, flood control, emergency power needs, or multiple-purpose operations for other project uses.

## **D. Real-Time Operations**

Real-time operations are a combination of experience, craft, and science—a blending of the immediate (next hour, next day) needs of the Pacific Northwest community. Those needs include electric power, fish and wildlife protection, protection of life and property from floods, navigation, irrigation, municipal water, recreation, project maintenance and repair, scientific research, and so on. Sometimes they compete with one another for priority; most often planners, dispatchers, and

real-time schedulers working together can accommodate all the needs. Again, at different times of the water year, different needs will take top priority—flood control, fish and wildlife, power production.

**Actual Energy Regulation.** Reservoir operators begin the operating year with rule curves based on historical streamflows. They must also satisfy numerous project and system requirements and meet electricity loads with a combination of hydro and other power plants. To reconcile all of these requirements, an Actual Energy Regulation (AER) study is produced at least twice a month throughout the operating year. The AER updates the system's operation and draft rights and obligations as they change with new stream-flow forecasts.

The Northwest Power Pool Study Group conducts the AER regulation studies. One input to the studies is an energy content curve for each storage project, supplied by the project's owner, that accounts for specific conditions in the current operating year. The AER combines each utility's FELCC with actual and current estimates of stream-flow and defines draft points to produce the FELCC and meet other system and project requirements. In low water years, when reservoirs must be drafted below their energy content curves to produce FELCC, the AER will set **proportional draft points**,

which define drafting points for all reservoirs.

**Nonpower Requirements.** The fish and wildlife needs are addressed as described in the previous section. Other nonpower needs may include enough depth at ferry crossings so ferry boats will not run aground or the slight raising of a lake level to free a grounded boat from a sand bar. When divers are in the water making repairs to a project, or cleaning debris screens near a spillway, lake levels and flows are carefully controlled to maximize safety considerations.

**BPA's Day-to-Day Operations.** BPA has its own planning process to determine the power generating requests it will make to the Corps and Reclamation and to guide operation of thermal resources and decisions on power purchases. Each

week a new operating plan is prepared that looks a month ahead. These weekly operating plans are an important tool to enable BPA to make decisions about the availability of energy for Northwest utility and industrial customers and for export from the region. They let BPA "determine its inventory" so that it can function efficiently in the energy marketplace.

**In-Lieu Energy.** In-lieu energy is another key feature of day-to-day operations. In-lieu energy, established in the PNCA, is the means by which a downstream party to the PNCA can receive energy in-lieu of water stored in an upstream reservoir.

If there is water stored in the reservoir above the energy content curve draft level, owners of projects downstream from that reservoir may request the

*Water stored during a 'wet' year can be carried over to the following year.*



*Hungry Horse Dam is an important component of the region's power generation system, turning water into kilowatts of electricity.*

**Proportional Draft Points:** PDPs are drawdown limits for reservoirs when water conditions require drafting below energy content curves to serve firm load.

*Weather is always the driving force behind a hydroelectric system.*

**River Reaches:** A general term used to refer to lengths along the river from one point to another, as in the reach from the John Day Dam to the McNary Dam.

release of the water under the Coordination Agreement. The upstream reservoir owner is obligated either to release the water or to deliver the energy equivalent in lieu of the release of water. Downstream parties that have received in-lieu energy must return it as the upstream storage reservoir returns to the energy content curve level.

**Hourly Power Operation.** Hydroelectric generating projects adjacent to one another are coordinated on at least an hourly basis to be efficient. BPA's main scheduling center

coordinates the hourly operation of the chain of ten projects on the Columbia and lower Snake rivers, from Lower Granite and Grand Coulee to Bonneville Dam.

The seven projects on the middle Columbia River from Grand Coulee through Priest Rapids are also in a continuum along the river. These projects, owned by several different utilities, are operated as a group under the Hourly Coordination Agreement and dispatched by Grant County PUD in Ephrata, Washington. Most of the hydro projects along other **river reaches**

are under the control of a single utility or agency to assure coordinated operation.

## E. System Operation: In Action

While storage reservoirs follow a fairly similar pattern of operation each year, operation does vary in accordance with water conditions. This section describes actual operations for 1996 and 1998 based on the Columbia River Water Management Group's Annual Reports.

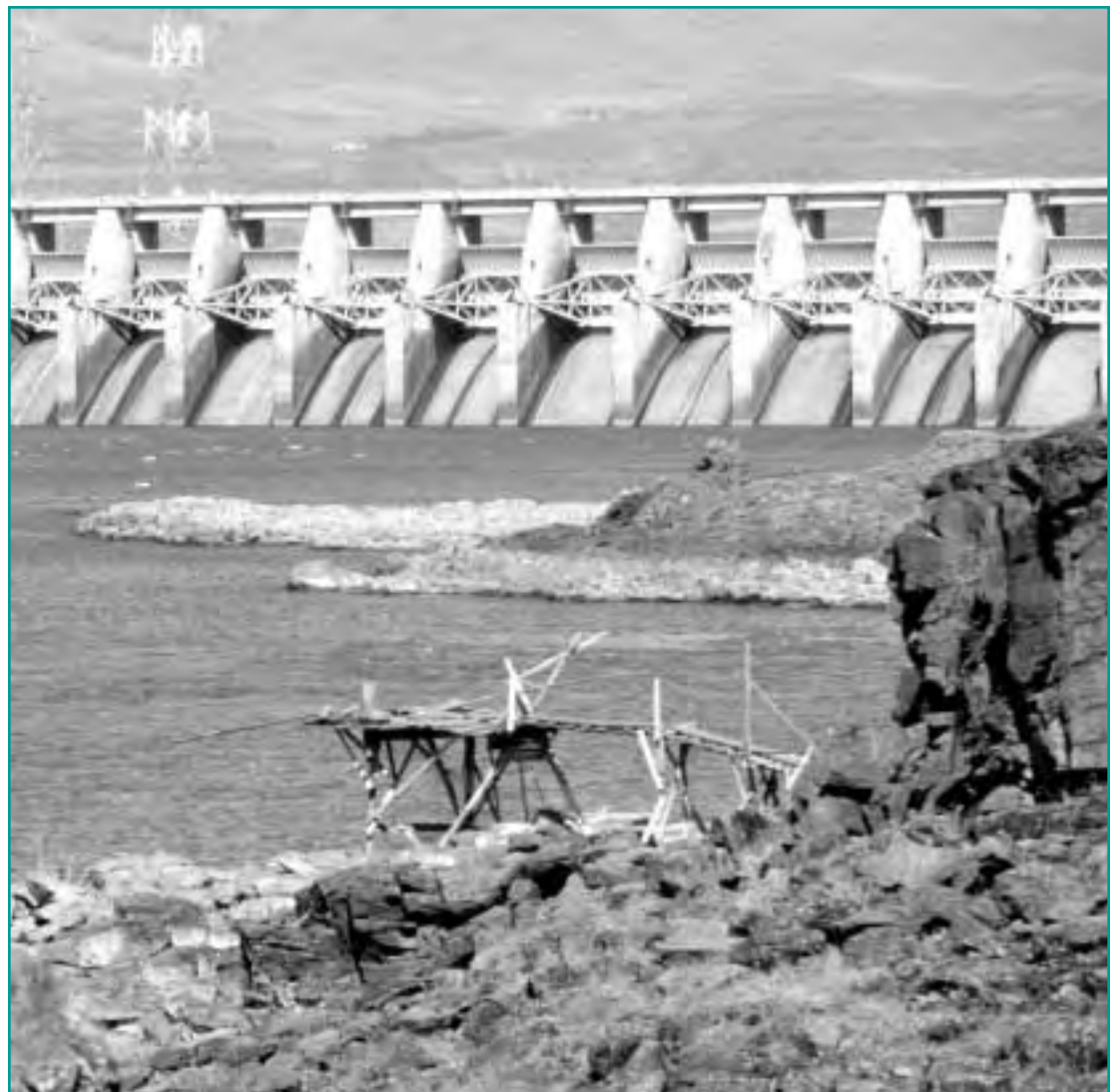

Flow at The Dalles was 93 percent of normal in 2000.

**Operation of the system in a high-runoff water year, 1995-96**

**Flood Control.** Water year 1996 was full of challenges, the first of which was a precipitation pattern which brought six flood events, two of which were record-setting. A well-above-normal snowpack brought above-normal river discharges presenting challenges in water quality, fish migration, energy production, and energy marketing. The only non-challenge was an abundance of irrigation water which met all irrigation demands and refilled irrigation reservoirs depleted after 10 years of low water years.

A moist tropical airmass on a strong jet stream, with origins near Hawaii, arrived in the Northwest at Thanksgiving 1995, resulting in heavy rains and high river discharges in northwest Oregon and western Washington. Record floods were observed in some Washington streams, some in excess of their 100-year floods.

With eight weeks of recovery and cool-to-cold weather and a mounting snowpack, the same pattern arrived in early February. Immediately preceding this storm, warm temperatures arrived and began melting the snowpack. Five days of warm rain on the snowpack, from Puget Sound through the mid-Willamette Valley and eastward through the Snake River basin in Idaho created many new peak flow records, breaking even

some set in the preceding November.

The most serious flooding between February 2 and 9 occurred in northwestern Oregon—between 25 and 38 cm (10 and 15 inches) of rain fell in Coastal and Cascade locations. With the Columbia River running high (8.29 m, or 27.2 feet, at Vancouver, Washington) and the Willamette River mainstem flooding, the Willamette crested in Portland at the top of the seawall (elevation 8.70 m, or 28.55 feet). Severe flooding occurred between Salem and Portland and from Portland to the Columbia's mouth at Astoria, Oregon.

Through optimal operation of Canadian storage dams and the skillful actions of the Corps and Reclamation, an estimated \$2.3 billion of February flood damage was avoided. Navigation in the Portland Harbor was closed for several days during the flood peak, and tugboats were freed up to prevent floating homes from being washed away and to prevent pier and bridge abutment damage from floating debris and debris buildup.

The February flood damaged salmon redds in the Columbia; some of that impact was reduced by using project storage to reduce water velocities, preserve redds, and reduce the flushing of immature salmon downstream.

**Electric Energy.** The Coordinated System storage level at the beginning of the 1995-96 operating year was

89.2 percent of full, far higher than the previous year's beginning of 74.7 percent of full. Due to high streamflows during the year, the system generally operated to operating rule curves or flood control for the entire period, producing large amounts of surplus energy. At the close of 1995-96, the system storage energy was 99.4 percent of full.

On July 2 and 3, low voltage at a thermal plant in Wyoming resulted in a Pacific Northwest blackout. On August 10, a combination of factors resulted in a blackout affecting 4 million utility customers in 14 Western states. Those factors included: lack of generation at The Dalles due to fish spill requirements, heavy loads over the Southern Intertie due to a heat wave in California, and an electric arc-over between sagging high-voltage lines and nearby trees.

**Fish.** On July 21, 1995, the power supply managers of BPA and B.C. Hydro signed a short-term letter agreement which stored water at Libby while drawing out the same amount from the Treaty's Duncan Reservoir during mid-July through August, and then returning that water to Duncan while drawing Libby down September through December 1995. Subsequently, the Treaty Operating Committee signed a nonpower uses agreement, running from January 1, 1996, through July 31, 1996, which: (1) allowed storage of flow augmentation

*Fish habitat can be damaged if water from early snowmelt or heavy rains cannot be controlled.*

*Even in a 'normal' runoff year, the shape—or timing—of the runoff is important.*



*Droughts hurt many water uses, including fish migration.*

water in early spring with a release in late spring and early summer; (2) preserved the minimum streamflow over salmon redds at Vernita Bar below Priest Rapids; (3) protected Canadian whitefish eggs in the Columbia during January through March; and (4) provided minimum flows below Arrow Reservoir for trout spawning during April and May.

With the February snowpack washout, the flows in the Columbia were occasionally less than required by fisheries agencies. Intentional spill for fish passage was fully implemented. The flows resulted in temperatures lower than the previous year but also in increased total dissolved gas.

Nearly 76 million juvenile salmon were released from hatcheries, a 10 percent decrease in numbers released from the previous year.

### ***Operation of the system in a normal-runoff water year, 1997-98***

**Flood Control.** Water year 1997-98, in terms of its volume runoff as measured at The Dalles Dam, was 100 percent of normal. However, the detail of when and where rain fell and when snow melted to produce streamflow was anything but normal.

In looking at the mean streamflow on a monthly basis and a “normal” streamflow range of 80 percent to 120 percent of the long-term mean, the following months in water year 1998 were higher than normal: October, November, May, July, and August. The following months were lower than normal: December, February, April, and June. Of the remainder, March and September were within shouting distance of normal; in January, of 14 major stations which track

streamflow, three were below the 80 percent mark (and five below 90 percent) while four were above 120 percent of normal.

The fall of 1998 marked the end of the 20th century’s longest and strongest El Niño pattern, the breakup of which split the jet stream to force the major storm tracks into British Columbia and south into California, leaving the Pacific Northwest in a “weather backwash.” Temperatures in the basin averaged slightly above normal, which kept the snowpack below normal.

Numerous small (but no major) floods occurred from October through April. In May, a storm circled through California and then up into central and eastern Oregon, producing extreme rainfall in the high desert plains around Prineville, Oregon—causing significant flood damage.

**Electric Energy.** The Coordinated System storage level at the beginning of the 1997-98 operating year was 99.1 percent of full. Due to high streamflows during the year, the system generally operated to operating rule curves or flood control for the entire period, producing large amounts of surplus energy. At the close of 1997-98, the system storage energy was 99.4 percent of full.

On April 1, BPA, as a part of the Treaty’s U.S. Entity, began delivering Canadian Entitlement power from U.S. dams to Canada. The Entitlement is Canada’s half of the

increased firm power made available by the construction of Mica, Duncan, and Arrow. Canada's share for the first 30 years of the Treaty had been sold to a consortium of U.S. utilities; as that sale expires in phases, the entitlement returned to Canada increases incrementally.

**Fish.** An August 1997 agreement among BPA and B.C. Hydro power managers and the Treaty Operating Committee provided for water storage in Libby and concurrent release from

Arrow during August with a subsequent release in September through the following January (the "Libby-Arrow Swap"). Water that otherwise would have been released from a Libby 6.1 m (20 ft) drawdown to meet biological opinion flows in the U.S. was instead provided by Arrow.

A nonpower uses agreement similar to the one described earlier for the period January 1 through July 31, 1998, was signed by the Treaty Operating Committee in September

of 1997. An Operating Committee agreement on reduced flows below Arrow for Canadian whitefish in December through mid-January was also signed in September, 1997.

Juvenile salmon outmigration was greater than normal, but most returning adult runs were below 10-year averages, except for coho and Snake River fall chinook runs, which were above their 10-year averages.



*Within a water year, operating agreements can mitigate the impacts of unusual runoff patterns.*

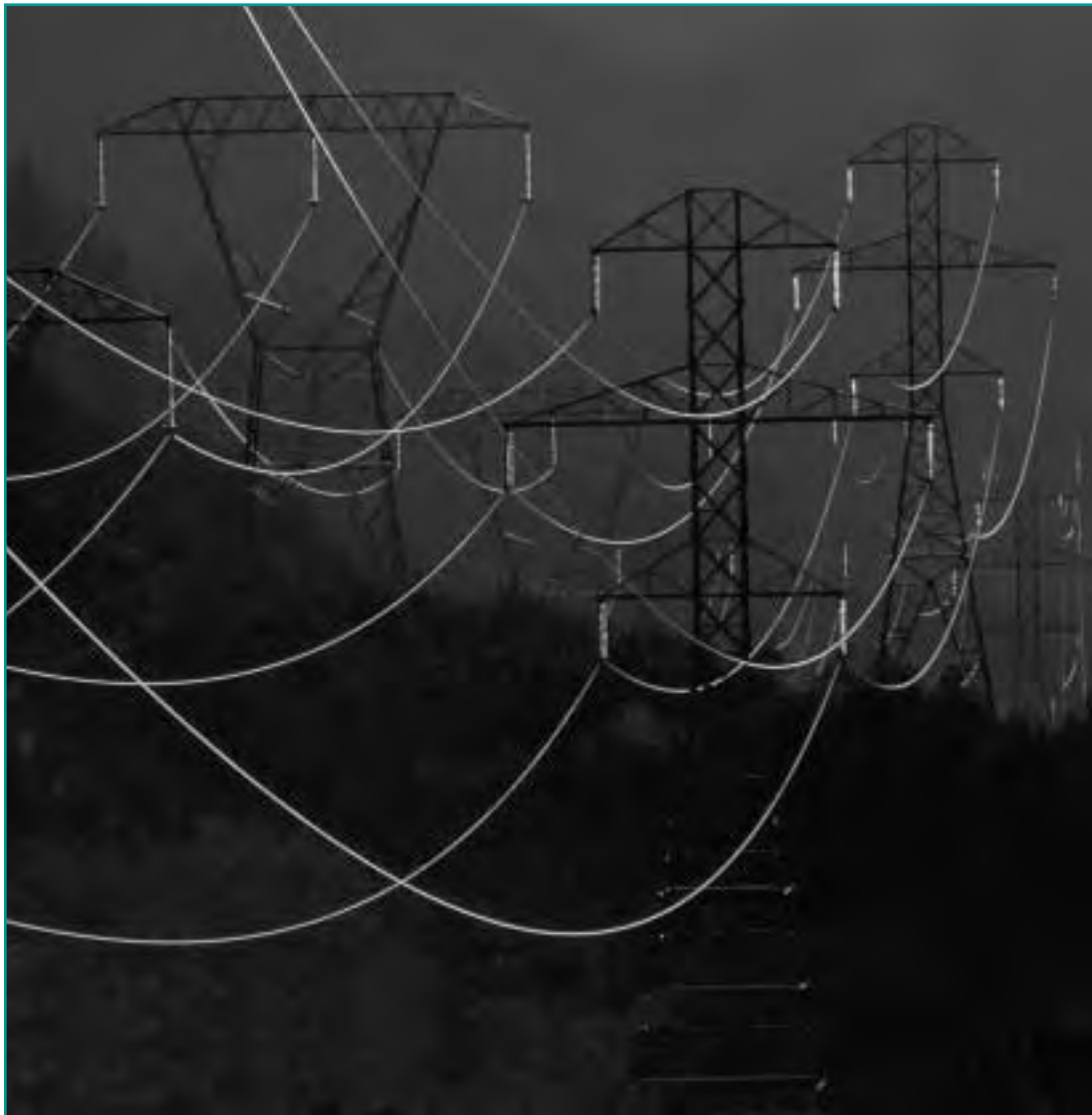

BPA purchased power from utilities outside the region in 1988 to keep reservoirs from being drafted too heavily when runoff forecasts were poor.

## VII. Conclusion

Thanks to cooperation among all the river's users, the dams and reservoirs of the Columbia River now serve more purposes than was ever anticipated when they were built. As demands on the river multiply and the region's population grows, the system will continue to be hard pressed to meet all needs fully.

The Columbia River System Operation Review gave us a chance to step back and examine how each use of the river affects all other uses and to consider what the consequences might be of changing the way the system operates. Do we have the best balance



*While electricity generation was an important stimulus for building many Federal projects, it is only one aspect of multiple-purpose operations today.*

among uses? Can we agree on future courses of action that will provide more benefits? This publication has tried to describe how the Columbia River system

works today. Our response to changing needs and conditions will determine how it will be operated tomorrow.



*The Columbia River system provides countless benefits to the region in wet and dry years alike. River managers face the challenge of continually balancing the benefits among all users.*

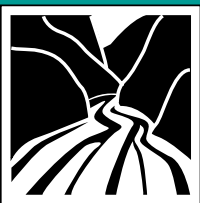



*The System Operation Review gave us a chance to step back and examine river management.*

*Fish ladders provide adult fish a way around dams.*



# Appendix A. Pacific Northwest Hydro Projects



The Pacific Northwest contains a variety of hydro projects. This appendix lists the major projects by general owner (Federal ownership versus private, state, country, etc., collectively described as non-Federal), by river basin, and by whether electric power is produced at the project. Not every dam in the region is included in this list. The focus is on larger dams.

## Kootenai Basin

### Canada

Aberfeldie  
Brilliant  
Duncan  
Kootenay Canal  
Lower Bonnington  
Seven Mile  
South Slocan  
Upper Bonnington  
Waneta  
Whatshan

### Federal with Power

Libby  
Hungry Horse  
Albeni Falls

### Federal without Power

Gold Lake  
Horte  
Lower Crow  
Mud Lake  
Nine Pipe  
Fish Lake  
Lake Como  
Jessup  
Twin Lake  
Lion Lake  
Black Lake  
Dry Creek (Tabor)  
Hillside Lake  
Hubbart  
Jocko (Lower Jocko Lake)  
Kickinghorse  
Little Bitterroot  
Lower Dry Fork  
Lower Lake No. 2  
McDonald  
Mission  
Pablo  
Post Creek (McDonald)  
Tabot  
Upper Dry Fork  
Stony Lake  
North Fork Flume Creek

### Non-Federal with Power

Smith Creek  
Moyie River  
Milltown  
Big Fork (Flathead)  
Kerr  
Cabinet Gorge  
James E. White  
Noxon Rapids  
Thompson Falls  
Boundary  
Box Canyon  
Power Lake  
Monroe Street  
Post Falls  
Upper Falls  
Upriver  
Little Falls  
Long Lake  
Nine Mile

### Non-Federal without Power

Kootenai (Zonolite)  
Basin Creek  
Tin Cup  
Lower Willow Creek  
Nevada Creek  
Big Creek

Fred Burr  
Mill Lake  
Painted Rocks  
Ashley  
Upper Twin Lake  
Little Blue  
Priest Lake  
Sullivan Creek  
Sullivan Lake

## Upper Columbia Basin

### Canada

Hugh Keenleyside  
Mica  
Revelstoke

### Federal with Power

Chief Joseph  
Grand Coulee

### Federal without Power

Twin Lakes  
Beth Lake  
Banks Lake (North Dam)  
Owhi Lake  
Aloma 1 (Conconully)  
Spectacle  
Nada  
Upper Snow Lake  
Columbia Marsh  
Coyote  
Lower Goose  
Moses Lake  
Scootenev Reservoir

### Non-Federal with Power

Deep Creek  
Meyers Falls  
Wells  
Chelan  
Company Creek  
Main Canal Headworks  
Potholes East Canal Headworks  
O'Sullivan Dam  
Quincy Chute  
Potholes East Canal 66.0  
Russell D Smith  
Rock Island  
Rocky Reach  
Wanapum  
Trinity  
Summer Falls  
Priest Rapids

### Non-Federal without Power

Enloe  
Patterson  
Manson (Antilon)  
Wapato  
Colchuck  
Dryden  
Eightmile  
Tumwater Canyon  
Upper Wheeler  
Bennett  
Long Lake (Pinto)

## Middle Columbia Basin

### Federal with Power

McNary  
John Day  
The Dalles

### Federal without Power

Mill Creek  
Indian Lake  
McKay  
Three Mile Falls  
Willow Creek (Heppner)  
Trout Creek  
Olive Lake  
Crane Prairie  
Little Three Creek  
Sparks  
Suttle Lake  
Three Creek  
Wickiup  
Crescent Lake  
Prineville  
Happy Valley (Canyon)  
Haystack  
Wasco  
King Reservoir (Walton Lake)

### Non-Federal with Power

Twin Reservoirs  
Condit  
Odell Creek  
Powerdale  
Spring Creek  
Bend Power  
Cline Falls  
Opal Springs  
Pelton  
Pelton Reregulation  
Round Butte

### Non-Federal without Power

Milton-Freewater  
Poplar Springs  
Crow Creek  
Green Point  
Lake Laurance  
Wind River  
Canyon Creek Meadows  
Bull Prairie  
Arnold  
Odell Lake  
White River  
Antelope Flat  
Bear Creek  
Ochoco  
Badger (Hood River)  
Pine Hollow

## Lower Columbia Basin

### Federal with Power

Bonneville

### Federal without Power

Trillium Lake  
Wahkeena Rearing Reservoir  
SRS

### Non-Federal with Power

Bull Run No. 1  
Bull Run No. 2  
Cowlitz Falls  
Little Sandy  
Marmot  
Roslyn  
Ariel (Lake Merwin)  
Swift  
Yale  
Packwood  
Mayfield  
Mossyrock

*Continued on next page*

**Non-Federal without Power**

Bull Run  
 Lackamas  
 North Fork  
 Barrier  
 Bear Creek Dam (Astoria Reservoir)  
 Indian Creek  
 Wickiup (Clatsop)  
 Youngs River

**Upper Snake Basin****Federal with Power**

Palisades  
 Minidoka

**Federal without Power**

Cross Cut  
 Grassy Lake  
 Grays Lake - Clarks Cut  
 Ririe  
 Blackfoot  
 Blackfoot Equalizer

**Non-Federal with Power**

Island Park  
 American Falls  
 Little Wood Reservoir  
 Idaho Falls (City Plant)  
 Idaho Falls (Lower Plant)  
 Idaho Falls (Upper Plant)  
 Ponds Lodge  
 Ashton  
 St. Anthony  
 Felt  
 Gem State  
 Portneuf River  
 Billingsley Creek  
 Bliss  
 Briggs Creek  
 Clear Lake  
 Faulkner  
 Hazelton  
 Lower Salmon  
 Shoshone Falls  
 Twin Falls  
 Upper Salmon Falls  
 Wilson Lake  
 Birch Creek  
 John H. Koyle  
 Lower Malad  
 Magic Dam  
 Upper Malad  
 Shoshone

**Non-Federal without Power**

Arcadia  
 Twin Buttes  
 Hawkins  
 Portneuf (Chesterfield Reservoir)  
 Magic Water  
 Salmon Falls  
 Big Lost River  
 Bliss (Big Wood River)  
 Dog Creek  
 Malad High Drop  
 Ryegrass  
 Fish Creek

**Middle Snake Basin****Federal with Power**

Anderson Ranch  
 Black Canyon  
 Boise Diversion

**Federal without Power**

Pot Holes Creek  
 Mountain View (Boyle Creek)  
 Atlanta  
 Arrowrock

Deer Flat  
 Golden Gate  
 Hubbard  
 Lower Deer  
 Nampa (Deer Flat Upper)  
 Beulah (Agency Valley)  
 Juntura (Warm Springs)  
 Mahon's Reservoir  
 Harper  
 Bully Creek  
 Deadwood  
 Harry Nelson  
 Mann Creek  
 Mason Dam (Phillips Lake)  
 Thief Valley

**Non-Federal with Power**

Owyhee Tunnel No 1  
 Atlanta Power Station  
 Lucky Peak  
 Cascade  
 C.J. Strike  
 Swan Falls  
 Barber  
 Horseshoe Bend  
 Brownlee  
 Oxbow  
 Hells Canyon  
 Goodrich  
 Rock Creek

**Non-Federal without Power**

Long Tom  
 Mountain Home (Rattlesnake Creek)  
 Antelope  
 Kirby  
 Blacks Lake  
 Orchard  
 Cottonwood (Drewsey)  
 Malheur  
 Paddock Valley  
 Sage Hen  
 Callender  
 Hancock (Fish Lake)  
 Little Payette  
 Payette Lake  
 C. Ben Cross  
 Clear Creek  
 Oxbow Bypass  
 Unity  
 Wolf Creek

**Lower Snake Basin****Federal with Power**

Little Goose  
 Lower Granite  
 Ice Harbor  
 Lower Monumental  
 Dworshak

**Federal without Power**

Lower Pine Lake  
 Upper Bear  
 Manns Lake  
 Soldiers Meadow

**Non-Federal with Power**

Mill Creek  
 Wallowa Falls  
 Sunshine  
 Hettinger

**Non-Federal without Power**

Beaver Creek (La Grande)  
 Wallowa Lake  
 Spring Valley  
 Mosquito Flat  
 Indianola  
 Lapwai Lake (Winchester)  
 Troy  
 Elk River

**Yakima Basin****Federal with Power**

Roza  
 Chandler

**Federal without Power**

Cle Elum  
 Easton  
 Kachess  
 Keechelus  
 Roza  
 Bumping Lake  
 Clear Creek  
 French Canyon  
 Tieton  
 Sunnyside

**Non-Federal with Power**

Naches  
 Wapato Dam-Drop No 2  
 Wapato Dam-Drop No 3

**Willamette Basin****Federal with Power**

Dexter  
 Hills Creek  
 Lookout Point  
 Cougar  
 Big Cliff  
 Detroit  
 Foster  
 Green Peter

**Federal without Power**

Fall Creek  
 Cottage Grove  
 Dorena  
 Fern Ridge  
 Blue River  
 Mill City Diversion  
 Morgan Brothers  
 Scoggins Water Power  
 Timber Lake

**Non-Federal with Power**

Thompson's Mills  
 Carmen-Smith  
 Leaburg  
 McKenzie  
 Trail Bridge  
 WALTERVILLE  
 Water Street  
 Willamette Falls  
 Brunswick Creek  
 Faraday  
 North Fork  
 Oak Grove (Frog Lake)  
 Oak Grove (Lake Harriet)  
 Oak Grove (Timothy Lake)  
 River Mill  
 Lake Oswego

**Non-Federal without Power**

North Fork (Benton)  
 Lebanon  
 Franzen  
 Mercer  
 Mompano  
 Haskins (Walter Link)  
 Silver Creek  
 Binford

**Rogue Basin****Federal with Power**

Green Springs  
 Lost Creek



## Appendix B. Glossary

**Acre-foot:** The amount of water necessary to cover one acre (43,560 square feet) to a depth of one foot.

**Anadromous Fish:** Fish such as salmon and steelhead trout that hatch in fresh water, migrate to and mature in the ocean, and then return to fresh water as adults to spawn.

**Authorizing Legislation:** Congressional approval for the construction of any Federal water project.

**Bank Protection:** Techniques for preventing washout of bank soils, such as planting vegetation, covering with rock, or introducing fine mesh screening over the surface.

**Combustion Turbine:** Electricity-generating device that burns fossil fuels—gas, diesel, or oil—to create steam, which then turns a generator and produces electric power. In some combustion turbines, the steam-creating process is bypassed and the turbine acts like a large-scale jet engine to produce power.

**Critical Water Conditions:** The worst streamflows on record; for the Columbia River basin, the period 1928-1932.

**Crown Corporation:** A Canadian government-created corporation designed to carry out functions in the public interest, such as the B.C. Hydro and Power Authority. Crown corporations can be created either by Federal or Provincial law.

**CSPE Utilities:** Those 41 utilities which banded together in the 1960s, sold municipal bonds for \$254 million, and purchased the first 30 years' worth of the Canadian Entitlement (one-half of the downstream benefits) created by erection of Mica, Duncan, and Keenleyside dams in British Columbia.

**Demand:** The amount of power being used at any given time. Northwest demand is seasonal, peaking in the winter with heating loads; in the Southwest, the peak demand is in the summer with cooling loads.

**Dissolved Gas Level:** Air, and more specifically nitrogen, which dissolves in water falling onto a river surface as that air is pushed under water.

**Diversion:** Taking water out of a river channel for municipal, industrial, or agricultural use.

**Draft Limit:** Lowest level to which a reservoir can be drawn down.

**Drafting:** Process of releasing water from storage in a reservoir.

**Dredging:** Removal of rock and sediment from the bottom of ship channels to maintain sufficient depth for ships to pass.

**Exchange Power:** The process of one utility lending power to another to be paid back at a later date.

**Fall Chinook Salmon:** Anadromous salmon stock which returns from the ocean in late summer and early fall to spawn.

**Federal Project Operators:** Those Federal agencies that operate dams and reservoirs. In the case of the Columbia River, the U.S. Army Corps of Engineers and the Bureau of Reclamation in the U.S. Department of the Interior.

**Federally Recognized Tribes:** An Indian group or confederation of groups officially acknowledged as a tribe by the U. S. government for purposes of legislation, consultation, and benefits. Of over 400 groups nationwide identifying themselves as Indian tribes, fewer than 300 have been Federally recognized.

**Firm Energy:** Energy produced on a guaranteed basis with critical water conditions.

**Fish Ladder:** Series of stair-step pools that enables fish to get past a dam by swimming and jumping from one pool elevation to another.

**Fish Passage Efficiency:** Percentage of the total number of fish that pass a dam without going through turbines.

**Flip Lip:** Structural device on some dams that redirects water coming through a spillway, which prevents the deep plunging action creating nitrogen gas supersaturation.

**Flood Control Rule Curve:** Also called the Upper Rule Curve, the elevations that set the amount of storage space that must be maintained in a reservoir to reduce damaging flood conditions downstream.

**Flood Control:** Management of space behind a reservoir or series of reservoirs to capture runoff in volumes sufficient to prevent flooding of normally dry land.

**Flood Wall:** Barrier, usually concrete or metal, constructed to keep out high water—often found near a pier or urban waterfront.

**Flow:** Rate and volume of water in a river past a given point.

**Freshet:** Heavy runoff that occurs in the river when streams are at their peak with spring snowmelt.

**International Joint Commission:** Six-person Canada- U.S. board created by the 1909 Boundary Water Treaty to resolve disputes on waters shared by the two nations.

**Levee:** A raised embankment built to keep out floodwaters.

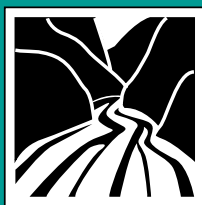

**Locks:** Mechanical devices, shaped like an elongated box, which add or drain water to raise or lower ships around dam structures.

**Maintenance Outage:** The shutting down of a generating unit for routine maintenance.

**Megawatt:** Measure of electrical power equal to one million watts. Megawatts delivered over time are measured in megawatt-hours.

**Multipurpose Facilities:** The Columbia River and the reservoir system are used for many purposes or uses. Projects that were authorized to serve a variety of purposes are referred to as “multipurpose.”

**Nonfirm Energy:** Energy that can be generated with water that is available in excess of that needed for firm energy production.

**Northern Pikeminnow:** A giant member of the minnow family, native to the Columbia River, that is a predator of young salmon.

**Operating Requirements:** Limits within which a reservoir, dam, or system must be operated. Some are required by Congress, while others evolve with operating experience.

**Operating Year:** The period August 1 through the following July 31.

**Peak Flow:** The maximum rate of water flow during a specific time period at a specific location on a stream or river.

**Planning Studies:** Hydroelectric operating studies that simulate how the river will be operated in certain conditions (total streamflow, shape of spring snowmelt) in the near term.

**Priority Rights:** In Federal statutes, the favoring of one group over another, such as public entities over private utilities, in the purchase of Federal electric power, also known as “preference.”

**Proportional Draft Points:** Drawdown limits for reservoirs when water conditions require drafting below energy content curves to serve firm load.

**Reservoir Drawdown:** Lowering of the level of a reservoir for the purposes of increasing water velocity and mimicking the original river cross section present before the reservoir’s construction.

**Resident Fish:** Fish that are permanent inhabitants of a body of water.

**River Reach:** General term used to refer to a specific stretch along a river from one point to another.

**Rule Curve:** Water level, represented graphically as a curve, that guides reservoir operations.

**Runoff:** That portion of precipitation, snowmelt, or irrigation water that runs off the land into streams or other surface water.

**Smolt:** Juvenile salmon or steelhead migrating to the ocean and beginning its transformation from a fresh water fish to a saltwater environment.

**Snowpack:** Accumulation of snow in the mountains that builds up in the late fall and winter.

**Spill:** Water released from a dam over the spillway instead of being directed through the turbines.

**Streamflow Records:** Historical records of annual streamflows; for the Columbia River, over 100 years’ of streamflow records are available.

**Streamflow:** The rate and volume of water flowing in various sections of a river.

**Temperature Control:** The Corps and Reclamation have installed equipment at some dams that can regulate the temperature of water released from the reservoirs. This allows water temperature downstream in the river to be controlled. Temperature control is achieved by drawing water from different elevations in a reservoir. Cold water is drawn from deep in the reservoir; warm water is drawn from near the surface. The two water segments are then released from the dam at the same time.

**Transmission Grid:** The regional network of high-voltage lines that transmits electric power from generating sources to points of consumption.

**Trust Responsibility:** The Federal obligation to provide services to protect and enhance Indian lands, resources, and self-government and to include social and economic programs to raise standard of living and well-being of Indian people.



## Appendix C. Acronyms and Abbreviations

AER	Actual Energy Regulation
aMW	Average Megawatt
ARC	Assured Refill Curve
B.C. Hydro	British Columbia Hydro and Power Authority
BPA	Bonneville Power Administration
cfs	cubic feet per second
cm	Centimeter
Corps	U.S. Army Corps of Engineers (also USACE)
CRC	Critical Rule Curve
CSPE	Canadian Storage Power Exchange
DGT	Dissolved Gas Team (fish)
DSI	Direct Service Industry
ECC	Energy Content Curve
EIS	Environmental Impact Statement
EPA	Environmental Protection Agency
ESA	Endangered Species Act
FCRC	Flood Control Rule Curve
FCRPS	Federal Columbia River Power System
FELCC	Firm Energy Load Carrying Capability
FERC	Federal Energy Regulatory Commission
FONSI	Finding of No Significant Impact
IPC	Idaho Power Company
kcfs	thousand cubic feet per second
kW	kilowatt
m <sup>3</sup> /s	cubic meters per second
Maf	Million acre-feet
MPC	Montana Power Corporation
MW	megawatt
NEPA	National Environmental Policy Act
NMFS	National Marine Fisheries Service
NWPPC	Northwest Power Planning Council
ORC	Operating Rule Curve
PGE	Portland General Electric subsidiary of Enron
PDP	Proportional Draft Point
PNCA	Pacific Northwest Coordination Agreement
PP&L	Pacific Power and Light subsidiary of Scottish Power
PUD	public (or people's) utility district
Reclamation	U.S. Bureau of Reclamation (also USBR)
SCL	Seattle City Light
SCT	System Configuration Team (fish)
SOR	System Operation Review
TCL	Tacoma City Light
TMT	Technical Management Team (fish)
USACE	U.S. Army Corps of Engineers
USFWS	U.S. Fish and Wildlife Service
VECC	Variable Energy Content Curve
VRC	Variable Rule Curve
WWP	Washington Water Power, now Avista

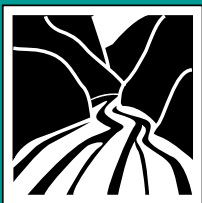



*Fish habitat revitalization is important to species recovery.*

## Appendix D. Reference List

Bonneville Power Administration. July 1990. "Multipurpose Dams of the Pacific Northwest."

Bonneville Power Administration. March 1989. "The Columbia River Treaty Revisited." *Backgrounder*.

Bonneville Power Administration. July 1987. "The World's Biggest Fish Story: The Columbia River's Salmon." *Backgrounder*.

Bonneville Power Administration. September 1985. "Running the Rivers: How the Federal Power System Operates in Low-Water Years." *Issue Alert*.

Bonneville Power Administration. 1964. "The Pacific Northwest Coordination Agreement." A paper presented to the Winter Power Meeting of the Institute of Electronics Engineers in New York, January 1965.

Columbia River Water Management Group. 1988. "Columbia River Water Management Report for Water Year 1988."

Columbia River Water Management Group. 1987. "Columbia River Water Management Report for Water Year 1987."

Columbia River Water Management Group. 1987. "Columbia River Water Management Report for Water Year 1986."

Northwest Power Planning Council. The NWPPC publishes a variety of papers and reports on energy and fish and wildlife issues in the Northwest. The Council's most recent Fish and Wildlife Program and Regional Energy Plan are also useful references.

System Operation Review Interagency Team. 1990. "the Columbia River: A System Under Stress."

U.S. Army Corps of Engineers, North Pacific Division. 1985. "Preliminary Review of Flood Control - Columbia River Basin."

U.S. Army Corps of Engineers, North Pacific Division. 1984 "Columbia River Basin Master Water Control Manual."

All three system Operation Review agencies have extensive libraries and welcome public inquires.

