

FMI 3-90.10
January 2008

**Chemical, Biological, Radiological, Nuclear, and
High Yield Explosives Operational Headquarters**

DISTRIBUTION RESTRICTION: Approved for public release; distribution is unlimited.

HEADQUARTERS, DEPARTMENT OF THE ARMY

This publication is available at Army Knowledge Online
<www.us.army.mil> and the General Dennis J. Reimer Training and
Doctrine Digital Library at <www.train.army.mil>.

Change 1
Field Manual Interim
No. 3-90.10

Headquarters
Department of the Army
Washington, DC, 15 February 2011

Chemical, Biological, Radiological, Nuclear, and High Yield Explosives Operational Headquarters

1. Change Field Manual Interim (FMI) 3-90.10, 24 January 2008, as follows:

Remove old pages:
v and vi

Insert new pages:
v and vi

2. A bar (|) marks new or changed material.
3. File this transmittal sheet in front of the publication.

DISTRIBUTION RESTRICTION: Approved for public release; distribution is unlimited.

FMI 3-90.10, C1
15 February 2011

By Order of the Secretary of the Army:

GEORGE W. CASEY, JR.
General, United States Army
Chief of Staff

Official:

JOYCE E. MORROW
Administrative Assistant to the
Secretary of the Army
1106205

DISTRIBUTION:

Active Army, Army National Guard, and U.S. Army Reserve: Not to be distributed; electronic media only.

PIN: 084591-001

Chemical, Biological, Radiological, Nuclear, and High Yield Explosives Operational Headquarters

Contents

| | | Page |
|------------------|---|------------|
| | PREFACE | v |
| | INTRODUCTION | vii |
| Chapter 1 | OPERATIONAL ENVIRONMENT..... | 1-1 |
| | Understanding the Operational Environment | 1-1 |
| | Operational Variables | 1-4 |
| | The Nature of Chemical, Biological, Radiological, Nuclear, and High Yield Explosives Operations..... | 1-8 |
| | Unified Action | 1-10 |
| | Soldier and Civilian Teams..... | 1-12 |
| Chapter 2 | UNIT STRUCTURE, CAPABILITIES, AND AUGMENTATION | 2-1 |
| | Mission and Mission Sets | 2-1 |
| | The Headquarters Structure | 2-3 |
| | Command Group | 2-3 |
| | Operational Command Post | 2-4 |
| | Main Command Post | 2-7 |
| | Specialized Organic Response Assets | 2-9 |
| | Augmentation | 2-12 |
| Chapter 3 | FULL SPECTRUM OPERATIONS | 3-1 |
| | The Spectrum of Conflict | 3-1 |
| | The Operational Concept | 3-2 |
| | The Elements of Full Spectrum Operations | 3-7 |
| Chapter 4 | WEAPONS OF MASS DESTRUCTION ELIMINATION OPERATIONS..... | 4-1 |
| | The Elimination Mission | 4-1 |
| | Encountering Weapons of Mass Destruction Elimination Sites | 4-8 |
| Chapter 5 | COMMAND AND CONTROL..... | 5-1 |
| | General..... | 5-1 |

DISTRIBUTION RESTRICTION: Approved for public release; distribution is unlimited.

Contents

| | | |
|-------------------|---|-----------------------|
| | The Role of the Commander..... | 5-2 |
| | Enabling Information Superiority..... | 5-3 |
| | The Operations Process | 5-5 |
| Chapter 6 | SUSTAINMENT | 6-1 |
| | Sustainment Planning | 6-1 |
| | Sustainment Support | 6-1 |
| | Nonstandard Requirements..... | 6-2 |
| Appendix A | FUNDAMENTALS OF COMBATING WEAPONS OF MASS DESTRUCTION..... | A-1 |
| Appendix B | STAFF ROLES AND RESPONSIBILITIES..... | B-1 |
| Appendix C | WEAPONS OF MASS DESTRUCTION COORDINATION ELEMENTS..... | C-1 |
| Appendix D | NUCLEAR DISABLEMENT TEAMS..... | D-1 |
| Appendix E | CHEMICAL, BIOLOGICAL, RADIOLOGICAL, NUCLEAR, AND HIGH YIELD EXPLOSIVES ANALYTICAL AND REMEDIATION ACTIVITY | E-1 |
| Appendix F | JOINT ELIMINATION COORDINATION ELEMENTS..... | F-1 |
| Appendix G | TRAINING FOR FULL SPECTRUM OPERATIONS | G-1 |
| Appendix H | MEDICAL LABORATORY SUPPORT..... | H-1 |
| | SOURCE NOTES | Source Notes-1 |
| | GLOSSARY | Glossary-1 |
| | REFERENCES..... | References-1 |
| | INDEX | Index-1 |

Figures

| | |
|--|------|
| Figure 1-1. ASCOPE construct with examples..... | 1-8 |
| Figure 1-2. The joint spectrum of operations..... | 1-11 |
| Figure 2-1. Example of a CBRNE operational headquarters..... | 2-3 |
| Figure 2-2. Example of a JOC for a JTF-E headquarters..... | 2-5 |
| Figure 2-3. Example of a MCP of the CBRNE operational headquarters | 2-8 |
| Figure 2-4. Example of WCEs within the CBRNE operational headquarters..... | 2-10 |
| Figure 2-5. Example of NDTs within the CBRNE operational headquarters..... | 2-11 |
| Figure 2-6. Example of a CARA within the CBRNE operational headquarters | 2-12 |
| Figure 2-7. Example of a JECE and other augmentation in support of a JTF-E | 2-13 |
| Figure 3-1. The spectrum of conflict | 3-1 |
| Figure 3-2. Full spectrum operations—the Army’s operational concept..... | 3-2 |
| Figure 3-3. WMD mission areas within the spectrum of conflict..... | 3-3 |
| Figure 3-4. Example of employments – CBRNE operational headquarters..... | 3-5 |
| Figure 3-5. Example of WCE support to an Army or joint command..... | 3-6 |
| Figure 3-6. Example of OCP support to a joint command | 3-6 |
| Figure 3-7. Example of JTF-E support to a joint command..... | 3-7 |
| Figure 4-1. Operational and tactical tasks in the WMD-E mission area..... | 4-2 |

Figure 4-2. Operational task – isolation 4-3

Figure 4-3. Operational task – exploitation 4-5

Figure 4-4. Operational task – destruction 4-7

Figure 4-5. WMD-E operational tasks – step-by-step 4-11

Figure 4-6. Example of maneuver forces locating WMD-E targets 4-12

Figure 4-7. Example of CBRN brigade exploitation force maneuvering to WMD-E targets 4-13

Figure 4-8. Example of consolidation to support monitoring and redirection missions. 4-14

Figure 5-1. C2 for CBRNE operations 5-2

Figure 5-2. CCIR 5-4

Figure 5-3. Developing SU 5-5

Figure 5-4. Operations process 5-6

Figure 5-5. The MDMP 5-7

Figure 5-6. TECHINT collection and processing 5-9

Figure 5-7. CCIR development and review process 5-11

Figure 5-8. Tasking development example 5-16

Figure 6-1. Example of logistics support for WMD-E forces 6-2

Figure A-1. NMS-CWMD A-1

Figure A-2. Response to proliferation continuum A-4

Figure A-3. Strategic military framework to combat WMD A-6

Figure A-4. CBRNE operational headquarters’ role in combating WMD A-8

Figure B-1. Staff elements of the OCP B-2

Figure B-2. Staff elements of the MCP B-7

Figure C-1. Example of a WCE C-3

Figure E-1. CARA structure E-2

Figure E-2. Concept of an RRT and MMAS performing continuous operations E-4

Figure H-1. Levels of identification confidence H-6

Figure H-2. The “new” LRN designation H-12

Tables

| | |
|---|-----|
| Table 3-1. Elements of full spectrum operations | 3-7 |
| Table G-1. Collective task training | G-4 |

Preface

Doctrine provides a military organization with unity of effort and a common philosophy, language, and purpose. An field manual interim (FMI) is a Department of the Army (DA) publication that provides expedited delivery of urgently needed doctrine the proponent has approved for use without placing it through the standard development process. Unless an FMI is rescinded, information it disseminates is incorporated into a new or revised field manual (FM). This FMI provides doctrine for operations of the chemical, biological, radiological, nuclear, and high yield explosives (CBRNE) operational headquarters.

FMI 3-90.10 is intended to facilitate the operations and training requirements of the CBRNE operational headquarters as they organize, prepare for, and conduct operations. Its interim format will evolve into an official FM after lessons learned from training and operational experiences are incorporated into future Army doctrine.

This manual is organized into six chapters and seven appendixes to provide additional detail on selected topics. A brief description of the chapters and appendixes is provided below:

- Chapter 1 examines the operational environment (OE) and the nuances that apply to the CBRNE operational headquarters.
- Chapter 2 provides a description of the CBRNE operational headquarters, its subordinate elements, and key augmentation that will typically support the headquarters.
- Chapter 3 lays the foundations and framework combating weapons of mass destruction (WMD) across the spectrum of conflict and in support of full spectrum operations.
- Chapter 4 discusses weapons of mass destruction elimination (WMD-E) operations that are the focus for the CBRNE operational headquarters. A general scenario provides a framework for examples of WMD-E operations.
- Chapter 5 provides the basic construct of command, control, and support relationships as they are likely to impact on the CBRNE operational headquarters, its subordinate elements, and other potential augmentation as the CBRNE headquarters and its elements conduct operational missions.
- Chapter 6 discusses sustainment of the CBRNE operational headquarters and its subordinate elements. This chapter describes the integrated sustainment effort required to support CBRNE operations.
- Appendix A provides a description of the strategic framework and the fundamentals of combating WMD. This appendix primarily supports the material in Chapter 4 by explaining the framework that the CBRNE operational headquarters supports.
- Appendix B provides a more detailed description of the staff roles and responsibilities within the CBRNE operational headquarters. Primary focus is on the main command post (MCP) and the operational command post (OCP). This appendix provides additional depth for Chapter 2.
- Appendix C provides more detailed information on the weapons of mass destruction coordination element (WCE), an organic subordinate element of the CBRNE operational headquarters.
- Appendix D provides more detailed information on the nuclear disablement team (NDT), an organic subordinate element of the CBRNE operational headquarters.
- Appendix E provides more detailed information on the chemical, biological, radiological, nuclear, and high yield explosive analytical remediation activity (CARA), an organic subordinate element of the CBRNE operational headquarters.
- Appendix F provides more detailed information on the joint elimination coordination element (JECE). The JECE is a critical joint augmentation for the CBRNE operational headquarters and other operational level commands.

- Appendix G provides a discussion of training for the CBRNE operational headquarters and its subordinate elements for full spectrum operations.
- Appendix H provides a discussion of medical laboratory support and its applicability to WMD-E operations.

Terms that have joint or Army definitions are identified in both the glossary and the text. Glossary terms: The glossary lists most terms used in FMI 3-90.10 that have joint or Army definitions. Terms with an asterisk in the glossary indicate that this FM is the proponent FM (the authority). Text references: Definitions printed in boldface in the text indicate that this FM is the proponent FM. These terms and their definitions will be incorporated into the next revision of FM 1-02. For other definitions in the text, the term is italicized, and the number of the proponent FM follows the definition. This publication applies to the officers and Soldiers assigned to operational headquarters; commanders and staffs of joint task forces (JTFs), corps, and divisions; Active Army, the Army National Guard (ARNG)/Army National Guard of the United States (ARNGUS), and the United States Army Reserve (USAR) unless otherwise stated.

The proponent for this publication is the United States Army Training and Doctrine Command (TRADOC). Send comments and recommendations on Department of the Army (DA) Form 2028 (Recommended Changes to Publications and Blank Forms) directly to Commandant, United States Army Chemical School, ATTN: ATZT-TDD-C, 320 MANSCEN Loop, Suite 220, Fort Leonard Wood, Missouri 65473-8929. Submit an electronic DA Form 2028 or comments and recommendations in the DA Form 2028 format by e-mail to <leon.mdottddcbrndoc@conus.army.mil>.

Unless this publication states otherwise, masculine nouns and pronouns do not refer exclusively to men.

Introduction

When the United States (U.S.) military initiated the attack into Iraq to begin Operation Iraqi Freedom (OIF) in the spring of 2003, one of the main objectives was to find, exploit, and eliminate Iraq's WMD program and capabilities. For decades, U.S. military forces have developed specialized forces and trained conventional forces to attack or seize high value targets, but the U.S. military had never trained, organized, or prepared to seize, exploit and eliminate a nation's WMD program.

The WMD-E mission was, and remains, an entirely new operational demand imposed on U.S. military forces. OIF required the hasty fielding of new and largely untested WMD-E capabilities, and in a short period of just a few months, the U.S. Department of Defense organized, trained, and deployed two ad hoc organizations: the 75th Exploitation Task Force and the Iraq Survey Group. When integrated into other military units in support of major headquarters, they provided a rudimentary capability for WMD-E. Based on this experience, the Department of Defense (DOD) decided to activate a full time capability for integration into planning for future military operations against global adversaries who may possess WMD.

In a speech at the National Defense University on 13 May 2003, the Undersecretary of Defense, Paul Wolfowitz, announced, "Since WMD in the hands of rogue states and terrorists is the greatest security threat we face in this decade, we will continue to have a requirement for a robust WMD-E capability... The elimination capability that we put together...before Operation Iraqi Freedom will need to be retained, enhanced and institutionalized...In future conflicts we should not end up playing 'pickup games' when we are trying to put together forces for eliminating WMD. We must ensure that there are sufficient forces in peacetime, adequately trained, organized and equipped for that mission." Likewise, the national military strategy to combat weapon of mass destruction (NMS-CWMD) confirmed this by stating, "DOD must develop, institutionalize, and exercise a joint capability to eliminate WMD in uncertain environments...Commanders should be prepared to conduct elimination activities from the initiation of operation until it is determined that a transfer of authority to another agency is warranted."

WMD-E is taking on an ever greater national security importance and is gaining a higher priority in defense planning. National security will depend upon the ability of commanders and staffs to understand and address the challenging and unique operational considerations for eliminating WMD programs, weapon systems, and materials. The Quadrennial Defense Review (QDR) released February 6, 2006 provides a shift in emphasis toward meeting challenges in a new strategic environment. Although the QDR maintains the emphasis on DOD support to homeland security (HLS) and nonproliferation, it amplified the requirement for performing WMD-E missions against potential adversaries with known WMD programs or terrorist organizations that seek such weapons. The 2006 QDR states that, "The military departments will organize, train, and equip joint forces for this increasingly important mission." The 2006 QDR also details how the DOD will continue to transform itself to better balance its capabilities across four categories of challenges introduced and outlined in the March 2005, National Defense Strategy of the United States of America. These are:

- Traditional challenges posed by states employing conventional forces in well-established forms of military competition.
- Irregular challenges from state and nonstate actors employing methods such as terrorism and insurgency.
- Catastrophic challenges involving the acquisition, possession, and use of WMD by state and nonstate actors; and deadly pandemics and other natural disasters that produce WMD-like effects.
- Disruptive challenges from state and nonstate actors who employ technologies and capabilities (such as biotechnology, cyber and space operations, or directed energy weapons) in new ways to counter U.S. military advantages.

The military strategic goal, as outlined in the February 2006 NMS-CWMD, is to ensure that the U.S. and its forces, allies, partners, and interests are neither coerced nor attacked by enemies with WMD. The strategy further refines the three pillars of the 2002 national strategy to combat weapons of mass destruction (NS-CWMD): nonproliferation (NP), counterproliferation (CP), and consequence management (CM)—into eight military mission areas. The eight military mission areas are—

- Offensive operations.
- Elimination operations.
- Interdiction operations.
- Active defense.
- Passive defense.
- Weapons of mass destruction consequence management (WMD-CM).
- Security cooperation and partnership activities.
- Threat reduction cooperation (TRC).

The CBRNE headquarters has been created to perform a critical role in countering WMD. The role of the CBRNE operational headquarters in the NS-CWMD is highlighted in Appendix A, Figure A-4. For further discussion of this framework and the specifics of WMD-E, see Chapter 4 and Appendix A.

The mission of the CBRNE operational headquarters is to deploy and conduct operations in support of combatant commanders (CCDRs) or other government agencies (OGAs) to counter CBRNE and WMD threats, in support of national combating WMD objectives. Its core focus is on tactical, operational, and strategic exploitation and elimination operations.

When directed by the United States Joint Forces Command (USJFCOM), the CBRNE operational headquarters will provide the core elements, augmented with joint and interagency enablers under a joint manning document, to form a joint task force headquarters for WMD elimination (JTF-E).

Chapter 1

Operational Environment

This chapter discusses the operational environment (OE) using six interrelated variables of political, military, economic, social, information, infrastructure, and the two added Army variables of physical environment and time (PMESII-PT). Each variable affects how Army forces combine, sequence, and conduct military operations. Commanders tailor forces, employ diverse capabilities, and support different missions to accomplish military objectives. An analysis of these variables assist commanders in defining the conditions, circumstances, and influences that affect operational options considered to plan, coordinate, support, execute, and sustain WMD-E operations. Also discussed are the nature of CBRNE operations in the OE and the effect of the OE on WMD-E teams.

UNDERSTANDING THE OPERATIONAL ENVIRONMENT

1-1. FM 3-0 provides an analysis of the OE using PMESII-PT. Joint doctrine describes the *operational environment* as a composite of the conditions, circumstances, and influences that affect the employment of military forces and bear on the decisions of the unit commander (JP 1-02). The military variables of PMESII-PT explore the capabilities of all relevant actors in a given OE. Conceptually they provide a holistic view of the situation, the environment's characteristics, and they represent a multidimensional perspective essential for anticipating how full spectrum operations will affect the OE and ultimately joint and national objectives.

1-2. Many OEs will include areas suffering from economic collapse, resource competition, ideological differences, and failed infrastructure. In the last twenty years, the global WMD threat has shifted focus from state threats to one that also includes terrorists, extremists, terrorist networks, transnational threats, nongovernmental organizations (NGOs), businesses, rogue scientists or technicians, as well as individuals acting independently of any organization.

1-3. To address state and nonstate actor WMD threats, the U.S. military, in support of the NS-CWMD and NMS-CWMD, can expect increased requirements to conduct NP, CP, and CM missions. Today more than ever, the Nation depends on the joint force to defend the homeland and safeguard global U.S. interests.

1-4. As in present day, the foreseeable future will also require a more versatile Army trained and ready to conduct operations in complex OEs and prepared to meet an anticipated increasing range of domestic and international WMD threats. Recent significant changes impacting the OE that affect WMD-E include:

- A threat scenario in which adversaries are not readily identifiable.
- A significant degree of joint and single service interaction for domestic missions involving state and local governments, and international missions supporting foreign governments and NGOs, multinational forces, and contractors.
- Increased coordination of organizations and functions to achieve appreciable gains.
- Simultaneous, geographically dispersed operations that will result in extremely long and potentially unsecured lines of communication (LOC).
- A potentially complex noncontiguous area of operations (AO) where boundaries are not clearly defined.
- The prevalence of joint organizations at the operational level and single service organizations operating in a collaborative or interdependent joint environment at the tactical level.

1-5. *Threats* are people, groups, conditions, or natural phenomena that have the potential to damage or destroy life, vital resources, or institutions (FM 3-0). The U.S. will use all instruments of national power (diplomatic, informational, military, and economic) to prepare for and manage these threats. Enemies of the U.S. are feverishly developing or attempting to acquire WMD, both for deterrence and to threaten opponents.

1-6. The potential for U.S. forces to face some kind of CBRNE incident in an OE remains a serious challenge. This threat can come from nation-states and nonstate actors alike, sometimes simultaneously, and can be presented in many forms. Persistent and nonpersistent CBRNE hazards may result from the accidental or deliberate release of toxic industrial chemicals (TIC) or toxic industrial materials (TIM), detonation of an improvised explosive device (IED) or chemical variant of an IED, or an adversary's use of a radiological dispersal device. CBRNE or hazardous materials (HAZMAT) contamination can occur following exploitation of an unsecured WMD facility or laboratory, following infrastructure breakdown, or result from collateral damage caused by lethal weapons, sabotage by an adversary, or simply result from a naturally occurring or manmade accident.

1-7. Present-day conflicts in the war on terrorism reveal enemy forces that combine conventional and asymmetric weapons in a variety of combinations to confront Army forces. U.S. enemies have learned that conventional military operations alone against superior Army forces more often result in outright defeat. Consequently, enemies resort to adaptive tactics and strategies that minimize U.S. strengths while providing opportunities to inflict mass casualties on U.S. forces, prolong the conflict, and undermine U.S. resolve. These enemies rationalize the use of WMD in situations and conditions that the U.S. may consider immoral and unacceptable.

1-8. In terms of the threat categories described in the 2004 National Military Strategy of the United States of America, terrorist networks may employ irregular, catastrophic, or disruptive methods to challenge U.S. security interest. Irregular threats employ "unconventional" methods to counter the traditional advantages of stronger opponents. Catastrophic threats involve the acquisition, possession, and use of weapons of mass destruction (WMD) or methods producing WMD like effects. Disruptive threats may come from terrorist organizations that develop and use breakthrough technologies to negate current U.S. advantages in key operational domains.

1-9. Enemies may regard the use of WMD as politically or militarily acceptable in ways that are largely incomprehensible within civilized norms. Irregular, catastrophic, and disruptive threats are often transnational, operating worldwide without regard to political boundaries. Deterrence strategies may prove ineffective against irrational actors. Completely eliminating an adversary's capability to acquire, store, and employ these weapons becomes a crucial component in the end state of any campaign.

1-10. Adversaries will continue to look at the use of WMD or other CBRNE capabilities as a way to maintain an asymmetric advantage over U.S. forces as well as allied and coalition partners. They will use CBRNE capabilities to shape the OE and:

- Inflict unacceptable casualties.
- Create conditions to deter or defeat entry operations.
- Erode public support, the support of allies or coalition members, and the basic will to fight.

STRATEGIC AND REGIONAL THREATS

1-11. Nonstate actors and states possessing CBRNE capabilities or the ability to develop a CBRNE capability may threaten the U.S. These threats may be strategic threats to the homeland, threats to regional stability, or have operational/tactical effects.

NONSTATE ACTORS

1-12. Individuals and organizations seeking to acquire, develop, or proliferate WMD pose a grave threat to U.S. national security. CBRNE capabilities in the possession of nonstate actors could potentially kill large numbers of people with little or no warning. The relationship between nonstate actors and CBRNE constitutes one of DOD's top priorities. Proactive measures must be implemented to prevent them from

acquiring or developing CBRNE capabilities. The threat is further complicated by the operations of multinational networks, potentially with the support of states, which proliferate WMD precursors, technologies, and knowledge. These global proliferation activities employ a combination of secrecy, dispersion, and fiscal resources that must be located, monitored, and ultimately targeted.

1-13. The U.S. cannot become focused on just the threat of a nonstate actor acquiring and using a traditional military CBRNE capability. Nonstate actors can also take advantage of the numerous TIMs that exist for day-to-day commercial activity. A nonstate actor could obtain access to commercial items such as ammonium nitrate, lead azide, mercury fulminate and use it to create a WMD. In early 2007, U.S. forces saw this kind of activity during OIF when insurgents stole chlorine tanks and integrated them as one of the components of vehicle-borne IEDs.

STATE ACTORS

1-14. Nation states with active CBRNE programs possess a wide range of employment capabilities. These range from conventional (such as ballistic and cruise missiles) to unconventional (such as improvised radiological devices and crop dusters). The challenge lies in assessing the intent and capabilities of the state's leadership.

REGIONAL THREATS

1-15. The proliferation of missile technology has enabled many states to acquire delivery systems that can range well beyond their immediate regions. A number of states have systems that can strike targets within the U.S. These long-range CBRNE delivery systems may enable enemies to deter U.S. action, deny access to its territory or intermediate staging bases, or preempt a pending operation. Enemies may also strike U.S. allies in an attempt to affect or alter U.S. policy.

1-16. The nonemployment challenges of states possessing WMD (such as presence, proliferation, and stability disruption) may prove to be the most challenging and dangerous to U.S. interests. It can disrupt U.S. and international efforts to foster stability and curtail proliferation activity. The perceived imbalance in power can lead to active proliferation among neighboring states; it could deliver a severe blow to ongoing NP and CP or other diplomatic and economic efforts.

1-17. If eliminating enemy WMD is the principal objective of a campaign; the defeat or destruction of the enemy's other military capability becomes a necessary step to achieve the larger goal. Creating the conditions required to completely eliminate enemy WMD requires ground forces and often specialized units trained to address the complex nature of asymmetrical hazards.

1-18. With the assistance of conventional ground forces, specialized teams from CBRNE operational headquarters can do more than eliminate WMD threats. The capture and subsequent documentation of areas an enemy has kept secret may have enormous diplomatic and informational power. As with the destruction of enemy WMD, the capture and worldwide exposure of enemy sites may be essential to the success of a campaign and contribute directly to liberating an oppressed and terrorized population.

THREATS TO WEAPONS OF MASS DESTRUCTION SITES

1-19. Securing and safely controlling or managing WMD sites is critical for every military operation. The landscape in an OE may be shaped as a consequence of deliberate or accidental destruction of these sites. Due to their importance, occupying enemies may defend or sabotage a WMD site while others may abandon the area before confronting Army, joint and/or coalition forces. Once abandoned, specialized teams from the CBRNE operational headquarters may also encounter civilians attempting to ransack the area who are expressing anger against a former oppressor or radicals who are upset over philosophical or political differences. Threats to the WMD site may include secondary effect hazards to civilians that work or live at and around the site. Each WMD or potential WMD site has unique characteristics and tactical and technical challenges for commanders to consider. Planners need to develop detailed and coordinated contingency plans to address each site that includes security and safety with a worst case "what if" scenario mindset.

THREATS TO THE CHEMICAL, BIOLOGICAL, RADIOLOGICAL, NUCLEAR, AND HIGH YIELD EXPLOSIVES OPERATIONAL HEADQUARTERS

1-20. Threats to the CBRNE operational headquarters and its subordinate elements exist throughout the spectrum of conflict. These threats may be coordinated or independent of each other, but their effects are frequently cumulative. The CBRNE operational headquarters may have to operate in noncontiguous AOs with no sustainment area. This makes every Soldier, vehicle, and facility more vulnerable to attack than in a combat zone divided into contiguous AOs. Additionally, the Global Information Grid's (GIG's) connectivity and joint and Army forces' reliance on electronic information systems make deployed forces vulnerable to electronic attack. Finally, the physical environment will add to the complexity of operations. Operations may take place in failed and failing states with limited infrastructure. Commanders may decide to operate in complex or austere areas to maneuver against enemy concentrations or avoid population centers. Within this context and OE, the CBRNE operational headquarters must be capable of assisting supported commanders by identifying, orchestrating, and tracking WMD-E operations.

ASYMMETRIC THREATS

1-21. Few aggressors will take on the U.S. military head-on; rather they will seek ways to negate advantage and undermine the Nation's will, credibility, and influence. Aggressors may be characterized by three areas of asymmetry:

- The asymmetric nature of an opponent (such as it is difficult to identify and target, or even negotiate with)
- The asymmetric nature of the opponent's ideas or culture (which are at variance to one's own beliefs, priorities, and moral constraints)
- The asymmetrical methods that an opponent may employ to counter a qualitative and quantitative advantage

OPERATIONAL VARIABLES

1-22. The Army uses Service and joint analytical tools and considers the military variables of PMESII-PT to help the commander understand the OE. Operational variables provide a view of the human factors which are extremely important to understand to accomplish strategic and operational military objectives. Military variables are relevant to campaign planning; however, they are too broad to be applied to tactical planning. At the tactical and operational level, the Army considers the mission, terrain and weather, troops and support available, time available and civil considerations (METT-TC). PMESII-PT and METT-TC provide relevant information (RI) that senior commanders use to frame operational problems; this analysis improves situational understanding (SU) and lends directly to mission accomplishment. The variables associated with the memory aid of PMESII-PT are discussed below.

THE POLITICAL VARIABLE

1-23. To recognize key actors and visualize an enemy's explicit and implicit aims and capabilities to achieve their goals, it is essential commanders understand and appreciate the political circumstances within an OE. Sources of political mobilization may originate from political leadership; religious, ethnic or economic communities; or in the indigenous security institutions such as the armed forces or police. Lessons learned from OIF and Operation Enduring Freedom (OEF) demonstrate how these actors can mobilize group identity, ideas, beliefs, actions, and violence to enhance their power and control over society, territory, and resources.

1-24. Part of the political analysis of an OE examines the concept of an enemy's "will." An enemy's determination and probability to use WMD may be estimated by understanding the values, morals, agendas, and required effort to field and leverage forces. The Army may face a determined and inferior force willing to target dangerous resources such as industry and facilities having TIC of TIM or industrial plants and facilities which produce nuclear materials and radiological byproducts.

1-25. The NS-CWMD and the NMS-CWMD establish a framework for how U.S. forces handle the challenges of CBRNE capabilities in the OE. A CBRNE incident and preparedness to respond coupled with a U.S. response will have impacts on the political dimension. The same holds true for political decisions in pre-conflict which may impact military actions such as what type of CBRNE capability U.S. forces would deploy to support operations.

THE MILITARY VARIABLE

1-26. Understanding the human characteristics of key actors and rogue leaders are especially important when predicting events in the OE. The military variable considers all relevant actors and their means to influence events or use of conventional forces and asymmetrical weapons in a given OE. Analysis should consider an adversary's willingness to sabotage industrial plants or high-containment laboratories having TIC/TIM materials or use more sophisticated and technological WMD. It is essential that adversaries believe they will suffer severe consequences and that their objectives will be denied if they threaten or resort to the use of WMD.

THE ECONOMIC VARIABLE

1-27. Commanders may view components of an OE's economic system as precursors signaling an adversary's potential use of WMD. Understanding the WMD hazards in the OE is an essential part of this analysis and includes tracking the import, export or production or availability of key materials and the production, distribution, and consumption of resources. Without actionable intelligence, U.S. forces may be unable to identify, prevent, defeat, or reverse the proliferation or use of WMD.

THE SOCIAL VARIABLE

1-28. To understand an adversary and their ability to influence in the OE, it is prudent to study the cultural, religious, and ethnic makeup of its people. Planning WMD-E operations requires an extensive understanding of the population which fit into four categories of intermixed people: the enemy, adversaries, supporters, and neutrals. In the OE it is often difficult to distinguish one from another.

1-29. A comprehensive study includes an understanding not just of the people, but of groups and institutions that exhibit shared identity, behaviors, values, and beliefs. When assigning missions, it is important that commanders consider special skills, language, and rapport with the local population as well as multinational partners' national sensitivities.

1-30. History has proven that military operations, leveraged without consideration of the social dynamics and implications, often result in the loss of popular support for U.S. objectives. It can also coerce groups into providing aid to enemy forces or at least passively protecting them. Without public support and the endorsement of the international community, the will of the forces involved, as well as the will of national governments to employ those forces, may be seriously undermined. The endstate often results in prolonged military occupation, conflicts and engagements, and sometimes civil war. If treated properly, however, citizens may provide critical information to U.S. or coalition forces about enemy activity hiding, transporting, selling, shipping, or preparing to use WMD materials.

THE INFORMATION VARIABLE

1-31. U.S. adversaries have long used propaganda as a nonlethal weapon to affect U.S. national will and to destroy or fragment coalition partnerships. Adversaries often use the media to impact U.S. popular opinion and global political decision making. Local, regional, national, and international broadcasts and internet media can rapidly disseminate competing views of military operations. Information may flow by less sophisticated means – couriers, graffiti, rumors, cultural symbols, air, literature, radio, or local print media. It may be necessary to notify the local populace and their neighbors of the threat posed by accidental or deliberate destruction of WMD. In some instances, enemies may try to incite panic by exaggerating, distorting, or shifting the blame for the threat. To achieve operational, strategic, and tactical objectives, commanders must engage the information environment.

THE INFRASTRUCTURE VARIABLE

1-32. Military operations are the result of deliberate and often complex planning designed to successfully deploy U.S. and coalition forces. To establish and sustain military operations, planners almost always seek to take advantage of existing entry points (ports, airfields, and other suitable landing sites); however, it is also essential to control sites in the OE having WMD weapons or sites that have a potential WMD effect. Deliberate or accidental destruction or degradation of some sites can impact the political, military, economic, social, and information systems in an OE and can prevent or significantly disrupt U.S. forces from achieving tactical, operational, and even strategic U.S. objectives.

THE PHYSICAL ENVIRONMENT VARIABLE

1-33. In the OE the physical circumstances and conditions that influence military operations on air, land, sea, and space include terrain and weather patterns made even more deadly and maneuver-restricting when combined with HAZMAT. The OE can be shaped by the enemy's tactical use of less sophisticated and often readily assessable TIC or TIM. Complex terrain includes terrain restricted by persistent hazards and shorter duration nonpersistent CBRNE contamination in the air and on the land and sea.

1-34. Some industrial materials can be used as a component for asymmetrical weapons that are even more hazardous when combined with water and influenced by naturally occurring weather. The topography and hydrology of the OE provide the essential ingredients and delivery mechanism. During intelligence preparation of the battlefield (IPB) it is essential to consider the physical environment and to conduct a complete analysis to determine if the enemy possesses the technical skill and determination to use available resources and the physical environment to deliver them.

1-35. Most if not all CBRNE operations will occur on the land, and therefore the greatest impact of a CBRNE incident will be to ground forces. CBRNE operations should take into consideration the four characteristics that distinguish land combat in the OE:

- **Scope.** CBRNE incidents and their impact on noncombatants, key terrain, and flagship capabilities.
- **Duration.** The continuous actions associated with land combat can be negatively impacted by the successful use of enemy CBRNE/WMD weapons.
- **Terrain.** Enemy CBRNE/WMD weapons can be employed against key terrain to negatively impact land combat operations. In addition the complexity of urban terrain and close combat can change and even enhance the use of CBRNE/WMD capabilities.
- **Permanence.** Enemy CBRNE/WMD weapons can be used to impact the ability of U.S. forces to successfully control populations and productivity centers during operations. The effects of CBRNE/WMD and HAZMAT may dramatically affect terrain for an extensive period of time.

1-36. Several attributes of the land environment affect WMD-E operations. These include—

- The requirement for proactive participation in the planning process and assessment of the need to deploy the CBRNE operational headquarters and/or its elements.
- The requirement to deploy and employ the CBRNE operational headquarters rapidly.
- The requirement for the CBRNE operational headquarters to operate for protracted periods (perhaps as the primary component of a JTF headquarters).
- The nature of close combat.
- Uncertainty, chance, and friction.

THE TIME VARIABLE

1-37. Military operations in the OE are influenced by time in terms of decision-cycles, operational pace, and planning horizons. Military planners attempt to project the commander's thoughts and designs and the enemy's action or reaction forward in time. Time impacts endurance and protraction of military operations; it's a critical planning factor when considering an adversary's potential use of industrial and military resources to launch CBRNE attacks and create toxic hazards. Timing is everything, and if not taken from an adversary, time can be wisely used to develop effective delivery plans to introduce toxins or to

preposition, sabotage, or conceal WMD. The CBRNE operational headquarters must be proactively involved in the planning process of units that it will support.

MISSION VARIABLES

1-38. To understand the OE requires a detailed analysis and solid understanding of the operational variables. This is the level at which the CBRNE operational headquarters typically operates. This awareness is essential and directly relevant to campaign planning; however, they are too broad to be applied to tactical planning. Army leaders narrow their focus to METT-TC. The OCP staff (see Chapter 2 and Appendix B) will use METT-TC to synthesize operational and tactical level information with local knowledge relevant to the WMD-E mission and to ensure that the target folders that they build for missions are properly focused and resourced.

1-39. Incorporating the analysis of the operational variables into METT-TC emphasizes the OE's human aspects, most obviously in civil considerations but in the other factors as well. This requires critical thinking, collaboration, continuous learning, and adaptation. It also requires analyzing local and regional perceptions. Many factors affect perceptions of the enemy, adversaries, supporters, and neutrals. These include—

- Language.
- Culture.
- Geography.
- History.
- Education.
- Beliefs.
- Perceived objective and motivation.
- Communications media.
- Personal experience.

1-40. One of the key categories of METT-TC is that of civil considerations. The staff analysis of this category improves SU and lends directly to mission accomplishment. Civil considerations are essential to developing effective plans for all operations—not just those dominated by stability or civil support. Full spectrum operations often involve stabilizing the situation, securing the peace, and transitioning authority to civilian control. Combat operations directly affect the populace, infrastructure and the force's ability to transition to host nation (HN) authority. The degree of the populace's expected support or resistance to Army forces affects nearly all operations

1-41. Figure 1-1, page 1-8 provides a graphical depiction and an example of the use of the memory aid ASCOPE. Commanders and staffs analyze civil considerations in terms of the categories expressed in this memory aid (ASCOPE: areas, structures, capabilities, organizations, people, events). CBRNE operations require the consideration of many of the items identified here as well as others that are not represented in this example.

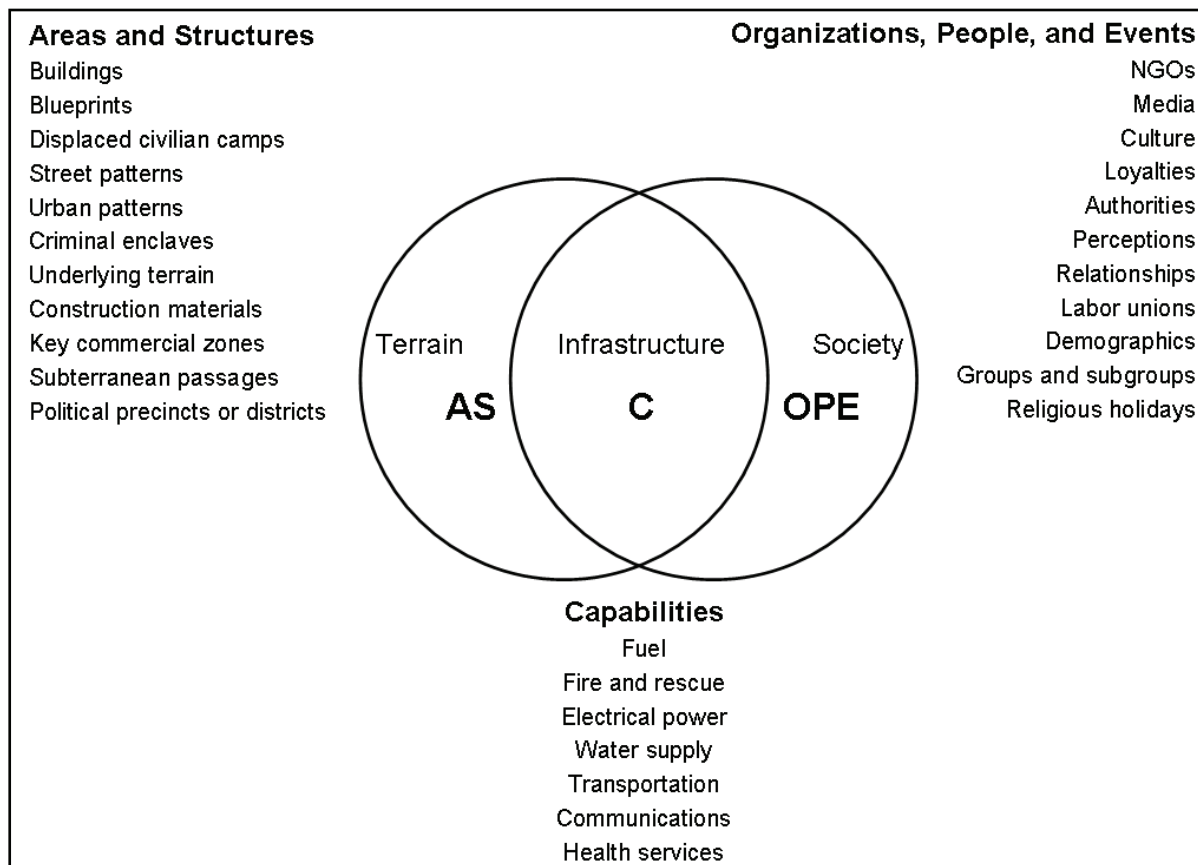

Figure 1-1. ASCOPE construct with examples

THE NATURE OF CHEMICAL, BIOLOGICAL, RADIOLOGICAL, NUCLEAR, AND HIGH YIELD EXPLOSIVES OPERATIONS

1-42. A CBRNE environment may best be described as one in which there is deliberate or accidental employment (or threat of employment) of:

- Chemical, biological, radiological, or nuclear weapons or material
- Deliberate attack or accidental exposure to contamination with TIMs, including TICs
- Deliberate attack or accidental exposure to contamination with radiological (radioactive) or nuclear properties

1-43. The OE may include CBRNE, HAZMAT, TIC, TIM hazards, and harmful WMD components. The OCP staff, WCE members, and WMD-E team leaders must fully appreciate and understand hazards and plan accordingly. In almost every case, chemical, biological, radiological, and nuclear (CBRN) reconnaissance and defense units are a part of tactical planning. However, many of the tactical chemical units have standard chemical warfare agent detectors that lack the capacity to correctly identify all known chemical and biological agents. Many tactical detection meters can yield a false positive when exposed to some TIC and TIM, and none are designed to identify oxygen-deficient areas.

1-44. CBRNE/WMD site exploitation may include Army or joint agency, multinational, and HN personnel to support activities inside a suspected or known facility. These teams may consist of a technical escort unit (TEU) and other specialized personnel who can conduct sampling and packaging, and escort chemical and biological materials back to a theater medical laboratory or to continental United States (CONUS) for further analysis or verification. Legally sufficient chain of custody procedures must be enforced when samples are collected, stored, transported, and analyzed.

1-45. WMD, CBRNE, HAZMAT, TIC, and TIM hazards almost always require planning and resources for decontamination. Normally the supported element identifies suitable decontamination sites with link-up points and manages the logistical requirements to bring specialized teams back to fully mission capable status. In the absence of that support, planners must realize and plan for prolonged operations in toxic or contaminated environments which consume protective ensemble and perishable decontamination supplies, and may require calibration and servicing of sophisticated detection and monitoring equipment and transportation assets.

EXPEDITIONARY AND CAMPAIGN REQUIREMENTS

1-46. *Campaign* is defined as a series of related military operations aimed at accomplishing a strategic or operational objective within a given time and space (JP 1-02). *Expeditionary* refers to armed force organized to accomplish a specific objective in a foreign country (JP 1-02). To accomplish the NS-CWMD at home and abroad (campaign and expeditionary), the CBRNE operational headquarters may rapidly deploy selected elements to provide WMD-E mission support with little or no notice.

1-47. Providing joint force commanders (JFCs) with expeditionary or campaign WMD-E support requires the CBRNE operational headquarters to be organized and equipped to be modular, versatile, capable, and ready to deploy by air, land, or sea. Specialized elements with unique skills must be easily task organized for each WMD-E mission. If not self sufficient, the unit, its attached elements, and its supporting headquarters must be prepared to coordinate appropriately for its life support and sustainment requirements. For more information about sustainment see Chapter 6.

1-48. Successful WMD-E operations are the result of detailed planning, available technical skills, and available resources and support from varying combinations of joint and interagency capabilities. Planners must make the most effective use of all available resources to include those able to participate through reachback.

1-49. CCDRs should integrate WMD-E missions into campaign plan development beginning at Phase 0 (Shape) of the joint planning process (see JP 3-0) and include WMD-E operation considerations through Phase V (Enable Civil Authorities). The process of transferring the mission to other United States government (USG)/international organizations at the appropriate time should also be considered. If forces are permanently assigned, this planning should include C2 and incorporate force training and exercising.

CLOSE COMBAT

1-50. In support of mission requirements, response teams from the CBRNE operational headquarters may face situations where they are in close proximity with an enemy. *Close combat* is defined as warfare carried out on land in a direct fire fight, supported by direct and indirect fires, air-delivered fires, and nonlethal engagement means. Distances between combatants may vary from several thousand meters to hand-to hand fighting (FM 3-0). Close combat would include all actions that place response teams in immediate contact with the enemy where the commander uses direct fire and movement. Using the best intelligence available, planners avoid placing specialized response teams in situations that may require them to simultaneously conduct close combat and technical operations.

UNCERTAINTY, CHANCE, AND FRICTION

1-51. Most military operations are characterized by uncertainty, chance, and friction. Leadership is the link that bonds Soldier and civilian teams conducting WMD-E operations just as it links the six warfighting functions (WFF) as the elements of combat power. WMD-E teams are expected to adapt and execute a variety of tasks in support of full spectrum operations under stress and often in complex OEs. While leadership serves to reduce the impact of uncertainty, chance, and friction, they are still commonplace and often obscure military operations. These include—

- Weather.
- Chaos and confusion.
- Complexity.

- Lack of accurate information.
- Errors in understanding or planning.
- Fatigue.
- Misunderstanding among multinational partners.
- Intense enemy fire.
- Difficult terrain.
- Personality clashes.
- Civilian population.

1-52. Both enemy and friendly actions may produce unintended consequences, further complicating a situation. Chance further complicates deployments, and military operations in the OE. Several factors that can reduce the effects of uncertainty, chance, and friction are—

- Good leadership.
- Flexible organizations.
- Dependable technology.
- Timely, accurate, and actionable intelligence.
- Continuous coordination.
- A properly developed and executed simple plan.

UNIFIED ACTION

1-53. Close coordination is the foundation of successful unified action. Army mission accomplishment is linked to the national strategic end state through joint campaigns and major operations. Unified action describes synchronization of activities between U.S. forces and various local, state, and federal government agencies to include the Central Intelligence Agency (CIA), Defense Intelligence Agency (DIA), DTRA, United States Strategic Command (USSTRATCOM), law enforcement, sister services, and other multinational and interagency partners, possibly even NGOs. Close coordination and cooperation is essential to successfully conduct WMD-E operations. CCDRs play a pivotal role in unifying actions; however, as a subordinate command or stand-alone command, the CBRNE operational headquarters and its deployed elements must also integrate and synchronize operations directly with the activities and operations of other military forces and nonmilitary organizations in the OE.

RANGE OF MILITARY OPERATIONS

1-54. Joint operations vary in size, purpose, and intensity within the spectrum of operations. (See Figure 1-2.) U.S. military forces are often simultaneously engaged in several types of joint operations across the joint range of foreign and domestic military operations.

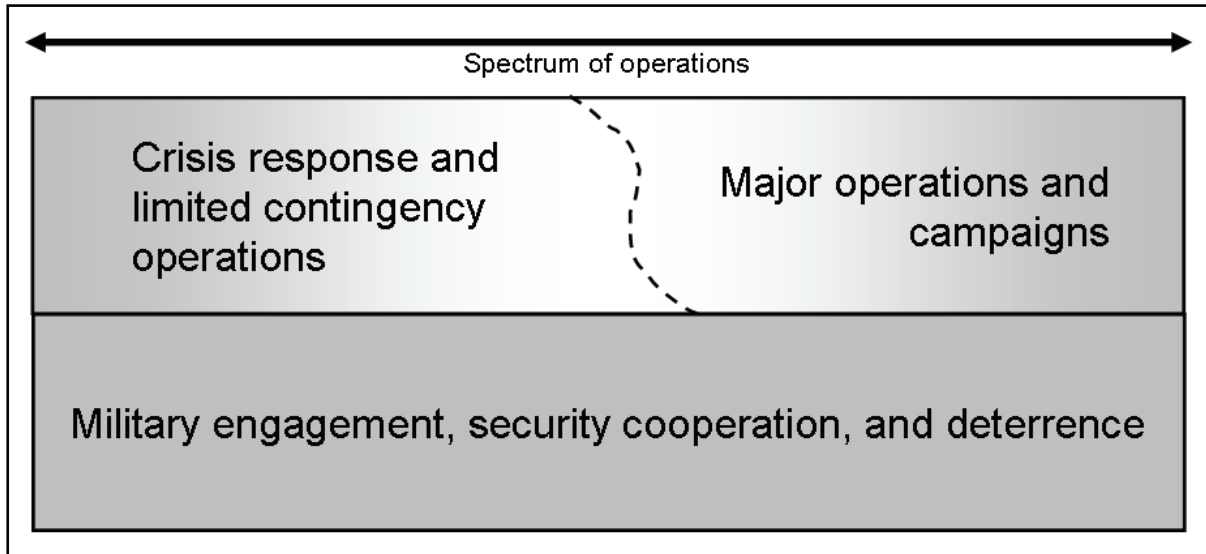

Figure 1-2. The joint spectrum of operations

INTERAGENCY COORDINATION AND COORDINATION WITH OTHER ORGANIZATIONS

1-55. Interagency coordination is inherent in unified action. Within the context of DOD involvement, *interagency coordination* is the coordination that occurs between elements of DOD and engaged USG agencies for the purpose of achieving an objective (JP 3-0). In addition, unified action involves synchronizing joint or multinational military operations with the activities of the following types of civilian organizations:

- Local and state government agencies (during civil support operations).
- Intergovernmental organizations.
- HN governmental organizations.
- NGOs.
- Contractors.

1-56. Nowhere is interagency coordination and coordination with other government organizations (OGOs) more important than during HLS missions within the U.S. These important missions involve proactive and reactive defense support to civil authorities. Interagency coordination and coordination with other government and NGOs are both necessary and essential; equally important is unified command of these forces.

1-57. Unified command of joint forces for HLS missions is authorized by a subsection of U.S. Code, Title 32, made public law with the passing of the National Defense Authorization Act (NDAA) of 2004. The NDAA allows either state or federal leadership to command a JTF consisting of both Title 10 (active duty) and Title 32 (National Guard) forces. Additionally, the Stafford Act allows the federal government to employ federal military assets at the state governor's request and allows an active duty task force headquarters to C2 these missions. The Department of Homeland Security's National Response Plan is an all encompassing federal plan that describes how tribes, towns, cities, states, and the federal government will conduct HLS missions and provides examples of when federal and state governors may employ military forces.

1-58. In wartime, the CBRNE operational headquarters exploits the capabilities of joint forces and the capabilities of other government and nongovernment agencies to conduct WMD-E missions. While the CBRNE operational headquarters directs specialized units with advanced CBRNE technologies, most elements have limited assets to defeat an opposing force and defend WMD sites; therefore, integrated WMD-E missions include extensive collaborate planning across the WFF (movement and maneuver, intelligence, fires, sustainment, command and control, and protection). The CBRNE operational

headquarters may establish liaison with these critical partners, especially those providing the necessary resources to address the WFF. Liaison officers (LNOs) foster SU of missions and tactics, facilitates transfer of information, and enhances mutual trust and confidence.

CIVILIAN ORGANIZATIONS AND CONTRACTORS

1-59. Military operations today take place in a more coherent political and civil context than ever before, and commanders are increasingly required to take account of military variables of PMESII-PT when planning and executing operations. An increased range and number of participants may be active in the OE making interface that much more important. Some participants may not naturally defer to the military view of events, and in some military or civil-military operations commanders must be prepared to manage a diverse range of civilian organizations; most more often than not having their own mission, viewpoints, and objectives.

1-60. Civilian organizations and contractors bring resources and capabilities that contribute to successful execution of national objectives in an OE. Civil-military cooperation provides the mechanism for Army planners to actively engage with civilian organizations and contractors to integrate their efforts as much as possible with Army and joint operations. Civil affairs elements typically establish liaison with most civilian organizations; however, it is neither practicable nor necessary to have the same relationship with all civilian organizations and contractors. The sensitivity of WMD-E missions often creates circumstances where there are those (civilian organizations or contractors) with whom it is appropriate to conduct coordinated planning, and those with whom it is more appropriate to engage through liaison and information sharing.

MULTINATIONAL OPERATIONS

1-61. *Multinational operations* are military actions conducted by forces of two or more nations, usually undertaken by the structure of a coalition or alliance (JP 3-16). Some nations possess CBRNE response units or teams with technology that provides depth and sustainment capabilities for planners to exploit.

1-62. In one example, the CBRNE operational headquarters may C2 missions under the authority of a UN resolution. Multinational operations are challenging and require detailed planning and coordination to integrate sophisticated scientific equipment, technologies, and capabilities of several national forces, often spread over considerable distances and across international boundaries. During multinational operations, the CBRNE operational headquarters will establish liaison with assigned multinational forces as soon as possible.

1-63. When integrating multinational response teams and units, the CBRNE operational headquarters commander and the staff should assign missions that reflect the capabilities and limitations of each national contingent, and must consider the same interrelated variables of PMESII-PT. Deployed elements of the CBRNE operational headquarters will provide the base elements for an appropriate JTF headquarters to provide the necessary C2 for such an operation.

SOLDIER AND CIVILIAN TEAMS

1-64. The CBRNE operational headquarters has some of the most sophisticated and highly technical CBRNE response equipment in the world. Results from tests conducted using its hardware and software may be used in international court and war tribunals. Mission success is however tied to more than just technology and science. It requires a Soldier, and sometimes a civilian counterpart, to operate the equipment and think through challenges that technology alone cannot solve. The CBRNE operational headquarters has training and readiness oversight of its assigned Soldiers and civilians who conduct these special missions; they represent the cornerstone for mission success.

THE LAW OF WAR AND RULES OF ENGAGEMENT

1-65. The *law of war* is that part of international law that regulates the conduct of armed hostilities (JP 1-02). The law of war (LOW) includes treaties and international agreements to which the U.S. is party as

well as applicable customary international laws. The purpose of the LOW are to protect both combatants and noncombatants from unnecessary suffering; to safeguard certain fundamental human rights of persons who fall into the hands of the enemy (prisoners of war), the wounded and sick, and civilians. It also facilitates peace restoration.

1-66. Rules of engagement (ROE) guide the use of lethal and nonlethal means, not to inhibit military action and initiative, but to channel it in ways that support the nation's stated goals. It is more than a morale issue; it is a critical contributor to WMD-E mission success.

1-67. The joint staff and CCDRs develop ROE, reviewed and approved by the President of the U.S. and Secretary of Defense (SecDef). ROE always recognize an individual's inherent right of self defense. ROE are tailored for each operation and may change during an operation.

1-68. The use of ROEs may be more restrictive for domestic operations and may be significantly different from those for overseas deployments. However, military personnel are always entitled to use force in self defense or in designated circumstances to protect others from death or serious bodily harm.

1-69. For United Nations (UN) operations there is a distinction between missions authorized under Chapter VI of the UN Charter (*Pacific Settlement of Disputes*) and Chapter VII (*Actions with Respect to Threats to the Peace, Breaches of the Peace, and Acts of Aggression*). The fundamental difference between these two chapters and their provisions is the authorization for the use of force. Chapter VI deals primarily with peaceful means of settling disputes but does not preclude the deployment of military forces. Therefore, the use of force under Chapter VI is normally confined to self defense. Chapter VII provides for additional means (but still within the realm of peace) of achieving compliance, enforcement actions, and the use of force up to and including deadly force to ensure a return to peace and stability.

TRAINING FOR FULL SPECTRUM OPERATIONS

1-70. The CBRNE operational headquarters is designed to conduct operations across the full spectrum of military operations. Response teams have unique technical skills that require extensive dedicated training on WMD-E tasks. Frequent updates of specialized technical equipment used by these personnel provide a significant training challenge. Operational success is the result of planning and executing individual and collective training that incorporates both tactical and technical challenges. It is essential that the CBRNE operational headquarters focus both time and resources to accomplish this objective.

1-71. Training should take into account the various aspects of the OE that these Soldiers and civilians are likely to face. Learning the specific nuances of the OE in which they will be operating in and adapting the training to address those challenges is an ongoing process. Refer to Appendix G for more information on training.

This page intentionally left blank.

Chapter 2

Unit Structure, Capabilities, and Augmentation

To achieve national combating WMD objectives, a CBRNE operational headquarters is designed, staffed, and trained to be the controlling headquarters to identify, target, plan, and coordinate service response to WMD threats. By design, this headquarters executes, tracks, and manages the response as well as provides C2 for Army and/or joint specialized CBRNE forces; executes WMD-E missions; and provides technical capabilities and CBRNE subject matter expertise to joint and Army commanders. Elements of this headquarters are designed to deploy and provide the core elements of a JTF headquarters in support of WMD-E or other similar missions. The inclusion of a JECE provided by USSTRATCOM is an essential element of such a JTF-headquarters. This chapter outlines the structure for a generic CBRNE operational headquarters, describes the unit's unique specialized capabilities, and discusses various deployable configurations and augmentation that it could receive. For more information on C2, see Chapter 5. For a more detailed discussion of staff roles and responsibilities, see Appendix B.

MISSION AND MISSION SETS

2-1. The mission of the CBRNE operational headquarters is to deploy and conduct operations in support of CCDRs or OGAs to counter CBRNE and WMD threats, in support of national combating WMD objectives. Its core focus is on tactical, operational, and strategic exploitation and elimination operations. This mission statement provides the framework for the three mission sets that focus the training of the elements of the CBRNE operational headquarters. The CBRNE operational headquarters may be called upon to provide assets to contribute to the spectrum of combating WMD-E operations in a role short of establishing a JTF-E headquarters.

2-2. The three primary mission sets that the CBRNE operational headquarters is designed for and required to be ready to execute include the WMD-E set, the JTF headquarters mission set, and the civil support mission set. In addition, the CBRNE operational headquarters could support other commands in any of the other mission areas under the NMS-CWMD (see Appendix A). These are discussed in greater depth in subsequent chapters.

WEAPONS OF MASS DESTRUCTION ELIMINATION MISSION SET

2-3. USSTRATCOM is the designated command for integrating and synchronizing WMD efforts for DOD. Included in the eight combating WMD mission areas is the mission area of conducting WMD-E operations. This mission area is defined by the operational tasks of isolation, exploitation, destruction, and monitoring, and redirection.

2-4. There are a number of scenarios when a WMD-E capability would be required. Potential scenarios include—

- Nonpermissive/combat operations like OEF and OIF where the U.S. military, either in a multinational or unilateral manner, replaces a regime that has a WMD capability.
- Nonpermissive/CP mission, possible in support of the Proliferation Support Initiative where a nation or nonstate actor such as Al Qaeda's WMD capability is the target of military operations. If this mission were a short-term operation, then it would be assigned to United States Special

Operations Command (USSOCOM). However, a WMD-E force from the CBRNE operational headquarters could provide teams or subject matter experts (SMEs) in support of USSOCOM.

- Permissive/crisis regime leadership collapse of a WMD power. For example, if the political leadership of another country collapses or if the leader of a nuclear power was deposed, the immediate control of WMD capabilities would be critical to U.S. security.
- Permissive/international cooperative is an instance where a WMD capable nation decides to change its policy. In this case a WMD-E force from the CBRNE operational headquarters could provide experts and capabilities to assess, implement controls, and begin on-order destruction of WMD materials.
- Permissive/uncertain stability operations in support of CP involving transfer or disablement of potential WMD materials/infrastructure.

JOINT TASK FORCE HEADQUARTERS MISSION SET

2-5. The CBRNE operational headquarters may be called upon to provide the core elements that when augmented with critical combat enablers and additional staff (to include the JECE) becomes a JTF-E headquarters. In a major contingency operation, the OCP and potentially as many as three WCEs could deploy to support a single CCDR. In this case, portions of the CBRNE operational headquarters staff and the JECE would form the joint operations center (JOC) to serve as the functional JTF-E headquarters for a larger JTF.

2-6. In another scenario, the CBRNE operational headquarters may be called upon to deploy the core elements to create a stand-alone JTF. An example of this might occur when at the invitation of a new government (under the Department of State [DOS]–threat reduction cooperation [TRC] program) the CBRNE operational headquarters would provide the primary elements to enable C2 for the elimination of existing stockpiles of WMD left over from a former regime within a given combatant command AOR. The OCP may be augmented by a JECE and the remainder of the reduction force will be designed based on the scale of the operation.

2-7. A third possibility is that the OCP does not deploy and only one or more WCE deploys in support of a JTF. In this case a deploying WCE would most likely support the CCDR’s staff and/or be attached to one of the CCDR’s subordinate headquarters. In this situation, the total specialized force requirement might only be a small number of CBRNE elements from among the assets available to the CBRNE operational headquarters (examples include an NDT, a single explosive ordnance disposal (EOD) company, or one of the CARA elements).

CIVIL SUPPORT MISSION SET

2-8. The CBRNE operational headquarters may be called upon to provide assets to contribute to civil support operations. Missions could include but are not limited to—

- Provide technical reachback capability in support of civil authorities.
- Collaborate and sustain relationships with joint and interagency intelligence organizations to support domestic CBRNE operations.
- Provide laboratory, WCE, NDT, and aviation support to CBRNE operations in support of civil authorities.
- Deploy selected elements in support of specified Joint Chiefs of Staff contingency plans.
- Remain capable of serving as a JTF-headquarters in support of homeland defense missions in a surge capacity.

2-9. The CBRNE Operational Headquarters will maintain WCE capability to support USNORTHCOM. The unit’s MCP serves as the home station operations center, site for technical reachback, and C2 node for the deployment of assets from the command in support of homeland defense missions.

2-10. The CBRNE Operational Headquarters also supports CBRNE emergency response missions within the United States. These could include chemical accident or incident response and assistance (CAIRA) for an accident or incident on a military installation involving the remnants of the chemical stockpile or in

response to other chemical material accidents or incidents within the U.S. and its territories, recovering chemical warfare materiel (RCWM) from an accident or discovery of military chemical munitions, or other potential emergency responses based on CBRNE expertise and assigned forces.

THE HEADQUARTERS STRUCTURE

2-11. The CBRNE operational headquarters includes a MCP which operates in sanctuary, and deployable units that include the OCP, six WCEs, two NDTs, and a CARA. Figure 2-1 illustrates the basic organization. The 20th Support Command (SUPCOM) is the only standing CBRNE operational headquarters in the DOD. This unit is comprised of approximately 70 percent military, and 30 percent civilian.

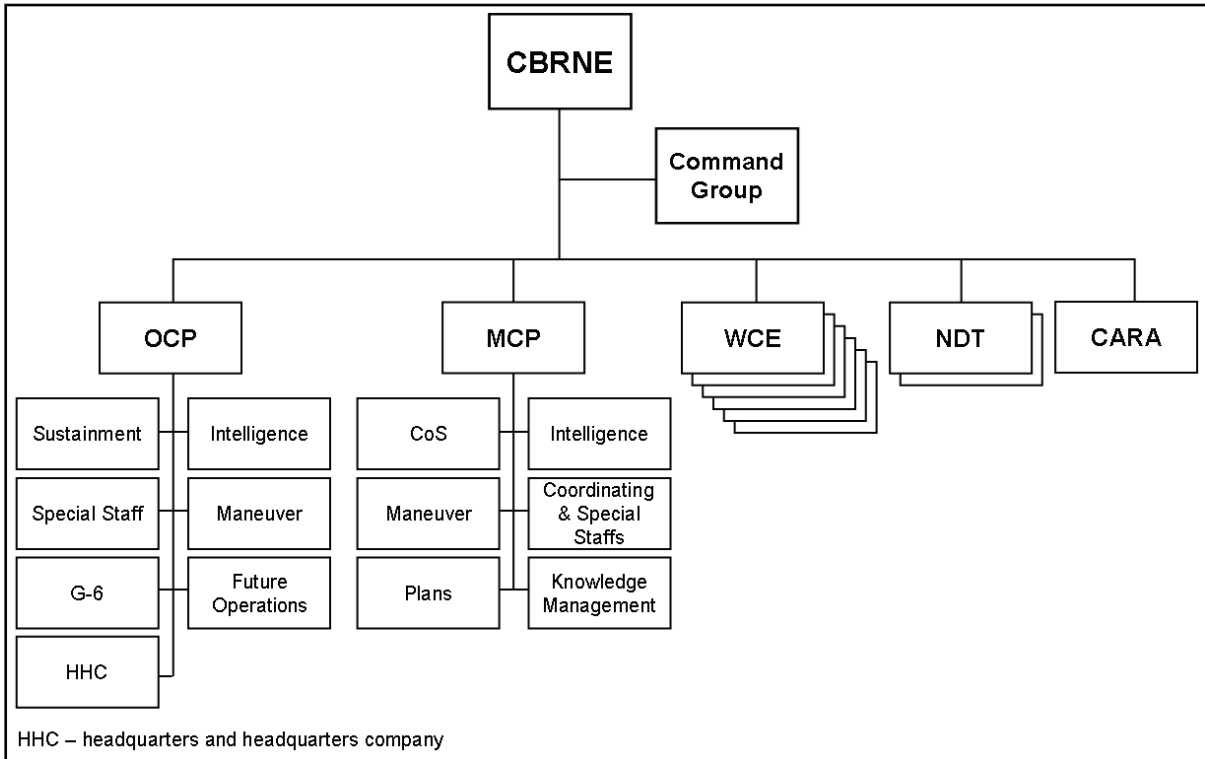

Figure 2-1. Example of a CBRNE operational headquarters

COMMAND GROUP

2-12. The command group consists of the commander, deputy commander, and the command sergeant major. It is 100 percent mobile. The purpose of the command group is to allow the commander to exercise personal leadership for any number or combination of missions.

COMMANDER

2-13. A CBRNE operational headquarters is normally commanded by a brigadier general because of the complex mission; synchronization of joint, interagency, and multinational capabilities; and the strategic OE in which the CBRNE operational headquarters operates. This headquarters will routinely conduct deliberate planning and support exercises with CCDRs and functional commands such as the USSOCOM. The commander is responsible and accountable for everything the CBRNE operational headquarters does or fails to do. This includes the authority and responsibility for effectively using all available resources for planning, organizing, coordinating, and controlling all military forces in accomplishing assigned missions. The commander provides subordinates with missions, resources, and a clear commander's intent. The

commander CBRNE operational headquarters will typically also be the commander of a JTF headquarters created using elements deployed from that headquarters.

DEPUTY COMMANDER

2-14. The deputy commander for a CBRNE operational headquarters is normally a senior colonel. The commander defines the deputy commander's roles, duties, and relationships with the staff and subordinate commanders. The deputy commander is normally assigned specific fields of interest and responsibilities and is prepared to assume command of the CBRNE operational headquarters at any time. When the commander is forward with deployed elements as part of a JTF headquarters, the deputy commander will typically be responsible for the remainder of operations within the CBRNE operational headquarters (to include the MCP) and ensures the JTF headquarters is receiving the necessary support to include reachback.

COMMAND SERGEANT MAJOR

2-15. The command sergeant major's primary role is to advise the commander on all matters concerning the enlisted Soldiers of the CBRNE operational headquarters. The command sergeant major—

- Enforces established policies and standards concerning enlisted Soldiers' performance, conduct, and mission preparations.
- Performs other duties the commander prescribes, including receiving and orienting newly assigned enlisted Soldiers and helping inspect command activities.
- Monitors and recommends actions as necessary on the morale and discipline of the CBRNE operational headquarters.

OPERATIONAL COMMAND POST

2-16. When alerted by USJFCOM to deploy as a JTF-E headquarters, the command will establish the OCP and other deployable elements to support WMD-E operations. C2 of forces for WMD-E operations is conducted from the OCP established in the vicinity of the supported ground force commander as dictated by conditions. However, initial C2 functions will be controlled from the MCP until the OCP is prepared to operate from its deployed location as a part of the JTF-E and other necessary deployed elements (to include the JECE) are functional.

2-17. The OCP is organized to accomplish three basic functions: *first*, to plan, develop, control, and coordinate the execution of current orders and operations (monitor and direct – current operations cell); *second*, to fuse available information through intelligence sources and add the current operations perspective to enable some predictive assessment to occur (assess - joint assessment center if formed); and *third*, to support the administrative requirements of the C2 function inherent when performing as a JOC.

2-18. The OCP is completely deployable and 50 percent mobile except for the operation maneuver section which is 100 percent mobile (see Figure 2-2). The OCP is the fusion center for WMD-E operations. The OCP is prepared to receive the necessary joint, interagency, intergovernmental, and multinational elements to become a fully functional JTF-E headquarters in support of the JFC's WMD-E operations. The size and structure of JTF headquarters may vary with requirements of the mission. The general functions of the OCP remain relatively consistent during WMD-E operations. The OCP is designed to:

- Conduct 24-hour operations.
- Maintain visibility of all CBRNE missions in theater and track, monitor, and report on all WMD related missions.
- Rapidly deploy to a joint operational area to support a JTF headquarters.
- Serve as the core element for an Army headquarters for WMD-E.
- Serve as the core element for the creation of JTF-E.
- Provide C2 of CBRNE assets and other Army, joint, multinational, and interagency forces.
- Perform reachback to the MCP and other necessary organizations.

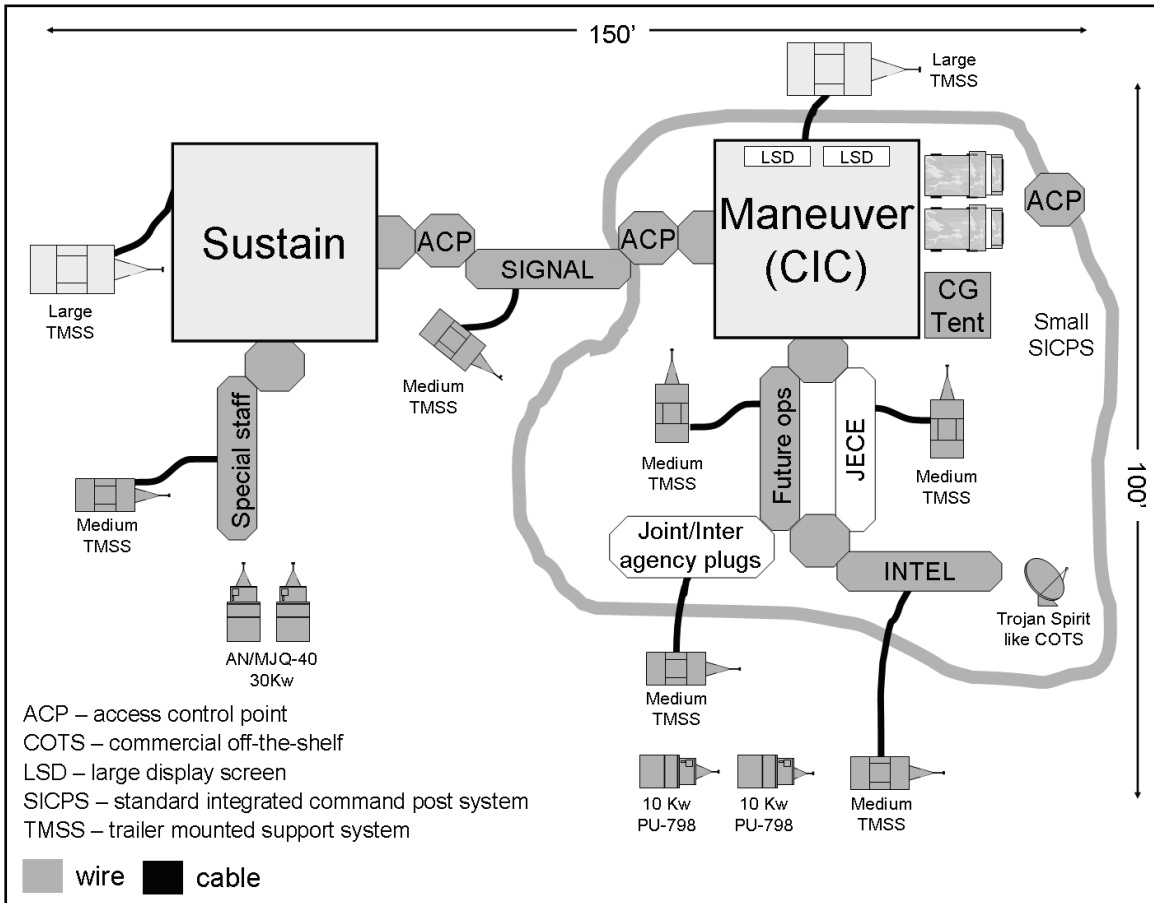

Figure 2-2. Example of a JOC for a JTF-E headquarters

2-19. In the Figure 2-2 example, the OCP has matured to become part of a JOC. This JOC includes the facilities and grounds that comprise the command group; JECE; all boards, centers, and cells; and any other joint, multinational, or interagency staff elements at the headquarters. It also includes all external entities or facilities in the immediate vicinity of the JOC that serve as integral components for WMD-E operations.

2-20. The final JOC layout is determined by the layout of the space available, and may be modified to best facilitate C2 and security considerations. Organizing the JOC will require special considerations to include—

- Adequate space for setup.
- Equipment support for day/night operations and sustainment for 24-hour operations.
- Orientation and training of personnel.
- Integration of all staff elements and liaisons.
- Transportation support.
- Reachback capability.
- Critical consideration of security.

2-21. The OCP is comprised of a command information center (CIC), intelligence center, future operations center, sustainment cell, signal cell, and special staff sections. These subordinate elements are described below.

COMMAND INFORMATION CENTER

2-22. The CIC is where current and future operations are tracked and managed and where operations orders (OPORDs) are produced and transmitted to subordinate units and higher headquarters. From this center, the commander of the CBRNE operational (or JTF-E) headquarters can C2 subordinate WMD-E units and monitor the effectiveness of each mission.

2-23. The center is networked with computers systems tied to video projection devices that display various decision support tool graphics and a common operational picture (COP) for the commander. The computer systems are networked and include headsets with microphones that are used by the staff to plan and track each WMD-E mission phase. Other systems are networked with plotters used to print detailed color maps. The center maintains the latest hardware and software for constructing and publishing downwind hazard predictions; tracking operations related to crisis response and CM; and maintaining the hazards database which is updated/maintained through reachback.

FUTURE OPERATIONS CELL

2-24. The future operations cell is responsible for planning and assessing operations for the mid-range horizon. This includes preparing branches. The future operations cell uses the military decision-making process (MDMP), or the MDMP in a time-constrained environment, to develop plans and orders. All staff sections assist as required.

2-25. The OCP future operations cell is capable of continuous operations as it develops plans and orders. It works closely with the coordinating and special staff sections, staff judge advocate (SJA) to ensure compliance with appropriate laws and the ROE. Operations security and CBRNE-related intelligence and analysis support are provided, as required, to Army forces, other joint/multinational forces, national-level intelligence activities, law enforcement agencies, and confirmatory and definitive reachback laboratories. The cell supports joint boards, centers, and cells as required.

INTELLIGENCE CELL

2-26. The intelligence cell requests, receives, and analyzes information from all sources to produce and distribute intelligence products. Its primary function is to satisfy intelligence requirements for the commander and staff. A varied number of specialized intelligence analysts from national level agencies and the joint Services may augment the cell. It also conducts continuous IPB (for Army and joint intelligence preparation of the operational environment for joint) to support future operations planning and target development. The center develops and tracks critical targets, performs all-source analysis, manages collection, and produces and maintains intelligence products. This center provides CBRNE-related intelligence support to lower echelons (such as a site exploitation team) depending on the established intelligence architecture.

2-27. CBRNE-related intelligence support to echelons below corps is normally provided through the WCE or the CBRN staff element at those echelons. The cell provides the commander, the staff, and assigned units with indications and warnings, intelligence reporting, SU, detailed target analysis (target folder information), postulated or post-event analysis of the impact of an incident on population centers. The intelligence cell also develops priority intelligence requirements (PIR) for the commander.

2-28. The CIC is linked into the OCP computer network which facilitates rapid transmission and dissemination of processed intelligence products. The cell has computers and phones that utilize a Non-Secure Internet Protocol Router Network (NIPRNET) and a SECRET Internet Protocol Router Network (SIPRNET). It is also joint worldwide intelligence communications system (JWICS) capable.

SUSTAINMENT CELL

2-29. The sustainment cell is comprised of assistant chief of staff, personnel (G-1), assistant chief of staff logistics (G-4), and assistant chief of staff, financial management (G-8) personnel. In support of WMD-E missions, the cell's primary function is to prepare the service support annex and movement plans and orders. The center is also responsible for coordinating logistic integration of supply, maintenance,

transportation, and services. The sustainment cell provides logistics management and in-transit visibility for the command.

SIGNAL CELL

2-30. The signal cell is responsible for designing the communication architecture and installing communications systems in support of the OCP. This cell advises the commander and staff on all matters concerning command, control, communication, and computer operations. It coordinates for and installs all classified and unclassified communications and automation systems to provide primary, alternate, and redundant means of communications and reliable data linkage with higher headquarters, subordinate units, mobile teams, and supporting government agencies and organizations. The signal cell is typically comprised of three sections: headquarters, reachback, and tactical communication.

2-31. Signal support augmentation will be based upon METT-TC. For more information about signal support to theater operations, see FMI 6-02.45.

SPECIAL STAFF ELEMENTS

2-32. The staff roles and responsibilities for the OCP special staff are discussed in greater detail in Appendix B. The special staff elements consist of the following:

- Medical.
- Inspector general (IG).
- Religious support.
- Staff judge advocate SJA.
- Public affairs.

Note. Planning considerations for the intelligence section in the OCP must include assessing the need for a fusion element and a collection management office. The fusion element is a small element specifically trained to manage technical intelligence (TECHINT) and information requirements; fuse information from national intelligence and CBRNE agencies; and synchronize efforts of the technical and intelligence augmentees supporting JTF-E. The collection management office is responsible for integrating intelligence, surveillance, and reconnaissance (ISR) assets in support of the WMD-E mission.

MAIN COMMAND POST

2-33. The MCP includes the components shown in Figure 2-3, page 2-8. The MCP assists the OCP in conducting future planning, analysis for current operations and future operations, sustainment coordination, and other staff functions. It is capable of controlling operations of deployed forces for a limited time until the OCP is deployed and an operational JTF-E headquarters is established.

2-34. The MCP operates under the general supervision of the Chief of Staff (CoS). It serves as the primary planning command post and coordination command post for logistics and sustainment to include human resources, legal, resource management, strategic communications, and IG support. It does the following:

- Conducts 24-hour operations.
- Operates at a home station facility.
- Provides C2 of all WMD-E operations until deployment of the OCP and the establishment of a JTF-E headquarters.
- Continues to provide C2 in support of the United States Northern Command (USNORTHCOM) for possible CBRNE operations in U.S. territories.
- Provides CBRNE technical advice and subject matter expertise through technical reachback.
- Provides C2 of forces, in conjunction with DOD agency assets, to mitigate hazards resulting from incidents involving the Nation's chemical warfare stockpile.

- Provides C2 for the recovery and disposal of legacy chemical and biological munitions and materials from formerly used defense sites.
- Coordinates air transportation and provides C2 for the technical escort and ground movement of chemical surety materials in support of the management of chemical stockpile and chemical defense research and development.
- Can act as the Army headquarters for WMD-E (for example, threat reduction cooperation).
- Supports the OCP in the conduct of WMD-E and WMD sensitive site exploitation missions.
- Provides forces and technical expertise to combatant commands for WMD-E operations.
- Provides forces and technical expertise to combatant commands for threat reduction cooperation missions.

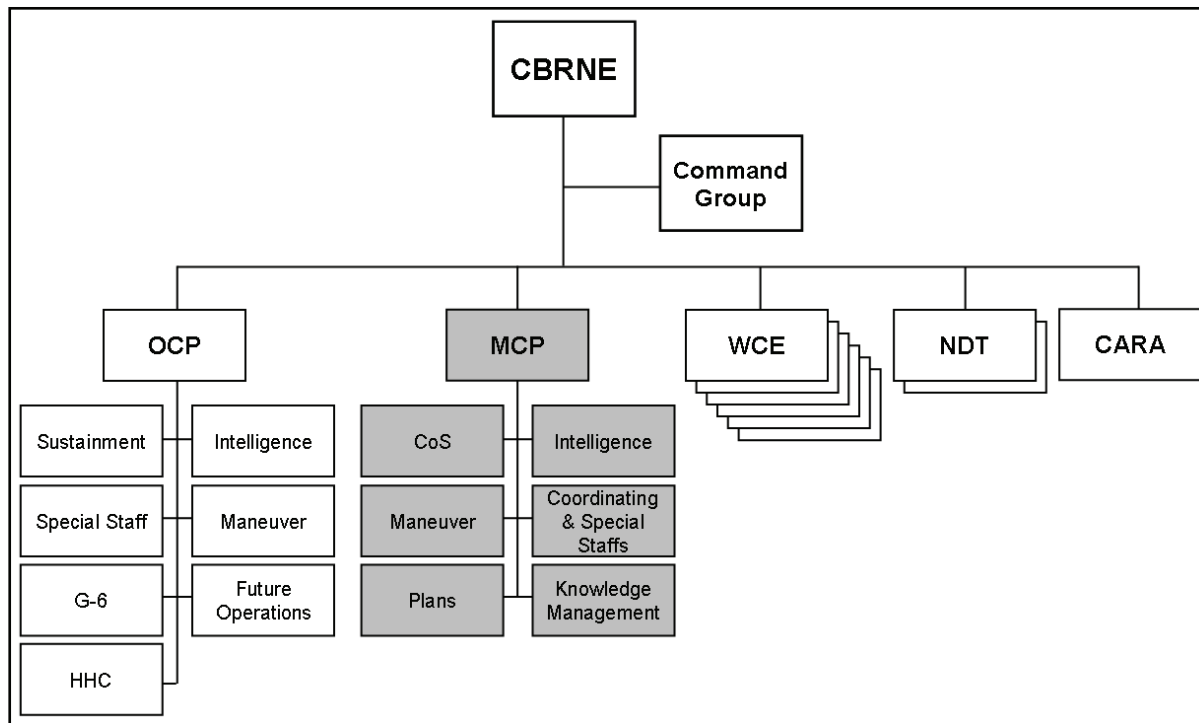

Figure 2-3. Example of a MCP of the CBRNE operational headquarters

MANEUVER CELL

2-35. The maneuver cell located in the home station operations center operates 24 hours a day and maintains C2 with the deployed OCP of the CBRNE operational headquarters, and its subordinate units. It manages requests for information and serves as a reachback focal point to provide WMD-E technical advice and guidance for deployed forces. It maintains the current operational picture of all deployed elements of the CBRNE operational headquarters and its subordinate units.

PLANS CELL

2-36. The plans cell located in the home station operations center operates 24 hours a day. It oversees planning for future operations. The cell participates in the legal review of plans and orders to ensure compliance with the LOW, international law, and ROE. It serves as a focal point for coordination with Army; multi-Service and joint agencies; and OGOs and OGAs providing technical advice to deployed forces.

INTELLIGENCE CELL

2-37. The intelligence cell located in the home station operations center operates 24 hours a day. This cell maintains SU of the AO through continuous redundant communications. The intelligence cell manages requests for information between the OCP and CONUS-based intelligence centers and agencies and CBRNE laboratories.

COORDINATING AND SPECIAL STAFF SECTIONS

2-38. The coordinating and special staffs of the MCP are located in the home station operations center. This cell in Figure 2-3 represents the following staff sections: G-1, G-4, assistant chief of staff command, control, communications, and computer operations (G-6), G-8, public affairs, surgeon and risk management, and SJA. These sections are described in more detail in Appendix B.

KNOWLEDGE MANAGEMENT CELL

2-39. The knowledge management cell is capable of continuous operations. It monitors the external information environment and recommends changes to the command information management plan to ensure it supports the standing operating procedures (SOPs) of the MCP.

SPECIALIZED ORGANIC RESPONSE ASSETS

2-40. The CBRNE operational headquarters contains three types of specialized organic response teams: WCE, NDT, and the CARA. These highly trained technical teams are designed to provide specialized technical CBRNE support. Teams can perform a number of tasks based upon the situation. They can:

- Assist in the exploitation effort.
- Conduct safe movement and transfer of munitions and/or radiological materials.
- Provide guidance to maneuver forces on how to secure and maintain safety on the site.
- Conduct initial disablement, destruction, and limited security for WMD material or production facilities to preclude adversarial use.
- Can be task organized to provide expertise on the initial site assessment.

WEAPONS OF MASS DESTRUCTION COORDINATION ELEMENT

2-41. There are six WCE teams in the CBRNE operational headquarters to support full spectrum CONUS and outside the continental United States (OCONUS) operations, as illustrated in Figure 2-4, page 2-10. Each is deployable and 100 percent mobile but is dependent on the support maintenance company for field maintenance support to include The Army Maintenance Management System (TAMMS). They provide constant CBRNE expertise to the supported command. For a more detailed description of the structure and capabilities of the WCE, see Appendix C. A WCE performs the following functions:

- Provides CBRNE technical support and reachback to the supported unit. In the case of an Army, Corps, or Division that support would be through that unit's organic CBRNE section.
- Assists supported commanders with the integration of CBRNE aspects into their antiterrorism/force protection plans.
- Serves as early entry command post for the OCP, as required.
- Provides liaison between supported commander and the JTF-E (or CBRNE operational headquarters).
- Provides CBRNE planning, modeling, and hazard prediction for CBRNE events to a supported commander or primary federal agency.
- Leads a limited CBRNE task force augmented by cells from other DOD and OGOs.
- Provides communications and technical data transfer for CBRNE forces and analytical labs.
- Requests and processes national-level imagery requirements.
- Fuses geospatial, operational, and threat intelligence data to develop CBRNE aspects of the COP.

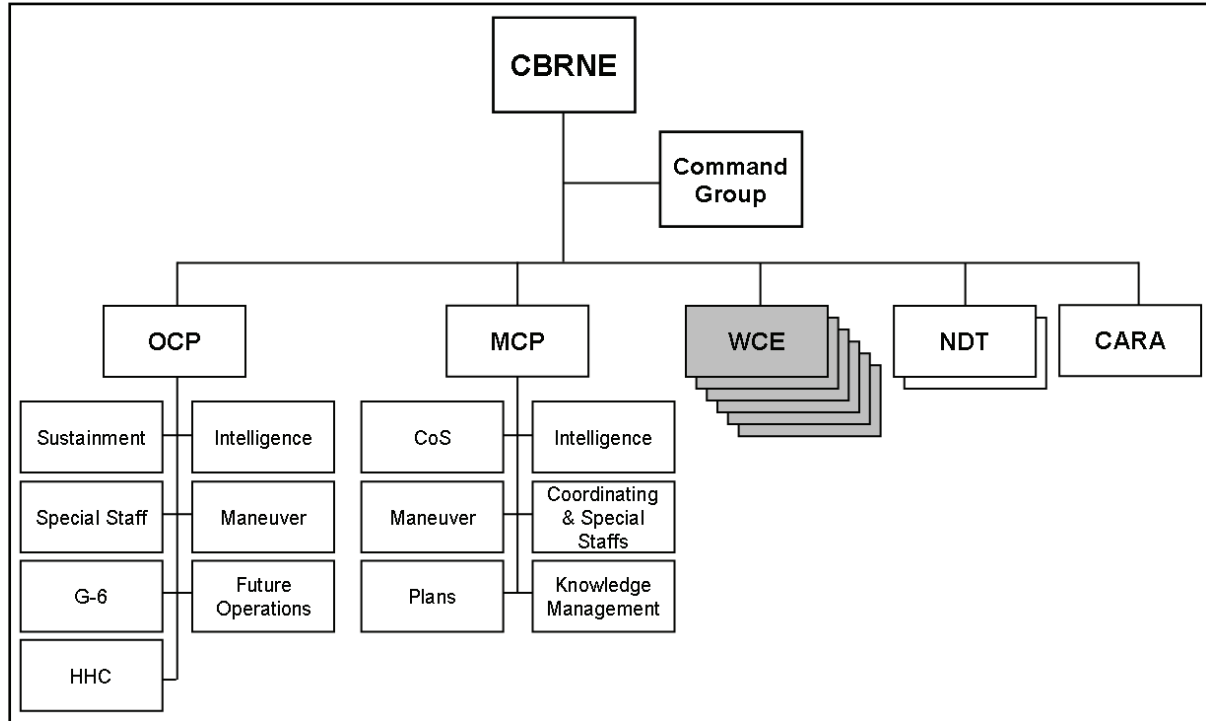

Figure 2-4. Example of WCEs within the CBRNE operational headquarters

NUCLEAR DISABLEMENT TEAM

2-42. The NDT is highlighted in Figure 2-5. It is deployable and 100 percent mobile but dependent on the support maintenance company for field maintenance support to include TAMMS. For a more detailed description of the structure and capabilities of the NDT, see Appendix C. An NDT performs the following functions:

- Exploits and disables nuclear WMD infrastructure in an uncertain or permissive environment.
- Identifies and monitors/minimizes radiological health risks.
- Packages/transport/safeguards nuclear and/or radiological material posing an immediate threat to friendly forces, on order.
- Collects and transports samples of radiological material/WMD intelligence for forensic analysis as required.
- Coordinates with higher headquarters to assist with disablement planning and execution.
- Assists in civil support operations mainly focused on nuclear search operations.

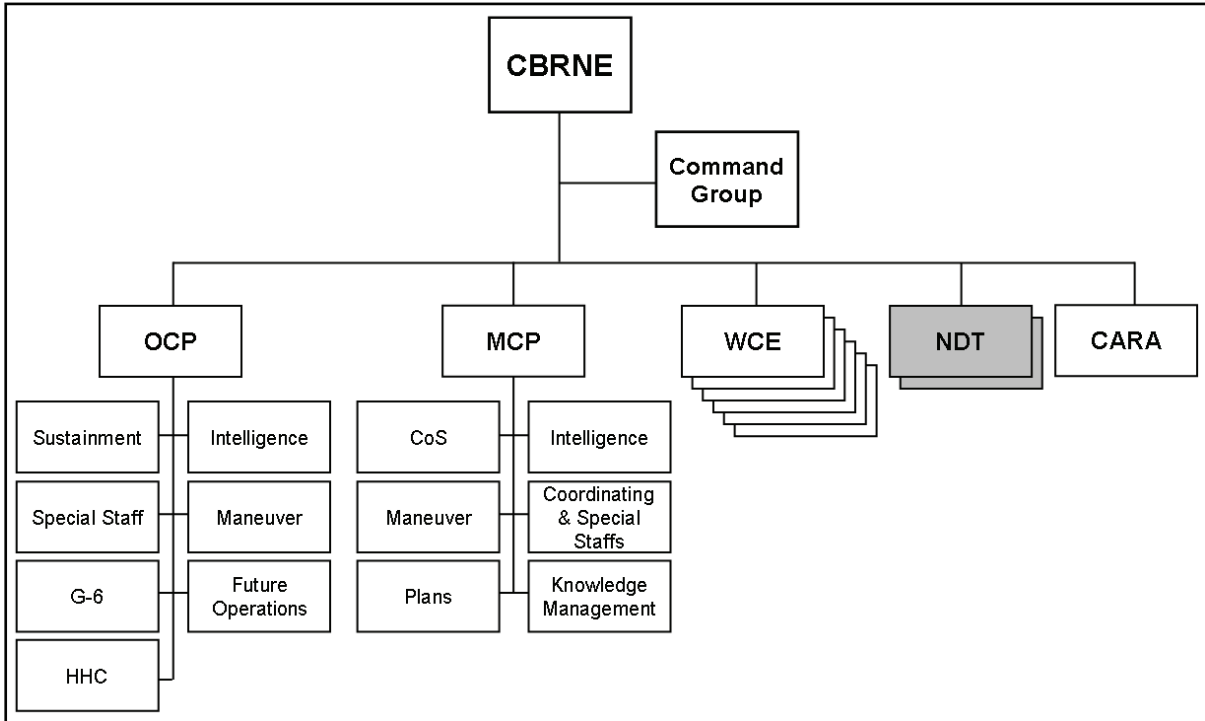

Figure 2-5. Example of NDTs within the CBRNE operational headquarters

CHEMICAL, BIOLOGICAL, RADIOLOGICAL, NUCLEAR, AND HIGH YIELD EXPLOSIVES ANALYTICAL REMEDIATION ACTIVITY

2-43. The CARA is highlighted in Figure 2-6, page 2-12. It provides tailored, modular, and deployable teams in support of specialized taskings received by the CBRNE operational headquarters. It is deployable and 100 percent mobile but dependent on the support maintenance company for field maintenance support to include TAMMS. This organization consolidates civilian CBRNE operational elements under a single organization providing a multifunctional pool of CBRNE technical expertise. Its mission essential task list (METL) includes conducting tactical deployment and movement, providing C2, conducting analytical laboratory and technical escort operations, and remediation and restoration operations. For a more detailed description of the structure and capabilities of the CARA, see Appendix E. The CARA provides the following:

- Command response teams.
- Chemical, biological, and explosives analysis.
- Biometric forensic analysis.
- Escort and transport of surety and nonsurety material.
- Aviation support for CBRNE emergency response within CONUS.
- Recovery of chemical warfare munitions.
- Near real-time air monitoring support to CBRNE operational teams.
- Limited foreign munitions exploitation.

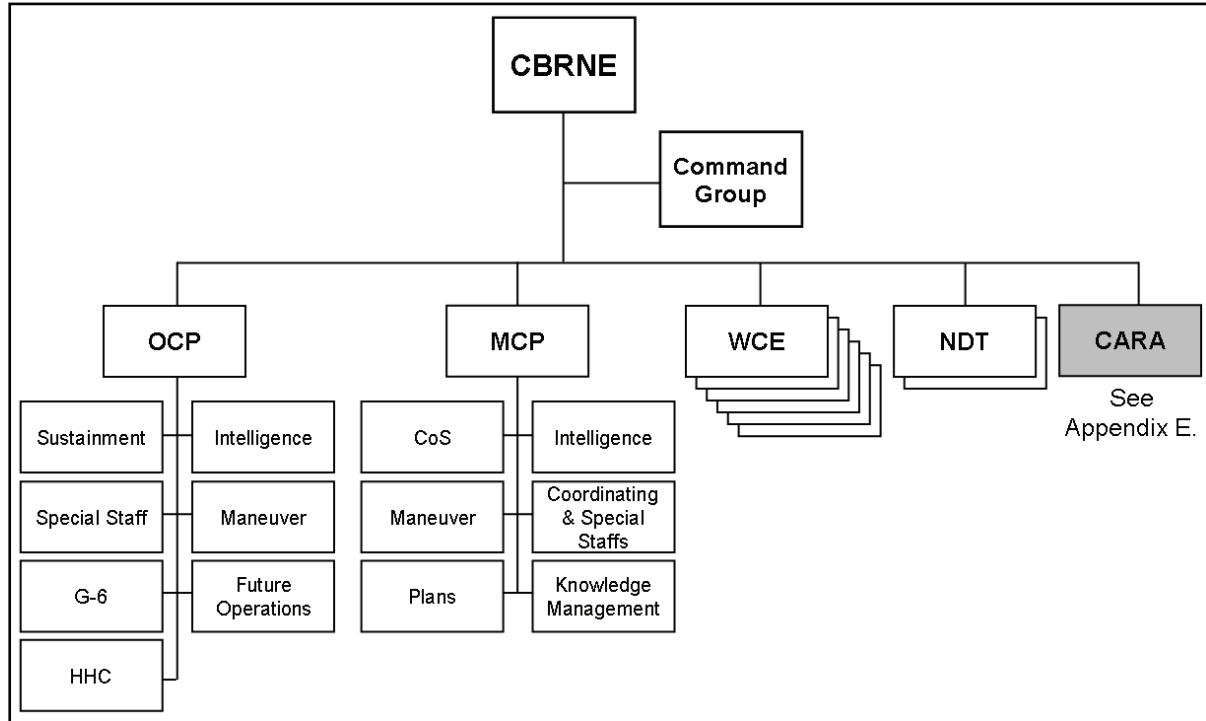

Figure 2-6. Example of a CARA within the CBRNE operational headquarters

AUGMENTATION

JOINT ELIMINATION COORDINATION ELEMENT

2-44. When the CBRNE operational headquarters is directed to form a JTF-E headquarters, it will fully integrate the JECE, a USSTRATCOM asset (see Figure 2-7). The JECE is a full time, joint C2 enabling element. It has a daily focus on the WMD-E mission and will provide USJFCOM with a trained and equipped staff element capable of enabling and/or augmenting a JTF-E headquarters. This will provide a JFC with the ability to bolster a standing headquarters or a JTF headquarters to conduct planning, exercises, and the execution of WMD-E operations. A more detailed explanation of the JECE can be found in Appendix F.

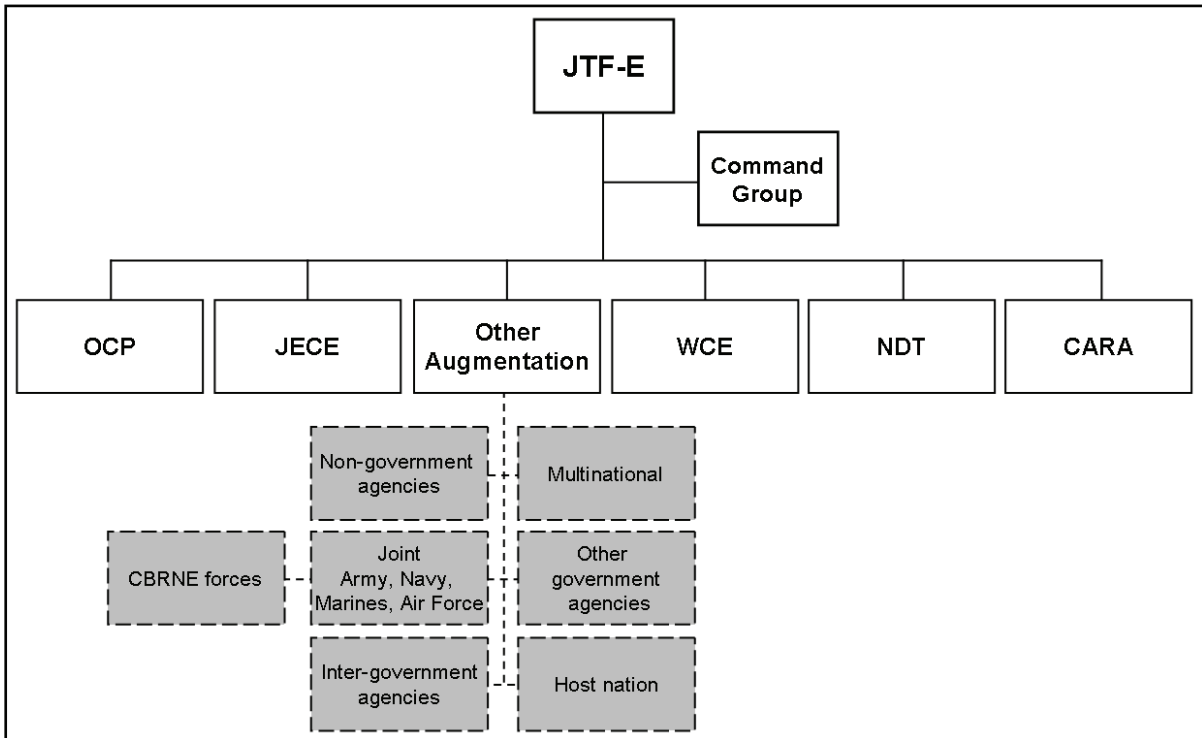

Figure 2-7. Example of a JECE and other augmentation in support of a JTF-E

OTHER AUGMENTATION

2-45. The OE in which elements of the CBRNE operational headquarters operate will often involve joint, interagency, and multinational considerations. When the OCP and other elements of the CBRNE operational headquarters is organized to become a JTF-E headquarters, this headquarters may include a combination of functional and technical experts from the DOD, be augmented by non-DOD personnel as appropriate, and have real-time reachback capability to the MCP and national-level technical experts and laboratories. These and other potential augmentation from a variety of possible Army and other Service CBRNE capabilities are also demonstrated in Figure 2-7. Additional augmentation may range from security elements to sustainment forces depending on the required task-organization or force-tailoring necessary to support a given mission. Coordination and management of technical and intelligence augmentees will be done by the fusion element in the assistant chief of staff, intelligence (G-2)/intelligence directorate of a joint staff; intelligence staff section (J-2) intelligence section.

2-46. The capabilities that may be attached to or otherwise augment the CBRNE operational headquarters, or its elements deployed as a JTF-E headquarters, will be dependent upon the factors of METT-TC and may come from a variety of sources. These include not only the complete range of CBRNE elements but also potentially combat, technical, intelligence, or sustainment organizations necessary to perform the mission. Joint targeting support and other staff augmentation may come from DOD and non-DOD organizations as required.

2-47. For additional information on the force structure and capabilities of CBRN units see FM 3-11. Similar information on EOD units can be found in FMI 4-30.50.

This page intentionally left blank.

Chapter 3

Full Spectrum Operations

This chapter describes the CBRNE operational headquarters' role across the continuum of operations and in support of the Army's operational concept of full spectrum operations. In full spectrum operations, land power is applied as part of unified action to defeat the enemy on land and establish the conditions that define the JFC's endstate. WMD threats add to the complexity of the OE requiring unique capabilities and scientific technical skills often exceeding those found in traditional ground forces or traditional CBRN and EOD units. The CBRNE operational headquarters may be required to execute any one or a combination of three mission sets in support of offensive, defensive, and stability or civil support operations; these missions sets are: JTF-E, JTF headquarters, and civil support. This chapter will describe the CBRNE operational headquarters deployed to provide C2 of WMD-E and potentially other elements in support of these three mission sets. For more information on full spectrum operations across the continuum of operations, see FM 3-0.

THE SPECTRUM OF CONFLICT

3-1. The OE is complex and often riddled with numerous WMD hazards such as enemy weapons, industrial facilities, refineries, and laboratories or research centers. The CBRNE operational headquarters is responsible for providing C2 to CBRNE units and specialized WMD-E elements to assist the commander in establishing conditions favorable for conducting subsequent operations and tasks.

3-2. The CBRNE operational headquarters is designed to execute its missions throughout the spectrum of conflict (see Figure 3-1). The spectrum of conflict spans from stable peace to general war. However, the four levels are not an exclusive set. Nonetheless, the spectrum of conflict provides a tool to understand and visualize the level of politically motivated violence and the corresponding role of the military in resolving conflict.

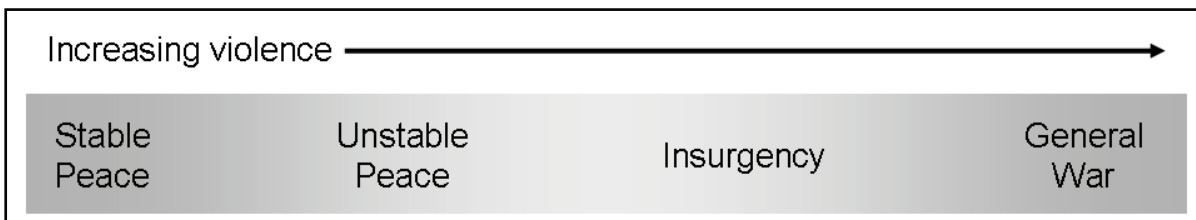

Figure 3-1. The spectrum of conflict

3-3. The CBRNE operational headquarters operates across the spectrum of conflict through ever-changing combinations of full spectrum operations using synchronized action, joint interdependent capabilities, and mission command.

3-4. Commanders must fully consider the inherent risks that affect the OE when conducting WMD-E missions. The CBRNE operational headquarters will employ synchronized action sensitive to the specific WMD-E mission after a thorough understanding of all dimensions of the OE.

THE OPERATIONAL CONCEPT

3-5. The Army’s operational concept of full spectrum operations is the core of its doctrine. Full spectrum operations (FM 3-0) are the purposeful, continuous, and simultaneous combinations of offense, defense, and stability or civil support operations to dominate the military situation at operational and tactical levels. When operations are conducted outside the U.S. and its territories, the CBRNE operational headquarters may simultaneously support three of the elements – offense, defense, and stability. Within the U.S. and its territories, operations support one or more of the elements offense, defense, and civil support. See Figure 3-2.

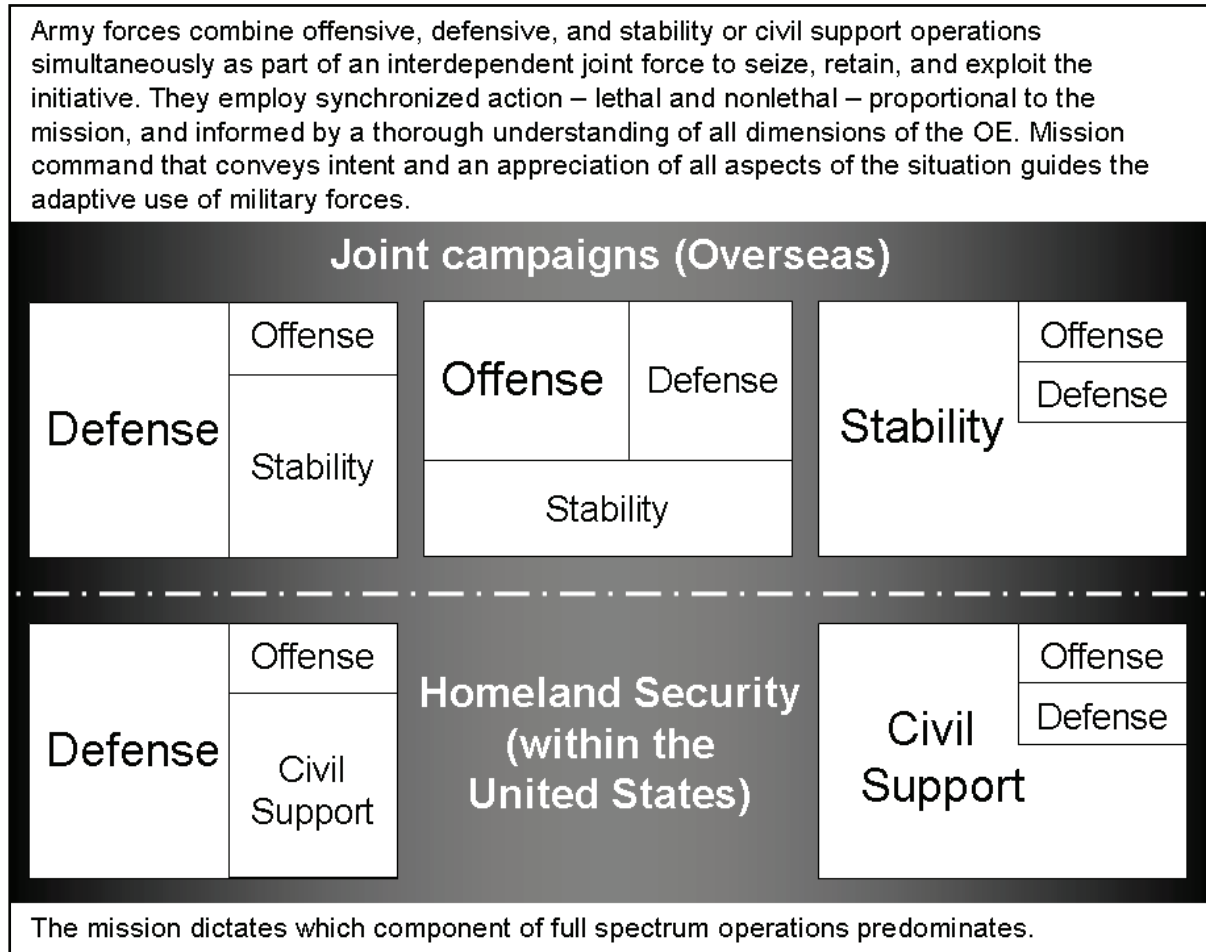

Figure 3-2. Full spectrum operations—the Army’s operational concept

3-6. Figure 3-3 relates the eight mission areas for combating WMD to their relative focus when laid across the spectrum of conflict and full spectrum operations. These general relationships assist in focusing these mission areas.

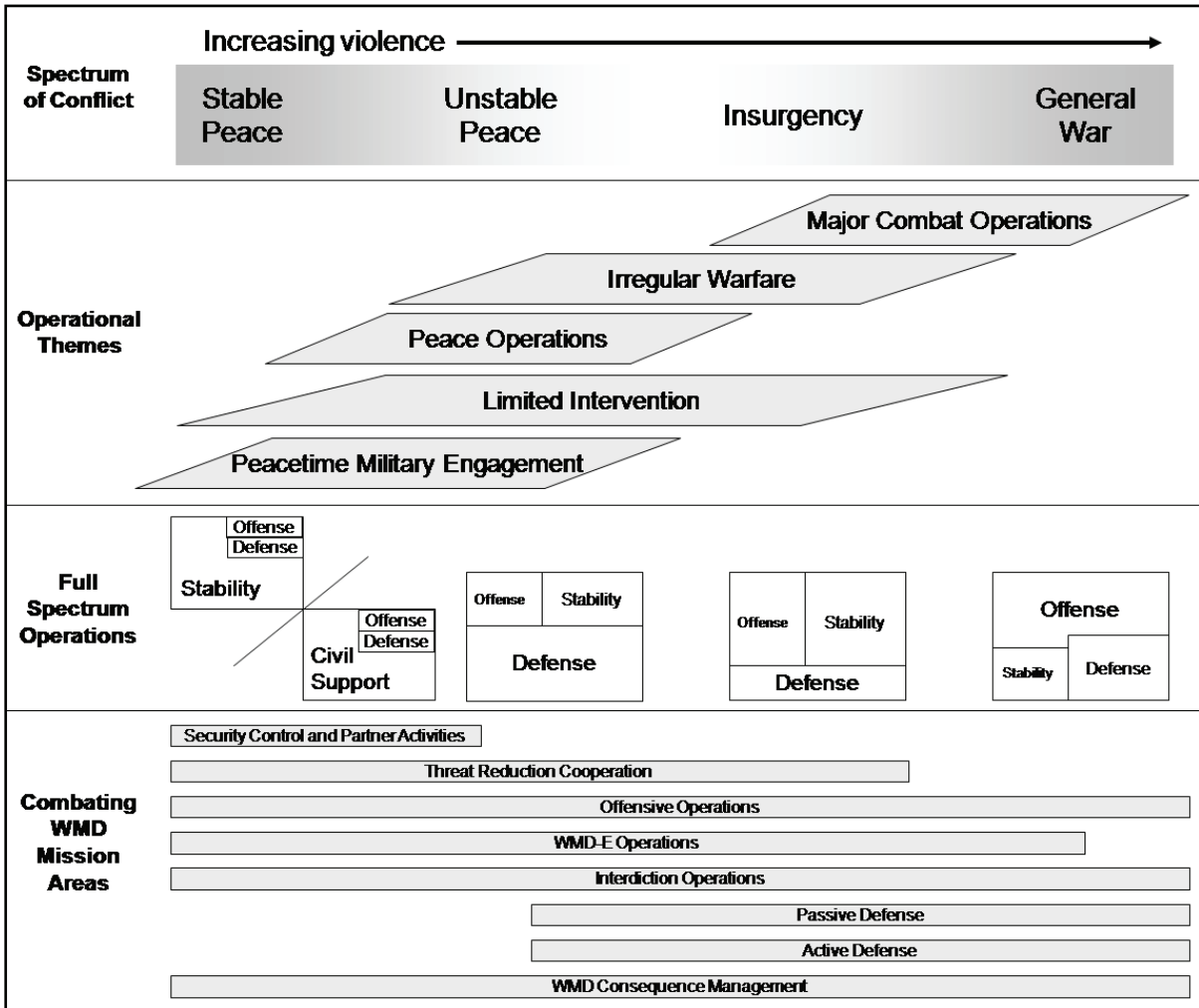

Figure 3-3. WMD mission areas within the spectrum of conflict

3-7. A number of WMD-E teams and various support elements may be required to conduct simultaneous offensive, defensive, stability, and civil support operations. The CBRNE operational headquarters staff and staff elements from its subordinate units collectively plan, coordinate, synchronize, and execute WMD-E and other directed operations. Chapter 5 provides a brief discussion of the planning process for missions that a CBRNE operational headquarters may perform.

3-8. During the planning process, response teams are tailored with specialized equipment, and trained and experienced personnel based on the type of CBRNE/WMD mission. Planners carefully consider the training and background of technicians and the leadership requirements necessary to face the technical and tactical complexities of each mission. They are often structured with security elements to facilitate their missions. Planning and coordination is accomplished to ensure adequate sustainment support various OEs. Communications support is configured based on the terrain and other aspects of the OE. Specialized teams are configured with redundant and powerful communication systems necessary to provide reliable voice and data transmission, C2, and reachback.

MISSION COMMAND AND FULL SPECTRUM OPERATIONS

3-9. The Army's preferred method of exercising C2 is mission command. *Mission command* is the conduct of military operations through decentralized execution based on mission orders. Successful mission command demands that subordinate leaders at all echelons exercise disciplined initiative, acting

aggressively and independently to accomplish the mission within the commander's intent. Mission command gives subordinates the greatest possible freedom of action within the commander's intent. Commanders focus their orders on the purpose of the operation rather than the details of how to perform assigned tasks. They delegate most decisions to subordinates. This minimizes detailed control and empowers subordinates' initiative. Mission command emphasizes timely decision making, understanding the higher commander's intent, and clearly identifying the subordinates' tasks necessary to achieve the desired end state. It improves subordinates' ability to act effectively in fluid, chaotic situations (see FM 3-0).

3-10. Mission command tends to be decentralized, informal, and flexible. Orders and plans are as brief and simple as possible. The fundamental basis of mission command is trust and mutual understanding between superiors and subordinates. It produces a command climate that requires subordinates to exercise initiative and rewards them for doing so. Mission command counters the uncertainty of war by empowering subordinates at the scene to make decisions quickly. Commanders rely on the ability of subordinates to coordinate with one another, using the human capacity to understand with minimum verbal information exchange.

3-11. As with other missions, those performed in support of WMD-E require mission command. What may be more critical are the specifics that are provided as part of commander's intent given the level of strategic relevance that may be attached to certain missions performed by the specialized CBRNE elements. While the communications capabilities organic to the WCE and other elements may be outstanding, planning should always include adequate commander's guidance to overcome potential loss of communication.

3-12. Mission command applies to all operations across the spectrum of conflict. The OE encountered during stability and civil support operations is often more complex than that encountered in offensive and defensive operations. The continuous, often volatile, interaction of brigades and smaller units to include the specialized CBRNE elements with the local populace during stability operations requires leaders willing to exercise initiative. They must be able and willing to solve problems without constantly referring to higher headquarters. Mission command encourages commanders to act promptly, consistently, and decisively in all situations. Under mission command, commanders explain not only the tasks assigned and their immediate purpose but also the higher commander's intent. Doing this helps junior commanders and their Soldiers understand what is expected of them and what constraints to apply. Most importantly, they understand the mission's purpose and context. The commander's intent also guides subordinates working with agencies not under military control. The sensitive and complex technical and tactical nature of WMD-E missions requires experienced leadership attuned to the tactical and operational mission objectives, and fully aware of the strategic and national implications.

EXAMPLE OF POTENTIAL EMPLOYMENT SCENARIOS

3-13. The CBRNE operational headquarters may be called upon to support multiple simultaneous operations overseas and in support of HLS missions. When supporting offensive, defensive, and stability or civil support operations, the CBRNE operational headquarters may be required to execute any one or a combination of the three mission sets described in Chapter 2. They are—

- WMD-E.
- JTF headquarters.
- Civil support.

3-14. The example illustrated in Figure 3-4 depicts a scenario with multiple missions requiring maximum deployment of assets from the CBRNE operational headquarters in support of joint campaigns overseas while also supporting HLS missions. This diagram depicts a major contingency in one CCDR area of responsibility (AOR), a small-scale contingency CBRNE response, and a mission with the CBRNE operational headquarters providing the core element for the creation of a stand-alone JTF headquarters supporting a TRC mission. The last two missions depicted are HLS events in the USNORTHCOM AOR.

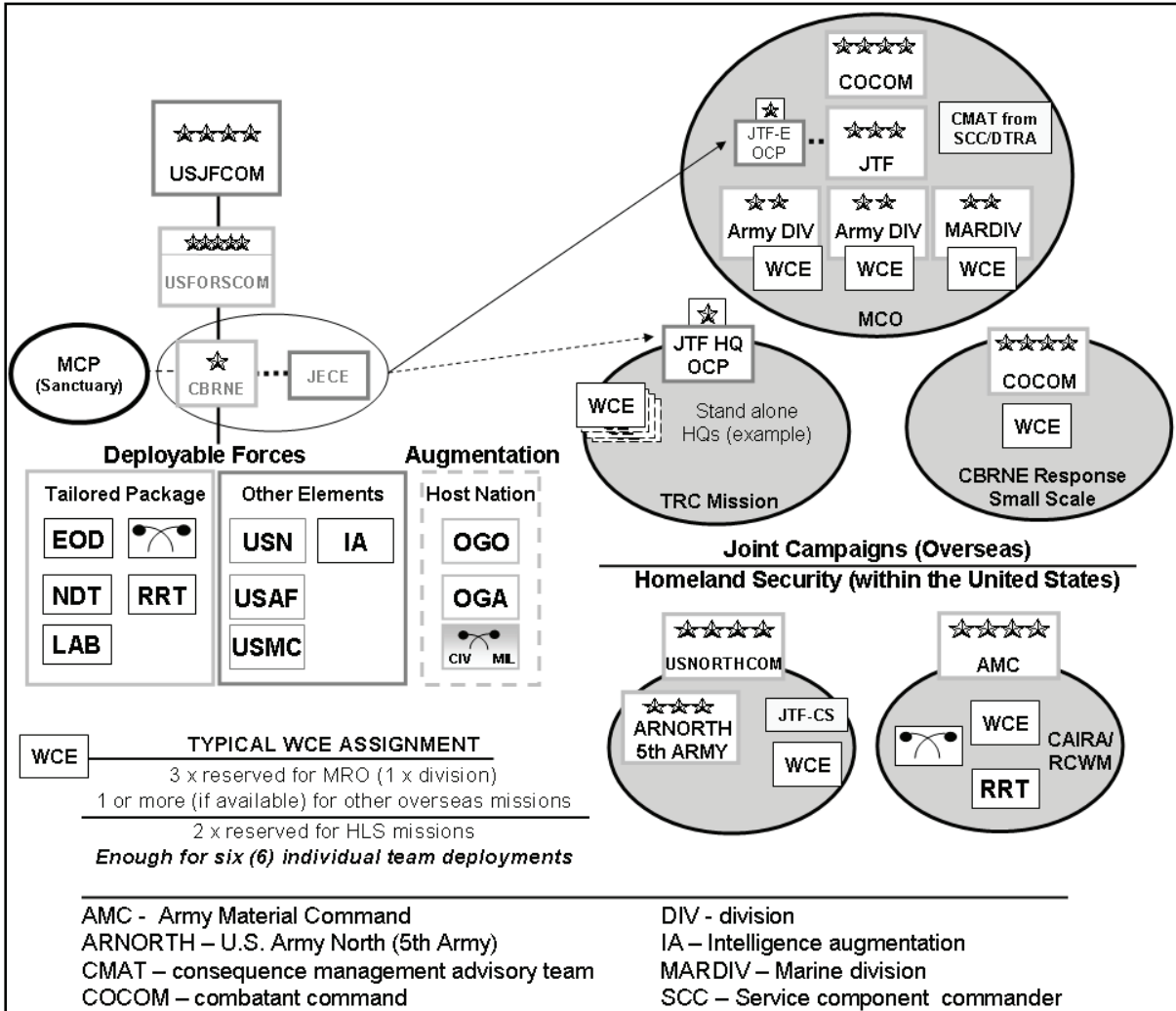

Figure 3-4. Example of employments – CBRNE operational headquarters

3-15. Chapter 2 discussed the three mission sets of the CBRNE operational headquarters. Within each of these three mission sets are a variety of potential employment scenarios for the subordinate C2 elements of the CBRNE operational headquarters. Figures 3-5 through Figure 3-7 (pages 3-6 and 3-7) provide examples of potential employment scenarios for these organic C2 components. They may be employed across various echelons of command in support of WMD-E operations.

Coordination Element Support of Army and Joint Commands

3-16. The first example of potential employment is of a WCE employed to provide additional CBRNE staff support, WMD-E subject matter expertise, and technical reachback capability for an Army division, corps, or a joint staff belonging to a commander, joint forces combatant command (JFCC) or JFC. This support will generally be provided through the Division, Corps, or JTF’s organic CBRNE element. This WMD-E support relationship is highlighted in Figure 3-5, page 3-6.

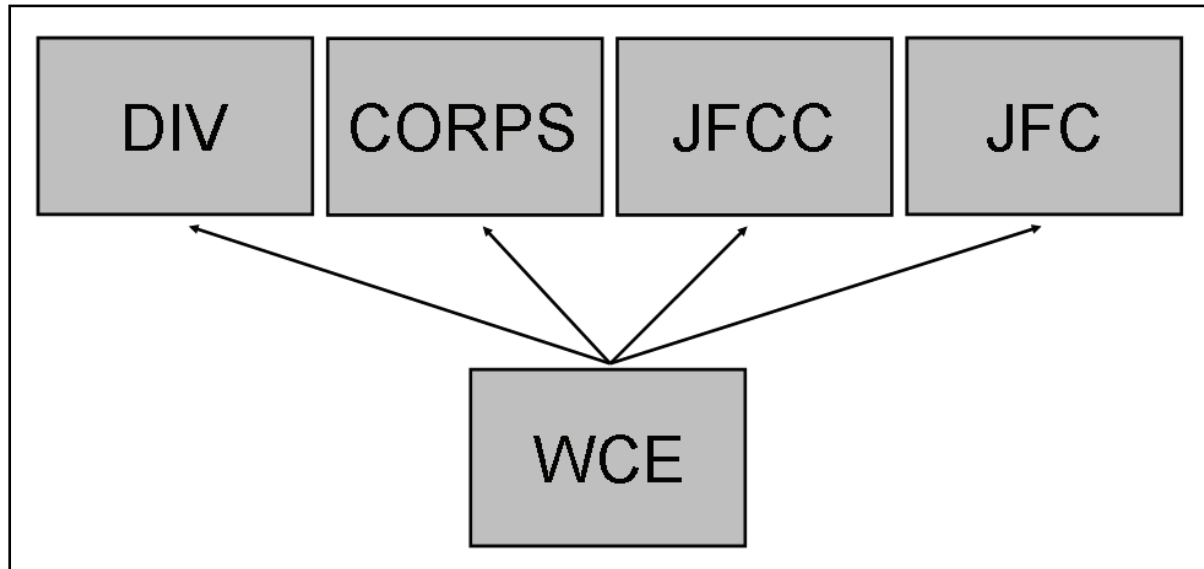

Figure 3-5. Example of WCE support to an Army or joint command

Operational Command Post support to a Joint Command

3-17. The second example of potential employment is of the OCP from the CBRNE operational headquarters being deployed (without JECE augmentation) to provide WMD-E operational support to a commander, joint forces land component (JFLCC) or JFC (see Figure 3-6). In this example the OCP may need to receive other augmentation elements to accomplish its' role. The type and degree of augmentation will vary depending on the type or scale of the WMD-E operation and/or the needs of the supported commander.

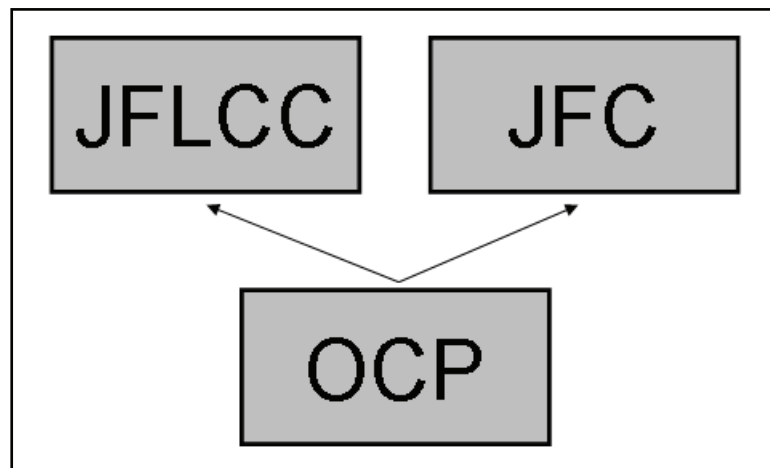

Figure 3-6. Example of OCP support to a joint command

Joint Task Force Elimination Headquarters Supporting a Joint Command

3-18. The third example of potential employment is an OCP being deployed and augmented by a JECE (and probably other augmentation elements as well) to form the core of a JTF-E. In this case the commander, CBRNE operational headquarters may be employed as the commander, JTF-E headquarters to provide WMD-E operational mission support to a JFLCC or a JFC (see Figure 3-7).

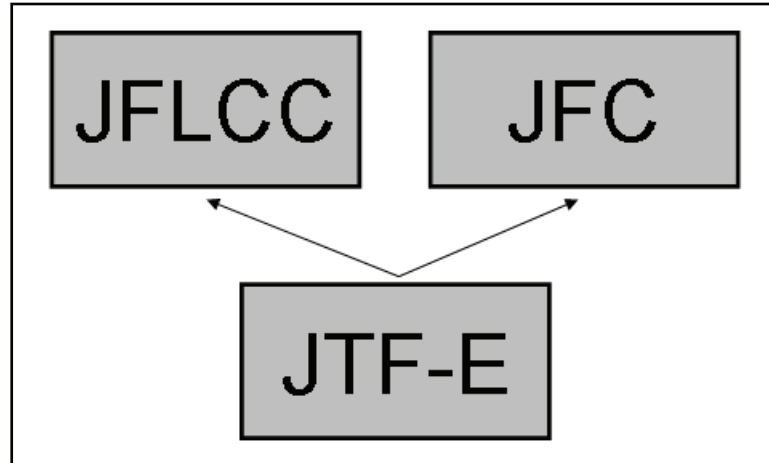

Figure 3-7. Example of JTF-E support to a joint command

THE ELEMENTS OF FULL SPECTRUM OPERATIONS

3-19. Full spectrum operations require simultaneous combinations of four elements—offense, defense, and stability or civil support. Table 3-1 lists the elements of full spectrum operations, the tasks associated with them, and the purposes of each (see FM 3-0). The CBRNE operational headquarters and its subordinate elements will perform their missions and tasks within this framework. Although the different elements will affect the considerations for WMD-E missions (see Chapter 4) the basic tasks remain constant. WMD-E forces adapt to the requirements of the OE and conduct their support to operations within it using synchronized action, joint interdependent capabilities, and mission command.

Table 3-1. Elements of full spectrum operations

| <i>Element</i> | <i>Tasks</i> | <i>Purposes</i> |
|----------------|---|--|
| Offense | <ul style="list-style-type: none"> • Movement to contact • Attack • Exploitation • Pursuit | <ul style="list-style-type: none"> • Dislocate, isolate, disrupt, and destroy enemy forces. • Seize key terrain. • Deprive the enemy of resources. • Develop intelligence. • Deceive and divert the enemy. • Create a secure environment for stability operations. |
| Defense | <ul style="list-style-type: none"> • Mobile defense • Area defense • Retrograde | <ul style="list-style-type: none"> • Deter or defeat enemy offensive operations. • Gain time. • Achieve economy of force. • Retain key terrain. • Protect the populace, critical assets, and infrastructure. |
| Stability | <ul style="list-style-type: none"> • Civil security • Civil control • Essential services restoration • Support to governance • Support to economic and | <ul style="list-style-type: none"> • Provide a secure environment. • Secure land areas of the joint operations area (JOA). • Meet the critical needs of the populace. • Develop local capacity for security, economy, and rule of law. |

Table 3-1. Elements of full spectrum operations

| <i>Element</i> | <i>Tasks</i> | <i>Purposes</i> |
|----------------|--|---|
| | infrastructure development | <ul style="list-style-type: none"> • Gain support for HN government. • Shape the environment for interagency and HN success. |
| Civil support | <ul style="list-style-type: none"> • Provide support in response to disaster. • Support civil law enforcement. • Provide other support as required. | <ul style="list-style-type: none"> • Save lives. • Restore essential services. • Maintain or restore law and order. • Protect infrastructure and property. • Maintain or restore local government. • Shape the environment for interagency success. |

OFFENSIVE OPERATIONS

3-20. *Offensive operations* are operations conducted to defeat and destroy enemy forces and seize terrain, resources, and population centers. They impose the commander's will on the enemy (FM 3-0). In combat operations, the offense is the decisive element of full spectrum operations. Against a capable, adaptive enemy, the offense is the most direct and sure means of seizing, retaining, and exploiting the initiative. Executing offensive operations compels the enemy to react, creating or revealing weaknesses that attacking forces can exploit. Successful offensive operations place tremendous pressure on defenders, creating a cycle of deterioration that can lead to their disintegration. This was the case in early 2003 in Iraq, when coalition operations led to the collapse of the Iraqi military and ultimately the Baathist regime of Saddam Hussein.

3-21. While planning for all operations will require flexibility and adaptability these are typically most critical during offensive operations due to the inherent friction. Planned targets may change and priorities of commitment for specialized teams will be affected as events on the ground unfold. Opportunity targets will tend to have an urgency to them that may be more time-sensitive than during most defense, stability, or civil support operations.

3-22. Good contingency planning is absolutely essential and must include task organizing and reserving assets to respond to targets of opportunity in a "be prepared" rather than "on order" frame of reference. These reserved assets must be organized with some degree of security augmentation or at least plan for security and other necessary assets to be added to the specialized teams to respond to targets of opportunity; replacing other specialize teams that have been rendered ineffective; or handling what may become lower priority targets than originally planned because of high value and time sensitive opportunity targets that primary specialized teams are shifted to. WMD-E tasks conducted during offensive operations must be able to operate within that friction.

DEFENSIVE OPERATIONS

3-23. *Defensive operations* are operations conducted to defeat an enemy attack, gain time, economize forces, and develop conditions favorable for offensive or stability operations. The defense alone normally cannot achieve a decision. However, it can create conditions for a counteroffensive that allows Army forces to regain the initiative (FM 3-0). Defensive operations can also establish a protective barrier behind which stability operations can progress. Defensive operations counter enemy offensive operations. They defeat attacks, destroying as much of the attacking enemy force as possible. They also preserve control over land, resources, and populations. Defensive operations retain terrain, guard populations, and protect critical capabilities. They can be used to gain time and economize forces so offensive tasks can be executed elsewhere.

3-24. The support of defensive operations will tend to have less urgent opportunity targets than during offensive operations, but opportunity targets must still be planned for. Since friendly forces control the

terrain that WMD-E forces are operating in it should provide somewhat better predictability at sites and enhance the likelihood and quality of security at those sites. More time and security may be available to conduct actions associated with exploitation, destruction, and monitoring and redirection than during the support of offensive operations. This may allow the use of non-DOD civilian organization assets that would typically not be viable when in support of offensive operations.

STABILITY OPERATIONS

3-25. *Stability operations* encompass various military missions, tasks, and activities conducted outside the United States in coordination with other instruments of national power to maintain or reestablish a safe and secure environment, provide essential governmental services, emergency infrastructure reconstruction, and humanitarian relief (JP 3-0). Stability operations can be conducted in support of a host-nation or interim government or as part of an occupation when no government exists. Stability operations involve both coercive and constructive military actions. They are designed to establish a safe and secure environment and facilitate reconciliation among local or regional adversaries. Stability operations can also establish political, legal, social, and economic institutions and support the transition to legitimate local governance.

3-26. While stability operations may span a wide range of levels of violence that range from stable to unstable, WMD-E tasks will typically be performed in a much more predictable environment. Flexibility and adaptability is still important but time sensitivity and special security may not be significant issues. Like defensive operations, this may allow the use of non-DOD civilian organization assets that would typically not be viable when in support of offensive operations. DOD efforts would likely be in support of other lead federal agencies and non-DOD assets are more likely to be used to support destruction and monitoring and redirection tasks.

CIVIL SUPPORT OPERATIONS

3-27. *Civil support* is Department of Defense support to United States civil authorities for domestic emergencies, and for designated law enforcement and other activities (JP 3-28). Civil support includes operations that address the consequences of natural or manmade disasters, accidents, and incidents within the United States and its territories. Army forces conduct civil support operations when the size and scope of events exceed the capabilities of domestic civilian agencies. The Army National Guard is often the first military force to respond on behalf of state authorities. In this capacity, it functions under Title 32, U.S. Code, authority or while serving on state active duty. The National Guard is suited to perform these missions; however, the scope and level of destruction may require states to request assistance from Federal authorities.

3-28. Support to civil authorities may have additional laws and restrictions to consider that would not be issues when conducting operations that are not within the U.S. and its territories. While there are always security considerations most support to civil authorities will allow non-DOD assets to perform most if not all tasks. Military support will typically be employed on Federal properties of when the magnitude or the urgency of an incident requires military units to enable civil authorities to respond in a timely and adequate manner. During civil support operations, the CBRNE operational headquarters may provide technical assistance along with specific resources and personnel in support of CBRNE CM to the lead federal agency and as directed through USNORTHCOM. The CBRNE operational headquarters may provide technical assistance and specific resources and personnel in support of civil support operations. WMD-E forces will still require the same types of support from the supported organization in civil support operations as it would in any other type of operation.

This page intentionally left blank.

Chapter 4

Weapons of Mass Destruction Elimination Operations

WMD-E operations are military operations to systematically locate, characterize, secure, disable, and/or destroy a state or nonstate actor's WMD programs and related capabilities in hostile or uncertain environments. This chapter details the four operational level tasks used to frame the conduct of WMD-E operations and explains the differences between planned and opportunity encounters of potential WMD sites. Finally, a generic scenario that displays examples of the operational tasks executed for WMD-E missions is provided at the end of the chapter. See Appendix A for a broader discussion of the fundamentals of combating WMD and their linkage to national military strategy.

THE ELIMINATION MISSION

4-1. WMD-E operations are one of the eight mission areas laid out in the NMS-CWMD and is aligned under the CP pillar for combating WMD. WMD-E operations occur at all levels of war (strategic, operational, and tactical). The CBRNE operational headquarters is focused on operations at the operational level and providing support and integrating guidance to the tactical level.

4-2. WMD-E operations consist of four operational level tasks: isolation, exploitation, destruction, and monitoring and redirection. These four steps may be performed simultaneously in geographically separate sites but each site typically transitions through each of the steps as well. Any non DOD agencies supporting WMD-E operations will normally require a secure environment in which to conduct these operations. See Figure 4-1, page 4-2 for the relationship of operational and tactical tasks within the mission area of WMD-E.

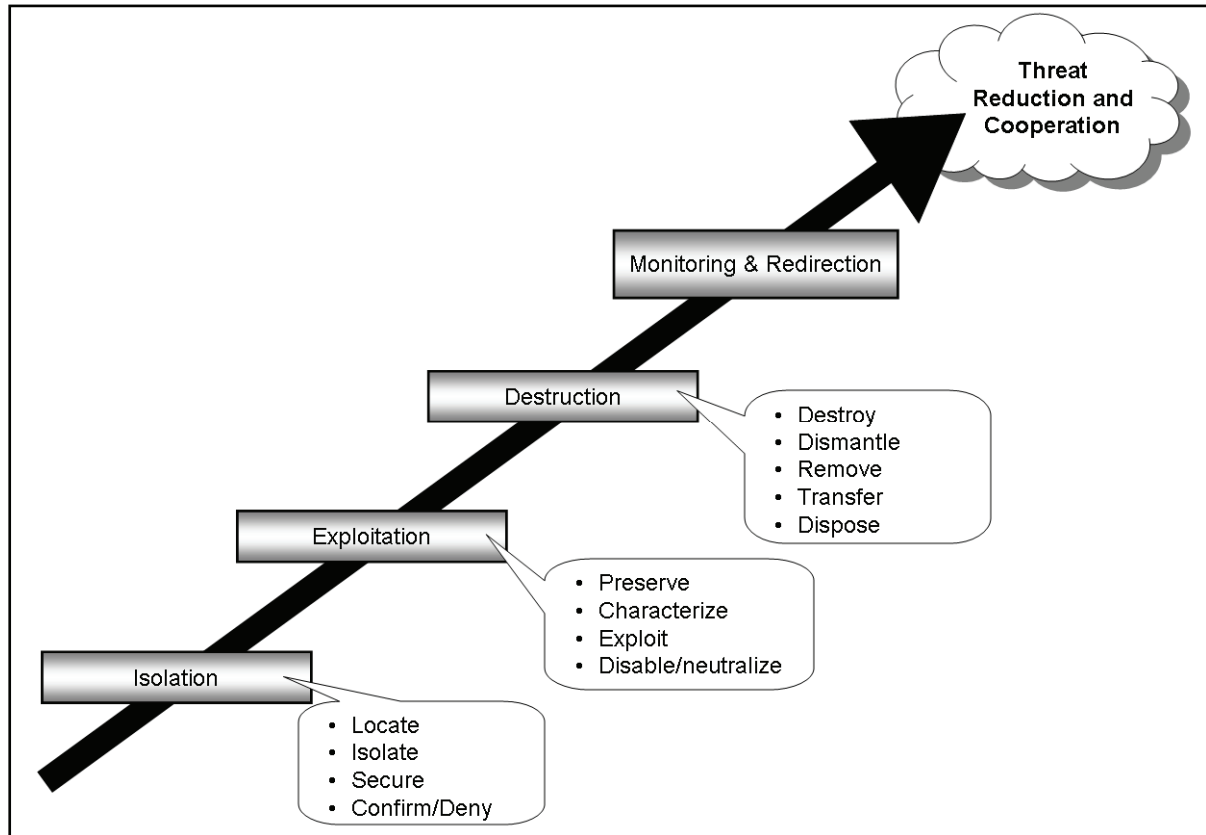

Figure 4-1. Operational and tactical tasks in the WMD-E mission area

ISOLATION

4-3. Isolation actions are the overall encirclement of the WMD program. This occurs at all three levels of war; although the operational task is by definition focused on the actions of the operational force.

4-4. The purpose of isolation is to physically secure suspected WMD sites, material, equipment and/or personnel. The objective is to ensure the suspected sites and materials are secure to prevent possible proliferation, pilfering, or destruction of potential forensic evidence; detain personnel; and prevent dispersion, contamination, or collateral effects of the release of dangerous WMD materials or agents. Such actions also ensure the safety of U.S. and coalition forces and the surrounding civilian population. General purpose forces must establish and maintain the conditions for elimination operations by securing sites to enable the other elimination tasks.

4-5. The operational task of isolation consists of four subordinate tactical tasks: isolate, secure, and confirm/deny. See Figure 4-2.

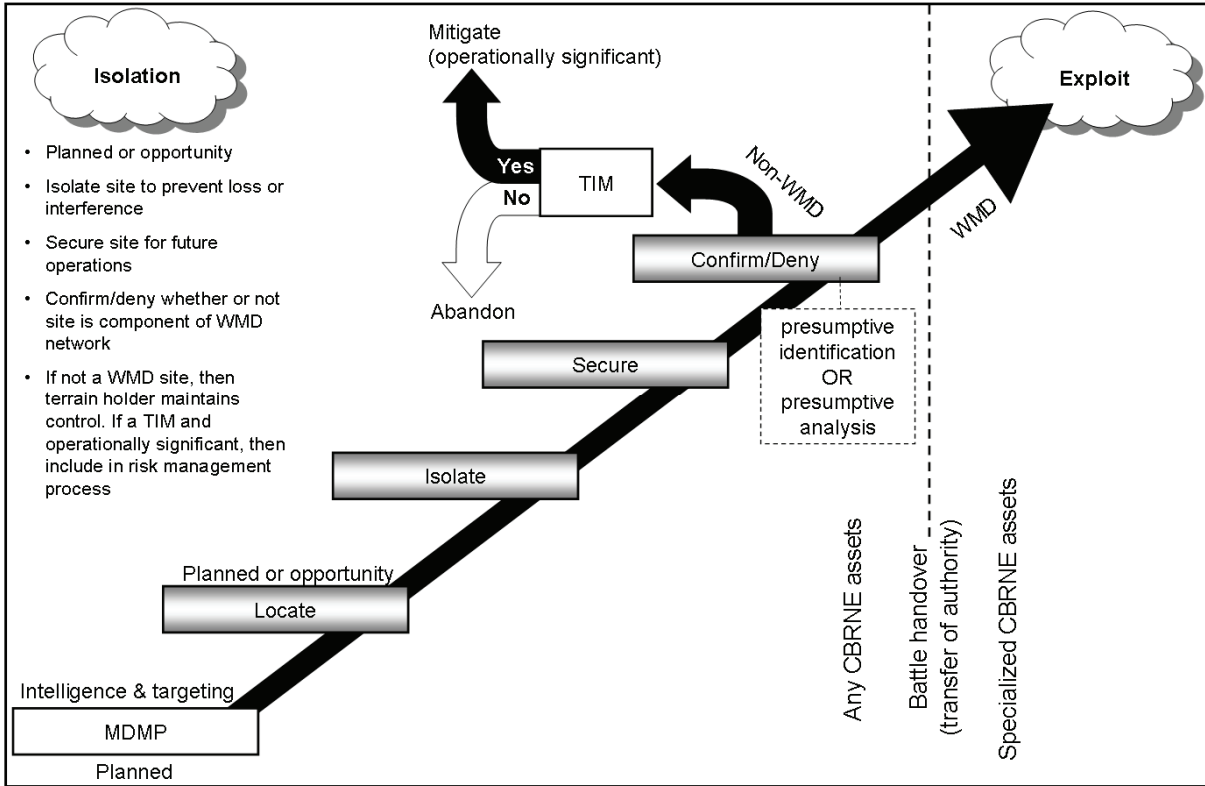

Figure 4-2. Operational task – isolation

Locate

4-6. This task includes continuously collecting actionable intelligence about adversary programs from the strategic to the tactical level. The new intelligence collected will expand, re-direct, and re-prioritize intelligence collection activities. During the prosecution of military operations, maneuver and support units will act upon that intelligence to physically locate adversaries’ WMD programs and associated networks; or they may encounter WMD sites inadvertently. Sites that are placed on a target list based on intelligence are planned targets and those sites inadvertently discovered become opportunity targets. The difference between planned and opportunity elimination operations will be discussed later in this chapter.

4-7. Planning should provide a target/site list prioritization method weapons of mass destruction master site list (WMSL) for determining which sites should be exploited. This planning should be done as part of the normal targeting process to ensure that all members of the planning and execution staff are aware of the plan and to utilize resources from the other elements of the targeting process to include intelligence.

Isolate

4-8. To *isolate* is a tactical mission task that requires a unit to seal off-both physically and psychologically-an enemy from his sources of support, deny an enemy freedom of movement, and prevent an enemy unit from having contact with other enemy forces (FM 3-90).

4-9. Once a known or suspected WMD site is located, actions are taken to physically isolate it. During this action, units must consider passive defense and WMD-CM measures due to the potential for material release. For suspect WMD sites that are inadvertently encountered by maneuver units, planners should consider additional security forces to accomplish site isolation, because maneuver units generally have higher priority military objectives than the isolation of WMD sites.

Secure

4-10. The term secure has several definitions. *Secure* is a tactical mission task that involves preventing a unit, facility, or geographical location from being damaged or destroyed as a result of enemy action (FM 3-90).

4-11. WMD sites are likely to be protected with some form of defenses. Planning should address how to detect, assess and defeat site defenses. It should also address how to establish and maintain secure control of WMD sites until the absence of CBRNE material is confirmed; the material has been eliminated or removed; or the mission and responsibility for security is transferred to another agency as part of TRC.

4-12. This may require coordination for additional assets based on the extent of site defenses and size and type of WMD sites. Planning must address the impact of security requirements for a large number of sites and future transition of the security mission to other organizations or forces.

4-13. Additionally, planning must also consider the need for robust, high bandwidth C2 at each site. The responsibility for a site's long term security, where there is no longer an immediate threat, may be transferred from the JTF-E to the lead agency for the TRC mission.

Confirm/Deny

4-14. Once sites are isolated and secured, CBRNE forces will attempt to confirm or deny the presence of WMD using organic testing equipment by performing presumptive identification or analysis to determine the potential for WMD presence. Presumptive identification requires a single technology and may be conducted by all CBRNE forces. Presumptive analysis requires the application of two or more technologies, and may require the application of the appropriate CBRNE force package, depending on the nature of the material in question. In either case, the findings will be reported according to the command's established reporting procedures—to include the technology(s) applied—and using established channels.

4-15. If the presence of WMD cannot be resolved using presumptive identification or presumptive analysis then additional specialized testing will be conducted to confirm or deny the presence of WMD. To accomplish this testing, CBRNE forces will collect samples and ensure the samples are properly escorted to a designated laboratory activity.

EXPLOITATION

4-16. The intent of exploitation is to gain an understanding of an adversary's WMD programs and capabilities to attribute and connect to the adversary's network, which may determine future targets; collect evidence of a WMD program; and provide protection from immediate WMD threats, if required.

4-17. Exploitation requires specialized skill sets that the CBRNE operational headquarters or JTF-E provides, with the assistance of CBRNE (CBRN and EOD), security, and support units; combat support agencies like DTRA; and other USG agencies like the Department of Energy (DOE) and the Department of State (DOS). Some of these agencies may require the establishment of a locally permissive environment to conduct their activities.

4-18. This operational task is not exactly the same as the definition of exploitation provided in FM 1-02 although the basic focus comes closest to the second definition. *Exploitation* – (DOD, North Atlantic Treaty Organization [NATO]) 1. Taking full advantage of success in military operations [Note: the NATO definition replaces “military operations” with “battle”], following up initial gains, [Note: the NATO definition ends here] and making permanent the temporary effects already achieved. See FM 3-0. 2. Taking full advantage of any information that has come to hand for tactical, operational, or strategic purposes. See FM 3-13. 3. An offensive operation that usually follows a successful attack and is designed to disorganize the enemy in depth. See FM 3-0.

4-19. The operational task of exploitation consist of four subordinate tactical tasks: preserve, characterize, exploit, and disable or neutralize (see Figure 4-3).

Preserve

4-20. In addition to tactical security, a primary challenge is to safeguard suspected materials until specialized forces can characterize the material and exploit the site. Long term security requirements for elimination operations are potentially overwhelming. Additional security forces should be planned for and assigned to the elimination mission based on the number and size of suspected WMD sites.

4-21. In the case of WMD materials located aboard vessels, identification of suitable airfields or ports and capable facilities may be required to accomplish follow on characterization and exploitation operations.

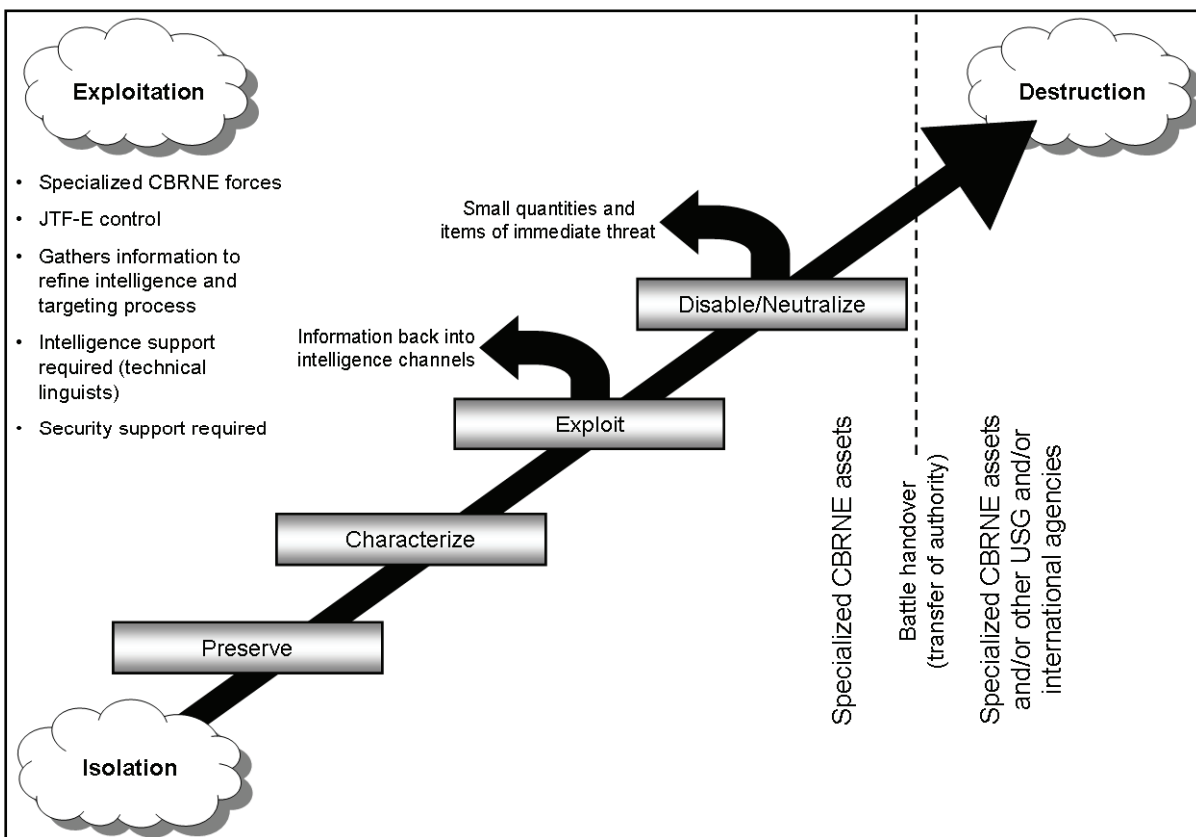

Figure 4-3. Operational task – exploitation

Characterize

4-22. Once a site is secure, dedicated task-organized exploitation assets are deployed. These assets have the necessary expertise and specialized equipment to characterize WMD weapons, materials, agents and delivery means; provide a presumptive analysis; and package and transport WMD material for shipment back to a pre-identified facility for confirmatory and/or definitive analysis.

4-23. Characterization includes detailed assessments that may take some time to accomplish, USG designated laboratories with internationally accepted confirmatory capabilities, as well as other assets with other required capabilities, may not be organic to theater.

Exploit

4-24. The exploitation assets conduct initial intelligence exploitation of program experts, documents, and other media as well as secure weapons material, agents, delivery means, and related processes and facilities found in and around the site. Characterization and exploitation may require additional assets not typically found within the JTF-E or organic to CBRNE forces. These include technical linguists for document

exploitation and interviews, technical and CBRNE intelligence analysts, engineer assets, and material handling and packaging capabilities.

4-25. This WMD-E tactical task is similar to but not exactly the same as the definition of exploit provided in FM 1-02. In information operations, to *exploit* is to gain access to adversary command and control systems to collect information or to plant false or misleading information (FM 3-13).

4-26. Detailed reports and imagery are sent to the appropriate agencies for further analysis. This analysis can lead to a re-prioritization of WMD sites or identify additional sites or experts to add to the WMSL.

4-27. Exploitation activities are essential for arresting further WMD proliferation, preventing WMD program regeneration and include taking full advantage of any information obtained for tactical, operational, or strategic purposes.

Disable/Neutralize

4-28. Exploitation assets will render harmless or destroy weapons, materials, agents, and delivery systems that pose an immediate threat to U.S forces, coalition partners, and the civilian population. The intent of disable/neutralize is to provide protection from WMD rather than to conduct the destruction of the WMD program.

4-29. To disable or neutralize in the context of WMD-E operations is similar to the term disable found in FM 1-02. As it applies to military operations, to *neutralize* is to [1] to render ineffective or unusable (FM 1-02); [2] to render enemy personnel or material incapable of interfering with a particular operation (see FM 3-90); [3] to render safe mines, bombs, missiles, and booby traps (see FM 3-34.214); or [4] to make harmless anything contaminated with a chemical agent (see FM 3-90).

DESTRUCTION

4-30. Once the site has been exploited, and it has been determined that it is not a component of a dual-use industry that will be designated for redirection, the operational task of destruction may begin. The purpose of this task is to destroy, dismantle, remove, transfer, or otherwise verifiably dispose of the adversary's WMD material, weapons equipment, and infrastructure.

4-31. While the ideal case is to conduct the operational task of destruction operations in a permissive environment, planning must include conducting this task in all environments and under all conditions until conditions permit transfer of responsibility to another agency.

4-32. Planning should include transfer of responsibility as soon as possible during operations to the agency or organizations responsible for conducting monitoring and redirection. A rapid battle handover (transfer of authority) of the destruction mission to a monitoring and redirection operation (MRO) is essential to returning the limited CBRNE assets for other WMD-E missions.

4-33. In some cases, the DOD (specifically the JTF-E) may have to retain responsibility for the destruction mission. Planners need to take this into consideration and be prepared to make recommendations as to what additional assets, if any, will be required to continue with the destruction mission while simultaneously supporting the other elimination tasks.

4-34. When planning a destruction mission consideration must also be given to the number and their respective sizes, types of material to be destroyed, exposure criteria, assets available; and the security environment in which the destruction mission will be accomplished. These factors may lead to the materials being shipped out of country for destruction or a consolidation within the HN to one or more sites for more efficient destruction operations.

4-35. The operational task of destruction consists of five subordinate tactical tasks: destroy, dismantle, remove, transfer, and dispose. Execution of all of these tactical tasks is not necessary for the successful execution of the operational task of destruction task. Any combination of tactical tasks may be executed for successful accomplishment of the operational task of destruction. Available resources, along with intelligence requirements and other higher level guidance will determine which tactical tasks are employed and against what portions of the WMD network (see Figure 4-4).

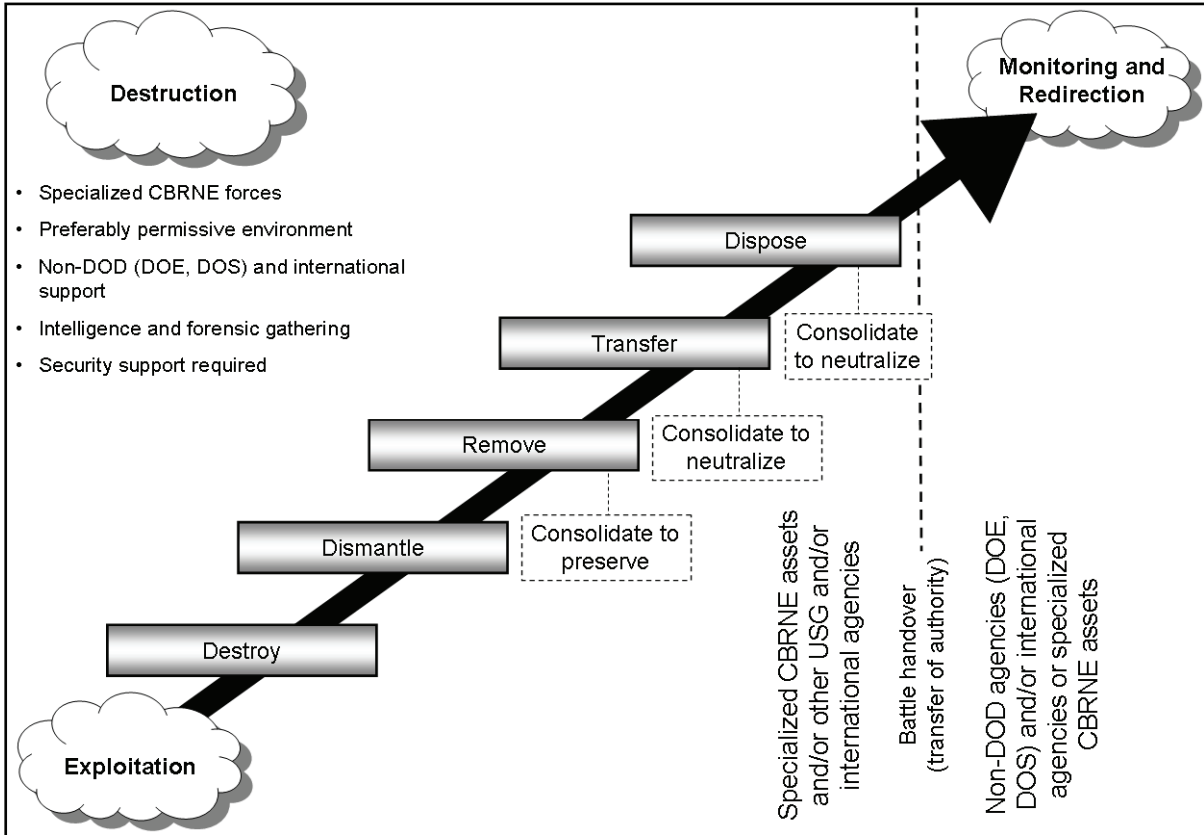

Figure 4-4. Operational task – destruction

Destroy

4-36. The WMD-E tactical task of destroy is similar to the definition of destroy. *Destroy* – 1. A tactical mission task that physically renders an enemy force combat-ineffective until it is reconstituted. 2. To damage a combat system so badly that it cannot perform any function or be restored to a usable condition without being entirely rebuilt (FM 3-90).

4-37. The tactical tasks of destroy is to damage a system or component of a WMD program so badly that it cannot perform any function or be restored to a usable condition without being entirely rebuilt. An example of this tactical task would be the destruction of CBRNE rounds by an Technical Escort unit.

Dismantle

4-38. The tactical task of dismantle is to take a system or component of a WMD network apart to the point where it would not be economically feasible, or cannot be rapidly restored to an operational state. This tactical task may also be used to break a large component into smaller components that then can be destroyed, removed, or transferred.

Remove

4-39. The tactical task of remove is taking a system or components of a system and moving them to another location for the purpose of preserving for forensic reasons or intelligence exploitation. This tactical task can be used to separate a flagship component from the remainder of a WMD network to hinder reestablishment of the program. The consolidation task begins as part of the remove task if the intent is to preserve evidence for technical exploitation.

Transfer

4-40. The tactical task of transfer is to take a system or components of a WMD network and transfer them to a peaceful purpose. This tactical task is most likely used when dealing with dual use type components of a WMD network. The consolidation task begins as a part of the transfer task if the intent is to neutralize the material and could potentially end here for military forces as a result of the transfer of authority to nonmilitary control.

Dispose

4-41. The tactical task of dispose is the moving or assigning components of a WMD network to the next phase of the elimination process that ensures the inability to reconstitute the WMD network. The consolidation task could continue here if military forces remain responsible for the dispose task.

MONITORING AND REDIRECTION

4-42. As with the operational task of destruction, this operational task is highly dependent on interagency and international organization support for execution. Typically this operational task is performed as part of a TRC mission and is passed on to non DOD agencies for execution.

4-43. Monitoring in the context of WMD-E missions is the continuous observation and examination of former WMD programs and sites to ensure that eliminated programs are not reconstituted. Redirection involves the transfer of material, equipment, and personnel to peaceful purposes. This portion of the operational task is normally performed as part of the TRC mission area and involves such agencies as the DOE, DOS, and other interagency and international partners.

4-44. The combatant command and its subordinate JTF headquarters should begin planning for this operational task as soon as dual use facilities are identified. Some planning considerations include—

- Agencies and organizations that should be involved in the TRC process.
- Continued security to include potential transfer of authority of the security mission.
- Resources required to be left behind (equipment, personnel, and so forth).
- Logistics support for the new operation.
- HN requirements in support of the TRC mission.

THREAT REDUCTION COOPERATION

4-45. Although it is not considered one of the four WMD-E operational tasks, TRC may be conducted sequentially as part of the transition from the operational task of monitoring and redirection. An example of this might occur when at the invitation of a new or friendly government (under the DOS–TRC program) the CBRNE operational headquarters would provide the primary elements to enable C2 for the elimination of existing stockpiles of WMD left over from a former regime within a given combatant command AOR. The final task is the transition to the TRC mission. TRC activities include long term destruction, redirection and monitoring, and are normally conducted in a permissive environment.

4-46. Depending on the OE it is possible that the JTF-E may be required to initiate the TRC mission area. The JTF-E needs to begin planning as soon as it anticipates it may have to conduct or support TRC so it can identify additional resources that may be required to augment the JTF-E.

ENCOUNTERING WEAPONS OF MASS DESTRUCTION ELIMINATION SITES

4-47. U.S. forces may encounter elimination sites under two circumstances: planned and opportunity. Planned targets are those that were known about in advance of the operation and are typically approached as a deliberate operation. An opportunity target is an unexpected or unconfirmed target that is identified after the operation has begun. The source of these opportunity targets may be from tactical maneuver elements that simply discover a WMD site during their movement and maneuver and report this

information. Response to these as well as planned targets will ideally be performed in a deliberate fashion, but the reality is that many may need to be treated as a hasty operation. See FM 3-90 for a discussion of hasty and deliberate planning and operations.

PLANNED ENCOUNTERS

4-48. A planned WMD-E operation is one that is developed as part of the JFC campaign plan. A planned elimination site is one in which the site and its general nature, extent, and purpose are known. The fact that some planned sites may only be suspect in nature due to limited intelligence information requires that planning provide flexibility for response to planned elimination sites. The JTF-E will develop a WMSL in conjunction with the JFC staff. Using intelligence from strategic and operational assets to identify potential WMD-E sites, the JTF-E will prioritize and nominate these targets for elimination in support of the overall campaign plan.

OPPORTUNITY ENCOUNTERS

4-49. Opportunity WMD-E operations will most likely occur in any conflict. An opportunity WMD-E operation is one in which the site is inadvertently discovered and no previous information or intelligence existed on the site. Opportunity encounters are not necessarily found by CBRNE elements but typically maneuver elements submitting reports and information through normal channels and should be submitted concurrently using the joint warning and reporting network.

Differences: Planned and Opportunity Elimination Sites

4-50. The JFC through the JTF-E has both general purpose CBRNE forces (such as CBRN reconnaissance elements, CBRN dual purpose elements, EOD elements) and specialized CBRNE forces (such as TEU, NDT, CARA) to conduct WMD-E operations on a target.

4-51. Based on the scope of the planned or opportunity site, forces will be assigned against the target to set the conditions for successful WMD-E operations. This assignment process follows the normal targeting process with nominations of targets and then assignment of available forces to respond to the targets. As information is gathered and refined into intelligence the JTF-E may find it necessary to re-prioritize targets on the target list.

4-52. Factors to consider when determining what unit or element will respond to a target include—

- Complexity of the elimination site (to include the level of CBRNE technical expertise required).
- Size of the elimination site.
- Environment.
- Exposure criteria and considerations.
- Unit/element capabilities and equipment (general purpose versus technical).
- Sample management considerations.

4-53. The key difference between planned and opportunity elimination sites are in the targeting. This typically affects the actions during the operational task of isolation. An opportunity elimination site has not been targeted by the JTF-E and targeting must be accomplished in a hasty fashion. Opportunity targets are typically discovered by maneuver units conducting tactical missions or conducting mission directed based on tactical intelligence in their AO. The first CBRNE unit to respond to an opportunity target will typically be the organic or supporting CBRNE element of the maneuver unit.

4-54. The unit making the opportunity encounter may conduct the first three tactical tasks (locate, isolate, secure) of the operational task of isolation depicted in Figure 4-2 depending on the nature of the target. Organic or supporting CBRNE equipment provides the tactical unit with the capability to conduct the tactical task of confirm/deny (to include presumptive identification and presumptive analysis) and report the findings according to appropriate reporting procedures.

4-55. Based on reports from an opportunity site, the JTF-E will begin to develop targeting information and begin planning the necessary coordination to transfer WMD-E responsibility for the target. Planners will consider the tactical situation and ensure adequate security elements are available.

4-56. The JTF-E also needs to be prepared to provide specialized CBRNE assets to support the operational task of isolation as well as other follow-on operational tasks associated with the target.

EXAMPLES OF WEAPONS OF MASS DESTRUCTION ELIMINATION MISSIONS

4-57. In this generic scenario, the CBRNE operational headquarters has been directed to create a JTF-E headquarters to support a CCDR in a joint operation occurring overseas in Pacifica (see Figures 4-6 through 4-8 on pages 4-11 through 4-13). The OCP has provided the core Army element to create the JTF-E headquarters and is augmented by a JECE to form a JOC for that JTF. The OCP may also receive LNOs from units with unique capabilities or missions. The JTF-E headquarters may deploy with additional specialized units (that is, traditional technical escort, EOD, and CBRNE chemical units) and other critical combat enablers to accomplish its specified WMD-E missions.

4-58. WMD-E missions are complex and may be conducted in permissive and nonpermissive environments and occur during combat and post-conflict phases. The JOC will develop and publish plans and orders. Plans and orders should describe how subordinate headquarters will C2, support, and receive the necessary resources to conduct and sustain WMD-E operations. Tactical C2 of WMD-E teams will most likely be conducted by a CBRNE task force headquarters EOD group/battalion or a CBRN brigade/battalion.

4-59. WMD-E teams may be assigned significantly different missions and subordinate headquarters must ensure plans and orders include detailed execution paragraphs that clearly communicate the commander's desired endstate. They must also describe what actions should or should not be executed to deny, degrade, disable, or damage WMD material, weapons equipment, and infrastructure (to include dual-use asset's infrastructure and capabilities) while minimizing collateral effects or unintended agent or material release.

4-60. Planners must include other considerations when task organizing specialized teams to respond to WMD-E missions. In some cases, due to their importance, enemy forces may defend WMD-E targets tenaciously. On the other hand, defenders may abandon a WMD site before confronting U.S. forces. This scenario portrays a particularly dangerous situation where friendly tactical forces are not available to provide additional security at the site. When friendly forces are not yet available, noncombatants may enter the site for any number of reasons. In doing so, noncombatants may not only expose themselves to great risk, but also endanger the nearby population. Ongoing military operations may also be interrupted or delayed. An historic example of this was the looting (by local civilians) of barrels containing radioactive materials at the Iraqi nuclear processing plant near Tuwaitha during OIF.

4-61. For each planned and opportunity target, the four operational level tasks discussed earlier in this chapter for WMD-E operations, are systematically preformed by WMD-E forces. Figure 4-5 provides a graphical depiction of each in a step by step fashion.

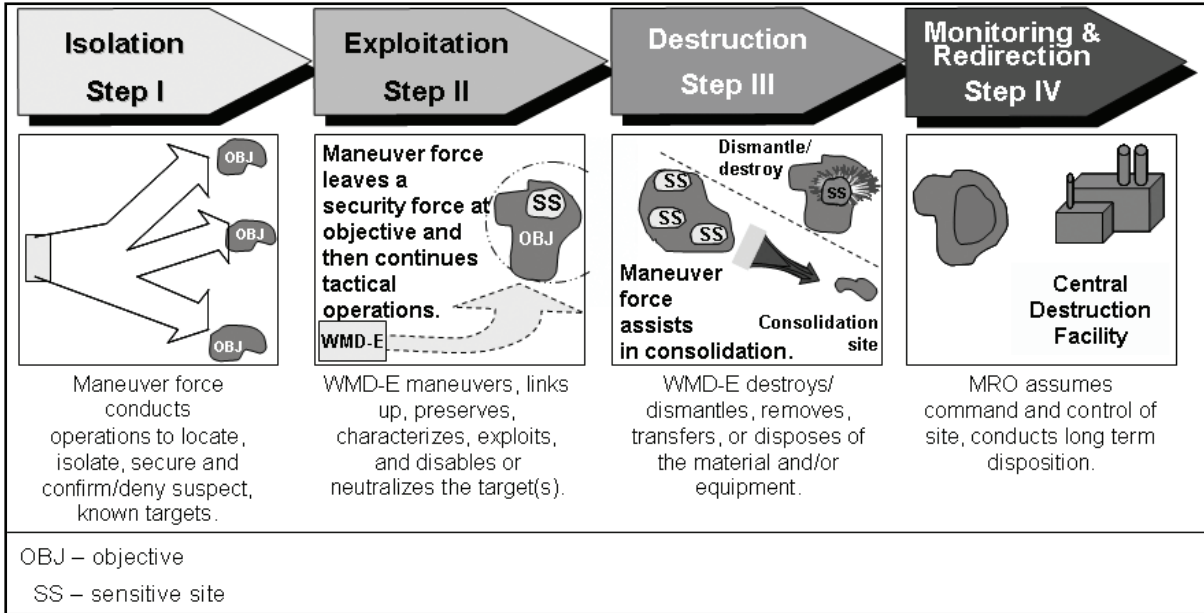

Figure 4-5. WMD-E operational tasks – step-by-step

4-62. In Figure 4-6, two different corps (each task organized with general purpose ISR, EOD, and CBRNE units) are maneuvering to locate planned WMD targets. As a target is located, teams execute the operational and tactical tasks (described earlier in this chapter) “step-by-step” to secure the WMD site and report to higher command. Figure 4-6, page 4-12 also depicts suspect planned targets which are believed to exist within each corps AO.

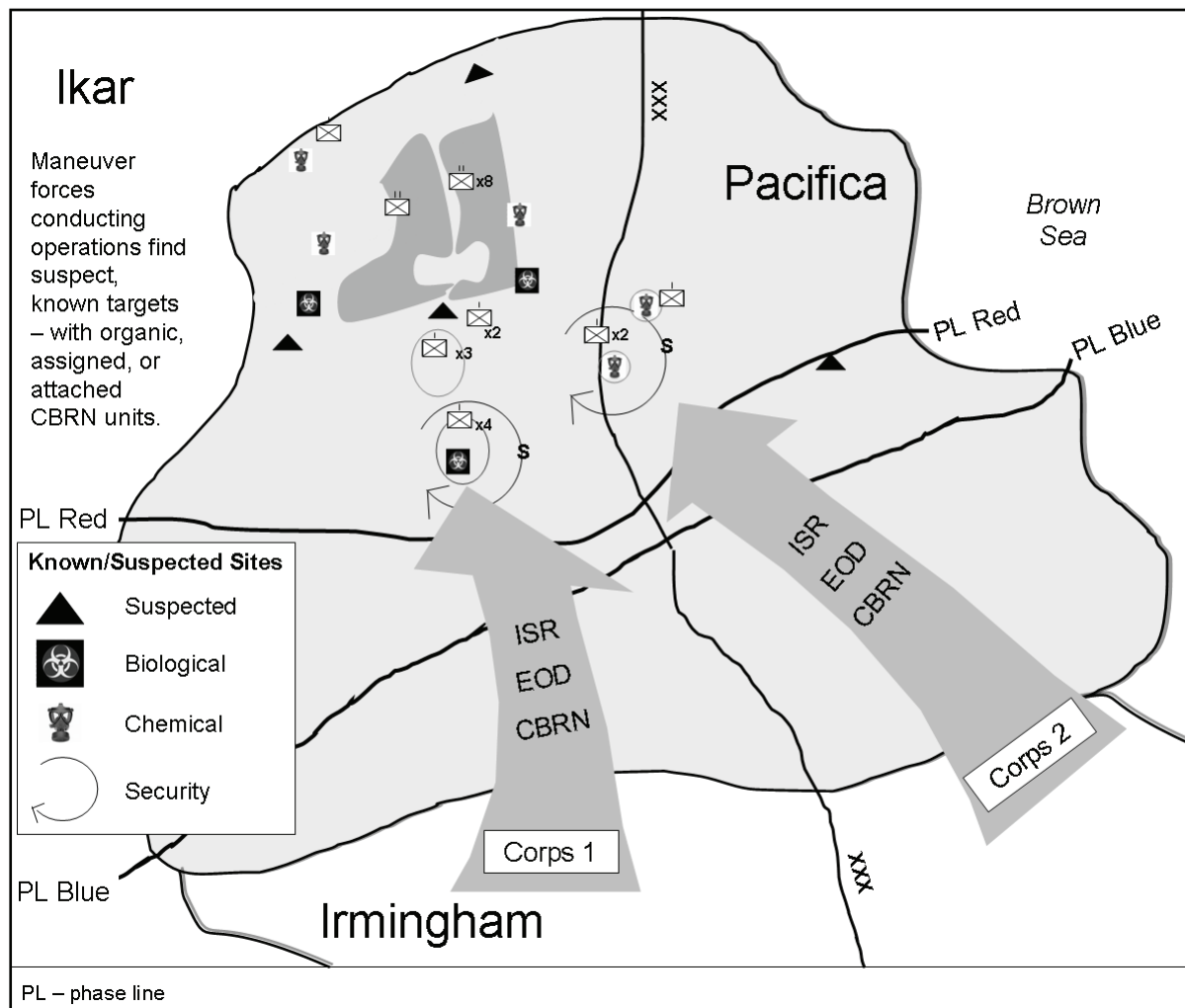

Figure 4-6. Example of maneuver forces locating WMD-E targets

4-63. Once security forces have created favorable conditions for specialized CBRNE teams, the next step in the elimination process is to advance elimination forces to exploit WMD targets. Figure 4-7, page 4-12 illustrates a CBRN brigade subordinate to a JTF-E headquarters directing WMD-E forces to maneuver forward to begin site exploitation. The CBRN brigade has a task organization that includes EOD and TEUs to allow it to perform this mission.

4-64. When a WMD target is exploited teams execute the subordinate tactical WMD-E tasks in a “step-by-step” fashion and report findings as required to higher command. These tactical tasks are typically time and resource intensive. The tasks include procedures to locate, characterize, and secure WMD materiel, weapons, equipment, personnel, and infrastructure, and the development of appropriate forensic evidence.

4-65. WMD-E exploitation forces provide specialized equipment and capabilities. WMD-E teams are modular and task organized for the specific OE of the site(s) they are assigned. WMD-E forces are capable of providing near real-time reachback (digital, voice, imagery), collecting technical information and intelligence; handling evidence; characterizing CBRNE materials; and conducting sample identification, collection, and mapping. As required they bring scientific technologies for presumptive field testing for suspect agents found at the site. If samples cannot be identified at the site, they are packaged and transported to laboratories for further analysis and certification. WMD-E forces conduct a complete assessment of the WMD site and develop a detailed report of the results. Figure 4-7 also illustrates the

movement of suspect samples to a lab or analytical facility. For additional information on laboratories, see Appendix H.

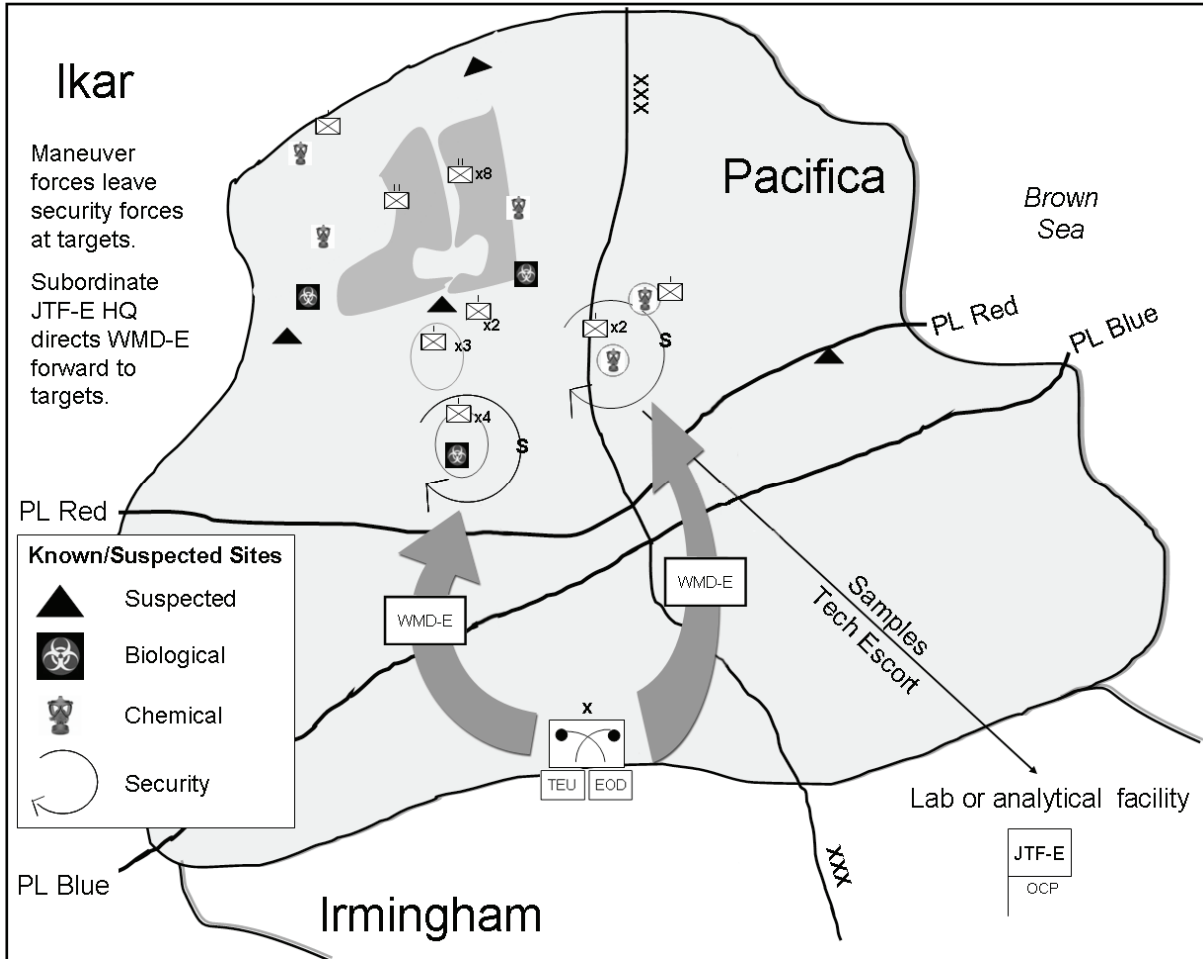

Figure 4-7. Example of CBRN brigade exploitation force maneuvering to WMD-E targets

4-66. *Monitoring and redirection operations* is defined as converting WMD programs, personnel, sites and facilities to prevent transfer, reconstitution, and misuse of residual dual-use capabilities (JP 3-40). MRO is a task-organized team of technical experts who can go to a CBRNE site and exploit the material, personnel, facility, munitions, or equipment. MROs may consist of a headquarters element; security, transportation, EOD, TEU, CARA elements, linguists, and potentially other technical representatives. MROs make recommendations regarding WMD dismantlement, disablement, or destruction requirements to the JTF-E headquarters. The supported combatant command (or subordinate element) maintains security of the WMD site until MRO actions are complete or until other combat forces are identified to assume the security mission.

4-67. Usually company-sized units support exploitation of a small WMD-E site. Examples include a group of warehouses, a medium-sized cave, or a walled compound. This support normally includes external security, tactical reserves, and one or more support teams working inside the site. In instances involving larger complexes, such as a factory or production and test facility, a battalion-sized force may be necessary to execute the mission, task-organizing companies to conduct a myriad of supporting tasks. In the case of a very small site, such as a single building, a platoon-sized force may be all that is required to support the exploitation. In each instance, the commander considers the size of the site and the threat, the contents of the site, the duration of the exploitation, and the nature of support required by the site exploitation team. In some instances, it may be necessary to continue to secure a site while a series of specialized exploitation teams assess and exploit the site, or to secure large sites while detailed site exploitation or weapons

disablement takes place. Army forces continue to secure WMD sites until relieved by other security forces or the site exploitation team has neutralized or destroyed the site.

4-68. Figure 4-8 depicts transportation of consolidated WMD material to a central destruction facility where a MRO assumes responsibility. In this example, a CBRN battalion has been given the mission of providing C2 for the continuous operations required to accomplish the consolidation mission. This graphic also illustrates the movement of suspect sample(s) by technical escort elements to a lab or analytical facility for continued analysis.

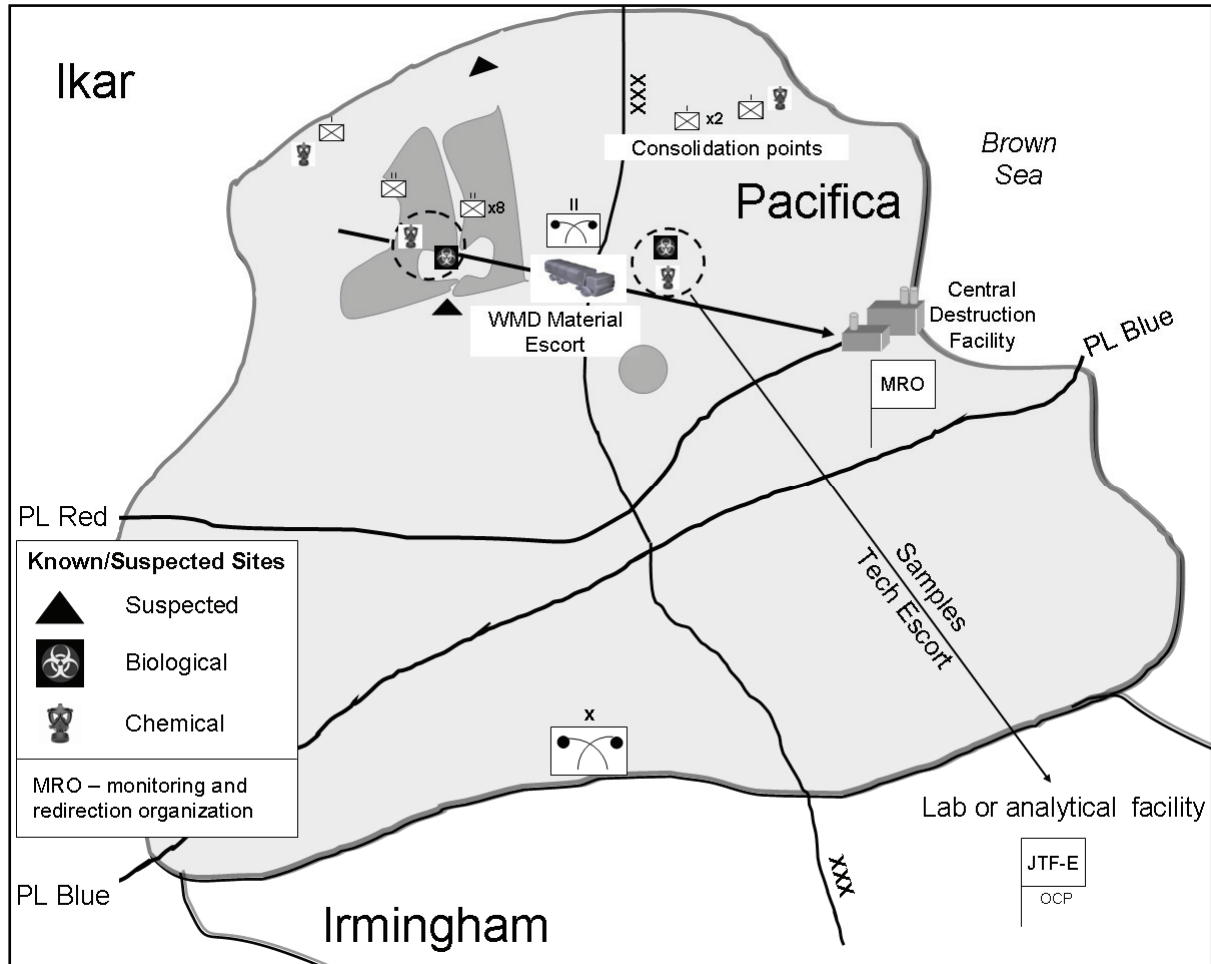

Figure 4-8. Example of consolidation to support monitoring and redirection missions

Chapter 5

Command and Control

The fundamentals of C2 are identified in FM 6-0. The CBRNE operational headquarters may be required to execute any one or a combination of three primary mission sets (WMD-E, JTF headquarters, civil support) in support of offensive, defensive, and stability or civil support operations. The headquarters and its subordinate elements require a robust C2 structure to perform these mission sets in support of WMD-E operations. Successful execution of WMD-E missions requires centralized, responsive, and unambiguous C2 that is responsive to the needs of the headquarters it supports—providing flexibility and agility in the performance of WMD-E operations and meeting the time-sensitive nature associated with many of them. Effective C2 is critical to the performance of the CBRNE operational headquarters, subordinate commanders, and supported headquarters. This chapter will discuss some of the specific (and, in some cases, unique) C2 considerations that affect the specialized organic WMD-E teams, subordinate CBRNE units, and augmenting CBRNE and WMD-E support that may come from or to the CBRNE operational headquarters. (When published, FM 3-11.6 will contain multi-Service doctrine for the aspects of CBRN C2.)

GENERAL

- 5-1. Command and control is the exercise of authority and direction by a properly designated commander over assigned and attached forces in the accomplishment of a mission (see FM 6-0). The exercise of C2 for WMD-E (planning, preparation, execution, and continuous assessment) is based on the fundamentals of full spectrum operations and mission command. Commanders visualize, describe, direct, and lead operations in terms of the six WFF.
- 5-2. The commander, CBRNE operational headquarters directly influences operations by his personal presence and through skillful use of his C2 systems. The capabilities provided via satellite communication (SATCOM) and digital information systems enable the commander to rapidly share RI with his subordinate commanders, staff, and higher headquarters. The commander can then employ his leadership to apply the appropriate technology, resources, and specialized teams required for WMD-E mission accomplishment.
- 5-3. The integration of CBRNE operational headquarters subordinate and specialized elements with conventional forces creates unique capabilities for WMD-E that might otherwise be unattainable. Flexible C2, specific mission generation processes, clear mission approval levels, and tactical interdependence can improve WMD-E team and conventional forces integration. To facilitate effective integration, several key areas should be addressed early in the planning process: ISR; integrated operations planning and target management; characteristics and capabilities/limitations of the supported unit; integration of subordinate elements; C2; security; and liaison with supported commands.
- 5-4. The C2 WFF encompasses the related tasks and systems that support commanders in exercising authority and direction. It includes those tasks associated with acquiring friendly information, managing all RI, and directing and leading subordinates. C2 is composed of all those actions taken by commanders and staffs that allow for the accomplishment of the mission (see Figure 5-1, page 5-2). C2 functions are performed through an arrangement of personnel, equipment, communications, facilities, and procedures employed by commanders in planning, directing, coordinating, and controlling forces.

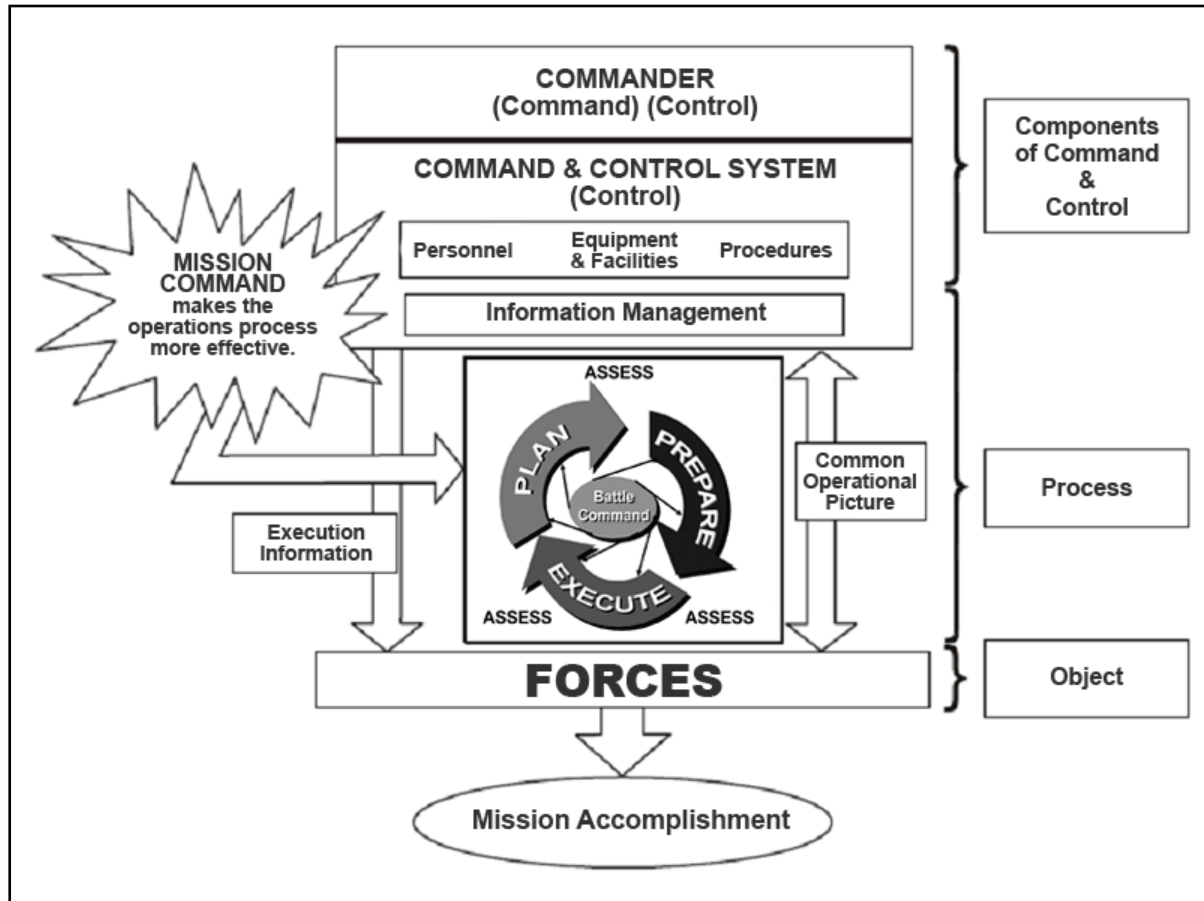

Figure 5-1. C2 for CBRNE operations

THE ROLE OF THE COMMANDER

5-5. The commander's role is to establish a command climate for the command, prepare the unit for operations, direct it during operations, and continually assess subordinates. Commanders visualize the nature and design of operations through estimates and input from subordinates. They describe support operations in terms of time, space, resources, purpose, and action; and employ intent, commander's critical information requirement (CCIR), and mission orders to direct planning, preparation, and mission execution.

5-6. Of all the activities required of the commander, CBRNE operational headquarters visualizing an operation from start to finish, and describing that visualization to his staff and subordinate commanders, are absolutely critical.

5-7. The commander's intent is a clear, concise statement of what WMD-E elements must do, and the conditions the specialized teams must meet to succeed. These conditions represent the WMD-E operation's desired endstate.

5-8. Subordinate commanders design and execute WMD-E operations around the CBRNE operational headquarters commander's intent. The commander, CBRNE operational headquarters develops the intent and concept of the operation within the framework of the supported commander's intent. During planning, the commander's intent drives the MDMP. Subordinates use the commander's intent to decide what to do or when to reachback for additional guidance when faced with unforeseen complications while conducting WMD-E missions, and in situations where the concept of operations and tactics, techniques, and

procedures (TTP) or SOP no longer apply. Staffs work within the commander's intent to direct subordinate units and specialized teams and control resources supporting WMD-E operations.

5-9. The commander's intent focuses the operations process. This process (plan, prepare, and execute with continuous assessment) is described in detail in FMI 5-0.1 and FM 5-0. Although planning, preparing, executing, and assessing occur continuously in operations, they need not occur sequentially. The CBRNE operational headquarters must prepare to perform all four actions simultaneously, and the commander's intent is at the center of the process.

5-10. The operations, intelligence, and targeting process are most prominent in driving the MDMP, WMD-E task organization, mission assignment and execution, and WMD-E mission assessment activities. This synchronized process generates planned WMD-E missions and transforms opportunity targets into executable and supportable WMD-E missions.

ENABLING INFORMATION SUPERIORITY

5-11. Commanders can neither make decisions nor act to implement them without information. The amount of information that is available today and will be in the future makes managing information and turning it into effective decisions and actions critical to success. Since effective C2 depends on getting RI to the right person at the right time, information management (IM) is crucial to C2. IM narrows the gap between RI commanders require and the RI they have. C2 systems manage information for one overriding purpose—to enable commanders to make timely decisions in spite of the fog and friction of operations. All information given to commanders must be RI; that is, commanders should only receive information they need to exercise C2. Staffs ensure this RI is accurate, timely, usable, complete, precise, and reliable.

5-12. Reconnaissance performed by CBRN and other elements provides information. In the general sense, *information* is the meaning humans assign to data, while in the context of the cognitive hierarchy; it is data that have been processed to provide further meaning (FM 6-0). Information gives structure and shape to military operations and the OE (see FM 6-0). Commanders and staffs can then give meaning to and gain understanding of the events and conditions in which they make decisions and conduct operations.

5-13. *Relevant information* encompasses all information of importance to the commander and staff in the exercise of C2 (FM 3-0). [Intelligence is a subset of RI.] An *operational picture* is a single display of RI within a commander's area of interest (FM 3-0), and a *common operational picture* is an operational picture tailored to the user's requirements, based on common data and information shared by more than one command (FM 3-0). Data and information from all echelons of command are shared among all users to create the COP. Although ideally the COP is a single display, it may include more than one display and information in other forms. By applying judgment to the COP, commanders achieve SU, upon which they base decisions. However, maintaining an accurate COP is complex and difficult. IM contributes to the information superiority necessary for an accurate COP.

5-14. IM is a component of all C2 systems. *Information management* is the provision of RI to the right person at the right time in a usable form to facilitate SU and decision making. It uses procedures and information systems to collect, process, store, display, and disseminate information (FM 3-0). IM provides structure through which to process and communicate information and to put decisions into action. Therefore, it is a contributor to information superiority.

5-15. Information becomes RI if it supports exercising C2 for a mission and is accurate, timely, usable, complete, precise, and reliable. RI provides the basis for creating and maintaining the COP and the substance of execution information. It is the basis for achieving SU. Commanders state the RI they need by establishing the CCIR. The commander alone decides what information is critical based on his experience and the estimate of the situation, the mission, input from his staff, and the higher commander's intent. CCIR consist of two primary components (see Figure 5-2, page 5-4):

- **Priority intelligence requirements.** *Priority intelligence requirements* are those intelligence requirements for which the commander has an anticipated and stated priority in planning and decision making (JP 2-01.1).

- **Friendly force information requirements (FFIR).** *Friendly force information requirements* are information the commander and staff need about the forces available for the operation (FM 6-0). This could include unit strength, disposition, capability, and readiness.
- **Essential elements of friendly information (EEFI).** EEFI are not CCIR but become priorities on a level with CCIR when a commander designates them. They also generate CCIR (usually PIR to determine if the enemy is collecting against or has detected EEFI). *Essential elements of friendly information* are the critical aspects of a friendly operation that, if known by the enemy, would subsequently compromise, lead to failure, or limit success of the operation and, therefore, must be protected from enemy detection (see FM 3-0).

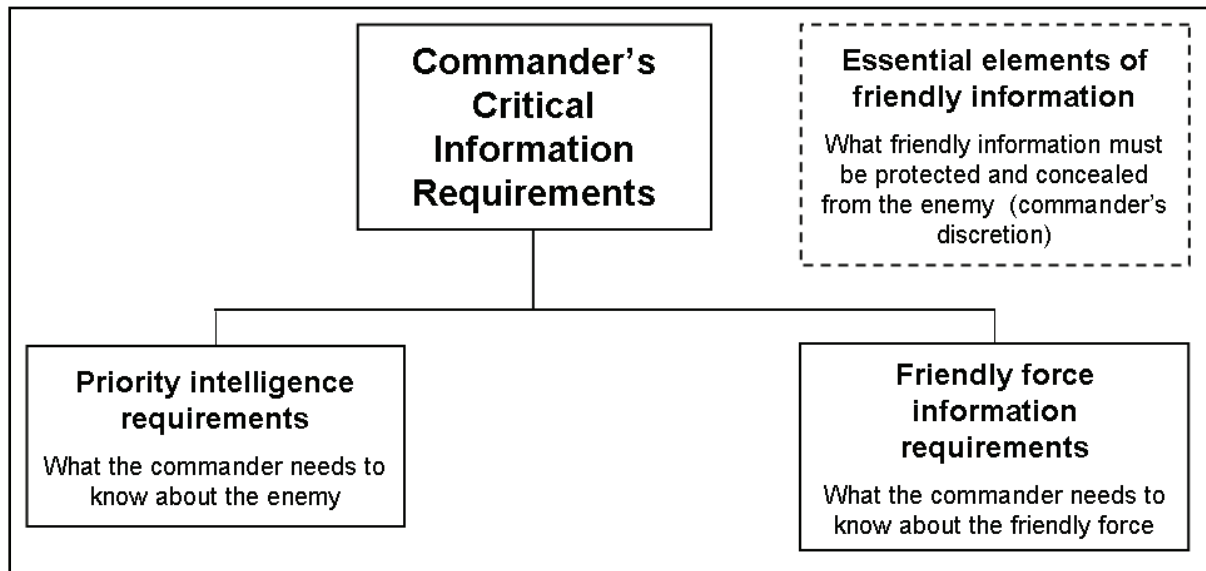

Figure 5-2. CCIR

5-16. IM, including priorities commanders set by establishing and continuously updating their CCIR, support commanders' achieving and maintaining SU. SU and commander's visualization are based on RI provided by functional experts in the C2 system who process data into information. As commanders achieve SU, they use commander's visualization to determine the end state and the ways of getting from the present state to the endstate. Figure 5-3 graphically depicts the commander's development of SU.

5-17. At the start of the MDMP, the commander expects to have gaps in information needed to plan and execute WMD-E missions. Nevertheless, they make some initial decisions. The commander must decide and articulate to the JOC/OCP staff which information, including intelligence, is needed to fill those gaps and attain a comprehensive SU before task organizing for WMD-E missions. Commanders use CCIR to focus information collection on RI they need to support the commander's visualization and make critical decisions. Staffs translate CCIR into execution information by tasking assets to collect the information required to answer them. For example, the MCP may provide the JOC/OCP critical technical reachback support for planning and executing WMD-E missions.

5-18. ISR is an integral part of the WMD-E mission. The ISR plan is not an military intelligence-specific product and is often the most important parts of providing information and intelligence that contributes to answering CBRNE and WMD-E-specific CCIR. The JOC/OCP may combine the efforts of traditional CBRNE forces and specialized WMD-E elements to conduct networked CBRNE/WMD-E reconnaissance. See FM 3-11.19 for more discussion on CBRN reconnaissance.

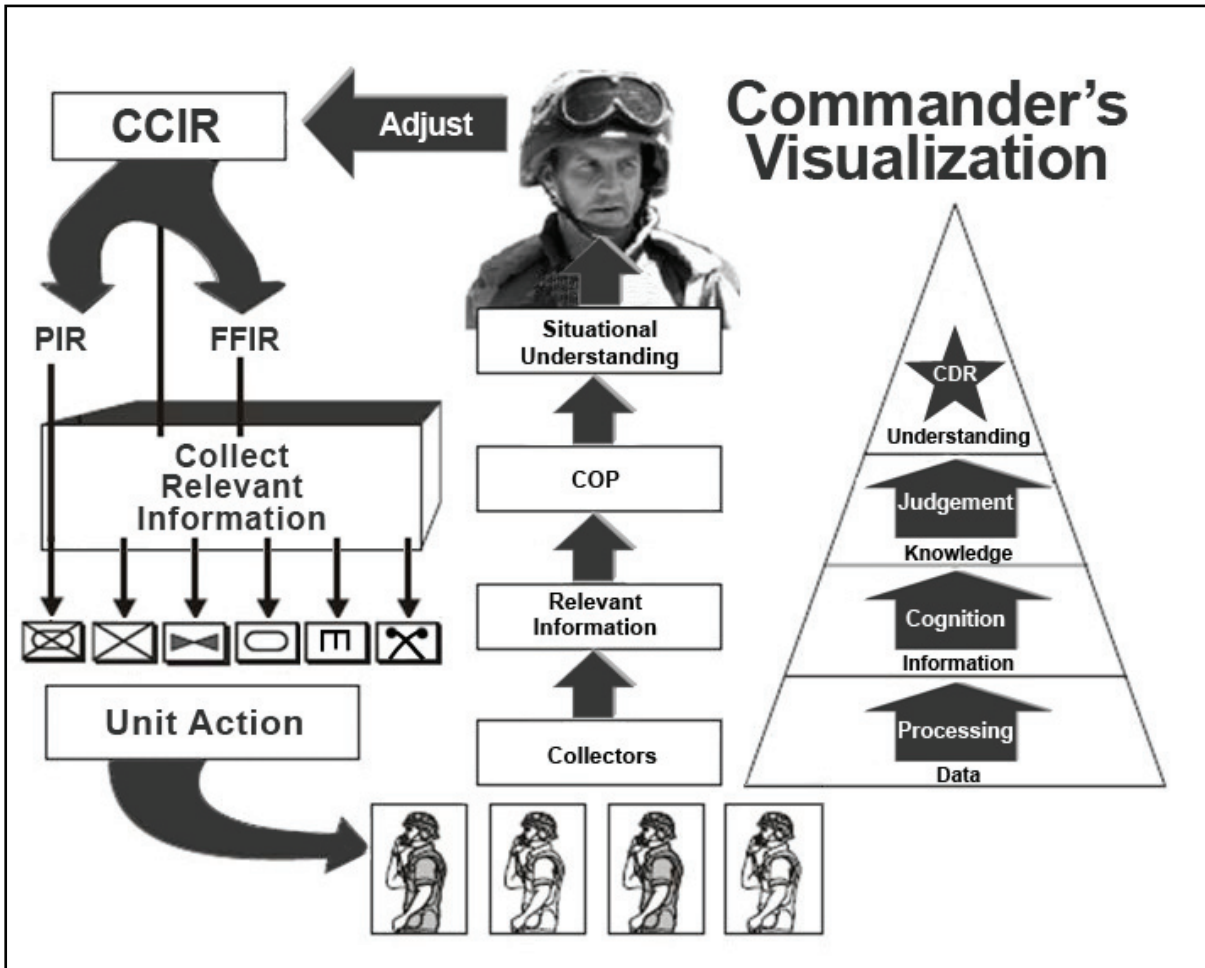

Figure 5-3. Developing SU

5-19. The MDMP application requires specific information to make decisions, develop courses of action (COAs), and issue orders. ISR information is critical and relative to time. This information may contribute to the staff's and the commander's improved understanding of information that may impact ongoing and future WMD-E operations. The JOC/OCP will analyze the information collected and incorporate it into the planning process.

THE OPERATIONS PROCESS

5-20. Full spectrum operations follow a cycle of planning, preparation, execution, and continuous assessment (see Figure 5-4, page 5-6). These cyclic activities may be sequential or simultaneous. They are usually not discrete; they overlap and recur as circumstances demand. As a whole, they make up the operations process. The operations process consists of the major C2 activities performed during operations: planning, preparation, execution, and continuous assessment. Battle command drives the operations process. Throughout the operations process, commanders synchronize forces and WFFs to accomplish missions. They use the operations process model to help them decide when and where to make decisions, issue guidance, and provide command presence. Commanders and staffs develop and use control measures for this coordination.

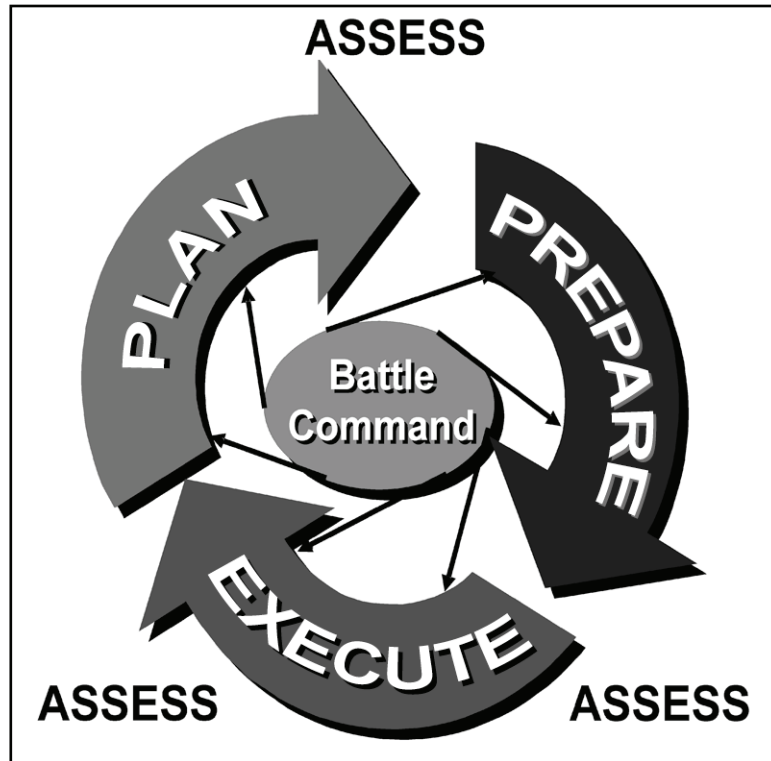

Figure 5-4. Operations process

5-21. During planning, the commander's intent drives the MDMP. The commander and staff use the MDMP to develop plans and orders (see FM 5-0). The MDMP is not a stand-alone process; it is synchronized with several other processes. These other processes do not occur at distinct points within the MDMP. They may occur before, during, or after the MDMP.

THE MILITARY DECISION-MAKING PROCESS

5-22. Planning is a form of decision making. *Decision making* is selecting a course of action as the one most favorable to accomplish the mission (FM 6-0). Not all decisions require the same level of planning. Commanders make hundreds of decisions during operations in an environment of great uncertainty, unpredictability, and constant change. The commander makes some decisions very quickly. Other decisions are deliberate, using the MDMP and a complete staff to create a fully developed and written order. The MDMP is defined in detail in FM 5-0 (see Figure 5-5). JP 5-0 provides the planning construct in a joint environment in much the same manner.

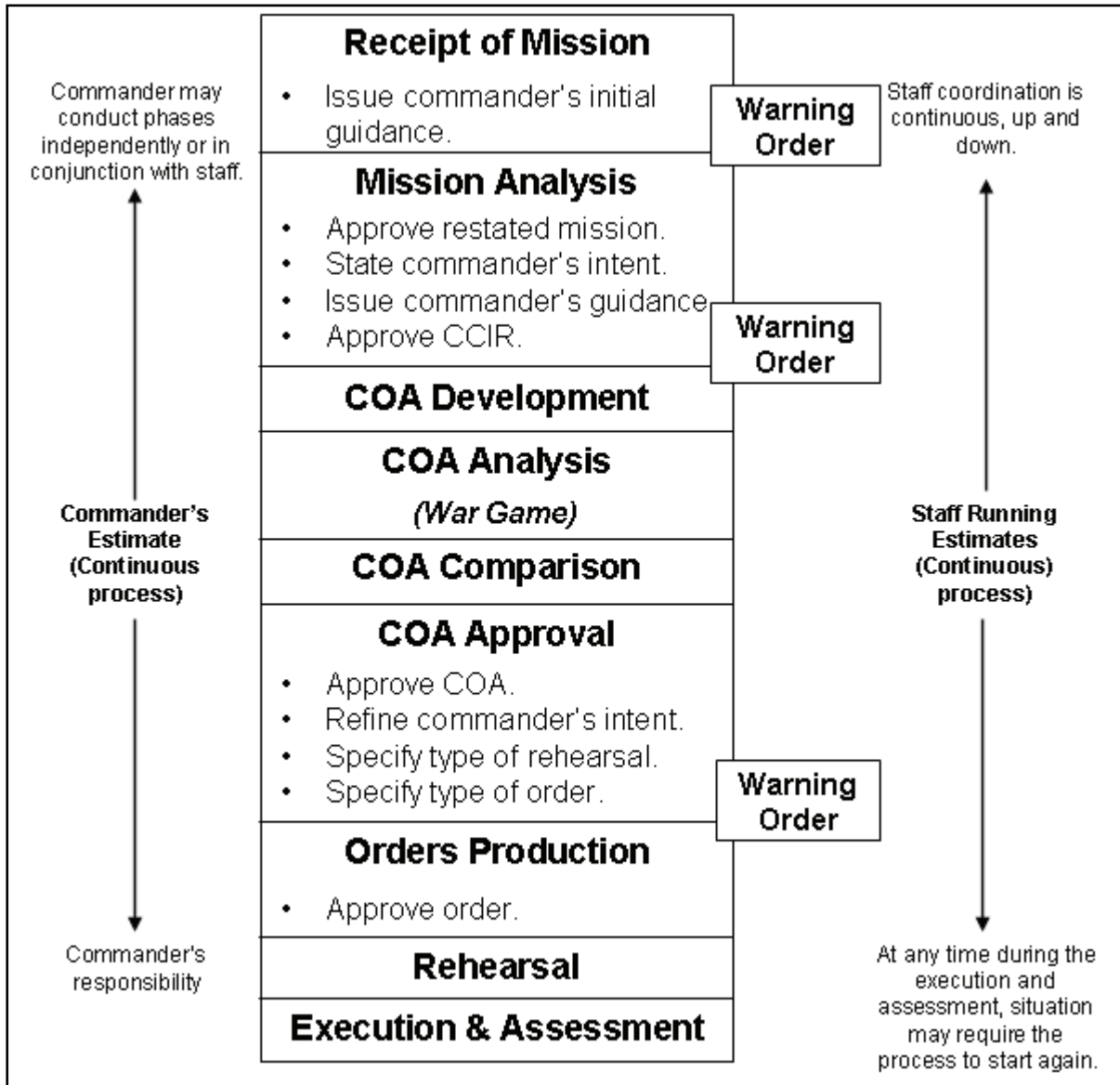

Figure 5-5. The MDMP

RUNNING ESTIMATE

5-23. The staff running estimate is used as a logical thought process and extension of the MDMP. It is conducted by all staff sections, concurrently with the planning process of the supported force commander, and is continually refined. This estimate allows for early integration and synchronization of CBRNE considerations into combined arms planning processes. In their staff running estimates, staff sections continuously consider the effect of new information and update the following: assumptions, friendly force status, effects of enemy activity, civil considerations, and conclusions and recommendations. A section's staff running estimate assesses the following:

- Friendly force capabilities with respect to ongoing and planned operations.
- Enemy capabilities as they affect the section's area of expertise for both current operations and future plans.
- Civil considerations as they affect the section's area of expertise for both current operations and future plans.

- Environment's effect on current and future operations from the section's perspective.

5-24. The development and continuous maintenance of the staff running estimate drives the coordination between the CBRNE staff, supporting CBRNE or other elements, the supported commander, and other staff officers in the development of plans, orders, and the supporting annexes. Additionally, the allocation of CBRNE assets and resources assists in determining command and support relationships that will be used.

MISSION ANALYSIS

5-25. Mission analysis is the most important step of the planning process. Mission analysis allows the commander and staff to visualize the OE—to see the troops, the enemy, and the terrain/environment. The goal of mission analysis is to develop SU relative to the mission. Along with conducting a running estimate, the CBRNE staff begins developing the CBRNE vulnerability assessment, the mission-oriented protective posture analysis, the CBRNE threat status, CBRNE vulnerability reduction and protection measures, employment status, and task organization of subordinate CBRNE units and organic specialized teams.

5-26. To help the commander analyze and restate the mission quickly, the CBRNE staff begins analysis as soon as the order is received. The CBRNE staff identifies constraints, restrictions, and specified and implied tasks contained in their portion of the order.

5-27. The commander or CBRNE staff identifies the essential tasks (which define mission success) and includes them in the restated mission. The restated mission contains the elements of what, when, where, and why the unit will execute. Mission analysis consists of multiple tasks, which are not necessarily sequential. This gives the CBRNE staff a frame of reference to assess the commander's work and develop their own visualization.

ROLE OF INTELLIGENCE

5-28. The role of CBRNE intelligence is focused to ensure that leaders understand the full technological capabilities of the threat. With this understanding, leaders can adopt appropriate countermeasures, operations, and tactics. The strength of the U.S. military lies, in part, to the diversity and extent of its technology base. While the U.S. aspires to be the leader in integrating technology, the threat can achieve temporary technological advantage in certain areas by acquiring modern systems, advanced technological knowledge, or specific capabilities. The world arms market is willing to provide these advanced systems and materiel to countries or individuals with the resources to pay for them. In many other cases, commercial off-the-shelf technologies can be modified to perform the same function as technologies generally used for military applications. A concerted TECHINT program focused on CBRNE capability is vital to providing precise direction and purpose within the U.S. research and development process to ensure quick and efficient neutralization of this advantage.

INTELLIGENCE GOALS

5-29. CBRNE intelligence has three primary goals:

- To ensure U.S. armed forces maintain technological advantage against any adversary.
- To ensure U.S. armed forces maintain proper protection levels.
- To provide tailored, timely, and accurate CBRNE intelligence to the planners and leaders throughout the spectrum of operations.

INTELLIGENCE COLLECTION AND PROCESSING

5-30. In this example, the commander, JTF-E receives mission-oriented intelligence on enemy forces within the JOA from the higher headquarters J-2. The J-2 depends upon the ISR effort to collect and provide information on the enemy and the OE. Figure 5-6 depicts a cyclical process of receiving intelligence from multiple means into the technical response fusion cell. Intelligence is analyzed and if necessary, reachback to technical level WMD experts is accomplished via requests for information (RFIs).

Intelligence fusion enables the JOC current operations and future operations planners to synchronize operations.

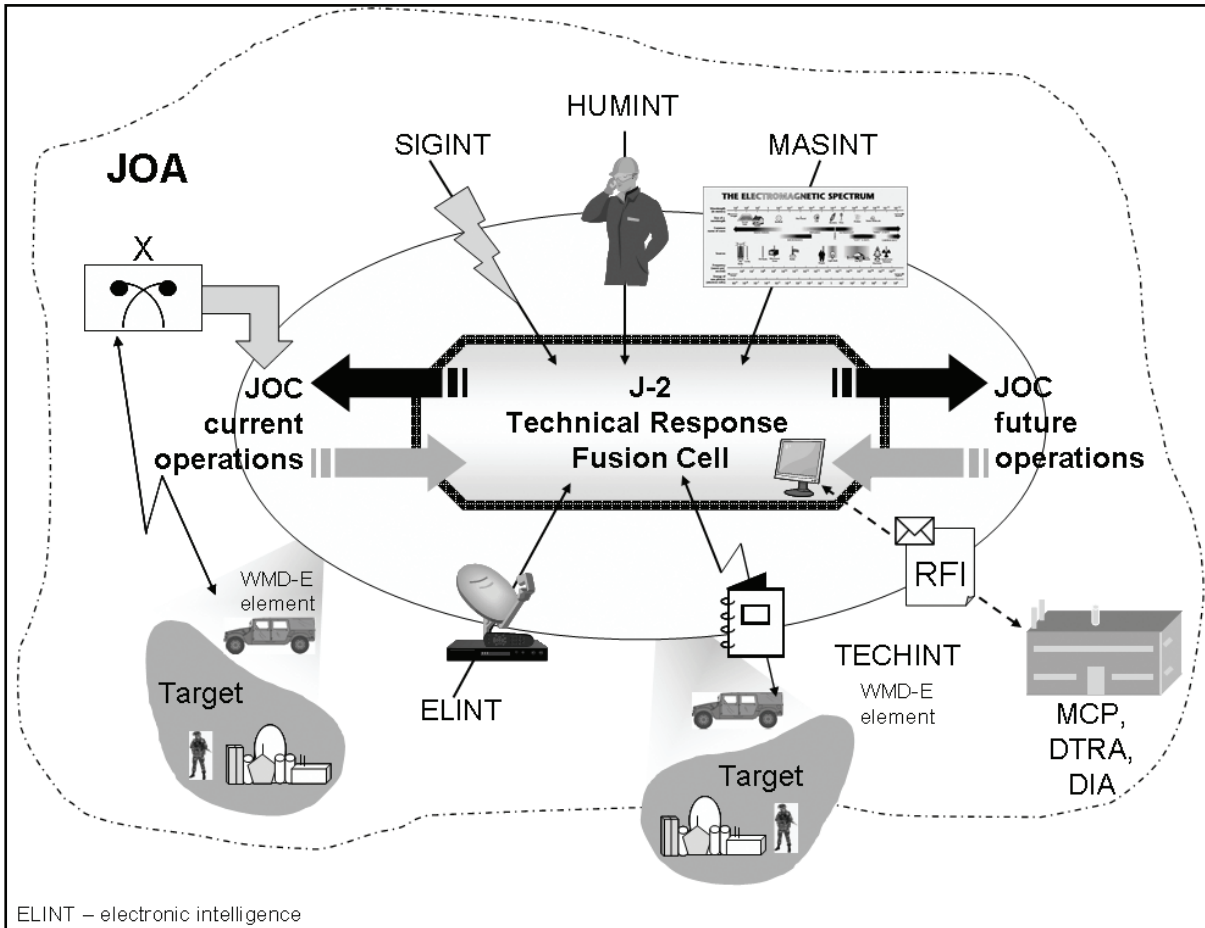

Figure 5-6. TECHINT collection and processing

INTELLIGENCE PROCESSING

5-31. WMD-E intelligence collection includes locating, capturing, exploiting, reporting, and evacuating or destroying captured enemy materiel. WMD-E intelligence collection usually begins when an organization or individual reports the identification of a site used to produce or store WMD materiel or the acquisition of an unusual, new, or newly employed threat materiel. However, there are often indications that the enemy may have acquired materiel not yet associated with the threat among the myriad of intelligence products available. Conversely, it may be known that the threat is using a particular item, the capabilities of which are unknown to U.S. forces.

CAPTURING SUSPECT MATERIEL

5-32. Military units will normally safeguard captured enemy materiel and report it through intelligence channels in their reporting chain. The location of WMD-E/CBRNE intelligence elements will be positioned according to the METT-TC factors; however, there may be WMD-E/CBRNE representation at the corps G-2 or the CCDR J-2 as well as division level organizations. The WMD-E/CBRNE representative or element will contribute to verifying if the type of WMD materiel is of intelligence value and determine its further disposition in conjunction with the unit's staff.

EXPLOITING PLANNED AND OPPORTUNITY TARGETS

5-33. At each successive echelon of exploitation, WMD-E intelligence analysts add to the overall body of information on an item by either adding to previous reports or by preparing new reports. The designated J-2 exploitation cell or other national level scientific and TECHINT activities prepare more advanced technical reports and analysis.

REPORTING INTELLIGENCE INFORMATION

5-34. WMD-E intelligence is of critical importance to the JTF-E, including answers to the PIR. Intelligence is disseminated via the most expeditious means possible. Routine WMD intelligence reports and products are usually transmitted through the unit's existing intelligence communications architecture or intelligence reachback technologies. WMD-E intelligence products are reported or disseminated in a variety of forms. The requestor must ensure that the WMD intelligence product can be transmitted over the available or selected communications systems. This includes verifying the appropriate security level of the communications systems.

ANALYSIS OF INTELLIGENCE INFORMATION

5-35. WMD-E TECHINT analysts use checklists established by scientific and TECHINT agencies, laboratories, and the JTF-E designated J-2 intelligence cell to analyze each type of the adversary's WMD materiel for which intelligence requirements exist. Analysis always begins with what is and what is not known about the WMD materiel. WMD-E units maintain procedures and plans for sampling, analyzing, and handling materiel.

5-36. WMD-E intelligence processing starts (simultaneously with collection) with the identification of a suspected WMD site or the capture of WMDE materiel of intelligence value. According to METT-TC factors, a WMD-E team may move to the location of the materiel at the capture site or wait until the WMD materiel is evacuated before verification. After verification, the WMD-E team decides if further exploitation is required. If the materiel is verified as WMD materiel of intelligence interest, the information is sent to the J-2.

COMMANDER'S CRITICAL INFORMATION REQUIREMENTS

5-37. The establishment of CCIRs are important to the planning process and the conduct of operations. A *commander's critical information requirement* is an information requirement identified by the commander as being critical to facilitating timely decision-making. The two key elements are friendly force information requirements and priority intelligence requirements (JP 3-0).

5-38. The commander, JTF-E has specific information requirements, directly affecting decisions and successful execution of WMD-E operations. CCIR are prioritized information requirements that are identified and approved by the commander. Once answered, CCIRs enable the commander to better understand the flow of the operation, identify risks, and make timely decisions to fulfill his intent and retain the initiative.

Commander's Critical Information Requirements Development and Management

5-39. When a CCIR is met or indications that one is about to be met, it is announced to all members of the staff and appropriate subordinate operations centers. As CCIRs are obtained, the JOC staff will validate reports using at least two sources when appropriate—and when time and/or mission allows.

5-40. The JOC staff will develop a collection plan for each CCIR and assign them to the appropriate staff section. As part of the validation process, each CCIR is analyzed for implications on current and future WMD-E operations.

5-41. CCIRs are briefed to the commander, JTF-E and include recommendations or modifications to current CCIRs, and may recommend additional CCIRs. CCIRs are continually assessed for relevancy

(against the agreed upon measures of effectiveness) even while WMD-E operations are underway. Figure 5-7 is an example of the CCIR development and review process as it specifically applies to a JTF-E.

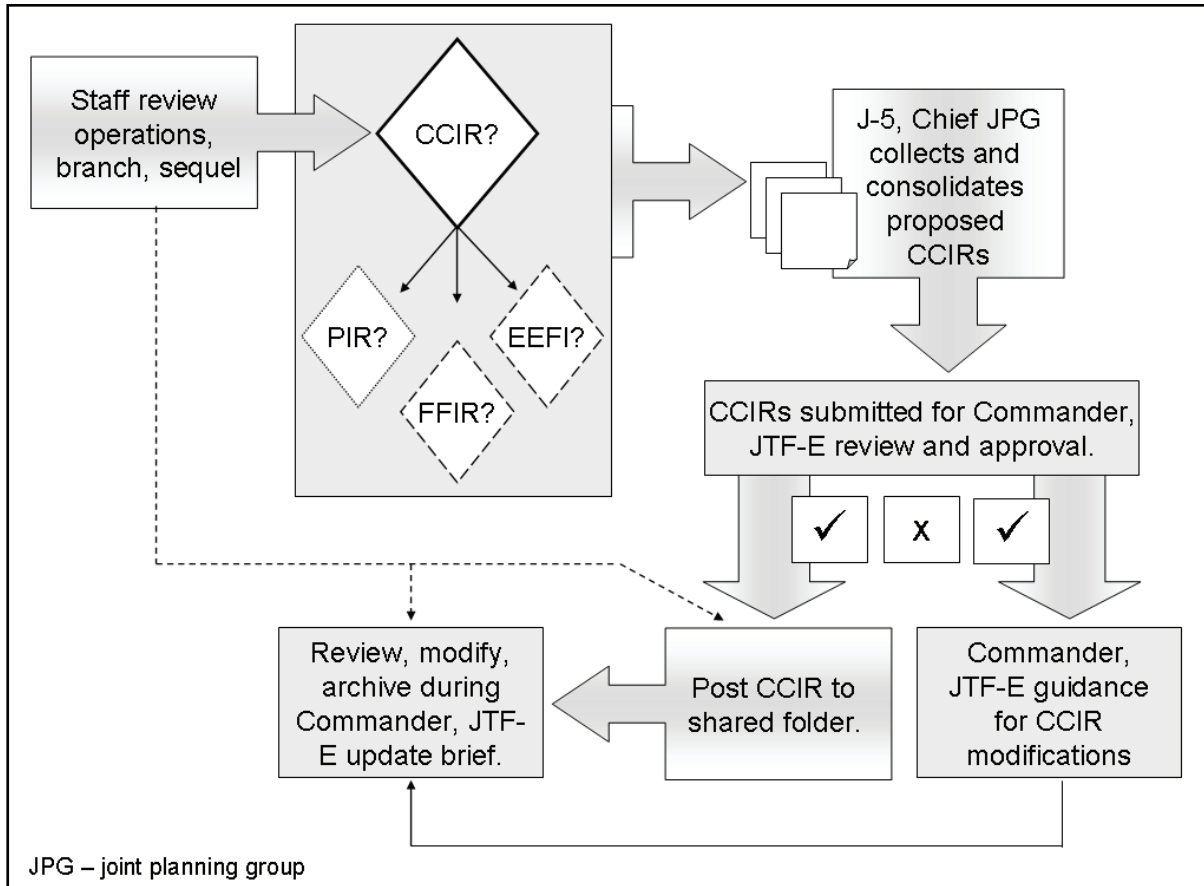

Figure 5-7. CCIR development and review process

Commander’s Critical Information Requirements for Intelligence

5-42. Intelligence focused CCIRs for WMD-E operations fall into two categories: pre-discovery of WMD materiel, or; and post-discovery of threat WMD capabilities. Pre-discovery could be described as a situation when capabilities are known to exist to manufacture, produce, and/or store WMD in various delivery platforms. Post-discovery could be described as a situation where U.S. forces have reliable information that the enemy has used WMD or there is an incident involving WMD. Both are considered by intelligence analysts along with pre-discovery intelligence CCIRs, but are separately categorized because of the immediacy of a no notice event and crisis action planning. Both CCIR types help to validate assumptions about the OE and the threat.

5-43. CCIR help the staff focus on the information the commander requires and feels is critical. This enhances the staff’s ability to integrate (filter) information and remain focused on the information of the highest value. CCIR may change as events unfold and they require continuous assessment for relevance to current and future situations. Listed below are examples of some pre- and post-discovery CCIRs:

- Pre-discovery Commander’s critical information requirements.
 - Is there credible evidence that a WMD capability exists?
 - Has a suspected state, nation, or terrorist group been identified?
 - Is it a domestic or foreign terrorist group?
 - Is the group capable of successfully employing a CBRNE weapon?
 - Has a specific locations been identified as the target?

- Has a specific target(s) been identified?
- Is the target civilian or military?
- What is the significance/importance of the target(s)?
- Has the target(s) been designated as critical infrastructure?
- What resources/infrastructure does the target have to mitigate CBRNE effects or assist in mitigating CBRNE effects?
- What kind of CBRNE weapon will the terrorists likely employ?
- How will the weapon be deployed (for example air, land, or sea)?
- What is the size/yield of the weapon and/or quantity of material to be used?
- Will weather aggravate or mitigate the effects of the weapon?
- Will weather facilitate or impair WMD-E support operations?
- Will terrain aggravate or mitigate the effects of the weapon?
- Will terrain facilitate or impair WMD-E operations?
- Post-discovery Commander's critical information requirements.
 - What kind of CBRNE weapon was used?
 - What were the immediate effects (personnel, equipment, and infrastructure) of the CBRNE weapon?
 - What are the long term effects of the CBRNE weapon on personnel, equipment, and infrastructure?
 - Did the environment (terrain or weather, for example) mitigate or aggravate the CBRNE effects?

INTELLIGENCE, SURVEILLANCE, AND RECONNAISSANCE

5-44. ISR is also critical to the planning process and the conduct of operations. *Intelligence, surveillance, and reconnaissance* is an activity that synchronizes and integrates the planning and operation of sensors, assets, and processing, exploitation, and dissemination systems in direct support of current and future operations. This is an integrated intelligence and operations function. (JP 2-01.1).

5-45. Tracking of adversary activity enables commanders to maintain comprehensive intelligence on adversaries' capabilities and possibly gain information on their intentions. Monitoring WMD programs is often complicated by the dual-use nature of chemical, biological, radiological, and nuclear materials. Pharmaceutical and petrochemical factories can mask chemical and biological weapons production programs. Radiological materials are commonly used in support of the medical community, and all nuclear reactors, whether designed specifically for peaceful electric-power production or for production of weapons-grade material, produce plutonium of various grades that can be used to make nuclear weapons. Distinguishing between peaceful civilian industrial use and hostile use requires robust intelligence and surveillance capabilities.

5-46. ISR is an integral part of the warfighting mission. Because the MDMP application requires specific information to make decisions, develop COAs, and issue orders, ISR information is critical, relative to time, during mission analysis. The commander and staff deploy reconnaissance assets early in the planning process to facilitate early collection. The commander and staff analyze the information collected and incorporate it into the planning process. As stated previously, the ISR plan is not a military intelligence-specific product and is often the most important part of providing information and intelligence that contributes to answering CBRNE-specific CCIR.

5-47. Commanders integrate CBRNE reconnaissance missions and surveillance means to form an integrated ISR plan that capitalizes on their different capabilities. CBRNE reconnaissance is often the most important part of this activity, providing data that contribute to answering the CCIRs. As such, commanders conduct it with the same care as any other operation. CBRNE reconnaissance operations are normally executed before completing the plan. In fact, information on which the final plan is based is often gathered by CBRNE reconnaissance operations executed while the overall command is in the preparation

phase. Timely and accurate intelligence of the WMD/CBRNE threat and hazards encourages audacity and facilitates actions that may negate enemy superiority in personnel and materiel.

5-48. Commanders direct CBRNE reconnaissance using the ISR annex to the order. (See FM 5-0.) They should consider requesting assistance from sources outside of their control, including long-range surveillance teams and joint assets. Commanders ensure the synchronization of CBRNE reconnaissance missions with the other ISR components to continuously update and improve their SU.

5-49. CBRNE reconnaissance is not a static, one-time effort that achieves a goal and stops. As reconnaissance forces gather information, the staff modifies the collection plan to account for new information and to redirect ISR efforts. Commanders and staffs continuously review intelligence products and synchronize their reconnaissance efforts within the ISR plan. They focus on the most important remaining gaps, emphasizing the established or revised CCIRs. Because most CBRNE reconnaissance elements can only accomplish presumptive identification for WMD, specialized CBRNE assets will be required to complete reconnaissance beyond that point. Commanders balance several factors against their need for RI. This includes—

- The ability of CBRNE reconnaissance units to gather the information.
- The risk to CBRNE reconnaissance assets during collection of information and samples.
- The ability to sustain the CBRNE reconnaissance effort over time.
- The requirement to have CBRNE reconnaissance assets available at critical times and places.

5-50. The result is a continuous feed of RI that facilitates the commander's SU and ultimately allows him to make better decisions.

INTELLIGENCE LIAISON (TO SUPPORTED HEADQUARTERS)

5-51. J-2 intelligence support to echelons below corps is normally provided by a WCE or other elements subordinate to the CBRNE operational headquarters/JTF-E headquarters, such as a CBRN brigade or EOD group intelligence officer (S-2), or an EOD or CBRN battalion S-2.

5-52. WCE's ensure WMD-E intelligence information is fused with other intelligence disciplines. They assist the supported unit in synchronizing WMD-E intelligence collection requirements with the higher headquarters and supported headquarters collection plan. WCE members will assist the supported headquarters intelligence staff with WMD-E specific TECHINT. In that capacity, the WCE's primary goal is to determine whether the results of the WMD-E intelligence production meet the unit's PIR or intelligence requirements.

5-53. The WCE assigned to a supported command will contribute to assessing WMD related intelligence products for accuracy and relevance. WCE personnel will conduct an analysis to determine if the received intelligence information answers the commander's PIR or intelligence requirements. WCE's will provide feedback to WMD-E intelligence analysts to improve the effectiveness and efficiency of the WMD-E intelligence process. The WCE will also assist the supported unit in developing and evaluating the success of ISR efforts and with dissemination of assessments to the JTF-E headquarters, its staff, and pertinent units or personnel.

INTELLIGENCE REACHBACK

5-54. WMD-E missions are complex and by nature present highly technical life-threatening hazards to specialized WMD-E teams. The JOC/OCP staff works in unison with supported headquarters to achieve SU for each WMD-E mission or target. The JOC/OCP will immediately establish an ongoing dialogue with subordinate units G/S-2 personnel to establish and synchronize intelligence collection and RFI requirements.

5-55. WMD-E teams often rely on reachback to provide information for further analysis to more thoroughly understand how to best solve technical issues. TECHINT requirements may require reachback to national level intelligence sources. RFI may originate from WMD-E teams providing support to a unit or from independent specialized teams assigned a more specific mission by the JOC/OCP or subordinate headquarters. The JOC/OCP staff will validate intelligence information and forward and track RFIs. RFIs

that cannot be answered by resident SMEs are typically sent to USJFCOM using the community on-line intelligence system for end users and managers.

5-56. RFIs from specialized WMD-E teams are often not raw intelligence but more technical information in nature. The MCP reachback cell located in “sanctuary” is the focal point and fusion center to assist forward deployed WMD-E elements in investigating technical and scientific issues. Some WMD-E intelligence RFI may be submitted to The Department of Justice Intelligence Operations Center at the DIA.

JOINT TARGET DEVELOPMENT

5-57. The CBRNE Operational Headquarters will be closely involved in the targeting process. Missions will come to the Operational Headquarters through the targeting process. Targets fall into two general categories: planned and immediate. Planned target have gone through the entire targeting process and the deliberate planning process before they are serviced. Immediate targets would be targets found during the execution of another mission and the planning for these targets would be simultaneous to servicing and follow and abbreviated planning process.

5-58. Although targets can be a geographical area, complex, or installation planned for capture or destruction by military forces, targets also include the wide array of mobile and stationary forces, equipment, capabilities, and functions that an enemy commander can use to conduct operations. Target development, also called *targeting*, is the process of selecting targets and matching the appropriate response to them on the basis of operational requirements, capabilities, and limitations (JP 3-0).

5-59. A *joint targeting coordination board* is a group formed by the joint force commander to accomplish broad targeting oversight functions that may include but are not limited to coordinating targeting information, providing targeting guidance and priorities, and refining the joint integrated prioritized target list. The board is normally comprised of representatives from the joint force staff, all components, and if required, component subordinate units (JP 3-60).

5-60. The JOC/OCP receives targeting intelligence from the supported commander and other intelligence sources. WMD-E target nomination and tracking is normally developed at the joint level. A joint targeting coordination board (JTTCB) provides a forum in which all components can articulate strategies and priorities for future operations to ensure that they are synchronized and integrated. The JTTCB normally facilitates and coordinates joint force targeting activities with the components’ scheme of maneuver to ensure the JTF commander’s priorities are met.

5-61. Targeting is an integral part of WMD-E planning and the decision-making processes. The commander, JTF-E/CBRNE operational headquarters relies on tactical level commanders to effectively synchronize the targeting process. The commander, JTF-E/CBRNE operational headquarters best influences the outcome of future WMD-E missions by setting the conditions for WMD-E missions and planning the resources (such as security, linguist, and logistical supplies) to provide reliable WMD-E mission support. The targeting process is accomplished by the components applying service-developed TTP within a joint framework established by the commander.

5-62. Successful targeting for the commander, JTF-E/CBRNE operational headquarters means identifying and prioritizing WMD-E targets and approaching mission planning and task organization after reviewing and considering essential target information.

Targeting Cycle

5-63. The joint targeting cycle is a continuous six-phased process and is shown below.

- **Phase 1.** Commander’s objectives, guidance, and intent.
- **Phase 2.** Target development, validation, nomination, and prioritization.
- **Phase 3.** Capabilities analysis and force assignment.
- **Phase 4.** Commander’s decision and force assignment.
- **Phase 5.** Mission planning and force execution.
- **Phase 6.** Combat assessment.

5-64. The commander, JTF-E provides advice to the JFC to help set priorities, provide clear targeting guidance, and determine the weight of effort to be provided for WMD-E operations. To accomplish this, the commander, JTF-E identifies high-value and high-payoff targets for WMD-E to meet the CCDR or the land component commander guidance to achieve assigned missions and objectives.

5-65. The primary focus of the JTCB is to ensure the target priorities, guidance, and associated effects are linked to the commander JTF's objectives. Briefings at the JTCB should focus on ensuring that targeting efforts are coordinated and synchronized with intelligence and operations (by all components and applicable staff elements). The JTCB reviews targeting information developed by senior officers.

Targeting Products

5-66. Products normally produced at a JTCB are—

- The joint target list.
- Restricted target list.
- No-strike list.
- Targeting assessment.
- Joint integrated prioritized target list.

Target Intelligence

5-67. Target intelligence performs the following functions:

- Provides target development support at the operational/tactical level.
- Collates and reports battle damage assessments.
- Performs target analysis.
- Supports requirements for target intelligence from the CCDR or designated coalition headquarters and the JTCB.

Joint Mission Coordination Board Elimination

5-68. The joint mission coordination board elimination (JMCE) is an organization option that the commander, JTF-E may employ to coordinate and de-conflict WMD-E operations. The JMCE is analogous in function to the JTCB—although the JMCE is likely to be a smaller organization. The purpose of the JMCE is to coordinate selected site missions with the command staff in the JTCB for each day's mission cycle; and de-conflict any daily JTCB targets with ongoing or potential WMD-E missions to ensure that appropriate specialized teams and support assets and priorities are assigned.

Targeting Board Process

5-69. Figure 5-8, page 5-16 depicts the organizational role and processes of a JMCE. The top half of the figure depicts the relationship at the combatant commander level. Particularly important are the intelligence processes that are managed by the combatant command J-2 and the coordination between the operations directorate of a joint staff; operations staff section (J-3), the plans directorate of a joint staff; plans staff section (J-5), and the JTCB. The JMCE for elimination fulfills a key role in prioritization, coordination, and de-confliction of WMD-E requirements.

5-70. The two arrows in Figure 5-8, page 5-16 illustrate the close coordination between the JMCE and the JTCB. This ensures the WMD-E targets are properly integrated into overall targeting lists, with appropriate levels of priority. In this regard, the following are four key functions of the JMCE:

- Target development.
- Tasking considerations.
- WMD-E mission variable considerations.
- Prioritization and follow-on activities.

Tasking Development

5-71. The JMCB-E develops taskings for tactical execution of specific WMD-E requirements, which are executed by the JTF-E, or other organization(s) established by the CCDR to execute WMD-E responsibilities at the tactical level. Throughout the mission planning process, the JMCB-E coordinates closely with the JTF-E J-3, as depicted by the two-way arrow between the board and the JTF-E J-3. This may include membership by JTF-E J-3 personnel on the board, technical information to prioritize and de-conflict missions, and other advice in support of mission coordination. Finally, the JMCB-E is a critical consumer of intelligence information. The relationship between the board, the combatant command, and JTF-E J-2 organizations is depicted by the dotted arrows on the left side of Figure 5-8.

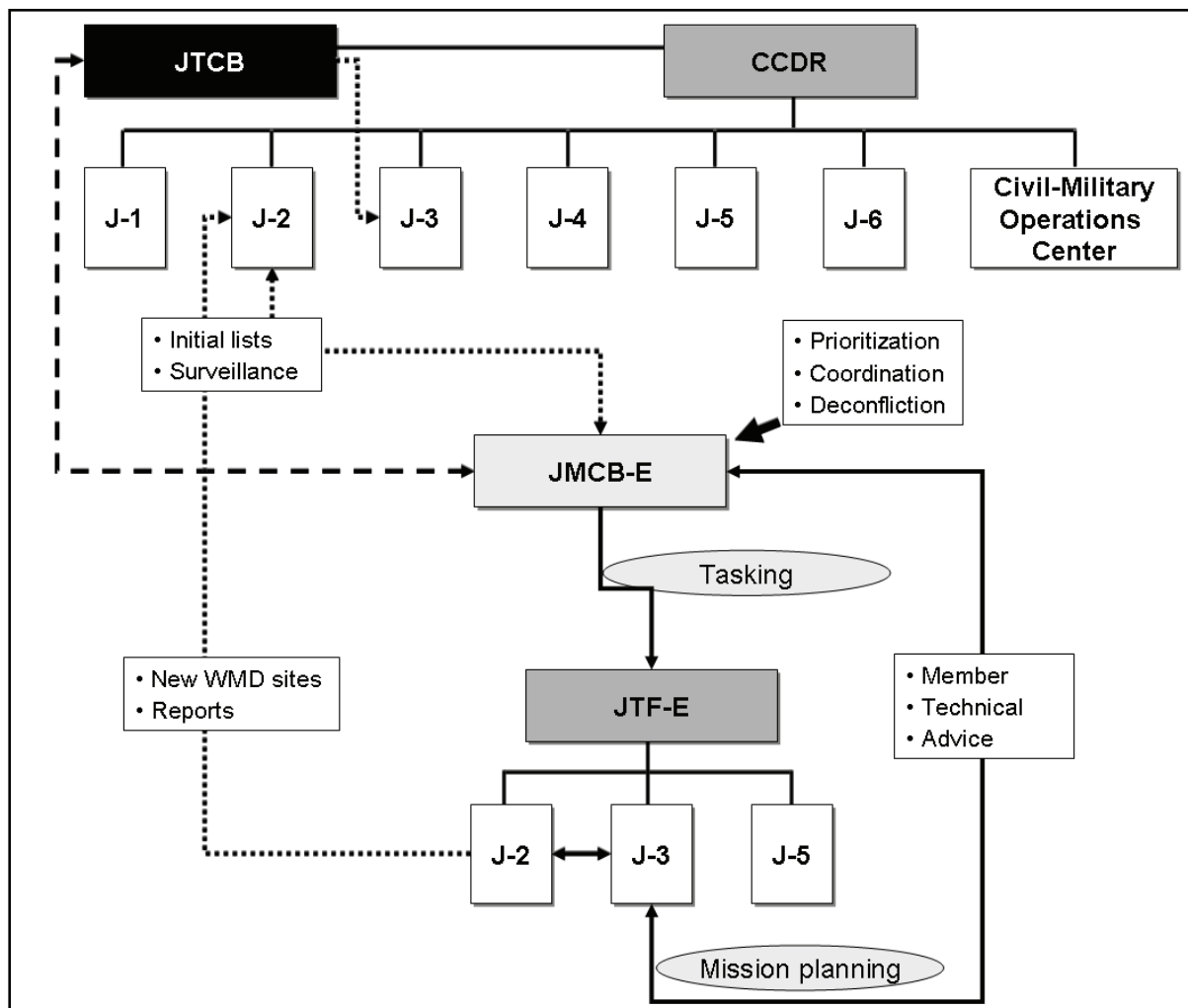

Figure 5-8. Tasking development example

Tasking Considerations

5-72. The daily tasking process of the JMCB-E is intended to incorporate a logical method for the planning, coordination, de-confliction, allocation and assignment of WMD-E missions. The JMCB-E will support this process through the development of a prioritization list for WMD-E planning. This prioritization list contains the prioritized requirements for WMD-E at each identified or suspected site in the combatant command's JOA.

Target Folders

5-73. A *target folder* is a folder, hardcopy or electronic, containing target intelligence and related materials prepared for planning and executing action against a specific target (JP 2-01.1). Joint units conduct deliberate target assessments as part of the intelligence preparation of the operational environment and prepare target folders for each site assessed. They use these folders to war game how they would respond if a CBRNE-related incident occurred at these sites and to prepare tentative CBRNE vulnerability reduction measures and response plans for each. Pertinent information collected by the units for each target is maintained in the target folder for use in a future response. Information could include floor plans, site maps, routes in and out, potential staging areas, and a determination of prevailing winds to produce downwind hazard predictions. While there is no standard format for these assessment target folders. Suggested content would include the material that is identified below.

- Target number
- Threat overview security
- Site overview
- Site history
- CBRN agent presence or other hazards
- Simulation analysis
- Agent data
- Personnel (noncombatants)
- Background information
- Graphics
 - Drawings
 - Maps
 - Photos
 - Building plans
- Site description
- Site significance
- Environmental hazards as a result of accidental release
- Terrain
- Collection strategies
- Additional site exploitation
- Command guidance
 - Contamination avoidance and desired endstate
 - Communications/technical reachback procedures
 - Special sample collection, storage, and management procedures
 - Operational exposure guidance and turn-back dose rate
- Transportation
- Roads
- Analyst comments
- Projects and agents

Prioritization and Follow-on Activities for Targeting

5-74. Additions and deletions to the targeting list and the requirement to adjust or build new target folders should be expected as a result of reports from field operations, damage assessment from special operations at WMD sites, and/or international or coalition force reports. National intelligence means and aerial surveillance should be used extensively to support the continued identification, location, and use of WMD sites on the list. Aerial surveillance of all WMD sites is an important part of establishing the prioritization list for WMD-E and should be reviewed on a daily basis (although less frequent reviews may be required

in certain types of operations and in certain conditions). During these review sessions the following activities may be accomplished by the JCMB-E:

- At the beginning of WMD-E operations, developing the initial prioritization list of all known WMD sites within the JOA. This list should contain detailed information regarding the identification, location, and characterization of each site (both confirmed and suspected). It is likely that the responsibility for the initial list will reside with the J-2 at the combatant command. Information may be made available through all national means, international agencies, and/or coalition forces.
- Incorporating new WMD sites (for both confirmed or suspected) into the prioritization list during ongoing operations involves the analysis of requirements and the assignment of priorities for any new WMD sites. The J-5 of the combatant staff should support the initial prioritization of all WMD sites once the initial list has been developed by the J-2. It should also provide prioritization of all new targets once they are added to the list.
- Providing feedback and review regarding WMD missions that are underway and those that are completed. This may include summaries of WMD-E progress made at specific WMD sites by the JTF-E (or other organization(s) responsible for execution of WMD-E tasks).
- Identification and selection of upcoming WMD sites for elimination, identifying the following three groups:
 - Those to be exploited.
 - Those to be disposed of.
 - Those to be monitored.
- With the JTCB's air tasking order, de-conflicting WMD sites to ensure that appropriate assets are assigned to each site or that the JTCB targets lists are modified to account for WMD-E considerations (such as targets are withheld from air attack and assigned to the JTF-E).
- Revisions of mission sets are assigned to the JTF-E (or other organization(s) assigned responsibility for WMD-E operations) along with suspense times for execution to be completed.
- Support of the JTF-E (or other organization(s) assigned responsibility for WMD-E operations) in analyzing the mission set and, if shortfalls in resources exist, coordinating to obtain additional resources or assesses other options to address the mission tasking until organic assets become available.
- JCMB-E planning and management materials are updated, as appropriate.

ORGANIZATIONS THAT MAY SUPPORT TARGETING

5-75. Joint targeting support comes from DOD and non-DOD organizations as required. Listed below are some of those agencies that may assist the CBRNE operational headquarters and its subordinate elements in the targeting process.

- **USJFCOM Quick Reaction Team.** The Quick Reaction Team is a nonpermanent, rapidly deployable team (with 24-hours at the request of a CCDR) of targeteers and collections managers designed to provide immediate crisis support to CCDRs. The team is integrated into existing theater intelligence organizations and deploy with no organic automated data processing or communications support.
- **Defense Intelligence Agency.** The DIA provides all-source intelligence resources on a broad array of targeting problems across the spectrum of operations. DIA provides a human intelligence (HUMINT) and measurement and signature intelligence (MASINT) capability.
- **National Security Agency.** The National Security Agency provides critical intelligence support to operational targeting. This may include analysis of communications networks or other aspects of the information architecture, as well as operational signals intelligence (SIGINT).
- **National Geospatial Intelligence Agency.** The National Geospatial Intelligence Agency provides support to targeting including imagery exploitation and the production of digital and physical maps and charts.

- **Joint Information Operations Center.** The Joint Information Operations Center is a subordinate functional component of USSTRATCOM, provides federated support, including intelligence in support of several information operations capabilities.
- **Joint Warfare Analysis Center.** The Joint Warfare Analysis Center is an element of USJFCOM, provides analysis of engineering, scientific, and intelligence data and the integration of these disciplines with requirements for target system analysis. The JWAC has specialized expertise in the analysis of civilian infrastructure including electric power, telecommunications, petroleum, oils, and lubricants, LOC, commodities, critical industries, military logistics, and strategic assessments and impacts.
- **Defense Threat Reduction Agency.** The DTRA maintains special tools and expertise for analyzing potential WMD targets and providing plume hazard projections based on destruction of targets storing HAZMAT including biological, chemical, and radiological agents. DTRA provides target characterization and high fidelity weapons effects modeling to support physical and functional defeat of hardened and deeply buried targets. DTRA also verifies existing foreign controls of stockpiles of nuclear-related equipment and materials.
- **Service-Supporting Organizations.** Service support organizations include the Army's National Ground Intelligence Center, the Office of Naval Intelligence, Marine Corps Intelligence Activity, and the National Air Intelligence Center.
- **Department of State.** The DOS is a key contributor of valuable information dealing with potential no-strike/restricted targets and nongovernmental issues.
- **Department of Energy.** Through its national laboratories, DOE provides significant CBRN process analysis data related to CP facilities and installations.
- **Other National Organizations.** Included are the Federal Bureau of Investigations (FBI), Department of Commerce, Department of Transportation, Department of the Treasury, and potentially other organizations that may provide valuable support for specific targeting although they may not normally provide such support.

PLANS AND ORDERS

5-76. The staff prepares the plan or order by turning the selected COA into a clear, concise concept of operations for WMD-E missions and mission specific required supporting information. The concept of operations for the approved COA becomes the concept of operations for the plan. The COA sketch becomes the basis for the operations overlay. Plans and orders provide all primary information that subordinates need for mission execution. Mission orders avoid unnecessary constraints that inhibit subordinate initiative. The staff assists subordinate unit staffs with their planning and coordination. See FM 3-0 for more information on plans and orders).

Planning Weapons of Mass Destruction Elimination Missions

5-77. The planning process begins with receiving or anticipating a new mission (see Figure 5-5). This mission can come from an order issued by higher headquarters or be derived from an ongoing WMD-E operation. For example, the commander may determine—based on a change in enemy dispositions, friendly-force dispositions, or other OE factors—that there is an opportunity to accomplish the higher commander's intent by a means different from the original contingency operations.

5-78. WMD-E operations require detailed planning to be successful. The planner must consider the hazards that may result from conducting a WMD-E mission and the impact of WMD-E operations on military operations, the general population, and operational and strategic plans. Assessments include mission analysis, COA development, and the analysis and comparison of enemy and friendly COAs. WMD-E planning is dynamic and continuous and requires a synchronized staff to work together to ensure that WMD-E planning is fully integrated into higher headquarters and subordinate unit plans and orders.

5-79. Planned WMD-E missions primarily originate at the CCDR level where JTCB members assign target numbers to WMD-E sites. WMD-E targets are assigned tracking numbers at these boards, and in most

cases, these planned targets are moved to a specialized WMSL. After further analysis, WMSL targets are included into a more comprehensive joint integrated prioritized target list (JIPTL).

Weapons of Mass Destruction Elimination Mission Variables to Consider

5-80. Specific WMD-E, disposition, and monitoring and redirection activities required at each site, as well as the priority assigned to them, are functions of a number of variables. The JMCB-E should analyze each of these variables when evaluating and deciding upon WMD-E priorities. These may include—

- Size of WMD facility (or facilities).
- Type of WMD facilities (or facilities).
- Nature and scope of exploitation, disposition, and/or monitoring and redirection requirements.
- Environment or level of uncertainty (hostile, uncertain, permissive).
- Time available.
- Availability of technical experts and advisors.
- Availability of transportation assets.

Command and Support Relationships

5-81. Traditional CBRNE defense units augmenting the CBRNE operational headquarters or JTF-E headquarters are typically task organized in either a command or support relationship. WMD-E elements organic to the CBRNE operational headquarters may be further task organized to a chemical brigade, EOD Group, tactical maneuver units, or to specialized forces. The command and support relationships of specialized elements supporting civil support operations will be designated in the tasking directive. Command relationships prescribe the supporting WMD-E element's chain of command and the degree of authority that a commander exercises over the WMD-E element. See FM 3-0 and FM 5-0 for further discussion of command and support relationships.

Command Relationships

5-82. WMD-E elements are task organized in a variety of ways, depending on the mission, and current and future requirements. This task-organization drives the command or support relationship decision-making process. Command authority over specialized WMD-E teams is given to the maneuver commander in support of planned (known or suspected) WMD targets. Command relationships can be designated as attached or operational control (OPCON).

5-83. An attached relationship is a more restrictive command and support relationship for a specialized WMD-E team. This is appropriate when a subordinate maneuver commander needs task organization or direct command authority over WMD-E teams or personnel for a prolonged period of time. The commander of the supported organization exercises the same degree of C2 over task-organized WMD-E assets as organic units. When attached, WMD-E elements are temporarily placed in the unit it supports. In this relationship, the WMD-E element receives all of its missions and support from the supported unit and not from the CBRNE operational headquarters/JTF-E headquarters or subordinate chemical brigade or battalion. Additionally, the supported unit commander may task organize specialized WMD-E teams or personnel as appropriate. Time, distance, and communications all play a part in the decision to choose an attached relationship. A key factor inherent in an attachment decision is ensuring that the attachment occurs as early as possible to ensure full integration into the maneuver force.

5-84. In an OPCON relationship, the WMD-E element receives all of its taskings and missions from the supported unit. The supported-unit commander retains the same authority over the WMD-E element as over organic units and may task organize the specialized WMD-E element as appropriate. Logistical support is coordinated by the CBRNE operational headquarters/JTF-E headquarters unless the CBRNE operational/JTF-E headquarters has coordinated with a subordinate chemical brigade or battalion to manage the logistical network for certain classes of supply. The OPCON relationship is appropriate when a maneuver unit needs task organization or direct-command authority over WMD-E elements; however, there is a need for the parent organization to remain responsible for providing logistical support. The supported unit will still be required to furnish Class IV/V barrier materials; and units in an OPCON status

may receive Class I, III, V, and IX support to the maximum extent possible from the supported unit. Specific support to WMD-E elements in an OPCON status must be coordinated between the parent unit and the supported unit before the OPCON directive becomes effective. The OPCON relationship is also a method of giving the maneuver commander authority over a WMD-E element when the duration of the support is short and it is likely that the supporting WMD-E element can be supported by its parent unit without impacting the established sustainment infrastructure.

Support Relationship

5-85. All command, administrative, and logistical responsibilities remain with the parent unit in a support relationship. The CBRNE commander organizes the unit and sub-allocates tasks in a manner that most effectively meets the needs of the maneuver commander. In a direct support (DS) relationship, a CBRNE unit answers directly to the supported unit's requests for support. Logistical support is provided by the parent CBRNE unit, and the CBRNE unit is commanded by its parent CBRNE unit commander. In a general support (GS) relationship, a CBRNE unit receives missions and all support from its parent CBRNE unit.

5-86. In a DS relationship, the CBRNE element answers directly to the maneuver commander's request for support. This is usually appropriate when the maneuver commander needs a high degree of responsiveness from CBRNE elements but does not need task organization authority or the burdens that go with it. All logistical support to a unit in DS is provided by the parent organization unless specific exceptions have been coordinated with the supported unit. A DS relationship is typically used when it is anticipated that a change to the CBRNE element task organization may require frequent shifting of a CBRNE element to multiple locations. The logistics system can best support this in a DS role where the parent unit remains responsible for logistics and other types of support to the unit.

5-87. In a GS relationship, the CBRNE element supports the maneuver element as a whole, not as any particular part or subdivision. This is appropriate when central control and flexibility in employing limited CBRNE forces is required.

This page intentionally left blank.

Chapter 6

Sustainment

This chapter discusses the role of logistics in support of WMD-E missions. For the most part, the CBRNE operational headquarters is dependent on the supported unit for most classes of supply and services. Specialized teams will require “push package” logistics and maintenance support coordinated and synchronized by the G/logistics directorate of joint staff; logistics staff section (J-4), especially for COTS technologies and perishable supplies and equipment that are not in the normal supply system and cannot typically be accomplished by supported units. G/J-4 logistics plans will be integrated with the other staff OPORD annexes, and coordinated with the appropriate higher echelon logistics staffs. G/J-4 personnel must be involved early in the staff planning and undertake an analysis of the logistics support capabilities of each of the COAs considered. G/J-4 planners must identify those issues unique to the operation by integrating logistical operations with the concept of operations. Examples include the location and accessibility of key supply points; critical items; bottlenecks (through-put problems); movements (airfield, seaport and main supply route capacity); civilian and HN augmentation; and possibly contractual support. See FM 4-0 for a discussion of the sustainment WFF.

SUSTAINMENT PLANNING

6-1. The CBRNE operational headquarters is designed with minimal internal sustainment capabilities. This requires that all elements from the CBRNE operational headquarters receive some level of support from the supported unit. It is crucial that this is taken into consideration during the planning process by both the CBRNE operational headquarters and the supported unit. This required support includes basic requirements in the class I, III B/P, V, VI, and some IX supply. CBRNE elements may also need administrative support like postal operations support.

SUSTAINMENT SUPPORT

6-2. The CBRNE operational headquarters typically receives its support from a sustainment brigade within the AO. The sustainment brigade is a multifunctional logistics organization providing support for multiple brigade sized units. It is tailored, task organized, and uses modular subunits (battalions, companies, platoons) to perform specific functions. The sustainment brigade is primarily concerned with the continuous management and flow of stocks, and allocation of reinforcing maintenance support in the AO to provide operational reach to maneuver commanders and other supported units.

6-3. Replenishment operations are deliberate and time sensitive logistics operations conducted by ground or air by a corps sustainment support battalion (CSSB). Nonstandard replenishment operations are also deliberate and time sensitive operations but may be conducted by any logistics unit, based on proximity and assets available. Sustainment brigades use their CSSBs to provide replenishment to echelons above brigade, brigade support battalions (BSBs), and forward support companies (FSCs) along with field services and other services as required.

6-4. A CSSB is typically tasked to provide standard replenishment operations to echelons above brigade. A CSSB may provide support directly to a FSC; however, a CSSB typically provides standard replenishment operations to a BSB, and then the BSB provides standard replenishment operations to a FSC. There are circumstances when given the proximity of the CSSB to a FSC they will provide

nonstandard replenishment/logistical support directly to the FSC. Specialized teams in the CBRNE operational headquarters conducting WMD-E missions may receive nonstandard replenishment/logistical support from a FSC simply due to the WMD-E team's proximity in the area (See Objective #1 in Figure 6-1).

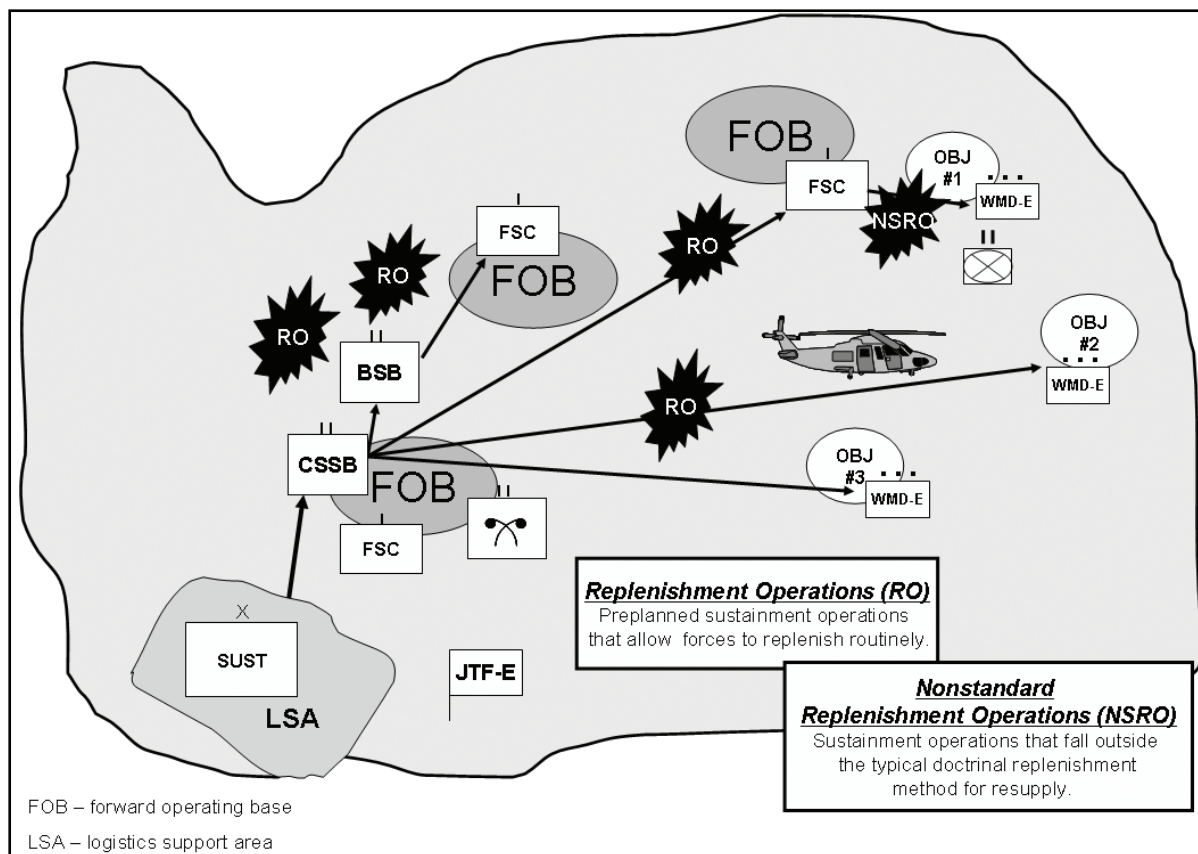

Figure 6-1. Example of logistics support for WMD-E forces

NONSTANDARD REQUIREMENTS

6-5. An additional consideration in the sustainment planning process is the unique equipment that the CBRNE operational headquarters and its subordinate elements will possess. The CBRNE operational headquarters is equipped with unit specific and COTS equipment. This may require contracted logistics support to ensure sustainability of these systems. In addition to the requirements previously listed, some other unique requirements necessary to support WMD-E operations include material handling equipment; engineer assets; ground and air transportation for equipment, personnel, and samples; and logistical support for the WMD-E team when there is a requirement to remain on site for 24 hours or more. These are some of the requirements necessary for the successful execution of the WMD-E mission. The JTF-E staff must ensure that as part of the deliberate planning process their mission analysis specifically includes these and other like requirements and that these considerations are included early in the planning process for proper support and execution of WMD-E missions.

6-6. All deployed elements of the CBRNE operational headquarters need to plan for and be prepared to support the various joint, interagency, intergovernmental, and multinational augmentation that they may receive to assist with the WMD-E mission.

6-7. Specific support capabilities are not organic to the CBRNE operational headquarters and its subordinate elements. Some of the specific requirements associated with those elements are found in the following paragraphs.

MAIN COMMAND POST

- 6-8. The MCP requires installation support for—
- Predeployment.
 - Staging.
 - Soldier readiness functions.
 - Unit movement.
 - Airfield operations.
 - Facilities (including space for a home-station operations center).

OPERATIONAL COMMAND POST

- 6-9. The OCP requires the following support:
- Food service.
 - Water.
 - Fuel.
 - Medical.
 - Field services.
 - Field maintenance.
 - Contracted support maintenance.
 - Electronic communications repair.
 - Mobility.
 - Power generation.
 - Connectivity.
 - Bandwidth to link to the joint C2 architecture.
 - Joint augmentation to the OCP staff when designated as a JTF E.
 - Linguist/translator.
 - Information operations planning and integration.
 - Psychological operation planning and integration.
 - Intelligence personnel as members of the weapon intelligence team. Their focus is to support intelligence requirements by providing situational awareness and conducting tactical document exploitation/target exploitation-extraction of immediate actionable intelligence information from documents and material-without determining future comprehensive exploitation. A more comprehensive analysis is performed by the human intelligence analytical cell located in the weapons intelligence detachment at division.
 - Security.

SPECIALIZED ELEMENTS

6-10. WCEs require all forms of sustainment from the supported commander (minus reachback communications and organic transportation). NDTs require all forms of sustainment from the supported commander (minus organic transportation and equipment). Elements of the CARA require all forms of sustainment from the supported commander (minus organic transportation and equipment) as well as security. They typically rely on a WCE or the OCP for reachback requirements.

This page intentionally left blank.

Appendix A

Fundamentals of Combating Weapons of Mass Destruction

The proliferation of WMD is a global problem that routinely crosses combatant commands' geographical boundaries. The challenge of combating WMD necessitates an integrated and dynamic approach that leverages activities of three pillars: NP, CP, and WMD-CM. The increasing availability of highly destructive technology combined with a variety of weapons and means of delivery from both nonstate and state actors greatly intensifies the problem. WMD in the possession of nonstate actors could potentially kill large number of people without warning. The link between nonstate actors and WMD constitutes one of DOD's top priorities.

THE PROLIFERATION OF WEAPONS OF MASS DESTRUCTION

A-1. In February 2005, the SecDef designated USSTRATCOM as the supported command for combating WMD. Combating WMD has taken on greater national security importance in recent years and has been accorded a higher priority in defense planning. To fulfill its responsibilities as the DOD lead for integrating and synchronizing department efforts to improve combating WMD capabilities, USSTRATCOM has undertaken several initiatives, including a requirements analysis of WMD interdiction and WMD-E (two mission areas that fall under combating WMD). See Figure A-1.

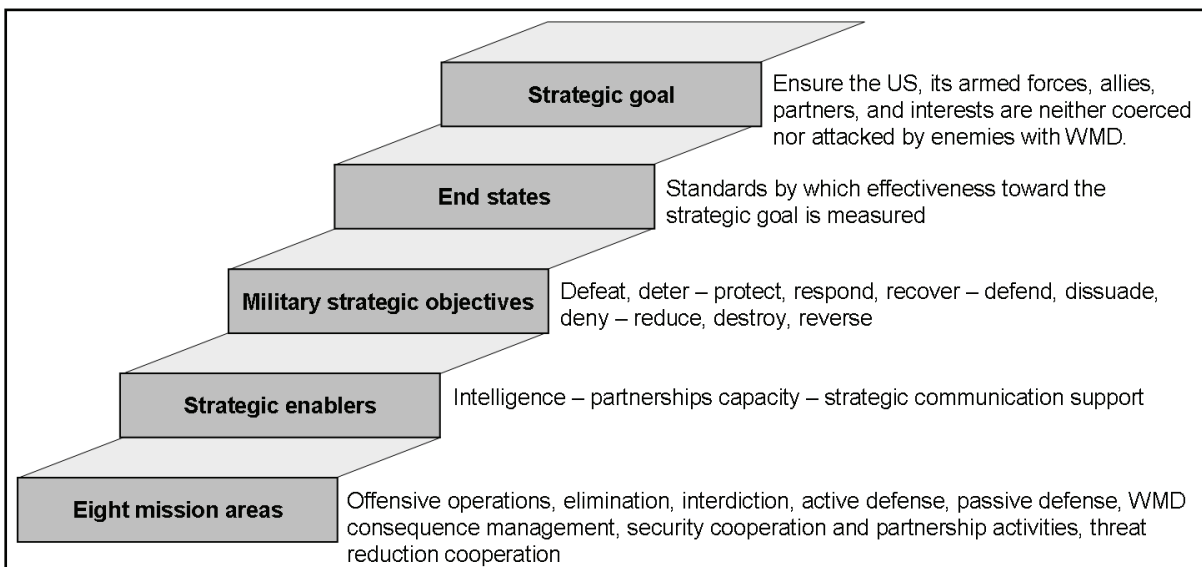

Figure A-1. NMS-CWMD

A-2. Section V of the 2006, National Security Strategy for Combating WMD places the highest priority on preventing enemies from obtaining WMDs. The WMD-E mission area is a key element of this strategy, as it addresses the requirement to conduct urgent operations in uncertain environments where it is necessary to systematically seize, secure, remove, disable, or destroy an adversary's WMD capability.

A-3. Various WMD NP and CP efforts and activities have been important elements of national security posture for decades, but these are primarily focused on nation-states. However, an array of traditional, irregular, catastrophic, and disruptive [WMD] capabilities and methods will continue to threaten U.S. interests. Therefore, DOD must continue to develop better capabilities to reduce the threat from the proliferation of WMDs.

TERMINOLOGY DESCRIPTIONS

NONPROLIFERATION

A-4. NP involves those actions (for example, diplomacy, arms control, multilateral agreements, threat reduction assistance, and export controls) taken to prevent the proliferation of WMD that seek to dissuade or impede access to, or distribution of, sensitive technologies, material, and expertise. NP efforts must dissuade or impede the proliferation of WMD, as well as slow and make more costly the access to sensitive technologies, material, and expertise. Activities shall include—

- Providing inspection, monitoring, verification, and enforcement support for NP treaties and WMD control regimes
- Supporting TRC and export control activities
- Participating in research activities domestically
- Conducting military-to-military exchanges
- Assisting in the identification of potential proliferants before they decide to acquire or expand their WMD capabilities
- Planning and conducting denial operations if so directed by the President

COUNTERPROLIFERATION

A-5. CP involves those actions taken to defeat the threat by stopping or rolling back current WMD programs, defeat delivery systems; and/or use of WMD against the U.S. as well as U.S. military forces, friends, and allies. The full range of operational capabilities will be required to counter the threat and use of WMD. The objective of CP operations is to deter, interdict, defend, and eliminate the WMD threat across the full range of possible WMD acquisition, development, and employment scenarios. These capabilities must be fully integrated into existing and emerging military transformation plans and the homeland security posture. In addition, CP must be fully integrated into the basic doctrine, training, and equipping of all forces with the objective of ensuring sustained operations to decisively defeat WMD armed adversaries. CP operations are intended to reduce the WMD threat and require a balanced and integrated concept of operations to defeat hostile WMD threats.

CONSEQUENCE MANAGEMENT

A-6. CM involves those actions taken to respond to the consequences and effects of WMD used against U.S., U.S. forces and interests abroad; and to assist friends and allies to restore essential services. WMD-CM operations facilitate a return to stability by minimizing or mitigating the effects of WMD contaminants to provide timely assistance to affected public, government, and U.S. military installations. Operations are intended to assist affected public, government, and U.S. military installations to reduce a population's vulnerability to the effects of WMD contaminants by supporting preventive or precautionary measures (for example, pre-positioning vaccines, first responder equipment, training, personal decontamination supplies; and identifying healthcare facilities), developing and rehearsing response plans/protocols (exercising command and control, identifying and training response personnel, determining legal and physical constraints, determining requirements for attribution and legal prosecution, practicing decontamination procedures, developing reachback capabilities for technical experts) and restoring necessary life-sustaining services (for example, medical care, electrical power, and communications and transportation infrastructure).

ELIMINATION OPERATIONS

A-7. Elimination operations systematically locate, characterize, secure, disable, and/or destroy a hostile nation's or organization's capability to research, develop, test, produce, store, deploy, or employ the full-range of CBRNE hazards (for example, WMD, WMD-related material or facilities, or TIM. It is not simply finishing a work in progress, but includes the entire process of locating and characterizing (exploitation) as well as destroying, removing, or neutralizing them (destruction and disposition) and ensuring that they will not be reconstituted or transferred in the future (monitoring and redirection).

A-8. The eight mission areas are defined in the NMS-CWMD and these (with the exception of the last two) should only be used in conjunction with the discussion generated by referring to that document. They are defined as follows:

- **Offensive operations.** Lethal (both conventional and nuclear) and/or nonlethal operations to defeat, neutralize, or deter a WMD threat or subsequent use of WMD. (This term and its definition are applicable only in the context of the NMS-CWMD and cannot be referenced outside of the discussion of that publication.)
- **Elimination operations.** Military operations to systematically locate, characterize, secure, disable, and/or destroy a state or nonstate actor's WMD program(s) and related capabilities in hostile or uncertain environments. (This term and its definition are applicable only in the context of the NMS-CWMD and cannot be referenced outside the discussion of that publication.)
- **Interdiction operations.** Operations to stop the transit of WMD, delivery systems and associated technologies, materials, and expertise between states and between state and nonstate actors of proliferation concern in any environment. (This term and its definition are applicable only in the context of the NMS-CWMD and cannot be referenced outside the discussion of that publication.)
- **Active defense.** Military measures to prevent, deter, or defeat the delivery of WMD. Measures include offensive and defensive, conventional or unconventional actions to detect, divert, and destroy an adversary's WMD and/or delivery means while en route to their target. (This term and its definition are applicable only in the context of the NMS-CWMD and cannot be referenced outside the discussion of that publication.)
- **Passive defense.** Measures to minimize or negate the vulnerability and effects of WMD employed against U.S. and partner/allied armed forces, as well as U.S. military interests, installations, and critical infrastructure. (This term and its definition are applicable only in the context of the NMS-CWMD and cannot be referenced outside the discussion of that publication.)
- **WMD consequence management.** Actions taken to mitigate the effects of a WMD attack or event and restore essential operations and services at home and abroad. (This term and its definition are applicable only in the context of the NMS-CWMD and cannot be referenced outside the discussion of that publication.)
- **Security cooperation and partnership activities.** Activities to improve partner and allied capacity to combat WMD across the eight mission areas through military-to-military contact, burden sharing arrangements, combined military activities, and support to international activities.
- **Threat reduction cooperation.** Activities undertaken with the consent and cooperation of HN authorities to enhance physical security, and to reduce, dismantle, redirect, and/or improve protection of a state's existing WMD program, stockpiles, and capabilities.

COMBATING THE WEAPONS OF MASS DESTRUCTION THREAT

A-9. The U.S. confronts WMD threats through mutually reinforced and interdependent actions across three pillars: NP, CP, and WMD-CM. See Figure A-2, page A-4.

A-10. The U.S. response must integrate all of the capabilities of the NP, CP, and WMD-CM framework and demonstrate that U.S. military forces and civilian governments are fully capable, organized, trained, and equipped to deny, destroy, or respond to, and mitigate the effects of, WMD proliferation, and use. The challenge lies in assessing the intent and capabilities of the state's leadership. The success of combating WMD depends on how effectively CCDRs apply all three pillars against WMD challenges. NP policy uses the full range of diplomatic, economic, informational, and military instruments of national power to prevent the development and proliferation of WMD.

A-11. Prior strategies focused on passive defense and WMD-CM activities; while the NMS-CWMD emphasizes offensive activities. This proactive strategy to combat WMD requires JFCs to focus on an integrated approach that emphasizes all three pillars in varying degrees throughout an adversary's

proliferation continuum. All three pillars must be leveraged to employ an effective strategy to combat WMD.

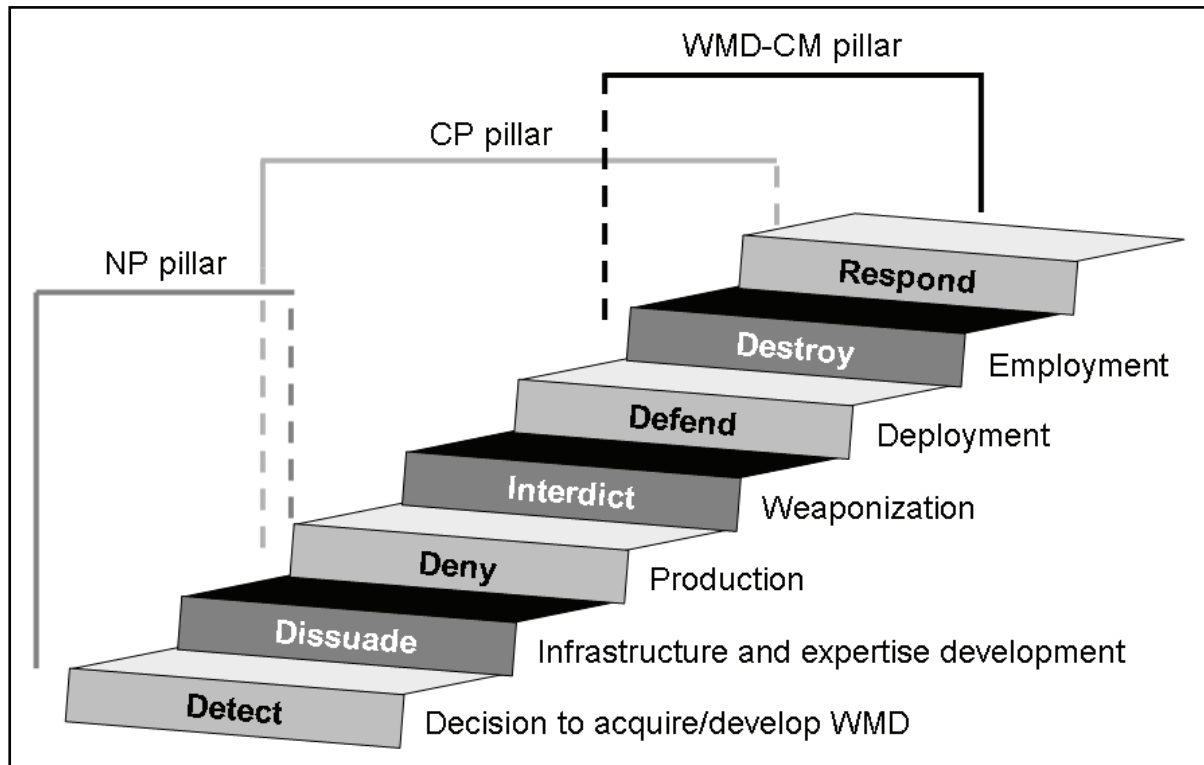

Figure A-2. Response to proliferation continuum

A-12. The sustainment and repetition of the proliferation continuum represents stages adversaries may execute to develop and/or acquire WMD. Adversaries may at any point along the proliferation continuum choose to bypass one of the development steps by acquiring the capability and therefore accelerate the WMD development process. Proactive actions can be taken at every stage of the continuum process to successfully counter the proliferation of WMD. The generic activities include: decision; infrastructure and expertise development; production; weaponization; deployment; and employment. A proliferant group or nation requires the will, equipment, technical knowledge, people, money, and time to successfully develop and sustain this process. This continuum may be encountered in a noncontiguous fashion, that is, an adversary may buy a weapon system ready for immediate employment and thus bypass stages such as production and weaponization.

SIX PRINCIPLES FOR COMBATING WEAPONS OF MASS DESTRUCTION

A-13. To ensure that the U.S., its armed forces, allies, partners, and interests are neither threatened nor attacked by WMD, U.S. armed forces must be prepared to: defeat and deter WMD use and deter next use; defend against, respond to, and recover from WMD use; prevent, dissuade, or deny WMD proliferation or possession; and reduce, eliminate, or reverse WMD possession. There are six guiding principles that underpin the NMS-CWMD and should be used by U.S. armed forces as a foundation for development of all combating WMD concepts of operations and plans. The six principles are—

- **Active, layered, defense-in-depth.** To protect the U.S. and defeat aggressors, the U.S. armed forces must establish an active defense. The U.S. armed forces will focus military planning, posture, operations, and capabilities, according to mission essential tasks, on the active, forward and layered defense of the U.S., its allies, partners, and interests.

- **SU and integrated C2.** The decision to employ specialized combating WMD capabilities for simultaneous operations demands a highly flexible and adaptive C2 process informed by timely, credible, and actionable intelligence.
- **Global force management.** Any combating WMD capabilities developed in the future must be visible to combatant command planners and include responsive and agile forces that can be rapidly task organized and equipped to accomplish assigned missions.
- **Capabilities-based planning.** The U.S. must plan for and develop capabilities that could be employed against a range of threats and associated capabilities while balancing the requirements for targeted strategies against known proliferators.
- **Effects-based approach.** The U.S. will use an effects-based approach in planning, execution, and assessments to achieve efficient results and reduce risk to mission and campaign objectives, as well as to combating WMD-related resources.
- **Assurance.** Where possible, the U.S. will encourage action by like-minded states, work with international allies and partners, and operate through regional states to combat WMD actively.

STRATEGIC MILITARY FRAMEWORK

A-14. The strategic military framework to combat WMD (See Figure A-3, page A-6) consists of *ends* (the military strategic goal and associated end state), *ways* (military strategic objectives), and *means* (combatant commands, military departments, and combat support agencies) applied across the three pillars of the NS-CWMD (NP, CP, and WMD-CM).

Ends (Military Strategic Goal and Associated Endstate)

A-15. The military strategic goal is to ensure that the U.S., its armed forces, allies, partners, and interests are neither coerced nor attacked by enemies using WMD. Nine specific end states (see Figure A-4, page A-8) delineate standards by which effectiveness can be measured. The end states are:

- U.S. armed forces, in concert with other elements of U.S. National power, deter WMD use.
- U.S. armed forces are prepared to defeat an adversary threatening to use WMD and prepare to deter follow-on use.
- Existing worldwide WMD is secure and the U.S. armed forces contribute as appropriate to secure, reduce, reverse, or eliminate it.
- Current or potential adversaries are dissuaded from producing WMD.
- Current or potential adversaries WMD is detected and characterized and elimination sought.
- Proliferation of WMD and related materials to current and/or potential adversaries is dissuaded, prevented, defeated, or reversed.
- U.S. armed forces assist in attributing the source of attack, respond decisively, and/or deter future attacks.
- Allies and U.S. civilian agencies are capable partners in combating WMD.

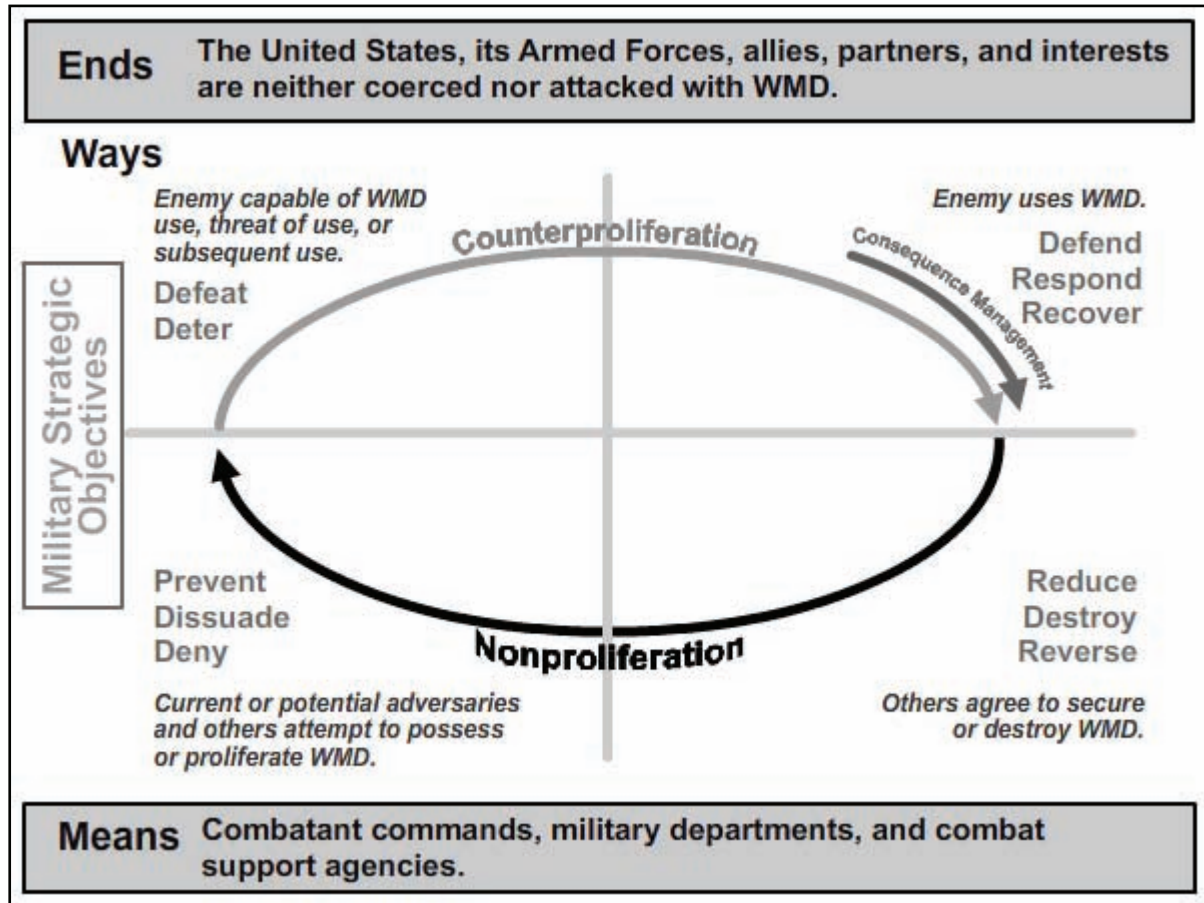

Figure A-3. Strategic military framework to combat WMD

Ways (Military Strategic Objectives)

A-16. The military strategic objectives are achieved through eight missions conducted across the combating WMD continuum.

- **Defeat and deter WMD use and subsequent use.** Adversaries must believe they will suffer severe consequences and that their objectives will be denied if they threaten or resort to the use of WMD.
- **Protect, respond, and recover from WMD use.** The purpose of this objective is to respond to an adversary who has used WMD on the battlefield or against strategic U.S. interests. To protect and recover from WMD use, U.S. armed forces will execute passive defense measures and be prepared to conduct WMD-CM activities.
- **Defend, dissuade, or deny WMD proliferation or possession.** To prevent, dissuade or deny adversaries or potential adversaries from possessing or proliferating WMD, U.S. armed forces will be prepared to conduct offensive operations. The military must also support interdiction efforts, security cooperation, and NP efforts.
- **Reduce, destroy, or reverse WMD possession.** To reverse WMD programs and reduce WMD and related material stockpiles, the U.S. armed forces will support TRC as well as be prepared to assist in cooperative stockpile destruction activities.

Means (Combatant Commands, Military Departments, and Combat Support Agencies)

A-17. The combatant commands, military departments, and combat support agencies are the means to accomplish military strategic objectives. Commander, USSTRATCOM is the lead CCDR for integrating

and synchronizing DOD in combating WMD. Consistent with this assignment, USSTRATCOM will integrate and synchronize applicable DOD-wide efforts across the doctrine, organization, training, material, leadership, personnel, and facilities spectrum. Combatant commanders will continue to execute combating WMD missions within their AORs. Military efforts will need to be integrated with other organizations and nations that possess capabilities, resources, or information that can contribute to the mission.

- **Strategic enablers.** Strategic enablers are crosscutting capabilities that facilitate execution of the military strategy. They enhance the effectiveness and integration of military combating WMD mission capabilities. Commanders must continually assess enabling capabilities and identify required improvements. Three strategic enablers facilitate DOD's efforts to combat WMD: intelligence, partnership capacity, and strategic communication support. Intelligence directly supports strategy, planning, and decision making; facilitates improvements in operational capabilities; and informs programming and risk management. To reduce uncertainty, the intelligence capability must exploit a variety of sources, facilitate information sharing, and improve SU.
- **Partnership capacity.** Building partnership capacity, bilaterally and multilaterally, enhances the capability to combat WMD. The U.S. should build on and leverage government, NGOs, corporate, and international partner capabilities. Security cooperation efforts should not only focus on missile defense cooperation or the proliferation security initiative, but equally stress passive defense, elimination, and WMD-CM cooperation.
- **Strategic communication support.** The military plays a significant supporting role in the larger U.S. government effort to communicate and demonstrate its resolve. Strategic communications shape perceptions at the global, regional, and national levels. U.S. words and actions reassure allies and partners and underscore, to potential adversaries, the costs and risks associated with WMD acquisition and use.

MILITARY MISSION AREAS

A-18. The military mission involves dissuading, deterring, and defeating those who seek to harm the U.S., its allies, and partners through WMD use or threat of use. This mission is in direct support of the three pillars (NP, CP, and CM) of the national strategy for combating WMD. Across the four military strategic objectives, U.S. armed forces may be called upon to carry out eight missions: offensive operations, elimination, interdiction, active defense, passive defense, WMD-CM, security cooperation and partner activities, and TRC. Capabilities development should address and prioritize the critical capability needs of these eight mission areas. Offensive operations may include lethal and nonlethal options (for example, elements of space and information operations) to deter or defeat a WMD threat or subsequent use of WMD.

A-19. The NMS-CWMD identifies WMD-E operations as “military operations to systematically locate, characterize, secure, disable, and/or destroy a state or nonstate actor’s WMD programs and related capabilities in hostile or uncertain environments.” WMD-E encompasses three primary subtasks. They include—

- **Executing sensitive site exploitation.** SSE involves locating, characterizing, and securing CBRNE materiel, weapons, equipment, personnel, and infrastructure, and developing appropriate forensic evidence.
- **Executing disposition.** Executing disposition involves destroying, dismantling, rendering safe, removing, transferring, or otherwise verifiably disposing of CBRNE materiel, weapons, equipment, and infrastructure.
- **Executing monitoring and redirection.** This involves monitoring, inspecting, and redirecting/converting the CBRNE infrastructure.

ROLE OF THE CHEMICAL, BIOLOGICAL, RADIOLOGICAL, NUCLEAR, AND HIGH YIELD EXPLOSIVES OPERATIONAL HEADQUARTERS

A-20. The role of military forces within the NMS-CWMD is greatest in CP operations, which use low-density, high-demand, specialized forces. The military role decreases in CM and NP operations, as those missions are primarily performed by OGAs with military support. The primary role and capability of the CBRNE operational headquarters is focused on the WMD-E mission set within the CP pillar. See Figure A-4.

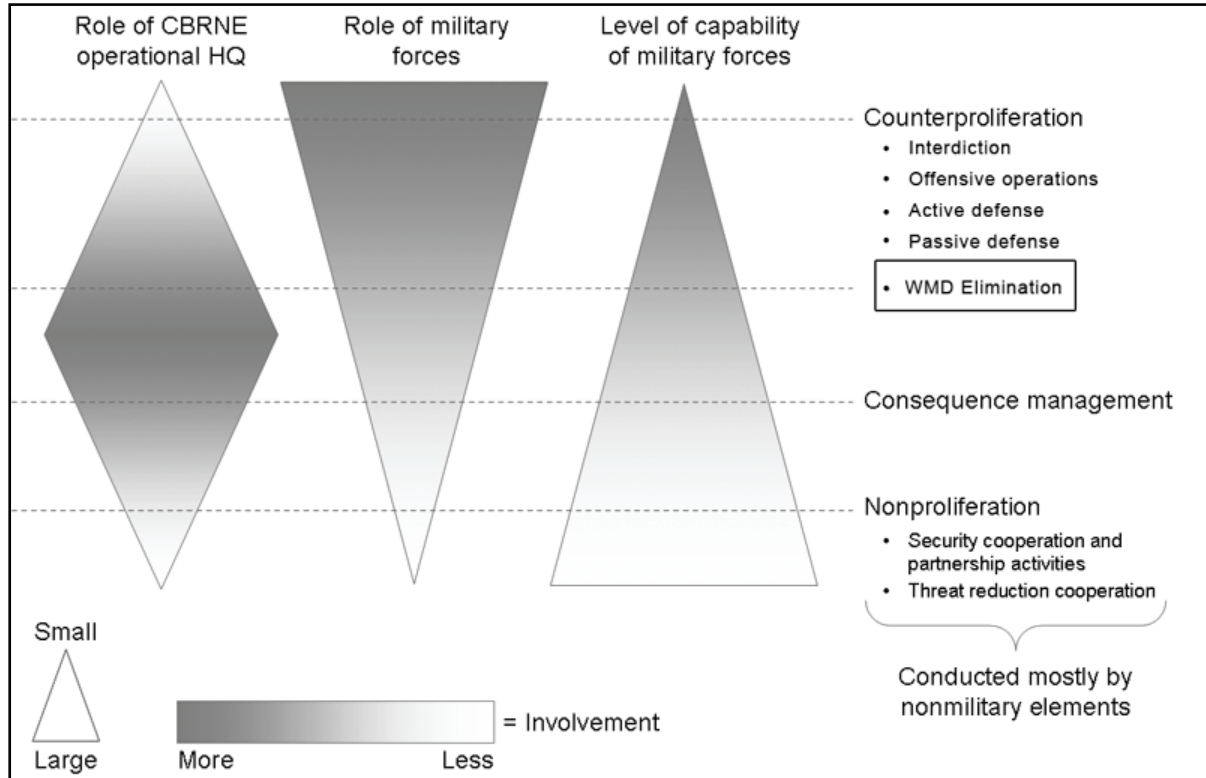

Figure A-4. CBRNE operational headquarters' role in combating WMD

Appendix B

Staff Roles and Responsibilities

The commander's staff must function as a single, cohesive unit. Team members not only know their respective responsibilities, but are familiar, considerate and respectful of the responsibilities and duties of other staff members. Staffs prepare and issue plans and orders to execute their commanders' decisions, coordinating all necessary details. Staff sections prepare and maintain running estimates and members make recommendations to help commanders reach decisions and establish policies. Staffs also assist their commanders by ensuring that subordinates execute their decisions and report the endstate. This appendix provides a list of staff roles and responsibilities commonly performed by staff officers assigned to a CBRNE operational headquarters. This listing should not be taken as a comprehensive listing but as a starting point for the development of a staff SOP and a staff METL.

FLEXIBLE STRUCTURE FOR UNIQUE MISSIONS

B-1. The CBRNE operational headquarters staff needs to be prepared to transform into a staff for a JTF and must fully understand the additional requirements required of a joint staff. This includes boards, centers, and cells that may require representation from the CBRNE operational headquarters, or that the CBRNE operational headquarters may have to implement in the role of a JTF-E.

B-2. The staff for a CBRNE operational headquarters needs to be prepared to receive liaisons and elements from various agencies. This can include agencies like the DTRA, DIA, CIA, National Ground Intelligence Center, joint services, multinational partners, and other NGOs/NGAs like the International Atomic Energy Agency. The staff must include in their deliberate planning process the unique requirements that go along with accepting and employing these augmentations. These factors should include as a minimum health, security, communications, workspace, and accountability issues. See Figure B-1, page B-2.

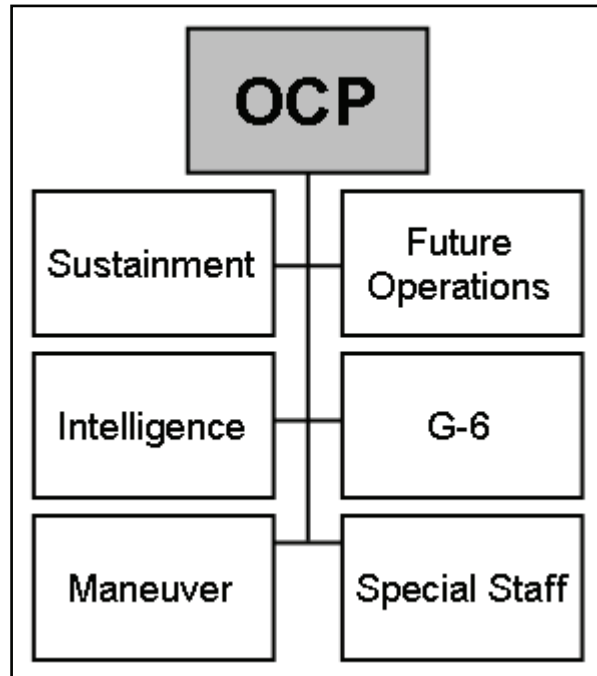

Figure B-1. Staff elements of the OCP

STAFF ELEMENTS OF THE OPERATIONAL COMMAND POST

B-3. The OCP staff includes a sustainment G-1/G-4 cell, G-2 cell, assistant chief of staff, operations (G-3) or maneuver cell, assistant chief of staff, plans (G-5) (future operations) cell, G-6 cell, and a special staff. On activation by USJFCOM as the base element for a JTF-E the staff functions will become J-code position. The JECE and positions on a USJFCOM validated joint manning document will be integrated in the JTF-E headquarters staff.

SUSTAINMENT CELL

B-4. The OCP G-1/G-4 sustainment cell is capable of continuous operations and performs the following functions:

- Manages G1/4 sustainment cell operations for the OCP.
- Coordinates, integrates, and synchronize human resources support operations and functions.
- Performs personnel accountability and strength reporting.
- Performs personnel readiness management.
- Conducts casualty operations.
- Coordinates casualty affairs.
- Conducts postal operations support.
- Manages civilian personnel functions.
- Coordinates the logistic integration of supply, maintenance, transportation, and services for the OCP.
- Determines current and future supply requirements.
- Monitors equipment readiness status.
- Prepares the service support annex to plans and orders.
- Prepares the movement plan to plans and orders.
- Coordinates and schedules transportation operations.
- Advises units and current transportation requirements and movement restrictions.

- Determines current and future supply needs; recommends logistic allocations and priorities.
- Prepares service support plans; monitors equipment readiness and CBRNE-specific supply items.
- Provides support to joint boards, centers, and cells as required; Joint Personnel Reception Center, Contracting Office, Joint Movement Center.

INTELLIGENCE CELL

- B-5. The OCP intelligence cell is capable of continuous operations and performs the following functions:
- Performs intelligence synchronization and ISR integration in support of global CBRNE operations for the theater and JOA.
 - Processes requests for information in support of WMD-E operations.
 - Develops PIR in support of CBRNE SSE operations.
 - Serves as the focal point for all operational headquarters intelligence functions.
 - Assists the G-3 with operations security requirements.
 - Performs special security officer (SSO) duties.
 - Provides CBRNE intelligence products and analysis of processed information; produces intelligence products and disseminates processed intelligence to tactical, operational, and strategic users across the NIPRNET, SIPRNET, and JWICS.
 - Develops, refines, and validates CBRNE threats in conjunction with other staff elements.
 - Establishes intelligence architecture capable of communicating with tactical units as well as with national-level intelligence agencies and confirmatory and definitive reachback laboratories.
 - Coordinates CBRNE imagery requirements with operational and national level assets.
 - Processes time sensitive information collected from the exploitation of CBRNE operations and disseminates resultant intelligence.
 - Provides assessment of enemy electronic capabilities and recommends countermeasures when augmented with technical expertise.
 - Develops PIR for inclusion in the CCIR.
 - Develops and refines running intelligence estimates, intelligence threat picture, and performs predictive intelligence assessments in conjunction with other staff elements.
 - Develops, operates, and maintains a CBRNE intelligence digital environment that seamlessly collaborates with joint and interagency intelligence sources in conjunction with CBRNE SMEs.
 - Ensures continuous intelligence collaboration between the OCP, the MCP, and WCEs.
 - Fuses multidiscipline intelligence assets and products to develop the threat WMD COP.
 - Provides support to joint boards, centers, and cells as required.

MANEUVER CELL

- B-6. The OCP maneuver cell is capable of continuous operations and performs the following functions:
- Synchronizes organic and supporting assets to support current operations.
 - Assesses the current situation, including friendly force status, and maintains the current operations running estimate.
 - Maintains C2 of deployed CBRNE operational headquarters assets, subordinate units, and the command relationship with higher headquarters.
 - Synchronizes joint WMD-E operations.
 - Operates an operations center to provide battle management functions for CBRNE operations.
 - Serves as a reachback focal point for deployed CBRNE operational headquarters forces.
 - Manages requests for information submitted by OCP staff cells and sections.
 - Provides liaison and coordination with civil-military organizations for support to the OCP.
 - Plans, coordinates, executes operational security program.

- Helps coordinate HN support for CM operations.
- Helps coordinate with local authorities when CBRNE events occur.
- Support to joint boards, centers, and cells as required: JOC, Joint Security Coordination Center, Information Management Cell, and Joint Targeting Coordination Board.

FUTURE OPERATIONS CELL

B-7. The OCP future operations cell is capable of continuous operations and performs the following functions:

- Reviews, develops, and coordinates the CBRNE aspects of war and contingency plans.
- Helps the supported commander plan to establish the conditions for nonmilitary execution of remediation and redirection.
- Develops plans and orders for CBRNE response while working closely with the CBRNE coordination element and SJA to ensure compliance with the LOW, international law, and ROE.
- Provides policy, tasks, and guidance for developing supporting plans to subordinate units.
- Provides operations security and CBRNE-related intelligence and analysis support to Army forces, other joint/multinational forces, national-level intelligence activities, law enforcement agencies, and confirmatory and definitive reachback laboratories, as required.
- Provides support to joint boards, centers, and cells as required: Future Operations Synchronization Board, Plans and Orders Cell, Joint Planning Group.

COMMAND, CONTROL, COMMUNICATIONS, AND COMPUTER OPERATIONS CELL

B-8. The OCP G-6/command, control, communications, and computer operations cell is capable of continuous operations and performs the following functions:

- Provides the technical link between the OCP and the supported commander's command post for all communications platforms.
- Provides dedicated voice, data, and video links between the OCP and the MCP to support CBRNE operational headquarters reachback to DOD and interagency assets.
- Provides tactical voice communications support between the OCP, subordinate maneuver forces, and CBRNE operational headquarters forces.
- Incorporates and manages a set of integrated applications, processes, and services that provide the capability for command post operations.
- Supports 24-hour OCP operations.
- Develops the command information management plan per the commander's guidance.
- Tailors the command information management plan to support the command post SOPs.
- Continuously monitors the information environment and recommends changes in the command information management plan.
- Develops file and data management procedures.
- Provides spectrum management.
- Manages the quality of service of the information technology services provided by the higher headquarters, including the interoperability of the network with external networks that are not controlled by the G-6 (that is, the Global Broadcast System, Trojan Spirit, and combat service support very small aperture terminal).
- Coordinates satellite access requests and deconflicts frequencies.
- Resolves, reports, and coordinates with other agencies to resolve radio frequency conflicts.
- Support to joint boards, centers, and cells as required: Joint Network Operations Control Center, Network Monitoring Cell.

HEADQUARTERS AND HEADQUARTERS COMPANY

B-9. The headquarters and headquarters company is deployable and 50 percent mobile. It is capable of continuous operations and performs the following functions:

- Supports 24-hour operations.
- Provides supply and limited transportation to the deployed headquarters.
- Coordinates for medical, postal, field services, food services, and morale, welfare, and recreation to the deployed headquarters.
- Coordinates Soldier readiness program requirements for deployed forces.
- Manages personnel records, reports, replacements, and discipline.
- Coordinates family readiness group operations.
- Coordinates casualty evacuation for the deployed headquarters.
- Serves as headquarters commandant for the OCP.
- Relies on Support Maintenance Company for field maintenance of ground, armament, ground support equipment, communications/electronics and communications security. Unit will attach its mechanics with tool kits to the unit providing the field maintenance support for the duration of that support.

OPERATIONAL COMMAND POST – SPECIAL STAFF ELEMENTS

B-10. The OCP staff includes special staff members that include medical, IG, religious support, SJA, and public affairs elements.

Force Health Protection

B-11. For deployments, the requirement for a medical element will depend on the type of mission assigned to the CBRNE operational headquarters. When deployed, the medical element is capable of continuous operations and performs the following functions:

- Manages and monitors the command's medical support and force health protection programs.
- Issues policy, sets priorities, and develops command-wide strategies to effectively and efficiently perform this management control function in addition to supporting emergency planning and special operations.
- Provides technical expertise in the Army Health System to include health service support, force health protection as well as the medical effects of CBRNE operations.
- Coordinates the capability to conduct medical surveillance and monitoring programs for chemical, biological, and radiological exposure of CBRNE personnel conduction operations.
- Coordinates and plans for required medical support.
- Includes a surgeon, medical planner, nuclear science officer (preventive medicine officer), and medical operations noncommissioned officer (NCO) knowledgeable in CBRNE to help establish and monitor overall CBRNE activities.
- Provides support to joint boards, centers, and cells as required: joint blood program office, chemical-biological rapid response team, medical fusion cell.

Inspector General Element

B-12. For deployments, the requirement for an IG element will depend on the type of mission assigned to the CBRNE operational headquarters. When deployed, the IG element will be capable of continuous operations and performs the following functions:

- Conducts assistance visits and reports to the commander on the health, welfare, maintenance, morale, and esprit de corps of the CBRNE operational headquarters.
- Provides a sounding board for the commander and serves as his trusted agent. As such, the IG reports directly to the commander and acts as an extension of the eyes, ears, voice, and conscience of the commander.

- Conducts IG technical inspections.
- Conducts IG investigations.
- Establishes and maintains contact with IG elements in the OE.
- Establishes reporting requirements for subordinate unit IG sections and maintains a working relationship with those sections.
- Provides support to joint boards, centers, and cells as required.

Religious Support Element

B-13. For deployments, the requirement for a religious support element (RSE) will depend on the type of mission assigned to the CBRNE operational headquarters. The Chaplain supervises the RSE to provide or perform direct personal religious support, to include advising the commander and staff on moral and ethical decision making, and the religious dynamics of the indigenous population in the JOA. When deployed, the RSE will be capable of continuous operations and performs the following functions:

- Plans, coordinates, and supervises all religious support within the CBRNE operational headquarters.
- Directs, coordinates, integrates, and synchronizes all religious support activities and plans for current and future operations with headquarters staff and subordinate units, and with other DOD, government, Service, and joint agencies when required.
- Provides policy and guidance on the development of religious support plans of subordinate units.
- Establishes and maintains communications with higher and subordinate units religious support personnel.
- Deploys with elements of the command when necessary and/or coordinates with religious support assets in operational area to ensure religious support services are provided.
- Deploys to coordinate religious support services and assures adequate religious support assets are available in the event of a major accident or incident.
- Requests through appropriate channels, additional religious support assets in the form of chaplain detachments or individual personnel, when required.
- Advises commanders on religious support for the next of kin notification process and is a member of the notification team (if available), but is not to be detailed as the casualty notification officer.

Staff Judge Advocate Element

B-14. For deployments, the requirement for a SJA element will depend on the type of mission assigned to the CBRNE operational headquarters. During peacetime, war, HLS, and operations other than war missions, the SJA element will be capable of continuous operations and performs the following functions:

- Provides legal advice and legal services to the command on the core legal disciplines (military justice, international and operational law, administrative and civil law, claims, and legal assistance).
- Participates in planning process, including strategy and COA development to ensure operations plans (OPLANs) and OPORDs comply with all applicable law.
- Provides general advice in legal subdisciplines (that is, contract and fiscal law, environmental law, and intelligence activities law).
- Supervises the administration of military justice, and ensures that the rights of individuals are protected and the interests of justice are served.
- Provides legal advice to centers, groups, bureaus, cells, offices, elements, boards, working groups, and planning teams including joint planning groups, current and future operations planning.
- Serves as the single point of contact for component SJAs regarding legal matters affecting forces assigned or attached to the CBRNE operational HQ.

- Ensures all plans, ROE, rules of force, and policies and directives are consistent with DOD law of armed conflict program and domestic and international law.

Public Affairs Element

B-15. The strategic communications element is capable of continuous operations and performs the following functions.

- Provides CBRNE public affairs support worldwide.
- Develops and provides CBRNE public affairs guidance.
- Coordinates CBRNE command internal/external information programs.
- Conducts the CBRNE public affairs program in the JOA.
- Provides support to joint boards, centers, and cells as required: Joint Information Bureau.

STAFF ELEMENTS OF THE MAIN COMMAND POST

B-16. The MCP operates 24/7 in sanctuary at a home station emergency operations center (see Figure B-2). The CoS serves as crisis action team leader and senior nuclear weapons advisor. The primary staff at the MCP includes: a knowledge management cell, G-2 intelligence cell, and G-3 maneuver, and G-3 plans cells. The MCP staff also has a coordinating and special staff section that is discussed beginning with paragraph B-23.

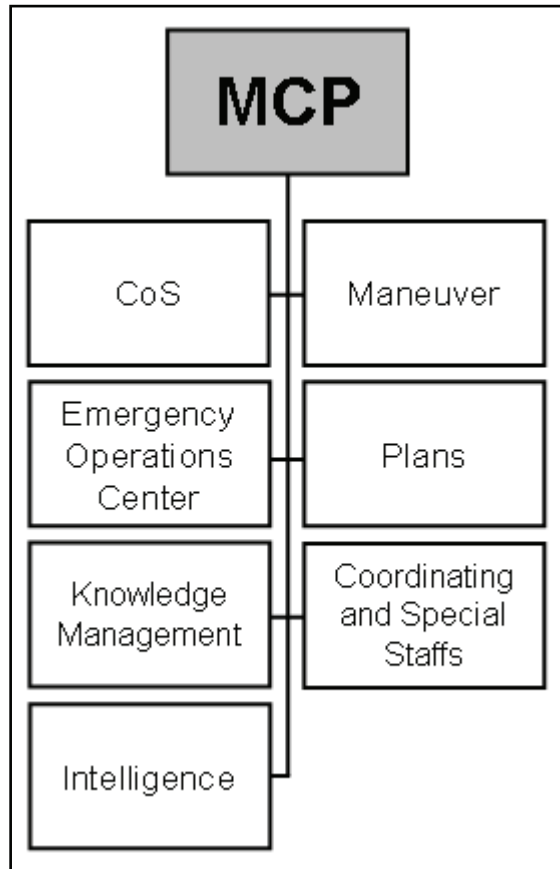

Figure B-2. Staff elements of the MCP

CHIEF OF STAFF

B-17. The CoS performs the following functions:

- Organizes people, information management procedures, equipment, and facilities to support C2 functions.
- Provides embedded/full-time command representation to supported commanders.
- Establishes and revises the command post SOPs.
- Provides an embedded/full-time coordination element to higher headquarters.
- Provides a mobile command post capability for the command group to provide C2 for civil support operations.

EMERGENCY OPERATIONS CENTER

B-18. Conducts 24-hour operations and performs the following functions:

- Provides C2 of all CBRNE operations until deployment of the OCP; continues to provide C2 for CBRNE operations outside the JOA where the OCP is operating.
- Provides C2 for technical operations. (Technical operations are actions to detect, identify, assess, render safe, dismantle, transfer, dispose of CBRNE incident devices/materials and/or unexploded ordnance [UXO] and IEDs.)
- Provides CBRNE technical advice and subject matter expertise.
- Provides C2 of forces to mitigate hazards resulting from incidents involving the Nation's chemical warfare stockpile together with DOD agency assets.
- Provides C2 for the recovery and disposal of legacy chemical and biological munitions and materials from formerly used defense sites.
- Conducts air transportation and provides C2 for the technical escort and ground movement of chemical surety materials in support of the management of chemical stockpile and chemical defense research and development.
- Acts as the Army headquarters for WMD-E in support of small-scale contingency operations.
- Supports the OCP in the conduct of WMD-E and WMD SSE missions.
- Provides C2 of specialized CBRNE assets.
- Provides forces and technical expertise to combatant commands for WMD SSE, disablement, disposition/demilitarization, and elimination operations.
- Supports OCP and JTF-E as necessary on joint boards, centers, and cells.

KNOWLEDGE MANAGEMENT CELL

B-19. The knowledge management cell is capable of continuous operations and performs the following functions:

- Incorporates and manages a set of integrated applications, processes, and services that provide the capability for command post operations.
- Supports 24-hour operations.
- Tailors the command information management plan to support the command post SOPs.
- Develops the command information management plan per the commander's guidance.
- Continuously monitors the external information environment and recommends changes to the command information management plan.
- Develops file and data management procedures.
- Performs web portal management.
- Performs web tool management.
- Performs collaborative tool management.
- Performs database management.

- Performs application support/management.
- Supports the OCP as required.

INTELLIGENCE CELL

B-20. The MCP intelligence cell is capable of continuous operations and performs the following functions:

- Maintains SU of the OE for the committed force through continuous communications with the OCP.
- Manages requests for information between the OCP and CONUS based intelligence agencies and CBRNE laboratories.
- Produces intelligence products within 24 hours in support of the OCP.
- Maintains oversight of the command and subordinate unit security programs and operations, including the following:
 - SSO.
 - Personnel security.
 - Physical security.
 - Information security.
 - Antiterrorism/force protection.
 - Special programs.
- Serves as focal point for all operational MCP intelligence functions.
- Assists the G-3 in operations security requirements.
- Provides CBRNE intelligence products and analysis support to Army, joint, multinational, and national intelligence activities, law enforcement agencies, and confirmatory and definitive reachback laboratories.
- Conducts intelligence production, dissemination, and support activities (including special category) across the NIPRNET, SIPRNET, and JWICS.
- Develops, refines, and validates CBRNE threats.
- Establishes intelligence architecture capable of communicating with the OCP as well as with national level intelligence agencies and confirmatory and definitive reachback laboratories.
- Coordinates CBRNE imagery requirements with operational and national level assets.
- Processes time sensitive information collected from the exploitation of CBRNE operations and disseminates resultant intelligence.
- Determines PIR for inclusion in the CCIR.
- Develops and refines CBRNE intelligence estimates, intelligence reports and messages.
- Provides the commander with the CBRNE intelligence threat picture and predictive intelligence assessments.
- Develops, operates, and maintains a CBRNE intelligence digital environment that seamlessly collaborates with joint and interagency intelligence activities.
- Ensures continuous intelligence collaboration between the OCP and CONUS based agencies.
- Fuses multidiscipline intelligence assets and products to develop the threat COP.

MANEUVER CELL

B-21. The MCP maneuver cell is capable of continuous operations and performs the following functions:

- Synchronizes organic and supporting assets to support current operations.
- Assesses the situation, including friendly force status, and maintains the current operations running estimate.
- Maintains C2 with deployed CBRNE operational headquarters assets, subordinate units, and higher headquarters.
- Synchronizes joint WMD-E operations.

- Operates an operations center to provide battle management functions for CBRNE operations.
- Serves as a reachback focal point for deployed CBRNE operational headquarters forces.
- Manages requests for information submitted by the OCP.
- Provides dedicated fixed and rotary wing transportation in support of the MCP.
- Provides emergency response asset transport (and movement to disposition when required) of recovered chemical/biological warfare material.
- Supports the Army research and development mission by transporting research quantities of chemical surety materiel.

PLANS CELL

B-22. The MCP plans cell is capable of continuous operations and performs the following functions:

- Assesses the training status of subordinate units.
- Develops the training portion of command inspection program.
- Evaluates subordinate training programs.
- Develops command training plans, programs, and directives.
- Recommends training needs.
- Manages subordinate institutional training requirements for low-density, high-demand military occupational specialties.
- Provides trained and ready CBRNE forces to CCDRs.
- Controls the command's training budget.
- Plans, coordinates, and directs individual and collective CBRNE training requirements.
- Plans, coordinates, and directs new COTS equipment training.
- Reviews, develops, and coordinates the CBRNE aspects of war and contingency plans.
- Develops plans and orders for CBRNE response while working closely with the combatant command LNOs, OCP, and SJA to ensure compliance with the LOW, international law, and ROE.
- Provides policy, tasks, and guidance for developing subordinate units' supporting plans.
- Synchronizes resource-constrained execution of the commander's management of change.
- Coordinates through USFORSCOM with TRADOC, Army Materiel Command (AMC), DTRA, Technology Support Working Group, and Army Support Activity to improve force effectiveness and operational capabilities.
- Produces the commander's operational need statements; urgent material release; prioritization of research, development, and acquisition needs; and similar products.
- Coordinates for expertise from the plans and training cells. Serves as trusted agent for exercises and training directed by supported headquarters.
- Reviews and provides recommended changes to applicable agencies on policy, regulatory guidance, and doctrine, organization, training, materiel, leadership and education, personnel, and facilities (DOTMLPF).
- Provides project management recommendations on advanced concept technology demonstrations, rapid prototyping, the warfighter rapid acquisition program, and similar programs.
- Maintains operational oversight of all special access program mission tasking requirements.
- Monitors alternate compensatory countermeasures for the MCP.
- Conducts technical training validations to verify that mission-tasking-letter capabilities are available as required.
- Coordinates with other national assets in developing and maintaining training programs, equipment sets, and mission-oriented deployment planning.

COORDINATING AND SPECIAL STAFF SECTIONS

B-23. The coordinating and special staff sections represented in the MCP includes the G-1, G-4, G-6, public affairs, chaplain, IG, SJA, and surgeon/risk management.

Personnel

B-24. The G-1 MCP section is capable of continuous operations and performs the following functions:

- Manages overall human resources support and functions.
- Conducts personnel readiness management, to include distribution of personnel, replacements, and strength accounting.
- Manages personnel records/reports.
- Manages and conduct personnel information management.
- Performs personnel accountability and strength reporting.
- Conducts morale, welfare, and recreation support.
- Conducts casualty operations.
- Manages postal operations.
- Manages essential personnel services.
- Manages civilian personnel functions.
- Advises the commander on personnel readiness issues and human resources support functions.
- Maintains the commander's senior rater profile.
- Performs personnel administrative support planning.
- Conducts human resources support planning.

Logistics

B-25. The MCP G-4 section performs the following functions:

- Coordinates the logistic integration of supply, maintenance, transportation, and services.
- Determines current and future supply requirements.
- Monitors equipment readiness status.
- Prepares the service support annex to plans and orders.
- Prepares movement plans and movement portions of plans and orders.
- Coordinates and schedules transportation operations.
- Advises units of current transportation requirements and movement restrictions.
- Plans for deployments and contingencies.
- Coordinates contracting support.

Command, Control, Communications, and Computer Operations

B-26. The MCP G-6 section is capable of continuous operations and performs the following functions:

- Prepares, maintains, and updates command information management estimates, plans, and orders per the command information management plan.
- Establishes procedures for managing relevant information and employing information systems to develop the COP in coordination with the G-3.
- Coordinates with staff sections and cells to ensure information quality criteria (accuracy, timeliness, usability, completeness, precision, reliability) are maintained.
- Coordinates local information network capabilities and services.
- Monitors and reports the status of the information network; coordinates future network connectivity.
- Coordinates future command, control, communications, and computer operations interface with joint and multinational (including host-nation) forces.

- Plans the transition of responsibility for the tactical network from the CBRNE operational headquarters to permanent operational-level signal assets (information technology systems budget or commercial/contract).
- Installs cable systems: coordinates and supervises team members in the construction, installation, and recovery of cable and wire communications systems and auxiliary equipment.
- Secures access to the MCP network and monitors accesses and activities internal to the network.
- Integrates network management, information dissemination management, and information assurance functions.
- Maintains network connectivity across the MCP, including units deployed to a JOA, en route to a JOA, and at home station.
- Manages the MCP network from the applications residing on individual platforms through the points at which the MCP network connects to the GIG.
- Executes deliberate modifications to the MCP network to meet the commander's needs.
- Manages requirements: accepts, validates, and tracks the headquarters and subordinate units' communications requirements (such as computers, cellular phones, or radios)
- Monitors network performance.

Financial Management

B-27. The MCP G-8 section is capable of continuous operations and performs the following functions:

- Provides financial and resource management services.
- Provides finance policy and technical guidance.
- Determines requirements and allocates resources.
- Prepares, reconciles, justifies, and manages budgets.
- Identifies, acquires, distributes, and controls funding.
- Tracks, analyzes, and reports budget execution.
- Maintains accounting records and captures costs.
- Manages disbursement of funds.
- Manages U.S. and nonU.S. pay functions involving military, DOD civilian, foreign national, HN, internees, and travel and miscellaneous pay.
- Advises the commander and staff on the following:
 - Current economic situation including the economic impact of expenditures on the local economy
 - Availability and status of banking facilities in the AO
 - Command currency control program
- Manages limited fund and nonappropriated fund accounting, as determined by theater policy.
- Provides vendor pay.
- Provides accounting services.
- Develops and performs resource management.
- Provides banking and currency support.
- Coordinates financial support of procurement and contracting.
- Coordinates local procurement support with the G-1/adjutant general for personnel, and with the G-4 for material and services.
- Establishes a management control process.
- Establishes and manages programs.
- Provides stewardship of resources.

Strategic Communications

B-28. The MCP strategic communications section is capable of continuous operations and performs the following functions:

- Assists forward deployed elements of the CBRNE operational headquarters in strategic communications planning (assess, estimate, strategy, monitor).
- Executes information strategies (information acquisition, production, distribution, and protection).
- Conducts media facilitation. This includes the following:
- Establishes media operations to include:
 - Access
 - Register/orient
 - Media security policy briefings
 - Respond to queries
- Conducts strategic communications training. This includes the following:
 - Professional strategic communications training
 - Media interaction for Soldiers and Army civilians
 - Media training for key leaders
- Maintains community relations. This includes the following:
 - Provides liaison to the community.
 - Increases public awareness.
 - Supports recruiting/inspire patriotism.

Chaplain

B-29. The chaplain provides or performs direct personal religious support, to include advising the commander and staff on moral and ethical decision making, and the religious dynamics of the indigenous population in the JOA. The chaplain section is capable of continuous operations and performs the following functions:

- Plans, coordinates, and supervises all religious support within the CBRNE operational headquarters.
- Directs, coordinates, integrates, and synchronizes all religious support activities and plans for current and future operations with headquarters staff and subordinate units, and with other DOD, government, Service, and joint agencies when required.
- Provides policy and guidance on the development of religious support plans of subordinate units.
- Establishes and maintains communications with higher and subordinate units religious support personnel.
- Deploys with elements of the command when necessary and/or coordinates with religious support assets in operational area to ensure religious support services are provided.
- Deploys to coordinate religious support services and assure adequate religious support assets are available in the event of a major accident or incident.
- Requests through appropriate channels, additional religious support assets in the form of chaplain detachments or individual personnel, when required.
- Advises commanders on religious support for the next of kin notification process and will be a member of the notification team (if available), but is not to be detailed as the casualty notification officer.

Inspector General

B-30. The MCP IG section is capable of continuous operations and performs the following functions:

- Observes and reports to the commander on the health, welfare, maintenance, morale, and esprit de corps of the CBRNE operational headquarters.
- Provides a sounding board for the commander and serves as his trusted agent. As such, the IG reports directly to the commander and acts as an extension of the eyes, ears, voice, and conscience of the commander.
- Establishes and maintains contact with IG elements located within the OE.
- Establishes reporting requirements for subordinate unit IG sections and maintains a working relationship with those sections.

Staff Judge Advocate

B-31. The MCP SJA section is capable of continuous operations and performs the following functions:

- Provides legal advice and legal services to the command on the core legal disciplines (military justice, international and operational law, administrative and civil law, claims, and legal assistance).
- Provides general advice in legal subdisciplines (that is, contract and fiscal law, environmental law, and intelligence activities law).
- Supervises administration of military justice and ensures that the rights of individuals are protected and the interests of justice are served.

Surgeon/Risk Management

B-32. The MCP surgeon/risk management section is capable of continuous operations and performs the following functions:

- Provides technical expertise in force health protection and the medical effects of CBRNE operations.
- Coordinates the capability to conduct medical surveillance and monitoring programs for chemical, biological, and radiological exposure of CBRNE personnel conduction operations.
- Includes a surgeon, medical planner, nuclear science officer (preventive medicine officer), and medical operations noncommissioned officer knowledgeable in CBRNE to assist in establishing and monitoring the overall CBRNE activities.

Appendix C

Weapons of Mass Destruction Coordination Elements

There are six WCEs in a CBRNE operational headquarters. The teams may have slight variations of officer assignment, but typically total 17 personnel per team. The two most likely employment scenarios for a WCE include: 1) WCE deploys as an advance party to provide limited command, control, communications, and computers for the CBRNE operational headquarter or a JTF-E HQ until the main body arrives to assume control, or 2) WCE deploys to augment a headquarters staff (typically division or above) to integrate CBRNE assets into operational planning, or to provide CBRNE subject matter expertise and reachback capability.

MISSION

C-1. The mission of the WCE is to on order, deploy and provide CCDRs, lead federal agency, or supported commanders with specialized CBRNE staff augmentation and technical subject matter expertise in support of CONUS or theater based CBRNE operations, accidents or incidents.

C-2. The WCE will normally be deployed under the TACON of the supported commander. The WCE can provide the supported commander with a dedicated specialized CBRNE cell. As a CBRNE cell, the WCE will liaison with the OCP and assist the commander and subordinate commands with the integration of DOD and interagency CBRNE assets into current and future plans.

C-3. Critical to all WCE roles is the ability to establish CBRNE technical reachback. The WCE is equipped with a robust communications section and a stand alone communications system to provide this support.

C-4. The WCE is scalable dependent upon the mission. Typically the WCE is organized into two shifts, with an operations officer and operations NCO per shift, as well as CBRNE SMEs (CBRN, EOD, and nuclear and CP operations), and organic intelligence analysts and signal support. This two shift capability allows the WCE to provide 24 hour continuous operations for the headquarters it is supporting.

C-5. In cases where the WCE supports an Army Division , Corps, or Army, the support they provide will be through the Headquarters organic CBRNE staff section.

CAPABILITIES

C-6. The WCE brings the following capabilities to the supported commander:

- CBRNE subject matter expertise (including CBRN, EOD, and nuclear and CP operations) as well as intelligence, and communications capabilities.
- The knowledge and experience to assist the commander and subordinate commands with the integration of the CBRNE operational headquarters, a potential JTF-E headquarters, and other CBRNE assets into current and future plans.
- Ability to assist in the planning, coordination, nesting, and execution of all facets of WMD-E operations from exploitation to disposal. The WCE provides CBRNE related expertise to the following staff level working groups within a deployed headquarters: The WCE will integrate into operational planning groups, and a variety of boards, bureaus, cells, centers, and workgroups. Examples include: targeting boards, effects boards as well as information and intelligence working groups.

- Capacity to fuse operational data and intelligence data to develop and maintain the CBRNE COP through a variety of intelligence working groups within the supported command.
- Secure worldwide communications reachback capability “linking the foxhole to academia and scientific experts” to ensure timely and accurate CBRNE support while maintaining a small footprint forward. Communications assets include satellite, phone, and video teleconferencing (VTC) ability in both secure and nonsecure modes to provide digital, voice, and imagery support. In addition the WCE deploys with the capability to link into all Army Battle Command Systems.
- Convert CBRNE hazard modeling data and data to battlefield effects in support of the commander’s plan.

C-7. The WCE is deployable and 100 percent mobile and requires the following support from the supported commander:

- All logistical support (such as MHE, maintenance, billeting, all classes of supply, communications security).
- Security escort from aerial port of debarkation/seaport of debarkation/JTF-E headquarters to the supported commander’s location.
- Workspace for personnel and theater specific communications hardware.

C-8. The WCE (see Figure C-1) consists of the following core competencies that provide CBRNE subject matter expertise, specialized intelligence support, and communications capabilities:

- EOD officer and NCOs (area of concentration [AOC] and military occupational specialty [MOS]-series 89).
- CBRN officers and NCOs (AOC/MOS-series 74).
- A nuclear research officer (functional area 52).
- MI specialists and a geospatial imager analyst (AOC/MOS-series 35/GG-0132-12).
- Communications NCOs and enlisted personnel (MOS-series 25).

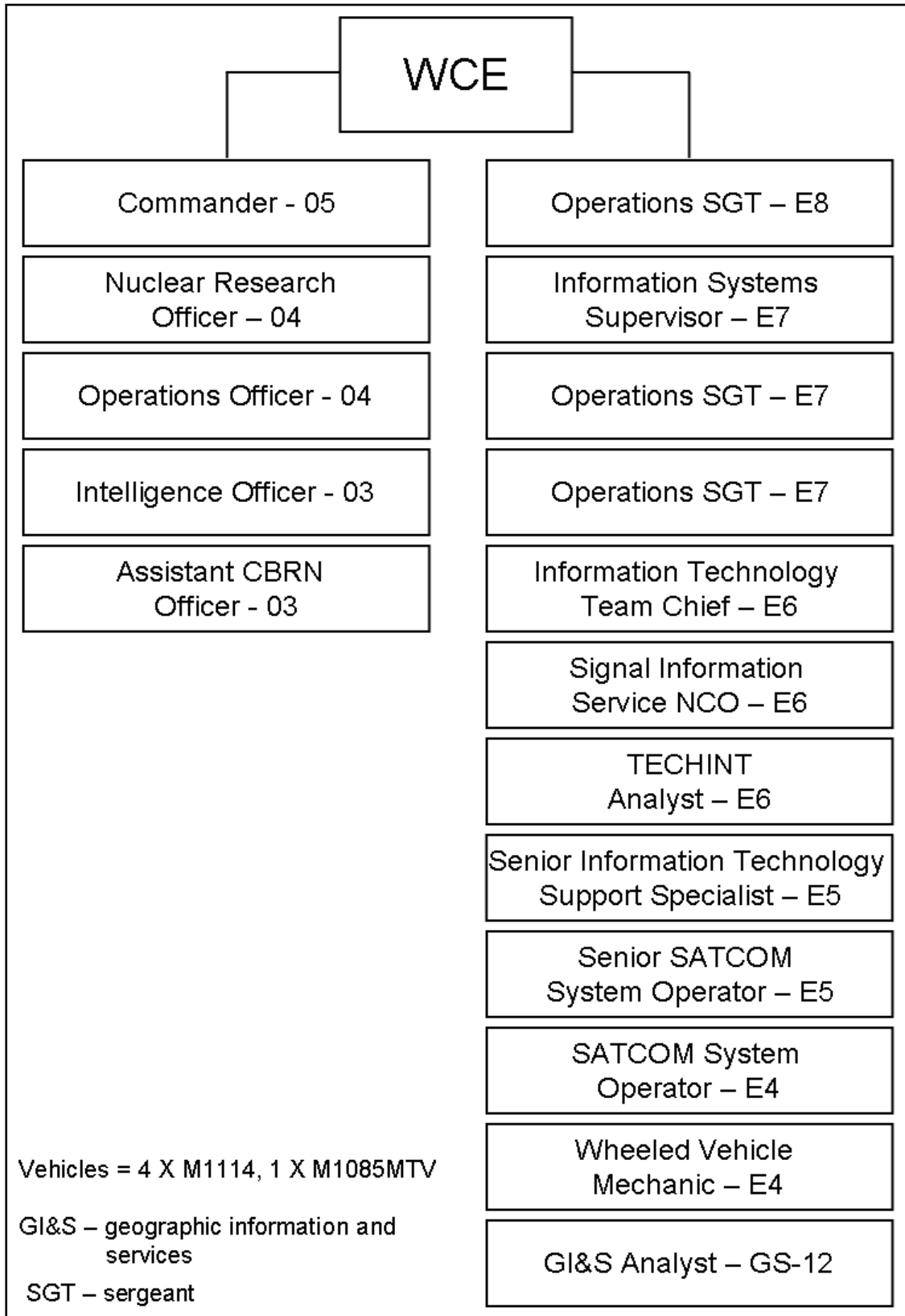

Figure C-1. Example of a WCE

C-9. In addition to tactical equipment (see Figure C-1), the WCE possesses communications equipment to support digital reachback. These systems include or will be similar to—

- **Deployable communications package—reachback system.** This package provides reachback to the Defense Information Systems Agency GIG for long haul services (SIPRNET, NIPRNET, voice, video, and ground station module cellular). It includes the (CONUS/OCONUS) capable system (one 2.0 m ANL auto painting_very small aperture terminal antenna).
- **Deployable Communications Local Area Network (LAN) System.** Each digital communications processor includes a LAN (CONUS/OCONUS) package for SIPRNET, NIPRNET connectivity. Each package includes—
 - Servers.
 - Laptops.
 - Facsimile machines.
 - Digital television.
 - Flat screen television.
 - Shredder.
 - Projectors.
 - Printers.
- **Voice over Internet protocol/Defense Switched Network VTC suite.** Voice over Internet protocol technology is the main communication enabler for WCE's internal and external voice communications. Each WCE will have Non-Secure Internet Protocol Router capability.
- **Battle Command Systems.** Each WCE is equipped with six maneuver control system-light and one all-source analysis system-light system. CBRNE response teams will not have Force XXI battle command-brigade and below or Blue Force Tracking capability and will rely upon security/escort elements with such systems to monitor their current operation location while performing WMD-E operations in a JOA.
- **International Maritime Satellite System (INMARSAT™) Broadband Global Access Network (BGAN™) Terminals.** The BGAN terminal is a portable (CONUS/OCONUS) SATCOM terminal that provides access to the highest bandwidth available on the BGAN network with multiple voice and data interfaces including—
 - SIPRNET, NIPRNET.
 - Secure/unclassified voice.
 - Facsimile.
 - Unclassified integrated services digital network (ISDN)/Internet protocol (IP) VTC, and wireless LAN connectivity.
- **INMARSAT M4 Terminals.** The M4 INMARSAT-128™ is a portable, dual-channel INMARSAT M4 SATCOM terminal providing voice and 128 kilobits per second data services. The antenna/outdoor unit is remote up to 500 feet (150 meters) away from the control console/indoor unit. It provides—
 - (CONUS/OCONUS) NIPRNET.
 - Secure/unclassified voice.
 - Facsimile.
 - Unclassified ISDN/IP VTC.
 - Secure point to point ISDN video using the SCOTTY™.

- **INMARSAT B™ Terminal.** The INMARSAT B terminal is a portable, single channel INMARSAT SATCOM terminal providing voice and 64 kilobits per second data services. Ruggedized constructions provides shock and weather resistance. It provides—
 - (CONUS/OCONUS) NIPRNET.
 - Secure/ unclassified voice.
 - Facsimile.
 - Unclassified ISDN.
 - Unclassified public switched telephone network.
- **INMARSAT Mini™ Terminal.** The INMARSAT Mini terminal is a portable, single channel INMARSAT SATCOM terminal providing voice services. Ruggedized construction provides shock and weather resistance. It provides—
 - Unclassified voice.
 - Facsimile.
 - Unclassified ISDN at 64 kilobits per second.
- **SCOTTY.** The SCOTTY mobile unit is a portable video unit. SCOTTY enables video communication and data transfer including Internet access and email from the field, from moving vehicles, aircraft, and ships. The communication equipment is ruggedized, portable, and interoperable with NATO standard encryption and connects to the most important networks such as IP, ISDN, very small aperture terminal, or INMARSAT. It provides—
 - (CONUS/OCONUS) NIPRNET.
 - Unclassified ISDN/IP VTC.
 - Secure PT to PT ISDN video using the secure terminal equipment (STE).
- **STE.** The STE/Office is the evolutionary successor to the STU-III. The STE provides high speed (128 kilobits per second) secure data and voice communications. The STE cryptographic engine is on a removable Fortezza Plus KRYPTON™ PCMCIA card. The systems are future narrow band digital terminal, and backward compatible with STU-III. It is also ISDN and analog capable.

This page intentionally left blank.

Appendix D

Nuclear Disablement Teams

There are two NDTs organic to a CBRNE operational headquarters. Each team has 11 personnel per team. The NDT can operate in split team mode for limited periods of time; however, additional support is required for split team operations. Central to NDT operations are the specialists who provide the subject matter expertise to conduct operations in a hazardous industrial and dangerous radiological environment. NDT operations focus on nuclear weapon programs with an emphasis on uranium purification and conversion to uranium hexafluoride, uranium enrichment technologies, highly enriched uranium conversion facilities, uranium parts fabrication, nuclear reactors, spent nuclear fuel reprocessing, plutonium extraction, plutonium parts fabrication, and nuclear component (such as neutron generators, firing circuits, and high explosives lens fabrication) design, manufacturing, and testing facilities.

MISSION

D-1. The mission of the NDT is to rapidly and efficiently exploit and disable nuclear or radiological WMD infrastructure and components in an OCONUS uncertain or permissive environment to deny near-term capability or reuse by enemy forces and facilitate follow-on WMD-E operations.

D-2. As part of the disablement process, the NDT will, on order, locate, identify, characterize, package, transport, and safeguard special nuclear materials and those nuclear/radiological materials that pose an immediate threat to friendly forces or civilian personnel in order to reduce friendly force radiation exposure hazards and deny/eliminate threat sources of material for radioactive dispersal devices.

D-3. As part of the CBRNE operational headquarters, an NDT will normally be deployed in a general support role to the theater commander with mission dependent direct support allocation to designated commanders on an area/site specific basis. However, an NDT can also deploy separately from the JTF-E. In which case it will most often be OPCON to the supported command.

CAPABILITIES AND LIMITATIONS

D-4. An NDT is robust and capable of operating in highly contaminated environments to disable all types of nuclear/radiological infrastructure in support of WMD-E missions. An NDT can conduct as many as four simultaneous nuclear disablement operations at one time. It consists of 11 personnel deployed in three high mobility multipurpose wheeled vehicle (HMMWV) and two medium tactical vehicles (each armed with a .50 machine gun). Three trailers are also available to include one to carry generators and two M1095 medium tactical vehicle trailers. The core competencies of its personnel include—

- EOD officer (military occupational specialty [MOS]-series 89).
- CBRN officers and NCOs (MOS-series 74).
- Nuclear research officers (MOS-series 52).
- Medical science officer (72A67) and NCO (MOS-series 68S).
- Operations officers (01A).

D-5. In addition to the vehicles and trailers identified above, equipment capabilities within an NDT include but are not limited to—

- Radioisotope detect, identify, and sample kit.
- Radioisotope package, store, and transport kit.
- Radiation safety and personal protective equipment kit.
- Nuclear disablement kit.
- Decontamination, hotline, and cleanup kit.
- Handheld portable nuclide identification system.
- VDR-2 radiac set.
- UDR-14 radiac set.
- Two generators.
- ISU-90.
- Field safe.
- Laptop computers.
- Tent/shelter for the contamination control line.
- Tents with the capability to sleep 10 personnel each.

D-6. NDT operations will span from small sites such as the Tuwaitha yellow cake storage facility (high contamination hazard) through medium sites such as plutonium production reactor (high potential for collateral damage) to large sites such as a reprocessing facility with a collocated metal fabrication plant (severe environmental and criticality hazards). Large site operations will require significant augmentation, to include battalion-sized security, more than one response team, and a decontamination platoon at a minimum.

D-7. The NDT brings the following capabilities to the supported commander:

- Exploit and disable nuclear WMD infrastructure in an OCONUS uncertain or permissive environment with the ability to characterize the purpose of the site, the types of nuclear and radiological materials present, and the proliferation risk of the site.
- Conduct disablement operations for near-term denial with techniques that will support follow-on WMD-E operations for long term disablement or conversion.
- Package/transport/safeguard nuclear and/or radiological material that poses an immediate threat to friendly and coalition forces or local civilian populations.
- Collect/transport samples of radiological material/WMD intelligence for forensic analysis.
- Establish objective criteria to determine which radiation sources have the potential to pose a hazard to friendly forces.
- Eliminate threat sources of material for radiological dispersal devices.
- Produce high confidence level radioisotope identification and characterization of special nuclear, industrial and medical radiological materials.
- Possess specialized radiological search capability in the form of ground vehicle mounted and personnel carried equipment for area search of suspect sites.

TYPICAL TASK ORGANIZATION OF A NUCLEAR DISABLEMENT TEAM

D-8. The NDT organizes into three teams—each with a primary focus in relation to the objective. Besides these teams, an NDT will need a hotline to EOD expertise and reachback to a deployed laboratory or a gold-standard national laboratory to provide specialized expertise.

- **Team 1 (focus on initial entry).**
 - **Objective:** Locate and mark all hazards.
 - **Contains:** Health physics and EOD expertise.

- **Team 2 (focus on characterization and identification).**
 - **Objective:** Characterize the site infrastructure and material.
 - **Contains:** Health physics and nuclear engineering and physics expertise.
- **Team 3 (focus on disablement and packaging).**
 - **Objective:** Disable critical infrastructure and package material as necessary.
 - **Contains:** Health physics, technical escort, and nuclear related EOD expertise.

ACTIONS OF THE NUCLEAR DISABLEMENT TEAM

D-9. The NDT can perform any or all of the actions shown below on the objective.

Site Survey

- Assess site for hazards (UXO, TICs/TIMs).
- Conduct an EOD sweep of the target.
- Identify and locate gross hazard and contamination levels.
- Mark cleared areas and hazard areas.
- Characterize radiation environment—map dose rates.
- Define site assessment requirements.
- Sketch/photograph/video the site to support further planning activities.

Site Assessment

- Identify and characterize all nuclear and radiological materials and isotopes.
- Determine future suitability for storage.
- Develop map of the area with all dose rates at known distances (could be part of exploitation paragraph also, but should be done during characterization phase).

Exploitation

- Secure documents for review by intelligence organizations.
- Take material samples – package and transport to laboratory.
- Detain staff for questioning.

Disablement

- Conduct deliberate disablement operations (control contamination).
 - An NDT will not “render safe” weaponized sensitive nuclear material, a nuclear device, or radiological dispersal device. These actions will be done through other established programs.
 - Disablement operations cannot cause release of radioactive materials, TIMs, or any other hazard into the environment/surrounding area.
 - Teams will treat all uranium compounds as highly enriched materials to preclude criticality accidents.
- Conduct controlled shut down operational processes.
- Extract nuclear materials from processing equipment.
- Disable processing equipment permanently.
- Remove critical equipment to prevent reconstitution.
- Record equipment list for future WMD-E operations.
- Conduct hasty disablement operations (contamination probable).
 - Shut down operational processes as safely as possible.
 - Induce catastrophic event to disable processing equipment.
 - Verify that equipment is disabled.

Elimination

- Conduct complete physical inventory of nuclear and radiological materials.
- Package materials for transportation.
- Load and ship materials.
- Report results to command.

Control Contamination

- Use site survey data to establish exclusion zone.
- Establish “hot line” to control entry to and exit from exclusion zone.
- Collect and package contaminated waste (that is, used personal protective equipment).
- Decontaminate equipment and personnel.
- Manage exposure levels using as low as reasonably achievable (ALARA) principles such as identifying clean vs. dirty and low dose areas.
- Safely remediate the site (time permitting) using field expedient methods.

Establish Local Nuclear and Radiological Materials Collection Points

- Nuclear
 - Establish physical security for storage site.
 - Create safe geometry spacing.
 - Prepare safe geometry storage containers.
 - Establish inventory control process.
- Radiological
 - Establish physical security for storage site.
 - Prepare shielding material.
 - Prepare storage cells.
 - Establish inventory control process.

SUPPORT TO THE NUCLEAR DISABLEMENT TEAM

D-10. The NDT is deployable and 100 percent mobile but requires the following mission dependent support:

- A WCE or other organization to provide C2 and reachback support.
- Beyond the organic five days of supply. sustainment capability and two-week supply of expendables/nondurable items.
- A CBRNE response team for decontamination and first entry monitoring support as well as CBRNE sampling, packaging, transportation and, if necessary, Level A support.
- Life support, interpreters, technical linguists, combat medics, decontamination assets, a security package (route, convoy, and local security at a minimum), and engineering support as required.
- Site security until exploitation operations is complete for each potential WMD site (security must remain at sites confirmed to have WMD until all items of proliferation concern are removed to prevent looting and loss of positive control of special nuclear material.).
- A prioritized list of sites to exploit and CCIR firmly established to assist the NDT in mission planning and support requirement allocation and tasking.
- Transportation augmentation for collection and movement of material to temporary storage facility.

Appendix E

Chemical, Biological, Radiological, Nuclear, and High Yield Explosives Analytical and Remediation Activity

A CARA has a mobile analytical laboratory (MAL) section, two remediation response sections (East and West), and an (U.S. focused) aviation section organic to a CBRNE operational headquarters (see Figure E-1, page E-2). A CARA is led by a director and is primarily composed of Department of the Army civilians (DACs). Central to CARA are the specialists who provide the subject matter expertise to conduct analytical laboratory operations, technical escort operations, and remediation and restoration operations. This organization is designed to deploy specialized tailored packages that go forward to actively obtain samples rather than waiting for samples to be brought back by other escort elements. The linkage to the organic MAL is designed to facilitate a tremendous reduction in the feedback time by providing in theater sample confirmation results.

MISSION

E-1. The mission of the CARA is to conduct operations in support of CCDRs or OGAs to counter CBRNE and WMD threats in support of national combating WMD objectives. A CARA provides tailored, mobile, modular, and deployable teams supporting expeditionary forces; and ensures continued support to the DOD's CBRNE defense and related initiatives through safe and secure material escort.

TASKING AUTHORITY

E-2. As part of the CBRNE operational headquarters, the CARA will typically deploy one or more MAL, remediation response team (RRT), or mobile munitions assessment system (MMAS) elements in a general support role to the theater commander under the C2 of a JTF-E with mission dependent direct support allocation to designated commanders on an area/site specific basis. Each of these elements can also deploy separately from the JTF-E. In this case these elements will most often be placed OPCON to the supported command.

CAPABILITIES

E-3. The MAL is organized into three operational configurations: light, heavy, and chemical/biological monitoring. Remediation response sections (East and West) are primarily used to support HLS missions. However, RRTs and MMASs may deploy in situations where the size or complexity of the planned or opportunity target requires additional capabilities and resources beyond what can be provided by subordinate forces under the C2 of a JTF-E headquarters. The structure of a CARA is presented in Figure E-1, page E-2.

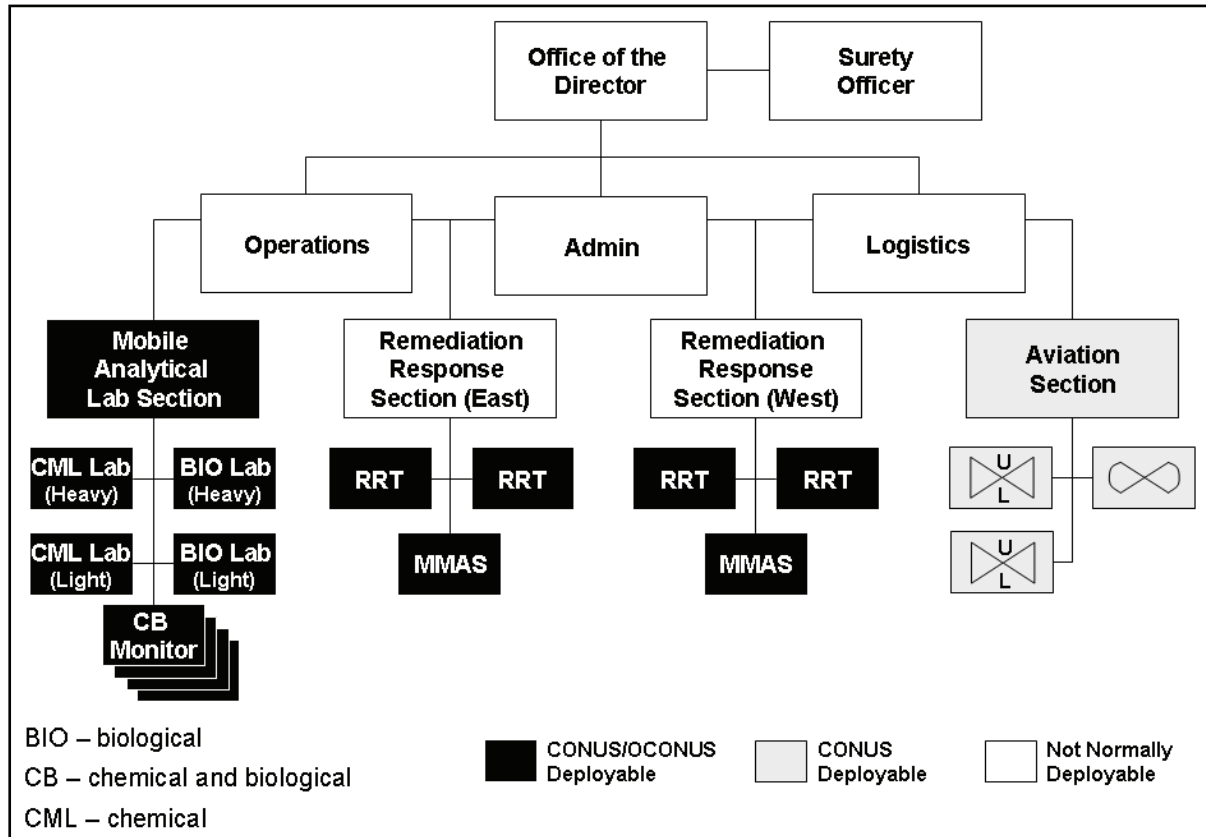

Figure E-1. CARA structure

MOBILE ANALYTICAL LABORATORY SECTION

E-4. The MAL section provides analytical scientists and technicians to support CCDRs and other government agencies to detect, identify, quantify, and characterize chemical, biological, explosives, and biometric evidence to support intelligence, investigative information, mission planning, exploitation, remediation, and CM activities directed at WMD-E.

E-5. The light MAL configurations are two rapidly deployable suites of modular and tailored laboratory instruments for immediate operations at the request of a ground force commander. The light MALs bring a selected package of confirmatory standard analytical instrumentation. The light MALs are deployable via C-130, and deploy on the ground in a shelter equipped HMMWV with a trailer mounted generator and storage container.

E-6. The heavy MAL configurations are two 20 foot expandable shelter/containers that are deployed into a theater sanctuary area. The heavy MAL configuration brings a full brick and mortar lab-like facility with confirmatory standard capabilities. The heavy MAL is deployed via C-17 and requires an marginal terrain vehicle to be ground transportable.

E-7. The chemical/biological monitoring MAL configurations are four light medium tactical vehicles with shelter and towed generator sets. The monitoring vans will provide a ground force commander with the data and knowledge of occupational exposure limitations as defined by Occupational Safety and Health Administration (OSHA), Center for Disease Control and Prevention (CDC), United States Army Center for Health Promotion and Preventive Medicine (USACHPPM), and the U.S. Surgeon General during CBRN material recovery or long term site remediation.

E-8. The MAL brings the following capabilities to the supported commander:

- Receipt and storage of solid, liquid, and vapor/gas samples
- A catalog of samples and the results of forensic analysis
- Forensic analysis
 - Identification of the constituents of the solid, liquid, and vapor/gas sample
 - Characterization of the sample
 - Quantification of the threats
 - Secure and positive control of samples and sample related data
- Sample related deliverables
 - Split sample for additional analysis as needed
 - Sensitive analytical data and results transmission
- Self-administration of the daily operation of the mobile laboratories
- Safe (and according to applicable laws, regulations, and customs) storage, transportation, and/or treatment and destruction (as needed) of any HAZMAT resulting from the laboratory operations.

E-9. The MAL requires assistance from the supported commander. Staffed by DA civilian scientists, the MAL has no self-protection assets, life support equipment, and possesses only minimal administrative and logistics support. Additionally the MALs have limited communications ability between vehicles and require a deployed communication support (such as available through a WCE) for technical reachback and support.

REMEDIATION RESPONSE SECTIONS (EAST AND WEST)

E-10. The remediation response sections are each composed of two RRTs and a single MMAS. The RRTs are tailored teams designed to conduct CBRNE emergency response, site assessments, technical escort of surety and non-surety materials, remediation, recovery and disposal chemical/biological materials and munitions, and reachback in support of CCDRs and OGAs. The MMASs provide a mobile capability (that is almost a portable diagnostic laboratory) that can rapidly respond to assess a chemical weapon. The unit includes a variety of sophisticated, portable assessment devices to include several x-ray systems, computer systems to record and store data, air monitors, a weather station, audio/video and communications equipment, equipment, and a portable isotopic neutron spectroscopy system.

E-11. The remediation response sections deploy their RRTs and MMASs to respond to mission requirements. Figure E-2, page E-4 provides a graphical representation of the continuous operations capability of an RRT that is teamed with an MMAS to perform response operations at a particular site.

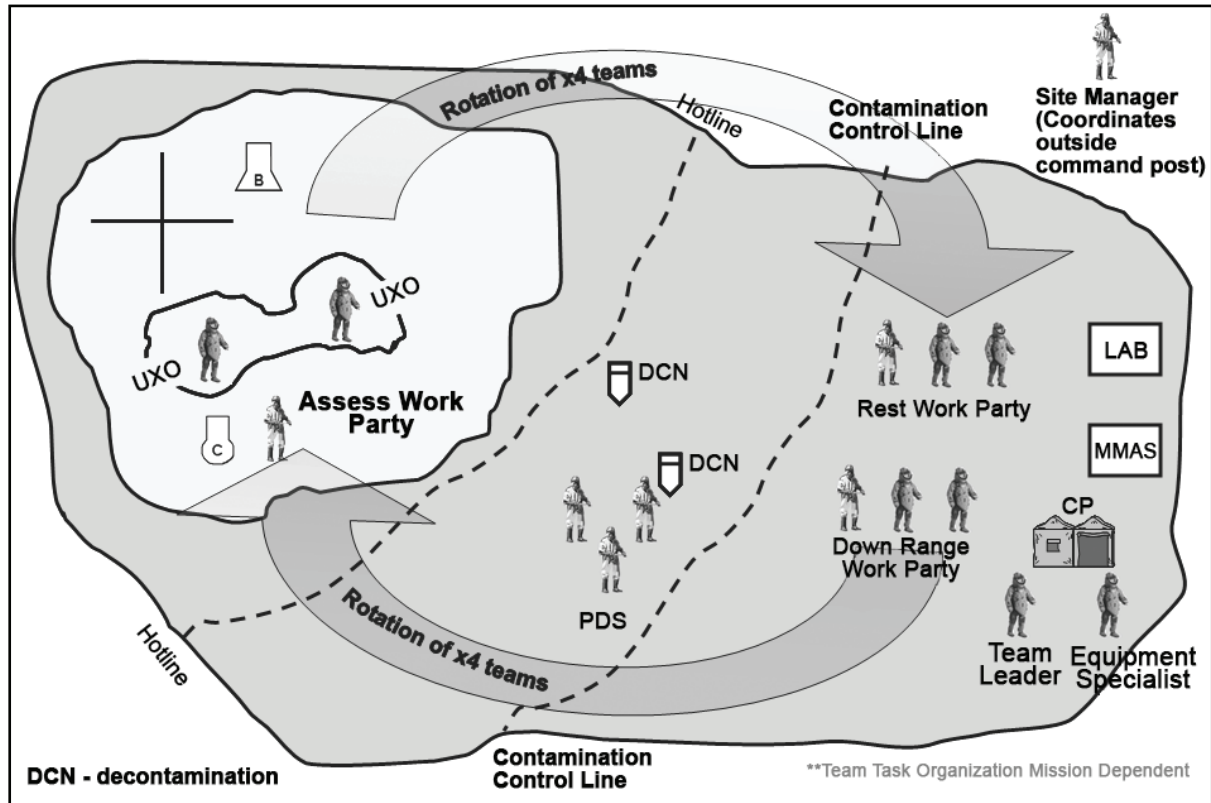

Figure E-2. Concept of an RRT and MMAS performing continuous operations

AVIATION SECTION

E-12. The aviation section is responsible for deploying, providing sustainment support, and redeployment support for specialized CBRNE forces conducting WMD-E missions in support of national combating WMD objectives. This aviation asset provides dedicated, experienced, tenured, and proficient fixed and rotary wing aviation support for the transport of chemical surety and non-surety materials, RCWM, and command response teams. This section will typically only support operations in U.S. territories.

Appendix F

Joint Elimination Coordination Elements

A JECE from the USSTRATCOM combines with the OCP to create the JOC for a JTF-E headquarters. In that role they provides the necessary core joint staff augmentation (J-1 through J-7) to enhance intelligence, operations/training, and planning capabilities for the headquarters. The intelligence section coordinates support for the planning process and, when directed, assists in the rapid stand-up and integration of the JTF-E intelligence organizations and capabilities. The operations/training section stays current on WMD related issues; coordinates WMD-E training; and designs, participates in, and integrates joint exercises. The plans section reviews WMD-E plans, assists in the development of supporting operational plans, and assists the operations/training section with SU of WMD-E missions that are being performed by subordinate units.

THE ROLE OF THE JOINT ELMINATION COORDINATION ELEMENT

F-1. The SecDef will direct the establishment of a JECE to facilitate the rapid creation of a JTF-E or provide direct augmentation to a combatant command or other operational level command. When a contingency requires the creation of a JTF-E headquarters, the JECE provides a portion of the augmentation necessary for the establishment of that headquarters and is specifically used to establish a JOC. When a separate JTF-E headquarters is not required, the JECE may be used to directly augment a combatant command or provide a subordinate Service or functional component with the augmentation necessary to allow that headquarters to provide joint C2 for WMD-E operations within their AO. USJFCOM will define the specific command relationships between the JECE and the supported command.

F-2. The JECE is a standing joint element assigned to a USSTRATCOM. It conducts operational level WMD-E mission planning (including deliberate, crisis action, and adaptive planning), joint training, and WMD-E operations exercises in support of JFC requirements. The JECE will focus on the activities and operations necessary to train and prepare joint forces and their C2 elements to conduct WMD-E missions. To accomplish this mission, the JECE will:

- Review combatant command OPLAN and OPORDs.
- Assist subordinate commands within combatant commands in the development of operational and tactical level planning for elimination missions (deliberate, crisis action, and adaptive planning) when requested.
- Plan, participate in, and conduct joint elimination training and exercises in support of CCDR requirements and to ensure the readiness of JECE personnel.
- Assist combatant commands with the development and execution of joint training exercises involving WMD-E through the United States Strategic Command Center for Combating Weapons of Mass Destruction when requested.
- Assist USSTRATCOM (DOD lead for combating WMD) in prioritizing DOD WMD-E planning and support activities.
- Maintain worldwide SU of WMD-E operations to focus activities in support of CCDR requirements.
- Provide support to a JTF-E commander when a JTF-E is established.

F-3. The JECE was primarily created to provide a joint capability to enable or augment a JFC headquarters or subordinate Service/functional component staff to become a JTF-E headquarters. The support relationship of the JECE to the CBRNE operational headquarters for JTF-E operations was established to facilitate the rapid formation of a joint C2 capability for elimination missions during a crisis. Due to this unique relationship, close coordination between the JECE and the CBRNE operational headquarters is required.

F-4. The JECE will provide the interface between the CBRNE operational headquarters and the joint community. It will assist integration of Service elimination capabilities, to include the CBRNE operational headquarters, into joint elimination planning, training, and exercises, in coordination with USJFCOM, Service component commanders, and other Service commands. When requested, the JECE supports the planning and training efforts of Service components (to include the CBRNE operational headquarters and subordinate elements). The JECE provides joint elimination and C2 expertise and serves as the advocate for joint elimination capabilities and resources through the United States Strategic Command Center for Combating Weapons of Mass Destruction (SCC-WMD) to USSTRATCOM.

F-5. During a contingency, a JECE will be available to support requests for assistance related to WMD-E operations. This operational request will typically occur either through a SecDef execution order to USSTRATCOM to provide the JECE directly to a CCDR, or through an execution order to USJFCOM to establish a JTF-E for further assignment to a supported commander. The supported commander and/or appropriate Chairman of the Joint Chiefs of Staff order will define the command relationships and roles between the JECE and the JTF-E headquarters. The size and scope of an adversary's WMD program will determine the requirements for the size of the JTF-E and assigned forces.

F-6. A CCDR will request a JTF-E from USJFCOM to meet WMD-E requirements. USJFCOM will establish the JTF-E. USJFCOM will use a prepare to deploy order for WMD-E mission support as the initial basis for sourcing forces for the JTF-E. Once the JTF-E is established, OPCON of the JECE and other designated forces will transfer to the JTF-E commander.

F-7. Large scale WMD-E operations may require the formation of the JTF-E as a functional JTF subordinate to a parent JFC. The JECE can serve as the core joint element to enable a Service headquarters element to form a joint command structure for WMD-E operations.

F-8. Small scale WMD-E operations may be handled without the formation of a JTF-E headquarters. In this case a CCDR's (or subordinate headquarters'), pre-existing command structure may be augmented with a JECE to provide joint WMD-E expertise. In this configuration, specific WMD-E operational forces would be included in the command structure of functional components rather than under the centralized C2 of a JTF-E headquarters.

JOINT ELIMINATION COORDINATION ELEMENT ORGANIZATION

F-9. The JECE organization consists of a leadership section and five groups organized as a functional joint staff. The JECE staff will typically be absorbed into the appropriate functional staff organization of a JTF-E headquarters when a JTF-E is formed as part of the JOC.

F-10. The leadership section is organizationally responsible for C2 of the JECE. The JECE CoS is responsible for the day-to-day leadership functions and for overseeing all aspects of JECE operations, planning, training, and mission support.

F-11. The JECE J-1/4 will provide personnel and joint personnel service planning support for the WMD-E mission, to include specialized medical support. While the responsible CCDR (USSTRATCOM) will provide functional personnel and manpower support, the JECE J-1/4 will provide day-to-day joint personnel support to the JECE CoS. This section is also responsible for the material management, sustainment, and logistics operations functions of the JECE and integrates WMD-E operations specific logistics support into plans and exercises.

F-12. The JECE J-2 will leverage SCC-WMD capabilities to maintain SU specific to WMD-E. This section will maintain SU of threats and issues; coordinate intelligence support requirements for JECE

planning, and; when requested, advise supported commands on intelligence campaign planning for elimination operations. During a crisis, the JECE J-2 will monitor events and advise the JECE CoS of possible focus areas. When requested, this section will support CCDR's and/or JTF-E commander's development of WMD-E intelligence requirements, identification restricted targets, and recommend prioritized potential site exploitation planning.

F-13. The JECE J-3/engineering staff section; Operational Plans and Joint Force Development Directorate, Joint Staff (J-7) will coordinate with CCDRs through the SCC-WMD to conduct WMD-E training and exercises with combatant commands, other DOD and USG agencies, and forces designated to provide WMD-E capabilities. The JECE J-3/J-7 will improve coordination and training by establishing habitual relationships with those commands and forces. These activities will enhance and institutionalize WMD-E capabilities by gaining additional expertise; providing routine interactions; and ensuring forces are adequately organized, trained, and equipped to accomplish the WMD-E mission. During a crisis and when requested, the J-3/J-7 will coordinate crisis-specific training and assist the supported CCDR in operational-level WMD-E specific COA development and analysis.

F-14. The JECE J-5 will coordinate with CCDRs through the SCC-WMD to determine the priority of areas and requirements for WMD-E planning. The JECE J-5 will support SCC-WMD efforts to assist CCDRs' development of operational and tactical level WMD-E plans, and assist designated units in planning for WMD-E operations. Day-to-day operations would include updating existing plans and orders or developing new plans for potential crisis areas. During a crisis and when requested, this section will coordinate crisis-specific planning and conduct planning for establishment and deployment of the JTF-E headquarters in support of CCDR or JTF-E commander requirements.

F-15. The JECE engineering staff section; Operational Plans and Joint Force Development Directorate, Joint Staff (J-6) will develop command, control, communications, and computers plans and architectures for WMD-E operations to ensure interoperability of command, control, communications, and computers systems at the operational and tactical levels. This section will determine JECE command, control, communications, and computers requirements and coordinate with the CCDRs through the SCC-WMD, the Services, and units conducting WMD-E operations to integrate command, control, communications, and computers systems for WMD-E operations.

JOINT ELIMINATION COORDINATION ELEMENT AUTHORITIES, RESPONSIBILITIES, AND RELATIONSHIPS

F-16. The JECE will leverage the SCC-WMD capabilities to accomplish its mission and:

- Use the SCC-WMD Situational Awareness Division as the day-to-day conduit for intelligence and information on possible elimination sites and programs to prioritize planning activities and anticipate requests for planning support based on reported events and intelligence.
- Use the SCC-WMD Interagency Division to coordinate interagency support for elimination operations, planning, and exercise support.
- Coordinate with the SCC-WMD Plans and Doctrine Division for planning support to CCDRs, joint and Service doctrine and TTP for elimination operations, as well as all joint training and exercise activities related to WMD-E operations.
- Coordinate through the SCC-WMD to support WMD-E operational and tactical level planning, training, and exercise requirements of CCDRs.
- Report resource and capability shortfalls or new capability requirements for WMD-E across the DOTMLPF spectrum to the SCC-WMD Concepts, Assessments, and Capabilities Division for evaluation and potential resolution through the Joint Capabilities Integration and Development System process.
- Support the CBRNE operational headquarters in its coordination with the joint community (to include CCDRs) and appropriate Army staff elements. Provides specialized expertise to support joint elimination planning, training, exercises, and the identification of joint capability gaps and resource shortfalls for the WMD-E mission.

F-17. The relationship between the JECE and the commander, CBRNE operational headquarters varies between steady state operations and when the creation of a JTF-E is directed. Key relationship differences between the JECE and the CBRNE operational headquarters include:

- The JECE and the CBRNE operational headquarters are separate units during steady state operations. The JECE and the CBRNE operational headquarters will retain separate chains of command and organizational structures. The JECE will support the CBRNE operational headquarters mission to be prepared to form a JTF-E headquarters. This includes coordinating for joint training and exercises for WMD-D missions and exercising as a part of a JTF-E headquarters (to include deployment preparation activities).
- The JECE will operate in support of the commander, CBRNE operational headquarters when the commander has been designated as the commander, JTF-E. The commander of the JTF-E headquarters has the authority to direct the general direction of the support provided by the JECE for WMD-E mission support.
- Both in steady state operations and when a JTF-E has been formed, the JECE focus is at the operational level of war, and on the integration between the operational and tactical levels of war. The JECE will provide the interface between the CBRNE operational headquarters and the joint community to support the planning, training, and rapid formation of a JTF-E headquarters.

F-18. In addition to supporting the CBRNE operational headquarters, the JECE will be available to support the CCDRs' operational level planning and training for WMD-E missions. Any headquarters receiving the JECE as staff augmentation should be prepared to provide all necessary support to the JECE.

Appendix G

Training for Full Spectrum Operations

Applying current doctrine to staff training is unique in that a staff is considered neither a unit nor organization in the traditional sense, but rather a collection of officers, NCOs and Soldiers organized to support the commander with C2. The staff is essentially an extension of the commander. Planning and executing staff training within the CBRNE operational headquarters provides the commander (and more directly the CoS) with a unique set of challenges to support the designed splitting of the staff to support operational deployments. While the MCP continues to operate within CONUS the OCP is designed to deploy and provide the core Army element for the formation of a JTF-E headquarters. As this occurs, the OCP integrates with a JECE and potentially other staff augmentation to create a JOC for the JTF-E headquarters. The CBRNE operational headquarters will develop a joint training plan to meet the training requirements for a JTF-E headquarters. The most severe training challenges are those that deal with time, synchronizing individual and element/cell training with MCP and OCP training, and developing short-range and near term cell and element staff training. In essence, the CoS must determine how to train the staff to achieve METL/joint mission essential task list (JMETL) proficiency both horizontally and vertically across the command posts and this includes the JMETL staff requirements. For more information on training see FM 7-0, FM 7-1, and Chairman, Joint Chiefs of Staff Manual (CJCSM) 3500.03B.

STAFF MISSION ESSENTIAL TASK LIST DEVELOPMENT

G-1. Staffs have always developed METLs. However, the unique organization and mission of the CBRNE operational headquarters make it prudent to also consider developing a focused METL for each of the headquarters command posts (MCP and OCP) and their subordinate cells. The process used to develop a staff METL is the same as cited in FM 7-1, but with some subtle differences. Key among those is that the CoS, not the commander, primarily drives the METL (and JMETL) development process for the staff based on the headquarters wartime mission and the commander's guidance. The staff METL/JMETL represents those critical tasks that the command posts and their subordinate cells must be able to perform to assist the commander with C2. Once approved, the METL provides the focus for battle staff training.

HEADQUARTERS STAFF MISSION ESSENTIAL TASK LIST DEVELOPMENT SEQUENCE

G-2. The CoS involves command post officers in charge (OICs), cell leaders, and their noncommissioned officers in charge (NCOICs) in METL development, to create a team approach to staff training that is battle focused. Participation by command post OICs, cell leaders, and key NCOs develops a common understanding of the headquarters staff's critical operational mission requirements, so that METLs developed throughout the staff are mutually supporting and nested with the higher echelon. Command post OICs and cell leaders subsequently apply the insights gained during preparation of the staff's METL to the development of their command post and cell METLs. Element leaders (officers and NCOs) must understand the headquarters staff's METL so that they can identify the appropriate element and individual staff tasks for each collective mission essential task. The same process must be accomplished to identify applicable JMETL.

G-3. The staff, led by the CoS, develops the staff METL. A checklist for staff METL development includes the following:

- Analyze the headquarters assigned mission and METL and identify specified and implied staff tasks.
- Analyze the OE and other external guidance to identify any other staff tasks.
- Review the CBRNE operational headquarters mission and METL.
- Use the command post-to-task matrix to identify those collective tasks that are critical for wartime accomplishment. These tasks become the staff METL.
- Sequence the METL tasks as they are expected to occur during the execution of the wartime mission or command post operations.
- Back-brief the CG and obtain approval of the recommended staff METL.
- Provide the approved METL to the staff.

MISSION ESSENTIAL TASK LIST DEVELOPMENT SEQUENCE

G-4. Upon approval of the staff METL, the sequence for METL development described above is repeated using the same process from higher to lower for each of the command posts and subordinate cells.

G-5. The CoS initiates the process by providing the commander's guidance and the approved staff METL to the command post OICs. The command post OICs provide their guidance and command post METL to the cell leaders to develop their METL. Cell leaders in turn provide their METL and guidance to the element leaders who begin the bottom up approach by identifying critical tasks or battle tasks that support the higher echelon METL. A generic checklist for command post and cell METL development follows:

- The higher echelon command post/cell initiates the process for subordinates by providing guidance, which includes the wartime mission and METL, along with the approved staff/command post METL, to the subordinate elements.
- Command post/cell staffs, led by the OIC, review the higher echelon's METL in conjunction with the unit mission and METL.
- Command post/cell staffs review the OE and other external guidance to identify other staff tasks.
- Command post/cell staffs use the command post-to-collective task matrix as a starting point to identify the collective tasks that are critical in assisting the commander with C2 during operations.
- Command post/cell staffs sequence METL tasks as they are expected to unfold during the operation.
- Command post/cells back-brief higher echelons to obtain approval of their METL. Each higher echelon selects specific tasks from their subordinate echelon's METL as their staff battle tasks.
- A staff battle task, like a unit's, is a subordinate's mission essential task that is so critical that its accomplishment determines the success of the next higher echelon's mission essential task. Staff battle tasks are selected at the element level. Similar command posts may have different staff battle tasks selected, depending on their unique responsibilities and functions. Staff battle tasks allow the CoS and subordinate staff leaders to define the training tasks that integrate the WFF and receive the highest priority for resources, such as training areas, facilities (to include virtual and constructive simulations), materiel, and funds.
- Elements identify critical tasks that support the cell's METL. Similarly, the cell develops a METL that supports the command post METL.
- Command post/cell OICs provide the approved METL to their command post/cell. Upon approval, the command post/cell METLs are typically modified only if changes occur in the unit's mission and/or staff METL.

ESTABLISH TRAINING OBJECTIVES

G-6. Once the METL is approved, the CoS, assisted by the command post and cell leaders, establishes training objectives for the entire staff. Training objectives include the conditions and standards that describe the situation or environment and ultimate endstate criteria that the staff must meet to successfully

perform each task. Training objectives and standards for the METL can be obtained from commander's guidance, approved training and evaluation outlines, Soldier training publications, higher headquarters command guidance, and local SOPs. It is important that every task have a condition, standard, and performance steps so that all training can be evaluated and measured against a benchmark.

CHIEF OF STAFF TRAINING ASSESSMENT

G-7. The CoS sets specific training goals for the staff. These goals are based on guidance from the commander, the CoS's vision, and guidance provided in appropriate doctrinal manuals. The CoS's initial METL assessment serves as the starting point for developing the staff training strategy. The training assessment is the CoS's comparison of the staff's current proficiency, to include the proficiency of individual staff officers, command posts, cells and elements, with the proficiency required to support the commander with C2 in support of full spectrum operations. However, to be most effective, an ongoing evaluation process must be implemented to ensure that the staff remains focused on preparation for its role in assisting the commander with C2. The CoS and his primary staff officers (along with their NCOICs) assess the organization's current proficiency on mission-essential tasks against the required standard. The CoS indicates the current proficiency by rating each task as "T" (trained), "P" (needs practice), or "U" (untrained). The outcome of the training assessment identifies the staff's training requirements. The METL assessment compares current levels of training with the Army standard and is used to update staff goals and objectives.

ESTABLISH TRAINING PRIORITIES

G-8. The CoS establishes training priorities for staff training METL tasks after completing the training assessment. The priorities established are based on the CoS's assessment, the criticality of each task, and the training emphasis the task should receive.

DEVELOP STAFF TRAINING STRATEGY AND CHIEF OF STAFF TRAINING GUIDANCE

G-9. The training strategy developed and executed by the staff to train to standard in its critical wartime missions is developed based on the staff METL, training assessment and training priorities established by the CoS. Through the training strategy, the CoS establishes training goals, describes training objectives, and most importantly, determines the staff's training priorities. The staff training strategy articulates the CoS's staff training guidance which includes the commander's training guidance and vision.

G-10. To develop the staff training strategy, the CoS must rely on input from subordinate staff leaders (command post, cell, element leaders, and their NCOICs). Their input is crucial to identifying the individual, leader and digital training requirements; the functional and supporting collective tasks; training audience; the type training events that best accomplish the training and meet training objectives; and finally, the estimated resources (facilities, terrain requirements, and/or simulations) required to conduct the training events to standard. The end result is a preliminary training strategy which includes an estimation and tentative scheduling of resources, a general understanding of the various training requirements and key events. Training for the staff should be scheduled so that it occurs in a progressive and sequential manner using the Army's crawl-walk-run approach.

G-11. Training during the "crawl" phase focuses on achieving individual, section, command post element, and cell task proficiency before progressing to staff group and full staff training. Examples would include: individual specific competencies and digital systems operator training. In the "walk" phase, staff training and drills focus on critical intra-command post element staff control processes and coordination. During the "run" phase of training, staff training is multi-echelon involving the full staff, inter-command post, and cell and element coordination. Training focuses on critical command-oriented staff processes, such as MDMP and IPB, which directly affect full staff proficiency.

COLLECTIVE TASKS

G-12. Table G-1, page G-4 provides a list of collective tasks for training.

Table G-1. Collective task training

| <i>Section</i> | <i>Number</i> | <i>Description</i> |
|-----------------------|---------------|--|
| Intelligence | 03-4-0002 | Maintain a current estimate. |
| | 03-4-0003 | Maintain the current situation. |
| Movement and Maneuver | 63-2-4550 | Set up unit headquarters, dining facility, and bivouac areas. |
| | 63-2-4822 | Perform home station activities upon redeployment. |
| Protection | 03-1-0066 | Prepare for nuclear attack. |
| | 03-1-0070 | Prepare for a chemical attack. |
| | 03-4-0018 | Prepare for a biological attack. |
| | 03-5-1015 | Conduct CBRN analytical functions. |
| | 03-6-0001 | Develop a CBRN defense plan. |
| | 03-6-9404 | Direct CBRN defense operations. |
| Sustainment | 08-2-0004 | Evacuate casualties. |
| | 08-2-0232 | Treat CBRN contaminated casualties. |
| | 09-1-0405 | Coordinate support. |
| | 12-6-0006 | Conduct personnel accounting and strength reporting. |
| | 12-6-0007 | Perform essential personnel services. |
| | 12-6-0008 | Conduct unit postal operations. |
| | 12-7-4012 | Provide legal support. |
| | 14-8-0001 | Plan theater resource management operations. |
| | 14-8-0002 | Manage theater fiscal resources. |
| | 14-8-0004 | Account for theater resource utilization. |
| | 16-1-1001 | Conduct unit religious support. |
| | 16-6-1020 | Perform religious support operations in AOR. |
| | 63-2-4012 | Set up unit command post. |
| | 63-6-4030 | Coordinate transportation support. |
| | 63-6-4034 | Coordinate support for reconstitution and regeneration operations. |
| | 63-6-4133 | Plan support operations. |
| | 63-7-2406 | Coordinate force health protection support. |
| | 63-7-2601 | Conduct human resources management operations. |
| | 63-7-2602 | Direct casualty management operations. |
| | 63-7-2623 | Provide IG support. |
| C2 | 03-4-0004 | Plan chemical-unit employment. |
| | 03-4-0007 | Conduct a chemical-vulnerability analysis. |
| | 03-4-0008 | Conduct biological-vulnerability analysis. |
| | 03-4-0009 | Conduct nuclear-vulnerability analysis. |
| | 03-4-0010 | Process nuclear, biological, and chemical reports. |
| | 03-4-0011 | Process weather data. |
| | 03-4-0012 | Prepare contamination predictions. |
| | 03-4-0013 | Coordinate chemical/biological survey/sampling operations. |
| | 03-4-0014 | Coordinate radiological-survey operations. |
| | 03-4-0015 | Recommend operational exposure guidance. |

Table G-1. Collective task training

| Section | Number | Description |
|----------------|---------------|--|
| | 03-4-0016 | Coordinate with staffs on CBRN related issues. |
| | 03-4-0017 | Prepare CBRN plans and orders. |
| | 03-4-0020 | Implement the CBRN warning and reporting system. |
| | 03-4-1017 | Monitor CBRN and smoke operations. |
| | 08-6-9006 | Monitor the health of the command – surgeon. |
| | 09-1-0403 | Develop explosive ordnance disposal support plan. |
| | 12-6-0003 | Provide morale, welfare, and recreation support. |
| | 20-7-1020 | Coordinate ISR effort. |
| | 20-7-5121 | Coordinate movement control. |
| | 20-7-5150 | Plan civil-military operations. |
| | 20-7-5151 | Coordinate interface/liaison between U.S. military forces and local authorities/NGOs. |
| | 20-7-5152 | Coordinate negotiations with and between OGOs and NGOs. |
| | 20-7-6172 | Process relevant information to create a COP. |
| | 20-7-6174 | Disseminate cop and execution information to higher, lower, adjacent, supported, and supporting organizations. |
| | 20-7-6183 | Develop staff estimates. |
| | 20-7-6193 | Develop CCIR recommendations. |
| | 20-7-6213 | Maintain synchronization. |
| | 20-7-6221 | Maintain continuity of C2. |
| | 20-7-6230 | Plan public affairs operations. |
| | 20-7-6233 | Implement higher headquarters public affairs themes. |
| | 41-5-0010 | Coordinate for foreign nation support. |
| | 63-6-2026 | Complete the OPORD/OPLAN, annexes, and appendixes. |
| | 63-6-2049 | Assess tactical situation and operations (communications). |
| | 63-6-4016 | Establish communications. |
| | 63-6-4038 | Maintain communications. |
| | 63-7-2211 | Revise tactical SOPs. |
| | 71-6-0029 | Synchronize tactical operations. |
| | 71-7-6190 | Plan using the MDMP. |

OPERATING AS JOINT TASK FORCE

G-13. As previously identified, the OCP will be required to develop a JMETL to be prepared to operate as part of the JOC in a JTF-E headquarters. Coordination with the JECE will be necessary to address the METL/JMETL requirements associated with operating collectively as a JOC for a JTF headquarters. The JMETL is the JFC’s list of priority joint tasks, derived from plans and orders, along with associated conditions and measurable standards. It constitutes the JFC’s warfighting requirements. Procedures for JMETL development are found (see web site: <<http://www.dtic.mil/doctrine/training/JMETLbook.pdf>>) in the JMETL Handbook.

This page intentionally left blank.

Appendix H

Medical Laboratory Support

Medical laboratory support is an important component for CBRNE operations and WMD-E missions. This appendix provides the basic information necessary to understand the type of support provided as part of medical laboratory support.

GENERAL

H-1. Medical laboratory services must continue their support role even under CBRN conditions. For the provision of clinical and diagnostic support, the facility must be located in a contamination-free area or be inside collective protection. Designated laboratories within the theater will analyze CBRN samples/specimens (including in theater field confirmation identification of biological warfare [BW] agents by evaluating specimens from symptomatic patients and animals and environmental samples collected from the AO).

H-2. At Role II, medical laboratory support at this level is extremely limited; it consists of clinical laboratory procedures in direct support of medical treatment facility (MTF) and forward surgical team (FST) activities. Laboratory personnel prepare collected suspect CBRN specimens for submission to the supporting laboratory for analysis; the specimens are forwarded to supporting medical laboratories and chain of custody is maintained.

H-3. At Role III, medical laboratory support in a combat support hospital (CSH) is intended for providing clinical laboratory support and is primarily in support of acute surgical cases, blood services, and immediate services required for intensive care operations. Only extremely limited microbiology services (parasitological exams and gram stains) are provided. In a mature theater, the microbiology services may be augmented to include limited cultures and sensitivity testing. Patients with documented or suspected exposure to CBRN weapons/agents will be medically evaluated, specimens will be collected, packaged, and an established chain of custody will be in place. The specimens will be forwarded through technical channels to the supporting medical laboratory (such as the Army medical laboratory [AML]) for analysis.

H-4. At Role IV, clinical laboratories in the field hospitals have the ability to perform a general, but limited, array of analytical procedures in hematology, urinalysis, chemistry, microbiology, serology, and blood banking. Patient specimens of suspected BW or chemical warfare (CW) agent exposures are forwarded through technical channels to the supporting medical laboratory.

H-5. The AML is the specialized magnetic resonance imaging theater laboratory that provides clinical and nonclinical medical “field” confirmatory laboratory support. Its mission is on order, deploy worldwide in tailored teams to conduct health threat detection, confirmation & medical surveillance for CBRNE occupational/environmental health & endemic diseases and CM to protect and sustain the health of the force across the full spectrum of operations. It is organized as—

- **Headquarters section.**
- **CBRN section.** Conducts analytical chemistry support by providing confirmation level analysis for the identification of CW agents and other chemical threats in air, water, soil, or other matrices.
- **Endemic disease section.** Provides field confirmatory analysis of BW agents in environmental and clinical samples using multiple methodologies; provides diagnostic capability to identify outbreaks of regionally specific endemic diseases; and serves as a resource of information for higher command medical personnel.

- **Environmental/occupational health section.** Provides theater level environmental threat assessments by conducting air, water, entomological, epidemiological, and radiological surveillance while serving as a resource of information for theater medical personnel.

H-6. When equipped and staffed, the AML provides in-theater field confirmation identification of CBRN samples or specimens. Using sophisticated equipment and methods, the AML has the capability to detect and identify CBRN agents in a variety of specimens/samples (such as human, air, soil, water, animals, vegetation, and food). DS from CONUS-based laboratories aid the AML with identification of CBRN agents. Command decision on use of protective/preventive measures and patient care may be based on the AML findings. Proper collection, packaging, and rapid shipment of specimens by MTFs and samples from other sources will ensure effective, timely, and accurate laboratory analyses.

H-7. At Role V (CONUS), designated Role V medical laboratories such as United States Army Medical Research Institute for Infectious Disease (USAMRIID), CDC, and Naval Medical Research Center (NMRC) perform analyses to provide definitive identification of suspect BW and CW agents for the President and SecDef purposes. The definitive identification of suspect BW agents also aids commanders in the AO in maintaining the health of their command.

SAMPLES/SPECIMEN COLLECTION AND MANAGEMENT OF CHEMICAL, BIOLOGICAL, RADIOLOGICAL AND NUCLEAR CONTAMINANTS

H-8. The means to initiate a CBRN sample/specimen collection and analysis mission include—

- Routine operating procedures.
- Presumptive biological samples from biological detection systems.
- Combat injuries.
- Symptomatic individuals.
- Commander RFI through C2 channels.

H-9. The decision makers and initiators of a CBRN sample/specimen collection and analysis mission include joint and Service-specific commanders, command surgeons, and their supporting medical and CBRN staff elements.

H-10. Collection of environmental and food samples is conducted by preventive medicine detachment, chemical operations specialists, damage control personnel, the food inspection detachment, public health officers, or bioenvironmental engineers (BEEs). Medical personnel in a clinical or hospital setting will collect clinical specimens (for example, serum, blood, and other body fluids) and provide these to the laboratory for analysis. The collection team provides transportation of samples between the collection site and the laboratory analysis site. The laboratory team provides consultation, as needed, regarding the types and sources of sample specimens to collect.

H-11. Samples are collected and initially packaged by the unit obtaining the sample. The sample is properly labeled, double-bagged, and prepared for evacuation. Ensuring that the chain of custody is maintained, the sample is evacuated to a sample transfer point for further evacuation, or possibly to a ship-based medical laboratory for field confirmatory identification. It is critical that the sample be maintained at 4 degrees Celsius (39.2 degrees Fahrenheit) during storage and transport. If a sample transfer point is used, a sample courier receives the sample for transport to an in-theater medical laboratory or ship-based laboratory for field confirmatory identification to support any appropriate treatment decisions. If there is an in-theater AML, the sample can be split for in-theater field confirmatory analysis and evacuation to CONUS for analysis and definitive identification. A portion of the initial sample will ultimately be evacuated to CONUS for definitive identification. If background samples are requested by an in-theater laboratory or ship-based laboratory, for whatever reason, evacuation will be conducted in the same manner ensuring that the chain-of custody is maintained throughout the transfer or evacuation process. Sampling and evacuation procedures are discussed in detail in FM 3-11.86.

Notes. 1. The term “sample” refers to nonhuman and nonanimal origin. The term “specimen” refers to human and animal origin. 2. Always consider that chemical agents may have been employed. Check for chemical agents before collecting a biological sample/specimen. Chemical agents can damage or destroy biological agents. Also, chemical agents not identified in the sample/specimen can pose a hazard to receiving laboratory personnel. Mark all samples that are potentially contaminated with chemical agents as such. 3. Precautions should be taken to protect the sample/specimen collector from potential BW agents; at a minimum, respiratory protection and rubber gloves must be worn. Additional care must be taken when collecting samples/specimens to prevent cross contamination. Gloves must be changed or decontaminated between sample/specimen collections. 4. Samples will not be delivered to the clinical laboratory of an MTF for analysis. They must be delivered to the designated supporting medical laboratory for processing. This will prevent accidentally spreading a biological agent in the MTF

H-12. The CCDR must ensure it has an executable plan to get the samples to the supporting laboratories. In some cases, dedicated TEU assets are used to escort samples. The priority for dedicated TEU assets will likely go to escorting samples from the theater back to the CONUS-based nationally recognized reference laboratories for definitive analysis and identification.

CHAIN OF CUSTODY

H-13. Samples suspected of containing biological threat agents (BTAs) must be collected and transported using accepted chain of custody procedures (such as DA Form 4137 [Evidence/Property Custody Document] DD Form 1911 [Materiel Courier Receipt], or other forms acceptable to law enforcement and federal agencies) to ensure sample-handling integrity for legal purposes. The Judge Advocate General’s office provides guidance and reviews on chain of custody procedures. See FM 3-11.86 and Joint Biological Agent Identification and Diagnostic System (JBAIDS) CONOPS for policy details. Chain of custody procedures are used to track all holders of the sample until sample destruction.

H-14. A strict chain of custody must be maintained for every sample or specimen collected. The chain of custody document must accompany the sample or specimen during transport from the point of collection to the receiving medical laboratory to the final disposition of the sample. Each time the sample or specimen is transferred, the receiving person must sign the document to show that the sample or specimen was received and state what happened to it during custody. The document will provide answers to the following questions about the sample or specimen.

- Who collected the sample?
- When was it collected?
- Who has maintained custody of it?
- What has been done with it at each change of custody?

H-15. The samples or specimens must be appropriately packaged, labeled, and evacuated to the designated medical and/or environmental laboratory for confirmation of a biological attack. The standard chain of custody for the evacuation could be as follows:

- Sampling unit.
- Sample courier or other command-designated courier personnel.
- In-theater supporting laboratory.
- Designated CONUS laboratory.

H-16. For clinical specimens, routine clinical laboratory custody procedures will be employed until the presence of a BTA is suspected based on prior intelligence or initial laboratory testing at which time chain of custody procedures will be initiated. Chain of custody forms may be initiated prior to determining the presence of a BTA, if desired.

H-17. Chain of custody forms are employed when moving samples to different locations within the same laboratory facility, upon shift changes, and when shipping/transporting samples to another laboratory.

Every aliquot of sample *must* be accounted for on the chain of custody forms until approved for disposal or destruction by the FBI or commander.

H-18. For discussion on the collection and management of suspect BW and CW agent specimens and samples, refer to the following:

- FM 4-02.283/NTRP 4-02.21/AFMAN 44-161(I)/MCRP 4-11.1B.
- FM 8-284/NTRP 4-02.23 (NAVMED P-5042)/AFMAN (I) 44-156/MCRP 4-11.1C.
- FM 8-285/NAVMED P-5041/AFJMAN 44-149/FMFM 11-11.
- Air Force Medical Service Concept of Operations for the Air Force Prevention and Aerospace Medicine Teams.
- Allied Medical Publication (AMedP) 8.
- JBAIDS Concept of Operations.
- FM 4-02.7.
- FM 3-11.86.

HANDLING AND STORAGE OF SAMPLES WITHIN THE LABORATORY

INCOMING SAMPLE DISINFECTION

H-19. Although sample containers should have been decontaminated at the time of collection, upon arrival at the laboratory, the outer sample container should be disinfected again (for example, wipe with 5% bleach solution) and placed into a protective container (for example, zip-lock bag). This procedure may be performed outside the entrance to the laboratory so as to prevent contamination of the laboratory.

STORAGE

H-20. Samples should be stored at temperatures appropriate for the sample type, which is usually in a refrigerator (14 degrees Celsius [57.2 degrees Fahrenheit]) for a short time (up to 1 hour) until it can be processed. After the sample has been split (for example, aliquot taken for analysis), the unused portion of the sample is usually stored in the refrigerator. Because of the hazardous nature of the samples, good physical security should be maintained on the storage area. Storage containers are to be physically secured to control access so as to maintain chain of custody and assure biosafety.

SAMPLE ACCESSIONING

H-21. Recording pertinent data about the sample in the laboratory records is critical so that the sample can be tracked and results reported to the appropriate physician, unit, or agency. Using established laboratory SOPs and worksheets; record the type of sample, location from which it was obtained, date and time of collection, sample identifying number patient identifying information (if appropriate), and other pertinent information; and assign a unique laboratory accession number to each individual sample. In this process, the laboratory must record the sample identification number assigned by the collector, if one exists (see FM 3-11.86). Data may be maintained using paper records or computer databases, if available, and meet the needs of the laboratory. The operations security of such records shall be maintained.

BIOLOGICAL SAFETY IN THE LABORATORY

H-22. According to standard safety practices and Service-specific directives, medical units/facilities will analyze clinical and/or environmental samples according to their established laboratory SOPs and current doctrine and policies. This will minimize the potential for spreading contamination within the laboratory facility and MTF. Standard precautions (that is, gloves, appropriate respiratory protection, long-sleeved laboratory coat) must be used when handling and analyzing samples. All samples are considered infectious and potential threats until otherwise determined. Samples should be processed in a Class I or II biological safety cabinet while utilizing standard precautions to protect personnel from sample aerosolization and to protect samples from cross-contamination in the laboratory.

H-23. Due to METT-TC, it may not be feasible for the specimen/sample to be shipped in a timely manner to a laboratory having better containment capabilities. Therefore, under these circumstances, field laboratories should use the best containment and decontamination procedures to process the initial samples. On occasion, CDC and World Health Organization field laboratories have used biological safety level (BSL

H-24.)-2 conditions for these agents. A health risk assessment should be completed to evaluate risk, adequacy of control measures, and the need for additional controls such as powered air pressure respirator (PAPR). Services will determine procurements of additional environmental engineering controls. If additional respiratory protection is utilized, Services must ensure that proper certification and training are achieved.

H-25. Specific recommendations for handling samples that may contain Ebola, Marburg, or Variola viruses are as follows:

- Commanders should make the greatest effort possible to protect the laboratory personnel from these agents. However, assays for these agents are available in field deployed laboratories because the need for laboratory results in a timely manner is so great.
- If rapid test results are urgently needed and no laboratory with suitable biological containment facilities is nearby, the initial sample should be processed using the best biological safety methods possible. Once the patient or environmental material is known to contain Ebola, Marburg, or Variola, all reasonable efforts should be made to send future similar samples to a laboratory with appropriate biological containment facilities. However, if this is not feasible, the strictest biological safety methods possible should be used to process future samples. Commanders should make all reasonable efforts to limit the further exposure of laboratory personnel to these agents. Use of a PAPR is one partial solution.
- All bio-hazardous waste should be disposed of using normal biohazard waste transport, tracking, and disposal (incineration) procedures.

CONFIDENCE LEVELS OF LABORATORY ANALYSIS

H-26. “Field” Presumptive Identification for BTA is achieved by the detection of a biological marker through the use of a single test methodology (for example, hand-held immunological assay, JBAIDS, Bio-Detection System Alarm). When a CBRN/medical/environmental team sample (soil, water), specimen (body fluids such as blood) collector arrives at the contamination site without a biomarker detection device, the sample/specimen taken from the site must be sent by courier to a laboratory (for example, sample/specimen to the AML or clinical specimen to CSH with JBAIDS) that has the testing capability. See Figure H-1, page H-6.

H-27. “Field” Confirmatory Identification is achieved through the use of devices, materials, or technologies that detect biomarkers using two or more independent biomarker results (for example, one biomarker is detected by two or more independent methodologies or more than one biomarker is detected by a single methodology). Examples include:

- Hand-held immunological assay plus nucleic acid amplification
- Nucleic acid amplification using two different biomarkers (for example, gene targets)

H-28. After the CSH identifies the clinical specimen as a biological threat agent, the specimen then is sent by courier to a specialized laboratory/team with advanced microbiological capabilities and highly skilled medical personnel such as the USA’s AML, the United States Air Force’s (USAF’s) biological augmentation team (BAT), or the United States Navy’s (USN’s) Forward Deployable Preventive Medicine Units (FDPMU) when available in the AO. If these specialized laboratories/teams are unavailable, clinical specimens that are presumptive positive for BTA may be forwarded to the nearest reference laboratory including the OCONUS locations at Landstuhl Regional Medical Center, Germany; Tripler Medical Center, Hawaii; and 121st General Hospital, Korea. Medical departments on aircraft carriers (CVs); aircraft carriers (nuclear) (CVNs); amphibious assault ships (general purpose); hospital ships; and command ships are also equipped to provide confirmatory testing capability for environmental samples from other ships assigned to a carrier strike group and expeditionary strike group.

H-29. The definitive identification for BTA is achieved by thorough testing and identification by nationally recognized reference laboratories such as the USAMRIID, the NMRC, or CDC. These laboratories have highly skilled testing personnel who employ a broad variety of methodologies that are capable of detecting and characterizing numerous biological markers, thus providing the highest levels of accuracy. This highest level of identification is necessary to ensure definitive and unequivocal identification due to the potential international impact as well as for forensic purposes. The sample/specimen is transported from the confirmatory facility to the nationally recognized reference laboratory by tech escort or courier.

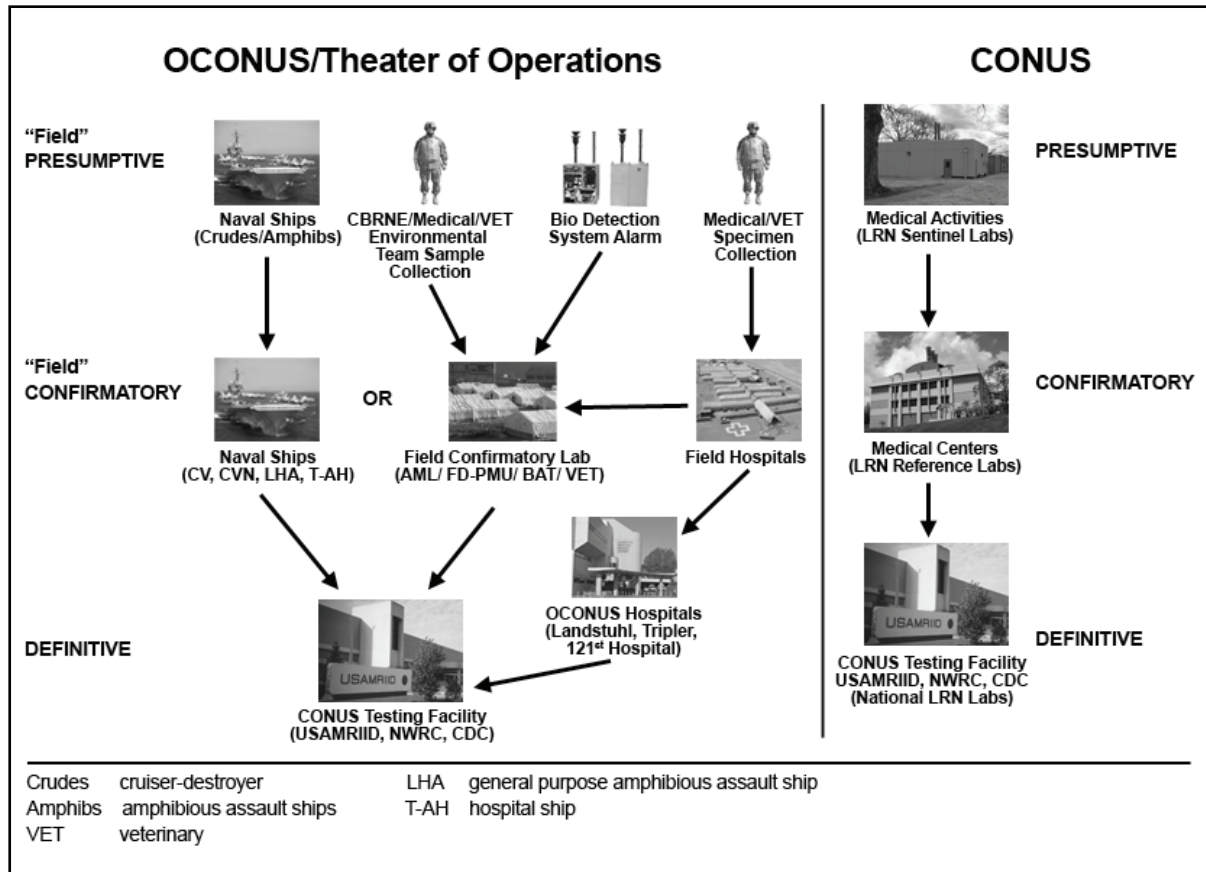

Figure H-1. Levels of identification confidence

JOINT BIOLOGICAL AGENT IDENTIFICATION AND DIAGNOSTIC SYSTEM

H-30. The JBAIDS is a laboratory instrument system that provides medical leaders and commanders with rapid and specific identification of BTA. Through the use of advanced scientific technology (polymerase chain reaction [PCR]), infectious diseases, whether naturally occurring or intentional, can be identified quickly and with high sensitivity and specificity. This rapid identification enables commanders and health care providers to make data-based decisions that govern early warning, intervention, and prevention to include clinical diagnosis of patient disease upon Food and Drug Administration (FDA) clearance of the assays.

H-31. The JBAIDS is a reusable, portable, modifiable identification and diagnostic system for biological agents, and is capable of simultaneous reliable identification of multiple BTA of operational significance. JBAIDS will enhance protection of the force by providing medical personnel and commanders the capability to determine appropriate treatment, effective preventive measures, and prophylaxis in response to the presence of biological agents. JBAIDS is configured to support reliable, fast, and specific identification of biological agents from a variety of clinical specimens and environmental samples. The

intent is to provide timely, accurate identification of specific biological agents to support clinical observations, operational decision making, and data archiving.

H-32. The JBAIDS is being developed utilizing a Block up-grade strategy (3 blocks/increments) to leverage rapidly developing technologies in the identification and diagnostic capabilities arena. The reporting function is compatible with existing C2 using paper reports and manual inputs. In future versions of JBAIDS, reports will be compatible with theater information management systems; data output will be packaged for optimal use by medical staff and by commanders; and the system will interface with existing and future C2 systems.

H-33. Block I (Increment I) uses are adjunct to—

- Clinical diagnosis.
- Medical surveillance.
- Environmental sampling activities (for example, air, water, food, entomology, veterinary).
- Forensic activities.

H-34. In clinical settings, JBAIDS will be used according to FDA guidelines. Prior to FDA approval for diagnostic testing, results must be confirmed using established diagnostic methods. The FDA approval process will be ongoing throughout the development and fielding period.

H-35. JBAIDS (Block-I) Set. The initial JBAIDS is comprised of an analytical instrument with computer and printer, assay reagents for extracting and identifying nucleic acid from various biological agents, and protocols for identification of 10 BTA from multiple sample types.

JBAIDS CONFIDENCE LEVEL

H-36. The JBAIDS employs a single methodology (nucleic acid amplification), so according to doctrine, when a sample is positive only by a JBAIDS assays for a single BTA gene target (that is, one biomarker using a single methodology), the result should be interpreted as being presumptive. However, when using DOD doctrine, a JBAIDS positive result may be interpreted as being a confirmatory identification when (1) two gene targets are used for JBAIDS assay or when (2) JBAIDS is the second methodology employed to test a sample that is already a positive result by another methodology. The Laboratory Response Network (LRN) policy requires testing according to LRN-approved protocols, and LRN-presumptive results must be confirmed by a LRN reference laboratory performing additional LRN-approved tests.

- **Example #1:** If a Joint Biological Point Detection System sample tests positive at the detector site, that result is regarded as a “field” presumptive positive. If the JBAIDS result at the field confirmatory laboratory is also positive, the result can be referred to as being a confirmed positive result because of the employment of two methodologies. This sample is then sent to a national reference laboratory for definitive testing. If the JBAIDS result had been negative, then the sample would be called negative with no further testing required unless there were significant reason to doubt the results (for example, other test results, intelligence, or laboratory OIC’s belief that system error occurred).
- **Example #2:** If a sample being tested initially at a laboratory employing JBAIDS produces positive results for two gene targets, the result can be interpreted as being a field confirmatory identification for the agent(s) for which two gene targets are positive (one methodology, but positive for two independent biomarkers).
- **Example #3:** If a sample being tested initially at a laboratory employing JBAIDS produces a JBAIDS positive result for a single gene target only, it would be considered to be a “field” presumptive positive until confirmed by another biomarker or methodology.
- **Example #4:** If a clinical sample being tested using JBAIDS in a CONUS hospital laboratory is positive, the sample must then be handled according to LRN protocols where it may be retested and submitted to a LRN reference laboratory for confirmation.

OPERATIONAL EMPLOYMENT

H-37. Various types of CONUS and OCONUS laboratories in all Services will use JBAIDS for identification of BTA, although in somewhat different ways, depending on the role and other capabilities of the individual laboratory. Precisely which organizations will process which samples will be determined at the MTF commander, JFC, or at United States Army Medical Command levels.

JOINT BIOLOGICAL AGENT IDENTIFICATION AND DETECTION SYSTEM EMPLOYMENT

H-38. The JBAIDS is a laboratory capability employed by certain field-deployed laboratories and fixed-site CONUS and OCONUS sites that provides a protection tool to enhance the decision making of physicians and commanders of MTFs, installations, and combatant units. Laboratories employing JBAIDS include—

- FDPMU.
- Field hospitals.
- Fixed site hospitals.
- Theater confirmatory testing facilities.
- Naval ships.
- Definitive testing facilities.

UNITED STATES ARMY OPERATIONS

H-39. The Army will employ JBAIDS to support the analysis of environmental and clinical samples within the deployed and HLS settings, depending on the role of the laboratory. Examples of how and where the Army will field the JBAIDS include—

- AMLs—theater confirmatory testing as well as initial testing.
- Medical team, infectious disease— augments various types of medical laboratories with presumptive and confirmatory testing.
- Preventive medicine detachments – screening environmental sample types.
- Veterinary food inspection detachments – screening of food.
- DOD veterinary food inspection laboratory – testing of food.
- CSH laboratories – clinical diagnosis.
- Fixed-facility medical treatment facilities – clinical diagnosis and confirmatory testing.
- USAMRIID – research and comparison testing.

UNITED STATES NAVY OPERATIONS

H-40. The Navy will employ JBAIDS to support the analysis of environmental and clinical samples within the deployed and HLS settings, depending on the role of the laboratory. These will include both afloat and ashore units, such as—

- Medical departments on aircraft carriers, amphibious ships, amphibious assault ships, and command ships. The role is to provide confirmatory testing capability for samples and specimens from these and other ships assigned to either a carrier strike group or an expeditionary strike group.
- Hospital ships provide clinical diagnosis.
- Fleet hospitals/expeditionary medical facilities perform clinical diagnosis and confirmatory testing.
- Navy environmental and preventive medical units provide confirmatory testing and technical reachback.
- FDPMU provide initial and confirmatory testing.
- NMRC conduct technical reachback support to operational users and to conduct medical surveillance.

UNITED STATES AIR FORCE OPERATIONS

H-41. The USAF will employ JBAIDS to support the analysis of environmental and clinical specimens within the deployed and HLS settings, depending on the role of the laboratory. The USAF will field the JBAIDS to the medical chemical, biological, radiological, nuclear and high yield explosives (MCRBNE) team and the Homeland Defense Laboratory Response Team.

H-42. The USAF's unit type designation biological augmentation team (FFBAT) is a deployable two-person team that utilizes the JBAIDS to test samples to identify biological agents in support of theater joint and Service commander installation protection programs. The FFBAT is deployed as part of the MCRBNE Team and supports other deployed medical CBRN or epidemiological teams.

H-43. The Homeland Defense Laboratory Response Team is a non-deployable two-person team that utilizes the JBAIDS to test samples for biological agent identification at home station, fixed installation locations. This team supports programs that provide protection to the force and local HLS responses as required by the installation commander. The LRT works hand-in-hand with the Threat Agent Surveillance Team (BEE Team).

UNITED STATES MARINE CORPS OPERATIONS

H-44. The USMC will employ JBAIDS to support the analysis of environmental and clinical samples within the deployed and HLS settings, depending on the role of the laboratory. The USMC will field the JBAIDS to surgical companies and the Chemical Biological Incident Response Force as described below:

- The Surgical Companies provide clinical diagnosis and confirmatory testing for medical surveillance and protection of the force.
- The Chemical Biological Incident Response Force provides confirmatory identification of environmental samples for force protection measures and HLS responses.

NATIONALLY RECOGNIZED REFERENCE LABORATORIES (DEFINITIVE)

H-45. Definitive level of identification is a means of devices, materials, or technologies that detect based on two or more independent biomarker results using different methodologies. The definitive identification process can be accomplished in several hours to two days, depending on the number of tests required. This level of identification is performed in a reference laboratory with a broader variety of methodologies available and highly skilled testing personnel, thus providing the highest levels of accuracy. Final sample or specimen identification is accomplished at one of the nationally recognized CONUS reference laboratories such as USAMRIID, the NMRC, or the CDC. The preliminary findings by the supporting laboratories provide leadership with valid information that can be used to initiate protective, preventive, and initial casualty care procedures, however, definitive identification is required for legal/retaliatory actions.

UNITED STATES ARMY MEDICAL RESEARCH INSTITUTE OF INFECTIOUS DISEASES

H-46. The mission of USAMRIID is to conduct basic and applied research on biological threats resulting in medical solutions to protect all Service members. USAMRIID, (Fort Detrick, Maryland) conducts basic and applied research on biological threats resulting in medical solutions to protect military Service members. It provides medical and scientific SMEs and technical guidance to commanders and senior leaders on prevention and treatment of hazardous diseases and prevention and medical management of biological casualties.

H-47. Since its inception, USAMRIID has played a key role as the DOD's lead laboratory for medical aspects of biological defense. The Institute develops vaccines, drugs, diagnostics, and information to protect U.S. Service members from BW threats and endemic diseases. It is an organization of the U.S. Army Medical Research and Materiel Command and is the lead medical research laboratory for the U.S. Biological Defense Research Program. It is the only laboratory within DOD with the capability to study

highly hazardous viruses and highly hazardous infectious agents requiring maximum containment at BSL-4.

CENTERS FOR DISEASE CONTROL AND PREVENTION

H-48. The CDC is one of the 13 major operating components of the Department of Health and Human Services which is the principal agency in the US government for protecting the health and safety of all Americans. It is a nationally-recognized reference laboratory providing definitive identification of suspect biological agents. The CDC is available to support installation leadership with a broad spectrum of laboratory support. Since it was founded in 1946 to help control malaria, CDC has remained at the forefront of public health efforts to prevent and control infectious and chronic diseases, injuries, workplace hazards, disabilities, and environmental health threats.

NAVAL MEDICAL RESEARCH CENTER SILVER SPRING, MARYLAND

H-49. The NMRC is a premier research organization that is one of DOD's nationally recognized reference laboratories that can provide definitive identification of biological agents. The Biological Defense Research Directorate (BDRD) of the NMRC serves as a national resource providing testing and analysis for the presence of anthrax and other potential biological hazards. The mission of the NMRC is to enhance the health, safety, performance and deployment readiness of Navy and Marine Corps personnel. The NMRC conducts basic and applied biomedical research, development, testing and evaluations in the areas of biological defense, bone marrow, combat casualty care, and infectious diseases. The NMRC invites the contributions of scholars and research specialists into its scientific regimen so as to develop and provide state-of-the art research methodologies to enhance HSS and deployment readiness.

BIOLOGICAL DEFENSE RESEARCH DIRECTORATE

H-50. This directorate under NMRC has the capability in the rapid and confirmatory detection and identification of BTA in clinical and environmental samples; the directorate explores basic and applied scientific research methodologies for the development of diagnostic assays for the detection of biological and chemical agents during peacetime and wartime. Research personnel have designed, developed, and tested a new prototype immunochromatographic assay device which enables multiple assays to be performed simultaneously. In addition, researchers have been instrumental in the advancement and refinement of confirmatory identification of threat agents utilizing PCR methodologies in tandem with innovative, state of the art biosensor technologies.

H-51. The BDRD has become a leader in the field of detection including hand-held assays, molecular diagnostics, and confirmatory analysis. More recently, NMRC researchers have made great strides in developing a new DNA-based vaccine to protect against anthrax.

OTHER DEPARTMENT OF DEFENSE LABORATORIES

H-52. Following is a list of other DOD laboratories:

- The United States Army Medical Research Institute of Chemical Defense can provide laboratory support for the identification of CW agents from human specimens and technical guidance on prevention, protection, and medical management of CW agent injuries.
- The Armed Forces Radiobiology Research Institute can provide technical and laboratory support for nuclear and radiological incidents or events. They can provide identification on the type of radiological hazard that exists and provide recommendations on shielding, hazard levels, and preventive measures. However, their laboratory support capabilities are very limited.
- The USACHPPM can provide technical and laboratory support for TIM incidents.
- The Army Materiel Command Treaty Laboratory was established to verify compliance with the Chemical Weapons Convention. It is an ISO 9001 registered quality system that was pre-deployed to support the FBI during the Olympics in Atlanta.
- Edgewood Research, Development and Engineering Center maintains a rapidly deployable mobile environmental monitoring and technical assessment system. This Mobile Analytical

Response System provides a state-of-the-art analytical assessment of chemical or biological hazards at incident sites.

- The Office of Naval Research Science & Technology Reserve Program (or Program 38) has a small cadre dedicated to chemical, biological, and radiological defense. These include medical Service corps officers, hospital corpsmen, and officers of assorted line designators.
- The Navy Environmental and Preventive Medicine Unit and the Navy Disease Vector Ecology Control Center are strategically located at installations around the world to meet HSS requirements and to perform confirmation identification of samples/specimens. FDPMU have deployable teams with the capability of performing field confirmatory identification of samples/specimens.
- The Navy Environmental Health Center provides functional oversight of the laboratory services associated with field activities.
- The USAF Institute for Occupational Health (radiochemistry laboratory) can provide definitive identification of radiological samples.
- The USAF BEE units can provide field confirmatory identification of chemical, biological, and radiological agents.
- The USAF's BAT can provide commanders with field confirmatory identification with rapid, specific pathogen identification.

LABORATORY RESPONSE NETWORK

H-53. The LRN was established in 1999 by the CDC. The mission of the LRN is to maintain an integrated national and international network of laboratories that are fully equipped to respond quickly to acts of chemical or biological terrorism, emerging infectious diseases, and other public health threats and emergencies. There are 149 laboratories in the LRN. The LRN includes state and local public health, veterinary, military, and international laboratories.

H-54. The LRN is an early warning network to detect the covert use of pathogenic agents. It uses procedures established by the CDC and is based on grouping laboratories into one of four different levels, A through D, according to their ability to support the diagnostic needs presented by a bioterrorism event.

H-55. Level A laboratories have minimal agent identification capabilities. Their primary role is to rule out and refer to their nearest Level B laboratory. Level B laboratories perform identification, confirmation, and susceptibility testing. Levels A and B are designated as Sentinel laboratories under the new LRN (see Figure H-2, page H-12). Level C laboratories include state and other large facility laboratories with advanced capacity for testing to include some molecular techniques. It is designated as a Reference laboratory. The Armed Forces Institute of Pathology has a level C laboratory. Level D laboratories include the CDC and USAMRIID, and are designated as National laboratories. These sites have BSL-4 laboratories and special surge capacity as well as advanced molecular typing techniques. Recognizing that most DOD clinical laboratories currently have the capability to operate at Level A and that this added capacity would enhance the LRN, the CDC is looking at DOD laboratories to participate in the LRN.

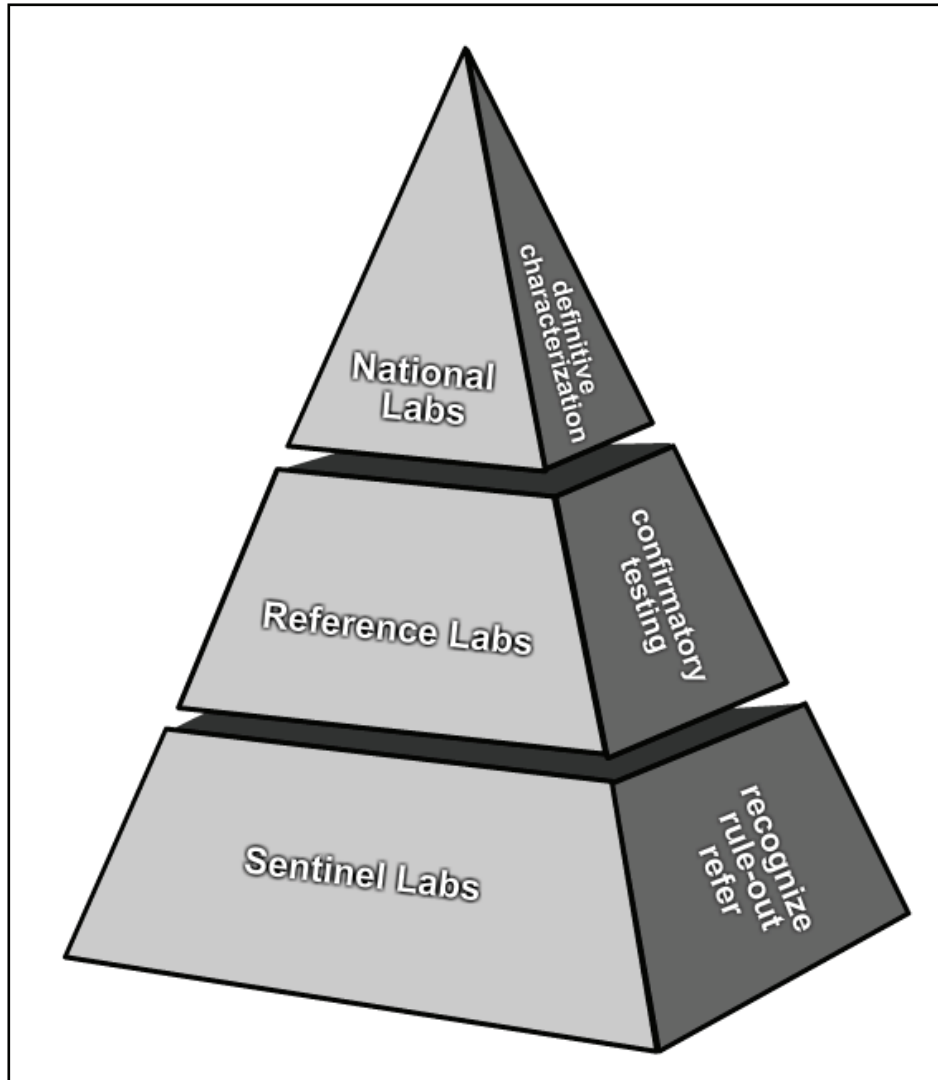

Figure H-2. The "new" LRN designation

Source Notes

These are the sources used, quoted, or paraphrased in this publication. They are listed by page number. Where material appears in a paragraph, both page and paragraph number are listed.

- vii “Since WMD in the hands of rogue states...”: Paul Wolfowitz, Remarks made during the National Defense University Conference on Counterproliferation, 13 May 2003. Available at <<http://www.defenselink.mil/speeches/2003/sp20030513-depsecdef0203.html>>. Accessed on 10 September 2007.
- vii “DOD must develop, institutionalize, and exercise...”: National Military Strategy to Combat Weapons of Mass Destruction, 13 February 2006, Chairman of the Joint Chiefs of Staff, Washington, DC 20318, Page, 24, paragraph entitled “Elimination Operations.”
- vii The military departments will...”: 2006 Quadrennial Defense Review Report, signed by the Secretary of Defense on 6 February, 2006. See page 34, paragraph entitled “Response Dimension,” First paragraph, last sentence.

This page intentionally left blank.

Glossary

SECTION I – ACRONYMS AND ABBREVIATIONS

| Acronym | Definition |
|--------------------|--|
| ACP | access control point |
| ALARA | as low as reasonably achievable |
| AMC | Army Materiel Command |
| AMedP | allied medical publication |
| AML | Army medical laboratory |
| AO | area of operation |
| AOC | area of concentration |
| AOR | area of responsibility |
| ARNG | Army National Guard |
| ARNGUS | Army National Guard of the United States |
| ARNORTH | U.S. Army North (5 th Army) |
| BAT | biological augmentation team |
| BDRD | Biological Defense Research Directorate |
| BEE | bioenvironmental engineer |
| BGAN TM | Broadband Global Access Network |
| BIO | biological |
| BSB | brigade support battalion |
| BSL | biological safety level |
| BTA | biological threat agent |
| BW | biological warfare |
| C2 | command and control |
| CAIRA | chemical accident or incident response and assistance |
| CARA | chemical, biological, radiological, nuclear, and high yield explosives analytical remediation activity |
| CB | chemical and biological |
| CBRN | chemical, biological, radiological, and nuclear |
| CBRNE | chemical, biological, radiological, nuclear, and high yield explosives |
| CCDR | combatant commander |
| CCIR | commander's critical information requirements |
| CDC | Centers for Disease Control and Prevention |
| CG | commanding general |
| CIA | Central Intelligence Agency |
| CIC | Command Information Center |

| | |
|----------------|---|
| CM | consequence management |
| CMAT | consequence management advisory team |
| CML | Chemical |
| COA | course of action |
| COCOM | combatant command |
| CONUS | continental United States |
| CONV | Conventional |
| COP | common operational picture |
| CoS | Chief of Staff |
| COTS | commercial off-the-shelf |
| CP | counterproliferation |
| CSH | combat support hospital |
| CSSB | corps sustainment support battalion |
| CV | aircraft carrier |
| CVN | aircraft carrier (nuclear) |
| CW | chemical warfare |
| DA | Department of the Army |
| DAC | Department of the Army Civilian |
| DCN | decontamination |
| DIA | Defense Intelligence Agency |
| DIV | division |
| DOE | Department of Energy |
| DOD | Department of Defense |
| DOS | Department of State |
| DOTMLPF | doctrine, organization, training, materiel, leader education, personnel, and facilities |
| DS | direct support |
| DTRA | Defense Threat Reduction Agency |
| EEFI | essential elements of friendly information |
| ELINT | electronic intelligence |
| EOD | explosive ordnance disposal |
| FBI | Federal Bureau of Investigation |
| FDA | Food and Drug Administration |
| FDPMU | forward deployable preventive medicine unit |
| FEF | final electronic file |
| FFIR | friendly force information requirements |
| FM | field manual |
| FMI | field manual interim |
| FOB | forward operating base |

| | |
|------------------|--|
| FRAGO | fragmentary order |
| FSC | forward support company |
| FST | forward surgical team |
| G-1 | assistant chief of staff, personnel |
| G-2 | assistant chief of staff, intelligence |
| G-3 | assistant chief of staff, operations |
| G-4 | assistant chief of staff, logistics |
| G-5 | assistant chief of staff, civil affairs |
| G-6 | assistant chief of staff command, control, communications, and computer operations |
| G-8 | assistant chief of staff, financial management |
| GI&S | geographic information and services |
| GIG | Global Information Grid |
| GS | general support |
| HAZMAT | hazardous material |
| HHC | headquarters and headquarters company |
| HLS | homeland security |
| HMMWV | high mobility multipurpose wheeled vehicle |
| HN | host nation |
| HUMINT | human intelligence |
| IA | intelligence augmentation |
| IED | improvised explosive device |
| IG | inspector general |
| IM | information management |
| INMARSAT™ | International Maritime Satellite System |
| IP | Internet protocol |
| IPB | intelligence preparation of the battlefield |
| ISDN | integrated services digital network |
| ISR | intelligence, surveillance, and reconnaissance |
| J-2 | intelligence directorate of a joint staff; intelligence staff section |
| J-3 | operations directorate of a joint staff; operations staff section |
| J-4 | logistics directorate of a joint staff; logistics staff section |
| J-5 | plans directorate of a joint staff; plans staff section |
| J-6 | communications system directorate of a joint staff; command, control, communications, and computer systems staff section |
| J-7 | engineering staff section; Operational Plans and Joint Force Development Directorate, Joint Staff |
| JBAIDS | Joint Biological Agent Identification and Diagnostic System |
| JECE | joint elimination coordination element |

| | |
|---------------|--|
| JFC | joint force commander |
| JFCC | joint forces combatant command |
| JFLCC | commander, joint forces land combatant |
| JIPTL | joint integrated prioritized target list |
| JMCB-E | joint mission coordination board elimination |
| JMETL | joint mission essential task list |
| JOA | joint operations area |
| JOC | joint operations center |
| JP | joint publication |
| JPG | joint planning group |
| JTCB | joint targeting coordination board |
| JTF | joint task force |
| JTF-E | joint task force elimination |
| JWICS | joint worldwide intelligence communications system |
| LAN | local area network |
| LNO | liaison officer |
| LOC | lines of communication |
| LOW | law of war |
| LRN | laboratory response network |
| LSA | logistics support area |
| LSD | large display screen |
| MAL | mobile analytical laboratory |
| MARDIV | Marine division |
| MASINT | measurement and signature intelligence |
| MCBRNE | medical chemical, biological, radiological, nuclear, and high yield explosives |
| MCP | main command post |
| MCRP | Marine Corps reference publication |
| MCWP | Marine Corps warfighting publication |
| MDMP | military decision-making process |
| METL | mission essential task list |
| MHE | materiel handling equipment |
| MMAS | mobile munitions assessment system |
| MOS | military occupational specialty |
| MRO | monitoring and redirection operation |
| MTF | medical treatment facility |
| NATO | North Atlantic Treaty Organization |
| NDAA | National Defense Authorization Act |
| NCO | noncommissioned officer |

| | |
|------------------|---|
| NCOIC | noncommissioned officer in charge |
| NDT | nuclear disablement team |
| NGO | nongovernmental organization |
| NIPRNET | Non-Secure Internet Protocol Router Network |
| NMRC | Naval Medical Research Center |
| NMS-CWMD | national military strategy to combat weapons of mass destruction |
| NP | Nonproliferation |
| NS-CWMD | national strategy to combat weapons of mass destruction |
| NSRO | nonstandard replenishment operations |
| OBJ | Objective |
| OCONUS | outside the continental United States |
| OCP | operational command post |
| OE | operational environment |
| OEF | Operation Enduring Freedom |
| OGA | other government agency |
| OGO | other government organization |
| OIC | officer in charge |
| OIF | Operation Iraqi Freedom |
| OPCON | operational control |
| OPLAN | operation plan |
| OPORD | operation order |
| OSHA | Occupational Safety and Health Administration |
| PAPR | powered air pressure respirator |
| PCR | polymerase chain reaction |
| PIR | priority intelligence requirement |
| PL | phase line |
| PMESII-PT | political, military, economic, social, information, infrastructure, and the two added Army variables of physical environment and time |
| QDR | Quadrennial Defense Review |
| RCWM | recovered chemical warfare materiel |
| RFI | request for information |
| RI | relevant information |
| RO | replenishment operations |
| ROE | rules of engagement |
| RRT | remediation response team |
| RSE | religious support element |
| S-2 | intelligence officer |
| SATCOM | satellite communication |
| SCC | service component commander |

| | |
|-------------------|--|
| SCC-WMD | United States Strategic Command Center for Combating Weapons of Mass Destruction |
| SecDef | Secretary of Defense |
| SGT | sergeant |
| SICPS | Standard integrated command post system |
| SIGINT | signals intelligence |
| SIPRNET | SECRET Internet Protocol Router Network |
| SJA | staff judge advocate |
| SME | subject matter expert |
| SOP | standing operating procedures |
| SS | sensitive site |
| SSE | sensitive site exploitation |
| SSO | special security officer |
| STE | secure terminal equipment |
| SU | situational understanding |
| SUPCOM | support command |
| TAMMS | The Army Maintenance Management System |
| TECHINT | technical intelligence |
| TEU | technical escort unit |
| TIC | toxic industrial chemical |
| TIM | toxic industrial material |
| TMSS | trailer mounted support system |
| TRADOC | United States Army Training and Doctrine Command |
| TRC | threat reduction cooperation |
| TTP | tactics, techniques, and procedures |
| TV | television |
| UN | United Nations |
| U.S. | United States |
| USACHPPM | United States Army Center for Health Promotion and Preventive Medicine |
| USAF | United States Air Force |
| USAMRIID | United States Army Medical Research Institute for Infectious Diseases |
| USAR | United States Army Reserve |
| USFORSCOM | United States Army Forces Command |
| USG | United States government |
| USJFCOM | United States Joint Forces Command |
| USMC | United States Marine Corps |
| USN | United States Navy |
| USNORTHCOM | United States Northern Command |
| USSOCOM | United States Special Operations Command |

| | |
|-------------------|--|
| USSTRATCOM | United States strategic command |
| UXO | unexploded ordnance |
| VTC | video teleconferencing |
| WFF | warfighting function |
| WMD | weapons of mass destruction |
| WCE | weapons of mass destruction coordination element |
| WMD-CM | weapons of mass destruction consequence management |
| WMD-E | weapons of mass destruction elimination |
| WMSL | weapons of mass destruction master site list |

SECTION II – TERMS

ASCOPE

A memory aid for the characteristics considered under civil considerations: areas, structures, capabilities, organizations, people, events. (FM 6-0)

campaign

A series of related military operations aimed at accomplishing a strategic or operational objective within a given time and space. (JP 5-0)

civil support

Department of Defense support to United States civil authorities for domestic emergencies, and for designated law enforcement and other activities. (JP 3-28)

close combat

Warfare carried out on land in a direct fire fight, supported by direct and indirect fires, air-delivered fires, and nonlethal engagement means. Distances between combatants may vary from several thousand meters to hand-to hand fighting. (FM 3-0)

command and control

(DOD) The exercise of authority and direction by a properly designated commander over assigned and attached forces in the accomplishment of the mission. Command and control functions are performed through an arrangement of personnel, equipment, communications, facilities, and procedures employed by a commander in planning, directing, coordinating, and controlling forces and operations in the accomplishment of the mission. (Army) The exercise of authority and direction by a properly designated commander over assigned and attached forces in the accomplishment of a mission. Commanders perform command and control functions through a command and control system. (FM 6-0)

commander's critical information requirement

An information requirement identified by the commander as being critical to facilitating timely decision-making. The two key elements are friendly force information requirements and priority intelligence requirements. (JP 3-0)

common operational picture

(DOD) A single identical display of relevant information shared by more than one command. A common operational picture facilitates collaborative planning and assists all echelons to achieve situational awareness. (Army) An operational picture tailored to the user's requirements, based on common data and information shared by more than one command. (FM 3-0)

decision making

Selecting a course of action as the one most favorable to accomplish the mission. (FM 6-0)

defensive operations

Operations conducted to defeat an enemy attack, gain time, economize forces, and develop conditions favorable for offensive or stability operations. The defense alone normally cannot achieve a decision. However, it can create conditions for a counteroffensive that allows Army forces to regain the initiative. (FM 3-0)

destroy

1. A tactical mission task that physically renders an enemy force combat-ineffective until it is reconstituted. 2. To damage a combat system so badly that it cannot perform any function or be restored to a usable condition without being entirely rebuilt. (FM 3-90)

essential elements of friendly information

(DOD) Key questions likely to be asked by adversary officials and intelligence systems about specific friendly intentions, capabilities, and activities so they can obtain answers critical to their operational effectiveness. (Army) The critical aspects of a friendly operation that, if known by the enemy, would subsequently compromise, lead to failure, or limit success of the operation and, therefore, must be protected from enemy detection. (see FM 3-13)

expeditionary force

Armed force organized to accomplish a specific objective in a foreign country. (JP 3-0)

exploit

In information operations, to gain access to adversary command and control systems to collect information or to plant false or misleading information. (FM 3-13)

exploitation

(DOD, NATO) 1. Taking full advantage of success in military operations [Note: the NATO definition replaces “military operations” with “battle”], following up initial gains, [Note: the NATO definition ends here] and making permanent the temporary effects already achieved. See FM 3-0. 2. Taking full advantage of any information that has come to hand for tactical, operational, or strategic purposes. See FM 3-13. 3. An offensive operation that usually follows a successful attack and is designed to disorganize the enemy in depth. See FM 3-0.

friendly force information requirements

(DOD) Information the commander and staff need to understand the status of friendly force and supporting capabilities. (Army) Information the commander and staff need about the forces available for the operation. (FM 6-0)

information

(DOD) 1. Facts, data, or instructions in any medium or form. 2. The meaning that a human assigns to data by means of known conventions used in their representation. (NATO) Unprocessed data of every description which may be used in the production of intelligence. (Army) 1. In the general sense, the meaning humans assign to data. 2. In the context of the cognitive hierarchy, data that have been processed to provide further meaning. (FM 6-0)

information management

The provision of relevant information to the right person at the right time in a usable form to facilitate situational understanding and decisionmaking. It uses procedures and information systems to collect, process, store, display, and disseminate information. (FM 3-0)

intelligence, surveillance, and reconnaissance

An activity that synchronizes and integrates the planning and operation of sensors, assets, and processing, exploitation, and dissemination systems in direct support of current and future operations. This is an integrated intelligence and operations function. (JP 2-01.1)

interagency coordination

Within the context of Department of Defense involvement, the coordination that occurs between elements of Department of Defense and engaged United States government agencies for the purpose of achieving an objective. (JP 3-0)

isolate

A tactical mission task that requires a unit to seal off—both physically and psychologically—an enemy from his sources of support, deny an enemy freedom of movement, and prevent an enemy unit from having contact with other enemy forces. (FM 3-90)

joint targeting coordination board

A group formed by the joint force commander to accomplish broad targeting oversight functions that may include but are not limited to coordinating targeting information, providing targeting guidance and priorities, and refining the joint integrated prioritized target list. The board is normally comprised of representatives from the joint force staff, all components, and if required, component subordinate units. (JP 3-60)

law of war

That part of international law that regulates the conduct of armed hostilities. (JP 1-02)

METT-TC

A memory aid used in two contexts: (1) In the context of information management, the major subject categories into which relevant information is grouped for military operations: mission, enemy, terrain and weather, troops and support available, time available, civil considerations. (2) In the context of tactics, the major factors considered during mission analysis. (FM 6-0)

monitoring and redirection operations

Converting weapons of mass destruction programs, personnel, sites and facilities to prevent transfer, reconstitution, and misuse of residual dual-use capabilities. (JP 3-40)

multinational operations

Military actions conducted by forces of two or more nations, usually undertaken by the structure of a coalition or alliance. (JP 3-16)

neutralize

(DOD) [1]. As applies to military operations, to render ineffective or unusable; [2] to render enemy personnel or material incapable of interfering with a particular operation (see FM 3-90); [3] to render safe mines, bombs, missiles, and booby traps (see FM 3-34.214); or [4] to make harmless anything contaminated with a chemical agent. See FM 3-9.

offensive operations

Operations conducted to defeat and destroy enemy forces and seize terrain, resources, and population centers. They impose the commander's will on the enemy. (FM 3-0)

operational environment

(DOD) A composite of the conditions, circumstances, and influences which affect the employment of military forces and bear on the decisions of the unit commander. (JP 3-0) Some examples are as follows: a. **permissive environment**—Operational environment in which host country military and law enforcement agencies have control as well as the intent and capability to assist operations that a unit intends to conduct. b. **uncertain environment**—Operational environment in which host government forces, whether opposed or receptive to operations that a unit intends to conduct, do not have totally effective control of the territory and population in the intended operational area. c. **hostile environment**—Operational environment in which hostile forces have control and the intent and capability to effectively oppose or react to the operations a unit intends to conduct. See FM 3-07.

operational picture

A single display of relevant information within a commander's area of interest. (FMI 5-0.1)

priority intelligence requirements

An intelligence requirement, stated as a priority for intelligence support, that the commander and staff need to understand the adversary or the operational environment. (JP 5-0)

relevant information

All information of importance to the commander and staff in the exercise of C2. (FM 3-0)

secure

(DOD, NATO) In an operational context, to gain possession of a position or terrain feature with or without force, and to make such disposition as will prevent, as far as possible, its destruction or loss by enemy action. See FM 3-90. (Army) 1. A tactical mission task that involves preventing a unit, facility, or geographical location from being damaged or destroyed as a result of enemy action. (FM 3-90) 2. One of the five breaching fundamentals. Those actions which eliminate the enemy's ability to interfere with the reduction and passage of combat power through a lane. Secure may be accomplished by maneuver or by fires. (FM 3-34.2)

stability operations

An overarching term encompassing various military missions, tasks, and activities conducted outside the United States in coordination with other instruments of national power to maintain or reestablish a safe and secure environment, provide essential governmental services, emergency infrastructure reconstruction, and humanitarian relief. (JP 3-0)

target

1. An area, complex, installation, force, equipment, capability, function, or behavior identified for possible action to support the commander's objectives, guidance, and intent. Targets fall into two general categories: planned and immediate. 2. In intelligence usage, a country, area, installation, agency, or person against which intelligence operations are directed. 3. An area designated and numbered for future firing. 4. In gunfire support usage, an impact burst that hits the target. (JP 3-60)

targeting

The process of selecting targets and matching the appropriate response to them on the basis of operational requirements, capabilities, and limitations. (JP 3-0)

This page intentionally left blank.

References

SOURCES USED

These are the sources quoted or paraphrased in this publication.

ARMY PUBLICATIONS

- DA Form 2028, *Recommended Changes to Publications and Blank Forms*
- DA Form 4137, *Evidence/Property Custody Document*
- DD Form 1911, *Materiel Courier Receipt*
- FM 1-02, *Operational Terms and Graphics* {MCRP 5-12A}, 21 September 2004
- FM 3-0, *Operations*, 14 June 2001
- FM 3-11, *Multiservice Tactics, Techniques, and Procedures for Nuclear, Biological, and Chemical Operations*, 10 March 2003
- FM 3-11.86, *Multiservice Tactics, Techniques, and Procedures for Biological Surveillance*, 4 October 2004
- FM 3-13 (FM 100-6), *Information Operations: Doctrine, Tactics, Techniques, and Procedures*, 28 November 2003 (To be revised as FM 3-13)
- FM 3-34.210 (FM 20-32.), *Explosive Hazards Operations*, 27 March 2007
- FM 3-34.214 (FM 5-250), *Explosives and Demolitions*, 11 July 2007
- FM 3-90, *Tactics*, 4 July 2001
- FM 4-02.283, *Treatment of Nuclear and Radiological Casualties* {NTRP 4-02.21/AFMAN 44-161(1)/MCRP 4-11.1B}, 20 December 2001
- FM 4-02.7 (8-10-7), *Health Service Support in a Nuclear, Biological, and Chemical Environment Tactics, Techniques, and Procedures*, 1 October 2002 (To be revised as FM 4-02.7.)
- FM 5-0, *Army Planning and Orders Production*, 20 January 2005
- FM 6-0, *Mission Command: Command and Control of Army Forces*, 11 August 2003
- FM 7-0, *Training the Force*, 22 October 2002
- FM 7-1, *Battle Focused Training*, 15 September 2003
- FM 8-284, *Treatment of Biological Warfare Agent Casualties* {NTRP 4-02.23 (NAVMED P-5042)/AFMAN (I) 44-156/MCRP 4-11.1C}, 17 July 2000
- FM 8-285, *Treatment of Chemical Agent Casualties and Conventional Military Chemical Injuries* {NAVMED P-5041/AFMAN 44-149/FMFM 11-11}, 18 September 2007
- FMI 4-30.50, *Modular Explosive Ordnance Disposal Operations*, 31 July 2006
- FMI 5-0.1, *The Operations Process*, 31 March 2006
- FMI 6-02.45, *Signal Support to Theater Operations*, 5 July 2007
- Operational and Organizational Concept for Chemical, Biological, Radiological, Nuclear, and High-Yield Explosives (CBRNE) Operational Headquarters, HQ, TRADOC*, 22 June 2006.

JOINT PUBLICATIONS

- CJCSI 3110.16A, *Military Capabilities, Assets, and Units for Chemical, Biological, Radiological, Nuclear, and High-Yield Explosive Consequence Management Operations*, 10 January 2007
- CJCSM 3500.03B, *Joint Training Manual for the Armed Forces of the United States*, 31 August 2007
- Handbook for Joint Weapons of Mass Destruction (WMD) Elimination Operations*, 18 May 2007

References

- JP 1-02, *Department of Defense Dictionary of Military and Associated Terms*, 12 April 2001 (as amended 17 October 2007)
- JP 2-01, *Joint and National Intelligence Support to Military Operations*, 7 October 2004
- JP 3-0, *Joint Operations*, 17 September 2006
- JP 3-11, *Joint Doctrine for Operations in Nuclear, Biological, and Chemical Environments*, 11 July 2000
- JP 3-16, *Multinational Operations*, 7 March 2007
- JP 3-27, *Homeland Defense*, 12 July 2007
- JP 3-28, *Civil Support*, 14 September 2007
- JP 3-40, *Joint Doctrine for Combating Weapons of Mass Destruction*, 8 July 2004
- JP 3-60, *Joint Targeting*, 13 April 2007
- JP 5-0, *Joint Operation Planning*, 26 December 2006

MISCELLANEOUS

- Charter of the United Nations, Chapter VI (Pacific Settlement of Disputes)*, 30 May 2000
- Charter of the United Nations, Chapter VII (Action with Respect to Threats to the Peace, Breaches of the Peace, and Acts of Aggression)*, 20 July 1979
- Defense Threat Reduction Agency, Support to Operations (Operation Iraqi Freedom), Advanced Systems and Concepts Office*, 15 June 2004
- DOD Directive, Number 2062.02, *Combating Weapons of Mass Destruction (WMD) Policy*, 19 April 2007
- Handbook for Joint Weapons of Mass Destruction (WMD) Elimination Operations*, 18 May 2007
- Joint Mission Essential Task List (JMETL) Handbook*, September 2002
- Joint Concept of Operations for JBAIDS*, 17 February 2006
- JTF-WMD Elimination: An Operational Architecture for Future Contingencies*, 28 April 2004
- National Defense Strategy of the United States of America*, March 2005
- National Military Strategy of the United States of America: A Strategy for Today, a Vision for Tomorrow*, 2004
- National Military Strategy to Combat Weapons of Mass Destruction*, 13 February 2006
- National Security Strategy of the United States of America*, March 2006
- National Strategy to Combat Weapons of Mass Destruction*, December 2002
- Operational and Organizational Concept for Chemical, Biological, Radiological, Nuclear, and High-Yield Explosives (CBRNE) Operational Headquarters*, 22 June 2006
- Public Law, 108-136, *National Defense Authorization Act for Fiscal Year 2004*, 24 November 2003
- Quadrennial Defense Review Report*, 6 February 2006

DOCUMENTS NEEDED

These documents must be available to the intended users of this publication.

READINGS RECOMMENDED

These sources contain relevant supplemental information.

Air Force Medical Service Concept of Operations for the Air Force Prevention and Aerospace Medicine Teams, 10 September 1999

Allied Medical Publication 8: Medical Planning Guide for Estimation of NBC Battle Casualties (Nuclear), Ratified by NATO in 2001

- CJCSI 3110.16A, *Military Capabilities, Assets, and Units for Chemical, Biological, Radiological, Nuclear, and High-Yield Explosive Consequence Management Operations*, 10 January 2007
- FM 3-11.19, *Multiservice Tactics, Techniques, and Procedures for Nuclear, Biological, and Chemical Reconnaissance* {MCWP 3-37.4/NTTP 3-11.29/ATTP(1) 3-2.44}, 30 July 2004
- FM 3-11.21, *Multiservice Tactics, Techniques, and Procedures for Nuclear, Biological, and Chemical Aspects of Consequence Management* {MCRP 3-37.2C/NTTP 3-11.24/AFTTP(1) 3-2.37}, 12 December 2001
- FM 3-34.2, *Combined Arms Breaching Operations*, 31 August 2000 (To be revised as FM 3-90.11)
- FM 3-90.15, *Sensitive Site Operations*, 25 April 2007
- FM 3-100.12, *Risk Management for Multiservices Tactics, Techniques, and Procedures* {MCRP 5-12.1/NTTP 5-03.5/ATTP(1) 3-2.34}, 15 February 2001
- FM 3-101, *Chemical Staffs and Units*, 19 November 1993
- FM 4-02, *Force Health Protection in a Global Environment*, 13 February 2003
- FM 7-15, *The Army Universal Task List*, 31 August 2003

This page intentionally left blank.

Index

A

AMC, Army Materiel
Command, B-11
Armed Forces Radiobiology
Research Institute, H-12
Army and Joint Command -
support, 3-6
augmentation, iv, v, 2-1, 2-7,
2-13, 2-14, 3-7, 3-9, 6-1, 6-3,
D-2, D-5, F-1, G-1
aviation section, E-1, E-4

B

BAT, biological augmentation
team. See FFBAT
BDRD, Biological Defense
Research Directorate, H-11
BSB, brigade support battalion,
6-1
BSL, biological safety level,
H-5, H-11, H-13
BTA, biological threat agent,
H-3, H-6, H-8, H-11

C

CARA, chemical, biological,
radiological, nuclear, and
high yield explosive
analytical remediation
activity, v, 2-2, 2-10, 2-12,
6-4, E-1, E-2
mission, E-1
mobile analytical laboratory
section, See MAL, E-2
tasking authority, E-1
CBRN, chemical, biological,
radiological, and nuclear,
1-8, 2-14, 3-1, 4-10, 4-12, 5-
3
CBRNE, chemical, biological,
radiological, nuclear, and
high yield explosives, iv
CCIR, commander's critical
information requirements,
5-2, 5-4, 5-10
development and
management, 5-11
intelligence, surveillance,
and reconnaissance, See
ISR, 5-12
post-discovery, 5-12
pre-discovery, 5-12

CDC, Center for Disease
Control and Prevention, E-3,
H-2, H-5, H-10, H-11, H-12
chain of custody, 1-9, H-1, H-2,
H-3, H-4
chaplain, B-6, B-11, See RSE
characterize, 4-1, 4-5, 4-12,
A-3, A-7, D-1, D-2, D-3, E-2
CIA, Central Intelligence
Agency, 1-10, B-1
CIC, command information
center, 2-6
civil support operations, 1-11,
2-2, 2-11, 3-1, 3-3, 3-4, 3-5,
3-9, 3-10, 5-1, 5-21
civilian teams, 1-10, 1-12
close combat, 1-6, 1-9, 8
CM, consequence
management, viii, A-2, A-7,
B-4, E-2, H-1
combating WMD, 2-1, 3-3, 4-1,
A-1, A-4, A-5, A-6, A-7, A-8,
E-1, E-4, F-1, F-2
role of the CBRNE
operational headquarters,
viii
six principles, A-5
combating WMD, See WMD, iv
command, iv, 2-4, 5-1
command group, 2-4
command information
center, See CIC, 2-6
command relationships,
5-21
command sergeant major,
2-4
command, control,
communications, and
computers, B-4
commander's critical
information requirements,
See CCIR, 5-2
support relationships, 5-22
command mission command,
3-5
commander, 2-4, 5-2
deputy commander, 2-4,
3-5
role of the commander, 5-2
confirm, 4-2, 4-4, 4-10
coordinating and special staff
sections, 2-6, 2-9, B-11

coordination element
joint elimination
coordination element,
See JECE, v
weapons of mass
destruction, See WCE, iv
COP, common operational
picture, 2-6, 5-3, B-12, C-2
CoS, Chief of Staff, 2-8, B-7, B-
8, G-1, G-2, G-3
COTS, commercial off-the-
shelf, 6-1, 6-2, B-11
CSH, combat support hospital,
H-1, H-6, H-9
CSSB, corps sustainment
support battalion, 6-1

D

definitive analysis, 4-5, H-3
deny, 4-2, 4-4, 4-10, 4-11, A-4,
A-5, A-6, D-1
destroy, 4-6, 4-7, 4-14, A-1,
A-3, A-7, H-3, 8
deter, 1-2, 1-3, 3-8, A-2, A-3,
A-5, A-6
DIA, Defense Intelligence
Agency, 1-10, 5-14, 5-19,
B-1
disable, 4-1, 4-5, 4-6, 4-11,
A-1, A-3, A-7, D-1, D-2, D-4
dismantle, 4-6, 4-7, 4-8, A-3, B-
8
dispose, 4-6, 4-7, 4-8, 5-19,
B-8, H-5
disposition, 5-21, A-3, A-8, B-9,
B-10, H-3

E

EEFI, essential elements of
friendly information, 5-4
elimination
mission, 4-1, 4-5, 4-10, F-1,
F-2
mission planning, 5-20
mission set, 2-1
mission variables, 5-21
operations, F-3
encounters, 4-1, 4-3, 4-9
opportunity, 4-9
planned, 4-9
endemic disease, H-1, H-2,
H-11

EOC, emergency operations center, B-7, B-8
 EOD, explosive ordnance disposal, 2-2, 2-14, 3-1, 4-4, 4-8, 4-9, 4-10, 4-11, 4-12, 4-13, C-1, C-2, D-1, D-2, D-3, E-3, G-4
 ERDEC, Edgewood Research Development and Engineering Center, H-12
 exploit/exploitation, vii, 1-9, 2-1, 2-7, 2-8, 2-10, 2-11, 2-12, 3-8, 3-10, 4-1, 4-3, 4-4, 4-5, 4-6, 4-12, 4-13, 4-14, 5-9, 5-10, 5-12, 5-18, 5-19, 5-21, 6-3, A-3, A-7, B-3, B-10, C-1, D-1, D-2, D-3, D-5, E-2, F-3

F

FFIR, friendly force information requirements, 5-4
 field laboratories, H-5
 FSC, forward support company, 6-1, 6-2
 FST, forward surgical team, H-1
 full spectrum operations, iv, 1-1, 1-7, 1-10, 3-1, 3-3, 5-6 elements, v, 3-8, 3-9 fundamentals, 5-1 mission command, 3-4 training, 1-13, G-1, G-3

H

HHC, headquarters and headquarters company, B-5
 HLS, homeland security, vii, 1-11, 3-5, B-6, E-2, H-9, H-10

I

IG, inspector general, 2-7, 2-8, B-5, B-6, B-11, B-14, G-4
 IM, information management, 5-3, 5-4
 information superiority, 5-3 enabling, 5-3
 intelligence, 1-9, 1-10, 1-12, 2-2, 2-5, 2-6, 2-7, 2-10, 2-11, 3-8, 4-3, 4-6, 4-8, 4-9, 4-12, 5-3, 5-4, 5-11 analysis, 5-10 cell, 2-9 collection and processing, 5-8, 5-9 commander's critical information requirements, See CCIR, 5-2

fusion, 5-9 goals, 5-8 intelligence, surveillance, and reconnaissance, See ISR, 5-12
 IPB, intelligence preparation of the battlefield, 1-6 liaison to supported headquarters, 5-13 priority intelligence requirements, See PIR, 5-4 reachback, 5-14 reporting, 5-10 requirements, 4-7 role, 5-8 technical, See TECHINT, 5-8

interagency coordination, 1-11, 9
 interdiction operations, viii, A-3
 isolate/isolation, 2-1, 3-8, 4-1, 4-2, 4-3, 4-4, 4-10, 9

J

JBAIDS, Joint Biological Agent Identification and Diagnostic System, H-3, H-4, H-6, H-7, H-8, H-9 confidence levels, H-6 operational employment, H-8
 JECE, joint elimination coordination element, v, 2-1, 2-2, 2-4, 2-6, 2-13, 3-7, 4-10, B-2, F-1, F-2, F-3, F-4, G-1, G-6 role, F-1
 JFC, joint force commander, 1-9, 2-5, 2-13, 3-1, 3-6, 3-7, 4-9, 5-15, A-4, F-1, F-2, G-6, H-9

JFCC, joint forces combatant command, 3-6
 JMCB-E, joint mission coordination board elimination, 5-16, 5-17, 5-21
 JMETL, joint mission essential task list, G-1, G-2, G-6
 JOC, joint operations center, 2-2, 2-5, 2-6, 4-10, 5-4, 5-5, 5-9, 5-11, 5-14, B-4, F-1, F-2, G-1, G-6

joint force development directorate, F-3
 JTCB, joint targeting coordination board, 5-15, 5-16, 5-19, 5-20

JTF-E, joint task force elimination, viii, 2-1, 2-2, 2-4, 2-5, 2-6, 2-8, 2-10, 2-13, 2-14, 3-1, 3-7, 3-8, 4-4, 4-6, 4-9, 4-10, 4-12, 4-13, 5-8, 5-10, 5-11, 5-13, 5-15, 5-16, 5-19, 5-21, 6-2, B-1, B-2, B-9, C-1, C-2, D-1, E-1, E-2, F-1, F-2, F-3, F-4, G-1, G-6
 JWICS, joint worldwide intelligence communications system, 2-7, B-3, B-10

K

knowledge management cell, 2-10, B-7, B-9

L

laboratory, 2-3, 2-6, 2-9, 2-12, 2-14, 3-1, 4-4, 4-6, 4-13, 5-10, 5-20, B-3, B-4, B-9, B-10, D-2, D-3, E-1, E-2, E-3, H-1, H-2, H-3, H-4, H-5 combat support hospital, See CSH, H-9 confirmatory, H-8 definitive, H-6, H-10 facilities, H-11 field-deployed, H-9 laboratory response network, See LRN, H-12, H-13 Laboratory Response Network, See LRN, H-8 levels A-D, H-13 Naval Medical Research Center, See "NMRC, Navy Medical Research Center" NMRC, H-10 Naval Medical Research Center, See NMRC, H-11 OCONUS, H-8 reference, H-2, H-6, H-8, H-10 response team, H-10 locate, 1-3, 4-1, 4-2, 4-3, 4-5, 4-10, 4-11, 4-12, A-3, A-7, D-1, D-3, H-1
 logistics, 2-7, 2-8, 5-20, 5-22, 6-1, E-3 directorate, 6-1 management, 2-7
 LOW, law of war, 1-13, 2-9, B-4, B-11

M

MAL, mobile analytical laboratory, E-1, E-2, E-3
 MAL, mobile analytical laboratory section, E-2

- maneuver cell, 2-9, B-2, B-3, B-10
- MARS, Mobile Analytical Response System, H-12
- MCP, main command post, 2-8, 2-9, G-1
communications with OCP, B-4
geographic location, B-7
intelligence collaboration, B-3
primary focus, iv
reachback, 2-14, 5-5, 5-14
required installation support, 6-3
staff elements, B-8
- MDMP, military decision-making process, 2-6, 5-3, 5-4, 5-5, 5-6, 5-7, 5-13, G-4
- medical
element, B-5
planner, B-5, B-15
science officer, D-2
- medical laboratory support, v, H-1
- METL, mission essential task list, 2-12, B-1, G-1
development sequence, G-2
staff development sequence, G-1
training objectives, G-3
- METT-TC, mission, terrain and weather, troops and support available, time available and civil considerations, 1-4, 1-7, 2-14, 5-9, 5-10, H-5
- military mission areas, viii, A-7
- mission analysis, 5-8
- mission analysis, 5-13, 5-20, 6-2
- mission command, 3-1, 3-4, 3-5, 3-8, 5-1
- mission of the
CARA, E-1
CBRNE operational headquarters, 2-1
JECE, F-1
NDT, D-1
WCE, C-1
- mission sets, 2-1, 3-5, 3-6, 5-1, 5-19
- MMAS, mobile munitions assessment system, E-1, E-2, E-3, E-4
- MRO, monitoring and redirection operation, 4-6, 4-13, 4-14
- MTF, medical treatment facility, H-1, H-2, H-3, H-5, H-9
- multinational, 2-4, 2-5, 2-6, 2-14, 6-3, B-1, B-4, B-10, B-12, 10
- ### N
- NDT, nuclear disablement team, v, 2-2, 2-10, 2-11, 4-9, D-1, D-2, D-3, D-4
actions at the objective, D-3
capabilities and limitations, D-1
mission, D-1
support requirements, D-4
task organization, D-2
- NDVECC, Navy Disease Vector Ecology Control Center, H-12
- NIPRNET, Non-Secure Internet Protocol Router Network, 2-7, B-3, B-10, C-4, C-5
- NMRC, Navy Medical Research Center, H-2, H-6, H-10, H-11
- NMS-CWMD, national military strategy to combat weapons of mass destruction, vii, viii, 1-1, 1-5, 2-1, A-3, A-5, A-7, A-8
- NP, nonproliferation, viii, 1-1, 1-3, A-1, A-2, A-4, A-5, A-7, A-8
- NS-CWMD, national strategy to combat weapons of mass destruction, viii, 1-1, 1-5, 1-9, A-5
- nuclear and counterproliferation officer, C-1, C-2
- ### O
- OCP, operational command post, iv, 1-8, 2-2, 2-3, 2-4
augmentation, 2-14, 4-10, 5-5, C-1
capabilities, 2-5
deployability, 2-5, G-1
employment example, 3-7
functions, 2-4
joint mission essential task list, See JMETL, G-6
reachback, 5-14, 6-4
relationship to MCP, 2-8
structure, 2-6
support requirements, 6-3
targeting intelligence, 5-14
- OGO, other government organization, 1-11, 2-9, 2-10, G-5
- opportunity, 4-10
target/site, 4-1, 4-10, 4-11, 5-3, E-2
- OSHA, Occupational Safety and Health Administration, E-3
- ### P
- PIR, priority intelligence requirements, 2-7, 5-4, 5-10, 5-14, B-3, B-10
- planned
target/site, 3-9, 4-1, 4-3, 4-9, 4-11, 5-10, E-2
- planning
WMD-E missions, 5-8, 5-21
- plans and orders, 2-6, 2-7, 2-9, 4-10, 5-6, 5-20, B-1, B-2, B-4, B-11, F-3, G-5, G-6
- plans cell, 2-9, B-7, B-10
- PMESII-PT, 1-1
- preserve, 4-5, 4-8
- presumptive
testing/identification, 4-4, 4-5, 4-10, 4-12, 5-13, H-2, H-6, H-8, H-9
- ### R
- RCWM, recovering chemical warfare materiel, 2-3, E-4
- recover, A-5, A-6
- redirection, 2-1, 3-10, 4-1, 4-6, 4-9, 4-13, 4-14, 5-21, A-3, A-8, B-4
- reduce
WMD programs, A-2, A-3, A-5, A-7
- remediation, v, 2-12, B-4, E-1, E-3
activity, E-2
response sections (east and west), E-1, E-3, E-4
response team, E-1
- remove/transfer hazard, 4-4, 4-6, 4-7, 4-8, A-1, D-4, D-5
- required support, iv, 5-22, 6-1, 6-3
JECE, F-3
MCP, 6-3
NDT, D-1, D-4
OCP, 6-3
specialized elements, 6-3
training, G-3
WCE, C-2

RFI, request for information, 5-9, 5-14, H-2
RI, relevant information, 1-4, 5-1, B-12, G-5
risk management, 2-10, A-7, B-11, B-15
ROE, rules of engagement, 1-13, 2-6, 2-9, B-4, B-7, B-11
RRT, remediation response team, E-1, E-2, E-3, E-4
RSE, religious support element, B-5, B-6, See chaplain
running estimate, 5-7, 5-8, B-1, B-3, B-10

S

sample, 1-9, 4-13, 5-13, G-5, H-1, H-2
 analysis, 1-9, 4-12, 5-10, D-2, H-2, H-9
 collection, 4-4, 5-18, D-4, E-1, E-3, H-1, H-4
 storage, H-4
 suspect, 4-13, 4-14
 transport, 2-11, 6-2, H-2
SCC-WMD, US Strategic Command Center for Combating WMD, F-2, F-3, F-4
secure, 4-1, 4-2, 4-4, 4-5, 4-6, 4-10, 4-11, 4-12, 4-14, A-1, A-3, A-5, A-7
signal cell, 2-6, 2-7
SIPRNET, SECRET Internet Protocol Router Network, 2-7, B-3, B-10, C-4
SJA, staff judge advocate, 2-6, 2-8, 2-10, B-4, B-5, B-6, B-7, B-11, B-15
special staff elements, 2-7
specialized organic response asset, 2-10
specimen collection, H-1, H-2, H-3, H-4, H-5, H-6, H-7, H-9, H-10, H-12
spectrum, 1-10, 2-1, 5-8
 full spectrum operations, iv, 1-1, 1-7, 1-10, 1-13, 2-10, 3-1, 3-3, 3-4, 3-8, 5-6, G-1

 spectrum of conflict, iv, 1-4, 3-1, 3-4, 3-5
SSE, sensitive site exploitation, A-8, B-3, B-9
OCP, operational command post, B-2
staff roles and responsibilities, iv, 2-1, 2-7, B-1
staff running estimate, 5-7, 5-8
SU, situational understanding, 1-4, 1-7, 1-12, 2-7, 2-9, 5-3, 5-4, 5-5, 5-8, 5-13, 5-14, A-5, A-7, B-9, F-2, F-3
support relationships, iv, 3-6, 5-8, 5-21, 5-22, F-2
surgeon, 2-10, B-5, B-11, B-15, G-5, H-2
suspect materiel, capturing, 5-9
sustainment
 cell, 2-6, 2-7, B-2
 nonstandard requirements, 6-2
 planning, 6-1, 6-2

T

target
 development, 2-7, 5-14, 5-15, 5-16
 folder, 1-7, 2-7, 5-17, 5-18
 opportunity, 4-1, 4-10, 4-11, 5-3
 organizations that may support, 5-19
 planned, 3-9, 4-1, 4-3, 4-9, 4-11, 5-10, E-2
 prioritization, 4-3, 4-6, 5-15, 5-16, 5-17, 5-18, 5-19, B-11
 WMSL, 4-3
TECHINT, technical intelligence, 2-8, 5-9, 5-10, 5-14
TEU, technical escort unit, 1-9, 4-9, 4-12, 4-13, H-3
threat
 asymmetrical, 1-3, 1-5, 1-6
 nonstate actor, vii, viii, 1-1, 1-2, 1-3, A-1, A-3
 regional, vii, 1-2, 1-3, 3-10
 state, viii
 state actor, vii, 1-1
 strategic, 1-2

threats, 1-2
 WMD sites, 1-3
TIC, toxic industrial chemical, 1-2, 1-5, 1-6, 1-8, 1-9, D-3
TIM, toxic industrial material, 1-2, 1-3, 1-5, 1-6, 1-8, 1-9, A-3, D-3, H-12
training
 collective task, G-2, G-3, G-4
 METL, G-1
 requirements, iv, B-11, G-1, G-3
transfer, 4-4, 4-6, 4-7, 4-8, 4-10, 4-13, A-3, A-8, B-8, D-4, D-5, H-2, H-3

U

unified action, 1-10, 1-11, 3-1
USACHPPM, US Army Center for Health Promotion and Preventive Medicine, E-3, H-12
USAMRIID, US Army Medical Research Institute for Infectious Disease, H-2, H-6, H-9, H-10, H-11, H-13
USNORTHCOM, United States Northern Command, 2-3, 3-6, 3-10
USSOCOM, United States Special Operations Command, 2-2, 2-4
USSTRATCOM, United States Strategic Command, 1-10, 2-1, 2-13, 5-19, A-1, A-7, F-1, F-2, F-3
UXO, unexploded ordnance, B-8, D-3

W

WFF, warfighting function, 1-10, 1-12, 5-1, 5-6, 6-1, G-2
WMD, weapons of mass destruction
 combating, iv
WMD-CM, WMD consequence management, viii, 4-3, A-1, A-2, A-4, A-5, A-6, A-7
WMSL, weapons of mass destruction master site list, See target, 4-3, 4-6, 4-9, 5-20

FMI 3-90.10
24 January 2008

By Order of the Secretary of the Army:

GEORGE W. CASEY, JR
General, United States Army
Chief of Staff

Official:



JOYCE E. MORROW
Administrative Assistant to the
Secretary of the Army
0801702

DISTRIBUTION:

Active Army, Army National Guard, and US Army Reserve: Not to be distributed. Electronic media only.

PIN: 084591-000