

**FM 7-100.4**



**Opposing Force  
Organization Guide**

**MAY 2007**

**HEADQUARTERS, DEPARTMENT OF THE ARMY**  
**DISTRIBUTION RESTRICTION: Approved for public release; distribution is unlimited.**

## Foreword

In today's complicated and uncertain world, it is impossible to predict the exact nature of future conflict that might involve the U.S. Army. So the Army must be ready to meet the challenges of any type of conflict, in all kinds of places, and against all kinds of threats. This is the nature of the contemporary operational environment (COE) and the makeup of the opposing force (OPFOR) used in training for the COE.

The Deputy Chief of Staff for Intelligence (DCSINT) of the U.S. Army Training and Doctrine Command (TRADOC) is the responsible official for the development, management, administration, and approval functions of the COE concept across the Army. Thus, the TRADOC DCSINT is responsible for documenting the doctrine, organization, and capabilities of an OPFOR that is appropriate for training the Army's leaders, Soldiers, and units for the COE.

In the FM 7-100 series, the TRADOC Office of the Deputy Chief of Staff for Intelligence (ODCSINT) has created a flexible baseline for an OPFOR that can be adapted to meet a variety of different training requirements in a number of different scenarios that reflect the COE. The OPFOR organizations outlined in FM 7-100.4 and the associated online organizational directories represent a realistic composite of potential adversaries the Army might encounter in real-world situations of the near- and mid-term. However, the world is constantly changing, as are the threats and challenges for which the Army must be prepared. The Army must remain flexible, as must the OPFOR designed to serve as a challenging sparring partner in the training environment.

This manual is approved for use in all Army training venues. However, as the OPFOR and other aspects of the COE are integrated into Army training, the TRADOC DCSINT and the intelligence community will continue research and analysis of real-world developments and trends. The goal of this continued effort is to keep our OPFOR and our understanding of the COE relevant as the world around us changes. Thus, this manual, along with the associated online organizational directories, is intended to be a living document, the ODCSINT will modify and change it as often as necessary in order to ensure its continued relevance in light of changes and developments in the COE. In anticipation of such changes, this manual will be published in electronic format available online at Army Knowledge Online (AKO) at <http://www.us.army.mil>. The electronic version of the manual, as well as the organizational directories to which the manual is linked, are available on the Battle Command Knowledge System (BCKS) at <https://dcsint-threats.leavenworth.army.mil/COE/default.aspx>. Users need to monitor both these sites for periodic updates.



MAXIE L. MCFARLAND  
Deputy Chief of Staff for Intelligence  
U.S. Army Training and Doctrine Command

# Opposing Force Organization Guide

## Contents

	Page
<b>PREFACE .....</b>	<b>v</b>
<b>INTRODUCTION.....</b>	<b>vi</b>
<b>Chapter 1 OPFOR ROLES AND RELATIONSHIPS IN TRAINING.....</b>	<b>2-1</b>
OPFOR for the Contemporary Operational Environment .....	2-1
Role in Training .....	2-1
Tie-In with Other Manuals in the FM 7-100 Series.....	2-2
<b>Chapter 2 ADMINISTRATIVE FORCE STRUCTURE.....</b>	<b>2-1</b>
<b>Section I – Nation-State Forces: Strategic Level .....</b>	<b>2-1</b>
National-Level Command Structure .....	2-1
Service Components .....	2-2
Theater Headquarters .....	2-6
<b>Section II – Nation-State Forces: Operational Level.....</b>	<b>2-7</b>
<b>Section III – Nation-State Forces: Tactical Level .....</b>	<b>2-8</b>
Divisions .....	2-8
Maneuver Brigades .....	2-8
Battalions.....	2-8
Companies .....	2-9
Platoons.....	2-9
Aviation Units.....	2-9
Nondivisional Units .....	2-9
<b>Section IV – Non-State Actors.....</b>	<b>2-9</b>
Paramilitary Organizations .....	2-9
Noncombatants .....	2-13
<b>Section V – Organizational Directories .....</b>	<b>2-14</b>
Files for OPFOR Units.....	2-15
Folders for OPFOR Unit Files .....	2-19

---

**Distribution Restriction:** Approved for public release; distribution is unlimited.

<b>Chapter 3</b>	<b>TASK-ORGANIZING</b> .....	<b>3-1</b>
	<b>Section I – Fundamental Considerations</b> .....	<b>3-1</b>
	U.S. Training Requirements.....	3-1
	OPFOR Doctrine .....	3-2
	<b>Section II – Nation-State Forces: Strategic Level</b> .....	<b>3-4</b>
	Supreme High Command .....	3-4
	Strategic Framework.....	3-5
	<b>Section III – Nation-State Forces: Operational Level</b> .....	<b>3-5</b>
	Field Group .....	3-6
	Operational-Strategic Command .....	3-7
	<b>Section IV – Nation-State Forces: Tactical Level</b> .....	<b>3-12</b>
	Tactical Groups .....	3-12
	Detachments.....	3-14
	Integrated Fires Command .....	3-15
	Integrated Support Command.....	3-16
	Internal Task-Organizing.....	3-16
	Special-Purpose Forces.....	3-17
	Internal Security Forces .....	3-17
	<b>Section V – Non-State Actors</b> .....	<b>3-18</b>
	Insurgent and Guerrilla Forces .....	3-18
	Other Paramilitary Forces .....	3-18
	Noncombatants.....	3-19
	<b>Section VI – Exploitation of Noncombatants and Civilian Assets</b> .....	<b>3-20</b>
	By Military Forces.....	3-20
	By Paramilitary Forces.....	3-21
	<b>Section VII – Unit Symbols for OPFOR Task Organizations</b> .....	<b>3-21</b>
	<b>Section VIII – Building an OPFOR Order of Battle</b> .....	<b>3-23</b>
	Step 1. Determine the Type and Size of U.S. Units.....	3-23
	Step 2. Set the Conditions .....	3-23
	Step 3. Select Army Tactical Tasks .....	3-23
	Step 4. Select OPFOR Countertasks .....	3-24
	Step 5. Determine the Type and Size of OPFOR Units.....	3-24
	Step 6. Review the AFS Organizational Directories .....	3-24
	Step 7. Compile the Initial Listing of OPFOR Units for the Task Organization.	3-24
	Step 8. Identify the Base Unit .....	3-24
	Step 9. Construct the Task Organization.....	3-25
	Step 10. Repeat Steps 4 through 9 as Necessary .....	3-25
<b>Chapter 4</b>	<b>EQUIPMENT OPTIONS</b> .....	<b>4-1</b>
	Baseline Equipment .....	4-1
	Worldwide Equipment Guide .....	4-4
<b>Appendix A</b>	<b>ADMINISTRATIVE FORCE STRUCTURE ORGANIZATIONAL DIRECTORIES LISTING</b> .....	<b>A-1</b>
	Volume I – Divisions and Divisional Units.....	A-1
	Volume II – Nondivisional Units .....	A-4

	Volume III – Paramilitary and Nonmilitary Actors.....	A-6
	Volume IV – Other .....	A-7
<b>Appendix B</b>	<b>BUILDING AN OPFOR TASK ORGANIZATION .....</b>	<b>B-1</b>
	Task Organization Example .....	B-1
	Building from the Bottom Up .....	B-30
<b>Appendix C</b>	<b>LOCAL INSURGENT ORGANIZATION FROM THE AFS ORGANIZATIONAL DIRECTORIES .....</b>	<b>C-1</b>
	Insurgent Organizations .....	C-1
	Local Insurgent Organization Example .....	C-1
<b>Appendix D</b>	<b>MOTORIZED INFANTRY COMPANY FROM THE AFS ORGANIZATIONAL DIRECTORIES .....</b>	<b>D-1</b>
	Infantry and Motorized Infantry Companies .....	D-1
	Motorized Infantry Company Example .....	D-1
<b>Appendix E</b>	<b>GUERRILLA HUNTER/KILLER COMPANY FROM THE AFS ORGANIZATIONAL DIRECTORIES .....</b>	<b>E-1</b>
	Guerrilla Organizations.....	E-1
	Guerrilla Hunter/Killer Company Example .....	E-1
	<b>GLOSSARY .....</b>	<b>Glossary-1</b>
	<b>REFERENCES .....</b>	<b>References-1</b>
	<b>INDEX.....</b>	<b>Index-1</b>

## Figures

Figure 2-1. National-Level Command Structure and Service Components.....	2-2
Figure 2-2. Internal Security Forces in the Ministry of the Interior .....	2-4
Figure 2-3. Peacetime Administrative Force Structure .....	2-7
Figure 2-4. Infantry Squad Personnel and Equipment (Example) .....	2-17
Figure 2-5. Basic Listing of Folders in AFS Organizational Directories .....	2-20
Figure 3-1. Wartime Fighting Force Structure.....	3-6
Figure 3-2. Allocation of Forces to an OSC (Example).....	3-7
Figure 3-3. Possible OSC Organization (Example).....	3-8
Figure 3-4. Possible IFC Components in an OSC .....	3-9
Figure 3-5. OSC Task Organization, with ISC Example .....	3-11
Figure 3-6. Possible DTG Organization (Example).....	3-13
Figure 3-7. Possible BTG Organization (Example).....	3-14
Figure 3-8. Battalion-Size Detachment (BDET) Example .....	3-15
Figure 3-9. Company-Size Detachment (CDET) Example .....	3-15
Figure 3-10. Possible IFC Components in a DTG.....	3-16
Figure 3-11. OSC Symbol .....	3-21
Figure 3-12. Motorized Infantry-Based DTG Symbol .....	3-21
Figure 3-13. Mechanized Infantry-Based DTG Symbol .....	3-22

## Contents

---

Figure 3-14. Tank-Based BTG Symbol.....	3-22
Figure 3-15. Heliborne Infantry-Based BDET Symbol.....	3-22
Figure 3-16. Attack Helicopter-Based BDET Symbol.....	3-22
Figure 3-17. Mechanized Infantry-Based CDET Symbol.....	3-23
Figure 4-1. Motorized Infantry Company Principal Items of Equipment List .....	4-2
Figure 4-2. Motorized Infantry Company Personnel and Equipment Chart.....	4-3
Figure B-1. Basic Task-Organized OPFOR (Example) .....	B-3
Figure B-2. Separate Motorized Infantry Brigade from AFS to Use as a Baseline Unit .....	B-5
Figure B-3. Local Insurgent Organization from AFS to Use as a Baseline Unit.....	B-7
Figure B-4. Folders for Task Organization.....	B-9
Figure B-5. Brigade Tactical Group (Motorized) (Antiarmor-Light).....	B-12
Figure B-6. Rows 1 and 2 .....	B-13
Figure B-7. BTG (Mtzd) (Antiarmor-Lt) Personnel and Equipment List, Page 1 .....	B-19
Figure B-8. BTG (Mtzd) (Antiarmor-Lt) Personnel and Equipment List Continued, Page 2 .....	B-20
Figure B-9. BTG (Mtzd) (Antiarmor-Lt) Personnel and Equipment List Continued, Page 3 .....	B-21
Figure B-10. BTG (Mtzd) (Antiarmor-Lt) Personnel and Equipment List Continued, Page 4 .....	B-22
Figure B-11. BTG (Mtzd) (Antiarmor-Lt) Personnel and Equipment List Continued, Page 5 .....	B-23
Figure B-12. Folders and Files for Task Organization.....	B-25
Figure B-13. Folders and Files for Task Organization (Continued).....	B-26
Figure B-14. Local Insurgent Organization (Affiliated).....	B-28
Figure B-15. Local Insurgent Organization Equipment (Affiliated) .....	B-29

## Tables

Table 3-1. Command and Support Relationships.....	3-3
Table 4-1. Equipment Tier Table (Example).....	4-9
Table 4-2. Systems Substitution Matrix (Example).....	4-11
Table B-1. Initial Listing of OPFOR Units Required for Task Organization .....	B-4
Table B-2. Specific Units Required for BTG Task Organization.....	B-5

This publication is available at  
Army Knowledge Online ([www.us.army.mil](http://www.us.army.mil)) and  
General Dennis J. Reimer Training and Doctrine  
Digital Library at ([www.train.army.mil](http://www.train.army.mil)).

## Preface

This manual is one of a series that describes an opposing force (OPFOR) for training U.S. Army commanders, staffs, and units. See the References section for a list of the manuals in this series. Together, these manuals outline an OPFOR that can cover the entire spectrum of military and paramilitary capabilities against which the Army must train to ensure success in any future conflict.

Applications for this series of manuals include field training, training simulations, and classroom instruction throughout the Army. All Army training venues should use an OPFOR based on these manuals, except when mission rehearsal or contingency training requires maximum fidelity to a specific real-world threat. Even in the latter case, trainers should use appropriate parts of the OPFOR manuals to fill information gaps in a manner consistent with what they do know about a specific threat.

This publication applies to the Active Army, the Army National Guard/Army National Guard of the United States, and the United States Army Reserve unless otherwise stated.

The proponent for this publication is the United States Army Training and Doctrine Command (TRADOC). Send comments and recommendations on DA Form 2028 directly to the Contemporary Operational Environment and Threat Integration Directorate (CTID), TRADOC Intelligence Support Activity (TRISA)-Threats, of the TRADOC Office of Deputy Chief of Staff for Intelligence (DCSINT) at the following address: Director, CTID, TRISA-Threats, ATTN: ATIN-T (Bldg 53), 700 Scott Avenue, Fort Leavenworth, KS 66027-1323.

This publication is available at Army Knowledge Online (AKO) at <http://www.us.army.mil> and linked to online organizational directories on the Battle Command Knowledge System (BCKS) at <https://dcsint-threats.leavenworth.army.mil/COE/default.aspx>. Readers should monitor those sites for the status of this manual and information regarding updates. Periodic updates, subject to the normal approval process, will occur as a result of the normal production cycle in accordance with TRADOC regulation 25-36, paragraphs 2-17 and 4-7. The date on the cover and title page of the electronic version will reflect the latest update.

Unless this publication states otherwise, masculine nouns or pronouns do not refer exclusively to men.

# Introduction

This manual is part of the FM 7-100 series, which describes an opposing force (OPFOR) that exists for the purpose of training U.S. forces for potential combat operations. This OPFOR reflects the characteristics of military and paramilitary forces that may be present in the contemporary operational environment (COE). Like those real-world threats, the OPFOR will continue to present new and different challenges for U.S. forces. The COE is constantly changing, and it is important for U.S. Army training environments to keep pace with real-world developments. This manual differs from others in the FM 7-100 series in that it includes both OPFOR doctrine regarding organization (administrative force structure and task-organized fighting force structure) and training-related issues from a U.S. viewpoint.

This organization guide also differs from other FMs in the fact that it is linked to online organizational directories. TRADOC DCSINT maintains these directories and continuously updates them, as necessary, to represent contemporary and emerging capabilities. In order to provide a comprehensive menu of the numerous types of OPFOR organizations in the detail required for the Army's live, virtual, and constructive training environments, these directories exceed the scope and size that can be accommodated within a traditional FM format. The directories contain over 10,000 pages detailing OPFOR organizations. From this menu, users can select and download just those parts needed to build the appropriate OPFOR for a particular exercise. Task-organizing an exercise order of battle also requires that users have the ability to use downloaded organizations in an interactive manner. For these reasons, it is necessary for this FM to be linked to organizational diagrams and associated equipment inventories made available in electronic form that users can download and manipulate as necessary in order to create task organizations capable of fighting in adaptive ways that typify the COE.

## CONTEMPORARY OPERATIONAL ENVIRONMENT

In planning a training scenario and its road to war, trainers need to take into consideration the entire operational environment (OE) and its impact on the OPFOR's order of battle (OB). The DOD officially defines an *operational environment* as "a composite of the conditions, circumstances, and influences that affect the employment of capabilities and bear on the decisions of the commander" (JP 1-02 and JP 3-0). The *contemporary operational environment* (COE) is the synergistic combination of all the critical variables and actors that create the conditions, circumstances, and influences that can affect military operations today and in the near- and mid-term.

The COE has a direct impact on the architecture and capabilities of OPFOR organizations. Proper task-organizing can either mitigate or exploit the environment by the proper selection of organization and/or equipment. This enables the appropriate OPFOR to perform countertasks that challenge the ability of U.S. units to perform the tasks in their mission essential task list (METL) in training environments.

The COE is the holistic view of the environment in the near- and mid-term that comprises the conditions, circumstances, and influences that affect the training and employment of military forces. Analysis of the COE focuses on eight interrelated variables:

- Political.
- Military.
- Economic.
- Social.
- Information.
- Infrastructure.
- Physical environment.
- Time.



An assessment of these critical variables and their relationships helps to understand any OE and its impact on the Army.

The COE is particularly valuable in training. In order to develop adaptive leaders capable of operating in any OE, the Army requires challenging training scenarios, an OPFOR model, and OPFOR doctrine. This provides an adaptive, asymmetric OPFOR in order to train, develop, and prepare Soldiers and leaders to overcome threats in a complex and adaptive OE. It also provides a benchmark to measure training effectiveness and combat development activities. See FM 3-0.2 (to be published) for further discussion of the COE and its application to training.

## **REAL WORLD**

In the real world, the COE is the entire set of conditions, circumstances, and influences that U.S. Armed Forces can expect to face when conducting military operations to further the interests of the United States, its friends, and allies. The COE is “contemporary” in the sense that it does not represent conditions that existed only in the past or that might exist only in the remote future, but rather those conditions that exist today and in the clearly foreseeable near- and mid-term future. This COE consists not only of the military and/or paramilitary capabilities of potential real-world adversaries, but also of the manifestations of the seven other variables that help define any OE.

## **TRAINING**

In training environments, the COE is the OE created to approximate the demands of the real-world COE and to set the conditions for desired training outcomes. This involves the appropriate combination of an OPFOR (with military and/or paramilitary capabilities representing a composite of a number of potential adversaries) and other OE variables in a realistic, feasible, and plausible manner. The purpose of the COE in training simulations is to produce the necessary training outcomes.

---

*Note.* The same type of COE conditions can be created to support some combat development activities that do not require simulation of a specific real-world potential adversary. However, some combat development activities may require portrayal of an OE that extends further into the future than is typical for the COE; in that case, they are dealing with the *future operational environment* (FOE).

---

## **OPPOSING FORCE**

As a training tool, the OPFOR must be a challenging, uncooperative sparring partner capable of stressing any or all warfighting functions and mission-essential tasks of the U.S. force. Training for the COE requires an OPFOR that is “a plausible, flexible military and/or paramilitary force representing a composite of varying capabilities of actual worldwide forces, used in lieu of a specific threat force, for training and developing U.S. forces” (Army Regulation 350-2). This manual introduces the baseline organizational structures of a flexible, thinking, adaptive OPFOR.

As the real-world conditions and capabilities change over time, OPFOR doctrine, organizations, and equipment capabilities will evolve along with them, to continue to provide the Army an OPFOR appropriate for the COE. Thus, the OPFOR will remain capable of presenting realistic and relevant challenges that are appropriate to meet evolving training requirements at any given point in time.

**This page intentionally left blank.**

## Chapter 1

# OPFOR Roles and Relationships in Training

An opposing force (OPFOR) is a training tool that should allow the U.S. Army to train against a challenging and plausible sparring partner that represents the range of possible opponents the Army could face in actual conflict. It enables training of all arms of the Army and prepares the Army for potential combat operations.

## OPFOR FOR THE CONTEMPORARY OPERATIONAL ENVIRONMENT

1-1. Training U.S. forces for the contemporary operational environment (COE) requires a different kind of OPFOR from that of the past. The OPFOR must be less predictable and not based on the armed forces of a particular country or non-state actor. In today's world, the U.S. Army must be prepared to go into any operational environment (OE) and perform its full range of missions. It must be ready to do so in the face of a wide variety of possible threats and at the same time be prepared to deal with third-party actors that may have other interests. Not all threats are purely military in nature. Therefore, the U.S. Army now defines an OPFOR as "a plausible, flexible military and/or paramilitary force representing a composite of varying capabilities of actual worldwide forces, used in lieu of a specific threat force, for training and developing U.S. forces" (Army Regulation 350-2).

1-2. In some training environments, a military force or a paramilitary force alone may be the OPFOR. In other cases, military forces may have paramilitary forces acting in loose affiliation with them, or acting separately from them within the same training environment. These relationships depend on the scenario, which is driven by training requirements.

1-3. Various agencies and experts have different lists of real-world threats the United States might have to face. If the U.S. Army were to pick any one of these threats as *the* threat against which to train, that threat would almost certainly not be the one that all Army forces would actually fight. What is needed is a composite that is representative of the full range and variety of possible threats and OEs. It must have a bit of everything—it could be virtually anybody, anywhere. Therefore, this manual is linked to directories of organizations that provide a representative composite of real-world military and paramilitary organizations. With this composite as a baseline, trainers have the flexibility to task-organize and adjust the capabilities of an OPFOR to fit the most demanding U.S. Army training requirements and provide a framework for training that creates the leaders, soldiers, and unit skills necessary for success on the next battlefield—wherever that might be.

## ROLE IN TRAINING

1-4. As a training tool, the OPFOR must be a challenging, uncooperative sparring partner, capable of stressing any or all warfighting functions and mission-essential tasks of the U.S. force. However, it must also be tailored to meet specific training requirements.

---

*Note.* Although the OPFOR is primarily a training tool, it may be used for other purposes. For example, some combat development activities that do not require simulation of a specific real-world potential adversary may use an OPFOR to portray the "threat" or "enemy."

---

1-5. As a baseline for developing specific OPFORs for specific training environments, this manual describes an OPFOR that is representative of the forces of contemporary nation-states and non-state actors. This composite of the characteristics of real-world military and paramilitary forces provides a framework for the realistic and relevant portrayal of capabilities that U.S. forces might face in the COE. This manual is

applicable to the entire U.S. Army training community, including the OPFORs at all of the combat training centers, the TRADOC schools, and units in the field.

1-6. The FM 7-100 series, as a whole, covers not only the military and paramilitary forces of a nation-state, but also other, non-state paramilitary organizations and nonmilitary actors that might be present in a region of the world. The United States, as an extraregional power becoming involved in such a region, might have to deal with any or all of these types of military, paramilitary, and nonmilitary elements. It might encounter these elements individually or, more likely, in combination with other such elements. Whether these elements operate in concert or independently, they are an important part of the COE.

1-7. Trainers need to consider the total OE—not just the military or threat dimension—in designing training environments. All the other critical variables can affect the overall OE and the military, paramilitary, and nonmilitary entities that are part of it.

1-8. The baseline OPFOR organizations linked to this manual do not constitute an OPFOR order of battle (OB). Rather, they provide a framework from which trainers can develop a specific OPFOR OB appropriate for their particular training requirements. Within this framework, scenario writers and exercise designers have considerable flexibility in determining what the OPFOR actually has at a given point in time or a given place on the battlefield—in a particular scenario. In some cases, an organization taken straight from the OPFOR administrative force structure may meet the requirements for a particular U.S. Army training environment. In most cases, however, it will be necessary to task-organize the OPFOR organizations in order to portray the right mix of units and equipment for stressing the mission essential task list (METL) of U.S. units in particular training environments.

1-9. Thus, the baseline organizations presented in the organizational directories linked to this manual are intended to be tailored and task-organized in a manner that is appropriate for the training objectives. Depending on the training requirement, the OPFOR may be a large, medium, or small force. Its technology may be state-of-the-art, relatively modern, obsolescent, obsolete, or an uneven combination of these categories. Its ability to sustain operations may be limited or robust.

1-10. During the road to war leading up to events in a training scenario, the OPFOR may play the role of a “threat” (potential enemy) that is on the verge of becoming an enemy. However, the actual training event usually deals with a state of hostilities. Thus, once hostilities begin in the training event, the OPFOR acts as the “enemy” of the U.S. force in the training environment.

## **TIE-IN WITH OTHER MANUALS IN THE FM 7-100 SERIES**

1-11. This organization guide is meant to be used in conjunction with other manuals in the FM 7-100 series. Together, these manuals outline an OPFOR that can cover the entire spectrum of military and paramilitary capabilities against which the Army must train to ensure success in the types of OEs it can expect to encounter in the clearly foreseeable future.

### **OPFOR STRATEGY, OPERATIONS, AND TACTICS**

1-12. This organization guide ties in with the national-level organizations described in detail in FM 7-100, *Opposing Force Doctrinal Framework and Strategy*. Organizations from the OPFOR administrative force structure (found in the online directories linked to this manual) should be task-organized in accordance with OPFOR doctrine in FM 7-100.1, *Opposing Force Operations*, and FM 7-100.2, *Opposing Force Tactics*.

### **PARAMILITARY ORGANIZATIONS AND NONMILITARY ACTORS**

1-13. This organization guide ties in with FM 7-100.3, *Opposing Force: Paramilitary Organizations and Nonmilitary Actors* (to be published). See that manual for more detail on the nature and activities of such actors.

## WORLDWIDE EQUIPMENT GUIDE

1-14. Chapters 3 and 4 each provide a link to the *Worldwide Equipment Guide* (WEG) online. The WEG contains equipment data, tier tables, and substitution matrices for the various categories of equipment found in OPFOR organizations. Training planners can employ the tier tables and substitution matrices in the WEG to find appropriate substitutes for baseline equipment shown in the organizational directories. Within each functional category of equipment, there are four tiers representing different levels of capability, with Tier 1 representing the highest level of capability and modernity. The WEG also contains technical data on the capabilities of systems identified as “Principal Items of Equipment” in the organizational directories and/or listed in the tier tables.

**This page intentionally left blank.**

## Chapter 2

# Administrative Force Structure

This chapter and the organizational directories to which it is linked provide the administrative force structure (AFS) to be used as the basis for OPFOR organization in all Army training, except real-world-oriented mission rehearsal exercises. This includes the forces of nation-state actors as well as key non-state actors. In most cases, the organizations found in the AFS will require task-organizing (see chapter 3) in order to construct an OPFOR order of battle appropriate for a training event.

### SECTION I – NATION-STATE FORCES: STRATEGIC LEVEL

2-1. When the OPFOR consists of or includes the military and/or paramilitary forces of a nation-state, the national-level structure of that state, including the overall military and paramilitary structure, should follow the patterns described in FM 7-100. Those patterns are summarized here. (See FM 7-100 for more detail.)

2-2. The FM 7-100 series refers to the country in question as “the State.” In specific U.S. Army training environments, however, the generic name of the State may give way to other fictitious country names used in the specific training scenarios. (See Army Regulation 350-2 for additional guidance concerning the use of country names in a scenario.) The State possesses various military and paramilitary forces with which to pursue its national interests. This section of chapter 2 describes the national-level command structure and the various services that control these forces.

2-3. The State’s Armed Forces have an *administrative force structure* (AFS) that manages military forces in peacetime. This AFS is the aggregate of various military headquarters, organizations, facilities, and installations designed to man, train, and equip the forces. Within the AFS, tactical-level commands have standard organizational structures (as depicted in the organizational directories). However, these AFS organizations normally differ from the OPFOR’s wartime fighting force structure. (See chapter 3 on Task-Organizing.)

2-4. The AFS includes all components of the Armed Forces—not only regular, standing forces (active component), but also reserve and militia forces (reserve component). For administrative purposes, both regular and reserve forces come under the headquarters of their respective service component. Each of the six service components is responsible for manning, equipping, and training of its forces and for organizing them within the AFS.

### NATIONAL-LEVEL COMMAND STRUCTURE

2-5. The State employs its military forces, along with its other instruments of power, to pursue its tactical, operational, and strategic goals and, thus, support its national security strategy. The national-level command structure includes the National Command Authority, the Ministry of Defense, and the General Staff. (See figure 2-1 on page 2-2.)

### NATIONAL COMMAND AUTHORITY

2-6. The National Command Authority (NCA) exercises overall control of the application of all instruments of national power in planning and carrying out the national security strategy. The NCA allocates forces and establishes general plans for the conduct of national strategic campaigns. The NCA exercises control over the makeup and actions of the Armed Forces through the Ministry of Defense and the General Staff.

## MINISTRY OF DEFENSE

2-7. The Ministry of Defense (MOD) is responsible for the day-to-day administration of the Armed Forces and for the readiness and overall development of the six service components of the Armed Forces. However, the General Staff has direct control over the six services. In wartime, the MOD merges with the General Staff to form the Supreme High Command (SHC).

## GENERAL STAFF

2-8. The General Staff is a major link in the centralization of military command at the national level, since it provides staff support and acts as the executive agency for the NCA. Together with the MOD, the General Staff forms the SHC in wartime. The General Staff has direct control over the six services, and all military forces report through it to the NCA. The Chief of the General Staff commands the SHC.

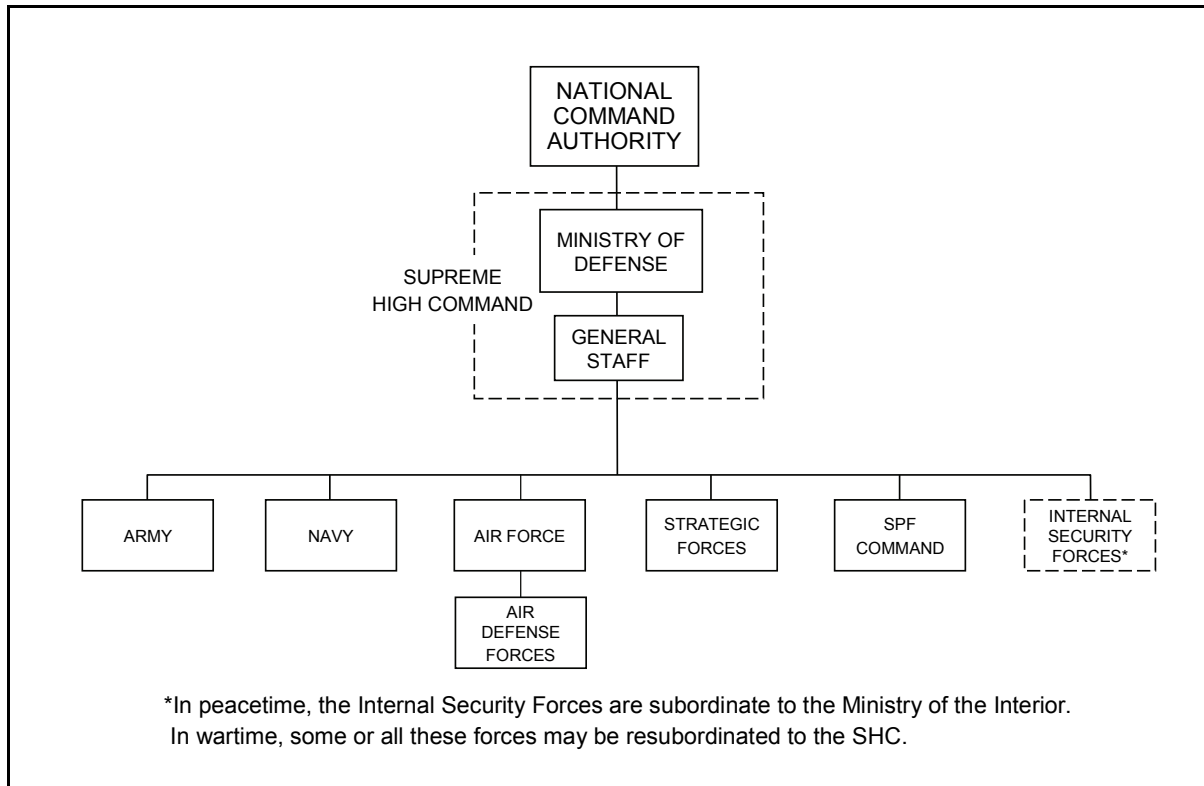

Figure 2-1. National-Level Command Structure and Service Components

## SERVICE COMPONENTS

2-9. The Armed Forces generally consist of six services. These include the Army, Navy, Air Force (which includes the national-level Air Defense Forces), Strategic Forces (with long-range rockets and missiles), Special-Purpose Forces (SPF) Command, and Internal Security Forces. The Internal Security Forces are subordinate to the Ministry of the Interior in peacetime, but become subordinate to the SHC in time of war. The Armed Forces field some reserve component forces in all services, but most reserve forces are Army forces. Militia forces belong exclusively to the ground component.

---

**Note.** Regular, reserve, and militia forces of the State can maintain various relationships with insurgent, guerrilla, and possibly criminal organizations.

---



## ARMY

2-10. The Army includes tank, mechanized infantry, motorized infantry, and a small number of airborne and special-purpose forces (Army SPF). The Army fields both rocket and tube artillery to support ground operations. The Army also has some long-range rockets and surface-to-surface missiles (SSMs). Fire support capability includes attack helicopters of Army aviation. The Army is assigned large numbers of shoulder-fired surface-to-air missiles (SAMs) and will also have mobile air defense units in support.

## NAVY

2-11. The State maintains a regional force-projection navy with a significant access-control capability built on small surface combatants, submarines, surface- and ground-based antiship missile units, and antiship mines. The Navy has a limited amphibious capability and possesses naval infantry capable of conducting forcible entry against regional opponents. The Navy also fields organic Special-Purpose Forces (Naval SPF).

---

*Note.* If the State in a particular scenario is a landlocked country, it may not have a navy.

---

## AIR FORCE

2-12. The Air Force, like the Navy, is fundamentally a supporting arm. Its aircraft include fighters, bombers, tactical transport, tankers, airborne early warning aircraft, electronic warfare (EW) aircraft, reconnaissance aircraft, and auxiliaries. The State's national-level Air Defense Forces are subordinate to the Air Force. Similar to other services, the Air Force has its own organic Air Force SPF.

## STRATEGIC FORCES

2-13. The Strategic Forces consist of long-range rocket and missile units. The missiles of the Strategic Forces are capable of delivering chemical, biological, radiological, and nuclear (CBRN) munitions, and the NCA is the ultimate CBRN release authority. The State considers the Strategic Forces capability, even when delivering conventional munitions, the responsibility of the NCA. Therefore, the NCA is likely to retain major elements of the Strategic Forces under its direct control or under the SHC or a theater headquarters in wartime. In some cases, the SHC or theater commander may allocate some Strategic Forces assets down to operational-level commands. Conventionally-armed rocket and missile units may be assigned directly in support of air, naval, and ground forces.

## SPECIAL-PURPOSE FORCES COMMAND

2-14. The SPF Command includes both SPF units and elite commando units. The General Staff or SHC normally reserves some of these units under its own control for strategic-level missions. It may allocate some SPF units to subordinate operational or theater commands, but can still task the allocated units to support strategic missions, if required.

2-15. Four of the five other service components also have their own SPF. In contrast to the units of the SPF Command, the Army, Navy, and Air Force SPF are designed for use at the operational level. The Internal Security Forces also have their own SPF units. These service SPF normally remain under the control of their respective services or a joint operational or theater command. However, SPF from any of these service components could become part of joint SPF operations in support of national-level requirements. The SPF Command has the means to control joint SPF operations as required.

2-16. Any SPF units (from the SPF Command or from other service components' SPF) that have reconnaissance or direct action missions supporting strategic-level objectives or intelligence requirements would normally be under the direct control of the SHC or under the control of the SPF Command, which reports directly to the SHC. Also, any service SPF units assigned to joint SPF operations would temporarily come under the control of the SPF Command or perhaps the SHC.

2-17. Most of the service SPF units are intended for use at the operational level. Thus, they can be subordinate to operational-level commands even in the AFS. In peacetime and in garrisons within the State, SPF of both the SPF Command and other services are organized administratively into SPF companies, battalions and brigades.

*Note.* SPF can organize, train, and support local irregular forces (insurgents or guerrillas and possibly even criminal organizations) and conduct operations in conjunction with them. SPF missions can also include the use of terror tactics.

## INTERNAL SECURITY FORCES

2-18. The State maintains internal security forces to deal with various internal threats to the regime. In peacetime, the Chief of Internal Security heads the forces within the Ministry of the Interior that fall under the general label of “internal security forces.” (See figure 2-2.) Most of the internal security forces are uniformed, using military ranks and insignia similar to those of the other services of the State’s Armed Forces.

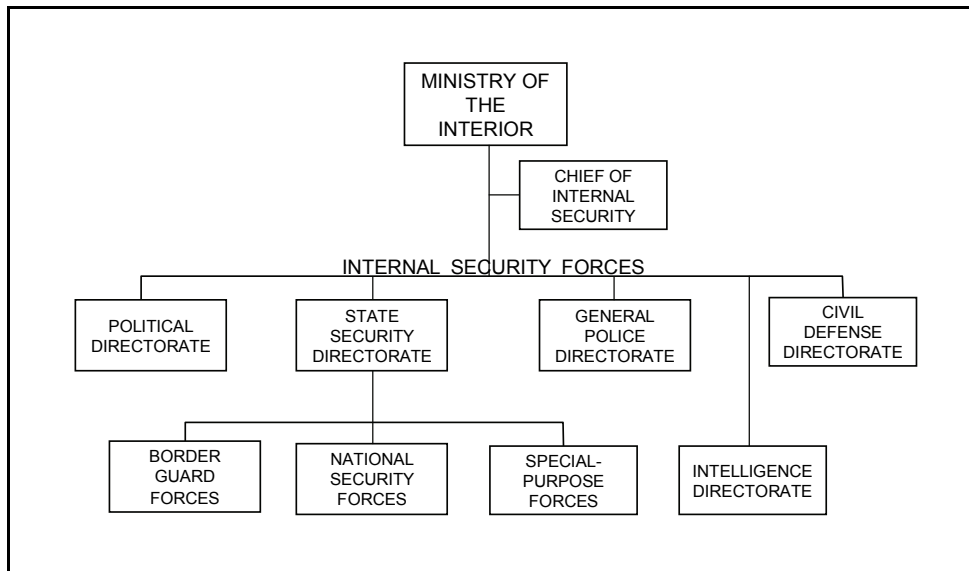

**Figure 2-2. Internal Security Forces in the Ministry of the Interior**

2-19. During wartime, some or all of the internal security forces from the Ministry of the Interior become subordinate to the SHC. Thus, they become the sixth service component of the Armed Forces. At that time, the formal name “Internal Security Forces” applies to all forces resubordinated from the Ministry of the Interior to the SHC, and the General Staff controls and supervises their activities. The forces resubordinated to the SHC are most likely to come from the State Security Directorate, the General Police Directorate, or the Civil Defense Directorate.

### State Security Directorate

2-20. The State Security Directorate has elements deployed throughout the State. Many of these elements are paramilitary units equipped for combat. They include Border Guard Forces, National Security Forces, and Special-Purpose Forces. Together with the regular Armed Forces, these paramilitary forces help maintain the State's control over its population in peace and war.

2-21. The Border Guard Forces consist of a professional cadre of officers and noncommissioned officers (NCOs) supplemented by conscripts and civilian auxiliaries. During war, they may be assigned to a military unit to guard a newly gained territory or to conduct actions against the enemy. The Border Guard

Forces may also have one or more independent special border battalions. These constitute an elite paramilitary force of airborne-qualified personnel trained in counterterrorism and commando tactics. When the SHC assumes control of Border Guard Forces in wartime, the General Staff provides overarching administrative and logistics support in the same manner as with a regular military force.

2-22. The National Security Forces are organized along military lines and equipped with light weapons and sometimes heavy weapons and armored vehicles. This organization conducts liaison with other internal security forces and with other services of the State's Armed Forces and may combine with them to conduct certain actions. An operational-level command of the State's Armed Forces may include one or more security brigades to augment its military capability. This type of brigade not only increases the military combat power, but also offers a very effective and experienced force for controlling the local population. Security battalions, companies, and platoons are similar to equivalent infantry units in the regular Armed Forces and can thus be used to augment such forces.

2-23. Within the State Security Directorate, the Ministry of the Interior has its own Special-Purpose Forces (SPF). These are the most highly-trained and best-equipped of the internal security forces. The State Security Directorate maintains its SPF units as a strategic reserve for emergency use in any part of the State or even outside State borders. The commando-type SPF forces can conduct covert missions in support of other internal security forces or regular military forces. SPF activities may include the formation and training of an insurgent force in a neighboring country. In wartime, the SHC may use them to secure occupied territory or to operate as combat troops in conjunction with other services of the Armed Forces.

### **General Police Directorate**

2-24. The General Police Directorate has responsibility for national, district, and local police. In some circumstances, police forces at all three levels operate as paramilitary forces. They can use military-type tactics, weapons, and equipment. National Police forces include paramilitary tactical units that are equipped for combat, if necessary. These uniformed forces may represent the equivalent of an infantry organization in the regular Armed Forces. Within the various national- and district-level police organizations, the special police are the forces that most resemble regular armed forces in their organization, equipment, training, and missions. Because some special police units are equipped with heavy weapons and armored vehicles, they can provide combat potential to conduct defensive operations if required. Thus, special police units could be expected to supplement the Armed Forces in a crisis situation.

### **Civil Defense Directorate**

2-25. The Civil Defense Directorate comprises a variety of paramilitary and nonmilitary units. While the majority of Civil Defense personnel are civilians, members of paramilitary units and some staff elements at the national and district levels hold military ranks. Civil Defense paramilitary units are responsible for the protection and defense of the area or installation where they are located. Even the nonmilitary, civil engineering units can supplement the combat engineers of the Armed Forces by conducting engineer reconnaissance, conducting explosive ordnance disposal, and providing force-protection construction support and logistics enhancements required to sustain military operations.

### **RESERVES AND MILITIA**

2-26. Although all six services can field some reserve forces, most of the reserve forces are Army forces. All militia forces belong to the Army component. Overall planning for mobilization of reserves and militia is the responsibility of the Organization and Mobilization Directorate of the General Staff. Each service component headquarters would have a similar directorate responsible for mobilization of forces within that service. Major geographical commands (and other administrative commands at the operational level and higher) serve as a framework for mobilization of reserve and militia forces.

---

*Note.* The Army is normally the dominant partner among the services, but relies on the mobilization of reserve and militia forces to conduct sustained operations. These additional forces are not as well-trained and -equipped as the standing Army. Militia forces are composed primarily of infantry and can act in concert with regular forces.

---

2-27. During mobilization, some reserve personnel serve as individual replacements for combat losses in active units, and some fill positions (including professional and technical specialists) that were left vacant in peacetime in deference to requirements of the civilian sector. However, reservists also man reserve units that are mobilized as units to replace other units that have become combat-ineffective or to provide additional units necessary for large, sustained operations.

2-28. Like active force units, most mobilized reserve and militia units do not necessarily go to war under the same administrative headquarters that controlled them in peacetime. Rather, they typically become part of a task-organized operational- or tactical-level fighting command tailored for a particular mission. In most cases, the mobilized reserve units would be integrated with regular military units in such a fighting command. In rare cases, however, a reserve command at division level or higher might become a fighting command or serve as the basis for forming a fighting command based partially or entirely on reserve forces.

## THEATER HEADQUARTERS

2-29. For the State, a *theater* is a clearly defined geographic area in which the State's Armed Forces plan to conduct or are conducting military operations. Within its region, the State may plan or conduct a strategic campaign in a single theater or in multiple theaters, depending on the situation. The General Staff may create one or more separate theater headquarters even in peacetime, for planning purposes. However, no forces would be subordinated to such a headquarters until the activation of a particular strategic campaign plan.

---

*Note.* The term *theater* may have a different meaning for the State than for a major extraregional power, such as the United States. For an extraregional power with global force-projection capability, a theater is any one of several geographic areas of the world where its forces may become involved. For the State, however, the only theater (or theaters) in question would be within the region of the world in which the State is located and is capable of exerting its regionally-centered power. The extraregional power may not define the limits of this specific region in exactly the same way that the State defines it, in terms of its own perceptions and interests. Within its region, the State may plan or conduct a strategic campaign in a single theater or in multiple theaters, depending on the situation.

---

2-30. A theater headquarters provides flexible and responsive control of all theater forces. When there is only one theater, as is typical, the theater headquarters may also be the field headquarters of the SHC, and the Chief of the General Staff may also be the theater commander. Even in this case, however, the Chief of the General Staff may choose to focus his attention on national strategic matters and to create a separate theater headquarters, commanded by another general officer, to control operations within the theater.

2-31. When parts of the strategic campaign take place in separated geographical areas and there is more than one major line of operations, the State may employ more than one theater headquarters, each of which could have its own theater campaign plan. In this case, albeit rare, the SHC field headquarters would be a separate entity exercising control over the multiple theater headquarters.

2-32. The existence of one or more separate theater headquarters could enable the SHC to focus on the strategic campaign and sustaining the forces in the field. A theater headquarters acts to effectively centralize and integrate General Staff control over theater-wide operations. The chief responsibility of this headquarters is to exercise command over all forces assigned to a theater in accordance with mission and

aim assigned by the SHC. A theater headquarters links the operational efforts of the OPFOR to the strategic efforts and reports directly to the SHC.

2-33. If the General Staff or SHC elects to create more than one theater headquarters, it may allocate parts of the AFS to each of the theaters, normally along geographic lines. One example would be to divide Air Force assets into theater air armies. Another would be to assign units from the SPF Command to each theater, according to theater requirements. During peacetime, however, a separate theater headquarters typically would exist for planning purposes only and would not have any forces actually subordinated to it.

**SECTION II – NATION-STATE FORCES: OPERATIONAL LEVEL**

2-34. The organizational directories do not show organization charts or equipment lists for operational-level commands. That is because there are no standard organizations above division level in the AFS. However, the directories do provide the organizational building blocks for constructing operational-level commands appropriate to a given training scenario.

2-35. In peacetime, each service commonly maintains its forces grouped under single-service operational-level commands (such as corps, armies, or army groups) for administrative purposes. In some cases, forces may be grouped administratively under operational-level geographical commands designated as military regions or military districts (see note). There are no standard “table of organization and equipment (TOE)” organizations for these echelons above division. For example, an army group can consist of several armies, corps, or separate divisions and brigades. In peacetime, the internal security forces are under the administrative control of the Ministry of the Interior. (See figure 2-3.) Normally, these administrative groupings differ from the Armed Forces’ go-to-war (fighting) force structure (see chapter 3).

*Note.* A military district may or may not coincide with a political district within the State government.

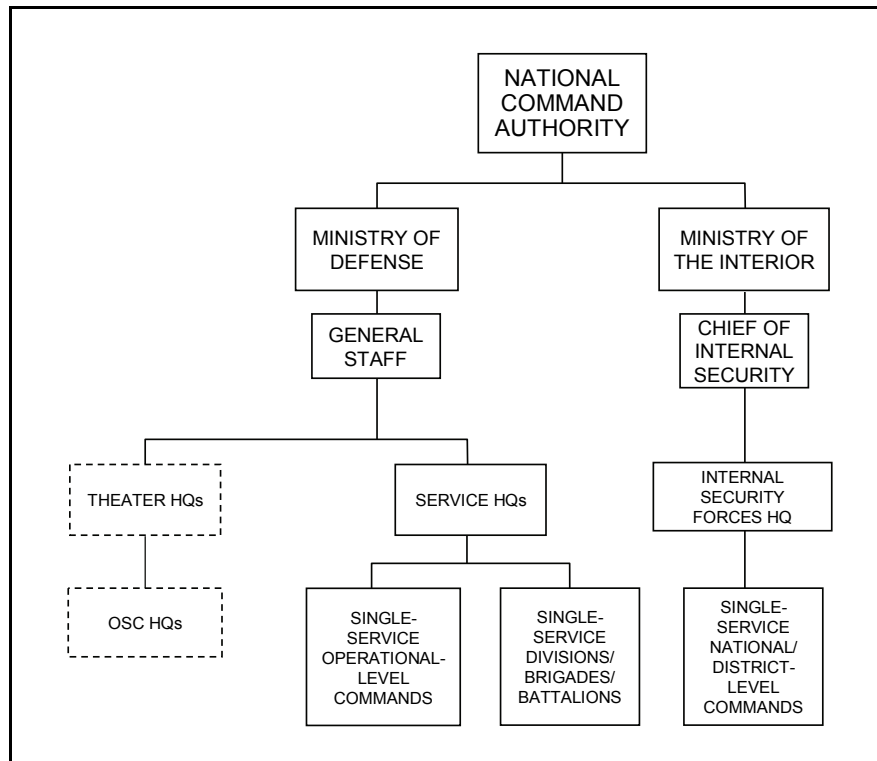

**Figure 2-3. Peacetime Administrative Force Structure**

2-36. In wartime, most major administrative commands continue to exist under their respective service headquarters. However, their normal role is to serve as force providers during the creation of operational-level fighting commands. Operational-level commands of the AFS generally remain in garrison and continue to exercise command and control (C2) and administrative supervision of any of their original subordinates (or portions thereof) that do not become part of the fighting force structure. See chapter 3 for more information on the formation of wartime fighting commands.

## SECTION III – NATION-STATE FORCES: TACTICAL LEVEL

2-37. In the OPFOR's AFS, the largest tactical-level organizations are divisions and brigades. In peacetime, they are often subordinate to a larger, operational-level administrative command. However, a service of the Armed Forces might also maintain some separate single-service tactical-level commands (divisions, brigades, or battalions) directly under the control of their service headquarters. (See figure 2-3 on page 2-7.) For example, major tactical-level commands of the Air Force, Navy, Strategic Forces, and the SPF Command often remain under the direct control of their respective service component headquarters. The Army component headquarters may retain centralized control of certain elite elements of the ground forces, including airborne units and Army SPF. This permits flexibility in the employment of these relatively scarce assets in response to national-level requirements.

2-38. For these tactical-level organizations (division and below), the AFS organizational directories contain standard "TOE" structures. However, these administrative groupings normally differ from the OPFOR's go-to-war (fighting) force structure. (See chapter 3 on Task-Organizing.)

### DIVISIONS

2-39. In the OPFOR's AFS, the largest tactical formation is the division. Divisions are designed to be able to serve as the basis for forming a division tactical group (DTG), if necessary. (See chapter 3.) However, a division, with or without becoming a DTG, could fight as part of an operational-strategic command (OSC) or an organization in the AFS (such as army or military region) or as a separate unit in a field group (FG).

### MANEUVER BRIGADES

2-40. The OPFOR's basic combined arms unit is the maneuver brigade. In the AFS, some maneuver brigades are constituent to divisions, in which case the OPFOR refers to them as *divisional brigades*. However, some are organized as *separate brigades*, designed to have greater ability to accomplish independent missions without further allocation of forces from a higher tactical-level headquarters. Separate brigades have some subordinate units that are the same as in a divisional brigade of the same type (for example, the headquarters), some that are especially tailored to the needs of a separate brigade [marked "(Sep)" in the organizational directories], and some that are the same as units of this type found at division level [marked "(Div)"].

2-41. Maneuver brigades are designed to be able to serve as the basis for forming a brigade tactical group (BTG), if necessary. However, a brigade, with or without becoming a BTG, can fight as part of a division or DTG, or as a separate unit in an OSC, an organization of the AFS (such as army, corps, or military district), or an FG.

### BATTALIONS

2-42. In the OPFOR's force structure, the basic unit of action is the battalion. Battalions are designed to be able to execute basic combat missions as part of a larger tactical force. A battalion most frequently would fight as part of a brigade, BTG, or DTG. A battalion can also serve as the basis for forming a battalion-size detachment (BDET), if necessary. (See chapter 3.)

## COMPANIES

2-43. OPFOR companies most frequently fight as part of a battalion or BTG. However, companies are designed to be able to serve as the basis for forming a company-size detachment (CDET), if necessary. (See chapter 3.)

## PLATOONS

2-44. In the OPFOR's force structure, the smallest unit typically expected to conduct independent fire and maneuver tactical tasks is the platoon. Platoons are designed to be able to serve as the basis for forming a reconnaissance or fighting patrol. A platoon typically fights as part of a company, battalion, or detachment.

## AVIATION UNITS

2-45. The OPFOR has a variety of attack, transport, multipurpose, and special-purpose helicopters that belong to the ground forces (Army) rather than the Air Force. Hence the term *army aviation*. Army aviation units follow the organizational pattern of other ground forces units, and are thus organized into brigades, battalions, and companies.

2-46. Air Force organizations are grouped on a functional, mission-related basis into divisions, regiments, squadrons, and flights. For example, a bomber division is composed primarily of bomber regiments, and a fighter regiment is composed mainly of fighter squadrons. The Air Force also has some mixed aviation units with a combination of fixed- and rotary-wing assets; these follow the normal Air Force organizational pattern, with mixed aviation regiments and squadrons. However, rotary-wing subordinates of these mixed aviation units would be battalions and companies (rather than squadrons and flights), following the pattern of similar units in army aviation. Various fixed- and/or rotary-wing Air Force assets may be task-organized as part of a joint, operational-level command in wartime.

## NONDIVISIONAL UNITS

2-47. Units listed as "*nondivisional*" [marked "(Nondiv)"] in the AFS organizational directories might be found in any of the operational-level commands discussed above, or in a theater command, or directly subordinate to the appropriate service headquarters. The OPFOR force structure contains brigade- and battalion-size units of single arms such as SAM, artillery, SSM, antitank, combat helicopter, signal, and EW. In wartime, these nondivisional units can become part of a task-organized operational- or tactical-level command. These units almost always operate in support of a larger formation and only rarely as tactical groups or detachments, or on independent missions.

## SECTION IV – NON-STATE ACTORS

2-48. Aside from the military and/or paramilitary forces of a nation-state, the OPFOR might consist of or include the forces of non-state paramilitary actors. The operational environment (OE) also includes various types of nonmilitary actors, although they are not part of the OPFOR.

## PARAMILITARY ORGANIZATIONS

2-49. Non-state paramilitary organizations are distinct from the regular armed forces of the State or any other country, but resemble them in organization, equipment, training, or mission. Therefore, the AFS organizational directories include baseline organizations for insurgent and guerrilla forces (see examples in appendixes C and E), as well as criminal organizations and private security organizations.

## INSURGENT ORGANIZATIONS

2-50. Insurgent organizations have no regular, fixed "table of organization and equipment" structure. The mission, environment, geographic factors, and many other variables determine the configuration and composition of each insurgent organization and its subordinate cells. Their composition varies from

organization to organization, mission to mission, environment to environment. The structure, personnel, equipment, and weapons mix all depend on specific mission requirements. So do the size, specialty, number, and type of subordinates.

2-51. There are several factors that differentiate the structure and capability of an insurgent organization (direct action cells) from the structure and capability of a guerrilla organization. Since the insurgent organization is primarily a covert organization, it typically has a cellular structure to prevent compromise of the overall organization. By comparison, the guerrillas' organization reflects their kinship to a more formal military structure (battalion, company, platoon, squad, and fire team or task-organized hunter/killer battalion, H/K company, H/K group, H/K section, and H/K team).

2-52. Insurgent organizations generally do not have much of the heavier and more sophisticated equipment that guerrilla organizations can possess (see below). The weapons of the insurgents are generally limited to small arms, antitank grenade launchers, and improvised explosive devices (IEDs) with very few crew-served weapons (82-mm mortar, 107-mm single-tube rocket launcher). In the event the insurgents require heavier weapons or capabilities they might obtain them from guerrillas, or the guerrilla organization might provide its services depending on the relationship between the two organizations at the time.

### Higher Insurgent Organizations

2-53. The term *higher insurgent organization* includes any insurgent organization at regional, provincial, district, or national level, or at the transnational level. Cities, towns, or villages with a large population or covering a large geographic area are considered regions and may therefore control several local insurgent and/or guerrilla organizations. Higher insurgent organizations usually contain a mix of local insurgent and guerrilla organizations. Each of these organizations provides differing capabilities.

### Local Insurgent Organizations

2-54. Local insurgent organizations are typically composed of from three to over 30 cells. All of the direct action cells could be multifunction (or multipurpose), or some may have a more specialized focus. The single focus may be a multifunction direct action mission, assassination, sniper, ambush, kidnapping, extortion, hijacking and hostage taking, or mortar and rocket attacks. Each of these may be the focus of one or more cells. More often, the direct action cells are composed of a mix of these capabilities and several multifunction cells. There are also a number of types of supporting cells with various functions that provide support to the direct action cells or to the insurgent organization as a whole. Thus, a particular insurgent organization could be composed of varying numbers of multifunction or specialty direct action cells, supporting cells, or any mix of these.

2-55. Appendix C provides an example of a typical local insurgent organization, taken from volume III of the AFS organizational directories. For illustrative purposes, this example includes a reasonable number of multifunction direct action cells (four) and at least one cell of each of the 18 other, more specialized types. The dashed boxes in the organizational graphic indicate the possibilities for varying numbers of each type of cell, depending on the functions required for the insurgent organization to accomplish its mission.

2-56. Local insurgent organizations may or may not be associated with or subordinate to a higher insurgent organization at the regional, national, or transnational level. The local insurgents may operate independently, without central guidance or direction from the overall movement, and may not be associated with a larger, higher insurgent movement in any manner. The local insurgent organization can therefore be subordinate to, loosely affiliated with, or completely autonomous and independent of higher insurgent organizations. Any relationship of insurgent organizations to higher or lower organizations may be one of affiliation or dependant upon only a single shared or similar goal. These relationships are generally fluctuating and may be fleeting, mission dependent, event- or agenda-oriented, or for any other reasons or motivations.

### Relationships to Other Paramilitary Actors

2-57. Insurgent organizations may have some type of relationship with guerrilla organizations and/or criminal organizations or other actors, based on similar or shared goals and/or interests. The nature of the



shared goal/interest determines the tenure and type of relationship and the degree of affiliation. The affiliation with criminal organizations is dependent only on the needs of the criminal organization at a particular time. In some cases, lower-level guerrilla organizations may be subordinate to a local insurgent organization. Higher insurgent organizations also may have guerrilla organizations subordinate to them.

## **GUERRILLA ORGANIZATIONS**

2-58. Guerrilla organizations come in various shapes and sizes. They may be as large as several brigades or as small as a platoon and/or independent hunter/killer (H/K) teams. The structure of the organization depends on several factors including the physical environment, sociological demographics and relationships, economics, and support available from external organizations and countries. In any case, a guerrilla organization might be affiliated with forces from other countries or external organizations. Some guerrilla organizations may constitute a paramilitary arm of an insurgent movement, while others may pursue guerrilla warfare independently from or loosely affiliated with an insurgent organization.

2-59. Compared to insurgent organizations as a whole, guerrilla organizations have a more military-like structure. Within this structure, guerrilla organizations have some of the same types of weapons as a regular military force. The guerrilla organization contains weapons up to and including 120-mm mortars, antitank guided missiles (ATGMs), and man-portable air defense systems (MANPADS), and can conduct limited mine warfare and sapper attacks. Other examples of equipment and capability the guerrillas have in their organizations that the insurgents generally do not have are 12.7-mm heavy machineguns; .50-cal antimateriel rifles; 73-, 82-, and 84-mm recoilless guns; 100- and 120-mm mortars; 107-mm multiple rocket launchers; 122-mm rocket launchers; GPS jammers; and signals intelligence capabilities.

2-60. While both insurgent and guerrilla organizations are very effective and lethal in close and populated terrain, the guerrilla organizations can perform more typical fire and maneuver tactics. The guerrilla organization can, and often does, use terror tactics; however it is best suited to conduct irregular or unconventional warfare tactics.

### **Guerrilla Brigades**

2-61. The composition of the guerrilla brigade may vary. A basically rural, mountainous, or forested area with no major population centers might have a guerrilla brigade with only one or two battalions (or five or six companies) with little or no additional combat support or combat service support. A guerrilla brigade operating astride a major avenue of approach, or one that contains several major population (urban) or industrial centers, might be a full guerrilla brigade with additional combat support or combat service support elements.

### **Guerrilla Battalions**

2-62. Often a brigade-sized guerrilla force may not be appropriate—a guerrilla battalion or a task-organized battalion may be sufficient. A guerrilla battalion may be any combination of guerrilla companies or guerrilla H/K companies. When a battalion consists predominantly of guerrilla H/K companies, it may be considered a guerrilla H/K battalion. A typical task-organized-battalion might have four or five guerrilla H/K companies, organic battalion units, and a weapons battery from brigade (with mortar, antitank, and rocket launcher platoons) and possibly intelligence and electronic warfare (IEW) support.

### **Guerrilla Companies**

2-63. The guerrilla company fights unconventionally with platoons, squads, and fire teams. When organized for combat as a guerrilla H/K company, it also fights unconventionally, but with H/K groups, sections, and teams. The guerrilla H/K company is simply a restructured guerrilla company. Therefore, they both contain the same number of personnel and similar numbers of equipment. Complete battalions and brigades—or any part thereof—can be organized for combat as H/K units.

2-64. The typical guerrilla H/K company is broken into three H/K groups. Each group has four sections of three H/K teams each. Thus, the company contains a total of 36 H/K teams. There are actually 39 H/K

teams, if the two sniper teams and the company scouts in the company's headquarters and command section are counted.

2-65. The guerrilla H/K company or battalion is especially effective and lethal in close environments (such as urban, forest, or swamp). The task-organized H/K team structure is ideal for dispersed combat. The structure that makes H/K teams virtually impossible to isolate and kill in a dispersed fight also allows them to melt into the population and terrain whenever necessary.

### **PRIVATE SECURITY ORGANIZATIONS**

2-66. Private security organizations (PSOs) are business enterprises or local ad hoc groups that provide security and/or intelligence services, on a contractual or self-interest basis, to protect and preserve a person, facility, or operation. PSO teams may consist of bodyguard teams, patrol teams, stationary guard teams, or information and investigation teams.

2-67. PSOs are diverse in regard to organizational structure and level of capability. The weapons and equipment mix is based on team specialization/role and varies. Other example equipment includes listening and monitoring equipment, cellular phones, cameras, facsimiles, computers, motorcycles, helicopters, all-terrain vehicles, antitank disposable launchers, submachine guns, and silenced weapons. See FM 7-100.3 for more detail on PSOs.

### **CRIMINAL ORGANIZATIONS**

2-68. Criminal organizations are normally independent of nation-state control and large-scale organizations often extend beyond national boundaries to operate regionally or worldwide. Individual drug dealers and criminals or small-scale criminal organizations (gangs) do not have the capability to adversely affect legitimate political, military, and judicial organizations—but the large-scale organizations do. The weapons and equipment mix varies, based on type and scale of criminal activity. Criminal organizations at the higher end of the scale can take on the characteristics of a paramilitary organization.

2-69. By mutual agreement, or when their interests coincide, criminal organizations may become affiliated with other non-state paramilitary actors, such as insurgent or guerrilla forces. Insurgents or guerrillas controlling or operating in the same area can provide security and protection to the criminal organization's activities in exchange for financial assistance or arms. Guerrilla or insurgent organizations can create diversionary actions, conduct reconnaissance and early warning, money laundering, smuggling, transportation, and civic actions on behalf of the criminal organization. Their mutual interests can include preventing U.S. or local government forces from interfering in their respective spheres.

2-70. At times, criminal organizations might also be affiliated with nation-state military and/or paramilitary actors. In time of war, for instance, the State can encourage and materially support criminal organizations to commit actions that contribute to the breakdown of civil control in a neighboring country. Additional information is provided in FM 7-100.3.

### **OTHER ARMED COMBATANTS**

2-71. In any OE, there are likely to be nonmilitary personnel who are armed but not part of an organized paramilitary or military structure. Nevertheless, they may be disgruntled and hostile. Some of these nonaffiliated personnel may possess small arms legally to protect their families, homes, and/or businesses. When a catalyst occurs, they can use their "defensive" weapons to attack. Some might only be opportunists who decide to attack a convoy, a vehicle, or a soldier in order to make a profit. Their motives might be religious, racial, or cultural differences, or revenge, hatred, or greed. Some are just angry at the United States. The reasons are immaterial—armed civilians are ubiquitous.

2-72. Such armed combatants may represent a large portion of the undecided in a population—those who have yet to determine which side they are on. They may also be those who are going to change sides. They might be completely neutral one minute, and the next they might be on the side of the enemy. Any number of catalysts might cause them to change sides. The event causing the change might be the injury or death of a family member, loss of property, or the perceived disrespect of their culture, religion, or tribe. Their

decision will probably not remain permanent. They might change sides several times depending on the circumstances directly affecting their lives. Once they commit themselves to a side, they are easier to categorize.

## **UNARMED COMBATANTS**

2-73. The local populace contains various types of unarmed nonmilitary personnel who, given the right conditions, may decide to purposely and materially support hostilities against the United States. This active support or participation may take many forms, not all of which involve possessing or using weapons. In an insurgent organization, for example, unarmed personnel might conduct recruiting, financing, intelligence-gathering, supply-brokering, transportation, courier, or information warfare functions (including videographers and camera operators). Technicians and workers who fabricate IEDs might not be armed. The same is true of people who provide sanctuary for combatants. Individuals who perform money-laundering or operate front companies for large criminal organizations might not be armed. Individual criminals or small gangs might be affiliated with a paramilitary organization and perform support functions that do not involve weapons. Unarmed religious, political, tribal, or cultural leaders might participate in or actively support a paramilitary organization. Unarmed media or medical personnel may become affiliated with a military or paramilitary organization. Even unarmed individuals who are coerced into performing or supporting hostile actions and those who do so unwittingly can in some cases be categorized as combatants. Thus, various types of unarmed combatants can be part of the OPFOR. In short, an unarmed combatant is any unarmed person who engages in hostilities or who purposely and materially supports hostilities against the United States or its co-belligerents. This includes support that takes place off the battlefield.

## **NONCOMBATANTS**

2-74. The online directories also include nonmilitary actors that are not part of the OPFOR but might be present in the OE. As noncombatants, they are currently either friendly or neutral. They can be either armed or unarmed, and have the potential to become combatants in certain conditions. They might provide support to combatants—either willingly or unwillingly.

## **ARMED NONCOMBATANTS**

2-75. There are likely to be armed noncombatants who are not part of any military or paramilitary organization. Some may be in possession of small arms legally to protect their families, property, and/or businesses. Some may use weapons as part of their occupation (for example, hunters, security guards, or local police). Some may be minor criminals who use their weapons for activities such as extortion and theft; they might even steal from U.S. forces, to make a profit. They may be completely neutral or have leanings for either side, or several sides. However, they are not members of or directly affiliated with a hostile faction. Such armed noncombatants are ubiquitous. Their numbers vary from one individual to several hundred. The types, behaviors, and impact of such persons are discussed in detail in FM 7-100.3. Given the fact that they are already armed, it would be easy for such noncombatants to become combatants, if their situation changes.

## **UNARMED NONCOMBATANTS**

2-76. At a minimum, other actors in the OE include unarmed noncombatants. They are an integral part of the OE and cannot be excluded. Examples of common types of unarmed noncombatants can also be found in the organizational directories. These include medical teams, media, humanitarian relief organizations, transnational corporations, displaced persons, transients, foreign government and diplomatic personnel, and local populace. These nonmilitary actors may be neutral or potential side-changers, depending on their perception of U.S. actions. Changes in the situation might cause some previously unarmed noncombatants to become combatants and perhaps to take up arms. See FM 7-100.3 for more detail on the types of actors summarized here.

## SECTION V – ORGANIZATIONAL DIRECTORIES

2-77. This organization guide is linked to online organizational directories, which TRADOC DCSINT maintains and continuously updates, as necessary, to represent contemporary and emerging capabilities. These directories provide a comprehensive menu of the numerous types of OPFOR organizations in the detail required for the Army's live, virtual, and constructive training environments. To meet these various requirements, the directories contain over 10,000 pages of organizational information, breaking out most OPFOR units down to squad-size components. However, some training simulations either cannot or do not need to portray OPFOR units down to that level of resolution. From this extensive menu, therefore, trainers and training planners can select and extract only the units they need, in the appropriate level of detail for their specific training requirements.

---

**Note.** The organizations in these directories do not constitute an OPFOR order of battle (OB). However, trainers and training planners can use these organizational building blocks to construct an OPFOR OB that is appropriate for their training requirements. To do so, it will often be necessary to create task organizations from the available building blocks. It may also be necessary to substitute different pieces of equipment for those listed for units in the organizational directories.

---

2-78. The organizational information contained in the directories exceeds the scope and size that can be accommodated within a traditional FM format. The magnitude of task-organizing an exercise order of battle also requires that users have the ability to use downloaded organizations in an interactive manner. For these reasons, it is necessary for this FM to be linked to organizational diagrams and associated equipment inventories made available in electronic form that users can download and manipulate as necessary in order to create task organizations capable of fighting in adaptive ways that typify the COE.

---

**Note.** For illustrative purposes, this FM contains several examples from the online AFS organizational directories. **Readers are reminded that even the baseline OPFOR organizations are subject to change over time.** Therefore, readers should always consult the online directories for the latest, most up-to-date versions of organizational data.

---

2-79. Online directories of OPFOR organizations in the AFS are accessible by means of the following link to the TRADOC ADCSINT-Threats portal on the Battle Command Knowledge System (BCKS): <https://dcsint-threats.leavenworth.army.mil/COE/default.aspx>; then click on "FM 7-100.4 Organization Guide," then on "Admin Force Structure-Organizational Directories." Alternatively, users can click here on the following link: [Organizational Directories](#); then click on Volume I, II, II, or IV of the organizational directories. Access to BCKS requires use of Army Knowledge Online (AKO) user name and password. (It may be necessary to enter these more than once in order to arrive at the proper location.) If the user is already logged into AKO (by user name and password or by Common Access Card login), no further login may be necessary.

2-80. The directories consist of four volumes: Divisions and Divisional Units; Nondivisional Units; Paramilitary and Nonmilitary Actors; and Other. These directories are maintained and continuously updated, as necessary, by the Deputy Chief of Staff for Intelligence, U.S. Army Training and Doctrine Command (TRADOC DCSINT), in order to represent contemporary and emerging capabilities. The TRADOC DCSINT is designated as "the responsible official for the development, management, administration, integration, and approval functions of the OPFOR Program across the Army" (Army Regulation 350-2).

2-81. The role of these directories is to provide a menu of OPFOR units to use in task-organizing to stress U.S. Army training. These directories do not constitute an order of battle (OB) but rather a menu of capabilities. Chapter 3 provides guidance on how to task-organize the OPFOR from the pieces contained in the online directories. In some cases, task-organizing may not be required (particularly at lower tactical levels), and OPFOR fighting organizations may be lifted directly from the AFS. However, it is often

necessary to tailor these standard organizations into task organizations better suited for training requirements.

2-82. There is no such thing as a standard structure for major operational-level commands in the AFS: corps, armies, army groups, military districts, or military regions. Therefore, the online directories provide only the organizational structures for the types of units likely to be found in one of these echelons-above-division commands in the peacetime AFS. In an OPFOR OB, some of these units will have become part of a task organization at operational or tactical level.

## FILES FOR OPFOR UNITS

2-83. The architectural build of the OPFOR units located on the BCKS is simple and straightforward. The organizations were built from the bottom up, solely for trainers and planners to use to select and build OPFOR organizations to execute OPFOR countertasks. The build for the organizational directories started at the lowest level, breaking out the organization, personnel, and equipment down to squad-size components, since some training simulations may require that level of resolution. If some trainers or training planners do not require that level of detail, they can extract from the organizational directories the entries starting at the lowest level that is required for their particular exercise OB.

2-84. All of the OPFOR organizations listed in the AFS organizational directories on BCKS are constructed using Microsoft Office 2000® or Microsoft Office 2003® software (MS Word®, MS PowerPoint®, and MS Excel®) so the trainer could tailor and/or task-organize them individually or collectively to meet specific training and/or simulation requirements. Most trainers and simulators have MS Office® software available and a basic knowledge of its use. See appendix B for detailed instructions that should enable a trainer with only a basic knowledge of MS Office® (MS Word®, MS PowerPoint®, and MS Excel®) to build a task-organized structure using available software.

2-85. The basic entry for each organization is built in an MS Word® document. This Word® document provides details for the OPFOR organization and contains four basic sets of information: unit name, organizational graphics, personnel information, and principal items of equipment (unless personnel and equipment are listed in a separate MS Excel® spreadsheet). For examples, see appendix D, which contains the complete entries for the motorized infantry company and the personnel and equipment spreadsheets for the motorized infantry battalion as they appear in the AFS organizational directories on BCKS.

### UNIT NAME

2-86. The name of the unit appears in a heading at the top of each page in the organizational directory. Each Word® or Excel® file name includes the name of the highest unit described in that file.

2-87. The names of some units (usually battalions or companies) in the AFS organizational directories are *followed* by the label “(Div)” or “(Sep).” Here, “(Div)” indicates that the battalion or company in question is the version of its type organization normally found at division level in the AFS. Separate brigades in the AFS have some subordinates that are the same as at division level and are therefore labeled “(Div).” Other subordinates that are especially tailored to the needs of a separate brigade are labeled “(Sep).” Any subordinates of a separate brigade that are the same as their counterparts in a divisional brigade do not have either of these labels. Units with “(Sep)” following their names are not separate battalions or separate companies. To avoid confusion, any unit that is actually “separate” would have the modifier “Separate” (or abbreviated “Sep”) *preceding* its name rather than following it.

2-88. Some units (usually brigades and battalions) could have the label “(Nondiv)” following their names in order to identify them as “nondivisional” assets (not subordinate to a division). Other units with the same basic name may have the label “(Div)” to distinguish them as being “divisional” (subordinate to a division). For example, the Materiel Support Brigade (Nondiv) has a different structure from the Materiel Support Brigade (Div).

## ORGANIZATIONAL GRAPHICS

2-89. The organizational graphics are built in MS PowerPoint® and then inserted into an MS Word® document. The organizational charts for specific organizations in the online directories depict all possible subordinate units in the AFS. Aside from the basic organization, the organizational directory entry for a particular unit may contain notes that indicate possible variations and alternatives.

---

*Note.* Some of the graphics in this FM are based on MS PowerPoint® (.ppt) graphics in the online organizational directories. In the process prescribed for FM publication, however, they may have been converted to another format and thus can no longer be opened or manipulated as PowerPoint® objects. If users of this FM need these graphics in PowerPoint® form, they will have to go to the organizational directories.

---

2-90. Organization charts in the online directories display units in a standard line-and-block chart format. These charts show unit names as text in a rectangular box (rather than using “enemy” unit symbols in diamonds, as is often the custom in OPFOR OBs for training exercises). There are a number of reasons for this, mostly in the interest of clarity: The OPFOR has some units whose nature and names (appropriate to their nature) do not correspond directly to unit symbols in FM 1-02, which are designed primarily for depicting the nature of U.S. units. Therefore, the use of text allows organizational charts to be more descriptive of the true nature of OPFOR units. The space inside a rectangular box is better suited than a diamond for showing the unit names as text, thus allowing organization charts to display a larger number of subordinate units in a smaller space.

## PERSONNEL AND EQUIPMENT LISTS

2-91. For each unit, the organizational directories provide a very detailed listing of personnel and equipment. For some training requirements, the OPFOR OB might not need to include personnel numbers. A particular OB might not require a listing of all equipment, but only major end items. In such cases, trainers and training planners can extract the appropriate pages from the organizational directories and then simplify them by eliminating the detail they do not need. However, the directories make the more detailed version available for those who might need it.

2-92. At the lowest-level organizations (for example, infantry squad), where the organizational chart does not show a unit breaking down into further subordinate units, the organizational directories list individual personnel with their individual weapons. (Figure 2-4 shows the example of an infantry squad, taken from page 9 of the Word® document for the motorized infantry battalion in the AFS organizational directories. See appendix D for additional details on the motorized infantry platoon, company, and battalion.) At this level, each individual’s duty title/position/function is identified for all OPFOR personnel organic to the organization described. The duty title is followed by the individual’s rank category:

- (O) = Officers (commissioned and warrant).
- (N) = Noncommissioned officers.
- ( ) = Enlisted personnel. This is usually blank and reflected only in the personnel totals.

---

*Note.* Charts for insurgent organizations are the exception, since they do not show personnel broken down into the three rank categories. Insurgents are not part of a formalized military structure and are therefore not broken down by rank. See appendix C for an example of insurgent organization. For additional information on insurgents, see FM 7-100.3.

---

2-93. Directly following the individual’s title and rank category is the number of personnel occupying that position, such as (x1) or (x2). This is followed by the nomenclature of the individual’s assigned personal weapon, such as AK-74M or SVD. In some cases, an individual may have two assigned weapons; for example, an individual assigned a 7.62-mm GP MG, PKM may also be assigned a 9-mm Pistol, PM. This reads as PKM/PM in the listing. In some instances, the individual also serves as the gunner/operator of a weapon—this is also identified. In figure 2-4, for instance, the Grenadier (x1) is the gunner/operator of the

ATGL, Panzerfaust 3-T600. His personal weapon is the 5.45-mm Carbine, AKS-74U. The Riflemen (x2) are assigned the 5.45-mm Assault Rifle, AK-74M with the 40-mm Under-Barrel Grenade Launcher, GP-30 (similar to the U.S. M16/M203).

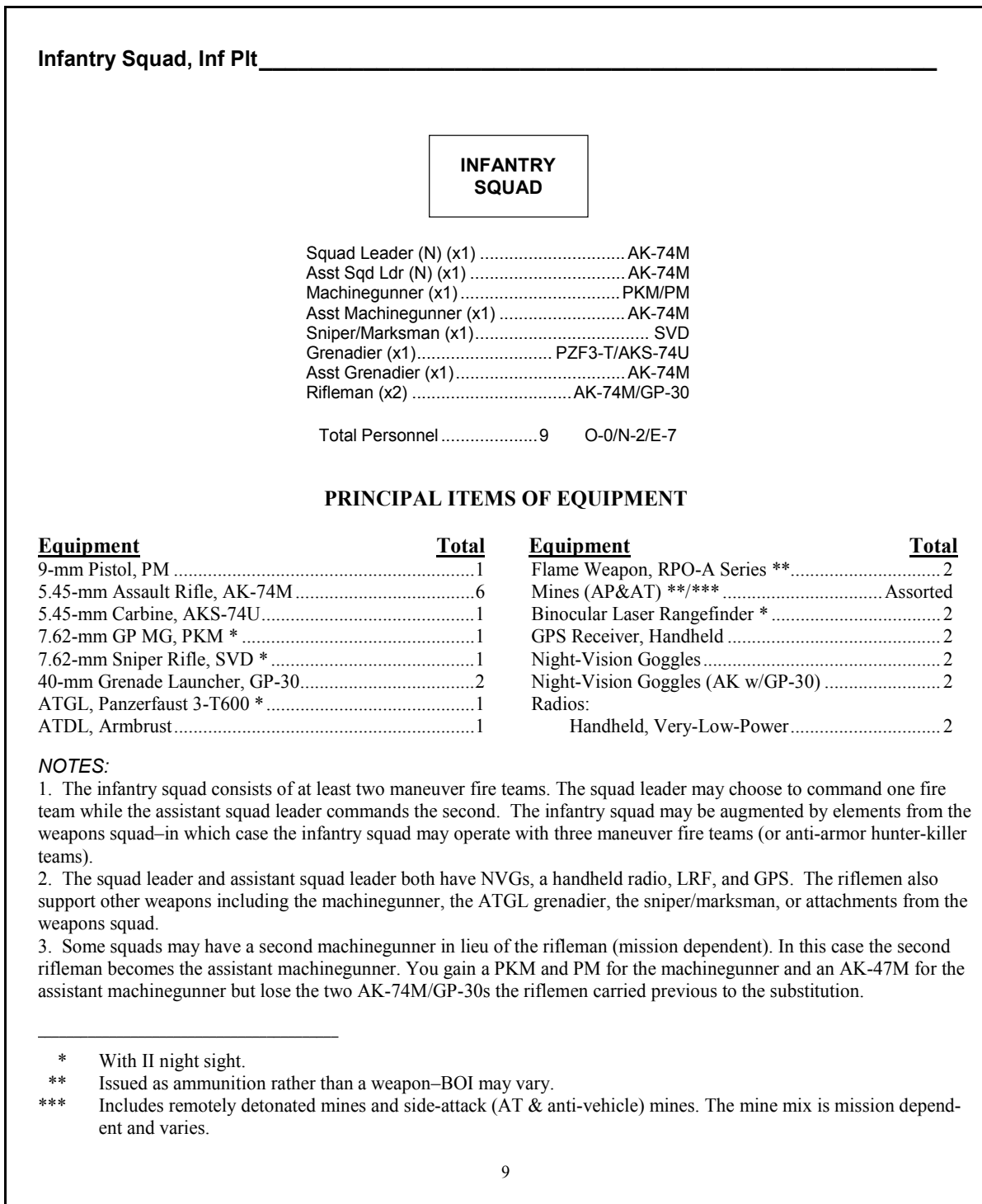

**Figure 2-4. Infantry Squad Personnel and Equipment (Example)**

2-94. Personnel totals for a unit are listed below the detailed listing of individual personnel and their equipment (or directly below the organizational chart for larger units). The first number reflects the total

personnel in that organization. The second set of numbers breaks down the total number of personnel by rank category. In this case, “E” is used for enlisted personnel. In figure 2-4 on page 2-17, for example, the personnel for the infantry squad indicate that there are no officers, two noncommissioned officers, and seven enlisted personnel—for a total of nine personnel.

2-95. For organizations from the lowest levels up through battalion level (in some cases up to brigade level), the basic MS Word® entry in the AFS organizational directories includes a listing of “Principal Items of Equipment.” This list gives the full nomenclature for each item of equipment and the total number of each item in the unit. Figure 2-4 on page 2-17 shows an example of this for the infantry squad.

2-96. Some weapons are issued as a munition rather than an individual’s assigned weapon. An example of this is the Flame Weapon, RPO-A Series (see figure 2-4 on page 2-17). Generally, a footnote accompanies these weapons, stating that they are issued as ammunition rather than a weapon—therefore the basis of issue (BOI) may vary. Anyone in the unit might fire these weapons, and the numbers of these weapons in an organization vary. Often they are carried in a vehicle, or kept on hand, until needed.

2-97. Sometimes a weapon is not assigned a gunner. In this case, a note generally describes the relationship. Some organizations, especially Special-Purpose Forces, have a wide selection of weapons and equipment available due to their multipurpose mission capability. The final selection of weapons and equipment is determined by the specific mission required at the time. These weapon and equipment numbers are easily adjusted using MS Word® and/or MS Excel®.

---

**Note.** Some of the graphics in this FM are based on MS Excel® (.xls) spreadsheets in the online organizational directories. In the process prescribed for FM publication, however, they may have been converted to another format and thus can no longer be opened or manipulated as Excel® objects. If users of this FM need these spreadsheets in Excel® form, they will have to go to the organizational directories.

---

2-98. For larger organizations, personnel and equipment numbers are listed in MS Excel® spreadsheets. There is a vertical column for each subordinate unit and a horizontal row for each item of equipment, with an automatically summed total at the right end of each row for the total number of each item of equipment in the overall organization. When the overall organization contains multiples of a particular subordinate unit, the unit designation at the top of the column indicates the number of like units (for example, “Hunter/Killer Groups (x3)” for the three hunter/killer groups in a hunter/killer company of a guerrilla battalion). In the interest of space, however, the spreadsheet format is not used for smaller units. Instead, they list “Total Personnel” and “Principal Items of Equipment” as part of the MS Word® document. Brigades and some battalions list personnel and equipment in both formats.

## FOOTNOTES

2-99. Footnotes apply to lists of personnel and equipment, in either Word® or Excel® format. Each footnote has a number of asterisks that link it to footnote reference with the same number of asterisk in the equipment list. Some footnotes explain—

- Characteristics of a piece of equipment (for example, “\* With thermal sight”).
- Why the total for a particular item of equipment is flexible (for example, “\*\* Issued as ammunition rather than a weapon—the BOI varies”).
- The types of weapons or equipment that might be included under “Assorted.”
- Possible equipment substitutions and their affect on personnel numbers.

2-100. In an Excel® spreadsheet, footnotes with reference asterisks in the top row of a column can provide information about the subordinate unit in that column. Most often, this type of footnote explains that the equipment numbers in that column have already been multiplied to account for multiple subordinates of the same type. For example, the reference “Motorized Infantry Company (x3)\*” is linked to a footnote that explains: “\* The values in this column are the total number for three companies.” Other footnotes serve the same purposes as in a Word® document.



## NOTES

2-101. Notes in a Word® document generally apply to the organization as a whole or its relationship with other organizations. Occasionally, they provide additional information on a particular part of the organization. In either case, notes are numbered (unless there is only one), but the number is not linked to a particular part of the organization. Various types of notes can explain—

- The nature of the organization and possible variations in its structure.
- Possible augmentation with additional equipment.
- Personnel options. For example: “Some squads may have a second machinegunner in lieu of a rifleman (mission dependant).”
- Unit capabilities or limitations. For example: “The infantry platoon has sufficient assets to transport the platoon headquarters and weapons squad. It is dependent upon augmentation from higher (battalion transport platoon) to transport the three infantry squads over distance.”
- Which personnel man a particular weapon or piece of equipment.
- How units or personnel are transported.
- How a unit or subordinate is employed and the types of tactics used.
- How assets of one subordinate can be allocated to other subordinates.

2-102. Especially for paramilitary and nonmilitary entities, notes describe various possible mixtures of personnel, equipment, and subordinates that might occur. Notes may reference another manual in the FM 7-100 series for more information regarding the organization described.

## FOLDERS FOR OPFOR UNIT FILES

2-103. The organizational directories of the AFS are contained in four volumes on BCKS. Each volume is divided into folders that contain the OPFOR unit files. These folders and files serve as the menu for OPFOR baseline units. The OPFOR organizational directories are continually updated on the BCKS; therefore, the listing below is dynamic. Over time, additional units will be added and existing units will be modified and updated, as necessary, to represent contemporary and emerging capabilities. Although the list of OPFOR units may change, the basic architecture of the organizational directories will remain essentially the same. Figure 2-5 on page 2-20 shows the basic listing of folders in the organizational directories. For a more detailed listing of folders and files for OPFOR units in the AFS organizational directories, see appendix A.

2-104. A particular training venue might not require the level of detail found in the MS Excel® spreadsheets and MS Word® equipment lists in the organizational directories. However, the use of these tools is a good way to avoid the sometimes significant errors that can result from more expedient methods of performing the OPFOR OB function. (See appendix B.)

- Volume I – Divisions and Divisional Units**
  - 01 Mechanized Infantry Division (IFV)**
    - 01 Mechanized Infantry Division (IFV)**
    - 02 Division Headquarters and Staff**
    - 03 Integrated Fires Command and Integrated Support Command**
    - 04 Mechanized Infantry Brigade (IFV) (X3)**
    - 05 Tank Brigade (Div)**
    - 06 Self-Propelled Artillery Brigade**
    - 07 Air Defense Brigade (Short-Range)**
    - 08 Materiel Support Brigade (Div)**
    - 09 Antitank Battalion**
    - 10 Reconnaissance Battalion**
    - 11 Sniper Company**
    - 12 Engineer Battalion**
    - 13 Signal Battalion**
    - 14 Chemical Defense Battalion**
    - 15 Medical Battalion**
  - 02 Mechanized Infantry Division (APC) (see appendix A)**
  - 03 Tank Division (see appendix A)**
  - 04 Motorized Infantry Division (see appendix A)**
- Volume II – Nondivisional Units**
  - 01 Separate Combat Brigades**
    - 01 Separate Mechanized Infantry Brigade (IFV)**
    - 02 Separate Mechanized Infantry Brigade (APC)**
    - 03 Separate Tank Brigade**
    - 04 Separate Motorized Infantry Brigade**
  - 02 Combat Brigades (Nondivisional)**
    - 01 Special-Purpose Forces Brigade**
    - 02 Multiple Rocket Launcher Brigade (Nondiv)**
  - 03 Combat Support Units (Nondivisional)**
    - 01 Smoke Battalion (Nondiv)**
  - 04 Combat Service Support Units (Nondivisional)**
    - 01 Materiel Support Brigade (Nondiv)**
- Volume III – Paramilitary and Nonmilitary Actors**
  - 01 Combatants**
    - 01 Armed Combatants**
      - 01 Insurgent Organizations**
        - 01 Local Insurgent Organization**
        - 02 Higher Insurgent Org (Regional, National, Transnational)**
      - 02 Guerrilla Brigade**
    - 02 Unarmed Combatants**
  - 02 Noncombatants**
    - 01 Armed Noncombatants**
    - 02 Unarmed Noncombatants**
- Volume IV – Other**
  - 01 Glossary**
  - 02 Brigade Tactical Group (Motorized) (Antiarmor-Light), Example**
    - OPFOR Task Organization**
  - 03 Other Nondivisional Units**

Figure 2-5. Basic Listing of Folders in AFS Organizational Directories

## Chapter 3

# Task-Organizing

The concept of task-organizing for combat is not unique to the OPFOR. It is universal, performed at all levels, and has been around as long as combat. The U.S. Army defines a *task organization* as “A temporary grouping of forces designed to accomplish a particular mission” and defines *task-organizing* as “The process of allocating available assets to subordinate commanders and establishing their command and support relationships” (FM 1-02). Task-organizing of the OPFOR must follow OPFOR doctrine (see FMs 7-100, 7-100.1, and 7-100.2) and reflect requirements for stressing U.S. units’ mission essential task list (METL) in training.

### SECTION I – FUNDAMENTAL CONSIDERATIONS

3-1. The purpose behind task-organizing the OPFOR is to build an OPFOR order of battle (OB) that is appropriate for U.S. training requirements. The OPFOR administrative force structure (AFS) organizational directories are *not* the OPFOR OB. The OB is the OPFOR’s go-to-war, fighting force structure.

### U.S. TRAINING REQUIREMENTS

3-2. The OPFOR’s reason for existence is to serve as an appropriately challenging sparring partner in U.S. training. Although, from the OPFOR doctrinal view, task-organizing is a *top-down* process, the process of building the OPFOR OB for a training event is best approached in a *bottom-up* manner—for practical purposes. That is because the task organizations at one level of command are the building blocks for determining the overall organization and total equipment holdings of the next-higher command. From the perspective of U.S. Army training, OPFOR task organization is also based on the missions and tasks the OPFOR needs to perform in order to stress U.S. units’ METL.

3-3. At some point, the holdings of the higher levels of command become irrelevant to a particular training event. Generally, this occurs when those assets no longer have an effect on OPFOR capabilities within the particular area of responsibility (AOR) where the training event occurs. If trainers build the OPFOR OB from the bottom up, they will know when to stop—or at least when all they need is a general organizational outline, rather than a detailed OB.

---

*Note.* It is possible to have a training scenario that begins when the OPFOR is still entirely in its peacetime AFS—or that peacetime organization is all the U.S. force knows about the OPFOR’s organization. Then an implied task for the U.S. unit(s) would be to conduct further OB analysis to determine what parts of the OPFOR currently have been task-organized and how. In most cases, however, the training scenario begins at a point when the OPFOR has already task-organized its forces for combat. In those cases, the AFS as a whole is merely a part of the road to war, which outlines how this fight came to take place and how the U.S. unit(s) become challenged by certain OPFOR unit(s). Aside from the OPFOR unit(s) required to perform specific countertasks to challenge U.S. METL tasks, everything else could be a mere backdrop—to explain the larger context in which this particular fight occurs and perhaps where some of the assets came from to form this particular OPFOR task organization.

---

## OPFOR DOCTRINE

3-4. U.S. training requirements normally dictate the size and type of OPFOR needed. Nevertheless, the OPFOR OB needs to make sense within the OPFOR doctrinal framework, including the OPFOR task-organizing process. From the OPFOR doctrinal view, task-organizing is a *top-down* process. That is because the higher commander is always the one who decides the missions of his subordinates and allocates additional resources for some of those missions. The allocated units can have several types of command and support relationship with the receiving command.

### ALLOCATION AND SUBALLOCATION OF ASSETS

3-5. OPFOR commanders must consider where the assets required for a particular task organization are located within the OPFOR administrative force structure (AFS) and how to get them allocated to the task organization that needs them. Particularly at the tactical level, the base organization around which a tactical group or detachment is formed may not have the organizational or equipment assets necessary to carry out the mission. Its next higher headquarters might have such assets at its disposal to allocate downward, or those assets might first have to be allocated from outside that parent organization in order for the parent organization to further suballocate them to the task organization. The latter could be the case, for instance, when a brigade tactical group (BTG) within a division or division tactical group (DTG) needs attack helicopters to augment its fire support or transport helicopters to enable a heliborne landing. If the BTG needs these assets in a subordinate (constituent or dedicated) command relationship rather than just a supporting relationship, a higher headquarters would have to allocate the helicopter units to the division or DTG, which would in turn suballocate them to this BTG.

3-6. When tactical-level commands become part of the fighting force structure, they often receive additional assets that better enable them to perform a mission for which they are task-organized. If some of their original subordinates are inappropriate or otherwise not required for the assigned mission, the tactical-level organizations typically leave these behind, under the command and control (C2) of their next-higher headquarters that remains in the AFS framework. The higher headquarters could provide these units to another task organization or hold them in reserve for possible future requirements.

---

**Note.** The OPFOR must understand its own strengths and weaknesses, and those of its enemy. An OPFOR commander must consider how to counter or mitigate what the other side has and/or how to exploit what he has on his own side. The mitigation or exploitation may be by means of equipment, tactics, or organization—or more likely all of these. However, the process generally starts with the proper task organization of forces with the proper equipment to facilitate appropriate tactics, techniques, and procedures (TTP).

---

### OPFOR COMMAND AND SUPPORT RELATIONSHIPS

3-7. OPFOR units are organized using four command and support relationships, summarized in table 3-1 and described in the following paragraphs. Command relationships define command responsibility and authority; they establish the degree of control and responsibility commanders have on forces operating under their control. Support relationships define the purpose, scope, and effect desired when one capability supports another. These relationships may shift during the course of an operation in order to best align the force with the tasks required. The general category of *subordinate* units includes both constituent and dedicated relationships; it can also include interagency and multinational (allied) subordinates.

Table 3-1. Command and Support Relationships

Relationship	Commanded by	Logistics from	Positioned by	Priorities from
Constituent	Gaining	Gaining	Gaining	Gaining
Dedicated	Gaining	Parent	Gaining	Gaining
Supporting	Parent	Parent	Supported	Supported
Affiliated	Self	Self or "Parent"	Self	Mutual Agreement

### Constituent

3-8. Constituent units are those forces assigned directly to a unit and forming an integral part of it. They may be organic to the table of organization and equipment of the administrative structure forming the basis of a given unit, assigned at the time the unit was created, or attached to it after its formation. From the view of an OPFOR commander, a unit has the same relationship to him regardless of whether it was originally organic or was later assigned or attached.

### Dedicated

3-9. Dedicated is a command relationship identical to constituent with the exception that a dedicated unit still receives logistics support from a parent organization of similar type. An example of a dedicated unit would be the case where one or two surface-to-surface missile (SSM) battalions from an SSM brigade could be dedicated to an operational-strategic command (OSC). Since the OSC does not otherwise possess the technical experts or transloading equipment for missiles, the dedicated relationship permits the SSM battalion(s) to fire exclusively for the OSC while still receiving its logistics support from the parent SSM brigade. Another example of a dedicated unit would be the case where a specialized unit, such as an attack helicopter company, is allocated to a brigade tactical group (BTG). Since the base brigade does not otherwise possess the technical experts or repair facilities for the aviation unit's equipment, the dedicated relationship permits the helicopter company to execute missions exclusively for the BTG while still receiving its logistics support from its parent organization. In OPFOR plans and orders, the dedicated command relationship is indicated by "(DED)" next to a unit title or symbol.

---

*Note.* The dedicated relationship is similar to the U.S. concept of operational control (OPCON), but also describes a specific logistics arrangement. This is something for exercise designers to consider when developing the OPFOR order of battle. They should not "chop" part of an SSM unit to an OSC, DTG or BTG without its support structure. If the gaining unit does not have the ability to support the SSM unit logistically, it might be better to keep it in a dedicated relationship. If the gaining unit also does not have the capability to exercise command over the SSM unit, it might be better to keep it in a supporting relationship.

---

### Supporting

3-10. Supporting units continue to be commanded by and receive their logistics from their parent headquarters, but are positioned and given mission priorities by their supported headquarters. This relationship permits supported units the freedom to establish priorities and position supporting units while allowing higher headquarters to rapidly shift support in dynamic situations. The supporting unit does not necessarily have to be within the supported unit's AOR. An example of a supporting unit would be a fighter-bomber regiment supporting an OSC for a particular phase of the strategic campaign plan (SCP) but ready to rapidly transition to a different support relationship when this OSC becomes the theater reserve in a later phase. Another example of a supporting unit would be a multiple rocket launcher (MRL) battalion

supporting a BTG for a particular phase of an operation but ready to rapidly transition to a different support relationship when the BTG becomes the DTG reserve in a later phase. In OPFOR plans and orders, the supporting relationship is indicated by “(SPT)” next to a unit title or symbol.

---

*Note.* The supporting relationship is the rough equivalent of the U.S. concept of direct support (DS). Note that there is no general support (GS) equivalent. That is because what would be GS in the U.S. Army is merely something that is constituent to the parent command in the OPFOR. In U.S. doctrine (FM 5-0) the format for task-organizing says: “List subordinate units under the C2 headquarters to which they are assigned, attached, or in support. Place DS units below the units they support.” In an OPFOR OB, therefore, units in the supporting status (like U.S. DS) could be considered part of the task organization of the “supported” unit. For units that are supporting, but not subordinate, it may be better to keep them and their equipment listed under their parent unit’s assets, unless that parent unit is not included in the OB. In any case, trainers will need to know what part of the parent unit will actually affect the situation.

---

### **Affiliated**

3-11. Affiliated organizations are those operating in a unit’s AOR that the unit may be able to sufficiently influence to act in concert with it for a limited time. No “command relationship” exists between an affiliated organization and the unit in whose AOR it operates. Affiliated organizations are typically nonmilitary or paramilitary groups such as criminal organizations, terrorists, or insurgents. In some cases, affiliated forces may receive support from the OSC, DTG, or BTG as part of the agreement under which they cooperate. Although there would typically be no formal indication of this relationship in OPFOR plans and orders, in rare cases “(AFL)” is used next to unit titles or symbols.

---

*Note.* Although there is no “command” relationship between the two organizations, the military command may have the ability to influence an affiliated paramilitary organization to act in concert with it for a limited time. For example, it might say: “If you are going to set off a car bomb in the town square, we would appreciate it if you could do it at 3 o’clock tomorrow afternoon.” In organizational charts for an OPFOR task organization, affiliated forces are shown with a dashed line (rather than a solid one) connecting them to the rest of the task organization. The dashed line indicates only a loose affiliation, but no direct command relationship with the military unit with which they are affiliated. For units that are affiliated, but not subordinate, it may be better to list their personnel and equipment separately or under their parent unit’s assets, if there is a parent organization. However, trainers will need to know what part of the parent unit will actually affect the situation. If affiliated forces are not included in organization charts or equipment totals for the task organization, they have to be accounted for elsewhere in the OPFOR OB.

---

## **SECTION II – NATION-STATE FORCES: STRATEGIC LEVEL**

3-12. In the wartime fighting force structure, the national-level command structure still includes the National Command Authority (NCA), the Ministry of Defense (MOD), and the General Staff. The only difference is that the MOD and General Staff merge to form the Supreme High Command. How the Armed Forces are organized and task-organized depends on the type of operations they are conducting under the State’s strategic framework.

### **SUPREME HIGH COMMAND**

3-13. In wartime, the State’s NCA exercises C2 via the Supreme High Command (SHC), which includes the MOD and a General Staff drawn from all the service components. In peacetime, the MOD and General Staff operate closely but separately. During wartime, the MOD and General Staff merge to form the SHC, which functions as a unified headquarters. (See figure 3-1 on page 3-6.)

## STRATEGIC FRAMEWORK

3-14. For most training scenarios, strategic-level organizations serve only as part of the road to war background. Within the OPFOR strategic framework, it makes a difference whether the exercise portion of the scenario takes place during regional, transition or adaptive operations. (See FM 7-100 for more detail on these strategic-level courses of action.)

3-15. For *regional operations* against a weaker neighboring country, the OPFOR might not have needed to use all the forces in its AFS in forming its fighting force structure—only “all means necessary” for the missions at hand. As U.S. and/or coalition forces begin to intervene, the OPFOR begins *transition operations* and shifts more AFS units into the wartime fighting structure—possible mobilizing reserves and militia to supplement regular forces. For *adaptive operations* against U.S. and coalition forces, the OPFOR would use “all means available.” Even those forces that were previously part of the fighting force structure might need to be task-organized differently in order to deal with extraregional intervention.

3-16. If the OPFOR originally task-organized to fight a regional neighbor, it would (if it has time) modify that task organization in preparation for fighting an intervening U.S. or coalition force. OPFOR units may have suffered combat losses during the original fight against a neighboring country or in the early stages of the fight against U.S. or coalition forces. In such cases, the OPFOR task organizations might have to change in order to sustain operations. Lost or combat-ineffective units might be replaced by units from the reserves, paramilitary units from the Internal Security Forces, or regular military units from other commands, which are still combat effective—or by additional units from the AFS. If not already the case, OPFOR military forces may incorporate nongovernmental paramilitary forces (insurgent, guerrilla, or even criminal), at least in an affiliated relationship.

### SECTION III – NATION-STATE FORCES: OPERATIONAL LEVEL

3-17. In the peacetime AFS, each service of the Armed Forces commonly maintains its forces grouped under single-service operational-level commands (such as corps, armies, or army groups) for administrative purposes. In some cases, forces may be grouped administratively under operational-level geographical commands designated as military regions or military districts. (See chapter 2 for more detail on these administrative groupings.) However, these administrative groupings normally differ from the Armed Forces’ go-to-war (fighting) force structure. (See figure 3-1 on page 3-6.)

3-18. In wartime, most major administrative commands continue to exist under their respective service headquarters. However, their normal role is to serve as force providers during the creation of operational-level fighting commands, such as field groups (FGs) or operational-strategic commands (OSCs). OSC headquarters may exist in peacetime, for planning purposes, but would not yet have any forces actually subordinate to them. The same would be true of any theater headquarters planned to manage multiple OSCs. FGs, on the other hand, are not normally standing headquarters, but may be organized during full mobilization for war.

3-19. The original operational-level administrative headquarters normally remain “in garrison” during conflict. After transferring control of its major fighting forces to one or more task-organized fighting commands, an administrative headquarters, facility, or installation continues to provide depot- and area support-level administrative, supply, and maintenance functions. A geographically-based administrative command also provides a framework for the continuing mobilization of reserves to complement or supplement regular forces.

3-20. In rare cases, an administrative command could function as a fighting command. This could occur, for instance, when a particular administrative command happens to have just the right combination of forces for executing a particular strategic campaign plan. (This is not likely to be the case at division level and higher.) Another case would be in times of total mobilization, when an administrative command has already given up part of its forces to a fighting command and then is called upon to form a fighting command with whatever forces remain under the original administrative headquarters.

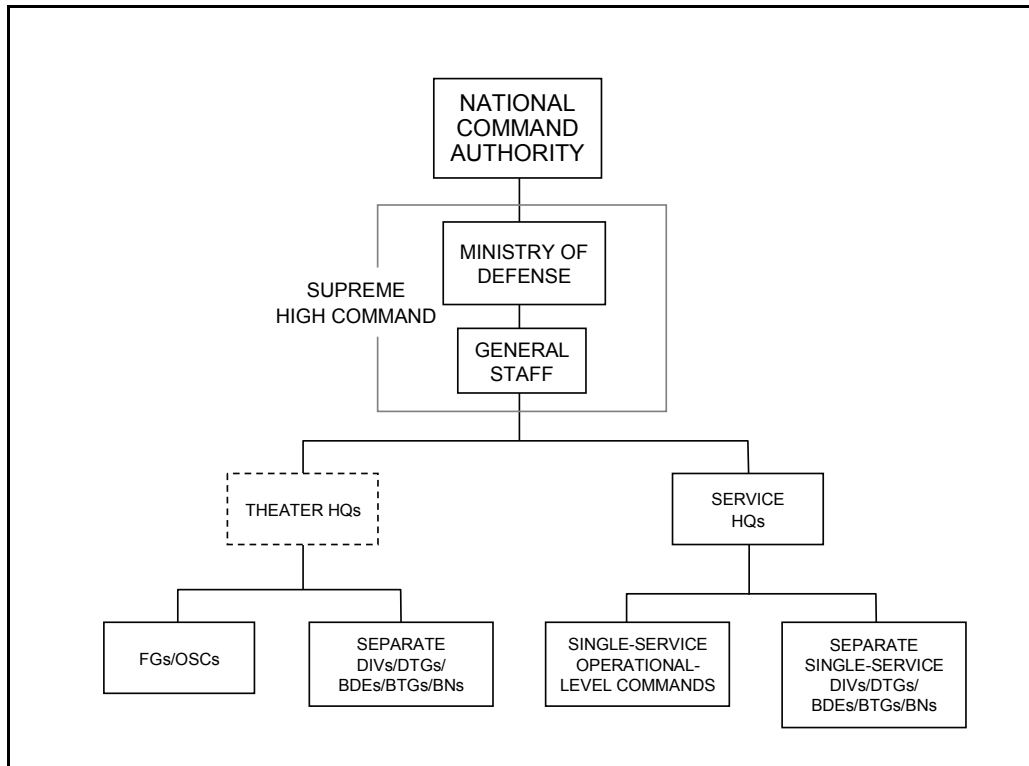

**Figure 3-1. Wartime Fighting Force Structure**

3-21. The operational level of command is that which executes military tasks assigned directly by a strategic campaign plan (SCP). The most common OPFOR operational-level commands are FGs and OSCs. There is also the possibility that a division or DTG could be directly subordinate to the SHC in the fighting force structure and thus perform tasks assigned directly by an SCP. In such cases, the OPFOR would consider the divisions or DTGs to be operational-level commands. More typically, however, they perform tactical missions as subordinates of an FG or OSC.

## FIELD GROUP

3-22. A field group is the largest operational-level organization, since it has one or more smaller operational-level commands subordinate to it. An FG is a grouping of subordinate organizations with a common headquarters, a common AOR, and a common operation plan. FGs are always joint and interagency organizations and are often multinational. However, this level of command may or may not be necessary in a particular SCP. An FG may be organized when the number of forces and/or the number of major military efforts in a theater exceeds the theater commander's desired or achievable span of control. This can facilitate the theater commander's remaining focused on the theater-strategic level of war and enable him to coordinate effectively the joint forces allocated for his use.

3-23. The General Staff does not normally form standing FG headquarters, but may organize one or more during full mobilization, if necessary. An FG can be assigned responsibilities in controlling forces in the field during adaptive operations in the homeland, or forward-focused functionally (an FG may be assigned an access-control mission). However, FGs may exist merely to accommodate the number of forces in the theater.

3-24. FGs are typically formed for one or more of the following reasons:

- An SCP may require a large number of OSCs and/or operational-level commands from the AFS. When the number of major military efforts in a theater exceeds the theater commander's desired or achievable span of control, he may form one or more FGs.



- In rare cases when multiple operational-level commands from the AFS become fighting commands, they could come under the control of an FG headquarters.
- Due to modifications to the SCP, a standing operational-level headquarters that was originally designated as an OSC headquarters may receive one or more additional operational-level commands from the AFS as fighting commands. Then the OSC headquarters would transition into an FG headquarters.

## OPERATIONAL-STRATEGIC COMMAND

3-25. The OPFOR's primary operational organization is the OSC. Once the General Staff writes a particular SCP, it forms one or more standing OSC headquarters. Each OSC headquarters is capable of controlling whatever combined arms, joint, interagency, or multinational operations are necessary to execute that OSC's part of the SCP. However, the OSC headquarters does not have any forces permanently assigned to it.

3-26. Figure 3-2 shows an example of allocation of forces to an OSC. A basic difference between an OSC and tactical-level task organizations is that the latter are built around an existing organization. In the case of an OSC, however, all that exists before task-organizing is the OSC headquarters. Everything else in this example is color coded to show where it came from. Figure 3-2 shows under the OSC all the major units from the AFS that are allocated to the OSC headquarters in this example, but does not reflect how those units might be task organized within the OSC.

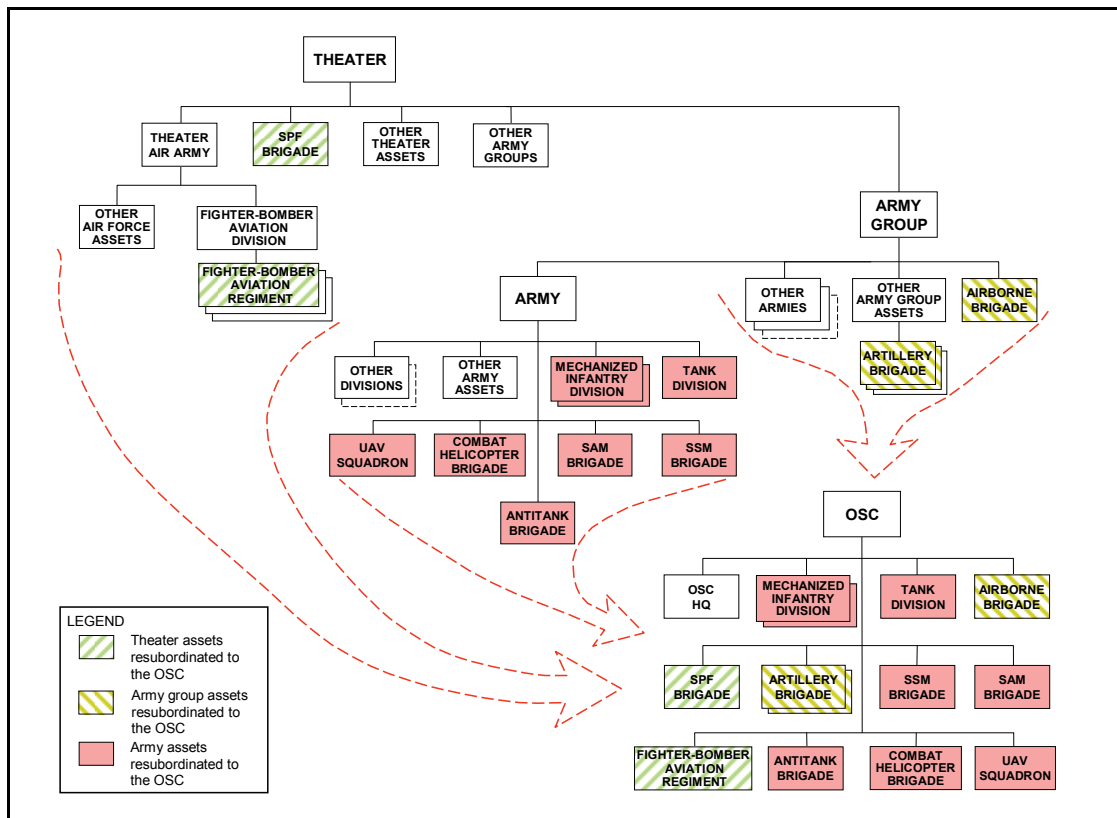

**Figure 3-2. Allocation of Forces to an OSC (Example)**

3-27. The units allocated from the AFS to form the OSC typically come from an army group, army, or corps (or perhaps a military district or military region) or from forces directly subordinate to a service headquarters. There can also be cases where forces from the services have initially been allocated to a theater headquarters and are subsequently re-allocated down to the OSC. The organizations shown under the OSC, like those shown under the theater headquarters in this example, indicate a pool of assets made

available to that command. The commander receiving these assets may choose to retain them at his own level of command, or he may choose to sub-allocate them down to one or more of his subordinates for their use in their own task organization.

3-28. When the NCA decides to execute a particular SCP, each OSC participating in that plan receives appropriate units from the OPFOR's AFS, as well as interagency and/or multinational forces. Forces subordinated to an OSC may continue to depend on the AFS for support.

3-29. If a particular OSC has contingency plans for participating in more than one SCP, it could receive a different set of forces under each plan. In each case, the forces would be task-organized according to the mission requirements in the given plan. Thus, each OSC consists of those division-, brigade-, and battalion-size organizations allocated to it by the SCP currently in effect. These forces also may be allocated to the OSC for the purpose of training for a particular SCP. When an OSC is neither executing tasks as part of an SCP nor conducting exercises with its identified subordinate forces, it exists as a planning headquarters.

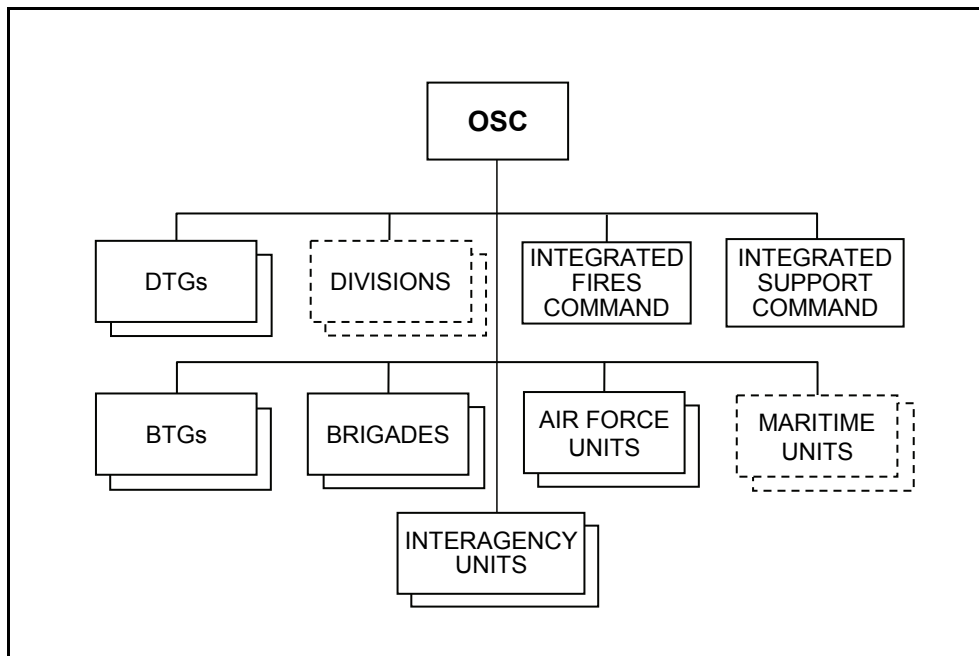

**Figure 3-3. Possible OSC Organization (Example)**

3-30. Figure 3-3 shows an example of the types of organizations that could make up a particular OSC organization. The numbers of each type of subordinate and whether they actually occur in a particular OSC can vary. As shown in this example, the composition of an OSC is typically joint, with Air Force and possibly maritime (naval or naval infantry) units, and it can also be interagency. If some of the allocated forces come from another, allied country, the OSC could be multinational. The simplified example of an OSC shown here does not show all the combat support and combat service support units that would be present in such an organization. Many of these support units are found in the integrated fires command and the integrated support command (outlined below). Other support units could be allocated initially from the AFS to the OSC, which further allocates them to its tactical subordinates.

3-31. Once allocated to an OSC, a division or brigade often receives augmentation that transforms it into a DTG or BTG, respectively. However, an OSC does not have to task-organize subordinate divisions and brigades into tactical groups. Most divisions would become DTGs, but some maneuver brigades in the AFS may be sufficiently robust to accomplish their mission without additional task-organizing.

3-32. The OPFOR has great flexibility regarding possible OSC organizations for different missions. There is virtually no limit to the possible permutations that could exist. The allocation of organizations to an OSC

depends on what is available in the State's AFS, the mission requirements of that OSC, and the requirements of other operational-level commands. In a U.S. Army training exercise, the OSC should get whatever it needs to give the U.S. unit a good fight and challenge its METL tasks.

## INTEGRATED FIRES COMMAND

3-33. The integrated fires command (IFC) is a combination of a standing C2 structure and task organization of constituent and dedicated fire support units. (See figure 3-4.) All division-level and above OPFOR organizations possess an IFC C2 structure. The IFC exercises command of all constituent and dedicated fire support assets retained by its level of command. This includes aviation, artillery, and missile units. It also exercises command over all reconnaissance, intelligence, surveillance, and target acquisition (RISTA) assets allocated to it. Any units that an OSC (or any headquarters at echelons above division) suballocates down to its subordinates are no longer part of its IFC. (See FM 7-100.1 for more detail on the IFC at OSC level.)

*Note.* Based on mission requirements, the commander may also allocate maneuver forces to the IFC. This is most often done when he chooses to use the IFC command post to provide C2 for a strike, but can also be done for the execution of other missions.

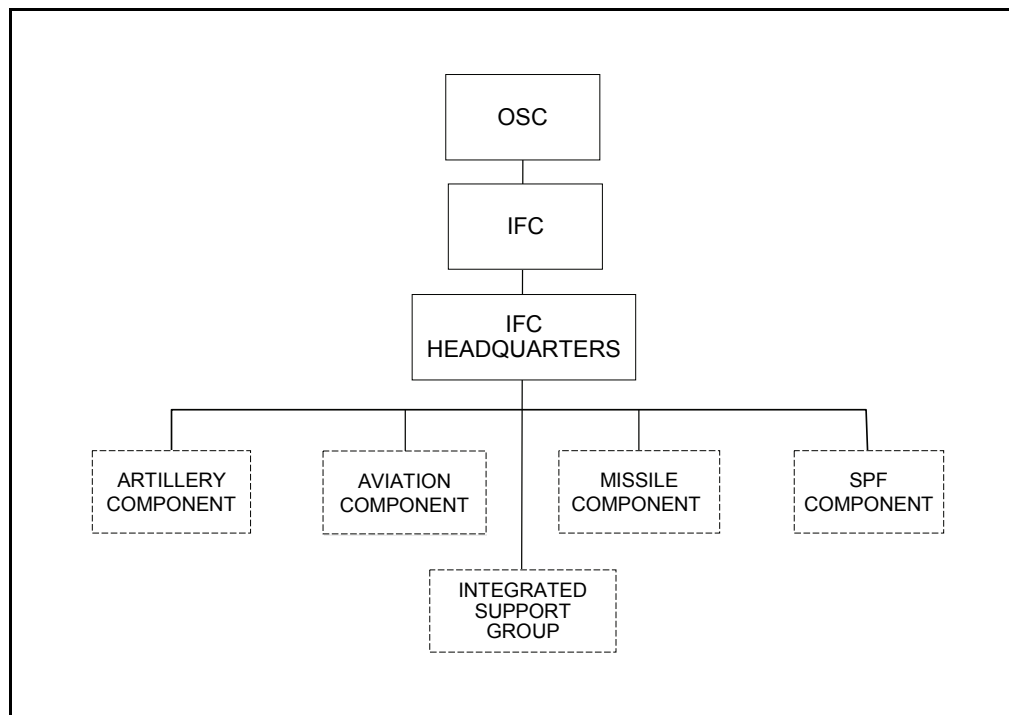

**Figure 3-4. Possible IFC Components in an OSC**

3-34. The number and type of fire support and RISTA units allocated to an IFC is mission-dependent. The IFC is not organized according to a table of organization and equipment, but is task-organized to accomplish the missions assigned.

### IFC Headquarters

3-35. The OSC IFC headquarters, like the overall OSC headquarters, exists in peacetime in order to be ready to accommodate and exercise C2 over all forces made subordinate to it in wartime. The IFC headquarters is composed of the IFC commander and his command group, a RISTA and information warfare (IW) section, an operations section, and a resources section. Located within the operations section

is the fire support coordination center (FSCC). To ensure the necessary coordination of fire support and associated RISTA, the operations section of the IFC headquarters also includes liaison teams from subordinate units.

### **Artillery Component**

3-36. The artillery component is a task organization tailored for the conduct of artillery support during combat operations. In an OSC's IFC, it is typically organized around one or more artillery brigades, or parts of these that are not allocated in a constituent or dedicated relationship to tactical-level subordinates. The artillery component includes appropriate target acquisition, C2, and logistics support assets.

3-37. The number of artillery battalions assigned to an IFC varies according such factors as mission of friendly units, the enemy (U.S.) situation, and terrain. However, the number of artillery units also can vary based on the capabilities of the supporting artillery fire control system.

### **Aviation Component**

3-38. The aviation component is a task organization tailored for the conduct of aviation operations. The aviation component is task-organized to provide a flexible and balanced air combat organization capable of providing air support to the OSC commander. It may be organized around an Air Force aviation regiment or an air army, or parts of these, as required by the mission. It may also include rotary-wing assets from Army aviation. It includes ground attack aviation capability as well as requisite ground and air service support assets.

### **Missile Component**

3-39. The missile component is a task organization consisting of long-range missiles or rockets capable of delivering conventional or chemical, biological, radiological, and nuclear (CBRN) munitions. It is organized around an SSM or rocket battalion or brigade and includes the appropriate logistics support assets. Missile and rocket units may come from the Strategic Forces or from other parts of the AFS (where they may be part of a corps, army, or army group).

### **Special-Purpose Forces Component**

3-40. The SPF component normally consists of assets from an SPF brigade. Units may come from the national-level SPF Command or from Army, Air Force, and Navy SPF. If an OSC has received SPF units, it may further allocate some of these units to supplement the long-range reconnaissance assets a division or DTG has in its own IFC. However, the scarce SPF assets normally would remain at OSC level.

### **Integrated Support Group**

3-41. The integrated support group (ISG) is a compilation of units performing logistics tasks that support the IFC in a constituent or dedicated command relationship. For organizational efficiency, various units performing other combat support and combat service support tasks might be grouped into the ISG, even though they may support only one of the major units or components of the IFC. The ISG can perform the same functions as the OSC's integrated support command (see below), but on a different scale and tailored to the support requirements of the IFC

3-42. There is no standard ISG organizational structure. The number, type, and mix of subordinate units vary based on the operational support situation. In essence, the ISG is tailored to the mission and the task organization of the IFC. An ISG can have many of the same types of units as shown in figure 3-5 for one example of ISC subordinates, but tailored in size and functions to support the IFC.

### **INTEGRATED SUPPORT COMMAND**

3-43. The integrated support command (ISC) is the aggregate of combat service support units (and perhaps some combat support units) allocated from the AFS to an OSC in a constituent or dedicated command relationship and not suballocated in a constituent or dedicated command relationship to a subordinate

headquarters within the OSC. Normally, the OSC further allocates part of its combat service support units to its tactical-level subordinates and some, as an ISG, to support its IFC. The rest remain in the ISC at OSC level to provide overall support of the OSC. For organizational efficiency, other combat service support units may be grouped in this ISC, although they may support only one of the major units of the OSC. Sometimes, an ISC might also include units performing combat support tasks (such as chemical defense, IW, or law enforcement) that support the OSC. Any units that an OSC suballocates down to its subordinates are no longer part of its ISC. (See FM 7-100.1 for more detail on the ISC at OSC level.)

### ISC Headquarters

3-44. The ISC headquarters is composed of the ISC commander and his command group, an operations section, and a resources section. The operations section provides the control, coordination, communications, and IW support for the ISC headquarters. Located within the operations section is the support operations coordination center (SOCC). The SOCC is the staff element responsible for the planning and coordination of support for the OSC. In addition to the SOCC, the operations section has subsections for future operations and airspace operations. The resources section consists of logistics and administrative subsections which, respectively, execute staff supervision over the ISC's logistics and personnel support procedures. The ISC headquarters includes liaison teams from subordinate units of the ISC and from other OSC subordinates to which the ISC provides support. These liaison teams work together with the SOCC to ensure the necessary coordination of support for combat operations.

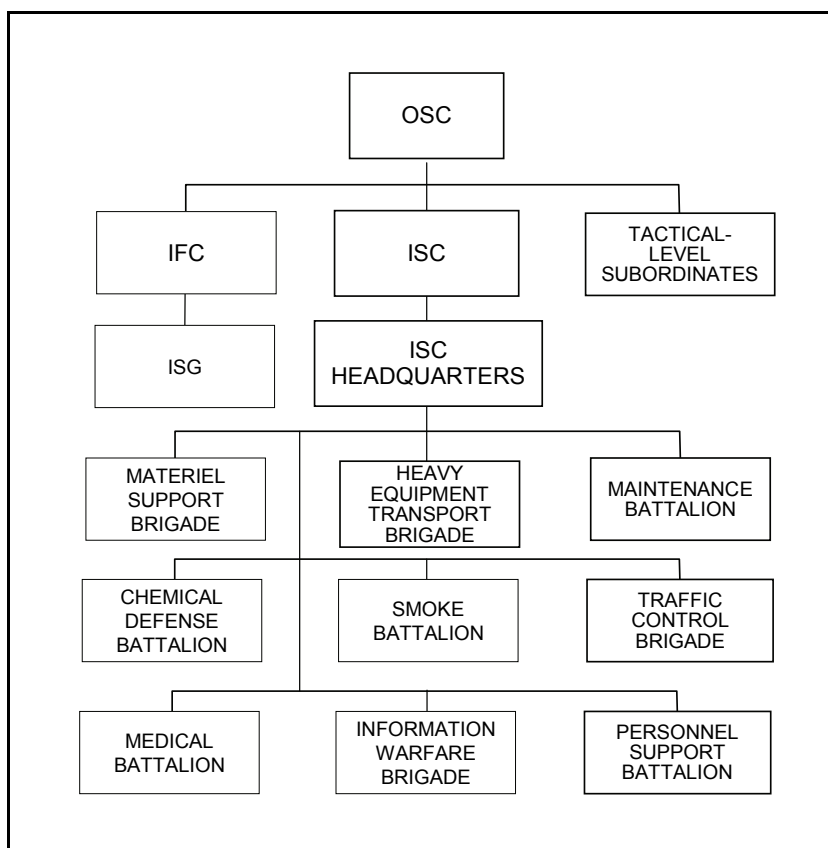

**Figure 3-5. OSC Task Organization, with ISC Example**

### ISC Task-Organizing

3-45. The units allocated to an OSC and its ISC vary according to the mission of that OSC and the support requirements of other operational-level commands. The OSC resources officer (in consultation with his

chiefs of logistics and administration and the ISC commander) determines the proper task organization of logistics and administrative support assets allocated to the OSC. He suballocates some assets to the IFC and to other OSC subordinates based on support mission requirements. The remainder he places under the ISC commander. Figure 3-5 on page 3-11 shows a typical OSC organization, with an example of the types of combat service support and combat support units that might appear in an OSC ISC.

3-46. The number and type of units in the ISC and ISG will vary according to the number and size of supported units in the OSC and its IFC, respectively. For example, an ISC supporting an OSC composed mainly of tank and mechanized infantry units will differ from an ISC supporting an OSC composed mainly of infantry or motorized infantry units. When the logistics units are no longer required for ISC or ISG functions, they will revert to control of their original parent units in the AFS or otherwise will be assigned to other operational-level commands, as appropriate.

## **SECTION IV – NATION-STATE FORCES: TACTICAL LEVEL**

3-47. In the OPFOR's AFS, the largest tactical-level organizations are divisions and brigades. In wartime, they are often subordinate to a larger, operational-level command. Even in wartime, however, some separate single-service tactical commands (divisions, brigades, or battalions) may remain under their respective service headquarters or come under the direct control of the SHC or a separate theater headquarters. (See figure 3-1 on page 3-6.) In any of these wartime roles, a division or brigade may receive additional assets that transform it into a tactical group.

### **TACTICAL GROUPS**

3-48. A *tactical group* is a task-organized division or brigade that has received an allocation of additional land forces in order to accomplish its mission. Thus, a tactical group differs from higher-level task organizations in that it is built around the structure of an already existing organization. Tactical groups formed from divisions are *division tactical groups* (DTGs), and those formed from brigades are *brigade tactical groups* (BTGs). In either of those cases, the original division or brigade headquarters becomes the DTG or BTG headquarters, respectively.

3-49. The additional forces that transform a division or brigade into a tactical group may come from within the MOD, from the Ministry of the Interior, or from affiliated forces. Typically, these assets initially are allocated to an OSC or FG, which further allocates them to its tactical subordinates. If the tactical group operates as a separate command, it may receive additional assets directly from the theater headquarters or the SHC that are necessary for it to carry out an operational-level mission. If a DTG has a mission directly assigned by an SCP or theater campaign plan, it acts as an operational-level command. If a DTG has a mission assigned by an intermediate operational-level command (such as an FG or an OSC), then it acts as a tactical-level command.

3-50. A DTG or BTG may receive augmentation from other services of the State's Armed Forces. However, it does not become joint. That is because it can accept such augmentation only in the form of land forces, such as special-purpose forces from the SPF Command or naval infantry from the Navy. Augmentation may also come from other agencies of the State government, such as border guards or national police that have not been resubordinated to the SHC in wartime.

3-51. Any division or brigade receiving additional assets from a higher command becomes a DTG or BTG. In addition to augmentation received from a higher command, a DTG or BTG normally retains the assets that were originally subordinate to the division or brigade that served as the basis for the tactical group. However, it is also possible that the same higher command that augments a division or brigade to transform it into a tactical group could use units from one division or brigade as part of a tactical group that is based on another division or brigade. The purpose of a tactical group is to ensure unity of command for all land forces in a given AOR.

3-52. A DTG may fight as part of an OSC or as a separate unit in an FG or directly under a theater headquarters or the SHC. A BTG may fight as part of a division or DTG or as a separate unit in an OSC or FG.

## DIVISIONS AND DTGS

3-53. Divisions in the AFS are designed to be able to serve as the basis for forming a division tactical group (DTG), if necessary. Thus, they are able to—

- Accept constituent flame weapons, artillery (cannon and rocket), engineer, air defense, chemical defense, antitank, medical, logistics, signal, and electronic warfare (EW) units.
- Accept dedicated and supporting surface-to-surface missile (SSM), Special-Purpose Forces (SPF), aviation (combat helicopter, transport helicopter), and unmanned aerial vehicle (UAV) units. A division may accept these type units as constituent if it is also allocated their essential logistics support.
- Integrate interagency forces up to brigade size.

3-54. Figure 3-6 gives an example of possible DTG organization. Some of the units belonging to the DTG are part of the division on which it is based. Note that some brigades are task-organized into BTGs, while others may not be and have structures that come straight out of the organizational directories for the AFS. Likewise, some battalions and companies may become detachments. Besides what came from the original division structure, the rest of the organizations shown come from a pool of assets the parent operational-level command has received from the AFS and has decided to pass down to the DTG. All fire support units that were organic to the division or allocated to the DTG (and are not suballocated down to a BTG) go into the integrated fires command (IFC). Likewise, combat service support units go into the integrated support command (ISC). As shown here, DTGs can also have affiliated forces from paramilitary organizations.

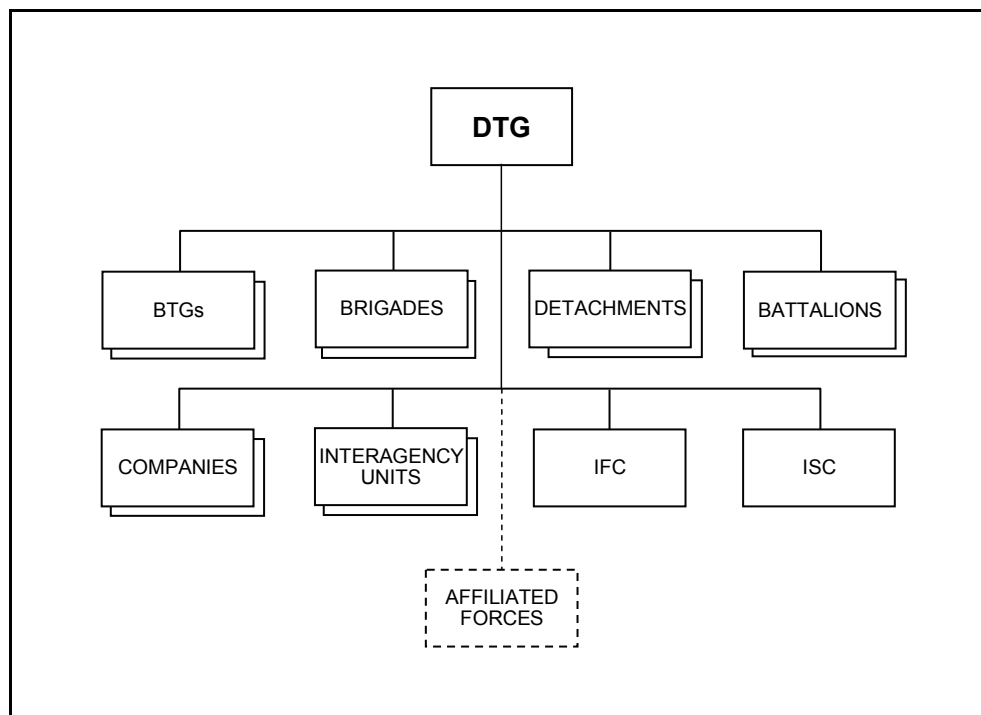

**Figure 3-6. Possible DTG Organization (Example)**

3-55. The division that serves as the basis for a DTG may have some of its brigades task-organized as BTGs. However, just the fact that a division becomes a DTG does not necessarily mean that it forms BTGs. A DTG could augment all of its brigades, or one or two brigades, or none of them as BTGs. A division could augment one or more brigades into BTGs, using the division's own constituent assets, without becoming a DTG. If a division receives additional assets and uses them all to create one or more BTGs, it is still designated as a DTG.

## MANEUVER BRIGADES AND BTGS

3-56. In the AFS, divisional or separate maneuver brigades are robust enough to accomplish some missions without further allocation of forces. However, maneuver brigades are designed to be able to serve as the basis for forming a brigade tactical group (BTG), if necessary. Thus, they are able to—

- Accept constituent flame weapons, artillery (cannon and rocket), engineer, air defense, antitank, logistics, and signal units.
- Accept dedicated and supporting chemical defense, medical, EW, SSM, SPF, aviation (combat helicopter, transport helicopter), and UAV units. A brigade may accept these type units as constituent if it is also allocated their essential logistics support.
- Integrate interagency forces up to battalion size.

3-57. Figure 3-7 give an example of possible BTG organization. This example shows that some battalions and companies of a BTG may be task-organized as detachments, while others are not. Although not shown here, BTGs (and higher commands) can also have affiliated forces from paramilitary organizations.

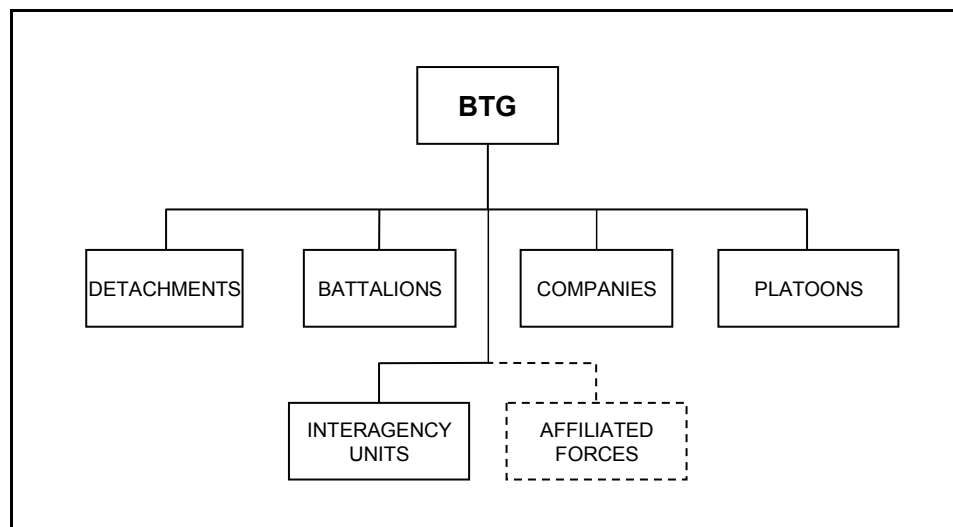

**Figure 3-7. Possible BTG Organization (Example)**

3-58. Unlike higher-level commands, OPFOR brigades and BTGs do not have an IFC or an ISC. Brigade and BTG headquarters have a fire support coordination center (FSCC) in their operations section, but are not expected to integrate fires from all systems and services without augmentation.

## DETACHMENTS

3-59. A *detachment* is a battalion or company designated to perform a specific mission and allocated the forces necessary to do so. Detachments are the OPFOR's smallest combined arms formations and are, by definition, task-organized. To further differentiate, detachments built from battalions can be termed *BDETs* and those from companies *CDETs*. The forces allocated to a detachment suit the mission expected of it.

They may include—

- Artillery or mortar units.
- Air defense units.
- Engineer units (with obstacle, survivability, or mobility assets).
- Heavy weapons units (including heavy machineguns, automatic grenade launchers, and antitank guided missiles).
- Units with specialty equipment such as flame weapons, specialized reconnaissance assets, or helicopters.
- Chemical defense, antitank, medical, logistics, signal, and EW units.



- Interagency forces up to company for BDETs or platoon for CDETs.

BDETs can accept dedicated and supporting SPF, aviation (combat helicopter, transport helicopter) and UAV units. Figures 3-8 and 3-9 provide examples of a BDET and a CDET, respectively.

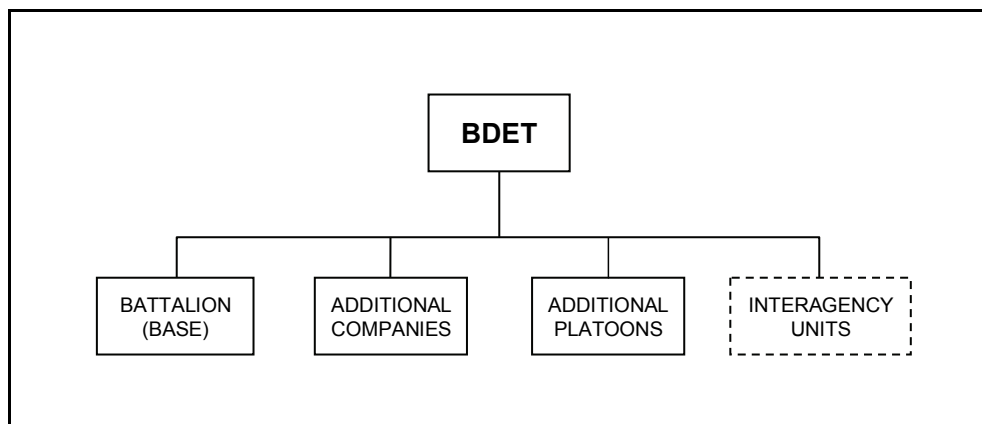

**Figure 3-8. Battalion-Size Detachment (BDET) Example**

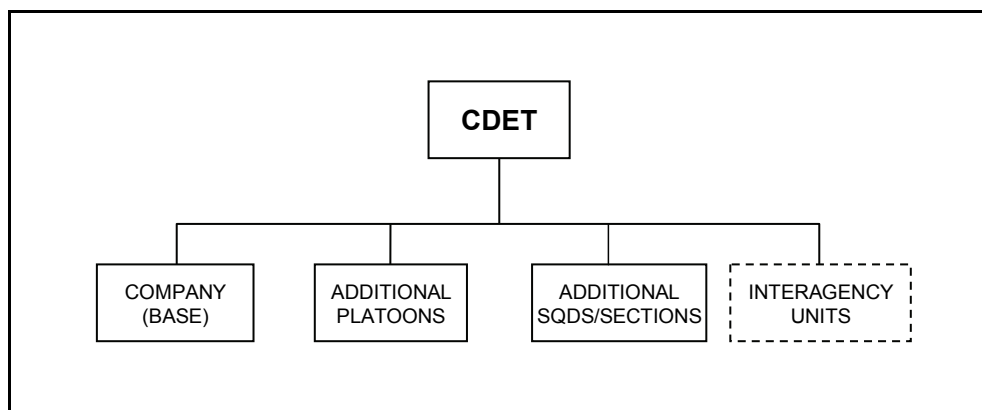

**Figure 3-9. Company-Size Detachment (CDET) Example**

3-60. The basic type of OPFOR detachment—whether formed from a battalion or a company—is the independent mission detachment. Independent mission detachments are formed to execute missions that are separated in space and/or time from those being conducted by the remainder of the forming unit. Other common types of detachment include—

- Counterreconnaissance detachment.
- Movement support detachment.
- Obstacle detachment.
- Reconnaissance detachment.
- Security detachment.
- Urban detachment.

## INTEGRATED FIRES COMMAND

3-61. A division or DTG would have an IFC similar to that found in an operational-level command (see figure 3-10 on page 3-16). The primary difference is that its aviation component would include only Army aviation assets. Also, rather than an “SPF component” as at the operational level, the division or DTG IFC would have a “long-range reconnaissance component” that most often would not include scarce SPF assets. Even when allocated to a DTG, probably in a supporting status, the SPF would pursue tactical goals in

support of operational objectives. Any units that a division or DTG suballocates down to its subordinates are no longer part of its IFC. An IFC C2 structure and task organization is not found below division or DTG level. (See FM 7-100.2 for more detail on the IFC at division or DTG level.)

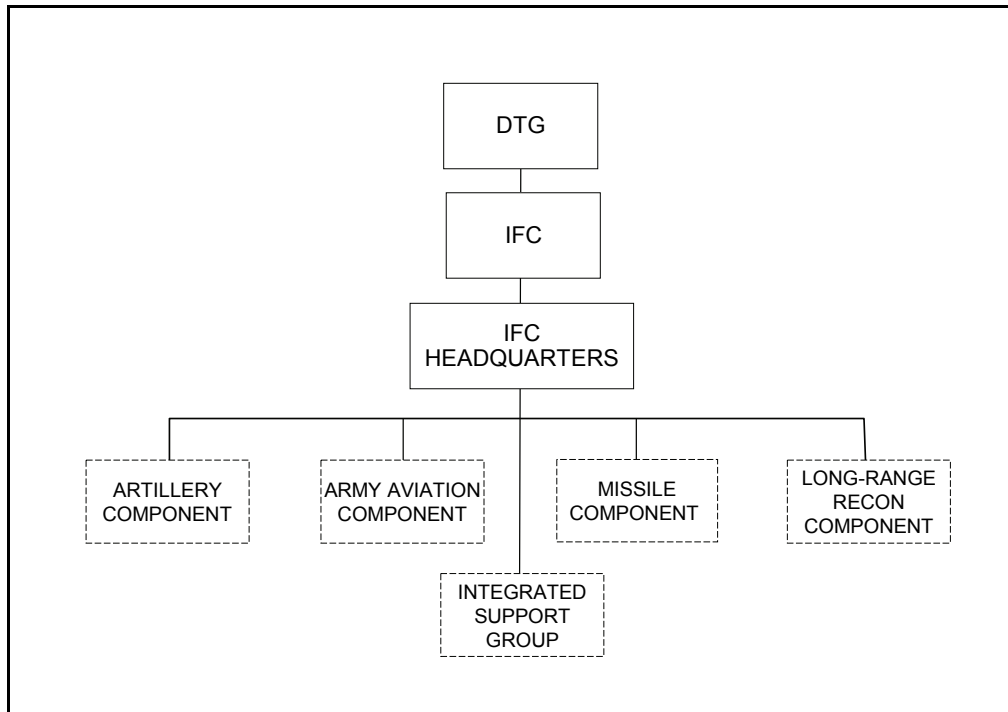

**Figure 3-10. Possible IFC Components in a DTG**

---

*Note.* In rare cases, such as when a division or DTG would have the mission of conducting a strike, the commander might also allocate maneuver forces to the IFC.

---

## INTEGRATED SUPPORT COMMAND

3-62. A division or DGT would have an ISC similar to that found in an OSC (see figure 3-5 on page 3-11). An ISC C2 structure and task organization is not found below division or DTG level. Any units that a division or DTG suballocates down to its subordinates are no longer part of its ISC. (See FM 7-100.2 for more detail on the ISC at division or DTG level.)

## INTERNAL TASK-ORGANIZING

3-63. Given the pool of organizational assets available to him, a commander at any level has several options regarding the task-organizing of his subordinates. An OSC is always a task organization. An OSC allocated divisions and/or separate brigades would almost always provide those immediate tactical-level subordinates additional assets that would transform them into DTGs and BTGs tailored for specific missions. However, it is not necessary that all divisions or divisional brigades (or even separate brigades) become tactical groups. That is the higher commander's option.

3-64. At any level of command, a headquarters can direct one or more of its subordinates to give up some of their assets to another subordinate headquarters for the creation of a task organization. Thus, a division could augment one or more brigades into BTGs, using the division's own constituent assets, without becoming a DTG. A brigade, using its own constituent assets, could augment one or more battalions into BDETs (or direct a battalion to form one or more CDETs) without becoming a BTG. A battalion could use its own constituent assets to create one or more CDETs without becoming a BDET.

3-65. If a division receives additional assets and uses them all to create one or more BTGs, it is still designated as a DTG. If a brigade receiving additional assets does not retain any of them at its own level of command but uses them all to transform one or more of its battalions into BDETs, it is still a BTG.

## SPECIAL-PURPOSE FORCES

3-66. In wartime, some SPF units from the SPF Command or from the Army, Navy, Air Force, or Internal Security Forces SPF may remain under the command and control of their respective service headquarters. However, some SPF units also might be suballocated to operational- or even tactical-level commands during the task-organizing process.

3-67. When the OPFOR establishes more than one theater headquarters, the General Staff may allocate some SPF units to each theater. From those SPF assets allocated to him in a constituent or dedicated relationship, the theater commander can suballocate some or all of them to a subordinate OSC.

3-68. The General Staff (or a theater commander with constituent or dedicated SPF) can allocate SPF units to an OSC in a constituent or dedicated relationship or place them in support of an OSC. These command and support relationships ensure that SPF objectives support the overall mission of the OSC to which the SPF units are allocated. Even in a supporting relationship, the commander of the OSC receiving the SPF unit(s) establishes those units' objectives, priorities, and time of deployment. The OSC commander may employ the SPF assets allocated to him as constituent or dedicated as part of his integrated fires command (IFC), or he may suballocate some or all of them to his tactical-level subordinates. Even SPF units allocated to an OSC may conduct strategic missions, if required.

3-69. The SPF units of the Army, Navy, Air Force, and Internal Security Forces may remain under the control of their respective services (or be allocated to a joint theater command). However, they are more likely to appear in the task organization of an OSC. In that case, the OSC commander may choose to suballocate them to tactical-level subordinates. If necessary, SPF from any of these service components could become part of joint SPF operations in support of national-level requirements. In that case, they could temporarily come under the control of the SPF Command or the General Staff.

3-70. Regardless of the parent organization in the AFS, SPF normally infiltrate and operate as small teams. When deployed, these teams may operate individually, or they may be task-organized into detachments. The terms team and detachment indicate the temporary nature of the groupings. In the course of an operation, teams can leave a detachment and join it again. Each team may in turn break up into smaller teams (of as few as two men) or, conversely, come together with other teams to form a larger team, depending on the mission. At a designated time, teams can join up and form a detachment (for example, to conduct a raid), which can at any moment split up again. This whole process can be planned before the operation begins, or it can evolve during the course of an operation.

## INTERNAL SECURITY FORCES

3-71. During wartime, some or all of the internal security forces from the Ministry of the Interior become subordinate to the SHC. Thus, they become the sixth service component of the Armed Forces, with the formal name "Internal Security Forces." The SHC might allocate units of the Internal Security Forces to a theater command or to a task-organized operational- or tactical-level military command that is capable of controlling joint and/or interagency operations. In such command relationships, or when they share a common area of responsibility (AOR) with a military organization, units of the Internal Security Forces send liaison teams to represent them in the military organization's staff. (See chapter 2 of this manual and FM 7-100.3 for more detail on the various types of internal security forces and their possible roles in the OPFOR's wartime fighting force structure.)

## SECTION V – NON-STATE ACTORS

3-72. Various types of non-state actors might be part of the OPFOR, affiliated with it, or support it in some manner. Even those who do not belong to the OPFOR or support it directly or willingly could be exploited or manipulated by the OPFOR to support its objectives.

## INSURGENT AND GUERRILLA FORCES

3-73. Insurgent organizations are irregular forces, meaning that there is no “regular” table of organization and equipment. Thus, the baseline insurgent organizations in the organizational directories represent the “default” setting for a “typical” insurgent organization. If an OPFOR OB has more than one local insurgent organization, no two insurgent organizations should look exactly alike. Trainers and training planners should vary the types and numbers of cells to reflect the irregular nature of such organizations.

3-74. The baseline organization charts and equipment lists for individual cells include many notes on possible variations in organization or in numbers of people or equipment within a given organization. When developing an OB for a specific insurgent organization for use in training, users may exercise some latitude in the construction of cells. Some cells might need to be larger or smaller than the “default” setting found in the organizational directories. Some entire cells might not be required, and some functional cells might be combined into a single cell performing both functions. However, trainers and training planners would need to take several things into consideration in modifying the “default” cell structures:

- What functions the insurgents need to be able to perform.
- What equipment is needed to perform those functions.
- How many people are required to employ the required equipment.
- The number of vehicles in relation to the people needed to drive them or the people and equipment that must be transported.
- Equipment associated with other equipment (for example, an aiming circle/goniometer used with a mortar or a day/night observation scope used with a sniper rifle).

3-75. Any relationship of independent local insurgent organizations to regional or national insurgent structures may be one of affiliation or dependant upon a single shared or similar goal. These relationships are generally fluctuating and may be fleeting, mission dependant, or event- or agenda-oriented. Such relationships can arise and cease due to a variety of reasons or motivations.

3-76. When task-organizing insurgent organizations, guerrilla units might be subordinate to a larger insurgent organization, or they might be loosely affiliated with an insurgent organization of which they are not a part. A guerrilla unit or other insurgent organization might be affiliated with a regular military organization. A guerrilla unit might also become a subordinate part of an OPFOR task organization based on a regular military unit.

3-77. Even in the AFS organizational directories, some guerrilla units were already reconfigured as hunter/killer units. In the fighting force structure represented in an OPFOR OB, some additional guerrilla units may become task-organized in that manner.

## OTHER PARAMILITARY FORCES

3-78. Insurgent and guerrilla forces are not the only paramilitary forces that can perform countertasks that challenge a U.S. unit’s METL. Other possibilities are criminal organizations and private security organizations. Sometimes the various types of paramilitary organizations operate in conjunction with each other when it is to their common benefit.

### CRIMINAL ORGANIZATIONS

3-79. Criminal organizations may employ criminal actions, terror tactics, and militarily unconventional methods to achieve their goals. They may have the best technology, equipment, and weapons available, simply because they have the money to buy them. Criminal organizations may not change their structure in wartime, unless wartime conditions favor or dictate different types of criminal action or support activities.

3-80. The primary motivation of drug and other criminal organizations is financial profit. Thus, the enemies of these organizations are any political, military, legal, or judicial institutions that impede their actions and interfere with their ability to make a profit. However, there are other groups that conduct drug-trafficking or other illegal actions as a means to purchase weapons and finance other paramilitary activities.

3-81. When mutual interests exist, criminal organizations may combine efforts with insurgent and/or guerrilla organizations controlling and operating in the same area. Such allies can provide security and protection or other support to the criminal organization's activities in exchange for financial assistance, arms, and protection against government forces or other common enemies. The amount of mutual protection depends on the size and sophistication of each organization and the respective level of influence with the government or the local population.

3-82. Criminal organizations may conduct civic actions to gain and maintain support of the populace. A grateful public can provide valuable security and support functions. The local citizenry may willingly provide ample intelligence collection, counterintelligence, and security support. Intelligence and security can also be the result of bribery, extortion, or coercion.

### **PRIVATE SECURITY ORGANIZATIONS**

3-83. Private security organizations (PSOs) are business enterprises or local ad hoc groups that provide security and/or intelligence services, on a contractual or self-interest basis, to protect and preserve a person, facility, or operation. Some PSOs might be transnational corporations. Others might be domestic firms that supply contract guard forces, or they might be local citizen organizations that perform these actions on a volunteer basis. Their clients can include private individuals and businesses (including transnational corporations) or even insurgent or criminal organizations.

3-84. The level of sophistication and competence of a commercial PSO is often directly related to a client's ability to pay. For example, a drug organization can afford to pay more than many small countries. The leader of an insurgent or criminal organization might employ a PSO to provide bodyguards or conduct surveillance or a search at a site prior to his arrival. Another group, such as a drug organization or a transnational corporation, may contract a PSO to guard its facilities. During the conduct of their duties, members of a PSO may take offensive actions. For example, a patrol may conduct a small-scale ambush to counter an intrusion. The allegiance of PSOs can vary from fanatical devotion to just doing a job for purely financial reasons. Each organization is tailored to serve its customer's needs.

### **NONCOMBATANTS**

3-85. Noncombatants might be friendly, neutral, or hostile toward U.S. forces. Even if they are not hostile, they could get in the way or otherwise affect the ability of U.S. units to accomplish their METL tasks. Some might become hostile, if U.S. forces do not treat them properly. Noncombatants may be either armed or unarmed.

3-86. A military or paramilitary force can manipulate an individual or group of noncombatants by exploiting their weaknesses or supplying their needs. For example, an insurgent, guerrilla, drug, or criminal organization might use bribery or extortion to induce noncombatants to act as couriers or otherwise support its activities. It might also coerce a businessperson into running a front company on its behalf. A paramilitary organization might orchestrate a civil disturbance by encouraging the local populace to meet at a public area at a certain time. Members of the paramilitary group could then infiltrate the crowd and incite it to riot or protest. Sometimes, they might pay members of the local populace to conduct a demonstration or march.

### **UNARMED NONCOMBATANTS**

3-87. Common types of unarmed noncombatants found in the organizational directories include medical teams, media, humanitarian relief organizations, transnational corporations, local populace, displaced persons, transients, and foreign government and diplomatic personnel. The directories allow for adjusting the number of unarmed noncombatants by employing multiples of the basic organization shown. Thus, numbers can vary from one individual to as many as several hundred. While such noncombatants are normally unarmed, there is always the potential for them to take up arms in reaction to developments in the OE and their perception of U.S. actions. Therefore, it is increasingly difficult to distinguish between combatants and noncombatants.

3-88. Unarmed noncombatants are likely to be present in any OE. For training in METL tasks other than those dealing with armed conflict, these noncombatants are present as key players. However, armed conflict will draw in more of some groups, such as displaced persons, humanitarian relief organizations, and media. Even in the midst of armed conflict, U.S. units will still need to deal with the local populace and all the other kinds of unarmed noncombatants. Insurgents can melt into the general populace—or perhaps were always part of it.

### **ARMED NONCOMBATANTS**

3-89. There are also likely to be armed noncombatants who are not part of any military or paramilitary organization. Some may be in possession of small arms legally to protect their families or as part of their profession (for example, hunters, security guards, or local police). They may be completely neutral or have leanings for either, or several sides. Some may be affiliated with the one faction or the other, but are not members. Opportunists may decide to hijack a convoy or a vehicle by force of arms. Some are just angry at the United States. Some may be motivated by religious, ethnic, and cultural differences, or by revenge, anger, and greed. The reasons are immaterial—armed noncombatants are ubiquitous. The organizational directories allow for adjusting the number of armed noncombatants by employing multiples of the basic organization shown. Thus, numbers can vary from one individual to as many as several hundred. The armed noncombatants may have vehicles or may not be associated with any vehicle.

## **SECTION VI – EXPLOITATION OF NONCOMBATANTS AND CIVILIAN ASSETS**

3-90. Some noncombatant personnel and civilian assets may be available as additional resources for OPFOR military and/or paramilitary forces. Because these assets are not part of the peacetime, administrative force structure of military or paramilitary organizations, they do not appear under those organizations in the online AFS organizational directories. In wartime, however, they may be incorporated or co-opted into a military or paramilitary force. Willingly or unwillingly (sometimes unwittingly), such personnel and equipment can supplement the capabilities of a military or paramilitary organization. Therefore, trainers and training planners should also take these assets into account when building an OPFOR OB.

### **BY MILITARY FORCES**

3-91. In wartime, the State and its armed forces might nationalize, mobilize, confiscate, or commandeer civilian transportation assets that are suitable for supporting military operations. These assets can include trucks, boats, or aircraft. The OPFOR would organize these assets into units that resemble their military counterparts as much as possible. For example, civilian trucks and their operators could be formed into a cargo transport company or a whole materiel support battalion. One difference might be that the operators are not armed. This is either because weapons are not available or because the OPFOR does not trust the operators—who may have been coerced into entering this military-like force, along with their vehicles or craft. Civilian construction workers and their equipment (such as dump trucks, back hoes, dozers, and cement mixers) could be formed into an engineer support company or a road and bridge construction company. Medical professionals, engineers, mechanics, and other persons with key skills might also be pressed into military service in wartime, even though they had no connection with the military forces in their peacetime, administrative force structure.

### **BY PARAMILITARY FORCES**

3-92. Non-state paramilitary forces also could mobilize additional support assets in the same ways—except for nationalization. Again, they could organize these assets into units or cells that are similar to their counterparts in the particular paramilitary organization. In this case, transport vehicles could include civilian cargo trucks, vans, pickup trucks, automobiles, all-terrain vehicles, motorcycles, bicycles, or carts. For the purposes of a paramilitary organization, transportation assets can extend beyond vehicles and craft to draft animals and noncombatant personnel used as bearers or porters. Individuals might receive pay for their services or the use of their vehicles, or they might be coerced into providing this assistance. A front

organization could employ such assets without individuals or vehicle owners being aware of the connection with the paramilitary organization. In other cases, individuals or groups might volunteer their services because they are sympathetic to the cause. When such individuals or their vehicles are no longer required, they melt back into the general populace.

## SECTION VII – UNIT SYMBOLS FOR OPFOR TASK ORGANIZATIONS

3-93. Unit symbols for all OPFOR units employ the diamond-shaped frame specified for “hostile” units in FM 1-02. When there is a color capability, the diamond should have red fill color. All OPFOR task organizations should use the “task force” symbol placed over the “echelon” (unit size) modifier above the diamond.

3-94. An OSC is the rough equivalent of a U.S. joint task force (JTF). Therefore, the map symbol for an OSC is derived from the JTF symbol in FM 1-02 (see figure 3-11.)

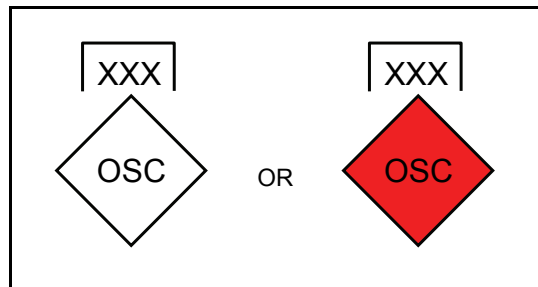

**Figure 3-11. OSC Symbol**

3-95. At the tactical level, the area inside the diamond contains the symbol for the branch or function of the unit. For OPFOR task organizations, this part of the symbol reflects the type of unit (for example, tank, mechanized infantry, or motorized infantry) in the AFS, which served as the “base” around which the task organization was formed and whose headquarters serves as the headquarters for the task organization. In many cases, the task organization might also retain the alphanumeric unit designation of that base unit as well. Figures 3-12 through 3-17 (on pages 3-21 through 3-23) provide examples for various types of OPFOR task organizations at the tactical level.

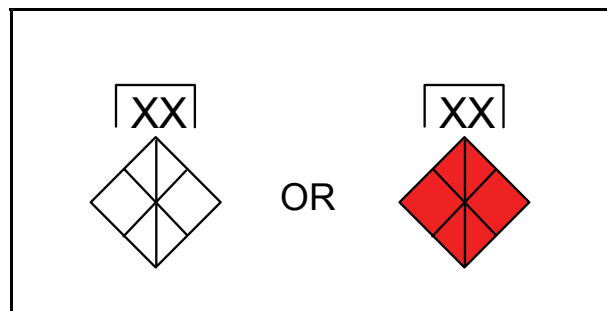

**Figure 3-12. Motorized Infantry-Based DTG Symbol**

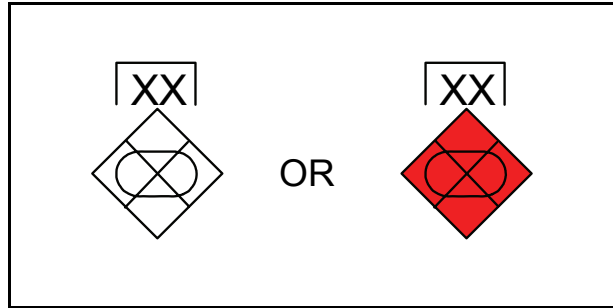

Figure 3-13. Mechanized Infantry-Based DTG Symbol

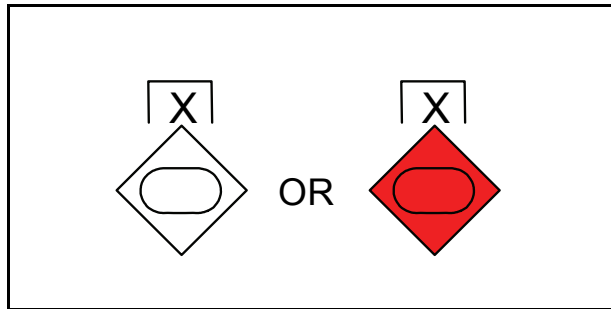

Figure 3-14. Tank-Based BTG Symbol

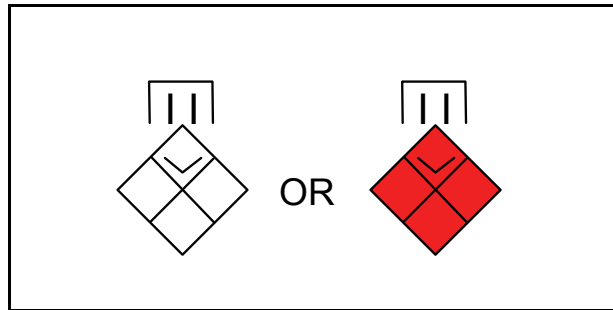

Figure 3-15. Heliborne Infantry-Based BDET Symbol

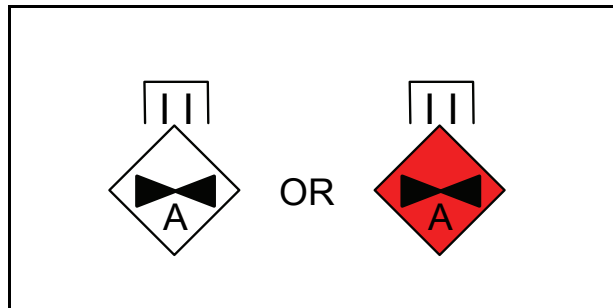
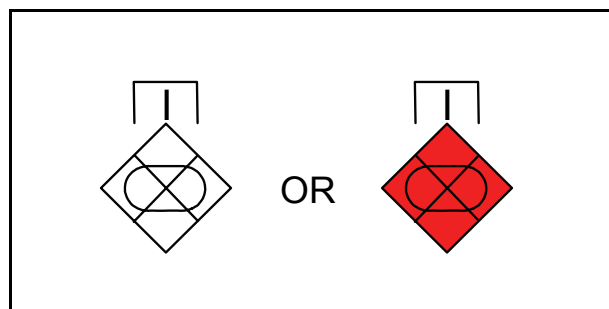

Figure 3-16. Attack Helicopter-Based BDET Symbol





**Figure 3-17. Mechanized Infantry-Based CDET Symbol**

## SECTION VIII – BUILDING AN OPFOR ORDER OF BATTLE

3-96. For effective training, an OPFOR must be task-organized to stress those tasks identified in the U.S. unit's mission essential task list (METL). The U.S. unit commander identifies those areas (or training objectives) requiring a realistic sparring partner. The U.S. unit's organization and mission drives the task-organizing of the OPFOR. OPFOR task-organizing is accomplished to either stress issues identified in the U.S. unit's METL or it is accomplished in order to exploit the OPFOR strength and U.S. weakness. Steps 1 through 3 of the process outlined below define the scope and purpose of the training exercise. This sets the stage for Steps 4 through 9, which determine the kind of OPFOR needed to produce the desired training. The entire process results in building the appropriate OPFOR order of battle (OB).

### STEP 1. DETERMINE THE TYPE AND SIZE OF U.S. UNITS

3-97. The U.S. commander who acts as the senior trainer (commander of the parent organization of the unit being trained) determines the type and size of unit he wants trained for a specific mission or task. The first step in exercise design is for the senior trainer to determine the exact troop list for the training unit. The senior trainer should identify the task organization of the unit to be trained.

### STEP 2. SET THE CONDITIONS

3-98. The senior trainer ensures the unit's training objectives support its approved METL. Each training objective has three parts: task, condition, and standard. The COE—including the OPFOR—is the condition. The exercise planner has the task of actual creating the framework for the exercise and its conditions. For the training scenario, the exercise planner develops reasonable courses of action (COAs) for the U.S. unit and reasonable COAs for the OPFOR consistent with the COE and the FM 7-100-series manuals. The exercise planner determines the size and type of OPFOR organizations. The conditions under which U.S. units perform tasks to achieve training objectives include the time of day or night, weather conditions, the type of OPFOR, the type of terrain, the CBRN environment, the maturity of the theater, and the OE variables in play. During scenario development, all the conditions for the exercise OE are set.

### STEP 3. SELECT ARMY TACTICAL TASKS

3-99. The U.S. commander reviews the Army Universal Task List (AUTL) in FM 7-15. As a catalogue, the AUTL can assist a commander in his METL development process by providing all the collective tasks possible for a tactical unit of company-size and above and staff sections. From the AUTL, the U.S. commander selects specific Army tactical tasks (ARTs) on which he wants to train.

---

*Note.* Commanders use the AUTL to extract METL tasks only when there is no current mission training plan (MTP) for that echeloned organization, there is an unrevised MTP to delineate tasks, or the current MTP is incomplete.) The AUTL does not include tasks Army forces perform as part of joint or multinational forces at the operational and strategic levels. Those tasks are included in the Universal Joint Task List (UJTL) (CJCSM 3500.04C).

---

## **STEP 4. SELECT OPFOR COUNTERTASKS**

3-100. Trainers and planners select OPFOR countertasks to counter or stress each selected ART for the U.S. unit. Appendix A of FM 7-100.2 provides an “OPFOR Universal Task List.” This is a listing of OPFOR tactical countertasks for various ARTs found in the AUTL. If, for example, the U.S. unit’s METL includes ART 5.1.1 (Overcome Barriers/Obstacles/Mines), the OPFOR countertask would involve creating barriers or obstacles or emplacing mines. If the U.S. unit’s METL includes tasks under ART 4.0 (Air Defense), the OPFOR needs to have aviation units. If the U.S. unit’s METL includes ART 5.3.2 (Conduct NBC [CBRN] Defense), the OPFOR needs to have a CBRN capability. If the U.S. unit’s METL includes counterinsurgency operations, the OPFOR should include insurgents.

## **STEP 5. DETERMINE THE TYPE AND SIZE OF OPFOR UNITS**

3-101. Trainers and planners select the appropriate type and size of OPFOR unit or units capable of performing the OPFOR countertasks. The type of OPFOR unit is determined by the type of capability required for each OPFOR countertask. The size of the OPFOR organization is determined by the required capability and the size of the U.S. unit(s) being trained.

## **STEP 6. REVIEW THE AFS ORGANIZATIONAL DIRECTORIES**

3-102. Once the U.S. units and tactical tasks have been matched with OPFOR countertasks and OPFOR units capable of providing counters to each ART, trainers and planners review the list of units in OPFOR organizational directories on the Battle Command Knowledge System (BCKS). They review this menu of OPFOR units to find out what kinds and sizes of OPFOR units are available in the AFS, and the options given.

## **STEP 7. COMPILE THE INITIAL LISTING OF OPFOR UNITS FOR THE TASK ORGANIZATION**

3-103. Trainers and planners compile an initial listing of OPFOR units for the task organization. This initial listing could use one of the two task organization formats provided in FM 5-0: outline and matrix.

## **STEP 8. IDENTIFY THE BASE UNIT**

3-104. Trainers and planners again review the OPFOR organizational directories to determine which standard OPFOR unit most closely matches the OPFOR units in the initial task organization list. This OPFOR unit will become the “base” unit to which modifications are made, converting it into a task organization. (At the tactical level, all OPFOR task organizations are formed around a “base” unit, using that unit’s headquarters and all or some of its original subordinates as a core to which other OPFOR units are added in order to supply capabilities missing in the original “base” organization.) While the base unit for a task organization is most commonly a ground maneuver unit of a regular military force, that does not necessarily have to be the case. (For example, an aviation unit might serve as the base for a task organization that includes infantry units to provide security at its base on the ground.) It is even possible that the base unit for the required task organization might be other than a regular military unit. (For example, an insurgent or guerrilla organization might have a small military unit affiliated with it, as “advisors.”)

3-105. Before extracting the “base” unit from the organizational directories, trainers and training planners should determine how much of the organizational detail in the directories they actually need for their particular training exercise or simulation. The directories typically break out subordinate units down to squad-size components. However, some simulations either cannot or do not need to provide that level of resolution. Therefore, trainers and training planners should identify the lowest level of organization that will actually be portrayed. If the only task-organizing involved will be internal to that level of base unit, any internal task-organizing is transparent to the users. However, if any subordinate of that base unit receives assets from outside its immediate higher organization, it might be necessary to first modify the

subordinate into a task organization and then roll up the resulting personnel and equipment totals into the totals for the parent organization in the OPFOR OB for the exercise.

## STEP 9. CONSTRUCT THE TASK ORGANIZATION

3-106. Trainers and planners modify the standard OPFOR baseline unit to become the new task organization. This can involve changes in subordinate units, equipment, and personnel. If training objectives do not require the use of all subordinates shown in a particular organization as it appears in the AFS, users can omit the subordinate units they do not need. Likewise, users can add other units to the baseline organization in order to create a task organization that is appropriate to training requirements. Users must ensure that the size and composition of the OPFOR is sufficient to meet training objectives and requirements. However, total assets organic to an organization or allocated to it from higher levels should not exceed that which is realistic and appropriate for the training scenario. Skewing the force ratio in either direction negates the value of training. Therefore, specific OBs derived from the organizational directories are subject to approval by the trainers' OPFOR-validating authority.

3-107. Some trainers and planners may be very proficient with MS Office®. For these people, the steps for converting an AFS baseline unit to a task-organized OPFOR are straightforward and simple. Once the units comprising the task-organization have been identified and the AFS baseline unit has been selected, the following sub-steps are then followed:

- **Step 9a.** Create folders in MS Windows Explorer® to accommodate the MS Word® and MS Excel® files copied and/or modified from those in the AFS directories using in the process explained below.
- **Step 9b.** Modify the organizational graphics in the MS Word® document using the inserted PowerPoint® graphic. Remove the units not needed in the task organization and add the new ones that are required. Re-insert the PowerPoint® graphic into the MS Word® document.
- **Step 9c.** Modify personnel and equipment charts. Even for those lower-level units that have only an MS Word® document in the AFS organizational directories, it is recommended to use an MS Excel® chart as a tool for rolling up personnel and equipment totals for the modified unit. Update the subordinate units at the tops of the columns on the Excel® spreadsheet page. Adjust all of the equipment numbers in appropriate rows, by unit columns. Once the new personnel and equipment numbers are updated in MS Excel®, transfer the appropriate numbers back to the basic Word® organizational document.
- **Step 9d.** Adjust equipment tiers, if necessary, to reflect different levels of modernity and capability (see chapter 4).
- **Step 9e.** Update folders and file paths to reflect the conversion from an AFS organization to a task-organized unit.

The task-organized detachment, BTG, DTG, or OSC is finished. For detailed instructions on performing Step 9 and its sub-steps, see appendix B.

## STEP 10. REPEAT STEPS 4 THROUGH 9 AS NECESSARY

3-108. Repeat Step 9 for as many task organizations as are required to perform the OPFOR countertasks. In each case, select a baseline AFS unit and modify it as necessary.

3-109. Training may reveal the need for the U.S. unit to train against other ARTs. If so, trainers and planners must repeat Steps 4 through 9.

**This page intentionally left blank.**

## Chapter 4

# Equipment Options

The administrative force structure (AFS) organizational directories provide example equipment types and the numbers of each type typically found in specific organizations. The purpose is to give trainers and training planners a good idea of what an OPFOR structure should look like. However, training requirements may dictate some modifications to this baseline. Therefore, training planners have several options by which they can modify equipment holdings to meet particular training requirements.

### BASELINE EQUIPMENT

4-1. For each organization in the OPFOR AFS, the online organizational directories list “Principal Items of Equipment” in the basic MS Word® document and/or list “Personnel and Items of Equipment” in an MS Excel® chart. (Figures 4-1 and 4-2 on pages 4-2 and 4-3 show the equipment list for a motorized infantry company in both formats.) In most cases, this equipment corresponds to Tier 2 in the tier tables of the *Worldwide Equipment Guide* (WEG) online. However, some elite units, such as Special-Purpose Forces, may have Tier 1 equipment. On the other hand, insurgent and guerrilla organizations typically have older, less capable equipment. (For more information on equipment tiers, see Equipment Tier Tables in the section on the WEG later in this chapter.)

---

**Note.** For illustrative purposes, this FM contains several examples from the online AFS organizational directories and the online WEG. Readers are reminded that even the baseline OPFOR organizations are subject to change over time. The equipment found in those organizations can also change. Therefore, readers should always consult the online directories for the latest, most up-to-date versions of organizational and equipment data. (See page 4-4 for a link to the online WEG.)

---

4-2. For larger units, equipment lists in the AFS directories take the form of an Excel® spreadsheet that provides a quick overview of the holdings for subordinate units and equipment totals for the unit as a whole. When the organization chart indicates multiple, identical units subordinate to a particular organization (using stacked blocks), the spreadsheet column for those particular subordinates indicates equipment totals already multiplied by the number of such units present. The heading with the subordinate unit name at the top of such a column indicates that multiplication by adding an annotation, for example “(x2)” or “x3,” after the name of the subordinate unit type.

---

**Note.** In a unit with multiple subordinates of the same type, one or more of these like subordinates may be augmented or decremented in different ways in the process of task-organizing. In such cases, users will need to replace this column in the spreadsheet with multiple columns reflecting the differences created.

---

4-3. Footnotes linked to the equipment nomenclature in the “Equipment” or “Personnel and Items of Equipment” column in equipment lists may serve one of two purposes. Sometimes, such a footnote indicates additional information about that piece of equipment or a possible substitute for it. In other cases, it may indicate possible variations in the quantity of that particular item of equipment.

## Infantry Company, Mtzd Inf Bn

### PRINCIPAL ITEMS OF EQUIPMENT

<u>Equipment</u>	<u>Total</u>	<u>Equipment</u>	<u>Total</u>
9-mm Pistol, PM .....	18	Truck, Medium .....	2
5.45-mm Assault Rifle, AK-74M .....	131	Trailer, Cargo, 1-Axle .....	2
5.45-mm Carbine, AKS-74U .....	21	Trailer, Cargo, 2-Axle .....	2
7.62-mm GP MG, PKM * .....	12	Trailer, Utility .....	7
7.62-mm Sniper Rifle, SVD * .....	11	Trailer, Water (1,200-Liter) .....	1
.50-cal Antimateriel Rifle, M82A1 * .....	2	Smoke Pots, Drums, Barrels, and Grenades .....	Assorted
12.7-mm HMG, NSV * .....	8	Aiming Circle/Goniometer .....	1
35-mm AGL-Light, W-87 * .....	9	Binocular Laser Rangefinder * .....	42
40-mm Grenade Launcher, GP-30 .....	30	GPS Receiver, Handheld .....	53
60-mm Mortar, Light, Type 90 * .....	3	Laser Target Designator ** .....	3
ATGM Launcher, Milan 3 ** .....	3	Observation Scope, Day/Night * or ** .....	2
ATGM Lchr, Manportable-SR, Eryx * .....	3	Radar, GSR, Manportable, Fara-1 .....	3
ATGL-Long Range, RPG-29 * .....	6	Thermal Viewer, Handheld, Sophie .....	14
ATGL, Panzerfaust 3-T600 * .....	9	Night-Vision Goggles .....	61
ATDL, Armbrust *** .....	9	Night-Vision Goggles (Driver) .....	12
ATDL, RPG-27 *** .....	4	Night-Vision Goggles (AK w/GP-30) .....	30
Flame Weapon, RPO-A Series .....	23	Night-Vision Sight (Aiming Circle) .....	1
Minefield Breaching System- Explosive Charge, ZRP-2 **** .....	3	Radios: Handheld, Very-Low-Power .....	48
Mine-Scattering System, Manportable, PKM .....	3	Manpack, Low-Power .....	6
Mines (AP&AT) ***/***** .....	Assorted	Vehicle Mount, Medium-Power .....	12
Tactical Utility Vehicle, UAZ-469 .....	7	Warning Receiver .....	1
Truck, Light .....	3		

\* With II night sight.

\*\* With thermal sight.

\*\*\* Issued as ammunition rather than a weapon– the BOI may vary.

\*\*\*\* No dedicated operator/BOI. It is carried until needed

\*\*\*\*\* Includes remotely detonated mines and side-attack (AT & anti-vehicle) mines.

Figure 4-1. Motorized Infantry Company Principal Items of Equipment List

<b>Motorized Infantry Company</b>					
<b>Personnel and Items of Equipment</b>	<b>Hq &amp; Service Section</b>	<b>Motorized Infantry Platoon X3*</b>	<b>Weapons Platoon</b>		<b>TOTAL</b>
<b>Personnel</b>					
Officers	2	3	1		<b>6</b>
NCO	2	27	14		<b>43</b>
Enlisted	8	99	25		<b>132</b>
<b>Total Personnel</b>	<b>12</b>	<b>129</b>	<b>40</b>		<b>181</b>
<b>Equipment</b>					
9-mm Pistol, PM		15	3		<b>18</b>
5.45-mm Assault Rifle, AK-74M	12	87	32		<b>131</b>
5.45-mm Carbine, AKS-74U		18	3		<b>21</b>
7.62-mm GP MG, PKM	3	9			<b>12</b>
7.62-mm Sniper Rifle, SVD		9	2		<b>11</b>
.50-cal Antimateriel Rifle, M82A1			2		<b>2</b>
12.7-mm HMG, NSV	2	3	3		<b>8</b>
35-mm AGL-Light, W-87		6	3		<b>9</b>
40-mm Grenade Launcher, GP-30	3	24	3		<b>30</b>
60-mm Mortar, Light, Type 90			3		<b>3</b>
ATGM Launcher, Milan 3			3		<b>3</b>
ATGM Lchr, Manportable-SR, Eryx		3			<b>3</b>
ATGL-Long Range, RPG-29		6			<b>6</b>
ATGL, Panzerfaust 3-T600		9			<b>9</b>
ATDL, Armbrust		9			<b>9</b>
ATDL, RPG-27	3		1		<b>4</b>
Flame Weapon, RPO-A Series	2	21			<b>23</b>
Minefield Breach System-Explosive ZRP-2	3				<b>3</b>
Mine-Scattering System, Manport, PKM	3				<b>3</b>
Mines (AP&AT)	Assort	Assort	Assort		<b>Assort</b>
Tactical Utility Vehicle, UAZ-469	2	3	2		<b>7</b>
Truck, Light	1		2		<b>3</b>
Truck, Medium	2				<b>2</b>
Trailer, Cargo, 1-Axle			2		<b>2</b>
Trailer, Cargo, 2-Axle	2				<b>2</b>
Trailer, Utility	2	3	2		<b>7</b>
Trailer, Water (1,200-Liter)	1				<b>1</b>
Smoke Pots, Drums, Barrels & Grenades	Assort				<b>Assort</b>
Aiming Circle/Goniometer			1		<b>1</b>
Binocular Laser Rangefinder	2	27	13		<b>42</b>
GPS Receiver, Handheld	5	30	18		<b>53</b>
Laser Target Designator	1		2		<b>3</b>
Observation Scope, Day/Night			2		<b>2</b>
Radar, GSR, Manportable, Fara-1			3		<b>3</b>
Thermal Viewer, Handheld, Sophie	1	6	7		<b>14</b>
Night-Vision Goggles	1	30	30		<b>61</b>
Night-Vision Goggles (Driver)	5	3	4		<b>12</b>
Night-Vision Goggles (AK w/GP-30)	3	24	3		<b>30</b>
Night-Vision Sight (Aiming Circle)			1		<b>1</b>
<b>Radios:</b>					
Handheld, Very-Low-Power	3	30	15		<b>48</b>
Manpack, Low-Power	1	3	2		<b>6</b>
Vehicle Mount, Medium-Power	5	3	4		<b>12</b>
Warning Receiver	1				<b>1</b>
<b>NOTES:</b>					
* The values in this column are the total number for three platoons.					
** This company may be augmented by high-mobility/all-terrain vehicles.					
Page 1					

Figure 4-2. Motorized Infantry Company Personnel and Equipment Chart

4-4. The OPFOR order of battle (OB) must meet the training requirements, based on the menu of possible organizational parts provided in the directories. If a particular piece of equipment is not appropriate for a specific scenario, trainers may substitute another system according to the guidelines in the WEG. However, such substitutions are subject to approval by the trainers' OPFOR-validating authority. Training planners should exercise caution in modifying equipment holdings, since this impacts on an OPFOR unit's organizational integrity and combat capabilities.

### WORLDWIDE EQUIPMENT GUIDE

4-5. The *Worldwide Equipment Guide* (WEG) is accessible online by means of the following link to the TRADOC ADCSINT-Threats portal on the Battle Command Knowledge System (BCKS): <https://dcsint-threats.leavenworth.army.mil/COE/default.aspx>; then click on "COE," then on "Worldwide Equipment Guide." Alternatively, users can click here on the following link: [Worldwide Equipment Guide](#). Access to BCKS requires use of Army Knowledge Online (AKO) user name and password. If the user is already logged into AKO (by user name and password or by Common Access Card login), no further login may be necessary.

4-6. The WEG directories consist of three volumes: Volume 1, Ground Systems; Volume 2, Airspace and Air Defense; and Volume 3, Naval and Littoral Systems. These directories are maintained and continuously updated, as necessary, by the Deputy Chief of Staff for Intelligence, U.S. Army Training and Doctrine Command (TRADOC DCSINT). The TRADOC DCSINT is designated as "the responsible official for the development, management, administration, integration, and approval functions of the OPFOR Program across the Army" (Army Regulation 350-2).

### EQUIPMENT DATA

4-7. The WEG contains technical data on the capabilities of systems identified as "Principal Items of Equipment" in the AFS organizational directories and/or in the equipment tier tables or substitution matrices of the WEG. On the following three pages are examples of the kind of information the WEG provides. The three systems chosen as examples are highly capable in today's operational environments. They are widely proliferated and are likely to be encountered by U.S. forces in real-world areas of conflict. Therefore, they are good candidates for inclusion in OPFOR OBs used in training that is realistic and relevant for the COE.

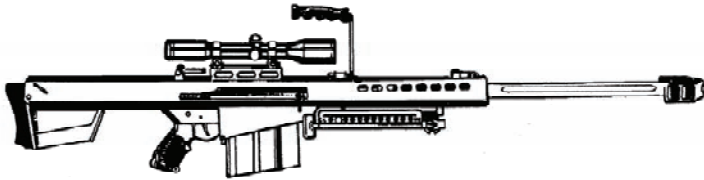

**United States M82A1A .50-cal Antimateriel Rifle**

	<p><b>Ammunition Types</b></p> <p><b>.50-cal cartridge</b>                  Raufoss Grade A                  Ball (M2/M33)                  AP (M2)                  AP-I (M8)                  API-T (M20)                  Tracer (M10/21)                  SLAP (M903)                  MP (MK211 Mod 0)</p>	<p><b>Typical Combat Load</b></p> <p>30</p>
<p><b>SYSTEM</b></p> <p><b>Alternative Designations:</b> None  <b>Date of Introduction:</b> Early 1980s  <b>Proliferation:</b> Widespread (27+)</p> <p><b>Description:</b>                  Weight (kg):                      Empty (w/o magazine): 14.75                  Length (mm):                      Overall: 1,448                      Barrel: 736                  Rate of Fire (rd/min): 20                  Operation: Recoil                  Feed: 10-rd detachable box magazine                  Fire Mode: Semi-automatic only</p> <p><b>SIGHTS</b></p> <p><b>Name:</b> Unertl                  Type: Optical (matches trajectory of .50-cal Raufoss Grade A)                  Magnification: 10x</p> <p><b>Name:</b> Swarovski                  Type: Optical (with ranging reticle)                  Magnification: 10x42  <b>Night Sights Available:</b> yes</p> <p><b>AMMUNITION</b></p> <p><b>Name:</b> Raufoss Grade A (match)(DODIC A606) (USMC)                  Caliber/length: .50-cal BMG/12.7-mm x 99-mm (NATO)                  Type: Standard operating round                  Range (m) (equipment-size targets):                      Maximum (w/scope): 1,800                  Muzzle Velocity (m/s): 854</p> <p><b>Name:</b> MP NM140 (Nammo) MK211 Mod 0                  Caliber/length: .50-cal BMG/12.7-mm x 99-mm (NATO)                  Type: Multipurpose                  Range (m) (equipment-size targets):                      Maximum (w/scope): 1,800                  Armor Penetration: 11 mm @45° @1,000 m                  Fragmentation: 20 fragments after hitting 2 mm steel                  Incendiary Effect: Ignition of JP4 and JP8                  Accuracy: &lt;15 cm @ 550 m                  Muzzle Velocity (m/s): 915</p>	<p><b>Name:</b> AP-S NM173 (Nammo)                  Caliber/length: .50-cal BMG/12.7-mm x 99-mm (NATO)                  Type: Armor piercing                  Range (m) (equipment-size targets):                      Maximum (w/scope): 1,800                  Armor Penetration: 11 mm @30° @1,500 m                  Accuracy: &lt;15 cm @ 550 m                  Muzzle Velocity (m/s): 915</p> <p><b>Name:</b> M903 (Olin)                  Caliber/length: .50-cal BMG/12.7-mm x 99-mm (NATO)                  Type: Saboted Light Armor Penetrator (SLAP) (actual bullet is tungsten .30 inch penetrator wrapped in a .50-cal plastic sabot)                  Range (m) (equipment-size targets):                      Maximum (w/scope): 1,500                  Armor Penetration: 19 mm (.75 in) @1,500 m                  Accuracy: INA                  Muzzle Velocity (m/s): 1,014</p> <p><b>Name:</b> M8                  Caliber/length: .50-cal BMG/12.7-mm x 99-mm (NATO)                  Type: Armor piercing incendiary                  Range (m) (equipment-size targets):                      Maximum (w/scope): 1,800                  Armor Penetration: 20 mm @ 100 m                  Accuracy: &lt;25 cm @ 550 m                  Muzzle Velocity (m/s): 881</p> <p><b>Name:</b> M20                  Caliber/length: .50-cal BMG/12.7-mm x 99-mm (NATO)                  Type: Armor piercing incendiary-Tracer                  Trace (m): 91 to 1,463                  Armor Penetration: 20 mm @ 100 m                  Accuracy: &lt;25 cm @ 550 m                  Muzzle Velocity (m/s): 887</p> <p><b>VARIANTS</b></p> <p><b>Model 95:</b> Bullpup bolt action, 5-round magazine</p>	

**NOTES**

The M82A1A provides maneuver commanders with the tactical option of employing snipers with an antimateriel weapon to augment present 7.62-mm antipersonnel sniper rifles. Recoil equals 7.62x51-mm levels. The USMC uses Raufoss Grade A ammunition, but the rifle is capable of firing any standard 12.7x99-mm Browning machinegun ammunition.

## Russian 105-mm Antitank Grenade Launcher RPG-29

	Ammunition Types	Typical Combat Load
	<p>105-mm grenade HEAT (tandem)</p> <p>HE thermobaric</p>	<p>3</p> <p>As needed</p>

**SYSTEM**

**Alternative Designations:** Vampir

**Date of Introduction:** Late 1980s

**Proliferation:** Former Soviet Union

**Description:**

Crew: 2  
 Caliber (tube) (mm): 105  
 Weight (w/o sight) (kg): 11.5  
 Length (transport) (mm): 1,000  
 Length (firing) (mm): 1,850  
 Life of Tube/barrel: 300  
 Rate of Fire (rd/min): INA  
 Fire From Inside Building: INA  
 Maximum Target Speed (km/h): INA  
 Emplacement/displacement time (min): <0.25

**SIGHTS**

**Daysight:**

Name: 1P-38  
 Type: Iron, optical, and LRF-based FCS  
 Magnification: INA  
 Location: Left side  
 Sighting Range (m): 500  
 Weight (kg): .6

Name: Simrad IS2000 or similar sight for RPG-29 Mounted  
 Type: LRF-based FCS with ballistic computer  
 Magnification: INA  
 Location: Left side  
 Sighting Range (m): 800 m for this mount  
 Weight (kg): INA

**Night Sight:**

Name: 1PN51, 1PN52 standard RPG-29 or RPG-29N  
 Type: II sight  
 Weight (kg): 2.1  
 Name: KN250F or similar sight for RPG-29 Mounted  
 Type: 3 gen II clip-on sight designed to work with daysight  
 Magnification: 1 X  
 Location: Left side  
 Sighting Range (m): 600-800 for vehicle targets, 300+ man  
 Weight (kg): INA

**AMMUNITION**

**Name:** PG-29V  
**Caliber (warhead):** 105  
**Type:** Tandem HEAT (shaped charge)  
**Range (m):**  
 Effective: 500m, 800 for RPG-29 mounted (used by OPFOR)  
**Penetration (m):**  
 Armor: 750 + (650 behind ERA)  
 Concrete and brick: 1.5 +  
 Brick: 2 +  
 Earth: 3.7 +  
**Length (mm):** INA  
**Complete Round Weight (kg):** 6.7  
**Muzzle Velocity (m/s):** 280

**Other Ammunition:** A multipurpose HE thermobaric grenade is also used. Blast effects are the same as the TBG-7V.

**VARIANTS**

**RPG-29N:** Night sight only variant

**RPG-29 Mounted:** For use as a mounted crew-served system. This variant can fit on a vehicle with a pintle mount, or be dismounted to a tripod ground mount. The RPG-29 Mounted variant has a fire control system with an optical sight, laser rangefinder and ballistic data computer for increased range and precision. This increases the *effective range of the mounted system to 800 m* against a stationary target with a hit probability of 80%. The system can fire at all (including moving) to its maximum range, even with a reduced Ph. This variant would be expected to include HE in its mix of grenades. For Tier 1 and Tier 2 COE OPFOR, **RPG-9 Mounted** is the crew weapon in Weapons Squads and other supporting tactical units. In later time frame, this system or equivalent could become the standard squad ATGL for maneuver forces.

**RPG-32/Hashim:** New Russian/Jordanian ATGL to launch RPG-29V and HE thermobaric grenades. The launcher base is a short tube extension with optics and trigger assembly, which attach to the the grenade canister, resulting in a shoulder-launcher with up to 700 m range. Grenades come two per carry case. This is another example of an expanding AT trend of fitting large lethal warheads onto ATGLs. Another example fitting canister on launcher base is PF-98 (pg 1-34).

**NOTES**

The RPG-29 replaces SPG-9 as an all-purpose small unit artillery against the gamut of targets, including vehicles, personnel, buildings, and any other direct-fire targets within range - including helicopters.

The RPG-29 can be broken down into two parts for one soldier carry. It can be made ready to fire within a few seconds. A folding bipod is provided to assist aiming during prone firing. RPG-27, PG-7VR for RPG-7V, and RPG-32/Hashim use the same (PG-29V) warhead.

## British High Velocity Missile System Starstreak

	<p align="center"><b>Weapons &amp; Ammunition Types</b></p> <p>Ready missiles</p>	<p align="center"><b>Typical Combat Load</b></p> <p align="center">Dismount 3 Team in Vehicle 5</p>
<p><b>SYSTEM</b>  <b>Alternative Designation:</b> Shoulder-Launched (SL) Starstreak  <b>Date of Introduction:</b> 2000 (1997 for vehicle mount)  <b>Proliferation:</b> At least 6 countries  <b>Target:</b> FW, heli  <b>Description: (SL configuration)</b>  System: Consists of launcher and canistered missiles  Crew: 2 with a loader (one possible)</p> <p><b>ARMAMENT</b>  <b>Launcher</b>  Name: Aiming Unit  System Dimensions:  Length: 1.4 m with missile  Diameter: 274 mm  System Weight (kg): 24.3 with missile  Reaction Time (sec): &lt;6  Time Between Launches (sec): &lt;30 sec  Reload Time (sec): &lt;25 sec est  Fire on the Move: Yes, in short halt</p> <p><b>Missile</b>  Name: Starstreak. Canistered missile includes a booster, a 2nd stage propelled missile body, and three separating guided darts.  Range (m):  Max. Range: 6,000-7,000  Min. Range: 300 (guided)  Altitude (m):  Max. Altitude: 5,000  Min. Altitude: 0  Dimensions (mm):  Length: 1400  Diameter: 127  Missile Speed: 1,364 m/s, Mach 4</p>	<p>Propulsion: 2-stage missile, eject, guided flight to target for darts  Flight Time to max range (sec): 5  Guidance: SACLOS Laser beam rider  Warhead Type: Three darts, each with a 25-mm rod and Frag-HE liner  Penetration (mm): 120+ all LAVs  Fuze Type: Contact with time delay.  Delayed blast then follows penetrator  Probability of Hit (Ph%): 60 FW, 80 heli  Self-Destruct (sec): Yes, INA</p> <p><b>FIRE CONTROL</b>  <b>Sights w/Magnification:</b>  Day sight: Avimo stabilized optical sight with lead bias system  Field of View (°): INA  Acquisition Range (m): 7000+</p> <p>Night sight: Thales clip-on thermal sight  Acquisition Range (km): 4-5 est</p> <p><b>Other Acquisition Aides:</b>  ADAD: British passive thermal IR scanners on remote tripod or vehicle mount with 240° FOV automatic cueing system.</p> <p>Missile team employs an azimuth plotting board, such as the Russian 1L15-1 azimuth plotting board, to provide direction of approach for aerial targets (see WEG pg 5-18).</p> <p><b>VARIANTS</b>  <b>Lightweight Multiple Launcher (LML):</b>  Pedestal launcher on a tripod, with brackets for three launch canisters. The</p>	<p>launcher can also be mounted on a light vehicle, such as a TUV. A demonstrator uses the LML on a Panhard tactical truck.</p> <p><b>Armored Starstreak or (SP HVM):</b> Vehicle is a Stormer tracked APC chassis, with an 8-missile launcher. The passive IR fire control system uses ADAD, an auto-tracker and thermal sight for high-volume SHORAD support. It was successfully tested against light armored vehicle (LAV) targets. The launcher can be mounted on other vehicles.</p> <p><b>Starstreak Lightweight Vehicle (LWV):</b> British Land Rover truck converted into an SP SAM launcher system with a 6-canister launcher, ADAD auto-tracker, and TV/thermal FCS. Launcher can be mounted on other vehicles.</p> <p><b>Seastreak:</b> Single-stage missile naval variant in a 12-missile launcher, with mm-wave radar FCS.</p> <p><b>Helstreak or Air-to-air Starstreak (ATASK):</b>  Apache helicopter launch conversion program.</p> <p><b>Starburst:</b> British Javelin missile system converted to use Starstreak laser beam-rider guidance. This variant is in production with conversions underway.</p> <p><b>Optional Use:</b> As an air defense/anti-armor (multi-role) system. Starstreak can be employed against ground targets, such as light armored vehicles, and snipers in bunkers or buildings. The missile and its darts, with a unique combination of penetrator and following Frag-HE, have been successfully tested against vehicle targets. With a missile cost of 1/2 to 1/3 of competing MANPADS, the system could be used as a fire support asset to complement ATGM launchers and vehicle weapons.</p>

**NOTES**

Ground-based air defense weapon system optimized for use against armored helicopters and low flying high-performance aircraft. Missile employs smokeless propellant for minimal signature. Coupled with minimum flight time and LBR guidance, the system is essentially immune to countermeasures other than obscurants. Because of the high velocity, the system exceeds the hit probability of competing systems against high-speed aircraft on receding flight paths.

The Starstreak's lower cost and capabilities as a multi-role missile system could justify employment other than straight substitution. A consideration is the SACLOS guidance, which makes it less effective against agile fixed-wing aircraft from some aspects. Therefore, a better arrangement would be to replace a portion (33-50%) of the MANPADS. Given the lower cost of Starstreak and its multi-role capability, it could replace a portion of the expensive MANPADS with more Starstreaks for more lethality at lower cost. For instance, an 18-MANPADS battery could be reduced 33% to 12 MANPADS while adding 12 Starstreaks, with the latter used as a multi-role system. With 50% of the MANPADS replaced, the mix would be 9 MANPADS and 18 Starstreaks. Such a substitution would be based on the expected adversary weapons mix.

## EQUIPMENT TIER TABLES

4-8. The WEG contains Tier Tables for the various categories of equipment found in OPFOR organizations. Training planners can employ these tables to adjust the level of capabilities of equipment from the baseline shown in the AFS organizational directories. Within each functional category of equipment, there are four tiers representing different levels of capability, with Tier 1 representing the highest level of capability and modernity.

---

*Note.* *Niche systems* and *niche technology upgrades* provide capabilities that exceed the general capability level of the overall force. For example, a Tier 3 force might have a few systems from Tier 1 or 2. Applying a niche technology upgrade to one or more subsystems of a Tier 2 legacy system could raise its level of capability to the equivalent of a Tier 1 system. (See the sections on Equipment Upgrades and Emerging Technology Trends later in this chapter.)

---

4-9. **Tier 1** reflects systems across the different functional areas that a major military force with state-of-the-art technology would generally have. At Tier 1, new or upgraded systems are limited to those robust systems fielded in military forces or currently developed and marketed for sale, with capabilities and vulnerabilities that can be portrayed for training.

4-10. **Tier 2** reflects modern competitive systems fielded in significant numbers for the last 10 to 20 years, with limitations or vulnerabilities being diminished by available upgrades. Although forces are equipped for operations in all terrains and can fight day and night, their capability in range and speed for several key systems may be somewhat inferior to U.S. capability.

4-11. **Tier 3** systems date back generally 30 to 40 years. They have limitations in all three subsystems categories: mobility, survivability, and lethality. Systems and force integration are inferior. However, guns, missiles, and munitions can still challenge vulnerabilities of U.S. forces. Niche upgrades can provide synergistic and adaptive increases in force effectiveness.

4-12. **Tier 4** systems reflect 40- to 50-year-old systems, some of which have been upgraded numerous times. These represent equipment typically found in forces of Third World or smaller developed countries. Use of effective strategy, adaptive tactics, niche technologies, and terrain limitations could enable a Tier 4 OPFOR to challenge the effectiveness of a U.S. force in achieving its goals. This tier includes militia, guerrillas, special police, and other forces.

4-13. To achieve specific training objectives, trainers and training planners can substitute other equipment for those items listed in the baseline. Equipment tier tables and substitution matrices list alternative systems with varying levels of capability and modernity. The baseline systems, as well as those listed in tier tables and substitution matrices, are built in large numbers and proliferated throughout the world. (That is part of the criteria for their inclusion in the WEG.) Thus, the country of origin or an actual country possessing such systems does not necessarily pose a threat to the United States. However, these widely used systems provide an OPFOR with capabilities that could present a challenge in U.S. Army training.

4-14. Table 4-1 provides a sample of systems listed in the Tier Tables (from volume 1 of the WEG). This example is based on the assessment of tiers in 2006.

4-15. OPFOR organizations and equipment must support the entire spectrum of COE training scenarios for the U.S. Army. The contemporary OPFOR, as described in the FM 7-100 series, represents rational and adaptive adversaries, and offers flexibility for use in training applications and scenarios for U.S. training. The main part of the WEG deals with systems that are widely proliferated in the current timeframe. Lists of equipment on the Tier Tables offer convenient baseline examples arranged in capability tiers for use in composing OPFOR equipment arrays for training scenarios. Each volume of the WEG also has a chapter on Emerging Technology Trends. Tables in those chapters offer an extended capabilities tier for the near and mid-term.

**Table 4-1. Equipment Tier Table (Example)**

	<b>Tier 1</b>	<b>Tier 2</b>	<b>Tier 3</b>	<b>Tier 4</b>
Main Battle Tank	T-90S	T-72B (Improved)	Chieftain	T-55AM
Amphibious Tank	Type 63AModernized	Type 63AM	M1985	PT-76B
Tracked HACV	2S25	AMX-10 PAC 90	AMX-13	M41A3
Wheeled HACV	AMX-10RC Desert Storm	AMX-10RC	EE-9	EE-9
Towed Light Howitzer	D-30	D-30	D-30	D-30
Towed Medium How/Gun	G5	2A65	2A36	D-20
Self-Propelled Howitzer	G6, AU-F1T	G6, 2S19	2S3M	2S1
Multiple Rkt Launcher	Prima	Prima	BM-21	Type 63
Heavy MRL	9A52-2	9A52-2	9P140	Fadjr-3
1-Round Rkt Launcher	9P132	9P132	9P132	9P132
Amphibious SP How	2S1	2S1	2S1	2S1

4-16. The Tier Tables were developed in order to portray systems for adversaries with differing budgetary levels and force capabilities. Systems in a tier reflect more or less comparable levels of modernity, for use with a force at that level of capability. Each tier provides an equivalent level of modernization for systems across different functional areas. The tier tables are also another tool for OPFOR customers to use to alter systems in simulations to reflect different levels of modernity. One can find an item of equipment at Tier 2 in the baseline equipment list for a given OPFOR organization, note its counterpart at a higher or lower tier, and then substitute to build the same unit (for example, division, brigade, battalion) for a different tier. The key to using the tables is to know the tier capability of the initial organizations.

4-17. An OPFOR OB should contain a mix of systems that realistically vary in fielded age and generation. Given the modern reality of budget constraints on military spending, the WEG authors have tempered depiction of new, expensive systems to a fraction of any force. The more common modernization approach within the higher tiers is to upgrade existing systems.

4-18. The Tier Tables are less concerned with systems' age than realistically reflecting a capability to be addressed in training. Not all systems and functional areas have to be modernized equally or simultaneously. The OPFOR may have one system 10 to 20 years older than others in a functional area. In a given time frame, military forces often will emphasize upgrades in one functional area while modernizing or maintaining lower tier levels in other functional areas.

4-19. Some systems are used in common in lower and higher tiers. For instance, because of the need for improved anti-armor, air defense, and precision artillery munitions, these capabilities are shared across several tier levels. Older 4x4 tactical utility vehicles that are 30 to 40 years old still offer effective support capability, and may extend across three tier levels. Common use of some OPFOR systems also reduces the database maintenance requirement.

4-20. No force in the world has all of its systems at the most modern tier. Even the best force in the world has a mix of state-of-the-art (Tier 1) systems, as well as mature (Tier 2), and somewhat dated (Tier 3) legacy systems. Much of the latter systems have been upgraded to some degree, but may exhibit the limitations of their original state of technology. Even modern systems recently purchased may be

considerably less than state-of-the-art, due to limited military budgets and limited user training and maintenance capabilities. Thus, even new systems may not exhibit Tier 1 or Tier 2 capability. As forces later field systems with emerging technologies, legacy systems may be more suitable for employment in certain conditions, or they may be upgraded and continue to be competitive. Adversaries with lower-tier systems can use adaptive technologies and tactics, or obtain niche technology systems to challenge the advantages of a modern force.

4-21. A major emphasis in the COE is flexibility in use of forces and in doctrine. This also means that the OPFOR, given rational and justifiable force development methodology, has the flexibility to adapt the systems mix to support doctrine and plans. The tiers provide the baseline list for determining the force mix, based on scenario criteria. The OPFOR compensates for capability limitations by using innovative and adaptive tactics, techniques, and procedures (TTP). Some of these limitations may be caused by the lack of sophisticated equipment or integration capability, or by insufficient numbers. Forces can be tailored, in accordance with OPFOR doctrine, to form tactical groups and other task organizations.

### SYSTEMS SUBSTITUTION MATRICES

4-22. In each volume of the WEG, a Systems Substitution Matrix table provides comparative data for users who would like to substitute other systems for OPFOR systems listed in the baseline organizational directories. For each system, the table shows the system name, its tier level, and the WEG page on which data for that system begins. Within each functional area, systems are displayed in groups (with spaces separating the groups) of systems of like type that could be substituted for one another. Within each group, the system shown in *italics* is the one listed in FM 7-100.4 as the baseline system (normally Tier 2) in some OPFOR organization. Within each grouping by type, most systems are listed in tier order, and can be substituted to fit scenario requirements. Some systems span the boundary between two tiers (for example, “3-4”). Other systems can be used at more than one tier (for example, “3 and 4”). Table 4-2 provides a sample from the Systems Substitution Matrix in volume 1 of the WEG. Tiers shown in this example are based on the assessment of tiers in 2006.

4-23. Trainers also should keep in mind that substitutions of major weapon systems may also affect the types and numbers of supporting and related systems. For example—

- A towed artillery system needs an appropriate prime mover vehicle.
- Some air defense systems need radars that are not on the weapon platform.
- An under-barrel grenade launcher needs to be compatible with the assault rifle on which it is mounted.
- A mortar system may need an aiming circle/goniometer.

4-24. Within each functional category of equipment, there are four tiers representing different levels of capability, with Tier 1 representing the highest level of capability and modernity. Not all tiers of a given system category may be represented in the WEG.

### EQUIPMENT UPGRADES

4-25. An OPFOR force developer has the option to make selective adjustments such as use of niche technology upgrades (for example, in tanks, cruise missiles, or rotary-wing aircraft) to offset U.S. advantages. (See the Equipment Upgrades chapter in each volume of the WEG). Forces may include niche systems that exceed the general capability level of the overall force. For example, a Tier 3 force might have a few systems from Tier 1 or 2. As the “current” timeframe shifts each year, more systems from higher tiers could be expected to be added to the force. The WEG authors will always be ready to assist a developer in selecting niche systems and upgrades for use in OPFOR portrayal. The scenario developer should be cognizant of the need to justify changes and systems selected. With savvy use of TTP and systems available, all tiers can offer challenging OPFOR capabilities for training.

Table 4-2. Systems Substitution Matrix (Example)

	Tier	Page		Tier	Page
<b>Armored Personnel Carriers</b>			<b>Main Battle Tanks</b>		
<i>BTR-80A</i> .....	2	2-15	<i>T-72B/T-72B (Improved)</i> .....	2	4-23
BTR-90 .....	1-2	2-16	Challenger 2 .....	1	4-5
BTR-T Heavy APC .....	1-2	2-19	T-90M .....	1	4-33
BTR-80 .....	3	2-14	T-90S .....	1	4-31
Pandur .....	3	2-23	T-80U .....	1-2	4-29
WZ 551A .....	3	2-25	Chieftain Mk 5 .....	2-3	4-7
VTT-323 .....	3-4	2-24	Leopard 2 .....	2-3	4-11
BTR-60PB .....	3-4	2-13	T-64B .....	2-3	4-21
BTR-D Airborne APC .....	3-4	2-18	T-80B .....	2-3	4-27
M113A1 .....	3-4	2-21	Type 96 .....	2-3	4-39
YW 531H/Type 85 .....	3-4	2-27	T-72M1 .....	3	4-25
BOV-M .....	4	2-10	AMX-30 .....	3-4	4-3
BTR-152 .....	4	2-17	Leopard 1A1 .....	3-4	4-9
BTR-60PA .....	4	2-11	M60A1/M60A3 .....	3-4	4-13
MT-LB .....	4	2-22	T-55AMV .....	3-4	4-17
YW 531A/531C/Type 63-II .....	4	2-26	T-62M .....	3-4	4-19
			Type 59-II .....	4	4-37
			T-34 .....	4	4-15
<b>Infantry Fighting Vehicles</b>			<b>Heavy Armored Combat Vehicles</b>		
<i>BMP-2M Modernized</i> .....	2	2-39	<i>2S25 Self-Propelled AT Gun</i> .....	1-2	5-9
BMP-3M IFV .....	Near Term	2-43	<i>Type 63A Mod Amphibious Tank</i> .....	1-2	5-21
BMP-3 UAE IFV .....	1	2-41	<i>AMX-10RC Armored Recon Veh</i> .....	2-3	5-12
Kliver IFV Turret .....	1	2-49	AMX-10 PAC90 Fire Support Veh .....	3	5-11
BMD-3 Airborne .....	2	2-31	EE-9 Armored Recon Veh .....	3	5-14
Marder 1IFV .....	2-3	2-45	M1985/PT-85 Light Tank .....	3	5-17
Warrior IFV .....	2-3	2-47	AMX-13 Light Tank .....	3-4	5-13
AMX-10P IFV .....	3	2-28	Scorpion Trkd Combat Recon Veh .....	3-4	5-20
BMP-2 IFV .....	3	2-37	M41A3 Walker Light Tank .....	4	5-16
BMP-1P IFV .....	3-4	2-35	M36 SP AT Gun .....	4	5-15
BMD-1/BMD-1P Airborne .....	4	2-29	PT-76B Amphibious Tank .....	4	5-19
BMP-1 IFV .....	4	2-33			

4-26. Upgrades enable military forces to employ technological niches to tailor their force against a specific adversary, or to integrate niche upgrades in a comprehensive and well-planned modernization program. Because of the competitive export market and varying requirements from country to country, a system may be in production simultaneously in many different configurations, as well as variants fulfilling other roles. In light of this trend, OPFOR equipment selected for portrayal in training simulations should not be limited to the original production model of a system. Rather, training planners should select a version of the system that reflects the OPFOR's overall strategy and modernization plans and likely constraints that would apply.

4-27. An adaptive OPFOR will introduce new combat systems and employ upgrades on existing systems to attain a force structure that supports its plans and doctrine. Because the legacy force mix was selected in accordance with earlier plans and options, the use of upgrades will always be an attractive option, compared to costly new acquisitions. Equipment Upgrade chapters in the WEG consider only upgrades currently available (or marketed with production and fielding expected in the near term) for systems in Tiers 1 through 4. However, the WEG's Emerging Technology Trends chapters anticipate a wider variety of upgrades that could be applied to currently fielded systems.

## EMERGING TECHNOLOGY TRENDS

4-28. The equipment data and Tier Tables in the WEG reflect legacy systems that are fielded and available to various forces worldwide at the time the latest version of the WEG directories is posted on BCKS. As time passes, new systems and whole new technologies will be fielded and available to the OPFOR. (See the Emerging Technology Trends chapter in each volume of the WEG.)

4-29. The most notable difference between the OPFOR force mix and that of U.S. forces is that the OPFOR would typically have a broader mix of older systems and a lower proportion of state-of-the-art systems. Rather, the OPFOR typically relies more on adaptive applications, niche technologies, and selected proven upgrades. The OPFOR will retain expensive legacy systems, but with affordable upgrades and technology niches. A judicious mix of equipment, strategic advantages, and sound OPFOR principles can enable even lesser (lower-tier) forces to challenge the capabilities of U.S. forces.

4-30. OPFOR systems must represent reasonable responses to U.S. force developments and developments in other countries. A rational, thinking OPFOR would study force developments of its adversaries, as well as approaches of the best forces worldwide, then attempt to exploit and counter them. For instance, U.S. Future Combat System technologies would trigger the OPFOR to modify equipment and tactics to counter them. Given economic constraints, the OPFOR has the option of incrementally adding higher-tier systems to lower-tier units, as selective upgrades. However, it might also upgrade legacy systems with subsystem technology upgrades in order to keep pace with state-of-the-art systems fielded by U.S. forces or possibly by its regional neighbors.



## Appendix A

# Administrative Force Structure Organizational Directories Listing

The organizational directories of the OPFOR administrative force structure (AFS) are contained in four volumes on the Battle Command Knowledge System (BCKS). The folders and unit files in these directories serve as the menu for OPFOR baseline units. The OPFOR organizational directories are continually updated on the BCKS. Therefore, the listing below is dynamic. Although the list of OPFOR units in the directories might change over time, the basic architecture of the menu remains. The basic organizational directory listing is as follows:

---

**Note.** The organizations in these directories do not constitute an OPFOR order of battle (OB). However, trainers and training planners can use these organizational building blocks to construct an OPFOR OB that is appropriate for their training requirements. To do so, it will often be necessary to create task organizations from the available building blocks. It may also be necessary to substitute different pieces of equipment for those listed for units in the organizational directories.

**Note.** For illustrative purposes, this FM contains several examples from the online AFS organizational directories. **Readers are reminded that even the baseline OPFOR organizations are subject to change over time.** Additional units will be added and existing units will be modified and updated, as necessary, to represent contemporary and emerging capabilities. Therefore, readers should always consult the online directories for the latest, most up-to-date versions of organizational data.

---

## VOLUME I – DIVISIONS AND DIVISIONAL UNITS

### 01 Mechanized Infantry Division (IFV) (the architecture for all divisions is similar)

#### 01 Mechanized Infantry Division

- 01 Mechanized Infantry Division (IFV).doc
- 02 Mechanized Infantry Division (IFV) Equipment.xls

#### 02 Division Headquarters and Staff

- 01 Division Headquarters and Staff.doc

### 03 Integrated Fires Command (IFC)/Integrated Support Command (ISC)

- 01 Integrated Fires Command Headquarters.doc
- 02 Integrated Fires Command Structure.ppt
- 03 Integrated Support Command Headquarters.doc
- 04 Integrated Support Command Structure.ppt

### 04 Mechanized Infantry Brigade (IFV) (X3)

- 01 Mechanized Infantry Brigade.doc
- 01A Mechanized Infantry Brigade (IFV).doc
- 01B Mechanized Infantry Brigade (IFV) Equipment.xls
- 02 Brigade Headquarters and Staff.doc
- 03 Mechanized Infantry Battalion (IFV).doc
- 03A Mechanized Infantry Battalion (IFV).xls
- 04 Tank Battalion (31-Tank).doc
- 04A Tank Battalion (31-Tank) Equipment.xls
- 05 Self-Propelled Artillery Battalion (18-gun).doc

- 05A Self-Propelled Artillery Battalion 152-mm.xls
- 06 Air Defense Battalion (Short-Range).doc
- 06A Air Defense Battalion (Short-Range).xls
- 07 Antitank Battalion, Brigade (Div).doc
- 08 Reconnaissance Company.doc
- 09 Sniper Platoon.doc
- 10 Engineer Company.doc
- 11 Signal Company.doc
- 12 Materiel Support Company.doc
- 13 Maintenance Company.doc
- 14 Chemical Defense Platoon.doc
- 15 Medical Platoon.doc
- 05 Tank Brigade (Div)**
  - 01 Tank Brigade.doc
  - 01A Tank Brigade Equipment.doc
  - 01B Tank Brigade (Div) Equipment.xls
  - 02 Brigade Headquarters and Staff.doc
  - 03 Mechanized Infantry Battalion (IFV)
  - 04 Tank Battalion (31-Tank).doc
  - 04A Tank Battalion (31-Tank).xls
  - 05 Self-Propelled Artillery Battalion (18-gun) (152-mm).doc
  - 05A Self-Propelled Artillery Battalion (18-gun) (152-mm).xls
  - 06 Air Defense Battalion (Short-Range).doc
  - 06A Air Defense Battalion (Short-Range).xls
  - 07 (not used)
  - 08 Reconnaissance Company.doc
  - 09 (not used)
  - 10 Engineer Company.doc
  - 11 Signal Company.doc
  - 12 Materiel Support Company.doc
  - 13 Maintenance Company.doc
  - 14 Chemical Defense Platoon.doc
  - 15 Medical Platoon.doc
- 06 Self-Propelled Artillery Brigade**
  - 01 Self-Propelled Artillery Brigade Equip.doc
  - 02 Brigade Headquarters and Staff.doc
  - 02A Self-Propelled Artillery Brigade Equipment.xls
  - 03 Self-Propelled Artillery Battalion (152-mm) (18-gun).doc
  - 03A Self-Propelled Artillery Battalion (152-mm) Equipment.xls
  - 04 Multiple Rocket Launcher Battalion (122-mm) (18-Launcher).doc
  - 04A Multiple Rocket Launcher Battalion (122-mm) (18-Launcher).xls
  - 05 Target Acquisition Battery.doc
  - 06 MANPADS Platoon.doc
  - 07 Materiel Support Battalion.doc
  - 07A Materiel Support Battalion.xls
  - 07B Ammunition Transport Company.xls
  - 07C Cargo Transport Company.xls
  - 08 Maintenance Company.doc
  - 09 Signal Company.doc
  - 10 Chemical Defense Platoon.doc
  - 11 Medical Platoon.doc
- 07 Air Defense Brigade (Short-Range)**
  - 01 Air Defense Brigade (Short-Range).doc
  - 02 Air Defense Brigade (Short-Range) Equipment.xls

**08 Materiel Support Brigade (Div)**

- 01 Materiel Support Brigade.doc
- 01A Materiel Support Brigade.xls
- 02 Brigade Headquarters and Staff.doc
- 03A Materiel Support Battalion.doc
- 03B Materiel Support Battalion Equipment.xls
- 03D Cargo Transport Company.xls
- 04A Maintenance Battalion.doc
- 04B Maintenance Battalion.xls
- 04C Tracked Vehicle Maintenance Company.xls
- 04E Wheeled Vehicle Maintenance Company.xls
- 05A Heavy Equipment Transport Battalion.doc
- 05B Heavy Equipment Transport Battalion Equipment.xls
- 05C Heavy Equipment Transport Company.xls
- 06A POL Transport Battalion.doc
- 06B POL Battalion Equipment.xls
- 06C POL Company Equipment.xls
- 07 (not used)
- 08 Signal Platoon.doc
- 09 Chemical Defense Platoon.doc

**09 Antitank Battalion**

- 01 Antitank Battalion (Sep).doc
- 02 Antitank Battalion (Sep) Equipment.xls

**10 Reconnaissance Battalion**

- 01 Reconnaissance Battalion (Div).doc
- 02 Reconnaissance Battalion Equipment.xls

**11 Sniper Company**

- 01 Sniper Company.doc
- 02 Sniper Company Equipment.xls

**12 Engineer Battalion**

- 01 Engineer Battalion.doc
- 02 Engineer Battalion Equipment.xls

**13 Signal Battalion**

- 01 Signal Battalion.doc
- 02 Signal Battalion.xls

**14 Chemical Defense Battalion**

- 01 Chemical Defense Battalion.doc
- 02 Chemical Defense Battalion Equipment.xls
- 03 Decontamination Company Equipment.xls

**15 Medical Battalion**

- 01 Medical Battalion.doc
- 02 Medical Battalion Equipment.xls
- 03 Medical Company Equipment.xls
- 03A Collection and Evacuation Company Equipment.xls

**02 Mechanized Infantry Division (APC)** (see AFS, BCKS for complete listing)

**03 Tank Division** (see AFS, BCKS for complete listing)

**04 Motorized Infantry Division** (see AFS, BCKS for complete listing)

---

*Note.* The organizational directory architecture for the Mechanized Infantry Division (APC), the Tank Division, and the Motorized Infantry Division is similar to that shown above for the Mechanized Infantry Division (IFV).

---

## VOLUME II – NONDIVISIONAL UNITS\*

### 01 Separate Combat Brigades

#### 01 Separate Mechanized Infantry Brigade (IFV) (typical breakout)

- 01 Separate Mechanized Infantry Brigade (IFV).doc
- 01A Separate Mechanized Infantry Brigade (IFV)
- 02 Brigade Headquarters and Staff.doc
- 03 Mechanized Infantry Battalion (IFV).doc
- 03A Mechanized Infantry Battalion (IFV) Equipment.xls
- 04 Tank (41-Tank) (Sep).doc
- 04A Tank Battalion (Sep) Equipment.xls
- 04B Light Tank Battalion (Sep) Equipment.xls
- 05 Composite Artillery Battalion (Sep).doc
- 05A Composite Artillery Battalion (Sep) Equipment.xls
- 06 Antitank Battalion (Sep).doc
- 06A Antitank Battalion, (Sep) Equipment.xls
- 07 Reconnaissance Battalion (Sep).doc
- 07A Reconnaissance Battalion (Sep) Equipment.xls
- 08 Sniper Platoon.doc
- 09 Air Defense Battalion (Short-Range) (Sep).doc
- 09A Air Defense Battalion (Short-Range) (Sep) Equipment.xls
- 10 Engineer Battalion (Sep).doc
- 10A Engineer Battalion (Sep) Equipment.xls
- 11A Materiel Support Battalion.doc
- 11B Materiel Support Battalion Equipment.xls
- 11C Ammunition Transport Company Equipment.xls
- 11D Cargo Transport Company Equipment.xls
- 12A Maintenance Battalion.doc
- 12B Maintenance Battalion Equipment.xls
- 12C Tracked Vehicle Maintenance Company Equipment.xls
- 12D Wheeled Vehicle Maintenance Company Equipment.xls
- 12E Ordnance Maintenance Company Equipment.xls
- 13 Signal Company (Sep).doc
- 14 Chemical Defense Company (Sep).doc
- 14A Chemical Defense Company (Sep) Equipment.xls
- 15 Medical Company (Sep).doc
- 15A Medical Company (Sep) Equipment.xls
- 02 Separate Mechanized Infantry Brigade (APC) (see AFS, BCKS for complete listing)
- 03 Separate Tank Brigade (see AFS, BCKS for complete listing)
- 04 Separate Motorized Infantry Brigade (see AFS, BCKS for complete listing)

### 02 Combat Brigades (Nondivisional)

#### 01 Special-Purpose Forces (SPF) Brigade

- 01A Special-Purpose Forces Brigade.doc
- 01B Special-Purpose Forces Brigade Equipment.xls
- 02 Brigade Headquarters Staff.doc
- 03A Special-Purpose Forces Battalion.doc
- 03B Special-Purpose Forces Battalion Equipment.xls
- 03C Special-Purpose Forces Company Equipment.xls
- 04A Long-Range Signal Company (SPF).doc
- 04B Long-Range Signal Equipment (SPF).xls
- 05A Materiel Support (SPF).doc
- 05B Materiel Support Company (SPF) Equipment.xls
- 06 Medical Platoon (SPF).doc

**02 Multiple Rocket Launcher (MRL) Brigade (Nondivisional)**

- 01 MRL Brigade (Nondiv).doc
- 01A MRL Brigade (Nondiv) Equipment.xls
- 02 Brigade Headquarters and Staff.doc
- 03A MRL Battalion (220-mm) (18-launcher).doc
- 03B MRL Battalion (220-mm) (18-launcher) Equipment.xls
- 04A MRL Battalion (300-mm) (12-launcher).doc
- 04B MRL Battalion (300-mm) (12-launcher) Equipment.xls
- 05 Target Acquisition Battery.doc
- 06 MANPADS Platoon (APC).doc
- 07A Materiel Support Battalion.doc
- 07B Materiel Support Battalion Equipment.xls
- 07C Ammunition Transport Company Equipment.xls
- 07D Cargo Transport Company Equipment.xls
- 08 Maintenance Company, Wheeled.doc
- 09 Signal Company (Sep).doc
- 10 Chemical Defense Platoon.doc
- 11 Medical Platoon.doc

**03 Combat Support Units (Nondivisional)**

**01 Smoke Battalion (Nondiv)**

- 01 Smoke Battalion (Nondiv).doc
- 02 Smoke Battalion Equipment.xls
- 02A Smoke Company Equipment.xls

**04 Combat Service Support Units (Nondivisional)**

**01 Materiel Support Brigade (Nondivisional)**

- 01 Materiel Support Brigade (Nondiv).doc
- 01A Materiel Support Brigade (Nondiv) Equipment.xls
- 02 Brigade Headquarters and Staff.doc
- 03A Materiel Support Battalion.doc
- 03B Materiel Support Battalion Equipment.xls
- 03C Ammunition Transport Company Equipment.xls
- 03D Cargo Transport Company Equipment.xls
- 04A Maintenance Battalion.doc
- 04B Maintenance Battalion Equipment.xls
- 04C Tracked Vehicle Maintenance Company Equipment.xls
- 04D Wheeled Vehicle Maintenance Company Equipment.xls
- 04E Ordnance Maintenance Company Equipment.xls
- 05A HET Battalion.doc
- 05B HET Battalion Equipment.xls
- 05C HET Transport Company Equipment.xls
- 06A POL Transport Battalion.doc
- 06B POL Transport Battalion Equipment.xls
- 07A Mobile Security Battalion (Nondiv).doc
- 07B Mobile Security Battalion (Nondiv) Equip.xls
- 08 Signal Platoon.doc
- 09 Chemical Defense Platoon.doc
- 10 Medical Platoon.doc

---

*\*Note.* The Other Nondivisional Units in volume IV are temporary low-resolution placeholders for units not yet described in the format and detail afforded nondivisional units in volume II. Over time, those organizations will be fleshed out in higher resolution and added to volume II.

---

## VOLUME III – PARAMILITARY AND NONMILITARY ACTORS

Paramilitary and nonmilitary-chart.ppt

### 01 Combatants

#### 01 Armed Combatants

01 Armed Combatants.doc

#### 01 Insurgent Organizations

##### 01 Local Insurgent Organization

01A Local Insurgent Organization.doc

01B Local Insurgent Organization Equipment.xls

01C Direct Action Cells-insurgents-Equipment.xls

01D Direct Action Cells-multifunction-Equipment.xls

01E Technical Support Cell Equipment.xls

##### 02 Higher Insurgent Organizations (Regional, National, Transnational)

02A Higher Insurgent Organization.doc

02B Higher Insurgent Organization Equipment.xls

#### 02 Guerrilla Brigade

##### 01 Guerrilla Brigade, Headquarters and Staff

01A Guerrilla Brigade.doc

01B Brigade Headquarters and Staff.doc

01C Guerrilla Brigade Equipment.xls

01D Brigade Headquarters Equipment.xls

01E Command Group and Staff Equipment.xls

01F Command Section Equipment.xls

01G Staff Section Equipment.xls

##### 02 Guerrilla Battalion

01 Guerrilla Battalion.doc

02A Guerrilla Battalion Equipment.xls

03A Hunter/Killer Company Equipment.xls

03B Headquarters Command Sect Equipment.xls

03C Hunter/Killer Group Equipment.xls

03D Hunter/Killer Section 1,2,3 Equipment.xls

03E Hunter/Killer Section 4 Equipment.xls

04A Guerrilla Company Equipment.xls

04B Headquarters Service Section Equipment.xls

04C Guerrilla Platoon Equipment.xls

04D Weapons Platoon Equipment.xls

05 Weapons Company Equipment.xls

##### 03 Weapons Battalion

01 Weapons Battalion.doc

01A Weapons Battalion Equipment.xls

02A Towed Mortar Battery (120-mm).doc

02B Towed Mortar Battery (120-mm) Equipment.xls

03A Rocket Launcher Battery (107-mm and 122-mm).doc

03B Rocket Launcher Battery (107-mm & 122-mm) Equipment.xls

04A Antitank Battery.doc

04B Antitank Battery Equipment.xls

05A Transport Section.doc

##### 04 Reconnaissance Company

01A Reconnaissance Company.doc

01B Reconnaissance Company Equipment.xls

01C Intelligence/Electronic Warfare Platoon Equipment.xls

**05 Sapper Company**

01A Sapper Company.doc

01B Sapper Company Equipment.xls

**06 Transport Company**

01 Transport Company.doc

**07 Signal Platoon**

01 Signal Platoon.doc

**08 Medical Platoon**

01 Medical Platoon.doc

**02 Unarmed Combatants**

01 Unarmed Combatants.doc

**02 Noncombatants**

**01 Armed Noncombatants**

Personal Security Force.doc

**01 Unarmed Noncombatants**

Unarmed Noncombatants.doc

**VOLUME IV – OTHER**

**01 Glossary**

**02 Brigade Tactical Group (Motorized) (Antiarmor-Light), Example OPFOR Task-Organization**

**03 Other Nondivisional Units\***

---

*\*Note.* The Other Nondivisional Units in volume IV are temporary low-resolution placeholders for units not yet described in the format and detail afforded other nondivisional units in volume II. Over time, these organizations will be fleshed out in higher resolution and added to volume II.

---

**This page intentionally left blank.**



## Appendix B

# Building an OPFOR Task Organization

Chapter 3 describes the process of task-organizing for combat and its role in matching the appropriate OPFOR task organization to the training objectives of the unit to be trained. This appendix explains in more detail how trainers and training planners modify an OPFOR organization from the administrative force structure (AFS) listed in the organizational directories on the Battle Command Knowledge System (BCKS) into an OPFOR task organization for countering the tasks listed in FM 7-15, Army Universal Task List (AUTL). For illustrative purposes, the appendix describes a particular example based on hypothetical tasks and OPFOR countertasks. Then, it provides detailed guidance on how to task-organize OPFOR units from the bottom up.

---

*Note.* All of the OPFOR organizations listed in the AFS organizational directories on BCKS are constructed using Microsoft Office 2000® or Microsoft Office 2003® software (MS Word®, MS PowerPoint®, and MS Excel®). The use of these commonly available tools should allow trainers and planners to tailor and/or task-organize units individually or collectively to meet specific training and/or simulation requirements. Most trainers and simulations personnel have MS Office® software available and a basic knowledge of its use. The following instructions enable a trainer with only a basic knowledge of MS Office® (MS Word®, MS PowerPoint®, and MS Excel®) to build a task-organized structure using available software.

*Note.* For illustrative purposes, this FM contains several examples from the online AFS organizational directories. Readers are reminded that even the baseline OPFOR organizations are subject to change over time. Therefore, readers should always consult the online directories for the latest, most up-to-date versions of organizational data.

---

## TASK ORGANIZATION EXAMPLE

B-1. The last part of chapter 3 outlines nine steps in the process of creating the properly task-organized OPFOR for an exercise. The first part of this appendix provides more detailed guidance, based on an example. This example covers all nine steps. However, it concentrates on Step 9—how to modify a standard OPFOR baseline unit (selected from the AFS) to become a new, task-organized OPFOR unit.

### STEPS 1 THROUGH 3. SELECT TRAINING UNITS AND TASKS

B-2. For this example, it is assumed that the senior commander (commander of the U.S. unit to be trained) identified the units he wants trained in selected tasks. In this example, the training units consist of a lightly armored force of two brigade-size units. The commander's primary training objective is to conduct an assault and sustained combat to destroy an OPFOR brigade defending in complex terrain. His secondary training objective is to restore and maintain civil order.

B-3. The U.S. commander (senior trainer) also has reviewed FM 7-15, Army Universal Task List (AUTL) and has determined the specific tactical collective tasks on which he wants to train his unit. The specific Army Tactical Tasks (ARTs) selected from the AUTL are—

- ART 5.1.1 Overcome Barriers/Obstacles/Mines

- ART 8.1.2 Conduct an Attack
- ART 8.1.3 Exploitation
- ART 8.3.1.2 Conduct Peace Enforcement Operations
- ART 8.3.2.3 Conduct Combat Operations in Support of Foreign Internal Defense (Counter Insurgents and Terrorists)
- ART 8.3.7 Combat Terrorism

B-4. Thus, the U.S. commander (senior trainer) has completed the Steps 1 through 3 of the process outlined at the end of chapter 3, which define the scope and purpose of the training exercise. Now the training planners know that the enemy of the OPFOR (the training unit) is lightly armored, mobile, and lethal, and consists of at least two or more brigade-level units. The training commander has determined the level and types of units he wants trained and the specific tasks on which he wants them trained. This sets the stage for Steps 4 through 9, which determine the kind of OPFOR needed to produce the desired training. The entire process results in building the appropriate OPFOR order of battle (OB), which must provide appropriate organizations capable of countering (stressing) those tasks selected from the AUTL.

### **STEP 4. SELECT OPFOR COUNTERTASKS**

B-5. The mission of the OPFOR is to counter the training unit, with capabilities that challenge the training unit's ability to accomplish its tasks. In this case, the training unit's mission is to attack and destroy the OPFOR. Therefore, the OPFOR's mission is to prevent the training unit (enemy) from destroying the OPFOR and, if possible, destroy attacking enemy. The OPFOR could accomplish this by defending with light, mobile forces in complex terrain and perhaps employing guerrilla warfare tactics. The training commander has also selected a task to restore civil order. One way of countering this task is for the OPFOR to possess an organization capable of providing or instigating civil disorder to stress the training. The commander also wants to train against ART 8.3.7 (Combat Terrorism). One way to counter this task is for the OPFOR to include insurgents using terror tactics.

### **STEP 5. DETERMINE THE TYPE AND SIZE OF OPFOR UNITS**

B-6. Next, trainers and planners determine the appropriate type and size OPFOR units capable of performing the OPFOR countertasks and conducting persistent fights on several levels. For the maneuver fight, defending against two brigade-size U.S. units, the OPFOR needs a brigade-size organization. The optimal OPFOR organization for conducting such a defense in complex terrain would include relatively light, motorized infantry, perhaps some even lighter guerrilla forces, and preferably some mechanized infantry, combined with an antiarmor capability against lightly armored U.S. forces. Such a mix of forces would entail the use of a brigade tactical group (BTG) task organization. In addition, a local insurgent force can provide the training unit with an opportunity to combat terrorism.

#### **Motorized Infantry Forces**

B-7. The OPFOR organizations determined to best counter (stress) the ARTs consist of a BTG based on a motorized infantry brigade, with an antiarmor capability against lightly armored forces to counter the maneuver fight, and an affiliated local insurgent organization to counter ART 8.3.7, Combat Terrorism. The BTG also can have guerrilla and special-purposes forces subordinate to it.

#### **Guerrilla Forces**

B-8. The BTG could include a guerrilla battalion to provide a wider training spectrum and a realistic training experience that reflects the COE. Guerrilla warfare is one of many threats that exist in the COE, but it does not necessarily occur in isolation from other threats. While guerrilla organizations can be completely independent of a parent insurgent organization, they are often either a part of the overall insurgency or affiliated with the insurgent groups. Guerrilla units can also be subordinate to a larger, more conventional force. For purposes of illustration and simplicity, in this example case, the guerrilla battalion is subordinated to the larger conventional maneuver force, the BTG. The guerrillas are a Tier 3 and 4

organization. (Equipment tiering is discussed in chapter 4.) The inclusion of guerrillas provides countertasks to the following ARTs—

- ART 8.3.1.2 Conduct Peace Enforcement Operations
- ART 8.3.2.3 Conduct Combat Operations in Support of Foreign Internal Defense (Counter Insurgents and Terrorists)

For details on the guerrilla hunter/killer company and the personnel and equipment list for the guerrilla battalion, see appendix E.

**Special-Purpose Forces**

B-9. Special-Purpose Forces (SPF) can bring another dimension to the training environment. Therefore, the BTG could integrate an SPF company and an SPF deep attack/reconnaissance platoon integrated into its task organization. The SPF units are a Tier 1 (modern) force multiplier providing a completely different level and style of OPFOR countertasks to the fight. While SPF units can also be independent of maneuver forces on the battlefield, and generally are, they can also be subordinate to a maneuver organization. For simplicity, this example has the SPF units subordinate to a parent maneuver organization—the BTG. The inclusion of the SPF provides countertasks to the following ARTs—

- ART 8.3.1.2 Conduct Peace Enforcement Operations
- ART 8.3.2.3 Conduct Combat Operations in support of Foreign Internal Defense (Counter Insurgents and Terrorists)

**Insurgent Forces**

B-10. Insurgent forces can provide an OPFOR countertask capability to ART 8.3.7 (Combat Terrorism). A typical insurgent organization also provides the OPFOR with an information warfare (IW) capability to stress ART 7.10.3 (Maintain Community Relations), which is an implied task inherent to several selected ARTs. Even a local insurgent organization provides a wide spectrum of insurgent capabilities. It is complete with direct action cells, IW cells, improvised explosive devices (IEDs), IED factories, suicide bombers, and even weapons of mass destruction. The relationship between the BTG and the local insurgent organization, in this example, is one of loose affiliation, rather than subordination.

**Overall OPFOR Organization**

B-11. In this example case, the appropriate OPFOR required to meet the commander’s training requirements consists of two parts: the **Brigade Tactical Group (Motorized) (Antiarmor-Light)** and an **affiliated Local Insurgent Organization**. See figure B-1.

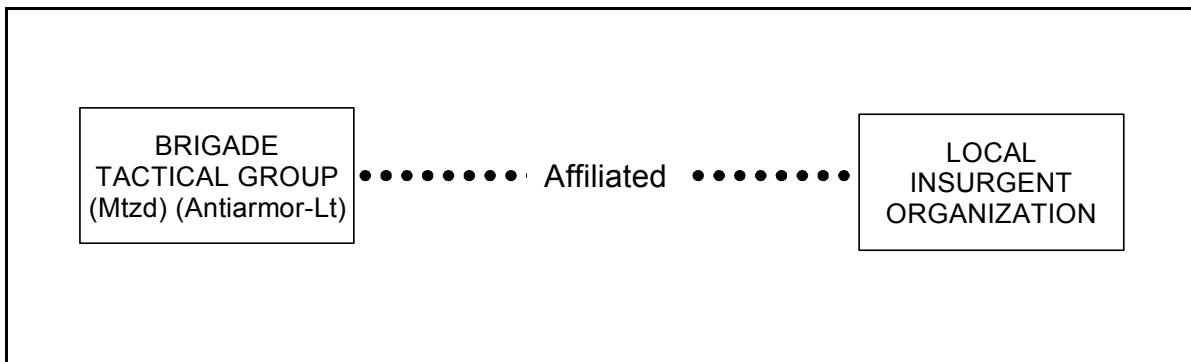

**Figure B-1. Basic Task-Organized OPFOR (Example)**

**STEP 6. REVIEW THE AFS ORGANIZATIONAL DIRECTORIES**

B-12. The trainers and planners review the list of units in the OPFOR organizational directories on BCKS to determine what kinds and sizes of units are available in the AFS. At this point, the purpose is only to review the menu of options available.

**STEP 7. COMPILING THE INITIAL LISTING OF OPFOR UNITS FOR THE TASK ORGANIZATION**

B-13. From the AFS menu, trainers and planners compile an initial listing of OPFOR units for the task organization (see table B-1). At this point, the purpose is only to identify the units available, without concern for any higher-level command to which they are subordinate in the AFS.

**Table B-1. Initial Listing of OPFOR Units Required for Task Organization**

BTG Headquarters	SPF Deep Attack/Recon Platoon
Motorized Infantry Battalion (x2)	Air Defense Battalion (Motorized)
Mechanized Infantry Battalion (APC)	Engineer Battalion
Guerrilla Battalion (Hunter/Killer)	Materiel Support Battalion
Antitank Battalion	Maintenance Battalion (APC/Motorized)
Artillery Battalion	Signal Company
Reconnaissance Battalion (Motorized)	Chemical Defense Company
SPF Company	Medical Company
Sniper Company	

**STEP 8. IDENTIFY THE BASE UNIT**

B-14. Trainers and planners again review the OPFOR organizational directories to determine which standard OPFOR unit most closely matches the OPFOR units in the initial task organization list. This OPFOR unit will become the “base” unit to which modifications are made, converting it into a task organization.

**Separate Motorized Infantry Brigade**

B-15. For the main maneuver force, the leading candidate seems to be a motorized infantry brigade, of which the organizational directories show two types: divisional and separate. Of the two, the separate motorized infantry brigade has a much more robust antiarmor capability, with an antitank battalion of the type normally found in a division. As a base unit, this brigade can easily accommodate guerrillas and SPF into its task organization to meet training requirements.

B-16. Once training planners have determined the OPFOR units they need to be part of the task organization, they review the AFS organizational directories and select that OPFOR unit most closely representing the combination of units identified in the initial list for the task organization. In this example case, the OPFOR separate motorized infantry brigade in the AFS organizational directories most closely matches the task-organized requirement. To prepare for the task-organizing process, the separate motorized infantry brigade was extracted, exactly as it is posted, from the AFS organizational directories (see figure B-2). This AFS brigade will serve as the base (core) that will be modified and built upon to create the task-organized **Brigade Tactical Group (Motorized) (Antiarmor-Light)** seen in figure B-5 on page B-12. Some units originally subordinate to the separate motorized brigade will be transferred out of the base structure, since they are not needed. Meanwhile, other units that were not part of the base unit will be added in order to provide additional capabilities that are required. From the OPFOR perspective, higher headquarters determines where these units are allocated to or from. If the next higher headquarters does not have a subordinate unit that it can allocate for the task organization, it passes the requirement to (or through) its next higher headquarters until the appropriate unit can be allocated.

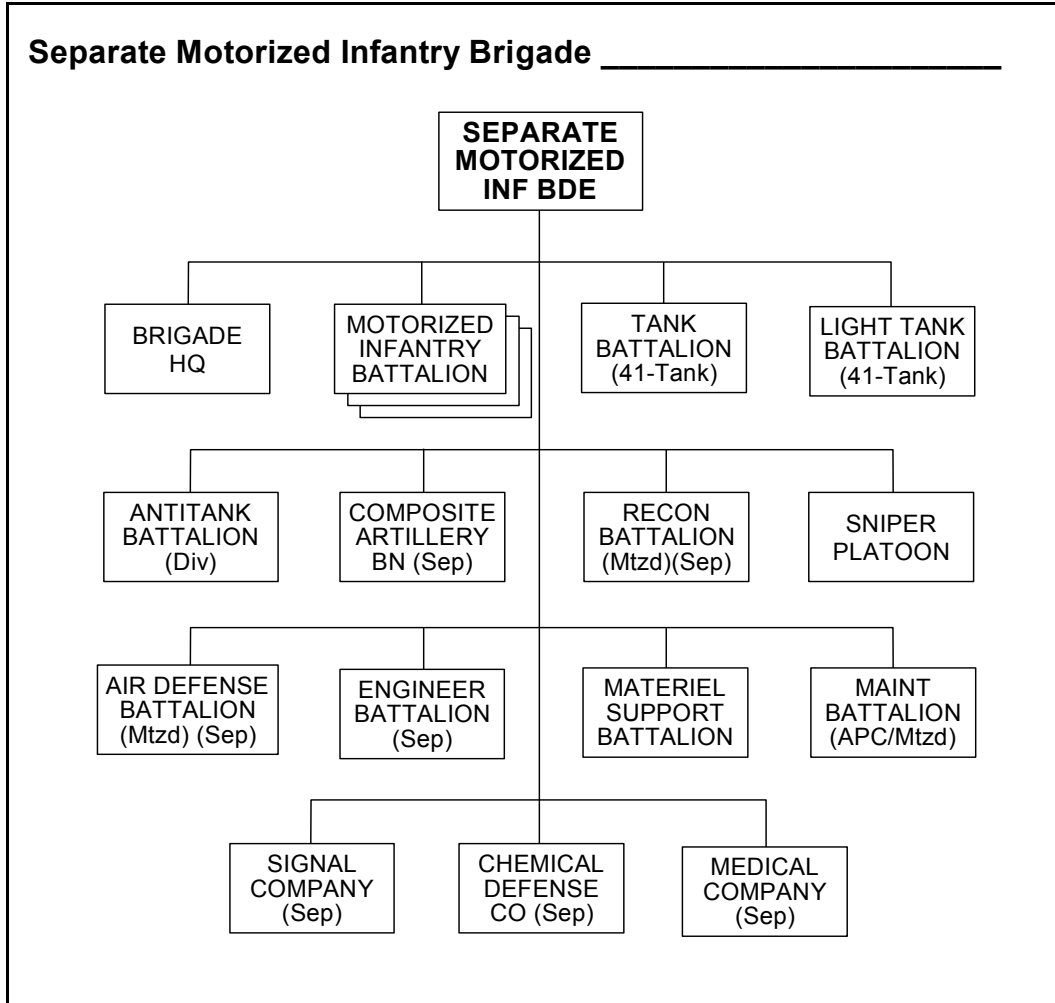

**Figure B-2. Separate Motorized Infantry Brigade from AFS to Use as a Baseline Unit**

B-17. The separate motorized infantry brigade already contains many of the units required for the BTG (Mtzd) (Antiarmor-Lt) task organization. The task-organizing process has determined that the BTG consists of the specific units listed in table B-2.

**Table B-2. Specific Units Required for BTG Task Organization**

BTG Headquarters (based on Bde HQ)	SPF Deep Attack/Recon Platoon
Motorized Infantry Battalion (x2)	Air Defense Battalion (Motorized)
Mechanized Infantry Battalion (APC)	Engineer Battalion (Sep)
Guerrilla Battalion (Hunter/Killer)	Materiel Support Battalion
Antitank Battalion (Div)	Maintenance Battalion (APC/Motorized)
Composite Artillery Battalion (Sep)	Signal Company (Sep)
Reconnaissance Battalion (Motorized) (Sep)	Chemical Defense Company (Sep)
SPF Company	Medical Company (Sep)
Sniper Company	

*Note.* For simplicity, all of the units forming the BTG task organization in this example are constituent to the BTG. The local insurgent group is affiliated with the BTG, but it is not part of the BTG. For additional information on command relationships see chapter 3. Also see chapter 2 for an explanation of the “(Div)” and “(Sep)” designations following the names of some units (usually battalions or companies) in the AFS.

*Note.* In this example, again for the sake of simplicity, none of the battalions or companies in the BTG have been task-organized into detachments. In reality, such task-organizing of subordinate units could very well be required in order to produce the right challenge to the training unit’s METL. In that case, training planners creating the OPFOR order of battle (OB) would have to start from the bottom up—first creating the necessary task organizations at the lowest levels of organization and then rolling them up into the personnel and equipment totals for the overall task organization. For example, rather than exchanging its original sniper platoon for a sniper company, the brigade becoming a BTG could have received a standard sniper company and then added its own sniper platoon to that company to create an augmented company-size detachment (CDET). See the Building from the Bottom Up section later in this appendix.

---

### Local Insurgent Organization

B-18. The AFS organizational directories include a “typical” local insurgent organization. (See figure B-3.) This baseline organization shows the various types of cells often found in insurgent organizations. However, the dashed boxes in the organizational chart indicate possible variations in the numbers of cells of each type that might be present in a particular insurgent organization. These cell types represent the various functions that can contribute to the OPFOR countertasks in this example.

### Noncombatants

B-19. This task organization does not include all the players in the COE or even on the battlefield. At a minimum, other players include armed and unarmed noncombatants. They are an integral part of the operational environment and cannot be excluded. Examples of common types of noncombatants can also be found in the organizational directories. The types, behaviors, and impact of such noncombatants are discussed in detail in FM 7-100.3.

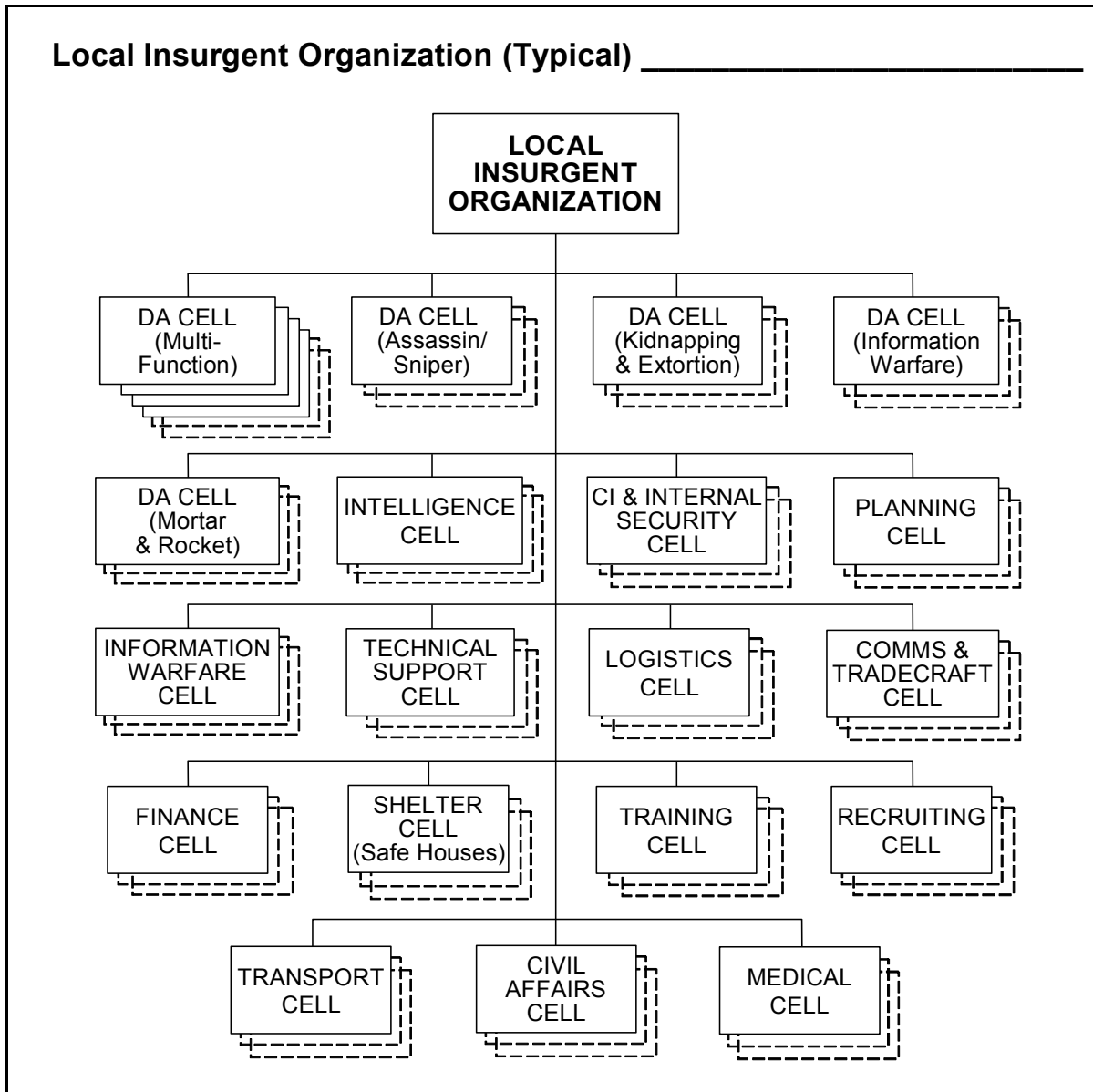

**Figure B-3. Local Insurgent Organization from AFS to Use as a Baseline Unit**

### STEP 9. CONSTRUCT THE TASK-ORGANIZED BTG

B-20. There are several differences between the final task-organized BTG (Mtzd) (Antiarmor-Lt) and the AFS separate motorized infantry brigade. Not all units originally subordinate to a standard separate motorized infantry brigade will be needed to complete the task organization, while additional units will be added to provide countertasks to the selected ARTs. Higher headquarters will allocate or re-allocate units depending on their need in the task-organized unit. In this task-organizing process, the AFS separate motorized infantry brigade—

- Loses the two tank battalions. Transferred back to higher headquarters and possibly allocated to another task organization.
- Loses one motorized infantry battalion. Transferred back to higher and possibly allocated to another task organization.

B-21. The task-organized BTG—

- Gains a mechanized infantry battalion (APC) in lieu of the one motorized infantry battalion. This battalion was allocated from a mechanized infantry brigade subordinate to the same higher headquarters.
- Gains a guerrilla battalion (hunter/killer). This battalion was probably subordinate to an insurgent organization operating in the area but, by mutual agreement between the higher headquarters of the guerrilla battalion and that of the BTG, has been made subordinate to the BTG only for the duration of the mission for which this task organization was created.
- Gains an SPF company. This company, originally part of a larger SPF organization, was allocated through higher headquarters.
- Upgrades from a sniper platoon to a sniper company. The upgrade was allocated by higher headquarters from a division that is also subordinate to the same higher headquarters. In turn, that division might receive the sniper platoon that was originally part of the separate motorized infantry brigade.
- Gains an SPF deep attack/reconnaissance platoon. This platoon was originally part of a larger SPF organization and was allocated through higher headquarters.

### Summarized Sub-Steps of Step 9

B-22. Some trainers and planners may be very proficient with MS Office®. For these people, the steps for converting an AFS baseline unit to a task-organized OPFOR are straightforward and simple. Once the units comprising the task-organization have been identified and the AFS baseline unit has been selected, the following sub-steps are then followed:

- **Step 9a.** Create folders in MS Windows Explorer® to accommodate the MS Word® and MS Excel® files copied and/or modified from those in the AFS directories using in the process explained below.
- **Step 9b.** Modify the organizational graphics in the MS Word® document using the inserted PowerPoint® graphic. Remove the units not needed in the task organization and add the new ones that are required. Re-insert the PowerPoint® graphic into the MS Word® document.
- **Step 9c.** Modify personnel and equipment charts. Even for those lower-level units that have only an MS Word® document in the AFS organizational directories, it is recommended to use an MS Excel® chart as a tool for rolling up personnel and equipment totals for the modified unit. Update the subordinate units at the tops of the columns on the Excel® spreadsheet page. Adjust all of the equipment numbers in appropriate rows, by unit columns. Once the new personnel and equipment numbers are updated in MS Excel®, transfer the appropriate numbers back to the basic Word® organizational document.
- **Step 9d.** Adjust equipment tiers, if necessary, to reflect different levels of modernity and capability (see chapter 4).
- **Step 9e.** Update folders and file paths to reflect the conversion from an AFS organization to a task-organized unit.

The task-organized detachment, BTG, DTG, or OSC is finished. If there are any questions on the steps outlined above, see the detailed instructions directly below in this appendix.

### Step 9a. Create Folders

B-23. A preliminary step before beginning to actually build the OPFOR task organization is for trainers to create folders in MS Windows Explorer® to accommodate the MS Word® and MS Excel® files they will copy and/or modify from those in the AFS directories using in the process explained below. The use of a sequential numbering of folders and files (see the arrangement in the AFS organizational directories) ensures the units are presented in the proper sequence when accessed in Windows Explorer®. This method has proven by far to be the simplest when dealing with a large number of documents, many with similar



titles. Figure B-4 shows the folders that will be required for creating the BTG (Mtzd) (Antiarmor-Light) and the Local Insurgent Organization.

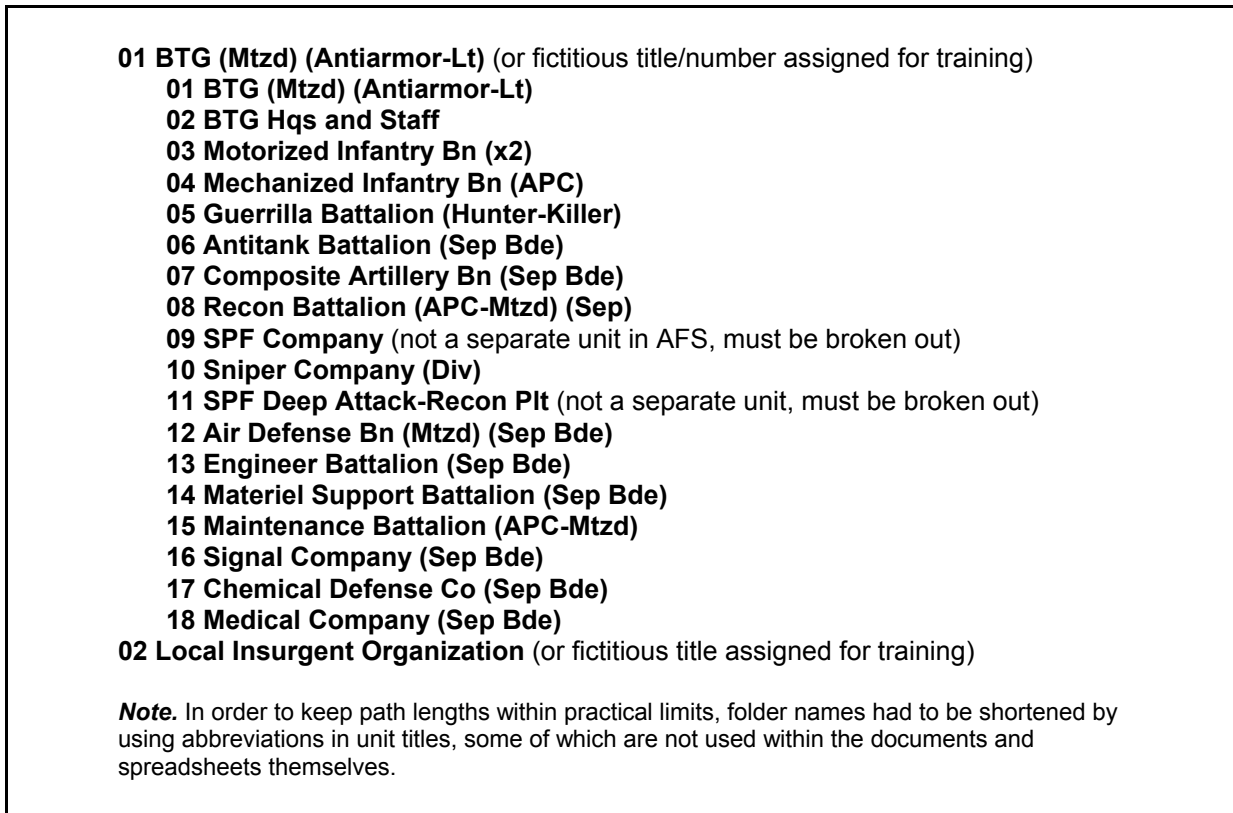

**Figure B-4. Folders for Task Organization**

**Step 9b. Modify Organizational Graphics into a Task-Organized OPFOR Unit**

B-24. The organizational graphics in the AFS are built using either MS Office 2000® or MS Office 2003®. Therefore, the modifications should be made using similar software. The graphics are built in MS PowerPoint® and then inserted into the MS Word® document. Figure B-2 on page B-5 shows the organization used as the baseline for modification in this example. Figure B-5 on page B-12 shows the finished task-organized unit. The following paragraphs walk through the process of making the changes in PowerPoint® and then re-inserting the finished organizational graphic back into the MS Word® document.

B-25. There are several steps to modifying an existing MS PowerPoint® graphic and reinserting it into the MS Word® document. None of these steps is difficult, but most are sequential. These steps apply only to MS Word® and MS PowerPoint® in MS Office 2000® or MS Office 2003®.

**Step 9b(1). Save as New Document**

B-26. Save the MS Word® document titled “Separate Motorized Infantry Brigade” as the “Brigade Tactical Group (Motorized) (Antiarmor-Light).” In the *Save As* process, save the new document into the “01 BTG (Mtzd) (Antiarmor-Lt)” folder created in Step 9a.

**Step 9b(2). Change Title Line**

B-27. In the newly saved MS Word® document “Brigade Tactical Group (Motorized) (Antiarmor-Light),” change the title line above the graphic from “Separate Motorized Infantry Brigade” to read “Brigade Tactical Group (Motorized) (Antiarmor-Light).”

**Step 9b(3). Open the Graphic**

B-28. To open the PowerPoint® graphic—

- Click once on the center of the graphic (the PowerPoint® slide inserted into the Word® document).
- The outline of the box containing the graphic should appear highlighted, showing small squares on the four corners and a small square in the center of each side.
- Right click once on the box (outline).
- A drop-down menu appears.
- Select **Presentation Object** and **Open**.
- This opens the PowerPoint® slide to allow making changes to it.

**Step 9b(4). Make Changes in the Graphic**

B-29. Make the following changes in PowerPoint®:

B-30. **Step 9b(4)(a)**. Change title box at the top of the line-and-block chart from “SEPARATE MOTORIZED INFANTRY BRIGADE” to “BRIGADE TACTICAL GROUP (Mtzd) (Antiarmor-Lt).” Stretch the box left-to-right to allow for word spacing.

B-31. **Step 9b(4)(b)**. Change “BRIGADE HQ” to read “BTG HQ”.

B-32. **Step 9b(4)(c)**. Delete one of the three “MOTORIZED INFANTRY BATTALION” boxes.

B-33. **Step 9b(4)(d)**. Change the “TANK BATTALION (41-Tank)” to read “MECHANIZED INFANTRY BN (APC).” Stretch the box left-to-right to allow for word spacing.

B-34. **Step 9b(4)(e)**. Change the “LIGHT TANK BATTALION (41-Tank) to read “GUERRILLA BATTALION (Hunter/Killer).”

B-35. **Step 9b(4)(f)**. Add an additional (entire) row of four organizational boxes with all lines. Since there are now more units than the separate brigade template, the additional units require additional boxes.

- Highlight all of the lines and blocks in the PowerPoint® graphic. This can be done by holding down the **Shift** key while selecting them individually. However, an easier method is to move the mouse to the upper left hand corner, left click on that corner, and then hold down the left mouse button while moving the cursor diagonally downward to the bottom right corner before releasing it.
- Leave all of the graphics highlighted and tap the UP arrow key (↑) until all organizations have moved towards the top of the slide enough to make room for the additional row. Remember always save after each step.
- Highlight the bottom box (three units) similar to the process in the first bullet under Step 9b(4)(f). Move them down toward the bottom of the slide enough to leave room to insert the fourth row. Tap the DOWN arrow key (↓) if necessary to bring the bottom row down.
- Highlight the entire next-to-last-row (starts with Air Defense Battalion). Include all units on that row and all lines. Copy that row (either using the **Copy** function from the **Edit** menu at the top left of the PowerPoint® slide, or hit **Control + C** while it is highlighted). Paste the copied row (next to last from the bottom) using the **Paste** function from the **Edit** menu (or **Control + V**) above the bottom row into the space created when you moved the bottom row down.
- Move the copied row (with text still in the box) to become the fourth row.
- Properly align/adjust the spacing of the rows.

B-36. **Step 9b(4)(g)**. Change “SNIPER PLATOON” at the right end of the third row to read “SPF COMPANY.”

B-37. **Step 9b(4)(h)**. Change the four units in the fourth row as follows:

- Change “AIR DEFENSE BATTALION (Mtzd) (Sep)” to read “SNIPER COMPANY.”
- Change “ENGINEER BATTALION (Sep)” to read “SPF DEEP ATK/RECON PLT.”

- Change “MATERIEL SUPPORT BATTALION” to read “AIR DEFENSE BATTALION (Mtzd) (Sep).”
- Change “MAINT BATTALION (APC/Mtzd)” to read “ENGINEER BATTALION (Sep.)”

B-38. **Step 9b(4)(i).** Change the four units on the next to last (fifth) row to read—

- MATERIEL SUPPORT BATTALION
- MAINT BATTALION (APC/Mtzd)
- SIGNAL COMPANY (Sep)
- CHEMICAL DEFENSE CO (Sep)

B-39. **Step 9b(4)(j).** Keep only the middle box on the bottom (sixth) row:

- Delete the box on either side of the middle one.
- Add “MEDICAL COMPANY (Sep) in the last (middle) box in the bottom (sixth) row.

B-40. **Step 9b(4)(k).** Extend the line running from the “BRIGADE TACTICAL GROUP (Motorized) (Antiarmor-Light)” box at the top of the diagram to the “MEDICAL COMPANY (Sep)” box at the bottom.

B-41. **Step 9b(4)(l).** In PowerPoint®, highlight all of the unit boxes. Then click on **Draw** at the bottom left. Click on **Order**, then **Bring to Front**. This puts the lines behind the boxes and puts multiple boxes in their proper sequence. In order for this to work all of the boxes must have white **Fill**.

---

**Note.** If trainers use PowerPoint® often for this purpose, they might wish to go to Tools at the top of the screen, select **Customize**, **Drawing**, and **Bring to Front**. Drag the **Bring to Front** icon to their tool bar. Then all that is necessary is to highlight all of the unit boxes and click on the **Bring to Front** icon.

---

B-42. **Step 9b(4)(m).** Add fictitious unit designators, if desired for training purposes. The last step to building the task-organization graphic might be the addition of fictitious alphanumeric unit designators or fictitious honorific titles to the task organization and/or its subordinates. Some example fictitious designators or titles might be the 66th BTG (Mtzd) (Antiarmor-Lt), the Ali-Babba Battalion instead of Guerrilla Battalion, or the Glorious Path Organization instead of Local Insurgent Organization.

---

**Note.** If such fictitious unit designators are used in the graphic, they should also appear in the corresponding folder and file names for these units and in the unit names as they appear in MS Word® documents and MS Excel® spreadsheets.

---

B-43. **Step 9b(4)(n).** In PowerPoint®, go to **File** at the top left of the screen. Select **Update** and click on it. (If trainers would like to save this as a PowerPoint® file separate from the Word® document, they can also click on **Save As** under **File**.) Under **File** again, select **Close and Return**. This updates the PowerPoint® in the Word® document. Use the **Crop** function to eliminate extra spacing in the Word® document. Be careful not grab the document by the top or sides without clicking on the **Crop** function. If the **Crop** function is not used the document will be either stretched or compressed out of relational aspect.

B-44. **Step 9b(4)(o).** The completed BTG graphic in the MS Word® document should look exactly like that shown in figure B-5 on page B-12.

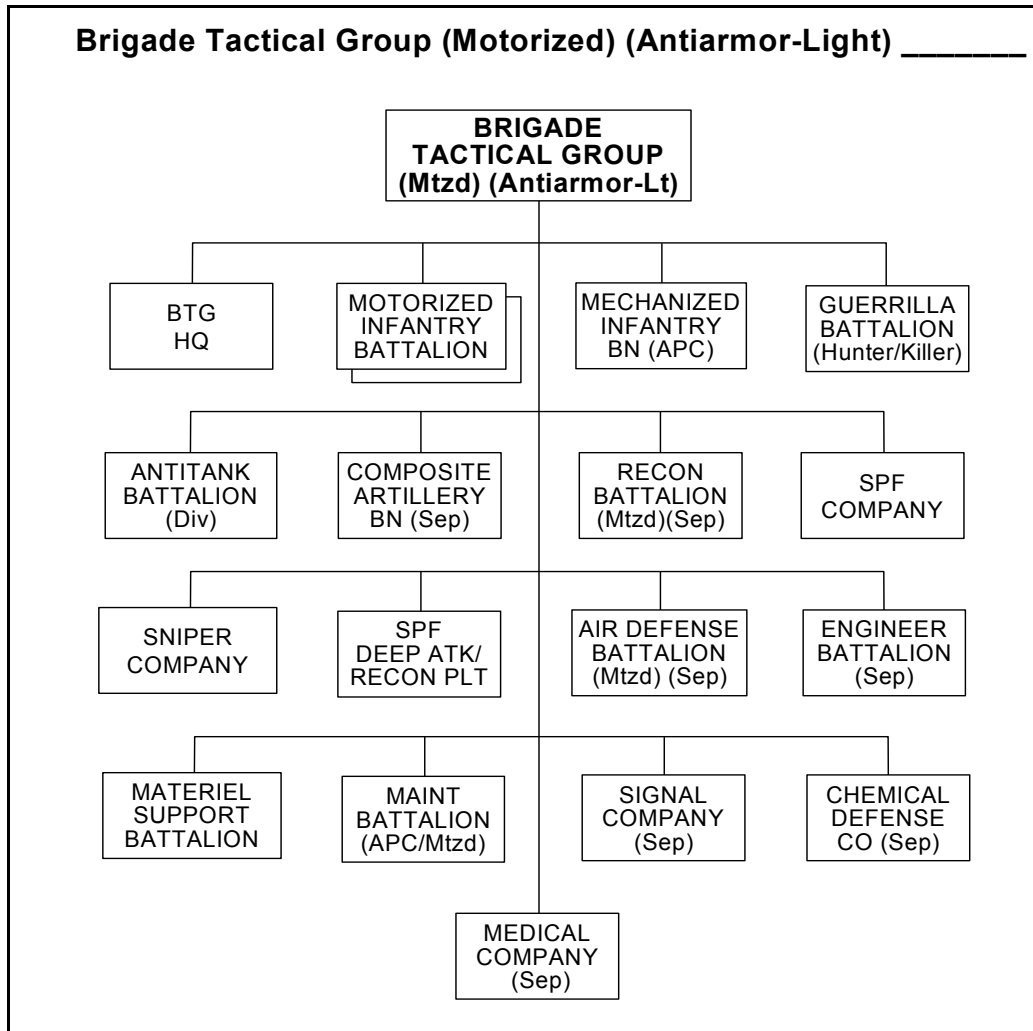

**Figure B-5. Brigade Tactical Group (Motorized) (Antiarmor-Light)**

B-45. In this example, for the sake on simplicity, none of the battalions or companies subordinate to the BTG has been task-organized into a detachment. If they were, trainers would also need to modify the organizational graphics of those subordinates to reflect how they are task-organized. In this simplified example, however, all that is required is to copy the files for these battalions and companies “as-is” from the AFS organizational directories into the proper folder created in Step 9a.

**Step 9c. Modify Personnel and Equipment Charts**

B-46. For the BTG in this example, the personnel and equipment numbers are contained in an MS Excel® spreadsheet. Although it is possible to build a new MS Excel® chart from scratch, it is not recommended. The simplest method of creating the new Excel® chart is similar to that used for modifying organizational graphics, as described above. Training planners should find an existing MS Excel® chart for a similar unit in the AFS organizational directories and modify it into a personnel and equipment chart reflecting the newly created task-organized OPFOR unit. For illustrative purposes, this part of appendix B will continue to use the AFS separate motorized infantry brigade as the example baseline OPFOR unit. It remains the OPFOR unit with subordinates most closely resembling those of the initial listing of units for the task organization in Step 7. The end result is the conversion of the “Separate Motorized Infantry Brigade” MS Excel® chart into the “Brigade Tactical Group (Motorized) (Antiarmor-Light)” MS Excel® chart reflecting all of the units in the task organization. The completed organization will include a complete

listing of all personnel and equipment, by subordinate unit, in the newly formed BTG (Mtzd) (Antiarmor-Lt) and the totals for the BTG.

B-47. There are several steps to modifying an existing MS Excel® chart into the example task-organized BTG (Mtzd) (Antiarmor-Lt). None of these steps is difficult but most are sequential. These steps apply only to MS Excel® in MS Office 2000® or MS Office 2003®.

**Step 9c(1). Save Chart as New Chart**

B-48. Save the MS Excel® chart titled “Separate Motorized Infantry Brigade” in the AFS as the “Brigade Tactical Group (Motorized) (Antiarmor-Light).” In the *Save As* process, save the new chart under the “01 BTG (Mtzd) (Antiarmor-Lt)” folder created in Step 9a. The resulting chart will serve as the basis for making the necessary modifications.

**Step 9c(2). Change Chart Title in Row 1**

B-49. In the newly saved MS Excel® chart “Brigade Tactical Group (Motorized) Antiarmor-Light,” at the top of the page (Row 1), change the title line from “Separate Motorized Infantry Brigade” to read “Brigade Tactical Group (Mtzd) (Antiarmor-Light).”

**Step 9c(3). Modify the List of Subordinate Units in Row 2**

B-50. Row 2 of the MS Excel® chart should reflect the units in the BTG (Mtzd) (Antiarmor-Lt). For consistency in the task-organizing process, Row 2 should show the subordinate units in the same sequential order as they appear in the organizational chart shown in figure B-5 on page B-12. Thus, Row 2 for the BTG (Mtzd) (Antiarmor-Lt) should appear as shown in figure B-6.

Brigade Tactical Group (Mtzd) (Antiarmor-Light)																		
Personnel and Items of Equipment	BTG Headquarters *	Motorized Infantry Bn X2 **	Mechanized Infantry Bn (APC)	Guerrilla Bn (Hunter/Killer)	Antitank Bn (Sep Bde, Div, Nondlv)	Composite Artillery Battalion *	Recon Bn (Mtzd) (Sep Bde)	SPF Company	Sniper Company (Div)	SPF Deep Attack/Recon Plt	Air Defense Bn (Mtzd) (Sep Bde)	Engineer Battalion (Sep Bde)	Material Support Battalion *	Maintenance Battalion, APC/Mtzd	Signal Company (Sep) *	Chem Defense Co (Sep Bde) *	Medical Company (Sep Bde) *	TOTAL

**Figure B-6. Rows 1 and 2**

B-51. Therefore, the next task is to modify the subordinate units (old Sep Mtzd Inf Bde) listed in Row 2 to reflect the units selected to be part of the task-organized BTG (Mtzd) (Antiarmor-Lt). This modification consists of several steps of deleting some units not used in the task organization and adding new columns to provide a space for including new units into the task organization:

- Change “Brigade Headquarters” in Column B to read “BTG Headquarters.” The asterisk (note) still applies; so it remains.
- The “Motorized Infantry Bn X3” in Column C should be modified to reflect two motorized infantry battalions required for the task-organized BTG vice the three originally in the separate motorized infantry brigade. Change the “X3” to “X2”. Delete all the items of equipment numbers in Column C under the motorized infantry battalion. They are no longer correct, since these numbers reflect three battalions rather than the two required now. Delete the numbers now rather than try to recall later if the numbers reflect two or three battalions. Later, at Step 9c(4)(a), it will be time to enter the proper numbers of equipment for the total of two motorized infantry battalions. Keep the note reference \*\* after the “X2.” However, Note \*\* at the bottom

of the page is now incorrect and must be modified to read: “The values in this column are the total number for *two* battalions.” Repeat on all pages.

- The two tank battalions in Columns D and E of the original chart are not part of the BTG. To delete these two columns, highlight the entire columns by clicking on the “D” and “E” at the top of the chart, then go to *Edit* at the top left of the screen, and click *Delete*.

---

*Note.* To remove a column or row from a spreadsheet, do not use the “*Del*” button on the keyboard; that only “clears” the content of cells in the column or row, but the column or row still exists (just with empty cells). Columns (labeled A, B, C, and so forth) or rows (labeled 1, 2, 3, and so forth) can be removed only by highlighting the entire column or row and then going to the toolbar at the very top of the screen and clicking on *Edit/Delete*.

---

- Now it is necessary to add the mechanized infantry battalion (APC), which is a new unit, to the chart. However, there is no column in which to put it. The mechanized infantry battalion (APC) should be listed in the proper sequence (reflecting the sequence in the BTG organizational graphic in figure B-5 on page B-12). Therefore, this battalion is placed directly to the right of the “Motorized Infantry Bn X2” in Column C. Highlight the original Column D, click on *Insert* at the top of the screen, and then click on *Columns*. There should now be an empty Column D in between the “Motorized Infantry Bn X2” in Column C and the antitank battalion (now in Column E). The newly inserted Column D should automatically be included in the summing formulas which roll up the personnel and equipment numbers to provide totals in the right-hand column. Click on the cell in Column D, Row 2, which is still vacant. Type in one space and then “Mechanized Infantry Bn (APC).” The one space before typing moves the text off the line for easier reading. The personnel and equipment numbers will be added in Step 9c(4)(b).
- Add the guerrilla battalion (hunter/killer) as the fourth entry. This is also a new unit to the BTG, and thus there is no column in which to put it. The guerrilla battalion (hunter/killer) must also be listed in the proper sequence (as in the organizational graphic in figure B-5 on page B-12). Therefore, this battalion must be directly to the right of the mechanized infantry battalion (APC) in column D. Highlight the current Column E, click on *Insert* at the top of the screen, and then click on *Columns*. There should now be an empty Column E in between the mechanized infantry battalion (APC) in Column D and the antitank battalion in what is now Column F. This new column also should automatically be included in the summing formulas. Click on the cell in Column E, Row 2, which is still vacant. Type in one space and then “Guerrilla Battalion (Hunter/Killer).” The personnel and equipment numbers will be added in Step 9c(4)(c).
- Column F, (Antitank Battalion), Column G (Composite Artillery Battalion), and Column H (Recon Battalion) do not require any modification. They remain as they were in the separate motorized infantry brigade. The personnel and equipment numbers in these organizations are correct and require no further action.
- The sniper platoon now in Column I is not part of the BTG. Delete Column I, Sniper Platoon, by clicking on the “I” at the top of the chart to highlight the entire column, then clicking on *Edit* at the top left of the screen, and clicking *Delete*.
- The SPF company is the eighth entry. This is another unit new to the BTG. Once again, there is no column in which to enter it. The SPF company should be listed in the proper sequence (as in the organization graphic in figure B-5 on page B-12). The SPF company must be positioned directly after the Recon Bn (Mtzd) (Sep Bde) now in column H. Highlight the current Column I, click on *Insert* at the top of the screen, and then click on *Columns*. There should now be an empty Column I between the Recon Bn (Mtzd) (Sep Bde) in Column H and the air defense battalion (Mtzd) (Sep Bde) which moved to Column J. Click on the cell in Column I, Row 2, which is still vacant. Type in one space and then “SPF Company.” The personnel and equipment numbers will be added in Step 9c(4)(e).
- The sniper company is the ninth entry. This is another unit new to the BTG. Once again, there is no column in which to enter it. The sniper company is placed directly to the right of the SPF company now in Column I. Highlight the current Column J, click on *Insert* at the top of the

screen, and then click on **Columns**. There should now be an empty Column J between the SPF company in Column I and the air defense battalion (Mtzd) (Sep Bde) which moved to Column K. Click on the cell in Column J, Row 2, which is still vacant. Type in one space and then “Sniper Company.” The personnel and equipment numbers will be added in Step 9c(4)(f).

- The SPF deep attack/reconnaissance platoon is the tenth entry. This is another unit new to the BTG. Once again, there is no column in which to enter it. The SPF deep attack/reconnaissance platoon should be positioned directly to the right of the sniper company now in Column J. Highlight the current Column K, click on **Insert** at the top of the screen, and then click on **Columns**. There should now be an empty Column K between the sniper company in Column J and the air defense battalion (Mtzd) (Sep Bde) which moved to Column L. Click on the cell in Column K, Row 2, which is still vacant. Type in one space and then “SPF Deep Attack/Recon Plt.” The personnel and equipment numbers will be added in Step 9c(4)(g).
- The following units listed in Columns L thru R require no further action—
  - Column L = Air defense battalion.
  - Column M = Engineer battalion.
  - Column N = Materiel support battalion.
  - Column O = Maintenance battalion.
  - Column P = Signal company.
  - Column Q = Chemical defense company.
  - Column R = Medical company.
- The totals in Column S will be automatically calculated using the summing formulas. No action is required for this column. Once the personnel and equipment numbers have been added to new and modified units and the chart completely updated, Column S (Total) will accommodate the update by automatically calculating the sums. For additional guidance on automatic summation, see Using Spreadsheets to Facilitate Roll-Ups in the section on Building from the Bottom Up later in this appendix.

---

**Note.** When making changes to the unit titles in Row 2, do not forget to carry those changes to all of the pages in the chart. Also check any asterisks in Row 2 and ensure the notes to which they are linked at the bottom of the page(s) still apply.

---

**Step 9c(4). Update Personnel and Equipment Numbers**

B-52. Once Row 2 has been modified to reflect all of the units in the BTG, the personnel and items of equipment must be updated. The items of equipment in Column A are modified by adding equipment not listed in the baseline Excel® chart and deleting equipment no longer used by units in the task organized BTG. After all the proper items of equipment are reflected in Column A, training planners must enter the appropriate personnel and equipment totals for each individual unit in Columns B through R.

---

**Note.** When entering numbers in columns, it is recommended to highlight the column currently being worked on, in order to limit confusion and avoid placing numbers into the wrong column. Highlight the column by clicking on the letter designating that column at the very top of the Excel® chart and then click on the **Fill Color** icon in the toolbar and select a color. The column will remain highlighted during entry of numbers. (Just clicking on the letter at the top of the column temporarily highlights the entire column, but the highlighting turns off as soon as one clicks on a cell to enter data.) When entries in that column are complete, click on the letter at the top of the column again, then click on the **Fill Color** icon and select **No Fill** to turn off the highlighting in the completed column.

---

B-53. Task-organized units generally require additional types of equipment. Specific types of equipment in Column A should not be deleted until the Excel® chart is completely finished. If the item of equipment is

deleted too early in the process, the piece of equipment may not be available in the event another unit modified later in the process requires that piece of equipment. Trainers would then need to go back and re-enter the item they just deleted (by creating a new row and filling in the information). The best method is to wait until all other modifications to the Excel® chart have been made and then delete the rows for any items of equipment for which the total in Column S is a zero.

B-54. Make sure that all units carried over from the original Excel® chart have not been altered in ways that would change their personnel and equipment numbers. Units that have been modified, or are new, to the BTG must have the appropriate personnel and equipment numbers entered into the chart (cell by cell). The data must be entered individually by unit (column). Units new to the BTG often have some items of equipment that were not included in the original equipment listing in Column A. New rows for these additional items of equipment will be added, one unit (column) at a time, when updating the equipment data.

B-55. In this example BTG, the following units require new or modified personnel and equipment data:

- Column C: Motorized Infantry Battalion (x2).
- Column D: Mechanized Infantry Battalion (APC).
- Column E: Guerrilla Battalion (Hunter/Killer).
- Column I: SPF Company.
- Column J: Sniper Company.
- Column K: SPF Deep Attack/Reconnaissance Platoon.

B-56. **Step 9c(4)(a). Column C: *Motorized Infantry Battalion (x2)***. In the AFS organizational directories, go to Volume II – Echelons Above Division, 01 Separate Combat Brigades, 04 Sep Motorized Inf Bde, 03A Mtzd Inf Bn Equip.xls to select the appropriate baseline unit. Multiply the total numbers in Column L (in the Mtzd Inf Bn chart) by two, to reflect the total numbers for the two motorized infantry of battalions that are part of the BTG. Transfer the numbers of the motorized infantry battalion (which have been multiplied by two) into the appropriate cells in Column C, Motorized Infantry Bn X2 of the BTG (Mtzd) (Antiarmor-Lt) MS Excel® chart.

---

**Note.** The values in Column C (of the BTG chart) are the total numbers for *two* battalions. Ensure that the footnote with the same number of asterisks as in the reference at the top of Column C, Row 2 states this. This column does not require any modifications to the equipment list in Column A. It is simply a matter of changing the numbers from three battalions to two battalions.

**Note.** In this particular example, neither of the motorized infantry battalions in Column C was task-organized into a detachment. If that were the case, it would be necessary to create a separate column for the unit that became a BDET, since its personnel and equipment numbers would be different from those of a battalion. Even if both the motorized infantry battalions retained in this BTG were transformed into BDETs, it is unlikely that they would both be task-organized in the same way. Therefore, the two BDETs would still require separate columns in the Excel® chart.

---

B-57. **Step 9c(4)(b). Column D: *Mechanized Infantry Battalion (APC)***. In the AFS organizational directories, go to Volume I – Division and Divisional Units, 02 Mechanized Infantry Division (APC), 04 Mech Inf Bde (APC), 03A Mech Inf Bn (APC) Equip.xls to select the appropriate baseline unit. Transfer the numbers of the mechanized infantry battalion (APC) from Column K (TOTAL) of the mechanized infantry battalion (APC) into the appropriate cells in Column D, Mechanized Inf Bn (APC) of the BTG (Mtzd) (Antiarmor-Lt) MS Excel® chart. Start with transferring the personnel numbers and then add the numbers of equipment.

B-58. Some of the types of equipment belonging to the mechanized infantry battalion (APC) are yet not listed in Column A. This equipment must be added. Although the process is sequential, it is simple.



Trainers should begin updating (adding) personnel and equipment numbers in Column D of the Excel® chart until they run across an item of equipment not listed in Column A.

B-59. The first item of equipment not listed in Column A of the BTG Excel® chart is the ACRV, 1V152. The proper sequential placement for the ACRV, 1V152 in the BTG Excel® chart is between the ACRV, 1V14-3, Cmd & Observation Post in Row 11 and the ACRV 1V15-3, Cmd & Observation Post in Row 12. A new row (in which to place the ACRV, 1V152) needs to be created in between Rows 11 and 12. In order to insert the new row, highlight the entire Row 12 from the left side of the chart. Once Row 12 is highlighted, click on **Insert** at the top of the screen, and then **Row**. A blank row has now been inserted between previous Rows 11 and 12. In Column A of that row, type “ACRV, 1V152.” Since there is one ACRV, 1V152 in the mechanized infantry battalion (APC), add the number “1” in Row 12 (ACRV, 1V152), Column D (Mech Inf Bn (APC)).

B-60. Once the new row has been added and filled in with the updated data/number, ensure the automatic summing formula is entered in Column S “Total” on the right side of the chart. To create the correct formula for automatic summing in the “Total” column, users can click on any cell in the “Total” column containing the correct formula for its row and **Copy** and **Paste** that formula into the “Total” cell in the new row; the letters designating the row in the formula should automatically change to the letter of the new row. The chart should automatically add the numbers in columns B thru R, with the total shown in Column S.

B-61. Continue transferring the numbers from the mechanized infantry battalion (APC) personnel and equipment chart to the BTG chart. Insert any new rows necessary. Fill them out and follow the instructions above until Column D, mechanized infantry battalion (APC) is completed in the BTG chart. When complete, move on to Column E, guerrilla battalion (hunter/killer).

B-62. **Step 9c(4)(c). Column E: Guerrilla Battalion (Hunter/Killer).** In the AFS organizational directories, go to Volume III – Paramilitary and Nonmilitary Organizations, 01 Guerrilla Brigade, 02 Guerrilla Bn, Guer Bde, 02A Guer Bn-Equip.xls to select the appropriate baseline unit. Transfer the personnel and equipment numbers from the AFS guerrilla battalion (hunter/killer) Excel® chart to Column E, guerrilla battalion (hunter/killer) of the BTG chart in accordance with the instructions above. Once the transfer and update is complete, move on to Column I, SPF Company.

B-63. **Step 9c(4)(d). Column F (Antitank Bn) thru Column H (Recon Bn).** These units were part of the baseline AFS separate motorized infantry brigade. Since no internal modifications are involved here, the columns for these units are complete and require no modification.

B-64. **Step 9c(4)(e). Column I: SPF Company.** In the AFS organizational directories, go to volume II – Nondivisional Units, 02 Combat Brigades, 01 Special-Purpose Forces Brigade, 03B SPF Bn Equip.xls, Column C (SPF Company in the Excel® equipment chart) to select the appropriate baseline unit. In this case, the SPF company is not listed separately in the MS Excel® document. In that document, it is rolled up as a part of “SPF Company (X3)” of the SPF Battalion. Therefore, the numbers in Column C of the SPF Bn Excel® chart must be divided by three to acquire the number for a single SPF company. Once the personnel and equipment numbers for only one SPF company have been determined, transfer those numbers into Column I, SPF Company, of the BTG chart in accordance with the instructions above. Once the transfer and update is complete, move on to Column J, Sniper Company.

B-65. **Step 9c(4)(f). Column J: Sniper Company.** In the AFS organizational directories, go to volume I – Divisions and Divisional Units, 04 Motorized Infantry Division, 11 Sniper Co to select the appropriate baseline unit. Then transfer the sniper company numbers into Column J, Sniper Company, of the BTG chart in accordance with the instructions above.

B-66. **Step 9c(4)(g). Column K: SPF Deep Attack/Reconnaissance Platoon.** In the AFS organizational directories, go to volume II – Nondivisional Units, 02 Combat Brigades, 01 Special-Purpose Forces Brigade, 03B SPF Bn Equip.xls, Column D (SPF Deep Attack/Reconnaissance Platoon in the Excel® equipment chart) to select the appropriate baseline unit. Then transfer the Deep Attack/Reconnaissance Platoon numbers into Column K, SPF Deep Attack/Reconnaissance Platoon, of the BTG chart in accordance with the instructions above.

B-67. **Step 9c(4)(h). Column L through Column R.** These units were part of the baseline AFS separate motorized infantry brigade. Since no internal modifications are involved here, the columns for these units are complete and require no modification.

B-68. **Step 9c(4)(i). Column S: Total.** This column automatically totals the equipment numbers in Columns A through R. It should not require any action.

***Step 9c(5). Delete Unused Rows***

B-69. Once the Excel® chart is complete and all units have their equipment entered, it is easy to determine which items of equipment are not needed in the chart. A look at the totals column (the last Column on the right-hand side) reveals that some items of equipment have “0” (zero) for the total. These items of equipment may then be deleted. After reviewing the notes at the bottom of the page for applicability, the final formatting adjustments may then be made to the Excel® chart.

***Step 9c(6). Update Notes***

B-70. The “Notes” listed at the bottom of the page amplify either the units listed in Row 2 or items of equipment listed in Column A. Care must be taken to ensure the asterisk (\*) reference(s) in Row 2 or Column A match the appropriate note(s). For the convenience of the user, the notes pertaining to units in Row 2 (which appears at the top of each page in a multi-page Excel® chart) are repeated at the bottom of each page. Update these notes as necessary, to correspond to changes in organization or equipment.

***Step 9c(7). Format the Chart***

B-71. In this BTG example, the MS Excel® personnel and equipment chart is five pages long (323 rows) and 19 columns wide. This example chart uses portrait orientation and fits on a standard-size, 8.5x11-inch paper. If necessary, equipment charts can easily be formatted to landscape orientation to fit the standard-size paper. The heights of the rows and widths of columns are adjusted by first highlighting the row (or column), clicking on **Format** at the top of the screen and selecting **Row** (or **Column**) and adjusting the row height (or column width). Several attempts may be needed until the adjustments are satisfactory. In order to fit this chart on standard paper, with a portrait orientation, the following format parameters were used:

- Column Width.
  - A = 36.14
  - B through Column R= 4.29
  - S (Totals) = 5
- Row Height.
  - 1 = 25
  - 2 = 170
  - All other rows = 13

***Step 9c(8). Completed Chart***

B-72. The task-organized Brigade Tactical Group (Motorized) (Antiarmor-Light) personnel and equipment roll up in MS Excel® should now be complete. The completed BTG (Mtzd) (Antiarmor-Lt) equipment charts are seen in figures B-7 through B-11 (on pages B-19 through B-23).

Brigade Tactical Group (Mtzd) (Antiarmor)																		
Personnel and Items of Equipment	BTG Headquarters *	Motorized Infantry Bn X2 **	Mechanized Infantry Bn (APC)	Guerrilla Bn (Hunter/Killer)	Antitank Bn (Sep Bde, Div, Nondiv) *	Composite Artillery Battalion *	Recon Bn (Mtzd) (Sep Bde)	SPF Company	Sniper Company (Div)	SPF Deep Attack/Recon Plt	Air Defense Bn (Mtzd) (Sep Bde)	Engineer Battalion (Sep Bde)	Materiel Support Battalion *	Maintenance Battalion, APC/Mtzd	Signal Company (Sep) *	Chem Defense Co (Sep Bde) *	Medical Company (Sep Bde) *	TOTAL
	<b>Personnel</b>																	
Officer	41	74	33	35	26	39	26	14	5	4	38	23	25	32	5	6	47	473
NCO	43	402	133	211	73	151	82	27	42	8	124	104	59	94	20	30	31	1634
Enlisted	105	1396	555	765	355	515	378	118	78	25	595	572	487	497	118	111	109	6779
<b>Total Personnel</b>	<b>189</b>	<b>1872</b>	<b>721</b>	<b>1011</b>	<b>454</b>	<b>701</b>	<b>486</b>	<b>159</b>	<b>135</b>	<b>37</b>	<b>757</b>	<b>699</b>	<b>571</b>	<b>623</b>	<b>143</b>	<b>147</b>	<b>187</b>	<b>8892</b>
<b>Equipment</b>																		
ACRV, 1V110, Battery FDC		2																2
ACRV, 1V13-3, Fire Control Post						4												4
ACRV, 1V14-3, Cmd & Observation Post						4												4
ACRV, 1V152, Artillery Command Post			1															1
ACRV, 1V15-3, Cmd & Observation Post						1												1
ACRV, 1V16-3, Fire Control Post						1												1
ACV, BMP-1KSh, Cmd & Staff Veh			1		2											8		11
ACV, BRDM-2UM												1						1
ACV, BTR-80, Kusetka, Cmd & Staff Veh	6		1			2	4				1	2	2	2				20
ACV, BTR-80, Kusetka, Comms Jammer							2											2
ACV, BTR-80, Kusetka, Ground Station							1											1
ACV, BTR-80, Kusetka, Radar Intcpt/DF							3											3
ACV, BTR-80, Kusetka, Radio Intcpt/DF							3											3
ACV, Air Def, Sboraka w/DOG EAR Radar											4							4
Air Def Acq & Coord Unit, ACU (Crotale)											3							3
APC, BTR-80A	2		46								2	9						59
APC, BTR-80AK, Command Veh							4					2						6
Artillery Locating Radar, IL220U/IL219						1												1
ATGM Launcher Vehicle, AMX-10 HOT 3					12													12
CRV, BRDM-2M w/ATGM Lchr, HOT 3			1				13											14
CRV, BRM-3K, Combat Recon Veh							3											3
IFV, BMP-2M					9							7						16
Mobile Recon Post, PRP-4M					4	12												16
Multipurpose Vehicle, MT-LBT					12										1			13
SAM Launcher, Firing Unit (Crotale)											6							6
Sound Ranging Set, SORAS 6						1												1
Sensor Vehicle-Tracked, HJ-62C							2											2
Towed AA Gun/Missile Sys, Skyguard											4							4
w/Aspide MK 1 Missile Launcher &											8							8
Towed AA Gun, GDF-003											8							8
Truck, Command and Staff Vehicle	13	4					1				1					1		20
9-mm Pistol, PM	4	114	37	39	3	3	7	159		37	3	3	3	3				459
5.45-mm Assault Rifle, AK-74M	170	1478	380		289	654	345	30	99	5	654	574	540	586	121	141	143	6209
5.45-mm Carbine, AKS-74U	15	214	269		162	44	134	88		26	96	122	28	34	22	6		1260
5.45-mm LMG, RPK-74							10											10
7.62-mm Assault Rifle, AKM				765			46											811
7.62-mm Carbine, AKMS				90														90
7.62-mm GP MG, PKM	10	160	41	64	8	12	32			14	34	24	8	38	3	5	11	464
7.62-mm LMG, RPK				80														80
7.62-mm Sniper Rifle, Mosin/Nagant				30														30
7.62-mm Sniper Rifle, SVD		66	36	6		1	28	36		6	2							181
.50 BMG Antimateriel Rifle, M82A1		12	6	6				14	36	3								77
12.7-mm HMG, NSV	8	94	28	9	38	29	29	16	26	3	76	20	22	31	14	5		448
23-mm Chain Gun										3								3
35-mm AGL-Light, W-87	7	66	42		4		7	16		4	2	7	2	2				159
40-mm AGL-Heavy, CIS 40		12						18		4								34
40-mm Grenade Launcher, BG-15				141														141
40-mm Grenade Launcher, GP-30	43	344	150		87	123	103	29	65	5	115	104	39	101	31	31	15	1385
<b>NOTES:</b>																		
* Same basic organization for IFV, APC, and motorized units. APC units substitute wheeled APCs for IFVs in the tracked units, etc.																		
** The values in this column are the total number for two battalions.																		
*** Tactical Utility Veh, Amphib, VBR w/Trailer, Amphib, can be substituted for Tactical Utility Vehicle, UAZ-469																		
Page 1 <span style="float: right;">(continued)</span>																		

Figure B-7. BTG (Mtzd) (Antiarmor-Lt) Personnel and Equipment List, Page 1

Brigade Tactical Group (Mtzd) (Antiarmor) (continued)																		
Personnel and Items of Equipment	BTG Headquarters *	Motorized Infantry Bn X2 **	Mechanized Infantry Bn (APC)	Guerrilla Bn (Hunter/Killer)	Antitank Bn (Sep Bde, Div, Nondiv) *	Composite Artillery Battalion *	Recon Bn (Mtzd) (Sep Bde)	SPF Company	Sniper Company	SPF Deep Attack/Recon Plt	Air Defense Bn (Mtzd) (Sep Bde)	Engineer Battalion (Sep Bde)	Material Support Battalion *	Maintenance Battalion, APC/Mtzd	Signal Company (Sep) *	Chem Defense Co (Sep Bde) *	Medical Company (Sep Bde) *	TOTAL
60-mm Mortar, Light, Type 90 or 60-mm Commando Mortar, M70		18		9			9											36
73-mm Recoilless Gun, SPG-9/9M				3														3
82-mm Recoilless Gun, Type 65-1				9														9
81-mm W-87, or 82-mm 2B14-1 Mortars or 100-mm Mortar, Type 71 or 120-mm Mortar, Type 86 (W86)				6														6
107-mm MRL, Type 63/63-1 or Type 85				3														3
120-mm SP Combination Gun, 2S23			6															6
120-mm Towed Combo Gun, 2B16 or 120-mm Towed Mortar, MO-120-RT		12																12
122-mm MRL, 9A51/PRIMA						6												6
125-mm Antitank Gun, 2A45M					12													12
155-mm SP How, G6/Rhino						18												18
Air Defense/Antiarmor System, Starstreak							3			3								6
ATGM Launcher, 9P151, AT-13/METIS-M				4														4
ATGM Launcher, HOT-3		6	7				13											26
ATGM Launcher, Manportable, AT-13			9															9
ATGM Lchr, Manportable-SR, Eryx		18	5				2	12		3								40
ATGM Launcher, Milan 3		18																18
ATGL-Long Range, RPG-29		36	18															54
ATGL, Panzerfaust 3-T600	3	58	31		21	1	3	14		3	3	4						141
ATGL, RPG-7V				62														62
ATDL, Armbrust		54	36					24		3	2							119
ATDL, RPG-22				102					26									128
ATDL, RPG-27	15	154	94		65	54	85	28		4	88	66	32	40	14	8		747
Bunkerbuster				4				26		3		9						42
Demolition Material		Assort	Assort	Assort	Assort		Assort	Assort		Assort		Assort						Assort
Demolition Set, Underwater								3				4						7
Flame Weapon, RPO-A Series	6	138	45	77	8	15	6	27	6	3	27	15	9	15	2	3		402
MANPADS Launcher, SA-14				2														2
MANPADS Launcher, SA-18		12	6		6		6				18							48
Mine Detector, Handheld				5				5										10
Minefield Control Set				6				6										12
Mine-Scattering System, Manport, PKM	3	30	25	2			24	14		3	2	24						127
Mines (AP&AT)	Assort	Assort	Assort	Assort			Assort	Assort		Assort	Assort	Assort						Assort
Aircraft, Ultra-Light								6										6
Ambulance		6			3	3					3	3	3	3			6	30
Ambulance, BMM-1			3				3											6
Armored Engineer Tractor, IMR-2M												1						1
ARV, Tracked					3	3					3	3	3	5				20
ARV, Tracked, BREM-1							3											3
ARV, Tracked, Repair (w/crane), RM-G							3											3
ARV, Wheeled, BREM-K			6															6
Back Hoe, Wheeled												2						2
Boat, Assault w/Motor												11						11
Boat, Inflatable, Zodiac												4						4
Bridge, Tank-Launched, AVLB												3						3
Bridge, Truck-Launched, TMM-3												4						4
Ditching Machine, MDK-3												2						2
Dozer												1						1
Engineer Recon Vehicle, IRM												3						3
Fork Lift, Tactical												1						1
Front End Loader, Wheeled												2						2
Light Strike Vehicle, FAV									14									14

**NOTES:**

- \* Same basic organization for IFV, APC, and motorized units. APC units substitute wheeled APCs for IFVs in the tracked units, etc.
- \*\* The values in this column are the total number for two battalions.
- \*\*\* Tactical Utility Veh, Amphib, VBR w/Trailer, Amphib, can be substituted for Tactical Utility Vehicle, UAZ-469

Figure B-8. BTG (Mtzd) (Antiarmor-Lt) Personnel and Equipment List Continued, Page 2

Brigade Tactical Group (Mtzd) (Antiarmor) (continued)																		
Personnel and Items of Equipment	BTG Headquarters *	Motorized Infantry Bn X2 **	Mechanized Infantry Bn (APC)	Guerrilla Bn (Hunter/Killer)	Antitank Bn (Sep Bde, Div, Nondiv)	Composite Artillery Battalion *	Recon Bn (Mtzd) (Sep Bde)	SPF Company	Sniper Company	SPF Deep Attack/Recon Pit	Air Defense Bn (Mtzd) (Sep Bde)	Engineer Battalion (Sep Bde)	Materiel Support Battalion *	Maintenance Battalion, APC/Mtzd	Signal Company (Sep) *	Chem Defense Co (Sep Bde) *	Medical Company (Sep Bde) *	TOTAL
Medical Aid Station, BMM-2			1				1											2
Medical Aid Station, Van		2																2
Mine Detector Vehicle, DIM												2						2
Minefield Breaching Vehicle, UR-77												2						2
Minefield Breach Sys-Explosive ZRP-2		18	3		4							27						52
Minelayer, GMZ-3												3						3
Minelayer, Scatterable, UMZ												9						9
Minelayer, Towed, PMZ-4												3						3
Motorcycle		24	6	10	3	3	12				3	3	3	3	3			73
NBC Recon Vehicle, RKHM/RKhM-4-01																3		3
Radar, EW/TA/AD C2, GIRAFFE AMB											2							2
Route-Clearing Vehicle, BAT-2												2						2
Skid Loader w/Trailer												2						2
Tactical Utility Veh, Amphib, VBR ***			12				1					9						22
Tactical Utility Vehicle, UAZ-469 ***	21	146	19	3	21	42	52	52	21		56	17	29	35	12	3	22	551
Tracked Amphibian, PTS-2												12						12
Tracked Ferry, PMM-2												8						8
Tractor, Grader												1						1
Transloader							24					32						56
Truck, Concrete												1						1
Truck, Crane		2	2		2	7	2				2	5	8	4				34
Truck, Crane Shovel												2						2
Truck, Decon, ARS-14K																6	1	7
Truck, Decon DDA-52/66																4	1	5
Truck, Decon, TMS-65M																4		4
Truck, Dump												3						3
Truck, Heavy												10	80					90
Truck, Heavy w/Crane												9						9
Truck, Kitchen	1	4	1		2	2	1				2	2	2	2			1	20
Truck, Light	9	28	13	26	16	22	7	10	4		22	18	5	16	9	2	8	215
Truck, Light (Digital Data)		2	1	1	1	1	1				1	1	1	1	3			14
Truck, Light (Prime Mover)		12		3														15
Truck, Light (Wire)		2	1	1	1	1	1				1	1	1	1				11
Truck, Medium	6	80	9	15	22	48	11		1		44	69	73	45	1	20	34	478
Truck, Medium, Refrigerated																	1	1
Truck, Medium w/Crane											19	2						21
Truck, Meterological Complex						1												1
Truck, POL (5,000-Liter)			4				4						12			5		25
Truck, POL (7,000-Liter)						7												7
Truck, Sawmill												1						1
Truck, Signal				1														1
Truck, Tractor, HET												8						8
Truck, Van				1														1
Truck, Water (2,000-Liter)		4			2	2					2	2	2	2		6		22
Truck, Water (9,500-Liter)													6			17		23
Truck, Water Purification												1						1
Truck, Wrecker		6			3	3					3	3	3	7				28
UAV, Fox-AT2							4											4
UAV Launcher, Trailer, 2-Axle							1											1
UAV, Manportable, Skylark										6								6
UAV Transport, Truck, Medium							1											1
Van, Hospital																	9	9
Van, Light														12				12
Van, Maintenance	1	6	1		3	15	1				17	3	3	68				118
Van, Missile Test & Maint											12							12
Van, Signal		2	1		1	1	1				1	1	1	1	5			15
Van, Signal (Net)															2			2
<b>NOTES:</b>																		
* Same basic organization for IFV, APC, and motorized units. APC units substitute wheeled APCs for IFVs in the tracked units, etc.																		
** The values in this column are the total number for two battalions.																		
*** Tactical Utility Veh, Amphib, VBR w/Trailer, Amphib, can be substituted for Tactical Utility Vehicle, UAZ-469																		

Figure B-9. BTG (Mtzd) (Antiarmor-Lt) Personnel and Equipment List Continued, Page 3

Brigade Tactical Group (Mtzd) (Antiarmor) (continued)																		
Personnel and Items of Equipment	BTG Headquarters *	Motorized Infantry Bn X2 **	Mechanized Infantry Bn (APC)	Guerrilla Bn (Hunter/Killer)	Antitank Bn (Sep Bde, Div, Nondiv)	Composite Artillery Battalion *	Recon Bn (Mtzd) (Sep Bde)	SPF Company	Sniper Company	SPF Deep Attack/Recon Plt	Air Defense Bn (Mtzd) (Sep Bde)	Engineer Battalion (Sep Bde)	Material Support Battalion *	Maintenance Battalion, APC/Mtzd	Signal Company (Sep) *	Chem Defense Co (Sep Bde) *	Medical Company (Sep Bde) *	TOTAL
Van, Signal (Relay)															3			3
Van, Signal (SATCOM)															2			2
Van, Signal (Tactical Phone)															3			3
Van, Sound Ranging						1												1
Van, Survey						2												2
Trailer, Amphibious, PKP												12						12
Trailer, Air Compressor								1				1						2
Trailer, Cargo, 1-Axle	6	24	12	19	17	17	6	4	4		16	16	6	23	15	4	3	192
Trailer, Cargo, 2-Axle	6	80	9	15	20	60	11		1		65	67	150	42	1	14	33	574
Trailer, Decon (OWR DEKON 6000)																4	1	5
Trailer, Generator	2	6	2	3	3	8	3				14	5	3	17	11		14	91
Trailer, Kitchen	1		1				1										1	4
Trailer, POL (2,000-Liter)				2														2
Trailer, POL (4,200-Liter)		8	4		4	10	4				4	4	4	4		17		63
Trailer, POL (5,800-Liter)													12					12
Trailer, Semi, HET												8						8
Trailer, Refrigerated, 2-Axle																	1	1
Trailer, Ultra-Light Aircraft								3										3
Trailer, Utility, Amphib ***			12				1					9						22
Trailer, Utility ***	21	144	19	3	21	42	52	52	21	14	56	17	32	35	12	3	17	561
Trailer, Van											8							8
Trailer, Water (1,200-Liter)	1	12	1	4	2	2	1				2	3	2	2			9	41
Trailer, Water (2,000-Liter)				2				1										3
Trailer, Water (4,200-Liter)																21		21
Trailer, Water (5,800-Liter)													6					6
Smoke Pots, Drums, Barrels & Grenades		Assort	Assort	Assort	Assort	Assort	Assort	Assort		Assort								Assort
Aiming Circle/Goniometer		10	2	18				4										34
Anti-Veh/Anti-Personnel Wire-Rolls				9				Assort										9
Automated Fire Control System		8	4	1														13
Binocular Laser Rangefinder	15	372	92	86	39	84	59	62	45	18	53	54	13	19	6	10		1027
Boat, Assault w/Motor								Assort				Assort						Assort
Boat, Inflatable, Zodiac, w/Motor								6										6
Camera, CCD-UAV							4											4
Camera Digital		12	6	11			21	34		12		13						109
Camera, FLIR-UAV							4											4
Closed-Circuit Rebreather System								24										24
Comms Radio DF Set, Manportable								12		3								15
Comms Radio Intercept Set, Manportable								12		3								15
Diving Set, Indiv, SCUBA								24				23						47
Electrical, Carpentry, & Plumbing Sets		Assort		Assort				Assort				Assort						Assort
Electric Welding/Cut Equip, Underwater								4				4						8
Electronic Plotting Board		12	6	2	6		6	3		3	18							56
Flexible Stor Tank (POL) (500/1000-Liter)				4				2										6
Flexible Stor Tank (Water) (500/1000-Liter)				4				2										6
Flexible Storage Tank (40,000-Liter)						4							4			5	2	15
Generator Set, Portable				10				23										33
GPS Jammer, Manportable, 4-25 Watt								48		6								54
GPS Receiver, Handheld	47	570	129	94	105	225	118	154	64	33	251	193	230	205	43	47	65	2573
GPS Receiver, Divers, Underwater w/Ant								8										8
Laser Guidance Unit, 9S53					12													12
Laser Rangefinder		6	6			8	2											22
Laser Target Designator		40	16		14	12	17	16	36	3		2						156
Laser Target Designator Pod-UAV							4											4

**NOTES:**  
 \* Same basic organization for IFV, APC, and motorized units. APC units substitute wheeled APCs for IFVs in the tracked units, etc.  
 \*\* The values in this column are the total number for two battalions.  
 \*\*\* Tactical Utility Veh, Amphib, VBR w/Trailer, Amphib, can be substituted for Tactical Utility Vehicle, UAZ-469

Figure B-10. BTG (Mtzd) (Antiarmor-Lt) Personnel and Equipment List Continued, Page 4

Brigade Tactical Group (Mtzd) (Antiarmor) (continued)																		
Personnel and Items of Equipment	BTG Headquarters *	Motorized Infantry Bn X2 **	Mechanized Infantry Bn (APC)	Guerrilla Bn (Hunter/Killer)	Antitank Bn (Sep Bde, Div, Nondiv)	Composite Artillery Battalion *	Recon Bn (Mtzd) (Sep Bde)	SPF Company	Sniper Company	SPF Deep Attack/Recon Plt	Air Defense Bn (Mtzd) (Sep Bde)	Engineer Battalion (Sep Bde)	Material Support Battalion *	Maintenance Battalion, APC/Mtzd	Signal Company (Sep) *	Chem Defense Co (Sep Bde) *	Medical Company (Sep Bde) *	TOTAL
Litters, Medical				10				12										22
Medical Set, Autopsy																	1	1
Medical Set, Dental																	3	3
Medical Set, General			1					4									10	15
Medical Set, Surgical								2									7	9
Minefield Control Sets												13						13
Mine Detector, Handheld												16						16
Mixer, Concrete												1						1
Mortuary Set																	2	2
Observation Scope, Day/Night		12		18				16	36	3								85
Oxygen Support System (Abn)								Assort										Assort
Periscopic Aiming Circle, PAB2A						11												11
Parachutes, Cargo								Assort										Assort
Parachutes, High-Altitude Precision								Assort										Assort
Parachutes, Individual								Assort										Assort
Parachutes, Powered								Assort										Assort
Parachutes, Ramair								Assort										Assort
Pharmacy Set								1									1	2
Piledriver, Set												1						1
Radar, GSR, Manportable, Fara-1	1	60	29			12	11	24		3	2							142
Radar, GSR, Portable, Credo-1E		6					3				1							10
Sensor Sets		6	4	3			20	15		3	2							53
Soil Penetrometer, Portable								2				6						8
Antenna, GPS Jamming, Directional								12		3								15
Antenna, Mast HF/UHF/VHF		6	3	12	3	3	35	18		3	3	3	3	3	28	2		125
Antenna, Satellite		6	3	12	3	3	35	18		3	3	3	3	3	16	1		112
Telephone Field Cable, 1 km		16	8	8	8	8	8	8				8	8	8				96
Telephone, Landline		30	15	15	15	15	15	8			15	15	15	15				173
Telephone Set		8	4	4	4	4	4	4			4	4	4	4				48
Telephone Switchboard		2	1	1	1	1	1	4			1	1	1	1				15
Tent, Command Post				3														3
Tent, General Purpose																	21	21
Tent, Medical																	6	6
Tent, Medical Aid Station				2				4										6
Tent, Medium								1										1
Tent, Mortuary, Refrigerated																	1	1
UAV Ground Station, Computer, Laptop								4		3								7
UAV Maintenance & Repair Kit								4		3								7
Water Purification Set								1										1
Wire Cutter, Set				13				3										16
Thermal Viewer, Handheld, Sophie	10	170	33		30	20	45	44	36	14	27	11	4					444
Night-Vision Goggles	6	608	21	89	50	199	44	67	74	18	188	195	222	191	17	35	56	2080
Night-Vision Goggles (Driver)	50	328	70	33	95	224	103	61	26	14	233	226	231	196	40	62	84	2076
Night-Vision Goggles (AK w/GP-30)	43	344	150		87	123	95	29	65	5	115	104	39	101	31	31	15	1377
Night-Vision Sight (Aiming Circle)		6					11	4										21
Radios:																		
Base Station, LR Cordless Telephone				15														15
Handheld, LR Cordless Telephone				67														67
Handheld, Satellite Telephone								32		14								46
Handheld, Very-Low-Power	8	388	117	233	18	57	80	148	79	37	44	45	7	24	4	1	14	1304
Manpack, Burst Transceiver								17		14								31
Manpack, Low-Power	2	174	45	62	69	125	54	51	39	4	56	68	186	98	17	25	5	1080
Manpack, SATCOM Transceiver								19		4								23
Vehicle Mount, High-Power								1										1
Vehicle Mount, Medium-Power	76	248	96	43	84	190	109	60	24	14	217	134	54	68	81	37	49	1584
Vehicle Mount, Radio-Relay								4										4
Vehicle Mount, SATCOM Transceiver								19		14								33
Warning Receiver	10	38	14	11	20	35	47	34	1	4	48	21	21	27	2	12	4	349
<b>NOTES:</b>																		
* Same basic organization for IFV, APC, and motorized units. APC units substitute wheeled APCs for IFVs in the tracked units, etc.																		
** The values in this column are the total number for two battalions.																		
*** Tactical Utility Veh, Amphib, VBR w/Trailer, Amphib, can be substituted for Tactical Utility Vehicle, UAZ-469																		

Figure B-11. BTG (Mtzd) (Antiarmor-Lt) Personnel and Equipment List Continued, Page 5

**Step 9d. Adjust Equipment Tiers**

B-73. In this example, there was no demonstrable need to change the equipment listed in the AFS organizational directories for the units making up this task organization to equipment in a different tier (or to something in the same tier listed in a substitution matrix). Four tiers of system capability are available, with Tier 1 representing the greatest level of capability and modernization. The separate motorized infantry brigade used as the base unit for the BTG task organization is a Tier 2 unit. Tier 2 reflects modern, competitive systems fielded in significant numbers for the last 10 to 20 years. The SPF company and the SPF deep attack/reconnaissance platoon added to the BTG are elite units that have more high-technology, state-of-the-art, Tier 1 equipment. The guerrilla battalion that becomes part of this BTG has a mixture of Tier 3 and Tier 4 equipment. However, forces with lower-tier systems can use adaptive tactics or make adaptive use of existing technologies in ways that challenge the technological advantages of modern forces.

B-74. Thus, the OPFOR units selected to counter ARTs have a mix of Tier 1, 2, 3, and 4 units, which are appropriate for the OPFOR in this situation. In other situations, however, organizations in the AFS directories may or may not reflect the appropriate mix of systems for a particular training requirement. When necessary, therefore, the Tier Tables and Systems Substitution Matrices in the Worldwide Equipment Guide (WEG) are another tool for trainers and planners to use to alter systems in simulations to reflect different levels of modernity and capability. The proper mix (tiering) of OPFOR weapons and equipment has a major impact on the quality of training received. See chapter 4 for further detail on Tier Tables and Systems Substitution Matrices.

**Step 9e. Update Folders and File Paths**

B-75. Once the organizational graphics and personnel and equipment data for the OPFOR task-organized BTG (Mtzd) (Antiarmor-Lt) have been completed, the paths to the documents and files in MS Windows Explorer® may need to be reorganized and arranged to reflect the conversion from an AFS organization to a task-organized unit. Trainers can arrange the folders and files to suit their needs or whatever they are the most comfortable with. However, the use of a sequential numbering of folders and files ensures the units are presented in the proper sequence when accessed in Windows Explorer®. This method has proven by far to be the simplest when dealing with a large number of documents, many with similar titles. For the BTG (Mtzd) (Antiarmor-Lt), the recommended folders (in bold), MS Word® documents, and MS Excel® spreadsheet titles are as shown in figures B-12 and B-13 (on pages B-26 and B-26).



**Note.** In order to keep path lengths within practical limits, folder and file names had to be shortened by using abbreviations (some of which are not used within the documents and spreadsheets themselves).

**01 BTG (Mtzd) (Antiarmor-Lt)** (or title/number assigned for training) (Folder)

**01 BTG (Mtzd) (Antiarmor-Lt)** (Folder)

01 BTG (Mtzd) (Antiarmor-Lt).doc

01A BTG (Mtzd) (Antiarmor-Lt) Equip.xls

**02 BTG Hqs and Staff** (Folder)

02 Bde Hqs and Staff.doc

**03 Motorized Infantry Bn (x2)** (Folder)

03 Motorized Inf Bn.doc

03A Mtzd Inf Bn-Equip.xls

03B Mtzd Inf Co-Equip.xls

03C Mtzd Inf Plt-Equip.xls

03D Weapons Plt-Equip.xls

**04 Mechanized Infantry Bn (APC)** (Folder)

04 Mech Inf Bn (APC).doc

04A Mech Inf Bn (APC)-Equip.xls

**05 Guerrilla Battalion (Hunter-Killer)** (Folder)

01 Guer Bn (Hunter-Killer).doc

02 Guer Bn-Equip.xls

03A Hunter-Killer Co, HK Bn-Equip.xls

03B Hq and Cmd Sect, HK Co-Equip.xls

03C Hunter-Killer Group, HK Co-Equip.xls

03D Hunter-Killer Sect 1,2, and 3-Equip.xls

03E Hunter-Killer Sect 4-Equip.xls

04A Guer HK Co-Equip.xls

04B Hq and Svc Sect, Guer Co-Equip.xls

04C Guer Plt, Guer Co-Equip.xls

04D Wpns Plt, Guer Co-Equip.xls

05A Wpns Co, Guer Bn-Equip.xls

**06 Antitank Battalion (Sep Bde)** (Folder)

06 AT Bn (Sep).doc

06A AT Bn (Sep)-Equip.xls

**07 Composite Artillery Bn (Sep Bde)** (Folder)

07 Composite Arty Bn (Sep).doc

07A Composite Arty Bn (Sep)-Equip.xls

**08 Recon Battalion (APC-Mtzd) (Sep)** (Folder)

08 Recon Battalion (APC-Mtzd) (Sep).doc

08A Recon Battalion (APC-Mtzd) (Sep)-Equip.xls

**09 SPF Company** (Folder) (not a separate unit in AFS; must be broken out)\*

09 SPF Company.doc

09A SPF Company-Equip.xls

\***Note.** This is not separate stand-alone unit in the AFS organizational directories. It is organic to a larger organization and must be split out in order to use it in a task-organization. The best method is to copy the parent organization to a blank MS Word® document and **Save As** a separate unit. In this case the document is saved as "SPF Company.doc." The process is similar for the MS Excel® charts. Simply locate the Excel® chart of the parent unit and **Save As** a new chart with the title of the subordinate unit being split out (SPF Company-Equip.xls). Once saved as a new Excel® chart, simply delete all that does not apply. What is left should be the Excel® chart for the split-out organization (SPF Company).

(continued)

**Figure B-12. Folders and Files for Task Organization**

### TASK-ORGANIZED OPFOR (continued)

**Note.** In order to keep path lengths within practical limits, folder and file names had to be shortened by using abbreviations (some of which are not used within the documents and spreadsheets themselves).

- 10 Sniper Company (Div) (Folder)**
  - 10 Sniper Company (Div).doc
  - 10A Sniper Company (Div)-Equip.xls
- 11 SPF Deep Attack-Recon Plt (Folder) (not a separate unit in AFS; must be broken out)\***
  - 11 SPF Deep Attack-Recon Plt.doc
  - 11A SPF Deep Attack-Recon Plt-Equip.xls
- 12 Air Defense Bn (Mtzd) (Sep Bde) (Folder)**
  - 12 Air Defense Bn (Mtzd) (Sep).doc
  - 12A Air Defense Bn (Mtzd) (Sep)-Equip.xls
- 13 Engineer Battalion (Sep Bde) (Folder)**
  - 13 Engineer Battalion (Sep) (APC-Mtzd).doc
  - 13A Engineer Battalion (Sep) (APC-Mtzd)-Equip.xls
- 14 Materiel Support Battalion (Sep Bde) (Folder)**
  - 14A Materiel Support Battalion.doc
  - 14B Materiel Support Battalion-Equip.xls
  - 14C Ammo Trans Co-Equip.xls
  - 14D Cargo Trans Co-Equip.xls
- 15 Maintenance Battalion (APC-Mtzd) (Folder)**
  - 15 Maint Bn (APC-Mtzd).doc
  - 15A Maint Bn (APC-Mtzd)-Equip.xls
- 16 Signal Company (Sep Bde) (Folder)**
  - 16 Signal Company (Sep).doc
- 17 Chemical Defense Co (Sep Bde) (Folder)**
  - 17 Chemical Defense Co (Sep).doc
  - 17A Chemical Defense Co (Sep)-Equip.xls
- 18 Medical Company (Sep Bde) (Folder)**
  - 18 Medical Company (Sep).doc
  - 18A Medical Company (Sep)-Equip.xls
- 02 Local Insurgent Organization (or fictitious title assigned for training) (Folder)**
  - 01 Local Insurgent Organization.doc
  - 02 Local Insurgent Organization-Equip.xls
  - 03 Direct Action Cells-Insurgency-Equip.xls
  - 04 Direct Action Cells-Multifunction-Equip.xls
  - 05 Technical Support Cell-Equipment.xls

**\*Note.** This is not separate stand-alone unit in the AFS organizational directories. It is organic to a larger organization and must be split out in order to use it in a task-organization. The best method is to copy the parent organization to a blank MS Word® document and **Save As** a separate unit. In this case the document is saved as "SPF Deep Attack-Recon Plt.doc." The process is similar for the MS Excel® charts. Simply locate the Excel® chart of the parent unit and **Save As** a new chart with the title of the subordinate unit being split out (SPF Deep Attack-Recon Plt-Equip.xls). Once saved as a new Excel® chart, simply delete all that does not apply. What is left should be the Excel® chart for the split-out organization (SPF Deep Attack-Recon Plt).

**Figure B-13. Folders and Files for Task Organization (Continued)**

## STEP 10. CONSTRUCT THE LOCAL INSURGENT ORGANIZATION

B-76. The sub-steps for creating the appropriate local insurgent organization are the same as those outlined for the BTG task organization in Step 9. Therefore, the discussion here will be limited to the differences.

B-77. One key difference is that insurgent organizations are irregular forces, meaning that there is no “regular” table of organization and equipment. There is no “standard” structure for an insurgent organization. Thus, the baseline insurgent organizations in the AFS organizational directories represent only the “default setting” for a “typical” insurgent organization. The organizational graphic for a “typical” local insurgent organization (see figure B-3 on page B-7) therefore included several dashed boxes indicating the possibility of different multiples of the basic cell types. The baseline organizational charts and lists of personnel and equipment include many “Notes” on possible variations in organization or in numbers of people or equipment within a given organization.

B-78. When developing an OB for a specific insurgent organization for use in training, training planners need to take several things into consideration:

- What functions the insurgents need to be able to perform.
- What equipment is needed to perform those functions.
- How many people are required to employ the required equipment.
- The number of vehicles in relation to the people needed to drive them or the people and equipment that must be transported.
- Equipment associated with other equipment (for example, an aiming circle/goniometer used with a mortar or a day/night observation scope used with a sniper rifle).

B-79. When task-organizing insurgent organizations, guerrilla units might be subordinate to a larger insurgent organization, or they might be loosely affiliated with an insurgent organization of which they are not a part. A guerrilla unit or other insurgent organization might be temporarily subordinated to or affiliated with a regular military organization.

B-80. For illustrative purposes, the local insurgent organization in this example uses the “default setting” shown in the spreadsheet in the organizational directories (see figure B-15). This provides a reasonable number of multifunction direct action cells (four) and at least one of each of the other types of more specialized direct action cells and other cells. Since the ARTs chosen for the U.S. training unit’s METL did not specify what kind of insurgent actions or terror tactics would be employed, this “default” organization offers a wide variety of capabilities that can stress the training unit’s METL. For details on the local insurgent organization, including personnel and equipment listings, see appendix C. In this example, the local insurgent organization is not actually part of the BTG, but rather is only loosely affiliated with it.

### Step 10a. Create Folders

B-81. Since the local insurgent organization is affiliated with the BTG in this example, a folder “02 Local Insurgent Organization” was already created in Step 9a (see figure B-4). Now it is time to make necessary modifications to the files that go into that folder.

### Step 10b. Modify Organizational Graphics

B-82. Since the “default setting” shown in the AFS Excel® chart seems appropriate for the local insurgent organization in this example, only a few modifications are necessary in the PowerPoint® organizational graphic. Save the Word® document as a new document under the “02 Local Insurgent Organization” folder created in Step 9a. In the Word® document, change the title line by deleting the “(Typical).” Open the PowerPoint® graphic and delete all the dashed boxes. The result is shown in figure B-14 on page B-28. If desired for training purposes, change the generic name “Local Insurgent Organization” to a fictitious name, such as “Glorious Path Organization.”

B-83. The Word® document in the AFS organizational directories also includes several pages of “Notes.” Trainers will need to delete or modify notes that do not apply to this particular local insurgent organization.

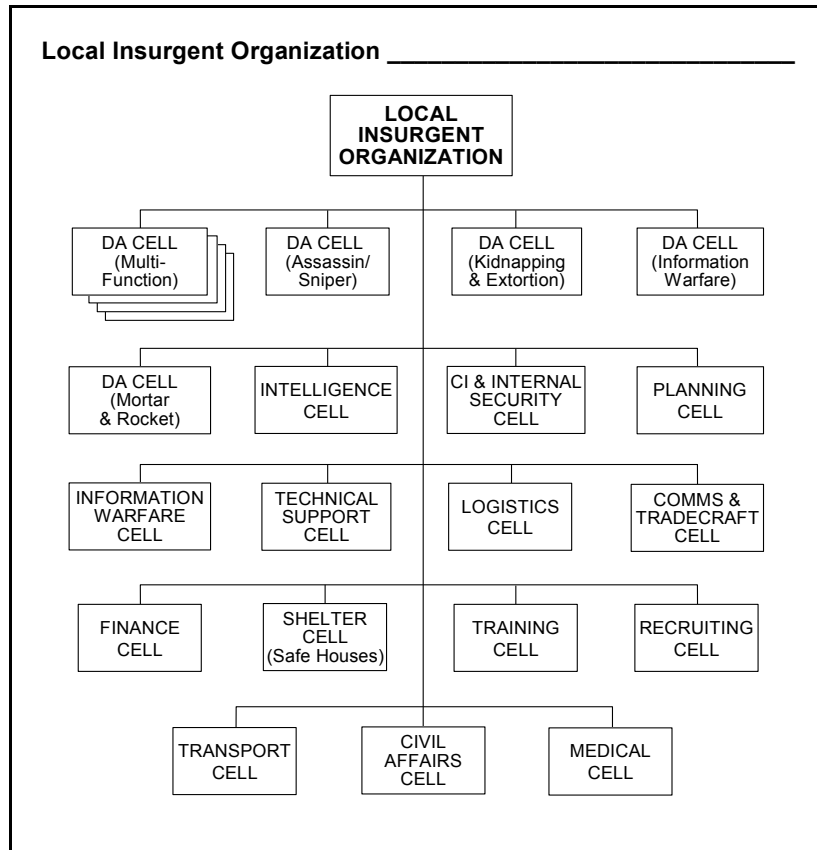

Figure B-14. Local Insurgent Organization (Affiliated)

**Step 10c. Modify Personnel and Equipment Charts**

B-84. The training planners in this example elected to use the “default setting” for subordinate units, as shown in the local insurgent organization Excel® chart in the AFS organizational directories. Therefore, no modifications are necessary. The result is figure B-15.

B-85. For a given local insurgent organization (other than the one chosen for this example), it may be necessary to change the numbers of various types of cells in the organization from the “default setting” shown in the AFS organizational directories. The “default” local insurgent organization has four multifunction direct action cells. If the desired organization needs a different number of such cells, training planners will have to divide the personnel and equipment by four and multiply by the actual number of these cells. If the actual OB has only one of these cells, it will be necessary to delete the “(X4)\*” after “Direct Action Cell (Multifunction)” in Row 2 and the corresponding Note at the bottom of the Excel® chart. If the actual number of such cells is a multiple other than “(X4),” the asterisk should remain, but the Note must change “four” to the appropriate number.

B-86. The “default” local insurgent organization has one of each of the other possible types of cells. In an actual OB, some of these types of cells could appear in multiples. Both the PowerPoint® organizational chart and the Excel® personnel and equipment chart must be modified to reflect the actual numbers of each type of cell. When there are multiple units in several columns of the Excel® chart, it is simpler to use the same reference asterisk(s) in Row 2 for each such unit, with one Note saying: “The values in these columns are the total number for multiple cells for each type.”

B-87. Likewise, some types of cells might not be used in a particular insurgent organization. In that case, it will be necessary to delete their boxes in the MS PowerPoint® organizational chart and their columns in the MS Excel® spreadsheet.

Local Insurgent Organization																					
Personnel and Items of Equipment	Local Leader	Direct Action Cell (Multifunction) (X4) *	Direct Action Cell (Assassin/Sniper)	Direct Action Cell (Kidnap/Extortion)	Direct Action Cell (Information Warfare)	Direct Action Cell (Mortar & Rocket)	Intelligence Cell	CI & Internal Security Cell	Planning Cell	Information Warfare Cell	Technical Support Cell	Logistics Cell	Comms & Tradecraft Cell	Finance Cell	Shelter Cell	Training Cell	Recruiting Cell	Transport Cell	Civil Affairs Cell	Medical Cell	TOTAL
	<b>Total Personnel</b>	1	32	8	8	8	13	5	5	5	13	21	5	8	5	5	5	5	8	5	6
9-mm Pistol, PM	1	8	2	2	2	3	4	4	4	5	9	4	5	4	4	4	4	2	4	4	<b>79</b>
7.62-mm Assault Rifle, AKM		4	2	1	1	2	1	1	1	1	4	1	1	1	1	1	1	1	1	1	<b>27</b>
7.62-mm Carbine, AKMS	1	16	4	4	4	7	3	3	3	11	13	3	6	3	3	3	3	6	3	4	<b>103</b>
7.62-mm GP MG, PKM		4	1	1	1	1															<b>8</b>
7.62-mm LMG, RPK		4	2	1	1	2	1	1	1	1	4	1	1	1	1	1	1	1	1	1	<b>27</b>
7.62-mm Sniper Rifle, Mosin/Nagant		4	2	1	1	1															<b>9</b>
40-mm Grenade Launcher, BG-15		4	2	1	1	2	1	1	1	1	4	1	1	1	1	1	1	1	1	1	<b>27</b>
60-mm Mortar, Light, Type 90 or 60-mm Commando Mortar, M70						1															<b>1</b>
107-mm Lchr Single-Tube, Type 85, or 107-mm Single-Tube, MONOTUBE						1															<b>1</b>
ATGL, RPG-7V		8	2	2	2	2															<b>16</b>
ATDL, RPG-22		4	1	1	1	1															<b>8</b>
Demolitions Fuze/Detonators		Assort	Assort	Assort	Assort	Assort					Assort										<b>Assort</b>
Demolitions Materiel		Assort	Assort	Assort	Assort	Assort					Assort										<b>Assort</b>
IED, Individual, Vest											3										<b>3</b>
IED, Vehicle Borne (VBIED)											2										<b>2</b>
IED, WMD											1										<b>1</b>
Improvised Explosive Device (IED)		16	4	4	4	4					20										<b>52</b>
Mines (AP&AT)		Assort	Assort	Assort	Assort	Assort					Assort										<b>Assort</b>
Motorcycle/motorscooter/bicycle													3								<b>3</b>
Sedan, Civilian		4	1	1	1	2	2	1	1	2	4	1	1	2	1	1	2	2	1	1	<b>31</b>
Truck, Medium, Commercial																					<b>1</b>
Truck, Pickup 1/2 ton, Civilian		4	1			2		1	1	1	1	1				1		1	1	1	<b>16</b>
Van, Civilian				1	1						4		1		1			1		1	<b>10</b>
Aiming Circle/Goniometer						1															<b>1</b>
Antenna, Satellite					2					2			3	2			1				<b>10</b>
Binoculars		4	2	2	1	3	3	2	1	2	5	1	1	1	2	1	1	1	1	1	<b>35</b>
Camcorder, Video		4	1	2	3	2	2	1		4	4	1	2	1	1	1	1	1	2	1	<b>34</b>
Camera, Digital		4	1	2	3	2	2	1	1	4	4	1	2	1	1	1	1	1	2	1	<b>35</b>
Electrician Set			1		1						8										<b>10</b>
GPS Receiver, Handheld	1	4	1	1	1	3	2	1	2	2	9	2	4	2	2	2	2	4	2	2	<b>49</b>
Laser Rangefinder, Handheld			2																		<b>2</b>
Litters, Medical																				3	<b>3</b>
Medical Set																				2	<b>2</b>
Observation Scope, Day/Night			2																		<b>2</b>
Night-Vision Goggles		4	4	1	2	3	2	2	1	2	4	2	4	1	2	2	2	4	2	2	<b>46</b>
Radios:																					
Base Station, LR Cordless Telephone											2		1	1							<b>4</b>
Cell Phone	1	12	3	3	4	7	5	5	5	12	51	5	5	5	5	5	5	8	5	6	<b>157</b>
Computer, Desktop					4					8		2	3	3			1		3		<b>24</b>
Computer, Laptop	1	4	1	1	8	3	5	5	5	12	13	3	5	5	5	5	5	3	5	2	<b>96</b>
Computer, PDA	1	4	1	1	8	3	5	5	5	12	9	5	5	5	5	5	5	3	5	2	<b>94</b>
Handheld, LR Cordless, Telephone	1	4	1	1	4	2	5	5	5	8	13	5	5	5	5	3			5	1	<b>83</b>
Handheld, Very-Low-Power	1	32	8	8	8	13	5	5	5	12	21	5	5	5	5	5	5	3	5	6	<b>162</b>
Manpack, Low-Power											4								8	5	<b>17</b>
Portable, Satellite Telephone	1	4	1	1	3	1	1	1	1	5	5	1	3	3	1	1	1	1	2	1	<b>38</b>
Vehicle Mount, Medium Power											1		1								<b>2</b>
<b>NOTES:</b>																					
* The values in this column are the total number for four Multifunction Direct Action Cells.																					

Figure B-15. Local Insurgent Organization Equipment (Affiliated)

B-88. As indicated in notes in the MS Word® document for the AFS local insurgent organization, there might be cases where the functions normally performed by specialized cells would be combined into a single cell. If the structure of the “Direct Action Cell (Multifunction)” does not cover the requirements for the necessary merging of functions, training planners might need to create a new, task-organized cell that combines the necessary functions. Examples of the latter might be a combined Intelligence and Information Warfare Cell, a combined Logistics and Transport Cell, or a combined Recruiting and Training Cell. If it is necessary to create such “hybrid” cells, training planners will need to use the “bottom-up” process to get the right organization, personnel, and equipment at the lowest level and then roll it up into the next higher organization.

### **Step 10d. Adjust Equipment Tiers**

B-89. In this example, there was no demonstrable need to change the equipment listed in the AFS local insurgent organization to equipment in a different tier (or to something in the same tier listed in a substitution matrix). When necessary, however, the Tier Tables and Systems Substitution Matrices in the Worldwide Equipment Guide (WEG) are another tool for trainers and planners to use to alter systems in simulations to reflect different levels of modernity and capability. Although four tiers of systems capability are available, a typical local insurgent organization, as shown in the AFS organizational directories, would have mostly Tier 4 equipment. However, even an insurgent organization, especially one that is well financed, can have some higher-tier systems, perhaps in certain niche technology areas. The proper mix (tiering) of OPFOR weapons and equipment has a major impact on the quality of training received. Organizations in the AFS directories may or may not reflect the appropriate mix for a particular training requirement.

B-90. For this example, Tier 4 was deemed appropriate. However, forces with lower-tier systems can use adaptive tactics or make adaptive use of existing technologies in ways that challenge the technological advantages of modern forces. See chapter 4 for further detail on Tier Tables and Systems Substitution Matrices.

### **Step 10e. Update Folders and File Paths**

B-91. Once the organizational graphics and personnel and equipment data for the OPFOR task-organized local insurgent organization have been completed, the paths to the documents and files in MS Windows Explorer® may need to be reorganized and arranged to reflect the conversion from an AFS organization to a task-organized unit. The users can arrange the folders and files to suit their needs or whatever they are the most comfortable with. However, the use of a sequential numbering of folders and files ensures the units are presented in the proper sequence when accessed in Windows Explorer®. This method has proven by far to be the simplest when dealing with a large number of documents, many with similar titles. For the local insurgent organization, the recommended folders (in bold), MS Word® documents, and MS Excel® spreadsheet titles are as shown in figure B-13 on page B-26.

## **BUILDING FROM THE BOTTOM UP**

B-92. For the sake of simplicity, the BTG (Mtzd) (Antiarmor-Lt) example above did not include any task organizations below the BTG level. In reality, however, it may be necessary to task-organize at lower levels in order to achieve the desired challenges to the training unit. If all units in an OB come straight out of the AFS organizational directories with no modifications, that OB probably does not portray adequately the OPFOR’s ability to organize its forces adaptively to achieve the optimal effect.

B-93. Training planners need to start at the very bottom to look for places where task-organizing is appropriate to the training requirements. At whatever organizational level the need for a task organization is identified, they must make the appropriate modifications to personnel, equipment, and organization charts. Then, they must roll up the personnel and equipment to the place in the OB where the higher-level headquarters has received no assets from outside its own original organization—thus, it is not a detachment or a tactical group, but has the same name given to it in the AFS.

## STEP 9. CONSTRUCT TASK-ORGANIZED BTG SUBORDINATES

B-94. The same basic procedures used in the BTG example in the first part of this appendix also apply to the creation of lower-level task organizations. One difference is that many organizations below brigade level do not have an MS Excel® chart in the AFS organizational directories. Instead, they list personnel and equipment numbers as part of the basic MS Word® document for the organization in question. If training planners task-organize any of these lower-level units, however, it is recommended to use Excel® charts as a tool to keep things straight when rolling up modified personnel and equipment numbers into each successive higher organization.

B-95. Adjustments and/or modification to the existing organizations and equipment charts are uncomplicated and easy to make, as long as the adjustments are taken one at a time and remain bite-size. Otherwise, the trainer making the changes might easily become completely overwhelmed and lost in the process.

### Step 9a. Create Folders

B-96. If one or more of the BTG subordinates is task-organized into a detachment, the folder name should change to reflect that. If one of the two motorized infantry battalions becomes a detachment, or if both become detachments but in different ways, this will require two separate folders to replace the single folder “03 Motorized Infantry Bn (x2).”

### Step 9b. Modify Organizational Graphics

B-97. Any change from company to CDET or battalion to BDET status needs to be reflected in the appropriate organizational graphics. This affects the graphic for the unit becoming a detachment, as well as the graphic for the parent unit to which the detachment is subordinate. When the unit task-organized as a detachment is one of multiple like units displayed as “stacked” boxes in the organizational graphic for its parent organization, it will need to be “unstacked” and split out from like units that did not become detachments.

### Step 9c. Modify Personnel and Equipment Lists

B-98. In the interest of space, the AFS organizational directories did not use MS Excel® spreadsheets for some smaller units. For those units, personnel and equipment were listed in the MS Word® portion of the directory. This Word® document contains three basic sets of information: organizational graphics; personnel information, and principal items of equipment (unless personnel and equipment are listed in a separate MS Excel® spreadsheet). A typical personnel and equipment list for a lower-level OPFOR unit is similar to the infantry squad, infantry platoon (extracted from the AFS motorized infantry battalion folder) shown in figure 2-2 in chapter 2 (page 2-4). Appendix D contains the complete motorized infantry company and the motorized infantry battalion personnel and equipment spreadsheet. The complete motorized infantry battalion, the motorized infantry brigade, and the motorized infantry division are all available in the AFS organizational directories on BCKS.

#### *Total Personnel and Principal Items of Equipment*

B-99. The recommended process for making modifications and adjustments to personnel and equipment is similar to the way the organizations were built in the AFS organizational directories—from *bottom up*. The process of building the necessary units, with any required modifications, begins with the very lowest levels and culminates in the desired OPFOR countertask capability at the highest levels.

B-100. For the lowest-level units, the Word® document in the organizational directories includes a listing of all individual members of the unit, their title or function, and their assigned personal weapons. (See figure 2-5 in chapter 2 [page 2-20] for the example of the infantry squad.) For example, at infantry squad level, make the changes to each individual’s weapons and equipment first. After these changes have been made, add up all the personnel and equipment in the squad to update the listings of “Total Personnel” and “Principal Items of Equipment” in the Word® document. Then move to the next level (the infantry

platoon), make changes, and add all the totals for the platoon. The listing of total personnel and principal items of equipment for the infantry platoon includes the entire infantry platoon and all its subordinates: the platoon headquarters, three infantry squads, and a weapons squad. All of equipment and personnel of these subordinates are rolled up into the listing for the infantry platoon organization. The infantry platoon and other infantry company subordinates are, in turn, rolled up to become the infantry company. The infantry company and other battalion subordinates are then rolled up to become the motorized infantry battalion, and so forth. If training planners change anything in any subordinate unit, it affects the roll-up for the next higher unit.

B-101. The build progresses upward from there, individual-by-individual, weapon-by-weapon, system-by-system, page-by-individual page, until each subordinate organization is built and rolled up into its parent organization. This is a very detailed process requiring knowledge at many different levels. Often, the organizational directories specify even the vehicle in which each individual rides. If there is a key to success in building a proper OPFOR organization to stress specific training requirements (other than knowledge or research), it is to focus on bite-size portions. Address only one page at a time. Follow this procedure a step at a time until the organization is complete, whether it is a company or CDET, a battalion or BDET, a brigade or BTG, a division or DTG, or an OSC.

B-102. The personnel and equipment lists in the MS Word® document do not automatically roll up numbers for a total. At this stage, each individual unit (and multiples of units) must be totaled manually. The sum is then entered manually in building the personnel and equipment list for the parent organization. Because of the possibility of human error in rolling up the totals, it is recommended to use MS Excel® as a tool for doing this process in a systematic and accurate manner. Once trainers have built the appropriate personnel and equipment totals in an Excel® chart, they can transfer these numbers into the corresponding Word® document.

#### *Using Spreadsheets to Facilitate Roll-Ups*

B-103. Training planners may need to create a new spreadsheet for a lower-level organization that did not have a spreadsheet in the AFS organizational directories, in order to keep track of adjustments to it. If so, an easy way to create one is to make a copy of the spreadsheet of a higher-level organization that includes the unit in question. That way, the spreadsheet automatically has rows for all the equipment types needed for the smaller subordinate unit (and some other rows that may need to be deleted). It also has summing formulas in its “Total” column for adding up equipment numbers in each row. Find the existing spreadsheet to serve as the basis for the new one. Then, *Save As* and rename this spreadsheet with the name of the smaller unit or task organization.

B-104. The next step is to clear (but not delete) the columns for units that will not be used in the smaller baseline organization. Do not clear Column A with equipment names or the “Total” column. Also, do not clear the columns for any unit(s) of the original parent organization that will be added to this lower-level base unit during task-organizing (see note below).

---

*Note.* If any unit(s) from original parent organization will become part of the task organization based on the smaller unit, trainers may wish to “save” the columns for these units rather than having to re-create them. However, retaining the columns for these units in their original positions can interfere with the next step (creating a spreadsheet with personnel and equipment totals for the smaller base organization). Therefore, it is necessary to temporarily move the columns for these units to be saved to a position to the right of the “Total” column; thus, for the time being, they will not affect the building of the new totals for the smaller baseline unit from the summing formulas contained in the cells of the “Total” column (for summing of columns to its left). To do so, highlight the column(s) to be saved, click on *Edit/Copy*, highlight a column to the right of the “Total” column, and click on *Edit/Paste*. Once trainers have built the correct totals for the smaller base unit and are ready to begin task-organizing, they can move these “saved” columns into their correct positions at the left. To do so, highlight the column(s) to be moved, click on *Edit/Cut*, highlight a column to the left of the “Total” column, and click on *Edit/Paste*.

---



B-105. Then create new column headings in Row 2 for the target smaller unit's original subordinates and break down the original overall personnel and equipment totals among them, using numbers from the appropriate Word® documents. When entering numbers in columns, it is recommended to highlight the column currently being worked on, in order to limit confusion and avoid placing numbers into the wrong column. Highlight the column by clicking on the letter designating that column at the very top of the Excel® chart and then click on the **Fill Color** icon in the toolbar and select a color. The column will remain highlighted during entry of numbers. (Just clicking on the letter at the top of the column temporarily highlights the entire column, but the highlighting turns off as soon as one clicks on a cell to enter data.) When entries in that column are complete, click on the letter at the top of the column again, then click on the **Fill Color** icon and select **No Fill** to turn off the highlighting in the completed column. Make sure that the numbers summed in the "Total" column match the totals for the base unit, before task-organizing (see note below).

---

**Note.** When creating an Excel® chart for a smaller baseline unit that does not have one in the AFS organizational directories, trainers should ensure that the resulting personnel and equipment totals match the previous AFS listings. As a quality-control yardstick, they should compare the totals in the new Excel® chart with the totals shown in an AFS Word® document for the smaller unit or in that unit's column of the Excel® chart for its parent unit. This quality control measure should occur before the trainers begin making modifications to the smaller unit—adding or deleting from the base units originally subordinate to it—during the task-organizing process.

---

B-106. At this point, move columns for any temporarily "saved" to the right of the "Total" column into their correct positions to the left (see note above). This may again place numbers in the "Total" column for some equipment rows not used in the smaller base unit.

B-107. Then insert new columns for additional units made subordinate in the task organization, look up those units in the organizational directories, and enter their equipment numbers in the appropriate rows. At this point, it may be necessary to insert additional rows in the spreadsheet in order to accommodate equipment types that were not in the base unit or its parent organization. To create the right formula for automatic summing of a new row in the "Total" column, users can click on any cell in the "Total" column containing the correct formula for its row and **Copy** and **Paste** that formula into the "Total" cell in the new row; the letters designating the row in the formula should automatically change to the letter of the new row. To determine whether there is a formula associated with a cell in the "Total" column, click on that cell; if there is a formula, it should appear in the formula bar at the top of the screen—for example, "=SUM(B26:L26)" for automatically summing the numbers in Columns B through L of Row 26. To copy this formula into another row, highlight the cell that has a formula and then click on **Edit/Copy**. The selected cell will appear with a flashing dotted line around it. Then move the cursor to the cell that needs the formula and click on **Edit/Paste**. This cell will then receive the same formula, except that it will have a different row number—for example, "=SUM(B27:L27)." Repeat the **Edit/Paste** procedure to insert similar formulas into as many cells as need them. Finally, hit the **Esc** (escape) key to stop the flashing on the original cell from which you copied the formula. The spreadsheet should automatically revise the summing formulas to include any added columns (if the inserted column is not to the left of columns included in the original formulas).

B-108. After completing the above steps, any row with a "0" (zero) in the "Total" column should contain equipment not actually found in the unit that is the subject of this spreadsheet. Double-check the source documents and charts for the numbers entered manually to make sure this is true. Then delete the rows for equipment not found in this unit (before and after task-organizing). Delete any columns not used for this unit's subordinates.

B-109. Upon completion of each stage for lower-level subordinates of an organization, it is recommended that trainers enter the data into an MS Excel® spreadsheet for the next-higher organization. When the MS Excel® chart has appropriate summing formulas entered into it, it rolls up the numbers automatically into personnel and equipment totals for the higher organization. The automatic roll-up feature of MS Excel®

significantly reduces mathematical fatigue and resultant errors. The Excel® charts provide quick access to totals of personnel and primary equipment at each echelon, which are the information most frequently needed.

---

*Note.* As trainers build to each successively higher-level organization, they must keep in mind that some units or parts of units that were originally directly subordinate to that command in the AFS are now subordinate to a lower-level task organization. Personnel and equipment totals for those units should now be rolled up into the higher organization as part of the respective lower-level task organization. Therefore, it will be necessary to delete or decrement some entries in Excel® charts for the higher-level organization in order to avoid double-counting these assets.

---

### **Step 9d. Adjust Equipment Tiers**

B-110. A big difference when building task organizations from the bottom up is that this step is likely to occur at an earlier stage in the process. Start the substitution at the lowest level where the system is found, so that the numbers of it (and related systems) get rolled up into higher organizations. In an infantry squad, for example, trainers could select a different assault rifle or a different antitank grenade launcher from the appropriate Tier Table or Systems Substitution Matrix. Some substitutions might apply only to elite units (for example, SPF) or to a unit given niche technology for a special mission. The proper mix (tiering) of OPFOR weapons and equipment has a major impact on the quality of training received. See chapter 4 for further detail on Tier Tables and Systems Substitution Matrices.

### **Step 9e. Update Folders and File Paths**

B-111. Once the organizational graphics and personnel and equipment data have been completed up to the desired organizational level, the paths to the documents and files in MS Windows Explorer® may need to be reorganized and arranged to reflect the conversion from AFS organizations to task-organized units. Trainers might need to arrange newly created Excel® charts or Word® documents in their proper places in the sequence. They can arrange the folders and files to suit their needs or whatever they are the most comfortable with. However, the use of a sequential numbering of folders and files ensures the units are presented in the proper sequence when accessed in Windows Explorer®. This method has proven by far to be the simplest when dealing with a large number of documents, many with similar titles.

## **STEP 10. CONSTRUCT OTHER TASK ORGANIZATIONS**

B-112. Then, the training planners start again at the lowest level in any other part of the OB that requires a task organization. Again, they build up the place where the higher headquarters has received no assets from outside its own original organization and would still have the same name as in the AFS. They repeat this process for as many “branches” of the organizational “tree” as need task organization.

## Appendix C

# Local Insurgent Organization from the AFS Organizational Directories

This appendix provides an example of the information for a local insurgent organization found in the administrative force structure (AFS) organizational directories. It also describes various cells within such an organization.

---

*Note.* For illustrative purposes, this FM contains several examples from the online AFS organizational directories. Readers are reminded that even the baseline OPFOR organizations are subject to change over time. Therefore, readers should always consult the online directories for the latest, most up-to-date versions of organizational data.

---

## INSURGENT ORGANIZATIONS

C-1. Insurgent organizations have no regular “table of organization and equipment” structure. The mission, environment, geographic factors, and many other variables determine the configuration and composition of each insurgent organization and its subordinate cells.

C-2. Insurgent organizations are typically composed of from three to over 30 cells. All of the direct action cells could be multifunction (or multipurpose), or some may have a more specialized focus. The single focus may be a multifunction direct action mission, assassination, sniper, ambush, kidnapping, extortion, hijacking and hostage taking, or mortar and rocket attacks. Each of these may be the focus of one or more cells. More often, the direct action cells are composed of a mix of these capabilities and several multifunction cells. There are also a number of types of supporting cells with various functions that provide support to the direct action cells or to the insurgent organization as a whole. Thus, a particular insurgent organization could be composed of varying numbers of multifunction or specialty direct action cells, supporting cells, or any mix of these.

## LOCAL INSURGENT ORGANIZATION EXAMPLE

C-3. This appendix provides an example of a typical local insurgent organization, taken from volume III of the AFS organizational directories. For illustrative purposes, this example includes a reasonable number of multifunction direct action cells (four) and at least one cell of each of the 18 other, more specialized types. The dashed boxes in the organizational graphic indicate the possibilities for varying numbers of each type of cell, depending on the functions required for the insurgent organization to accomplish its mission. For the overall local insurgent organization and for any cell where organizational diagrams show varying numbers of subordinate teams, personnel and equipment totals reflect only the cells in solid boxes.

Local Insurgent Organization (Typical)

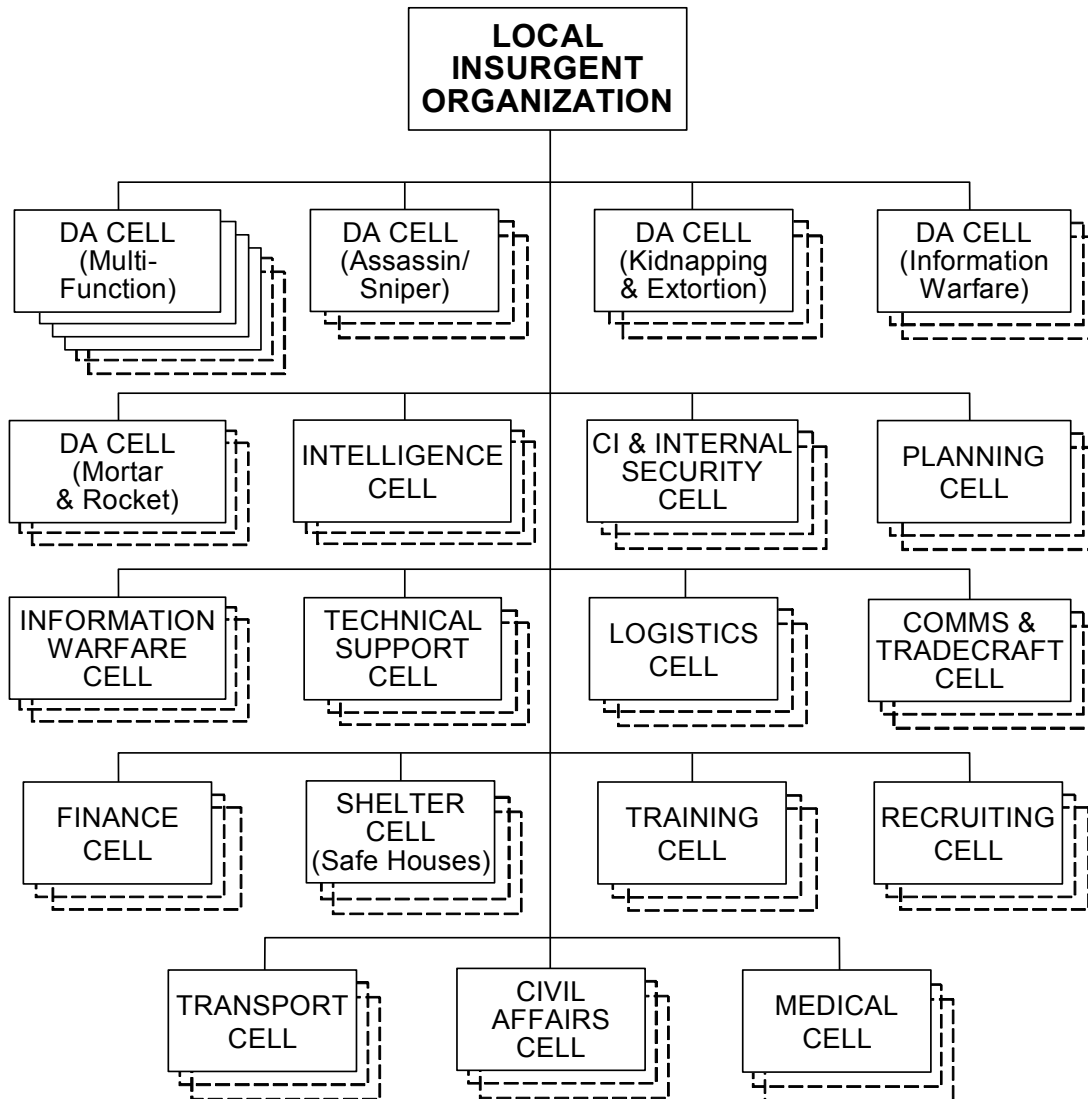

Local Insurgent Leader (x1) ..... PM/AKMS

Total Personnel ..... 171

NOTES: See next page.

## Local Insurgent Organization (Typical) (continued)

---

### NOTES:

1. Personnel and equipment totals for the “typical” example reflect only the cells shown in solid boxes in the organizational diagram for the Local Insurgent Organization (Typical).
2. Insurgent organizations are amorphous. Their ability to continually adapt to all aspects of their environment is directly relational to their survivability and lethality. These dynamic organizations manifest themselves primarily by their unpredictability; their ability to influence and to blend in with the population; their shifting architectures, affiliations, alliances, behaviors, TTP (tactics, techniques, and procedures), and players; and their spectrum of lethality—ranging from improvised explosive devices (IEDs) to weapons of mass destruction (WMD).
3. The term *local insurgent organization* includes any insurgent organization below regional, provincial, or district level. This includes small cities, towns, villages, parishes, communities, neighborhoods, and/or other lower-level insurgent organizations. Cities with a large population or covering a large area may be considered regions; therefore, they may control several local insurgent organizations.
4. The leader of any insurgent organization may be one individual, with or without advisors; several individuals and advisors; or a council. The leader may also be a tribal, cultural, political, or religious leader. A leadership council may be comprised of tribal, religious, political, secular, radical sectarian, or other personnel, or any combination of the above.
5. There are several factors that differentiate the structure and capability of the insurgent organization (direct action cells) from the structure and capability of a guerrilla organization. The insurgent organization is primarily a covert organization. Its structure is cellular and more typical of groups using terror tactics, while the guerrilla’s organization reflects their kinship to a more formal military structure (battalion, company, platoon or hunter/killer [H/K] group, H/K section, H/K team).

The weapons of the insurgents are generally limited to small arms, RPG-7Vs, and IEDs with very few crew-served weapons (82-mm mortar, 107-mm single tube rocket launcher). A guerrilla organization contains weapons up to and including 120-mm mortars, ATGMs, and MANPADS, and can conduct limited mine warfare and sapper attacks. While both organizations are very effective and lethal in close and populated terrain, the guerrilla organizations can perform more typical fire and maneuver tactics. The guerrilla organization can, and often does, use terror tactics; however, it is best suited to conduct irregular or unconventional warfare tactics.
6. Local insurgent organizations are not always subordinate to a regional, national, or transnational insurgent organization. The local insurgent organization may not be associated with a larger insurgent movement in any way. Local insurgent organizations can be either subordinate or loosely affiliated, or they may be completely autonomous/independent of regional and national insurgent organizations. Similarly, a regional insurgent organization may or may not be associated with or subordinate to a larger insurgent organization. Any relationship of independent local insurgent organizations to regional or national structures may be one of affiliation or dependant upon only a single shared or similar goal. These relationships are generally fluctuating and may be fleeting, mission dependent, event- or agenda-oriented, or for any other reasons or motivations.
7. Many insurgent organizations operate independently, without central guidance or direction from the overall movement. In some cases, the local insurgent organization may provide only financial support and general guidance to their action elements (organic direct action cells). There may be loose coordination of attacks due to a specific affiliation, after which the organizations revert back to their independent modes.

Continued

## Local Insurgent Organization (Typical) (continued)

---

*NOTES:* (continued)

8. The decentralized characteristic of many of the insurgent organizations enhances the security of the organization by effectively eliminating the ability of the enemy to penetrate the organization. This same decentralized structure allows the organization to survive to fight another day without a current leader. When the leader of the organization is eliminated, the remaining direct action cells (or cell members) simply merge into another insurgent organization, splinter off on their own, or offer their services up for bid. When individual fighters are killed, they are simply replaced, with limited down time for the cell.

9. Local insurgent organizations may have some type of relationship with guerrilla organizations and/or criminal organizations or noncombatants, based on similar or a shared goal(s) and/or interest(s). The nature of the shared goal or interest determines the tenure and type of relationship and the degree of affiliation. The affiliation with criminal organizations is dependent only on the needs of the criminal organization at a particular time. In some cases, lower-level guerrilla organizations may be subordinate to a local insurgent organization.

10. Insurgent organizations generally do not possess much of the heavier and more sophisticated equipment that guerrilla organizations possess. Some examples of equipment and capability the guerrillas have in their organizations that the insurgents generally do not have are: 73/82/84-mm recoilless guns; 100-mm and 120-mm mortars; 107-mm MRLs; 122-mm rocket launchers; 12.7-mm HMGs; .50-cal BMG antimateriel rifles; ATGMs; MANPADS; GPS jammers; and mine warfare and signals intelligence capabilities. In the event the insurgents require these weapons or capabilities, they may either obtain them from guerrillas or the guerrilla organization may provide its services depending on the relationship between the two organizations at the time.

11. Insurgent organizations receive a wide variety of support from noncombatants, on and off the battlefield. The support provided by many different categories of noncombatants ranges from only being sympathetic to the goals of the insurgents, to providing monetary support, to actively supporting and engaging in combat alongside the insurgents and/or guerrillas. The relational dynamics includes all of the players in the insurgents' environment. Direct action personnel may use, fight alongside of, or assist affiliated forces and guerrillas to achieve their common goals or for any other agenda.

12. Although the local insurgent organization may use irregular or unconventional warfare and/or terror tactics to achieve their goals, their primary tactic is terror. The local insurgent organization is the action arm of the overall insurgent movement. The subordinate direct action cells are the actual fighters and shooters. They perform the sabotage and assassinations, IED emplacement, and other functions.

13. The mission, environment, geographic factors, and many other variables determine the configuration and composition of each insurgent organization and its subordinate direct action cells. Insurgent organizations are typically composed of anywhere from 3 to over 30 cells (22 cells is the "default" for a "typical" local insurgent organization). The cells can be all multifunction (or multipurpose), or each with a different focus, or all the cells may be composed of a single focus or specialty, supporting cells, or any mix of these. The single focus may be a multifunction direct action mission, assassination, sniper, ambush, kidnapping, extortion, hijacking and hostage-taking, or mortar and rocket attacks. Each of these may also be the focus of one or two cells (possibly more). More often, the direct action cells are composed of a mix of these capabilities and several multifunction cells, regardless of the number of cells employed at one time.

Continued

## Local Insurgent Organization (Typical) (continued)

---

*NOTES:* (continued)

14. Most insurgent organizations are composed of mix of separate specialty cells and multifunction cells, all designed to operate independently (if necessary) once they have started their missions. The insurgent organization will always possess all the specialty capabilities listed above (although not necessarily in separate cells).

15. The multifunction direct action cell should be used as a default for all direct action cells not requiring unique specialties. The multifunction direct action cell possesses all of the specialized capabilities to a lesser degree. Every direct action cell is capable of performing all of the missions listed above. When not engaged in specialized activities, the specialized cells also serve as multifunction direct action cells.

16. The people in an insurgent organization are likely to be indistinguishable from the local population (other than weaponry, which they may conceal or discard) because they generally are part of the population. This is a great strength. Their ability to blend in with the population usually has direct impact on their survivability. When weapons are required, insurgents may attempt to appear as if they are local militia, police, security guards, or other acceptable armed groups.

17. Insurgent organizations usually contain a mixture of men, women, and children. Local women and children may be used as runners, videographer/camera operators, messengers, scouts, guides, suicide bombers, drivers, porters, snipers, lookouts, or in other roles. They may also emplace and/or detonate IEDs, booby traps, and mines. Women (and possibly children) may be fighters and participate in “drive-bys,” assassinations, ambushes and/or assaults. They may also serve (willingly or unwillingly) as suicide bombers.

18. The intelligence, counterintelligence and security, planning, information warfare, logistics, communications and tradecraft, technical support, finance, training, recruiting, transport, civil affairs, shelter, and medical cells also subordinate to the insurgent organization either support the role of the direct action cells or exploit their successes. Some insurgent organizations may not have separate cells for all of the above functions; however, someone in the organization must be designated to perform these functions. For example, the intelligence cell may also incorporate the counterintelligence and security functions, or a local cell working out of a member’s home may not require additional shelter or transportation.

19. Key events (and results) of all direct action cell activities are digitally recorded on video and still cameras. Upon mission completion, the digitized recordings are turned over to the information warfare cell for manipulation and exploitation. The videographer/camera operator may attempt to blend in with the crowds and may disassociate him/herself from the operation. In other situations, the key event/activity will be staged for the camera.

20. Depending on the mission, the local insurgent organization may be augmented by any and every type of personnel and/or vehicle. Vehicles could be motorcycles, trucks, agricultural trucks, commercial trucks, liquid cargo carriers (for POL or water), flat beds, busses, farm trailers, tractors, sedans, ½ ton civilian pickup trucks (such as Toyotas or Nissans), high-mobility/all terrain vehicles, bicycles, or carts.

21. Insurgents may have no vehicles or supplies at all and depend completely on caches, porters, or other transportation or supply means. Local sympathizers may volunteer their equipment and services. Insurgents may requisition or confiscate local civilian transportation assets and materiel. This includes the use of civilian personnel for porters and possibly as lookouts and security personnel. Draft animals may also be used as bearers or porters.

22. For additional information on the insurgent organization see FM 7-100.3.

Local Insurgent Organization (Typical) (continued)

PRINCIPAL ITEMS OF EQUIPMENT

<u>Equipment</u>	<u>Total</u>
9-mm Pistol, PM.....	79
7.62-mm Assault Rifle, AKM .....	27
7.62-mm Carbine, AKMS .....	103
7.62-mm GP MG, PKM .....	8
7.62-mm LMG, RPK .....	27
7.62-mm Sniper Rifle, Mosin/Nagant .....	9
40-mm Grenade Launcher, BG-15 .....	27
60-mm Mortar, Light, Type 90 or 60-mm Commando Mortar, M70.....	1
107-mm Single-Tube, Type 85 or 107-mm Single-Tube, MONOTUBE.....	1
ATGL, RPG-7V .....	16
ATDL, RPG-22 .....	8
Demolition, Fuzes & Detonators .....	Assorted
Demolition Materiel .....	Assorted
IED, Individual, Vest.....	3
IED, Vehicle Borne (VBIED) .....	2
IED, WMD .....	1
Improvised Explosive Devices (IED).....	52
Mines (AP, AT, & AV) .....	Assorted
Motorcycle/motorscooter/bicycle .....	3
Sedan, Civilian .....	31
Truck, Medium, Commercial .....	1
Truck, Pickup ½ ton, Civilian .....	16
Van, Civilian.....	10
Aiming Circle/Goniometer .....	1

<u>Equipment</u>	<u>Total</u>
Antenna, Satellite .....	10
Binoculars.....	33
Camcorder, Video.....	34
Camera, Digital.....	35
Electrician Set.....	10
GPS Receiver, Handheld .....	49
Laser Rangefinder, Handheld .....	2
Litters, Medical.....	3
Medical Set.....	2
Observation Scope, Day/Night.....	2
Night-Vision Goggles.....	46
Radios:	
Base Station, Long Range	
Cordless Telephone.....	4
Cell Phone.....	157
Computer, Desktop .....	24
Computer, Laptop .....	96
Computer, PDA.....	94
Handheld, Long-Range Cordless- Telephone.....	83
Handheld, Very-Low-Power.....	162
Manpack, Low-Power.....	17
Portable, Satellite Telephone .....	38
Vehicle Mount, Medium Power.....	2



Local Insurgent Organization (Typical) (continued)

Local Insurgent Organization																					
Personnel and Items of Equipment	Local Leader	Direct Action Cell (Multifunction) (X4) *	Direct Action Cell (Assassin/Sniper)	Direct Action Cell (Kidnap/Extortion)	Direct Action Cell (Information Warfare)	Direct Action Cell (Mortar & Rocket)	Intelligence Cell	CI & Internal Security Cell	Planning Cell	Information Warfare Cell	Technical Support Cell	Logistics Cell	Comms & Tradecraft Cell	Finance Cell	Shelter Cell	Training Cell	Recruiting Cell	Transport Cell	Civil Affairs Cell	Medical Cell	TOTAL
<b>Total Personnel</b>	1	32	8	8	8	13	5	5	5	13	21	5	8	5	5	5	5	8	5	6	<b>171</b>
9-mm Pistol, PM	1	8	2	2	2	3	4	4	4	5	9	4	5	4	4	4	4	2	4	4	<b>79</b>
7.62-mm Assault Rifle, AKM		4	2	1	1	2	1	1	1	1	4	1	1	1	1	1	1	1	1	1	<b>27</b>
7.62-mm Carbine, AKMS	1	16	4	4	4	7	3	3	3	11	13	3	6	3	3	3	3	6	3	4	<b>103</b>
7.62-mm GP MG, PKM		4	1	1	1	1															<b>8</b>
7.62-mm LMG, RPK		4	2	1	1	2	1	1	1	1	4	1	1	1	1	1	1	1	1	1	<b>27</b>
7.62-mm Sniper Rifle, Mosin/Nagant		4	2	1	1	1															<b>9</b>
40-mm Grenade Launcher, BG-15		4	2	1	1	2	1	1	1	1	4	1	1	1	1	1	1	1	1	1	<b>27</b>
60-mm Mortar, Light, Type 90 or 60-mm Commando Mortar, M70						1															<b>1</b>
107-mm Lchr Single-Tube, Type 85, or 107-mm Single-Tube, MONOTUBE						1															<b>1</b>
ATGL, RPG-7V		8	2	2	2	2															<b>16</b>
ATDL, RPG-22		4	1	1	1	1															<b>8</b>
Demolitions Fuze/Detonators		Assort	Assort	Assort	Assort	Assort					Assort										<i>Assort</i>
Demolitions Materiel		Assort	Assort	Assort	Assort	Assort					Assort										<i>Assort</i>
IED, Individual, Vest											3										<b>3</b>
IED, Vehicle Borne (VBIED)											2										<b>2</b>
IED, WMD											1										<b>1</b>
Improvised Explosive Device (IED)		16	4	4	4	4					20										<b>52</b>
Mines (AP, AT & AV)		Assort	Assort	Assort	Assort	Assort					Assort										<i>Assort</i>
Motorcycle/motorscooter/bicycle													3								<b>3</b>
Sedan, Civilian		4	1	1	1	2	2	1	1	2	4	1	1	2	1	1	2	2	1	1	<b>31</b>
Truck, Medium, Commercial																		1			<b>1</b>
Truck, Pickup 1/2 ton, Civilian		4	1			2		1	1	1	1	1				1		1	1	1	<b>16</b>
Van, Civilian				1	1						4		1		1			1		1	<b>10</b>
Aiming Circle/Goniometer						1															<b>1</b>
Antenna, Satellite					2					2			3	2			1				<b>10</b>
Binoculars		4	2	2	1	3	3	2	1	2	5	1	1	1	2	1	1	1	1	1	<b>35</b>
Camcorder, Video		4	1	2	3	2	2	1		4	4	1	2	1	1	1	1	1	2	1	<b>34</b>
Camera, Digital		4	1	2	3	2	2	1	1	4	4	1	2	1	1	1	1	1	2	1	<b>35</b>
Electrician Set			1		1						8										<b>10</b>
GPS Receiver, Handheld	1	4	1	1	1	3	2	1	2	2	9	2	4	2	2	2	2	4	2	2	<b>49</b>
Laser Rangefinder, Handheld			2																		<b>2</b>
Litters, Medical																					<b>3</b>
Medical Set																					<b>2</b>
Observation Scope, Day/Night			2																		<b>2</b>
Night-Vision Goggles		4	4	1	2	3	2	2	1	2	4	2	4	1	2	2	2	4	2	2	<b>46</b>
<b>Radios:</b>																					
Base Station, LR Cordless Telephone											2		1	1							<b>4</b>
Cell Phone	1	12	3	3	4	7	5	5	5	12	51	5	5	5	5	5	5	8	5	6	<b>157</b>
Computer, Desktop					4					8		2	3	3			1		3		<b>24</b>
Computer, Laptop	1	4	1	1	8	3	5	5	5	12	13	3	5	5	5	5	5	3	5	2	<b>96</b>
Computer, PDA	1	4	1	1	8	3	5	5	5	12	9	5	5	5	5	5	5	3	5	2	<b>94</b>
Handheld, LR Cordless, Telephone	1	4	1	1	4	2	5	5	5	8	13	5	5	5	5	5	3		5	1	<b>83</b>
Handheld, Very-Low-Power	1	32	8	8	8	13	5	5	5	12	21	5	5	5	5	5	5	3	5	6	<b>162</b>
Manpack, Low-Power											4								8	5	<b>17</b>
Portable, Satellite Telephone	1	4	1	1	3	1	1	1	1	5	5	1	3	3	1	1	1	1	2	1	<b>38</b>
Vehicle Mount, Medium Power											1		1								<b>2</b>
<b>NOTES:</b>																					
* The values in this column are the total number for four Multifunction Direct Action Cells.																					
Page 1																					

**Direct Action Cells (Typical), Insurgent Organization**

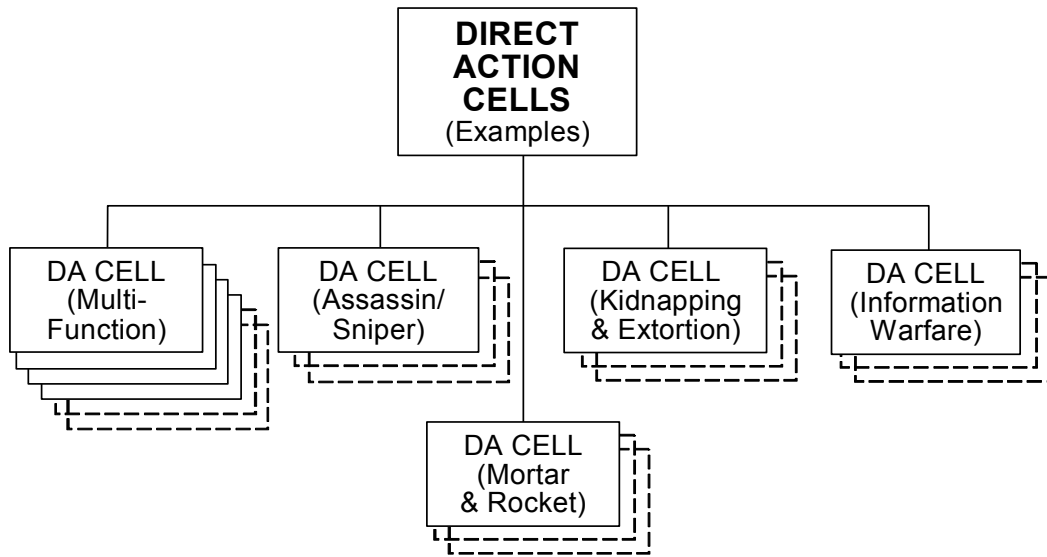

Total Personnel ..... 69

**PRINCIPAL ITEMS OF EQUIPMENT**

<u>Equipment</u>	<u>Total</u>
9-mm Pistol, PM.....	17
7.62-mm Assault Rifle, AKM .....	10
7.62-mm Carbine, AKMS .....	35
7.62-mm GP MG, PKM .....	8
7.62-mm LMG, RPK.....	10
7.62-mm Sniper Rifle, Mosin/Nagant .....	9
40-mm Grenade Launcher, BG-15 .....	10
60-mm Mortar, Light, Type 90 or 60-mm Commando Mortar, M70.....	1
107-mm Single-Tube, Type 85 or 107-mm Single-Tube, MONOTUBE.....	1
ATGL, RPG-7V .....	16
ATDL, RPG-22 .....	8
Demolition, Fuzes & Detonators .....	Assorted
Demolition Materiel .....	Assorted
Improvised Explosive Devices (IED).....	32
Mines (AP, AT, & AV) .....	Assorted
Sedan, Civilian .....	9
Truck, Pickup ½ ton, Civilian .....	7
Van, Civilian.....	2

<u>Equipment</u>	<u>Total</u>
Aiming Circle/Goniometer .....	1
Antenna, Satellite .....	2
Binoculars.....	12
Camcorder, Video.....	12
Camera, Digital.....	12
Electrician Set.....	1
GPS Receiver, Handheld .....	10
Laser Rangefinder, Handheld .....	2
Observation Scope, Day/Night .....	2
Night-Vision Goggles.....	14
Radios:	
Cell Phone.....	29
Computer, Desktop .....	4
Computer, Laptop .....	17
Computer, PDA.....	17
Handheld, Long-Range Cordless- Telephone.....	12
Handheld, Very-Low-Power.....	69
Portable, Satellite Telephone .....	10

NOTES: See next page.

## Direct Action Cells (Typical), Insurgent Organization (continued)

---

### NOTES:

1. Personnel and equipment totals for the “typical” direct action cells in this example reflect only the cells shown in solid boxes in the organizational diagram for the Direct Action Cells (Typical).
2. The direct action cells are the action element of the insurgency movement. They contain the actual fighters and shooters of the insurgency. The direct action cells perform the sabotage and assassinations, IED/VBIED (and suicide bombers) emplacement and detonation, extortion, kidnapping, hostage-taking, sniping, firing of mortars and rockets, and other functions. Direct action cells may also use irregular or unconventional warfare tactics when these tactics better suit their mission, but their primary tactic to achieve their goals is terror. The organizational structure, weapons mix, and other factors limit the direct action cell’s ability to use tactics other than terror tactics.
3. The mission, environment, geographic factors, and many other variables determine the configuration and composition of each direct action cell. Direct action cells do not have a fixed structure. Cell composition is not fixed and varies from cell to cell, mission to mission, environment to environment. The structure, personnel, equipment, and weapons mix all depend on specific mission requirements. The size, specialty, and number of cells employed also depend on the size, number, and specialties required for specific missions, environment, geographic factors, and other variables.
4. The insurgent organization may consist of as few as one direct action cell or as many as 20 or more direct action cells, depending on the mission and other factors. The “default” number of direct action cells is eight (four multifunction cells and four specialty cells).
5. A direct action cell typically contains from 6 to 10 personnel (8 personnel is the default, which includes 2 drivers). The cells can be as small as 2 people or consist of over 20 people (broken into teams if necessary), depending on mission, vehicle requirements, support and security personnel, and other variables.
6. Direct action cells easily lend themselves to be broken down into subordinate teams whenever necessary. Example direct action teams may include functions such as security team, support team, transportation team, or sniping team. As always, this depends on the size of the cell, the nature of its mission, cell dispersion, command and control requirements, and other variables or functions required for mission success.
7. Direct action personnel may use, fight alongside of, or assist affiliated forces and guerrillas to achieve their common goals or for any other agenda.
8. In order to accommodate capabilities representing missions unique to the OPFOR insurgent organization, several example direct action cell structures are provided, each representing a different specialty and capability. Some examples of these specialty cells include, but are not limited to, assassination and sniper; kidnapping and extortion; information warfare; and mortar and rocket cells.
9. Direct actions cells can be all multifunction, or each with a different focus, or all the cells may be composed of a single focus or specialty, or any mix of these. The single focus may be a multifunction direct action mission, assassination, sniper, ambush, kidnapping, extortion, hijacking and hostage-taking, computer attack, or mortar and rocket attacks. Each of these may also be the focus of one or two cells (possibly more). More often, the direct action cells are composed of a mix of these capabilities and several multifunction cells, regardless of the number of cells employed at one time.

Continued

## Direct Action Cells (Typical), Insurgent Organization (continued)

---

*NOTES:* (continued)

10. All direct action cells are designed to operate independently (if necessary) once they have started their mission. The insurgent organization will always possess all the specialty capabilities listed above (although not necessarily in separate cells). The multifunction direct action cell should be used as a default for all direct action cells not requiring unique specialties. The multifunction direct action cell possesses all of the specialized capabilities to a lesser degree. Every direct action cell is capable of performing all of the missions listed above. When not engaged in specialized activities, the specialized cells also serve as multifunction direct action cells.

11. In some cases, the insurgent organization may only provide financial support and general guidance to its subordinate direct action cells. While these direct action cells may not be completely independent of the insurgent organization, they may be forced to provide for themselves in several areas. A typical example of this is a smaller direct action cell separated from the parent organization by distance, population, or ability to communicate securely (or all of these). It may not have access to the expertise or products (IEDs) provided by the technical support cell. An IED cell of this nature is generally quite small and may consist of only three or four personnel, including a lookout, a triggerman, and the IED emplacer. The IED cell emplaces the IEDs, and the triggerman detonates them at the appropriate time. Direct action (multifunction) IED cells of this type may represent a fairly large number of direct action cells.

12. Direct action cells are dispersed. They are not normally colocated with each other or with the control element of the local insurgent organization. Although in some cases direct action cells may come together to provide mutual support to another cell, they usually carry out their mission independent of other cells. The direct action cells may be widely dispersed due to geographical reasons, to cover a large segment of the population, or for security reasons. The dispersion of the direct action cells not only distributes the influence of the insurgency to a wider area, but also enhances the security of the local insurgent organization.

13. Direct action personnel are likely to be indistinguishable from the local population (other than weaponry, which they may conceal or discard) because they generally are part of the population. Their ability to blend in with the population usually is in direct relationship to their ability to survive. When weapons are required, they may attempt to appear as if they are local militia, police, security guards, or other acceptable armed groups.

14. Depending on the mission, direct action cells may be augmented by any and every type of personnel and/or vehicle. Vehicles could be motorcycles, trucks, agricultural trucks, commercial trucks, liquid cargo carriers (for POL or water), flat beds, busses, farm trailers, tractors, sedans, ½ ton civilian pickup trucks (such as Toyotas or Nissans), high-mobility/all terrain vehicles, bicycles, or carts. Insurgent personnel may have no vehicles or supplies at all and depend completely on caches, porters, or other transportation or supply means.

15. Local sympathizers may volunteer their equipment and services. The cells may requisition or confiscate local civilian transportation assets and materiel. This includes the use of civilian personnel for porters and possibly as lookouts and security personnel. Draft animals may also be used as bearers or porters.

Continued

**Direct Action Cells (Typical), Insurgent Organization (continued)** \_\_\_\_\_

*NOTES:* (continued)

16. Direct action personnel may be a mixture of men, women, and children. Local women and children may be used as runners, videographer/camera operators, messengers, scouts, guides, suicide bombers, drivers, porters, snipers, lookouts, or in other roles. They may also emplace and/or detonate IEDs, booby traps, and mines. Women (and possibly children) may be fighters and participate in “drive-bys,” assassinations, ambushes, and/or assaults. They may also serve (willingly or unwillingly) as suicide bombers.

17. Key events (and results/successes) of all direct action cell activities are digitally recorded on digital video and still cameras. Upon mission completion, the recordings are turned over to the information warfare cell for manipulation and exploitation. The videographer/camera operator may attempt to blend in with the crowds and may disassociate him/herself from the operation. In other situations the key event/activity will be staged for the camera. Sympathizers among the local populace may also serve in this role.

18. For additional information, see FM 7-100.3.

**Direct Action Cell (Multifunction), Insurgent Organization**

**DA CELL  
(Multi-  
Function)**

Cell Leader (x1).....PKM  
 Asst Cell Leader (x1)..... AKM/BG-15  
 Grenadiers (x2) .....RPG/AKMS  
 Security Pers/Marksman (x1) ..... Mosin/Nagant  
 Security Pers (x1)..... RPK  
 Driver (x2) ..... PM/AKMS

Total Personnel..... 8

**PRINCIPAL ITEMS OF EQUIPMENT**

<u>Equipment</u>	<u>Total</u>	<u>Equipment</u>	<u>Total</u>
9-mm Pistol, PM.....	2	Binoculars.....	1
7.62-mm Assault Rifle, AKM .....	1	Camcorder, Video.....	1
7.62-mm Carbine, AKMS .....	4	Camera, Digital.....	1
7.62-mm GP MG, PKM .....	1	Electrician Set.....	1
7.62-mm LMG, RPK.....	1	GPS Receiver, Handheld .....	1
7.62-mm Sniper Rifle, Mosin/Nagant .....	1	Night-Vision Goggles.....	1
40-mm Grenade Launcher, BG-15 .....	1	Radios:	
ATGL, RPG-7V .....	2	Cell Phone.....	3
ATDL, RPG-22 * .....	1	Computer, Laptop .....	1
Demolition, Fuzes&Detonators ** .....	Assorted	Computer, PDA.....	1
Demolition Materiel *** .....	Assorted	Handheld, Long-Range Cordless-	
Improvised Explosive Device (IED) **** .....	4	Telephone.....	1
Mines (AP, AT, & AV) ***** .....	Assorted	Handheld, Very-Low-Power.....	8
Sedan, Civilian .....	1	Portable, Satellite Telephone .....	1
Truck, Pickup ½ ton, Civilian .....	1		

NOTES: See next page.

- \* The ATDL is issued as ammunition rather than a weapon—the BOI may vary. They are not assigned to an individual.
- \*\* Assorted fuzes/detonators include time, optical, pressure, pressure release, command armed fuzes, sensor fuzes (acoustic, optical, infrared, seismic, magnetic), command detonated (electronic, radio frequency [RF], pressure release).
- \*\*\* Includes bangalore torpedoes, shaped charges, AT grenades, other tactical demolitions.
- \*\*\*\* Each multifunction direct action cell has at least four assorted types of IED and remote detonation devices. The number and type of IED varies and is determined by the current mission.
- \*\*\*\*\* Includes remotely detonated mines, booby traps, and side-attack (AT & anti-vehicle) mines. The mix is mission dependent and varies.

## Direct Action Cell (Multifunction), Insurgent Organization (continued)

### NOTES:

1. The multifunction direct action cell is the backbone of the insurgency. These are the fighters. These cells may also use irregular or unconventional warfare tactics when these tactics better suit their mission, but their primary tactic to achieve their goals is terror. When using IEDs, the multifunction direct action cell usually breaks down into teams.
2. Bombs (specifically IEDs) are the weapon of choice for the insurgent organization. They are inexpensive, relatively easy to build, and extremely destructive. Bombs may be very sophisticated or extremely simple. Bombs (IEDs) are used in support of assassination, maiming, sabotage, and producing mass casualties. The multifunction direct action cells acquire IEDs (usually unassembled pre-manufactured components) from the technical support cell. The multifunction cell assembles and adds fuzes and detonators to the IEDs. The IED team usually includes at least three people; a lookout, a triggerman, and the IED emplacer. The team emplaces the IEDs, and the triggerman detonates them at the appropriate time. If additional assistance or IED expertise is required, they receive it from the technical support cell.
3. In some cases, the insurgent organization may only provide financial support and general guidance to its subordinate direct action cells. While these direct action cells may not be completely independent of the insurgent organization, they may be forced to provide for themselves in several areas. A typical example of this is a smaller direct action cell separated from the parent organization by distance, population, or ability to communicate securely (or all of these). The cell may not have access to the expertise or products (IEDs) provided by the technical support cell. An IED cell of this nature is generally quite small and may consist of only three or four personnel, including a lookout, a triggerman, and the IED emplacer. The IED cell emplaces the IEDs, and the triggerman detonates them at the appropriate time. Small direct action (multifunction) IED cells of this type may represent a fairly large number of direct action cells.
4. The multifunction cells can also perform sabotage, assassinations, extortion, kidnapping, hostage-taking, sniping, firing of mortars and rockets, and other functions. The multifunction direct action cell is the basic direct action cell structure. All direct action cells are built around this structure.
5. The mission, environment, geographic factors, and many other variables determine the configuration and composition of each direct action cell. Direct action cells do not have a fixed structure. Cell composition is not fixed and varies from cell to cell, mission to mission, environment to environment. The structure, personnel, equipment, and weapons mix all depend on specific mission requirements. Personnel select weapons appropriate to the mission. The RPG, RPK, and/or sniper rifle may be needed in some cases and not in others. Other weapons and equipment are added as required.
6. There may be as few as one multifunction direct action cell as many as twenty or more multifunction direct action cells, depending on the mission and other factors. The default number of multifunction direction action cells is four.
7. The multifunction cell typically contains from 6 to 10 personnel (8 personnel is the default, which includes 2 drivers). The cells can be as small as two people or consist of over 20 people (broken into teams if necessary), depending on mission, vehicle requirements, support and security personnel, and other variables.

Continued

**Direct Action Cell (Multifunction),  
Insurgent Organization (continued)**

---

*NOTES:* (continued)

8. The multifunction direct action cell should be used as a default for all direct action cells not requiring unique specialties. All multifunction cells are cross-trained to perform all functions and thus possess all of the specialized capabilities to a lesser degree. When not engaged in specialized activities, the specialized cells also serve as multifunction direct action cells.
9. Direct action personnel may be a mixture of men, women, and children. Local women and children may be used as runners, videographer/camera operators, messengers, scouts, guides, suicide bombers, drivers, porters, snipers, lookouts, or in other roles. They may also emplace and/or detonate IEDs, booby traps, and mines. Women (and possibly children) may be fighters and participate in “drive-bys,” assassinations, ambushes and/or assaults. They may also serve (willingly or unwillingly) as suicide bombers. These functions can also be performed by personnel outside of the cell.
10. Direct action personnel may use, fight alongside of, or assist affiliated forces, other direct action cells, and guerrillas to achieve their common goals or for any other agenda.
11. Key events (and results/successes) of all direct action cell activities are digitally recorded on digital video and still cameras. Upon mission completion, the recordings are turned over to the information warfare cell for manipulation and exploitation. The videographer/camera operator may attempt to blend in with the crowds and may disassociate him/herself from the operation. In other situations, the key event/activity will be staged for the camera. Sympathizers among the local populace may also serve in this role.
12. For additional information on insurgent direct action cells, see FM 7-100.3.



**Direct Action Cell (Assassination and Sniper), Insurgent Organization \_\_\_\_\_**

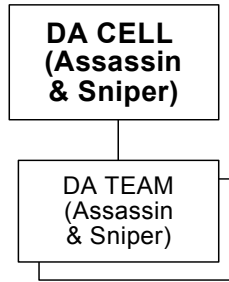

Cell Leader/Team Leader/Obs (x1) ..... AKM/BG-15  
 Team Leader/Observer (x1) .....AKM/BG-15/PKM  
 Sniper/Designator (x2) ..... Mosin/Nagant/RPK  
 Assistant Sniper/Grenadier (x2) .....RPG/AKMS  
 Driver/Security Pers (x2) ..... PM/AKMS

Total Personnel..... 8

**PRINCIPAL ITEMS OF EQUIPMENT**

<u>Equipment</u>	<u>Total</u>	<u>Equipment</u>	<u>Total</u>
9-mm Pistol, PM.....	2	Camcorder, Video.....	1
7.62-mm Assault Rifle, AKM .....	2	Camera, Digital.....	1
7.62-mm Carbine, AKMS .....	4	Electrician Set.....	1
7.62-mm GP MG, PKM .....	1	GPS Receiver, Handheld .....	1
7.62-mm LMG, RPK.....	2	Laser Rangefinder, Handheld .....	2
7.62-mm Sniper Rifle, Mosin/Nagant .....	2	Observation Scope, Day/Night.....	2
40-mm Grenade Launcher, BG-15 .....	2	Night-Vision Goggles.....	4
ATGL, RPG-7V .....	2	Radios:	
ATDL, RPG-22 .....	1	Cell Phone.....	3
Demolition, Fuzes & Detonators * .....	Assorted	Computer, Laptop .....	1
Demolition Materiel ** .....	Assorted	Computer, PDA.....	1
Improvised Explosive Device (IED) *** .....	4	Handheld, Long-Range Cordless-	
Mines (AP, AT & AV) **** .....	Assorted	Telephone.....	1
Sedan, Civilian .....	1	Handheld, Very-Low-Power.....	8
Truck, Pickup ½ ton, Civilian .....	1	Portable, Satellite Telephone .....	1
Binoculars.....	2		

**NOTES:** See next page.

- \* Includes bangalore torpedoes, shaped charges, AT grenades, other tactical demolitions.
- \*\* Includes remotely detonated mines, booby traps, and side-attack (AT & anti-vehicle) mines. The mix is mission dependent and varies.
- \*\*\* Assorted fuzes/detonators include time, optical, pressure, pressure release, command armed fuzes, sensor fuzes (acoustic, optical, infrared, seismic, magnetic), command detonated (electronic, radio frequency [RF], pressure release).
- \*\*\*\* Each assassination and sniper direct action cell has at least four assorted types of IED and remote detonation devices. The number and type of IED varies and is determined by the current mission.

## Direct Action Cell (Assassination and Sniper), Insurgent Organization (continued)

---

### NOTES:

1. The primary mission of the assassination and sniper cell is to terrorize the population and/or to assassinate preselected persons. The cell may indiscriminately select individual targets in crowded marketplaces or religious and political gatherings with the sole intent to terrorize. This direct action cell is extremely lethal in conducting individual assassinations and ambushes.
2. An assassination is a deliberate action to kill political leaders or VIPs, versus the killing of common people, which is considered murder. The insurgent assassinates or murders people it cannot intimidate, who have left the group, or who have some symbolic significance for the enemy or world community. Insurgent organizations may refer to these killings as “punishment.” Many targets of assassination are symbolic and often have a great psychological impact on the enemy. For example, assassinating an enemy negotiator or successful businessperson can demonstrate the enemy’s inability to protect its own people.
3. An assassination and sniper cell could select its own targets based on opportunity, as long as hitting such targets supports (or does not conflict with) the overall goals of the insurgent organization. However, the insurgent leadership can exercise centralized control as necessary, in order to orchestrate concerted action or to achieve a specific goal in its area of influence.
4. Assassination methods include remotely-detonated bombing, the use of firearms, and poisoning. The target’s vulnerabilities determine the method of assassination. For example, a target (individual) who drives to work along the same route each day may be vulnerable to a sniper attack. Each action requires detailed planning by many cells. The insurgent leadership and/or the planning cell selects the assassination target after considering the input from the other cells. The assassination cells take actions similar to those taken for a kidnapping. The difference is that a kidnapping seeks to keep the target alive, while an assassination or murder does not.
5. The structure, personnel, equipment, and weapons mix all depend on specific mission requirements. Weapons appropriate to each mission are selected. The other equipment is left behind or cached. The RPG, RPK, and/or sniper rifle may be needed in some cases and not in others. Other weapons and equipment are added as required. The assassination and sniper cell has the same baseline of weapons and equipment as the multifunction direct action cell.
6. The assassination and sniper cell consists of two teams. The cell leader serves as the team leader of one team. Each team consists of five men: a team leader/observer (spotter), a sniper (shooter)/target designator, an assistant sniper, a security person, and a driver. If a vehicle is not required, the driver may serve as an additional security person or ammo bearer.
7. When the role of the assassination and sniper cell reverts to that of a multipurpose cell, the following role shifts occur. The cell leader remains as the cell leader and a team leader of one of the teams. He retains the assault rifle AKM, with the 40-mm under-barrel grenade launcher BG-15. The team leader of the second team puts aside his AKM/BG-15 and becomes the machinegunner, carrying a 7.62-mm general-purpose machinegun PKM. He remains in charge of the second team. The snipers in both teams put aside their Mosin/Nagant sniper rifles and become the gunners of the 7.62-mm light machineguns RPK. The assistant sniper/designator puts aside his 7.62-mm Carbine AKMS and becomes a grenadier with an RPG-7V. All cell members assist in carrying ammunition and RPG rounds.
8. Every direct action cell is capable of performing all of the insurgent organization missions. When not engaged in specialized activities, the assassination and sniper cell serves as a multifunction direct action cell. Depending on mission requirements, the assassination and sniper cell may also serve as a reconnaissance element, a stay-behind element, or provide security for other direct action cells. For additional information, see FM 7-100.3.

**Direct Action Cell (Kidnapping and Extortion), Insurgent Organization \_\_\_\_\_**

**DA CELL  
(Kidnapping  
& Extortion)**

Cell Leader (x1) .....PKM  
 Asst Cell Leader (x1) ..... AKM/BG-15  
 Grenadiers (x2).....RPG/AKMS  
 Security Pers/Marksman (x1)..... Mosin/Nagant  
 Security Pers (x1) ..... RPK  
 Driver (x2)..... PM/AKMS

Total Personnel ..... 8

**PRINCIPAL ITEMS OF EQUIPMENT**

<u>Equipment</u>	<u>Total</u>	<u>Equipment</u>	<u>Total</u>
9-mm Pistol, PM.....	2	Van, Civilian.....	1
7.62-mm Assault Rifle, AKM .....	1	Binoculars.....	2
7.62-mm Carbine, AKMS .....	4	Camcorder, Video.....	2
7.62-mm LMG, RPK.....	1	Camera, Digital.....	2
7.62-mm GP MG, PKM .....	1	GPS Receiver, Handheld.....	1
7.62-mm Sniper Rifle, Mosin/Nagant .....	1	Night-Vision Goggles.....	1
40-mm Grenade Launcher, BG-15 .....	1	Radios:	
ATGL, RPG-7V .....	2	Cell Phone.....	3
ATDL, RPG-22 * .....	1	Computer, Laptop .....	1
Demolition, Fuzes&Detonators ** .....	Assorted	Computer, PDA.....	1
Demolition Materiel *** .....	Assorted	Handheld, Long-Range Cordless-	
Improvised Explosive Device (IED) **** .....	4	Telephone.....	1
Mines (AP, AT & AV) ***** .....	Assorted	Handheld, Very-Low-Power.....	8
Sedan, Civilian .....	1	Portable, Satellite Telephone .....	1

**NOTES:** See next page.

- 
- \* The ATDL is issued as ammunition rather than a weapon—the BOI may vary. They are not assigned to an individual.
  - \*\* Assorted fuzes/detonators include time, optical, pressure, pressure release, command armed fuzes, sensor fuzes (acoustic, optical, infrared, seismic, magnetic), command detonated (electronic, radio frequency [RF], pressure release).
  - \*\*\* Includes bangalore torpedoes, shaped charges, AT grenades, other tactical demolitions.
  - \*\*\*\* Each kidnapping and extortion direct action team has at least four assorted types of IED and remote detonation devices. The number and type of IED varies and is determined by the current mission.
  - \*\*\*\*\* Includes remotely detonated mines, booby traps, and side-attack (AT & anti-vehicle) mines. The mix is mission dependent and varies.

## Direct Action Cell (Kidnapping and Extortion), Insurgent Organization (cont)

---

### NOTES:

1. The primary mission of this direct action cell is to conduct kidnapping, extortion, hijacking, and hostage-taking. These acts help to finance the organization and serve to influence and/or terrorize the population. Each action, particularly a kidnapping, requires detailed planning and support by a number of other cells.
2. A kidnapping and extortion cell could select its own targets based on opportunity, as long as hitting such targets supports (or does not conflict with) the overall goals of the insurgent organization. However, the insurgent leadership can exercise centralized control as necessary, in order to orchestrate concerted action, and might identify certain targets or types of targets in order to achieve a specific goal in its area of influence.
3. The intelligence cell provides information on the target's vulnerabilities, weaknesses, and routine behavior. Every member of the insurgent organization, as well as sympathizers, can help gather this target information. The intelligence cell must thoroughly analyze the target so that it can advise the insurgent leadership, the planning cell, and/or the kidnapping and extortion cell on selection of the target site and method of kidnapping. Human intelligence is vital when planning and conducting a kidnapping, and the intelligence cell continuously conducts surveillance on the target to identify potential security flaws. It then determines flaws that the direct action cell can exploit.
4. The intelligence cell and/or the kidnapping and extortion cell conducts detailed reconnaissance and surveillance of potential kidnap sites to determine the best site, considering cover, concealment, and escape routes in its evaluation. Once the target and site are selected, the kidnapping and extortion cell (and/or the planning cell and intelligence cell) conducts detailed analysis to provide the kidnapping and extortion direct action cell with the requisite data on the target. The information required depends on the location of the target and site but includes—
  - The exact route the target uses.
  - The method of conveyance.
  - Specifics of conveyance, such as its size, shape, speed, and construction.
  - The number of security personnel, their location, disposition, and type of weapons used.
  - The target's likes, dislikes, allergies, habits, and routines.
5. After planning and reconnaissance, the kidnapping and extortion direct action cell conducts the actual action. For a kidnapping, the cell leader designates a specific team to conduct the kidnapping. After receiving intelligence, the team rehearses specific kidnapping techniques, such as an ambush or abduction, and finalizes planning. The team plans the escape route in great detail because of the complexities of transporting the victim. It usually disables the victim to make the escape easier. The team determines the best method of disabling the victim (such as drugging, stunning, or binding him).
6. The information warfare cell helps create and maintain the fear caused by kidnapping and extortion through its propaganda and media manipulation means.
7. Every direct action cell is capable of performing all of the insurgent organization missions. When not engaged in specialized activities the kidnapping and extortion direct action cell serves as a multifunction direct action cell. All cell members assist in carrying ammunition and RPG rounds.
8. For additional information, see FM 7-100.3.

**Direct Action Cell (Information Warfare), Insurgent Organization \_\_\_\_\_**

<p><b>DA CELL (Information Warfare)</b></p>
---

Cell Leader/Sr IW Spec (x1) .....PKM  
 Asst Cell Leader/Sr IW Spec (x1) ..... AKM/BG-15  
 IW Spec (Video)/Grenadier (x1).....RPG/AKMS  
 IW Spec (Comms)/Grenadier (x1) .....RPG/AKMS  
 Computer Tech/Security Pers (x1)..... RPK  
 IW Spec/Marksman (x1) ..... Mosin/Nagant  
 IW Spec/Driver (x2) ..... PM/AKMS

Total Personnel ..... 8

**PRINCIPAL ITEMS OF EQUIPMENT**

<u>Equipment</u>	<u>Total</u>	<u>Equipment</u>	<u>Total</u>
9-mm Pistol, PM.....	2	Binoculars.....	1
7.62-mm Assault Rifle, AKM .....	1	Camcorder, Video.....	3
7.62-mm Carbine, AKMS .....	4	Camera, Digital.....	3
7.62-mm GP MG, PKM .....	1	Electrician Set.....	1
7.62-mm LMG, RPK.....	1	GPS Receiver, Handheld.....	1
7.62-mm Sniper Rifle, Mosin/Nagant .....	1	Night-Vision Goggles.....	2
40-mm Grenade Launcher, BG-15 .....	1	Radios:	
ATGL, RPG-7V .....	2	Cell Phone.....	4
ATDL, RPG-22 * .....	1	Computer, Desktop .....	4
Demolition, Fuzes&Detonators ** .....	Assorted	Computer, Laptop .....	8
Demolition Materiel *** .....	Assorted	Computer, PDA.....	8
Improvised Explosive Device (IED) **** .....	4	Handheld, Long-Range Cordless- Telephone.....	4
Mines (AP, AT, & AV) ***** .....	Assorted	Handheld, Very-Low-Power.....	8
Sedan, Civilian .....	1	Portable, Satellite Telephone .....	3
Van, Civilian.....	1		
Antenna, Satellite .....	2		

**NOTES:** See next page.

- \* The ATDL is issued as ammunition rather than a weapon—the BOI may vary. They are not assigned to an individual.
- \*\* Assorted fuzes/detonators include time, optical, pressure, pressure release, command armed fuzes, sensor fuzes (acoustic, optical, infrared, seismic, magnetic), command detonated (electronic, radio frequency [RF], pressure release).
- \*\*\* Includes bangalore torpedoes, shaped charges, AT grenades, other tactical demolitions.
- \*\*\*\* Each direct action cell (information warfare) has at least four assorted types of IED and remote detonation devices. The number and type of IED varies and is determined by the current mission.
- \*\*\*\*\* Includes remotely detonated mines, booby traps, and side-attack (AT & anti-vehicle) mines. The mix is mission dependent and varies.

## Direct Action Cell (Information Warfare), Insurgent Organization (continued)

---

### NOTES:

1. The direct action cell (information warfare) supports the insurgent organization's information warfare (IW) plan and may or may not receive guidance from the information warfare cell. The direct action nature of this cell and its title indicate the nature of its objective, purpose, and role. IED and other attacks are often used to support the overall information warfare plan. These attacks may also be used in a manner to cause (shift) blame for the attack to their enemy.
2. Depending on the size, nature, and focus of the insurgent organization, the direct action cell (IW) may be capable of several functions. Some example functions performed by this cell are selective sabotage actions; information management; media manipulation (misinformation and disinformation—psychological warfare [PSYWAR]); communications (cyber embeds via Internet sites, propaganda and indoctrination videos, broadcast successes of the direct action teams); civic actions; and assist in the cyber-mining for intelligence. All of these functions are integrated to further short- and long-range goals.
3. Some of the functions may require specialized expertise. For example, the media manipulation function (PSYWAR) may require expertise and/or advice from a cleric; a political, a tribal, ethnic, or cultural leader; or other experts. Portions of the direct action cell (IW) are probably dispersed.
4. The mission, environment, geographic factors, and many other variables determine the configuration and composition of each direct action cell. Direct action cells do not have a fixed structure. Cell composition is not fixed and varies from cell to cell, mission to mission, environment to environment. The structure, personnel, equipment, and weapons mix, all depend on specific mission requirements. Personnel select weapons appropriate to the mission. The RPG, RPK, and/or sniper rifle may be needed in some cases and not in others. Other weapons and equipment are added as required, such as computers, computer rigged vehicles, specialized antennas, and communications.
5. The direct action cell (IW) typically contains from 6 to 10 personnel (8 personnel is the default, which includes 2 drivers). The cells can be as small as 2 people or consist of over 20 people (broken into teams if necessary), depending on mission, vehicle requirements, support and security personnel, and other variables. Some functions can also be performed by personnel outside of the cell.
6. There may be as few as one direct action cell (IW) to over 20 direct action cells (IW), depending on the mission and other factors.
7. Direct action personnel may be a mixture of men, women, and children. Local women and children may be used as runners, videographer/camera operators, messengers, scouts, guides, suicide bombers, drivers, porters, snipers, lookouts, or in other roles. They may also emplace and/or detonate IEDs, booby traps, and mines. Women (and possibly children) may be fighters and participate in “drive-bys”, assassinations, ambushes and/or assaults. They may also serve (willingly or unwillingly) as suicide bombers.
8. Every direct action cell is capable of performing all of the insurgent organization missions. When not engaged in specialized activities, the direct action cell (IW) serves as a multifunction direct action cell. All cell members assist in carrying ammunition and RPG rounds.
9. Several members of the direct action cell (IW) may be hired information warfare specialists or “gun fighters.”
10. For additional information on direct action information warfare, see FM 7-100.3.

**Direct Action Cell (Mortar and Rocket), Insurgent Organization \_\_\_\_\_**

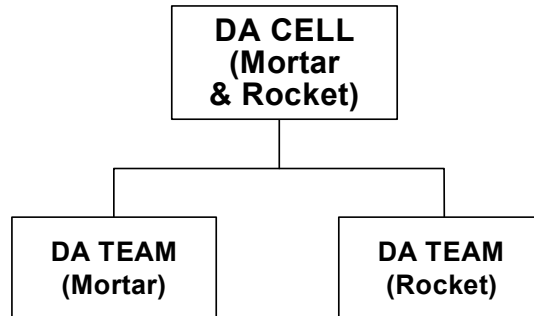

Cell Leader (x1)..... PM/PKM

Total Personnel ..... 13

**PRINCIPAL ITEMS OF EQUIPMENT**

<u>Equipment</u>	<u>Total</u>
9-mm Pistol, PM.....	3
7.62-mm Assault Rifle, AKM .....	2
7.62-mm Carbine, AKMS .....	7
7.62-mm GP MG, PKM .....	1
7.62-mm LMG, RPK.....	2
7.62-mm Sniper Rifle, Mosin/Nagant .....	1
40-mm Grenade Launcher, BG-15 .....	2
60-mm Mortar, Light, Type 90 or 60-mm Commando Mortar, M70 *....	1
107-mm Lchr Single-Tube, Type 85, or 107-mm Single-Tube, MONOTUBE.....	1
ATGL, RPG-7V .....	2
ATDL, RPG-22 ** .....	1
Demolition, Fuzes&Detonators *** .....	Assort
Demolition Materiel **** .....	Assorted
IED ***** .....	4

<u>Equipment</u>	<u>Total</u>
Mines (AP, AT & AV) ***** .....	Assorted
Sedan, Civilian .....	2
Truck, Pickup ½ ton, Civilian .....	2
Aiming Circle/Goniometer .....	1
Binoculars.....	3
Camcorder, Video.....	2
Camera, Digital.....	2
GPS Receiver, Handheld .....	3
Night-Vision Goggles.....	3
Radios:	
Cell Phone.....	7
Computer, Laptop .....	3
Computer, PDA.....	3
Handheld, Long-Range Cordless- Telephone.....	2
Handheld, Very-Low-Power.....	13
Portable, Satellite Telephone .....	1

NOTES: See next page.

## Direct Action Cell (Mortar and Rocket), Insurgent Organization (continued) \_\_\_\_

- \* 81/82-mm mortars (W-87 81-mm or 2B14-1 82-mm) may be substituted for the 60-mm mortar. When 81/82-mm mortars are used, the team size is increased by three personnel (ammo bearers) for a total team size of seven personnel.
- \*\* The ATDL is issued as ammunition rather than a weapon—the BOI may vary. They are not assigned to an individual.
- \*\*\* Assorted fuzes/detonators include time, optical, pressure, pressure release, command armed fuzes, sensor fuzes (acoustic, optical, infrared, seismic, magnetic), command detonated (electronic, radio frequency [RF], pressure release).
- \*\*\*\* Includes bangalore torpedoes, shaped charges, AT grenades, other tactical demolitions.
- \*\*\*\*\* Each mortar and rocket direct action cell has at least four assorted types of IED and remote detonation devices. The number and type of IED varies and is determined by the current mission.
- \*\*\*\*\* Includes remotely detonated mines, booby traps, and side-attack (AT & anti-vehicle) mines. The mix is mission dependent and varies.

### NOTES:

1. The primary purpose of the mortar and rocket direct action cell is to either terrorize or influence the local populace and governing authorities. It may indiscriminately fire into crowded marketplaces and religious gatherings with the intent to terrorize. Targets may also include religious or national icons and/or landmarks.
2. These attacks are often used to support the overall information warfare plan. They may also be used in a manner to cause (shift) blame for the attack to their enemy.
3. Every direct action cell is capable of performing all of the insurgent organization missions. When not engaged in specialized activities, the mortar and rocket direct action cell serves as a multifunction direct action cell. The mortars, rockets, and associated equipment may be cached or left behind, in which case the members carry the weapons and munitions load similar to the multifunction cell. All cell members assist in carrying ammunition and RPG rounds.
4. In some cases, a 120-mm Mortar, Type 86 (W86) may be substituted for the 81/82-mm mortar or 60-mm mortars. However, this substitution requires a light truck to transport each 120-mm mortar. Generally, however, if the insurgents require 100-mm or 120-mm mortars, they look to the guerrillas for support.
5. Improvised 107-mm single-tube rocket launchers are common. The improvised launchers may be fabricated from PVC pipe, iron, or any other available material. Improvised 107-mm rocket firing pads can be constructed of dirt, bamboo frames, crossed stakes, road embankments, a dike between two rice fields, the brim of a combat trench, an earth mound, or a bomb crater.
6. For additional information, see FM 7-100.3.



**Direct Action Team (Mortar), Direct Action Cell (Mortar and Rocket) \_\_\_\_\_**

<p><b>DA TEAM (Mortar) (60-mm)</b></p>
--

Mortar Team Leader/Asst Cell Ldr (x1) .....AKM/BG-15  
 Mortar Gunner/Marksman (x1) .....Type 90/Mosin-Nagant  
 Asst Mort Gunner/Grenadier (x1) ..... RPG/AKMS  
 Ammo Bearer/Asst Grenadier (x1) ..... AKMS  
 Driver/Ammo Bearer (x1) ..... AKMS  
 Driver/ Security Pers (x1) ..... PM/RPK

Total Personnel ..... 6

**PRINCIPAL ITEMS OF EQUIPMENT**

<u>Equipment</u>	<u>Total</u>	<u>Equipment</u>	<u>Total</u>
9-mm Pistol, PM.....	2	Truck, Pickup ½ ton, Civilian .....	1
7.62-mm Assault Rifle, AKM .....	1	Aiming Circle/Goniometer .....	1
7.62-mm Carbine, AKMS .....	3	Binoculars.....	2
7.62-mm LMG, RPK.....	1	Camcorder, Video.....	1
7.62-mm GP MG, PKM .....	1	Camera, Digital.....	1
7.62-mm Sniper Rifle, Mosin/Nagant .....	1	GPS Receiver, Handheld .....	3
40-mm Grenade Launcher, BG-15 .....	1	Night-Vision Goggles.....	2
60-mm Mortar, Light, Type 90		Radios:	
or 60-mm Commando Mortar, M70 *....	1	Cell Phone.....	4
ATGL, RPG-7V .....	1	Computer, Laptop .....	1
ATDL, RPG-22 ** .....	1	Computer, PDA.....	1
Demolition, Fuzes&Detonators *** .....	Assorted	Handheld, Long-Range Cordless-	
Demolition Materiel **** .....	Assorted	Telephone.....	1
IED ***** .....	2	Handheld, Very-Low-Power.....	7
Mines (AP, AT & AV) ***** .....	Assorted	Portable, Satellite Telephone .....	1
Sedan, Civilian .....	1		

NOTES: See next page.

**Direct Action Team (Mortar),  
Direct Action Cell (Mortar and Rocket) (cont)**

---

- \* 81/82-mm mortars (W-87 81-mm or 2B14-1 82-mm) may be substituted for the 60-mm mortar. When 81/82-mm mortars are used, the team size is increased by three personnel (ammo bearers) for a total team size of seven personnel.
- \*\* The ATDL is issued as ammunition rather than a weapon—the BOI may vary. They are not assigned to an individual.
- \*\*\* Assorted fuzes/detonators include time, optical, pressure, pressure release, command armed fuzes, sensor fuzes (acoustic, optical, infrared, seismic, magnetic), command detonated (electronic, radio frequency [RF], pressure release).
- \*\*\*\* Includes bangalore torpedoes, shaped charges, AT grenades, other tactical demolitions.
- \*\*\*\*\* Each mortar direct action team has at least two assorted types of IED and remote detonation devices. The number and type of IED varies and is determined by the current mission.
- \*\*\*\*\* Includes remotely detonated mines, booby traps, and side-attack (AT & anti-vehicle) mines. The mix is mission dependent and varies.

**NOTES:**

1. The primary purpose of the mortar direct action team is to either terrorize or influence the local populace and governing authorities. It may indiscriminately fire into crowded marketplaces and religious gatherings with the intent to terrorize. Targets may also include religious or national icons and/or landmarks.
2. These attacks are often used to support the overall information warfare plan. They may also be used in a manner to cause (shift) blame for the attack to their enemy.
3. As with all direct action cells, key events (and results/successes) are digitally recorded on digital video and still cameras. Upon mission completion, the recordings are turned over to the information warfare cell for manipulation and exploitation. The videographer/camera operator may attempt to blend in with the crowds and may disassociate him/herself from the operation. In other situations, the key event/activity will be staged for the camera. Sympathizers among the local populace may also serve in this role.
4. When the mortar and ammunition are transported in a vehicle, the ammo bearer may not be required. Additional ammo bearers may be used when necessary. Noncombatant personnel or draft animals may also be used as bearers or porters.
5. In some cases, a 120-mm Mortar, Type 86 (W86) may be substituted for the 81/82-mm mortar. However, this substitution requires a light truck to transport each 120-mm mortar. Generally, however, if the insurgents require 100-mm or 120-mm mortars they look to the guerrillas for support.
6. For additional information, see FM 7-100.3.

Direct Action Team (Rocket), Direct Action Cell (Mortar and Rocket) \_\_\_\_\_

**DA TEAM  
(Rocket)  
(107-mm)**

Rocket Team Leader (x1) ..... AKM/BG-15  
 Rocket Gunner/LMG Gunner (x1)..... Type 85/RPK  
 Asst Rocket Gunner/Grenadier(x1).....RPG/AKMS  
 Ammo Bearer/Asst Grenadier (x1)..... AKMS  
 Driver/Ammo Bearer (x1)..... AKMS  
 Driver/Security Per/Marksman (x1)..... PM/AKMS  
  
 Total Personnel..... 6

**PRINCIPAL ITEMS OF EQUIPMENT**

<u>Equipment</u>	<u>Total</u>	<u>Equipment</u>	<u>Total</u>
9-mm Pistol, PM.....	1	Truck, Pickup ½ ton, Civilian .....	1
7.62-mm Assault Rifle, AKM .....	1	Binoculars.....	1
7.62-mm Carbine, AKMS .....	4	Camcorder, Video.....	1
7.62-mm LMG, RPK.....	1	Camera, Digital.....	1
40-mm Grenade Launcher, BG-15 .....	1	GPS Receiver, Handheld .....	1
107-mm Lchr Single-Tube, Type 85, or 107-mm Single-Tube, MONOTUBE.....	1	Night-Vision Goggles.....	1
ATGL, RPG-7V .....	1	Radios:	
Demolition, Fuzes & Detonators * .....	Assorted	Cell Phone.....	3
Demolition Materiel ** .....	Assorted	Computer, Laptop .....	1
Improvised Explosive Device (IED) *** .....	2	Computer, PDA.....	1
Mines (AP, AT & AV) **** .....	Assorted	Handheld, Long-Range Cordless- Telephone.....	1
Sedan, Civilian .....	1	Handheld, Very-Low-Power.....	6

NOTES: See next page.

- 
- \* Assorted fuzes/detonators include time, optical, pressure, pressure release, command armed fuzes, sensor fuzes (acoustic, optical, infrared, seismic, magnetic), command detonated (electronic, radio frequency [RF], pressure release).
  - \*\* Includes bangalore torpedoes, shaped charges, AT grenades, other tactical demolitions.
  - \*\*\* Each rocket direct action team has at least two assorted types of IED and remote detonation devices. The number and type of IED varies and is determined by the current mission.
  - \*\*\*\* Includes remotely detonated mines, booby traps, and side-attack (AT & anti-vehicle) mines. The mix is mission dependent and varies.

**Direct Action Team (Rocket),  
Direct Action Cell (Mortar and Rocket) (continued)**

---

**NOTES:**

1. The primary purpose of the rocket direct action team is to either terrorize or influence the local populace and governing authorities. It may indiscriminately fire into crowded marketplaces and religious gatherings with the intent to terrorize. Targets may also include religious or national icons and/or landmarks.
2. These attacks are often used to support the overall information warfare plan. They may also be used in a manner to cause (shift) blame for the attack to their enemy.
3. As with all direct action cells, key events (and results/successes) are digitally recorded on digital video and still cameras. Upon mission completion, the recordings are turned over to the information warfare cell for manipulation and exploitation. The videographer/camera operator may attempt to blend in with the crowds and may disassociate him/herself from the operation. In other situations, the key event/activity will be staged for the camera. Sympathizers among the local populace may also serve in this role.
4. When the rockets are transported in a vehicle, the extra ammo bearer may not be required. Additional ammo bearers may be used whenever necessary. Noncombatant personnel or draft animals may also be used as bearers/porters.
5. Improvised 107-mm single-tube rocket launchers may be common. They may be fabricated from PVC pipe, iron, or any other available material. Improvised 107-mm rocket firing pads can be constructed of dirt, bamboo frames, crossed stakes, road embankments, a dike between two rice fields, the brim of a combat trench, an earth mound, or a bomb crater.
6. For additional information, see FM 7-100.3.

**Intelligence Cell, Insurgent Organization** \_\_\_\_\_

<p><b>INTELLIGENCE CELL</b></p>
-------------------------------------

Cell Leader/Sr Intel (x1) ..... PM/AKMS  
 Asst Cell Leader (x1) ..... PM/AKMS  
 Targeting (x1) ..... AKMS  
 Driver/Intel Pers (x1) ..... PM/AKM/BG-15  
 Driver/Intel Pers (x1) ..... PM/RPK  
  
 Total Personnel ..... 5

**PRINCIPAL ITEMS OF EQUIPMENT**

<u>Equipment</u>	<u>Total</u>
9-mm Pistol, PM.....	4
7.62-mm Assault Rifle, AKM .....	1
7.62-mm Carbine, AKMS .....	3
7.62-mm LMG, RPK.....	1
40-mm Grenade Launcher, BG-15 .....	1
Sedan, Civilian .....	2
Binoculars.....	3
Camcorder, Video.....	2
Camera, Digital.....	2
GPS Receiver, Handheld.....	2

<u>Equipment</u>	<u>Total</u>
Night-Vision Goggles.....	2
Radios:	
Cell Phone.....	5
Computer, Laptop .....	5
Computer, PDA.....	5
Handheld, Long-Range Cordless- Telephone.....	5
Handheld, Very-Low-Power.....	5
Portable, Satellite Telephone .....	1

*NOTES:* See next page.

## Intelligence Cell, Insurgent Organization (continued)

---

### NOTES:

1. The intelligence cell plans, coordinates, and implements the insurgent intelligence collection plan and provides intelligence information to internal and external consumers. The cell also conducts reconnaissance to obtain information about the activities, tactics, and resources of the enemy. Reconnaissance methods include surveillance, use of informants, and infiltration of enemy organizations. Observation is the most common method used to conduct reconnaissance.
2. In addition to conducting intelligence analysis, typical activities of any intelligence cell in the insurgent organization may include tracking enemy movements; determining enemy TTP; scouting potential targets; establishing enemy vulnerabilities; selecting attack locations; and stalking potential assassination targets.
3. Intelligence cell personnel may serve in any occupation (such as a taxi or delivery driver, or truck driver) which allows them to blend in with the population and still provides them the flexibility and mobility needed to gather information.
4. Every member of the insurgent organization is an intelligence-gathering mechanism. The insurgent organization usually produces its own general intelligence and targeting information, to include enemy orders of battle. Information in raw form may be freely provided by sympathizers conducting surveillance on behalf of the insurgent organization while living, traveling, or working near either a target area or the enemy. Raw information may also be purchased locally from affiliated insurgents, guerrillas, or criminal organizations.
5. The insurgent organization's intelligence is usually superior to the enemy's due to its intimate first-hand knowledge of all aspects of the local environment, penetration of governmental structures, relationships with the population, and its ability to maintain observation across the countryside or urban area.
6. Collecting information, overtly and clandestinely, is a continuous function performed by every insurgent organization. Overt activities include the open collection of information by individuals who circulate among the people. Clandestine activities involve secret collection of information. This can include information collected through the use of extortion, bribery, or coercion. Groups clandestinely collect information using electronic devices and human-intelligence agents who may join or infiltrate popular organizations, government organizations, and nongovernmental organizations.

When planning any action, an intelligence cell analyzes information from both overt and clandestine sources. " Sleeper agents," members of the insurgent organization (or insurgent movement) who may reside within the target area for years, often have the specific mission of gathering information. The information they gather may later serve to support direct action missions.
7. The information gathered by the insurgent organization is used to plan future activities and determine the feasibility of planned actions. In the offense, efforts are concentrated on the enemy at his location and the area surrounding the target. In the defense, the reconnaissance effort is to determine when and where the enemy will conduct offensive actions against friendly forces. When affiliated with a higher (regional or national) insurgent organization, the information may be further disseminated for combined attacks.
8. For additional information on insurgent intelligence activities and operations, see FM 7-100.3.

**Counterintelligence and Internal Security Cell, Insurgent Organization \_\_\_\_\_**

<p><b>CI AND SECURITY CELL</b></p>
--

Cell Leader (x1) ..... PM/AKMS  
 Asst Cell Ldr/Ch CI (x1) ..... PM/AKMS  
 Chief Security (x1) ..... AKMS  
 Driver/CI Per (x1)..... PM/AKM/BG-15  
 Driver/Security Pers (x1)..... PM/RPK

Total Personnel ..... 5

**PRINCIPAL ITEMS OF EQUIPMENT**

<u>Equipment</u>	<u>Total</u>	<u>Equipment</u>	<u>Total</u>
9-mm Pistol, PM.....	4	GPS Receiver, Handheld.....	1
7.62-mm Assault Rifle, AKM .....	1	Night-Vision Goggles.....	2
7.62-mm Carbine, AKMS .....	3	Radios:	
7.62-mm LMG, RPK.....	1	Cell Phone.....	5
40-mm Grenade Launcher, BG-15 .....	1	Computer, Laptop .....	5
Sedan, Civilian .....	1	Computer, PDA.....	5
Truck, Pickup ½ ton, Civilian .....	1	Handheld, Long-Range Cordless-	
Binoculars.....	2	Telephone.....	5
Camcorder, Video.....	1	Handheld, Very-Low-Power.....	5
Camera, Digital.....	1	Portable, Satellite Telephone .....	1

**NOTES:**

1. The local insurgent organization must place great emphasis on the conduct of internal counterintelligence (CI) activities because of the criticality of maintaining cohesion within the hazardous environment in which it operates, and the susceptibility to infiltration by enemy agents. If the local insurgent organization is infiltrated it will not survive.
2. It is within the CI and security cell that all operations security (OPSEC) measures for the organization’s activities, as well as other security measures, are developed, disseminated, and enforced. In most organizations, violation of these security rules can result in immediate death to the violator and/or his family members. Members of the CI and security cell infiltrate other cells to identify security weaknesses or breaches. This cell is responsible for maiming or assassinating current or former insurgent members who commit breaches. Paranoia among the members actually increases security, since all members desire to remain free of suspicion. Individuals assigned to the CI and security cell are usually mature, experienced, or senior in the organization.
3. The cellular structure of the organization helps ensure against the compromise of the identity, location, or activities of leaders and members of other cells should there be a breach of internal security.
4. For additional information, see FM 7-100.3.

**Planning Cell, Insurgent Organization**

**PLANNING  
CELL**

Cell Leader/Sr Planner (x1) ..... PM/AKMS  
 Asst Ldr/Current Plans (x1)..... PM/AKMS  
 Current Plans (x1)..... AKMS  
 Future Plans/Driver (x1)..... PM/AKM/BG-15  
 Asst Plans/Driver (x1) ..... PM/RPK  
  
 Total Personnel ..... 5

**PRINCIPAL ITEMS OF EQUIPMENT**

<u>Equipment</u>	<u>Total</u>	<u>Equipment</u>	<u>Total</u>
9-mm Pistol, PM.....	4	GPS Receiver, Handheld.....	2
7.62-mm Assault Rifle, AKM .....	1	Night-Vision Goggles.....	1
7.62-mm Carbine, AKMS .....	3	Radios:	
7.62-mm LMG, RPK.....	1	Cell Phone.....	5
40-mm Grenade Launcher, BG-15 .....	1	Computer, Laptop .....	5
Sedan, Civilian .....	1	Computer, PDA.....	5
Truck, Pickup ½ ton, Civilian .....	1	Handheld, Long-Range Cordless-	
Binoculars.....	2	Telephone.....	5
Camcorder, Video.....	1	Handheld, Very-Low-Power.....	5
Camera, Digital.....	1	Portable, Satellite Telephone .....	1

*NOTE:* For additional information, see FM 7-100.3.



**Information Warfare Cell, Insurgent Organization**

**INFORMATION  
WARFARE  
CELL**

Cell Leader/Sr IW Spec (x1)..... PM/AKMS  
 Asst Cell Leader/Sr IW Spec (x1)..... PM/AKMS  
 IW Specialist (Video) (x2)..... AKMS  
 IW Specialist (Comms) (x2)..... AKMS  
 Computer Technician (x2)..... AKMS  
 IW Specialist (x1) ..... AKMS  
 IW Specialist (x1) ..... AKM/BG-15  
 IW Specialist/Driver (x1)..... PM/RPK  
 IW Specialist/Driver (x2)..... PM/AKMS

Total Personnel ..... 13

**PRINCIPAL ITEMS OF EQUIPMENT**

<u>Equipment</u>	<u>Total</u>	<u>Equipment</u>	<u>Total</u>
9-mm Pistol, PM.....	5	GPS Receiver, Handheld.....	2
7.62-mm Assault Rifle, AKM.....	1	Night-Vision Goggles.....	2
7.62-mm Carbine, AKMS.....	11	Radios:	
7.62-mm LMG, RPK.....	1	Cell Phone.....	12
40-mm Grenade Launcher, BG-15.....	1	Computer, Desktop.....	8
Sedan, Civilian.....	2	Computer, Laptop.....	12
Van, Civilian.....	1	Computer, PDA.....	12
Antenna, Satellite.....	2	Handheld, Long-Range Cordless-	
Binoculars.....	2	Telephone.....	8
Camcorder, Video.....	4	Handheld, Very-Low-Power.....	12
Camera, Digital.....	4	Portable, Satellite Telephone.....	5

**NOTES:**

1. The information warfare (IW) cell plans, coordinates, and implements the insurgent organization’s IW plan and provides guidance and assistance to the direct action cells (IW) whenever required. IED and other attacks are often used to support the overall information warfare plan. These attacks may also be used in a manner to cause (shift) blame for the attack to their enemy.
2. Depending on the size, nature, and focus of the insurgent organization, the IW cell may be capable of several functions. Some example functions performed by the IW cell are information management (internal methods, links, and security); media manipulation (PSYWAR) and public affairs designed to influence the population; communications (cyber embeds via Internet sites, propaganda videos, broadcast successes of direct action teams, printing); rumor control (misinformation and disinformation); selective sabotage actions; civic actions; indoctrination training; fund-raising (including international); recruiting; and assist in cyber-mining for intelligence. All these functions are integrated to further short- and long-range goals.
3. Some of the functions may require specialized expertise. For example, the media manipulation function (PSYWAR) may require expertise and/or advice from a cleric; a political, a tribal, ethnic, or cultural leader; or other experts. Portions of the IW cell are probably dispersed.
4. For additional information on information warfare, see FM 7-100.3.

**Technical Support Cell, Insurgent Organization**

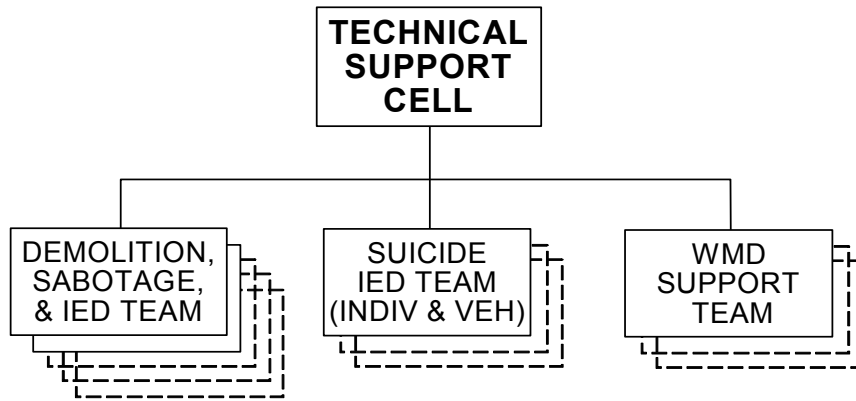

Cell Leader (x1) ..... PM/AKMS

Total Personnel ..... 21

**PRINCIPAL ITEMS OF EQUIPMENT**

<u>Equipment</u>	<u>Total</u>
9-mm Pistol, PM.....	9
7.62-mm Assault Rifle, AKM .....	4
7.62-mm Carbine, AKMS .....	13
7.62-mm LMG, RPK.....	4
40-mm Grenade Launcher, BG-15 .....	4
Demolition, Fuzes/Detonators * .....	Assorted
Demolition Materiel ** .....	Assorted
IED, Individual, Vest *** .....	3
Vehicle Borne IED (VBIED) *** .....	2
IED, WMD *** .....	1
Improvised Explosive Device (IED) *** .....	20
Mines (AP, AT, & AV) **** .....	Assorted
Sedan, Civilian .....	4
Truck, Pickup ½ ton, Civilian .....	1
Van, Civilian.....	4
Binoculars.....	5
Camcorder, Video.....	4

<u>Equipment</u>	<u>Total</u>
Camera, Digital.....	4
Electrician Set.....	8
GPS Receiver, Handheld .....	9
Night-Vision Goggles.....	4
Radios:	
Base Station, Long-Range	
Cordless-Telephone .....	2
Cell Phone.....	51
Computer, Laptop .....	13
Computer, PDA.....	9
Handheld, Long-Range Cordless-	
Telephone.....	13
Handheld, Very-Low-Power.....	21
Manpack, Low-Power.....	2
Portable, Satellite Telephone .....	5
Vehicle Mount, Medium Power.....	1

NOTES: See next page.

## Technical Support Cell, Insurgent Organization (continued)

- \* Assorted fuzes/detonators include time, optical, pressure, pressure release, command armed fuzes, sensor fuzes (acoustic, optical, infrared, seismic, magnetic), command detonated (electronic, radio frequency [RF], pressure release).
- \*\* Includes bangalore torpedoes, shaped charges, AT grenades, other tactical demolitions.
- \*\*\* The number and types of IEDs and fuzing varies. Each demolition, sabotage, and IED team has at least 10 IEDs fabricated and on-hand at any given time. Each suicide IED team has at least three IED vests and two VBIEDs fabricated and on-hand at any given time (the two VBIEDs may be any type of vehicle). Each WMD support team has at least one WMD IED fabricated and on-hand at any given time; others may be in various stages of manufacture.
- \*\*\*\* Includes remotely detonated mines, booby traps, and side-attack (AT & anti-vehicle) mines. The mix is mission dependent and varies.

### NOTES:

1. The number of teams subordinate to the technical support cell is not fixed and varies depending on the specific mission, environment, geographic factors, and many other variables. Personnel and equipment totals for the “typical” technical support cell in this example reflect only the teams shown in solid boxes in the organizational diagram for the Technical Support Cell. The “default” is two demolition, sabotage, and IED teams, one suicide IED team, and one WMD support team.

2. The technical support cell is the primary bomb factory for the insurgent organization. This cell manufactures IEDs, suicide bombs (individual and vehicular), WMDs, and booby traps (booby traps are actually a subcategory of IEDs). It is responsible for all acquisition, manufacturing, and storage of IEDs, road-side bombs, WMD, suicide bombs (individual and vehicle), side-attack (AT and anti-vehicle) mines, and other tactical demolitions and fuzing (including remote detonators).

The cell prepares these devices for distribution to other elements of the insurgent organization or affiliated organizations and/or persons. Some technical support cells may be located in factories in small villages (or other remote areas or local accommodations) where they build their IEDs and then smuggle them into cities, where suppliers may then sell them (distribute them) to insurgent organizations. For security and survival, all of these activities are generally surreptitious.

3. Bombs (specifically IEDs) are the weapon of choice for the insurgent organization. They are inexpensive, the materials are readily available, are relatively easy to build, and are extremely destructive. Bombs may be very sophisticated or extremely simple. Bombs (IEDs) easily lend themselves to terrorizing the population and are used in support of assassination, maiming, sabotage, mass casualties, and mass disruption. The mix is always mission-dependent and always varies. Direct action cells (multifunction) acquire IEDs (usually unassembled pre-manufactured components) from the technical support cell. The direct action (multifunction) cell then assembles and adds fuzes and detonators to the IEDs.

At a minimum, the direct action (multifunction) IED team or a small multifunction cell using IEDs usually includes at least three people: a lookout, an IED emplacer, and the triggerman. The multifunction team (or cell) emplaces the IEDs, and the triggerman detonates them at the appropriate time. Whenever training, additional assistance, or IED expertise is required, the direct action (multifunction) teams or cells receive it from the technical support cell.

4. IED attacks are often used to support the overall information warfare plan. They may also be used in a manner to cause (shift) blame for the attack to their enemy.

Continued

## Technical Support Cell, Insurgent Organization (continued)

---

*NOTES:* (continued)

5. Some direct action (multifunction) cells may not have access to the expertise or products (IEDs) provided by the technical support cell. In these cases, the direct action (multifunction) cells receive the appropriate training from the technical support cell enabling them to manufacture limited quantities of IEDs for their own use.
6. Although members of the technical support cell are very capable of emplacing and detonating IEDs and other demolitions, they normally do not do so. Their expertise is far too critical for them to routinely go on direct action missions. Direct action cells emplace and trigger the IEDs. On occasion, a representative from the technical support cell may be required to accompany the direct action cell to properly emplace and detonate the device, especially when dealing with WMD IEDs.
7. The technical support cell may train, advise, and provide expertise to direct action teams, especially the multifunction teams, on how, where, and when, to emplace and detonate munitions and on the proper assembly, fuzing, and detonation of the devices. Technical support cell personnel also provide instruction on remotely detonated mines, IEDs, booby traps, road-side bombs, tactical demolitions, WMD, suicide bombs, and side-attack (AT and anti-vehicle) mines.
8. The OPFOR commonly uses IEDs as “secondary devices” to detonate on the arrival of responding personnel. IEDs can be detonated by a variety of means, including remote, command, electrical, trip wire, pressure, time, and others.
9. Insurgent organizations use indiscriminate techniques such as mass casualty activities, weapons of mass effects/disruption, and chemical, biological, radiological, and nuclear (CBRN) weapons, to accomplish their goals. Those insurgent organizations requiring specific expertise in the fabrication, emplacement, and detonation of radiation (dirty bombs) and biological weapons acquire the expertise and material from outside the local insurgent organization.
10. CBRN weapons are the potential weapon of choice for organizations employing terror tactics, since the actual or threat of use of CBRN weapons is real and very feasible. Insurgents might threaten the use of these weapons as “saber rattlers” in response to political or military actions, or they may actually use these weapons to terrorize the population.
11. Most insurgent organizations have easy access to toxic industrial chemicals (TICs). TICs are highly toxic commercial chemical substances with acute toxicity that are produced in large quantities for industrial purposes. They can be solid, liquid, or gas. These are the normal weapons of choice for the WMD support team.
12. Cell personnel may be a mixture of men, women, and children. Local women and children may be used as scouts, guides, suicide bombers, drivers, lookouts, or in other roles. Whenever necessary, they may also emplace and/or detonate IEDs, booby traps, and mines. They may also serve (willingly or unwillingly) as suicide bombers.
13. Cell composition is not fixed and varies from cell to cell, mission to mission, environment to environment. This includes the personnel, equipment, and weapons mixes. Personnel select equipment and weapons appropriate to the mission.
14. For additional information on the technical support cell, see FM 7-100.3.

**Demolition, Sabotage, and IED Team, Technical Support Cell \_\_\_\_\_**

**DEMOLITION,  
SABOTAGE  
& IED TEAM**

Team Leader/Sr Demo Expert (x1)..... PM/AKMS  
 Asst Tm Ldr/Demo Expert/Electrician (x1).... AKMS  
 Demo Specialist/Communications (x1) ..... AKMS  
 Demo Specialist/Computer Tech (x1) ..... PM/RPK  
 Demo Specialist/Fuze (x1)..... AKM/BG-15

Total Personnel ..... 5

**PRINCIPAL ITEMS OF EQUIPMENT**

<u>Equipment</u>	<u>Total</u>	<u>Equipment</u>	<u>Total</u>
9-mm Pistol, PM.....	2	GPS Receiver, Handheld .....	2
7.62-mm Assault Rifle, AKM .....	1	Night-Vision Goggles.....	1
7.62-mm Carbine, AKMS .....	3	Radios:	
7.62-mm LMG, RPK.....	1	Base Station, Long-Range	
40-mm Grenade Launcher, BG-15 .....	1	Cordless-Telephone .....	1
Demolition, Fuzes/Detonators * .....	Assorted	Cell Phone.....	15
Demolition Materiel ** .....	Assorted	Computer, Laptop .....	3
Mines (AP, AT, & AV) *** .....	Assorted	Computer, PDA.....	2
Improvised Explosive Device (IED) **** .....	10	Handheld, Long-Range Cordless-	
Sedan, Civilian .....	1	Telephone.....	3
Van, Civilian.....	1	Handheld, Very-Low-Power.....	5
Binoculars.....	1	Manpack, Low-Power.....	2
Camcorder, Video.....	1	Portable, Satellite Telephone .....	1
Camera, Digital.....	1	Vehicle Mount, Medium Power.....	1
Electrician Set.....	2		

**NOTES:** See next page.

- \* Assorted fuzes/detonators include time, optical, pressure, pressure release, command armed fuzes, sensor fuzes (acoustic, optical, infrared, seismic, magnetic), command detonated (electronic, RF, pressure release).
- \*\* Includes bangalore torpedoes, shaped charges, AT grenades, other tactical demolitions.
- \*\*\* Includes remotely detonated mines, booby traps, and side-attack (AT & anti-vehicle) mines. The mix is mission dependent and varies.
- \*\*\*\* The number and types of IEDs and fuzing varies. The demolition, sabotage, and IED team has at least 10 IEDs fabricated and on-hand at any given time. Other IEDs may be in various stages of manufacture.

## Demolition, Sabotage, and IED Team, Technical Support Cell (continued)

---

### NOTES:

1. The demolition, sabotage, and IED team is the primary IED and tactical munitions factory for the technical support cell. This team manufactures IEDs, suicide bombs (individual and vehicular), and booby traps (booby traps are actually a subcategory of IEDs). It is responsible for all acquisition, manufacturing, and storage of IEDs, suicide bombs, road-side bombs, side-attack (AT and anti-vehicle) mines, and other tactical demolitions and fuzing (including remote detonators). If necessary, this team could also fabricate WMD.

The team prepares these devices for distribution to other elements of the insurgent organization or affiliated organizations and/or persons. Some demolition, sabotage, and IED teams may be located in factories in small villages (or other remote areas or local accommodations) where they build their IEDs and then smuggle them into cities, where suppliers may then sell them (distribute them) to insurgent organizations. For security and survival, all of these activities are generally surreptitious.

2. The number of demolition, sabotage, and IED teams subordinate to the technical support cell is not fixed and varies depending on the specific mission, environment, geographic factors, and many other variables. The default is two demolition, sabotage, and IED teams. All technical support cells have at least two demolition, sabotage, and IED teams.

3. All demolition, sabotage, and IED team personnel may serve as drivers. They are also cross-trained to perform all functions necessary to fabricate IEDs.

4. Although members of the demolition, sabotage, and IED team are very capable of emplacing and detonating IEDs and other demolitions, they normally do not do so. Their expertise is far too critical for them to routinely go on direct action missions. Direct action cells emplace and trigger the IEDs. On occasion, a representative from the demolition, sabotage, and IED team may be required to accompany the direct action cell to properly emplace and detonate the device.

5. The demolition, sabotage, and IED team may train, advise, and provide expertise to direct action teams, especially the multifunction teams, on how, where, and when, to emplace and detonate munitions and on the proper assembly, fuzing, and detonation of the devices. Demolition, sabotage, and IED team personnel also provide instruction on remotely detonated mines, IEDs, booby traps, road-side bombs, tactical demolitions, and side-attack (AT and anti-vehicle) mines.

6. The OPFOR commonly uses IEDs as “secondary devices” to detonate on the arrival of responding personnel. IEDs can be detonated by a variety of means, including remote, command, electrical, trip wire, pressure, time, and others.

7. Team personnel may be a mixture of men, women, and children. Local women and children may be used as scouts, guides, suicide bombers, drivers, lookouts, or in other roles. Whenever necessary, they may also emplace and/or detonate IEDs, booby traps, and mines. They may also serve (willingly or unwillingly) as suicide bombers.

8. Team composition is not fixed and varies from team to team, mission to mission, environment to environment. This includes the personnel, equipment, and weapons mixes. Personnel select equipment and weapons appropriate to the mission.

9. These attacks are often used to support the overall information warfare plan. They may also be used in a manner to cause (shift) blame for the attack to their enemy.

10. For additional information, see FM 7-100.3.

**Suicide IED TEAM (Individual and Vehicular), Technical Support Cell \_\_\_\_\_**

**SUICIDE  
IED TEAM  
(Indiv & Veh)**

Team Leader/Sr Demo Expert (x1) .....PM/AKMS  
 Asst Tm Ldr/Demo Expert/Electrician/Fuze (x1) ..... AKMS  
 Demo Specialist/Communications (x1) ..... AKMS  
 Demo Specialist/Computer Tech (x1) ..... PM/RPK  
 Demo Specialist/Mechanic/Welder (x1) ..... AKM/BG-15

Total Personnel ..... 5

**PRINCIPAL ITEMS OF EQUIPMENT**

<u>Equipment</u>	<u>Total</u>	<u>Equipment</u>	<u>Total</u>
9-mm Pistol, PM.....	2	Camcorder, Video.....	1
7.62-mm Assault Rifle, AKM .....	1	Camera, Digital.....	1
7.62-mm Carbine, AKMS .....	3	Electrician Set.....	2
7.62-mm LMG, RPK.....	1	GPS Receiver, Handheld.....	2
40-mm Grenade Launcher, BG-15 .....	1	Night-Vision Goggles.....	1
Demolition, Fuzes/Detonators * .....	Assorted	Radios:	
Demolition Materiel ** .....	Assorted	Cell Phone.....	10
Mines (AP, AT, & AV) *** .....	Assorted	Computer, Laptop .....	3
IED (Individual) Vest **** .....	3	Computer, PDA.....	2
Vehicle Borne IED (VBIED) **** .....	2	Handheld, Long-Range Cordless-	
Sedan, Civilian .....	1	Telephone.....	3
Truck, Pickup ½ ton, Civilian .....	1	Handheld, Very-Low-Power.....	5
Van, Civilian.....	1	Portable, Satellite Telephone .....	1
Binoculars.....	1		

**NOTES:** See next page.

- 
- \* Assorted fuzes/detonators include time, optical, pressure, pressure release, command armed fuzes, sensor fuzes (acoustic, optical, infrared, seismic, magnetic), command detonated (electronic, RF, pressure release).
  - \*\* Includes bangalore torpedoes, shaped charges, AT grenades, other tactical demolitions.
  - \*\*\* Includes remotely detonated mines, booby traps, and side-attack (AT & anti-vehicle) mines. The mix is mission dependent and varies.
  - \*\*\*\* The number and types of IED/VBIEDs and fuzing varies. The suicide IED team has at least three IED vests and two VBIEDs fabricated and on-hand at any given time. The two VBIEDs may be any type of vehicle. Other IED vests and VBIEDs may be in various stages of manufacture.

**Suicide IED TEAM (Individual and Vehicular),  
Technical Support Cell (continued)**

---

*NOTES:*

1. The number of suicide IED/VBIED teams subordinate to the technical support cell is not fixed and varies depending on the specific mission, environment, geographic factors, and many other variables. The default is one suicide IED/VBIED team. All technical support cells have at least one suicide IED/VBIED team.
2. All suicide IED/VBIED team personnel are cross-trained to perform all functions necessary to fabricate IEDs and VBIEDs including automotive welding and fabrication.
3. Although members of the IED/VBIED team are very capable of detonating IED/VBIEDs and other demolitions, they normally do not do so—even to detonate a suicide IED/VBIED carried or driven by someone else. Their expertise is far too critical for them to routinely go on direct action missions. Direct action cells are responsible for the emplacement and detonation of the IED/VBIEDs.
4. Suicide bombers/drivers are recruited by the recruiting cell, and turned over to direct action cells to properly emplace the individual-carried IEDs and VBIEDs. Once the direct action cell has ensured the proper emplacement of the IED/VBIED, they can either trigger the IED/VBIEDs remotely or use other detonation methods. On occasion, a representative from the IED/VBIED team may be required to accompany the direct action cell to ensure proper emplace and detonation of the device/VBIED.
5. For additional information on suicide IED (individual) and VBIEDs, see FM 7-100.3.



**Weapons of Mass Destruction (WMD) Support Team,  
Technical Support Cell**



Team Leader/Sr Demo Expert/Chem Tech (x1) ..... PM/AKMS  
 Asst Tm Ldr/Demo Expert/Electrician/Fuze (x1)..... AKMS  
 Demo Specialist/Communications/Radiation (x1)..... AKMS  
 Demo Specialist/Computer Tech (x1)..... PM/RPK  
 Demo Specialist/Chemical Spec (x1) ..... AKM/BG-15

Total Personnel ..... 5

**PRINCIPAL ITEMS OF EQUIPMENT**

<u>Equipment</u>	<u>Total</u>	<u>Equipment</u>	<u>Total</u>
9-mm Pistol, PM.....	2	Camera, Digital.....	1
7.62-mm Assault Rifle, AKM .....	1	Electrician Set.....	2
7.62-mm Carbine, AKMS .....	3	GPS Receiver, Handheld .....	3
7.62-mm LMG, RPK.....	1	Night-Vision Goggles.....	1
40-mm Grenade Launcher, BG-15.....	1	Radios:	
Demolition, Fuzes/Detonators *.....	Assorted	Cell Phone.....	10
Demolition Materiel ** .....	Assorted	Computer, Laptop.....	3
Mines (AP, AT, & AV) *** .....	Assorted	Computer, PDA.....	2
IED, WMD **** .....	1	Handheld, Long-Range Cordless- Telephone.....	3
Sedan, Civilian .....	1	Handheld, Very-Low-Power .....	5
Van, Civilian .....	1	Portable, Satellite Telephone.....	1
Binoculars.....	1		
Camcorder, Video .....	1		

NOTES: See next page.

- \* Assorted fuzes/detonators include time, optical, pressure, pressure release, command armed fuzes, sensor fuzes (acoustic, optical, infrared, seismic, magnetic), command detonated (electronic, RF, pressure release).
- \*\* Includes bangalore torpedoes, shaped charges, AT grenades, other tactical demolitions.
- \*\*\* Includes remotely detonated mines, booby traps, and side-attack (AT & anti-vehicle) mines. The mix is mission dependent and varies.
- \*\*\*\* The number and types of WMD (CBRN) IEDs and fuzing varies. The WMD support team has at least one WMD IED fabricated and on-hand at any given time. Others may be in various stages of manufacture.

## **Weapons of Mass Destruction (WMD) Support Team, Technical Support Cell (continued)**

---

### **NOTES:**

1. To accomplish their goals, insurgent organizations use indiscriminate techniques such as mass casualty activities; weapons of mass effects/disruption; bombings or standoff attacks; or chemical, biological, radiological, and nuclear (CBRN) weapons. Those insurgent organizations requiring specific expertise in the fabrication, emplacement, and detonation of radiation (dirty bombs) and biological weapons acquire the expertise and material from outside the local insurgent organization.
2. The primary purpose of the WMD support team is to create weapons used to either terrorize or influence the local populace and governing authorities. Such weapons may be indiscriminately placed in crowded marketplaces and religious gatherings with the intent to terrorize. Targets may also include religious or national icons and/or landmarks.
3. CBRN weapons are the potential weapon of choice for organizations employing terror tactics, since the actual or threat of use of CBRN weapons is real and very feasible. Insurgent organizations may obtain or use CBRN weapons for a variety of motives. Insurgents might threaten the use of these weapons as “saber rattlers” to raise the ante in response to foreign political or military actions, or to achieve a specific objective, or they may actually use these weapons to terrorize the population.
4. The number of WMD support teams subordinate to the technical support cell is not fixed and varies depending on the specific mission, environment, geographic factors, and many other variables. The default is one WMD support team. All technical support cells have at least one WMD support team.
5. Most WMD support teams have easy access to toxic industrial chemicals (TICs). TICs are highly toxic commercial chemical substances with acute toxicity that are produced in large quantities for industrial purposes. They can be solid, liquid, or gas. These are the normal weapons of choice for the WMD support team.
6. Although members of the WMD support team are very capable of emplacing and detonating WMD IEDs and other demolitions, they normally do not do so. The team member’s expertise is far too critical for them to routinely go on direct action IED emplacement missions. Direct action cells emplace and trigger the IEDs. On occasion, a representative from the WMD support team may be required to accompany the direct action cell to ensure proper emplacement and detonation of the weapon.
7. All WMD support team personnel are cross-trained to perform all functions necessary to fabricate WMD IEDs.
8. WMD IED attacks are used to support the overall information warfare plan. They may also be used in a manner to cause (shift) blame for the attack to their enemy. For example, even though a mass release of TICs causing numerous noncombatant casualties was due to an IED explosion, the insurgent organization might be able to blame the casualties on the enemy as an intentional act.
9. For additional information on insurgent CBRN weapons and WMD and their employment, see FM 7-100.3.

**Logistics Cell, Insurgent Organization**

<p><b>LOGISTICS CELL</b></p>
----------------------------------

Cell Leader/Sr Logistician (x1) ..... PM/AKMS  
 Asst Cell Leader (x1)..... PM/AKMS  
 Logistics Specialist (x1)..... AKMS  
 Spt Spec/Driver (x1)..... PM/AKM/BG-15  
 Spt Spec/Driver (x1)..... PM/RPK  
  
 Total Personnel ..... 5

**PRINCIPAL ITEMS OF EQUIPMENT**

<u>Equipment</u>	<u>Total</u>	<u>Equipment</u>	<u>Total</u>
9-mm Pistol, PM.....	4	Night-Vision Goggles .....	2
7.62-mm Assault Rifle, AKM .....	1	Radios:	
7.62-mm Carbine, AKMS .....	3	Cell Phone .....	5
7.62-mm LMG, RPK.....	1	Computer, Desktop.....	2
40-mm Grenade Launcher, BG-15 .....	1	Computer, Laptop.....	3
Sedan, Civilian .....	1	Computer, PDA .....	5
Truck, Pickup ½ ton, Civilian .....	1	Handheld, Long-Range Cordless-	
Binoculars.....	1	Telephone .....	5
Camcorder, Video .....	1	Handheld, Very-Low-Power .....	5
Camera, Digital .....	1	Portable, Satellite Telephone.....	1
GPS Receiver, Handheld.....	2		

**NOTES:**

1. The logistics cell is the resource planner for the insurgent organization. It is responsible for the planning, acquisition, and distribution of all resources—human and materiel.
2. For additional information, see FM 7-100.3.

**Communications and Tradecraft Cell, Insurgent Organization**

**COMMS &  
TRADECRAFT  
CELL**

Cell Leader/Sr Comms (x1)..... PM/AKMS  
 Asst Cell Leader (x1)..... AKMS  
 Tradecraft Spec (x1)..... AKMS  
 Comms Spec/Driver (x1)..... PM/AKM/BG-15  
 Computer Tech/Driver (x1)..... RPK  
 Courier/Comms Spec/Motorcycle (x3)..... PM/AKMS

Total Personnel..... 8

**PRINCIPAL ITEMS OF EQUIPMENT**

<u>Equipment</u>	<u>Total</u>	<u>Equipment</u>	<u>Total</u>
9-mm Pistol, PM.....	5	Night-Vision Goggles.....	4
7.62-mm Assault Rifle, AKM .....	1	Radios:	
7.62-mm Carbine, AKMS .....	6	Base Station, Long-Range	
7.62-mm LMG, RPK.....	1	Cordless-Telephone .....	1
40-mm Grenade Launcher, BG-15 .....	1	Cell Phone.....	5
Motorcycle/motor scooter/bicycle .....	3	Computer, Desktop .....	3
Sedan, Civilian .....	1	Computer, Laptop .....	5
Van, Civilian.....	1	Computer, PDA.....	5
Antenna, Satellite .....	3	Handheld, Long-Range Cordless-	
Binoculars.....	1	Telephone.....	5
Camcorder, Video.....	2	Handheld, Very-Low-Power.....	5
Camera, Digital.....	2	Portable, Satellite Telephone .....	3
GPS Receiver, Handheld.....	4	Vehicle Mount, Medium Power.....	1

**NOTES:**

1. The communications and tradecraft cell is the communications planner for the insurgent organization. The cell facilitates communications inside and outside of the organization. It also provides a courier service and maintains dead-drop locations and other tradecraft (clandestine) communications. Close coordination is maintained with the IW cell for Internet communications.
2. The communications and tradecraft cell advises on the feasibility of all insurgent activities from a communications perspective. It determines the internal communications equipment necessary for the success of direct action missions. The cell also provides communications, tradecraft, and steganography expertise and training as required.
3. Typically, the courier uses a ubiquitous civilian model motorcycle, moped, motor scooter, bicycle, sedan, or even a taxi. The courier probably will not have an overt weapon or radio and will appear to be a noncombatant. Another insurgent may ride with the courier as a lookout or to provide security. Depending on the circumstances, some couriers may not use vehicles and will be used instead as foot messengers. Couriers may be male, female, or even children. Messages may be written, digital, via Internet, encrypted, or memorized and presented orally.
4. The cell is equipped with small SATCOM antennas, long-range cordless telephones, and provides digital and secure communications.
5. For additional information on insurgent communications and tradecraft, see FM 7-100.3.

**Finance Cell, Insurgent Organization**

<p><b>FINANCE CELL</b></p>
--------------------------------

Cell Leader/Ch Financial Off (x1)..... PM/AKMS  
 Asst Cell Leader (x1)/Future Plans (x1)..... PM/AKMS  
 IW integration/Finance Spec (x1)..... AKMS  
 Finance Spec/Driver (x1)..... PM/AKM/BG-15  
 Accountant/Driver (x1)..... PM/RPK

Total Personnel ..... 5

**PRINCIPAL ITEMS OF EQUIPMENT**

<u>Equipment</u>	<u>Total</u>	<u>Equipment</u>	<u>Total</u>
9-mm Pistol, PM.....	4	Radios:	
7.62-mm Assault Rifle, AKM .....	1	Base Station, Long-Range	
7.62-mm Carbine, AKMS .....	3	Cordless-Telephone.....	1
7.62-mm LMG, RPK.....	1	Cell Phone .....	5
40-mm Grenade Launcher, BG-15 .....	1	Computer, Desktop.....	3
Sedan, Civilian .....	2	Computer, Laptop.....	5
Antenna, Satellite .....	2	Computer, PDA .....	5
Binoculars.....	1	Handheld, Long-Range Cordless-	
Camcorder, Video .....	1	Telephone.....	5
Camera, Digital .....	1	Handheld, Very-Low-Power .....	5
GPS Receiver, Handheld.....	2	Portable, Satellite Telephone.....	3
Night-Vision Goggles .....	1		

**NOTES:**

1. The finance cell is the financial and economic planner for the insurgent organization. It plans fund-raising activities (including bribery, extortion, and robbery, and operating front companies) to finance and resource the insurgent organization's activities. This includes local, regional, and links to national and international fund-raising activities. The cell also determines the roles of direct action cells and other cells in acquiring additional funds for the insurgent organization.
2. Finance personnel establish and monitor internal and external funding and funds management mechanisms. Similarly, skilled IW operators appeal to the local and international community, possibly through the media, for political, monetary, and logistics support.
3. The finance cell determines the internal financial requirements necessary for the success of direct action missions.
4. Recruiting may be wittingly or unwittingly financed from both governmental and nongovernmental donations and grants.
5. For additional information on the role and mission of the finance cell and funding the insurgent organization, see FM 7-100.3.

**Shelter (Safe Houses) Cell, Insurgent Organization** \_\_\_\_\_

<p><b>SHELTER CELL</b></p>
--------------------------------

Cell Leader (x1).....	PM/AKMS
Asst Cell Leader (x1).....	PM/AKMS
Insurgent (x1).....	AKMS
Insurgent/Driver (x1).....	PM/AKM/BG-15
Insurgent/Driver (x1).....	PM/RPK
Total Personnel.....	
	5

**PRINCIPAL ITEMS OF EQUIPMENT**

<u>Equipment</u>	<u>Total</u>	<u>Equipment</u>	<u>Total</u>
9-mm Pistol, PM.....	4	GPS Receiver, Handheld.....	2
7.62-mm Assault Rifle, AKM.....	1	Night-Vision Goggles.....	2
7.62-mm Carbine, AKMS.....	3	Radios:	
7.62-mm LMG, RPK.....	1	Cell Phone.....	5
40-mm Grenade Launcher, BG-15.....	1	Computer, Laptop.....	5
Sedan, Civilian.....	1	Computer, PDA.....	5
Van, Civilian.....	1	Handheld, Long-Range Cordless-	
Binoculars.....	2	Telephone.....	5
Camcorder, Video.....	1	Handheld, Very-Low-Power.....	5
Camera, Digital.....	1	Portable, Satellite Telephone.....	1

**NOTES:**

1. The shelter cell plans for, and provides, secure accommodation (safe houses) for direct action cells, visiting and high-ranking insurgents, and other cell members. Maximum use is made of local assistance and facilities regardless of capability. Sympathizers in the local populace may volunteer their homes, equipment, vehicles, and services.
2. Whenever necessary, the shelter cell conducts coordination with the intelligence, planning, logistics, and transportation cells.
3. For additional information, see FM 7-100.3.

**Training Cell, Insurgent Organization**

**TRAINING  
CELL**

Cell Leader/Ch Trainer (x1) ..... PM/AKMS  
 Asst Cell Leader/Sr Trainer (x1) ..... PM/AKMS  
 Training Spec (x1) ..... AKMS  
 Training Spec/Driver (x1)..... PM/AKM/BG-15  
 Training Spec/Driver (x1)..... PM/RPK  
  
 Total Personnel ..... 5

**PRINCIPAL ITEMS OF EQUIPMENT**

<u>Equipment</u>	<u>Total</u>	<u>Equipment</u>	<u>Total</u>
9-mm Pistol, PM.....	4	GPS Receiver, Handheld.....	2
7.62-mm Assault Rifle, AKM.....	1	Night-Vision Goggles.....	2
7.62-mm Carbine, AKMS.....	3	Radios:	
7.62-mm LMG, RPK.....	1	Cell Phone.....	5
40-mm Grenade Launcher, BG-15.....	1	Computer, Laptop.....	5
Truck, Pickup ½ Ton, Civilian.....	1	Computer, PDA.....	5
Sedan, Civilian.....	1	Handheld, Long-Range Cordless-	
Binoculars.....	1	Telephone.....	5
Camcorder, Video.....	1	Handheld, Very-Low-Power.....	5
Camera, Digital.....	1	Portable, Satellite Telephone.....	1

**NOTES:**

1. The training cell plans and facilitates training for the insurgent organization. Basic instruction covers the organization, duties, and responsibilities of the insurgent organization; basic marksmanship; surveillance and intelligence-collection methods; and basic tactical instruction and communications techniques. Examples of specialized instruction may include advanced tactical instruction, such as the proper conduct of ambushes, assassination, and sniper activities; advanced surveillance and intelligence-collection methods; kidnapping and extortions; and advanced skill training.
2. Training may be centralized or conducted at the cell level depending on the structure and mission of the insurgent organization. Generally, it is a combination of both, with the basics taught in a centralized location and specific mission and functional training conducted at the local cellular level.
3. For additional information on insurgent training, see FM 7-100.3.

**Recruiting Cell, Insurgent Organization**

**RECRUITING  
CELL**

Cell Leader/Ch Recruiter (x1) ..... PM/AKMS  
 Asst Cell Leader/Sr Recruiter (x1) ..... PM/AKMS  
 Recruiting Spec (x1) ..... AKMS  
 Recruiting Spec/Driver (x1)..... PM/AKM/BG-15  
 Recruiting Spec/Driver (x1)..... PM/RPK  
  
 Total Personnel ..... 5

**PRINCIPAL ITEMS OF EQUIPMENT**

<u>Equipment</u>	<u>Total</u>
9-mm Pistol, PM.....	4
7.62-mm Assault Rifle, AKM .....	1
7.62-mm Carbine, AKMS .....	3
7.62-mm LMG, RPK.....	1
40-mm Grenade Launcher, BG-15 .....	1
Sedan, Civilian .....	2
Antenna, Satellite .....	1
Binoculars.....	1
Camcorder, Video.....	1
Camera, Digital.....	1
GPS Receiver, Handheld.....	2

<u>Equipment</u>	<u>Total</u>
Night-Vision Goggles.....	2
Radios:	
Cell Phone.....	5
Computer, Desktop .....	1
Computer, Laptop .....	5
Computer, PDA.....	5
Handheld, Long-Range Cordless- Telephone.....	3
Handheld, Very-Low-Power.....	5
Portable, Satellite Telephone .....	1

*NOTES:* See next page.



## Recruiting Cell, Insurgent Organization (continued)

---

### NOTES:

1. The recruiting cell is the manpower resourcing and recruitment planner for the insurgent organization. Insurgent organizations may attempt to recruit current or former members of national armed forces, both as trained operatives and as agents in place. Recruiting may be for particular skills, training, and/or qualifications and may not be tied to ideological characteristics. Recruits might not be aware of the true nature of the organization they are joining.
2. Often, legitimate organizations can serve as recruiting grounds for insurgent organizations. Recruiting is often associated with the proliferation of a radical religious sect or groups associated with militant ethnic or nationalist agendas. The organizations from which individuals can be recruited need not necessarily be violent or illegal themselves, but simply contain populations that are sympathetic to the same goals as the insurgent organization.
3. The recruiting cell uses many varied and different methods to persuade potential insurgents to join them. Some of these methods/reasons may be monetary, religious, ethic, nationalistic, anger, promise of power, or fear. Recruiting may be wittingly or unwittingly financed from both governmental and nongovernmental donations and grants.
4. Insurgents may also use coercion and leverage to gain limited or one-time cooperation from useful individuals. This cooperation can range anywhere from gaining information to conducting a suicide bombing. Blackmail and intimidation are also common forms of coercion. Threats to family members are also employed. Coercion is often directed at personnel in government security and intelligence organizations.
5. Internal security is the primary concern of the insurgent organization when recruiting. Once a potential recruit has passed the intense screening process and has been preselected for recruitment, he/she is then closely monitored by the CI and internal security cell prior to full recruitment. Insurgents at all levels are well aware that, if the local insurgent organization is infiltrated, it (or the insurgents in it) will not survive.
6. The Internet is a powerful recruitment tool. The recruiting cell maintains close coordination with the information warfare cell.
7. For additional information on insurgent recruiting methods and practices, see FM 7-100.3.

Transportation Cell, Insurgent Organization

<p><b>TRANSPORT CELL</b></p>
----------------------------------

Cell Leader/Ch Transportation (x1) ..... PM/AKMS  
 Asst Cell Ldr/Sr Spt Spec (x1)..... PM/AKM/BG-15  
 Transport Spec (x1)..... PM/RPK  
 Transport Spec/Driver (x1) ..... AKMS  
 Spt Spec/Driver (x4)..... AKMS  
  
 Total Personnel..... 8

**PRINCIPAL ITEMS OF EQUIPMENT**

<u>Equipment</u>	<u>Total</u>	<u>Equipment</u>	<u>Total</u>
9-mm Pistol, PM.....	2	Camera, Digital.....	1
7.62-mm Assault Rifle, AKM .....	1	GPS Receiver, Handheld .....	4
7.62-mm Carbine, AKMS .....	6	Night-Vision Goggles.....	4
7.62-mm LMG, RPK.....	1	Radios:	
40-mm Grenade Launcher, BG-15 .....	1	Cell Phone.....	8
Sedan, Civilian .....	2	Computer, Laptop .....	3
Truck, Pickup ½ ton, Civilian .....	1	Computer, PDA.....	3
Truck, Medium, Commercial .....	1	Handheld, Long-Range Cordless-	
Van, Civilian.....	1	Telephone.....	3
Binoculars.....	1	Handheld, Very-Low-Power.....	8
Camcorder, Video.....	1	Portable, Satellite Telephone .....	1

NOTES: See next page.

## Transportation Cell, Insurgent Organization (continued)

---

### NOTES:

1. The transportation cell plans and facilitates transportation for the insurgent organization. It responds to transportation requirements of other cells in the organization, especially the logistics and direct action cells. If sufficient (or specific) transportation is not available, the transportation cell will either provide or arrange it.
2. Insurgents may have no vehicles or supplies at all and depend completely on caches, porters, or other transportation or supply means. Local sympathizers may volunteer their equipment and services.
3. Depending on the mission, the local insurgent organization may be augmented by any and every type of personnel and/or vehicle. Vehicles could be motorcycles, trucks, agricultural trucks, commercial trucks, liquid cargo carriers (for POL or water), flat beds, busses, farm trailers, tractors, sedans, ½ ton civilian pickup trucks (such as Toyotas or Nissans), high-mobility/all terrain vehicles, bicycles, or carts.
4. Insurgents requisition or confiscate local civilian transportation assets and materiel. Anything of transportation value will be used, or confiscated. This includes the use of civilian personnel for porters and possibly as lookouts and security personnel. Draft animals may also be used as bearers and/or porters.
5. The vehicles in the transportation cell are indistinguishable from civilian vehicles and are always kept as dispersed as possible, in order to prevent detection and destruction by enemy forces. Rarely, if ever, will all vehicles in the cell be colocated.
6. Whenever possible, vehicles will be dispersed for use by locals as commercial, delivery, agricultural, general cargo, construction, militia, and general-purpose vehicles used in every day life. When required, the transportation cell will assemble the appropriate mix of vehicles to transport items and/or personnel to a specific location. The vehicles then melt back into the general population and environment.
7. Insurgents rely heavily on local and packaged water and POL products (fuel, oil, grease, or lubricants). These packages range from 1- and 5-gallon cans to 55-gallon drums.
8. For additional information on insurgent transportation, see FM 7-100.3.

**Civil Affairs Cell, Insurgent Organization**



Cell Leader/Ch Civil Affairs (x1) .....	PM/AKMS
Asst Cell Leader/Sr Civil Affairs (x1) .....	PM/AKMS
Civil Affairs Spec/Videographer (x1).....	AKMS
CA & Media Spec/Driver (x1) .....	PM/AKM/BG-15
CA Spec/Driver (x1) .....	PM/RPK
Total Personnel..... 5	

**PRINCIPAL ITEMS OF EQUIPMENT**

<u>Equipment</u>	<u>Total</u>	<u>Equipment</u>	<u>Total</u>
9-mm Pistol, PM.....	4	Night-Vision Goggles.....	2
7.62-mm Assault Rifle, AKM .....	1	Radios:	
7.62-mm Carbine, AKMS .....	3	Cell Phone.....	5
7.62-mm LMG, RPK.....	1	Computer, Desktop .....	3
40-mm Grenade Launcher, BG-15 .....	1	Computer, Laptop .....	5
Sedan, Civilian .....	1	Computer, PDA.....	5
Truck, Pickup ½ ton, Civilian .....	1	Handheld, Long-Range Cordless-	
Binoculars.....	1	Telephone.....	5
Camcorder, Video.....	2	Handheld, Very-Low-Power.....	5
Camera, Digital.....	2	Portable, Satellite Telephone .....	2
GPS Receiver, Handheld.....	2		

**NOTES:**

1. The civil affairs cell is responsible for the planning, preparation, and implementation of all civil affairs activities for the insurgent organization. The civil affairs cell may work closely with the information warfare cell for media manipulation.
2. Key events (and results/successes) of all insurgent organizations are digitally recorded on digital video and still cameras. The recordings are turned over to the information warfare cell for manipulation and exploitation and/or to sympathetic media for local or worldwide distribution.
3. The videographer/camera operator may attempt to blend in with the crowds and may disassociate him/herself from the operation. In other situations, the key event/activity will be staged for the camera. Sympathizers in the local populace may also serve in this role.
4. For additional information, see FM 7-100.3.

**Medical Cell, Insurgent Organization**

**MEDICAL  
CELL**

Cell Leader/Ch Medic (x1)..... PM/AKMS  
 Asst Cell Leader/Sr Medic (x1)..... PM/AKMS  
 Medic (x1) ..... AKMS  
 Medic/Driver (x1)..... AKMS  
 Medic Asst/Driver (x1)..... PM/AKM/BG-15  
 Medic Asst/Driver (x1)..... PM/RPK

Total Personnel ..... 6

**PRINCIPAL ITEMS OF EQUIPMENT**

<u>Equipment</u>	<u>Total</u>	<u>Equipment</u>	<u>Total</u>
9-mm Pistol, PM.....	4	Litters, Medical.....	3
7.62-mm Assault Rifle, AKM.....	1	Medical Set, General.....	2
7.62-mm Carbine, AKMS.....	4	Night-Vision Goggles.....	2
7.62-mm LMG, RPK.....	1	Radios:	
40-mm Grenade Launcher, BG-15.....	1	Cell Phone.....	6
Sedan, Civilian.....	1	Computer, Laptop.....	2
Truck, Pickup ½ ton, Civilian.....	1	Computer, PDA.....	2
Van, Civilian.....	1	Handheld, Long-Range Cordless-	
Binoculars.....	1	Telephone.....	1
Camcorder, Video.....	1	Handheld, Very-Low-Power.....	6
Camera, Digital.....	1	Portable, Satellite Telephone.....	1
GPS Receiver, Handheld.....	2		

**NOTES:**

1. Insurgent medics are combatants. When necessary—they fight. A medical aid station is usually set up in a (fairly) safe area, while other medics may accompany direct action cells or other insurgents. Insurgent medical personnel may be a mixture of men and women. Women may make up 50% or more of the medical cell strength.
2. The insurgent force has a limited medical capability; however, local medical support is probably available to differing degrees. Whenever possible, insurgent medical care is coupled with local medical assets in the area. Maximum use is made of local medical assistance and facilities regardless of medical capability.
3. Insurgents may or may not have the services of a civilian medical officer (physician) available. If available, the physician can provide immediate trauma stabilization and minor surgical intervention, while the medics provide limited medical intervention, minor surgery, and treatment of most common illnesses and lesser wounds.

Continued

## Medical Cell, Insurgent Organization (continued)

---

*NOTES:* (continued)

4. Sympathizers in the local populace may volunteer their homes, equipment, vehicles, and services. Sympathizers may also assist in the evacuation of wounded insurgents to civilian, militia, state, or even military facilities. Insurgents may receive assistance from local civilian medical personnel to treat their ill and wounded. Noncombatants may also be conscripted or forced to serve as litter bearers. When necessary, supported insurgent direct action cells receive litters from the medical cell to transport wounded. The supported insurgent force provides its own litter bearers.
5. Severe and longer-term medical care relies on evacuation to civilian or other medical facilities. More routine and excess ill and wounded are backhauled in general-purpose cargo vehicles, carts, or even taxis to a civilian medical facility.
6. Whenever possible, medical functions are performed in tents, tunnels, caves, or local accommodations. In some instances, the medical cell will attempt to collocate with a village clinic.
7. For additional information on medical care available to insurgents, see FM 7-100.3.

## Appendix D

# Motorized Infantry Company from the AFS Organizational Directories

This appendix provides an example of the information for an infantry company and its subordinates, as found in the administrative force structure (AFS) organizational directories under the motorized infantry battalion. It also includes the Excel® spreadsheet for the personnel and equipment in the motorized infantry battalion as a whole.

---

*Note.* For illustrative purposes, this FM contains several examples from the online AFS organizational directories. Readers are reminded that even the baseline OPFOR organizations are subject to change over time. Therefore, readers should always consult the online directories for the latest, most up-to-date versions of organizational data.

---

## INFANTRY AND MOTORIZED INFANTRY COMPANIES

D-1. OPFOR infantry units that are not mechanized (equipped with APCs or IFVs) may be motorized infantry (truck-mounted) or just plain infantry (without trucks). The infantry company has sufficient assets to transport the headquarters and primary weapons systems such as mortars and ATGMs (weapons platoon). To transport the three infantry platoons over distance, however, it is dependent upon augmentation from the transportation platoon of a motorized infantry battalion. Movement of the entire infantry company (organic and individual weapons, equipment, ammunition, and supplies) requires an additional six medium trucks (two per platoon). When an infantry company receives these transportation assets, it becomes a motorized infantry company. Its subordinate infantry platoons and their infantry squads become motorized infantry platoons and squads. Once the move is complete, the trucks return to the battalion transportation platoon. At that point, the company again becomes essentially an infantry company, with infantry platoons and infantry squads.

## MOTORIZED INFANTRY COMPANY EXAMPLE

D-2. The example on the following pages comes from the Motorized Infantry Brigade folder in volume I of the AFS organizational directories. Therefore, the infantry company in question is part of a motorized infantry battalion. Since it is truck-mobile, with trucks available from the transportation platoon of the motorized infantry battalion, it is a motorized infantry company.

**Infantry Company, Inf and Mtzd Inf Bn** \_\_\_\_\_

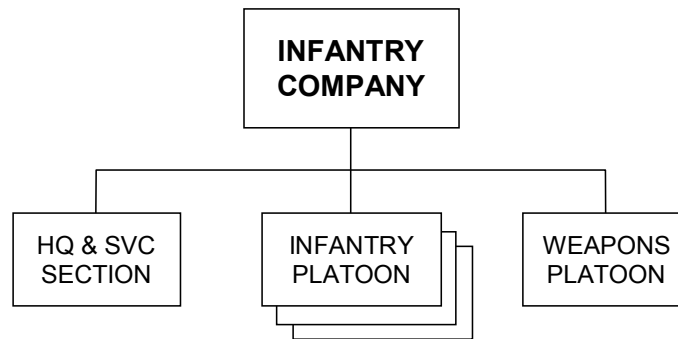

Total Personnel ..... 181      O-6/N-43/E-132

**NOTES:**

1. The infantry company has sufficient assets to transport the headquarters and primary weapons systems such as mortars and ATGMs (weapons platoon). It is dependent upon augmentation from higher (battalion transport platoon) to transport the three infantry platoons over distance. Movement of the entire infantry company (organic and individual weapons, equipment, ammunition, and supplies) requires an additional six medium trucks (two per platoon). Once the move is complete the trucks return to the battalion transport platoon.
2. The infantry company may also be augmented by motorcycles or high-mobility/all terrain vehicles depending on the mission.



Infantry Company, Inf and Mtzd Inf Bn (continued)

PRINCIPAL ITEMS OF EQUIPMENT

<u>Equipment</u>	<u>Total</u>	<u>Equipment</u>	<u>Total</u>
9-mm Pistol, PM.....	18	Truck, Medium .....	2
5.45-mm Assault Rifle, AK-74M.....	131	Trailer, Cargo, 1-Axle.....	2
5.45-mm Carbine, AKS-74U.....	21	Trailer, Cargo, 2-Axle.....	2
7.62-mm GP MG, PKM * .....	12	Trailer, Utility .....	7
7.62-mm Sniper Rifle, SVD * .....	11	Trailer, Water (1,200-Liter) .....	1
.50-cal Antimateriel Rifle, M82A1 * .....	2	Smoke Pots, Drums, Barrels, and Grenades .....	Assorted
12.7-mm HMG, NSV * .....	8	Aiming Circle/Goniometer .....	1
35-mm AGL-Light, W-87 * .....	9	Binocular Laser Rangefinder * .....	42
40-mm Grenade Launcher, GP-30 .....	30	GPS Receiver, Handheld .....	53
60-mm Mortar, Light, Type 90 * .....	3	Laser Target Designator ** .....	3
ATGM Launcher, Milan 3 ** .....	3	Observation Scope, Day/Night * or ** .....	2
ATGM Lchr, Manportable-SR, Eryx * .....	3	Radar, GSR, Manportable, Fara-1 .....	3
ATGL-Long Range, RPG-29 * .....	6	Thermal Viewer, Handheld, Sophie.....	14
ATGL, Panzerfaust 3-T600 * .....	9	Night-Vision Goggles .....	61
ATDL, Armbrust *** .....	9	Night-Vision Goggles (Driver).....	12
ATDL, RPG-27 *** .....	4	Night-Vision Goggles (AK w/GP-30) .....	30
Flame Weapon, RPO-A Series .....	23	Night-Vision Sight (Aiming Circle) .....	1
Minefield Breaching System- Explosive Charge, ZRP-2 **** .....	3	Radios: Handheld, Very-Low-Power .....	48
Mine-Scattering System, Manportable, PKM .....	3	Manpack, Low-Power .....	6
Mines (AP&AT) ***/***** .....	Assorted	Vehicle Mount, Medium-Power .....	12
Tactical Utility Vehicle, UAZ-469.....	7	Warning Receiver.....	1
Truck, Light.....	3		

- \* With II night sight.
- \*\* With thermal sight.
- \*\*\* Issued as ammunition rather than a weapon—the BOI may vary.
- \*\*\*\* No dedicated operator/BOI. It is carried until needed
- \*\*\*\*\* Includes remotely detonated mines and side-attack (AT & anti-vehicle) mines.

Headquarters and Service Section, Inf Co

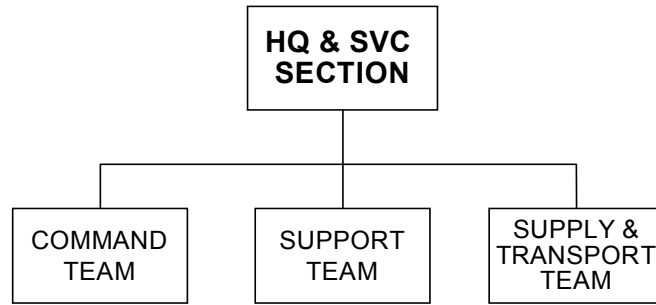

Total Personnel..... 12                      O-2/N-2/E-8

**PRINCIPAL ITEMS OF EQUIPMENT**

<u>Equipment</u>	<u>Total</u>	<u>Equipment</u>	<u>Total</u>
5.45-mm Assault Rifle, AK-74M .....	12	Trailer, Water (1,200-Liter) .....	1
7.62-mm GP MG, PKM * .....	3	Smoke Pots, Drums, Barrels, and Grenades .....	Assorted
12.7-mm HMG, NSV * .....	2	Binocular Laser Rangefinder * .....	2
40-mm Grenade Launcher, GP-30.....	3	GPS Receiver, Handheld.....	5
ATDL, RPG-27 ** .....	3	Laser Target Designator **** .....	1
Flame Weapon, RPO-A Series ** .....	2	Thermal Viewer, Handheld, Sophie.....	1
Minefield Breaching System- Explosive Charge, ZRP-2 *** .....	3	Night-Vision Goggles .....	1
Mine-Scattering System, Manportable, PKM *** .....	3	Night-Vision Goggles (Driver) .....	5
Mines (AP&AT) ***/***** .....	Assorted	Night-Vision Goggles (AK w/GP-30) .....	3
Tactical Utility Vehicle, UAZ-469 .....	2	Radios:	
Truck, Light.....	1	Handheld, Very-Low-Power .....	3
Truck, Medium.....	2	Manpack, Low-Power .....	1
Trailer, Cargo, 2-Axle .....	2	Vehicle Mount, Medium-Power .....	5
Trailer, Utility.....	2	Warning Receiver.....	1

**NOTE:** The headquarters and service section may be augmented by additional vehicles, trucks, tactical utility vehicles (TUVs), motorcycles, or high-mobility/all-terrain vehicles depending on the mission.

- \* With II night sight.
- \*\* Issued as ammunition rather than a weapon—the BOI may vary.
- \*\*\* No dedicated operator. It is carried by the headquarters and service section until needed.
- \*\*\*\* With thermal sight.
- \*\*\*\*\* Includes remotely detonated mines and side-attack (AT & anti-vehicle) mines.

**Command Team, HQ & Svc Section**

**COMMAND  
TEAM**

Company Commander (O) (x1).....AK-74M  
 RTO (x1) .....AK-74M  
 Driver (TUV) (x1)..... AK-74M/GP-30  
  
 Total Personnel ..... 3                      O-1/N-0/E-2

**PRINCIPAL ITEMS OF EQUIPMENT**

<u>Equipment</u>	<u>Total</u>	<u>Equipment</u>	<u>Total</u>
5.45-mm Assault Rifle, AK-74M.....	3	Thermal Viewer, Handheld, Sophie.....	1
7.62-mm GP MG, PKM */** .....	1	Night-Vision Goggles .....	1
40-mm Grenade Launcher, GP-30 .....	1	Night-Vision Goggles (Driver).....	1
ATDL, RPG-27 *** .....	1	Night-Vision Goggles (AK w/GP-30).....	1
Flame Weapon, RPO-A Series.....	1	Radios:	
Tactical Utility Vehicle, UAZ-469.....	1	Handheld, Very-Low-Power .....	1
Trailer, Utility.....	1	Manpack, Low-Power .....	1
Binocular Laser Rangefinder *.....	1	Vehicle Mount, Medium-Power.....	1
GPS Receiver, Handheld.....	1	Warning Receiver.....	1
Laser Target Designator **** .....	1		

---

\* With II night sight.  
 \*\* A 7.62-mm GP MG is mounted on the utility vehicle. A tripod mount is also carried for the ground support role. Whoever is not driving operates the vehicle MG.  
 \*\*\* Issued as ammunition rather than a weapon—the BOI may vary.  
 \*\*\*\* With thermal sight. No dedicated operator.

Support Team, HQ & Svc Section

**SUPPORT  
TEAM**

Deputy Commander (O) (x1).....AK-74M  
 First Sergeant (N) (x1)..... AK-74M/GP-30  
 Driver (Trk) (x1).....AK-74M  
 Driver (TUV) (x1).....AK-74M  
 Medic (x1) .....AK-74M  
  
 Total Personnel..... 5            O-1/N-1/E-3

**PRINCIPAL ITEMS OF EQUIPMENT**

<u>Equipment</u>	<u>Total</u>	<u>Equipment</u>	<u>Total</u>
5.45-mm Assault Rifle, AK-74M .....	5	Mine-Scattering System,	
7.62-mm GP MG, PKM */** .....	1	Manportable, PKM **** .....	1
12.7-mm HMG, NSV */** .....	1	Mines (AP&AT) ***/***** .....	Assorted
40-mm Grenade Launcher, GP-30.....	1	Smoke Pots, Drums, Barrels,	
ATDL, RPG-27 *** .....	1	and Grenades .....	Assorted
Flame Weapon, RPO-A Series *** .....	1	Binocular Laser Rangefinder * .....	1
Tactical Utility Vehicle, UAZ-469 .....	1	GPS Receiver, Handheld.....	2
Truck, Light.....	1	Night-Vision Goggles (Driver) .....	2
Trailer, Utility .....	1	Night-Vision Goggles (AK w/GP-30) .....	1
Trailer, Water (1,200-Liter).....	1	Radios:	
Minefield Breaching System-		Handheld, Very-Low-Power .....	2
Explosive Charge, ZRP-2 **** .....	1	Vehicle Mount, Medium-Power .....	2

- 
- \* With II night sight.
  - \*\* A 12.7-mm HMG is mounted on the light truck. A 7.62-mm GP MG is mounted on the TUV. A tripod mount is also carried for the ground support role. Whoever is not driving operates the vehicle MG.
  - \*\*\* Issued as ammunition rather than a weapon—the BOI may vary.
  - \*\*\*\* No dedicated operator. It is carried by the support team until needed.
  - \*\*\*\*\* Includes remotely detonated mines and side-attack (AT & anti-vehicle) mines.

**Supply & Transportation Team, HQ & Svc Section**

**SUPPLY &  
TRANSPORT  
TEAM**

Supply Sergeant (N) (x1).....AK-74M  
 Driver/Sup Spec (x2).....AK-74M  
 Sup Spec (x1) ..... AK-74M/GP-30  
  
 Total Personnel ..... 4                      O-0/N-1/E-3

**PRINCIPAL ITEMS OF EQUIPMENT**

<u>Equipment</u>	<u>Total</u>	<u>Equipment</u>	<u>Total</u>
5.45-mm Assault Rifle, AK-74M.....	4	Mine-Scattering System,	
7.62-mm GP MG, PKM */** .....	12	Manportable, PKM **** .....	2
12.7-mm HMG, NSV */** .....	1	Mines (AP&AT) ***/***** .....	Assorted
40-mm Grenade Launcher, GP-30 .....	1	GPS Receiver, Handheld .....	2
ATDL, RPG-27 *** .....	1	Night-Vision Goggles (Driver).....	2
Truck, Medium.....	2	Night-Vision Goggles (AK w/GP-30) .....	1
Trailer, Cargo, 2-Axle .....	2	Radio:	
Minefield Breaching System-		Vehicle Mount, Medium-Power .....	2
Explosive Charge, ZRP-2 **** .....	2		

**NOTE:** Corner mounted mechanical hoists are used to load/unload the vehicles.

- 
- \* With II night sight.
  - \*\* A 12.7-mm HMG is mounted on one medium truck and a 7.62-mm GP MG is mounted on the other. Whoever is not driving operates the vehicle MG. A tripod mount is also carried for the ground support role.
  - \*\*\* Issued as ammunition rather than a weapon—the BOI may vary.
  - \*\*\*\* No dedicated operator. It is carried by the transport team until needed.
  - \*\*\*\*\* Includes remotely detonated mines and side-attack (AT & anti-vehicle) mines.

**Infantry Platoon, Inf Co**

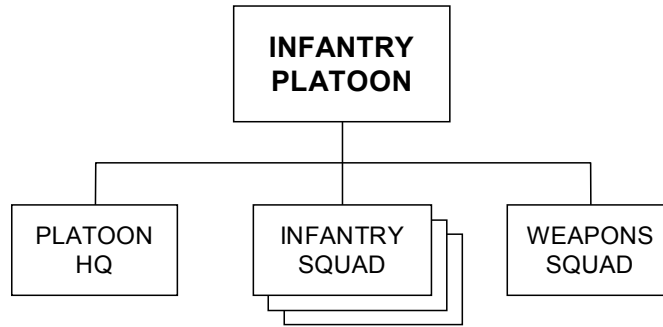

Total Personnel..... 43      O-1/N-9/E-33

**PRINCIPAL ITEMS OF EQUIPMENT**

<u>Equipment</u>	<u>Total</u>	<u>Equipment</u>	<u>Total</u>
9-mm Pistol, PM.....	5	Mines (AP&AT) ***/****	Assorted
5.45-mm Assault Rifle, AK-74M.....	29	Tactical Utility Vehicle, UAZ-469.....	1
5.45-mm Carbine, AKS-74U.....	6	Trailer, Utility .....	1
7.62-mm GP MG, PKM * .....	3	Binocular Laser Rangefinder * .....	9
7.62-mm Sniper Rifle, SVD * .....	3	GPS Receiver, Handheld.....	10
12.7-mm HMG, NSV */** .....	1	Thermal Viewer, Handheld, Sophie.....	2
35-mm AGL-Light, W-87 * .....	2	Night-Vision Goggles .....	10
40-mm Grenade Launcher, GP-30.....	8	Night-Vision Goggles (Driver) .....	1
ATGM Lchr, Manportable-SR, Eryx * .....	1	Night-Vision Goggles (AK w/GP-30) .....	8
ATGL-Long Range, RPG-29 * .....	2	Radios:	
ATGL, Panzerfaust 3-T600 * .....	3	Handheld, Very-Low-Power .....	10
ATDL, Armbrust .....	3	Manpack, Low-Power .....	1
Flame Weapon, RPO-A Series *** .....	7	Vehicle Mount, Medium-Power .....	1

**NOTES:**

1. The infantry platoon has sufficient assets to transport the platoon headquarters and weapons squad. It is dependent upon augmentation from higher (battalion transport platoon) to transport the three infantry squads over distance. Movement of the entire infantry platoon (organic and individual weapons, equipment, ammunition, and supplies) requires an additional 2 medium trucks. Once the move is complete the trucks return to the battalion transport platoon.
2. One of the infantrymen is cross-trained as a medic.
3. The infantry platoon may be augmented by motorcycles or high-mobility/all terrain vehicles depending on the mission.

---

\* With II night sight.  
 \*\* A 12.7-mm HMG is mounted on the TUV. A tripod mount is also carried for the ground support role. Whoever is not driving operates the vehicle HMG.  
 \*\*\* Issued as ammunition rather than a weapon—BOI may vary.  
 \*\*\*\* Includes remotely detonated mines and side-attack (AT & anti-vehicle) mines. The mine mix is mission dependent and varies.

Platoon Headquarters, Inf Plt

**PLATOON  
HQ**

Platoon Leader (O) (x1).....AK-74M  
 Platoon Sergeant (N) (x1) ..... AK-74M/GP-30  
 RTO (x1) .....AK-74M  
 Driver (TUV) (x1).....AK-74M  
  
 Total Personnel .....4            O-1/N-1/E-2

**PRINCIPAL ITEMS OF EQUIPMENT**

<u>Equipment</u>	<u>Total</u>	<u>Equipment</u>	<u>Total</u>
5.45-mm Assault Rifle, AK-74M.....	4	Thermal Viewer, Handheld, Sophie.....	1
12.7-mm HMG, NSV */** .....	1	Night-Vision Goggles .....	2
40-mm Grenade Launcher, GP-30 .....	1	Night-Vision Goggles (Driver).....	1
Mines (AP&AT) ***/**** .....	Assorted	Night-Vision Goggles (AK w/GP-30) .....	1
Tactical Utility Vehicle, UAZ-469.....	1	Radios:	
Trailer, Utility.....	1	Handheld, Very-Low-Power .....	2
Binocular Laser Rangefinder *.....	1	Manpack, Low-Power .....	1
GPS Receiver, Handheld.....	2	Vehicle Mount, Medium-Power .....	1

- 
- \* With II night sight.
  - \*\* A 12.7-mm HMG is mounted on the vehicle. A tripod mount is also carried for the ground support role. Whoever is not driving operates the vehicle HMG.
  - \*\*\* Issued as ammunition rather than a weapon—BOI may vary.
  - \*\*\*\* Includes remotely detonated mines and side-attack (AT & anti-vehicle) mines. The mine mix is mission dependent and varies.

**Infantry Squad, Inf Plt**

<b>INFANTRY SQUAD</b>
---------------------------

Squad Leader (N) (x1).....	AK-74M
Asst Sqd Ldr (N) (x1).....	AK-74M
Machinegunner (x1) .....	PKM/PM
Asst Machinegunner (x1) .....	AK-74M
Sniper/Marksman (x1) .....	SVD
Grenadier (x1) .....	PZF3-T/AKS-74U
Asst Grenadier (x1) .....	AK-74M
Rifleman (x2).....	AK-74M/GP-30
 Total Personnel.....	9                      O-0/N-2/E-7

**PRINCIPAL ITEMS OF EQUIPMENT**

<u>Equipment</u>	<u>Total</u>	<u>Equipment</u>	<u>Total</u>
9-mm Pistol, PM.....	1	Flame Weapon, RPO-A Series ** .....	2
5.45-mm Assault Rifle, AK-74M .....	6	Mines (AP&AT) **/** .....	Assorted
5.45-mm Carbine, AKS-74U .....	1	Binocular Laser Rangefinder * .....	2
7.62-mm GP MG, PKM * .....	1	GPS Receiver, Handheld.....	2
7.62-mm Sniper Rifle, SVD * .....	1	Night-Vision Goggles .....	2
40-mm Grenade Launcher, GP-30.....	2	Night-Vision Goggles (AK w/GP-30) .....	2
ATGL, Panzerfaust 3-T600 * .....	1	Radios:	
ATDL, Armbrust .....	1	Handheld, Very-Low-Power .....	2

**NOTES:**

1. The infantry squad consists of at least two maneuver fire teams. The squad leader may choose to command one fire team while the assistant squad leader commands the second. The infantry squad may be augmented by elements from the weapons squad—in which case the infantry squad may operate with three maneuver fire teams (or anti-armor hunter-killer teams).
2. The squad leader and assistant squad leader both have NVGs, a handheld radio, LRF, and GPS. The riflemen also support other weapons including the machinegunner, the ATGL grenadier, the sniper/marksman, or attachments from the weapons squad.
3. Some squads may have a second machinegunner in lieu of the rifleman (mission dependent). In this case the second rifleman becomes the assistant machinegunner. You gain a PKM and PM for the machinegunner and an AK-47M for the assistant machinegunner but lose the two AK-74M/GP-30s the riflemen carried previous to the substitution.

---

\* With II night sight.  
 \*\* Issued as ammunition rather than a weapon—BOI may vary.  
 \*\*\* Includes remotely detonated mines and side-attack (AT & anti-vehicle) mines. The mine mix is mission dependent and varies.



**Weapons Squad, Inf Plt**

**WEAPONS  
SQUAD**

Squad Leader (N) (x1).....	AK-74M
Asst Squad Leader (N) (x1).....	AK-74M/GP-30
ATGM Gunner (x1).....	Eryx/AKS-74U
Asst ATGM Gunner (x1).....	AK-74M
Grenadier (x2).....	RPG-29/AKS-74U
Asst Grenadier (x2).....	AK-74M
AGL Gunner (x2).....	W-87/PM
Asst AGL Gunner (x2).....	AK-74M
 Total Personnel .....	12            O-0/N-2/E-10

**PRINCIPAL ITEMS OF EQUIPMENT**

<u>Equipment</u>	<u>Total</u>	<u>Equipment</u>	<u>Total</u>
9-mm Pistol, PM.....	2	Mines (AP&AT) **/** .....	Assorted
5.45-mm Assault Rifle, AK-74M.....	7	Binocular Laser Rangefinder * .....	2
5.45-mm Carbine, AKS-74U.....	3	GPS Receiver, Handheld .....	2
35-mm AGL-Light, W-87 * .....	2	Thermal Viewer, Handheld, Sophie.....	1
40-mm Grenade Launcher, GP-30 .....	1	Night-Vision Goggles .....	2
ATGM Lchr, Manportable-SR, Eryx * .....	1	Night-Vision Goggles (AK w/GP-30) .....	1
ATGL-Long Range, RPG-29 * .....	2	Radios:	
Flame Weapon, RPO-A Series ** .....	1	Handheld, Very-Low-Power .....	2

**NOTES:**

1. The squad leader and the assistant squad leader both have a handheld radio, LRF, and GPS. The squad leader has a thermal viewer while the assistant squad leader has an NVG.
2. The weapons squad may be employed as a squad or it may be allocated to support separate infantry squads. This augmentation enables the infantry squad to operate with three maneuver fire teams (or anti-armor hunter/killer teams).

---

\* With II night sight.  
 \*\* Issued as ammunition rather than a weapon—BOI may vary.  
 \*\*\* Includes remotely detonated mines and side-attack (AT & anti-vehicle) mines. The mine mix is mission dependent and varies.

**Weapons Platoon, Inf Co**

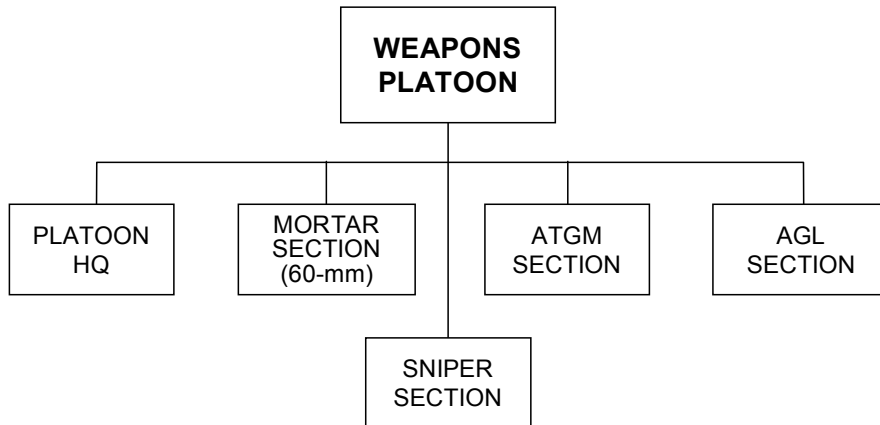

Total Personnel..... 42      O-1/N-14/E-25

**PRINCIPAL ITEMS OF EQUIPMENT**

<u>Equipment</u>	<u>Total</u>
9-mm Pistol, PM.....	3
5.45-mm Assault Rifle, AK-74M.....	32
5.45-mm Carbine, AKS-74U.....	3
7.62-mm Sniper Rifle, SVD * .....	2
.50-cal Antimateriel Rifle, M82A1 */**.....	2
12.7-mm HMG, NSV */** .....	3
35-mm AGL-Light, W-87 * .....	3
40-mm Grenade Launcher, GP-30.....	3
60-mm Mortar, Light, Type 90 *.....	3
ATGM Launcher, Milan 3 *** .....	3
ADTL, RPG-27 .....	1
Mines (AP&AT) ****/***** .....	Assorted
Tactical Utility Vehicle, UAZ-469 ** .....	2
Truck, Light ** .....	2
Trailer, Cargo (1-Axle).....	2
Trailer, Utility.....	2

<u>Equipment</u>	<u>Total</u>
Aiming Circle/Goniometer.....	1
Binocular Laser Rangefinder * .....	13
GPS Receiver, Handheld.....	18
Laser Target Designator *** .....	2
Observation Scope, Day/Night * or *** .....	2
Radar, GSR, Manportable, Fara-1.....	3
Thermal Viewer, Handheld, Sophie.....	7
Night-Vision Goggles .....	26
Night-Vision Goggles (Driver) .....	4
Night-Vision Goggles (AK w/GP-30) .....	3
Night-Vision Sight (Aiming Circle).....	1
Radios:	
Handheld, Very-Low-Power .....	15
Manpack, Low-Power .....	2
Vehicle Mount, Medium-Power .....	4

**NOTE:** The weapons platoon may be augmented by motorcycles or high-mobility/all terrain vehicles depending on the mission.

- \* With II night sight.
- \*\* A 12.7-mm HMG is mounted on the vehicle. A tripod mount is also carried for the ground support role. Whoever is not driving operates the vehicle HMG.
- \*\*\* With thermal sight.
- \*\*\*\* Issued as ammunition rather than a weapon—BOI may vary.
- \*\*\*\*\* Includes remotely detonated mines and side-attack (AT & anti-vehicle) mines. The mine mix is mission dependent and varies.

**Platoon Headquarters, Wpns Plt**

---

<p><b>PLATOON HQ</b></p>
------------------------------

Platoon Leader (O) (x1).....	AK-74M
Platoon Sergeant (N) (x1) .....	AK-74M/GP-30
Driver (TUV) (x1).....	AK-74M
Driver (Trk) (x2).....	AK-74M
RTO (x1) .....	AK-74M
 Total Personnel .....	 6                      O-1/N-1/E-4

**PRINCIPAL ITEMS OF EQUIPMENT**

<u>Equipment</u>	<u>Total</u>	<u>Equipment</u>	<u>Total</u>
5.45-mm Assault Rifle, AK-74M.....	6	GPS Receiver, Handheld .....	2
12.7-mm HMG, NSV */** .....	2	Thermal Viewer, Handheld, Sophie.....	1
40-mm Grenade Launcher, GP-30 .....	1	Night-Vision Goggles .....	2
Mines (AP&AT) ***/***** .....	Assorted	Night-Vision Goggles (Driver).....	3
Tactical Utility Vehicle .....	1	Night-Vision Goggles (AK w/GP-30) .....	1
Truck, Light ****...	2	Radios:	
Trailer, Cargo (1-Axle).....	2	Handheld, Very-Low-Power .....	2
Trailer, Utility.....	1	Manpack, Low-Power .....	1
Binocular Laser Rangefinder *.....	1	Vehicle Mount, Medium-Power .....	3

**NOTE:** Corner-mounted mechanical hoists are used to load/unload the vehicles.

- 
- \* With II night sight.
  - \*\* A 12.7-mm HMG is mounted on both light trucks and the TUV. A tripod mount is also carried for the ground support role. Whoever is not driving, or an infantryman, operates the vehicle HMG.
  - \*\*\* Issued as ammunition rather than a weapon—BOI may vary.
  - \*\*\*\* Includes remotely detonated mines and side-attack (AT & anti-vehicle) mines. The mine mix is mission dependent and varies.
  - \*\*\*\*\* One truck transports both the mortar and AGL sections while the other truck transports the ATGM section. When the trucks are not required for direct support to the weapons platoon they re-subordinate to the infantry company supply & transportation team to provide general support to the company.

**Mortar Section (60-mm), Wpns Plt, Infantry Company** \_\_\_\_\_

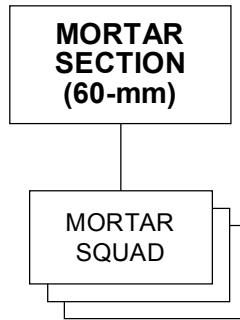

Total Personnel ..... 9                      O-0/N-3/E-6

**PRINCIPAL ITEMS OF EQUIPMENT**

<u>Equipment</u>	<u>Total</u>	<u>Equipment</u>	<u>Total</u>
60-mm Mortar, Light, Type 90 *.....	3	Night-Vision Goggles .....	9
5.45-mm Assault Rifle, AK-74M .....	9	Night-Vision Sight (Aiming Circle).....	1
Aiming Circle/Goniometer .....	1	Radios:	
Binocular Laser Rangefinder * .....	3	Handheld, Very-Low-Power .....	3
GPS Receiver, Handheld .....	3		

**NOTES:**

1. The mortar section leader also serves as the squad leader of one of the three squads.
2. The mortar section receives transportation support from the weapons platoon headquarters. This section may be augmented by motorcycles or high-mobility/all terrain vehicles depending on the mission.
3. The section may be allocated by squad.

---

\* 81/82-mm mortars (W-87 81-mm or 2B14-1 82-mm) may be substituted for the 60-mm light mortar. When 81/82-mm mortars are used the squad size is increased by three personnel (ammo bearers) for a total squad size of five personnel (section size of 16 personnel).

**Mortar Squad, Mortar Section**

<p><b>MORTAR SQUAD</b></p>
--------------------------------

Squad Leader (N) (x1).....AK-74M  
 Gunner (x1).....AK-74M  
 Asst Gunner/Ammo Bearer (x1).....AK-74M  
 Total Personnel ..... 3            O-O/N-1/E-2

**PRINCIPAL ITEMS OF EQUIPMENT**

<u>Equipment</u>	<u>Total</u>	<u>Equipment</u>	<u>Total</u>
60-mm Mortar, Light, Type 90 *	1	Night-Vision Goggles	3
5.45-mm Assault Rifle, AK-74M	3	Radios:	
Binocular Laser Rangefinder *	1	Handheld, Very-Low-Power	1
GPS Receiver, Handheld	1		

**NOTES:**

1. The mortar section leader also serves as the squad leader of one of the two squads.
2. The mortar squad receives transportation support from the weapons platoon headquarters. This squad may be augmented by motorcycles or high-mobility/all terrain vehicles depending on the mission.

---

\* 81/82-mm mortars (W-87 81-mm or 2B14-1 82-mm) may be substituted for the 60-mm light mortar. When 81/82-mm mortars are used the squad size is increased by three personnel (ammo bearers) for a total squad size of five personnel (section size of 16 personnel).

**ATGM Section, Wpns Plt**

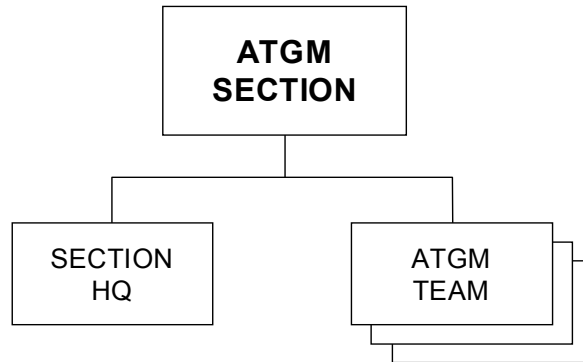

Section Leader (x1) .....AK-74M

Total Personnel..... 10                      O-0/N-4/E-6

**PRINCIPAL ITEMS OF EQUIPMENT**

<u>Equipment</u>	<u>Total</u>	<u>Equipment</u>	<u>Total</u>
ATGM Launcher, Milan 3 *	3	GPS Receiver, Handheld.....	4
5.45-mm Assault Rifle, AK-74M.....	7	Thermal Viewer, Handheld, Sophie.....	4
5.45-mm Carbine, AKS-74U.....	3	Night-Vision Goggles .....	10
Mines (AP&AT) **/** .....	Assorted	Radios:	
Binocular Laser Rangefinder **** .....	4	Handheld, Very-Low-Power .....	4

**NOTES:**

1. The ATGM section may be employed as a section or it may be allocated by team to each infantry platoon.
2. The ATGM section receives transportation support from one of the light trucks in weapons platoon headquarters. This section may be augmented by motorcycles or high-mobility/all terrain vehicles depending on the mission.
3. The ATGM section receives antitank or anti-vehicle mine warfare support for antiarmor ambushes etc from the infantry elements in the company or from the battalion/brigade. Some mines are carried in the weapons platoon headquarters vehicle until needed.

- 
- \* With thermal sight.
  - \*\* Includes remotely detonated mines and side-attack (AT & anti-vehicle) mines. The mine mix is mission dependent and varies.
  - \*\*\* Issued as ammunition rather than a weapon—BOI may vary.
  - \*\*\*\* With II night sight.

**ATGM Team, ATGM Section**



Team Leader/ATGM Asst Gunner (N) (x1).....AK-74M  
ATGM Gunner (x1).....AKS-74U  
ATGM Asst Gunner/Ammo Bearer (x1).....AK-74M  
  
Total Personnel..... 3            O-0/N-1/E-2

**PRINCIPAL ITEMS OF EQUIPMENT**

<u>Equipment</u>	<u>Total</u>	<u>Equipment</u>	<u>Total</u>
ATGM Launcher, Milan 3 *	1	Thermal Viewer, Handheld, Sophie	1
5.45-mm Assault Rifle, AK-74M	2	Night-Vision Goggles	3
5.45-mm Carbine, AKS-74U	1	Radios:	
Binocular Laser Rangefinder **	1	Handheld, Very-Low-Power	1
GPS Receiver, Handheld	1		

*NOTE:* The ATGM team receives its transportation support from one of the light trucks in weapons platoon headquarters. This team may be augmented by motorcycles or high-mobility/all terrain vehicles depending on the mission.

\* With thermal sight.  
\*\* With II night sight.

**Automatic Grenade Launcher (AGL) Section, Wpns Plt \_\_\_\_\_**

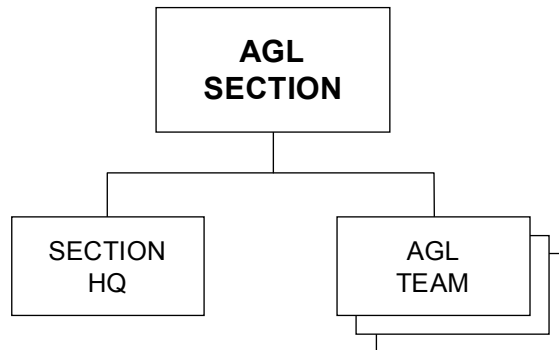

Section Leader (x1) ..... AK-74M

Total Personnel..... 10                      O-0/N-4/E-6

**PRINCIPAL ITEMS OF EQUIPMENT**

<u>Equipment</u>	<u>Total</u>	<u>Equipment</u>	<u>Total</u>
9-mm Pistol, PM.....	3	Radar, GSR, Manportable, Fara-1.....	3
5.45-mm Assault Rifle, AK-74M.....	7	Night-Vision Goggles .....	7
35-mm AGL-Light, W-87 * .....	3	Radios:	
Binocular Laser Rangefinder *.....	3	Handheld, Very-Low-Power .....	4
GPS Receiver, Handheld.....	4		

**NOTE:** The AGL section may be employed as a section or it may be broken up into teams to support separate infantry platoons.

---

\* With II night sight.



Automatic Grenade Launcher (AGL) Team, AGL Section \_\_\_\_\_

**AGL  
TEAM**

Team Leader/Asst AGL Gunner (N) (x1).....AK-74M  
AGL Gunner (x1).....W-87/PM  
Radar Operator/Ammo Bearer (x1).....AK-74M  
  
Total Personnel ..... 3            O-0/N-1/E-2

**PRINCIPAL ITEMS OF EQUIPMENT**

<u>Equipment</u>	<u>Total</u>	<u>Equipment</u>	<u>Total</u>
9-mm Pistol, PM.....	1	Radar, GSR, Manportable, Fara-1 .....	1
5.45-mm Assault Rifle, AK-74M.....	2	Night-Vision Goggles .....	2
35-mm AGL-Light, W-87 * .....	1	Radios:	
Binocular Laser Rangefinder *.....	1	Handheld, Very-Low-Power .....	1
GPS Receiver, Handheld.....	1		

\* With II night sight.

**Sniper Section, Wpns Plt**

<p><b>SNIPER SECTION</b></p>
----------------------------------

Squad Leader/Sr Sniper (N) (x1) .....	AK-74M/GP-30
Team Leader/Observer (N) (x1) .....	AK-74M/GP-30
Sniper/Designator (x2).....	SVD or M82A1
Driver (TUV) (x1) .....	AK-74M
 Total Personnel .....	 5                      O-0/N-2/E-3

**PRINCIPAL ITEMS OF EQUIPMENT**

<u>Equipment</u>	<u>Total</u>	<u>Equipment</u>	<u>Total</u>
5.45-mm Assault Rifle, AK-74M .....	3	Laser Target Designator ***** .....	2
7.62-mm Sniper Rifle, SVD * .....	2	Observation Scope, Day/Night * or ***** .....	2
.50-cal Antimateriel Rifle, M82A1 * .....	2	Thermal Viewer, Handheld, Sophie .....	2
12.7-mm HMG, NSV */** .....	1	Night-Vision Goggles .....	2
40-mm Grenade Launcher, GP-30.....	2	Night-Vision Goggles (Driver) .....	1
ATDL, RPG-27 *** .....	1	Night-Vision Goggles (AK w/GP-30) .....	2
Tactical Utility Vehicle, UAZ-469 **** .....	1	Radios:	
Trailer, Utility .....	1	Handheld, Very-Low-Power .....	2
Binocular Laser Rangefinder * .....	2	Manpack, Low-Power .....	1
GPS Receiver, Handheld .....	2	Vehicle Mount, Medium-Power .....	1

**NOTES:**

1. The sniper section consists of two sniper teams. The squad leader serves as the team leader of one sniper team. Each sniper team consists of a team leader/observer (spotter) and a sniper (shooter)/target designator.
2. The sniper carries either a 7.62-mm or .50 BMG sniper rifle depending on the mission. The other rifle remains behind with the TUV or headquarters element.
3. The primary mission of the sniper section is to serve in the conventional sniper-countersniper role. Depending on mission requirements however, the sniper team may also serve as a reconnaissance element, a laser target designation team (artillery sniper), a stay-behind element, or as part of a hunter/killer team.
4. The sniper section may be augmented by motorcycles or high-mobility/all terrain vehicles depending on the mission.

---

\* With II night sight.  
 \*\* 12.7-mm HMGs are mounted on the TUVs and the truck. A tripod ground mount is also carried. Whoever is not driving operates the HMG.  
 \*\*\* Issued as ammunition rather than a weapon; therefore the BOI may vary.  
 \*\*\*\* ATVs and/or motorcycles may be substituted for TUVs.  
 \*\*\*\*\* With thermal sight.

---

*Note.* The following pages show the personnel and equipment for the entire motorized infantry battalion, in spreadsheet format.

---

Motorized Infantry Battalion

Motorized Infantry Battalion											
Personnel and Items of Equipment	Battalion Headquarters	Motorized Infantry Company X3 *	Towed Mortar/Combo Gun Btry	Recon Platoon	ATGM Platoon	AGL Platoon	MANPAD Platoon	Signal Platoon	Transport Platoon	Materiel Support Platoon	TOTAL
<b>Personnel</b>											
Officers	7	18	5	1	1	1	1	1	1	1	37
NCO	2	129	15	7	10	10	4	5	3	16	201
Enlisted	14	396	51	35	30	26	26	28	25	67	698
<b>Total Personnel</b>	<b>23</b>	<b>543</b>	<b>71</b>	<b>43</b>	<b>41</b>	<b>37</b>	<b>31</b>	<b>34</b>	<b>29</b>	<b>84</b>	<b>936</b>
<b>Equipment</b>											
9-mm Pistol, PM	3	54									57
5.45-mm Assault Rifle, AK-74M	20	393	70	34	34	37	25	34	29	63	739
5.45-mm Carbine, AKS-74U		63	1	9	7		6			21	107
7.62-mm GP MG, PKM	2	36	9	9	6	1		3	7	7	80
7.62-mm Sniper Rifle, SVD		33									33
.50-cal Antimateriel Rifle, M82A1		6									6
12.7-mm HMG, NSV	3	24	5	3			7	3		2	47
35-mm AGL-Light, W-87	1	27		1	4						33
40-mm AGL-Heavy, CIS 40						6					6
40-mm Grenade Launcher, GP-30	4	90	17	16	13		8	8	7	9	172
60-mm Mortar, Light, Type 90		9									9
120-mm Towed Combo Gun, 2B16 or 120-mm Towed Mortar, MO-120-RT			6								6
ATGM Launcher, HOT-3					3						3
ATGM Launcher, Milan 3		9									9
ATGM Lchr, Manportable-SR, Eryx		9									9
ATGL-Long Range, RPG-29		18									18
ATGL, Panzerfaust 3-T600	1	27			1						29
ATDL, Ambrust		27									27
ATDL, RPG-27	4	12	7	15	10	7	7	3	1	11	77
Flame Weapon, RPO-A Series		69									69
MANPADS Launcher, SA-18							6				6
Minefield Breach System-Explosive ZRP-2		9									9
Mine-Scattering System, Manport, PKM		9		3	3						15
Mines (AP&AT)		Assort		Assort	Assort						Assort
Ambulance										3	3
ACRV, 1V110			1								1
Medical Aid Station, Van					9					1	1
Motorcycle ****								3			12
Tactical Utility Vehicle, UAZ-469	6	21	8	7	10	7	7	3	1	3	73
Truck, Command and Staff Vehicle	1							1			2
Truck, Crane										1	1
Truck, Kitchen										2	2
Truck, Light		9	3					1		1	14
Truck, Light (Digital Data)								1			1
Truck, Light (Prime Mover)			6								6
Truck, Light (Wire)								1			1
Truck, Medium		6							20	14	40
Truck, Water (2,000-Liter)										2	2
Truck, Wrecker										3	3
Van, Maintenance										3	3
Van, Signal								1			1
<b>NOTES:</b>											
* The values in this column are the total number for three companies.											
** High-mobility/all-terrain vehicles can be substituted for motorcycles.											
(continued)											

## Motorized Infantry Battalion (continued)

Motorized Infantry Battalion (continued)											
Personnel and Items of Equipment	Battalion Headquarters	Motorized Infantry Company X3*	Towed Mortar/Combo Gun Btry	Recon Platoon	ATGM Platoon	AGL Platoon	MANPAD Platoon	Signal Platoon	Transport Platoon	Material Support Platoon	TOTAL
Trailer, Cargo, 1-Axle		6	3					2		1	12
Trailer, Cargo, 2-Axle		6							20	14	40
Trailer, Generator								1		2	3
Trailer, POL (4,200-Liter)										4	4
Trailer, Utility	6	21	8	7	10	7	7	3		3	72
Trailer, Water (1,200-Liter)		3							1	2	6
Smoke Pots, Drums, Barrels & Grenades		Assort									Assort
Aiming Circle/Goniometer		3	2								5
Automated Fire Control System			4								4
Binocular Laser Rangefinder	5	126	10	17	10	11	7				186
Camera Digital				6							6
Electronic Plotting Board							6				6
GPS Receiver, Handheld	5	159	17	17	16	11	8	10	11	31	285
Laser Rangefinder			3								3
Laser Target Designator		9	5	3	3						20
Observation Scope, Day/Night		6									6
Radar, GSR, Manportable, Fara-1		9	3	9	3	6					30
Radar, GSR, Portable, Credo-1E				3							3
Sensor Sets				3							3
Antenna, Mast HF/UHF/VHF								3			3
Antenna, Satellite								3			3
Telephone Field Cable, 1 km								8			8
Telephone, Landline								15			15
Telephone Set								4			4
Telephone Switchboard								1			1
Thermal Viewer, Handheld, Sophie	4	42	5	16	10	1	7				85
Night-Vision Goggles		183	28	11	18	23	4		1	36	304
Night-Vision Goggles (Driver)	7	36	16	16	10	7	7	11	21	33	164
Night-Vision Goggles (AK w/GP-30)	4	90	17	16	13		8	8	7	9	172
Night-Vision Sight (Aiming Circle)		3									3
Radios:											
Handheld, Very-Low-Power	3	144	12	5	5	10	11	1		3	194
Manpack, Low-Power		18	15	13	9			7	8	17	87
Vehicle Mount, Medium-Power	10	36	17	7	10	7	7	14	2	14	124
Warning Receiver	4	3		4			7			1	19
<b>NOTES:</b>											
* The values in this column are the total number for three companies.											
Page 2											

## Appendix E

# Guerrilla Hunter/Killer Company from the AFS Organizational Directories

This appendix provides an example of the information for a guerrilla hunter/killer company and its subordinates, as found in the administrative force structure (AFS) organizational directories under the guerrilla battalion. It also includes the Excel® spreadsheets for the personnel and equipment in the guerrilla hunter/killer company and for the guerrilla battalion as a whole.

---

*Note.* For illustrative purposes, this FM contains several examples from the online AFS organizational directories. Readers are reminded that even the baseline OPFOR organizations are subject to change over time. Therefore, readers should always consult the online directories for the latest, most up-to-date versions of organizational data.

---

## GUERRILLA ORGANIZATIONS

E-1. Guerrilla organizations come in various shapes and sizes. They may be as large as several brigades or as small as a platoon and/or independent hunter/killer (H/K) teams. The structure of the organization depends on several factors including the physical environment, sociological demographics and relationships, economics, and support available from external organizations and countries. In any case, a guerrilla organization might be affiliated with forces from other countries or external organizations.

E-2. The composition of the guerrilla brigade may vary. A basically rural, mountainous, or forested area with no major population centers might have a guerrilla brigade with only one or two battalions (or five or six companies) with little or no additional combat support or combat service support. A guerrilla brigade operating astride a major avenue of approach, or one that contains several major population (urban) or industrial centers, might be a full guerrilla brigade with additional combat support or combat service support elements.

E-3. Often a brigade-sized guerrilla force may not be appropriate—a guerrilla battalion or a task-organized battalion may be sufficient. A typical task-organized-battalion might have four or five guerrilla H/K companies, organic battalion units, and a weapons battery from brigade (with mortar, antitank, and rocket launcher platoons) and possibly IEW support.

## GUERRILLA HUNTER/KILLER COMPANY EXAMPLE

E-4. The guerrilla H/K company is simply a restructured guerrilla company. Therefore, they both contain the same number of personnel and similar numbers of equipment. The guerrilla company fights unconventionally with platoons, squads, and fire teams. When organized for combat as a guerrilla H/K company, it also fights unconventionally, but with H/K groups, sections, and teams. The task-organized, lethal H/K team structure is ideal for dispersed combat such as fighting in built-up areas, especially urban combat. Complete battalions and brigades—or any part thereof—can be organized for combat as H/K units.

E-5. A guerrilla battalion may be any combination of guerrilla companies or guerrilla H/K companies. When a battalion consists predominantly of guerrilla H/K companies, it may be considered a guerrilla H/K battalion. The guerrilla H/K company/battalion is especially effective and lethal in close environments

(such as urban, forest, or swamp). The structure that makes H/K teams virtually impossible to isolate and kill in a dispersed fight also allows them to melt into the population and terrain whenever necessary.

**Guerrilla Hunter/Killer Company, Guerrilla Battalion**

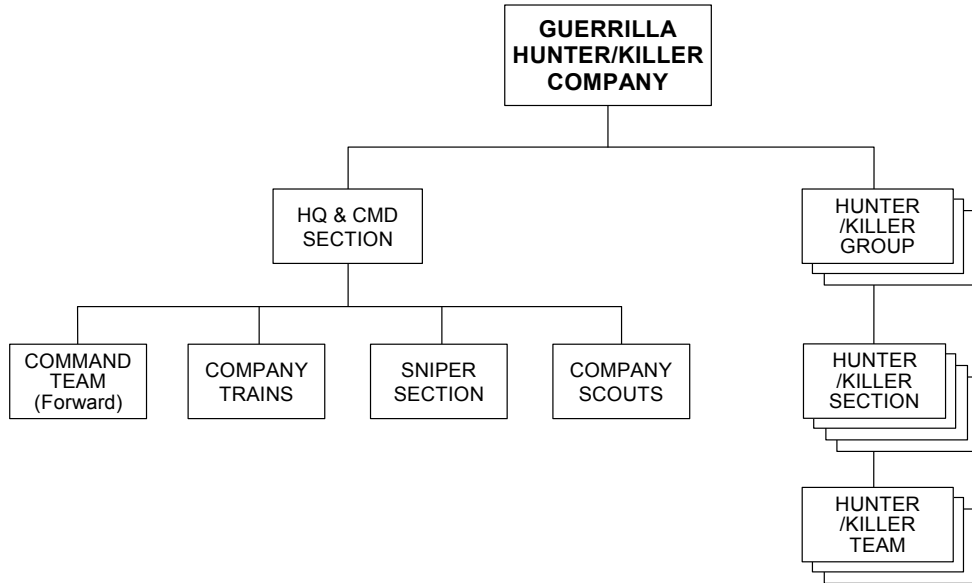

Total Personnel..... 228      O-6/N-49/E-173

**NOTES:**

1. The guerrilla company can be organized for combat into a “guerrilla hunter/killer (H/K) company.” Guerrilla company assets are augmented and restructured for combat into task organized lethal H/K teams. The H/K team structure is ideal for dispersed combat such as fighting in built-up areas, especially urban combat. Complete battalions and brigades can be organized for combat as H/K units. The guerrilla H/K company is broken into three H/K groups. Each group has four sections of three infantry H/K teams each. The company contains a total of 36 H/K teams—39 H/K teams if the two sniper teams and the company scouts are counted.
2. The guerrilla H/K company has sufficient assets to transport munitions and materiel for the immediate fight. The two organic trucks (one light, one medium) provide the company a degree of operational autonomy from the battalion. The area of responsibility for guerrilla units may be fairly large. The company is dependent upon support from higher (i.e., battalion transport platoon), or external sources to transport materiel, (caches, civilian augmentation), for a sustained fight.
3. Vehicles may be a mix of military and civilian. The guerrilla company may be augmented by military or civilian vehicles (motorcycles, trucks, cars, bicycles, carts, or high-mobility/all terrain vehicles) or personnel depending on the mission. Local sympathizers may volunteer their equipment and services. The commander may requisition or confiscate local civilian transportation assets and materiel. This includes the use of noncombatant personnel to serve as porters. The guerrillas may have no vehicles at all and depend on caches, porters, or other transportation means.
4. The guerrillas may, or may not, be in uniform. They may wear civilian clothing and be indistinguishable from the local population (other than weaponry which they may conceal or discard). Some, or all, may be “part-time” soldiers and melt into the general populace when not assembled to conduct paramilitary operations.

**Guerrilla Hunter/Killer Company, Guerrilla Bn (continued)**

---

**PRINCIPAL ITEMS OF EQUIPMENT**

<u>Equipment</u>	<u>Total</u>	<u>Equipment</u>	<u>Total</u>
9-mm Pistol, PM.....	12	Trailer, Water (1,200-Liter) .....	1
7.62-mm Assault Rifle, AKM .....	166	Generator Set, Portable .....	1
7.62-mm Carbine, AKMS .....	21	Smoke Pots, Drums, Barrels, and Grenades .....	Assorted
7.62-mm LMG, RPK.....	18	Aiming Circle/Goniometer .....	3
7.62-mm GP MG, PKM * .....	12	Binocular Laser Rangefinder .....	15
7.62-mm Sniper Rifle, Mosin/Nagant .....	9	GPS Receiver, Handheld .....	13
7.62-mm Sniper Rifle, SVD * .....	2	Observation Scope, Day/Night * .....	2
.50-cal Antimateriel Rifle, M82A1 * .....	2	Antenna, Mast HF/UHF/VHF.....	1
12.7-mm HMG, NSV * .....	2	Antenna, Satellite.....	1
40-mm Grenade Launcher, BG-15 .....	28	Night-Vision Goggles.....	12
60-mm Mortar, Light, Type 90 or 60-mm Commando Mortar, M70 ** .....	3	Night-Vision Goggles (Driver).....	2
82-mm Recoilless Gun, Type 65-1 * .....	3	Radios:	
ATGL, RPG-7V .....	18	Base Station, Long-Range Cordless- Telephone.....	1
ATDL, RPG-22 *** .....	28	Handheld, Long-Range Cordless- Telephone.....	6
Demolition Materiel **** .....	Assorted	Handheld, Very-Low-Power .....	54
Flame Weapon, RPO-A Series ** .....	24	Manpack, Low-Power .....	7
Mines (AP&AT) ***** .....	Assorted	Vehicle Mount, Medium-Power.....	2
Truck, Light.....	1	Warning Receiver.....	1
Truck, Medium.....	1		
Trailer, Cargo, 2-Axle .....	1		

**NOTE:** The guerrilla hunter/killer company is simply a restructured guerrilla company. Therefore, they both contain the same number of personnel and similar numbers of equipment (see footnotes \*\*/\*\*\*\* below).

- 
- \* With II night sight.
  - \*\* The H/K company may have three additional three 60-mm Commando Mortars, M70 (for a total of six), distributed to H/K Team Two in Section One for each H/K group. Additional personnel are not required.
  - \*\*\* Although based on personnel and equipment numbers of the guerrilla company, the H/K company has additional equipment due to the dispersed nature of H/K team employment. RPG-22 (+7), RPO-A (+4).
  - \*\*\*\* Includes bangalore torpedoes, shaped charges, AT grenades, other tactical demolitions.
  - \*\*\*\*\* Includes remotely detonated mines, IEDs, booby traps, and side-attack (AT & anti-vehicle) mines. The mix is mission dependent and varies.

---

*Note.* See next page for listing of personnel and equipment of the guerrilla hunter/killer company in spreadsheet format, broken down by subordinate organizations.

---

## Guerrilla Hunter/Killer Company, Guerrilla Bn (continued)

Hunter/Killer Company, Guerrilla Bn					
Personnel and Items of Equipment	HQ and Command Section	Hunter/Killer Groups (x3) *			TOTAL
<b>Personnel</b>					
Officers	3	3			6
NCO	7	42			49
Enlisted	14	159			173
<b>Total Personnel</b>	<b>24</b>	<b>204</b>			<b>228</b>
<b>Equipment</b>					
9-mm Pistol, PM		12			12
7.62-mm Assault Rifle, AKM	22	144			166
7.62-mm Carbine, AKMS		21			21
7.62-mm GP MG, PKM		12			12
7.62-mm LMG, RPK		18			18
7.62-mm Sniper Rifle, Mosin/Nagant		9			9
7.62-mm Sniper Rifle, SVD	2				2
.50-cal Antimateriel Rifle, M82A1	2				2
12.7-mm HMG, NSV	2				2
40-mm Grenade Launcher, BG-15	7	21			28
60-mm Mortar, Light, Type 90 or 60-mm Commando Mortar, M70 **		3			3
82-mm Recoilless Gun, Type 65-1		3			3
ATGL, RPG-7V		18			18
ATDL, RPG-22 ****	4	24			28
Demolitions Materiel ***	Assort	Assort			Assort
Flame Weapon, RPO-A Series ****	3	21			24
Mines (AP&AT) *****	Assort	Assort			Assort
Truck, Light	1				1
Truck, Medium	1				1
Trailer, Cargo, 2-Axle	1				1
Trailer, Water (1,200-Liter)	1				1
Generator Set, Portable	1				1
Smoke Pots, Drums, Barrels & Grenades	Assort	Assort			Assort
Aiming Circle/Goniometer		3			3
Antenna, Mast HF/UHF/VHF	1				1
Antenna Satellite	1				1
Binocular Laser Rangefinder	6	9			15
GPS Receiver, Handheld ***	7	6			13
Observation Scope, Day/Night	2				2
Night-Vision Goggles ***	6	6			12
Night-Vision Goggles (Driver)	2				2
Radios:					
Base Station, LR Cordless Telephone	1				1
Handheld, LR Cordless Telephone	3	3			6
Handheld, Very-Low-Power	9	45			54
Manpack, Low-Power	4	3			7
Vehicle Mount, Medium-Power	2				2
Warning Receiver	1				1
<b>NOTES:</b>					
* The values in this column are the total number for three H/K Groups.					
** The H/K Co may have an additional three 60-mm Cmdo Mortars, M70, (for total of 6), distributed to H/K team Two in Section One for each H/K Group. Additional personnel are not required.					
*** Includes bangalore torpedoes, shaped charges, AT grenades, other tactical demolitions					
**** The H/K Company has additional items of this equipment due to the dispersed nature of employment. RPG-22 (+7), RPO-A (+4)					
***** Includes remotely detonated mines, IEDs, booby traps, & side-attack (AT & AV) mines					
Page 1					



**Headquarters and Command Section, Hunter/Killer Company** \_\_\_\_\_

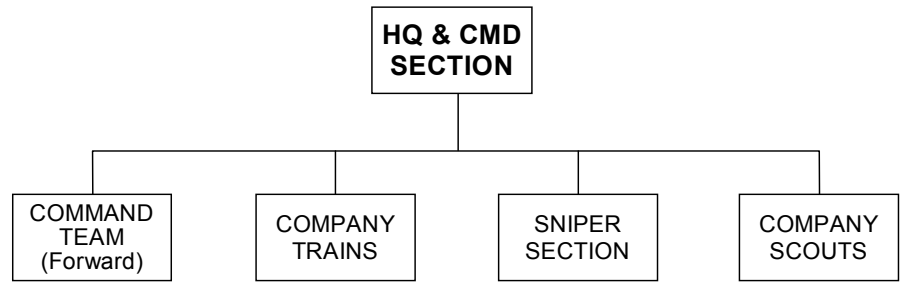

Total Personnel ..... 24      O-3/N-7/E-14

**PRINCIPAL ITEMS OF EQUIPMENT**

<u>Equipment</u>	<u>Total</u>
7.62-mm Assault Rifle, AKM .....	22
7.62-mm Sniper Rifle, SVD * .....	2
.50-cal Antimateriel Rifle, M82A1 * .....	2
12.7-mm HMG, NSV * .....	2
40-mm Grenade Launcher, BG-15 .....	7
ATDL, RPG-22 .....	4
Demolition Materiel **/** .....	Assorted
Flame Weapon, RPO-A Series ** .....	3
Mines (AP&AT) **/** .....	Assorted
Truck, Light.....	1
Truck, Medium.....	1
Trailer, Cargo, 2-Axle .....	1
Trailer, Water (1,200-Liter).....	1
Generator Set, Portable.....	1
Smoke Pots, Drums, Barrels, and Grenades .....	Assorted

<u>Equipment</u>	<u>Total</u>
Antenna, Mast HF/UHF/VHF .....	1
Antenna, Satellite.....	1
Binocular Laser Rangefinder .....	6
GPS Receiver, Handheld .....	7
Observation Scope, Day/Night * .....	2
Night-Vision Goggles .....	6
Night-Vision Goggles (Driver) .....	2
Radios:	
Base Station, Long-Range Cordless- Telephone .....	1
Handheld, Long-Range Cordless- Telephone .....	3
Handheld, Very-Low-Power .....	9
Manpack, Low-Power .....	4
Vehicle Mount, Medium-Power .....	2
Warning Receiver.....	1

**NOTE:** The headquarters and command section may be augmented by additional military and civilian vehicles, trucks, bicycles, carts, tactical utility vehicles (TUVs), motorcycles, or high-mobility/all-terrain vehicles, etc., depending on the mission. The headquarters and command section may have no vehicles at all and depend on caches, porters, or other transportation and resupply means.

- \* With II night sight.
- \*\* Issued as ammunition rather than a weapon—the BOI may vary. No dedicated operator.
- \*\*\* Includes bangalore torpedoes, shaped charges, AT grenades, other tactical demolitions.
- \*\*\*\* Includes remotely detonated mines, IEDs, booby traps, and side-attack (AT & anti-vehicle) mines. The mix is mission dependent and varies.

**Command Team, Hq & Cmd Section, Hunter/Killer Company** \_\_\_\_\_

<b>COMMAND TEAM (Forward)</b>
---------------------------------------

Company Commander (O) (x1) .....AKM  
 Dep Cdr-Tactics (O) (x1) .....AKM  
 First Sergeant (N) (x1)..... AKM/BG-15  
 RTO (x1).....AKM  
 Messenger/Runner (x1)..... AKM/BG-15  
 Medic (x1).....AKM

Total Personnel ..... 6            O-2/N-1/E-3

**PRINCIPAL ITEMS OF EQUIPMENT**

<u>Equipment</u>	<u>Total</u>	<u>Equipment</u>	<u>Total</u>
7.62-mm Assault Rifle, AKM .....	6	Radios:	
40-mm Grenade Launcher, BG-15 .....	2	Handheld, Long-Range Cordless-	
ATDL, RPG-22 * .....	1	Telephone .....	2
Binocular Laser Rangefinder.....	2	Handheld, Very-Low-Power .....	2
GPS Receiver, Handheld.....	2	Manpack, Low-Power .....	1
Night-Vision Goggles.....	1		

**NOTES:**

1. The command team locates forward with H/K company.
2. The former weapons platoon leader now performs as a “deputy commander for tactics.”

---

\* Issued as ammunition rather than a weapon—the BOI may vary.

## Company Trains , Hq & Cmd Section

---

**COMPANY  
TRAINS**

Deputy Commander (O) (x1).....	AKM
Trains Sr Sgt (N) (x1).....	AKM/BG-15
Supply Sergeant (N) (x1).....	AKM/BG-15
Driver/Sup Spec (x2).....	AKM
Sup Spec (x3) .....	AKM
 Total Personnel .....	 8                      O-1/N-2/E-5

### PRINCIPAL ITEMS OF EQUIPMENT

<u>Equipment</u>	<u>Total</u>	<u>Equipment</u>	<u>Total</u>
7.62-mm Assault Rifle, AKM .....	8	Binocular Laser Rangefinder .....	1
12.7-mm HMG, NSV */** .....	2	GPS Receiver, Handheld .....	2
40-mm Grenade Launcher, BG-15 .....	2	Smoke Pots, Drums, Barrels, and Grenades .....	Assorted
ATDL, RPG-22 *** .....	2	Night-Vision Goggles (Driver) .....	2
Flame Weapon, RPO-A Series *** .....	2	Radios:	
Demolition Materiel ***/**** .....	Assorted	Base Station, Long-Range Cordless- Telephone .....	1
Mines (AP&AT) ***/***** .....	Assorted	Handheld, LR Cordless-Telephone .....	1
Truck, Light.....	1	Handheld, Very-Low-Power .....	3
Truck, Medium.....	1	Manpack, Low-Power .....	1
Trailer, Cargo, 2-Axle .....	1	Vehicle Mount, Medium-Power.....	2
Trailer, Water (1,200-Liter).....	1	Warning Receiver.....	1
Antenna, Mast HF/UHF/VHF .....	1		
Antenna, Satellite .....	1		

**NOTES:**

1. The deputy commander is in charge of the company trains.
2. Two vehicle-mounted 12.7-mm HMGs assist in the security of the company trains and in an AA role. They may be brought forward with tripod mounts to assist in the battle.
3. The former weapons platoon sergeant now serves as the trains' senior sergeant.
4. Some local sympathizers may volunteer their equipment and services. The commander may requisition or confiscate local civilian transportation assets. Noncombatant personnel or draft animals may be used as bearers/porters. May be augmented by military or civilian vehicles (motorcycles, trucks, cars, bicycles, carts, or high-mobility/all terrain vehicles) or personnel.
5. Corner-mounted mechanical hoists are used to load and unload the two trucks.

- 
- \* With II night sight.
  - \*\* A 12.7-mm HMG is mounted on both trucks. Whoever is not driving operates the vehicle HMG. A tripod mount is also carried for the ground support role.
  - \*\*\* Issued as ammunition rather than a weapon—the BOI may vary. No dedicated operator.
  - \*\*\*\* Includes bangalore torpedoes, shaped charges, AT grenades, other tactical demolitions.
  - \*\*\*\*\* Includes remotely detonated mines, IEDs, booby traps, and side-attack (AT & anti-vehicle) mines. The mix is mission dependent and varies.

**Sniper Section, Hq & Cmd Section**

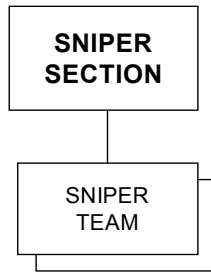

Section Leader/Sr Sniper (N) (x1) ..... AKM/BG-15  
 Team Leader/Observer (N) (x1) ..... AKM/BG-15  
 Sniper/Designator (x2)..... SVD or M82A1  
 Assistant Sniper (x2) ..... AKM

Total Personnel ..... 6            O-0/N-2/E-4

**PRINCIPAL ITEMS OF EQUIPMENT**

<u>Equipment</u>	<u>Total</u>	<u>Equipment</u>	<u>Total</u>
7.62-mm Assault Rifle, AKM .....	4	Observation Scope, Day/Night * .....	2
7.62-mm Sniper Rifle, SVD * .....	2	Night-Vision Goggles .....	2
.50-cal Antimateriel Rifle, M82A1 * .....	2	Radios:	
40-mm Grenade Launcher, BG-15 .....	2	Handheld, Very-Low-Power .....	2
Binocular Laser Rangefinder.....	2	Manpack, Low-Power .....	1
GPS Receiver, Handheld.....	2		

**NOTES:**

1. The sniper section consists of two sniper teams. The section leader serves as the team leader of one sniper team. Each sniper team consists of a team leader/observer (spotter) a sniper (shooter)/target designator and an assistant sniper. The assistant sniper provides additional security, transports equipment, and may serve as a sniper/observer backup.
2. The sniper carries either a 7.62-mm or .50-cal sniper rifle depending on the mission. The other rifle is carried by the assistant sniper until needed.
3. The primary mission of the sniper section is to serve in the conventional sniper-countersniper role. Depending on mission requirements however the sniper team may also serve as a reconnaissance element, a stay-behind element, or as part of a hunter/killer team.
4. The sniper section may be augmented by available military or civilian vehicles (cars, trucks, motorcycles, carts, bicycles, or high-mobility/all terrain vehicles) depending on the mission.

---

\* With II night sight.

**Company Scouts, Hq & Cmd Section**

---

**COMPANY  
SCOUTS**

Scout Team Ldr/Sr Scout (N) (x1) .....	AKM/BG-15
Asst Tm Ldr/Scout (N) (x1) .....	AKM/RPG-22
Scout/RTO (x1) .....	AKM
Scout (x1) .....	AKM/RPO-A
 Total Personnel .....	 4                      O-0/N-2/E-2

**PRINCIPAL ITEMS OF EQUIPMENT**

<u>Equipment</u>	<u>Total</u>	<u>Equipment</u>	<u>Total</u>
7.62-mm Assault Rifle, AKM .....	4	GPS Receiver, Handheld .....	1
40-mm Grenade Launcher, BG-15 .....	1	Night-Vision Goggles .....	3
ATDL, RPG-22 * .....	1	Radios:	
Flame Weapon, RPO-A Series * .....	1	Handheld, Very-Low-Power .....	2
Mines (AP&AT) */** .....	Assorted	Manpack, Low-Power .....	1
Binocular Laser Rangefinder** .....	1		

**NOTES:**

1. The scout team leader/senior scout is the former recoilless gun section leader. The assistant team leader is the former machinegun section leader. The RTO/Scout is the former RTO for the weapons platoon, and the remaining scout is a former supply specialist with the HQ & Svc Section.
2. Transportation when required will be provided by either the TUVs from the command team or the trucks from the trains.

---

\* Issued as ammunition rather than a weapon—the BOI may vary. No dedicated operator.  
 \*\* Includes remotely detonated mines, IEDs, booby traps, and side-attack (AT & anti-vehicle) mines.  
 \*\*\* With II night sight.

**Hunter/Killer Group, Guer H/K Company**

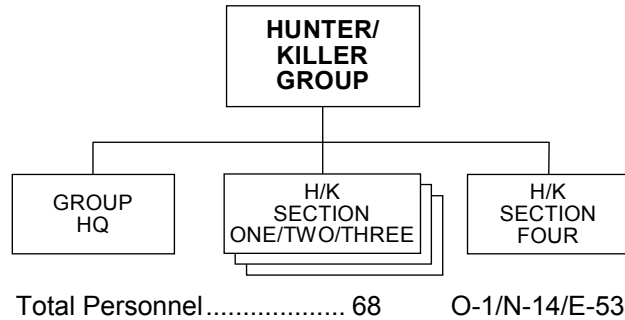

**PRINCIPAL ITEMS OF EQUIPMENT**

<u>Equipment</u>	<u>Total</u>	<u>Equipment</u>	<u>Total</u>
9-mm Pistol, PM.....	4	Flame Weapon, RPO-A Series ** .....	7
7.62-mm Assault Rifle, AKM .....	48	Mines (AP&AT) **/** .....	Assorted
7.62-mm Carbine, AKMS .....	7	Smoke Pots, Drums, Barrels, and Grenades .....	Assorted
7.62-mm LMG, RPK .....	6	Aiming Circle/Goniometer.....	1
7.62-mm GP MG, PKM * .....	4	Binocular Laser Rangefinder .....	3
7.62-mm Sniper Rifle, Mosin/Nagant .....	3	GPS Receiver, Handheld.....	2
40-mm Grenade Launcher, BG-15 .....	7	Night-Vision Goggles .....	2
60-mm Mortar, Light, Type 90 or 60-mm Commando Mortar, M70.....	1	Radios:	
82-mm Recoilless Gun, Type 65-1 * .....	1	Handheld, Long-Range Cordless- Telephone .....	1
ATGL, RPG-7V .....	6	Handheld, Very-Low-Power .....	15
ATDL, RPG-22 ** .....	8	Manpack, Low-Power .....	1
Demolition Materiel *** .....	Assorted		

**NOTES:**

1. The H/K groups are identical, as are Sections One, Two, and Three of the groups. Section Four is organized differently.
2. Local sympathizers may volunteer their equipment and services. The commander may requisition or confiscate local civilian transportation assets. Noncombatant personnel or draft animals may be used as bearers/porters. Ammunition and assorted mines are distributed (cross-leveled) amongst members of the group.
3. The guerrilla H/K group may be augmented by military or civilian vehicles (motorcycles, trucks, cars, bicycles, carts, or high-mobility/all-terrain vehicles) or personnel depending on the mission.
4. One of the guerrillas is cross-trained as a medic.

---

\* With II night sight.  
 \*\* Issued as ammunition rather than a weapon—the BOI may vary. No dedicated operator.  
 \*\*\* Includes bangalore torpedoes, shaped charges, AT grenades, other tactical demolitions.  
 \*\*\*\*\* Includes remotely detonated mines, IEDs, booby traps, and side-attack (AT & anti-vehicle) mines. The mix is mission dependent and varies.

**Group Headquarters, Guerrilla H/K Company** \_\_\_\_\_

<b>GROUP HQ</b>
---------------------

Group Leader (O) (x1) ..... AKM  
 Group Sergeant (N) (x1) ..... AKM/BG-15  
 RTO (x1) ..... AKM  
  
 Total Personnel ..... 3                      O-1/N-1/E-1

**PRINCIPAL ITEMS OF EQUIPMENT**

<u>Equipment</u>	<u>Total</u>	<u>Equipment</u>	<u>Total</u>
7.62-mm Assault Rifle, AKM .....	3	Radios:	
40-mm Grenade Launcher, BG-15 .....	1	Handheld, Long-Range Cordless-	
Binocular Laser Rangefinder .....	2	Telephone .....	1
GPS Receiver, Handheld .....	2	Handheld, Very-Low-Power .....	2
Night-Vision Goggles .....	2	Manpack, Low-Power .....	1

---

\* With II night sight.

Hunter/Killer Sections One, Two, Three, H/K Group One & Two \_\_\_\_\_

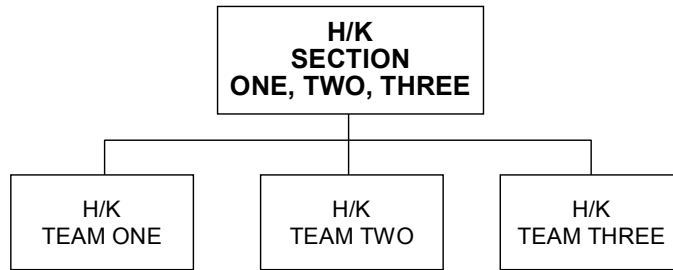

Total Personnel ..... 16      O-0/N-3/E-13

**PRINCIPAL ITEMS OF EQUIPMENT**

<u>Equipment</u>	<u>Total</u>	<u>Equipment</u>	<u>Total</u>
9-mm Pistol, PM.....	1	ATDL, RPG-22 **.....	2
7.62-mm Assault Rifle, AKM .....	10	Demolition Materiel **/** .....	Assorted
7.62-mm Carbine, AKMS .....	2	Flame Weapon, RPO-A Series **.....	2
7.62-mm LMG, RPK .....	2	Mines (AP&AT) **/**** .....	Assorted
7.62-mm GP MG, PKM * .....	1	Smoke Pots, Drums, Barrels, and Grenades .....	Assorted
7.62-mm Sniper Rifle, Mosin/Nagant .....	1	Radios:	
40-mm Grenade Launcher, BG-15 .....	2	Handheld, Very-Low-Power .....	3
ATGL, RPG-7V .....	2		

**NOTES:**

1. H/K Sections One, Two, and Three are identical. The subordinate teams (One, Two, and Three) differ.
2. Some teams may have a 7.62-mm GP MG, PKM in lieu of a 7.62-mm LMG, RPK (mission dependent). Equipment may be transferred between H/K sections and teams.
3. Depending on the tactical circumstances, some sections/teams may have additional ammo bearers. Noncombatant personnel or draft animals may also be used as bearers/porters.

---

\* With II night sight.  
 \*\* Issued as ammunition rather than a weapon—the BOI may vary. No dedicated operator.  
 \*\*\* Includes bangalore torpedoes, shaped charges, AT grenades, other tactical demolitions.  
 \*\*\*\* Includes remotely detonated mines, IEDs, booby traps, and side-attack (AT & anti-vehicle) mines. The mix is mission dependent and varies.



H/K Team One, Sections One, Two, Three

<p><b>TEAM ONE</b></p>
----------------------------

Section/Team Leader (N) (x1).....AKM/BG-15  
 Light Machinegunner (x1)..... RPK  
 Grenadier (x1) ..... RPG-7V/AKMS  
 Asst Grenadier (x1) ..... AKM  
 Sniper/Marksman (x1) .....Mosin/Nagant

Total Personnel.....5            O-0/N-1/E-4

**PRINCIPAL ITEMS OF EQUIPMENT**

<u>Equipment</u>	<u>Total</u>	<u>Equipment</u>	<u>Total</u>
7.62-mm Assault Rifle, AKM .....	2	Demolition Materiel */** .....	Assorted
7.62-mm Carbine, AKMS .....	1	Smoke Pots, Drums, Barrels, and Grenades .....	Assorted
7.62-mm LMG, RPK .....	1	Mines (AP&AT) */*** .....	Assorted
7.62-mm Sniper Rifle, Mosin/Nagant .....	1	Radios:	
40-mm Grenade Launcher, BG-15 .....	1	Handheld, Very-Low-Power .....	1
ATGL, RPG-7V .....	1		

**NOTE:** The team leader also serves as the section leader.

- 
- \* Issued as ammunition rather than a weapon—the BOI may vary. No dedicated operator.
  - \*\* Includes bangalore torpedoes, shaped charges, AT grenades, other tactical demolitions.
  - \*\*\* Includes remotely detonated mines, IEDs, booby traps, and side-attack (AT & anti-vehicle) mines. The mix is mission dependent and varies.

H/K Team Two, Sections One, Two, Three

---

<b>TEAM TWO</b>
---------------------

Asst Section Ldr/Team Ldr (N) (x1)..... AKM/BG-15  
 Light Machinegunner (x1)..... RPK  
 Grenadier (x1) ..... RPG-7V/AKMS  
 Asst Grenadier (x1) .....AKM  
 Ammo Bearer (x1) ..... AKM/RPO-A  
 Rifleman (x1) .....AKM/RPG-22

Total Personnel ..... 6            O-0/N-1/E-5

**PRINCIPAL ITEMS OF EQUIPMENT**

<u>Equipment</u>	<u>Total</u>	<u>Equipment</u>	<u>Total</u>
7.62-mm Assault Rifle, AKM .....	4	Flame Weapon, RPO-A Series ** .....	1
7.62-mm Carbine, AKMS .....	1	Mines (AP&AT) **/** .....	Assorted
7.62-mm LMG, RPK .....	1	Smoke Pots, Drums, Barrels, and Grenades .....	Assorted
40-mm Grenade Launcher, BG-15 .....	1	Radios:	
ATGL, RPG-7V .....	1	Handheld, Very-Low-Power .....	1
ATDL, RPG-22 * .....	1		
Demolition Materiel **/*** .....	Assorted		

- 
- \* Issued as ammunition rather than a weapon—the BOI may vary. No dedicated operator.
  - \*\* Includes bangalore torpedoes, shaped charges, AT grenades, other tactical demolitions.
  - \*\*\* Includes remotely detonated mines, IEDs, booby traps, and side-attack (AT & anti-vehicle) mines. The mix is mission dependent and varies.

**H/K Team Three, Sections One, Two, Three**

---

**TEAM  
THREE**

MG Tm Ldr (N)/Asst MG gunner (x1) ..... AKM  
 Machinegunner (x1)..... PKM/PM  
 Rifleman (x1) ..... AKM/RPG-22  
 Rifleman (x1) ..... AKM/RPO-A  
 Ammo Bearer (x1) ..... AKM

Total Personnel..... 5                      O-0/N-1/E-4

**PRINCIPAL ITEMS OF EQUIPMENT**

<u>Equipment</u>	<u>Total</u>	<u>Equipment</u>	<u>Total</u>
9-mm Pistol, PM.....	1	Smoke Pots, Drums, Barrels, and Grenades .....	Assorted
7.62-mm Assault Rifle, AKM .....	4	Mines (AP&AT) **/**** .....	Assorted
7.62-mm GP MG, PKM * .....	1	Radios:	
ATDL, RPG-22 ** .....	1	Handheld, Very-Low-Power .....	1
Flame Weapon, RPO-A Series ** .....	1		
Demolition Materiel **/*** .....	Assorted		

- 
- \* With II night sight.
  - \*\* Issued as ammunition rather than a weapon—the BOI may vary. No dedicated operator.
  - \*\*\* Includes bangalore torpedoes, shaped charges, AT grenades, other tactical demolitions.
  - \*\*\*\* Includes remotely detonated mines, IEDs, booby traps, and side-attack (AT & anti-vehicle) mines. The mix is mission dependent and varies.

Hunter/Killer Section Four, H/K Group

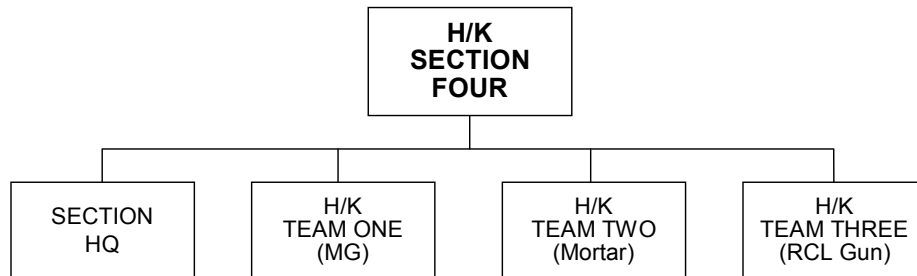

Total Personnel ..... 17      O-0/N-4/E-13

**PRINCIPAL ITEMS OF EQUIPMENT**

<u>Equipment</u>	<u>Total</u>	<u>Equipment</u>	<u>Total</u>
9-mm Pistol, PM.....	1	Demolition Materiel **/**	Assorted
7.62-mm Assault Rifle, AKM .....	15	Mines (AP&AT) **/**	Assorted
7.62-mm Carbine, AKMS .....	1	Smoke Pots, Drums, Barrels,	
7.62-mm GP MG, PKM * .....	1	and Grenades .....	Assorted
60-mm Mortar, Light, Type 90 or		Aiming Circle/Goniometer.....	1
60-mm Commando Mortar, M70 .....	1	Binocular Laser Rangefinder .....	1
82-mm Recoilless Gun, Type 65-1 * .....	1	Radios:	
ATDL, RPG-22 ** .....	2	Handheld, Very-Low-Power .....	4
Flame Weapon, RPO-A Series ** .....	1		

**NOTES:**

1. Section Four is constructed using augmentation from the company weapons platoon. It is augmented with one (of three) 7.62-mm GP MG, PKMs; one (of three) Type 90, 60-mm mortars; and one (of three) 82-mm Type 65-1 recoilless guns from the company weapons platoon.
2. The teams may receive additional transportation support from the headquarters and command section.
3. Ammunition is also distributed amongst members of the company. Some teams may have additional ammo bearers. Noncombatant personnel or draft animals may also be used as bearers/porters.

---

\* With II night sight.  
 \*\* Issued as ammunition rather than a weapon—the BOI may vary. No dedicated operator.  
 \*\*\* Includes bangalore torpedoes, shaped charges, AT grenades, other tactical demolitions.  
 \*\*\*\* Includes remotely detonated mines, IEDs, booby traps, and side-attack (AT & anti-vehicle) mines. The mix is mission dependent and varies.

**Section Headquarters, Hunter/Killer Section Four** \_\_\_\_\_

SECTION  
HQ

Section Ldr/MG Section Ldr (x1) ..... AKM  
Total Personnel..... 1            O-0/N-1/E-0

**PRINCIPAL ITEMS OF EQUIPMENT**

<u>Equipment</u>	<u>Total</u>	<u>Equipment</u>	<u>Total</u>
7.62-mm Assault Rifle, AKM .....	1	Radio:	
		Handheld, Very-Low-Power .....	1

*NOTE:* The section leader was formerly the MG section leader for the platoon MG section.

---

\* With II night sight.

**Team One (Machinegun), Hunter/Killer Section Four** \_\_\_\_\_

<b>TEAM ONE (Machinegun)</b>
--------------------------------------

MG Tm Ldr (N)/Asst MG gunner (x1) ..... AKM  
 Machinegunner (x1)..... PKM/PM  
 Ammo Bearer (x1) ..... AKM/RPG-22  
 Ammo Bearer (x1) ..... AKM/RPO-A

Total Personnel ..... 4            O-0/N-1/E-3

**PRINCIPAL ITEMS OF EQUIPMENT**

<u>Equipment</u>	<u>Total</u>	<u>Equipment</u>	<u>Total</u>
9-mm Pistol, PM.....	1	Smoke Pots, Drums, Barrels, and Grenades .....	Assorted
7.62-mm Assault Rifle, AKM .....	3	Mines (AP&AT) **/** .....	Assorted
7.62-mm GP MG, PKM * .....	1	Radio:	
ATDL, RPG-22 ** .....	1	Handheld, Very-Low-Power .....	1
Flame Weapon, RPO-A Series ** .....	1		

**NOTE:** This team was formerly in the machinegun section, company weapons platoon.

- 
- \* With II night sight.
  - \*\* Issued as ammunition rather than a weapon—the BOI may vary. No dedicated operator.
  - \*\*\* Includes remotely detonated mines, IEDs, booby traps, and side-attack (AT & anti-vehicle) mines.

**Team Two (Mortar), Hunter/Killer Section Four**

---

**TEAM  
TWO  
(Mortar)**

Mortar Team Leader (N) (x1)..... AKM  
 Mortar Gunner (x1)..... Type 90/AKM  
 Asst Gunner/Ammo Bearer (x1) ..... AKM  
 Ammo Bearer (x1)..... AKM/RPG-22

Total Personnel..... 4                      O-0/N-1/E-3

**PRINCIPAL ITEMS OF EQUIPMENT**

<u>Equipment</u>	<u>Total</u>	<u>Equipment</u>	<u>Total</u>
7.62-mm Assault Rifle, AKM .....	4	Smoke Pots, Drums, Barrels, and Grenades .....	Assorted
60-mm Mortar, Light, Type 90 or 60-mm Commando Mortar, M70 *.....	1	Aiming Circle/Goniometer .....	1
ATDL, RPG-22 ** .....	1	Radios:	
Mines (AP&AT) **/** .....	Assorted	Handheld, Very-Low-Power .....	1

**NOTE:** This team was formerly in the mortar section of the company weapons platoon.

- 
- \* The H/K company may have three additional three 60-mm Commando Mortars, M70 (for a total of six), distributed to H/K Team Two in Section One for each H/K group. Additional personnel are not required.
  - \*\* Issued as ammunition rather than a weapon—the BOI may vary. No dedicated operator.
  - \*\*\* Includes remotely detonated mines, IEDs, booby traps, and side-attack (AT & anti-vehicle) mines.

**Team Three (RCL Gun), Hunter/Killer Section Four** \_\_\_\_\_

<b>TEAM THREE (RCL Gun)</b>
-------------------------------------

Team Leader (N) (x1) .....AKM  
 RG Gunner (x1).....RCL Gun/AKMS  
 RG Asst Gunner (x1).....AKM  
 RG Ammo Bearer (x5).....AKM

Total Personnel ..... 8            O-0/N-1/E-7

**PRINCIPAL ITEMS OF EQUIPMENT**

<u>Equipment</u>	<u>Total</u>	<u>Equipment</u>	<u>Total</u>
7.62-mm Assault Rifle, AKM .....	7	Mines (AP&AT) **/** .....	Assorted
7.62-mm Carbine, AKMS .....	1	Binocular Laser Rangefinder .....	1
82-mm Recoilless Gun, Type 65-1 * .....	1	Radios:	
Smoke Pots, Drums, Barrels, and Grenades.....	Assorted	Handheld, Very-Low-Power .....	1

**NOTE:** This team was formerly in the recoilless gun section, company weapons platoon.

- 
- \* With II night sight.
  - \*\* Issued as ammunition rather than a weapon—the BOI may vary. No dedicated operator. It is carried by the transport team until needed.
  - \*\*\* Includes remotely detonated mines, IEDs, booby traps, and side-attack (AT & anti-vehicle) mines.

---

*Note.* The following pages show the personnel and equipment for the entire guerrilla hunter/killer battalion, in spreadsheet format.

---



**Guerrilla Battalion Personnel and Equipment**

Guerrilla Battalion, Guerrilla Brigade										
Personnel and Items of Equipment	Battalion Headquarters	Guerr Hunter/Killer Company (x2)	Guerrilla Company (x1)	Weapons Company	Recon Platoon	Sapper Platoon	Transport Platoon	Signal Section	Medical Section	TOTAL
<b>Personnel</b>										
Officers	7	12	6	6	1	1	1	1		35
NCO	2	98	49	34	7	9	3	5	4	211
Enlisted	11	346	173	102	34	41	23	22	13	765
<b>Total Personnel</b>	<b>20</b>	<b>456</b>	<b>228</b>	<b>142</b>	<b>42</b>	<b>51</b>	<b>27</b>	<b>28</b>	<b>17</b>	<b>1011</b>
<b>Equipment</b>										
9-mm Pistol, PM	3	24	12							39
7.62-mm Assault Rifle, AKM	14	332	166	128	27	39	24	20	15	765
7.62-mm Carbine, AKMS		42	21	10	6	4		7		90
7.62-mm GP MG, PKM	3	24	15	5	6	4	5	1	1	64
7.62-mm LMG, RPK	3	36	18	4	6	8	3	1	1	80
7.62-mm Sniper Rifle, Mosin/Nagant		18	9		3					30
7.62-mm Sniper Rifle, SVD		4	2							6
.50-cal Antimateriel Rifle, M82A1		4	2							6
12.7-mm HMG, NSV		4	2	3						9
40-mm Grenade Launcher, BG-15	4	56	28	21	10	9	6	4	3	141
60-mm Mortar, Light, Type 90 or 60-mm Commando Mortar, M70		6	3							9
73-mm Recoilless Gun, SPG-9/9M				3						3
81-mm W-87, or 82-mm 2B14-1 Mortars or 100-mm Mortar, Type 71 or 120-mm Mortar, Type 86 (W86)				6						6
82-mm Recoilless Gun, Type 65-1		6	3							9
107-mm MRL, Type 63/63-1 or Type 85				3						3
ATGM Launcher, 9P151, AT-13/METIS-M				4						4
ATGL, RPG-7V	1	36	18		3	4				62
ATDL, RPG-22	4	56	21	6	6	4	3	2		102
Bunker Buster						4				4
Demolition Materiel **		Assort	Assort	Assort	Assort	Assort				Assort
Flame Weapon, RPO-A Series		48	20	2	3	4				77
MANPADS Launcher, SA-14				2						2
Mine Detector, Handheld						5				5
Minefield Control Set						6				6
Mine-Scattering System, Manport, PKM						2				2
Mines (AP&AT) ***		Assort	Assort	Assort	Assort	Assort				Assort
Motorcycle					3			7		10
Tactical Utility Vehicle, UAZ-469	1			1			1			3
Truck, Light	3	2	1	5	3	4	6		2	26
Truck, Light (Digital Data)								1		1
Truck, Light (Prime Mover)				3						3
Truck, Light (Wire)								1		1
Truck, Medium		2	1	2			10			15
Truck, Signal								1		1
Truck, Van	1									1
Truck, Water (2,000-Liter)										0
Van, Maintenance										0
Van, Signal										0
<b>NOTES:</b>										
* The values in this column are the total number for two companies.										
** Includes bangalore torpedoes, shaped charges, AT grenades, and other tactical demolitions.										
*** Includes remotely detonated mines, IEDs, booby traps, and side-attack (AT & anti-vehicle) mines.										
Page 1 (continued)										

## Guerrilla Battalion Personnel and Equipment (continued)

Guerrilla Battalion (continued)											
Personnel and Items of Equipment	Battalion Headquarters	Guer Hunter/Killer Company (x2)	Guerrilla Company (x1)	Weapons Company	Recon Platoon	Sapper Platoon	Transport Platoon	Signal Section	Medical Section		TOTAL
<b>Equipment (continued)</b>											
Trailer, Cargo, 1-Axle	3			4	3	4	2	2	1		19
Trailer, Cargo, 2-Axle		2	1	2			10				15
Trailer, Generator	1							1	1		3
Trailer, POL (2,000-Liter)							2				2
Trailer, Utility	1			1			1				3
Trailer, Water (1,200-Liter)		2	1	1							4
Trailer, Water (2,000-Liter)							2				2
Smoke Pots, Drums, Barrels & Grenades		Assort	Assort	Assort		Assort	Assort				Assort
Aiming Circle/Goniometer		6	3	9							18
Anti-Veh/Anti-Personnel Wire-Rolls						9					9
Automated Fire Control System				1							1
Binocular Laser Rangefinder	3	30	15	20	11	7					86
Camera Digital					9	2					11
Electrical, Carpentry, & Plumbing Sets						Assort					Assort
Electronic Plotting Board				2							2
Flexible Stor Tank (POL) (500/1000-Liter)							4				4
Flexible Stor Tank (Water) (500/1000-Liter)							4				4
Generator Set, Portable	1	2	1	2		2		1	1		10
GPS Receiver, Handheld	5	26	13	20	11	7	5	6	1		94
Litters, Medical									10		10
Medical Set, General									1		1
Observation Scope, Day/Night		4	2	3	9						18
Sensor Sets					3						3
Tent, Command Post	2			1							3
Tent, Medical Aid Station									2		2
Water Purification Set							2				2
Wire Cutter, Set							13				13
Antenna, Mast HF/UHF/VHF	4	2	1	2				3			12
Antenna, Satellite	4	2	1	2				3			12
Telephone Field Cable, 1 km								8			8
Telephone, Landline								15			15
Telephone Set								4			4
Telephone Switchboard								1			1
Night-Vision Goggles	5	24	12	14	13	11	5	3	2		89
Night-Vision Goggles (Driver)	4	4	2	5	6	4	5	2	1		33
<b>Radios:</b>											
Base Station, LR Cordless Telephone	4	2	1	1	3			4			15
Handheld, LR Cordless Telephone	8	12	6	8	9	2	1	21			67
Handheld, Very-Low-Power	3	108	54	41	10	13		2	2		233
Manpack, Low-Power	2	14	7	13	4	9	4	7	2		62
Vehicle Mount, Medium-Power	8	4	2	9	3	4	3	9	1		43
Warning Receiver	3	2	1	3	1			1			11
<b>NOTES:</b>											
* The values in this column are the total number for two companies.											
Page 2											

# Glossary

## SECTION I – ACRONYMS AND ABBREVIATIONS

<b>AA</b>	antiaircraft
<b>abn</b>	airborne
<b>acq</b>	acquisition
<b>ACRV</b>	artillery command and reconnaissance vehicle
<b>ACU</b>	acquisition and coordination unit (air defense)
<b>ACV</b>	armored command vehicle
<b>AD</b>	air defense
<b>afl</b>	affiliated
<b>AGL</b>	automatic grenade launcher
<b>ammo</b>	ammunition
<b>amphib</b>	amphibious
<b>ant</b>	antenna
<b>AOR</b>	area of responsibility
<b>AP</b>	antipersonnel (mine), armor-piercing (ammunition)
<b>APC</b>	armored personnel carrier
<b>AP-I</b>	armor-piercing incendiary (ammunition)
<b>API-T</b>	armor-piercing incendiary tracer (ammunition)
<b>ART</b>	Army tactical task
<b>assort</b>	assorted
<b>asst</b>	assistant
<b>AT</b>	antitank
<b>ATDL</b>	antitank disposable launcher (one-shot)
<b>ATGL</b>	antitank grenade launcher
<b>ATGM</b>	antitank guided missile
<b>atk</b>	attack
<b>AUTL</b>	Army Unified Task List
<b>AV</b>	anti-vehicle (mine)
<b>bde</b>	brigade
<b>BDET</b>	battalion-size detachment
<b>BMG</b>	Browning machinegun (.50 cal)
<b>bn</b>	battalion
<b>BOI</b>	basis of issue
<b>BTG</b>	brigade tactical group
<b>btry</b>	battery
<b>CA</b>	civil affairs

<b>cal</b>	caliber
<b>CBRN</b>	chemical, biological, radiological, and nuclear
<b>CCD</b>	charged-coupled device (camera)
<b>CDET</b>	company-size detachment
<b>Cdr</b>	commander
<b>Ch</b>	chief
<b>chem</b>	chemical
<b>CI</b>	counterintelligence
<b>CJCSM</b>	Chairman, Joint Chiefs of Staff Memorandum
<b>cm</b>	centimeter(s)
<b>cmd</b>	command
<b>cmdo</b>	commando
<b>co</b>	company
<b>COA</b>	course of action
<b>COE</b>	contemporary operational environment
<b>combo</b>	combination
<b>comms</b>	communications
<b>coord</b>	coordination
<b>CRV</b>	combat reconnaissance vehicle
<b>CTID</b>	Contemporary Operational Environment and Threat Integration Directorate, TRADOC DCSINT
<b>DA</b>	direct action (cell)
<b>DCSINT</b>	Deputy Chief of Staff for Intelligence
<b>decon</b>	decontamination
<b>ded</b>	dedicated
<b>demo</b>	demolitions
<b>Dep</b>	deputy
<b>DF</b>	direction finding
<b>div</b>	division, divisional
<b>DOD</b>	Department of Defense
<b>DS</b>	direct support
<b>DTG</b>	division tactical group
<b>E</b>	enlisted
<b>equip</b>	equipment
<b>ERA</b>	explosive reactive armor
<b>est</b>	estimate(d)
<b>EW</b>	early warning (radar), electronic warfare
<b>EW</b>	electronic warfare
<b>FCS</b>	fire control system
<b>FDC</b>	fire direction center
<b>FG</b>	field group

---

<b>FLIR</b>	forward-looking infrared (thermal sensor)
<b>FM</b>	field manual
<b>FOE</b>	future operational environment
<b>FOV</b>	field of view
<b>Frag-HE</b>	fragmentation-high-explosive (ammunition)
<b>FSCC</b>	fire support coordination center
<b>FW</b>	fixed-wing (aircraft)
<b>GP MG</b>	general-purpose machinegun
<b>GPS</b>	global positioning system
<b>GS</b>	general support
<b>GSR</b>	ground surveillance radar
<b>guer</b>	guerrilla
<b>H/K</b>	hunter/killer
<b>HACV</b>	heavy armored combat vehicle
<b>HE</b>	high-explosive (ammunition)
<b>HEAT</b>	high-explosive antitank (ammunition)
<b>HET</b>	heavy equipment transporter
<b>HF</b>	high frequency (communications)
<b>HMG</b>	heavy machinegun
<b>how</b>	howitzer
<b>HQ</b>	headquarters
<b>Hqs</b>	headquarters
<b>IED</b>	improvised explosive device
<b>IEW</b>	intelligence and electronic warfare
<b>IFC</b>	integrated fires command
<b>IFV</b>	infantry fighting vehicle
<b>II</b>	image intensification (night sighting system)
<b>in</b>	inch(es)
<b>INA</b>	information not available
<b>indiv</b>	individual
<b>inf</b>	infantry
<b>intcpt</b>	intercept
<b>intel</b>	intelligence
<b>IR</b>	infrared
<b>ISC</b>	integrated support command
<b>ISG</b>	integrated support group
<b>IW</b>	information warfare
<b>JP</b>	joint publication
<b>JTF</b>	joint task force
<b>kg</b>	kilogram(s)
<b>km/h</b>	kilometers per hour

<b>LAV</b>	light armored vehicle
<b>LBR</b>	laser beam rider (guidance)
<b>lchr</b>	launcher
<b>ldr</b>	leader
<b>LMG</b>	light machinegun
<b>LML</b>	lightweight multiple launcher
<b>LR</b>	long-range
<b>LRF</b>	laser rangefinder
<b>lt</b>	light
<b>LWV</b>	lightweight vehicle
<b>m</b>	meter(s)
<b>m/s</b>	meters per second
<b>maint</b>	maintenance
<b>MANPADS</b>	manportable air defense system
<b>manport</b>	manportable
<b>mech</b>	mechanized
<b>METL</b>	mission essential task list
<b>MG</b>	machinegun
<b>min</b>	minute(s)
<b>mm</b>	millimeter(s)
<b>MOD</b>	Ministry of Defense
<b>MP</b>	multipurpose (ammunition)
<b>MRL</b>	multiple rocket launcher
<b>MS</b>	Microsoft®
<b>MTP</b>	mission training plan
<b>mtzd</b>	motorized
<b>N</b>	noncommissioned officer(s)
<b>NCA</b>	National Command Authority
<b>NCO</b>	noncommissioned officer
<b>nondiv</b>	nondivisional
<b>NVG</b>	night-vision goggles
<b>O</b>	officer(s)
<b>OB</b>	order of battle
<b>obs</b>	observer
<b>ODCSINT</b>	Office of the Deputy Chief of Staff for Intelligence
<b>OE</b>	operational environment
<b>OPCON</b>	operational control
<b>OPFOR</b>	opposing force
<b>OPSEC</b>	operations security
<b>OSC</b>	operational-strategic command
<b>PDA</b>	personal digital assistant

---

<b>pers</b>	personnel
<b>Ph</b>	probability of hit
<b>plt</b>	platoon
<b>POL</b>	petroleum, oils, and lubricants
<b>psnl</b>	personnel
<b>PSO</b>	private security organization
<b>PSYWAR</b>	psychological warfare
<b>RCL</b>	recoilless (gun)
<b>rd</b>	round(s)
<b>recon</b>	reconnaissance
<b>RF</b>	radio frequency
<b>RG</b>	recoilless gun
<b>RISTA</b>	reconnaissance, intelligence, surveillance, and target acquisition
<b>RG</b>	recoilless gun
<b>rkt</b>	rocket
<b>SACLOS</b>	semiautomatic command-to-line-of-sight (guidance)
<b>SAM</b>	surface-to-air missile
<b>SATCOM</b>	satellite communications
<b>SCP</b>	strategic campaign plan
<b>sec</b>	second(s)
<b>sect</b>	section
<b>sep</b>	separate
<b>sgt</b>	sergeant
<b>SHC</b>	Supreme High Command
<b>SHORAD</b>	short-range air defense
<b>SL</b>	shoulder-launched
<b>SLAP</b>	saboted light armor penetrator (ammunition)
<b>SOCC</b>	support operations coordination center
<b>SP</b>	self-propelled
<b>spec</b>	specialist
<b>SPF</b>	Special-Purpose Forces
<b>spt</b>	supporting, support
<b>sqd</b>	squad
<b>SR</b>	short-range
<b>sr</b>	senior
<b>SSM</b>	surface-to-surface missile
<b>stor</b>	storage
<b>sup</b>	supply
<b>svc</b>	service
<b>sys</b>	system
<b>TA</b>	target acquisition

<b>TBP</b>	to be published
<b>tech</b>	technician
<b>TIC</b>	toxic industrial chemical(s)
<b>tm</b>	team
<b>TOE</b>	table of organization and equipment
<b>TRADOC</b>	U.S. Army Training and Doctrine Command
<b>trans</b>	transportation
<b>trk</b>	truck
<b>trkd</b>	tracked
<b>TTP</b>	tactics, techniques, and procedures
<b>TUV</b>	tactical utility vehicle
<b>TV</b>	television
<b>UAV</b>	unmanned aerial vehicle
<b>UHF</b>	ultra-high frequency (communications)
<b>UJTL</b>	Universal Joint Task List
<b>U.S.</b>	United States
<b>USMC</b>	United States Marine Corps
<b>VBIED</b>	vehicle-borne improvised explosive device
<b>veh</b>	vehicle
<b>VHF</b>	very-high frequency (communications)
<b>VIP</b>	very important person
<b>w/</b>	with
<b>w/o</b>	without
<b>WEG</b>	Worldwide Equipment Guide
<b>WMD</b>	weapons of mass destruction
<b>wpns</b>	weapons

## SECTION II – TERMS

### **contemporary operational environment**

The synergistic combination of variables and actors that create the conditions, circumstances, and influences that can affect military operations today and in the near- and mid-term.

### **operational environment**

A composite of the conditions, circumstances, and influences that affect the employment of capabilities and bear on the decisions of the commander. (JP 1-02, FM 1-02)

### **opposing force**

A plausible and flexible military and/or paramilitary force representing a composite of varying capabilities of actual worldwide forces used in lieu of a specific threat force, for training or developing U.S. forces.



# References

## DOCUMENTS NEEDED

These documents must be available to the intended users of this publication.

JP 1-02. *Department of Defense Dictionary of Military and Associated Terms*. Available online:  
<http://www.dtic.mil/doctrine/jel/doddict/>

FM 1-02. *Operational Terms and Graphics*. 21 September 2004.

## READINGS RECOMMENDED

These sources contain relevant supplemental information.

FM 3-0.2, *The Contemporary Operational Environment*. TBP.

FM 7-100. *Opposing Force Doctrinal Framework and Strategy*. 1 May 2003.

FM 7-100.1. *Opposing Force Operations*. 27 December 2004.

FM 7-100.2. *Opposing Force Tactics*. TBP.

FM 7-100.3. *Opposing Force: Paramilitary and Nonmilitary Organizations and Tactics*. TBP.

**This page intentionally left blank.**

# Index

Entries are by paragraph number unless page (p.) or pages (pp.) is specified. After a page reference, the subsequent use of paragraph reference is indicated by the paragraph symbol (¶). For topics with multiple entries, **bold type** indicates the main entry.

## A

administrative force structure, pp. 2-1–2-20, ¶2-3  
AFS organizational directories, 2-3, **2-77–2-104**, pp. **A-1–A-7**, ¶B-12  
role in wartime, 3-17–3-20, 3-47

affiliated forces, 2-57, 2-58, 2-69, 2-70, **3-11**, 3-16, 3-49, 3-54, 3-76, 3-104, B-8, B-11, B-80

airborne units, 2-37

Air Defense Forces, 2-9, 2-12

Air Force, 2-9, **2-12**, 2-37  
Air Defense Forces, 2-9, 2-12  
Air Force SPF, 2-12, 2-15, 3-40, 3-66, 3-69  
aviation units, 2-45–2-46  
in OSC, 3-30  
theater air armies, 2-33

army (operational-level command), 2-35, 2-39, 2-41, 2-82, 3-17, 3-27, 3-39

Army (service component), 2-9, **2-10**  
airborne units, 2-37  
Army aviation, 2-10, 2-45, 3-38  
Army SPF, 2-10, 2-15, 2-37, 3-40, 3-66, 3-69

army group, 2-35, 2-82, 3-17, 3-27, 3-39

aviation component of IFC, 3-38, 3-61

aviation units, **2-45–2-46**, 3-59

## B

baseline equipment, 4-1–4-12

base(line) unit for task-organizing, 3-104, B-14

battalions, 2-42

battalion-size detachment, 2-42, **3-59**, 3-64, 3-65, B-97  
unit symbols, 3-95

Battle Command Knowledge System, p. v, ¶2-79, 4-5

BDET. See battalion-size detachment.

Border Guard Forces, **2-20–2-21**, 3-50

brigades,  
divisional brigades, 2-40  
maneuver brigades, **2-40–2-41**, 3-56  
separate brigades, 2-40, 2-87, B-15

brigade tactical group, 2-41, 3-48, 3-50–3-52, 3-54, 3-55, **3-56–3-58**, 3-63, 3-64, p. A-7  
example, B-1–B-17, B-20–B-75, B-94–B112  
unit symbols, 3-95

BTG. See brigade tactical group.

## C

CDET. See company-size detachment.

COE. See comtemporary operational environment.

combatants,  
armed combatants, 2-71–2-72, pp. A-6–A-7  
nation-state forces, 2-1–2-47, 3-12–3-71  
paramilitary forces, 1-13, **2-49–2-73**, pp. A-6–A-7  
unarmed combatants, 2-73, p. A-7

command and support relationships, 3-7–3-11

companies, 2-43

company-size detachment, 2-43, **3-59**, 3-64, p. B-6n, ¶B-97  
unit symbols, 3-95

contemporary operational environment, pp. vi–vii

constituent forces, **3-8**, 3-33, 3-43, 3-68, p. B-6n

corps, 2-35, 2-41, 2-82, 3-17, 3-27, 3-39

countertasks. See opposing force, countertasks.

criminal organizations, p. 2-2n, p. 2-4n, ¶2-49, 2-57, **2-68–2-70**, **3-79–3-82**  
relation to guerrillas, 2-69, 3-81  
relation to insurgent movement, 2-69, 3-81  
relation to PSOs, 3-83

## D

dedicated forces, **3-9**, 3-33, 3-43, 3-59, 3-68

detachments, 3-54, 3-57, **3-59–3-60**, 3-64, 3-65, p. B-6n  
unit symbols, 3-95

displaced persons, 2-76, 3-87–3-88

divisional units, 2-40, 2-87, pp. A-1–A-3

divisions, **2-39**, 2-41, pp. A-1–A-3

division tactical group, 2-39, 2-41, 3-21, 3-48–3-52, **3-53–3-55**, 3-63, 3-64  
unit symbols, 3-95

DTG. See division tactical group.

## E

equipment lists, 2-93, 2-95–2-98

equipment options, pp. 4-1–4-12  
baseline equipment, 4-1–4-2  
emerging technology trends, 4-28–4-30  
equipment data, 4-7  
equipment upgrades, 4-25–4-27  
systems substitution matrices, **4-22–4-24**, B-74, B-89–B-90, B-110

tier tables, **4-8–4-21**, B-73–B-74, B-89–B-90, B-110

Worldwide Equipment Guide, 1-14, 4-5–4-30

Entries are by paragraph number unless page (p.) or pages (pp.) is specified. After a page reference, the subsequent use of paragraph reference is indicated by the paragraph symbol (¶). For topics with multiple entries, bold type indicates the main entry.

## F

field group, 2-39, 2-41, 3-18, 3-21, **3-22–3-24**, 3-49, 3-52  
 fighting force structure, 2-35, 2-38, 3-17, 3-71  
 foreign government and diplomatic personnel, 2-76, 3-87

## G

General Staff, 2-5, 2-7, **2-8**, 2-14, 2-19, 2-26, 2-29, 2-30, 3-12, 3-13, 3-23, 3-25, 3-67–3-69  
 guerrilla forces, 2-49, 2-51–2-53, 2-57, **2-58–2-65**, **3-76–3-77**, E-1–E-3  
 guerrilla battalion, **2-62**, p. A-6, ¶B-8, pp. E-21–E-22  
 guerrilla brigade, 2-58, **2-61**, pp. A-6–A-7, ¶E-2–E-3  
 guerrilla company, **2-63–2-65**  
 hunter/killer battalion, 2-62, 2-65  
 hunter/killer company, 2-62, **2-63–2-65**, E-4–E-20  
 hunter/killer group, 2-63, 2-64  
 hunter/killer section, 2-64, p. E-12, p. E-16  
 hunter/killer team, 2-58, 2-63, 2-64, 2-65, pp. E-13–E-15, pp. E-18–E-20  
 relation to criminal organizations, 2-69, 3-81  
 relation to insurgent movement, 2-58, 2-59, B-8  
 relation to nation-state forces, 3-16, 3-76, 3-104, B-8  
 trained by SPF, p. 2-4n

## H

humanitarian relief organizations, 2-76, 3-87–3-88  
 hunter/killer units. See guerrilla forces.

## I

independent mission detachment, 3-60

infantry units,  
 infantry company, D-1, pp. D-2–D-20  
 infantry platoon, pp. D-8–D-11  
 infantry squad, p. D-10  
 motorized infantry battalion, pp. D-21–D-22  
 motorized infantry company, D-1, pp. D-1–D-20

insurgent forces, 2-49, **2-50–2-57**, 2-58–2-59, **3-73–3-75**, 3-76, p. A-6, ¶B-10, C-1–C-2  
 higher insurgent organization, 2-53, 3-75, p. A-6  
 local insurgent organization, 2-54–2-56, 3-73, p. A-6, ¶B-18, B-76–B-91, pp. C-1–C-52  
 relation to criminal organizations, 2-57, 2-69, 3-81  
 relation to guerrillas, 2-51, 2-57, 2-58, 2-59, 3-76, B-8  
 relation to nation-state forces, 3-16, 3-76, 3-104  
 relation to PSOs, 3-83  
 trained by SPF, p. 2-4n  
 integrated fires command, artillery component, 3-36–3-37  
 aviation component, 3-38  
 IFC headquarters, 3-35  
 IFC in division or DTG, 3-40, 3-54, **3-61**  
 IFC in OSC, **3-33–3-42**  
 integrated support group, 3-41–3-42  
 missile component, 3-39  
 SPF component, 3-40

integrated support command  
 ISC headquarters, 3-44  
 ISC in division or DTG, 3-54, 3-62  
 ISC in OSC, **3-43–3-46**  
 ISC task-organizing, 3-45–3-46

integrated support group in IFC, **3-41–3-42**, 3-46  
 internally displaced persons, 2-76, 3-87–3-88  
 internal security forces, 2-9, **2-18–2-25**, 2-35, 2-37, 3-16, **3-71**

Civil Defense Directorate, 2-19, **2-25**  
 General Police Directorate, 2-19, **2-24**  
 Internal Security Forces SPF, 2-15, 3-66, 3-69  
 National Security Forces, 2-20, 2-22  
 State Security Directorate, 2-19, **2-20–2-23**

## L

local populace, 2-73, 2-76, 3-78, 3-82, 386–3-88, 3-92, pp. C-11, C-14, C-22, C-24, C-26, C-40, C-44, C-50, C-52, E-2

## M

maneuver brigades, 2-40–2-41  
 media, 2-73, 2-76, 3-87–3-88, pp. C-18, C-20, C-31, C-43, C-50  
 medical personnel (noncombatant), 2-73, 2-76, 3-87, 3-91, pp. C-51–C-52  
 military district, 2-35, 2-41, 2-82, 3-17, 3-27  
 military region, 2-35, 2-39, 2-82, 3-17, 3-27  
 militia forces, 2-4, 2-9, **2-26–2-28**  
 Ministry of Defense, 2-5, **2-7**, 3-12, 3-13, 3-49  
 Ministry of the Interior, 2-9, 2-18, 2-35, 3-49, 3-71  
 movement support detachment, 3-60

## N

National Command Authority, 2-5, **2-6**, 2-13, 3-12, 3-28  
 national-level command structure, 2-5–2-8  
 National Security Forces, 2-20, 2-22  
 nation-state forces. See opposing force.  
 Navy, 2-9, **2-11**, 2-37  
 in OSC, 3-30  
 naval infantry, 3-30, 3-50  
 Naval SPF, 2-11, 2-15, 3-40

Entries are by paragraph number unless page (p.) or pages (pp.) is specified. After a page reference, the subsequent use of paragraph reference is indicated by the paragraph symbol (§). For topics with multiple entries, bold type indicates the main entry.

noncombatants, 2-74–2-76,  
3-85–3-89, p. A-7, ¶B-19  
armed noncombatants,  
2-75, 3-89, p. A-7  
exploitation by OPFOR,  
3-86, 3-90–3-92  
unarmed noncombatants, 2-  
76, 3-87–3-88, p. A-7  
nondivisional units, 2-47, 2-88,  
pp. A-4–A-5, A-7  
nongovernmental  
organizations. See  
humanitarian relief  
organizations.  
nonmilitary actors, 1-13  
non-state actors, 2-43–2-76,  
3-72–3-89  
guerrilla forces. See main  
entry.  
insurgent forces. See main  
entry.  
noncombatants. See main  
entry.  
other paramilitary forces,  
3-78–3-84  
paramilitary organizations.  
See main entry.

## O

obstacle detachment, 3-60  
OE. See operational  
environment or  
contemporary operational  
environment.  
operational environment, p. vi  
contemporary, pp. vi–vii  
future, p. vii  
operational-strategic command,  
2-39, 2-41, 3-18, 3-21, 3-24,  
**3-25–3-46**, 3-49, 3-52, 3-63,  
3-67–3-69  
unit symbol, 3-94  
OPFOR. See opposing force.  
opposing force, p. vii, ¶1-1  
administrative force  
structure. See main entry.  
base unit, 3-104, B-14  
command and support  
relationships, 3-7–3-11  
countertasks, p. vi, ¶3-100,  
3-101, 3-102, 3-108,  
p. B-1, ¶B-5, B-6, B-9,  
B-10, B-18  
definition, 1-1  
doctrine, 1-12, 3-4–3-11

equipment options, pp. 4-1–  
4-12  
exploitation of  
noncombatants, 3-86,  
3-90–3-92  
fighting force structure,  
2-35, 2-38, 3-17, 3-71  
national-level command  
structure, 2-5–2-8  
nation-state forces  
(operational level), 2-34–  
2-36, 3-17–3-46  
nation-state forces  
(strategic level), 2-1–  
2-33, 3-12–3-16  
nation-state forces (tactical  
level), 2-37–2-47, 3-47–  
71  
order of battle, 1-8,  
p. 2-14n, ¶2-81, 3-1, 3-4,  
**3-96–3-109**  
role in training, 1-4–1-10  
roles and relationships in  
training, pp 1-1–1-3  
strategic framework, 3-12,  
**3-14–3-16**  
task-organizing. See main  
entry.  
unit symbols, 3-93–3-95  
order of battle. See opposing  
force, order of battle.  
organizational directories, 2-3,  
**2-77–2-104**  
files for OPFOR units, **2-83–**  
**2-102**, 3-107, B-22, B-  
24–B-75, B-81, B-91  
folders for OPFOR unit files,  
**2-103–2-104**,  
3-107, B-22–B-23, B-75,  
B-81, B-91, B-96, B-111  
footnotes, 2-99–2-100  
notes, 2-101–2-102  
organizational graphics,  
**2-89–2-90**, 3-107, B-24–  
B-45, B-82–B-83, B-97  
paramilitary forces. See  
main entry.  
personnel and equipment  
lists, **2-91–2-98**, 3-107,  
B-46–B-72, B-84–B-88,  
B-98–B-109  
unit name, 2-86–2-88, B-27,  
B-49, B-82  
OSC. See operational strategic  
command.

## P

paramilitary forces, 1-13, **2-49–**  
**2-73**, **3-73–3-84**, pp. A-6–  
A-7  
criminal organizations. See  
main entry.  
guerrilla forces. See main  
entry.  
in DTG, 3-54  
insurgent forces. See main  
entry.  
other armed combatants,  
2-71–2-72  
other paramilitary forces,  
3-78–3-84  
private security  
organizations. See main  
entry.  
personnel totals, 2-91–2-94  
peacetime administrative force  
structure. See administrative  
force structure.  
platoons, 2-44  
police. See also General Police  
Directorate.  
district police, 2-24  
local police, 2-24  
National Police forces,  
**2-24**, 3-50  
special police, 2-24  
populace (local), 2-73, 2-76,  
3-78, 3-82, 386–3-88, 3-92,  
pp. C-11, C-14, C-22, C-24,  
C-26, C-40, C-44, C-50,  
C-52, E-2  
private security organizations,  
2-49, **2-66–2-67**, **3-83–3-84**  
relation to insurgent or  
criminal organizations,  
3-83  
relation to transnational  
corporations, 3-83–3-84

## R

reconnaissance detachment, 3-  
60  
reserve component forces, 2-4,  
2-9, **2-26–2-28**, 3-16

## S

security detachment, 3-60  
security forces. See National  
Security Forces and private  
security organizations.

Entries are by paragraph number unless page (p.) or pages (pp.) is specified. After a page reference, the subsequent use of paragraph reference is indicated by the paragraph symbol (§). For topics with multiple entries, bold type indicates the main entry.

- separate units, 2-40, 2-87, B-15
  - service components, 2-4, **2-9–2-28**, 3-18, 3-27, 3-47, 3-66, 3-69, 3-71
  - special-purpose forces
    - Air Force SPF, 2-12, 2-15, 3-66, 3-69
    - Army SPF, 2-10, 2-15, 2-37, 3-59, 3-66, 3-69
    - equipment, 2-97
    - example, B-9
    - Internal Security Forces SPF, 2-15, 2-20, 2-23, 3-66, 3-69
    - Naval SPF, 2-11, 2-15, 3-66, 3-69
    - SPF Command, 2-9, **2-14–2-17**, 2-33, 2-37, 3-40, 3-66, 3-69
    - SPF component of OSC IFC, 3-40
    - SPF detachment, 3-70
    - SPF team, 3-70
    - task-organizing, 3-66–3-70
  - State, the, 2-2
  - State Security Directorate, 2-19, **2-20–2-23**
    - Border Guard Forces, **2-20–2-21**, 3-50
    - National Security Forces, 2-20, 2-22
  - Internal Security Forces SPF, 2-20, 2-23
  - Strategic Forces, 2-9, **2-13**, 2-37, 3-39
  - strategic framework, 3-12, **3-14–3-16**
  - subordinate units, 3-7
  - supporting relationships, **3-10**, 3-59, 3-68
  - Supreme High Command, 2-7, 2-8, 2-9, 2-13, 2-14, 2-19, 2-30–2-33, 3-12, **3-13**, 3-47, 3-50, 3-52, 3-71
- T**
- tactical groups, 3-48–3-58. *See also* brigade tactical group and division tactical group. unit symbols, 3-95
  - task organization, p. 3-1. *See also* task-organizing. example, pp. B-1–B-34 unit symbols, 3-93–3-95
  - task-organizing, **pp. 3-1–3-26**
    - bottom-up, B-92–B-112
    - internal, 3-63–3-65
  - theater headquarters, 2-13, 2-14, 2-15, **2-29–2-33**, 3-18, 3-22, 3-27, 3-47, 3-49, 3-52, 3-67–3-69
  - transients, 2-76, 3-87
  - transnational corporations, 2-76, 3-83, 3-84, 3-87
- U**
- United States
    - Army tactical tasks, 3-99, 3-100, 3-102, 3-109, B-3, B-5, B-7–B-10, B-74, B-80
    - mission essential task list, p. vi, ¶1-8, p. 3-1, ¶3-2, 3-32, 3-78, 3-85, 3-88, 3-96, 3-98–3-100, B-80
    - training requirements, 3-2–3-3, 3-96, 3-106
  - urban detachment, 3-60
- W**
- wartime fighting force structure, 2-35, 2-38, 3-17, 3-71
  - Worldwide Equipment Guide, 1-14, 4-5–4-30
    - emerging technology trends, 4-28–4-30
    - equipment data, 4-7
    - equipment upgrades, 4-25–4-27
    - systems substitution matrices, 4-22–4-24
    - tier tables, 4-8–4-21

**FM 7-100.4**  
**3 MAY 2007**

By order of the Secretary of the Army:

**GEORGE W. CASEY, JR.**  
*General, United States Army*  
*Chief of Staff*

Official:



**JOYCE E. MORROW**  
*Administrative Assistant to the*  
*Secretary of the Army*  
0710210

**DISTRIBUTION:**

*Active Army, Army National Guard, and United States Army Reserve:* Not to be distributed. Electronic media only.

