

C2, FM 10-579/TO 13C7-50-1

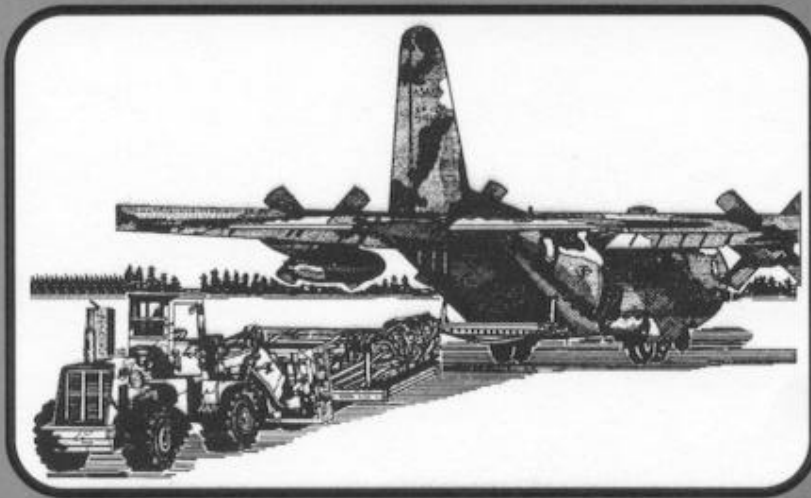

**AIRDROP OF SUPPLIES AND EQUIPMENT:  
RIGGING  
LANDING FIELD MAT**



■ **DISTRIBUTION RESTRICTION:** Approved for public release; distribution is unlimited. ■

**HEADQUARTERS  
DEPARTMENT OF THE ARMY  
DEPARTMENT OF THE AIR FORCE**



## DEPARTMENT OF THE ARMY

HEADQUARTERS UNITED STATES ARMY TRAINING AND DOCTRINE COMMAND  
FORT MONROE, VIRGINIA 23651-5000

REPLY TO  
ATTENTION OF

ATCD-SL (70-1f)

21 Oct 96

MEMORANDUM FOR DEPUTY CHIEF OF STAFF OPERATIONS AND PLANS,  
400 ARMY PENTAGON, ATTN: DAMO-FDL, WASHINGTON  
DC 20310-0400

SUBJECT: Quartermaster (QM) Functional Area Assessment (FAA)  
Response

1. References:

a. Message, HQDA, DAMO-FDL, 231825Z Apr 96, subject: QM FAA Results.

b. Memorandum, HQ TRADOC, ATCG, 29 Jul 96, Army Airdrop Capabilities Assessment.

2. At the 29 Mar 96 QM FAA briefing to the Director of Army Staff, the decision was reached to revisit the Army's decision to "shelf" Low Altitude Parachute Extraction System (LAPES) (reference 1a).

a. Reference 1b, solicited CINCs input for their positions on LAPES and assessments of airdrop capabilities. The CINCs responses will be used to chart the direction and role for airdrop in the 21st century.

b. Based on the responses received (enclosure), there is no strong support for LAPES airdrop capability at this time. The consensus for the airdrop capabilities is to continue support for current Low Velocity Airdrop System (LVAD), develop a 500-foot LVAD and further explore Advanced Precision Aerial Delivery System (APADS).

3. Further, we will continue to maintain a range of airdrop capabilities to support all contingencies throughout the Army. The results of the Army Airdrop Capabilities Assessment also will be incorporated into the Operational Concept for Aerial Delivery Operations and Improved Cargo Aerial Delivery Capability Mission Needs Statement being developed by the Quartermaster Directorate of Combat Developments, U.S. Army Combined Arms Support Command (CASCOM).

4. The HQ TRADOC POC is MAJ Higgins, Airborne Airlift Action Office, ATCD-SL, E-mail: higginsn@emh10.monroe.army.mil, DSN 680-2469/3921, datafax DSN 680-2520.

ATCD-SL

SUBJECT: Quartermaster (QM) Functional Area Assessment (FAA)  
Response

FOR THE DEPUTY CHIEF OF STAFF FOR COMBAT DEVELOPMENTS:

Encl

JOHN A. MANDEVILLE  
Colonel, GS  
Director, Combat Service Support

CF:

USACASCOM (ATCL-CG/ATCL-QC/ATCL-MES)

USAQMC&S (ATSM-CG/ATSM-ABN/FS)

USANRDEC (SSCNC-UT/AMSSC-PM)

<b>ORGANIZATION</b>	<b>LAPES</b>	<b>LVAD</b>	<b>500' LVAD</b>	<b>APADS</b>	<b>SPTS/ NOT SPEC</b>
<b>USSOCOM</b>		X	X	X	
<b>EUCOM</b>					X
<b>CENTCOM</b>		X	X		
<b>FORSCOM</b>		X	X	X	
<b>TRANSCOM</b>					X
<b>SOUTHCOM</b>	X			X	
<b>VIII ARMY</b>					X
<b>ACOM</b>					X

**USSOCOM:** Memorandum specifically states that the command does not support LAPES airdrop capability, but supports LVAD as well as APADS.

**EUCOM:** Draft memorandum specifically states that the command support the need for a low level airdrop capability. However, memorandum summarizes that the specific capability is not important as to have a capability to meet the required mission/threat profile.

**CENTCOM:** Memorandum specifically states that the command does not support LAPES airdrop capability, but support both current LVAD and 500-foot LVAD airdrop capabilities.

**FORSCOM:** 1st Endorsement specifically states that the command does not support LAPES airdrop capability, however supports LVAD, 500-foot LVAD and APADS.

**TRANSCOM:** Memorandum does not specifically address any airdrop capability as it talks to the 21st century requiring the full spectrum of tactical delivery methods.

**SOUTHCOM:** Memorandum specifically supports LAPES and APADS airdrop capabilities for their command.

**VIII ARMY:** E-Mail note for VIII Army states that the command has no input to the assessment as their plans call for a limited employment of airdrop.

**ACOM:** Sent request for input on 30 Sep 96. Received verbal response on 16 Oct 96 stating command is indifferent on the specific capability received.





DEPARTMENT OF THE ARMY  
HEADQUARTERS UNITED STATES ARMY TRAINING AND DOCTRINE COMMAND  
FORT MONROE, VIRGINIA 23651-3000

REPLY TO  
ATTENTION OF

6 SEP 1995

ATCD-SL (70-1f)

MEMORANDUM FOR

Major General Thomas W. Robison, Commander, U.S. Army Combined  
Arms Support Command and Fort Lee, Fort Lee, VA 23801-6000  
Major General Robert K. Guest, Commander, U.S. Army Quartermaster  
Center and School, Fort Lee, VA 23801-5030

SUBJECT: Low Altitude Parachute Extraction System (LAPES)  
Disassembly.

1. References:

a. Message, HQ TRADOC, ATCD-SL, 100930Z Jan 95, subject:  
LAPES.

b. OVVM Note, HQ USACASCOM, 30 March 95, subject: TRADOC  
Disassembly of LAPES.

2. The U.S. Army and other services recently have concurred that  
LAPES will be terminated, as this capability is no longer required  
as a viable wartime contingency airdrop option. However,  
Headquarters, Department of the Army (DA), Deputy Chief of Staff  
for Operations and Plans, has agreed that LAPES technology will be  
shelved, and all specialized equipment preserved for possible  
future use.

3. Take the necessary steps to terminate training and leader  
development concerning LAPES operations. Major General Guest's  
questions regarding the disassembly of LAPES (enclosed) with  
following guidance will be utilized:

a. "Does the U.S. Army Quartermaster Center and School  
(USAQMC&S) continue to publish LAPES procedures in their joint  
field manual (FMs)/technical order manuals?" "Do we publish the  
LAPES procedures that have been written but not been printed yet?"  
Publishing LAPES procedures in all joint publications, Army FMs,  
regulations, etc., will be discontinued and addressed in the next  
revision of the aforementioned documents. Concurrently, all LAPES  
procedures that have been written and not printed will not be  
published.

6 SEP 1995

ATCD-SL  
SUBJECT: Low Altitude Parachute Extraction System (LAPES)  
Disassembly

b. "Do we keep LAPES in our programs of instruction (POIs)?" "Do we teach LAPES to other services and our allies?" The USAQMC&S will remove LAPES procedures from PCI and cease teaching LAPES to other services and/or allies.

c. "What do we teach to folks that have LAPES equipment in their war reserves?" All instruction concerning LAPES procedures will be discontinued whether LAPES equipment is located in units or in war reserves.

d. "What is the DA/TRADOC guidance on disposition of unit, depot, and war reserves LAPES equipment?" All LAPES equipment in war reserves and depot should be preserved with the exception of a few items that can be utilized in other existing airdrop capabilities. Specifically, the Type V airdrop platforms and attitude control bars of the LAPES system are being utilized to augment current Low Velocity Airdrop Systems (LVADS) loads.

e. "What is the guidance to U.S. Army Test and Experimentation Command on force development test and experimentation certification of LAPES loads?" The certification of all LAPES loads at the Airborne Special Operations Test Directorate will be redirected toward testing and certification of LVADS loads.

4. HQ TRADOC POC is CPT Higgins or CPT Phillips, ATCD-SL, DSN 680-2469/3921, datafax DSN 680-2520.

FOR THE COMMANDER:

Encl



JOE N. BALLARD  
Major General, GS  
Chief of Staff

CF:  
HQDA (DAMO-FDL)  
CDR, NRDEC (SAFNC-UA)  
CDR, FORSCOM (FCJ3-FC)  
CDR, OPTEC (CSTE-CS, CSTE-OPM)  
CDR, ATCOM (AMSAT-W-TD)  
DIR, ABNSOTD (ATCT-AB)  
HQ TRADOC (ATCD-L, ATCD-RM, ATDO-A, ATTG-IT)

Date and time 07/18/95 10:28:11

From: HIGGINSN--MON1  
To: HIGGINSN--MON1

From: OPT NEIL HIGGINS, (AAACO), 680-2464  
Subject: TRADOC "DISASSEMBLY" OF LAPES

\*\*\*\*\*  
\* AIRBORNE AIRLIFT ACTION OFFICE \*  
\* (AAACO) \*  
\*\*\*\*\*

\*\* Forwarding note from BRUNEAUN--OMSNAMES 07/18/95 10:27 \*\*\*  
Received: from LEE-EMH2.ARMY.MIL by MONROE-EMH2.ARMY.MIL (IBM VM SMTP V2R2)  
with TCP; Tue, 18 Jul 95 10:27:22 EDT  
Received: from LEE1 by LEE-EMH2.ARMY.MIL (IBM VM SMTP V2R2) with SMTP id 3547;  
Tue, 18 Jul 95 10:29:34 EDT  
Comments: Converted from PROFS to RFC822 format by PUMP V2.2X  
Date: Tue, 18 Jul 95 10:29:26 EDT  
From: NORMAN BRUNEAU <BRUNEAUN@LEE-EMH2.ARMY.MIL>  
Subject: TRADOC "DISASSEMBLY" OF LAPES  
To: "NEIL HIGGINS- AAACO " <HIGGIN@MONROE-EMH1.ARMY.MIL>

\*\* Resending note of 06/30/95 09:23

From: LARRY MC MILLIAN AAA <MCILLI@MONROE-EMH1.ARMY.MIL>  
To: NORMAN BRUNEAU  
Subject: TRADOC "DISASSEMBLY" OF LAPES

NEIL- HERE ARE THE QUESTIONS THAT MG GUEST WANTS DA/ TRADOC TO ANSWER RE LAPES, AS I UNDERSTAND HIS GUIDANCE. I HAVE DISCUSSED THESE W/ OUR ABN DPT. IF THESE QUESTIONS MAKE SENSE, GIVE ME AN "UP" BEFORE I FORMALLY SEND ANYTHING OUT. MG GUEST WANTS SPECIFIC GUIDANCE FM TRADOC ON LAPES, RESPONSE NEEDS TO BE CLEAR AND TO THE POINT. A LOT OF THIS WILL HINGE ON WHAT ACC PLANS TO DO W/ LAPES NOW THAT THE AIR STAFF HAS GIVEN THEM THE GREEN LIGHT TO KILL IT. IF THEY PLAN TO PLACE IT ON THE SHELF OR KEEP A LIMITED OR CONTINGENCY CAPABILITY, THAT WILL DRIVE YOUR ANSWER TO US, AT THIS POINT I THINK ACC WILL DO WHATEVER THE ARMY WANTS, AS THEIR PRIMARY CUSTOMER. I WILL NOT REHASH HOW THE ARMY DECIDED THEY DIDNT NEED LAPES. QUESTIONS FOLLOW:

- DOES THE GMS CONTINUE TO PUBLISH LAPES PROCEDURES IN THEIR JOINT FM/TO MANUALS?
- DO WE PUBLISH THE LAPES PROCEDURES THAT HAVE BEEN WRITTEN BUT HAVE NOT BEEN PRINTED YET?
- DO WE REMOVE ALL LAPES PROCEDURES FROM ALREADY PUBLISHED MANUALS?
- DO WE KEEP LAPES IN OUR POI?
- DO WE TEACH LAPES TO OTHER SERVICES AND OUR ALLIES?
- WHAT DO WE TEACH TO FOLKS THAT HAVE LAPES EQUIPMENT IN THEIR WAR RESERVES?
- WHAT IS THE DA/TRADOC GUIDANCE ON DISPOSITION OF UNIT, DEPOT, AND WAR RESERVE LAPES EQUIPMENT?
- WHAT IS THE GUIDANCE TO TEXCOM ON THE FUTE CERTIFICATION OF LAPES LOADS?

I KNOW THESE ARE TOUGH QUESTIONS, BUT THEY HAVE TO BE ASKED. HQ STAFFS CANNOT SIMPLY SAY "KILL IT" AND MOVE ON TO THE NEXT ISSUE. I DONT THINK WE ARE DOING OUR JOB IF WE LEAVE IT UP TO THE SCHOOLHOUSE TO INTERPRET SKETCHY GUIDANCE. THAT PLACES US IN THE POSSIBLE POSITION OF BEING ACCUSED OF NOT FOLLOWING ORDERS.

LETS TALK.....NORM

TRK 2/47

SEP 11 11 08:30AM CSSRD FT MONROE VA *File 1*

**DEPARTMENT OF THE ARMY**  
QUARTERMASTER CENTER AND SCHOOL  
1201 22D STREET  
FORT LEE, VIRGINIA 23801-1601

ATSM-ABN-FS

15 Dec 96

MEMORANDUM FOR RECORD

SUBJECT: Airdrop Equipment Update

Reference:

- a. Phone conversation between CW4 Mahon, CASCOM and Dick Harper, Weapons System Management Office, Army Aviation Troop Command. Subject : sab
- b. Phone conversation between CW4 Mahon, CASCOM and Don Stump, Logistics Management Specialist, Office, Deputy Chief of Staff for Logistics. Subject. sab
- c. Phone conversation between CW4 Mahon, CASCOM and Chief Msgt Okraneck, Hqrs Air Combat Command. Subject sab
- d. msg dtg R 181348Z Feb 94. subject: FCIF item: Type II platforms, PEFTC and SL/CS for Air Force unilateral training

1. Based on information received from the references a-c above, the following update is provided per request ref c, above.
  - a. The type II modular platform no longer exists within any contingency stocks. Therefore, maintaining Joint Inspection training program is no longer required for this equipment.
  - b. The Parachute Extraction Transfer Force Coupling (PEFTC) no longer exists within any contingency stocks. Therefore, maintaining Joint Inspection training program is no longer required for this equipment.
  - c. The metric platform interim rigging procedures are no longer valid as they apply to metric platforms. Those rigging procedures which have dual application with the type V platform are still valid for the type V platform.
  - d. The static line connector strap (SL/CS) currently has limited application. Only those loads that specifically require this system are authorized use of this system. The SL/CS is not an across the board substitute for the Extraction Force Transfer Coupling (EFTC). These authorized loads are specific in nature and will normally be found in the special operations arena of airdrop loads. This system is not authorized for use IAW ref d, above.
2. For additional questions/information contact the undersigned at DSN 687-4733, Fax 3084.

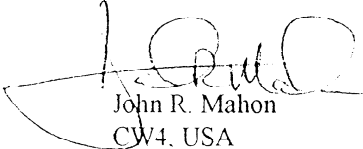
  
John R. Mahon  
CW4, USA  
Senior Airdrop Systems  
Technician

CHANGE  
No. 2

HEADQUARTERS  
DEPARTMENT OF THE ARMY  
DEPARTMENT OF THE AIR FORCE  
Washington, DC, 20 March 1998

**AIRDROP OF SUPPLIES AND EQUIPMENT:  
RIGGING LANDING FIELD MAT**

This change adds the procedures for rigging the Landing Field Mat for low-velocity airdrop.

FM 10-579/TO 13C7-50-1, 19 April 1985, is changed as follows:

1. New or changed material is identified by a vertical bar (█) in the margin opposite the changed material.
2. File this transmittal sheet in front of the publication for reference purpose.
3. Remove old pages and insert new pages as indicated below:

**Remove old pages**

Cover 1  
i through iii  
1-1  
3-1 and 3-2  
-----  
-----  
Glossary- 1  
References-1

**Insert new pages**

Cover 1  
i through iv  
1-1  
3-1 and 3-2  
3-39 through 3-59  
4-1 through 4-32  
Glossary-1  
References- 1

█ **DISTRIBUTION RESTRICTION:** Approved for public release; distribution is unlimited. █

By Order of the Secretary of the Army:

Official:

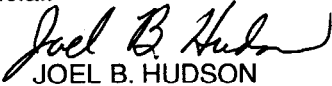
  
JOEL B. HUDSON  
*Administrative Assistant to the  
Secretary of the Army*  
04365

DENNIS J. REIMER  
*General, United States Army  
Chief of Staff*

**DISTRIBUTION:**

**Active Army, Army National Guard, and U.S. Army Reserve: To be distributed in accordance with the initial distribution number 110943, requirements for FM 10-579.**

CHANGE  
NO. 1

HEADQUARTERS  
DEPARTMENT OF THE ARMY  
DEPARTMENT OF THE AIR FORCE  
Washington, DC, 8 May 1996

**AIRDROP OF SUPPLIES AND EQUIPMENT  
RIGGING LANDING FIELD MAT**

This change adds the procedures for rigging the rapid runway repair kit on a type V platform for low-velocity airdrop.

FM 10-579/TO 13C7-50-1, 19 April 1985, is changed as follows:

1. New or changed material is identified by a vertical bar in the margin opposite the changed material.
2. Remove old pages and insert new pages as indicated below:

<b>Remove pages</b>	<b>Insert pages</b>
i and ii	i through iii
1-1	1-1
	3-1 through 3-38
Glossary-1	Glossary-1
References-1	References-1

3. File this transmittal sheet in front of the publication for reference purposes.

**DISTRIBUTION RESTRICTION.** Distribution authorized to US government agencies only to protect technical or operational information from automatic dissemination under the International Exchange Program or by other means. This determination was made on 30 April 1991. Other requests for this document will be referred to AIRBORNE AND FIELD SERVICES DEPARTMENT, USA QUARTERMASTER CENTER AND SCHOOL, 1010 SHOP ROAD, FORT LEE, VA 23801-1502.

**DESTRUCTION NOTICE.** Destroy by any method that will prevent disclosure of contents or reconstruction of the document.

**FIELD MANUAL**  
**No. 10-579**  
**TECHNICAL ORDER**  
**No. 13C7-50-1**

**AIRDROP OF SUPPLIES AND EQUIPMENT:  
 RIGGING LANDING FIELD MAT**

**TABLE OF CONTENTS**

	Paragraph	Page
<b>PREFACE</b>		iv
<b>CHAPTER 1 INTRODUCTION</b>		
Description of Items	1-1	1-1
Special Considerations	1-2	1-1
<b>CHAPTER 2 RIGGING STEEL MAT FOR LOW-VELOCITY AIRDROP</b>		
Description of Load	2-1	2-1
Preparing Platform	2-2	2-1
Placing Honeycomb	2-3	2-3
Placing Binding Lashings	2-4	2-3
Placing Steel Mat	2-5	2-4
Building and Placing Endboards	2-6	2-5
Lashing Load	2-7	2-6
Safetying Suspension Slings	2-8	2-6
Stowing Cargo Parachutes	2-9	2-6
Installing Extraction System	2-10	2-7
Installing Release System	2-11	2-7
Positioning Extraction Parachute	2-12	2-7
Marking Rigged Load	2-13	2-8
Equipment Required	2-14	2-8

■ **DISTRIBUTION RESTRICTION:** Approved for public release; distribution is unlimited. ■



### CHAPTER 3 RIGGING THE RAPID RUNWAY REPAIR KIT FOR LOW-VELOCITY AIRDROP ON A TYPE V PLATFORM

#### Section I RIGGING RAPID RUNWAY REPAIR KIT ON A 24-FOOT, TYPE V PLATFORM

Description of Load	3-1	3-1
Preparing Platform	3-2	3-1
Building and Positioning Honeycomb Stacks	3-3	3-3
Building Repair Kit Containers	3-4	3-6
Positioning Repair Kits in Containers	3-5	3-9
Securing and Positioning Containers	3-6	3-10
Building, Positioning, and Securing Front and Rear Endboards	3-7	3-11
Installing Lashings	3-8	3-16
Installing Suspension Slings	3-9	3-22
Safelying Suspension Slings	3-10	3-25
Building, Positioning and Securing Parachute Stowage Platform	3-11	3-26
Stowing Cargo Parachutes	3-12	3-30
Installing Release System	3-13	3-31
Installing Extraction System	3-14	3-32
Installing Provisions for Emergency Restraints	3-15	3-34
Placing Cargo Extraction Parachute	3-16	3-34
Marking Rigged Load	3-17	3-34
Equipment Required	3-18	3-34

#### Section II RIGGING THE RAPID RUNWAY REPAIR KIT ON A 20-FOOT, TYPE V PLATFORM

Description of Load	3-19	3-39
Preparing Platform	3-20	3-39
Building and Positioning Honeycomb Stacks and Secure Load	3-21	3-41
Building, Positioning, and Securing Front and Rear Endboards	3-22	3-47
Installing Lashings	3-23	3-49
Installing Suspension Slings and Deadman's Tie	3-24	3-52
Stowing Cargo Parachutes	3-25	3-53
Installing Release System	3-26	3-54
Installing Extraction System	3-27	3-55
Installing Provisions for Emergency Restraints	3-28	3-57
Placing Cargo Extraction Parachute	3-29	3-57
Marking Rigged Load	3-30	3-57
Equipment Required	3-31	3-57

### CHAPTER 4 RIGGING THE RAPID RUNWAY REPAIR (RRR) KIT-ALPHA ON A 32-FOOT, TYPE V PLATFORM FOR LOW-VELOCITY AIRDROP

Description of Load	4-1	4-1
Preparing Platform	4-2	4-1
Building and Placing Honeycomb Stacks	4-3	4-3
Lifting and Positioning Folded Fiberglass Mat Rapid Runway Repair (RRR) Kit	4-4	4-5
Building, Positioning, and Securing Front and Rear Endboards	4-5	4-9
Installing Lashings	4-6	4-10
Rigging Accompanying Load	4-7	4-16

	Paragraph	Page
Installing and Safetying Suspension Slings	4-8	4-23
Stowing Cargo Parachutes	4-9	4-24
Installing Release System	4-10	4-26
Installing Extraction System	4-11	4-27
Installing Provisions for Emergency Restraints	4-12	4-29
Placing Cargo Extraction Parachute	4-13	4-29
Marking Rigged Load	4-14	4-29
Equipment Required	4-15	4-29

**GLOSSARY**  
**REFERENCES**

Glossary-1  
References-1

## PREFACE

### SCOPE

This manual tells and shows how to prepare and rig the steel landing field mat and how to rig the rapid runway repair kits for low-velocity airdrop from C-130, C-141, C-5, and C-17 aircraft. It is designed to be used by all parachute riggers.

### USER INFORMATION

The proponent of this publication is HQ TRADOC. You are encouraged to report any errors or omissions and to suggest ways to make this a better manual. Army personnel, send comments on DA Form 2028 directly to:

Director  
Aerial Delivery and Field Services Department  
USA Quartermaster Center and School  
1010 Shop Road  
Fort Lee, Virginia 23801-1502

Air Force personnel, send your reports on AFTO Form 22 through:

Headquarters  
Air Mobility Command (AMC/DOKT)  
402 Scott Drive, Unit 3A1  
Scott AFB, Illinois 62225-5302

Air Force personnel in Special Operations Command, send your reports on AFTO Form 22 through:

HQ AFSOC/DOXT  
100 Bartley St., Suite 260  
Hurlburt Field, Florida 32544-5273

to:

Director  
Aerial Delivery and Field Services Department  
USA Quartermaster Center and School  
1010 Shop Road  
Fort Lee, Virginia 23801-1502

Also send information copy of AFTO Form 22 to:

HQ SA-ALC/TILD  
485 Quentin Roosevelt Road  
Kelly AFB, Texas 78241-6421

Unless this publication states otherwise, masculine nouns and pronouns do not refer exclusively to men.

# CHAPTER 1 INTRODUCTION

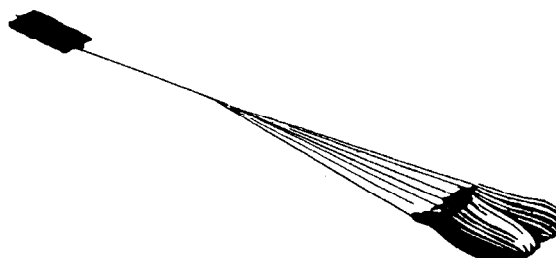
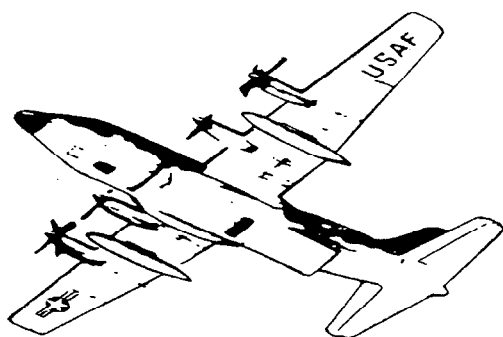

---

---

## 1-1. Description of Items

The description of items covered in this manual are listed below.

**a. Steel Landing Field Mat.** The steel landing field mat consists of 39 pieces of steel mat weighing 5,850 pounds. Each piece weighs 150 pounds, is 144 inches long and is 22 inches wide. Pieced aluminum or steel may be dropped using these procedures; however, the weight and parachute requirements must be computed.

**b. The Rapid Runway Repair Kit rigged on a 24-foot, Type V Platform.** The rapid runway repair kit consists of fiberglass sheets, plastic supports, metal fittings and the tools to erect the structure. The kit is contained in locally fabricated wooded boxes. A total of four rapid runway repair kits will be rigged on this load. The load is 288 inches long, 90 inches high, 108 inches wide, and 24,360 pounds.

**c. The Rapid Runway Repair Kit rigged on a 20-foot, Type V Platform.** The rapid runway repair kit consists of fiberglass sheets, plastic supports, metal fittings and the tools to erect the structure. The kit is contained in factory build shipping wooded boxes. A total of two rapid runway repair kits will be rigged on this load. The load is 222 inches long, 22 inches high, 89 inches wide, and 14,080 pounds.

**d. The Rapid Runway Repair Kit-ALPHA, rigged on a 32-foot, Type V Platform.** The folded fiberglass mat rapid runway repair kit-ALPHA consists of two mat sections, an equipment box and eight metal boxes filled with bolts and washers. The load is 401 inches long with a 17 inch rear overhang, 59 1/2 inches high, 108 inches wide, and 13,260 pounds.

## 1-2. Special Considerations

**a.** The wooden shipping boxes can be locally fabricated.

**b.** A copy of this manual must be available for the joint airdrop inspectors to use during the before-loading and after-loading inspections.

## CHAPTER 3

### RIGGING THE RAPID RUNWAY REPAIR KIT FOR LOW-VELOCITY AIRDROP ON A TYPE V PLATFORM

#### Section I

#### RIGGING THE RAPID RUNWAY REPAIR KIT ON A 24-FOOT, TYPE V PLATFORM

##### 3-1. Description of Load

The rapid runway repair kit consists of fiberglass sheets, plastic supports, metal fittings and the tools to erect the structure. The kit contains no materials requiring special handling and is not fragile. The kit is contained in a locally fabricated wooden container. A total of four rapid runway repair kits will be rigged in this load. The rapid runway repair kit must be in a box as described in Figure 3-4. The load requires five G-11C cargo parachutes and is rigged on a 24-foot, type V platform for low-velocity airdrop.

##### 3-2. Preparing Platform

Prepare a 24-foot, type V platform as follows:

*a. Inspecting Platform.* Inspect, or assemble and inspect, the platform according to TM 10-1670-268-20&P/TO 13C7-52-22.

##### Note:

If the platform must be assembled, install the suspension links when assembling the platform. See Figure 3-1 for the location of the suspension links.

*b. Installing Suspension Links.* Install eight suspension links on the assembled platform according to FM 10-500-2/TO 13C7-1-5.

*c. Installing Tandem Links.* Install two tandem links as shown in Figure 3-1.

*d. Attaching and Numbering Clevises.* Attach and number 82 clevis assemblies as shown in Figure 3-1.

##### Notes

1. The nose bumper may or may not be installed.
2. Measurements given in this chapter are from the front edge of the platform, NOT from the front edge of the nose bumper.

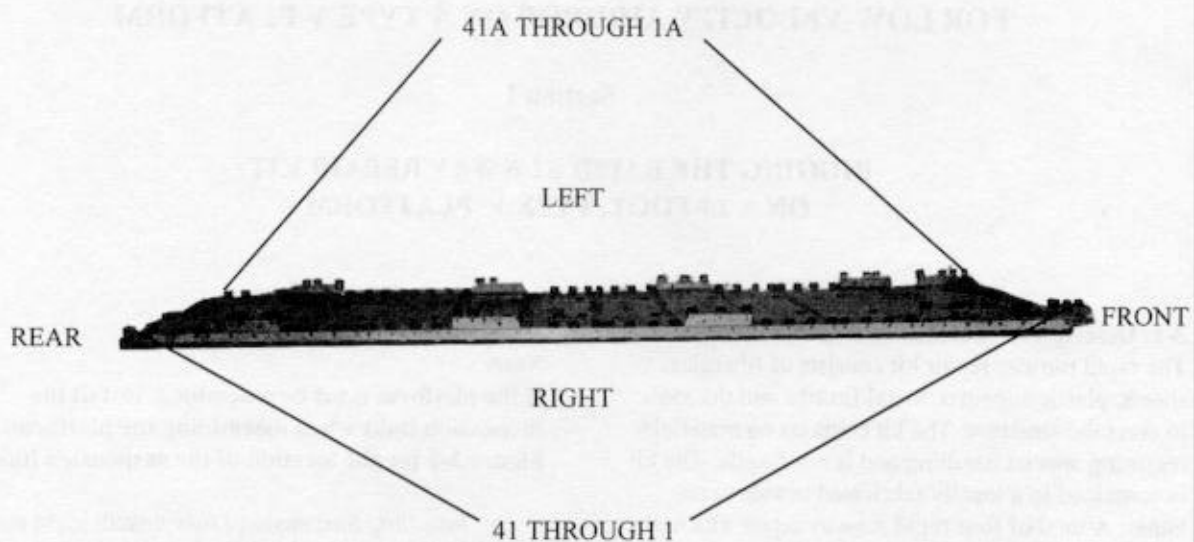

Step:

1. Install suspension links to each platform side rail to bushing holes 6, 7, and 8; 18, 19, and 20; 29, 30, 31; 41, 42, and 43.
2. Install a tandem link on the front of each platform side rail using holes 1, 2, and 3.
3. Install clevises on bushings 1, 2, 3, and 4 on each front tandem link.
4. Install clevises on bushings 2, 3, and 4 on the first set of suspension links.
5. Install clevises on bushings 1, 3, and 4 on the second set of suspension links.
6. Install clevises on bushings 3 and 4 on the third set of suspension links.
7. Install clevises on bushings 1, 2, and 3 on the fourth set of suspension links.
8. Starting at the front of the platform, install clevises on each platform side rail using the bushings bolted on holes 9, 10, 11, 12, 13, 14, 15, 16, 21, 22, 23, 24, 25, 26, 27, 33, 34, 35, 36, 37, 38, 39, 40, 45, and 48.
9. Starting at the front of the platform, number the clevises bolted to the right side rail from 1 through 41 and those bolted to the left side rail from 1A through 41A.

Figure 3-1. Platform prepared

### 3-3. Building and Positioning Honeycomb Stacks

Build 10 honeycomb stacks according to FM 10-500-2/TO 13C7-1-5 and as shown in Figure 3-2.

Position the stacks on the platform as shown in Figure 3-3.

#### Notes:

1. Center the honeycomb stacks on the base layer 16 inches from the front edge of the platform.
2. These drawings are not drawn to scale.

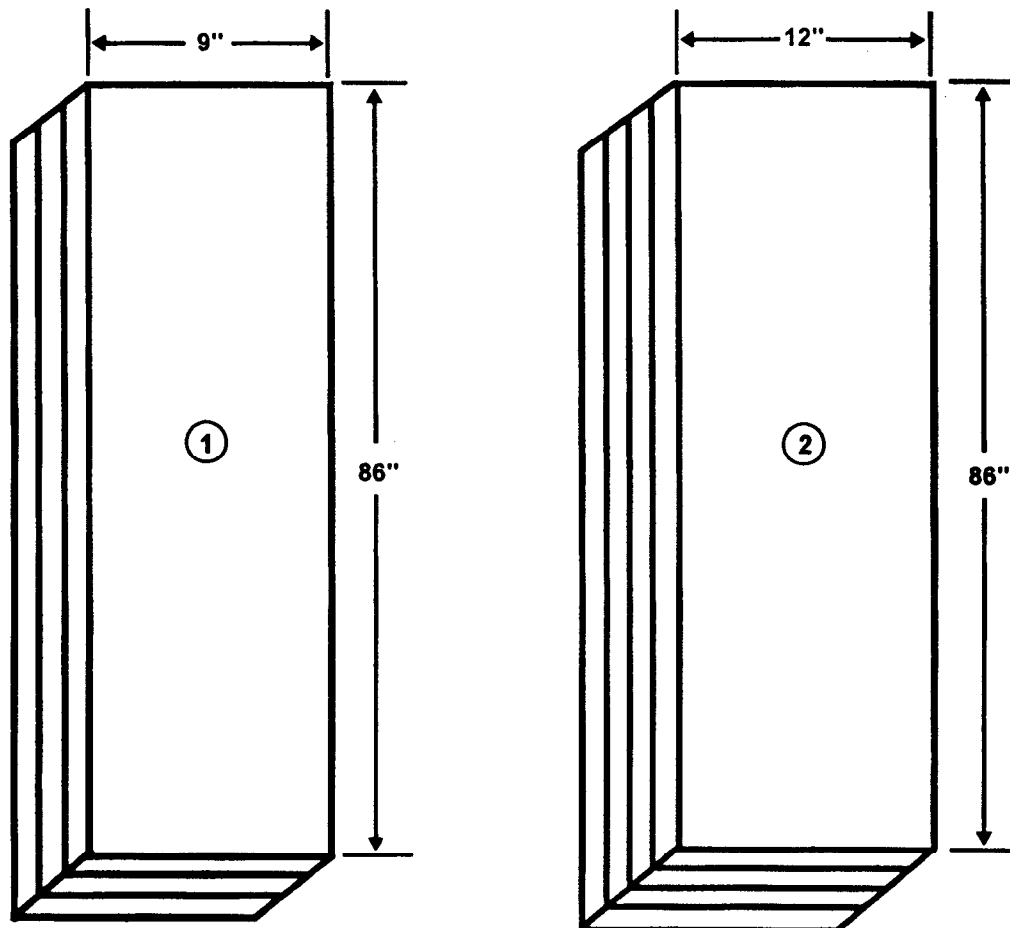

- ① Use three 86- by 9-inch pieces of honeycomb to form stacks 1, 2, 4, 6, 8, and 10.
- ② Use four 86- by 12-inch pieces of honeycomb to form stacks 3, 5, 7, and 9.

Figure 3-2. Honeycomb stacks built



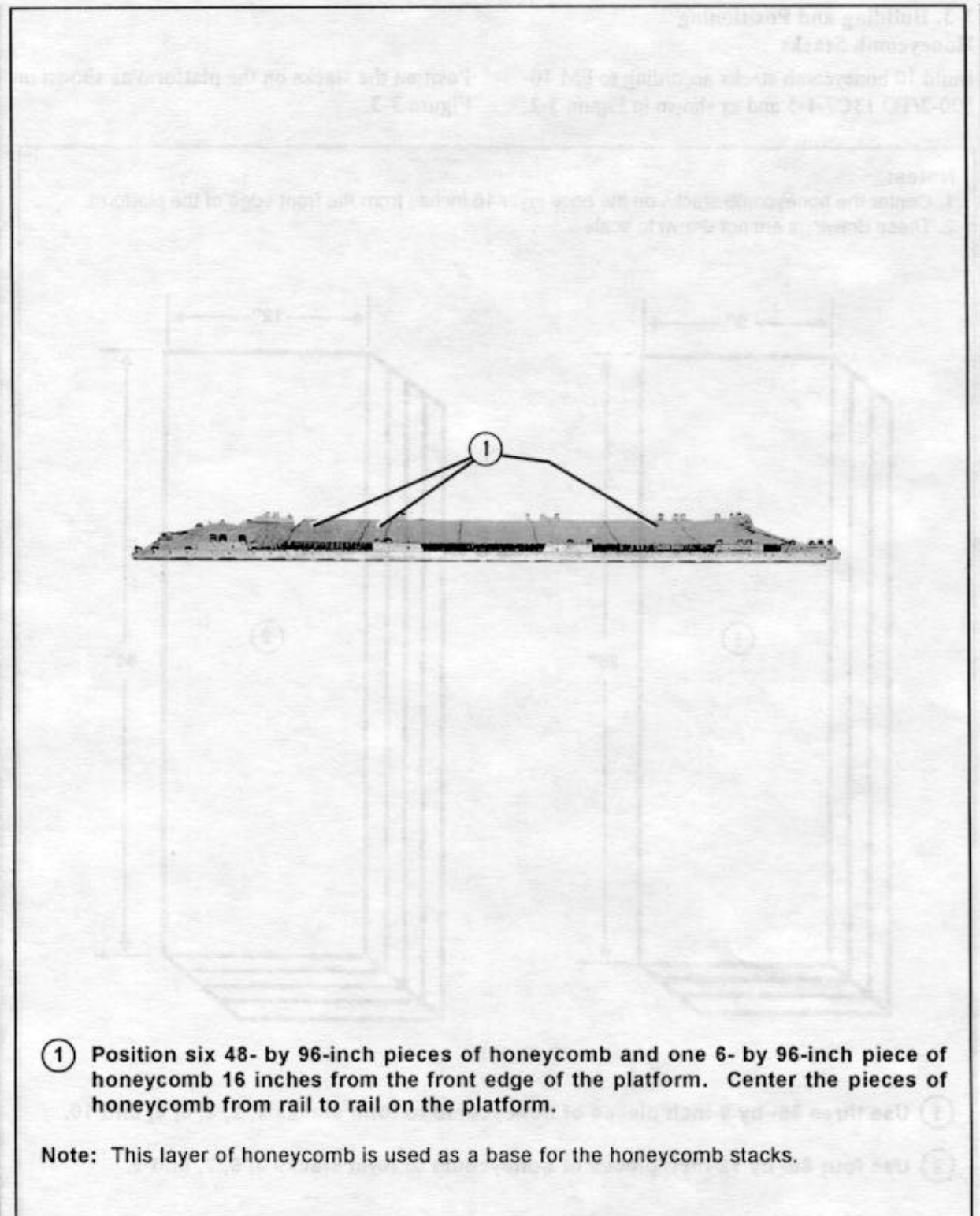

- ① Position six 48- by 96-inch pieces of honeycomb and one 6- by 96-inch piece of honeycomb 16 inches from the front edge of the platform. Center the pieces of honeycomb from rail to rail on the platform.

**Note:** This layer of honeycomb is used as a base for the honeycomb stacks.

*Figure 3-3. Honeycomb stacks positioned*



Note: Boxes may vary in size and honeycomb stacks may have to be shifted.

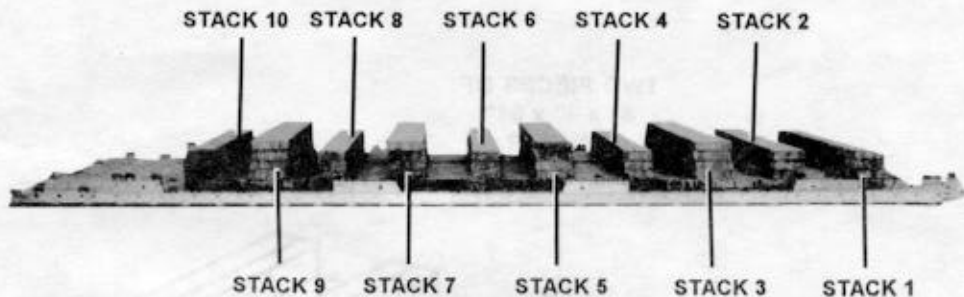

Stack Number	Position of Stack on Platform
	Place stack:
1	16 inches from the front edge of the platform.
2	18 inches from the rear of stack 1.
3	13 1/2 inches from the rear of stack 2.
4	14 inches from the rear of stack 3.
5	16 inches from the rear of stack 4.
6	12 inches from the rear of stack 5.
7	14 inches from the rear of stack 6.
8	13 inches from the rear of stack 7.
9	10 inches from the rear of stack 8.
10	11 inches from the rear of stack 9.

Figure 3-3. Honeycomb stacks positioned (continued)

### 3-4. Building Repair Kit Containers

Build four runway repair kit containers using the procedures shown in Figure 3-4.

**Note:** This drawing is not drawn to scale.

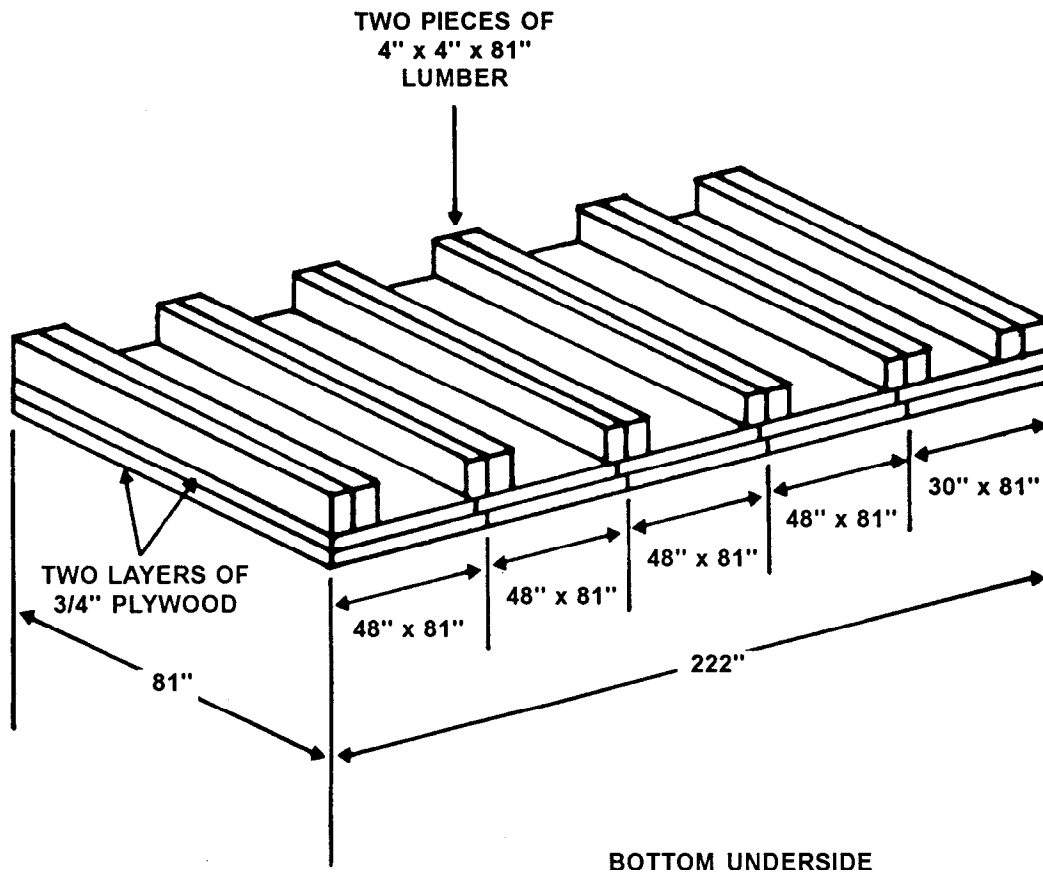

**Step:**

1. Place eight 3/4- by 81- by 48-inch pieces of plywood and two 3/4- by 81- by 30-inch pieces of plywood together on a flat surface to form two layers of plywood. Make sure the plywood layers are staggered.
2. Nail twelve 4- by 4- by 81-inch pieces of lumber to the layers of plywood using 10d nails. Space the lumber as shown above.

**Note:** Make sure the seams of the plywood are covered by the lumber.

*Figure 3-4. Repair kit containers built*

Note: These drawings are not drawn to scale.

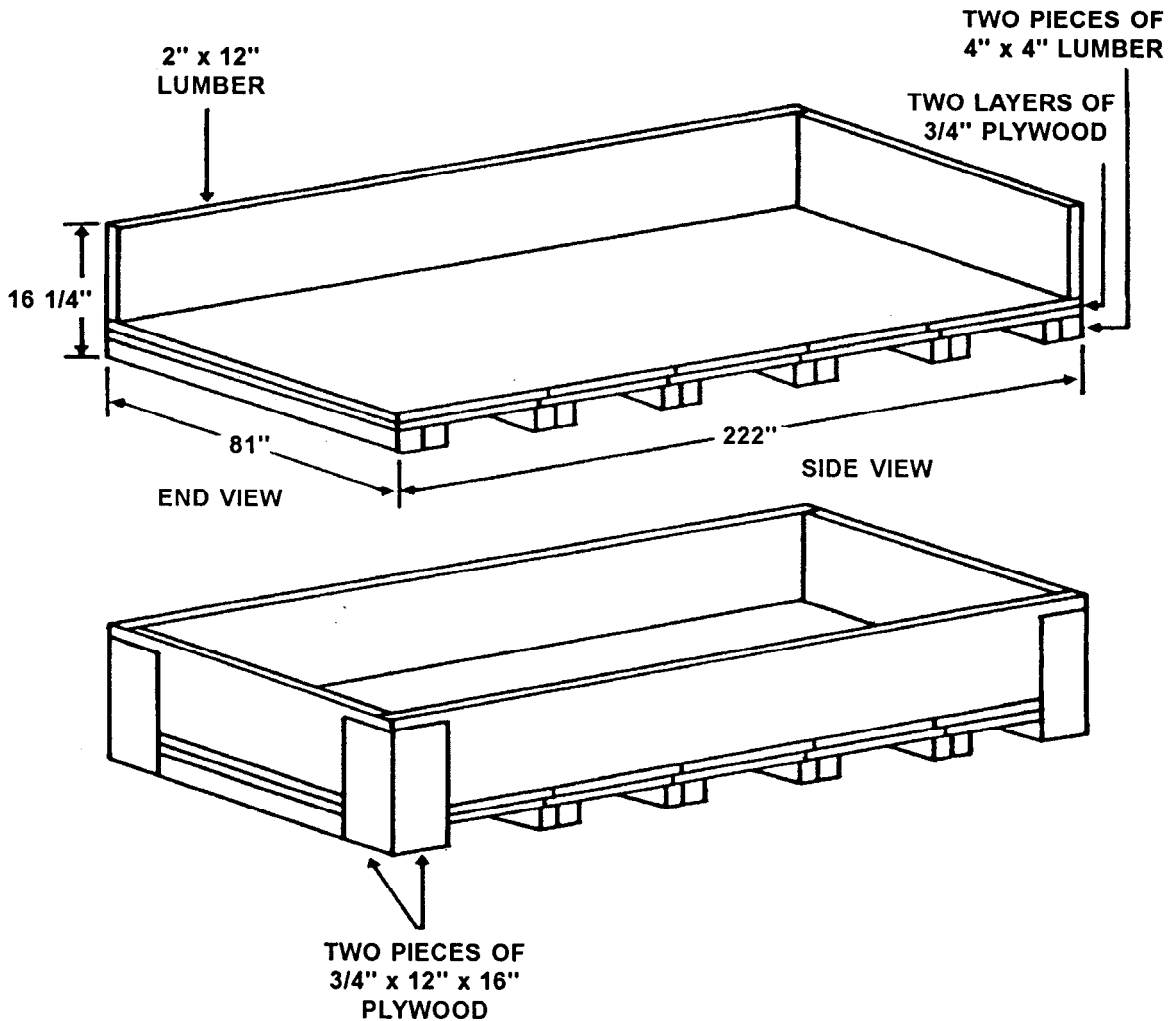

**Step:**

3. Build the sides and ends of the container as shown above using 2- by 12-inch pieces of lumber. Nail the lumber together and to the layers of plywood using 6d nails.

Note: Make sure the outside edges of the lumber are flush with the outside edges of the plywood.

4. Reinforce the joints of lumber together using 2- by 12-inch pieces of lumber (not shown).
5. Reinforce each outside corner of the container using two 3/4- by 12- by 16-inch pieces of plywood as shown above.

Figure 3-4. Repair kit containers built (continued)

Note: These drawings are not drawn to scale.

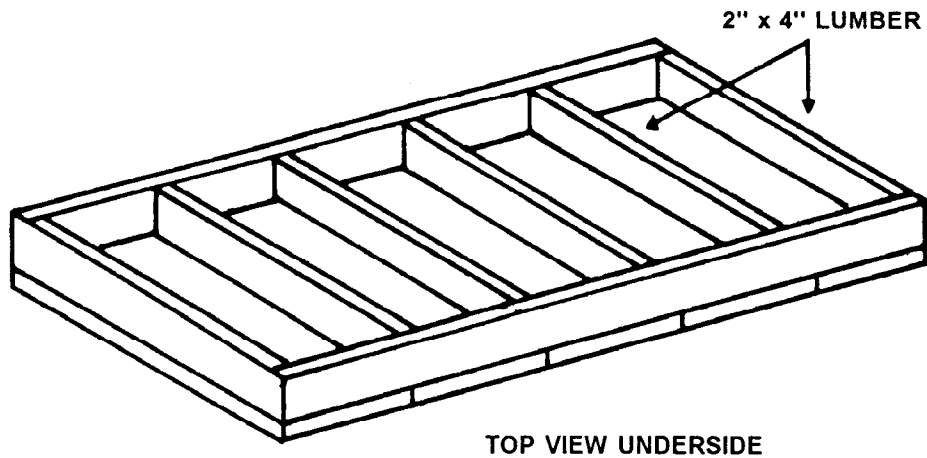
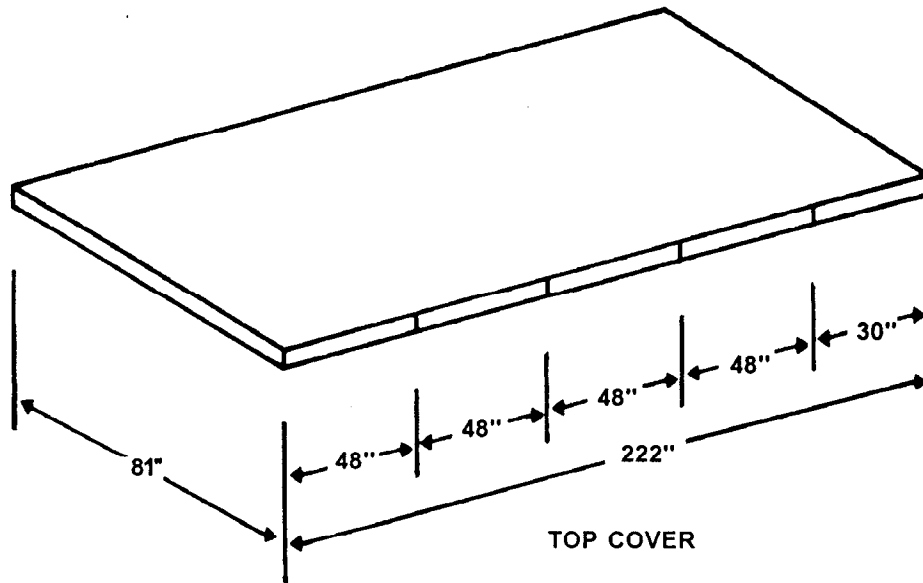

Step:

6. Place four 3/4- by 81- by 48-inch pieces of plywood and one 3/4- by 81- by 30-inch piece of plywood together on a flat surface to form the top cover.
7. Frame the inside of the top cover as shown above using 2- by 4-inch pieces of lumber nailed flat side down. Nail through the plywood into the lumber.

Figure 3-4. Repair kit containers built (continued)

**3-5. Positioning Repair Kits in Containers**

Position a runway repair kit in each of the containers as described in Table 3-1.

**Table 3-1. Items contained in the rapid runway repair kit**

Item	Quantity
Bolt, Hex 1- by 5/8-inch .....	60 each
Bolt, Exp 6- by 9/16-inch .....	30 each
Box, Wooden 12- by 30- by 4-inch .....	1 each
Broom .....	3 each
Cord, Outdoor Electric, 50-foot.....	1 each
Disk, Metal, Flat 3 1/2-inch .....	60 each
Disk, Metal, Beveled 3 1/2-inch .....	30 each
Gloves, Leather .....	11 pair
Grid, Sand Confinement .....	8 each
Hammer, Claw .....	2 each
Hammer, Rotary, TE-22 .....	2 each
Matting, Poly-Fiberglass .....	5 each
Nut, Hex 9/16-inch .....	30 each
Plastic Sheeting .....	2 rolls
Plier, Channel Lock .....	1 each
Rake .....	2 each
Rule, Red End Engineer, 6-foot.....	2 each
Rule, Tape Measure (KT12Y) .....	2 each
Screwdriver, F/T .....	2 each
Shovel .....	2 each
Socket Set, 7/16-inch through 1 1/4-inch .....	1 set
Strap, Nylon.....	1 each
Twine, Cotton, 3-ply .....	1 roll
Utility Knife .....	2 each
Washer, Bolt .....	29 each
Wrench, Adjustable 12-inch.....	2 each
Wrench, Plier, 7-inch .....	1 each
Wrench, 2-Prong .....	1 each

**Note:** Packing and accounting for the items in the containers is the responsibility of the owning unit.

### 3-6. Securing and Positioning Containers

Secure and position the containers as shown in Figure 3-5.

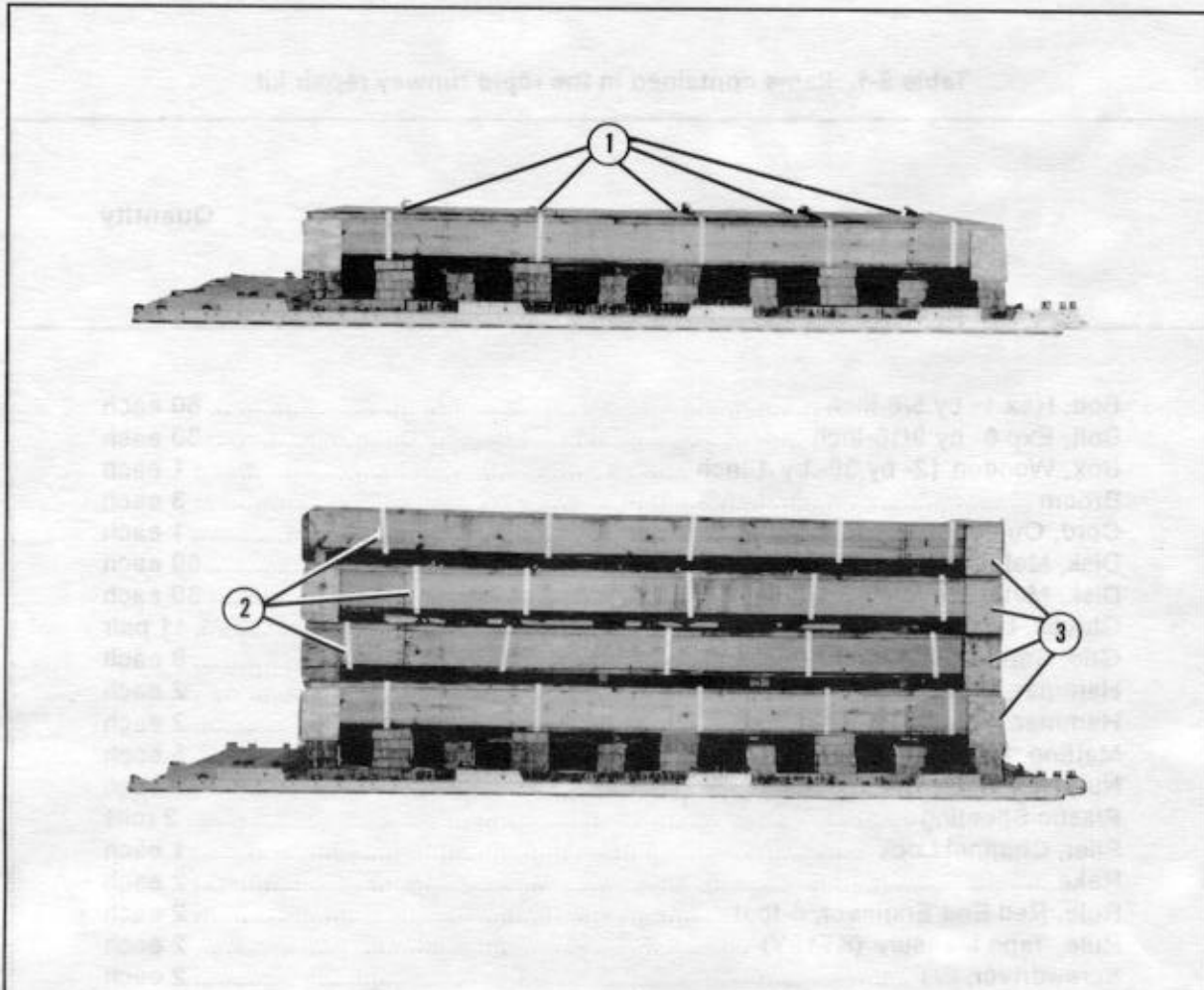

- ① Form five 30-foot lashings according to FM 10-500-2/TO 13C7-1-5. Pass the lashings around the container as shown above. Secure the ends of the lashings with load binders and D-rings. Lift the containers onto the platform using an adequate lifting device.
- ② Repeat step 1 for the other three containers.
- ③ Position the containers on the honeycomb stacks squarely with no overhang.

**Note:** Strapping, steel 5/8-inch may be used in place of the 30-foot lashings.

*Figure 3-5. Containers secured and positioned*

**3-7. Building, Positioning and Securing Front and Rear Endboards**

Build the front and rear endboards as shown in Figures 3-6 and 3-7. Position and secure the endboards as shown in Figure 3-8. Each endboard

is a double thickness of 3/4-inch plywood. Nail the outside layer to the inside layer of each endboard.

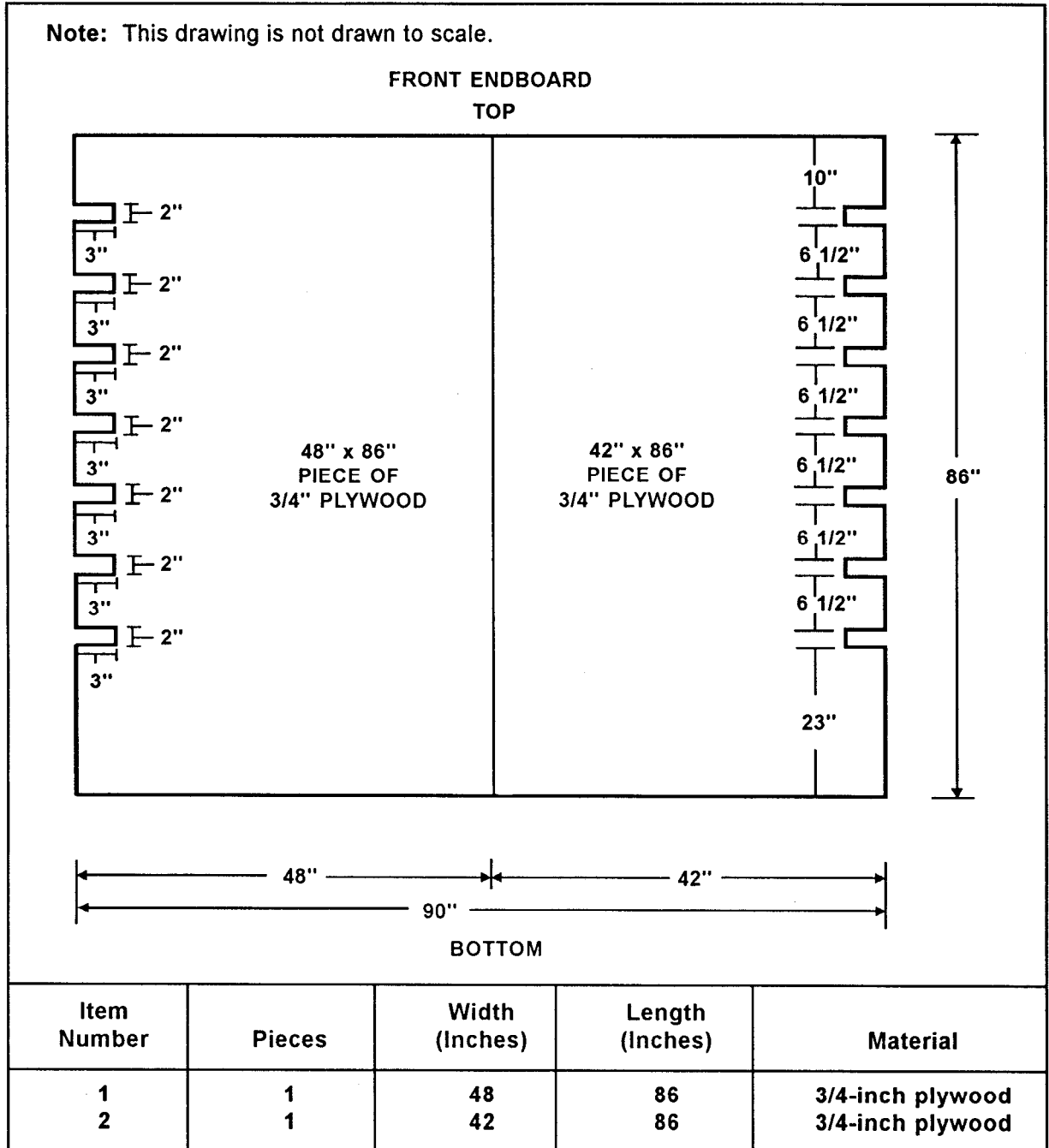
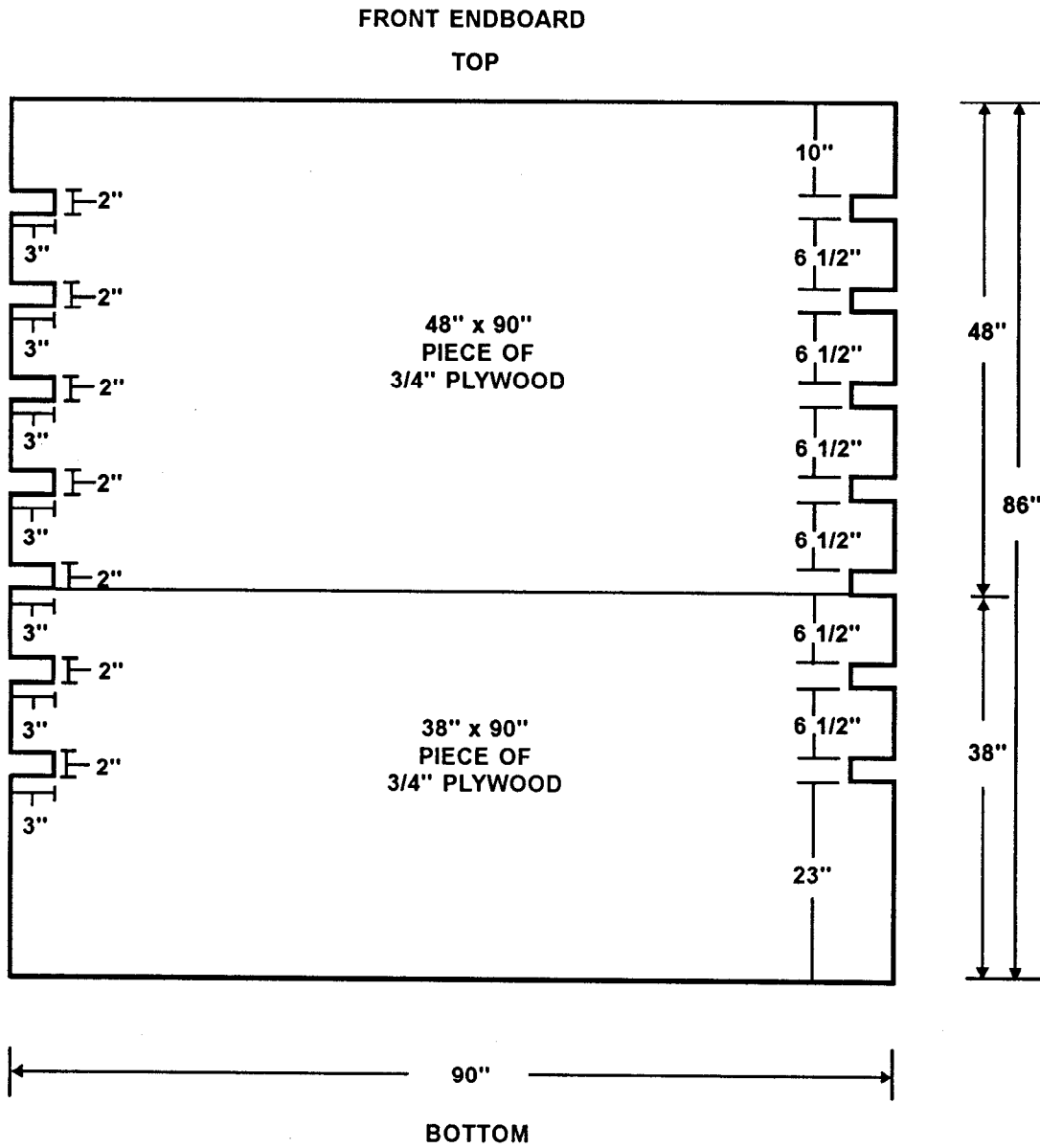

Figure 3-6. Materials required to build front endboard

Note: This drawing is not drawn to scale.



Item Number	Pieces	Width (Inches)	Length (Inches)	Material
3	1	48	90	3/4-inch plywood
4	1	38	90	3/4-inch plywood

Figure 3-6. Materials required to build front endboard (continued)



Note: This drawing is not drawn to scale.

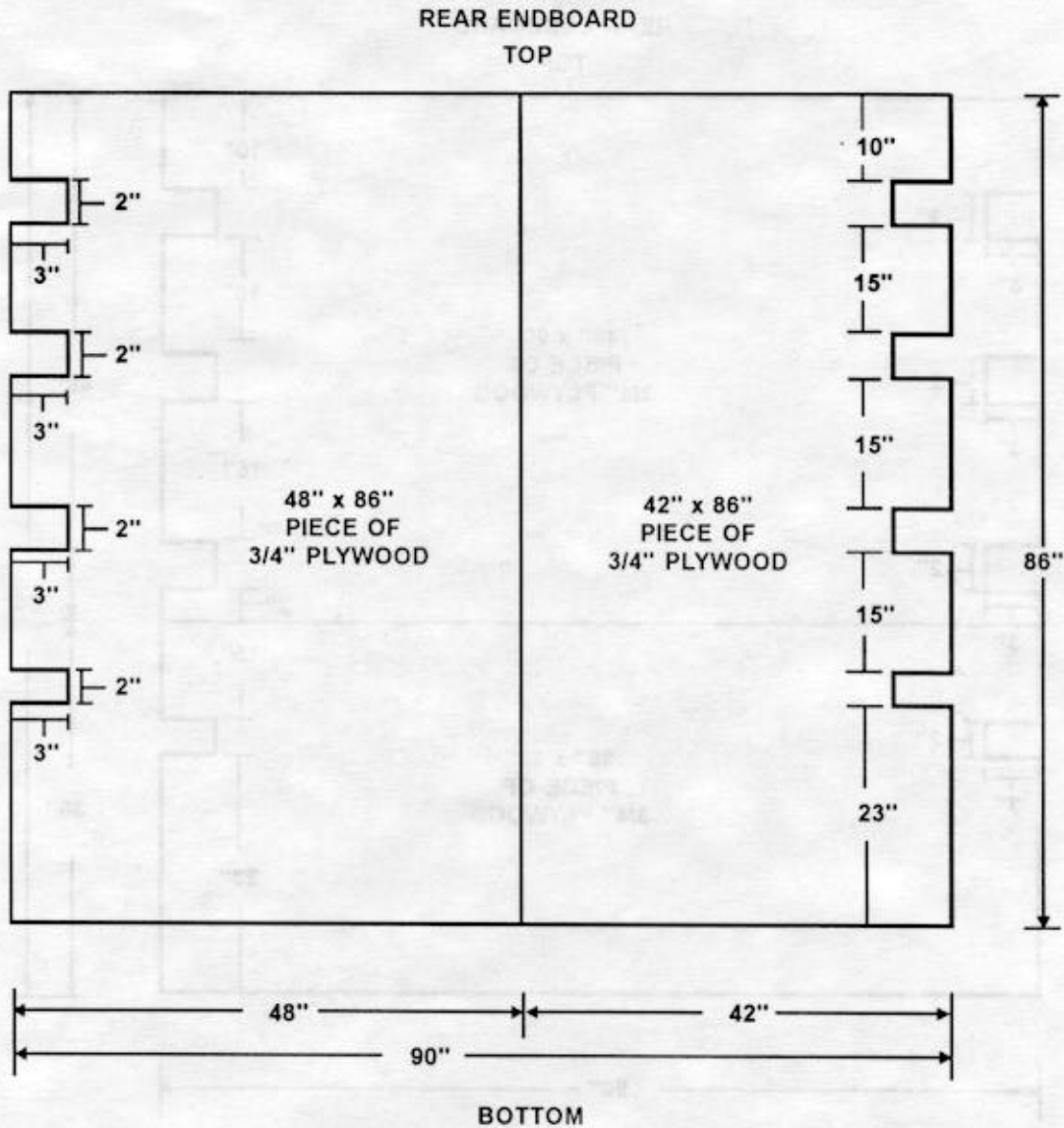

Item Number	Pieces	Width (Inches)	Length (Inches)	Material
1	1	48	86	3/4-inch plywood
2	1	42	86	3/4-inch plywood

Figure 3-7. Materials required to build rear endboard



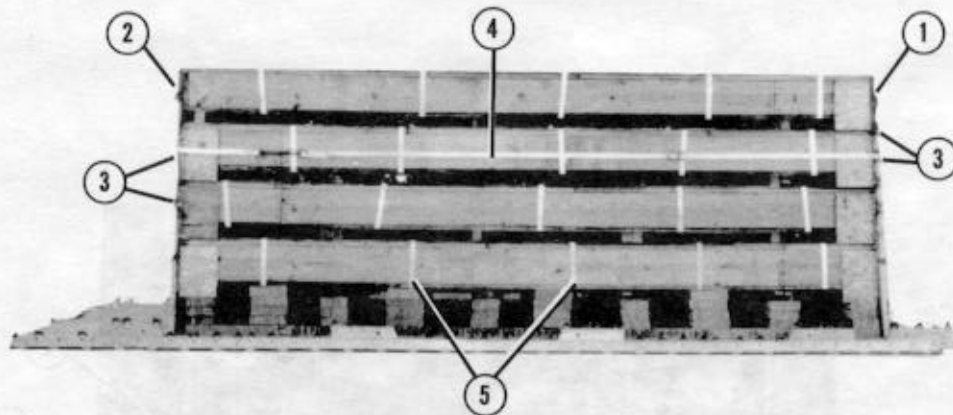

- ① Place the seven notch endboard on the front of the platform.
- ② Place the four notch endboard on the rear of the platform against the load.
- ③ Pad the second and third notches from the top of each endboard.
- ④ Form a 75-foot lashing according to FM 10-500-2/TO 13C7-1-5. Run the lashing through the second set of cutouts to hold the endboards in place. Secure the lashing with a loadbinder and two D-rings.
- ⑤ Form five 30-foot lashings according to FM 10-500-2/TO 13C7-1-5. Pass each lashing over the top and around the containers. Secure each of the lashings on top of the containers with a loadbinder and two D-rings.

Note: A 75-foot length of type III nylon cord may be used in place of the 75-foot lashing.

Figure 3-8. Endboards positioned and secured

### 3-8. Installing Lashings

Lash the load to the platform as shown in Figure 3-9 and form 30-foot through 90-foot lashings according to FM 10-500-2/TO 13C7-1-5.

**Note:** Notches are numbered 1 through 7, top to bottom on the front endboard.

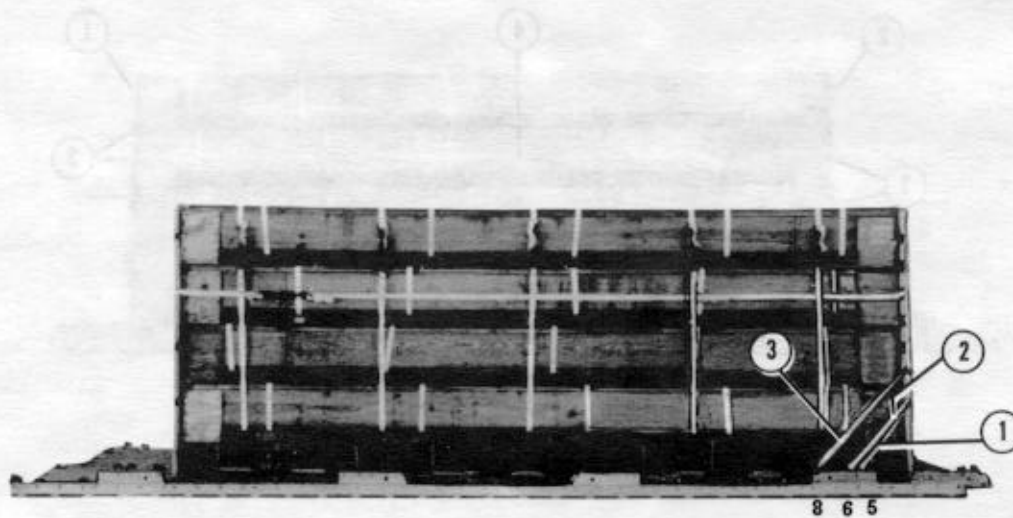

Lashing Number	Tie-down Clevis Number	Instructions
*1	5 and 5A	Install lashing: Through notch 7. Secure lashing on front of endboard. Through notch 7. Secure lashing on front of endboard. Through notch 6. Secure lashing on front of endboard.
*2	6 and 6A	
*3	8 and 8A	
*30-foot lashing		

Figure 3-9. Lashings installed

**Note:** Notches are numbered 1 through 7, top to bottom on the front endboard.

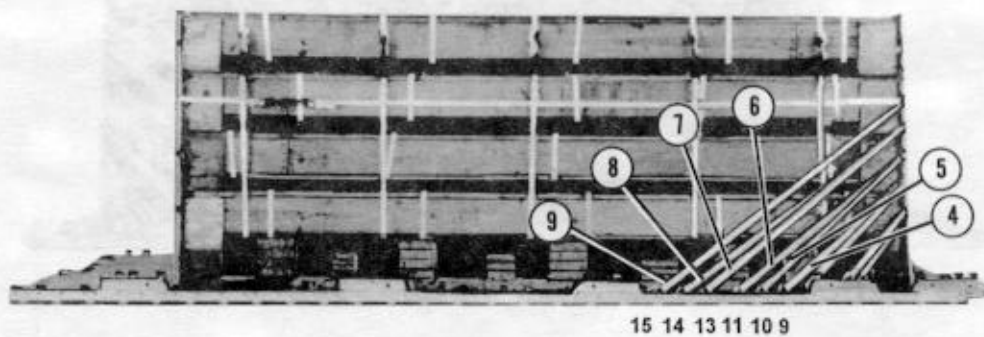

Lashing Number	Tie-down Clevis Number	Instructions
**4	9 and 9A	Install lashing: Through notch 6. Secure lashing on front of endboard.
**5	10 and 10A	Through notch 5. Secure lashing on front of endboard.
**6	11 and 11A	Through notch 5. Secure lashing on front of endboard.
**7	13 and 13A	Through notch 4. Secure lashing on front of endboard.
**8	14 and 14A	Through notch 4. Secure lashing on front of endboard.
**9	15 and 15A	Through notch 3. Secure lashing on front of endboard.
**45-foot lashing		

Figure 3-9. Lashings installed (continued)



**Note:** Notches are numbered 1 through 7, top to bottom on the front endboard.

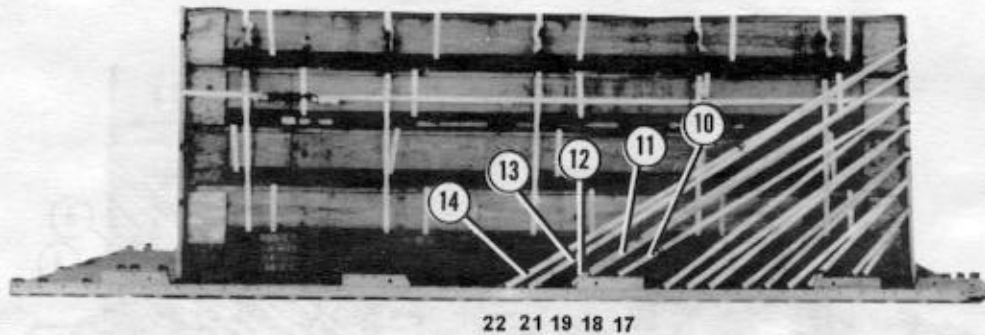

Lashing Number	Tie-down Clevis Number	Instructions
***10	17 and 17A	Install lashing: Through notch 3. Secure lashing on front of endboard.
***11	18 and 18A	Through notch 2. Secure lashing on front of endboard.
***12	19 and 19A	Through notch 2. Secure lashing on front of endboard.
***13	21 and 21A	Through notch 1. Secure lashing on front of endboard.
***14	22 and 22A	Through notch 1. Secure lashing on front of endboard.
***60-foot lashing		

Figure 3-9. Lashings installed (continued)

**Note:** Notches are numbered 1 through 4, top to bottom on the rear endboard.

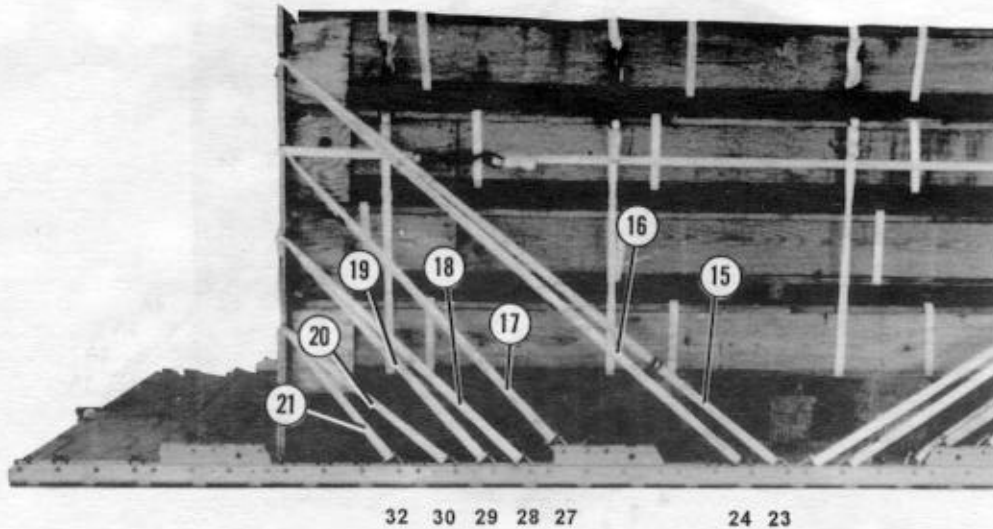

Lashing Number	Tie-down Clevis Number	Instructions
***15	23 and 23A	Install lashing: Through notch 1. Secure lashing on rear of endboard.
***16	24 and 24A	Through notch 1. Secure lashing on rear of endboard.
**17	27 and 27A	Through notch 2. Secure lashing on rear of endboard.
**18	28 and 28A	Through notch 3. Secure lashing on rear of endboard.
**19	29 and 29A	Through notch 3. Secure lashing on rear of endboard.
*20	30 and 30A	Through notch 4. Secure lashing on rear of endboard.
*21	32 and 32A	Through notch 4. Secure lashing on rear of endboard.
*30-foot lashing **45-foot lashing ***60-foot lashing		

Figure 3-9. Lashings installed (continued)

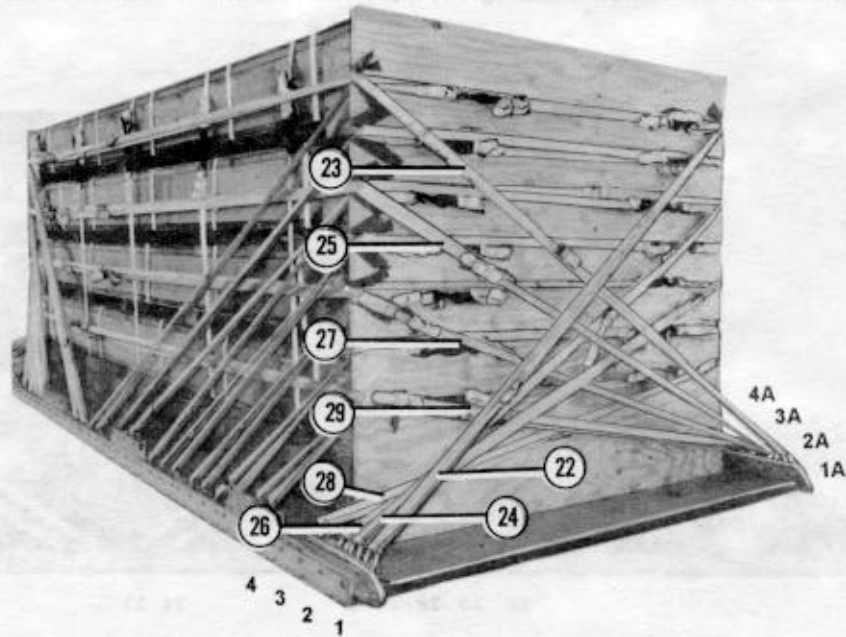

Lashing Number	Tie-down Clevis Number	Instructions
****22	1 and 37	Install lashing: Through front endboard notch 1, around the load, through rear endboard notch 1, and to clevis 37.
****23	1A and 37A	Through front endboard notch 1, around the load, through rear endboard notch 1, and to clevis 37A.
****24	2 and 36	Through front endboard notch 3, around the load, through rear endboard notch 2, and to clevis 36.
****25	2A and 36A	Through front endboard notch 3, around the load, through rear endboard notch 2, and to clevis 36A.
****26	3 and 35	Through front endboard notch 5, around the load, through rear endboard notch 3, and to clevis 35.
****27	3A and 35A	Through front endboard notch 5, around the load, through rear endboard notch 3, and to clevis 35A.
****28	4 and 34	Through front endboard notch 6, around the load, through rear endboard notch 4, and to clevis 34.
****29	4A and 34A	Through front endboard notch 6, around the load, through rear endboard notch 4, and to clevis 34A.
****90-foot lashing		

Figure 3-9. Lashings installed (continued)



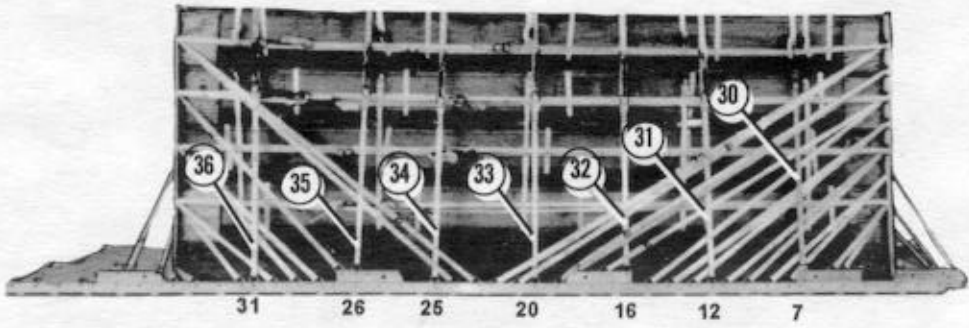

Lashing Number	Tie-down Clevis Number	Instructions
**30	7 to 7A	Install lashing: Through clevis 7, over top of the load, to clevis 7A.
**31	12 to 12A	Through clevis 12, over top of the load, to clevis 12A.
**32	16 to 16A	Through clevis 16, over top of the load, to clevis 16A.
**33	20 to 20A	Through clevis 20, over top of the load, to clevis 20A.
**34	25 to 25A	Through clevis 25, over top of the load, to clevis 25A.
**35	26 to 26A	Through clevis 26, over top of the load, to clevis 26A.
**36	31 to 31A	Through clevis 31, over top of the load, to clevis 31A.
**45-foot lashing		

Figure 3-9. Lashings installed (continued)

### 3-9. Installing Suspension Slings.

Install the suspension slings as shown in Figure 3-10.

**Note:** When attaching the free end of the sling, a four-point link may be used in place of the three-point link.

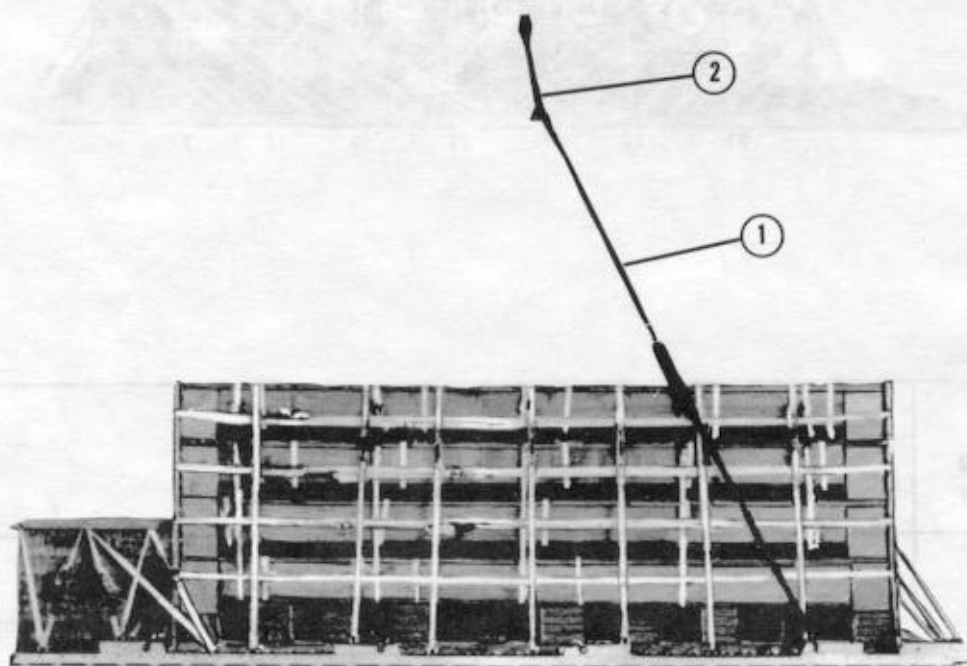

- ① Attach a 16-foot (4-loop), type XXVI nylon webbing sling to the bell portion of a large suspension clevis. Bolt the large suspension clevis to the first suspension link on the right side of the platform. Attach the free end of the sling to a three-point link.
- ② Attach a 3-foot (4-loop), type XXVI nylon webbing sling to the top spacer of the three-point link.

Figure 3-10. Suspension slings installed

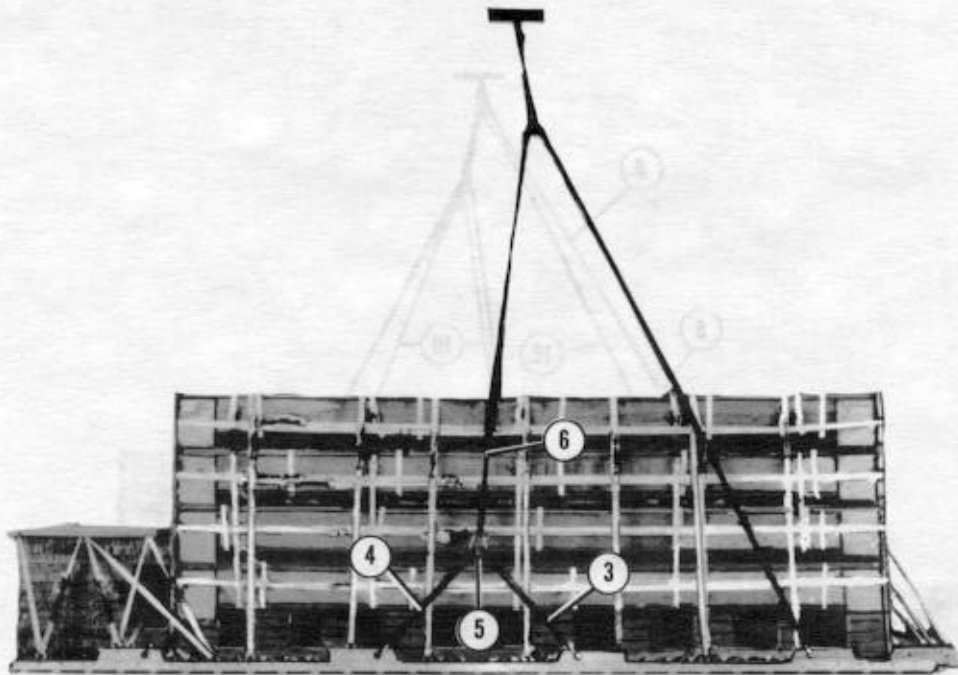

- ③ Attach a 3-foot (4-loop), type XXVI nylon webbing sling to the bell portion of a large suspension clevis. Bolt the large suspension clevis to the second suspension link on the right side of the platform.
- ④ Attach a 3-foot (4-loop), type XXVI nylon webbing sling to the bell portion of a large suspension clevis. Bolt the large suspension clevis to the third suspension link on the right side of the platform.
- ⑤ Attach the free ends of both 3-foot slings to the bell portion of a large suspension clevis on the right side of the platform.
- ⑥ Attach a 12-foot (4-loop), type XXVI nylon webbing sling around the bolt portion of the large suspension clevis used in step 5. Attach the free end of the sling to the three-point link or four-point link.

*Figure 3-10. Suspension slings installed (continued)*

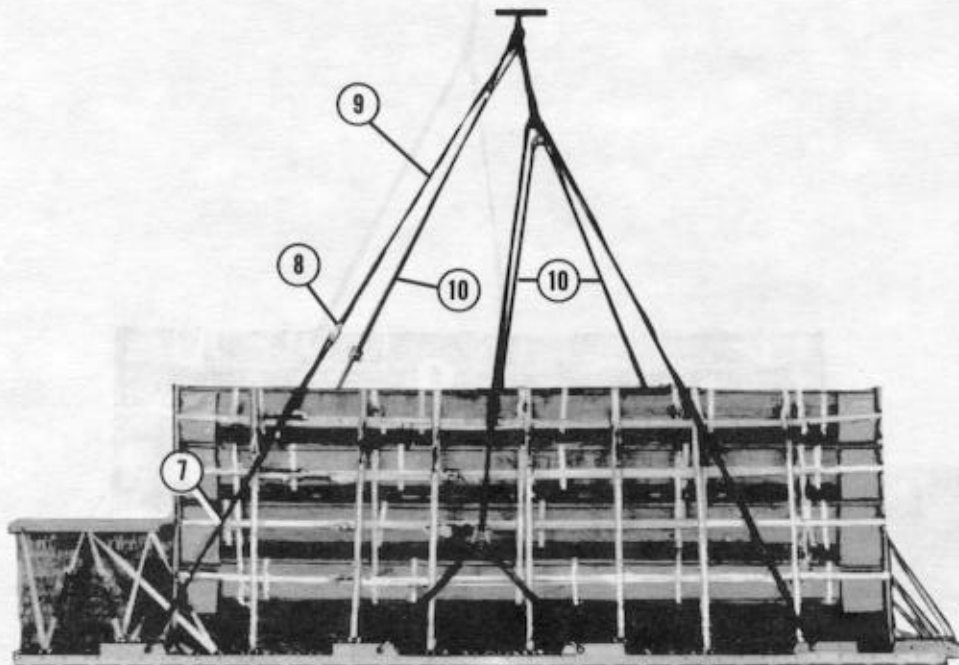

- ⑦ Attach a 9-foot (4-loop), type XXVI nylon webbing sling to the bell portion of a large suspension clevis. Attach the suspension clevis to the fourth suspension link.
- ⑧ Attach a 3 3/4-inch two-point link to the free end of the 9-foot sling.
- ⑨ Attach an 11-foot (4-loop), type XXVI nylon webbing sling to the free end of the 3 3/4-inch two-point link.
- ⑩ Repeat steps 1 through 9 for the left side of the platform.

Figure 3-10. Suspension slings installed (continued)

### 3-10. Safeying Suspension Slings

Safety the suspension slings according to FM 10-500-2/TO 13C7-1-5 and as shown in Figure 3-11.

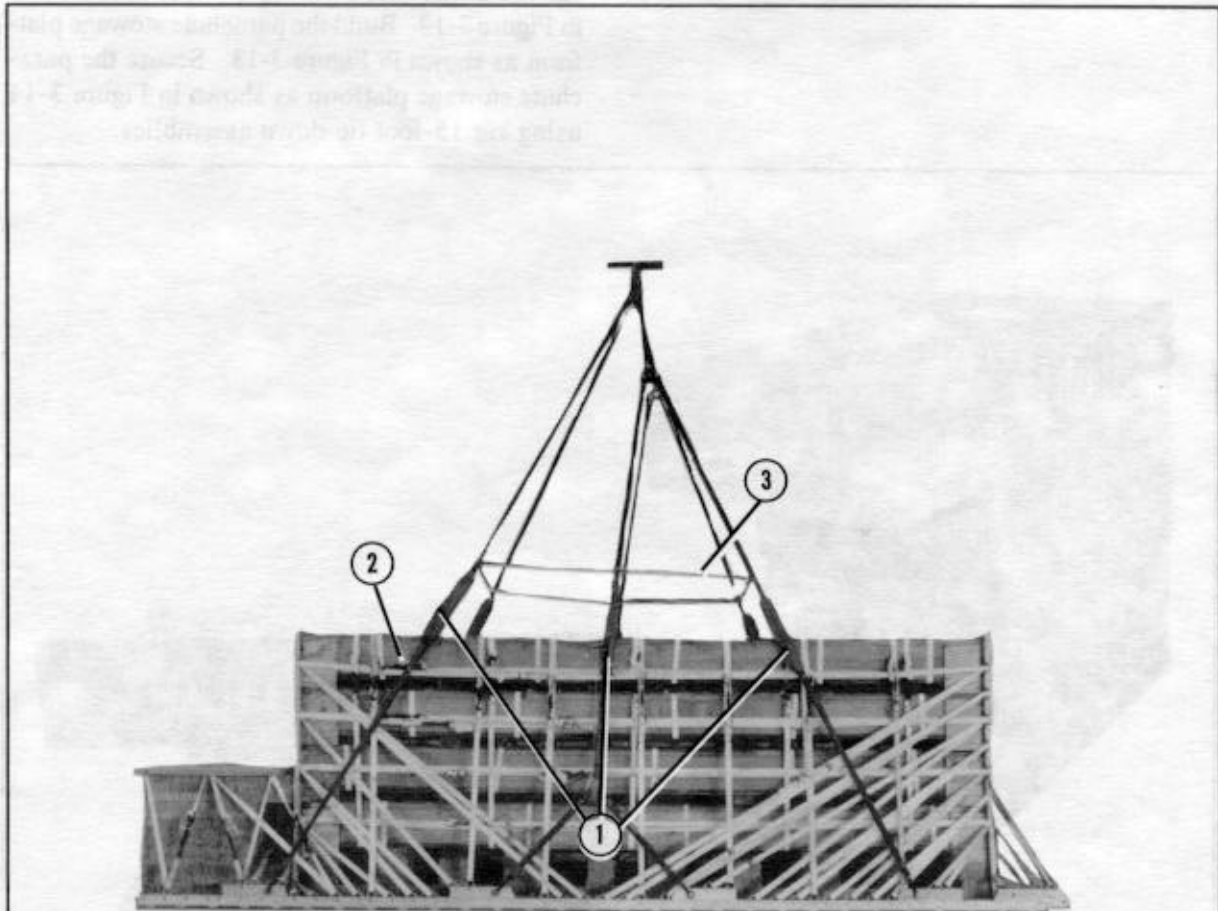

- ① Wrap the slings with felt and pressure-sensitive tape where the slings make contact with the load.
- ② Safety tie the slings across the load, from right to left using type III nylon cord.
- ③ Install a deadman's tie to the suspension slings according to FM 10-500-2/TO 13C7-1-5.

Figure 3-11. Suspension slings safetied



**3-11. Building, Positioning, and Securing Parachute Stowage Platform**

Build and position two honeycomb supports for the parachute stowage platform as shown in Figure 3-12. Build the parachute stowage platform as shown in Figure 3-13. Secure the parachute stowage platform as shown in Figure 3-14 using six 15-foot tie-down assemblies.

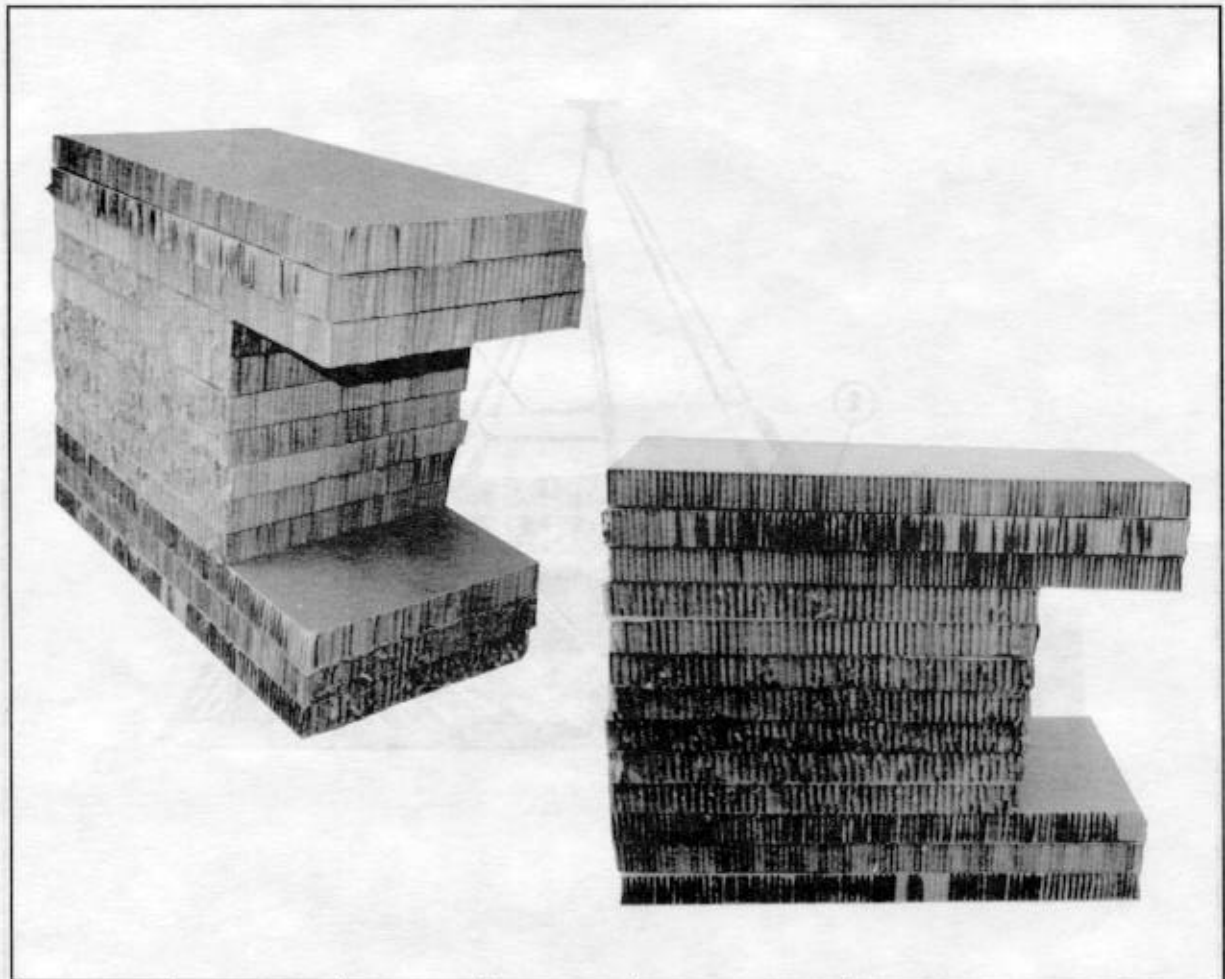

Stack	Width (inches)	Length (inches)	Pieces	Material	Instructions
1 and 2	24	48	3	Honeycomb	Form as base.
	24	36	7	Honeycomb	Place on rear of base.
	24	48	3	Honeycomb	Place on 36-inch pieces of honeycomb.

Figure 3-12. Honeycomb supports built and positioned

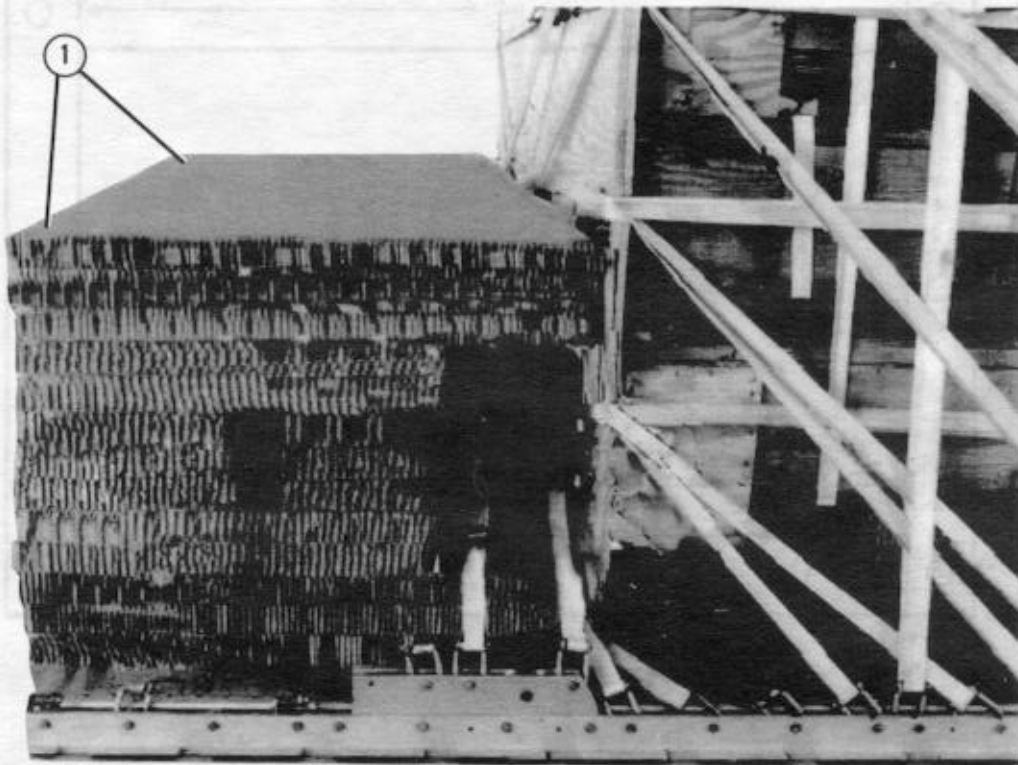

- ① Position stack 1 and 2 on the rear of the platform, flush against the rear of the load.

*Figure 3-12. Honeycomb supports built and positioned (continued)*

Note: This drawing is not drawn to scale.

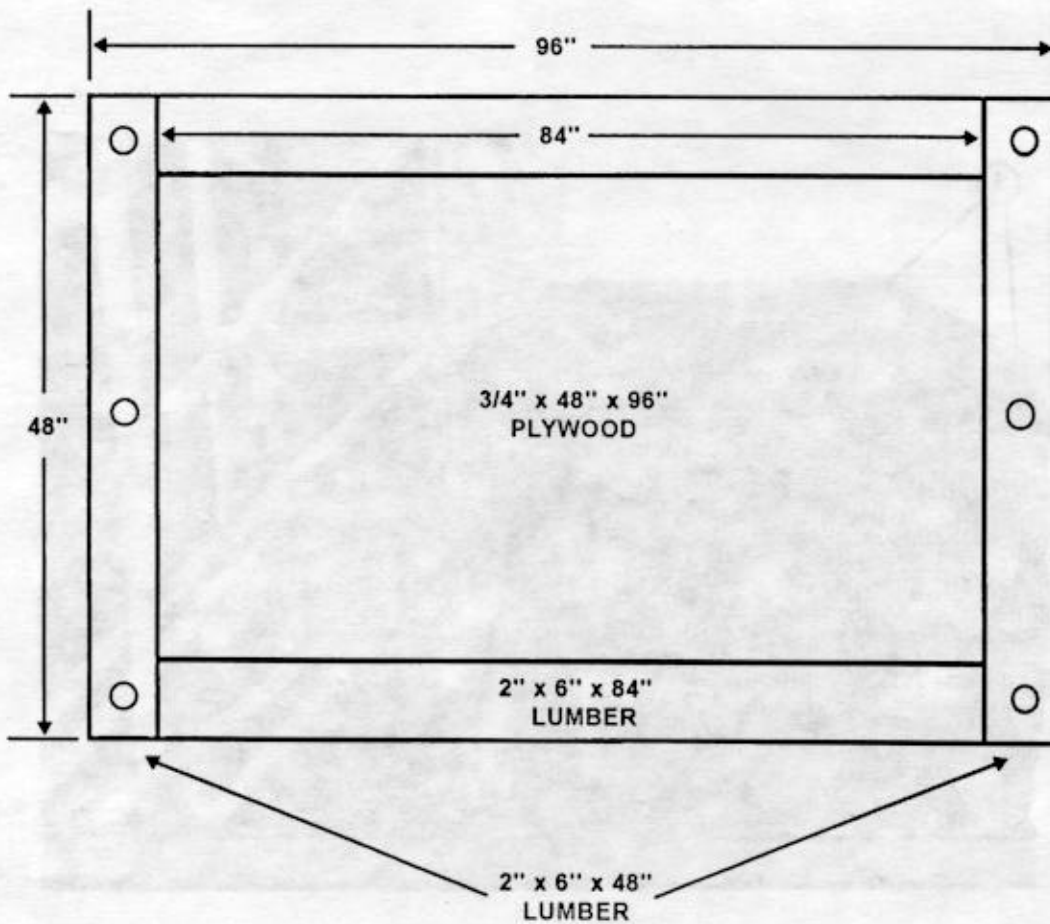

Item Number	Pieces	Width (Inches)	Length (Inches)	Material
1	1	96	48	3/4-inch plywood
2	2	6	48	2- by 6- inch lumber
3	2	6	84	2- by 6- inch lumber

Figure 3-13. Parachute stowage platform built



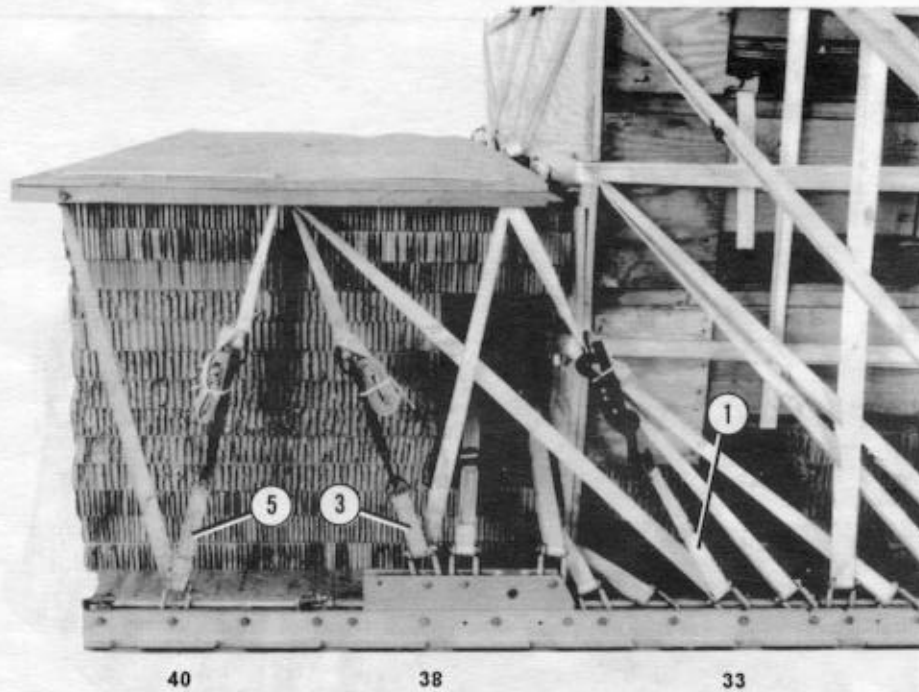

Lashing Number	Tie-down Clevis Number	Instructions
1	33	Pass lashing: Through center hole and then through rear hole of parachute stowage platform, right side.
2	33A	Through center hole and then through rear hole of parachute stowage platform, left side.
3	38	Through rear hole and then through center hole of parachute stowage platform, right side.
4	38A	Through rear hole and then through center hole of parachute stowage platform, left side.
5	40	Through front hole and then through center hole of parachute stowage platform, right side.
6	40A	Through front hole and then through center hole of parachute stowage platform, left side.

Figure 3-14. Parachute stowage platform secured

### 3-12. Stowing Cargo Parachutes

Stow five G-11C cargo parachutes on the parachute stowage platform as shown in Figure 3-15.

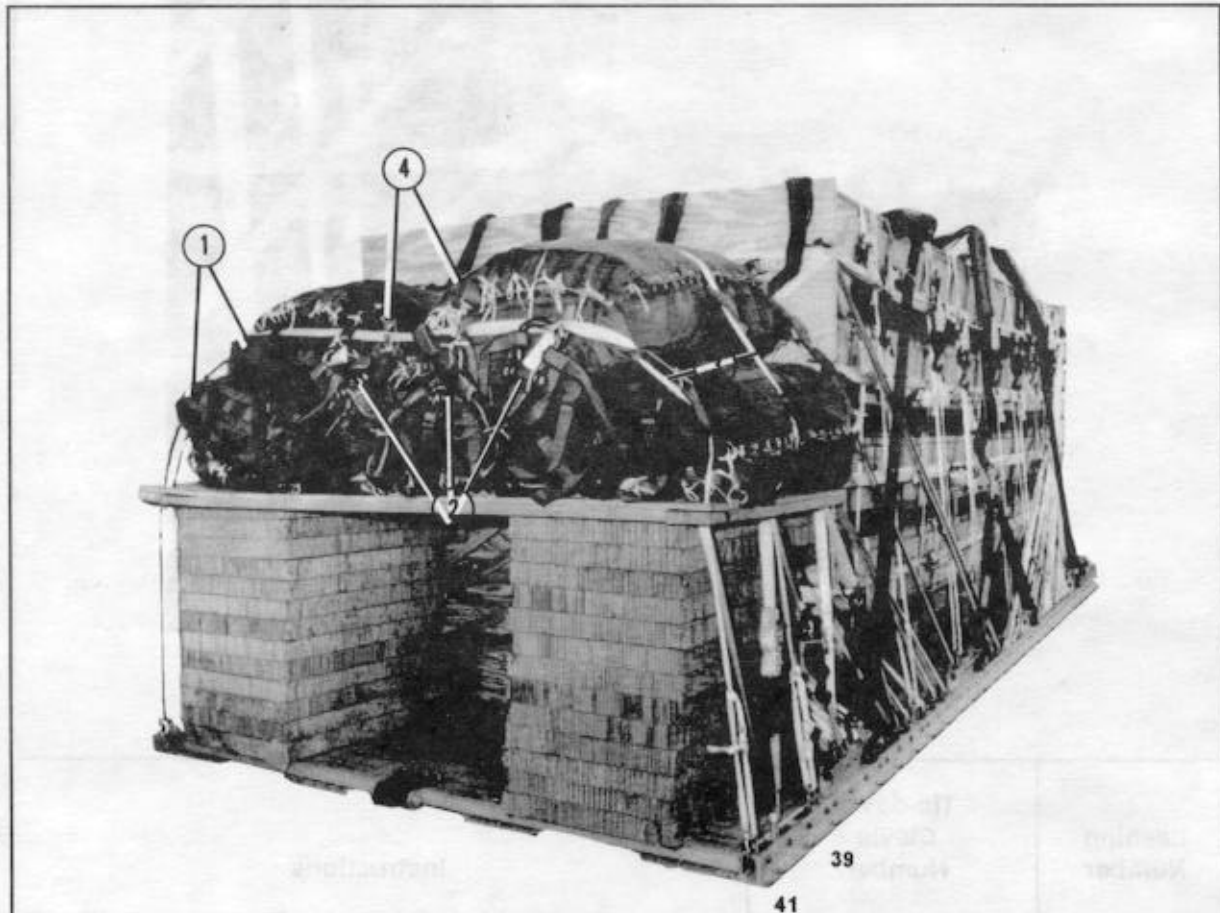

- ① Stow five G-11C cargo parachutes according to FM 10-500-2/TO 13C7-1-5.
- ② Group the bridle assemblies as shown in FM 10-500-2/TO 13C7-1-5.
- ③ Restrain the cargo parachutes to the platform using two lengths of type VIII nylon webbing according to FM 10-500-2/TO 13C7-1-5. Tie the ends of the webbing to platform clevises 39 and 39A and 41 and 41A.
- ④ Install two multicut parachute release straps according to FM 10-500-2/TO 13C71-5.

Figure 3-15. Parachutes stowed

### 3-13. Installing Release System

Prepare and install the M-2 release system according to FM 10-500-2/TO 13C7-1-5 and as shown in Figure 3-16.

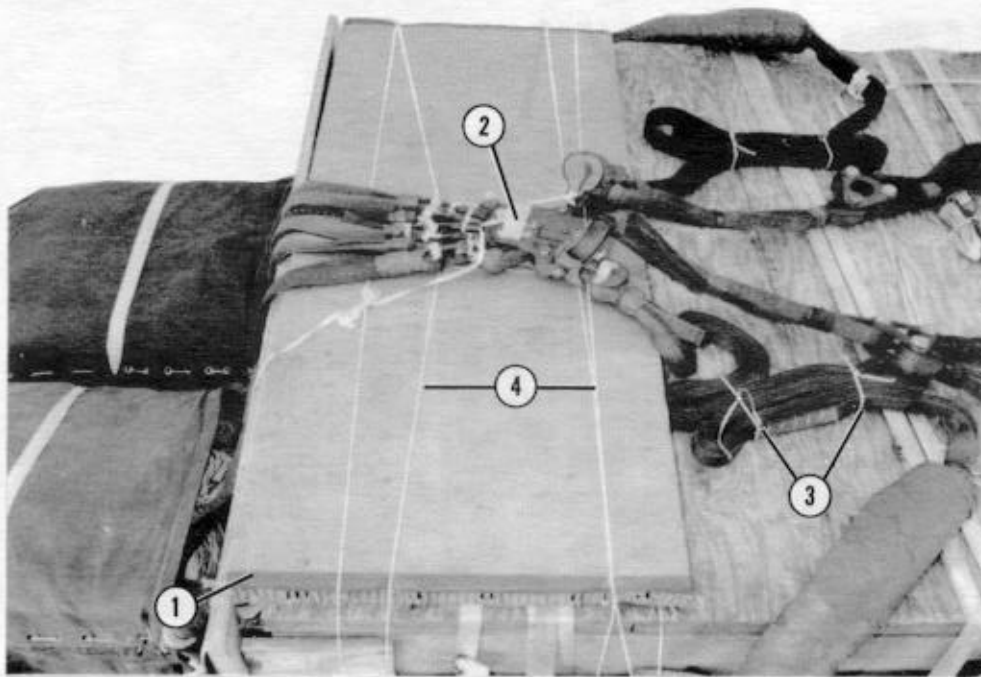

- ① Place a 36- by 84-inch piece of honeycomb on top of the load. Tape the edges of the honeycomb with pressure-sensitive tape and secure with type III nylon cord to convenient points on the platform.
- ② Prepare an M-2 cargo release assembly according to FM 10-500-2/TO 13C7-1-5. Place the M-2 release on the honeycomb and attach the release to the suspension slings and the cargo parachutes according to FM 10-500-2/TO 13C7-1-5.
- ③ Fold the suspension slings. Secure the folds with lengths of type I, 1/4-inch cotton webbing.
- ④ Secure the top and bottom of the M-2 cargo parachute release according to FM 10-500-2/TO 13C7-1-5.

Figure 3-16. Release system installed

### 3-14. Installing Extraction System

Prepare and install the EFTC extraction system according to FM 10-500-2/TO 13C7-1-5 and as shown in Figures 3-17 and 3-18.

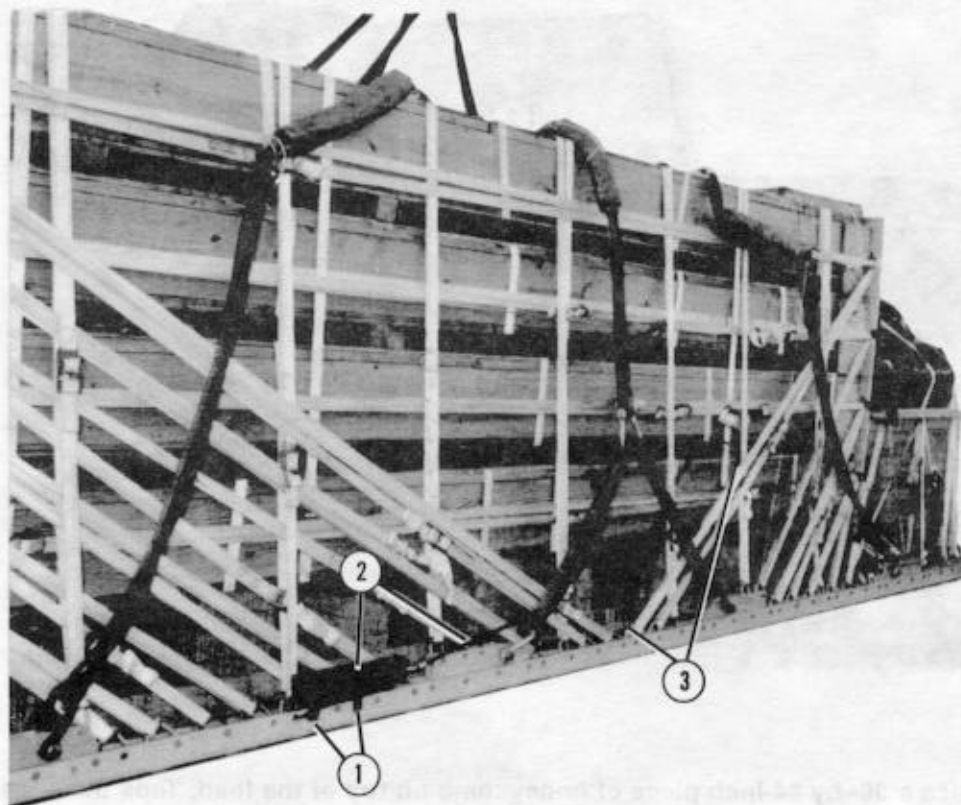

- ① Attach the EFTA mounting brackets to the rear mounting holes on the left platform side rail.
- ② Install the actuator to the EFTA mounting brackets with a 24-foot cable.
- ③ Safety the 24-foot cable to the lashings along the left platform side rail using lengths of type I, 1/4-inch cotton webbing.

*Figure 3-17. Actuator and cable installed*



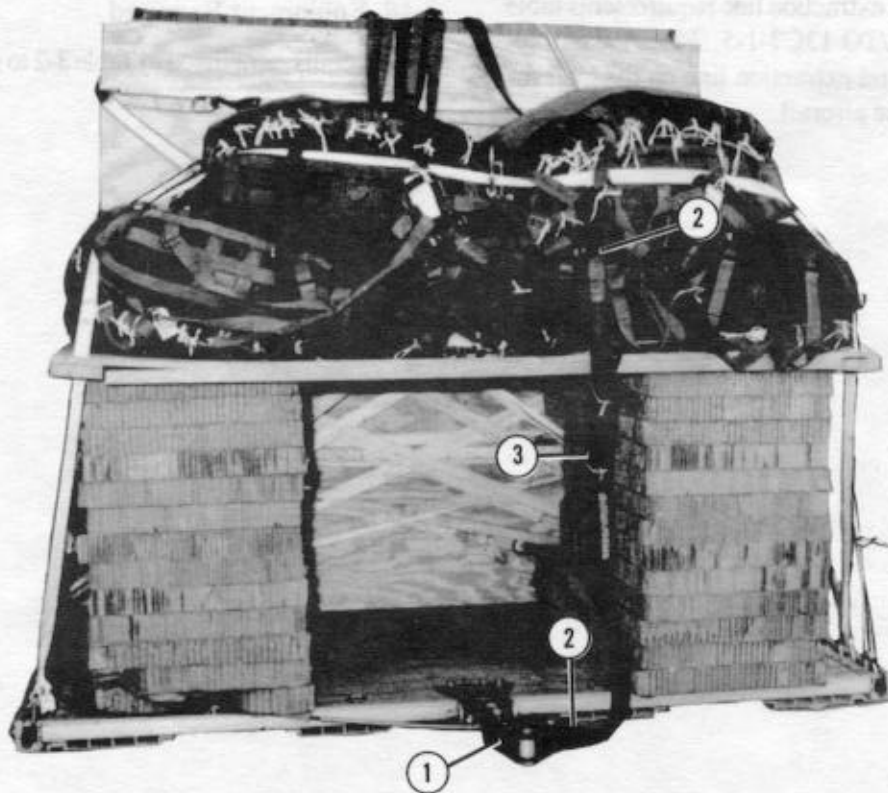

- ① Attach the latch assembly and adapter to the extraction bracket according to FM 10-500-2/TO 13C7-1-5.
- ② Connect one end of a 12-foot (2-loop), type XXVI nylon webbing sling as a deployment line to the right spacer of the link assembly. Connect the free end of the deployment line to the center large clevis on the 3-foot clustering clevis.
- ③ Fold the excess deployment line. Secure the folds with type I, 1/4-inch cotton webbing.

*Figure 3-18. Extraction system installed*

### 3-15. Installing Provisions for Emergency Restraints

Install provisions for emergency restraints according to FM 10-500-2/TO 13C7-1-5.

### 3-16. Placing Cargo Extraction Parachute

Select the extraction parachute and extraction line needed using the extraction line requirements table in FM 10-500-2/TO 13C7-1-5. Place the extraction parachute and extraction line on the load for installation in the aircraft.

### 3-17. Marking Rigged Load

Mark the rigged load according to FM 10-500-2/TO 13C7-1-5 and as shown in Figure 3-19. If the load varies from the one shown, the weight, height, tip-off curve, CB, and parachute requirements must be recomputed.

### 3-18. Equipment Required

Use the equipment listed in Table 3-2 to rig this load.



**CAUTION**  
 Make final rigger inspection required by FM 10-500-2/TO 13C7-1-5 before the load leaves the rigging site.

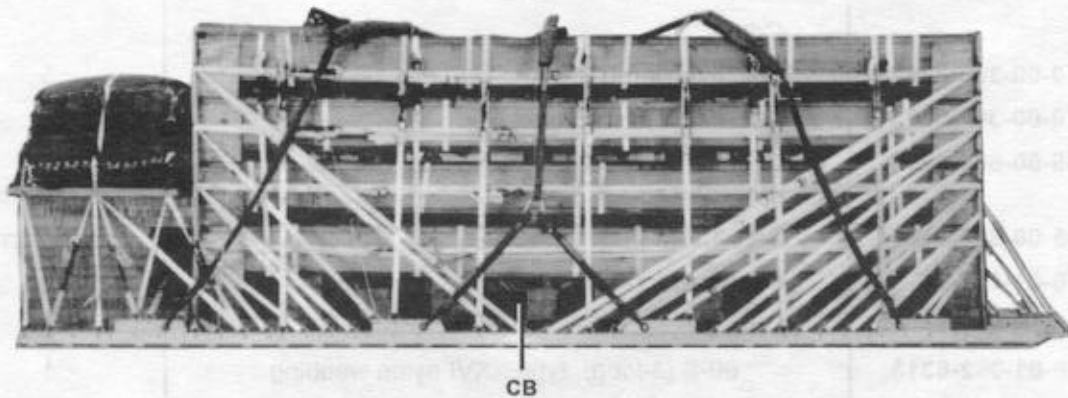

**RIGGED LOAD DATA**

Weight: Load shown .....	24,360 pounds
Maximum load allowed .....	26,250 pounds
Height .....	90 inches
Width .....	108 inches
Length .....	288 inches
Overhang: Front .....	0 inches
Rear .....	0 inches
CB (from front edge of platform) .....	136 inches
Extraction system (adds 18 inches to platform length) .....	EFTC

*Figure 3-19. Rapid runway repair kits rigged for low-velocity airdrop on a type V platform*

Table 3-2. Equipment required for rigging the rapid runway repair kit for low-velocity airdrop on a type V platform

National Stock Number	Item	Quantity
8040-00-273-8713	Adhesive, paste, 1-gal	As required
	Clevis, suspension:	
4030-00-090-5354	1-in (large)	11
4020-00-240-2146	Cord, nylon, type III, 550-lb	As required
1670-00-434-5782	Coupling, airdrop, extraction force transfer w/ 24-ft cable	1
	Cover:	
1670-00-360-0328	Clevis, large	5
1670-00-360-0329	Link assembly (type IV)	15
8135-00-664-6958	Cushioning material, packaging, cellulose wadding	As required
8305-00-958-3685	Felt, 1/2-in thick	As required
1670-01-183-2678	Leaf, extraction line	2
	Line, extraction:	
1670-01-062-6313	60-ft (3-loop), type XXVI nylon webbing	1
1670-01-107-7615	140-ft (3-loop), type XXVI nylon webbing	1
	Link assembly:	
	Two-point:	
5306-00-435-8994	Bolt, 1-in diam, 4-in long	4
5310-00-232-5165	Nut, 1-in, hexagonal	4
1670-00-003-1953	Plate, side, 3 3/4-in	4
1670-00-003-1954	Plate, side, 5 1/2-in	4
5365-00-007-3414	Spacer, large	4
1670-01-307-0155	Three-point	2
1670-00-783-5988	Type IV	15
	Lumber:	
5510-00-220-6146	2- by 4-in:	As required
5510-00-220-6148	2- by 6-in:	
	48	2
	84	2



Table 3-2. Equipment required for rigging the rapid runway repair kit for low-velocity airdrop on a type V platform (continued)

National Stock Number	Item	Quantity
5510-00-220-6148	4- by 4-in: 81	48
5315-00-010-4657	Nail, steel wire, common, 6d	As required
5315-00-010-4661	Nail, steel wire, common, 10d	As required
8135-00-283-0667	Strapping, steel 5/8-in	As required
1670-00-753-3928	Pad, energy-dissipating, honeycomb, 3- by 36- by 96-in 24- by 36-in 24- by 48-in 36- by 84-in 38- by 30-in 38- by 96-in 48- by 30-in 48- by 96-in 86- by 9-in 86- by 12-in	23 sheets (14) (12) (1) (1) (2) (1) (2) (15) (16)
1670-01-016-7841	Parachute: Cargo, G-11C	5
1670-00-262-1797	Cargo extraction: 28-ft or	1
1670-00-040-8135	28-ft, heavy-duty	1
	Platform, AD, type V, 32-ft:	1
	Bracket:	
1670-01-162-2375	Inside EFTA	(1)
1670-01-162-2374	Outside EFTA	(1)
1670-01-162-2372	Clevis assembly	(82)
1670-01-162-2376	Extraction bracket assembly	(1)
1670-01-247-2389	Suspension link	(8)
1670-01-162-2381	Tandem link	(2)

Table 3-2. Equipment required for rigging the rapid runway repair kit for low-velocity airdrop on a type V platform (continued)

National Stock Number	Item	Quantity
5530-00-128-4981	Plywood, 3/4-in: 12- by 16-in 43- by 90-in 45- by 86-in 81- by 30-in 81- by 48-in 96- by 48-in	62 sheets (16) (8) (8) (12) (48) (1)
1670-01-097-8817	Release, cargo parachute, M-2	1
	Sling, cargo airdrop: For deployment line:	
1670-01-062-6303	12-ft (2-loop), type XXVI nylon webbing	1
	For riser extensions:	
1670-01-062-6302	20-ft (2-loop), type XXVI nylon webbing	20
	For suspension slings:	
1670-01-062-6306	3-ft (4-loop), type XXVI nylon webbing	8
1670-01-062-6305	9-ft (4-loop), type XXVI nylon webbing	2
1670-01-062-6310	11-ft (4-loop), type XXVI nylon webbing	2
1670-01-062-6308	16-ft (4-loop), type XXVI nylon webbing	2
1670-00-040-8219	Strap, parachute release, multicut comes w 3 knives	2
8305-00-074-5124	Tape, adhesive, 2-in	As required
1670-00-937-0271	Tie-down assembly, 15-ft	199
	Webbing:	
8305-00-268-2411	Cotton, 1/4-in, type I	As required
	Nylon:	
	Tubular:	
8305-00-082-5752	1/2-in <u>or</u>	As required
8305-00-268-2453	1/2-in	As required
8305-00-263-3591	Type VIII	As required

## Section II

### RIGGING THE RAPID RUNWAY REPAIR KIT ON A 20-FOOT, TYPE V PLATFORM

#### 3-19. Description of Load

The rapid runway repair kit consists of fiberglass sheets, plastic supports, metal fittings and the tools to erect the structure. The load consists of two factory built wooden shipping boxes measuring 22 inches in height, 89 inches in width, 222 inches in length and weighing approximately 5,380 pounds. The kit contains no materials requiring special handling and is not fragile. The rapid runway repair kit is rigged with three G-11 cargo parachutes on a 20-foot, type V platform for low-velocity airdrop. It has a total rigged weight of 14,080 pounds, an 18 inch rear overhang and a center of balance of 124 inches from the front edge of the platform.

**Note:** The wooden shipping boxes can be locally fabricated as outlined in *Figure 3-4*.

#### 3-20. Preparing Platform

Prepare a 20-foot, type V platform as given below.

*a. Inspecting Platform.* Inspect, or assemble and inspect, the platform according to TM 10-1670-268-20&P/TO 13C7-52-22.

**Note:**

**If the platform must be assembled, install the suspension links when assembling the platform. See *Figure 3-20* for the location of the suspension links.**

*b. Installing Suspension Links.* Install four suspension links on the assembled platform according to FM 10-500-2/TO 13C7-1-5 and as shown in *Figure 3-20*.

*c. Installing Tandem Links.* Install two tandem links as shown in *Figure 3-20*.

*d. Attaching and Numbering Clevises.* Attach and number 38 clevis assemblies as shown in *Figure 3-20*.

- Notes: 1. The nose bumper may or may not be installed.  
 2. Measurements given in this section are from the front edge of the platform, NOT from the edge of the nose bumper.

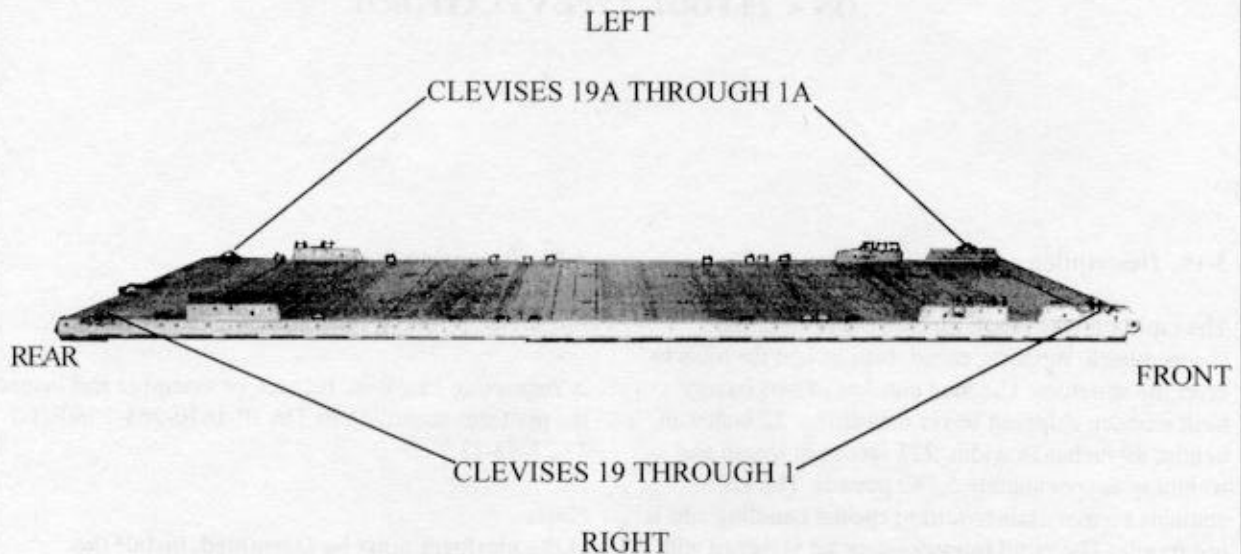

**Step:**

1. Inspect, or assemble and inspect, the platform according to TM 10-1670-268-20&P/TO 13C7-52-22.
2. Install a tandem link to the front of each platform side rail using holes 1A, 2A, and 3A.
3. Install a suspension link to the right and left platform side rails using holes 6, 7, 8 and 6A, 7A, 8A.
4. Install a second suspension link to the right and left platform side rails using holes 33, 34, 35 and 33A, 34A, 35A.
5. Install platform clevises on bushing 2, doubled on the tandem links.
6. Install platform clevises on the first suspension links on bushings 1, 2, 3 (add an extra clevis to the clevis on bushing 3).
7. Install platform clevises on the second suspension links on bushings 2 and 4.
8. Starting at the front of each platform side rail, install clevises on the bushings bolted on holes 11, 12, 13, 15, 23, 24, 26, 31, 37, and double 38.
9. Starting at the front of the platform, number the clevises bolted on the right side 1 through 19 and those bolted on the left side from 1A through 19A.
10. Label the tie-down rings according to FM 10-500-2/TO 13C7-1-5.

*Figure 3-20. Platform prepared*

### 3-21. Building and Positioning Honeycomb Stacks and Secure Load

Build 10 honeycomb stacks according to FM 10-500-2/TO 13C7-1-5 and as shown in *Figure 3-21*. Position the honeycomb stacks on the platform as shown in *Figure 3-22*.

Position the boxes on the platform and secure the boxes closed as shown in *Figure 3-23*.

Note: This drawing is not drawn to scale.

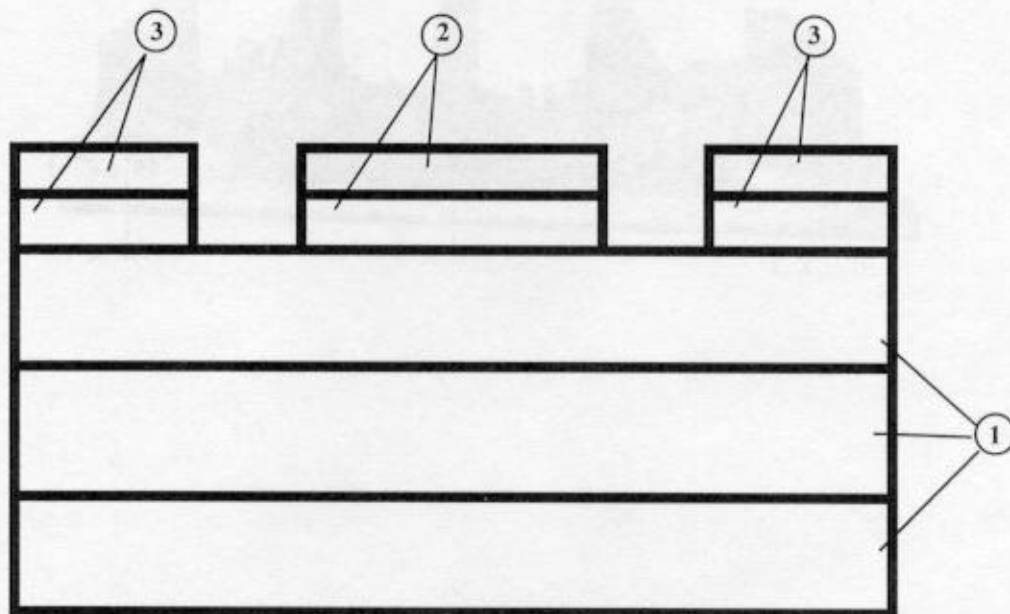

- ① Glue three 12- by 89-inch pieces of honeycomb together to form stacks 1, 2, 3, 4, 5, 6, 7, 8, 9, and 10.
- ② Glue two 12- by 45-inch pieces of honeycomb centered and glued to base of stacks 1, 2, 3, 4, 5, 6, 7, 8, 9 and 10.
- ③ Using four 12- by 15-inch pieces of honeycomb, glue two pieces flush with each outside edge of base of stacks 1, 2, 3, 4, 5, 6, 7, 8, 9, and 10.

*Figure 3-21. Honeycomb stacks built*



Note: Boxes may vary in size and honeycomb stacks may have to be shifted.

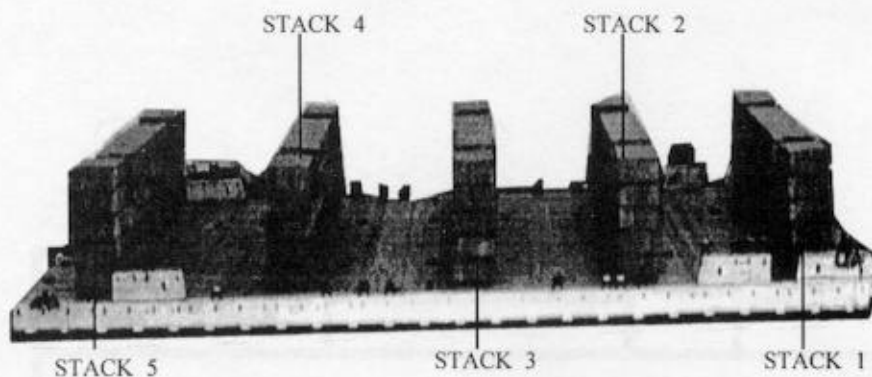

Stack Number	Position of Honeycomb Stacks on Platform
1	Position Stack 1, centered and 5 inches from front edge of platform.
2	Position Stack 2, centered and 42 1/2 inches from the rear of Stack 1.
3	Position Stack 3, centered and 41 inches from the rear of Stack 2.
4	Position Stack 4, centered and 41 inches from the rear of Stack 3.
5	Position Stack 5, centered and 44 inches from the rear of Stack 4.

Figure 3-22. Honeycomb stacks positioned

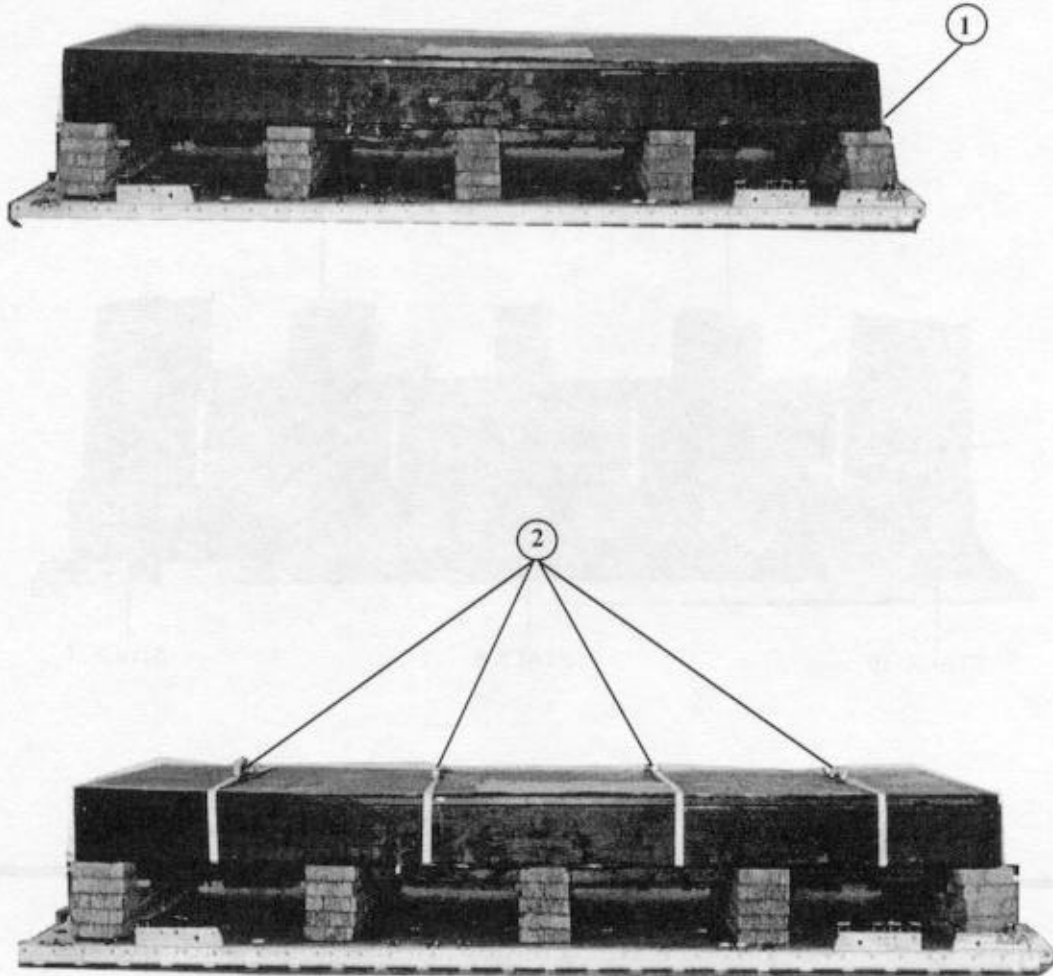

- ① Position the box centered on the five honeycomb stacks with the front edge of the box 2 inches from the front edge of Stack 1. The rear stack should be adjusted to allow 2 inches of the stack to extend past the end of the box.
- ② Secure the box closed with four 15-foot lashings. Run each lashing around the box, one at each point centered between the honeycomb stacks. Secure the load binders on top of the box.

Figure 3-23. Honeycomb stacks and load positioned

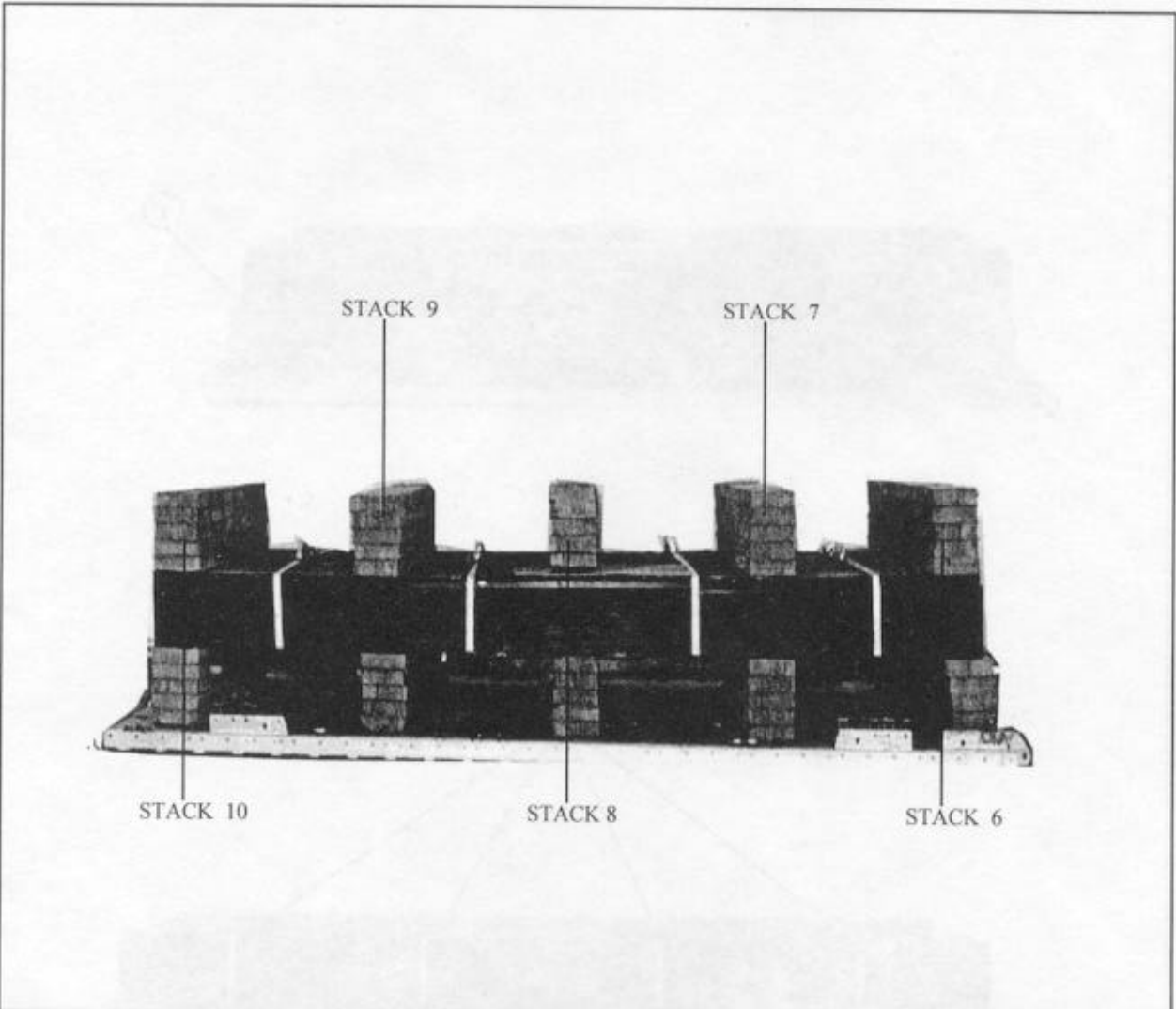

Stack Number	Position of Honeycomb Stacks on Box
6	Position Stack 6, even with the front edge of the box.
7	Position Stack 7, 40 1/2 inches from the rear of Stack 6.
8	Position Stack 8, 41 inches from the rear of Stack 7.
9	Position Stack 9, 41 inches from the rear of Stack 8.
10	Position Stack 10, even with the rear edge of the box.

Figure 3-23. Honeycomb stacks and load positioned (continued)



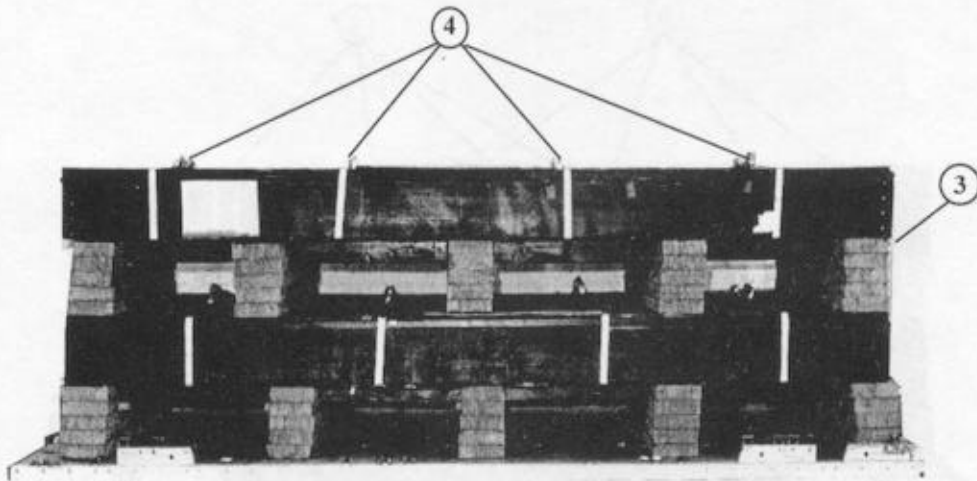

- ③ Position the second box centered on the honeycomb with the front of the box even with the front of stack 6.
- ④ Secure the box closed as outlined in step 2.

Figure 3-23. Honeycomb stacks and load positioned (continued)

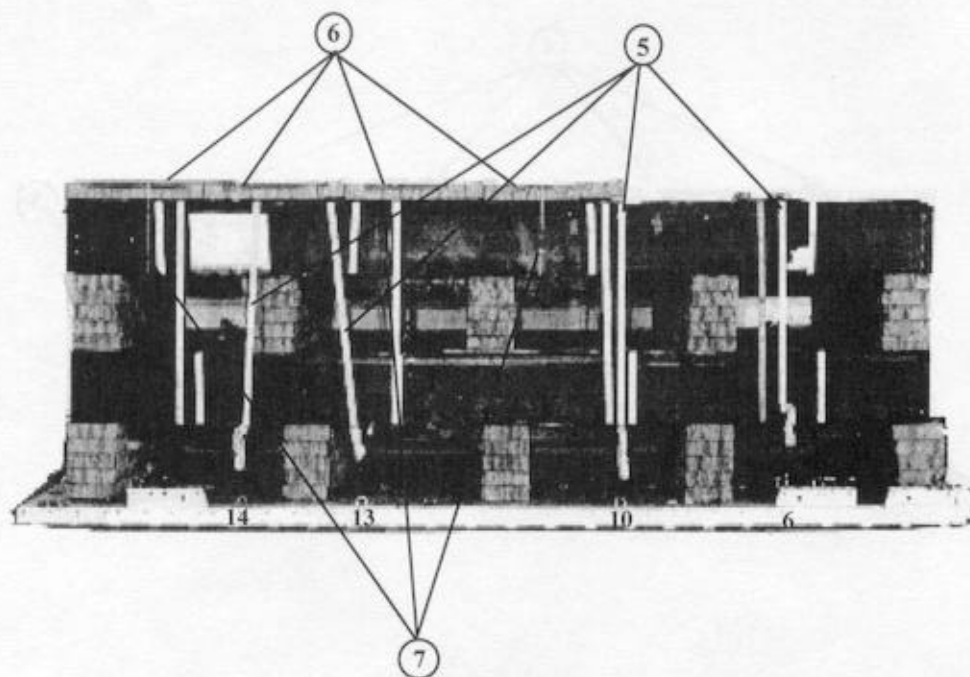

- ⑤ Form four 30-foot lashings and secure the boxes to the platform by centering the lashings on the top box and securing the running ends starting from the front of the load to clevises 6 and 6A, 10 and 10A, 13 and 13A, 14 and 14A.
- ⑥ Cut four pieces of honeycomb 36 inches by 89 inches and position the honeycomb side by side with the first piece even with the rear edge of the box.
- ⑦ Secure in place with lengths of type III nylon cord.

Figure 3-23. Honeycomb stacks and load positioned(continued)

### 3-22. Building, Positioning and Securing Front and Rear Endboards

Build the front and rear endboards as shown in *Figure 3-24*. Position and secure the endboards as shown in *Figure 3-25*.

- Notes: 1. This drawing is not drawn to scale.  
2. All measurements are given in inches.

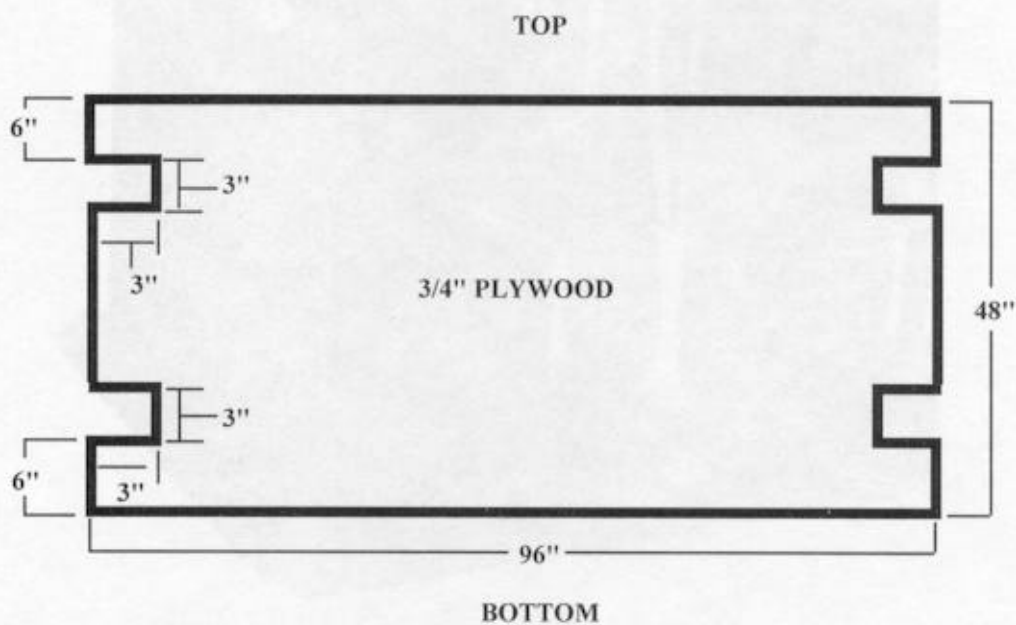

Item Number	Pieces	Width (Inches)	Length (Inches)	Material
1	1	48	96	3/4-inch plywood
2	1	48	96	3/4-inch plywood

*Figure 3-24. Materials required to build endboards*

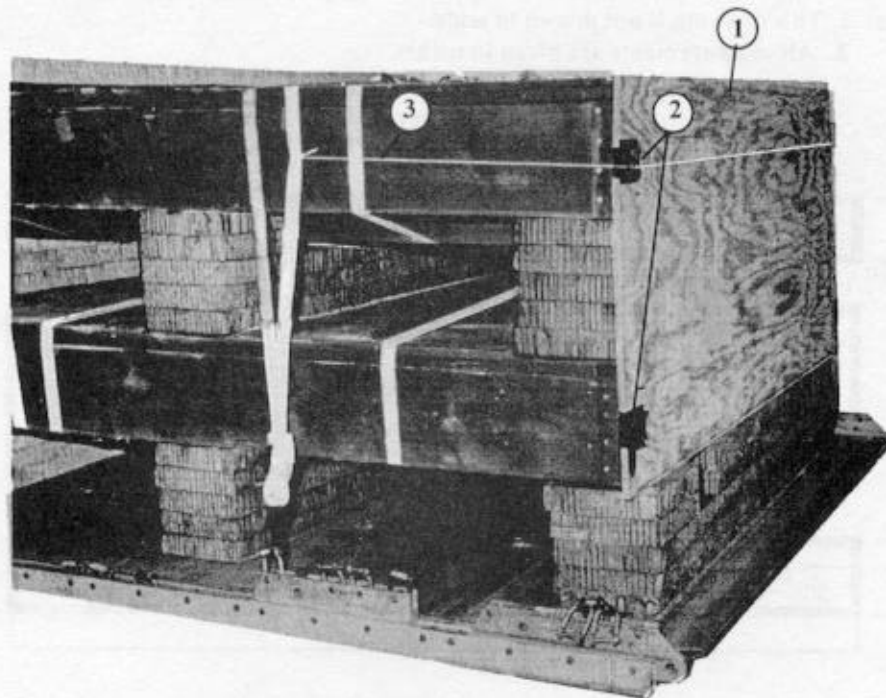

- ① Position one endboard on each end of the load centered and flush with boxes.
- ② Tape the notches of each endboard.
- ③ Safety the endboards with type III nylon cord.

*Figure 3-25. Endboards positioned*

### 3-23. Installing Lashings

Lash the load to the platform as shown in *Figures 3-26 through 3-28* and form 30 foot through 45 foot lashings according to FM 10-500-2/TO 13C7-1-5.

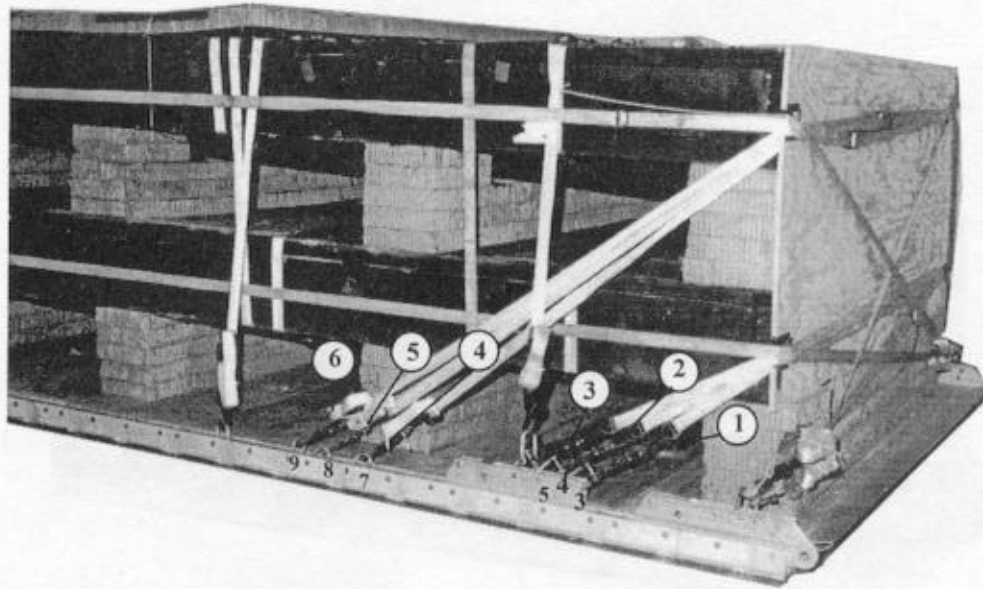

Lashing Number	Tie-down Clevis Number	Instructions
		Pass lashings through:
		Note: *30-foot lashings
*1	3 to 3A	Bottom notch front endboard.
*2	4 to 4A	Bottom notch front endboard.
*3	5 to 5A	Bottom notch front endboard.
*4	7 to 7A	Top notch front endboard.
*5	8 to 8A	Top notch front endboard.
*6	9 to 9A	Top notch front endboard.

*Figure 3-26. Lashings 1 through 6 installed*

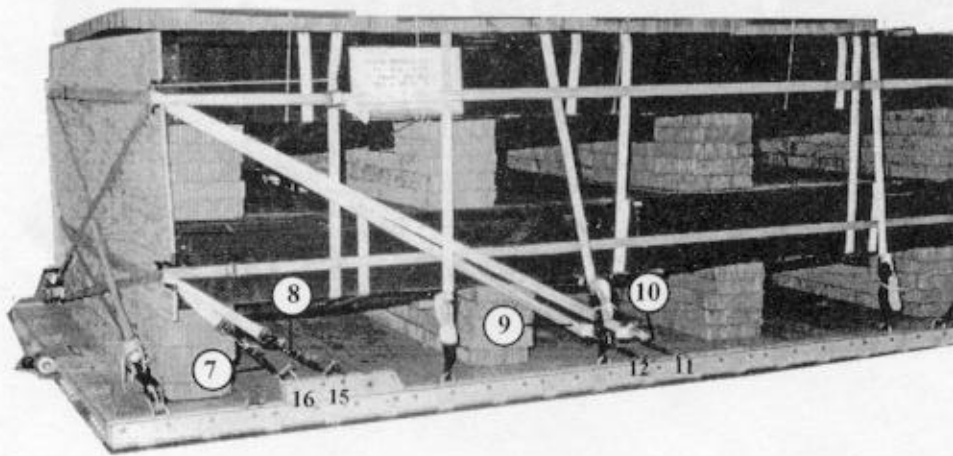

Lashing Number	Tie-down Clevis Number	Instructions
		Pass lashings through:
		Note: *30-foot lashings
*7	16 to 16A	Bottom notch rear endboard.
*8	15 to 15A	Bottom notch rear endboard.
*9	12 to 12A	Top notch rear endboard.
*10	11 to 11A	Top notch rear endboard.

Figure 3-27. Lashings 7 through 10 installed



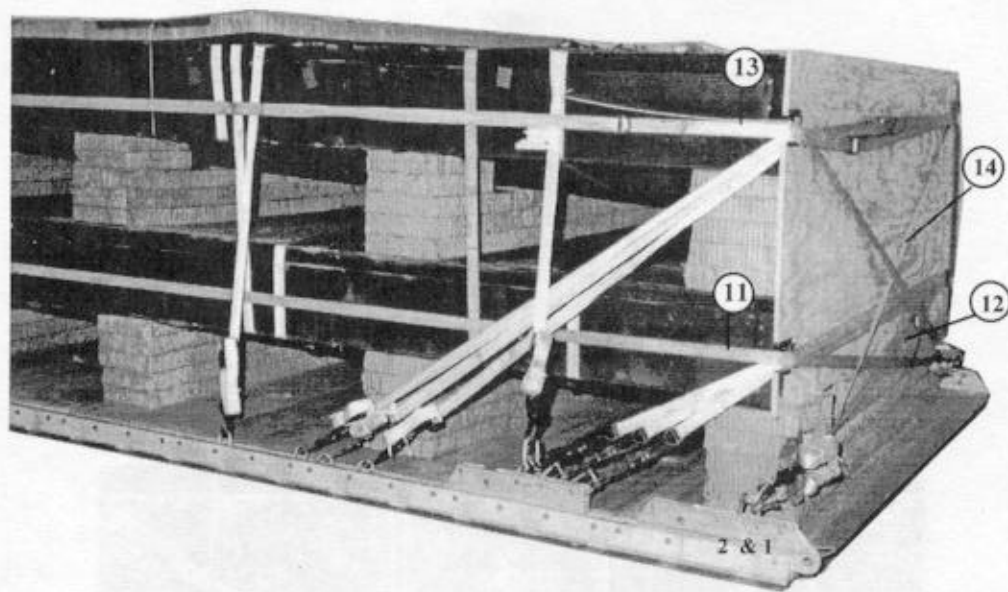

Lashing Number	Tie-down Clevis Number	Instructions
		Pass lashing through:
		Note: **45-foot lashings
**11	2 to 18	Bottom notch left side front and rear.
**12	2A to 18A	Bottom notch right side front and rear.
**13	1 to 19	Top notch left side front and rear.
**14	1A to 19A	Top notch right side front and rear.

Figure 3-28. Lashings 11 through 14 installed

### 3-24. Installing Suspension Slings and Deadman's Tie

Install the suspension slings and Deadman's tie as shown in *Figure 3-29*.

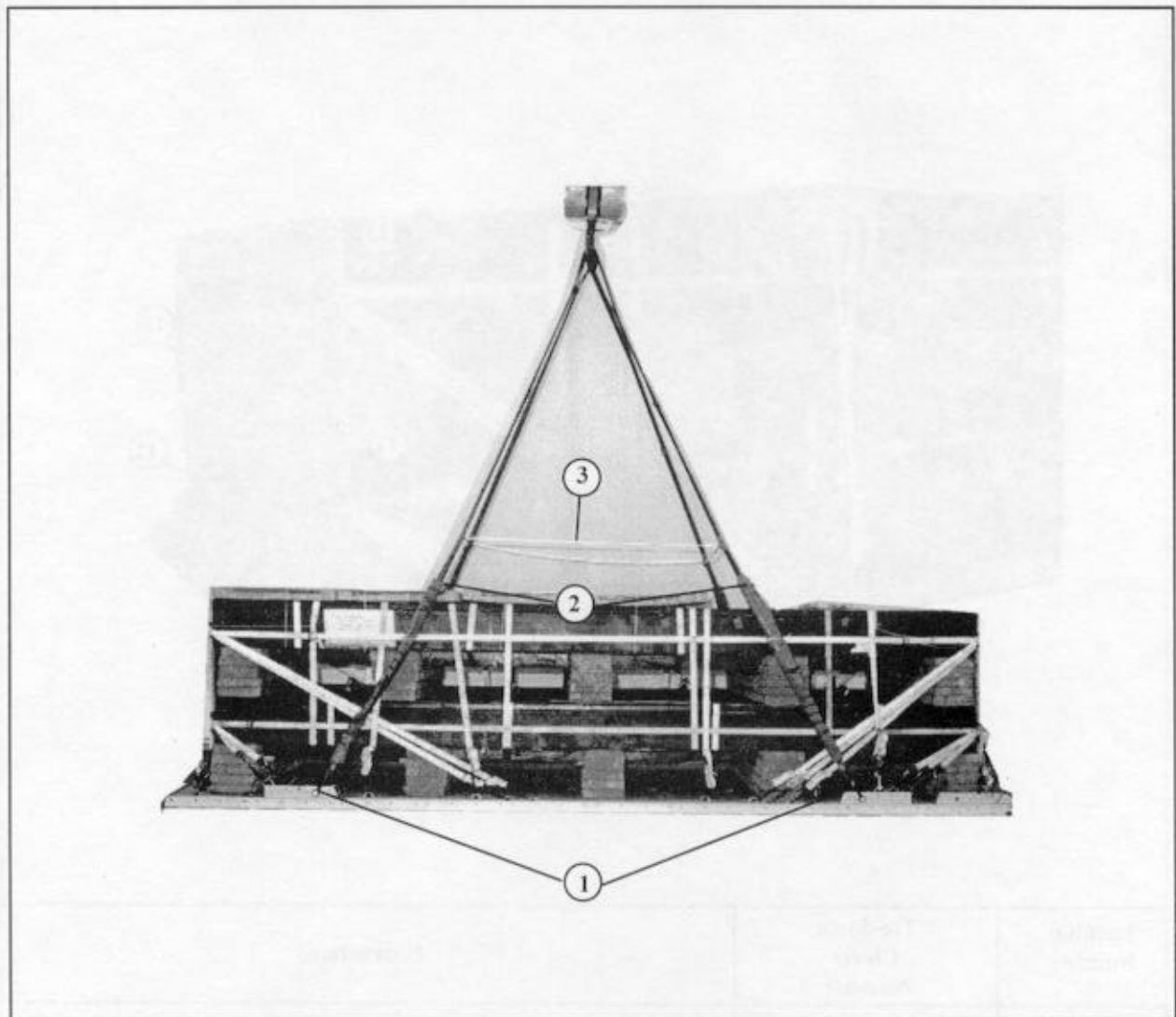

- ① Place a large clevis in one end of the four 16-foot (4-loop), type XXVI nylon suspension slings. Attach the large clevises to each suspension link.
- ② Pad the slings with felt and pressure sensitive tape from the large clevis to 6-inches above the top of the load.
- ③ Raise the slings and install the Deadman's tie according to FM 10-500-2/TO 13C7-1-5.

*Figure 3-29. Suspension slings installed*



### 3-25. Stowing Cargo Parachutes

Prepare, stow and restrain three G-11 cargo parachutes on top of the honeycomb according to FM 10-500-2/TO 13C7-1-5 and as shown in *Figure 3-30*. Restrain the parachutes using clevises 15 and 15A, and 17 and 17A.

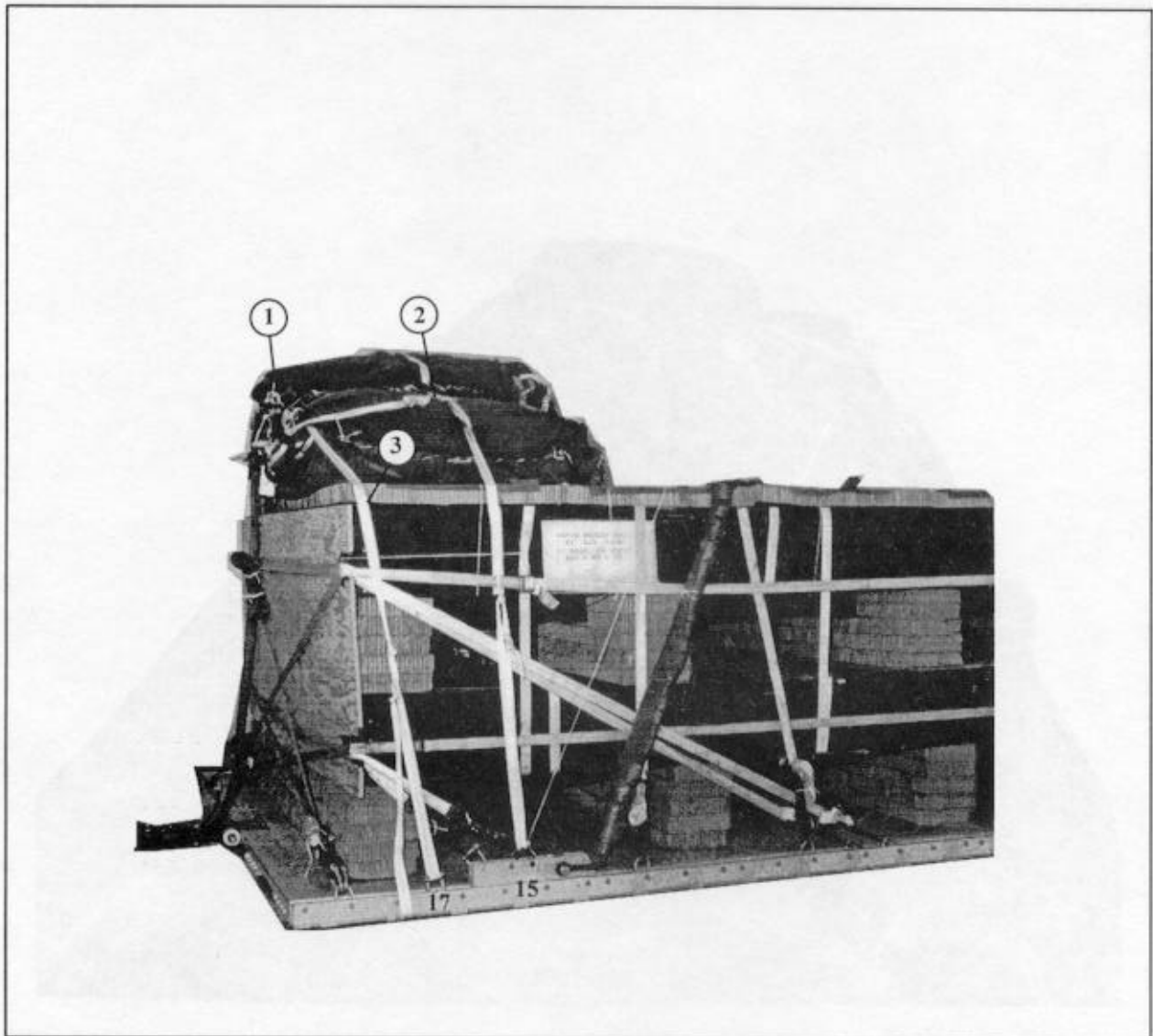

- ① Stow three G-11 cargo parachutes on the load according to FM 10-500-2/TO 13C7-1-5.
- ② Run one length of type VIII nylon webbing from platform clevis 15, through the center carrying handles, to platform clevis 15A, and secure.
- ③ Run one length of type VIII nylon webbing from platform clevis 17, through the rear carrying handles, to platform clevis 17A, and secure.

*Figure 3-30. Cargo parachutes positioned*

### 3-26. Installing Release System

Prepare and install the M-1 release system according to FM 10-500-2/TO 13C7-1-5 and as shown in *Figure 3-31*.

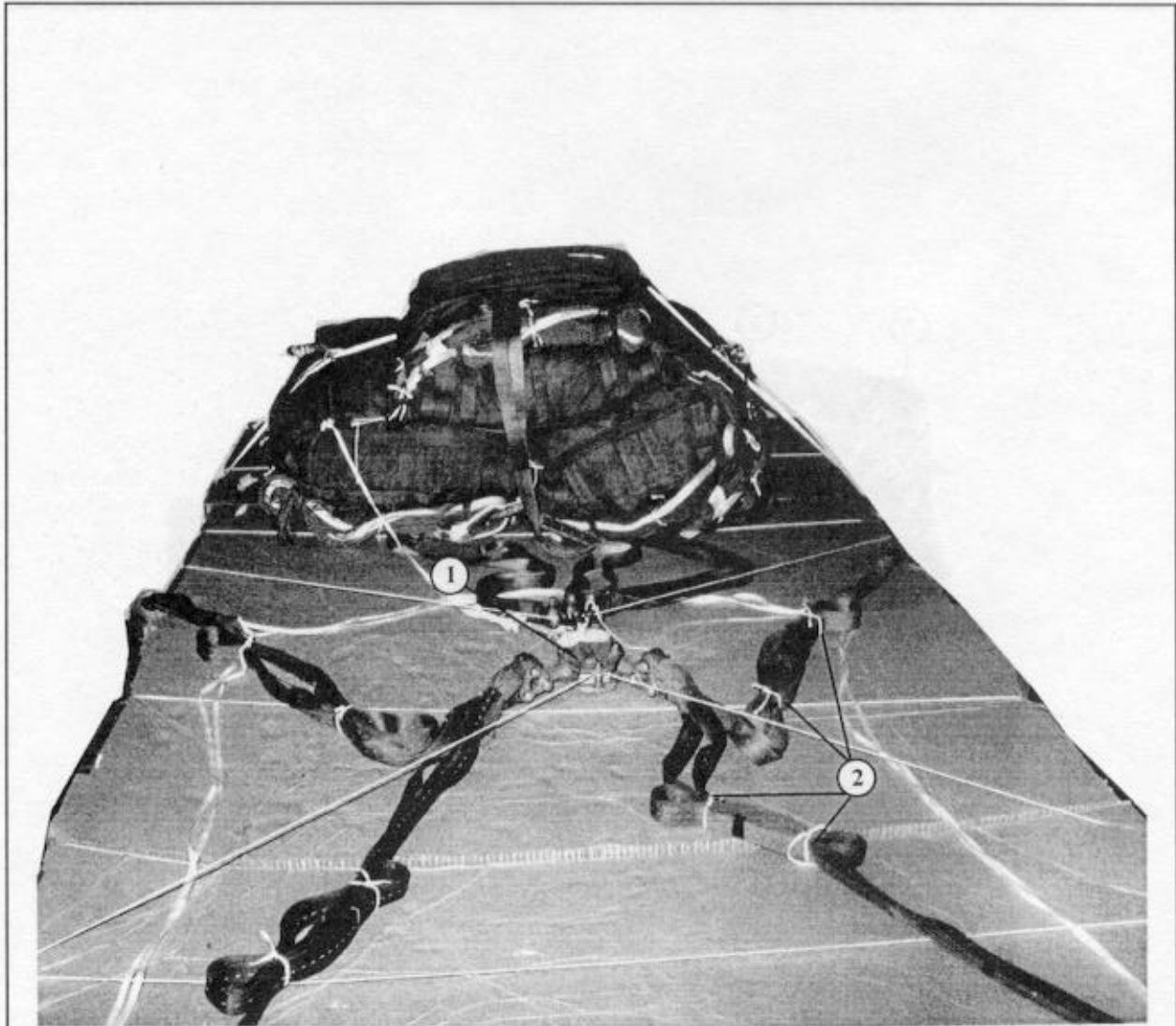

- ① Position and install the M-1 release assembly on top of the honeycomb on top of the load. Safety it to the load in accordance with FM 10-500-2/TO 13C7-1-5.
- ② Safety suspension slings according to FM 10-500-2/TO 13C7-1-5.

*Figure 3-31. Release assembly installed*

### 3-27. Installing Extraction System

Prepare and install the extraction force transfer coupling (EFTC) system according to FM 10-500-2/TO 13C7-1-5 and as shown in *Figure 3-32*.

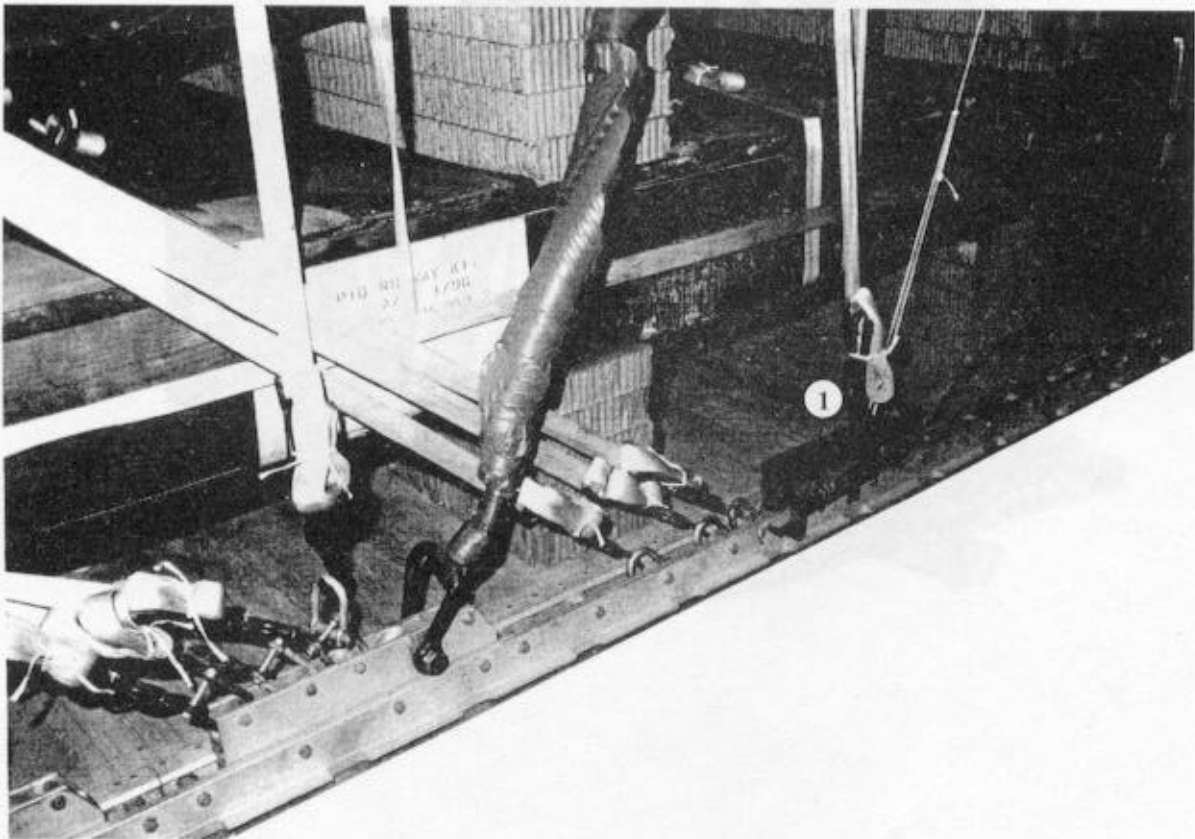

- ① Install the components of the EFTC in accordance with FM 10-500-2/TO 13C7-1-5. Use the forward mounting holes for the EFTC bracket.

*Figure 3-32. Extraction system installed*

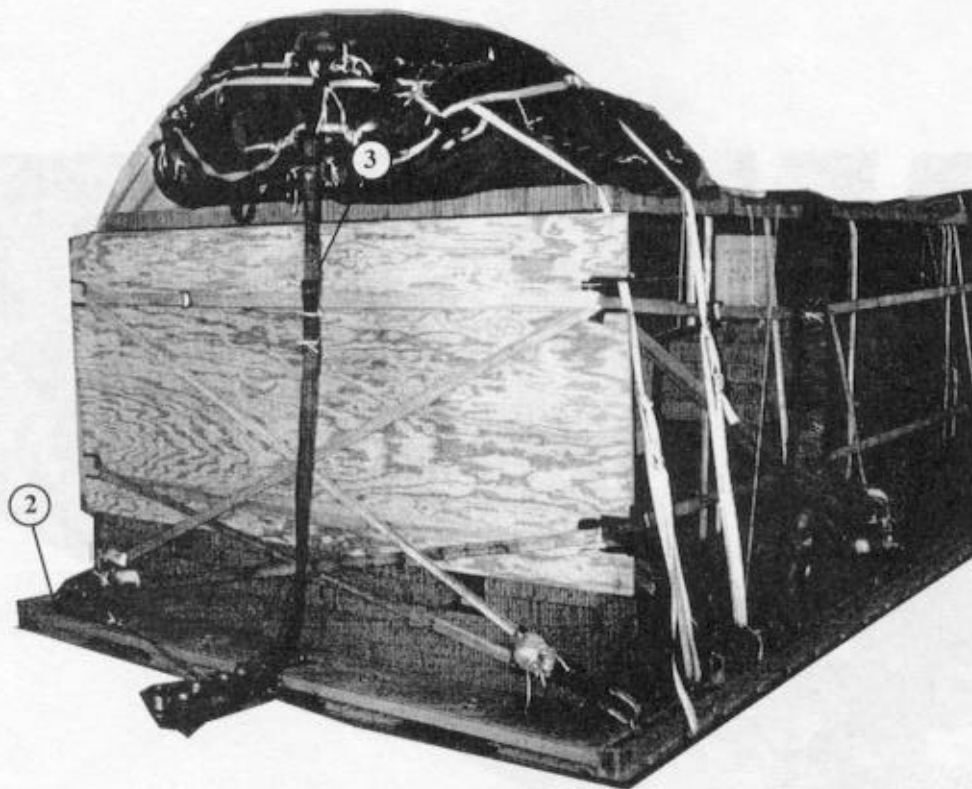

- ② Attach a 20-foot EFTC cable and safety the cable to tiedown ring D10 using one turn Type I, 1/4-inch cotton webbing.
- ③ Attach a 9-foot (2-loop), type XXVI nylon sling to be used as a deployment line.

Figure 3-32. Extraction system installed (continued)

**3-28. Installing Provisions for Emergency Restraints**

Install provisions for emergency restraints according to FM 10-500-2/TO 13C7-1-5.

**3-29. Placing Cargo Extraction Parachute**

Select the extraction parachute and extraction line needed using the extraction line requirements table in FM 10-500-2/TO 13C7-1-5. Place the extraction parachute and extraction line on the load for installation in the aircraft.

**3-30. Marking Rigged Load**

Mark the rigged load according to FM 10-500-2/TO 13C7-1-5 and as shown in *Figure 3-32*. If the load varies from the one shown, the weight, height, tip-off curve, CB, and parachute requirements must be recomputed.

**3-31. Equipment Required**

Use the equipment listed in *Table 3-3* to rig this load.

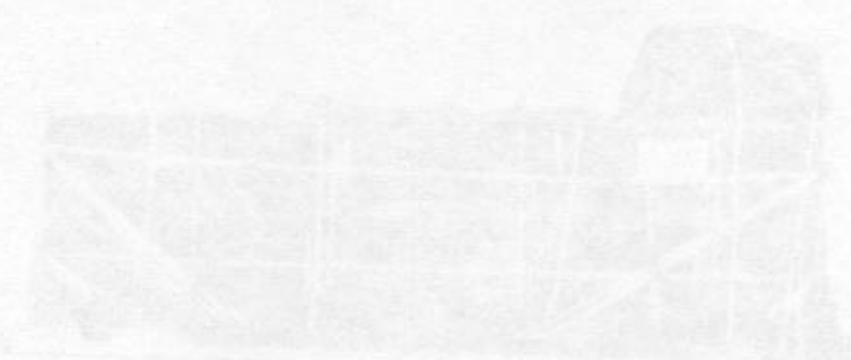

*(Table 3-3 content is extremely faded and illegible)*



**CAUTION**  
 Make the final rigger inspection required by FM 10-500-2/TO 13C7-1-5 before the load leaves the rigging site.

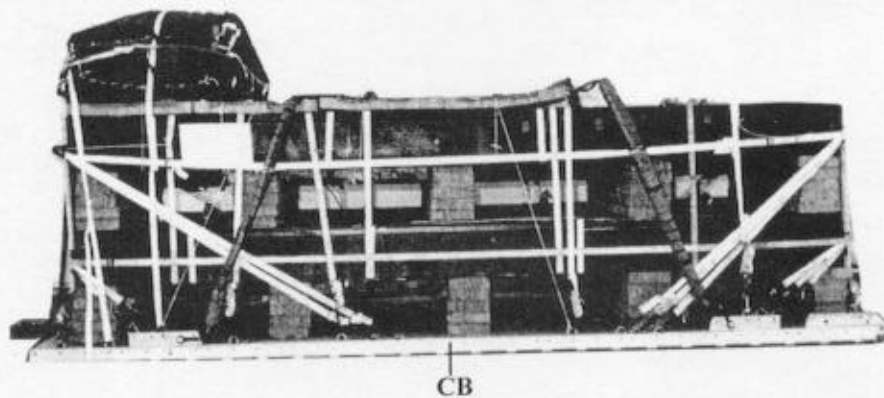

**RIGGED LOAD**

Weight: Load shown	14,080 pounds
Maximum rigged weight	15,750 pounds
Height:	67 inches
Width:	108 inches
Length:	258 inches
Overhang: Front	0 inches
Rear (from extraction bracket)	18 inches
Center of Balance (CB): (from front edge of platform)	124 inches
Extraction System: (add 18 inches to length of platform)	EFTC

Figure 3-32. Rapid runway repair kit rigged for low-velocity airdrop on a 20-foot, type V platform

Table 3-3. Equipment required for rigging the rapid runway repair kit for low-velocity airdrop on a 20-foot, type V platform

National Stock Number	Item	Quantity
8040-00-273-8713	Adhesive, paste, 1-gal	As required
4030-00-090-5354	Clevis, suspension, 1-in (large)	8
4020-00-240-2146	Cord, nylon, type III, 550-lb	As required
1670-00-434-5787	Coupling, airdrop, extraction force transfer with 20-foot cable	1
8135-00-664-6958	Cushioning material, packing, cellulose wadding	As required
8305-00-958-3685	Felt, 1/2-in thick	As required
1670-01-183-2678	Leaf, extraction line	2
	Line, extraction:	
1670-01-062-6313	60-ft (3-loop), type XXVI nylon webbing (C-130)	1
1670-01-107-7615	140-ft (3-loop), type XXVI nylon webbing (C-141, C-5, and C-17)	1
1670-00-753-3928	Pad, energy-dissipating, honeycomb, 3- by 36- by 96-in	19 sheets
	Parachute:	
1670-01-016-7841	Cargo, G-11B	3
	Cargo extraction:	
1670-01-063-3716	22-ft	1
	Platform, AD, type V 20-ft:	1
1670-01-353-8425	Bracket assembly, coupling	(1)
1670-01-162-2372	Clevis assembly (type V)	(42)
1670-01-162-2376	Extraction bracket assembly	(1)
1670-01-247-2389	Suspension link	(4)
1670-01-162-2381	Tandem link (Multi-purpose)	(2)
5530-00-128-4981	Plywood, 3/4- by 48- by 96-in	2 sheets
1670-01-097-8816	Release, cargo parachute, M-1	1
	Sling, cargo, airdrop:	
	For deployment:	
1670-01-062-6304	9-foot (2-loop), type XXVI nylon webbing	1
	For riser extensions:	
1670-01-062-6302	20-foot (2-loop), type XXVI nylon webbing	6
	For suspension slings:	
1670-01-062-6308	16-foot (4-loop), type XXVI nylon webbing	4
1670-00-040-5340	Strap, parachute release, multicut comes with 3 knives	2
	Tape:	
8305-00-074-5124	Adhesive, 2-in	As required
	Masking, 2-in	As required
1670-00-937-0271	Tie-down assembly, 15-ft	46
	Webbing:	
8305-00-268-2411	Cotton, 1/4-in, type I	As required
	Nylon:	
	Tubular:	
8305-00-082-5752	1/2-in <u>or</u>	As required
8305-00-268-2453	1/2-in	As required
8305-00-263-3591	Type VIII	As required

## CHAPTER 4

**RIGGING THE RAPID RUNWAY REPAIR (RRR) KIT-ALPHA  
ON A 32-FOOT, TYPE V PLATFORM  
FOR LOW-VELOCITY AIRDROP****4-1. Description of Load**

The folded fiberglass mat Rapid Runway Repair (RRR) Kit-ALPHA consists of two mat sections, an equipment box and eight metal boxes filled with bolts and washers. The folded fiberglass mat RRR kit is rigged with three G-11 cargo parachutes on a 32-foot, type V platform for low-velocity airdrop. It has a total rigged weight of 13,260 pounds, height of 59 1/2 inches, width of 108 inches, and length of 401 inches with a 17 inch rear overhang and a center of balance (CB) of 189 inches from the front edge of the platform.

**4-2. Preparing Platform**

Prepare a 32-foot, type V platform as given below.

*a. Inspecting Platform.* Inspect, or assemble and inspect, the platform according to TM 10-1670-268-20&P/TO 13C7-52-22.

**Note:**

**If the platform must be assembled, install the suspension links when assembling the platform. See *Figure 4-1* for the location of the suspension links.**

*b. Installing Suspension Links.* Install eight suspension links on the assembled platform according to FM 10-500-2/TO 13C7-1-5 and as shown in *Figure 4-1*.

*c. Installing Tandem Links.* Install two tandem links as shown in *Figure 4-1*.

*d. Attaching and Numbering Clevises.* Attach and number 44 clevis assemblies as shown in *Figure 4-1*.



- Notes: 1. The nose bumper may or may not be installed.  
 2. Measurements given in this section are from the front edge of the platform, NOT from the edge of the nose bumper.

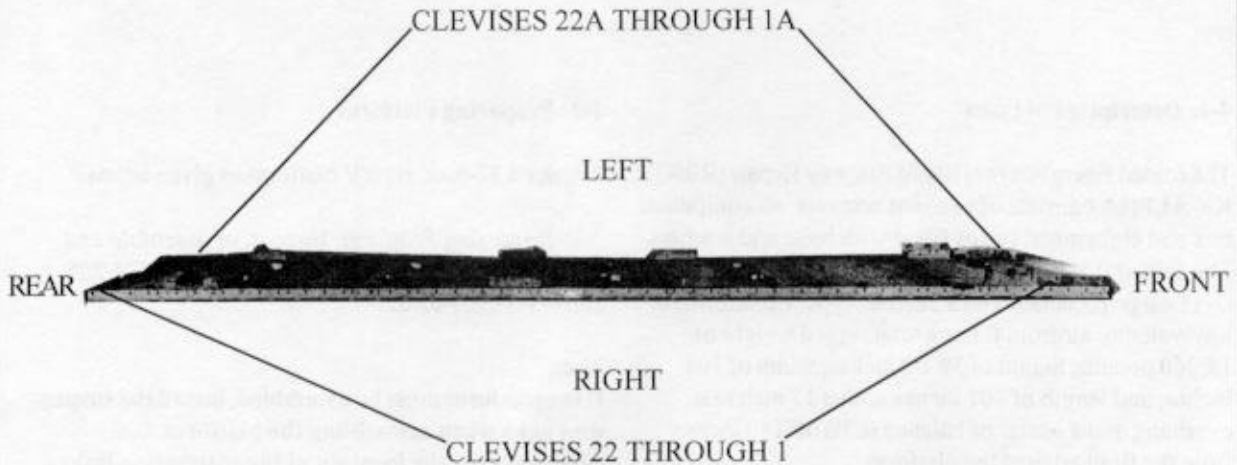

**Step:**

1. Inspect, or assemble and inspect, the platform according to TM 10-1670-268-20&P/ TO 13C7-52-22.
2. Install a tandem link on the front of each platform side rail using holes 1, 2, and 3.
3. Install a suspension link on each side rail using holes 6, 7, 8, 26, 27, 28, 37, 38, 39, 57, 58, and 59.
4. Install a clevis on bushings 1, 2, and 4 on the first suspension link.
5. Install a double clevis on the fourth suspension link on bushing 2.
6. Starting at the front of each platform side rail, install clevises on the bushings bolted on holes 4, double 10 only, 11, 16, 19, 22, 33, 45, 51, 53, 54, 55, 61, 63, and 64.
7. Starting at the front of the platform, number the clevises bolted on the right side 1 through 22 and those bolted on the left side from 1A through 22A.
8. Label the tie-down rings according to FM 10-500-2/TO 13C7-1-5.
9. Preposition single tie-down lashings through the following deck rings running each through it's own D-ring: A2, B2, A6, B6, B9, A12, A15, and B15.

Figure 4-1. Platform prepared

### 4-3. Building and Positioning Honeycomb Stacks

Build eight honeycomb stacks according to FM 10-500-2/TO 13C7-1-5 and as shown in *Figure 4-2*. Position the honeycomb stacks on the platform as shown in *Figure 4-3*.

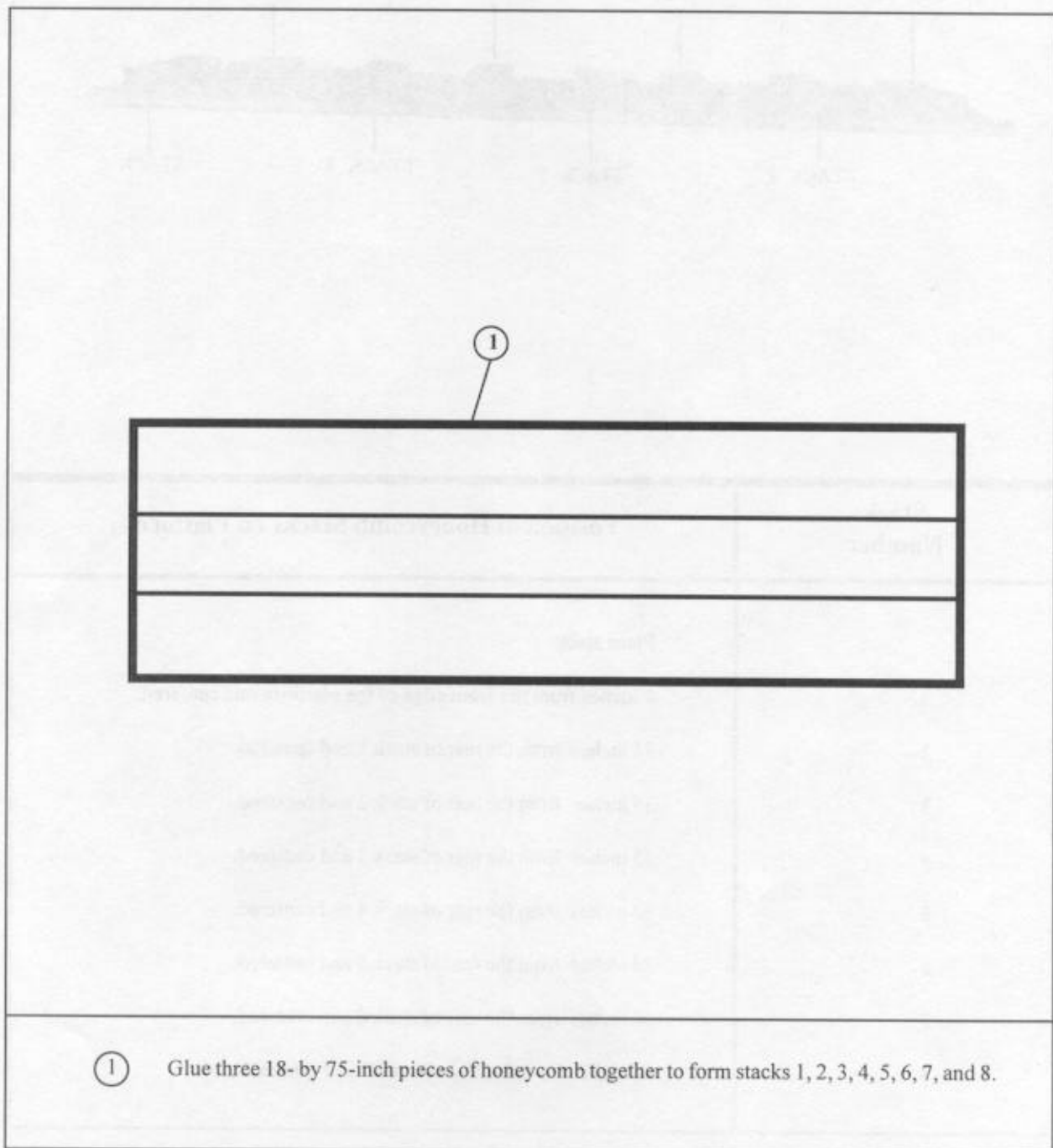

*Figure 4-2. Honeycomb stacks built*

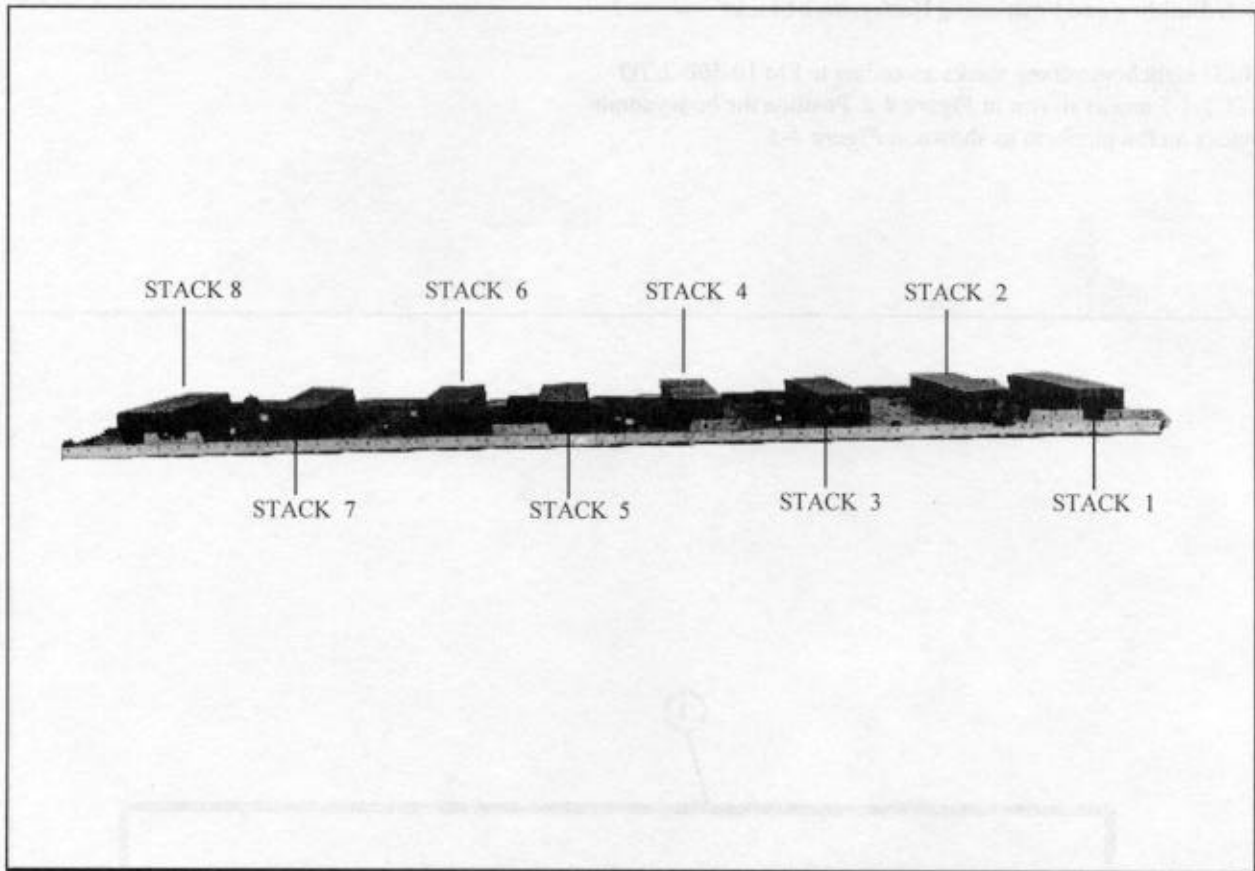

Stack Number	Position of Honeycomb Stacks on Platform
	Place stack:
1	6 inches from the front edge of the platform and centered.
2	24 inches from the rear of stack 1 and centered.
3	35 inches from the rear of stack 2 and centered.
4	35 inches from the rear of stack 3 and centered.
5	32 inches from the rear of stack 4 and centered.
6	24 inches from the rear of stack 5 and centered.
7	36 inches from the rear of stack 6 and centered.
8	36 inches from the rear of stack 7 and centered.

Figure 4-3. Honeycomb stacks positioned

#### 4-4. Lifting and Positioning Folded Fiberglass Mat Rapid Runway Repair (RRR) Kit

Lift one section of the folded fiberglass mat RRR kit by using a combination of tie-down lashings as shown in *Figure 4-4*.

Position the mats on the honeycomb stacks as shown in *Figures 4-5 through 4-7*.

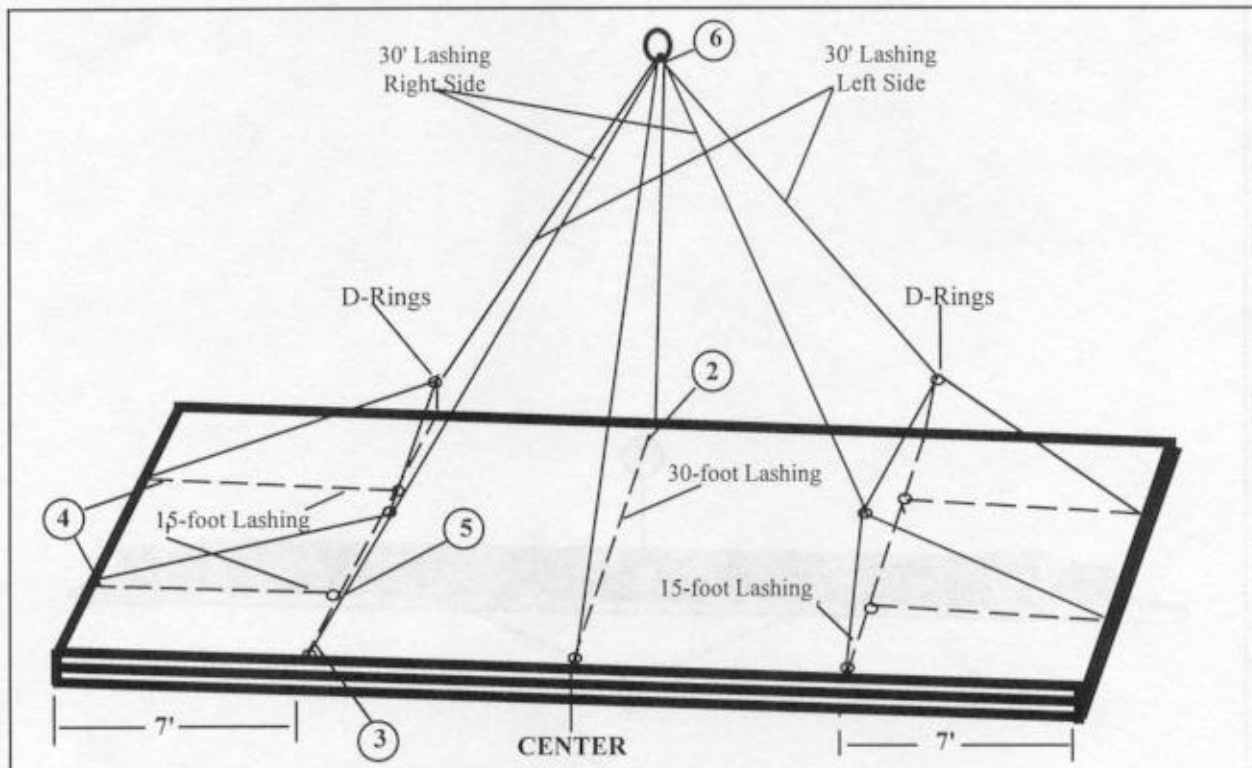

- ① Using a forklift, place the section to be lifted on adequate dunnage (not shown).
- ② Form a 30-foot lashing and pass around the center of the matting.
- ③ Evenly space and position two 15-foot lashings on each end of the mat. Place the D-rings under the mat 7 feet from the ends.
- ④ Run a 15-foot lashing on each end of the mat through the D-rings of the lashings in step 3. Connect the running end of the lashing to its own D-ring forming a loop around the mat. Attach the running ends of the lashings in step 3 to the looped lashing with D-rings keeping the ends evenly spaced.
- ⑤ Form two 30-foot lashings and connect the running end of one of the 30-foot lashings on the left side at the point where the lashings in steps 3 and 4 connect. Repeat the steps for the right side.
- ⑥ Place the centers of all the 30-foot lashings on a crane and lift the mat. Adjust the lashings as needed to balance evenly.

*Figure 4-4. Lifting lashings positioned*

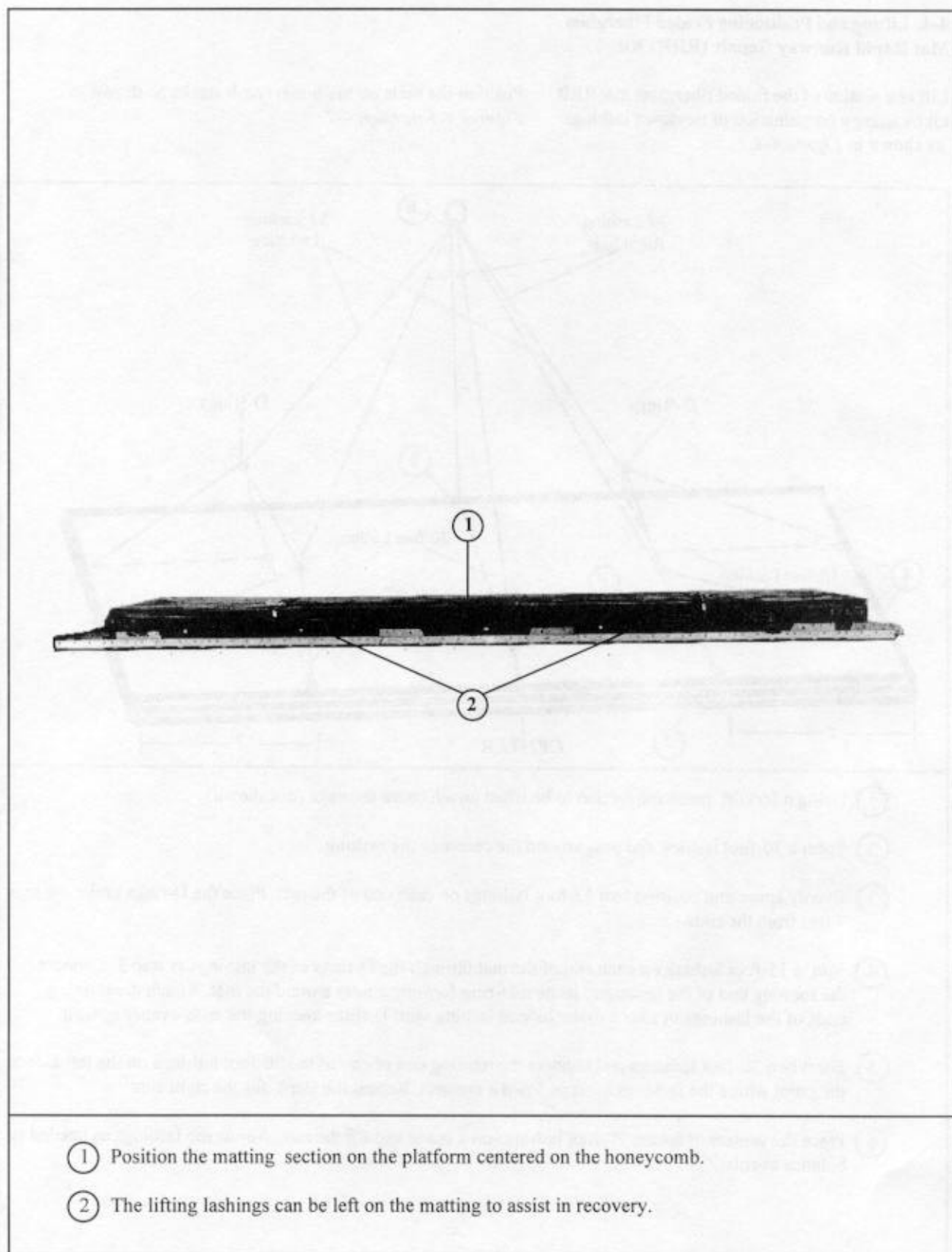
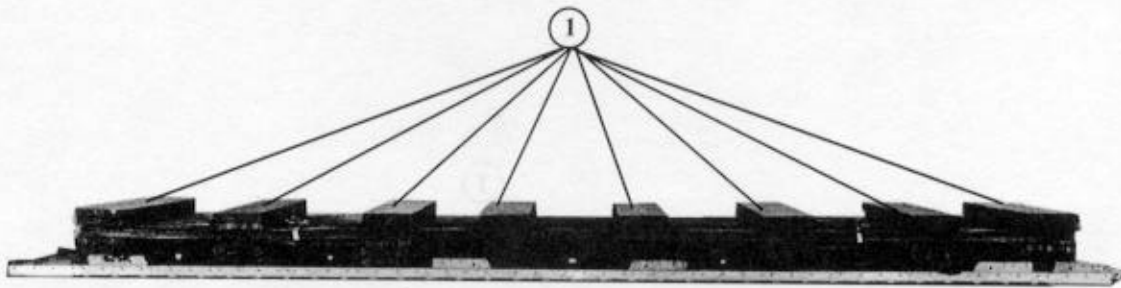

Figure 4-5. Matting section positioned on honeycomb stacks



- ① Cut and glue eight stacks of honeycomb each with two layers measuring 18 by 75 inches. Place them on top of the matting section one directly over the stacks positioned on the platform.

*Figure 4-6. Second honeycomb stacks positioned on matting*



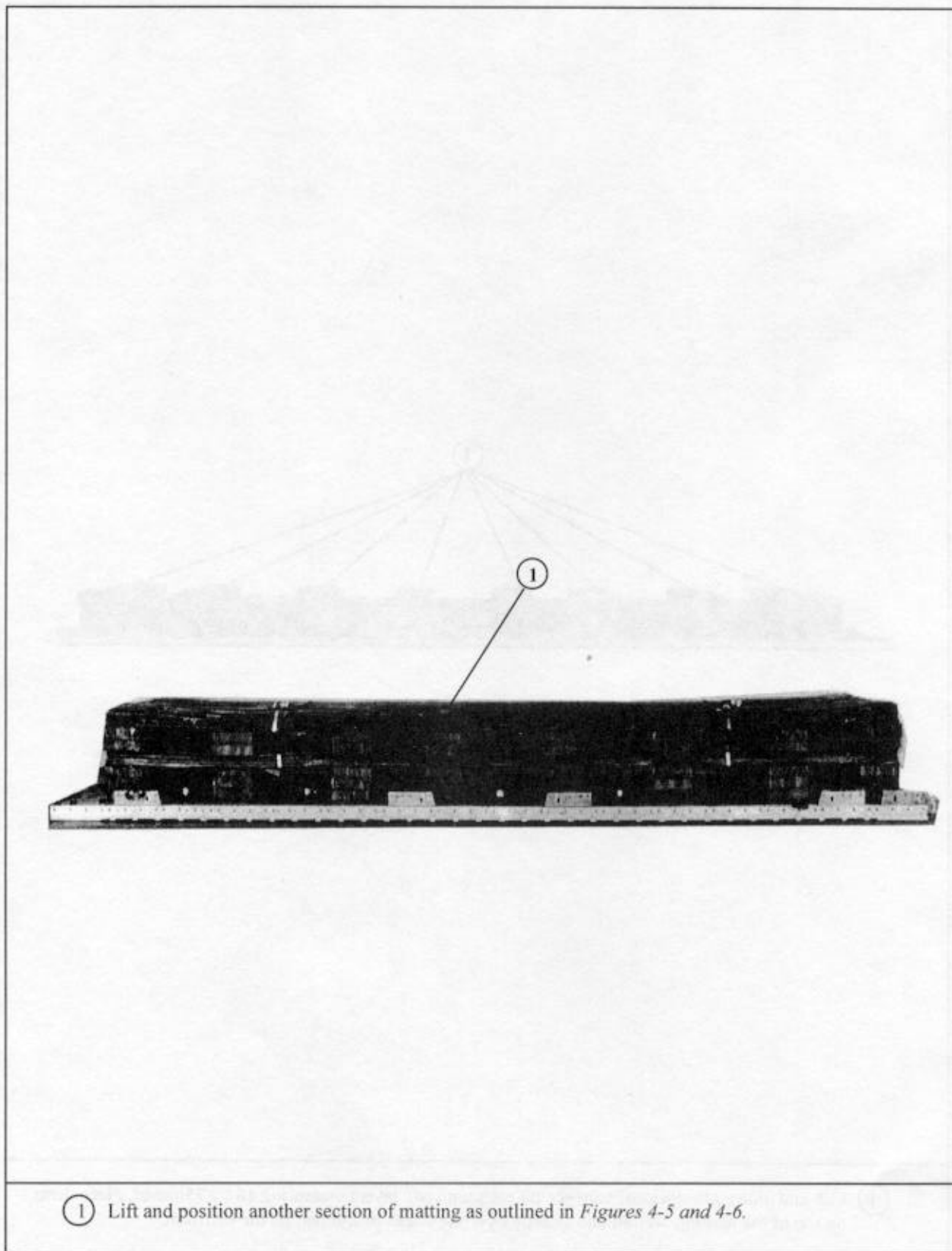

*Figure 4-7. Second matting section positioned*



#### 4-5. Building, Positioning and Securing Front and Rear Endboards

Build the front and rear endboards as shown in *Figure 4-8*. Place a piece of honeycomb 36 inches by 75 inches, flat behind, centered and flush with endboards as shown in *Figure 4-10*. Each endboard consists of a double thickness of 3/4-inch plywood. Nail the outside layer to the inside layer of each endboard. Position and secure the endboards as shown in *Figures 4-10, 4-11, 4-12, and 4-14*.

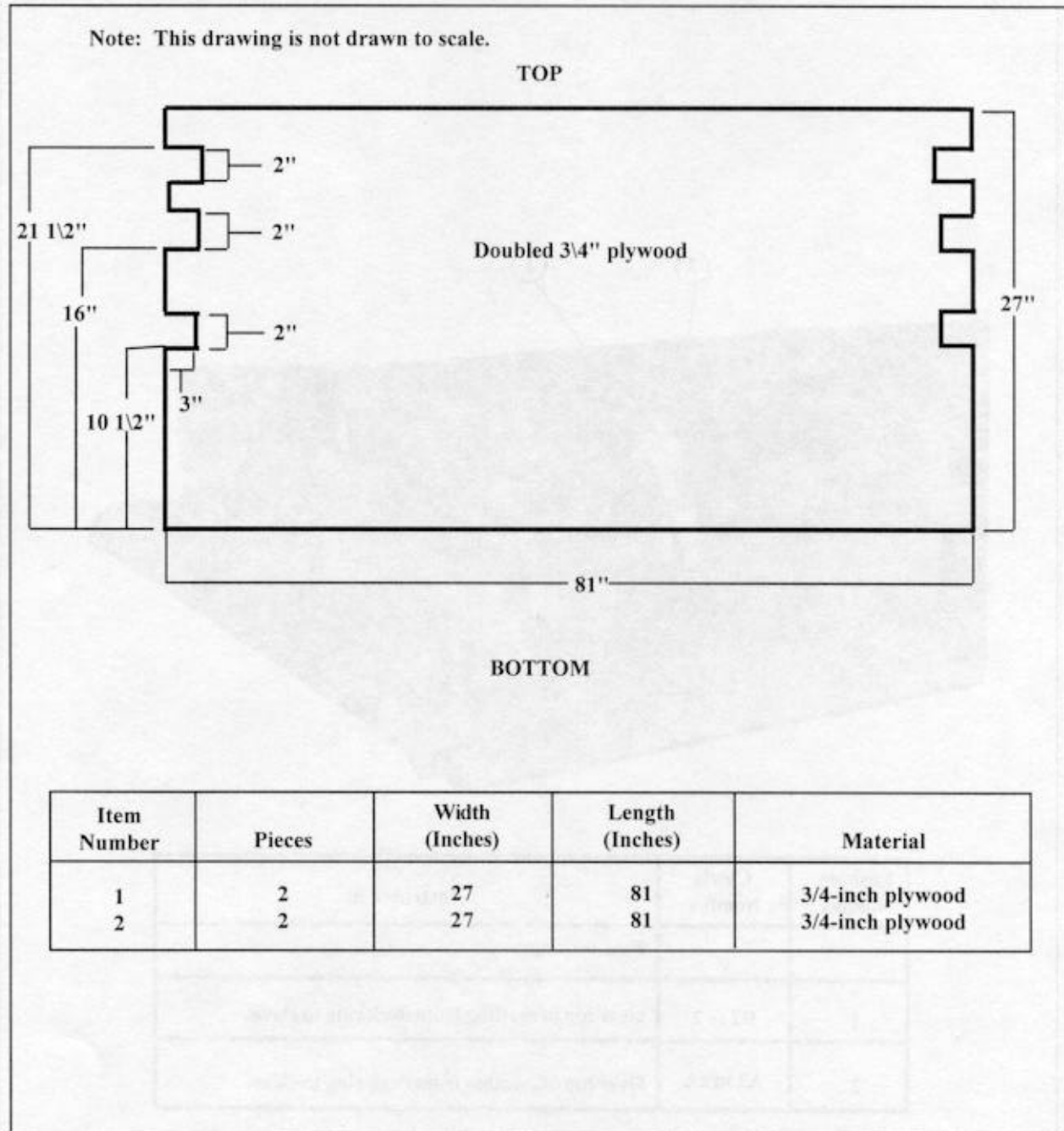

Figure 4-8. Materials required to build load endboards

#### 4-6. Installing Lashings

Lash the load to the platform as shown in *Figures 4-9 through 4-14*. Form 30-foot and 45-foot lashings in accordance with FM 10-500-2/TO 13C7-1-5.

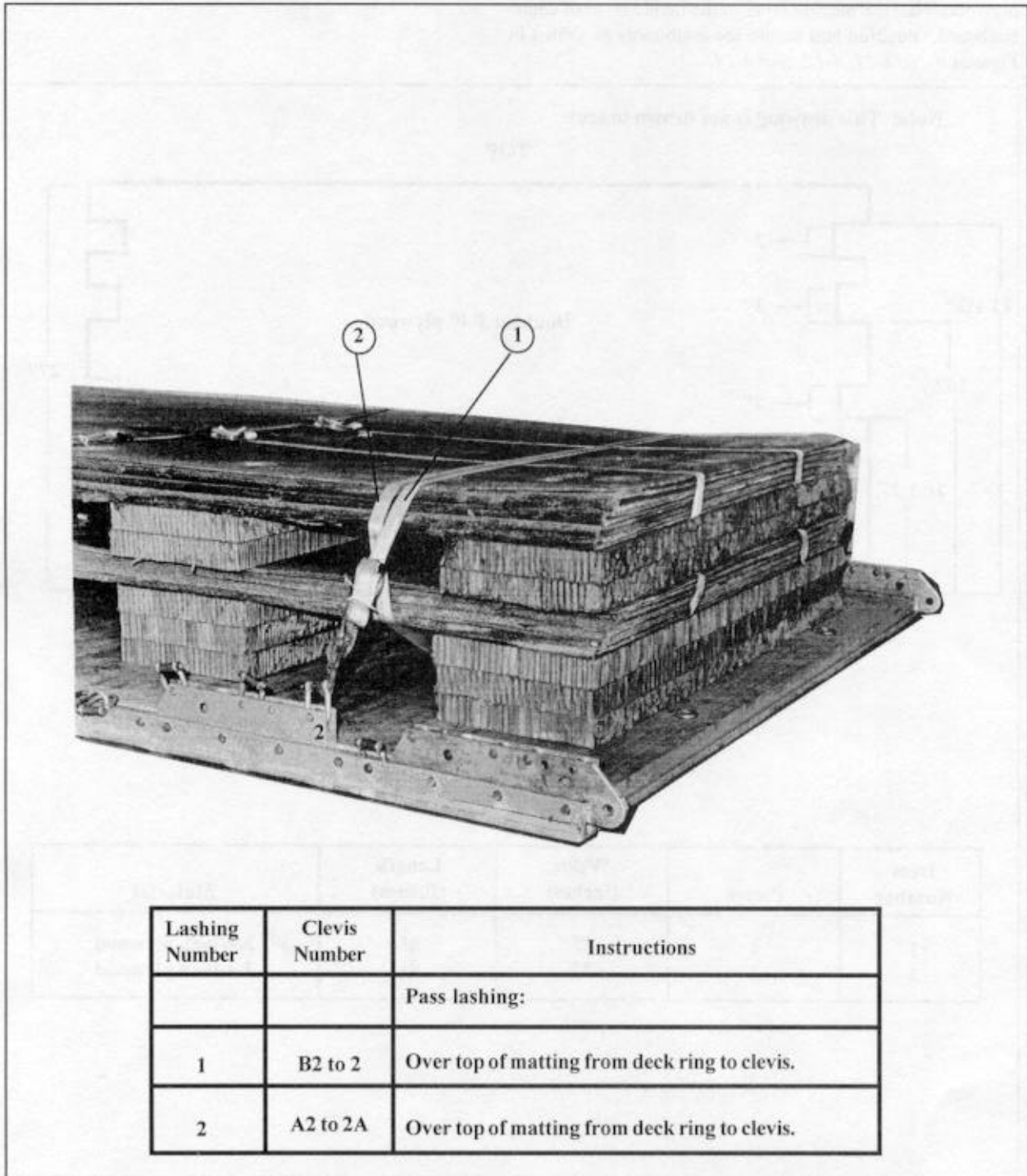
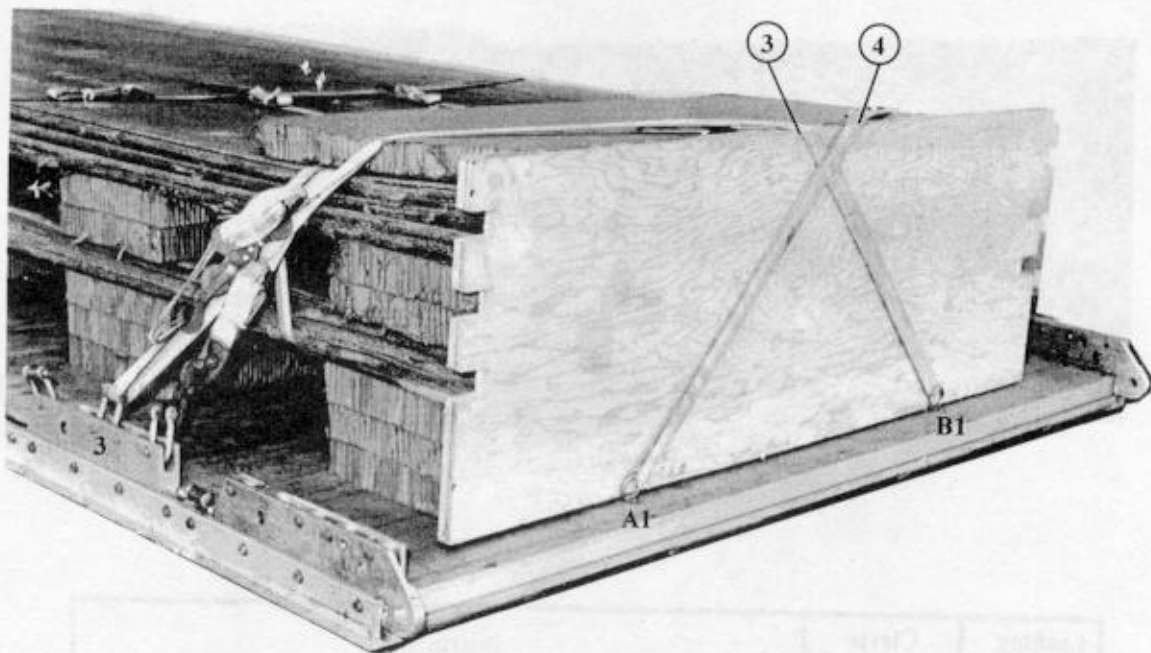
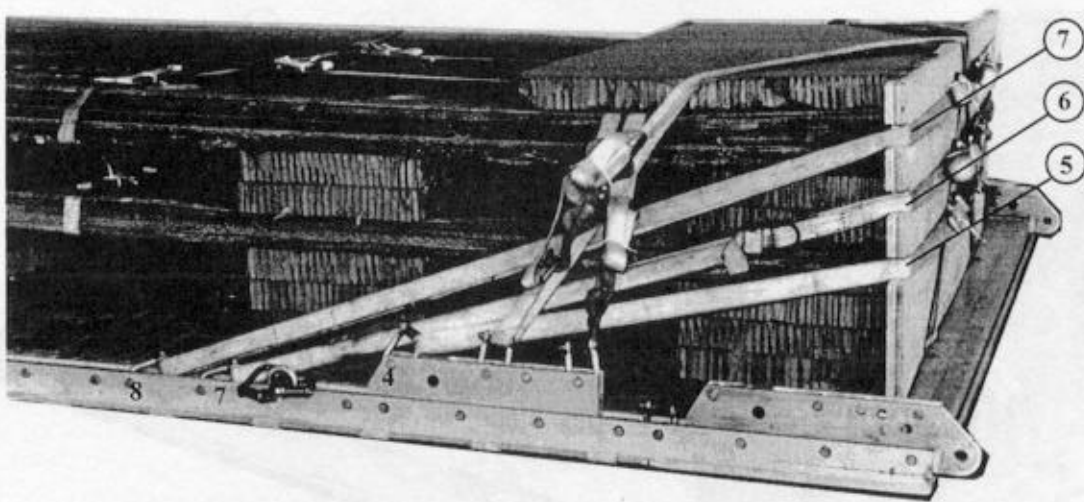

Figure 4-9. Lashings 1 and 2 installed



Lashing Number	Clevis Number	Instructions
		Note: *30-foot lashing.
		Pass lashing:
*3	3 to B1	From clevis over top of endboard through deck ring back to clevis.
*4	3A to 1A	From clevis over top of endboard through deck ring back to clevis.

Figure 4-10. Lashings 3 and 4 installed



Lashing Number	Clevis Number	Instructions
		Note: *30-foot lashing, **45-foot lashing.
		Pass lashing:
*5	4 to 4A	Through bottom notch of endboard.
**6	7 to 7A	Through middle notch of endboard.
**7	8 to 8A	Through top notch of endboard.

Figure 4-11. Lashings 5 through 7 installed

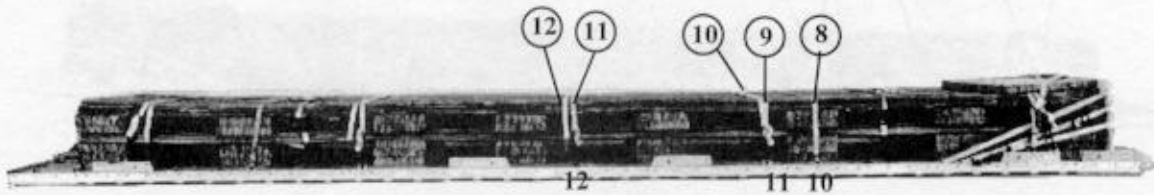

Lashing Number	Clevis Number	Instructions
		Pass lashing:
8	10 to 10A	Through clevis 10 and own D-ring over matting to clevis 10A.
9	B6 to 11	Over top of matting from deck ring to clevis.
10	A6 to 11A	Over top of matting from deck ring to clevis.
11	B9 to 12	Over top of matting from deck ring to clevis.
12	A9 to 12A	Over top of matting from deck ring to clevis.

Figure 4-12. Lashings 8 through 12 installed



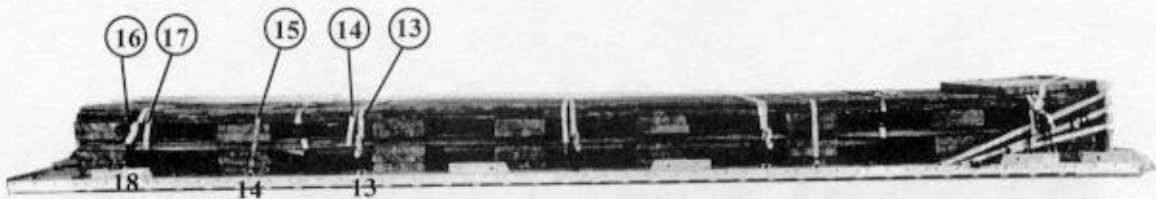

Lashing Number	Clevis Number	Instructions
		Pass lashing:
13	B12 to 13	Over top matting from deck ring to clevis.
14	A12 to 13A	Over top matting from deck ring to clevis.
15	14 to 14A	Through clevis 14 and its own D-ring over matting to clevis 14A.
16	B15 to 18	Over top matting from deck ring to clevis.
17	A15 to 8A	Over top matting from deck ring to clevis.

Figure 4-13. Lashings 13 through 17 installed



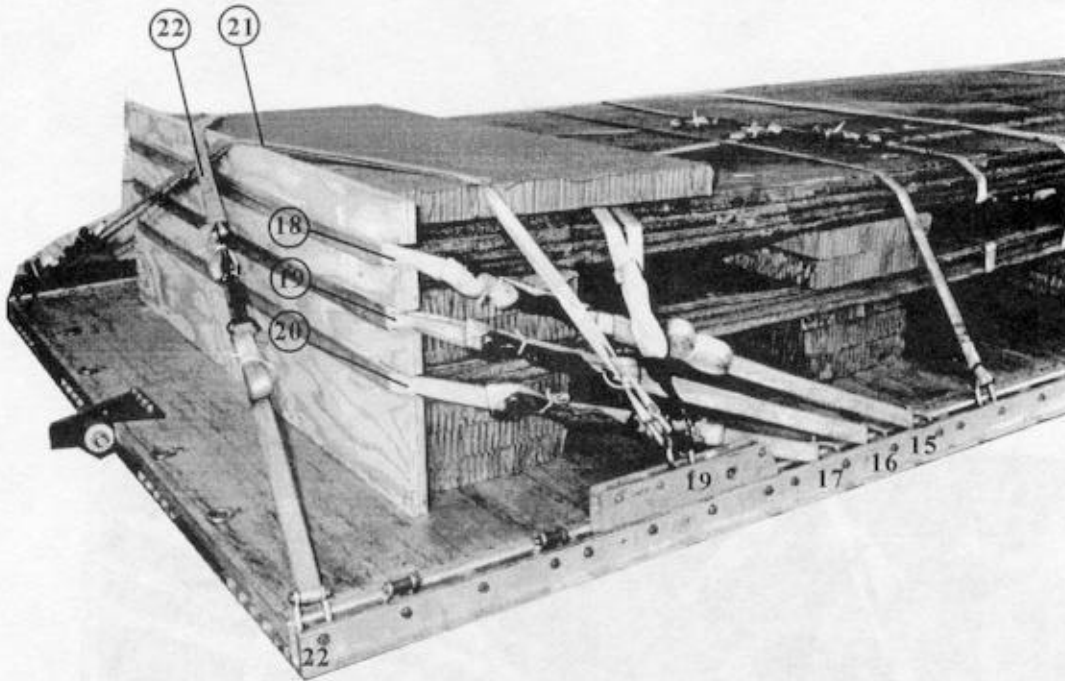

Lashing Number	Clevis Number	Instructions
		Note: *30-foot lashing.
		Pass lashing:
*18	15 to 15A	Through top notch of endboard.
*19	16 to 16A	Through middle notch of endboard.
*20	17 to 17A	Through bottom notch of endboard.
*21	19 to 22A	Over top of endboard (Do not tighten).
*22	19A to 22	Over top of endboard (Do not tighten).

Figure 4-14. Lashings 18 through 22 installed

#### 4-7. Rigging Accompanying Load

Rig the accompanying loads as shown in *Figures 4-15 through 4-19*.

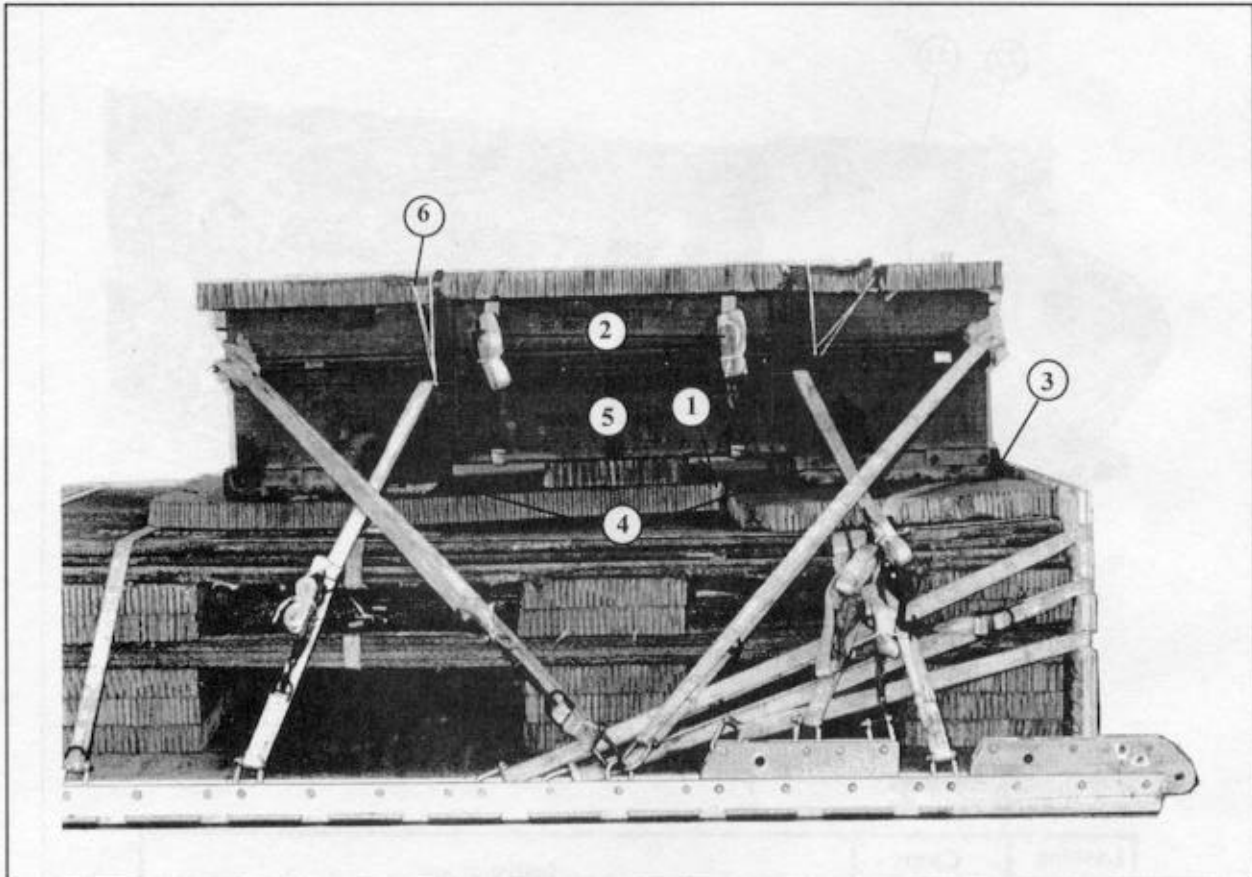

- ① Cut and position a 36- by 68-inch piece of honeycomb on top of matting long ways and flush with the honeycomb against the endboard.
- ② Secure the equipment box closed with two tiedown lashings.
- ③ Position the equipment box centered and long ways, 4 1/2 inches from endboard on top of honeycomb.
- ④ Cut two 20- by 24-inch pieces of honeycomb. Place one piece under the front and one under the rear of the equipment box.
- ⑤ Cut one 16- by 27-inch piece of honeycomb. Place it under the center of the box and glue it to the honeycomb positioned on top of the matting.
- ⑥ Place a 36- by 96-inch piece of honeycomb on top of the box and secure in place with type III nylon cord.

*Figure 4-15. Equipment box positioned*

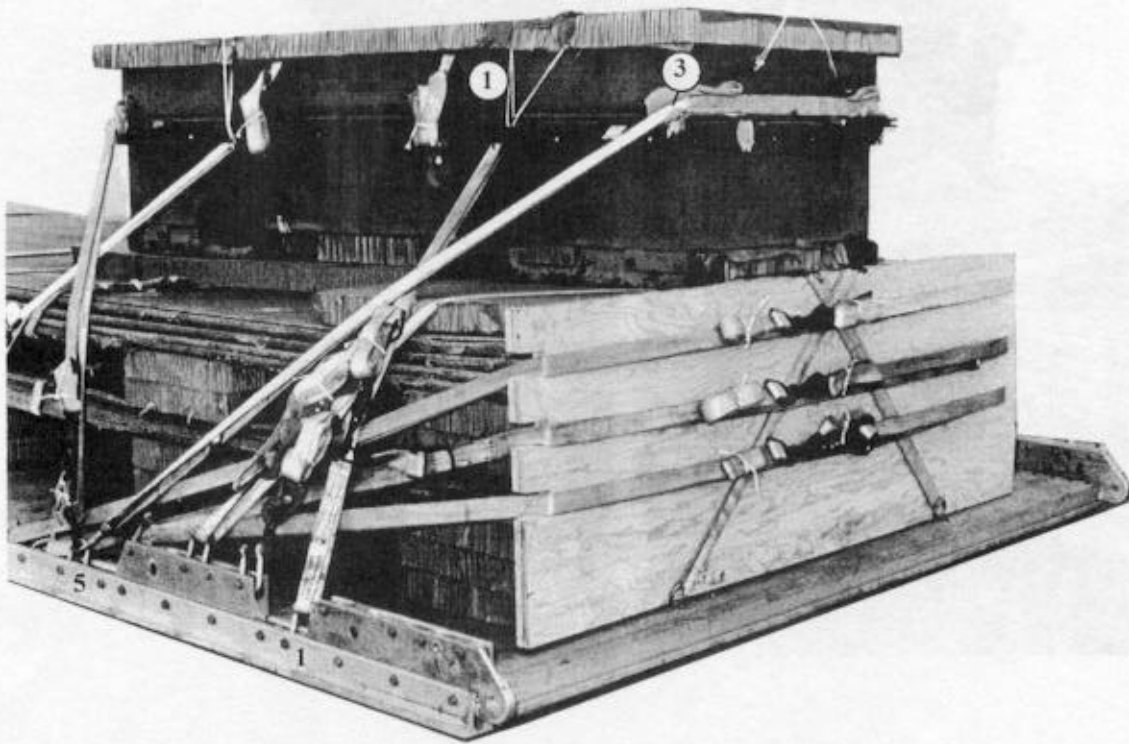

Lashing number	Clevis Number	Instructions
		Note: *30-foot lashing.
		Pass lashing:
1	1	Through right front carrying handle.
2	1A	Through left front carrying handle.
*3	5 to 5A	Up and around front end of box (over lip of lid). Pad lid with cellulose.

Figure 4-16. Equipment box secured

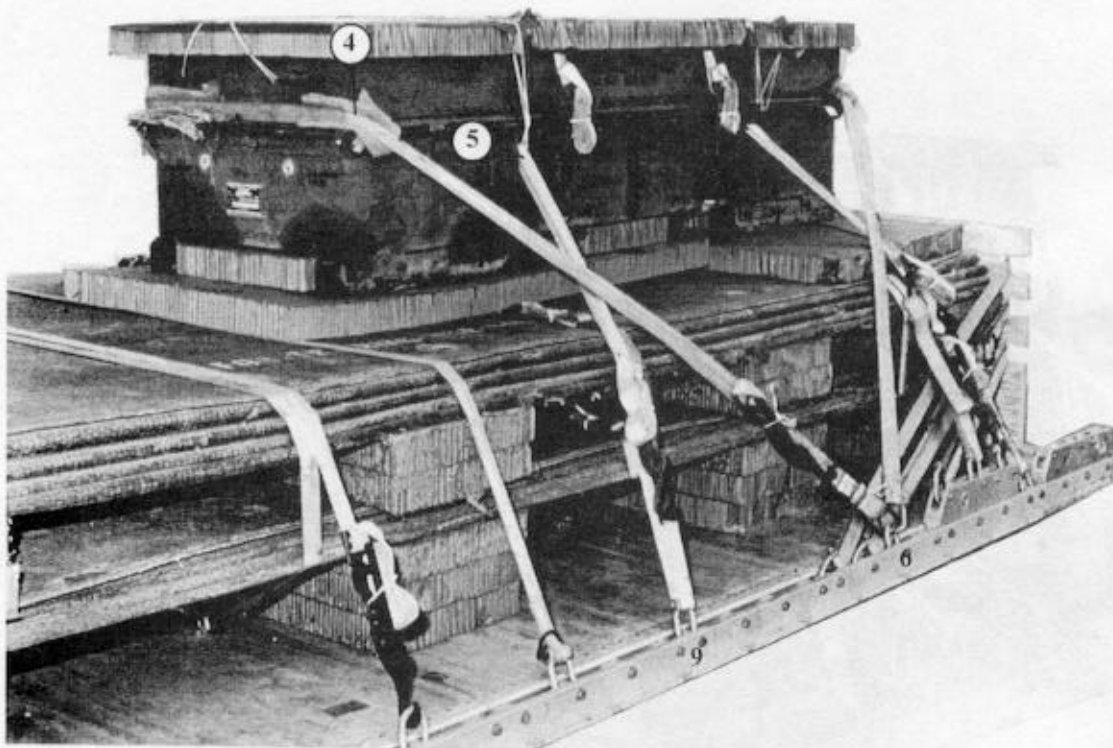

Lashing Number	Clevis Number	Instructions
		Note: *30-foot lashing.
		Pass lashing:
*4	6 to 6A	Up and around rear end of box (over lip of lid). Pad lid with cellulose.
5	9	Through right rear carrying handle.
6	9A	Through left rear carrying handle.

Figure 4-16. Equipment box secured (continued)

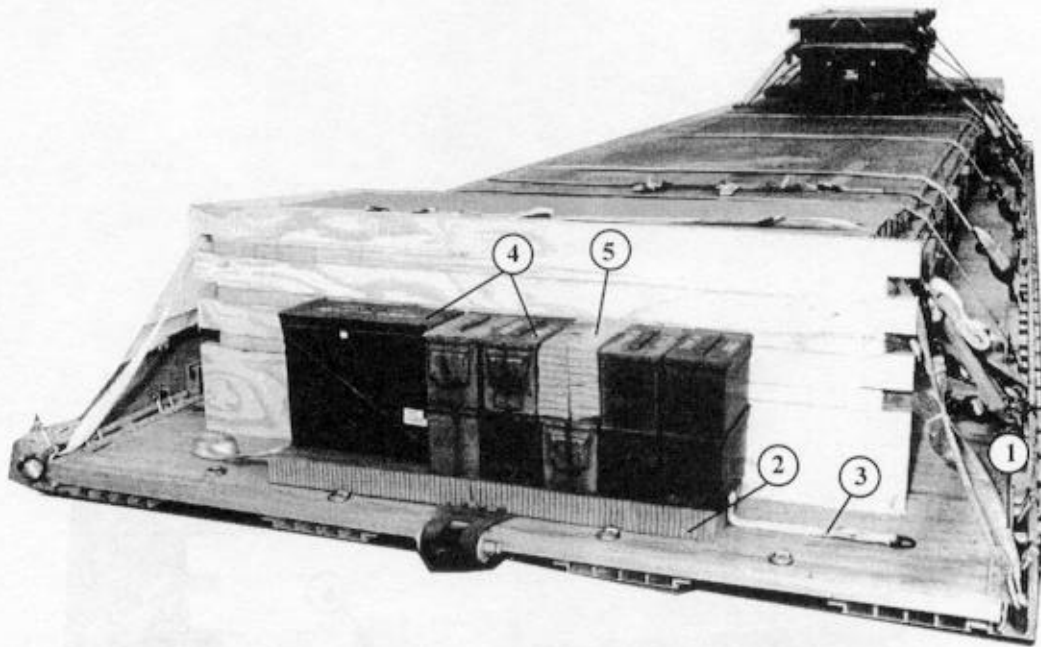

- ① Loosen lashings 21 and 22.
- ② Place a 12- by 48-inch piece of honeycomb centered and flush with endboard.
- ③ Place a tiedown lashing on top of honeycomb.
- ④ Place parts boxes on honeycomb.
- ⑤ Fill gaps with honeycomb as needed.

Figure 4-17. Parts boxes positioned



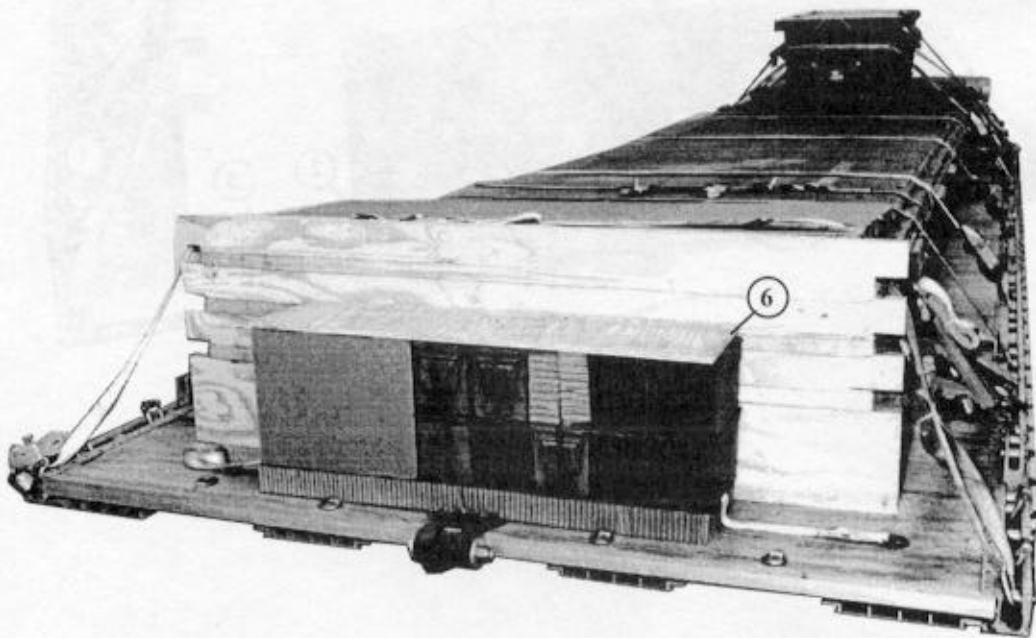

- ⑥ Place a 12- by 48-inch piece of 3/4-inch plywood on top of parts boxes.

*Figure 4-17. Parts boxes positioned (continued)*



Note: This drawing is not drawn to scale.

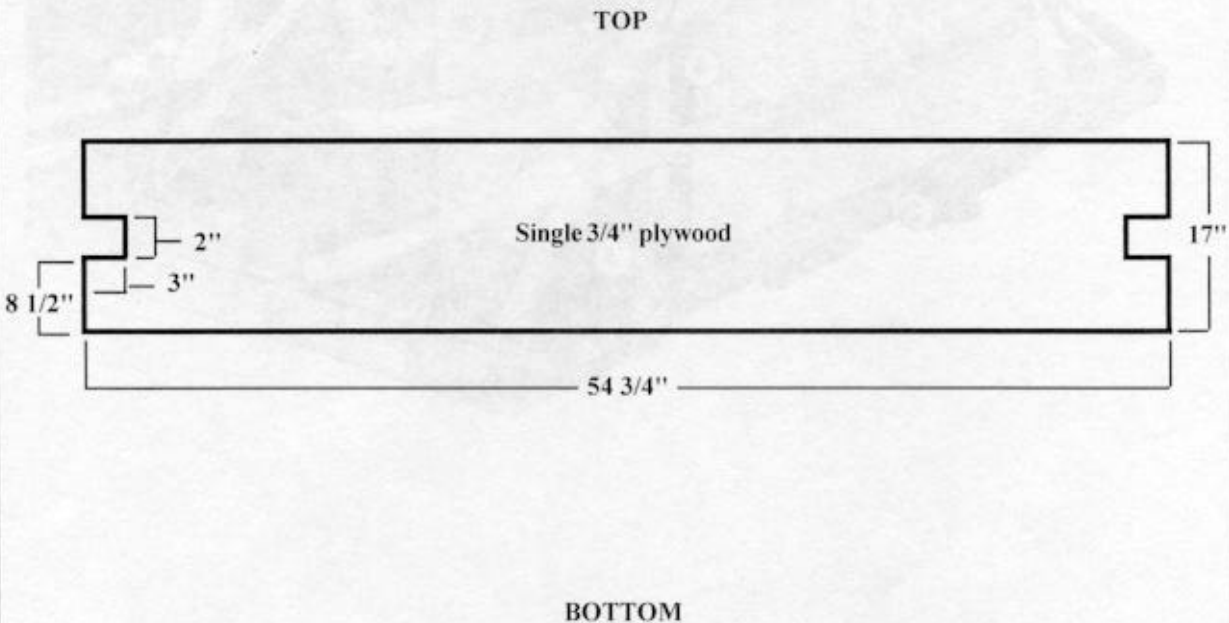

Item Number	Pieces	Width (Inches)	Length (Inches)	Material
1	1	17	54 3/4	3/4-inch plywood

Figure 4-18. Material required to build parts boxes endboard

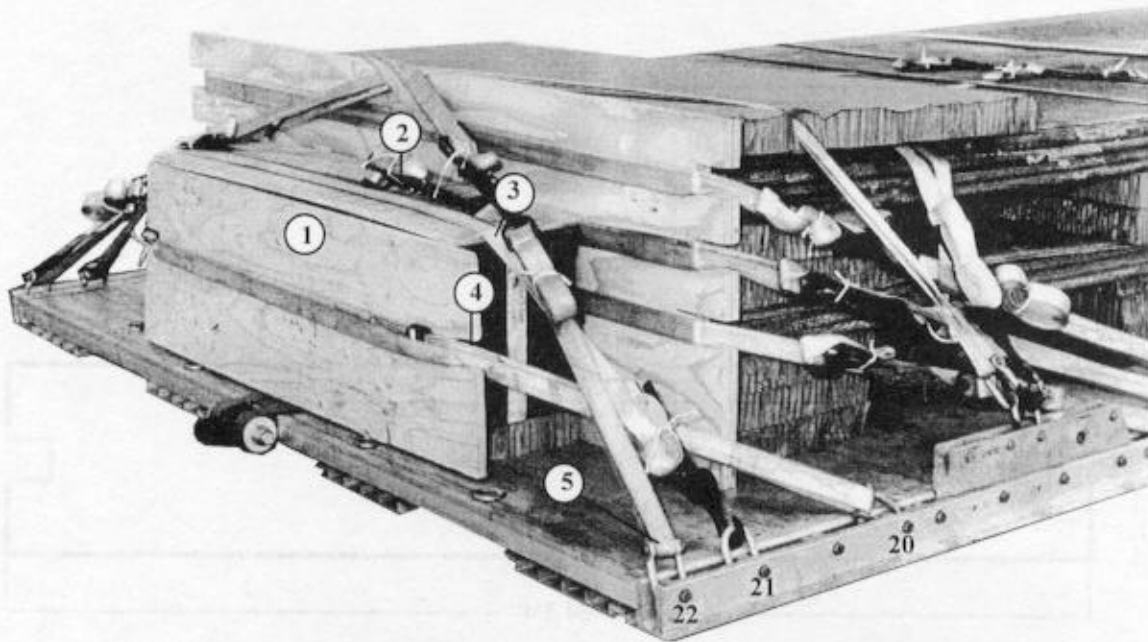

- ① Place the parts boxes endboard centered and flush against parts boxes and secure endboard .
- ② Secure prepositioned lashing in *Figure 4-19*, step 3 on top of plywood.
- ③ Run a lashing through clevis 21A and it's own D-ring and over top of parts boxes and clevis 21.
- ④ Run a 30-foot lashing through the notch of endboard and clevises 20 and 20A.
- ⑤ Secure lashings 21 and 22.

*Figure 4-19. Parts boxes secured*

#### 4-8. Installing and Safetying Suspension Slings

Install and safety the suspension slings in accordance with FM 10-500-2/TO 13C7-1-5 and as shown in *Figure 4-20*.

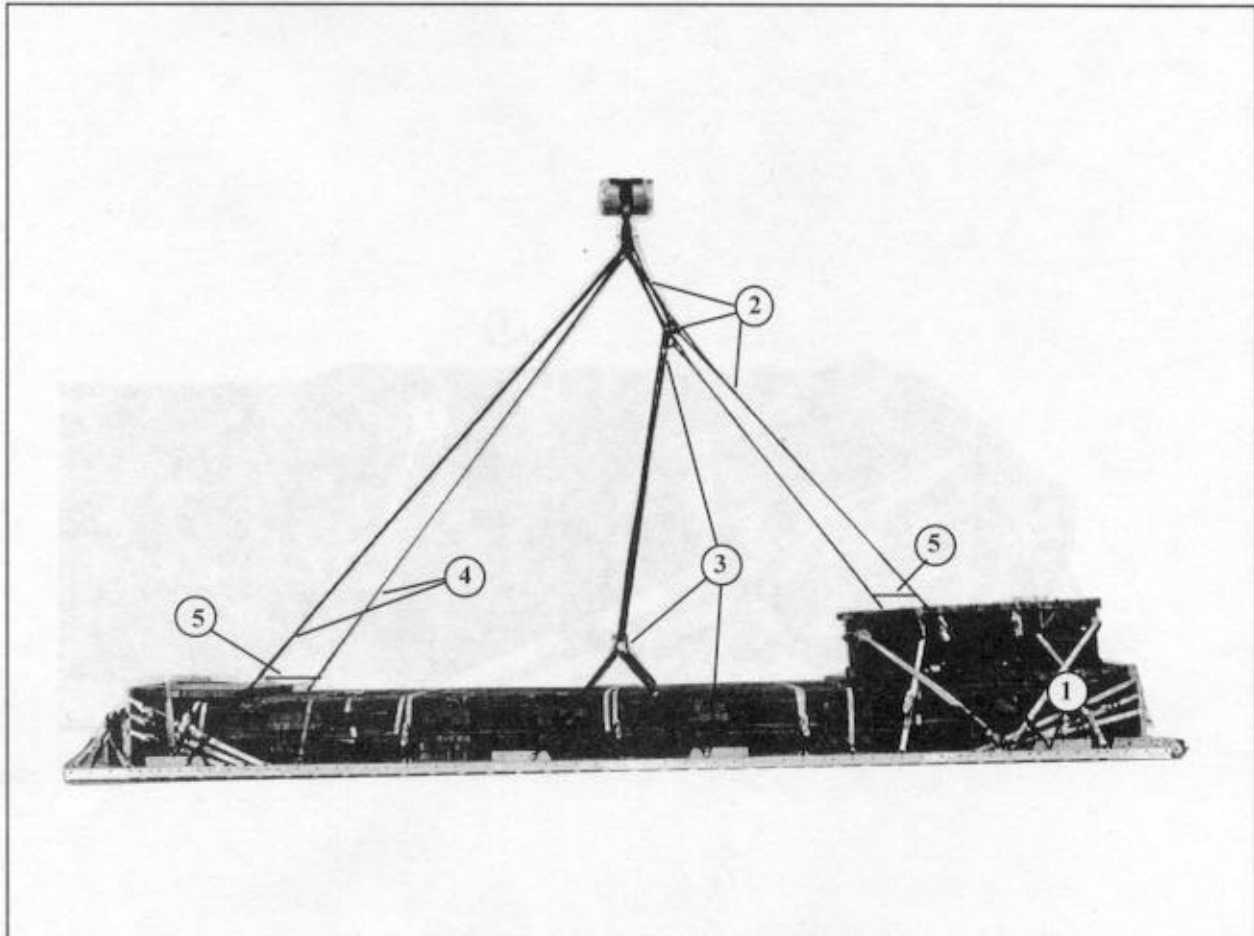

- ① Attach large clevises to the platform suspension links.
- ② Attach a 16-foot (2-loop), type XXVI nylon suspension sling to each center suspension link, each front suspension link and three point link, and 3-foot (2-loop), type XXVI nylon sling.
- ③ Attach a 3-foot (2-loop), type XXVI nylon suspension sling to each center suspension link and join them with a large clevis. Attach and half a 20-foot (2-loop), type XXVI nylon suspension sling to the large clevis and three point link.
- ④ Attach a 20-foot (2-loop), type XXVI nylon suspension sling to each of the rear suspension links.
- ⑤ Raise the slings and safety the two front and rear suspension slings with a double length of 1/2-inch tubular nylon.

*Figure 4-20. Suspension slings installed*

#### 4-9. Stowing Cargo Parachutes

Prepare, stow and restrain three G-11 cargo parachutes according to FM 10-500-2/TO 13C7-1-5 and as shown in *Figure 4-21*.

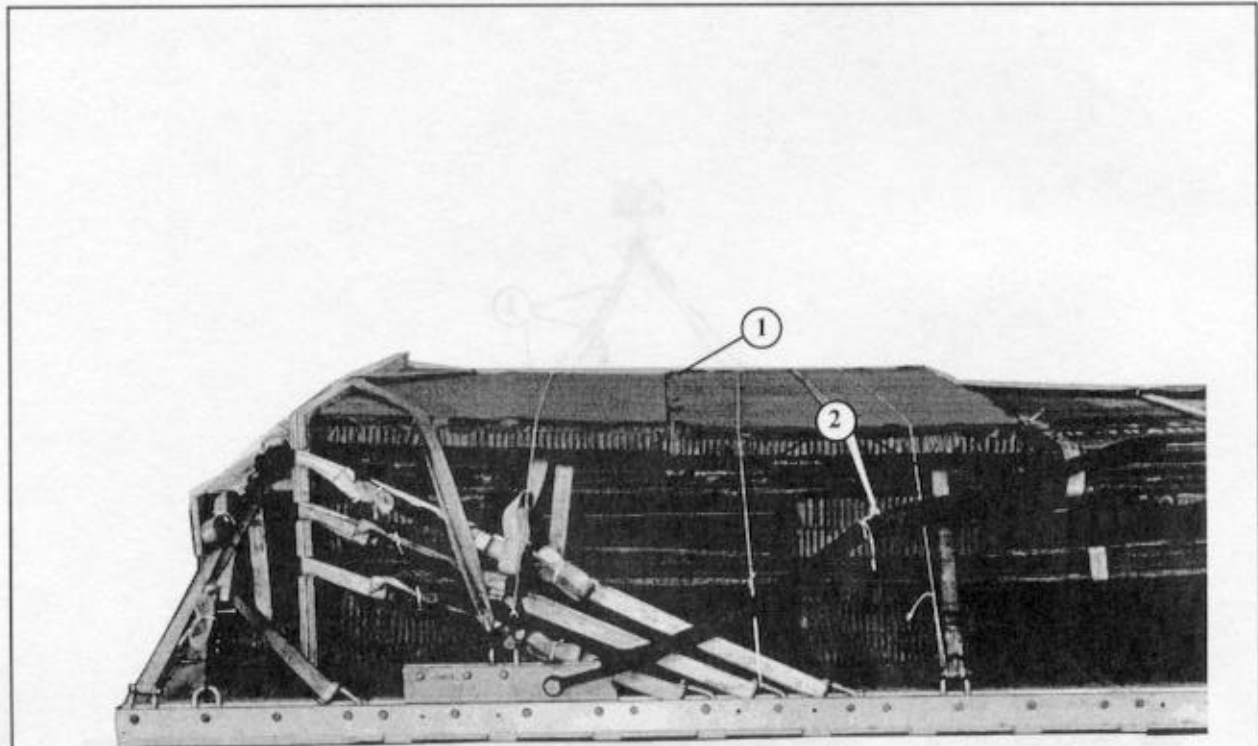

- ① Place a 36- by 75-inch piece of honeycomb on top of the matting flush with the rear piece of previously placed honeycomb.
- ② Secure in place with three lengths of type III nylon cord.

*Figure 4-21. Cargo parachutes positioned*

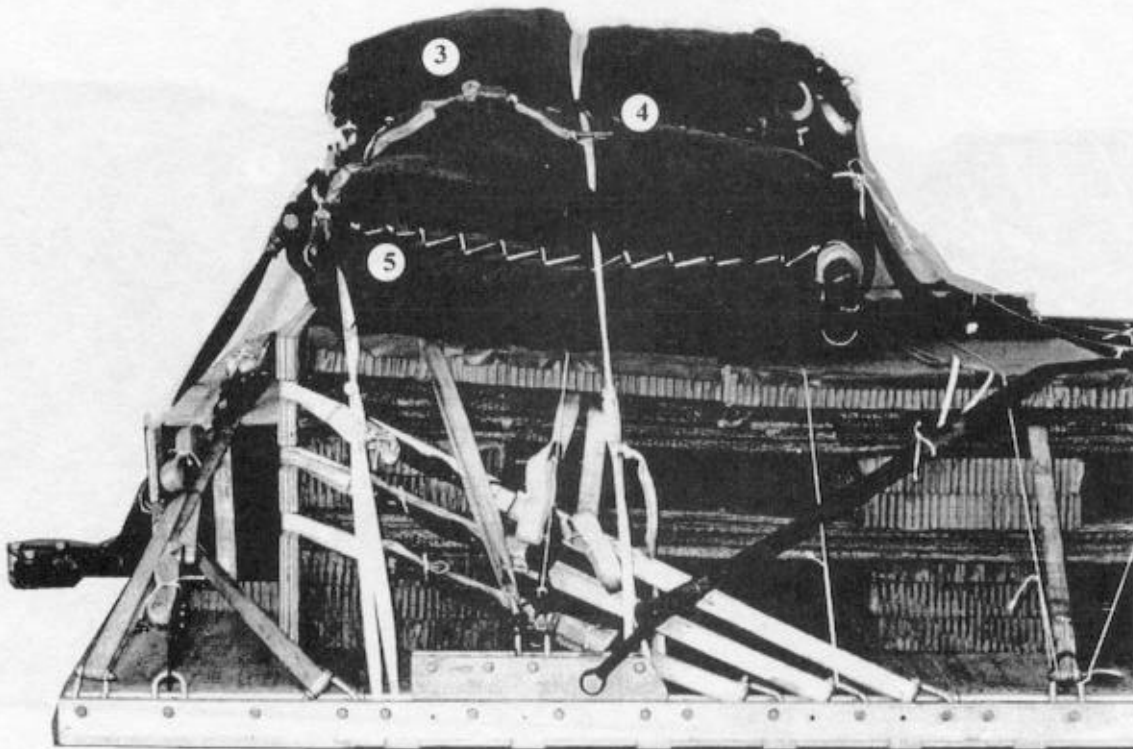

- ③ Stow three G-11 cargo parachutes on the load according to FM 10-500-2/TO 13C7-1-5.
- ④ Run one length of type VIII nylon webbing from bushing 1 on the left rear suspension link through the center carrying handles and bushing 1A on the right rear suspension link and secure.
- ⑤ Run one length of type VIII nylon webbing from platform bushing 60 on left side of platform through the rear carrying handles and bushing 60A on the right side of platform and secure.

Figure 4-21. Cargo parachutes positioned (continued)



#### 4-10. Installing Release System

Prepare and install the M-1 release system according to FM 10-500-2/TO 13C7-1-5 and as shown in Figure 4-22.

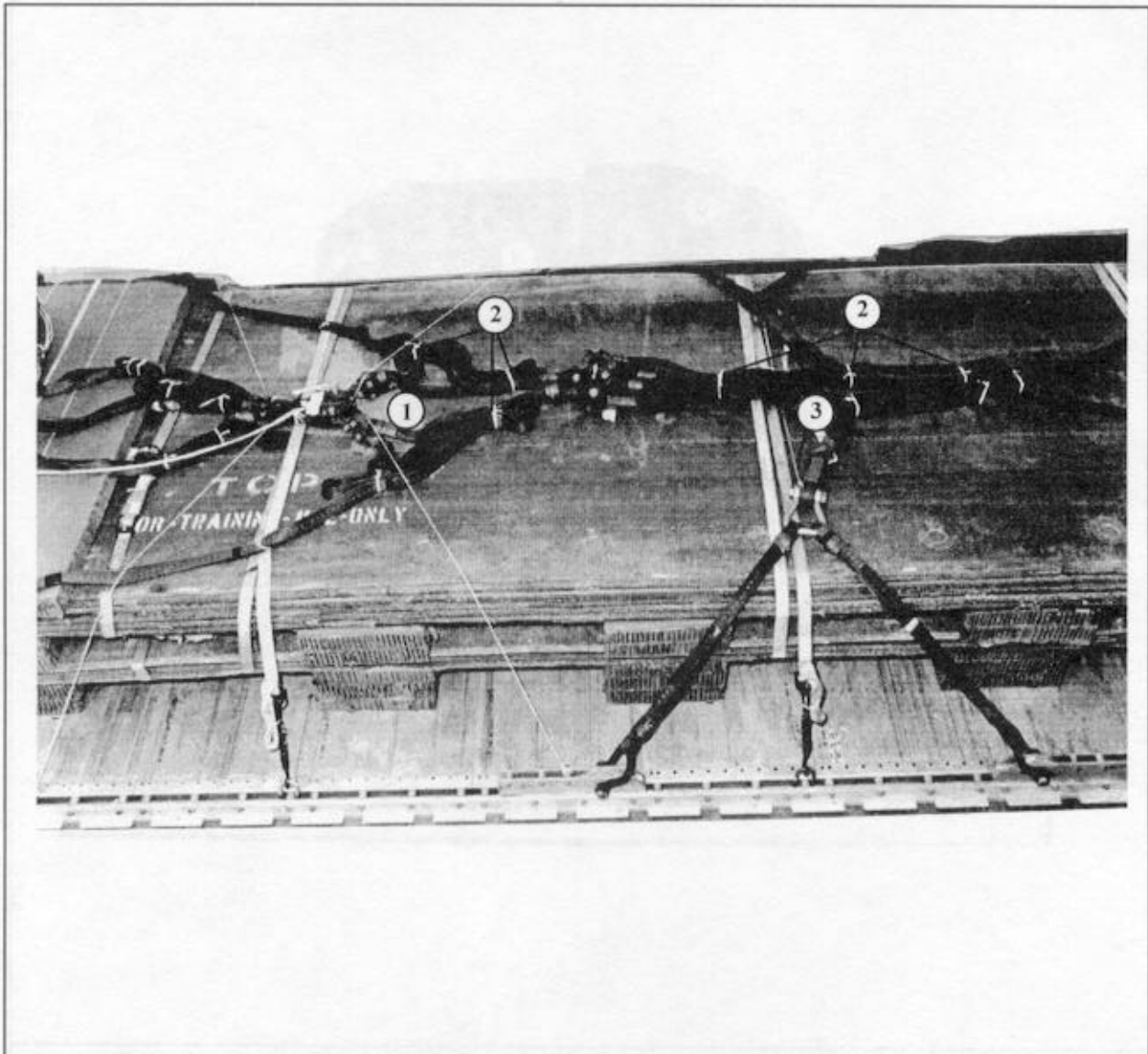

- ① Position and install the M-1 release assembly on the matting and according to FM 10-500-2/TO 13C7-1-5.
- ② Safety all suspension slings according to FM 10-500-2/TO 13C7-1-5.
- ③ Safety tie large clevises with length of type III nylon cord.

Figure 4-22. Release system installed



#### 4-11. Installing Extraction System

Prepare and install the extraction force transfer coupling (EFTC) system according to FM 10-500-2/TO 13C7-1-5 and as shown in *Figure 4-23*.



- ① Install the components of the EFTC according to FM 10-500-2/TO 13C7-1-5. Use the rear mounting holes for the EFTC bracket.

*Figure 4-23. Extraction system installed*

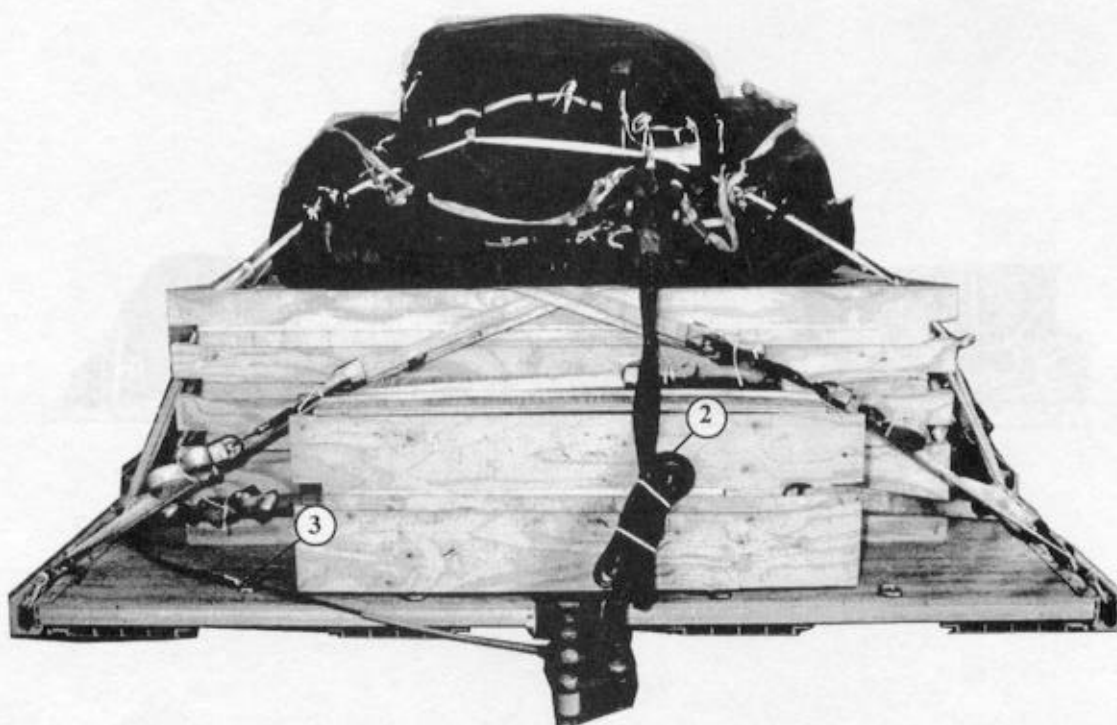

- ② Attach a 9-foot (2-loop), type XXVI nylon sling to be used as a deployment line.
- ③ Use a 28-foot EFTC cable and safety the cable to tiedown ring D16 and along the side rail using one turn of type I, 1/4-inch cotton webbing.

Figure 4-23. Extraction system installed (continued)



**CAUTION**  
Make the final inspection required by FM 10-500-2/TO 13C7-1-5 before the load leaves the rigging site.

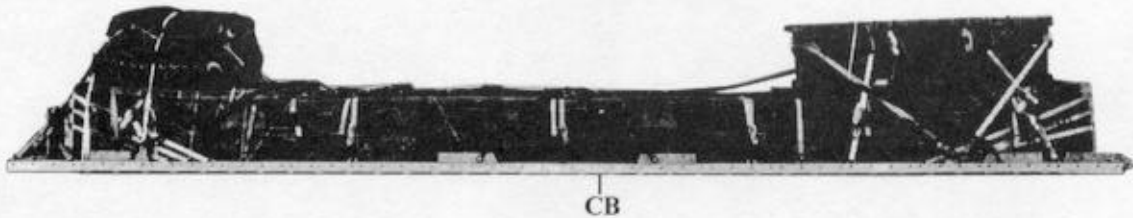

**RIGGED LOAD DATA**

Weight: Load shown	13,260 pounds
Maximum rigged weight	13,500 pounds
Height:	59 1/2 inches
Width:	108 inches
Length:	401 inches
Overhang: Front	0 inches
Rear (extraction bracket)	17 inches
Center of Balance (CB): (from the edge of the platform)	189 inches
Extraction System: (add 18 inches to length of platform)	EFTC

Figure 4-24. Rapid runway repair kits -ALPHA rigged for low-velocity airdrop on type V platform

Table 4-1. Equipment required for rigging the rapid runway repair kit-ALPHA for low-velocity airdrop on a 32-foot type V platform

National Stock Number	Item	Quantity
8040-00-273-8713	Adhesive, paste, 1-gal	As required
	Clevis, suspension:	
4030-00-090-5354	1-in (large)	15
4020-00-240-2146	Cord, nylon, type III, 550-lb	As required
1670-00-157-6527	Coupling, airdrop, extraction force transfer with 28-ft cable	1
	Cover:	
1670-00-360-0328	Clevis, large	5
1670-00-360-0329	Link assembly (type IV)	3
1670-01-183-2678	Leaf, extraction line	2
	Line, extraction:	
1670-01-062-6313	60-ft (3-loop), type XXVI nylon webbing (C-130)	1
1670-01-107-7651	140-ft (3-loop), type XXVI nylon webbing (C-141, C-5, and C-17)	1
	Link assembly:	
1670-01-307-0155	Three-point	2
1670-00-783-5988	Type IV	3
	Nail, steel wire, common:	
5315-00-010-4657	6d	As required
5315-00-010-4661	10d	As required
1670-00-753-3928	Pad, energy-dissipating, honeycomb, 3- by 36- by 96-in	9 sheets
	Parachute:	
1670-01-016-7841	Cargo, G-11B	3
1670-01-063-3716	Cargo extraction, 22-ft	1
	Platform, AD, type V, 32-ft:	
1670-01-162-2372	Clevis assembly	44
1670-01-162-2376	Extraction bracket assembly	(1)
1670-01-247-2389	Suspension link	(8)
1670-01-162-2381	Tandem link	(2)
5530-00-128-4981	Plywood, 3/4-in:	3 Sheets
1670-01-097-8816	Release, cargo parachute, M-1	1
	Sling, cargo airdrop:	
	For deployment line:	
1670-01-062-6304	9-ft (2-loop), type XXVI nylon webbing	1
	For riser extensions:	
1670-01-062-6302	20-ft (2-loop), type XXVI nylon webbing	6
	For suspension slings:	
1670-01-062-6301	3-ft (2-loop), type XXVI nylon webbing	6
1670-01-063-7761	16-ft (2-loop), type XXVI nylon webbing	2
1670-01-062-6302	20-ft (2-loop), type XXVI nylon webbing	2
5340-00-040-8219	Strap, parachute release, multicut comes with 3 knives	2
8305-00-074-5124	Tape, adhesive, 2-in	As required
1670-00-937-0271	Tie-down assembly, 15-ft	48

Table 4-1. Equipment required for rigging the rapid runway repair kit-ALPHA for low-velocity airdrop on a 32-foot type V platform (continued)

National Stock Number	Item	Quantity
8305-00-268-2411	Webbing: Cotton, 1/4-in, type I	As required
8305-00-082-5752	Nylon: Tubular: 1/2-in or	As required
8305-00-268-2453	1/2-in	As required
8305-00-263-3591	Type VIII	As required



## GLOSSARY

<b>ACB</b>	attitude control bar	<b>HHDS</b>	heavy drop derigging system
<b>AD</b>	airdrop	<b>in</b>	inch
<b>AFB</b>	Air Force base	<b>LAPE</b>	low-altitude parachute-extraction
<b>AFR</b>	Air Force regulation	<b>LAPES</b>	low-altitude parachute-extraction system
<b>AFTO</b>	Air Force technical order	<b>lb</b>	pound
<b>ATTN</b>	attention	<b>No</b>	number
<b>CB</b>	center of balance	<b>NSN</b>	national stock number
<b>d</b>	penny	<b>OVE</b>	on-vehicular equipment
<b>DA</b>	Department of the Army	<b>OVM</b>	operator vehicle maintenance
<b>DC</b>	District of Columbia	<b>psi</b>	pound per square inch
<b>DD</b>	Department of Defense	<b>RRR</b>	rapid runway repair kit
<b>diam</b>	diameter	<b>TM</b>	technical manual
<b>EFTA</b>	extraction force transfer actuator	<b>TO</b>	technical order
<b>EFTC</b>	extraction force transfer coupling	<b>TRADOC</b>	United States Army Training and Doctrine Command
<b>FM</b>	field manual	<b>US</b>	United States
<b>ft</b>	feet	<b>w</b>	with
<b>gal</b>	gallon	<b>yd</b>	yard
<b>HQ</b>	headquarters		

## REFERENCES

**FM 10-500-2/TO 13C7-1-5.** *Airdrop of Supplies and Equipment: Rigging Airdrop Platforms.* 1 November 1990.

**TM 10-1670-208-20&P/TO 13C3-4-12.** *Organizational Maintenance Manual Including Repair Parts and Special Tools List for Platforms, Type II Modular and LAPES/Airdrop Modular.* 10 August 1978.

**TM 10-1670-268-20&P/TO 13C7-52-22.** *Organizational Maintenance Manual with Repair Parts and Special Tools List: Type V Airdrop Platform.* 1 June 1986.

**TM 10-1670-277-23&P/TO 13C5-28-2/NAVAIR 13-1-30.** *Unit and Intermediate DS Maintenance Manual Including Repair Parts and Special Tool List for Parachute, Cargo Type: 28-ft Diam, Cargo Extraction.* 9 October 1990.

**TM 10-1670-280-23&P/TO 13C5-31-2/NAVAIR 13-1-31.** *Unit and Intermediate DS Maintenance Manual Including Repair Parts and Special Tools List for Parachute, Cargo Type: 100-ft Diam, G-11A, G-11B, G-11C.* 5 August 1991.

**AFTO Form 22.** *Technical Order Publication Improvement Report.* April 1973.

**DA Form 2028.** *Recommended Changes to Publications and Blank Forms.* February 1974.

**PIN: 021571-002**