

**ARMY FM 10-500-45
AIR FORCE TO 13C7-10-201**



AIRDROP OF SUPPLIES AND EQUIPMENT

**RIGGING
120-MILLIMETER
MORTARS**



DISTRIBUTION RESTRICTION: Distribution authorized to US government agencies only to protect technical or operational information from automatic dissemination under the International Exchange Program or by other means. This determination was made on 30 April 1991. Other requests for this document will be referred to Commander, US Army Quartermaster Center and School, ATTN: ATSM-ABN-FS, Fort Lee, VA 23801-5038.

DESTRUCTION NOTICE: Destroy by any method that will prevent disclosure of contents or reconstruction of this document.

DEPARTMENTS OF THE ARMY AND THE AIR FORCE

Distribution Restriction: Approved for public release. Distribution is unlimited

FIELD MANUAL
NO. 10-500-45
TECHNICAL ORDER
NO. 13C7-10-201

HEADQUARTERS
DEPARTMENT OF THE ARMY
DEPARTMENT OF THE AIR FORCE
Washington DC, 3 October 1995

AIRDROP OF SUPPLIES AND EQUIPMENT RIGGING MORTARS

TABLE OF CONTENTS

	Paragraph	Page
PREFACE		iii
CHAPTER 1 INTRODUCTION		
Description of Items	1-1	1-1
Special Considerations	1-2	1-1
CHAPTER 2 RIGGING 120-MILLIMETER MORTAR WITH 1 1/4-TON HMMWV TRUCK ON THE 28-FOOT PLATFORM FOR LOW-VELOCITY AIRDROP		
Description of Load	2-1	2-1
Preparing Platform	2-2	2-1
Preparing Honeycomb Stacks	2-3	2-3
Positioning Honeycomb Stacks and Drive-Off Aids	2-4	2-6
Positioning Accompanying Load on Platform	2-5	2-8
Building Endboards and Lashing Ammunition	2-6	2-11
Preparing Truck	2-7	2-16
Preparing Mortar	2-8	2-17
Lifting and Positioning Truck and Installing Drive-off Aids	2-9	2-18
Lifting and Positioning Mortar	2-10	2-19
Lashing Truck and Mortar	2-11	2-21
Installing Protective Honeycomb, Load Cover, and Safety Ties	2-12	2-24
Installing and Safetying Suspension Slings	2-13	2-26
Stowing Cargo Parachutes	2-14	2-31
Installing Release System	2-15	2-32
Installing Extraction System	2-16	2-33

DISTRIBUTION RESTRICTION: Distribution authorized to US government agencies only to protect technical or operational information from automatic dissemination under the International Exchange Program or by other means. This determination was made on 30 April 1991. Other requests for this document will be referred to Commander, US Army Quartermaster Center and School, ATTN: ATSM-ABN-FS, Fort Lee, VA 23801-5038.

DESTRUCTION NOTICE: Destroy by any method that will prevent disclosure of contents or reconstruction of this document.

***This publication supercedes FM 10-545/TO13C7-10-201, 27 September 1988.**

Distribution Restriction: Approved for public release. Distribution is unlimited

	Paragraph	Page
Installing Provisions for Emergency Restraints	2-17	2-34
Placing Cargo Extraction Parachute	2-18	2-34
Marking Rigged Load	2-19	2-34
Equipment Required	2-20	2-35
 CHAPTER 3		
RIGGING DISASSEMBLED 120-MILLIMETER MORTAR IN 1 1/4-TON HMMWV TRUCK ON THE 16-FOOT TYPE V PLATFORM FOR LOW-VELOCITY AIRDROP		
Description of Load	3-1	3-1
Preparing Platform	3-2	3-1
Preparing and Positioning Honeycomb Stacks	3-3	3-1
Preparing Truck	3-4	3-1
Stowing Accompanying Load	3-5	3-1
Installing Drive-Off Aids on Platform	3-6	3-13
Lifting and Positioning Truck and Installing Drive-Off Aids	3-7	3-13
Lashing Truck	3-8	3-13
Installing, Padding, and Safetying Suspension Slings	3-9	3-13
Stowing Cargo Parachutes	3-10	3-13
Installing Release	3-11	3-13
Installing Extraction System	3-12	3-13
Installing Provisions for Emergency Restraints	3-13	3-13
Placing Extraction Parachute	3-14	3-13
Marking Rigged Load	3-15	3-14
Equipment Required	3-16	3-15
 GLOSSARY		Glossary-1
REFERENCES		References-1

PREFACE

SCOPE

This manual is designed to be used by all parachute riggers. It tells and shows how to rig the 120-millimeter mortar in the trailer-mounted configuration with a 1 1/4-ton HMMWV-series truck for low-velocity airdrop from a C-130, C-141, or C-5 aircraft. This manual also shows the 120-millimeter mortar rigged in a 1 1/4-ton HMMWV-series truck for low-velocity airdrop from a C-130, C-141, or C-5 aircraft.

USER INFORMATION

The proponent for this publication is HQ TRADOC. You are encouraged to report any errors or omissions and suggest ways to improve this manual. ARMY personnel, send your comments on DA Form 2028 directly to:

Commander
US Army Quartermaster Center and School
ATTN: ATSM-ABN-FS
Fort Lee, Virginia 23801-5036

Air Force personnel, send your reports on AFTO Form 22 through:

Headquarters
Air Mobility Command (AMC/DOTX)
402 Scott Drive, Unit 3A1
Scott AFB, Illinois 62225-5302

Air Force personnel in Air Combat Command, send your reports on AFTO form 22 through:

HQ ACC/DOTW
205 Dodd Blvd, Suite 101
Langley AFB, VA 23665-2789

Air Force personnel in Special Operations Command, send your reports on AFTO Form 22 through:

HQ AFSOC/DOXT
100 Bartley St, Suite 260
Hurlburt Field, FL 32544-5273

to:

Commander
ATTN: ATSM-ABN-FS
Fort Lee, Virginia 23801-5036

Also send information copy of AFTO Form 22 to:

San Antonio ALC/LDILT
Kelly AFB, Texas 78241-5000

CHAPTER I
INTRODUCTION

1-1. Description of Items

The descriptions and unrigged data for the items covered in this manual are given below.

a. The M-120 120-millimeter mortar consists of a cannon tube, mounts, baseplate, sights, and the M-1100 trailer. The mortar is transported in a truck or towed on its trailer. The M-120 in its trailer-mounted configuration weighs 716 pounds, is 45 inches in height, 94 inches in length and 60 inches in width. The height is not reducible. The mortar without the trailer, assembled, and in its firing position weighs 317 pounds.

b. The 1 1/4-ton HMMWV-series trucks dropped with this mortar are the cargo/troop carrier configuration. The trucks are described in FM 10-517/TO 13C7-1-111.

1-2. Special Considerations

Special considerations for this manual are described below.

a. The loads covered in this manual will include hazardous materials as defined in AFJMAN 24-204. The hazardous material must be packaged, marked, and labeled as required by AFJMAN 24-204.

b. A copy of this manual must be available to the joint airdrop inspectors during the before and after-loading inspections.

c. FM 10-517/TO 13C7-1-5 is required to rig these loads.

CHAPTER 2

**RIGGING 120-MILLIMETER MORTAR
WITH 1 1/4-TON HMMWV TRUCK
ON THE 28-FOOT PLATFORM
FOR LOW-VELOCITY AIRDROP****2-1. Description of Load**

The M-120 120-millimeter mortar is rigged in its trailer-mounted configuration with a 1 1/4-ton HMMWV-series truck and thirty boxes of 120-millimeter ammunition. The load is rigged on a 28-foot, Type V airdrop platform with three G-11B cargo parachutes for low-velocity airdrop from a C-130, C-141, or C-5 aircraft. The mortar weighs 760 pounds, is 45 inches in height, 94 inches in length and 60 inches in width. The height is not reducible. Thirty boxes of 120-mm ammunition weighing 2,700 pounds are rigged on the platform. Ammunition and crew equipment weighing up to 1,800 pounds may be stowed in the truck.

NOTE: ANY HMMWV-SERIES TRUCK WITH THE CARGO/TROOP CARRIER CONFIGURATION MAY BE RIGGED ON THIS LOAD.

2-2. Preparing Platform

Prepare a 28-foot, type V airdrop platform as described below.

a. Inspecting Platform. Inspect, or assemble and inspect, the platform as outlined in TM 10-1670-268-20&P/TO 13C7-52-22.

NOTE: IF THE PLATFORM MUST BE ASSEMBLED, INSTALL THE SUSPENSION LINKS WHEN ASSEMBLING THE PLATFORM. SEE FIGURE 2-1 FOR THE LOCATION OF THE SUSPENSION LINKS.

b. Installing Suspension Links. Install the suspension links on assembled platforms according to FM 10-500-2/TO 13C7-1-5.

CHAPTER 2

c. **Installing Tandem Links.** Install a tandem link on the front of each rail as shown in Figure 2-1.

d. **Installing and Numbering Clevises.** Bolt and number 44 clevis assemblies as shown in Figure 2-1.

- NOTES: 1. THE NOSE BUMPER MAY OR MAY NOT BE INSTALLED.
 2. MEASUREMENTS GIVEN IN THIS CHAPTER ARE FROM THE FRONT EDGE OF THE PLATFORM, NOT FROM THE FRONT EDGE OF THE NOSE BUMPER.

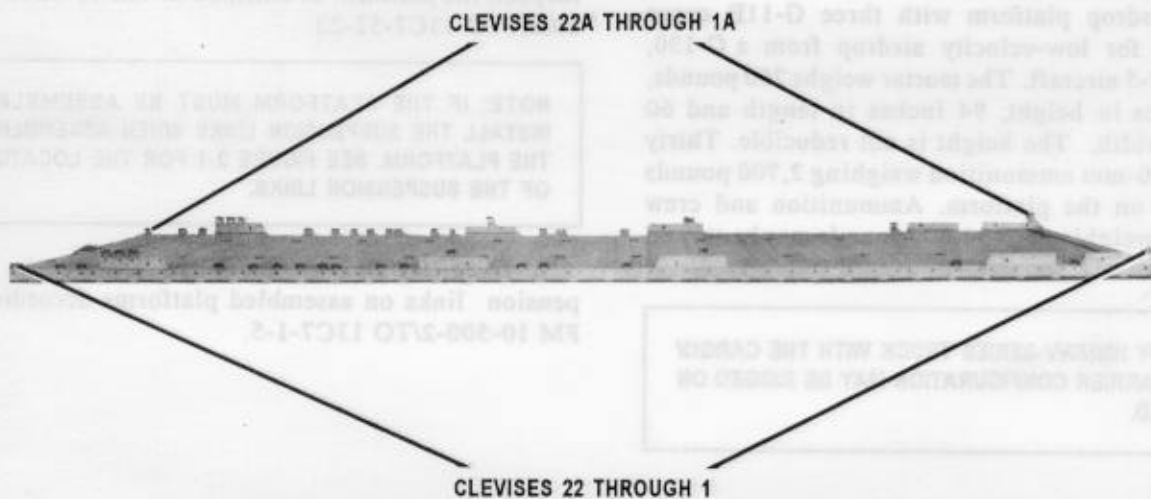

Step:

1. Install a tandem link on the front of each platform side rail using holes 1, 2, and 3.
2. Install four suspension links to each side rail using bushing holes 6, 7, 8, 22, 23, 24, 33, 34, and 35, 49, 50, and 51.
3. Install a clevis on bushing 1 on each front tandem link.
4. Install a clevis on bushing 2 on the second set of suspension links.
5. Install a clevis on bushing 2 on the the third set of suspension links.
6. Install a clevis on bushings 2, 3, and 4 on the fourth set of suspension links.
7. Starting at the front of the platform, install clevises on each platform side rail using the bushings bolted on holes 4, 10, 26, 30, 31, 37, 38, 40, 41, 42, 43, 44, 46, 53, 54, and 56.
8. Starting at the front of the platform, number the clevises bolted to the right side rail from 1 through 44 and those bolted to the left side rail from 1A through 44A.
9. Label the tie-down rings according to FM 10-500-2/TO 13C7-1-5.

Figure 2-1. Platform prepared

2-3. Preparing Honeycomb Stacks

Prepare the honeycomb stacks for the truck as shown in Figures 2-3 and 2-4 of Chapter 2, FM 10-517/TO 13C7-1-111. These stacks will be numbered 1, 2, and 3.

Prepare the honeycomb stacks for the mortar and accompanying ammunition as shown in Figures 2-2 and 2-3 of this manual.

NOTE: THE FRONT AND REAR SIDES WILL NOT BE GLUED TO THE BASE AT THIS TIME.

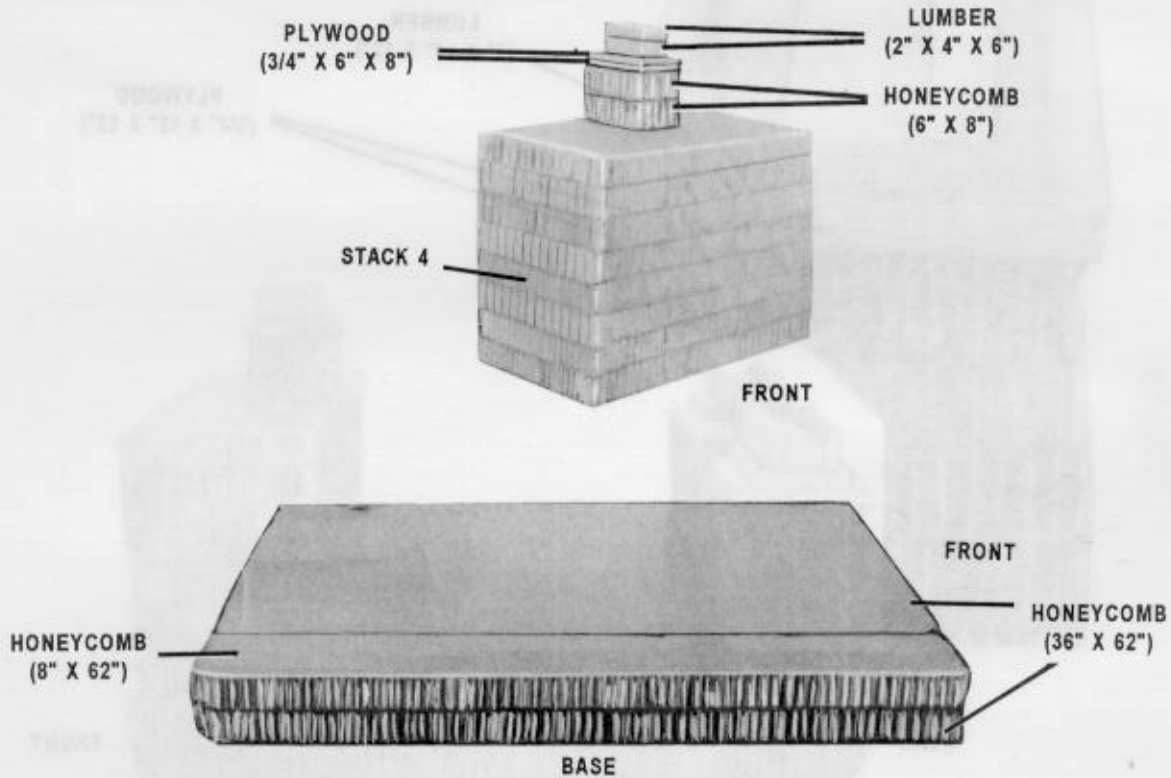

Stack Number	Pieces	Width (Inches)	Length (Inches)	Material	Instructions
4	2	36	62	Honeycomb	Alternate layers to form a two-layer base. Stack pieces flush. Stack flush and center the 6-inch side along the rear edge of stack. Place on top of 6- by 8-inch pieces of honeycomb. Center the lumber flat on top of the plywood.
	2	8	62	Honeycomb	
	8	36	16	Honeycomb	
	2	6	8	Honeycomb	
	2	6	8	3/4-inch Plywood	
	2	4	6	2- by 4-inch lumber	

Figure 2-2. Stack 4 prepared

NOTE: STACK 4 IS SHOWN ASSEMBLED FOR REFERENCE PURPOSES ONLY. THE FRONT AND REAR SIDES OF THE STACK ARE NOT TO BE GLUED TO THE BASE AT THIS TIME.

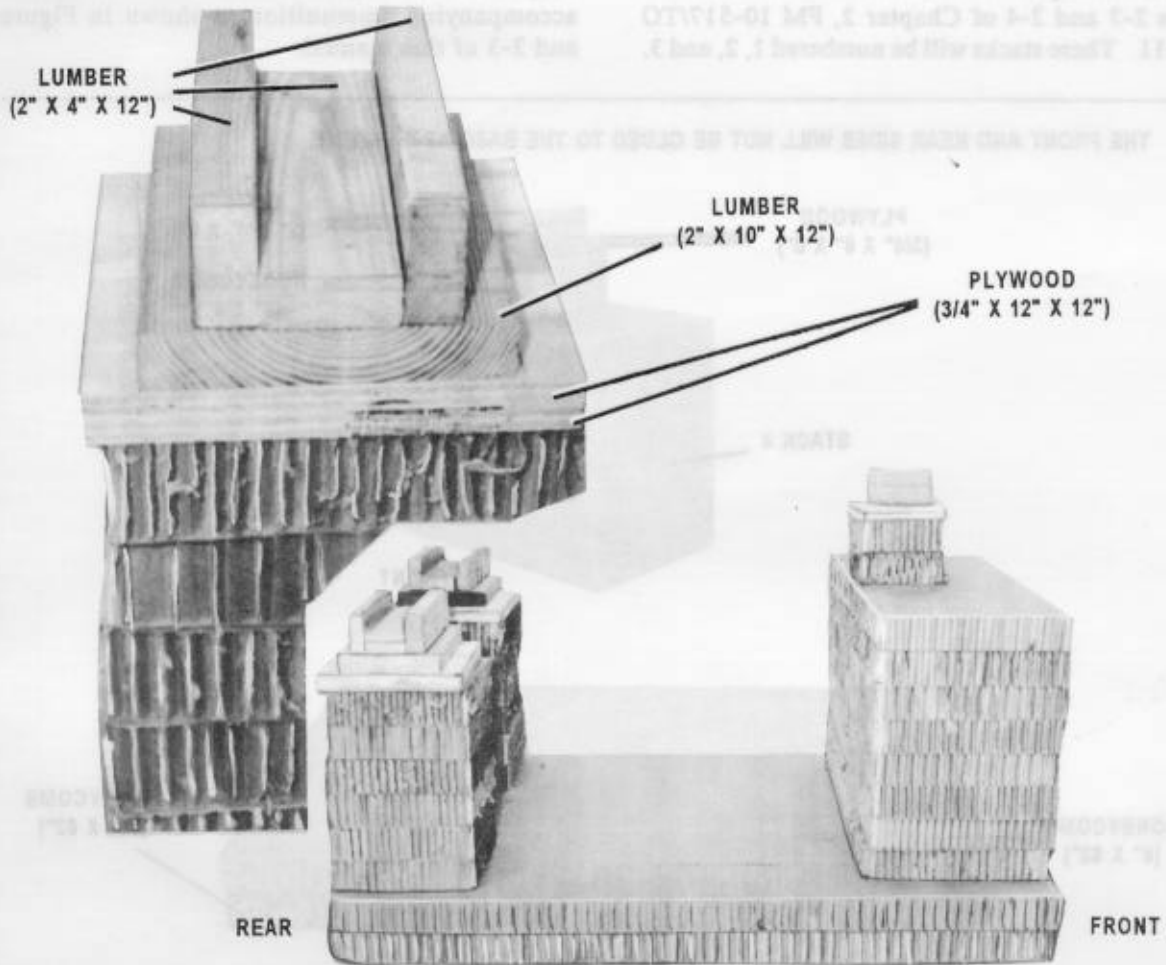

Stack Number	Pieces	Width (Inches)	Length (Inches)	Material	Instructions
4	12	12	12	Honeycomb	Form two stacks of six layers each. Place two pieces on top of each 12- by 12-inch stack of honeycomb. Center and nail a piece on each of the 12- by 12-inch pieces of plywood. Center and nail a 12-inch piece of 2- by 4-inch lumber on the 2- by 10-inch pieces. Nail a piece on edge along each side of the pieces nailed flat.
	4	12	12	3/4-inch Plywood	
	2	12	10	2- by 10-inch lumber	
	6	12	4	2- by 4-inch lumber	

Figure 2-2. Stack 4 prepared (continued)

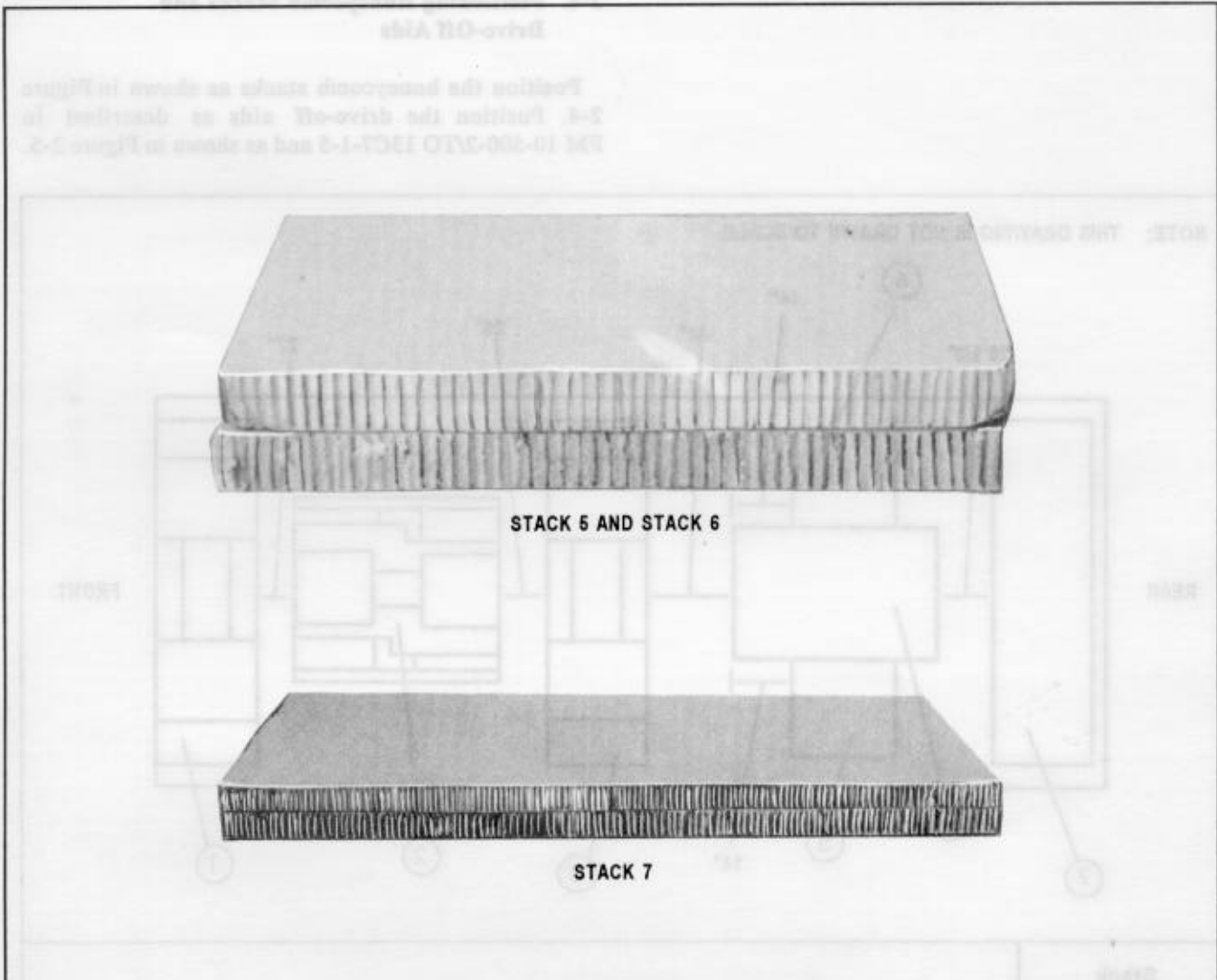

Stack Number	Pieces	Width (Inches)	Length (Inches)	Material	Instructions
5 & 6	2	20	36	Honeycomb	Form stack.
7	2	82	32	Honeycomb	Form stack.

Figure 2-3. Stacks 5, 6 and 7 prepared

2-4. Positioning Honeycomb Stacks and Drive-Off Aids

Position the honeycomb stacks as shown in Figure 2-4. Position the drive-off aids as described in FM 10-500-2/TO 13C7-1-5 and as shown in Figure 2-5.

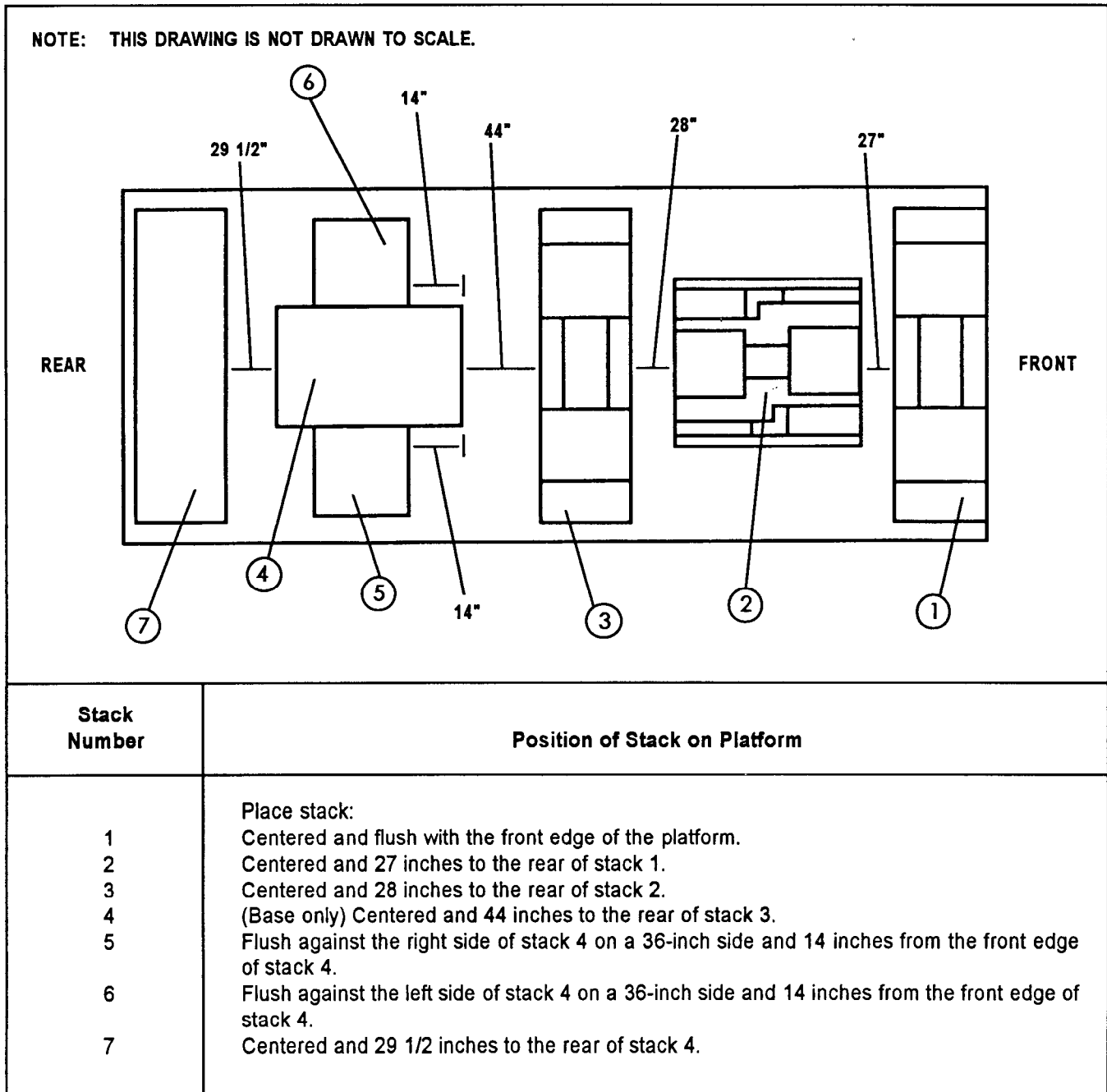
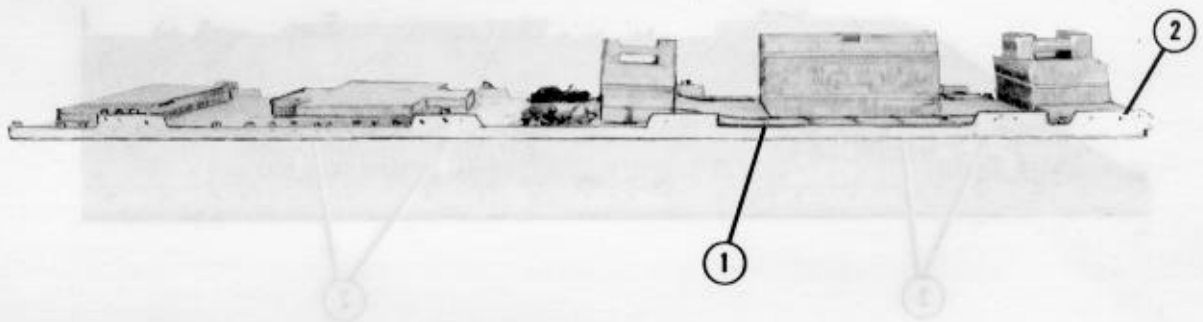

Figure 2-4. Honeycomb stacks placed on platform



- ① Position the drive-off aids on the platform as outlined in FM 10-500-2/TO 13C7-1-5. Place the drive-off aids under stack 1 and over stack 3.
- ② Pass a length of type V or 1-inch tubular nylon webbing through the second bushing on each tandem link, through the end loop of the drive-off aid, and through the nearest tie-down ring. Secure the ends of the webbing as shown in FM 10-500-2/TO 13C7-1-5.

Figure 2-5. Drive-off aids positioned

2-5. Positioning Accompanying Load on Platform

Position and secure thirty boxes of 120-mm ammunition on the platform as shown in Figure 2-6.

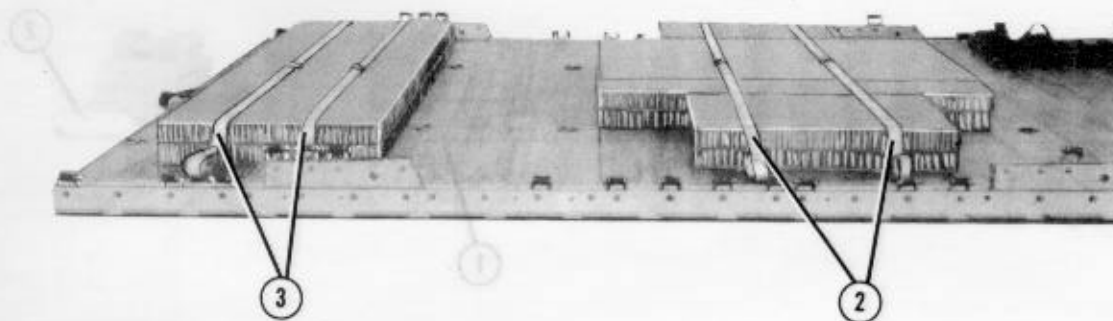

- ① Form four 30-foot lashings according to FM 10-500-2/TO 13C7-1-5.
- ② Position two 30-foot lashings across stacks 4, 5, and 6. The front lashing will be 22 inches from the front edge of stack 4. The rear lashing will be 18 inches from the front lashing.
- ③ Position two 30-foot lashings across stack 7. The front lashing will be 8 inches from the front edge of stack 7. The rear lashing will be 16 inches from the front lashing.

Figure 2-6. Accompanying load positioned and secured

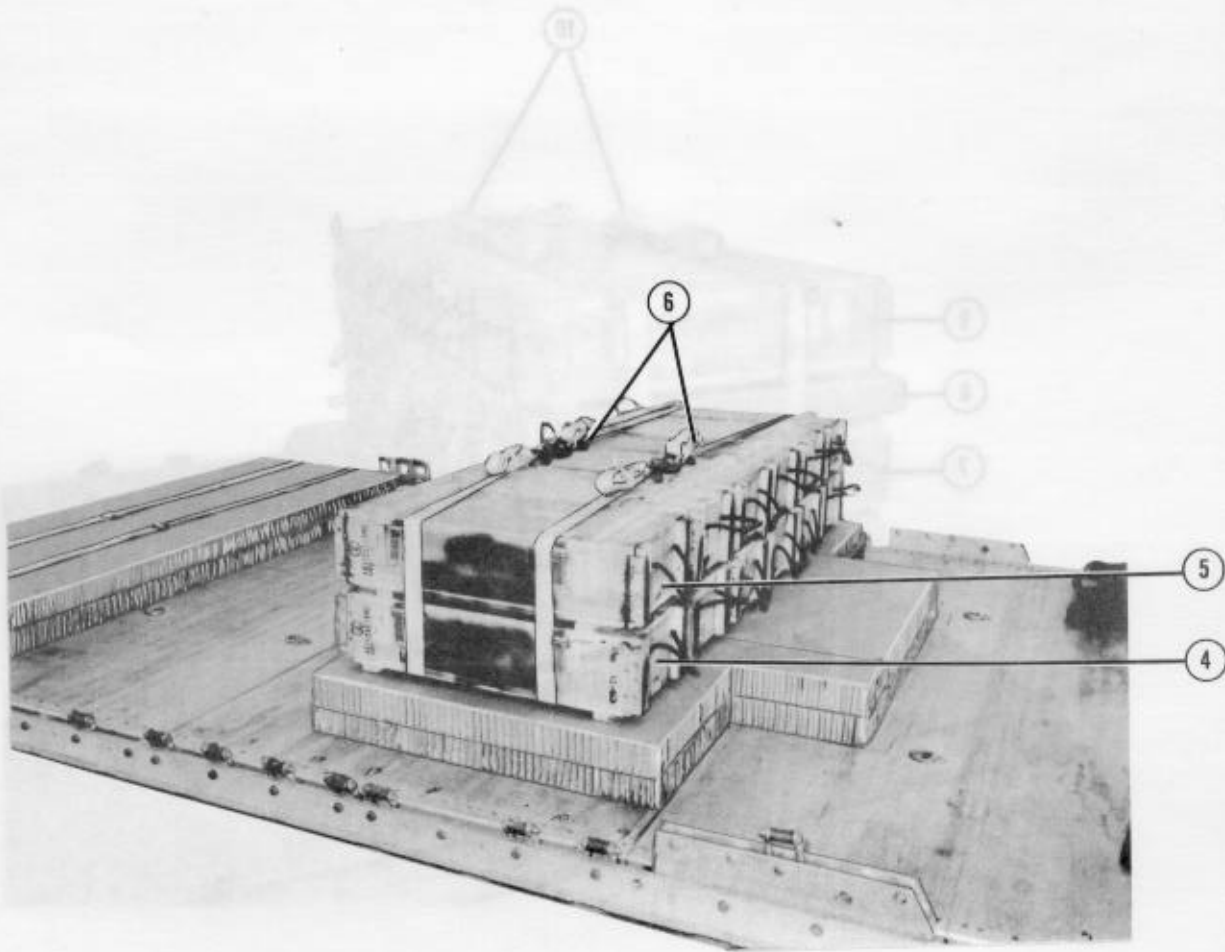

- ④ Place six boxes of ammunition on the lashings pre-positioned on honeycomb stacks 4, 5, and 6. Make sure the first box of ammunition is 2 inches from the left edge of stack 6.
- ⑤ Place six boxes of ammunition on top of the boxes placed in step 4.
- ⑥ Secure each lashing on top of the ammunition boxes with a load binder and two D-rings.

Figure 2-6. Accompanying load positioned and secured (continued)

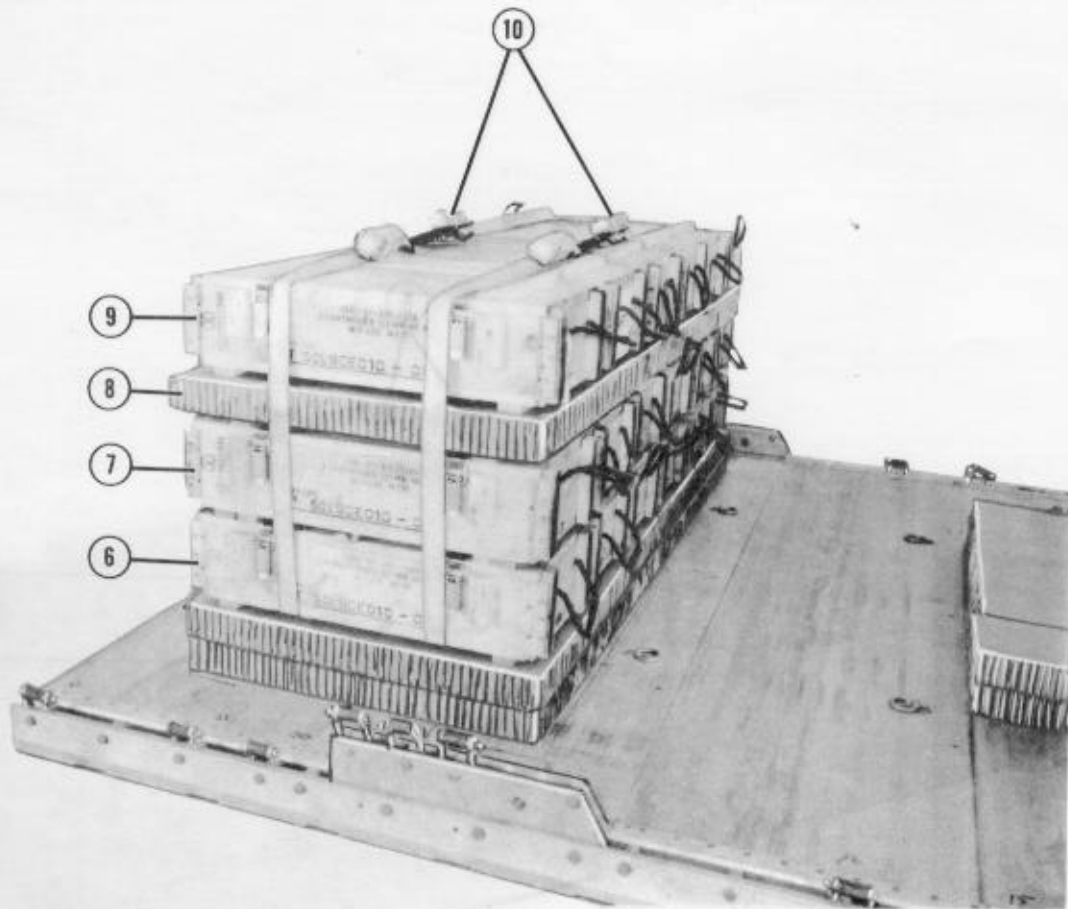

- ⑥ Place six boxes of ammunition on the lashings pre-positioned on honeycomb stack 7. Make sure the first box of ammunition is flush with the left edge of stack 7.
- ⑦ Place six boxes of ammunition on top of the boxes placed in step 6.
- ⑧ Place a 82- by 32-inch piece of honeycomb on top of the boxes of ammunition.
- ⑨ Place six boxes of ammunition on top of the honeycomb.
- ⑩ Secure the lashings on top of the boxes with a load binder and two D-rings.

Figure 2-6. Accompanying load positioned and secured (continued)

2-6. Building Endboards and Lashing Ammunition

Build and position four endboards as shown in Figure 2-7. Lash the ammunition to the platform as shown in Figure 2-8. Place and glue the front and rear sides of stack 4 as shown in Figure 2-9.

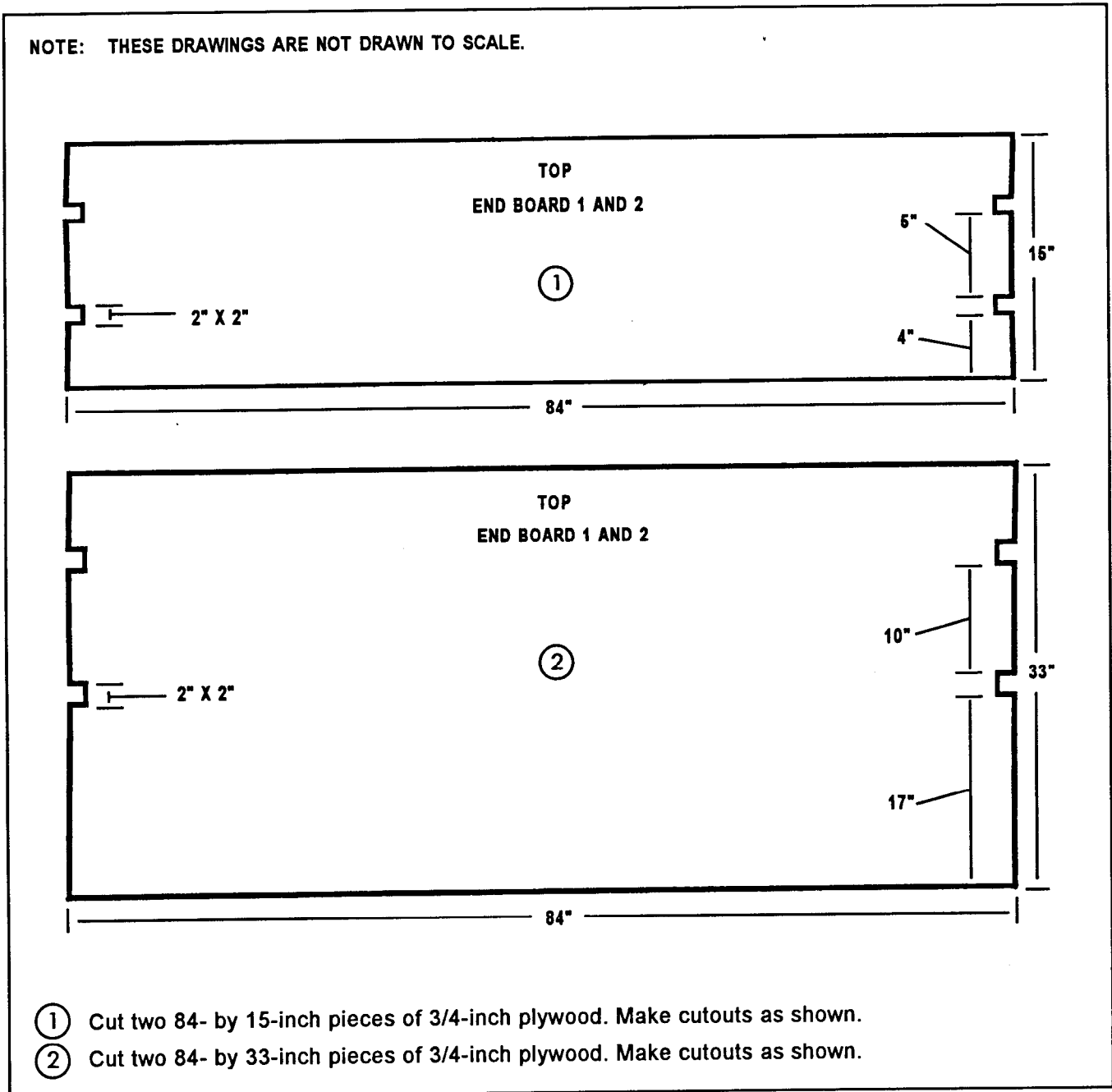

Figure 2-7. Endboards built and positioned

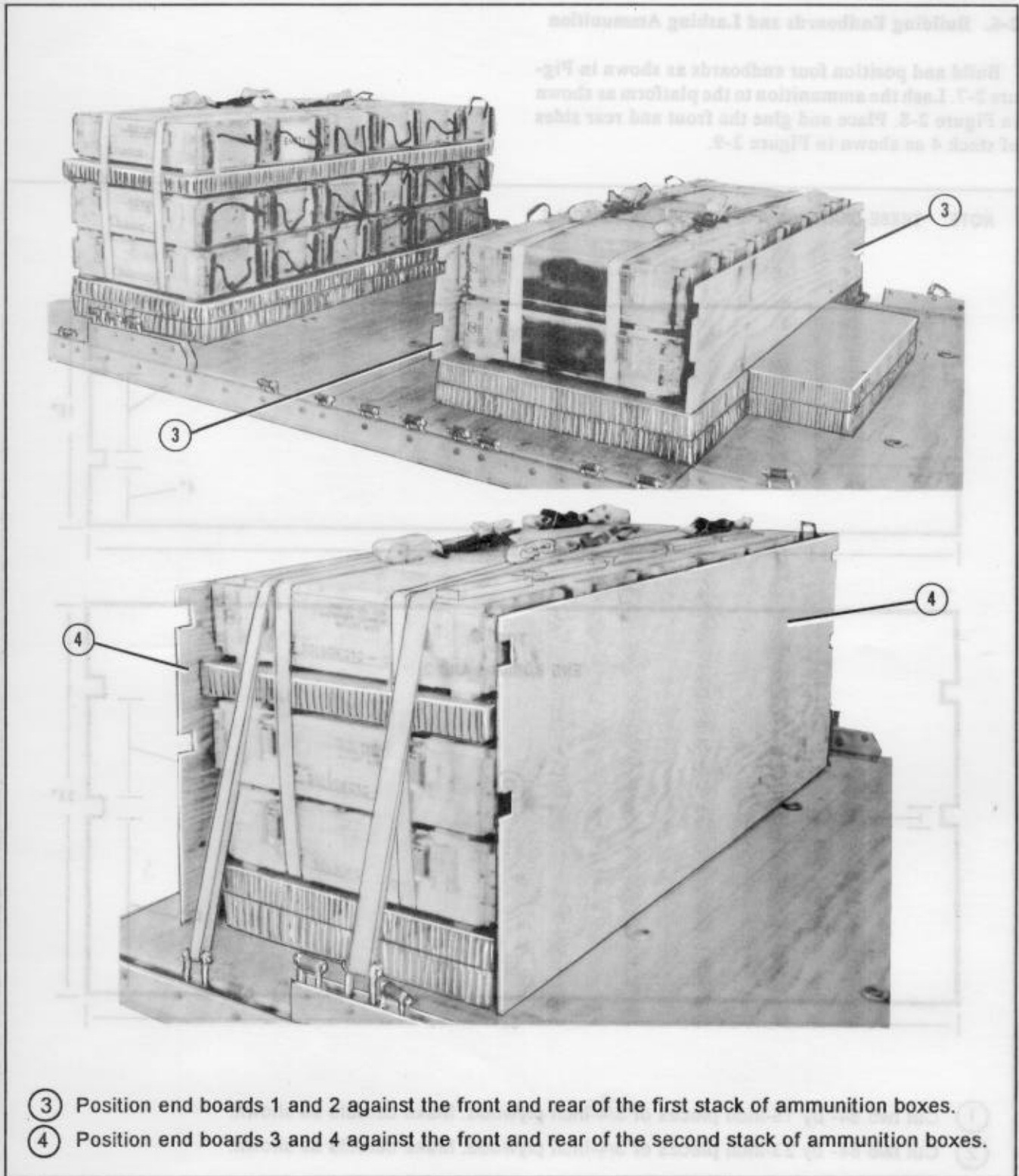
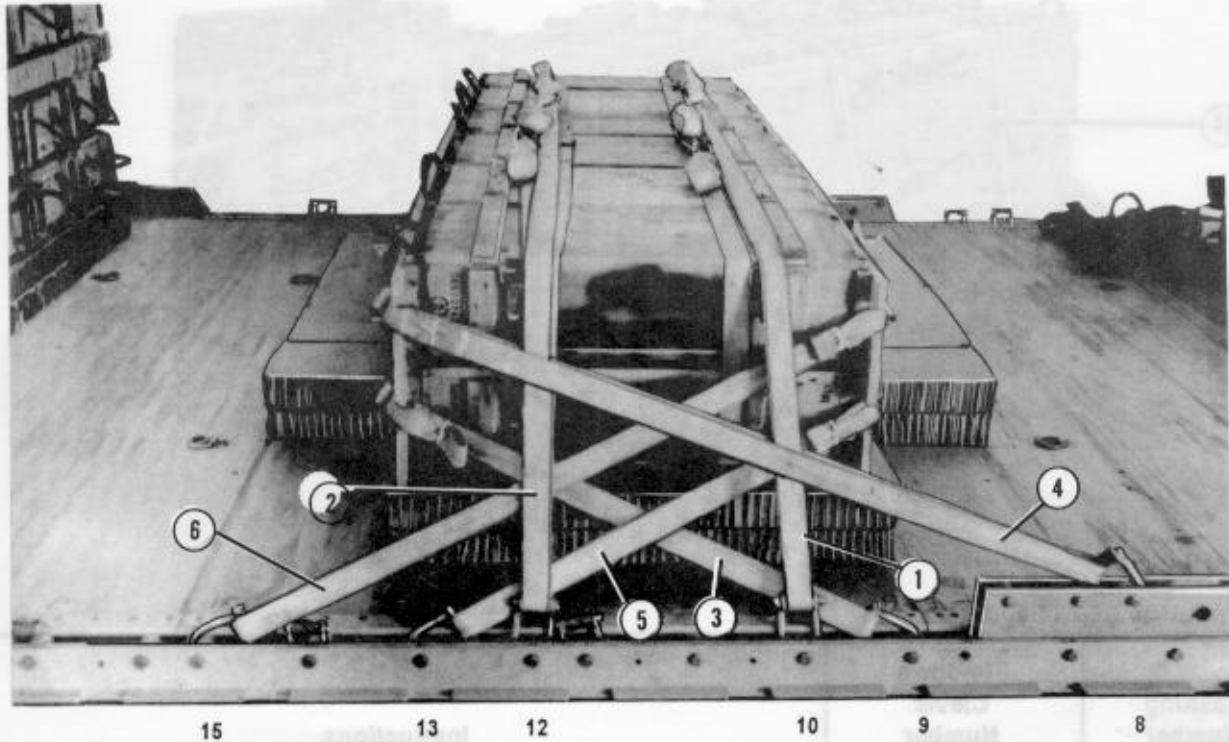

Figure 2-7. Endboards built and positioned (continued)



Lashing Number	Tie-down Clevis Number	Instructions
*1	10 and 10A	Pass lashing: Over ammunition boxes, through clevises, secure lashing on top of boxes.
*2	12 and 12A	Over ammunition boxes, through clevises, secure lashing on top of boxes.
*3	9 and 9A	Through bottom notches of endboard 2, through clevises, secure lashing on right rear of endboard.
*4	8 and 8A	Through top notches of endboard 2, through clevises, secure lashing on right rear of endboard.
*5	13 and 13A	Through bottom notches of endboard 1, through clevises, secure lashing on right front of endboard.
*6	15 and 15A	Through top notches of endboard 1, through clevises, secure lashing on right front of endboard.

*Denotes 30-foot lashings

Figure 2-8. Ammunition lashed

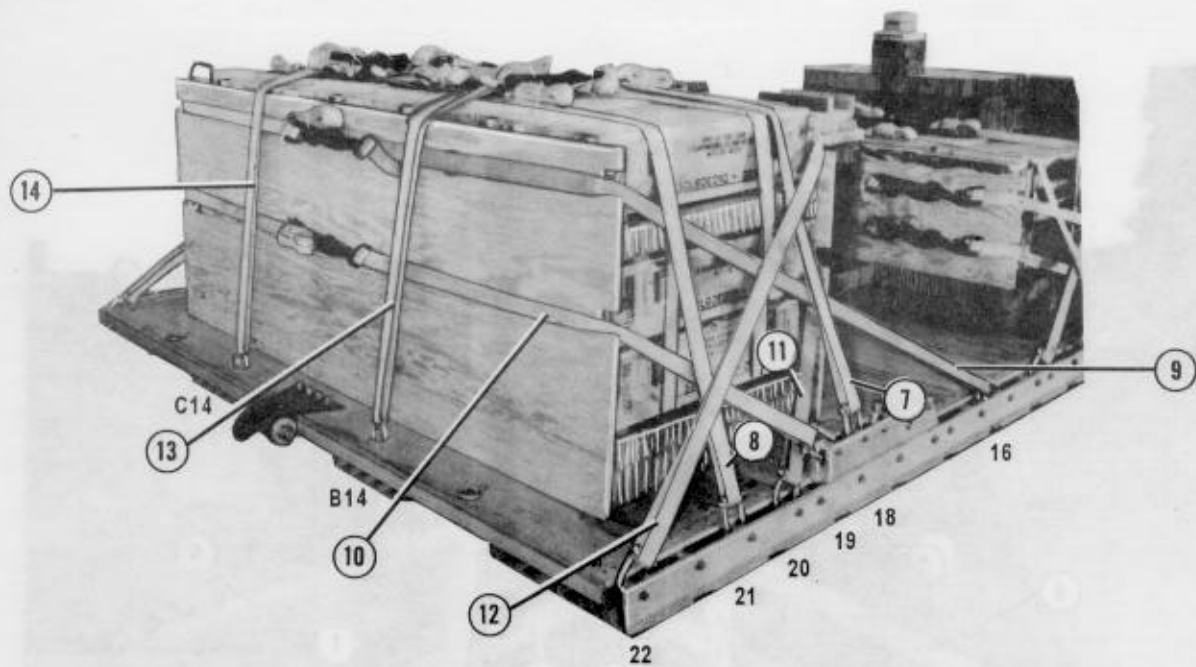

Lashing Number	Tie-down Clevis Number	Instructions
*7	18 and 18A	Pass lashing: Over ammunition boxes, through clevises, secure lashing on top of boxes.
*8	21 and 21A	Over ammunition boxes, through clevises, secure lashing on top of boxes.
**9	16 and 16A	Through top notches of endboard 4, through clevises, secure lashing on rear of endboard.
*10	19 and 19A	Through top notches of endboard 4, through clevises, secure lashing on rear of endboard.
*11	20 and 20A	Through bottom notches of endboard 3, through clevises, secure lashing on front of endboard.
*12	22 and 22A	Through top notches of endboard 3, through clevises, secure lashing on front of endboard.
*13	A13 and B14	Over ammunition boxes, through tie-down rings, secure lashing on top of boxes.
*14	B13 and C14	Over ammunition boxes, through tie-down rings, secure lashing on top of boxes.
<p>*Denotes 30-foot lashings **Denotes 45-foot lashing</p>		

Figure 2-8. Ammunition lashed (continued)

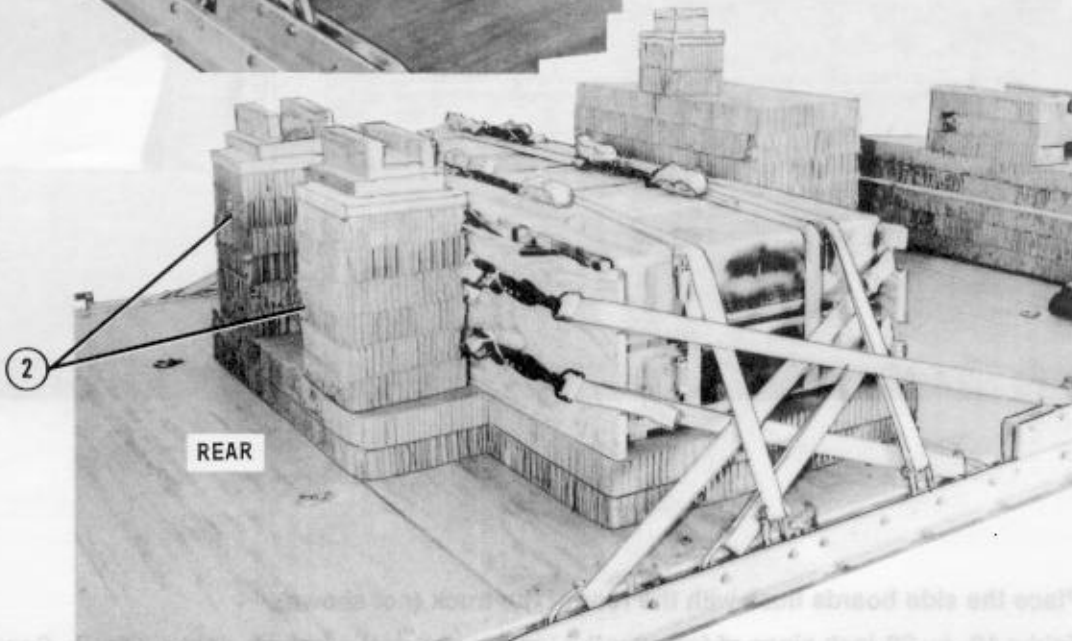
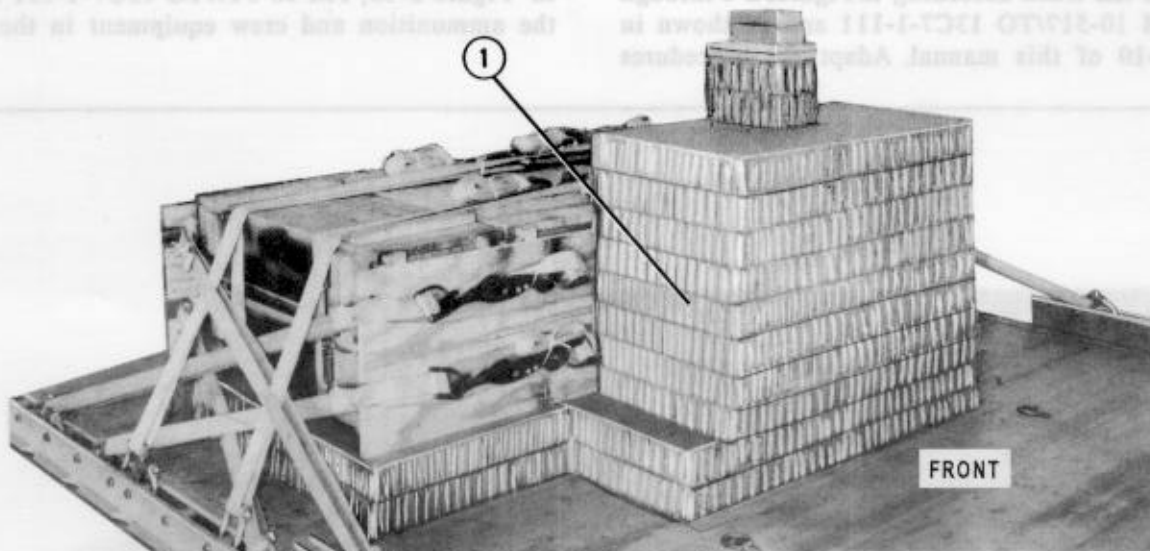

- ① Place and glue the front end of stack 4 flush with the front edge of the base and centered as shown.
- ② Place and glue the rear ends of stack 4 flush with the rear edge of the base and 5 inches from the left and right sides, facing as shown.

Figure 2-9. Front and rear of stack 4 placed

2-7. Preparing Truck

Prepare the truck according to Figures 2-6 through 2-13, FM 10-517/TO 13C7-1-111 and as shown in Figure 2-10 of this manual. Adapt the procedures

in Figure 2-15, FM 10-517/TO 13C7-1-111 to stow the ammunition and crew equipment in the truck.

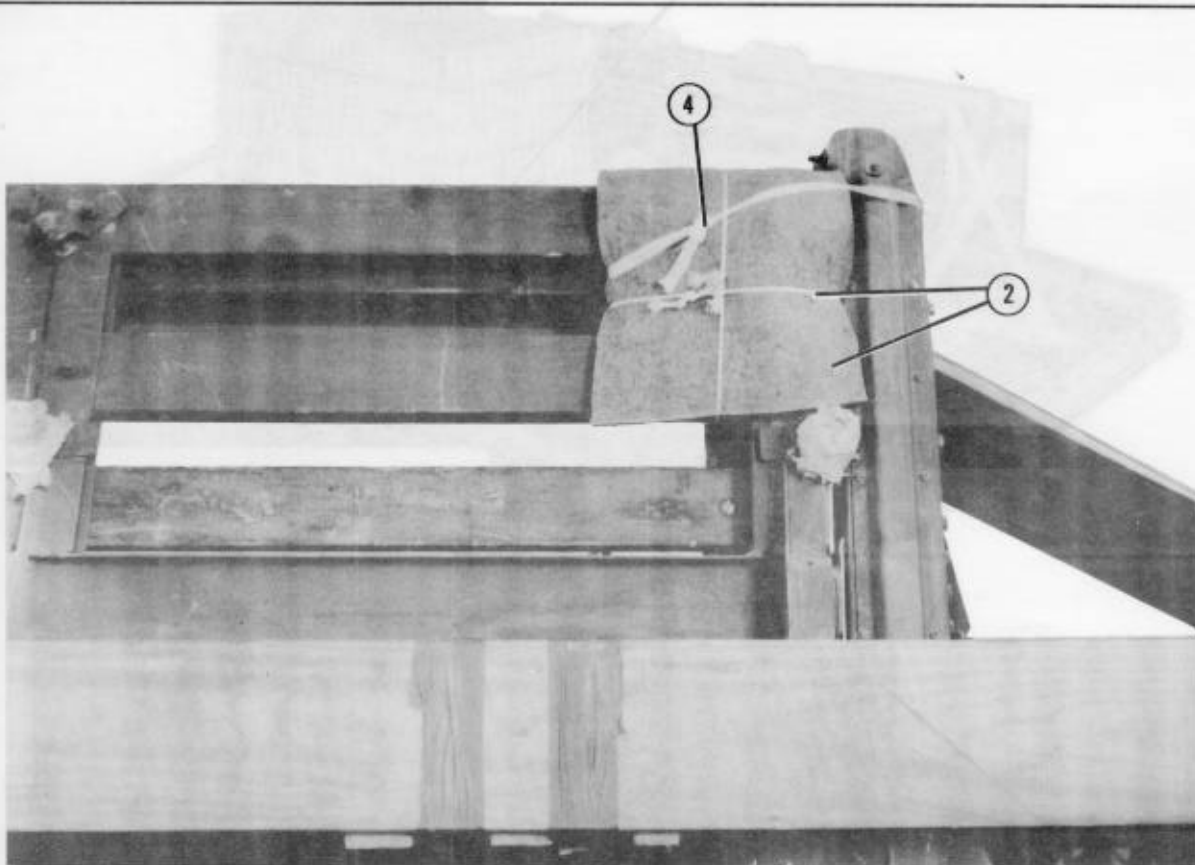

- ① Place the side boards flush with the rear of the truck (not shown).
- ② Fold a 10- by 20-inch piece of felt over the top forward section of the right side rail. Secure the felt in place using a piece of type III nylon cord.
- ③ Repeat step 2 for the left side of the truck (not shown).
- ④ Pass a length of 1/2-inch tubular nylon webbing through the side rail and around the roof support frame. Secure the ends of the webbing with a surgeons knot and locking knot.
- ⑤ Repeat step 4 for the left side of the truck (not shown).

Figure 2-10. Truck prepared

2-8. Preparing Mortar

Prepare the mortar as shown in Figure 2-11.

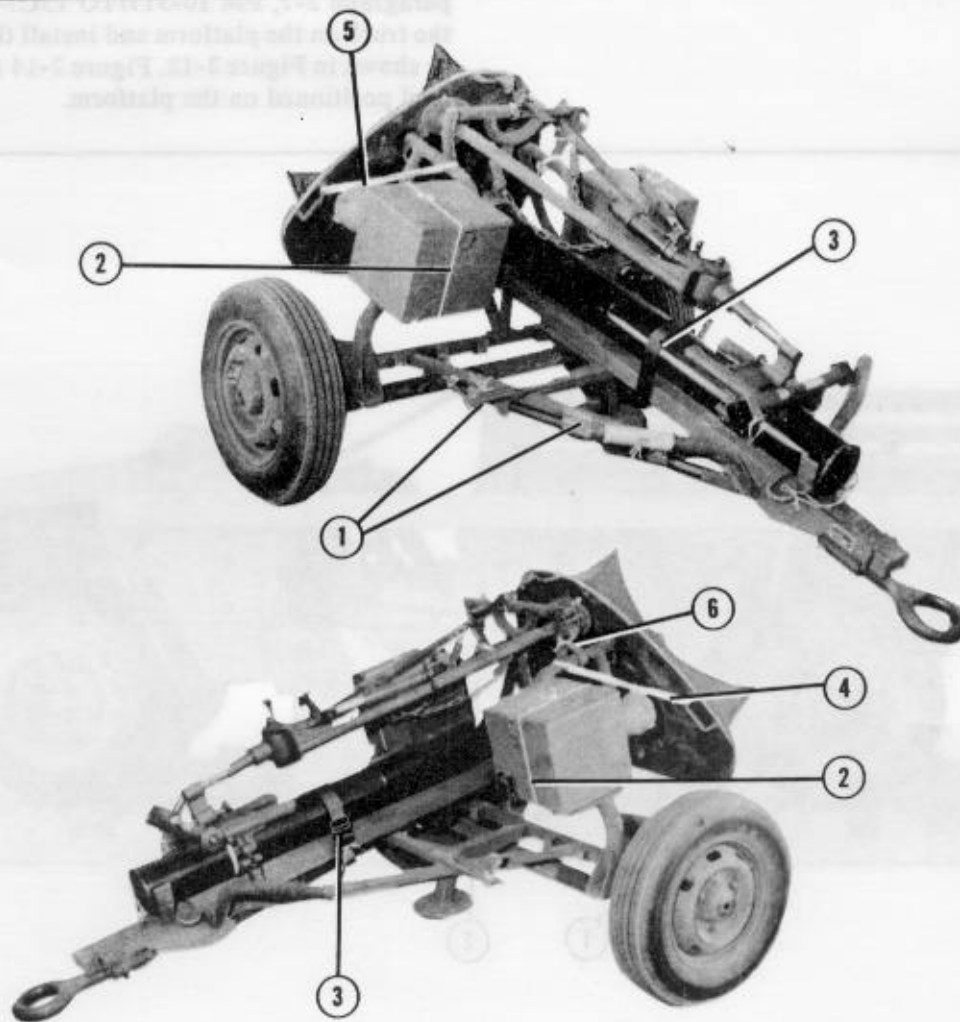

- ① Secure the cleaning staff sections to the support frame using tape and type III nylon cord.
- ② Safety each tool box with a length of type III nylon cord.
- ③ Fasten an A-7A strap around the barrel and trailer frame.
- ④ Run a length of 1/2-inch tubular nylon webbing through the right base plate handle and around the right side support bar. Secure the ends with a surgeons knot and locking knot.
- ⑤ Repeat step 4 for the left side of the mortar.
- ⑥ Safety the tripod latch closed with a length of type III nylon cord.

Figure 2-11. Mortar prepared

2-9. Lifting and Positioning Truck and Installing Drive-off Aids

Install the lifting slings on the truck as explained in paragraph 2-7, FM 10-517/TO 13C7-1-111. Position the truck on the platform and install the drive-off aids as shown in Figure 2-12. Figure 2-14 shows the entire load positioned on the platform.

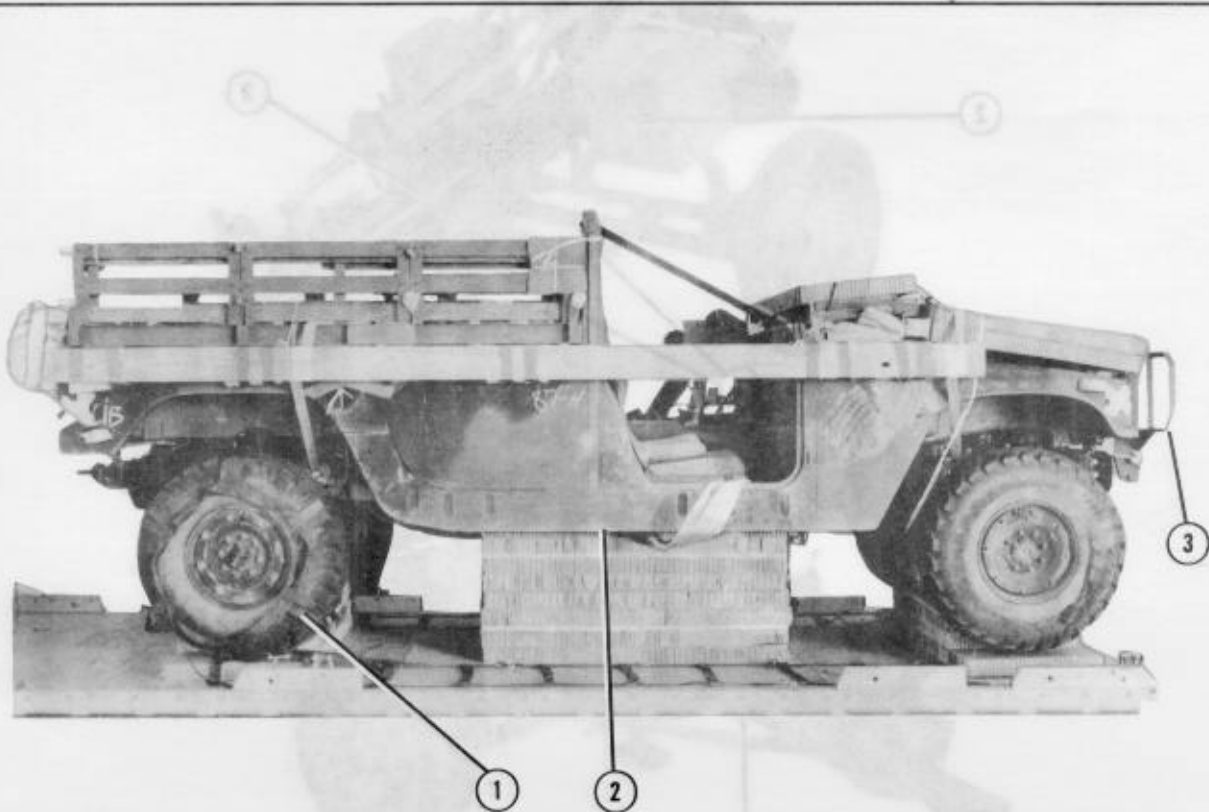

- ① Suspend the truck far enough over the stacks to install the drive-off aids to the rear wheels. Wind the drive-off aids around the rear wheels until the drive-off aids are under slight tension. Tie the end loop of each drive-off aid to the nearest cross-piece with type I, 1/4-inch cotton webbing.
- ② Be sure that the suspension cross members of the truck rest solidly on stacks 1 and 3. Be sure that the frame rails rest on stack 2.
- ③ Allow the truck to overhang the front edge of the platform 10 1/2 inches.

Figure 2-12. Truck placed and drive-off aids installed

2-10. Lifting and Positioning Mortar

Lift and position the mortar as shown in Figure 2-13.

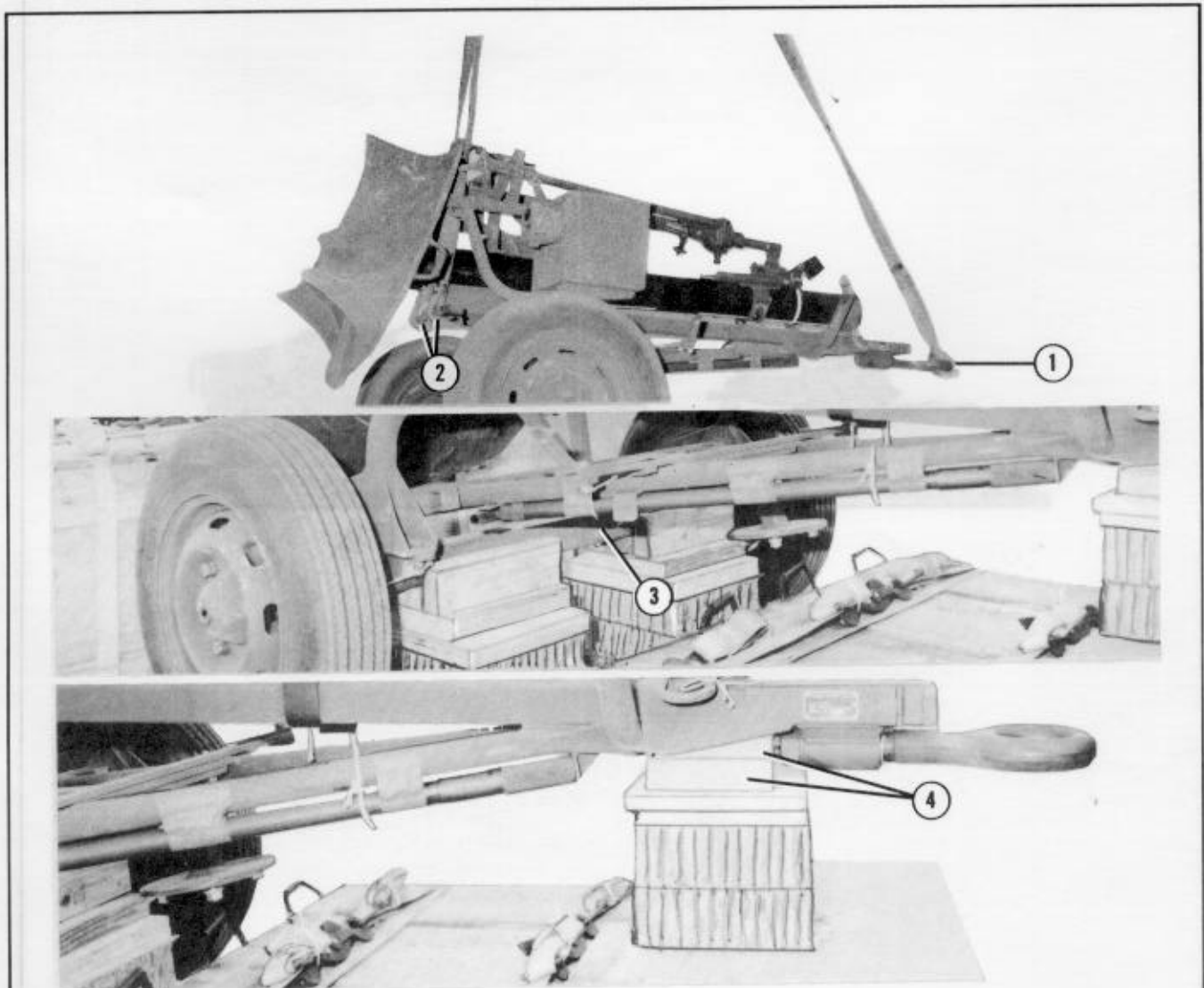

- ① Girth hitch an 11-foot (2-loop), type XXVI nylon webbing sling around the lunette.
- ② Place an end loop of a 9-foot (2-loop), type XXVI nylon webbing sling around the carrying handle behind each rear wheel.
- ③ Place the mortar onto stack 4, with the baseplate to the rear. Set the axle in the channel provided.
- ④ Be sure that the wood blocks at the front of stack 4 fit into the depression in the trailer tongue behind the lunette.

Figure 2-13. Mortar lifted and positioned

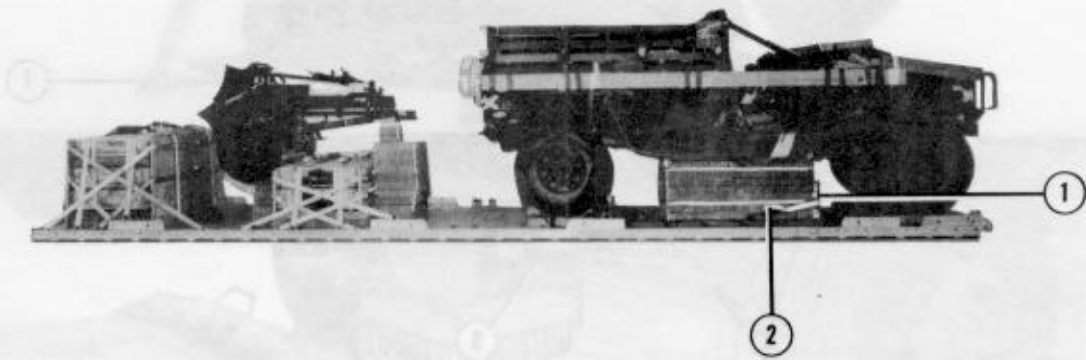

- ① Place a 12- by 42-inch piece of honeycomb on edge against the front of stack 2.
- ② Run a 15-foot lashing through tie-down ring B5 and through its own D-ring. Run the lashing around the honeycomb placed in step 1. Secure the lashing to tie-down ring A5 with a D-ring and a load binder.

Figure 2-14. Load positioned on platform and restraint lashing placed

2-11. Lashing Truck and Mortar

Lash the truck and the mortar to the platform as shown in Figure 2-15. Install the lashings according to FM 10-500-2/TO 13C7-1-5.

NOTE: FOUR LASHINGS FOR THE TRUCK ARE PRE-POSITIONED IN ACCORDANCE WITH FM 10-517/TO 13C7-1-111.

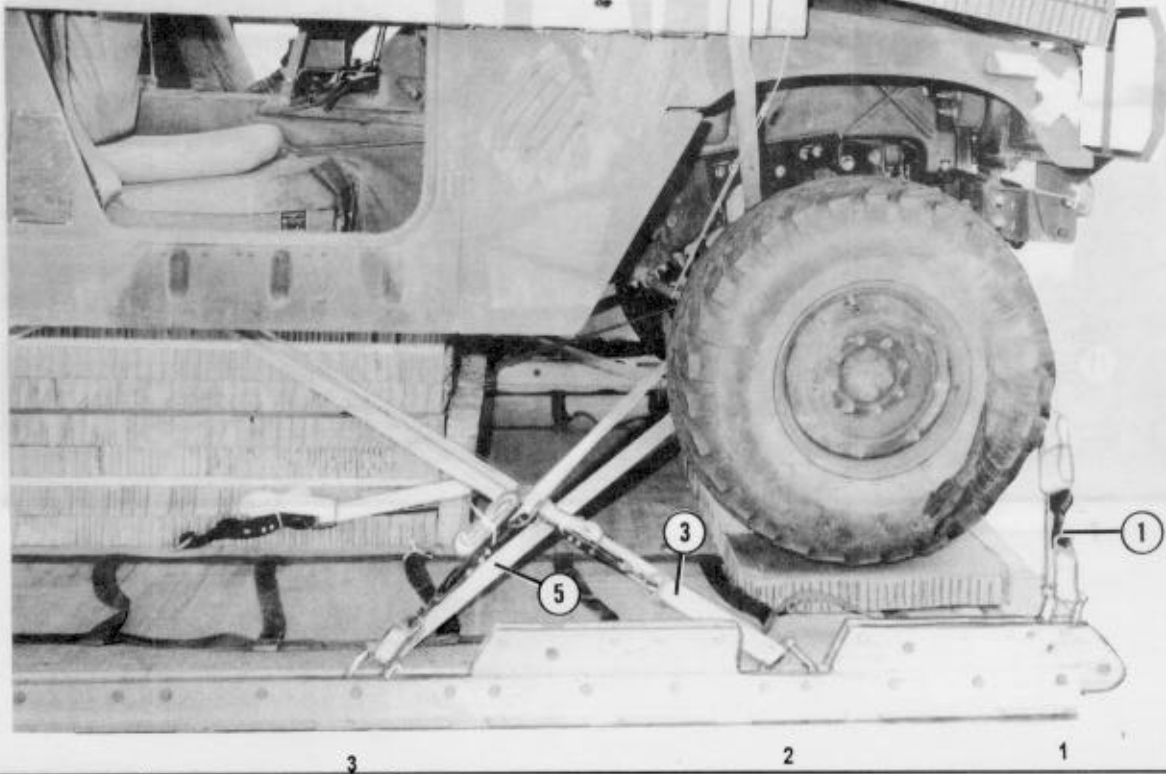

Lashing Number	Tie-down Clevis Number	Instructions
1	1	Pass lashing: Through tie-down bracket on end of right frame rail.
2	1A	Through tie-down bracket on end of left frame rail.
*3	2	Around right frame rail cross member.
*4	2A	Around left frame rail cross member.
5	3	Around right lower control arm.
6	3A	Around left lower control arm.

*Denotes pre-positioned lashings.

Figure 2-15. Lashings installed

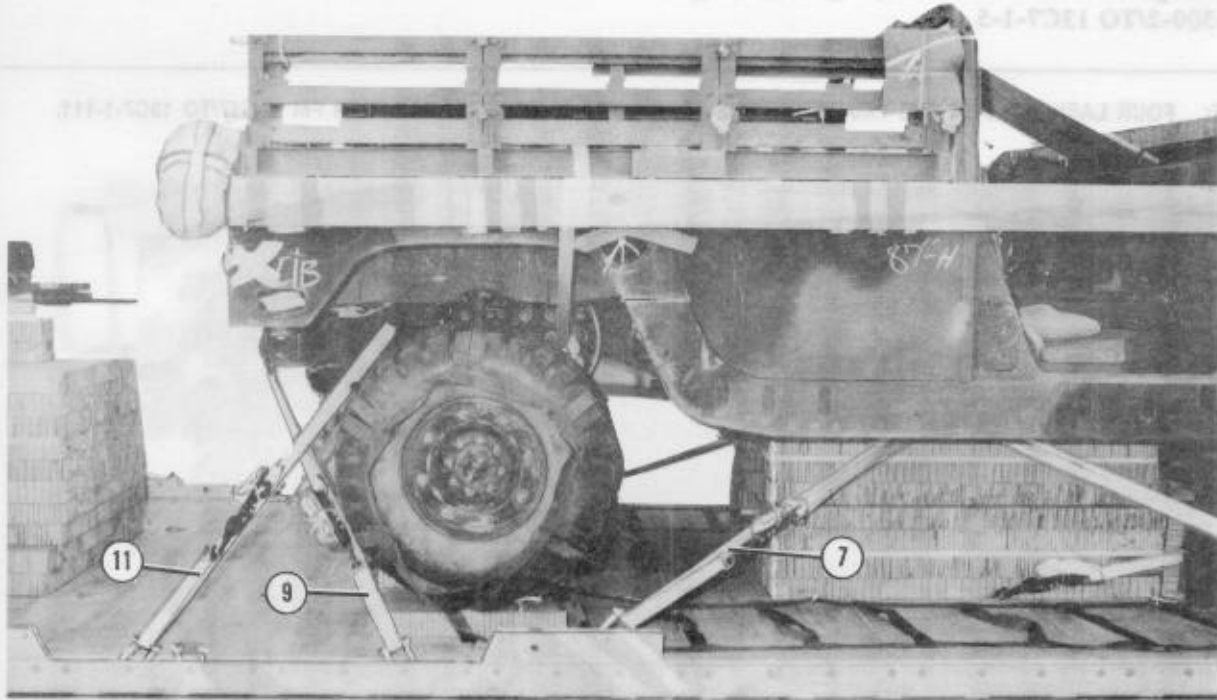

7 5 4

Lashing Number	Tie-down Clevis Number	Instructions
*7	4	Pass lashing: Around right frame rail cross member.
*8	4A	Around left frame rail cross member.
9	5	Through right rear lifting shackle.
10	5A	Through left rear lifting shackle.
11	7	Through tie-down bracket behind right rear coil spring.
12	7A	Through tie-down bracket behind left rear coil spring.

*Denotes pre-positioned lashings.

Figure 2-15. Lashings installed (continued)

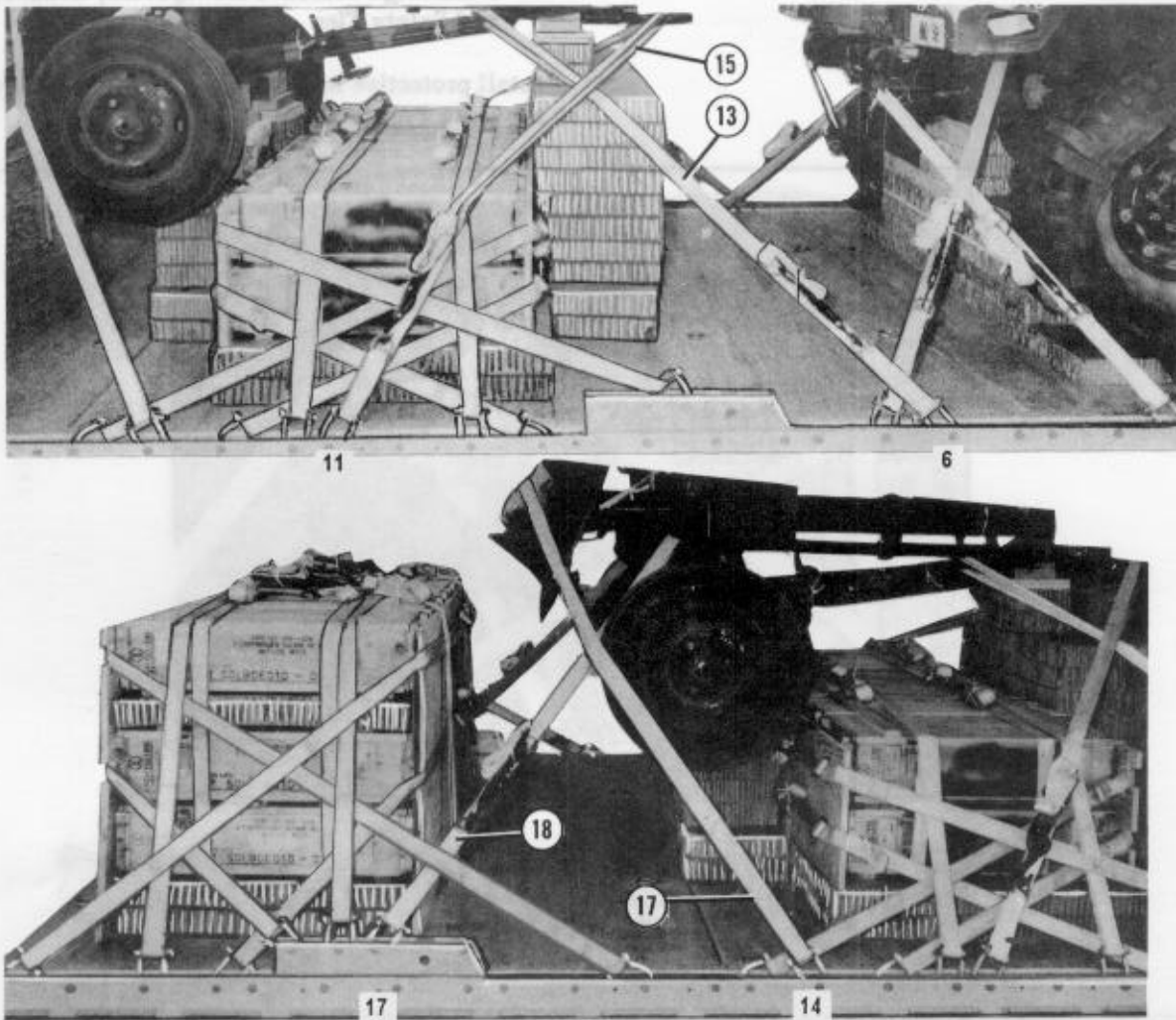

Lashing Number	Tiedown Clevis Number	Instructions
13	6	Pass lashing: Around trailer frame, right side.
14	6A	Around trailer frame, left side.
15	11	Through trailer lunette.
16	11A	Through trailer lunette.
*17	14 and 14A	Over center of base plate, through both clevises.
18	17	Around trailer support behind tool box, right side.
19	17A	Around trailer support behind tool box, left side.

*Denotes 30-foot lashing

Figure 2-15. Lashings installed (continued)

2-12. Installing Protective Honeycomb, Load Cover and Safety Ties

Install protective honeycomb, cover, and safety ties as shown in Figure 2-16.

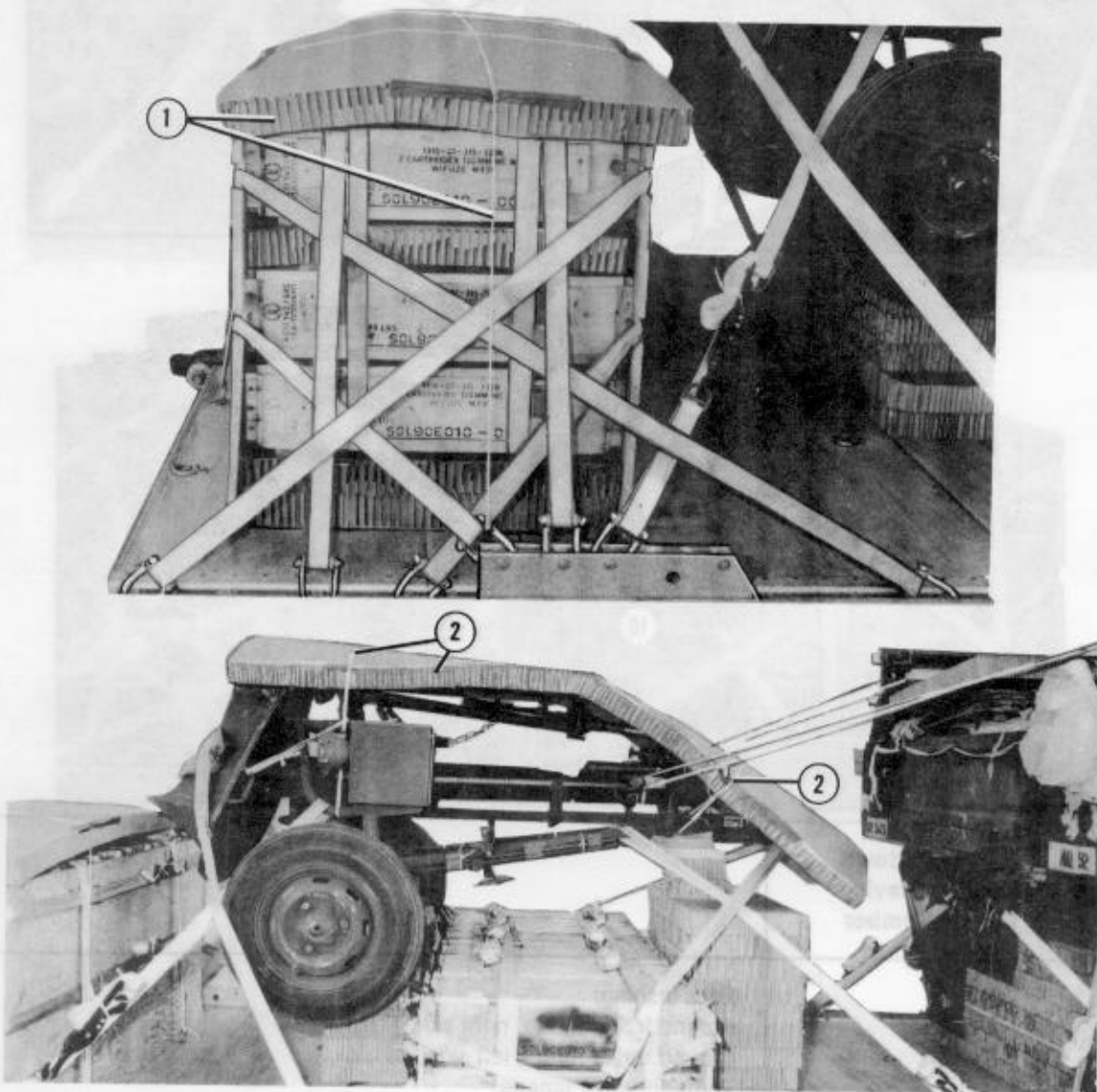

- ① Place a 36- by 81-inch piece of honeycomb on top of the boxes of ammunition. Secure the honeycomb to convenient points with type III nylon cord.
- ② Place a 96- by 36-inch piece of honeycomb over the mortar. Secure the honeycomb to the trailer with type III nylon cord.

Figure 2-16. Honeycomb, cover and ties installed

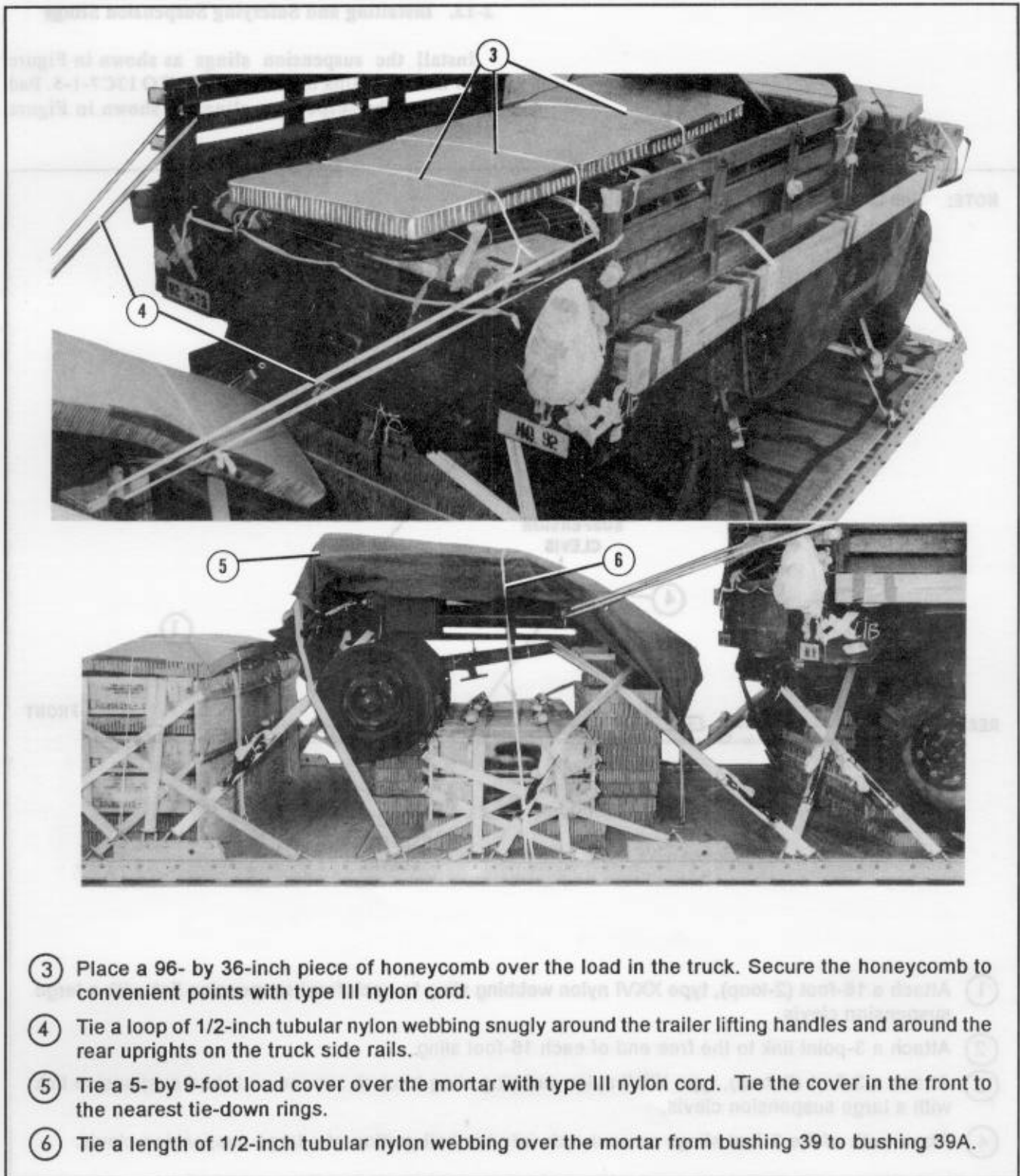

Figure 2-16. Honeycomb, cover, and ties installed (continued)

2-13. Installing and Safetying Suspension Slings

Install the suspension slings as shown in Figure 2-17 and according to FM 10-500-2/TO 13C7-1-5. Pad and safety the suspension slings as shown in Figure 2-18.

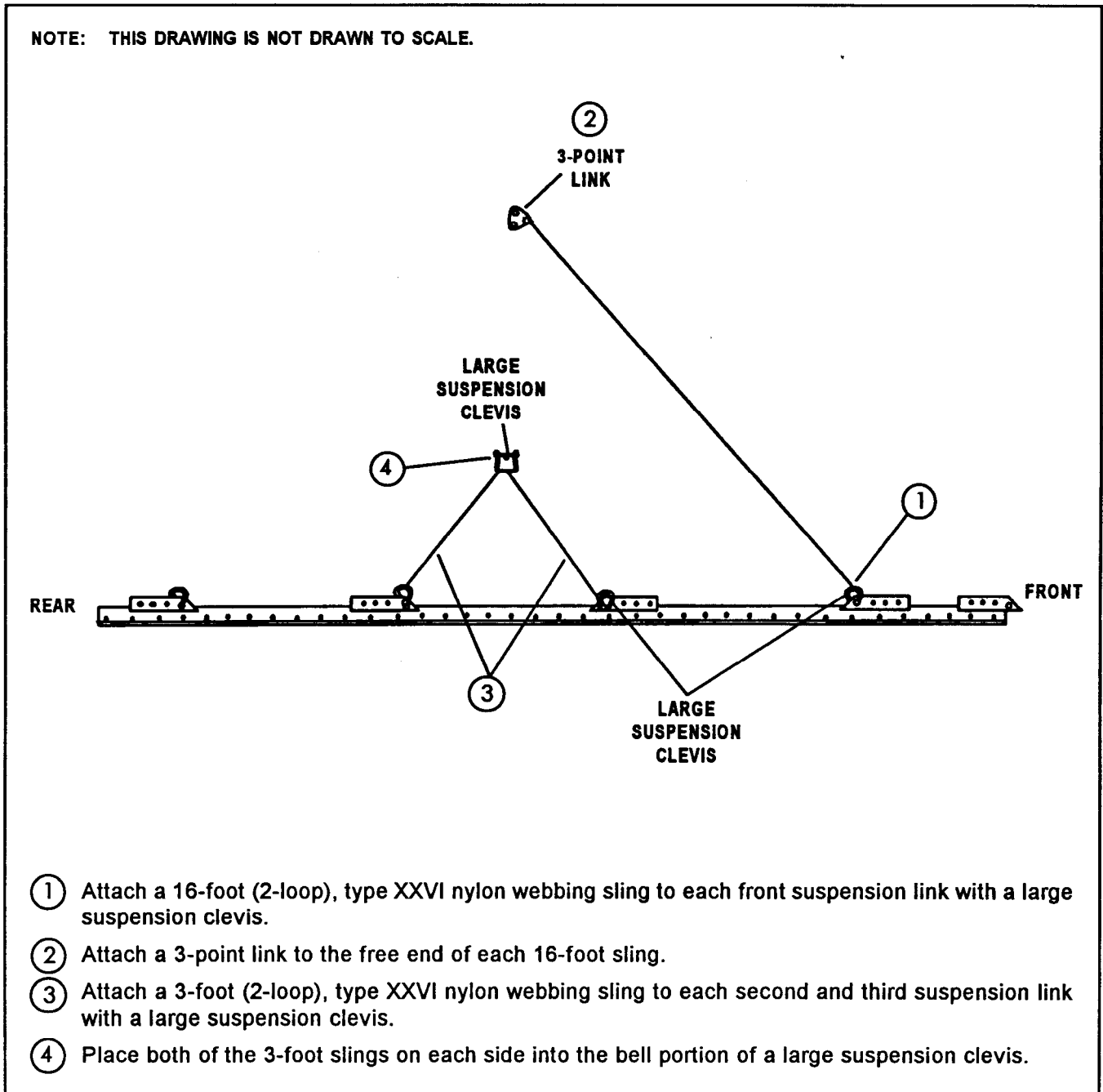
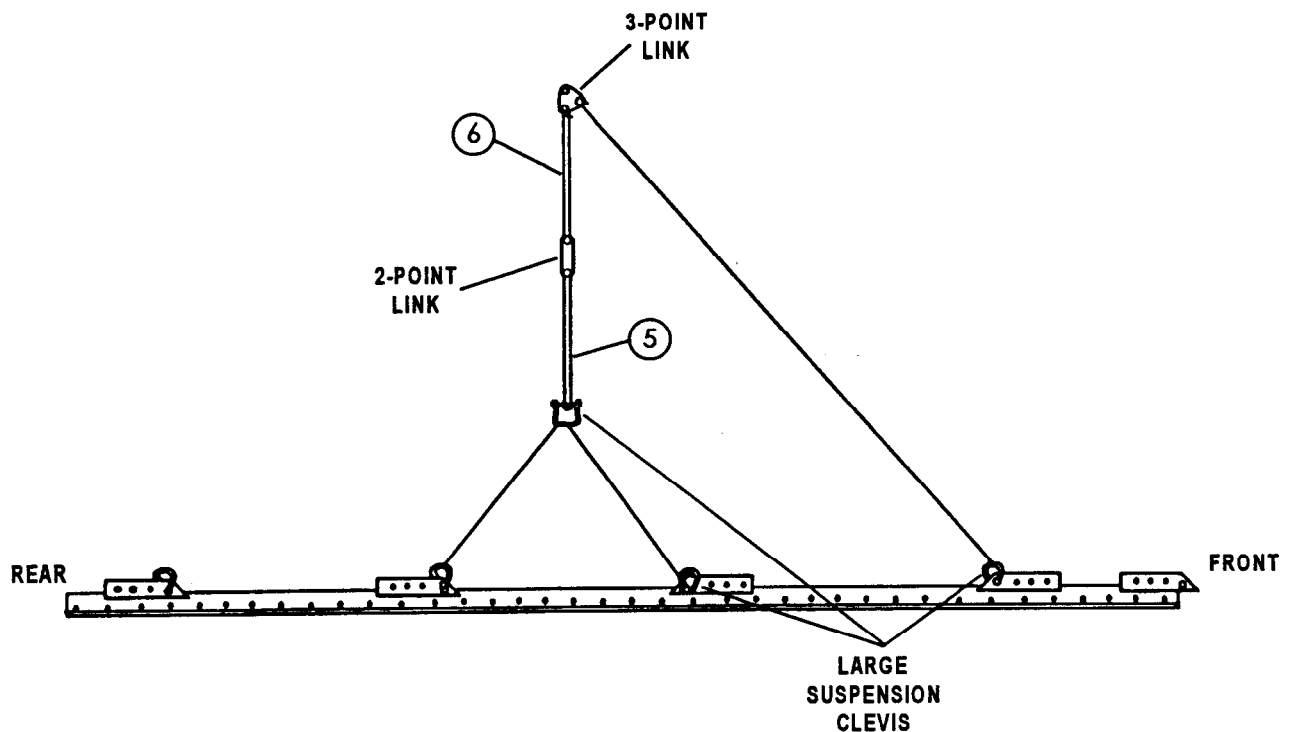

Figure 2-17. Suspension slings installed

NOTE: THIS DRAWING IS NOT DRAWN TO SCALE.



- ⑤ Pass an 11-foot (2-loop), type XXVI nylon webbing sling through a 5 1/2-inch two-point link. Bolt both end loops to the large suspension clevis used in step 4.
- ⑥ Pass an 11-foot (2-loop), type XXVI nylon webbing sling through the 5 1/2-inch two-point link used in step 5. Attach both end loops to the three-point link on the front suspension sling.

Figure 2-17. Suspension slings installed (continued)

NOTE: THIS DRAWING IS NOT DRAWN TO SCALE.

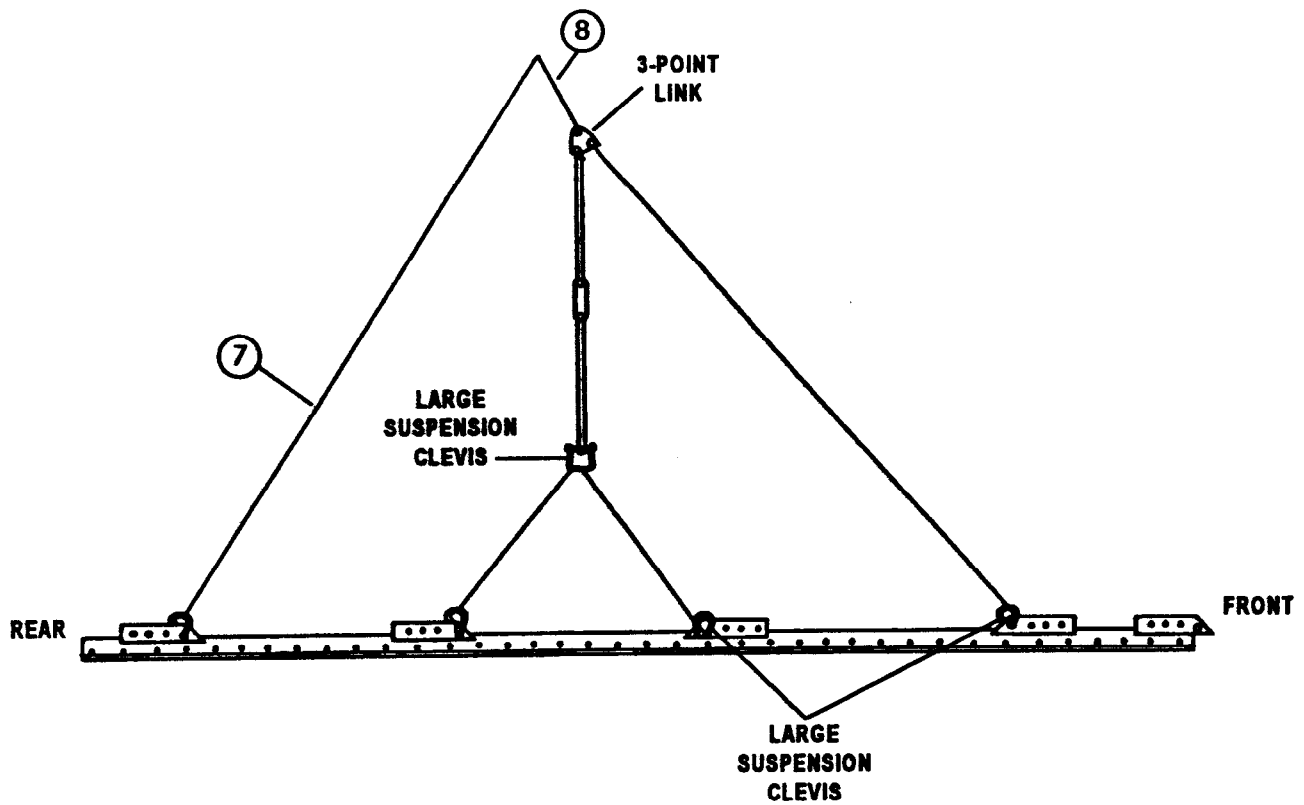

- ⑦ Attach a 20-foot (2-loop), type XXVI nylon webbing sling to each rear suspension link with a large suspension clevis.
- ⑧ Attach a 3-foot (2-loop), type XXVI nylon webbing sling to the top spacer of each three-point link.

Figure 2-17. Suspension slings installed (continued)

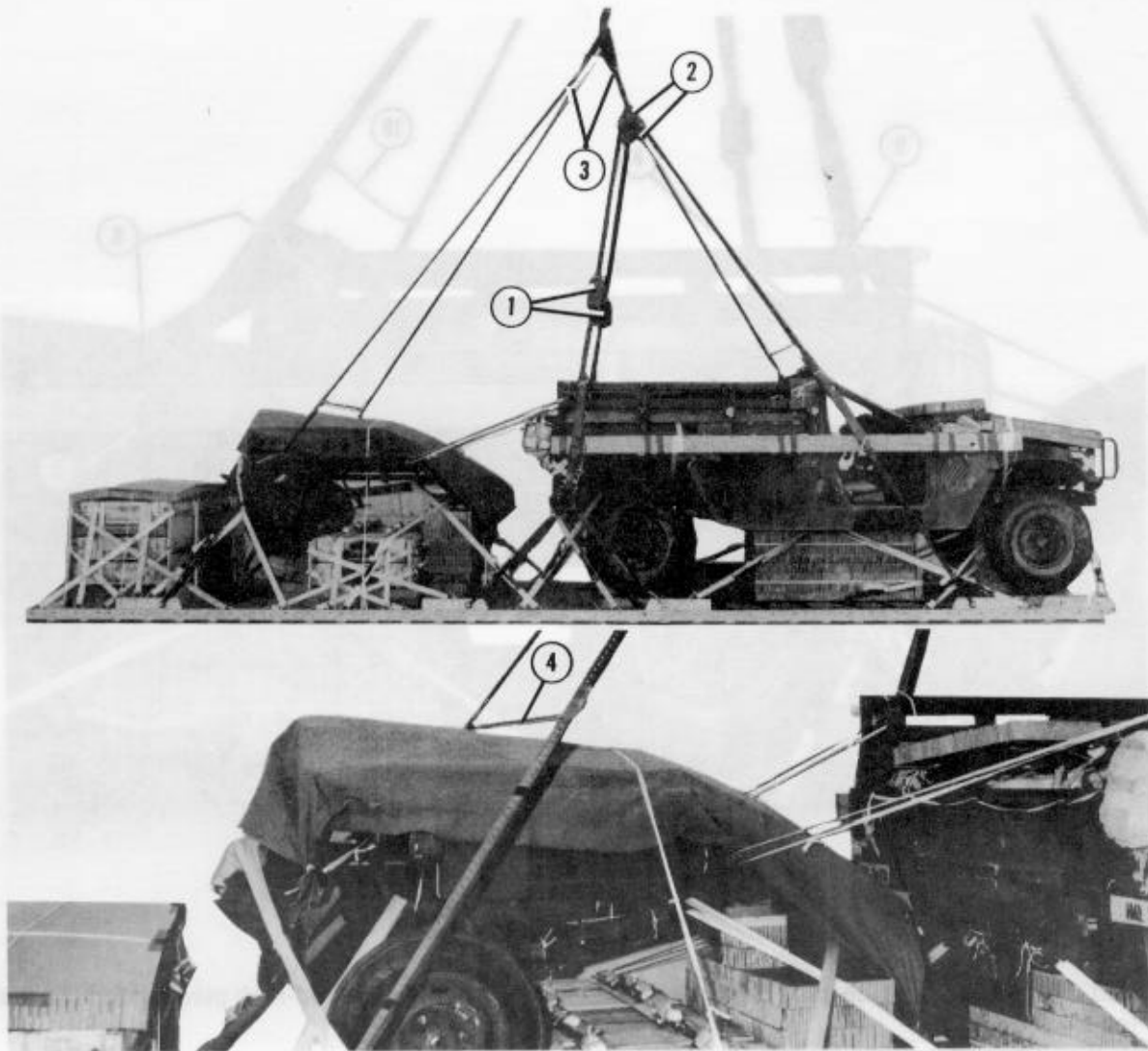

- ① Pad the two-point links with felt taped in place.
- ② Pad the three-point links with felt taped in place.
- ③ Attach the rear suspension slings and the 3-foot slings joining the front and center suspension slings to the crane hook. Raise the suspension slings.
- ④ Safety tie the rear suspension slings to each other 6 inches above the load with a double length of 1/2-inch tubular nylon webbing. Adapt the procedures in Figure 3-12, FM 10-500-2/TO 13C7-1-5 to tie and tape the webbing.

Figure 2-18. Suspension slings padded and safetied



- ⑤ Pad the front suspension sling 51 inches from the clevis with a 6- by 38-inch piece of felt. Tape the felt in place.
- ⑥ Safety tie the padded portion of the front slings to the roof support frame and to the body side boards of the truck with type I, 1/4-inch cotton webbing.
- ⑦ Safety tie the large clevis of the center slings to the truck using type III nylon cord.
- ⑧ Pad the center suspension sling 17 inches from the large clevis with a 6- by 38-inch piece of felt.
- ⑨ Safety tie the padded portion of the center slings to the truck side rails with type I, 1/4-inch cotton webbing.
- ⑩ Safety tie the front slings to each other 6 inches above the load with a double length of 1/2-inch tubular nylon webbing. Adapt the procedures in Figure 3-12, FM 10-500-2/TO 13C7-1-5 to tie and tape the webbing.

Figure 2-18. Suspension slings padded and safetied (continued)

2-14. Stowing Cargo Parachutes

Stow three G-11B cargo parachutes on the load according to FM 10-500-2/TO 13C7-1-5 and as shown in Figure 2-19.

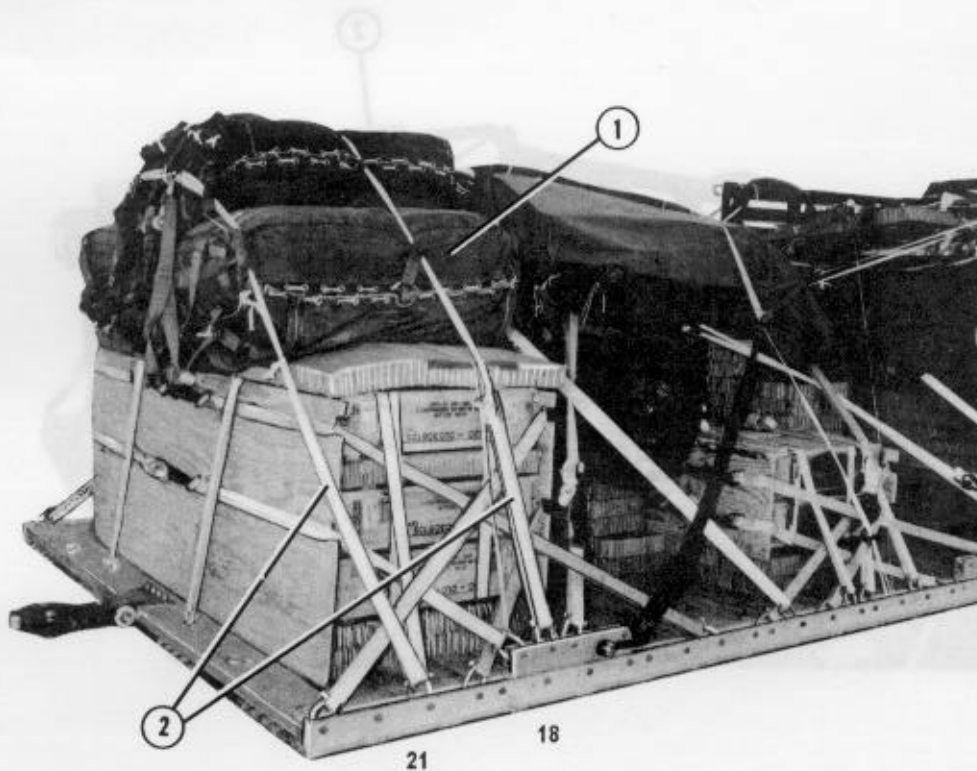

- ① Prepare and install three G-11B cargo parachutes on the load according to FM 10-500-2/TO 13C7-1-5.
- ② Restrain the cargo parachutes to the platform with two lengths of type VIII nylon webbing according to FM 10-500-2/TO 13C7-1-5. Tie the front restraint strap to clevises 18 and 18A. Tie the rear restraint strap to clevises 21 and 21A.

Figure 2-19. Parachutes stowed

2-15. Installing Release System

Prepare and install the M-1 release system according to FM 10-500-2/TO 13C7-1-5 and as shown in Figure 2-20.

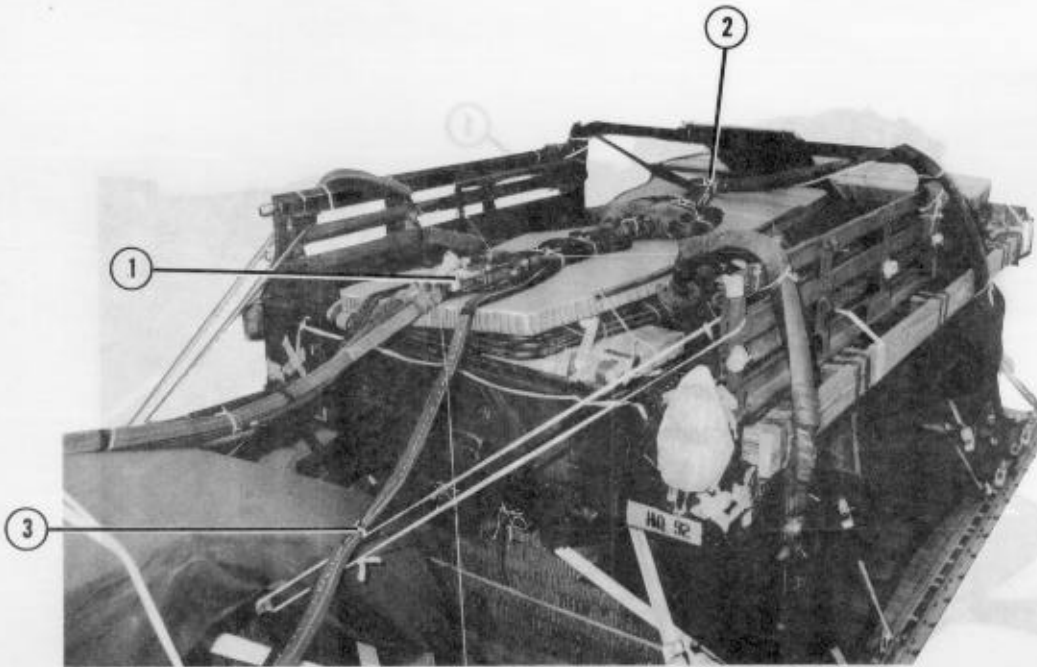

- ① Prepare and install an M-1 cargo parachute release assembly according to FM 10-500-2/TO 13C7-1-5. Place the M-1 release on the honeycomb pre-positioned in the bed of the truck.
- ② Fold the suspension slings. Secure the folds with lengths of type I, 1/4-inch cotton webbing.
- ③ Tie the rear suspension slings to the 1/2-inch tubular nylon webbing placed in Figure 2-16, step 4 with type I, 1/4-inch cotton webbing.

Figure 2-20. Release system installed

2-16. Installing Extraction System

Install the EFTC extraction system according to FM 10-500-2/TO 13C7-1-5 and as shown in Figure 2-21.

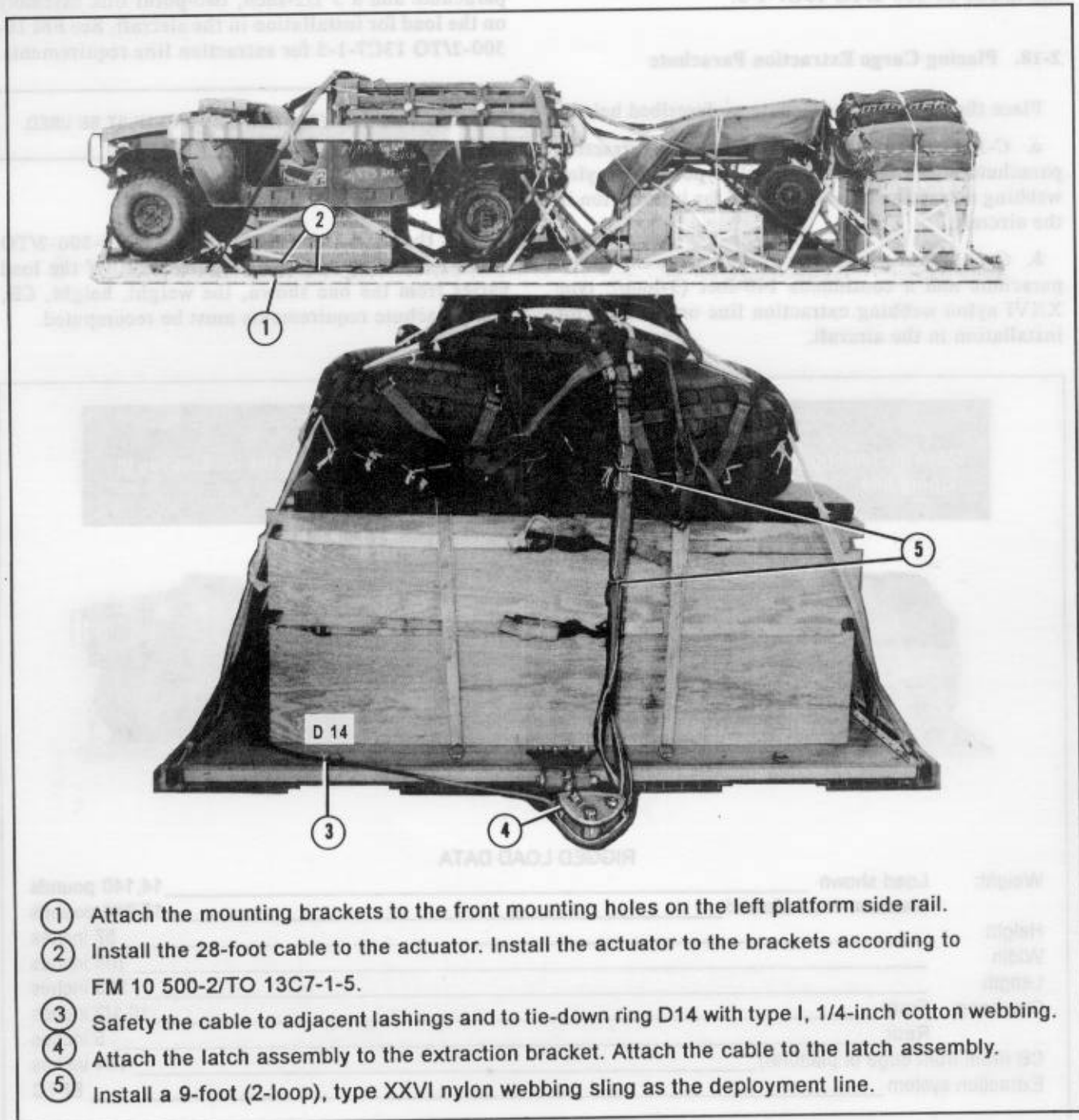

- ① Attach the mounting brackets to the front mounting holes on the left platform side rail.
- ② Install the 28-foot cable to the actuator. Install the actuator to the brackets according to FM 10 500-2/TO 13C7-1-5.
- ③ Safety the cable to adjacent lashings and to tie-down ring D14 with type I, 1/4-inch cotton webbing.
- ④ Attach the latch assembly to the extraction bracket. Attach the cable to the latch assembly.
- ⑤ Install a 9-foot (2-loop), type XXVI nylon webbing sling as the deployment line.

Figure 2-21. EFTC installed

2-17. Installing Provisions for Emergency Restraints

Install provisions for emergency restraints according to FM 10-500-2/TO 13C7-1-5.

2-18. Placing Cargo Extraction Parachute

Place the extraction parachute as described below.

a. C-130 Aircraft. Place a 22-foot cargo extraction parachute and a 60-foot (3-loop), type XXVI nylon webbing extraction line on the load for installation in the aircraft.

b. C-141 Aircraft. Place a 22-foot cargo extraction parachute and a continuous 140-foot (3-loop), type XXVI nylon webbing extraction line on the load for installation in the aircraft.

c. C-5 Aircraft. Place a 22-foot cargo extraction parachute and a 5 1/2-inch, two-point link assembly on the load for installation in the aircraft. See FM 10-500-2/TO 13C7-1-5 for extraction line requirements.

NOTE: A SLING/EXTRACTION LINE BAG MUST BE USED.

2-19. Marking Rigged Load

Mark the rigged load according to FM 10-500-2/TO 13C7-1-5 and as shown in Figure 2-22. If the load varies from the one shown, the weight, height, CB, and parachute requirements must be recomputed.

CAUTION
Make the final rigger inspection required by FM 10-500-2/TO 13C7-1-5 before the load leaves the rigging site.

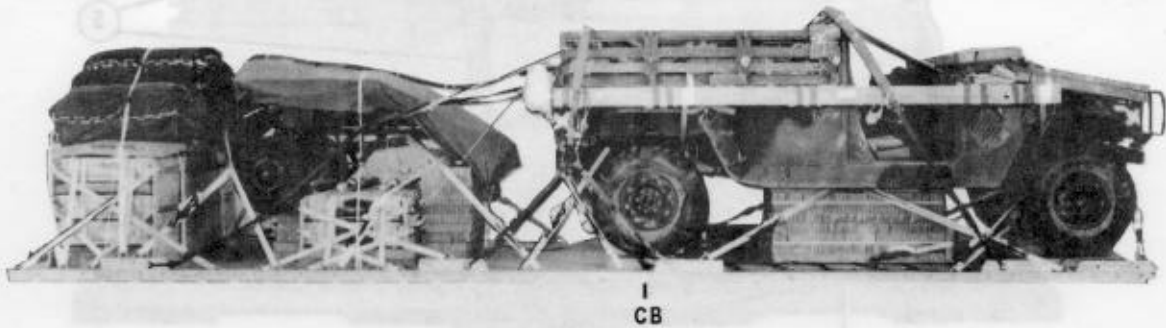

RIGGED LOAD DATA

Weight:	Load shown _____	14,140 pounds
	Maximum load allowed _____	15,750 pounds
Height	_____	87 inches
Width	_____	108 inches
Length	_____	363 inches
Overhang:	Front _____	10 1/2 inches
	Rear _____	5 inches
CB (from front edge of platform)	_____	164 inches
Extraction system	_____	EFTC

Figure 2-22. 120-mm mortar and 1 1/4-ton truck rigged for low-velocity airdrop on a type V platform

2-20. Equipment Required

Use the equipment listed in Table 2-1 to rig this load.

Table 2-1. Equipment required for rigging 120-mm mortar and 1 1/4-ton truck for low-velocity airdrop on a type V platform

National Stock Number	Item	Quantity
1670-00-162-4981	Adapter, coupling, EFTC	2
5365-00-405-9293	Spacer	2
8040-00-273-8713	Adhesive, paste, 1-gal	As required
	Clevis, suspension:	
4030-00-678-8562	3/4-in (medium)	8
4030-00-090-5354	1-in (large)	11
4020-00-240-2146	Cord, nylon, type III, 550-lb	As required
1670-00-157-6527	Coupling, airdrop, extraction force transfer w 28-ft cable	1
	Cover:	
1670-00-360-0328	Clevis, large	3
1670-00-360-0329	Link assembly (type IV)	3
8135-00-664-6958	Cushioning material, packaging, cellulose wadding	As required
8305-00-958-3685	Felt, 1/2-in thick	As required
1670-01-183-2678	Leaf, extraction line	2
	Line, extraction:	
1670-01-062-6313	60-ft (3-loop), type XXVI nylon webbing	1
1670-01-107-7651	140-ft (3-loop), type XXVI nylon webbing	1
	Link assembly:	
	Two-point:	
5306-00-435-8994	Bolt, 1-in diam, 4-in long	4
5310-00-232-5165	Nut, 1-in, hexagonal	4
1670-00-003-1953	Plate, side, 3 3/4-in	4
1670-00-003-1954	Plate, side, 5 1/2-in	4
5365-00-007-3414	Spacer, large	4
1670-00-783-5988	Type IV	2
	Lumber:	
5510-00-220-6146	2- by 4-in:	4 linear feet
5510-00-220-6148	2- by 6-in:	13 linear feet
5510-00-220-6248	2- by 10-in:	1 linear foot
5315-00-010-4657	Nail, steel wire, common, 6d	As required
1670-00-753-3928	Pad, energy-dissipating, honeycomb, 3- by 36- by 96-in	22 sheets
	Parachute:	
1670-01-016-7841	Cargo, G-11B	3

Table 2-1. Equipment required for rigging 120-mm mortar and 1 1/4-ton truck for low-velocity airdrop on a type V platform (continued)

National Stock Number	Item	Quantity
	Cargo extraction:	
1670-01-063-3716	22-ft.....	1
	Platform, AD, type V, 28-ft	1
	Bracket:	
1670-01-162-2375	Inside EFTA	(1)
1670-01-162-2374	Outside EFTA	(1)
1670-01-162-2372	Clevis assembly	(46)
1670-01-162-2376	Extraction bracket assembly	(1)
1670-01-247-2389	Suspension link	(8)
1670-01-162-2381	Tandem link	(2)
5530-00-128-4981	Plywood, 3/4-in:	4 sheets
1670-01-097-8816	Release, cargo parachute, M-1	1
	Sling, cargo airdrop:	
1670-00-251-1153	A-7A	1
	For deployment line:	
1670-01-062-6304	9-ft (2-loop), type XXVI nylon webbing	1
	For riser extensions:	
1670-01-062-6302	20-ft (2-loop), type XXVI nylon webbing	6
	For lifting:	
1670-01-062-6304	9-ft (2-loop), type XXVI nylon webbing	4
1670-01-063-7760	11-ft (2-loop), type XXVI nylon webbing	1
1670-01-062-6303	12-ft (2-loop), type XXVI nylon webbing	6
	For suspension slings:	
1670-01-062-6301	3-ft (2-loop), type XXVI nylon webbing	6
1670-01-063-7760	11-ft (2-loop), type XXVI nylon webbing	4
1670-01-062-6302	20-ft (2-loop), type XXVI nylon webbing	2
1670-00-998-5116	Strap, parachute release, W/fastener and guillotine knife	2
8305-00-074-5124	Tape, adhesive, 2-in	As required
1670-00-937-0271	Tie-down assembly, 15-ft	73
1670-00-431-8486	Vehicle drive-off aid	1
	Webbing:	
8305-00-268-2411	Cotton, 1/4-in, type I	As required
	Nylon:	
	Tubular:	
8305-00-082-5752	1/2-in or	As required
8305-00-268-2453	1/2-in	As required
8305-00-264-6151	1-in	As required
	Type V	As required
8305-00-263-3591	Type VIII	As required

CHAPTER 3

RIGGING DISASSEMBLED 120-MILLIMETER MORTAR IN 1 1/4-TON HMMWV TRUCK ON THE 16-FOOT TYPE V PLATFORM FOR LOW-VELOCITY AIRDROP

3-1. Description of Load

The unrigged 1 1/4-ton HMMWV truck is described in Chapter 1 of FM 10-517/TO 13C7-1-111. The truck is rigged on a 16-foot, type V airdrop platform with two G-11B cargo parachutes for low-velocity airdrop from a C-130, C-141, or C-5 aircraft. The disassembled mortar, weighing 317 pounds, is included in the accompanying load, which is not to exceed 2,000 pounds. The maximum rigged weight of this load is 10,000 pounds.

3-2. Preparing Platform

Prepare a 16-foot, type V platform using four tandem links and 20 clevis assemblies as shown in Figure 2-2 of FM 10-517/TO 13C7-1-111.

3-3. Preparing and Positioning Honeycomb Stacks

Prepare and position the honeycomb stacks as shown in Figures 2-3 through 2-5 of FM 10-517/TO 13C7-1-111.

3-4. Preparing Truck

Prepare the truck as shown in Figures 2-6 through 2-13 of FM 10-517/TO 13C7-1-111.

3-5. Stowing Accompanying Load

Stow the accompanying load as shown in Figure 3-1 of this manual.

CAUTION: Only ammunition listed in FM 10-500-53/TO 13C7-18-41 may be airdropped. Package, mark and label hazardous material according to AFR 71-4/TM 38-250.

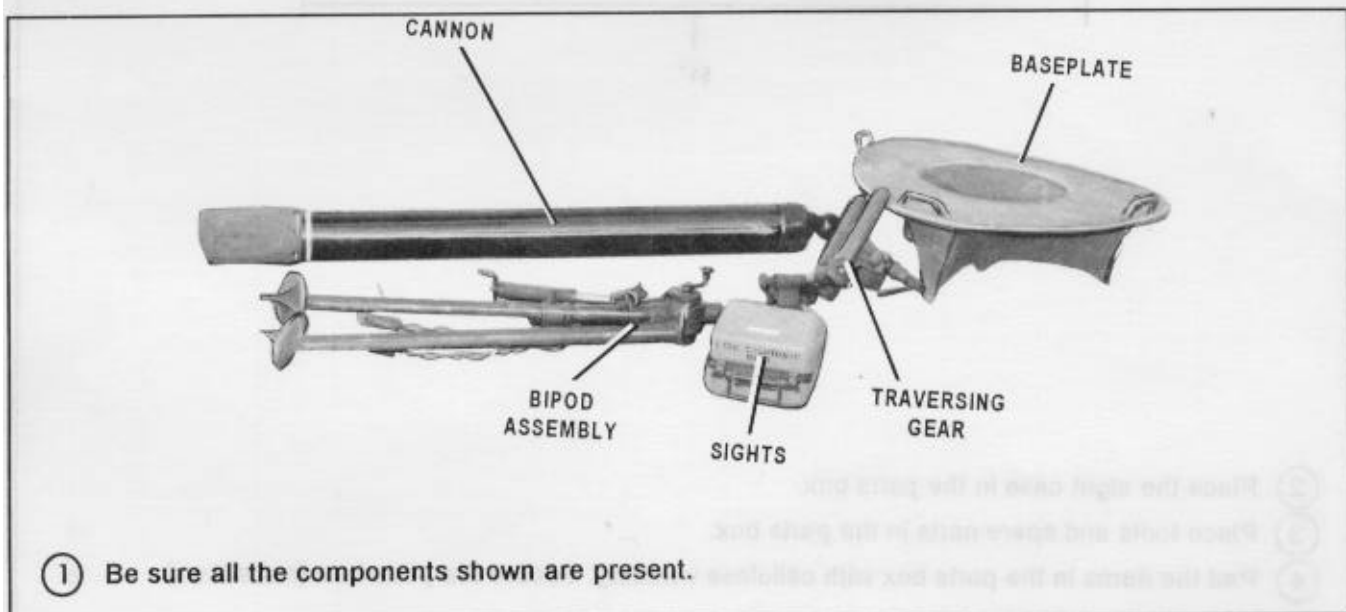
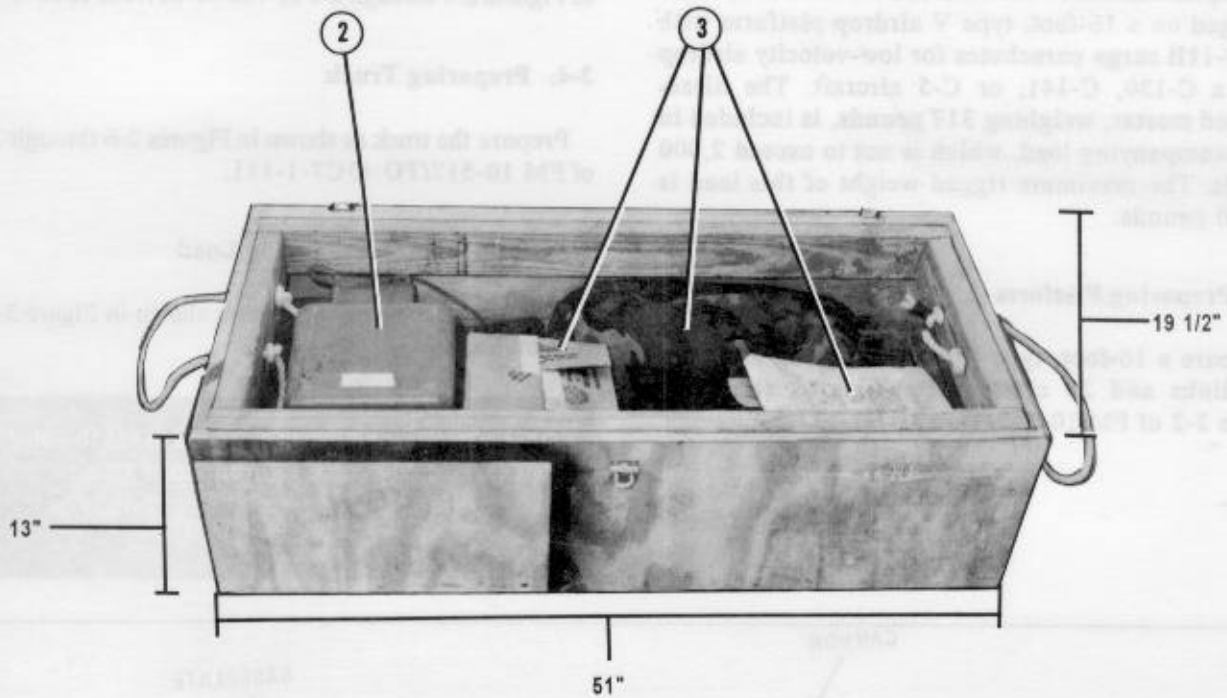

Figure 3-1. Accompanying load stowed

NOTE: THE PARTS BOX MUST NOT EXCEED THE DIMENSIONS SHOWN.



- ② Place the sight case in the parts box.
- ③ Place tools and spare parts in the parts box.
- ④ Pad the items in the parts box with cellulose wadding. Secure the parts box (not shown).

Figure 3-1. Accompanying load stowed (continued)

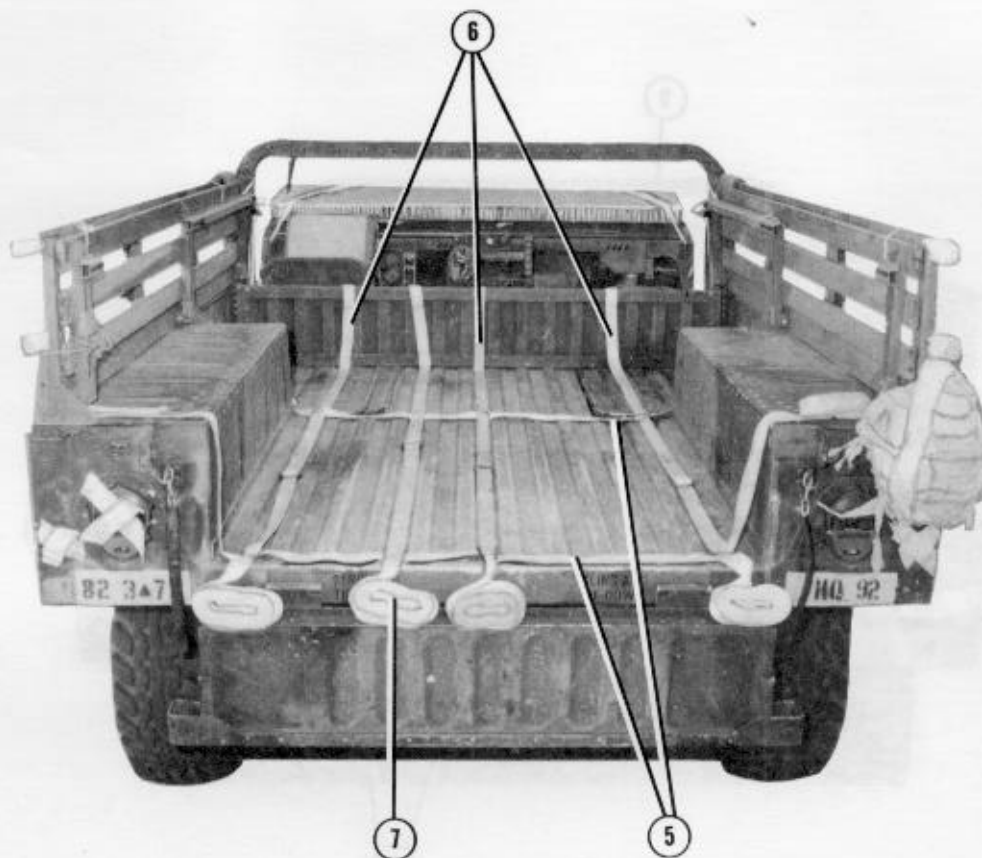

- ⑤ Lay two 15-foot lashings width-wise across the cargo bed, passing them through the center and rear tie-down rings in the cargo bed floor.
- ⑥ Form three 30-foot lashings according to FM 10-500-2/TO 13C7-1-5. Lay the lashings lengthwise across the cargo bed, passing them through the left, right, and center tie-down rings in the cargo bed floor.
- ⑦ Form an additional 30-foot lashing. Place the lashing lengthwise between the left and center tie-down rings.

Figure 3-1. Accompanying load stowed (continued)

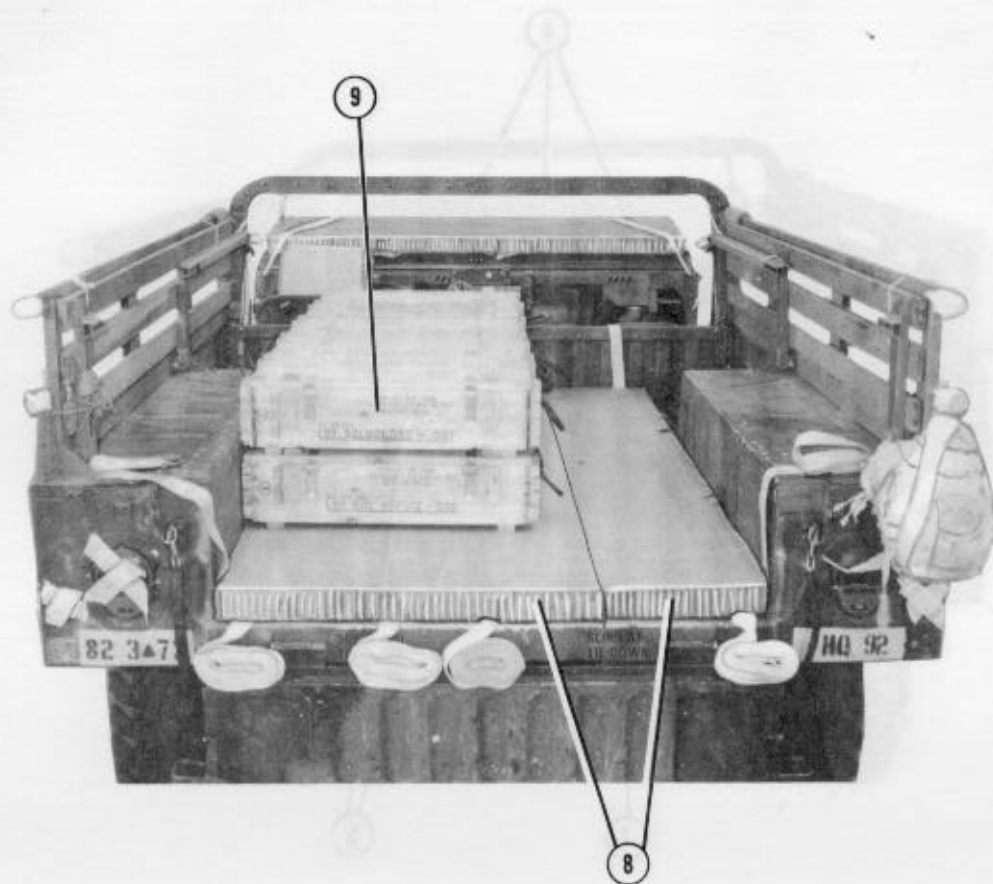

- ⑧ Cover the cargo bed using two pieces of honeycomb to make a 40- by 80-inch layer.
- ⑨ Place 10 boxes of ammunition on the left side of the cargo bed as shown.

Figure 3-1. Accompanying load stowed (continued)

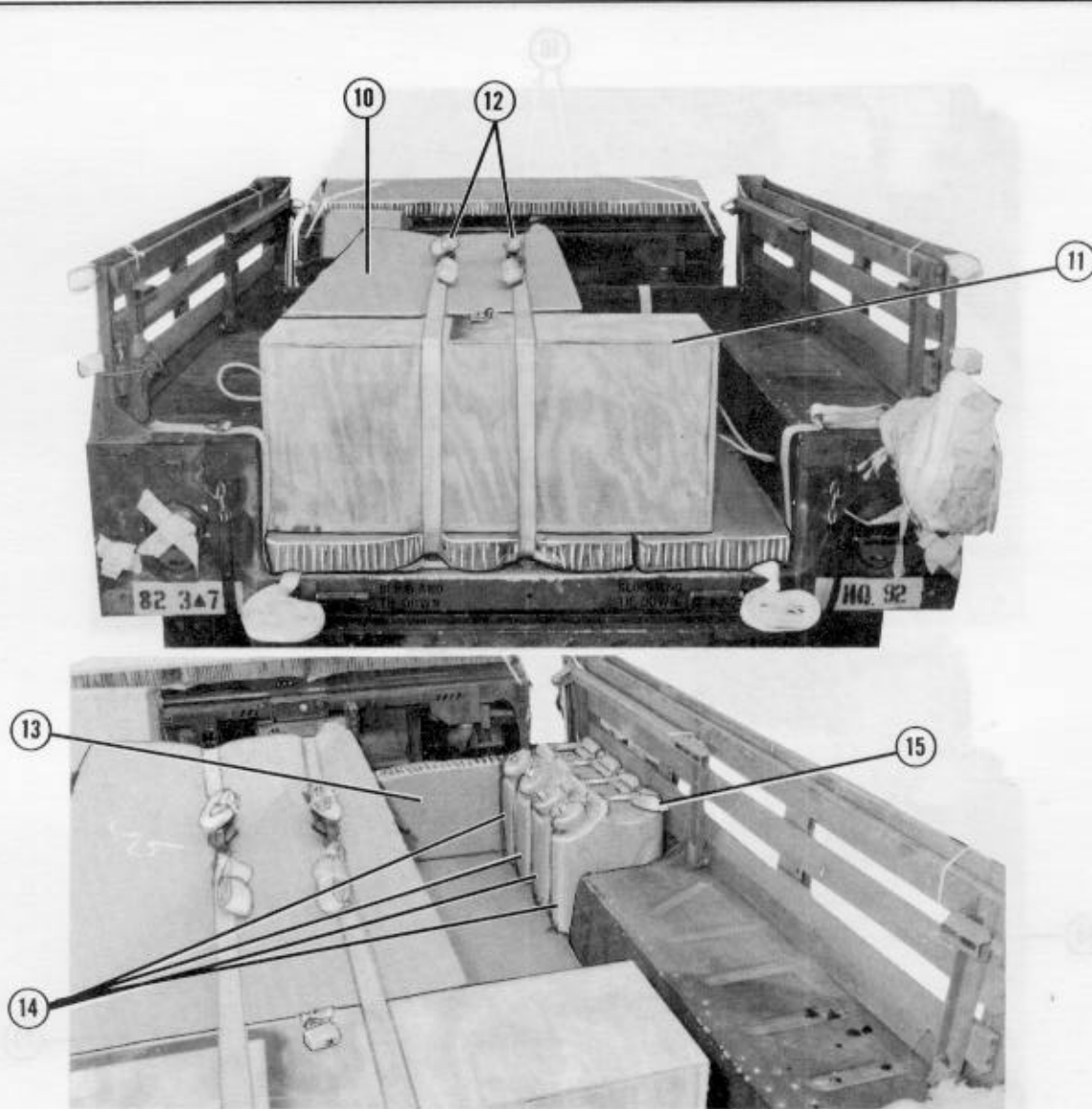

- ⑩ Place a 32- by 68-inch piece of honeycomb on top of the boxes.
- ⑪ Position the parts box flush against the boxes of ammunition.
- ⑫ Secure the center prepositioned lashings around the boxes of ammunition and parts box.
- ⑬ Place a 34- by 14-inch piece of honeycomb against the right front wall.
- ⑭ Place four cans of water or fuel in the right front corner.
- ⑮ Pass a 15-foot lashing through the can handles and around the uprights on the side rails. Secure the lashing on the outside.

Figure 3-1. Accompanying load stowed (continued)

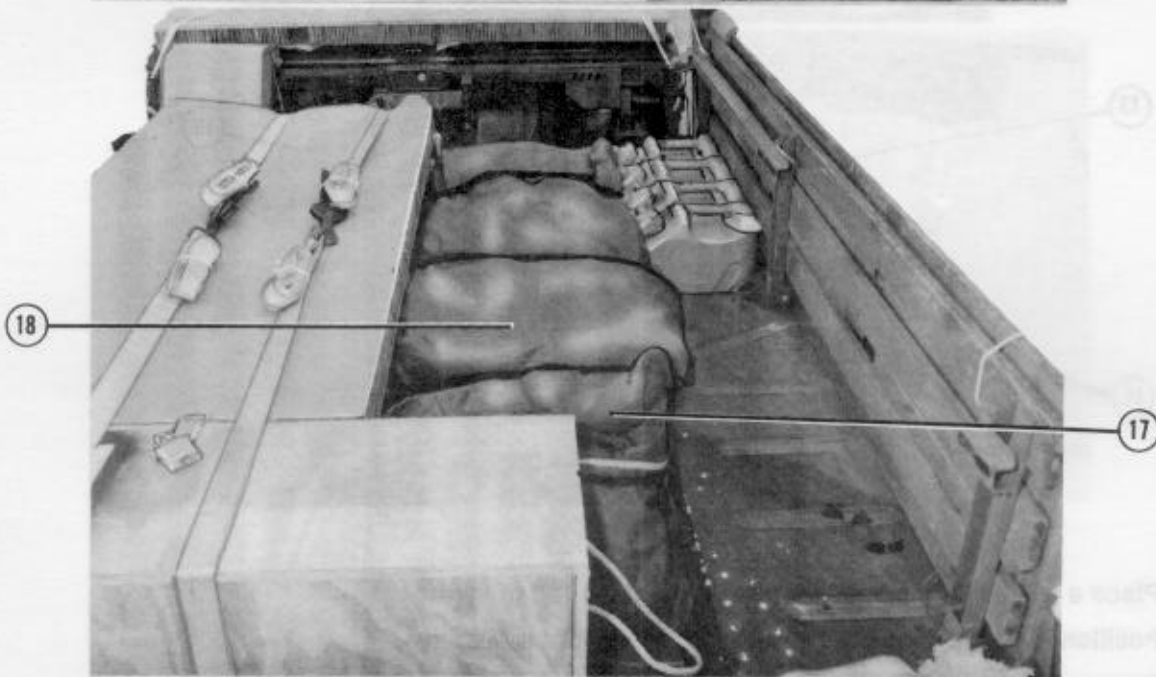
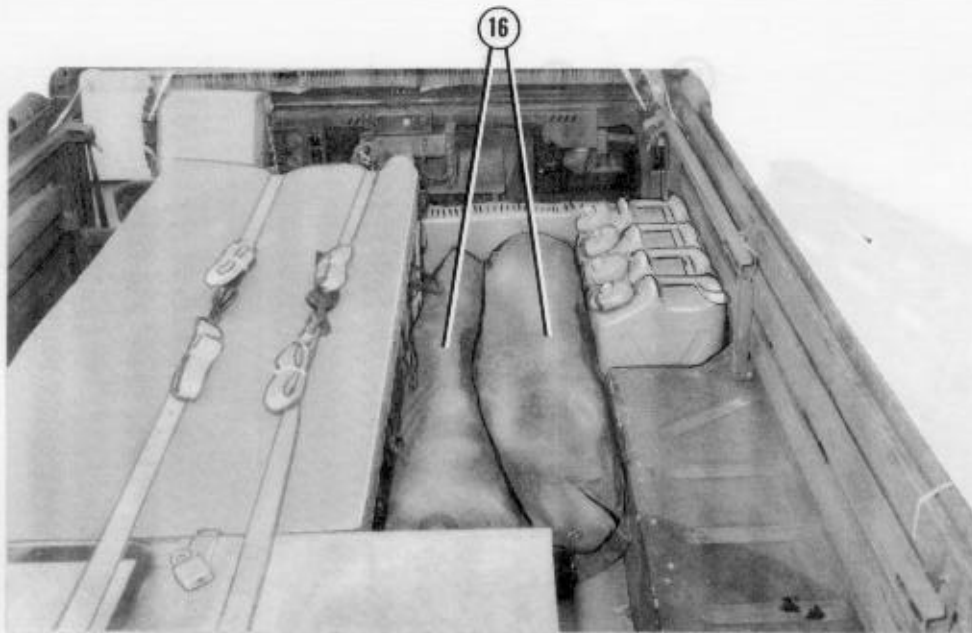

- ①⑥ Position two camouflage pole bags between the ammunition boxes and cans.
- ①⑦ Fold the cargo cover. Place the cover between the pole sets and the parts box.
- ①⑧ Position a camouflage net bag on top of the pole bags.

Figure 3-1. Accompanying load stowed (continued)

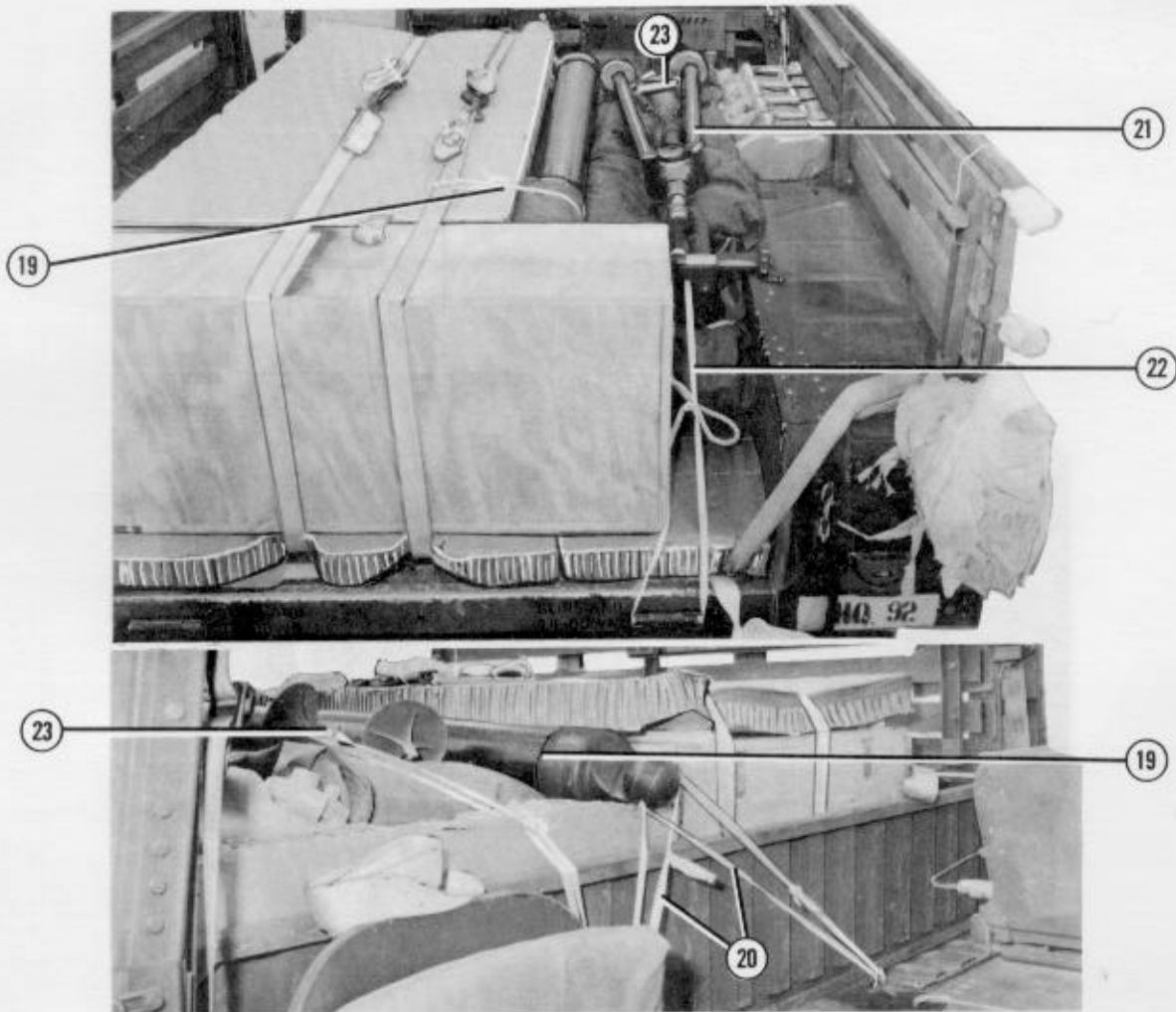

- ①⑨ Position the mortar tube on top of the net bag and against the ammunition boxes with the breech cap to the front. Tie the tube to the center lashing with 1/2-inch tubular nylon webbing.
- ②⑩ Secure the mortar by passing two lengths of 1/2-inch tubular nylon webbing through the breech cap cross bore hole and to both front tie-down rings.
- ②⑪ Place the bipod on the net bag with the extensions to the front, and the buffer assembly on the cargo cover.
- ②⑫ Pass a length of 1/2-inch tubular nylon webbing around the traversing gear assembly and around the tailgate hinge, and tie securely.
- ②⑬ Pass a length of 1/2-inch tubular nylon webbing through both bipod extension rings and tie the webbing to the right front tie-down ring.

Figure 3-1. Accompanying load stowed (continued)

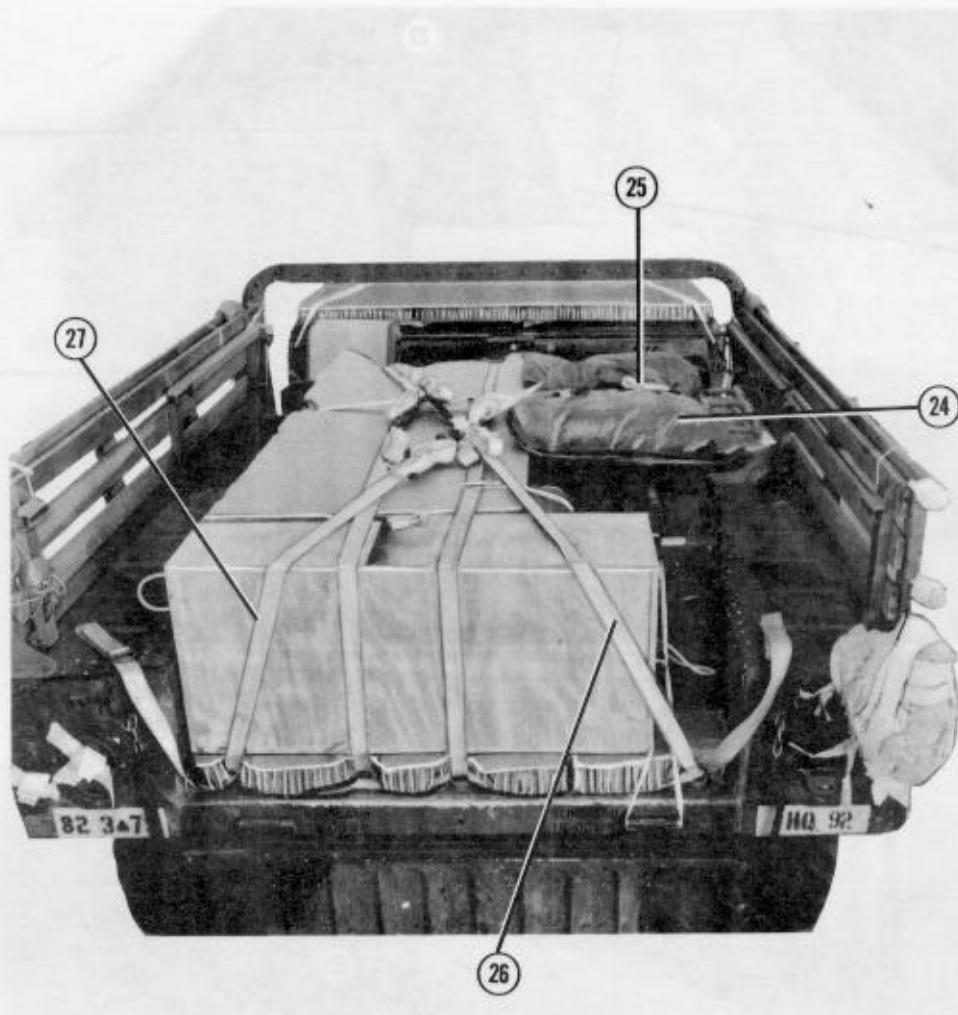

Position the mortar tube on top of the net bag and against the ammunition boxes with the muzzle
end to the front. Tie the tube to the center lashing with 1/2-inch tubular nylon webbing.
Secure the mortar by passing two lengths of 1/2-inch tubular nylon webbing through the break
cap cross bars and to both front tie-down rings.
Place the bipod on the net bag with the extensions to the front and the buffer assembly on the
cargo cover.

- ②④ Position a second camouflage net set on top of the bipod and mortar tube.
- ②⑤ Secure the front 15-foot lashing placed in step 5 on top of the second camouflage net.
- ②⑥ Join the left front and right rear 30-foot lashings placed in step 6 with two D-rings and a load binder.
- ②⑦ Join the left rear and right front 30-foot lashings placed in step 6 with two D-rings and a load binder.

Figure 3-1. Accompanying load stowed (continued)

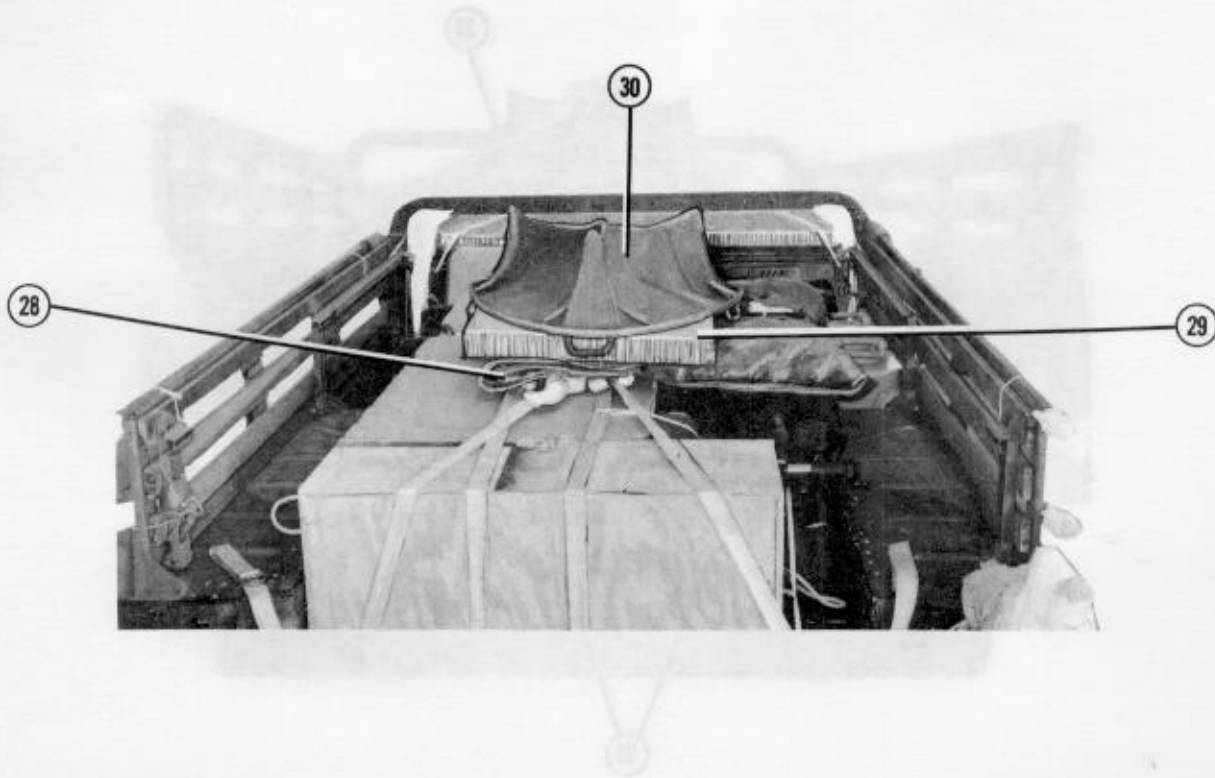

- ②⑧ Position the truck cab cover on top of the load binders of the secured lashings.
- ②⑨ Position a 31- by 36-inch piece of honeycomb on top of the cab cover.
- ③⑩ Center the mortar baseplate on the honeycomb with the center carrying handle facing down and to the rear.

Figure 3-1. Accompanying load stowed (continued)

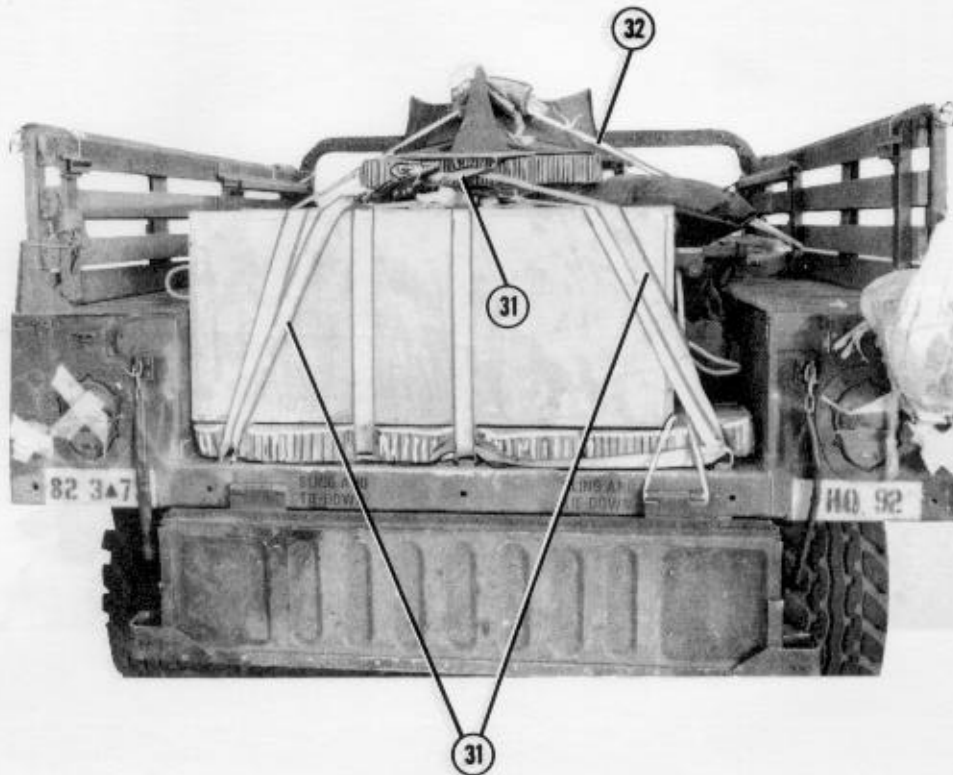

- ③① Pass the rear lashing placed in step 5 over the parts box and through the center carrying handle of the baseplate. Secure the lashing with a D-ring and a load binder.
- ③② Pass a double length of 1/2-inch tubular nylon webbing over the baseplate and secure the webbing to the left and right side rails of the truck. Pad the baseplate with cellulose wadding.

Figure 3-1. Accompanying load stowed (continued)



- ③③ Pass a 15-foot lashing through the right carrying handle of the baseplate and through the right front cargo tie-down ring. Secure the lashing with a load binder and D-ring.
- ③④ Pass a 15-foot lashing through the left carrying handle of the baseplate and through the left front cargo tie-down ring. Secure the lashing with a load binder and D-ring.

Figure 3-1. Accompanying load stowed (continued)

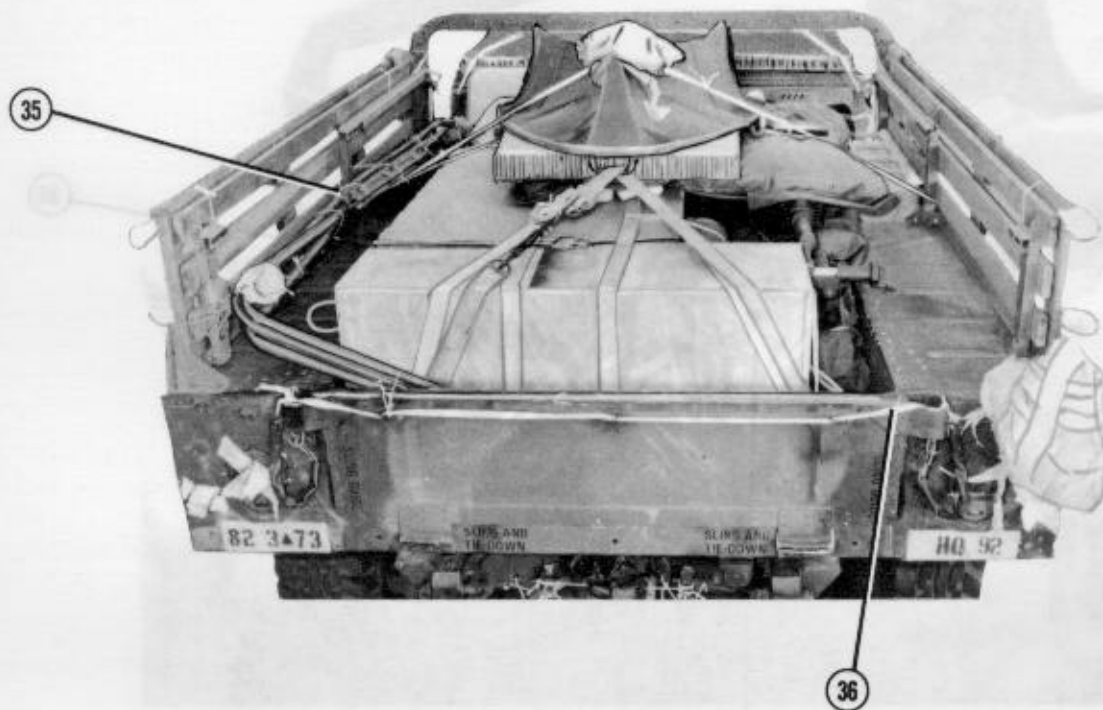

- ③⑤ Position the bows of the truck on the left side of the cargo bed. Secure the bows to the side rails using type III nylon cord.
- ③⑥ Close the tailgate. Secure it to the chain brackets with a single length of 1/2-inch tubular nylon webbing.

Figure 3-1. Accompanying load stowed (continued)

3-6. Installing Drive-off Aids on Platform

Install the drive-off aids on the platform as shown in Figure 2-16 of FM 10-517/TO 13C7-1-111.

3-7. Lifting and Positioning Truck and Installing Drive-off Aids

Install the lifting slings and position the truck on the platform as described in Figure 2-17, FM 10-517/TO 13C7-1-111. Install the drive-off aids and honeycomb restraint lashing as shown in Figure 2-18 of FM 10-517/TO 13C7-1-111.

3-8. Lashing Truck

Lash the truck as shown in Figures 2-19 and 2-20 of FM 10-517/TO 13C7-1-111.

3-9. Installing, Padding, and Safetying Suspension Slings

Install, pad, and safety the suspension slings as shown in Figure 2-21 of FM 10-517/TO 13C7-1-111.

3-10. Stowing Cargo Parachutes

Stow the cargo parachutes on the load as shown in Figure 2-22 of FM 10-517/TO 13C7-1-111.

3-11. Installing Parachute Release

Prepare and install an M-1 cargo parachute release according to FM 10-500-2/TO 13C7-1-5 and as shown in Figure 2-25 of FM 10-517/TO 13C7-1-111.

3-12. Installing Extraction System

Install the extraction system as shown in Figure 2-23 of FM 10-517/TO 13C7-1-111.

3-13. Installing Provisions for Emergency Restraints

Install provisions for emergency restraints according to FM 10-500-2/TO 13C7-1-5.

3-14. Placing Extraction Parachute

Place the extraction parachute as described below.

a. C-130 Aircraft. Place a 22-foot cargo extraction parachute and a 60-foot (3-loop), type XXVI nylon webbing extraction line on the load for installation in the aircraft.

b. C-141 Aircraft. Place a 22-foot cargo extraction parachute and a continuous 140-foot (3-loop), type XXVI nylon webbing extraction line on the load for installation in the aircraft.

c. C-5 Aircraft. Place a 22-foot cargo extraction parachute and a two-point 5 1/2-inch link assembly on the load for installation in the aircraft. See FM 10-500-2/TO 13C7-1-5 for extraction line requirements.

NOTE: A SLING/EXTRACTION LINE BAG MUST BE USED.

3-15. Marking Rigged Load

Mark the rigged load according to FM 10-500-2/TO 13C7-1-5 and as shown in Figure 3-2. Complete DD Form 1387-2, and securely attach it to the load. Indicate on DD Form 1387-2 that the equipment fuel tanks

and batteries have been prepared according to AFR 71-4/TM 38-250. If the load varies from the one shown, the weight, height, CB, and parachute requirements must be recomputed.

CAUTION
 Make the final rigger inspection required by FM 10-500-2/ TO 13C7-1-5 before the load leaves the rigging site.

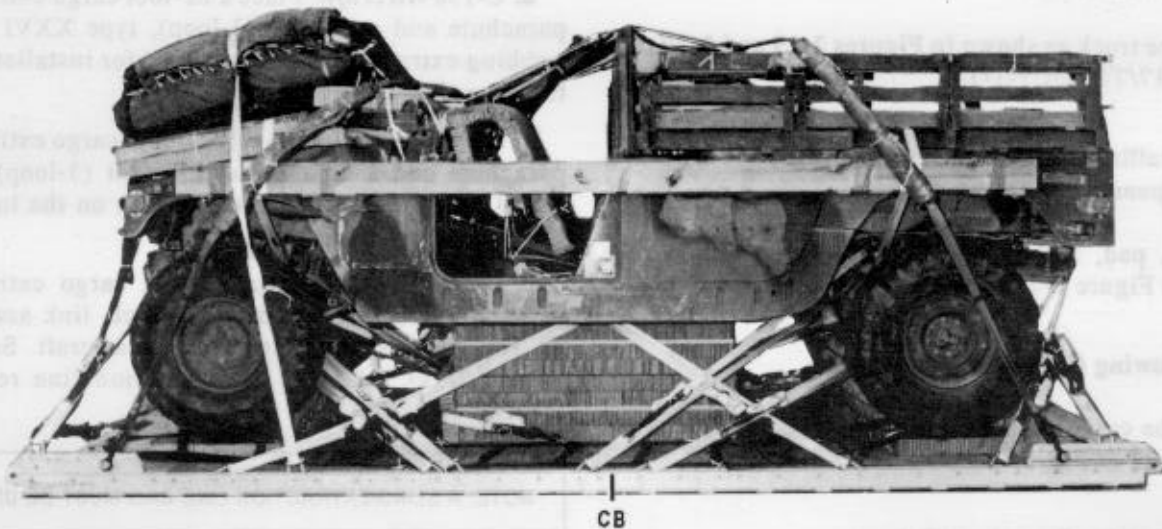

RIGGED LOAD DATA

Weight:	Load shown	_____	9,950 pounds
	Maximum load allowed	_____	10,000 pounds
Height (with two G-11B parachutes)	_____	_____	86 inches
Width	_____	_____	108 inches
Length	_____	_____	215 inches
Overhang: Front	_____	_____	0 inches
	Rear	_____	0 inches
CB (from front edge of platform)	_____	_____	95 inches

Figure 3-2. 1 1/4-ton HMMWV truck with 120-millimeter mortar rigged for low-velocity airdrop

3-16. Equipment Required

Use the equipment listed in Table 3-1 to rig this load.

Table 3-1. Equipment required for rigging 120-mm mortar in 1 1/4-ton truck for low-velocity airdrop

National Stock Number	Item	Quantity
8040-00-273-8713	Adhesive, paste, 1-gal	As required
	Clevis, suspension:	
4030-00-678-8562	3/4-in (medium)	6
4030-00-090-5354	1-in (large)	5
4020-00-240-2146	Cord, nylon, type III, 550-lb	As required
1670-00-434-5785	Coupling, airdrop, extraction force transfer w 16-ft cable	1
1670-00-360-0329	Cover, link assembly, type IV	3
8135-00-664-6958	Cushioning material, packaging, cellulose wadding	As required
8305-00-958-3685	Felt, 1/2-in thick	As required
1670-01-183-2678	Leaf, extraction (2 ea used for line bag)	2
	Line, extraction:	
1670-01-062-6313	60-ft (3-loop), type XXVI nylon webbing	1
1670-01-107-7651	140-ft (3-loop), type XXVI nylon webbing (for C-141)	1
	Link assembly,	
	Two-point (for C-130)	1
5306-00-435-8994	Bolt, 1-in diam, 4-in long	(2)
5310-00-232-5165	Nut, 1-in	(2)
1670-00-003-1953	Plate, side, 3 3/4-in	(2)
5365-00-007-3414	Spacer, large	(2)
1670-00-783-5988	Type IV	3
5510-00-220-6148	Lumber, 2- by 6-in:	As required
1670-00-753-3928	Pad, energy-dissipating, honeycomb,	
	3- by 36- by 96-in:	13 sheets
	Parachute:	
	Cargo:	
1670-01-016-7841	G-11B	2
	Cargo extraction:	
1670-01-063-3716	22-ft or	1
1670-00-687-5458	22-ft (C-130 only)	1
	Platform, AD, type V, 16-ft:	1
	Bracket:	
1670-01-162-2375	Inside EFTA	(1)
1670-01-162-2374	Outside EFTA	(1)
1670-01-162-2372	Clevis, assembly (type V)	(20)
1670-01-162-2376	Extraction bracket assembly	(1)
1670-01-162-2381	Tandem link (multi-purpose)	(4)
5530-00-128-4981	Plywood, 3/4-in:	As required

Table 3-1. Equipment required for rigging 120-mm mortar in 1 1/4-ton truck for low-velocity airdrop (continued)

National Stock Number	Item	Quantity
1670-01-097-8816	Release, cargo parachute, M-1	1
1670-01-062-6304	Sling, cargo, airdrop: For deployment line: 9-ft (2-loop), type XXVI nylon webbing	1
1670-01-062-6304	For lifting: 9-ft (2-loop), type XXVI nylon webbing	2
1670-01-062-6303	12-ft (2-loop), type XXVI nylon webbing	2
1670-01-062-6302	For riser extension: 20-ft (2-loop), type XXVI nylon webbing	2
1670-01-063-7761	For suspension: 16-ft (2-loop), type XXVI nylon webbing	4
1670-00-040-8219	Strap, parachute release, multi-cut, comes w 3 knives	2
7510-00-266-5016	Tape, adhesive, 2-in	As required
1670-00-937-0271	Tie-down assembly, 15-ft	35
1670-00-431-8486	Vehicle drive-off aid	1
8305-00-268-2411	Webbing: Cotton, 1/4-inch, type I	As required
8305-00-082-5752	Nylon, tubular, 1/2-in, 1,000 lb, natural	As required
8305-00-268-2455	Nylon, tubular, 1-in, 4,000-lb, olive drab	As required
8305-00-263-3591	Nylon, type VIII, 3,600-lb	As required

GLOSSARY

ACB attitude control bar	HQ headquarters
AD airdrop	HMMWV high mobility multi-purpose wheeled vehicle
AFB Air Force base	in inch
AFJMAN armed forces joint manual	LAPE low-altitude parachute-extraction
AFR Air Force regulation	LAPES low-altitude parachute-extraction system
AFTO Air Force technical order	lb pound
ATTN attention	No number
CB center of balance	NSN national stock number
d penny	OVE on-vehicular equipment
DA Department of the Army	OVM operator vehicle maintenance
DC District of Columbia	psi pound per square inch
DD Department of Defense	TM technical manual
diam diameter	TO technical order
EFTA extraction force transfer actuator	TRADOC United States Army Training and Doctrine Command
EFTC extraction force transfer coupling	US United States
FM field manual	w with
ft feet	yd yard
gal gallon	

REFERENCES

- AFJMAN 24-0204** *Packing and Materials Handling: Preparing of Hazardous Material for Military Air Shipments.* November 1994.
- AFR 71-4/TM 38-250** *Packaging and Materials Handling: Preparation of Hazardous Materials for Military Air Shipment.* 15 January 1988.
- FM 10-500-2/TO 13C7-1-5** *Airdrop of Supplies and Equipment: Rigging Airdrop Platforms.* 1 November 1990.
- FM 10-517/TO 13C7-1-111** *Airdrop of Supplies and Equipment: Rigging 1 1/4-Ton Utility Truck (HMMWV).* 14 November 1989.
- TM 9-1015-250-10** *Operator's Manual for Mortar, 120-mm. Operator's Manual For Mortar, 120 MM: Towed M120 And Mortar, 120 MM: Carrier-Mounted M121.* 15 January 1993, Superceded March 1993.
- TM 9-2320-280-10/TO 36A12-1A-2091-1/*TM 2320-10/6** *Operator's Manual for Truck, Utility.* April 1985.
- TM 10-1670-268-20&P/13C7-52-22** *Organizational Maintenance Manual with Repair Parts and Special Tools List: Type V Airdrop Platform.* 1 June 1986.
- TM 10-1670-279-23&P/TO 13C5-27-2 NAVAIR 13-1-27** *Unit and Intermediate (DS) Maintenance Manual Including Repair Parsts and Tools List for Parachute, Cargo Type: 22-foot Diameter, Cargo Extraction.* 6 November 1989.
- TM 10-1670-280-23&P/TO 13C5-31-2 NAVAIR 13-1-31** *Unit and Intermediate (DS) Maintenance Manual Parachute, Cargo Type: 100-foot Diameter, Model G-11B and Model G-11C.* 5 August 1991.
- AFTO Form 22** *Technical Order Publication Improvement Report.* April 1973.
- DA Form 2028** *Recommended Changes to Publications and Blank Forms.* February 1974.
- DD Form 1387-2** *Special Handling Data/Certification.* June 1986.

** The extra TM number is for the Marine Corps.*

FM 10-500-45/TO 13C7-10-201
3 OCTOBER 1995

By Order of the Secretary of the Army:
By Order of the Secretary of the Air Force:

Official:



JOEL B. HUDSON

*Acting Administrative Assistant to the
Secretary of the Army*

00758

DENNIS J. REIMER
*General, United States Army
Chief of Staff*

DISTRIBUTION:

Active Army, USAR, and ARNG: To be distributed in accordance with DA Form 12-11E, requirements for FM 10-500-45, *Airdrop of Supplies and Equipment: Rigging 120-Millimeter Mortars* (Qty rqr block no. 0893)

PIN: 074082-000