

ATP 3-04.94 (FM 3-04.104)

**Army Techniques Publication for Forward Arming and
Refueling Points**

January 2012

DISTRIBUTION RESTRICTION: Approved for public release; distribution is unlimited.

Headquarters, Department of the Army

This publication is available at
Army Knowledge Online (www.us.army.mil) and
General Dennis J. Reimer Training and Doctrine
Digital Library at (www.train.army.mil).

Army Techniques Publication for Forward Arming and Refueling Points

Contents

Preface	vii
Chapter 1	Purpose, Organization, and Mission Command	1-1
	Section I – Purpose and Organization	1-1
	Purpose	1-1
	Aviation Support Battalion	1-1
	Forward Support Company	1-2
	Section II – Mission Command	1-2
	Responsibilities	1-2
	Aircraft Control	1-3
	Radio Communications	1-3
Chapter 2	Employment	2-1
	Section I - Planning Factors	2-1
	Types of Forward Arming and Refueling Points	2-1
	Site Selection	2-2
	Tactical Enablers.....	2-4
	Section II – Refueling Equipment	2-6
	Advanced Aviation Forward Area Refueling System	2-6
	Heavy Expanded Mobility Tactical Truck Tanker Aviation Refueling System	2-9
	Personnel Refueling Requirements	2-11
	Refueling Nozzles	2-12
	Equipment Setup.....	2-14
	Modular Fuel System	2-15
	Section III – Refueling Operations	2-16
	Ground Vehicles.....	2-16
	Emergency Procedures	2-17
	Refueling Point Safety Requirements	2-18
	Aerial Emplacement.....	2-19
	Section IV – Arming Operations	2-22
	Ammunition Storage.....	2-22
	Ammunition Safety Procedures	2-22

DISTRIBUTION RESTRICTION: Approved for public release; distribution is unlimited.

***This publication supersedes FM 3-04.104, 3 August 2006.**

Contents

	Armament Pad Setup.....	2-24
	Personnel Requirements	2-24
	Simultaneous Arming and Refueling.....	2-25
	Armament Configurations for the AH-64 and OH-58D	2-26
	Volcano Arming Operations	2-28
	Section V – Operational Environments	2-29
	Night Operations	2-29
	Desert Operations.....	2-30
	Cold Weather Operations	2-32
	Long Term Operations	2-33
Chapter 3	Training	3-1
	Qualification Training	3-1
	Training Realism	3-1
	Individual and Collective Training	3-1
	Critical Skills.....	3-1
	Multiple Forward Arming and Refueling Point Operations.....	3-4
	Security	3-5
	Firefighting and Rescue Procedures.....	3-5
	Recommended Unit Sling-Load Training.....	3-10
	Aqua-Glo Test Preparation Procedures.....	3-11
	Fuel Sampling Procedures.....	3-12
	Fuel Test Procedures.....	3-12
Chapter 4	Sustainment.....	4-1
	Planning Considerations	4-1
	Resupply	4-1
	Class III Requirements.....	4-2
	Class V Requirements	4-3
	Argon Gas	4-3
	Transportation	4-4
Appendix A	Standard Hand and Arm Signals	A-1
Appendix B	Load Plans	B-1
Appendix C	Forward Arming and Refueling Point Planning Checklist.....	C-1
Appendix D	Environmental Protection Considerations	D-1
Appendix E	Comprehensive Risk Assessment for Forward Arming and Refueling Points	E-1
Appendix F	Forward Arming and Refueling Point Site Inspection Checklist	F-1
Appendix G	Sample Forward Arming and Refueling Point Standard Operating Procedure	G-1
Glossary	Glossary-1
References	References-1
Index	Index-1

Figures

Figure 1-1. Aviation support battalion	1-2
Figure 1-2. Forward support company structure.....	1-2
Figure 2-1. Sample forward arming and refueling point zone.....	2-3
Figure 2-2. AN/TSQ-198 tactical terminal control system.....	2-5
Figure 2-3. Advanced aviation forward area refueling system.....	2-6
Figure 2-4. Advanced aviation forward area refueling system layout.....	2-7
Figure 2-5. Advanced aviation forward area refueling system setup under various wind conditions.....	2-8
Figure 2-6. Unisex connections	2-9
Figure 2-7. Heavy expanded mobile tactical truck tanker refueling system components and layout	2-11
Figure 2-8. Open-port nozzle adapter.....	2-13
Figure 2-9. Model 125-1000 closed-circuit refueling nozzle	2-13
Figure 2-10. CCR system nozzle	2-14
Figure 2-11. D-1 center point refueling nozzle.....	2-14
Figure 2-12. Modular fuel system	2-15
Figure 2-13. Modular fuel system with heavy expanded mobile tactical truck and trailer	2-16
Figure 2-14. Heavy expanded mobile tactical truck and forward arming and refueling point layout	2-17
Figure 2-15. Extended range fuel system II functional components.....	2-20
Figure 2-16. Typical layout for fat cow refueling points	2-21
Figure 2-17. Simultaneous rearming and refueling forward arming and refueling point layout	2-26
Figure 2-18. AH-64 armament configurations.....	2-27
Figure 2-19. OH-58D authorized armament configurations.....	2-28
Figure 2-20. Example of a site layout for a volcano arming point.....	2-29
Figure 2-21. T-formation advanced aviation forward area refueling system setup	2-31
Figure 2-22. Notional long term forward arming and refueling point on an airfield.....	2-34
Figure 3-1. Rolling forward arming and refueling point setup.....	3-4
Figure 3-2. Load with two lift points	3-11
Figure 4-1. Flow of Class III/V supplies to the forward arming and refueling point	4-2
Figure A-1. Proceed to next ground guide	A-1
Figure A-2. This way	A-2
Figure A-3. Move ahead.....	A-2
Figure A-4. Turn to left (port)	A-3
Figure A-5. Turn to right (starboard)	A-3
Figure A-6. Move upward.....	A-4
Figure A-7. Hover.....	A-4
Figure A-8. Move downward	A-5

Contents

Figure A-9. Move to right.....	A-5
Figure A-10. Move to left.....	A-6
Figure A-11. Slow down.....	A-6
Figure A-12. Stop.....	A-7
Figure A-13. Fire.....	A-7
Figure A-14. Wave-off.....	A-8
Figure A-15. Affirmative (all clear).....	A-8
Figure A-16. Negative (not clear).....	A-9
Figure A-17. Move back.....	A-9
Figure A-18. Land.....	A-10
Figure A-19. Tail to right (starboard).....	A-11
Figure A-20. Tail to left (port).....	A-12
Figure A-21. Clearance for personnel to approach aircraft.....	A-12
Figure A-22. Cut engine(s) or stop rotor(s).....	A-13
Figure A-23. Connect auxiliary power unit (day).....	A-14
Figure A-24. Disconnect auxiliary power unit (day).....	A-15
Figure A-25. Hook up load.....	A-15
Figure A-26. Release load.....	A-16
Figure A-27. Load has not been released.....	A-16
Figure A-28. Install (day).....	A-17
Figure A-29. Remove (day).....	A-18
Figure A-30. Ground hand signals.....	A-19
Figure A-31. Ground hand signals (concluded).....	A-20
Figure B-1. M978 heavy expanded mobility tactical truck tanker.....	B-1
Figure B-2. M977 heavy expanded mobile tactical truck cargo vehicle.....	B-2
Figure B-3. M989A1 heavy expanded mobility ammunition trailer.....	B-3
Figure B-4. Suggested ammunition load plan 1.....	B-3
Figure B-5. Suggested ammunition load plan 2.....	B-4
Figure B-6. Suggested ammunition load plan 3.....	B-4
Figure D-1. Spill kit.....	D-5
Figure E-1. Comprehensive risk assessment for forward arming and refueling points (part 1).....	E-1
Figure E-2. Comprehensive risk assessment for forward arming and refueling points (part 2).....	E-2

Tables

Table 2-1. Forward arming and refueling point safety requirements	2-18
Table 2-2. Common items used during rearm operations	2-23
Table 2-3. Rearm point and ready ammunition storage area minimum safe distances (in ft).....	2-24
Table 3-1. Recommended instructional blocks for sling-load training	3-10
Table 4-1. Average fuel consumption rates	4-3
Table 4-2. Cargo capacity comparison for ammunition	4-3
Table B-1. Load plan key	B-5
Table B-2. Cargo planning and transportation requirements.....	B-5
Table C-1. Forward arming and refueling point planning checklist.....	C-1
Table F-1. Forward arming and refueling point site inspection checklist.....	F-1
Table G-1. Sample standard operating procedure	G-1

Preface

This Army techniques publication (ATP) describes forward arming and refueling point (FARP) operations for aviation units. It provides aviation commanders, staff elements, aviation support battalions (ASBs), and forward support company (FSC) personnel with a comprehensive overview of the purpose, organization, and operation of a FARP. It also includes planning considerations for FARP setup and transportation planning considerations for Class III and V products. The principles in this ATP apply to all aviation units potentially involved in forward arming and refueling missions.

The Combined Arms Support Command is the proponent for these operations and the military occupational specialties related to fueling and ammunition operations. This ATP specifies the unique procedures that ammunition, arming, and refueling personnel perform during FARP and rapid refuel operations in the primary assembly area (AA).

Field manual (FM) 10-67-1 provides more detailed information on petroleum operations as well as applicable checklists. Units should ensure FARP personnel have the current version of FM 10-67-1 and this ATP available while conducting FARP operations. For more detailed information on ammunition operations, refer to FM 4-30.1.

Technical manuals (TMs) cited in this ATP are available at www.logsa.army.mil.

This ATP applies to the Active Army, the Army National Guard (ARNG)/Army National Guard of the United States (ARNGUS), and the United States Army Reserve (USAR) unless otherwise stated.

The proponent for this publication is the United States Army Aviation Center of Excellence (USAACE). Users of this manual are invited to send comments and suggested improvements using Department of the Army (DA) Form 2028 (Recommended Changes to Publications and Blank Forms), to Commander, USAACE, ATTN: ATZQ-TD-D, Fort Rucker, AL 36362-5263, or email the Directorate of Training and Doctrine (DOTD) at av.doctrine@us.army.mil. This and other aviation doctrinal manuals can be found via Army Knowledge Online (AKO) at <https://www.us.army.mil/suite/page/394729> or by calling Defense Switched Network (DSN) 558-3551 or (334) 255-3551.

Chapter 1

Purpose, Organization, and Mission Command

The FARP enables commanders to extend their reach within the brigade combat team (BCT), division, or corps areas of operation (AO) during attack, air assault, or aviation support missions. The FARP's ability to provide fuel and ammunition where and when needed on the battlefield is vital to the success of Army aviation combat missions. This chapter provides a general discussion of the FARP's purpose and an in-depth look at its organization and command structure.

SECTION I – PURPOSE AND ORGANIZATION

PURPOSE

- 1-1. A FARP is a temporary facility that is organized, equipped, and deployed as far forward, or widely dispersed, as tactically feasible to provide fuel and ammunition necessary for the sustainment of aviation maneuver units in combat. Establishing a FARP allows commanders to extend the range of their aircraft or significantly increase time on station by eliminating the need for aircraft to return to the aviation unit's central base of operations to refuel and rearm. FARPs may be task organized to provide maintenance support as well as air traffic control (ATC) services, if required.
- 1-2. FARPs are employed in support of aviation operations when the distance covered or endurance requirements exceed normal capabilities of the aircraft. FARPs may also be employed during rapid advances, when field trains are unable to keep pace.

AVIATION SUPPORT BATTALION

- 1-3. The ASB (figure 1-1, page 1-2) is comprised of four companies: the headquarters and support company (HSC), the distribution (DISTRO) company, the network signal company, and the aviation support company (ASC).
- 1-4. The HSC provides medical support and conducts field-ground maintenance and recovery.
- 1-5. The DISTRO company provides support for the aviation brigade and receives, temporarily stores, and issues Class III Bulk. The DISTRO company also establishes and operates Class III (aviation fuel) and Class V (ammunition) transload sites in the brigade sustainment area to resupply brigade operations. Utilizing brigade and battalion assets, the DISTRO company provides fuel to all brigade aircraft within the AA.
- 1-6. The network signal company provides network and signal support to the combat aviation brigade (CAB) headquarters.
- 1-7. The ASC provides intermediate maintenance and support for on-aircraft and critical off-aircraft field level maintenance and maintenance of unmanned aircraft systems. The ASC also conducts battle damage assessment and repair while providing backup support to the aviation maintenance company. The ASC may provide armament personnel to FSCs upon request.

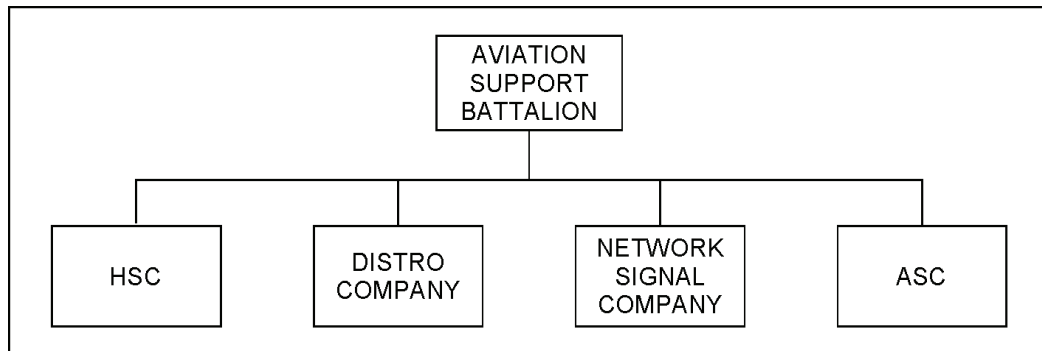

Figure 1-1. Aviation support battalion

FORWARD SUPPORT COMPANY

1-8. All aviation battalions are assigned an organic FSC. Within each FSC is a DISTRO platoon, which is assigned Class III (petroleum, oils, and lubricants [POL]) and V (ammunition) personnel. FSCs in attack reconnaissance battalions are unique in that they are assigned armament maintenance personnel within the component repair platoon.

1-9. Aviation battalion FSCs (figure 1-2) are organized with a company headquarters, field feeding section, DISTRO platoon, and a ground maintenance platoon. The DISTRO platoon provides aircraft refuel capability, ammunition specialists, water, and transportation. When mission dictates, FSCs can be augmented by the ASB with personnel and equipment.

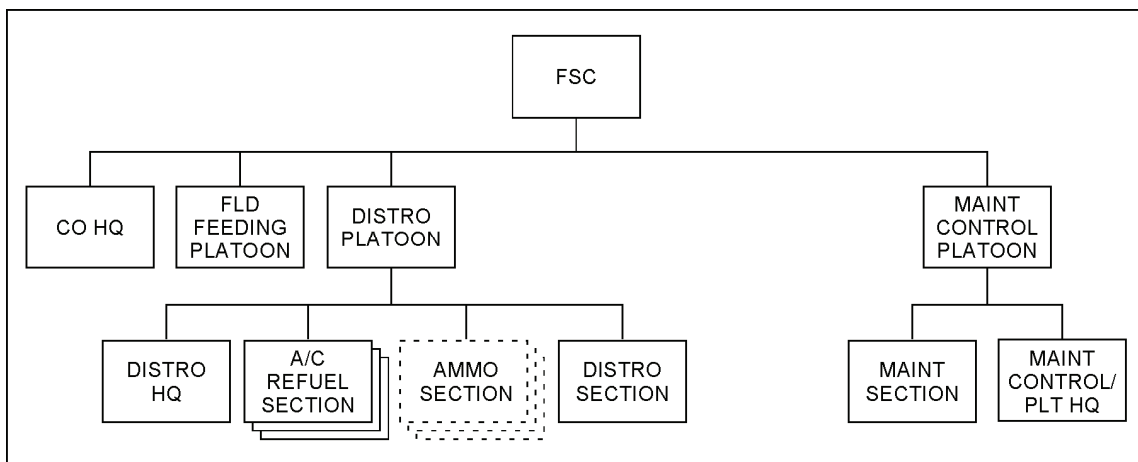

Figure 1-2. Forward support company structure

SECTION II – MISSION COMMAND

RESPONSIBILITIES

1-10. FSC commanders are responsible for accomplishing the FARP mission within the battalions. FSC commanders assist operations staff officers (S-3) in formulating the FARP plan and coordinate fuel and

ammunition requirements with the unit's staff officers (S-4). FSC commanders may request additional FARP support from the ASB when requirements exceed the FSC's capabilities. The increased tempo of operations and/or density of traffic may also require air traffic service (ATS) assets.

1-11. A safety officer (SO) will certify the FARP prior to use. If an SO is not available, the commander will designate an appropriately trained individual to certify the FARP according to the FARP checklist in the unit's standard operating procedure (SOP).

AIRCRAFT CONTROL

1-12. The control of aircraft within the FARP is critical to the safety and overall efficiency of the operation. The proximity of the FARP to the battlefield may restrict the use of radar for positive aircraft control. The most effective means of control are a thorough briefing and a well-written and rehearsed SOP that outlines FARP procedures for aircrews and FARP personnel. Additionally, offset, low-output non-directional radio beacons and global positioning systems (GPSs) may be low risk methods for locating FARPs. Hand and arm or ATC light gun signals may be used as an aid to procedural aircraft control.

RADIO COMMUNICATIONS

1-13. The FARP internal network provides FARP personnel with information on the current status of inbound aircraft and ammunition requirements. In order to reduce the enemy's ability to target and engage electronic emissions, the use of radios must be kept to a minimum; however, each FARP should have at least three frequency modulated (FM) radios capable of secure voice or secure data burst transmissions. This allows simultaneous monitoring of both the command and administrative and supporting networks. The command network provides information that may affect the FARP's operation. Due to the danger posed by radio frequency (RF) energy, aircraft will not transmit during fueling or arming operations. Due to line of sight and range limitations of FM radios, the distance and/or location of the FARP may prevent monitoring and/or transmitting on the designated command frequency. Therefore, using aircraft as retransmission or relay is an option as long as the mission variables are considered. These radios should be used to transmit only when—

- The FARP is under attack.
- The FARP relocates or ceases operations.
- The FARP is not operational at the scheduled time.
- A request is made to resupply Class III/V products.
- The status of the FARP changes (in this case, the radio is used to report damage or contamination).

1-14. The tactical situation and SOP will dictate the use of radio frequencies. When possible, outbound aircraft should relay critical messages from the FARP to unit headquarters or unit trains. This will help prevent the enemy from electronically pinpointing the FARP's location. When possible, FARP reports and other communications should be conducted in person.

This page intentionally left blank.

Chapter 2

Employment

The FSC and the ASB DISTRO company must be prepared to sustain aviation forces with fuel and ammunition during combat missions. The success of aviation missions is directly related to the effectiveness of the FARP and the personnel who run the FARP. Mission success depends on training, planning, and coordination before FARP operations begin. This chapter discusses planning, equipment, refueling and arming operations, and operational environments.

SECTION I - PLANNING FACTORS

TYPES OF FORWARD ARMING AND REFUELING POINTS

2-1. Aircraft fuel distribution is accomplished through two means: rapid refuel points (RRP) and FARPs. RRP are established to rapidly refuel large numbers of aircraft during surge periods, such as air assaults. RRP are generally longer duration operations that are time consuming to establish and difficult to move. The bulk fuel storage and distribution capability of the RRP allows the air assault task force to refuel a complete light and/or heavy serial simultaneously, thus minimizing ground time and enhancing the rapid buildup of combat power. Maintaining separation between heavy and light aircraft requires separating the RRP into heavy and light sections. The total number of points is mission, enemy, terrain and weather, troops and support available, time available, civil considerations (METT-TC) dependent. When operated by more than one unit, the RRP is known as a consolidated RRP.

2-2. There are four types of FARPs: active, silent, jump, and rolling. FARPs are employed to support and sustain the full spectrum of Army aviation missions. FARPs are normally established by battalions, which are manned and equipped to refuel and rearm aircraft under combat conditions using various types and setups.

ACTIVE

2-3. The active FARP is normally located in the main battle area close to the AO. It provides the fuel and ammunition necessary for the employment of aviation units in combat. The active FARP provides rapid simultaneous refueling and rearming of combat aircraft.

SILENT

2-4. For long duration missions, units deploy multiple FARPs, some of which will serve as active FARPs while the rest remain silent until activated, thus assuming the role of the active FARP. This activation occurs at predetermined times or decision points. The silent FARPs have all the equipment and personnel necessary to assume the role of the active FARP.

JUMP

2-5. A jump FARP is an operation used when scope, assets, and time are limited. The jump FARP provides the commander with rapid refuel/rearm capability when normal FARP operations are not tactically sound.

2-6. A jump FARP is employed for specific missions with limited scope and is composed of an Advanced Aviation Forward Area Refueling System (AAFARS), 500-gallon collapsible fuel drums, ammunition

(when the mission dictates) and a heavy expanded mobile tactical truck (HEMTT) Tanker, M978. The jump FARP can be transported by ground or air assets as dictated by time or geographical constraints.

ROLLING

2-7. The rolling FARP allows aircraft providing convoy security to refuel and rearm at the convoy's location. This minimizes the security impact on the convoy by reducing the travel time associated with returning to an established FARP.

Note. FARP personnel must remain vigilant due to the hasty nature of rolling FARP operations.

SITE SELECTION

2-8. A FARP site selection is METT-TC dependent and is a function of the battalion S-3. The FARP should be located as close to the forward line of own troops (FLOT) or area of contention as the tactical situation permits. The intent is to reduce the distance traveled by the aircraft, thereby increasing aircraft time on station while simultaneously striking a balance that exposes the FARP to the least possible risk. FARPs are sometimes established within a FARP zone. The FARP zone is an area forward or remote from the AA and usually short of the FLOT or objective, which is designated to provide several FARP locations that support ongoing attack or air assault operations. The size of the FARP zone is METT-TC dependent and may cover several hundred square kilometers. It is divided into several sectors, each of which is several square kilometers and suitable for supporting one or more FARP locations. In desert areas, a FARP zone may be 60 to 70 kilometers long by 20 to 40 kilometers wide. Other areas (such as mountains, jungle, or close compartmented terrain) may require the sector to be widely separated to find enough suitable locations. Figure 2-1, page 2-3, is a sample FARP zone. One or more sectors may be active at any one time based on mission requirements, threat analysis, and terrain; this information will be provided to the aviation battalions, ATS, and FARP personnel. Aviation's ability to move quickly also requires the FARP to be able to move quickly to maintain support.

2-9. When planning a FARP to support aviation units, the FARP should—

- Meet unit mission requirements.
- Provide support throughout the battlefield under all conditions.
- Avoid threat observation and engagement.

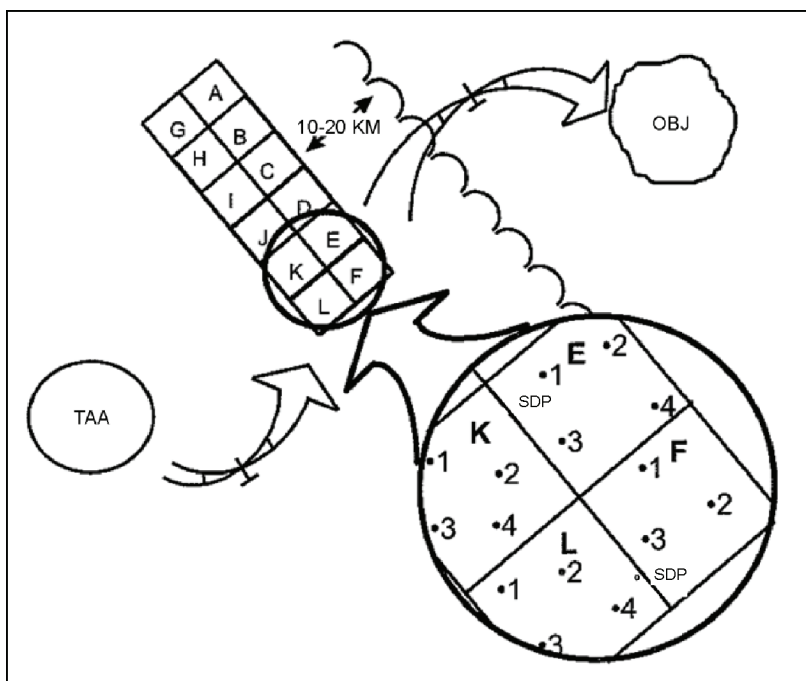

Figure 2-1. Sample forward arming and refueling point zone

PLANNING CONSIDERATIONS

2-10. FARP activities are mission dependent. Commanders and staff planners should consider the variables of METT-TC when determining FARP locations:

- Mission:
 - Ground tactical plan.
 - Mission command constraints.
 - Personnel and equipment configuration.
 - Aircraft number and type.
 - Airspace management.
 - Security and survivability (air defense artillery [ADA], field artillery, and intelligence, surveillance, and reconnaissance).
 - Safety.
- Enemy:
 - Capabilities.
 - Posture.
 - Weapon systems.
- Terrain and weather:
 - Terrain and surface analysis.
 - Tactical dispersement of aircraft and vehicles.
 - Terrain folds and reverse slopes for cover and concealment.
 - Ground main supply routes.
 - Air avenues of approach (ingress and egress).
 - Sand.
 - Weather hazards (wind, snow, rain).

- Other battlefield characteristics.
- Mobility constraints.
- Time and support available:
 - Duration of support.
 - Distance constraints (FARP to objective and FARP to supply distribution point [SDP]).
 - FARP setup.
 - Supply distribution methods.
- Civil considerations:
 - Civilian populations (activities and attitudes).
 - Cultures.
 - Organizations.
 - Leaders within the AO.
 - Cultural sites.
 - Political environments.
 - Economic conditions.

TACTICAL ENABLERS

DEFENSIVE OPERATIONS

2-11. The enemy threat can neutralize aviation force effectiveness by preventing aircraft from arming and refueling; therefore, the FARP will be a high-priority target for the enemy. Class III/V stocks in the AO will likely be subject to chemical, biological, radiological, and nuclear (CBRN) ground, tactical air, air assault, and artillery attacks. Local sympathizers and insurgents may even harass FARP operations.

2-12. Units train as they fight and must regard defensive operations as a priority. Aviation units that do not spend adequate time training on defensive operations are often unsuccessful at repelling threat assaults.

Air Defense

2-13. Air defense (AD) support is staffed through ADA headquarters. The S-3 coordinates and supervises the support and activities of the AD force throughout the operation. Based on the commander's priorities, the AD officer and the S-3 allocate specific AD weapons and designate the positions the weapons will occupy.

2-14. The FARP has a limited organic AD capability. The firepower of the FARP includes M240 machine guns, semi-automatic weapons, and other small arms. These weapons can make a difference during an air attack. Small arms fires may not destroy attacking enemy aircraft; however, they may distract pilots long enough for them to miss their target.

Field Artillery

2-15. The CAB supports the maneuver BCTs. The aviation brigade's fire support officer (FSO) coordinates with the BCT or fires brigade FSO for fire support. The aviation battalion FSO coordinates with the aviation brigade FSO for required fire support. The aviation battalion S-3 designates the locations of the FARPs and provides locations and movement times so fire support can be planned.

Intelligence

2-16. The aviation commander must "see" the battlefield in order to defeat the enemy. Commanders must know as much as possible about the enemy, weather, and terrain. This intelligence helps the commander make decisions, issue orders, and successfully employ forces on the battlefield. It also helps the commander determine the best locations for FARPs. The intelligence staff officer (S-2) collects, processes, and interprets information from subordinate and higher echelon units.

2-17. The FSC commander and DISTRO platoon leader must keep well informed on the intelligence situation so that future FARP operations can be anticipated and planned. Armed with up-to-date intelligence, the FSC commander and DISTRO platoon leader can assist the S-3 in determining how to best support the mission. Current knowledge of the enemy will help FSC leadership avoid threat targeting of the FARP through sensor weapons.

FIGHTER MANAGEMENT

2-18. Leaders need to be cognizant of the high operational tempo and the potential for extreme fatigue. Leaders should take appropriate measures to ensure adequate rest cycles for their Soldiers. Fighter management is a command function and is an integral part of the risk management process. When tired from extended operations, it takes a cooperative effort from all team members to ensure the proper crew mix is available at optimum performance levels for the mission.

ENGINEERING CONSIDERATIONS

2-19. Airpower and its associated support assets require engineering support. Engineer assets increase the mobility, countermobility, survivability, and sustainment of a FARP. Engineering support can be requested through the brigade/battalion S-3.

AIR TRAFFIC SERVICES

2-20. The use of ATS in a FARP is also METT-TC dependent. Under some circumstances ATS units can provide the aviation commander with a greater measure of safety and synchronization and should be considered in FARP operations planning.

2-21. One ATS company is assigned to each CAB general support aviation battalion to provide a full range of terminal and en route ATS for the division AO. The ATS company's tactical aviation control team (TACT) is best suited for FARP operations. TACTs can manage the flow of airborne and taxiing aircraft for a faster, safer, and more efficient operation, with a minimal footprint on the FARP area.

2-22. Each TACT is equipped with the AN/TSQ-198 Tactical Terminal Control System (TTCS) (figure 2-2) and the AN/TRN-30(V) 1 non-directional beacon (NDB). The NDB can be operated continuously or by demand-activation. A non-precision instrument approach procedure may be developed for the NDB to safely recover aircraft during marginal and less than visual meteorological conditions. The TTCS and mission equipment are sling loadable by a utility helicopter (UH)-60 or larger helicopter and transportable by a single C-130 aircraft sortie.

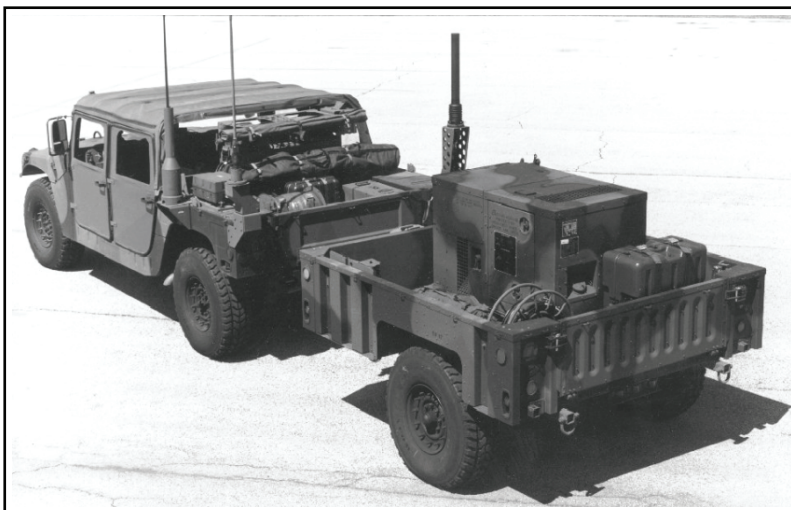

Figure 2-2. AN/TSQ-198 tactical terminal control system

SECTION II – REFUELING EQUIPMENT

ADVANCED AVIATION FORWARD AREA REFUELING SYSTEM

WARNING

Follow environmental and safety regulations during aircraft refueling procedures. The guidance listed in this document may also be used as supplementary information.

Wear protective equipment and clothing to avoid personnel injury or death in the event that a fuel accident occurs. Do not inhale petroleum fumes in enclosed areas or areas without adequate ventilation.

Should a fuel spill occur and fuel is splashed in the eyes, flush eyes with water and seek medical attention immediately. Entering a warm room wearing fuel-soaked clothing can be dangerous. The potential for static electricity is increased and may cause fire sparks and/or ignition which could result in personnel injury or death.

2-23. The AAFARS (figures 2-3 and 2-4, page 2-7) is a two-man portable system. AAFARS components include a 220-gallon per minute (GPM) diesel engine pump, standard element separator, lightweight suction/discharge hoses, and dry-break couplings.

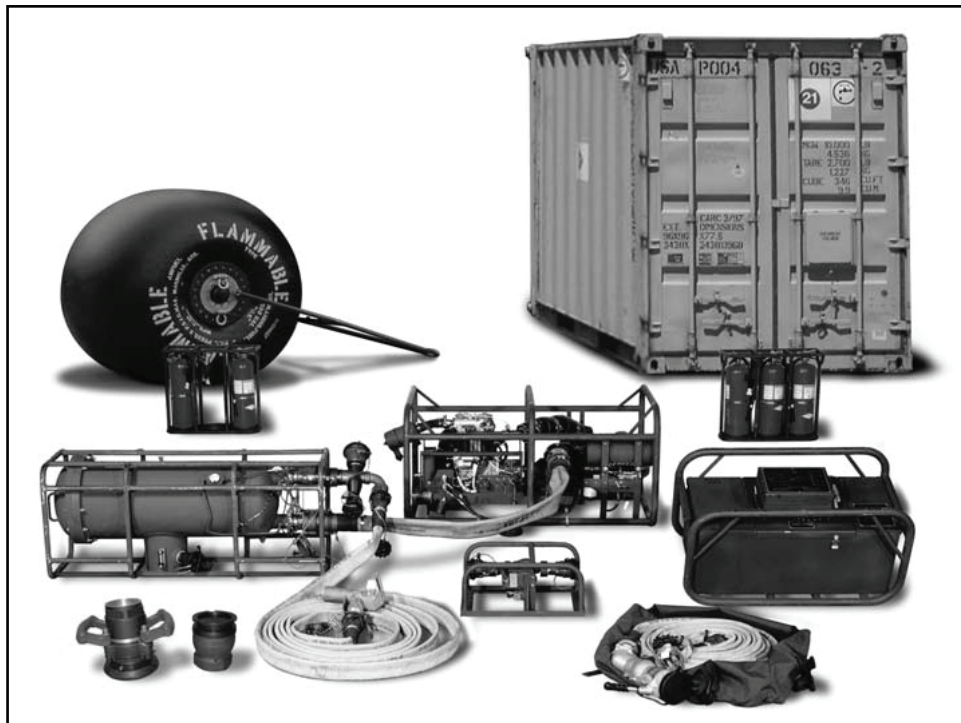

Figure 2-3. Advanced aviation forward area refueling system

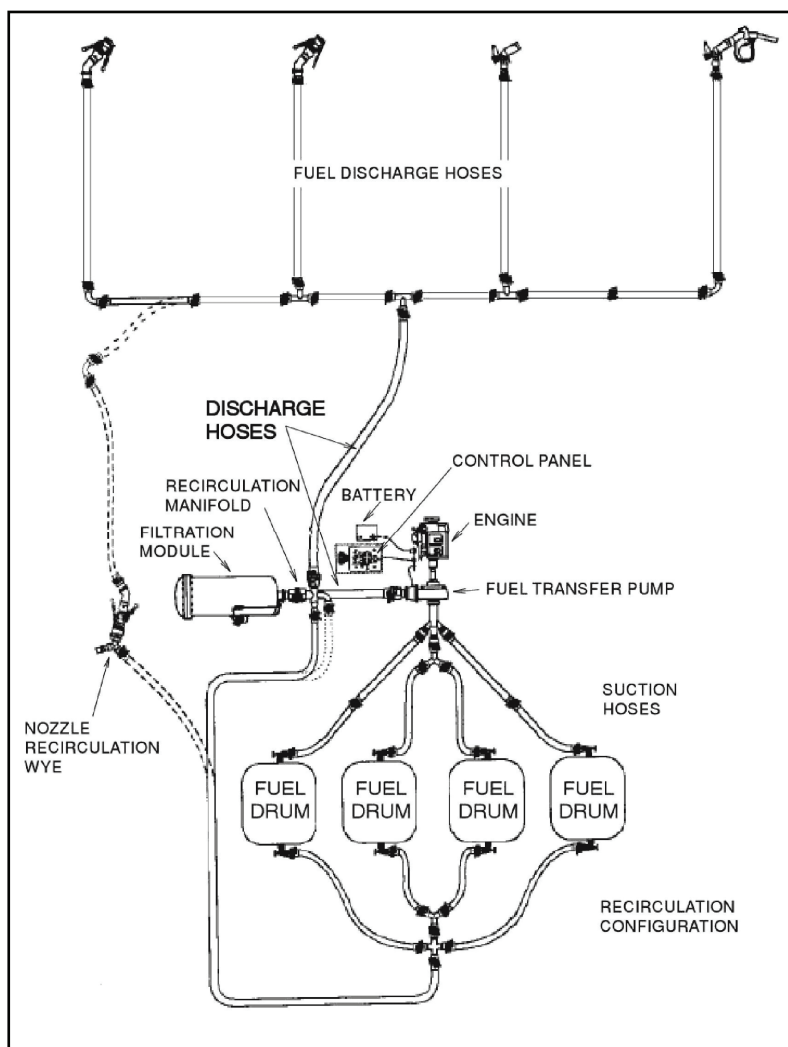

Figure 2-4. Advanced aviation forward area refueling system layout

2-24. The AAFARS is a four-point refuel system providing a minimum of 55 GPM at each refuel point simultaneously. A distance of 100 feet separates each refueling point. There is only a two to three GPM pressure drop to the last point of the system. The primary fuel source is the 500-gallon collapsible drum. The key AAFARS function is to simultaneously refuel four helicopters in tactical locations using center point refueling (D-1 nozzle), closed circuit refueling (CCR), or open-port nozzles. The system interfaces with existing Army, United States Air Force (USAF), Navy, and United States Marine Corps (USMC) aircraft and is interoperable with North Atlantic Treaty Organization and other joint, interagency, intergovernmental, and multinational refuel equipment.

2-25. The setup of the AAFARS system should take advantage of terrain features, thus achieving maximum dispersion and obstacle avoidance. When planning the layout of the AAFARS system, personnel must consider the minimum spacing required between aircraft during refueling. The spacing will depend on the type of aircraft and its rotor size; double rotor blade length is the standard separation. Proper spacing reduces the possibility of collision and prevents damage caused by rotor wash. The rotor hub-to-rotor hub spacing is dependent on the type of aircraft.

2-26. If the area has a prevailing wind pattern, the refueling system should be placed at a right angle to the wind, thus allowing helicopters to land, refuel, and take off into the prevailing wind pattern. The refueling

points should also be laid out on the higher portion of a sloped site, not in a hollow or valley. Fuel vapors are heavier than air, and they flow downhill. To reduce the explosion hazard, the fuel source should be kept downwind of the aircraft's exhaust. The same considerations apply to any FARP setup. Aircraft movement should be limited in desert and snow environments where wind and rotor wash may cause brownout or whiteout. Special considerations will be necessary when aircrews are operating with night vision devices (NVDs). Figure 2-5 shows an AAFARS set up under various wind conditions.

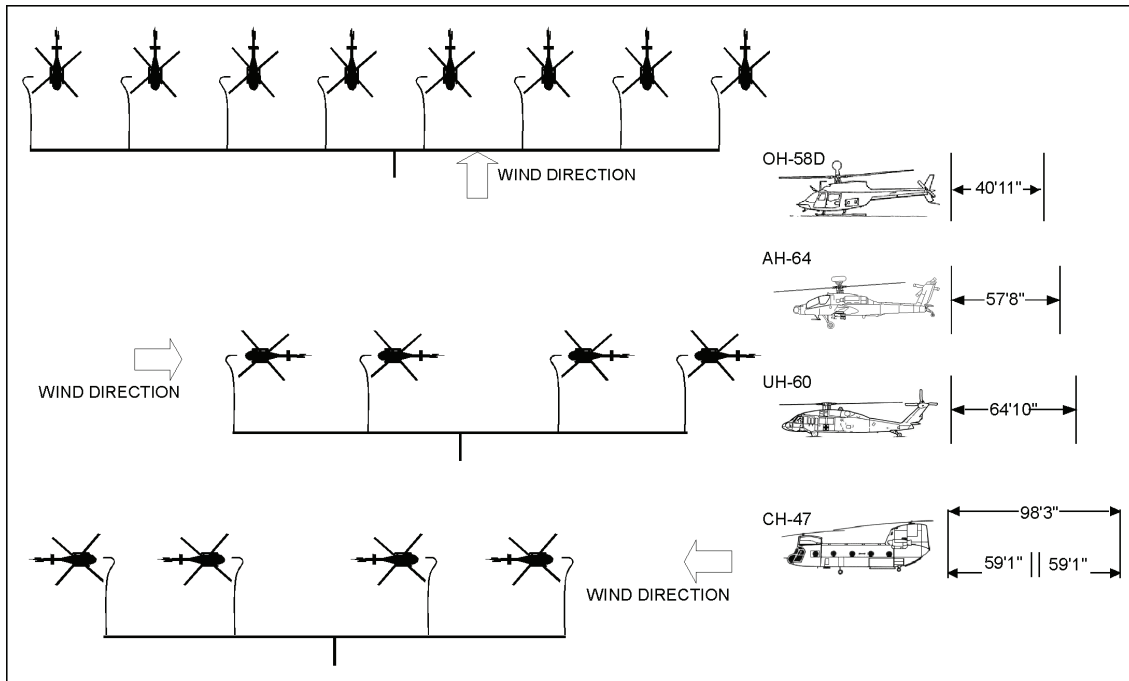

Figure 2-5. Advanced aviation forward area refueling system setup under various wind conditions

HEAVY EXPANDED MOBILITY TACTICAL TRUCK TANKER AVIATION REFUELING SYSTEM

CHARACTERISTICS

WARNING

Follow environmental and safety regulations during aircraft refueling procedures. The guidance listed in this document may also be used as supplementary information. Wear protective equipment and clothing to avoid personnel injury or death in the event that a fuel accident occurs. Do not inhale petroleum fumes in enclosed areas or areas without adequate ventilation. Should a fuel spill occur and fuel is splashed in the eyes, flush eyes with water and seek medical attention immediately. Entering a warm room wearing fuel-soaked clothing can be dangerous. The potential for static electricity is increased and may cause fire sparks and/or ignition which could result in personnel injury or death.

Note. Refueling can be accomplished with the aircraft engines turned on or running (hot or rapid refuel), with the aircraft engines operating off the auxiliary power unit (APU) (warm refuel), or with the aircraft engines turned off (cold refuel). In a field environment, a unit will normally use the hot refueling method. Ensure that unit-specific standard operating procedures are followed when refueling aircraft.

2-27. The HEMTT tanker refueling system (HTARS) is a kit consisting of enough hoses, fittings, and nozzles to expand the HEMTT tankers capability to hot refuel (or rapid refuel), up to four helicopters simultaneously using the on-board fuel-servicing pump. The equipment is lightweight, has manually operated controls, and is equipped with valve and swivel adapters that allow connections between camlock and unisex type fittings for unisex connections (figure 2-6). This equipment can be used in forward areas and transported in the storage box of the HEMTT.

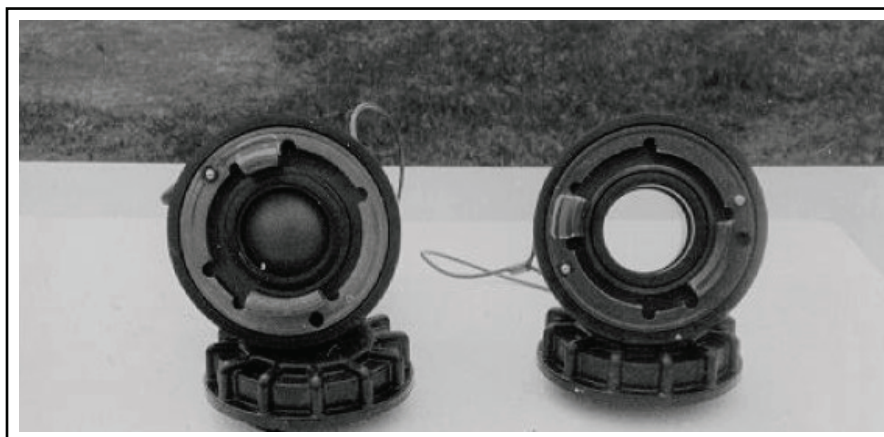

Figure 2-6. Unisex connections

SUPPORT EQUIPMENT

2-28. Fire extinguishers must be located at each refueling nozzle, pump, and filter assembly. Water cans and waste fuel pans should be located at each refueling point. Taking these precautions enables operators to wash fuel off skin and clothes, wash dirt off fuel nozzles, and contain fuel if a spill occurs. Contaminated soil from fuel will be dug up and placed in containers; the containers will be disposed of according to the unit SOP. Any spillage will be handled in accordance with (IAW) host nation or United States environmental regulations. Unit SOPs must include a waste fuel plan for all refueling operations during peacetime.

EQUIPMENT

WARNING

All fuel spills will be considered a fire and an environmental hazard.

2-29. The HTARS (figure 2-7, page 2-11) consists of—

- **Discharge hoses.** HTARS consists of both 2- and 3-inch (in) discharge hoses. One 3-inch by 50-foot hose is used to connect the HTARS to the HEMTT tanker. Ten 2-inch by 50-foot discharge hoses transfer the fuel from the HEMTT tanker to the aircraft; six hoses are used in the manifold and one in each of the four issue lines. There are 11 carrying straps for easy handling of rolled hoses.
- **Valves and fittings.** The following valves and fittings are components of the HTARS:
 - Three T-connectors designed to split the flow of fuel, with a flow control handle to open and close the valve.
 - Two elbow connectors to direct the flow of fuel.
 - Three valved adapters to connect threaded and unisex parts and camlock and unisex parts.
 - One swivel adapter to connect camlock and unisex parts.
- **Nozzles.** HTARS consists of four CCR nozzles with unisex adapters. Four overwing nozzles can be mated to the CCR nozzles to perform open-port refueling. The system has one recirculation nozzle that can be connected to the HEMTT tanker to recirculate fuel in the system. HTARS is equipped with a fuel sample port. The recirculation nozzle mates to the CCR nozzle. There are four D-1 nozzles to equip the system for center point refueling.
- **Over-pack spares.** Each system has one over-pack spare with additional parts and accessories. The over-pack spares include the following hardware: one T-connector, one 2-inch by 50-foot discharge hose, one carrying strap for easier handling of the rolled hoses, 10 dust seals, two dust caps, and four grounding rods.

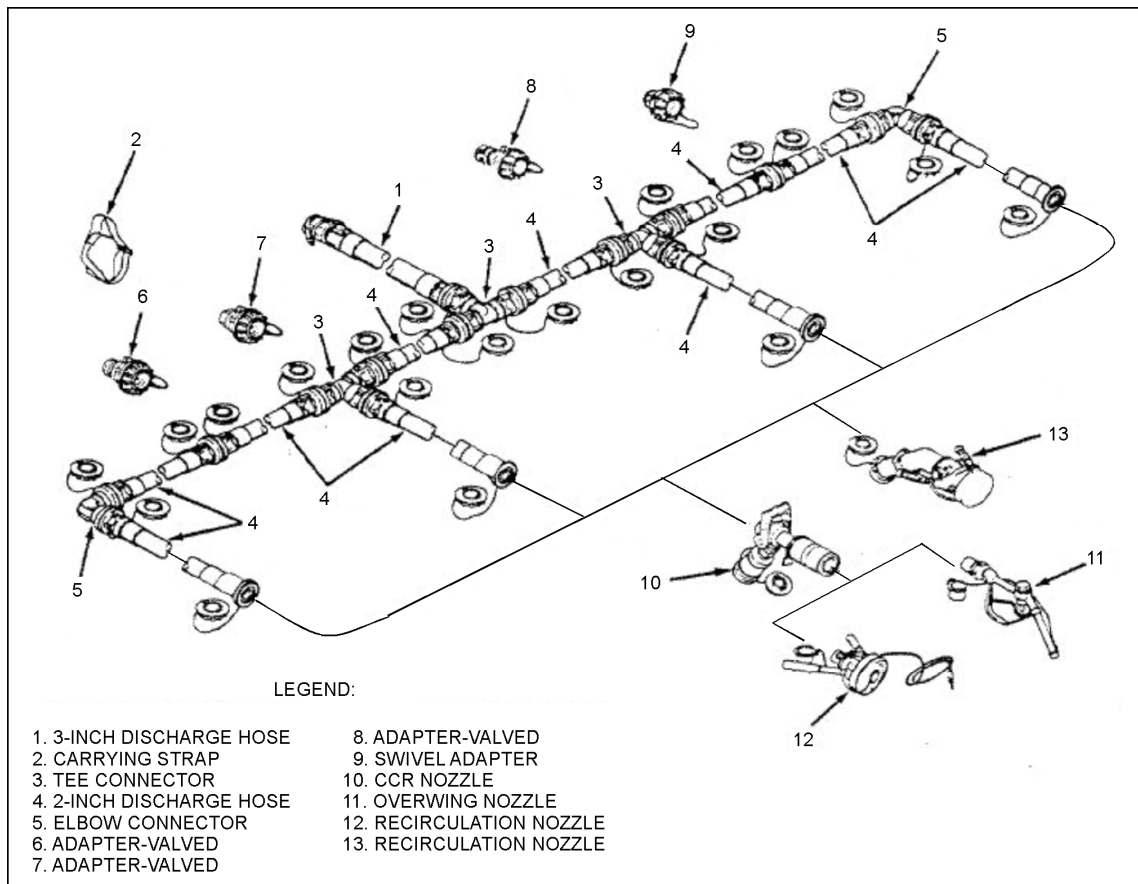

Figure 2-7. Heavy expanded mobile tactical truck tanker refueling system components and layout

PERSONNEL REFUELING REQUIREMENTS

WARNING

Wear protective equipment and follow environmental safety procedures and supplemental guidance specified in this document during aircraft refueling to avoid personnel injury or death. Should a fuel spill occur and fuel is splashed in the eyes, seek medical attention immediately.

Entering a warm room wearing fuel-soaked clothing can be dangerous. The potential for static electricity is increased and may cause fire sparks and/or ignition which could result in personnel injury or equipment damage.

2-30. Three personnel are required during refueling: the first person operates the fuel nozzle, the second person remains at the emergency fuel shutoff valve, and the third person stands outside the main rotor disk of the aircraft at a point where both the pilot at the controls and the refueler with the nozzle are visible. The third person may be from the FARP or one of the aircraft crewmembers.

2-31. Refuelers must wear protective clothing consisting of—

- **Uniform.** A serviceable, fire retardant flight suit uniform will be worn with sleeves down. A special common table of allowances authorization may be required.
- **Helmet.** The helmet assembly, rearming refueling personnel (HARRP) is the authorized helmet. Two versions are available for issue: HGU-24/P (communications-equipped) and HGU-25/P (aural protector only). The helmets are provided in four hat sizes and include eye protection. The cranial impact shells are available in seven different colors and can be used to differentiate between the functions of personnel in the FARP for example—
 - POL personnel.
 - Ammunition handlers.
 - Armament personnel.
 - Medical personnel.
 - Maintenance personnel.
- **Goggles.** Sun, wind, and dust goggles will be worn if the HARRP or flight helmet is not available. Ensure goggles are splash proof. Splash proof goggles will save the unit time and money required to order replacement goggles due to sand and dust.
- **Hearing protection.** Both earplugs and ear protectors will be worn.
- **Gloves.** Gloves must be worn at all times during refueling operations. Replace gloves that become saturated with fuel.
- **Boots.** Approved fire retardant boots will be worn. Boots will not have any metal on the sole including exposed nails on a worn-down sole. This could cause a spark on contact with a hard surface causing a fire.

WARNING

If fuel is splashed in the eyes, flush eyes with water and seek medical attention immediately. If fuel is swallowed, seek medical attention immediately.

Entering a warm room wearing fuel-soaked clothing can be dangerous. The potential for static electricity is increased and may cause fire sparks and/or fire which could result in personnel injury or equipment damage.

2-32. If a fuel handler's clothes become soaked with fuel, the handler should discontinue refueling operations and leave the area immediately. The handler should wet clothes with water before removing them and wash fuel off skin with soap and water as soon as possible.

REFUELING NOZZLES

2-33. Refueling can be accomplished with the aircraft engines running (hot or rapid refuel), with engines running off the auxiliary power unit (APU) (warm refuel), or with the engines off (cold refuel). In a field environment, a unit will normally use the "hot" refueling method. The two hot methods of refueling an aircraft are open-port refueling and CCR.

Note. POL handlers must ensure pump systems are set to correct pressure as this differs with each type of aircraft.

OPEN-PORT REFUELING

2-34. Open-port refueling is accomplished with an automotive type nozzle (figure 2-8, page 2-13), which is inserted into a fill port of a larger diameter. It is not as fast or as safe as CCR. The larger port allows fuel

vapors to escape. Airborne dust, dirt, rain, snow, and ice can get into the fill port during refueling; therefore, the quality of the fuel could be degraded. Spills from overflowing tanks are more likely to occur during open-port refueling. Rapid refueling by the open-port method is restricted to combat or vital training; the aviation unit commander makes the final decision. Simultaneous arming and open-port refueling activities will only be conducted when the combat situation and benefits of reduced ground time outweigh the risks involved.

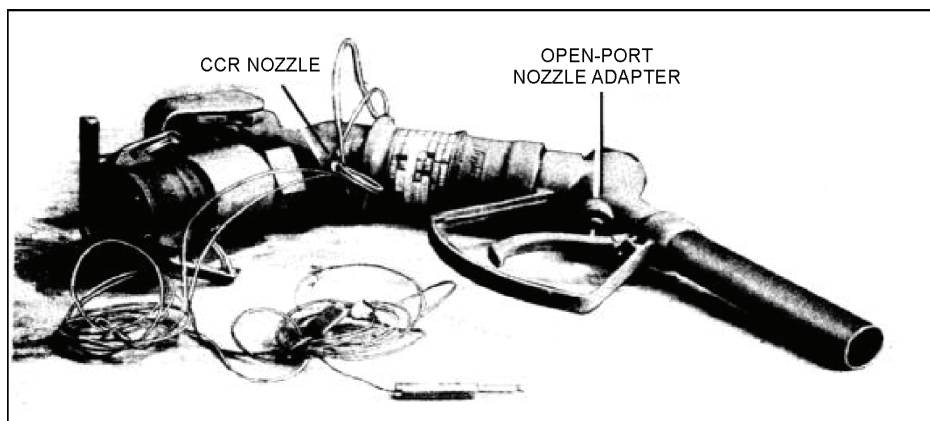

Figure 2-8. Open-port nozzle adapter

CLOSED-CIRCUIT REFUELING

WARNING

As aircraft move through the air, they build up static electricity, which also builds up on refueling equipment as fuel passes through the hoses. The refueler must ground the aircraft, fuel nozzle, and pump assembly to prevent sparks and explosions. Refuelers must remember static electricity buildup is greater in cool, dry air than in warm, moist air.

2-35. CCR is accomplished with a nozzle (figure 2-9) that mates with and locks into the fuel tank. This connection prevents fuel spills and vapors from escaping at the aircraft fill port and reduces fuel contamination.

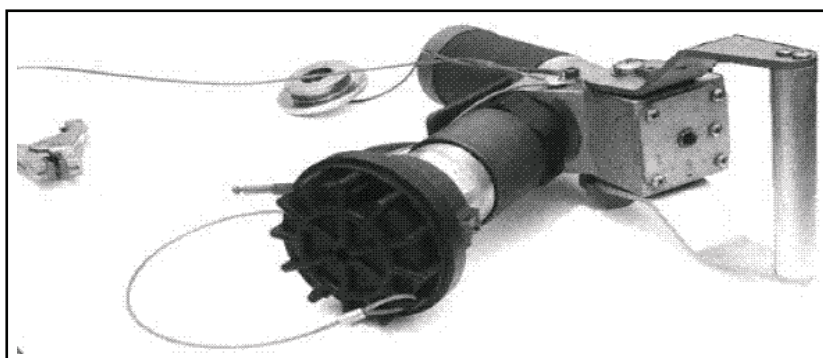

Figure 2-9. Model 125-1000 closed-circuit refueling nozzle

2-36. The Army has two refueling systems: the CCR system (figure 2-10) and the D-1 pressure system (figure 2-11), also called the center point system. The D-1 pressure system components, except for the receiver, are mounted on the M970 (5,000-gallon semitrailer tanker) and M978 HEMTT (2,500-gallon tank vehicle). The D-1 pressure system includes a re-circulation nozzle.

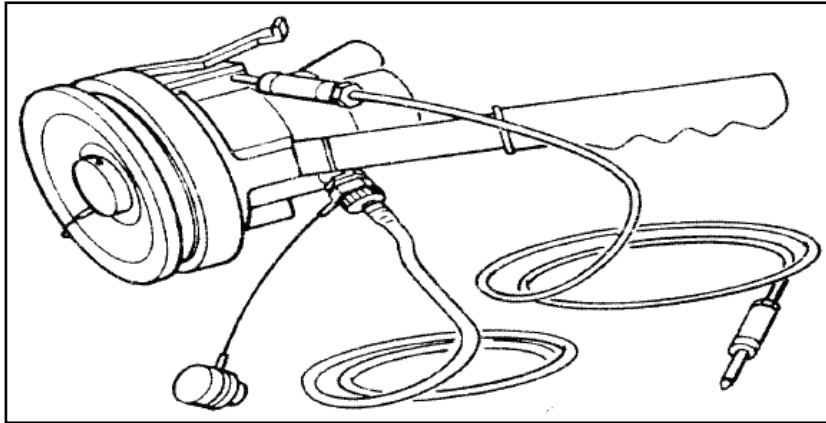

Figure 2-10. CCR system nozzle

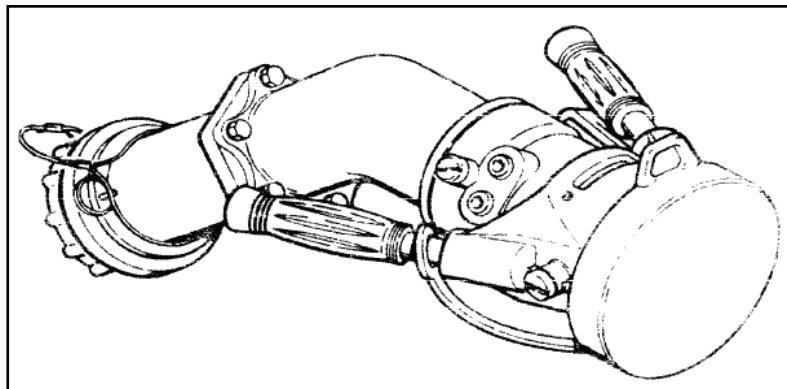

Figure 2-11. D-1 center point refueling nozzle

2-37. The main difference between the CCR nozzle and the D-1 nozzle is the D-1 nozzle provides a higher fuel flow rate. The CCR nozzle can also be adapted to open-port refueling; the D-1 nozzle cannot. The CCR nozzle is 2 inches wide; the D-1 nozzle is either 2 ½ inches or 3 inches wide. The CCR provides 100 GPM compared to 150 to 200 GPM for the 2 ½-inch D-1 nozzle and 300 GPM for the 3-inch D-1 nozzle.

Note. The pilot is normally responsible for monitoring the fuel gauge and signaling the refueler when to stop refueling the aircraft.

A 15-pound per square inch differential return pressure restricts the fuel flow rate of the attack helicopter (AH)-64 to 56 GPM during CCR.

EQUIPMENT SETUP

2-38. To ensure the refueling equipment is set up properly, refuelers must—

- Check the pump assembly and the filter/separator for proper grounding.
- Check the pump engine for oil leaks and oil level.
- Check filter/separator pressure differential indicators.

- Replace filter elements and drain accumulated water from pump assembly, as necessary.
- Ensure couplings are properly seated and free of cracks.
- Ensure sandbags are used to elevate the couplings.
- Check the exterior of hoses for signs of blistering, saturation, and nicks or cuts.
- Check the hose for weak or soft spots within 12 inches of the couplings.
- Test hoses at normal operating pressure.
- Check hoses for abnormal twisting or ballooning.
- Ensure nozzles have serviceable couplings and dust covers.
- Ensure refuel points have all the required nozzles to conduct closed-circuit and open-port refueling operations.
- Check the nozzle filter screen daily.
- Ensure each nozzle has two ground wires. One has an alligator clip on the end of it; it is the grounding cable. The other wire has a plug; it is the bonding wire. These wires are used to connect the aircraft to a 5-foot grounding rod.
- Ensure the nozzle is kept off the ground by hanging it on the grounding rod.
- Ensure the dust cap or plug is never removed from an opening until it is ready to be coupled to the next piece of equipment.
- Ensure the equipment is drained immediately after uncoupling.
- Ensure the removed caps and plugs are coupled together to keep them clean.

MODULAR FUEL SYSTEM

2-39. The modular fuel system (MFS) is currently being fielded. The MFS provides the ability to rapidly establish a fuel distribution and storage capability without bulk fuel storage (distribution bag farm) or engineering support. The system can be used at any location without the availability of construction and materials handling equipment (MHE). The MFS consists of fourteen 9,464 liter/2,500 gallon tank racks and two pump filtration modules (figure 2-12). The MFS increases mobility, capacity, and speed in fuel distribution, while decreasing deployment and recovery time. The MFS is compatible with the HEMTT, load handling system, and the palletized load system truck and trailer.

2-40. The MFS tank racks can also be used for line haul of bulk petroleum throughout the joint operations area. By using two tank racks (one on the truck and one on the trailer [figure 2-13, page 2-16]), the palletized load system and load handling system can transload up to 18,927 liters/5,000 gallons of bulk petroleum per trip.

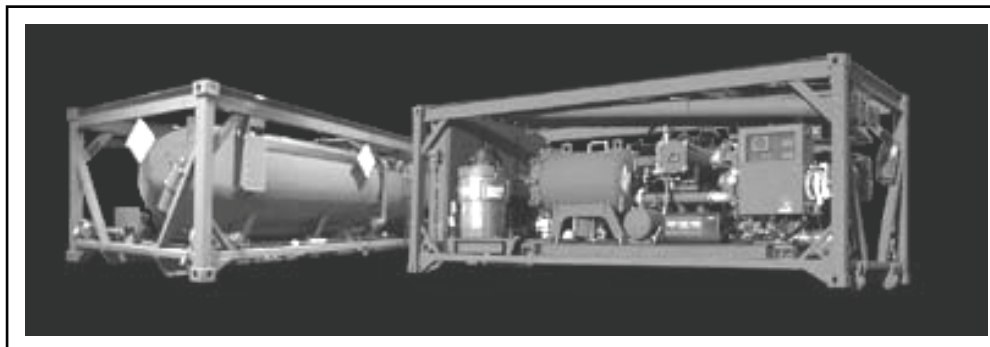

Figure 2-12. Modular fuel system



Figure 2-13. Modular fuel system with heavy expanded mobile tactical truck and trailer

SECTION III – REFUELING OPERATIONS

GROUND VEHICLES

2-41. FARPs are normally emplaced using ground vehicles carrying bulk quantities of Class III/V products. Ground vehicles are the primary means used to displace and resupply FARPs. Ground-mobile FARPs have the advantage of moving and positioning large amounts of bulk POL. However, ground-mobile FARPs also have several disadvantages when emplacing FARPs, such as limited rapid positioning of FARPs, subjectivity to road and traffic conditions, and vehicle accessibility terrain limits. Upon mission completion, empty vehicles must return to distant supply points before they are available to emplace a new FARP. Normally, the same vehicles transporting the FARP will accomplish resupply. If a single vehicle is lost, the success of the mission may be jeopardized; therefore, a backup option must be planned.

2-42. The advantages of using small ground vehicles, such as the high-mobility multipurpose wheeled vehicle (HMMWV), as an AAFARS platform to emplace the FARP include increased mobility, maneuverability, and ease of concealment. The disadvantage is additional support is required to complete the FARP package.

2-43. A 3/4-ton trailer offers the FARP a tremendous capability: the entire AAFARS can be bolted to the frame. When set up, this system provides an extremely mobile refueling capability. The system is light enough to be transported by HMMWV or sling loaded by UH-60. To complete the FARP package, fuel and ammunition can be emplaced by air or ground.

2-44. The HMMWV can transport ammunition from the cargo truck to the armament pad. It can also move the 500-gallon collapsible fuel drums around the FARP, if the collapsible fuel drum tow assembly is available.

2-45. The HEMTT (M977) and the HEMTT tanker (M978) are the primary movers of Class III/V supplies to the FARP (figure 2-14, page 2-17). The M977 can carry 22,000 pounds of cargo. An onboard crane mounted on the rear of the M977 has a 2,500-pound lift capability. The crane enables the HEMTT to load and off-load ammunition without MHE. The M978 tanker holds 2,500 gallons of fuel and provides two refueling points. When paired with the HTARS and the AAFARS, the M978 can simultaneously refuel four aircraft. When two M978 trucks are positioned properly, an eight-point refueling operation can be run. Leadership must ensure proper manning and equipment assets are forecasted. The heavy expanded mobility ammunition trailer (HEMAT) (M989) is used with the M977 or M978. The HEMAT can carry 22,000

pounds of ammunition. The HEMAT can also carry four 500-gallon collapsible drums or two 600-gallon pods of fuel.

2-46. The 5-ton HEMAT can transport either ammunition or fuel. When it transports fuel, the HEMAT is normally set up with a tank pump unit consisting of two 600-gallon fuel pods and refueling equipment for two fuel points. The 5-ton HEMAT can also be configured to tow a 1 ½-ton trailer with either a 600-gallon fuel pod, a 500-gallon fuel drum, or the trailer can be used to transport crated or loose ammunition.

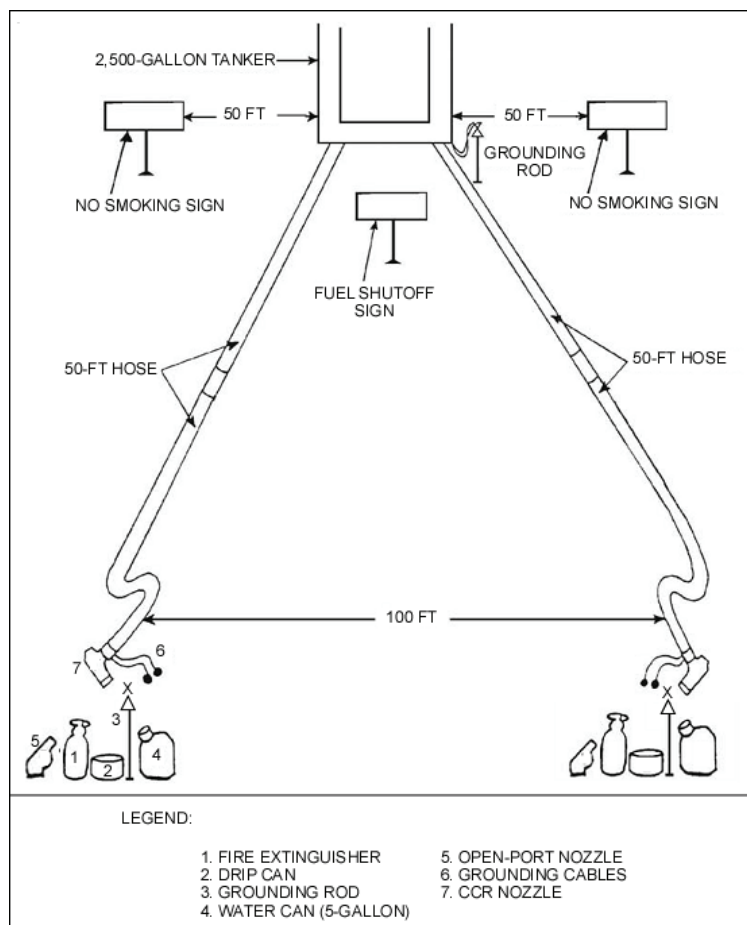

Figure 2-14. Heavy expanded mobile tactical truck and forward arming and refueling point layout

EMERGENCY PROCEDURES

2-47. In case of fire, the following procedures will be followed:

- The fireguard signals the pump operator with the “infinity” sign to signify “cease pumping.”
- The POL operator immediately shuts down the pump on the tanker or the AAFARS/HEMTT pump.
- Whoever is tending the nozzle removes the nozzle from the aircraft and, if the fire is small enough, attempts to put out the fire using the available fire extinguisher. When the Tri-Max fire extinguisher is available, it is used first to blanket the canopies to allow an exit corridor for the pilots. The first priority is crew safety.
- Aircraft not directly involved depart to their respective holding areas (HAs) in a counter-clockwise traffic pattern.

- If the situation permits, every attempt is made to remove the tanker from the scene of the fire. For operation of the AAFARS with 500-gallon collapsible drums, close all butterfly valves and elbow couplers if time permits.
 - If an aircraft is burning, disconnect the HEMTT.
- 2-48. Aircraft not involved will take off in the following manner:
- The closest aircraft on each side of the burning aircraft will depart first. If the closest aircraft on either side cannot depart immediately, coordinate for the next aircraft in line to depart.
 - Initial departure is straight out until clear of the FARP.
 - Aircraft on the left side of the burning aircraft will turn left from a short upwind.
 - Aircraft on the right side of the burning aircraft will turn left from an extended upwind.
 - Aircraft will go to a designated HA.
- 2-49. As soon as possible, the command post (CP) is notified and communications are maintained between the FARP and the CP. All personnel not directly involved in the emergency will move upwind of the FARP at least 100 meters. After steps listed in paragraphs 2-47 and 2-48 are accomplished, all personnel should move to a safe distance away from the hazard.

REFUELING POINT SAFETY REQUIREMENTS

2-50. Refuel point safety requirements for support equipment, nozzles and hoses, aircraft control, and site preparation are contained in table 2-1. Safety requirements before and during site operations are also discussed. For more detailed information regarding FARP safety requirements, see FM 10-67-1.

Table 2-1. Forward arming and refueling point safety requirements

<i>Safety equipment</i>
Fire extinguishers are present at the pump assembly and each refueling nozzle.
Fire extinguishers meet the standards outlined in FM 10-67-1.
Sufficient water is available to wash fuel spills from personnel or to wet fuel-soaked clothing before removing the clothing.
POL handlers have on protective clothing as prescribed in FM 10-67-1.
Explosion-proof flashlights are required for night operations.
NO SMOKING, DANGER, PASSENGER MARSHALING AREA, RESTRICTED AREA, ALARM, and EMERGENCY SHUTOFF signs are posted.
Ignition sources are collected outside the dispensing area.
Grounding rods are required at the pump filter separator and each dispensing point nozzle.
Grounding rods conform to specifications in FM 10-67-1.
<i>Nozzles and hoses</i>
Each nozzle is properly grounded with the handling wire attached.
Dust covers are attached and used.
Both closed-circuit and open-port nozzles are available for use.
Hoses are tested at normal operating pressure with the nozzle closed.
Hoses are long enough to allow the minimum required distance between aircraft for dispensing.
Hoses are inspected for signs of blistering, saturation, nicks, or cuts.
Hoses and nozzles have clean nozzle screens.
Hoses and nozzles must be configured in a curved pattern.
<i>Aircraft control and equipment</i>
The parking area for each refuel/rearm dispensing point is clearly marked.
A trained air traffic controller is available at each FARP location (METT-TC dependent).
The FARP has two-way radio communications with aircraft before and immediately after refueling.
The refueling site is equipped with a lighting system for night operations (METT-TC dependent).

Table 2-2. Forward arming and refueling point safety requirements (continued)

Site preparation
The size of the site is adequate for the operation.
The area has been cleared of loose sticks, stones, and other debris that might cause foreign object damage (FOD).
All equipment and materiel that can be camouflaged is covered with appropriate camouflage.
Vehicles use one set of existing track marks to reduce tracks.
The selected FARP area and perimeter have been secured.
The vehicles are emplaced to allow a timely exit.
Before refueling operations
Sufficient personnel are assigned to the equipment – one fireguard, one person to operate the pump, and one person to operate each nozzle.
A fuel sample is taken from each dispensing nozzle.
The complete system is checked for proper operation, pressure, and leaks.
Site operation
Communication means are established to control traffic at refueling locations.
Passengers are briefed on proper dismounting/mounting procedures and proceed to the marshaling area while the aircraft is refueling.
Ground guides are provided for aircraft.
Ground guides use proper marshaling signals.
Nonessential personnel deplane before refueling.
The fire extinguisher is carried from its position near the grounding rod to the side of the aircraft next to the refueling port.
Refueling personnel ensure all radios, except the radio used to monitor air traffic, are turned off.
Refueling personnel ensure armament aboard the aircraft is set on SAFE.
Aircraft are properly grounded before they are refueled/rearmed.
The nozzle is bonded to the aircraft before the refueling cap is opened.
The dust cap is replaced on the nozzle after each refueling.
Nozzles are placed on the nozzle hanger (grounding rod) after use.
The nozzle grounding cable is attached to the grounding rod when not in use.
If tank vehicles are used as the fuel source for rapid refueling, the refueling will be properly conducted.
FARP personnel are familiar with emergency fire and rescue procedures.
FARP personnel are familiar with fuel spill procedures.
A copy of the unit's refueling SOP is available, and FARP personnel are familiar with its contents. (AR 385-10).
Appropriate measures are in place to facilitate reconstitution and recovery of FARP assets in case of damage.

AERIAL EMPLACEMENT

2-51. Emplacing FARPs by air offers three major advantages:

- Improved battlefield mobility.
- Expanded choice range for site selection (not limited to road accessibility).
- Minimized threat potential in forward areas.

2-52. Emplacing FARPs by air has major disadvantages, including—

- Dependence on availability of supporting aircraft. If the enemy is advancing and support aircraft are not available for FARP displacement, the FARP could be lost.
- Requirement for dedicated aircraft to move bulk quantities of Class III/V products and MHE.
- Additional aircraft traffic could compromise the FARP's location.

- Aircraft that sling load equipment and supplies cannot fly nap-of-the-earth and are more visible to enemy sensors and missiles.

FAT COW

2-53. The cargo helicopter (CH)-47's extended range fuel system (ERFS) II, also known as Fat Cow, is a modular, interconnectable system. The primary mission is to provide a safe and convenient means of increasing the range and endurance of the CH-47D helicopter to include—

- Worldwide self-deployment capability.
- Transporting fuel for forward area refueling operations.

2-54. Fat Cow operational advantages include—

- The CH-47 is a rapidly employed FARP.
- Fat Cow is ideally suited for short duration, forward operations.
- The site is cleared within minutes.
- The Fat Cow can be pressure refueled for faster turnaround.

2-55. Fat Cow disadvantages include—

- A safety hazard may be created if the blades are turning on the aircraft during refueling.
- The CH-47 fuel burn rate increases tremendously with the added weight of fuel.
- The signature of the CH-47 makes the operation vulnerable to detection and attack.

Extended Range Fuel System II

2-56. ERFS II is an autonomous system (figure 2-15); the power to operate both types of pumps is supplied by the helicopter electrical system. Unlike the ERFS, the AAFARS transfer is accomplished by a pump rated at 120 GPM located on the aft tank of the ERFS II. The pump supplies two refueling points 200 feet from the helicopter (figure 2-16, page 2-21). The ERFS II provides the CH-47D with up to 2,400 gallons of auxiliary fuel for worldwide self-deployment or forward area refueling. For mission flexibility, one, two, or three 800 gallon tanks can be installed. Regardless of configuration, the principles of operation remain the same.

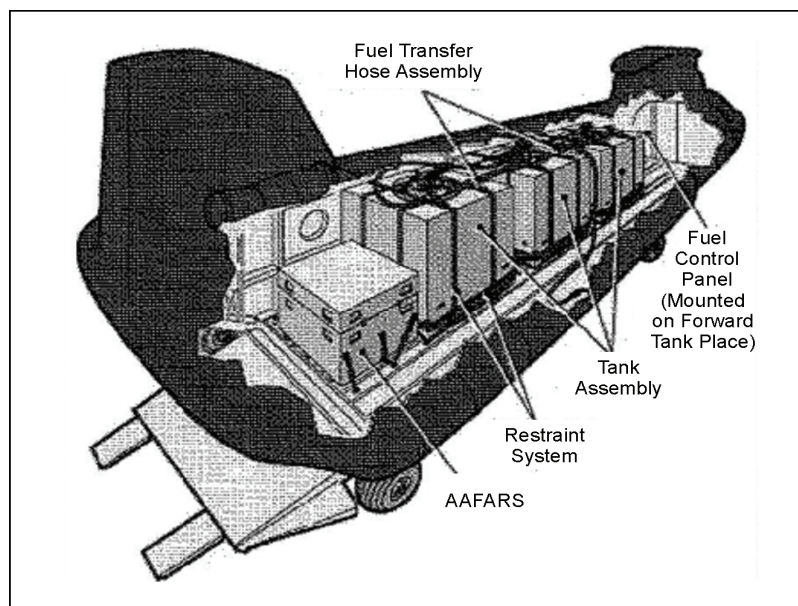

Figure 2-15. Extended range fuel system II functional components

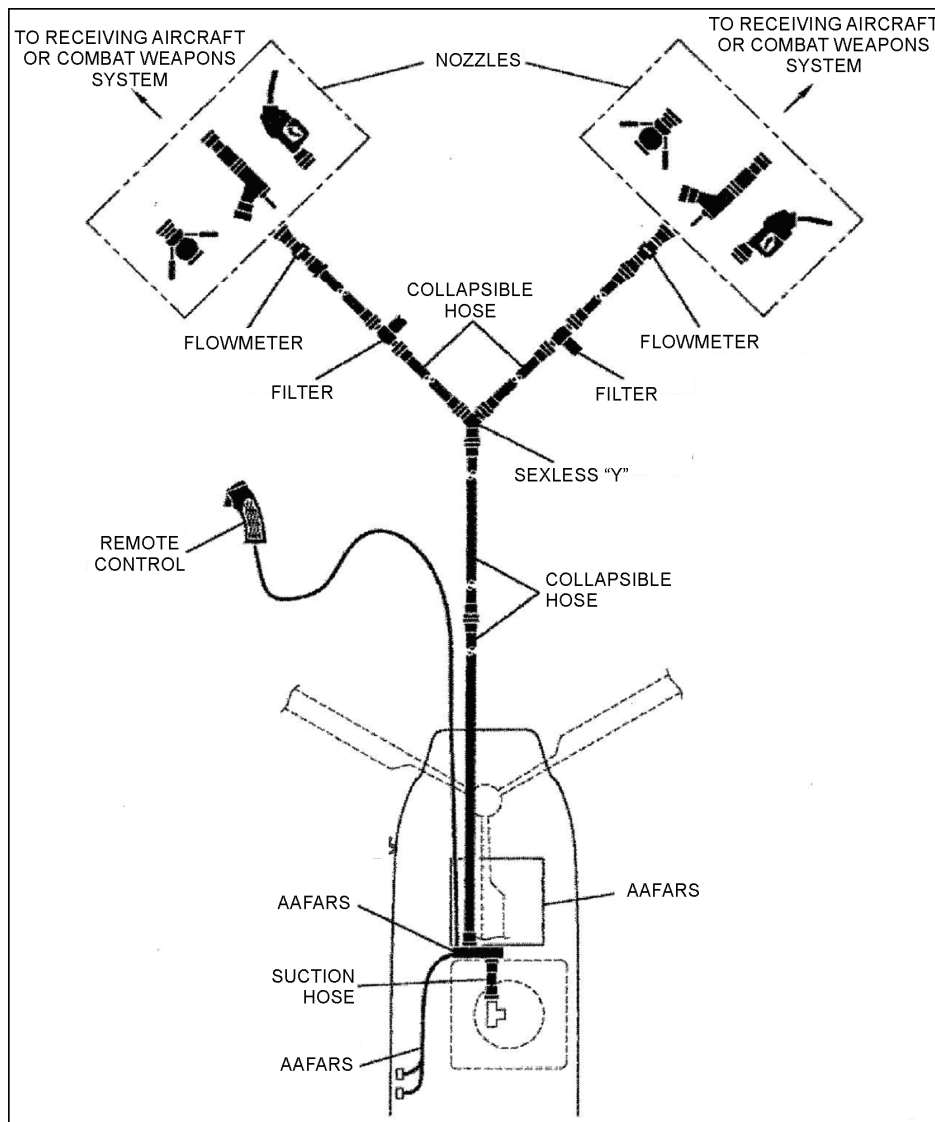

Figure 2-16. Typical layout for fat cow refueling points

FAT HAWK

2-57. Similar refueling operations can be accomplished with the UH-60. The AAFARS is carried inside the aircraft while fuel is extracted from the aircraft's external or internal fuel tanks. Advantages and disadvantages of ERFS II operations also apply to Fat Hawk operations. Normal operations consists of two external stores support system equipped UH-60 aircraft with three to four POL personnel, a combat lifesaver or combat medic, security personnel, armament personnel, and armament and refuel equipment to support the mission.

SECTION IV – ARMING OPERATIONS

AMMUNITION STORAGE

2-58. The ready ammunition storage area (RASA) contains the ammunition required to support the mission beyond the minimum for one load. The RASA requires separate areas for the assembling and disassembling of rockets, aircraft flares, and malfunctioned ammunition. For more information on ammunition storage, see Department of the Army Pamphlet (DA Pam) 385-64.

2-59. The basic load storage area (BLSA) is a separate area from the RASA. The BLSA contains the specific quantity of ammunition required and authorized to be on hand at the unit to support three days of combat. A basic load includes ammunition (such as small arms, grenades, and mines) in addition to aircraft specific ammunition.

2-60. Ammunition is stored by lot number to facilitate proper accountability. Ammunition handlers will—

- Ensure ammunition accountability.
- Maintain accurate lot number records.
- Ensure lots are not mixed at—
 - The RASA.
 - The BLSA.
 - The rearm pads.
- Improvise means of transporting ready ammunition to the rearm pads.
- Ensure rated load weight of the trailer or cart is not exceeded.
- Secure and balance the load to prevent the ammunition from tumbling or the vehicle from tipping over.
- Cover the trailer or cart to protect the ammunition in inclement weather.

AMMUNITION SAFETY PROCEDURES

2-61. All personnel must observe the required safety procedures to prevent the accidental firing of ammunition or propellants. Improper handling or stray electricity may cause ammunition to explode and result in loss of life or serious injury to personnel.

2-62. Rocket fin protector springs are designed to short-circuit the igniter leads, thus preventing accidental ignition. The shorting wire clips and fin protectors must be installed on all rockets immediately after an aircraft launcher is unloaded and when the rockets are not in a launcher. A sufficient quantity of clips and protectors must be on hand at each rearm pad. Personnel should not discard the clips and protectors once an aircraft is armed. Personnel should remember the wires and clips can cause FOD to aircraft if not properly secured.

WARNING

Complete rounds, rocket motors, or fuze-warhead combinations may detonate prematurely when mishandled, resulting in the loss of a life or an aircraft. Rocket motors and complete rockets that have been dropped from higher than 2 ft, whether crated or uncrated, must be turned in to the supporting ammunition supply point. DA Form 581 (Request for Issue and Turn-in of Ammunition) must reflect the reason for the rejection.

2-63. Personnel must assemble rockets according to the instructions in TM 9-1340-222-20. Returned unfired rockets and rockets remaining in aircraft launchers after a mission must meet torque requirements before the next mission.

2-64. In base camps or semi-permanent training facilities, units should build barricades around the RASA, the BLSA, and rearm pads. Barricades should be at least 3 feet thick to effectively reduce hazards from a fire or an explosion. Rockets are pointed toward berms, barricades, and open spaces and not toward aircraft, personnel, and built-up areas.

2-65. Ammunition should be protected from the weather. If ammunition is covered in a high-temperature environment, it is important to ensure the covering does not excessively heat the ammunition. Dark covers placed directly on pallets of ammunition can create temperatures up to 180 degrees Fahrenheit, which will damage missile systems and ammunition. The covering selected for use in high-temperature environments should shade the ammunition and allow air circulation.

2-66. Rockets should be stored on wooden pallets since they allow air circulation. If unpacked rockets must be stored on racks and not stacked directly on the ground, rockets should be blocked or secured in place to prevent them from rolling off the racks.

2-67. The RASA is limited to 2,000 pounds of net explosive weight (NEW) per cubicle. Table 2-2 lists the common items used during helicopter rearm operations. The following example illustrates this limitation: 1,340 of H490 (10 pounds NEW) = 200 rounds per cubicle (200 x 10 = 2,000). The NEW is computed based on the weight of the explosive filler in the item of ammunition. In the case of rockets, the NEW is the combined explosive weight (the amount of explosive filler and the propellant in the motor).

Note. When completing these calculations, refer to TM 9-1340-222-20.

Table 2-3. Common items used during rearm operations

<i>Item</i>	<i>NEW</i>
Hellfire missile	34.4 lbs
Rocket 2.75-in, high explosive (HE) (H489 or H 490)	10.0 lbs
Rocket 2.75-in, HE (H488 or H534)	11.0 lbs
Cartridge, 30 mm, HE (B130 or B131)	.058 ozs
Cartridge, 20mm, HE (A653)	.028 ozs
.50 caliber, all brass	.121 ozs
.50 caliber, all steel	.111 ozs

2-68. Table 2-3 (page 2-24) lists the minimum distances permitted between rearm points, RASAs, and non-ammunition related activities that require safety distances. (Inhabited buildings also include tents used as living quarters.)

Table 2-4. Rearm point and ready ammunition storage area minimum safe distances (in ft)

<i>From</i>	<i>To</i>	<i>Barricaded</i>	<i>Unbarricaded</i>
Rearm point	Rearm point	100-180*	100-180*
Rearm point	Inhabited building and unmanned aircraft	400	800
Rearm point	Public highways	240	480
Rearm point	POL storage areas	450	800
Ready ammunition	Rearm point	75	140
Ready ammunition	Inhabited buildings and unmanned aircraft	505	1010
Ready ammunition	Public highways	305	610
Ready ammunition	POL storage areas	505	1010

*Distances are based on rotor clearance.

ARMAMENT PAD SETUP

2-69. Armament pad setup will affect overall aircraft turnaround times. During combat missions, enough ammunition for at least one arming sequence should be placed on the armament pad before an aircraft arrives. The ammunition should be laid out in the order it will be loaded. A full load of ammunition must be ready to load in case the aircraft has expended its entire initial load.

WARNING

Position aircraft so that its weapons are not pointed toward the fuel source, ammunition HA, or troop sleeping tent in case of weapon discharge. To avoid personnel injury, do not walk in front of aircraft weapons systems.

PERSONNEL REQUIREMENTS

2-70. Two personnel are required to upload/download the weapon systems. When a full complement of ammunition is required, the safest approach is to load the turret weapon system first, followed by the inboard wing stores. For more information on arming instructions, see the appropriate aircraft operator's manual.

2-71. FARPs with eight service points, theoretically, require at least ten refuelers: eight to refuel aircraft and two manning the emergency shut-off valves. It also requires sixteen arming personnel (two per service point). This requirement can overextend the FSC's Class III/V personnel, especially if there is a need for a second FARP.

2-72. To prevent overextending the FSC, personnel can be cross-trained to assist in multiple FARP functions. Units can train 89Bs (ammunition specialists), 92Fs (petroleum supply specialists), and copilots to assist in arming functions. At a 50-GPM rate, a 92F can finish refueling in as little as six minutes and then assist in arming.

2-73. Pilots and copilots may alternate leaving the aircraft to assist in minor arming functions such as lifting Hellfire missiles and loading rockets. Units can also arrange for the transportation of FARP personnel to other FARP locations, excluding unit drivers.

SIMULTANEOUS ARMING AND REFUELING

CAUTION

Unless imminent threat exists, safe all weapon systems before the aircraft is refueled.

2-74. Minimizing aircraft ground-time in the FARP is important for two reasons: aircraft are extremely vulnerable on the ground, and the longer it takes to service aircraft, the less time aircraft are conducting attack operations.

2-75. The number of refuel/rearm pads at a FARP is dependent upon mission requirements and the number of aircraft to be serviced. Normally, FARPs will have four refuel/rearm pads, with up to a maximum of eight pads. This quantity supports simultaneous servicing of most company-sized organizations. Each HEMTT tanker and AAFARS can service up to four refuel points. Extra refuel hose capacity allows units to cross-level fuel from HEMTT tankers to 500-gallon drums without interrupting aircraft refueling. With sufficient drums in place, units can transfer tanker fuel to drums, allowing tankers to return to the sustainment area for resupply. This practice is a good strategy for FARPs preparing to displace and requiring full fuel capability at the next location. An alternate strategy is to initially locate all filled drums at the second FARP, thereby, allowing tankers from the initial location to resupply without returning to the sustainment area. Simultaneous arming and refueling minimizes ground-time. However, simultaneous rearming and refueling is risky, and the aviation commander must ensure personnel receive the proper training to accomplish the tasks. Simultaneous arming and refueling operations are an SOP requirement and must be a well-rehearsed team effort.

2-76. Arming the weapon systems is accomplished in a specific sequence using an approved checklist. The weapon systems must be inspected for safe operation, starting with the outboard weapon systems and moving inboard. The rocket management system is turned on and a stray current check is conducted on the rocket pods. The wing stores opposite the refueling port should be the only weapon systems loaded while the aircraft is being refueled. Once refueling is complete, the turret weapon system inboard weapon systems are loaded, followed by the outboard weapon systems on the refueling port side of the aircraft. The necessary maintenance equipment must be brought to the FARP to maintain each weapon system. For example, materials for cleaning weapons, oils for lubricating weapons, and a multimeter for conducting stray current checks should be available.

2-77. When planning the number of rearm and refuel points for a FARP, the platoon leader should consider how aircraft maintenance problems will be addressed. An aircraft maintenance pad is suggested to ensure that maintenance problems do not tie up a refueling and rearming pad and degrade the FARP operation. Figure 2-17, page 2-26, is an example of a simultaneous rearming and refueling FARP layout.

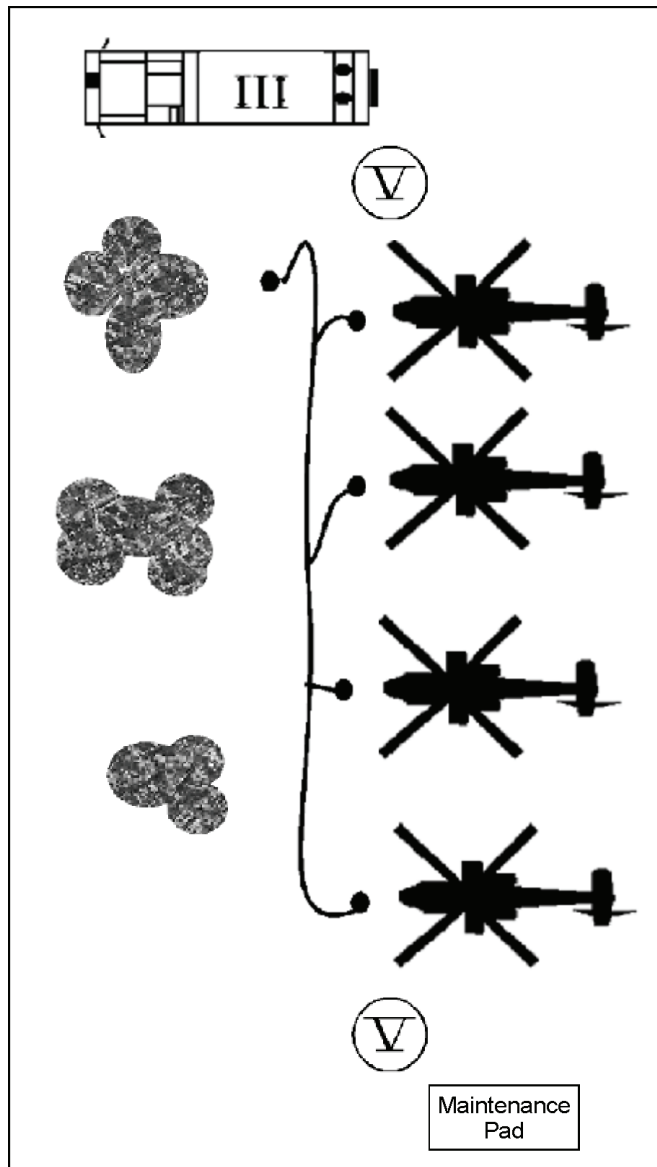

Figure 2-17. Simultaneous rearming and refueling forward arming and refueling point layout

ARMAMENT CONFIGURATIONS FOR THE AH-64 AND OH-58D

2-78. The authorized armament configurations for the AH-64 and observation helicopter (OH)-58D are shown in figure 2-18, page 2-27, and figure 2-19, page 2-28. Refer to the applicable TM for specific aircraft danger areas.

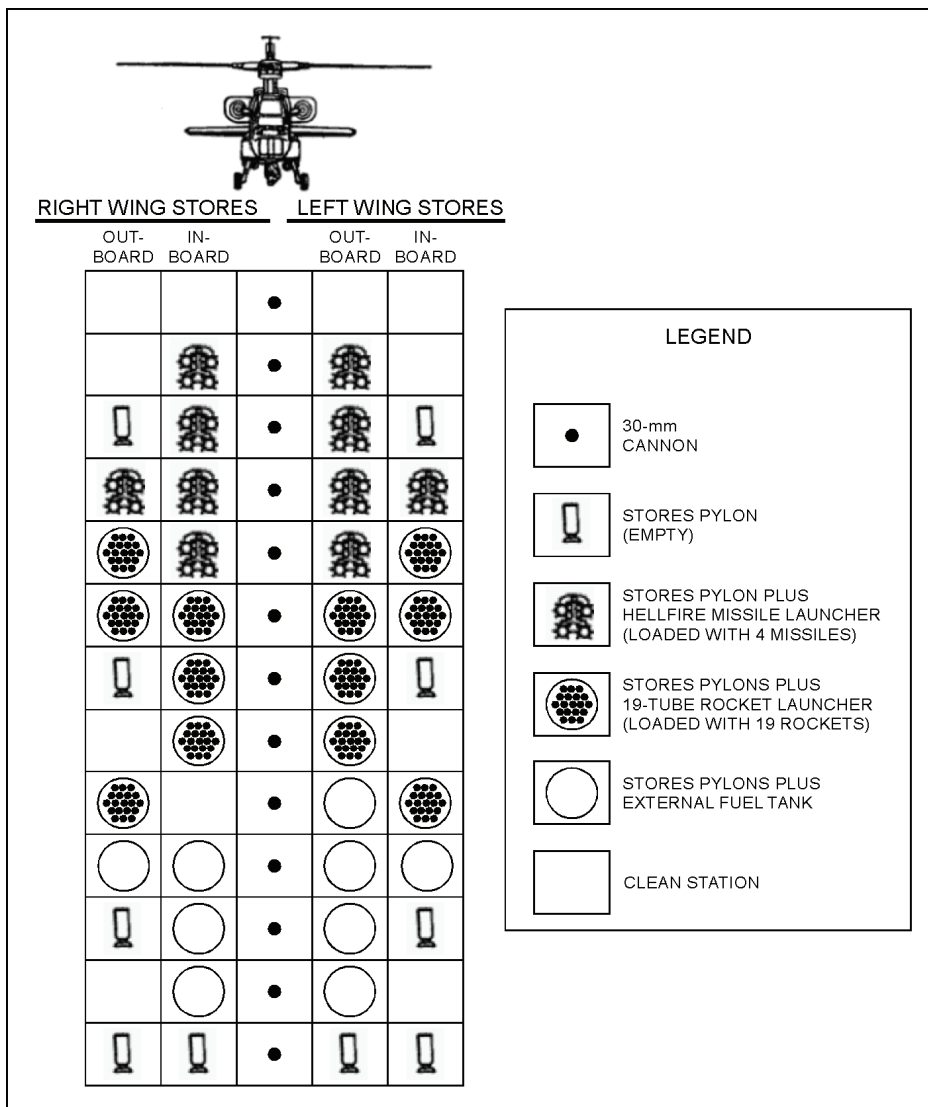

Figure 2-18. AH-64 armament configurations

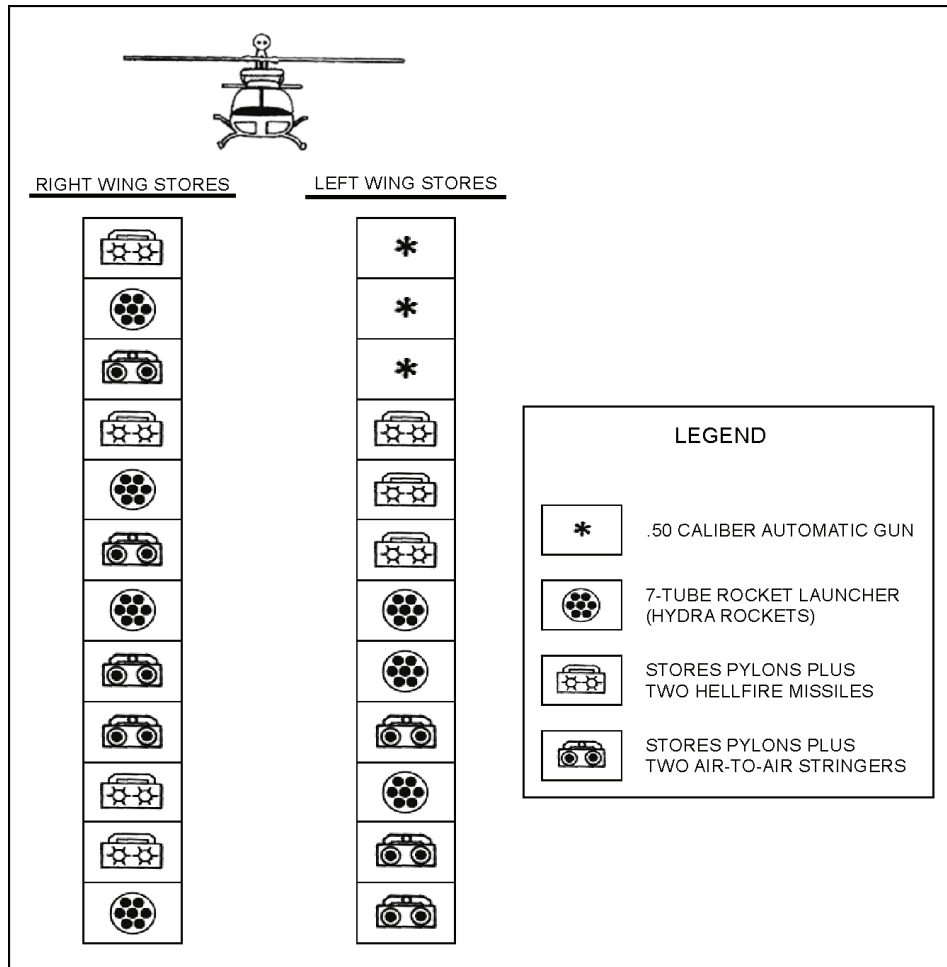

Figure 2-19. OH-58D authorized armament configurations

VOLCANO ARMING OPERATIONS

2-79. UH-60 aircraft equipped with the Volcano system require arming in a manner similar to attack reconnaissance helicopters. An assault helicopter battalions aviation maintenance company/aviation maintenance troops lack the arming personnel organic to attack reconnaissance HSCs. Units use crew chiefs, combat engineers, or other trained personnel to load and arm Volcano canisters. This level of training is essential for safe arming operations. If a unit forecasts operations, it should request additional engineering personnel for the duration of the operation.

2-80. Loading and arming can occur in the unit AA or near a RRP. Volcano aircraft should assume a position at least 1,000 meters from CPs, major routes, nonessential personnel, and fuel storage areas.

2-81. The total weight of the armed air Volcano system is 2,886 kilograms (more than 6,350 pounds). Because fully loaded Volcano aircraft approach maximum gross weight, ground conditions should be firm or steel/wood planking landing pads should be provided. Armed aircraft should avoid refueling near (within 375 meters) other aircraft. Simultaneous arming and refueling is not necessary or recommended.

2-82. Figure 2-20, (page 2-29) is an example of a site layout for Volcano arming. Arming personnel dig a dud pit where they place damaged or misfired canisters. Personnel store live canisters to the front left and right of the aircraft and spent canisters to the rear left and right, taking care to avoid the tail rotor. Personnel

and vehicles must avoid areas directly adjacent to the M139 dispensers. Accidental discharge could strike personnel, and mine arming would occur within 2 ½ minutes after the discharge occurs. If such a discharge occurs, the aircraft and loading personnel are required to reposition at least 640 meters away (1,000 meters in the event of fire), and loading personnel are required to notify explosive ordnance disposal personnel.

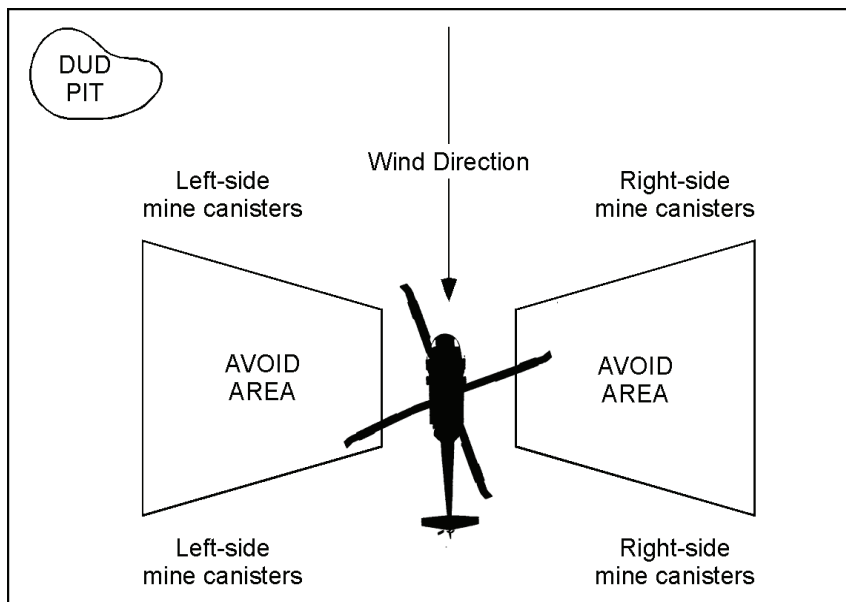

Figure 2-20. Example of a site layout for a Volcano arming point

2-83. Each launcher rack functions as a carrier and launcher platform for a 40-mine canister. Aircraft can mount up to four M139 dispenser racks, two on each side of the UH-60. Loaders insert canisters into the 40 keyholes, rows 1 through 4 from bottom to top and columns 1 through 10 from left to right. This loading sequence is important if the rack carries less than a full load of mines. As loaders insert the mine canisters, a green latch secures the canister to the rack and a red latch arms the canister.

2-84. The rack has two electric receptacles: one for the power connector and one for the launcher rack cable running to the dispensing control unit.

2-85. After the mission, spent canisters are discarded at least 30 meters to the left or right rear of the aircraft at the 4 and 8 o'clock positions. Live canisters are returned to ammunition supply points for future use or repackaging. Misfired canisters are placed in the dud pit, and explosive ordnance disposal (EOD) personnel are to be notified.

SECTION V – OPERATIONAL ENVIRONMENTS

NIGHT OPERATIONS

2-86. The unit should establish a detailed SOP for night operations. This SOP should include—

- FARP marking and lighting.
- Light color designations.
- Predetermined active time.
- Airspace procedures in effect.
- Secure radio frequencies to be used.
- Items for pilots brief.

2-87. Delays will occur because of low-light levels. Light discipline is extremely important, and personnel must guard against the tendency to ignore inadequate light levels. FARP personnel should use NVDs when available to enhance safety and eliminate problems and concerns associated with low-light conditions.

2-88. Once the FARP is in position, it should remain under blacked out lighting, minimal unsecure radio traffic, and limited operational status until the predetermined active time as briefed to the user pilots. Arriving aircraft should use predetermined secure frequencies to let ATC and FARP personnel know friendly aircraft are in bound at the initial entry point.

2-89. The location of the FARP can be marked in several ways. If aircrews are equipped with NVDs, a low-level infrared light source may be used. Alternate marking techniques include a flashlight with colored lenses, chemical lights, or colored bean bag lights. If the existing light level is high, such as during a full moon, engineer tape or other high-contrast materials staked to the ground may adequately mark the site.

2-90. During arming and refueling operations, artificial lights may be needed. Color-coded, low-intensity light sources may be used to indicate the takeoff and landing area direction and pad sites.

2-91. The use of artificial lights in the FARP poses several problems, including—

- FARP personnel may experience limited visibility or be in total darkness until aircraft arrive.
- Night vision may be temporarily impaired when personnel initially start to work in a lighted environment.
- FARP personnel will constantly have to adjust from a no-light to a low-light working environment.
- FARP personnel may need time for their night vision to readapt each time the light level changes.

2-92. When placed nearby, the glow from a chemical light can disturb a worker's vision. Objects may be blurred when looked at closely. Artificial light sources are a problem because they cannot be placed to adequately illuminate the work and leave both hands free.

DESERT OPERATIONS

2-93. The desert environment poses many difficult problems for FARP operations, such as adequate water supply, heat casualties, and extensive dehydration. Other considerations include—

- Terrain.
- Dust control.
- Mobility.
- Flying techniques.
- High-density altitude.
- The AAFARS systems.

TERRAIN

2-94. The desert has many different types of sand. Sand may be as fine as talcum powder or as coarse as gravel. Off-road vehicle mobility will be affected by the type of sand. In many areas, a crust may form on the surface of the sand; if the crust is dark-colored, the sand is very coarse. In such situations, the light sand has been blown away, leaving a gravel and sand mix. This surface crust may become so hard a helicopter could land with almost no dust signature. Using hard surfaces is critical for eliminating brownout conditions. Site surveys are critical to ensure hard surface areas are located and used for FARP locations.

2-95. The flat terrain and poor relief of the desert create serious navigational problems; therefore, FARPs must be established in easily recognizable positions. The use of NVDs will assist in locating FARP positions. Navigation equipment, such as a GPS, makes desert navigation easier.

2-96. Desert activities can be observed from as far away as 10 kilometers, or 20 kilometers when observed from high ground. Cover and concealment are imperative since FARPs are targets of opportunity for the enemy.

DUST CONTROL

2-97. There are several dust control products available. The Army has contracts with some of the companies which produce these products. Dust control products are polymer-based emulsions used primarily to stabilize all soils from dust and erosion. They are specifically engineered for ease of use (engineer applied). Dust control products are designed to work into the soil to maximize the penetration depth. The result is a thick protective barrier with a rigid, stable base. Once cured, these products become completely transparent, leaving the natural landscape to appear untouched. Product results are based on the application rate used. Modest applications can create a light temporary surface crust that is permeable by water and is useful for dust control needs. Heavy applications can generate results similar to the qualities of cement. Dust control products are biodegradable and environmentally safe to use. The following is a list of the dust control agent attributes:

- Dries flexible.
- Dries odorless.
- Nonhazardous.
- Slip-resistant, safe to walk and drive on.
- Ecologically and environmentally safe.
- Dyes and pigments can be added.
- Water resistant.
- Self mixes with water for application by engineer units.
- Nonflammable, nonvolatile.
- Noncorrosive, safe for all equipment.
- Stops dust particles of 2½ and greater microns in size.
- Non-tracking, nontransferable (will not be picked up by vehicles or aircraft).
- Ultraviolet ray resistant.
- Alkaline soil resistant.

MOBILITY

2-98. Air emplacement is the easiest and fastest way to establish a FARP in a desert environment. Two AAFARS systems set up in a T-formation, as shown in figure 2-21 allows for adequate separation from the turning rotors. The T-formation AAFARS setup can support four refueling points. The FARP should be positioned to facilitate ground vehicle support. This eases the strain of trying to resupply by air.

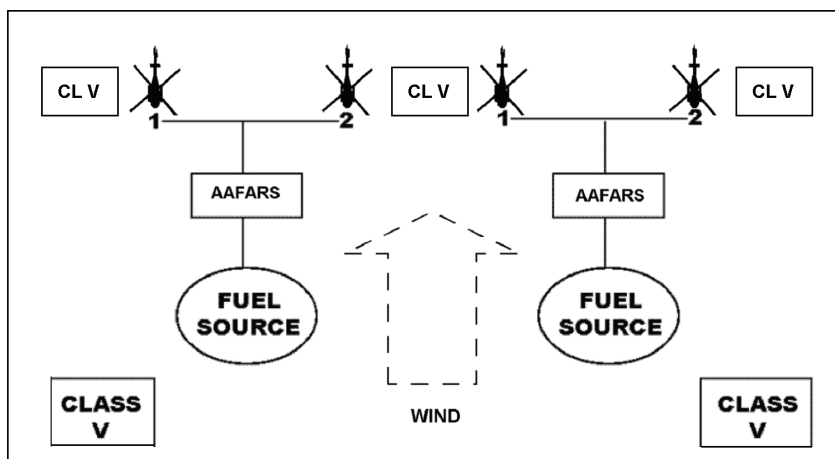

Figure 2-21. T-formation advanced aviation forward area refueling system setup

FLYING TECHNIQUES

2-99. The dust signatures of aircraft operating in the desert will be reduced if airspeed is kept above effective translational lift. In-ground effect hovering should not be attempted; instead, approaches should be planned and executed to the ground. Correct desert flying techniques will help ensure the aircrew maintains visual contact with the ground. FARP layouts should be adjusted to allow shallower approaches to the ground.

HIGH-DENSITY ALTITUDE

2-100. High-density altitudes will affect aircraft performance during desert operations. For example, in the early morning when density altitude is lowest, the UH-60 may be able to carry two full 500-gallon collapsible fuel drums. At the hottest part of the day, the UH-60 may only be able to carry one collapsible fuel drum. An attack helicopter may have to carry less than a full load of ammunition and/or fuel. In either case, the FARP must be prepared for more frequent trips for refuel/reload.

ADVANCED AVIATION FORWARD AREA REFUELING SYSTEMS

2-101. The AAFARS must be dug in or sandbagged to optimize performance in a desert environment. The fuel source (500-gallon collapsible drum) should be level to or higher than the pump. All small engine-driven equipment must be protected from blowing sand to prevent mechanical problems. The following procedures will help ensure the continued operation of the AAFARS system:

- Replace filter/separator elements when contaminated or when the pressure differential indicator shows they must be changed.
- Change or clean oil filters according to the operator's manual.
- Clean all small engine air filters.
- Perform preventive maintenance checks and services twice a day.

ADDITIONAL CONDITIONS

2-102. Other desert-specific conditions which all personnel should be aware of include—

- Visual illusions (mirages) will affect all personnel.
- Dust storms will restrict the ability to see and breathe.
- Continued exposure to bright sunlight will cause severe eyestrain or sun blindness unless personnel take proper preventive measures.
- Light can be seen for great distances over flat terrain. A pink filter can be seen more than 5 miles away by someone using an NVD.
- Ground vehicles are easy to identify in the desert. Silhouettes and shadows are easily detected because they contrast with the lighter natural background.
- In sandy areas, turret weapon systems will need frequent cleaning and a light coat of lubricant. Using lubricants without proper cleaning will cause a buildup of sand in the gear mechanism. This will cause weapons to jam. Optical sights should be protected from blowing sand that could scar the protective windows for the helicopter sight unit systems.
- APUs and engine inlet covers should be used if aircraft are shut down in the FARP.

COLD WEATHER OPERATIONS

2-103. Aviation units must be prepared to operate in cold environments. Low temperatures, fog, freezing rain, snow, ice, frozen ground, and, at times, muddy ground characterize the winter battlefield. FARP operations are difficult under these conditions. Detailed planning and training are necessary to overcome them.

2-104. Snow, ice, and mud may reduce vehicle mobility on the winter battlefield, complicating FARP displacement. Commanders should plan for aerial emplacement when possible. If ground displacement is

necessary, more time for movement should be allowed. Regardless of the displacement method used, the breakdown and setup of the FARP will take more time on the winter battlefield than in other environments.

2-105. Keeping the body warm and functioning at an optimal level are challenges for personnel exposed to low temperature conditions within a FARP. Wind chill caused by helicopter rotor wash may result in cold injuries even when air temperatures are not extremely cold. Troop leading procedures, such as a warm-up tent and pre-combat checks (to ensure all required cold weather gear is serviceable and available to all FARP personnel), must be used to prevent cold weather injuries or hypothermic reactions. Work period and warm-up period times should be defined in unit SOPs.

2-106. Fuel spilled on bare skin or soaked into clothing will have a cooling effect as it evaporates, increasing the probability of a cold injury. Since fuel has a lower freezing temperature than water, frostbite could result when skin is exposed to both fuel and temperature decreases. Personnel handling cold ammunition will need mittens or other protection. FARP personnel will also need a lighter pair of gloves when manual dexterity is needed to perform delicate operations. Commanders should ensure FARP personnel are properly equipped and trained to function in a cold environment.

2-107. Marking the FARP for aircraft control requires special consideration on the winter battlefield. Engineer's tape cannot be used on snow as a marker for aircraft control. Marker panels can quickly become obscured by falling snow. Hand and arm signals and flashlights may be used, depending on weather conditions. Maneuvering aircraft on loose snow surfaces may cause clouds of blowing snow, which can partially or totally obscure ground guides or other control measures. Blowing snow could cause aircrews to become disoriented and lose aircraft control. Site preparation measures may include snow removal to lessen the effects of white out, ensuring there are no hidden obstacles, and ensuring the terrain is suitable for the FARP location. These problems can be reduced by packing the snow or by spraying the snow's surface with water to form a crust of ice.

2-108. Camouflage of the FARP on the winter battlefield can be difficult, particularly where there is complete snow cover. Using white covers and snow as camouflage is a possible solution. The best solution is to avoid open snowfields when selecting FARP locations; instead, the FARP should be located near partially wooded or urban areas.

2-109. Electrically grounding FARP equipment and aircraft is a problem. Frozen ground makes the emplacement of grounding rods difficult and reduces the effectiveness of the electrical ground. To emplace grounding rods, holes may have to be drilled or the ground thawed and grounding rods placed in those areas. To ensure the proper flow of electricity, paper or other absorbent material is filled in around the rod and then soaked with salt water.

2-110. Maintenance requirements for aircraft and FARP equipment will increase during adverse weather conditions. When aircraft icing occurs, FARP personnel may have to deice the aircraft. In cases of extremely thick ice, a heater or an aviation ground power unit may be the only effective deicing equipment available. Ammunition can freeze. Deice caps for the Hellfire missiles are available. The caps are fitted over the seeker to prevent it from freezing. Rocket pod covers are also available. The covers fit snugly over the rockets, and the rockets can be fired through them. All of the FARP equipment must be "winterized" with additional antifreeze or low-temperature lubricants.

2-111. Static electricity is more prevalent in cold environments because of low humidity.

LONG TERM OPERATIONS

2-112. FARPs operating in a mature area of operations for long periods of time should make every effort to employ standard setups allowing for ease of use by the aviation units relying on the FARP's services. FARPs should locate away from the runways and taxiways to ensure the normal flow of ground and air traffic on the airfield is not disrupted. This would also avoid a FARP setup that could be 90 degrees off from the prevailing wind, which would require pilots to land in a crosswind. FARPs should always be set up landing into the prevailing winds and allowing takeoff with the prevailing winds.

2-113. FARPs should avoid setups that utilize a pull-through system, which cause conflicts in traffic flow. A pull-through system causes aircraft with fuel ports on the right side to enter the FARP opposite the

normal entry direction. The result of this type setup could be that the weapon systems of one AH-64 aircraft are pointed directly at the tail of another AH-64 aircraft being refueled at a position located in front of it. The AH-64 in the front would have their weapons pointed directly at the landing pad of the FARPs normal flow of traffic resulting in obvious safety issues.

2-114. FARPs should use a pull-up system where aircraft pull up next to each other, which eliminates safety concerns caused by the pull-through system for refueling. Every effort should be made to ensure takeoff direction is with the prevailing winds. This may be accomplished by using a departure inverted Y. The inverted Y eliminates safety issues often associated with tail wind takeoffs.

2-115. Each FARP must have an adequate number of refuel points based on the number of aircraft flying and refueling within the FARP's AO. Standards for extended use FARPs should be established and published by the headquarters for the area of operations thus, creating structure and uniformity in the layout, design, number of refuel points, and pad numbering system, left to right. Requiring minimum standards for long term FARPs would eliminate confusion and delays in service.

2-116. Reliable communications between incoming aircraft and FARP personnel must be established. Secure fills for FARP communications may have to be established. FARP personnel equipped with very high frequency or ultra high frequency radio capability could monitor ATC tower frequencies and be alerted to pilots' intentions to refuel, reducing delays in service and saving mission time and fuel. ATC tower frequencies are used as common traffic advisory frequencies during hours the tower is not open. This allows FARP personnel to quickly react to pilot requests for services.

2-117. Army aviation missions must operate efficiently and effectively. Standardizing FARP locations, procedures, layouts, operations, and communications for long-term FARPs established on forward operating bases (FOBs) and airfields is conducive to mission efficiency and effectiveness. Figure 2-22 depicts a notional long term FARP on an airfield.

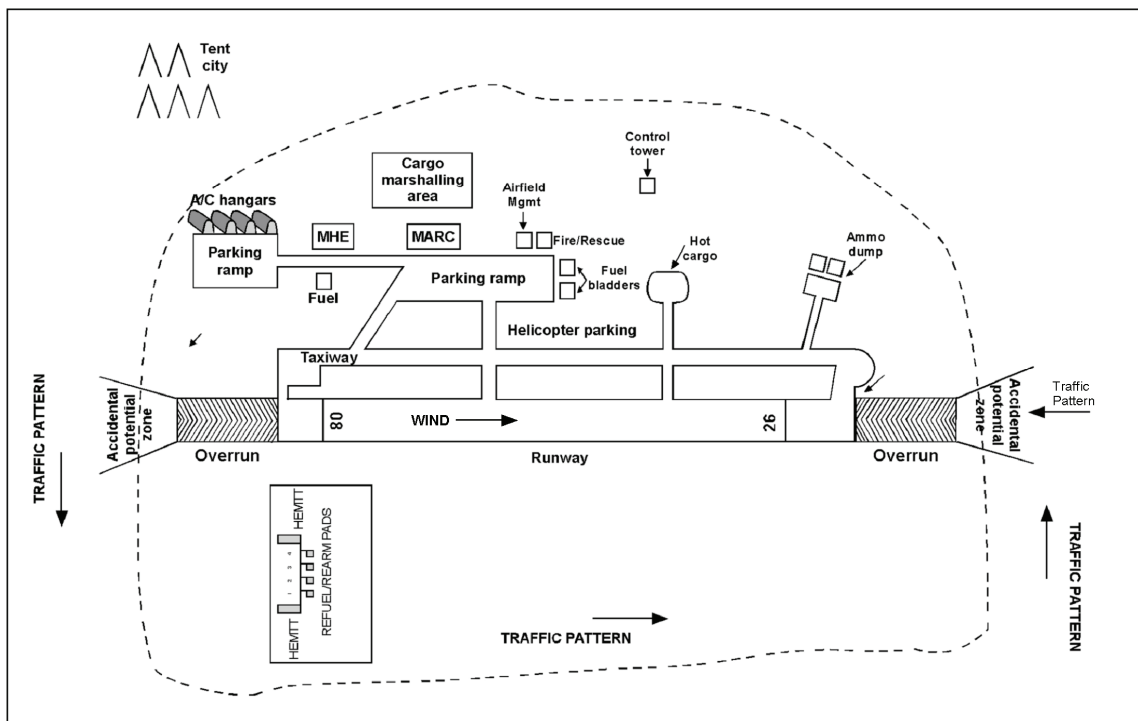

Figure 2-22. Notional long term forward arming and refueling point on an airfield

Chapter 3

Training

Mission success depends on the ability of FARP personnel to set up and provide rapid and responsive arming and refueling services. Mission success involves integrating individual skills with team training, resulting in safe and well-coordinated operations.

QUALIFICATION TRAINING

3-1. The different arming configurations of aircraft require armament personnel be trained in the handling, loading, and arming of all armament systems. Armament TMs contain the required training levels for aircraft armament/missile systems repairers. Because of the dangers of arming "hot aircraft," the commander must ensure ammunition specialists are thoroughly trained in handling ammunition around aircraft. The commander should establish a cross-training program to maximize the use of FARP personnel. Units can train all other FARP personnel to assist in arming operations by moving Hellfire missiles into position and loading rockets.

TRAINING REALISM

3-2. Training must be as realistic as possible. As such, all facets of FARP operations must be trained and practiced under combat-like conditions. The unit training program allows for 24-hour operations under varying levels of mission-oriented protective posture.

3-3. Aviation commanders must integrate all personnel into FARP training and provide Soldiers with the quality of training required. Realistic training benefits the FARP personnel as well as the aviation units in general. Realistic training can identify problem areas that may be otherwise ignored.

INDIVIDUAL AND COLLECTIVE TRAINING

3-4. A successful FARP operation is the product of a series of progressive skill-building programs, which include cross-training assigned and attached personnel. Coordinated operations are achieved by integrating team training with programs emphasizing personal skill development, incrementally progressing as individuals are integrated into operational teams.

3-5. The commander must also evaluate the FARP team's ability to deploy and operate. A continual evaluation process will help identify the capabilities and limitations of the FARP. A unit training program should be developed to meet specific unit needs and correct any deficiencies.

CRITICAL SKILLS

3-6. FARP operations will be successful when all FARP personnel are trained to operate as a team. This training should not be limited to arming and refueling activities, but should also include the following critical skills:

- Operating the four types of FARPs.
- Protection procedures, such as—
 - Firefighting and rescue procedures.
 - CBRN detection and decontamination.

- Self-aid and buddy-aid procedures.
- Security.
- Safety procedures of the FARP (see appendix D).
- Class III/V helicopter sling load operations.
- Day and night land navigation proficiency, as described in FM 3-25.26.
- NVD training.
- Extensive driver training.
- Convoy procedures.
- FARP maintenance operations and procedures.
- Spill containment training.

MOVEMENT PLAN

3-7. The movement plan for a FARP is an essential part of its convoy procedures. It should include—

- An advance party.
- March tables.
- A route reconnaissance.
- Alternate site locations.

3-8. Detailed movement planning improves the accuracy of the FARP's operational timeline and should include details about individual vehicle and trailer load plans. Appendix C contains suggested load plans.

3-9. An advance party, equipped with CBRN detection equipment and a security team, should be sent to the proposed site to determine its suitability. If the site is usable, the advance party will identify areas for equipment placement. If the site is not suitable for FARP operations, the advance party will divert the remainder of FARP personnel and equipment to an alternate location. When the remainder of FARP personnel and equipment arrive, the advance party should guide each vehicle into position. Greater detail on convoy operations can be found in FM 4-01.45.

Advance Party Actions

3-10. When the convoy is ready, the advance party moves to the FARP location. Upon arrival, personnel will establish security, conduct a CBRN survey, reconnoiter the site, and perform other tasks outlined in the unit SOP and the applicable Army Training and Evaluation Program publication. If the site is unsuitable or the enemy is nearby, the advance party reports this information to the tactical operation center; the advance party then requests to move to the alternate site and notifies the remaining FARP elements. When the site is deemed suitable, the advance party—

- Determines the landing direction.
- Determines and marks refuel and rearm points, truck emplacements, and ammunition emplacements.
- Sets up the equipment.

Site Preparation

3-11. The FARP site will be surveyed prior to operational use to make certain the area is safe and free of extraneous or unacceptable equipment and debris. Potential flying objects should be removed to prevent injury to personnel or damage to equipment. The rotor wash from helicopters can cause these objects to become hazards. In addition, scrub brush, small trees, or other vegetation may need to be cleared from landing and takeoff areas. The use of pre-designated landing, takeoff, and hovering areas will minimize accidents, incidents, and injuries. The areas around rearming and refueling points and pump assemblies should be cleared of dried grass and leaves to prevent potential fires.

3-12. Aircraft can sink in wet, snow-covered, thawing, or muddy ground. Pierced steel planking or other suitable material staked to the ground can be used to reinforce the ground.

RELOCATION

3-13. Several guidelines determine the relocation of a FARP. By definition, the FARP should be temporary, not staying anywhere longer than three to six hours (unless it is hardened and located in a secure area, such as a FOB). When threat levels change rapidly or when the sustainment area threat dictates, the FARP must be moved often. In a static situation, frequent movement of the FARP may not be necessary. Where air parity or enemy air superiority exists, the FARP must be moved often. The FARP should be moved only after it fulfills the support requirements of mission aircraft.

Note. If CBRN contaminants exist, equipment should be decontaminated before it is moved from the FARP site.

3-14. A FARP may be relocated for any of the following reasons:

- The FARP comes under attack.
- The order to relocate is received by radio.
- The order to relocate is received by face-to-face message.
- A preplanned relocation time has been set.
- A preplanned relocation occurs after a specific event; for example, after the FARP has serviced a specific company or a specific number of aircraft.
- The last element to use the FARP delivers the message to relocate it.
- A decision or trigger point is used.

3-15. The message to relocate a FARP is passed in fragmentary order format and will contain, at a minimum, the following information:

- Eight-digit grid coordinates of the next site and an alternate site.
- Time the FARP is to be mission-ready.
- Fuel and ammunition requirements.
- Passage-of-lines contacts, frequencies, call signs, and ingress and egress points.
- Enemy situation at the next site.
- March table or movement overlay.
- An SDP to the fragmentary order.

3-16. If time allows, a map reconnaissance and a survey of the proposed site should be conducted before a FARP site is selected. A site survey is critically important; maps may not be current and sites are not always as they are depicted on the map.

3-17. Once ordered to relocate, FARP elements should begin an orderly movement. After the FARP has been moved, no evidence should remain that the area was ever occupied.

Rolling Forward Arming and Refueling Point Setup and Operation

3-18. Rolling FARP operations are conducted during convoys of ground assets with aircraft operating in an overwatch posture. The convoy will come to a temporary halt. Personnel will block and secure the road at each end of the convoy by posting armed lead and trail vehicles during the FARP operation. The other vehicles within the convoy will provide left- and right-flank security, giving the FARP operation a 360-degree perimeter.

3-19. Rolling FARP (figure 3-1) setup and operation are conducted upon completion of the following steps:

- Select the aircraft landing area.
- Determine refueling and rearming positions.
- Ensure 100 foot separation from aircraft to the nearest vehicle.
- Break down ammunition and prepare the load.
- Reposition the fuel vehicle to the parking location.
- Place the fuel hose in position.

3-20. One aircraft will land on the hard surface road for refuel/rearm operations as the other aircraft maintains aerial security. After the first aircraft has rearm/refueled, it will resume aerial security as the second aircraft lands for rearm/refuel.

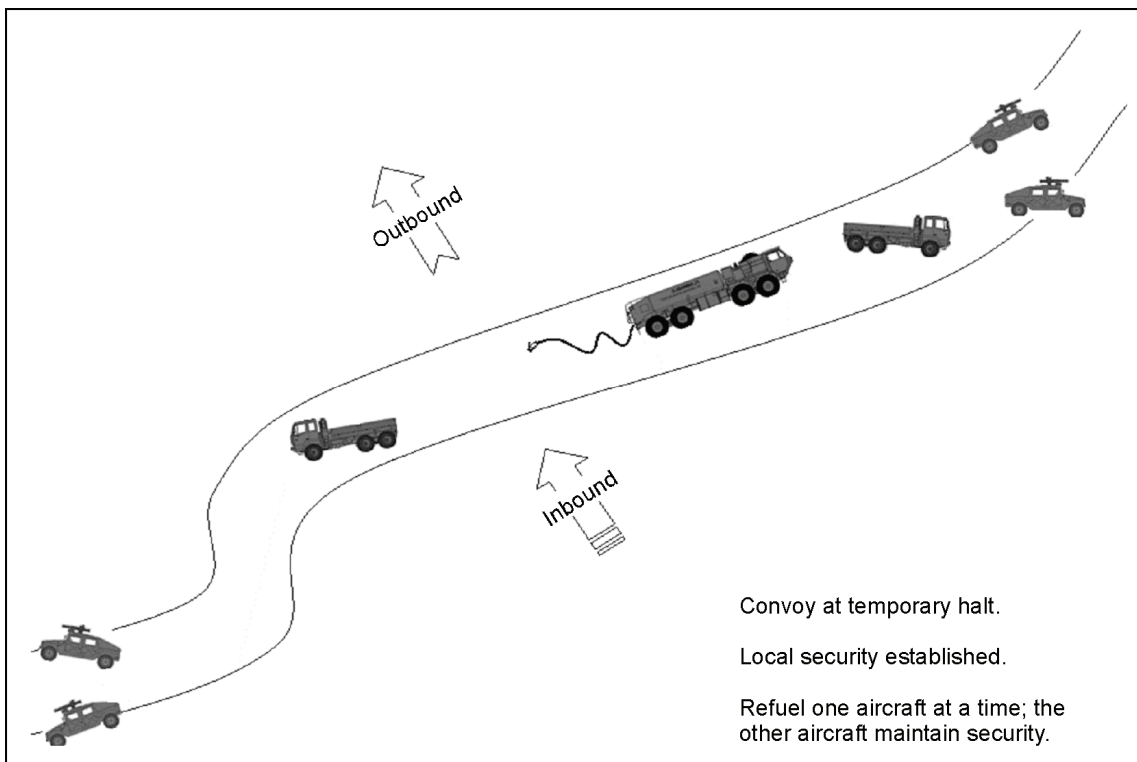

Figure 3-1. Rolling forward arming and refueling point setup

MULTIPLE FORWARD ARMING AND REFUELING POINT OPERATIONS

3-21. The degree of air superiority and the mission variables will determine the number of FARPs and the number of refueling points at each FARP; multiple FARP operations may be necessary. Assets should be arranged to set up two or three independent and mobile FARP operations. The ideal situation would include an active FARP, a silent or relocating FARP preparing to go active, and a rapid reaction air emplaced jump FARP on standby.

3-22. The active FARP conducts refueling and rearming operations. The silent FARP has all equipment and personnel at the future site, but it is not operational. The jump FARP is employed for special missions.

The jump FARP is typically transported by air then emplaced when dictated by time or geographical constraints. It allows for the uninterrupted support of aviation elements during FARP relocation and resupply.

3-23. The mode of transportation is determined by the availability of assets and the urgency of the mission. FARPs should continue operations until another FARP becomes operational, unless the tactical situation demands otherwise. Splitting Class III/V personnel and equipment into three independent FARPs is challenging, so organizing each FARP will depend on the mission and the way commanders want to employ these assets.

3-24. The timing of supplies must be coordinated when multiple FARPs are used. If Class III/V supplies are being pushed forward, the FARP should stop receiving supplies at a designated time. This time should be based on estimated Class III/V usage rates and should allow the FARP to use all of its supplies. Any Class III/V products not used should be transported to the new site. Otherwise, the supplies should be camouflaged and picked up later. The supplies should be destroyed only as a last resort. For more information on the destruction of assets, see TM 750-244-3.

SECURITY

3-25. The FARP should have enough organic security to defend against the anticipated threat. Too much security equipment will hinder the movement of the FARP; however, inadequate security will rob the FARP of its ability to protect itself long enough to move. The aviation unit must coordinate with the ground unit responsible for the AO in which the FARP is to be located for AD and ground security support. Normally, the FARP will be integrated into the brigade's AD umbrella.

3-26. The advance party may include Stinger assets, AD assets, CBRN attack monitoring and warning equipment and personnel, and crew-served weapons. The first asset employed is the CBRN attack monitoring and warning equipment. Monitoring equipment must be placed upwind of the FARP site. A limited antitank capability can be provided by using light antitank weapons. If available, electronic early warning systems should be placed on likely avenues of approach not covered by listening or observation posts. Quick-response forces may be formed from attack helicopters in or near the FARP. A quick-response force may also be formed from non-flying members of the unit who have been organized into a UH-60 transportable quick-response team.

3-27. If the FARP is attacked, personnel must be able to execute a scatter plan, including movement to rallying points. Rallying points increase personnel survivability and allow personnel to regain control of the situation. Unit SOPs should contain procedures to execute a scatter plan and procedures for a reconstitution plan.

3-28. If the FARP site is under attack or under a threat of being overrun—

- Stop refueling.
- Evacuate supported aircraft.
- Disconnect aircraft or vehicle being fueled from the fuel supply source/system by disconnecting the 50-foot pot hose from the side of the aircraft or port of the vehicle.
- Abandon the system and evacuate the FARP area.

FIREFIGHTING AND RESCUE PROCEDURES

3-29. Fighting and extinguishing petroleum fires effectively requires a well-organized plan. Every Class III supply point operation should have a fire prevention and firefighting plan. The plan may be simple or complex, but it should cover, in detail, all possible fire problems.

Responsibilities

3-30. Firefighting and rescue training are engineer responsibilities. On a fixed airfield where there is a fire department, the fire chief or fire marshal is responsible for training firefighters and rescue crews, including auxiliary personnel. When there is no fire department or nearby engineer activity, or when the nearest engineer activity is not staffed to provide training, the unit commander must ensure adequate training is provided. The unit commander usually delegates this duty to the unit SO. Countless training scenarios can be used to train personnel. Actual use of assigned equipment on test fires is effective in keeping motivation high during the routine aspects of the training program. This program should include a training plan or outline that provides continuous training for all personnel that details and evaluates the scope, depth, and effectiveness of the program. A guide to the subject matter and examples of practical exercises are described in the following sections.

Basics of Firefighting

WARNING

Flames may result when an extinguishing agent is first applied to fires in which petroleum is present. Extinguishing agents must be applied with caution to avoid personnel injuries.

3-31. Training should be repeated as new personnel come into the unit. In the tactical phase of training, basics should be reviewed and students should practice with equipment. Aside from instructors, students should be taught only a minimal amount of theory in order to react intelligently to an emergency and for motivation. The subjects to be included in this phase of training are described below:

- **Hazards.** Explain sources of ignition (such as fuel) and static electricity. Emphasize the rate at which flames spread on aviation fuels. Also, cover the ignition dangers of flammable, vapor-air mixtures. Teach aircraft safety including the hazard of rotor blades, the location and types of armaments carried on Army aircraft, the reaction of armaments in fires, and the dangers of approaching operating aircraft engines.
- **Principles of fire and fire extinguishing.** Instruct personnel about the three elements required for fire (fuel, air, and ignition source), factors that contribute to the spread of fire, and the principles of fire extinguishing. Personnel should understand which approach is appropriate for what type of fire at a refueling point. Keep the information simple; relate information directly to practical fire situations personnel are most likely to experience in their duties.
- **Principles and types of fire extinguishers.** Discuss the different types of fire extinguishers that could be used in everyday operations. Explain the type or class of fire for which each is intended, the active agent or agents in each type of extinguisher, and the principle on which its effectiveness depends. For detailed information see FM 10-67-1. Include a brief review of extinguisher theory before actually using the extinguisher.
- **Use and care of equipment.** The common types of fire extinguishers used are dry chemical, carbon dioxide foam, and water. Demonstrate the proper technique for each fire extinguisher. After the explanation and demonstration, have personnel operate each type of extinguisher. Rotate personnel so each will become thoroughly familiar with the fire extinguishers. Train personnel to work individually and as a team. Teach personnel to inspect fire extinguishers as part of their command maintenance program. Personnel should ensure the fire extinguisher is in place and the pressure gage shows required pressure. Periodic technical inspection, maintenance, recharging, or replacement is an engineer responsibility.
- **Knowledge of layout.** Train personnel to be familiar with all features of the FARP. Students should also be instructed to get to any location by the shortest route (in all kinds of weather and

in darkness). Emphasis should be placed on the locations of all fire and emergency equipment, where and how to shut off fuel flow, and where and how to give the alarm (audio and visual). If there is a water system on site, ensure students know where outlets are and how to open them if necessary.

- **First aid.** Personnel who may be deployed at temporary FARP or AAFARS points should be given priority for first aid training. The training officer should coordinate with the nearest medical treatment facility to arrange for periodic first aid instructions to be given by either the institution's medical personnel or a trained first aid instructor. If possible, a member of the unit involved in aircraft refueling should become qualified as a first aid instructor so the training capability will exist within the unit. Emphasize the first aid procedures most likely to be needed during refueling. These might include burns, smoke inhalation, movement of injured personnel, and other firefighting and crash rescue first aid needs.
- **Aircraft identification.** Personnel must recognize the aircraft that may use the refueling point. Therefore, the ability to identify each type of aircraft is crucial. Explain to personnel that a thorough knowledge of the various aircraft is required in order to successfully fight a fire and rescue trapped personnel. In an emergency situation, personnel may work in smoke, fumes, or darkness. Have personnel train with actual aircraft whenever possible.

Basic Crash Rescue Training

3-32. Never assume an aircraft accident has been fatal to the aircrew. Fire is often a delayed result of a crash impact, and, if the firefighting response is immediate, personnel in the aircraft may be rescued. Regardless of the extent of the fire or limited firefighting capability, firefighting and crash rescue operations should start immediately. Basic crash rescue training must focus on how to approach and get into the aircraft. Teach personnel the principal hazards, including armaments and fuel that could potentially arise when attempting an approach and entry.

Approach

3-33. The aircraft route of approach is determined by the position of personnel in the aircraft, the position of the armaments aboard, and the location of the fire and the wind direction if the aircraft is on fire. Use crash rescue charts to train personnel on the best method of approach for each type of aircraft (FM 10-67-1). Use different fire and crash situations, and when possible, train personnel using actual aircraft. Training exercises should include various routes of approach where personnel identify the location of personnel on board and rehearse opening aircraft exits.

Entry

3-34. Use crash rescue charts (if available) to teach personnel where the exits are and where personnel may be located in each type of aircraft. Familiarize trainees with every opening device or release handle inside and outside the aircraft. Personnel should be proficient in opening, closing and/or operating all aircraft exits and entrance ways in order to effectively work in either darkness, smoke, or other low-visibility conditions.

Evacuation

3-35. Train personnel to decide whether the hazards of a situation mandate that aircrews should be evacuated from the aircraft instantly, or whether the fire should be fought first until additional help arrives to assist in the rescue effort. Sometimes wreckage or twisted controls make it difficult or impossible to rescue personnel without additional rescue and evacuation assistance. Extreme care should be used when moving the injured. Train personnel how to release the aircrew from safety belts and shoulder harnesses.

Removal of Injured Personnel

3-36. There is no substitute for actual experience in removing injured personnel. For emergency training to be effective, a complete aircraft emergency scenario should be created. If an aircraft seat is used in a training session, a Soldier should act as an unconscious victim (limp, deadweight), and additional support personnel should practice releasing and removing the casualty from a seat. The first aid instructor should teach the best way to move the victim. It is always easiest to remove a Soldier through the normal route in and out of the aircraft. Rescuers should only try and enter by another route if the door or canopy is jammed and impossible to open. Whenever possible, practice with an actual aircraft to allow personnel being trained a chance to become familiar with the small space and limited approach and exit possibilities.

TACTICAL FIREFIGHTING AND RESCUE TRAINING

3-37. Once personnel have learned the basic firefighting and crash rescue procedures, emphasis should be placed on the tactics of attacking various fires. Fires at refueling points can involve aircraft and petroleum, petroleum alone, and either grass or brush. During tactical training, hot drills are performed. Tactical training should be directed toward developing speed, tactics of deployment, and teamwork required to conduct successful firefighting and crash rescue operations. Teach conservation of fire extinguishing agents.

Fire in Refueling Areas

3-38. In case of fire in the refueling area, personnel should—

- Stop refueling at all points.
- Turn all pumps off.
- Close all valves.
- Evacuate personnel from the area.
- Evacuate aircraft from the area.
- Attempt to fight the fire.
- Notify higher command, when possible.

Fire on Aircraft During Refuel Operation

3-39. In case of fire on board FARP aircraft, personnel should—

- Stop refueling at all points.
- Turn all pumps off.
- Close all valves.
- Evacuate personnel from the aircraft that is on fire.
- Attempt to shut down the aircraft that is on fire.
- Evacuate all other aircraft from the area.
- Attempt to fight the fire.

Fuel Leaks

3-40. In case of fuel leaks, personnel should—

- Stop refueling at the affected refueling point.
- Turn all pumps off.
- Turn the valves to the leak off.
- Repair or replace the affected pieces.
- Open valves and start the pumps.
- Check for additional leaks.
- Proceed with refueling operations.

Aircraft Fires and Crashes

3-41. The tactical aim in fighting aircraft fires is first to make rescue possible and second to try to save the aircraft. The primary objective is to isolate the fuselage from the fire, cool it, and establish and maintain a fire-free escape route until all personnel are evacuated. When possible, build a sample fire in a crashed fuselage, or build a mock-up to use so personnel can practice with an actual fire. The basic procedures to follow include—

- **Position equipment.** Teach personnel where to position firefighting and rescue equipment (mobile or hand-held). The following practices should be taught and reinforced:
 - The equipment operator must be able to see the fire or wreck and its surroundings.
 - The equipment must be positioned where it will not be engulfed in fire. On flat terrain, the best position is upwind. On a slope, the equipment must be placed up-slope from the fire or crash because both fuel and fuel vapors run downhill.
 - The equipment should not block access to the fire or crash.
 - The equipment must be placed so the fire can be fought effectively. If rescue is involved, the equipment must be positioned so the flames can be kept away from trapped personnel and a safe escape route kept open until everyone is out of the aircraft.
- **Approach the aircraft.** Teach personnel how to properly approach the aircraft during a fire. This includes how to enter into different types of aircraft and the location of exits, fuel tanks, armaments, and other flammables and explosives on board. If the aircraft engine is operating, warn personnel to be cognizant of the position of rotor blades or propellers, turbine engine air intake and exhaust vents, as well as the effect of rotor or prop wash on the stream of a fire extinguishing agent.
- **Practice rescue.** During training exercises, emergency and evacuation personnel should practice entering the aircraft and releasing and removing personnel.
- **Give first aid.** A simulation of likely injuries and first aid prevention practices should be performed.

Petroleum Fires

3-42. Train personnel in the tactics of approaching petroleum fires not involving an aircraft. The principles of approach to a site and the positioning of equipment are the same as for an aircraft fire. Re-emphasize both fuel and fuel vapors flow downhill, and that fire and rescue personnel must consider the danger of being engulfed by fire. Teach personnel that if the fire involves flowing fuel, the first priority is to shut off the flow. Be sure each person knows where cutoffs are and how to close fuel nozzles and valves that shut down pumps. If there are emergency cutoffs, ensure personnel know where they are and how to operate them. If possible, float some fuel on water in an empty berm and have personnel practice putting out the fire.

Grass and Brush Fires

3-43. Personnel should be aware that the nature of the fire determines the appropriate approach and the most effective plan for extinguishing a fire. If fire extinguishers for Class A fires are available, train personnel to fight grass and brush fires. Students should anticipate that aircraft or petroleum fires often lead to grass or brush fires. Wind usually determines the direction a grass fire moves, so the best approach is from upwind. Therefore, students should be instructed that the most successful approach to eliminate or extinguish a fire should begin at the upwind edge and then proceed to the sides of the fire. However, at a refueling point, personnel must consider the position of the fuel supply and the aircraft in relationship to the wind and fire. Depending on the location of the fire and the speed of its advance, it may be necessary to attack the fire from downwind or crosswind to disengage it from the fuel supply and aircraft.

RECOMMENDED UNIT SLING-LOAD TRAINING

3-44. Table 3-1 lists the recommended types of instruction and the hours of required training for units performing sling-load operations. Aerial emplacement of FARPs necessitates personnel be trained in sling-load operations. For more detailed information refer to FM 4-20.197.

Table 3-1. Recommended instructional blocks for sling-load training

<i>Instructional block</i>	<i>Hours</i>
Types of helicopters and limitations	0.5
Cargo carrying devices (A-22/nets)	0.5
Sling sets (10K/20K)	0.5
Reach pendants/hardware	0.5
DA Form 7382 (Sling Load Inspection Record)	0.5
Signalman duties and responsibilities	1.5
Hookup team duties and responsibilities	0.5
Safety equipment	0.5
Preparation and setup of landing zone/pickup zone	1.0
Rigging A-22 cargo bag and cargo nets	2.0
Rigging fuel blivets	2.0
Rigging HMMWV	2.0
Rigging exercise (sling load)	3.0

RIGGING FUEL BLIVETS

3-45. It is possible to rig a load, such as a fuel drum, that has only two lift points. In this case, run two chains through each hookup point. This allows the full capacity of the sling to be used. When using four sling legs and two lift points, all sling legs may not vary more than six inches in length. If the load is less than half the capacity of the sling set, use just two sling legs, one leg to each hookup point as shown in figure 3-2, page 3-11. All rigging must be conducted under the supervision of and verified by certified sling load riggers.

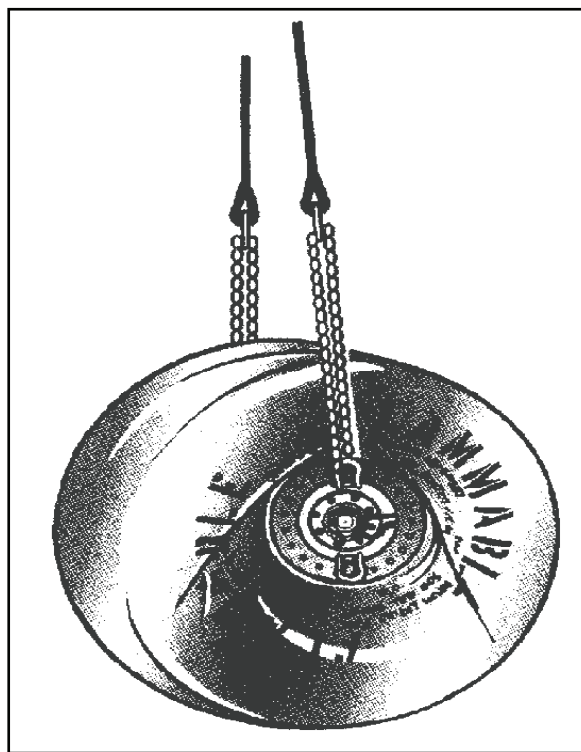

Figure 3-2. Load with two lift points

AQUA-GLO TEST PREPARTION PROCEDURES

3-46. FARP personnel will follow the guidance in the applicable TMs when conducting of Aqua-Glo testing. The procedures are briefly listed below but may not be all-inclusive due to the changes in FM 10-67-1. Personnel should perform the following procedures for Aqua-Glo testing:

- Put a fully charged battery into the meter assembly (A fully charged battery will operate the ultraviolet light for about one hour. About 30 tests can be performed on one charge.)
- Turn the ultraviolet lamp assembly upside down and open the test pad slot. Using tweezers, take the recalibration standard pad and place it, colored side in toward the lamp, in the test pad slot. Do not touch the pad with your fingers; always handle it with the tweezers. Turn the lamp assembly right side up.
- Slide the meter assembly into the tracks on the ultraviolet lamp assembly.
- Recalibrate the meter assembly after each battery change and before each working day as follows:
 - Turn the ultraviolet lamp on by pushing the lamp switch to ON and by holding the switch down for ten seconds. When the switch is pushed down, a high-pitched sound is emitted that should drop to a low-pitched sound when the pressure on the switch is released. These sounds indicate the lamp is on. If the pitch of the sound does not drop when the pressure is released on the switch, the battery needs to be recharged.
- Move the lever on the lamp assembly across its scale to the set number indicated on the recalibration standard pad. For example, if the set number on the pad is 5.3, move the lever to 5.3. Hold the hooded meter switch button in until the pointer above the meter scale becomes steady and holds its position (approximately 30 seconds).

- If the meter pointer does not point to zero, unscrew the plug screw on the side of the meter. Use the small screwdriver provided with the kit to adjust the meter so that the pointer points to zero.
- Take the recalibration standard pad out of the test pad slot using the tweezers and put it back in the kit pocket.
- Wipe the green glass light filters with a clean, soft cloth or paper towel.

FUEL SAMPLING PROCEDURES

3-47. Couple the detector pad holder assembly, with the toggle valve closed (parallel to the line), to the sampling coupler. The detector pad holder assembly includes plastic tubing, a detector pad holder, a toggle valve, and a sampling coupler.

3-48. Flush the detector pad assembly as follows:

- Put the end of the plastic tubing in a container that will hold more than one gallon of fuel.
- Open the toggle valve by turning the handle up (at a right angle to the line).
- Let approximately one gallon of fuel flow through the assembly into the container.
- Close the toggle valve and uncouple the detector pad assembly.

3-49. Unscrew the two halves of the detector pad holder. Using the tweezers, take a detector pad out of its envelope and put it, yellow side out, in the recess in the outlet side of the pad holder. Screw the pad holder assembly back together. Do not open the pad envelope until you are ready to put the pad in the holder. Do not touch the pad with your fingers; always use the tweezers. The pad can absorb moisture from the air and from skin, causing the test results to be false.

3-50. Couple the detector pad holder assembly back to the sampling coupler, with the toggle valve closed, and put the end of the plastic tubing into the neck of the plastic sampling bottle.

3-51. Open the toggle valve and allow 500 milliliters of fuel to flow into the sample bottle and close the valve.

3-52. Uncouple the detector pad holder assembly from the sampling coupler and unscrew the detector pad holder. Slip one prong of the tweezers into the notch in the pad holder and lift the test pad out.

3-53. Press the wet test pad between dry paper towels or blotters to remove the excess fuel. Press down on the test pad firmly, move the test pad with the tweezers to a dry place on the towel or blotter, and press again. Repeat the blotting process on a new dry spot on the towel or blotter until the excess fuel is removed.

FUEL TEST PROCEDURES

3-54. Use the tweezers to lift the damp test pad off the towel or blotter and put the test pad in the test pad slot in the bottom of the ultraviolet lamp assembly. Ensure the yellow side faces the ultraviolet lamp.

3-55. Turn on the lamp. Push in on the hooded button of the meter assembly with your left hand. While watching the meter scale, move the lever of the ultraviolet lamp assembly with your right hand until the meter points to zero.

3-56. Release pressure on the hooded button and shut off the lamp switch as soon as the meter pointer settles to zero. The meter pointer should stabilize in about one minute.

3-57. Record the reading from the scale behind the lever at the point where the lever is located. With a 500-milliliter sample, this scale reads directly into parts per million of water in the fuel. If the reading is 9 parts per million or below, the test is finished and the fuel may be used. If the reading is 10 parts per million (the lever is at 10) and the meter will not point to zero, perform the following procedures:

- Repeat the procedures in paragraphs 3-52 through 3-58.
- Open the toggle valve and allow 100 milliliters of fuel to flow into the sample bottle. Close the valve.

- Repeat the procedures in paragraphs 3-49 through 3-52.

3-58. Record the reading from the scale behind the point where the lever is located. Multiply that reading by 5 to find the parts per million of water in the sample. For example, if the scale reading is 3; 15 parts per million of water is in the fuel. (The maximum reading with the Aqua-Glo test for a 100-milliliter sample is 60 (5 x 12). A 100-milliliter sample is the smallest amount that will give an accurate test result.

3-59. Disconnect and remove the fuel and the fuel system equipment from service immediately if the fuel on retest shows more than 10 parts per million of water. Follow the guidance in FM 10-67-1 for inspecting and testing the fuel and equipment.

This page intentionally left blank.

Chapter 4

Sustainment

Sustainment for FARP operations requires detailed planning and coordination. The CAB and battalion staffs must anticipate Class III/V needs and coordinate with the Combat Sustainment Support Battalion (CSSB) and sustainment brigade to ensure requirements are met. This chapter discusses Class III/V planning considerations, resupply, and transportation.

PLANNING CONSIDERATIONS

4-1. The following are planning considerations for the sustainment of FARP operations:

- Availability of higher echelon support.
- Sustainment units' support for the aviation mission (Class III/V).
- Location within the AO.
- Mission duration.
- Aircraft configurations/ammunition mix.
- MHE transportation requirements.

4-2. The operational tempo of the battle may affect planning for FARP sustainment activities. For example, a high intensity mission may create a greater need for ammunition than for fuel. As a result, aircraft may return to the FARP more often to rearm than to refuel. The opposite is also true.

RESUPPLY

4-3. Resupply operations must keep pace with the tempo of the battle. Resupply is best accomplished during non-peak times or when vehicles can be protected from enemy observation and indirect fires. Resupply actions should start as soon as the operation permits. These actions are affected by—

- Availability of unit resupply assets.
- Current situation.
- Expected usage rates.
- Mission changes.
- Distances involved.
- Adequacy of road networks and the ability to travel off-road.

4-4. The FSC commander reports the status of Class V and Class III Bulk to the battalion S-4 who, based on information and guidance provided by the commander and S-3, requests resupply through the CAB S-4. The CAB S-4 consolidates the subordinate battalion's request and coordinates through the ASB's support operation section with the sustainment brigade's CSSB for required resupply. Three methods used for resupply are the supply point, unit, and throughput distribution methods. Figure 4-1, page 4-2, shows the flow of Class III/V supplies to the FARP.

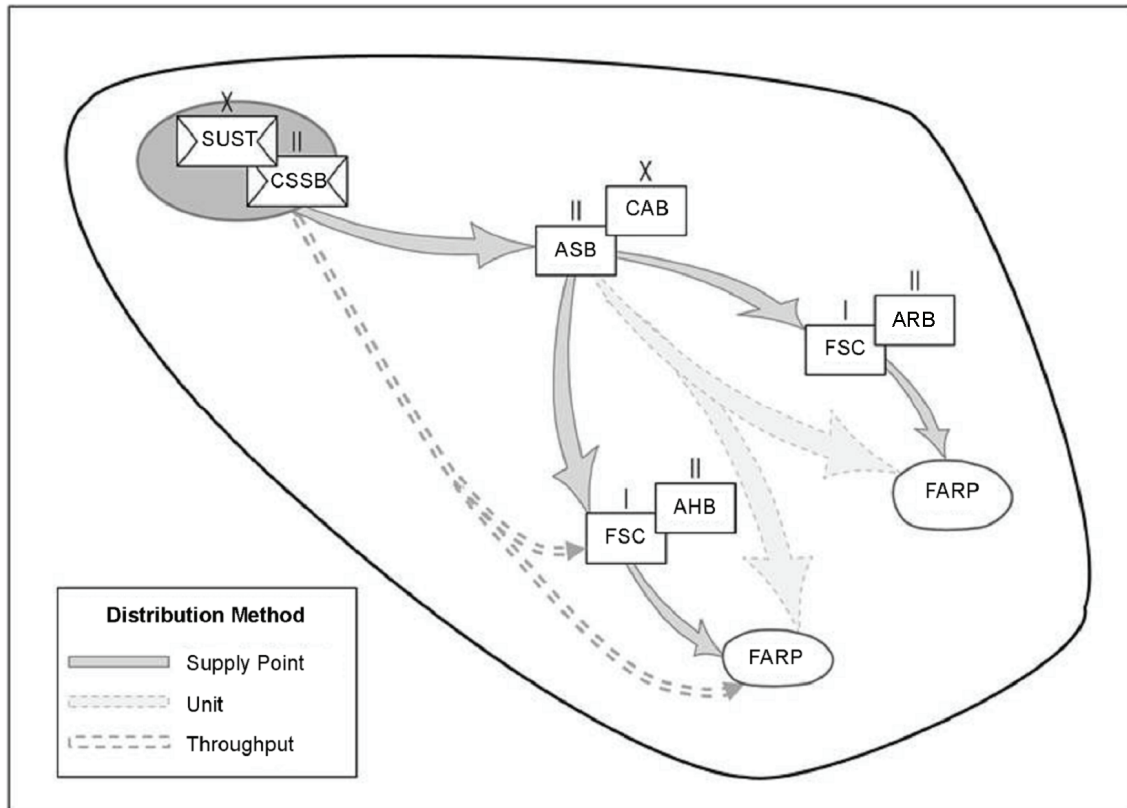

Figure 4-1. Flow of Class III/V supplies to the forward arming and refueling point

4-5. For the supply point distribution method, the supporting unit issues supplies to the supported unit at a supply point. The supported unit moves the supplies with its organic transport vehicles. With this method of resupply, the supported battalion's FSC distribution platoon moves to the ASB's fuel transfer point and/or ammunition transfer and holding point and transports Class III/V Bulk supplies to the FARP.

4-6. For the unit distribution method, the supporting unit issues and delivers supplies to the supported unit's location. With this method, the ASB distribution company delivers the Class III/V Bulk supplies either to the battalion FSC or directly to the FARP.

4-7. The throughput distribution method is similar to the unit method except shipments bypass one or more echelons in the supply chain to speed delivery forward to the end-users. Throughput distribution provides more efficient use of transportation assets, and supplies are handled or transloaded less.

4-8. Transloading of Class III Bulk to resupply the FARP should be kept to a minimum. Each time Class III Bulk is transloaded between carriers, the fuel must be tested by both the supplier and the recipient. Each transload of Class III Bulk increases the chance of contaminated fuel and delivery time.

CLASS III REQUIREMENTS

4-9. Two factors determine the amount of fuel required at a FARP: number of aircraft to be supported and duration of the mission.

4-10. The mission fuel requirement can be calculated as “mission duration multiplied by number of aircraft multiplied by fuel consumption in gallons per hour.” Table 4-1 depicts the fuel capacity and average consumption rates for helicopters that may need fuel in the FARP.

Table 4-1. Average fuel consumption rates

<i>Helicopter</i>	<i>Capacity (in gals)</i>	<i>Consumption rate (GPH)</i>
		<i>JP8</i>
AH-64A/D	370	175
CH-47D/F	1,030	514
OH-58D	112	44
OH-58D (armed)	112	110
UH-60A/L/M	362	175
UH-72A	225	80

4-11. Once fuel requirements have been calculated, the transportation needed to move fuel can be determined. If fuel shortages occur during the mission, the turnaround times to resupply points become a critical planning factor. If supplies are delivered by aircraft, planning may also include support for the CH-47 or UH-60 aircraft which carry the supplies.

CLASS V REQUIREMENTS

4-12. The battalion S-3 in conjunction with the S-4 calculates the amount of ammunition needed for the mission. For combat operations the S-4 will calculate the required supply rate (RSR) against the controlled supply rate (CSR). The RSR is the estimated amount of ammunition needed to sustain the operations of a combat force without restrictions for a specific period. RSR is expressed in rounds per weapon per day and is used to state ammunition requirements. The CSR is the rate of ammunition consumption. CSR is expressed in rounds per day per unit, weapon system, or individual support for a given period. The battalion S-4 compares the CSR against the RSR then remedies shortages by requesting more ammunition, cross-leveling, or prioritizing support. Once the Class V requirements have been determined, these figures can be used to calculate how much transportation will be required.

4-13. The approximate number of vehicles needed to transport the Class V products can be calculated using table 4-2.

Table 4-2. Cargo capacity comparison for ammunition

<i>Munitions</i>	<i>HEMTT</i>	<i>HEMAT</i>	<i>5-ton short bed</i>	<i>5-ton long bed</i>	<i>1½-ton trailer</i>
Hellfire	36	36	27	45	9
Stinger	54	72	36	54	9
Hydra 2.75-in	240	240	180	300	60
30-mm	10,368	10,368	10,560	10,560	2,640
.50-caliber	152,582	54,142	24,610	24,610	7,792

4-14. Transloading of Class V to resupply the FARP should be kept to a minimum. Each time Class V is transloaded between carriers the ammunition must be inventoried and receipted. Transloading Class V increases delivery time.

ARGON GAS

4-15. The OH-58D air-to-air Stinger system requires argon gas for missile seeker cooling. A fully charged coolant bottle (6,000 pounds per square inch) will provide forty 45-second engagements or ten 3-minute

engagements. Based on the mission and the anticipated usage, a supply of argon gas should be on hand. For additional information on air-to-air Stinger and argon refill requirements, see TM 1-1520-248-10 and TM 9-1440-431-23.

TRANSPORTATION

4-16. Resupply turnaround times are critical considerations during the planning sequence. The distance between the FARP and the resupply point, route conditions, and the threat level can directly affect continuous FARP operations. If it takes too long to get supplies, the unit's mission could be jeopardized because of a Class III/V shortage.

4-17. The convoy commander dictates normal speed, catch-up speed, and vehicle intervals during the convoy brief as determined by METT-TC according to the terrain, threat, and available assets. Speed determinations must also factor in additional considerations including—

- Physical characteristics of the roadway along the route (grades, sharp turns, and urban environments).
- Speed of the slowest vehicle based on capability, type, or weight of load.
- Weather conditions.
- Fatigue levels and experience level of vehicle drivers.
- Day, night, and blackout conditions.
- Types of convoy vehicles and their mechanical condition.
- Degree of urgency the convoy requires.
- Condition of the roads (dust, mud, snow, and ice).
- Presence of civilian vehicles on roads.

4-18. Interval distances may vary throughout the convoy route. The recommended interval distance is 75 and 100 meters between vehicles on open rural roads. Intervals in urban areas are more restricted, but sufficient intervals must be maintained to preserve maneuverability. Optimal timing should mitigate enemy effectiveness, maximize mutually supportive overlapping fires, and allow for a safe stopping distance between vehicles.

4-19. When resupply demand exceeds the available organic transport vehicles, several transportation options are available to the commander, including—

- Utilizing all available unit vehicles, not just the FSC vehicles.
- Coordinating support from the ASB distribution company.
- Coordinating CSSB throughput delivery to the FARP location.
- Prepositioning Class III/V Bulk at or near the FARP.
- Utilizing utility or cargo aircraft.

Appendix A

Standard Hand and Arm Signals

This appendix features common hand and arm signals used by FARP personnel. This appendix implements portions of standardization agreements (STANAGs) 3117 and 2999. For more detailed information on hand and arm signals, refer to FM 21-60.

PROCEED TO NEXT GROUND GUIDE

A-1. Position both arms extended on the same side at shoulder level to indicate direction of next ground guide (figure A-1).



Figure A-1. Proceed to next ground guide

THIS WAY

A-2. Position arms above head in vertical position with palms facing inward (figure A-2, page A-2).



Figure A-2. This way

MOVE AHEAD

A-3. Position arms slightly apart with palms facing backward and repeatedly moving upward and backward from shoulder height. Indicate the speed desired by rapidity of arm motions (figure A-3).



Figure A-3. Move ahead

TURN TO LEFT (PORT)

A-4. Position right arm down, and point to the left wheel or skid; move left arm repeatedly upward and backward. Indicate rate of turn by rapidity of arm motions (figure A-4).



Figure A-4. Turn to left (port)

TURN TO RIGHT (STARBOARD)

A-5. Position left arm down and point to the right wheel or skid; move right arm repeatedly upward and backward. Indicate rate of turn by rapidity of arm motions (figure A-5).



Figure A-5. Turn to right (starboard)

MOVE FORWARD

A-6. Extend arms horizontally to the side, beckoning upward with palms turned up. Indicate rate of ascent by speed of movement (figure A-6).

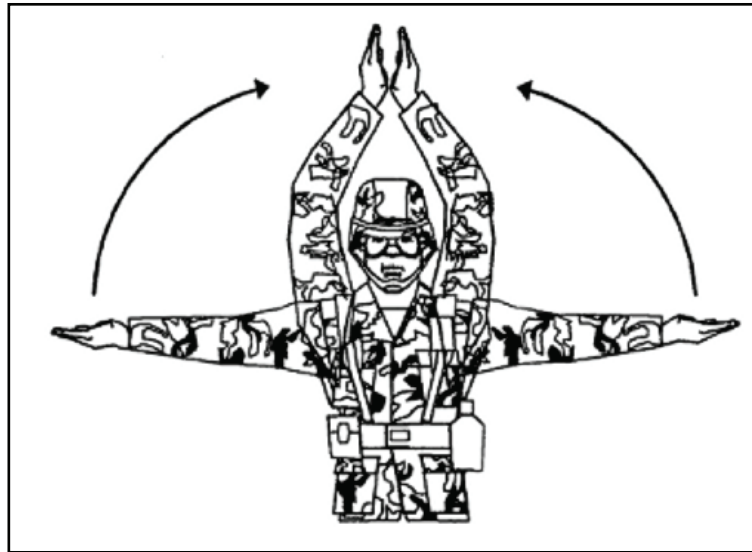

Figure A-6. Move upward

HOVER

A-7. Extend arms horizontally to the side with palms turned down (figure A-7).



Figure A-7. Hover

MOVE DOWNWARD

A-8. Extend arms horizontally to the side, beckoning downward with palms turned down. Indicate rate of descent by rapidity of arm motions (figure A-8).

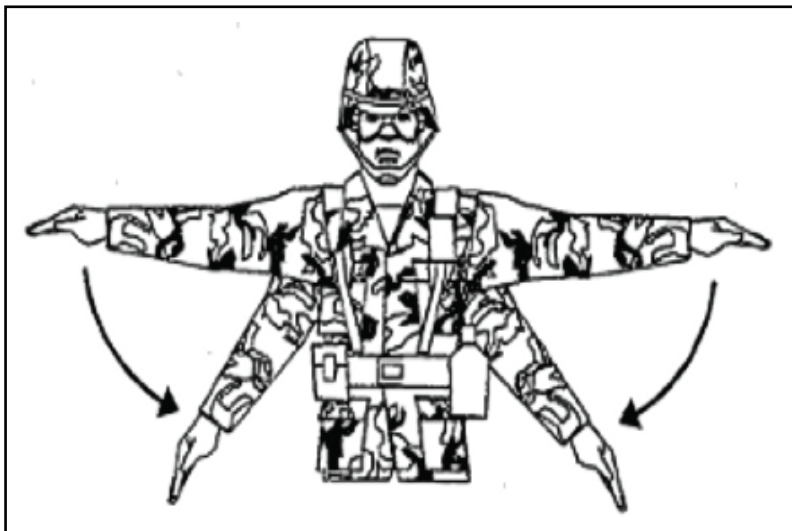

Figure A-8. Move downward

MOVE TO RIGHT

A-9. Extend left arm horizontally sideways in the direction of movement, swing right arm over the head in the same direction in a repeating movement (figure A-9).

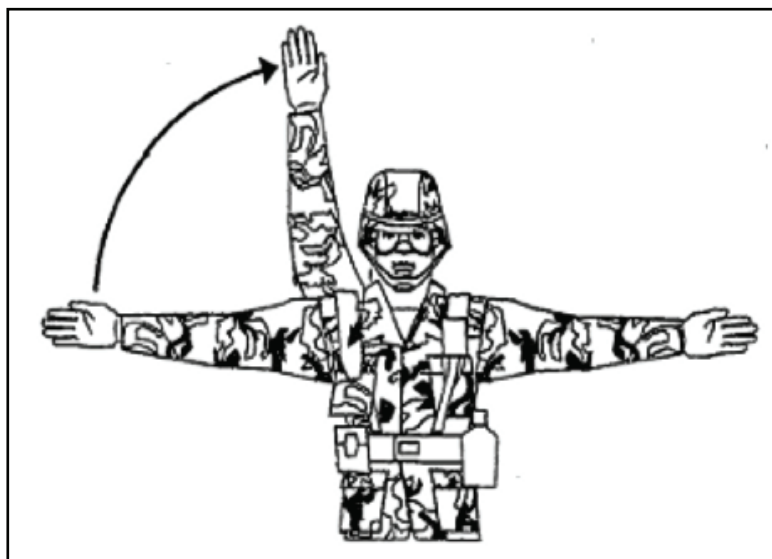

Figure A-9. Move to right

MOVE TO LEFT

A-10. Extend right arm horizontally sideways in the direction of movement, swing left arm over the head in the same direction in a repeating movement (figure A-10).

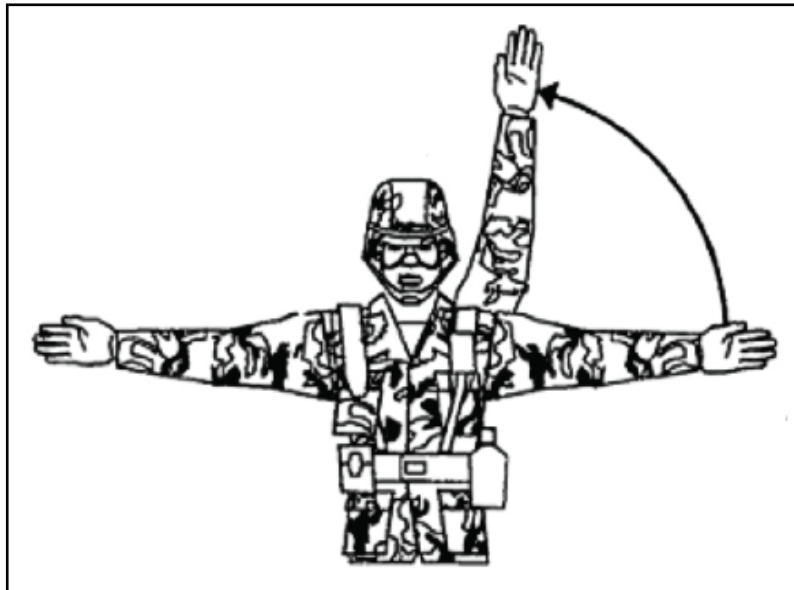

Figure A-10. Move to left

SLOW DOWN

A-11. Position arms down with palms toward the ground, move arms up and down repeatedly (figure A-11).



Figure A-11. Slow down

STOP

A-12. Cross arms above head with palms facing forward (figure A-12).



Figure A-12. Stop

FIRE

A-13. Make a rapid horizontal figure-eight motion at waist level with either arm, pointing at source of fire with the other (figure A-13).

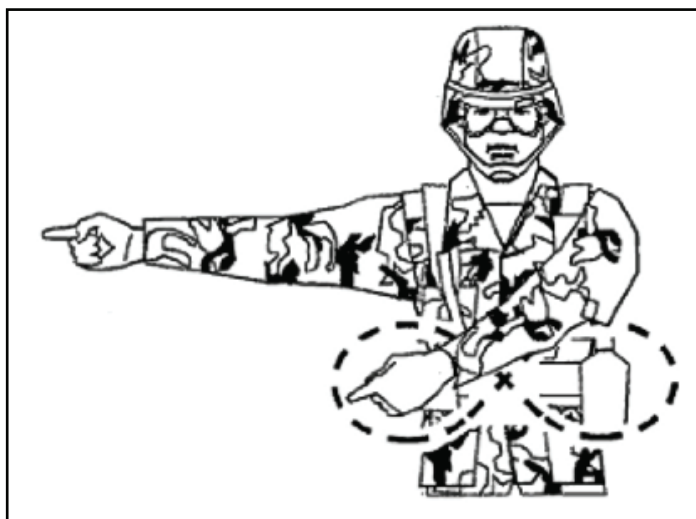

Figure A-13. Fire

WAVE OFF

A-14. Position arms over head, wave both arms (figure A-14).



Figure A-14. Wave-off

AFFIRMATIVE (ALL CLEAR)

A-15. Raise hand with thumb turned up (figure A-15).



Figure A-15. Affirmative (all clear)

NEGATIVE (NOT CLEAR)

A-16. Position arm out, hand below waist level, with thumb turned down (figure A-16).



Figure A-16. Negative (not clear)

MOVE BACK

A-17. Hold hands down by side; face palms forward with elbows straight. Repeatedly move arms forward and upward to shoulder height (figure A-17).

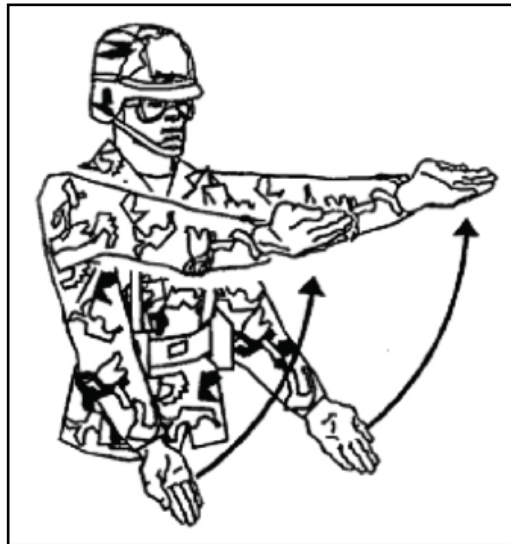

Figure A-17. Move back

LAND

A-18. Cross hands and extend arms downward in front of the body (figure A-18).



Figure A-18. Land

TAIL TO RIGHT (STARBOARD)

A-19. Point left arm down and move right arm from overhead vertical position to horizontal forward position. Repeat right arm movement (figure A-19).



Figure A-19. Tail to right (starboard)

TAIL TO LEFT (PORT)

A-20. Point right arm down and move left arm from an overhead vertical position to a horizontal forward position. Repeat left arm movement (figure A-20, page A-12).



Figure A-20. Tail to left (port)

CLEARANCE TO APPROACH AIRCRAFT

A-21. Perform a beckoning motion with right hand at eye level (figure A-21).



Figure A-21. Clearance for personnel to approach aircraft

CUT ENGINE(S) OR STOP ROTOR(S)

A-22. Extend either arm or hand to a level position with shoulder with palm facing down; draw the extended hand across neck in a “throat-cutting” motion (figure A-22).

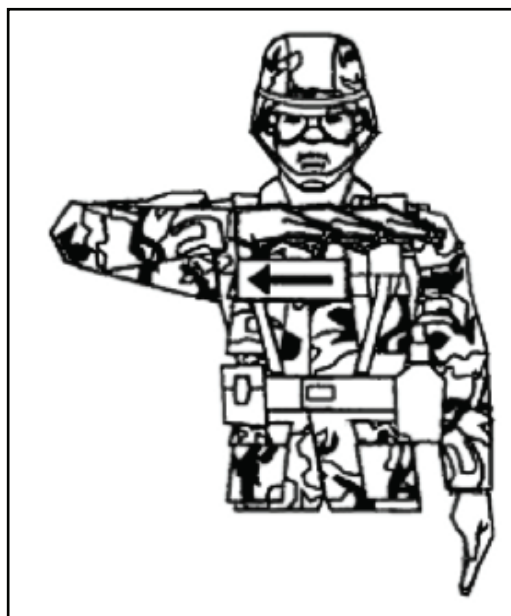

Figure A-22. Cut engine(s) or stop rotor(s)

CONNECT AUXILIARY POWER UNIT

A-23. The following are day and night hand and arm signals to connect APUs:

- **Day.** Extend hands overhead; push first two fingers of right hand into fist of left hand (figure A-23).
- **Night.** Same movement as day except the left-hand lighted wand is vertical and the right-hand lighted wand is horizontal.



Figure A-23. Connect auxiliary power unit (day)

DISCONNECT AUXILIARY POWER UNIT

A-24. The following are day and night hand and arm signals to disconnect APUs:

- **Day.** Extend hands overhead; pull first two fingers of right hand away from left fist (figure A-24, page A-15).
- **Night.** Same movement as day except the left-hand lighted wand is vertical and the right-hand lighted wand is horizontal.



Figure A-24. Disconnect auxiliary power unit (day)

HOOK UP LOAD

A-25. Create a rope climbing motion with hands (figure A-25).

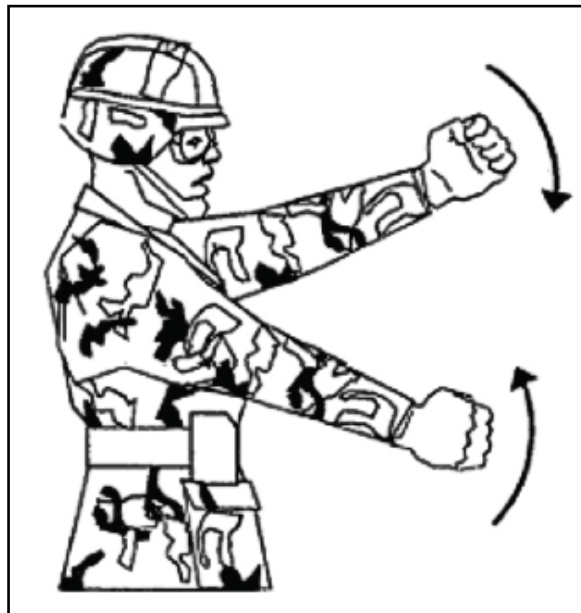

Figure A-25. Hook up load

RELEASE LOAD

A-26. Extend left arm forward horizontally with fists clenched; perform a slicing horizontal motion with right hand palm facing down below left arm (with palm facing down) (figure A-26).



Figure A-26. Release load

LOAD HAS NOT BEEN RELEASED

A-27. Bend left arm horizontally across chest with fist clenched and palm turned down; open right hand pointed up vertically to center of left fist (figure A-27).



Figure A-27. Load has not been released

INSTALL UNDERCARRIAGE PINS

A-28. The following are the day and night hand and arm signals for installing undercarriage pins:

- **Day.** Extend arms above head. The right hand clasps left forearm and the left fist is clenched (figure A-28).
- **Night.** Similar to the day signal, except the right wand is placed against the left forearm. The wand in the left hand is held vertically. (Downlocks/undercarriage pins).

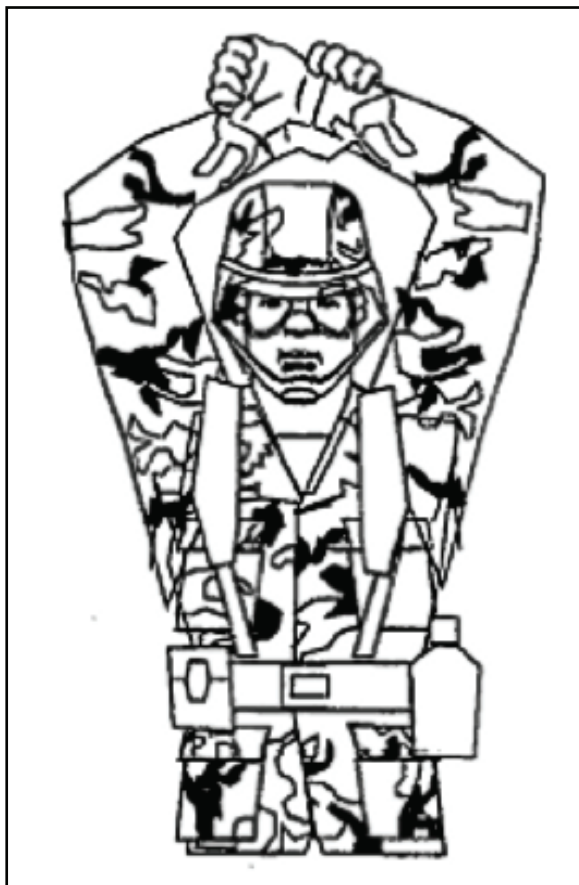

Figure A-28. Install (day)

REMOVE UNDERCARRIAGE PIN

A-29. The following are the day and night hand and arm signals for removing the undercarriage pins.

- **Day.** Extend arms and hands in “install-downlocks” position. The right hand unclasps the left forearm (figure A-29, page A-18).
- **Night.** Similar to the day signal, except the right wand is placed against the left forearm. (Downlocks/undercarriage pins).



Figure A-29. Remove (day)

ARMING SIGNALS

A-30. The following two graphics depict common ground hand signals (figures A-30, page A-19, and A-31, page A-20).

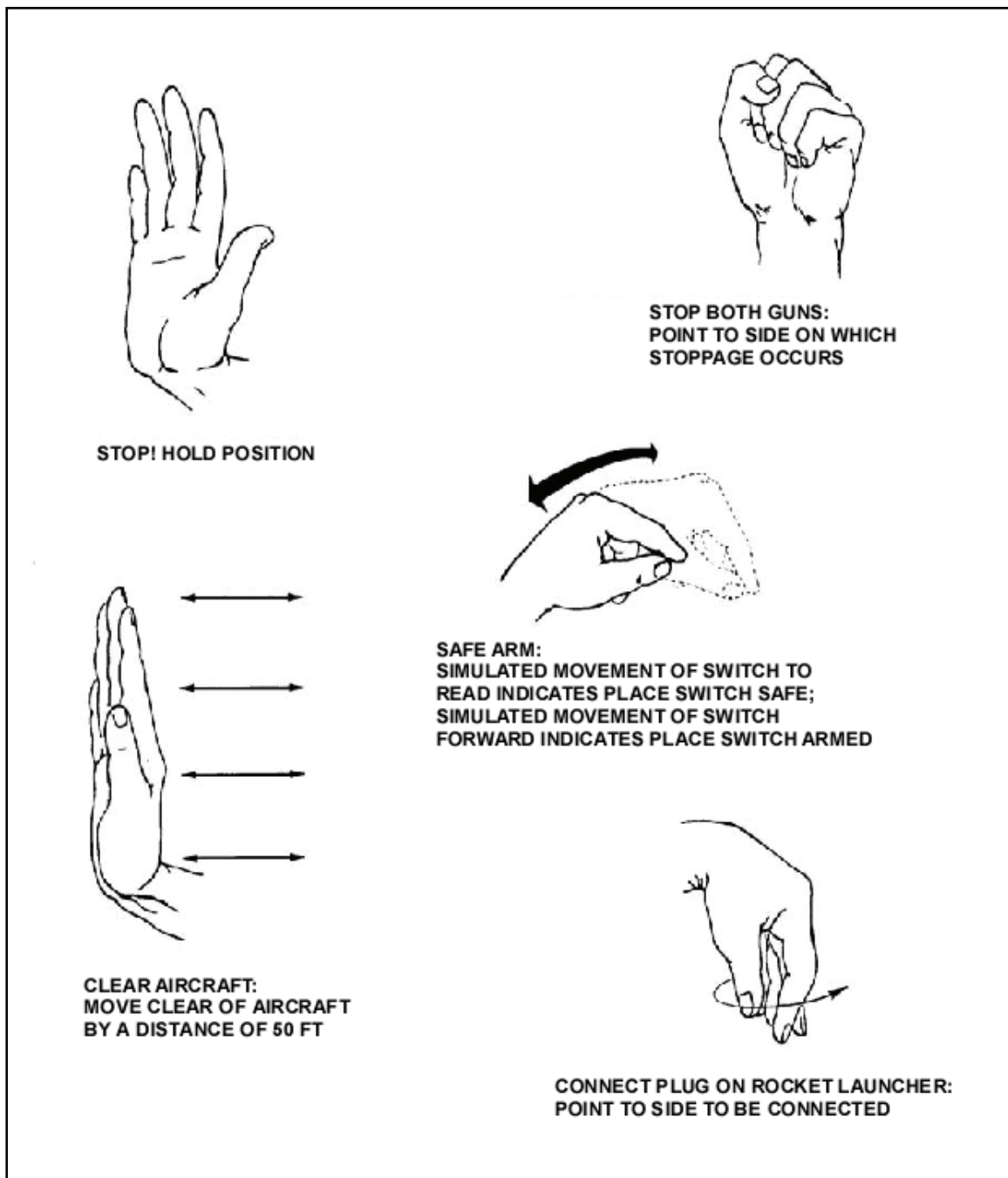

Figure A-30. Ground hand signals

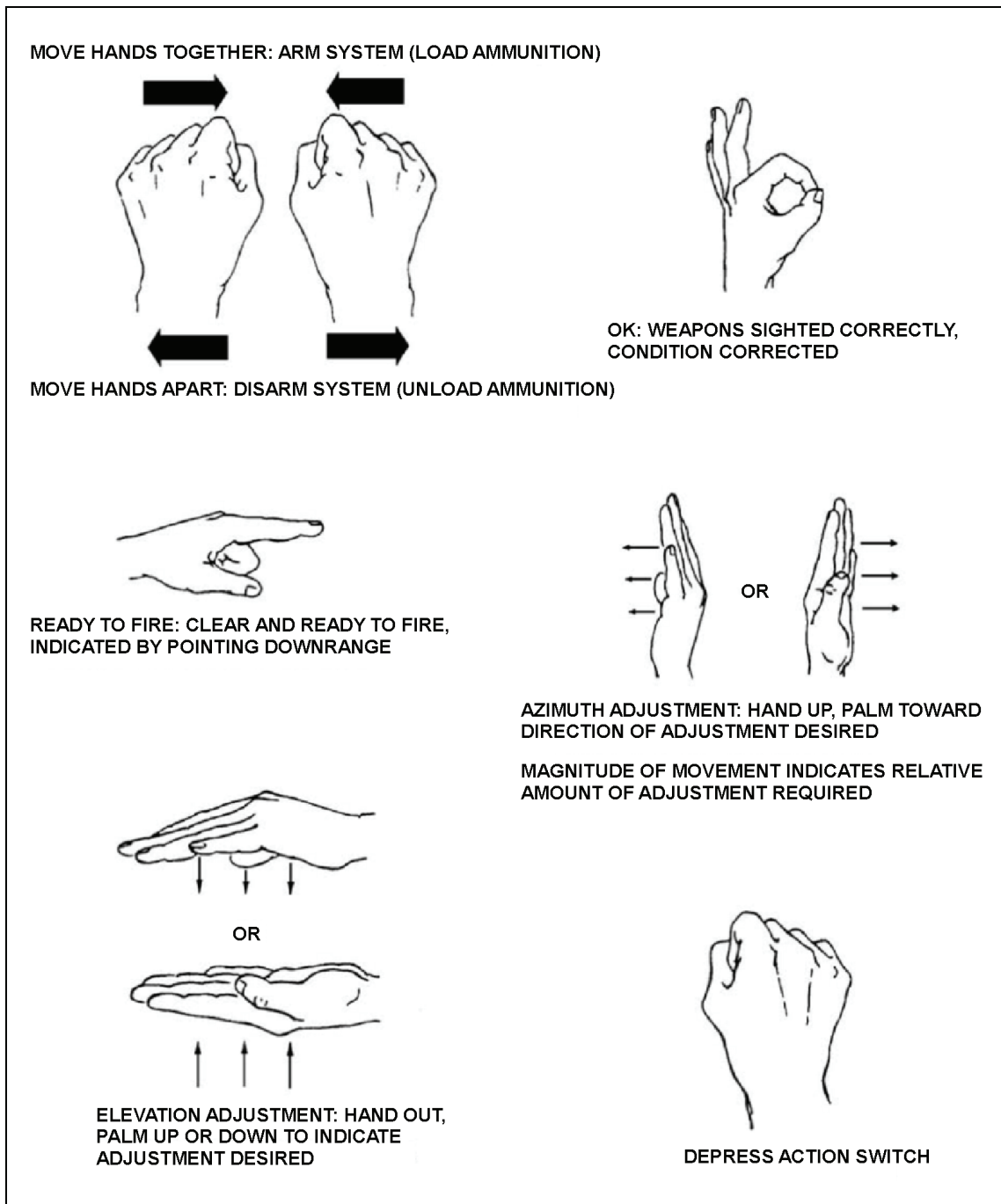

Figure A-31. Ground hand signals (concluded)

Appendix B

Load Plans

The M978 HEMTT tanker, M977 HEMTT cargo vehicle, and M989A1 HEMAT support FARP operations. Efficient loading of these vehicles will facilitate smooth operations and help ensure adequate support for the mission. This appendix provides suggested load plans for the M978 HEMTT, M977 HEMTT, and the M989A1 HEMAT.

HEAVY EXPANDED MOBILITY TACTICAL TRUCK TANKER

B-1. The HEMTT tanker can carry 2,500 gallons of fuel, of which 2,250 gallons are usable. When paired with the HTARS, the HEMTT tanker can simultaneously refuel four aircraft. Figure B-1 shows the front and rear views of the M978 HEMTT tanker.

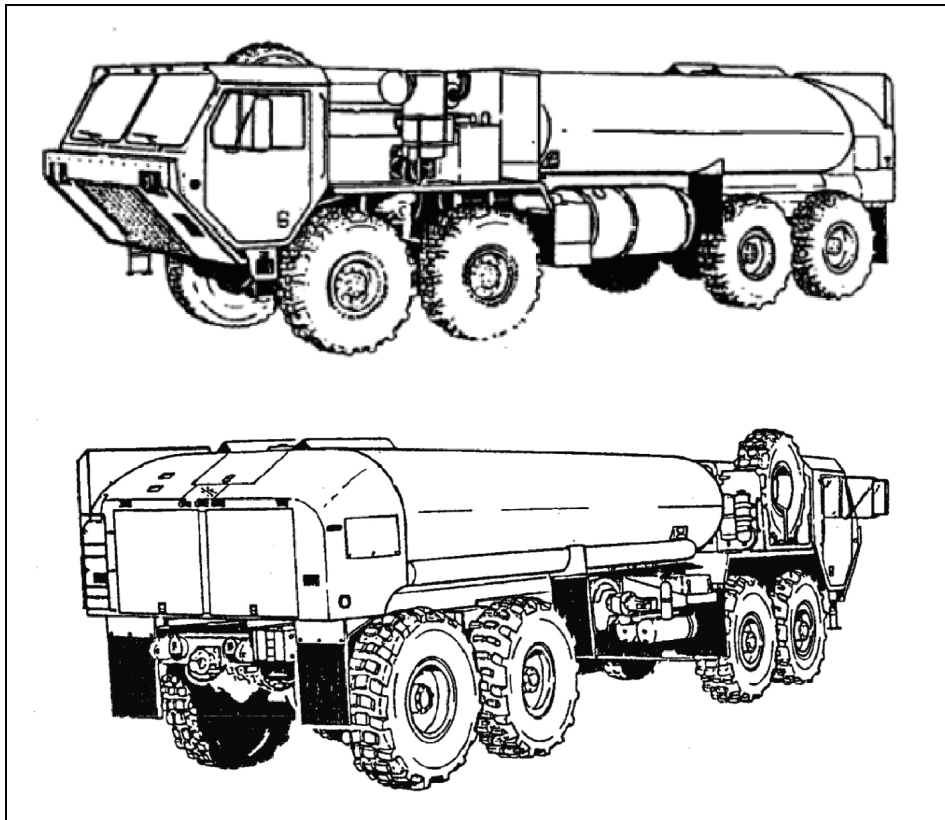

Figure B-1. M978 heavy expanded mobility tactical truck tanker

HEAVY EXPANDED MOBILITY TACTICAL TRUCK CARGO VEHICLE

B-2. The HEMTT cargo vehicle is equipped with a material-handling crane, which has a 2,500-pound load capacity at a 19-foot boom radius. The 18-foot cargo body can carry 22,000 pounds. When carrying ammunition, the HEMTT will exceed its available space capacity before exceeding its available weight limit. Figure B-2 shows the front and rear views of the M977 HEMTT cargo vehicle.

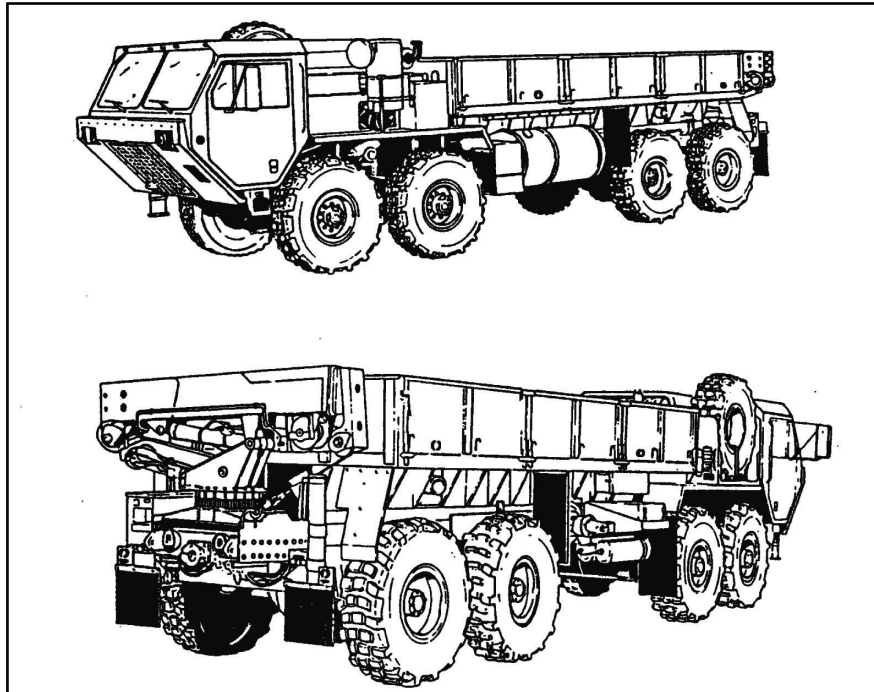

Figure B-2. M977 heavy expanded mobile tactical truck cargo vehicle

HEAVY EXPANDED MOBILITY AMMUNITION TRAILER

B-3. The HEMTT is the prime mover for the HEMAT. The HEMAT can carry 22,000 pounds. Figure B-3, page B-3, shows the M989A1 HEMAT. Figure B-4, page B-3, and figures B-5 and B-6, page B-4, show suggested ammunition load plans. Table B-1, page B-5, is the essential load plan key for figures B-4, page B-3, and figures B-5 and B-6, page B-4. Table B-2, page B-5, provides a guide for cargo planning and transportation requirements.

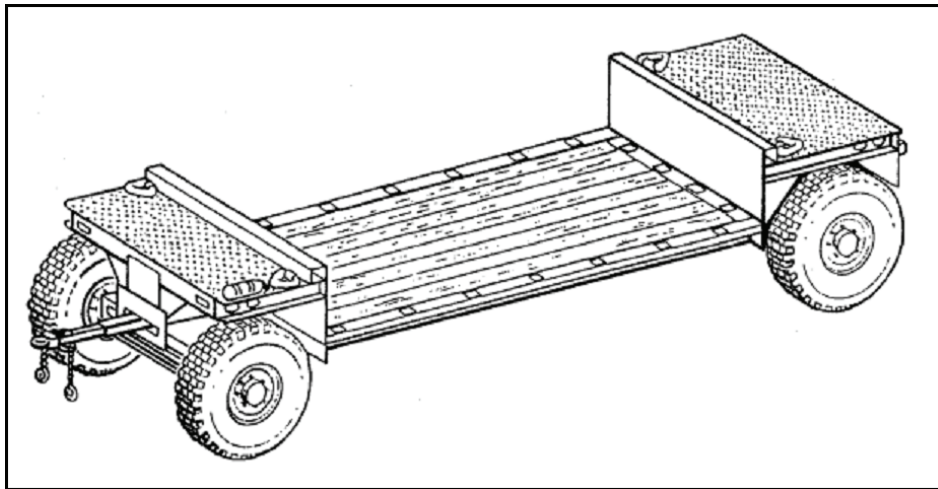

Figure B-3. M989A1 heavy expanded mobility ammunition trailer

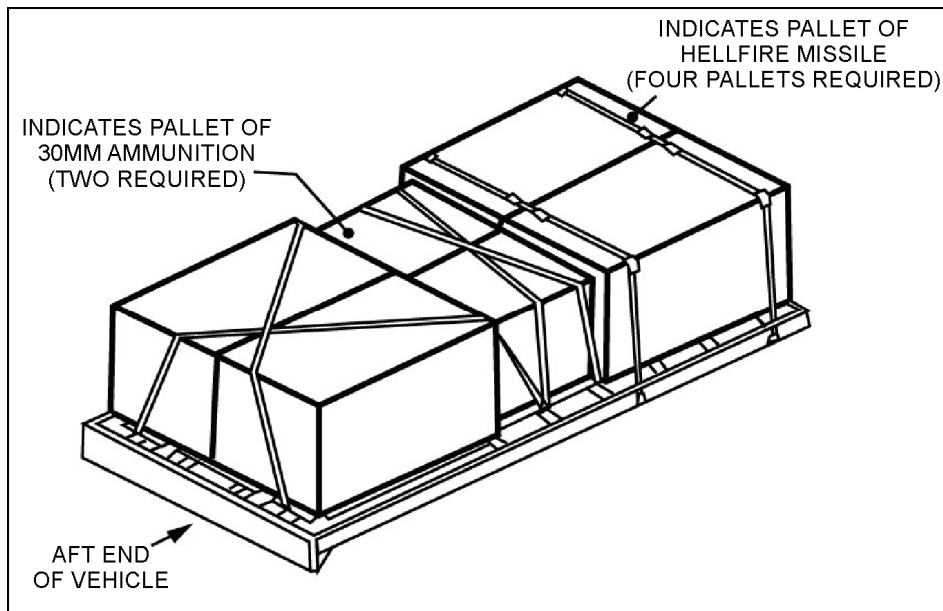

Figure B-4. Suggested ammunition load plan 1

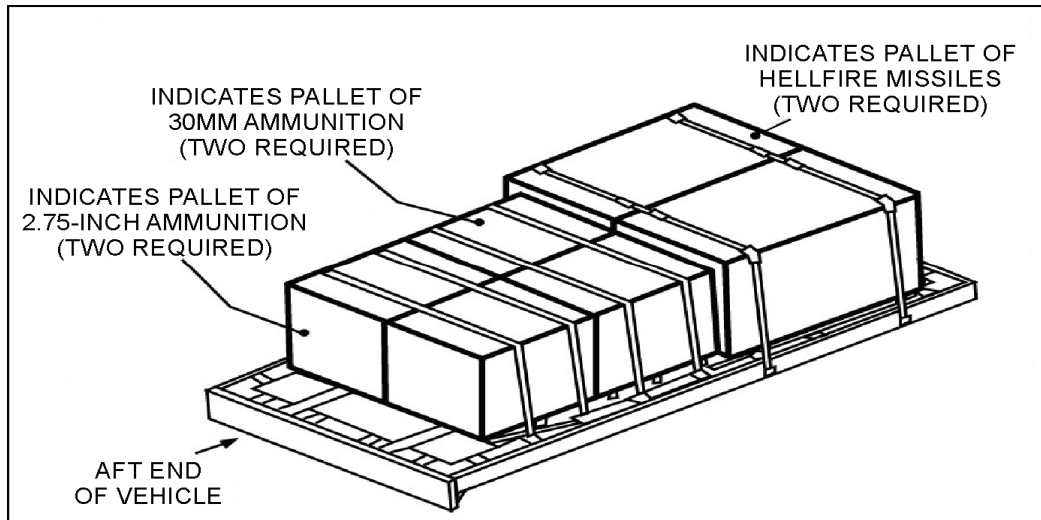

Figure B-5. Suggested ammunition load plan 2

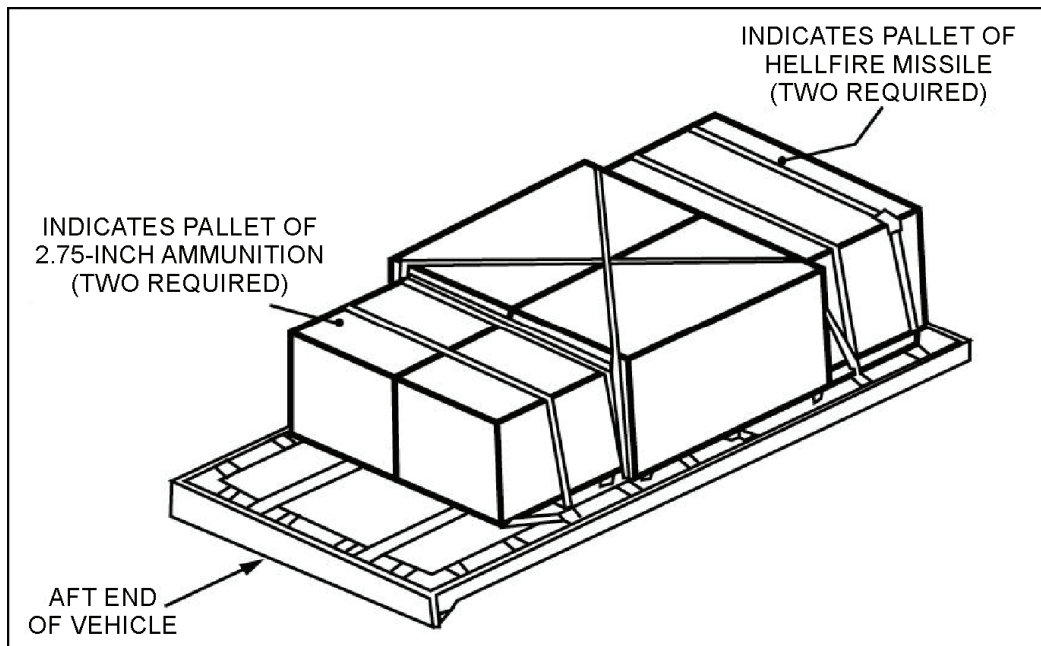

Figure B-6. Suggested ammunition load plan 3

Table B-1. Load plan key

<i>Load plan 1</i>		
<i>Item</i>	<i>Quantity</i>	<i>Approximated weight (lbs)</i>
30mm pallet	2	7,472
RF hellfire pallet	4	7,200
	Total weight	14,672
<i>Load plan 2</i>		
<i>Item</i>	<i>Quantity</i>	<i>Approximated weight (lbs)</i>
2.75-in rocket pallet	2	5,032
RF hellfire pallet	3	5,400
	Total weight	10,432
<i>Load plan 3</i>		
<i>Item</i>	<i>Quantity</i>	<i>Approximated weight (lbs)</i>
RF hellfire pallet	2	3,600
30mm pallet	2	7,472
2.75-in rocket pallet	2	5,032
	Total weight	16,104

Table B-2. Cargo planning and transportation requirements

	<i>HEMTT-C</i>	<i>HEMAT</i>
Hellfire	27 (3 pallets)	18 (2 pallets)
Rockets	336 (7 pallets)	240 (5 pallets)
30mm	15840	13200
Fuel	2500 (1 tank)	

This page intentionally left blank.

Appendix C

Forward Arming and Refueling Point Planning Checklist

The FARP mission requires the platoon leader to consider certain critical elements during the planning, preparation, and execution phases of the operation. This appendix (table C-1) provides a sample planning checklist. This checklist is not all inclusive but is provided for units to develop specific planning checklists.

Table C-1. Sample forward arming and refueling point planning checklist

<i>Emplacement plan</i>
Air and ground.
Resupply route clearance.
<i>Movement plan</i>
Major supply route clearance.
Advance and/or quartering parties.
Movement of assets (separate serials).
Convoy briefing.
<i>Security plan</i>
ADA.
CBRN (M8 alarms).
Perimeter.
<i>Site layout</i>
Sketch or diagram.
Availability of FARP site layout to personnel before the mission begins.
Pilots' brief.
Traffic pattern, HAs, airspace control measures (ACM), fire support coordination measures, and pad locations.
Number of points and type of nozzles at each point.
Duration of the mission (number of turns).
Class III/V estimate versus amount on hand.
Simultaneous rearming and refueling.
Resupply.
Certification and safety of FARP plan.
Designated maintenance area.
Enemy.
Threat briefing from the S-2.
Threat weapon system ranges (artillery).
CBRN threat.
<i>Command, control, and communication</i>
Radios (primary and alternate frequencies).
Lost communications procedures.

**Table C-1. Sample forward arming and refueling point planning checklist
(continued)**

Command, control, and communication
Lighting.
CBRN decontamination (dirty FARP plan).
Location (on graphics).
Pilot decontamination team awareness.
Signals (emergency, hand, and arm).
Extraction and displacement plan.
Event-driven (decision point based on enemy situation).
Communications (decision authority for the FARP moves).
Subsequent location.
Preparation
Troop leading procedures (warning order, pre-combat inspection, and rehearsal).
Site preparation (FOD and police call).
Personnel (qualified and trained, technical inspectors, and combat lifesavers).
Equipment
Equipment is working and available.
Boresighting of the aircraft.
Loading of Class V onto the aircraft.
Platoon briefing
Mission.
Friendly situation.
Enemy situation.
Graphics on maps.
Compliance with SOPs.
Pilot briefing
Layout.
FARP location(s).
Procedures/traffic pattern.
ATS support (METT-TC dependent?).
Operation time.
Frequencies (primary/alternate).
Ammo availability.
ACM/fire support coordination measures in affect.
Execution
Plan versus reacting.
Enforce FARP turnaround times.
Gather and compile Class III/V pre- and post-mission statistics.
Ensure safe operations.
Supply
Coordinate resupply activities to take place during darkness or limited visibility conditions.
Coordinate with the S-4 for transportation of all classes of supply.

Appendix D

Environmental Protection Considerations

The successful blending of military missions with environmental challenges is of utmost importance to commanders. Conserving, protecting, and restoring our natural and cultural resources is a top priority for the Army.

ARMY ENVIRONMENTAL MANAGEMENT POLICY

D-1. The Army maintains stewardship of over 20 million acres of land. The Army's guiding principle is that work and actions be environmentally sustainable. The Army's Environmental Management Policy—

- Integrates environmental consideration into all Army activities.
- Allocates resources and training to protect the environment.
- Ensures installation operations are environmentally acceptable and enhances the life of military and civilian members.
- Minimizes the generation of waste.
- Cleans up sites of past contamination.

D-2. The Army's environmental management policy is contained within AR 200-1. Commanders must comply with AR 200-1 in order to ensure an effective environmental policy.

LIABILITY

D-3. Civil and criminal penalties are associated with improper environmental management. Commanders are ultimately responsible for enforcing Federal regulations or policies and should be familiar with the following acts:

- Clean Air Act.
- Hazardous Materials Transportation Act.
- Occupational Safety and Health Act.
- Resource Conservation and Recovery Act.
- Safe Drinking Water Act.
- Toxic Substances Control Act.

D-4. Penalties vary by statute and include fines per day of violation and imprisonment from 1 to 15 years. In case of civil enforcement, the installation and its budget would suffer the consequences of a violation. Commanders must understand direct participation in the violation of an environmental statute could subject them to prosecution in federal district court.

D-5. The commander must act promptly to correct environmental violations. Failure to correct environmental violations could result in prosecution with or without direct involvement in the violation. If violations do occur, the best course of action for the commander is to inform the appropriate regulatory authorities immediately and engage in good faith efforts to comply.

SPILL DEFINITIONS

D-6. A spill is broadly defined as a release of any kind of a petroleum product or hazardous substance into the environment. Spill reaction is based largely on the nature of the material spilled. The three types of spills are—

- **Small priming spill.** A small priming spill covers less than 18 inches in all directions.
- **Small spill.** A small spill extends less than 10 feet in any direction, covers less than 50 square feet, and is not continuous.
- **Large spill.** A large spill extends farther than 10 feet in any direction, covers an area in excess of 50 square feet, or is continuous.

D-7. Reportable oil spills are defined as any spill reaching a stream, creek, river, or any other body of water in harmful quantities. Any oil spill with the potential to come into contact with the local water table will be reported. Harmful quantities violate water quality standards and cause a film, sheen, or discoloration to the surface of the water or adjoining shorelines. They also cause sludge or emulsion to be deposited beneath the surface of the water or upon adjoining shorelines.

D-8. The information relative to spill size and reportable spills discussed in this chapter applies only to oil spills and not to hazardous substances. The commander or on-site coordinator is the only person authorized to report spills. Commanders or on-site coordinators will report spills of any kind they deem significant, including any spill resulting in fire or explosion.

SPILL DISCOVERY

D-9. The initial component in the spill-response plan is discovery. The primary responsibility of a discoverer is to notify the proper authorities who are trained and equipped to deal with an environmental incident. When a spill is discovered, the discoverer will—

- Use personal protective equipment (PPE), including gloves, goggles, and suits.
- Extinguish all cigarettes.
- Perform the spill-drill REACT:
 - Remove the source.
 - Envelop the spill.
 - Absorb/accumulate.
 - Containerize the hazardous waste (HW).
 - Transmit a report.

D-10. Defensive actions should begin as soon as possible to prevent or minimize damage to public health and welfare or to the environment. Some general actions include—

- Eliminating sources of sparks or flames.
- Controlling the source of the discharge.
- Placing physical barriers, such as berms or dikes, to deter the spread of the oil.
- Preventing the discharge of contaminated water into storm drains or the sewer system.
- Recovering the oil or minimize its effects.

D-11. Place recovered oil and contaminated absorbents, such as rags, in Department of Transportation-approved containers for disposal as HW.

SPILL CLEANUP

D-12. Specific actions to be taken for oil spills (small priming, small, and large spills) are discussed below. The commander or on-site coordinator will direct cleanup operations.

REACTING TO A SMALL PRIMING SPILL

D-13. By reacting quickly, personnel eliminate hazards that could cause injury. Reacting quickly also limits the time the spill has to seep into the ground, which makes cleanup easier and helps protect water resources. Once the body and skin has been appropriately protected from exposure to hazardous materials, solutions or liquids, the following precautions should be followed:

- Remove the source:
 - If dripping occurs from the fuel source, stop the drip with a wooden plug or putty.
 - If from a leaky connection, tighten the connection or replace the broken parts.
- Envelop the spill:
 - If flowing, put an absorbent sock or pad down to catch the flow.
 - Use a shovel to build a small dam or berm.
- Absorb/accumulate:
 - If on a hard surface, put down dry sweep.
 - If on a gravel or mud surface, lay an absorbent sock or pad on the spill.
- Containerize the HW:
 - Place used absorbent material in a plastic bag or container.
 - Use the on-vehicle equipment shovel or entrenching tool to dig up the contaminated soil and place it in a container or plastic bag. Be sure to bring the container or bag to a proper HW collection point.
- Transmit a report:
 - Inform the supervisor of what was spilled and the action taken to resolve the spill.
 - Report regulatory enforcement actions and reportable spills through command channels according to AR 200-1.

REACTING TO SMALL AND LARGE SPILLS

D-14. After personnel have protected themselves from exposure, the following actions will be performed:

- Remove the source:
 - Attempt to stop the flow from the container.
 - Place the leaking container into another container or try to catch the leak with another container.
 - Secure the area.
- Envelop the spill:
 - Retrieve the nearest spill response kit.
 - Put the booms at the bottom of the flow or dig a dike/berm to stop the flow into streams.
- Absorb/accumulate:
 - Place the appropriate absorbent material (dry sweep, pads) on the spill in the middle of the boomed-off area.

- Containerize the HW:
 - Use a shovel to place contaminated materials (including soil, booms, pads or other materials) in a plastic bag or a waste drum.
- Transmit a report:
 - If a spill is too large to handle alone, follow REACT procedures and seek help immediately.

ASSESSMENT

D-15. Every step of the spill-response process requires each responding individual to continually assess the situation and take the next appropriate action. Upon initial discovery, the discoverer and/or supervisor will compile the following information:

- Time and type of incident.
- Name and quantity of spilled material involved (to the extent known) and the rate of release.
- Direction of the spill vapor or smoke release.
- Fire and/or explosion possibility.
- Coverage area of the spill and intensity of any fire or explosion.
- Extent of injuries (if any).
- Status of cleanup.
- Whether a spill team is on-site or en route.
- Whether a spill team is adequate.
- Estimated time to completion.
- Name of commander and contact information.

D-16. The commander or on-site coordinator will determine the appropriate response based upon the potential risks associated with the spill and whether an imminent or actual threat exists to human health or the environment. The appropriate notifications will be made, and the response team dispatched to control, contain, and clean up any spilled material if the following situations occur:

- The spill could result in the release of flammable or combustible liquids or vapors, thus causing a fire- or gas explosion hazard.
- The spill could cause the release of toxic liquids or fumes.
- The spill can be contained on the site, but the potential exists for ground water contamination.
- The spill cannot be contained on the site, resulting in off-site soil contamination and/or surface-water contamination.

SPILL KITS

D-17. Spill kits (figure D-1, page D-5) should be maintained in and around all locations where hazardous material (HM)/HW is stored, handled, or disposed of. Various types of kits can be ordered through the Army supply system and should include rubber gloves, safety goggles, putty, a rubber mallet, wooden plugs, absorbent booms, absorbent pads, plastic bags, and, in some cases, a disposal barrel.



Figure D-1. Spill kit

HAZARDOUS MATERIAL/HAZARDOUS WASTES SUPPLIES

CONTAINERS

D-18. The following are Department of Transportation containers, or equivalent, with a brief description. These national stock number (NSN) items are available through the Army supply system:

- 8105-00-848-9631; Bag, polyolefin, 5 milliliters, 36 x 54 inches.
- 8125-00-174-0852; Bottle, plastic, 1 gallons (Polyethylene).
- 8125-00-731-6016; Bottle, plastic, 13 gallons.
- 8125-00-888-7069; Bottle, plastic, 5 gallons.
- 8110-00-254-5719; Drum, steel, 1 gallons.
- *8100-00-128-6819; Drum, steel, 1 gallons (17C).
- *8110-00-254-5722; Drum, steel, 4 gallons.
- *8110-00-282-2520; Drum, steel, 5 gallons (17C).
- *8110-00-254-5713; Drum, steel, 6 gallons (with ring).
- *8110-00-366-6809; Drum, steel, 30 gallons (17C).
- *8110-00-030-7779; Drum, steel, 30 gallons.
- *8110-00-030-7780; Drum, steel, 50 gallons (17C).
- *8110-00-823-8121; Drum, steel, 55 gallons (17M).
- *8110-01-282-7615; Drum, polyethylene, 55 gallons.
- *8110-01-101-4055; Disposal drum, steel, 85 gallons (no lining).
- *8110-01-101-4056; Recovery drum, steel, 85 gallons (Epoxy Phenolic lining).
- *8110-01-101-4055 Drum, HM.

Note. *Refers to open top containers.

D-19. For information on bung containers, refer to Federal Logistics or contact your S-4 for assistance.

ABSORBENT

D-20. The following is a list of absorbent materials and their associated NSNs.

- 5640-00-801-4176; Insulation thermal vermiculite (UI bag) (packaging material).
- 4235-01-423-1466; Loose absorbent, 1 cubic feet bag (4 each per box).
- 4235-01-423-0711; Loose absorbent, 2 cubic feet bag (3 each per case).
- 4235-01-423-1463; Pads, 18 inches x 18 inches x 3 inches (30 each per box).
- 4235-01-423-1465; Socks, 4 inches x 8 feet (10 each per box).
- 4235-01-423-1467; Socks, 2 inches x 10 feet (20 per box).
- 4235-01-423-2787; Boom with clamps, 10 inches x 10 feet.

SPILL KITS

D-21. The following is a list of spill kits available through the Army supply system. For further information on spill kits, visit the LOGSA Web site (www.logsa.army.mil).

- 4235-01-432-7909 includes:
 - Four 18-inch x 18-inch pads.
 - Two 2-inch x 5-foot socks.
 - One 3/4-cubic feet bag.
 - Two waste disposal bags.
 - One water-resistant nylon tote bag.
- 4235-01-432-7912 includes:
 - One 25-gallon drum with seven 8-inch x 18-inch x 3-inch pads.
 - One 4-inch x 8-foot sock.
 - Two 4-inch x 4-foot socks.
 - One 3/4-cubic feet bag.
 - Two Tyvek suits.
 - Two pairs of nitrile gloves.
 - One pair of safety goggles.
 - Three disposable bags.
- 4235-01-423-7214 includes:
 - One 55-gallon drum with fifteen 18-inch x 18-inch x 3-inch pads.
 - Two 4-inch x 8-foot socks.
 - Two 4-inch x 4-foot socks.
 - Three 3/4-cubic feet bags.
 - Three Tyvek suits.
 - Three pairs of nitrile gloves.
 - Three pairs of safety goggles.
 - Five disposal bags.
- 4235-01-423-7221 includes:
 - One 55-gallon drum with ten 18-inch x 18-inch x 3-inch pads.
 - Five 2-foot x 10-foot socks.

- Five 3/4-cubic feet bags.
- Two quarts of emulsifier.
- Two pairs of nitrile gloves.
- One folding shovel.
- One 3.5-gallon bucket.
- Two Tyvek suits.
- Two pairs of safety goggles.
- One scoop.
- Five disposal bags.

This page intentionally left blank.

Appendix E

Comprehensive Risk Assessment for Forward Arming and Refueling Points

The risk management cycle for FARPS is tied directly to the training and maintenance process. Risk management is the process of identifying, assessing, and controlling risks arising from operational factors and making decisions that balance costs with mission benefits. Figures E-1 and E-2, page E-2, are risk assessment matrices for use by units to mitigate risk and balance costs with mission benefits.

SUBTASK	HAZARDS	INITIAL RISK LEVEL	CONTROLS	RESIDUAL RISK LEVEL	HOW TO IMPLEMENT	HOW TO SUPERVISE (WHO)	WAS CONTROL EFFECTIVE
Aviation operations	Failure to mark and identify obstacles. Improper layout of FARP.	High	Survey area of operation and establish hazard maps and restricted flight areas as first order of business	Med	Verbal OPORD Briefing ATP 3-04.94	Direct Supervision PCC/PCI	Yes
	Foreign object damage (FOD).	Med	Ensure that approach departure, and FARP areas are clear of loose items that could be affected by rotorwash. Perform FOD checks following maintenance.	Low	Verbal OPORD Briefing ATP 3-04.94	Direct Supervision PCC/PCI	Yes
	Working around aircraft during rearm and refuel.	High	Approach aircraft as specified in TM and follow all directions from the crew and only approach when signaled to do so. No horseplay around aircraft.	Med	Verbal OPORD SOP ATP 3-04.94	Direct Supervision PCC/PCI	Yes
	Damage to aircraft and injury to personnel from inadvertent movement of aircraft on FARP without permission.	High	Brief movement procedures prior to FARP operations. Single source authorization for movement only.	Med	Verbal OPORD Briefing	Direct Supervision PCC/PCI	Yes
	Aircraft collision on approach and takeoff	Med	Aircraft sequencing will be strictly controlled and adhered to. No movement will take place without proper authorization of FARP OIC.	Low	Verbal OPORD Briefing	Direct Supervision PCC/PCI	Yes
	Accidental firing of ordinance	Med	Follow proper dearming procedures as specified in TM prior to landing at FARP.	Low	Verbal OPORD SOP Aircraft Checklist	Direct Supervision PCC/PCI	Yes
Aircraft refueling	Environmental contamination.	Med	Ensure fuel handlers are familiar with and adhere to FM 10-67-1 and ATP 3-04.94 procedures. Continuously inspect fuel storage, handling, and working areas for hazardous conditions. Ensure spill kits and equipment are available. Develop an emergency spill response plan and ensure FARP personnel are familiar with it.	Low	Verbal OPORD ATP 3-04.94 FM 10-67-1	Direct Supervision PCC/PCI	Yes
	Fuel contamination	Med	Keep caps and covers on systems Purge tanks and lines at the beginning and end of operations. Use only clean, serviceable hoses and nozzles.	Low	Verbal SOP Briefing	Direct Supervision PCC/PCI	Yes
	Ignition of fuel/fire.	Med	Brief personnel and rehearse the fire plan and fire fighting techniques. No smoking except in designated areas. Brief fuel shut-off procedures to all personnel.	Low	Verbal SOP Briefing	Direct Supervision PCC/PCI	Yes
	Lack of proper fire extinguishers and fire-fighting equipment.	Med	Ensure the correct type of fire extinguishers are available and ready (inspected). Place fire extinguishers at each pad and fuel point.	Low	Verbal SOP Briefing	Direct Supervision PCC/PCI	Yes
	Personnel hazards-noise, fuel contamination, and fatigue	Med	Proper PPE will be worn at all times within the FARP operating area to include: hearing protection and eye protection. Fuelers must wear fire retardant gear and gloves.	Low	Verbal OPORD SOP ATP 3-04.94	Direct Supervision PCC/PCI	Yes

Figure E-1. Comprehensive risk assessment for forward arming and refueling points (part 1)

Appendix E

SUBTASK	HAZARDS	INITIAL RISK LEVEL	CONTROLS	RESIDUAL RISK LEVEL	HOW TO IMPLEMENT	HOW TO SUPERVISE (WHO)	WAS CONTROL EFFECTIVE
Aircraft maintenance and rearming operations	Accidental ordnance detonation or firing.	High	Ensure proper grounding of aircraft and safety pins are installed on the firing racks. Enforce proper power down procedures on all weapons systems.	Low	Verbal OPORD Briefing ATP 3-04.94	Direct Supervision PCC/PCI	Yes
	Personnel injury-slipping, tripping, or falling.	Med	Conduct safety briefing prior to the FARP going "hot."	Low	Verbal SOP Briefing	Direct Supervision PCC/PCI	Yes
	Inadvertent movement of the weapon system during rearm/dearm.	Med	Pilots ensure all weapons systems are powered down correctly. Communication with the pad chief ensures this is conducted prior to loading live ammunition.	Low	Verbal SOP Briefing	Direct Supervision PCC/PCI	Yes
	Adverse weather/wildlife.	Med	Communicate weather conditions with FARP OIC, allowing a decision for loading/unloading procedures to begin or end. Wildlife will be left alone at all times.	Low	Verbal SOP Briefing ATP 3-04.94	Direct Supervision PCC/PCI	Yes
	Hot/cold injuries	Med	Identify hot/cold weather injuries prior to a "hot" FARP. Implement precautions to prevent injuries (warming tent, air conditioned shelter, expendable for shop, portable, aircraft maintenance).	Low	Verbal OPORD Briefing ATP 3-04.94	Direct Supervision PCC/PCI	Yes
	Dropping munitions	Med	Enforce requirement to have two qualified personnel to arm aircraft. Practice and reinforce proper lifting techniques with ground handling equipment.	Low	Verbal SOP Briefing ATP 3-04.94	Direct Supervision PCC/PCI	Yes
	Improper tank vehicle or fuel supply operations	Med	Ensure properly trained and experienced personnel are the only authorized ones to handle, inspect, and utilize equipment.	Low	Verbal SOP Briefing	Direct Supervision PCC/PCI	Yes
	Static electricity	Med	Proper bonding and grounding procedures. Prohibit operation of high frequency radios within 100 feet of the FARP.	Low	Verbal SOP Briefing	Direct Supervision PCC/PCI	Yes

Figure E-2. Comprehensive risk assessment for forward arming and refueling points (part 2)

Appendix F

Forward Arming and Refueling Point Site Inspection Checklist

The aviation safety officer (ASO) or the commander's designated representative and the FARP OIC should work in a collaborative effort to safe the FARP prior to starting FARP operations. Table F-1 is a sample checklist to be used by both the ASO and the FARP OIC to ensure the FARP is safe for operations. Units are encouraged to add to this checklist as their operations dictate.

Table F-1. Forward arming and refueling point site inspection checklist

FARP:	
1	Are daily logs being kept on Aqua-Glo testing?
2	Is the unit conducting monthly fuel filter effective tests and keeping a log?
3	Date of last fuel sample taken? Is it current?
4	Are the berm liners the correct size for the bags being used?
5	Are the berm liners securely fastened at the top of all berms?
6	Are the berm liners free of tears and worn spots?
7	Does the bag have the date of its inspection stenciled on it?
8	Is the date stenciled on the side of the last filter separator filter changed (for each bag)?
Safety equipment	
9	Are the fire extinguishers present for each pump assembly and one for each nozzle? (Minimum size is 20 lbs).
10	Is sufficient water available to wet fuel soaked clothes before removal?
11	Are spark proof flashlights (chemical lights) available for night operations?
12	Are all applicable signs (no smoking, danger, restricted area, emergency shut off) posted in the appropriate areas per FM 10-67-1?
13	Are grounding rods emplaced at the filter separators and fuel dispensing ports?
14	Do grounding rods emplaced conform to specifications in FM 10-67-1?
Nozzles and hoses	
15	Does the nozzle have proper bonding device for operations?
16	Are both CCR and open-port nozzles available for use?
17	Are dust cover serviceable and being used for the nozzles?
18	Has the system been turned on and tested at normal operating pressure with the nozzle closed?
19	Does the site layout ensure proper space between aircraft refueling points IAW FM 10-67-1? Minimum distance rotor hub-to-rotor hub: <ul style="list-style-type: none"> • CH-47: side by side 180 ft nose to tail 140 ft. • UH-1, UH-60, AH-1, AH-64, OH-58: 100 ft. • AH-64 and all other light aircraft: side by side 150 ft.
20	Are the dispensing hoses configured in a curved pattern?
21	Do the hoses show signs of blistering, saturation, nicks, or cuts?
22	Are the hoses and nozzles clean and free of dirt?

Table F-1. Forward arming and refueling point site inspection checklist (continued)

23	Are the 100-mesh nozzle screens clean?
Aircraft control and equipment	
24	Is the parking area for the fuel dispensing point clearly marked?
25	Is an air traffic controller or pathfinder at each FOB?
26	Does the FARP have two-way radio communication before and after refueling operations with aircraft and the control tower?
27	Is the FARP set up for night operations (light sets or chemical lights) and are supplies on hand?
Site preparation	
28	Has the area (fuel system supply point, FARP) been cleared of debris?
29	Does the layout ensure proper spacing between aircraft?
30	Are vehicles combat parked, allowing for a timely exit?
31	Does the FARP take advantage of buildings and existing structures?
Before refuel operations	
32	Are drip pans placed at each dispensing point?
33	Are sufficient personnel assigned to the equipment?
34	Has the complete system been checked for proper operation, pressure, and leaks?
Site operations	
35	Is there an established communication means to control traffic at the refueling site?
36	Are passengers disembarked and escorted to a marshalling area while aircraft refuels?
37	Are ground guides being used for the aircraft when appropriate?
38	Are aircraft either pointed in a safe direction during refueling or is armament turned off and set on safe?
39	Are the aircraft properly grounded before they are refueled?
40	Are the nozzles bonded to the aircraft before the refueling cap is opened?
41	Are the dust caps replaced after each refueling and then hung on the stand afterwards?
42	Are grounding cables attached to the ground rods when not in use?
43	Are tank vehicle operations done correctly IAW appropriate TMs?
44	Are personnel familiar with emergency fire and rescue procedures? Date pre-accident plan was tested:
45	Are refueling personnel familiar with procedures for fuel spills? Is there a contingency plan and equipment?
46	Are spill kits at each refueling point and by all pumps?
47	Is a copy of the SOP available and POL personnel familiar with its contents (including a plan for emptying the berms in the event of precipitation or spill)?
48	Are measures in place to facilitate reconstitution and recovery of FARP assets in the event of damage?
49	Are personnel using proper PPE (gloves, goggles, hearing protection) while handling fuel and refueling aircraft?
50	Are material data sheets on site? <ul style="list-style-type: none"> • 50k bags • 20k bags • 10k bags • Elbows • T-valves

Table F-1. Forward arming and refueling point site inspection checklist (continued)

	<ul style="list-style-type: none"> • Tri-Max fire extinguisher • 20 lb fire extinguisher • 4-in by 10-ft hoses • 4-in by 35-ft hoses • 4-in by 50-ft hoses • CCR nozzles • D1 nozzles
350-GPM pump (NSN 4320-01-259-5956)	
	<ul style="list-style-type: none"> • Wheel mounted • Skit mounted
51	Are operators licensed to operate the 350-GPM pump?
52	Is the appropriate TM present?
53*	Is the operator preventative maintenance checks and services being conducted daily and are deficiencies being annotated on DA Form 5988-E (Equipment Inspection Maintenance Worksheet) or DA Form 2404 (Equipment Inspection and Maintenance Worksheet)?
54*	Does the FARP noncommissioned officer in charge (NCOIC) maintain at the minimum one copy of the DA Form 5988-E or 2404 for each piece of equipment?
55*	Does the maintenance support unit track 350-GPM pump by The Army Maintenance Management System?
56*	Does the NCOIC have point of contact information for their maintenance support unit (point of contact for breakdowns)?
57*	Is unit level maintenance being conducted?
58*	Are service packets being maintained?
Parts	
59*	Are the quick supply store (QSS) parts (service parts and repair parts) on hand?
60*	Are the authorized stockage list parts stocked and well organized?
61*	Are the QSS parts for the 350-GPM pump easy to locate?
62*	Are repair and service parts being ordered during the services and properly tracked?
63*	Are hard to find parts being fabricated or procured through logistics personnel?
64*	Are parts received being installed in a timely manner?
65*	Are needed serviced parts on hand for 20-level maintenance (oil and fuel filters)?
66*	Are the needed repair parts or QSS being maintained at supporting maintenance units?
Operations	
67*	Are there any replacement or backup 350-GPM pumps available if the primary pumps fail?
68	Is the equipment properly grounded?
*These items will be checked against DA Form 5988-E or DA Form 2404. Items wil not keep the FARP from becoming operational.	

This page intentionally left blank.

Appendix G

Sample Forward Arming and Refueling Point Standard Operating Procedure

Table G-1 is a sample FARP SOP outlining specific organizational responsibilities, procedures, and safety concerns. Units should tailor general SOPs to match the operations, needs, and challenges unique to the organization.

Table G-1. Sample standard operating procedure

Responsibilities
<p>S-3—</p> <ul style="list-style-type: none"> • Selects the general area for FARPs and coordinates land usage. • Briefs the S-4 on the information necessary to develop a supply plan. • Ensures reconnaissance of the proposed locations is conducted. • Develops and briefs the Army airspace integration plan for the FARP.
<p>S-4—</p> <ul style="list-style-type: none"> • Ensures fuel and ammunition are allocated for mission execution. • Forecasts resupply requirements for 24, 48, and 72 hrs out. • Maintains historical data in regards to issues in the last 24, 48, and 72 hrs.
<p>Platoon leader—</p> <ul style="list-style-type: none"> • Selects the specific site for FARPs in coordination with the S-3. • Plans, rehearses, and executes FARP missions. • Oversees all FARP operations. • Reports to the S-4 IAW the tactical SOP for fuel and ammunition status. • Coordinates with the platoon sergeant for special issue/mission requirements. • Ensures all Soldiers are licensed in all assigned equipment.
<p>Platoon sergeant—</p> <ul style="list-style-type: none"> • Trains and evaluates Soldiers IAW the Army Training and Evaluation Program/security technical procedures. • Assists the platoon leader in the execution of FARP operations. • Provides guidance and oversight to section sergeants. • Ensures all sections have adequate classes of supply for missions. • Ensures communications are established for FARP operations. • Ensures Soldiers are licensed on all assigned equipment.
<p>FARP NCOIC—</p> <ul style="list-style-type: none"> • Directly supervises and controls personnel and the FARP. • Ensures SOP, FOD, and safety guidelines are adhered to at all times. • Controls aircraft flow in to and out of the FARP. • Reports the status of fuel and ammunition at the beginning and close of duty. • Ensures daily preventative maintenance checks and services and quality surveillance is conducted.

Table G-2. Sample standard operating procedure (continued)

<p>FARP shift NCOIC—</p> <ul style="list-style-type: none"> • Ensures the FARP meets unit standards IAW SOP. • Ensures all Soldiers perform proper safety procedures IAW the FARP SOP. • Ensures the spill contingency plan is utilized, if needed. • Ensures proper training is conducted annually. • Ensures proper paperwork is completed at the end of shift.
<p>Aircraft fuel handler—</p> <ul style="list-style-type: none"> • Ensures safety is maintained at all times. • Reports any safety concerns to the supervisor. • Ensures proper refueling procedures IAW FM 10-67-1.
<p>Ammo NCOIC (if ammo is present)—</p> <ul style="list-style-type: none"> • Is responsible for the requisition, storage, transportation, and issue of Class V. • Ensures all ammunition safety handling and storage procedures all followed. • Supervises the guard force at the ammunition HA. • Reports Class V status to the platoon sergeant daily. • Oversees monthly inventory of all stored ammunition.
<p>Pad chief (if ammo is present)—</p> <ul style="list-style-type: none"> • Is responsible for all operations at the assigned pad. • Is the first Soldier to approach the aircraft and the last to depart. • Keeps an accurate count of ammunition on the pad and coordinates with the ammo section for resupply. • Ensures proper refuel/rearm procedures are followed. • Ensures the pad is clear of FOD and all safety standards are adhered too.
<p>Safety</p> <p>FARP operations are inherently dangerous due to the close proximity of flammable liquids, moving equipment, and ammunition. The following precautions will be taken to minimize this danger while handling products:</p> <ul style="list-style-type: none"> • Do not approach the aircraft until positive communication is established between the pad chief and the pilot in command and the signal to approach has been given. • “NO SMOKING” signs will be posted and enforced at all FARPs and POL storage areas. • Fire extinguishers will be serviceable and present at all times. • Equipment will be grounded and bonded at all times. • All spills will be reported immediately and corrective action taken. • All vehicles and equipment will be inspected every shift to prevent leaks, faulty hoses, defective nozzles, dry rotted gaskets, and improper filter separator operation. • Protective clothing will be worn at all time, including— <ul style="list-style-type: none"> ■ Field-wear: full blouse and trouser uniforms with the sleeves down, cotton undershirt, and boots. No nylon clothing. (Army combat uniform will be allowed as long as the proper bonding procedures are conducted prior to refueling operations.) ■ Eye and hearing protection. ■ Flight deck helmet or advanced combat helmet. • All paperwork will be checked for incoming fuel to ensure there is no mixture of fuels. <p>Precautions will be made to minimize the presence of vapor formations by ensuring adequate airflow and ignition sources are minimized or eliminated. This is done by posting signs, training, and following the SOP.</p> <p>Precautions will be utilized for transferring and storing petroleum products to include—</p> <ul style="list-style-type: none"> • Avoid overfilling tanks. • Use designated walkways. • Ventilate and clean vehicles and containers.

Table G-2. Sample standard operating procedure (continued)

<ul style="list-style-type: none"> • Observe published safety rules when operating, loading, and transporting POL products. • Use secondary containers when transferring fuel, as needed. • Ensure the correct product goes into the properly labeled container.
<p>Ground guides will be used at all times when moving vehicles on any FARP, flight line, or motor pool. Vehicles will not drive directly across the flight line unless on a designated route assigned by the tower. If ammo is present, extreme care will be exercised during all ammunition operations. All dunnage and empty containers will be removed from the FARP pads after each use to minimize FOD damage and to promote a safe work area.</p> <p>Any individual who spots an unsafe act must halt the observed operation immediately. Operations will not resume until the unsafe condition is correct.</p>
<p><i>Fire prevention</i></p> <p>An active fire prevention program is the key to petroleum fire safety. The platoon accomplishes this by conducting monthly fire inspections, firefighting training, and having a documented firefighting plan. Fire prevention inspections will occur prior to, during, and after all FARP equipment use. The following items require inspection:</p> <ul style="list-style-type: none"> • Fire extinguishers for serviceability and accountability. • Pumps for leaks and spills. • Tanks for leaks and spills. • Hoses, valves, and nozzles for leaks, tears, and dry rot. <p>The following are characteristics of a firefighting plan:</p> <ul style="list-style-type: none"> • The primary resource for firefighting is the Soldier closest to the fire with the means and equipment to extinguish the fire. • The primary concern is the isolation of the fuel source from the fire; therefore, the signal must be given immediately to shut off the flow of fuel at the pump. • In the event of an aircraft fire, the fireguard will signal the pilots with a horizontal figure-eight motion to execute an emergency shutdown (see Appendix A, figure A-13). The primary consideration for the fireguard becomes the refueler and aircrew, not the aircraft. • Personnel must always be aware of ammunition placement (if present) and if possible, prevent the fire from getting to the ammunition. • An individually tailored and separate firefighting SOP will be posted for each FARP location. This SOP will address personnel responsibilities, evacuation routes, fire drills, location and contact numbers for the fire department, and fire extinguisher serviceability and accountability.
<p><i>Site selection criteria</i></p> <p>Roadrunner FARPs are located on the battlefield using the METT-TC analysis. The following are planning guidelines for optimal site selection:</p> <ul style="list-style-type: none"> • Size. The site must have enough open ground for the aircraft to land and take off safely. The minimum distance between points is 100 ft for OHs, UHs, and AHs. The minimum distance between points is 200 ft for CHs. Ample room is required for approach/departure routes into and out of the FARP. An obstacle clearance ratio of 10:1 is used for the approach and departure ends of the FARP. A landing point requires 100 ft of horizontal clearance for a 10 ft tall tree if it is on the approach or departure path of the helicopter. Enemy situation may dictate the increase in size of the FARP to allow for maximum displacement of aircraft while in the FARP. • Terrain. Tree lines, vegetation, shadows, terrain folds, and reverse slopes will be used, when available, to mask the FARP from enemy observation. The optimal site has a woodland background or a cluttered, rocky background. • Ground slope. The site must be flat or have less than a 7 degree slope. • Elevation. The situation will dictate the location of the FARP. When available, it will be placed on high ground to minimize vapor buildup around the FARP site. • Drainage. FARPs will not be placed where a spill can drain into a body of water or other environmentally sensitive area. The site should have adequate draining but be firm enough to support the weight of trucks, aircraft, and FARP equipment.

Table G-2. Sample standard operating procedure (continued)

<ul style="list-style-type: none"> • Vapors. FARPs should be placed uphill from a valley or slope. Fuel vapors are denser than air; therefore, vapors' densities can concentrate and form a high level of explosiveness. Wind directions should also be considered. Wind direction can force vapors to travel across exhaust fumes, which could ignite the vapors.
<p>General pad configuration/layout</p>
<p>General. All pads, regardless of the system being used, will have similar equipment. Ammunition quantities on each pad will depend on availability of crane/forklift support and aircraft configuration.</p> <p>Equipment. The following is a list of equipment located at each pad:</p> <ul style="list-style-type: none"> • Grounding rod with chemical light or marshalling beacon. • CCR nozzle. • D-1 nozzle. • Fire extinguisher (20 lbs). • 5-gal water can. • Drip pan. • Fuel can for flushing lines. • Clear jar for fuel samples. • Ground cable. • Open-port nozzle. • 30-gal bag spill kit. <p>Ammunition placement (if present). Placement of ammunition will be mission oriented and will be dependent on aircraft weapon configurations. The number of aircraft utilizing the FARP will also dictate the quantity of ammunition. Ammunition should be arranged as follows:</p> <ul style="list-style-type: none"> • .50-caliber ammunition is placed on the left side of the pad to allow easy access to the .50-caliber weapon system. No more than 2,500 rounds will be on any single point. • 2.75-in folding fin aerial rocket will be placed on both sides of the pad to facilitate the loading of the rocket pod on either side of the aircraft. Rockets will be oriented downrange at all times. Rockets will be segregated by type of ammunition (HE, multipurpose sub-munition and flechette). • Hellfire missiles are placed on the right or left side of the pad depending on configuration and number of missiles being fired by aircraft. Missiles will be stored on the pad in their shipping containers until loading.
<p>Aircraft arrival, refuel, and departure procedures</p>
<p>Aircraft arrival. The following are aircraft arrival procedures:</p> <ul style="list-style-type: none"> • Ground and air avenues of approach must be masked to prevent the enemy from targeting the FARP either visually or electronically. • Traffic into the FARP is right traffic unless otherwise briefed. • Pads are numbered from the fuel source in sequential order. Unless briefed otherwise, the pilots will land on the pad closest to the refueling source. • Pilots should make every attempt to contact the FARP prior to arrival to ensure FARP personnel are ready for FARP operations upon arrival. • The FARP monitors battalion command or tactical operations center Net and the established FARP frequency. • Once the aircraft has landed, the aircrew will ensure the rearm/refuel checklist is utilized and will give the appropriate signal to the pad chief. <p>Refuel procedures. The following are refuel procedures for OH-58D and AH-64 aircraft:</p> <ul style="list-style-type: none"> • The pad chief will approach the aircraft from the right side of the aircraft and use the grounding cable to ground the aircraft (if ammo is needed). If there is no ammo, the fireguard will ground the aircraft using the grounding cable. • The aircraft crew will inform the FARP via radio-telephone operator if ammo/fuel is needed.

Table G-2. Sample standard operating procedure (continued)

<ul style="list-style-type: none"> • If refueling is required, the refueler will conduct refueling procedures by bonding the nozzle to the aircraft and inserting the appropriate nozzle. The refueler will ensure the nozzle is seated correctly and then open the valve. At that time the refueler will signal the fireguard to initiate the fuel flow. • The fireguard will ensure the refueler has stopped refuel operations and disconnected the nozzle from the aircraft and replaced the fuel cap. • At the discretion of the pad chief, rearm procedures can be initiated during refuel operations to reduce the amount of time needed. • The left side weapon system will be checked and loaded by armament personnel before the weapon system on the right side (refuel side) is completed. The pad chief will ensure the rearm procedures do not hamper refuel operations. • The pad chief/refueler will disconnect ground from the aircraft if operations are complete and ensure all persons are clear of the aircraft. <p>The following are refuel procedures for UH-60 and CH-47 aircraft:</p> <ul style="list-style-type: none"> • The pad chief/refueler will ensure all passengers and crew chiefs have exited the aircraft prior to refueling operations. The pad chief will signal the personnel exiting the aircraft to the passenger marshalling area located near the FARP. • The pad chief/refueler will attach the grounding cable to the aircraft, and the refueler will accomplish refuel operations using the appropriate nozzle. • The pad chief/refueler will signal for the crew chiefs and passengers to move from the marshalling area to the aircraft for boarding. <p>Departure procedures. The following are departure procedures:</p> <ul style="list-style-type: none"> • Once the pad chief/refueler has completed refuel/rearm procedures, a FOD check will be conducted on both sides of the aircraft. • The pad chief/refueler will disconnect the grounding cable and show it to the aircrew to signal that the aircraft is ready for departure. • Depending on the FARP layout, aircraft will either back out off the FARP or fly through the points. • Traffic for departure is right traffic unless otherwise briefed. • Aircrews will attempt to contact the FARP prior to departure. • The pad chief/refueler will conduct a FOD check and inventory ammunition and/or fuel.
<p>General guidelines</p> <p>Safety. The NCOIC will ensure all personnel on the range site have read and are familiar with this SOP prior to performing any mission the range. All personnel will receive a safety briefing prior to departure to the range site. The NCOIC will ensure all additional instructions are fully understood by all personnel who will be working on or entering the rearm line.</p> <p>Operations. The standard arming line consists of one maintenance pad furthest to the right and six rearm pads. The points will be equipped with the following equipment:</p> <ul style="list-style-type: none"> • One fire extinguisher. • One grounding rod with cable. • One FARP box, supplied as required for that pad. • One tool box to support 30-mm operations. • One loader/downloader. • One M-91 test set, as available. • Two pallets for downloading munitions. • Spare parts (maintenance pad). • One multimeter, as available. <p>Night operations. The main emphasis for night operations is deliberate actions and safety awareness. Light markers will be activated one-half hour prior to dusk. One bean bag light, or other designated light</p>

Table G-2. Sample standard operating procedure (continued)

<p>source, will be centered in front of each pad. Chemlights will be used to mark the tops of grounding rods. Each person on the rearm line will carry a chemlight in their camouflage bag. Armament personnel will wear green chemlights and refuelers will wear blue. This is a safety measure to designate moving objects from stationary ones.</p> <p>Gunnery safety. Basic safety rules shall be observed by all personnel operating beyond the rearm line. All personnel will wear hearing and eye protection while on the rearm line. Approach the aircraft from a 45 degree angle. Do not walk in front of any weapon system while on the range, loaded or not. Treat all weapon systems as armed. Whenever going around the tail of aircraft, walk around the outside of the "V" stakes.</p> <p>Cease fire procedures. Any individual who observes a condition that is potentially hazardous will immediately command "CEASE FIRE! CEASE FIRE! CEASE FIRE!" and notify the NCOIC.</p>
<p><i>Aircraft loading procedures (without refueling)</i></p> <p>The following are aircraft loading procedures (without refueling):</p> <ul style="list-style-type: none"> • Ensure the aircrew is aware of your presence (the pilots will turn navigation lights to low, strobes to off when the aircraft can approached). • Ground the aircraft and install ground safety pins. • Connect the mike cord (maintain contact and brief the crew on load). • Chock the aircraft landing gear. • Set missile launders to safe. • Load the 30mm gun. • Perform stray voltage check. • Load inboard launcher (right side). • Load outbound launcher (right side). • Load inboard launcher (left side). • Load outbound launcher (left side).
<p><i>Aircraft downloading procedures (without refuel)</i></p> <p>The following are aircraft downloading procedures (without refuel):</p> <ul style="list-style-type: none"> • Ensure the aircrew is aware of your presence. • Ground the aircraft and install ground safety pins. • Connect the mike cord (maintain contact and brief the crew). • Chock the aircraft landing gear. • Set missile launchers to safe. • Unload outboard launcher (right side). • Unload inboard launcher (right side). • Unload outboard launcher (left side). • Unload inboard launcher (left side). • Download the 30-mm gun.
<p><i>Aircraft loading procedures (with refuel)</i></p> <p>The following are aircraft loading procedures (with refuel):</p> <ul style="list-style-type: none"> • Ensure the aircrew is aware of your presence (the pilot will turn navigation lights to low and strobes to off when the aircraft is safe to approach). • Ground the aircraft and install ground safety pins. • Connect the mike cord (maintain contact and brief the crew). • Set missile launchers to safe. • Refuel personnel will then refuel the aircraft. • Load the 30-mm gun. • Perform stray voltage check.

Table G-2. Sample standard operating procedure (continued)

<ul style="list-style-type: none"> • Load inboard launcher (right side). • Load outboard launcher (right side). • Load inboard launcher (left side after completion of 30mm loading). • Load outboard launcher (left side).
<p><i>Aircraft downloading procedures (with refuel)</i></p> <p>The following are aircraft downloading procedures (with refuel):</p> <ul style="list-style-type: none"> • Ensure the aircrew is aware of your presence. • Ground the aircraft and install ground safety pins. • Connect the mike cord (maintain contact and brief the crew). • Chock the aircraft landing gear. • Set missile launchers to safe. • Unload outboard launcher (right side). • Unload inboard launcher (right side). • Refuel personnel will refuel aircraft. • Unload outboard launcher (left side). • Unload inboard launcher (left side). • Download the 30-mm gun.
<p><i>Clearing procedures</i></p> <p>Prior to aircraft departure from the rearm/dearm pad, all weapons clearings must be verified by the pilot in command of the aircraft. In addition, an entry will be made on the DA Form 2408-13-1 (Aircraft Inspection and Maintenance Record) stating, "WEAPONS CLEARING REQUIRED PRIOR TO AIRCRAFT DEPARTING RANGE. 30-MM REQUIRES CYCLING THREE TIMES PRIOR TO AIRCRAFT DEPARTURE." The entry will be signed off "completed" by the pilot in command of the aircraft.</p> <p>The following are clearing procedures:</p> <ul style="list-style-type: none"> • Download the 30-mm gun interactive electronic TM. • Ensure all cockpit switches are in the safe/off position. • Open the transfer housing door. • Clear all rounds from the gun housing. • Declutch the gun. • Download and cycle the carrier drive three times for normal gunnery loads to ensure the gun cleared. • Insert the cleaning rod in the barrel and fully seat rod against the bolt in the open position, verifying no rounds are in the barrel. • Stow the tray, clutch the wedge, turn the multiplex control switch to off, and close the extended forward avionics bay door. • Close the transfer housing door. • Ensure the bolt is to the rear and the transfer housing indicates green condition (feed). • Open the right hand forward avionics bay door and visually inspect for rounds in the carrier drive. • Ensure the pilot signs off the DA Form 2408-13-1 entry clearing the aircraft off the range.
<p><i>Handling of duds</i></p> <p>All rounds that have malfunctioned in some manner, are dented or cracked, have been dropped during handling, or are unserviceable in any manner shall be removed from the rearm line. Discrepant rounds will be immediately moved to the designated disposal area or a HA to await disposal by EOD personnel. Under no circumstance will these items be handled by unqualified personnel.</p>
<p><i>Specific loading procedures</i></p> <p>Specific loading procedures will be IAW with applicable TMs and ARs.</p>
<p><i>Pad cleanup</i></p> <p>All pads must be policed prior to aircraft departure. All empty containers will be removed from the line and</p>

Table G-2. Sample standard operating procedure (continued)

returned to the ammunition handlers. This will minimize injury to personnel or damage to aircraft caused by flying debris.
<i>Ammunition sling-out procedures</i>
<p>Sling-out areas are constructed near the ammunition storage area. Prevailing wind direction must be considered when selecting a location. The sling-out pad must be clear of overhead wires and cables. The pad should be located so that helicopter approach and departure will not pass over ammunition storages areas or inhabited areas.</p> <p>MHE must be kept clear of the area where the helicopter descends or ascends. MHE should be available to move ammunition from the sling-out area to the storage area.</p> <p>Appropriate firefighting equipment must be maintained on site at all times. Static electricity discharge probes will be used as required by FM 4-20-197.</p>
<i>Emergency procedures</i>
<p>The following procedures will be followed in the event of an actual or simulated (training) emergency:</p> <ul style="list-style-type: none"> • In case of a fire not involving ammunition— <ul style="list-style-type: none"> ▪ Clear all aircraft out of the FARP. ▪ Shut down damaged aircraft. ▪ Fight fires, if possible. ▪ Treat injured personnel and evacuate as soon as possible. ▪ Notify higher command. ▪ Regroup and relocate. • In case of a fire involving ammunition— <ul style="list-style-type: none"> ▪ Clear all aircraft out of the FARP. ▪ Shut down damaged aircraft. ▪ If not possible to contain fire, clear all personnel from the rearm line to cover. ▪ Treat inured personnel and evacuate as soon as possible. ▪ Notify higher command. ▪ Regroup and relocate.

Glossary

SECTION I - ACRONYMS

AA	assembly area
AAFARS	Advanced Aviation Forward Area Refueling Systems
ACM	airspace control measures
AD	air defense
ADA	air defense artillery
AH	attack helicopter
AKO	Army Knowledge Online
AO	area of operations
APU	auxiliary power unit
AR	Army regulation
ARB	attack reconnaissance battalion
ASB	aviation support battalion
ASC	aviation support company
ASO	aviation safety officer
ATC	air traffic control
ATS	air traffic services
ATP	Army techniques publication
BCT	brigade combat team
BLSA	basic load storage area
CAB	combat aviation brigade
CBRN	chemical, biological, radiological, and nuclear
CCR	closed circuit refueling
CF	cubic feet/foot
CH	cargo helicopter
CP	command post
CSR	controlled supply rate
CSSB	combat sustainment support battalion
DA	Department of the Army
DA Pam	Department of the Army pamphlet
DISTRO	Distribution company
DOTD	Directorate of Training and Doctrine
DSN	Defense Switched Network
EOD	explosive ordnance disposal
ERFS	extended range fuel system
FARP	forward arming and refueling point
FLOT	forward line of own troops

Glossary

FM	field manual, frequency modulated
FOB	forward operating base
FOD	foreign object damage
FSC	forward support company
FSO	fire support officer
GPS	global positioning system
HA	holding area
HARRP	helmet assembly, rearming refueling personnel
HE	high explosive
HEMAT	heavy expanded mobility ammunition trailer
HEMTT	heavy expanded mobile tactical truck
HM	hazardous material
HMMWV	high-mobility multipurpose wheeled vehicle
HQ	headquarters
HSC	headquarters and support company
HTARS	HEMTT tanker refueling system
HW	hazardous waste
IAW	in accordance with
IDN	initial distribution number
LOGSA	Logistics Support Activity
METT-TC	mission, enemy, terrain and weather, troops and support available, time available, civil considerations
MFS	Modular Fuel System
MHE	materials handling equipment
NCOIC	noncommissioned officer in charge
NDB	nondirectional beacon
NEW	net explosive weight
NVD	night vision device
OH	observation helicopter
OIC	officer in charge
OPORD	operation order
PCC/PCI	pre-combat checklist/pre-combat inspection
POL	petroleum, oils, and lubricants
PPE	personal protective equipment
QSS	quick supply store
RASA	ready ammunition storage area
RF	radio frequency
RRP	rapid refuel point
RSR	required supply rate
S-2	intelligence staff officer
S-3	operations staff officer

S-4	logistics staff officer
SDP	supply distribution point
SO	safety officer
SOP	standing operating procedure
STANAG	standardization agreement
TACT	tactical aviation control team
TOC	tactical operations center
TM	technical manual
TTCS	Tactical Terminal Control System
UH	utility helicopter
UI	unit of issue
USMC	United States Marine Corps
U.S.	United States
USAACE	United States Army Aviation Center of Excellence
USAF	United States Air Force

This page intentionally left blank.

References

These publications are sources for additional information on the topics in this ATP. Most joint publications (JPs) are found at <http://www.dtic.mil/doctrine/doctrine.htm>. Most Army publications are found online at <http://www.apd.army.mil>. *This source was also used to develop this publication.

SOURCES USED

These are the sources quoted or paraphrased in this publication.

ARMY REGULATIONS

AR 200-1. *Environmental Protection and Enhancement*. 13 December 2007.

AR 385-10. *The Army Safety Program* (*RAR 001, 11/7/2008; *RAR 002, 09/03/2009; *RAR 003, 06/14/2010). 23 August 2007.

DEPARTMENT OF THE ARMY PAMPHLETS

DA Pam 385-64. *Ammunition and Explosives Safety Standards*. 24 May 2011.

FIELD MANUALS

FM 3-04.111. *Aviation Brigades*. 07 December 2007.

FM 3-04.113. *Utility and Cargo Helicopter Operations*. 07 December 2007.

FM 3-04.120. *Air Traffic Services Operations*. 16 February 2007.

FM 3-04.126. *Attack Reconnaissance Helicopter Operations*. 16 February 2007.

FM 3-25.26. *Map Reading and Land Navigation*. 18 January 2005.

FM 4-0. *Sustainment*. 30 April 2009.

FM 4-01.45. *Multi-Service Tactics, Techniques, and Procedures for Tactical Convoy Operations*. 05 January 2009.

FM 4-02.7. *Multiservice Tactics, Techniques, and Procedures for Health Service Support in a Chemical, Biological, Radiological, and Nuclear Environment*. 15 July 2009.

FM 4-20.197. *Multiservice Helicopter Sling Load: Basic Operations and Equipment*. 20 July 2006.

FM 4-30.1. *Munitions Distribution in the Theater of Operations*. 16 December 2003.

FM 10-67. *Petroleum Supply in Theaters of Operations (Including C1)*. 18 February 1983.

FM 10-67-1. *Concepts and Equipment of Petroleum Operations*. 02 April 1998.

FM 10-67-2. *Petroleum Laboratory Testing and Operations*. 02 April 1997.

FM 21-60. *Visual Signals*. 30 September 1987.

STANDARDIZATION AGREEMENTS

STANAG 2999. *Use of Helicopter in Land Operations*. 31 October 2008.

STANAG 3117. *Aircraft Marshalling Signals*. 27 March 2007.

TECHNICAL MANUALS

TM 1-1520-248-10. *Operator's Manual for Army OH-58D Helicopter (Including C1 to C7)*. 30 June 2011.

TM 9-1340-222-20. *Unit Maintenance Manual for 2.75-inch Low Spin, Folding Fin Aircraft Rockets; 2.75-inch Spin Stabilized, Wrap Around Fin Aircraft Rockets; 66-MM, Light Antitank Weapon Systems; 3.5-inch Rockets; and M3A2E1 Rocket Motor (JATO)*. 30 September 1994.

References

TM 9-1440-431-23. *Aviation Unit and Aviation Intermediate Maintenance Manual for Air-to-Air Stinger (ATAS) Weapon System Consisting of: Launcher, Guided Missile Aircraft, XM292 (NSN 1440-01-244-9681) Electronics Components Assembly: AN/ASQ-201 (1420-01-244-9680)*. 31 October 1989.

TM 750-244-3. *Procedures for Destruction of Equipment to Prevent Enemy Use (Mobility Equipment Command)*. 23 September 1969.

OTHER PUBLICATIONS

CTA 50-900. *Clothing and Individual Equipment*. 01 September 1994.

DOCUMENTS NEEDED

These documents must be available to the intended users of this publication.

DEPARTMENT OF THE ARMY FORMS

DA Forms are available on the Army Publishing Directorate Web site at (www.apd.army.mil):

- *DA Form 581. *Request for Issue and Turn-in of Ammunition*.
- *DA Form 2028. *Recommended Changes to Publications and Blank Forms*.
- *DA Form 2404. *Equipment Inspection and Maintenance Worksheet*.
- *DA Form 2408-13-1. *Aircraft Inspection and Maintenance Record*.
- *DA Form 5988-E (EGA). *Equipment Inspection Maintenance Worksheet*.
- *DA Form 7382. *Sling Load Inspection Record*.

WEB SITES RECOMMENDED

The following source may be used to access and/or download Army publications.

DEPARTMENT OF THE ARMY

USAMC Logistics Support Activity (LOGSA) Electronic Technical Manuals (ETM) www.logsa.army.mil.

Index

A

Advanced Aviation Forward Area Refueling System (AAFARS), 2-1, 2-6, 2-7, 2-8, 2-16, 2-17, 2-18, 2-20, 2-21, 2-25, 2-30, 2-31, 2-32, 3-7

air defense (AD), 2-4, 3-5

air defense artillery (ADA), 2-4

air traffic control (ATC), 1-3, 2-30, 2-34

air traffic service (ATS), 1-3, 2-2, 2-5

area of operations (AO), 1-1, 2-1, 2-4, 2-5, 2-34, 4-1

assault helicopter battalion (AHB), 1-2

assembly area (AA), vii, 2-2, 2-28

attack reconnaissance battalion (ARB), 1-2

auxiliary power unit (APU), 2-9, 2-12

aviation safety officer (ASO), F-1

aviation support battalion (ASB), vii, 1-1, 1-2, 1-3, 2-1, 4-1, 4-2, 4-4

aviation support company (ASC), 1-1

B

basic load storage area (BLSA), 2-22, 2-23

brigade combat team (BCT), 1-1, 2-4

C

chemical, biological, radiological, and nuclear (CBRN), 2-4, 3-1, 3-2, 3-3, 3-5

closed circuit refueling (CCR), 2-7, 2-10, 2-12, 2-13, 2-14

Combat Aviation Brigade (CAB), 1-1, 2-4, 2-5, 4-1

combat sustainment support battalion (CSSB), 4-1, 4-4

command post (CP), 2-18, 2-28

controlled supply rate (CSR), 4-3

D

distribution (DISTRO), 1-1, 1-2, 2-1, 2-5

E

extended range fuel system (ERFS), 2-20, 2-21

F

foreign object damage (FOD), 2-19, 2-22

forward line of own troops (FLOT), 2-2

forward operating base (FOB), 2-34, 3-3

forward support company (FSC), vii, 1-1, 1-2, 1-3, 2-1, 2-5, 2-24, 4-1, 4-2, 4-4

G

general support aviation battalion (GSAB), 1-2, 2-5

H

hazardous material (HM), D-4, D-5

hazardous waste (HW), D-2, D-3, D-4

headquarters and support company (HSC), 1-1

heavy expanded mobile tactical truck (HEMTT), 2-9, 2-10, 2-11, 2-14, 2-15, 2-16, 2-17, 2-18, 2-25, 4-3, B-1, B-2

heavy expanded mobility ammunition trailer (HEMAT), 2-16, 2-17, 4-3, B-1, B-2

helmet assembly, rearming refueling personnel (HARRP), 2-12

HEMTT tanker refueling system (HTARS), 2-9, 2-10, 2-16, B-1

high explosive (HE), 2-23

high-mobility multipurpose wheeled vehicle (HMMWV), 2-16, 3-10

holding area (HA), 2-17, 2-18, 2-24

I

intelligence staff officer (S-2), 2-4

L

logistics staff officer (S-4), 1-3, 4-1, 4-3, D-6

M

materials handling equipment (MHE), 2-15, 2-16, 2-19, 4-1

mission, enemy, terrain and weather, troops and support available, civil considerations (METT-TC), 2-1, 2-2, 2-5, 2-18, 4-4

Modular Fuel System (MFS), 2-15

N

nap-of-the-earth (NOE), 2-20

net explosive weight (NEW), 2-23

night vision device (NVD), 2-8, 2-30, 2-32, 3-2

noncommissioned officer in chare (NCOIC), F-3, F-4, G-1, G-2, G-5, G-6

non-directional beacon (NDB), 2-5

O

operations staff officer (S-3), 1-2, 2-2, 2-4, 2-5, 4-1, 4-3

P

palletized load system (PLS), 2-15

petroleum, oils, and lubricants (POL), 1-2, 2-12, 2-16, 2-17, 2-18, 2-21, 2-24

R

radio frequency (RF), 1-3

rapid refuel point (RRP), 2-1, 2-28

rapid supply rate (RSR), 4-3

ready ammunition storage area (RASA), 2-22, 2-23

S

safety officer (SO), 1-3, 3-6

Index

standard operating procedure
(SOP), 1-3, 2-10, 2-19, 2-25,
2-29, 3-2

T
tactical aviation control team
(TACT), 2-5

Tactical Terminal Control
System (TTCS), 2-5

ATP 3-04.94 (FM 3-04.104)
26 January 2012

By Order of the Secretary of the Army:

Official:



JOYCE E. MORROW
*Administrative Assistant to the
Secretary of the Army*
1135601

RAYMOND T. ODIERNO
*General, United States Army
Chief of Staff*

DISTRIBUTION:

*Active Army, the Army National Guard, and the United States Army Reserve: Not to be distributed;
electronic media only.*

