

**EVALUATION OF BEST MANAGEMENT PRACTICES FOR
HIGHWAY RUNOFF CONTROL**

**Low Impact Development Design Manual for Highway Runoff Control
(LID Design Manual)**

Prepared for
National Cooperative Highway Research Program
Transportation Research Board
National Research Council

**The Low Impact Development Center, Inc.
GeoSyntec Consultants
University of Florida
Oregon State University**

FOREWORD

This *LID Design Manual* for National Cooperative Highway Research Program (NCHRP) Project 25-20(01) is one of three reports of the project *Evaluation of Best Management Practices and Low Impact Development for Highway Runoff Control* that present results of this project, which ran between August 2002 and May 2006. The overall objective of the project is to provide for the highway engineer selection guidance toward implementation of best management practice (BMP) and low impact development (LID) facilities for control of stormwater quality in the highway environment. The *Research Report* provides research and information regarding the current state of information pertaining to the control of highway stormwater runoff. Appropriate BMP selection guidance is presented in the third project report, *User's Guide for BMP/LID Selection* (also known as the *Guidelines Manual*).

The project was completed through the collegial cooperation of four project team organizations:

- Oregon State University, Corvallis
- GeoSyntec Consultants, Portland, OR and Boston
- University of Florida, Gainesville
- Low Impact Development Center, Beltsville, MD

Writing of all reports has been a team effort. Key personnel in the project include:

- Wayne C. Huber, P.E., Ph.D., Oregon State University, Principal Investigator
- James P. Heaney, P.E., Ph.D., University of Florida, Co-Principal Investigator
- Eric W. Strecker, P.E., GeoSyntec Consultants, Co-Principal Investigator
- Neil Weinstein, P.E., LID Center, Co-Investigator

Other principal authors on the project team, listed alphabetically, include:

- Angela Brown, Oregon State University
- Philip Jones, LID Center
- Christopher Kloss, LID Center
- Joong Lee, Ph.D., University of Florida
- Marc A. Leisenring, GeoSyntec Consultants
- Chelisa A. Pack, University of Colorado
- Dan Pankani, GeoSyntec Consultants
- Marcus M. Quigley, P.E., GeoSyntec Consultants
- Derek N. Rapp, University of Colorado
- Andi Thayumanavan, GeoSyntec Consultants
- William J. Wells, Oregon State University

Others contributing to the project include:

- Ian K. Besaw, Oregon State University
- Donna Bodine, Aquatus Environmental
- Steven George, GeoSyntec Consultants
- E. Todd Hesse, GeoSyntec Consultants
- James R. Lundy, P.E., Ph.D., Oregon State University

- Peter O. Nelson, Ph.D., Oregon State University
- Gary Palhegyi, GeoSyntec Consultants
- Aaron Poresky, GeoSyntec Consultants
- Matt Rea, GeoSyntec Consultants
- John J. Sansalone, P.E., Ph.D., University of Florida

This project has been conducted in parallel with a similar effort sponsored by the Water Environment Research Foundation, namely WERF 02-SW-1, Critical Assessment of Stormwater Treatment and Control Selection Issues. By mutual agreement of the two agencies, NCHRP and WERF, portions of the content of the three NCHRP reports and of the WERF report are presented in duplicate, with similar or identical text. However, the emphasis of the NCHRP project is upon management of stormwater in the highway environment, with additional focus on LID design in the highway setting. The focus of the WERF project is management of stormwater in the broader urban environment and without the additional LID design focus.

CONTENTS

Foreword.....	i
Contents	iii
List of Figures.....	iv
List of Tables	v
Acknowledgments.....	vi
Abstract.....	vii
1.0 Taxonomy of Road and Drainage Systems.....	1-1
2.0 Highway Costs and Cost Components.....	2-1
2.1 Cost Components.....	2-1
2.2 Added Cost of BMPs for Highway Systems.....	2-2
3.0 LID and Highway Systems	3-1
3.1 LID Concepts.....	3-1
3.2 General LID Definitions	3-2
3.3 Hydrology and Water Balance.....	3-4
3.4 Stormwater Management Practices.....	3-5
3.5 LID Stormwater Management Framework.....	3-7
4.0 Integrating LID into Highway Design	4-1
4.1 Safety	4-1
4.2 Maintenance.....	4-1
4.3 Vector Control	4-1
4.4 Highway Structural Integrity and Relation to AASHTO Design Guidelines ...	4-2
4.5 Design of LID Facilities in the Highway Environment.....	4-3
5.0 Bioretention.....	5-1
6.0 Bioslope	6-1
7.0 Catch Basins.....	7-1
8.0 Gutter Filter.....	8-1
9.0 Infiltration Trenches/Strips	9-1
10.0 Permeable Pavement.....	10-1
11.0 Pollution Prevention/Street Sweeping	11-1
12.0 Surface Sand Filter.....	12-1
13.0 Soil Amendments.....	13-1
14.0 Swales	14-1
15.0 Vegetation/Landscaping	15-1
References.....	R-1

LIST OF FIGURES

Figure 3.1	Natural Hydrologic Cycle	3-4
Figure 3.2	Hydrologic Cycle of a Developed Environment.....	3-5
Figure 4.1	Sources of Water in Roadbeds	4-3
Figure 5.1	Bioretention Cell in Adelphi Road Median, Adelphi, MD	5-1
Figure 5.2	Typical Bioretention Cell Cross-Section	5-1
Figure 5.3	An Offline Bioretention Cell	5-6
Figure 5.4	An Inline Bioretention Cell.....	5-6
Figure 5.5	Types of Storage Available in a Bioretention Cell with Underdrain.....	5-9
Figure 6.1	Potential Bioslope Location in WV	6-1
Figure 6.2	Typical Bioslope Cross-Section.....	6-1
Figure 7.1	Snout in a Catch Basin.....	7-1
Figure 7.2	Typical Catch Basin.....	7-1
Figure 8.1	Gutter Filter Along U.S. Route 1, Mount Rainier, MD	8-1
Figure 8.2	Typical Gutter Filter Cross-Section	8-1
Figure 9.1	Infiltration Trench in Roadway Median	9-1
Figure 9.2	Infiltration Trench Cross-Section	9-1
Figure 9.3	Types of Storage Available in an Infiltration Trench with Underdrain.....	9-6
Figure 10.1	Permeable Paver Blocks	10-1
Figure 10.2	Typical Permeable Pavement Cross-Section	10-1
Figure 10.3	Types of Storage Available in Permeable Pavement System with Underdrain...	10-7
Figure 11.1	Street Sweeping	11-1
Figure 12.1	Surface Sand Filter.....	12-1
Figure 12.2	Austin Sand Filter	12-1
Figure 13.1	Final Grading of Soil Amendments	13-1
Figure 13.2	Cross-Section of Soil Amendment.....	13-1
Figure 14.1	Vegetated Swale Along Roadside.....	14-1
Figure 14.2	Swale Cross-Section	14-1
Figure 14.3	Wet Swale	14-7
Figure 14.4	Types of Storage Available in a Swale with Underdrain.....	14-10
Figure 15.1	Roadway Vegetation.....	15-1

LIST OF TABLES

Table 1.1	Ownership of U.S. Highways, 2002	1-1
Table 1.2	Roads Owned by State Highway Agencies, 2002	1-2
Table 2.1	2002 Highway Construction Costs in Florida.....	2-2
Table 3.1	Effectiveness of BMPs in Meeting Stormwater Management Objectives & Unit Operations Employed.....	3-7

ACKNOWLEDGMENTS

The project team was supported by extensive and expert guidance from NCHRP Project Officer, Mr. Christopher J. Hedges and from the NCHRP 25-20(01) Project Panel:

Mr. Harold G. Hunt, Chair, Caltrans
Mr. Fred G. Bank, Federal Highway Administration
Mr. Edwin F. Drabkowski, Environmental Protection Agency
Mr. Rod Frederick, P.E., US Environmental Protection Agency
Dr. Edwin E. Herricks, University of Illinois - Urbana-Champaign
Dr. Howard Jongedyk, Interested Observer
Mr. Edward Molash, Washington State DOT
Mr. Vincent J. Palumbo, P.E., Rhode Island DOT
Dr. Richard E. Price, US Army Corps of Engineers
Ms. Shari M. Schaftlein, Washington State DOT
Mr. Mark E. Sengenberger, Adirondack Park Agency
Dr. William J. Snodgrass, P.E., Ontario Ministry of Transportation
Mr. Carlos H. Swonke, Turner Collie & Braden, Inc.
Mr. Raj Veeramachaneni, Maryland DOT

Dr. Steven B. Chase, FHWA Liaison, Federal Highway Administration
Ms. Kimberly Fisher, TRB Liaison, Transportation Research Board
Mrs. Winnie Matshona, Project Assistant, NCHRP, Transportation Research Board
Mrs. Sarah Shaw Tatoun, Project Assistant, NCHRP, Transportation Research Board

The project team is especially grateful to Dr. Michael Barrett of the University of Texas at Austin, who unselfishly provided extensive additional information about his monitoring sites in Austin. Dr. Donald Stanley of East Carolina University was very helpful in providing additional information about the Moyewood Pond site in Greenville, North Carolina.

Five Master of Science theses resulted directly or indirectly from the support of this project:

- Ian K. Besaw, Oregon State University
- Angela Brown, Oregon State University
- Chelisa A. Pack, University of Colorado
- Derek N. Rapp, University of Colorado
- William J. Wells, Oregon State University

ABSTRACT

In recognition of the importance of stormwater quality management in the highway environment, the National Cooperative Research Program sponsored this Project 25-20(01) to prepare guidance for evaluation and selection of best management practice (BMP) and low impact development (LID) facilities in the highway environment. The focus is upon “large, linear highway systems,” e.g., freeways, expressways, interstates, and major DOT highways, as opposed to the broader urban transportation system.

The set of three reports is intended to provide guidance in less (*User’s Guide, LID Design Manual*) or more (*Research Report*) theoretical detail for selection of BMP/LID facilities in the highway environment. The principal target audience for the *Research Report* is technical and research oriented, e.g., stormwater experts in DOTs, regulatory agencies and the academic research community. The *User’s Guide* is intended to be a concise BMP/LID evaluation procedure that may be used by highway engineers across the country as a means for selection and design of a particular BMP or LID facility for a site. The target audience for this product consists of knowledgeable engineers (drainage engineers, environmental engineers, etc.) who make BMP selection decisions. Similarly, the target audience for this *LID Design Manual* consists of knowledgeable engineers (drainage engineers, environmental engineers etc.) who make LID design decisions, both within departments of transportation and for consultants. For eleven LID options, this *Manual* includes information on applicability, siting, materials, hydrology, hydraulics, safety, maintenance, costs, structural integrity, and effectiveness with regard to targeted pollutants. As a detailed manual that includes specifications, typical figures, etc. it will serve to help educate engineers in these techniques.

[This page intentionally left blank]

1.0 TAXONOMY OF ROAD AND DRAINAGE SYSTEMS

Nearly four million miles of roads exist in the United States, as shown in Table 1.1. Over 77% of these roads are in rural areas. Federal Highway Administration (FHWA) statistics classify urban and rural roads according to population density rather than by design capacity or other functional characteristics. Section 3.1 of the *User's Guide* presents a discussion of several different roadway classification schemes that can be used to characterize roadways; some of which are useful for evaluating the appropriateness of integrating LID techniques into highway and near highway environments. In keeping with this manual's focus on the handling and treatment of stormwater, *urban* and *rural* will be defined here according to the type of runoff conveyance system used. The 2003 Florida DOT definition of *urban* and *rural* provides a precedent for this taxonomy:

- Urban roads: Those having closed drainage systems that imply the use of curbs and gutters.
- Rural roads: Those having open drainage systems such as ditches.

The focus of this manual will be on how low impact development (LID) can be incorporated into both urban and rural roads. The first four chapters of this manual provide background information on highway statistics, costs, LID design, and the applicability of LID for highway applications. Chapters 5 through 15 provided detailed design guidance for individual LID techniques.

Typically, state transportation agencies own and manage about 20% of these roads (some states, such as Virginia, maintain almost all of the highway and local roadway systems). Restricting our attention to DOT highways focuses our efforts on the 20% of the transportation network that carries the bulk of the traffic. The DOT highways can be considered to be large-scale facilities with extensive infrastructure designed either to convey water generated from the roadway system or to convey off-site stormwater through the system.

As shown in Table 1.2 nearly 86% of total roads are rural; interstate and other expressways account for about 19.4% of the total mileage. Interstates, other expressways, and other principal arterial roads typically have four or more lanes and carry a disproportionately large amount of the total traffic flow.

Table 1.1. Ownership of U.S. Highways, 2002.

Organization	Miles			% of Total
	Rural	Urban	Total	
State Highway Agency	662,855	110,434	773,289	19.5%
County	1,628,510	144,615	1,773,125	44.7%
Town or City	606,398	624,163	1,230,561	31.0%
Other Jurisdictions	56,254	12,695	68,949	1.7%
Federal Agency	117,751	2,819	120,570	3.0%
Total	3,071,768	894,726	3,966,494	100.0%
% of Total	77.4%	22.6%	100.0%	

Source: <http://www.fhwa.dot.gov/policy/ohim/hs02/re.htm>

Table 1.2. Roads Owned by State Highway Agencies, 2002.

Type of Road	Miles			% of Total
	Rural	Urban	Total	
Interstate	31,445	12,528	43,973	5.7%
Other Expressways	97,784	8,477	106,261	13.7%
Other Principal Arterial	130,362	35,787	166,149	21.5%
Minor Arterial	195,939	24,535	220,474	28.5%
Collector	67,092	11,726	78,818	10.2%
Local	140,233	17,386	157,619	20.4%
Total	662,855	110,439	773,294	100.0%
% of Total	85.7%	14.3%	100.0%	

Source: <http://www.fhwa.dot.gov/policy/ohim/hs02/re.htm>

2.0 HIGHWAY COSTS AND COST COMPONENTS

2.1 Cost Components

Highway construction and maintenance is comprised of numerous components, including stormwater management. Each of these factors must be evaluated to determine its impacts on the cost of highway design and construction. Major components of the life cycle cost of a highway include the following:

- *Capital expenditures.* This includes costs for initial construction, periodic milling and resurfacing, and lane additions. These costs are fairly easy to estimate for the road itself due to the excellent existing databases and process-level cost estimating procedures.
- *Right-of-way acquisition costs.* These costs vary widely, especially in urban areas. Land costs are a critical component in evaluating wet-weather controls. Thus, it is risky to make generalizations about the costs of “best” management practices unless land costs are explicitly accounted for.
- *Utilities relocation costs.* These costs vary widely, especially in urban areas. The need to relocate utilities should be carefully considered during the selection and design of LID practices. When evaluating alternative practices, subsurface area and depth requirements should be assessed with respect to existing subsurface infrastructure. In areas with potential utility conflicts, choose a practice with less subsurface space requirements or route runoff to an area not as congested with underground utilities. If utilities must be relocated as part of a highway realignment or improvement project anyway, the costs associated with integrating an LID practice into the highway environment may be reduced.
- *Operation and maintenance costs.* These costs can be estimated for standard highway maintenance. They can be affected significantly depending on the type of best management practice (BMP) that is selected.

Construction costs for highways built by the Florida DOT, which can be considered a representative system for the purposes of this discussion, are shown in Table 2.1 for rural and urban roads. Rural and urban are defined in terms of the use of curb and gutter drainage. The added construction cost for curb and gutter for urban highways ranges from only 2.4% for four lane roads to nearly 30% for two lane roads. Some of this added cost can be attributed to the cost of closed drainage systems associated with curbs and gutters. These costs *exclude* right-of-way costs, which add an overall average of 20% to the cost of construction. Right-of-way costs vary widely especially in urban areas. Accordingly, the cost-effectiveness of BMPs that are land intensive is primarily a function of land costs. Strong economies of scale exist in highway construction as a function of the number of lanes, increasing costs by the number of lanes to the 0.62 power. Process level cost estimates would be needed to partition out the true incremental cost of going from open to closed drainage systems. These costs would tend to vary widely for closed systems since each highway has a unique set of opportunities to link up to riparian drainage systems. Other costs, such as economic impacts of construction disturbance and long-term impacts of increased traffic or noise, are more difficult to estimate.

It is difficult to separate the cost of highway drainage from the total cost of the highway for several reasons:

- A significant part of pavement cost is to control moisture levels in the pavement and its appurtenances. These designs influence the drainage system.
- Curb and gutter is installed for multiple purposes, not just for drainage. For example, it provides safety for pedestrians from vehicles.
- The right-of-way is used for multiple purposes and not just drainage (Washington State DOT 2003).

In LID, conveyance systems may also be recognized as treatment systems, potentially replacing ponds or other end-of-pipe approaches. Consequently, when BMPs are compared, it is necessary to specify explicitly how costs are apportioned among other drainage components and their purposes (Heaney et al. 1999).

Table 2.1. 2002 Highway construction costs in Florida.

Category	Lanes	Type	Construction Cost*, \$/mile	Paved Shoulder Width, ft.	Auxilliary or Refuge Lane, ft.	Routine Maintenance \$/year
State Rural Roads	2	Undivided	\$ 2,172,300	5		\$ 21,700
State Rural Roads	4	Undivided	\$ 4,018,600	10		\$ 40,700
State Rural Roads	6	Interstate	\$ 4,858,900	10		\$ 60,800
State Rural Roads	6	Undivided	\$ 4,276,100	5		\$ 60,800
State Rural Roads	6	Divided	\$ 4,098,000	5		\$ 60,800
State Rural Roads	8	Interstate	\$ 5,453,800	10		N/A
State Rural Roads	8	Undivided	\$ 5,178,900	10		N/A
State Rural Roads	8	Divided	\$ 5,184,600	10		N/A
State Urban Roads#	2	Undivided	\$ 2,821,800		10	\$ 26,300
State Urban Roads#	4	Interstate	\$ 4,765,100	10		\$ 26,300
State Urban Roads##	4	Undivided	\$ 3,305,100		12	\$ 58,500
State Urban Roads##	4	Divided	\$ 4,273,200		9	\$ 58,500
State Urban Roads#	6	Interstate	\$ 5,706,100	10		\$ 115,000
State Urban Roads##	6	Undivided	\$ 3,979,500		12	\$ 115,000
State Urban Roads##	6	Divided	\$ 4,946,300		8.5	\$ 115,000
State Urban Roads#	8	Interstate	\$ 6,278,700	10		\$ 129,400
State Urban Roads##	8	Undivided	\$ 4,636,000		12	\$ 129,400
State Urban Roads##	8	Divided	\$ 5,473,000		8.5	\$ 129,400

* These costs exclude costs for intersections/interchanges, right of way, landscaping, traffic signals, preliminary engineering, and construction engineering inspection.

#Includes curb and gutter

##Includes 5 foot sidewalk, and curb and gutter.

Florida DOT. 2003. *2002 Transportation Costs*. Tallahassee, FL

2.2 Added Cost of BMPs for Highway Systems

As stated previously, the costs associated with integrating stormwater BMPs and LID practices into the highway environment vary widely and are highly dependent on the level of urbanization at the site. Studies of BMPs in the Washington, DC area focused on their use in ultra-urban settings that have the following attributes (FHWA 2000):

- Limited space available for BMP implementation (less than 0.5 ha [1 ac]).
- Drainage area imperviousness greater than 50 percent.
- Property value of land over \$215 per square meter (\$20 per square foot).
- Location of BMP in right-of-way (only available space).

- Existence of build-out conditions at the site (lot-line to lot-line development).

Property values of at least \$20 per square foot correspond to land costs of at least \$870,000 per acre. Thus, land costs for highways could range from a few thousand dollars to well over a million dollars per acre in ultra-urban settings. As such, when evaluating alternative BMP practices in space-limited locations, designs that utilize small footprint areas, can be easily integrated into existing right-of-way infrastructure, or can be designed to be multiple-use facilities should be preferred.

[This page intentionally left blank]

3.0 LID AND HIGHWAY SYSTEMS

3.1 LID Concepts

LID is a stormwater management strategy concerned with reducing the hydrologic impact of development and maintaining or restoring the natural hydrologic and hydraulic functions of a site to achieve natural resource protection objectives and fulfill environmental regulatory requirements. LID employs a variety of natural and built features that reduce the rate of runoff, filter out its pollutants, and facilitate infiltration and evapotranspiration of water. By reducing water pollution and increasing groundwater recharge, LID helps to improve the quality of receiving waters and stabilize the flow rates of nearby streams.

LID incorporates a set of overall site design strategies as well as highly localized, small-scale, decentralized source control techniques known as Integrated Management Practices (IMPs). IMPs may be integrated into infrastructure or landscape design. LID takes a decentralized approach that disperses flows and manages runoff closer to where it originates. The optimal LID site design minimizes runoff volume and preserves existing flow paths. Because LID embraces a variety of useful techniques for controlling runoff, designs can be customized according to local regulatory and resource protection requirements, as well as site constraints. New development projects, redevelopment projects, and capital improvement projects can all be viewed as candidates for implementation of LID.

Generally, site design strategies for any project will address the arrangement of roads, parking areas, and other features, and the conveyance of runoff across the site. Some examples of LID site design strategies include:

- Grade to encourage sheet flow and lengthen flow paths.
- Maintain natural drainage divides to keep flow paths dispersed.
- Disconnect impervious pavement areas from the storm drain network, allowing runoff to be conveyed over pervious areas prior to entering a centralized conveyance system.
- Preserve the naturally vegetated areas and soil types that slow runoff, filter out pollutants, and facilitate infiltration.
- Direct runoff into or across vegetated areas to help filter runoff and encourage recharge and evapotranspiration.
- Provide small-scale distributed features and devices that help meet regulatory and resource objectives.
- Treat pollutant loads where they are generated, or prevent their generation.

The historical approach to stormwater management for highway design has been to collect and convey stormwater through swales or pipes to a centralized end-of-pipe discharge point or treatment system. Topography frequently constrains the length and extent of any centralized system; examples include rolling hills in piedmont areas and flat slopes in coastal zones. Highways can therefore be considered to be a linear series of distributed, drainage networks. As a result, the existing highway runoff infrastructure in the United States is inherently “distributed” and may provide unintentional, but likely significant, water quality and quantity benefits. Therefore, a key difference between conventional and LID design is the scale of the distribution of drainage networks and the integration of water quality controls into the network. The LID

approach is not a significant departure from instances of current design where curb-and-gutter systems are not typically used, except that the conveyance distance is minimized by collecting and treating runoff relatively close to the point of generation. Given this objective, LID provides a formal framework in which to select appropriate designs for surface drainage, landscaping, and infiltration.

This framework allows for LID to meet objectives besides replicating pre-development conditions, and helps to expand stormwater management to address community development issues and programs. This new paradigm presents several new considerations to the stormwater planning community, including the following.

- LID emphasizes incorporating conservation concepts into the site design and maintaining existing runoff and recharge patterns. This allows for the creation of site developments that support resource protection goals for a given watershed. Designers should consider impacts on habitats and sensitive environmental areas rather than simply meet one-dimensional requirements such as a standard discharge rate.
- The entire range of storm event frequency and duration can be addressed. Many conventional approaches target control for only a few specific storm events (e.g. 2-year, 24-hour). By using natural processes of storage and infiltration, smaller but much more frequent *micro-scale* storms can be controlled. Micro-scale storms are frequently occurring storms of short duration, and constitute 70-90% of the total annual precipitation (Wright and Heaney 2001). Larger storms can be controlled by adding sufficient storage volume distributed throughout the site.
- By using minimization techniques, the volume of stormwater and required area for treatment can be reduced. This reduction in infrastructure can potentially save capital and increase the area of developable land (Thurston et al. 2003).
- Stormwater controls can be designed for targeted pollutant issues. A treatment train approach can be used where multiple unit treatment operations and processes can be utilized by a variety of techniques, allowing treatment to occur all along the flow path.
- Stormwater controls can be integrated into the landscape or infrastructure. This creates opportunities to share costs for construction, construct facilities incrementally, and create aesthetically pleasing landscapes and building components that manage stormwater (NAHBRC 2003).

This new paradigm for stormwater management has created flexibility and opportunities in the development and implementation of stormwater management programs throughout the country. State and local governments and institutions are now exploring how best to use LID to meet their stormwater program requirements.

3.2 General LID Definitions

LID is a decentralized source control stormwater management strategy. The LID site design approach can be used to address planning as well as overall watershed regulatory requirements and resource protection goals. This approach utilizes an optimal combination of the following design and management elements:

- *Conservation Design*. Overall conservation goals, such as wetlands protection, habitat preservation, or aesthetic requirements, are integrated into the design.

- *Minimize Development Impacts.* Sensitive environmental areas, such as soils with high infiltration rates or potential for erosion, and stands of mature vegetation, are preserved by using highly detailed, site-specific design and engineering strategies and techniques. In the highway environment, this may include additional emphasis placed on alignment at the early stages of design. However, many other factors besides stormwater management will influence the chosen alignment.
- *Maintain Watershed Timing.* Designs preserve runoff patterns and timing of peak runoff rates at existing or pre-developed conditions.
- *Integrated Management Practices (IMPs).* IMPs are multifunctional, small-scale, source control stormwater management practices that can be integrated directly into the infrastructure and landscape. IMPs are an integral component of the highway design section; selection of specific IMPs depends on the alignment and cross-sectional profile conditions.
- *Pollution Prevention (P2).* Use of management techniques and materials that reduce or eliminate pollution at its source, instead of allowing it to be conveyed downstream. P2 can be achieved through a combination of materials selection and operation and maintenance procedures.

An LID design integrates natural hydrologic functions into the design to replicate the processes of storage, detention, infiltration, evaporation and transpiration, or uptake by plants in order to reduce runoff volume, attenuate peak runoff rates, or filter and remove pollutants from runoff. By incorporating controls specifically into upland areas, impacts to wetlands and other sensitive areas can be reduced or eliminated.

Highly impervious environments tend to concentrate runoff flows, potentially accumulating stormwater volumes that are too large to effectively be treated by many BMPs. The design techniques listed below can be used with many types of BMPs and LID practices to disperse runoff flows and reduce the volume, velocity, and pollutant loading of runoff.

- Time of concentration (t_c) practices, such as surface roughening, increase the time it takes for runoff to flow across a site to the drainage point or a BMP. Slowing runoff velocity potentially reduces erosion and increases the potential for infiltration.
- A flow splitter allows the runoff volume from a drainage area to be split into two or more quantities (“sub-volumes”). Typically, flow splitters are used to manage flow rates into a BMP and isolate the water quality volume (WQV) in order to provide water quality treatment or manage a portion of a storm event with one or more BMPs. Many jurisdictions define the WQV as the first 0.5 in. to 1 in. of rain over the impervious drainage area. However, modeling often provides a more precise estimate of the optimal flow rates and WQV for a particular geographic location and site conditions; see Chapter 7 of the *User’s Guide* and Chapter 10 of the *Research Report* for detailed discussions.
- When possible, pavement widths can be narrowed to reduce the total impervious surface area and increase the pervious area available for infiltration.
- Disconnection of impervious surfaces may be possible, in order to prevent the accumulation of large runoff volumes. Disconnection allows impervious runoff to flow onto a pervious surface, where infiltration can occur and the flow rate and pollutant load can be attenuated.

- Curb cuts can be used to dissipate runoff and provide partial disconnection in areas where curbs are required for safety or structural reasons. For a more detailed discussion see Section 5.1.4 of the *User's Guide*.

3.3 Hydrology and Water Balance

Development affects the natural hydrologic cycle as shown in Figures 3.1 and 3.2. The hydrologic cycle consists of the following processes: convection, precipitation, runoff, storage, infiltration, evaporation, transpiration, and subsurface flow.

A hydrologic budget describes the amounts of water flowing into and out of an area along different paths over some discrete unit of time (daily, monthly, annually). Grading and the laying of pavement typically affect the hydrologic budget by decreasing rates of infiltration, evaporation, transpiration and subsurface flow, reducing the availability of natural storage, and increasing runoff. In a natural condition such as a forest, it may take one or two inches of rainfall to generate runoff. In the developed condition, even very small amounts of rainfall (e.g., tenths of an inch) can generate runoff because of soil compaction and directly-connected impervious areas. The result is a general increase in the volume and velocity of runoff, which in turn increases the amount of pollution that is carried into receiving waters and amplifies the generation of sediment and suspended solids resulting from channel and bank erosion.

Both LID and conventional stormwater management techniques attempt to control rates of runoff using accepted methods of hydrologic and hydraulic analysis. The particular site characteristics that are considered will depend on the nature of the project. Land use, soil type, slope, vegetative cover, size of drainage area and available storage are typical site characteristics that affect the generation of runoff. The roughness, slope and geometry of stream channels are key characteristics that affect their ability to convey water.

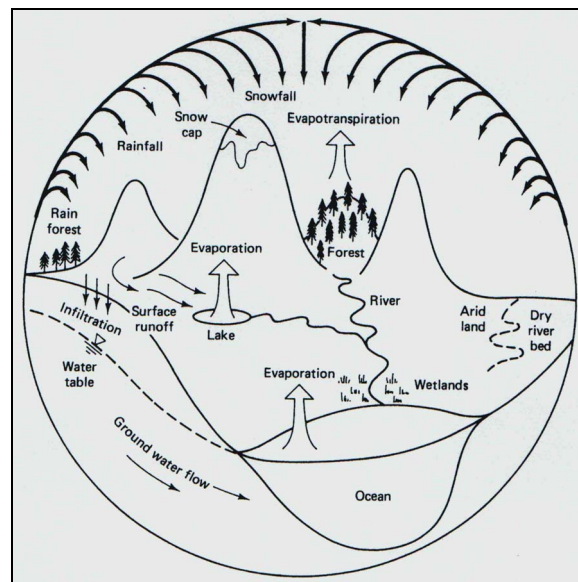

Figure 3.1. Natural Hydrologic Cycle. Source: McCuen, 2005.

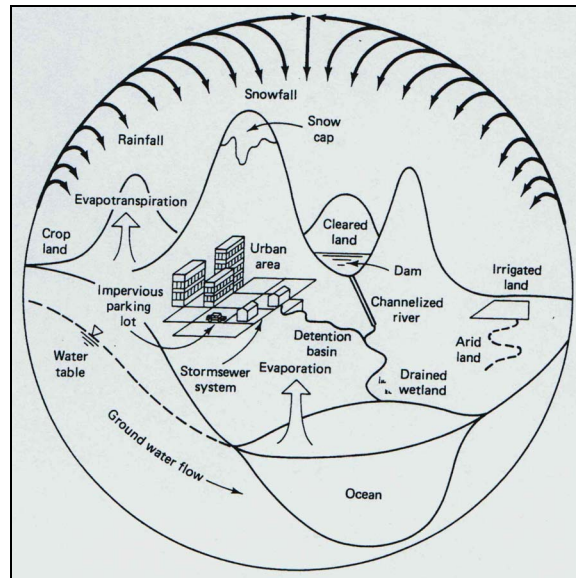

Figure 3.2. Hydrologic Cycle of a Developed Environment. Source: McCuen, 2005.

While conventional approaches to stormwater management design typically include only the hydrologic components of precipitation, runoff conveyance and storage capacity within their scopes, LID design recognizes the significance of other components of the hydrologic cycle as well. How these other components are actually taken into account will depend on the information available and purpose of the design. One LID design objective, for example, may be to maintain a natural groundwater recharge rate for a given site. Determining the appropriate number, size, and location of infiltration devices can require an extensive atmospheric data set (temperature and precipitation) to calculate evapotranspiration rates, along with hydrologic soil properties (porosity, hydraulic conductivity, and soil suction head).

3.4 Stormwater Management Practices

An important part of the discussion on stormwater management is the definition and classification of the types of practices and strategies on how to most effectively use them. Traditionally, the term BMP has been used to describe a specific stormwater treatment technique or approach. The term BMP implies that the analyst has found the best practice from a candidate group of controls. There is a lack of established protocols for the selection and management of BMPs. Generally, BMPs are selected because of a presumptive water quality control characteristic (e.g. remove 80% of total suspended solids or capture 80% of the 2-year, 24-hour storm). The designer is usually required to select a practice that meets the minimum regulatory standard.

The LID approach is based on selecting distributed small-scale controls that can maintain or replicate the hydrology of pre-development conditions or achieve another identified regulatory requirement or resource protection goal. Rather than work from a small range or list of BMPs, the goal is to achieve the highest efficiency or effectiveness at meeting the pre-development condition or other requirements. Wright and Heaney (2001) present an overview of how distributed BMPs can be an integral and cost-effective component of stormwater management in urban areas. They argue that sustainability principles such as decentralized or distributed systems may provide better long-term solutions because the stormwater is managed close to its

source in a distributed manner, reducing the need for extensive conveyance systems and detention facilities.

Control of frequent *micro-storms* is a critical concern for managing stormwater quality, a key LID strategy, and one of the most important recent advances in stormwater management. This is achieved by taking full advantage of distributed small-scale storage, detention, infiltration, and evaporation functions within the site. Large events can be controlled by increasing the detention and retention volume of more centralized facilities. Wright and Heaney (2001) suggest the following guiding principles for the control of micro-scale storms:

- Minimize directly connected impervious area (DCIA).
- Increase flow paths and time of concentration.
- Increase infiltration, but not at the expense of nuisance flooding.

Stormwater management practices are simply referred to in this research effort as "BMPs" for both conventional BMPs and LID practices. The effectiveness of these practices is evaluated primarily according to their effectiveness at reducing stormwater discharge volumes, attenuating peak discharge rates, and improving water quality. Table 3.1 summarizes BMP performance at satisfying these criteria and identifies unit processes employed. Additional discussion of unit processes can be found in Chapter 5 of the *User's Guide for BMP/LID Selection*.

Table 3.1. Effectiveness of BMPs in Meeting Stormwater Management Objectives & Unit Operations Employed.

BMP	Volume	Peak Discharge	Water Quality	Unit Operation/Process
<i>LID Practices</i>				
Bioretention	●	●	●	Volume reduction; microbially mediated transformation; uptake and storage, size separation, sorption
Bioslope	●	●	●	Volume reduction; microbially mediated transformation; uptake and storage, size separation, sorption
Catch Basin Controls			○	Size separation and exclusion; density, gravity, inertial separation
Gutter Filter		○	●	Size separation and exclusion; physical sorption
Infiltration Trenches/Strips	●	●	●	Volume reduction; size separation and exclusion; chemical sorption processes
Permeable Pavement	●	●	●	Volume reduction; size separation and exclusion
Pollution Prevention/Street Sweeping			○/●	N/A
Surface Sand Filter	○	○	●	Size separation and exclusion; microbially mediated transformation, sorption
Soil Amendments	●	●	●	Volume reduction; size separation and exclusion; microbially mediated transformation; uptake and storage, sorption
Swales	●	●	●	Volume reduction; density, gravity, inertial separation; microbially mediated transformation, sorption
Vegetation/Landscaping	●	●	●	Volume reduction; microbially mediated transformation; uptake and storage
<i>Conventional and Innovative BMPs</i>				
Advanced Biological Systems	●	●	●	Microbially mediated transformation; uptake and storage
Detention and Retention Ponds		●	○	Flow and volume attenuation; density, gravity, inertial separation; coagulation/flocculation
Disinfection Systems			●	Chemical disinfection
Flocculent/Precipitant Injection			●	Coagulation/flocculation
Sedimentation Ponds & Forebays		●	○	Flow and volume attenuation; density, gravity, inertial separation
Surface Filters (Filter Fabrics)			○	Size separation and exclusion

Key: ● High effectiveness ● Medium effectiveness ○ Low effectiveness Blank: No Impact
 Rankings are qualitative. “High effectiveness” means that one of the BMP’s primary functions is to meet the objective. “Medium effectiveness” means that a BMP can partially meet the objective but should be used in conjunction with other BMPs. “Low effectiveness” means that the BMP’s contribution to the objective is a byproduct of its other functions, and another decentralized control should be used if that objective is important.

This manual provides detailed design sheets for the LID practices in the table above. Additional information on the conventional and innovative BMPs, as well as some LID practices is available in the *User’s Guide for BMP/LID Selection*. It is noted that this manual includes design information on catch basin controls and pollution prevention, practices not typically associated with LID. Their inclusion highlights their applicability for use in distributed stormwater controls and LID treatment trains.

3.5 LID Stormwater Management Framework

The definition of LID as a BMP can be refined to evaluate LID within the context of the overall stormwater management functional components of the highway system. The basic characteristics of highway systems and how LID can be evaluated in the context of these systems can be summarized as follows:

- LID favors the use of decentralized source control systems. Linear highway systems are typically decentralized already since the available controllable drainage area is only the right-of-way.
- Over 85% of state DOT roads are “rural”. Assuming that these rural roads use open drainage systems, the vast majority of them would already control micro-storms by infiltration on the adjacent right-of-way. The major exceptions would occur where curb and gutter are needed due to steep slopes and/or poor soil infiltration. Consequently, swale drainage would tend to be the dominant BMP for the majority of highways.
- The remaining 15% of the state DOT roads have curbs and gutters and associated closed drainage systems. Arguments have been advanced to reduce or eliminate curb and gutter for low use access roads and low use parking areas (Li et al. 1998, Heaney et al. 1999). Curb and gutter drainage is often an essential safety component of high use state DOT transportation networks. Control of micro-storms in these facilities must be developed as part of a closed drainage system.
- Unlike urban development, where land use can be viewed as a decision variable to reduce wet-weather impacts, state highway designers do not typically have the option of changing the road location. They can, and already do, use trading approaches to mitigate wet-weather impacts by more intensive controls elsewhere.

4.0 INTEGRATING LID INTO HIGHWAY DESIGN

Stormwater management is one of several major highway design considerations. As with many new technologies and practices, concerns exist over how to successfully integrate LID with safety, structural and other primary concerns of highway design. Generally, because of the rural nature of the majority of U.S. highways and the distributed, small-scale size of LID controls, integration of this stormwater management strategy can be readily accomplished.

A primary goal of LID is to replicate the pre-development hydrologic regime of developed environments. In practice this means reducing the volume, peak discharge, and pollutant loads of stormwater and minimizing the hydrologic impacts of stormwater runoff. LID practices utilize vegetation and infiltration to reduce volumes and increase the time of concentration (t_c) of runoff. To successfully integrate LID practices into a site, careful consideration must be given to where to introduce trees and vegetation and the most suitable location to pond and infiltrate stormwater. Four main factors (safety, maintenance, vector control, and highway structural integrity) comprise the main concerns involved with introducing LID stormwater controls.

4.1 Safety

Introducing trees and vegetation and the temporary ponding of stormwater in LID control devices are perceived to negatively impact highway safety. However, because many LID practices are incorporated in medians and roadway setbacks, they do not pose a significantly increased safety risk. Those installations along highway shoulders and in narrow medians may, in fact, provide the safety benefits of providing a crash cushion and reducing glare/reflections. As with any stormwater infrastructure, fixed object hazards may pose a safety concern and sizing, construction, and placement of these objects needs consideration.

4.2 Maintenance

Maintenance, and the associated cost and ease of performing it, greatly influence the effectiveness of stormwater BMPs. A common perception concerning maintenance of LID installations is that the burden will be greater than for conventional, centralized controls. While it is true that the efficiency of LID installations at capturing sediments and gross particulates does require routine removal and disposal, the time and level of effort to remove accumulated pollutants is often less for LID installations than for underground, conventional BMPs.

Additionally, LID maintenance activities can often be molded into existing highway maintenance programs. The vegetated and natural design of LID controls requires maintenance similar to that of any landscaped or grassed area. Landscape maintenance for highways is typically focused on mowing and removal of trash and debris. These two components, along with mulching and vegetation inspection, constitute the major requirements of LID maintenance. Those maintenance activities that are not incorporated into landscaping and mowing programs are similar to the maintenance required for conventional stormwater BMPs.

4.3 Vector Control

Vector control is an increasing concern related to all stormwater control practices. Because LID uses longer stormwater flow pathways and infiltration, stormwater ponding is a common component of LID treatment. There has been some concern that LID practices that ponded water

will give mosquitoes greater breeding opportunities. However, properly maintained LID practices are designed to drain within 48 – 72 hours, a shorter interval than the mosquito gestation period. The one exception to this design criterion is the wet swale, which has a permanent pool of water and is used in low-lying areas with a flat terrain and poor infiltration capacity. The local vector control agency should be contacted and a vector control program prepared whenever a wet swale is considered. Other LID practices that pond water for greater than 48 – 72 hours need to be inspected for operational problems. Overall, LID may reduce the threat of mosquitoes generated from stormwater control because the majority of practices pond water only temporarily, as compared to other conventional controls that may often contain a large, permanent pool of water.

4.4 Highway Structural Integrity and Relation to AASHTO Design Guidelines

In 1820, John McAdam noted that regardless of the thickness of the structure, many roads in Great Britain deteriorated rapidly when the subgrade was saturated. Several studies conducted in the 1950s and 1960s have documented the adverse effects of moisture on pavement performance (Highway Research Board 1952, 1955, 1962), moisture that can enter the roadbed system in several ways (Figure 4.1). These effects include softening of pavement layers (reduced stiffness), degradation of material quality, and loss of bond between pavement layers (e.g., asphalt to asphalt) (ARA Inc. 2001). In recognition of these adverse effects, most pavement design procedures attempt to account for the possible presence of moisture when selecting and sizing the thickness of pavement layers.

The most widely used empirical design procedure, AASHTO (1993) *Pavement Design Guide*, uses drainage coefficients to account for the effects of moisture on base and subbase layers. Coefficients are based on the projected time for the layer to drain and the percentage of time the layer is expected to be saturated. For example, the effective thickness of a base layer would be increased by forty percent if free-draining aggregates were used in a relatively dry environment. Conversely, the effective thickness of a base layer would be reduced by sixty percent if the material did not drain and the layer was expected to be saturated more than twenty-five percent of the time. It should be noted that under these circumstances, most designers would select alternate materials.

Changes in subgrade soil modulus (stiffness) resulting from changes in moisture (or frost) are taken into account in the AASHTO procedure through an empirical approach termed the relative damage concept. Fundamentally, more pavement damage results when subgrade soils are less stiff. Many agencies have collected data on the effects of moisture changes on the modulus of subgrade soils. The Washington Department of Transportation (1998) reports that subgrade soil moduli may be reduced by as much as twenty-five percent compared to summer values due to increases in moisture.

Pavement designers are moving toward mechanistic-empirical (ME) design procedures such as the one developed under NCHRP Project 1-37A, *Development of the 2002 Guide for the Design of New and Rehabilitated Pavement Structures*. This implementation of ME design relies on an incremental damage accumulation approach to estimate pavement distress. The effect of excess moisture on unbound granular and subgrade layers is considered through reductions in layer moduli (ARA Inc. 2001). These reductions in moduli result in increased stresses and strains in

the pavement system. In turn the increased stress and strain can be related to increased accumulation of distress through modeling.

Four approaches commonly used to control or reduce moisture problems in pavements are (ARA Inc. 2001):

- Prevent moisture from entering the pavement system,
- Use materials that are insensitive to the effects of moisture,
- Incorporate design features to minimize moisture damage,
- Quickly remove moisture that enters the pavement system.

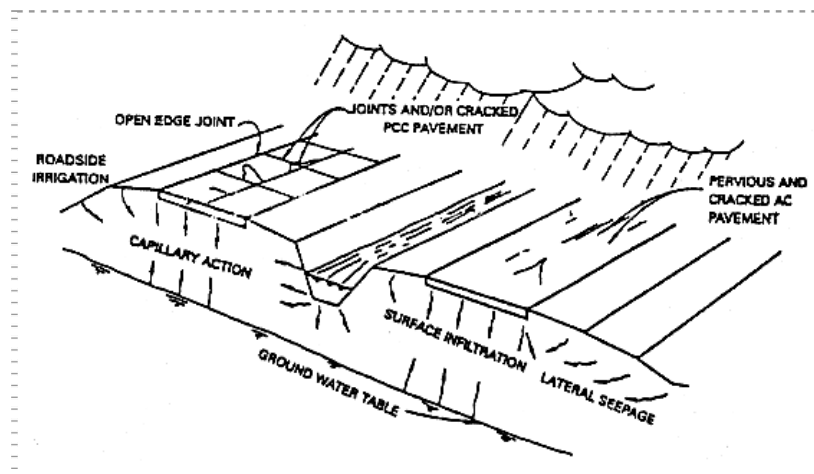

Figure 4.1. Sources of water in roadbeds. Source: AASHTO (1992) *Highway Drainage Guidelines*.

LID's use and incorporation of stormwater infiltration has resulted in some concerns that it could affect the structural integrity of the highway structure. Many of the LID practices use exfiltration of water into the soil as a way to filter and decrease stormwater run off. This exfiltration could contribute to or increase the lateral flow beneath the highway and the structural integrity of the highway could be compromised. To minimize structural integrity problems properly designed LID practices do not intersect with the water table and are placed below the pavement subgrade. If the area has poor hydraulic conductivity, underdrains will be placed to rapidly drain water so that saturation conditions will not persist. The LID measures proposed in this manual generally do not contribute to any of the problems noted above and in fact may actually increase the structural integrity of the road by helping to decrease any lateral flow and removing more water from the area than before.

4.5 Design of LID Facilities in the Highway Environment

The remainder of this *Manual* describes design tools for use of eleven LID techniques in the highway environment. The design guidelines incorporate issues raised earlier in this section in addition to the usual engineering considerations of materials, siting, structural integrity, safety, maintenance, hydrology, hydraulics, and effectiveness for targeted pollutants. The eleven practices described herein may not be all-inclusive; for instance, the *User's Guide*, Section 5.1.4,

describes curb cuts as an LID practice. Curb cuts are considered a means to bioretention in this manual.

5.0 Bioretention

DEFINITION Bioretention cells are vegetated depressions that treat runoff by rapid filtering through bioretention soil media. Biological and chemical reactions in the mulch, soil matrix, and root zone; physical straining; and infiltration into the underlying subsoil improve runoff water quality. Bioretention cells reduce the peak discharge rate by detaining water through surface ponding and storage in soil and gravel layers, and by providing control structures for outflow. They reduce the runoff volume by retaining water and allowing it to infiltrate into the subsoil.

LOCATION	<ul style="list-style-type: none"> • Median • Roadway setback • Pretreatment for ponds 	
FIXED-OBJECT HAZARD?	<ul style="list-style-type: none"> • No (see safety section) 	
EFFECTIVENESS	<ul style="list-style-type: none"> • Water quality HIGH • Volume MEDIUM • Peak discharge HIGH 	
STORAGE CAPACITY	<ul style="list-style-type: none"> • Water quality volume • Additional storage for greater peak control 	
TARGETED POLLUTANTS	<ul style="list-style-type: none"> • TSS • Oil and grease • Heavy metals • Nutrients 	

Figure 5.1. Bioretention cell in Adelphi Road median, Adelphi, MD. Note curb cuts for water entry.

CROSS-SECTION

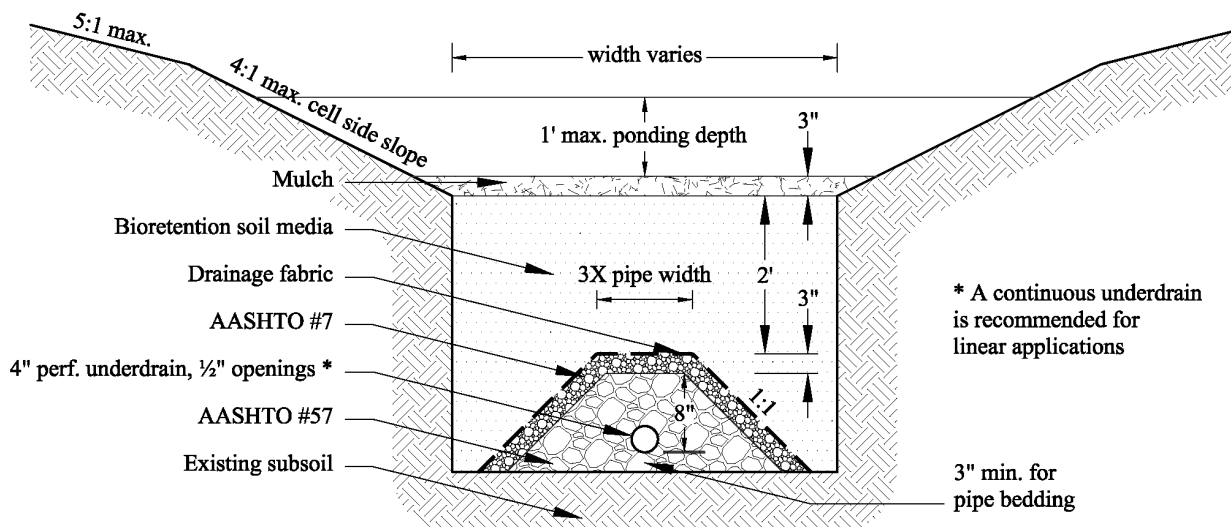

Figure 5.2. Typical bioretention cell cross-section. Not to scale.

Siting Guidelines

These guidelines and criteria will help determine whether bioretention cells are appropriate for use in a given location. Brief explanations are also provided.

Guideline	Explanation
The impervious drainage area should be 0.5 ac. or less.	Bioretention cells are small-scale devices that should be distributed across a site, not centralized ponds.
The minimum distance from the cell invert to bedrock or to the seasonally high water table is 2'.	<ul style="list-style-type: none"> ● Bedrock: This will help ensure that infiltrating runoff does not become perched on an impervious layer. ● Water table: This will help prevent groundwater from seeping upward into the cell.
Slopes immediately adjacent to a bioretention cell should be between 2% and 20%.	<ul style="list-style-type: none"> ● 2% minimum: Ensure positive flow into the cell. ● 20% maximum: Steep slopes are prone to erosion.
Do not clear wooded areas to construct bioretention cells.	Existing wooded areas are natural, stormwater management resources. It is counterproductive to clear a vegetated area only to construct another one.
Perform an analysis of the existing soils at the start of the design phase in order to determine whether an underdrain is needed (see "Outflow Design" below).	The need for an underdrain will influence the rest of the design. If subsoils have a low permeability but no underdrain is provided, the cell will drain poorly and ponded water may persist.
Maintain 1' vertical and 5' horizontal clearance from the bioretention cell to any storm drain.	This is a standard utility clearance for storm drains. Aside from possible construction and maintenance impacts, however, there are no clearance requirements for other utilities.
Locate the bioretention cell at least 5' downgradient from the edge of the roadway.	Minimize potential safety and structural conflicts with roadway.
Bioretention cells must be situated to provide safe and ready access to maintenance vehicles and workers.	An unsafe access point will jeopardize workers and may reduce the amount of maintenance work performed.

Materials

REQUIRED MATERIALS

These required components correspond to the cross-section above. Cost is given in 2005 dollars.

Item	Depth	Cost	Specification	Purpose
Bioretention soil media (BSM)	2' – 3'	\$40 – \$60 / C.Y.	Engineered soil mix classified as “sandy loam” or “loamy sand,” uniformly mixed and free of sticks and stones. Total clay content must be less than 5%. Components: <ul style="list-style-type: none"> • 50% sand (ASTM C-33 double-washed) • 30% planting soil (free of noxious weed seeds) • 20% mulch (2X shredded hardwood) 	<ul style="list-style-type: none"> • Growth medium for plants and microbes • Stormwater storage in void space • Pollutant removal: biological, chemical, and physical processes
Mulch	2” – 4”	\$30 – \$35 / C.Y.	<ul style="list-style-type: none"> • 2X shredded hardwood bark, aged for 12 months minimum. • Must be free of seeds and other plant material. • This is a separate quantity from the mulch that is part of the bioretention soil media. 	<ul style="list-style-type: none"> • Prevents clogging by capturing sediment • Critical to pollutant removal • Protects plants • Increases stormwater retention
Plants	n/a	\$5 – \$20 ea.	<ul style="list-style-type: none"> • Plants must be salt-tolerant in regions where deicing materials are used, and must be able to withstand periods of high and low moisture. • Supplemental irrigation may be used until plants are established. • Select plants that do not require irrigation after becoming established. • Native plants may have lower maintenance requirements. 	<ul style="list-style-type: none"> • Pollutant removal through root uptake • Roots provide habitat for microbes • Nutrient cycling • Landscaping/habitat • Volume reduction through evapo-transpiration • Roots help maintain soil permeability
Pea gravel	3” – 8”	\$30 – \$35 / C.Y.	<ul style="list-style-type: none"> • AASHTO No. 7 • Washed, river-run, round diameter 	<ul style="list-style-type: none"> • Diaphragm to prevent underdrain pipe from clogging
Gravel	1' – 3'	\$30 – \$35 / C.Y.	<ul style="list-style-type: none"> • AASHTO No. 57 • Double-washed blue stone 	<ul style="list-style-type: none"> • Stormwater storage in void space
Drainage fabric	n/a	\$1 – \$5 / S.Y.	<ul style="list-style-type: none"> • Use Equivalent Opening Size (EOS) of #50 sieve to avoid clogging by fine particles. • Min. permeability 125 GPM/ft². Must be greater than that of BSM. 	<ul style="list-style-type: none"> • Place between BSM and gravel layers to prevent migration of fines.

OPTIONAL MATERIALS

These bioretention cell components may be needed in some cases. See below for additional discussion. The materials correspond to the cross-section above. Cost is given in 2005 dollars.

Item	Depth	Cost	Specification	Purpose
Underdrain pipe	n/a	\$8 – \$15 / L.F.	<ul style="list-style-type: none"> • Perforated PVC, 4” min. dia. • Flexible ADS pipe may be used. • Slope must be 0.5% or greater to ensure positive drainage. 	<ul style="list-style-type: none"> • Provide positive drainage where subsoil has low permeability
Observation and cleanout pipe	n/a	\$8 – \$15 / L.F.	<ul style="list-style-type: none"> • Non-perforated PVC. • Join to underdrain with “T” connection. 	<ul style="list-style-type: none"> • Used to determine whether cell is dewatering properly • Backflushing underdrain
Liner	n/a	\$1 / S.Y.	<ul style="list-style-type: none"> • Plastic pond liner or equivalent. • Minimum thickness is 30 mil. 	<ul style="list-style-type: none"> • Prevent cross-contamination • Prevent infiltration to sensitive groundwater resources

ADDITIONAL MATERIAL DETAILS

Soil and gravel

- Test the bioretention soil media before installation. It must have a pH of 5.5 to 6.5 and an organic content of 1.5 to 3%. As stated above, clay content must be less than 5%. The saturated hydraulic conductivity of the bioretention soil media must be rapid enough to allow surface ponding to completely drain within three (3) to four (4) hours.
- The minimum cover (soil and gravel combined) above the underdrain is 2’.
- Use a minimum 3” of #57 gravel below the underdrain to provide bedding, even if no additional storage is desired.

Liner

- Install a liner below the underdrain and bottom gravel layer when potential cross-contamination is a concern: either from polluted runoff contaminating groundwater, or from contaminated soils leaching pollutants into stormwater. Place soil above the liner by hand to prevent puncture. If polluted runoff is a concern, the underdrain should be able to be capped in the event of a spill.

Underdrain

- See “Outflow Design” below.
- All storm drain pipe joints and interfaces in the vicinity of the cell, including underdrain and overflow tie-ins, should be sealed to prevent exfiltration and cavitation.
- All cells deeper than 2’ and all cells with underdrains must have one (1) or more observation/cleanout wells, centered in the cell.
- A continuous underdrain is recommended for linear applications.
- Do not wrap the underdrain with drainage fabric – it will clog.

Hydrology and Hydraulics

HYDROLOGIC AND WATER QUALITY CONTROLS

The following table summarizes the types of runoff controls provided by bioretention cells. See Chapter 3 for additional discussion of these controls.

Control	Effectiveness	Discussion
Water quality	High	<ul style="list-style-type: none"> ● Bioretention cells are typically sized to capture at least the first 0.5” of runoff, and are therefore effective in reducing concentrations of: <ul style="list-style-type: none"> ○ Total Suspended Solids ○ Oil and grease ○ Heavy metals ○ Phosphorus, and to a lesser extent, nitrogen. ● Water quality processes include: <ul style="list-style-type: none"> ○ Settling ○ Physical straining ○ Organic complexing ○ Uptake by roots ○ Degradation by microbes
Volume	Medium	<ul style="list-style-type: none"> ● Bioretention cells cause retention of runoff through: <ul style="list-style-type: none"> ○ Exfiltration into the subsoil (if subsoil has adequate permeability) ○ Subsurface storage below the underdrain (if present) ○ Evapotranspiration by vegetation ● Detention storage is provided through a combination of: <ul style="list-style-type: none"> ○ Surface ponding and use of control structures ○ Subsurface storage in soil and gravel layers above the underdrain
Peak discharge	High	<ul style="list-style-type: none"> ● By providing the storage mechanisms described above, bioretention cells are highly effective at reducing the peak discharge rate. ● When the cell is full, bypass flow will leave the cell with only minimal attenuation of the peak rate.

OFFLINE VS. INLINE SYSTEMS

A bioretention cell can be offline or inline, depending on site constraints and the configuration of the existing drainage system. Offline systems are preferable because they tend to minimize the transport of pollutants and debris downstream. (Both types of systems may use underdrains.) The difference between offline and inline cells is how the cell handles excess runoff when the maximum ponding depth has been reached. Several characteristics are compared below.

	Offline cells	Inline cells
In main flow path?	No – located to the side of main flow path	Yes
Acts as a sump?	No	Yes
Inflow	Runoff from main flow path enters cell until maximum ponding depth is reached or flow splitter design flow rate is exceeded.	All runoff drains to the cell, whether or not the cell is full.
Excess flow	Does not enter the cell. Follows the main flow path to a BMP, structure, or outlet.	Drains from cell to a conveyance system through a riser or other defined exit point.
Conveyance	Design main system for extreme events.	If required, design cell for extreme events.

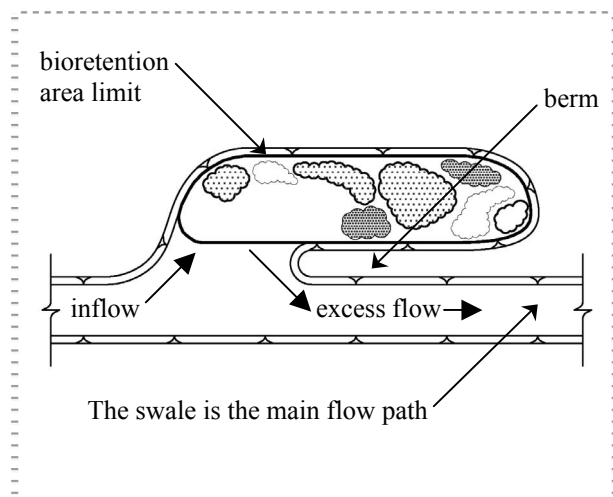

Figure 5.3. An offline bioretention cell. Adapted from PGDER.

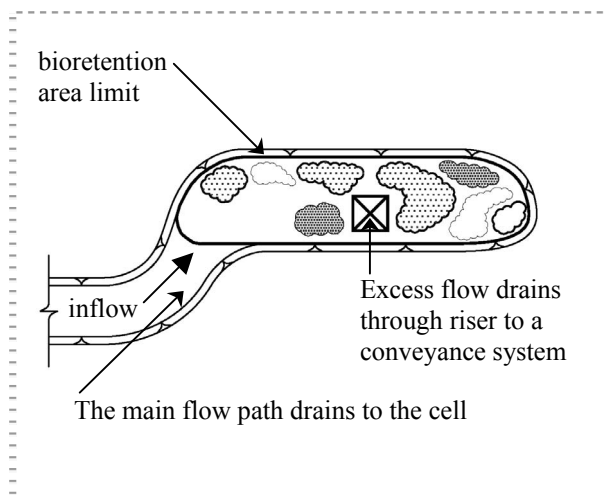

Figure 5.4. An inline bioretention cell. Adapted from PGDER.

INFLOW DESIGN

Stormwater can enter a bioretention cell in several ways:

- Sheet flow from open-section roadways
- Channelized flow from swales, flow-splitting devices, gutter drains, or storm drain outlets.
- Shallow concentrated flow from curb cuts.

Runoff Velocity

In all cases, inflow structures must reduce the runoff velocity to a non-erosive rate ($< \sim 2$ fps) in order to prevent erosion. This will also help to evenly distribute runoff across the entire surface of the cell. Common methods of distributing runoff and slowing its velocity are:

- Grass filter strips. Must be sufficiently wide to reduce velocity and trap sediment. May not be practical where space is at a premium.
 - Level spreaders can be used with filter strips to “un-concentrate” flows.

- Riprap aprons/gabions. Typically used when inflow is not sheet flow, e.g. curb cuts. Helpful when space constraints exist.
- Other practices to increase Time of Concentration (t_c) (see introduction to design sheets).

OUTFLOW DESIGN

Stormwater exits a bioretention cell through a combination of:

- Infiltration into the subsoil (in some cases, depending on soil type)
- Underdrain outflow into an adequate conveyance system
- Bypass flow or overflow when the cell's storage capacity has been reached

Bypass Flow

Every bioretention cell must have a provision for bypass flow or overflow to handle excess runoff. For offline cells, bypass flow automatically occurs when the maximum ponding depth is reached: excess runoff simply continues down the main flow path rather than entering the cell. This may simply consist of a curb inlet immediately downstream from the entrance to the cell. For inline cells, excess runoff spills into an overflow structure such as a standpipe, riser, or yard inlet. The jurisdiction may require that the overflow structure be able to safely pass flows from extreme events such as the 100-year storm. For both types of cells, bypass and overflow devices can be designed as flow splitters, diverting the excess runoff volume away from the cell and into the main conveyance system. See "Safety Issues," below, for safety concerns that may affect the design of the overflow structure.

Underdrain

An underdrain should be installed when the saturated conductivity of the existing subsoil is less than 1 in/hr, in order to provide positive outflow for runoff that filters down through the cell. The purpose of the underdrain is to drain away water which the existing subsoil cannot infiltrate rapidly enough. An underdrain may not be required if the saturated conductivity of the existing subsoil exceeds 1 in/hr. Five feet or more of underdrain closest to a storm drain tie-in must be non-perforated to prevent exfiltration into the storm drain. The hydraulic capacity of the underdrain should equal or exceed the maximum flow rate through the cell, as determined by the saturated conductivity of the bioretention soil media.

Underdrains must have positive drainage to a free outlet such as the storm drain system, a natural or engineered channel, permeable open space, or other appropriate outfall, subject to vertical space constraints and the requirements of the jurisdiction. Provide outfall protection for the underdrain as necessary. Do not tie in to a storm drain if:

- it is anticipated that backflow into the underdrain may regularly result from hydrostatic pressure in the storm drain, or if
- the underdrain outfall is lower than the typical flowline in the storm drain.

For additional information, refer to AASHTO's (1992) *Highway Drainage Guidelines*.

SIZING AND STORAGE

The water quality volume (WQV) is commonly used as a minimum basis for sizing a bioretention cell. Jurisdictions typically define the WQV to equal the first 0.5 in. to 1 in. of runoff from the impervious drainage area. Undersized cells may be prone to erosion, re-

suspension of accumulated sediment, frequent bypass flow, reduced pollutant capture, or other problems.

It is important to note that although a cell may be sized to capture the WQV, the actual volume treated may be much larger, and the entire runoff volume can be treated for many storms. Because runoff rapidly filters through the soil and gravel layers and then flows into the underdrain or subsoil, the cell will drain even as it continues to fill. Some jurisdictions consider the saturated conductivity of the subsoil in their bioretention sizing equation in order to reduce the required storage volume.

Detention storage is provided through surface ponding, and within the gravel layers. By accounting for subsurface storage in the total storage volume, the cell surface area may be decreased while still meeting design volume requirements. The detention storage volume can be estimated as follows.

Equation 5.1. Basic bioretention sizing equation.

$$\text{Detention volume} = (\text{cell surface area}) \times (\text{ponding depth} + \text{soil depth} \times n_{\text{soil}} + \text{gravel depth} \times n_{\text{gravel}})$$

where:

n_{soil} is the estimated soil porosity (0.25 typical)

n_{gravel} is the estimated gravel porosity (0.35 typical)

Detention volume \geq WQV

In bioretention cells with underdrains, water stored above the underdrain will exit through the underdrain. This is considered detention storage. Detained water ultimately leaves the bioretention cell through the underdrain or the bypass structure, and some form of downstream conveyance will be necessary. A limited amount of retention will occur as a result of evapotranspiration (ET) and exfiltration into the subsoil. Retained water is permanently taken out of the system. In addition, retention / recharge storage can be provided by adding a gravel layer below the underdrain. This “dead” storage will be drawn down over time by exfiltration into the subsoil. See Figure 5.5 below for an illustration. In cells without underdrains, all water is retained because it is lost to ET or exfiltration into the subsoil. The portion lost to ET is relatively small as compared to exfiltration, especially as the storm size increases. However, volume reductions from ET may be significant in dry seasons or geographic regions.

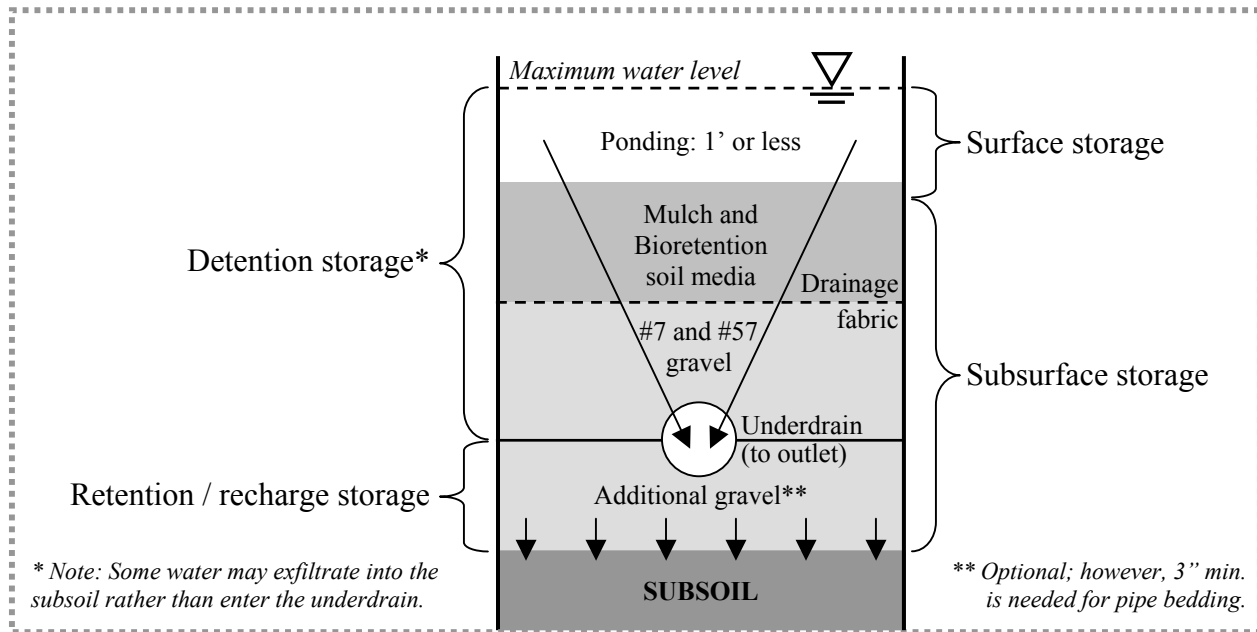

Figure 5.5. Types of storage available in a bioretention cell with underdrain

The storage volume selected by the designer depends on stormwater management objectives, site constraints (e.g. surface area, vertical clearance), and available storage upstream and downstream of the cell. For instance, some jurisdictions may not require volume or peak reduction if the conveyance system discharges directly to a tidal river, thereby reducing storage requirements. One benefit of increasing the storage volume is a reduction in the bypass flow from large storms.

Any volume of stormwater in excess of the WQV can be stored by increasing the:

- maximum ponding depth (should not exceed 1', however),
- depth of soil and/or gravel above the underdrain,
- depth of gravel below the underdrain (retention), or
- the cell surface area.

The storage volume can be re-calculated using the above equation.

Construction

Preventing soil compaction, erosion, and deposition of fines are key construction issues for bioretention cells. Guidelines are listed below.

- Avoid running equipment over the bioretention cell footprint to prevent soil compaction.
- To the greatest extent possible, stabilize the area draining to the cell before constructing the bioretention cell to prevent premature clogging by sediment.
- Place sod or a compost berm around the bioretention cell until all construction is complete and the drainage area has been fully stabilized.
- Do not stockpile excavated material in the area where the bioretention cell is to be constructed.

- After excavating the bioretention cell, it can be used as a temporary sediment trap. Before resuming construction, however, excavate one (1) additional foot to remove accumulated sediment.
- Take care not to compact the bioretention soil media with construction equipment. Use 8 – 12” lifts. Lightly water each lift to naturally compact the soil. The cell can be overfilled with the soil media to compensate for eventual natural compaction, which may reach 20%. Level the surface with a rake.
- Allow adequate time for the bioretention soil media to be tested if it does not come from a pre-approved source. See testing criteria on page 5-4.
- Shield drainage fabric from sunlight (UV radiation) if it will not be installed immediately.

Safety and Structural Issues

VEHICLE SAFETY

Potential vehicle safety concerns, both real and perceived, are listed below. The introduction contains additional information on the relationship between BMPs and roadway safety. Also see the *AASHTO Roadside Design Guide* and NCHRP Report 500, Volume 3: *A Guide for Addressing Collisions with Trees in Hazardous Locations*. The NCHRP report appendices, available online, provide design guidance.

Safety concern	Discussion	Possible remedies
Fixed-object hazards: <ul style="list-style-type: none"> • Vegetation • Flow control devices 	<p>Any tree or shrub in the cell can become a fixed-object hazard if the trunk diameter grows greater than 4".</p> <p>Any rigid flow control device (e.g. overflow structure) is a potential fixed-object hazard, especially if:</p> <ul style="list-style-type: none"> • Width is 4" or greater • Made of metal or concrete 	<ul style="list-style-type: none"> • Don't plant large-diameter vegetation. Minimize height and width of flow control devices. • Establish an appropriate offset. • Prune to keep trees small. This may significantly increase the maintenance burden, however. • If large trees or flow control devices are used, avoid placing bioretention cell: <ul style="list-style-type: none"> ○ in the clear zone ○ at the bottom of non-recoverable slopes ○ in the tangent position on the outside of curves ○ in chronic accident spots • Install a traffic barrier (i.e. guardrail). • Prune or remove trees in the cell, including volunteers. • Design flow control structures to crumple if struck. • Use an alternate flow control structure, such as an earthen spillway.
Sight distance / Visual obstruction	Vegetation taller than 3' may reduce sight distance around the inside of curves, block signage, or create other visual obstructions.	<ul style="list-style-type: none"> • Maintain 3' maximum vegetation height where an unobstructed view is critical, including: <ul style="list-style-type: none"> ○ inside curves (geometry varies) ○ in advance of signs ○ around median crossings ○ around at-grade intersections • Plant shorter vegetation as necessary.
Ponding / Standing water	This is largely a perceived concern, and will not pose a safety hazard when normal design parameters are used.	<ul style="list-style-type: none"> • Ensure that the maximum ponding depth is 6" to 1'. • Ensure that surface ponding completely drains within 24 hours (max) through proper design, construction, and maintenance and inspection. A three (3) to four (4) hour interval is the design drain time, however.

SAFETY BENEFITS

Bioretention cells may also provide safety benefits for roadway users under certain circumstances. The vegetation in bioretention cells may reduce glare and act as a crash cushion for errant vehicles.

Safety benefit	Discussion	Considerations
Crash cushion	Thick groundcover (e.g. shrubs) may act as a crash barrier, or at least cushion and slow errant vehicles.	<ul style="list-style-type: none"> • Ensure that final trunk or stem diameter is less than 4" • Maintain vegetation height to preserve sight distance • Vegetation must not obscure higher-risk objects • 5 to 10 years of growth may be needed for vegetation to be an effective cushion or barrier.
Reduce glare / reflection	Vegetation may reduce headlight glare or other visual hazards.	<ul style="list-style-type: none"> • See above.

MAINTENANCE WORKER SAFETY

See the maintenance section below for a discussion.

STRUCTURAL INTEGRITY

Structural concern	Discussion	Avoidance
Subsurface drainage <ul style="list-style-type: none"> • Lateral seepage from saturated cells. • See Figure 4.1 	<ul style="list-style-type: none"> • Bioretention cells pond water temporarily and exfiltrate it to the subsoil. • Water trapped in the roadbed structural section is unacceptable because it accelerates pavement deterioration. 	<ul style="list-style-type: none"> • Bioretention cells do not intersect the water table. The minimum distance from the cell invert to the seasonally high water table is 2'. In areas with high groundwater, the bioretention cell profile must be reduced, or another BMP must be selected. • Saturated conditions do not persist in properly designed, constructed, and maintained bioretention cells. Underdrains, provided when the saturated conductivity of the existing subsoil < 1 in/hr, will rapidly drain free water by gravity in the same manner as conventional subsurface drainage systems. Bioretention cells with underdrains may actually help to intercept and divert subsurface flows. • Ensure that the maximum ponding elevation is lower than the bottom of the pavement subgrade.
Slope stability	<ul style="list-style-type: none"> • Bioretention cell side slopes must not create stability problems for adjacent roadbed structural section. 	<ul style="list-style-type: none"> • Consult a geotechnical engineer to insure that the angle of repose of the bioretention cell side slope is appropriate for the soil type.

Maintenance

MAINTENANCE REQUIREMENTS

The primary maintenance requirement for bioretention cells is to inspect the treatment area's components and repair or replace them if necessary. Generally, maintenance is the same as the routine periodic maintenance that is required of any landscaped area. For example, on an annual basis, the following tasks are recommended for bioretention cells:

- Remove accumulated sediment and debris from the cell and its control structures.

- Replace any dead or stressed plants.
- Replenish the mulch layer to maintain design depth.
- Stabilize any eroded areas within or that drain to the bioretention cell.

Depending on the season, geographic location, and type of vegetation, irrigation may be needed during plant establishment. These factors will also determine the irrigation frequency. “Established” means that the soil cover has been maintained for at least one year since replanting. Native plants may require less irrigation than non-natives. In periods of extended drought, temporary supplemental irrigation may be used to maintain plant vitality. Irrigation may be done using an automatic system or manually by landscape maintenance workers.

WORK CREW

With proper training, bioretention cell maintenance will be able to be performed by a crew of two (2) to three (3) workers, or an existing landscaping crew.

MAINTENANCE WORKER SAFETY / TEMPORARY TRAFFIC CONTROL

To ensure worker safety, maintenance work on bioretention cells requires temporary traffic control (TTC) devices. References include:

- *Manual on Uniform Traffic Control Devices*, by the Federal Highway Administration
- State or local TTC manuals
- *AASHTO Roadside Design Guide*, chapter 9

Bioretention cells themselves and their control structures pose no inherent hazards to maintenance workers besides those associated with normal landscaping activities. The primary safety concern is to provide adequate distance between the work area and the travel lanes, and to ensure safe access to the work area. General guidelines for TTC activities are given below. Staging areas can include materials stockpiles and parking for equipment and personal vehicles.

Location of work zone	Type of closure	TTC device
Beyond shoulder. Sufficient space for staging and worker safety.	No closure needed	ROAD WORK AHEAD sign
<ul style="list-style-type: none"> • Beyond shoulder. Insufficient space for staging and safety. • Shoulder. Sufficient space for staging and worker safety. 	Close shoulder	<ul style="list-style-type: none"> • Channelizing devices (e.g. cones) • Temporary barriers and crash cushions • Truck-mounted attenuator
<ul style="list-style-type: none"> • Shoulder. Insufficient space for staging and worker safety. • Edge of travel lane 	Close travel lane	

In order to ensure long-term effectiveness of bioretention cells, associated BMPs (see “Treatment Train Options”), and surrounding open space, do not place staging areas:

- in areas prone to erosion, and
- in areas where soil permeability must be preserved.

Because staging activities can erode or compact sensitive soils, the staging area may need to be located on an adjacent paved surface. To ensure worker safety, the shoulder or travel lane may need to be closed. Also, temporary or permanent barriers should be used for longer-duration work such as major reconstruction.

PERFORMANCE AND INSPECTION

To ensure proper performance, visually inspect that stormwater is infiltrating properly into the bioretention cell. The primary indicator of cell failure is slow or no drawdown of ponded water. Water ponding in a bioretention cell for more than 48 hours may indicate operational problems. Corrective measures include inspection for and removal of accumulated sediments. Backflushing the underdrain through the cleanout pipe is another option. Samples of the bioretention media should be taken in the case of poor infiltration to determine the condition of the media (e.g. clay content). Full or partial replacement of the bioretention media may be required to restore the flow rate through the cell. Alternately, soil amendments can first be applied in an attempt to restore permeability. Perform this inspection:

- annually in the spring, or before the beginning of the wet season, and
- after extreme events (e.g. after hurricanes).

Aesthetics

Bioretention cells are landscaped stormwater management devices and can provide a neutral to positive visual impact along the roadway. Properly designed, they will blend in with other landscaping – especially from the point of view of a vehicle moving at highway speeds. Ponded water will drain within 24 hours if the cell is designed, constructed, and maintained correctly. Using native vegetation may help the bioretention cell to blend in with its surroundings and may reduce the maintenance burden. At a minimum, bioretention cells should be maintained for appearance as often as other landscaped roadway areas.

Treatment Train Options

Below is a list of other BMPs that can work in concert with bioretention cells to provide supplementary or complementary stormwater benefits. Also note that bioretention cells may be able to serve as pretreatment areas for conventional stormwater ponds.

BMP	Purpose	U/S	D/S
Bioswale or grassed swale	<ul style="list-style-type: none"> • Convey stormwater to or from the bioretention cell • Reduce runoff velocity • Provide pretreatment • Provide additional storage volume 	X	X
Infiltration trench	<ul style="list-style-type: none"> • Gain additional reductions in volume and peak by directing bioretention cell outflow into infiltration trench 		X
Inlet controls	<ul style="list-style-type: none"> • Install in overflow riser, if used, to trap floatables and debris. 		X
Flow splitter	<ul style="list-style-type: none"> • Separate a specific volume of water (e.g. WQV) from the total flow and direct it into the bioretention cell. Or, divert excess volume away from cell. • Can be upstream, or can be part of overflow structure 	X	
Pollution prevention	<ul style="list-style-type: none"> • Use P2 techniques to reduce loadings of pollutants entering the cell (e.g. fertilizers, herbicides and pesticides, oil) 	X	
Soil amendments	<ul style="list-style-type: none"> • Use soil amendments to restore the permeability of bioretention soil as an alternative to soil replacement. 		
Street sweeping	<ul style="list-style-type: none"> • Regular street sweeping can reduce loadings of sediment and debris entering the cell. 	X	
Tc practices	<ul style="list-style-type: none"> • Use Time of Concentration practices to reduce the velocity of runoff entering the cell. 	X	

U/S = upstream of bioretention cell D/S = downstream of bioretention cell

[This page intentionally left blank]

6.0 Bioslope

DEFINITION Bioslopes are embankments that treat runoff by rapid filtering through an engineered soil media commonly known as an ecology mix. Also called ecology embankments, bioslopes use a variety of physical, chemical, and biological processes to improve water quality. Bioslopes are similar to vegetated filter strips, but instead of filtering runoff via sheet flow through thatch and surface soils, runoff is rapidly infiltrated into a gravel trench and then filtered via subsurface flow through the ecology mix. The ecology mix bed is a flow-through device and does not provide significant detention, and only minimal retention storage. However, volume reduction may be achieved through storage in a gravel underdrain, and peak discharge rate may be reduced by movement through the ecology mix bed. A bioslope is usually indistinguishable from ordinary embankments, and its footprint is usually contained within the embankment.

LOCATION	<ul style="list-style-type: none"> • Median embankment • Side slope 	
FIXED-OBJECT HAZARD?	<ul style="list-style-type: none"> • No 	
EFFECTIVENESS	<ul style="list-style-type: none"> • Water quality HIGH • Volume MEDIUM • Peak discharge MEDIUM 	
STORAGE CAPACITY	<ul style="list-style-type: none"> • Optional retention and recharge storage in gravel underdrain 	
TARGETED POLLUTANTS	<ul style="list-style-type: none"> • TSS • Heavy metals • Phosphorus 	

Fig. 6.1. Potential bioslope location in WV. Source: Lib. of Congress.

CROSS-SECTION

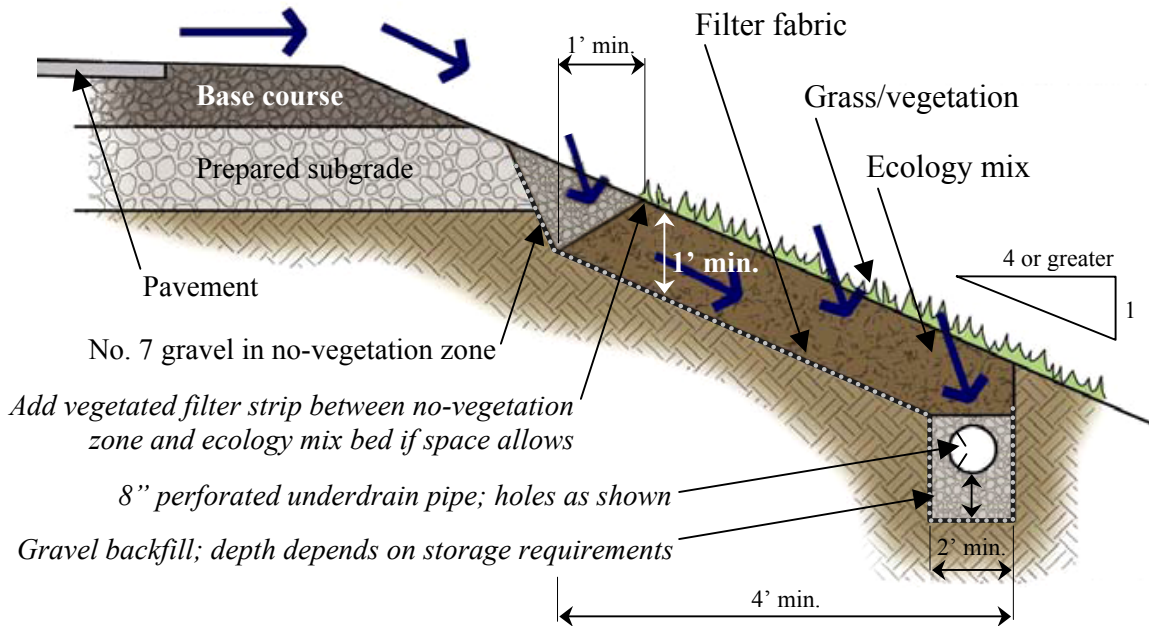

Figure 6.2. Typical bioslope cross-section. Not to scale. Italicized items are optional.
Source: Adapted from Pierce County, WA.

Siting Guidelines

These guidelines and criteria will help determine whether bioslopes are appropriate for use in a given location. Brief explanations are also provided.

Guideline	Explanation
Longitudinal gradients should be 4% or less.	Avoid generating erosive velocities in dual bioslopes.
<ul style="list-style-type: none"> • Side slopes must be less than 33%. • Side slopes between 15% and 25% are preferable. 	Bioslope may become unstable because of friction limitations when side slopes approach 25%. Steeper slopes may be terraced, but a geotechnical engineer must be consulted.
The bioslope must be situated so that runoff is conveyed by sheet flow from the highway to the bioslope.	Any type of flow besides sheet flow can lead to erosion and cause flows to bypass the ecology mix bed.
The total flow path length to the top of the bioslope (e.g. the no-vegetation zone) should be kept to a minimum, preferably 30' or less.	Longer flow paths tend to develop shallow concentrated flow instead of sheet flow and cause erosion and greater pollutant transport because of higher velocities.
Perform an analysis of the existing soils at the start of the design phase in order to determine whether an underdrain is needed (see "Outflow Design" below).	The need for an underdrain will influence the rest of the design. If subsoils have a low permeability but no underdrain is provided, the bioslope will drain poorly and bypass flow will be more frequent.
Do not clear wooded areas, wetlands, or wetland buffers to construct bioslopes.	Existing vegetated areas are natural and stormwater management resources, and the negative effect of clearing may outweigh the benefit of the bioslope.
Do not construct bioslopes in seismic hazard areas (e.g. active fault zones, soil liquefaction areas). Avoid areas with potentially unstable slopes without consulting a geotechnical engineer.	Bioslopes are intended for use on stable slopes only.
Do not construct bioslopes in a zone of seasonal groundwater inundation.	This will ensure that an adequate hydraulic gradient will be present.
Maintain 1' vertical and 5' horizontal clearance from the bioslope to any storm drain.	This is a standard utility clearance for storm drains. Aside from possible construction and maintenance impacts, however, there are no clearance requirements for other utilities.
Bioslopes must be situated to provide safe and ready access to maintenance vehicles and workers.	An unsafe access point will jeopardize workers and may reduce the amount of maintenance work performed.

Materials

REQUIRED MATERIALS

These required components correspond to the cross-section above. Cost is given in 2005 dollars.

Item	Depth	Cost	Specification	Purpose										
Grass seed	n/a	\$20 / M.S.F.	<ul style="list-style-type: none"> Native grass mix 	<ul style="list-style-type: none"> Stabilize ecology mix Provide pretreatment of runoff Nutrient cycling Blend in with landscape Roots help maintain soil permeability 										
Ecology mix	1' min.	\$40 – \$60 / C.Y.	<ul style="list-style-type: none"> Ecology mix components: 	<ul style="list-style-type: none"> Allow for rapid filtering of stormwater Pollutant removal through ion exchange, physical straining, bio-filtration, precipitation Add alkalinity to runoff Retain moisture to foster biomass growth 										
			<table border="1"> <thead> <tr> <th>Component</th> <th>Quantity (proportional)</th> </tr> </thead> <tbody> <tr> <td>Crushed mineral aggregate screenings 3/8" to #10 sieve (pea gravel)</td> <td>3 C.Y.</td> </tr> <tr> <td>Perlite (horticultural grade): >70% larger than 18 mesh <10% smaller than 120 mesh</td> <td>1 C.Y. per 3 C.Y. pea gravel</td> </tr> <tr> <td>Dolomite #0, gradation #16 sieve</td> <td>10 lb per C.Y. perlite</td> </tr> <tr> <td>Gypsum #0, gradation #8 to #16 sieve</td> <td>1.5 lb per C.Y. perlite</td> </tr> </tbody> </table>		Component	Quantity (proportional)	Crushed mineral aggregate screenings 3/8" to #10 sieve (pea gravel)	3 C.Y.	Perlite (horticultural grade): >70% larger than 18 mesh <10% smaller than 120 mesh	1 C.Y. per 3 C.Y. pea gravel	Dolomite #0, gradation #16 sieve	10 lb per C.Y. perlite	Gypsum #0, gradation #8 to #16 sieve	1.5 lb per C.Y. perlite
			Component		Quantity (proportional)									
			Crushed mineral aggregate screenings 3/8" to #10 sieve (pea gravel)		3 C.Y.									
			Perlite (horticultural grade): >70% larger than 18 mesh <10% smaller than 120 mesh		1 C.Y. per 3 C.Y. pea gravel									
Dolomite #0, gradation #16 sieve	10 lb per C.Y. perlite													
Gypsum #0, gradation #8 to #16 sieve	1.5 lb per C.Y. perlite													
Pea gravel	1' min.	\$30 – \$35 / C.Y.	<ul style="list-style-type: none"> AASHTO No. 7 Calcitic or dolomitic limestone is preferable, to add alkalinity and improve removal of dissolved metals 	<ul style="list-style-type: none"> Fills trench in no-vegetation zone Collects large particles Levels flow Encourages infiltration 										
Filter fabric	n/a	\$1 – \$5 / S.Y.	<ul style="list-style-type: none"> Use Equivalent Opening Size (EOS) of #50 sieve to avoid clogging by fine particles. Min. permeability 125 GPM/ft². Must be greater than that of ecology mix. 	<ul style="list-style-type: none"> Separate bioslope materials from underlying structural soils and road subgrade Direct flows downslope 										
Mulch	2" – 5"	\$30 – \$35 / C.Y.	<ul style="list-style-type: none"> 2X shredded hardwood mulch, aged for 12 months minimum. Must be free of seeds and other plant material. 	<ul style="list-style-type: none"> Place mulch to protect grass seed on newly-constructed bioslope. 										
Guideposts	3' high	\$5 – \$10 ea.	<ul style="list-style-type: none"> Non-reflective Brown or green Flexible 	<ul style="list-style-type: none"> Delineate the bioslope for maintenance workers 										

OPTIONAL MATERIALS

These bioslope components may be needed in some cases. See below for additional discussion. The materials correspond to the cross-section above. Cost is given in 2005 dollars.

Item	Depth	Cost	Specification	Purpose												
Underdrain pipe	n/a	\$8 – \$15 / L.F.	<ul style="list-style-type: none"> Perforated PVC, 8” max. diameter Use AASHTO M 278 standard. Slope must be 0.5% or greater to ensure positive drainage. 	<ul style="list-style-type: none"> Provide positive drainage where subsoil has low permeability 												
Observation and cleanout well	n/a	\$8 – \$15 / L.F.	<ul style="list-style-type: none"> Non-perforated PVC. Join to underdrain with “T” connection. 	<ul style="list-style-type: none"> Used to determine whether underdrain is dewatering properly Backflushing underdrain 												
Gravel backfill	6” min.	\$30 – \$35 / C.Y.	<ul style="list-style-type: none"> Can be crushed, processed, or naturally occurring. Free from all non-stone material Grading specifications are per Washington State DOT standard specifications, Section 9-03.12(4): <table border="1" data-bbox="695 961 1105 1161"> <thead> <tr> <th>Sieve size</th> <th>% Passing by weight</th> </tr> </thead> <tbody> <tr> <td>1” square</td> <td>100</td> </tr> <tr> <td>3/4” square</td> <td>80 – 100</td> </tr> <tr> <td>3/8” square</td> <td>10 – 40</td> </tr> <tr> <td>U.S. No. 4</td> <td>0 – 4</td> </tr> <tr> <td>U.S. No. 200</td> <td>0 – 2</td> </tr> </tbody> </table>	Sieve size	% Passing by weight	1” square	100	3/4” square	80 – 100	3/8” square	10 – 40	U.S. No. 4	0 – 4	U.S. No. 200	0 – 2	<ul style="list-style-type: none"> Provides bedding for underdrain pipe Provides additional storage / recharge volume in underdrain trench
Sieve size	% Passing by weight															
1” square	100															
3/4” square	80 – 100															
3/8” square	10 – 40															
U.S. No. 4	0 – 4															
U.S. No. 200	0 – 2															
Liner	n/a	\$1 / S.Y.	<ul style="list-style-type: none"> Plastic pond liner or equivalent. Minimum thickness is 30 mil. 	<ul style="list-style-type: none"> Prevent cross-contamination 												

ADDITIONAL MATERIAL DETAILS

Soil and gravel

- Over time, sediment may become integrated into the top several inches of the ecology mix bed, providing additional capacity for physical straining or sorption of heavy metals.
- Use a minimum 6” of gravel below the underdrain to provide bedding, even if no additional storage is desired.

Grass

- See Construction section for instruction on grass establishment.

Liner

- An impervious liner can be used instead of the filter fabric if potential cross-contamination is a concern: either from polluted runoff contaminating groundwater, or from contaminated soils leaching pollutants into stormwater. Place the ecology mix above the liner by hand to prevent puncture. If polluted runoff is a concern, the underdrain should be able to be capped in the event of a spill.

- Similarly, if deemed necessary, the gravel trench in the no-vegetation zone can be lined to prevent exfiltration into the road subgrade.

Underdrain

- See “Outflow Design” below.
- All storm drain pipe joints and interfaces in the vicinity of the bioslope, including underdrain and overflow tie-ins, should be sealed to prevent exfiltration and cavitation.
- All bioslopes with an underdrain must have observation/cleanout wells of the same diameter as the underdrain, spaced 20’ on center. However, if the underdrain slope is greater than 3%, cleanouts are not required. Cleanouts should be as flush to the ground surface as possible to avoid creating a fixed-object hazard.
- Do not wrap the underdrain with filter fabric – it will clog.

Guideposts

- Guideposts are necessary to delineate the bounds of the bioslope because it will blend in with adjacent embankments.
- To avoid confusing drivers, do not use reflective or brightly colored guideposts.
- Guideposts must be flexible to avoid creating a fixed-object hazard.
- Place guideposts at both corners on the toe of the bioslope, and every 50 feet in between.

Hydrology and Hydraulics

HYDROLOGIC AND WATER QUALITY CONTROLS

The following table summarizes the types of runoff controls provided by bioslopes. See Chapter 3 for additional discussion of these controls.

Control	Effectiveness	Discussion
Water quality	High	<ul style="list-style-type: none"> ● Bioslopes are designed to infiltrate runoff from all storms up to a design intensity, and are therefore effective in reducing concentrations of: <ul style="list-style-type: none"> ○ Total Suspended Solids ○ Heavy metals ○ Phosphorus ● Water quality processes include: <ul style="list-style-type: none"> ○ Physical straining ○ Ion exchange ○ Biofiltration ○ Precipitation ○ pH buffering (add alkalinity)
Volume	Medium	<ul style="list-style-type: none"> ● Bioslopes cause retention of runoff through: <ul style="list-style-type: none"> ○ Exfiltration into the subsoil (if subsoil has adequate permeability) ○ Storage in the gravel trench below the underdrain (if present) ○ Evapotranspiration by vegetation ● Bioslopes have minimal detention storage because they do not allow ponding and because the ecology mix drains rapidly. ● Credit for volume reduction should not be taken for any portions of the bioslope footprint that are above compacted soils.
Peak discharge	Medium	<ul style="list-style-type: none"> ● Bioslopes can help reduce the peak discharge rate from all storms up to the design rainfall intensity because of movement across the vegetated surface, percolation through the ecology mix, and infiltration into the subsoil (if subsoil has adequate permeability).

INLINE SYSTEM

Bioslopes are inherently inline BMPs because they receive sheet flow directly from the pavement surface. Inline BMPs are located in the main flow path. The bioretention design sheet contains a detailed discussion of offline vs. inline BMPs.

INFLOW DESIGN

Runoff must flow onto the bioslope as sheet flow. Sheet flow will distribute runoff across the entire surface of the bioslope, helping to prevent rilling and erosion and to maximize the volume of runoff that infiltrates into the ecology mix bed. The no-vegetation zone, a gravel trench located between the roadway and the ecology mix bed, acts as a level spreader that promotes even distribution of runoff across the entire length of the bioslope. It also allows for infiltration and collects large particles. The no-vegetation zone should be 1' to 3' wide and at least 12" deep. If space allows, a vegetated filter strip can be constructed between the no-vegetation zone and the ecology mix bed to further distribute the flow and reduce its velocity. The soil beneath the vegetated filter strip can be amended with compost to increase its permeability.

OUTFLOW DESIGN

Stormwater exits a bioslope through a combination of infiltration into the subsoil (in some cases, depending on soil type) and underdrain outflow into an adequate conveyance system. Infiltration into the subsoil can occur under the ecology mix bed or at the gravel underdrain, if present. Providing for overflow is not necessary because bioslopes have no ponding capacity. Bypass

flow will only occur in extreme events when the flow rate from the highway exceeds the hydraulic capacity of the bioslope, or if improper maintenance leads to concentrated flows. Bypass flow is characterized by runoff traveling down the surface of the bioslope as sheet flow instead of infiltrating into the ecology mix bed.

Underdrain

When the long-term infiltration rate through the ecology mix is greater than the infiltration rate through the subsoil, an underdrain is needed in order to provide positive outflow for runoff at the toe of the bioslope. Generally, an underdrain should be installed when the subsoil is classified as Natural Resources Conservation Service (NRCS) Hydrologic Soil Group C or D. An underdrain may not be needed for Group A and B soils. The purpose of the underdrain is to drain water that the existing subsoil cannot infiltrate rapidly enough. Five feet or more of underdrain closest to a storm drain tie-in must be non-perforated to prevent exfiltration into the storm drain. The hydraulic capacity of the underdrain should equal or exceed the maximum flow rate through the bioslope, as determined by the saturated hydraulic conductivity of the ecology mix.

Underdrains must have positive drainage to a free outlet such as the storm drain system, a natural or engineered channel, permeable open space, or other appropriate outfall, subject to vertical space constraints and the requirements of the jurisdiction. Provide outfall protection for the underdrain as necessary. Do not tie in to a storm drain if:

- it is anticipated that backflow into the underdrain may regularly result from hydrostatic pressure in the storm drain, or if
- the underdrain outfall is lower than the typical flowline in the storm drain.

For additional information, refer to AASHTO's *Highway Drainage Guidelines*.

DUAL BIOSLOPES

Dual bioslopes are two individual bioslopes constructed on both median side slopes that share a single underdrain. Other linear depressions such as drainage ditches or swales may also be suitable for dual bioslopes. The underdrain or the channel itself can be used to convey extreme events. The conveyance requirement for such channels will vary by jurisdiction. For example, the Washington State Department of Transportation requires conveyance of the 25-year storm with a 1' freeboard. Inflow must still be conveyed to dual bioslopes as sheet flow, not channelized.

SIZING AND STORAGE

Flow rate is the primary factor for sizing a bioslope. When sizing a bioslope for its drainage area, the long-term flow rate through the ecology mix must be at least as great as the design peak discharge rate from the drainage area. Include a 50% safety factor when assigning a long-term conductivity rate to the ecology mix. The general sizing equation is given below.

Equation 6.1. General bioslope sizing equation.

$$Q_{highway} \leq Q_{infiltration} \rightarrow (I_{highway} \times Area_{pavement}) \leq (LTIR \times Area_{bioslope})$$

where:

$Q_{highway}$	= design flow rate from the highway segment (cfs)
$Q_{infiltration}$	= design long-term flow rate through the bioslope (cfs)
$I_{highway}$	= design maximum rainfall intensity (in/hr)
$LTIR$	= long-term infiltration rate through the ecology mix bed (in/hr)*
$Area_{pavement}$	= highway drainage area size (ft ²)
$Area_{bioslope}$	= area of bioslope that treats $Area_{pavement}$ (ft ²)

* 14 in/hr is typical. This includes a 50% safety factor.

According to Equation 6.1, the area of a bioslope is influenced by three factors: the contributing pavement area, the long-term infiltration rate through the ecology mix bed, and the design maximum rainfall intensity. Because a bioslope is generally as long as the drainage area it is intended to treat, the width of the bioslope can be determined as follows.

Equation 6.2. Simplified bioslope sizing equation.

$$Bioslope\ width \geq (average\ pavement\ width) \times (I_{highway} / LTIR)$$

The bioslope width should be at least 4 (four) feet. Round up the bioslope width to the nearest foot. Where the pavement width varies significantly, calculate the bioslope width for each pavement section.

A dual bioslope may have a shorter length than the pavement section it treats as long as the dimensions satisfy Equation 6.1; i.e., the long-term flow rate through the dual bioslope must equal or exceed the design flow rate from the pavement.

Gravel storage

The water quality volume (WQV) concept does not apply to bioslopes because they provide treatment by continuous, rapid filtering through the ecology mix. Bioslopes do not allow ponding, and the ecology mix does not provide any significant amount of retention or detention storage. However, the gravel underdrain trench can be used to provide retention/recharge volume if necessary.

In bioslopes with an underdrain, the gravel underdrain trench can be widened or deepened beyond its minimum dimensions to provide retention/recharge storage. This storage is located below the invert of the underdrain pipe. It is important to note that the available underdrain storage volume will not affect the hydraulic capacity of the bioslope, which is determined by the flow rate through the ecology mix. Bioslopes without an underdrain typically lack this gravel storage area. However, significant infiltration should still occur because bioslopes without underdrains are typically located on A or B soils.

The underdrain storage volume can be estimated as follows. The underdrain is assumed to be continuous along the length of the bioslope. The minimum width of the gravel underdrain trench is 2 feet.

Equation 6.3. Underdrain storage calculation.

$$\text{Storage vol.} = (\text{bioslope length}) \times (\text{gravel cross-sectional area}) \times n_{\text{gravel}}$$

where:

n_{gravel} is the estimated gravel porosity (0.35 typical)

The gravel cross-sectional area includes only the area below the underdrain.

Water stored below the underdrain will slowly infiltrate into the subsoil, and is considered to be retention or recharge storage. This volume of water is permanently taken out of the system and can be subtracted from storage requirements in downstream BMPs.

Construction

Preventing soil compaction, erosion, and deposition of fines are key construction issues for bioslopes. Guidelines are listed below.

- If possible, avoid running equipment over any non-structural side slopes within the bioslope footprint to prevent soil compaction.
- To the greatest extent possible, stabilize the area draining to the bioslope before constructing the bioslope to prevent premature clogging by sediment.
- The bioslope must not receive runoff until the drainage area has been fully stabilized.
- Place sod or a compost berm around the bioslope until all construction is complete and the drainage area has been fully stabilized.
- Do not stockpile excavated material in the area where the bioslope is to be constructed.
- Take care not to compact the ecology mix with construction equipment. Use 8 – 12” lifts. Lightly water each lift to naturally compact the soil. The bioslope can be overfilled with the ecology mix to compensate for natural compaction. Level the surface with a rake.
- Shield filter fabric from sunlight (UV radiation) if it will not be installed immediately.
- After placing grass seed, fertilize with organic fertilizer and lay 2” – 4” of mulch to protect the seed and stabilize the slope until grass is established. Pay attention to local seeding windows.

Safety and Structural Issues

VEHICLE SAFETY

Potential vehicle safety concerns, both real and perceived, are listed below. The introduction contains additional information on the relationship between BMPs and roadway safety. Also see the AASHTO *Roadside Design Guide* and NCHRP Report 500, Volume 3: *A Guide for Addressing Collisions with Trees in Hazardous Locations*. The NCHRP report appendices, available online, provide design guidance.

Safety concern	Discussion	Possible remedies
Fixed-object hazards: <ul style="list-style-type: none"> • Vegetation • Cleanout wells 	Large, woody vegetation and underdrain cleanouts are potential fixed-object hazards.	<ul style="list-style-type: none"> • Bioslopes do not generally contain woody vegetation. • Construct cleanout wells so they are as flush with the ground surface as possible. • Prune or remove volunteer trees.
Sight distance / Visual obstruction	Large vegetation may pose a visual obstruction.	<ul style="list-style-type: none"> • Grass is typically the only vegetation established on bioslopes.
Ponding / Standing water	Bioslopes have no ability to pond water.	<ul style="list-style-type: none"> • No action is necessary.
Recoverable slope	Slopes steeper than 25% are non-recoverable, and slopes steeper than 33% are rollover hazards.	<ul style="list-style-type: none"> • The roadway cross-section determines whether this hazard exists, not the presence of a bioslope. • 25% is the upper limit of recommended side slopes; see “Siting Guidelines.”

SAFETY BENEFITS

Single and dual bioslopes do not provide unique safety benefits.

MAINTENANCE WORKER SAFETY

See the maintenance section below for a discussion.

STRUCTURAL INTEGRITY

Structural concern	Discussion	Avoidance
Subsurface drainage <ul style="list-style-type: none"> • Lateral seepage from bioslope 	<ul style="list-style-type: none"> • Bioslopes are designed to maximize infiltration into the ecology mix bed. • Water trapped in the roadbed structural section is unacceptable because it accelerates pavement deterioration. 	<ul style="list-style-type: none"> • Saturated conditions do not persist in properly designed, constructed, and maintained bioslopes. Underdrains, provided when the long-term infiltration rate through the ecology mix exceeds the infiltration rate through the subsoil, will rapidly drain free water by gravity in the same manner as conventional subsurface drainage systems. Bioslopes with underdrains may actually help to intercept and divert subsurface flows. • The filter fabric below the ecology mix bed will help to guide runoff downslope to the underdrain.
Slope stability	<ul style="list-style-type: none"> • Bioslopes must not create stability problems for the adjacent roadbed structural section. 	<ul style="list-style-type: none"> • Consider terracing slopes between 25% and 33%; consult a geotechnical engineer. • Avoid side slopes greater than 25% to ensure that the ecology mix remains stable. • Efficient drainage through the ecology mix and (if present) into the underdrain will prevent saturated conditions from forming.

Maintenance

MAINTENANCE REQUIREMENTS

The primary maintenance requirement for bioslopes is to inspect the treatment area's components and repair or replace them if necessary. Generally, maintenance is the same as the routine periodic maintenance that is required of any roadway side slope. Follow the existing maintenance schedule for roadside mowing and debris removal. Use a retractable-arm mower to avoid compacting the ecology mix. Other routine maintenance activities are listed below.

- Repair any eroded areas as soon as they are noted.
- Remove weeds or other volunteers from the no-vegetation zone and other bioslope components. Spot application of herbicides, as needed, is permissible.
- As necessary, stabilize, repair, and re-grade any areas that have been damaged by vehicles running off the road (e.g. no-vegetation zone). This will stop erosion, prolong the life of the bioslope, and ensure that flows are uniformly distributed.
- Remove accumulated sediment and debris from no-vegetation zone and bioslope surface.

On an annual basis, perform the following tasks:

- Reseed or resod bare or stressed areas. Place mulch to stabilize the area.
- Perform a conductivity test to determine whether the infiltration rate of the ecology mix has decreased.
- If an underdrain is present and the depth of accumulated sediment in the underdrain pipe is greater than 0.5", flush the pipe through the cleanout wells.

WORK CREW

With proper training, bioslope maintenance will be able to be performed by a crew of two (2) to three (3) workers, or an existing landscaping crew.

MAINTENANCE WORKER SAFETY / TEMPORARY TRAFFIC CONTROL

To ensure worker safety, maintenance work on bioslopes requires temporary traffic control (TTC) devices. References include:

- *Manual on Uniform Traffic Control Devices*, by the Federal Highway Administration
- State or local TTC manuals
- *AASHTO Roadside Design Guide*, chapter 9

Bioslopes pose no inherent hazards to maintenance workers besides those associated with normal landscaping activities. The primary safety concern is to provide adequate distance between the work area and the travel lanes, and to ensure safe access to the work area. General guidelines for TTC activities are given below. Staging areas can include materials stockpiles and parking for equipment and personal vehicles.

Location of work zone	Type of closure	TTC device
Beyond shoulder. Sufficient space for staging and worker safety.	No closure needed	ROAD WORK AHEAD sign
<ul style="list-style-type: none"> • Beyond shoulder. Insufficient space for staging and safety. • Shoulder. Sufficient space for staging and worker safety. 	Close shoulder	<ul style="list-style-type: none"> • Channelizing devices (e.g. cones) • Temporary barriers and crash cushions • Truck-mounted attenuator
<ul style="list-style-type: none"> • Shoulder. Insufficient space for staging and worker safety. • Edge of travel lane 	Close travel lane	

In order to ensure the long-term effectiveness of bioslopes, associated BMPs (see “Treatment Train Options”), and surrounding open space, do not place staging areas:

- in areas prone to erosion, and
- in areas where soil permeability must be preserved.

Because staging activities can erode or compact sensitive soils, the staging area may need to be located on an adjacent paved surface. To ensure worker safety, the shoulder or travel lane may therefore need to be closed. Also, temporary or permanent barriers should be used for longer-duration work such as major reconstruction.

PERFORMANCE AND INSPECTION

To ensure long-term performance, visually inspect to make certain that the runoff:

- is being conveyed as sheet flow, and
- is infiltrating properly into the bioslope.

Perform this inspection:

- annually in spring, or before the beginning of the wet season, and
- after extreme events (e.g. after hurricanes).

If either condition is not evident, excess bypass flow may be occurring. This may cause reduced water quality treatment for runoff. Evidence of excess bypass flow includes:

- channelized flow down the slope, and
- rill formation or other erosion.

If excess bypass flow is occurring, first inspect the pavement edge, no-vegetation zone, and vegetated filter strip, if present, for an uneven surface or excessive accumulation of sediment and debris. It is especially important for the no-vegetation zone to have an even slope so that it is an effective level spreader. Remove debris, stabilize, repair, and re-grade as necessary to restore an even slope. Ruts less than 1’ wide can be filled with soil or gravel. If ruts are greater than 1’ wide, the area may need to be re-graded.

If the slopes are even but runoff is not infiltrating, perform a conductivity test to determine the infiltration rate of the ecology mix. Partial or complete replacement of the ecology mix may be required if the infiltration rate has decreased significantly. Bioslopes are a relatively new technology and little data exists on the long-term performance of the ecology mix. However, the media in bioretention cells, a similar technology, has performed successfully without replacement for over ten years.

Aesthetics

Because grass is used for a vegetative cover, bioslopes appear identical to normal embankments for both stationary observers and those traveling at highway speeds. At a minimum, bioslopes should be maintained for appearance as often as other landscaped roadway areas.

Treatment Train Options

Below is a list of other BMPs that can work in concert with bioslopes to provide supplementary or complementary stormwater benefits.

BMP	Purpose	U/S	D/S
Bioretention cell	<ul style="list-style-type: none"> Gain additional reductions in volume and peak by directing bioslope outflow into bioretention cell. Modest nitrogen removal is possible. 		X
Bioswale	<ul style="list-style-type: none"> Gain additional reductions in volume and peak by directing bioslope outflow into bioswale. Modest nitrogen removal is possible. Convey stormwater away from the bioslope underdrain outfall. 		X
Infiltration trench	<ul style="list-style-type: none"> Gain additional reductions in volume and peak by directing bioslope outflow into infiltration trench. 		X
Pollution prevention	<ul style="list-style-type: none"> Use P2 techniques to reduce loadings of pollutants entering the bioslope (e.g. fertilizers, herbicides and pesticides, oil). 	X	
Soil amendments	<ul style="list-style-type: none"> Use soil amendments to restore the permeability of the vegetated filter strip, if present. 	X	
Street sweeping	<ul style="list-style-type: none"> Regular street sweeping can reduce loadings of sediment and debris entering the bioslope. 	X	

U/S = upstream of bioslope D/S = downstream of bioslope

7.0 Catch Basin Controls

DEFINITION Catch basin controls, as defined herein, are underground devices and designs connected directly to the storm drain system that prevent sediment, oils, floatable trash, and debris from being transmitted further along the system. If designed with a sedimentation sump, catch basins themselves may capture and retain sediment, but other devices may be used within the catch basins or within stand alone, underground vaults to increase pollutant removal. For instance, several catch basin insert devices are available (mostly proprietary) that use screens, baffles, filter fabrics, and absorbents to capture and retain pollutants within the catch basin. Oil-water separators, sedimentation tanks, and hydrodynamic separators (flow-through devices with a settling or separation unit) are examples of underground devices, also considered catch basin controls in this document, that can be used to remove sediments and other stormwater pollutants. Catch basin controls may be used by themselves or with other BMPs as part of a stormwater treatment train. However, these controls are generally considered pre-treatment devices, as they typically provide limited treatment when compared to other BMPs. Additional information on these technologies can be found in Section 5.2 of the *User's Guide*.

LOCATION	<ul style="list-style-type: none"> Ideal for hotspots of floatable pollutants (i.e. oil) 	
FIXED-OBJECT HAZARD?	<ul style="list-style-type: none"> No 	
EFFECTIVENESS	<ul style="list-style-type: none"> Water quality <input type="text" value="LOW"/> Volume <input type="text" value="N/A"/> Peak discharge <input type="text" value="N/A"/> 	
STORAGE CAPACITY	<ul style="list-style-type: none"> None 	
TARGETED POLLUTANTS	<ul style="list-style-type: none"> Total Suspended Solids Floatables and debris Hydrocarbons 	

Figure 7.1. Snout in a catch basin. Source: Best Management Products

CROSS-SECTION

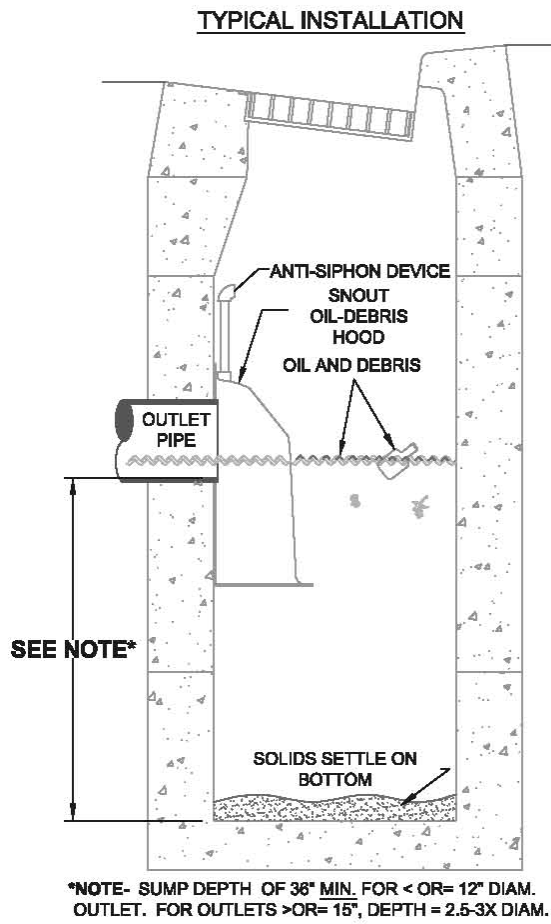

Figure 7.2 Typical Catch Basin with Snout Installed

Siting Guidelines

These guidelines and criteria will help determine whether catch basin controls are appropriate for use in a given location. Brief explanations are also provided.

Guideline	Explanation
Catch basin controls are typically installed in closed-section roadways.	Curbs, barriers, inlets, etc. channel runoff into the catch basin control.
Catch basin controls should be sited in a location with the largest possible volume.	The deeper the basin, the more effective the unit will be, both in terms of pollutant removals and reducing frequency of maintenance. Greater volume also means fewer cycles between maintenance operations, because the structure has a greater capacity.
Catch basin controls must be situated to provide safe and ready access to maintenance vehicles and workers.	An unsafe access point will jeopardize workers and may reduce the amount of maintenance work performed.
Hydrocarbon booms may be used to increase removals in areas with high hydrocarbon concentrations.	Hydrocarbon booms are an additional method of capturing oil and grease and other hydrophobic pollutants.

Materials

REQUIRED MATERIALS

These required components correspond to the cross-section above. Cost is given in 2005 dollars.

Item	Depth	Cost	Specification	Purpose
Precast reinforced concrete vault	Min. 3 × outlet pipe diameter	\$125 – \$175 / C.Y. concrete	<ul style="list-style-type: none"> • 6" minimum wall thickness • 4000 psi 28-day concrete • #5 rebar 6" CCEW 	<ul style="list-style-type: none"> • Provides a impervious basin capturing pollutants

OPTIONAL MATERIALS

These optional components correspond to the cross-section above. Note that there are many alternative proprietary and non-proprietary devices to choose from. The following costs provide a general example. Cost is given in 2005 dollars.

Item	Depth	Cost	Specification	Purpose
SNOOUT®	n/a	\$220-\$3900 per SNOOUT®	<ul style="list-style-type: none"> • Depends on the size of outflow pipe 	<ul style="list-style-type: none"> • Remove floating debris and pollutants
Trash rack	n/a	Variable	<ul style="list-style-type: none"> • High hydraulic capacity 	<ul style="list-style-type: none"> • Trap large debris • Allow small debris to pass • Intercept sheet flow
Hydrodynamic separator	n/a	Variable	<ul style="list-style-type: none"> • Sized according to catch basin dimensions 	<ul style="list-style-type: none"> • Remove sediments and other pollutants
Hydrocarbon boom	n/a	\$135-165	<ul style="list-style-type: none"> • Sorbent material should be specifically designed to absorb oil and grease. Amorphous alumina silicate is preferred. 	<ul style="list-style-type: none"> • Absorbs hydrocarbons.

Hydrology and Hydraulics

HYDROLOGIC AND WATER QUALITY CONTROLS

The following table summarizes the types of runoff controls provided by catch basin devices. See Chapter 3 for additional discussion of these controls.

Control	Effectiveness	Discussion
Water quality	Low	<ul style="list-style-type: none"> • Catch basin controls are able to reduce concentrations of: <ul style="list-style-type: none"> ○ Floatable pollutants ○ Debris and trash ○ Hydrocarbons • Water quality processes include: <ul style="list-style-type: none"> ○ Hydrodynamic separation
Volume	N/A	<ul style="list-style-type: none"> • Catch basin controls do not provide retention or detention of stormwater.
Peak discharge	N/A	<ul style="list-style-type: none"> • Catch basin controls do not decrease peak discharge flow rate.

INLINE SYSTEM

Catch basin controls are inherently inline BMPs because they receive flow either directly from roadways or as part of a treatment train. For all but the most extreme storm events, runoff within the drainage area of the catch basin will pass through the basin before entering the storm drain.

INFLOW DESIGN

Stormwater enters a catch basin from longitudinal gutter flow.

Catch basins are typically installed in closed-section roadways, where curbs or barriers adjacent to the catch basin help to direct runoff into the inlet. Either mountable or standard curbs can be used for this purpose.

OUTFLOW DESIGN

No exfiltration into the subsoil will occur because the vault is impermeable. All storm water exits through the outflow pipe.

Bypass Flow

There will be no bypass flow if the outflow pipe and selected catch basin control are designed, maintained, and sized correctly. For additional information, refer to AASHTO's *Highway Drainage Guidelines*.

SIZING

The performance of catch basin controls is related to the volume in the sump (i.e., the storage in the catch basin below the outlet). Lager *et al.* (1977), described an "optimal" catch basin sizing criteria, which relates all catch basin dimensions to the diameter of the outlet pipe (D).

Dimensions are:

Equation 7.1. Optimal catch basin size

The diameter of the catch basin should be equal to 4D
The sump depth should be at least 4D. This depth should be increased if cleaning is infrequent or if the area draining to the catch basin has high sediment loads
The top of the outlet pipe should be 1.5 D from the inlet to the catch basin

The volume selected by the designer depends on site constraints including the area of runoff to be collected, adjacent utilities, and connections to the collection system.

Construction

Catch basin construction should follow recommendations and specifications for either pre-cast or cast-in-place concrete. Installation of catch basin controls should follow manufacturer specifications.

Safety and Structural Issues

VEHICLE SAFETY

Potential vehicle safety concerns, both real and perceived, are listed below. The introduction contains additional information on the relationship between BMPs and roadway safety. Also see the AASHTO *Roadside Design Guide*.

Safety concern	Discussion	Possible remedies
Ponding / Standing water	This is largely a perceived concern, and will not pose a safety hazard when normal design parameters are used.	<ul style="list-style-type: none">Regular maintenance should prevent clogging which could lead to flooding.

SAFETY BENEFITS

Catch basin controls do not provide safety benefits.

MAINTENANCE WORKER SAFETY

See the maintenance section below for a discussion.

STRUCTURAL INTEGRITY

Structural concern	Discussion	Avoidance
Subsurface drainage <ul style="list-style-type: none">• Lateral seepage from catch basins.	<ul style="list-style-type: none">• Impervious concrete catch basins do not allow water to exfiltrate.	<ul style="list-style-type: none">• Maintain catch basins and control devices to prevent deterioration and ensure proper operation.

Maintenance

MAINTENANCE REQUIREMENTS

The primary maintenance activities are to remove accumulated trash and sediments and inspect the basin and controls for deterioration and operation..

- It is best to schedule maintenance based on the solids collected in the sump. Optimally, the structure should be cleaned when the sump is half full (e.g. when 2 feet of material collects in a 4 foot sump, clean it out).
- Checking sediment depth and noting the surface pollutants in the structure will be helpful in planning maintenance. Catch basin controls trap floatable debris and oils on the surface and grit and sediment settle to the bottom of the structure.
- Structures should be cleaned if a spill or other incident causes a larger than normal accumulation of pollutants in a structure.
- Maintenance is best done with a vacuum truck.
- If oil absorbent hydrophobic booms are being used in the structure to enhance hydrocarbon capture and removals, they should be checked on a monthly basis, and serviced or replaced when more than 2/3 of the boom is submerged, indicating a nearly saturated state.
- All collected wastes must be handled and disposed of according to local environmental requirements.

WORK CREW

With proper training, catch basin maintenance will be able to be performed by a crew of two (2) to three (3) workers, or an existing maintenance crew.

MAINTENANCE WORKER SAFETY / TEMPORARY TRAFFIC CONTROL

To ensure worker safety, maintenance work on catch basins requires temporary traffic control (TTC) devices. References include:

- *Manual on Uniform Traffic Control Devices*, by the Federal Highway Administration
- State or local TTC manuals
- *AASHTO Roadside Design Guide*, chapter 9

Catch basins themselves and their control structures pose no inherent hazards to maintenance workers but are likely to be classified as confined spaces. The primary safety concern is to

provide adequate distance between the work area and the travel lanes, and to ensure safe access to the work area. General guidelines for TTC activities are given below. Staging areas can include materials stockpiles and parking for equipment and personal vehicles.

Location of work zone	Type of closure	TTC device
Beyond shoulder. Sufficient space for staging and worker safety.	No closure needed	ROAD WORK AHEAD sign
<ul style="list-style-type: none"> • Beyond shoulder. Insufficient space for staging and safety. • Shoulder. Sufficient space for staging and worker safety. 	Close shoulder	<ul style="list-style-type: none"> • Channelizing devices (e.g. cones) • Temporary barriers and crash cushions • Truck-mounted attenuator
<ul style="list-style-type: none"> • Shoulder. Insufficient space for staging and worker safety. • Edge of travel lane 	Close travel lane	

PERFORMANCE AND INSPECTION

To ensure proper performance, visually inspect that catch basin for accumulated debris and sediments and perform regular, routine maintenance.

Aesthetics

Catch basin controls do not provide aesthetic benefits.

Treatment Train Options

Below is a list of other BMPs that can work in concert with catch basins to provide supplementary or complementary stormwater benefits.

BMP	Purpose	U/S	D/S
Pollution prevention	<ul style="list-style-type: none"> • Use P2 techniques to reduce loadings of pollutants entering the catch basin (e.g. fertilizers, herbicides and pesticides, oil) 	X	
Street sweeping	<ul style="list-style-type: none"> • Regular street sweeping can reduce loadings of sediment and debris entering the catch basin. 	X	

U/S = upstream of catch basin D/S = downstream of catch basin

[This page intentionally left blank.]

8.0 Gutter Filter

DEFINITION Gutter filters are precast concrete gutter vaults that treat runoff by rapid filtering through gravel and a filter medium such as sand. They are installed in place of gutters in closed-section roadways, adjacent to a channelizing device such as a curb or traffic barrier. Gutter filters improve water quality through physical and chemical processes. The filter is a flow-through device and does not provide detention or retention storage. However, the peak discharge rate may be reduced by movement through the gravel and filter medium. Gutter filters are similar to exfiltration trenches sometimes used in open drainage systems where a curb and grate are not needed to direct the runoff to the gravel trench containing the underdrain. Additional information on exfiltration trenches is provided in Section 5.1.2 of the *User's Guide*.

<p>LOCATION</p>	<ul style="list-style-type: none"> • Either side of a closed-section roadway (median or shoulder) 	
<p>FIXED-OBJECT HAZARD?</p>	<ul style="list-style-type: none"> • No 	
<p>EFFECTIVENESS</p>	<ul style="list-style-type: none"> • Water quality MEDIUM • Volume N/A • Peak discharge LOW 	
<p>STORAGE CAPACITY</p>	<ul style="list-style-type: none"> • None 	
<p>TARGETED POLLUTANTS</p>	<ul style="list-style-type: none"> • Total Suspended Solids • Fecal coliform • Oxygen depleting substances 	

Figure 8.1. Gutter filter along U.S. Route 1, Mount Rainier, MD.

CROSS-SECTION

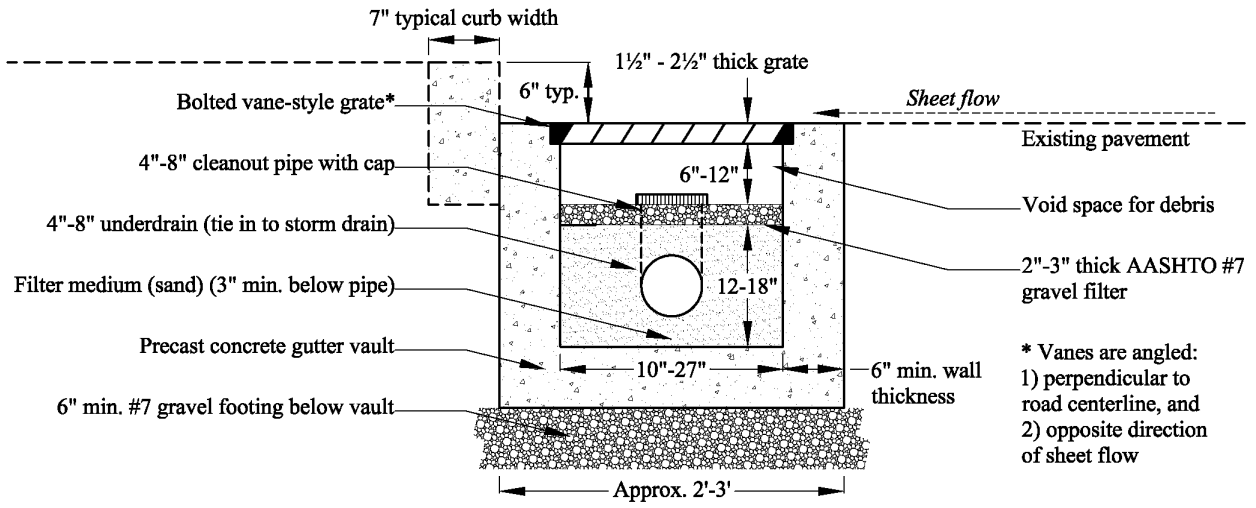

Figure 8.2. Typical gutter filter cross-section. Not to scale. Rebar not shown for clarity.

Siting Guidelines

These guidelines and criteria will help determine whether gutter filters are appropriate for use in a given location. Brief explanations are also provided.

Guideline	Explanation
Gutter filters are typically installed in closed-section roadways.	Curbs, barriers, etc. channel runoff into the gutter filter. Gutter filters can be installed to intercept sheet flow from open-section roadways, but other BMPs such as swales and bioslopes may be more economical. Also, closed-section roadways tend to have less open space available for BMP construction.
The roadway section must be straight.	Concrete vaults are precast in straight segments to simplify installation, and can be installed anywhere. Curved sections are possible, but design and construction costs would be significantly higher.
Gutter filters must be installed in shoulders or breakdown lanes. Do not use them for roads in which the travel lane abuts the curb or barrier.	Gutter filters should not be used for travel lanes because the metal grates will reduce traction. NOTE: Generally, use of gutter filters will not require increased road width.
Gutter filters should not be installed where regular backflow from the storm drain into the gutter filter underdrain is likely.	Stormwater can only exit a gutter filter through the underdrain, which is tied in to the conventional storm drain system. If the elevation or capacity of the storm drain is likely to cause regular backflow into the underdrain, the gutter filter will not be able to provide positive drainage and may not be suitable in that location.
There is no restriction on longitudinal gradients.	Gutter filters will capture roadway runoff as both sheet flow and concentrated gutter flow, regardless of slope.
There is no restriction on flow path length.	Gutter filters will capture roadway runoff as sheet flow or as concentrated flow, regardless of flow path length.
There is no restriction on lateral gradients in the lane containing the gutter filter.	The gravel bed below the gutter vault should be level.
Maintain 1' vertical and 5' horizontal clearance from the gutter filter to any storm drain.	This is a standard utility clearance for storm drains. Aside from possible construction and maintenance impacts, however, there are no clearance requirements for other utilities.
Gutter filters must be situated to provide safe and ready access to maintenance vehicles and workers.	An unsafe access point will jeopardize workers and may reduce the amount of maintenance work performed.

Materials

REQUIRED MATERIALS

These required components correspond to the cross-section above. Cost is given in 2005 dollars.

Item	Depth	Cost	Specification	Purpose
Precast reinforced concrete vault	3' – 4' total depth	\$125 – \$175 / C.Y. concrete	<ul style="list-style-type: none"> • 6" minimum wall thickness • Approx. 2' – 3' total width (varies) • Straight sections • 4000 psi 28-day concrete • #5 rebar 6" CCEW 	<ul style="list-style-type: none"> • Contains gravel, filter media, and underdrain • Supports weight of vehicles • Provides a frame for the grates
Metal grate	2" min. thick		<ul style="list-style-type: none"> • High hydraulic capacity • Bolted vane-style grates intended for transverse drainage • Unpainted ASTM A-48, Class 35B gray iron • Must support a wheel load capacity of 16,000 pounds per dual wheel, not including safety factor. 	<ul style="list-style-type: none"> • Support weight of vehicles • Trap large debris • Allow small debris to pass • Intercept sheet flow and concentrated gutter flow
Pea gravel	3" – 8"	\$30 – \$35 / C.Y.	<ul style="list-style-type: none"> • AASHTO No. 7 • Washed, river-run, round diameter 	<ul style="list-style-type: none"> • Diaphragm to prevent filter media and underdrain from clogging • Gravel footing below vault
Sand	12" – 18"	\$30 – \$40 / C.Y.	<ul style="list-style-type: none"> • ASTM C-33 double-washed 	<ul style="list-style-type: none"> • Filter medium for rapid filtering • Pollutant removal through physical and chemical processes
Underdrain pipe	n/a	\$8 – \$15 / L.F.	<ul style="list-style-type: none"> • Perforated PVC, 4" min. dia. • Slope must be 0.5% or greater to ensure positive drainage. 	<ul style="list-style-type: none"> • Provide positive drainage for runoff that has percolated through the filter medium.
Observation and cleanout well	n/a	\$8 – \$15 / L.F.	<ul style="list-style-type: none"> • Non-perforated PVC. • Join to underdrain with "T" connection. 	<ul style="list-style-type: none"> • Used to determine whether underdrain is dewatering properly • Backflushing underdrain

OPTIONAL MATERIALS

There are no optional construction materials for gutter filters although alternate filtering material may be used.

ADDITIONAL MATERIAL DETAILS

Concrete vault

- Maintain 3” clear rebar on all sides except at junction with curb, where rebar shall protrude 6” vertically to lock into CIP (Cured-In-Place) curb.
- Vault can be constructed with either standard or mountable curbs.
- Place waterstops along rebar where bottom and side slabs meet.
- The internal width of the vault will be determined by the widths of the available grates.
- Vaults are typically cast in 10’ sections.
- Curved CIP gutter vault sections can be used instead of straight precast vaults; design and construction costs will be significantly higher. Precasting allows for greater precision, standardization, and economy of scale.
- Install expansion joints at all junctions of gutter vault sections. Use 1/2" preformed non-extruding joint filler.
- Provide a uniform, level subgrade under the entire gutter filter with AASHTO #7 gravel, as noted above.

Grate

- Security bolts may be used to fasten grates to vault sections, if desired.
- Use vane-style grates to maximize hydraulic efficiency. Vanes should be perpendicular to the road centerline and face into the direction of sheet flow.
- Contact the manufacturer for an appropriate safety factor to calculate ultimate loading.

Underdrain

- See “Outflow Design” below.
- Underdrain tie-in(s) with the storm drain should be sealed to prevent exfiltration and cavitation.
- Underdrains are required in all gutter filters, regardless of dimensions and slope.
- Do not wrap the underdrain with drainage fabric – it will clog.

Cleanouts

- Cleanouts are required in all gutter filters. Cleanouts should be spaced 20’ on center and must have the same diameter as the underdrain.
- Cleanouts must be capped, and the bottom of the cap should be flush with the top of the gravel layer.

Hydrology and Hydraulics

HYDROLOGIC AND WATER QUALITY CONTROLS

The following table summarizes the types of runoff controls provided by gutter filters. See Chapter 3 for additional discussion of these controls.

Control	Effectiveness	Discussion
Water quality	Medium	<ul style="list-style-type: none"> ● Gutter filters are designed to infiltrate runoff from all storms up to a design intensity, and are effective in reducing concentrations of: <ul style="list-style-type: none"> ○ Total Suspended Solids ○ Fecal coliform ○ Oxygen depleting substances ● Water quality processes include: <ul style="list-style-type: none"> ○ Settling ○ Physical straining ○ Adsorption to filter medium
Volume	N/A	<ul style="list-style-type: none"> ● Gutter filters are rapid filtering devices and do not provide retention or detention of stormwater. ● The concrete vault is impermeable and no exfiltration into the subsoil occurs.
Peak discharge	Low	<ul style="list-style-type: none"> ● Gutter filters can provide modest reductions in the peak discharge rate from all storms up to the design rainfall intensity because of percolation through the filter medium. ● Depending on storm duration, storm intensities greater than the design rainfall intensity may cause temporary ponding within the void space and concentrated gutter flow above the grate surface.

INLINE SYSTEM

Gutter filters are inherently inline BMPs because they receive sheet flow and concentrated gutter flow directly from the pavement surface. For all storm intensities equal to or less than the design rainfall intensity, runoff within the drainage area of the gutter filter will pass through the gutter filter before entering the storm drain. The bioretention design sheet contains a detailed discussion of offline vs. inline BMPs.

INFLOW DESIGN

Stormwater can enter a gutter filter cell in two ways:

- Transverse sheet flow
- Longitudinal gutter flow

Gutter filters are typically installed in closed-section roadways, where curbs or barriers adjacent to the gutter filter help to direct runoff into the vault. Either mountable or standard curbs can be used for this purpose. Vane-style grates provide the greatest hydraulic efficiency. The #7 gravel filter helps prevent scouring and cavitation of the sand filter medium by high-velocity flows.

OUTFLOW DESIGN

Filtered stormwater exits a gutter filter through underdrain flow; the underdrain connects to a conventional conveyance system such as a storm drain inlet. No exfiltration into the subsoil will occur because the vault is impermeable.

Bypass Flow

In extreme events when the rainfall intensity exceeds the design rainfall intensity, the void space may temporarily fill with stormwater and bypass flow will occur as gutter flow above the grate surface. Conventional curb or gutter inlets must be placed downstream of the gutter filter to ensure that such flows are safely drained from the roadway.

Underdrain

Underdrains must have positive drainage to a free outlet such as the storm drain system, a natural or engineered channel, permeable open space, or other appropriate outfall, subject to vertical space constraints and the requirements of the jurisdiction. Five feet or more of underdrain closest to a storm drain tie-in must be non-perforated to prevent exfiltration into the storm drain. The hydraulic capacity of the underdrain should equal or exceed the maximum flow rate through the filter, as determined by the saturated conductivity of the gutter filter.

Provide outfall protection for the underdrain as necessary. Do not tie into a storm drain if:

- it is anticipated that backflow into the underdrain may regularly result from hydrostatic pressure in the storm drain, or if
- the underdrain outfall is lower than the typical flowline in the storm drain.

For additional information, refer to AASHTO's *Highway Drainage Guidelines*.

SIZING AND STORAGE

The only sizing concern for gutter filters is to make sure the outfall is sized correctly to handle the flow rate through the gutter filter.

Construction

The major concern with construction is to make sure that site is stabilized before installation to prevent erosion and loss of sediments.

Safety and Structural Issues

VEHICLE SAFETY

Potential vehicle safety concerns, both real and perceived, are listed below. The introduction contains additional information on the relationship between BMPs and roadway safety. Also see the *AASHTO Roadside Design Guide*.

Safety concern	Discussion	Possible remedies
Ponding / Standing water	This is largely a perceived concern, and will not pose a safety hazard when normal design parameters are used.	<ul style="list-style-type: none">• If properly designed, bypass flow will enter stormwater outlet and will not create standing water

SAFETY BENEFITS

Gutter filters do not provide any safety benefits.

MAINTENANCE WORKER SAFETY

See the maintenance section below for a discussion.

STRUCTURAL INTEGRITY

Since gutter filters are encased in a concrete vault they should not have any structural integrity issues.

Maintenance

MAINTENANCE REQUIREMENTS

The primary maintenance concern for gutter filters is the removal of trash and accumulated sediment and hydrocarbons. Accumulated trash and large debris on the grate surface should be removed every 7 to 14 days. This can be done in conjunction with street sweeping. Remove debris that has accumulated in the void space between the gravel layer and the grate four (4) times per year. This activity can be molded into the existing inlet cleaning schedule.

On an annual basis, perform the following tasks:

- Inspect the concrete structure for cracking and spalling
- Check for ponded water and evidence of clogging

WORK CREW

With proper training, gutter filter maintenance will be able to be performed by a crew of two (2) to three (3) workers, or an existing maintenance crew.

MAINTENANCE WORKER SAFETY / TEMPORARY TRAFFIC CONTROL

To ensure worker safety, maintenance work on gutter filters require temporary traffic control (TTC) devices. References include:

- *Manual on Uniform Traffic Control Devices*, by the Federal Highway Administration
- State or local TTC manuals
- *AASHTO Roadside Design Guide*, chapter 9

Gutter filters themselves and their control structures pose no inherent hazards to maintenance workers besides those associated with normal landscaping activities. The primary safety concern is to provide adequate distance between the work area and the travel lanes, and to ensure safe access to the work area. General guidelines for TTC activities are given below. Staging areas can include materials stockpiles and parking for equipment and personal vehicles.

Location of work zone	Type of closure	TTC device
<ul style="list-style-type: none">• Shoulder. Sufficient space for staging and worker safety.	Close shoulder	<ul style="list-style-type: none">• Channelizing devices (e.g. cones)• Temporary barriers and crash cushions• Truck-mounted attenuator
<ul style="list-style-type: none">• Shoulder. Insufficient space for staging and worker safety.• Edge of travel lane	Close travel lane	

In order to ensure long-term effectiveness of gutter filters, associated BMPs (see “Treatment Train Options”), and surrounding open space, do not place staging areas:

- in areas prone to erosion, and
- in areas where soil permeability must be preserved.

Because staging activities can erode or compact sensitive soils, the staging area may need to be located on an adjacent paved surface. To ensure worker safety, the shoulder or travel lane may need to be closed. Also, temporary or permanent barriers should be used for longer-duration work such as major reconstruction.

PERFORMANCE AND INSPECTION

If “first flush” flows are observed to bypass the gutter filter, first remove all debris both above and below the grate. If this does not solve the problem, the filter media or underdrain may be clogged. First make an attempt to backflush the underdrain. If this still does not solve the problem, one or both layers will need to be replaced. The color of the sand through the cross-section will help to determine the required depth of sand replacement. Hydrocarbon-contaminated sand will require special handling and disposal measures.

Perform this inspection:

- annually in spring, or before the beginning of the wet season, and
- after extreme events (e.g. after hurricanes).

Aesthetics

Gutter filters should have a neutral visual impact along the roadway. Properly designed, they will blend in with other roadway structures – especially from the point of view of a vehicle moving at highway speeds.

Treatment Train Options

Below is a list of other BMPs that can work in concert with gutter filters to provide supplementary or complementary stormwater benefits. Also note that gutter filters may be able to serve as pretreatment areas for conventional stormwater ponds.

BMP	Purpose	U/S	D/S
Bioretention cell	<ul style="list-style-type: none"> • Gain reductions in volume and peak by directing gutter filter outflow into bioretention cell. • Modest nitrogen removal is possible. 		X
Bioswale or grassed swale	<ul style="list-style-type: none"> • Convey stormwater from the gutter filter • Reduce runoff velocity • Provide additional storage volume 		X
Flow splitter	<ul style="list-style-type: none"> • Separate a specific volume of water (e.g. WQV) from the total flow and direct it into the gutter filter. Or, divert excess volume away from gutter filter. • Can be upstream, or can be part of overflow structure 	X	
Pollution prevention	<ul style="list-style-type: none"> • Use P2 techniques to reduce loadings of pollutants entering the filter (e.g. fertilizers, herbicides and pesticides, oil) 	X	
Street sweeping	<ul style="list-style-type: none"> • Regular street sweeping can reduce loadings of sediment and debris entering the filter. 	X	

U/S = upstream of gutter filter D/S = downstream of gutter filter

9.0 Infiltration Trenches/Strips

DEFINITION An infiltration trench is an excavated trench lined with filter fabric and backfilled with stone. These systems encourage stormwater infiltration into subsurface soils and work well in space limited applications.

LOCATION	<ul style="list-style-type: none"> • Median • Roadway setback 	
FIXED-OBJECT HAZARD?	<ul style="list-style-type: none"> • No (see safety section) 	
EFFECTIVENESS	<ul style="list-style-type: none"> • Water quality MEDIUM • Volume MEDIUM • Peak discharge MEDIUM 	
STORAGE CAPACITY	<ul style="list-style-type: none"> • Water quality volume • Additional storage for greater peak control 	
TARGETED POLLUTANTS	<ul style="list-style-type: none"> • Total Suspended Solids • Nutrients • Coliform bacteria • Some soluble metals 	

Fig. 9.1. Infiltration trench in roadway median

CROSS-SECTION

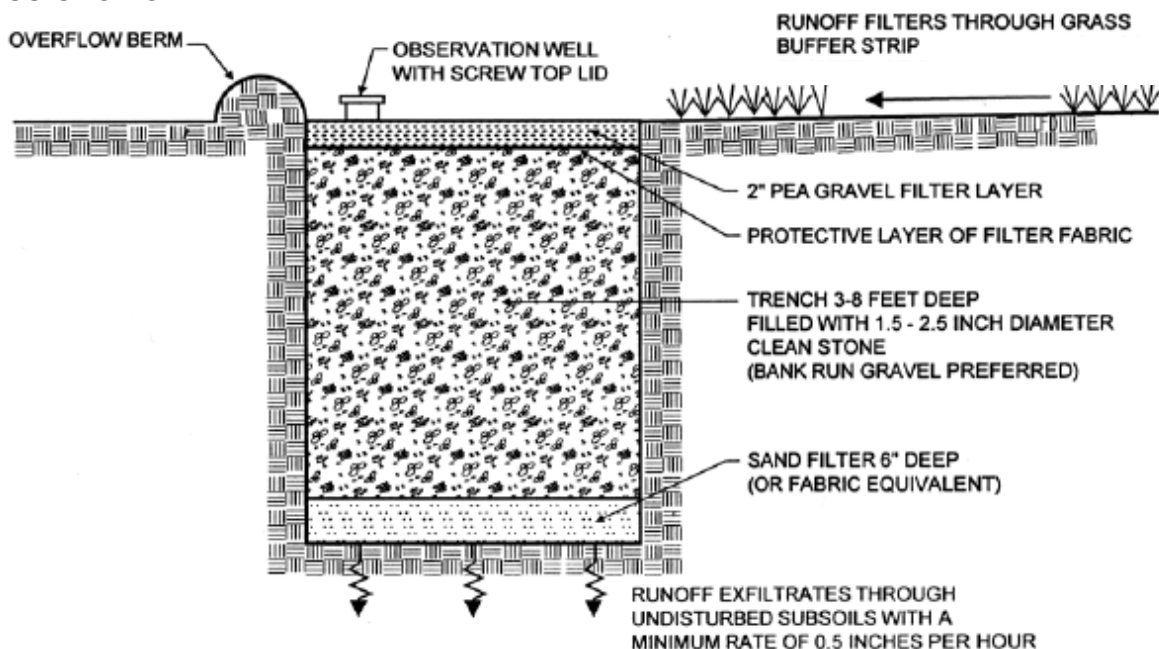

Figure 9.2. Infiltration Trench Cross-section. Source: MDE

Siting Guidelines

These guidelines and criteria will help determine whether infiltration trenches are appropriate for use in a given location. Brief explanations are also provided.

Guideline	Explanation
The impervious drainage area should be 5 ac. or less.	Trenches are designed to manage stormwater from small drainage areas.
Slopes immediately adjacent to an infiltration trench should be between 2% and 20%.	<ul style="list-style-type: none"> ● 2% minimum: Ensure positive flow into the trench. ● 20% maximum: Steep slopes are prone to erosion.
The minimum distance from the infiltration trench to bedrock or to the seasonally high water table is 2'.	<ul style="list-style-type: none"> ● Bedrock: This will help ensure that infiltrating runoff does not become perched on an impervious layer. ● Water table: This will help prevent groundwater from seeping upward into the trench.
Perform an analysis of the existing soils at the start of the design phase in order to determine whether an underdrain is needed (see "Outflow Design" below).	The need for an underdrain will influence the rest of the design. If subsoils have a low permeability but no underdrain is provided, the trench will drain poorly.
Maintain 1' vertical and 5' horizontal clearance from the trench to any storm drain.	This is a standard utility clearance for storm drains. Aside from possible construction and maintenance impacts, however, there are no clearance requirements for other utilities.
Locate the infiltration trench at least 5' downgradient from the edge of the roadway.	Minimize potential safety and structural conflicts with roadway.

Materials

REQUIRED MATERIALS

These required components correspond to the cross-section above. Cost is given in 2005 dollars.

Item	Depth	Cost	Specification	Purpose
Gravel	1' – 3'	\$30 – \$35 / C.Y.	<ul style="list-style-type: none"> • AASHTO No. 57 • Double-washed blue stone 	<ul style="list-style-type: none"> • Filter layer to remove suspended particulates and sediment • Stormwater storage in void space
Stone	3' – 8'	\$25 – 35 / C.Y.	<ul style="list-style-type: none"> • AASHTO No. 1 or 2 	<ul style="list-style-type: none"> • Stormwater storage in void space
Filter fabric	n/a	\$1 – \$5 / S.Y.	<ul style="list-style-type: none"> • Use Equivalent Opening Size (EOS) of #50 sieve to avoid clogging by fine particles. • Min. permeability 125 GPM/ft². Must be greater than that of permeable soil. 	<ul style="list-style-type: none"> • Separate gravel reservoir from underlying soils. • Separate layers of differing sized stone and gravel
Pea gravel	3" – 8"	\$30 – \$35 / C.Y.	<ul style="list-style-type: none"> • AASHTO No. 7 • Washed, river-run, round diameter 	<ul style="list-style-type: none"> • Diaphragm to prevent underdrain pipe from clogging

OPTIONAL MATERIALS

These trench components may be needed in some cases. Grass filter strips should be added in locations with high sediment loading to remove the sediment before it reaches the infiltration trench. See below for additional discussion about underdrain pipe and grass strips. Cost is given in 2005 dollars.

Item	Depth	Cost	Specification	Purpose
Underdrain pipe	n/a	\$8 – \$15 / L.F.	<ul style="list-style-type: none"> • Perforated PVC, 4" min. dia. • Flexible ADS pipe may be used. • Slope must be 0.5% or greater to ensure positive drainage. 	<ul style="list-style-type: none"> • Provide positive drainage where subsoil has low permeability
Observation and cleanout pipe	n/a	\$8 – \$15 / L.F.	<ul style="list-style-type: none"> • Non-perforated PVC. • Join to underdrain with "T" connection. 	<ul style="list-style-type: none"> • Used to determine whether cell is dewatering properly • Backflushing underdrain
Liner	n/a	\$1 / S.Y.	<ul style="list-style-type: none"> • Plastic pond liner or equivalent. • Minimum thickness is 30 mil. 	<ul style="list-style-type: none"> • Prevent cross-contamination

ADDITIONAL MATERIAL DETAILS

Liner

- Install a liner below the underdrain and bottom gravel layer when potential cross-contamination is a concern: either from polluted runoff contaminating groundwater, or from contaminated soils leaching pollutants into stormwater. Place soil above the liner

by hand to prevent puncture. If polluted runoff is a concern, the underdrain should be able to be capped in the event of a spill.

Underdrain

- See “Outflow Design” below.
- All storm drain pipe joints and interfaces in the vicinity of the infiltration trench, including the underdrain, should be sealed to prevent exfiltration and cavitation.
- Do not wrap the underdrain with filter fabric – it will clog.
- Use a minimum 3” of #57 gravel below the underdrain to provide bedding, even if no additional storage is desired.

Hydrology and Hydraulics

HYDROLOGIC AND WATER QUALITY CONTROLS

The following table summarizes the types of runoff controls provided by infiltration trenches. See Chapter 2 for additional discussion of these controls.

Control	Effectiveness	Discussion
Water quality	Medium	<ul style="list-style-type: none"> • Infiltration trenches are typically sized to capture and convey at least the 10-year storm volume. Pretreatment storage for the first 0.1” of runoff per impervious area is typically provided. Trenches are designed to adequately treat the water quality volume of runoff and are therefore effective in reducing concentrations of: <ul style="list-style-type: none"> ○ Total Suspended Solids ○ Heavy metals ○ Phosphorus, and to a lesser extent, nitrogen. • Water quality processes include: <ul style="list-style-type: none"> ○ Settling ○ Physical straining ○ Infiltration
Volume	Medium	<ul style="list-style-type: none"> • Infiltration Trenches cause retention of runoff through: <ul style="list-style-type: none"> ○ Infiltration into porous underlying soil and subsequent exfiltration into the subsoil (if subsoil has adequate permeability) • Detention storage is provided through: <ul style="list-style-type: none"> ○ Subsurface storage in gravel layers above the underdrain
Peak discharge	Medium	<ul style="list-style-type: none"> • By providing the storage mechanisms described above, infiltration trenches help to reduce the peak discharge rate. • Infiltration trenches also decrease the peak discharge rate by introducing surface roughness which impedes stormwater flow.

INFLOW DESIGN

Stormwater can enter a trench in several ways:

- Sheet flow from open-section roadways.
- Channelized flow from flow-splitting devices, gutter drains, or storm drain outlets.

Runoff Pretreatment

In all cases, pretreatment must be provided prior to the infiltration trench in order to remove sediments and prevent clogging. Common methods of reducing sediment loading:

- Grass filter strips. Must be sufficiently wide to reduce velocity and trap sediment. May not be practical where space is at a premium.
- Gravel aprons. Pea gravel may be used prior to the trench to intercept and provide additional treatment for lateral sheet flows.

OUTFLOW DESIGN

Stormwater exits an infiltration trench through a combination of:

- Infiltration into the subsoil, and
- Underdrain outflow into an adequate conveyance system.

Underdrain

An underdrain should be installed when the saturated conductivity of the existing subsoil is less than 1 in/hr, in order to provide positive outflow for runoff that filters down through the trench. The purpose of the underdrain is to drain away water which the existing subsoil cannot infiltrate rapidly enough. An underdrain may not be required if the saturated conductivity of the existing subsoil exceeds 1 in/hr. Five feet or more of underdrain closest to a storm drain tie-in must be non-perforated to prevent exfiltration into the storm drain. The hydraulic capacity of the underdrain should equal or exceed the maximum infiltration rate of the permeable soil underlying the trench, as determined by its saturated conductivity.

Underdrains must have positive drainage to a free outlet such as the storm drain system, a natural or engineered channel, permeable open space, or other appropriate outfall, subject to vertical space constraints and the requirements of the jurisdiction. Provide outfall protection for the underdrain as necessary. Do not tie in to a storm drain if:

- it is anticipated that backflow into the underdrain may regularly result from hydrostatic pressure in the storm drain, or if
- the underdrain outfall is lower than the typical flowline in the storm drain.

For additional information, refer to AASHTO's *Highway Drainage Guidelines*.

SIZING AND STORAGE

The water quality volume (WQV) is commonly used as a minimum basis for sizing a infiltration trench, but additional calculations are required to ensure that it can adequately treat the 10-year design storm flow rate. Undersized trenches may be prone to reduced pollutant capture or an inability to successfully convey stormwater runoff.

Equation 9.1. Infiltration trench sizing equations.

Water Quality Volume Sizing:

Calculate trench depth using the following equations:

$$D = (WQV + RFV) / (SA)$$

Where:

D = depth

WQV = Water Quality Volume

RFV = rock fill volume

SA = Surface Area of trench

Since infiltration trenches are often placed in areas with limited surface area such as medians, depth is the only variable that can be increased to accommodate a large volume of runoff.

In infiltration trenches with underdrains, water stored above the underdrain will exit through the underdrain. This is considered detention storage. Detained water ultimately leaves the trench through the underdrain, and some form of downstream conveyance will be necessary. A limited amount of retention will occur as a result of exfiltration into the subsoil. Retained water is permanently taken out of the system. In addition, retention / recharge storage can be provided by adding a gravel layer below the underdrain. This “dead” storage will be drawn down over time by exfiltration into the subsoil. See Figure 9.3 below for an illustration. In trenches without underdrains, all water is retained because of exfiltration into the subsoil.

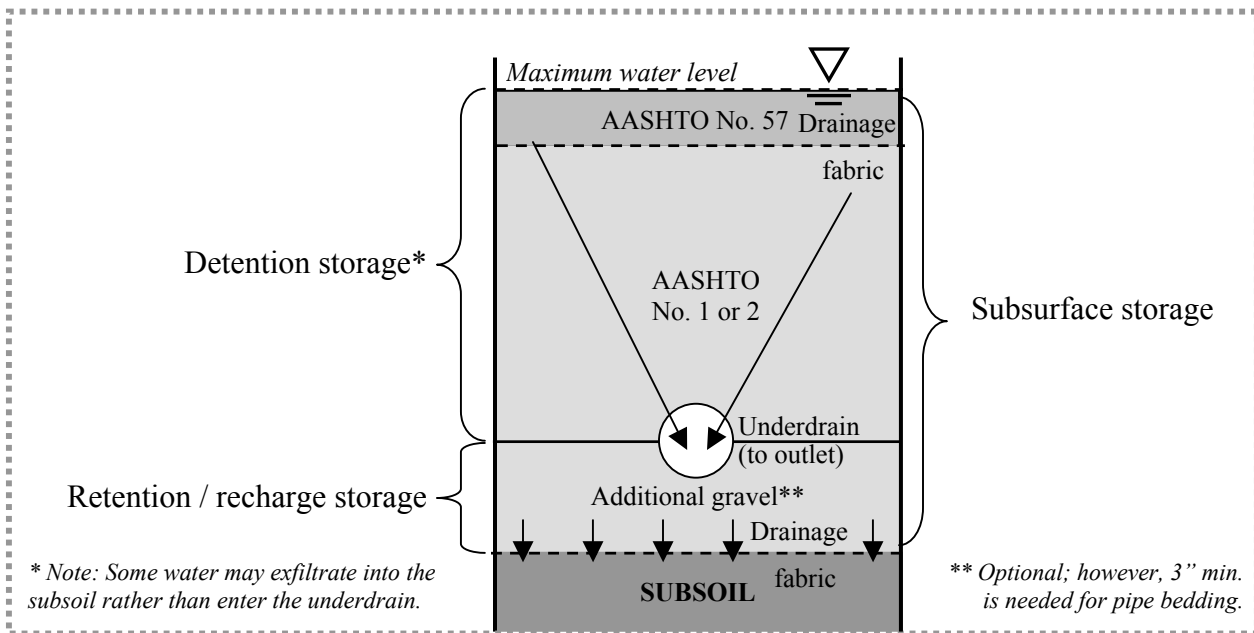

Figure 9.3. Types of storage available in an infiltration trench with underdrain.

The storage volume selected by the designer depends on stormwater management objectives, site constraints and available storage upstream and downstream of the trench. For instance, some jurisdictions may not require volume or peak reduction if the conveyance system discharges directly to a tidal river, thereby reducing storage requirements.

Any volume of stormwater in excess of the WQV can be stored by increasing the maximum depth or surface area of the trench.

Construction

Guidelines for constructing infiltration trenches are listed below.

- Stabilize the entire area draining to the facility before construction begins. If impossible, place a diversion berm around the perimeter of the infiltration site to prevent sediment from entering during construction. Stabilize the entire contributing drainage area before allowing any runoff to enter once construction is complete.
- Shield drainage fabric from sunlight (UV radiation) if it will not be installed immediately.
- Runoff pretreatment is required for all infiltration trench installations. Grass filter strips should be installed around the infiltration trench to intercept roadway runoff, reduce its velocity and filter and remove sediments.

Safety and Structural Issues

VEHICLE SAFETY

Potential vehicle safety concerns, both real and perceived, are listed below. The introduction contains additional information on the relationship between BMPs and roadway safety. Also see the *AASHTO Roadside Design Guide*.

Safety concern	Discussion	Possible remedies
Fixed-object hazards: <ul style="list-style-type: none"> • Observation / clean-out wells 	Any rigid structure (e.g. observation well) is a potential fixed-object hazard, especially if: <ul style="list-style-type: none"> • Width is 4" or greater • Made of metal or concrete 	<ul style="list-style-type: none"> • Establish an appropriate offset. • Install a traffic barrier (i.e. guardrail). • Design observation structures to crumple if struck.
Ponding / Standing water	This is largely a perceived concern, and will not pose a safety hazard when normal design parameters are used.	<ul style="list-style-type: none"> • Ensure that the water quality volume is stored in the infiltration trench no longer than 48 hours (max) through proper design, construction, and maintenance and inspection.

SAFETY BENEFITS

Infiltration trenches do not provide unique safety benefits.

MAINTENANCE WORKER SAFETY

See the maintenance section below for a discussion.

STRUCTURAL INTEGRITY

Structural concern	Discussion	Avoidance
Subsurface drainage <ul style="list-style-type: none"> • Lateral seepage from saturated trenches. • See Figure 4.1. 	<ul style="list-style-type: none"> • Infiltration trenches store water temporarily and exfiltrate it to the subsoil. • Water trapped in the roadbed structural section is unacceptable because it accelerates pavement deterioration. 	<ul style="list-style-type: none"> • To keep water out of the road base and subgrade, the trench bottom should be below the roadway's base course. A trench depth of 18" is typically sufficient to accomplish this requirement. • Saturated conditions do not persist in properly designed, constructed, and maintained infiltration trenches. Underdrains, provided when the saturated conductivity of the existing subsoil < 1 in/hr, will rapidly drain free water by gravity in the same manner as conventional subsurface drainage systems. Trenches with underdrains may actually help to intercept and divert subsurface flows.

Maintenance

MAINTENANCE REQUIREMENTS

The primary maintenance requirement for infiltration trenches is to inspect the treatment area for sediment and debris accumulation.

On an annual basis, perform the following tasks:

- Remove accumulated sediment and debris from the pretreatment grass or gravel filter strip and trench.
- Stabilize any eroded areas in the grass filter strip.

WORK CREW

Infiltration trench maintenance will be able to be performed by a typical crew of two (2) to three (3) workers.

MAINTENANCE WORKER SAFETY / TEMPORARY TRAFFIC CONTROL

To ensure worker safety, maintenance work on infiltration trenches requires temporary traffic control (TTC) devices. References include:

- *Manual on Uniform Traffic Control Devices*, by the Federal Highway Administration
- State or local TTC manuals
- *AASHTO Roadside Design Guide*, chapter 9

Infiltration trenches themselves and any associated flow structures pose no inherent hazards to maintenance workers besides those associated with normal mowing activities. The primary safety concern is to provide adequate distance between the work area and the travel lanes, and to ensure safe access to the work area. General guidelines for TTC activities are given below. Staging areas can include materials stockpiles and parking for equipment and personal vehicles.

Location of work zone	Type of closure	TTC device
Beyond shoulder. Sufficient space for staging and worker safety.	No closure needed	ROAD WORK AHEAD sign
<ul style="list-style-type: none"> • Beyond shoulder. Insufficient space for staging and safety. • Shoulder. Sufficient space for staging and worker safety. 	Close shoulder	<ul style="list-style-type: none"> • Channelizing devices (e.g. cones) • Temporary barriers and crash cushions • Truck-mounted attenuator
<ul style="list-style-type: none"> • Shoulder. Insufficient space for staging and worker safety. • Edge of travel lane 	Close travel lane	

In order to ensure long-term effectiveness of infiltration trenches, associated BMPs (see “Treatment Train Options”), and surrounding open space, do not place staging areas:

- in areas prone to erosion, and
- in areas where soil permeability must be preserved.

Because staging activities can erode or compact sensitive soils, the staging area may need to be located on an adjacent paved surface. To ensure worker safety, the shoulder or travel lane may need to be closed. Also, temporary or permanent barriers should be used for longer-duration work such as major reconstruction.

PERFORMANCE AND INSPECTION

To ensure proper performance, visually inspect that stormwater is infiltrating properly into the trench. The primary indicator of trench failure is slow or no drawdown of stormwater. Water ponding in a trench may indicate operational problems. Corrective measures include inspection for and removal of accumulated sediments. Backflushing the underdrain through the cleanout pipe is another option.

Perform this inspection:

- annually, and
- after extreme events (e.g. after hurricanes).

Aesthetics

Infiltration trenches are stormwater management devices and can provide a neutral to positive visual impact along the roadway. Properly designed, they will blend in with other landscaping – especially from the point of view of a vehicle moving at highway speeds. At a minimum, trenches should be maintained for appearance as often as other roadway areas.

Treatment Train Options

Below is a list of other BMPs that can work in concert with infiltration trenches to provide supplementary or complementary stormwater benefits. Also note that infiltration trenches may be able to serve as pretreatment areas for conventional stormwater ponds.

BMP	Purpose	U/S	D/S
Grass filter strip	<ul style="list-style-type: none"> • Provides pretreatment of runoff by filtering and removing sediments • Reduces velocity of surface runoff 	X	
Bioretention cell	<ul style="list-style-type: none"> • Provides treatment for infiltration trenches effluent • Provides pretreatment of infiltration trenches influent • Provide additional storage volume 	X	X
Bioswale / swale	<ul style="list-style-type: none"> • Gain additional reductions in volume and peak by directing infiltration trench outflow into bioswale. • Convey stormwater away from the infiltration trench underdrain outfall. 		X
Pollution prevention	<ul style="list-style-type: none"> • Use P2 techniques to reduce loadings of pollutants entering the infiltration trenches (e.g. fertilizers, herbicides and pesticides, oil) 	X	
Street sweeping	<ul style="list-style-type: none"> • Regular street sweeping can reduce loadings of sediment and debris entering the infiltration trench. 	X	
Tc practices	<ul style="list-style-type: none"> • Use Time of Concentration practices to reduce the velocity of runoff entering the infiltration trench. 	X	

U/S = upstream of infiltration trench D/S = downstream of infiltration trench

10.0 Permeable Pavement

DEFINITION Permeable or porous pavement is generally categorized into two types: (1) open graded asphalt or concrete with reduced fines and a special binder that allows for the rapid flow of water; or (2) impermeable paver blocks that are installed with gaps between the pavers to allow stormwater to penetrate into the subsurface. Permeable pavements decrease runoff volume by allowing stormwater to infiltrate and improve water quality by filtering the stormwater through the aggregate subbase. Pollutant removal mechanisms include physical removal and absorption and adsorption.

<p>LOCATION</p>	<ul style="list-style-type: none"> • Breakdown lanes • Pull offs • Road shoulders • Rest stops 	
<p>FIXED-OBJECT HAZARD?</p>	<ul style="list-style-type: none"> • No 	
<p>EFFECTIVENESS</p>	<ul style="list-style-type: none"> • Water quality MEDIUM • Volume HIGH • Peak discharge HIGH 	
<p>STORAGE CAPACITY</p>	<ul style="list-style-type: none"> • Optional retention and recharge storage in gravel underdrain 	
<p>TARGETED POLLUTANTS</p>	<ul style="list-style-type: none"> • Total Suspended Solids • Heavy metals • Motor oil 	

Fig. 10.1. Permeable paver blocks.

CROSS-SECTION

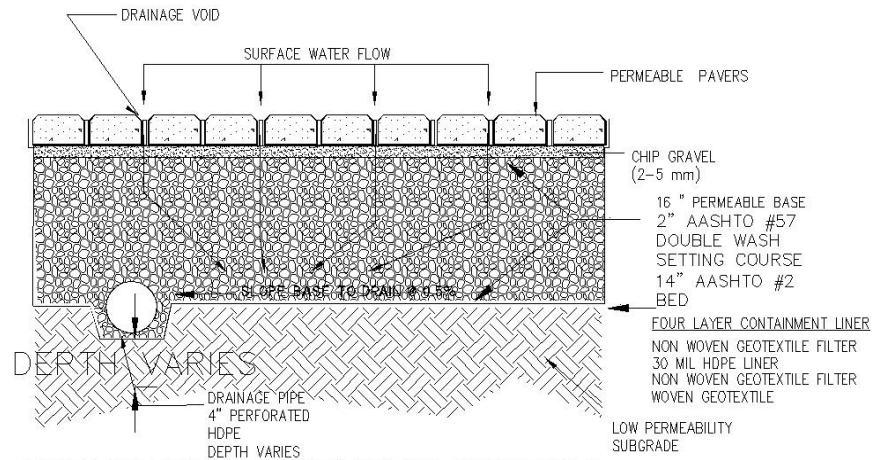

Figure 10.2. Typical permeable pavement cross-section. Not to scale.

Siting Guidelines

These guidelines and criteria will help determine whether permeable pavements are appropriate for use in a given location. Brief explanations are also provided.

Guideline	Explanation
<p>Install permeable pavements in shoulder, breakdown lanes, and rest stops; not in travel lanes. However, open-graded asphalt friction courses (OGFCs) can be used on top of an impermeable base layer to quickly drain stormwater to the roadside to be treated, infiltrated, and/or routed to the storm drain system. See Section 5.1 of the <i>User's Guide</i> for a brief discussion of OGFCs. Thicker (2 to 4 inches) layers allow water to move through the surface layer and into the base layer(s) below. Whether concrete or asphalt, the goal is to remove the water from the surface and allow it to infiltrate. Systems such as those described in this LID Manual are not widely used on high-volume routes.</p>	<p>Permeable pavements are best suited for areas that will not be subject to high traffic volumes or high rates of travel speed. Paver blocks are not suitable for high rate travel speeds because of the block design. The open graded asphalt and concrete in permeable pavements does not wear well in travel lanes. Shoulder and breakdown lanes, because of the lower frequency use and generally lower travel velocities are preferred locations for permeable pavements.</p> <p>OGFCs are used by many states (FL, AZ, CA) on medium and high volume routes and are used to reduce noise and improve frictional characteristics of the surface (safety). OGFCs are very thin (<3/4 inch) and therefore must be supported by a thicker section (usually asphalt). There is some reduction surface runoff due to the porous nature of the OGFC, but the runoff still ends up in the gutter or ditch and with high intensity events, there is very little difference between a dense-graded mix and an OGFC in terms of "surface" water.</p>
<p>Locate permeable pavements in areas that are not subject to high sediment loading.</p>	<p>Sediments can clog the open pores of permeable pavements, retarding infiltration and requiring additional maintenance.</p>

Materials

REQUIRED MATERIALS

These required components correspond to the cross-section above. Cost is given in 2005 dollars.

Item	Depth	Cost	Specification	Purpose
Porous asphalt	2" – 4"	\$0.50 - \$1 /S.F.	<ul style="list-style-type: none"> Open-graded coarse aggregate bonded together with standard bituminous asphalt. Aggregate should not contain small fine particles and should be comprised of particles >600 µm. 	<ul style="list-style-type: none"> Supports vehicular traffic and loads. Open-grade void space allows stormwater to infiltrate into gravel storage bed.

Item	Depth	Cost	Specification	Purpose
Porous concrete	2" – 4"	\$2 - \$7/ S.F.	<ul style="list-style-type: none"> Mixture of Portland cement, uniform open-graded coarse aggregate, admixtures, and water with a 15-25% void space. 	<ul style="list-style-type: none"> Supports vehicular traffic and loads. Open-grade void space allows stormwater to infiltrate into gravel storage bed.
Concrete paving blocks	n/a	\$5 - \$10/ S.F.	<ul style="list-style-type: none"> Concrete pavers requirements set forth in ASTM C 936 - Standard Specification for Interlocking Concrete Paving Units. Average compressive strength of 8,000 psi (55 MPa) with no individual unit under 7,200 psi (50 MPa). Average absorption of 5% with no unit greater than 7% when tested in accordance with ASTM C 140. Resistance to 50 freeze-thaw cycles when tested according to ASTM C 67. 	<ul style="list-style-type: none"> Supports vehicular traffic and loads. Voids between paver blocks allow stormwater to infiltrate into the gravel storage bed.
Pea gravel	3" – 8"	\$30 – \$35 / C.Y.	<ul style="list-style-type: none"> AASHTO No. 7 Washed, river-run, round diameter 	<ul style="list-style-type: none"> Diaphragm to prevent underdrain pipe from clogging
Gravel	1' – 3'	\$30 – \$35 / C.Y.	<ul style="list-style-type: none"> AASHTO No. 57 Double-washed blue stone 	<ul style="list-style-type: none"> Stormwater storage in void space
Underdrain pipe	n/a	\$8 – \$15 / L.F.	<ul style="list-style-type: none"> Perforated PVC, 8" max. diameter Use AASHTO M 278 standard. Slope must be 0.5% or greater to ensure positive drainage. 	<ul style="list-style-type: none"> Provide positive drainage where subsoil has low permeability
Filter fabric	n/a	\$1 – \$5 / S.Y.	<ul style="list-style-type: none"> Use Equivalent Opening Size (EOS) of #50 sieve to avoid clogging by fine particles. Min. permeability 125 GPM/ft². 	<ul style="list-style-type: none"> Separate gravel reservoir from underlying soils.

OPTIONAL MATERIALS

These permeable pavement components may be needed in some cases. See below for additional discussion. The materials correspond to the cross-section above. Cost is given in 2005 dollars.

Item	Depth	Cost	Specification	Purpose
Observation and cleanout well	n/a	\$8 – \$15 / L.F.	<ul style="list-style-type: none"> • Non-perforated PVC. • Join to underdrain with “T” connection. 	<ul style="list-style-type: none"> • Used to determine whether underdrain is dewatering properly • Backflushing underdrain
Liner	n/a	\$1 / S.Y.	<ul style="list-style-type: none"> • Plastic pond liner or equivalent. • Minimum thickness is 30 mil. 	<ul style="list-style-type: none"> • Prevent cross-contamination

ADDITIONAL MATERIAL DETAILS

Liner

- An impervious liner can be used instead of the filter fabric if potential cross-contamination is a concern: either from polluted runoff contaminating groundwater, or from contaminated soils leaching pollutants into stormwater. Place the gravel storage bed above the liner by hand to prevent puncture. If polluted runoff is a concern, the underdrain should be able to be capped in the event of a spill.

Underdrain

- See “Outflow Design” below.
- All storm drain pipe joints and interfaces in the vicinity of the permeable pavements, including underdrain, should be sealed to prevent exfiltration and cavitation.
- Permeable pavements with an underdrain should have observation/cleanout wells of the same diameter as the underdrain. However, if the underdrain slope is greater than 3%, cleanouts are not required. Cleanouts should be as flush to the ground surface as possible to avoid creating a fixed-object hazard.
- Do not wrap the underdrain with filter fabric – it will clog.

Open-Graded Asphalt Friction Courses

- Open-graded asphalt friction courses (OGFCs), also known as "popcorn" asphalt, have been in use in the United States for a number of years. These mixtures are typically placed in thickness of approximately $\frac{3}{4}$ inch. The mixes reduce tire spray and road noise and improve traction. OGFCs can also be used on top of an impermeable base layer to quickly drain stormwater to the roadside to be treated, infiltrated, and/or routed to the storm drain system.

Hydrology and Hydraulics

HYDROLOGIC AND WATER QUALITY CONTROLS

The following table summarizes the types of runoff controls provided by permeable pavements. See Chapter 3 for additional discussion of these controls.

Control	Effectiveness	Discussion
Water quality	Medium	<ul style="list-style-type: none"> ● Permeable pavements can be designed to infiltrate and store runoff from a range of storm events, and are therefore effective in reducing concentrations of: <ul style="list-style-type: none"> ○ Total Suspended Solids ○ Heavy metals ● Water quality processes include: <ul style="list-style-type: none"> ○ Physical straining ○ Absorption ○ Adsorption ○ pH buffering (add alkalinity)
Volume	High	<ul style="list-style-type: none"> ● Permeable pavements cause retention of runoff through: <ul style="list-style-type: none"> ○ Exfiltration into the subsoil (if subsoil has adequate permeability) ○ Subsurface storage below the underdrain (if present) ● Detention storage is provided through: <ul style="list-style-type: none"> ○ Subsurface storage in gravel layers above the underdrain
Peak discharge	High	<ul style="list-style-type: none"> ● By providing the storage mechanisms described above, permeable pavements are highly effective at reducing the peak discharge rate.

INLINE SYSTEM

Permeable pavements are a unique stormwater control technique because the infrastructure is the BMP. Therefore, permeable pavements are inline systems infiltrating rainfall onto the surface of the pavement and stormwater runoff from adjacent impermeable surfaces.

INFLOW DESIGN

Stormwater enters permeable pavements in the following ways:

- Sheet flow from open-section roadways.
- Infiltration of precipitation falling on the surface of the permeable pavements.

OUTFLOW DESIGN

Stormwater exits permeable pavements through a combination of:

- Infiltration into the subsoil (in some cases, depending on soil type).
- Underdrain outflow into an adequate conveyance system.

Underdrain

An underdrain should be installed in order to provide positive outflow for runoff that filters down through the gravel storage bed. The purpose of the underdrain is to drain away water which the existing subsoil cannot infiltrate rapidly enough. An underdrain may not be required if the saturated conductivity of the existing subsoil exceeds 1 in/hr. Five feet or more of underdrain closest to a storm drain tie-in must be non-perforated to prevent exfiltration into the storm drain. The hydraulic capacity of the underdrain should equal or exceed the maximum flow rate through the gravel storage bed.

Underdrains must have positive drainage to a free outlet such as the storm drain system, a natural or engineered channel, permeable open space, or other appropriate outfall, subject to vertical space constraints and the requirements of the jurisdiction. Provide outfall protection for the underdrain as necessary. Do not tie in to a storm drain if:

- it is anticipated that backflow into the underdrain may regularly result from hydrostatic pressure in the storm drain, or if
- the underdrain outfall is lower than the typical flowline in the storm drain.

For additional information, refer to AASHTO's *Highway Drainage Guidelines*.

SIZING AND STORAGE

The water quality volume (WQV) is commonly used as a minimum basis for sizing permeable pavement systems. Jurisdictions typically define the WQV to equal the first 0.5" to 1" of runoff from the impervious drainage area.

It is important to note that although a system may be sized to capture the WQV, the actual volume treated may be much larger, and the entire runoff volume can be treated for many storms. Because runoff rapidly filters through the gravel layers and then flows into the underdrain or subsoil, the system will drain even as it continues to fill. Some jurisdictions consider the saturated conductivity of the subsoil in their permeable pavement sizing equation in order to reduce the required storage volume.

Detention storage is provided within the gravel layers. The detention storage volume can be estimated as follows.

Equation 10.1. Basic permeable pavement sizing equation.

$$\text{Detention volume} = (\text{permeable pavement surface area}) \times (\text{gravel depth}) \times n_{\text{gravel}}$$

where:

n_{gravel} is the estimated gravel porosity (0.35 typical)

Detention volume \geq WQV

In permeable pavements with underdrains, water stored above the underdrain will exit through the underdrain. This is considered detention storage. Detained water ultimately leaves the permeable pavement system through the underdrain, and some form of downstream conveyance will be necessary. A limited amount of retention will occur as a result of exfiltration into the subsoil. Retained water is permanently taken out of the system. In addition, retention / recharge storage can be provided by adding a gravel layer below the underdrain. This "dead" storage will be drawn down over time by exfiltration into the subsoil. See Figure 10.3 below for an illustration.

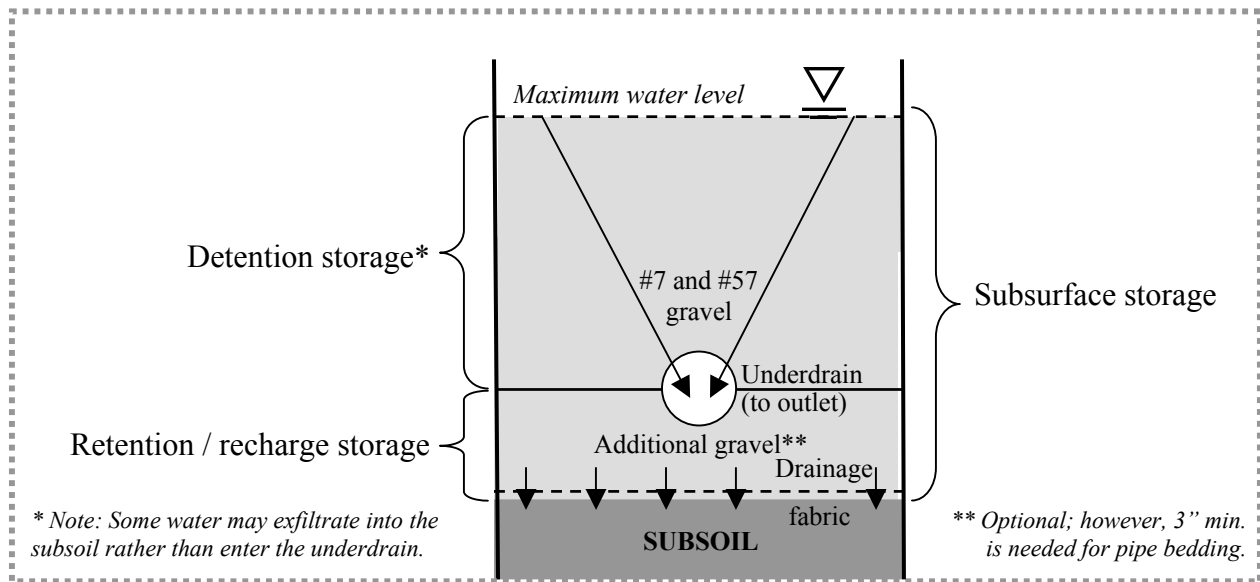

Figure 10.3. Types of storage available in a permeable pavement system with underdrain.

The storage volume selected by the designer depends on stormwater management objectives, site constraints (e.g. surface area, vertical clearance), and available storage downstream of the system. For instance, some jurisdictions may not require volume or peak reduction if the conveyance system discharges directly to a tidal river, thereby reducing storage requirements.

Any volume of stormwater in excess of the WQV can be stored by increasing the:

- depth gravel above the underdrain, or
- depth of gravel below the underdrain (retention).

The storage volume can be re-calculated using the above equation.

Construction

Preventing excessive compaction of the gravel storage bed is the key construction issue for permeable pavements. Guidelines are listed below.

- Construction of permeable pavements will be similar to that of conventional pavements. Installation of paver blocks may require additional time for placement of the blocks.
- Similar materials and construction techniques are required for permeable and conventional pavements.
- The largest difference between permeable and conventional pavements is the depth of the aggregate subbase and the addition of the geotextile material.
- Shield filter fabric from sunlight (UV radiation) if it will not be installed immediately.

Safety and Structural Issues

VEHICLE SAFETY

Potential vehicle safety concerns, both real and perceived, are listed below. The introduction contains additional information on the relationship between BMPs and roadway safety. Also see the *AASHTO Roadside Design Guide*.

Safety concern	Discussion	Possible remedies
Ponding / Standing water	If stormwater is conveyed to permeable pavement faster than it can infiltrate, it will runoff as it would on conventional pavement.	<ul style="list-style-type: none"> No action is necessary.

SAFETY BENEFITS

Permeable pavements may also provide safety benefits for roadway users under certain circumstances. These pavements may reduce surface ponding and increase tire traction.

Safety benefit	Discussion	Considerations
Reduce surface ponding	Permeable materials may reduce standing water and help reduce the risk of hydroplaning.	<ul style="list-style-type: none"> Ensure that pavements are maintained to optimize infiltration rate.
Increased tire traction	Permeable pavements may have higher friction coefficients, increasing tire traction and reducing tire spray.	<ul style="list-style-type: none"> See above.

MAINTENANCE WORKER SAFETY

See the maintenance section below for a discussion.

STRUCTURAL INTEGRITY

Structural concern	Discussion	Avoidance
Subsurface drainage <ul style="list-style-type: none"> Lateral seepage from gravel storage bed 	<ul style="list-style-type: none"> Permeable pavements are designed to maximize infiltration into the gravel storage bed. Water trapped in the roadbed structural section is unacceptable because it accelerates pavement deterioration. 	<ul style="list-style-type: none"> Saturated conditions do not persist in properly designed, constructed, and maintained permeable pavement systems. Underdrains, provided when the long-term infiltration rate through the gravel storage bed exceeds the infiltration rate through the subsoil, will rapidly drain free water by gravity in the same manner as conventional subsurface drainage systems. Permeable pavement systems with underdrains may actually help to intercept and divert subsurface flows.

Maintenance

MAINTENANCE REQUIREMENTS

The primary maintenance requirement for permeable pavements is to inspect the treatment area's components and repair or replace them if necessary.

On an annual basis, perform the following tasks:

- Remove accumulated sediment and particulates from the permeable pavements void spaces. This is typically done using high-efficiency vacuum sweepers or power washing.

WORK CREW

Permeable pavement maintenance will be able to be performed by a crew of one (1) or two (2) workers operating mechanized road sweeping or vacuuming equipment.

MAINTENANCE WORKER SAFETY / TEMPORARY TRAFFIC CONTROL

To ensure worker safety, maintenance work on permeable pavements requires temporary traffic control (TTC) devices. References include:

- *Manual on Uniform Traffic Control Devices*, by the Federal Highway Administration
- State or local TTC manuals
- *AASHTO Roadside Design Guide*, chapter 9.

Permeable pavements pose no inherent hazards to maintenance workers besides those associated with normal roadway maintenance activities. The primary safety concern is to provide adequate distance between the work area and the travel lanes, and to ensure safe access to the work area. General guidelines for TTC activities are given below. Staging areas can include parking for equipment and personal vehicles.

Location of work zone	Type of closure	TTC device
<ul style="list-style-type: none">• Shoulder. Sufficient space for staging and worker safety.	Close shoulder	<ul style="list-style-type: none">• Channelizing devices (e.g. cones)• Temporary barriers and crash cushions• Truck-mounted attenuator
<ul style="list-style-type: none">• Shoulder. Insufficient space for staging and worker safety.• Edge of travel lane	Close travel lane	

In order to ensure the long-term effectiveness of associated BMPs (see “Treatment Train Options”), and surrounding open space, do not place staging areas:

- in areas prone to erosion, and
- in areas where soil permeability must be preserved.

Because staging activities can erode or compact sensitive soils, the staging area may need to be located on an adjacent paved surface. To ensure worker safety, the shoulder or travel lane may therefore need to be closed. Also, temporary or permanent barriers should be used for longer-duration work such as major reconstruction.

PERFORMANCE AND INSPECTION

To ensure proper performance, visually inspect that stormwater is infiltrating properly into the permeable pavements during a runoff-producing storm event. The primary indicator of system failure is excessive runoff from the permeable pavement surface. Corrective measures include inspection and removal of accumulated sediments or particulates. Backflushing the underdrain through the cleanout pipe is another option. Perform this inspection annually.

Aesthetics

Permeable pavements are similar in appearance to conventional pavements and should have a neutral visual impact along the roadway. However, paver blocks may be used to improve the aesthetics of the roadway by introducing a new pattern or differently colored surface material. Also, porous asphalt can also reduce noise by absorbing sound in the pore spaces.

Treatment Train Options

Below is a list of other BMPs that can work in concert with permeable pavements to provide supplementary or complementary stormwater benefits.

BMP	Purpose	U/S	D/S
Bioswale or grassed swale	<ul style="list-style-type: none">• Convey stormwater from the permeable pavement• Reduce runoff velocity• Provide additional storage volume		X
Bioretention cell	<ul style="list-style-type: none">• Gain additional reductions in volume and peak by directing permeable pavement outflow into bioretention cell.• Additional pollutant removal is possible.		X
Infiltration trench	<ul style="list-style-type: none">• Gain additional reductions in volume and peak by directing permeable pavement outflow into infiltration trench.		X
Street sweeping	<ul style="list-style-type: none">• Regular street sweeping can prevent or remove sediment and particulates that clog voids in permeable pavements.	X	

U/S = upstream of permeable pavement D/S = downstream of permeable pavement

11.0 Pollution Prevention/Street Sweeping

DEFINITION Pollution Prevention (P2) is a general term for any activity or management action that reduces or eliminates pollutants before they are propagated downstream. The goal of P2 is to incorporate programs and techniques to keep non-point source (NPS) pollutants out of runoff. This helps to reduce pollutant loads entering BMPs, which enhances their performance and improves their longevity. Reduction of fertilizer, pesticide, and herbicide use and the implementation of regular street sweeping and catch basin cleaning are common P2 techniques. This section will focus of street sweeping.

LOCATION	<ul style="list-style-type: none"> • Either side of a closed-section roadway (median or shoulder) 	
FIXED-OBJECT HAZARD?	<ul style="list-style-type: none"> • No 	
EFFECTIVENESS	<ul style="list-style-type: none"> • Water quality LOW-MEDIUM • Volume N/A • Peak discharge N/A 	
STORAGE CAPACITY	<ul style="list-style-type: none"> • None 	
TARGETED POLLUTANTS	<ul style="list-style-type: none"> • Total Suspended Solids • Total phosphorus • Total nitrogen • Oxygen depleting substances • Heavy metals 	
		<p>Figure 11.1. Street Sweeping. Source: http://www.chesapeake.va.us</p>

Siting Guidelines

These guidelines and criteria will help determine whether street sweeping is appropriate for use in a given location. Brief explanations are also provided.

Guideline	Explanation
Street Sweeping can be used in closed and urban roadways	Street sweeping is most effective in urban settings with debris and sediment on road surfaces

Materials

REQUIRED MATERIALS

The cost of these required components is given in 2005 dollars.

Item	Depth	Cost	Specification	Purpose
Street Sweeper	n/a	\$40 - \$85 / hr or \$15 - \$30 / curb mile	<ul style="list-style-type: none"> Should follow local and state regulations 	<ul style="list-style-type: none"> Cleans debris and other pollutants off the surface of the street

OPTIONAL MATERIALS

There are no optional materials for street sweeping. However, there are many different types of sweepers to choose from (see below).

ADDITIONAL MATERIAL DETAILS

Street sweeper types:

- *Mechanical sweepers* employ a rotating gutter broom to remove particles from the street gutter area, with a water spray used to control dust.
- *Vacuum-assisted sweepers* also use gutter brooms to remove particles from the street. However, the refuse is then placed in the path of a vacuum intake that transports the dirt to the hopper.
- *Tandem sweeping* operations involve two successive cleaning passes, first by a mechanical (broom and conveyor belt) sweeper, followed immediately by a vacuum-assisted sweeper.
- *Regenerative air sweepers* blow air onto the pavement and immediately vacuum it back to entrain and capture accumulated sediments. Air is regenerated for blowing through a dust separation system.
- *Vacuum-assisted dry sweepers* combine the important elements of tandem sweeping into a single unit.

Generally, vacuum-assisted and regenerative air sweepers are more efficient than mechanical sweepers at removing finer sediments, which often bind a higher proportion of heavy metals. The performance of sweepers can be enhanced by operating them at optimal speeds (6 to 8 mph), ensuring that brushes are properly adjusted, and ensuring that appropriate rotation rates and sweeping patterns are used. Tests conducted on the newer vacuum-assisted dry sweepers have shown they have significantly enhanced capabilities to remove sediment compared to conventional sweepers, with projected reductions of up to 79 percent in total suspended solids loadings from urban streets. In addition, these sweepers are extremely effective at removing respirable (PM₁₀) particulate matter (particles with an aerodynamic diameter less than or equal to 10 microns) compared to conventional sweepers and are designed to help meet National Ambient Air Quality standards.

Hydrology and Hydraulics

HYDROLOGIC AND WATER QUALITY CONTROLS

The following table summarizes the types of runoff controls provided by street cleaners. See Chapter 3 for additional discussion of these controls.

Control	Effectiveness	Discussion
Water quality	Low – Medium	<ul style="list-style-type: none"> ● Street sweeping are effective in reducing concentrations of: <ul style="list-style-type: none"> ○ Total Suspended Solids ○ Total phosphorus ○ Total nitrogen ○ Oxygen depleting substances ○ Heavy metals ● Water quality processes include: <ul style="list-style-type: none"> ○ Mechanical sweeping and/or vacuuming
Volume	N/A	<ul style="list-style-type: none"> ● Street cleaning does not affect the volume of stormwater.
Peak discharge	N/A	<ul style="list-style-type: none"> ● Street cleaning does not affect peak discharge rates.

INLINE SYSTEM

Street sweeping in neither an inline system nor an offline system.

INFLOW DESIGN

Street sweeping has no inflow design criteria.

OUTFLOW DESIGN

Street cleaning does not affect outflow design.

SIZING AND STORAGE

The only sizing consideration for street sweeping is evaluating the curb miles needed to be cleaned with the number of street cleaners and drivers.

Construction

Street Sweeping has no construction concerns.

Safety and Structural Issues

VEHICLE SAFETY

Potential vehicle safety concerns, both real and perceived, are listed below. The introduction contains additional information on the relationship between BMPs and roadway safety. Also see *Manual on Uniform Traffic Control Devices*, by the Federal Highway Administration.

Safety concern	Discussion	Possible remedies
Moving-object hazards	<ul style="list-style-type: none"> Street sweepers pose a potential hazard to motorists. 	<ul style="list-style-type: none"> Color and mark vehicles with signs, flags, rotating/strobe lights, truck-mounted attenuators. Arrow panels or portable changeable message signs may follow a train of street sweeping vehicles to help warn motorists of street cleaning activity.

SAFETY BENEFITS

There are no safety benefits associated with street cleaning.

MAINTENANCE WORKER SAFETY

See the maintenance section below for a discussion.

STRUCTURAL INTEGRITY

Street sweeping has no structural integrity problems.

Maintenance

MAINTENANCE REQUIREMENTS

The primary maintenance requirement for street sweeper:

- Ensure there are adequately trained sweeper operators and maintenance personnel.
- Provide traffic control officers to enforce parking restrictions.
- Choose sweeping frequencies and cleaning routes to optimize overall sweeping efficiencies.
- Make appropriate arrangements for disposal of collected waste.
- Reduce source loadings through various measures such as public awareness of proper disposal procedures for used oil and yard waste, and enforcement of erosion control and stormwater pollution prevention practices at urban construction sites.
- Perform routine maintenance on the street sweepers.

WORK CREW

With proper training, street cleaning will be able to be performed by a crew of one (1) to three (3) workers, or an existing maintenance crew.

MAINTENANCE WORKER SAFETY / TEMPORARY TRAFFIC CONTROL

To ensure worker safety and vehicle safety, street sweeping may require temporary traffic control (TTC) devices. References include:

- *Manual on Uniform Traffic Control Devices*, by the Federal Highway Administration
- State or local TTC manuals

PERFORMANCE AND INSPECTION

To achieve a 30% removal of street dirt, the sweeping interval should be less than two times the average interval between storms. To achieve 50% removal, sweeping must occur at least once between storms. Generally two passes per run should be conducted, which will result in the removal of up to 75% of total solids present before sweeping. Certain conditions may warrant increased sweeping frequencies. These include streets with high traffic volumes in industrial areas and streets with high litter or erosion zones. In addition, the sweeping frequency should be increased before any regional wet season to remove accumulated sediments.

Aesthetics

Street sweeping can provide a neutral to positive visual impact along the roadway by removing accumulated trash, debris and sediment.

Treatment Train Options

Any of the other BMPs may be used downstream of street sweeping practices. Street sweeping is a pollution prevention practice intended to reduce pollutant loading to other BMPs and receiving streams.

[This page intentionally left blank]

12.0 Surface Sand Filter

DEFINITION A sand filter is a flow-through system designed to improve water quality from impervious drainage areas by filtering runoff through sand. It consists of one or more sedimentation and filtration chambers or areas to treat runoff. Pollutant removal in sand filters occurs primarily through straining and sedimentation. Treated effluent is collected by underdrain piping and discharged to the existing stormwater collection system. A sand filter occupies a small footprint compared to its drainage area.

LOCATION	<ul style="list-style-type: none"> • Median • Roadway setback 	
FIXED-OBJECT HAZARD?	<ul style="list-style-type: none"> • No 	
EFFECTIVENESS	<ul style="list-style-type: none"> • Water quality <input type="text" value="MEDIUM"/> • Volume <input type="text" value="LOW"/> • Peak discharge <input type="text" value="LOW"/> 	
STORAGE CAPACITY	<ul style="list-style-type: none"> • n/a 	
TARGETED POLLUTANTS	<ul style="list-style-type: none"> • Total Suspended Solids • Oxygen depleting substances • Metals • Fecal coliform bacteria 	

Fig. 12.1. Surface Sand Filter. Source: Portland BES

CROSS-SECTION

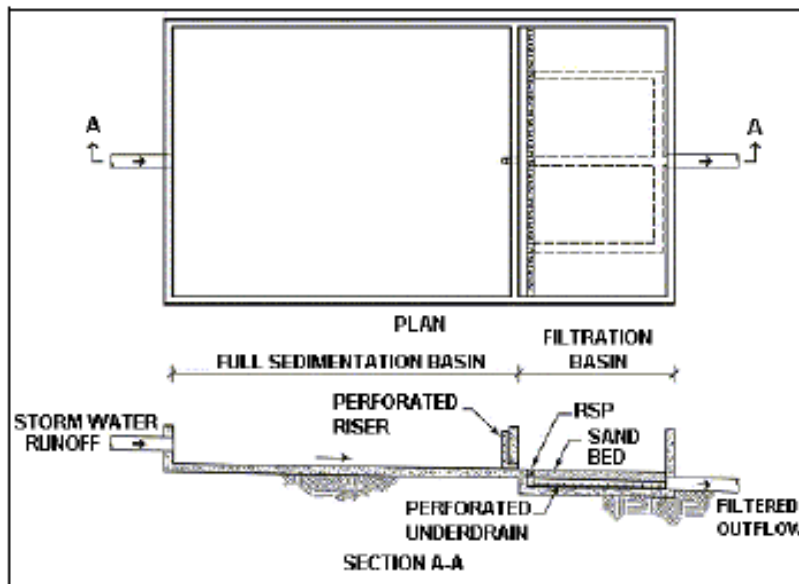

Fig. 12.2. Austin Sand Filter. Source: California Department of Transportation.

Siting Guidelines

These guidelines and criteria will help determine whether a surface sand filter is appropriate for use in a given location. Brief explanations are also provided.

Guideline	Explanation
To avoid the use of pumps, sufficient hydraulic head should be available to operate filters by gravity flow (about 3 ft of head)	Pumps at sand filter sites generally do not perform well and will greatly increase operating and maintenance costs.
Sand filters are appropriate for sites with limited open space.	Limited open space or constrained spaces will likely make detention systems or vegetated BMPs impractical.
The bottom of the sand filter should be 2' to 4' above the seasonally high groundwater table.	This will prevent damage caused by a rising groundwater table. If the sand filter must be located below this recommended elevation, extra weight must be added to the filter in order to counteract buoyancy.

Materials

REQUIRED MATERIALS

These required components correspond to the cross-section above. Cost is given in 2005 dollars.

Item	Depth	Cost	Specification	Purpose
Top gravel layer	~2"	\$30 – \$35 / C.Y	<ul style="list-style-type: none"> • AASHTO # 57 • Calcitic or dolomitic limestone is preferable, to add alkalinity and improve removal of dissolved metals 	<ul style="list-style-type: none"> • Collects large particles • Levels flow • Encourages filtration
Fine aggregate concrete sand	18" min final compacted depth	\$15 - \$25 / C.Y.	<ul style="list-style-type: none"> • Use locally available sand specification which is generally equivalent to the requirements for fine aggregate contained in ASTM C-33, Grade A Fine Aggregate Sand 	<ul style="list-style-type: none"> • Collects small particles and filters storm water
Underdrain pipe	n/a	\$8 - \$15 / C.Y.	<ul style="list-style-type: none"> • 6" typical • Perforated PVC, 8" max. diameter • Use AASHTO M 278 standard. • Slope must be 0.5% or greater to ensure positive drainage. 	<ul style="list-style-type: none"> • Collects water from sand filter and transfers the water to desired location
Pea gravel	3" – 8"	\$30 – \$35 / C.Y.	<ul style="list-style-type: none"> • AASHTO No. 7 • Washed, river-run, round diameter 	<ul style="list-style-type: none"> • Diaphragm to prevent underdrain pipe from clogging

OPTIONAL MATERIALS

These sand filter components may be needed in some cases. See below for additional discussion. The materials correspond to the cross-section above. Cost is given in 2005 dollars.

Item	Depth	Cost	Specification	Purpose
Observation and cleanout pipe	n/a	\$8 – \$15 / L.F.	<ul style="list-style-type: none"> • Non-perforated PVC. • Join to underdrain with “T” connection. 	<ul style="list-style-type: none"> • Used to determine whether filter is dewatering properly • Backflushing underdrain
Pump	n/a	Variable	<ul style="list-style-type: none"> • Pumps should be sized to provide the same filter flow rate as an equivalent gravity system. 	<ul style="list-style-type: none"> • Allows use of sand filters in the absence of sufficient hydraulic head.

ADDITIONAL MATERIAL DETAILS

Underdrain

- See “Outflow Design” below.
- All storm drain pipe joints and interfaces in the vicinity of the cell, including underdrain and overflow tie-ins, should be sealed to prevent exfiltration and cavitation.
- All cells deeper than 2’ and all cells with underdrains must have one (1) or more observation/cleanout wells, centered in the cell.
- Do not wrap the underdrain with drainage fabric – it will clog.

Pumps

- Pumps have been used in situations where gravity feed sand filters are not practical due to a lack of space or hydraulic head.
- While using pumps helps to overcome some design problems they add significant to the maintenance of the sand filter and cost of operation and a power source be available.
- If a sand filter is designed to require a pump then the pump should be sized to a specification that generally matches a gravity-feed system.

Hydrology and Hydraulics

HYDROLOGIC AND WATER QUALITY CONTROLS

The following table summarizes the types of runoff controls provided by permeable pavement. See Chapter 3 for additional discussion of these controls.

Control	Effectiveness	Discussion
Water quality	Medium	<ul style="list-style-type: none"> • Sand filters are designed to filter at least the water quality volume of runoff, and are therefore effective in reducing concentrations of: <ul style="list-style-type: none"> ○ Total Suspended Solids ○ Heavy metals (iron, lead, and zinc) ○ Oxygen depleting substances ○ Fecal coliform • Water quality processes include: <ul style="list-style-type: none"> ○ Physical straining ○ Settling
Volume	Low	<ul style="list-style-type: none"> • Sand filters allow stormwater to flow through quickly and do not provide substantial storage.
Peak discharge	Low	<ul style="list-style-type: none"> • Sand filters do not significantly impact the peak discharge flow rate.

INLINE SYSTEM

Sand filters are designed as inline treatment units, providing pollutant capture and removal prior to stormwater entering the collection system.

INFLOW DESIGN

The inflow of water into the sand filter is designed to be channelized from flow-splitting devices, gutter drains, or storm drain outlets.

Sedimentation Basins

Sedimentation basins are installed prior to the sand filter to capture gross particulates and debris. Two (2) sedimentation basin designs are commonly used: a full sedimentation system and a partial sedimentation system. The full sedimentation system is designed to collect and treat the water quality volume of runoff, at least the first ½” of runoff. The partial system is used when conditions and space are not available for the full sedimentation system. It has the capacity to hold only a portion (at least 20%) of the first flush volume. The remaining flow bypasses the basin directly to the sand filter.

OUTFLOW DESIGN

Stormwater exits a sand filter through a combination of:

- Underdrain outflow into an adequate conveyance system, and
- Bypass flow or overflow when the sand filter’s design flow rate is exceeded.

Bypass Flow

Bypass flow will only occur in extreme events when the stormwater flow rate to the system exceeds the capacity of sand filter. Excess runoff spills into an overflow structure such as a standpipe, riser, or yard inlet. The jurisdiction may require that the overflow structure be able to safely pass flows from extreme events such as the 100-year storm. Bypass and overflow devices can be designed as flow splitters, diverting the excess runoff volume away from the cell and into the main conveyance system. See “Safety Issues,” below, for safety concerns that may affect the design of the overflow structure.

Underdrain

The purpose of the underdrain is to provide positive outflow for runoff flowing through the sand filter. Five feet or more of underdrain closest to a storm drain tie-in must be non-perforated to prevent exfiltration into the storm drain. The hydraulic capacity of the underdrain should equal or exceed the maximum flow rate through the sand filter.

Underdrains must have positive drainage to a free outlet such as the storm drain system, a natural or engineered channel, permeable open space, or other appropriate outfall, subject to vertical space constraints and the requirements of the jurisdiction. Provide outfall protection for the underdrain as necessary. Do not tie in to a storm drain if:

- it is anticipated that backflow into the underdrain may regularly result from hydrostatic pressure in the storm drain, or if
- the underdrain outfall is lower than the typical flowline in the storm drain.

For additional information, refer to AASHTO's *Highway Drainage Guidelines*.

SIZING AND STORAGE

The water quality volume (WQV) is commonly used as a minimum basis for sizing a surface sand filter, but additional calculations are required to ensure that it can adequately convey the 10-year design storm flow rate. Jurisdictions typically define the WQV to equal the first 0.5" to 1" of runoff from the impervious drainage area.

Equation 12.3. Filter flow rates

$$A_f = (I_a \times H \times d_f) / [k \times (h + d_f) \times t_f]$$

where:

A_f = Surface area of sand bed (acres or square feet)

I_a = impervious drainage area contributing runoff to the basin (acres or feet)

H = runoff depth to be treated (feet)

d_f = sand depth (feet)

k = coefficient of permeability for sand filter (feet per hour)

h = average depth of water above surface of the sand media between full and empty basin conditions (feet) (1/2 max. depth)

t_f = time required for runoff volume to pass through media (hours)

Target loading rate (flow rate):

Rapid sand filters – 2-3 gpm/ft ²	(sand only)
Dual-media filter – minimum 4-6 gpm/ft ²	(gravel and sand)
Multi-media filters – above 5-10 gpm/ft ²	(different gradation of sand and gravel)

$$\text{Filter loading rate} = Q/A$$

Construction

Access to the sand filter and minimizing future maintenance are the key construction issues for a surface sand filter. Construction guidelines are listed below.

- Minimize basin depth to save excavation and shoring costs and to avoid the need for pumps.
- Use locally available sand specification which is generally equivalent to the requirements for fine aggregate contained in ASTM C-33.
- Include ramps into each basin to facilitate access where side slopes are steeper than 1:4 (V:H), with width appropriate for required maintenance equipment to maximize ease of regular maintenance, including foot and vehicle access.
- Transfer water from the sedimentation basin to the filter basin by using a perforated riser surrounded by a trash rack with rate control provided by an orifice plate attached to the riser outlet. The outlet riser should enter at the floor of the sedimentation chamber rather than the wall to ensure that the chamber will completely drain between storm events.
- Provide energy dissipation (riprap or rock gabion) in front of the riser outlet to prevent scouring of the sand filter bed.
- Do not use level spreaders in the filter basin to distribute the runoff.
- Slope the sedimentation chamber floor toward the riser outlet for easier maintenance and improved draining.
- Cover the sand filter or add locations to attach netting to keep unwanted birds out of open sand filters if a problem is likely to occur during operation of the device.
- To avoid clogging, do not place any filter fabric horizontally in the sand filter.
- If construction is planned up-gradient of the proposed location, it should be completed before installation of the sand in the filter.

Arid Climates

In arid climates it is often necessary to increase storage in the sediment chamber to account for the higher sediment loads. Designers should consider increasing the volume of sediment chamber to up to 40% of the water quality volume.

Cold Climates

In cold climates, filters can be used, but surface or perimeter filters will not be effective during the winter months, and may have unintended consequences from a frozen filter bed. Using alternative conveyance measures such as a weir system between the sediment chamber and filter bed may avoid freezing associated with the traditional standpipe. Where possible, the filter bed should be below the frost line. Some filters, such as the peat sand filter, should be shut down during the winter. These media will become completely impervious during freezing conditions. Using a larger underdrain system to encourage rapid drainage during the winter months may prevent freezing of the filter bed. Finally, the sediment chamber should be larger in cold climates to account for road sanding (up to 40% of the water quality volume).

Safety and Structural Issues

VEHICLE SAFETY

Potential vehicle safety concerns, both real and perceived, are listed below. The introduction contains additional information on the relationship between BMPs and roadway safety. The NCHRP report appendices, available online, provide design guidance.

Safety concern	Discussion	Possible remedies
Fixed-object hazards: <ul style="list-style-type: none">• Flow control devices• Concrete filter basin	Any rigid flow control device (e.g. overflow structure) is a potential fixed-object hazard, especially if: <ul style="list-style-type: none">• Width is 4" or greater• Made of metal or concrete	<ul style="list-style-type: none">• Minimize height and width of flow control devices.• Establish an appropriate offset.• Install a traffic barrier (i.e. guardrail).• Design flow control structures to crumple if struck.
Ponding / Standing water	This is largely a perceived concern, and will not pose a safety hazard when normal design parameters are used.	<ul style="list-style-type: none">• Ensure that underdrain pipe is sized and installed to meet or exceed the sand filter design flow rate. With proper design and under normal conditions, water should move quickly through the filter without ponding or standing water.

SAFETY BENEFITS

Surface sand filters do not provide unique safety benefits.

MAINTENANCE WORKER SAFETY

See the maintenance section below for a discussion.

STRUCTURAL INTEGRITY

Structural integrity should not be compromised by the use of self-contained, sand filter units in concrete basins.

Maintenance

MAINTENANCE REQUIREMENTS

The primary maintenance concern for surface sand filters is the removal of trash and accumulated sediment and hydrocarbons. If the filter does not drain within the design drawdown time, the top layer of sand or gravel should be replaced. The color of the sand through the cross-section will help to determine the required depth of sand replacement. Hydrocarbon-contaminated sand will require special handling and disposal measures. Accumulated trash and large debris should be removed every 7 to 14 days. Rake the top layer to break up surface clogging four (4) times per year. Vacuum accumulated sediment from the sand filter surface two (2) times per year.

On a monthly basis, perform the following tasks:

- Ensure that contributing area, sedimentation basin, inlets, and outlets are clear of debris.
- Ensure that the contributing area is stabilized and mowed, with clippings removed.

- Check to ensure that the filter surface is not clogging (Also after moderate and major storms).
- Ensure that activities in the drainage area minimize oil/grease and sediment entry to the system.

On an annual basis, perform the following tasks:

- Check to see that the filter bed is clean of sediments, and the sediment chamber is not more than ½ full of sediment. Remove sediment if necessary.
- Make sure that there is no evidence of deterioration, spalling or cracking of concrete.
- Inspect inlets, outlets and overflow spillway to ensure good condition, and no evidence of erosion.
- Repair or replace any damaged structural parts.
- Ensure that flow is not bypassing the facility.

WORK CREW

With proper training, surface sand filter maintenance will be able to be performed by a crew of two (2) to three (3) workers.

MAINTENANCE WORKER SAFETY / TEMPORARY TRAFFIC CONTROL

To ensure worker safety, maintenance work on sand filters may require temporary traffic control (TTC) devices. References include:

- *Manual on Uniform Traffic Control Devices*, by the Federal Highway Administration
- State or local TTC manuals
- *AASHTO Roadside Design Guide*, chapter 9

Surface sand filters pose no inherent hazards to maintenance workers besides those associated with normal maintenance activities. The primary safety concern is to provide adequate distance between the work area and the travel lanes, and to ensure safe access to the work area. General guidelines for TTC activities are given below. Staging areas can include materials stockpiles and parking for equipment and personal vehicles.

Location of work zone	Type of closure	TTC device
Beyond shoulder. Sufficient space for staging and worker safety.	No closure needed	ROAD WORK AHEAD sign
<ul style="list-style-type: none"> • Beyond shoulder. Insufficient space for staging and safety. • Shoulder. Sufficient space for staging and worker safety. 	Close shoulder	<ul style="list-style-type: none"> • Channelizing devices (e.g. cones) • Temporary barriers and crash cushions • Truck-mounted attenuator
<ul style="list-style-type: none"> • Shoulder. Insufficient space for staging and worker safety. • Edge of travel lane 	Close travel lane	

To ensure worker safety, the shoulder or travel lane may need to be closed. Also, temporary or permanent barriers should be used for longer-duration work such as major reconstruction.

PERFORMANCE AND INSPECTION

To ensure proper performance, visually inspect that stormwater is infiltrating properly into the sand filter. The primary indicator of cell failure is slow or no drawdown of stormwater. Ponding in a surface sand filter may indicate operational problems. Monitor and record the water level periodically to ensure proper drainage through the sand filter. For the first year, monitor quarterly and after every large storm. If the sand filter is performing as designed, monitor twice yearly. If not, see maintenance section above.

Corrective measures include inspection for and removal of accumulated sediments. Backflushing the underdrain through the cleanout pipe is another option. Full or partial replacement of the sand and filter media may be required to restore the flow rate through the filter. If excess bypass flow is occurring, inspect the sand filter for clogging and erosion and for an uneven surface or excessive accumulation of sediment and debris. Perform this inspection:

- annually, and
- after extreme events (e.g. after hurricanes).

Aesthetics

Surface sand filters, when properly located and designed should have a neutral visual impact along the roadway. However, excessive trash in the sediment chamber may negatively affect aesthetics.

Treatment Train Options

Below is a list of other BMPs that can work in concert with permeable pavement to provide supplementary or complementary stormwater benefits.

BMP	Purpose	U/S	D/S
Bioretention cell	<ul style="list-style-type: none"> • Gain reductions in volume and peak flow by directing sand filter outflow into bioretention cell. 		X
Bioswale	<ul style="list-style-type: none"> • Gain reductions in volume and peak flow by directing sand filter outflow into bioswale. • Convey stormwater away from the sand filter underdrain outfall. • Provide conveyance to and pretreatment for the sand filter. 	X	X
Flow splitter	<ul style="list-style-type: none"> • Separate a specific volume of water (e.g. WQV) from the total flow and direct it into the sand filter. Or, divert excess volume away from the sand filter. • Can be upstream, or can be part of overflow structure 	X	
Pollution prevention	<ul style="list-style-type: none"> • Use P2 techniques to reduce loadings of pollutants entering the sand filter (e.g. fertilizers, herbicides and pesticides, oil). 	X	
Street sweeping	<ul style="list-style-type: none"> • Regular street sweeping/vacuuming can reduce pollutant loading to the sand filter. 	X	

U/S = upstream of sand filter D/S = downstream of sand filter

[This page intentionally left blank]

13.0 Soil Amendments

DEFINITION Soil amendments, which include both soil conditioners and fertilizers, make the soil more suitable for the growth of plants and increase water retention capabilities. Compost amendments and soils for water quality enhancement are also used to enhance native or disturbed and compacted soils. These measures change the physical, chemical, and biological characteristics of the soil allowing it to more effectively reduce runoff volume and filter pollutants. Soil amendments are valuable in areas with poor soils because they can help add available plant nutrients and sustain vegetative cover, reduce long-term erosion, and help reduce runoff volumes and peak discharges by absorbing water.

LOCATION	<ul style="list-style-type: none"> • Median • Roadway setback 	
FIXED-OBJECT HAZARD?	<ul style="list-style-type: none"> • No 	
EFFECTIVENESS	<ul style="list-style-type: none"> • Water quality MEDIUM • Volume MEDIUM • Peak discharge MEDIUM 	
STORAGE CAPACITY	<ul style="list-style-type: none"> • Additional storage for greater peak control 	
TARGETED POLLUTANTS	<ul style="list-style-type: none"> • Total Suspended Solids • Heavy metals • Phosphorus 	

Fig. 13.1. Final grading of soil amendments.
Source: U.S. EPA

CROSS-SECTION

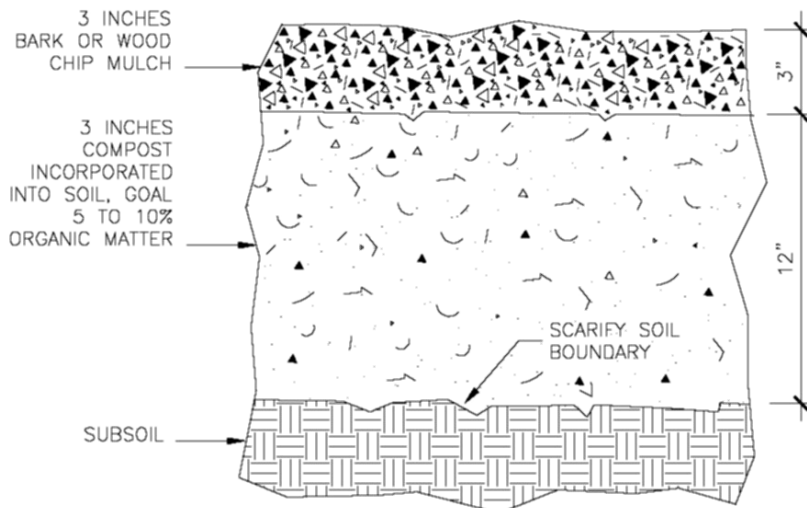

Figure 13.2 .Cross-section of soil amendment.

Siting Guidelines

These guidelines and criteria will help determine whether soil amendments are appropriate for use in a given location. Brief explanations are also provided.

Guideline	Explanation
Do not clear wooded areas to apply soil amendments.	Existing wooded areas are natural stormwater management resources. It is generally counterproductive to clear a vegetated area to construct a stormwater management system.
Perform an analysis of the physical and chemical characteristics of the existing soils at the start of the design phase.	The soil analysis will help determine the appropriate amendments to use and the quality of the existing soils.
Soil amendments must be used in areas that allow safe and ready access to maintenance vehicles and workers.	An unsafe access point will jeopardize workers and may reduce the amount of maintenance work performed.

Materials

REQUIRED MATERIALS

These required components correspond to the cross-section above. Cost is given in 2005 dollars.

Item	Depth	Cost	Specification	Purpose
Soil and site preparation	6" – 12"	\$5 - \$8 / S.Y.	<ul style="list-style-type: none"> • A routine soil infiltration rate analysis. 	<ul style="list-style-type: none"> • Evaluates typical concerns of compaction, water-logged soils, poor cover conditions, and decreased organic content.
Compost, soil conditioners, or fertilizers.	n/a	\$15 - \$30 / C.Y.	<ul style="list-style-type: none"> • Disk or mechanically work amendments into native soil • Unconventional sources such as rock and mineral powders may reduce the release of nutrients into runoff, e.g., http://attra.ncat.org/attra-pub/altsoilamend.html 	<ul style="list-style-type: none"> • Increases infiltration rates and water retention properties of soil.
Grass seed	n/a	\$20 / M.S.F.	<ul style="list-style-type: none"> • Native grass mix 	<ul style="list-style-type: none"> • Stabilizes amended area. • Blend in with landscape. • Roots help maintain soil permeability.

Item	Depth	Cost	Specification	Purpose
Mulch	~3"	\$30 – \$35 / C.Y.	<ul style="list-style-type: none"> • 2X shredded hardwood mulch, aged for 12 months minimum. • Must be free of seeds and other plant material. 	<ul style="list-style-type: none"> • Place mulch to protect grass seed on newly-constructed soil amendment.

OPTIONAL MATERIALS

Soil amendments have no optional materials.

ADDITIONAL MATERIAL DETAILS

Location

- Soil amendments can improve the water retention capacity and properties of almost any soil but have the greatest impact in areas with poorly draining native soils.
- Many BMPs discussed in these design sheets use infiltration into the soil to improve runoff water quality and reduce runoff volume. Therefore, soil amendments may be used during the construction and/or maintenance of BMPs to increase soil permeability and BMP effectiveness. For example, water quality swales and grass filter strips can be treated with soil amendments to improve performance and increase their permeability, i.e. effectiveness as pretreatment devices.

Techniques

- A variety of techniques are included as potential soil amendments including aerating; fertilizing; and adding compost, other organic matter, or lime to the soil.

Hydrology and Hydraulics

HYDROLOGIC AND WATER QUALITY CONTROLS

The following table summarizes the types of runoff controls provided by soil amendments. See Chapter 3 for additional discussion of these controls.

Control	Effectiveness	Discussion
Water quality	Medium	<ul style="list-style-type: none"> • Soil amendments are designed to infiltrate runoff and are effective in reducing mass loadings of: <ul style="list-style-type: none"> ○ Total Suspended Solids ○ Heavy metals ○ Phosphorus • Water quality processes include: <ul style="list-style-type: none"> ○ Physical straining ○ Adsorption ○ Organic complexing ○ Degradation by microbes • Although soil amendments may increase the total concentration of nutrients, they can decrease the <i>mass</i> of pollutants transported downstream because the runoff volume can be significantly reduced.
Volume	Medium	<ul style="list-style-type: none"> • Soil amendments cause retention of runoff through:

Control	Effectiveness	Discussion
		<ul style="list-style-type: none"> ○ Absorption to organic material (e.g., peat) ○ Exfiltration into the subsoil ○ Evapotranspiration by vegetation
Peak discharge	Medium	<ul style="list-style-type: none"> ● They can help reduce the peak discharge rate from all storms by enhancing the water retention and infiltration properties of native soils.

INLINE SYSTEM

Soil amendments are inherently inline BMPs because they receive flow directly from the pavement surface, conveyance structures, or directly from the rainfall.

INFLOW DESIGN

There is no specific inflow design for soil amendments.

OUTFLOW DESIGN

Stormwater exits amended soils by infiltrating into the subsoil. If storm intensity and runoff flow rate exceed the hydraulic capacity of the amended soils, stormwater will bypass the amended soils as overland flow. Overland flow across amended soils will only occur in extreme precipitation events or if improper maintenance leads to concentrated flows and the development of a preferred flow path caused by erosion.

SIZING AND STORAGE

Soil amendments are intended to increase the hydraulic capacity of existing soils, increasing their ability to absorb stormwater and process pollutants. There are no specific sizing or storage needs.

Construction

Preventing soil compaction, erosion, and deposition of fines are key construction issues for soil amendments. Guidelines are listed below.

- Amended soils should not receive runoff until the drainage area has been fully stabilized.
- Place sod or a compost berm around the amended soils until all construction is complete and the drainage area has been fully stabilized.
- Do not stockpile excavated material in the area to be amended.

Safety and Structural Issues

VEHICLE SAFETY

Soil amendments do not pose either real or perceived potential vehicle safety concerns, as they are enhancements to existing soils and do not add any overflow or conveyance structures or introduce large vegetation. The introduction contains additional information on the relationship between BMPs and roadway safety. Also see the AASHTO *Roadside Design Guide*.

SAFETY BENEFITS

Soil amendments do not provide unique safety benefits.

MAINTENANCE WORKER SAFETY

See the maintenance section below for a discussion.

STRUCTURAL INTEGRITY

Structural concern	Discussion	Avoidance
Subsurface drainage <ul style="list-style-type: none"> • Lateral seepage from saturated soils. 	<ul style="list-style-type: none"> • Amended soils infiltrate and retain stormwater, and exfiltrate it to the subsoil. • Water trapped in the roadbed structural section is unacceptable because it accelerates pavement deterioration. 	<ul style="list-style-type: none"> • Saturated conditions do not persist in properly maintained amended soils. Soil amendments enhance the water management capabilities of native soils.

Maintenance

MAINTENANCE REQUIREMENTS

Routine inspection of amended soils should evaluate factors that may decrease the soil's infiltration capacity, aeration and organic content. Typical post-construction concerns include areas subject to compaction, hydric or waterlogged soils, poor cover conditions, increased development, and a decrease in organic content. In addition, an occasional soil infiltration rate analysis of amended soils in potential problem areas is recommended. Generally, maintenance is the same as the routine periodic maintenance that is required of any roadway offsets or median. Follow the existing maintenance schedule for roadside mowing and debris removal. Use a retractable-arm mower to avoid compacting the soil.

On an annual basis, perform the following tasks:

- Visually inspect amended soils for compacted soils, waterlogged soils, or diseased vegetation.
- Reseed bare or stressed areas. Place mulch to stabilize the area.
- If infiltration rates are not satisfactory try mechanical aeration
- Repair any eroded areas as soon as they are noted.
- Remove weeds or other volunteers from the no-vegetation zone and other soil amendment components. Spot application of herbicides, as needed, is permissible but should be minimized. The routine placement of mulch will control many nuisance weed problems.
- As necessary, stabilize, repair, and re-grade any areas that have been damaged by vehicles running off the road (e.g. no-vegetation zone). This will stop erosion, prolong the life of the soil amendment, and ensure that flows are uniformly distributed.
- Take corrective actions, including aeration, deep tilling, and adding additional amendments, as necessary to restore the infiltration capacity of the soil.

WORK CREW

With proper training, amended soil maintenance will be able to be performed by a crew of two (2) to three (3) workers, or an existing landscaping crew.

MAINTENANCE WORKER SAFETY / TEMPORARY TRAFFIC CONTROL

To ensure worker safety, maintenance work on amended soils requires temporary traffic control (TTC) devices. References include:

- *Manual on Uniform Traffic Control Devices*, by the Federal Highway Administration
- State or local TTC manuals
- *AASHTO Roadside Design Guide*, chapter 9

Soil amendments pose no inherent hazards to maintenance workers besides those associated with normal landscaping activities. The primary safety concern is to provide adequate distance between the work area and the travel lanes, and to ensure safe access to the work area. General guidelines for TTC activities are given below. Staging areas can include materials stockpiles and parking for equipment and personal vehicles.

Location of work zone	Type of closure	TTC device
Beyond shoulder. Sufficient space for staging and worker safety.	No closure needed	ROAD WORK AHEAD sign
<ul style="list-style-type: none"> • Beyond shoulder. Insufficient space for staging and safety. • Shoulder. Sufficient space for staging and worker safety. 	Close shoulder	<ul style="list-style-type: none"> • Channelizing devices (e.g. cones) • Temporary barriers and crash cushions • Truck-mounted attenuator
<ul style="list-style-type: none"> • Shoulder. Insufficient space for staging and worker safety. • Edge of travel lane 	Close travel lane	

In order to ensure the long-term effectiveness of soil amendments, associated BMPs (see “Treatment Train Options”), and surrounding open space, do not place staging areas:

- in areas prone to erosion, and
- in areas where soil permeability must be preserved.

Because staging activities can erode or compact sensitive soils, the staging area may need to be located on an adjacent paved surface. To ensure worker safety, the shoulder or travel lane may therefore need to be closed. Also, temporary or permanent barriers should be used for longer-duration work such as major reconstruction.

PERFORMANCE AND INSPECTION

To ensure long-term performance, visually inspect to make certain that the runoff is infiltrating properly into the soil amendment. Evidence of improper infiltration will include channelized flow paths, rill formation, or other erosion. Reductions in infiltration capacity typically result from compaction or extensive root matting of groundcovers, such as grasses. Also inspect for compacted or waterlogged soils, bare spots, and diseased vegetation.

Perform this inspection:

- annually in spring, or before the beginning of the wet season, and
- after extreme events (e.g. after hurricanes).

Aesthetics

Because grass is used for a vegetative cover, soil amendments appear identical to other roadside areas for both stationary observers and those traveling at highway speeds. At a minimum, soil amendments should be maintained for appearance as often as other landscaped roadway areas.

Treatment Train Options

Below is a list of other BMPs that can work in concert with amended soils to provide supplementary or complementary stormwater benefits. In general, soil amendments can be used as a maintenance or enhancement procedure for any vegetated BMP.

BMP	Purpose	U/S	D/S
Bioswale or swale	<ul style="list-style-type: none"> Convey stormwater to amended soils. 	X	
Pollution prevention	<ul style="list-style-type: none"> Use P2 techniques to reduce loadings of pollutants entering amended soils (e.g. fertilizers, herbicides and pesticides, oil). 	X	
Street sweeping	<ul style="list-style-type: none"> Regular street sweeping can reduce loadings of sediment and debris entering the soil amendment. 	X	
Tc practices	<ul style="list-style-type: none"> Use Time of Concentration practices to reduce the velocity of runoff entering the soil amendments 	X	

U/S = upstream of amended soils D/S = downstream of amended soils

14.0 Swales

DEFINITION Swales are broad, shallow channels designed to convey stormwater runoff and treat it by vegetative filtering and infiltration. The swales are vegetated along the bottom and sides of the channel, with side vegetation at a height greater than the maximum design flow depth. The design of swales seeks to reduce stormwater volume through infiltration, improve water quality through infiltration and vegetative filtering, and reduce runoff velocity by increasing flow path lengths and channel roughness.

LOCATION	<ul style="list-style-type: none"> • Median • Roadway setback • Pretreatment for ponds 	
FIXED-OBJECT HAZARD?	<ul style="list-style-type: none"> • No (see safety section) 	
EFFECTIVENESS	<ul style="list-style-type: none"> • Water quality HIGH • Volume MEDIUM • Peak discharge MEDIUM 	
STORAGE CAPACITY	<ul style="list-style-type: none"> • Water quality volume • Additional storage for greater peak control 	
TARGETED POLLUTANTS	<ul style="list-style-type: none"> • TSS • Sediment • Heavy metals 	

Fig. 14.1. Vegetated swale along roadside.

CROSS-SECTION

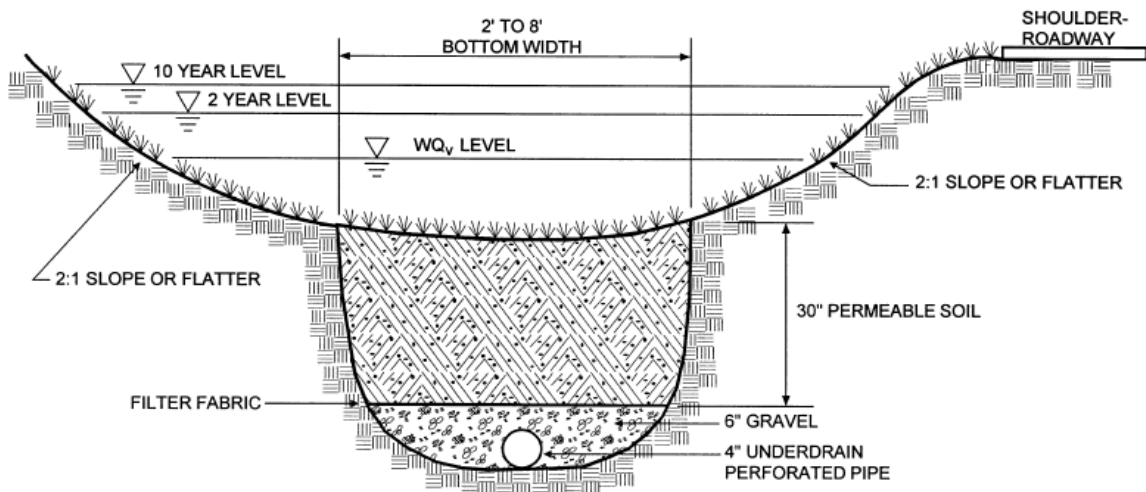

Figure 14.2. Swale Cross-section. Source: MDE

Siting Guidelines

These guidelines and criteria will help determine whether swales are appropriate for use in a given location. Brief explanations are also provided.

Guideline	Explanation
The impervious drainage area should be 5 ac. or less.	Swales are generally designed to manage stormwater from small drainage areas. Larger drainage areas may be accommodated by using flow splitters and multiple parallel swales.
The swale channel length should be directly proportional to the roadway length.	To ensure adequate conveyance and treatment capacity, the swale should be installed along the full length of roadway from which it will be receiving stormwater runoff, if possible. Doing so will minimize swale flow rates and allow appropriate stormwater residence times within the swale.
The longitudinal slope of the swale should be between 1% and 4%.	A minimum slope of 1% is necessary to ensure an adequate stormwater flow rate within the channel. Longitudinal slopes greater than 4% may result in greater than desired flow rates that will scour and erode the channel. In locations with steeper slopes, check dams may be used to create individual drainage sections within the swale with gentler slopes. To properly treat the water quality volume of runoff, the channel velocity of a one-inch rainfall should be 1 fps or less.
Side slopes should 3:1 or flatter but never steeper than 2:1.	Modest side slopes allow for appropriate volume capacity with modest channel depths and a sufficient wetted perimeter.
The bottom of the swale shall be between 2 and 8 feet wide.	Swale bottoms greater than 2 feet wide provide adequate surface area by promoting shallow flow depths during the water quality design storm event. Bottoms less than 8 feet wide prevent gullying or channel braiding.
The minimum distance from the swale invert to bedrock or to the seasonally high water table is 2'.	<ul style="list-style-type: none"> ● Bedrock: This will help ensure that infiltrating runoff does not become perched on an impervious layer. ● Water table: This will help prevent groundwater from seeping upward into the cell.
Maintain 1' vertical and 5' horizontal clearance from the swale to any storm drain.	This is a standard utility clearance for storm drains. Aside from possible construction and maintenance impacts, however, there are no clearance requirements for other utilities.

Materials

REQUIRED MATERIALS

These required components correspond to the cross-section above. Cost is given in 2005 dollars.

Item	Depth	Cost	Specification	Purpose
Permeable soil	30"	\$20 – \$30 / C.Y.	<ul style="list-style-type: none"> • Soil underlying swale should have an infiltration rate of 0.3 inches per hour or greater. 	<ul style="list-style-type: none"> • Allows infiltration of stormwater • Stormwater storage in void space • Pollutant removal – biological, chemical, and physical processes
Sod	n/a	\$2 – \$4 / S.F.	<ul style="list-style-type: none"> • Should be free of weeds. • Should be grown to a height greater than the water quality design depth. • Supplemental irrigation may be used until the sod is established. • The use of fertilizers and pesticides should be avoided. 	<ul style="list-style-type: none"> • Provides pollutant removal • Reduces stormwater velocities • Provides channel stability
Grass seed	n/a	\$1 – \$2 / S.F.	<ul style="list-style-type: none"> • Should be free of weeds. • Should be grown to a height greater than the water quality volume depth. • Supplemental irrigation may be used until grass is established. • The use of fertilizers and pesticides should be avoided. 	<ul style="list-style-type: none"> • Provides pollutant removal • Reduces stormwater velocities • Provides channel stability
Underdrain pipe	n/a	\$8 – \$15 / L.F.	<ul style="list-style-type: none"> • Perforated PVC, 4" min. dia. • Flexible ADS pipe may be used. • Slope must be 0.5% or greater to ensure positive drainage. 	<ul style="list-style-type: none"> • Provide positive drainage where subsoil has low permeability
Pea gravel	6"	\$30 – \$35 / C.Y.	<ul style="list-style-type: none"> • AASHTO No. 7 • Washed, river-run, round diameter 	<ul style="list-style-type: none"> • Diaphragm to prevent underdrain pipe from clogging
Filter fabric	n/a	\$1 – \$5 / S.Y.	<ul style="list-style-type: none"> • Use Equivalent Opening Size (EOS) of #50 sieve to avoid clogging by fine particles. • Min. permeability 125 GPM/ft². Must be greater than that of permeable soil. 	<ul style="list-style-type: none"> • Place between permeable soil and gravel layers to prevent migration of fines.

OPTIONAL MATERIALS

These swale components may be needed in some cases. See below for additional discussion. The materials correspond to the cross-section above. Cost is given in 2005 dollars.

Item	Depth	Cost	Specification	Purpose
Bioretention soil media (BSM) (see bioswale discussion below)	30"	\$40 – \$60 / C.Y.	Engineered soil mix classified as “sandy loam” or “loamy sand,” uniformly mixed and free of sticks and stones. Total clay content must be less than 5%. Components: <ul style="list-style-type: none"> • 50% sand (AASHTO C-33 double-washed) • 30% planting soil (free of noxious weed seeds) • 20% mulch (2X shredded hardwood) 	<ul style="list-style-type: none"> • Growth medium for plants and microbes • Stormwater storage in void space • Pollutant removal – biological, chemical, and physical processes
Gravel (see bioswale discussion below)	2’ – 3’	\$30 – \$35 / C.Y.	<ul style="list-style-type: none"> • AASHTO No. 57 • Double-washed blue stone 	<ul style="list-style-type: none"> • Stormwater storage in void space
Wetland plants (see wet swale discussion below)		\$5 - \$20 ea.	<ul style="list-style-type: none"> • Plants must be suited for wetland and saturated soil conditions. • Native plants may have lower maintenance requirements. 	<ul style="list-style-type: none"> • Pollutant removal through settling and vegetative filtering
Plants	n/a	\$5 – \$20 ea.	<ul style="list-style-type: none"> • Plants must be salt-tolerant in regions where deicing materials are used, and must be able to withstand periods of high and low moisture. • Supplemental irrigation may be used until plants are established. • Select plants that do not require irrigation after becoming established. • Native plants may have lower maintenance requirements. 	<ul style="list-style-type: none"> • Pollutant removal through root uptake • Roots provide habitat for microbes • Nutrient cycling • Landscaping/habitat • Volume reduction through evapo-transpiration • Roots help maintain soil permeability
Liner	n/a	\$1 / S.Y.	<ul style="list-style-type: none"> • Plastic pond liner or equivalent. • Minimum thickness is 30 mil. 	<ul style="list-style-type: none"> • Prevent cross-contamination

ADDITIONAL MATERIAL DETAILS

Bioretention soil media and gravel

- Test the bioretention soil media before installation. It must have a pH of 5.5 to 6.5 and an organic content of 1.5 to 3%. As stated above, clay content must be less than 5%. The saturated conductivity of the bioretention soil media must be rapid enough to allow surface ponding to completely drain within three (3) to four (4) hours.
- The minimum cover (soil and gravel combined) above the underdrain is 2’.
- Use a minimum 3” of #57 gravel below the underdrain to provide bedding, even if no additional storage is desired.

Plants

- In addition to grass or sod, other vegetation types including shrubs and small trees may be planted in the swale.

Liner

- Install a liner below the underdrain and bottom gravel layer when potential cross-contamination is a concern: either from polluted runoff contaminating groundwater, or from contaminated soils leaching pollutants into stormwater. Place soil above the liner by hand to prevent puncture. If polluted runoff is a concern, the underdrain should be able to be capped in the event of a spill.

Underdrain

- See “Outflow Design” below.
- All storm drain pipe joints and interfaces in the vicinity of the swale, including the underdrain, should be sealed to prevent exfiltration and cavitation.
- Do not wrap the underdrain with filter fabric – it will clog.

Hydrology and Hydraulics

HYDROLOGIC AND WATER QUALITY CONTROLS

The following table summarizes the types of runoff controls provided by swales. See Chapter 3 for additional discussion of these controls.

Control	Effectiveness	Discussion
Water quality	High	<ul style="list-style-type: none"> ● Swales are typically sized to capture and convey at least the 10-year storm volume. However, treatment is usually only provided for the water quality design flow rate (e.g., 0.2 in/hr). Pretreatment storage for the first 0.1” of runoff per impervious area is typically provided. Swales are designed to adequately treat the water quality volume of runoff and are therefore effective in reducing concentrations of: <ul style="list-style-type: none"> ○ Total Suspended Solids ○ Heavy metals ○ Phosphorus, and to a lesser extent, nitrogen. ● Water quality processes include: <ul style="list-style-type: none"> ○ Settling ○ Physical straining ○ Infiltration
Volume	Medium	<ul style="list-style-type: none"> ● Swales cause retention of runoff through: <ul style="list-style-type: none"> ○ Infiltration into porous underlying soil and subsequent exfiltration into the subsoil (if subsoil has adequate permeability) ● Detention storage is provided through a combination of: <ul style="list-style-type: none"> ○ Surface ponding ○ Subsurface storage in soil and gravel layers above the underdrain
Peak discharge	Medium	<ul style="list-style-type: none"> ● By providing the storage mechanisms described above, swales are effective at reducing the peak discharge rate. ● Swales also decrease the peak discharge rate by routing water through a vegetated channel, introducing surface roughness which impedes stormwater flow.

DESIGN ALTERNATIVES

In addition to the dry swale described above, two other swale design options are available: wet swales and bioswales. Wet swales are well suited for treating roadway runoff in low lying or flat terrain areas. These systems differ from dry swales in that they maintain a permanent volume of water within the bottom of the channel. Rather than the bottom invert of the channel being located 2’ above the water table, the channel bottom invert of a wet swale is placed below the seasonally high elevation of the water table. Wetland plantings are used in lieu of grass or sod within the area of the channel that will permanently maintain the volume of water. Settling and vegetative filtering are the predominant pollutant removal mechanisms in wet swales and the infiltration rate is effectively zero. Because wet swales maintain a permanent pool, the local vector control agency should be contacted whenever a wet swale is considered.

Bioswales are modified dry swales that use bioretention media beneath the swale to enhance the effect that swales have on water quality, runoff volume, and peak runoff rate. These systems perform the same functions as traditional grassed swales by serving as a conveyance structure and filtering and infiltrating runoff. They differ, however, because the use of bioretention media enhances infiltration, water retention, and nutrient and pollutant removal. Like bioretention cells, bioswales encourage infiltration in order to retain runoff volume and use a variety of physical,

chemical, and biological processes to reduce runoff pollutant loadings. Refer to the bioretention cell design sheet for information on the operations and mechanisms of bioretention systems.

Check dams (stone, biologs, wood, concrete) may be used in swales to act as flow spreaders and encourage sheet flow along the swale. Check dams also allow installation of swales in areas of slopes greater than 4% by creating individual drainage sections with lower percentage slopes. Check dams may also be used as a stormwater detention mechanism, encouraging infiltration and retarding discharge.

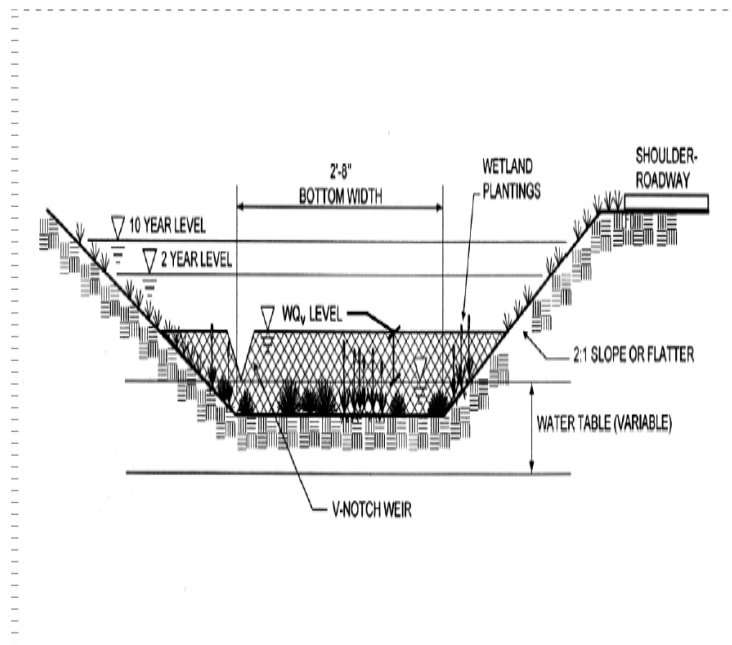

Figure 14.3. Wet Swale. Source: MDE.

INFLOW DESIGN

Stormwater can enter a swale in several ways:

- Sheet flow from open-section roadways.
- Channelized flow from flow-splitting devices, gutter drains, or storm drain outlets.

Runoff Velocity

In all cases, inflow structures must reduce the runoff velocity to a non-erosive rate ($< \sim 2$ fps) in order to prevent erosion. Common methods of distributing runoff and slowing its velocity are:

- Grass filter strips. Must be sufficiently wide to reduce flow depths and velocity and trap sediment. May not be practical where space is at a premium.
- Gentle side slopes. The vegetated side slopes of the swale should be as shallow as possible to allow pretreatment of lateral sheet flows.
- Gravel aprons. Pea gravel may be used prior to the swale side slope to intercept and provide additional treatment for lateral sheet flows.
- Check dams. Used when inflow to the swale is from piped inlets or concentrated conveyance structures. Check dams act as flow spreaders and decrease runoff velocity.
- Other practices to increase Time of Concentration (T_c) (see introduction to fact sheets).

OUTFLOW DESIGN

Stormwater exits a swale through a combination of:

- Infiltration into the subsoil (in some cases).
- Underdrain outflow into an adequate conveyance system.

Underdrain

An underdrain should be installed for dry swale designs when the saturated conductivity of the existing subsoil is less than 1 in/hr or slopes are less than 2%, in order to provide positive outflow for runoff that filters down through the swale. The purpose of the underdrain is to drain away water which the existing subsoil cannot infiltrate rapidly enough. An underdrain may not be required if the saturated conductivity of the existing subsoil exceeds 1 in/hr or slopes are greater than 2%. Five feet or more of underdrain closest to a storm drain tie-in must be non-perforated to prevent exfiltration into the storm drain. The hydraulic capacity of the underdrain should equal or exceed the maximum infiltration rate of the permeable soil underlying the swale, as determined by its saturated conductivity.

Underdrains must have positive drainage to a free outlet such as the storm drain system, a natural or engineered channel, permeable open space, or other appropriate outfall, subject to vertical space constraints and the requirements of the jurisdiction. Provide outfall protection for the underdrain as necessary. Do not tie in to a storm drain if:

- it is anticipated that backflow into the underdrain may regularly result from hydrostatic pressure in the storm drain, or if
- the underdrain outfall is lower than the typical flowline in the storm drain.

For additional information, refer to AASHTO's *Highway Drainage Guidelines*.

SIZING AND STORAGE

The water quality volume (WQV) or water quality design flow rate are commonly used as a minimum basis for sizing a swale, but additional calculations are required to ensure that it can adequately convey the 10-year design storm flow rate. Jurisdictions typically define the WQV to equal the first 0.5" to 1" of runoff from the impervious drainage area. Undersized swales may be prone to erosion, re-suspension of accumulated sediment, reduced pollutant capture, or an inability to successfully convey stormwater runoff.

The calculated volume of water within a swale is a function of the trapezoid created by the width of the swale bottom, the side slopes, and the width of the maximum water storage surface. The width of the maximum water storage surface is dependent upon the maximum ponding depth, which should be no greater than 12" at the swale's longitudinal mid-point and 18" at the effluent end of the swale. A minimum 3" of freeboard should also be included in to the swale design.

Equation 14.1. Swale sizing equations.

Water Quality Volume Sizing:

1. $Storage\ surface\ width = [(WQV) - (pretreatment\ volume)] \div [(swale\ length) \times (mid-point\ depth)]$

2. $Swale\ bottom\ width = (storage\ surface\ width) - [2 \times (swale\ slope) \times (mid-point\ depth)]$

where:

swale slope = 4 for a 4:1 side slope

10-year Design Storm Conveyance:

3. *Manning Equation to determine velocity*

$$v = [(1.49) \div n] \times r^{2/3} \times s^{1/2}$$

where:

n is the roughness coefficient

r is the hydraulic radius of the channel

s is the longitudinal percent slope (e.g., 2% = 0.02)

4. *Continuity Equation to determine additional cross-sectional area:*

$$A = Q_{10} \div v$$

where:

A is the additional cross-sectional area required above the water quality volume

Q₁₀ is the 10-year design storm flow rate

v is the velocity

Swale Depth:

5. $Minimum\ channel\ depth = (effluent\ end\ ponding\ depth) + (10-year\ storm\ depth) + (freeboard)$

where:

effluent end ponding depth ≤ 18"

freeboard ≤ 3"

In swales with underdrains, water stored above the underdrain will exit through the underdrain. This is considered detention storage. Detained water ultimately leaves the swale through the underdrain or the bypass structure, and some form of downstream conveyance will be necessary. A limited amount of retention will occur as a result of exfiltration into the subsoil. Retained water is permanently taken out of the system. In addition, retention / recharge storage can be provided by adding a gravel layer below the underdrain. This “dead” storage will be drawn down over time by exfiltration into the subsoil. See Figure 14.4 below for an illustration. In swales without underdrains, all water is retained because of exfiltration into the subsoil.

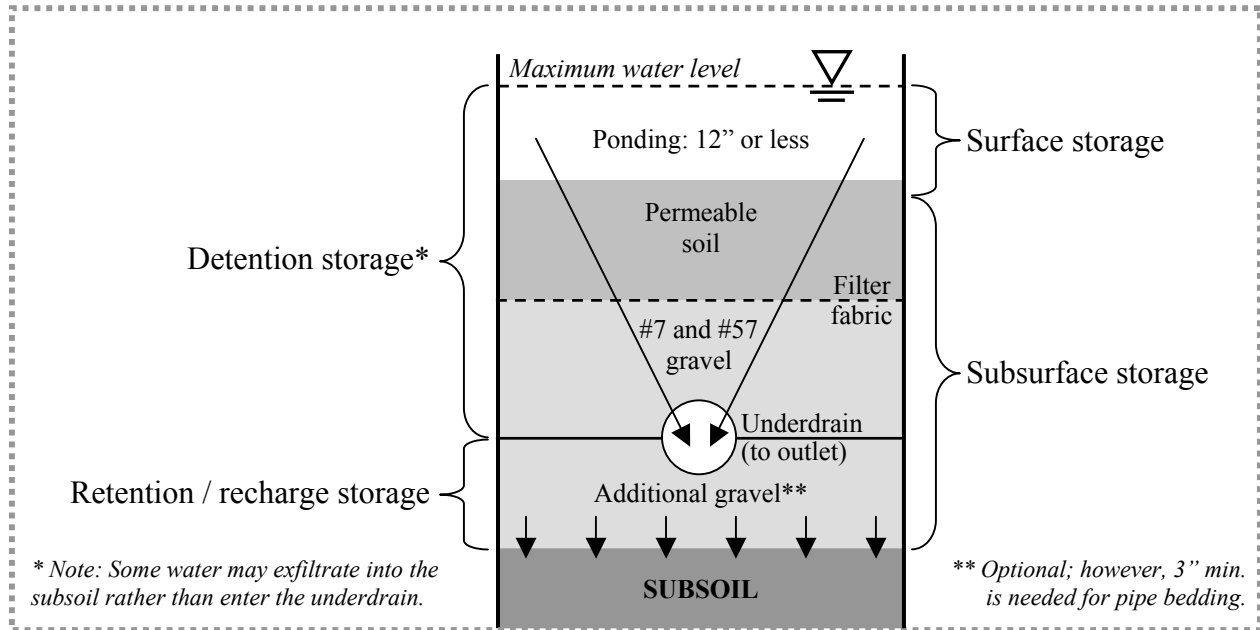

Figure 14.4. Types of storage available in a swale with underdrain

The storage volume selected by the designer depends on stormwater management objectives, site constraints (e.g. channel depth and slope), and available storage upstream and downstream of the swale. For instance, some jurisdictions may not require volume or peak reduction if the conveyance system discharges directly to a tidal river, thereby reducing storage requirements.

Any volume of stormwater in excess of the WQV can be stored by:

- increasing the maximum ponding depth (should not exceed 12" at the swale mid-point or 18" at the end of the swale, however),
- increasing the depth of soil above the underdrain,
- increasing the depth of gravel below the underdrain (retention), or
- decreasing the swale side slope.

Construction

Preventing soil compaction and erosion are key construction issues for swales. Guidelines are listed below.

- Avoid running equipment over the channel bottom of the swale to prevent compacting the permeable soil.
- Do not stockpile excavated material in the area where the swale is to be constructed.
- When installing permeable soil and underdrain system, take care not to compact the soil with construction equipment. Use 8 – 12" lifts. Lightly water each lift to naturally compact the soil. The cell can be overfilled with the soil to compensate for eventual natural compaction. Level the surface with a rake.
- Installation of a bioswale should follow the construction guidelines in the bioretention cell design sheet.
- Shield filter fabric from sunlight (UV radiation) if it will not be installed immediately.

Safety and Structural Issues

VEHICLE SAFETY

Potential vehicle safety concerns, both real and perceived, are listed below. The introduction contains additional information on the relationship between BMPs and roadway safety. Also see the AASHTO *Roadside Design Guide* and NCHRP Report 500, Volume 3: *A Guide for Addressing Collisions with Trees in Hazardous Locations*. The NCHRP report appendices, available online, provide design guidance.

Safety concern	Discussion	Possible remedies
Ponding / Standing water	This is largely a perceived concern, and will not pose a safety hazard when normal design parameters are used.	<ul style="list-style-type: none"> • Ensure that the maximum ponding depth is 12” at the longitudinal mid-point of the swale and 18” at the effluent end of the swale. • Ensure that the water quality volume is stored in the swale no longer than 48 hours (max) through proper design, construction, and maintenance and inspection. • Contact the local vector control agency before considering a wet swale.
Fixed-object hazards: <ul style="list-style-type: none"> • Vegetation 	Any tree or shrub in the swale can become a fixed-object hazard if the trunk diameter grows greater than 4".	<ul style="list-style-type: none"> • Don’t plant large-diameter vegetation. • Establish an appropriate offset. • Prune to keep trees small. This may significantly increase the maintenance burden, however. • Install a traffic barrier (i.e. guardrail). • Prune or remove trees in the swale, including volunteers.
Sight distance / Visual obstruction	Vegetation taller than 3’ may reduce sight distance around the inside of curves, block signage, or create other visual obstructions.	<ul style="list-style-type: none"> • Maintain 3’ maximum vegetation height where an unobstructed view is critical, including: <ul style="list-style-type: none"> ○ inside curves (geometry varies) ○ in advance of signs ○ around median crossings ○ around at-grade intersections • Plant shorter vegetation as necessary.

SAFETY BENEFITS

Swales may also provide safety benefits for roadway users under certain circumstances. The vegetation in swales may reduce glare and act as a crash cushion for errant vehicles.

Safety benefit	Discussion	Considerations
Crash cushion	Groundcover may act as a crash barrier, or at least cushion and slow errant vehicles.	<ul style="list-style-type: none"> • Maintain vegetation height to preserve sight distance. • Vegetation must not obscure higher-risk objects.
Reduce glare / reflection	Vegetation may reduce headlight glare or other visual hazards.	<ul style="list-style-type: none"> • See above.

MAINTENANCE WORKER SAFETY

See the maintenance section below for a discussion.

STRUCTURAL INTEGRITY

Structural concern	Discussion	Avoidance
Subsurface drainage <ul style="list-style-type: none"> • Lateral seepage from saturated cells. • See Figure 4.1 	<ul style="list-style-type: none"> • Swales pond water temporarily and exfiltrate it to the subsoil. • Water trapped in the roadbed structural section is unacceptable because it accelerates pavement deterioration. 	<ul style="list-style-type: none"> • To keep water out of the road base and subgrade, the swale bottom should be below the roadway's base course. A swale depth of 18" is typically sufficient to accomplish this requirement. • Saturated conditions do not persist in properly designed, constructed, and maintained swales (wet swales excluded). Underdrains, provided when the saturated conductivity of the existing subsoil < 1 in/hr, will rapidly drain free water by gravity in the same manner as conventional subsurface drainage systems. Swales with underdrains may actually help to intercept and divert subsurface flows. • Ensure that the maximum ponding elevation is lower than the bottom of the pavement subgrade.
Slope stability	<ul style="list-style-type: none"> • Swales side slopes must not create stability problems for adjacent roadbed structural section. 	<ul style="list-style-type: none"> • Consult a geotechnical engineer to insure that the angle of repose of the swale side slope is appropriate for the soil type.

Maintenance

MAINTENANCE REQUIREMENTS

The primary maintenance requirement for swales is to inspect the treatment area for sediment and debris accumulation and the mow the grass. Generally, maintenance is the same as the routine periodic maintenance that is required of any roadway shoulder area. However, the main exception is that the grass within the swale should not be mowed lower than the height of the water quality design depth. Repair any eroded areas as soon as they are noted.

On an annual basis, perform the following tasks:

- Remove accumulated sediment and debris from the swale.
- Stabilize and resod any eroded areas within the swale.

WORK CREW

Swale maintenance will be able to be performed by a typical mowing crew of two (2) to three (3) workers.

MAINTENANCE WORKER SAFETY / TEMPORARY TRAFFIC CONTROL

To ensure worker safety, maintenance work on swales requires temporary traffic control (TTC) devices. References include:

- *Manual on Uniform Traffic Control Devices*, by the Federal Highway Administration
- State or local TTC manuals
- *AASHTO Roadside Design Guide*, chapter 9

Swales themselves and any associated flow structures pose no inherent hazards to maintenance workers besides those associated with normal mowing activities. The primary safety concern is to provide adequate distance between the work area and the travel lanes, and to ensure safe access to the work area. General guidelines for TTC activities are given below. Staging areas can include materials stockpiles and parking for equipment and personal vehicles.

Location of work zone	Type of closure	TTC device
Beyond shoulder. Sufficient space for staging and worker safety.	No closure needed	ROAD WORK AHEAD sign
<ul style="list-style-type: none">• Beyond shoulder. Insufficient space for staging and safety.• Shoulder. Sufficient space for staging and worker safety.	Close shoulder	<ul style="list-style-type: none">• Channelizing devices (e.g. cones)• Temporary barriers and crash cushions• Truck-mounted attenuator
<ul style="list-style-type: none">• Shoulder. Insufficient space for staging and worker safety.• Edge of travel lane	Close travel lane	

In order to ensure long-term effectiveness of swales, associated BMPs (see “Treatment Train Options”), and surrounding open space, do not place staging areas:

- in areas prone to erosion, and
- in areas where soil permeability must be preserved.

Because staging activities can erode or compact sensitive soils, the staging area may need to be located on an adjacent paved surface. To ensure worker safety, the shoulder or travel lane may need to be closed. Also, temporary or permanent barriers should be used for longer-duration work such as major reconstruction.

PERFORMANCE AND INSPECTION

To ensure proper performance, visually inspect that stormwater is infiltrating and conveying properly in the swale. The primary indicator of cell failure is slow or no drawdown of ponded water. Water ponding in a swale for more than 48 hours may indicate operational problems. Corrective measures include inspection for and removal of accumulated sediments. Backflushing

the underdrain through the cleanout pipe is another option. Erosion within the channel also indicates operational problems. Reseeding may be required to prevent erosion. Aerating or partially or fully replacing the permeable soil may be required to restore infiltration. Alternately, soil amendments can first be applied in an attempt to restore permeability. Perform this inspection:

- annually in spring, or before the beginning of the wet season, and
- after extreme events (e.g. after hurricanes).

Aesthetics

Swales are grassed and vegetated stormwater management devices and can provide a neutral to positive visual impact along the roadway. Properly designed, they will blend in with other landscaping – especially from the point of view of a vehicle moving at highway speeds. Pondered water will drain within 48 hours if the cell is designed, constructed, and maintained correctly. At a minimum, swales should be maintained for appearance as often as other landscaped roadway areas.

Treatment Train Options

Below is a list of other BMPs that can work in concert with swales to provide supplementary or complementary stormwater benefits. Also note that swales may be able to serve as pretreatment areas for conventional stormwater ponds.

BMP	Purpose	U/S	D/S
Bioretention cell	<ul style="list-style-type: none"> • Provides treatment for swale effluent • Provides pretreatment of swale influent • Provide additional storage volume 	X	X
Infiltration trench	<ul style="list-style-type: none"> • Gain additional reductions in volume and peak by directing swale outflow into infiltration trench 		X
Pollution prevention	<ul style="list-style-type: none"> • Use P2 techniques to reduce loadings of pollutants entering the swales (e.g. fertilizers, herbicides and pesticides, oil) 	X	
Soil amendments	<ul style="list-style-type: none"> • Use soil amendments to restore the permeability of swales as an alternative to soil replacement. 		
Street sweeping	<ul style="list-style-type: none"> • Regular street sweeping can reduce loadings of sediment and debris entering the swale. 	X	
Tc practices	<ul style="list-style-type: none"> • Use Time of Concentration practices to reduce the velocity of runoff entering the swale. 	X	

U/S = upstream of swale D/S = downstream of swale

15.0 Vegetation/Landscaping

DEFINITION Natural and reintroduced vegetation provides stormwater management and pollutant removal. Vegetated areas intercept and infiltrate rainfall decreasing stormwater volumes. Plants, trees, and other vegetation remove pollutants from infiltrated stormwater through root zone uptake. Incorporating vegetation into the landscape is a stormwater management technique that utilizes environmentally beneficial mechanisms naturally occurring in the environment.

LOCATION	<ul style="list-style-type: none"> • Median • Roadway setback 	
FIXED-OBJECT HAZARD?	<ul style="list-style-type: none"> • No (see safety section) 	
EFFECTIVENESS	<ul style="list-style-type: none"> • Water quality HIGH • Volume HIGH • Peak discharge HIGH 	
STORAGE CAPACITY	<ul style="list-style-type: none"> • N/A 	
TARGETED POLLUTANTS	<ul style="list-style-type: none"> • Total Suspended Solids • Oil and grease • Heavy metals • Nutrients 	

Figure 15.1. Roadway vegetation.
Source: City of Vancouver Greenways Program

Siting Guidelines

These guidelines and criteria will help determine whether landscaped vegetation is appropriate for use in a given location. Brief explanations are also provided.

Guideline	Explanation
Locate the vegetated landscape at least 5' downgradient from the edge of the roadway.	Minimize potential safety and structural conflicts with roadway.
Vegetated landscapes must be situated to provide safe and ready access to maintenance vehicles and workers.	An unsafe access point will jeopardize workers and may reduce the amount of maintenance work performed.

Materials

REQUIRED MATERIALS

The cost of these required components is given in 2005 dollars.

Item	Depth	Cost	Specification	Purpose
Plants and vegetation	n/a	\$5 – \$50 ea. (depends on maturity and type)	<ul style="list-style-type: none"> • Native plants may have lower maintenance requirements. • Supplemental irrigation may be used until plants are established. • Select plants that do not require irrigation after becoming established. 	<ul style="list-style-type: none"> • Landscaping/habitat • Pollutant removal through root uptake • Roots provide habitat for microbes • Volume reduction through evapo-transpiration • Roots help maintain soil permeability
Mulch	2” – 4”	\$30 – \$35 / C.Y.	<ul style="list-style-type: none"> • 2X shredded hardwood bark, aged for 12 months minimum. • Must be free of seeds and other plant material. 	<ul style="list-style-type: none"> • Protects plants
Grass seed	n/a	\$15 - \$20/ M.S.F.	<ul style="list-style-type: none"> • Native grass mix • Should be free of weeds • The use of fertilizers and pesticides should be avoided 	<ul style="list-style-type: none"> • Provide treatment of runoff • Blend in with landscape • Roots help maintain soil permeability

OPTIONAL MATERIALS

There are no optional materials for vegetation and landscaping.

Hydrology and Hydraulics

HYDROLOGIC AND WATER QUALITY CONTROLS

The following table summarizes the types of runoff controls provided by vegetated landscape. See Chapter 3 for additional discussion of these controls.

Control	Effectiveness	Discussion
Water quality	High	<ul style="list-style-type: none"> ● Vegetated landscaping is effective in reducing concentrations of: <ul style="list-style-type: none"> ○ Total Suspended Solids ○ Oil and grease ○ Heavy metals ○ Phosphorus, and to a lesser extent, nitrogen. ● Water quality processes include: <ul style="list-style-type: none"> ○ Settling ○ Physical straining ○ Organic complexing ○ Uptake by roots ○ Degradation by microbes
Volume	High	<ul style="list-style-type: none"> ● Vegetated landscapes cause retention of runoff through: <ul style="list-style-type: none"> ○ Infiltration into the soil ○ Evapotranspiration by vegetation
Peak discharge	High	<ul style="list-style-type: none"> ● By providing the storage mechanisms described above, vegetated landscaping is highly effective at reducing the peak discharge rate.

OFFLINE VS. INLINE SYSTEMS

Landscaped vegetation is not typically classified as online or offline because it is not specifically part of a treatment system. Preserving or reintroducing vegetation is an effort to maintain a natural environmental state with its hydrologic function. Vegetated areas will normally only generate stormwater runoff during extreme precipitation events. Maintained vegetated areas become part of a stormwater management control process when roadway runoff is directed to the area to infiltrate stormwater and reduce its peak flow.

INFLOW DESIGN

Stormwater can enter a vegetated landscape in several ways:

- Sheet flow from open-section roadways
- Channelized flow from swales and flow-splitting devices
- Shallow concentrated flow from curb cuts

Runoff Velocity

In all cases, inflow structures must reduce the runoff velocity to a non-erosive rate ($< \sim 2$ fps) in order to prevent erosion. This will also help to evenly distribute runoff across the vegetated area. Common methods of distributing runoff and slowing its velocity are:

- Grass filter strips. Must be sufficiently wide to reduce velocity and trap sediment. May not be practical where space is at a premium.
 - Level spreaders can be used with filter strips to “un-concentrate” flows.
- Riprap aprons/gabions. Typically used when inflow is not sheet flow, e.g. curb cuts. Helpful when space constraints exist.
- Other practices to increase Time of Concentration (T_c) (see introduction to design sheets).

OUTFLOW DESIGN

Stormwater exits vegetated areas through a combination of:

- Infiltration into the soil
- Evapotranspiration by vegetation
- Overland flow

For additional information, refer to AASHTO's *Highway Drainage Guidelines*.

SIZING AND STORAGE

Vegetative landscaping preserves or restores a more natural environmental state by maintaining the land's ability to absorb stormwater and process pollutants. Landscaped vegetation does not have any specific sizing or storage needs.

Construction

Preventing soil compaction, erosion, and deposition of fines are key construction issues for vegetated landscape. Guidelines are listed below.

- Avoid running equipment over the area to be landscaped to prevent soil compaction.
- Do not stockpile excavated material in the area where the vegetated landscape is to be placed.

Safety and Structural Issues

VEHICLE SAFETY

Potential vehicle safety concerns, both real and perceived, are listed below. The introduction contains additional information on the relationship between BMPs and roadway safety. Also see the AASHTO *Roadside Design Guide* and NCHRP Report 500, Volume 3: *A Guide for Addressing Collisions with Trees in Hazardous Locations*. The NCHRP report appendices, available online, provide design guidance.

Safety concern	Discussion	Possible remedies
Fixed-object hazards: <ul style="list-style-type: none"> Vegetation 	Any tree or shrub in the cell can become a fixed-object hazard if the trunk diameter grows greater than 4".	<ul style="list-style-type: none"> Don't plant large-diameter vegetation. Establish an appropriate offset. Prune to keep trees small. This may significantly increase the maintenance burden, however. Avoid placing vegetated landscape: <ul style="list-style-type: none"> in the clear zone at the bottom of non-recoverable slopes in the tangent position on the outside of curves in chronic accident spots Install a traffic barrier (i.e. guardrail). Prune or remove trees.
Sight distance / Visual obstruction	Vegetation taller than 3' may reduce sight distance around the inside of curves, block signage, or create other visual obstructions.	<ul style="list-style-type: none"> Maintain 3' maximum vegetation height where an unobstructed view is critical, including: <ul style="list-style-type: none"> inside curves (geometry varies) in advance of signs around median crossings around at-grade intersections Plant shorter vegetation as necessary.

SAFETY BENEFITS

Vegetation may also provide safety benefits for roadway users under certain circumstances by reducing glare and acting as a crash cushion for errant vehicles.

Safety benefit	Discussion	Considerations
Crash cushion	Thick groundcover (e.g. shrubs) may act as a crash barrier, or at least cushion and slow errant vehicles.	<ul style="list-style-type: none"> Ensure that final trunk or stem diameter is less than 4" Maintain vegetation height to preserve sight distance Vegetation must not obscure higher-risk objects 5 to 10 years of growth may be needed for vegetation to be an effective cushion or barrier.
Reduce glare / reflection	Vegetation may reduce headlight glare or other visual hazards.	<ul style="list-style-type: none"> See above.

MAINTENANCE WORKER SAFETY

See the maintenance section below for a discussion.

STRUCTURAL INTEGRITY

Vegetation and landscaping do not pose any structural problems.

Maintenance

MAINTENANCE REQUIREMENTS

The primary maintenance requirement for landscaped areas is to inspect the health of the plants and vegetation and replace them if necessary. Repair any eroded areas as soon as they are noted.

On an annual basis, perform the following tasks:

- Replace any dead or stressed plants.
- Stabilize any eroded areas that drain to the landscaped area.

Depending on the season, geographic location, and type of vegetation, irrigation may be needed during plant establishment. These factors will also determine the irrigation frequency.

“Established” means that the soil cover has been maintained for at least one year since replanting. Native plants may require less irrigation than non-natives. In periods of extended drought, temporary supplemental irrigation may be used to maintain plant vitality. Irrigation may be done using an automatic system or manually by workers.

WORK CREW

With proper training, vegetated landscape maintenance will be able to be performed by a crew of two (2) to three (3) workers, or an existing landscaping crew.

MAINTENANCE WORKER SAFETY / TEMPORARY TRAFFIC CONTROL

To ensure worker safety, maintenance work on bioretention cells requires temporary traffic control (TTC) devices. References include:

- *Manual on Uniform Traffic Control Devices*, by the Federal Highway Administration
- State or local TTC manuals
- *AASHTO Roadside Design Guide*, chapter 9

Vegetated landscapes themselves structures pose no inherent hazards to maintenance workers besides those associated with normal landscaping activities. The primary safety concern is to provide adequate distance between the work area and the travel lanes, and to ensure safe access to the work area. General guidelines for TTC activities are given below. Staging areas can include materials stockpiles and parking for equipment and personal vehicles.

Location of work zone	Type of closure	TTC device
Beyond shoulder. Sufficient space for staging and worker safety.	No closure needed	ROAD WORK AHEAD sign
<ul style="list-style-type: none"> • Beyond shoulder. Insufficient space for staging and safety. • Shoulder. Sufficient space for staging and worker safety. 	Close shoulder	<ul style="list-style-type: none"> • Channelizing devices (e.g. cones) • Temporary barriers and crash cushions • Truck-mounted attenuator
<ul style="list-style-type: none"> • Shoulder. Insufficient space for staging and worker safety. • Edge of travel lane 	Close travel lane	

In order to ensure long-term health of vegetation and the effectiveness of associated BMPs (see “Treatment Train Options”) and surrounding open space, do not place staging areas:

- in areas prone to erosion, and
- in areas where soil permeability must be preserved.

Because staging activities can erode or compact sensitive soils, the staging area may need to be located on an adjacent paved surface. To ensure worker safety, the shoulder or travel lane may need to be closed. Also, temporary or permanent barriers should be used for longer-duration work such as major reconstruction.

PERFORMANCE AND INSPECTION

To maintain the health and vitality of the vegetation, visually inspect the condition of the plants, vegetation, and soil. Replacement of plants and vegetation may be required periodically and soil amendments can be used to maintain soil permeability. Perform this inspection:

- annually in spring, or before the beginning of the wet season, and
- after extreme events (e.g. after hurricanes).

Aesthetics

Vegetated landscapes can provide a positive visual impact along the roadway. Properly maintained vegetation and green space generally tend to improve the overall aesthetics of any area including roadways and transportation corridors.

Treatment Train Options

Below is a list of other BMPs that can work in concert with vegetated areas to provide supplementary or complementary stormwater benefits.

BMP	Purpose	U/S	D/S
Bioswale or grassed swale	<ul style="list-style-type: none"> • Convey stormwater to the vegetative landscape. • Reduce runoff velocity. • Provide pre-treatment. • Provide additional storage volume. 	X	
Pollution prevention	<ul style="list-style-type: none"> • Use P2 techniques to reduce loadings of pollutants entering the vegetated area (e.g. fertilizers, herbicides and pesticides, oil). 	X	
Soil amendments	<ul style="list-style-type: none"> • Use soil amendments to restore the permeability of vegetative landscaping soil. 	X	
Street sweeping	<ul style="list-style-type: none"> • Regular street sweeping can reduce loadings of sediment and debris entering the landscaped areas. 	X	

U/S = upstream of vegetated landscape D/S = downstream of vegetated landscape

[This page intentionally left blank]

REFERENCES

ARA, Inc, ERES Division (2001). *Guide for Mechanistic-Empirical Design of New and Rehabilitated Pavement Structures – Appendix SS: Hydraulic Design, Maintenance, and Construction Details of Subsurface Drainage Systems*, National Cooperative Highway Research Program, Washington, DC, February.

American Association of State Highway and Transportation Officials (AASHTO) (1992). *Highway Drainage Guidelines*. American Association of State Highway and Transportation Officials, Washington DC.

American Association of State Highway and Transportation Officials (AASHTO) (1993). *AASHTO Guide for Design of Pavement Structures 1993*. American Association of State Highway and Transportation Officials, Washington DC.

Cheng, M.S, Coffman, L.S. and Clar, M.L. (2001). “Low Impact Development Hydrologic Analysis,” *Urban Drainage Modeling*, R.W. Brashear and C. Maksimovic, eds., Proc. of the Specialty Symposium of the World Water and Environmental Resources Conference, ASCE, Environmental and Water Resources Institute, Orlando, FL, May 2001, pp. 659-681.

CH2M-Hill (2000). *Soil Improvement Project: Exploring the Alternatives*. Snohomish County Public Works, Solid Waste Management Division, Vol. 1, Snohomish County, Snohomish, WA.

CIRIA (2000a). *Sustainable Urban Drainage Systems – Design Manual for Scotland and N Ireland*. C521, London, UK.

CIRIA (2000b). *Sustainable Urban Drainage Systems – Design Manual for England and Wales*. C522, London, UK.

CIRIA (2000c). *Sustainable Urban Drainage Systems – Best Practice*. C523, London, UK.

Claassen, V., Haynes, J. and Paswater, P. (2000). *Compost Demonstration Project, Placer County: Use of Compost and Co-Compost as a Primary Erosion Control Material*, Publication #443-99-018, California Integrated Waste Management Board, Sacramento, January,.

Colwell, S., Horner, R.R., Booth, D.B. and Gilvydis, D. (2000). *A Survey of Roadside Ditches and Swales*, Center for Urban Water Resources Management, Dept. of Civil Engineering, University of Washington, Seattle.
(<http://depts.washington.edu/cwws/Research/Reports/ditchesg15.pdf>)

Davis, A. Shokohian, M., Sharma, H., Minami, C. and Winogradoff, D. (2003). “Water Quality Improvement through Bioretention: Lead, Copper, and Zinc Removal,” *Water Environment and Resources*, Vol. 75, No. 1, pp. 73-82, Jan/Feb.

Demars, K., Long, R. and Ives, J. (2000). *Use of Wood Waste Materials for Erosion Control*, New England Transportation Consortium, NETCR 20, Project No. 97-3, April.

District of Columbia Office of Planning (2003). *Anacostia Waterfront Initiative Master Plan*, Washington, DC.

Federal Highway Administration (2000) *Stormwater Best Management Practices in an Ultra-Urban Setting: Selection and Monitoring*. Washington, D.C. FHWA-EP-00-002.
<http://www.fhwa.dot.gov/environment/ultraurb/>

Goldstein, N. (2001a). "Education, Education, Education: Compost and Stormwater Management - Tapping the Potential," *BioCycle*, Vol. 43, No. 10.

Goldstein, N. (2001b). "Erosion, Sediment Control: Compost Product Performance," *BioCycle*, Vol. 43, No. 9.

Heaney, J.P. (2000). Principles of Integrated Urban Water Management. Chapter 2 in Field, R., Heaney, J.P., Pitt, R. and R. Field, Eds. *Innovative Urban Wet-Weather Flow Management Systems*. Technomics Publishing Co., Lancaster, PA, 68 p.
<http://www.epa.gov/ednrmrl/publish/book/epa-600-r-99-029/index.html>

Heaney, J.P., Sample, D. and Wright, L. (1999). *Costs of Urban Stormwater Systems*. US EPA Report EPA/R-02/021, National Risk Management Research Laboratory, Cincinnati, OH, 113 p.
<http://www.epa.gov/ORD/NRMRL/Pubs/600R02021/600R02021.html>

Highway Research Board (1952). *Final Report on Road Test One – MD*, Special Report 4, Washington DC, Highway Research Board.

Highway Research Board (1955). *The WASHO Road Test*, Special Reports 18 and 22, Washington DC, Highway Research Board.

Highway Research Board (1962). *The AASHO Road Test – Report 5, Pavement Research*, Special Report 61E, Washington DC, Highway Research Board.

Huber, W.C., Nelson, P.O., Eldin, N.N., Williamson, K.J. and Lundy, J.R. (2001). "Environmental Impact of Runoff from Highway Construction and Repair Materials: Project Overview," *Transportation Research Record* 1743, National Academy Press, Washington, DC, pp. 1 – 9.

Li, J., Orland, R. and Hogenbirk, T. (1998). "Environmental Road and Lot Drainage Designs: Alternatives to Curb-Gutter-Sewer System," *Canadian Journal of Civil Engineers*, Vol.25, pp. 26 – 39.

LID Center (2000). "Low Impact Development (LID), A Literature Review," EPA-841-B-00-005, Office of Water, Environmental Protection Agency, Washington, DC.

Maryland Department of Natural Resources (1983). *Maryland Standards and Specifications for Infiltration Practices in Stormwater Management*. Maryland Department of Natural Resources, Annapolis.

McAdam, J.L. (1820). *Report to the London Board of Agriculture*, London, England.

McCoy, S. and Cogburn, B. (2001). "Motivated By Manure: Texas Makes Inroads with Highway Use of Compost," *BioCycle* Vol. 42, No.1.

McCuen, R.H. (2005). *Hydrologic Analysis and Design*. Third Edition, Prentice Hall, Upper Saddle River, NH.

McCuen, R.H. and Okunola, O. (2002). "Extension of TR-55 for Microwatersheds," *Journal of Hydrologic Engineering*, Vol. 7, No. 4, pp. 319-325, July/August.

Milwaukee Metropolitan Sewer District (2003). *Low Impact Development Quicksheet Model Users Manual*, Milwaukee, WI.

National Association of Homebuilders Research Center (NAHBRC) (2003). *The Practice of Low Impact Development*. Prepared for U.S. Department of Housing and Urban Development. Washington, D.C.

Naval Facilities Engineering Command (In publication 2004). *Low Impact Development Design Manual*. Department of Defense, Washington, DC.

Novotny V. and Olem, H. (1994). *Water Quality: Prevention, Identification, and Management of Diffuse Pollution*, John Wiley and Sons, Inc. New York

Persyn, R.A., Glanville, T.D., and Richard, T.L. (2002). "Evaluation of Soil Erosion and Soil Erodibility Factors for Composted Organics on Highway Right-of-Ways," Paper Number: 022081, Proc. American Society of Agricultural Engineers, Saint Joseph, MI.

Prince George's County Department of Environmental Resources (PGDER) (1998). *Western Branch Stormwater Management Study*, Prince George's County, Largo MD.

Prince George's County Department of Environmental Resources (1997). *Low Impact Development Design Manual*. Prince George's County Department of Environmental Resources, Prince George's County, Largo, MD.

Prince George's County Department of Environmental Resources (2000a). *Low-Impact Development Design Strategies: An Integrated Design Approach*, Depart. of Environmental Resources, Prince George's County, Largo, MD.

Prince George's County Department of Environmental Resources (2000b) *Low-Impact Development Design Manual*. Dept. of Environmental Resources, Prince George's County, Largo, MD.

Puget Sound Action Team (2003). *Natural Approaches to Stormwater Management: Low Impact Development in Puget Sound*, Olympia, WA.

http://www.psat.wa.gov/Publications/LID_studies/lid_natural_approaches.pdf

R. Alexander Associates, Inc. (2003). *Compost Use on State Highway Applications*, Composting Council Research and Education Foundation, Harrisburg, PA.

<http://www.epa.gov/epaoswer/non-hw/compost/highway/>

Richard, T.L., Persyn, R.A., and Glanville, T.D. (2002). "Cover Crop Production and Weed Control on Highway Right-of-Ways Using Composted Organics," Paper Number: 022051, Proc. American Association of Agricultural Engineers, Saint Joseph, MI.

Sabourin, J.F. and Associates, Inc. (1999). *Executive Summary: Update on the Performance Evaluation of Grass Swales and Perforated Pipe Drainage Systems*, Project 970155, Ministry of the Environment, Toronto, Ontario.

Sansalone J.J. and Buchberger, S.G. (1995). "An Infiltration Device as a Best Management Practice for Immobilizing Heavy Metals in Urban Highway Runoff," *Water Science and Technology*, Vol. 32, No.1, pp. 119-125.

Satkofsky, A. (2002). "High Quality Mulch Finds Erosion Control Niche," *BioCycle*, Vol. 43, No. 1.

Soil Conservation Service (updated 1972). *SCS National Engineering Handbook, Section 4, Hydrology*, Soil Conservation Service, U.S. Dept. Agriculture, U.S. Government Printing Office, Washington, D.C.

Soil Conservation Service (1986). *Urban Hydrology for Small Watersheds*, Technical Release 55, 2nd ed., U.S. Dept. Agriculture, NTIS PB87-101580, Springfield, VA, (microcomputer version 2.1 and documentation available at: http://www.ftw.nrcs.usda.gov/tech_tools.html).

Strecker, E.W. (2001). "Low Impact Development (LID): Is it Really Low or Just Lower?," In: *Linking Stormwater BMP Designs and Performance to Receiving Water Impact Mitigation*, *Proceedings of An Engineering Foundation Conference*, Snowmass Village, Colorado, August 2001, Ben R. Urbonas, Ed., American Society of Civil Engineers, Reston, VA, ISBN 0-7844-0602-2, pp. 210-222.

Strecker, E.W., Quigley, M.M., Urbonas, B. and Jones, J. (2004). "Analyses of the Expanded EPA/ASCE International BMP Database and Potential Implications for BMP Design," *Proc. EWRI World Water and Environmental Resources Congress*, Salt Lake City, ASCE, Reston, VA.

Taylor Associates, Inc. (2001) *Flow and Water Quality Monitoring Plan, State Route 5 at Lacey, Compost Addition Draft*, Prepared for: Washington Department of Transportation, Olympia.

Thurston, H.H., Szlag, D, and Lemberg, B. (2003). "Controlling Storm-Water Runoff with Tradable Allowances for Impervious Surfaces," *Journal of Water Resources Planning and Management*, September/October, pp. 409-418.

Tyler, R. (2001). "Replacing Conventional Methods: Compost Filter Berms and Blankets Take on the Silt Fence," *BioCycle*, Vol. 42, No. 1, January.

Urban Drainage and Flood Control District (2001). *Urban Storm Drainage Criteria Manual*, Denver, CO.

US EPA (1997). *Innovative Uses of Compost Erosion Control, Turf Remediation, and Landscaping*. EPA530-F-97-043, Washington, DC.

U.S. Green Building Council (2004). *LEED New Construction Reference Guide*, Washington, DC. (http://www.usgbc.org/LEED/LEED_Main.asp)
Virginia Department of Conservation and Recreation (VDCR) 1999, State Stormwater Management Manual, Richmond, VA

Wanielista, M.P., Yousef, Y.A. and Avellaneda, E. (1988). *Alternatives for the Treatment of Groundwater Contaminants: Infiltration Capacity of Roadside Swales*, Report FL-ER-38-88, Florida DOT, Tallahassee.

Washington Department of Ecology (WDOE) (2001). *Stormwater Management Manual for Western Washington: Volume III -- Hydrologic Analysis and Flow Control Design/BMPs*. Washington State Department of Ecology, Olympia.

Washington State DOT (1998). *WSDOT Pavement Guide Interactive*, Washington State Department of Transportation, Olympia.

Washington State DOT (WSDOT) (2001). *A Case Study of Benefit-Cost Analysis: Soil Bioengineering as an Alternative for Roadside Management*, Olympia.

Washington State DOT (WSDOT) (2003) *Roadside Manual*. Olympia.

Wright, L. and Heaney, J.P. (2001). "Design of Distributed Stormwater Control and Reuse Systems," Chap. 11 in Mays, L.W., Ed. *Stormwater Collection Systems Design Handbook*, McGraw-Hill, New York, p. 11.1-11.49.

Yu, S.L., Kuo, J-T. and Fassman, E.A. (2001). "Field Test of Grassed-Swale Performance in Removing Runoff Pollution," *Journal Water Resources Planning and Management*, Vol. 127, No. 3, pp. 168-171, May/June.

[This page intentionally left blank]