

# **GOES Data Collection Platform Radio Set (DCPRS) CERTIFICATION STANDARDS at 300 bps and 1200 bps**

---

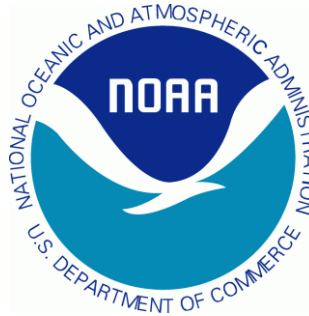

---

**Version 2.0**

**NOAA / NESDIS**

**Effective date: June 2009**

Prepared by Noblis under Contract No. DG133E-07-CQ-0030

## TABLE OF CONTENTS

SECTION 1 - DCPRS Certification Documentation Requirements.....	1
1.1 Required Documentation .....	1
1.2 Emission Designators.....	1
1.3 Nameplate Information .....	1
SECTION 2 - DCPRS Data Rate and Operating Mode Requirements.....	2
2.1 DCPRS Self-Timed reporting Mode Accuracy.....	2
2.1.1 Inhibiting Transmissions.....	2
2.1.2 Proof of Performance .....	2
2.2 DCPRS Random Reporting Mode Requirements .....	2
2.3 DCPRS Interrogate Reporting Mode Requirements .....	2
SECTION 3 - DCPRS Data Format Requirements .....	3
3.1 DCPRS Message Format .....	3
3.2 Data Scrambling.....	4
3.3 Trellis Encoding.....	4
3.4 Encoder Flush and Carrier Turn-Off.....	5
3.5 DCPRS Modulation Encoding .....	6
3.6 DCPRS Data Formats .....	6
3.6.1 Prohibited Characters .....	6
3.6.2 End Of Transmission (EOT) .....	6
SECTION 4 - DCPRS Performance Requirements .....	7
4.1.1 RF Power Output .....	7
4.1.2 DCPRS Antenna .....	8
4.1.2.1 Antenna Polarization.....	8
4.1.2.2 DCPRS Antenna Gain.....	8
4.2 GOES DCS Operating Frequency Requirements .....	8
4.2.1 Operating Channels and Frequencies.....	8
4.2.2 Frequency Stability, Long Term .....	8
4.2.3 Short Term Frequency Stability.....	8
4.3 DCPRS Modulation Output Symbol Rate .....	9
4.4 DCPRS Phase Modulation and Noise.....	9
4.4.1 Carrier Phase Noise.....	9
4.4.2 Phase Modulation Bias.....	9
4.4.3 RMS Phase Error .....	9
4.5 DCPRS Transmit Spectrum .....	9
4.6 Fail-safe Operating Requirements.....	11
APPENDIX A - Recommended Test Equipment and Test Set Up.....	13
APPENDIX B - GOES DCS Pseudo-Binary Data and Other Definitions.....	18
APPENDIX C - Filter Definition for the DAMS-NT Receiver/Demodulator.....	23
APPENDIX D - GOES DCPRS Transmit Frequencies .....	27
APPENDIX E - GOES DCPRS Phase Noise Budget.....	31

## LIST OF FIGURES

Figure 1. Trellis Encoder Functional Diagram .....	5
Figure 2. Emission Mask for 300 bps Operation .....	10
Figure 3. Emission Mask for 1200 bps Operation .....	11
Figure A-1. Typical test set-up.....	14
Figure A-2. Spectrum Analysis Reference Levels.....	17
Figure B-1. DCPRS Transmit Format.....	18
Figure B-2. DCPRS Message or Sensor Data Format .....	18
Figure B-3. 12-Bit Precision Data.....	19
Figure B-4. 18-Bit Precision Data.....	19

# **GOES DCS 300/1200 BPS DCPRS CERTIFICATION STANDARDS FOR SELF-TIMED, RANDOM REPORTING, and INTERROGATE OPERATION**

## **Introduction**

DCPRS Certification is achieved by demonstrating that a radio transmitter fulfills each of the requirements set forth in this document. NESDIS certification is "type certification", wherein a representative production unit is tested and found to fulfill all stated requirements. NESDIS certification of individual production units (those having the same model number) is not required. **As a standard, this document represents mandatory requirements—waivers will not be accepted.**

To obtain "Type Acceptance" the manufacturer shall submit the DCPRS schematics, data flow chart, electronics parts design data, unit, and system test data, and perform tests to demonstrate that each requirement herein is met. This includes but is not limited to analysis of the DCPRS' design and performance characteristics, performing unit tests at room temperature, and over a range of temperatures and power supply (battery voltage) variations.

Certification testing shall be performed using standard laboratory test equipment from a nationally recognized manufacturer, using the NOAA supplied Certification Test Set, or using other test equipment for which NOAA approval has been obtained as described in Appendix A. Test guidelines, procedures, etc. are also described in Appendix A of this document. The NOAA Certification Test Set will be loaned for a period of up to sixty (60) days to manufacturers after the required documentation and design data requirements in Section 1 have been accepted and/or approved by the NOAA NESDIS Certification Official.

Manufacturers are required to supply all other test equipment needed to demonstrate compliance with the certification requirements. All test equipment to be used must be identified in the manufacturer's initial request for DCP certification and have verified calibrations to an established test laboratory. A list of the recommended test equipment, a typical test set up, and some of the capabilities of the NOAA provided test set are included in Appendix A. Specific test channels for use by manufacturers shall be assigned by NESDIS OSDPD as required.

## **Document Organization**

The GOES DCPRS certification requirements are set forth in the following four sections. The first section identifies the DCPRS certification documentation required. The second section defines the DCPRS certification reporting mode requirements. The third section focuses upon the DCPRS transmit data format requirements which are not considered to be temperature dependent. The fourth section involves requirements for which performance may vary over temperature and power supply variation such as output power, frequency stability, modulation stability, carrier phase noise, transmit spectrum, etc.

## **SECTION 1 - DCPRS Certification Documentation Requirements**

### **1.1 Required Documentation**

Manufacturers shall submit the following documentation at least 60 days prior to beginning the formal DCPRS certification testing. While NESDIS may review and comment on this documentation, all documentation is considered 'PROPRIETARY' – for government eyes only, and not available to any other party unless so identified by the manufacturer.

- a. DCPRS Model Number with its respective data and/or specification sheet(s).
- b. DCPRS electrical and electronic circuit schematics.
- c. DCPRS software flow-charts that identify how the DCPRS reporting method(s) - random, self-timed, interrogated, message formatting/generation, frequency and time stability functions, Fail-safe operation, other functions are fulfilled.
- d. DCPRS antenna gain, polarization, axial ratio, and VSWR information. This information shall be used with the power amplifier output to determine the DCPRS EIRP for Certification purposes.
- e. Manufacturers Proposed Test Procedures including test data sheets.
- f. DCPRS oscillator aging analysis data to demonstrate that the specified aging requirements are met.
- g. Preliminary DCPRS Transmit Spectrum (see paragraph 4.5).

### **1.2 Emission Designators**

The official emission designations for the DCPRS transmissions are provided below and shall be used whenever an emission designator is required.

- a. For 300 bps user data rate: 300HG1D.
- b. For 1200 bps user data rate: 1K20G1D.

### **1.3 Nameplate Information**

Each DCPRS shall include a durable nameplate on its outer surface that shall contain the following information as a minimum:

- a. Manufacturer's name, model number, and serial number
- b. Certification date for this model
- c. Defined input voltage range (see Section 4.0)
- d. Maximum and minimum output power in dBm
- e. Approved antenna gain, polarization, and type for use with this DCPRS (e.g. 11 dBi RHCP Yagi)
- f. Emission designator(s) applicable to this model

## **SECTION 2 - DCPRS Data Rate and Operating Mode Requirements**

A DCPRS may be designated for either 300 bps or for 1200 bps. Further, the DCPRS manufacturer shall clearly state the reporting mode(s) for the Model/unit (i.e. Self-timed, Random, or Interrogate). A combination of two operating modes is permitted providing this is so identified and that all applicable mode requirements are met. The DCPRS certification official will identify specific channels, GOES ID/DCP Address, and time slots as needed for any ‘on-the-air’ or ‘GOES testing.’

### **2.1 DCPRS Self-Timed reporting Mode Accuracy**

All DCPRS transmissions shall control the start time of their initial carrier-only period to be within less than or equal to  $\pm 0.25$  seconds from the assigned reporting time (referenced to UTC) over the full range of operating conditions.

#### **2.1.1 Inhibiting Transmissions**

The DCPRS shall include an algorithm to ensure that transmissions are inhibited whenever it is possible that any part of a transmission might occur outside of the assigned reporting period  $\pm 0.25$  seconds. The algorithm shall be included in the Certification test report and shall contain a written explanation of the time required for 0.25 seconds deviation from UTC and all other factors used to ensure this requirement is met.

#### **2.1.2 Proof of Performance**

During Certification tests the manufacturer shall show how the difference between the internal clock and UTC is calculated and shall show how the requirement of 2.1.1 will be met. The manufacturer shall demonstrate the basic factor(s) such as drift rate, used in the calculations.

### **2.2 DCPRS Random Reporting Mode Requirements**

For random reporting certification, manufacturers shall demonstrate that the DCPRS transmits at a maximum total transmit time of 3 seconds for 300 bps and 1.5 seconds for 1200 bps. Definitions of pseudo binary and other concepts are included in Appendix B. Random reporting certification testing requires that manufacturer’s demonstrate random message generation on an approved NESDIS channel and transmit DCP messages in the random mode for eight (8) or more hours with an average repeat interval of 15 minutes. One of the data values to be transmitted in this testing shall be a message number counter.

### **2.3 DCPRS Interrogate Reporting Mode Requirements**

For DCPRS interrogate mode certification, the unit shall be tested as a transmit/receive system. Thus not only all the DCPRS transmit but also the GOES Command Receiver requirements must be demonstrated. The DCPRS command receiver requirements shall be set forth in a separate document (TBD) that will be referenced here when created.

## SECTION 3 - DCPRS Data Format Requirements

### 3.1 DCPRS Message Format

The format of all messages shall meet the following requirements.

Carrier 0.5s/ 0.25s	Clock States 3 '0-1'	FSS 15 bits	GOES ID 32 bits	Flag Word 8 bits	DCP DATA Max: 32,000 bits @ 300 bps 128,000 bits @ 1200 bps	EOT	Encoder Flush 32 bits
---------------------------	----------------------------	----------------	--------------------	------------------------	---	-----	-----------------------------

↑ Start of Scrambling and Coding

NOTES: ASCII EOT use for ASCII and Pseudo Binary Formats  
International EOT used for Binary Format  
Actual Message Length may not Exceed Fail-Safe Limits

**Carrier:** 0.500 ±0.005 seconds for 300 bps  
0.250 ±0.005 seconds for 1200 bps  
The turn-on time shall be less than 10.0 mS to less than 1 dB below the average output power that occurs during the carrier-only period. Any positive overshoot is not included in the turn-on time.

**Clock:** 3 symbol periods, first 180°, then 0°, then 180°, as shown below:

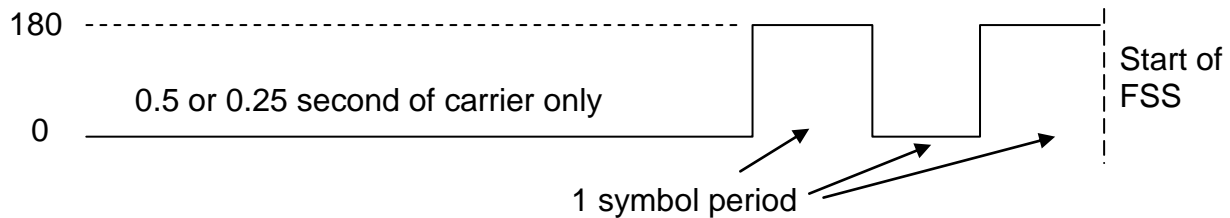

#### Frame Synchronization Sequence (FSS):

The following 15-bit pattern shall be sent at the appropriate symbol rate with "0" representing 0 degrees and "1" representing 180 degrees:  
(MSB) 001111100110101 (LSB) The left most bit is transmitted first.

After the FSS is transmitted the GOES ID and all data shall be scrambled, and trellis encoded, as defined below.

#### GOES ID/DCP address:

31 bits plus an extra "0" inserted as the LSB to form four 8-bit Bytes

The GOES ID is a 31-bit Bose-Chaudhuri-Hocquenghem (BCH) encoded address with a zero included as the 32<sup>nd</sup> LSB. This address shall be transmitted as the first 4 bytes of the data in the message in exactly the same manner as all the other data bytes in the message. For example, given the Hex ID of **CE 12 00 B8**, the first byte transmitted is **CE** Hex,

followed by **12** Hex, followed by **00** Hex, followed by **B8** Hex or:

**11001110 00010010 00000000 10111000**

**Flag Word: (LSB)** Bit 1 spare, undefined  
 Bit 2 Clock updated since last transmission = 1, not = 0  
 Bit 3 Data Compression on =1, off = 0 Possible Future Enhancement  
 Bit 4 New Coding on = 1, off = 0 Possible Future Enhancement (Code format not yet defined)  
 Bit 5 spare, undefined  
 Bit 6 = 1 if ASCII or Pseudo Binary, otherwise = 0  
 Bit 7 = 1 if Pseudo Binary or Binary, otherwise = 0  
 (MSB) Bit 8 Odd parity for ASCII formatted data

### 3.2 Data Scrambling

Starting with the first bit of the GOES ID, all DCPRS data shall be scrambled. The DCPRS serial data stream shall be “exclusive ORed” (XOR) with the serial binary string represented by the table below. It is shown as 40 bytes using Hex symbols for convenience, and shall be used in a circular fashion throughout the message.

53	12	72	B2	54	62	AA	E4	DB	A7	56	08	A8	09	B4	BF	61	DC	50	E3
AB	7F	00	87	6D	F5	58	CC	CF	3E	E7	2A	7E	9B	5C	4D	CE	A5	3C	0A

Scrambling shall be performed on a byte-by-byte basis. For example, the first byte of the GOES ID example, CE (Hex), would be XOR with the first byte in the table, 53 (Hex), i.e., the serial string 1100 1110 XOR with the serial string 0101 0011 to produce 1001 1101, or 9D (Hex). Then the second byte of the GOES ID, 12 (Hex), would be XOR with the second byte in the table, 12 (Hex), to produce 00 (Hex), and so on. After the last byte of the table 0A (Hex), has been XOR with the 40th byte of the DCPRS message, the table would be cycled and the 41st message byte XOR with the first byte in the table, 53 (Hex). This sequence would continue as many times as required for the duration of the message, including the EOT and flush bits.

### 3.3 Trellis Encoding

Figure 1 provides a Functional Block Diagram of the Trellis encoder required.



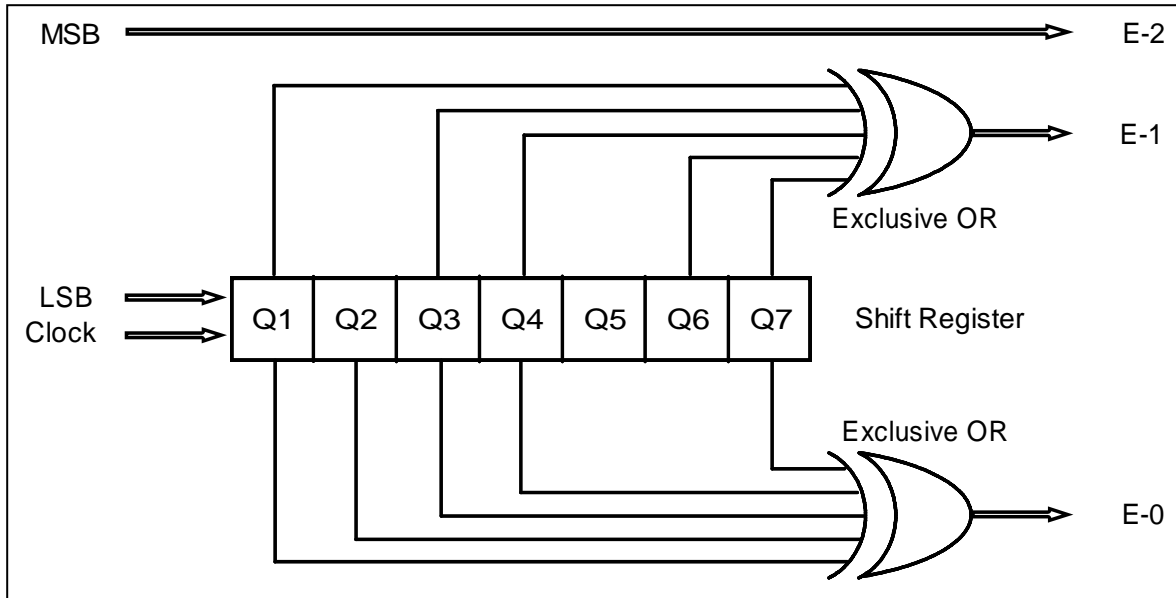

**Figure 1. Trellis Encoder Functional Diagram**

This logic generates sets of tri-bits, which are used to generate each 8-PSK symbol to be modulated.

Each data byte contains 8 bits. These bits are split into four 2-bit pairs as shown in the table below. Each 2-bit pair is fed into the trellis encoder in order. Pair 1 is fed into the encoder, then pair 2, pair 3, and pair 4. Then pair 1 of the next byte, pair 2, etc.

MSB			LSB
Bits 7 & 6	Bits 5 & 4	Bits 3 & 2	Bits 1 & 0
Bit Pair 4	Bit Pair 3	Bit Pair 2	Bit Pair 1

The trellis encoder takes a 2-bit pair and encodes it to a 3-bit symbol. This 3-bit symbol is then mapped to one of the eight phases for transmission as shown in Table 1, Section 3.5. The initial state of the encoder shall be all zeros.

### 3.4 Encoder Flush and Carrier Turn-Off

At the end of the message after the EOT, an additional 32 zero (0) data bits shall be input to the scrambler to flush the encoder and decoder. After the resulting 16 symbol periods are transmitted, the carrier power shall be turned off. The turn-off transition shall not start until the end of the 16th symbol period and shall be a maximum of 15 milliseconds in duration, in which time the power shall be reduced by at least 50 dB.

### 3.5 DCPRS Modulation Encoding

The transmitted data shall be phase mapped from the trellis encoder as follows:

E-2 MSB	E-1 Bit	E-0 LSB	Phase Symbol Degrees
0	0	0	0
0	0	1	45
0	1	0	135
0	1	1	90
1	0	0	180
1	0	1	225
1	1	0	315
1	1	1	270

**Table 1. Phase Encoding Table**

### 3.6 DCPRS Data Formats

Three data formats shall be demonstrated: ASCII, Pseudo Binary, and Binary. HDR pseudo binary shall be compatible with the description in Appendix B.

#### 3.6.1 Prohibited Characters

The requirement in previous versions of this document, that transmission of certain specified control characters was prohibited, has been deleted. Requirements for Binary Mode will be set when a binary format is proposed and accepted. Manufacturers should be aware that the receivers are programmed to end reception of any message when an EOT character (defined below) is detected and may therefore wish to ensure an EOT is never transmitted in the body of a message.

#### 3.6.2 End Of Transmission (EOT)

ASCII and Pseudo Binary Format Mode - An EOT character, bit pattern 00000100, transmitted with the LSB first, shall be sent immediately after the last symbol of sensor data. This bit pattern is an ASCII EOT with odd parity.

Binary Mode shall be in accordance with the Binary Protocol Specification, published separately. (When created and accepted, the document name will be inserted here.)

## SECTION 4 - DCPRS Performance Requirements

DCPRS performance requirements shall be demonstrated over a  $-40^{\circ}\text{C}$  to  $50^{\circ}\text{C}$  temperature range and over a power supply voltage range that is defined by the manufacturer. The DC power supply voltage shall be monitored both before and during a transmission and the RF transmission shall be inhibited if the defined range is exceeded.

### 4.1 DCPRS Effective Isotropic Radiated Power (EIRP)

#### 4.1.1 RF Power Output

- a. When transmitting to the GOES-13 or later satellites, the DCPRS shall operate with an effective EIRP of 37 to 41 dBm for a 300 bps link. For 1200 bps, the DCPRS shall operate with an EIRP of 43 to 47 dBm.
- b. When transmitting to the GOES-11 or GOES-12 satellites, the DCPRS may be operated with a maximum EIRP up to 44 dBm for 300 bps and up to 50 dBm for 1200 bps.
- c. The actual range of transmit output power that any DCPRS is designed to produce shall be stated by the manufacturer and listed on the nameplate. The manufacturer shall show during Certification testing that all applicable parameters are met at both the high and low power extremes to the satisfaction of the Certification Official and at any other intermediate power level that the Certification Official may consider necessary to ensure the requirements of these parameters will be met at all powers and operational conditions.
- d. The manufacturers stated limits shall not be exceeded under any combination of normal operational conditions.
- e. During actual operation of the DCPRS the effective EIRP level shall be determined by comparison to the level of the Pilot signal(s) transmitted from the NOAA site(s), as viewed at the CDA Stations.
- f. A means of adjusting the output power is required. Access to the power adjustment shall only be possible through a digital interface so that changing the power level requires an external computer. The digital interface shall be made accessible by commands received from a distant location (including, but not limited to, the DCP Command system).
- g. The minimum power adjustment step size shall be equal to or less than 1 dB

NOTE: The GOES-13 and later satellite transponders have been designed to operate over the uplink EIRPs listed in subsection a) above. An EIRP that is higher than the maximum will tend to overload the transponder and is prohibited. An EIRP that is less than the minimum may not provide an acceptable error rate when a large number of channels are simultaneously active. Performance also depends on the sensitivity of the receiving station and the system design assumes this G/T is at least 15 dB/K. **The minimums are cited because they are the lower limits of the system design, but users are permitted to use lower EIRP at their own risk.**

## **4.1.2 DCPRS Antenna**

### **4.1.2.1 Antenna Polarization**

DCPRS antenna polarization shall be right-hand circular, according to IEEE Standard 65.34.159 and have an axial ratio not more than 6 dB on axis.

### **4.1.2.2 DCPRS Antenna Gain**

The DCPRS antenna transmit gain shall be such that in combination with the DCP output power the maximum EIRP is not exceeded.

## **4.2 GOES DCS Operating Frequency Requirements**

### **4.2.1 Operating Channels and Frequencies**

The DCPRS shall be able to operate at any of the designated channel center frequencies.

For DCPRS operating at 300 bps:

The DCPRS shall be able to tune to 532 channels at 750 Hz increments, from 401.701000 MHz to 402.099250 MHz. The channel 1 center frequency shall be 401.701000 MHz, the center frequency of the next channel (301) shall be 401.701750 MHz, the next channel (2) center frequency shall be 401.702500 MHz, etc., up to channel 566 at 402.099250 MHz.

For DCPRS operating at 1200 bps:

The DCPRS shall be able to tune the following sub-groups of channels in 2250 Hz increments. The first such channel shall be channel number 301, then channel number 3, channel number 304, etc., up to channel number 565, at 402.097750 MHz.

The assigned DCPRS operating channel center frequencies for 300 bps and for 1200 bps operations are set forth in Appendix D. All frequencies listed in Appendix D shall be provided for 300 bps operation. Only those shown in bold shall be available for 1200 bps operation. However, actual operation at 1200 bps will be authorized only on a subset of these potential channels by the Office of the NOAA GOES DCS Program Manager.

For certification testing, manufacturers shall demonstrate the synthesis of each of these over the entire range of the possible operation and at a minimum of five frequencies for 300 bps and five for 1200 bps selected at random by the NESDIS Certification Official.

### **4.2.2 Frequency Stability, Long Term**

The DCPRS output frequency shall be maintained to within  $\pm 125$  Hz of the channel center frequency due to any combination of operational conditions and for any channel.

### **4.2.3 Short Term Frequency Stability**

The DCPRS output frequency shall maintain a short term stability rate of less than  $\pm 1$  Hz/second. This rate shall apply for any time period from 10 milliseconds to 110 seconds

and over all rated operating conditions. For certification testing the frequency shall be measured using at least a 12 digits per second frequency counter and a measurement interval of less than one second. The required rate shall be shown for the actual time intervals between each measurement over a period of at least 60 seconds, or for the duration of the failsafe timeout period, whichever is shorter. The transmitter turn-on transient shall be included in either case.

### **4.3 DCPRS Modulation Output Symbol Rate**

- a. 300 bps certification the output symbol rate shall be 150 symbols per second  $\pm 0.025\%$
- b. 1200 bps certification the output symbol rate shall be 600 symbols per second  $\pm 0.025\%$

For certification testing the DCPRS is to be set to transmit 0.5 second of carrier and then a continuous stream of “0-1” or 0° and 180° clock transitions at the respective symbol rate. The symbol period is to be measured at the “I” output of the test demodulator.

### **4.4 DCPRS Phase Modulation and Noise**

For certification testing phase modulation and noise measurements shall be referenced to the zero degrees modulation phase transmitted during the message preamble and perfect 45 degree increments around the 360 degree circle.

#### **4.4.1 Carrier Phase Noise**

The phase noise of the unmodulated carrier shall be equal to, or less than 2.0 degrees RMS, when integrated over the range 2 Hz to 150 Hz for 300 bps, and 6 Hz to 600 Hz for 1200 bps. Certification testing may use any frequency range that includes either or both of these ranges, e.g. a measurement for 2 Hz to 1000 Hz could show compliance for both data rates. The 2.0 degree limit shall be met under any combination of operational conditions.

#### **4.4.2 Phase Modulation Bias**

The worst case offset or bias of any of the 8-ary modulation points shall be equal to, or less than 1.0 degrees, under any combination of operational conditions.

#### **4.4.3 RMS Phase Error**

The RMS phase error due to all causes except phase modulation bias, and under any combination of operational conditions, shall be equal to, or less than 2.5 degrees. This shall include the contribution due to carrier phase noise per 4.4.1.

### **4.5 DCPRS Transmit Spectrum**

The DCPRS shall be designed to be received by the NOAA CDA stations. The DAMS-NT receiver/demodulator will use a Square Root Raised Cosine filter with a roll-off factor ( $\alpha$ ) = 1.0. Details are provided in Appendix C of this Certification Standard.

When modulated with a random data stream and measured on a spectrum analyzer, the peak response of the undesired part of the emission, relative to the peak response in the necessary bandwidth (NB), shall be equal to, or better than the following limits. (The NB is 300 Hz for 300 bps and 1200 Hz for 1200 bps.)

- At any frequency removed from the channel center frequency by more than 75% of the NB, up to and including 150%, at least 25 dB attenuation.
- At any frequency removed from the channel center frequency by more than 150%, up to and including 300%, at least 35 dB attenuation.
- At any frequency removed from the channel center frequency by more than 300% of the NB, at least  $43 + 10 \log (P)$  dB attenuation, where P is the total mean power in watts in the necessary bandwidth. (NOTE: This includes harmonics and any spurious radiation.)

Spectral masks are provided for reference in Figures 2 and 3. See Appendix A for measurement requirements and reference notes.

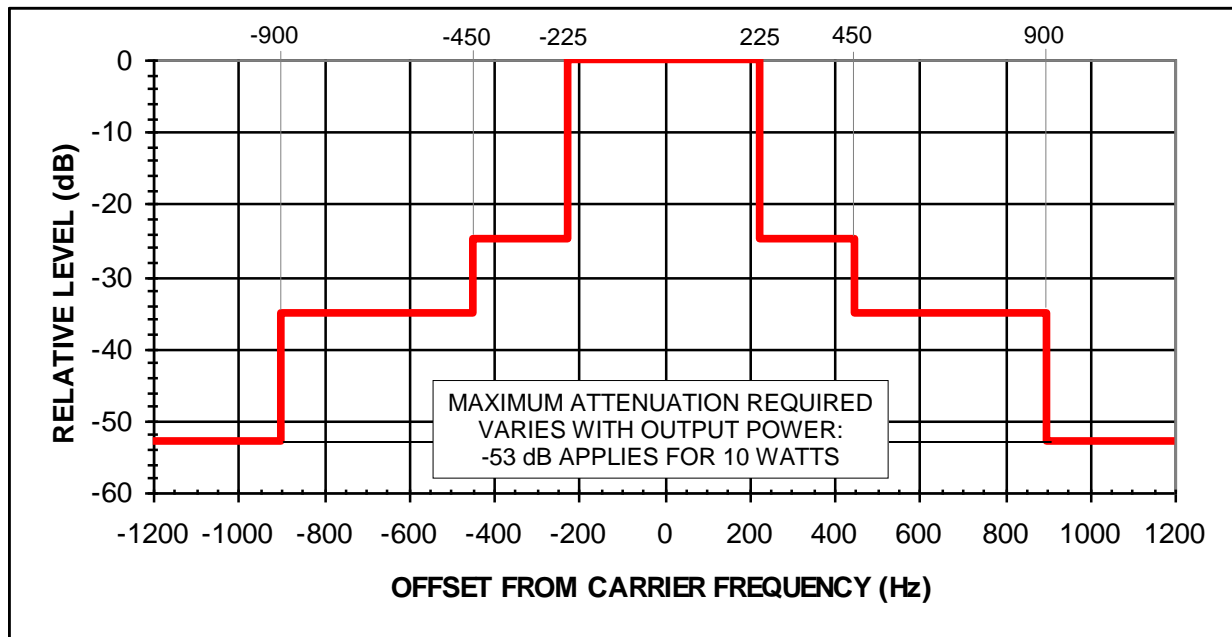

**Figure 2. Emission Mask for 300 bps Operation**

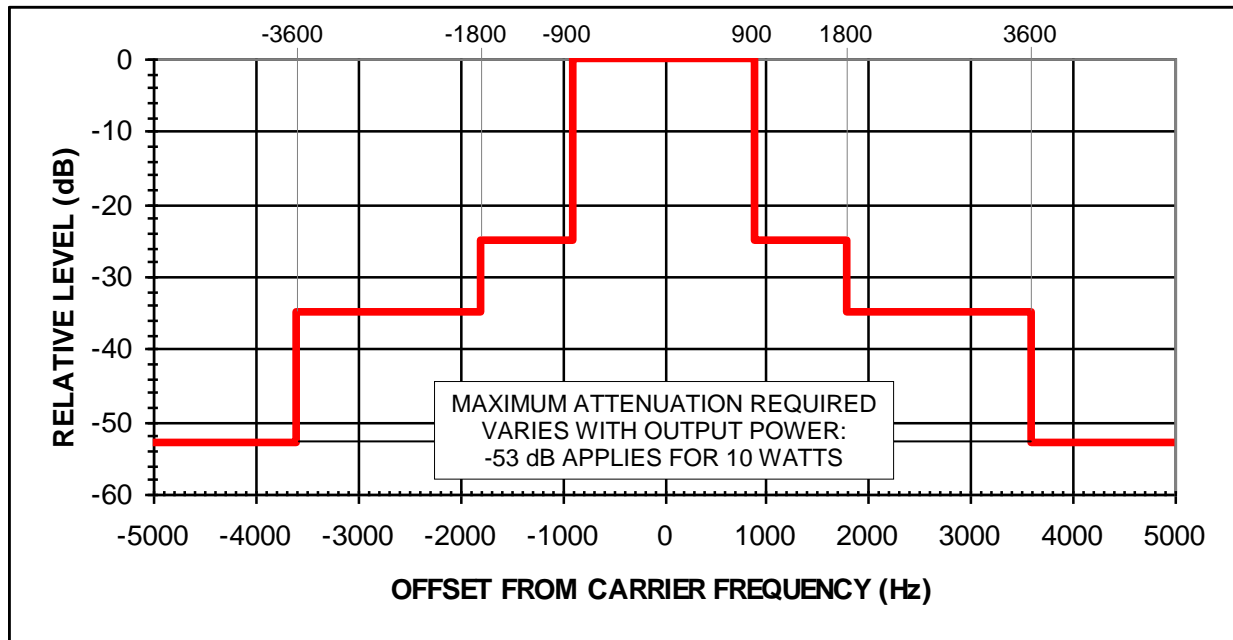

**Figure 3. Emission Mask for 1200 bps Operation**

#### 4.6 Fail-safe Operating Requirements

An independent or separate fail-safe circuit shall be provided to prevent a DCPRS from operating in an uncontrolled fashion. This independent circuit shall automatically and “permanently” shut off the transmitter if either of the following two conditions is violated.

- a. Message is too long.

For 1200 bps transmissions the maximum message length shall be 128,000 bits.

For 300 bps transmissions the maximum message length shall be 32,000 bits.

These maximum message lengths are near 110 seconds, including the message format requirements. If a message contains more than these numbers of bits, the fail-safe may be tripped. If the total message length exceeds 110 seconds, the fail-safe shall be tripped.

- b. Message is sent too soon.

There shall be a minimum of 30 seconds off-time between successive transmissions. If a second message is transmitted before 30 seconds has expired, then the fail-safe shall be tripped.

The above term “permanently” requires a manual (i.e. not automated) intervention or reset of the DCPRS in order to restore the unit for operational use in the DCS. The reset command, and its opposite, remote activation of the fail-safe command, shall be provided via a digital interface connection. A switch located in or on the DCPRS may also be provided, but must be of a type and in a location that will preclude accidental operation.

The digital interface shall be made accessible by commands received from a distant location (including, but not limited to, the DCP Command system).

The fail-safe capability must be demonstrated over the full range of operating conditions. Removal of DC power from the DCPRS shall not affect the operation of this function.

**Note: The Inhibiting Transmission requirements of subsections 2.1.1 and 4.0 are specifically NOT included in this subsection.**



## **APPENDIX A - Recommended Test Equipment and Test Set Up**

In general, any requirement in this Certification Standard may be demonstrated using either COTS test equipment from a nationally recognized manufacturer, or the NOAA provided test set for which NOAA approval has been granted. Other items of test equipment are not prohibited, but must be shown to be equal to, or better than the above two options in all factors that contribute to the accuracy of the test result. All test equipment shall be properly calibrated and traceable to NIST standards, at the time the Certification tests are performed. The preliminary test results provided to the Certification Official shall include a complete list of all test equipment that has been and will be used and shall include any showing of equivalence that may be necessary for non-standard equipment.

Delivery of all test results related to any Certification shall be as an electronic file using Microsoft Word or in Adobe PDF format.

When NOAA has acquired the Certification Test Set the list of tests for which its use has been approved will be inserted here.

**Spectrum Analyzer (SA)** - The SA is needed to perform spectrum tests. The SA must be able to measure to the third harmonic at 1206 MHz and have the Resolution Bandwidth, averaging capability, etc. necessary to demonstrate compliance with the required spectrum.

**Counter/Frequency Meter (FM)** - The FM is needed to measure transmit frequencies (401.7 to 402.1 MHz) and to measure the transmit symbol rate. The FM shall be accurate to 0.001 PPM (parts per million) and shall have a resolution of at least 12 digits per second.

**Digital Multi-Meter (DMM)** - The DMM may be used for power supply voltage, RMS response to measure phase noise, and other measurements as deemed appropriate.

**RF Power Meter (RFPM)** - The RFPM is used to measure the RF power amplifier output power. The response needs to be to RMS power. A Bird Wattmeter Model 43 with  $\pm 3$  per cent accuracy at full range or approved equal is acceptable for these measurements. The element power rating shall be such that the power measurements shall be in the top half of the range.

**Signal Generator (SG)** - The SG is to be used for mixing the 402 MHz signal to the 5 MHz IF of the test demodulator. The SG phase noise shall be  $< 0.1$  degree RMS.

**Environmental Test Chamber (ETC)** - The ETC is used to control the ambient test temperature of the DCP unit under test. A  $-40^{\circ}\text{C}$  to  $50^{\circ}\text{C}$  range or greater is required.

**General Purpose Oscilloscope** - To measure or observe the relationship of "I" and "Q" signals.

**Laptop or IBM PC** - To interface with the NOAA provided Demodulator Test Set and to record the results of the COTS test equipment.

**Low Frequency Signal Controller/Modulator** - An HP 33120A or equivalent. Used to generate modulation patterns and IF signals.

## DCPRS Test Capabilities Required

During certification testing manufacturers must be able to disable or enable the DCP fail-safe circuitry as needed. Further a number of test sequences must be available on the unit to test various DCP functions. These include the following:

- |                                      |  |
|--------------------------------------|--|
| a. Carrier only                      | carrier phase noise, frequency               |
| b. Clock pattern "0-1"               | clock pattern check, symbol rate             |
| c. Repeating short message sequence  | format checks                                |
| d. Longer message, repeating pattern | modulation, power, and spectrum measurements |

The typical test set up is shown in Figure A-1.

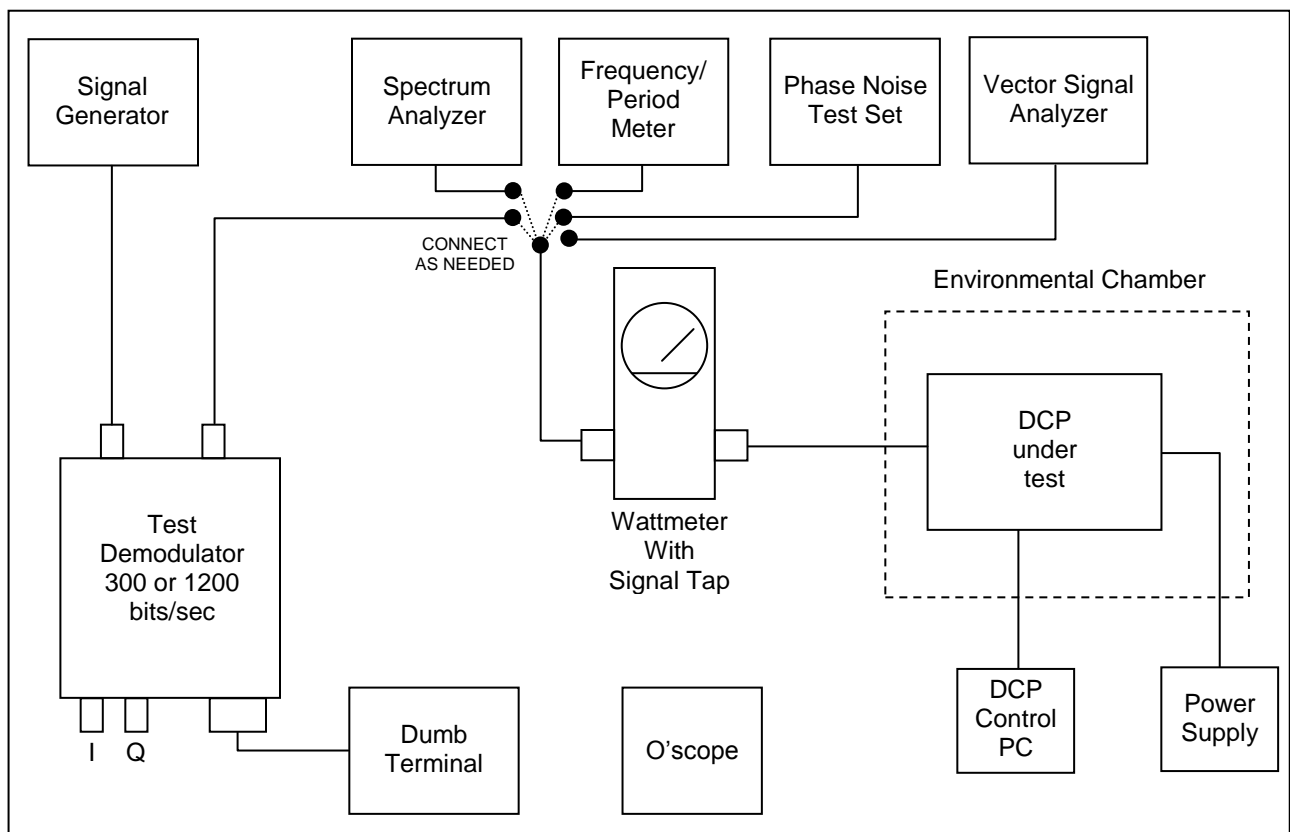

**Figure A-1. Typical test set-up**

Some of the capabilities/features of the Test Demodulator are highlighted below:

## **Unique Software Functions For the Test Set Demodulator**

The demodulator makes signal quality measurements of all the signal variables of power, frequency, and phase. In the test case the measurements are required to be made in different sequences and accuracy. In the test case the noise floor is the base line phase noise of the system since the S/N typical of live signals is not applicable.

### Power Measurement

The total signal power out of the DCPRS shall be measured without external filtering. Power measurements shall be made specifically for unmodulated carrier, clock, and random 8 PSK modulation under standard conditions. Accuracy shall be  $\pm 3\%$  of full scale, or better. If the measurements are equal ( $\pm 0.3$  watt) only 8 PSK modulated power need be measured at other conditions.

### Frequency Measurement

Since some of the frequency measurements must be made at short intervals, less than 1 second, and with a resolution of better than 1 Hz, the frequency counter must have a 12 digit per second capability, or better. The calibration must be valid at the time of the test and traceable to NIST.

### Carrier Phase Noise Measurement

The unmodulated carrier shall be measured for phase noise using a phase noise test set and integrating over the specified frequency offsets from the carrier, or by using the NOAA provided test set. Integration over more than the required range is permitted, but the 2.0 degree limit must not be exceeded.

### RMS Phase Error and Modulation Bias Measurement

A random set of symbols (of at least 10,000 symbols) shall be sent by the test transmitter. The phase is measured for each symbol and the average and RMS jitter determined for each of the 45-degree nominal modulation nodes. Either a commercial vector signal analyzer or the NOAA provided test set may be used. This same process will provide a measurement of both these requirements.

### Symbol Rate

After carrier is sent clock symbols are sent continuously. There are two points of measurement for symbol rate on the front panel of the demodulator - the symbol strobe pulses and the "I" phase detector output. The time between pulses should indicate 150 or 600 symbol per second rate.

### Message Format

The test transmitter sends a defined message to the test receiver. That same message should be repeated at the demodulator.

### Carrier Length

The carrier length is the time between the detection of power level and first phase transition after phase lock.

### Clock and MLS bits

Phase "1" or "0" sent to the output port. The exact transmission pattern is displayed.

### Turn-on and Turn-off Times

The output signal shall be viewed on a storage oscilloscope set so that the rise and fall times can be seen to be equal to, or less than the requirements.

### Scrambling and Trellis Encoding

If the correct encoding is followed, the data sent to the output port will be intelligible. An incorrect pattern will provide a meaningless data string. A test mode is provided to print out the measured symbol phase in terms of phase bin. The phase bins are numbered 0 to 71. This is the raw data prior to any processing.

### EOT Detection

This should be visible in the test mode and from the demodulator recognition mask.

### **Spectrum Analyzer Measurements**

There are three reasons for measuring the power spectral distribution of the transmit output:

1. Ensure the emission meets the required NTIA out-of-band requirements
2. That these measurements use the correct reference and peak points
3. That there are no significant CW-like spurs produced

Therefore, although the spectrum analyzer settings may be varied at the contractor's discretion, within the specified ranges, the Certification Official shall require additional measurements with different settings if it seems such settings might produce a more accurate picture of some part of the emission, e.g. if the CO thinks a spur could possibly be shown at a higher level.

The required emission masks are provided in Figures 2 and 3. Averaging of multiple sweeps (trace averaging) IS REQUIRED, except the CO may drop this requirement after the first measurement unless needed to accurately locate the peak of the main modulation lobe and the accuracy is necessary to show the emission limits are met. Averaging of the levels at different frequencies (low VBW) IS NOT permitted.

Averaging is necessary to determine the true peaks of the signal as shown in A-2 below.

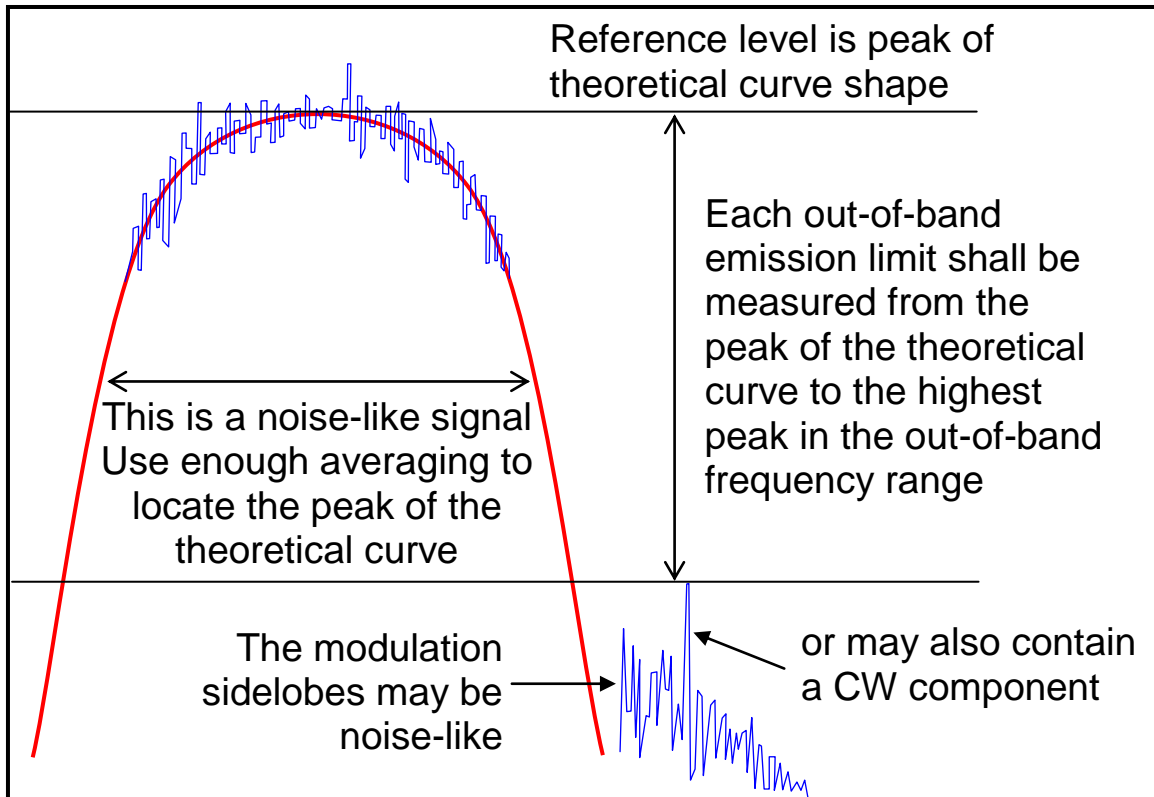

**Figure A-2. Spectrum Analysis Reference Levels**

#### Recommended SA Settings

- Use FFT Mode
- RBW = 10 Hz to 1 Hz
- VBW = 3 \* RBW or more (Not applicable to FFT modes.)
- Detector type = RMS or Peak/Maximum for Swept modes, Sample or Peak/Maximum for FFT mode.

#### ADDITIONAL NOTES:

1. The results of these measurements are the differences between the main lobe peak and other peaks in the specified bands. The absolute levels indicated by these measurements are not relevant and shall not be used for any part of these certification requirements.
2. Although it is preferred that the span for the close-in sideband measurements be the same as is shown in Figures 2 and 3, the CO may choose to permit narrower spans if the available test equipment would take too long to all of the desired span on one display. The contractor shall demonstrate to the satisfaction of the CO that accuracy is maintained throughout the full set of measurements on both sides of the main lobe.
3. The SA settings used to measure the harmonic levels relative to the peak of the main lobe shall be adjusted to show either the harmonic or background noise is below the required level. As this is relative to the main modulation peak, any changes in the SA settings (except the center frequency) may require re-measuring the modulation peak power level per hertz.

## APPENDIX B - GOES DCS Pseudo-Binary Data and Other Definitions

### General

This standard specifies a standard format for Data Collection Platforms (DCPs) transmitting on random reporting channels. The format has been structured so as to also be compatible with many self-timed (in particular) and interrogated DCPs. The standard is based heavily on two assumptions: First, the proper interpretation and utilization of random data requires a data processing element within the data flow. Second, that the format of all transmissions from a complying platform can be decodable through the use of a properly constructed data base which is to be contained within the data processing facility.

This standard defines the necessary attributes of both a DCP and a data base to make the data processable and useful. The manner in which a DCP can be described by the data base determines both the format and the operating characteristics of the DCP.

### DCPRS Message Format

The DCPRS transmission format is set forth in paragraph 3.1 for the pre-amble (carrier, clock, and FSS), the GOES ID code, and Flag Word (see Figure B-1). The sensor or message data shall consist of a single 8-bit header word, followed by data from one or more sensors. As shown in Figure B-2, the header word is always a number between 0 and 63 and represents the entry number in a DCP information file which describes the format being used for that message. Thus, a DCP is capable of transmitting up to 64 different formats and each format can be determined fully by knowing the header word and accessing a data base for that particular DCP.

PRE-AMBLE	GOES ID 31-BIT ADDRESS	FLAG WORD	MESSAGE 1	SP	MESSAGE 2	SP	MESSAGE N	EOT
-----------	------------------------	-----------	-----------	----	-----------	----	-----------	-----

**Figure B-1. DCPRS Transmit Format**

EIGHT BIT HEADER WORD	SENSOR 1 DATA	SENSOR 2 DATA	SENSOR N DATA
-----------------------	---------------	---------------	---------------

**Figure B-2. DCPRS Message or Sensor Data Format**

The sensor data after each header word must adhere to the following requirements:

1. Pseudo Binary Data Format

All header and sensor data will be converted to pseudo binary, regardless of its format from the sensor (analog, BCD, grey-coders, events, etc.). All data will be transmitted in a "modified ASCII" format utilizing 6- bits of an 8-bit character to represent part of each binary number. For data requiring 12-bit precision, two consecutive modified ASCII characters are needed as shown in the example below:

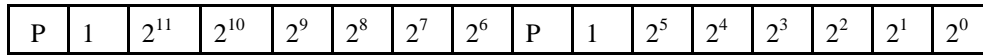

1st DATA CHARACTER

2nd DATA CHARACTER

**Figure B-3. 12-Bit Precision Data**

For 18-bit precision, three characters are required:

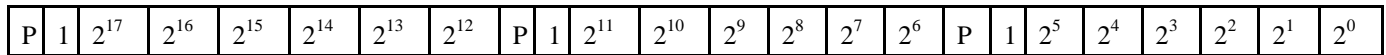

1st DATA CHARACTER

2nd DATA CHARACTER

3rd DATA CHARACTER

**Figure B-4. 18-Bit Precision Data**

Note that bits 7 and 8 of each character are a \*"one" and an odd parity bit, respectively\*. Thus, data is always expressed by N characters, each character representing N x 6 bits of information. Data within a character is transmitted least significant bit first.

\*The 6-bit binary data sequence of all ones may be transmitted as 01111111 (an ASCII "DEL" character) or 10111111 (an ASCII "?" character).

2. Signed Parameters

Many parameters, temperatures in particular, may be expressed with negative values. In addition, the direction of change in a reading is often useful information and similar such parameter-related flags should also be handled efficiently. Therefore, data may be expressed in one of three ways:

- a) as a positive fixed point value of precision (N x 6);
- b) as a signed value in two's complement form having a precision of (plus or minus) (N x 6 - 1); or
- c) as a positive fixed point number of precision (N x 6 - 1) with the high order bit used as a flag.

As an example of a negative value, a temperature value of 17 degrees below zero could be expressed with six bits as 101111. Whereas, a signed value of \*+17 degrees would be expressed as 010001. See "Definitions" for an explanation of two's complement arithmetic.

For parameters not having negative values, but designated as being a parameter with a flag, the high order bit is the flag and the remaining bits are data in binary form. The precise interpretation of the flag bit is to be defined in the DCP's associated data base. As an example, the 11-bit precision accumulated precipitation value of 000001111011 (123) could indicate both the value of 1.23 inches (accumulated) and the fact that it is raining at

the time of the measurement. Conversely, a value of 100001111011 indicates the same reading but signifies that no perceptible change has occurred since the last sensor update.

### 3. Order of Reporting

The most current data will be reported first within the DCP message.

### 4. Limitations on Data Content

This standard per se, places no restriction on the number of parameters being sensed, the accuracy of the measurements, or the number of readings within a message. The format of the message must, however, be describable by a data base (located in the receive system's computer) containing, at least, the following elements:

- a. For each parameter being reported;
  - 1) Precision of the measurement being reported. This will always be a multiple of 6 (6, 12, 18, 24, etc.) unless it is a signed parameter or has a high-order flag bit (than it is 5, 11, 17, 23, etc.).
  - 2) A flag indicating whether or not the data signed, or has a flag bit.
  - 3) Calibration coefficients which will be applied to the data (if necessary).
- b. For each possible format to be transmitted;
  - 1) The message format number (0-63) which corresponds to the 8-bit header word beginning each message.
  - 2) Parameter cycle time (in seconds or minutes) - an N/A (not appropriate) flag may be used to indicate data is not reported in cycles.
  - 3) Cycle offset (in minutes) -- the time delay from the end of the last complete update cycle, reported, to the beginning of transmission. If this value is N/A, the data is assumed to be transmitted in real-time, or the time delay between measurement and reporting is to be reported as a parameter within the message. This value will be \*N/A for random or interrogated transmissions.
  - 4) A list of parameters contained within the message (or parameter cycle, if the data is reported in cycles): along with the time of the sensor update relative to the beginning of the message. If any given parameter is updated (reported) several times within a cycle, that parameter (with the corresponding time) will be listed for each update.

If time delay is itself a reported parameter, it will be listed in the data base--the \*DCP will transmit this value immediately before all parameters associated with it.



- 5) Cycles per message (if appropriate). This value indicates the number of times the listed parameters are repeated. An N/A flag would indicate either no repeats, or an indeterminate number of parameter groups (a time delay value, with one or more data values).
- 6) Multiple Messages Within A Transmission. A transmission may contain more than one message. Generally, multiple messages will be used when two or more formats (as defined in the data base) are needed to transmit all the desired data. Multiple messages can also be utilized to transmit new data along with previously transmitted data --- where possible, multiple parameter cycles should be utilized in lieu of multiple messages.

Transmissions containing multiple messages will have a single ASCII space character (00100000 - LSB first) between each message. Note: the seventh bit ( ) is a zero and thus is not a valid data character.

- 7) Bad Data. If a sensor fails, or if for some reason the DCP is unable to transmit, proper data, an ASCII (/) character (00101111) may be substituted for each data character. Note, the 7th bit of this character is not a one, and cannot therefore be a valid data character.

## Other DCPRS Definitions

Transmission	The combination of clear radio carrier and all bits of identification, data and any special sequences sent by a DCP.
Message	Relates to all or a portion of the data segment of a transmission; the message is a segment of data that is fully defined in a DCP management data base; a transmission will contain one or more messages.
Header Word	An 8-bit character whose low order 6-bits make up a binary number that identified a format retry stored in a DCP management data base for a specific DCP. A header word begins each message.
DCP	Contains one record per DCP that includes Data Base the Management characteristics of each parameter measured, plus a list of format entries that will identify each potential data message that the DCP can formulate and transmit.
Parameter	Data element measured by a sensor. Common hydrometeorology parameters include stream stage, precipitation, and temperature.
Parameter Update	Entry of a value (composite or point) for into a parameter DCP message. The value may be an instantaneous value or a computed value based on many sensor values measured since the last message update.
Cycle	A procedure used by a DCP in acquiring and formatting multiple readings obtained over a period of time. Generally a cycle consists of specific measurements taken at prescribed times within a defined interval. A DCP may acquire and report data for several such time intervals by precisely repeating the prescribed cycle for each consecutive interval.
Two's Complement	A method of expressing negative numbers so that subtraction may be performed by a simple fixed-precision binary accumulator (adder). The negative value of a binary number is computed by complementing each bit and then adding one. (Example: The equation $4-6=-2$ is computed as $4+(-6)=-2$ , which in 6-bit binary is $000100 + 111001 = 111101$ ). The magnitude of a negative value is determined by taking its two's-complement. (i.e., $-(-2)=+2$ or $-(11101)=000010$ ).

## APPENDIX C - Filter Definition for the DAMS-NT Receiver/Demodulator

The filter used is a 427 tap FIR, Square Root Raised Cosine filter, with  $\alpha = 1.0$  and oversampling  $F_s = 53.3333$  per symbol

The filter equation is:  $A = \sum_i^n C_i \cdot S_i$   
 Where  $C_i$  is the  $i^{\text{th}}$  coefficient and  $S_i$  is the  $i^{\text{th}}$  sample

**Table of Coefficients**

Tap No.	Coefficient	Tap No.	Coefficient	Tap No.	Coefficient
-213	-2.346064E-04	-180	2.328434E-04	-147	-1.944238E-05
-212	-2.340988E-04	-179	2.061592E-04	-146	3.937713E-05
-211	-2.302946E-04	-178	1.759651E-04	-145	9.928710E-05
-210	-2.231837E-04	-177	1.426024E-04	-144	1.594818E-04
-209	-2.128013E-04	-176	1.064640E-04	-143	2.191290E-04
-208	-1.992290E-04	-175	6.798996E-05	-142	2.773803E-04
-207	-1.825940E-04	-174	2.766316E-05	-141	3.333820E-04
-206	-1.630683E-04	-173	-1.399688E-05	-140	3.862871E-04
-205	-1.408675E-04	-172	-5.644001E-05	-139	4.352663E-04
-204	-1.162484E-04	-171	-9.909232E-05	-138	4.795200E-04
-203	-8.950653E-05	-170	-1.413634E-04	-137	5.182902E-04
-202	-6.097254E-05	-169	-1.826542E-04	-136	5.508713E-04
-201	-3.100860E-05	-168	-2.223645E-04	-135	5.766221E-04
-200	-3.923689E-09	-167	-2.599019E-04	-134	5.949755E-04
-199	3.162997E-05	-166	-2.946893E-04	-133	6.054487E-04
-198	6.346451E-05	-165	-3.261736E-04	-132	6.076524E-04
-197	9.505962E-05	-164	-3.538337E-04	-131	6.012986E-04
-196	1.259695E-04	-163	-3.771886E-04	-130	5.862079E-04
-195	1.557486E-04	-162	-3.958045E-04	-129	5.623148E-04
-194	1.839580E-04	-161	-4.093024E-04	-128	5.296725E-04
-193	2.101710E-04	-160	-4.173641E-04	-127	4.884557E-04
-192	2.339800E-04	-159	-4.197386E-04	-126	4.389623E-04
-191	2.550019E-04	-158	-4.162469E-04	-125	3.816130E-04
-190	2.728841E-04	-157	-4.067862E-04	-124	3.169497E-04
-189	2.873099E-04	-156	-3.913335E-04	-123	2.456323E-04
-188	2.980038E-04	-155	-3.699478E-04	-122	1.684337E-04
-187	3.047360E-04	-154	-3.427715E-04	-121	8.623276E-05
-186	3.073263E-04	-153	-3.100303E-04	-120	6.591797E-09
-185	3.056483E-04	-152	-2.720329E-04	-119	-8.917955E-05
-184	2.996316E-04	-151	-2.291686E-04	-118	-1.801834E-04
-183	2.892644E-04	-150	-1.819041E-04	-117	-2.717984E-04
-182	2.745948E-04	-149	-1.307794E-04	-116	-3.627673E-04
-181	2.557314E-04	-148	-7.640235E-05	-115	-4.517977E-04

Tap No.	Coefficient	Tap No.	Coefficient	Tap No.	Coefficient
-114	-5.375773E-04	-67	9.663422E-05	-20	3.376186E-02
-113	-6.187913E-04	-66	-1.992294E-04	-19	3.585149E-02
-112	-6.941392E-04	-65	-5.114425E-04	-18	3.791409E-02
-111	-7.623530E-04	-64	-8.367883E-04	-17	3.993912E-02
-110	-8.222148E-04	-63	-1.171672E-03	-16	4.191613E-02
-109	-8.725749E-04	-62	-1.512139E-03	-15	4.383472E-02
-108	-9.123695E-04	-61	-1.853891E-03	-14	4.568472E-02
-107	-9.406379E-04	-60	-2.192317E-03	-13	4.745617E-02
-106	-9.565390E-04	-59	-2.522518E-03	-12	4.913946E-02
-105	-9.593667E-04	-58	-2.839338E-03	-11	5.072537E-02
-104	-9.485647E-04	-57	-3.137407E-03	-10	5.220513E-02
-103	-9.237389E-04	-56	-3.411171E-03	-9	5.357051E-02
-102	-8.846697E-04	-55	-3.654945E-03	-8	5.481385E-02
-101	-8.313210E-04	-54	-3.862948E-03	-7	5.592815E-02
-100	-7.638482E-04	-53	-4.029361E-03	-6	5.690710E-02
-99	-6.826037E-04	-52	-4.148367E-03	-5	5.774512E-02
-98	-5.881406E-04	-51	-4.214211E-03	-4	5.843744E-02
-97	-4.812130E-04	-50	-4.221247E-03	-3	5.898007E-02
-96	-3.627750E-04	-49	-4.163993E-03	-2	5.936991E-02
-95	-2.339767E-04	-48	-4.037185E-03	-1	5.960472E-02
-94	-9.615710E-05	-47	-3.835830E-03	0	5.968314E-02
-93	4.916489E-05	-46	-3.555258E-03	1	5.960472E-02
-92	2.003023E-04	-45	-3.191174E-03	2	5.936991E-02
-91	3.554145E-04	-44	-2.739708E-03	3	5.898007E-02
-90	5.125241E-04	-43	-2.197460E-03	4	5.843744E-02
-89	6.695363E-04	-42	-1.561548E-03	5	5.774512E-02
-88	8.242602E-04	-41	-8.296454E-04	6	5.690710E-02
-87	9.744322E-04	-40	-2.197265E-08	7	5.592815E-02
-86	1.117742E-03	-39	9.284236E-04	8	5.481385E-02
-85	1.251858E-03	-38	1.956135E-03	9	5.357051E-02
-84	1.374459E-03	-37	3.082872E-03	10	5.220513E-02
-83	1.483260E-03	-36	4.307695E-03	11	5.072537E-02
-82	1.576045E-03	-35	5.628944E-03	12	4.913946E-02
-81	1.650698E-03	-34	7.044240E-03	13	4.745617E-02
-80	1.705230E-03	-33	8.550471E-03	14	4.568472E-02
-79	1.737819E-03	-32	1.014381E-02	15	4.383472E-02
-78	1.746831E-03	-31	1.181970E-02	16	4.191613E-02
-77	1.730855E-03	-30	1.357290E-02	17	3.993912E-02
-76	1.688731E-03	-29	1.539748E-02	18	3.791409E-02
-75	1.619577E-03	-28	1.728687E-02	19	3.585149E-02
-74	1.522811E-03	-27	1.923387E-02	20	3.376186E-02
-73	1.398180E-03	-26	2.123071E-02	21	3.165565E-02
-72	1.245777E-03	-25	2.326907E-02	22	2.954322E-02
-71	1.066058E-03	-24	2.534017E-02	23	2.743475E-02
-70	8.598590E-04	-23	2.743475E-02	24	2.534017E-02
-69	6.284056E-04	-22	2.954322E-02	25	2.326907E-02
-68	3.733220E-04	-21	3.165565E-02	26	2.123071E-02

Tap No.	Coefficient	Tap No.	Coefficient	Tap No.	Coefficient
27	1.923387E-02	74	1.522811E-03	121	8.623276E-05
28	1.728687E-02	75	1.619577E-03	122	1.684337E-04
29	1.539748E-02	76	1.688731E-03	123	2.456323E-04
30	1.357290E-02	77	1.730855E-03	124	3.169497E-04
31	1.181970E-02	78	1.746831E-03	125	3.816130E-04
32	1.014381E-02	79	1.737819E-03	126	4.389623E-04
33	8.550471E-03	80	1.705230E-03	127	4.884557E-04
34	7.044240E-03	81	1.650698E-03	128	5.296725E-04
35	5.628944E-03	82	1.576045E-03	129	5.623148E-04
36	4.307695E-03	83	1.483260E-03	130	5.862079E-04
37	3.082872E-03	84	1.374459E-03	131	6.012986E-04
38	1.956135E-03	85	1.251858E-03	132	6.076524E-04
39	9.284236E-04	86	1.117742E-03	133	6.054487E-04
40	-2.197265E-08	87	9.744322E-04	134	5.949755E-04
41	-8.296454E-04	88	8.242602E-04	135	5.766221E-04
42	-1.561548E-03	89	6.695363E-04	136	5.508713E-04
43	-2.197460E-03	90	5.125241E-04	137	5.182902E-04
44	-2.739708E-03	91	3.554145E-04	138	4.795200E-04
45	-3.191174E-03	92	2.003023E-04	139	4.352663E-04
46	-3.555258E-03	93	4.916489E-05	140	3.862871E-04
47	-3.835830E-03	94	-9.615710E-05	141	3.333820E-04
48	-4.037185E-03	95	-2.339767E-04	142	2.773803E-04
49	-4.163993E-03	96	-3.627750E-04	143	2.191290E-04
50	-4.221247E-03	97	-4.812130E-04	144	1.594818E-04
51	-4.214211E-03	98	-5.881406E-04	145	9.928710E-05
52	-4.148367E-03	99	-6.826037E-04	146	3.937713E-05
53	-4.029361E-03	100	-7.638482E-04	147	-1.944238E-05
54	-3.862948E-03	101	-8.313210E-04	148	-7.640235E-05
55	-3.654945E-03	102	-8.846697E-04	149	-1.307794E-04
56	-3.411171E-03	103	-9.237389E-04	150	-1.819041E-04
57	-3.137407E-03	104	-9.485647E-04	151	-2.291686E-04
58	-2.839338E-03	105	-9.593667E-04	152	-2.720329E-04
59	-2.522518E-03	106	-9.565390E-04	153	-3.100303E-04
60	-2.192317E-03	107	-9.406379E-04	154	-3.427715E-04
61	-1.853891E-03	108	-9.123695E-04	155	-3.699478E-04
62	-1.512139E-03	109	-8.725749E-04	156	-3.913335E-04
63	-1.171672E-03	110	-8.222148E-04	157	-4.067862E-04
64	-8.367883E-04	111	-7.623530E-04	158	-4.162469E-04
65	-5.114425E-04	112	-6.941392E-04	159	-4.197386E-04
66	-1.992294E-04	113	-6.187913E-04	160	-4.173641E-04
67	9.663422E-05	114	-5.375773E-04	161	-4.093024E-04
68	3.733220E-04	115	-4.517977E-04	162	-3.958045E-04
69	6.284056E-04	116	-3.627673E-04	163	-3.771886E-04
70	8.598590E-04	117	-2.717984E-04	164	-3.538337E-04
71	1.066058E-03	118	-1.801834E-04	165	-3.261736E-04
72	1.245777E-03	119	-8.917955E-05	166	-2.946893E-04
73	1.398180E-03	120	6.591797E-09	167	-2.599019E-04

Tap No.	Coefficient	Tap No.	Coefficient	Tap No.	Coefficient
168	-2.223645E-04	183	2.892644E-04	198	6.346451E-05
169	-1.826542E-04	184	2.996316E-04	199	3.162997E-05
170	-1.413634E-04	185	3.056483E-04	200	-3.923689E-09
171	-9.909232E-05	186	3.073263E-04	201	-3.100860E-05
172	-5.644001E-05	187	3.047360E-04	202	-6.097254E-05
173	-1.399688E-05	188	2.980038E-04	203	-8.950653E-05
174	2.766316E-05	189	2.873099E-04	204	-1.162484E-04
175	6.798996E-05	190	2.728841E-04	205	-1.408675E-04
176	1.064640E-04	191	2.550019E-04	206	-1.630683E-04
177	1.426024E-04	192	2.339800E-04	207	-1.825940E-04
178	1.759651E-04	193	2.101710E-04	208	-1.992290E-04
179	2.061592E-04	194	1.839580E-04	209	-2.128013E-04
180	2.328434E-04	195	1.557486E-04	210	-2.231837E-04
181	2.557314E-04	196	1.259695E-04	211	-2.302946E-04
182	2.745948E-04	197	9.505962E-05	212	-2.340988E-04
				213	-2.346064E-04

### Impulse response

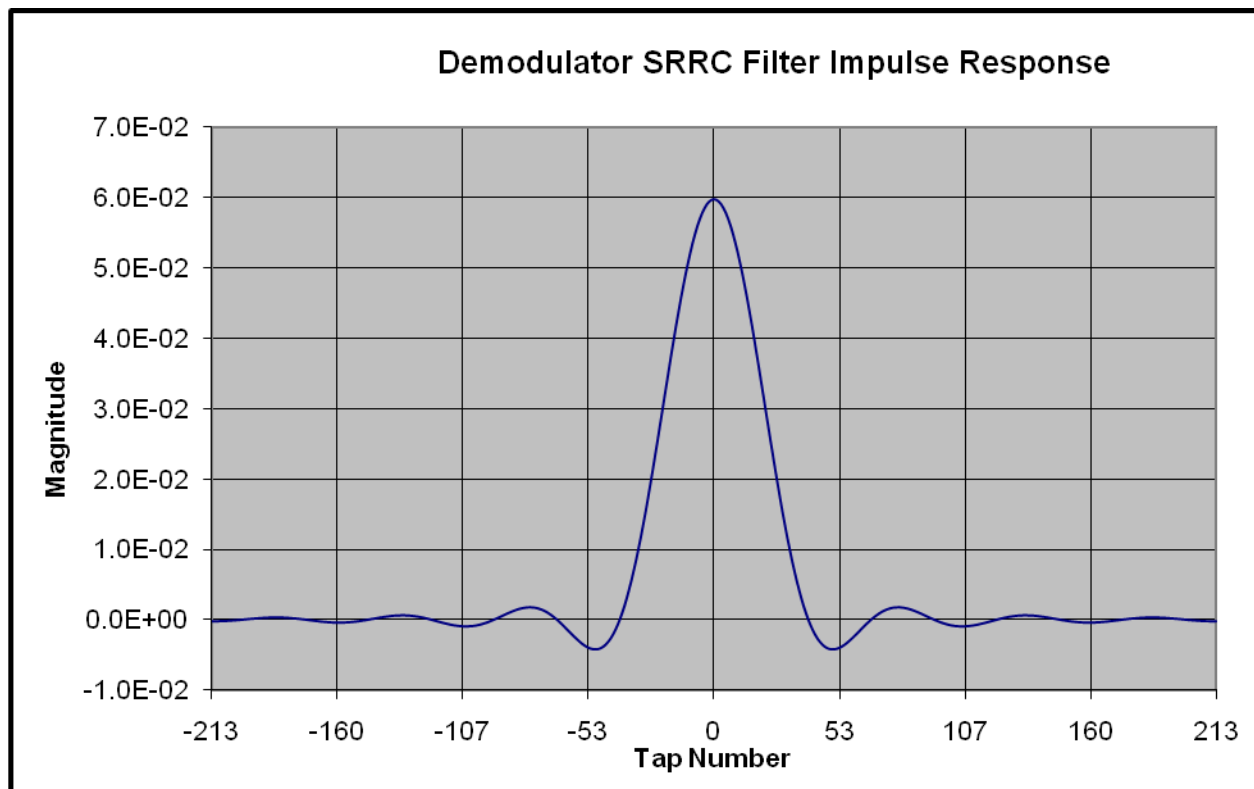

## APPENDIX D - GOES DCPRS Transmit Frequencies

CHANNEL NUMBER	CENTER FREQUENCY	CHANNEL NUMBER	CENTER FREQUENCY	CHANNEL NUMBER	CENTER FREQUENCY
1	401.701000	323	401.734750	46	401.768500
<b>301</b>	<b>401.701750</b>	<b>24</b>	<b>401.735500</b>	<b>346</b>	<b>401.769250</b>
2	401.702500	324	401.736250	47	401.770000
302	401.703250	25	401.737000	347	401.770750
<b>3</b>	<b>401.704000</b>	<b>325</b>	<b>401.737750</b>	<b>48</b>	<b>401.771500</b>
303	401.704750	26	401.738500	348	401.772250
4	401.705500	326	401.739250	49	401.773000
<b>304</b>	<b>401.706250</b>	<b>27</b>	<b>401.740000</b>	<b>349</b>	<b>401.773750</b>
5	401.707000	327	401.740750	50	401.774500
305	401.707750	28	401.741500	350	401.775250
<b>6</b>	<b>401.708500</b>	<b>328</b>	<b>401.742250</b>	<b>51</b>	<b>401.776000</b>
306	401.709250	29	401.743000	351	401.776750
7	401.710000	329	401.743750	52	401.777500
<b>307</b>	<b>401.710750</b>	<b>30</b>	<b>401.744500</b>	<b>352</b>	<b>401.778250</b>
8	401.711500	330	401.745250	53	401.779000
308	401.712250	31	401.746000	353	401.779750
<b>9</b>	<b>401.713000</b>	<b>331</b>	<b>401.746750</b>	<b>54</b>	<b>401.780500</b>
309	401.713750	32	401.747500	354	401.781250
10	401.714500	332	401.748250	55	401.782000
<b>310</b>	<b>401.715250</b>	<b>33</b>	<b>401.749000</b>	<b>355</b>	<b>401.782750</b>
11	401.716000	333	401.749750	56	401.783500
311	401.716750	34	401.750500	356	401.784250
<b>12</b>	<b>401.717500</b>	<b>334</b>	<b>401.751250</b>	<b>57</b>	<b>401.785000</b>
312	401.718250	35	401.752000	357	401.785750
13	401.719000	335	401.752750	58	401.786500
<b>313</b>	<b>401.719750</b>	<b>36</b>	<b>401.753500</b>	<b>358</b>	<b>401.787250</b>
14	401.720500	336	401.754250	59	401.788000
314	401.721250	37	401.755000	359	401.788750
<b>15</b>	<b>401.722000</b>	<b>337</b>	<b>401.755750</b>	<b>60</b>	<b>401.789500</b>
315	401.722750	38	401.756500	360	401.790250
16	401.723500	338	401.757250	61	401.791000
<b>316</b>	<b>401.724250</b>	<b>39</b>	<b>401.758000</b>	<b>361</b>	<b>401.791750</b>
17	401.725000	339	401.758750	62	401.792500
317	401.725750	40	401.759500	362	401.793250
<b>18</b>	<b>401.726500</b>	<b>340</b>	<b>401.760250</b>	<b>63</b>	<b>401.794000</b>
318	401.727250	41	401.761000	363	401.794750
19	401.728000	341	401.761750	64	401.795500
<b>319</b>	<b>401.728750</b>	<b>42</b>	<b>401.762500</b>	<b>364</b>	<b>401.796250</b>
20	401.729500	342	401.763250	65	401.797000
320	401.730250	43	401.764000	365	401.797750
<b>21</b>	<b>401.731000</b>	<b>343</b>	<b>401.764750</b>	<b>66</b>	<b>401.798500</b>
321	401.731750	44	401.765500	366	401.799250
22	401.732500	344	401.766250	67	401.800000
<b>322</b>	<b>401.733250</b>	<b>45</b>	<b>401.767000</b>	<b>367</b>	<b>401.800750</b>
23	401.734000	345	401.767750	68	401.801500

**NOTE BOLD TYPE Face identifies potential 1200 bps Channel assignments.**

**GOES DCPRS TRANSMIT FREQUENCIES (Continued)**

CHANNEL NUMBER	CENTER FREQUENCY	CHANNEL NUMBER	CENTER FREQUENCY	CHANNEL NUMBER	CENTER FREQUENCY
368	401.802250	91	401.836000	413	401.869750
<b>69</b>	<b>401.803000</b>	<b>391</b>	<b>401.836750</b>	<b>114</b>	<b>401.870500</b>
369	401.803750	92	401.837500	414	401.871250
70	401.804500	392	401.838250	115	401.872000
<b>370</b>	<b>401.805250</b>	<b>93</b>	<b>401.839000</b>	<b>415</b>	<b>401.872750</b>
71	401.806000	393	401.839750	116	401.873500
371	401.806750	94	401.840500	416	401.874250
<b>72</b>	<b>401.807500</b>	<b>394</b>	<b>401.841250</b>	<b>117</b>	<b>401.875000</b>
372	401.808250	95	401.842000	417	401.875750
73	401.809000	395	401.842750	118	401.876500
<b>373</b>	<b>401.809750</b>	<b>96</b>	<b>401.843500</b>	<b>418</b>	<b>401.877250</b>
74	401.810500	396	401.844250	119	401.878000
374	401.811250	97	401.845000	419	401.878750
<b>75</b>	<b>401.812000</b>	<b>397</b>	<b>401.845750</b>	<b>120</b>	<b>401.879500</b>
375	401.812750	98	401.846500	420	401.880250
76	401.813500	398	401.847250	121	401.881000
<b>376</b>	<b>401.814250</b>	<b>99</b>	<b>401.848000</b>	<b>421</b>	<b>401.881750</b>
77	401.815000	399	401.848750	122	401.882500
377	401.815750	100	401.849500	422	401.883250
<b>78</b>	<b>401.816500</b>	<b>400</b>	<b>401.850250</b>	<b>123</b>	<b>401.884000</b>
378	401.817250	101	401.851000	423	401.884750
79	401.818000	401	401.851750	124	401.885500
<b>379</b>	<b>401.818750</b>	<b>102</b>	<b>401.852500</b>	<b>424</b>	<b>401.886250</b>
80	401.819500	402	401.853250	125	401.887000
380	401.820250	103	401.854000	425	401.887750
<b>81</b>	<b>401.821000</b>	<b>403</b>	<b>401.854750</b>	<b>126</b>	<b>401.888500</b>
381	401.821750	104	401.855500	426	401.889250
82	401.822500	404	401.856250	127	401.890000
<b>382</b>	<b>401.823250</b>	<b>105</b>	<b>401.857000</b>	<b>427</b>	<b>401.890750</b>
83	401.824000	405	401.857750	128	401.891500
383	401.824750	106	401.858500	428	401.892250
<b>84</b>	<b>401.825500</b>	<b>406</b>	<b>401.859250</b>	<b>129</b>	<b>401.893000</b>
384	401.826250	107	401.860000	429	401.893750
85	401.827000	407	401.860750	130	401.894500
<b>385</b>	<b>401.827750</b>	<b>108</b>	<b>401.861500</b>	<b>430</b>	<b>401.895250</b>
86	401.828500	408	401.862250	131	401.896000
386	401.829250	109	401.863000	431	401.896750
<b>87</b>	<b>401.830000</b>	<b>409</b>	<b>401.863750</b>	<b>132</b>	<b>401.897500</b>
387	401.830750	110	401.864500	432	401.898250
88	401.831500	410	401.865250	133	401.899000
<b>388</b>	<b>401.832250</b>	<b>111</b>	<b>401.866000</b>	<b>433</b>	<b>401.899750</b>
89	401.833000	411	401.866750	134	401.900500
389	401.833750	112	401.867500	434	401.901250
<b>90</b>	<b>401.834500</b>	<b>412</b>	<b>401.868250</b>	<b>135</b>	<b>401.902000</b>
390	401.835250	113	401.869000	435	401.902750

**NOTE BOLD TYPE Face identifies potential 1200 bps Channel assignments.**



**GOES DCPRS TRANSMIT FREQUENCIES (Continued)**

CHANNEL NUMBER	CENTER FREQUENCY	CHANNEL NUMBER	CENTER FREQUENCY	CHANNEL NUMBER	CENTER FREQUENCY
136	401.903500	458	401.937250	181	401.971000
<b>436</b>	<b>401.904250</b>	<b>159</b>	<b>401.938000</b>	<b>481</b>	<b>401.971750</b>
137	401.905000	459	401.938750	182	401.972500
437	401.905750	160	401.939500	482	401.973250
<b>138</b>	<b>401.906500</b>	<b>460</b>	<b>401.940250</b>	<b>183</b>	<b>401.974000</b>
438	401.907250	161	401.941000	483	401.974750
139	401.908000	461	401.941750	184	401.975500
<b>439</b>	<b>401.908750</b>	<b>162</b>	<b>401.942500</b>	<b>484</b>	<b>401.976250</b>
140	401.909500	462	401.943250	185	401.977000
440	401.910250	163	401.944000	485	401.977750
<b>141</b>	<b>401.911000</b>	<b>463</b>	<b>401.944750</b>	<b>186</b>	<b>401.978500</b>
441	401.911750	164	401.945500	486	401.979250
142	401.912500	464	401.946250	187	401.980000
<b>442</b>	<b>401.913250</b>	<b>165</b>	<b>401.947000</b>	<b>487</b>	<b>401.980750</b>
143	401.914000	465	401.947750	188	401.981500
443	401.914750	166	401.948500	488	401.982250
<b>144</b>	<b>401.915500</b>	<b>466</b>	<b>401.949250</b>	<b>189</b>	<b>401.983000</b>
444	401.916250	167	401.950000	489	401.983750
145	401.917000	467	401.950750	190	401.984500
<b>445</b>	<b>401.917750</b>	<b>168</b>	<b>401.951500</b>	<b>490</b>	<b>401.985250</b>
146	401.918500	468	401.952250	191	401.986000
446	401.919250	169	401.953000	491	401.986750
<b>147</b>	<b>401.920000</b>	<b>469</b>	<b>401.953750</b>	<b>192</b>	<b>401.987500</b>
447	401.920750	170	401.954500	492	401.988250
148	401.921500	470	401.955250	193	401.989000
<b>448</b>	<b>401.922250</b>	<b>171</b>	<b>401.956000</b>	<b>493</b>	<b>401.989750</b>
149	401.923000	471	401.956750	194	401.990500
449	401.923750	172	401.957500	494	401.991250
<b>150</b>	<b>401.924500</b>	<b>472</b>	<b>401.958250</b>	<b>195</b>	<b>401.992000</b>
450	401.925250	173	401.959000	595	401.992750
151	401.926000	473	401.959750	196	401.993500
<b>451</b>	<b>401.926750</b>	<b>174</b>	<b>401.960500</b>	<b>496</b>	<b>401.994250</b>
152	401.927500	474	401.961250	197	401.995000
452	401.928250	175	401.962000	497	401.995750
<b>153</b>	<b>401.929000</b>	<b>475</b>	<b>401.962750</b>	<b>198</b>	<b>401.996500</b>
453	401.929750	176	401.963500	498	401.997250
154	401.930500	476	401.964250	199	401.998000
<b>454</b>	<b>401.931250</b>	<b>177</b>	<b>401.965000</b>	<b>499</b>	<b>401.998750</b>
155	401.932000	477	401.965750	200	401.999500
455	401.932750	178	401.966500	500	402.000250
<b>156</b>	<b>401.933500</b>	<b>478</b>	<b>401.967250</b>	<b>201</b>	<b>402.001000</b>
456	401.934250	179	401.968000	501	402.001750
157	401.935000	479	401.968750	202	402.002500
<b>457</b>	<b>401.935750</b>	<b>180</b>	<b>401.969500</b>	<b>502</b>	<b>402.003250</b>
158	401.936500	480	401.970250	203	402.004000

**NOTE BOLD TYPE Face identifies potential 1200 bps Channel assignments.**

**GOES DCPRS TRANSMIT FREQUENCIES (Continued)**

CHANNEL NUMBER	CENTER FREQUENCY	CHANNEL NUMBER	CENTER FREQUENCY	CHANNEL NUMBER	CENTER FREQUENCY
503	402.004750	226	402.038500	548	402.072250
<b>204</b>	<b>402.005500</b>	<b>526</b>	<b>402.039250</b>	<b>249</b>	<b>402.073000</b>
504	402.006250	227	402.040000	549	402.073750
205	402.007000	527	402.040750	250	402.074500
<b>505</b>	<b>402.007750</b>	<b>228</b>	<b>402.041500</b>	<b>550</b>	<b>402.075250</b>
206	402.008500	528	402.042250	251	402.076000
506	402.009250	229	402.043000	551	402.076750
<b>207</b>	<b>402.010000</b>	<b>529</b>	<b>402.043750</b>	<b>252</b>	<b>402.077500</b>
507	402.010750	230	402.044500	552	402.078250
208	402.011500	530	402.045250	253	402.079000
<b>508</b>	<b>402.012250</b>	<b>231</b>	<b>402.046000</b>	<b>553</b>	<b>402.079750</b>
209	402.013000	531	402.046750	254	402.080500
509	402.013750	232	402.047500	554	402.081250
<b>210</b>	<b>402.014500</b>	<b>532</b>	<b>402.048250</b>	<b>255</b>	<b>402.082000</b>
510	402.015250	233	402.049000	555	402.082750
211	402.016000	533	402.049750	256	402.083500
<b>511</b>	<b>402.016750</b>	<b>234</b>	<b>402.050500</b>	<b>556</b>	<b>402.084250</b>
212	402.017500	534	402.051250	257	402.085000
512	402.018250	235	402.052000	557	402.085750
<b>213</b>	<b>402.019000</b>	<b>535</b>	<b>402.052750</b>	<b>258</b>	<b>402.086500</b>
513	402.019750	236	402.053500	558	402.087250
214	402.020500	536	402.054250	259	402.088000
<b>514</b>	<b>402.021250</b>	<b>237</b>	<b>402.055000</b>	<b>559</b>	<b>402.088750</b>
215	402.022000	537	402.055750	260	402.089500
515	402.022750	238	402.056500	560	402.090250
<b>216</b>	<b>402.023500</b>	<b>538</b>	<b>402.057250</b>	<b>261</b>	<b>402.091000</b>
516	402.024250	239	402.058000	561	402.091750
217	402.025000	539	402.058750	262	402.092500
<b>517</b>	<b>402.025750</b>	<b>240</b>	<b>402.059500</b>	<b>562</b>	<b>402.093250</b>
218	402.026500	540	402.060250	263	402.094000
518	402.027250	241	402.061000	563	402.094750
<b>219</b>	<b>402.028000</b>	<b>541</b>	<b>402.061750</b>	<b>264</b>	<b>402.095500</b>
519	402.028750	242	402.062500	564	402.096250
220	402.029500	542	402.063250	265	402.097000
<b>520</b>	<b>402.030250</b>	<b>243</b>	<b>402.064000</b>	<b>565</b>	<b>402.097750</b>
221	402.031000	543	402.064750	266	402.098500
521	402.031750	244	402.065500	566	402.099250
<b>222</b>	<b>402.032500</b>	<b>544</b>	<b>402.066250</b>		
522	402.033250	245	402.067000		
223	402.034000	545	402.067750		
<b>523</b>	<b>402.034750</b>	<b>246</b>	<b>402.068500</b>		
224	402.035500	546	402.069250		
524	402.036250	247	402.070000		
<b>225</b>	<b>402.037000</b>	<b>547</b>	<b>402.070750</b>		
525	402.037750	248	402.071500		

**NOTE BOLD TYPE Face identifies potential 1200 bps Channel assignments.**

## APPENDIX E - GOES DCPRS Phase Noise Budget

A phase noise budget has been established for the entire DCS so that each part of the system can be individually tested, independent of the other parts, and still be assured that all components that meet their assigned requirement will provide acceptable system function.

The proposed budget for the DCPRS is derived as follows:

1. The demodulators are expected to normally operate with a bit error rate near 1 in  $10^7$ , and it is desired that errors due to phase noise should be about two orders of magnitude better, i.e., about 1 in  $10^9$ .
2. Phase noise is a normal or Gaussian distributed variable, with standard deviation,  $\sigma$ . Therefore the dual-tail, Normal Error Integral gives a probability of 1 in  $10^9$  that it exceeds  $6.1\sigma$  from its mean value.
3. The total phase error required to cause bit errors in an 8PSK demodulator is 22.5 degrees, half of the 45 degree phase shift between each of the nominal phase states.
4. This document proposes a DCPRS phase offset/bias 1.0 degrees.
5.  $22.5 - 1.0 = 21.5$  and  $21.5 / 6.1 = 3.52$
6. Therefore, the total system phase noise must be 3.5 degrees or less.
7. The phase noise in the GOES-N primary and redundant DCPR transponders has been measured at 0.5 degrees, worst case. Therefore an allocation of 1.0 degrees is proposed for all of the GOES-N and GOES-R series of satellites.
8. The DCPRS phase noise required by the current Certification Standards is 2.5 degrees.
9. The phase noise allocation proposed for the dual down conversion receive path at WCDAS is 2.0 degrees.
10. The phase noise allocation proposed for the additional down conversion at the input to the demodulators at WCDAS is 1.0 degrees.
11. The RSS for all these components of the system phase noise is 3.5 degrees.

The integration limits for calculating phase noise are 2 Hz and 150 Hz for the 300 bps channels and 6 Hz and 600 Hz for the 1200 bps channels. These are the values that will apply to the demodulators at WCDAS and have been set as the standard to be used for the satellite and DCPRS requirements. It is recommended that these values also be used in the design of future demodulators for WCDAS and/or DRGS, at these data rates.