

NIST GCR 12-917-18

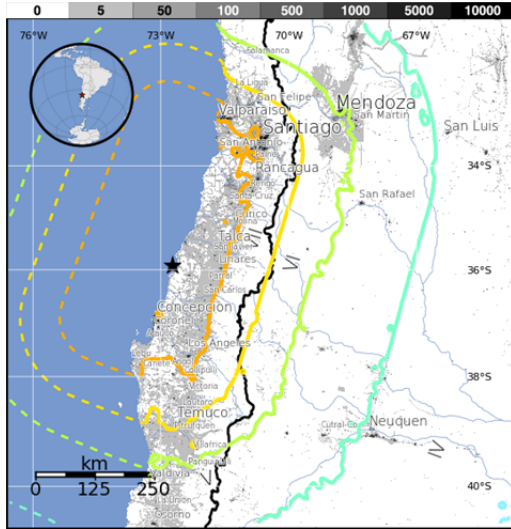

Comparison of U.S. and Chilean Building Code Requirements and Seismic Design Practice 1985-2010

NEHRP Consultants Joint Venture
*A partnership of the Applied Technology Council and the
Consortium of Universities for Research in Earthquake Engineering*



NIST
National Institute of
Standards and Technology
U.S. Department of Commerce

Disclaimers

This report was prepared for the Engineering Laboratory of the National Institute of Standards and Technology (NIST) under the National Earthquake Hazards Reduction Program (NEHRP) Earthquake Structural and Engineering Research Contract SB134107CQ0019, Task Order 10279. The contents of this publication do not necessarily reflect the views and policies of NIST or the U.S. Government.

This report was produced by the NEHRP Consultants Joint Venture, a joint venture of the Applied Technology Council (ATC) and the Consortium of Universities for Research in Earthquake Engineering (CUREE). While endeavoring to provide practical and accurate information, the NEHRP Consultants Joint Venture, the authors, and the reviewers assume no liability for, nor express or imply any warranty with regard to, the information contained herein. Users of information contained in this report assume all liability arising from such use.

Unless otherwise noted, photos, figures, and data presented in this report have been developed or provided by NEHRP Consultants Joint Venture staff or consultants engaged under contract to provide information as works for hire. Any similarity with other published information is coincidental. Photos and figures cited from outside sources have been reproduced in this report with permission. Any other use requires additional permission from the copyright holders.

Certain commercial software, equipment, instruments, or materials may have been used in the preparation of information contributing to this report. Identification in this report is not intended to imply recommendation or endorsement by NIST, nor is it intended to imply that such software, equipment, instruments, or materials are necessarily the best available for the purpose.

NIST policy is to use the International System of Units (metric units) in all its publications. In this report, however, information is presented in U.S. Customary Units (inch-pound), as this is the preferred system of units in the U.S. earthquake engineering industry.

Cover photo – Isoseismal Map, February 27, 2010, Maule earthquake (United States Geological Survey, 2011)

NIST GCR 12-917-18

Comparison of U.S. and Chilean Building Code Requirements and Seismic Design Practice 1985-2010

Prepared for
*U.S. Department of Commerce
National Institute of Standards and Technology
Engineering Laboratory
Gaithersburg, MD 20899*

By
NEHRP Consultants Joint Venture
*A partnership of the Applied Technology Council and the
Consortium of Universities for Research in Earthquake Engineering*

October 2012



U.S. Department of Commerce
Rebecca M. Blank, Acting Secretary

National Institute of Standards and Technology
*Patrick D. Gallagher, Under Secretary of Commerce
for Standards and Technology, and Director*

Participants

National Institute of Standards and Technology

John (Jack) R. Hayes, Jr., Director, National Earthquake Hazards Reduction Program
Steven L. McCabe, Deputy Director, National Earthquake Hazards Reduction Program

NEHRP Consultants Joint Venture

Applied Technology Council
201 Redwood Shores Parkway, Suite 240
Redwood City, California 94065
www.ATCouncil.org

Consortium of Universities for
Research in Earthquake Engineering
1301 S. 46th Street, Building 420
Richmond, California 94804
www.CUREE.org

Joint Venture Management Committee

James R. Harris
Robert Reitherman
Christopher Rojahn
Andrew Whittaker

Joint Venture Program Committee

Jon A. Heintz (Program Manager)
Michael Constantinou
C.B. Crouse
James R. Harris
William T. Holmes
Jack Moehle
Andrew Whittaker

Project Technical Committee

Ronald O. Hamburger (Project Director)
Patricio Bonelli
Rene Lagos
Loring A. Wyllie, Jr.

Working Group Members

Ady Aviram
Jose A. Flores Ruiz

Preface

The NEHRP Consultants Joint Venture is a partnership between the Applied Technology Council (ATC) and the Consortium of Universities for Research in Earthquake Engineering (CUREE). In 2007, the National Institute of Standards and Technology (NIST) awarded a National Earthquake Hazards Reduction Program (NEHRP) “Earthquake Structural and Engineering Research” contract (SB1341-07-CQ-0019) to the NEHRP Consultants Joint Venture to conduct a variety of tasks, including Task Order 10279 entitled “Comparison of Present Chilean and U.S. Model Building Code Seismic Provisions and Seismic Design Practices.”

This work is part of a series of investigations into the performance of engineered construction during the February 27, 2010, Maule earthquake in Chile. It is intended to provide an understanding of the similarities and differences between U.S. and Chilean seismic design codes and practices so that meaningful conclusions can be drawn from the observed performance of buildings in Chile, and that seismic-resistant construction can be improved in the United States.

The NEHRP Consultants Joint Venture is indebted to the leadership of Ron Hamburger, Project Director, and to the members of the Project Technical Committee, consisting of Loring Wyllie, Patricio Bonelli, and Rene Lagos, who identified and compared relevant code provisions and seismic design practices, and developed the resulting observations and conclusions. Working groups, consisting of Ady Aviram and Jose Flores Ruiz, provided translation services and performed comparative design studies. A special debt of gratitude is owed to our Chilean partners who collected and generously shared seismic design provisions, material design standards, ground motions, comparative studies, and other information that was instrumental in performing this work. The names and affiliations of all who contributed to this report are provided in the list of Project Participants.

The NEHRP Consultants Joint Venture also gratefully acknowledges Jack Hayes (NEHRP Director) and Steve McCabe (NEHRP Deputy Director) for their input and guidance in the preparation of this report, and Peter N. Mork for ATC report production services.

Jon A. Heintz
Program Manager

Table of Contents

Preface	iii
List of Figures	vii
List of Tables.....	xi
1. Introduction	1-1
1.1 Objectives and Scope.....	1-1
1.2 Background Information.....	1-3
1.2.1 Geography, Population, and Industry	1-3
1.2.2 Regional Seismicity	1-4
1.2.3 Construction Practice.....	1-4
1.3 The Maule Earthquake of February 27, 2010	1-5
1.4 Report Organization and Content	1-10
2. Chilean Practice.....	2-1
2.1 Operative Codes.....	2-1
2.1.1 NCh433 Loading Standard	2-1
2.1.2 NCh430 Concrete Design Standard.....	2-3
2.2 Typical Chilean Design Practice.....	2-4
2.2.1 Seismic Design of Nonstructural Components	2-10
2.3 Chilean Design Criteria	2-11
2.3.1 Seismic Zonation	2-11
2.3.2 Site Class	2-12
2.3.3 Occupancy Categories	2-13
2.3.4 Load Combinations.....	2-13
2.3.5 Structural Systems	2-13
2.3.6 Analysis Procedures.....	2-14
2.3.7 Static Analysis	2-14
2.3.8 Modal Response Spectrum Analysis	2-17
3. U.S. Practice	3-1
3.1 Evolution of U.S. Seismic Design Codes	3-1
3.2 Operative Codes.....	3-3
3.2.1 ASCE 7 Loading Standard.....	3-3
3.2.2 ACI 318 Concrete Design Standard.....	3-4
3.3 Typical U.S. Design Practice	3-4
3.4 U.S. Design Criteria.....	3-8
3.4.1 Maximum Considered Earthquake Shaking	3-8
3.4.2 Site Class	3-11
3.4.3 Design Earthquake Shaking.....	3-12
3.4.4 Risk Category	3-13
3.4.5 Seismic Design Category.....	3-13
3.4.6 Load Combinations.....	3-14
3.4.7 Structural Systems	3-16

3.4.8	Irregularities	3-17
3.4.9	Analysis Procedures	3-18
3.4.10	Equivalent Lateral Force Procedure	3-19
3.4.11	Modal Response Spectrum Analysis.....	3-23
4.	Comparison of U.S. and Chilean Seismic Design Requirements	4-1
4.1	Seismic Design Loading.....	4-1
4.2	Reinforced Concrete Seismic Design Provisions.....	4-2
4.3	Observations and Conclusions on U.S. and Chilean Seismic Design Requirements	4-3
5.	Comparison of U.S. and Chilean Seismic Design Practice	5-1
5.1	Building Description	5-1
5.2	Observed Earthquake Damage	5-3
5.3	Analysis of Chilean Configuration.....	5-6
5.3.1	Site Response Spectra	5-7
5.3.2	Drift Response.....	5-9
5.3.3	Design Forces.....	5-15
5.4	Design and Analysis of U.S. Configuration	5-19
5.4.1	Drift Response.....	5-21
5.4.2	Design Forces.....	5-23
5.5	Observations and Conclusions on U.S. and Chilean Seismic Design Practice.....	5-25
	References	A-1
	Project Participants.....	B-1

List of Figures

Figure 1-1	Map of Chile showing the approximate epicenter location relative to major metropolitan areas.....	1-1
Figure 1-2	Partial collapse in the upper stories of the O’Higgins building in Concepción, Chile.....	1-2
Figure 1-3	Collapse of the Alto Rio building in Concepción, Chile	1-3
Figure 1-4	Isoseismal map of the 2010 Maule earthquake.....	1-6
Figure 1-5	Acceleration response spectra from all recording stations.....	1-8
Figure 1-6	Acceleration response spectra from Santiago – Centro	1-8
Figure 1-7	Acceleration response spectra from Viña del Mar – Centro	1-9
Figure 1-8	Acceleration response spectra from Constitución.....	1-9
Figure 2-1	Typical mid-rise and high-rise buildings in Santiago	2-6
Figure 2-2	Typical mid-rise and high-rise buildings in Viña del Mar.....	2-6
Figure 2-3	Typical floor plan of high-rise residential building in Chile	2-7
Figure 2-4	Typical cross-section of mid-rise residential building in Chile	2-7
Figure 2-5	Shallow lintel showing nominal reinforcement and lack of confinement in a residential building that was damaged in the 2010 Maule earthquake.....	2-8
Figure 2-6	Typical unconfined shear wall boundary zone detail permitted in NCh430.....	2-9
Figure 2-7	Damage to typical unconfined shear wall boundary zone observed in the 2010 Maule earthquake	2-9
Figure 2-8	Typical partially confined shear wall boundary zone details used by some Chilean engineers	2-9
Figure 2-9	Typical floor plan of high-rise office building in Chile.....	2-10
Figure 2-10	Seismic zonation maps for northern, central, and southern Chile contained in NCh433.....	2-11
Figure 2-11	Variation in seismic coefficient, C , as a function of period, T^* , in Zone 3, assuming $R=7$	2-16
Figure 2-12	Story force distribution as a fraction of base shear, for a hypothetical 10-story structure	2-17

Figure 2-13	Acceleration response spectra in Zone 3, with R^* and importance factor, I , taken as unity	2-19
Figure 2-14	Variation in response modification coefficient, R^* , as a function of site class and structural period, using NCh433 Equation 6-10, assuming $R_0=11$	2-19
Figure 2-15	Variation in response modification coefficient, R^* , as a function of site class and number of stories, N , using NCh433 Equation 6-11, assuming $R_0=11$	2-20
Figure 3-1	Typical floor plan of high-rise residential construction in the United States	3-5
Figure 3-2	Alternative floor plan typically associated with mid-rise residential construction in the United States	3-5
Figure 3-3	Typical coupled shear wall elevation in the United States.....	3-6
Figure 3-4	Ductile detailing for reinforcement of flexure-controlled coupling beams.....	3-6
Figure 3-5	Ductile detailing for reinforcement of shear-controlled coupling beams.....	3-7
Figure 3-6	Alternative detailing for reinforcement of shear-controlled coupling beams permitted by ACI 318-11	3-7
Figure 3-7	Typical confined shear wall boundary zone.....	3-8
Figure 3-8	Risk-Adjusted Maximum Considered Earthquake (MCE_R) S_S contour map for the Western United States.....	3-10
Figure 3-9	Risk-Adjusted Maximum Considered Earthquake (MCE_R) S_I contour map for the Western United States.....	3-11
Figure 3-10	Variation in base shear coefficient, C_S , as a function of period, T , for Risk Category II, special reinforced concrete bearing wall structures located in regions of high seismicity	3-21
Figure 3-11	Story force distribution as a fraction of base shear, for a hypothetical 10-story structure with $T=1$ second	3-22
Figure 3-12	Generalized design response spectra for various site classes, with R and I_e taken as unity	3-24
Figure 5-1	Typical floor plan, Chilean case study building.....	5-2
Figure 5-2	Transverse wall elevations, Chilean case study building	5-2
Figure 5-3	Transverse elevation of the case study building showing differential vertical displacements following the 2010 Maule earthquake	5-3
Figure 5-4	Overall damage sustained in the first-story transverse shear walls of the case study building.....	5-4

Figure 5-5	Cracking, spalling, crushing, and bar buckling in the transverse shear wall on Line 9.....	5-4
Figure 5-6	Cracking, spalling, crushing, and bar buckling in the transverse shear wall on Line 5.....	5-5
Figure 5-7	Crushing and bar buckling in the transverse shear wall on Line 1 resulting in significant differential vertical displacement.....	5-5
Figure 5-8	Three-dimensional ETABS model of the Chilean configuration of the case study building	5-6
Figure 5-9	Comparison of design response spectra for Viña del Mar, per NCh433.Of96, and San Francisco, California, per ASCE/SEI 7-05.....	5-8
Figure 5-10	Variation in response modification coefficient, R^* , as a function of period.....	5-9
Figure 5-11	Spectral acceleration ordinates for the Viña del Mar site divided by the value of R^* at each period.....	5-10
Figure 5-12	Maximum story drift ratios in the longitudinal direction at the center of mass, calculated per NCh433.Of96	5-11
Figure 5-13	Maximum story drift ratios in the longitudinal direction at an extreme corner, calculated per NCh433.Of96	5-11
Figure 5-14	Maximum story drift ratios in the transverse direction at the center of mass, calculated per NCh433.Of96	5-12
Figure 5-15	Maximum story drift ratios in the transverse direction at an extreme corner, calculated per NCh433.Of96	5-12
Figure 5-16	Maximum story drift ratios in the longitudinal direction at the center of mass, calculated per ASCE/SEI 7-05.....	5-13
Figure 5-17	Maximum story drift ratios in the longitudinal direction at an extreme corner, calculated per ASCE/SEI 7-05.....	5-13
Figure 5-18	Maximum story drift ratios in the transverse direction at the center of mass, calculated per ASCE/SEI 7-05.....	5-14
Figure 5-19	Maximum story drift ratios in the transverse direction at an extreme corner, calculated per ASCE/SEI 7-05.....	5-14
Figure 5-20	Design story shears in the transverse direction, per NCh433.Of96 (at strength level) and ASCE/SEI 7-05 (including redundancy factor).....	5-17
Figure 5-21	Design overturning moments in the transverse direction, per NCh433.Of96 (at strength level) and ASCE/SEI 7-05 (including redundancy factor)	5-17

Figure 5-22	Shear wall boundary element detailing for the case study building: (a) Chilean detailing; and (b) ACI 318 detailing for confinement.....	5-18
Figure 5-23	Strain distribution and confined boundary element for “T-shaped” wall configurations, per ACI 318.....	5-18
Figure 5-24	Comparison of U.S. configuration with Chilean shear wall layout.....	5-19
Figure 5-25	Comparison of typical transverse wall elevations: (a) Chilean configuration; and (b) U.S. configuration	5-20
Figure 5-26	Three-dimensional ETABS model of the U.S. building configuration	5-21
Figure 5-27	Maximum story drift ratios in the transverse direction for the U.S. building configuration, calculated per ASCE/SEI 7-05	5-22
Figure 5-28	Comparison of normalized story drift ratios for the U.S. configuration and the Chilean configuration, in the transverse direction at the center of mass	5-22
Figure 5-29	Comparison of normalized displacements for the U.S. configuration and the Chilean configuration, in the transverse direction at the center of mass	5-23
Figure 5-30	Design story shears for the U.S. configuration in the transverse direction, per ASCE/SEI 7-05	5-24
Figure 5-31	Design overturning moments for the U.S. configuration in the transverse direction, per ASCE/SEI 7-05.....	5-24
Figure 5-32	Shear wall boundary element detailing for the U.S. configuration	5-25

List of Tables

Table 1-1	Summary of Ground Motion Recordings from the 2010 Maule Earthquake	1-7
Table 2-1	Maximum Values of Seismic Coefficient, C_{max} , based on R	2-15
Table 4-1	Comparison of NCh433.Of96 and ASCE/SEI 7-10 Seismic Design Requirements	4-4
Table 5-1	Chilean Configuration Periods of Vibration	5-7
Table 5-2	Seismic Design Parameters used to Develop Site Response Spectra per NCh433.Of96 and ASCE/SEI 7-05	5-8
Table 5-3	Design Base Shear Parameters for Scaling of Response Spectrum Analysis Results per NCh433.Of96 and ASCE/SEI 7-05	5-16
Table 5-4	U.S. Configuration Periods of Vibration	5-21

On February 27, 2010, a magnitude 8.8 earthquake occurred off the coast near the Maule region of central Chile (Figure 1-1). The fault rupture generated wide-spread strong ground shaking and a damaging tsunami. The effects of shaking were observed in several major metropolitan areas, many of which also experienced damage in previous large-magnitude earthquakes that have occurred in the region.

As a result of frequent historic seismic activity, building codes in Chile have included consideration of seismic effects, and building practice has included seismic-resistant construction. Because modern Chilean practice has been largely modeled after U.S. practice, investigations into the performance of engineered structures during the 2010 Maule earthquake is important to future seismic design and construction practice in both the United States and Chile.

1.1 Objectives and Scope

This report presents a comparison of seismic design criteria and practices embodied in U.S. and Chilean building codes in the period immediately preceding the 2010 Maule earthquake. It is intended to provide background information for studies funded by the National Institute of Standards and Technology (NIST) and others as part of a series of investigations into the performance of buildings and other structures affected by the February 27, 2010, earthquake.

As a body, these studies are intended to identify the effectiveness of present design and construction practices in Chile and the United States, as well as potential modifications to these practices that could result in better performance in future events. In order to draw linkages between observed performance in Chile and implications for U.S. practice, an understanding of the similarities and differences between U.S. and Chilean seismic design philosophies is needed. Specifically, this report is intended to:

- Document building code requirements and design and construction practices in effect in Chile during the period 1985–2010.
- Compare operative codes and seismic design practices in Chile and the United States, and document observed differences.



Figure 1-1 Map of Chile showing the approximate epicenter location relative to major metropolitan areas (map courtesy of worldatlas.com).

Building construction in both Chile and the United States covers a wide range of building types and structural systems. This report focuses on mid-rise and high-rise reinforced concrete bearing wall structures that are typically used in high-density, multi-family residential construction. The reasons for this focus are:

- Structures of this type are common in both countries, and many are located in regions of high seismicity in the United States.
- Structures of this type are designed using sophisticated engineering techniques and typify the application of sophisticated building design and construction practices in both countries.
- Chilean practice in the design of these structures is based on U.S. building codes and standards (with some modifications), enabling lessons from observed performance to be applicable to design in both countries.
- Although the collective performance of these buildings was generally very good, a number of these buildings experienced heavy damage (Figure 1-2), and a few collapsed (Figure 1-3), as a result of the 2010 Maule earthquake.
- Structural drawings for many of these buildings are available for use in future detailed studies.

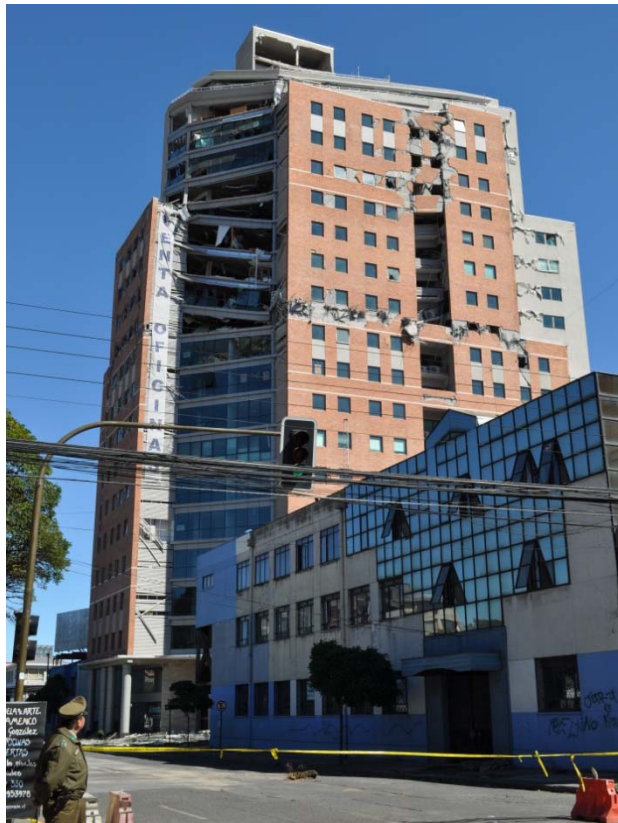

Figure 1-2 Partial collapse in the upper stories of the O'Higgins building in Concepción, Chile (photo courtesy of ATC).



Figure 1-3 Collapse of the Alto Rio building in Concepción, Chile (photo courtesy of ATC).

The period 1985–2010 was chosen because extensive study and documentation of Chilean design and construction practice was performed following the March 3, 1985 earthquake. The performance of buildings designed and constructed since 1985 is considered most relevant to current practice in both countries.

1.2 Background Information

1.2.1 Geography, Population, and Industry

The Republic of Chile is a modern, industrialized country extending approximately 4300 kilometers (2,700 miles) along the southern half of the Pacific coast of South America. It is bordered by Peru to the north, Bolivia to the northeast, Argentina to the east and Drake Passage to the south. Only 175 kilometers (109 miles) wide, its topography includes a central plain situated between coastal mountains on the west and the Andes Mountains to the east.

Chile's 2002 census reported a population of approximately 15.4 million people, with current estimates placing the population just over 17 million. About 89% of the population lives in urban areas. Approximately 5.9 million live in greater Santiago, which is the nation's capital and a modern city located near the middle of the country's central plain. Approximately 1 million live in the Valparaiso/Viña del Mar metropolplex located on the central coast to the north of Santiago, and another 1 million live in greater Concepción, a city located on the coast, south of Santiago.

The Chilean economy is one of the most stable in South America. In 2010, the gross domestic product (GDP) totaled approximately \$264 billion (\$U.S.) representing

approximately \$15,300 (\$U.S.) per capita. The GDP is composed of industry, including mineral production such as copper (42%); agriculture, including beef, fish, and wine (5%); and services/tourism (53%). [Data from *The World Factbook* (CIA, 2012).]

1.2.2 Regional Seismicity

The entire length of the Chile lies along a major subduction zone constituting the southwest rim of the Pacific Ring of Fire. In this region, the Nazca Plate is being subducted beneath the South American plate resulting in the uplift and volcanism of the Andes Mountains and frequent, large-magnitude earthquakes. The two plates are converging at approximately 7 meters (22 feet) per century. The United States Geological Survey (USGS) lists approximately 25 major earthquakes that have occurred within the country's borders since 1730. More than 20 of these events are estimated to have exceeded magnitude 7.0, eight have exceeded magnitude 8.0, and two have exceeded magnitude 9.0.

Prior to the 2010 Maule earthquake, notable historic events in the vicinity included the magnitude 7.5 earthquake in the Valparaíso region on July 8, 1971, and the magnitude 7.8 earthquake offshore of Valparaíso on March 3, 1985, which affected areas including Santiago, Valparaíso, and Viña del Mar. A magnitude 9.5 earthquake occurred in the Valdivia region on May 22, 1960. It affected areas including Concepción, and is regarded as the largest earthquake known to have occurred in the 20th Century. Together, these earthquakes produced strong ground shaking and widespread damage in areas that were also affected by the 2010 Maule earthquake, and resulted in a total of nearly 2000 fatalities. [Data from *Historic World Earthquakes* (USGS, 2009).]

1.2.3 Construction Practice

Urban centers include many tall residential and commercial structures constructed of reinforced concrete bearing wall systems. Low-rise residential, commercial, and institutional construction is typically cast-in-place concrete or confined masonry construction. The southern portion of the country, which has extensive forestation, includes some wood frame construction. Structural steel construction is typically limited to industrial facilities and long-span applications such as airport terminals and stadiums. The Chilean economy experienced major growth during the period 1990–2010 and, as a result, extensive building development occurred during this time period.

In 1985, Chilean seismic design requirements governing the strength and stiffness of buildings were similar to the requirements contained in Section 2312 of the *Uniform Building Code* (ICBO, 1982) then in use in the United States. Design and detailing provisions for concrete buildings were based on the German standard, DIN 1045,

Concrete and Reinforced Concrete (DIN, 1953), and had not been substantially changed for more than 20 years. As such, they did not contain modern seismic detailing provisions intended to provide ductile behavior. Many Chilean engineers at the time used ACI 318, *Building Code Requirements for Reinforced Concrete* (ACI, 1983) in lieu of requirements based on the German standard.

Although damage was extensive in the 1985 earthquake, taller concrete buildings in Valparaíso and Viña del Mar generally performed well. Floor plates in these buildings had dense shear wall patterns, and ratios of wall area to floor area were in the range of 5% to 10% at a typical floor. These buildings generally lacked special seismic detailing, but had enough strength and redundancy to perform well without extensive damage. There were, of course, some exceptions. More detailed information on building performance in the 1985 earthquake can be found in *Earthquake Spectra* (EERI, 1986).

Following the 1985 earthquake, engineers updated Chilean seismic design provisions based on contemporary *Uniform Building Code* requirements, and formally adopted ACI 318 (with modifications) as the basis for detailing of concrete structures. In the time leading up to the 2010 Maule earthquake, U.S. design concepts were embodied in Chilean seismic design practice in NCh433.Of96, *Earthquake Resistant Design of Buildings* (INN, 1996), and NCh430.Of2008, *Reinforced Concrete Design and Analysis Requirements* (INN, 2008). As a result, the 2010 Maule earthquake represents a unique opportunity to study the behavior of modern engineered reinforced concrete construction, similar to that present in the United States, in response to severe earthquake shaking.

1.3 The Maule Earthquake of February 27, 2010

The USGS reports that the Maule earthquake occurred at 3:34 am local time on February 27, 2010, in the Bio-Bio/Maule region of Central Chile. The earthquake had a moment magnitude, M_w , of 8.8, with an epicenter located at 35.909° South latitude, 72.733° West longitude, or approximately 105 kilometers (65 miles) north-northeast of Concepción, and 335 kilometers (210 miles) southwest of Santiago. The focal depth was estimated to be 35 kilometers (22 miles). The approximate location of the epicenter is shown in Figure 1-1.

The earthquake occurred along the subduction fault between the Nazca plate and the South American plate. The fault ruptured largely offshore, spreading westward, northward, and southward, extending 100 km (62 miles) in width and nearly 500 km (300 miles) in length. The fault slip generated wide-spread, severe ground shaking that was felt in cities including Santiago, Valparaíso, Viña del Mar, Talca, Concepción, Temuco, and Valdivia. Deformations in the ocean floor generated a tsunami that was severe in the cities of Constitución and Talcahuano near the fault-

rupture zone, and had measurable effects across the Pacific in portions of Mexico, New Zealand, Japan, Canada, and the United States (including Hawaii, Alaska, and the West Coast).

Figure 1-4 is an isoseismal map from USGS Pager showing the epicentral location and distribution of estimated intensity throughout the affected region. Much of Chile's central plain, including Santiago, experienced a Modified Mercalli Intensity (MMI) of VII, while communities closer to the coast experienced intensities of VIII to IX.

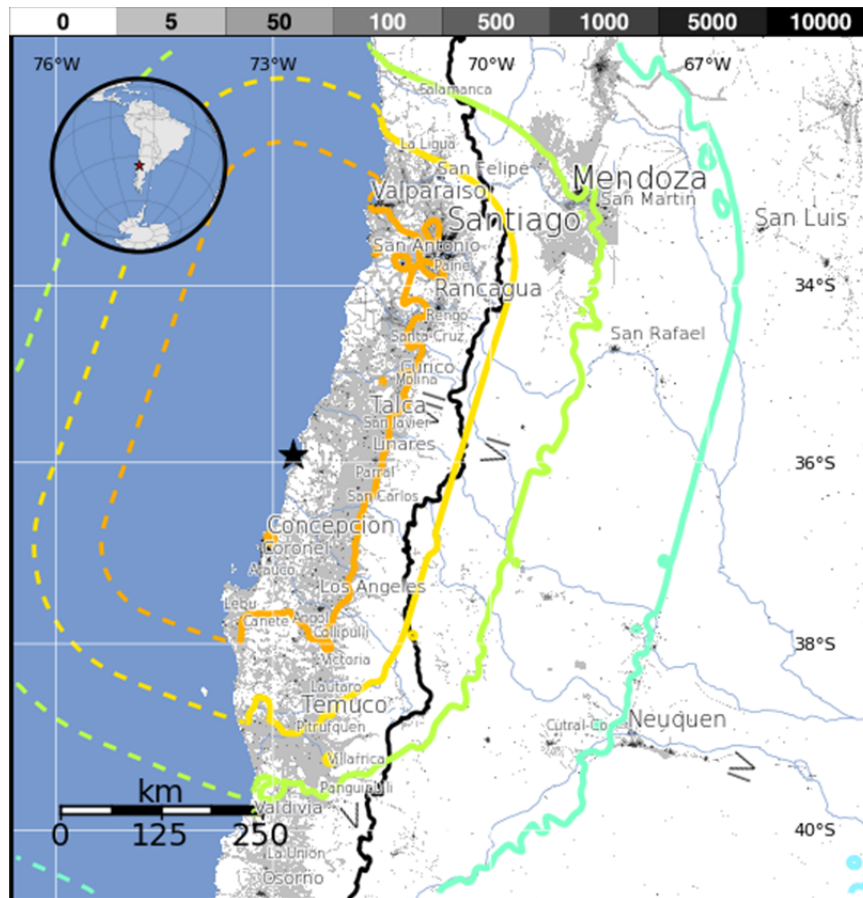

Figure 1-4 Isoseismal map of the 2010 Maule earthquake (USGS, 2011).

Multiple sources estimate that the 2010 Maule earthquake resulted in more than 520 fatalities, 12,000 injuries, and \$30 billion (\$U.S.) in damage and economic losses (EERI, 2010; USGS, 2012). According to USGS, at least 370,000 houses, 4,000 schools, and 79 hospitals were damaged or destroyed as a result of the earthquake. The earthquake also damaged highways, railroads, ports, and airports. Electricity, telecommunications, and water supply systems were disrupted, and some regions were without power and communication for days. Many of the casualties and much of the damage is attributed to the tsunami that initially struck the coast within 30 minutes of the ground shaking.

Modern engineered buildings generally performed very well, with only a few cases of collapse noted. EERI (2010) reported that approximately 50 multi-story reinforced concrete buildings were severely damaged, and four experienced partial or total collapse. Based on building surveys in the metropolitan region, the Engineers Association of Chile (2010) estimated that approximately 2% of engineered buildings experienced severe damage or collapse; 12% were damaged such that they were not useable until repaired; and 86% were useable immediately following the earthquake.

The Department of Civil Engineering, Faculty of Mathematics and Physical Sciences at the University of Chile maintains a strong-motion network in central and southern Chile. More than 20 stations recorded free-field ground motions from the 2010 Maule earthquake (Boroschek et al., 2010). Table 1-1 summarizes ground motion recordings with reported peak ground accelerations ranging as high 0.93g. Selected acceleration response spectra are shown in the figures that follow.

Table 1-1 Summary of Ground Motion Recordings from the 2010 Maule Earthquake (Boroschek et al., 2010)

No.	Station	Region	Latitude	Longitude	Station Type ¹	Peak Ground Acceleration, g	
						Dir.	Value
1	Angol ²	IX	-37.7947° (S)	-72.7081° (W)	QDR	NS	0.928
2	Concepción	VIII	-36.8261° (S)	-73.0547° (W)	SMA-1	Long.	0.402
3	Constitución	VII	-35.3401° (S)	-72.4057° (W)	SMA-1	Trans.	0.640
4	Copiapo	III	-27.355° (S)	-70.3413° (W)	QDR	NS	0.030
5	Curico	VII	-34.9808° (S)	-71.2364° (W)	QDR	NS	0.470
6	Hualane	VII	-34.95° (S)	-71.80° (W)	SMA-1	Trans.	0.461
7	Llolleo	V	-33.6167° (S)	-71.6176° (W)	SMA-1	Trans.	0.564
8	Matanzas	VI	-33.9593° (S)	-71.8727° (W)	SMA-1	Long.	0.342
9	Papudo	V	-32.5114° (S)	-71.4471° (W)	SMA-1	Trans.	0.421
10	Santiago- Centro	RM	-33.46° (S)	-70.69° (W)	SSA-2	Trans.	0.309
11	Santiago- La Florida	RM	-33.5248° (S)	-70.5383° (W)	K2	NS	0.236
12	Santiago- Maipu	RM	-33.5167° (S)	-70.7667° (W)	QDR	NS	0.562
13	Santiago- Penalolen	RM	-33.50° (S)	-70.579° (W)	QDR	NS	0.295
14	Santiago- Puente Alto	RM	-33.5769° (S)	-70.5811° (W)	QDR	NS	0.265
15	Talca	VII	-35.4233° (S)	-71.66° (W)	SMA-1	Long.	0.477
16	Vallenar	III	-28.5716° (S)	-70.759° (W)	QDR	NS	0.020
17	Valparaiso- UTFSM	V	-33.0356° (S)	-71.5953° (W)	SMA-1	Trans.	0.304
18	Valparaiso- Almendral	V	-33.0458° (S)	-71.6068° (W)	SMA-1	Trans.	0.265
19	Valdivia	X	-39.8244° (S)	-73.2133° (W)	QDR	EW	0.138
20	Viña del Mar- Centro	V	-33.0253° (S)	-71.5508° (W)	QDR	EW	0.334
21	Viña del Mar- El Salto	V	-33.0469° (S)	-71.51° (W)	Etna	NS	0.351

¹ QDR: Free-field analog, U. Chile; SMA-1: Free-field analog, U. Chile; Etna: Free-field digital, U. Chile; SSA-2: Free-field digital, U. Chile; K2: Free-field digital, METRO S.A.

² Station soil-structure interaction under evaluation.

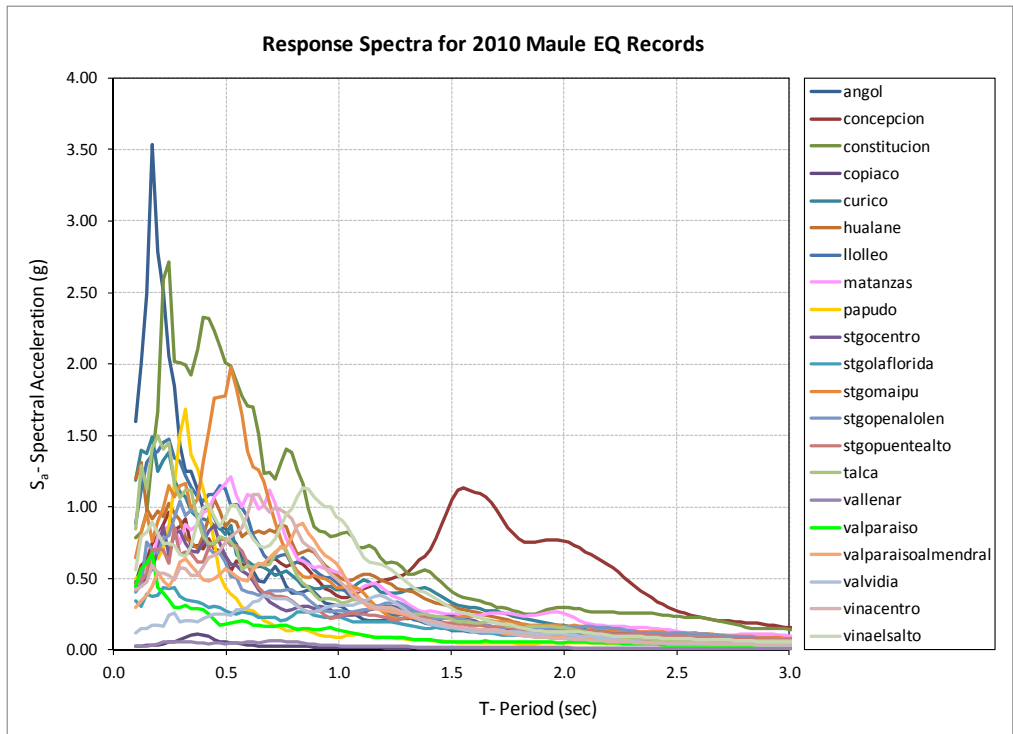

Figure 1-5 Acceleration response spectra from all recording stations (data from University of Chile, 2012).

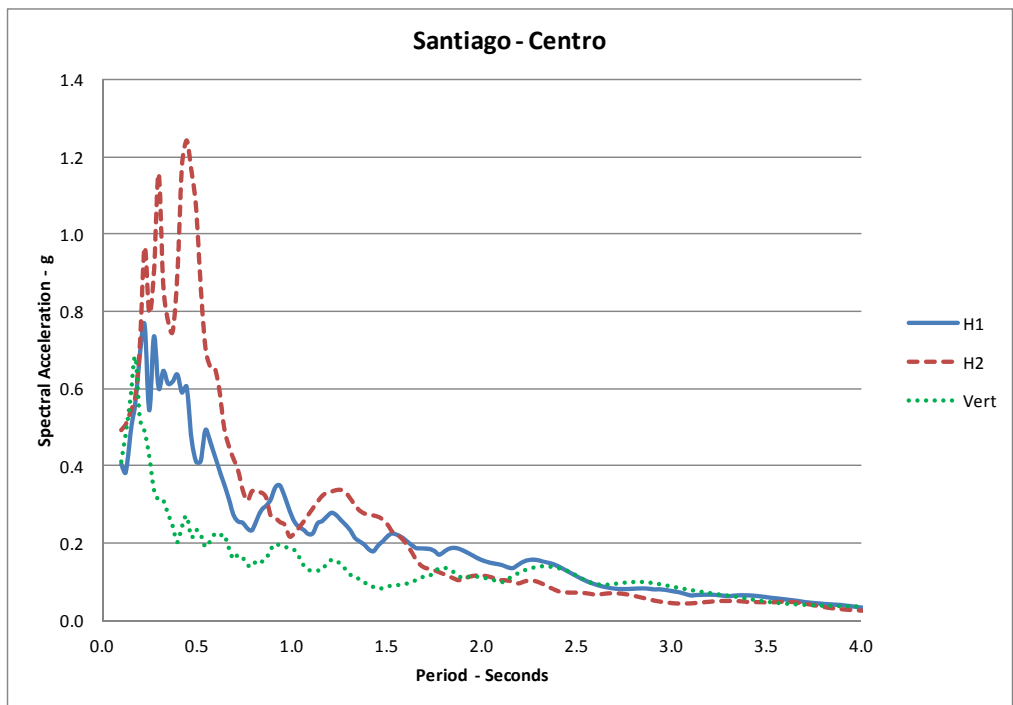

Figure 1-6 Acceleration response spectra from Santiago – Centro (data from University of Chile, 2012).

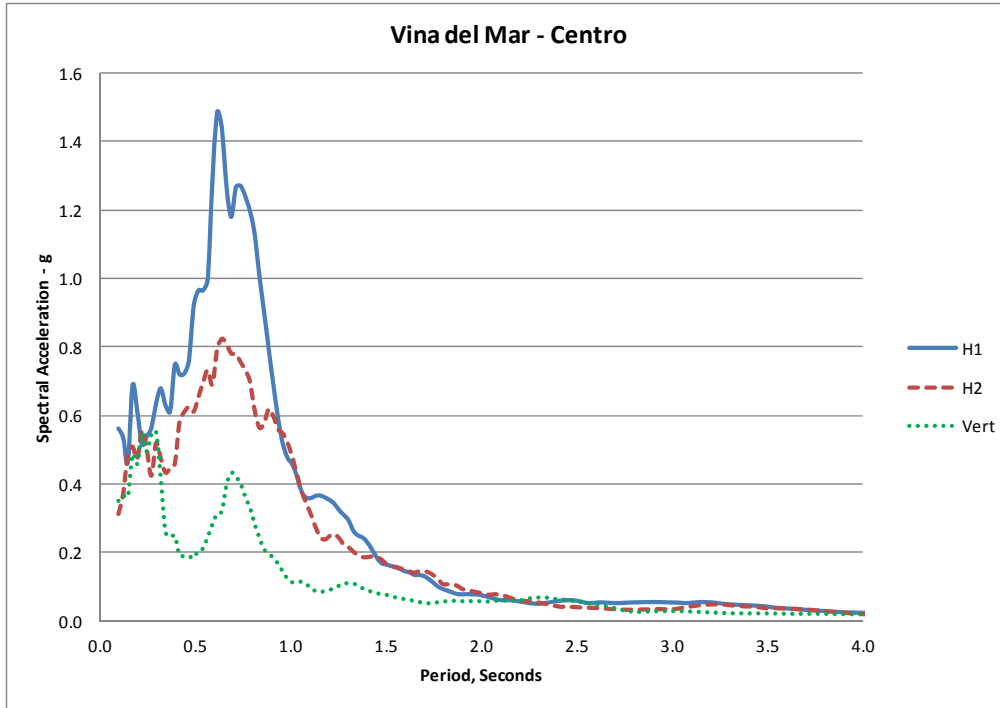

Figure 1-7 Acceleration response spectra from Viña del Mar – Centro (data from University of Chile, 2012).

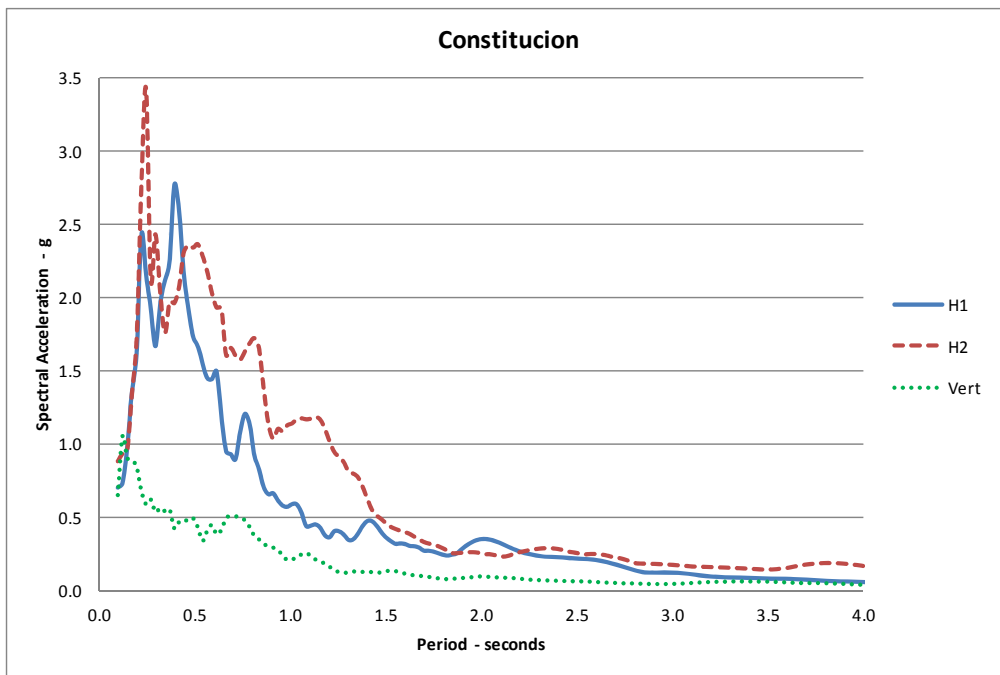

Figure 1-8 Acceleration response spectra from Constitución (data from University of Chile, 2012).

1.4 Report Organization and Content

This report summarizes building code requirements and design and construction practices in effect in Chile during the period 1985–2010, presents a similar summary for U.S. codes and practices, and documents the similarities and differences between the two.

Chapter 2 provides an overview of Chilean design practice during the period 1985–2010, reviews operative codes and standards and their detailed requirements, and discusses the typical configuration of mid-rise and high-rise concrete residential construction during this era.

Chapter 3 describes the evolution of U.S. seismic design provisions, provides an overview of past and present U.S. codes and design practice, and summarizes U.S. reinforced concrete design provisions that are not included in Chilean practice.

Chapter 4 presents a side-by-side comparison of design requirements in the United States and Chile, identifies similarities, and contrasts differences.

Chapter 5 compares design practice in the United States and Chile through a comparative evaluation considering both Chilean and U.S. design provisions applied to a typical Chilean building configuration and a similarly sized U.S. building configuration designed in accordance with U.S. practice.

2.1 Operative Codes

Building codes in Chile are developed and published by the Instituto Nacional de Normalización (National Standards Institute), or INN, which is the Chilean member organization of the International Organization for Standardization (ISO). INN publishes design criteria in the form of individual Normas (Standards). Two primary standards govern seismic-resistant design of reinforced concrete structures in Chile:

- NCh433 – *Earthquake Resistant Design of Buildings*
- NCh430 – *Reinforced Concrete Design and Analysis Requirements*

NCh433 encompasses requirements for calculating seismic loads for design of structures, comparable to Chapters 11 through 22 of ASCE/SEI 7, *Minimum Design Loads for Buildings and Other Structures*, in the United States. NCh430 sets the criteria for design and detailing of reinforced concrete structures, comparable to ACI 318, *Building Code Requirements for Structural Concrete*, in the United States.

2.1.1 NCh433 Loading Standard

Initial development of the NCh433 Chilean loading standard occurred in 1986 with the appointment of the Comité Coordinador de Normas Sismorresistentes (Committee on Standards for Seismic Resistance) by the INN. The initial document was submitted for public review in July 1989. After review and comment, it was adopted in 1993. Following publication as NCh433.Of93, INN established a series of working groups to review the use of the standard in practice, and to make recommendations for future updates. In 1996, a slightly modified version of the standard was published as NCh433.Of96, *Earthquake Resistant Design of Buildings* (INN, 1996), which was the version in effect at the time of the 2010 Maule earthquake.

NCh433.Of96 is closely related to seismic design requirements contained in various editions of the *Uniform Building Code*, which were used throughout the Western United States during the period 1988–2000. Both NCh433 and the *Uniform Building Code* of that era (ICBO, 1994) utilized seismic design requirements based on ATC 3-06, *Tentative Provisions for the Development of Seismic Regulations for Buildings* (ATC, 1978).

The requirements in NCh433.Of96 include a number of revisions to the procedures contained in the *Uniform Building Code* from which they were derived. Significant differences include:

- Adoption of seismic zonation maps particular to the seismic hazard in Chile.
- Adoption of site factors and spectral shapes appropriate to the characteristics of earthquake shaking associated with large magnitude subduction zone earthquakes.
- Specification of structural systems and corresponding design parameters appropriate to Chilean construction practices.

In the United States, the ATC 3-06 report served as the basis for seismic design provisions known as the *NEHRP Recommended Provisions for the Development of Seismic Regulations for New Buildings* (BSSC, 1985). Since their initial publication, the *NEHRP Provisions* have been further developed and continuously updated on a 3-year cycle. The *International Building Code* (ICC, 2000), successor to the *Uniform Building Code*, adopted seismic design criteria based on the 1997 edition of the *NEHRP Provisions* (BSSC, 1998), and beginning in 2006, adopted seismic design requirements by reference to ASCE/SEI 7-05, *Minimum Design Loads for Buildings and Other Structures* (ASCE, 2006). Important differences that have evolved between the seismic design provisions contained in the present *International Building Code* and those contained in the earlier *Uniform Building Code* include:

- Use of a revised definition of design earthquake shaking.
- Replacement of the concept of seismic zones with Seismic Design Categories based on consideration of site seismic hazard and building occupancy.
- Use of revised design parameters, including the response modification coefficient (R factor), the system overstrength factor (Ω_0), and deflection amplification factor (C_d).
- Addition of requirements to consider redundancy of the seismic force-resisting system in determining seismic loads.
- An expanded list of permissible structural systems.
- Specification of system detailing requirements independent of seismic zone.

Although the starting point was the same, the details of present seismic design loading requirements in each country have diverged as a result of the above-noted differences in the evolution and modification of *Uniform Building Code* requirements. NCh433 requirements are described in more detail in Section 2.3, contemporary U.S. requirements are described in Chapter 3, and similarities and differences are compared in Chapter 4.

2.1.2 NCh430 Concrete Design Standard

For many years, the Chilean standard for reinforced concrete was NCh429.Of1957, *Reinforced Concrete – Part I*, and NCh430.Of1961, *Reinforced Concrete – Part II*, based on the German standard, DIN 1045, *Concrete and Reinforced Concrete* (DIN, 1953). These provisions were not substantially changed for more than 20 years until 1983, when engineers selected ACI 318-83, *Building Code Requirements for Reinforced Concrete* (ACI, 1983) as the new Chilean standard for reinforced concrete design.

In 1993, after many years of unofficial use, the Chilean loading standard NCh433.Of93 formally adopted ACI 318-89 for the design of reinforced concrete structures. In 1996, the updated loading standard, NCh433.Of96, updated the reference to ACI 318-95 as the basis for reinforced concrete construction. Based on Chilean experience using ACI 318, it became apparent that additional modifications were necessary to better adapt the requirements to Chilean practice. These modifications are contained in NCh430.Of2008, *Reinforced Concrete Design and Analysis Requirements* (INN, 2008), which adopted ACI 318-05 as its fundamental basis, and annotated Chilean exceptions. This version was in effect for design of reinforced concrete structures at the time of the 2010 Maule earthquake.

Important exceptions to ACI 318-05 contained in NCh430.Of2008 include:

- Omission of requirements for confined boundary elements in reinforced concrete shear walls.
- Permissive use of the detailing requirements for Intermediate Moment Frames (ACI 318, Section 21.12) when primary lateral resistance is provided by walls with the strength to resist 75% of the specified seismic design forces, even in regions of high seismic risk in which special detailing criteria would typically apply.
- Replacement of references to ASTM material standards with appropriate references to Chilean Normas.
- Permissive use of concrete cubes rather than cylinders for testing concrete strength in production.
- Adoption of reduced cover requirements relative U.S. requirements for protection of reinforcement in various exposure conditions.
- Use of gross section properties, neglecting reinforcement, when calculating the distribution of internal forces within a structure, except in cases where P-delta stability effects are significant.
- Modification of load factors in load combinations, utilizing a factor of 1.4 on earthquake loads in lieu of 1.0, as specified in ACI 318.

- Modification of requirements for tension splices in reinforcement.

Reasons for these exceptions are based on differences in Chilean earthquake experience and evolution from historic practices. For example, concrete cubes are used for strength testing in lieu of concrete cylinders because Chilean practice evolved from European practices embodied in DIN 1045, which specified the use of cubes. When ACI 318 was adopted, Chile maintained this practice because Chilean testing agencies were familiar with the use of cubes. In recent years, concrete quality assurance testing for larger buildings has sometimes adopted the use of cylinders, as practiced in the United States.

The use of reduced concrete cover in Chile is also a result of historic precedent and practice embodied in DIN 1045. Past experience in Chile has resulted in few problems with corrosion of reinforcement in buildings, so when ACI 318 was adopted, historic cover requirements were maintained.

The permissive use of Intermediate Moment Frame detailing in buildings with primary lateral resistance provided by shear walls is based on judgment. Chilean engineers expect these buildings to be very stiff, that significant ductility demands on the frame elements in such systems will be unlikely, and that ductile detailing associated with Special Moment Frames will not be necessary.

Exclusion of provisions for confined boundary elements in reinforced concrete shear walls is a direct result of studies of buildings without confined boundaries that performed well in the 1985 earthquake. Investigations supporting this conclusion have been documented in reports by U.S. researchers, including Wood (1991) and Wood et al. (1987).

2.2 Typical Chilean Design Practice

Although building codes in the United States and Chile are similar, the typical configuration of structural systems in buildings of similar size and occupancy tend to be quite different. This can be attributed to several factors, including:

- The portion of the total construction cost associated with labor in Chile is significantly smaller than in the United States.
- Structural engineers in Chile are typically employed directly by the project developer, while structural engineers in the United States typically work as a subconsultant to the architect.
- Typical building configurations in use in Chile have generally provided good performance in past large-magnitude earthquakes.

The relatively low cost of construction labor relative to materials in Chile favors the use of distributed structural systems in which many elements provide lateral resistance. In contrast, the relatively high cost of labor in the United States drives

engineers towards designs that minimize the number of elements, reducing the amount of redundancy provided in structural systems. In Chile, buildings are typically designed using shorter spans, more vertical load resisting elements, and smaller structural elements with lighter reinforcement than comparable buildings in the United States.

Low-rise construction has traditionally consisted of masonry or concrete bearing wall buildings with relatively short spans and many walls. As building practices evolved, and mid-rise and high-rise construction became more prevalent, engineers continued these same practices, employing relatively short spans in floor systems and providing many load-bearing walls for both gravity and seismic force resistance. As a rule of thumb, Chilean engineers generally knew that they needed to provide shear walls with a cross sectional area equal to approximately 1% of the gross floor area above the first story. Based on past experience, they believed that special ductile detailing of these walls was not necessary. Building performance in past earthquakes, including events in 1971 and 1985, generally confirmed that these practices provided good performance.

The direct reporting relationship between the structural engineer and the developer gives Chilean engineers the ability to advocate sound structural design practice and caution against the risks associated with compromising structural design for the sake of architectural appearance. This relationship has contributed to the ongoing ability of Chilean engineers to produce designs with distributed seismic force-resisting elements and high levels of redundancy. This practice is in stark contrast to U.S. practice in which many engineers feel constrained in their ability to influence architectural design to accommodate favorable structural configurations. Even under this advantageous teaming relationship, however, Chilean engineers have reported that pressure to reduce system redundancy and consider more irregular configurations is increasing.

Typical Chilean mid-rise and high-rise construction favors reinforced concrete bearing wall construction. Concrete strengths typically range from 20 MPa (3 ksi) to 30 MPa (4.5 ksi). Reinforcing steel typically conforms to grade A630-420H in NCh204, *Reinforcing Steel – Hot-Rolled Rebar for Reinforced Concrete* (INN, 2006), with a yield strength of 420 MPa (60 ksi) and ultimate strength of 630 MPa (90 ksi).

Mid-rise and high-rise building configurations are mostly rectangular in plan, though more inventive forms can be found. High-rise construction often has extensive glazing with few exterior walls. Setbacks in building elevation occur, but are relatively rare. Photos of typical mid-rise and high-rise construction in Santiago and Viña del Mar are shown in Figure 2-1 and Figure 2-2, respectively.



Figure 2-1 Typical mid-rise and high-rise buildings in Santiago (photo courtesy of Rene Lagos).



Figure 2-2 Typical mid-rise and high-rise buildings in Viña del Mar (photo courtesy of ASCE).

A sample floor plan for a typical Chilean high-rise residential building is shown in Figure 2-3. A cross-section of a typical mid-rise Chilean residential building is shown in Figure 2-4.

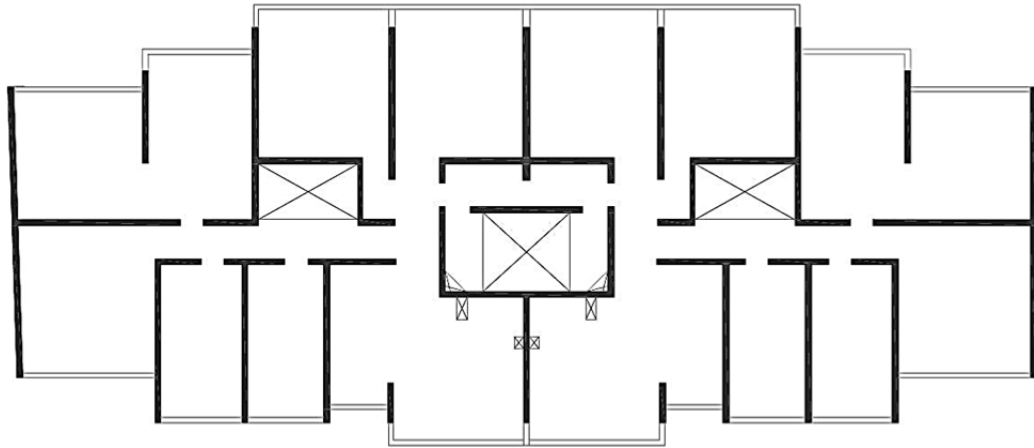

Figure 2-3 Typical floor plan of high-rise residential building in Chile (courtesy of Rene Lagos).

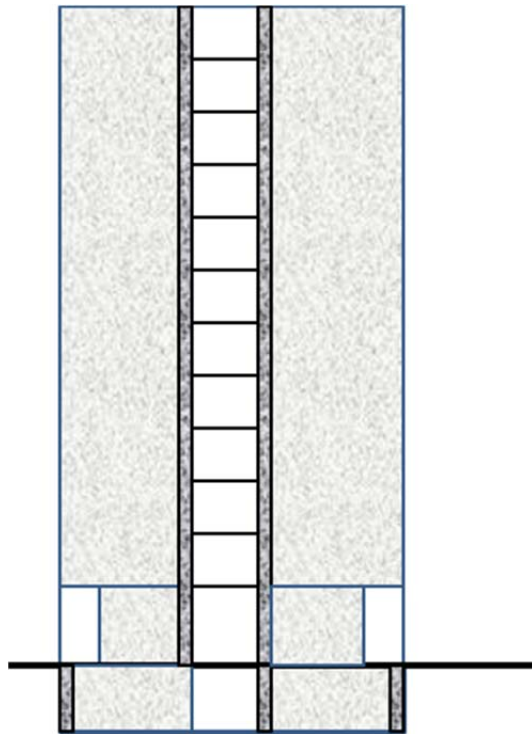

Figure 2-4 Typical cross-section of mid-rise residential building in Chile.

In residential construction, most interior walls are reinforced concrete structural walls. Typically these include corridor walls, party walls between individual units, and walls around stair and elevator cores. In larger units, walls between individual rooms can also be structural concrete. Structural walls tend to be 20 cm (8 inches) to 30 cm (12 inches) thick with two curtains of reinforcing steel. Nonstructural walls, where they exist, can be constructed of masonry or metal studs with plaster finishes.

Floors typically consist of flat slab construction with spans on the order of 6 to 8 meters. Floor heights are typically on the order of 3 meters or less. Doorways in structural walls occupy most of the story height leaving little room for coupling beams. Typically, a shallow lintel with nominal reinforcement spans over such doorways, as shown in Figure 2-5.



Figure 2-5 Shallow lintel showing nominal reinforcement and lack of confinement in a residential building that was damaged in the 2010 Maule earthquake (photo courtesy of ASCE).

Walls are typically reinforced with two curtains of small diameter bars (10 to 14 mm) arranged at uniform vertical and horizontal spacing. Engineers cluster larger diameter bars ranging from 20 mm (No. 7) to 32 mm (No. 11) at the ends of walls to resist computed flexural demands. Horizontal bars typically terminate with a 90° hook around the outer layer of boundary bars, as shown in Figure 2-6. In the 2010 Maule earthquake, this detailing practice resulted in the damage shown in Figure 2-7.

Although unconfined boundary elements are permitted in NCh430, not all Chilean engineers have universally implemented this in practice. Some engineers report that partial confinement of boundary zones is routinely provided using cross ties with alternating 90° and 135° hooks on every other vertical bar, as illustrated in Figure 2-8. The area of cross ties provided is generally not sufficient to fully satisfy ACI 318 criteria for confinement, but it is reported that buildings incorporating this type of detailing did not experience the type of damage shown in Figure 2-7.

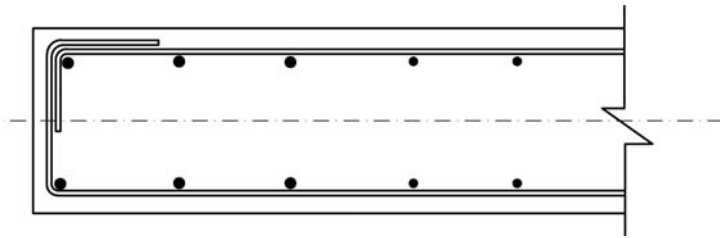

Figure 2-6 Typical unconfined shear wall boundary zone detail permitted in NCh430.



Figure 2-7 Damage to typical unconfined shear wall boundary zone observed in the 2010 Maule earthquake (photo courtesy of ASCE).

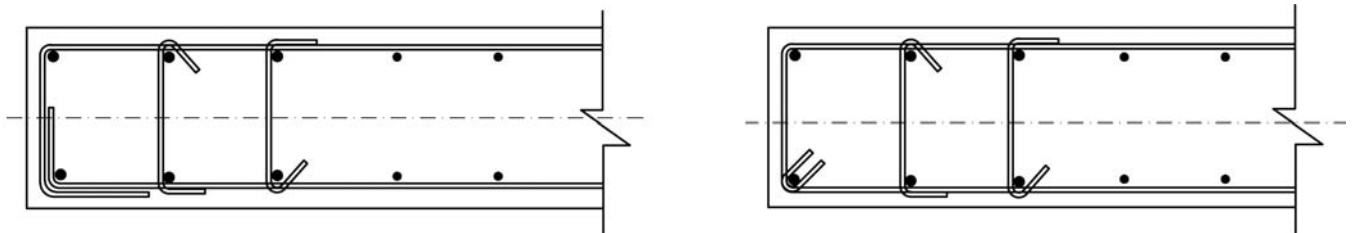

Figure 2-8 Typical partially confined shear wall boundary zone details used by some Chilean engineers.

Office buildings utilize similar construction, but generally have fewer structural walls than residential buildings. A typical floor plate for a high-rise office building is shown in Figure 2-9. Typical office construction comprises post-tensioned flat plate floors with spans of 8 to 10 meters (26 to 32 feet) and thicknesses varying from 17 to 20 cm (6-1/2 to 8 inches). Lateral resistance is provided by a dual system comprising concrete bearing walls around the central core and moment-resisting frames at the building perimeter.

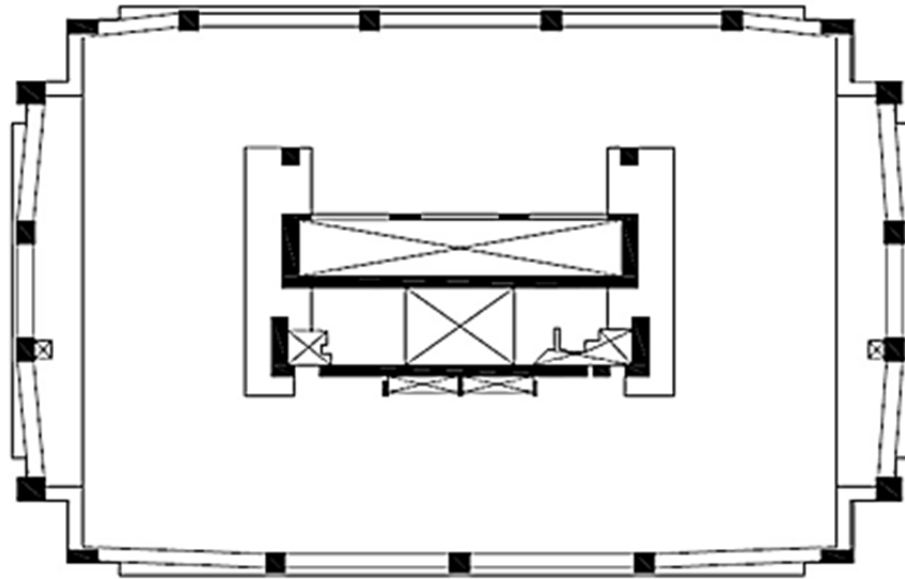

Figure 2-9 Typical floor plan of high-rise office building in Chile (courtesy of Rene Lagos).

Design practice for office buildings in Chile is highly automated. Seismic forces are determined using response spectrum analysis, and engineers typically use software such as ETABS, *Extended Three Dimensional Analysis of Building Systems* (Computers and Structures, Inc.), SAP2000, *Integrated Software for Structural Analysis and Design* (Computers and Structures, Inc.), or other similar software to model and design these structures. Analytical models typically employ fixed-base assumptions and utilize gross section properties. Contrary to U.S. practice, structural models typically include all structural elements, rather than just those comprising the seismic force-resisting system. Some engineers pay special attention and provide additional reinforcement in areas of irregularity and complex force transfer, however, this practice is not explicitly required by the code and is not reported to be universal.

2.2.1 Seismic Design of Nonstructural Components

Although NCh433 contains provisions for seismic design of nonstructural components including partitions, ceilings, and HVAC equipment, relatively little attention is given to this aspect of design in Chilean practice. This is, in part, because

structural engineers have not perceived that design of bracing and anchorage for nonstructural components is within their provenance. Other design professionals are not familiar enough with seismic design requirements to be concerned about bracing and anchorage of nonstructural components, and therefore, this aspect of seismic design has been frequently neglected.

2.3 Chilean Design Criteria

2.3.1 Seismic Zonation

Similar to the system used under the *Uniform Building Code* in the United States, NCh433 uses seismic zonation to establish design shaking intensities. Seismic zonation maps depict three seismic zones designating three levels of maximum effective soil acceleration, A_0 (peak ground acceleration). Zone 3 represents the highest design shaking intensity, with maximum effective soil acceleration, $A_0 = 0.4$ g. Zone 2 represents a more moderate shaking intensity, with $A_0 = 0.3$ g. Zone 1 represents the lowest design shaking intensity, with $A_0 = 0.2$ g.

Figure 2-10 shows the seismic zonation maps contained in NCh433. Zone 3 encompasses the coastal region, Zone 2 generally encompasses the central plain, and Zone 1 encompasses the eastern portion of the country along the western flank of the Andes.

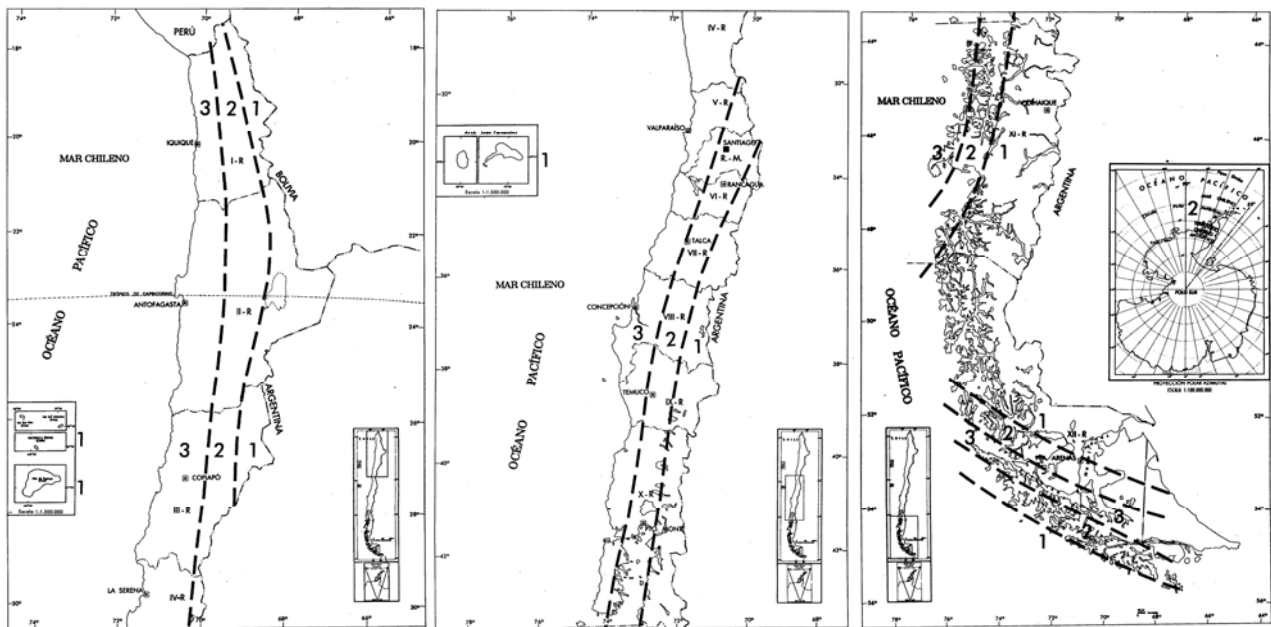

Figure 2-10 Seismic zonation maps for northern, central, and southern Chile contained in NCh433 (INN, 1996).

2.3.2 Site Class

NCh433 accounts for site effects on ground shaking intensity through assignment of spectral modification coefficients based on soil type (site class). Four soil types are defined:

- **Soil Type I.** Sites with near-surface rock having shear wave velocities of 900 m/s or greater, or uniaxial compressive strengths of 10 MPa and a fracture measure indicative of competent material defined by a specified maximum value of fracture lengths within a standard specimen. Rock is considered near-surface if the top of the rock is within 20 m of the surface with an overburden of firm soil, or within 10 m of the surface with an overburden of soil that is not considered firm.
- **Soil Type II.** Firm soil sites including: (a) soils with shear wave velocities of 400 m/s or greater in the upper 10 m; (b) dense gravel with a unit weight equal to or greater than 20 kN/m^3 , more than 95% of maximum compaction determined by the Modified Proctor Compaction Test, or relative density of 75% or more; (c) dense sand with a relative density greater than 75%, a penetration resistance index, N , of 40 or greater, or more than 95% of maximum compaction determined by the Modified Proctor Compaction Test; or (d) stiff cohesive soils with undrained shear strength equal to or greater than 0.10 MPa (compressive strength equal to or greater than 0.20 MPa), in specimens without fissures.
- **Soil Type III.** Soil sites including: (a) unsaturated sand with relative densities between 50% and 75%, a penetration resistance index, N , of more than 20; (b) unsaturated gravel or sand with compaction less than 95% of maximum determined by the Modified Proctor Compaction Test; (c) cohesive soils with undrained shear strength in the range of 0.025 MPa to 0.10 MPa; or (d) saturated sands with penetration resistance index, N , in the range of 20 to 40.
- **Soil Type IV.** Saturated cohesive soils with undrained shear strength equal to or less than 0.025 MPa (compressive strength equal to or less than 0.050 MPa).

Chilean engineers report that although site class descriptions include ranges of shear wave velocity, this parameter is seldom actually used in determining site class. More commonly, blow count, Modified Proctor Compaction, and shear strength are used. In some cases, a less formal system has been used in which sites with near surface rock are designated as Site Class I; those with gravel are designated as Site Class II; and those with sand are designated as Site Class III. It is reported that some structures on sandy soils classified in this manner did not perform well, and more rigorous consideration of the classification of soil is now under consideration.

Spectral shape factors are specified for each of these site classes. Liquefiable soils and soils subject to seismic-induced collapse require special study to determine site response and spectral characteristics.

2.3.3 *Occupancy Categories*

NCh433 considers occupancy in the determination of seismic design forces. Four building occupancy categories are defined based on importance, occupancy, and failure risk:

- **Category A.** Buildings intended to remain in operation following earthquakes, such as government buildings, police stations, power plants, and telephone switch centers.
- **Category B.** Buildings housing high-value contents, such as museums; high-occupancy buildings, including stadiums housing more than 2000 persons, or single rooms housing assemblies of 100 or more; schools and nurseries; prisons; and large retail stores or complexes.
- **Category C.** Ordinary buildings not classified as A or B.
- **Category D.** Buildings not normally used for human habitation.

Seismic design forces for Category A and Category B buildings are taken as 120% of the forces for category C (ordinary) buildings, while design forces for Category D buildings are taken as 60% of those for Category C (ordinary) buildings.

2.3.4 *Load Combinations*

Separate series of Allowable Stress Design (ASD) and Load and Resistance Factor Design (LRFD) load combinations are specified. ASD combinations include:

$$D + L \pm E$$
$$D \pm E$$

where D is defined as permanent load (dead load in the United States); L is live load; and, E is the load due to horizontal earthquake shaking. A 33.3% increase in allowable stresses is permitted for ASD load combinations including seismic loading. LRFD combinations include:

$$1.4(D + L \pm E)$$
$$0.9D \pm 1.4E$$

where all terms are as previously defined.

2.3.5 *Structural Systems*

NCh433 recognizes three general types of seismic force-resisting systems:

- Shear wall and other braced systems

- Moment-resisting space frame systems
- Dual systems containing a combination of the above two systems

These systems are further classified according to the material of construction. Structural response modification factors, designated as R or R_0 , are assigned based on system type and used to determine the design base shear.

2.3.6 Analysis Procedures

NCh433 recognizes two analytical procedures for determining seismic design forces: a static procedure and a modal response spectrum procedure. The modal response spectrum procedure can be used in the design of any building. The static analysis procedure is limited to the following applications:

- Ordinary structures (Category C), or uninhabited structures (Category D), located in Seismic Zone 1.
- Structures not exceeding 5 stories or 20 m in height.
- Structures with heights between 6 and 15 stories that meet certain measures of regularity. For these structures, the design base shear cannot be taken as less than the minimum base shear permissible for modal analysis.

Although the static analysis procedure is permitted for some buildings as tall as 15 stories, it is never actually used for such structures. Instead, the modal response spectrum procedure is typically used for design of structures of significant size.

Regardless of analysis procedure, seismic forces are required to be distributed to the various seismic force-resisting elements using a three-dimensional model having two translational and one rotational degree of freedom at each level. Buildings must be analyzed for seismic forces applied in each of two, approximately orthogonal directions.

Cantilevered elements including marquees, balconies, and similar elements must be designed for an effective vertical earthquake force equal to 30% of the dead and live loads. This is accomplished by simply increasing the design dead and live loads by 30% for these elements.

The permissible story drift ratio in each direction, measured at the center of mass of the floor plate, cannot exceed 0.002. At any point on the diaphragm, the story drift ratio cannot exceed the value at the center of mass by more than 0.001.

2.3.7 Static Analysis

The total seismic base shear in each direction, Q_0 , is determined from the formula:

$$Q_0 = CIP \quad (\text{NCh433 Eq. 6-1})$$

where, C is the seismic (base shear) coefficient; I , is an occupancy importance factor taken as 1.2 for Categories A and B, 1.0 for Category C, and 0.6 for Category D; and P is the effective seismic weight of the building above the base, taken as the weight of permanent elements plus a specified fraction of live loads, except roof live load. For typical public and private buildings, 25% of the specified live load is used in computing the seismic weight. In storage occupancies at least 50% of specified live load must be included in the seismic weight.

The seismic coefficient, C , is obtained from the equation:

$$C = \frac{2.75 A_0}{gR} \left(\frac{T'}{T^*} \right)^n \quad (\text{NCh433 Eq. 6-2})$$

where A_0 is the maximum effective soil acceleration determined by seismic zone; g is the acceleration due to gravity; R is a system-dependent structural response modification coefficient; T' is a characteristic site period that depends on soil type, T^* is the period of the mode with the highest translational mass participation in the direction under consideration; and n is a coefficient dependent on soil type.

For linear static analysis, values of the response modification coefficient, R , range from 7, for moment-resisting frames and certain shear wall and braced frame systems, to 2 for undefined systems. The value of T' varies from 0.2 seconds on rock (Class I) sites to 1.35 seconds on saturated clay sites. The exponent n varies from a value of 1.0 on rock sites to a value of 1.8 on saturated clay sites.

The value of C cannot be taken less than $A_0/6g$, and need not be taken greater than a maximum value, correlated with the value of R , listed in Table 2-1 below. Figure 2-11 plots the variation in the base shear coefficient, C , for ductile a structure with a response modification coefficient $R = 7$, in Zone 3, for varying structural period T^* , and for each of the four defined soil types (site classes).

Table 2-1 Maximum Values of Seismic Coefficient, C_{max} , based on R (from NCh433 Table 6.4)

Response Modification Coefficient, R	Maximum Seismic Coefficient, C_{max}
2	$0.90 A_0/g$
3	$0.60 A_0/g$
4	$0.55 A_0/g$
5.5	$0.40 A_0/g$
6	$0.35 A_0/g$
7	$0.35 A_0/g$

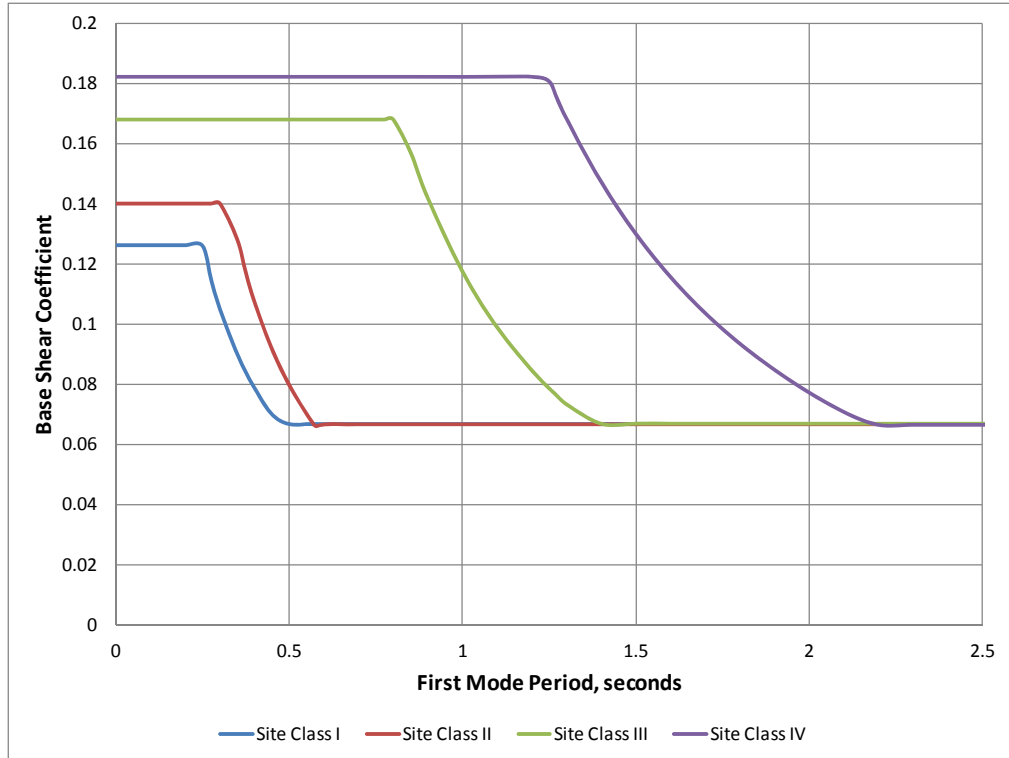

Figure 2-11 Variation in seismic coefficient, C , as a function of period, T^* , in Zone 3, assuming $R=7$.

NCh433 permits an additional reduction in required seismic design forces for buildings with seismic force-resisting systems consisting of either reinforced concrete walls, reinforced concrete walls in combination with frames, or reinforced concrete walls in combination with reinforced masonry walls. For such structures, the base shear coefficient, C , is permitted to be reduced by the factor, f , given by:

$$f = 1.25 - 0.5q \quad (\text{NCh433 Eq. 6-3})$$

where q is the smallest fraction of the total shear resisted by the reinforced concrete walls in the lower half of the building, in both directions of analysis. The value of q cannot be taken less than 0.5 nor greater than 1.0. For typical buildings composed entirely of reinforced concrete walls, the maximum base shear coefficient is reduced by NCh433 Eq. 6-3 to 75% of that shown in Table 2-1. In the case of one-story buildings with a rigid diaphragm at the roof, a reduced seismic force coefficient equal to 80% of the value determined by NCh433 Eq. 6-2 is specified.

For multi-story structures, 5 stories or less in height, the base shear force obtained from NCh433 Equation 6-1 is distributed vertically to each diaphragm level by the equation:

$$F_k = \frac{A_k P_k}{\sum A_j P_j} Q_0 \quad (\text{NCh433 Eq. 6-4})$$

where, Q_0 is the total base shear force, P_k and P_j are the effective seismic weight at levels k and j , respectively, and the coefficients A_k and A_j are defined by the equation:

$$A_k = \sqrt{1 - \frac{Z_{k-1}}{H}} - \sqrt{1 - \frac{Z_k}{H}} \quad (\text{NCh433 Eq. 6-5})$$

where Z_k and Z_{k-1} are the height of levels k and $k-1$ above grade, respectively, and H is the total height of the structure above grade.

For structures more than 5 stories, but less than 16 stories in height, NCh433 Equation 6-5, or other rational procedures, are used to distribute forces vertically within the structure. Figure 2-12 illustrates the resulting story force distribution using this formula on a hypothetical 10-story structure.

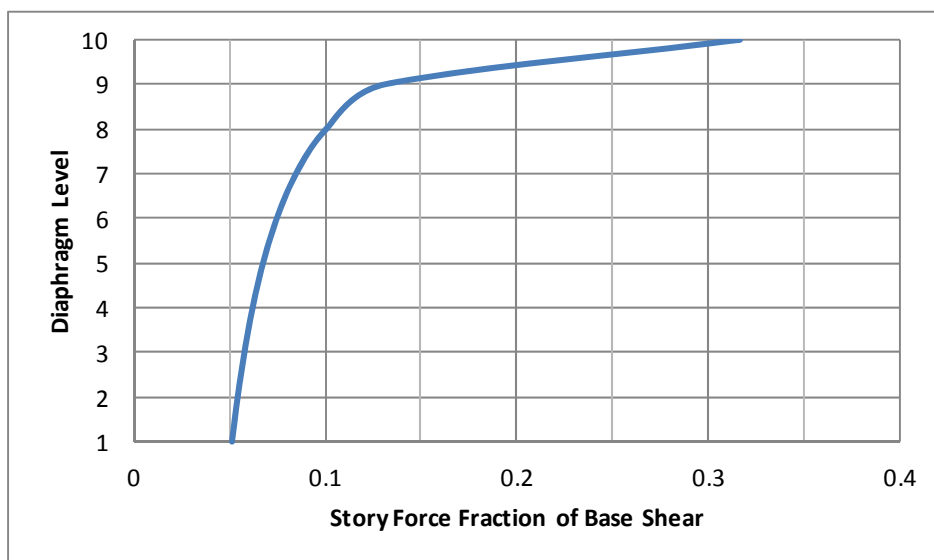

Figure 2-12 Story force distribution as a fraction of base shear, for a hypothetical 10-story structure.

In addition to the story forces obtained from NCh433 Equation 6-4, structures must be designed for the effects of an accidental torsional moment, applied at each story, calculated as the static force F_k at each story factored by an accidental eccentricity obtained from the expression $\pm 0.1b_k Z_k / H$, where b_k is the largest dimension of the structure at level k , perpendicular to the direction of analysis, and other terms are as previously defined. Two cases must be considered, one in which the accidental torsional moment is applied in a positive sense, and one in which the torsional moment is applied in a negative sense. For structures with limited torsional displacement under load, these torsional moments can be neglected.

2.3.8 Modal Response Spectrum Analysis

Modal response spectrum analysis must include sufficient natural modes such that at least 90% of the total mass of the structure is captured in each of the two horizontal

directions, and at least 90% of the torsional inertia of the structure is captured. The effects of accidental torsion must be considered either by displacing the center of mass at each level an amount equal to 5% of the diaphragm dimension in the direction perpendicular to the analysis, or by applying an accidental torsional moment at each level, obtained as the product of the incremental story shear obtained from the analysis and the accidental torsional eccentricity specified for static analysis. As in the case of static analysis, two cases of accidental torsion must be considered in response spectrum analysis, one with positive eccentricity, and one with negative eccentricity.

The design acceleration response spectrum is defined by the equation:

$$S_a(T) = \frac{IA_0\alpha}{R^*} \quad (\text{NCh433 Eq. 6-8})$$

where I is the occupancy importance factor as defined for static analysis; A_0 is the maximum effective soil acceleration determined by seismic zone; α is a modal response coefficient; and R^* is a system-, period-, and site-dependent response modification coefficient for response spectrum analysis.

The modal response coefficient α is obtained for each mode from the equation:

$$\alpha = \frac{1 + 4.5 \left(\frac{T_n}{T_o} \right)^p}{1 + \left(\frac{T_n}{T_o} \right)^3} \quad (\text{NCh433 Eq. 6-9})$$

where T_n is the period associated with mode n ; and T_o and p are parameters associated with soil type. Figure 2-13 plots response spectra derived using NCh433 Equation 6-8, for each of the four soil types, in Zone 3, with values of the occupancy importance factor, I , and response modification coefficient, R^* , taken as unity.

The period-dependent response modification coefficient is obtained from the equation:

$$R^* = 1 + \frac{T^*}{0.1T_0 + \frac{T^*}{R_0}} \quad (\text{NCh433 Eq. 6-10})$$

where T^* is the period of the mode with the highest translational mass participation in the direction under consideration; R_0 is a system-dependent response modification coefficient varying from 11 for the most ductile systems, such as reinforced concrete wall and moment-resisting frame buildings, to 3 for the least ductile systems, such as partially grouted reinforced masonry wall buildings. The equation for R^* is evaluated using the fundamental period of the building along each of two orthogonal axes.

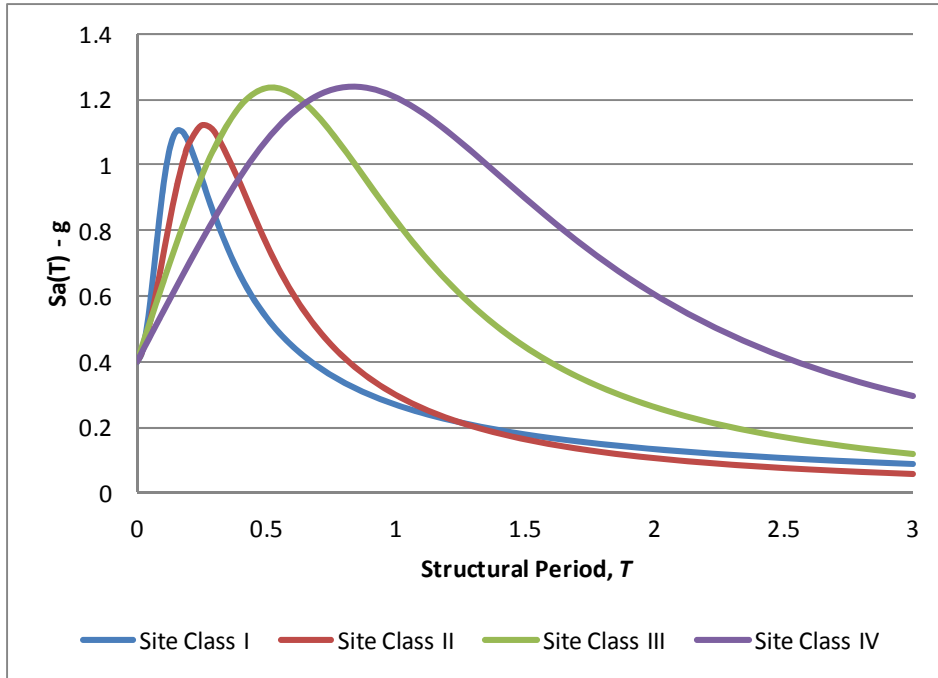

Figure 2-13 Acceleration response spectra in Zone 3, with R^* and importance factor, I , taken as unity.

Figure 2-14 shows the value of R^* derived from NCh433 Equation 6-10 as a function of structural period T^* and site class, for ductile structures with a specified value of $R_0 = 11$.

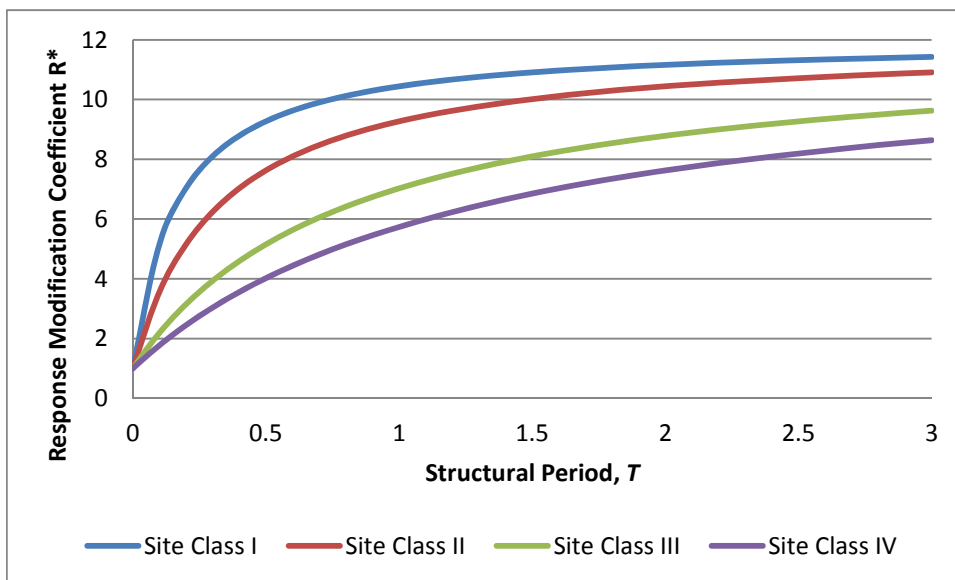

Figure 2-14 Variation in response modification coefficient, R^* , as a function of site class and structural period, using NCh433 Equation 6-10, assuming $R_0=11$.

For shear wall buildings, the response modification factor can be computed using the alternative formula:

$$R^* = 1 + \frac{NR_0}{4T_0R_0 + N} \quad (\text{NCh433 Eq. 6-11})$$

where N is the total number of stories, and all other terms are as previously defined. Figure 2-15 shows the value of R^* derived from NCh433 Equation 6-11, as a function of the number of stories, N , and site class, for ductile structures with a specified value of $R_0 = 11$.

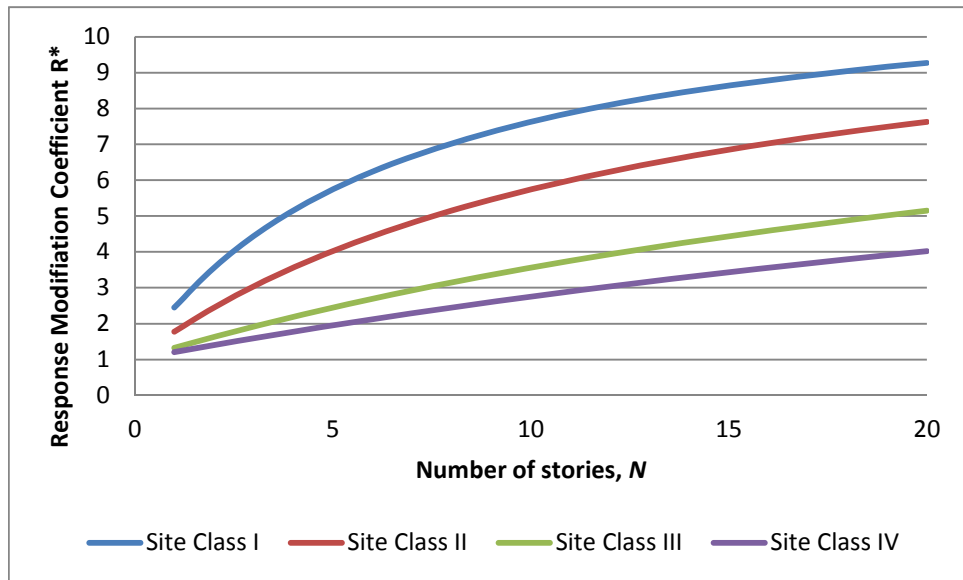

Figure 2-15 Variation in response modification coefficient, R^* , as a function of site class and number of stories, N , using NCh433 Equation 6-11, assuming $R_0 = 11$.

Modal combinations in the response spectrum analysis procedure are performed using either the complete quadratic combination (CQC) method, or an alternative method that considers the effects of soil impedance. The resulting base shear obtained from the combined modal response must not be less than $IA_0P/6g$, which is similar to the requirement for the static analysis procedure. Similarly, the base shear coefficient obtained from modal response spectrum analysis need not exceed the maximum base shear coefficient specified for the static analysis procedure.

The minimum base shear, $IA_0P/6g$, for ordinary (Category C) structures in Zone 3 has a value of $0.067P$. In practice, this controls the design for most buildings. Rather than scale the results of response spectrum analysis to this base shear level, Chilean engineers have adopted a practice of running an initial response spectrum analysis without response modification coefficients, and then determining the value of R^* necessary to achieve the minimum permissible base shear, which is nearly always less than the value permitted by NCh433 Equation 6-10 or Equation 6-11. Once this effective value of R^* is determined, the response spectrum is factored by this value, and the analysis is re-run to produce design-level forces.

3.1 Evolution of U.S. Seismic Design Codes

In the United States, building codes are locally developed and adopted at either the City, County, or State level. Almost all such agencies base their locally adopted codes on one of several model building codes, generally developed by non-profit professional associations of building officials, fire marshals and allied professionals. For many years, most building regulation in the United States was based on one of three different model codes: the *National Building Code* (NBC), developed by the Building Officials and Code Administrators International (BOCA), the *Standard Building Code* (SBC), developed by the Southern Building Code Congress International (SBCCI), and the *Uniform Building Code* (UBC), developed by the International Conference of Building Officials (ICBO). In general, local governments in the Northeast and Central United States tended to use the NBC; the Southeast tended to use the SBC; and the Western United States tended to use the UBC. Each of these model codes was traditionally published on a three-year cycle.

Although these codes were generally quite similar, a regional focus caused each to be the technical leader in areas of practice that were important in each region. The NBC, which served the major urban centers of the Eastern United States, was known for progressive criteria on fire and life safety issues; the SBC, which served the hurricane-prone Southeastern United States, was known for leadership in wind engineering; and the UBC, which served the seismically active Western United States, was known for leadership in seismic design criteria. Provisions developed by one model code agency in an area of leadership were often adopted by the other model codes in later editions.

The UBC was a self-contained code that included loading criteria as well as material design and detailing requirements for concrete, masonry, timber, and steel construction. Material design requirements were generally based on design standards published by industry associations, including the American Concrete Institute, American Institute of Steel Construction, National Forest Products Association and The Masonry Society, but were often substantially modified in the course of their adoption. Seismic design requirements contained in the UBC were primarily developed by the Seismology Committee of the Structural Engineers Association of California (SEAOC), a volunteer professional group that drafted both recommended code provisions and commentary that were submitted to the International Conference of Building Officials for adoption.

In 1971, the San Fernando earthquake near Los Angeles, California, resulted in severe damage to modern, code-conforming buildings. In response to this unanticipated damage, extensive study was undertaken to develop improved seismic design criteria. This effort resulted in the publication of ATC 3-06, *Tentative Provisions for the Development of Seismic Regulations for Buildings* (ATC, 1978), which became the basis for modern seismic design provisions in the United States.

In the mid-1980s, the SEAOC Seismology Committee revised the seismic provisions of the UBC based on the ATC 3-06 report, and the changes were implemented in the 1988 edition of the UBC. Although the ATC 3-06 recommendations were largely incorporated, the 1988 UBC included two major deviations:

- Rather than basing seismic design forces on ground motion contour maps that portrayed the risk of strong ground shaking in terms of an effective peak ground acceleration, C_a , and an effective velocity-related acceleration C_v , from which a design response spectrum could be constructed, the 1988 UBC continued to base seismic design forces on a series of four seismic zones. Each seismic zone was associated with a single value of maximum anticipated effective peak ground acceleration, which was presumed to be broadly applicable within the zone. Rules were provided to convert this effective peak ground acceleration into design spectra based on site soil conditions.
- Rather than utilizing a strength formulation, in which the required design seismic forces were associated with the onset of first major yielding in response to design ground motions, the 1988 UBC continued the use of an allowable stress design (ASD) formulation. Specified ASD forces were set at 0.7 times the strength level forces contained in ATC 3-06 (i.e., strength level forces divided by 1.4).

At about the same time, with funding provided by the Federal Emergency Management Agency (FEMA) under the National Earthquake Hazards Reduction Program, the National Institute of Building Sciences formed the Building Seismic Safety Council (BSSC). BSSC was charged with developing a series of recommended seismic design provisions based on the ATC 3-06 report. First published in 1985, the *NEHRP Recommended Provisions for the Development of Seismic Regulations for New Buildings* (BSSC, 1985) were more consistent with the recommendations contained in the original ATC 3-06 report. Since that time, the *NEHRP Provisions* have been further developed and continuously updated on a 3-year cycle by the BSSC Provisions Update Committee, a volunteer group of professional engineers, researchers, and industry representatives.

In 1992, the *NEHRP Provisions* were first adopted into building codes when the 1991 edition was transcribed into both the NBC and SBC. Then, in 1998, the American Society of Civil Engineers (ASCE) adopted the 1994 edition of the *NEHRP*

Provisions into its ASCE 7-98 Standard for *Minimum Design Loads for Buildings and Other Structures* (ASCE, 2000).

In the late 1990s, the three model code organizations (BOCA, SBCCI, and ICBO) merged into a single entity, entitled the International Code Council (ICC). The purpose of the ICC was to publish a single, nationally applicable model building code. The first edition of the *International Building Code* (ICC, 2000) adopted seismic design criteria based on the 1997 edition of the *NEHRP Recommended Provisions for Seismic Regulations for New Buildings and Other Structures* (BSSC, 1998). Subsequent editions of the IBC have been published on a 3-year cycle including the 2003, 2006, 2009, and most recently, the 2012 editions. Beginning in 2006, the IBC adopted seismic design requirements by reference to ASCE/SEI 7-05, *Minimum Design Loads for Buildings and Other Structures* (ASCE, 2006).

3.2 Operative Codes

By 2010, most local governments in the United States had adopted an edition of the IBC, with the 2006 edition being the most commonly adopted and enforced edition. There are, however, some U.S. communities that still use and enforce codes based on editions of the NBC, SBC or UBC legacy codes.

In this report, the requirements of the 2006 *International Building Code* (ICC, 2006) are taken as the predominant building code provisions governing design practice in the United States. Unlike predecessor model codes, the IBC is not a self-contained code. Instead, the IBC adopts structural design criteria through reference to a series of national consensus standards. The two standards most relevant to the design and construction of reinforced concrete structures are:

- ASCE/SEI 7 – *Minimum Design Loads for Buildings and Other Structures*
- ACI 318 – *Building Code Requirements for Structural Concrete*

3.2.1 ASCE 7 Loading Standard

The ASCE/SEI 7 Standard for *Minimum Design Loads for Buildings and Other Structures* specifies loads, load combinations, and seismic design requirements for structural systems and nonstructural components. Currently published on a 5-year cycle, the most recent editions are ASCE/SEI 7-05 (ASCE, 2006), and ASCE/SEI 7-10 (ASCE, 2010). With the exception of subtle, but important differences in the computation of design ground motion values, the two versions of the standard are very similar. The 2006 IBC and 2009 IBC refer to ASCE/SEI 7-05, while the 2012 IBC refers to ASCE/SEI 7-10. This report focuses on ASCE/SEI 7-10 requirements as the most current practice for specification of seismic design loading in the United States.

3.2.2 ACI 318 Concrete Design Standard

ACI 318 *Building Code Requirements for Structural Concrete* specifies requirements for design, detailing, and construction of reinforced concrete structures. Currently published on a 3-year cycle, recent editions include ACI 318-05 (ACI, 2005), ACI 318-08 (ACI, 2008), and most recently, ACI 318-11 (ACI, 2011). The 2006 IBC refers to ACI 318-05 and the 2009 IBC refers to ACI 318-08. Differences between the three latest editions of ACI 318 are subtle with regard to seismic design.

Since much of Chilean practice is based on ACI 318-05, basic reinforced concrete design and detailing criteria are not described herein. This report focuses on ACI 318-05 provisions governing design of reinforced concrete shear walls, and discussion is limited to requirements, such as confinement of boundary zones in concrete walls, which are specifically exempted in Chilean practice.

3.3 Typical U.S. Design Practice

The United States encompasses a broad range of seismic environments, from regions with essentially no seismic risk to regions of very high risk. Seismic design criteria specified in U.S. codes and standards vary widely depending on the seismicity of the region. In this report, discussion is focused on U.S. practice and code requirements associated with regions of high seismic risk.

In contrast with Chile, the cost of labor in the United States tends to be a more significant percentage of total construction cost, driving U.S. designers towards building configurations that minimize labor, even if this results in less than optimal use of materials. As a result, construction practice in the United States tends towards the use of longer spans, two-way flat slabs, and fewer structural walls. It is not unusual for large residential structures to have two to four main shear-resisting walls in each of two approximately orthogonal directions (Figure 3-1 and Figure 3-2). Often, these walls are placed around centrally located elevator or service cores, and columns are provided for gravity support where walls do not exist. Slabs are often post-tensioned to reduce floor thickness, thereby reducing the building mass and the associated seismic forces.

ASCE/SEI 7 limits the use of shear wall systems to buildings not exceeding 160 feet in height. If walls are arranged to provide superior torsional resistance, this limit is extended to 240 feet. Buildings exceeding these height limits must include a special moment frame that is capable of resisting at least 25% of the specified seismic design forces in combination with walls or braced frames. Recently, some engineers have exceeded these height limits using pure shear wall systems that have been designed using alternative means provisions of the building code. Alternative means provisions permit the use of alternative rational criteria to justify the design of

systems that do not conform to applicable prescriptive requirements. U.S. design practice using alternative means procedures is outside the scope of this report.

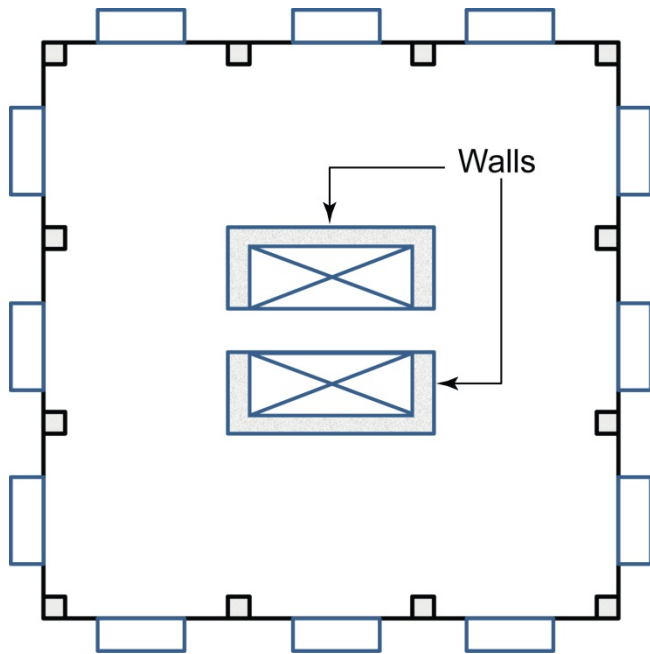

Figure 3-1 Typical floor plan of high-rise residential construction in the United States.

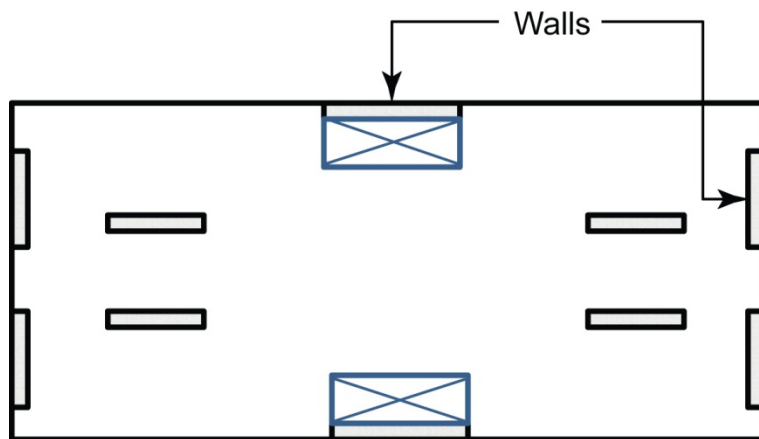

Figure 3-2 Alternative floor plan typically associated with mid-rise residential construction in the United States.

To assist in minimizing overturning forces on foundations, U.S. practice includes the use of coupling beams between pairs of walls, termed coupled walls (Figure 3-3). An important feature of U.S. design practice is the use of ductile detailing in areas expected to experience significant inelastic behavior. In shear wall systems, ductile detailing is typically required at the base of slender walls, where flexural yielding is anticipated, and in coupling beams, where shear yielding, flexural yielding, or both are anticipated.

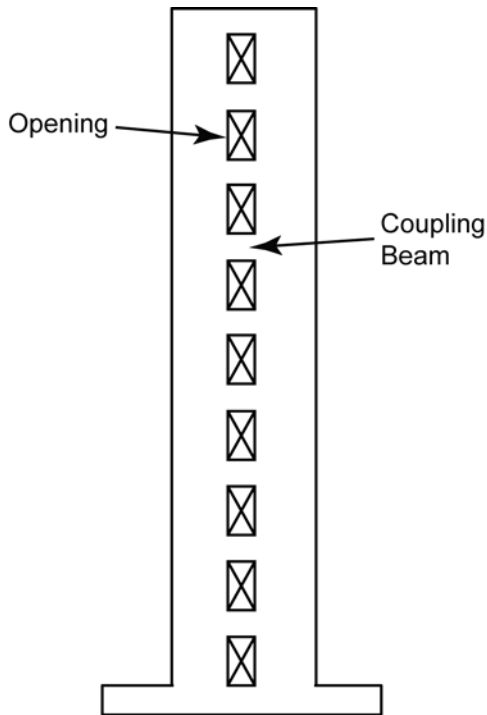

Figure 3-3 Typical coupled shear wall elevation in the United States.

Coupling beams are detailed to provide toughness and ductility, and are used in combination with flexural hinging at the base of walls to dissipate energy. Figure 3-4 illustrates typical ductile detailing for reinforcement of coupling beams with long span-to-depth ratios that are expected to experience flexural yielding, but not shear yielding. Longitudinal bars at the top and bottom of the coupling beam are fully developed into the wall piers on either side of the beam. Enclosed hoops, often with cross ties, are placed around these bars. At each end, closely spaced hoop reinforcing is provided to confine the concrete and laterally support the longitudinal bars in the region of anticipated flexural yielding. At mid-span, sufficient hoop reinforcing is provided so that the shear strength exceeds the shear associated with development of the expected flexural strength of the beam at each end.

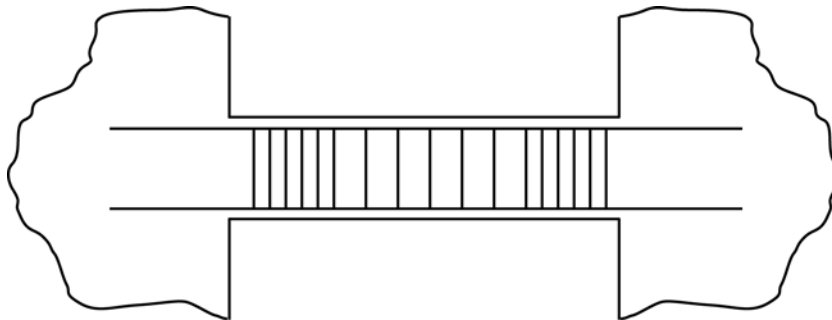

Figure 3-4 Ductile detailing for reinforcement of flexure-controlled coupling beams.

Figure 3-5 and Figure 3-6 illustrate alternative details for reinforcement for coupling beams with relatively short span-to-depth ratios that are expected to experience shear yielding. In both figures, diagonal bars are placed in an “X” configuration across the web of the coupling beam. Diagonal bars are fully developed into the adjacent wall piers and sized to carry 100% of the shear demand in the beams without the contribution of the concrete. Prior to 2011, confinement reinforcing in the form of closely spaced hoops was required around these bars, as shown in Figure 3-5. Horizontal bars are terminated without development into the wall so that the flexural strength of the beam, and consequently the shear demand, is not unintentionally increased. Additional hoop reinforcement is placed in the coupling beam, around the horizontal bars.

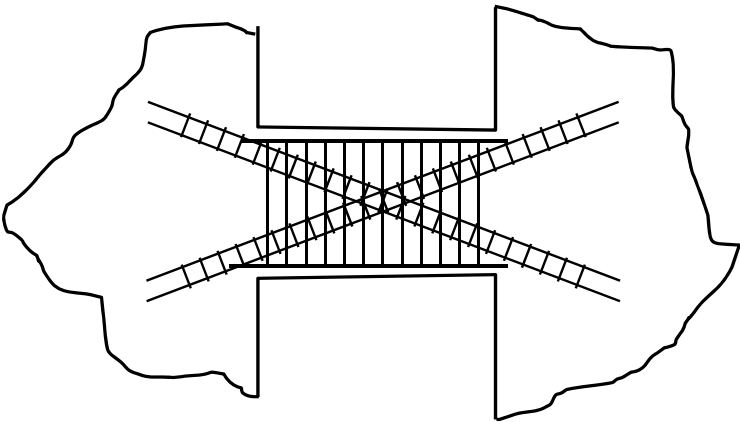

Figure 3-5 Ductile detailing for reinforcement of shear-controlled coupling beams.

This reinforcement pattern was found to be difficult and expensive to construct. In ACI 318-11, the alternative reinforcing pattern shown in Figure 3-6 was introduced. The principal difference in the alternative pattern is that confinement reinforcing is placed around the horizontal bars, rather than the diagonal bars.

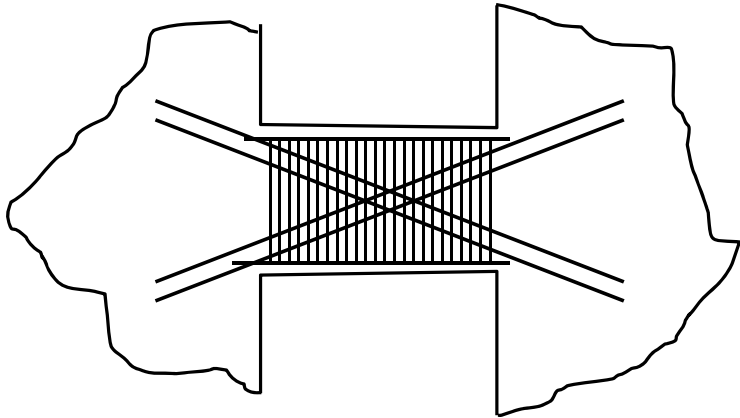

Figure 3-6 Alternative detailing for reinforcement of shear-controlled coupling beams permitted by ACI 318-11.

Elsewhere in walls, confinement reinforcing is required in regions of expected plastic hinging where compressive strains will exceed specified levels. Confinement reinforcing consists of closely-spaced, enclosed hoops with cross ties, in sufficient quantity to confine the concrete core and laterally support the vertical flexural steel, as shown in Figure 3-7.

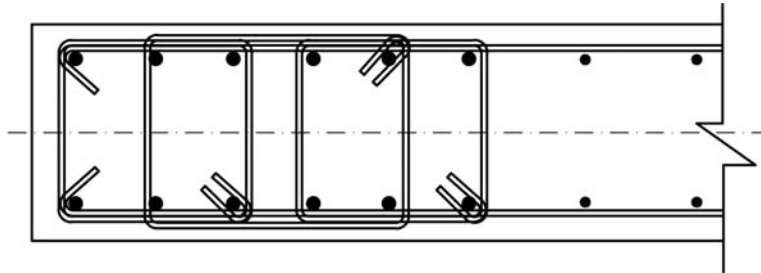

Figure 3-7 Typical confined shear wall boundary zone.

As in Chile, design practice for structures of this type is highly automated, though not completely automated. Modal response spectrum analysis is the preferred analytical technique, and software such as ETABS, *Extended Three Dimensional Analysis of Building Systems* (Computers and Structures, Inc.) is commonly used. Basic selection of reinforcing steel is commonly performed using the concrete design module associated with this software. Sizing of the members, evaluation of the need to provide confined boundary elements, selection of confinement reinforcing, and detailing of coupling beams is typically performed outside of the software.

3.4 U.S. Design Criteria

3.4.1 Maximum Considered Earthquake Shaking

Seismic forces are determined in accordance with ASCE/SEI 7. The process initiates with determination of the risk-adjusted Maximum Considered Earthquake (MCE_R) shaking, characterized by a 5% damped elastic acceleration response spectrum. This spectrum can be defined by site-specific seismic hazard analysis, or alternatively, using a generalized procedure, referring to seismic contour maps and adjustment coefficients related to site soil properties.

By definition, MCE_R shaking is the maximum shaking intensity considered for design of structures. For structures of ordinary occupancy, ASCE/SEI 7 anticipates not more than 10% chance of collapse, given the occurrence of MCE_R shaking, a level of shaking that itself has low probability of occurrence during the useful life of most structures. Rigorous reliability analyses verifying that code-conforming buildings can meet this performance objective have been performed on selected structural systems using the methodology contained in FEMA P-695, *Quantification of Building Seismic Performance Factors* (FEMA, 2009). Reliability analyses have not been performed on all systems, but the upper bound 10% conditional probability of collapse given MCE_R shaking remains a stated goal of the standard.

For most regions in the United States, MCE_R shaking has an exceedance probability of approximately 2% in 50 years (2,475 year recurrence interval). MCE_R shaking intensities have been adjusted such that when a standard fragility function (representative of the typical collapse vulnerability of structures conforming to minimum code criteria) is convolved with the hazard curve at a site, an annual collapse risk of 1% in 50 years is obtained. Depending on the seismicity in a given region, the actual recurrence interval for MCE_R shaking intensities can range from 2,000 years to more than 3,000 years.

An exception to this occurs in regions close to very active faults capable of producing large-magnitude earthquakes over shorter recurrence intervals (hundreds of years). Code committees have judged that in such regions, the above definition of MCE_R would result in seismic design forces that substantially exceed traditional force levels, which engineers believe to represent a practical maximum design level considering economic constraints. Accordingly, in selected regions, mostly located in coastal California and portions of the Wasatch and New Madrid seismic zones, MCE_R shaking is taken as the lesser of the probabilistic value described above, or a deterministic value for a characteristic earthquake on a nearby active fault taken as one standard deviation above the median value predicted by appropriate ground motion prediction models. Deterministic values cannot be taken less than minimum specified values based on historic shaking levels associated with seismic Zone 4 in the UBC of the late 1990s.

In the generalized procedure, MCE_R shaking is determined by reference to a series of maps that show contours for two shaking parameters:

- S_5 – 5% damped spectral response acceleration at a period of 0.2 seconds in the Eastern United States and 0.3 seconds in the Western United States, on sites with reference soil conditions associated with near-surface soft rock or very dense/firm soil.
- S_1 – 5% damped spectral response acceleration at a period of 1 second for structures on sites having similar reference soil conditions.

Figure 3-8 and Figure 3-9 show the S_5 and S_1 contour maps for the Western United States contained in ASCE/SEI 7. In regions of high seismicity, the contours have little geographic separation, making the maps impractical to read. Companion software maintained by the United States Geological Survey provides mapped values on the basis of latitude and longitude.

The short period spectral response acceleration parameter, S_5 , ranges from approximately 2.0g on sites within a few kilometers of major active faults to more typical values on the order of 1.0g to 1.5g on sites in regions of high seismicity, but located outside the near field. The 1-second period spectral response acceleration

parameter, S_I , can have values as large as 0.8g on sites located near major active faults, but more typically has values on the order of 0.4g to 0.6g in regions of high seismicity. Much lower values of these parameters occur in regions of lesser seismicity.

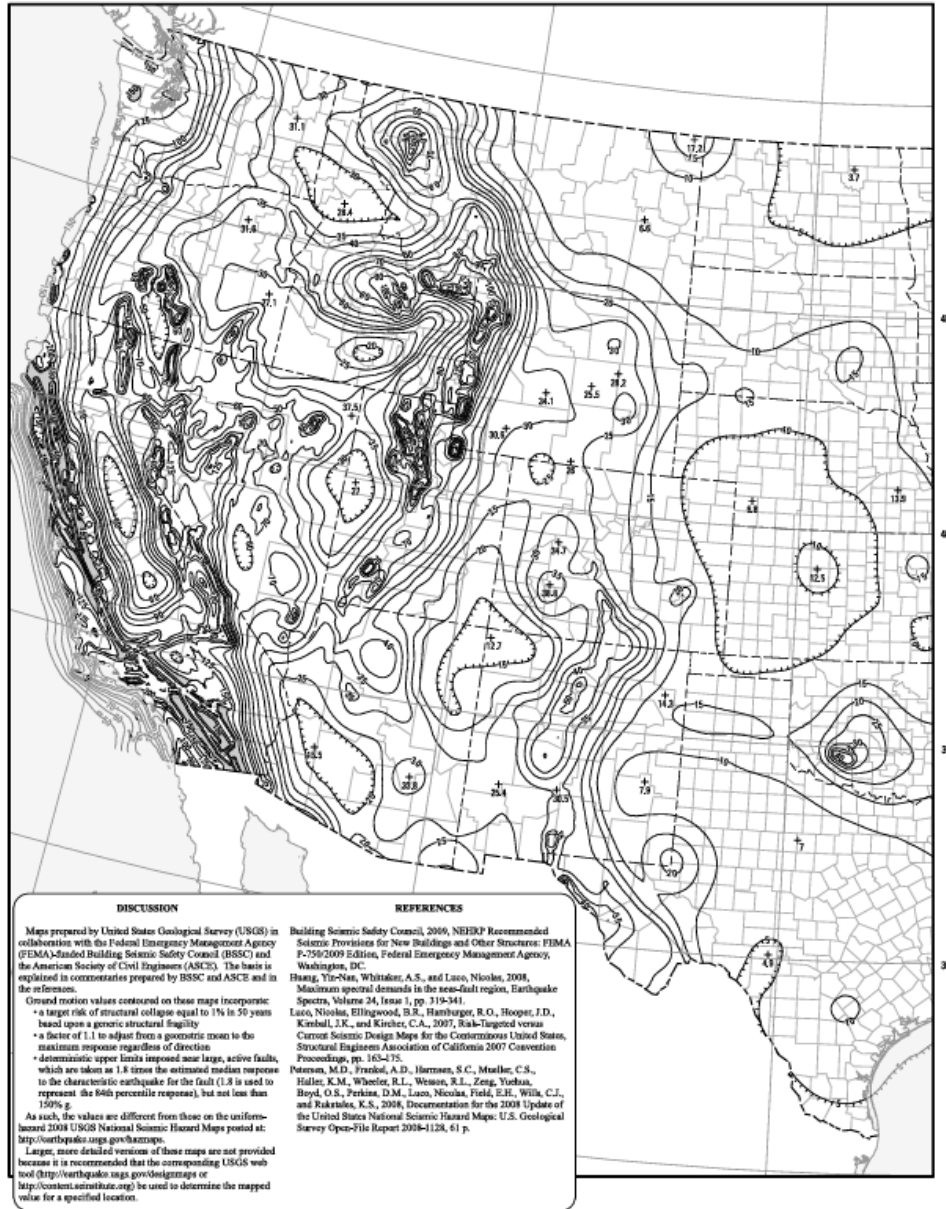

Figure 3-8 Risk-Adjusted Maximum Considered Earthquake (MCE_R) S_S contour map for the Western United States (ASCE/SEI 7-10 Figure 22-1, reproduced with permission from ASCE).

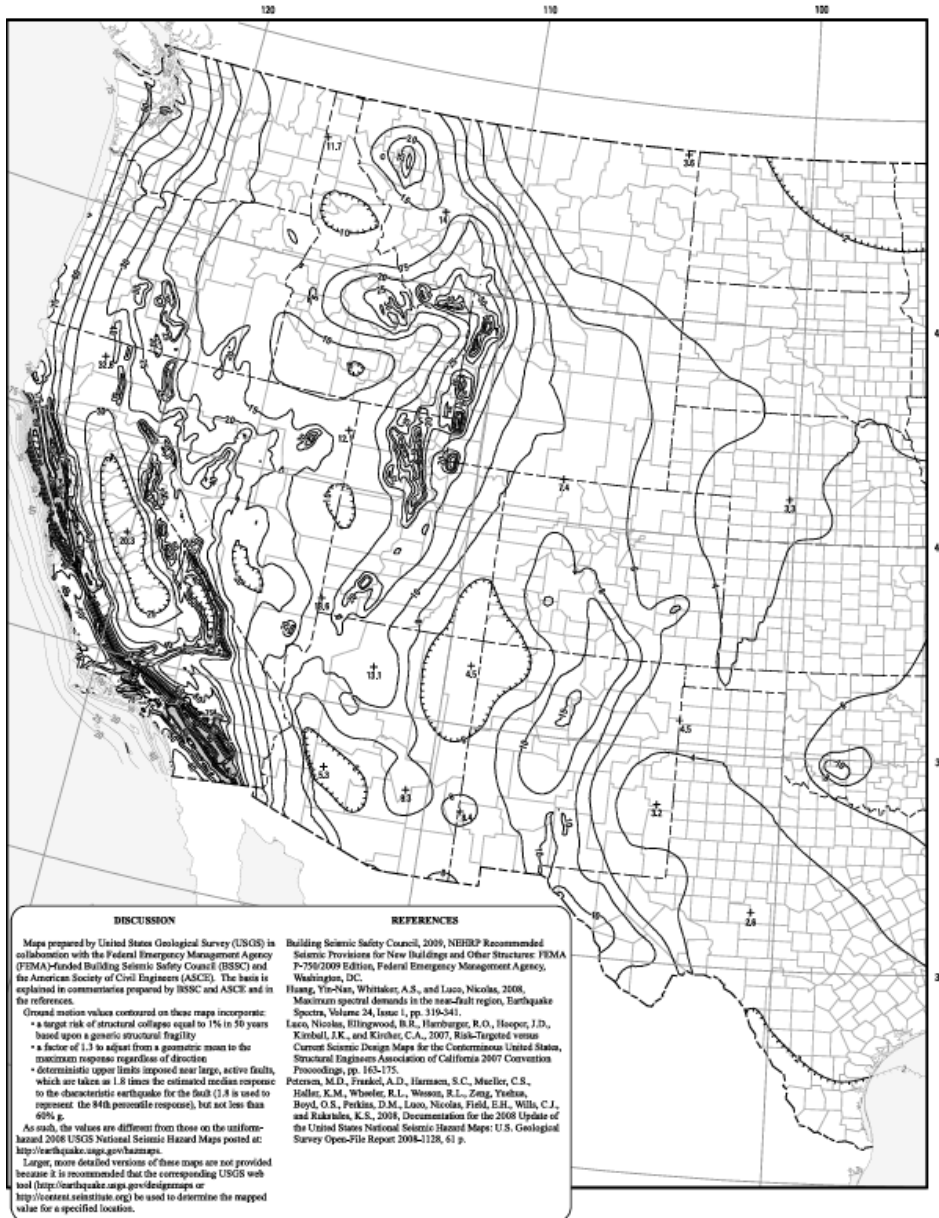

Figure 3-9 Risk-Adjusted Maximum Considered Earthquake (MCE_R) S_T contour map for the Western United States (ASCE/SEI 7-10, Figure 22-2, reproduced with permission from ASCE).

3.4.2 Site Class

Most structures are not located on sites matching the reference site conditions associated with the mapped values of S_S and S_T . ASCE/SEI 7 accounts for site effects on spectral shape through assignment of site coefficients based on soil type (site class). Six site classes are defined:

- **Site Class A.** Sites with near-surface hard rock, having an average shear wave velocity of 5,000 ft/s, or greater, in the upper 100 feet.

- **Site Class B.** Sites with near-surface rock having average shear wave velocity ranging from 2,500 ft/s to 5,000 ft/s in the upper 100 feet.
- **Site Class C.** Sites with very dense soil or soft rock in the upper 100 feet and average shear wave velocities ranging from 1,200 ft/s to 2,500 ft/s; standard penetration resistance exceeding 50 blows/ft; or undrained shear strengths exceeding 2,000 psf.
- **Site Class D.** Sites with stiff soils in the upper 100 feet and average shear wave velocities ranging from 600 ft/s to 1,200 ft/s; standard penetration resistance ranging from 15 blows/ft to 25 blows/ft; or undrained shear strengths ranging from 1,000 psf to 2000 psf.
- **Site Class E.** Sites with soft soils in the upper 100 feet and average shear wave velocities less than 600 ft/s; standard penetration resistance less than 15 blows/ft; or undrained shear strengths less than 1,000 psf.
- **Site Class F.** Sites with near surface soils that are vulnerable to failure or collapse under seismic loading including liquefiable soils, quick and highly sensitive clay, and collapsible, weakly cemented soils.

Site classes are determined by site-specific study. The use of default Site Class D is permitted unless the authority having jurisdiction has reason to believe that Site Classes E or F are present. For all sites except Site Class F, ASCE/SEI 7 specifies spectral shape modification factors, F_a and F_v that are used to adjust the mapped MCE_R spectral response acceleration parameters to site-adjusted values, S_{MS} and S_{M1} , using the following equations:

$$S_{MS} = F_a S_S \quad (\text{ASCE 7 Eq. 11.4-1})$$

$$S_{M1} = F_v S_1 \quad (\text{ASCE 7 Eq. 11.4-2})$$

Values of F_a and F_v depend on the site classification and the magnitude of S_S and S_1 , accounting for nonlinearity in soil response at high-amplitude shaking. In regions of high seismicity, values of F_a range from 0.8 on Site Class A sites to 1.1 on softer soil sites. Values of F_v range from 0.8 on Site Class A sites to 2.4 on Site Class E sites. On Site Class F sites, site-specific response analysis is required to set the values of these coefficients.

3.4.3 Design Earthquake Shaking

Seismic design forces are determined based on spectral response acceleration parameters for a reduced level of shaking, defined as Design Earthquake Shaking. Design earthquake spectral response acceleration parameters are obtained from the following equations:

$$S_{DS} = \frac{2}{3} S_{MS} \quad (\text{ASCE 7 Eq. 11.4-3})$$

$$S_{D1} = \frac{2}{3} S_{M1} \quad (\text{ASCE 7 Eq. 11.4-4})$$

3.4.4 Risk Category

Buildings are classified based on the risk to human life, health, and welfare as a result of damage or failure based on their occupancy or use. Four categories of risk are defined:

- **Risk Category I.** Buildings and other structures that are not normally used for human habitation, such as barns and certain storage structures, which pose minimal risk to life in the event of failure.
- **Risk Category II.** Ordinary occupancy buildings, including most commercial, industrial, and residential uses.
- **Risk Category III.** Buildings and other structures that pose a substantial risk to life in the event of failure, including assembly occupancies with large numbers of persons; certain education facilities; prisons; water treatment and power plants; and structures housing limited quantities of potentially hazardous materials.
- **Risk Category IV.** Buildings and other structures that pose a substantial risk to the surrounding community in the event of failure, including buildings designated as essential facilities necessary to assist in post-disaster recovery operations such as hospitals, police stations, and fire stations.

Importance factors, I_e , ranging from 1.0 to 1.5 are applied to seismic design forces based on the assigned Risk Category.

3.4.5 Seismic Design Category

Buildings are assigned to a Seismic Design Category (SDC) considering the assigned Risk Category and the design earthquake spectral response acceleration parameters, S_{DS} and S_{D1} . Six Seismic Design Categories are defined, ranging from A to F. Structures in Seismic Design Category A are not expected to experience damaging earthquake shaking. They are not required to be designed for seismic resistance, but they must meet basic structural integrity criteria including a complete lateral force-resisting system capable of resisting at least 1% of the weight of the building applied as a lateral force in each direction.

Seismic Design Category B includes Risk Category I, II, and III structures in regions of low seismicity, expected to experience Modified Mercalli Intensity (MMI) VI or lesser shaking. They must be designed for seismic forces determined using spectral response coefficients, but there are few rules prescribing detailing requirements and no limitations on the use of various structural systems. Similarly, there are no requirements for seismic bracing and anchorage of nonstructural components.

Seismic Design Category C includes Risk Category IV structures in regions of moderate seismicity, and Risk Category I, II and III structures in regions of moderate seismicity expected to experience MMI VII or lesser shaking. In Seismic Design Category C, there are some limitations on the use of structural systems of different heights, and nonstructural components must be anchored and braced to resist seismic forces.

Seismic Design Category D includes Risk Category IV structures in regions of moderate seismicity, and Risk Category I, II and III structures in regions of high seismicity expected to experience MMI VIII to IX shaking intensity. There are restrictions on the use of certain structural systems along with extensive prescriptive requirements for seismic detailing. Nonstructural components must be anchored and braced.

Seismic Design Category E applies to Risk Category I, II and III structures located within a few kilometers of major active faults, and Seismic Design Category F applies to Risk Category IV structures that are similarly located near such faults. In these Seismic Design Categories there are additional limitations on the use of structural systems and limitations on permissible structural irregularities. Most structures in regions of high seismicity are assigned to Seismic Design Category D, or higher.

3.4.6 Load Combinations

Design earthquake loads, E , include loads intended to account for the effects of both horizontal, E_h , and vertical, E_v , shaking. Horizontal earthquake loads are determined by any of several acceptable methods of analysis including equivalent lateral force, modal response spectrum analysis, linear response history, or nonlinear response history analysis. Vertical earthquake loads are taken as a fraction of the dead load effect on each member, D , using the equation:

$$E_v = 0.2S_{DS}D \quad (\text{ASCE 7 Eq. 12.4.4})$$

Vertical earthquake effects can be taken as positive (in the same sense as dead load effects) or negative (in the opposite sense as dead load effects). Horizontal earthquake effects are obtained using the equation:

$$E_h = \rho Q_E \quad (\text{ASCE 7 Eq. 12.4.3})$$

where Q_E are the load effects obtained as a result of lateral analysis, and ρ is a reliability factor associated with the redundancy and regularity of the structure. For structures with sufficiently redundant seismic force-resisting systems and regular configurations, this factor is assigned a value of unity. A structure is considered to be redundant if the removal of any one seismic force-resisting element within a story neither creates an extreme torsional irregularity, nor results in a reduction of story

shear exceeding 33% of the strength prior to removal of the element. Structures not complying with these criteria are assigned a redundancy factor of 1.3.

Vertical and horizontal seismic load effects are calculated on a strength basis. When combined with other load effects using strength design procedures, they are assigned a load factor of 1.0. When used in Allowable Stress Design procedures, these load effects are reduced by a factor of 0.7 (i.e., divided by 1.4). Load combinations that must be considered using strength design procedures include:

$$(1.2 + 0.2S_{DS})D + \rho Q_E + L + 0.2S \quad (\text{ASCE 7 Eq. 12.4.2.3-5})$$

$$(0.9 - 0.2S_{DS})D + \rho Q_E + 1.6H \quad (\text{ASCE 7 Eq. 12.4.2.3-7})$$

where L is the effect of live loads, S is the effect of snow, and H is the effect of lateral earth pressure, ground water or bulk materials.

The earthquake effects in the above load combinations are substantially reduced from force levels associated with elastic response to design earthquake shaking, considering the beneficial effects of inelastic behavior as a load-limiting mechanism. Certain critical elements that are deemed sensitive to the effects of overloading, the failure of which could lead to unacceptable behavior, are required to have additional strength to resist the maximum forces they are likely to experience as a result of structural overstrength. Such elements include columns beneath discontinuous frames and walls; connections in steel frames; primary seismic force-resisting elements in certain weak/soft story structures; and diaphragm chords and collectors. These elements must be designed for the following special load combinations:

$$(1.2 + 0.2S_{DS})D + \Omega_o Q_E + L + 0.2S \quad (\text{ASCE 7 Eq. 12.4.3.2-5})$$

$$(0.9 - 0.2S_{DS})D + \Omega_o Q_E + 1.6H \quad (\text{ASCE 7 Eq. 12.4.3.2-7})$$

where Ω_o is a structural system-dependent factor, with values generally ranging from 2 to 3, that is intended to account for the effects of structural overstrength. The product of $\Omega_o Q_E$ need not exceed the maximum force that the structural system is capable of delivering to the element, as determined by appropriate nonlinear analysis. All other terms are as previously defined.

Although not used in the design of concrete structures, ASCE/SEI 7 also includes Allowable Stress Design (ASD) load combinations that can be used in the design of structural steel, cold-formed steel, timber, and masonry structures. ASCE/SEI 7 does not permit a 1/3 increase in allowable stresses for ASD load combinations that include transient loads. However, the IBC has an alternative set of ASD load combinations that do include the use of a 1/3 allowable stress increase. Because IBC load combinations are more familiar to designers, and they result in somewhat more

economical designs, the ASD combinations specified in ASCE/SEI 7 are rarely used in practice.

In higher Seismic Design Categories, earthquake response in two orthogonal directions must be evaluated by simultaneously considering 100% of the computed seismic forces due to response in one direction, with 30% of the seismic forces computed for response in the orthogonal direction.

3.4.7 Structural Systems

ASCE/SEI 7 recognizes more than 80 different structural systems. Each system is designated by its basic classification (e.g., bearing wall, building frame, moment-resisting frame, or dual system); material of construction (e.g., masonry, reinforced concrete, structural steel, cold-formed steel, timber); and extent of seismic-resistant design and detailing requirements incorporated in the design procedures (e.g., special, intermediate, or ordinary). Systems thought to be capable of highly ductile performance with extensive safeguards preventing brittle failure modes are termed “special” systems. Systems with few safeguards against brittle failure, and are capable of only limited levels of inelastic response, are termed “ordinary.” Structures with fewer safeguards than “special” systems and more safeguards than “ordinary” systems are termed “intermediate.” Systems that have no provisions for ductile performance are termed “plain” or “not detailed for seismic resistance.” These designations lead to structural system names including special concrete bearing walls, intermediate concrete moment frames, and ordinary steel concentrically braced frames.

In Seismic Design Categories D, E, and F, there are extensive restrictions on the use of many of these structural systems, depending on height and Seismic Design Category. Generally, systems designated as “special” are permitted in these design categories, while systems designated as “intermediate” or “ordinary” may be permitted only for structures of limited height, or not permitted at all. All structures exceeding 160 feet in height are required to have a special moment frame capable of resisting at least 25% of the required minimum design seismic forces, unless they conform to certain configuration and regularity criteria. All structures taller than 240 feet must have such frames, regardless of their configuration or regularity.

Values of key design coefficients, R , C_d , and Ω_o are assigned in ASCE/SEI 7 Table 12.2-1 based on structural system designation. The response modification coefficient, R , is used to account for inherent system ductility and overstrength to derive acceptable minimum design strength levels. The deflection amplification factor, C_d , is used to amplify lateral displacements computed under design force levels to approximate actual displacements that will be experienced under MCE_R shaking. The overstrength factor, Ω_o , is used to amplify design forces of certain critical elements to protect against the effects of structural overstrength.

3.4.8 Irregularities

Irregularity associated with geometric, strength, or stiffness conditions can result in concentration of inelastic demands that is not well predicted by elastic analysis methods. Irregularities are categorized as either horizontal or vertical irregularities. Horizontal irregularities include:

- **Torsional irregularity.** Characterized by response under static applied forces that result in a story drift profile at any level in which the drift at one side is greater than 1.2 times the average story drift.
- **Extreme torsional irregularity.** Similar to torsional irregularity, except that the drift at one side is greater than 1.4 times the average story drift.
- **Reentrant corner irregularity.** A plan shape with two or more projecting wings (e.g., “L-shaped”) in which both plan projections beyond the reentrant corner exceed 15% of the dimension of the building in the direction under consideration.
- **Diaphragm discontinuity irregularity.** Characterized by diaphragm openings that exceed 50% of the gross floor area at a level.
- **Out-of-plane offset irregularity.** A condition in which a line of lateral resistance at a floor level is shifted horizontally in a direction perpendicular to the line of resistance at the level above.
- **Nonparallel system irregularity.** A configuration in which major vertical elements of the seismic force-resisting system are not aligned with the major orthogonal axes of the building.

Vertical irregularities include:

- **Stiffness irregularity.** A condition in which the lateral stiffness of any story is less than 70% of the stiffness in the story immediately above, or less than 80% of the average stiffness of the three stories above.
- **Extreme stiffness irregularity.** A condition in which the lateral stiffness of any story is less than 60% of the story immediately above, or less than 70% of the average stiffness of the three stories above.
- **Weight irregularity.** A condition in which the effective seismic mass of any story is greater than 150% of the effective mass of an adjacent story.
- **Vertical geometric irregularity.** A setback-type geometric condition in which the horizontal dimension of the seismic force-resisting system in any story is greater than 130% of the dimension in an adjacent story.

- **In-plane discontinuity irregularity.** An in-plane offset in a vertical element of the seismic force-resisting system that results in overturning demands on a supporting column, beam, or similar element below.
- **Weak story irregularity.** A condition in which the lateral strength of any story is less than 80% of the strength in the story above.
- **Extreme weak story irregularity.** A condition in which the lateral strength of any story is less than 65% of the strength in the story above.

The presence of one or more irregularities can trigger a requirement to design the structure using three-dimensional analysis or dynamic analysis. Irregularities can also force certain elements of the seismic force-resisting system to be designed with greater strength, considering the potential effects of structural overstrength. The presence of extreme soft or weak story irregularities is prohibited in Seismic Design Categories D, E, and F.

3.4.9 Analysis Procedures

ASCE/SEI 7 permits a number of different analytical procedures for determining horizontal seismic design forces, and their load effects, Q_E , on structural elements:

- Equivalent lateral force (ELF) procedure
- Simplified lateral force analysis procedure
- Modal response spectrum analysis procedure
- Response history procedure

The equivalent lateral force procedure is a linear static analysis procedure that is permitted for structures with regular configuration, regular strength and mass distribution, and heights less than 160 feet. Regular structures with heights exceeding 160 feet can be designed using this procedure if the fundamental period of response does not exceed $3.5T_S$, where T_S is given by the equation:

$$T_S = S_{D1} / S_{DS}$$

The simplified lateral force procedure is a simplified version of the equivalent lateral force procedure that can be used for 1-, 2- or 3-story structures with regular configurations, and is not discussed further in this report.

The modal response spectrum analysis procedure is permitted for use with any structure, as are the linear and nonlinear response history procedures. In practice, however, response history procedures are seldom used, and only the equivalent lateral force and modal response spectrum analysis procedures are discussed further.

3.4.10 Equivalent Lateral Force Procedure

The total design lateral force in each direction, V , is determined from the equation:

$$V = C_s W \quad (\text{ASCE 7 Eq. 12.8-1})$$

where W is the effective seismic weight taken as the dead load of the structure and all permanent equipment and furnishings. In storage and warehouse occupancies, 25% of the design floor live load is included in the effective seismic weight. In regions with ground snow loads exceeding 30 psf, 20% of the uniform design snow load is included in the seismic weight. In occupancies that include a significant number of interior partitions, the weight of these partitions is also included in the seismic weight, but is not taken as less than 10 psf over the floor area.

The total design lateral force, V , also called a base shear force, represents the minimum permissible strength to resist seismic forces, prior to onset of first significant yielding. For structures with significant inelastic response capability, the minimum design base shear force is set at a fraction of the strength necessary to resist design earthquake shaking without damage.

The seismic response coefficient, C_s , is a base shear coefficient obtained from a series of equations. The basic value of this coefficient is determined from:

$$C_s = \frac{S_{DS}}{\left(\frac{R}{I_e}\right)} \quad (\text{ASCE 7 Eq. 12.8-2})$$

where S_{DS} is the design spectral response acceleration parameter at short periods; R is the structural system-dependent response modification coefficient, and I_e is a risk category-dependent importance factor. The response modification coefficient, R , ranges from a value of 8 for highly ductile systems (e.g., special moment frames of steel or concrete) to values as low as 1.5 for systems that have little ability to absorb inelastic response. The importance factor, I_e , is assigned a value of 1.0 for Risk Category I and II structures, 1.25 for Risk Category III structures, and 1.5 for Risk Category IV structures.

For structures with first mode natural periods less than the long-period transitional period, T_L , the base shear coefficient need not exceed the value obtained from:

$$C_s = \frac{S_{D1}}{T \left(\frac{R}{I_e}\right)} \quad (\text{ASCE 7 Eq. 12.8-3})$$

where S_{D1} is the design spectral response acceleration parameter at a period of 1 second, and T is the period in the fundamental translational mode in the direction under consideration. The fundamental period, T , can be determined through modal

analysis, by applying the Rayleigh method, or using the approximate period equation of the form:

$$T_a = C_t h_n^x \quad (\text{ASCE 7 Eq. 12.8-7})$$

where h_n is the height of the structure above the base plane, C_t is a coefficient ranging from 0.2 to 0.3, and x is a coefficient ranging from 0.75 to 0.9. Both C_t and x depend on the type of seismic force-resisting system, and have been set based on correlation with measured periods obtained from strong motion recording instruments in typical buildings. If period is determined by analysis, the value cannot be taken greater than $C_u T_a$, where C_u is a coefficient that varies from 1.4 in regions of high seismicity to 1.7 in regions of lower seismicity. This limit is intended to prevent engineers from determining period using unrealistic analytical models that result in excessively small design base shear forces.

The long-period transitional period, T_L , represents the period at which design response spectra will generally transition from the constant-velocity domain to the constant displacement domain. The value of T_L is obtained from a map provided with the provisions, and depends on the magnitude of earthquakes dominating the hazard within a region. In the Western United States, the value of T_L generally ranges from a low of 8 seconds to a high of 12 seconds. For structures with periods exceeding T_L , the value of C_s need not exceed the value obtained from:

$$C_s = \frac{S_{DI} T_L}{T^2 \left(\frac{R}{I_e} \right)} \quad (\text{ASCE 7 Eq. 12.8-4})$$

Regardless of the value of C_s obtained from ASCE/SEI 7 equations 12.8-3 and 12.8-4, the value is never permitted to be less than:

$$C_s = 0.044 S_{DS} I_e \geq 0.01 \quad (\text{ASCE 7 Eq. 12.8-5})$$

On sites that are located within the near field of major active faults, as characterized by having a mapped 1-second spectral response acceleration parameter, S_1 , equal to or greater than 0.6, the value of C_s also cannot be taken less than the value obtained from:

$$C_s = 0.5 S_1 / \left(R / I_e \right) \quad (\text{ASCE 7 Eq. 12.8-6})$$

Figure 3-10 plots the variation in base shear coefficient, C_s , as a function of period, for bearing wall structures with special reinforced concrete shear walls located on sites conforming to Site Classes B, C, D, and E, with mapped spectral response acceleration parameters S_S equal to 1.5 and S_1 equal to 0.6. Sites with these values are located in regions of high seismicity, near one or more major active faults, but are outside the region where MCE_R ground shaking is limited by characteristic

earthquake magnitudes. Sites of this type are common in the San Francisco Bay Area and greater Los Angeles region. In the figure, the importance factor, I_e , is taken as 1.0, and the value of R is taken as 5, corresponding to Risk Category II, special reinforced concrete bearing wall structures.

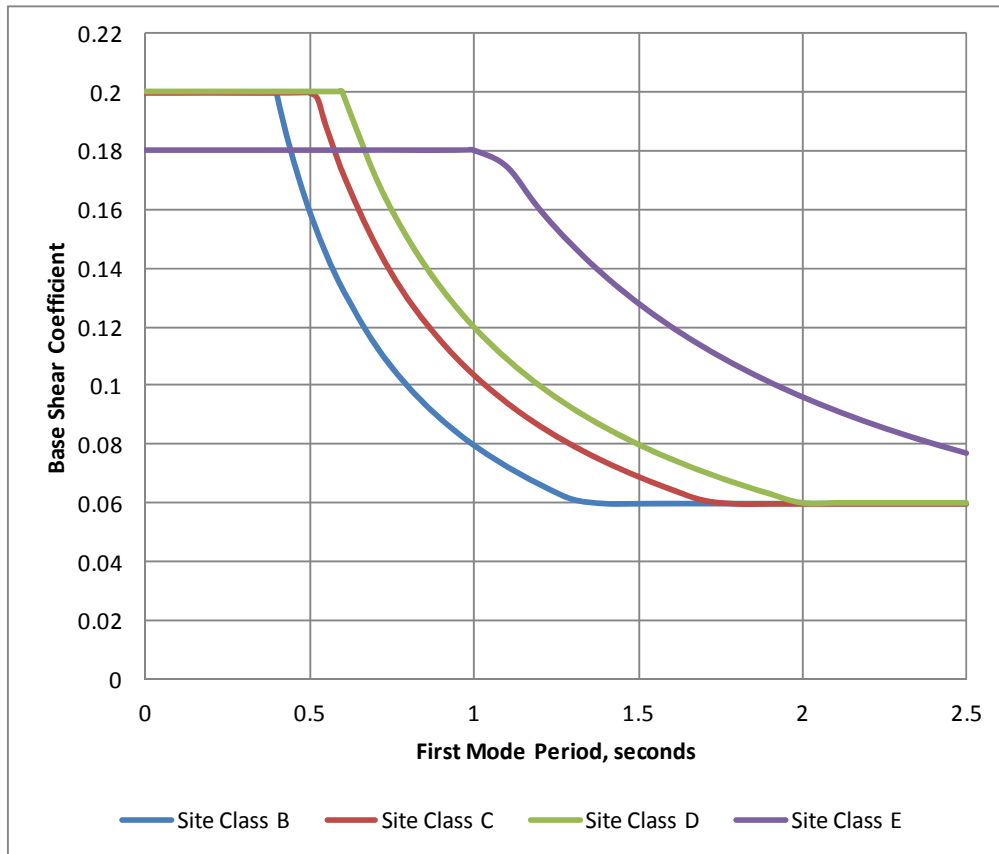

Figure 3-10 Variation in base shear coefficient, C_s , as a function of period, T , for Risk Category II, special reinforced concrete bearing wall structures located in regions of high seismicity.

For multi-story structures, the base shear force obtained from ASCE/SEI 7 Equation 12.8-1 is distributed vertically to each diaphragm level using:

$$F_x = C_{vx} V \quad (\text{ASCE 7 Eq. 12.8-11})$$

$$C_{vx} = \frac{w_x h_x^k}{\sum w_i h_i^k} \quad (\text{ASCE 7 Eq. 12.8-12})$$

where V is the total base shear force, w_x and w_i are the effective seismic weights at levels x and i , respectively, h_x and h_i are the respective heights of diaphragm levels x and i above the base plane, and the exponent k varies between 1.0 and 2.0 depending on the period of the structure.

Figure 3-11 illustrates the resulting story force distribution obtained from this equation for a hypothetical 10-story structure having a period of 1 second.

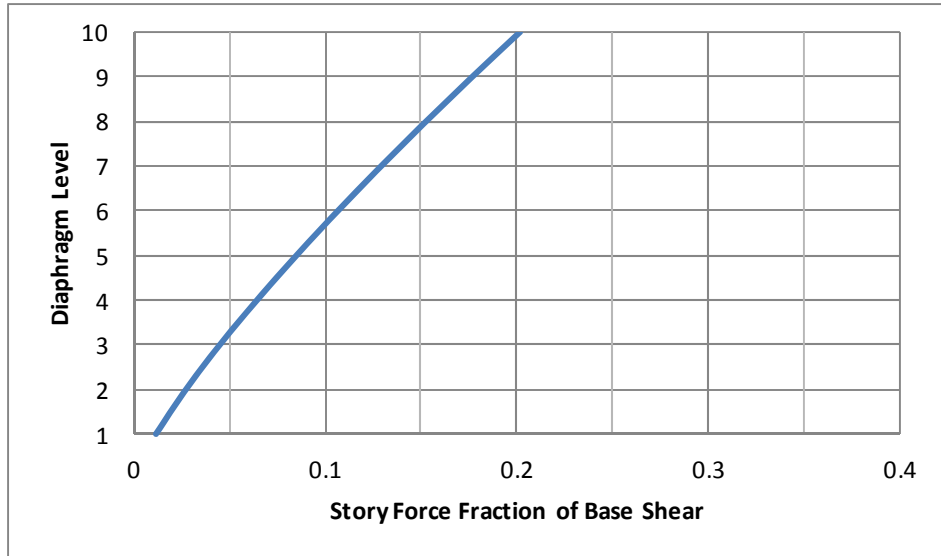

Figure 3-11 Story force distribution as a fraction of base shear, for a hypothetical 10-story structure with $T=1$ second.

In addition to the story forces obtained from ASCE/SEI 7 Equation 12.8-11, structures must be designed for the effects of an accidental torsional moment, applied at each story, calculated as the static force F_k at each level factored by an accidental eccentricity equal to 5% of the diaphragm dimension perpendicular to the line of application of the force.

Story drifts must be checked at each level to ensure they do not exceed maximum limiting values associated with the Risk Category and type of structural system presented in ASCE/SEI 7 Table 12.12.1. For comparison with drift criteria, the maximum inelastic response displacement, δ_M , is given by the equation:

$$\delta_M = \frac{C_d \delta_{max}}{I_e} \quad (\text{ASCE 7 Eq. 12.12-1})$$

where δ_{max} is the maximum story drift at any level, and C_d and I_e are as previously defined. In addition, adjacent, structurally independent structures must be separated by the square-root-sum-of-squares (SRSS) combination of the values of δ_M for each structure at each level.

The maximum inelastic response displacement, δ_M , is also used to evaluate $P-\Delta$ stability. The stability coefficient, θ , is computed using the equation:

$$\theta = \frac{P_x \Delta_x I_e}{V_x h_{sx} C_d} \quad (\text{ASCE 7 Eq. 12.8-16})$$

where P_x is the total vertical design load supported by story x , Δ_x is the story drift ratio at level x , V_x is the design story shear force at level x , h_{sx} is the story height at level x , and I_e and C_d are as previously described. A value of the stability coefficient

greater than or equal to 0.1 requires specific consideration of $P-\Delta$ effects in the analysis. A value of the stability coefficient that exceeds a limiting value, designated θ_{\max} , is not permissible unless suitable nonlinear analysis is used to demonstrate adequate stability.

3.4.11 Modal Response Spectrum Analysis

Modal response spectrum analysis must include sufficient natural modes such that at least 90% of the total mass of the structure is captured in each of the two horizontal directions, and at least 90% of the torsional inertia of the structure is captured. The effects of accidental torsion must be considered by displacing the center of mass at each level an amount equal to 5% of the diaphragm dimension in the direction perpendicular to the analysis.

The design acceleration response spectrum can be determined by site-specific hazard analysis or a generalized procedure based on the ground motion maps used for equivalent lateral force analysis. If site-specific seismic hazard analysis is used, a 5% damped, Maximum Considered response spectrum is determined, and the design spectrum is taken as 2/3 of the amplitude of the Maximum Considered spectrum.

The generalized procedure uses the design spectral response acceleration parameters, S_{DS} and S_{DI} , to develop the design spectrum. This spectrum follows the same basic shape as the base shear coefficient used in the equivalent lateral force procedure, and consists of four separate domains:

- For periods less than $T_0 = 0.2S_{DI}/S_{DS}$, the spectrum increases linearly from a value of $S_{DS}/2.5$.
- From period T_0 to period T_S , the spectrum has a constant value, S_{DS} .
- From period T_S to period T_L , the spectrum takes on the hyperbolic shape given by S_{DI}/T .
- For periods greater than T_L , the spectrum takes on the parabolic shape given by $S_{DI}T_L/T^2$.

Figure 3-12 presents generalized design response spectra for a Risk Category II structure located on sites conforming to Site Classes B, C, D, and E, with mapped spectral response acceleration parameters S_S equal to 1.5 and S_I equal to 0.6. For the spectra shown in the figure, the response modification coefficient, R , and importance factor, I_e , have been taken as unity.

Response quantities obtained from modal response spectrum analysis, including individual element forces and drifts, are combined using the square-root-sum-of-squares (SRSS) method, or in the case of closely spaced modes, by the complete quadratic combination (CQC) method, and then scaled by the quantity I_e/R . In each

of two orthogonal directions, the base shear is compared against the base shear from the equivalent lateral force procedure using the period obtained from the approximate period equation. If the base shear obtained using modal analysis in either direction is less than 85% of the equivalent lateral force base shear, all of the response quantities must be further scaled by the ratio $0.85V/V_t$, where V is the base shear determined using the equivalent lateral force procedure, and V_t is the base shear obtained from modal response spectrum analysis.

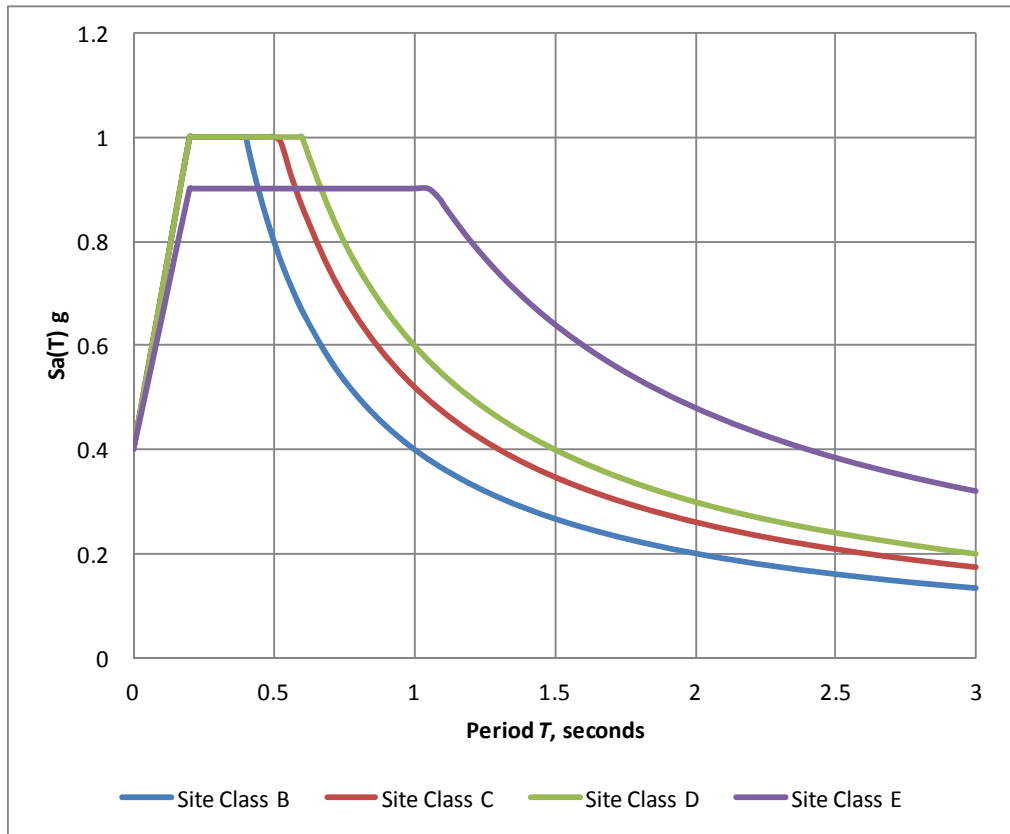

Figure 3-12 Generalized design response spectra for various site classes, with R and I_e taken as unity.

Designs based on the modal response spectrum analysis procedure are subject to the same story drift, separation, and stability requirements specified for the equivalent lateral force procedure.

Comparison of U.S. and Chilean Seismic Design Requirements

This chapter presents a comparison of U.S. and Chilean seismic design requirements, including seismic design loading and reinforced concrete seismic design provisions, over the period 1985–2010. This information has been excerpted from detailed summaries of Chilean seismic design requirements in Chapter 2 and U.S. seismic design requirements in Chapter 3.

4.1 Seismic Design Loading

The Chilean loading standard in effect at the time of the 2010 Maule earthquake was NCh433.Of96, *Earthquake Resistant Design of Buildings* (INN, 1996). The most current practice for specifying seismic design loading in the United States is ASCE/SEI 7-10, *Minimum Design Loads for Buildings and Other Structures* (ASCE, 2010). Relevant provisions from these two standards are summarized in side-by-side format in Table 4-1, together with commentary on substantive differences.

Chilean codes evolved from U.S. practice in the mid-1990s. Important developments in U.S. codes that have not been reflected in Chilean practice over this period include:

- Adoption of performance goals characterized by maximum acceptable probability of collapse conditioned on the occurrence of Maximum Considered Earthquake ground shaking.
- Definition of ground motion by reference to spectral response acceleration contour maps rather than broad seismic zones.
- Evolution of design ground motion from a pseudo-475 year earthquake basis, with a defined effective peak ground acceleration of 0.4g in the highest seismic zones, to specific calculation of design ground motion defined as a fraction (2/3) of a Maximum Considered Earthquake intensity with a probabilistic definition.
- Use of the maximum ground shaking component.
- Introduction of additional structural system variants, each with somewhat different detailing requirements, applicability, and design coefficients.
- Explicit consideration of potential system overstrength in the design of elements that, in the event of failure, could lead to collapse.
- Consideration of redundancy in determining seismic design forces.

- Evaluation of drifts and deflection at levels approximating actual response to earthquake shaking, rather than response to specified design loading.
- Adoption of strength-level, as opposed to allowable stress level, definition of seismic design forces.
- Refinement in the definition of system irregularities, and prohibition on some irregularities in regions of high seismic risk.
- Amplification of accidental torsion effects in torsionally irregular structures.

Conversely, enhancements incorporated in Chilean codes that have not been reflected in U.S. practice include:

- Period-dependent, response modification coefficients for use with modal response spectrum analysis techniques.
- Consideration of soil-foundation-structure interaction effects in modal response spectrum analysis.
- Adoption of spectral shapes appropriate to seismic hazards and site conditions prevalent in Chile.

4.2 Reinforced Concrete Seismic Design Provisions

The Chilean concrete design standard in effect in the period leading up to the 2010 Maule earthquake was NCh430.Of2008, *Reinforced Concrete Design and Analysis Requirements* (INN, 2008). This standard specifically adopted ACI 318-05 *Building Code Requirements for Structural Concrete* (ACI, 2005) as its fundamental basis, and identified the following exceptions to adapt the requirements to Chilean practice:

- Omission of requirements for confined boundary elements in reinforced concrete shear walls.
- Permissive use of the detailing requirements for Intermediate Moment Frames when primary lateral resistance is provided by walls with the strength to resist 75% of the specified seismic design forces, even in regions of high seismic risk.
- Replacement of references to ASTM material standards with appropriate references to Chilean Normas.
- Adoption of reduced cover requirements relative U.S. requirements for protection of reinforcement in various exposure conditions.
- Use of gross section properties, neglecting reinforcement, when calculating the distribution of internal forces within a structure, except in cases where P-delta stability effects are significant.
- Modification of load factors in load combinations, utilizing a factor of 1.4 on earthquake loads in lieu of 1.0, as specified in ACI 318.

- Permissive use of concrete cubes rather than cylinders for testing concrete strength in production.
- Modification of requirements for tension splices in reinforcement.

Developments in U.S. reinforced concrete design provisions in the period leading up to the 2010 Maule earthquake, which have not been reflected in Chilean concrete design practice, include:

- Adoption of confinement rules for concrete shear walls based on estimated compressive strains in the zone of anticipated plastic hinging.
- Adoption of enhanced rules for detailing of coupling beams in walls to provide enhanced inelastic response capability.

4.3 Observations and Conclusions on U.S. and Chilean Seismic Design Requirements

Overall, seismic design requirements in Chile and the United States are similar. Standards in Chile are comparable to U.S. codes and standards in regions of high seismicity during the mid-1990s. Analytical procedures and design of reinforced concrete elements are nearly identical, with certain important exceptions.

Seismic design concepts embedded in the standards in each country are based on ATC 3-06, *Tentative Provisions for the Development of Seismic Regulations for Buildings* (ATC, 1978). Although the fundamental basis is the same, the details of present seismic design loading requirements in each country have diverged as a result of differences in the evolution and modification of requirements as they existed in the *Uniform Building Code* of the 1990s. Earthquake forces in NCh433.Of96 are allowable stress level forces, and earthquake forces in ASCE/SEI 7-05 are strength level forces. In spite of these and other differences, it can be shown that a typical Chilean mid-rise to high-rise residential building would be designed for an equivalent strength-level base shear coefficient that is nearly identical to the U.S. base shear coefficient.

Although many enhancements to U.S. seismic design requirements have occurred over the period 1985–2010, in general, it appears unlikely that these enhancements would have had a significant impact on the performance of buildings in the 2010 Maule earthquake. As an exception to this generalization, specific enhancements most likely to have had impact on performance of Chilean structures include:

- Requirements for confinement in shear wall boundary zones and plastic hinge regions.
- Requirements for ductile detailing of coupling beams.
- Limitations on the use of certain irregular structural configurations.

Table 4-1 Comparison of NCh433.Of96 and ASCE/SEI 7-10 Seismic Design Requirements

Requirement	NCh433.Of96	ASCE/SEI 7-10	Comment
Scope	Minimum design requirements for buildings and components Procedures for repair of damaged structures	Minimum design loads for buildings and other structures including nonstructural components	
Seismic Design Provisions			
Performance Categories and Occupancy Importance Factors	A – Government, municipal, public service, police stations, power plants, $I = 1.2$ B – High and special occupancy, $I = 1.2$ C – Ordinary buildings, $I = 1.0$ D – Uninhabited buildings, $I = 0.6$	I – Uninhabited structures, $I = 1.0$ II – Ordinary structures, $I = 1.0$ III – Important and high occupancy structures, $I = 1.25$ IV – Essential structures, hospital, police, and fire stations, $I = 1.5$	
Seismic Zonation	3 geographic seismic zones	None	ASCE 7 uses Seismic Design Category for some criteria defined by seismic zone in NCh433
Design Ground Motion	Defined by zero period acceleration, A_0 , for each zone: Zone 1 – $A_0 = 0.2$ g Zone 2 – $A_0 = 0.3$ g Zone 3 – $A_0 = 0.4$ g	Defined by MCE_R acceleration contour maps that include: S_S – short period spectral response acceleration parameter ranging to 2.0 g S_T – 1 second spectral response acceleration parameter ranging to 0.8 g Peak Ground Acceleration ranging to 1.0 g	ASCE 7 spectral response acceleration parameters are maximum component direction. NCh433 ground motions are undefined as to component direction
Soil Type and Site Class	I – Rock with $v_s > 900$ m/s (3000 ft/s); uniaxial compressive strength > 10 MPa II – Firm soil with (a) $v_s > 400$ m/s; (b) dense gravel with unit weight > 20 kN/m ³ ; (c) dense sand with relative density $> 75\%$ or Modified Proctor Compaction $> 95\%$; (d) stiff cohesive soil with $s_u > 0.1$ MPa III – (a) unsaturated sand with relative density between 50% and 75%; (b) unsaturated gravel or sand with Modified Proctor Compaction $< 95\%$; (d) saturated sand with $20 < N < 40$ IV – saturated cohesive soil with $s_u < 0.025$ MPa Liquefiable soils require special study	A – Hard rock with $v_s > 5000$ ft/s B – Rock with 2500 ft/s $< v_s < 5000$ ft/s C – Dense soil with 1200 ft/s $< v_s < 2500$ ft/s; $N > 40$ blows/ft, $s_u > 2,000$ psf D – Stiff soil with 600 ft/s $< v_s < 1200$ ft/s; $15 < N < 50$; 1000 psf $< s_u < 2000$ psf E – Soft clay with $v_s < 600$ ft/s; $N < 15$; $s_u < 1000$ psf F – unstable, collapsible, liquefiable soils requiring site-specific study	

Table 4-1 Comparison of NCh433.Of96 and ASCE/SEI 7-10 Seismic Design Requirements (continued)

Requirement	NCh433.Of96	ASCE/SEI 7-10	Comment
Strength Load Combinations	$1.4(D + L \pm E)$ $0.9D \pm 1.4E$	$(1.2 + 0.2S_{DS})D + \rho Q_E + L + 0.2S$ $(0.9 - 0.2S_{DS})D + \rho Q_E + 1.6H$ $(1.2 + 0.2S_{DS})D + \Omega_o Q_E + L + 0.2S$ $(0.9 - 0.2S_{DS})D + \Omega_o Q_E + 1.6H$	NCh 433 earthquake forces are ASD level. ASCE 7 earthquake forces are strength level w/ consideration given to system redundancy, overstrength, and vertical seismic effects
Structural Systems	Shear wall and braced frames Moment-resisting space frames Dual systems combining moment-resisting frames w/ shear walls or braced frames	More than 80 systems including bearing wall, building frame, moment-frame, and dual systems with special, intermediate, ordinary, or no seismic detailing	
Design Parameters	Response modification coefficient, R or R^* , for static and dynamic force analysis procedures, respectively	R – Response modification coefficient C_d – Deflection amplification factor Ω_o – Overstrength factor	
Drift Limits	$0.002h$ at diaphragm center of mass Not more than $0.001h$ greater at any other point on the diaphragm	Varies from $0.01h$ to $0.25h$ depending on structural system type and Risk Category	ASCE 7 drift limits are evaluated after amplification by $C_d I_e$
Static Analysis Procedures			
Limitations	Occupancy Category C or D structures in Seismic Zone 1 Any structure 5 stories (20m) or less in height Regular structures up to 16 stories in height	Regular structures with heights less than 160 feet Regular structures with heights greater than 160 feet and $T < 3.5 T_s$	
Base Shear Equations	$Q_0 = CIP$ $C = \frac{2.75A_0}{gR} \left(\frac{T'}{T^*} \right)^n$ $C_{min} = A_0 / 6g$ C_{max} per NCh433 Table 6.4 (based on R)	$V = C_s W$ $C_s = \frac{S_{DS}}{\left(\frac{R}{I_e} \right)} \leq \frac{S_{D1}}{T \left(\frac{R}{I_e} \right)}$ $C_{Smin} = 0.044 S_{DS} I_e \geq 0.01$ $C_{Smin} = 0.5 S_1 / (R / I_e)$ near fault	

Table 4-1 Comparison of NCh433.Of96 and ASCE/SEI 7-10 Seismic Design Requirements (continued)

Requirement	NCh433.Of96	ASCE/SEI 7-10	Comment
Base Shear versus Period for Various Site Classes			NCh433 base shear forces are ASD level. ASCE 7 base shear forces are strength level. In both codes, strength level equals 1.4*ASD level.
Vertical Distribution of Forces	$F_k = \frac{A_k P_k}{\sum A_j P_j} Q_0$ $A_k = \sqrt{1 - \frac{Z_{k-1}}{H}} - \sqrt{1 - \frac{Z_k}{H}}$	$F_x = C_{vx} V$ $C_{vx} = \frac{w_x h_x^k}{\sum w_i h_i^k}$ <p>k = 1.0 for T < 0.5 seconds k = 2.0 for T > 2.5 seconds</p>	
Story force distribution for hypothetical 10-story structure			NCh433 story forces are higher than ASCE 7 story forces in the upper stories.
Accidental Torsion	$\pm 0.1 b_k \frac{Z_k}{H}$	Eccentricity taken as 5% of diaphragm dimension in the perpendicular direction	
Orthogonal Effects	Each direction considered separately	100% X + 30% Y 30% X + 100% Y	
Modal Response Spectrum Analysis Procedures			
General Design Spectrum	$S_a(T) = \frac{IA_0 \alpha}{R^*}$ $\alpha = \frac{1 + 4.5 \left(\frac{T_n}{T_o}\right)^p}{1 + \left(\frac{T_n}{T_o}\right)^3}$	<p>0 < T = 0.2 sec:</p> $S_a(T) = \frac{S_{DS}}{2.5} + \frac{T}{0.2} (0.6 S_{DS})$ <p>0.2 sec < T < T_s:</p> $S_a(T) = S_{DS}$ <p>T_s < T < T_L:</p> $S_a(T) = \frac{S_{D1}}{T}$ <p>T_L < T:</p> $S_a(T) = \frac{S_{D1} T_L}{T^2}$	

Table 4-1 Comparison of NCh433.Of96 and ASCE/SEI 7-10 Seismic Design Requirements (continued)

Requirement	NCh433.Of96	ASCE/SEI 7-10	Comment
Response Spectra for Various Site Classes			
Modal combination	CQC method	SRSS method; CQC method when modes are closely spaced	
Response Modification Coefficients	Period-dependent coefficients for each mode: $R^* = 1 + \frac{T^*}{0.1T_0 + \frac{T^*}{R_0}}$ For shear wall buildings: $R^* = 1 + \frac{NR_0}{4T_0R_0 + N}$	Mode- and period-independent response modification coefficient, R , same as for equivalent lateral force procedure	
Scaling	Scaled such that base shear is at least $IA_0P / 6g$ Need not exceed maximum base shear for static procedure	Scaled to not less than 85% of static base shear	
Orthogonal Effects	Independent analyses in each of two orthogonal directions	100% X + 30% Y 30% X + 100% Y	
Reinforced Concrete Design Provisions			
Basis	Per ACI 318-95, with exceptions NCh430.Of2008 has since adopted ACI 318-05, with exceptions	Per ACI 318-08	
Shear wall boundary zones	Designed for overturning forces	Confined when estimated compressive strains exceed limiting values	
Coupling beams	Generally not provided as part of seismic force-resisting system	Major elements of walls, detailed for inelastic response	

Comparison of U.S. and Chilean Seismic Design Practice

This chapter presents a comparative evaluation of a case study building used to investigate and illustrate differences between U.S. and Chilean seismic design practices. The subject building is a typical, mid-rise, reinforced concrete shear wall building in Chile that was damaged as a result of the 2010 Maule earthquake. The purpose of this comparison is to study how differences in code requirements and design practices would result in differences in structural configuration and detailing.

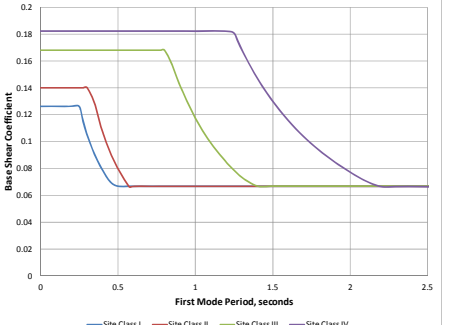
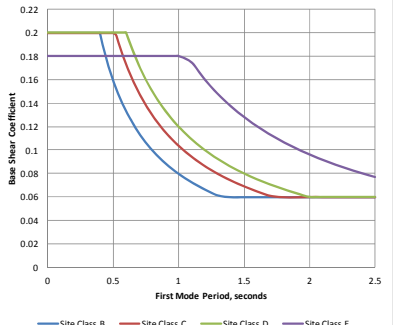
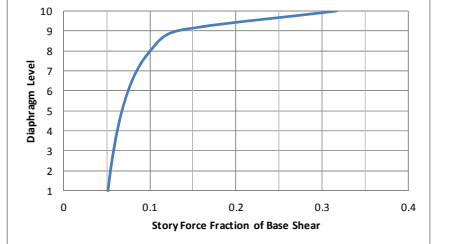
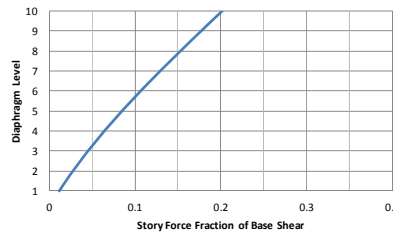
The case study building was analyzed using both NCh433.Of96, *Earthquake Resistant Design of Buildings* (INN, 1996) and ASCE/SEI 7-05, *Minimum Design Loads for Buildings and Other Structures* (ASCE, 2006). It was then redesigned as a hypothetical U.S. building, considering approximately the same seismic design environment and the same floor plate size and shape, utilizing shear wall configurations conforming to typical U.S. design practice. When needed, ACI 318-05, *Building Code Requirements for Structural Concrete* (ACI, 2005) was referenced for concrete material design requirements.

5.1 Building Description

The Chilean case study building is a 10-story reinforced concrete shear wall building that was designed and constructed in 1996. It has one basement level used for parking, and is fairly typical of the type of construction used in mid-rise residential occupancies in Chile. The case study site is located in Viña del Mar, and is considered by NCh433.Of96 to be Seismic Zone 3. The building is assumed to have been designed to the requirements of NCh433.Of96.

The building is rectangular in plan, measuring approximately 37 m long by 16 m wide (121 feet by 52 feet). The typical floor plan is shown in Figure 5-1. The basement story height is 3.6 m (11.5 feet), the first story height is 3.1 m (10 feet), and the typical story height is 2.6 m (8.5 feet). Typical transverse wall elevations showing the vertical configuration of the building are provided in Figure 5-2. As shown in the figure, most walls have a setback at their base to provide improved access to parking in the lower levels.

The structural system consists of a 13 cm (5 in.) reinforced concrete slab supported by 20 cm (8 in.) reinforced concrete bearing walls. Concrete was assumed to have a specified compressive strength $f'_c = 4,000$ psi.

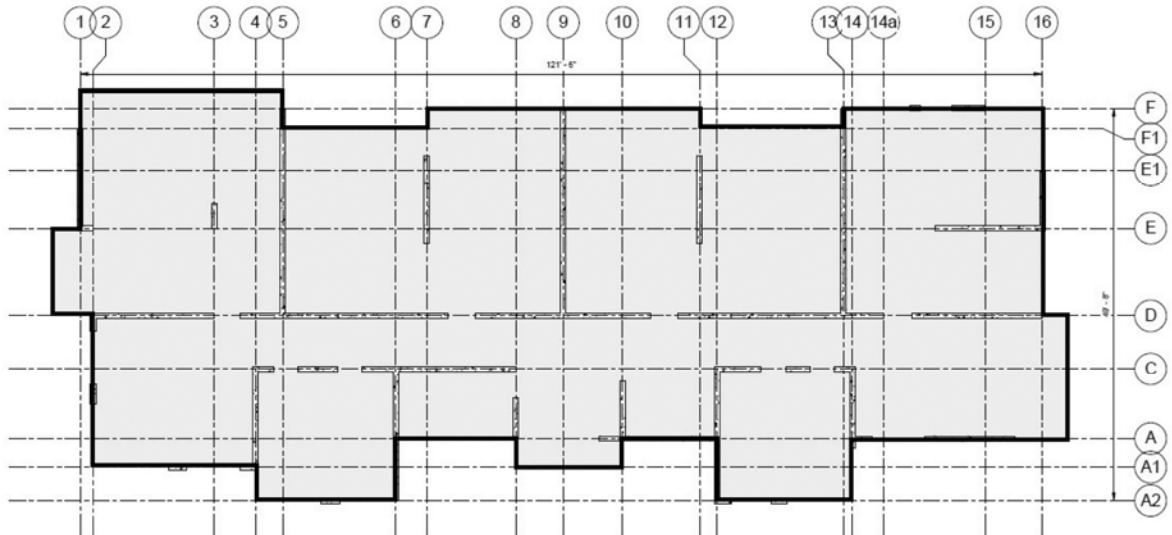

Figure 5-1 Typical floor plan, Chilean case study building.

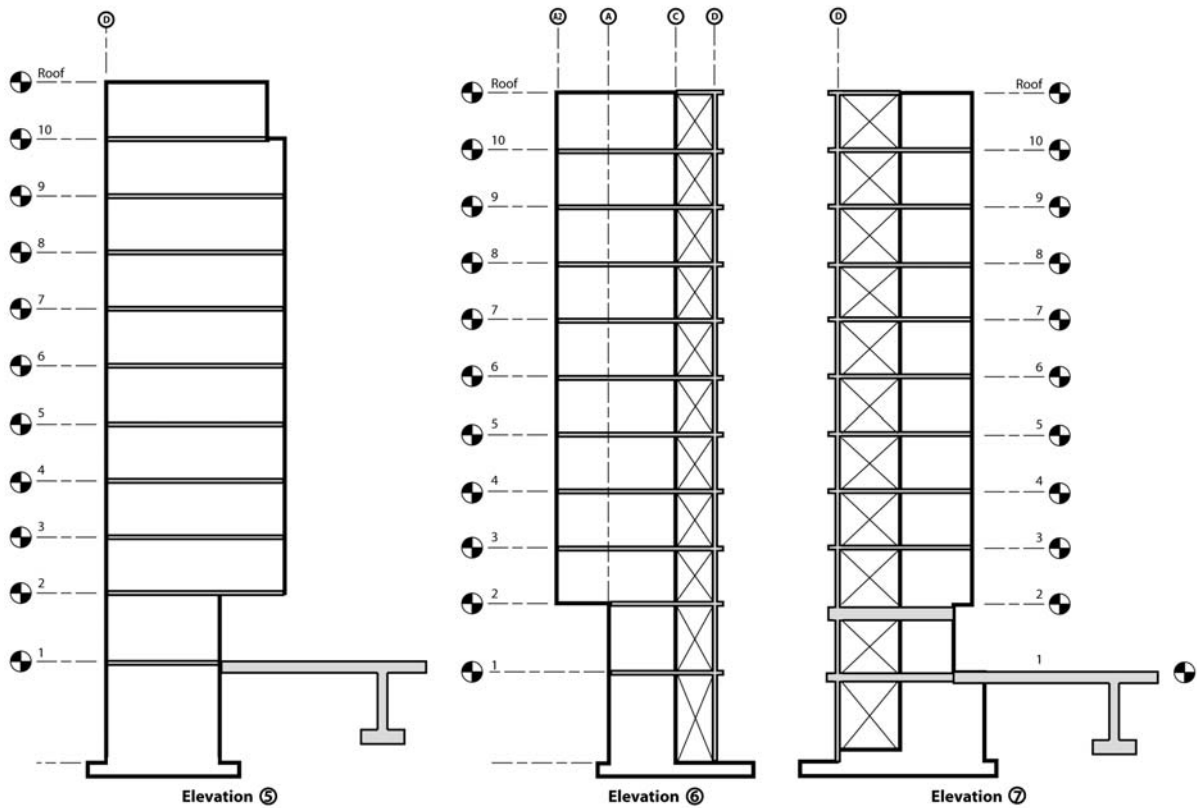

Figure 5-2 Transverse wall elevations, Chilean case study building.

5.2 Observed Earthquake Damage

The case study building sustained significant damage as a result of the 2010 Maule earthquake. Damage consisted of horizontal and diagonal cracking, spalling, crushing, and bar buckling in the reinforced concrete shear walls. Damage was concentrated primarily in the first story of the transverse shear walls, which led to differential vertical displacements on the order of 40 cm (16 in.) in the upper stories that damaged reinforced concrete beams and floor slabs.

Photos of observed damage are shown in Figures 5-3 through 5-7. Cracking and spalling were attributed to the “flag-shaped” configuration of the shear walls, which resulted in reduced cross-sections and increased stresses where demands were expected to be the highest. Crushing and bar buckling were attributed to a lack of confinement reinforcing in the form of closed hoops and cross ties in the shear wall boundary zones. In spite of the observed damage, however, the case study building did not collapse.



Figure 5-3 Transverse elevation of the case study building showing differential vertical displacements following the 2010 Maule earthquake (photo courtesy of Patricio Bonelli).



Figure 5-4 Overall damage sustained in the first-story transverse shear walls of the case study building (photo courtesy of Patricio Bonelli).



Figure 5-5 Cracking, spalling, crushing, and bar buckling in the transverse shear wall on Line 9 (photo courtesy of Patricio Bonelli).



Figure 5-6 Cracking, spalling, crushing, and bar buckling in the transverse shear wall on Line 5 (photo courtesy of Patricio Bonelli).



Figure 5-7 Crushing and bar buckling in the transverse shear wall on Line 1 resulting in significant differential vertical displacement (photo courtesy of Patricio Bonelli).

5.3 Analysis of Chilean Configuration

Three-dimensional, modal response spectrum analysis was performed using ETABS, *Extended Three Dimensional Analysis of Building Systems* (Computers and Structures, Inc.). In U.S. practice, members are classified in two groups: (1) members that are part of the intended seismic force-resisting system, such as concrete shear walls and diaphragms; and (2) members that are not intended to be part of the seismic force-resisting system, such as concrete columns, beams framing balconies, and spandrels connecting columns to walls. In typical U.S. practice, the latter group of elements is not considered when performing structural analysis for design. Consistent with Chilean practice, the structural model of the Chilean configuration of the case study building considered the contribution from all concrete elements in the building. A rendering of the ETABS model is shown in Figure 5-8.

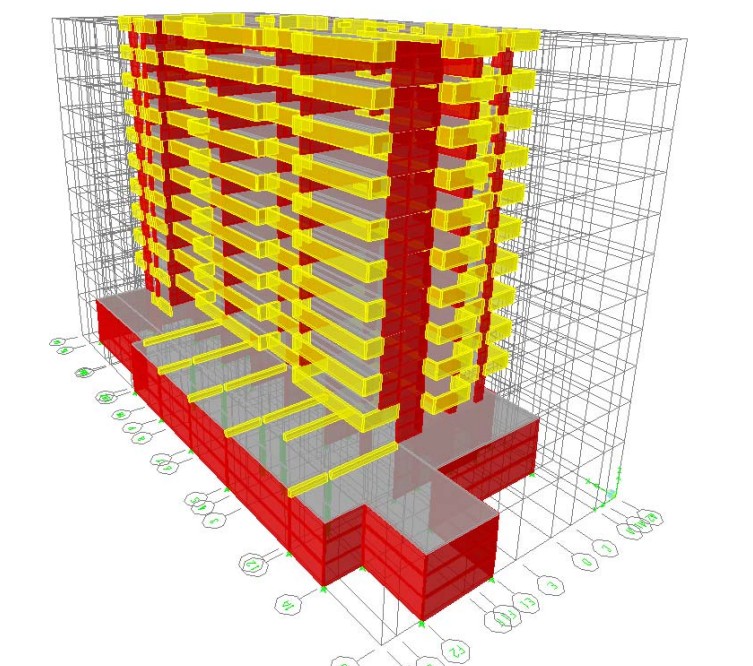

Figure 5-8 Three-dimensional ETABS model of the Chilean configuration of the case study building.

Assumed gravity loading in the building considered the structure self-weight, 25 psf of superimposed dead load, 150 kips of mechanical equipment located on the roof, and 40 psf of live load. In NCh433.Of96, the effective seismic weight includes the dead load plus a fraction (not less than 25%) of the live load, in this case taken as 10 psf. In ASCE/SEI 7-05, the effective seismic weight includes the dead load plus the actual weight of partitions (taken as not less than 10 psf). Live load is not considered, except in cases of storage loading. Although attributed to somewhat different sources in each code, the estimated seismic weight is approximately 7,900 kips in both cases. Consistent with current practice in both Chile and the United

States, the effective seismic weight has been calculated considering only the levels of the building that are above grade.

In NCh433.Of96, concrete structures are analyzed using gross section properties. In ASCE/SEI 7-05, Section 12.7.3 requires the use of effective stiffness of concrete elements to account for the effects of cracked sections in concrete structures. In ACI 318-05, Section 8.6 allows the use of “any set of reasonable assumptions,” and Section 10.11.1 provides guidance including factors of 0.35 times gross section properties for cracked shear walls, and 0.7 times gross section properties for uncracked shear walls.

Although ACI 318 Section 10.11.1 is intended for use in determining column slenderness effects, these values have been accepted by U.S. engineers as a standard of practice for concrete building response analysis. In typical cantilever shear walls, it is expected that cracking will be concentrated in the formation of plastic hinges at the base, and that little or no cracking will occur in the upper levels. It is, therefore, common practice in the United States to average these values, and to use 0.5 times gross section properties over the full height. Table 5-1 summarizes the periods of vibration of for the first three modes of response in the Chilean configuration, calculated using both gross section properties and cracked section properties (assuming 0.5 times gross section properties) over the full height of the shear walls.

Table 5-1 Chilean Configuration Periods of Vibration

Mode	Period (gross section properties)	Period (effective section properties)	Dominant Mass Participation
1	0.77 sec	1.06 sec	Rotation
2	0.65 sec	0.91 sec	Transverse direction
3	0.44 sec	0.62 sec	Longitudinal direction

5.3.1 Site Response Spectra

Site response spectra were constructed in accordance with NCh433.Of96 and ASCE/SEI 7-05. The case study site in Viña del Mar is classified as Seismic Zone 3 with Soil Type III. A similar site was assumed for the U.S. design, taken as a representative location in a region of high seismicity (San Francisco, California) with Site Class D. The parameters used to construct the design spectra are listed in Table 5-2. The derivation of these parameters is described in detail in Chapter 2 and Chapter 3.

A comparison of the spectra for the Viña del Mar and San Francisco sites is shown in Figure 5-9. These spectra have been plotted for R (and R^*) = 1.0 and I (and I_e) = 1.0. As such, they have not been adjusted for response modification or importance.

Table 5-2 Seismic Design Parameters used to Develop Site Response Spectra per NCh433.Of96 and ASCE/SEI 7-05

<i>NCh433.Of96</i>		<i>ASCE/SEI 7-05</i>	
Seismic Design Parameter	Value	Seismic Design Parameter	Value
Occupancy Category	C	Risk Category	II
Seismic Zone	3	S_s	1.5 g
A_0	0.4 g	S_1	0.65 g
Soil Type	III	Site Class	D
n	1.8	F_a	1.0
p	1.0	F_v	1.5
T_0	0.75 sec	S_{DS}	1.0 g
R^*	1.0	S_{D1}	0.65 g
Importance, I	1.0	T_0	0.13 sec
		T_s	0.65 sec
		R	1.0
		Importance, I_e	1.0

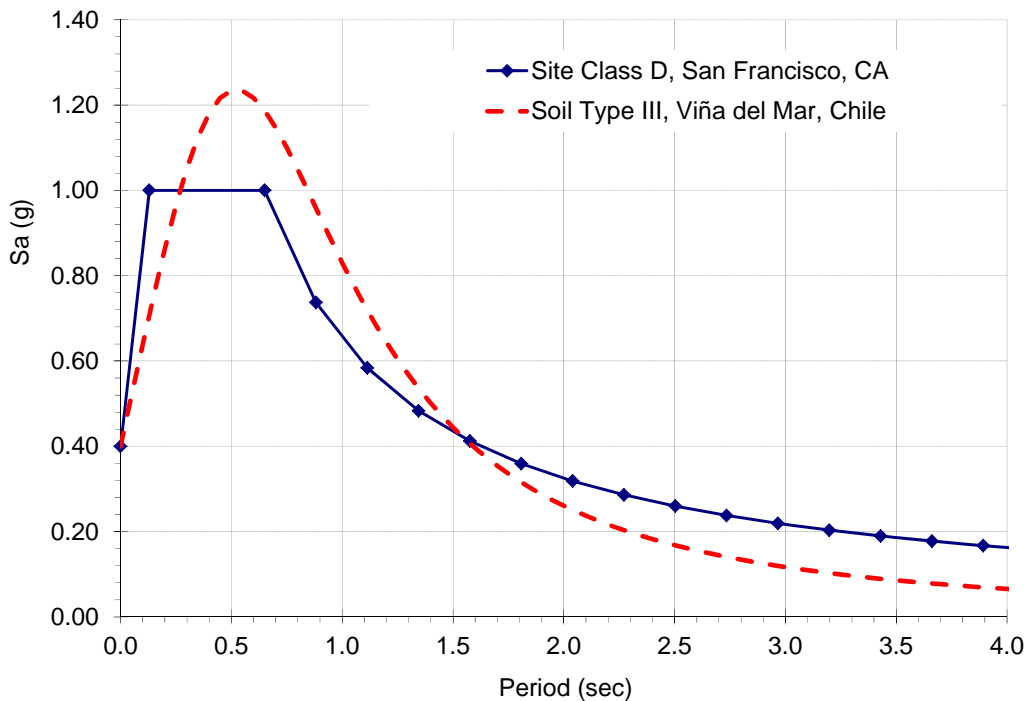

Figure 5-9 Comparison of design response spectra for Viña del Mar, per NCh433.Of96, and San Francisco, California, per ASCE/SEI 7-05.

5.3.2 Drift Response

Under NCh433.Of96, concrete buildings are modeled using gross section properties and analyzed for the site response spectrum reduced by the period-dependent response modification coefficient, R^* . A plot of R^* versus period is shown in Figure 5-10. Based on the transverse and longitudinal translational periods of 0.65 seconds and 0.44 seconds shown in Table 5-1, the values of R^* for the case study building would be 5.85 and 4.88 respectively, in each direction.

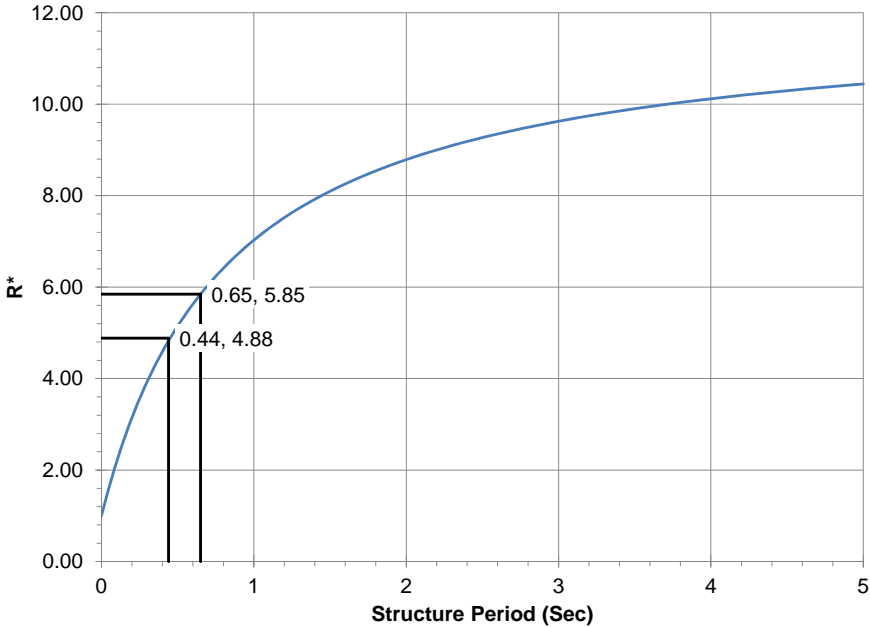

Figure 5-10 Variation in response modification coefficient, R^* , as a function of period.

The value of R^* cannot be taken so large that the resulting base shear is less than $IA_0P/6g$. In general, this limitation usually results in a lower effective value of R^* used in design. In Figure 5-11, spectral ordinates from the response spectrum for Viña del Mar are divided by the value of R^* at each period. In the figure, the minimum base shear coefficient $IA_0/6g = 0.067 g$ would control the design at periods exceeding 1.35 seconds, resulting in a maximum effective $R^* = 7.8$. For the case study building, this limitation does not control.

Under ASCE/SEI 7-05, concrete buildings are modeled using effective section properties and analyzed for design forces reduced by the response modification coefficient, R , and checked for drifts amplified by C_d . For special reinforced concrete shear walls, $R = 5$ in bearing wall systems, $R = 6$ in building frame systems, and $C_d = 5$. The distinction between bearing wall and building frame systems is not made in the Chilean code. ASCE/SEI 7-05 also has a minimum base shear coefficient. The typical value of $C_{Smin} = 0.044S_{DS}I_e = 0.044 g$, is significantly lower than the minimum coefficient specified in NCh433.Of96.

ASCE/SEI 7-05 limits the maximum period that can be used to calculate seismic forces and, in some cases, requires use of a redundancy factor, ρ , to amplify seismic design forces. These provisions have a similar effect in reducing the effective value of R that is used in design.

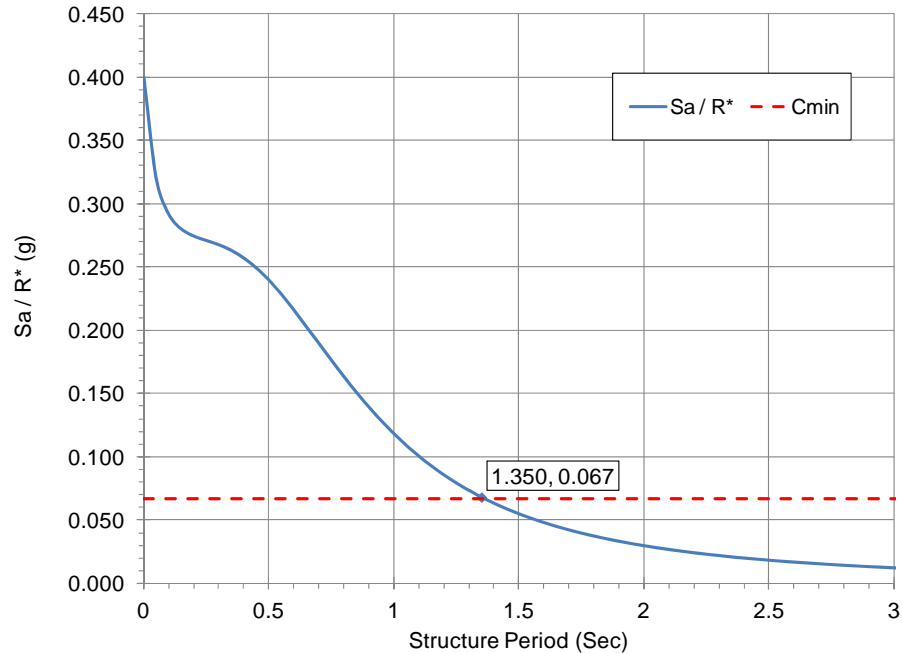

Figure 5-11 Spectral acceleration ordinates for the Viña del Mar site divided by the value of R^* at each period.

In both codes, maximum story drifts are compared against limiting values. In NCh433.Of96, the maximum story drift ratio under design forces (reduced by R^*) is 0.002 at the center of mass of the diaphragm. At extreme points on the diaphragm, the drift ratio cannot be more than 0.001 greater than the drift ratio at the center of mass. Depending on the magnitude of drift ratio at the center of mass, permissible drift ratios at extreme corners can be more than 1.5 times the values at the center of mass.

In ASCE/SEI 7-05, a building with maximum drift ratios exceeding 1.4 times the average drift ratio would be classified as having an extreme torsional irregularity. This type of irregularity is not permitted in Seismic Design Categories E or F. It is permitted in Seismic Design Category D, but its presence would trigger requirements including: (1) use of dynamic analysis procedures; (2) amplification of accidental torsional components of response; and (3) increase in diaphragm chord and collector design forces.

Maximum story drifts for the Chilean configuration of the case study building have been calculated using the Viña del Mar spectrum reduced by R^* , as specified in NCh433.Of96, and using the San Francisco spectrum amplified by C_d and reduced by

R , as specified in ASCE/SEI 7-05. The results are compared in Figures 5-12 through 5-19 for story drift ratios at the center of mass and extreme corners of the building. In all cases, an accidental torsional eccentricity of 5% has been included.

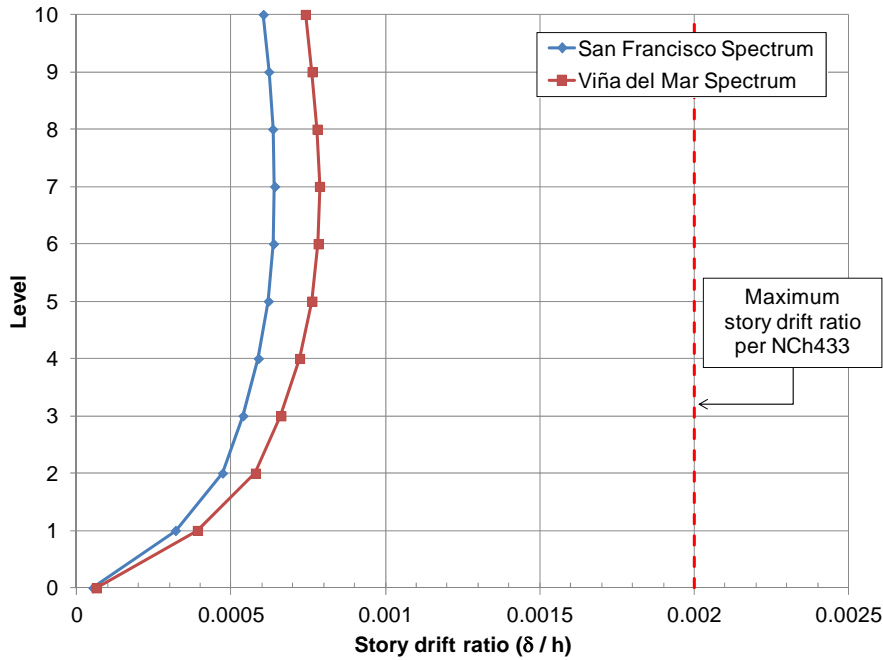

Figure 5-12 Maximum story drift ratios in the longitudinal direction at the center of mass, calculated per NCh433.Of96.

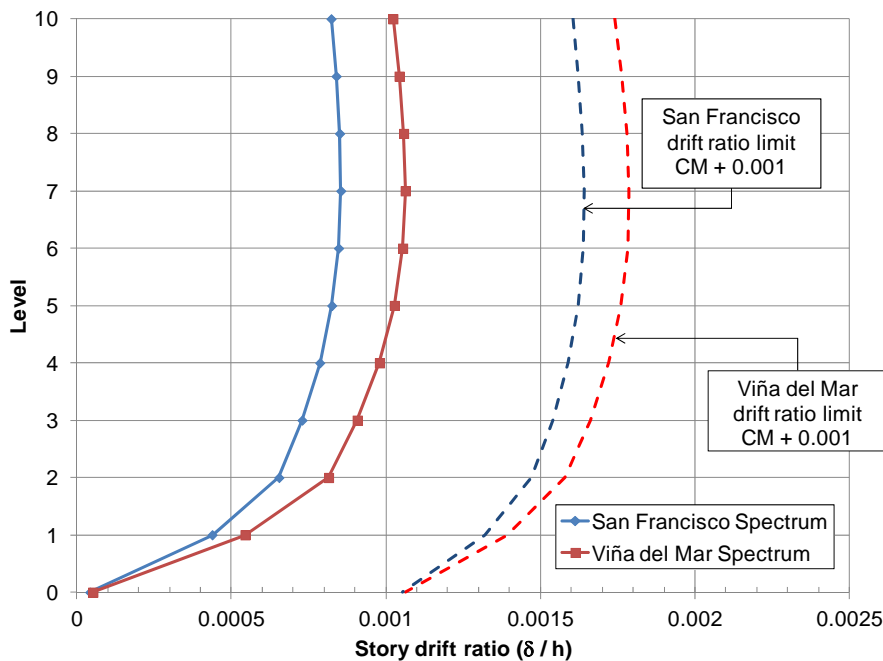

Figure 5-13 Maximum story drift ratios in the longitudinal direction at an extreme corner, calculated per NCh433.Of96.

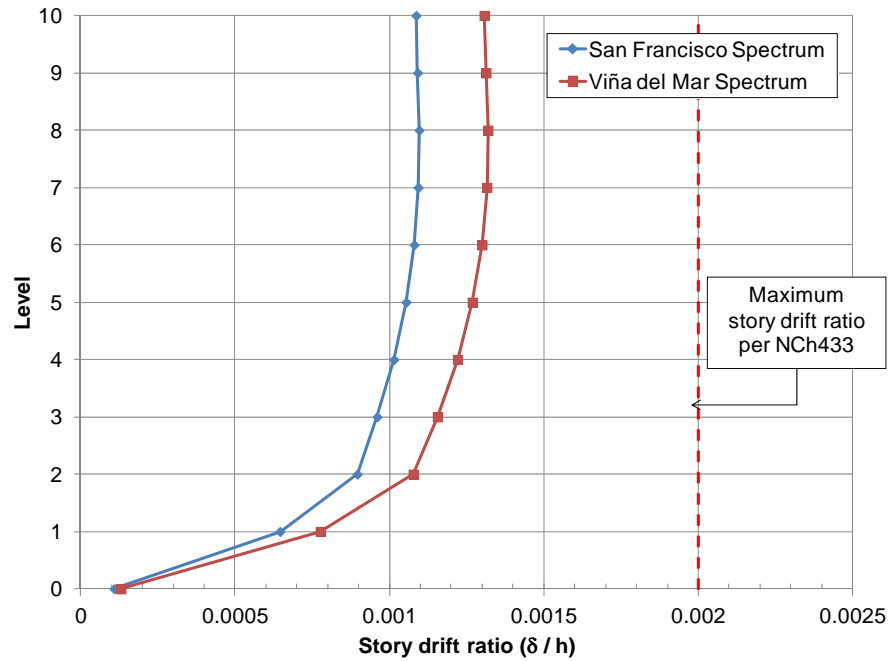

Figure 5-14 Maximum story drift ratios in the transverse direction at the center of mass, calculated per NCh433.Of96.

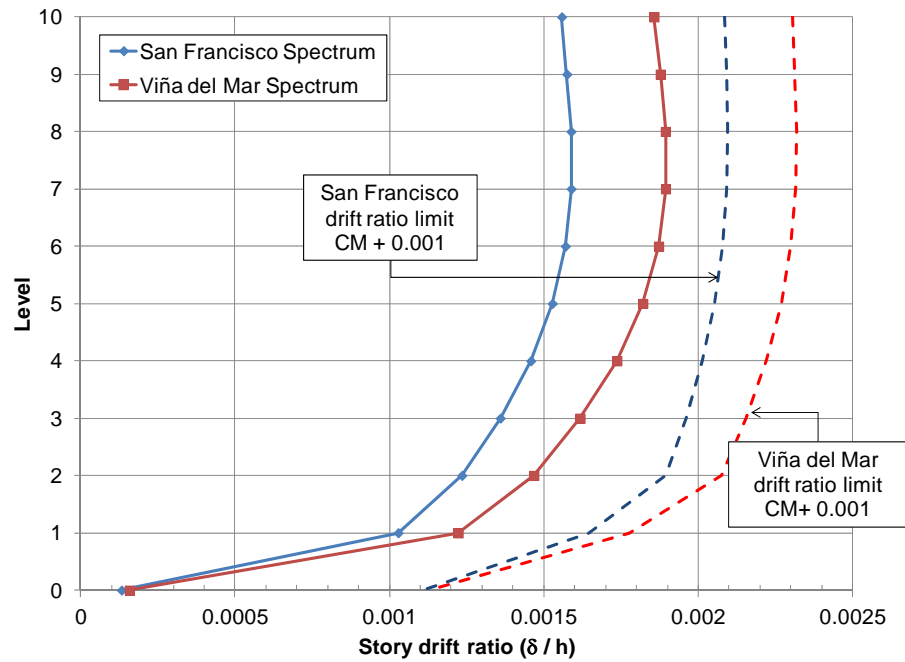

Figure 5-15 Maximum story drift ratios in the transverse direction at an extreme corner, calculated per NCh433.Of96.

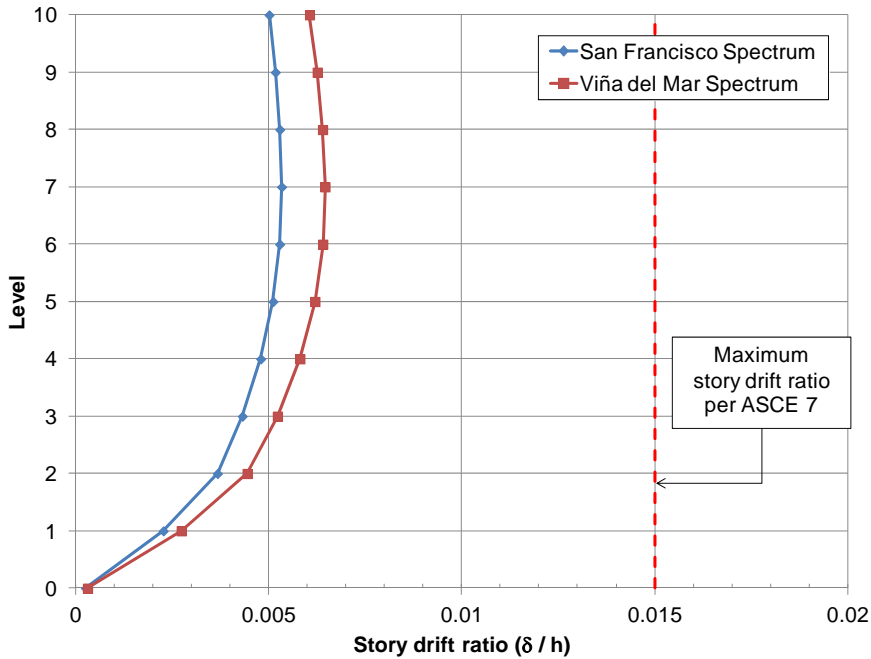

Figure 5-16 Maximum story drift ratios in the longitudinal direction at the center of mass, calculated per ASCE/SEI 7-05.

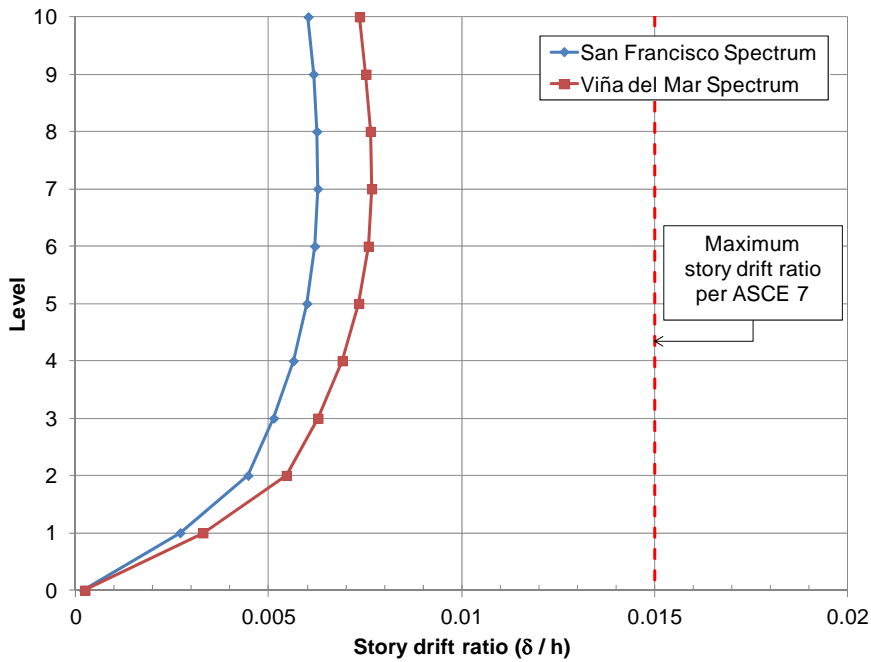

Figure 5-17 Maximum story drift ratios in the longitudinal direction at an extreme corner, calculated per ASCE/SEI 7-05.

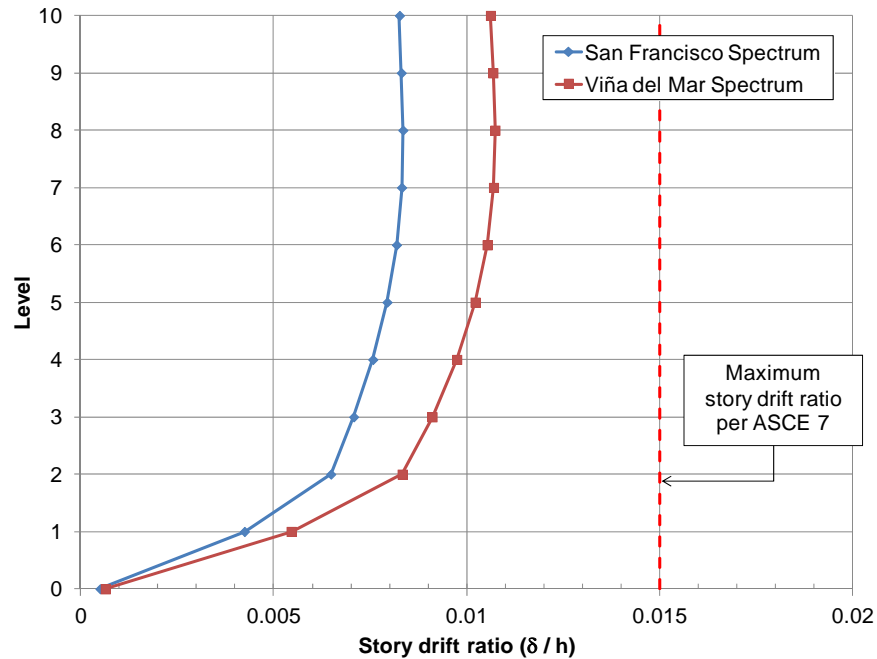

Figure 5-18 Maximum story drift ratios in the transverse direction at the center of mass, calculated per ASCE/SEI 7-05.

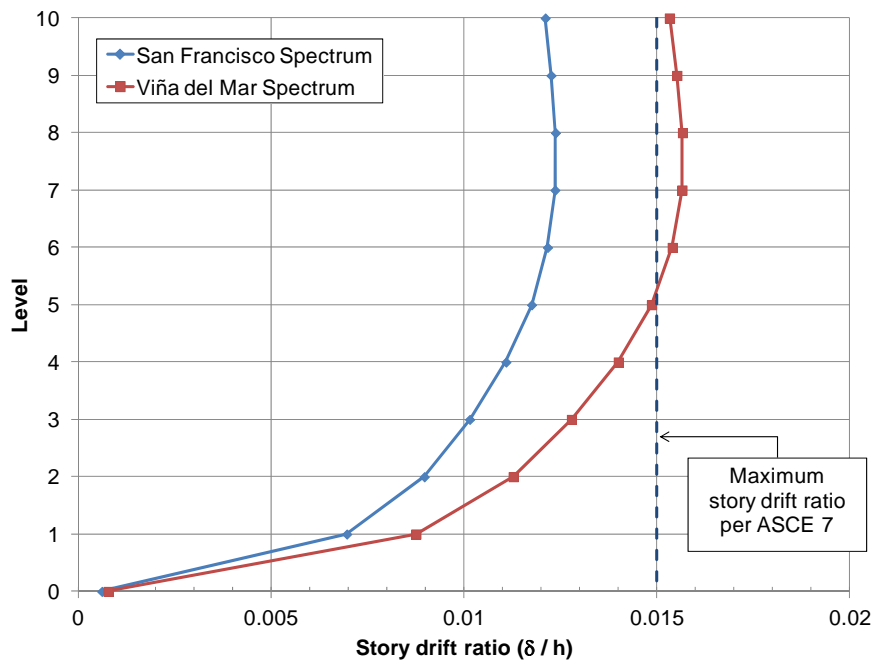

Figure 5-19 Maximum story drift ratios in the transverse direction at an extreme corner, calculated per ASCE/SEI 7-05.

Because the San Francisco spectrum includes a short period plateau, the Viña del Mar spectrum produced higher drifts in all cases. Although NCh433.Of96 specifies the use of gross section properties, drift demands exceeded ASCE/SEI 7-05 drift demands calculated using effective section properties and a displacement

amplification factor. This can be seen by comparing pairs of figures, such as Figures 5-14 and 5-18, for example. In NCh433.Of96, story forces are higher than ASCE/SEI 7-05 story forces in the upper stories. This observed difference in drift demands is attributed to differences in vertical force distribution between NCh433.Of96 and ASCE/SEI 7-05.

In all cases, drift demands in the transverse direction were more severe than in the longitudinal direction. This result is consistent with observations of more severe damage in the transverse shear walls following the 2010 Maule earthquake.

The drift limits of NCh433.Of96 were evaluated considering the Viña del Mar spectrum. The drift limits of NCh433.Of96 were also evaluated considering demands resulting from the San Francisco spectrum. Calculated drifts for the Chilean configuration were within the drift limits of NCh433.Of96 in all cases.

For comparison purposes, the drift limits of ASCE/SEI 7-05 were similarly evaluated for the Chilean configuration considering both the San Francisco spectrum and the Viña del Mar spectrum. Calculated drifts for the San Francisco spectrum were within the drift limits of ASCE/SEI 7-05, although the Chilean configuration building would be classified as having an extreme torsional irregularity by U.S. code provisions. Calculated drifts for the Viña del Mar spectrum exceeded ASCE/SEI 7-05 drift limits in the transverse direction.

5.3.3 Design Forces

In NCh433.Of96, earthquake forces are specified at Allowable Stress Design (ASD) levels. Using these forces in Load and Resistance Factor Design (LRFD) requires that they be factored by 1.4. Chilean strength-based load combinations are:

$$1.4(D + L \pm E)$$
$$0.9D \pm 1.4E$$

In ASCE/SEI 7-05, an extreme torsional irregularity triggers a redundancy factor, $\rho = 1.3$, which amplifies seismic design forces. The ASCE/SEI 7-05 equation for horizontal earthquake forces is:

$$E_h = \rho * Q_E$$

In both codes, base shears obtained from modal response spectrum analysis must be compared with base shear coefficients from static analysis. Values must be at least equal to minimum base shear requirements, and need not exceed maximum base shear requirements. In ASCE/SEI 7-05, modal response spectrum analysis results must be at least 85% of the static analysis base shear. Design practice in both countries includes scaling of response spectrum results to satisfy these limits.

Table 5-3 shows design base shear parameters used to scale modal response spectrum analysis results per NCh433.Of96 and ASCE/SEI 7-05.

Table 5-3 Design Base Shear Parameters for Scaling of Response Spectrum Analysis Results per NCh433.Of96 and ASCE/SEI 7-05

<i>NCh433.Of96</i>		<i>ASCE/SEI 7-05</i>	
Parameter	Value	Parameter	Value
Occupancy Category	C	Seismic Design Category	D
Effective Seismic Weight	7900 kips	Effective Seismic Weight	7900 kips
Seismic Zone	3	S_s	1.5 g
A_0	0.4 g	S_1	0.65 g
Soil Type	III	Site Class	D
n	1.8	F_a	1.0
ρ	1.0	F_v	1.5
T'	0.85	S_{DS}	1.0 g
S	1.2	S_{D1}	0.65 g
R	7	R (bearing wall)	5.0
Importance, I	1.0	Importance, I_e	1.0
T^* (longitudinal)	0.44 sec	Height, h_n	87 ft
T^* (transverse)	0.65 sec	$C_u T_a$	0.8 sec
C (longitudinal)	0.514 g		
C (transverse)	0.255 g	C_s	0.20 g
$C_{min} = A_0/6$	0.067 g	$C_{Smin} = 0.5 S_1 / (R/I_e)$	0.065 g
$C_{max} = 0.35SA_0$ (for $R=7$)	0.168 g	$C_{Smax} = S_{D1}/T (R/I_e)$	0.163 g
LRFD conversion	1.4	Redundancy, ρ	1.3
$1.4 * C_{max}$	0.24 g	$\rho * C_{Smax}$	0.21 g
Base shear $1.4 * E$	1900 kips	Base shear $\rho * E_h$	1680 kips

The response of the case study building is in the short-period range, so in both cases the maximum design base shear coefficients control. Considering the transverse direction as critical, Figures 5-20 and 5-21 show design story shears and overturning moments that have been scaled to match the base shears reported in Table 5-3. In the figures, results using the Viña del Mar spectrum have been scaled to match the base shear per NCh433.Of96 (at a strength design level), and results using the San Francisco response spectrum have been scaled to match the design base shear per ASCE/SEI 7-05 (including the redundancy factor).

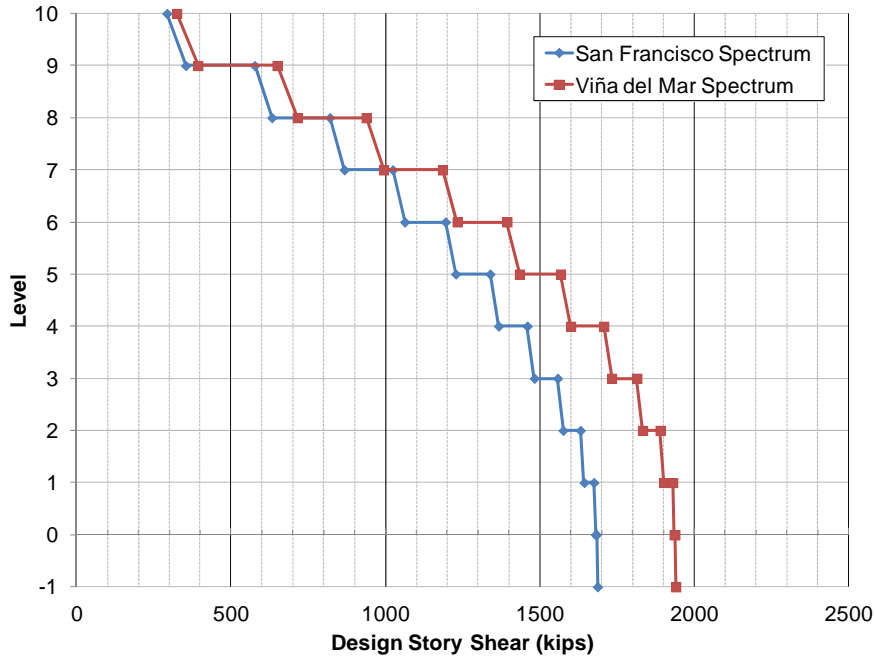

Figure 5-20 Design story shears in the transverse direction, per NCh433.Of96 (at strength level) and ASCE/SEI 7-05 (including redundancy factor).

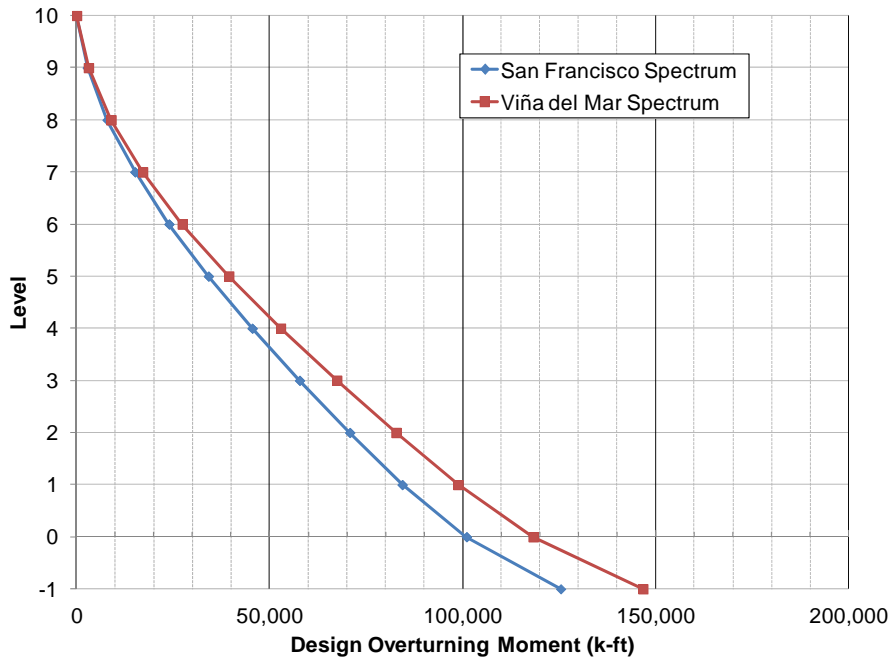

Figure 5-21 Design overturning moments in the transverse direction, per NCh433.Of96 (at strength level) and ASCE/SEI 7-05 (including redundancy factor).

For strength design of reinforced concrete elements, NCh433.Of96 references ACI 318-95. Current Chilean practice has since adopted ACI 318-05, but in both cases, the Chilean codes have waived the requirements for confinement of shear wall boundary zones.

Checking strength level design forces along typical transverse wall lines, Chilean wall strengths exceed required shear and flexural demands per NCh433.Of96. Checking compressive strain requirements for shear wall boundary zones, however, shows that confinement reinforcing would be required per ACI 318 limits. Typical Chilean shear wall detailing in the case study building is shown in Figure 5-22, along with the confined boundary zone detailing that would be required by ACI 318.

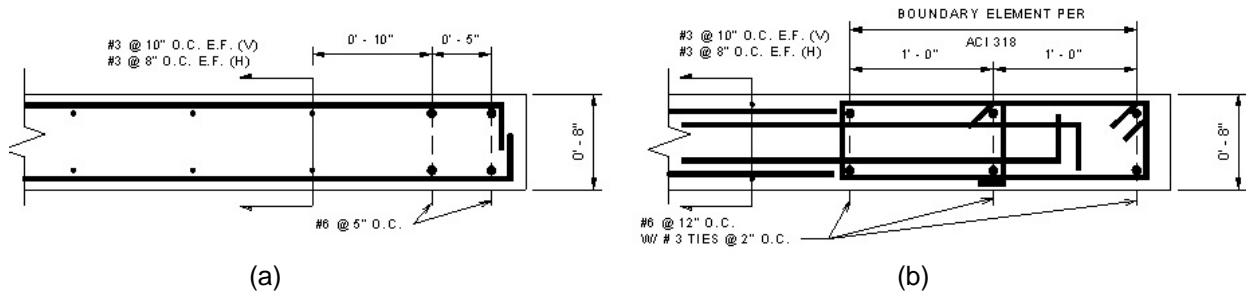

Figure 5-22 Shear wall boundary element detailing for the case study building: (a) Chilean detailing; and (b) ACI 318 detailing for confinement.

Figure 5-21 shows a typical flanged (i.e., “T-shaped”) wall configuration present in the Chilean case study building. It also shows the strain distribution and length of the confined boundary element that would be required in such walls per ACI 318.

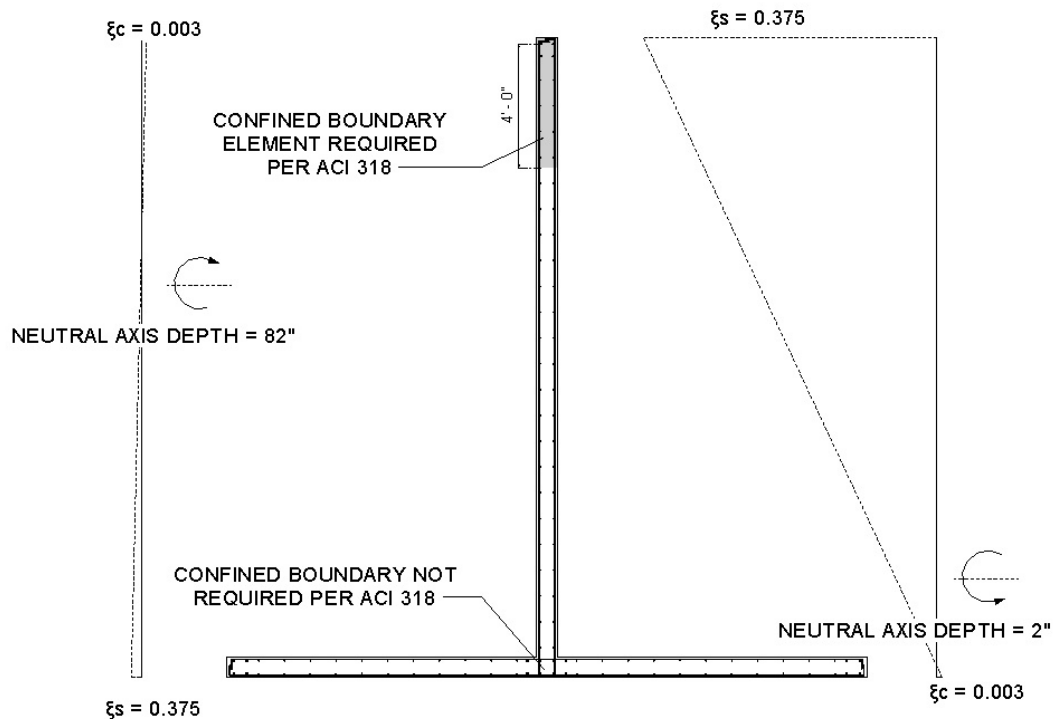

Figure 5-23 Strain distribution and confined boundary element for “T-shaped” wall configurations, per ACI 318.

In “T-shaped” wall configurations, ACI 318 specifies that the effective width of the flange should not exceed 25% of the height of the wall. The calculated tensile strain of 0.375 in/in exceeds the rupture strain of approximately 0.10 in/in. Excessive strain in the stem of “T-shaped” walls has been shown to limit the flexural capacity of the wall section, and negatively impact the ductility capacity. This result is consistent with observations of damage in the transverse shear walls following the 2010 Maule earthquake.

5.4 Design and Analysis of U.S. Configuration

In contrast with Chilean practice, U.S. practice is to configure buildings with longer spans and fewer structural walls. As a consequence, walls are thicker, allowing for easier placement of confinement reinforcing and lower compressive strains. A shear wall configuration for a hypothetical building was developed consistent with U.S. practice. A comparison with the Chilean shear wall layout is shown in Figure 5-24.

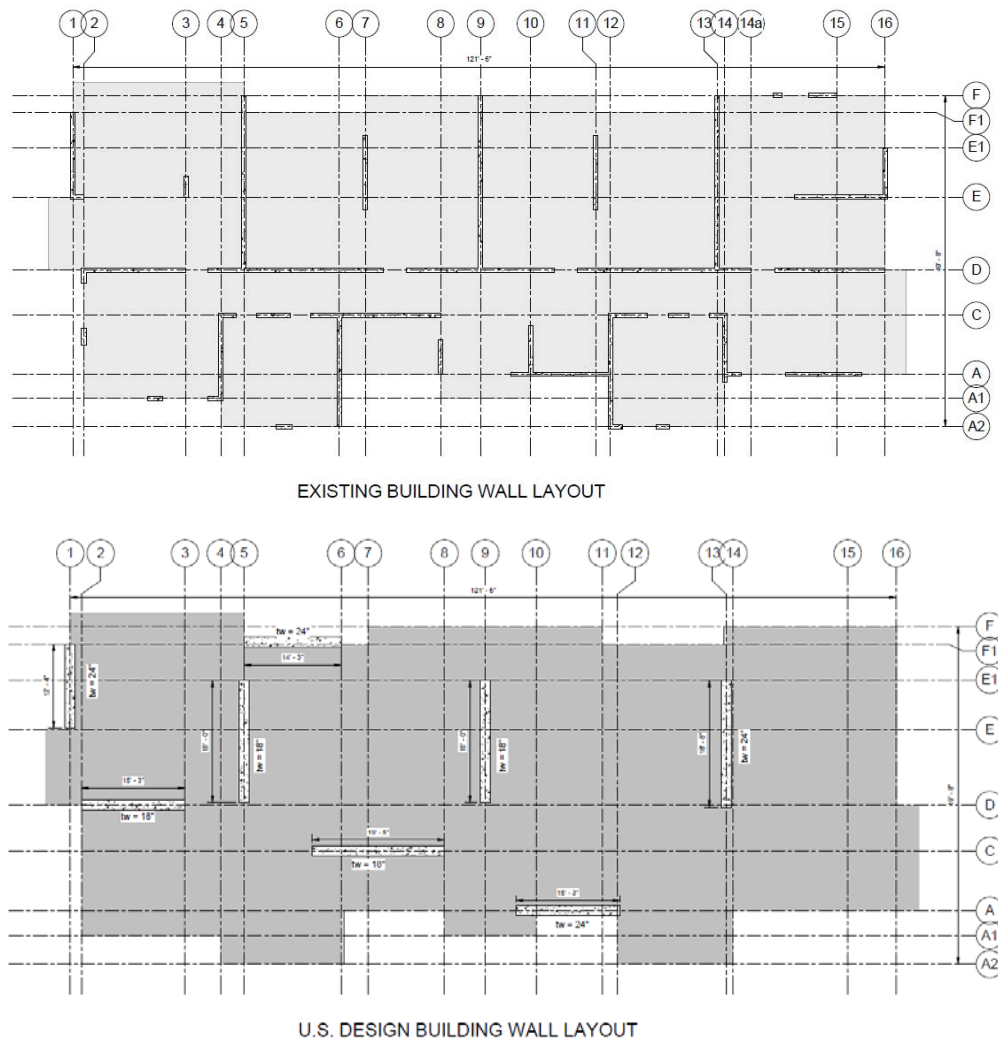

Figure 5-24 Comparison of U.S. configuration with Chilean shear wall layout.

This comparison is intended to illustrate differences in structural design practice and quantify the effects on detailing and potential behavior. No attempt was made to optimize the design of the U.S. configuration. It should also be noted that the U.S. configuration would not be suitable for Chilean architectural practice in which concrete walls also serve as partitions, acoustical barriers, and fire protection between units.

In the Chilean wall configuration, setbacks were provided at the base of the transverse walls. In the U.S. configuration, fewer walls provide fewer obstacles to circulation within the building. As a result, the setbacks have been eliminated and the base of the walls expanded to improve overturning resistance. Typical Chilean and U.S. transverse shear wall elevations are compared in Figure 5-25.

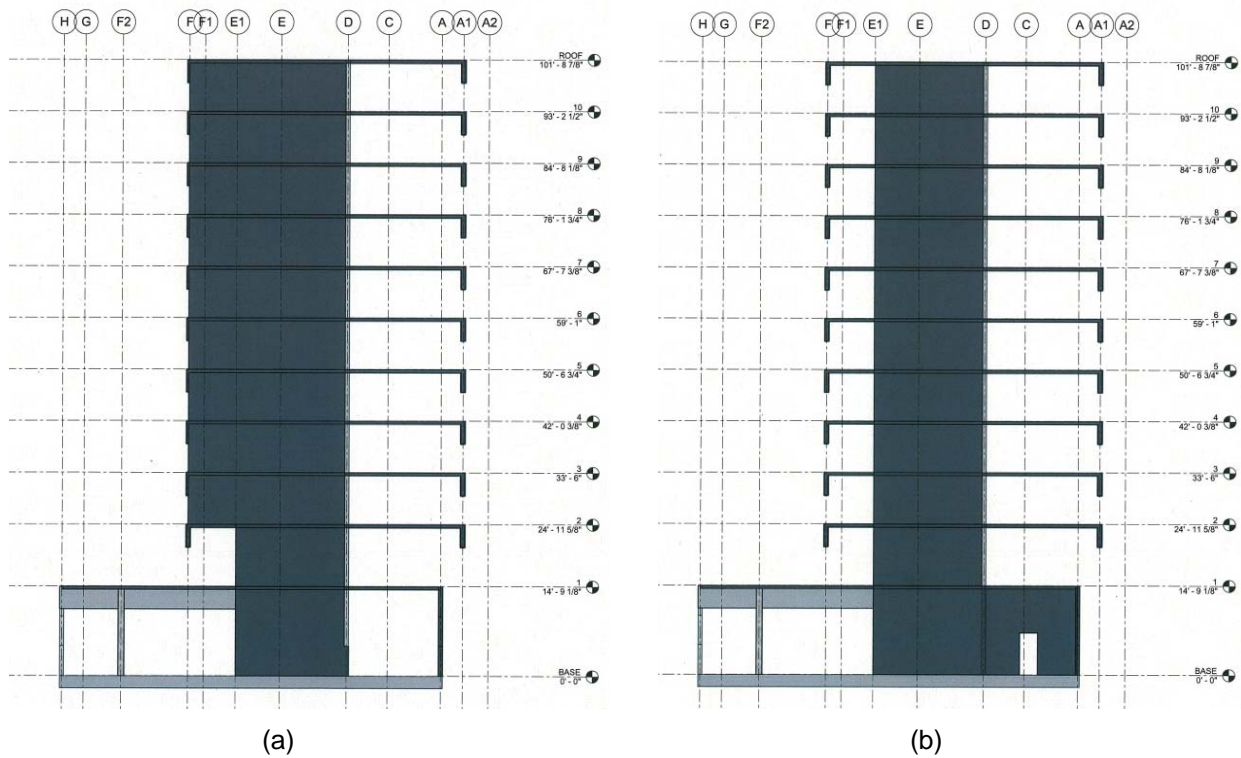

Figure 5-25 Comparison of typical transverse wall elevations: (a) Chilean configuration; and (b) U.S. configuration.

In designs with fewer walls, reliance on diaphragms and collectors to deliver loads to the walls is much greater. NCh433.Of96 requires that diaphragms have adequate strength and stiffness, but no other criteria are provided. ASCE/SEI 7-05 includes provisions for diaphragm design in which design forces are amplified relative to story forces to account for higher mode effects. Further amplification is required when certain building irregularities are present. Collector elements are intended to remain elastic, and special load combinations including the overstrength factor, Ω_0 , are used to provide this behavior.

Three-dimensional, modal response spectrum analysis of the U.S. configuration was performed using ETABS. A rendering of the ETABS model is shown in Figure 5-26. Consistent with U.S. practice, columns and beams that are not part of the designated seismic force-resisting system have not been included in the analysis. This approach can result in models that are significantly more flexible than actual structures.

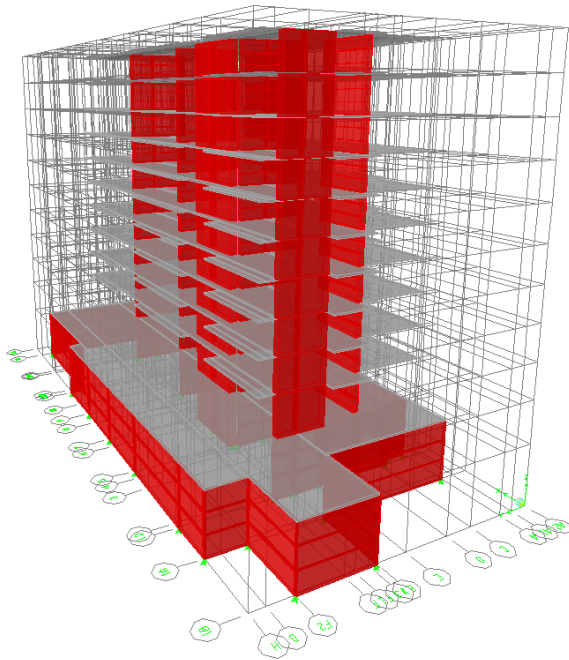

Figure 5-26 Three-dimensional ETABS model of the U.S. building configuration.

Table 5-4 summarizes the periods of vibration of for the first three modes of response in the U.S. building configuration, calculated using both gross section properties and cracked section properties.

Table 5-4 U.S. Configuration Periods of Vibration

Mode	Period (gross section properties)	Period (effective section properties)	Dominant Mass Participation
1	0.76 sec	1.06 sec	Longitudinal direction
2	0.74 sec	1.05 sec	Transverse direction
3	0.68 sec	0.93 sec	Rotation

5.4.1 Drift Response

Figure 5-27 shows the maximum story drift ratios in the transverse direction at the center of mass and corner of the U.S. building configuration, subjected to the San Francisco spectrum. The proposed wall layout complies with the story drift limits in ASCE/SEI 7-05.

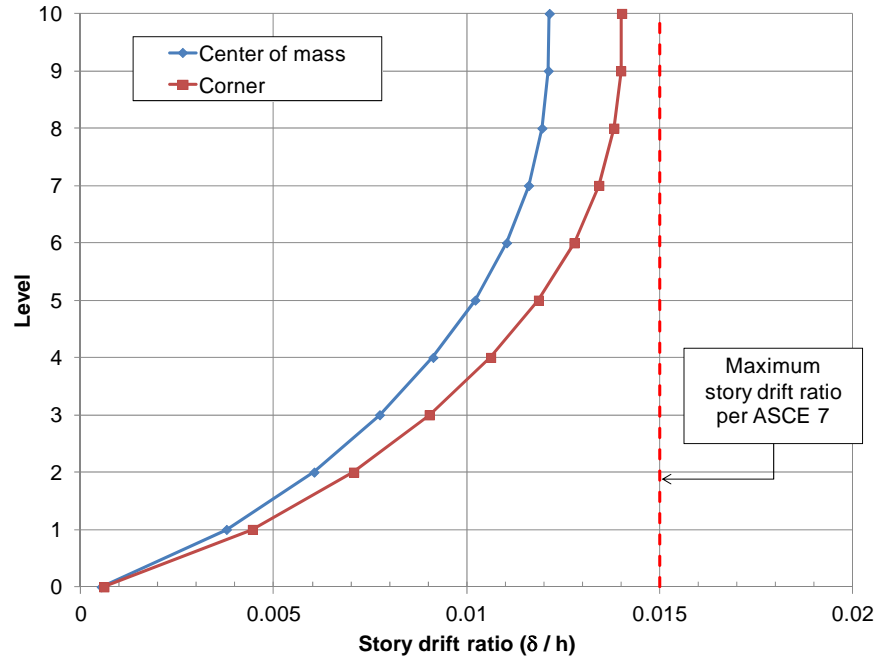

Figure 5-27 Maximum story drift ratios in the transverse direction for the U.S. building configuration, calculated per ASCE/SEI 7-05.

Figures 5-28 and 5-29 compare the maximum story drift ratios and maximum displacements in the transverse direction for the U.S. configuration and the Chilean configuration of case study building.

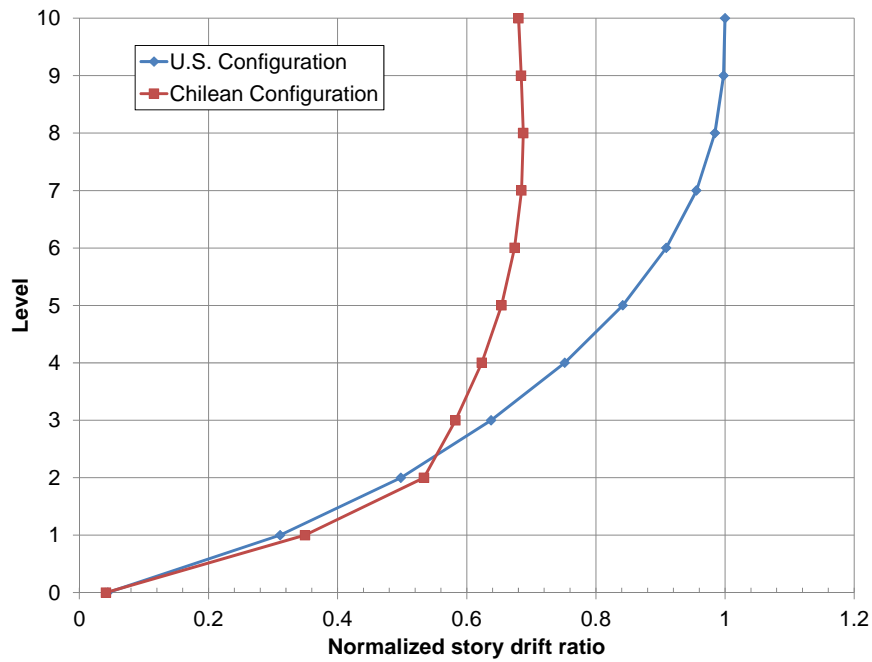

Figure 5-28 Comparison of normalized story drift ratios for the U.S. configuration and the Chilean configuration, in the transverse direction at the center of mass.

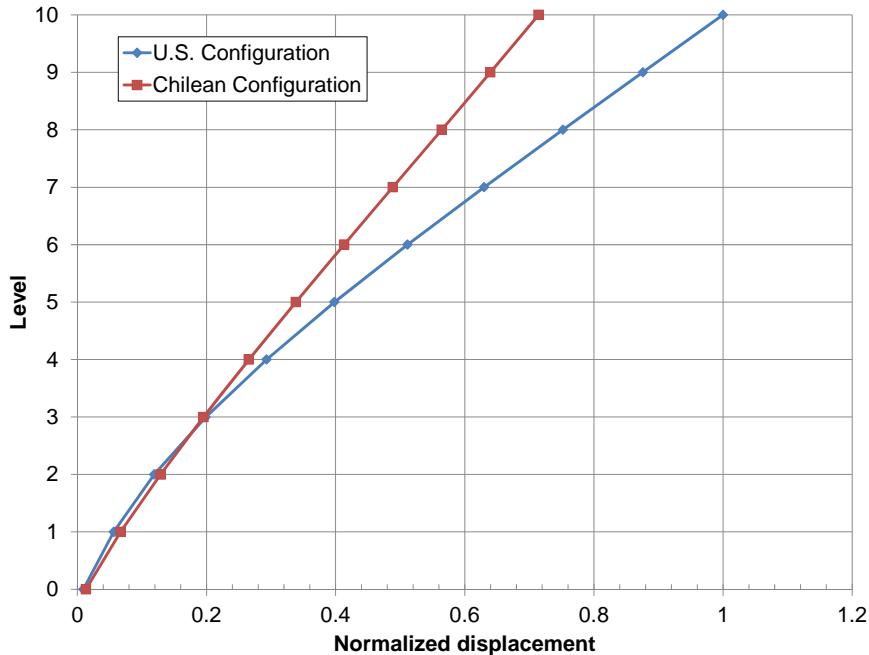

Figure 5-29 Comparison of normalized displacements for the U.S. configuration and the Chilean configuration, in the transverse direction at the center of mass.

Curves have been normalized to the values of drift ratio and displacement for the U.S. configuration at the roof. Drift ratios and displacements are higher for the U.S. configuration. In Figure 5-28, it appears that the Chilean configuration of the case study building develops a concentration of drift at the base, while the U.S. configuration distributes drift more uniformly over the height.

5.4.2 Design Forces

The same design base shear parameters shown in Table 5-3 were used to scale modal response spectrum analysis results per ASCE/SEI 7-05. With fewer walls, the U.S. configuration is comparatively less redundant, and a redundancy factor of 1.3 is still required. Consistent with U.S. practice, results were scaled to match a value of 85% of the static design base shear shown in Table 5-3. The resulting design story shears and overturning moments for the U.S. configuration are shown in Figures 5-30 and 5-31.

Confinement reinforcing would be required in the shear wall boundary elements, per ACI 318. Based on compressive strain limits, however, confinement would only be necessary over the first 12 inches from the face of the wall. Because of the heavy jamb reinforcement provided at the section, common U.S. practice would likely provide the same transverse reinforcement at all jamb reinforcing bars. Also, the horizontal wall reinforcing must be developed within the confined area of the

boundary zone. The resulting detail for a confined shear wall boundary element in the U.S. configuration is shown in Figure 5-32.

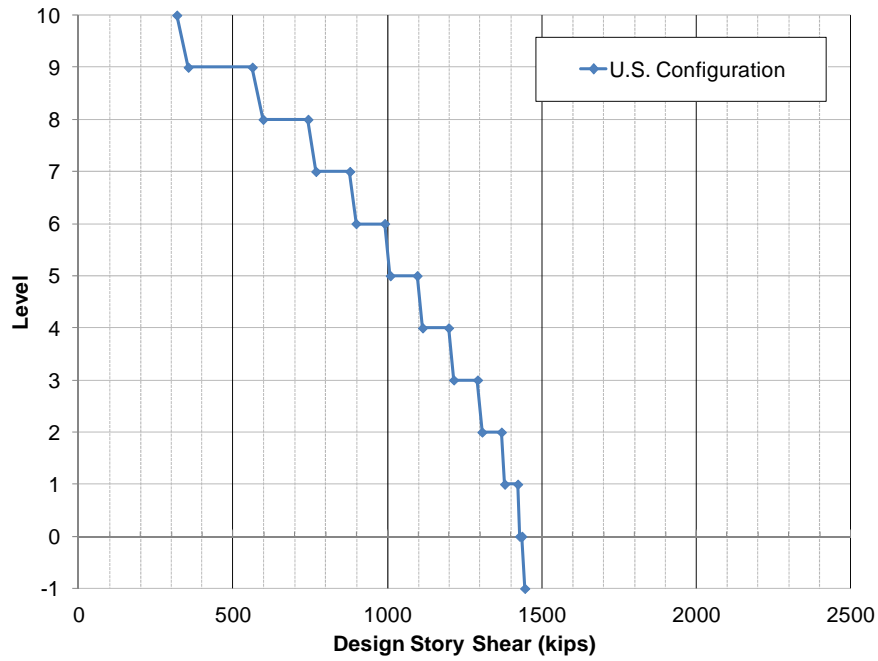

Figure 5-30 Design story shears for the U.S. configuration in the transverse direction, per ASCE/SEI 7-05.

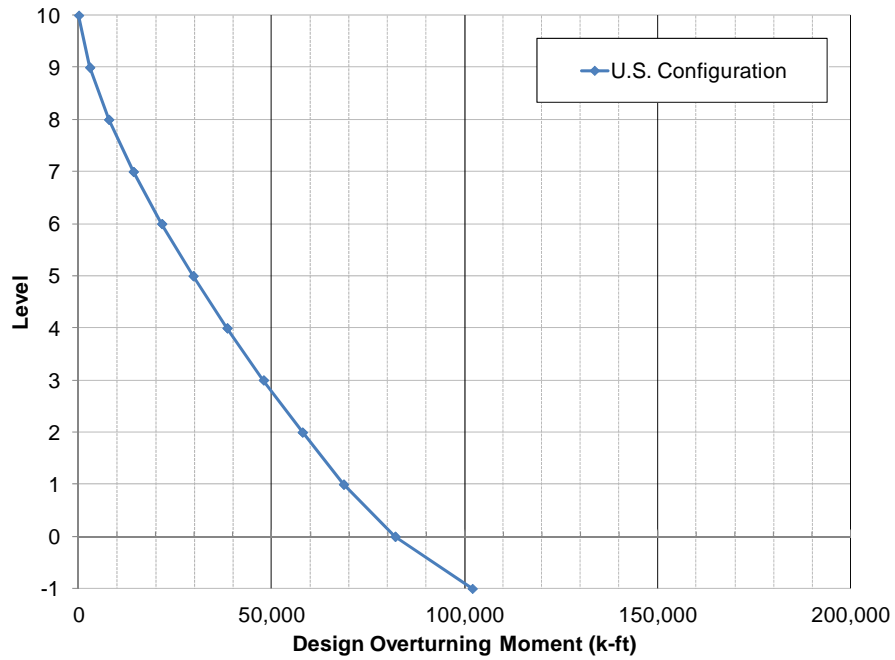

Figure 5-31 Design overturning moments for the U.S. configuration in the transverse direction, per ASCE/SEI 7-05.

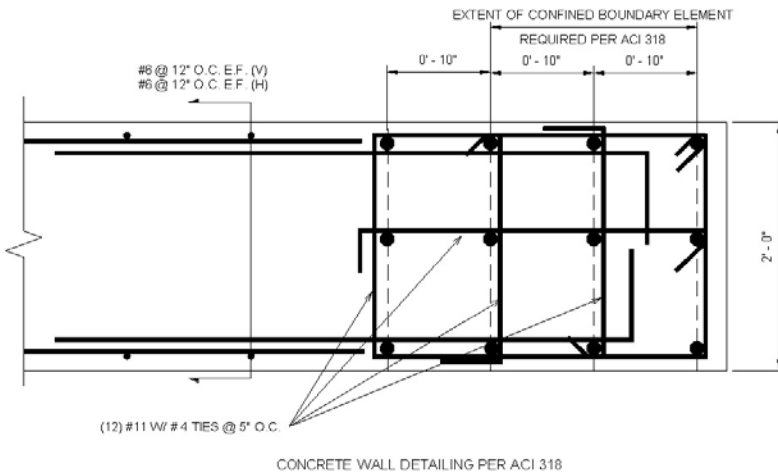

Figure 5-32 Shear wall boundary element detailing for the U.S. configuration.

5.5 Observations and Conclusions on U.S. and Chilean Seismic Design Practice

Differences in U.S. and Chilean seismic design practice are the result of evolution in construction techniques, differences in labor costs as a portion of total construction costs, and differences in the roles that structural engineers play in the building design process. Traditional Chilean practice is to configure buildings with relatively short floor spans and many load-bearing walls providing gravity and seismic force resistance. As a result, typical Chilean buildings have highly redundant configurations. This practice likely contributed to the ability of many buildings to withstand severe damage without collapse. As a consequence of this redundancy, and past experience with typical building configurations, requirements for ductile detailing in Chile are relaxed relative to U.S. requirements.

In contrast, U.S. practice is to configure buildings with longer spans and fewer structural walls. As a result, walls are thicker, allowing for easier placement of confinement reinforcing, and increased ductility capacity. As a consequence, U.S. designs have comparatively less redundancy than Chilean designs.

The Chilean case study building experienced severe damage and differential vertical displacement in the transverse shear walls as a result of the 2010 Maule earthquake. Cracking and spalling were attributed to the “flag-shaped” configuration of the shear walls, and crushing and bar buckling were attributed to a lack of confinement reinforcing in the form of closed hoops and cross ties in the shear wall boundary zones. In spite of this damage, the building did not collapse.

Evaluation of the Chilean configuration of the case study building for both NCh433.Of96 and ASCE/SEI 7-05 requirements, and comparison of the Chilean design with a hypothetical U.S. design, yielded the following observations:

- Chilean analysis of reinforced concrete structures considers gross section properties and all structural elements in the building, while U.S. practice considers effective section properties and only those elements designated as part of the seismic force-resisting system.
- Unreduced response spectra for NCh433.Of96 Soil Type III and ASCE/SEI 7-05 Site Class D, in regions of high seismicity, are similar in shape and magnitude, although the Chilean spectrum does not include a short period plateau. Chilean provisions do, however, include a maximum seismic design coefficient that varies with structural system.
- Permissible limits in NCh433.Of96 regarding drift at the diaphragm center of mass relative to the diaphragm edge would be classified as an extreme torsional irregularity in ASCE/SEI 7-05.
- NCh433.Of96 story forces (as a percentage of base shear) are higher than ASCE/SEI 7-05 story forces in the upper stories.
- When applied to the same structure, drift demands resulting from an application of NCh433.Of96 were more severe than drift demands per ASCE/SEI 7-05, even considering differences such as the use of effective section properties and a displacement amplification factor in ASCE/SEI 7-05. It appears that buildings meeting NCh433.Of96 drift requirements would also satisfy ASCE/SEI 7-05 drift requirements.
- Although attributed to somewhat different sources in NCh433.Of96 and ASCE/SEI 7-05, the estimated seismic weight is approximately the same in each code.
- Typical design base shear formulas, adjusted to a strength basis, produced nearly identical design base shear coefficients.
- The minimum base shear coefficient specified in NCh433.Of96 is approximately 50% higher than the minimum base shear coefficient specified in ASCE/SEI 7-05 for ordinary structures. When adjusted to a strength basis, it is approximately double.
- ACI 318-05 provisions would have resulted in the need for confinement reinforcing in the shear wall boundary zones of the Chilean configuration, especially in the case of unsymmetric flanged walls (i.e., “T-shaped” walls).

References

- ACI, 2011, *Building Code Requirements for Structural Concrete*, ACI 318-11, American Concrete Institute, Farmington Hills, Michigan.
- ACI, 2008, *Building Code Requirements for Structural Concrete*, ACI 318-08, American Concrete Institute, Farmington Hills, Michigan.
- ACI, 2005, *Building Code Requirements for Structural Concrete*, ACI 318-05, American Concrete Institute, Farmington Hills, Michigan.
- ACI, 1983, *Building Code Requirements for Reinforced Concrete*, ACI 318-83, American Concrete Institute, Farmington Hills, Michigan.
- ASCE, 2010, *Minimum Design Loads for Buildings and Other Structures*, ASCE/SEI 7-10, American Society of Civil Engineers, Reston, Virginia.
- ASCE, 2006, *Minimum Design Loads for Buildings and Other Structures*, ASCE/SEI 7-05, including Supplement No. 1, American Society of Civil Engineers, Reston, Virginia.
- ASCE, 2000, *Minimum Design Loads for Buildings and Other Structures*, ASCE 7-98, American Society of Civil Engineers, Reston, Virginia.
- ATC, 1978, *Tentative Provisions for the Development of Seismic Regulations for Buildings*, ATC 3-06, Applied Technology Council, Redwood City, California.
- Boroschek, R., Soto, P., and Leon, R., 2010, *Maule Region Earthquake, February 27, 2010, $M_w = 8.8$* , RENADIC Report 10/08 Rev. 2, University of Chile, Santiago, Chile.
- BSSC, 1985, *NEHRP Recommended Provisions for the Development of Seismic Regulations for New Buildings, Part 1: Provisions*, FEMA 95, prepared by the Building Seismic Safety Council for the Federal Emergency Management Agency, Washington, D.C.
- BSSC, 1998, *NEHRP Recommended Provisions for Seismic Regulations for New Buildings and Other Structures, Part 1: Provisions*, FEMA 302, 1997 Edition, prepared by the Building Seismic Safety Council for the Federal Emergency Management Agency, Washington, D.C.
- CIA, 2012, *The World Factbook*, Central Intelligence Agency, last updated April 11, 2012, <https://www.cia.gov/library/publications/the-world-factbook/geos/ci.html>.

- DIN, 1953, *Concrete and Reinforced Concrete*, DIN 1045, Beuth Verlag GmbH for the Deutsches Institut für Normung, Berlin, Germany.
- EERI, 2010, “The M_w 8.8 Chile Earthquake of February 27, 2010,” *EERI Newsletter*, June 2010, Vol. 44, No. 6.
- EERI, 1986, “The Chile Earthquake of March 3, 1985,” *Earthquake Spectra*, Vol. 2, No. 2.
- Engineers Association of Chile, 2010, *Informe Técnico Del Colegio De Ingenieros De Chile A.G. Sobre Los Efectos Del Terremoto En Edificaciones De Las Regiones Metropolitana, V Y VI*, Colegio de Ingenieros de Chile (Engineers Association of Chile), accessed June 30, 2012, http://www.ingenieros.cl/index.php?option=com_content&task=view&id=441&Itemid=451.
- FEMA, 2009, *Quantification of Building Seismic Performance Factors*, FEMA P-695, prepared by Applied Technology Council for the Federal Emergency Management Agency, Washington, D.C.
- ICBO, 1994, *Uniform Building Code*, International Conference of Building Officials, Whittier, California.
- ICBO, 1988, *Uniform Building Code*, International Conference of Building Officials, Whittier, California.
- ICBO, 1982, *Uniform Building Code*, International Conference of Building Officials, Whittier, California.
- ICC, 2006, *International Building Code*, International Code Council, Washington, D.C.
- ICC, 2000, *International Building Code*, International Code Council, Washington, D.C.
- INN, 2008, *Reinforced Concrete Design and Analysis Requirements*, NCh430.Of2008, Instituto Nacional de Normalización, Santiago, Chile.
- INN, 2006, *Reinforcing Steel – Hot-Rolled Rebar for Reinforced Concrete*, NCh204.Of2006, Instituto Nacional de Normalización, Santiago, Chile.
- INN, 1996, *Earthquake Resistant Design of Buildings*, NCh433.Of96, Instituto Nacional de Normalización, Santiago, Chile.
- University of Chile, 2012, “2010 1002271 Terremoto del Maule,” *Terremotos de Chile / Earthquakes of Chile*, accessed on March 22, 2012, <http://terremotos.ing.uchile.cl/registros/164>.
- USGS, 2012, *Magnitude 8.8 - Offshore Bio-Bio, Chile*, United States Geological Survey, last updated April 11, 2012, <http://earthquake.usgs.gov/earthquakes/eqinthenews/2010/us2010tfan/#summary>.

- USGS, 2011, *Pager - M 8.8 - Offshore Maule, Chile*, United States Geological Survey, last updated September 19, 2011, <http://earthquake.usgs.gov/earthquakes/pager/events/us/2010tfan/index.html>.
- USGS, 2009, *Historic World Earthquakes*, United States Geological Survey, last updated November 23, 2009, http://earthquake.usgs.gov/earthquakes/world/historical_country.php.
- Wood, S.L., 1991, "Performance of Reinforced Concrete Buildings During the 1985 Chile Earthquake: Implications for the Design of Structural Walls," *Earthquake Spectra*, Vol. 7, No. 4, pp. 607-638.
- Wood, S.L., Moehle, J.P., and Wight, J.K., 1987, *The 1985 Chile Earthquake: Observations on Earthquake-Resistant Construction in Viña del Mar*, University of Illinois at Urbana-Champaign, Urbana, Illinois.

Project Participants

National Institute of Standards and Technology

John (Jack) R. Hayes, Jr.
Engineering Laboratory (MS8604)
National Institute of Standards and Technology
100 Bureau Drive
Gaithersburg, Maryland 20899
www.NEHRP.gov

Steven L. McCabe
Engineering Laboratory (MS8604)
National Institute of Standards and Technology
100 Bureau Drive
Gaithersburg, Maryland 20899
www.NEHRP.gov

NEHRP Consultants Joint Venture

APPLIED TECHNOLOGY COUNCIL
201 Redwood Shores Parkway, Suite 240
Redwood City, California 94065
www.ATCouncil.org

CONSORTIUM OF UNIVERSITIES FOR
RESEARCH IN EARTHQUAKE ENGINEERING
1301 S. 46th Street, Building 420
Richmond, California 94804
www.CUREE.org

Joint Venture Management Committee

James R. Harris
J.R. Harris & Company
1775 Sherman Street, Suite 1525
Denver, Colorado 80203

Christopher Rojahn
Applied Technology Council
201 Redwood Shores Parkway, Suite 240
Redwood City, California, 94065

Robert Reitherman
Consortium of Universities for Research in
Earthquake Engineering
1301 S. 46th Street, Building 420
Richmond, California 94804

Andrew Whittaker
University at Buffalo
Dept. of Civil, Structural, and Environ. Engin.
230 Ketter Hall
Buffalo, New York 14260

Joint Venture Program Committee

Jon A. Heintz (Program Manager)
Applied Technology Council
201 Redwood Shores Parkway, Suite 240
Redwood City, California 94065

C.B. Crouse
URS Corporation
1501 4th Avenue, Suite 1400
Seattle, Washington 98101

Michael Constantinou
University at Buffalo
Dept. of Civil, Structural, and Environ. Engin.
132 Ketter Hall
Buffalo, New York 14260

William T. Holmes
Rutherford & Chekene
55 Second Street, Suite 600
San Francisco, California 94105

Jack Moehle
University of California, Berkeley
Dept. of Civil and Environmental Engineering
325 Davis Hall – MC 1792
Berkeley, California 94720

James R. Harris (ex-officio)
Andrew Whittaker (ex-officio)

Project Technical Committee

Ronald O. Hamburger (Technical Director)
Simpson Gumpertz & Heger
The Landmark @ One Market, Suite 600
San Francisco, California 94105

Rene Lagos
Rene Lagos y Asociados
Magdalena 140, Of. 2402
Santiago, Chile

Patricio Bonelli
Patricio Bonelli y Asociados LTDA.
Montana 853, Of. 401
Viña del Mar, Chile

Loring A. Wyllie, Jr.
Degenkolb Engineers
235 Montgomery Street, Suite 500
San Francisco, California 94104

Working Group Members

Ady Aviram
Simpson Gumpertz & Heger
The Landmark @ One Market, Suite 600
San Francisco, California 94105

Jose A. Flores Ruiz
Degenkolb Engineers
235 Montgomery Street, Suite 500
San Francisco, California 94104