

CECW-EW

DEPARTMENT OF THE ARMY
US Army Corps of Engineers
Washington, DC 20314-1000

EM 1110-2-2104
Change 1

Engineer Manual
No. 1110-2-2104

20 Aug 03

Engineering and Design
STRENGTH DESIGN FOR
REINFORCED-CONCRETE HYDRAULIC STRUCTURES

1. This Change 1 to EM 1110-2-2104, 30 June 1992, revised Table of Content and Chapter 3. Also commentary for Chapter 3 is added
2. File this changes in front of the publication for reference purposes

FOR THE COMMANDER:

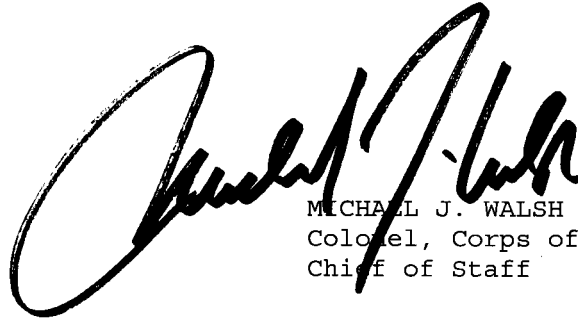

MICHAEL J. WALSH
Colonel, Corps of Engineers
Chief of Staff

CECW-ED Engineer Manual 1110-2-2104	Department of the Army U.S. Army Corps of Engineers Washington, DC 20314-1000	EM 1110-2-2104 30 June 1992
	Engineering and Design STRENGTH DESIGN FOR REINFORCED CONCRETE HYDRAULIC STRUCTURES	
	Distribution Restriction Statement Approved for public release; distribution is unlimited.	

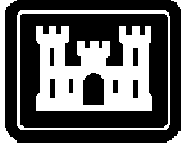

EM 1110-2-2104
30 June 1992

**US Army Corps
of Engineers**

ENGINEERING AND DESIGN

Strength Design for Reinforced-Concrete Hydraulic Structures

ENGINEER MANUAL

DEPARTMENT OF THE ARMY
US Army Corps of Engineers
Washington, DC 20314-1000

EM 1110-2-2104

CECW-ED

Engineer Manual
No. 1110-2-2104

30 June 1992

Engineering and Design
STRENGTH DESIGN FOR
REINFORCED-CONCRETE HYDRAULIC STRUCTURES

1. Purpose. This manual provides guidance for designing reinforced concrete hydraulic structures by the strength-design method. Plain concrete and prestressed concrete are not covered in this manual.
2. Applicability. This manual applies to all HQUSACE/OCE elements, major subordinate commands, districts, laboratories, and field operating activities having civil works responsibilities.

FOR THE COMMANDER:

MILTON HUNTER
Colonel, Corps of Engineers
Chief of Staff

This manual supersedes ETL 1110-2-312, Strength Design Criteria for Reinforced Concrete Hydraulic Structures, dated 10 March 1988 and EM 1110-2-2103, Details of Reinforcement-Hydraulic Structures, dated 21 May 1971.

Engineer Manual
No. 1110-2-2104

30 June 1992

Engineering and Design
STRENGTH DESIGN FOR
REINFORCED CONCRETE HYDRAULIC STRUCTURES

Table of Contents

<u>Subject</u>	<u>Paragraph</u>	<u>Page</u>
CHAPTER 1. INTRODUCTION		
Purpose	1-1	1-1
Applicability	1-2	1-1
References	1-3	1-1
Background	1-4	1-2
General Requirements	1-5	1-3
Scope	1-6	1-3
Computer Programs	1-7	1-3
Rescission	1-8	1-3
CHAPTER 2. DETAILS OF REINFORCEMENT		
General	2-1	2-1
Quality	2-2	2-1
Anchorage, Bar Development, and Splices	2-3	2-1
Hooks and Bends	2-4	2-1
Bar Spacing	2-5	2-1
Concrete Protection for Reinforcement	2-6	2-2
Splicing	2-7	2-2
Temperature and Shrinkage Reinforcement	2-8	2-3
CHAPTER 3. STRENGTH AND SERVICEABILITY REQUIREMENTS		
General	3-1	3-1
Stability Analysis	3-2	3-1
Required Strength	3-3	3-2
Design Strength of Reinforcement	3-4	3-6
Maximum Tension Reinforcement	3-5	3-6
Control of Deflections and Cracking	3-6	3-6
Minimum Thickness of Walls	3-7	3-7

EM 1110-2-2104
 Change 1
 20 Aug 03

<u>Subject</u>	<u>Paragraph</u>	<u>Page</u>
STRENGTH AND SERVICEABILITY COMMENTARY		
General	C.3-1	3-8
Stability Analysis	C.3-2	3-10
Required Strength	C.3-3	3-11
CHAPTER 4. FLEXURAL AND AXIAL LOADS		
Design Assumptions and General Requirements	4-1	4-1
Flexural and Compressive Capacity - Tension Reinforcement Only	4-2	4-1
Flexural and Compressive Capacity - Tension and Compression Reinforcement	4-3	4-3
Flexural and Tensile Capacity	4-4	4-5
Biaxial Bending and Axial Load	4-5	4-7
CHAPTER 5. SHEAR		
Shear Strength	5-1	5-1
Shear Strength for Special Straight Members	5-2	5-1
Shear Strength for Curved Members	5-3	5-2
Empirical Approach	5-4	5-2
APPENDICES		
Appendix A	Notation	A-1
Appendix B	Derivation of Equations for Flexural and Axial Loads	B-1
Appendix C	Investigation Examples	C-1
Appendix D	Design Examples	D-1
Appendix E	Interaction Diagram	E-1
Appendix F	Axial Load with Biaxial Bending - Example	F-1

CHAPTER 1

INTRODUCTION

1-1. Purpose

This manual provides guidance for designing reinforced-concrete hydraulic structures by the strength-design method.

1-2. Applicability

This manual applies to all HQUSACE/OCE elements, major subordinate commands, districts, laboratories, and field operating activities having civil works responsibilities.

1-3. References

- a. EM 1110-1-2101, Working Stresses for Structural Design.
- b. EM 1110-2-2902, Conduits, Culverts, and Pipes.
- c. CW-03210, Civil Works Construction Guide Specification for Steel Bars, Welded Wire Fabric, and Accessories for Concrete Reinforcement.
- d. American Concrete Institute, "Building Code Requirements and Commentary for Reinforced Concrete," ACI 318, Box 19150, Redford Station, Detroit, MI 48219.
- e. American Concrete Institute, "Environmental Engineering Concrete Structures," ACI 350R, Box 19150, Redford Station, Detroit, MI 48219.
- f. American Society for Testing and Materials, "Standard Specification for Deformed and Plain Billet-Steel Bars for Concrete Reinforcement," ASTM A 615-89, 1916 Race St., Philadelphia, PA 19103.
- g. American Welding Society, "Structural Welding Code-Reinforcing Steel," AWS D1.4-790, 550 NW Le Jeune Rd., P.O. Box 351040, Miami, FL 33135.
- h. Liu, Tony C. 1980 (Jul). "Strength Design of Reinforced Concrete Hydraulic Structures, Report 1: Preliminary Strength Design Criteria," Technical Report SL-80-4, US Army Engineer Waterways Experiment Station, 3909 Halls Ferry Road, Vicksburg, MS 39180.
- i. Liu, Tony C., and Gleason, Scott. 1981 (Sep). "Strength Design of Reinforced Concrete Hydraulic Structures, Report 2: Design Aids for Use in the Design and Analysis of Reinforced Concrete Hydraulic Structural Members Subjected to Combined Flexural and Axial Loads," Technical Report SL-80-4, US Army Engineer Waterways Experiment Station, 3909 Halls Ferry Road, Vicksburg, MS 39180.

EM 1110-2-2104
30 Jun 92

j. Liu, Tony C. 1981 (Sep). "Strength Design of Reinforced Concrete Hydraulic Structures, Report 3: T-Wall Design," Technical Report SL-80-4, US Army Engineer Waterways Experiment Station, 3909 Halls Ferry Road, Vicksburg, MS 39180.

1-4. Background

a. A reinforced concrete hydraulic structure is one that will be subjected to one or more of the following: submergence, wave action, spray, chemically contaminated atmosphere, and severe climatic conditions. Typical hydraulic structures are stilling-basin slabs and walls, concrete-lined channels, portions of powerhouses, spillway piers, spray walls and training walls, floodwalls, intake and outlet structures below maximum high water and wave action, lock walls, guide and guard walls, and retaining walls subject to contact with water.

b. In general, existing reinforced-concrete hydraulic structures designed by the Corps, using the working stress method of EM 1110-1-2101, have held up extremely well. The Corps began using strength design methods in 1981 (Liu 1980, 1981 and Liu and Gleason 1981) to stay in step with industry, universities, and other engineering organizations. ETL 1110-2-265, "Strength Design Criteria for Reinforced Concrete Hydraulic Structures," dated 15 September 1981, was the first document providing guidance issued by the Corps concerning the use of strength design methods for hydraulic structures. The labor-intensive requirements of this ETL regarding the application of multiple load factors, as well as the fact that some load-factor combination conditions resulted in a less conservative design than if working stress methods were used, resulted in the development of ETL 1110-2-312, "Strength Design Criteria for Reinforced Concrete Hydraulic Structures," dated 10 March 1988.

c. The revised load factors in ETL 1110-2-312 were intended to ensure that the resulting design was as conservative as if working stress methods were used. Also, the single load factor concept was introduced. The guidance in this ETL differed from ACI 318 Building Code Requirements and Commentary for Reinforced Concrete primarily in the load factors, the concrete stress-strain relationship, and the yield strength of Grade 60 reinforcement. ETL 1110-2-312 guidance was intended to result in designs equivalent to those resulting when working stress methods were used.

d. Earlier Corps strength design methods deviated from ACI guidance because ACI 318 includes no provisions for the serviceability needs of hydraulic structures. Strength and stability are required, but serviceability in terms of deflections, cracking, and durability demand equal consideration. The importance of the Corps' hydraulic structures has caused the Corps to move cautiously, but deliberately, toward exclusive use of strength design methods.

e. This manual modifies and expands the guidance in ETL 1110-2-312 with an approach similar to that of ACI 350R-89. The concrete stress-strain relationship and the yield strength of Grade 60 reinforcement given in ACI 318 are adopted. Also, the load factors bear a closer resemblance to ACI 318 and

are modified by a hydraulic factor, H_f , to account for the serviceability needs of hydraulic structures.

f. As in ETL 1110-2-312, this manual allows the use of a single load factor for both dead and live loads. In addition, the single load factor method is required when the loads on the structural component include reactions from a soil-structure stability analysis.

1-5. General Requirements

Reinforced-concrete hydraulic structures should be designed with the strength design method in accordance with the current ACI 318, except as hereinafter specified. The notations used are the same as those used in the ACI 318 Code and Commentary, except those defined herein.

1-6. Scope

a. This manual is written in sufficient detail to not only provide the designer with design procedures, but to also provide examples of their application. Also, derivations of the combined flexural and axial load equations are given to increase the designer's confidence and understanding.

b. General detailing requirements are presented in Chapter 2. Chapter 3 presents strength and serviceability requirements, including load factors and limits on flexural reinforcement. Design equations for members subjected to flexural and/or axial loads (including biaxial bending) are given in Chapter 4. Chapter 5 presents guidance for design for shear, including provisions for curved members and special straight members. The appendices include notation, equation derivations, and examples. The examples demonstrate: load-factor application, design of members subjected to combined flexural and axial loads, design for shear, development of an interaction diagram, and design of members subjected to biaxial bending.

1-7. Computer Programs

Copies of computer programs, with documentation, for the analysis and design of reinforced-concrete hydraulic structures are available and may be obtained from the Engineering Computer Programs Library, US Army Engineer Waterways Experiment Station, 3909 Halls Ferry Road, Vicksburg, Mississippi 39180-6199. For design to account for combined flexural and axial loads, any procedure that is consistent with ACI 318 guidance is acceptable, as long as the load factor and reinforcement percentage guidance given in this manual is followed.

1-8. Recission

Corps library computer program CSTR (X0066), based on ETL 1110-2-312, is replaced by computer program CASTR (X0067). Program CASTR is based on this new engineer manual.

CHAPTER 2

DETAILS OF REINFORCEMENT

2-1. General

This chapter presents guidance for furnishing and placing steel reinforcement in various concrete members of hydraulic structures.

2-2. Quality

The type and grade of reinforcing steel should be limited to ASTM A 615 (Billet Steel), Grade 60. Grade 40 reinforcement should be avoided since its availability is limited and designs based on Grade 40 reinforcement, utilizing the procedures contained herein, would be overly conservative. Reinforcement of other grades and types permitted by ACI 318 may be permitted for special applications subject to the approval of higher authority.

2-3. Anchorage, Bar Development, and Splices

The anchorage, bar development, and splice requirements should conform to ACI 318 and to the requirements presented below. Since the development length is dependent on a number of factors such as concrete strength and bar position, function, size, type, spacing, and cover, the designer must indicate the length of embedment required for bar development on the contract drawings. For similar reasons, the drawings should show the splice lengths and special requirements such as staggering of splices, etc. The construction specifications should be carefully edited to assure that they agree with reinforcement details shown on the drawings.

2-4. Hooks and Bends

Hooks and bends should be in accordance with ACI 318.

2-5. Bar Spacing

a. Minimum. The clear distance between parallel bars should not be less than 1-1/2 times the nominal diameter of the bars nor less than 1-1/2 times the maximum size of coarse aggregate. No. 14 and No. 18 bars should not be spaced closer than 6 and 8 inches, respectively, center to center. When parallel reinforcement is placed in two or more layers, the clear distance between layers should not be less than 6 inches. In horizontal layers, the bars in the upper layers should be placed directly over the bars in the lower layers. In vertical layers, a similar orientation should be used. In construction of massive reinforced concrete structures, bars in a layer should be spaced 12 inches center-to-center wherever possible to facilitate construction.

b. Maximum. The maximum center-to-center spacing of both primary and secondary reinforcement should not exceed 18 inches.

2-6. Concrete Protection for Reinforcement

The minimum cover for reinforcement should conform to the dimensions shown below for the various concrete sections. The dimensions indicate the clear distance from the edge of the reinforcement to the surface of the concrete.

<u>CONCRETE SECTION</u>	<u>MINIMUM CLEAR COVER OF REINFORCEMENT, INCHES</u>
Unformed surfaces in contact with foundation	4
Formed or screeded surfaces subject to cavitation or abrasion erosion, such as baffle blocks and stilling basin slabs	6
Formed and screeded surfaces such as stilling basin walls, chute spillway slabs, and channel lining slabs on grade:	
Equal to or greater than 24 inches in thickness	4
Greater than 12 inches and less than 24 inches in thickness	3
Equal to or less than 12 inches in thickness will be in accordance with ACI Code 318.	

NOTE. In no case shall the cover be less than:
1.5 times the nominal maximum size of aggregate,
or
2.5 times the maximum diameter of reinforcement.

2-7. Splicing

a. General. Bars shall be spliced only as required and splices shall be indicated on contract drawings. Splices at points of maximum tensile stress should be avoided. Where such splices must be made they should be staggered. Splices may be made by lapping of bars or butt splicing.

b. Lapped Splices. Bars larger than No. 11 shall not be lap-spliced. Tension splices should be staggered longitudinally so that no more than half of the bars are lap-spliced at any section within the required lap length. If staggering of splices is impractical, applicable provisions of ACI 318 should be followed.

c. Butt Splices

(1) General. Bars larger than No. 11 shall be butt-spliced. Bars No. 11 or smaller should not be butt-spliced unless clearly justified by design details or economics. Due to the high costs associated with butt splicing of bars larger than No. 11, especially No. 18 bars, careful

consideration should be given to alternative designs utilizing smaller bars. Butt splices should be made by either the thermit welding process or an approved mechanical butt-splicing method in accordance with the provisions contained in the following paragraphs. Normally, arc-welded splices should not be permitted due to the inherent uncertainties associated with welding reinforcement. However, if arc welding is necessary, it should be done in accordance with AWS D1.4, Structural Welding Code-Reinforcing Steel. Butt splices should develop in tension at least 125 percent of the specified yield strength, f_y , of the bar. Tension splices should be staggered longitudinally at least 5 feet for bars larger than No. 11 and a distance equal to the required lap length for No. 11 bars or smaller so that no more than half of the bars are spliced at any section. Tension splices of bars smaller than No. 14 should be staggered longitudinally a distance equal to the required lap length. Bars Nos. 14 and 18 shall be staggered longitudinally, a minimum of 5 feet so that no more than half of the bars are spliced at any one section.

(2) Thermit Welding. Thermit welding should be restricted to bars conforming to ASTM A 615 (billet steel) with a sulfur content not exceeding 0.05 percent based on ladle analysis. The thermit welding process should be in accordance with the provisions of Guide Specification CW-03210.

(3) Mechanical Butt Splicing. Mechanical butt splicing shall be made by an approved exothermic, threaded coupling, swaged sleeve, or other positive connecting type in accordance with the provisions of Guide Specification CW-03210. The designer should be aware of the potential for slippage in mechanical splices and insist that the testing provisions contained in this guide specification be included in the contract documents and utilized in the construction work.

2-8. Temperature and Shrinkage Reinforcement

a. In the design of structural members for temperature and shrinkage stresses, the area of reinforcement should be 0.0028 times the gross cross-sectional area, half in each face, with a maximum area equivalent to No. 9 bars at 12 inches in each face. Generally, temperature and shrinkage reinforcement for thin sections will be no less than No. 4 bars at 12 inches in each face.

b. Experience and/or analyses may indicate the need for an amount of reinforcement greater than indicated in paragraph 2-8a if the reinforcement is to be used for distribution of stresses as well as for temperature and shrinkage.

c. In general, additional reinforcement for temperature and shrinkage will not be needed in the direction and plane of the primary tensile reinforcement when restraint is accounted for in the analyses. However, the primary reinforcement should not be less than that required for shrinkage and temperature as determined above.

CHAPTER 3

STRENGTH AND SERVICEABILITY

3-1. General

a. Nonhydraulic vs. hydraulic structures. All reinforced-concrete hydraulic structures must satisfy both strength and serviceability requirements. In the strength design method this is accomplished by multiplying the service loads by appropriate load factors and for hydraulic structures multiplying by an additional hydraulic factor, H_f . The hydraulic factor is applied to the overall load factor equations. This increased loading is then used for obtaining the required nominal strength for the hydraulic structures. The hydraulic factor is used in lieu of performing an additional serviceability analysis.

b. Single and modified ACI 318 load factor approaches. Two methods are available for determining the factored moments, shears, and thrusts for designing hydraulic structures using the strength design method. They are the single load factor method and a method based on slight modification of the ACI 318 Building Code requirements. Both methods are described herein.

c. Stability requirement. In addition to strength and serviceability requirements, many hydraulic structures must also satisfy stability requirements under various loading and foundation conditions.

d. Nonhydraulic structures. Reinforced concrete structures and structural members that are not classified as hydraulic shall be designed according with this guidance, except the hydraulic factor shall not be used.

3-2. Stability Analysis

a. Unfactored loads. The stability analysis of hydraulic structures must be performed using unfactored loads in accordance with EM 2101 Stability Analysis of Hydraulic Structures. The unfactored loads and the resulting reactions are then used to determine the unfactored moments, shears and thrusts at critical sections of the structure. The unfactored moments, shears and thrusts are then multiplied by the appropriate load factors, and hydraulic factor when appropriate, to determine the required nominal strengths to be used in establishing the section properties.

b. Soil structure interaction load factors. The single load factor method must be used when the loads on the structural component being analyzed include reactions from a soil-structure interaction (SSI) stability analysis, such as footings for a wall. For simplicity and ease of application, the single load factor method should generally be used for all elements of such structures. The load factor method based on the ACI 318 Building Code may be used for some non-SSI related elements of the structure, but must be used with caution to assure that the load combinations do not produce unconservative results.

3-3. Required Strength

a. General. Reinforced concrete hydraulic structures and hydraulic structural members shall be designed to have a required strength, U_h , to resist dead and live loads in accordance with the following provisions. The hydraulic factor is to be applied in the determination of the required nominal strength for all combinations of axial load, moments and shear (diagonal tension). In particular, the shear reinforcement should be designed for the excess shear, the difference between the hydraulic factored ultimate shear force, V_{uh} , and the shear strength provided by the concrete, ϕV_c , where ϕ is the concrete resistance factor for shear design. Therefore, the design shear for the reinforcement, V_s , is given by

$$V_s \geq \left(\frac{V_{uh} - 1.3\phi V_c}{\phi} \right) \quad (3.1)$$

b. Single Load Factor Method. In the single load factor method, both the dead and live loads are multiplied by the same load factor.

$$U = 1.7(D + L) \quad (3.2)$$

where

U = factored loads for a nonhydraulic structure
 D = internal forces and moments from dead loads
 L = internal forces and moments from live loads

$$U_h = H_f [1.7(D + L)] \quad (3.3)$$

where

U_h = factored loads for a hydraulic structure
 H_f = hydraulic factor.

For hydraulic structures the basic load factor, 1.7, is multiplied by a hydraulic factor, H_f , where $H_f = 1.3$, except for members in direct tension. For members in direct tension, $H_f = 1.65$. Other values may be used subject to consultation with and approval from CECW-ED.

An exception to the above occurs when resistance to the effects of unusual or extreme loads such as wind, earthquake or other forces of short duration and low probability of occurrence are included in the design. For those cases, one of the following loading combinations should be used:

$$U = 0.75U_{W \text{ or } E} \quad (3.4)$$

for nonhydraulic structures and

$$U = H_f (0.75U_{W \text{ or } E}) \quad (3.5)$$

for hydraulic structures where

$U_{W \text{ or } E}$ = nonhydraulic factored loads including wind or earthquake effects.

c. Modified ACI 318. The load factors prescribed in ACI 318 may be applied directly to hydraulic structures with two modifications. The load factor for lateral fluid pressure, F , should be taken as 1.7 instead of the ACI 318 prescribed value of 1.4. Also, for hydraulic structures, the factored load combination for total factored design load, U , as prescribed in ACI 318 shall be increased by the hydraulic factor $H_f = 1.3$, except for members in direct tension. For members in direct tension, $H_f = 1.65$.

$$U = 1.4D + 1.7L \quad (3.6)$$

for nonhydraulic structures and

$$U_h = H_f U = H_f (1.4D + 1.7L) \quad (3.7)$$

for hydraulic structures.

For certain hydraulic structures such as U-frame locks and channels, the live load can have a relieving effect on the factored load combination used to determine the total factored load effects. In this case, the combination of factored dead and live loads with a live load factor of unity

$$U_h = H_f (1.4D + 1.0L) \quad (3.8)$$

should be investigated and reported in the design documents.

d. Earthquake effects. If resistance to earthquake loads, E , are required, the following definitions and load combinations shall apply.

1) Unusual and extreme loads. Earthquake loads are considered either unusual or extreme due to their low probability of occurrence and short duration. Yet, their low probability of occurrence also allows them to be combined with normal operating loads, such as normal operating pool levels for hydraulic structures, when developing load combinations.

2) Design earthquake definitions. In developing earthquake loads, three different earthquakes may need to be considered. The Maximum Credible Earthquake, MCE, the Maximum Design Earthquake, MDE, and the Operating Basis Earthquake, OBE are all potential critical earthquakes when designing for strength and serviceability.

a) Maximum Credible Earthquake (MCE). The MCE, as defined in ER 1110-2-1806, is the greatest earthquake that can reasonably be expected to be generated by a specific source near the structural site on the basis of seismological and geological evidence. Multiple MCE's may be defined for a given site, each with their own individual characteristic ground motion parameters and spectral shapes.

b) Maximum Design Earthquake (MDE). The MDE, as defined in ER1110-2-1806, is the maximum level of ground motion for which a structure is designed or evaluated. The associated performance requirement is that the project performs without catastrophic failure although severe damage or economic loss may be tolerated. For critical features, the MDE is the same as the MCE. For all other features, the MDE shall be selected as a lesser earthquake than the MCE, which provides economical designs meeting appropriate safety standards. The MDE can be characterized as a deterministic or probabilistic event. (A reasonable earthquake in many cases is associated with a 10-percent probability of being exceeded in 100 years, i.e., a return period of 950 years.) The MDE load is considered an extreme load case due to the very low probability (potentially high magnitude) of occurrence and should be combined with usual loads, normally expected loads and pool levels.

c) Operational Basis Earthquake (OBE). The OBE, as defined in ER1110-2-1806, is an earthquake that can reasonably be expected to occur within the service life of the project, that is, with a 50-percent probability of being exceeded during the service life. (This corresponds to a return period of 144 years for a project with a service life of 100 years.) The associated performance requirement is that the project function with little or no damage, and without interruption of function. The purpose of the OBE is to protect against economic losses from damage or loss of service, and therefore alternative choices of return period for the OBE may be based on economic considerations. The OBE is considered an unusual load due to the low probability of occurrence and should be used with usual loads, normally expected loads and pool levels.

3) OBE load factors. There are separate load factors for OBE's that are generated using standard (nonsite-specific) and site-specific ground motions. The load factor for a site-specific developed OBE reflects the increased reliability of the load by reducing the load factor.

a) Standard ground motion analysis. The load factors given below are to be used when the seismic coefficient or standard design spectrum is used for developing equivalent static seismic forces for an OBE. The load combinations including a nonsite specific OBE analysis are

$$U_E = 1.4(D + L) + 1.5E \quad (3.9)$$

and substituting into equation 3.5 gives

$$U_h = 0.75 [H_f (1.4(D+L) + 1.5E)] \quad (3.10)$$

for hydraulic structures. The dead and live loads in this equation are to be developed using normal operating conditions.

b) Site specific ground motion. Site-specific ground motions are typically used to perform time-history or response spectrum analyses. The site-specific response spectrum can be developed using a computer program such as DEQAS. The response spectrum must be developed using specific location data and the definition of an OBE. Similarly, a deterministic acceleration time history must reflect the specific dynamic characteristics of the site and the definition of an OBE. The load combinations including a site-specific OBE analysis are

$$U_E = 1.4(D+L) + 1.4E \quad (3.11)$$

and substituting into equation 3.4 gives

$$U_h = 0.75 [H_f (1.4(D+L) + 1.4E)] \quad (3.12)$$

The dead and live loads in this equation are to be developed using normal operating conditions.

4) MDE load factors. There are separate load factors for MDE's that are generated using standard and site-specific ground motions. The load factor for a site-specific developed MDE reflects the increased reliability of the load by reducing the load factor.

a) Standard ground motion. The load factors given below are to be used when the seismic coefficient or standard design spectrum is used for developing equivalent static seismic forces. These seismic coefficients or design spectra can be found using the procedure outlined in EM6050. The load combinations including a nonsite specific MDE analysis are

$$U_E = 1.0(D+L) + 1.25E \quad (3.13)$$

and substituting this equation into equation 3.4 gives

$$U_h = 0.75 [H_f (1.0(D+L) + 1.25E)] \quad (3.14)$$

The dead and live loads in this equation are to be developed using normal operating conditions.

b) Site specific ground motion. Site-specific ground motions are to be used to perform time-history or response spectrum analyses. The site-specific response spectrum can be developed using the procedure outlined in EM6050 using the NEHRP maps or a computer program such as DEQAS. The response spectrum must be developed using specific location data and the definition of an MDE. The load combinations including a site-specific MDE analysis are

$$U_E = 1.0(D + L) + 1.0E \quad (3.15)$$

and substituting this equation into equation 3.4 gives

$$U_h = 0.75 [H_f (1.0(D + L) + 1.0E)] \quad (3.16)$$

The dead and live loads in this equation are to be developed using normal operating conditions.

3-4. Design Strength of Reinforcement

a. Design should normally be based on 60,000 psi, the yield strength of ASTM Grade 60 reinforcement. Other grades may be used, subject to the provisions of paragraphs 2-2 and 3-4.b. The yield strength used in the design shall be indicated on the drawings.

b. Reinforcement with a yield strength in excess of 60,000 psi shall not be used unless a detailed investigation of ductility and serviceability requirements is conducted in consultation with and approved by CECW-ED.

3-5. Maximum Tension Reinforcement

a. For singly reinforced flexural members, and for members subject to combined flexure and compressive axial load when the axial load strength ϕP_n is less than the smaller of $0.10f_c'A_g$ or ϕP_b , the ratio of tension reinforcement ρ provided shall conform to the following:

1) Recommended limit = $0.25\rho_b$.

2) Maximum permitted upper limit not requiring special study or investigation = $0.375\rho_b$. Values above $0.375\rho_b$ will require consideration of serviceability, constructibility, and economy.

3) Maximum permitted upper limit when excessive deflections are not predicted when using the method specified in ACI 318 or other methods that predict deformations in substantial agreement with the results of comprehensive tests = $0.50\rho_b$.

4) Reinforcement ratios above $0.50\rho_b$ shall only be permitted if a detailed investigation of serviceability requirements, including computation of deflections, is conducted in consultation with and approved by CECW-ED. Under no circumstance shall the reinforcement ratio exceed $0.75\rho_b$.

b. Use of compression reinforcement shall be in accordance with provisions of ACI 318.

3-6. Control of Deflections and Cracking

a. Cracking and deflections due to service loads need not be investigated if the limits on

the design strength and ratio of the reinforcement specified in paragraphs 3-4.a and 3-5.a(3) are not exceeded.

b. For design strengths and ratios of reinforcement exceeding the limits specified in paragraphs 3-4.a and 3-5.a(3), extensive investigations of deformations and cracking due to service loads should be made in consultation with CECW-ED. These investigations should include laboratory tests of materials and models, analytical studies, special construction procedures, possible measures for crack control, etc. Deflections and crack widths should be limited to levels which will not adversely affect the operation, maintenance, performance, or appearance of that particular structure.

3-7. Minimum Thickness of Walls

Walls with height greater than 10 feet shall be a minimum of 12 inches thick and shall contain reinforcement in both faces.

CHAPTER 3

STRENGTH AND SERVICEABILITY COMMENTARY

C.3-1 General

a. Nonhydraulic vs. hydraulic structures. For hydraulic structures, cracking, vibrations and stability are major serviceability concerns. In the past the allowable stress design methodology was used and the allowable stress for concrete members in these hydraulic structures was reduced from $0.45f_c'$ to $0.35f_c'$. This reduction in allowable stress produced deeper concrete members with lower stress levels and increased reinforcing requirements. This increase in concrete depth is beneficial for hydraulic structures, which often depend on mass for stability (more concrete), are lightly reinforced (no shear reinforcement) and often susceptible to vibrations (mass and damping). The increased reinforcing requirements considerably help in improving crack control. The hydraulic factor is used in the Load and Resistance Factor Design of hydraulic structures for the same purpose. Note that $0.45/0.35$ is approximately 1.3 the value for H_f when a member is not in direct tension. The fact that the reduced allowable stress approach was sound and produced reasonable serviceability results led to incorporating this concept into the Load and Resistance Factor methodology. The use of a hydraulic factor is simple and eliminates the necessity for separate serviceability analyses.

b. Single and modified ACI 318 load factor approaches. The single load factor approach uses one load factor (1.7) for both dead and live load, whereas, ACI 318 uses different load factors for each of dead (1.4) and live load (1.7). USACE has chosen to use the ACI resistance factors which are higher than those found (derived) for USACE structures. Therefore, the load factors for the USACE structures are also slightly higher than they should be using conventional load and resistance factor approaches to develop USACE structural load factors.

In the case of hydraulic structures where fluid pressure is the primary live load, the ACI 318 method requires the use of a 1.4 load factor for fluid pressure. This ACI 318 requirement is overridden by this document stating that a load factor of 1.7 will be used for fluid pressure making the two procedures, nearly identical. The only difference being in the dead load factors of 1.7 versus 1.4 (ACI 318). For structures with large dead load components and limited fluid pressures, the ACI 318 procedure will provide lower strength requirements.

The need for load factors is best described through demand capacity relationships and safety. If structures were accurately analyzed, correctly designed, perfectly built and expectedly loaded, a capacity slightly beyond the demand would provide an adequate design. Unfortunately, most of these actions have uncertainties requiring the implementation of safety margins. Actual loads may be different in magnitude and distribution from the design loads. The loads may be instantaneous, daily, annual or once-in-a-service life. Modeling assumptions, limitations and simplifications may provide results that are slightly to radically different than the actual conditions. In addition to the relationship between demand and capacity, consequences of failure (importance) must be considered in the load factors. Loss of life and property or large economic

losses due to a failure requires a larger margin of safety than minor disruption of service or minor inconveniences.

The need for resistance factors is based on the variability of member strength. The strength of a member must exceed the demand for all foreseeable loads without failure or significant distress. The actual strength of each member is different than the nominal calculated values. These differences are related to variations in as-built versus assumed (analysis/design) material properties, cross-sectional dimensions, reinforcement placement, and also the accuracy of the analytical procedures. In certain instances, these variations cause a reduction in the actual strength compared to the calculated values.

In order to guarantee safety with respect to a structure or individual member, the nominal strength must be reduced by a (resistance) factor and the loads must be increased by (load) factors. These resistance factors, ϕ , account for the variability in the strength, in particular a possible reduced member strength from the calculated value, and the load factors, γ , account for possible overloaded or inappropriately loaded system from the assumed loading. This translates into an equation such as:

$$\phi R_n \geq \sum_{i=1}^l \gamma_i Q_i \quad (C3.1)$$

which is the basis for strength design where ϕ is the resistance factor (less than 1.0), R_n is the calculated nominal capacity of the member, γ_i is the load factor for the i^{th} load, Q_i is the i^{th} load type (dead, live, earthquake, etc.) and l is the number of load types.

Safety margins can be defined as the difference between the strength and the load effects as shown in Figure C3.1. The margin of safety is a random variable that gives rise to a probability distribution with the characteristics shown in Figure C3.2

The typical probability distribution used for defining the probability of failure is that for $\ln(R/Q)$, shown in Figure C3.3. Whenever the probability distribution is below zero in Figures C3.2 and C3.3, failure occurs. Therefore, the area (probability of failure) to the left of zero must be minimized to an acceptable value. This is typically achieved by forcing the mean value of the margin of safety to be a specified number of standard deviations from the origin. This multiplier is referred to as the safety index, β , and is typically taken as a value between 3 and 4. (AISC uses 2.5 for members with wind, 3.0 and 4.5 for connections for members with dead plus live and 1.75 for members with earthquake loads.) Historical data and back calculation of the safety indices from successful designs, has led to these values. The safety index is highly dependent upon the variability of the loading and member resistance. The value of the safety index is approximated by this formula:

$$\beta \cong \frac{\ln(R_m / Q_m)}{\sqrt{V_R^2 + V_Q^2}} \quad (C3.2)$$

where the subscript m stands for mean values of resistance and loads and, V , is the variability of the resistance, subscript R , and the load, subscript Q . A safety index between 3 and 4 provides a probability of failure on the order of one in one hundred thousand. Unfortunately, loads and strengths are rarely given as mean values, rather as nominal strengths and actual loads. Loads are usually provided as expected upper limits, not average values and the load factors need to be adjusted accordingly. The load and resistance factors can be selected based on a specified safety index and the (actual or perceived) variability of the loads and the strengths. ACI 318 resistance (ϕ) factors are based on a perceived value of R_m/R_n that is different than the ratio for USACE designed structures and the USACE design documents. Since the mean to nominal ratio for USACE designed members is larger than that for ACI 318, the USACE resistance factors should be lower, but in order to remain consistent with ACI 318, this difference is reflected in the increased load factors used by USACE. The increase in load factors also reflects the higher variability in the loadings seen by these structures.

C.3-2 Stability Analysis

a. Unfactored loads. Although there must be some inherent safety margin related to the stability of the structure, the stability of a structure is determined using the service loads. The stability of a structure is heavily dependent upon the actual ratio of loads such as dead to live loads. If unequal load factors are applied to the dead and live loads, the stability calculations no longer reflect the actual phenomenon and the potential for instability can be over exaggerated. (This typically occurs since the live load factor is typically larger than the dead load factor. Since the dead load (mass) is often used in hydraulic structures to counteract the live loads relative to stability, a smaller dead load factor would underestimate the structure's ability to resist the live load effects.) The components of the unfactored internal forces can then be multiplied by the appropriate load and hydraulic factors and combined in order to design the component members.

b. Soil structure interaction load factors. Soil-structure interaction requires the direct interaction of the soil, structure and loads. It is not advisable to separate the loads into their components, analyze the loads separately and then add multiples of the resulting forces as soil-structure systems typically are nonlinear systems and superposition of loads does not apply. Changing each component of the load in proportion to its load factor and performing an SSI analysis with this factored loading will not produce the same results as performing a series of analyses, one for each load type, and summing factored results for each component load. (Simply stated a factored load used in an SSI analysis typically will not produce the same result as taking the unfactored results and multiplying by the load factor. The results are dependent upon the stress-strain history of the soil which is typically non linear.) Therefore, it is best to perform the SSI analysis using the service loads and then apply one single load factor on the resulting internal force components. More detailed information can be found in EM 6051 (Time-History Dynamic Analysis of Concrete Hydraulic Structures) and in EM 2906 (Pile Foundations). Most SSI analyses performed to date are static P-Y curve analyses. As computing power increases and more nonlinear SSI software packages become available, each type of analysis and its interaction with load components must be carefully examined to ensure reasonable, accurate and realistic results.

C.3-3 Required Strength

a. General. The hydraulic factor is included within the V_{uh} term. This increase in V_{uh} will require an increase in the shear reinforcement or a deeper section to account for the increased design shear. This additional shear reinforcement and/or deeper sections are used to control cracking of the concrete, an important serviceability requirement for hydraulic structures. Historically, this method has produced structures with limited cracking and serviceability issues and reducing the need for extensive serviceability analyses in many instances.

b. Single Load Factor Method. The increase in H_f from 1.3 to 1.65 for members in direct tension is directly related to the historically lower allowable stress for direct tension members in the Allowable Stress Design code. The reason for increasing the hydraulic factor or decreasing the allowable stress for members in direct tension is to reduce the potential for crack propagation. Due to the difficulty in predicting crack propagation, this simpler approach of increasing the hydraulic factor coupled with successful experience led to this factor of 1.65.

The 0.75 factor accounts for the low probability of the maximum wind, earthquake or other short duration load occurring simultaneously with the maximum dead and live loads. These loads would be considered unusual or extreme loads such as an OBE, operating basis earthquake or the MCE, maximum credible earthquake.

c. Modified ACI 318. The first modification of changing the ACI 318 prescribed lateral fluid pressure factor from 1.4 to 1.7 is due to the high variability and importance of the USACE lateral fluid pressure loads. These loads are considered by the USACE to be similar to live loads for typical reinforced concrete structures. The second modification is to apply the hydraulic factor H_f as described in C.3-3.b.

It is also suggested that a load case using load factors of normal dead load factors and unity for the live load be used for certain hydraulic structures. For some internal forces, the use of different load factors for the dead and live loads can cause a relieving effect on the internal forces, similar to the discussion for stability in C.3-2.a.

d. Earthquake effects.

1) Unusual and extreme loads. Unusual or extreme loads are typically low probability and/or short duration loads. (Floods, high winds, and earthquakes are examples of these types of loads.) The likelihood of maximum combinations of these low probability/short duration loads is very small, therefore the combination of these low probability/short duration events are not required. Similarly, it is unlikely that the maximum earthquake will occur with the maximum live load; therefore the live load factors can be adjusted to reflect the low probability of this combination occurring. Also, for low probability/short duration loads, the expected stress levels and serviceability requirements can be modified to reflect their infrequent occurrence and short-lived effects on the structure.

2) Design earthquake definitions.

a) Maximum Credible Earthquake (MCE). A MCE is the greatest earthquake that can be reasonably generated by a specific source for the structure's region, a once in the lifetime of the source event. It is anticipated that inelastic action within the structure will take place during this type of event. The structure may not be operational after an MCE, but the structure should still be adequate in protecting lives and large economic consequences.

b) Maximum Design Earthquake (MDE). A MDE can be defined as the level of earthquake for which the structure could reasonably see once in its service life. Therefore, 10% probability in 100 years is reasonable for most cases, but may need to be redefined if large loss of life or large economic consequences would result from a once in a service life event, essentially an MDE. For critical structures and features, the MDE can be the maximum credible earthquake (MCE).

c) Operational Basis Earthquake (OBE). An OBE can be defined as an earthquake that the structure is likely to see in its service life. Therefore, 50% probability in 100 years is reasonable for most cases, but may need to be modified if a longer service life is expected or the need for a longer potential return period is chosen based on probable economic losses. In an OBE, the structure is to behave elastically with minimal amount of nonlinear behavior, therefore causing minor damage. The structure is to remain in operation or be operational in a short period of time with minor repairs after an OBE.

3) OBE load factors. Different load factors are used for OBE's generated using site-specific and standard procedures. The techniques used to generate site-specific earthquakes are assumed to produce more reliable (less variability) earthquakes, which produces a lower load factor. The standard (non-site specific) earthquakes are based on a generalization of the earthquake potential within the region, and they are considered less reliable (more variability) than a site-specific generated earthquake. Therefore, they will have higher load factors to reflect this increased variability.

a) Standard ground motion analysis. The reduction in the load factors for the dead and live loads is due to the unlikely probability of the maximum dead and live loads occurring with the OBE event. The higher load factor for the earthquake load is a direct result of the high variability (uncertainty) in this standard earthquake load. This uncertainty is a function of the nature of earthquakes coupled with the development and use of seismic coefficients without regards to site-specific seismic characteristics.

b) Site-specific ground motion. The earthquake load factor is reduced due to the determination of a site-specific earthquake that incorporates the potential sites and local attenuation characteristics in the earthquake load. Performing a site-specific seismic analysis to define a site-specific response spectrum or time history reduces the variability in the seismic load and therefore reduces the seismic load factor. The reduction is limited since earthquake load predictions are still uncertain with a fairly high variability and the likelihood of the structure seeing this earthquake during its lifetime is quite high.

4) MDE load factors. Different load factors are used for MDE's generated using site-specific and standard procedures. The techniques used to generate site-specific earthquakes are assumed to produce more reliable (less variability) earthquakes, which produces a lower load factor. The standard (non-site specific) earthquakes are based on a generalization of the earthquake potential within the region, and they are considered less reliable (more variability) than a site-specific generated earthquake. Therefore, they will have higher load factors to reflect this increased variability.

a) Standard ground motion analysis. The unity load factor on the dead and live loads is due to the very low probability of the maximum dead and live load occurring with the maximum design earthquake. Also, the unity load factors directly reflect the fact that the MDE is considered a once in a lifetime event and that limited inelastic behavior will be tolerated for this event. The lower load factor on the MDE earthquake load versus that for the OBE is due to the lower probability of occurrence of an MDE than an OBE.

b) Site-specific ground motion. The unity load factor on the dead and live loads is due to the very low probability of the maximum dead and live load occurring with the maximum design earthquake. The earthquake load factor is reduced to unity due to the site-specific procedure used to define the MDE. Performing a site-specific seismic analysis to define the site-specific response spectrum or time history reduces the variability in the seismic load and therefore reduces the seismic load factor. The reduction to unity for the earthquake load factor also reflects the once in the lifetime definition of the MDE and that limited inelastic behavior will be tolerated for this event.

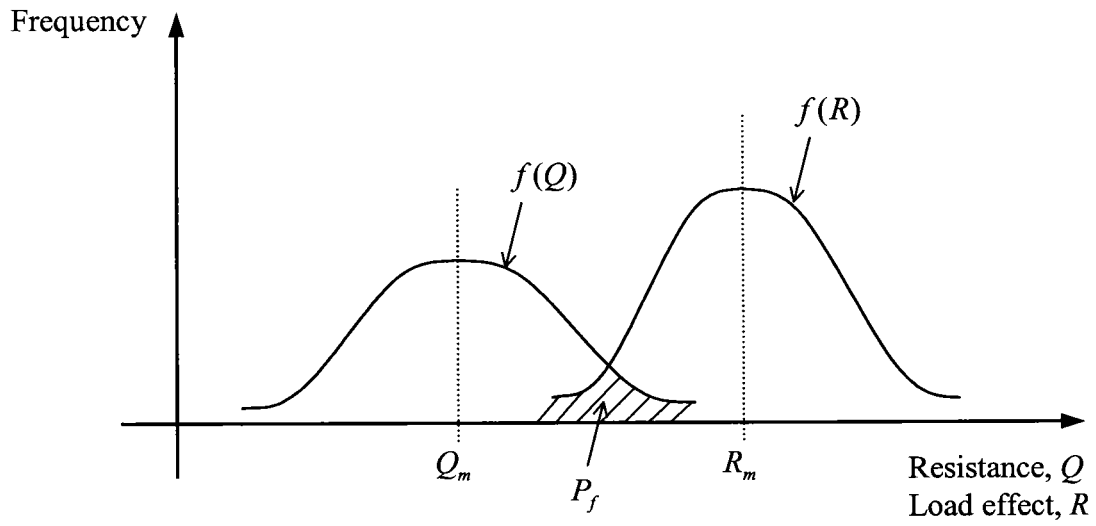

Figure C3.1. Probability density functions for strength and load effect

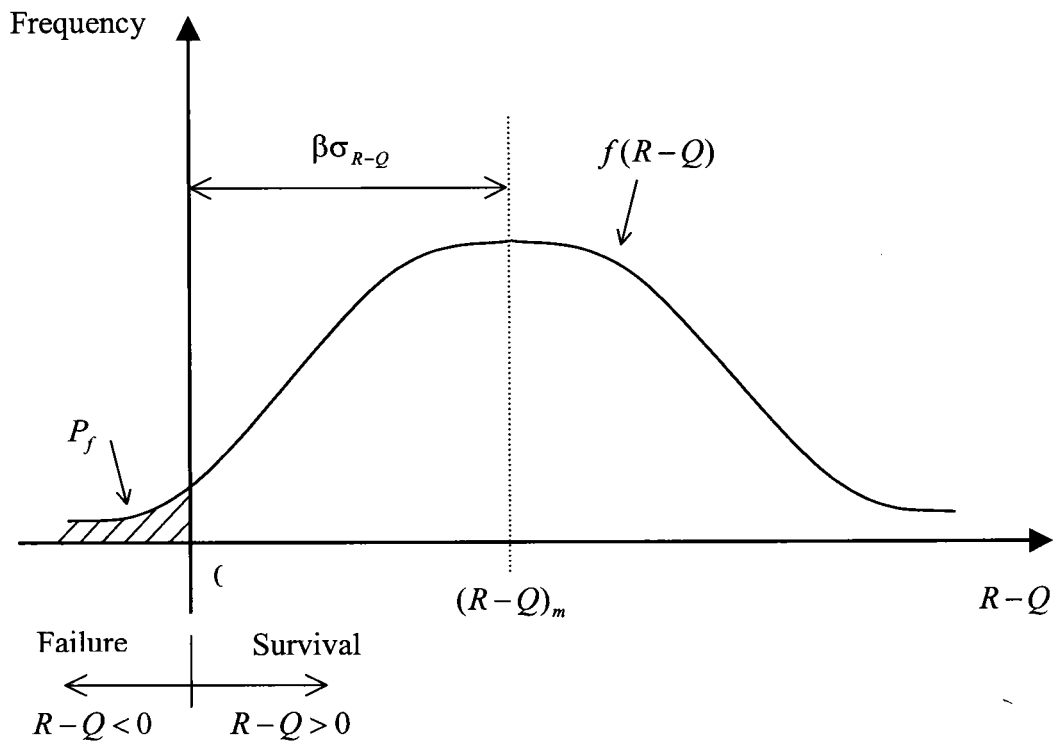

Figure C3.2. Characteristics of $R-Q$

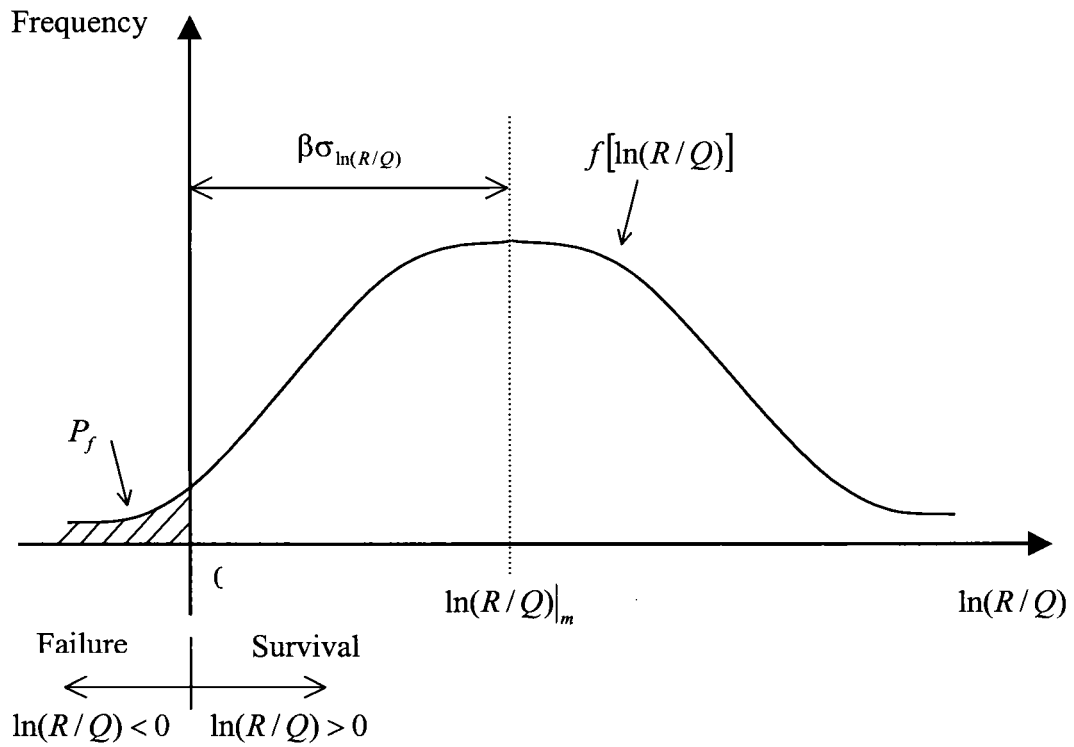

Figure C3.3. Characteristics of $\ln(R/Q)$

CHAPTER 4

FLEXURAL AND AXIAL LOADS

4-1. Design Assumptions and General Requirements

a. The assumed maximum usable strain ϵ_c at the extreme concrete compression fiber should be equal to 0.003 in accordance with ACI 318.

b. Balanced conditions for hydraulic structures exist at a cross section when the tension reinforcement ρ_b reaches the strain corresponding to its specified yield strength f_y just as the concrete in compression reaches its design strain ϵ_c .

c. Concrete stress of $0.85f'_c$ should be assumed uniformly distributed over an equivalent compression zone bounded by edges of the cross section and a straight line located parallel to the neutral axis at a distance $a = \beta_1c$ from the fiber of maximum compressive strain.

d. Factor β_1 should be taken as specified in ACI 318.

e. The eccentricity ratio e'/d should be defined as

$$\frac{e'}{d} = \frac{M_u/P_u + d - h/2}{d} \quad (4-11)^*$$

where e' = eccentricity of axial load measured from the centroid of the tension reinforcement

4-2. Flexural and Compressive Capacity - Tension Reinforcement Only

a. The design axial load strength ϕP_n at the centroid of compression members should not be taken greater than the following:

$$\phi P_{n(\max)} = 0.8\phi[0.85f'_c(A_g - \rho bd) + f_y\rho bd] \quad (4-12)$$

b. The strength of a cross section is controlled by compression if the load has an eccentricity ratio e'/d no greater than that given by Equation 4-3 and by tension if e'/d exceeds this value.

* P_u is considered positive for compression and negative for tension.

$$\frac{e'_b}{d} = \frac{2k_b - k_b^2}{2k_b - \frac{\rho f_y}{0.425 f_c}} \quad (4-13)$$

where

$$k_b = \frac{\beta_1 E_s \epsilon_c}{E_s \epsilon_c + f_y} \quad (4-14)$$

c. Sections controlled by tension should be designed so

$$\phi P_n = \phi(0.85 f_c k_u - \rho f_y) b d \quad (4-15)$$

and

$$\phi M_n = \phi(0.85 f_c k_u - \rho f_y) \left[\frac{e'}{d} - \left(1 - \frac{h}{2d} \right) \right] b d^2 \quad (4-16)$$

where k_u should be determined from the following equation:

$$k_u = \sqrt{\left(\frac{e'}{d} - 1 \right)^2 + \left(\frac{\rho f_y}{0.425 f_c} \right) \frac{e'}{d} - \left(\frac{e'}{d} - 1 \right)} \quad (4-17)$$

d. Sections controlled by compression should be designed so

$$\phi P_n = \phi(0.85 f_c k_u - \rho f_s) b d \quad (4-18)$$

and

$$\phi M_n = \phi(0.85 f_c k_u - \rho f_s) \left[\frac{e'}{d} - \left(1 - \frac{h}{2d} \right) \right] b d^2 \quad (4-19)$$

where

$$f_s = \frac{E_s \epsilon_c (\beta_1 - k_u)}{k_u} \geq -f_y \quad (4-20)$$

and k_u should be determined from the following equation by direct or iterative method:

$$k_u^3 + 2\left(\frac{e'}{d} - 1\right)k_u^2 + \left(\frac{E_s \epsilon_c \rho e'}{0.425 f_c d}\right)k_u - \frac{\beta_1 E_s \epsilon_c \rho e'}{0.425 f_c d} = 0 \quad (4-21)$$

e. The balanced load and moment can be computed using either Equations 4-5 and 4-6 or Equations 4-8 and 4-9 with $k_u = k_b$ and $\frac{e'}{d} = \frac{e'_b}{d}$. The values of e'_b/d and k_b are given by Equations 4-3 and 4-4, respectively.

4-3. Flexural and Compressive Capacity - Tension and Compression Reinforcement

a. The design axial load strength ϕP_n of compression members should not be taken greater than the following:

$$\phi P_{n(\max)} = 0.8\phi \left\{ 0.85 f'_c [A_g - (\rho + \rho')bd] + f_y (\rho + \rho')bd \right\} \quad (4-22)$$

b. The strength of a cross section is controlled by compression if the load has an eccentricity ratio e'/d no greater than that given by Equation 4-13 and by tension if e'/d exceeds this value.

$$\frac{e'_b}{d} = \frac{2k_b - k_b^2 + \frac{\rho' f'_s \left(1 - \frac{d'}{d}\right)}{0.425 f_c}}{2k_b - \frac{\rho f_y}{0.425 f_c} + \frac{\rho' f'_s}{0.425 f_c}} \quad (4-23)$$

The value k_b is given in Equation 4-4 and f'_s is given in Equation 4-16 with $k_u = k_b$.

c. Sections controlled by tension should be designed so

$$\phi P_n = \phi (0.85 f'_c k_u + \rho' f'_s - \rho f_y) b d \quad (4-24)$$

and

$$\phi M_n = \phi (0.85 f'_c k_u + \rho' f'_s - \rho f_y) \left[\frac{e'}{d} - \left(1 - \frac{h}{2d} \right) \right] b d^2 \quad (4-25)$$

where

$$f'_s = \frac{\left(k_u - \beta_1 \frac{d'}{d} \right)}{\left(\beta_1 - k_u \right)} E_s \epsilon_y \leq f_y \quad (4-26)$$

and k_u should be determined from the following equation by direct or iterative methods:

$$\begin{aligned} k_u^3 + \left[2 \left(\frac{e'}{d} - 1 \right) - \beta_1 \right] k_u^2 - \left\{ \frac{f_y}{0.425 f'_c} \left[\rho' \left(\frac{e'}{d} + \frac{d'}{d} - 1 \right) + \frac{\rho e'}{d} \right] \right. \\ \left. + 2 \beta_1 \left(\frac{e'}{d} - 1 \right) \right\} k_u + \frac{f_y \beta_1}{0.425 f'_c} \left[\frac{\rho' d'}{d} \left(\frac{e'}{d} + \frac{d'}{d} - 1 \right) + \frac{\rho e'}{d} \right] \\ = 0 \end{aligned} \quad (4-27)$$

d. Sections controlled by compression should be designed so

$$\phi P_n = \phi (0.85 f'_c k_u + \rho' f'_s - \rho f_y) b d \quad (4-28)$$

and

$$\phi M_n = \phi (0.85 f'_c k_u + \rho' f'_s - \rho f_s) \left[\frac{e'}{d} - \left(1 - \frac{h}{2d} \right) \right] b d^2 \quad (4-29)$$

where

$$f_s = \frac{E_s \epsilon_c (\beta_1 - k_u)}{k_u} \geq -f_y \quad (4-30)$$

and

$$f'_s = \frac{E_s \epsilon_c \left[k_u - \beta_1 \left(\frac{d'}{d} \right) \right]}{k_u} \leq f_y \quad (4-31)$$

and k_u should be determined from the following equation by direct or iterative methods:

$$\begin{aligned} k_u^3 + 2 \left(\frac{e'}{d} - 1 \right) k_u^2 + \frac{E_s \epsilon_c}{0.425 f'_c} \left[(\rho + \rho') \left(\frac{e'}{d} \right) \right. \\ \left. - \rho' \left(1 - \frac{d'}{d} \right) \right] k_u - \frac{\beta_1 E_s \epsilon_c}{0.425 f'_c} \left[\rho' \left(\frac{d'}{d} \right) \left(\frac{e'}{d} \right) \right. \\ \left. + \frac{d'}{d} - 1 \right] + \rho \left(\frac{e'}{d} \right) \left. \right] = 0 \end{aligned} \quad (4-32)$$

Design for flexure utilizing compression reinforcement is discouraged. However, if compression reinforcement is used in members controlled by compression, lateral reinforcement shall be provided in accordance with the ACI Building Code.

e. The balanced load and moment should be computed using Equations 4-14, 4-15, 4-16, and 4-17 with $k_u = k_b$ and $\frac{e'}{d} = \frac{e'_b}{d}$. The values of e'_b/d and k_b are given by Equations 4-13 and 4-4, respectively.

4-4. Flexural and Tensile Capacity

a. The design axial strength ϕP_n of tensile members should not be taken greater than the following:

$$\phi P_{n(\max)} = 0.8\phi(\rho + \rho') f_y b d \quad (4-33)$$

b. Tensile reinforcement should be provided in both faces of the member if the load has an eccentricity ratio e'/d in the following range:

$$\left(1 - \frac{h}{2d}\right) \geq \frac{e'}{d} \geq 0$$

The section should be designed so

$$\phi P_n = \phi(\rho f_y + \rho' f'_s) b d \quad (4-24)$$

and

$$\phi M_n = \phi(\rho f_y + \rho' f'_s) \left[\left(1 - \frac{h}{2d}\right) - \frac{e'}{d} \right] b d^2 \quad (4-25)$$

with

$$f'_s = f_y \frac{\left(k_u + \frac{d'}{d}\right)}{(k_u + 1)} \geq -f_y \quad (4-26)$$

and k_u should be determined from the following equation:

$$k_u = \frac{\rho' \frac{d'}{d} \left(1 - \frac{d'}{d} - \frac{e'}{d}\right) - \rho \frac{e'}{d}}{\rho \frac{e'}{d} - \rho' \left(1 - \frac{d'}{d} - \frac{e'}{d}\right)} \quad (4-27)$$

c. Sections subjected to a tensile load with an eccentricity ratio $e'/d < 0$ should be designed using Equations 4-5 and 4-6. The value of k_u is

$$k_u = -\left(\frac{e'}{d} - 1\right) - \sqrt{\left(\frac{e'}{d} - 1\right)^2 + \left(\frac{\rho f_y}{0.425 f_c}\right) \frac{e'}{d}} \quad (4-28)$$

d. Sections subject to a tensile load with an eccentricity ratio $e'/d < 0$ should be designed using Equations 4-14, 4-15, 4-16, and 4-17 if $A'_s > 0$ and $c > d'$.

4-5. Biaxial Bending and Axial Load

a. Provisions of paragraph 4-5 shall apply to reinforced concrete members subjected to biaxial bending.

b. For a given nominal axial load $P_n = P_u/\phi$, the following nondimensional equation shall be satisfied:

$$(M_{nx}/M_{ox})^k + (M_{ny}/M_{oy})^k \leq 1.0 \quad (4-29)$$

where

M_{nx}, M_{ny} = nominal biaxial bending moments with respect to the x and y axes, respectively

M_{ox}, M_{oy} = uniaxial nominal bending strength at P_n about the x and y axes, respectively

$K = 1.5$ for rectangular members
= 1.75 for square or circular members
= 1.0 for any member subjected to axial tension

c. M_{ox} and M_{oy} shall be determined in accordance with paragraphs 4-1 through 4-3.

CHAPTER 5

SHEAR

5-1. Shear Strength

The shear strength V_c provided by concrete shall be computed in accordance with ACI 318 except in the cases described in paragraphs 5-2 and 5-3.

5-2. Shear Strength for Special Straight Members

The provisions of this paragraph shall apply only to straight members of box culvert sections or similar structures that satisfy the requirements of 5-2.a and 5-2.b. The stiffening effects of wide supports and haunches shall be included in determining moments, shears, and member properties. The ultimate shear strength of the member is considered to be the load capacity that causes formation of the first inclined crack.

a. Members that are subjected to uniformly (or approximately uniformly) distributed loads that result in internal shear, flexure, and axial compression (but not axial tension).

b. Members having all of the following properties and construction details.

- (1) Rectangular cross-sectional shapes.
- (2) l_n/d between 1.25 and 9, where l_n is the clear span.
- (3) f'_c not more than 6,000 psi.
- (4) Rigid, continuous joints or corner connections.
- (5) Straight, full-length reinforcement. Flexural reinforcement shall not be terminated even though it is no longer a theoretical requirement.
- (6) Extension of the exterior face reinforcement around corners such that a vertical lap splice occurs in a region of compression stress.
- (7) Extension of the interior face reinforcement into and through the supports.

c. The shear strength provided the concrete shall be computed as

$$V_c = \left[\left(11.5 - \frac{l_n}{d} \right) \sqrt{f'_c} \sqrt{1 + \frac{N_u/A_g}{5\sqrt{f'_c}}} \right] bd \quad (5-1)$$

at a distance of $0.15\ell_n$ from the face of the support.

d. The shear strength provided by the concrete shall not be taken greater than

$$V_c = 2 \left[12 - \left(\frac{\ell_n}{d} \right) \right] \sqrt{f'_c} \, bd \quad (5-2)$$

and shall not exceed $10 \sqrt{f'_c} \, bd$.

5-3. Shear Strength for Curved Members

At points of maximum shear, for uniformly loaded curved cast-in-place members with $R/d > 2.25$ where R is the radius curvature to the centerline of the member:

$$V_c = \left[4\sqrt{f'_c} \sqrt{1 + \frac{N_u/A_g}{4\sqrt{f'_c}}} \right] bd \quad (5-3)$$

The shear strength shall not exceed $10 \sqrt{f'_c} \, bd$.

5-4. Empirical Approach

Shear strength based on the results of detailed laboratory or field tests conducted in consultation with and approved by CECW-ED shall be considered a valid extension of the provisions in paragraphs 5-2 and 5-3.

APPENDIX A

NOTATION

a_d	Depth of stress block at limiting value of balanced condition (Appendix D)
d_d	Minimum effective depth that a singly reinforced member may have and maintain steel ratio requirements (Appendix D)
e'	Eccentricity of axial load measured from the centroid of the tension reinforcement
e'_b	Eccentricity of nominal axial load strength, at balanced strain conditions, measured from the centroid of the tension reinforcement
H_f	Hydraulic structural factor equal to 1.3
k_b	Ratio of stress block depth (a) to the effective depth (d) at balanced strain conditions
k_u	Ratio of stress block depth (a) to the effective depth (d)
K	Exponent, equal to 1.0 for any member subject to axial tension, 1.5 for rectangular members and 1.75 for square or circular members, used in nondimensional biaxial bending expression
l_n	Clear span between supports
M_{DS}	Bending moment capacity at limiting value of balanced condition (Appendix D)
M_{nx}, M_{ny}	Nominal biaxial bending moments with respect to the x and y axes, respectively
M_{ox}, M_{oy}	Uniaxial nominal bending strength at P_n about the x and y axes, respectively
R	Radius of curvature to centerline of curved member

APPENDIX B

DERIVATION OF EQUATIONS FOR FLEXURAL AND AXIAL LOADS

B-1. General

Derivations of the design equations given in paragraphs 4-2 through 4-4 are presented below. The design equations provide a general procedure that may be used to design members for combined flexural and axial load.

B-2. Axial Compression and Flexure

a. Balanced Condition

From Figure B-1, the balanced condition, Equations 4-3 and 4-4 can be derived as follows:

From equilibrium,

$$\frac{P_u}{\phi} = 0.85 f'_c b k_u d - A_s f_s \quad (\text{B-1})$$

let

$$j_u = d - \frac{a}{2} = d - \frac{k_u d}{2} \quad (\text{B-2})$$

from moment equilibrium,

$$\frac{P_u e'}{\phi} = (0.85 f'_c b k_u d) (j_u d) \quad (\text{B-3})$$

Rewrite Equation B-3 as:

$$\begin{aligned} \frac{P_u e'}{\phi} &= (0.85 f'_c b k_u d) \left(d - \frac{k_u d}{2} \right) \\ &= (0.85 f'_c b d^2) \left(k_u - \frac{k_u^2}{2} \right) \\ &= 0.425 f'_c (2k_u - k_u^2) b d^2 \end{aligned} \quad (\text{B-4})$$

EM 1110-2-2104
30 Jun 92

From the strain diagram at balanced condition (Figure B-1):

$$\frac{c_b}{d} = \frac{\epsilon_c}{\epsilon_c + \epsilon_y}$$

$$\left(\frac{k_b d}{\beta_1} \right) = \frac{\epsilon_c}{\epsilon_c + \epsilon_y} \quad (\text{B-5})$$

since $\epsilon_y = \frac{f_y}{E_s}$

$$k_b = \frac{\beta_1 E_s \epsilon_c}{E_s \epsilon_c + f_y} \quad (\text{B-6, Eq. 4-4})$$

since $e'_b = \frac{P_b e'_b}{P_b}$ (B-7)

e'_b is obtained by substituting Equations B-4 and B-1 into Equation B-7 with $k_u = k_b$, $f_s = f_y$ and $P_u = P_b$.

$$e'_b = \frac{0.425 f'_c (2k_b - k_b^2) b d^2}{0.85 f'_c k_b b d - f_y \rho b d} \quad (\text{B-8})$$

Therefore

$$\frac{e'_b}{d} = \frac{2k_b - k_b^2}{2k_b - \frac{f_y \rho}{0.425 f'_c}} \quad (\text{B-9, Eq. 4-3})$$

b. Sections Controlled by Tension (Figure B-1).

ϕP_n is obtained from Equation B-1 with $f_s = f_y$ as:

$$\phi P_n = \phi (0.85 f'_c b k_u d - A_s f_y) \quad (\text{B-10, Eq. 4-5})$$

$$\phi P_n = \phi (0.85 f'_c k_u - \rho f_y) b d$$

The design moment ϕM_n is expressed as:

$$\phi M_n = \phi P_n e \quad (\text{B-11})$$

$$\phi M_n = \phi P_n \left[\frac{e'}{d} - \left(1 - \frac{h}{2d} \right) \right] d$$

Therefore,

$$\phi M_n = \phi (0.85 f'_c k_u - f_y \rho) \left[\frac{e'}{d} - \left(1 - \frac{h}{2d} \right) \right] b d^2 \quad (\text{B-12, Eq. 4-6})$$

Substituting Equation B-1 with $f_s = f_y$ into Equation B-4 gives

$$(0.85 f'_c k_u b d - f_y \rho b d) e' = 0.425 f'_c (2k_u - k_u^2) b d^2 \quad (\text{B-13})$$

which reduces to

$$k_u^2 + 2 \left(\frac{e'}{d} - 1 \right) k_u - \frac{f_y \rho e'}{0.425 f'_c d} = 0 \quad (\text{B-14})$$

Solving by the quadratic equation:

$$k_u = \sqrt{\left(\frac{e'}{d} - 1 \right)^2 + \left(\frac{\rho f_y}{0.425 f'_c} \right) \frac{e'}{d}} - \left(\frac{e'}{d} - 1 \right) \quad (\text{B-15, Eq. 4-7})$$

c. Sections Controlled by Compression (Figure B-1)

ϕP_n is obtained from Equation B-1

$$\phi P_n = \phi (0.85 f'_c k_u - \rho f_s) bd \quad (\text{B-16, Eq. 4-8})$$

and ϕM_n is obtained by multiplying Equation B-16 by e .

$$\phi M_n = \phi (0.85 f'_c k_u - \rho f_s) \left[\frac{e'}{d} - \left(1 - \frac{h}{2d} \right) \right] bd^2 \quad (\text{B-17})$$

The steel stress, f_s , is expressed as $f_s = E_s \epsilon_s$.

From Figure B-1.

$$\frac{c}{d} = \frac{\epsilon_c}{\epsilon_c + \epsilon_s}$$

or

$$\left(\frac{k_u d}{\beta_1} \right) = \frac{\epsilon_c}{\epsilon_c + \epsilon_s}$$

Therefore,

$$f_s = \frac{E_s \epsilon_c (\beta_1 - k_u)}{k_u} \quad (\text{B-18, Eq. 4-10})$$

Substituting Equations B-1 and B-18 into B-4 gives

$$\begin{aligned} 0.85 f'_c k_u b d e' - \left[\frac{E_s \epsilon_c (\beta_1 - k_u)}{k_u} \right] \rho b d e' \\ = 0.425 f'_c (2k_u - k_u^2) b d^2 \end{aligned} \quad (\text{B-19})$$

which can be arranged as

$$k_u^3 + 2 \left(\frac{e'}{d} - 1 \right) k_u^2 + \left(\frac{E_s \epsilon_c \rho e'}{0.425 f_c d} \right) k_u - \frac{\beta_1 E_s \epsilon_c \rho e'}{0.425 f_c d} = 0 \quad (\text{B-20, Eq. 4-11})$$

B-3. Flexural and Compressive Capacity-Tension and Compression Reinforcement (Figure B-2)

a. Balanced Condition

Using Figure B-2, the balanced condition, Equation 4-13 can be derived as follows:

From equilibrium,

$$\frac{P_u}{\phi} = 0.85 f_c' k_u b d + f_s' \rho' b d - f_s \rho b d \quad (\text{B-21})$$

In a manner similar to the derivation of Equation B-4, moment equilibrium results in

$$\frac{P_u e'}{\phi} = 0.425 f_c' (2k_u - k_u^2) b d^2 + f_s' \rho' b d (d - d') \quad (\text{B-22})$$

As in Equation B-6,

$$k_b = \frac{\beta_1 E_s \epsilon_c}{E_s \epsilon_c + F_y} \quad (\text{B-23})$$

$$\text{since } e_b' = \frac{P_b e'}{P_s} \quad (\text{B-24})$$

and using Equations B-21 and B-22:

$$e_b' = \frac{0.425 f_c' (2k_b - k_b^2) b d^2 + f_s' \rho' b d (d - d')}{0.85 f_c' k_b b d + f_s' \rho' b d - f_s \rho b d} \quad (\text{B-25})$$

which can be rewritten as

$$e'_b = \frac{(2k_b - k_b^2)d + \frac{f'_s \rho'}{0.425 f_c} (d - d')}{2k_b + \frac{f_s \rho'}{0.425 f_c} - \frac{f_y \rho}{0.425 f_c}}$$

or

$$\frac{e'_b}{d} = \frac{2k_b - k_b^2 + \frac{f'_s \rho' \left(1 - \frac{d'}{d}\right)}{0.425 f_c}}{2k_b - \frac{f_y \rho}{0.425 f_c} + \frac{f'_s \rho'}{0.425 f_c}} \quad (\text{B-26, Eq. 4-13})$$

b. Sections Controlled by Tension (Figure B-2)

ϕP_n is obtained as Equation B-21 with $f_s = f_y$.

$$\phi P_n = \phi (0.85 f'_c k_u + \rho' f'_s - \rho f_y) b d \quad (\text{B-27, Eq. 4-14})$$

Using Equations B-11 and B-27,

$$\phi M_n = \phi (0.85 f'_c k_u + \rho' f'_s - \rho f_y) \left[\frac{e'}{d} - \left(1 - \frac{h}{2d}\right) \right] b d^2 \quad (\text{B-28, Eq. 4-15})$$

From Figure B-2

$$\frac{\epsilon'_s}{c - d'} = \frac{\epsilon_y}{d - c} ; f'_s = E_s \epsilon'_s ; c = \frac{k_u d}{\beta_1}$$

Therefore,

$$\frac{f'_s}{E_s} = \left(\frac{k_u d}{\beta_1} - d' \right) \left(\frac{\epsilon_y}{d - \frac{k_u d}{\beta_1}} \right)$$

or

$$f'_s = \frac{\left(k_u - \beta_1 \frac{d'}{d} \right)}{\left(\beta_1 - k_u \right)} E_s \epsilon_y \quad (\text{B-29, Eq. 4-16})$$

Substituting Equation B-21 with $f_s = f_y$ into Equation B-22 gives,

$$\begin{aligned} & (0.85 f'_c k_u b d + f'_s \rho' b d - f_y \rho b d) e' \\ & = 0.425 f'_c (2k_u - k_u^2) b d^2 + f'_s \rho' b d (d - d') \end{aligned} \quad (\text{B-30})$$

Using Equation B-29, Equation B-30 can be written as:

$$\begin{aligned} & k_u^3 + \left[2 \left(\frac{e'}{d} - 1 \right) - \beta_1 \right] k_u^2 - \left\{ \frac{f_y}{0.425 f'_c} \left[\rho' \left(\frac{e'}{d} + \frac{d'}{d} - 1 \right) + \frac{\rho e'}{d} \right] \right. \\ & \left. + 2 \beta_1 \left(\frac{e'}{d} - 1 \right) \right\} k_u + \frac{f_y \beta_1}{0.425 f'_c} \left[\rho' \frac{d'}{d} \left(\frac{e'}{d} + \frac{d'}{d} - 1 \right) + \frac{\rho e'}{d} \right] \\ & = 0 \end{aligned} \quad (\text{B-31, Eq. 4-17})$$

c. Sections Controlled by Compression (Figures B-2)

ϕP_n is obtained from equilibrium

$$\phi P_n = \phi (0.85 f'_c k_u + \rho' f'_s - \rho f_s) b d \quad (\text{B-32, Eq. 4-18})$$

EM 1110-2-2104
30 Jun 92

Using Equations B-11 and B-32,

$$\phi M_n = \phi (0.85 f'_c k_u + \rho' f'_s - \rho f_s) \left[\frac{e'}{d} - \left(1 - \frac{h}{2d}\right) \right] b d^2 \quad (\text{B-33, Eq. 4-19})$$

From Figure B-2

$$\frac{\epsilon_s}{d - c} = \frac{\epsilon_c}{c} ; \quad f_s = E_s \epsilon_s ; \quad c = \frac{k_u d}{\beta_1}$$

which can be written as

$$f_s = \frac{E_s \epsilon_c (\beta_1 - k_u)}{k_u} \quad (\text{B-34, Eq. 4-20})$$

Also,

$$\frac{\epsilon'_s}{c - d'} = \frac{\epsilon_c}{c}$$

which can be rewritten as

$$f'_s = \frac{E_s \epsilon_c \left[k_u - \beta_1 \left(\frac{d'}{d} \right) \right]}{k_u} \quad (\text{B-35, Eq. 4-21})$$

From Equations B-21 and B-22

$$\begin{aligned} (0.85 f'_c k_u b d - f'_s \rho' b d - f_s \rho b d) e' \\ = 0.425 f'_c (2k_u - k_u^2) b d^2 + f'_s \rho' b d (d - d') \end{aligned} \quad (\text{B-36})$$

Substituting Equations B-34 and B-35 with $k_b = k_u$ into Equation B-36 gives

$$k_u^3 + 2 \left(\frac{e'}{d} - 1 \right) k_u^2 + \frac{E_s \epsilon_c}{0.425 f_c} \left[(\rho + \rho') \left(\frac{e'}{d} \right) - \rho' \left(1 - \frac{d'}{d} \right) \right] k_u - \frac{\beta_1 E_s \epsilon_c}{0.425 f_c} \left[\rho' \left(\frac{d'}{d} \right) \left(\frac{e'}{d} + \frac{d'}{d} - 1 \right) + \rho \left(\frac{e'}{d} \right) \right] = 0 \quad (\text{B-37, Eq. 4-22})$$

B-4. Flexural and Tensile Capacity

a. Pure Tension (Figure B-3)

From equilibrium (double reinforcement)

$$\phi P_n = \phi (A_s + A'_s) f_y \quad (\text{B-38})$$

For design, the axial load strength of tension members is limited to 80 percent of the design axial load strength at zero eccentricity.

Therefore,

$$\phi P_{n(\max)} = 0.8 \phi (\rho + \rho') f_y b d \quad (\text{B-39, Eq. 4-23})$$

b. For the case where $1 - \frac{h}{2d} \geq \frac{e'}{d} \geq 0$, the applied tensile resultant $\frac{P_u}{\phi}$ lies between the two layers of steel.

From equilibrium

$$\phi P_n = \phi (A_s f_y + A'_s f'_s)$$

or

$$\phi P_n = \phi (\rho f_y + \rho' f'_s) b d \quad (\text{B-40, Eq. 4-24})$$

and

$$\phi M_n = \phi P_n \left[\left(1 - \frac{h}{2d} \right) - \frac{e'}{d} \right] d$$

or

$$\phi M_n = \phi (\rho f_y + \rho' f_s') \left[\left(1 - \frac{h}{2d} \right) - \frac{e'}{d} \right] b d^2 \quad (\text{B-41, Eq. 4-25})$$

From Figure B-3,

$$\frac{\epsilon_s'}{a + d'} = \frac{\epsilon_y}{a + d}$$

which can be rewritten as

$$f_s' = f_y \frac{\left(k_u + \frac{d'}{d} \right)}{(k_u + 1)} \quad (\text{B-42, Eq. 4-26})$$

From Figure B-3 equilibrium requires:

$$A_s f_s e' = A_s' f_s' (d - d' - e') \quad (\text{B-43})$$

Substituting Equation B-42 and $f_s = f_y$ into Equation B-43 results in

$$k_u = \frac{\rho' \left(\frac{d'}{d} \right) \left(1 - \frac{d'}{d} - \frac{e'}{d} \right) - \rho \left(\frac{e'}{d} \right)}{\rho \left(\frac{e'}{d} \right) - \rho' \left(1 - \frac{d'}{d} - \frac{e'}{d} \right)} \quad (\text{B-44, Eq. 4-27})$$

c. The case where $(e'/d) < 0$ is similar to the combined flexural and compression case. Therefore, k_u is derived in a manner similar to the derivation of Equation B-15 and is given as

$$k_u = -\left(\frac{e'}{d} - 1 \right) - \sqrt{\left(\frac{e'}{d} - 1 \right)^2 + \left(\frac{\rho f_y}{0.425 f_c} \right) \frac{e'}{d}} \quad (\text{B-45, Eq. 4-28})$$

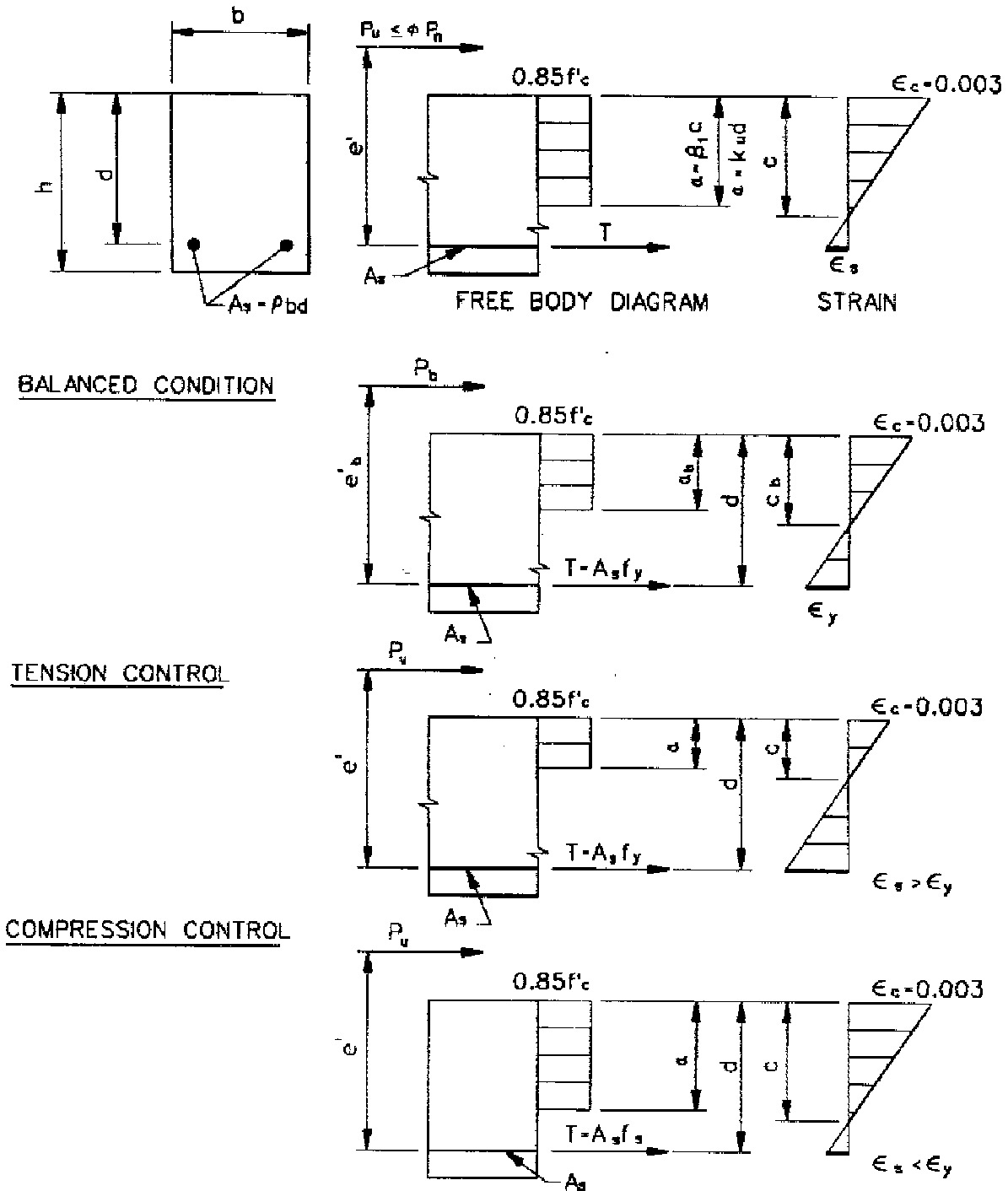

Figure B-1. Axial compression and flexure, single reinforcement

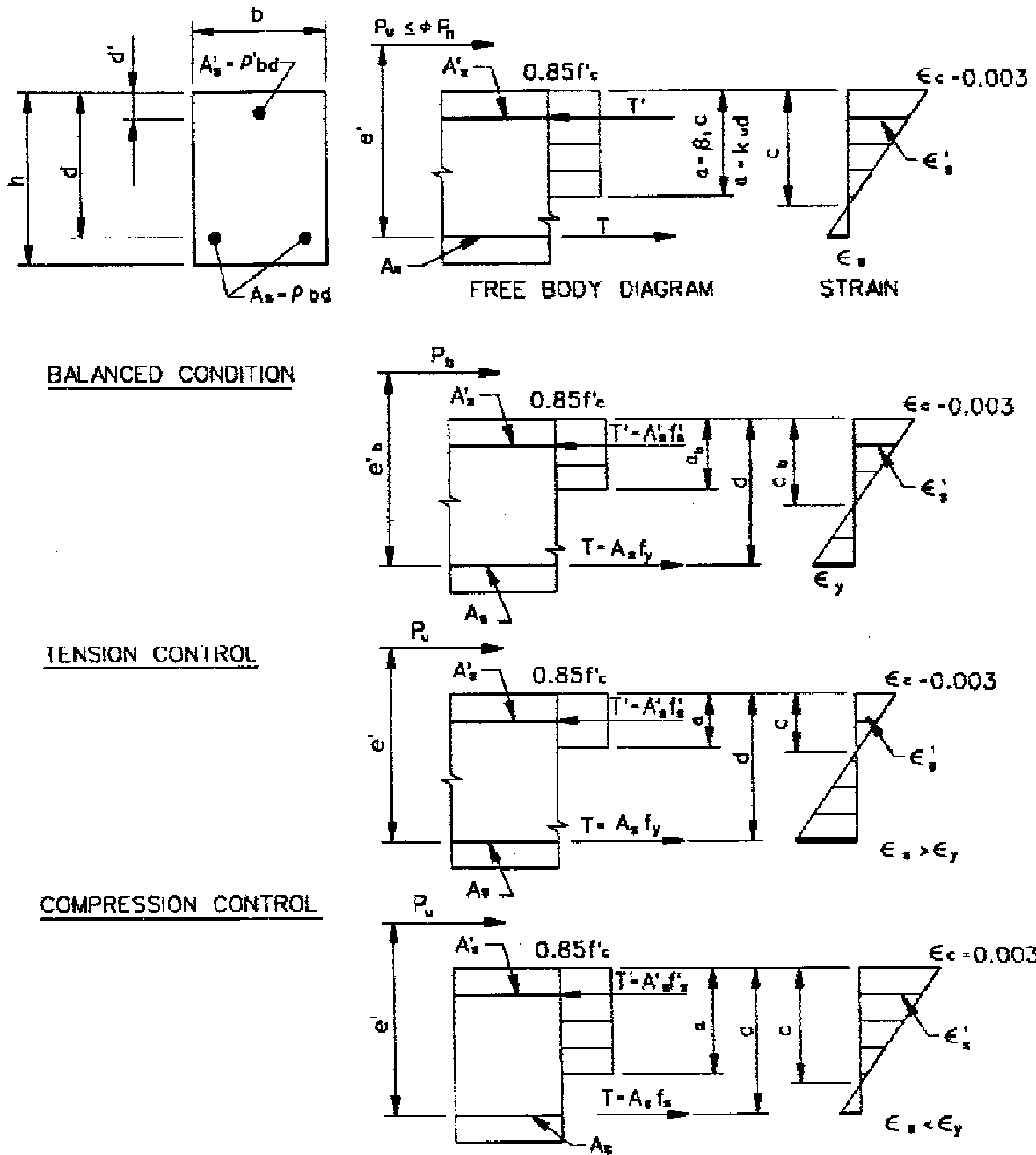
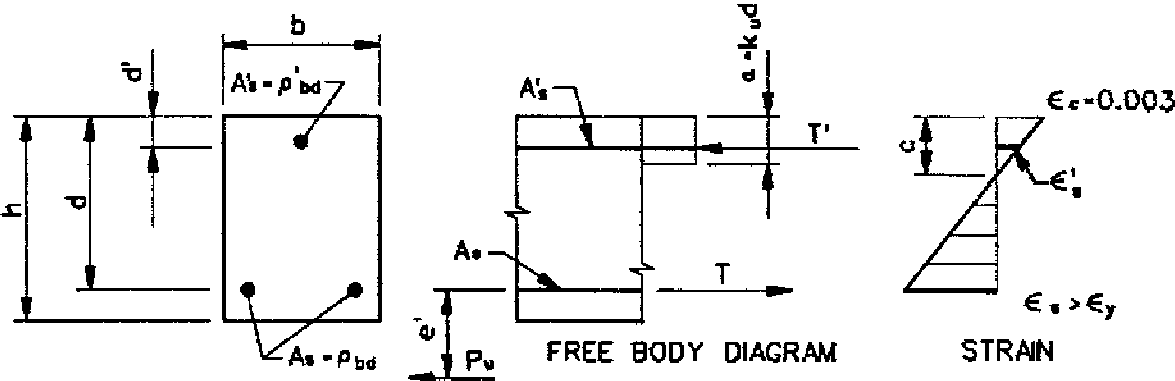
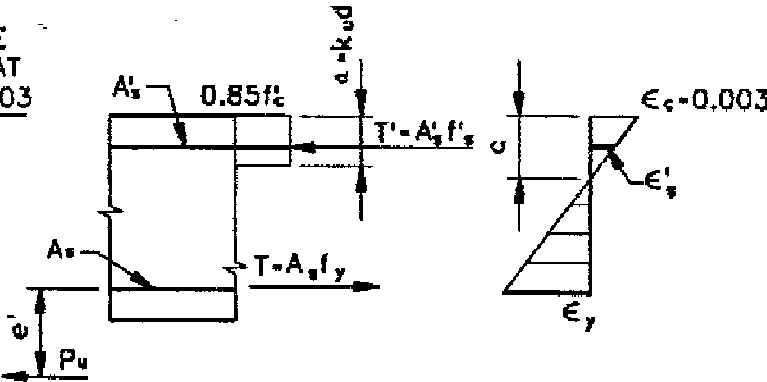

Figure B-2. Axial compression and flexure, double reinforcement



AXIAL TENSION, CONCRETE AT COMPRESSION FACE AT ULTIMATE STRAIN OF 0.003



AXIAL TENSION, BOTH LAYERS OF STEEL IN TENSION

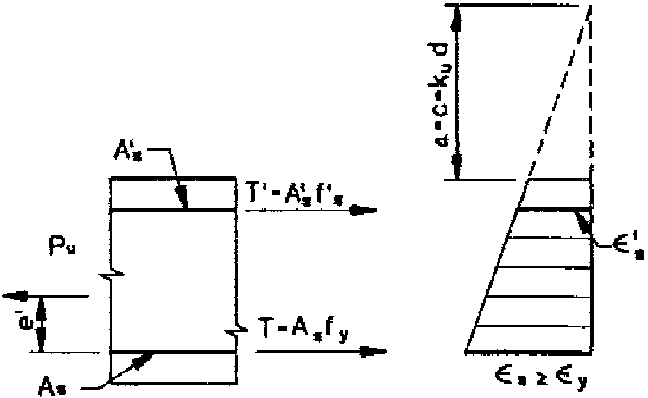

Figure B-3. Axial tension and flexure, double reinforcement

APPENDIX C

INVESTIGATION EXAMPLES

C-1. General

For the designer's convenience and reference, the following examples are provided to illustrate how to determine the flexural capacity of existing concrete sections in accordance with this Engineer Manual and ACI 318.

C-2. Analysis of a Singly Reinforced Beam

Given: $f'_c = 3 \text{ ksi}$ $\beta_1 = 0.85$
 $f_y = 60 \text{ ksi}$ $E_s = 29,000 \text{ ksi}$
 $A_s = 1.58 \text{ in.}^2$

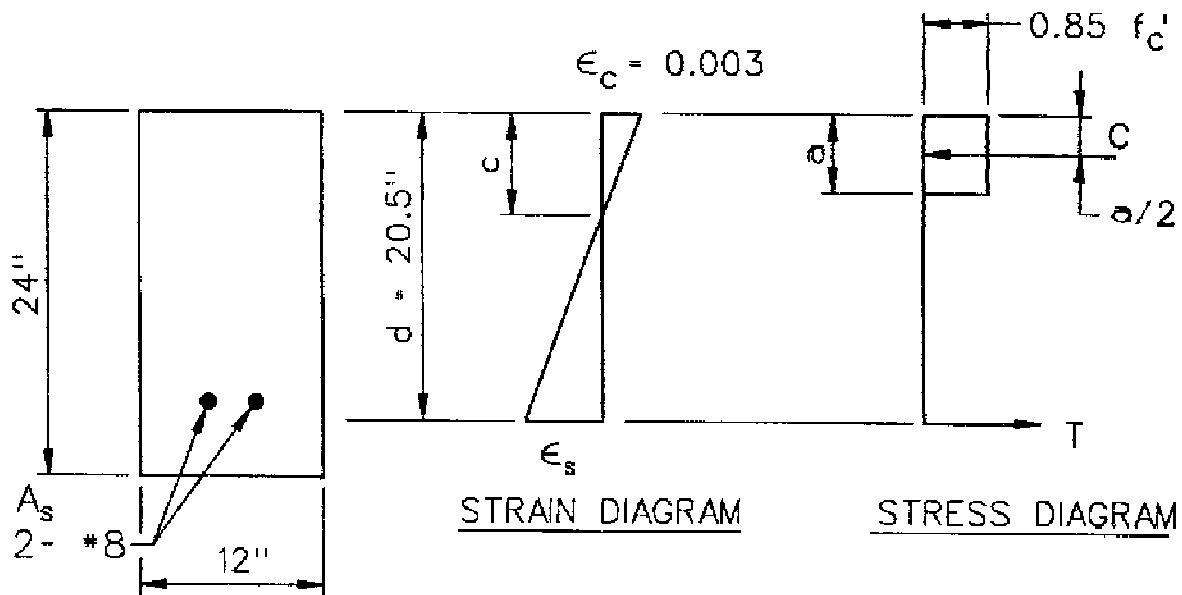

Solution:

1. Check steel ratio

$$\begin{aligned} \rho_{act} &= \frac{A_s}{bd} \\ &= \frac{1.58}{12(20.5)} \\ &= 0.006423 \end{aligned}$$

EM 1110-2-2104
30 Jun 92

$$\begin{aligned}\rho_b &= 0.85\beta_1 \frac{f'_c}{f_y} \left(\frac{87,000}{87,000 + f_y} \right) \\ &= 0.85 (0.85) \left(\frac{3}{60} \right) \left(\frac{87,000}{87,000 + 60,000} \right) \\ &= 0.02138\end{aligned}$$

in accordance with Paragraph 3-5 check:

$$\begin{aligned}0.25\rho_b &= 0.00534 \\ 0.375\rho_b &= 0.00802 \\ \rho_{act} &= 0.00642 \\ 0.25\rho_b &< \rho_{act} < 0.375\rho_b\end{aligned}$$

ρ_{act} is greater than the recommended limit, but less than the maximum permitted upper limit not requiring special study or investigation. Therefore, no special consideration for serviceability, constructibility, and economy is required. This reinforced section is satisfactory.

2. Assume the steel yields and compute the internal forces:

$$\begin{aligned}T &= A_s f_y = 1.58 (60) = 94.8 \text{ kips} \\ C &= 0.85 f'_c b a \\ C &= 0.85 (3) (12) a = 30.6a\end{aligned}$$

3. From equilibrium set $T = C$ and solve for a :

$$\begin{aligned}94.8 &= 30.6a \longrightarrow a = 3.10 \text{ in.} \\ \text{Then, } a &= \beta_1 c \longrightarrow c = \frac{3.10}{0.85} = 3.65 \text{ in.}\end{aligned}$$

4. Check ϵ_s to demonstrate steel yields prior to crushing of the concrete:

$$\frac{\epsilon_s}{20.5 - c} = \frac{0.003}{c}$$

$$\epsilon_s = 16.85 \left(\frac{0.003}{3.65} \right) = 0.0138$$

$$\epsilon_y = \frac{f_y}{E_s} = \frac{60}{29,000} = 0.00207$$

$\epsilon_s > \epsilon_y$ Ok, steel yields

5. Compute the flexural capacity:

$$\begin{aligned} \phi M_n &= \phi (A_s f_y) (d - a/2) \\ &= 0.90 (94.8) \left(20.5 - \frac{3.10}{2} \right) \\ &= 1616.8 \text{ in.-k} \\ &= 134.7 \text{ ft-k} \end{aligned}$$

C-3. Analysis of an Existing Beam - Reinforcement in Both Faces

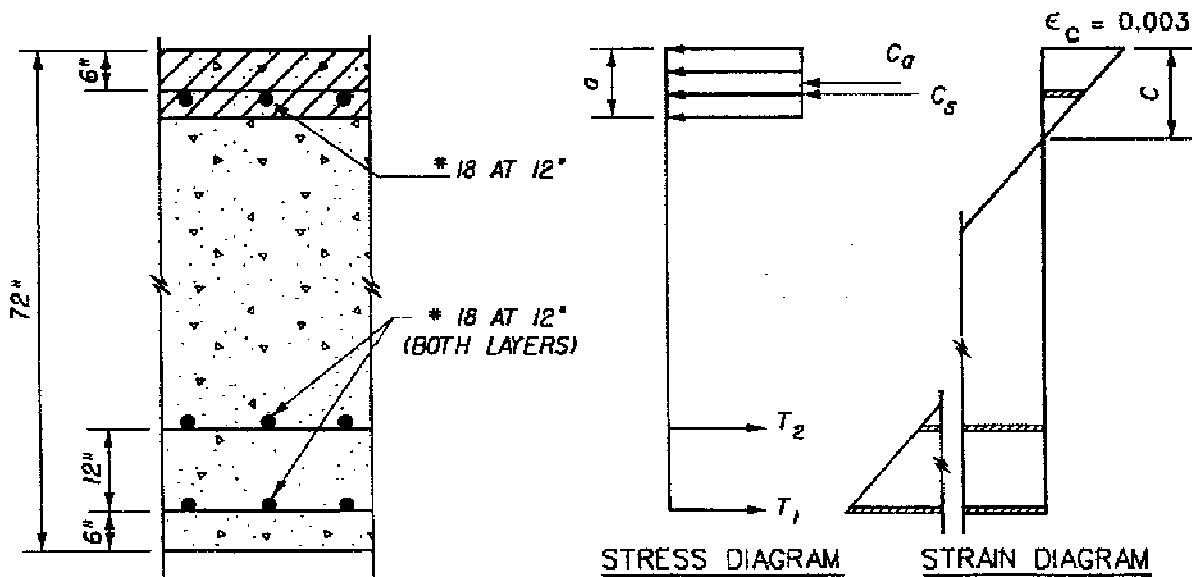

EM 1110-2-2104
30 Jun 92

Given: $f'_c = 3,000 \text{ psi}$ $\epsilon_c = 0.003$
 $f_y = 60,000 \text{ psi}$ $\beta_1 = 0.85$
 $A_s = 8.00 \text{ in.}^2$ $E_s = 29,000,000 \text{ psi}$
 $A'_s = 4.00 \text{ in.}^2$

Solution:

1. First analyze considering steel in tension face only

$$\rho = \frac{A_s}{bd} = \frac{8}{(60)(12)} = 0.011$$

$$\rho_{bal} = 0.85 \frac{\beta_1 f'_c}{f_y} = \frac{87,000}{87,000 + f_y} = 0.0214$$

$$\rho = \frac{0.011}{0.0214} \rho_{bal} = 0.51 \rho_b$$

Note: ρ exceeds maximum permitted upper limit not requiring special study or investigation = $0.375 \rho_b$. See Chapter 3.

$$T = A_s f_y$$

$$T = 8(60) = 480 \text{ kips}$$

$$\text{then } C_c = 0.85 f'_c b a = 30.6 a$$

$$T = C_c$$

$$\therefore a = 15.7 \text{ in. and } c = 18.45 \text{ in.}$$

By similar triangles, demonstrate that steel yields

$$\frac{\epsilon_c}{18.45} = \frac{\epsilon_{s(2)}}{54 - c} \Rightarrow \epsilon_{s(2)} = 0.0057 > \epsilon_y = 0.0021$$

ok; both layers of steel yield.

$$\text{Moment capacity} = 480 \text{ kips } (d - a/2)$$

$$= 480 \text{ kips } (52.15 \text{ in.})$$

$$M = 25,032 \text{ in.-k}$$

2. Next analyze considering steel in compression face

$$\rho' = \frac{4}{12(60)} = 0.0056$$

$$\rho - \rho' = 0.0054$$

$$= 0.85 \frac{\beta_1 f'_c}{f_y} \cdot \frac{d'}{d} \left(\frac{87,000}{87,000 - f_y} \right) = 0.016$$

$\rho - \rho' \leq 0.0116$ \therefore compression steel does not yield, must do general analysis using $\sigma : \epsilon$ compatibility

Locate neutral axis

$$T = 480 \text{ kips}$$

$$C_c = 0.85 f'_c b a = 30.6 a$$

$$C_s = A'_s (f'_s - 0.85 f'_c) = 4 (f'_s - 2.55)$$

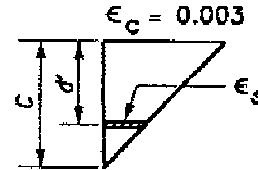

By similar triangles

$$\frac{\epsilon'_s}{c - d} = \frac{0.003}{c}$$

$$\text{Substitute } c = \frac{a}{0.85} = 1.176 a$$

$$\text{Then } \epsilon'_s = 0.003 - \frac{0.0153}{a}$$

$$\text{Since } f'_s = E \epsilon'_s \Rightarrow f'_s = \left(87 - \frac{443.7}{a} \right) \text{ ksi}$$

Then

$$C_s = 4\left(87 - 2.55 - \frac{443.7}{a}\right)\text{kips}$$

$$T = C_c + C_s = 480 \text{ kips}$$

Substitute for C_c and C_s and solve for a

$$30.6a + 337.8 - \frac{1774.8}{a} = 480$$

$$a^2 - 4.65a - 58 = 0$$

Then $a = 10.3$ in.

and $c = 12.1$ in.

Check $\epsilon'_s > \epsilon_y$

$$\text{By similar triangles } \frac{0.003}{12.1} = \frac{\epsilon'_s}{d - 12.1}$$

$$\epsilon'_s = 0.0119 > 0.0021$$

$$C_c = 30.6a \approx 315 \text{ kips}$$

$$C_s = 4(41.37) \approx 165 \text{ kips}$$

$$C_c + C_s = 480 \text{ kips} = T$$

$$\text{Resultant of } C_c \text{ and } C_s = \frac{315\left(\frac{10.3}{2}\right) + (165)(6)}{480} = 5.4 \text{ in.}$$

$$\text{Internal Moment Arm} = 60 - 5.4 = 54.6 \text{ in.}$$

$$M = 480(54.6) = 26,208 \text{ in.-k}$$

	<u>Comparison</u>	
	<u>Tension Steel</u>	<u>Compression</u>
	<u>Only</u>	<u>Steel</u>
a	15.7 in.	10.3 in.
c	18.45 in.	12.1 in.
Arm	52.15 in.	54.6 in.
M	25,032 in.-k	26,208 in.-k \Rightarrow 4.7 percent increase

APPENDIX D

DESIGN EXAMPLES

D-1. Design Procedure

For convenience, a summary of the steps used in the design of the examples in this appendix is provided below. This procedure may be used to design flexural members subjected to pure flexure or flexure combined with axial load. The axial load may be tension or compression.

Step 1 - Compute the required nominal strength M_n , P_n where M_u and P_u are determined in accordance with paragraph 4-1.

$$M_n = \frac{M_u}{\phi} \quad P_n = \frac{P_u}{\phi}$$

Note: Step 2 below provides a convenient and quick check to ensure that members are sized properly to meet steel ratio limits. The expressions in Step 2a are adequate for flexure and small axial load. For members with significant axial loads the somewhat more lengthy procedures of Step 2b should be used.

Step 2a - Compute d_d from Table D-1. The term d_d is the minimum effective depth a member may have and meet the limiting requirements on steel ratio. If $d \geq d_d$ the member is of adequate depth to meet steel ratio requirements and A_s is determined using Step 3.

Step 2b - When significant axial load is present, the expressions for d_d become cumbersome and it becomes easier to check the member size by determining M_{DS} . M_{DS} is the maximum bending moment a member may carry and remain within the specified steel ratio limits.

$$M_{DS} = 0.85f'_c a_d b (d - a_d/2) - (d - h/2)P_n \quad (D-1)$$

where

$$a_d = K_d d \quad (D-2)$$

and K_d is found from Table D-1.

Step 3 - Singly Reinforced - When $d \geq d_d$ (or $M_n \leq M_{DS}$) the following equations are used to compute A_s .

$$K_u = 1 - \sqrt{1 - \frac{M_n + P_n(d - h/2)}{0.425f'_c b d^2}} \quad (D-3)$$

$$A_s = \frac{0.85f'_c K_u b d - P_n}{f_y} \quad (D-4)$$

Table D-1

Minimum Effective Depth

f'_c (psi)	f_y (psi)	$\frac{\rho^*}{\rho_b}$	K_d	d_d (in.)
3000	60	0.25	0.125765	$\sqrt{\frac{3.3274M_n^{**}}{b}}$
4000	60	0.25	0.125765	$\sqrt{\frac{2.4956M_n^*}{b}}$
5000	60	0.25	0.118367	$\sqrt{\frac{2.1129M_n^*}{b}}$

* See Section 3-5. Maximum Tension Reinforcement

** M_n units are inch-kips.

where

$$K_d = \frac{\left(\frac{\rho}{\rho_b}\right) \beta_1 \epsilon_c}{\epsilon_c + \frac{f_y}{E_s}}$$

$$d_d = \sqrt{\frac{M_n}{0.85 f'_c k_d b \left(1 - \frac{k_d}{2}\right)}}$$

D-2. Singly Reinforced Example

The following example demonstrates the use of the design procedure outlined in paragraph D-1 for a Singly Reinforced Beam with the recommended steel ratio of $0.25 \rho_b$. The required area of steel is computed to carry the moment at the base of a retaining wall stem.

Given: $M = 41.65$ k-ft
(where M = moment from unfactored
dead and live loads)
 $f'_c = 3.0$ ksi
 $f_y = 60$ ksi
 $d = 20$ in.

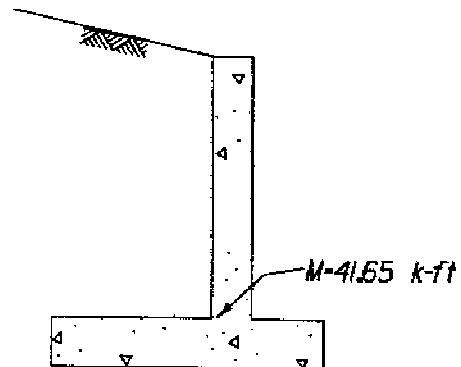

First compute the required strength, M_u .

$$M_u = 1.7 H_f(D + L)$$

$$M_u = (1.7)(1.3)(41.65) = 92.047 \text{ k-ft}$$

Step 1. $M_n = M_u/\phi = 92.047/0.90 = 102.274$ k-ft

$$\text{Step 2. } d_d = \sqrt{\frac{3.3274M_n}{b}} = 18.45 \text{ in.} \quad (\text{Table D-1})$$

$d > d_d$ therefore member size is adequate

$$\text{Step 3. } K_u = 1 - \sqrt{1 - \frac{M_n + P_n(d - h/2)}{0.425f'_c b d^2}} \quad (\text{D-3})$$

$$K_u = 1 - \sqrt{1 - \frac{(102.274)(12)}{(0.425)(3.0)(12)(20)^2}} = 0.10587$$

$$A_s = \frac{0.85f'_c K_u b d}{f_y} = \frac{(0.85)(3.0)(0.10587)(12)(20)}{60} \quad (\text{D-4})$$

$$A_s = 1.08 \text{ sq in.}$$

D-3. Combined Flexure Plus Axial Load Example

The following example demonstrates the use of the design procedure outlined in paragraph D-1 for a beam subjected to flexure plus small axial compressive load. The amount of tensile steel required to carry the moment and axial load at the base of a retaining wall stem is found.

Given: $M = 41.65 \text{ k-ft}$

$P = 5 \text{ kips}$ (weight of stem)

where M and P are the moment and

axial load from an unfactored

analysis.

$$f'_c = 3.0 \text{ ksi}$$

$$f_y = 60 \text{ ksi}$$

$$d = 20 \text{ in.}$$

$$h = 24 \text{ in.}$$

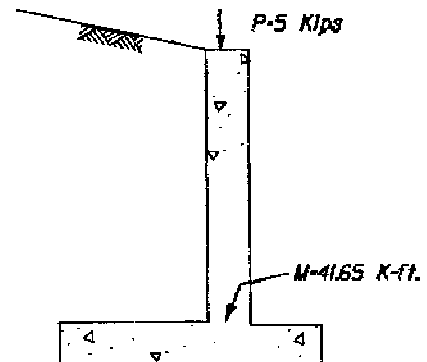

First compute the required strength, M_u , P_u

$$M_u = 1.7 H_f (D + L)$$

$$M_u = (1.7)(1.3)(41.65) = 92.047 \text{ k-ft}$$

$$P_u = 1.7 H_f (D + L)$$

$$P_u = (1.7)(1.3)(5.0) = 11.05 \text{ kips}$$

Since axial load is present a value must be found for ϕ .

For small axial load $\phi \cong 0.9 - [(0.20 P_u)/(0.10 f'_c A_g)]$

$$\phi \cong 0.88$$

Step 1. $M_n = M_u/\phi = 92.047/0.88 = 104.60 \text{ k-ft}$

$$P_n = P_u/\phi = 11.05/0.88 = 12.56 \text{ kips}$$

Step 2. $a_d = K_d d$ (D-2)

$$a_d = (0.12577)(20) = 2.515$$

$$M_{DS} = 0.85 f'_c a_d b (d - a_d/2.0) - (d - h/2.0) P_n$$
 (D-1)

$$M_{DS} = (0.85)(3.0)(2.515)(12)(20 - 1.258) - (20 - 12)(12.56)$$

$$M_{DS} = 1341.9 \text{ k-in. or } 111.82 \text{ k-ft}$$

$M_{DS} > M_n$ therefore member size is adequate

$$\text{Step 3. } K_u = 1 - \sqrt{1 - \frac{M_n + P_n(d - h/2)}{0.425f_c b d^2}}$$

$$K_u = 1 - \sqrt{1 - \frac{(12)104.6 + 12.56(20 - 12)}{(0.425)(3.0)(12)(20)^2}}$$

$$K_u = 0.11768$$

$$A_s = \frac{0.85f'_c K_u b d - P_n}{f_y}$$

$$A_s = \frac{(0.85)(3.0)(0.11768)(12)(20) - 12.56}{60} \quad (\text{D-4})$$

$$A_s = 0.99 \text{ sq in.}$$

D-4. Derivation of Design Equations

The following paragraphs provide derivations of the design equations presented in paragraph D-1.

(1) Derivation of Design Equations for Singly Reinforced Members. The figure below shows the conditions of stress on a singly reinforced member subjected to a moment M_n and load P_n . Equations for design may be developed by satisfying conditions of equilibrium on the section.

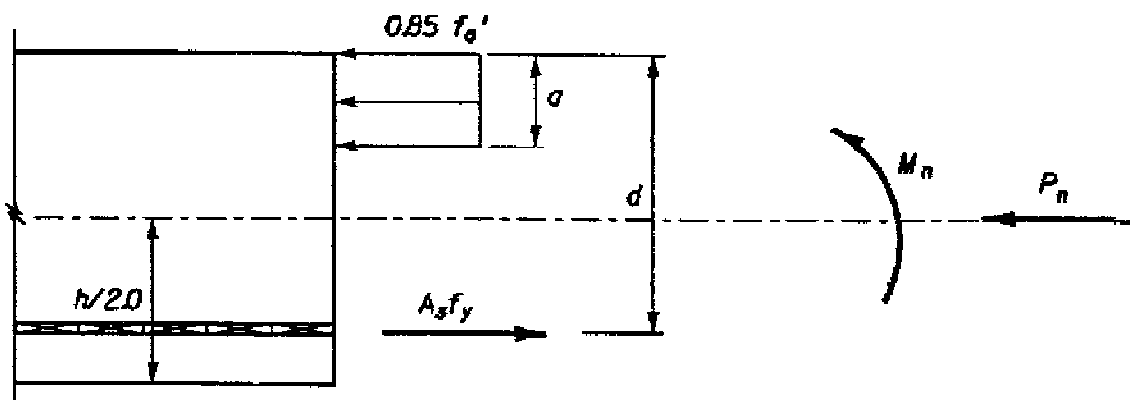

By requiring the ΣM about the tensile steel to equal zero

$$M_n = 0.85f'_c ab(d - a/2) - P_n(d - h/2) \quad (\text{D-5})$$

By requiring the ΣH to equal zero

$$A_s f_y = 0.85 f'_c ab - P_n \quad (D-6)$$

Expanding Equation D-5 yields

$$M_n = 0.85 f'_c abd - 0.425 f'_c a^2 b - P_n (d - h/2)$$

Let $a = K_u d$ then

$$M_n = 0.85 f'_c K_u b d^2 - 0.425 f'_c K_u^2 d^2 b - P_n (d - h/2)$$

The above equation may be solved for K_u using the solution for a quadratic equation

$$K_u = 1 - \sqrt{1 - \frac{M_n + P_n (d - h/2)}{0.425 f'_c b d^2}} \quad (D-3)$$

Substituting $K_u d$ for a in Equation D-6 then yields

$$A_s = \frac{0.85 f'_c K_u b d - P_n}{f_y}$$

(2) Derivation of Design Equations for Doubly Reinforced Members. The figure below shows the conditions of stress and strain on a doubly reinforced member subjected to a moment M_n and load P_n . Equations for design are developed in a manner identical to that shown previously for singly reinforced beams.

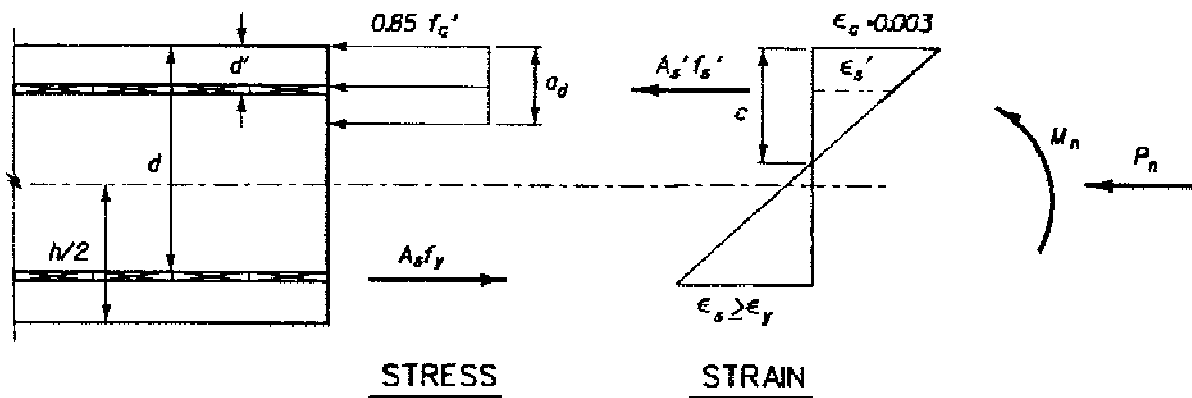

Requiring ΣH to equal zero yields

$$A_s = \frac{0.85f'_c K_d b d - P_n + A'_s f'_s}{f_y} \quad (D-7)$$

By setting $a_d = \beta_1 c$ and using the similar triangles from the strain diagram above, ϵ'_s and f'_s may be found:

$$f'_s = \frac{(a_d - \beta_1 d') \epsilon_c E_s}{a_d}$$

An expression for the moment carried by the concrete (M_{DS}) may be found by summing moments about the tensile steel of the concrete contribution.

$$M_{DS} = 0.85f'_c a_d b (d - a_d/2) - (d - h/2) P_n \quad (D-1)$$

Finally, an expression for A'_s may be found by requiring the compression steel to carry any moment above that which the concrete can carry ($M_n - M_{DS}$).

$$A'_s = \frac{M_n - M_{DS}}{f'_s (d - d')} \quad (D-8)$$

(3) Derivation of Expression of d_d . The expression for d_d is found by substituting $a_d = k_d d_d$ in the equation shown above for M_{DS} and solving the resulting quadratic expression for d_d .

$$d_d = \sqrt{\frac{M_{DS}}{[0.85f'_c K_d b (1 - K_d/2)]}} \quad (D-9)$$

D-5. Shear Strength Example for Special Straight Members

Paragraph 5.2 describes the conditions for which a special shear strength criterion shall apply for straight members. The following example demonstrates the application of Equation 5-1. Figure D-1 shows a rectangular conduit with factored loads, $1.7 H_f$ (dead load + live Load). The following parameters are given or computed for the roof slab of the conduit.

$$f'_c = 4,000 \text{ psi}$$

$$\ell_n = 10.0 \text{ ft} = 120 \text{ in.}$$

$$d = 2.0 \text{ ft} = 24 \text{ in.}$$

$$b = 1.0 \text{ ft (unit width)} = 12 \text{ in.}$$

$$N_u = 6.33(5) = 31.7 \text{ kips}$$

$$A_g = 2.33 \text{ sq ft} = 336 \text{ sq in.}$$

$$V_c = \left[\left(11.5 - \frac{120 \text{ in.}}{24 \text{ in.}} \right) \sqrt{4,000} \sqrt{1 + \left(\frac{31,700 \text{ lb}}{336 \text{ sq in.}} \right)} \right] (12 \text{ in.})(24 \text{ in.}) \quad \text{(D-10, Eq. 5-1)}$$

$$V_c = 134,906 \text{ lb} = 134.9 \text{ kips}$$

$$\text{Check limit } V_c = 10 \sqrt{f'_c} bd = 10 \sqrt{4,000} (12 \text{ in.})(24 \text{ in.}) = 182,147 \text{ lb}$$

Compare shear strength with applied shear.

$$\phi V_c = 0.85(134.9 \text{ kips}) = 114.7 \text{ kips}$$

V_u at $0.15(\ell_n)$ from face of the support is

$$\begin{aligned} V_u &= w \left(\frac{\ell_n}{2} - 0.15 \ell_n \right) \\ &= 15.0 \text{ kips/ft} \left[\left(\frac{10 \text{ ft}}{2} \right) - (0.15)(10 \text{ ft}) \right] \\ &= 52.5 \text{ kips} < \phi V_c ; \text{ shear strength adequate} \end{aligned}$$

D-6. Shear Strength Example for Curved Members

Paragraph 5-3 describes the conditions for which Equation 5-3 shall apply. The following example applies Equation 5-3 to the circular conduit presented in Figure D-2. Factored loads are shown, and the following values are given or computed:

EM 1110-2-2104
30 Jun 92

$$f'_c = 4,000 \text{ psi}$$

$$b = 12 \text{ in.}$$

$$d = 43.5 \text{ in.}$$

$$A_g = 576 \text{ sq in.}$$

$$N_u = 162.5 \text{ kips}$$

$$V_u = 81.3 \text{ kips at a section 45 degrees from the crown}$$

$$V_c = 4\sqrt{4,000} \left[\sqrt{1 + \left(\frac{162,500 \text{ lb}}{576 \text{ sq in.}} \right)} \right] (12 \text{ in.})(43.5 \text{ in.})$$

$$V_c = 192,058 \text{ lb} = 192.1 \text{ kips}$$

$$\text{Check limit } V_c = 10 \sqrt{f'_c} bd = 10 \sqrt{4,000} (12 \text{ in.})(43.5 \text{ in.}) = 330,142 \text{ lb}$$

Compare shear strength with applied shear

$$\phi V_c = 0.85(192.1 \text{ kips}) = 163.3 \text{ kips}$$

$$V_u < \phi V_c ; \text{ shear strength adequate}$$

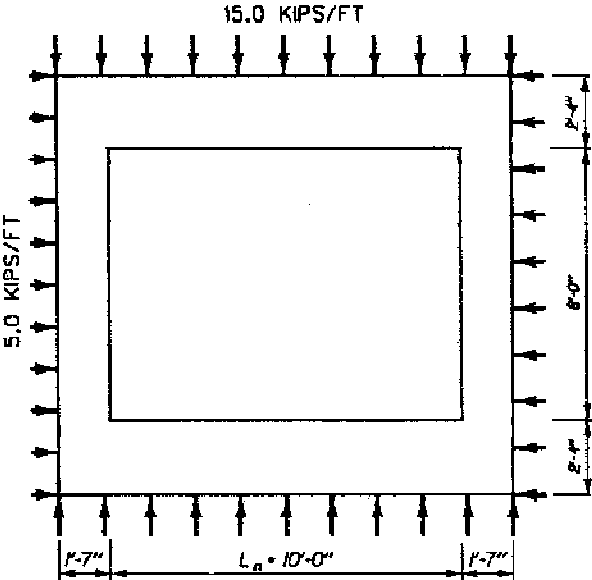

Figure D-1. Rectangular conduit

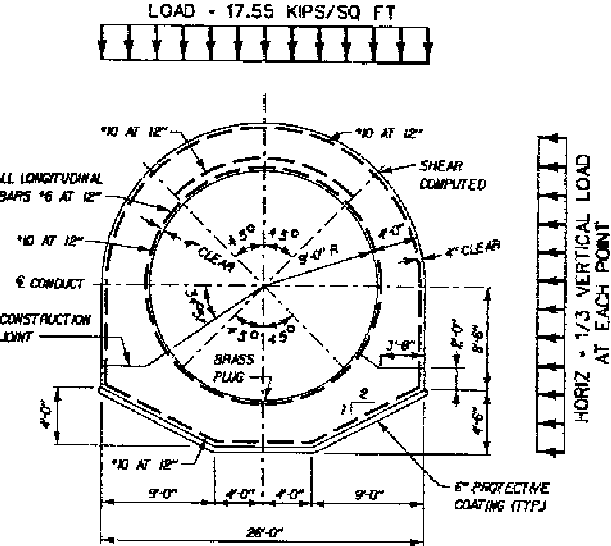

Figure D-2. Circular conduit

APPENDIX E

INTERACTION DIAGRAM

E-1. Introduction

A complete discussion on the construction of interaction diagrams is beyond the scope of this manual; however, in order to demonstrate how the equations presented in Chapter 4 may be used to construct a diagram a few basic points will be computed. Note that the effects of ϕ , the strength reduction factor, have not been considered. Using the example cross section shown below compute the points defined by 1, 2, 3 notations shown in Figure E-1.

- Given: $f'_c = 3.0$ ksi
 $f_y = 60$ ksi
 $A_s = 2.0$ sq in.
 $d = 22$ in.
 $h = 24$ in.
 $b = 12$ in.

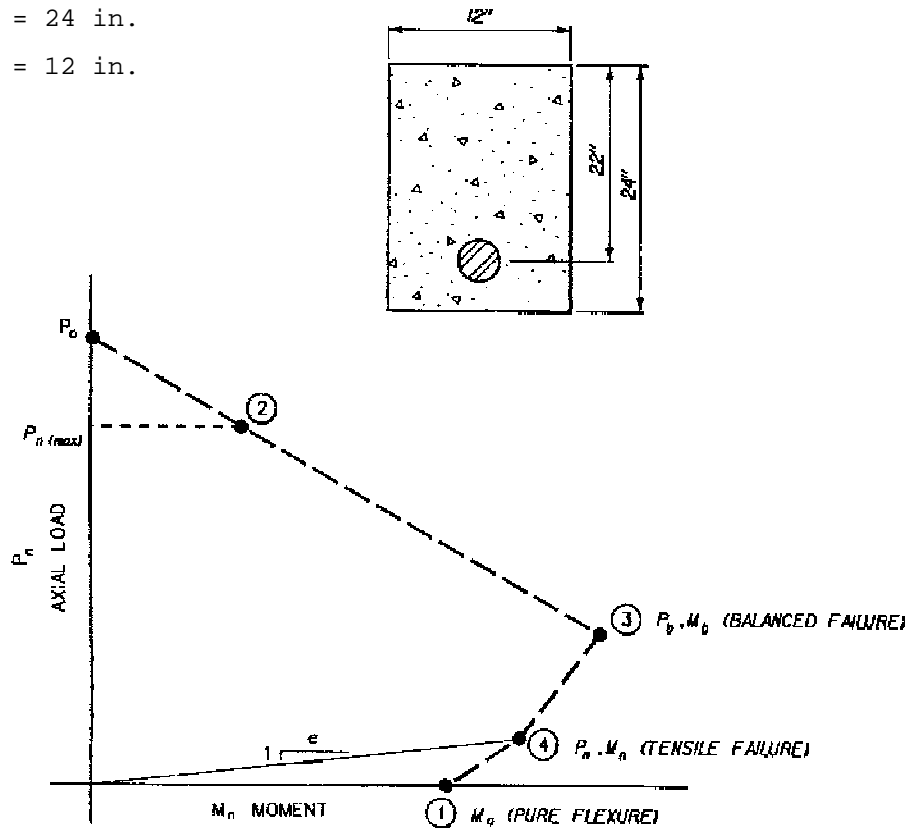
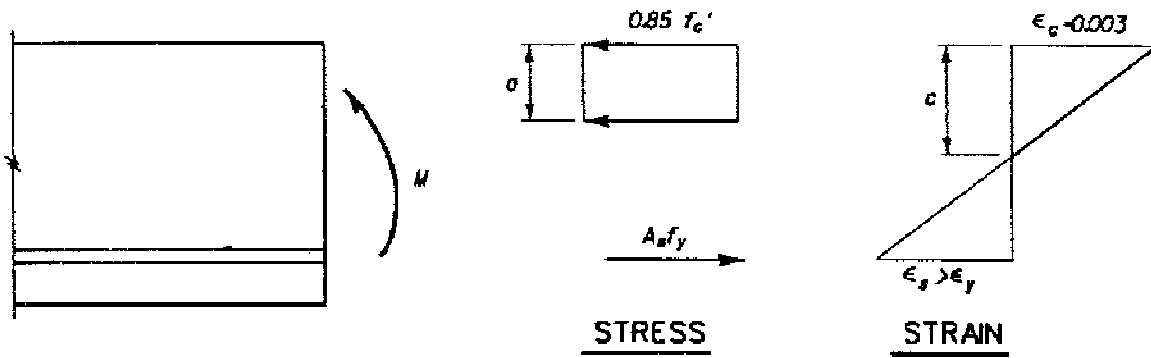

Figure E-1. Interaction diagram

E-2. Determination of Point 1, Pure Flexure



$$\phi M_n = \phi 0.85 f'_c a b (d - a/2)$$

$$a = \frac{A_s f_y}{0.85 f'_c b} = \frac{(2.0)(60.0)}{(0.85)(3.0)(12)} = 3.922 \text{ in.}$$

$$M_n = (0.85)(3.0)(3.922)(12)(22 - 1.961)$$

$$M_n = 2404.7 \text{ k-in.}$$

$$M_n = 200.4 \text{ k-ft}$$

(D-5)

E-3. Determination of Point 2, Maximum Axial Capacity

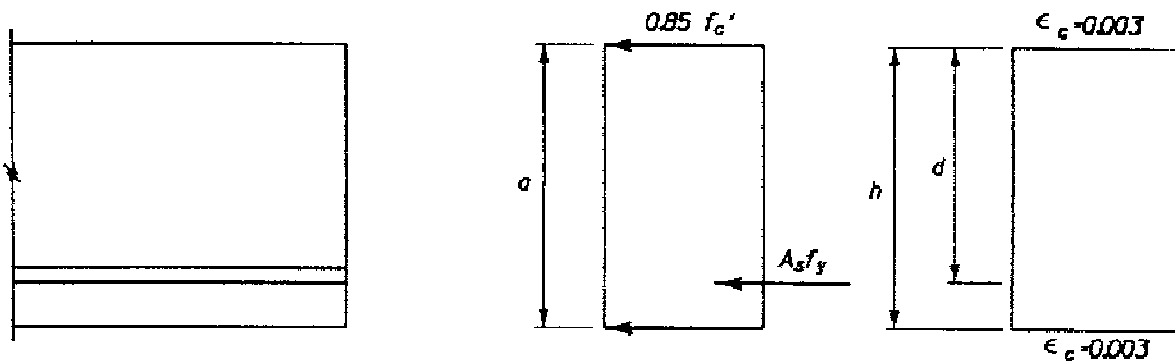

$$\begin{aligned}\phi P_{n(\max)} &= \phi 0.80 P_o \\ \phi P_{n(\max)} &= \phi 0.80 [0.85 f'_c (A_g - \rho b d) + f_y \rho b d] \\ P_{n(\max)} &= 0.80 [(0.85)(3.0)(288 - 2.0) + (60.0)(2.0)] \\ P_{n(\max)} &= 0.80(849.3) = 679.44 \text{ kips}\end{aligned}\tag{4-2}$$

E-4. Determination of Point 3, Balanced Point

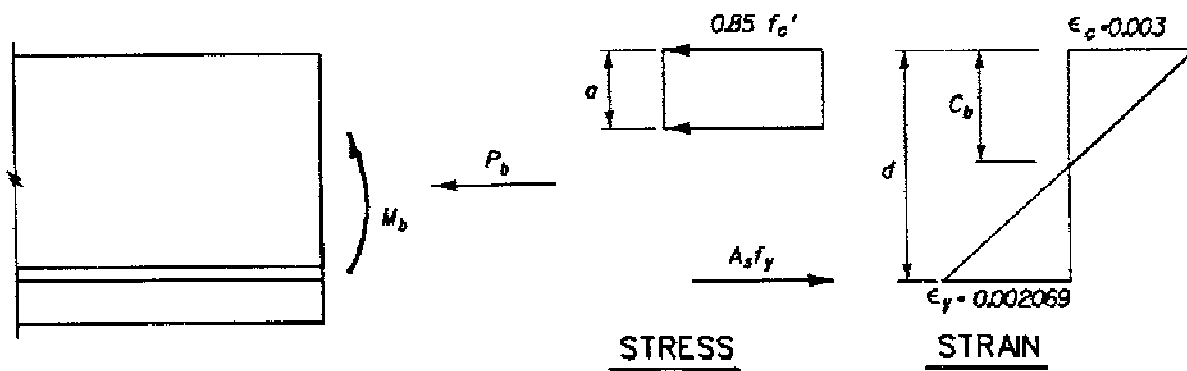

$$(1) \text{ Find } k_b = \frac{\beta_1 E_s \epsilon_c}{E_s \epsilon_c + f_y}\tag{4-4}$$

$$k_b = \frac{(0.85)(29,000)(0.003)}{(29,000)(0.003) + 60} = 0.5031$$

$$(2) \text{ Find } \frac{e'_b}{d} = \frac{2k_u - k_u^2}{2k_u - \frac{\rho f_y}{0.425 f'_c}}\tag{4-3}$$

$$\frac{e'_b}{d} = \frac{(2)(0.5031) - (0.5031)^2}{(2)(0.5031) - \frac{(0.00758)(60)}{(0.425)(3.0)}} = 1.15951$$

$$(3) \text{ Find } \phi P_b = \phi [0.85 f'_c k_b - \rho f_y] bd$$

$$P_b = [(0.85)(3.0)(0.5031) - (0.00758)(60.0)](12)(22.0)$$

$$P_b = 218.62 \text{ kips}$$

$$(4) \text{ Find } \phi M_b = \phi [0.85 f'_c k_b - \rho f_y] \left[\frac{e'}{d} - \left(1 - \frac{h}{2d} \right) \right] bd^2$$

$$M_b = [(0.85)(3.0)(0.5031) - (0.00758)(60)] \cdot$$

$$[1.15951 - (1 - 24.0/44.0)](12)(22.0)^2$$

(4-6)

$$M_b = 3390.65 \text{ k-in.}$$

$$M_b = 282.55 \text{ k-ft}$$

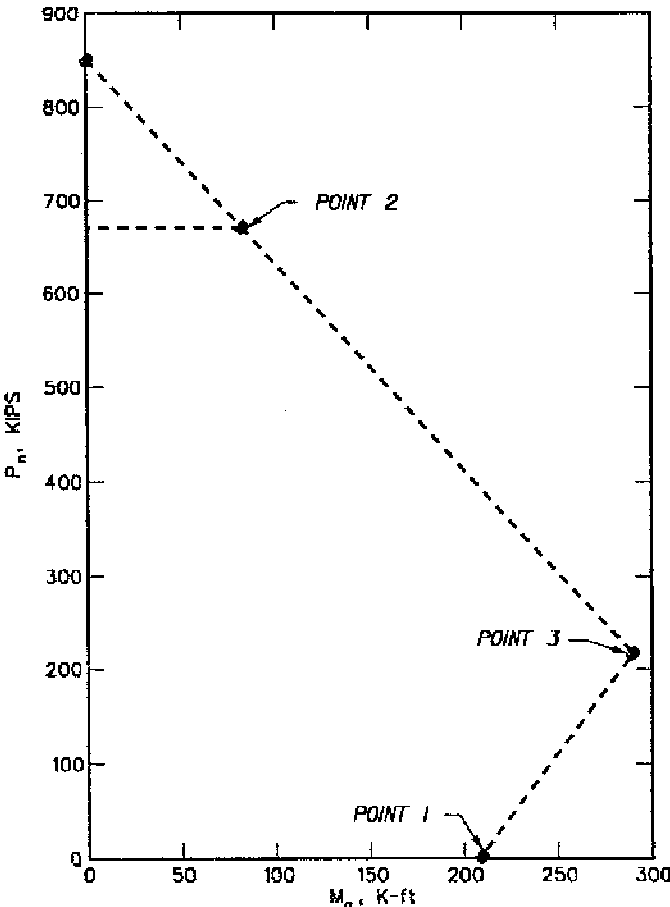

Figure E-2. Interaction diagram solution

APPENDIX F

AXIAL LOAD WITH BIAxIAL BENDING - EXAMPLE

F-1. In accordance with paragraph 4-5, design an 18- by 18-inch reinforced concrete column for the following conditions:

$$f'_c = 3,000 \text{ psi}$$

$$f_y = 60,000 \text{ psi}$$

$$P_u = 100 \text{ kips}, P_n = P_u/0.7 = 142.9 \text{ kips}$$

$$M_{ux} = 94 \text{ ft-kips}, M_{nx} = M_{ux}/0.7 = 134.3 \text{ ft-kips}$$

$$M_{uy} = 30 \text{ ft-kips}, M_{ny} = M_{uy}/0.7 = 42.8 \text{ ft-kips}$$

Let concrete cover plus one-half a bar diameter equal 2.5 in.

F-2. Using uniaxial design procedures (Appendix E), select reinforcement for P_n and bending about the x-axis since $M_{nx} > M_{ny}$. The resulting cross-section is given below.

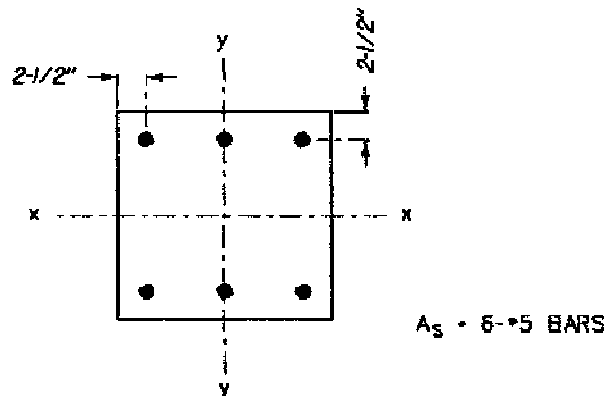

F-3. Figures F-1 and F-2 present the nominal strength interaction diagrams about x and y axes. It is seen from Figure F-2 that the member is adequate for uniaxial bending about the y-axis with $P_n = 142.9$ kips and $M_{ny} = 42.8$ ft-kips. From Figures F-1 and F-2 at $P_n = 142.9$ kips:

$$M_{ox} = 146.1 \text{ ft-kips}$$

$$M_{oy} = 145.9 \text{ ft-kips}$$

EM 1110-2-2104
30 Jun 92

For a square column, must satisfy:

$$(M_{nx}/M_{ox})^{1.75} + (M_{ny}/M_{oy})^{1.75} \leq 1.0$$

$$(134.3/146.1)^{1.75} + (42.8/145.9)^{1.75} = 0.98 < 1.0$$

If a value greater than 1.0 is obtained, increase reinforcement and/or increase member dimensions.

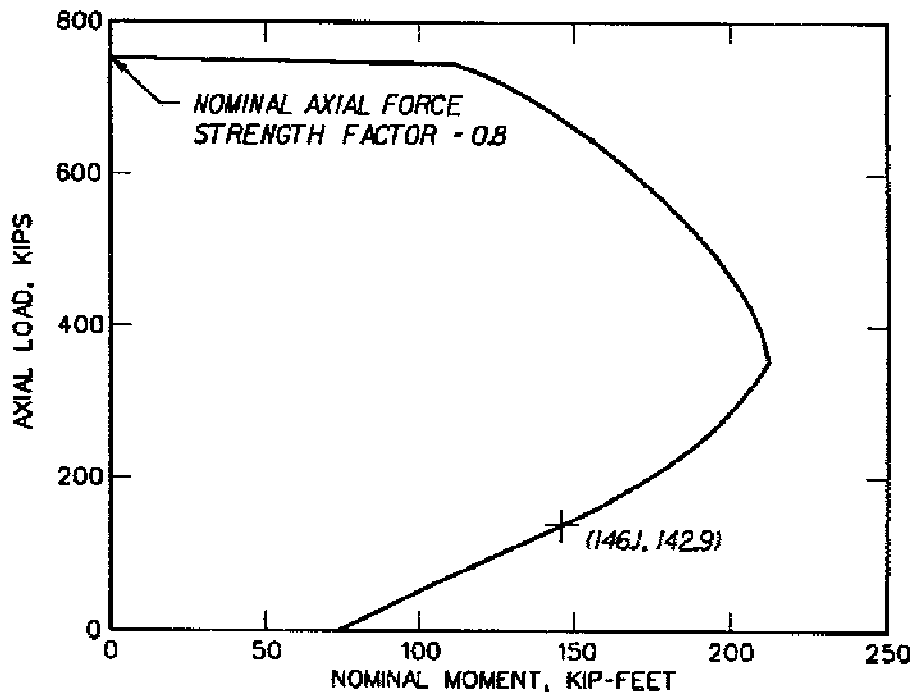

Figure F-1. Nominal strength about the X-axis

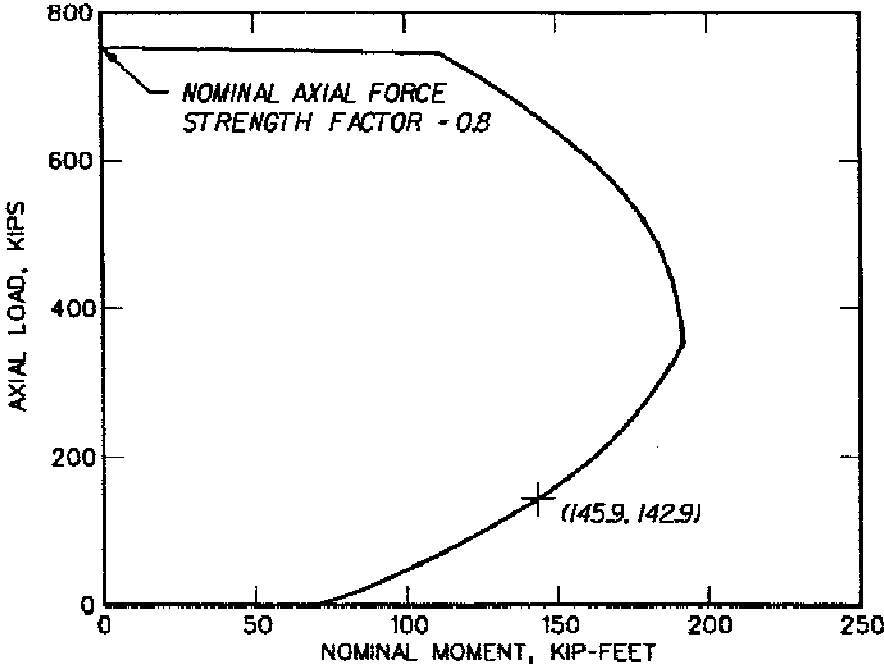

Figure F-2. Nominal strength about the Y-axis