

## CHAPTER 22

# Lighted Aids to Navigation— Oil Apparatus

## CONTENTS

	<i>Page</i>
22-1 GENERAL .....	22- 1
22-1-1 Definition and Constituent Parts.....	22- 1
22-2 INCANDESCENT OIL VAPOR LIGHT.....	22- 1
22-2-1 General.....	22- 1
22-2-5 Principles of Operation.....	22- 1
22-2-10 Types and Sizes.....	22- 1
22-2-15 Component Parts.....	22- 2
22-2-20 Single Tank System.....	22- 2
22-2-25 Double Tank System.....	22- 3
22-2-30 Operating Procedure, Single Tank System, Type A.....	22- 6
22-2-35 Operating Procedure, Double Tank Sys- tem, Type B.....	22- 8
22-2-40 Thermostat Alarm.....	22-10
22-2-45 Mantles.....	22-10
22-2-50 General Hints.....	22-10
22-3 ALADDIN LAMP.....	22-11
22-3-1 General.....	22-11
22-3-5 Principle of Operation, Component parts.....	22-11
22-3-10 Types.....	22-11
22-3-15 Operating Procedure.....	22-11
22-3-20 Maintenance.....	22-12
22-4 OIL WICK LANTERNS.....	22-12
22-4-1 Inland Waterway Triangular Lantern.....	22-12
22-4-5 Post Lanterns.....	22-12
22-4-10 Lens Lanterns.....	22-18
22-4-15 Lamps.....	22-19
22-4-20 Fuel (kerosene).....	22-19

## ILLUSTRATIONS

<i>Figure</i>	<i>Subject</i>	<i>Page</i>
22-1	I. O. V. lamp, 35-mm. type "B", single tank, with type "C" pump.....	22- 4
22-2	I. O. V. lamp, type "C" pump for single or double tank system.....	22- 5
22-3	Oil tank for double tank system.....	22- 5
22-4	Air tank for double tank system.....	22- 5
22-5	I. O. V. lamp, 35-mm., type "A".....	22- 6
22-6	Accessories and tools for 55-mm., type "B", I. O. V. lamp.....	22- 7
22-7	I. O. V. lamp, 55-mm., type "B".....	22- 7
22-8	Relief valve for type "B" lamp.....	22- 7
22-9	Thermostat for I. O. V. lamp.....	22- 9
22-10	Fourth order lens and accessory equipment.....	22-10
22-11	Assorted oil lamps.....	22-11
22-12	Standby lights.....	22-12
22-13	Triangular lanterns.....	22-13
22-14	Series "A" triangular oil lantern.....	22-14
22-15	Series "B" triangular oil lantern.....	22-15
22-16	Series "C" triangular oil lantern.....	22-16
22-17	Conversion of Series "B" to "C" triangular oil lantern.....	22-17
22-18	One-day post lantern and accessories.....	22-18
22-19	Eight-day post lantern and accessories.....	22-18
22-20	One-day lens lantern and accessories.....	22-18

**22-1 GENERAL****22-1-1 Definition and Constituent Parts—**

A. Oil-lighted aids to navigation apparatus consists of the component parts of oil-operated major lights, stand-by apparatus for major oil and electrically operated lights, and minor lights on fixed structures on the inland waterways. It may consist of lamps, mantles and wicks, tanks, piping, lanterns, and lenses.

**22-2 INCANDESCENT OIL VAPOR LIGHT****22-2-1 General—**

A. The incandescent oil vapor (I. O. V.) lamp is still in use in a number of major light stations. However, this equipment for use as the main light is being replaced by electrical apparatus as rapidly as conditions permit, although numerous stand-by installations remain in service. Kerosene is vaporized and burned in a mantle which produces an

intense white light. Spare parts for I. O. V. apparatus are stocked at Coast Guard supply centers.

**22-2-5 Principle of Operation—**

A. The principle of operation is the same as that of an ordinary blow torch. Kerosene oil from a tank is forced by air pressure through tubing to the vapor lamp where the oil is vaporized or generated into a gas by the heat radiated from the incandescent mantle. The generated gas or vapor passes through a tube and a small orifice, and is burned in a mantle.

**22-2-10 Types and Sizes—**

A. I. O. V. lamps are of two types and sizes, the type "A" 35- and 55-mm. sizes in which gas is generated in an inverted tube passing over the mantle, and the type "B" 35- and 55-mm. sizes in which gas is generated in an annular well surrounding the draft tube of the burner. The size designated indicates the approximate diameter of the mantle.



**B. Tank systems.**—Two tank systems are used; the single-tank system in which the air pressure is built up within the oil tank itself, and the double-tank system in which a separate air tank is connected to the oil tank. The two-tank system has a larger air capacity and will operate over a longer period without the need for additional pumping of air during the operating period. The single- and double-tank systems are in use with both type "A" and "B" 35- and 55-mm. lamps although the two-tank system was designed principally for the 55-mm. lamp.

### 22-2-15. Component Parts—

**A.** The component parts of the I. O. V. lamp consist of a base, a vaporizer tube, a vaporizer nozzle with pinhole atomizer, a bunsen tube with air intake and flame screen, a mantle, and an overflow or drain. Lists for ordering 35-mm. type "A" and 35-mm. type "B" I. O. V. light replacement parts may be found under Sections 22-2-20 and 22-2-25. Always be sure to prefix VL to the number when ordering parts for a vapor light. These parts are available only at the Coast Guard Supply Center, Jersey City, N. J.

### 22-2-20 Single Tank System—

**A.** The single-tank system (fig. 22-1) consists of a brass reservoir, 8½ inches in diameter and 37¼ inches high, containing an oil filling plug through which kerosene oil is poured into the reservoir; a ¼ inch needle valve with spigot fastened to a pump bracket on the side of the tank; a tube connecting the valve into the bottom of the tank, by means of which kerosene can be drained under air pressure into a drain can; a hand air pump with 1¾ inches diameter barrel fitted with a piston rod with leather cup plunger for pumping up air pressure (see fig. 22-2); a pressure gage, reading 0-100 pounds, installed on the top of the tank; a needle valve screwed into the boss on top of the tank which has a suction tube extending to within 2 inches of the reservoir; and a tube connecting the needle control valve to the vapor lamp.

**B. Fuel.**—In the one-tank system, the quantity of kerosene required to operate the light from sunset to sunrise is about 2 gallons for the 35 mm. and about 4 gallons for the 55 mm. lamps. The oil is placed in the tank which serves as a reservoir. Air is pumped over the kerosene in the upper part of the tank by means of the hand pump to the required pressure to force the kerosene against gravity to the vapor lamp. The air pressure is sufficient to allow for the consumption of the kerosene during the service period. The needle control valve in the tube to the vapor lamp is used to control the flow of kerosene at the required rate to burn the vapor lamp with a steady light. As the kerosene is consumed and the air pressure drops, it is necessary to regulate the flow of kerosene to the lamp by means of the control valve. It should be noted that the control valve in combination with correct air pressure regulates the burning of the vapor in the mantle.

**C. List of parts and accessories for 35-mm. Type B, Single Tank I. O. V. Lamp with Type C. Pump.** (When ordering, prefix VL to number.)

Part No.	Name
VL 10	Lamp assembled, includes parts Nos. 101 to 14 (except 135, 136, 137, and 138), as listed below.
101	Cover (two parts, with pins and rest).
102	Top.
103	Base.
104	Outer casing.
105	Outer casing, bottom.
106	Heat distributor.
107	Heating tube.
108	Heating-tube pins.
109	Air tube, two to each lamp.
110	Preheater assembled, includes nozzle and union.
115	Asbestos pads.
116	Asbestos jacket, inner.
117	Asbestos jacket, outer.
13	Vaporizer assembled, includes 1201 to 128.
1201	Vaporizer body with bent tube and nozzle holder brazed on.
121	Vaporizer plug.
122	Vaporizer-plug washer, aluminum, ⅜ x ½ inch.
123	Vaporizer-joint, washer, aluminum, ⅝ <sub>32</sub> x ⅜ inch.
124	Vaporizer nozzle, size 0.010 inch.
125	Vaporizer nozzle washer, aluminum, ⅜ <sub>16</sub> x ⅝ <sub>16</sub> inch.
126	Vaporizer strainer.
127	Vaporizer strainer gauze, ¾ x 1⅜ inch.
128	Vaporizer short tube.
1291	Screw, steel, 14-24, ½ inch low between 110 and 13.
130	Vaporizer protector.
131	Screw, brass, 8-32, ¼ inch long between 130 and 105.
135	Mantle, 35-mm.
136	Mantle holder.
137	Davit.
138	Davit screw.
14	Flame screen.
25	Type "C" pump, assembled, includes 250 to 270.
250	Pump handle.
251	Handle yoke.
252	Handle Pin.
253	Handle leather, 1⅝ <sub>16</sub> x ⅞ <sub>16</sub> x ⅛ inch.
254	Piston.
255	Piston rod.
256	Piston leather, 1⅝ <sub>16</sub> x ⅜ x ⅛ inch.
257	Piston spring.
258	Piston follower.
259	Piston nut.
260	Piston cotter.



Part No.	Name
VL 261	Cap.
262	Barrel.
263	Outlet-valve cage (attached to 554).
264	Outlet-valve plug.
265	Outlet-valve cage leather, $1\frac{5}{16}$ x $\frac{3}{4}$ x $\frac{1}{32}$ inch.
266	Inlet-valve cage.
267	Inlet-valve cage leather, $1\frac{1}{8}$ x $\frac{3}{4}$ x $\frac{1}{32}$ inch.
268	Valve.
269	Valve leather, $\frac{5}{8}$ x $\frac{1}{8}$ x $\frac{1}{32}$ inch.
270	Air chamber.
35	Air and oil tank, includes shell and heads only.
354	Pressure gage, 100 pounds.
355	Pressure-gage plug.
356	Needle-valve plug.
357	Oil-filling plug.
359	Oil-outlet plug, tube attached.
368	Washers (plug or drain), lead, $\frac{3}{8}$ x $\frac{5}{8}$ inch.
369	Strap, pump to tank.
374	Strap bolts and nuts.
375	Pump-holder bolts (between 25 and 35).
376	Drain-valve strap.
377	Drain-valve bolts and nuts.
378	Drain-valve screw.
379	Drain-valve outlet tube.
45	$\frac{1}{8}$ -inch needle valve, includes 451 to 458.
451	Body.
452	Stem.
453	Stem ring.
454	Gland.
455	Gland nut.
456	Handwheel.
457	Handwheel nut.
458	Packing, used also with 46 and 47.
46	$\frac{1}{4}$ -inch needle or drain valve, includes 461 to 467.
461	Body.
462	Stem.
463	Stem ring.
464	Gland.
465	Gland nut.
466	Handwheel.
467	Handwheel nut.
47	Relief valve, includes 471 to 478 and 458.
471	Body.
472	Stem.
473	Spring.
474	Gland.
475	Gland nut.
576	Handwheel, knob or screw attached.
577	Handwheel nut.
478	Valve-attaching screw, 10-32, $\frac{5}{8}$ inch long.
550	Connection, relief to lamp.
551	Connection, relief valve to drain can.
552	Connection, tank to relief valve 554.
554	Connection, pump to tank, includes 263 and 264.
556	Connection, tank to drain valve.
*557	Cleaning connection.
562	Connection union nut.
564	Connection union nut collar.

Part No.	Name
VL 565	Connection union nut washer, aluminum, $\frac{1}{4}$ x $\frac{1}{2}$ inch.
572	Connection union nut for 556.
576	Tank union nut for 556.
650	Reamer for vaporizer.
651	Vaporizer wrench, flat, $\frac{3}{8}$ inch square.
*652	Flat wrench, $1\frac{1}{16}$ x $\frac{7}{8}$ inch.
*653	Flat wrench, $\frac{3}{4}$ .
*654	Screw driver, 4-inch.
*655	Screw driver, $\frac{1}{2}$ -inch.
*656	Gas pliers, 5-inch.
657	Double male fitting.
658	Pricker, size 0.009 inch.
661	Mantle pedestal, 35 mm.
*664	Squirt can.
*665	Vaporizer cleaning wire.
*666	Funnel.
667	Gallon measure (drain can).
*668	Dark glasses.
*669	Tool box.
67	Lamp-starting drip cup.
671	Cup body.
672	Cup cover.
673	Attachment arm (upper).
674	Attachment arm (lower).
675	Attachment-arm screw.
676	Valve body.
677	Valve stem.
688	Outlet connection, complete.
681	Outlet-connection, nut.
682	Outlet-connection tube.
685	Angle screw driver.

\*Not shown in drawing.

## 22-2-25 Double Tank System—

A. In the double-tank system (see figs. 22-3 and 22-4), separate tanks are used for the oil reservoir and the air tank. The air tank is 8 inches in diameter and  $31\frac{1}{2}$  inches high, fitted with the following accessories: An air pump, strapped to the tank, with a tube connecting the outlet valve gage to the tank through a  $\frac{1}{8}$ -inch needle valve; a gage screwed into a boss on top of the air tank reading air pressure 0-100 pounds, and needle valve in the top, connected by a tube to the oil reservoir.

B. The oil reservoir is 8 inches in diameter and  $16\frac{1}{2}$  inches high, and is fitted with a hexagonal-headed filling plug, and washer, which is screwed tightly enough to withstand the air pressure of the system. The oil reservoir is placed on a metal stand at the same height as the air tank, and is fitted with a  $\frac{1}{8}$ -inch needle valve and spigot for draining the tank. A drain can is used in this connection. A needle valve is screwed into a boss in the top of the tank and is connected by a tube fitted with union couplings to the air tank. The oil reservoir is also fitted with a needle valve with a suction tube screwed into a boss on top of the tank and is connected to the vapor lamp by means of a tube with union couplings. The flow of kerosene to the vapor lamp is controlled by this valve.



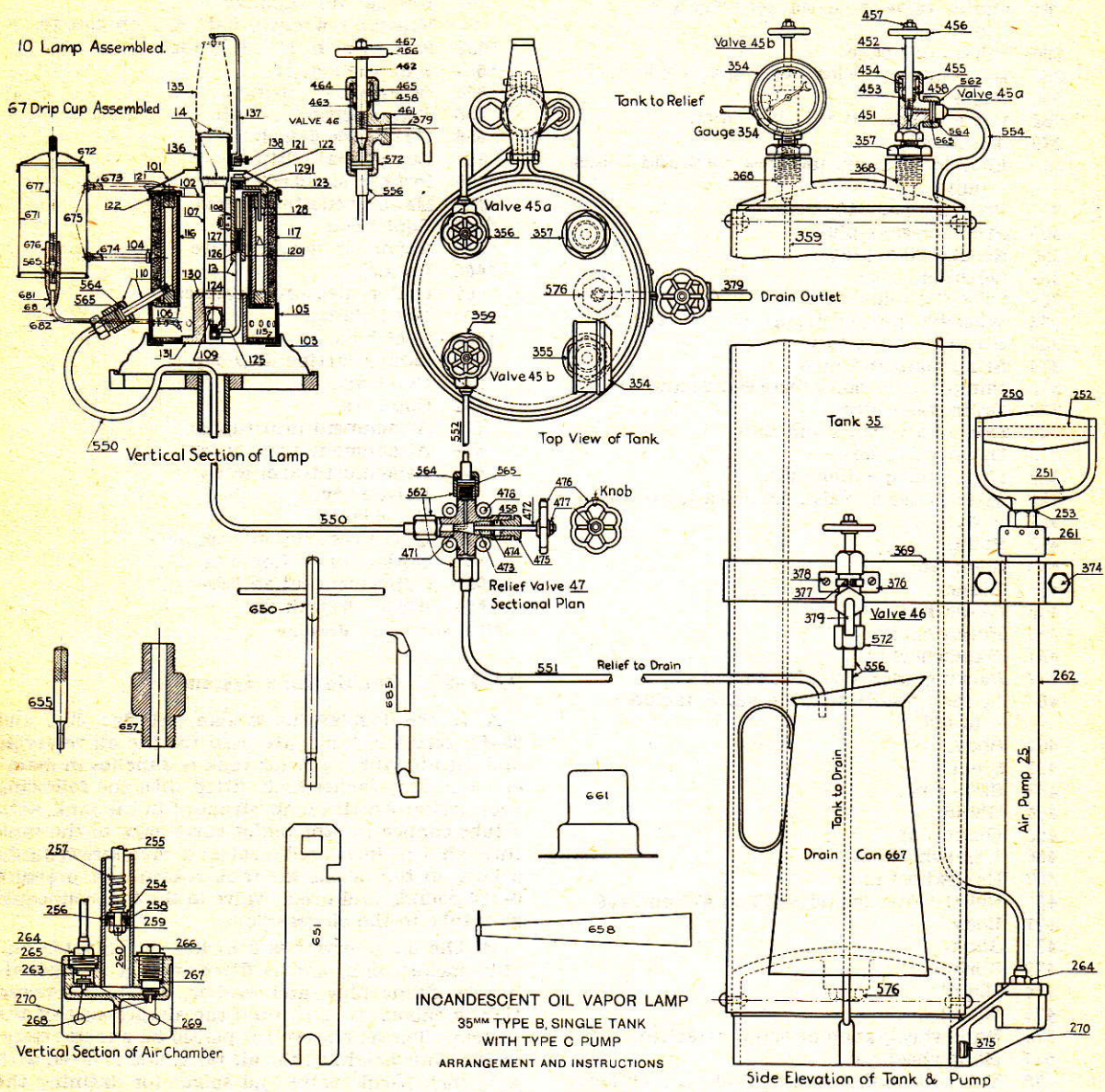
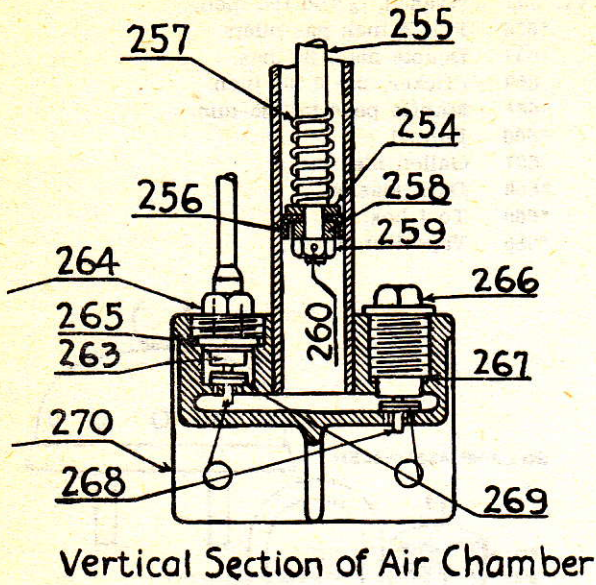

FIGURE 22-1.—I. O. V. lamp, 35 mm. type B, single tank, with type C pump.





Vertical Section of Air Chamber

FIGURE 22-2.—I. O. V. lamp, type C pump for single or double tank system.

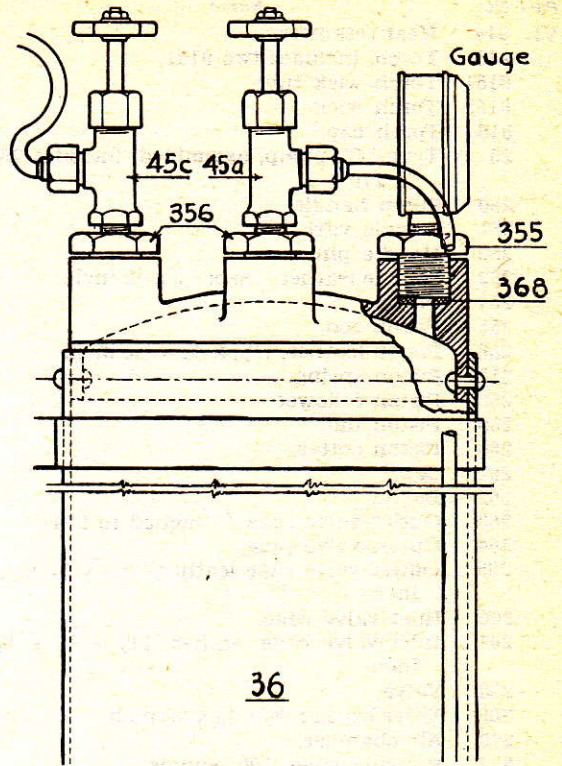

FIGURE 22-4.—Air tank for double-tank system.

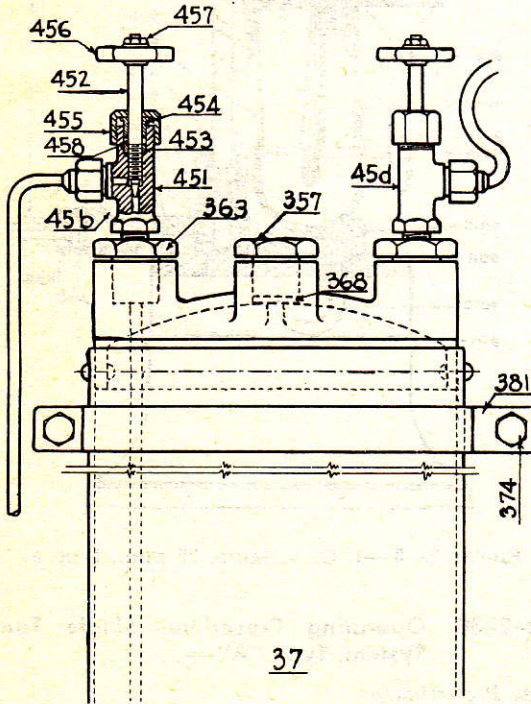

FIGURE 22-3.—Oil tank for double tank system.

C. List of parts and accessories for 35-mm. Type A, Double Tank I. O. V. Lamp With Type "C" Pump. (When ordering, prefix VL to number.)

Part No.	Name
VL 90	Lamp assembled, includes 901 to 14, as listed below.
901	35-mm. lamp stand.
9011	Base.
9012	Overflow pipe, complete.
9013	Oil nipple.
9014	Oil-nipple connection.
9015	Return-bend support.
9016	Centering pin with handle.
9017	Adjusting bushing.
9018	Adjusting bushing screws.
902	Vaporizer with ends.
9025	Vaporizer nut.
9028	Vaporizer guide.
903	Vaporizer-nut washer, lead, $\frac{5}{16} \times \frac{9}{16}$ inch.
905	Vaporizer nozzle.
906	Vaporizer-nipple washer, copper.
907	Vaporizer-nozzle sieve.
908	Bunsen tube.
9081	Bunsen tube screw.
9082	Bunsen cap.
14	Flame screen.
135	Mantle, 35-mm.
910	Mantle holder, new type.
913	Mantle davit, new type.



Part No.	Name
VL 914	Heat retainers.
915	Torch, includes two 9151.
9151	Torch-wick tube.
9152	Torch wick.
916	Torch cap.
25	Type "C" pump, assembled, includes 250 to 270.
250	Pump handle.
251	Handle yoke.
252	Handle pin.
253	Handle leather, $1\frac{5}{16} \times \frac{7}{16} \times \frac{1}{8}$ inch.
254	Piston.
255	Piston rod.
256	Piston leather, $1\frac{1}{16} \times \frac{3}{8} \times \frac{1}{16}$ inch.
257	Piston spring.
258	Piston follower.
259	Piston nut.
260	Piston cotter.
261	Cap.
262	Barrel.
263	Outlet-valve cage (attached to 554).
264	Outlet-valve plug.
265	Outlet-valve cage leather, $1\frac{5}{16} \times \frac{3}{4} \times \frac{1}{32}$ inch.
266	Inlet-valve cage.
267	Inlet-valve cage leather, $1\frac{1}{8} \times \frac{3}{4} \times \frac{1}{32}$ inch.
268	Valve.
269	Valve leather, $\frac{5}{8} \times \frac{1}{8} \times \frac{1}{32}$ inch.
270	Air chamber.
354	Pressure gage, 100 pounds.
355	Pressure-gage plug.
356	Needle-valve plug.
357	Oil-filling plug.
36	Air tank, includes shell and heads only.
364	Oil-outlet plug, tube attached, 4th order.
368	Washers (plug or drain) lead, $\frac{3}{8} \times \frac{5}{8}$ inch.
373	Strap, pump to air-tank.
374	Strap bolts and nuts, 20-18, 1 inch long.
375	Pump-holding bolts (between 25 and 36).
38	Oil-tank, 4th order, shell and heads only.
381	Strap, air to oil tank (2 parts) between 36 and 38.
383	Oil tank stand, fourth order.
45	$\frac{1}{8}$ -inch needle valve, includes 451 to 458.
451	Body.
452	Stem.
453	Stem ring.
454	Gland.
455	Gland nut.
456	Handwheel.
457	Handwheel nut.
458	Packing.
551	Connection tank to drain can, includes 562.
552	Connection, oil tank to lamp, includes 562.
553	Connection, air to oil tank, includes 562.
554	Connection, pump to air tank, includes 263, 264 and 562.
562	Connection union nut.
564	Connection union nut collar.
565	Connection union nut washer, aluminum, $\frac{1}{4} \times \frac{1}{2}$ inch.
651	Nozzle wrenches.

\*Not shown in drawing.

Part No.	Name
VL *652	Wrench, $\frac{7}{8}$ and $1\frac{1}{16}$ inch.
*656	Pair 5-inch gas pliers.
657	Double male fittings.
658	Pricker, size 0.009 inch.
661	Mantle pedestal, 35-mm.
*666	Funnel.
667	Gallon measure.
*668	Dark glasses.
*669	Tool box.
*686	Vaporizer brush.

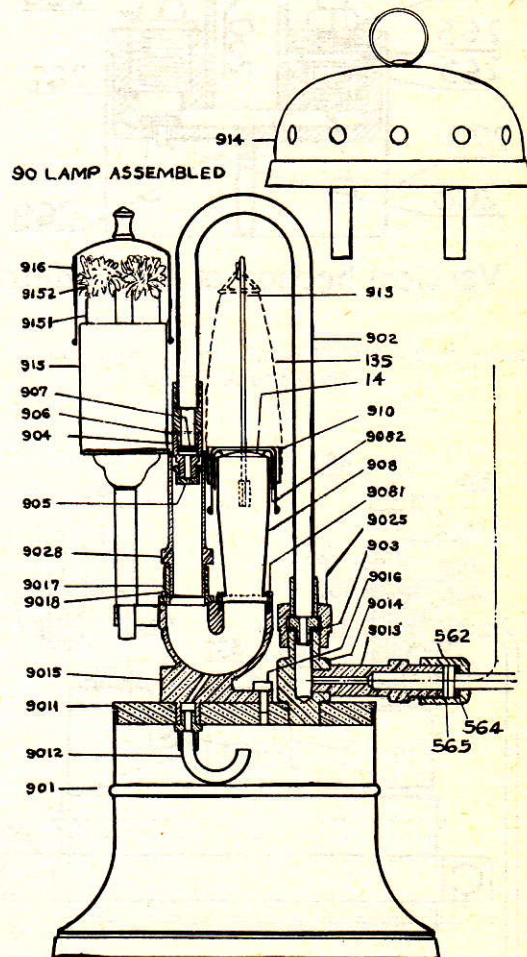

FIGURE 22-5.—I. O. V. lamp, 35 mm., type A.

## 22-2-30 Operating Procedure, Single Tank System, Type "A"—

### A. Preliminary:

- (1) Close all needle valves on the tank.
- (2) Remove the oil filling plug.
- (3) Fill the tank about one-half full of kerosene (2 gallons for 35-mm. and 4 gallons for 55-mm.) Use a funnel with a strainer.
- (4) Replace the oil filler plug. Be sure that the washer is in place.



(5) Open the needle valve in the air pump line and pump up a pressure of 40 pounds for 35-mm., or 60 pounds for 55-mm.

(6) Close the air pump needle valve.

(7) Place the mantle on the mantle holder and place on the mantle pedestal.

(8) Burn off the mantle (from the top).

**B. To start the lamp:**

(1) Fill the heating torch three-fourths full of alcohol. (See par. E below.)

(2) Remove the centering pin and revolve the return bend support until the torch is beneath the vaporizer tube.

(3) Light the torch and place heat retainer over the vaporizer.

(4) Allow the torch to burn from 8 to 10 minutes (until thumb cannot be held against the vaporizer tube just above the vaporizer nut) and open the discharge needle valve on the tank very slightly. A blue flame should appear on the flame screen.

(5) Remove and extinguish the heating torch (by using cap No. 916).

(6) Swing the bunsen tube under the vaporizer.

(7) Open the needle valve slowly until a good blue flame is obtained.

(8) Remove the heat retainer, install the mantle and adjust the flame.

(9) Clear the nozzle as necessary—use a 0.009 size prickler for 35-mm.—0.12 for 55-mm. (See fig. 22-6.)

**C. To extinguish the lamp:**

Turn off the needle valve in the fuel line from the tank to the lamp.

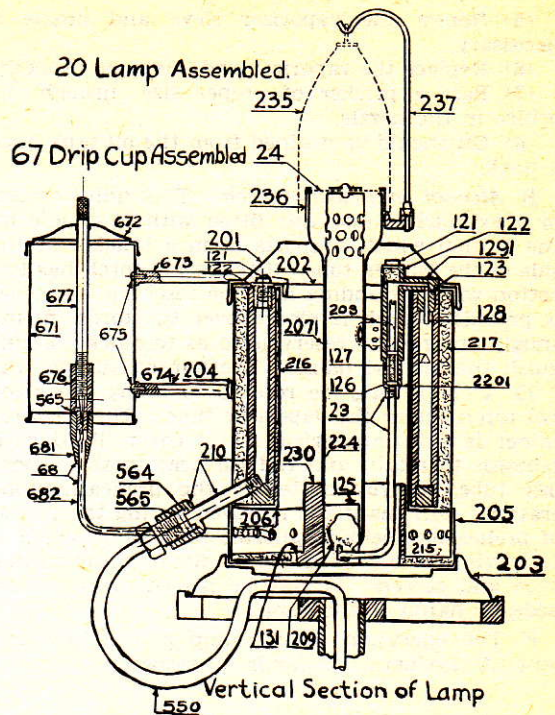

FIGURE 22-7.—I. O. V. lamp, 55 mm., type B.

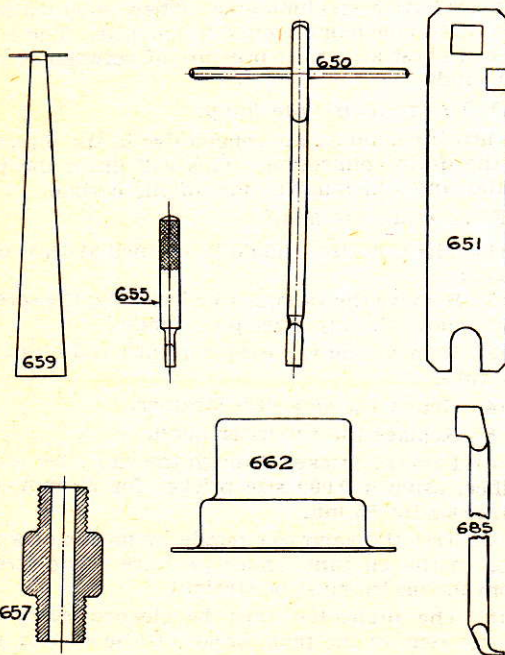

FIGURE 22-6.—Accessories and tools for 55 mm., type B, I. O. V. lamp.

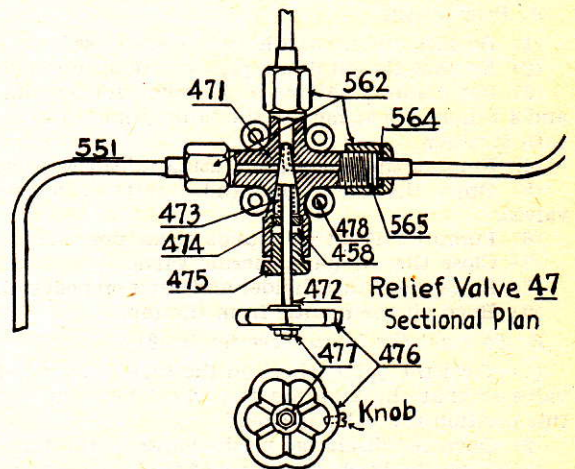

FIGURE 22-8.—Relief valve for type B lamp.

**D. To clean the lamp:**

(1) Remove the vaporizer by unscrewing the vaporizer nut.

(2) Remove the vaporizer nozzle.

(3) Soak the vaporizer in kerosene for several hours.

(4) Pass a vaporizer cleaning brush through the vaporizer several times to remove carbon and wash out thoroughly. (Paint remover is a better cleaner if available.)



(5) Renew the vaporizer sieve and nozzle if necessary.

(6) Replace the vaporizer and line it up properly.

(7) Pass a pricker of proper size through the orifice in the nozzle.

(8) Oil should be drained from the oil tank once a week.

**E. Alcohol preheating torch.**—This unit consists of a cylindrical reservoir fitted with a spindle on the bottom which supports it on a bracket at the side of the bunsen tube. The alcohol torch has two cotton wicks extending into the reservoir. A cover is provided which is placed over the torch, fitting snugly around the reservoir so as to quickly extinguish the alcohol flame. The bunsen tube of the I. O. V. lamp may be rotated to swing the alcohol torch under the vaporizer tube. The heat retainer is a hemispherical metal cover, lined with asbestos to retain and radiate heat to the vaporizer tube, thereby hastening the preheating operation. The mantle is removed during the period of preheating, being supported by a davit which is fastened to a metal base which fits over the bunsen tube and screen. It may be placed on a mantle pedestal handy to the lamp.

F. The operation of the lamp in the two-tank type "A" system is similar in all respects.

## 22-2-35 Operating Procedure, Two-Tank System, Type "B"—

### A. Preliminary:

- (1) Be sure all the needle valves are closed.
- (2) Remove the oil filling plug in the oil tank.
- (3) Put about 2 gallons of kerosene for 35 mm. and 4 gallons for 55 mm. in the tank, using a funnel with strainer.
- (4) Replace the filling plug, using a lead washer.
- (5) Open the air pump and intertank needle valves.
- (6) Pump up about 40 pounds of air pressure.
- (7) Close the air pump needle valve.
- (8) Place the mantle holder and davit on pedestal.
- (9) Burn off the mantle from the top.

### B. To start the lamp: (see fig. 22-8):

- (1) Turn the valve wheel on the three-way relief valve so that the knob on the wheel looks up; in this position the valve is closed.
- (2) Open the discharge needle valve on the tank.
- (3) Turn the knob on the relief valve toward the oil tank line long enough to half-fill the preheater (about 5 seconds).
- (4) Hang the drip cup assembly on the side of the lamp with the tube projecting through the small hole in the base.
- (5) Open the covers at the top of the lamp to allow free passage of flame.
- (6) Allow the alcohol to drip inside, and light.
- (7) Adjust the drip of alcohol just enough to keep a good flame inside of the lamp.
- (8) Allow the alcohol to burn about 12 minutes.

(9) *Caution.*—Turn the relief valve so that the knob is in the direction of the oil tank line for about 3 seconds, then turn back; a blue flame should appear at the flame screen and heating tubes.

*NOTE.*—If flame strikes back into the heating tube and burns there, or at the vaporizer nozzle, with a loud roaring sound, it must be put out quickly by blowing sharply through the air tube when full pressure is on.

(10) Continue to heat with alcohol until the preheater union is quite hot to the touch and the flame is blue and free from smoke.

(11) Give the relief valve a few quick turns toward the tank connection until the lamp is burning properly.

(12) If the flame becomes too large and persists for any length of time, turn the knob on the relief valve in the direction of the drain connection. Do not drain more oil than is necessary to reduce the flame.

(13) Turn the relief valve back sufficiently to cause the light to burn with a brilliant light and with a minimum consumption of kerosene.

**C. Regulating burning lamp.**—The proper burning of the lamp can be regulated to some extent by means of the covers located at the top of the lamp. If the lamp surges or if the mantle rises off the mantle davit, the lamp is too hot; open the covers slightly. If the lamp spits flame occasionally, it is too cool; close the covers. If the mantle shows too much blue flame around the sides, too much oil is being burned. This may be caused by too cool a lamp, too great a pressure, or too large a vaporizer nozzle. Do not change a nozzle until the other troubles have been eliminated. There should always be a slight blue flame around the mantle. The lamp operates best at the air pressure of between 40 and 60 pounds.

### D. To extinguish the lamp:

Turn the knob on the relief valve in the direction of the drain connection. This will drain the preheater and will remove most of the carbon.

### E. To clean the lamp:

- (1) The vaporizer should be cleaned at least once a week.
- (2) Remove the vaporizer by loosening the screws, and remove the vaporizer plug nozzle.
- (3) Remove the vaporizer strainer and clean out the tube.
- (4) Renew the vaporizer strainer.
- (5) Replace the vaporizer nozzle.
- (6) Pass the pricker through the vaporizer nozzle orifice, using a 0.009 size pricker for 35 mm. and 0.012 size for 55 mm.
- (7) Test the vaporizer nozzle by means of a test pipe to the oil tank under pressure. The stream from the orifice must be straight.
- (8) The preheater must be cleaned every few weeks; remove the plug, break up the carbon, and wash out with kerosene.



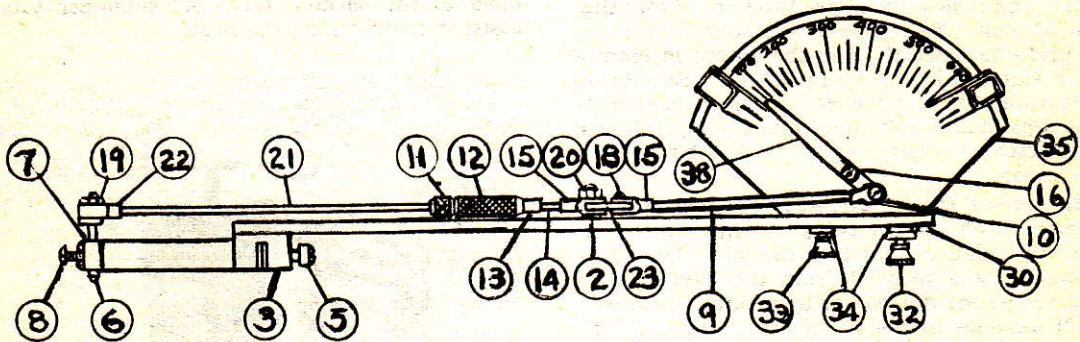
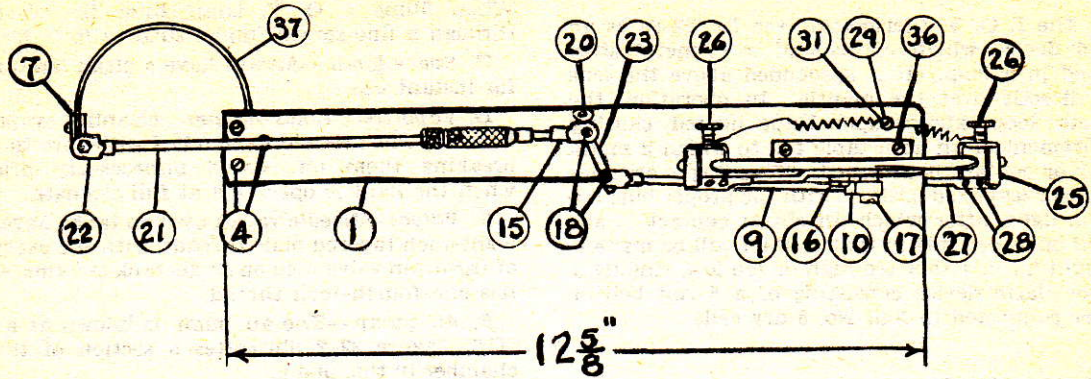

BILL OF MATERILAS		
Part No.	Description	Material
1	Bar .....	Steel.
2	Lever pivot .....	Do.
3	Expansion loop block .....	Do.
4	Block screws .....	Do.
5	Expansion loop set screws .....	Do.
6	End piece pin .....	Do.
7	Expansion loop end piece .....	Do.
8	End piece screws .....	Do.
9	Pointer rod .....	Do.
10	Pointer rod head .....	Do.
11	Lock nut .....	Do.
12	Adjusting nut .....	Do.
13	Adjusting nut sleeve .....	Do.
14	Short connecting rod .....	Do.
15	Jaws for rods .....	Do.
16	Pointer pivot .....	Do.
17	Pointer rod pivot .....	Do.
18	Pins for piece 15 .....	Do.
19	End piece pin nut .....	Do.
20	Nuts for pieces 2 and 16 .....	Do.
21	Long connecting rod .....	Do.
22	Long connecting rod head .....	Do.
23	Lever .....	Brass.
24	Adjusting nut pin .....	Steel.
25	Contact piece block .....	Fiber.
26	Contact piece block set screw .....	Do.
27	Contact piece .....	Silver solder.
28	Contact piece screws .....	Brass.
29	Insulating washer .....	Fiber.
30	Insulation .....	Do.
31	Binding post screw .....	Brass.
32	Binding post nut .....	Do.
33	Wire terminal clamp .....	Do.
34	Washer .....	Do.
35	Dial .....	Do.
36	Dial screws .....	Do.
37	Expansion loop .....	Thermostatic metal.
38	Pointer .....	Brass.

FIGURE 22-9.—Thermostat for I. O. V. lamp.



**22-2-40 Thermostat Alarm—**

A. The I. O. V. thermostat (see fig. 22-9) is an alarm device which consists of a bi-metal strip formed in a loop. It is suspended above the lens and directly over the mantle. In operation, the bi-metal loop extends upon being heated, causing a movement of an adjustable rod to which a metal finger or contact is attached. This finger assumes a more or less fixed position with the proper burning of the light, after which an alarm contact is adjusted on either side so that contact will be made if the light burns either too high or too low, ringing a simple alarm device consisting of a 6-volt bell or buzzer connected to four No. 8 dry cells.

**22-2-45 Mantles—**

A. *Size and type.*—There are two sizes of mantles, 35 and 55 mm. Each size is available in the so-called preformed mantle, and the autoform mantle which resembles a loosely knit silk sack. Both types are saturated with chemicals. These chemicals form a crystallized salt and retain a high degree of incandescence when heated by the burning of the oil vapor.

B. *Burning off the mantle.*—The preformed mantle is "burned off" before being put into operation, by applying a lighted match at the top. The autoform mantle is suspended from the davit and is secured to the mantle holder by means of a drawcord. It assumes proper shape when "burned off" by a relatively low flame from the bunsen tube.

C. *Interchangeability.*—Mantle holders are interchangeable to the extent that the preformed mantle may be used (with proper davits) on autoform mantle holders; however the autoform mantle may only be used with the autoform mantle holder.

D. *Caution.*—Mantles are fragile and should be handled with care.

**22-2-50 General Hints—**

A. *Cleanliness.*—The successful operation of I. O. V. lamps depends to a great extent on cleanliness of the apparatus. Uncontaminated oil is an absolute necessity.

B. *Individuality.*—Each lamp will be found to have its own peculiar characteristic and slightly different adjustments. It is fundamental, that if a lamp fails to burn properly after a nominal amount of pre-heating, something is wrong, and the answer will often be found in a dirty lamp or contaminated oil. Oil should be drawn from the tank frequently to remove sediment. Draw oil from the main supply in 5-gallon cans provided for the purpose. Filter the oil as it is poured into the can. Whenever possible, stow the oil in a relatively warm place before

using in the lamp. Cold oil does not burn well. When filling I. O. V. lamp, filter the oil again through a fine screen funnel such as Part No. 666.

C. *Spare lamp.*—Always have a clean lamp ready for instant use.

D. *Vaporizer holes.*—When cleaning vaporizer holes, prickers should be handled with care to avoid breaking them off. Avoid unnecessary pricking when the light is operating at full strength.

E. *Valves.*—Needle valves used on tanks have one-eighth-inch tapered male threads, with the exception of the drain valve used on single tank systems, which has one-fourth-inch thread.

F. *Air pump.*—The air pump is known as a type "C." Figure 22-2 illustrates a section of the air chamber in this pump.

G. *Maintaining heat.*—Copper windings are applied to the 55-mm. type "A" vaporizer tubes to assist in maintaining the heat.

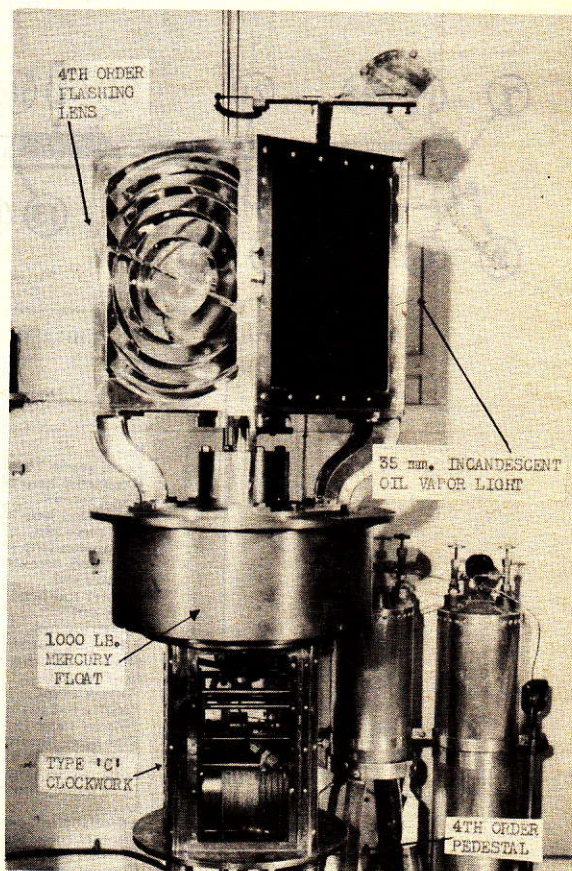

FIGURE 22-10.—Fourth order lens and accessory equipment.



**22-3 ALADDIN LAMP****22-3-1 General—**

A. The Aladdin kerosene mantle lamp is suitable for use either as a regular or standby source of light in a secondary major light station. It is used in the smaller optics and only an isolated few are still in service.

**22-3-5 Principle of Operation and Component Parts—**

A. The Aladdin lamp is a wick-burning low reservoir oil lamp, the flame of which brings a mantle located in the chimney into incandescence. The mantle is 3.1 cm. wide by 5.3 high and has a brightness of approximately 60 candlepower. The foot or bowl will hold about 1 quart of oil, which gives a burning time of approximately 15 hours.

**22-3-10 Types—**

A. Several types of Aladdin lamps will be found in use in the Service. Those most frequently used are the so-called Nu-type models "A" and "B" and the older type model No. 12. Some parts are interchangeable, such as chimneys, mantles, galleries, and flame spreaders. Parts which must be specifically ordered for the particular lamp in use are: Wicks, burner bases, outer wick tubes, wick raisers, and complete burner units. It will be noted that the thread which screws into the bowl on the Nu-type burners for models "A" and "B" is 9 threads to the inch, while the thread on the model 12 is 20 threads to the inch.

**22-3-15 Operating Procedure—**

A. The Aladdin lamp is simple to operate and is practically troublefree, providing ordinary handling, care, and cleanliness of operation is observed.

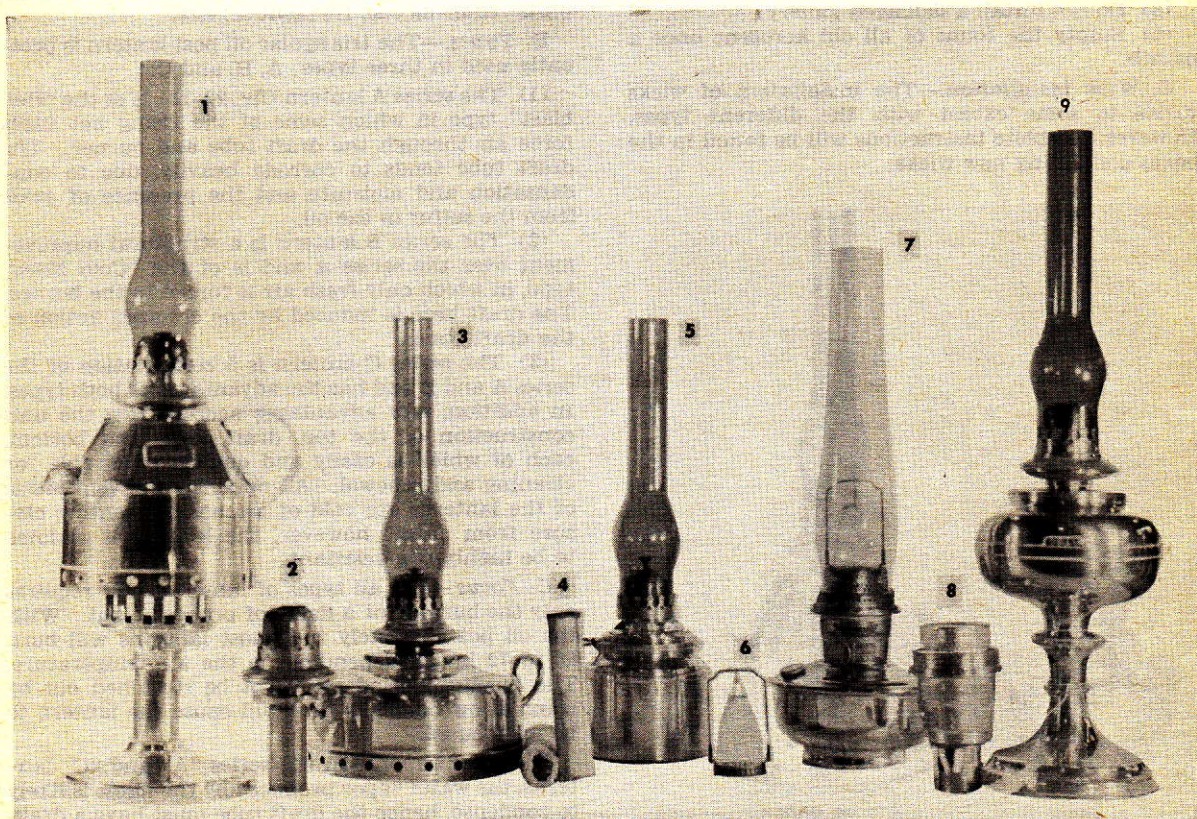

1. Fifth order service lamp with stand.
2. Gallery, and chimney holder for service and lens lamp.
3. One-day lens lamp.
4. Tubular wick for service, lens, and table lamp.
5. Five-day lens lamp.

6. Mantle with holder for all models Aladdin lamp.
7. Aladdin lamp, Nu-model, type "A."
8. Burner, and wick tube for Aladdin lamp.
9. Table lamp.

FIGURE 22-11.—Assorted oil lamps.



(1) Do not turn the wick to full mantle height immediately after lighting. Let the upper half, only, of the mantle glow for about 5 minutes so that all burner parts may become heated.

(2) Keep the wick free of dirt and do not allow it to become crusted with carbon. Use the prescribed wick cleaner gently to keep the wick clean and even.

(3) If the flame spreader becomes clogged, dented, or otherwise damaged, replace it.

(4) Keep the holes in the underside of the gallery open.

B. The above conditions and remedies cover a smoking lamp. Other helpful hints are:

(1) Be sure the mantles are properly locked in catches on the sides of the gallery.

(2) Lock the chimney securely, but not too tightly, in the gallery.

(3) Be sure that the outer wick tube is properly locked to the burner base.

(4) See that the flame spreader is all the way down on its seat in the inner wick tube.

(5) Do not install a damaged gallery.

(6) Empty the fount of all old kerosene once a month.

C. *Wick installation.*—The installation of wicks varies to some extent with the different types. However, complete instructions will be found in the boxes containing new wicks.

charred pieces of wick. When installing new wicks, it is preferable that the reservoir be emptied. The wick is then installed, moistened with a little oil at the top, lighted, and the flame adjusted even with the flame deflector and allowed to burn out. After allowing to cool, blow off the ashes and smooth off the top of the wick even with the top of the deflector tube with the fingers.

C. Do not fill the lamp too full. Allow for expansion.

D. When the wick is carefully and smoothly trimmed and the lamp filled, it may be lighted and the chimney put on. The wick should then be turned up until the flame is even with the deflector button.

## 22-4 OIL WICK LANTERNS

### 22-4-1 Inland Waterway Triangular Lantern—

A. The triangular oil lantern is extensively used on inland waterways, particularly in the Second District. However, it is gradually being replaced by units requiring less frequent service.

B. *Types.*—The triangular oil post lantern is presently used in three types; A, B, and C.

(1) The series A lantern (fig. 22-13) is of the "Hot blast" type in which some of the rising hot gases force air through the draft tube and burner. The draft tube tends to corrode heavily, due to condensation and moisture and the presence of acids from the sulfur in the oil.

(2) The series B lantern is a structural improvement over the series A and is of the "Cold blast" type, in which only fresh air is forced to the burner. The draft here is induced by the chimney action of the draft cone.

(3) The series C lantern is a combination of the series A and B and has the advantages of both types. In addition, new advantages accrue from the unit construction of the top, draft tube, and bottom, each of which is easily and quickly removable for cleaning and renewal. All openings for ventilation of the lanterns are void of screens, preventing closure from paint; however, the lantern is claimed to be highly bug-resistant.

C. *Focus.*—For all types of lanterns, this requires only the burning of a flame of proper height. With the oil pot absolutely full, most lanterns will burn 65 to 72 hours, depending on the air temperature. The burning period must not be stretched out by using a low flame, as that will cause the lantern to be misfocused.

D. *Water vapor.*—In the series "A" and "C" lanterns, the water vapor produced by the flame is likely to condense, hence the draft tube must have a drain hole in the bottom. In the series "C" lantern, improved drainage has been provided. During severe low temperatures, series "A" lanterns have been known to collect solid ice in the entire draft tube.

### 22-4-5 Post Lanterns—

A. Post lanterns are of two types; 1-day and 8-day. They are of similar construction, consisting of a brass base housing the lamp and upon which is set a 360° 150-mm. or 200-mm. pressed-glass lens. Fixed to the top of the lens is a brass ventilator top section.

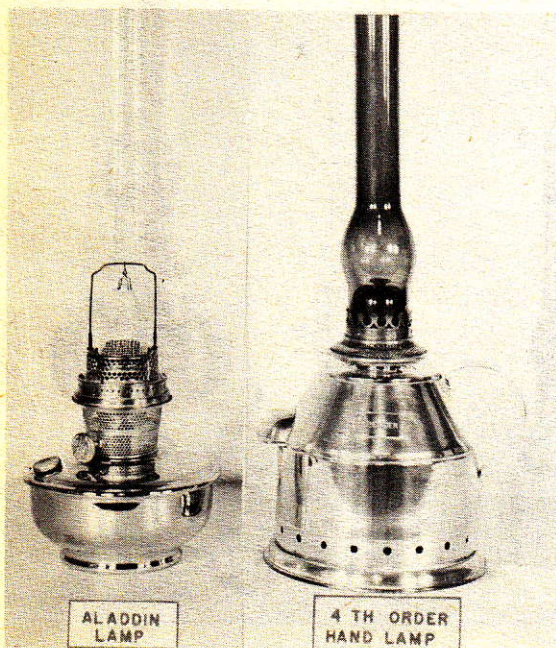

FIGURE 22-12.—Stand-by lights.

### 22-3-20 Maintenance—

A. Little maintenance is required in connection with the operation of these lanterns. Cleanliness, however, is essential.

B. *Trimming wicks.*—Wicks should never be trimmed with scissors, but should be rubbed smooth with the fingers, care being taken to remove any



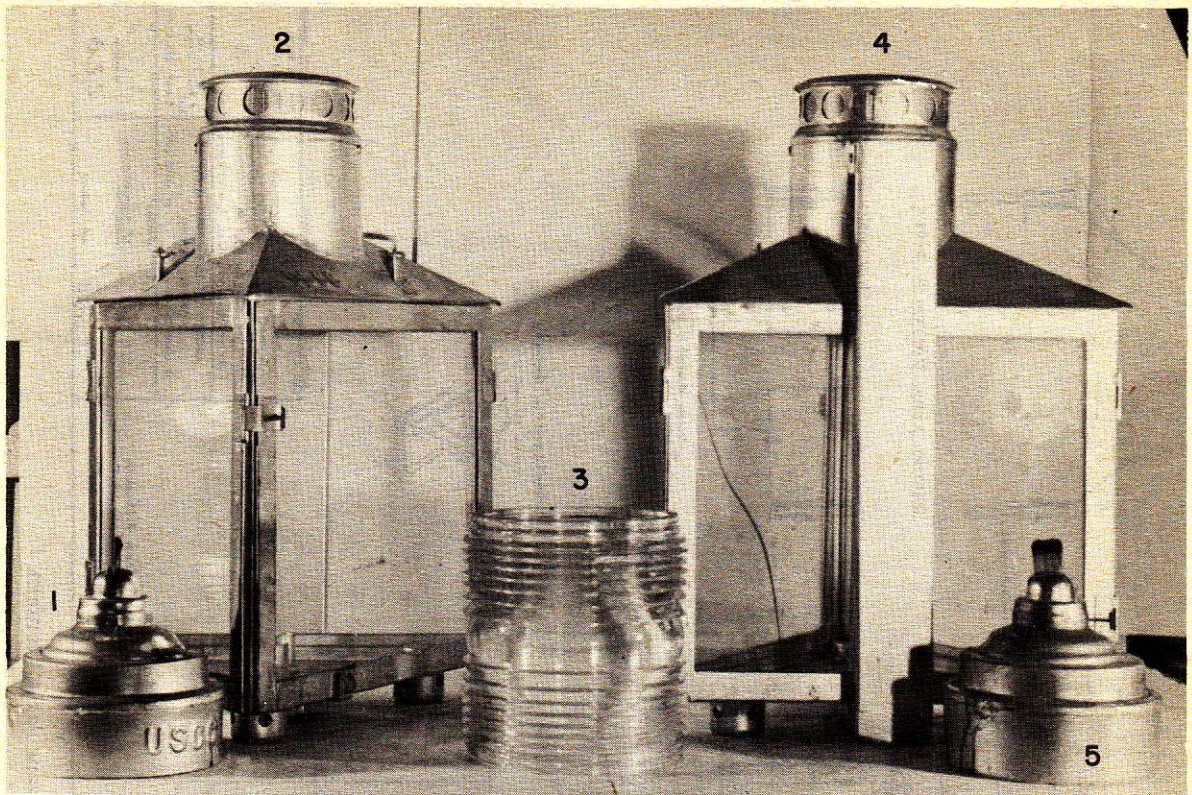

1. Side view of lamp for triangular lantern.
2. Front view of lantern.
3. Lens.
4. Rear view of lantern.
5. Front view of lamp.

FIGURE 22-13.—Triangular lanterns.

The assembly is protected by a cage of one-quarter inch brass rods secured to the lantern base and terminating in the brass handle located above the ventilator section. The lamp within the lantern base has a flat wick seven-eighths inch wide and takes a semiglobular shaped chimney with a flared bottom edge. The chimney is held in the burner by spring clips. Colored or clear chimneys are used as required.

**B. One-day post lanterns.**—The lamp in this lantern is of the low reservoir type. The oil reservoir is located immediately below the burner and holds enough oil to burn slightly in excess of 24 hours. It is constructed of brass, with a wick-regulating knob underneath the base. Turn the knob to the left to raise the wick.

**C. Eight-day post lantern.**—This lantern differs from the 1-day lantern in that a circular reservoir surrounding the entire lantern is located above the lens section. Oil is piped to a small constant level reservoir located outside the base and from which a feed line leads into the lamp reservoir. Oil is maintained at proper height in the constant level reservoir by means of a float valve. The upper reservoir will hold enough oil for approximately 8 days burning time. The lamp is installed in the post lantern from the bottom and is held in place by means of flat brass fingers which are engaged with

holding clips. To install the lamp, suspend the lantern and insert lamp so that the fingers will enter the holding clips by twisting the lamp to the left. In the case of 8-day lamps which have a constant level valve, the vent pipe must be located in the opening in the base.

**D. Placing the lamp in operation.**—In preparing a new wick, the lamp should be empty.

(1) Saturate the new wick with oil and insert in the lamp; turn it down nearly even with the wick tube.

(2) Light, insert the chimney in place, and allow the wick to burn out.

(3) Wipe off the ashes from the top of the wick and fill the lamp.

(4) Allow the wick to saturate for 5 minutes, then light.

(5) Turn up the wick gradually to prevent smoking or possible breaking of the chimney.

**E. To fill an 8-day reservoir:**

(1) Place the reservoir upside down on a slightly inclined surface, with the side to which the tube is attached at the highest point so as to allow all the air to escape.

(2) Fill the reservoir and tube entirely full, pull up the valve, reverse the reservoir, and set it in place on the lantern.



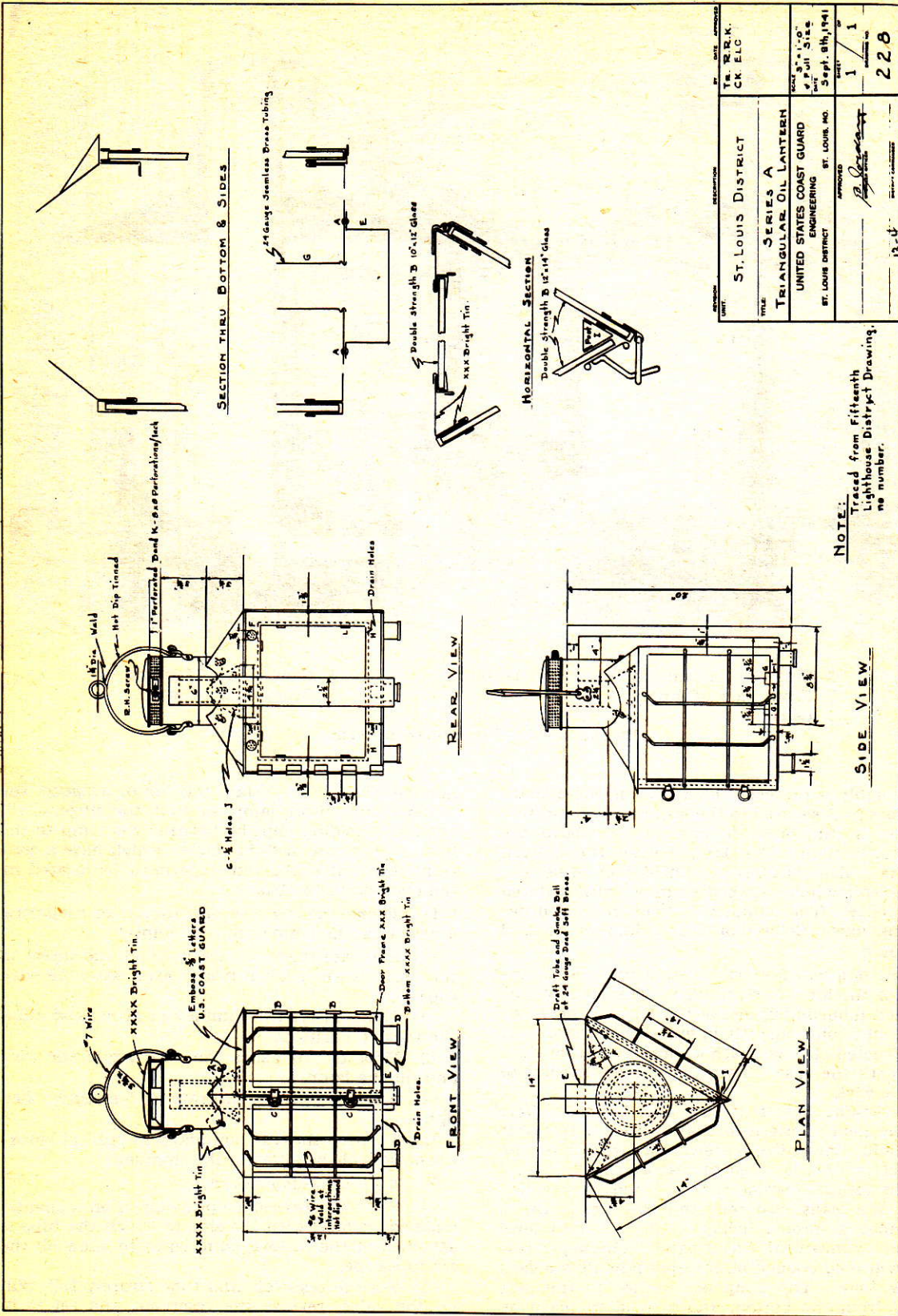

UNIT:	ST. LOUIS DISTRICT	DATE APPROVED:	TR. R.R.K. CR. ELC.
TITLE:	SERIES A TRIANGULAR OIL LANTERN	SCALE:	3" = 1'-0"
DESIGNED BY:	UNITED STATES COAST GUARD ENGINEERING ST. LOUIS, MO.	APPROVED:	1 / 1
ST. LOUIS DISTRICT			228

FIGURE 22-14.—Series "A" triangular oil lantern.



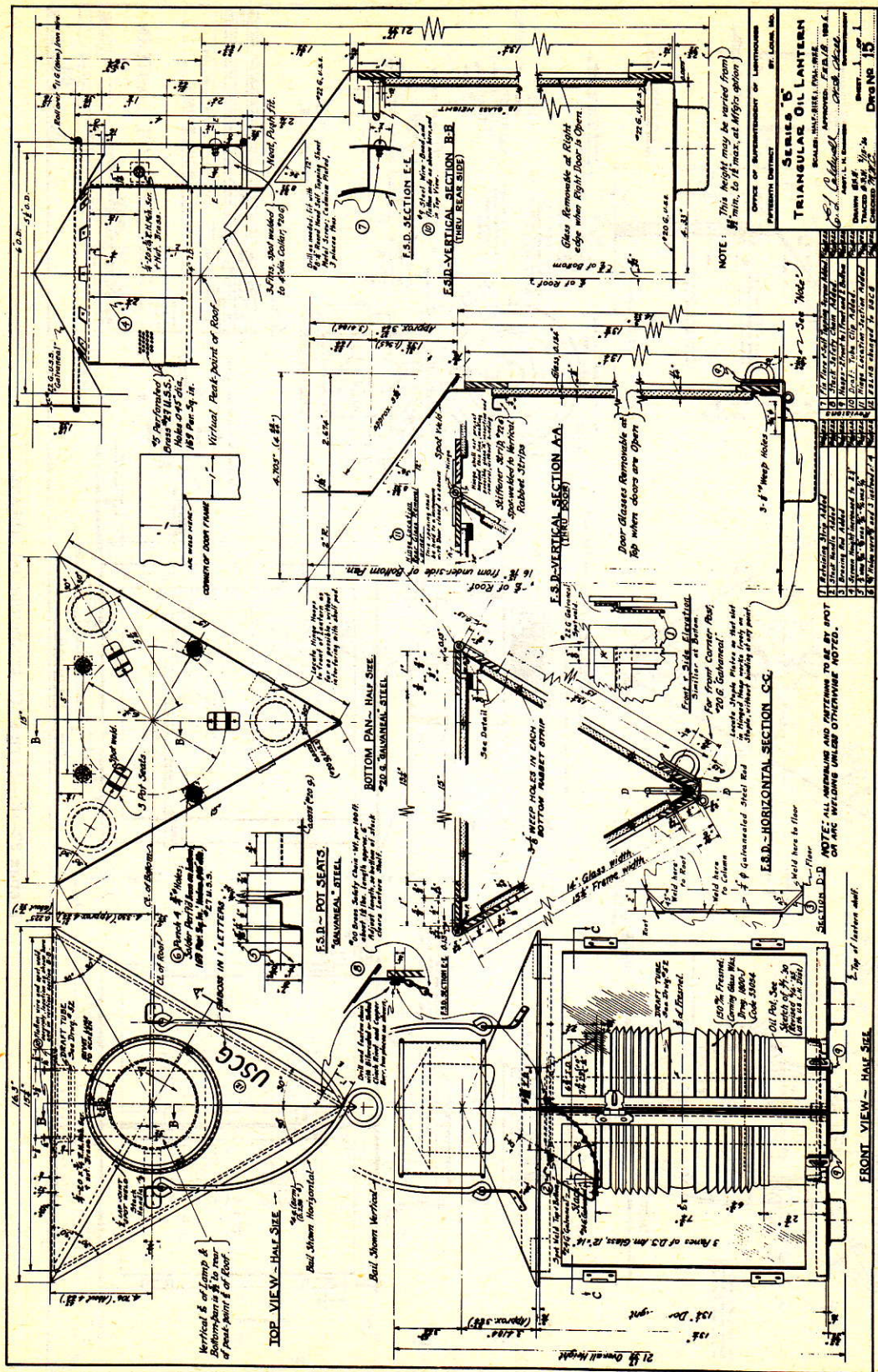

FIGURE 22-15.—Series 'B' triangular oil lantern.

DESIGNED BY: **W. L. M. L.**  
 DRAWN BY: **W. L. M. L.**  
 CHECKED BY: **W. L. M. L.**  
 APPROVED BY: **W. L. M. L.**  
 DATE: **1916**

**U.S. COAST GUARD**  
**NAVY DEPARTMENT**

U.S. COAST GUARD  
 U.S. LIGHT BUOY NO. 108  
 U.S. LIGHT BUOY NO. 109  
 U.S. LIGHT BUOY NO. 110

U.S. COAST GUARD  
 U.S. LIGHT BUOY NO. 108  
 U.S. LIGHT BUOY NO. 109  
 U.S. LIGHT BUOY NO. 110

1	Top View - Half Size
2	Front View - Half Size
3	Section A-A - Vertical Section Through Roof
4	Section B-B - Vertical Section Through Bear Side
5	Section C-C - Horizontal Section
6	Section D-D - Front View - Half Size
7	IOP View - Half Size
8	Bottom Pan - Half Size
9	Pot Seats - Horizontal - Steel
10	Bottom Pan - Half Size
11	Bottom Pan - Half Size
12	Bottom Pan - Half Size
13	Bottom Pan - Half Size
14	Bottom Pan - Half Size
15	Bottom Pan - Half Size
16	Bottom Pan - Half Size
17	Bottom Pan - Half Size
18	Bottom Pan - Half Size
19	Bottom Pan - Half Size
20	Bottom Pan - Half Size



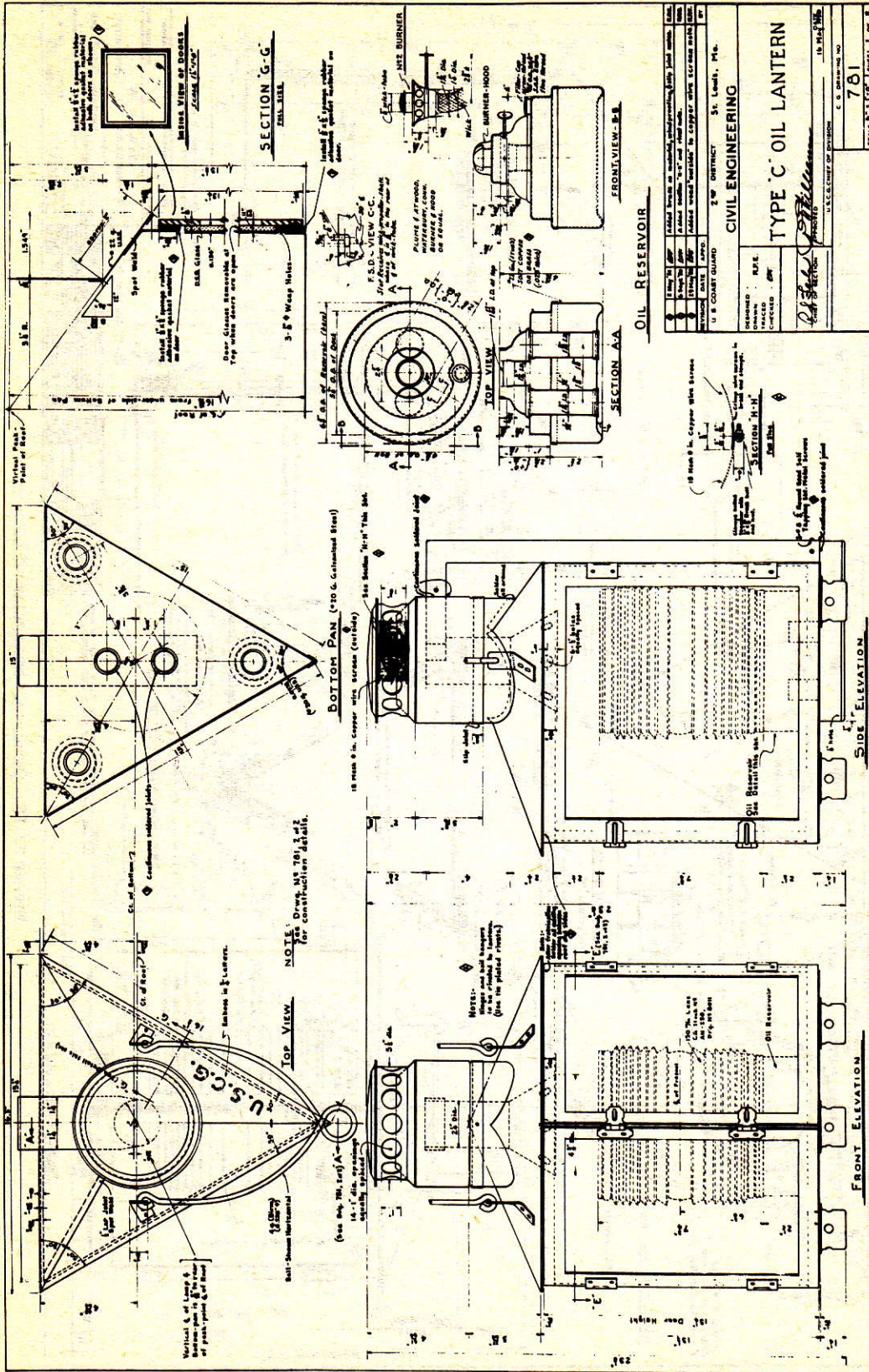

FIGURE 22-16.—Series "C" triangular oil lantern.



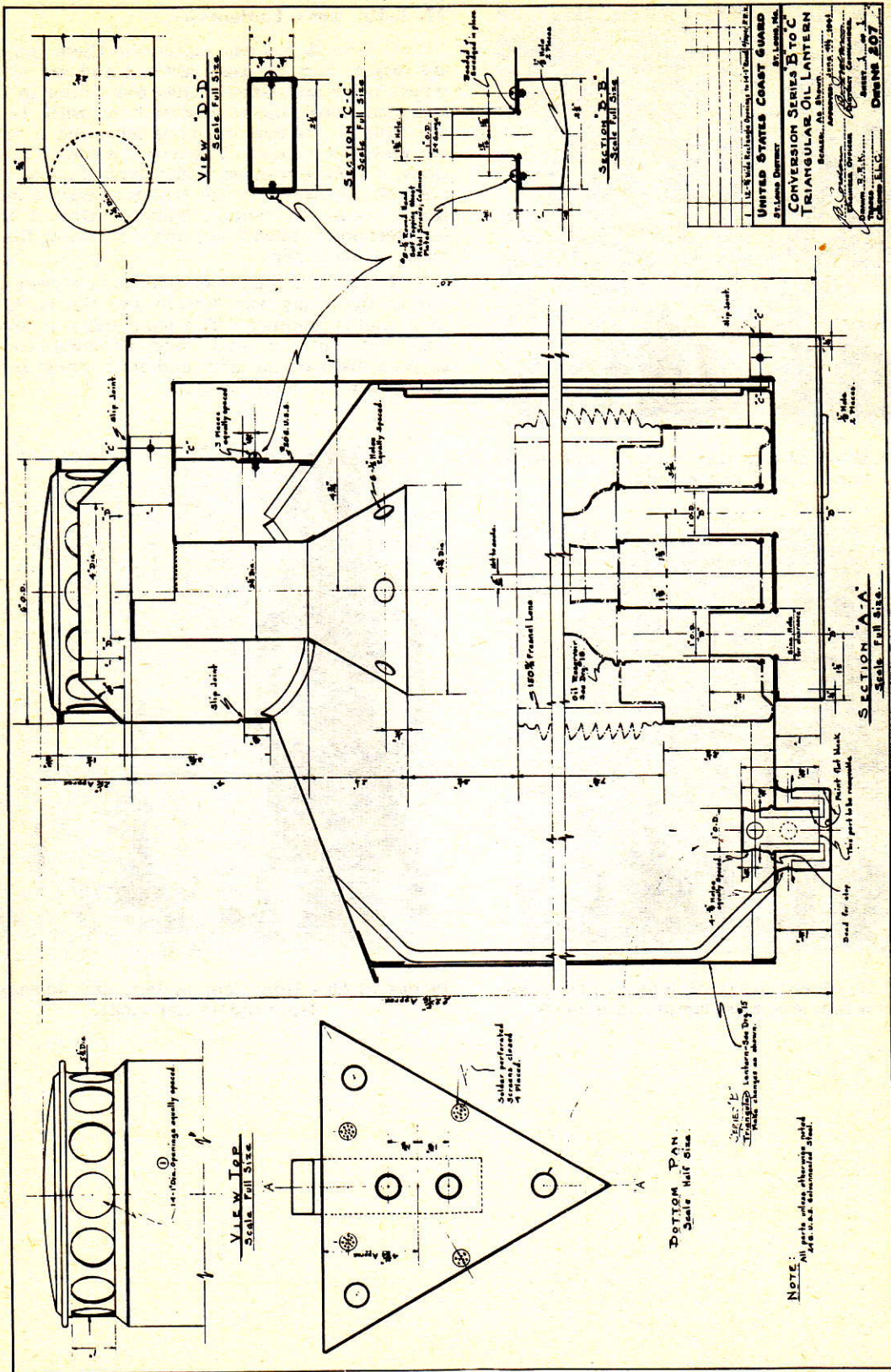

FIGURE 22-17.—Conversion of series "B" to "C" triangular oil lantern.



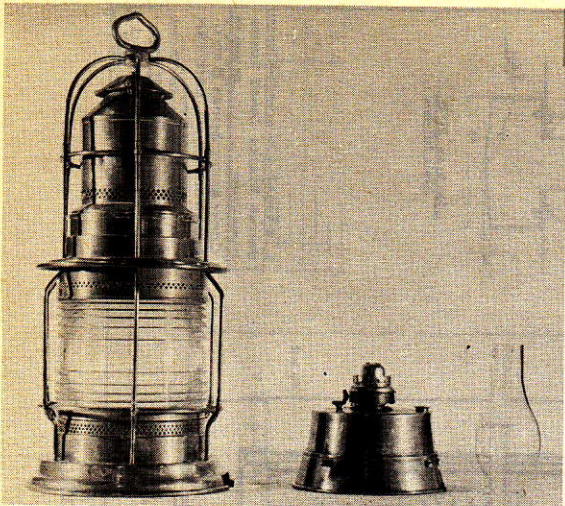

FIGURE 22-18.—One-day post lantern and accessories (lamp and chimney).

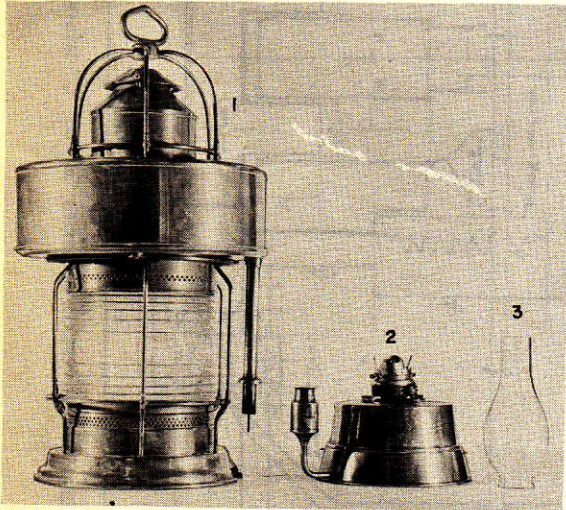

FIGURE 22-19.—Eight-day post lantern and accessories (constant level valve lamps and chimney).

#### 22-4-10 Lens Lanterns—

A. *One- and five-day lanterns.*—These lanterns are larger than the post lanterns and are of two types; 1-day and 5-day. They are similar in construction, consisting of a brass base which houses the lamp, a 300-mm. cut-glass lens, and a brass-top ventilator section. The lens is made up in sections; if a lantern shows a 360° light, these sections are 120° segments. Some lanterns show a directional beam and contain mirrors. One of these lens sections is hinged to provide access to the interior of the lantern.

B. The 5-day lantern has a circular reservoir similar to the 8-day post lantern and the oil is fed in a similar manner. The lamp takes a tubular wick and a fifth or sixth order chimney identical to those used in the fifth and sixth order service lamp shown in figure 22-11.

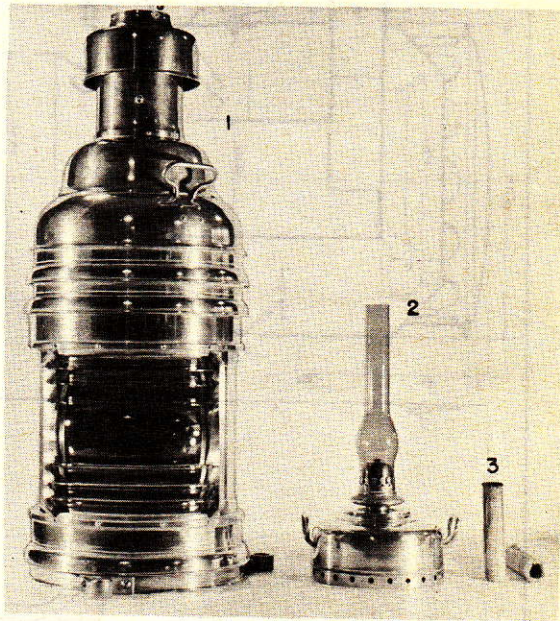

FIGURE 22-20.—1-day lens lantern and accessories (lamp and tubular wick).



**22-4-15 Lamps—**

A. Lamps used in oil wick lanterns and for standby lights in large lenses, are of two types. Those of the low reservoir type, where the entire supply of oil is contained in a fount directly below the burner, and the constant level type, where the bulk of the oil supply is contained in a reservoir outside of the lantern, from which oil is piped from a constant level valve to a lamp within the lantern.

B. The following is a list of lamps used with above-mentioned lanterns, and for other purposes, showing types of wick used:

Triangular lantern lamp-----	Flat wick.
Post lantern lamp, 1- and 8-day-----	Do.
Lens lantern, 1-day-----	Tubular wick.
Lens lantern, 5 days-----	Do.
Service lamp, fourth order for fourth order lenses.	Do.
Service lamps, fifth order for fifth and sixth order lenses.	Do.
Aladdin lamp, for fourth, fifth, and sixth order lenses.	Do.

C. Since wicks are available through C. G. supply depots, the quality can be accepted as satisfactory; but what is not generally recognized is the fact that since the oil burned is drawn up through the wick, the wick acts as a filter. If the oil for some reason becomes laden with dirt or dust, these foreign substances may in time clog the wick. Therefore, wicks should be changed occasionally.

**22-4-20 Fuel (Kerosene)—**

A. Only the best grade of kerosene must be used in oil-operated apparatus. A grade known as "Long Time Burning Oil" (in which the heavy and light parts of the oil stock are excluded, leaving only those hydrocarbons having the best illuminating value with a cotton wick) is acceptable.



## INDEX

A		Page	Incandescent Oil Vapor Lamp—Continued		Page
Aladdin Lamp.....		22-11	Operating procedure, single tank, Type A.....		22-6
Component parts.....		22-11	Principle of operation.....		22-1
Maintenance.....		22-12	Single tank system.....		22-2
Operating procedure.....		22-11	Table of parts, 35 mm. Type A, double tank system.....		22-5
Principle of operation.....		22-11	Table of parts, 35 mm. Type B, single tank system.....		22-2
Types.....		22-11	Thermostat alarm.....		22-10
C			Types and sizes.....		22-1
Constituent Parts.....		22-1	O		
D			Oil Wick Lanterns.....		22-12
Definition.....		22-1	Fuel.....		22-19
I			Lamps.....		22-19
Incandescent Oil Vapor Lamp.....		22-1	Lens lanterns.....		22-18
Alcohol preheating torch.....		22-8	Post lanterns.....		22-12
Component parts.....		22-2	Triangular lanterns.....		22-12
Double tank system.....		22-3	Wicks.....		22-19
General hints.....		22-10	T		
Mantles.....		22-10	Tables:		
Operating procedure, double tank, Type B.....		22-8	Parts and accessories for 35 mm., Type A, double tank system.....		22-5
			Parts and accessories for 35 mm., Type B, single tank system.....		22-2