

Army TM 5-803-5
Navy NAVFAC P-960
Air Force AFM 88-43
1 March 1981

Installation Design

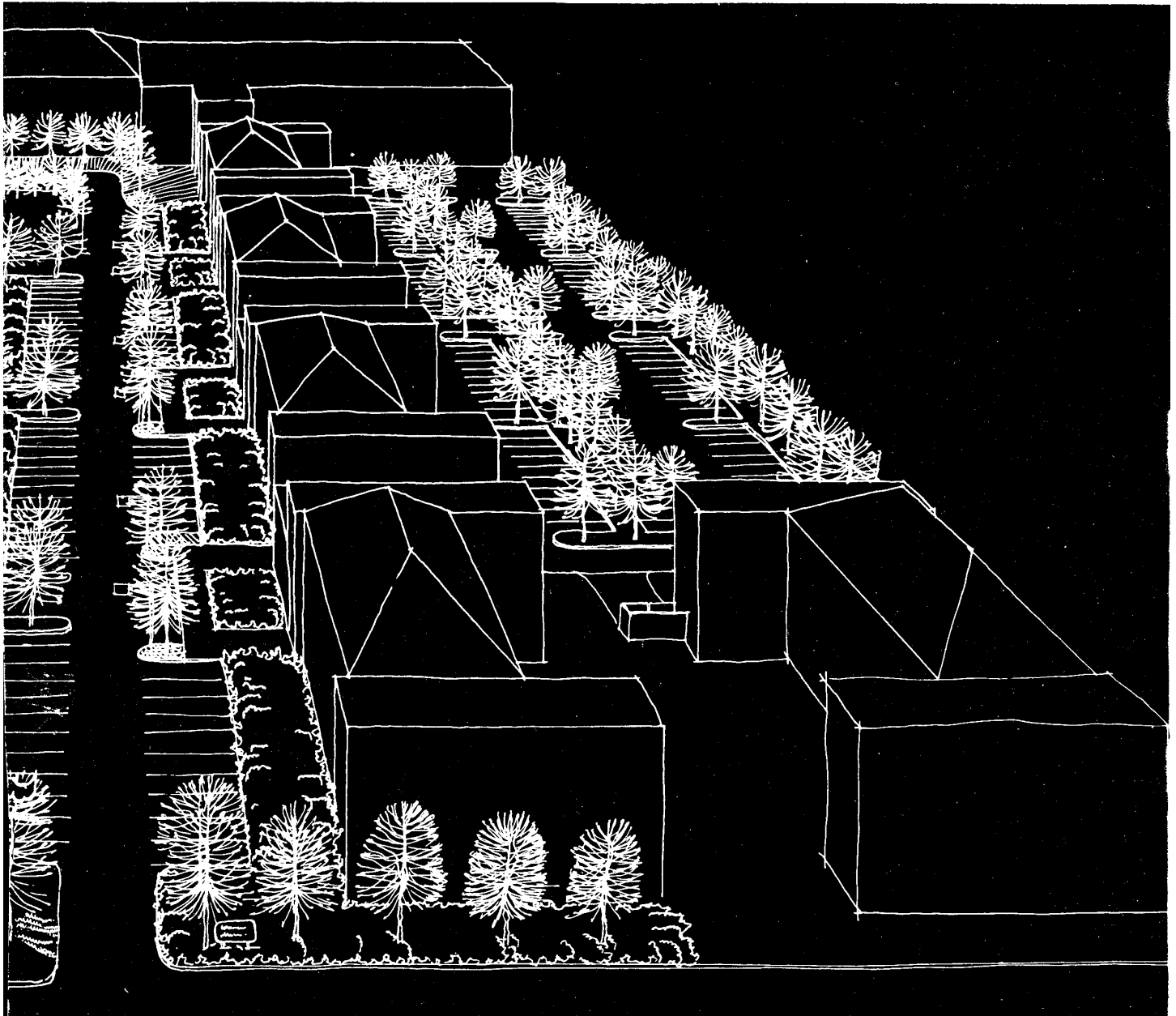

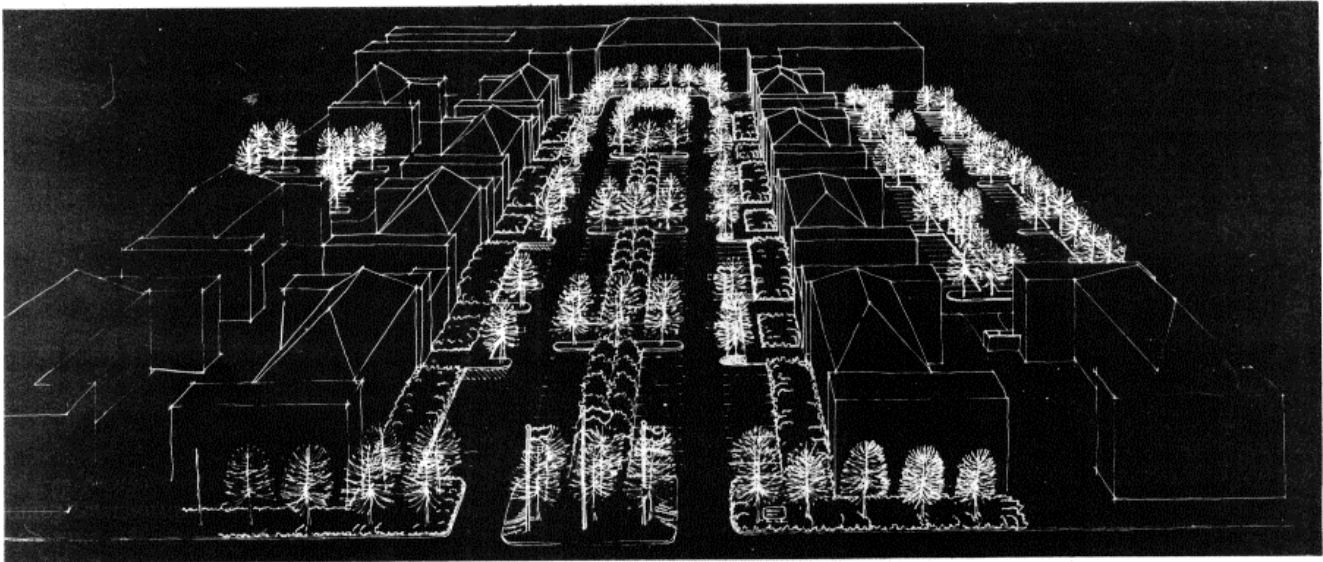

Installation Design

**Improving the
Visual
Environment**

Contents

1	Part I: General
2	Chapter 1: Introduction.
4	Chapter 2: Improving the Visual Quality of Military Installations.
9	Part II: Design Guidelines
11	Chapter 3: Buildings.
12	Section I: Observations and Objectives
14	Section II: Design Guidelines
27	Chapter 4: Roads.
28	Section I: Observations and Objectives
29	Section II: Design Guidelines
39	Chapter 5: Parking.
40	Section I: Observations and Objectives.
41	Section II: Design Guidelines
47	Chapter 6: Planting.
48	Section I: Observations and Objectives
49	Section II: Design Guidelines
59	Chapter 7: Plazas and Courtyards.
60	Section I: Observations and Objectives
61	Section II: Design Guidelines
67	Chapter 8: Walkways.
68	Section I: Observations and Objectives
69	Section II: Design Guidelines
77	Chapter 9: Bikeways.
78	Section I: Observations and Objectives.
79	Section II: Design Guidelines
85	Chapter 10: Signing.
86	Section I: Observations and Objectives.
87	Section II: Design Guidelines.
95	Chapter 11: Lighting.
96	Section I: Observations and Objectives
97	Section II: Design Guidelines
103	Chapter 12: Site Furnishings.
104	Section I: Observations and Objectives.
105	Section II: Design Guidelines
117	Chapter 13: Utilities.
118	Section I: Observations and Objectives
119	Section II: Design Guidelines.

123	Part III: Prototype Areas
124	Chapter 14: Main Entrances.
126	Chapter 15: Administrative Headquarters.
128	Chapter 16: Housing.
134	Chapter 17: Community Facilities.
136	Chapter 18: Industrial/Warehousing Areas.
139	Appendices
141	Appendix A: Related Military References.
143	Appendix B: Annotated Bibliography.
155	Appendix C: Model Scope of Work Statement and Design Consultant Selection Criteria for the Preparation of Installation Design Guides.

This manual supersedes TM 5-803-3, 1 July 1966, TM 5-822-3, 1 April 1963, and TM 5-830-1/NAVFAC P-904, 15 June 1976.

Part I General

Chapter 1.

Introduction.

1-1.

Purpose of the Manual.

A. Introduction.

Military installations should provide efficient and pleasant physical environments conducive to attracting and retaining skilled and motivated personnel. A military installation conveys a visual image in terms of its design character and organization that can be either clear, logical and attractive or cluttered, confused and disoriented. The design, location and maintenance of individual elements such as buildings, roads, parking lots, signing and planting, affect the quality of the visual environment. Each of these elements should be functional, attractive and harmonious with its surroundings to create an environment that enhances the capability of installations to support their missions and fosters pride in and commitment to military service.

B. Objective.

The objective of the **Installation Design Manual** is to provide guidance for improving the quality of the visual environment on Army, Navy and Air Force installations.

C. Scope.

The **Installation Design Manual** is a tool to improve the appearance and functioning of military installations by enhancing natural site assets; compatibly relating the natural and built environments; establishing an orderly organization of activities, circulation and open space system; achieving a consistent architectural character; and coordinating site components such as lighting, signing and street furniture to reduce clutter. This manual includes information gathered from a variety of sources and is intended to serve as a comprehensive reference of design guidance for military installations.

1. The manual provides observations of common problems, design objectives and specific design criteria for components comprising the exterior environment of an installation. It also illustrates their practical application in terms of prototypical design solutions for improving various types of facility areas commonly found on installations. Furthermore, the manual addresses how such guidance can be incorporated into the master planning and facility design process.

2. These guidelines are directed toward creating a visually cohesive and attractive installation that is consistent with good planning, design and environmental policy. They address both the design of new facilities as well as the improvement of existing facilities;

and they encompass both visual and functional considerations. Because of the need to address a variety of conditions that could be encountered on various installations, the design guidance is primarily generic in nature.

3. The design guidance in this manual has been devised for general application at all installations. It is intended that each installation will develop its own design guide, tailored to its specific situation and containing those guidelines dealing with such locationally specific conditions as climate and prevailing architectural character. Other modifications may be necessary in response to specific installation policies or some atypical condition that may exist at a particular installation.

D. Intended Users.

Improving the appearance and functioning of military installations requires quality design. This entails the interaction of two essential participants: 1) an enlightened client and 2) competent design professionals. The guidance offered in this manual is for use by Army, Navy and Air Force personnel responsible for installation planning and design as well as design firms, particularly those offering comprehensive architectural, planning and engineering services, who are under contract to plan and design military installations or facilities. This manual is directed to both audiences to promote a high level of awareness of potential design solutions and standards, as well as evaluation criteria. It is directed at making the military a better client and aiding design professionals in performing a higher quality of service.

1-2.

Organization of the Manual.

The **Installation Design Manual** is divided into three major parts and a set of appendices:

A. Part One: General.

Chapters 1 and 2 provide an introduction to the purpose and use of the manual, principles for improving the quality of military installations and the means of incorporating visual design considerations into the installation master planning process.

B. Part Two: Design Guidelines.

Chapters 3-13 provide design guidance for component elements that comprise the environment of military installations. These include: buildings, roads, parking, planting, plazas and courtyards, walkways, bikeways, signing, lighting, site furnishings and utilities. Each chapter deals with a specific component in terms of commonly observed problems, design objectives and design guidelines.

C. Part Three: Prototype Areas.

Chapters 14-18 illustrate how the use of an installation design guide can improve five prototypical facility areas commonly found on military installations. These prototype areas include: main installation entrances, administrative/headquarters areas, housing areas, community facilities and industrial/warehouse areas.

D. Appendices.

1. Appendix A: *Related Military References* lists applicable Department of Defense, Army, Navy and Air Force publications. Personnel from each service need follow only the references from their service and those of the Department of Defense. The only exception to this direction is with respect to handicapped criteria. Both Army and Air Force personnel are to follow DOD 4270 1M. Navy personnel are to follow the specific guidance provided in *DM-1 Series*.

2. Appendix B: *Annotated Bibliography* provides a selected listing of basic references on site planning and design.

3. Appendix C: *Model Scope of Work Statement and Design Consultant Selection Criteria for the Preparation of Installation Design Guides* offers guidance in the development of design guides.

1-3. Preparation of the Manual.

A. Process.

The preparation of this manual took over two years and involved four separate phases. These included field survey and research, during which visits were made to 15 separate military installations across the United States; problem analysis and organization, criteria definition and development; and criteria coordination and synthesis.

B. Participants.

This manual was prepared by an interdisciplinary team of design professionals working in collaboration with project representatives of the Army, Navy and Air Force. The various design disciplines involved included architects, planners, civil and electrical engineers, landscape architects and graphic designers. Army, Navy and Air Force personnel involved in the planning and design of installation facilities extensively reviewed draft forms of this manual. This interdisciplinary approach and military participation were utilized to produce a responsive, practical and comprehensive manual.

1-4. Proponent and User Comments.

The proponent agency of this manual is the Office of the Chief of Engineers, Department of the Army. Personnel are invited to send comments and suggested improvements on **DA Form 2028 (Recommended Changes to Publications)** to HQDA (DAEN-MPE-I) Washington, D C 20314. Navy personnel should send comments to NAV-FACENCOM HQ (Code 202), 200 Stovall Street, Alexandria, VA 22332. Air Force personnel should send comments to AF/LEEE, Washington, D C 20332.

Improving the Visual Quality of Military Installation.

2-1. Background.

A brief historical review of site development on military installations provides useful insights into the genesis of most installation plans and the problems that have developed over the years as missions have changed and the functional requirements of site planning have become more complex.

A. Historical Development Phases.

The historical development of installation plan forms can be generally grouped into three phases. The first of these phases was the quadrangle plan, influenced by defensive requirements (fig. 2-1). The second observable phase was characterized by the rigid and formal geometry of the Beaux Arts School which influenced military site planning in the late Nineteenth and early Twentieth Century (fig. 2-2).

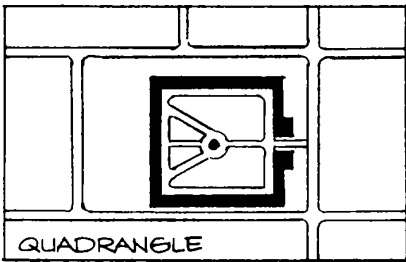

fig. 2-1.

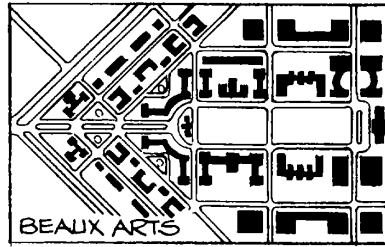

fig. 2-2.

The third period, which continues to strongly influence site planning today, was the World War II build-up which was characterized by the imposition of a gridiron circulation system and repetitive, checker-board, temporary construction (fig. 2-3). A dispersed plan concept was commonly employed during this period, locating facilities apart from each other in an attempt to minimize their vulnerability under a possible bombing attack.

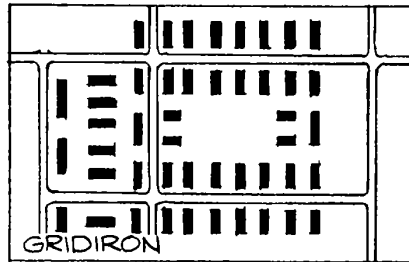

fig. 2-3.

B. Emerging Planning Issues.

The present organization, operations and development patterns of installations continue to be influenced by the gridiron system and the dispersed plan concept. The consequences of this era include facilities that exist as individual entities which have little relationship to their neighbors, either in terms of their architectural character or their functional and efficient operation. Today, energy conservation, operational efficiency and livability have emerged as primary installation planning considerations, replacing those of the now strategically obsolete dispersed plan concept.

C. Other Considerations.

Factors not related to the quality of site planning itself have contributed to the current difficulties of improving the visual image and functioning of military installations. These include limited funding resources for maintenance and improvements as well as the increased complexity and rapid changes in military missions and their program requirements.

2-2. General Guidelines.

The visual quality of a military installation cannot be fundamentally changed by a limited cosmetic approach to aesthetic considerations. Instead, a comprehensive approach based upon the following essential guidelines is necessary.

A. Enhance Existing Assets.

The overall physical image of military installations today can be significantly improved by enhancing those existing environmental assets present at each installation. These assets may include large reserves of natural open space, impressive landscape features, and historic and contemporary buildings of distinctive character.

B. Employ Practical, High Quality Design.

Many installations can be vastly improved at modest costs by a few simple improvement programs, such as a tree planting program and a coordinated signing system program. Concomitantly, when major investments in new facilities are contemplated, their design should contribute positively to the overall image and attractiveness of

the installation. This can be accomplished within reasonable budgetary restrictions by sensitive, practical, high quality design which does not necessarily cost more, either in terms of design fee or construction costs, than an inefficient or poorly executed design solution.

C. Utilize Sound Site Planning and Design Principles.

1. Site Analysis as the Foundation of Site Planning and Design. Careful consideration of natural and man-made site conditions is the foundation of both master planning and site planning design. Essential site features which should be considered include topography, vegetation, drainage, views, climate, availability of infrastructure (circulation and utility systems), and functional and aesthetic relationships to other site facilities.

2. Development of an Overall Conceptual Framework. Sound site planning cannot be achieved on a site-by-site, problem-by-problem basis, but must be based on a master plan which is properly conceived to allow each problem to be resolved as a part of a total concept. This conceptual framework starts with land use planning based on not only functional or mission requirements, but also on careful consideration of the ecological, physical and visual character of the installation, on future growth flexibility, on development of a circulation system which serves but does not dominate the setting, and on the perception and continuity of physical form of the built environment.

3. Integration and Coordination of Site Components. The design and detailing of site

components, including paving, plant materials, street furniture, lighting and signing, should be developed as a consistent system related functionally and aesthetically to such organizing elements as the circulation system, land use and activity centers. The coordination and orderly development of these component systems add greatly to establishing an improved image and more functional environment.

4. Energy Conservation.

Energy conservation objectives and site planning and design activities interface both at the master planning policy level as well as in the design and siting of individual facilities. Land use and transportation master planning should strive to minimize necessary auto trips by locating related activities together and developing a balanced transportation system which encourages pedestrian, bike and public transit as attractive alternatives to the auto. Building orientation, massing and detailing, as well as the interrelationship to adjacent buildings and planting, all have implications on site design to reduce energy consumption. The necessities of energy conservation require new criteria affecting building design decisions, and changes in previous concepts of building form and site relationships.

2-3. Relationship to the Master Planning Process.

While master planning procedures of the Army, Navy, and Air Force are different, they generally focus on existing physical conditions, future installation conditions, future installation requirements, and proposed land use and circulation.

If the visual quality of military installations is to be improved, design procedures as well as guidelines must be incorporated into the installation master planning process. It is at the master planning level that there is an appropriate overview directed at ensuring overall coordination and compatibility among individual program needs. Formulation of an installation design guide as part of the master planning process is the proposed mechanism to guide improvement of the visual quality of a military installation. The installation design guide would provide visual design guidelines and criteria consistent with master planning objectives.

2-4. Procedure for Developing a Design Guide.

A. The development of the installation design guide would be based on the general guidelines of the **Installation Design Manual**. However, the design guide would be responsive to such locationally specific conditions as climate, prevailing architectural character, indigenous plant materials, and any other atypical installation conditions or policies.

B. An interdisciplinary design team composed of architects, engineers, landscape architects and graphic designers should develop and implement the design guide in a four-step process. This four-step process, described in detail in the following paragraphs, is a general methodology for considering visual design impacts during master planning, site planning, architectural design, renovation and maintenance of installation facilities.

- Step 1: Assess the Existing Visual Environment
- Step 2: Formulate the Design Guide
- Step 3: Implement the Design Guide
- Step 4: Evaluate and Update 8-8.

2-5.

Step 1: Assess the Existing Visual Environment.

A. Overview Visual Survey.

An overview survey should be conducted initially to assess the existing visual environment of the installation. The purpose of this survey is to evaluate the visual quality of the installation and to identify dominant visual impressions, both positive and negative.

1. Those conducting the survey should imagine themselves seeing the installation for the first time, approaching and entering main gates and proceeding to major destinations within the installation.

2. Consideration should be given to conducting the overview survey both at nighttime as well as daytime. The after dark survey can assist in evaluating signing and lighting.

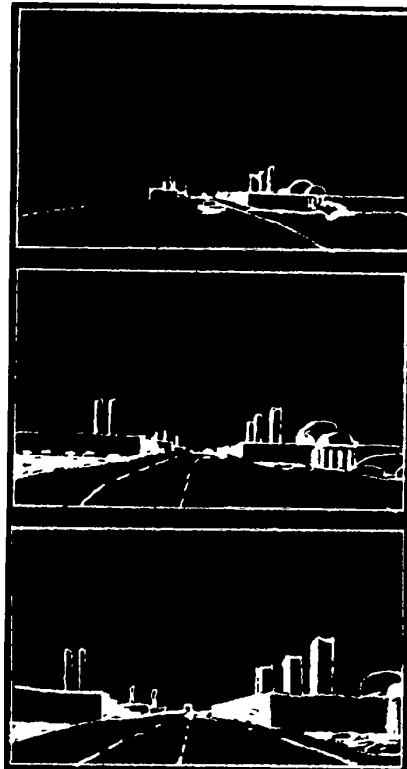

fig. 2-4.

3. Taking photographic sequences along these routes is a useful technique to document observations and to allow for a more careful study of specific elements that comprise the visual image of the installation (fig. 2-4).

4. During the survey, dominant visual impressions should be recorded on a map of the installation. A notation system can be used to record important observations such as focal points, edges, scenic views, etc. The mapping should record these elements as well as qualitative impressions such as attractive areas, streetscape clutter, etc.

B. Supplementary Visual Surveys.

Supplementary surveys directed at specific elements such as architectural character, signing, plant materials, etc., can be conducted when identified as an area of primary concern in the overview visual survey. The specific approach and level of data collection for these more detailed surveys will depend upon the particular requirements of the installation and the subject being considered. (See *Design Guidelines chapters of Part II of this manual for more detailed discussion of specific elements, especially Chapter 3: Buildings; Chapter 6: Planting; and Chapter 10: Signing.*)

C. Documentation of Findings.

The results of the visual survey should be documented in a written report with supporting graphic illustrations.

1. The report should essentially deal with the overall visual organization of the installation, its major visual assets and liabilities or problems and opportunities and any detailed visual reconnaissance of specific problem elements.

2. The graphic illustrations should clearly depict the major findings of the survey. This can be effectively done by an overlay method that locates and records major findings of the survey over a base map of the installation. Pertinent photographs and/or sketches can also be used to supplement the mapping graphics.

2-6.
Step 2: Formulate the Design Guide.

A. Goals and Objectives.

In order to develop a design guide, it is necessary to establish specific goals and objectives for improving the visual attractiveness of the installation. The specific mission, priorities, existing visual assets and liabilities, and planned changes for each installation should influence the formulation of these goals and objectives.

B. Overall Design Criteria and Guidelines.

After the design objectives of the individual installation have been established, design criteria responsive to these objectives should be formulated. These criteria should be developed for each of the major elements comprising the visual environment of the installation. Based upon these criteria, the design guide should establish overall design guidelines for the installation, including:

1. a general architectural design vernacular, indicating desired architectural character, massing, scale, materials and color palette;
2. plant materials, prototypical applications and details that are appropriate to the installation and its climate;
3. site planning and design guidelines for site systems including circulation (vehicular, pedestrian, bikeway), parking, signing, lighting and utilities;
4. a coordinated design system for site furnishings, signing and lighting.

C. Detailed Design Criteria and Guidelines.

Beyond the overall design guidelines, the scope and detail of the design guide can vary depending upon the specific needs of the installation. Initially, it could address in detail any or all of the subjects most appropriate to the installation. The design guide should be thought of as an evolving publication, where sections can be added or updated over time as needed.

D. Format.

The format of the design guide should make it easy to use, expand and update. Typically consisting of text, illustrations and photographs, the design guide should have its narrative keyed as directly as possible to its supporting graphic illustrations or photographs. A black and white, ring-bound format is recommended as an economical one that readily allows additions and updating.

E. Example.

As an example of what could be included in a design guide, the following objective, design criteria and design prototype were developed for a military installation in the Pacific Northwest.* *"Building Objective: Architectural materials should be expressive of Northwest building technology. Puget Sound is traditionally a lumber area. The centers of steel production and building component manufacturing are far away. There is, however, an abundance of concrete aggregate materials. Local clays for brick manufacturing are available but masonry labor rates are high."*

**Design Guide to Architecture, Landscape, Lighting, Graphics - Trident Support Site, (Bremerton, Washington) Department of Navy, pp 1-4, 1-6, 1-8 and 2-12*

"Building Design Criteria: It is recommended that all buildings in the core utilize architectural concrete as the basic wall material. All concrete, whether job poured or precast, should utilize warm-toned cement or color additive in order to overcome the cold grey tone, which until recently was typical of Northwest concrete, especially as viewed in wet weather."

"Site Furnishings Design Prototype: Bench (fig. 2-5): This is the basic element of the system and illustrates the proposed combination of concrete and wood. Concrete in the form of a standardized pre-cast concrete slab with 3/4" chamfered edges, incorporating light colored cement with the end product sandblasted. The concrete element forms the joint with the ground plane. Wood, treated with preservative but left unstained, is used for the seat and back. Use of oversized wood members is to achieve appropriate ruggedness and scale relationships. All edges shall be eased and all joints bolted and plugged where possible. The design is adaptable to leaving the back off for areas where short-term seating is anticipated. A wooden bench design with concrete supports or frame and contoured seat should be included for areas where a really comfortable bench is desirable."

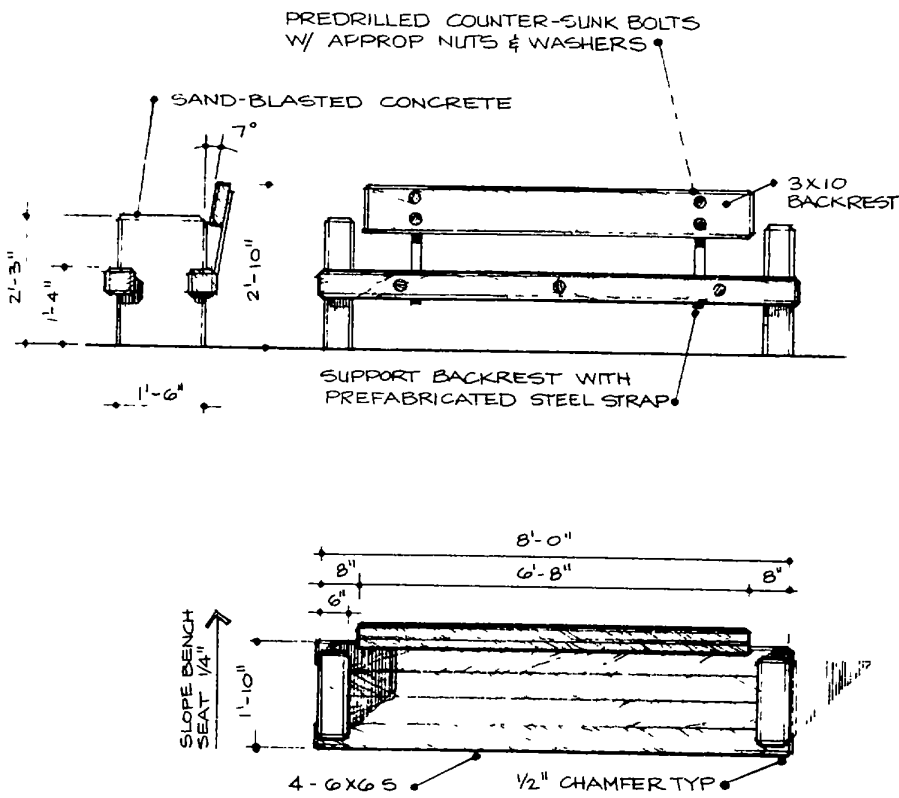

PROTOTYPE BENCH

fig. 2-5.

2-7. Step 3: Implement the Design Guide.

A. Funding.
 The plan for visual design improvements must be balanced against fiscal capabilities. Special funding may be available for certain projects, such as additional maintenance and renovation funding for designated historical structures; however, almost all of these improvements will be accomplished as part of the military construction program, and operations and maintenance funds.

B. Priorities.
 The rank ordering of the visual design goals and objectives will aid in establishing priorities. Potential projects should be evaluated as to their likely impact on these goals and objectives. Often this conscious exercise will result in modifications to or elimination of contemplated projects. Maintenance and improvement projects as well as construction projects should be evaluated in this manner.

C. Scheduling.
 Projects should be scheduled in annual work programs and phased according to their anticipated effect on all the goals and objectives of the master plan, not simply visual design considerations. Special consideration of system-wide improvements is necessary in order that the visual and functional impact of projects is not dispersed ineffectively.

D. Detailed Design and Evaluation.

Once it has been determined to include a project in an annual work program the selected architect-engineer and the responsible government personnel who serve as the client should follow the installation design guide to the greatest practical extent in both designing and evaluating the project. Furthermore, the design guide should be used by engineering, operations and maintenance personnel, and all other decision-makers who influence the visual environment on the installation.

2-8. Step 4: Evaluate and Update.

Periodically, the guidelines of the manual should be evaluated and updated relative to their effectiveness and possible changes in mission or priorities within the installation.

Part II Design Guidelines

Chapter 3. Buildings.

The image of an installation is largely determined by the design character and siting of its buildings. The objectives of the site planning and architectural design process must go beyond the need to satisfy

the functional requirements of a facility. It should strive to achieve an ordered sense of place - a comfortable, attractive and functional setting for its intended activities.

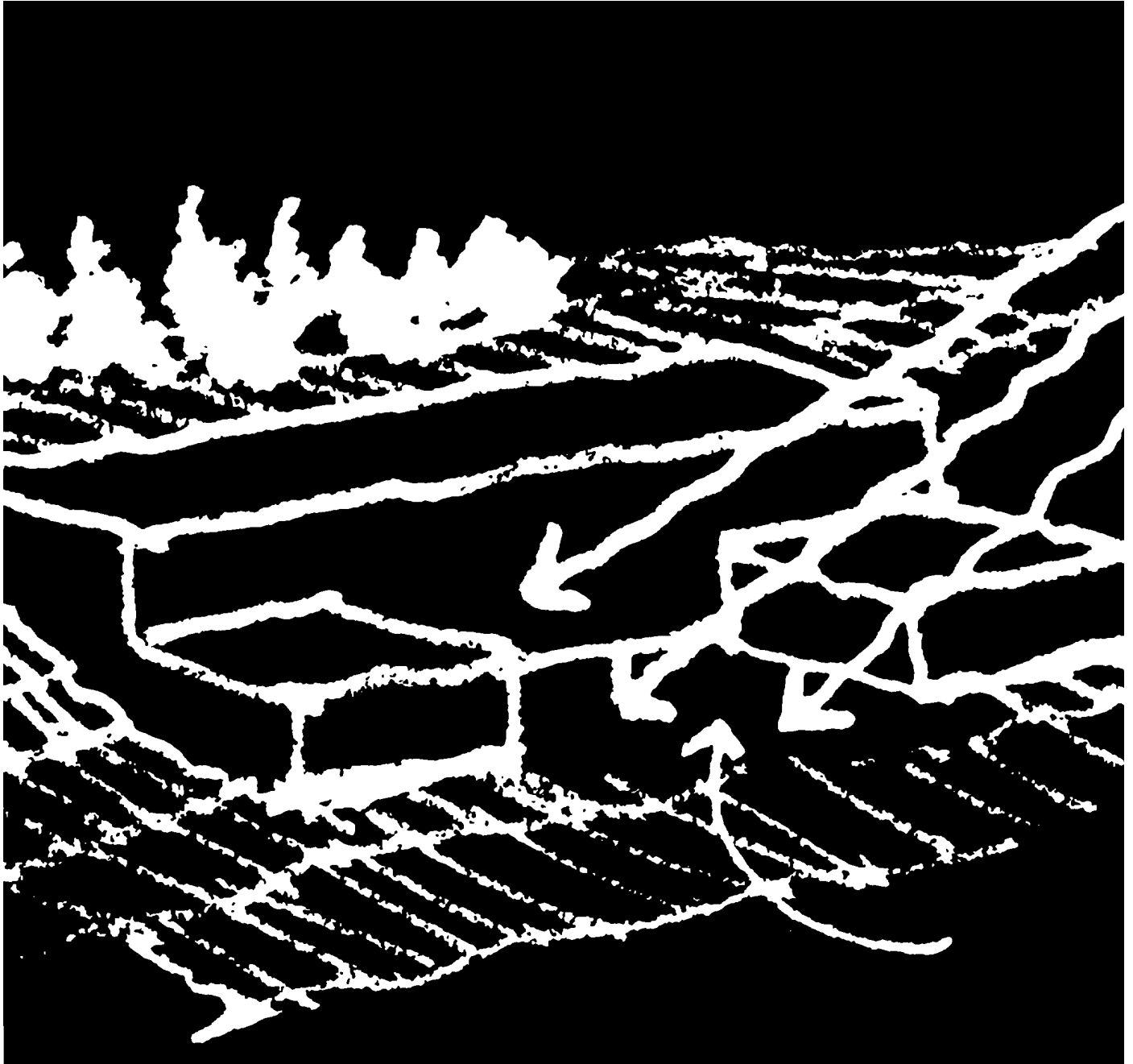

Section I:

Observations and Objectives.

3-1.

Typical Problems.

While field conditions vary considerably according to a particular installation's mission and setting, a number of common problems have occurred in the design character and siting of buildings at various installations.

A. Development Pattern.

Buildings are typically organized within a grid network of streets and utilities that can easily result in a visually monotonous development pattern and can limit facility design and expansion opportunities.

B. Design Process.

When facilities were sited on a case-by-case basis without an overall conceptual framework or master plan, a chaotic development pattern often resulted where facilities were poorly related, both visually and functionally, to each other as well as to the circulation and open space systems of the installation (*fig. 3-1*).

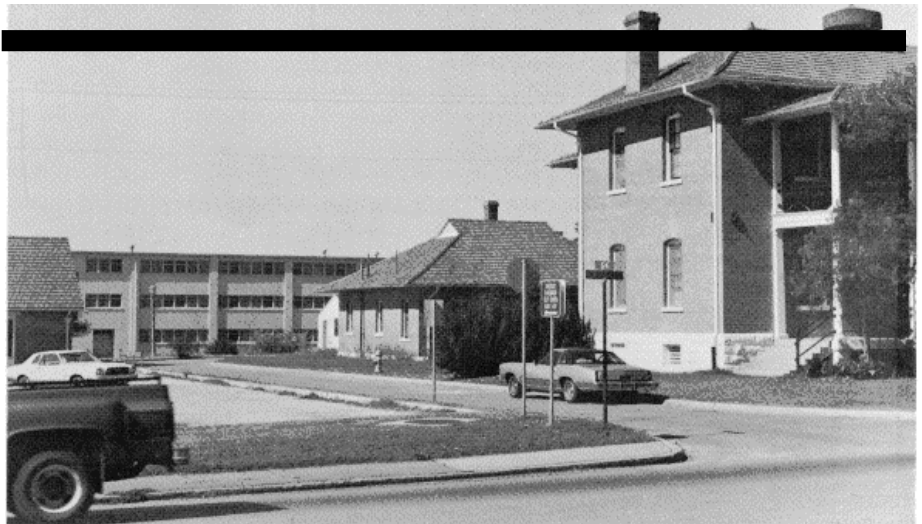

Fig. 3-1.

C. Relationship to Site Features.

Natural site features such as topography, trees and scenic views were often ignored in facility design. When properly recognized, such features can be preserved and enhanced as assets that compatibly relate facilities with their natural setting. Furthermore, environment disruption and landscape reconstruction costs can be minimized (*fig. 3-2*).



fig. 3-2.

D. Parking.

The voracious spatial demands of automobile parking and circulation commonly dominate the physical setting of facilities (*fig. 3-3*).



fig. 3-3.

E. Architectural Character.

The architectural character of new facilities is often incompatible with older development. In such cases, new buildings have either ignored the prevailing architectural character and scale of adjacent buildings or unsuccessfully attempted to relate them by some cosmetic or imitative technique. Successful examples have been accomplished by contemporary design that relates new buildings to older development by means of a compatible scale, massing, form, color and materials (*fig. 3-4*).



fig. 3-4.

F. Space between Building.

The space between buildings has often been considered "left-over" space without appropriate planting (fig. 3-5).



fig. 3-5.

G. Coordination with Site Development Components.

A lack of design coordination often exists between buildings and their site development components such as lighting, signing and street furniture.

H. Historic Preservation.

Many installations contain buildings of noteworthy historical architecture or areas of historical significance that provide an important sense of heritage. In some cases the integrity of the building or area has been damaged by either insensitive design modifications or introduction of incompatible elements into the area (fig. 3-6). Through preservation and adaptive

reuse, many of these resources can provide both functional facilities and a sense of history to an installation.

I. Climate Considerations.

Many buildings have been designed and sited with little regard to climatic conditions. Instead, there has been a heavy reliance on the mechanical and electrical systems of a building to overcome climatic conditions. Proper building orientation, building design and planting design can conserve energy as well as provide pedestrian protection and comfort from inclement weather, temperature extremes and intense sun glare (fig. 3-7).



fig. 3-6.

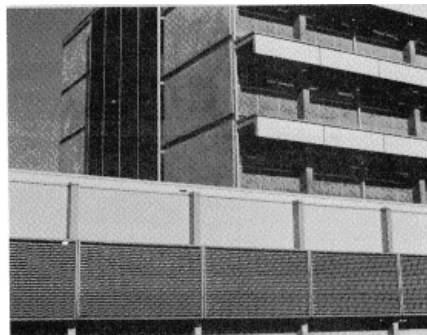

fig. 3-7.

3-2.

Objectives.

A. Adapt Building Design; to Natural Site Conditions.

1. Physiographic Features.

Respecting and using the natural environment to advantage requires careful consideration of site conditions such as topography, vegetation, tree cover, climate and views. The careful preservation, accentuation or studied alteration of natural site features enables new facilities to blend with their natural setting. Furthermore, such practices minimize plant replacement costs and negative environmental impacts of construction as well as future site maintenance problems. The destruction of the natural environment by the all too frequent development process of gross clearing, regrading to a "workable" profile, channelization of natural site drainage and then replanting should and can be avoided or minimized.

2. Climate.

Proper consideration should be given to prevailing winds, solar orientation and micro-climatic conditions. Building orientation as related to solar and wind conditions, building form in terms of shape, massing, fenestration and color, and planting can all be used to modify the adverse effects of climate. This will help to conserve energy through reduced dependence on a building's mechanical and electrical systems and to provide for pedestrian comfort and convenience.

B. Relate Buildings in Groups.

The most frequently encountered site planning problems on military installations is the planning of buildings in groups. This may involve either the fitting of a new building into the context of existing buildings or the incremental, long-range development of a planned group of buildings.

In either case, successful site planning and design requires dealing with many more factors than simply dropping the building into the center of a vacant site. Essential considerations include the organization of site access; the separation of auto, pedestrian and service traffic; the functional and visual organization of the space between buildings; the establishment of compatible scale and architectural character between buildings; provisions for anticipated growth and expansion; and the relationship of buildings to natural site features.

C. Develop a Coherent Architectural Character.

Most military installations have been developed over a long period of time. Often a new building is located among older facilities in an area with a prevailing character established by a given architectural style, material or scale. The character of the area may be the result of an historic regional style such as the Spanish Mission Style at Fort Sam Houston and the San Diego Naval Training Center. In other instances, an order has been established by a consistent use of materials, such as brick, and a similarity in massing and building height. Many factors contribute to perpetuating a coherent architectural character including scale, materials, color, massing, form, proportions, spatial relationships and supporting site components. This requires the talents of skilled architects.

A consistent and coherent architectural character fosters a "sense of order" and a "sense of place" within an installation. It is an important visual attribute to be carefully guarded and perpetuated by future development.

D. Preserve Historic Building and Areas.

Recognition and preservation of an installation's historical areas and architecture are important aspects of installation design and help foster and instill a sense of heritage among military personnel and civilians alike. In addition, these facilities provide an element of visual interest and variety. Maintaining an appropriate setting for these historic facilities is essential in preserving their visual integrity. These facilities often offer opportunities not limited to historic display, such as adaptive reuse of their interior space as functional facilities.

Section II:

Design Guidelines.

3-3.

Establishing and Implementing Architectural Guidelines.

Every installation should develop its own architectural guidelines to promote a coherent architectural character that provides visual order, clarity, interest and human scale within the installation. These architectural guidelines should be specific enough to assure basic harmony and coordination of architecture, yet flexible enough to promote variety and visual interest. Employ the following general process to establish architectural guidelines for an installation:

A. Assess the Existing Architectural Character.

Initially, the architectural character of most existing buildings within the installation should be identified and analyzed. This can be accomplished by a visual survey and background research conducted by a trained architect or team of architects, documenting their findings on a survey form, maps and photographs. The architectural style, historical or architectural importance, exterior condition and alterations of these buildings should be determined. In addition, the compatibility of each

building with its setting should be evaluated in terms of building form and height, materials, color and architectural details. Architecture of merit as well as areas of coherent architectural character and interest should serve to establish a prevailing architectural character upon which the architectural guidelines are to be based.

B. Evaluate Other Architectural Determinants.

Architectural guidelines should also be based upon other factors influencing the architectural character of the installation. These factors include climate, land form, landscape character, contemporary building technologies and economics of the area.

C. Formulate Architectural Guidelines.

Based upon the prevailing architectural character and other architectural determinants, architectural guidelines should be developed for the installation. These guidelines should specify the general architectural style, massing, form, materials, colors and details for new as well as renovated facilities. These architectural guidelines can be developed at three levels of detail:

1. overall guidelines governing the entire installation,
2. general guidelines for functional subareas or districts within the installation, and
3. specific design guidelines and criteria for a particular facility or building complex.

D. Implement Architectural Guidelines.

The architectural guidelines should be complemented in a twofold manner. First, they should serve as design criteria for architects under contract to prepare design plans for new or renovated facilities. Second, they should serve as evaluation criteria for military personnel responsible for overseeing the design of these new or renovated facilities.

Consideration can also be given to establishing a Design Review Board composed of government personnel and/or independent design consultants who would be responsible for reviewing design proposals and suggesting modifications prior to final approval of the design plans.

3-4. Adapt Buildings to Natural Site Conditions.

The site planning and design of buildings should relate harmoniously to the landscape character and climatic conditions.

A. Landscape Character.

Apply the following principles to minimize adverse impacts on the existing site (figs. 3-8 and 3-9).

fig. 3-8.

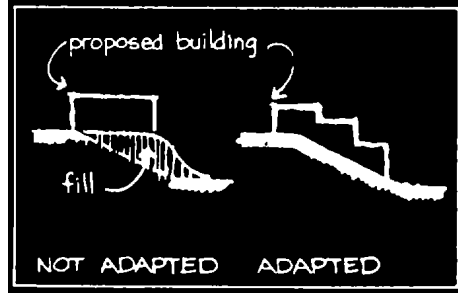
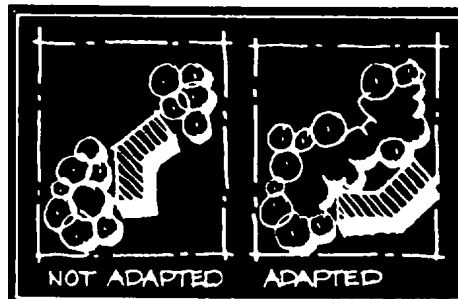

fig. 3-9.

1. Inventory existing natural terrain, vegetation and views prior to formulation of a site development concept.

2. Preserve, enhance and use advantageously such natural site features as mature trees and vegetation, terrain, and topographic features and scenic views and vistas.

3. Locate facilities that have expansive building types and parking requirements on relatively flat terrain. Generally, these are site areas with less than 6% slope gradients (fig. 3-10).

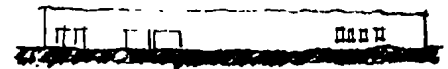

fig. 3-10.

4. Use moderately sloping (6 to 15% slope gradient) areas for residential or other less expansive building types that can adapt to the sloping terrain (fig. 3-11).



fig. 3-11.

5. Avoid development in steeper slope (greater than 15% slope gradient) areas where adverse environmental impacts and development costs begin to escalate dramatically.

6. Avoid development in natural drainage ways and flood plains; land uses for flood plain areas should be limited to open space preserves and outdoor recreation facilities.

7. Provide a reasonable balance of cut and fill.

8. Provide adequate continuous slopes for all parts of the site not occupied by buildings. These slopes should be graded to drain toward streets or natural drainage courses to keep to a minimum the number of required storm drains. Grassed slopes away from buildings should be a minimum of 6 inches vertical for a horizontal distance of 10 feet.

B. Climate.

Site and design buildings in response to the local climate to provide a comfortable setting for outdoor activities and to conserve energy by lessening the demands on the heating and air conditioning systems of a building. General guidelines for the siting and design

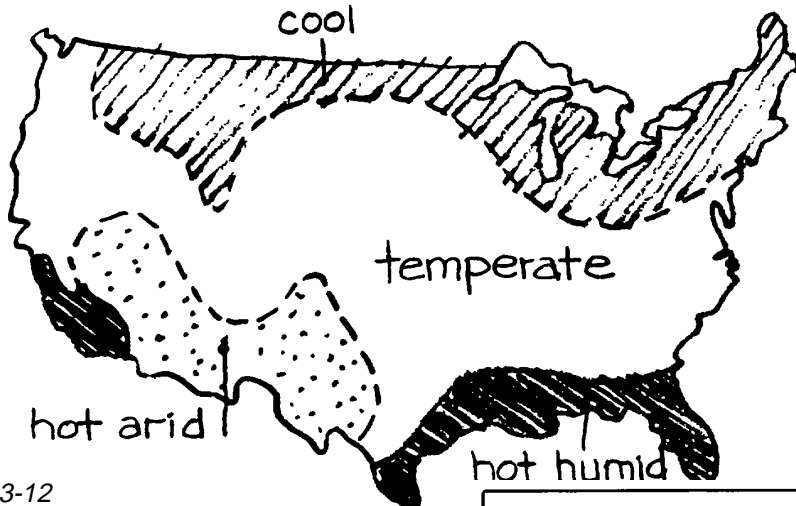

fig. 3-12

of buildings in various climatic regions are set forth below. Figure 3-12 illustrates the general extent of the four major climatic regions within the continental United States.

1. Cool Regions. Design and site buildings primarily for winter heat conservation by maximizing the warming effect of solar radiation in winter and reducing the impact of cold winter winds.

a. Utilize south and southeast facing slopes.

b. Orient active outdoor pedestrian areas of the building to the south.

c. Create protected sun pockets for outdoor pedestrian areas (fig. 3-13).

d. Utilize medium colored building surfaces exposed to the sun and dark colors on recessed surfaces to absorb solar radiation.

e. Use generous south facing windows to capture warming solar radiation within the building interior.

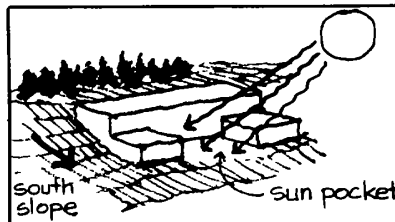

fig. 3-13.

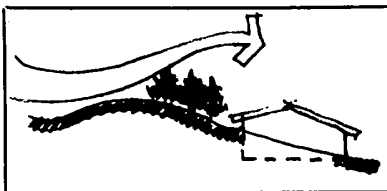

fig. 3-14.

f. Locate buildings on the leeward side of hills in the "wind shadow" (fig. 3-14).

g. Use the natural insulation of the earth where possible, such as building into hillsides, to reduce winter heat loss (fig. 3-14).

h. Use evergreens, earth berms or mounds and walls to provide winter wind screening of northern facing building walls.

i. Minimize unshielded window areas on exposed northern facing walls that face prevailing winter winds.

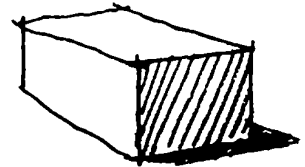

COMPACT

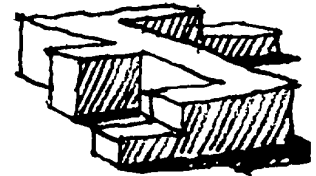

NOT COMPACT

fig. 3-15.

j. Minimize the extent of a building's exterior surface area by consolidating buildings or building masses into a compact configuration (fig. 3-15).

2. Temperate Regions.

Design and site buildings to balance the effects of seasonal thermal variations, promoting both winter warming and summer cooling in terms of seasonal solar orientation and prevailing wind direction.

a. Use deciduous trees to the east and west that allow penetration of warming winter sun but shade from the hot summer sun (fig. 3-16).

b. Utilize roof overhangs that shield window areas on south facing walls from the higher summer sun but admit the lower winter sun (fig. 3-17).

c. On higher buildings, sun shades can be used to control summer sun: horizontal sunshades over south facing windows, eggcrate type sunshades over east and west facing windows, and vertical fins on north facing windows are most effective.

fig. 3-16.

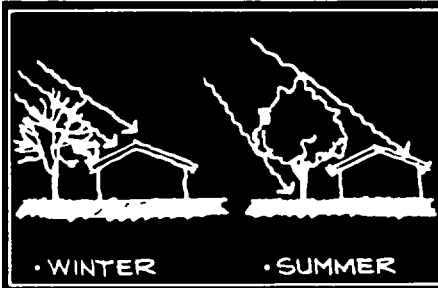

fig. 3-18.

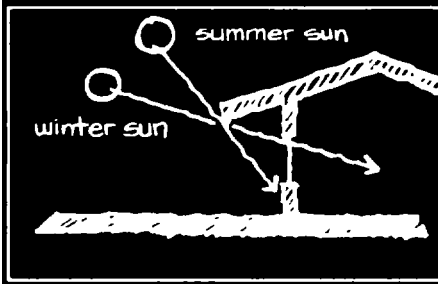
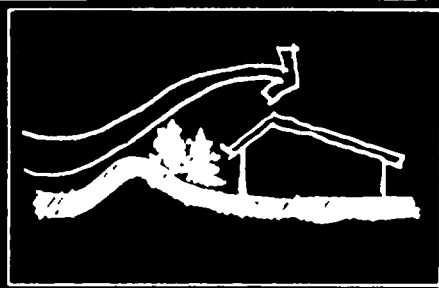

fig. 3-17.

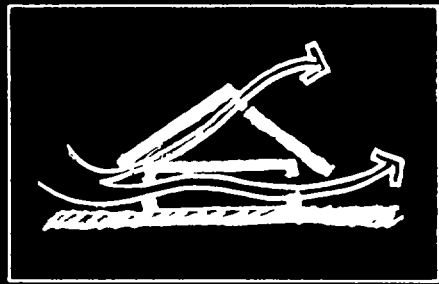

fig. 3-19.

d. Use medium color surfaces on exterior walls to balance the need for summer reflection and winter absorption of solar radiation; use light colored roofs to reflect summer sun; use dark absorbent colors only in recessed places protected from summer sun.

e. Use steeply pitched roofs on the winter windward side to deflect winter winds and reduce the exposed roof area directly facing winter winds (fig. 3-18).

f. Protect building walls exposed to winter winds with evergreens, earth berms or mounds, fences, walls or outbuildings such as garages or storage sheds that can serve as wind screens (fig. 3-18).

g. In appropriate buildings that will not be air conditioned, encourage cross ventilation and roof ventilation by prevailing summer breezes for cooling during hot summer months. This can be accomplished in terms of building orientation and window placement, roof and gable ventilation and planting based upon prevailing summer breezes (fig. 3-19).

3. Hot Arid Regions.

Design primarily to minimize building heat gain by solar radiation while maximizing shade and encouraging humidity in outdoor spaces around buildings.

a. Utilize densely arranged and shaded layouts of buildings, compact building shapes and shaded walkways and courtyards (fig. 3-20).

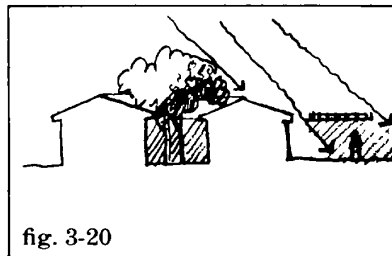

fig. 3-20

fig. 3-20.

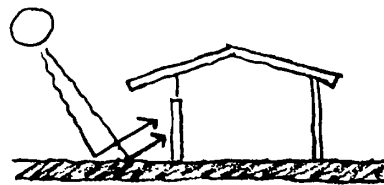

fig. 3-21.

b. Avoid paved ground surfaces which hold heat and produce sun glare (fig. 3-21).

c. Use light colored walls and roofs that reflect solar radiation; use dark colors under overhangs to reduce solar reflection into building interiors.

d. Shelter windows from direct solar radiation with sunshades, roof overhangs and plants; avoid east and west facing windows that are difficult to shade from low sun angles; set windows high in walls to avoid ground-reflected solar radiation.

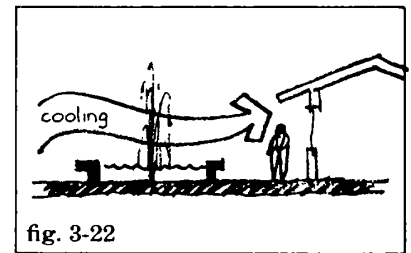

fig. 3-22

fig. 3-22.

e. Incorporate water features in site development concepts to maximize humidity and the cooling effects of evaporation from water (fig. 3-22).

f. Utilize dense overhead planting to provide shade, slow evaporation and hold humidity near ground level (fig. 3-23).



fig. 3-23.

g. Minimize paved areas and maximize planted ground covers to promote humidity and reduce solar reflection and glare.

4. Hot Humid Regions.

Design primarily to minimize building heat gain by solar radiation while promoting air movement and cross ventilation for comfort from humidity.

a. Maximize shade throughout the day, both to reduce solar radiation and sun glare.

b. Use window sunshading devices that provide protection from solar radiation but encourage air flow; minimize east and west facing walls and windows where solar control from low sun angles is difficult (*fig. 3-24*).

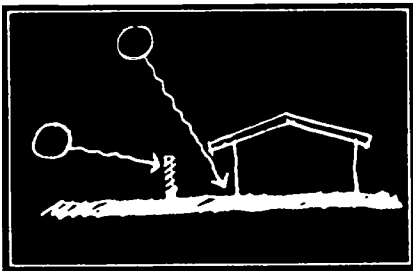

fig. 3-24.

c. Use roof overhangs for sun screening, rain and sun glare protection; utilize trellises as effective sun and glare control devices.

d. Utilize light colored roofs to reflect solar radiation.

e. Shade outside walkways with trees, building canopies or arcades.

f. Encourage closely located but physically separated building arrangements that promote air movement between buildings.

g. Orient streets and buildings to maximize cooling breezes; use vegetation to channel cooling breezes (*fig. 3-25*).

h. In non-air-conditioned buildings maximize roof ventilation and cross ventilation of living and working spaces.

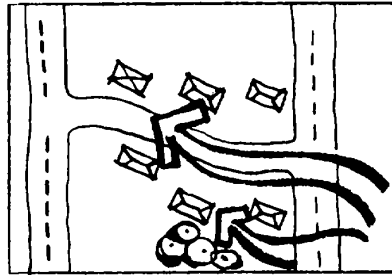

fig. 3-25.

i. Maximize openings and windows that promote cross ventilation.

j. Select building sites near the crest of hills or on the windward side or ridges to maximize wind flow.

k. Use high branching site vegetation that provides shade but allows passage of cooling breezes near ground level; avoid low vegetation that blocks air movement into and around buildings (*fig. 3-26*).

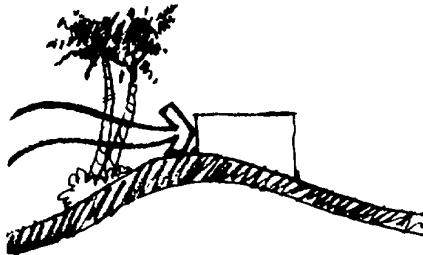

fig. 3-26.

3-5.

Relate Buildings in Groups.

Buildings that are located in groups should have strong visual and functional interrelationships. The design process of establishing compatible relationships between buildings in groups may entail either integrating a new building into an existing group of buildings or designing a totally new group of buildings that may be implemented at one time or in a phased development sequence.

A. Site Organization

The design of new buildings that are to become part of a group of buildings should be based upon an overall site development concept with adequate provisions for future flexibility and expansion.

1. Overall Site Development Concept.

Establish an overall site development concept that provides the framework within which individual buildings can be compatibly integrated and coordinated with other buildings and associated site development (*fig. 3-27*).

a. Carefully inventory existing site conditions, land suitability, buildings, parking, circulation, utilities and open space systems and climate prior to formulation of a site design concept.

b. Formulate a development program that includes: building space requirements; access requirements for pedestrians, vehicular and service traffic; parking requirements; adjacency requirements with other buildings; and utility service requirements.

c. Coordinate circulation and parking that serves the entire building group.

d. Coordinate the open space network of the building group with the overall open space system of the installation.

e. Formulate the general location, massing and orientation of new buildings in response to their program requirements and desired relationship to other buildings, site circulation systems, parking, open space, natural site features and climate.

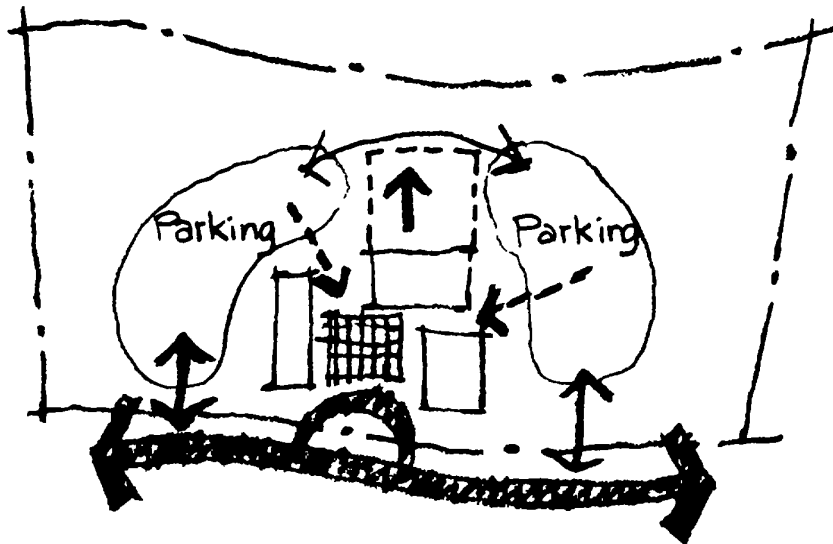

fig. 3-27.

2. Expansion Capability.

Anticipate future expansion needs of buildings in groups and incorporate them into the site development concept.

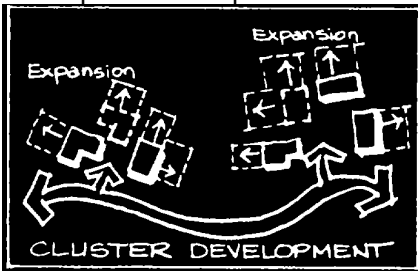

fig. 3-28.

a. Consider a cluster development pattern that can facilitate efficient use of land and preserve vacant land for future expansion of facilities (fig. 3-28).



fig. 3-29.

b. Consider future horizontal expansion for buildings such as company administration facilities (fig. 3-29).

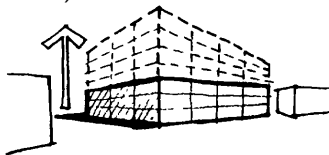

fig. 3-30.

c. Consider vertical expansion of buildings to preserve open space or adjacent buildings. Vertical expansion of buildings tends to be more costly and disruptive of existing building operations than horizontal expansion and requires the provision of adequate structural design, future parking and utilities (fig. 3-30).

d. Consider conversion of surface parking lots to multi-level parking structures to provide for building expansion when land is scarce and the intensity of new development can off-set the additional costs of the parking structure (fig. 3-31).

e. (consider vacating unnecessary streets or modifying the road network to make available space for building expansion within street right-of-ways. Careful attention must be given to any underground utilities within the vacated rights-of-way which can be costly to relocate.

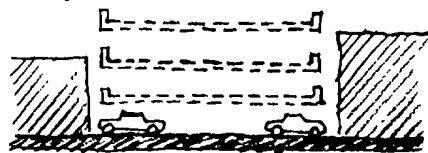

fig. 3-31.

3. Security Requirements.

By considering security requirements in the early phases of site planning, expensive and unsightly future modification can often be avoided. Use of natural barriers and the integration of security measures into facility design can minimize the necessity for obtrusive solutions, such as barbed wire fences, barricaded entrances and barred windows.

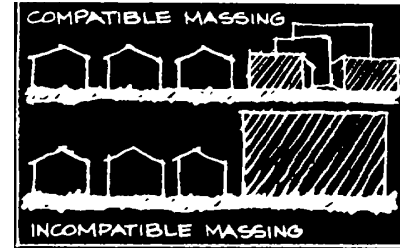

fig. 3-32.

B. Site Design.

Relate buildings compatibly in groups by means of site design that sensitively interrelates building forms and massing, open space between buildings, site circulation systems and site edges. (See TM 5-812-1 for minimum required space between buildings.)

1. Massing. The massing of a building refers to its overall bulk, or the volume of space which the building encloses. When massing a new building, the size and proportion of its exterior envelope and elevations should be designed to relate compatibly with adjacent structures. A large facility can be made to better relate to existing smaller facilities by dividing its mass into smaller components to create a building elevation that is more compatible or complementary, in terms of its size and proportions, to the adjacent structures. This is accomplished by manipulating the configuration of the floor plan and/or building height to break down the mass of the building into smaller elements (fig. 3-32).

2. Form. A building's form is an articulation of its basic massing and is characterized by shape and silhouette that should be employed to compatibly relate adjacent buildings. The size and proportion of a building's elevations and its roof are the primary form-giving characteristics that are important in relating a new building to its setting. In terms of their basic form, new buildings should be contemporary architectural expressions that adhere to and are evocative of the prevailing architectural forms of adjacent buildings. Similar forms should be employed not only to relate new buildings to adjacent structures

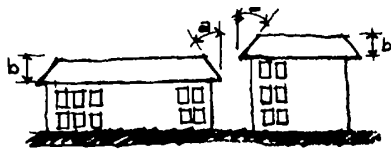
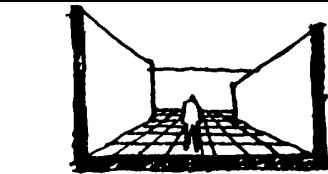

fig. 3-33.

but also to contribute to the overall architectural coherence of the installation (fig. 3-33).

3. Open Space. Create outdoor open spaces between buildings that relate buildings together and convey an appropriate scale, character and quality for their intended use. (See Chapter 7: Plazas and Courtyards.)

a. Enclosure. Use buildings and planting as elements of spatial enclosure to visually define and contain outdoor space. The degree of enclosure that is conveyed is determined by the type and number of containing sides that define the space, their distance apart and their height. The nature and extent of enclosure can be used to orient or direct people, to create a distinct sense of place or to create a transitional space between the built and natural environment (fig. 3-34).



SENSE OF PLACE

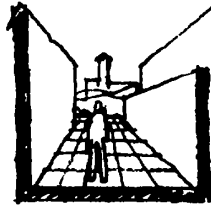

SENSE OF ORIENTATION

fig. 3-34.

b. Scale. Use the scale or size of an outdoor space as defined by buildings and planting to reinforce its intended use and desired character. Large outdoor spaces between buildings, especially symmetrical ones, tend to be formal and ceremonial in character, while smaller spaces convey a more personal and intimate setting (fig. 3-35).

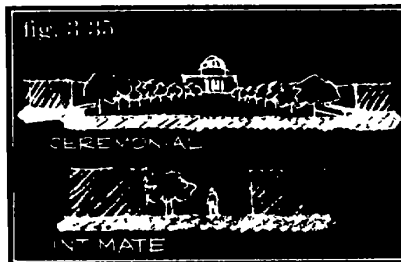

fig. 3-35.

c. Spatial Sequence. Modulate outdoor spaces between buildings, through variations in their volume and sense of enclosure, to provide a more interesting visual experience and identifiable

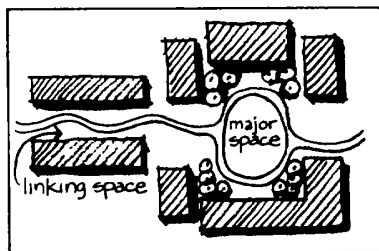

fig. 3-36.

hierarchy of spaces with within the group of buildings (fig. 3-36). An ordered sequence of outdoor spaces can provide a valuable sense of orientation, while discontinuous or maze-like sequences may be confusing and disorienting.

d. View Framing. The grouping of buildings can frame views, orient people to building entrances, or accentuate a key facility, landmark or dramatic vista (fig. 3-37). These views created by the arrangement of buildings and open space are important aspects of the visual quality of the environment that can be employed not only for visual interest but also to provide a sense of orientation for people using the facilities.

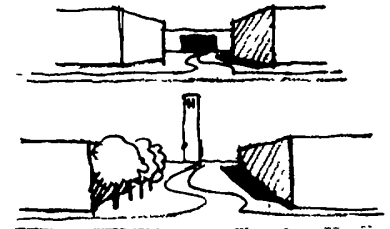

fig. 3-37.

4. Circulation and Parking.

Coordinate circulation systems and parking to relate buildings in groups.

a. Provide a balanced and coordinated circulation system to serve a group of buildings, including walkways, bikeways, automobile and service traffic. (See Chapter 4: Roads; Chapter 8: Walkways; and Chapter 9: Bikeways.)

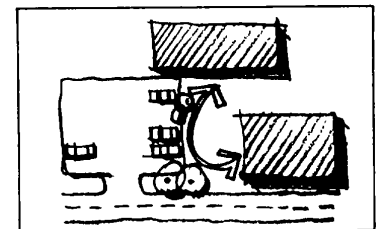

fig. 3-38.

b. Provide direct pedestrian connections between buildings, avoiding walkways that cross roads or parking lots (fig. 3-38).

c. Locate all building loading docks off-street and out-of-sight of main roadways and building entrances; employ appropriate fencing and/or planting to screen loading docks from adjacent buildings or areas (fig. 3-39).

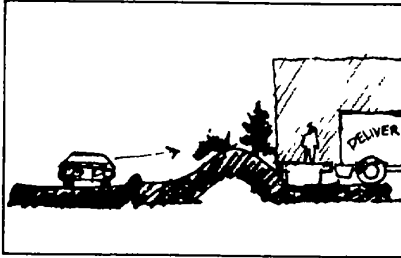

fig. 3-39.

d. Provide attractive and convenient parking by coordinating all parking that serves the group of buildings. (See Chapter 5: Parking.)

e. Prevent parking from dominating the visual setting of buildings in groups, especially from



fig. 3-40.

main roadways and other primary public viewing areas (fig. 3-40).

5. Site Edges. Provide appropriate and consistent landscape edge planting between offstreet parking facilities and main roadways, between pedestrian and vehicular-oriented areas, between different building groupings or land use areas, and along the perimeter of the installation. (See Chapter 6: Planting.)

a. Use plant materials as a transition or edge treatment between compatible adjacent facilities or to define and channel pedestrian traffic along a walkway.

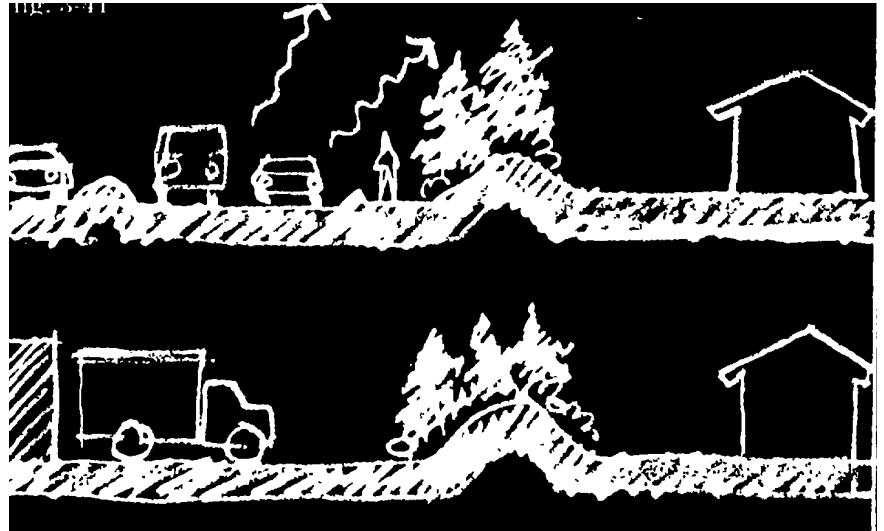

fig. 3-41.

b. Use a dense evergreen buffer area or planted earth berm for site edges where visual screening is needed, such as between visually incompatible facilities and land use areas or between parking areas and a building or street (fig. 3-41).

c. Use an earth berm or a solid wall combined with an open space buffer of dense planting, especially evergreens, for site edges where acoustical buffering as well as visual screening are necessary, such as between a major roadway and a residential area. (TM 5-803-2, NAVFAC P-970 and AFM 19-10 provide a comprehensive discussion of noise reduction techniques.)

d. Use a dense evergreen edge treatment where windscreening from chilling winter winds is desired, such as along pedestrian walkways.

e. Use fencing and walls at site edges only where essential for visual screening, security or acoustical buffering and where space does not permit landscape screening (fig. 3-42)



fig. 3-42.

C. Architectural Fenestration.

Building facades in terms of window and door openings and related details are defined as architectural fenestration. Design elements that can create a compatible fenestration treatment include scale, materials, color and rhythm.

1. Scale. Proportion and detail a building's exterior fenestration to the scale of adjacent buildings. Scale is conveyed by the fenestration of the building facade, where doorways, windows and other details enable people to gage its relative size and character in relationship to the size of the human body.

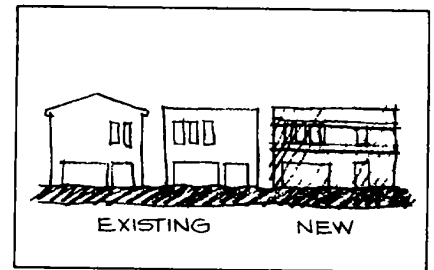
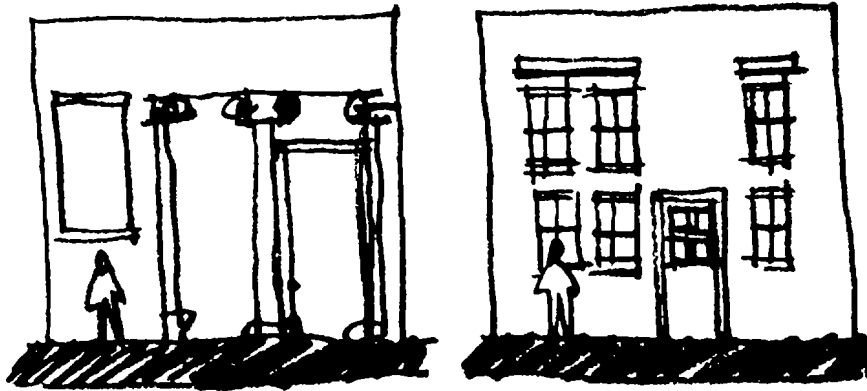

fig. 3-43.

a. When relating a new building to its setting, it is important that its design conveys a sense of scale that is compatible with adjacent buildings (fig. 3-43).



MONUMENTAL

HUMAN

fig. 3-44.

This can be accomplished by fenestration that is similarly sized and proportioned in terms of floor heights, window openings and strength of details.

b. Larger building facades with over-sized fenestration elements tend to create a more monumental scale while smaller buildings with more finely detailed fenestrations tend to create a more human scale (fig. 3-44).

c. Blank wall treatments tend not to convey scale, while building elevations with detailed fenestrations created by windows and relief, accentuated by shadow lines or color, convey a strong sense of scale (fig. 3-45).

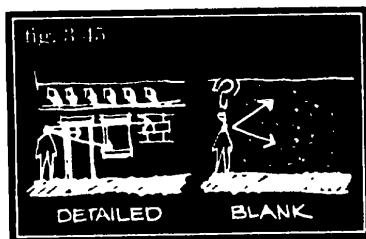

fig. 3-45.

2. **Materials.** Exterior building materials should provide a cohesive and consistent architectural character. If existing buildings have an architectural style worthy of merit, all future new construction should be compatible to that style.

a. Types of materials selected should vary with climatic conditions, thermal qualities, reflectivity and durability.

b. A cluttered, cosmetic application of a number of different materials on a facade should be avoided. Materials should be used consistently on all facades of a building.

c. Materials should be selected based upon their appropriateness to the building type, climatic conditions and the prevailing architectural design and landscape character of the installation. Wood, masonry and stucco tend to be the most appropriate materials for residential uses; masonry, steel, aluminum, concrete and glass tend to be the most appropriate materials for administrative or educational uses; masonry or steel frame with infill materials tend to be most appropriate for industrial uses.

d. Materials distinctive to an established architectural character worthy of merit should be adhered to consistently throughout an installation. Deviations from established materials should not be allowed without good reason.

However, economies. The use of similar materials, complementary colors and a compatibly scaled building can successfully relate new buildings to an historic style or setting.

3. **Color.** Relate buildings with compatible and complementary colors. Color is closely linked to the appropriate selection of exterior building materials and is a critical design element in relating adjacent buildings and creating a compatible visual environment within an installation.

a. In general, colors should be integral rather than applied to exterior building materials. Avoid surfaces that require costly periodic repainting.

b. Colors should be selected on the basis of the desired appearance and attractiveness of the building, its compatibility with adjacent building colors and the prevailing color scheme of the architectural and natural landscape character of the installation.

c. Colors should also be carefully selected for their ability to modify climatic conditions. Generally, light-colored building exteriors tend to reflect solar radiation and promote heat loss, but increase glare; dark-colored exteriors tend to absorb solar radiation, promote heat gain and reduce glare.

d. Exterior building colors should be limited in number and controlled by an established color palette for use throughout the installation. This palette should specify a limited number of coordinated and complementary colors that are subdued and harmonious.

e. Strong, loud colors should generally be avoided and used only for special identification purposes; where

they are employed they should not dominate or overpower the visual character of the setting.

f. Colors can be used to evoke an historical or regional architectural style that should be employed only where appropriate. Examples of this are the white stucco with red tile roof of the Spanish mission style in San Diego, subdued earthtones (hues of brown, soft green and beige's) associated with the Victorian era, and pastels associated with tropical architecture (pale violets, purples, greens and pinks). (See TM 5-807-7, *Color For Buildings*.)

fig. 3-46

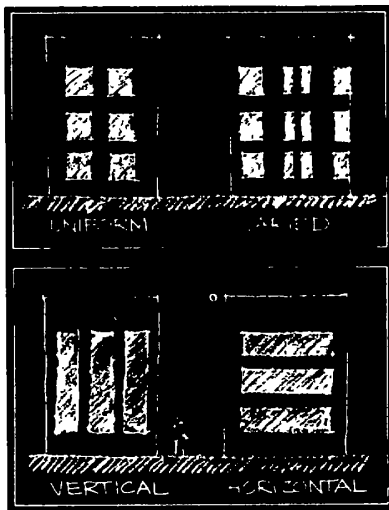

fig. 3-47.

4. Rhythm. Use the visual rhythm created by a fenestration design to compatibly relate buildings in groups.

a. Rhythm refers to the visual pattern or sequence of solids and voids that is created by structural expression, fenestration and shadow, lines along a building facade as well as the sequence of building masses and open space

between buildings. The pattern of this rhythm may be either uniform or varied as well as vertical or horizontal in accent (*figs. 3-46 and 3-47*).

b. The visual rhythm established by existing buildings should be recognized and utilized as a design tool to integrate a new building with its surroundings.

3-6.

Develop a Coherent Architectural Character.

A compatible and coherent overall architectural character should be promoted within an installation. Buildings within an installation should be designed within a common architectural vernacular or design vocabulary that promotes a coherent physical appearance, character, image and identity to the installation.

A. Derivations of a Coherent Design Character.

Establish architectural guidelines that specify a general design vocabulary for all buildings within the installation. The formulation of these guidelines should be derived from the following considerations as they relate to establishing a coherent massing, form, scale and materials among buildings within the installation.

1. Landscape/Landform

Character. The natural site character of the installation in terms of its terrain and vegetation may lend itself to a particular character of development and architecture.

2. Urban/Rural Context.

The general character of development within the installation, in terms of its intensity of land use, indicates a type and scale of development pattern and architecture that can range from

dense and urban to sparse and rural. The guidelines should specify a desired character or transition in character among facilities within the installation.

3. Climate. The climate of an installation should heavily dictate an appropriate character of development and architecture that is conducive to user comfort and energy conservation.

4. Prevailing Regional Architectural Character.

A regional architectural character that has historically developed in response to the climate, natural setting and available building materials of the region can provide a useful model for establishing the overall architectural guidelines for the installation.

5. Prevailing Architectural Character of the Installation.

The installation's prevailing architectural character may serve as the practical basis for establishing the guidelines for a coherent architectural character within the installation.

B. Design Applications.

Establish a coherent overall architectural character within the installation that can apply both to new building design and the renovation of existing buildings.

1. New Building Design.

Design new buildings to promote a coherent architectural character by means of a compatible contemporary architectural design expression.

a. Avoid trite cosmetic application of stylistic elements that allude to the architectural style of older installation buildings.

b. Encourage variety that is compatible with the overall character of the installation; avoid promoting a rigidly

homogeneous and monotonous architectural character.

c. Avoid prefabricated or modular prototype building systems whose designs are out of context with the natural setting or architectural character of the installation; utilize only those building systems that can be adapted compatibly to the site and architectural character of the installation. Where procurement schedules or economics dictate the use of these building systems, select those of compatible design, scale, color and materials. Consider the use of plant material and screening walls to lessen any negative visual impact of these building systems.

d. Installation planners should be particularly cognizant of the design and construction of community centers. There are usually two or more design and construction activities involved in the development of a community center, each with individual funding sources and methods of procurement. Considering this, each installation should establish architectural, site and functional standards very early in the planning of a community center. Coordination must be accomplished by an installation planner to ensure the standards are observed. Differences between designers should never result in deviations from the objective of a unified design for the community center.

2. Renovation of Existing Buildings. Consider design modifications that are harmonious with the desired overall visual image and character of the installation.

3-7 Preserve Historical Buildings and Areas.

The visual integrity of historically noteworthy buildings and areas on military installations must be maintained and preserved. (TM 5-801-1 and TM 5-801-2 provide specific guidance.)

A. Types of Noteworthy Facilities.

There are three categories of noteworthy buildings and areas which should be preserved.

1. Historical Architecture.

Buildings that are noteworthy from an architectural point of view and are examples of a particular style or period.

2. Historical Places. Buildings and areas that are noteworthy from an historical point of view because a significant event in national or military history occurred there.

3. Other Historical Facilities. Buildings that are less noteworthy from either an architectural or historical point of view, but are still usable and functional facilities that also provide visual interest and a sense of heritage to the installation.

B. Preservation Techniques.

Utilize appropriate preservation techniques to maintain the visual integrity of historically noteworthy buildings or areas and coordinate these with appropriate funding programs for repair, renovation or replacement.

1. Conservation is appropriate for buildings which are physically sound and have their original design integrity and value that

require only maintenance, such as cleaning, repointing or repainting, to preserve their good condition.

2. Renovation is applicable to buildings that require general upgrading of either their exterior or their interior.

3. Rehabilitation is applicable to buildings which have deteriorated or are economically and functionally outmoded, and require modernization of electrical, mechanical and structural elements to extend their useful life.

4. Restoration is applicable to structures of noteworthy historic, architectural or aesthetic importance whose integrity has been lost or covered up and must be restored to achieve their original appearance; this may require either full or partial restoration of either their interior or exterior.

5. Adaptive reuse is a form of rehabilitation whereby structures are converted from their original use to an entirely new use which is productive or practical.

6. Reconstruction or replication refers to structures that are recreated from original designs to portray some historical setting or to serve as an historical museum or display.

C. Preservation Guidelines.

Use the following procedures and treatments to preserve the visual integrity of historically noteworthy buildings or areas.

1. Inventory and document significant or noteworthy historical architecture and settings within the installation. (Required by *Executive Order 11593*, May 1973.)
 2. Preserve and appropriately use historic buildings or settings within the installation.
 3. Avoid alterations that detract from the design integrity of historic buildings and their setting, such as inappropriate building modifications and intrusion of incompatible uses, buildings or structures into their setting.
 4. When altering an historic structure, try to retain, uncover and/or restore as much of the original materials, details and design character of the building as is feasible; when introducing new parts or mixing old with new elements on the building exterior, it is essential to preserve the original design character. This should be accomplished by obtaining competent professional design assistance.
 5. Avoid imitative designs when introducing new buildings within the setting of historic buildings; encourage contemporary designs that are compatible with the old in their scale, form and use of materials.
 6. Encourage adaptive reuse of historic buildings as an economical means of providing functional space while providing a sense of heritage to the setting of the installation.
-

The vehicular circulation system provides not only a primary means of on-site access but also a primary vantage point along which people see an installation. In most cases, the road network is historically predetermined. While the existing road network may be functionally deficient, it may be costly and difficult to change because of the land uses, buildings

and utilities which have been located in response to its alignment. However, much can be done to improve the road network, both functionally and visually. Functionally, a hierarchical network can be created that separates incompatible types of traffic and promotes energy efficiency. Visually, this hierarchy can be reinforced to promote a better

comprehension, sense of orientation and ease of circulation for the motorist as well as a more attractive streetscape. (For guidance on road construction details and geometric design criteria, see *TM 5-822-2*; *AFM 88-7, Chapter 5*; and *NAVFAC DM-5 Series*.)

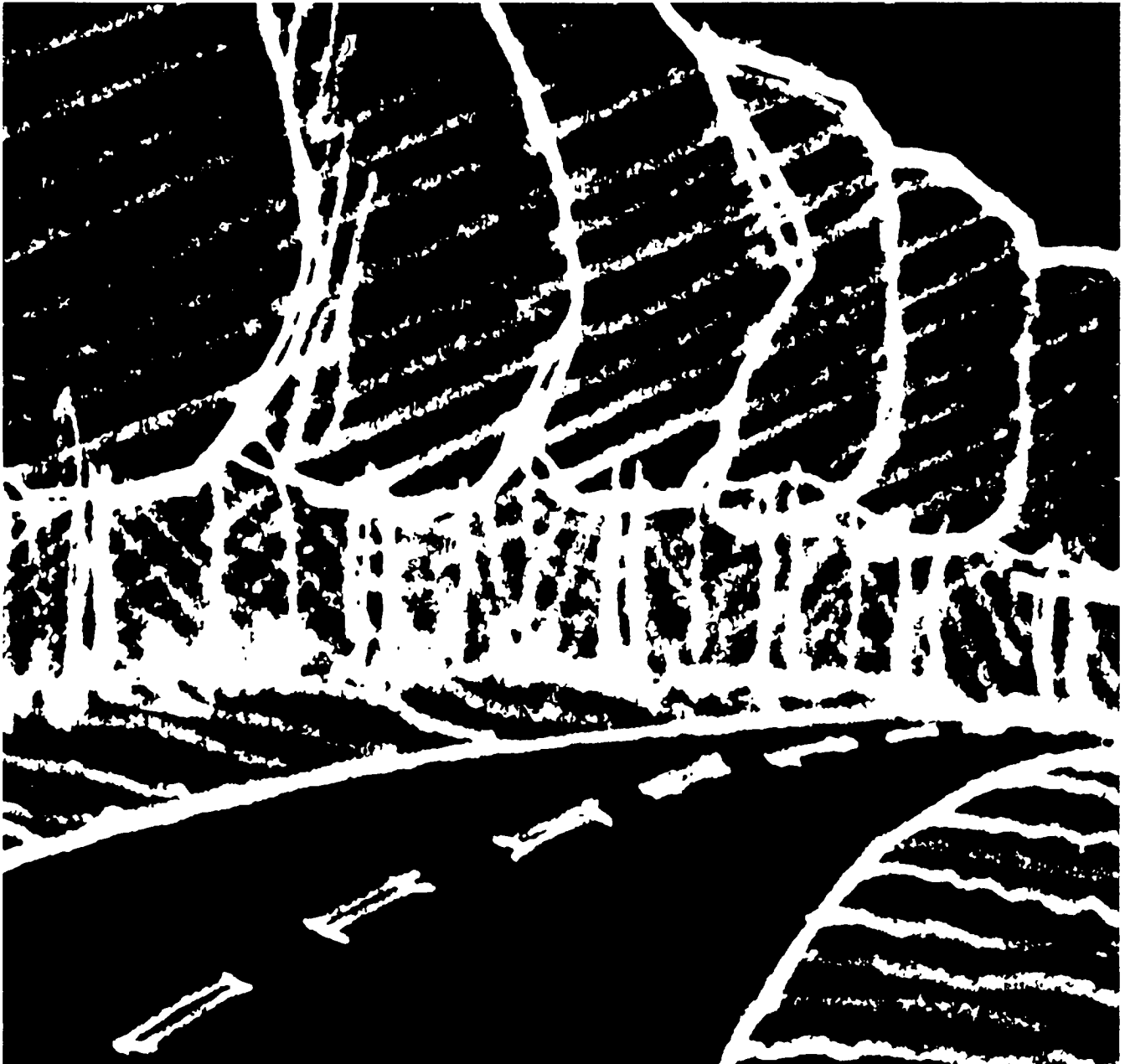

Observations and Objectives.

4-1. Typical Problems.

A. Road Network.

Most installations typically have a grid network of streets. However, strict adherence to this grid network often neglects natural site features and can constrain building design and expansion capabilities. Sometimes the grid system is combined with a curvilinear pattern of streets which can result in visual as well as functional problems in understanding the circulation system.

B. Circulation Hierarchy.

Various classification systems exist defining different functions that a road performs, i.e., primary, secondary, tertiary. It is desirable that road rights-of-way, pavement widths, speed limits, provisions of curbs and sidewalks, street lighting, street trees, traffic and parking controls, and other characteristics be varied to reflect and facilitate the functions that the road performs. This is often not the case on installations where undifferentiated networks result in a variety of problems such as through-traffic on local residential streets. In many cases a sense of the road hierarchy does not exist or has not been visually reinforced, resulting in an unclear system as well as unnecessary street segments.



fig. 4-1.

C. Intersections and Traffic Controls.

The grid network, most prevalent on installations, results in a maximum number of four-way intersections and necessitates a greater dependency on signalization and other traffic control devices. There has been inadequate consideration of the pedestrian and his safety where vehicular and pedestrian networks interface (fig. 4-1).

D. Channelization.

A common problem on military installations is unsafe and unsightly techniques for channeling vehicles, such as poles or guardrails mounted in the road pavement without protective curbing (fig. 4-2). The need for these devices is most often the result of improper intersection



fig. 4-2.

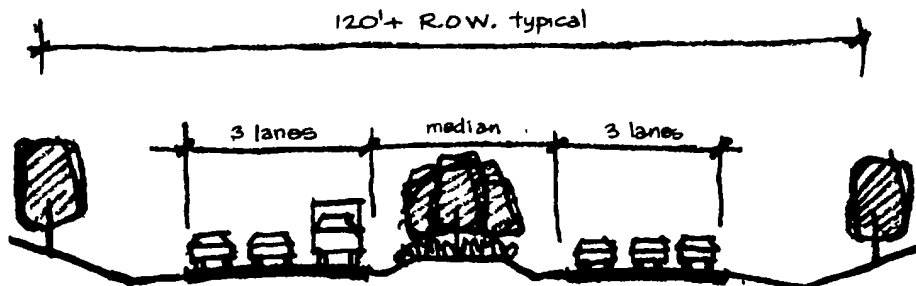

fig. 4-3.

design, but when necessary, their design need not be unsafe to motorists. In other cases where medians are used for channelization, planting that requires a high amount of maintenance or unattractive paving techniques are common, despite the availability of attractive but relatively maintenance-free plant materials that could be used.

E. Curbs and Gutters.

The incremental construction of curbs and gutters is typical at installations and often results in awkward transition areas (fig. 4-3).



HIGHWAY
Fig. 4-5.

A. Highways.

Highways provide primary high-speed traffic access to, around or through a military installation (fig. 4-5). Design characteristics of highways include:

1. Continuous, relatively straight or large radii curvilinear alignments that carry high speed through-traffic movement between major activity centers within the region.
2. A minimum of two lanes in each direction, typically divided by a median or median barrier.
3. Alignments that border land use areas rather than bisect them, and greenspace buffers between the road and adjacent uses.
4. Controlled access onto the road.
5. Either grade-separated or at grade channelized intersections with traffic signal controls.
6. Shoulders for emergency stopping but strict prohibition of on-street parking.
7. Street signing, lighting and planting that reflect the high speed nature of traffic movement.

B. Primary.

These roads provide the network connecting major activity centers within the installation (fig. 4-6). Design characteristics include:

1. Continuous, through-traffic alignments that are relatively straight or large-radii curvilinear to handle moderate-to-high speed traffic.

Fig. 4-6.

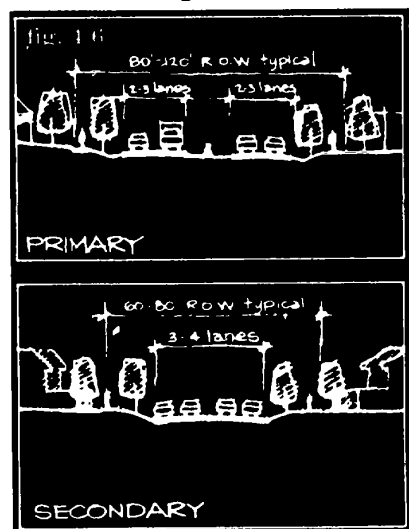

Fig. 4-7.

2. Alignments that form the boundary between different land use areas rather than bisect an area.
3. Two to three moving lanes in each direction, typically divided by a median.
4. Controlled access and a minimum of curb cuts limited to entrance-ways to major facilities or building groups.

5. At-grade channelized intersection with traffic signal controls.
6. On-street parking prohibited.
7. Adjacent sidewalks separated from the road by sizable planting strip.
8. Medians, street lighting, signing and planting that reinforce the moderate-to-high speed nature and importance of the road.

C. Secondary.

These roads provide the means of traffic movement between primary and tertiary roads (fig. 4-7). Design characteristics include:

1. Continuous through-traffic alignments between primary roads, either straight or curvilinear based

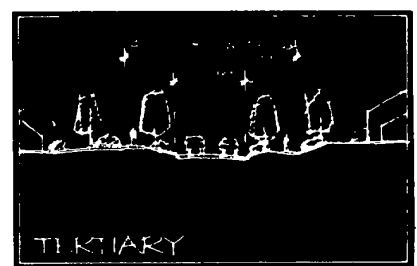

Fig. 4-8.

- upon the desired design speed, topography and land use pattern.
2. Direct access to abutting property.
 3. A maximum of two moving traffic lanes in each direction, either undivided or a boulevard with planted median.
 4. On-street parking generally prohibited.
 5. Sidewalks separated from the road by a planting strip.

6. Street lighting, signing and planting that reflect the moderate-to-slow speed nature of traffic and the character of the land use area they are within.

D. Tertiary.

These roads handle local traffic movement from secondary streets and provide direct access to abutting property (fig. 4-8). Design characteristics include:

1. Discontinuous alignments, except between secondary streets, to discourage through traffic.

2. Relatively short, straight or smaller radii curvilinear alignments in keeping with topography, land use and slow speed nature of traffic.

3. Generally a maximum of two moving traffic lanes, one in each direction.

4. On-street parking allowable on an infrequent overflow basis by the addition of a parallel parking lane or bay.

5. Curbs, gutters and sidewalks generally provided in residential areas with densities greater than two dwelling units per acre; sidewalks may be limited to only one side, depending upon need.

6. Street lighting, signing and planting in character with the slow speed nature of traffic and the land use area within which the road is located.

E. Cul-de-sacs.

These are short dead-end tertiary streets, primarily in residential areas. They connect at one end to a tertiary or secondary street and have a turnaround at their other end, providing direct access to abutting property while preventing through traffic. Design characteristics include:

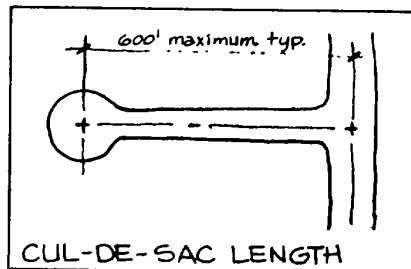

Fig. 4-9.

1. Short, straight or smaller radii curvilinear alignments that serve abutting property.

2. Generally a maximum of two traffic lanes, one in each direction.

3. Generally a maximum length of 600 feet, except in areas where terrain and low density development indicate a longer length, which in no case should exceed 1200 feet or 20 dwelling units, whichever is the lesser (fig. 4-9).

4. Turnarounds generally 70 to 90 feet in diameter at their ends to accommodate not only cars, but also fire and garbage trucks (fig. 4-10); turnarounds can be either symmetrical or offset; turnarounds can have center planting islands to reduce the expanse of paved area at the turnaround.

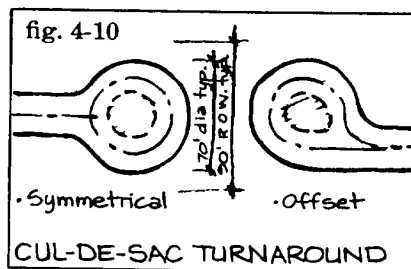

Fig. 4-10.

5. Infrequent over-spill parking can be provided on street by either parallel parking bays or within center island area of over-sized turnarounds.

6. Sidewalks, if any, are generally limited to one side of the road.

7. Street lighting, signing and planting in character with the slow speed nature of traffic and the land use area being served.

F. Other Roadway Types.

The vehicular circulation system of an installation can also contain several other types of roadways including rural roads and patrol roads.

1. **Rural Roads.** These roads are for traffic through sparsely developed areas of the installation (fig. 4-11). Design characteristics include:

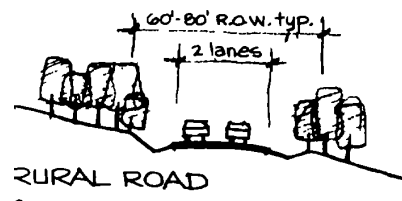

Fig. 4-11.

a. Generally two traffic lanes, one in each direction, with emergency pull-off shoulders.

b. Curbs and on-street parking generally not provided.

c. Street lighting generally not provided except at intersections.

d. Planting in character with the design speed and natural landscape character of the alignment; storm drainage in swales or ditches that blend into the natural landform.

2. **Service Roads.** These roads provide for service traffic only to adjacent buildings. Design characteristics include:

a. A maximum pavement width of 18 to 20 feet.

b. Continuous alignment between tertiary streets.

c. A possible location for overhead utility service to buildings.

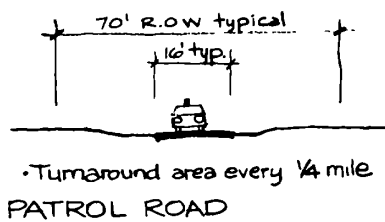

Fig. 4-12.

3. Patrol Roads. These are special roads for surveillance and security purposes that carry restricted, low volume vehicular traffic (fig. 4-12). Design characteristics include:

- a. Sixteen-foot wide road which may be paved without curbs and contoured to the natural landform.
- b. Turnaround lanes every 1/4 mile.

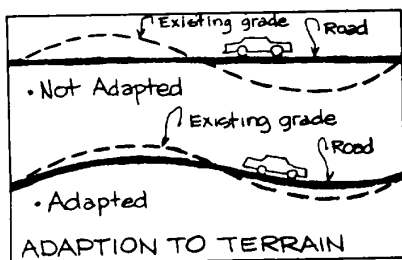

Fig. 4-13.

4-4. **Adapt Roads to Site Conditions.** New road alignments as well as improvements to existing roads should be harmonious with natural site conditions and the land use pattern of the installation. They should be designed to minimize negative environmental impacts, relieve driver monotony and provide a positive visual experience for the motorist.

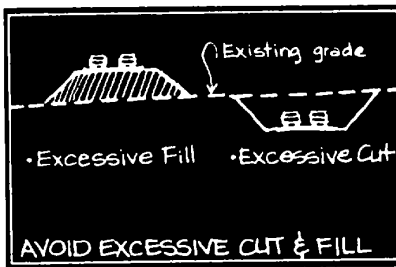

Fig. 4-14.

A. Blend Roads with the Natural Landform.

The horizontal and vertical alignment of roads should minimize landform disturbance and blend with the natural setting (fig. 4-13).

1. Minimize cut and fill slopes.
 - a. Avoid steep terrain that requires excess cut and fill to accommodate road alignments (fig. 4-14).
 - b. In rolling terrain, align roads to cross slopes diagonally or parallel to contours rather than perpendicular to contours (fig. 4-15).
 - c. Consider variable-width medians in rolling topography to minimize site disturbance (fig. 4-16). Medians can be used in this manner to reduce continuous pavement width, accommodate vertical grade differences between roadway surfaces within the median and preserve as much of the natural landform and vegetation as possible.
2. Mold cut and fill slopes to blend into the natural landform.

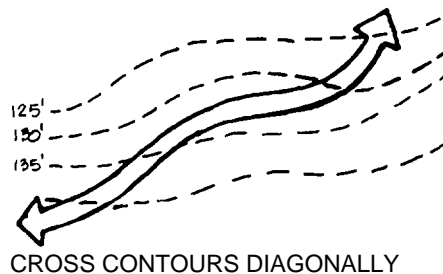

Fig. 4-15.

a. Round slopes to avoid creating sharp and unnatural slopes that contrast with the natural landform (fig. 4-17).

b. Warp slopes to become an extension of the natural landform by rounding them both horizontally and vertically (fig. 4-18).

c. Use excess excavation materials to create either mounds or fill areas that blend the road into the natural landform.



Fig. 4-16.

d. Use natural rock outcroppings as slope retaining elements (fig. 4-19). Form them in a natural way by random scarification when they must be partially removed to accommodate the road alignment.

3. Blend road drainage ditches, swales or channels into the natural landform.

a. Round the edges of road drainage ways to reduce contrasts with the natural landform (fig. 4-20).

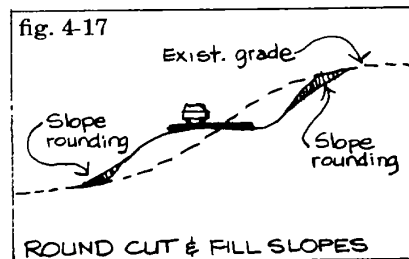

Fig. 4-17.

b. Vary the alignment of road drainage ways from that of the road according to the natural drainage system of the terrain, avoiding perfectly parallel alignments that are unnatural in appearance.

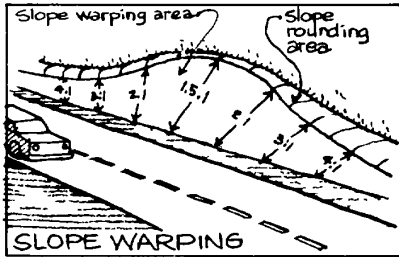

Fig. 4-18.

4. Consider the use of cluster development patterns since they minimize site disturbance as well as the costs of road development, especially in residential areas (fig. 4-21).

5. Utilize natural topographic conditions to create grade-separated pedestrian and bikeway road crossings.

a. At depressed road areas design overpasses connecting high points of natural terrain.

Fig. 4-19.

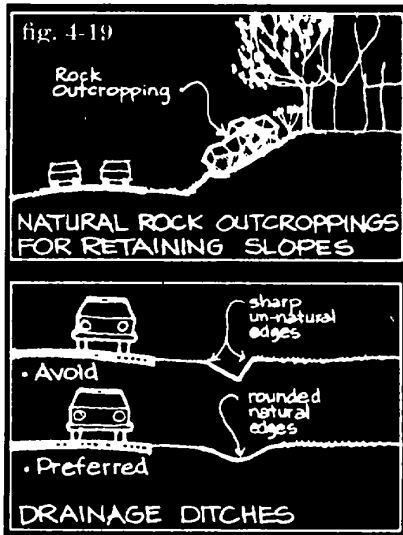
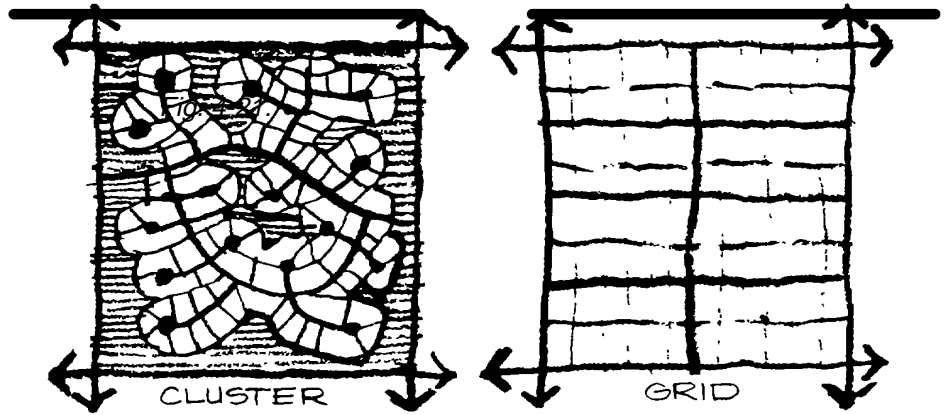

Fig. 4-20.

b. At elevated road areas design underpasses connecting low points of natural terrain (fig. 4-22).



B. Adapt Roads to the Natural Landscape Character.

Design roads to minimize disturbance to existing vegetation, to encourage revegetation in disturbed areas and to reduce the visual impact of landscape disturbance.

1. Minimize the amount of clearance of existing vegetation.

a. Align roads in open areas along the edge of forested areas, rather than through forested areas, whenever possible (fig. 4-23).

b. Carefully align roads to minimize earthwork, therefore reducing necessary clearing limits.

c. Clear only to the edge of necessary regrading or sight distance lines, rather than a uniform right-of-way clearance width (fig. 4-24).



Fig. 4-23.

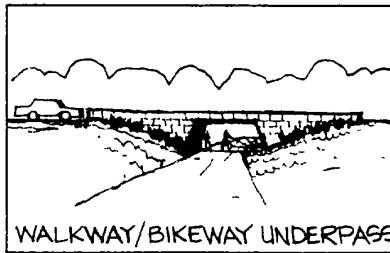

Fig. 4-22.

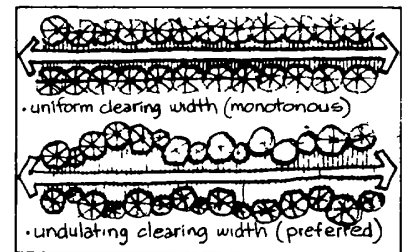

Fig. 4-24.

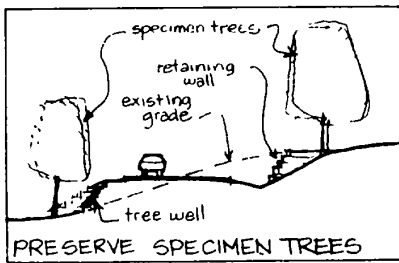

Fig. 4-25.

d. Utilize tree wells or retaining walls to preserve noteworthy specimen trees where cut and fill slopes would otherwise threaten the root system and survival of the tree (fig. 4-25).

2. Provide optimum conditions for revegetation of disturbed areas.

a. Follow proper fertilization, mulching and watering practices to encourage revegetation of disturbed areas.

b. Utilize proper planting techniques and planting seasons to promote revegetation and high survival rates of plant materials.

c. Consider planting holes or pockets and serrated slope edges on steeper cut and fill slopes to encourage revegetation and moisture retention on these slopes (fig. 4-26).

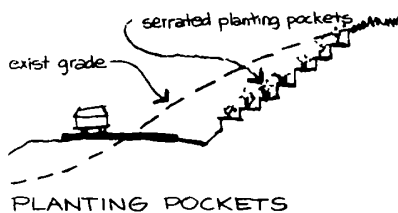

Fig. 4-26.

3. Revegetate disturbed areas to minimize their visual impact.

a. Use irregular or free-form clearing limits with undulating edges to vary the sequence of enclosure along the road; this adds

visual variety, promotes a natural landscape appearance and relieves visual monotony for motorists.

b. Feather edges with careful clearing of trees and shrubs to create a gradual transition of vegetation along the road, rather than a contrasting edge (fig. 4-27).

c. Encourage an informal mixture of native plant materials that will blend naturally with adjacent undisturbed vegetation.

d. Disperse new planting into undisturbed adjacent areas to reduce the contrast of the clearing edge.

Fig. 4-27.



Fig. 4-28.

e. Use massed plantings of appropriate size and form; avoid haphazard scattering as well as widely and regularly spaced planting that create a spotty appearance.

f. Use planting to emphasize positive visual elements, such as framing scenic views, and to minimize negative conditions, such as screening unsightly features.

4. Employ roadway planting

effectively for functional and safety-related uses as well as aesthetic ones.

a. Plant disturbed areas to minimize soil erosion and provide sediment control; follow proper soil erosion and sediment control practices during road construction.

b. Use planting to assist in driver guidance by delineating directional changes in the road alignment; planted edges make it easier for the driver to discern the outline of an oncoming curve (fig. 4-28).

c. Use planting to screen oncoming headlight glare.

d. Use planting to help control snow drifting onto the road.

e. Use planting to visually screen adjacent lands uses from road traffic.

C. Minimize Adverse Impacts of Roads on Adjacent Land Uses.

1. Air Pollution. Locate road alignments to minimize the impact of traffic-emitted pollutants on adjacent facilities.

a. Locate roads adjacent to land uses that are minimally affected by traffic-emitted air pollutants.

b. Reduce the impact of traffic emitted pollutants on more sensitive land use areas by providing planted buffers between them and locating roadways downwind of the prevailing wind pattern, especially summer winds.

2. Noise Pollution. The necessary abatement of excessive noise levels generated by auto

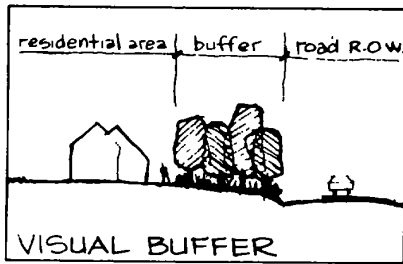

Fig. 4-29.

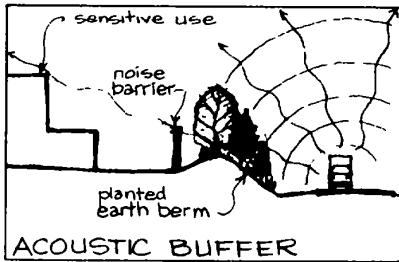

Fig. 4-30.

mobile and truck traffic should be taken into account when locating new roads or land uses; excessive traffic noise creates undesirable physical and psychological effects on people and their activities. (See TM 5-803-2, NAVFAC P-970 and AFM 19-10 for techniques to ameliorate the impact of vehicular generated noise, as well as that generated by aircraft, weapons and trains.)

a. Physically separate primary roadways from adjacent land uses whose normal functioning would be impaired by auto and truck traffic noise. Land uses considered sensitive to excessive traffic noise levels include:

- Residential areas
- Hospital and medical facilities
- Educational facilities
- Recreational facilities
- Religious facilities
- Administrative facilities
- Libraries
- Community facilities
- Child care facilities

b. Utilize noise abatement techniques such as earth berms,

sound walls and plant materials to reduce noise levels generated by traffic adjacent to sensitive land use areas (figs. 4-29 and 4-30).

c. Reroute truck traffic to roadways with less sensitive land uses adjacent to them; roadway noise nuisance is primarily associated with truck traffic.

4-5. Improve the Existing Network for Growth, Safety and Appearance.

The existing road network of an installation should be improved as needed for growth, safety and appearance. This may entail network changes, removal of traffic hazards and enhancement of the streetscape.

A. Network Modifications.

Modify and improve the existing road network as needed to accommodate increased traffic capacity, facility expansion, control

of undesirable through traffic, or intersection safety and flow.

1. Increasing Traffic Capacity. Minimize the visual impact of necessary street improvements for increased traffic capacity.

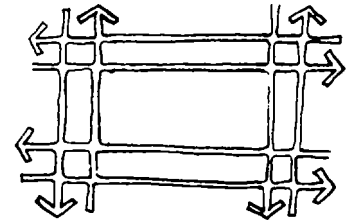

ONE-WAY COUPLET STREETS

Fig. 4-31.

a. Create one-way couplet streets on adjacent parallel streets to increase traffic flow capacity without new road construction (fig. 4-31).

b. When adding lanes to an existing street to increase its capacity, use a center median between the existing road and the proposed new lanes to preserve existing street trees (fig. 4-32).

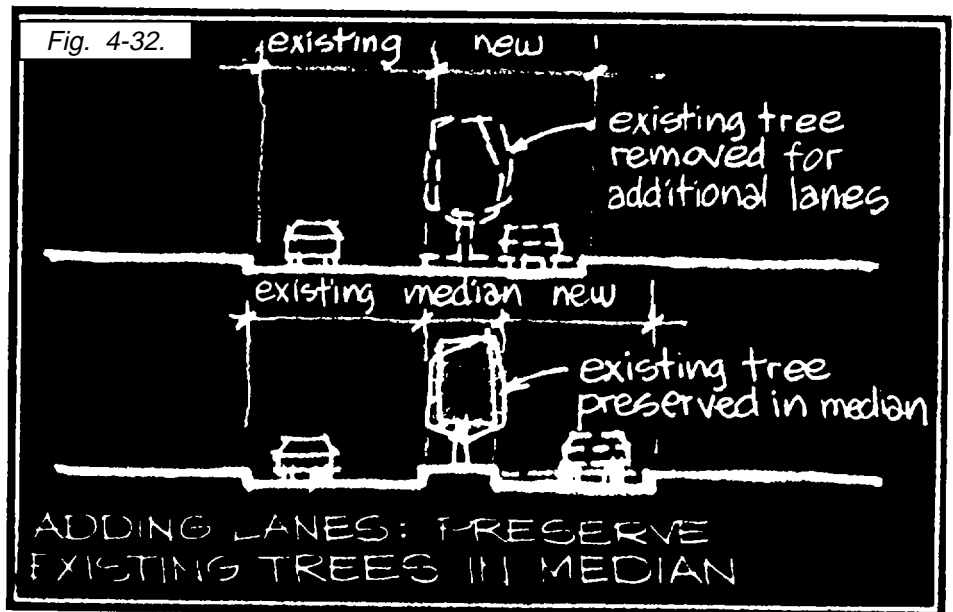

2. Accommodating Facility Growth. The introduction of a mega-block concept to accommodate either facility expansion or creation of a pedestrian precinct within a group of buildings that are presently separated by streets can be considered. Existing grid street systems that are undifferentiated and underutilized lend themselves to being converted to mega-blocks. Mega-blocks can be created by consolidating several blocks and utilizing existing perimeter streets more efficiently to enable abandoning interior street rights-of-way (fig. 4-33).

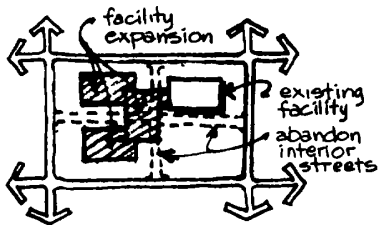

MEGA-BLOCK CONCEPT
Fig. 4-33.

3. Discouraging Through Traffic. Modify existing streets to discourage through traffic on local roads, especially in residential areas.

a. Convert a grid system into a series of internal loop roads that discourage through-traffic (fig. 4-34). This will also allow the creation of a central walkway where the existing grid system has been discontinued.

b. Convert a grid system into a series of internal cul-de-sacs that do not allow through-traffic (fig. 4-35). This may also provide additional home sites or a central walkway at the end of those streets that have been terminated.

4. Providing Safe and Attractive Intersections.

Improve existing intersections as needed to provide safe and efficient traffic flow for both pedestrian and vehicular traffic.

Fig. 4-34.

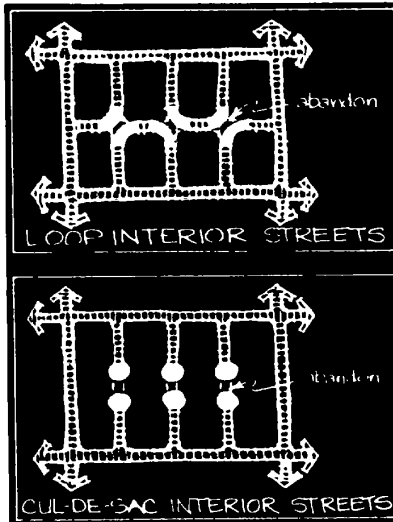
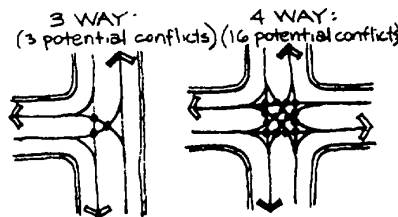

Fig. 4-35.

a. Introduce "T" intersections for tertiary road intersections with secondary or primary roads. This type of intersection has only three potential turning conflict points (as opposed to 16 at four-way intersections) and is particularly appropriate to reduce through-traffic and promote safety in residential and pedestrian areas (fig. 4-36).



INTERSECTIONS

Fig. 4-36.

b. Provide turning lanes to eliminate interference with through-traffic flow at major four-way intersections (fig. 4-37).

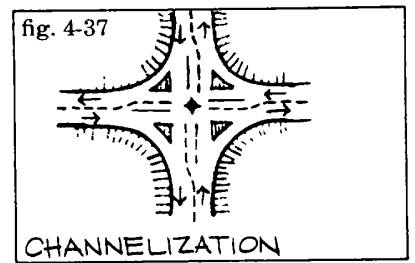

Fig. 4-37.

c. Provide safe pedestrian crosswalks at signalized intersections. (See Chapter 8: Walkways.)

d. Avoid complex intersections and correct existing ones. These type intersections include those with skewed approaches, jogged alignments, or with more than four approaches that create operational difficulties, safety hazards, decreased traffic flow capacity and unsightly large expanses of paving.

e. Connect parallel streets prior to an intersection with a major arterial or highway to minimize intersections with the major road (fig. 4-38).

f. Create local service drives paralleling a major road to provide access to individual abutting facilities while minimizing curb cuts along the main road which are unsafe and disruptive to traffic flow (fig. 4-39).

B. Removal of Traffic Hazards.

Remove and correct all existing traffic hazards along roads. Corrections of these deficiencies will often be justifiable on the basis of safety as well as appearance.

1. Inventory and Rank Traffic Hazards. Survey the installation to identify all potential traffic hazards and determine a priority listing of problems to be corrected based upon the severity of the hazard to personal safety.

2. Correct Unsafe Physical Obstructions near Streets.

Many of these obstructions, in addition to being unsafe, add greatly to the cluttered appearance of the streetscape.

a. Replace or correct culverts or headwalls that are too close to the street; provide protective curbing, guardrails and/or collision cushions.

b. Relocate signs, utility poles or fire hydrants that are too close to the street. In built-up areas, these should be no closer than two feet to the curb; along primary roads and highways these should be set back to a

Fig. 4-38.

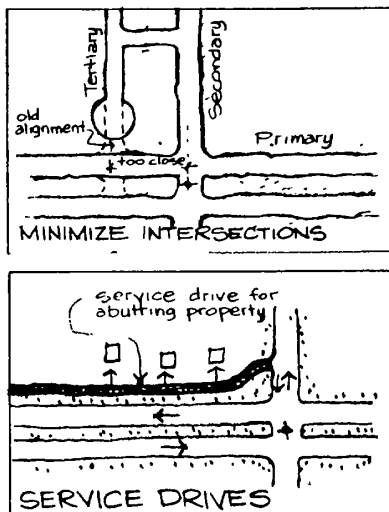

Fig. 4-39.

minimum of twelve feet from the edge of the pavement. Breakaway utility poles are desirable along highways.

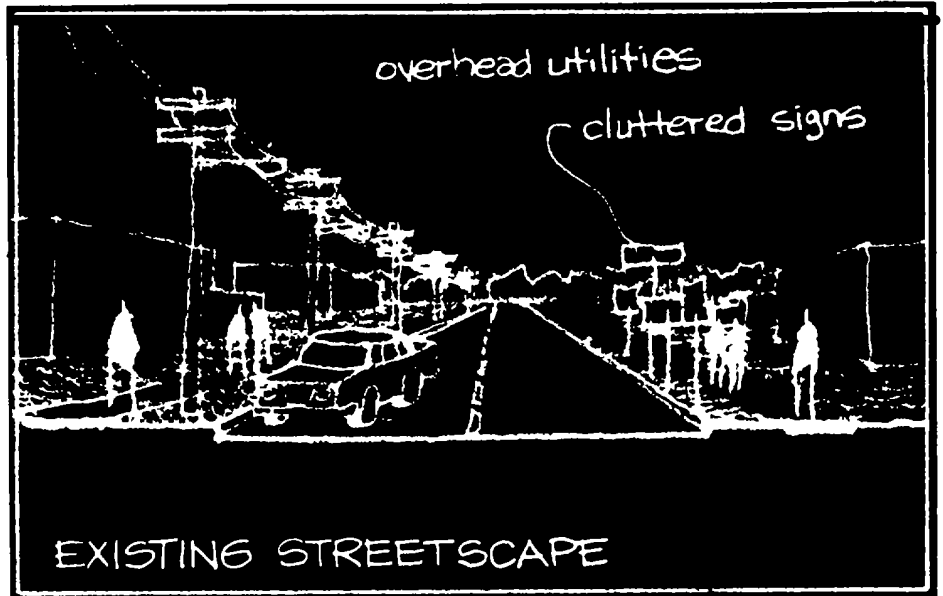

Fig. 4-40.



Fig. 4-41.

3. Correct Unsafe Physical Obstructions within the Roadway.

a. Provide curbing where necessary instead of using bollards, cones or guardrails.

b. The use of concrete median barriers that provide their own curbing are ideally suited for high-speed roads. These barriers should be continuous and their exposed ends should be detailed for safety.

c. Provide proper lighting and reflectors on potential roadway safety hazards.

C. Streetscape Improvement. Enhance the appearance of the streetscape by a coordinated design of its various components (figs. 4-40 and 4-41).

1. Minimize Streetscape Clutter.

Coordinate the design of streetscape elements to minimize clutter and provide an attractive roadway in keeping with its intended function and hierarchy in the overall network.

a. Planting. Consider planting as one of the simplest and most effective means of improving the visual quality of the installation's streetscape. Planting should be used to define the road hierarchy. Furthermore, planting should be used to screen headlight glare and to reduce the visual impact of adjacent surface parking lots and overhead utilities. (See Chapter 6: *Planting*; Chapter 5 *Parking*, and Chapter 13: *Utilities*.)

b. Lighting. Street lighting should be effectively used not only for public safety and security but also to strengthen the comprehension of the road hierarchy by varying the height, spacing and intensity of luminaires according to the type of road. (See Chapter 11: *Lighting*)

c. Signing. Create a unified, coordinated and consistent streetscape signing system that provides direction and information in an effective and attractive manner. (See Chapter 10: *Signing*.)

d. Utilities. Bury utilities wherever possible to avoid their unsightliness and cluttering of the streetscape. The burial of existing utilities should be associated with the construction of new structures and the renovation or demolition of existing structures. Where overhead utilities along the street are unavoidable, use trees and topographic features to minimize their visual impact. (See Chapter 13: *Utilities*.)

e. Street Furniture. Use a coordinated and unified design of functional street furniture along the streetscape, employing multi-use clustering of elements wherever possible to reduce clutter. (See Chapter 12: *Site Furnishings*.)

f. Paving. Use special paving to differentiate between pedestrian and vehicular areas, articulate areas of pedestrian and vehicular conflicts and indicate directions or controls in the circulation network. Paving designs such as at crosswalks should be consistent in design and application (See Chapter 8: *Walkways*.)

2. Curbs and Gutters.

Use a consistent design and application of curbs and gutters (fig. 4-42).

a. Use curbs and gutters to define the road edge and channel storm drainage in more densely developed areas of the installation.

b. Where density is relatively low or in rural areas, avoid curbs and gutters in favor of drainage swales or ditches that blend into the natural landform.

c. Provide necessary curbs with a unified design, avoid inconsistent or scattered applications of curbs and gutters within developed districts of the installation.

3. Medians. Use medians to safely separate or channel traffic, to reinforce the circulation hierarchy of the road network

and to provide safety islands for pedestrians at wide street crossings; provide appropriate planting of medians to visually reinforce the road hierarchy and minimize maintenance.

a. Grass can be used attractively in medians, but usually requires frequent mowing to be maintained.

b. Ground cover, such as ivy, requires little maintenance but tends to catch litter when used in medians.

c. Trees and shrubs with bark ground cover can provide both an attractive and relatively maintenance-free median if the bark can be controlled from scattering onto the road.

d. Concrete or paved medians tend to be utilitarian and relatively maintenance-free medians best suited for pedestrian areas; in other areas they can be unattractive if not combined with street trees.

e. Consider the possibilities of historic military equipment displays or flagpoles along medians to visually highlight special areas such as main entrances to the installation. However, care should be exercised in the design of these displays to avoid a cluttered appearance.

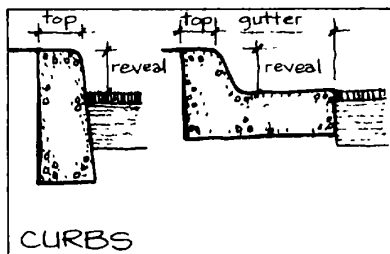
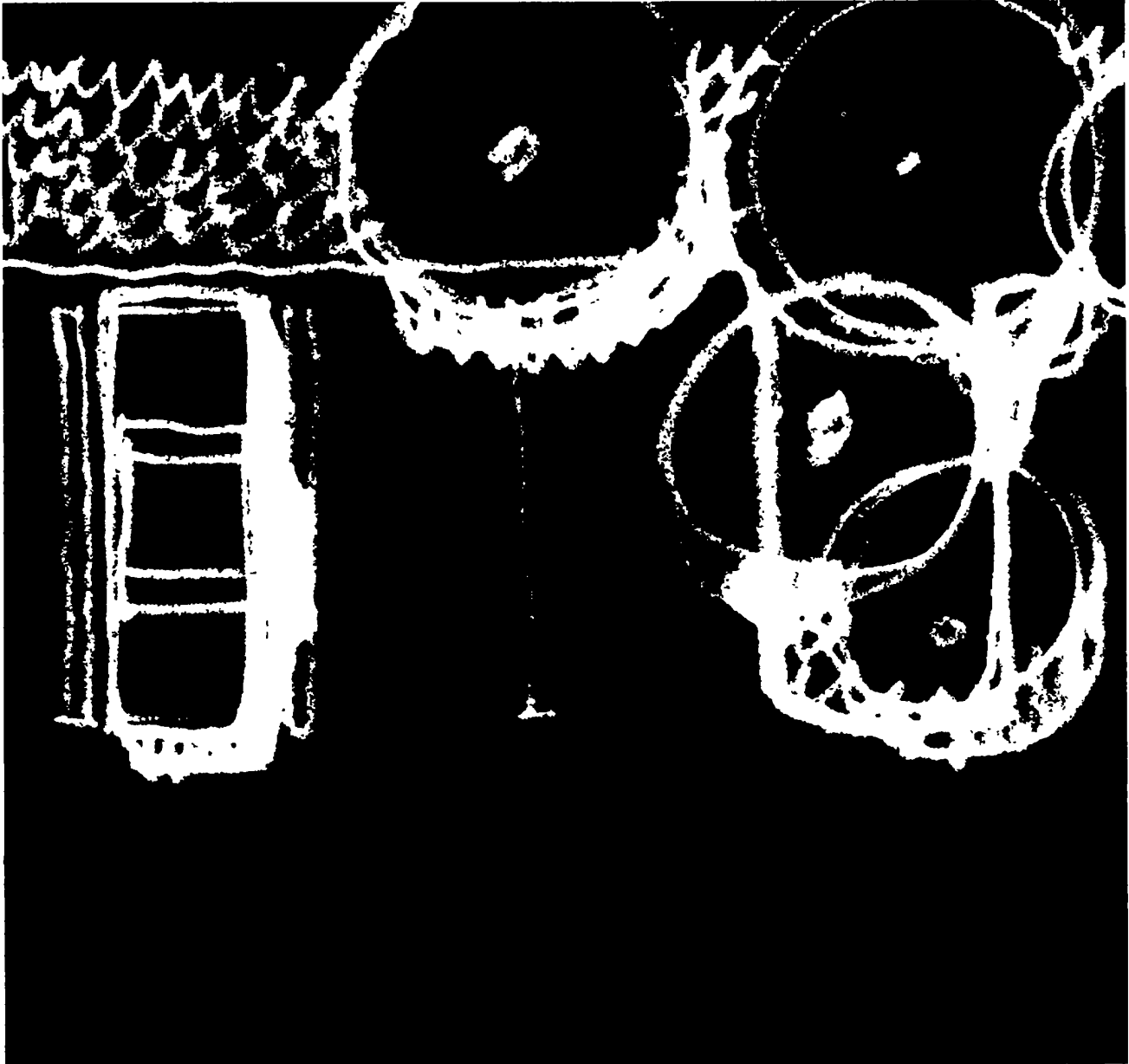

Fig. 4-42.

Parking is one of the most space-consuming land uses on military installations and typically dominates the landscape setting of facilities. It usually is one of the most visually disruptive elements within an installation. Opportunities for creating pleasant people-oriented spaces around and between buildings or providing

good views to and from buildings are too often given over to expansive surface parking lots with minimum design treatments to mitigate their negative impact on the visual quality of an installation. By locating facilities conveniently to each other and encouraging alternative modes of access, much can be accomplished to reduce

dependence upon the automobile and its parking requirements. While the provision of convenient parking facilities is essential, appropriate site planning and design treatments can be used to minimize their negative visual impact.



Section I:

Observations and Objectives.

5-1.

Typical Problems.

The design of parking facilities has too often been handled insensitively. They have been frequently located in poor relationship to streets, the facilities they serve, adjacent land uses and natural site features (*fig. 5-1*).



Fig. 5-1.

A. Off-street Parking.

Parking lots have often been designed without provision for plant materials, thereby creating the appearance of an unrelieved ocean of cars (*fig. 5-2*). Sometimes they have been built with unrestricted access from the street, mixing higher-speed street traffic with internal parking circulation, which is both unattractive and dangerous.

B. On-street Parking.

On-street parking, common in most military installations, results in large expanses of pavement, and often provides no opportunity for a more pleasant and attractive transition between the street and adjacent buildings (*fig. 5-3*). In addition, on-street parking reduces the traffic-carrying capacity of the roadway.



Fig. 5-2.

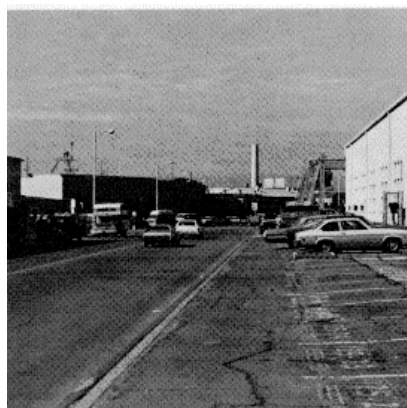

Fig. 5-3.

5-2.

Objectives.

A. Reduce the Visual Impact of Parking Facilities.

The provision of sufficient, conveniently located parking is a functional prerequisite in the site design of military installations. However, simply reacting to this need is not enough. Every feasible measure should be taken to

minimize the obtrusive effect of parking on the visual environment.

B. Minimize Parking Requirements and Land Coverage.

Parking requirements can be reduced by encouraging carpooling and alternative modes of travel. Areas within parking lots may be designed with smaller stalls to accommodate only small cars and-motorcycles thus reducing the total required land coverage. Furthermore, the economic and environmental factors that influence the use of parking structures should be taken into account.

Section II:

Design Guidelines.

5-3.

Types of Parking Facilities.

Provide parking in accordance with the following overall guidelines for various parking facility types.

A. On-street Parking.

On-street parking facilities include parallel parking on one or both sides of the street, and angled or perpendicular parking bays. In general, on-street parking should be avoided (*fig. 5-4*). Parallel on-street parking should only be allowed on cul-de-sacs and tertiary streets where infrequent visitor or overflow parking needs occur. Employee parking should not be allowed on residential streets.

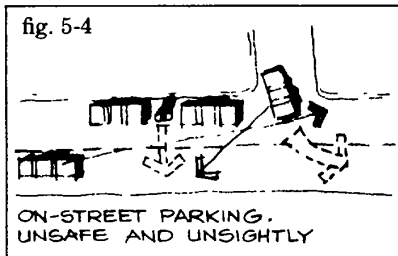

Fig. 5-4.

B. Off-street Surface Parking.

Adequate off-street parking eliminates the need for on-street parking. It should be the predominant method of automobile

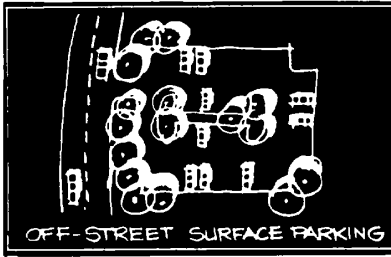

Fig. 5-5.

parking on installations. All installation facilities should provide sufficient off-street parking to meet their particular needs (*fig. 5-5*).

C. Parking Structures.

Parking structures, both below or above grade, have limited application at certain installations, particularly in densely developed areas where available land is scarce. Parking structures are expensive but can provide a number of benefits including efficient land use, reduced visual impact and protection of vehicles from inclement weather (*fig. 5-6*).

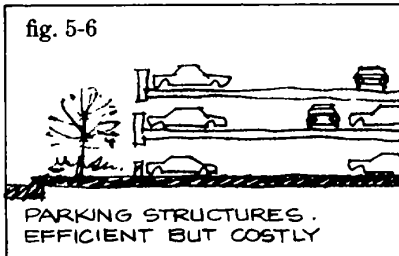

Fig. 5-6.

5-4. Off-street Surface Parking.

A. Area Requirements.

The total quantity of parking in any one location will vary with the needs of the facility. Criteria for determining the number of parking spaces for non-organizational vehicles authorized for various types of facilities are listed in Table 4-1 of DOD 4270. 1-M.

1. Allocate 400 square feet per car (includes access drives and planting islands) for initial planning purposes. (DOD authorizes 35 square yards or 315 square feet per car for parking lot space with normal entrance and exit.)

2. Minimize parking requirements of a facility by selecting a site that will allow the sharing of parking with other related activities and will promote other means of access, such as walkways and bikeways, between activities to reduce dependence on the automobile.

3. Small parking lots are usually preferable to large lots, as they enhance the visual environment by increasing the percentage of landscaped area to paved area and allow more conformance to natural topography (*fig. 5-7*). The unrelieved monotony of large parking areas may be altered by developing alternative designs, such as curvilinear plans (*fig. 5-8*). However careful design of curvilinear parking lots is necessary to avoid exceeding the authorized space per car.

Fig. 5-7.

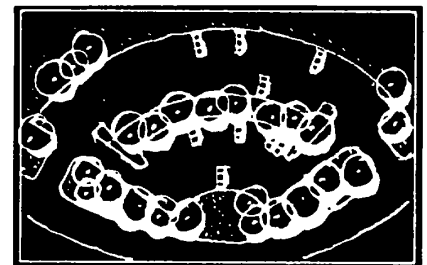
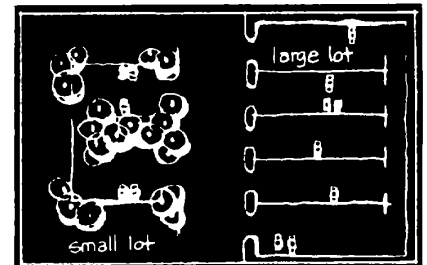

Fig. 5-8.

B. Locational Guidelines.

Locate parking facilities for convenience and safety.

1. Locate off-street parking convenient to building entrances.
2. Dead-end parking lots should generally be avoided.
3. Provide the opportunity for vehicular/pedestrian separation, especially in large parking lots.
4. Develop parking on relatively level areas to avoid excessive cut and fill situations that create erosion and landscape reconstruction problems (fig. 5-9).

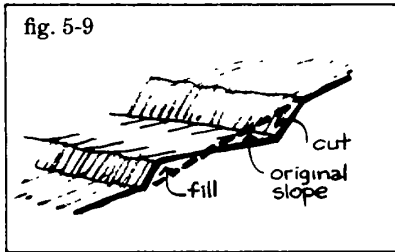

Fig. 5-9.

5. Use natural topography and existing trees to visually screen parking areas from adjacent facilities or other parking bays.
6. Headlight glare from parking vehicles may be avoided in residential areas if parking is located at a lower elevation than the structure. Parking located on the downgrade can be easily screened and will not obstruct site lines from the structure (fig. 5-10). If site conditions necessitate the location of parking at the same level or at a higher elevation than the structure, various screening techniques may be employed to shield headlight glare and reduce the negative visual impact of the parking lot.

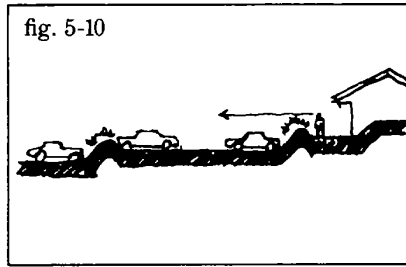

Fig. 5-10.

C. Parking Lot Layout.

In order to economize on space and provide easy circulation, parking areas should usually be laid out with 90-degree stalls and with aisles wide enough for two-way traffic. Where a slow rate of turnover is expected, 90 degree parking is particularly desirable.

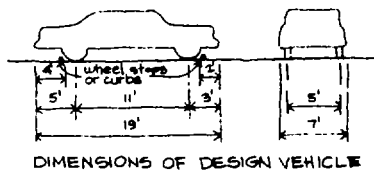

Fig. 5-11.

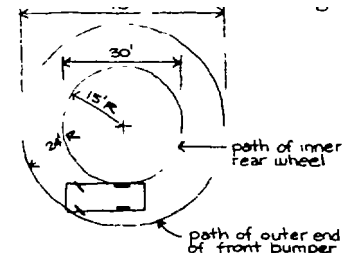

Fig. 5-12.

Where a fast rate of turnover is expected or where required by site limitations, 60 or 45-degree parking with one-way aisles may be used. However, the advantage of easy execution of 60- and 45-degree parking is frequently offset by the inconvenience of one-way aisles and roundabout circulation.

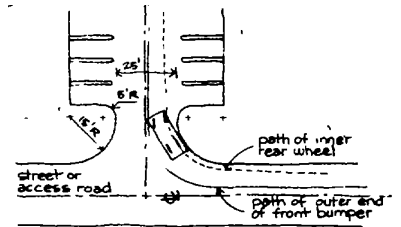

Fig. 5-13.

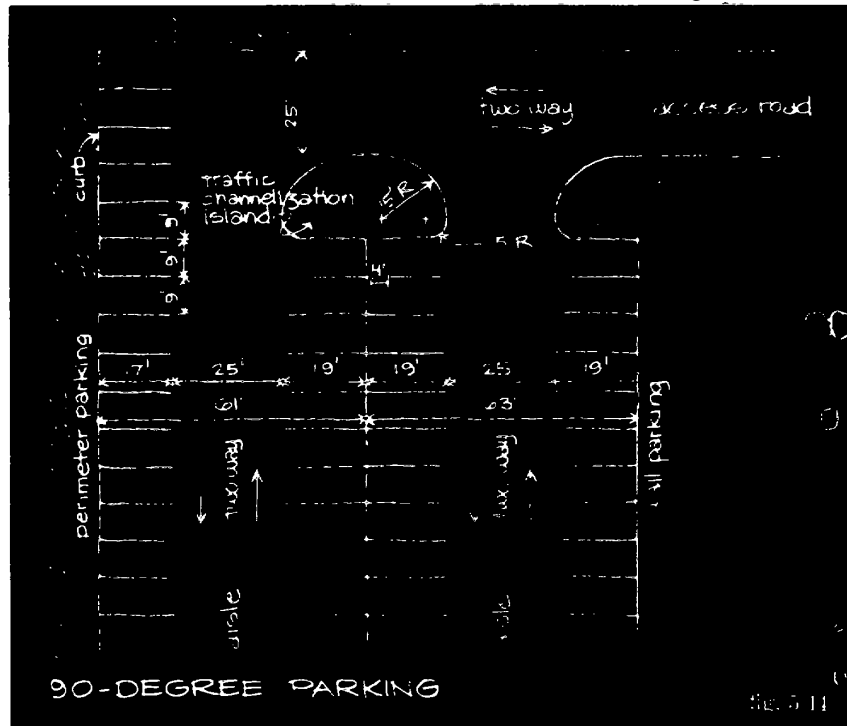

Fig. 5-14.

1. A separate parking area for employees of a facility should be considered to avoid a mixture of all-day parking with customer parking that has a fast turnover rate. An employee parking area should be physically separated from the main parking area by a barrier or should be located adjacent to and with access off of a service road to the facility.

2. Information on the design vehicle and dimensions for typical parking areas, with stalls arranged at 90 degrees, 60 degrees, 45 degrees and parallel to the aisle, are illustrated in figures 5-11 through 5-20. Note where the dimensions for perimeter parking stalls vary from those in the interior and from those against a wall.

3. When 90-degree on-street parking must be used, increase the stall length by 4 feet. When 60- or 45-degree on-street parking must be used, increase the stall length by 2 feet. For parallel on-street parking, increase the width by 2 feet.

4. When very large numbers of cars must be accommodated, a provision for small car parking is encouraged. Separate bays or portions of lots can be more compactly designed and thereby reduce the required amount of paving per car. Small car parking bays should be provided with 90-degree stalls, 7'-6" stall widths, and 17'-0" stall lengths with no overhang and 15'-0" stall length on the perimeter where an overhang is permitted. Driving aisles should be two-way and 18 feet wide.

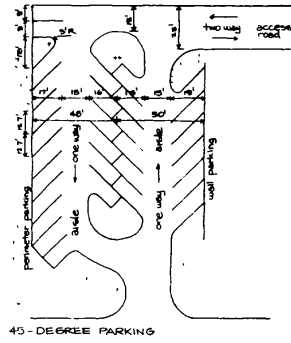

Fig. 5-15.

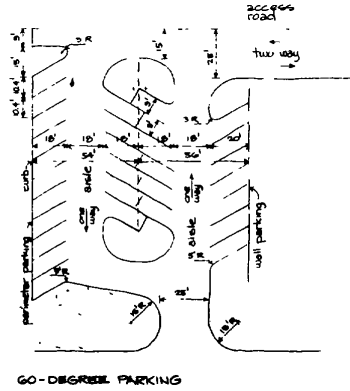

Fig. 5-16.

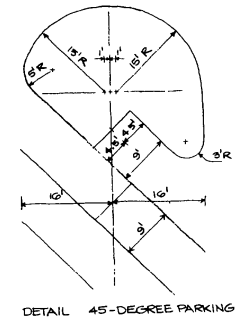

Fig. 5-17.

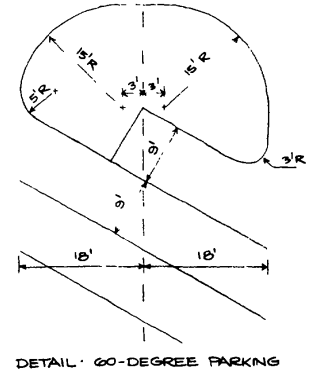

Fig. 5-18.

Fig. 5-19.

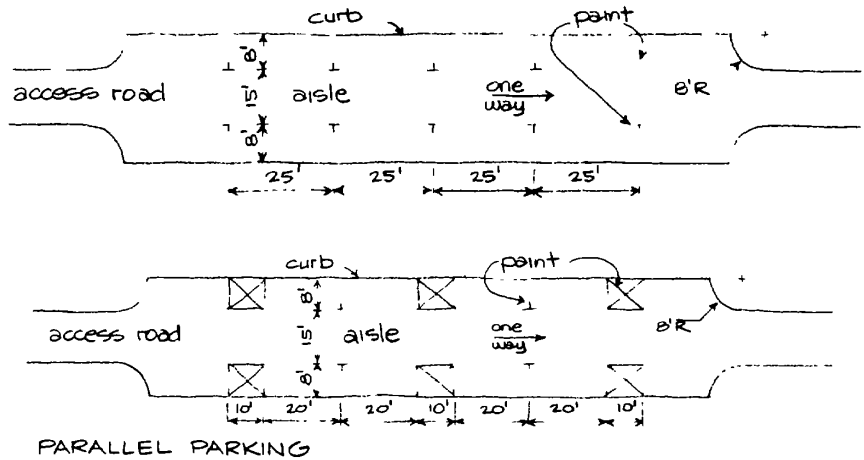

Fig. 5-20.

5. To minimize conflicts with street traffic, parking area entrances and exits should be kept to the minimum necessary for peak-hour requirements and located at least 50 feet from street intersections. Provide a minimum of 20 feet for the buffer strip separating a parking area from a street (fig. 5-21).

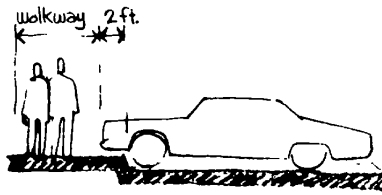

Fig. 5-23.

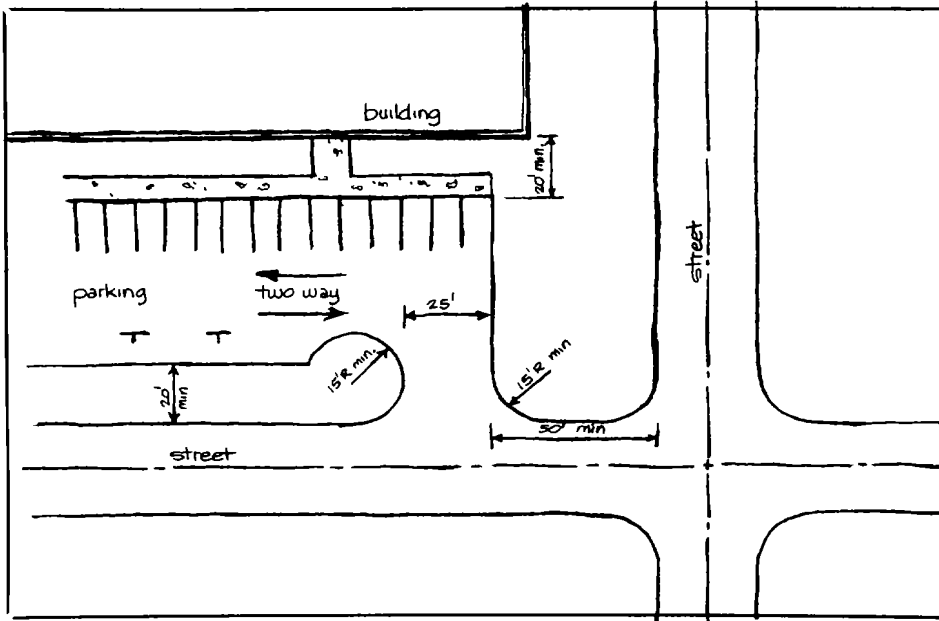

Fig. 5-21.

6. Avoid parking directly adjacent to buildings. Allow adequate space for planting and/or walks (20 feet minimum) between parking areas and adjacent buildings (fig. 5-22).

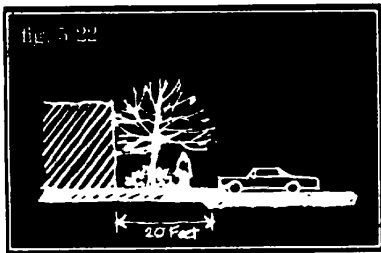

Fig. 5-22.

7. Walkways at the head of parking stalls should be two (2) feet wider than required by pedestrians to accommodate bumpers overhang (fig. 5-23).



Fig. 5-24.

8. When islands are used to separate parallel parking bays, the minimum width should be 12'-0" to provide a margin between overhanging bumpers and plants (fig. 5-24). Widths should vary upwards to accommodate existing topography and trees.

9. Intermediate islands, a minimum of 9'-0" wide, should be used to help define vehicular circulation areas in large parking

areas. To be effective there should be no more than 18 parking spaces between islands (fig. 5-25). Islands can be staggered and irregular in width to preserve existing trees, creating a natural or informal character, or they may be aligned regularly and of the same width, creating a formal character (fig. 5-26).



Fig. 5-25.

D. Other Type Vehicles.

Consider parking requirements of other type vehicles that may use the parking lot.

1. Design special parking spaces for recreational vehicles, boats and trailers as needed and with knowledge of their dimensions and turning radii.

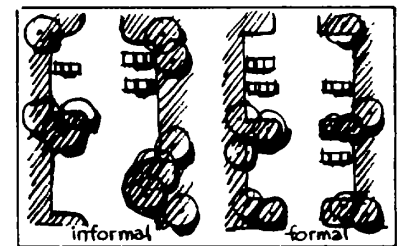

Fig. 5-26.

2. Provide properly signed parking areas for motorcycles and motorbikes within parking lots as needed. Parking lot corners can be used for motorcycle and bike parking (fig. 5-27).

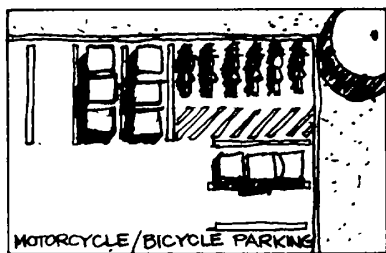

Fig. 5-27.

E. Parking Lot Details.

1. Paving. Provide hard-surfaced paving for high-use parking areas. Generally avoid gravel or-cinder paving, except for temporary construction uses.

2. Striping. All parking spaces and pedestrian crosswalks should be properly striped to define the space or crossing area. Striping color should contrast with pavement color. Double painted stripes between stalls are more effective for encouraging orderly parking than are single painted stripes (figures 5-28 through 5-30).

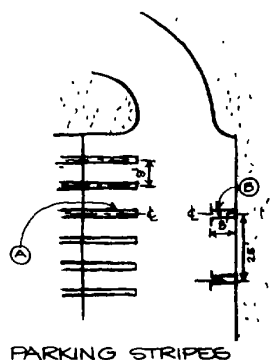

Fig. 5-28.

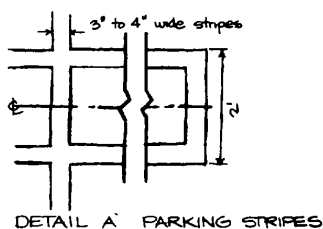

Fig. 5-29.

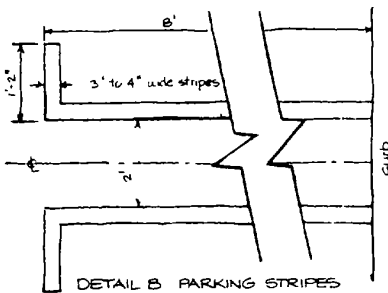

Fig. 5-30.

3. Drainage. Design drainage as a function of parking lot size, slope and drainage network location. Drainage to the naturally lower edge of a lot rather than the center of a lot is preferable.

4. Curbing. Use continuous curbing where possible to contain and channel drainage and to serve as wheel stops. Curbing is easier to maintain and visually preferable to wheel stops, but is more costly and must be designed with ramps for the handicapped.

5. Light Poles. Parking lot light fixtures should be located out of the way of traffic aisles and parking stalls. Ideally, lighting poles should be located in center or side islands, protected by raised curbs (fig. 5-31). Poles and fixtures should be in scale with the setting while providing the desired level of nighttime illumination.

6. Screen Planting. Perimeter screen planting of conifers can effectively control the adverse visual impact of parking lots (fig. 5-32). (See Chapter 6: Planting.) in addition, screen planting is an effective measure to prevent snow drifting into parking lots that are below surrounding grades (fig. 5-33) Screens must be set back from

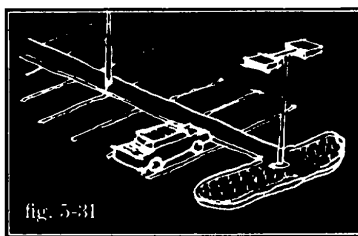
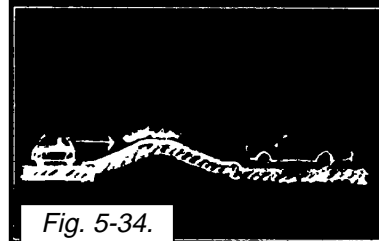
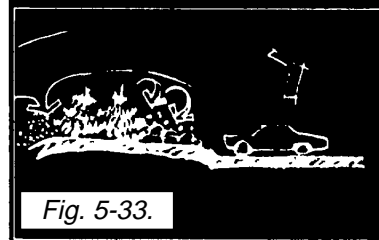
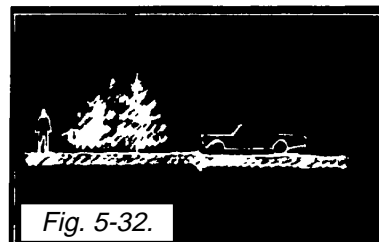

Fig. 5-31.

the pavement areas so that drifts will accumulate on the bordering area rather than on the pavement.

7. Earth Berms. Earth berms can effectively screen parking lots from view along major roadways (fig. 5-34). Planted earth berms along the perimeter of the lot facing the street should be designed relative to the 52" viewing height, or eye level, of a motorist. Earth berm design should be appropriate to the



landscape character of the setting, i.e., it can vary from a natural, informal shape and landscape character to a more formal character with even height and regimented planting .

8. Overhead Canopy. Use trees in islands to relieve visual monotony and to provide shade in large parking lots.

5-5 Parking Structures.

A. Feasibility.

Because multi-level parking is a more intense use of land, it permits land conservation for other potential uses such as building expansion and avoids the adverse visual impacts of its alternative-surface parking lots. However, since construction costs of parking structures are typically five to six times greater than surface parking, a dense land use configuration and a relative scarcity of land are normally required to justify their provision.

B. General Guidelines.

1. Location. The siting of multi-level parking structures must be done in relation to an overall master plan. Parking structures should be located close to activities generating parking requirements. In this regard, several well located smaller structures are preferable to one large structure.

2. Site Adaptation.

a. The design of multi-level parking structures should generally conform to the design guidelines of *Chapter 3: Buildings*.

b. Topography. Use existing topography to advantage in the design of parking structures. Multi-level parking structures can be accommodated on steeper topography more easily than large surface parking lots because large grade differences may be negotiated in a relatively short horizontal distance. This can also facilitate dual level access (*fig. 5-35*).

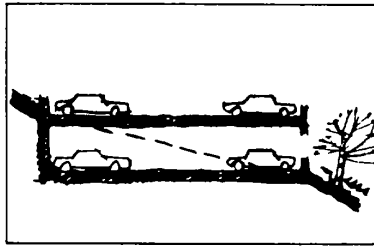

Fig. 5-35.

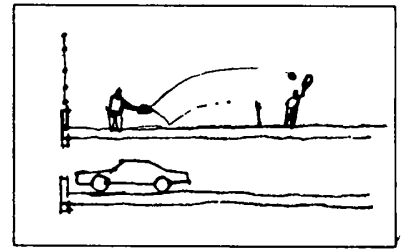

Fig. 5-38.

c. Efficiency. An above-grade continuous ramp parking structure is generally the most efficient and economical configuration. However, the ramped (non-horizontal) nature of the structure should be carefully designed relative to its appearance and relationship to adjacent buildings (*fig. 5-36*).

3. Roof Treatment. Parking structure roofs should be attractive from common vantage points such as adjacent buildings or roads. Consider the potential for creating attractive and functional uses of parking structure roofs, such as plazas atop underground structures (*fig. 5-37*), and recreational uses such as roof gardens, playgrounds, or tennis courts on parking structure roofs (*fig. 5-38*).

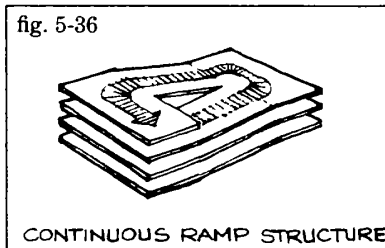

Fig. 5-36.

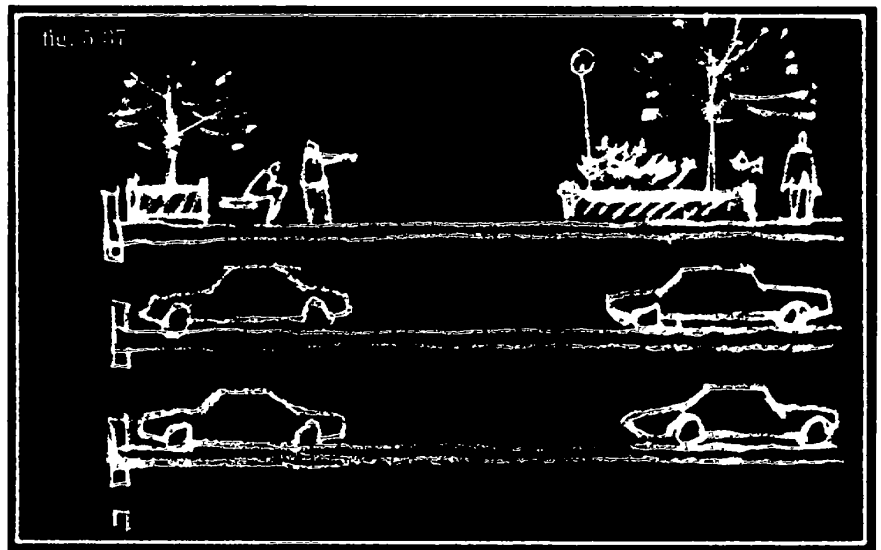
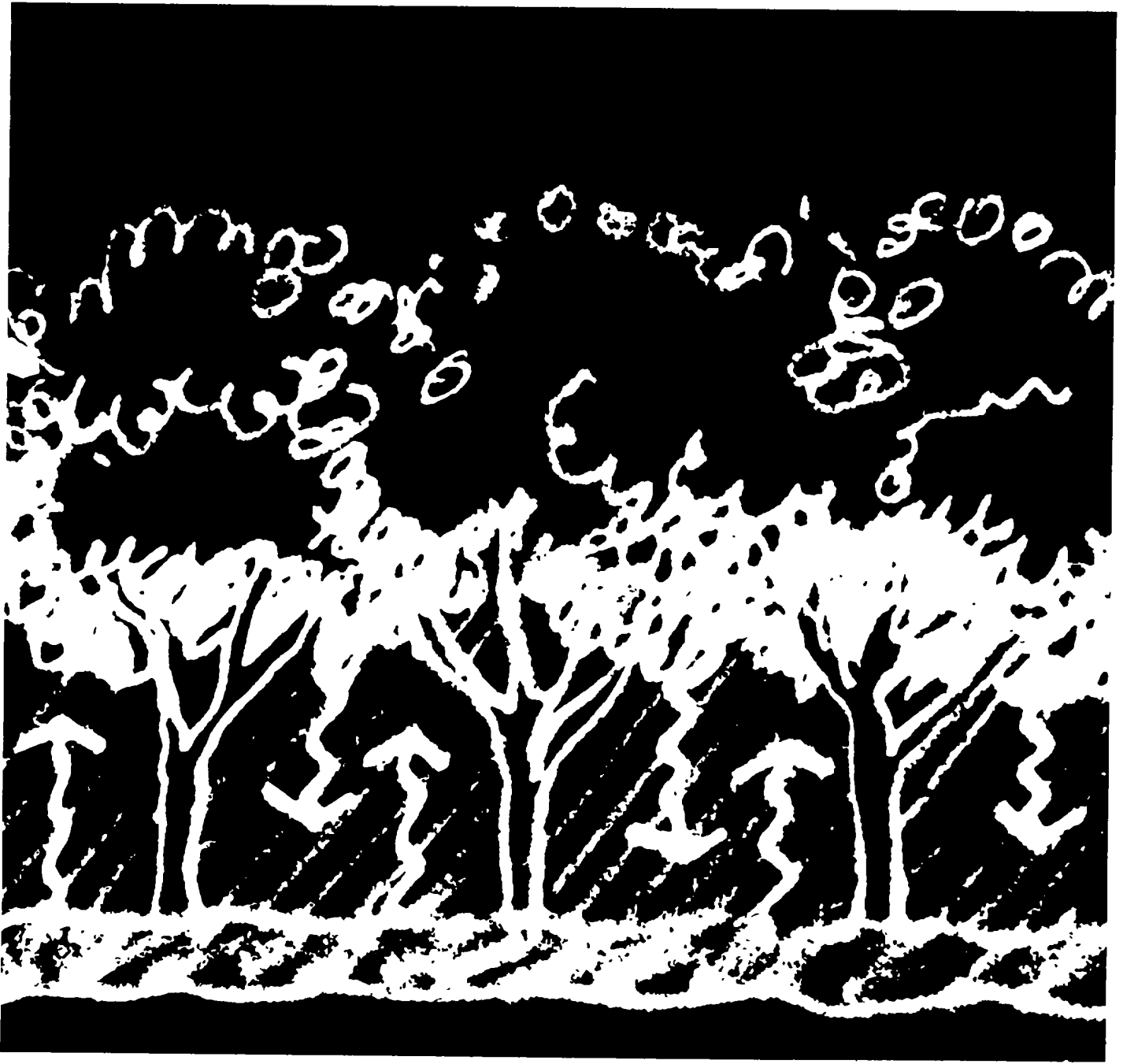

Fig. 5-37.

Most military installations contain generous areas of indigenous natural vegetation. They have provided not only a pleasant setting and visual asset but also have served to minimize the environmental impact of development while also modifying

climatic extremes in most older installations, past planting programs for streets, installation boundaries, open space and buildings have reached maturity and provide a character unmatched in more recent development (*figs 6-1 and 6-2*)



Section I:

Observations and Objectives.

6-1.

Typical Problems.

A. Budgets.

Budgets for plant materials have often been eliminated or reduced in recent developments creating stark, sparsely planted facility settings (*fig. 6-3*).

B. Functional Uses.

Planting design is sometimes misconceived as a means of providing only decoration or ornamentation, while ignoring the many functional uses.

C. Maintenance.

The planting design and selection of plant materials has too often ignored future maintenance costs.

6-2.

Objectives.

The overall objectives of planting are to improve the physical and psychological well-being of people who live and work on military installations. The specific objectives of planting can be stated as:



Fig. 6-2.

A. Preserve and Enhance Existing Landscape Resources.

Existing trees, forest lands and detail planting features are important resources and visual assets that should be carefully preserved and enhanced for functional as well as aesthetic uses.

B. Improve the Overall Visual Quality.

Aesthetic and functional applications of appropriate plant materials should be properly recognized and employed to help improve the landscape character

of military installations. This objective includes: harmoniously blending the built with the natural environment; providing scale and comfort to pedestrian environments; visually reinforcing the hierarchy of the road network; screening unsightly views or elements; and buffering incompatible land uses.

C. Improve the Environmental Quality of the Installation.

Better use should be made of plant materials for environmental quality and energy conservation. Plants can be effectively used in a variety of environmental applications including soil erosion control, air purification, noise abatement and climate modification.



Fig. 6-3.

D. Minimize Maintenance Requirements.

Appropriate plant selection and detailing can minimize maintenance requirements while improving the visual quality of an installation.

Section II:

Design Guidelines.

6-3.

Process.

A design process that includes conscientious site analysis, site design, plant selection and site detailing should be employed to achieve the desired objectives of a planting program.

A. Site Analysis.

A complete site survey and analysis of existing conditions must be undertaken, including an inventory of both natural and built environments. Site factors of fundamental concern relative to both the retention of existing, as well as the installation of new, plant materials include:

1. Visual factors
2. Climatic data
3. Existing vegetation
4. Soils
5. Hydrology
6. Topography/slope analysis
7. Spatial analysis
8. Program analysis
9. Circulation patterns
10. Noise factors
11. Security requirements
12. Maintenance requirements

B. Programming.

Before a planting design is begun, development of a program is necessary. A description of user requirements and environmental design objectives constitutes the program. User needs, environmental problems and maintenance capabilities should be carefully and thoroughly studied. In general, facilities in the 300, 500, 600 and 700 classes, as described in AR 415-28, NAVFAC P-72 and AFM 300-4, Vol. 4, require some planting. The extent of the planting will vary with each class and with each category of facility within the class. The function and prominence of the facility should be the guiding factor in determining the scope of planting.

C. Conceptual Design.

After site analysis and program data have been evaluated, a conceptual design can begin. This involves arranging plant material masses on the site to satisfy the needs and requirements established by the site analysis and program. Plant masses should be arranged in terms of their intended use relative to their forms and sizes, as opposed to specific species and varieties. The primary concern of the conceptual planting design phase is to provide solutions to the functional requirements of the site, upon which preliminary costing and phasing can be developed.

D. Specification of Plant Materials.

After a satisfactory conceptual design is developed and adequate funding is assured, a final planting plan should be prepared. This involves translating the desired forms and sizes of plant masses determined at the conceptual phase into specific species and varieties of plant materials. To successfully make this translation, a thorough knowledge of available plant materials and their functional characteristics is required.

6-4.

Principles.

A. Unity.

Unity is the most important requirement of a good planting design.

1. One means of producing unity in planting design is to enclose an open space or frame a vista. Open areas may be unified into attractive landscape features for a variety of uses such as athletic fields and parade grounds. Where a view beyond the open area reveals objectionable features in the winter, a screen composed primarily of evergreen material may be used. Where the view beyond is pleasant, deciduous trees and shrubs may predominantly be used in the landscape screen.

2. In an area of buildings otherwise characterized by mundane or incompatible architecture, the colors and textures of mature trees and shrubs tend to lessen the contrast between buildings, and visually unify the total composition of the area (fig. 6-4).

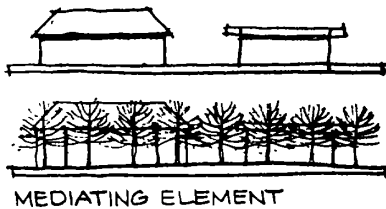

Fig. 6-4.

3. A plant or plant mass can be either a focal object that provides visual delight or a support element that helps to reinforce or frame a focal element such as a view, a piece of sculpture or a building (fig. 6-5).

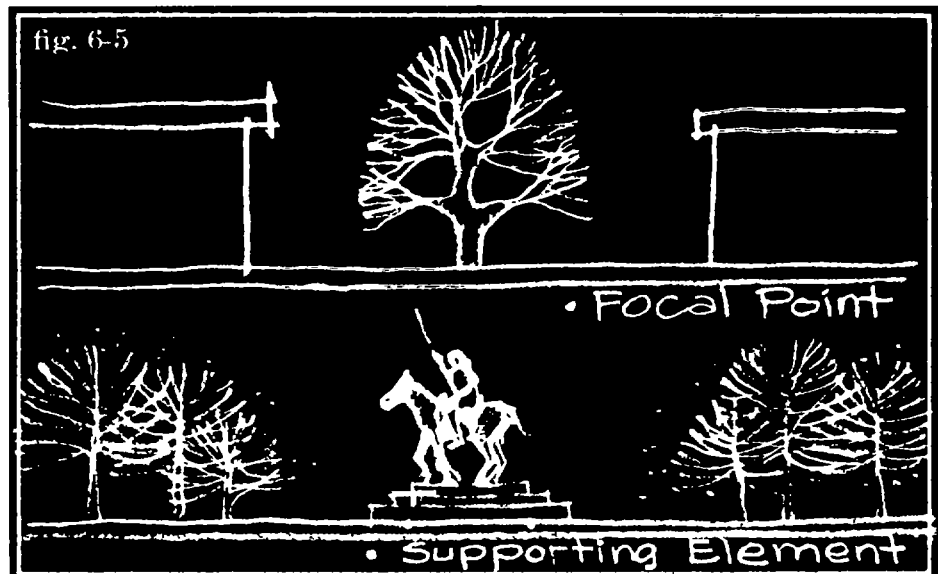

Fig. 6-5.

4. Plants can play two roles in relating a building to its setting. At a detail level, plants can visually integrate a building with its site where the outdoor ground plane meets the building mass (fig. 6-6). On a larger scale, plants can serve to naturally blend a building with its overall site setting.

B. Balance.

Balance is the arrangement of masses (plants or groups of plants) to achieve visual equilibrium by employing either a symmetrical or asymmetrical pattern.

1. Symmetrical or formal balance exists where the same number, size and type of plants are placed on each side of a visual dividing line such as a walkway. While informal or natural arrangement of plants is often desirable for overall appearance, the importance of certain areas, selected buildings or approaches to them can be emphasized by formal planting (fig. 6-7). Formality in planting requires high maintenance to retain a consistently satisfactory appearance. Plant losses are conspicuous, and difficult and costly to replace. Informal or naturalistic plantings soften the environment and, if losses occur, they are inconspicuous and may be replaced easily with small plants.

Fig. 6-6.

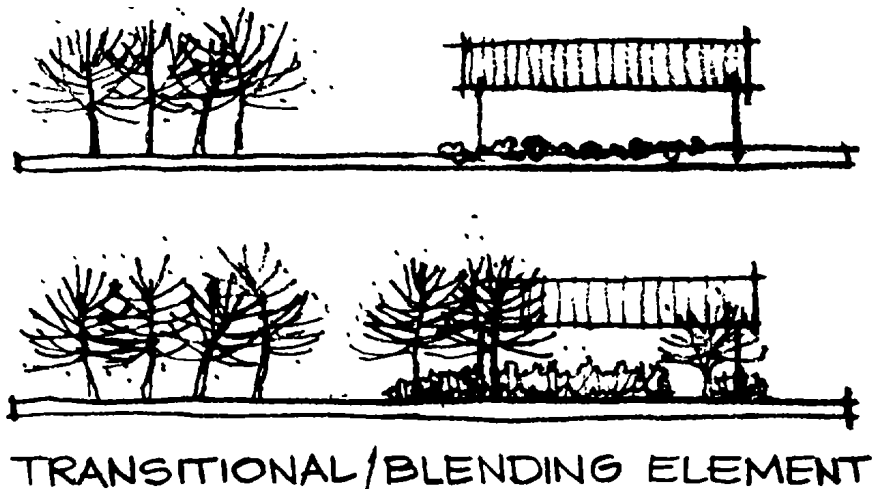

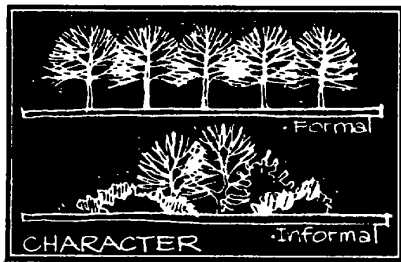

Fig. 6-7.

In planting along streets, excellent design results may be obtained by a combination of formal and informal planting of trees. Planting should be predominantly informal with only occasional use of symmetry to accent a particular architectural or site feature.

2. Asymmetrical balance can be achieved by using different types of plants in a mass or group which appear to balance. A large shade tree may have a balancing effect when used with a group of smaller ornamental trees or shrubs. Asymmetrical balance is more difficult to create because seasonal changes and growth alter the appearance of plants. However, if the plants are carefully selected, asymmetrical balance throughout the year is possible. Some deciduous plants, for example, have branching patterns which balance with other plants in the composition even during the winter when foliage color has changed or disappeared.

C. Contrast.

Contrast is achieved by the arrangement of plants in relation to each other in such a way that differences in size, shape, texture or color are apparent.

Plants can be selected and arranged to focus attention on other plants, as in the case of an evergreen hedge serving as an effective background for flowering

shrubs. A mass of low plants provides a good base for an entrance sign and in this way focuses attention on the sign. Similarly, large trees may be used to emphasize a building entrance (fig. 6-8) or a site feature, such as a gateway. In both cases the trees create a more human scaled environment and the contrast draws attention when seen from a distance or close-up.

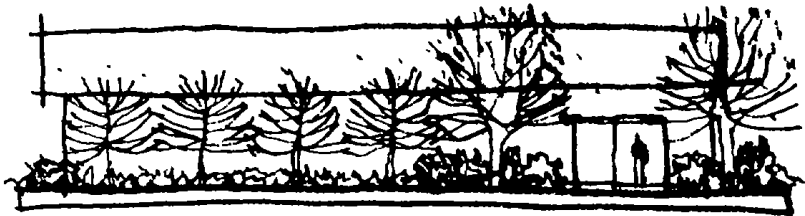

Fig. 6-8.

D. Rhythm.

Rhythm is achieved by a regular spacing of single plants or of plant masses, such as a row of trees or shrubs, or the

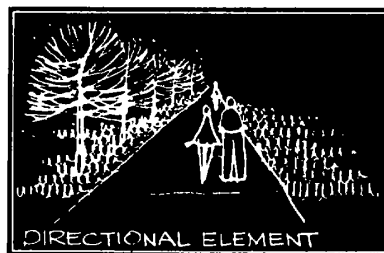

Fig. 6-9.

repetition of similar plant groupings (fig. 6-9). Rhythm produces emphasis and unity and is especially effective in articulating main routes of circulation by street tree planting. A more subtle form of rhythm on a large scale may be attained by variations in spacing and by repetition of such variations. Rhythm in color, shape or size may also be used.

E. Color and Texture.

The color and texture of plants can improve the appearance of an area as well as serve a functional use. Since light, shade and observer location affect both color and texture, the amount of sunlight falling on colorful plants should be considered in their location. Plants having a distinctive texture will look differently depending upon whether

they are seen with back or front lighting or from a distance or close-up. Plant surfaces may range from glossy to dull and this also affects their appearance.

1. Colors are classified in two basic emotional categories: warm colors (red, orange, yellow) which are stimulating, and cool colors (violet, blue, green) which are calming. Color can produce contrast, such as flowering shrubs with an evergreen background. Sharp contrasts should usually be avoided. Large masses of a single color of foliage or blossom are generally more satisfying than a heterogeneous mixture of several colors. "One of each kind" is a design style to avoid. Care should be exercised to pick colors which are harmonious when seen together. Many deciduous plant materials found in most parts of the country provide a variety of fall foliage coloration.

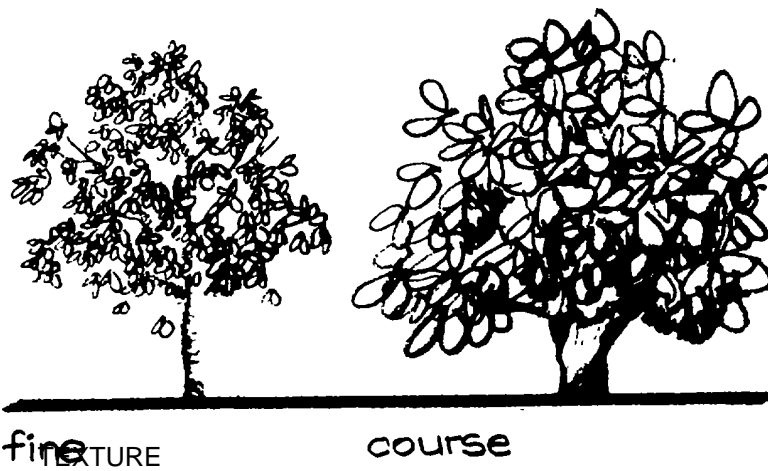

Fig. 6-10.

Some evergreens such as holly produce good fall and winter color with their berries.

2. Texture in plant materials can be coarse or fine (fig. 6-10). A plant will have a different texture depending upon the distance from which it is viewed and its relationship to surrounding materials. A planting screen which is intended to serve as a security measure can be very effective if it is composed of rough, thorny plants.

F. Simplicity.

Layout plans should be broad and simple in form so that excessive maintenance will not be required. Shrub beds should be simple in shape when they are bordered by turf requiring mowing. Isolated geometrically shaped beds of shrubs or ground covers make mowing of turf costly and detract from an orderly appearance. Large power mowing equipment cannot operate efficiently in areas cluttered with isolated plantings.

Hand trimming or the use of small mowers can be very costly in manpower. Lawn areas are simpler to mow if trees are planted in shrub beds or ground cover areas. Small hard-to-mow turf areas should be avoided by substituting ground covers or shrubs that require less maintenance.

G. Ultimate Effect.

Planting should be as permanent as possible. In the choice of plants and their arrangement, the ultimate effect must be kept constantly in mind. The overall plan should indicate the plants at approximately two thirds (2/3) of their ultimate size which will assist in providing the correct spacing. Short-lived plants which grow quickly should be used only where an immediate effect is essential or where, in the course of time, they may be removed as the space they occupy is filled by growth of the more permanent plants. Tall growing plants should usually not be planted under windows. For example, evergreens, which are forest trees in their native habitat, would either cut off light, air, and views from the windows or they would have to be sheared at frequent intervals. Planting in the

vicinity of traffic intersections must be of a low-growing or high-branching variety so as not to block vision from passing vehicles. It is better to choose trees and shrubs in smaller sizes and wait somewhat longer for the desired effects than it is to compromise by substituting inappropriate species. However, the use of a few large trees as accents will help create an early effect of permanence.

H. Spatial Articulation.

Plants can be used to create enclosed spaces and to separate spaces one from another (fig. 6-11). They can also be used to direct people through outdoor spaces by visually defining and reinforcing patterns of movement (fig. 6-12). The degree of enclosure, separation, or movement depends to a large

Fig. 6-11.

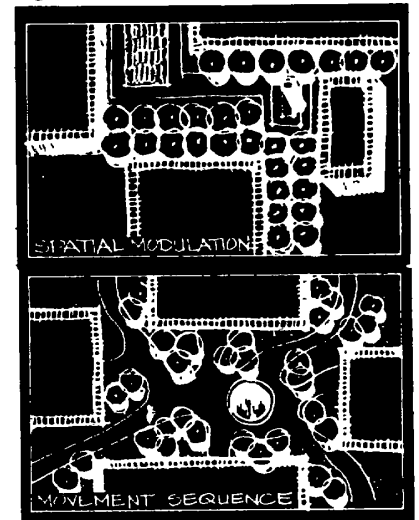

Fig. 6-12.

extent upon the density, form and type of plants used. Deciduous plants vary with the season, whereas evergreens do not.

1. Screen planting, implying that something is to be concealed from view, is achieved by the use of plants with dense, abundant foliage. Planting requires more room than a fence or wall to be effective for screening purposes, and requires more maintenance. Thus, where area limitations prohibit use of plants, a fence or wall softened in appearance with vines or a few shrubs may be a more effective and economical solution.

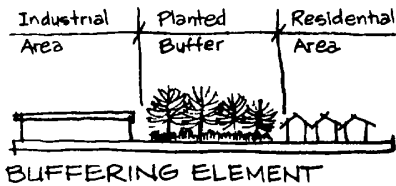

Fig. 6-13.

2. Plant materials to be used as buffers may be comprised of lawn areas; shade trees planted in groups; and combinations of shade trees, flowering trees and broad-leaved evergreen shrubs (fig. 6-13).

3. The use of street trees is one of the most effective means to visually soften, complement and define the road hierarchy. Trees provide shade and improve the overall visual quality of the installation. A systematic design approach should be employed to establish a coordinated street tree planting plan for the entire installation.

6-5.

Attributes.

A. Aesthetic Values.

Plantings made for utilitarian purposes, such as screening service areas or shading hot pavements, will simultaneously

improve the attractiveness and enhance the livability of an area. Variety is introduced, vistas may be created and bareness relieved. A desirable effect of planting is to cause apparent reduction in the scale of structures. The oppressive feeling of monumental scale is relieved by proper planting. Building groups may be

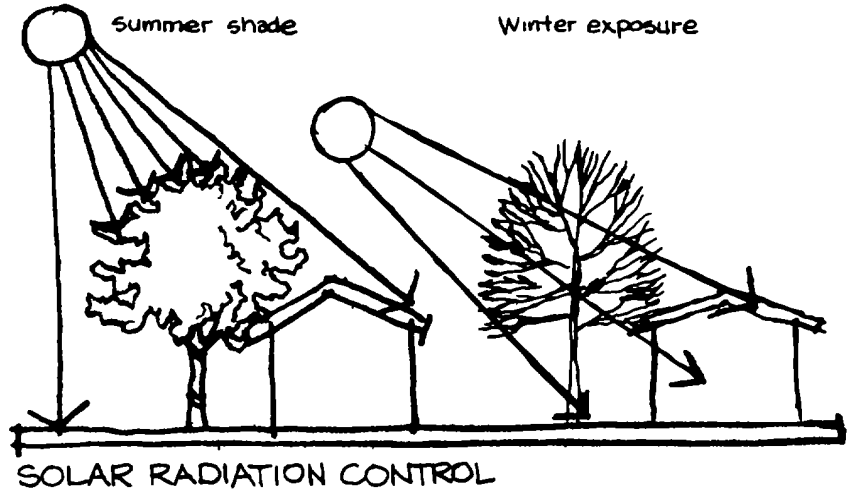

Fig. 6-14.

separated visually into several pleasant framed units, and individual buildings within a group may be enhanced. The use of shrubs and small trees arranged in strategic groups around a building often improves the appearance by softening structural lines. This also helps in integrating the building with its site and diverting attention from unattractive structural features. Vines on large, blank masonry walls can be pleasant but should not be used where injury to the structure may result.

B. Wildlife Conservation.

Plant materials are supportive of wildlife and encourage the number and variety of animal species.

C. Environmental Controls.

1. Energy Conservation.

Skillful utilization of plants can significantly increase the energy efficiency of buildings. Air

conditioning requirements for most buildings result from solar energy absorbed by building surfaces. By simply shading those portions of the building receiving the most sun, cooling requirements can be significantly reduced (fig. 6-14). During summer months, trees can provide shade and thus reduce cooling requirements; during winter

months, the bare branches of deciduous trees allow sunlight to reach exterior surfaces and thus help heat the building. (See Paragraph 3-4: *Adapt Buildings to Natural Site Conditions*, for a thorough discussion of climatic design considerations.)

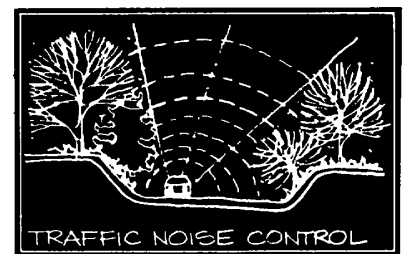

Fig. 6-15.

2. Reduction of Noise.

Dense foliage is of some use in absorbing and deadening noise (fig. 6-15). In such locations as open spaces between family housing areas and main traffic

arteries, deep belts of planting may prove beneficial in reducing traffic noise. Sounds caused by breezes rustling through the leaves and branches can also mask undesirable noise.

3. Wind Control. Wind is a climatic factor that can be either pleasant or unpleasant depending upon air temperatures, relative humidity and air velocities. Plants can be used as a wind control device by breaking, guiding, deflecting or filtering the wind (fig. 6-16). To properly design for wind control using plant materials a basic

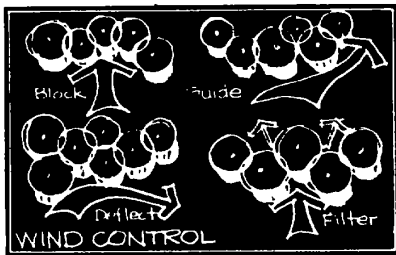

Fig. 6-16.

knowledge of air dynamics is necessary. Information about the directions of prevailing winds and their average speeds for different seasons of the year is, also necessary.

a. When plants are used as a wind barrier, wind can generally be affected for a distance of 2 to 5 times the height of the barrier to the windward side and 10 to 15 times the height of the barrier to the leeward side (fig. 6-17).

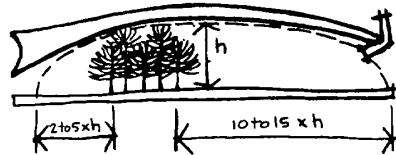

Fig. 6-17.

b. Plants tend to be better screens than fences or walls for windbreaks because they permit some degree of wind penetration. The distance of wind control on the leeward side is increased because less turbulence is created. The most effective density is a screen of about 60% (fig. 6-18).

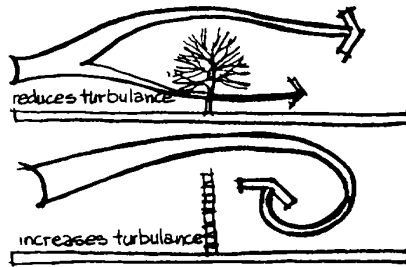

Fig. 6-18.

c. The depth of a shelter belt, or wind screen, has no real effect on the amount of wind protection provided; the primary factors providing effectiveness are the height and density of the plants (fig. 6-19).

d. Irregular forms tend to provide a more effective windbreak than evenly spaced plants. A variety of plant species and sizes also provides a better windbreak than

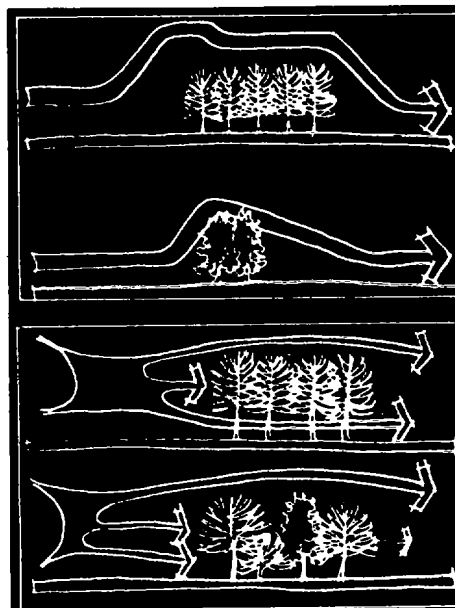

Fig 6-20.

one made up of one species (fig. 6-20).

e. Evergreen plants that branch to the ground are the most effective windbreaks year around. Deciduous trees and shrubs are effective only in the summer (fig. 6-21).

f. Wind velocities will be increased if permitted to penetrate under a high canopied tree. A gap in a windbreak will also tend to create stronger winds by funneling the air through the gap (fig. 6-22).

g. Snow drifting may be controlled by a series of plant barriers which increase and decrease wind velocities. This can be accomplished by sweeping an area of snow with strong winds and depositing it where wind velocity decreases (fig. 6-23).

4. Temperature Modification.

Vegetation reduces the ambient air temperature by the cooling effect of transpiration (evaporation) of water through the leaves and also by shading the ground. Natural vegetation covering the ground tends to stabilize temperature, decreasing extremes, whereas paved surfaces usually tend to increase temperatures. Shade trees are important for comfort practically everywhere in the United States. In all areas except genuinely subtropical and tropical areas,

Fig. 6-21.

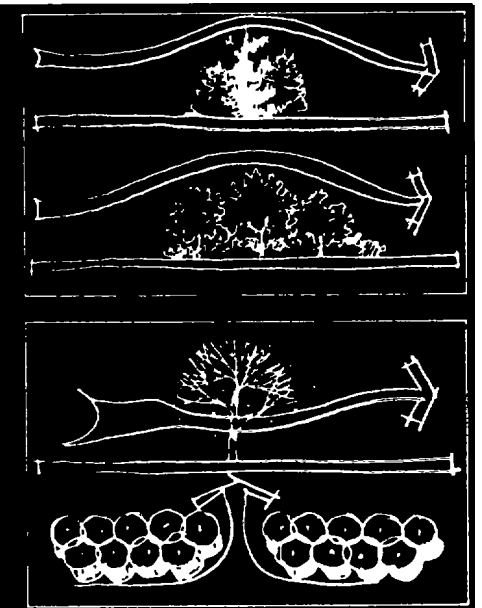

Fig 6-22.



SNOW DRIFT CONTROL

Fig. 6-23.

trees are best for this purpose since they furnish shade only during the summer and permit sun to come through in winter. Shade in parking areas is desirable through the use of large growing trees spaced about 40 to 50 feet apart. However, certain kinds of trees exude gummy substances or attract insects and should be avoided.

5. Glare and Reflection Reduction. Glare and reflection resulting from man-made materials found in the environment cause visual discomfort. Plants can effectively soften glare and reflection while adding to the aesthetic quality of an area. The degree of effectiveness with which plants can do this depends upon their height, density and location (fig. 6-24).

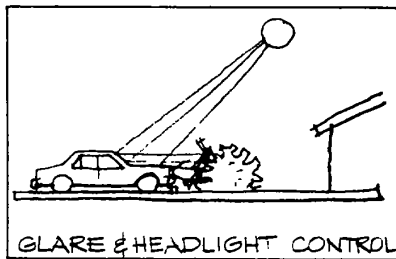

Fig. 6-24.

6. Erosion and Dust Control.

a. Water is the most significant eroding agent of soil. The two basic types of water erosion are

caused by splash and runoff. Splash erosion is best controlled by ground covers and deciduous plants when in leaf. Runoff or sheet erosion is best controlled by grasses and plants with very fibrous root systems (fig. 6-25).

b. Plants can help to control dust by creating a barrier or by stabilizing soil which is bare of vegetation. Twiggy, dense branching plants are effective as wind barriers. Ground covers, grasses and plants with fibrous root systems are most effective as soil stabilizers (fig 6-26) (See TM 5-830-2/AFM 88-17, Chapter 2 and TM5-830-3/AFM88-17, Chapter3, for specific guidance on planting turf and dust control.)

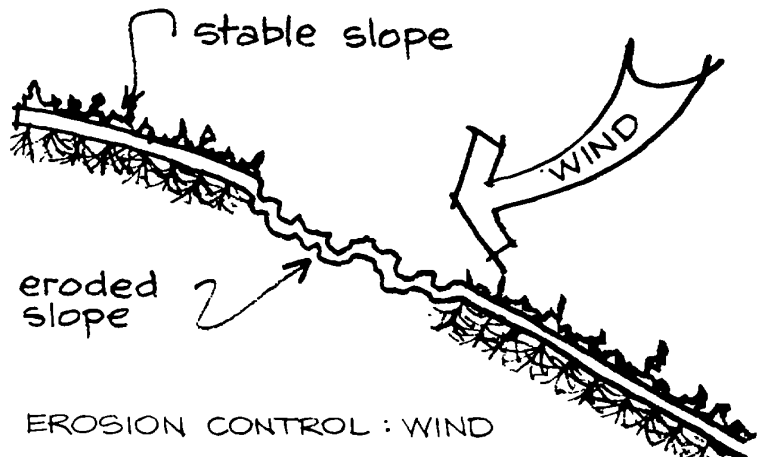

Fig. 6-25.

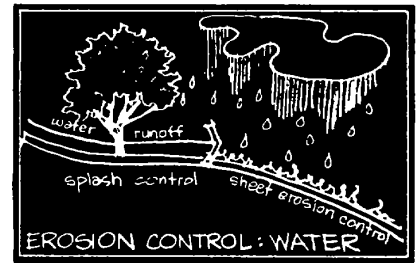

Fig. 6-26.

6-6.

Design Considerations.

A. Preservation.

For the general enhancement of developed areas, as much of the existing vegetation should be saved as is reasonably possible.

1. With high cost of extensive planting operations to restore cleared areas, often the total cost of complete clearing cannot be justified. In every case, the cost of replacing existing vegetation should be weighed against the cost of any special measures which must be taken for preservation, but the best decision cannot be reached by balancing costs alone.
2. Also to be considered is the time required to re-establish

equivalent plant growth. This analysis may justify saving existing vegetation even if it proves to be more costly initially. Where immediate control of dust or erosion is of prime importance, such a conclusion may be easy to reach. The reduction of clearing and grading operations to a minimum contributes much to conservation and environmental protection, and lowers construction cost.

3. Fast-growing trees regarded as weed types may comprise the predominant native vegetation in certain areas. Such trees are sometimes worthy of preservation until new ornamental plantings have matured and the weed trees can be removed.

4. During site construction, minor variations in road and walk design layout should be made to avoid the destruction of or damage to important vegetation.

B. Maintenance.

Maintenance and its resultant costs may be kept to a minimum by coordinated planning. Design factors which are basic to economical grounds maintenance, and which should be considered in the early design stages of a project, are described below.

1. Drainage. Good drainage of surface and subsoil is necessary not only for the successful growth of nearly all plants but also as an erosion-control measure. Subsurface drains should be installed when necessary to correct conditions of excessive soil saturation. An alternate to subsurface drains, in some cases, is to select plant materials tolerant to wet conditions. Good surface runoff of planted areas will be assured by proper grading. See *TM 5830-4*; *NAVFAC P905*; and *AFM 88-17, Chapter 4*.

2. Grading. Steep slopes, if planted in grass or other vegetative cover, are difficult and expensive to mow and maintain and are subject to erosion. Good grading design can often reduce the need for steep slopes. Grass slopes should not normally exceed a 3: 1 grade, with top and bottom rounded, to prevent erosion and facilitate mowing. Steeper slopes should be rip-rapped or planted with ground cover and/or other plants. Grading in the vicinity of existing

C. Plant Selection.

Trees, shrubs, ground covers, vines and turf comprise the palette of elements in planting compositions (*fig. 6-27*). The varieties selected should be as few as possible to satisfy the requirements and objectives of the design. By limiting the varieties of plants, rather than cluttering the design with a planting mixture, clashing colors and forms are less likely to occur, and a unified composition will be created.

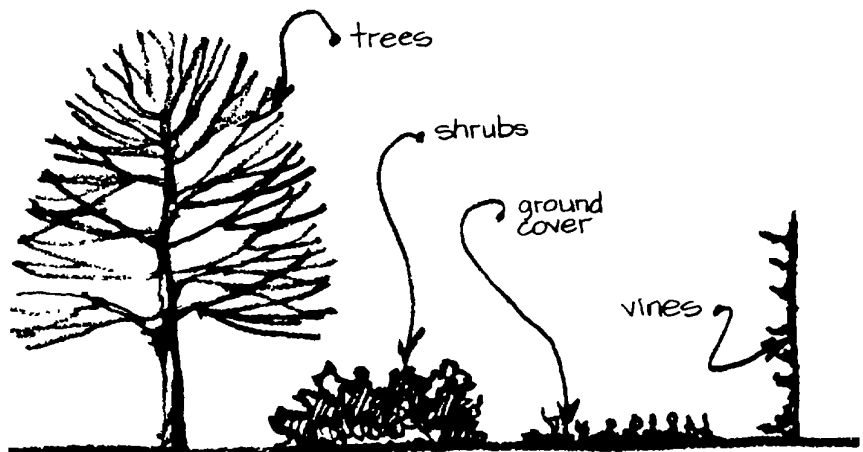

TYPES OF PLANT MATERIALS

Fig. 6-27.

trees to be retained should be avoided. Fill on and/or compaction of the soil within the foliage drip line will eventually kill the tree.

3. Detail Plating. Flower beds and sheared hedges require a great deal of costly maintenance and should be used sparingly in selected locations. Where flower beds and sheared hedges are appropriate, restraint in design is essential to their effectiveness and upkeep. Street trees should be located between the sidewalk and buildings, leaving the strip between the sidewalk and curb free for installing and servicing underground utilities.

Repetition with occasional contrast contributes to a successful planting design. In selecting plants for a given project, it is helpful to remember their growth characteristics. These characteristics are documented in landscape architecture literature and are available through libraries and government publications, some of which are listed in *Appendix B*. Only those plants capable of thriving with low maintenance under actual site conditions and which are able to produce the desired effect should be chosen. A guide to the selection of plants that can be used with confidence may be gained by an investigation of plants growing at the project site and also at the oldest parks and cemeteries in the same general vicinity.

Species of plants, whether native or naturalized, found thriving under adverse conditions are likely to be successful with minimum maintenance. The ecological association of plants is an additional factor to be considered when selecting plants since, in nature, plants grow in groups requiring similar soil and climatic conditions. Other important factors in the selection of plants are hardiness to temperature extremes, requirements in terms of soil fertility, ability to survive in very wet or dry soil conditions, the degree of tolerance to wind or salt air, ability to be transplanted and resistance to insects and diseases. Recommendations on the choice of plants which are tolerant of specific site conditions can be obtained from the Agricultural Extension Service; Soil and Water Conservation District; or from Federal, State, County, and City park and forest agencies.

1. Trees and Shrubs. To assure maximum effectiveness with the lowest maintenance, emphasis should be placed on the use of trees instead of the extensive use of shrubs. Properly selected trees will ultimately be less expensive to maintain than shrubs and they are more effective for environmental control. Clean, simple but effective planting designs can be achieved with trees and lawns and the judicious use of shrubs.

2. Evergreen and Deciduous. Deciduous trees offer a wide variety of effects because of seasonal changes, flowers, berries, fruit, and color and texture of bark. Evergreen trees and shrubs are advantageous, if adaptable to the area, because

they provide green color and contrasting background when deciduous plants are leafless. In southern states a wide variety of evergreen shrubs is readily available for use, but in more northerly areas the selection may be limited or costly. Where the latter is true, deciduous shrubs may be used for the greater part of the planting, introducing evergreen plants only at focal points in conjunction with important features and structures. In many areas of the country deciduous trees are very desirable since during cool months they permit a maximum amount of sunlight to penetrate.

3. Vines. The use and selection of vines must be very carefully done. Many vines climb by means of tendrils and disks or root-like hold-fasts which can damage wood or masonry walls. Maintenance and repair work can be difficult and costly if vines must first be removed. Generally, vines should be restricted to arbors, trellises and structures other than buildings.

Outdoor pedestrian-oriented spaces are often desirable in high employment and dense residential areas. When these spaces are enclosed or partially enclosed by buildings and are enhanced with appropriate landscaped features while being separated from traffic, parking and other distractions, they

can provide an attractive and relaxing contrast to activities and facilities around them. A plaza can serve as an entrance space to an important group of buildings. A courtyard in an office complex can provide pleasant views from the interiors of the surrounding buildings as well as a place for

lunchtime relaxation. In a residential area, courtyards can provide a space for informal gatherings and active recreation. For convenience, the term "plaza" will be used throughout this section to include both plazas and courtyards.

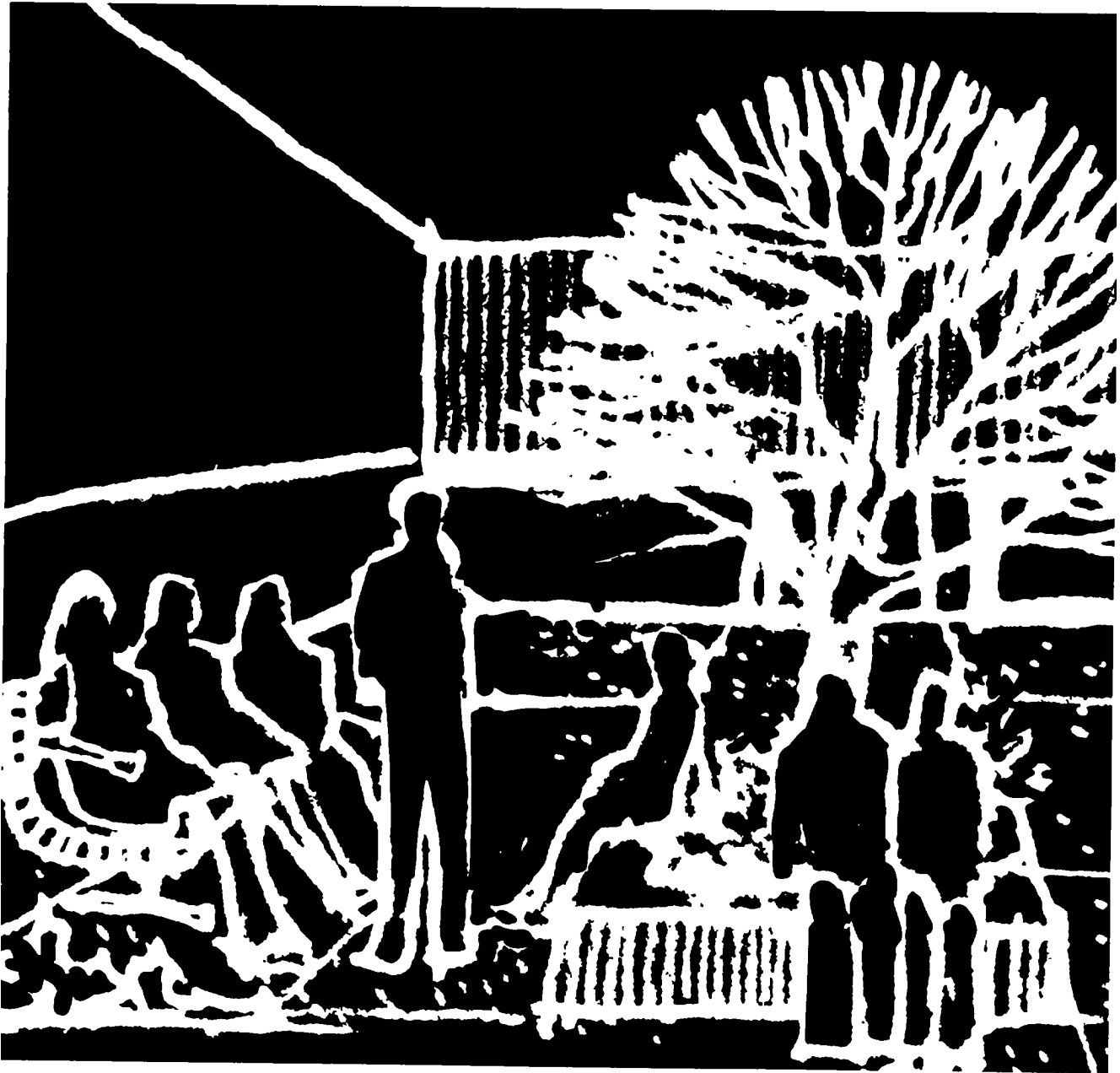

Section I:

Observations and Objectives.

7-1.

Typical Problems.

A. Location and Function.

In the past there has been a general lack of plaza facilities within installations, a fact that may express an oversight in considering user needs. In many cases, either an existing plaza or the opportunity to create a plaza has been usurped by the insatiable demands of parking, destroying the original design intent and attractiveness of the facility. Many existing plazas are uninviting to active use because of their scale, use of plant materials or lack of consideration for climatic conditions (*fig. 7-1*).

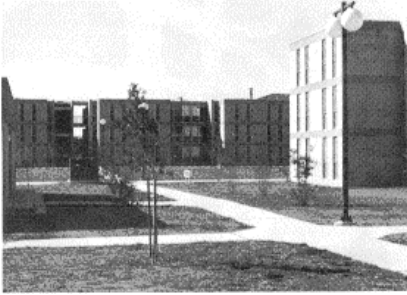

Fig. 7-1.

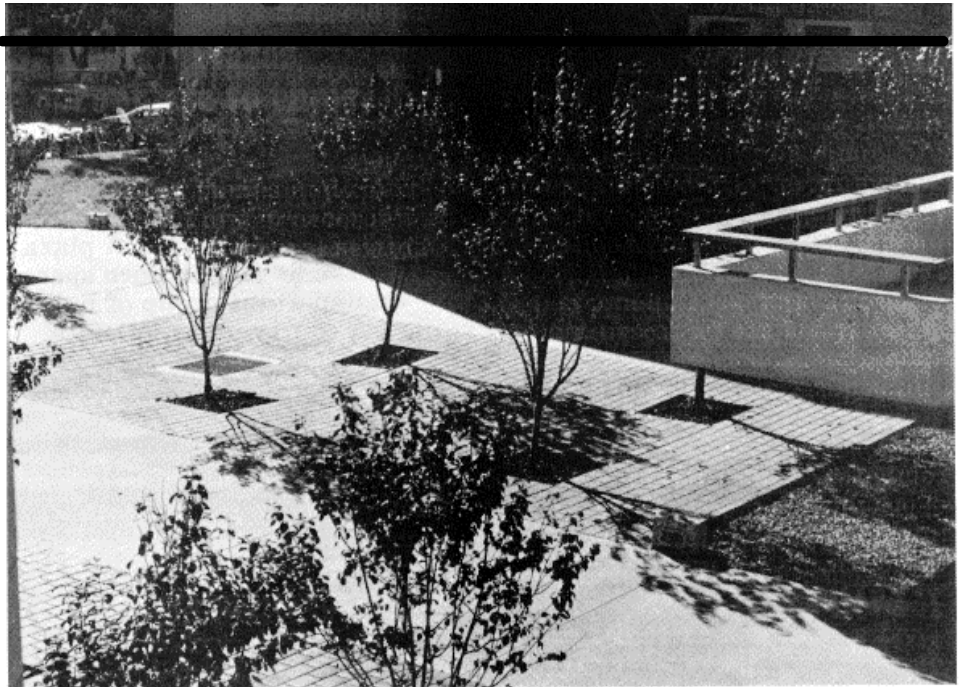

Fig. 7-2.

B. Materials and Details.

The materials and detailing of plazas often reflect improper consideration for maintenance, wear and climate factors.

7-2.

Objectives.

A. Locate Plazas in Response to user Requirements.

Exterior spaces provide desirable spatial experiences relating interior building spaces to the exterior circulation and open space systems of an installation.

A range of functions from passive visual enjoyment to active recreation can be appropriately provided by plazas.

B. Design Plazas Appropriate to their Setting

The design of plazas and courtyards should vary in accordance with their architectural

setting and climatic conditions as well as intended use. The medieval Italian piazzas, so fondly imitated by urban designers, can be extremely inhospitable and inappropriate in cold northern climates. Properly designed plazas and courtyards should relate harmoniously with the architectural and natural site character of their surroundings, and moderate climatic extremes.

C. Reduce Maintenance.

The materials, details and site furnishings utilized should minimize required maintenance while reinforcing the architectural character and site design concept of adjacent buildings. Grass and trees are appropriate in passive areas with light usage, and can be used to provide shade and reduce sun glare and temperature extremes. In high use areas with heavy pedestrian traffic, paving, tree grates and ground covers are appropriate to reduce maintenance and wear (*fig. 7-2*).

Section II:

Design Guidelines.

7-3.

Potential Uses of Plazas.

Establish plazas in response to user requirements. Possible functions include:

A. Entranceway.

A plaza may function as a formal entrance space to a building or group of buildings. As an entrance space, the plaza should accommodate and direct pedestrian traffic to the building (fig. 7-3).

fig. 7-3.

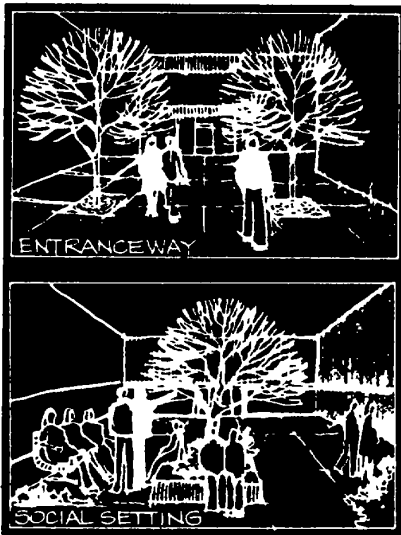

fig. 7-4.

B. Social Setting.

A plaza may provide an atmosphere for relaxation and provide opportunities for people to mingle, gather for lunch, or simply enjoy conversation (fig. 7-4).

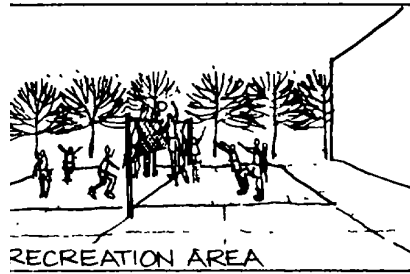

fig. 7-5.

C. Recreational Area.

Plazas may provide and encourage opportunities for both passive and active recreation

(fig. 7-5).

D. Visual Delight.

Plazas can offer pleasant views and visual relief for visitors and occupants of a building (fig. 7-6).

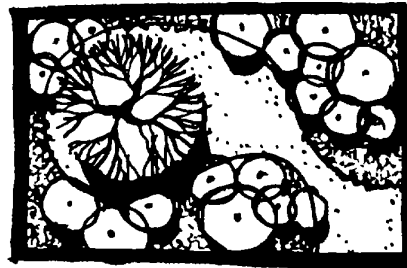

fig. 7-6.

E. Multifunctional Facility.

Most often plazas serve several functions but have one primary use.

7-4.

Site Design Consideration.

A. Site Feasibility.

Consider user needs and potential volume of pedestrian activity as the major factors affecting project feasibility. The amount of potential pedestrian activity will determine to a large extent the design and maintenance requirements of a plaza.

B. Site Setting.

Plazas should be designed appropriately to their setting. A

thorough site analysis should be conducted prior to design and include the following:

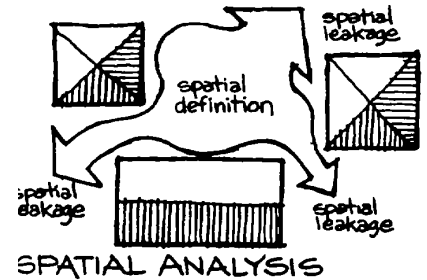

fig. 7-7.

1. **Spatial Analysis.** In many instances on military installations, locations for plaza development are already spatially defined by existing structures. In other instances, there is little or no existing definition. The desired degree of spatial definition as well as the character of the space should be determined initially (fig. 7-7).

2. **Topography.** Plaza design should incorporate existing topographic relief into its form where possible to add visual interest, preserve existing vegetation, and minimize cut and fill costs.

3. **Micro-climate.** Microclimate evaluation is an important factor in determining human comfort within proposed plazas. Wind intensity and direction, sun angle, duration of direct sun, average monthly temperatures, and seasonal precipitation for a proposed site should be evaluated during the site analysis stage of the design process.

4. **Circulation.** Existing and proposed circulation patterns, including pedestrian, vehicular

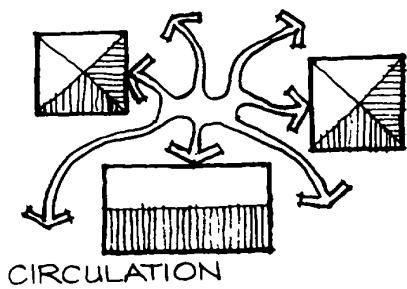

fig. 7-8.

and service traffic should be determined initially. Circulation patterns should be a major factor in the plaza design (fig. 7-8).

5. Views. Views, both to the proposed plaza from surrounding strategic viewing positions and looking from the proposed site, should be considered in

fig. 7-9.

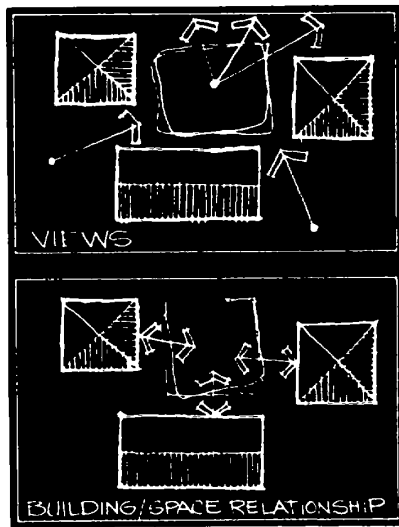

fig. 7-10.

terms of the potential role in the final plaza design (fig. 7-9).

C. Spatial Organization.

The manipulation of space is a major design tool in the formulation of a plaza. To successfully organize and alter a space relative to its surrounding environment, several elements of spatial organization must be considered, including:

1. Building/Space Relationship.

Plaza development should occur in conjunction with existing and/or proposed buildings which contain or partially define a plaza space. The buildings and the space should relate in a functional and visually compatible manner. The design of the plaza space must be integrated with adjacent buildings through the use of compatible scale and form (fig. 7-10).

2. Scale. The spatial relationship between plaza and buildings is the primary determinant of its scale, which can vary from a small intimate space to a large monumental space. The following ratios of building height to plaza width serve as guidelines for establishing a spatial definition at a scale and character that is appropriate for its intended use (fig. 7-11).

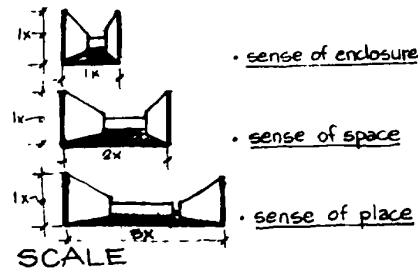

fig. 7-11.

- a. To establish a visual sense of enclosure, the ratio of length of plaza to height of building should not exceed 1: 1.
- b. To maintain a visual sense of space, the ratio should not exceed 2: 1.
- c. To maintain a visual sense of place, the ratio should not exceed 3:1.

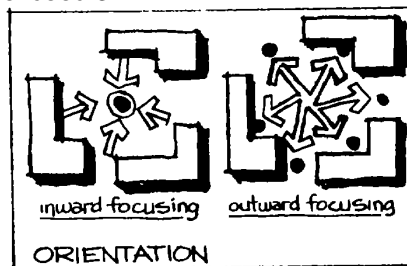

fig. 7-12.

3. Orientation.

The orientation of the plaza should be determined initially. A plaza may focus primarily inward or outward. An inwardly focused plaza creates a sense of visual containment, while an outwardly focused plaza directs or frames views beyond the plaza (fig. 7-12). The functional requirements of the space will often determine its orientation.

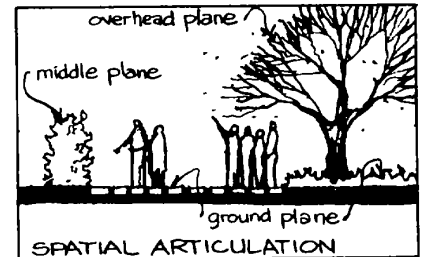

fig. 7-13.

4. Spatial Articulation.

The volumetric definition of a plaza space to reinforce its intended function is termed spatial articulation. This may be accomplished through careful design of the ground plane (paving, ground cover), middle plane (walls, trees, shrubs), and overhead plane (tree canopy, trellis) as well as in changes of level across the plaza space (fig. 7-13).

7-5.

Materials and Details.

Use appropriate materials, details and furnishings to create an appropriate plaza character, to reinforce its spatial and functional design concepts, to relate it compatibly with adjacent buildings and to minimize maintenance requirements.

A. Paving.

- 1. Refer to Chapter 8: Walkways, for a discussion of paving surfaces.

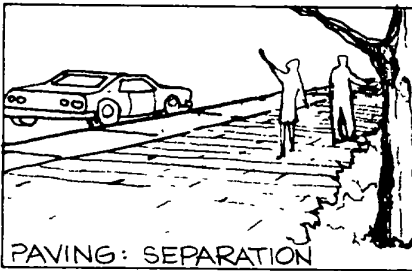

fig. 7-14.

2. Use a change in paving materials to indicate a distinct separation between pedestrian and vehicular traffic areas (fig. 7-14).
3. Choose surface materials for durability, visual accent, compatibility, scale and form.
4. Paving in high-use public places should provide hard, dry, non-slippery surfaces that can carry pedestrian traffic and occasional maintenance and emergency vehicular traffic.
5. Use paving materials to provide a sense of direction - for example, marking a path through a plaza. In this case, either the same material could be varied in pattern to delineate the pathway, or a change of material might be used. If another material is chosen, it should be compatible with the

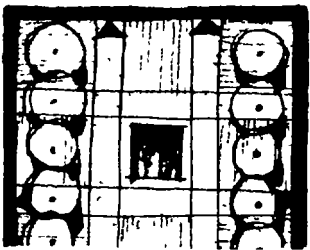

fig. 7-15.

background and not provide too sharp a contrast (fig. 7-15).

6. Use paving materials to provide a warning - for example, to indicate a change in level or a pedestrian path crossing a vehicular path. Demarcations that are integrated into the plaza paving, rather than a sign, are most effective (fig. 7-16).

7. Use paving to provide a scale reference. Usually smaller-scale paving indicates a more personable domain, and larger-scale a more public domain.

8. Use paving materials to define and reinforce the character of distinct areas within a plaza - for example, to set off small informal seating areas from large public gathering areas in terms of the paving pattern and delineation.

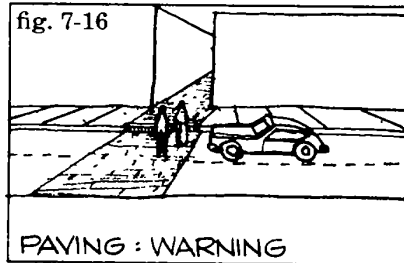

Fig. 7-16.

9. In a hot climate, minimize paving to reduce reflected solar radiation and air temperatures; planting areas should predominate over paved areas to facilitate shade and air cooling.

paved areas:

a. For paving against buildings consider drainage slope away from the building and compatibility of materials.

b. For paving against grass areas consider mowing requirements.

c. For paving against curbs and other hard surfaces consider snow removal and drainage.

E. Plant Materials.

Use plant materials in plazas to define spaces, modify climate, and provide scale and aesthetic elements. A variety of plant materials can be used. Deciduous trees are ideal in some regions because they provide shade during hot summer weather and permit warm sunlight to penetrate the space during cooler months (fig. 7-17). (See Chapter 6: Planting.)

C. Water Features.

Pools and fountains can provide a desirable aesthetic and functional element to a plaza design (fig. 7-18).

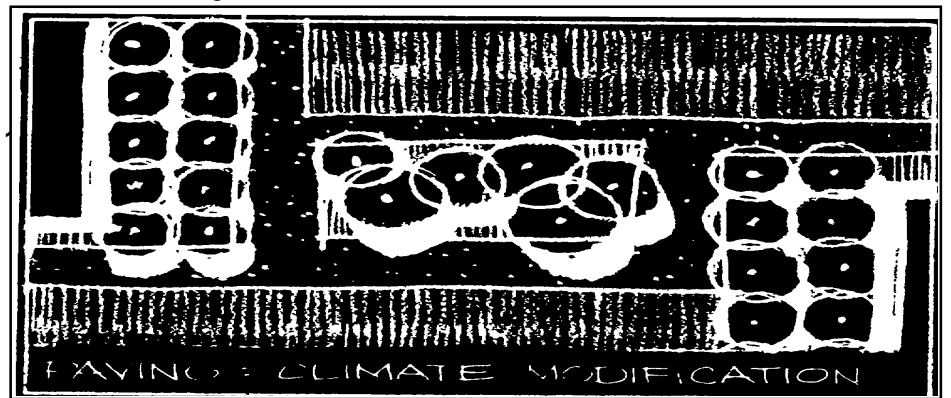

fig 7-17.

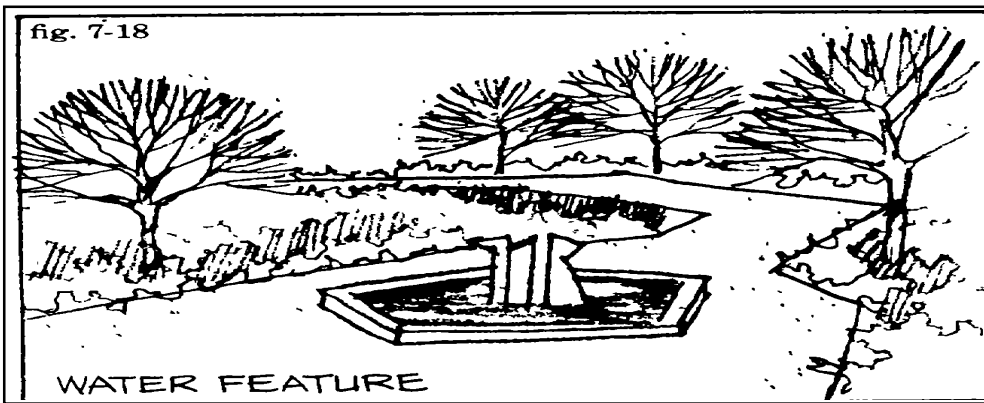

fig. 7-18.

1. Use basins, pools, and fountains to provide visual relief in areas set aside for socialization or recreation, or to provide a visual focal point in more formal plaza designs.

2. Use water features to temper the micro-climate of plazas. Water generally has a cooling effect and can be used to relieve excessive heat and dryness, especially in hot arid climates.

3. Fountains and cascading water features can provide not only an element of visual delight but also auditory relief in plazas. The sounds of these water features are very attractive and restful in their effect on people.

4. Although fountains are appropriate in diverse climates, their maintenance considerations vary. For example, in northern climates, fountains and pools should be designed to facilitate drainage during cold winter months, so that ice will not crack masonry, conduit pipes or spray fountain apparatus.

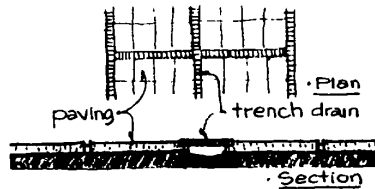

DRAINAGE

fig. 7-19.

D. Drainage.

In the development of plazas, water runoff is usually increased because the amount of paved area is increased. This runoff must be handled by an adequate storm drainage system.

1. Drainage systems should be incorporated into paving patterns and details (fig. 7-19).

2. Drainage can provide water to plant materials through the use of tree grates or porous pavement treatments (fig. 7-20).

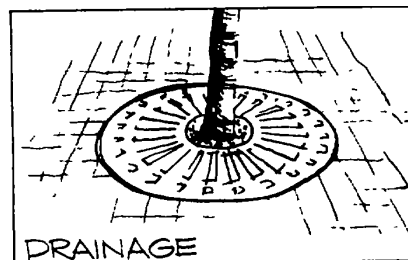

fig. 7-20.

E. Steps and Ramps.

Steps and ramps are important design elements used in making transitions between different plaza levels. Design guidelines on steps and ramps are covered in *Chapter 8: Walkways*. It should be stressed that steps and ramps should be designed for maximum convenience and comfort relative to plaza function and visual considerations (fig. 7-21). Furthermore, adequate provisions for the handicapped must be provided.

F. Lighting.

Lighting is an important element in the design of plazas. It can provide general illumination, accent, or mood, depending on the desired intensity and color rendition characteristics of the light source. Lighting standards themselves are also important elements in providing scale, defining space and adding visual interest to the design of plazas (fig. 7-22). The elements of lighting design are covered in *Chapter 11: Lighting*.

G. Benches and Beating.

Benches are important functional components of plaza design. They can also act as sculptural elements. They may be individual elements or incorporated into the design of planters and walls. Those with backs are generally more comfortable. Fountain or planter walls can also

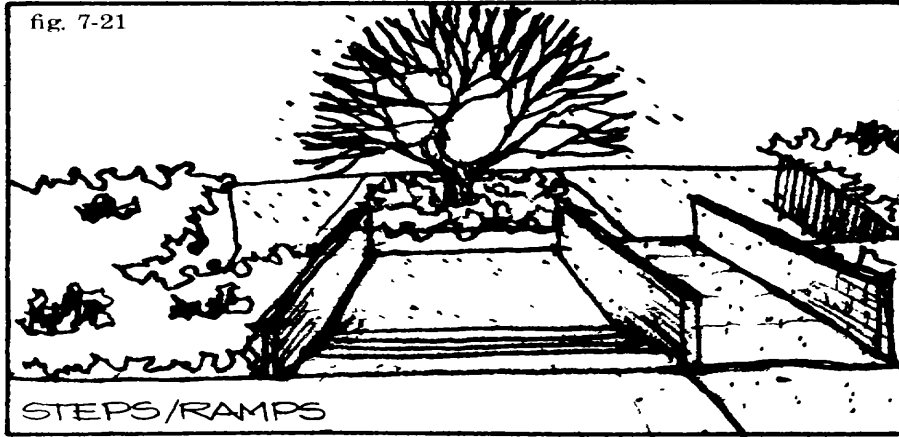

fig. 7-21.

serve as plaza seating surfaces (*fig. 7-23*). Design guidelines for benches and seating are found in *Chapter 12: Site Furnishings*.

H. Provisions for the Handicapped.

Refer to *Chapter 8: Walkways*, and *Chapter 12: Site Furnishings*.

fig. 7-22.

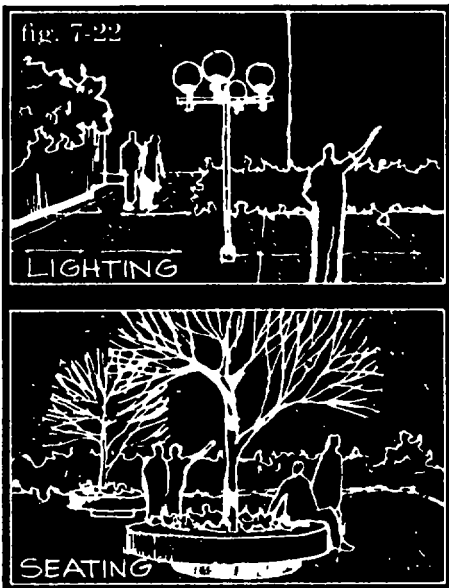

fig. 7-23.

Chapter 8: Walkways.

Pedestrian-oriented site planning and design can contribute much to the convenience, comfort and enjoyment of daily activities. In addition, energy conservation necessitates reduced dependence on the automobile and encouragement of pedestrian and other energy-efficient alternatives.



Section I:

Observations and Objectives.

8-1.

Typical Problems.

A. Network.

Visitors, employees and residents of military installations are heavily dependent upon the automobile, in part due to dispersed locations of related facilities and the lack of alternative circulation systems at many military installations. Pedestrian facilities are generally limited to sidewalks which often show little consideration of pedestrian generators, volumes and desire lines of travel, or the special needs of handicapped persons (*fig. 8-1*).

B. Pedestrian/Vehicular Separation.

Separation of pedestrian and vehicular circulation networks is often neglected. In many cases,



fig. 8-2.

the pedestrian network is discontinuous, forcing pedestrians to use roadways or to create footworn paths, a situation especially hazardous to children

C. Amenities.

Pedestrian facilities are often lacking in amenities and elements of visual interest. Instead they are generally located within an automobile-dominated environment which is neither pleasant, safe and delightful nor conducive to encouraging pedestrian travel (*fig. 8-3*).



fig. 8-3.

8-2.

Objectives.

A. Provide Safe and Secure Pedestrian Circulation Facilities.

The primary hazard to pedestrians is the moving vehicle. With no protection, the pedestrian is extremely vulnerable to injury.

Other safety hazards are the threat of assault in dark, unobserved locations and unseen obstacles along or in the path of travel. The design of the pedestrian system should minimize all of these hazards.

B. Provide Pedestrian Facilities in Response to Potential Demand.

Attractions and generators of pedestrian movement should be linked by a logical network. New pedestrian facilities can result in increased pedestrian activity if there is a valid potential demand.

C. Create a Pleasant Pedestrian-Scaled Environment with Elements of Visual Delight.

Pedestrian facilities should take maximum advantage of areas of visual enjoyment and be separated from the inhospitable influences created by automobiles and trucks.

D. Facilitate Movement and Access to Facilities by the Handicapped.

With proper sensitivity and consideration early in the design process, pedestrian circulation facilities may be designed to accommodate all persons. The modification of existing facilities for use by the handicapped is often more difficult but can be accomplished (See DOD 4270 1M for specific guidance Navy personnel are to follow the specific guidance in DM-1 Series)

Section II:

Design Guidelines.

8-3.

Principles of Pedestrian Walkway Design.

A. Continuity. A pedestrian walkway system should have five essential characteristics: A Continuity. The basic walkway system should provide a continuous, unbroken circulation network. The network should be complete, clear and legible for pedestrians to reach their destination, whether the pathway is curved or straight (fig. 8-4).

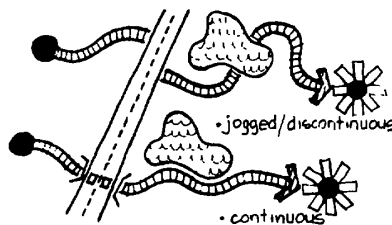

fig. 8-4.

B. Safety.

Walkways should provide safe, short crossings of roadways. Walkways should also be free of obstructions that would pose safety hazards. Walkways in locations away from streets should be lighted and integrated into the area development plan to enable

visual surveillance of the path (fig. 8-5). The horizontal alignment of walkways should usually follow the natural topography. Steps along the pathway should be avoided if possible.

fig. 8-5.

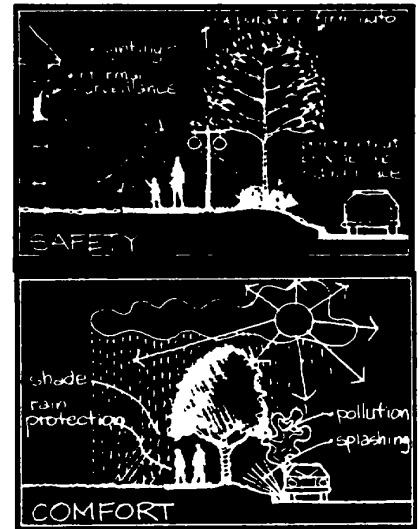
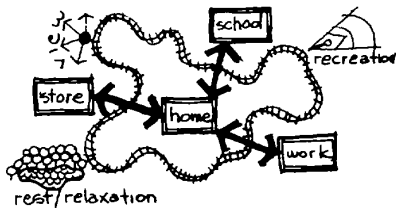

fig. 8-6.

C. Comfort.

Comfortable walking surfaces must be smooth, dry and level. They must have adequate width to handle the expected type and volume of traffic. Steep inclines should be avoided unless steps or ramps are used. Protection from hot sun, cold winds and rain is desirable and can be provided by either plant materials or structures. Separation from vehicular traffic, areas of toxic or noxious fumes and loud or abrasive noise is essential for pedestrian comfort as well as health and safety. Intermittent comfort features such as benches and drinking fountains further promote pedestrian comfort (fig. 8-6).



CONVENIENCE & DELIGHT

fig. 8-7.

D. Convenience Walking is a preferred means of transportation when destinations are close, when relaxation and exercise are desired, and when energy conservation is being promoted. Generators of pedestrian traffic should be conveniently linked together by an overall pedestrian network, designed within the parameters of maximum walking distances. By accommodating user needs, pedestrian travel can become a convenient alternative to the automobile. Walkways to shopping and work locations should be as short and direct as possible while recreation-oriented paths should be more indirect but scenic (fig. 8-7).

E. Delight.

Pathways can provide unexpected vistas, new discoveries and visual experiences that are more varied and exciting than those provided by automobile travel. The pedestrian circulation system should be designed to provide visual delight to encourage pedestrian use and enjoyment of the network.

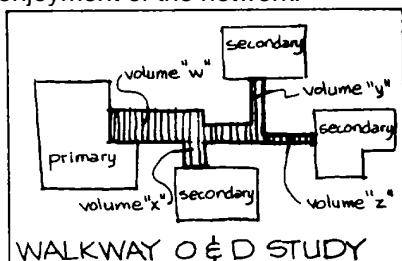

fig. 8-8.

8-4.

Designing Walkways.

A. Site Design Surveys.

There are two basic studies necessary to establish the framework within which an overall pedestrian walkway system can be designed:

fig. 8-9.

2. Safety study.

The safety study identifies actual and potential pedestrian-vehicle conflicts. These studies provide the basis for determining necessary pedestrian-vehicular network separations and pedestrian-vehicular coordination through various signalization and signing techniques.

fig. 8-11

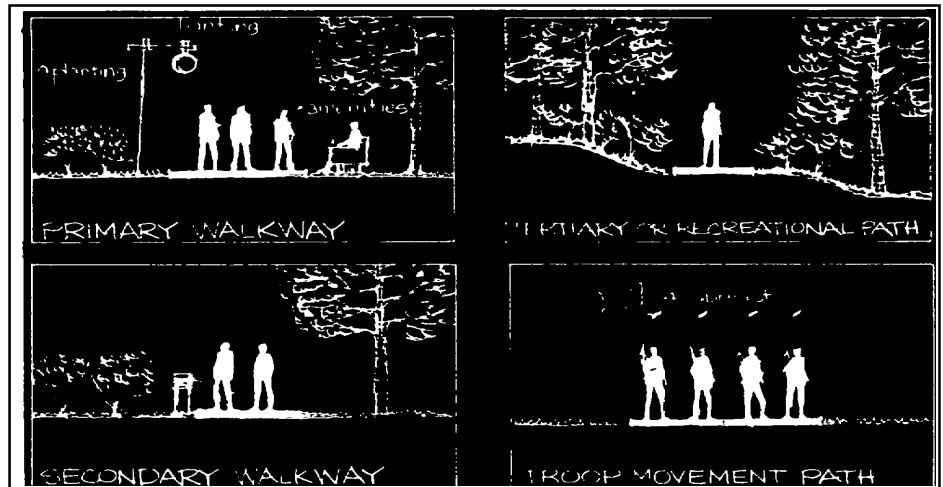

fig. 8-10.

fig. 8-12.

1. Origin-Destination Survey.

The origin-destination survey identifies the location of primary and secondary generators of pedestrian traffic. Primary generators generally are residential areas, parking facilities, transit terminals and similar facilities. Secondary generators are generally areas or facilities which are destination points primarily accessible by walking, such as athletic fields.

Other information identified by this survey includes pedestrian volumes between different facilities, walking distances between all major pedestrian destinations, and identification of routes which carry the largest amount of daily travel (fig. 8-8).

B. Walkway Network Hierarchy.

The pedestrian walkway system should be designed as a hierarchical network that provides different levels of use and convenience based upon the volume of pedestrian traffic and trip purpose. The origin-destination survey provides the basic data to design the network hierarchy. The design of each segment of the walkway should reflect its role within the overall network plan.

1. Primary Walkway.

This walkway classification is for those segments of the network that carry the highest volumes of pedestrian traffic between major activity centers or traffic generators. Primary walkways are generally characterized by: hard surface paving; high lighting levels,

depending upon location; a high level of pedestrian amenities, including benches and water fountains; and refinement of landscape features along the walkway (fig. 8-9).

2. Secondary Walkway.

This walkway classification is for moderate volume segments of the network that provide a direct interconnection between activity centers. Secondary walkways are generally characterized by: hard surface paving; lower lighting levels; fewer amenities, such as seating and drinking fountains; and quality landscape features along the walkway. The majority of walkways within installations would fall into this category (fig. 8-10).

3. Tertiary or Recreational Paths.

This walkway classification is for infrequently used walkway segments such as recreational paths. These walkways generally tend to be less direct but more scenic in character. Tertiary walkways are generally characterized by: hard surface or soft surface paving, such as wood chips; low illumination levels, if any; and a natural landscape character along the pathway (fig. 8-11).

4. Troop Movement Paths.

Installations with training facilities require special walkways for troops marching in formation between classrooms, barracks/dining hall facilities and parade grounds. These walkways should be hard surface and of adequate width to accommodate personnel walking four abreast (fig. 8-12).

C. Walkway Locations.

Often the combination of pedestrian and vehicle traffic on one right-of-way is detrimental to both users. The tempo and physical environment of these two forms of movement are generally incompatible and require some degree of separation.

1. Parallel to Street.

Walkway locations parallel to the street can be acceptable, depending upon the volume of vehicular and pedestrian traffic and the adequacy of the street right-of-way width to provide some degree of separation (fig. 8-13).

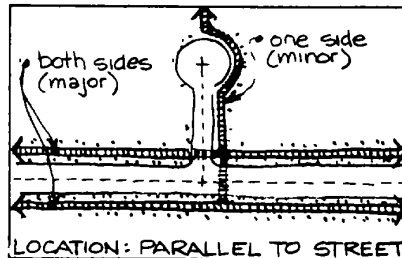

fig. 8-13.



fig. 8-14.

a. Planted buffer strips should separate walkways from major roadways (fig. 8-14).

b. Improved walkways and pedestrian-vehicular separation can sometimes be accomplished by transforming unsafe parallel parking lanes into planted buffer strips that can accommodate wider sidewalks and the provision of pedestrian amenities such as benches or bus stops.

c. Walkways on both sides of the street may not be necessary if pedestrian and vehicular traffic is low, especially in lower density residential areas. The test of need is its anticipated use and its role within the overall pedestrian network.

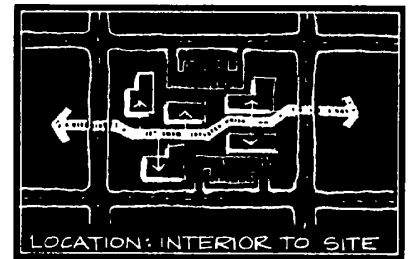

fig. 8-15.

2. Interior to the Site.

Pedestrian walkways are often best provided within the interior of a development site (fig. 8-15). This creates a pedestrian circulation system that is separated from vehicular traffic and that promotes increased utilization of a single walkway by serving existing buildings on both sides.

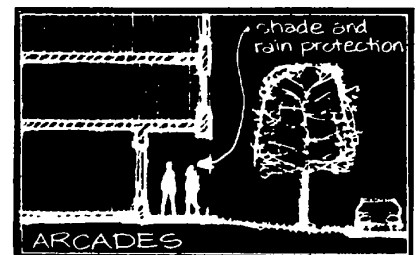

fig. 8-16.

without the disadvantages of unsafe street crossings, traffic noise, fumes or splashing. Safety from assault must be considered when the pedestrian is removed to a less active area. Lighting levels must be appropriately provided.

3. Arcades.

Pedestrian arcades along buildings encourage walkway use and comfort, especially in certain climates (fig. 8-16). Arcades provide protective

cover from hot summer sun and inclement weather conditions which otherwise would tend to be a strong deterrent to walking. Wherever possible pedestrian walkway arcades should be incorporated into building designs in major activity centers as part of the overall pedestrian walkway system.

4. Grade Separated Walkways. Wherever possible and practical, high-use pedestrian walkways that cross major roads should be grade separated from the vehicular circulation system to provide safety and convenience to both pedestrians and motorists. Grade separation can be accomplished by either overpasses or underpasses.

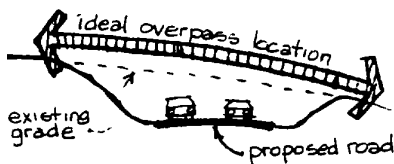

OVERPASS

fig. 8-17.

a. Overpasses. Pedestrian overpasses are generally the best means of grade separation and are best accomplished when the pedestrian network can be maintained relatively level without the need to climb stairs to cross the road. Their suitability depends largely on topographic conditions and the ability to depress the elevation of roads where they are to be crossed by the walkway structure (fig. 8-17).

Another form of pedestrian overpass is the second level walkway; this may have some application in densely developed areas where buildings across the street from each other can be connected by a second level bridge

if the pedestrian traffic demands between the two justify such a need (fig. 8-18).

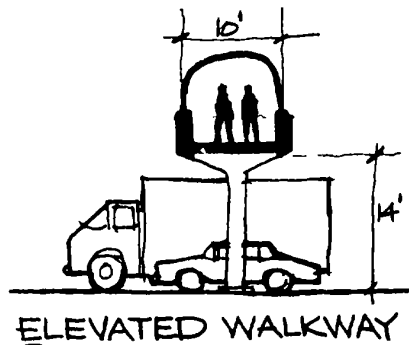

fig. 8-18.

b. Underpasses. Pedestrian underpasses are the second basic means of pedestrian-vehicular grade separation. To be effectively used, such facilities should be relatively short, wide, well ventilated and lighted and not entail extensive stair climbing (fig. 8-19).

8-6. Elements of the Pedestrian Network.

A. Sidewalks.

1. Width. Provide adequate sidewalk widths to handle the anticipated type and volume of pedestrian traffic. In general, a

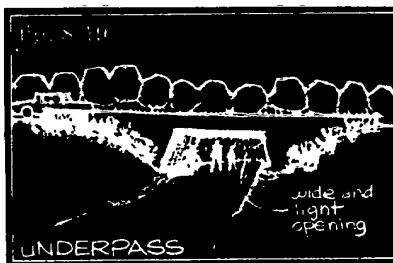

fig. 8-19.

minimum width of 4' - 0" is required for sidewalks (See DOD 4270 IM NAVFAC DM-5 Series, and AFM 88-7, Chapter 5)

2. Paving. Surfaces which are safe for all pedestrians, including

the handicapped, are stable, firm, and even, but have a non-skid surface and a minimum number of expansion and contraction joints. Surfaces can be categorized into three basic types.

a. Hard Surfaces. Asphalt, concrete, tile and brick laid in concrete are firm and regular surfaces well suited for walking, wheelchairs and baby carriages. Joints are filled and less than one-half inch wide. Ice and snow removal from these surfaces is easiest and may be performed without damage to the surface. Installation costs are high but maintenance costs are low. Concrete is especially well-suited for sidewalks because of its long economic life.

b. Variable Surfaces. Cobblestones, flagstone, exposed aggregate, brick laid in sand, wood decking and wood pavers laid in sand are irregular surfaces with wide joints which make wheelchair and baby carriage movement difficult (fig. 8-20). Ice and snow removal is difficult and may damage the surface. These surfaces are characterized by moderate to high installation costs and moderate maintenance requirements.

c. Soft Surfaces. These include earth, grass, and bark; their irregular and soft surfaces make walking difficult, especially for handicapped people, are more susceptible to erosion, require more maintenance, but are less costly to install. Gravel, pebbled, and soil cement surfaces are other irregular but harder surfaces that are less susceptible to erosion and easier to maintain.

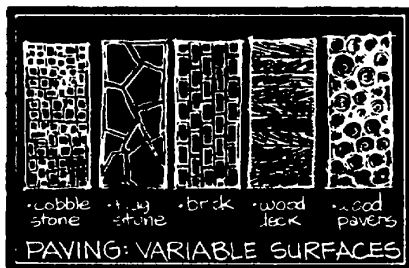

fig. 8-20.

3. Gradients. Walkways with a slope gradient equal to or less than 3% are preferred. Any walkway with a slope greater than 4.2% (1: 24) should be designated as a ramp. Sustained walkway grades greater than 3.3% (1: 30) should have a level landing at least 6x6 feet at 60foot intervals for rest and safety. Walkways should have a slightly sloped or crowned cross section to minimize icing and they should have positive grades to prevent ponding.

B. Intersections.

1. Walkway-Street Intersections.

a. Channelize pedestrian

traffic to designated crosswalks that provide safe and convenient street crossings. Pedestrian crosswalks can be of two types: street intersections or midblock. Crosswalks at street intersections with traffic signal controls are the best locations. Midblock crossings between intersections should generally be avoided because of their inherent safety problems; they should be limited to conditions where street crossings at signalized intersections are infrequent and inconvenient.

Fig. 8-21.

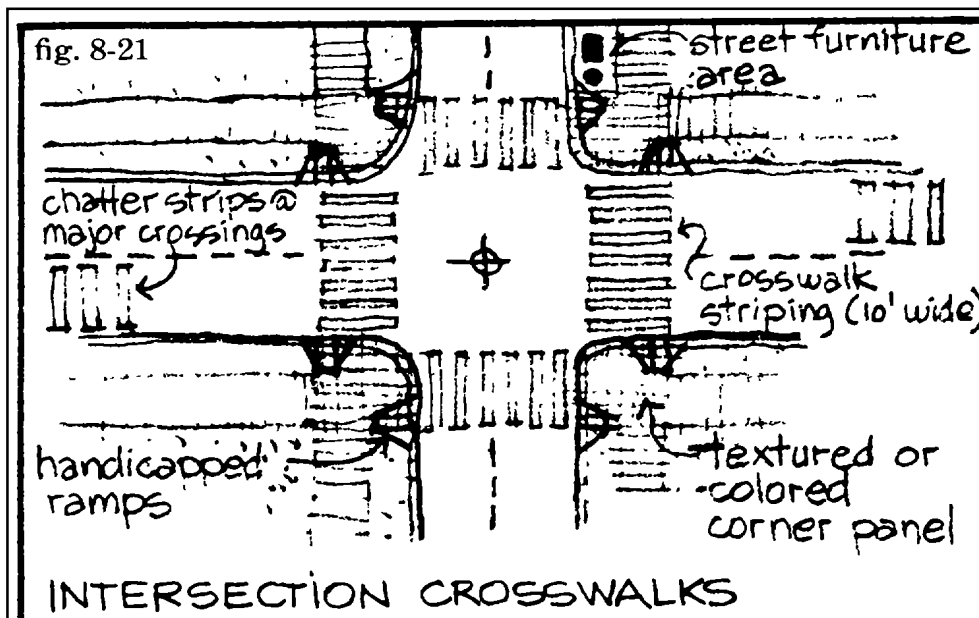

b. Crosswalks should be designed with clear and generous crosswalk patterns of bright colored, broad stripes, either applied or set into the pavement; sidewalk corner panels should provide curb-cut ramps for the handicapped that are contoured to the sidewalk; sidewalk corner panels that are colored or textured to provide a visual and tactile warning surface of the impending traffic conflict are preferred; chatter strips that warn approaching vehicular traffic are desirable at major

pedestrian crosswalk areas; street furniture such as mail boxes, newspaper racks or traffic control boxes should be clustered adjacent to the sidewalk corner panel so as not to impede pedestrian traffic (figs. 8-21 and 8-22).

2. Walkway-Bikeway Intersection. Design intersections with warning stripes to alert both bicyclists and pedestrians of potential conflict (fig. 8-23).

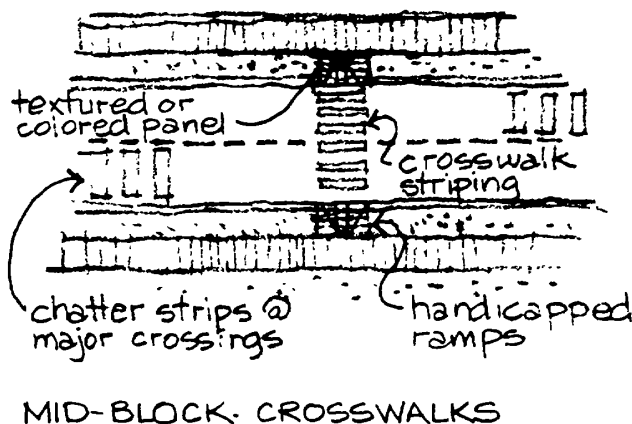
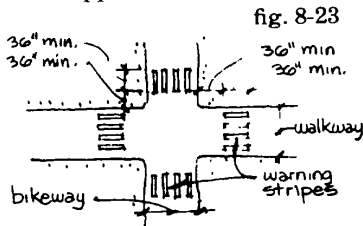

fig. 8-22.

3. Walkway-Building Exit Intersections. Doorway landing areas between exits and the walkway should provide an adequate queuing area for exiting pedestrians that will not impede or conflict with pedestrian traffic flow along the walkway (fig. 8-24). These landing areas should be level with or ramped to the walkway for the handicapped.



WALKWAY-BIKEWAY INTERSECTION

fig. 8-23.

4. Walkway-Walkway Intersections. Special design treatment should be considered where two walkways intersect; these areas are ideal locations for informational directories as well as other pedestrian amenities such as seating, a drinking fountain or a focal point feature. The intersection should be adequately sized to handle pedestrian cross-traffic; pedestrian amenities should be located to flank the intersection and not impede pedestrian traffic flow (fig. 8-25). (See Chapter 12: Site Furnishings.)

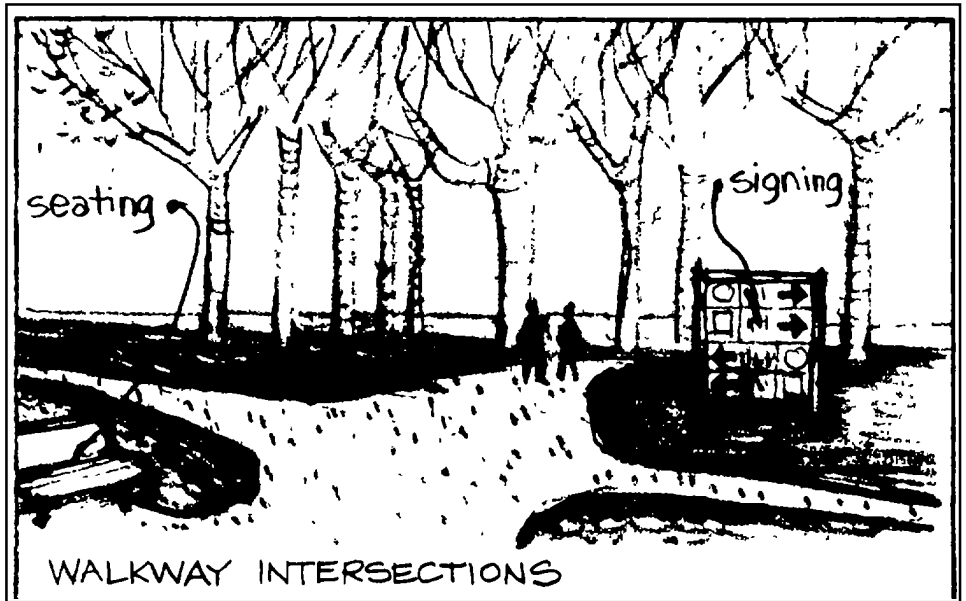

Fig. 8-25

C. Steps.

1. Overall Dimensions.

The minimum clear width for any exterior steps should be 4' - 0". The maximum rise between landings for unprotected steps exposed to the elements is 4' - 0"; where overhead weather protection is provided, a rise of 6' - 0" between landings is acceptable (fig. 8-26). Steps with less than three risers should generally be avoided because their lack of visual prominence may result in accidents.

2. Risers and Treads. All steps in a series should have a uniform tread width and riser height. A general formula for proportioning riser height to tread width is twice the riser height plus the tread width equals 26 inches. Riser heights for exterior stairs should be

between 5 and 7 inches while tread widths should be between 11 and 17 inches. A 5-3/4" riser with 14-1/2" tread is preferred. Steps should have solid risers and a rounded or chamfered nosing with a contrasting, nonslip surface at least one-inch wide on both riser

fig. 8-27.

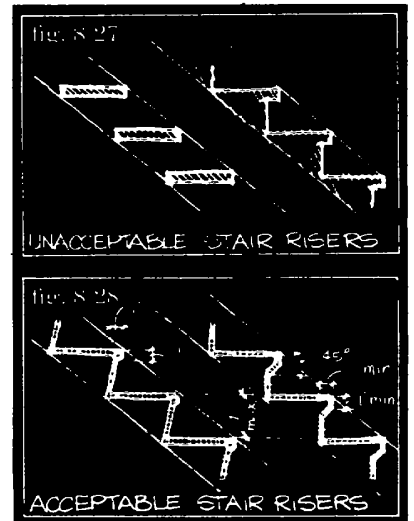
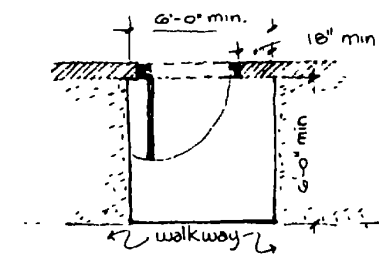

fig. 8-28.

and tread edge (figs. 8-27 and 8-28). Pitch stair treads forward at 1/8" per foot for surface drainage.



BUILDING EXIT LANDING

fig. 8-24.

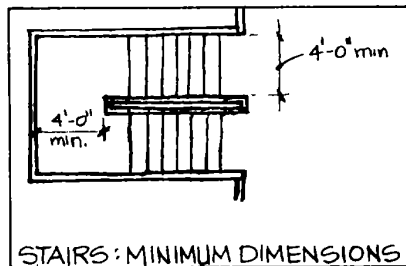
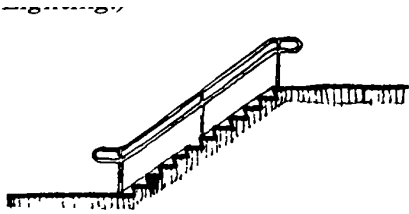

fig. 8-26.

3. Lighting. Exterior steps should have an average level of illumination which ensures safe nighttime use. (See Chapter 11: *Lighting.*)



HANDRAILS

fig. 8-29.

4. Handrails. Handrails for exterior steps should be provided on both sides. Handrails should extend past the tread, both at top and bottom of the steps, and should be continuous across landings where there is a drop-off. They should also be round or oval in cross section and the ends should be either rounded or turned into the wall (figs. 8-29 and 8-30)

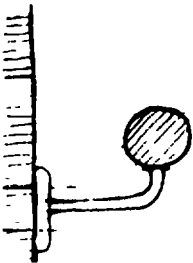

HANDRAILS

fig. 8-30.

D. Ramps.

Any walkway surface with a slope gradient in excess of 4.2% (5% for Navy) is considered a ramp. With the recognition of the necessity of providing access to facilities for handicapped persons, the use of ramps has become more prevalent. Ramps require a significant horizontal dimension in relation to the change in elevation that is achieved; therefore, their visual impact is greater than that of

steps serving the same function

for non-handicapped persons. Because of the increased visual impact of ramps, changes in grade should be carefully considered as early as possible in the design process. It is generally desirable to minimize the need for grade changes, if possible, and to compatibly integrate necessary ramps into the site and building design (fig. 8-31).

Fig. 8-31.

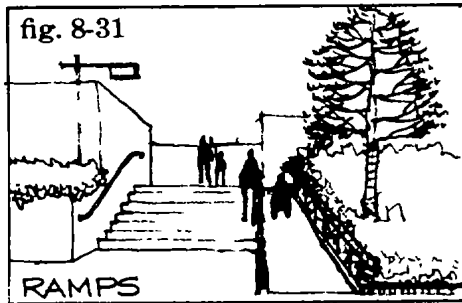

fig. 8-31

RAMPS

E. Street Furniture.

Walkway design should be coordinated with street furniture such as seating, trash receptacles, drinking fountains, lighting, etc. to accommodate pedestrian needs. These site furnishings should generally be located in distinct rest areas adjacent to the walkway for pedestrian enjoyment and relax on (fig. 8-32). (See Chapter 12: *Site Furnishings.*)

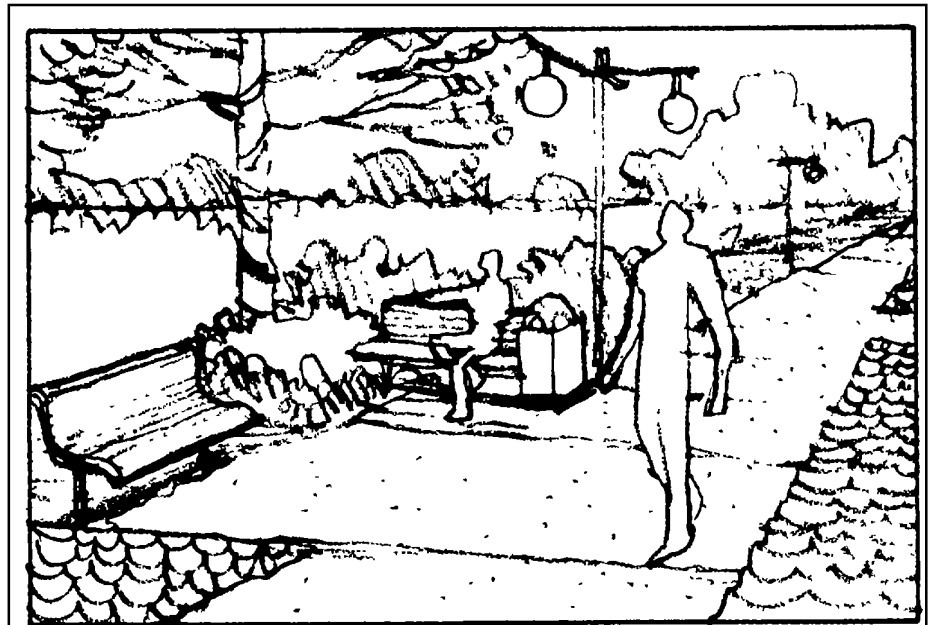
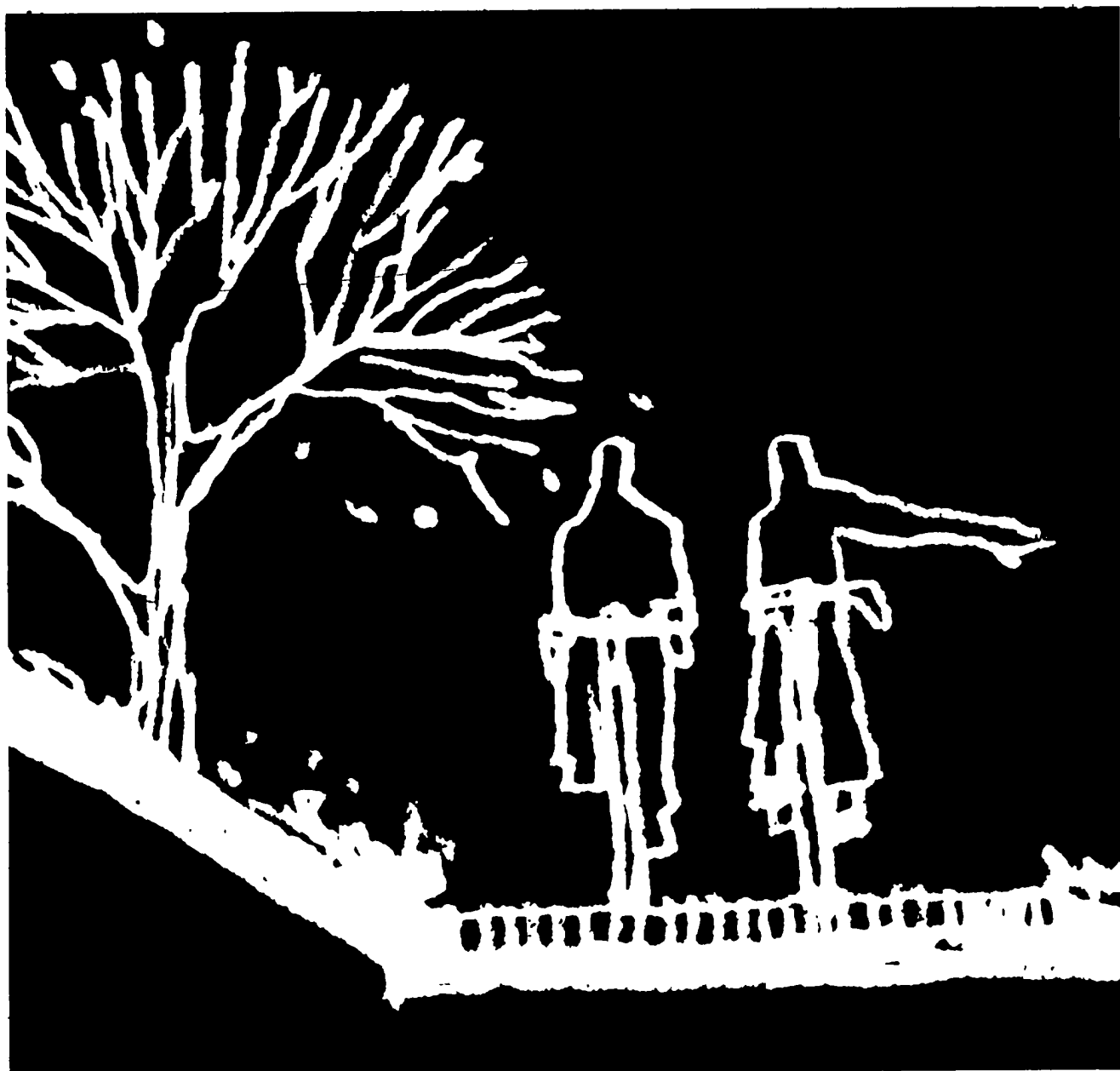

fig. 8-32.

Chapter 9. Bikeways.

Since the late 1960's, the popularity of the bicycle as a means of recreational and destination oriented travel has increased dramatically. The energy crisis, concern for physical fitness and increased recreational time are primary factors influencing this surge in bike ridership. Increased use of bikes on military

installations can easily be observed. The resulting pressure for better and safer facilities for bike travel and storage will increasingly be felt by installation planners and engineers. Bike travel should be encouraged not only to conserve energy but also to reduce automobile parking requirements.



Section I:

established demand requires development of safe

Observations and Objectives.

9-1.

Typical Problems.

A. Bikeway Networks.

The current state of bikeway facilities on most installations leaves room for much improvement. Typically, few provisions have been made for bike traffic. Bicyclists commonly are forced to share either the street with cars or the sidewalk with pedestrians, creating unsafe conditions for motorist, bicyclist and pedestrian alike (fig. 9-1). When bikeway provisions have been made, they are often incomplete networks that do not link employment centers and housing areas.

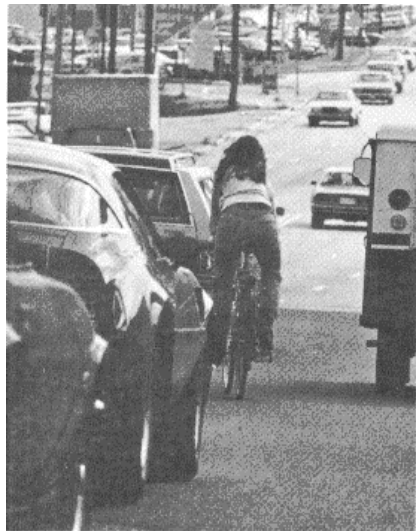

fig. 9-1.

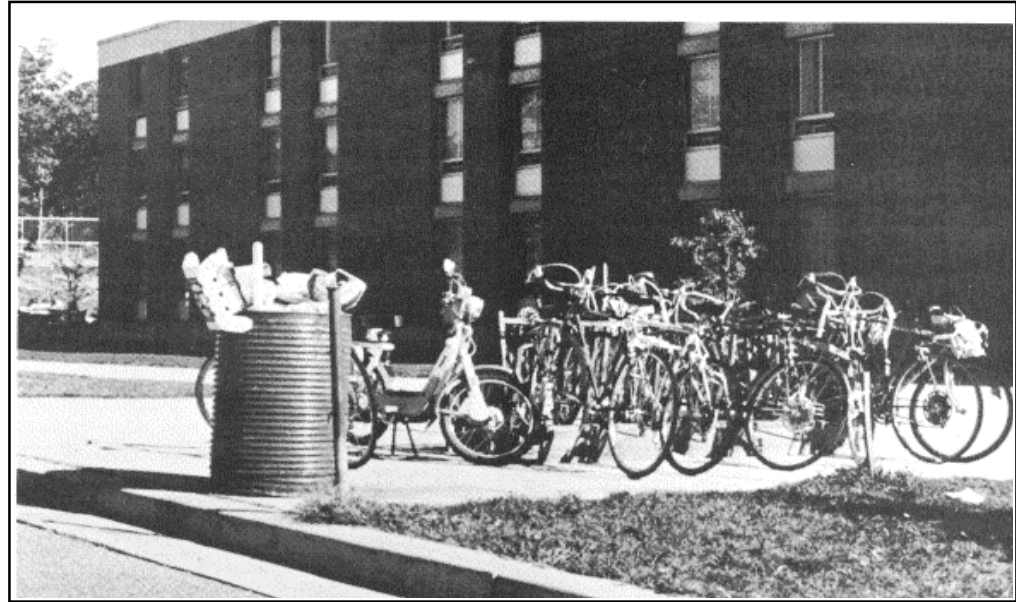

fig. 9-2.

B. Bicycle Parking Facilities.

In many instances, the size of the bicycle parking area does not meet the demand (fig. 9-2). Consequently, sidewalks and building entrances are blocked with the overflow. In other cases, bike racks are sometimes underutilized because they have been poorly located. Proper consideration for location and demand is necessary to provide attractive and convenient bike parking facilities.

9-2.

Objective.

A. Develop Bicycle Facilities as a Component of the Installation's Circulation System.

The development of bike facilities may be justifiable in response to existing demand. In addition, the encouragement of bicycle use within military installations can contribute to lessening the negative impact of the automobile and to meeting energy conservation objectives. To achieve these goals and to meet the

and properly located bikeways as a part of a balanced, multimodal transportation system.

B. Establish a Direct, Continuous and Safe Bikeway Network.

A bikeway system should provide direct routes between primary traffic origins and destinations within an installation. This network should be continuous to facilitate and encourage bike usage. Safety considerations in bikeway design include minimizing potential conflicts between bikes, pedestrians and vehicular circulation and eliminating potential stationary hazards along the bikeway network.

C. Develop Attractive and Convenient Bicycle Parking Areas in Response to Demand.

Bicycle parking areas should be designed and located to be both convenient and adequately sized. Care must be taken to avoid impeding pedestrian flow along walkways and at building entrances.

Section II:

Design Guidelines.

9-3. Bikeway Classification.

Bikeways are to be designed according to the following classification system which defines the types of bikeways and their degree of exclusiveness for bicycle use.

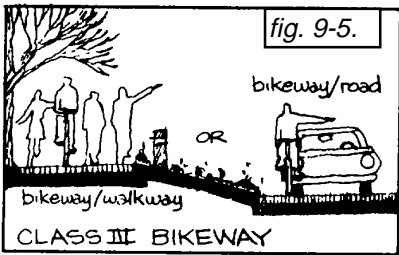
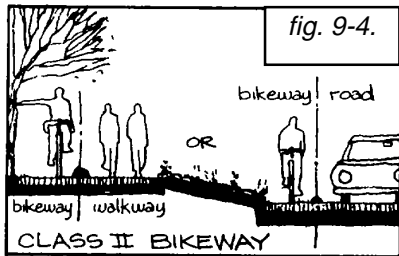
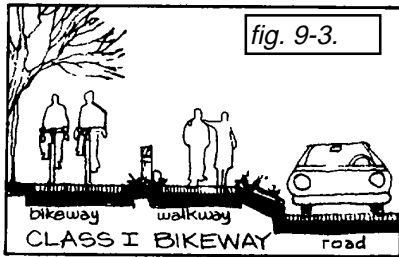

A. Class I Bikeway.

This is a completely separated right-of-way designated for the exclusive use of bicycles (fig. 9-3). Pedestrians and motorists crossing the bikeway should be discouraged from doing so.

B. Class II Bikeway.

This is a right-of-way restricted for the semi-exclusive use of bicycles (fig. 9-4). Through travel by motorists or pedestrians is discouraged. However, crossing over by pedestrians and motorists is allowed.

C. Class III Bikeways.

This is a right-of-way shared with either moving motor vehicles or pedestrians (fig. 9-5). The right-of-way is identified by signs or graphics stenciled on the pavement.



fig. 9-6.



fig. 9-7.

9-4.

Bikeway Design Standards.

A. Width of Pavement.

Establish bikeway pavement widths depending on the classification of the bikeway.

1. Class I Bikeways.

a. The minimum recommended width of an isolated Class I bikeway is 8'-0" (fig. 9-6). This allows two-way bicycle traffic as well as maintenance trucks.

b. The minimum recommended width of a one-way Class I bikeway adjacent to a sidewalk or roadway is 6'-6" (fig. 9-7). The adjacent roadway provides access by maintenance trucks. Two-way bikeways along roadways are not recommended because of the resultant intersection difficulties. The 6'-6" width allows one bicyclist to pass another.

2. Class II Bikeways. A continuous or intermittent curb is often utilized to provide the partial separation that is required for a Class II bikeway.

When positive separation such as this is utilized, the minimum recommended pavement width

for a one-way Class II bikeway is 6'-6", the same as for a one-way Class I facility.

3. Class III Bikeways.

Because the right-of-way is shared with either pedestrians or motor vehicles, these alternatives should only be used where traffic volumes are moderate to light.

a. Where one-way bicycle traffic will share the right-of-way with pedestrians, 4'-0" of pavement width should be added to accommodate bicycles (fig. 9-8). Since 6'-0" is the minimum recommended width for moderate two-way pedestrian traffic, this would result in a 10'-0" total pavement width. The bikeway should be identified with a painted stripe and signing. With this minimum width, one bicycle passing another would have to encroach on the pedestrian area. If heavy bicycle or pedestrian volumes make this encroachment unacceptable, a 6'-6" addition to the walkway pavement width would be required, resulting in a total pavement width of 12'-6".

fig. 9-8.

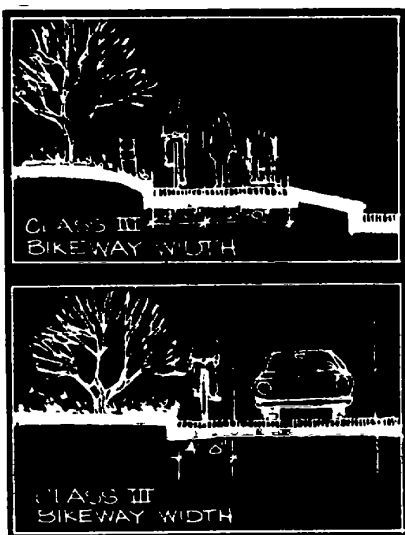

fig. 9-9.

b. Where one-way bicycle

traffic will share the right-of-way with motor vehicles, a 4'-0" pavement width should be reserved for bicycle travel (fig. 9-9). With an eight-foot lane for parked vehicles and a ten-foot lane for moving vehicles, this would result in a 22'-0" pavement width from the curb to the centerline of a tertiary street. With this minimum width, one bicycle passing another would have to encroach on the moving vehicle lane. If heavy bicycle or vehicular volumes make this encroachment unacceptable, a reserved 6'-6" pavement width would be required. In many cases, the only way to reserve this much pavement width along both sides of existing streets for bikeways would be to eliminate parallel parking. In addition to painted stripes, this alternative requires stenciled graphics on the pavement to identify the bikeway lanes.

B. Clearances.

Provide space for the cyclist based upon the following dimensions:

1. A 1'-6" minimum (2'-0" desirable) horizontal clearance is required from the edges of the bikeway surface to any stationary obstacle, change in grade, or soft shoulder (fig. 9-10).

2. An 8'-6" minimum (10'-0" desirable) vertical clearance should be provided from the surface of the bikeway to any overhead stationary obstacle.

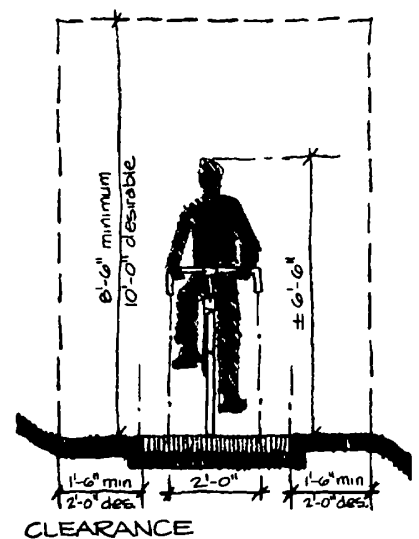

fig. 9-10.

C. Grades.

Relate bikeway gradients to the length of grade. While a maximum of +4.5% grade is desirable, a +10% grade is acceptable for distances less than 50 feet. These recommendations are primarily applicable to isolated Class I bikeways (fig. 9-11). For Class II and III bikeways, the gradients of existing street rights-of-way may in some cases exceed these desirable grades, and this should influence route selection. For one-way segments of bikeways, descent grades may exceed these recommendations.

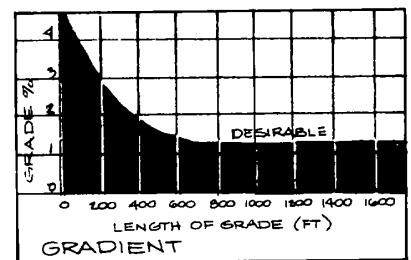

fig. 9-11.

D. Design Speed, Radius of Curvature and Superelevation. Utilize the following design speeds for isolated Class I bikeways:

Grade	Design Speed
+3% or more	15 mph
+3% to -7%	20 mph
-7% and steeper	30 mph

Based upon these design speeds, the radius of curvature and superelevation may be obtained from the accompanying chart (fig. 9-12). If pedestrians will constitute a significant portion of the traffic, the superelevation should not exceed 0.06 feet per foot.

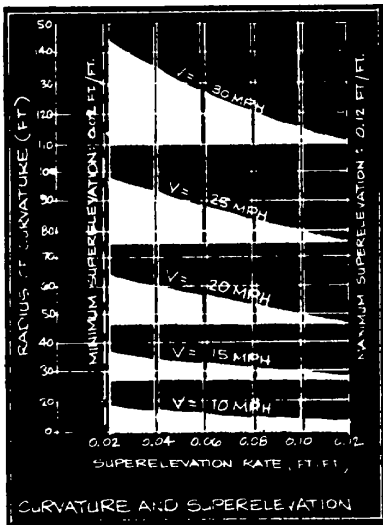

fig. 9-12.

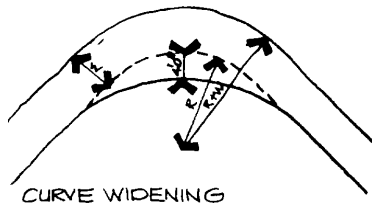

fig. 9-13.

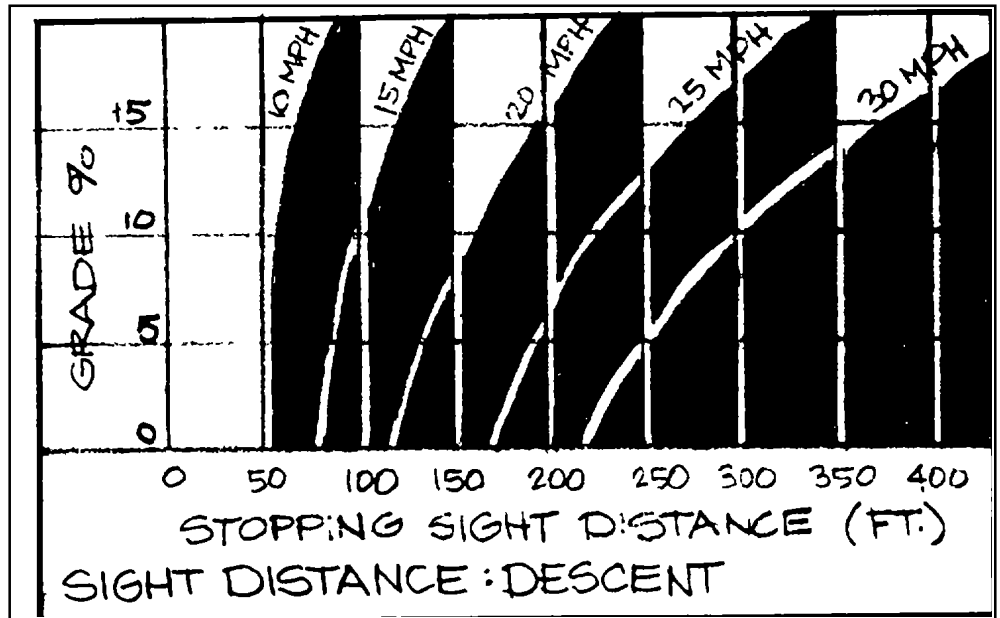

fig. 9-14.

E. Curve Widening.

Increase the width of the bikeway at a short radius curve (less than 100 feet) up to a maximum of four feet in order to provide additional lane width for cyclists leaning to the inside of a curve (fig. 9-13).

F. Sight Distance.

Utilizes the accompanying chart to relate bicycle speed and bikeway gradient to bicycle stopping distances (fig. 9-14). Use these distances as guides in providing adequate sight and warning distances at all locations of possible conflict, such as at intersections.

G. Paving Surfaces.

1. Class I Bikeways.

a. Design the pavement section of Class I bikeways in consideration of loading, local soil conditions and drainage. Class I bikeways should be designed to support an 8000-pound maintenance vehicle making infrequent trips. It is recommended that either asphaltic concrete or Portland cement concrete be utilized as the surface material. Although installation costs are higher for these materials than for loose aggregate and natural surfaces, wearing life is longer, they may be used in all weather conditions, and maintenance requirements are less.

b. Recommended Class I bikeway pavement sections are illustrated (fig. 9-15). The area adjacent to the bikeway surface should be back-filled to the bikeway surface grade, using topsoil, to reduce the hazard of running off the edge and to prevent edge chipping of the bikeway surface.

2. Class II and III Bikeways.

a. Normal pavement sections provided for sidewalks and roadways are generally acceptable for Class II and III bikeways. However, since bicycles do not have shock-absorbing suspension and tire pressures are high, pavement surfaces and expansion joints should be constructed and maintained as smooth as possible.

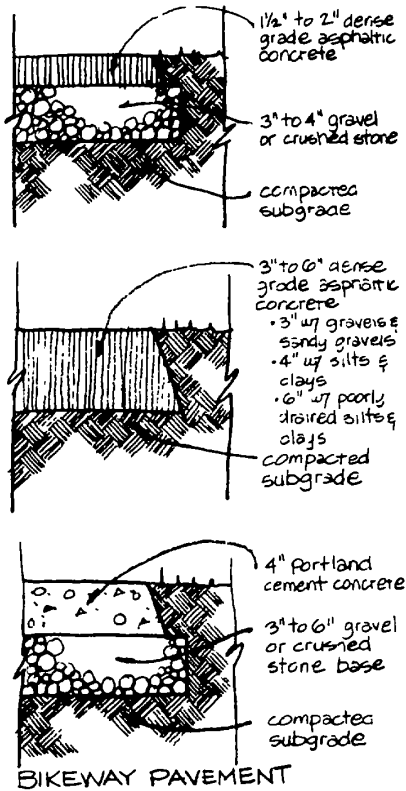

fig. 9-15.

b. Eliminate the danger of drainage grates with openings

parallel to bike travel along existing street rights-of-way. Parallel grates to the bikeway should not be permitted in marked bikeways. Improved grates have been developed and modifications are possible to make existing grates safe (fig. 9-16). However, the effect of these alternatives on the necessary drainage capabilities of the grate must be evaluated.

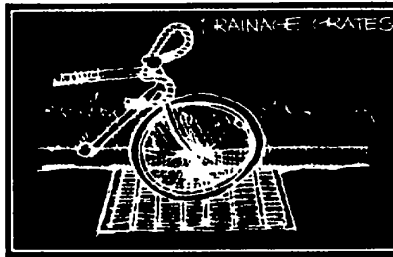

fig. 9-16.

9-5. Street Intersections and Crossings.

A. Class I Bikeways.

When possible, shift the bikeway crossing away from the intersection (fig. 9-17). A high percentage of bicycle/motor vehicle accidents occur at intersections. There is no single measure, with the exception of grade separation, that will eliminate the danger of accidents to cyclists at intersections. Shifting the crossing, however, can allow a queue area for a turning motor vehicle to wait without obstructing either the bikeway or through motor vehicle movement. Shifting the crossing applies normally only to Class I bikeways.

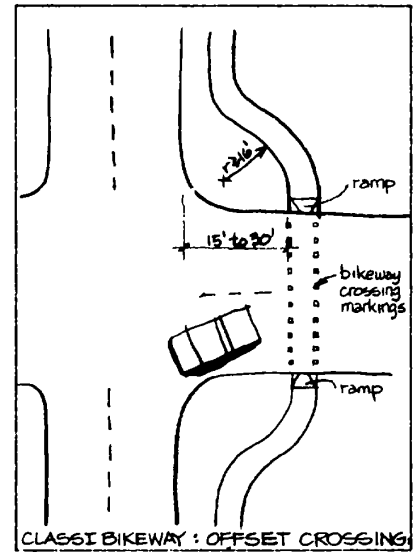

fig. 9-17.

B. Class II and III Bikeways.

When Class II and III bikeways utilize a portion of the roadway pavement, a different intersection design is required. A number of designs may be appropriate, depending on the classification of the intersecting streets and the volume of turning movements.

1. A typical design is illustrated showing the use of a broken white stripe at the intersection

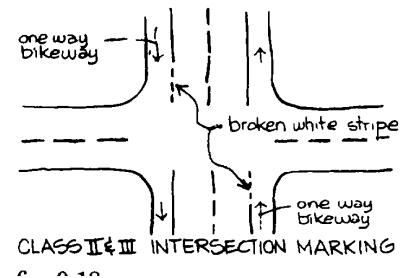

fig. 9-18.

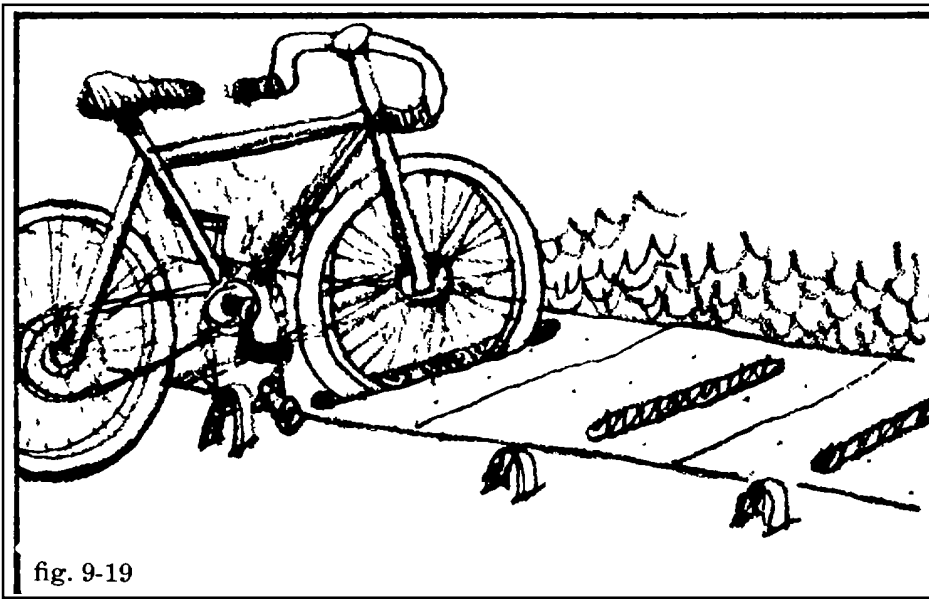

fig. 9-19

fig. 9-19.
 approach, indicating that lane changing is permitted with care (fig. 9-18).

2. If the intersecting street is a minor one and vehicle turns are few, a continuation of either solid or broken white stripes through the intersection may be appropriate.

9-6. Bicycle Parking.

A. Location.

1. Locate parking areas out of pedestrian pathways but in areas which are visually supervised, if possible.

2. Locate parking areas conveniently near the cyclist's destination, preferably within 50 feet of main entrances.

B. Design.

1. Provide secure racks or stanchions for bicycle parking. It is desirable to allow a wheel and the frame to be anchored to prevent detachment and theft of a portion of the bicycle (fig. 9-19).
2. A 2'-0" spacing between racks or stanchions is desirable to facilitate their use (fig. 9-20).
3. Carefully consider the design of bicycle racks or stanchions to prevent visual clutter or inharmonious appearance.
4. Avoid the indiscriminate use of portable pipe bicycle racks that do not provide a way of locking the entire bicycle.

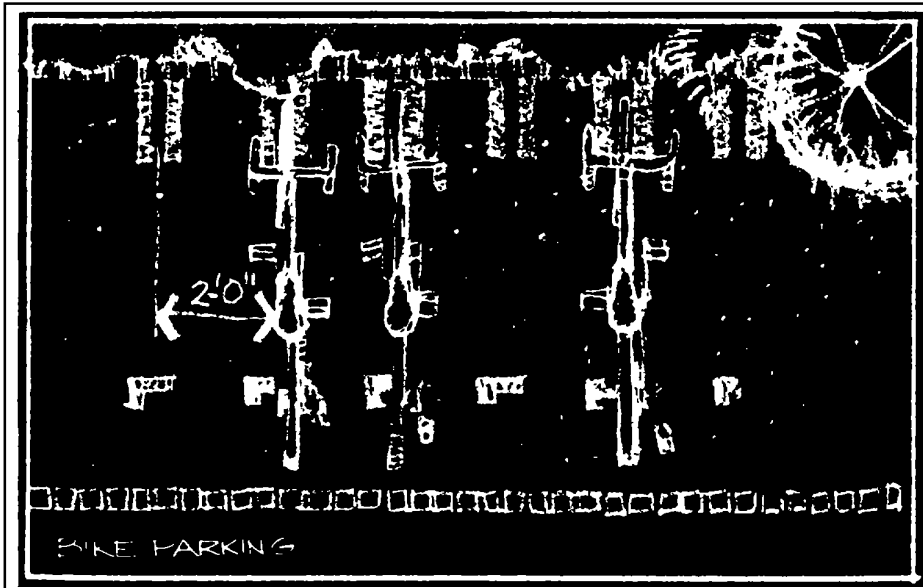
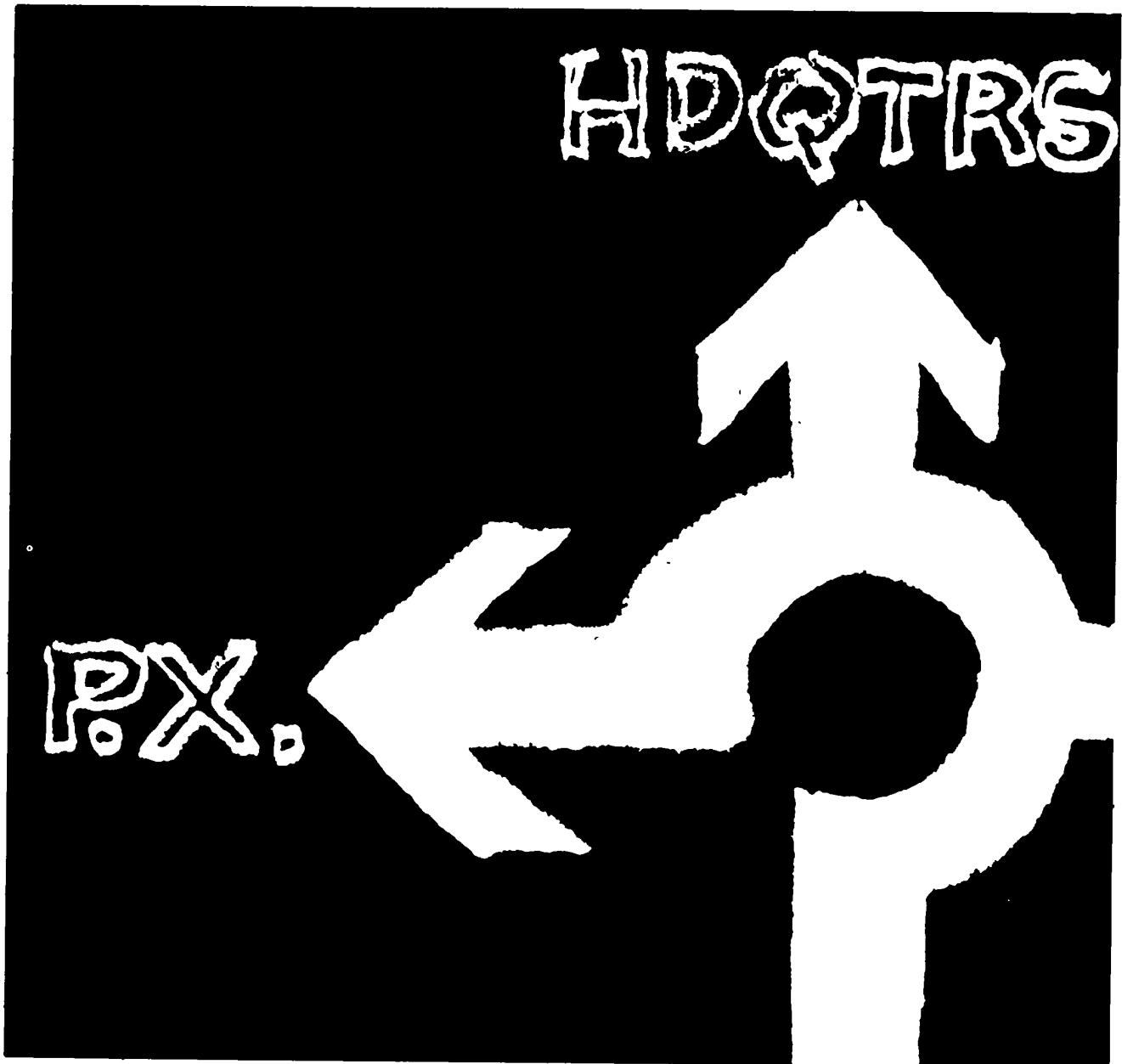

Fig. 9-20.

A sign's fundamental purpose is to communicate information. However, putting the message across emphatically is not enough; it must be attractive and harmonious with its surroundings. Consideration must be given not only to what a sign says but also how it says it, its visual appearance and organization, its

location, its structural support system and its relation to other signs within an installation. Establishing and implementing a coordinated signing system is a relatively simple, inexpensive but effective means of improving the visual appearance and functioning of an installation.



Section I:

Observations and Objectives.

10-1.

Typical Problems.

A. Coordination.

Outdoor signing and graphics on military installations are too often confusing, unattractive or obsolete. The motorist is not always provided with sufficient information at critical decision points, and is sometimes confused by a clutter of sign messages. A coordinated signing system seldom exists, and basic rules of visual communication are often overlooked. This often detracts from the overall image of an installation, frustrating the visitor and sometimes creating unsafe conditions

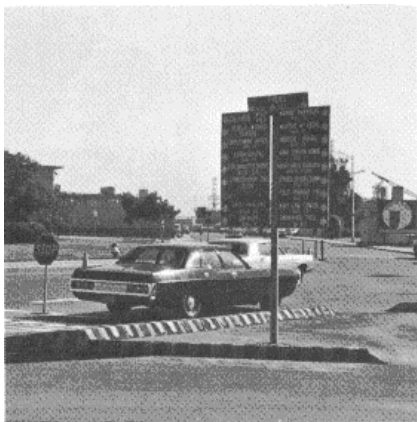

fig. 10-1.



fig 10-2



fig. 10-3.

B. safety.

Excessive information is often provided at decision points, allowing insufficient time for a driver to interpret and react. This results in traffic congestion and safety hazards (*fig. 10-1*).

C. Clutter.

Confusion and clutter result when signs of varying size, shape and function are added to existing signs with no consideration for their relationship to

each other. Without the discipline of an overall system, signs become both unattractive and ineffective (*fig. 10-2*).

D. Other Factors.

Other typical problems include redundancy of sign messages, inconsistency of signs of similar function, and inflexible sign systems that make changes of messages difficult and costly (*fig. 10-3*).

10-2. Objectives.

A. Communicate Necessary Information Effectively.

The information conveyed must be correct, clear, useful and visually comprehensible. The sequence and hierarchy of information that is communicated must correspond to user needs.

B. Contribute Positively to the Overall Visual Image of an Installation.

Signage should be consciously designed as an attractive, consistent, simple and uncluttered information system. The signing system should be coordinated with the design of other site furnishings to minimize the number of streetscape elements and reduce clutter.

C. Establish an Overall Signing System that is Coordinated, Consistent, Flexible and Economical.

A signing system should provide consistency and continuity to the overall visual image of an installation. The system should be adaptable to incremental changes and additions over time; a modular system can facilitate this requirement while maintaining the desired visual consistency. Initial and life-cycle cost implications of materials, mounting and fabrication alternatives must be considered in the design of the signing system.

Section II:

Design Guidelines.

10-3. Planning and Implementing a Signing System.

A. Process.

Employ the following general design process to establish a coordinated overall signing system.

1. Data Collection and Analysis.

Initially observe and analyze exterior pedestrian and vehicular traffic flow to identify significant decision making locations.

2. Site Plan and Schedule.

Locate all proposed signs on a site plan of the installation in accordance with distance and placement guidelines. Illustrate on the site plan the sequence of information to be conveyed. Precisely define, locate and key to a

schedule all identification, directional and regulatory signs (fig. 10-4).

3. Component Design and Specifications.

Design and develop procurement drawings and specifications of all elements that comprise the signing system including text, typography, color, illumination, support system and other standardized components. Full-size, mock-up samples in the color and type style combinations should be tested in position on the site before finalizing procurement drawings and specifications and embarking on a major signing program (fig. 10-5).

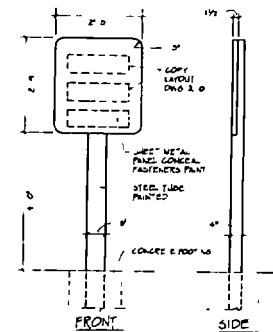

fig. 10-5.

4. Signing Manual.

Prepare a signing manual as a guide for continuing use of the system. The manual should include a site plan and schedule, component specifications, mandatory operating procedures and standards for administrative and shop personnel to ensure

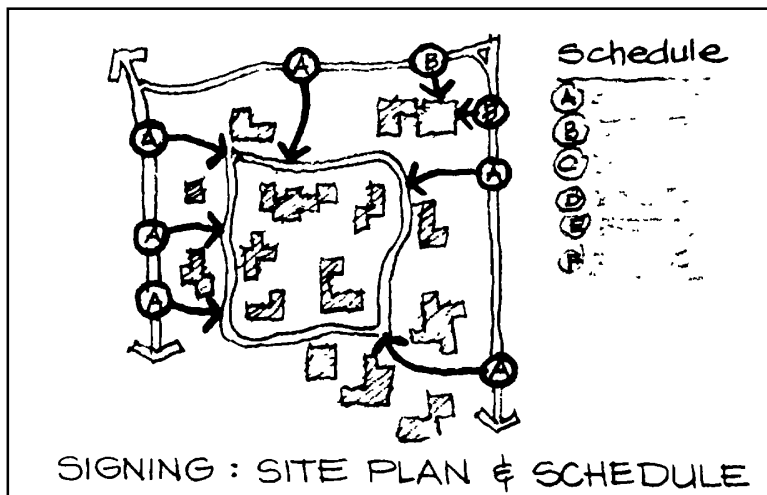

fig. 10-4.



SIGNING MANUAL

fig. 10-6.

consistent application of the system (fig. 10-6).

B. Purposes.

Orient the signing system study to fulfill the following purposes.

1. Provide signs only where a need exists.
2. Eliminate unnecessary or conflicting signs.
3. Ensure that the placement of signs relates to their function.
4. Provide signs that are visible and designed to attract viewers' attention.
5. Provide signs that are harmonious with their architectural and natural setting and contribute to the installations' overall image and identity.
6. Ensure that signs of similar function are consistent.
7. Ensure that all signs are legible.
8. Ensure that the wording of all signs is understandable and concise and that the message conveyed is correct, clear and understandable.
9. Provide a hierarchy of information that conveys information in the sequence most beneficial to the viewer.
10. Facilitate changes or incremental additions and deletions to the signing system as the need arises.
11. Provide an economical system in terms of implementation and maintenance.

12. Meet any special requirements for the handicapped.

10-4. Elements of a Signing System.

A. Types of Signs.

Signs should be organized into three general categories, each treated distinctly within the signing system.

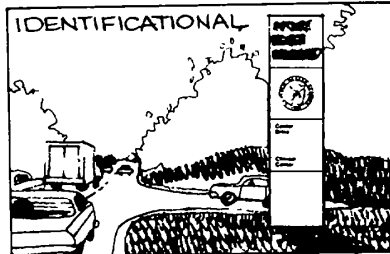

fig. 10-7.

1. Identification Signs.

These are naming signs which identify the installation, areas within the installation, major tenants, buildings and organizational or functional components. They tell the viewer where he is and since they always appear at entrances they greet the motorist or pedestrian and visually set the mood for other graphics on the site. They must be compatible in scale and character with the architecture surrounding them, or on which they are placed (fig. 10-7).

2. Directional Signs.

These signs serve to guide the

motorist or pedestrian in, around, and out of the installation. Signs intended for pedestrian guidance should be of a smaller scale and located so as not to conflict with signs intended for motorists. The legibility and positioning of directional signs as well as the ordering of information on them is critical to their effectiveness. Each installation requires careful analysis of pedestrian and vehicular traffic patterns to determine decision points and appropriate information and directions to be provided (fig. 10-8).

3. Regulatory Signs.

These signs set the rules for travel and parking on the installation. Included in this category are speed limit signs, signs controlling turning and lane usage, warning signs, signs controlling parking, etc. Related to these signs are pavement markings and traffic signals. All signs of this type should conform to the standards contained in the latest edition of the *Manual on Uniform Traffic Control Devices (MUTCD)* by the Federal Highway Administration. The *MUTCD* provides federal standards for design, shapes, colors, dimensions, symbols, word mes-

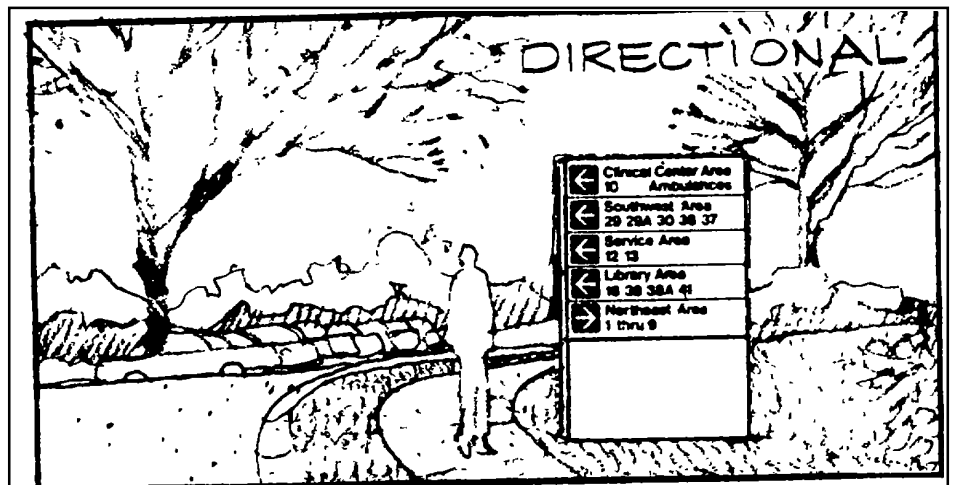

fig. 10-8.

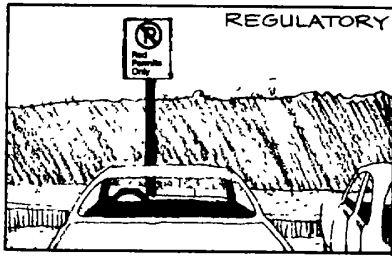

fig. 10-9.

sages, lettering, illumination, reflecting surfaces, locations and erection of all regulatory signs, signals and pavement markings (fig. 10-9).

B. Sign System Characteristics.

An installation's sign system should possess the following attributes:

1. Consistency. The sign system should be governed by standards, appropriate to the installation's needs, that are applied consistently throughout the installation. These standards include sign size, location, shape, typeface, symbols, colors, materials and mounting details.

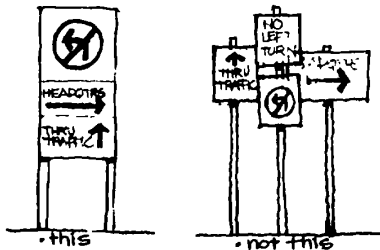

fig. 10-10.

2. Simplicity. Sign systems should be efficient and not overload the intended user with unnecessary information. An efficient system eliminates redundant signing and over-signing to reduce clutter, confusion, or hazardous conditions, especially at intersections. Sign messages should be simple because the amount of information a pedestrian or driver can receive, process and remember is limited. The act of

reading a sign should never distract his attention unduly from the act of driving. In general, the amount of information that is to be conveyed by a sign should be limited to ten items (an item of information being defined as a syllable, symbol, abbreviation or shape) (fig. 10-10). At a decision point, the driver should be presented with no more than two choices. Advance warning signs should be provided where necessary to reinforce information and allow additional time for the driver to process the information and act.

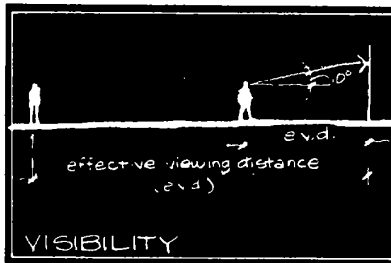

fig. 10-11.

3. Visibility. Signs should be located at significant decision points and positioned to provide a clear line-of-sight from the point of desired reading, free of obstructions and within a ten (10) degree angle of the decision maker's normal line of vision. The design of the sign should be capable of attracting the intended user's attention (fig. 10-11).

4. Legibility. A sign's type style, size of letters, letter/word/line spacing, copy positioning and color should be carefully selected for legibility, which is most crucial on all signs.

5. Hierarchy and Sequence. Signs, in terms of their wording and size of message, should provide a hierarchy of information whose sequence is most beneficial to the intended audience.

6. Coordination. The design of a sign system may be coordinated and integrated with the

design of lighting and site furnishings to minimize the number of individual streetscape elements and reduce clutter. Many manufactured systems exist that combine such elements as street lighting,

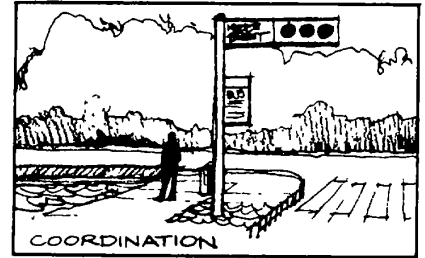

fig. 10-12.

traffic signals, graphics, telephones, litter containers and other site furnishings into an integrated system. This coordination not only improves the visual appearance of installations but also provides a unified location that promotes ease of pathfinding for both motorist and pedestrian (fig. 10-12).

7. Compatibility. Entrance signs, building identification signs and all free-standing signs should be well designed and constructed of quality materials in keeping with the architectural and natural site character of the installation.

8. Flexibility and Economy. A signing system should be able to be expanded, contracted or modified as required over time in response to mission changes, new buildings, demolition of buildings or relocation of building occupants. Modular signing systems with interchangeable components can greatly facilitate these changes. Signing hardware and basic message units should be designed to allow change of individual messages without affecting the remainder

of accompanying messages (fig. 10-13).

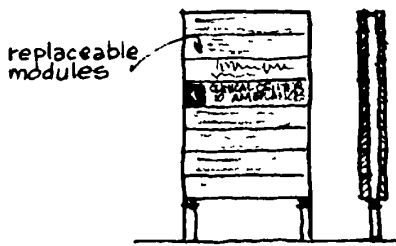

FLEXIBILITY

fig. 10-13.

10-5. Guidelines for Effective Communication.

A. Lettering.

Type style, letter size, letter/word/line spacing, and copy positioning should be carefully selected for legibility of the sign message.

1. Type Style. A sans-serif type style such as Helvetica Medium has been found to be one of the most easily read and handsome type styles for sign use. Other sans-serif or serif type faces that meet the following requirements are also acceptable. As a rule, a type style whose ratio of stroke width to capital letter height is 1: 5 for black letters on a white background, and 1: 6 or 1: 7 for white on black is recommended (fig. 10-14). Upper case letters should be approximately 1/3 larger than

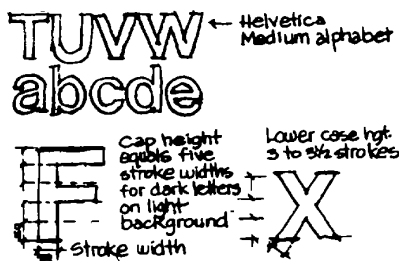

fig. 10-14.

the "x" height of lower case letters. Condensed or extended letter styles should be avoided. Upper and lower case lettering tends to enable quicker word recognition than all capital letters because of the varied word shapes they produce. The use of upper case lettering should be limited to a few essential situations such as directional information as found on a route number and direction sign (1-95 EAST) or the direction of an exit or turn (NEXT RIGHT).

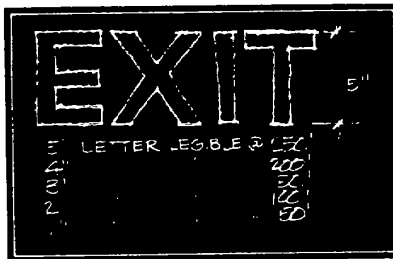

fig. 10-15.

2. Type Size. The standard guide in determining appropriate letter size of a highly legible type style is to provide 1" (one inch) of the letter height of an upper case "X" for each 50' (fifty feet) of viewing distance (fig. 10-15). Therefore, for a message to be legible from a distance of 250 feet, a 5" (five inch) letter height should be used.

3. Letter and Word Spacing. At longer viewing distances, letters tend to run together visually unless the letter' spacing is increased. Light lettering on a dark background tends to look bigger than dark letters on a light background and requires greater letter spacing and smaller stroke width. Likewise, internally lit signs may require greater spacing, depending on the intensity of light and the relationship of colors. Word spacing should be proportionate to the letter spacing used. All spacing should appear even.

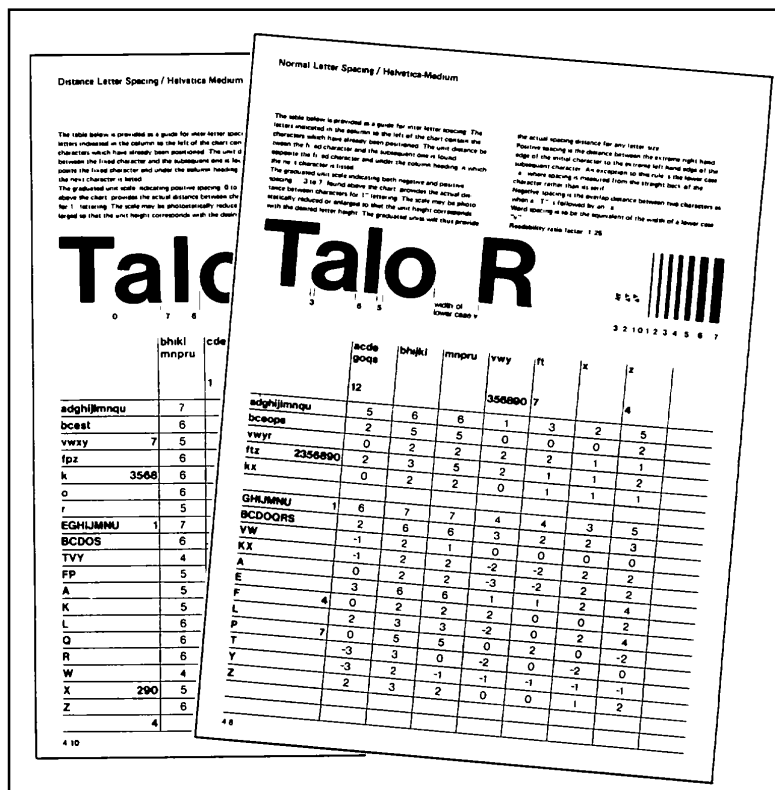
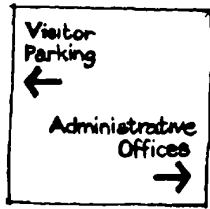

Fig. 10-16.

Letters and words spaced by a trained human eye are preferable to mechanical spacing. However, spacing guides are available (fig. 10-16).



COPY POSITIONING

fig. 10-17.

4. Copy Positioning. On most signs of more than a word or two, it is recommended that all copy (type and symbols) be flush left (without indentation) for ease of reading. However, on signs containing both left and right directional information, it often helps clarify the message if left turn information (including arrows) is flush left on the left of the sign and right turn information is flush right on the right side of the sign (fig. 10-17).

B. Symbols, Arrows and Diagrammatics.

Use symbols, arrows and diagrammatics where necessary and appropriate to convey needed information.

1. Symbols. The word "symbol" is used to refer to true symbols such as the Red Cross symbol and U.S. and interstate route shields, as well as pictograms (graphic expressions of actual objects) such as a

fig. 10-18.

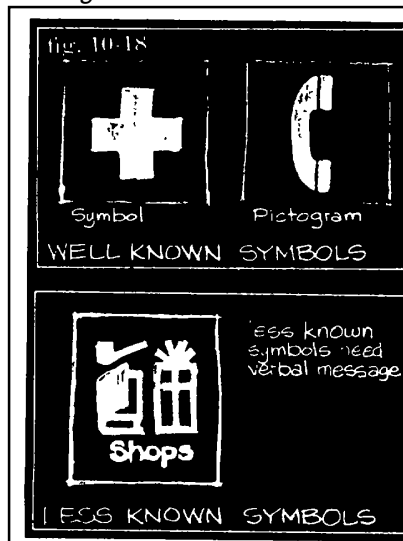

fig. 10-19.

telephone receiver (fig. 10-18). Symbols are useful for rapid communication, especially where they have become universally accepted and understood. However, symbols for complex objects or activities can be ambiguous and hinder, fig. 10-19 rather than aid, communication. Symbols should be used only when they permit a message to be more strongly stated or quickly understood. Symbols that have been adopted for national use such as the transportation related symbols established by the U.S. Department of Transportation should be the basis for those used on military installations. Normally, lettering should be used with symbols to avoid possible confusion (fig. 10-19).

2. Arrows. Arrows must be legible from a distance to clearly convey the intended direction. Recommended arrow forms are as illustrated (fig. 10-20).

3. Diagrammatics. A diagrammatic is a means of graphically depicting an upcoming road condition when words and arrows alone may be inadequate. When an intersection or lane configuration is complex, use of a diagrammatic can help the driver visualize the situation and act accordingly (fig. 10-21).

fig. 10-20.

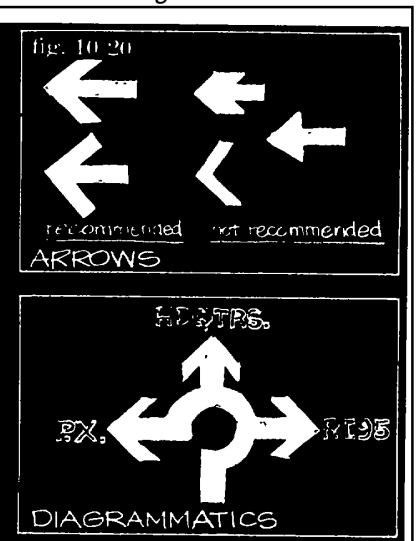

fig. 10-21.

C. Color.

Color coding should be used consistently to differentiate sign types, to convey their type and function and, where appropriate, to vary the apparent size or "target value" of a sign.

1. Target Value. The apparent size, or "target value" of a sign varies with its color. Yellow and white signs appear largest; red, blue and green signs appear mid-sized; and black signs appear the smallest. These apparent sizes are also affected by the contrast between the sign and its background. Theoretically, for best visibility, a sign should be darker against a bright day background, but brighter against a dark day or night background. Two techniques to improve sign visibility against diverse backgrounds are reflecting surfaces and substantial borders of a contrasting color value: dark for light signs and light for dark signs. In general, the width of the border should not exceed the stroke width of the major lettering on the sign.

2. Color Coding. The use of color on signing should be related to the color code conventions recommended by the Special

Committee on Color of the National Joint Committee on Uniform Traffic Control Devices.

This committee selected twelve colors for the color code of American Traffic Control signs, and the meanings of eight of these were specified, when used as background colors.

Red	Stop or prohibition
Green	Guide signs, permitted movement and parking
Blue	General public services
Yellow	Warning
Black	Part-time regulation
White	Full-time regulation
Orange	High danger (construction and maintenance)
Brown	Public recreation

Bright yellowgreen, light blue, purple and coral have been identified as suitable for traffic control, but their meanings are reserved for future needs. For a specific description of the use of these twelve colors, refer to the Manual on Uniform Traffic Control Devices for Streets and Highways.

D. Sign Size.

Signs must be sized so that they are visible and legible.

1. Figure/Ground Relationship.

The background of a sign helps to isolate the message from the visual complexity of the sign's surroundings. The more visually complex the surroundings, the more background is needed to facilitate communication. In residential areas and in other areas of relatively low-intensity development, it is recommended that the graphics and lettering constitute approximately 60 percent of the total sign area and the background 40 percent. In areas of high-intensity development, such as the core areas of the installation, the graphics and lettering should occupy 40 percent and the background 60 percent.

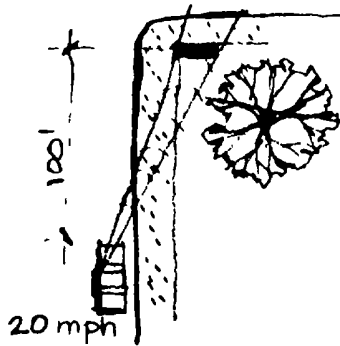

fig. 10-22.

2. Reading Distance. The distance that signs are located from the point of desired reading varies with the speed of the approaching driver (fig. 10-22).

20 mph:	100 feet
25 mph:	175 feet
30 mph:	250 feet

a. Depending on the area of graphics and lettering and following the above guidelines on letter size and figure/ground relationship, the necessary sign size may be determined.

b. For example, if it is desired that a sign be legible from 250 feet, a letter height of 5 inches is required (see 10-5 A2: Type Size). Using this size lettering, the overall message size may be determined - use 5 square feet for this example. If the sign were planned for a residential area, applying the figure/ground relationship guidelines would result in an overall sign size of 8.33 square feet. Depending on copy layout and the modular dimensions of the system, the length and width of the sign may be determined.

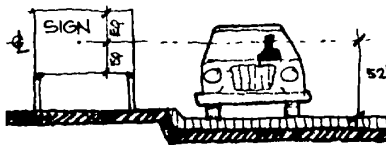

PLACEMENT

fig. 10-23.

E. Sign Placement.

Signs should be positioned for visibility and installed consistently in relationship to the roadway,

walkway or building they serve.

1. General Guidelines.

a. A sign must be positioned so that there is a clear line-of-sight from the point of desired reading. A reasonable guideline for the placement of vehicular-oriented signing is to establish the height of the sign so that the center line of the main panel is at the optimum viewing height for a person seated in an automobile (approximately 52" above the pavement surface) (fig. 10-23). If visual obstructions prevent sign placement at this height, the sign should be raised; however, avoid exceeding a 10 degree angle from the natural line of vision.

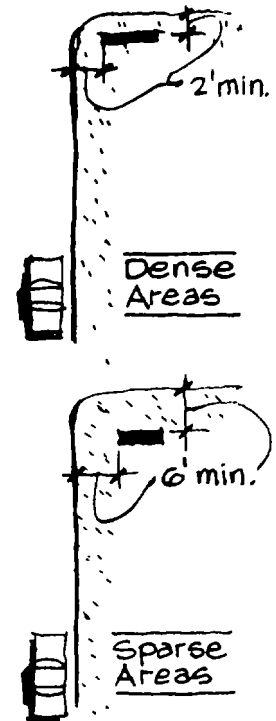

PLACEMENT

fig. 10-24.

b. Vehicular-oriented signs must be placed perpendicular to approaching traffic and not nearer to the pavement than 2 feet in densely developed areas

(6 feet is preferable and recommended for less dense areas) (fig. 10-24). If a vehicular-oriented sign is located within an area of pedestrian activity, a 7'-0" clearance should be maintained from the bottom of the sign panel to the pavement (fig. 10-25). Consult the Manual on Uniform Traffic Control Devices for other placement criteria, such as distance between signs.



fig. 10-25.

10-6. Special Signing.



HANDICAPPED SIGNING

fig. 10-26.

A. Signing for the Handicapped.

Signs should be provided to identify facilities dedicated to or accessible to the handicapped, such as parking spaces, building entrances and rest room facilities (fig. 10-26).

B. Installation Entrance Signs.

Main installation entrance signs are

the initial element in the identification signing hierarchy of an installation. While their design can be a special feature, it should be consistent with the installation's overall signing system and in character with the architectural/natural site setting of the installation. The size of the main entrance sign should be appropriate to its role

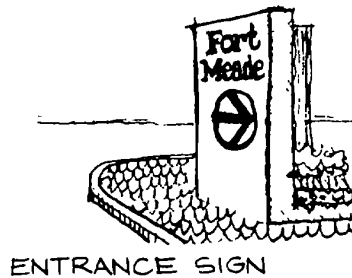

ENTRANCE SIGN

fig. 10-27.

in the hierarchy, the items of identification information needed and the approach speed of vehicles (fig. 10-27).

C. Building Identification Numbers.

Building identification numbers should be designed as part of the overall signing system of an installation. They should be located, sized and placed for visibility from their intended vantage point, consistent in design and mounting details with other building identification number signs, and compatible with the architectural character of the building (fig. 10-28).

1. They generally should be located at building entrances and/or other parts of the building visible from the main access street.

2. At many installations, building numbers are positioned at standard locations to provide easy

fire service identification.

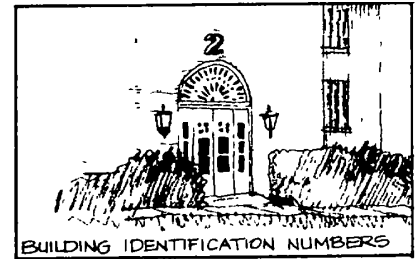

fig. 10-28.

Building identification numbers should be coordinated with fire service requirements, avoiding unnecessary redundancy and inconsistent design.

D. Memorial Plaques.

Memorial plaques represent a special type of sign. An installation should establish its own design policy for memorial plaques in response to their particular needs. The policy should establish a set of standards that covers all plaques, including standard sizes, materials, finish, copy type, mounting details and locations. (See Paragraph 12-11: Monuments and Memorials.)

E. Temporary Signs.

Temporary signs are frequently needed on installations and can be identificational, directional or regulatory in type. All temporary signs should conform to the general design guidelines established for the installation signing system, except for their materials which can be practical but capable of maintaining an attractive appearance throughout the expected life of the sign.

Lighting is a flexible medium with great potential to improve the visual character of an installation. Exterior lighting performs a number of functional uses, primarily related to nighttime safety, security and pathfinding. This is accomplished through a variety of applications to roads, walkways, plazas, parking lots, and buildings. Illumination

levels, color rendition, lighting patterns and other aspects of outdoor lighting design can be varied with lamp type, illuminate type, as well as fixture location, spacing, mounting height and details. Generally, emphasis in the past has been placed on achieving a higher level of illumination rather than improving other qualitative

aspects of outdoor lighting. Increased energy consciousness has forced a reappraisal of this emphasis on greater illumination levels. The design of outdoor lighting should be reoriented toward achieving a coordinated system that is attractive, functional and efficient.

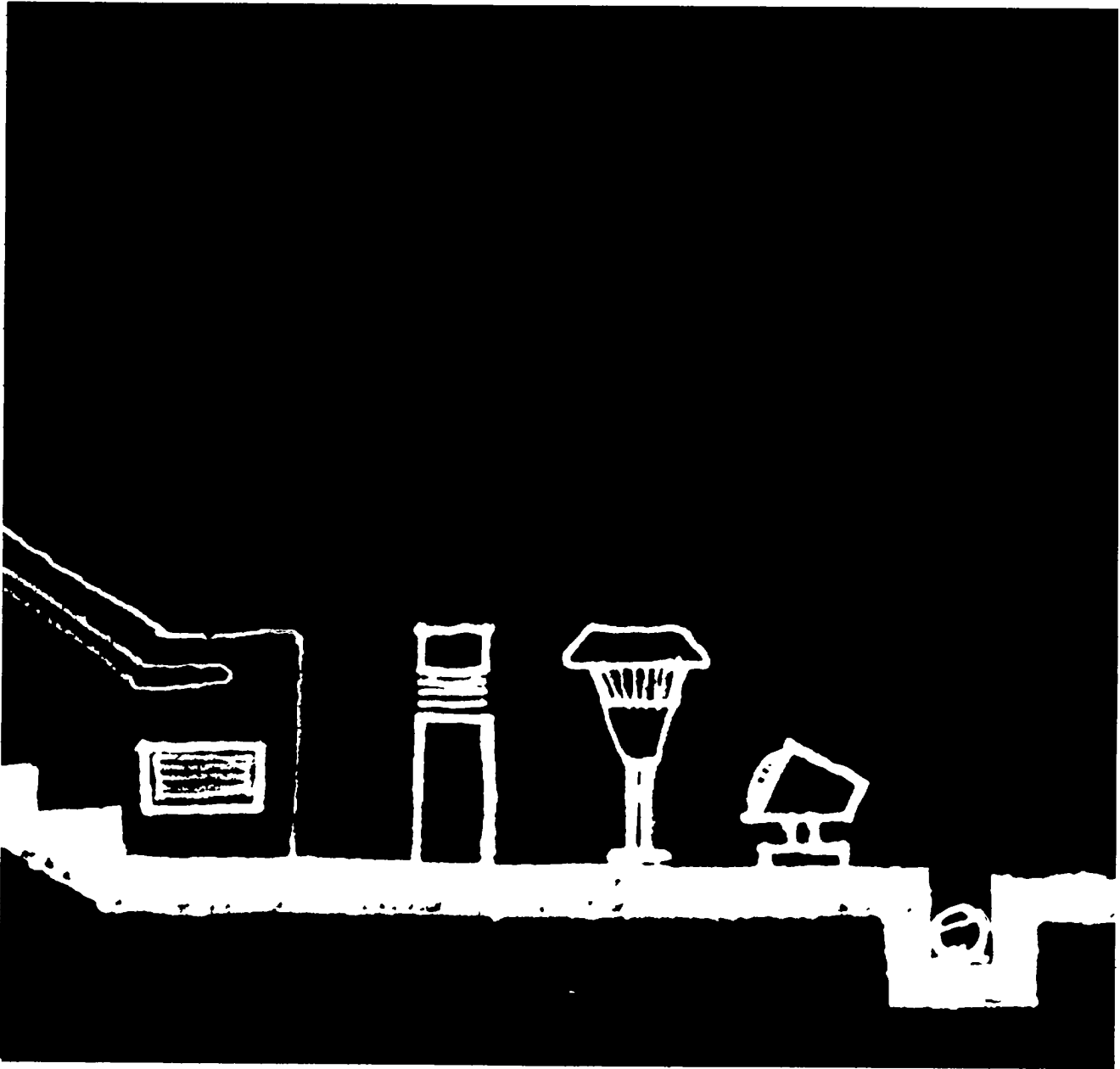

Section I:

Observations and Objectives.

11-1.

Typical Problems.

A. Roadway Lighting.

1. Roadway lighting on military installations has often been provided on overhead utility poles at a constant spacing along one side of the road (*fig. 11-1*). This predetermined spacing may be inappropriate for the desired lighting design, and allows for little differentiation between streets of varying functions or land use

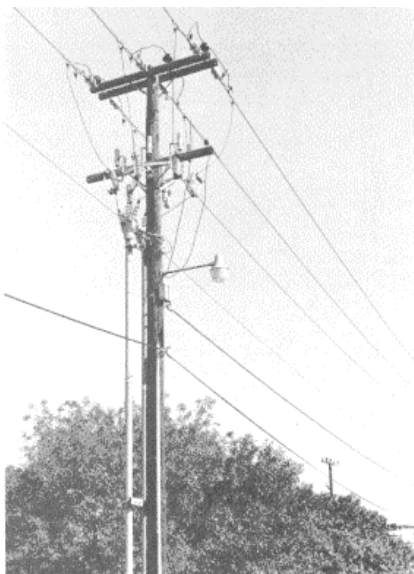

Figure 11-1.

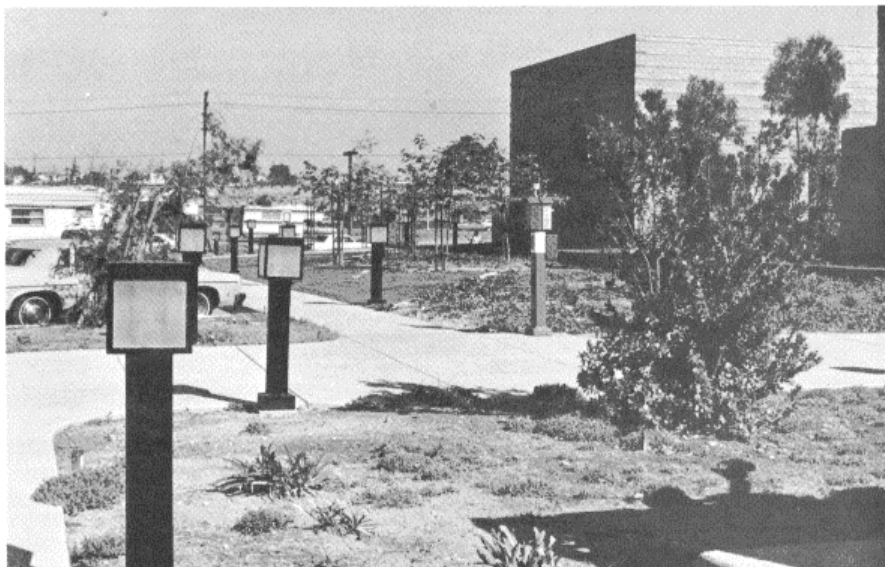

Figure 11-2.

districts. However, where underground utilities are not economically justifiable, attaching the luminaire to the utility pole minimizes the number of poles and thereby reduces visual clutter along the streetscape.

2. Often the street lighting system does not serve to define the circulation hierarchy of an installation. Street lighting should visually reinforce the importance and function of the roadway by means of its fixture design and level of illumination to provide a visual sense of nighttime orientation to the motorist. On residential streets, the scale of lighting standards and high level of illumination is often inappropriate; in some cases unshielded luminaires have been used, resulting in discomforting glare.

B. Pedestrian Lighting.

Pedestrian facilities that are

heavily traveled at night require lighting to illuminate the path and provide safety and security. Most of the pedestrian lighting observed on military installations has been associated with recent construction. Sometimes it is



Figure 11-3.

either overdone, stylistically incompatible with the adjacent surroundings, or highly susceptible to vandalism (*fig. 11-2*).

C. Parking Lot Lighting.

General illumination of parking areas is often needed for traffic as well as pedestrian safety and security, especially in high nighttime use areas. The recent trend in lighting large parking

areas using a relatively few, high mast standards is efficient from an engineering standpoint, but the scale of these standards is often in conflict with pedestrian activity and adjacent land uses (*fig. 11-3*).

D. Outdoor Architectural Lighting.

In some cases, outdoor lighting of buildings is used to highlight or accent a building at night. In general, this type of lighting should be avoided, except where building security is essential, or special effects are needed. Selective lighting of a few landmark buildings does, however, help provide a sense of orientation for nighttime motorists.

B. Overall Coordination.

Perhaps the most common visual problem that has existed with exterior lighting on military installations has been the lack of overall coordination. The style, scale, level of illumination and lamp type have often been applied inconsistently and have been uncoordinated in design.

11-2.

Objectives.

A. Express the Appropriate Image, Character and Scale of an Area.

Lighting should be related to the functions and scale of activities it serves. Lighting design should vary with the volume and type of traffic and with the visual character of development. Street and pedestrian lighting should be coordinated with other elements of

the streetscape, such as signing, landscape planting, paving materials, trash containers and bus shelters. A coordinated approach can greatly reduce visual clutter and confusion.

B. Convey a Sense of the Installation Organization.

At night, street lighting is the primary means of defining the hierarchy of the circulation system. By reinforcing this hierarchy and by illuminating signing and landmark features, exterior lighting can greatly contribute to a sense of orientation that enables people to easily find their way about the installation at night.

C. Promote safety and Security for Nighttime Use of the Installation.

For the nighttime driver, the lighting of roadways must illuminate obstructions and provide an understanding of oncoming conditions. This can reduce accidents and promote a better utilization of roadways by increasing safe speeds. Pedestrian lighting must also illuminate obstructions as well as provide a reassuring psychological feeling of security by minimizing dark shadows.

D. Minimize Operational Maintenance and Repair Costs.

Exterior lighting should be efficient and vandal-proof and should facilitate maintenance and repair.

Section II:

Design Guidelines.

11-3.

Basic Types of Exterior Lighting.

A. Low Level Lighting.

This type of lighting is provided by fixtures mounted at heights below eye-level and is typically

Figure 11-4.

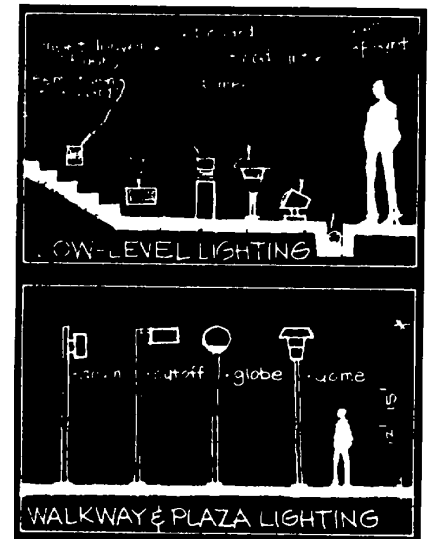

Figure 11-5.

used for special pedestrian walkway areas such as at stairways or along secondary pathways (*fig. 11-4*). It is characterized by very finite light patterns with low wattage capabilities. Light sources are either incandescent or fluorescent. They have simple maintenance requirements but are susceptible to vandalism.

B. Walkway and Plaza Lighting.

This type of lighting is provided by fixtures mounted at average heights between 12 to 15 feet and is used to light primary pedestrian walkways and plazas (fig. 11-5). They have potential multiple uses because of a large variety of fixtures and light patterns. Their light source is typically incandescent or mercury vapor. They are susceptible to vandalism.

Figure 11-6.

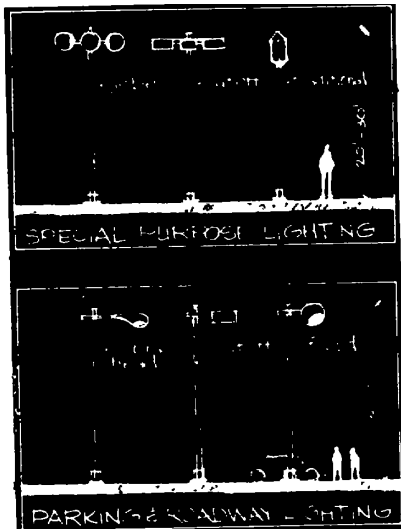

Figure 11-7.

C. Special Purpose Lighting.

This type of lighting is provided by fixtures mounted at an average height of between 20 to 30 feet and is used in recreational, commercial, residential and industrial applications (fig. 11-6). The light source is typically metal halide or mercury vapor. Fixtures are maintained by gantry.

D. Parking and Roadway Lighting.

This type of lighting is provided by fixtures mounted at average heights of between 30 to 50 feet and is typically used in large

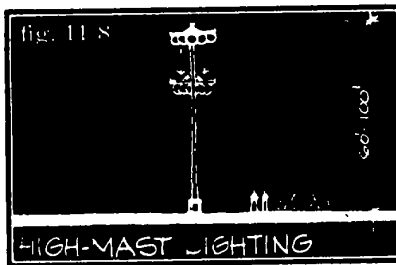

Figure 11-8.

recreational areas, parking lots and roadway applications (fig. 11-7). Light source is typically mercury vapor or high pressure sodium. Fixtures are maintained by gantry.

E. High Mast Lighting.

This type of lighting is provided by fixtures mounted at an average height of between 60 to 100 feet and is typically used for large area lighting of parking lots, recreational areas and highway interchanges (fig. 11-8). Light source is typically mercury vapor or high pressure sodium. Fixtures must be lowered on the pole for maintenance.

11-4.

Visual Elements of Lighting Design.

There are a number of variables to be considered in the technical design of exterior lighting including the level of illumination, luminaire location and type of luminaire. It is not the intent of this section to provide a comprehensive methodology or set of standards for the design of exterior lighting, most of which exists in current military manuals on the subject (see TM 5-811-1). The intent of this section is to deal with those elements of lighting design that affect the visual quality of the environment.

Therefore, discussion here is limited to visual considerations in selecting a lighting source and standard or pole.

A. Selection of Light Source.

A variety of light sources are available for exterior lighting, each with characteristic advantages and disadvantages which influence its appropriate use. A qualified illuminating engineer, in coordination with installation master planners, architects, landscape architects and civil engineers, should design the exterior lighting system and select light sources which are appropriate. The following general guidelines are offered here for appropriate use of various light sources on military installations.

1. High Pressure Sodium.

Because of its high efficacy, this lamp should be used for roadways and protective lighting systems, where relatively high lighting levels are required. The current trend in street lighting design incorporates this lamp in major street lighting design systems.

2. Metal Halide.

This lamp type is recommended for use in "people-gathering" areas such as churches, theaters, auditoriums and shopping centers. This lamp has a good color rendition and is not psychologically offensive to people.

3. Color-Corrected Mercury Vapor.

This lamp type is the least efficient source of the high intensity discharge family of lamps and is recommended for use in residential streets where lower lighting levels are desirable.

4. Incandescent.

This lamp type should only be used in pedestrian areas or when its warm color-strengthening characteristic is necessary. This limitation on use is primarily because of its low efficiency and short life span.

B. Selection of Light Standards (or Poles).

Luminaries can be mounted on existing utility poles to limit

additional clutter. However, wherever feasible, exterior lighting systems should be provided with standards, or poles, that yield the proper spacing and mounting height ratios for a given light problem.

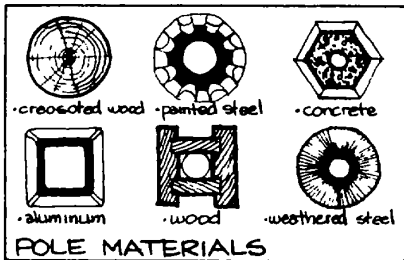

Figure 11-9.

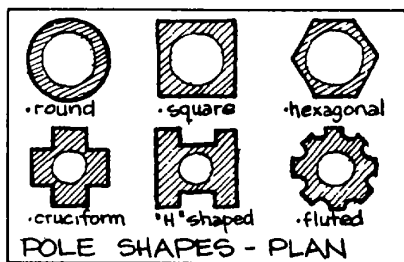

Figure 11-10.

1. Types of Standards or Poles. Lighting poles that are generally available include the following, listed in ascending order of expense: (figs. 11-9, 11-10 and 11-11).

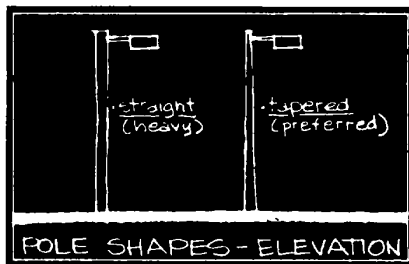

Figure 11-11.

a. Creosoted Wood. This pole type is purely utilitarian and should generally be avoided when establishing an overall lighting system for an installation. Its application should generally be limited only to where it already

exists (replacement) or temporary poles.

b. Painted Steel. This pole type provides a trim profile but requires regular maintenance. Baked-on powdered paint coatings that minimize maintenance are available in some localities but add considerably to costs. Painted steel poles are best used in community areas, residential streets and pedestrian lighting applications. Generally, they should be avoided because of maintenance requirements.

c. Concrete. The quality of appearance of concrete poles varies considerably from utilitarian to exposed-aggregate finishes. These types of poles have height limitations (approximately 50 feet) and their profile becomes large and visually cumbersome or heavy as their height increases. They require minimum maintenance and can be used in a variety of applications, except high mast uses. They generally blend well with the natural and architectural setting, especially when weathered or containing earth-tone aggregates.

d. Aluminum. These types of poles provide a thin profile and require little maintenance. They are available in a variety of finishes, but when left natural should have a brushed finish to minimize reflection and glare. They are best used in a variety of applications including community areas, residential streets and pedestrian lighting. Their major drawback is initial cost, which can be offset in life cycle cost by their low maintenance requirements.

e. Weathered and Decorative Wood. These types of poles are generally considered for special area applications where a high quality finish is desired that blends with the aesthetics of a particular setting, especially in pedestrian or residential areas. They are relatively expensive and susceptible to defacement by

vandals.

f. Weathered Steel. This type of pole is best used where high mast poles or minimum maintenance is required. This type of pole should be avoided in any areas where pedestrians might come into physical contact with the pole because of its staining characteristic. Initial costs are high but its practicality for high mast applications is more than justified because it is relatively maintenance-free.

2. General Selection Guidelines. Standards or poles should be selected based upon their functional and aesthetic appropriateness.

a. Generally, concrete and aluminum poles are the most attractive and practical systems for poles up to 50 feet in height.

b. Weathered steel poles should only be used for high-mast type lighting in areas where no pedestrian contact occurs.

c. The pole system selected should be used consistently throughout the installation.

d. Different pole types can be used for different systems, i.e., vehicular and pedestrian, but they should relate harmoniously, especially in areas where they may interface.

11-8.

Information and Orientation.

A well-designed street lighting system should define the circulation hierarchy of the installation (see Chapter 4), expose traffic conditions, and provide visual orientation to help both pedestrians and drivers find their way at night. During the daytime, the repetitive lighting standards should also contribute to this hierarchy and sense of order.

A. Reinforcing the Street Hierarchy.

Lighting should reinforce the street hierarchy by visually differentiating primary, secondary and tertiary streets. These differences in street importance should be expressed by varying the levels of illumination and the type, height and spacing of lighting standards. An example of hierarchical street lighting design is illustrated here. While specific elements of the lighting system will vary with the unique requirements of each installation, the functional/visual concept illustrated here should be consistently applied at all installations.

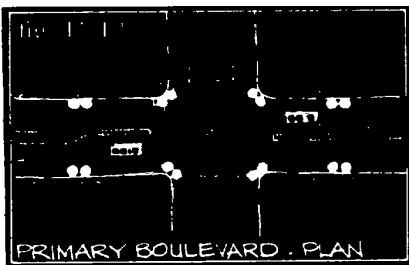

Figure 11-12.



Figure 11-13.

1. Primary Boulevard or Wide Primary Street.

Regularly spaced, paired luminaires mounted on 40-foot standards in an opposite arrangement (both sides of the street) define a primary boulevard or a wide primary street (figs. 11-12 and 11-13). In character, this is definitely an automobile-dominant road. When the basically continuous traffic flow is interrupted at a full intersection, the distinct pattern of an outdoor "room" clearly indicates a junction.

Major corners throughout the system are defined as outdoor "rooms" by the relationship of paired luminaires, arrangement of signal lights, illuminated street names, striped crosswalks and perhaps even a change in pavement color for the enclosed rectangular area at the intersection.

2. Primary Street.

Primary streets of narrower width are identified by regularly spaced, paired luminaires mounted on 40-foot standards along one side of the road (figs. 11-14 and 11-15). Preferably this side would be opposite the trees

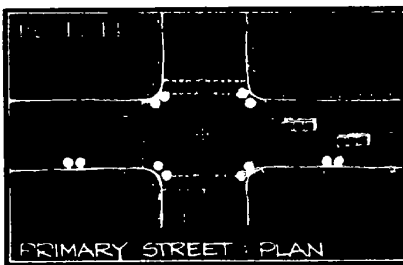

Figure 11-14.

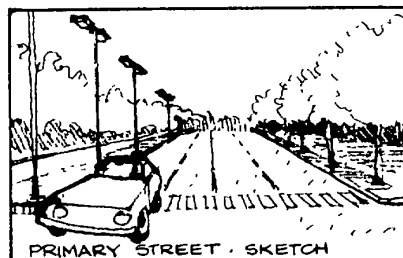

Figure 11-15.

or view. The illumination level is made higher at intersections so that drivers and pedestrians will be alerted to cross traffic.

3. Secondary Street.

Single luminaires placed opposite each other on 25-foot standards define a secondary street (figs. 11-16 and 11-17). Staggered spacing should be avoided because of the confusing, disorderly patterns which result, particularly on curves. The lighting is in obtrusive due to the straight-line design of the poles and the minimum luminaire

overhang.

4. Boulevard (Secondary or Tertiary). Paired luminaires on 25-foot standards in the median are utilized for these boulevards (figs. 11-18 and 11-19). A variation in lamp type (color corrected mercury for residential, high pressure sodium for other areas) could distinguish an area's land use. Intersections on a more heavily used street are marked by paired luminaires on 40-foot poles.

5. Tertiary Street. A typical tertiary residential street is identified by a single color-corrected mercury fixture at one side mounted on 15-foot poles

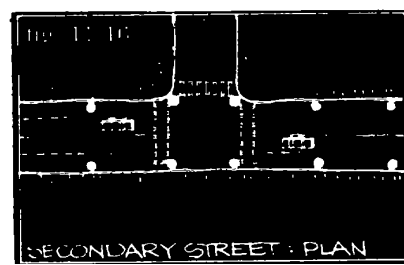

Figure 11-16.

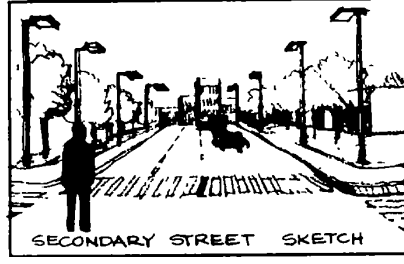

Figure 11-17.

(figs. 11-20 and 11-21). Intersections with similar residential streets are defined by pairing the fixtures. Intersections with a secondary or primary street are defined by lighting fixtures on 40-foot poles.

B. Landmarks.

Lighted buildings, monuments, fountains and other structures can serve as orientation landmarks for the nighttime driver. Care must be taken not to over-

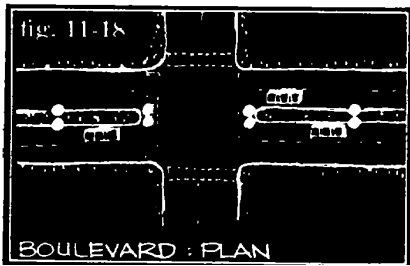

Figure 11-18.

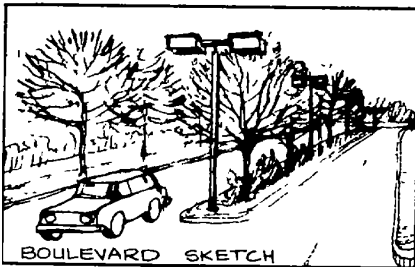

Figure 11-19.

do such lighting which would both detract from overall effectiveness and be wasteful of energy.

C. Site Furnishings.

Certain street furniture, such as fire alarms, but shelters and signing should be properly lighted for nighttime use.

11-6.

Image, Character and Scale.

A. Finish.

In order that street lighting not dominate the streetscape but serve as background, the materials should have a matte finish to avoid distracting reflections and highlights

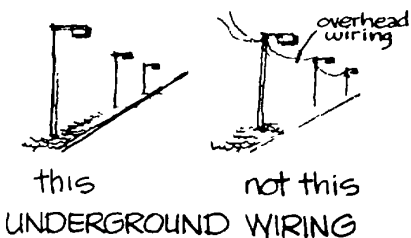

Figure 11-22.

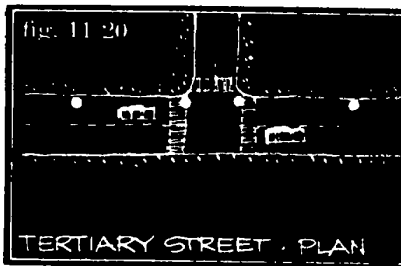

Figure 11-20.

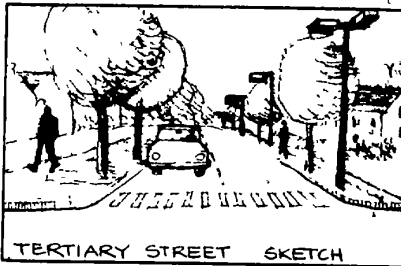

Figure 11-21.

B. Power Supply.

To reduce streetscape clutter, it is highly preferable to supply power by underground rather than overhead lines to fixtures wherever possible and practical (fig. 11-22).

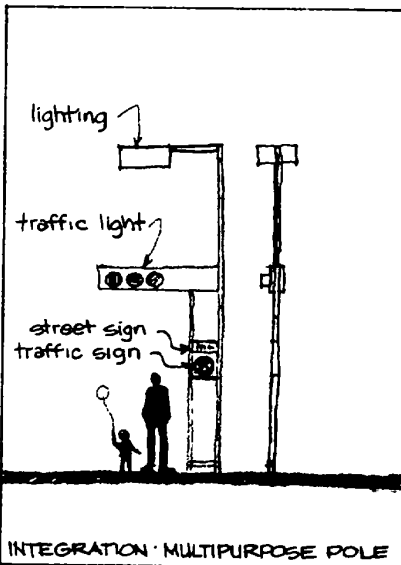

Figure 11-23.

C. Integration with Other Site Furnishings.

In order to reduce clutter, lighting standards should be integrated in design with street signs, traffic signs and signals (fig. 11-23).

D. Built-up/Non-Residential Areas.

In built-up areas, lines and planes of the fixtures should relate to buildings (poles vertical and arms horizontal) and overhanging arms and large directional fixtures should not dominate the view (fig. 11-24).

E. Residential Areas.

Commercial-sized standards, high-wattage lamps and unshielded luminaires should not be used in residential streets.

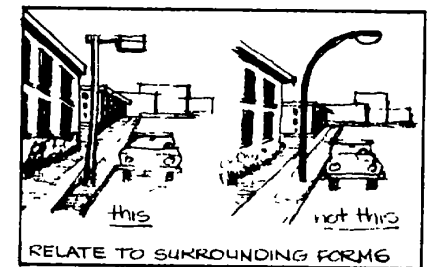

Figure 11-24.

F. Pedestrian Areas.

In areas of high pedestrian activity, warm color light sources of low intensity should be used. Low lighting standards or poles should be used to maintain the proper scale.

G. Historic Areas.

In historic areas, lighting should be compatibly designed with the architectural setting. However, it should not be imitative of lighting that is no longer available, such as electrified "gas" lamps.

11-7.

Safety and Security.

The primary purpose of exterior lighting is to provide a safe and secure nighttime environment. The illumination requirements should vary with the activities being performed and user needs.

A. Vehicular.

1. The driver must be able to see distinctly and locate accurately and quickly all significant details, such as the alignment of the road, any potential obstacles, signing and traffic control devices.

2. Intersections and other complex or irregular road configurations, such as curves, hills, converging traffic lanes, diverging traffic lanes or pedestrian crossings, require higher illumination levels. The illumination level for an intersection should be the summation of the levels of the intersecting roads (*fig. 11-25*).

3. In addition to higher illumination levels, the placement of lighting standards along curves is important to reveal to the driver, both by day and by night, the oncoming alignment of the roadway. Fixtures only on one side provide a clear and attractive pattern, as opposed to staggered fixtures on both sides, which are distracting by day and confusing by night (*figs. 11-26 and 11-27*).

4. Lighting standards should be placed so that they are not hazardous to pedestrians or vehicles. If a poor placement cannot be avoided, breakaway pole mounting details should be employed.

5. Disability glare, or glare that reduces the viewer's ability to see an object, should be controlled by careful attention to luminaire location and the use of cutoff or semi-cutoff luminaires.

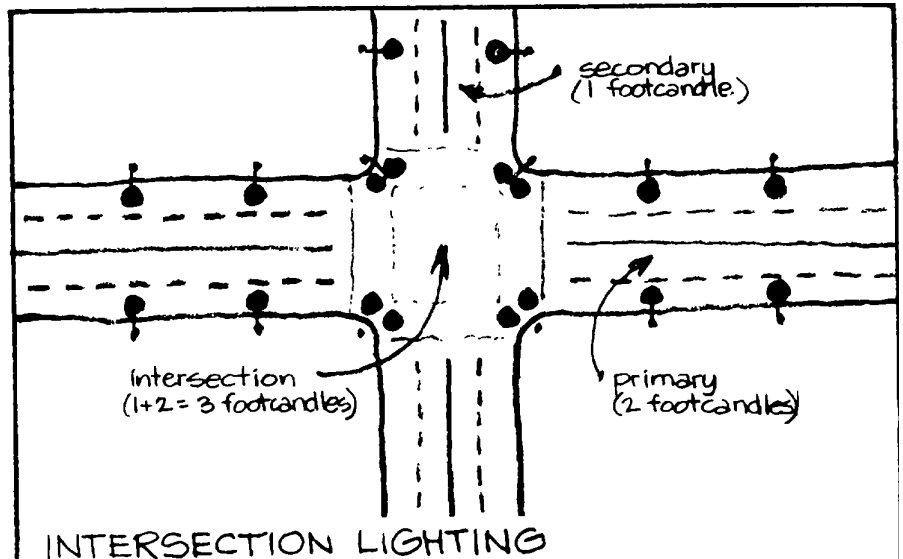

Figure 11-25

B. Pedestrian.

1. The pedestrian must also be able to see distinctly such features as the edges of the walkway, vehicles and obstacles.

Figure 11-26.

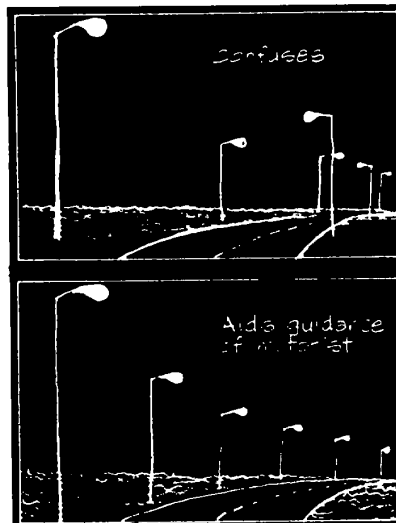

Figure 11-27.

2. In addition, the pedestrian has significant psychological nighttime needs requiring that dark shadows should be minimized to provide a sense of security.

3. Hazardous locations along pedestrian paths, such as changes in grade, require higher illumination levels or supplemental lower level lighting.

4. Light standards should be located so as not to impede pedestrian flow along walkways.

11-8.

Economy, Maintenance and Repair.

A. The location, height and details of lighting standards should allow easy maintenance and replacement of luminaires and lamps.

B. High-efficiency, long-life lamps should normally be utilized. Incandescent and color corrected lamps should be used as accents and in pedestrian areas.

C. Vandal and accident-prone mountings and luminaires should be avoided.

A wide variety of site furnishings is commonly found on military installations. These site furnishings include both utilitarian items such as benches, bus shelters, trash containers, or fences, as well as more symbolic elements such as flagpoles,

memorials and historic military equipment displays. With proper planning and design, site furnishings can not only fulfill their intended function but also contribute positively to the overall visual quality, image and identity of the military installation.



Section I:

Observations and Objectives.

12-1.

Typical Problems.

A. Site Variations.

Field conditions vary considerably from installation to installation in terms of the type and appearance of site furnishings. Some of this variation properly reflects the site setting, architectural character and climatic conditions of the particular installation (*fig. 12-1*). Other variations are qualitative in nature. While all installations provide these necessary site furnishings, some have done so in a more successful manner, both functionally and aesthetically, than others.

B. Compatibility.

The specific needs and appropriate locations for seating, shelters, trash containers, fencing and so on change considerably over time. Each type of site furnishing is typically selected individually and on an incremental basis. Therefore, it is not surprising to find a collection of unrelated seating and trash containers resting uncomfortably together on the same street corner (*fig. 12-2*). This lack of coordination as well as concern for detail, are the primary problems related to site furnishings.



Figure 12-1.

C. Coordination.

More successful examples of functional and attractive site furnishings are found at installations that have established an overall plan and coordinated design system of site furnishings. Less successful examples have resulted at installations which have followed a piecemeal approach of selecting site furnishings without proper regard for either user needs, site setting, architectural character or climatic conditions of the installation (*fig. 12-3*).



fig. 12-2.



Figure 12-3.

12-2.

Objectives.

A. Provide Site Furnishings Appropriate to their Intended Function.

The design of bus shelters should vary with climatic conditions. The design of fencing should vary with the function it is to perform. Care should be exercised in the selection of standardized site furnishings to make certain they are appropriate for a specific application at the installation.

B. Establish a Coordinated System of site Furnishings.

Site furnishings should be part of a coordinated system, based upon an overall design scheme that harmoniously relates furnishings to the architectural character of the installation and other site furnishings in terms of their scale, materials and details.

C. Consolidate and Simplify the Design of Site Furnishings.

The number of different site furnishings should be minimized and their design should be simplified. Site furnishings should neither clutter nor dominate the visual character of the installation. Wherever possible, they should be grouped together and be multi-functional.

D. Provide Consistency and Continuity in the Use of Site Furnishings.

Site furnishing designs should be utilized to unify the image and identity of the installation. Once a coordinated system of site furnishings has been established, it should be employed consistently throughout the installation and continuously followed over time.

E. Incorporate Adequate Provisions for the Handicapped.

Provisions for the handicapped should be incorporated into the design of site furnishings, especially in areas of the installation where handicapped persons might live, work, shop or visit.

Section II:

Design Guidelines.

12-3.

Benches, Seating and Tables.

1. Locate seating oriented to user needs of waiting and resting adjacent to paved walkways, entryways, and plazas, near the tops and bottoms of major stairs and ramps, at bus stops and other locations deemed appropriate by anticipated need and use.

2. Locate seating oriented to user needs of socializing, relaxing and eating in less formal spaces with a pleasant setting and view that are conducive to their intended purpose.

3. Seats should be set back 2'-0" from adjacent sidewalks to provide ample leg room and not to impede or obstruct pedestrian traffic.

4. A space of 4'-0" should be provided at the end of benches to enable strollers and wheelchairs to be parked (Figure 12-4).

5. A space of 5'-0" should be provided between the front edge of the seat and any stationary obstacle such as a water fountain, trash receptacle or sign post.

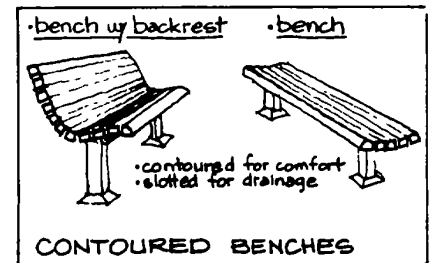

Figure 12-5.

6. Especially where longer-term sitting occurs, seats should be designed with back supports, contoured seats and arm rests for comfort in sitting and support in getting up and down from the seat (fig. 12-5).

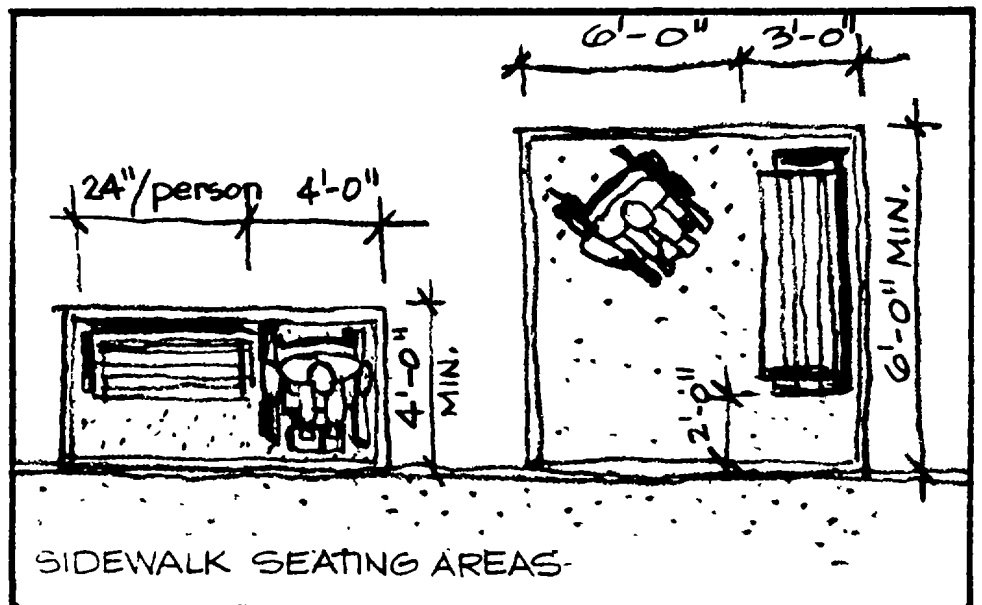

Figure 12-4.

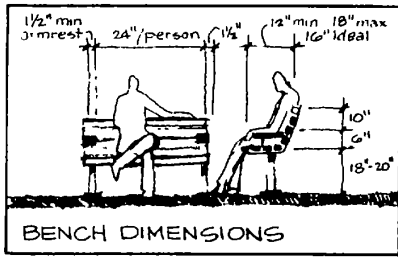

Figure 12-6.

7. Seat height should be 18"-20" from the ground and be uniform and level (fig. 12-6).

8. Seat depth should be 12" minimum to 18" maximum (16" ideal) and be pitched back at an angle of 0-5 degrees to the horizon (fig. 12-7).

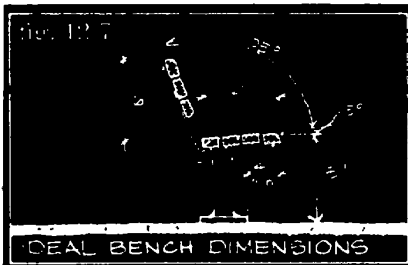

Figure 12-7.

9. Seat width should be 24" per person.

10. Back rests should be 15"-18" high (16" ideal) and at an angle of 90-110 degrees to the seat (105 degrees ideal).

11. Arm rests should be 6" high from the seat and be a minimum width of 1 1/2".

12. The seat should overhang the support legs by a minimum of 4" to provide heel space and to facilitate rising from a seating position.

13. Seat surfaces should be pitched or slotted to shed water.

14. Seats should be constructed to support a minimum of 250 pounds for each person they are designed to accommodate.

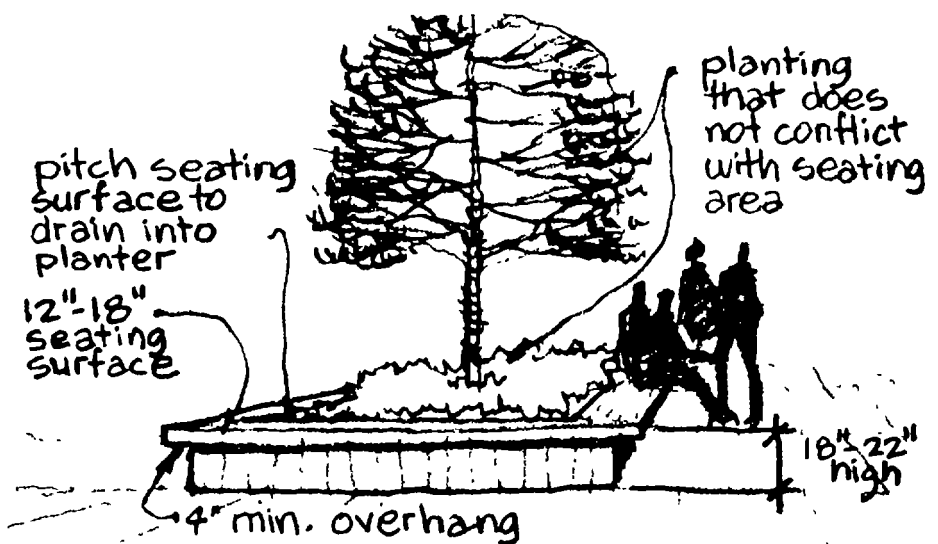

SEATING WALLS

fig. 12-8.

15. Seat surfaces should be smooth and constructed of materials that do not tend to either retain heat or cold, or splinter.

Redwood, alerce, and vertical grained tank stock douglas fir are recommended wood seating surfaces.

16. Seats should have no sharp edges or protruding hardware.

17. All wood should be nonsplintering and have rounded edges.

a. All metal should have rounded edges and be rustproof.

b. All mounting hardware should be concealed, recessed and/or plugged.

c. Seating in areas subject to vandalism should be selected with care for firm anchoring to the ground and durable materials.

B. Seating Walls.

1. Seat height should be 18"-22" (fig. 12-8).

2. Seat depth should be 12" minimum and 18" maximum.

3. Seating surface should be pitched 1/8" per 12" to allow surface water to drain back into the planting bed (fig. 12-9).

4. Seating surface should ideally have a 4" overhang from the planter wall for heel space and facilitate rising from a seating position.

5. Provide 2'-0" for leg space in front of the seat edge in order not to impede pedestrian traffic.

6. Use dull and light colored materials for seating surfaces that will be in direct sunlight to keep them cooler. Use dark and shiny surfaces only in shaded locations so they do not become uncomfortably hot in the direct sunlight.

7. Vegetation near seating walls should not conflict with pedestrians or people sitting; avoid species that are invasive, injurious or that shed excessive or staining debris.

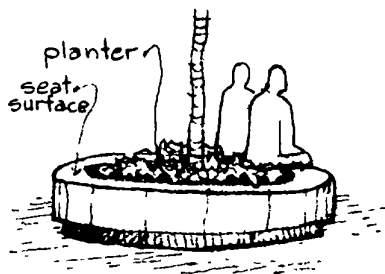

SEATING WALL

Figure 12-9.

C. Tables.

1. Table height should be 30"33" (fig. 12-10).
2. Table depth should be 18" minimum if utilized from one side only (36" if utilized from both sides).

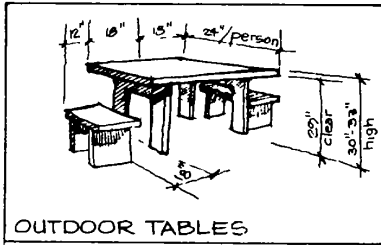

Figure 12-10.

3. Table length should be 24" per person.
4. Leg space under tables (from the inside edge of seat top to the nearest table support) should be 18".
5. A minimum vertical clearance of 9" should be provided between the seat top and the bottom edge of the table top.

Figure 12-11.

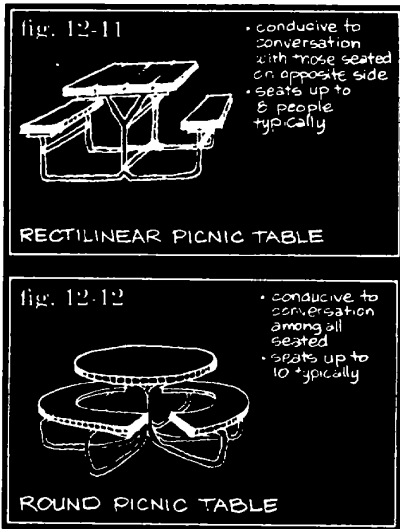

Figure 12-12.

6. Stationary picnic table benches should not have back rests (figs. 12-11 and 12-12).
7. Table tops should be smooth surfaced with no recesses that might hold water or food particles.
8. All edges and corners should have rounded, eased or chamfered edges; all hardware should be concealed, recessed or plugged.
9. Provisions for the handicapped.

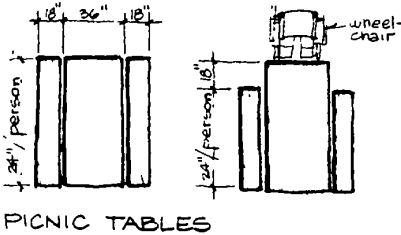

Figure 12-13.

- a. A clear space of 29" from the ground to the underside of the table should be provided for wheelchair-dependent persons to pull up beneath the table top at the end of the table; a minimum of 18" should be provided from the end of the table top to the nearest support leg (figs. 12-13 and 12-14).

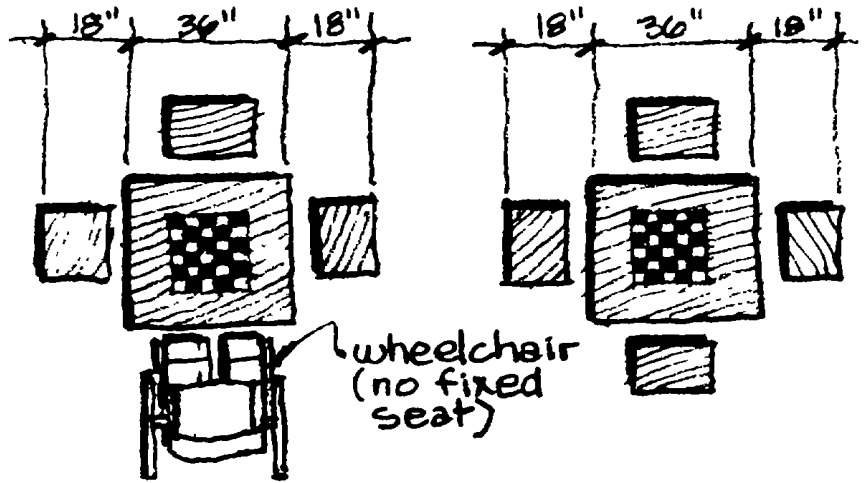

Figure 12-14.

- b. A clear width of 34" is necessary to accommodate a wheelchair-dependent person.
- c. Provisions should be made for hard-surfaced paved access for persons handicapped in their movement (crutches or canes), wheelchair-dependent persons and persons with strollers or carriages.

12-4. Outdoor Drinking Fountains, .

- A. Location.
 1. Drinking fountains should generally be located along walkways and hard-surfaced paved areas that are easily accessible (fig. 12-15).
 2. Drinking fountains should be located conveniently to a potable water supply line or well.

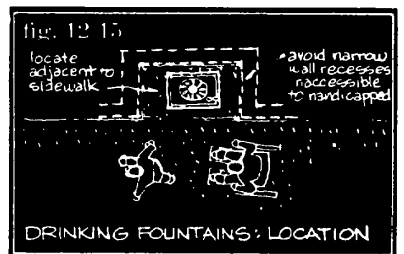

Figure 12-15.

- More frequent locations are required where outdoor eating occurs and on installations that have warm climates.

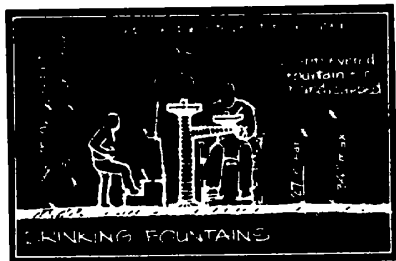

Figure 12-16.

B. equipment.

- Nozzle height should be 36"-39" from the ground for adults; the height for children should be 24"-30", provided by either a separate fountain or stepping blocks to an adult fountain (fig. 12-16). (See also "Provisions for the Handicapped" below.)
- Drinking fountain controls should preferably be hand-operated levers rather than knobs or foot pedals.
- Both nozzle and controls should be located at the front of the fountain.
- A minimum 18" wide paved area should be provided around the fountain to avoid both mud and puddles.
- Fountain bowls should be either bronze or stainless steel and equipped with strainers.

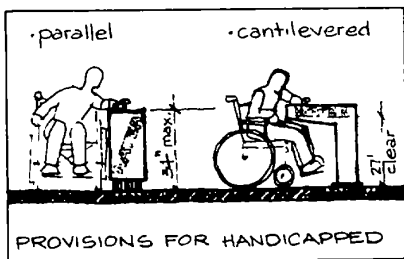

Figure 12-17.

- Stepping blocks for children should be located so as not to interfere with access to the fountain by either normal ambulant adults or wheelchair-dependent people.

C. Provisions for the Handicapped.

- Avoid locating fountains in narrow wall recesses with insufficient space for access by wheelchair-dependent persons.
- Specific provisions for wheelchair-dependent persons include a 12'-18" cantilevered fountain bowl with a nozzle height of 34" above the ground and a minimum 27" vertical clearance below the fountain bowl to the ground (fig. 12-17).
- Provide a hard-surfaced paved fountain pad with a minimum width of 36" and length of 4'-0" from the adjacent sidewalk.

12-5.

Outdoor Telephone Booths.

A. Location and Service.

- Telephone booths should be located relative to potential use, convenience and installation costs.
- Highly visible locations are best for better utilization and convenience as well as greater security from vandalism.
- All service line wiring should be underground or concealed.
- Telephone booths should be accessible by hard-surfaced paved sidewalks.
- Locate booths so as not to impede or obstruct pedestrian traffic on adjacent sidewalks.
- Telephone booths should be integrated with other street furnishings or convenience centers, such as bus or vending machine shelters, wherever possible.

B. Equipment.

- Provide overhead weather protection at a minimum height of 6'-6" from the ground; semi-enclosed housing systems with overhead weather protection and acoustical panels are preferable to totally enclosed telephone booth housing systems (fig. 12-18).
- Telephone booth materials should be easily maintained and resistant to vandalism smooth surfaced and resistant to defacing).
- Telephone booths should be equipped with lighting for nighttime use.

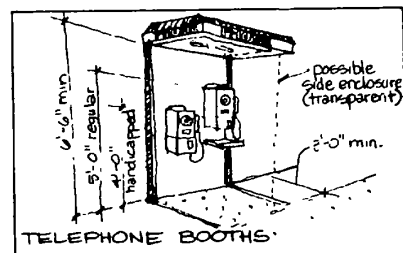

Figure 12-18.

- Normal telephone mounting height is 5'-0" from the coin slot to the ground. (See also "Provisions for the Handicapped" below.)
- Telephone booths should be mounted with a setback of 3'-0" from the sidewalk and with a minimum lateral spacing of 30" per telephone.
- Other provisions include telephone book storage, a package rest/writing ledge at a height of 30" from the ground with a pullout or fold-down seat.
- Attractive, modular telephone booth systems, available through the telephone company, are appropriate at locations requiring future flexibility to expand the number of available booths.

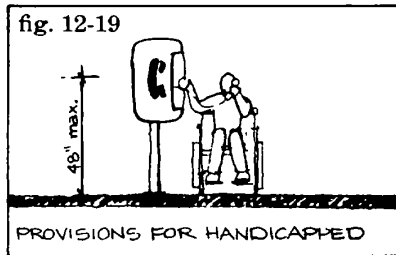

Figure 12-19.

C. Provisions for the Handicapped.

1. All groups of telephones should have at least one lower height telephone for use by the handicapped and children.

2. Telephone mounting height for the handicapped is 4'-0" maximum from the highest operating mechanism to the ground (*fig. 12-19*).

3. Other helpful provisions for the handicapped include volume controls on headsets and push button dials.

12-6.

Bus Shelters.

A. Location.

1. Bus shelters should be located where warranted by the degree of use and need for weather protection.

2. Bus shelters should be adjacent to paved sidewalks and not impede pedestrian traffic.

B. Design.

1. Bus shelters should provide protection from inclement weather conditions typical at the installation (*fig. 12-20*).

a. Installations in warmer climates generally require only overhead rain and sun protection.

b. Installations in colder climates require not only overhead protection but also enclosures on two or three sides for wind protection during colder periods of the year.

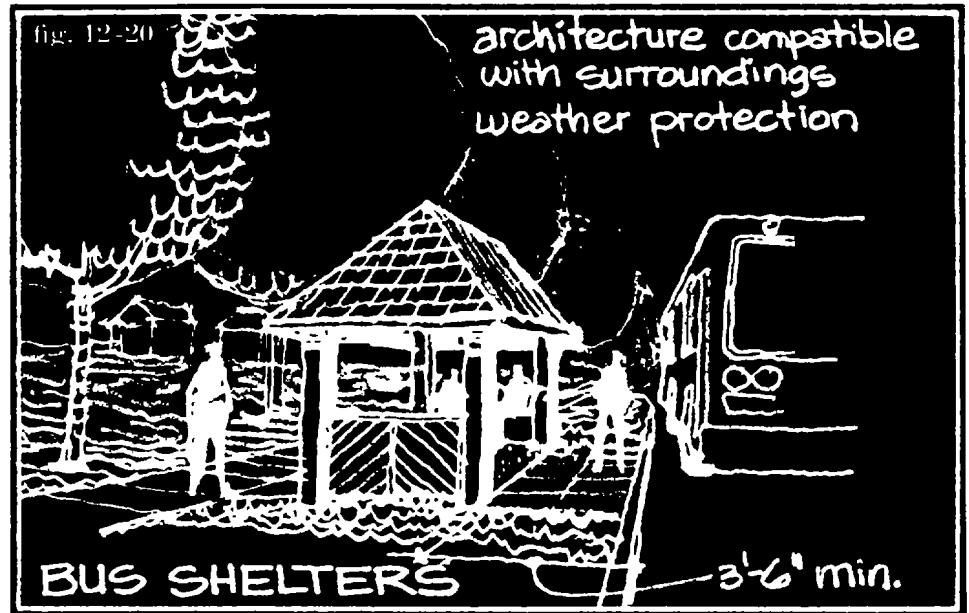

Figure 12-20.

2. Bus shelter designs should be simple, unobtrusive, consistent throughout the installation and harmonious with the architectural character of the installation in terms of their form, scale, materials and details.

3. Design bus shelters with sight lines to approaching buses; if the shelter has side enclosures, transparent openings should be provided for visibility and safety.

4. Bus shelter size depends on the anticipated use; the shelter can be generally sized by applying an area standard of 8 square feet/person to the typical maximum number of waiting persons at any one time during a day with inclement weather conditions. The seating capacity under cover should be equal to the average number of persons waiting at the bus stop.

5. Bus shelters should have a minimum size of 5' x 8' (40 square feet.)

6. Outdoor seating can be provided near the bus shelter for waiting during pleasant weather conditions.

7. Structural supports for bus shelters should be located out of the path of persons circulating within the shelter or passing the shelter.

8. All waiting areas at bus shelters should have hard-surfaced paving that adequately drains to prevent puddles.

9. The minimum setback from the curb should be 3'-6".

10. Provide a minimum height of 6'-6" from the ground to the underside of the protective roof or canopy.

11. Provide light at bus shelters that will be used at night.

12. Provide amenities such as bus route identification, scheduling and route maps, and an installation map directory. (*See Chapter 10: Signing.*)

13. Bus shelters should serve as a multi-functional facility; other site furnishings that could be incorporated into bus shelter design include a bulletin board, telephone booth, drinking fountain, mailbox, and newspaper vending machine.

C. Provisions for the Handicapped.

These include hard-surfaced paving and curb-free access. Sufficient space should be allocated for wheelchair circulation and parking within the bus shelter.

12-7.

Vending Machine Shelters.

A. Location.

1. Vending machine shelters should be provided to organize and consolidate vending machines into attractive convenience centers when these machines cannot be located in recessed building alcove spaces (fig. 12-21).

2. Vending shelters should generally be located conveniently to work and residential centers and picnic areas.

3. Locate shelters in highly visible places to attract users and provide security from vandalism.

4. Avoid locations near entrance areas to the installation.

5. Vending shelters should be accessible by hard-surfaced sidewalks, but not obstruct or impede pedestrian traffic.

6. Electrical feeder service to vending shelters should be underground or concealed.

B. Equipment and Design.

1. The design of the vending shelter enclosure should be harmonious with the architectural character of the surroundings in terms of its form, scale, materials, and details.

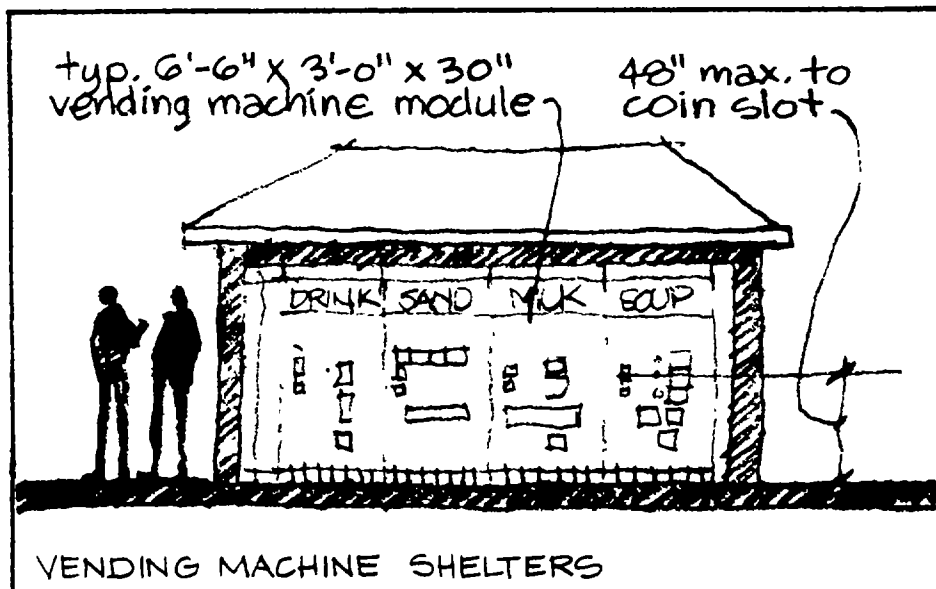

Figure 12-21.

2. Vending machines should be a coordinated system; typical vending machine modules are 36" wide, 30" deep, and 6'-6" high.

3. Vending shelters should preferably provide overhead weather protection for users as well as machines.

4. Provide adequate trash receptacles that are integrated with the design of the shelter.

5. Provide seating area, preferably both under protective cover as well as outdoor, adjacent to the shelter.

6. Provide light in front of the machines for nighttime use and security

7. Other accessory site furnishings that could be integrated with the design of the shelter include a telephone booth, mailbox, bulletin board, installation directory map, drinking fountain and newspaper vending machine.

C. Provisions for the Handicapped.

Hard-surfaced, barrier-free access should be provided. Vending machine systems should be provided with coin slots, selection buttons and dispensers at a maximum height of 4'-0" from the ground

12-8.

Kiosks.

A. Use and Location.

Kiosks can be used as information and notice centers, especially along high use pedestrian and visitor traffic areas (fig. 12-22).

1. Provide kiosks only in areas where they are needed; have high visibility as well as exposure to pedestrian traffic.

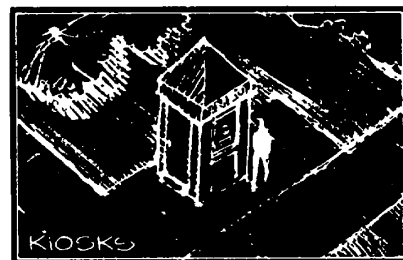

Figure 12-22.

2. Locate kiosks with sufficient hard-surfaced paved area for accommodating users without impeding passing pedestrian traffic.

B. Design.

Kiosks should be designed to fulfill their intended function while blending compatibly with their setting.

1. The form, scale, and materials of kiosks should relate harmoniously to the architectural character of their setting.

2. Try to establish a common design vocabulary for kiosks, bus shelters and vending shelters within the installation.

12-9.

Walls and Fencing.

A. Functions and Applicability.

1. Walls and fencing should be used appropriately for the following functions:

- Security
- Boundary definition
- Visual screening
- Wind screening
- Pedestrian and vehicular traffic control
- Retaining soil (grade change)
- Recreational ball screens (tennis, etc.)

2. Walls and fencing should be of appropriate design and materials to fulfill their function while in harmony with the character and appearance of their setting.

a. Chain link type fencing should generally be limited to uses such as security fencing, general boundary fencing or tennis court fencing.

b. Wood or masonry walls and fencing are generally the most compatible and harmonious materials for use in residential environments.

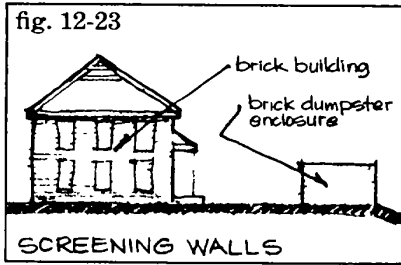

Figure 12-23.

c. Trash containers should be screened effectively with opaque fences or walls of appropriate design and materials compatible with the architectural character and setting (*fig. 12-23*).

d. Earth berms and plant materials are preferable to either walls or fencing when screening parking lots, loading and storage

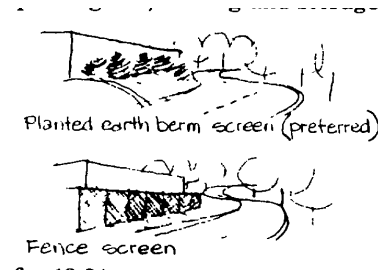

Figure 12-24.

areas, or similar functions from view along main roads of the installation (*fig. 12-24*).

3. The visual character of main entrances to installations should not be dominated by chain link type fencing; either more attractive type fencing should be used or the visual obtrusiveness of the chain link fencing should be minimized by the use of plant materials and dull black chain link fencing (vinyl clad).

B. Fencing.

1. Unless specifically designed for security purposes, fencing should not present any unnecessary dangers for people who might be tempted to climb over.

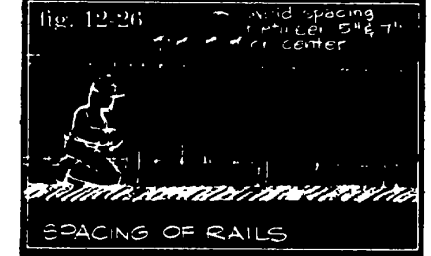
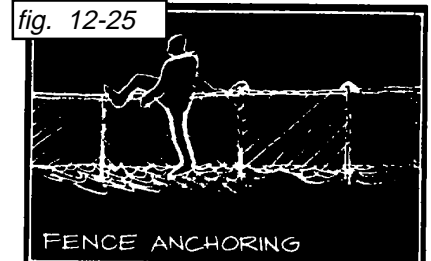

fig. 12-26

2. Support posts should be adequately strong and properly anchored to the ground so that the fence will not collapse under either high winds or the weight of a climber (*fig. 12-25*).

3. The fence material should be well-secured to all posts.

4. Fencing should be free of all dangerous appendages or projections that would be injurious to persons on an adjacent walkway or playfield; all exposed fastening devices and material edges should be rounded off, knuckled or capped to prevent cuts and abrasions.

5. All slatted fences and railings should avoid horizontal or vertical spacings between 5"-7" where children's heads might easily be caught between members (*fig. 12-26*).

C. Walls.

1. All necessary low wall designs should consider the possibility of incorporating seating surfaces, if appropriate.

2. Weep holes and wall drains should not drain onto and across walkways where they could create slippery ice spots during winter months in colder climates.

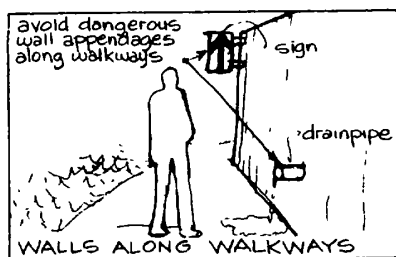

Figure 12-27.

3. Walls adjacent to pedestrian walkways should be free of appendages or projections such as drain pipes or signs that could injure passing pedestrians (fig. 12-27).

4. Handrails for the handicapped should be considered along higher walls adjacent to walkways.

D. Baffle Walls.

1. Baffle walls should be used to block direct views into an area without hindering access or providing doors, such as at entries to outdoor rest rooms (fig. 12-28).

2. There should be a minimum clearance of 4'-0" between walls of a baffle.

3. Where semi-ambulant people will use the facility, handrails mounted 32"-36" from the ground should be provided on the walls and be able to support 200 pounds.

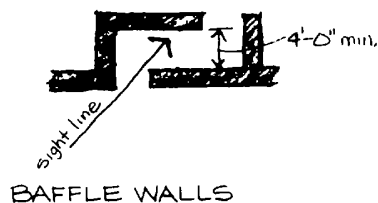

Figure 12-28.

E. Chain Barriers.

1. Chain barriers should generally be avoided as a fencing type because of their ineffectiveness and the safety hazards they create for pedestrians, bicyclists and

automobiles if inadequately identified as obstacles.

2. Chain barriers should only be used as vehicle barriers in areas such as drop-offs where there is low-speed traffic.

3. Vehicle chain barriers should be designed to be suspended between sturdy, well-anchored supports with the lowest (most slack) point of the chain being a minimum of 2'-8" above the ground; the chain barrier should be well-marked with reflector devices so that it can be easily recognized at night (fig. 12-29).

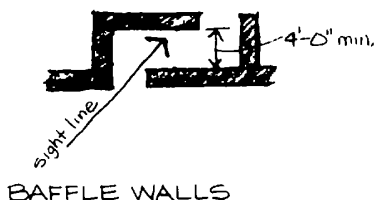

Figure 12-29.

F. Gates.

1. A gate should be compatible in design and materials to the fence or wall in which it is located.

2. The width of the gate should be adequate for wheelchair access.

3. Gates should be rigidly constructed to prevent racking and should be securely anchored to the wall or fence.

12-10.

Trash and Garbage Receptacles.

A. Trash Receptacles and Litter Baskets.

1. Trash receptacles should be attractive sidewalk furnishings of a consistent design throughout the installation (figs. 12-30, 12-31 and 12-32).

2. Combine trash receptacles with other site furnishings to create consolidated, multi-purpose facilities where possible.

Figure 12-30.

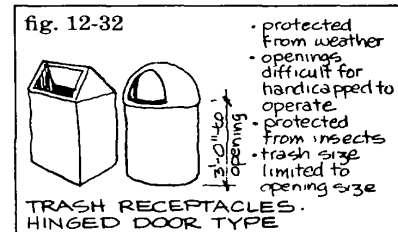
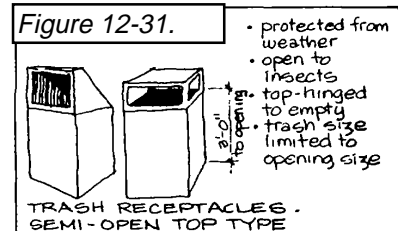
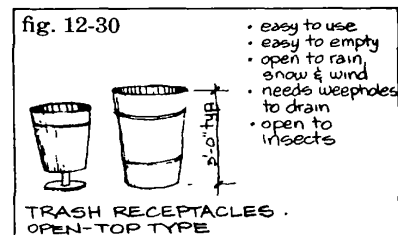
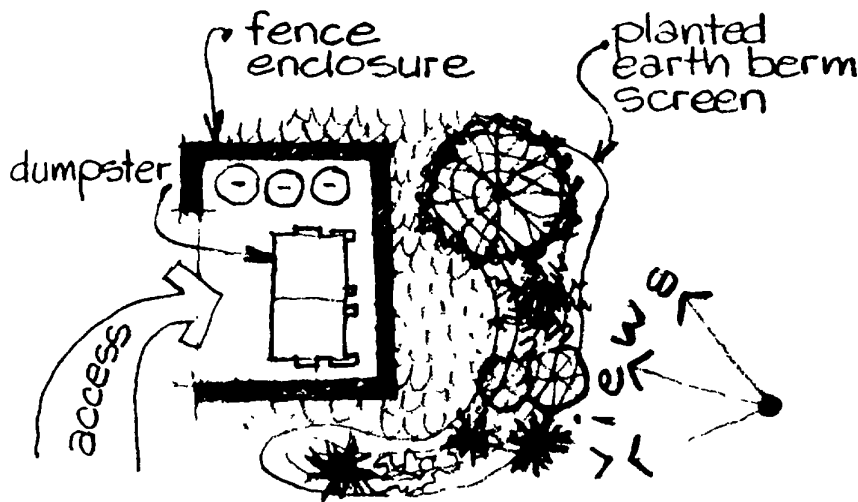

Figure 12-32.

3. Trash receptacles should be highly visible and immediately available for effective litter control. Locate receptacles conveniently and strategically along sidewalks, near major walkway intersections, building entrances, benches, vending machine areas and recreation and picnic areas.

4. Locate trash receptacles to the side of walkways so as not to impede pedestrian traffic or create safety hazards.

5. Trash receptacles should be of the proper size and distribution to provide adequate capacity and avoid overspilling; proper capacity depends on the rate of trash accumulation and the frequency of collection.



DUMPSTER SCREENING

fig. 12-33.

6. Receptacle designs with either disposable inner-linings or removable/reusable inner containers are preferable to self-dumping type designs (hinged bottom, top or sides).
7. Consider weather protection, odor containment, and desired insect-proofing when selecting a trash receptacle design.
8. Receptacles with hinged deposit door openings should be of the type that can be operated by a single hand movement; avoid foot-operated lid-type receptacles.
9. Trash deposit openings should be approximately 3'-0" above the ground.
10. Trash receptacles should be sufficiently strong and stable to resist overturning either by typical use, high winds, or animals seeking food.
11. All receptacle edges should be crimped, rounded and smooth to prevent cuts and abrasions and to encourage use.

B. Garbage Cans and Dumpster Containers.

1. Garbage cans and dumpster containers should be conveniently located to the facility they serve.
2. Avoid garbage can and dumpster locations adjacent to main roads and sidewalks of the installation.

Figure 12-34.

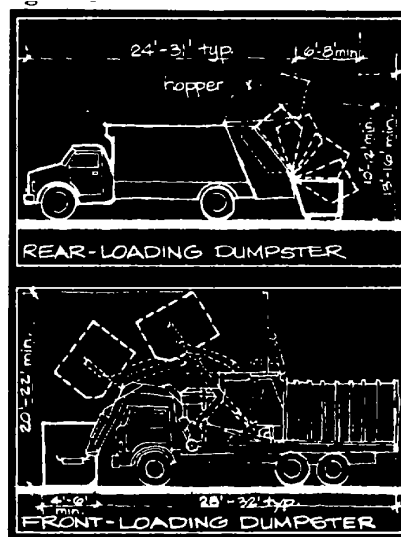

Figure 12-35.

3. All garbage can and dumpster container areas should be screened on at least three sides by an opaque fence or wall of sufficient height to block views of the containers (fig. 12-33).

4. In addition to the enclosure screening, plant material and earth berms should be used for general screening of the trash collection areas from view of main roads, sidewalks and building entrances.

5. Garbage can and dumpster container areas should be directly accessible by paved parking lot or service roads; adequate turning radius, parking length and overhead clearance (from trees, utilities and structures) should be provided for the trash collection vehicle (figs. 12-34 and 12-35).

6. All garbage can and dumpster container areas should be on hard-surface paved pads for ease of access and maintenance; any curb along the collection access side should be ramped.

7. Provide adequate storage capacity to handle accumulated refuse between collection periods (figs. 12-36, 12-37 and 12-38).

8. All garbage cans and dumpster containers should have properly fitting lids that can be securely fastened to contain odor and discourage animals and insects.

9. Dumpster lids or sliding doors should be easily operable by users; convenience steps should be provided if necessary for dumping into high containers. (fig. 12-39).

Figure 12-36.

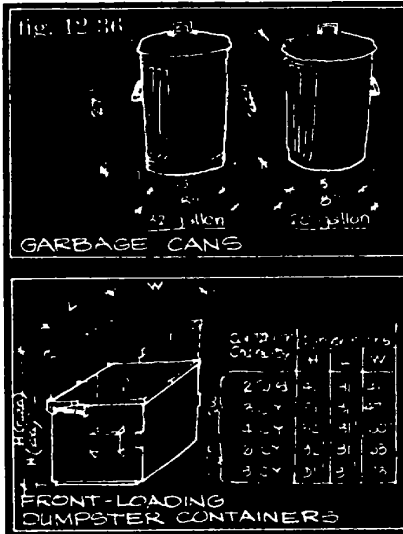

Figure 12-38.

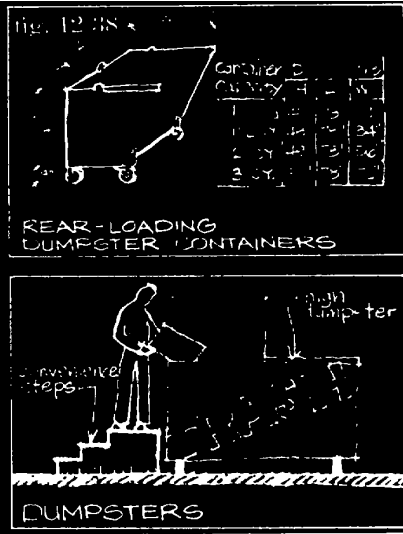

Figure 12-37..

C. Large Bulk Refuse Containers.

1. Large bulk refuse containers, such as might be used at shopping centers or industrial areas, should be located at a truck loading dock area of the facility they serve (fig. 12-40).

2. Large refuse containers should be located in a way to screen them from view of major roads, building entrances and adjacent residential, office or commercial areas. Large refuse containers should be screened by an attractive opaque enclosure, planting and/or earth berm.

3. Large refuse containers should be located on hard-surface paved pads or loading docks that are directly accessible by collection trucks; provide adequate turning radius, parking length and overhead clearance for the refuse collection truck and its container loading operation.

Figure 12-39
12-11.

Monuments and Memorials.

A. Memorial Plaques.

1. Memorial and commemorative plaques should be compatible in terms of their scale, materials and details with the architectural character of their settings; they should be designed as an integral part of a building design or landscape feature (fig. 12-41).

Fig. 12-40.

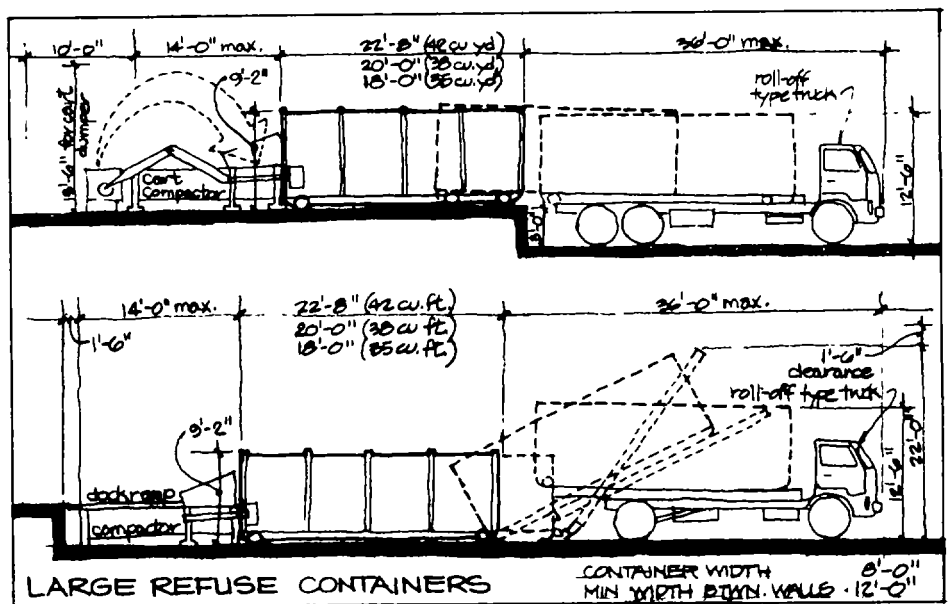

2. Where a number of memorials or commemorative plaques are contemplated for an installation, consideration should be given to organizing them in a central area or plaza specifically designed for such a purpose. (See Paragraph 10-6; Special Signing.)

B. Monuments and Historic Military Equipment Displays.

1. Monuments and military equipment displays should be carefully designed at prominent locations if they are to serve as visual focal points within the installation.

2. Where a number of historical military equipment is contemplated for display, they should not be spread indiscriminately throughout the installation, but rather consolidated into one

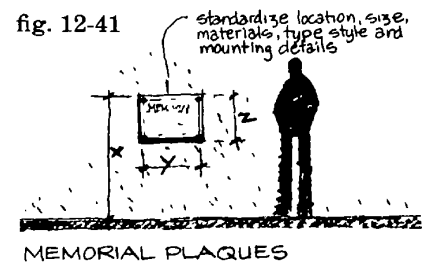

Figure 12-41.

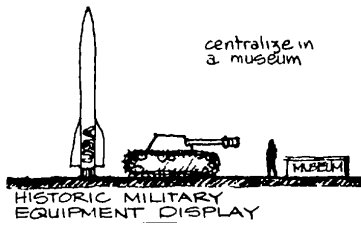

Figure 12-42.

area to create a central museum or exhibition facility within the installation (fig. 12-42).

12-12.

Miscellaneous.

A. Flagpoles.

1. A standard flagpole design should be used throughout the installation (fig. 12-43).
2. Avoid unnecessary flagpole locations and proliferation; con-

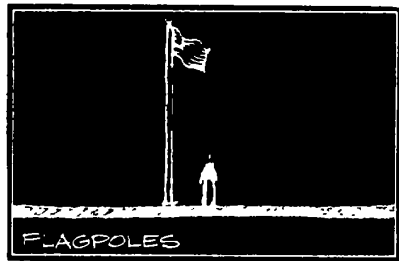

Figure 12-43.

sider creating a unique focal point by grouping flagpoles to create visual highlight and emphasis.

3. Use a hard-surface paving material on at least one side of a flagpole to facilitate personnel access for raising and lowering flags.

B. Mailboxes.

1. Locate mailboxes as close as possible to the buildings they serve; coordinate location with the Postal Service and type of delivery (fig. 12-44).
2. If group mailboxes are necessary, provide central locations that are weather protected and highly visible.
3. Where possible, combine group mailbox shelters with other multi-purpose shelters such as vending shelters, telephone or bulletin board areas.
4. Locate mailboxes adjacent to hard-surface walkways but not so as to impede pedestrian movement.
5. Freestanding mailbox shelters should relate harmoniously to the architectural character of the setting in terms of their form, materials and details.

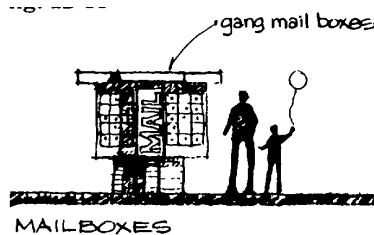

Figure 12-44.

Utility systems provide the basic infrastructure of power, communication, water and sewer services necessary for the operation of an installation. They have played a key role in determining the visual character of installations. First, their location and alignment have exerted a major influence on the historical

development pattern of installations and remain as primary considerations in determining the feasibility and location of future development. Second, street rights-of-way have traditionally been used for the location of most utility systems. This provides an efficient distribution system that serves development fronting on

both sides of the street, but results in a cluttered and unattractive streetscape when transmitted on overhead lines. Various planning and landscape design techniques can serve to reduce these negative impacts on the visual quality of military installations.



Section I:

Observations and Objectives.

13-1.

Typical Problems.

A. General Location.

Major reasons for locating utilities within street rights-of-way include minimizing utility easements, land clearance, capital investments and operational costs while maximizing the ease



Figure 13-1.

of access for maintenance and repair. However, there are also problems associated with siting utilities within the street right-of-way, including disruption of traffic caused by repairs and the clutter or unsightliness of above grade facilities along the streetscape (figs. 13-1 and 13-2).

B. Overhead Utilities.

The alternatives of siting utilities underground, behind facilities or behind plant screens have generally not been considered. Underground distribution may be more expensive initially, but it reduces breaks, does not interfere with trees, and eliminates the clutter of poles with overhead transmission lines.



Figure 13-2.



Figure 13-3.

Recently developed cable burying techniques have reduced costs substantially. Even if underground distribution cannot be justified, the opportunity usually exists to minimize the detrimental visual impact by proper location, screening and detailing.

C. Storm Drainage.

An inadequate or poorly designed storm drainage system is another problem observed at many installations. Often open drainage ditches or channels are improperly designed, resulting in a number of problems including: soil erosion, unsafe conditions, and recurrent and costly maintenance problems (fig. 13-3).

13-2.

Objectives.

A. Minimize the Visual Impact of Utilities.

Utility systems should be designed with a concern for their appearance. Past emphasis has been concerned almost solely with cost and efficiency. A pure functional expression of utility systems can be attractive. However, utility poles, above ground steam lines and open storm drains are often unsightly and detract from the appearance of an installation. These detrimental effects can be ameliorated through appropriate location, screening and detailing of utility systems.

B. Minimize the Environmental Impact of Utility Systems.

Utility systems should be designed to minimize adverse environmental impacts. Such concerns will also contribute to an improved visual environment. In particular, careful storm water drainage design should minimize soil erosion which can damage natural vegetation as well as be unsightly.

C. Design Utility Systems for Ease of Maintenance and Repair.

The most cost effective system is not always the one that costs the least initially. The location and detailing of system components can greatly affect maintenance and repair which are a large part of life-cycle costs of any system.

Section II:

Design Guidelines.

13-3.

Appearance.

A. Power and Telephone.

Unsightly overhead utilities should be relocated underground wherever possible; when not possible, the negative visual impact of these facilities should be minimized by location, alignment, design and screening.

1. Overhead Transmission Lines.

These facilities should be located compatibly with the landform and land use pattern of the installation; they should be screened from major viewing points by plant material and topographic features to minimize their silhouette and long views of the system; and they should have a simple and transparent design character.

a. Land Use. Overhead transmission lines should be aligned along edges of land use areas to avoid dividing an area and creating gaps or unusable areas; alignments should avoid scenic areas (fig. 13-4).

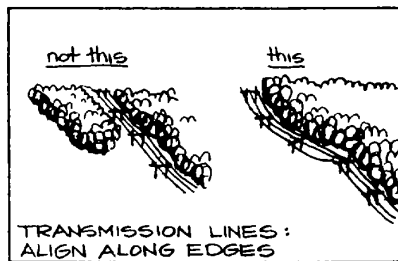

Figure 13-4.

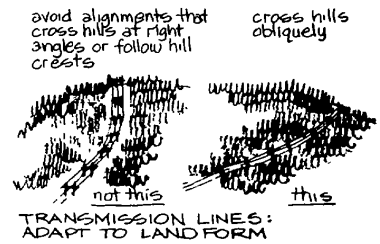

Figure 13-5.

b. Landform. Overhead transmission lines should conform to natural landforms which should be utilized to screen them from public view; hills should be crossed obliquely rather than at right angles; avoid alignments along hill crests or steep grades that expose facilities to view (fig. 13-5).

c. View Screening. Minimize long views and silhouette views of overhead transmission lines from along major roads and other public viewing areas. Avoid the "tunnel effect" of long, straight, uninterrupted views along the alignment by clearing vegetation only within the right-of-way that threatens the over-

Figure 13-6.

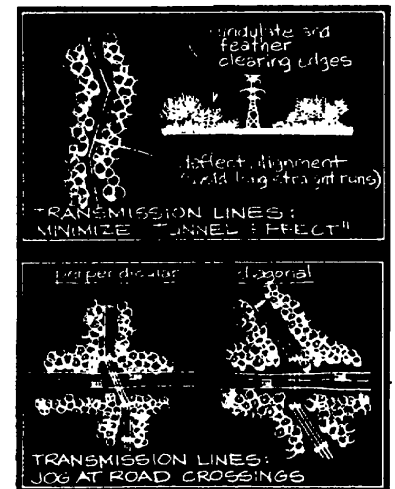

Figure 13-7.

head lines. Jog the alignment at road crossings and periodically undulate and feather plant materials along the edges of the right-of-way (figs. 13-6 and 13-7).

2. Distribution Lines.

Power distribution lines should preferably be located underground; if overhead, they should be located out of view from main public visibility areas or screened to be as unobtrusive as possible.

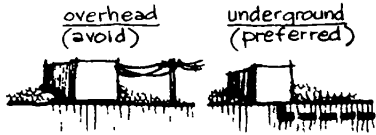

Figure 13-8.

a. Underground. Use underground distribution lines wherever possible, especially along major roads and silhouette exposure areas such as street crossings and building feeder service (fig. 13-8).

b. Overhead. Avoid alignments along major public circulation ways and, instead, use minor streets, alleyways or placements

Figure 13-9.

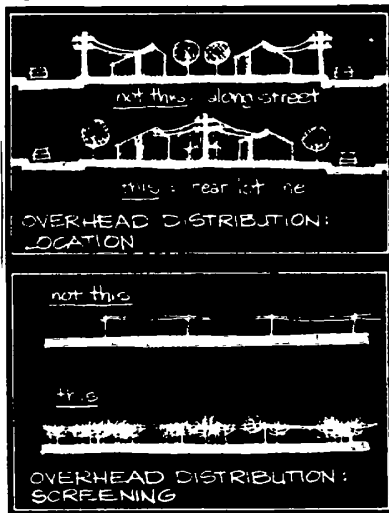

Figure 13-10.



Figure 13-11.

related to vegetation and topography that screen views and minimize their visual impact (fig. 13-9). Use trees to provide a backdrop to minimize the silhouette of facilities against the sky (fig. 13-10). Reduce the length of visible segments by interrupting views with trees or offsetting the location behind trees and topographic features where long views of the lines along a road would otherwise occur. Use poles and line attachments which have a simple design and whose color, materials and general appearance blend harmoniously with their surroundings. Minimize the number of poles and pole height while also making poles multi-functional, i.e., power, telephone, street lighting, etc.

3. Substations and Transformers. They should be located and designed to minimize their visual impact and be compatible with the character of their setting. Substations are best located in industrial use areas rather than in major public circulation areas (fig. 13-11).

Substations and transformers

Figure 13-12

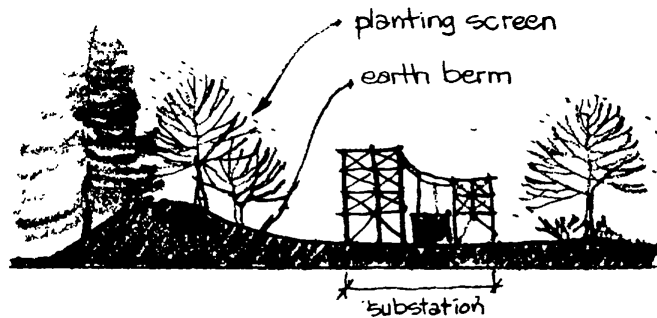

SUBSTATIONS: VISUAL & ACOUSTICAL SCREENING

should be screened from public view by means of plant materials, topography and enclosure walls (figs. 13-12 and 13-13). The noise generated can be muffled by using plants, earth berms and enclosure walls.

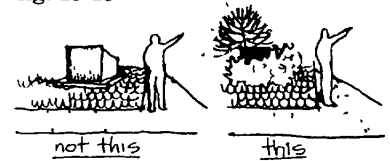

TRANSFORMERS: SCREENING

Figure 13-13.

B. Sewer and Water.

All sewer and water lines should be underground. Sewer and water treatment facilities should be screened from views of major roads and other installation facilities by the use of earth berms, plant materials, fencing and/or enclosure walls. A water storage tank that has visual strength in its form can be used as a focal point or identifying landmark that can aid in providing a sense of orientation

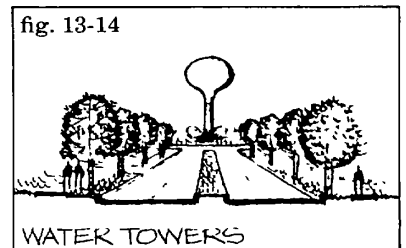

Figure 13-14.

within an installation (fig. 13-14). Fire hydrants should be highly visible and free of any screening; they should be a uniform design throughout the installation; avoid decorative painting of fire hydrants.

C. Storm Drainage.

Installation storm drainage systems should be appropriate to the character of development which they serve (fig. 13-15). Storm drainage systems in densely developed areas require the use of curbs, gutters and underground lines. Storm drainage systems in relatively low density areas should be handled

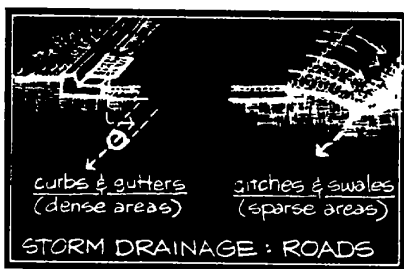

Figure 13-15.

by drainage swales and ditches which are compatibly contoured into the natural landform. Potential opportunities to create permanent ponds as special landscape features or temporary storm water retention ponds should be considered when designing the storm water control system of an installation (fig. 13-16). Temporary retention ponds, if designed with care, can be utilized during the normal, or dry stages, as recreational areas such as athletic fields or as portions of a golf course. Temporary retention ponds should normally be planted in grass.

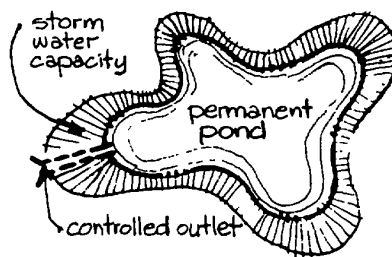

Figure 13-16.

13-4.

Environmental Impact.

A. Power and Telephone.

Minimize negative environmental impacts in the clearance and construction of these facilities. Select route alignments that will maximize preservation of the natural landscape and conserve natural resources. Avoid steep slope areas with high erosion potential and areas of water, marshlands or wildlife concentration. Also promote joint-use or common utility line easements to reduce the number of individual system rights-of-way. Clear only vegetation that physically threatens the transmission lines and avoid use of spray defoliants. Employ adequate erosion and sediment control practices to minimize soil erosion during construction.

B. Sewer and Water.

Minimize negative environmental impacts associated with sewer and water line construction and treatment facilities.

1. Treatment Facilities.

Sanitary sewer treatment facilities should provide adequate treatment of effluent to be released into a receiving stream that is capable of absorption; furthermore, treatment facilities should be designed with direct noise baffling, plant material and/or earth berm screening to

reduce noise. Consider potential spray irrigation disposal of treated effluent, particularly for recreation areas such as golf course and recreational fields.

2. Alignment.

Minimize negative environmental impacts associated with alignment and construction of underground sewer and water lines. Consider low pressure sewer line pumping systems utilizing street rights-of-way in areas where gravity sewer lines would cause excessive site clearance and regrading to accommodate an alignment other than in the street right-of-way.

C. Storm Drainage.

Design storm water drainage systems to protect downstream watersheds and waterways from flooding and silting.

1. Each project should be designed so that the surface water leaving the site after the project is complete is not significantly greater than that leaving prior to development of the site.

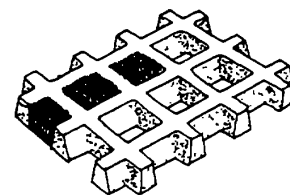

PERVIOUS PAVING BLOCKS

Figure 13-17.

2. Paved surfaces should be the minimum required and pervious areas of planting should be maximized to lessen storm water runoff. Consideration should be given to the use of pervious paving or paving blocks that permit grass to grow through them, as measures to reduce storm water runoff (fig. 13-17). While currently the maintenance and durability characteristics of these materials is not adequately proven,

they could be tested and evaluated in controlled sections on some projects to determine their suitability prior to any widespread application throughout an installation. Careful consideration should, however, be given to the potential hazards such paving systems might pose for handicapped individuals.

3. Artificial drainage courses, particularly outlet waterways, must be constructed of materials suitable to the quantity and velocity of storm water runoff. Where possible, they should be vegetative channels. Plant growth can be promoted by the addition of jute matting or paper protective linings (fig. 13-18).

4. Outlet waterways with slopes or flows greater than that which can be safely vegetated should be treated with riprap or gabion

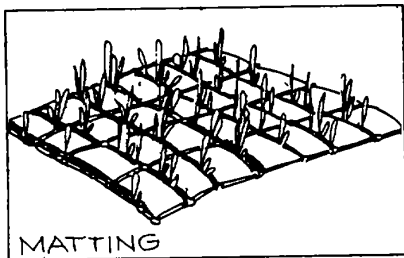

Figure 13-18.

mattresses. Concrete channelization should be avoided (fig. 13-19).

5. It is normally appropriate to perform a soil survey to predict the behavioral characteristics of areas yielding, receiving or impounding runoff.

6. Storm water management should be considered for each watershed rather than the area limited to new development. It is

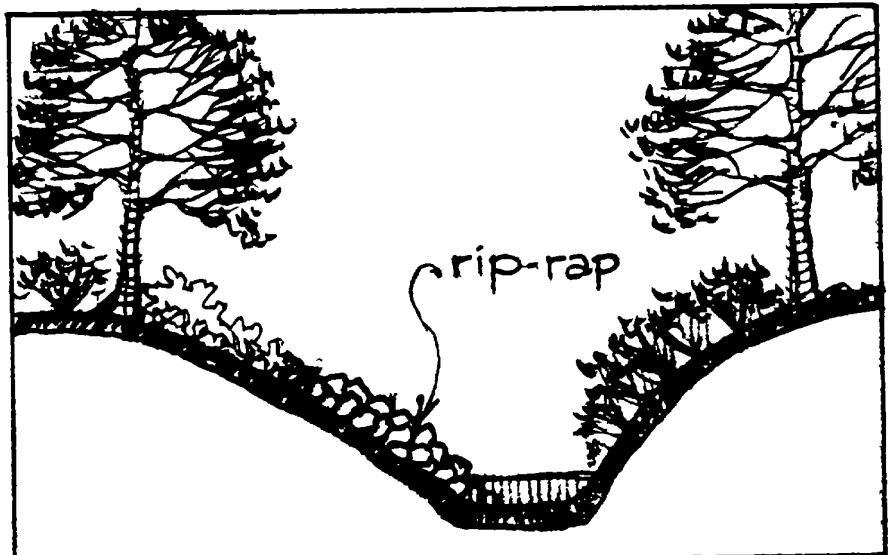

Figure 13-19.

usually advantageous to combine storm water management for several small developments in one facility.

7. Proper erosion and sediment control practices should be followed for disturbed areas during construction of all facilities within the installation. These include seeding, sediment control basins and structures.

13-5.

Maintenance and Repair.

Utility systems should be designed to minimize required maintenance and repair, provide access for maintenance and repair vehicles and minimize the disruptive effects of maintenance and repair operations.

A. Care should be taken to correct minor erosion problems early, before they develop into serious ones.

B. Storm water management ponds should be designed with side slopes flat enough to accommodate normal grass cutting equipment and with bottoms steep enough to allow complete drainage (fig. 13-20).

C. Storm water management ponds should be constructed with low-flow outlet channels suitable to carry flows without causing erosion.

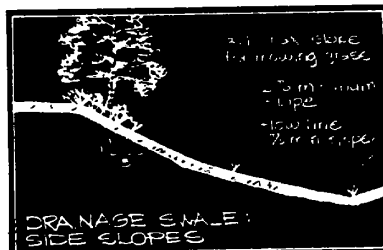

Figure 13-20.

This part visually summarizes the installation Design Manual, illustrating how the practical and coordinated use of the design guidelines can improve five prototypical facility areas commonly found on military installations. These prototype areas include: main installation entrances, administrative/headquarters areas, housing areas, community facilities and industrial/warehouse areas.

Part III Prototype Areas

Chapter 14.
Main Entrances.

Figure 14-1:

Main Entrance Problem.

Main entrances establish the initial visual impression of a military installation. In addition to serving as a gateway and checkpoint for access control and security, they are critical areas for directional and informational signing to guide motorists to their destination. The design of main entrances should be attractive as well as functional, conveying an appropriate "sense of entry" that reflects the desired image and identity of the installation. The existing main entrance illustrated here contains many problems observed at various installations, including:

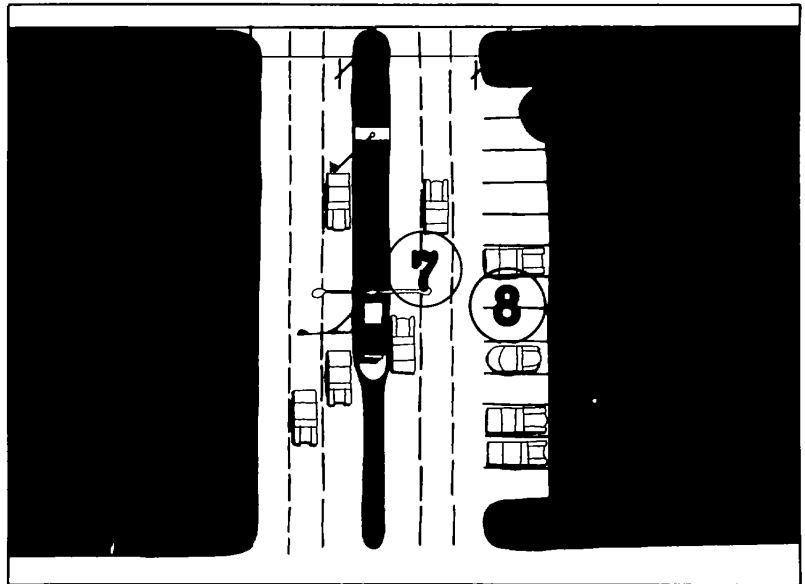

1. An unattractive overall appearance, lacking an appropriate physical "sense of entry."
2. Ineffective identificational signing.
3. Visually cluttered and competing elements along the entrance.
4. Unattractive overhead utility lines.
5. Barren landscape character.

6. Unattractive chain link boundary fencing.
7. No traffic channelization provisions for turning movements or temporary stopping without obstructing traffic.
8. Unsafe on-street parking.
9. No overhead weather protection at gatehouse checkpoint.
10. Uncoordinated directional signing.

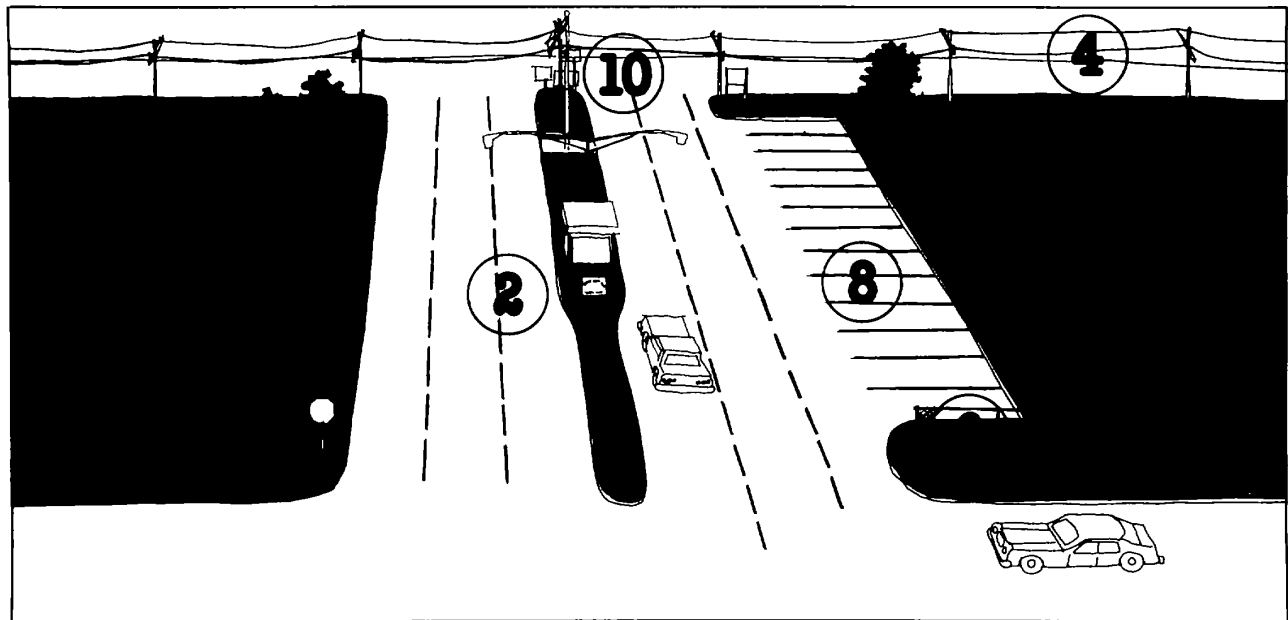

**Figure 14-2:
Main Entrance Solution.**

The primary visual design objective is to create an attractive and safe "sense of entry" that reflects an appropriate character, image and identity for the installation. Essential elements of the improvement program illustrated here include:

1. A pylon entrance sign serving as an identificational landmark for approaching traffic.
2. A simplified entry median design utilizing flagpoles to highlight entrance.
3. Overhead utility lines relocated underground.
4. Lighting standards relocated to minimize competing visual elements along entry median.
5. Low-maintenance ground cover planting to enhance entry median and reduce sun glare and solar heat reflection while preserving sight lines.
6. Street trees to spatially define entrance area and visually reinforce traffic circulation.
7. Plant material and dull black finish to minimize the visual prominence of the chain link boundary fencing.

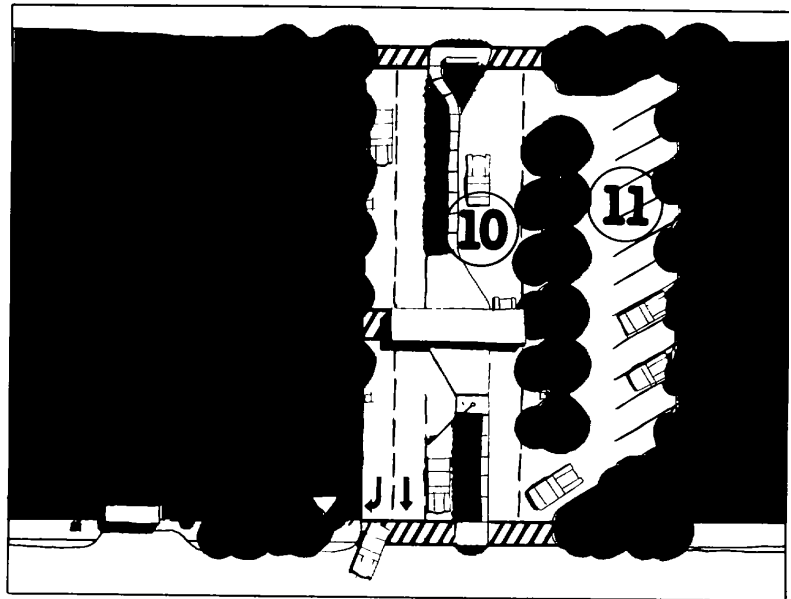

8. Overhead gatehouse canopy to define checkpoint and provide weather protection.
9. Coordinated directional signing at the strategic motorist decision point, designed as part of an overall signing system for the installation.
10. Provision of left turn lane and pull-off lane for temporary stopping to improve traffic channelization.

11. Provision of off-street parking with planted earth berm screening to minimize its visual impact.

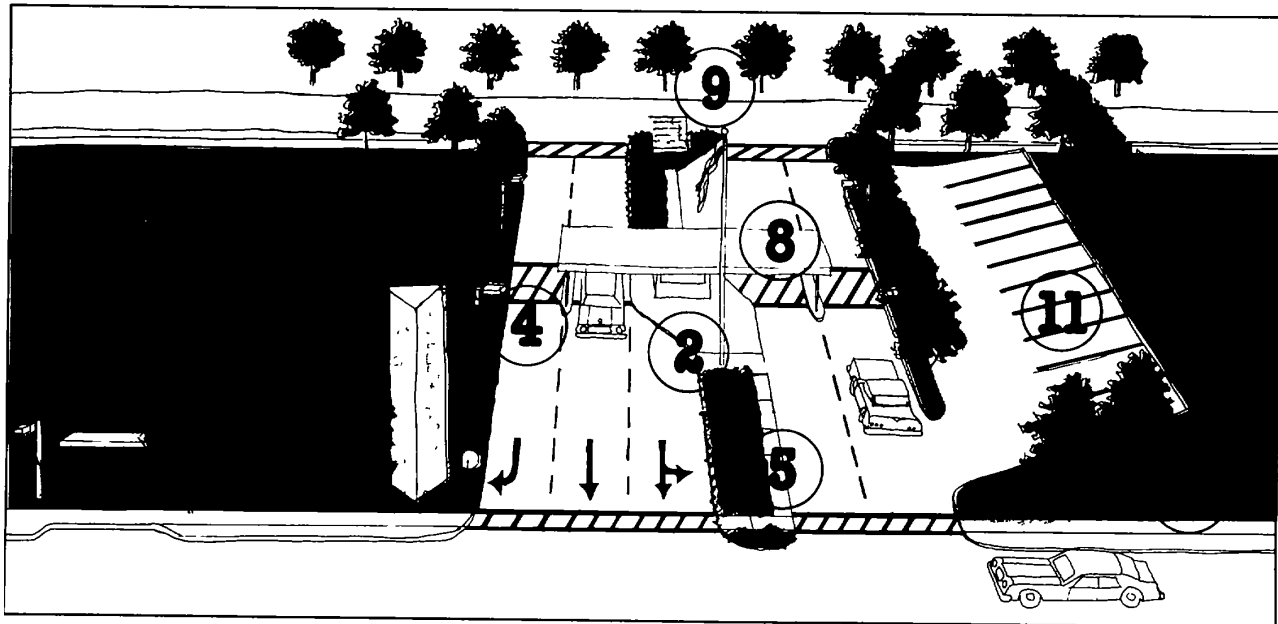

Chapter 15.

Administrative Headquarters.

Figure 15-1
Administrative Headquarters Problem.

Administrative Headquarters areas serve as the primary decision-making center of the installation and should provide an attractive working environment for military personnel and visitors. Typically, these facilities are centrally-located buildings of substantial architectural character whose setting has been modified to accommodate increased demands for automobile parking.

The Administrative Headquarters illustrated here contains a number of typical problems associated with the visual quality of these facilities at many installations. The example consists of a series of two- to three-story buildings connected by a covered pedestrian arcade and clustered around a central open space, originally designed as a landscaped courtyard but later converted into a parking lot to serve the complex. Specific problems include:

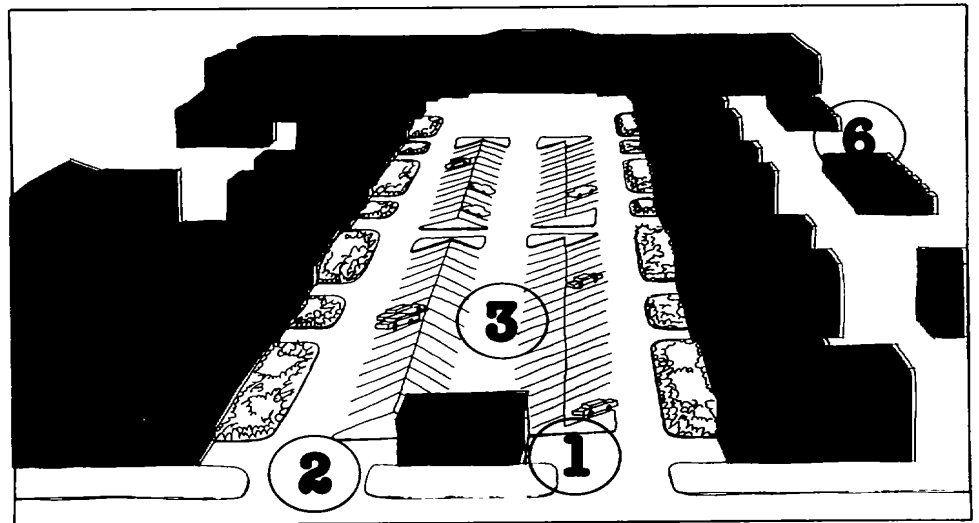
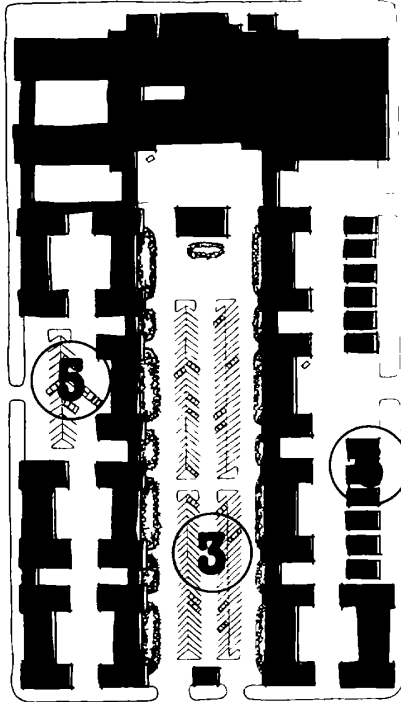
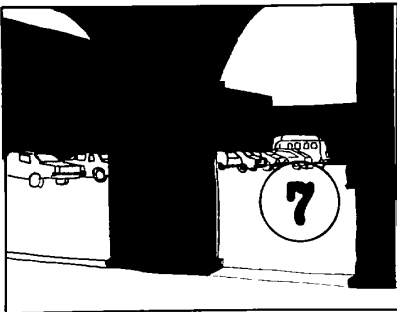

1. The main entrance into the facility is poorly defined.
2. Parking is not screened from main roads.
3. An inefficient central parking layout with expansive paving devoid of planting that creates an unattractive and uninviting setting for the architecturally noteworthy building complex.

4. No provisions for handicapped parking and access.
5. Inefficient and chaotic parking areas around the facility.
6. Unattractive and functionally obsolete temporary buildings that detract from the overall appearance of the facility.
7. Unnecessary parking located within a small courtyard originally intended for pedestrian use.
8. Lack of outdoor pedestrian amenities such as lunchtime seating areas, bus shelters, etc.
9. No provisions for bicycle parking.
10. Poorly defined building entrances which have identificational signing of inconsistent design.
11. Unscreened service yard/dumpster areas.

Fig. 15-2:
Administrative Headquarters
Solution.

The primary design objective here is to enhance the character, functioning and appearance of the building setting by minimizing the visual impact of parking and providing a pleasant planting design. Specific improvements illustrated here include:

1. An entry feature with flagpoles to highlight entrance, coordinated signing system to direct visitors and a planted earth berm to screen parking.
2. Redesigned central parking area to provide the proper number of spaces, a clear and convenient circulation pattern and planted islands with large deciduous trees for scale, shade and visual relief.
6. Provision for an attractively planted, drop-off/turnaround area with bus shelter at the main

building entrance.

7. Bicycle parking areas convenient to building entrances but not conflicting with pedestrian and vehicular circulation.
8. Drop-off areas and coordinated identificational signing at building entrances.
9. Existing low planting retained and enhanced to provide an attractive transition between ground plane and building masses and to articulate building entrances.
10. Service yard/dumpster areas screened from view of main building entrances and roads.

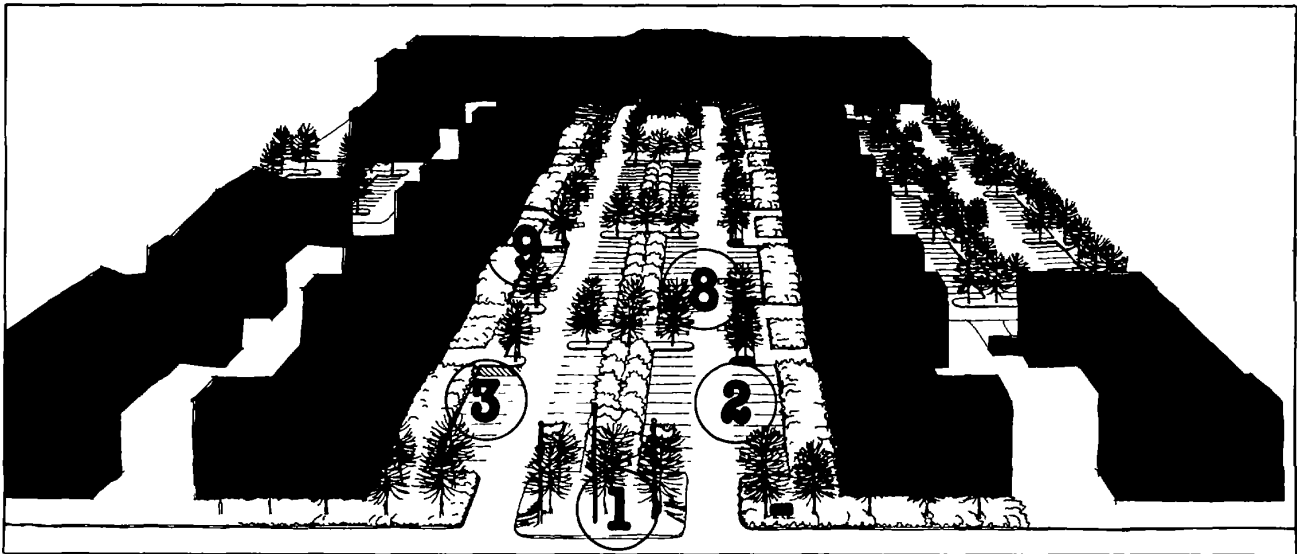
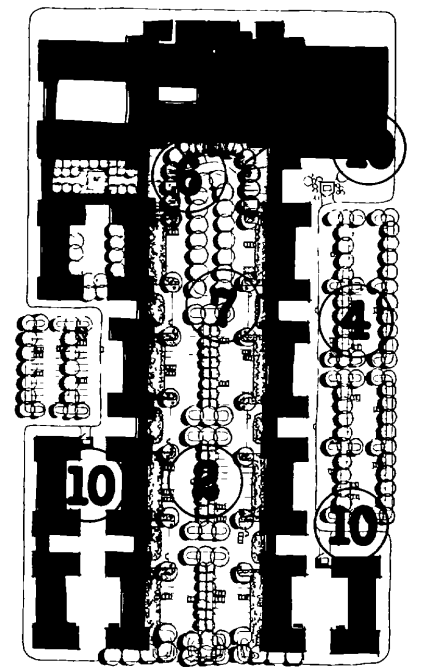

3. Provision for handicapped parking and curb ramps convenient to main building entrances.
4. Removal of obsolete temporary structures to create convenient peripheral parking lots.
5. Reconversion of the small courtyard into a pedestrian amenity for use and enjoyment by facility personnel.

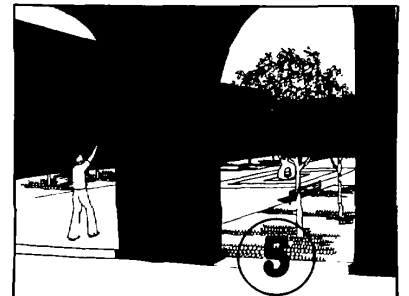

Housing.

Military installations typically contain three basic types of housing: troop housing, attached and detached family housing.

Typical problems and design improvements to make them more attractive residential environments are illustrated here for each of these housing types.

Fig. 16-1: Troop Housing Problem.

Troop housing is predominantly provided by dormitory-type buildings grouped around a mess hall and open space areas. The example illustrated here is a relatively new troop housing complex composed of three-story dormitory buildings connected to a mess hall and clustered around an open space network. Typical problems here include:

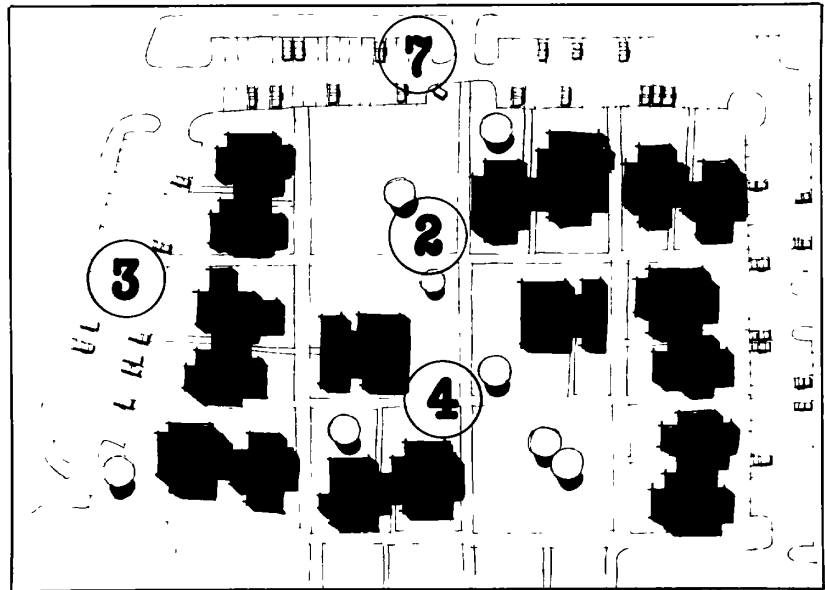
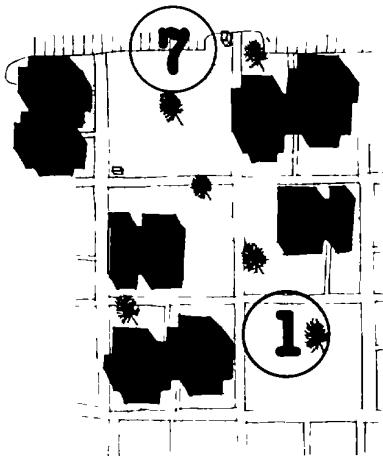

1. combined with the stark building masses that results in a harsh environment lacking in human scale.
2. Haphazard planting that disregards potential visual and functional usage.
3. No screening of parking lots from adjacent roads and buildings.
4. A regimented grid walkway system that is inefficient, does not reflect pedestrian desire lines of movement and fragments the common open space without regard to potential use.
5. Overhead utilities with attached lighting fixtures.
6. Visually prominent at-grade transformer with no screening.
7. Unscreened trash dumpster service area.

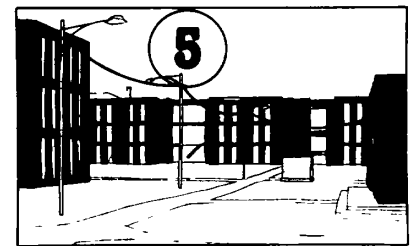
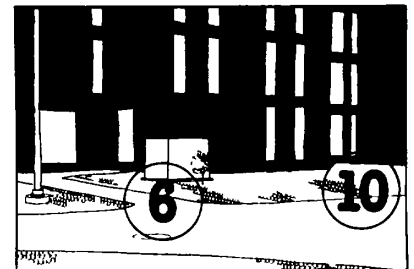

8. Lack of pedestrian amenities such as outdoor seating, drinking fountains and bus shelters.
9. No recreational amenities provided in conjunction with the open space and walkway systems.
10. Grounds maintenance problem created by grass turf extending to the building line.
11. Lack of identificational building signing.

Fig. 16-8: Troop Housing Solution.

The primary design objective here is to improve the visual character and functioning of the building setting by a planting program and provision of amenities that respond to user needs. Specific improvements include:

1. An extensive planting program to visually soften the stark building masses and ground plane defines the open space system and provides shade and human scale to the setting.
2. Evergreens combined with deciduous plant materials indigenous to the area to provide visual interest and winter greenery.
3. Deciduous shade trees used extensively on the south side of buildings to provide cooling summer shade and warming winter sun penetration.
4. Evergreen tree massing used extensively at the north end of the open space for wind screening of the prevailing cold winter winds.
5. Deciduous trees used extensively on the southeast end of the open space to allow cooling summer breeze penetration.
6. Planted earth berms with deciduous street trees between parking areas and the street for visual screening and shade.
7. Occasional planting islands within the parking lot relieve the monotony of large paved areas and provide shade.

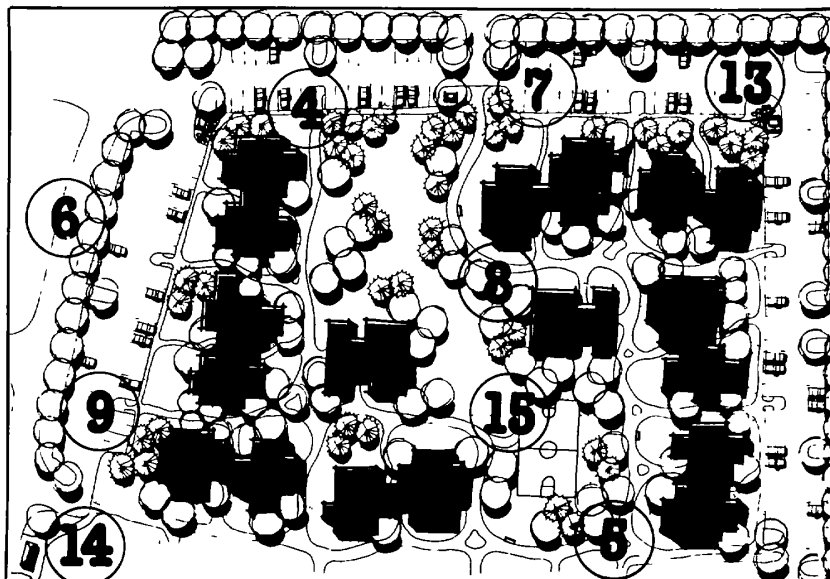
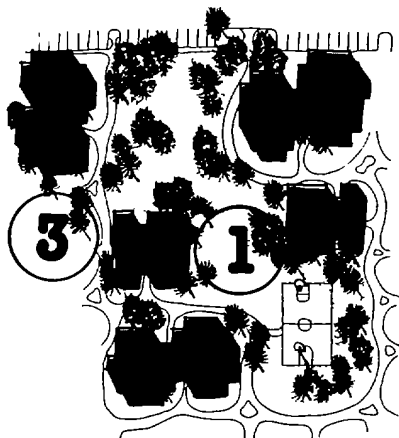

8. A meandering, free-flowing walkway system reflecting the desire lines of pedestrian traffic to provide an efficient, visually interesting and convenient network that enables the open space to be varied in size according to intended use.
9. Paved finger islands extending the walkway system into the parking area at strategic locations to provide collector nodes for pedestrians.
10. Unsightly overhead utilities relocated underground.
11. Pedestrian-scaled walkway lighting whose design is compatible with the architectural setting.
12. At-grade transformers located in inconspicuous areas and screened with plant material.
13. Trash dumpster enclosure fencing of compatible design and materials with the architectural setting to screen them from view of main streets and building entrances.
14. A conveniently located bus shelter of compatible architectural character with the setting that provides protection from inclement weather conditions typical to the installation.

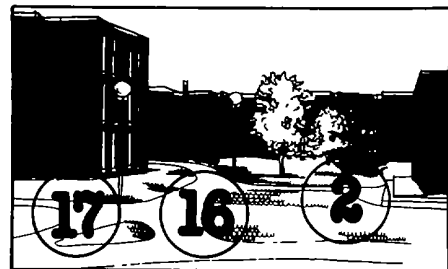
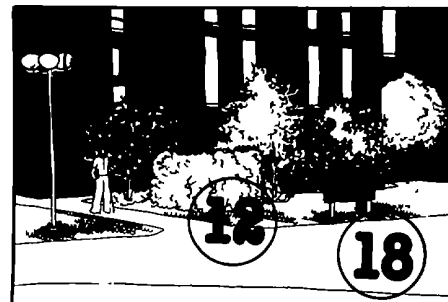

15. Outdoor recreational amenities provided as an integral part of the open space system.
16. Pedestrian amenities along the walkway such as seating areas with trash receptacles and drinking fountains.
17. Mowing strips with edging along the base of the buildings to facilitate easier maintenance of the grass lawn.
18. Identification signing at strategic decision points along the walkway network based upon a coordinated signing system.

Fig. 16-3: Attached Housing Problem.

Attached housing typically provides family housing for enlisted personnel and some officers. A cluster development pattern of attached housing can minimize development costs by reducing road lengths and utility runs, preserve usable open space and conserve sensitive natural resource areas; however, cluster development requires careful attention to provide privacy for individual units within their relatively dense building groupings. The example illustrated here is an attached housing cluster whose success as a pleasant residential environment has fallen short of its potential, primarily due to inadequate attention to site development details. Typical problems here include:

1. A sparsity of planting that creates a visually harsh residential environment and makes housing units more susceptible to extremes in climate conditions.
2. A large parking courtyard that lacks scale and screening for parked vehicles.
3. Housing units that lack privacy, especially end units.
4. Overhead utility lines that clutter.
5. Lighting fixtures mounted to utility poles.
6. A transformer located in a visually prominent area.
7. Individual mailboxes that clutter the streetscape.

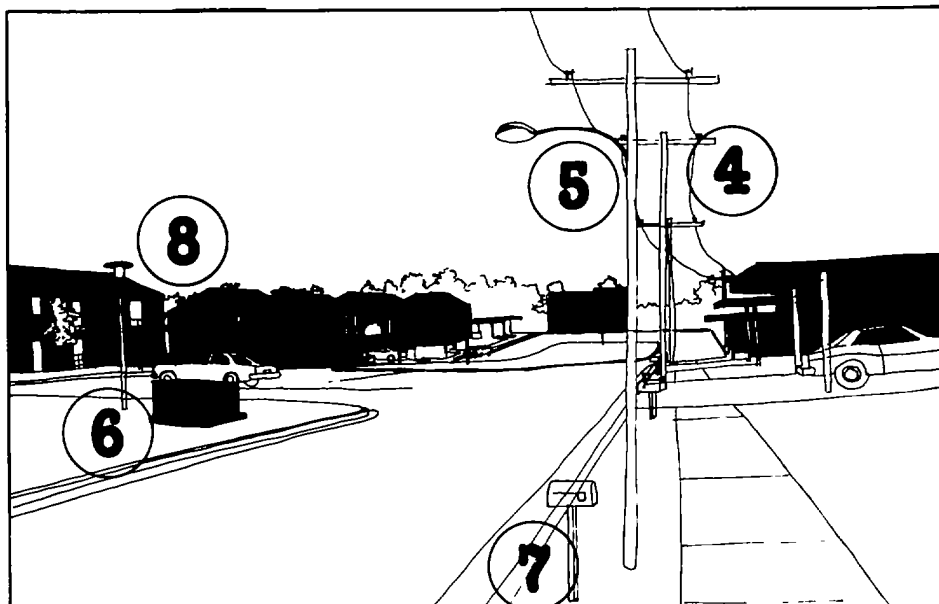

8. A lack of recreational amenities serving residents of the cluster, as exemplified by the basketball fixture mounted to the front of a carport which also detracts from the architectural character.

9. An unimaginative straight entrance road that disregards natural topographic conditions as well as the unsafe intersection.

10. Lack of walkways linking the housing cluster to the overall pedestrian circulation network of the installation.

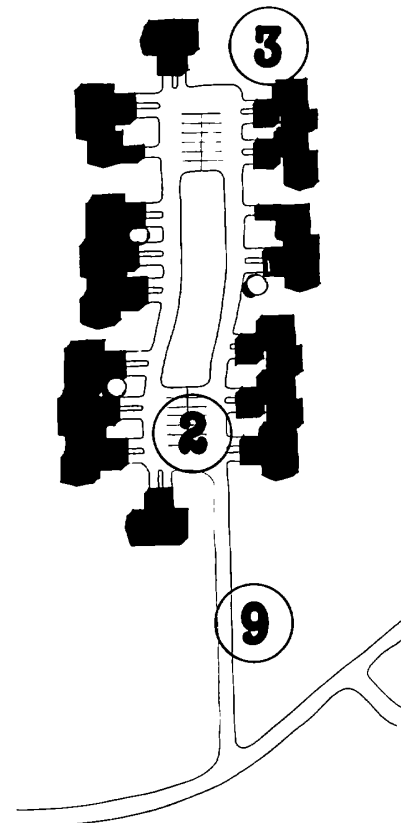
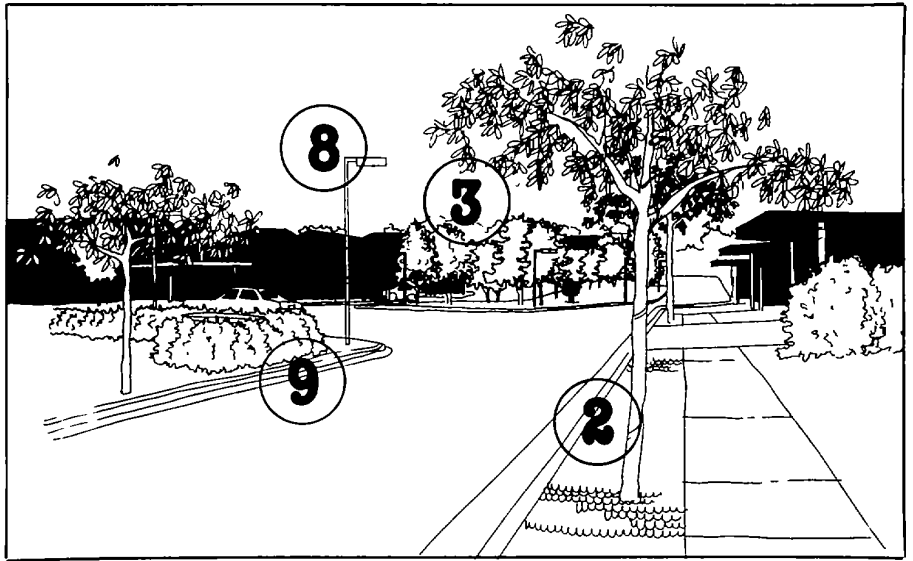

Fig 16-4: Attached Housing Solution.

Sensitive planting design provides the primary means for improving the visual appearance of the housing cluster. Specific improvements here include:

1. Shade trees in rear yards, especially along south facing units, as well as between groupings of housing units to blend units with their natural setting and beneficially modify microclimatic conditions.
2. Deciduous street trees along the edge of the parking courtyard to provide continuity to the housing cluster and buffer housing units from the parking area.
3. Informal planting in the center parking island to reduce the scale of the parking courtyard and provide
4. End parking stalls converted into planting islands to better define circulation and reduce the visual impact of the paved area.
5. Rear yard privacy fencing that is consistent in color, materials and height throughout the housing cluster.
6. Evergreen planting and tree massing to provide privacy screening for end housing units facing the entrance road.
7. Overhead utilities relocated underground.
8. Lighting fixtures whose design is compatible with the residential setting and does not produce glare into the houses.
9. Screening of at-grade transformer with evergreen shrubs.
10. Group mailboxes in the center island to reduce clutter and facilitate efficient and convenient mail distribution.
11. A convenient recreational area with facilities appropriate to resident needs.



12. Realignment of the entrance road to provide a more interesting approach that is more compatible with the natural topography and provides a safe intersection design with the entrance road to the housing cluster across the street.
13. Walkways that link the housing cluster to the recreation area, bus stop and the overall pedestrian circulation and open space systems of the installation.
14. An entrance feature with signing to identify the housing cluster.
15. A convenient bus shelter along the main road designed compatibly with the architectural character of the setting and providing protection from inclement weather conditions typical to the area.

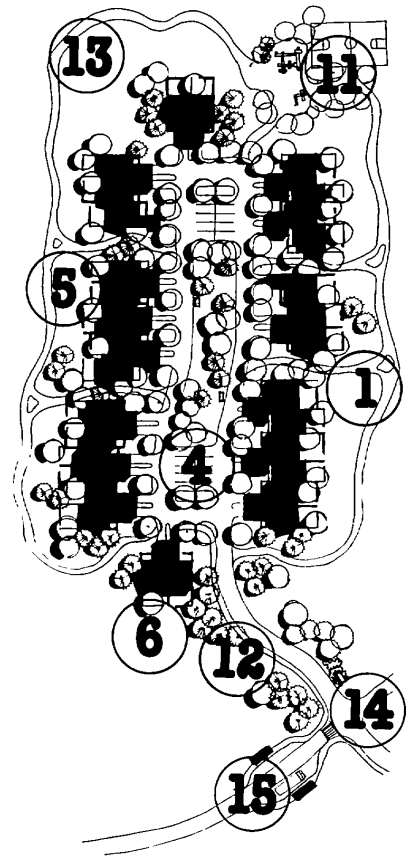
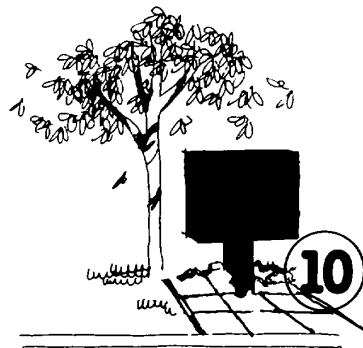
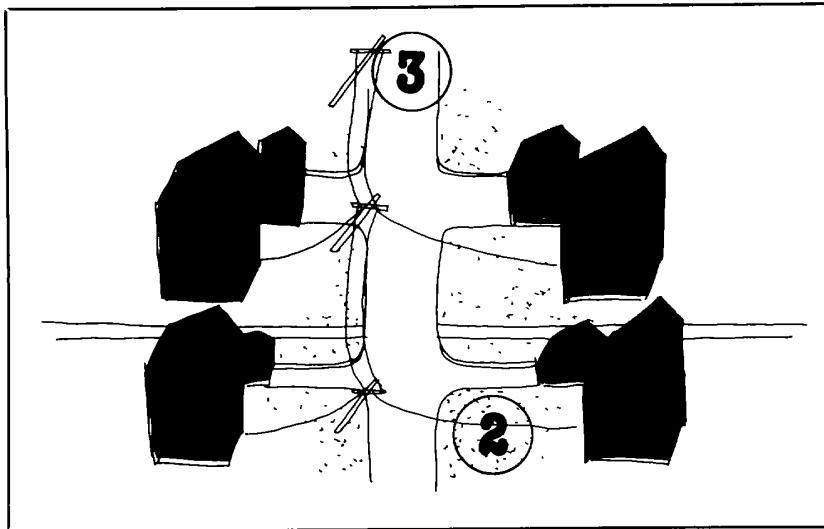
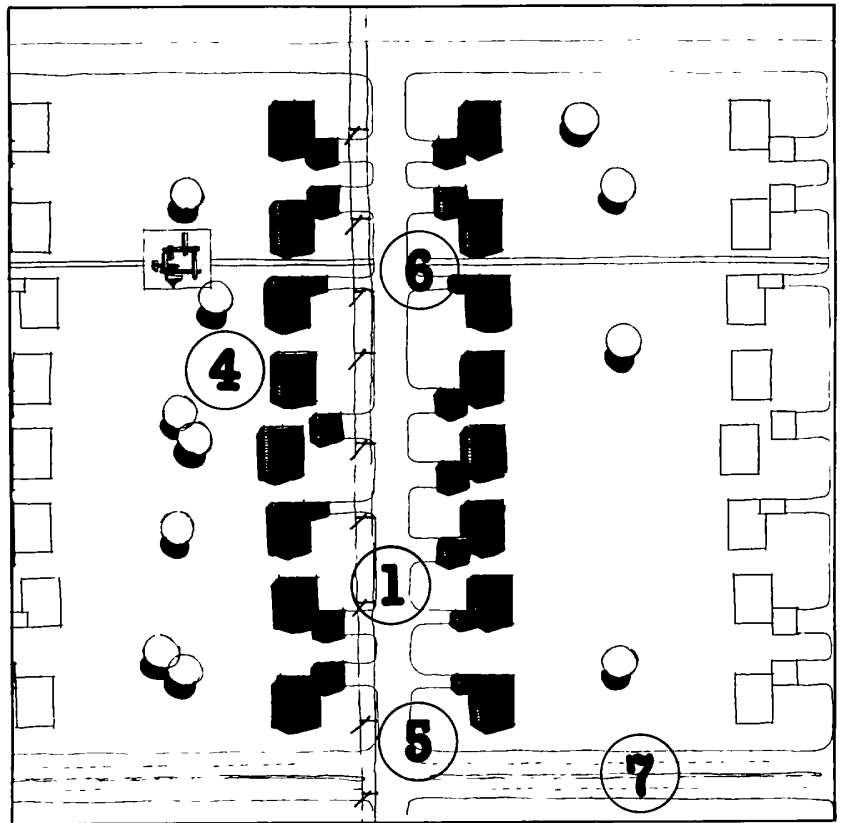

Fig. 16-5: Detached Housing Problem.

Detached single family housing on military installations typically provides family housing for higher ranking officers. There are many single family subdivision patterns found on installations, but the grid system is quite prevalent. The example illustrated here is a single family detached housing area with a grid street system. It contains a number of common visual problems including:

1. A grid street pattern with houses of identical design and street setback that creates a monotonous residential environment.
2. A lack of planting that consequently amplifies the monotonous development pattern and stark appearance of the neighborhood.
3. Overhead utilities that clutter the streetscape.
4. Little physical definition between public and private spaces.



5. Unsafe pedestrian circulation within the street as a result of lack of sidewalks.
6. Pedestrian access to the neighborhood play area limited to a rigidly aligned straight walkway with an undefined midblock street crossing.
7. Obtrusive traffic noise from the adjacent arterial road.

Fig. 16-6: Detached Housing Solution.

The primary design objective here is to provide a pleasant residential environment that ameliorates the otherwise monotonous and cluttered development pattern. Specific improvements include:

1. Deciduous street trees that provide visual continuity to the streetscape.
2. Informal planting that addresses the visual and functional requirements of each housing unit while providing overall visual interest to the regimented development pattern.
3. Underground utilities that minimize streetscape clutter.
4. Privacy fencing of consistent style, materials, color and height to define the boundary between public and private areas.
5. Varied alignment of privacy fencing to provide relief from the monotonous development pattern and avoid the "alley" effect created by continuous straight line fencing.

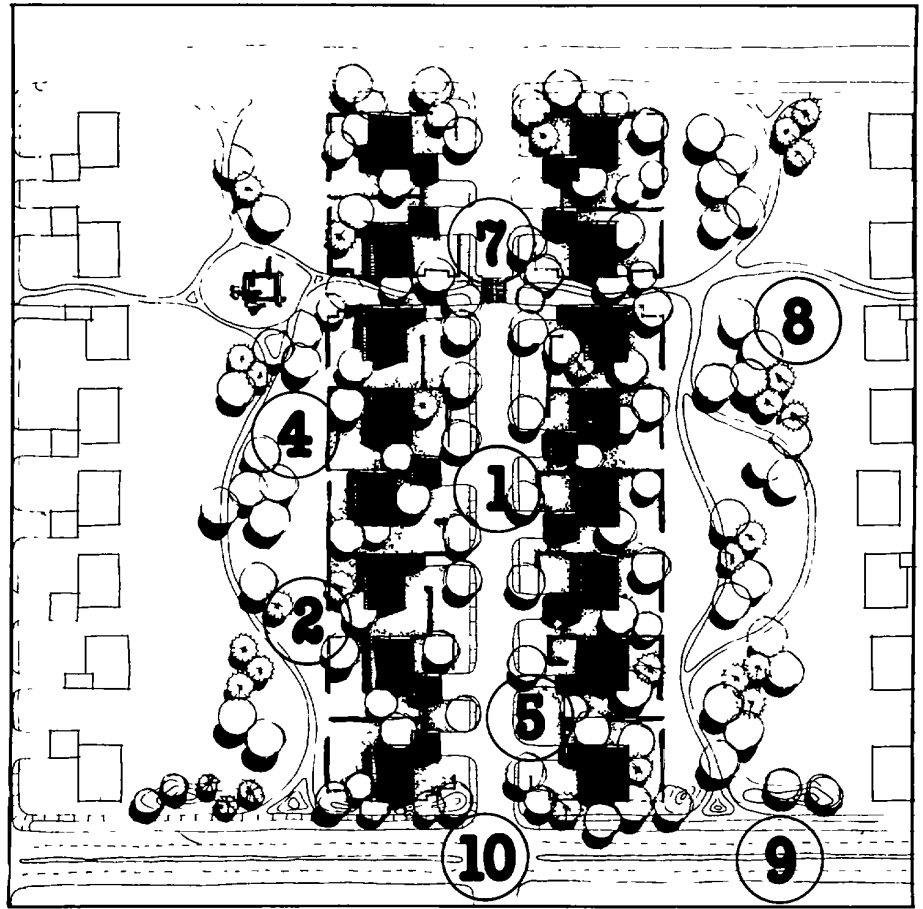

6. Sidewalks along the street.
7. A pedestrian path system with meandering alignment within the public open space and striped warnings at midblock crossings.
8. Increased tree massing within the public open space for visual interest and shade.
9. Planted earth berm to screen views and buffer traffic noise from the adjacent arterial road.
10. Clustered planting and stepped fencing at the street intersection into the neighborhood to create an entry statement.

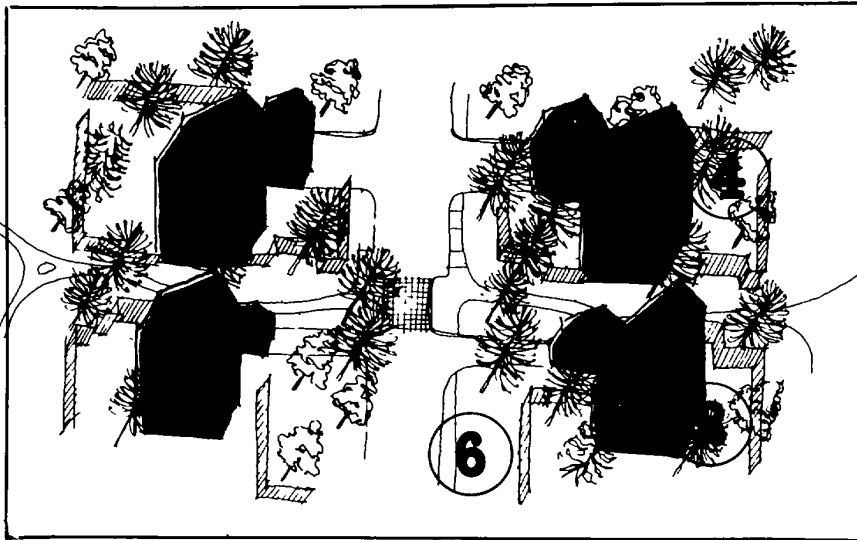

Chapter 17.

Community Facilities.

Fig. 17-1: Community Facility Problem.

Community facilities on military installations are analogous to the "shopping center" in civilian communities. They are typically comprised of the exchange, commissary, post office, library and commercial/retail type uses such as a bowling alley, barber shop, beauty shop, bank, dry cleaners and theater, clustered together in a central facility.

The example illustrated here contains typical visual problems associated with such facilities on many installations, including:

- 1. An expansive, barren parking lot dominating the visual setting and presenting unattractive views from the main road.
- 2. Signing whose location and design is ineffective, inconsistent or confusing.

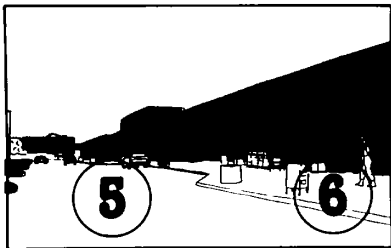

- 3. Overhead utilities that clutter the setting.
- 4. Loading dock areas that can be seen from adjacent land uses and roads.

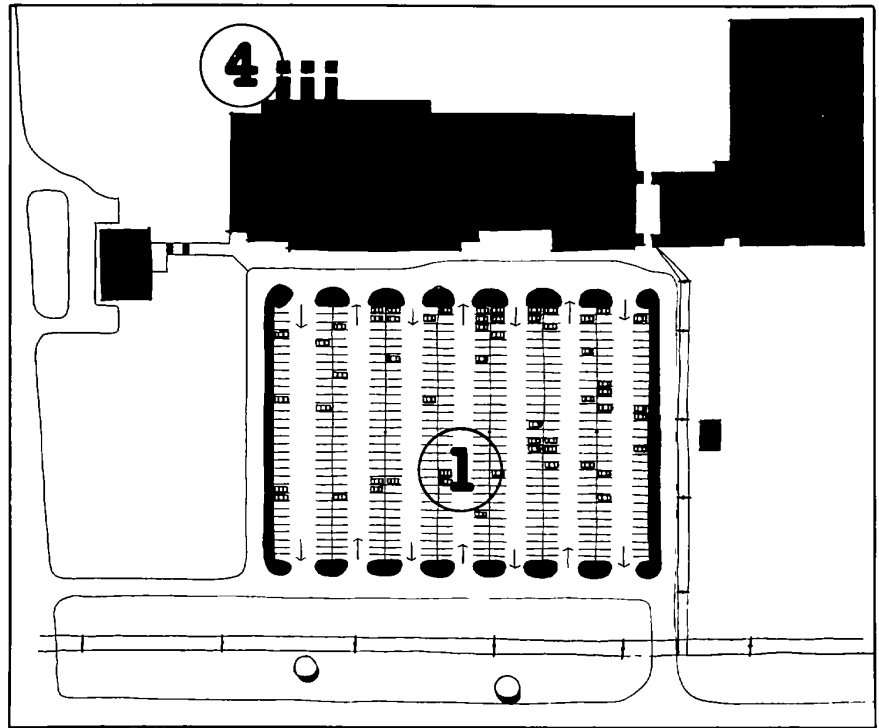

- 5. Lack of pedestrian crossing area definition.
- 6. Building frontage lacking definition as a pedestrian space and having uncoordinated and cluttered street furniture.

- 7. Parking lot lighting which lacks human scale, has inconsistent fixtures and pole types and lacks adequate protection from automobiles.

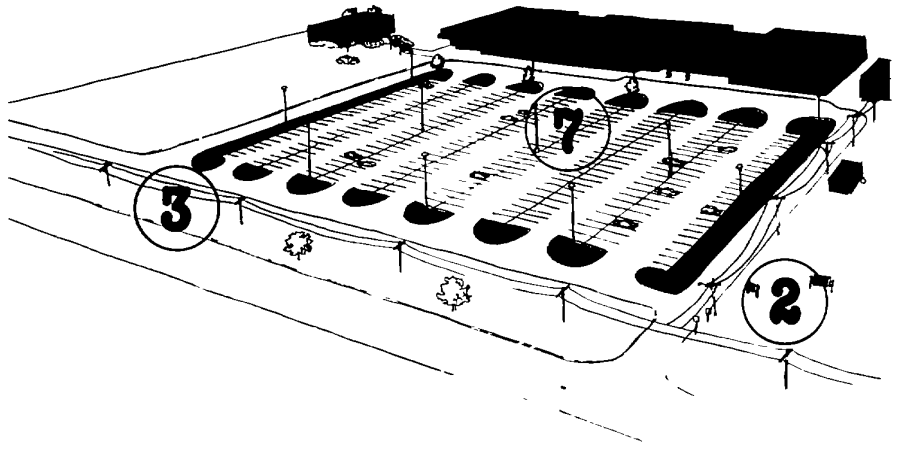
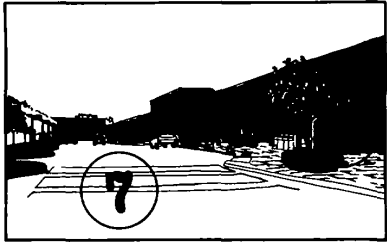

Fig. 17-2: Community Facility Solution.

The primary design objective here is oriented toward directing and circulating traffic safely while reducing the visual impact of the expansive barren parking lot that serves the complex. Specific improvements include:

1. Informal perimeter earth berm mounding and planting that screens the parking lot from main roads.
2. Redesigned parking lot layout that provides planting islands to break up the large expanse of paving, as well as to provide scale, shade and an area to deposit ploughed snow during winter months.



3. Effective entrance sign and coordinated directional signing system.
4. Deciduous street trees along the entrance drive and end islands of the parking lot that visually define vehicular circulation.
5. Overhead utilities relocated underground to reduce clutter.
6. Screening and fencing of loading dock service area.
7. Crosswalk striping that warns motorists of the pedestrian crossing area.

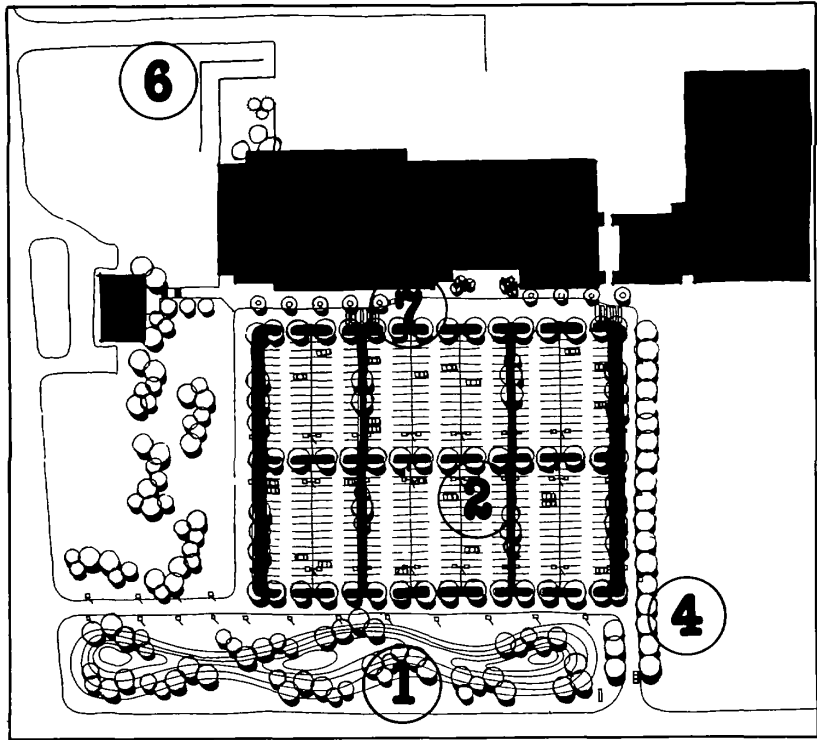

8. Parking lot lighting fixtures of coordinated design, pole locations protected from automobile damage and pole heights that do not have an overpowering scale.

9. Plants and coordinated pedestrian furnishings and amenities that define the pedestrian-oriented areas and highlight the building entrances.

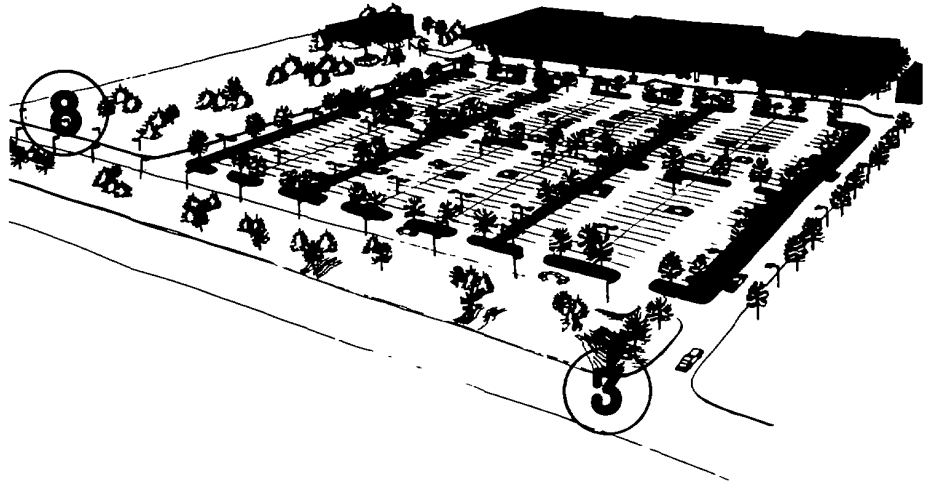

Industrial/ Warehousing Areas.

Fig. 18-1: Industrial/ Warehousing Problem.

Industrial/warehousing areas within military installations are utilitarian environments that should provide a safe and pleasant working environment while satisfying functional and security requirements. These areas are typically very stark environments characterized by problems such as:

1. Stark, plain building facades of variable upkeep and design vintage.
2. Continuous hard surface paving between buildings with no clear definition between vehicular and pedestrian circulation parking and service areas.
3. On-street parking.
4. Little or no planting.
5. Undefined or unused space between buildings.
6. Lack of outdoor amenities for area personnel.
7. Cluttered open storage yards that can be viewed from main roads and adjacent land use areas.
8. Unattractive and inconsistent street lighting fixtures and poles that do not provide adequate lighting for nighttime security and surveillance.

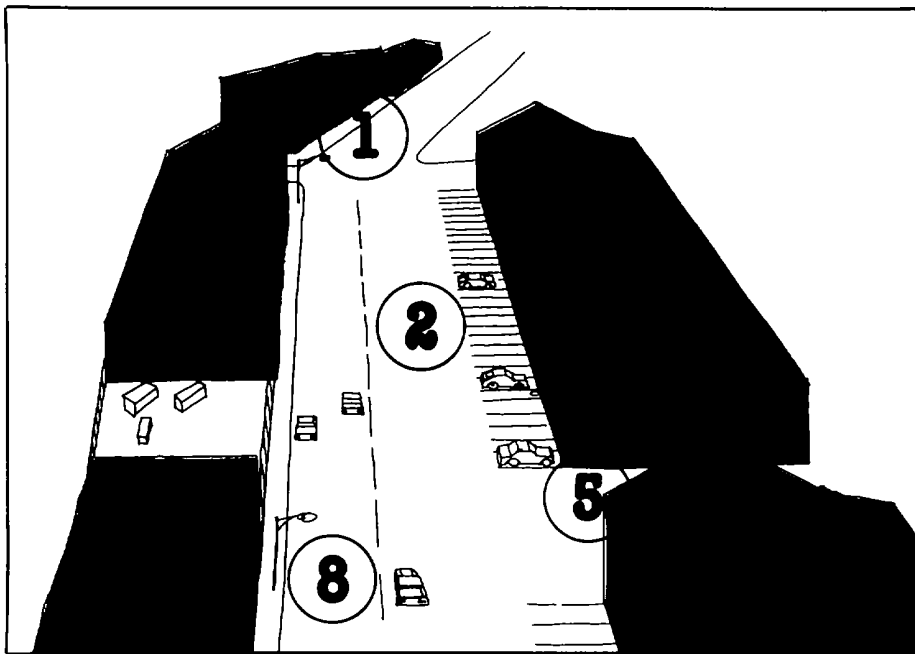
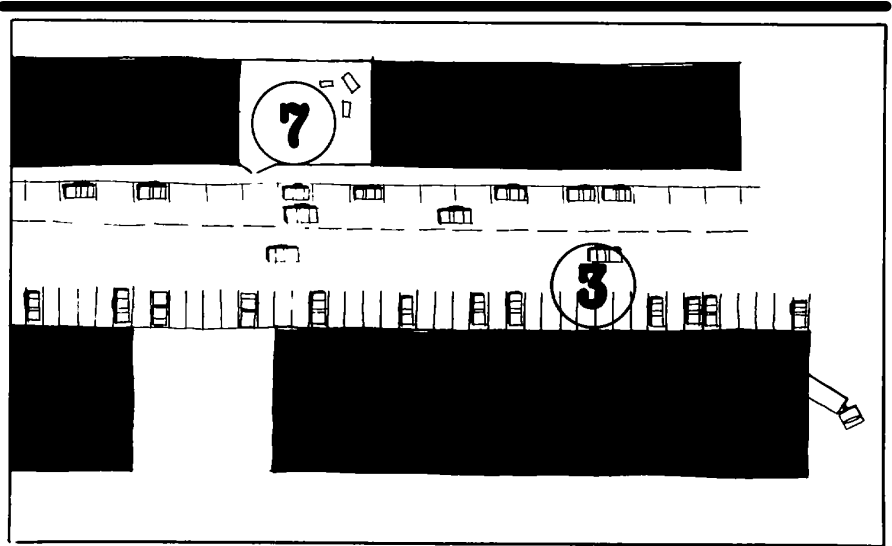
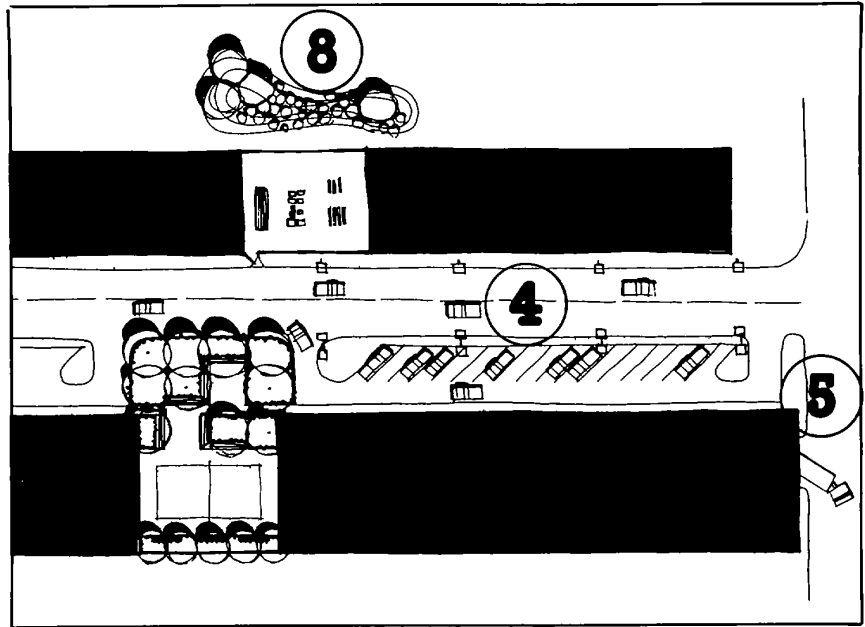

Fig. 18-2: Industrial/Warehousing Solution.

While it is appropriate that less effort be expended on visual concerns in these operational areas, there are still practical opportunities for improvement. Improvements in these areas should be oriented toward providing a safe utilitarian environment with some form of small or "vest pocket" amenities that provide visual relief and recreational facilities for area personnel. Proposed improvements illustrated here include:

1. Upgrade building appearance with a uniform level of maintenance throughout the area.
2. Provide visual interest and building identity to the stark setting by varying building colors within an established color palette of complementary colors.
3. Create a small focal point amenity such as a "vest pocket" park on unused space between buildings that introduces planting into the area and provides area personnel with an outdoor place for relaxation, lunch time eating and recreation.
4. Reorganize the street right-of-way to provide a clear delineation of vehicular circulation with curbing and striping.
5. Provide clearly defined building service bays with curbing and planting islands.
6. Relocate parking into offstreet parking bays within the existing space between buildings.



7. Provide sidewalks for safe pedestrian movement between buildings and parking.
8. Screen open storage areas from adjacent roads and land use areas with planted earth berms in front of security fencing.

9. Provide a coordinated street lighting system of attractive fixtures that provide necessary nighttime illumination for security and surveillance.

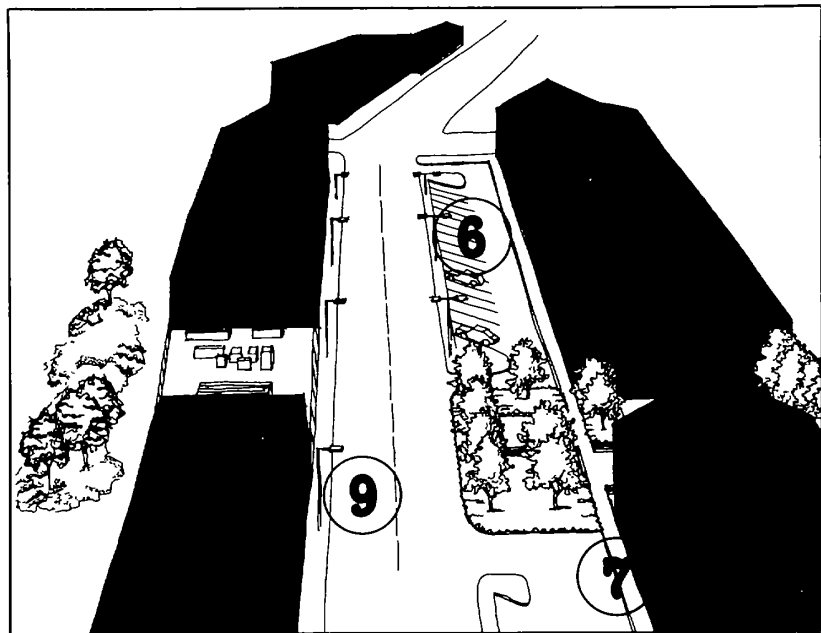

Appendices

Appendix A.

Related
Military
Reference.

1. Department of Defense References.

a. Manuals:

DOD 4270.1M, *Construction Criteria Manual*

b. Pamphlets:

Military Traffic Management Command (MTMC), No 55-9, *Do's and Don'ts for Transportation Master Planning*

Military Traffic Management Command (MTMC), No 55-10, *Traffic Engineering for Better Roads*

2. Department of the Army References.

a. Regulations:

AR 200-1, *Environmental Protection and Enhancement*

AR 210-20, *Master Planning for Permanent Army Installations*

AR 415-15, *Military Construction, Army (MCA) Program Development*

AR 415-20, *Project Development and Design Approval*

AR 415-28, *Department of the Army Facility Classes and Construction Categories*

b. Technical Manuals:

TM 5-800-1, *Construction Criteria for Army Facilities*

TM 5-801-1, *Historic Preservation Administrative Procedures*

TM 5-801-2, *Historic Preservation Maintenance Procedures*

TM 5-803-1, *Master Planning Principals and Procedures*

TM 5-803-2, *Planning In the Noise Environment*

TM 5-803-3, *Site Planning - General*

TM 5-803-6, *Site Planning of Community Centers*

TM 5-803-11, *Children's Play Areas and Equipment*

TM 5-807-7, *Color for Buildings*

TM 5-811-1, *Electrical Design*

TM 5-812-1, *Fire Prevention*

TM 5-813-5, *Water Distribution Systems*

TM 5-813-6, *Water Supply for Fire Protection*

TM 5-820-4, *Drainage and Erosion Control*

TM 5-822-2, *General Provisions and Geometric Design for Roads, Streets, Walks and Open Storage Areas*

TM 5-830-2, *Planting Turf*

TM 5-830-4, *Planting and Establishment of Trees, Shrubs, Ground Covers and Vines*

3. Department of the Navy References.

a. Design Manuals:

NAVFAC DM-1 Series, *Architecture*

NAVFAC DM-3 Series, *Mechanical Engineering*

NAVFAC DM-4 Series, *Electrical Engineering*

NAVFAC DM-5 *Series, Civil Engineering*
NAVFAC DM-33, *Hospital and Medical Facilities*
NAVFAC DM-34, *Administrative Facilities*
NAVFAC DM-35, *Family Housing*
NAVFAC DM-36 *Series, Troop Housing*
NAVFAC DM-37 *Series, Community Facilities*

b. Publications:

NAVFAC P-72, *Department of the Navy Facility Category Codes*
NAVFAC P-80, *Facility Planning Factor Criteria for Navy and Marine Corps Shore Installations*
NAVFAC P-272, *Definitive Designs for Naval Shore Facilities*
NAVFAC P-309, *Color for Naval Shore Facilities*
NAVFAC P-383, *Children's Play Areas and Equipment*
NAVFAC P-905, *Planting and Establishment of Trees, Shrubs, Ground Covers and Vines*
NAVFAC P-970, *Planning In the Noise Environment*

C. Instructions:

NAVFAC Instruction 11010 57B, *Site Approval of Naval Shore Facilities*
NAVFAC Instruction 11010 63A, *Planning Services for Navy and Marine Corps Shore Activities*

4. Department of the Air Force References.

a. Regulations:

AFR 86-4, *Master Planning*
AFR 88-33, *Planning and Design of Outdoor Sports Facilities*

b. Manuals:

AFM 85-6, *Land Management and Grounds Maintenance*
AFM 85-25, *Index - Guide Specifications for Military Family Housing*
AFM 88-2, *Air Force Design Manual, Definitive Designs of Air Force Structures*
AFM 88-7, Chapter 5, *General Provisions and Geometric Design for Roads, Streets, Walks and Open Storage Areas*
AFM 88-15, *Air Force Design Manual - Criteria and Standards of Air Force Construction*
AFM 88-17, Chapter 2, *Planting Turf*
AFM 88-17, Chapter 3, *Dust Control*
AFM 88-17, Chapter 4, *Planting and Establishment of Trees, Shrubs, Ground Covers and Vines*
AFM 88-25, *Family Housing Design*
AFM 88-30, *Children's Play Areas and Equipment*
AFM 88-50, *Criteria for Design and Construction of Air Force Health Facilities*
AFM 19-10, *Planning in the Noise Environment*
AFM 300-4, Volume 4, *Data Elements and Codes*

Appendix B.

Annotated Bibliography.

This bibliography provides a selected listing of basic references on general site planning and design; circulation planning; energy conservation; site design for the handicapped; historic preservation; plant materials; playground design; the design of signing, lighting and street furniture; and technical aspects of site design.

The materials included either apply directly to the design and planning of military installations or provide an overview of present thinking within the environmental design profession which may be useful to those making site planning decisions for military installations.

Bibliographic selections have been made from over 200 publications to illustrate and define the current state-of-the-art of site design without dwelling on analytical, academic or philosophical/historic materials in great detail. Except in special instances, materials dealing exclusively with the planning of urban centers have also been excluded.

General.

1. Eckbo, Garrett. *Urban Landscape Design*, McGraw-Hill, New York, 1964.

Discusses the art of space planning using examples ranging in scale from a building on a site to an entire neighborhood. Liberally illustrated with drawings and photographs of selected design solutions. Includes section on outdoor recreation.

2. Eckbo, Garrett. *The Landscape We See*, McGraw-Hill, New York, 1969.

Presents a view of the natural, economic and social processes which shape the built environment and the role that planning and site design can have in responding to and shaping these processes. Discusses the professional province of the architect and landscape architect and the objectives of urban design in improving the physical relationships among elements of the built environment.

3. Katz, Robert D. *Design of the Housing Site, A Critique of the American Practice*, Small Homes Council, Building Research Council, University of Illinois, Urbana, Illinois, 1967.

Identifies technical and procedural factors influencing the quality of residential development in the United States. Illustrated with most frequently encountered residential development plan types from high density urban to suburban. Common residential site planning problems presented, but this is not a "how-to" book.

4. Laurie, Michael. *An Introduction to Landscape Architecture*, American Elsevier Publishing Co., New York, 1975.

A series of essays on aspects of landscape architecture as currently practiced. Focus is on the synthesis of ecological and social parameters of land use policy and detail design form. The book is a general overview designed as an introductory text for students or persons in related design fields. Contains some good illustrated examples of landscape detailing and a section on microclimate control.

5. Lynch, Kevin. *Site Planning (Second Edition)*, The M.I.T. Press, Cambridge, Mass., 1971.

A standard reference and teaching text. Includes a thorough discussion of site planning theory, fundamentals of site analysis, organization of site activities and circulation systems. Technical sections follow discussion of design principles. Specific project types dealt with in greater detail are housing, commercial centers, industrial parks, institutions and recreational facilities.

6. Marlowe, Olwen C. *Outdoor Design, A Handbook For The Architect and Planner*, Watson-Guptill Publications, New York, 1977.

Discusses frequently encountered site design conditions and provides useful guidelines and techniques for treatment of site components. The book initially focuses on site clearance, ground contour and soil preparation issues and then proceeds to outline functional and aesthetic uses of landscape structures, lighting, paving materials, trees and shrubs and outdoor furniture.

7. McHarg, Ian L. *Design With Nature*, Doubleday/National History Press, Doubleday & Company, Inc., Garden City, New York, 1969.

An important polemic on how the principles of ecology can help solve the environmental problems faced in land development. Focus is on regional scale planning but the attitudes expressed are basic to planning at all scales. Includes case studies of regional ecological analysis leading to land use and site development conclusions.

8. McKeever, J. Ross, ed. *Community Builders Handbook*, The Urban Land Institute, 1200 18th Street, N.W., Washington, D.C. 20036, 1969.

Designed as a practical reference manual for residential and commercial land development. Establishes a high standard for private developers. Useful in defining practical design standards and alternative development patterns. Defines and illustrates land planning terms.

9. Newman, Oscar. *Design Guidelines for Creating Defensible Space*, National Institute of Law Enforcement and Criminal Justice, Law Enforcement Assistance Administration, U.S. Department of Justice, 1976.

Concise discussion of security problems encountered in residential site planning and building design. Contains definitive design criteria. Useful guide in organizing and relating public and private space. Application of criteria does not conflict with what is generally considered good residential site planning practice. Amply illustrated.

10. Rubenstein, Harvey M. *A Guide to Site Planning and Environmental Planning*. John Wiley & Sons, Inc., New York, 1969.

Presents the standard textbook approach to site planning beginning with site analysis of natural, cultural and aesthetic features leading to land use planning based primarily on vehicular and pedestrian circulation as the major organizing element. Combined with this exposition on design approach is background technical information covering engineering aspects of detailed site design.

11. Rutledge, Albert J. *Anatomy of A Park*, McGraw-Hill, New York, 1971.

Text on design principles and criteria for public open space to the layperson or administrator. Included are chapters outlining overall design objectives, aesthetics, functional considerations, and plan interpretation and evaluation. Excellent primer on open space and outdoor recreational design.

12. Robinette, Gary O. *Plants/People/and Environmental Quality*, U.S. Department of the Interior, National Park Service, Washington, D.C., 1972.

Discusses the properties of planting materials and their uses as architectural elements providing for visual screening, privacy control, space articulation; as engineering tools in erosion, traffic and acoustic control; and in controlling climatic factors of solar radiation,

temperature, precipitation and wind. Non-technical presentation makes this material useful to all design professionals concerned with environmental design.

13. Simonds, John Ornsbee. *Landscape Architecture*, McGraw-Hill, New York, 1961.

Generally considered an excellent manual on landscape design. Interesting material on pedestrian movement. Focuses on open space planning and on the single building on a natural site.

14. Tandy, Cliff. *Handbook Of Urban Landscape*, The Architectural Press, London, 1972.

This handbook serves as a useful reference providing a comprehensive view of landscape design for housing development, parks, recreational areas and children's playgrounds. The design guide sheets included in the handbook provide checklists of user requirements, design standards and techniques in the use of planting materials and other landscape elements.

15. Tandy, Cliff. *Landscape of Industry*, John Wiley & Sons, Inc., New York, 1974.

One of a few references on site planning for large industrial development. Topics covered include an historical review of industrial development and its effect on the landscape; typical ecological and landscape problems for a wide range of industrial types from large urban manufacturing facilities to mining, sewage treatment and power generational plants. Planning criteria for each industrial type and for land reclamation is discussed. Specific landscape design and construction problems and potential solutions are scattered throughout the text.

16. U.S. Dept. of Health, Education and Welfare. *How to See*, U.S. Government Printing Office, Washington, D.C., May 1973.

This is a training booklet published by the Social Security Administration, Office of Public Affairs, the content of which focuses on how much of our environment we really see. The author suggests that we see only a small part of what there is to see, both on and off the job. The booklet helps to open our eyes to a world of visual information available to us every minute but ignored by us much of the time. Both man-made and natural environments are illustrated throughout the booklet to show us what messages we receive or actually turn off.

17. The Urban Land Institute. *Industrial Development Handbook*, Community Builders Handbook Series, Washington, D.C., 1975.

The handbook outlines builder/developer procedures for the development of industrial parks. The objective of the handbook is to describe the planning, engineering and financial aspects of the development process. Practical design standards are recommended which, in conjunction with the illustrations included, provide an overview of the state-of-the-art in industrial and office park design.

Circulation Systems.

18. Appleyard, Donald; Lynch, Kevin; and Myler, John R. *The View from the Road*, M.I.T. Press, Cambridge, Mass., 1964.

Analyzes sequential visual experience on urban roads. Illustrates a notational system for recording sequential experience. Interesting presentation of the common problem of environmental chaos; a perception raiser, but does not address generic design solutions.

19. Breiner, Simon and Dean, William J. *The Pedestrian Revolution*, Streets Without Cars, Vintage Books, Random House, New York, 1974.

Presents case for improving the quality of the urban and suburban environment by modifying existing street systems to make walking easier, more efficient and more enjoyable. Specific suggestions are made for developing bicycle paths and for creating pedestrian systems. Contains illustrations of many implemented projects.

20. Fruin, John J. *Pedestrian Planning and Design*, Metropolitan Association of Urban Designers and Environmental Planners, Inc., P.O. Box 722, Church Street Station, New York, N.Y. 10008, 1971.

A primarily quantitative study of pedestrian movement characteristics. Topics include physiological and psychological factors affecting planning of pedestrian spaces, traffic and space characteristics of pedestrian movement and procedures for establishing pedestrian traffic demand levels and resulting space requirements. Includes discussion of the current developments in improving the pedestrian environment. Primarily relevant to urban or high-density pedestrian planning.

21. Institute of Transportation and Traffic Engineering. *Bikeway Planning Criteria and Guidelines*, School of Engineering and Applied Science, University of California, Los Angeles, 1972.

Prepared for the State of California for the purpose of establishing the most feasible and least expensive means of adopting existing and future public streets to safely accommodate bicycle traffic. Included are bikeway design characteristics, capacity criteria, safety considerations, alternative design solutions, and planning considerations.

22. Mayer, Richard W. *Bicycle Planning and Design*, American Society of Landscape Architects, Washington, D.C., 1978.

Discusses the implementation process, locational opportunities, network subsystems and specific design guidelines for bicycle facilities. Provides a useful case study demonstrating the development of a bikeway master plan.

23. Oregon State Highway Division. *Bikeway Design*, Salem, Oregon 97301, 1974.

Design standards are presented for bikeways which separate trails for joint use of bicyclists and pedestrians. Based on experience gained from implementation of the 1971 Oregon "Bicycle Bill." Criteria are structured around a classification of three bikeway types with criteria on such aspects as speeds, curves, width, clearances, grades, intersections, sight lines, signing and illumination. Considered one of the better design guides for bikeways separated from streets.

24. Ritter, Paul. *Planning for Man and Motor*, The MacMillan Company, New York, 1964.

Provides technical and aesthetic guidelines for the design of pedestrian and vehicular movement systems. Discussions are presented on historic development of these systems, state-of-the-art concepts in new towns, urban and residential areas and functional requirements for movement systems at all levels from regional to neighborhood.

25. Robinette, Gary O. *Parking Lot Landscape Development*, Environmental Design Press, Reston, Va., 1976.

Outlines visual and environmental problems typically associated with parking lots and develops design guidelines for better site and landscape treatment of existing and new parking areas. Issues addressed include location of parking lots in relation to buildings, screening and shading, parking dividers, pedestrian and vehicular separation and storm drainage.

26. U.S. Department of Agriculture, Forest Service. *National Forest Landscape Management*, Volume 2, Chapter 4 Roads, USDA, Agriculture Handbook, No. 483, Government Printing Office, Washington, D.C., 1976.

This government published handbook is concerned with-the impact of roadways on the scenic quality of natural settings. It provides useful insights into evaluating proposed road alignment and construction. Issues addressed include landform modifications, vegetation clearing and replanting, and design treatment of guardrails, culverts, retaining walls and signing.

27. U.S. Department of Transportation, Federal Highway Administration. *Safety & Locational Criteria for Bicycle Facilities*, User Manual Vol. I and Vol. II: Design and Safety Criteria (Draft), Report No. FHWA-RD-75-114, 1976.

Volume I addresses identification of need for and location of bikeways. Volume II is directed toward design and safety criteria for bikeways. Emphasis is on bikeways which share right-of-way with motor vehicles.

Energy Conservation.

28. American Institute of Architects. *Energy*, AIA, 1735 New York Avenue, N.W., Washington, D.C. 20006, 1975.

An information service on energy and the built environment. Developed as an "Energy Handbook," it includes a discussion of general approaches, opportunities for achieving energy-efficient design and identifies some tools and techniques useful in implementing energy efficient design solutions. Subscription includes a monthly newsletter of current developments concerning energy and the built environment.

29. American Institute of Architects Research Corporation. *Energy Conservation in Building Design*, AIA, 1735 New York Avenue, N.W., Washington, D.C. 20006, 1974.

Discusses design alternatives for reducing energy consumption, primarily in new buildings. Directed to architects and engineers. Subjects include site analysis, building orientation, configuration, interior space planning, mechanical and electrical system design and waste management. Sun and wind are discussed as alternative energy sources.

30. Caudill, William Wayne; Lawyer, Frank D.; and Bullock, Thomas A. *A Bucket of Oil*, Cahners Books, Boston, 1974.

Simply written overview of energy conservation in buildings. Brief discussion of siting, architectural form, interior space planning and mechanical and electrical systems. An easily read primer which is not burdened by technical information or extensive discussion.

31. Egan, David M. *Concepts in Thermal Comfort*, Prentice-Hall, Inc., Englewood Cliffs, New Jersey, 1975.

Chapter 2 of this comprehensive book presents basic reference material on climatic considerations in the siting and design of buildings. Includes illustrations of optimal building shapes and orientations for minimizing solar radiation and enhancing natural building ventilation.

32. Givoni, B. Man, *Climate and Architecture*, Applied Sciences Publishers Ltd., London, 1976.

A detailed engineering analysis of the relationship between climate and the built environment. Little information on general site planning but does include a technically oriented discussion of exterior building color and building orientation related to interior comfort.

33. Olgyay, Victor. *Design with Climate, Bioclimatic Approach to Architectural Regionalism*, Princeton University Press, 1963.

Classic and possibly best work emphasizing the need for a regional architecture based on climatic conditions. Covers concepts and principles of climatic analysis and effects of climate on people. Architectural principles are developed which include site selection, solar control, wind effects and use of materials. Includes prototype site plans and architectural form for four specific climatic regions.

34. National Academy of Sciences. *Solar Radiation Considerations in Building, Planning and Design*, Proceedings of a Working Conference, Printing and Publishing Office, National Academy of Sciences, 2101 Constitution Avenue, N.W., Washington, D.C. 20418, 1976.

Collection of papers which deal with various aspects of planning and design that use the natural and built environment to advantage in conserving energy. Of particular interest is Chapter V, "Architectural Design for Optimum Solar Effects," which includes a discussion on orientation, use of planting, design of windows and solar shading devices.

35. Robinette, Gary O. *Landscape Planning for Energy Conservation*, Environment Design Press, Reston, Va., 1977.

Provides site selection, building orientation and site design guidelines for each of the four major climatic regions of the United States. Graphic illustrations demonstrate the use of natural and man-made site elements for exploiting existing natural site energy resources and the promoting of energy conservation.

Barrier Free Site Design.

36. American Society of Landscape Architects Foundation. Barrier Free Site Design, U.S. Department of Housing and Urban Development, Office of Policy Development and Research, U.S. Government Printing Office, Washington, D.C. (Stock No. 0-51-923), 1975.

"The purpose of this publication is to provide in one source, for both administrators and designers, the necessary information that can lead to designs that consider the need of all persons using the outdoor environment."

37. American Standards Association. Making Buildings and Facilities Accessible to, and Usable by, the Physically Handicapped, (ANSI A117.1), 10 East 40th Street, New York, N.Y., 1961.

This standard specification for making buildings and facilities accessible to and usable by the handicapped has been incorporated by reference in most federal, state and local legislation and codes. It covers building approaches, parking, ramps, doors and entrances, toilets, drinking fountains, phones and warning signs.

38. Kliment, Stephen A. Into the Mainstream, A Syllabus for A Barrier-Free Environment, The American Institute of Architects, 1735 New York Avenue, N.W., Washington, D.C. 20036.

A guide to implementing a barrier-free environment written for administrators and designers. Provides historic background for barrier-free design, illustrates common barrier problems, suggests solutions and provides a listing of supplementary information sources.

Historic Preservation.

39. Bullock, Orin M. The Restoration Manual, The American Institute of Architects, Publication Division, Washington, D.C., 1966.

Introductory text on restoration of historic buildings. The purpose is to define a basic procedure to be followed in restoring a building in a manner compatible with its original design and construction. Written for the architect. Topics include historical, architectural and archaeological research specification for restoration work and typical design problems encountered in doing restoration work.

40. Cavaglieri, Giorgio, ed. Preservation and Building Codes, Preservation Press, National Trust for Historic Preservation, Washington, D.C., 1975.

Considers problems of adapting old buildings to new uses while making them safe. Contains 25 pages presented at the conference sponsored by National Trust for Historic Preservation. Takes the position that code requirements should be met and need not detract from preservation or restoration.

41. National Trust for Historic Preservation, Economic Benefits of Preserving Old Buildings, Washington, D.C., 1976.

Essays on the adaptive use of old buildings.

42. National Trust for Historic Preservation. How to Evaluate Historic Sites and Buildings, Washington, D.C., 1971.

Presents criteria for the significance of potentially historic structures and the feasibility of preservation.

Planting Materials.

- 43.** Wyman, Donald. *Trees for American Gardens*, Macmillan Co., New York, 1972.

A guide to more than 1000 species and varieties of trees recommended for North American soils. Includes descriptions of the natural habitat, hardiness, habits, foliage blossom-producing and fruit-bearing characteristics of each tree. Includes a section on trees recommended for particular needs and purposes, i.e., trees that withstand drought, trees that withstand city conditions.

- 44.** Wyman, Donald. *Shrubs and Vines for American Gardens*, Macmillan Co., New York, 1973.

A guide for more than 1,700 species and varieties of shrubs and vines recommended for North American soils. Provides for each species discussed detailed information on the landscaping usefulness of the plant, including time of bloom, foliage colors, type of fruit, height, habitat and most suitable growing conditions.

- 45.** Zion, Robert L. *Trees for Architecture and the Landscape*, Van Nostrand Reinhold Co., New York, 1968.

A book devoted to trees with excellent winter and summer photographic portraits and definitions intended to facilitate communication between landscape architect, the architect and the layperson. Also contains valuable practical considerations from buying to designing with trees and a state-by-state tree list.

Playgrounds.

- 46.** Dattner, Richard. *Design for Play*, Van Nostrand Reinhold Co., New York, 1969.

Outlines psychological and social function of children's play activities and develops design criteria for play facilities. Includes illustrations and evaluation of recently built playgrounds and presents criteria for playgrounds for handicapped children.

- 47.** Friedberg, M. Paul. *Handcrafted Playgrounds, Designs You Can Build Yourself*. Vintage Books, New York, 1975.

A sketch book of easily executed playground equipment ideas by a recognized authority in the field of children's play areas.

- 48.** Friedberg, M. Paul. *Play and Interplay, a Manifesto for New Design in Urban Recreational Environments*, Macmillan Co., New York, 1970.

Examines traditional concepts of play that have affected the design of children's playgrounds and recreational areas and facilities for teenagers, adults and the elderly. Deals primarily with the needs of people in urban environments, but the principles are applicable to other environments. Successful and unsuccessful playgrounds, equipment and materials are compared. Flexibility and fluidity of site treatment, and continuity of the total environment as a recreation tool are advocated.

- 49.** Hogan, Paul. *Playgrounds for Free: the Utilization of Used and Surplus Materials in Playground Construction*, The M.I.T. Press, Cambridge, Mass., 1974.1/4A visual documentary of recycled materi-

A visual documentary of recycled materials used in diverse recreation areas, primarily for small children. Applicable to the self-help projects on military installations.

Signing, Lighting and Street Furnitures

50. The American Institute of Graphic Arts. *Symbol Signs, The Development of Passenger/Pedestrian Oriented Symbols for Use in Transportation Related Facilities*, prepared for the U.S. Department of Transportation. Distributed by National Technical Information Service, U.S. Department of Commerce, (PB-239 352), 1974.

Presents a system of sign symbols and guidelines developed for the U.S. Department of Transportation for use in transportation-related facilities. Symbols are now being implemented on a national scale. When sign symbols are contemplated, it is suggested that these be considered as standards when appropriate.

51. Ashley/Myer/Smith, Architectural Planners. *City Signs and Lights*, The Boston Redevelopment Authority and the U.S. Department of Housing and Urban Development, 1971.

Study intended as "a first step in the process of planning and controlling signs and lights for the purpose of improving the flow of information in the city." Amply illustrates existing confusion and blight in private and public signing and lighting. Graphic informational systems and exterior lighting standards are developed, field testing reported, and model codes and implementation procedures proposed.

52. Fox, Martin and Carpenter, Edward K. *The Best in Environmental Graphics*, R.C. Publications, Inc., Washington, D.C., 1975.

Presentation of 18 environmental graphics programs selected by a juried competition sponsored by "Print" magazine, a trade journal of the graphic arts. Projects selected include "supergraphics," corporate graphic systems, graphic communication systems for airports, new community and municipal transportation. Illustrates the "state-of-the-art" in signing and graphics in both the private and public sectors.

53. Malt, Harold Lewis. *Furnishing The City*, McGraw-Hill, New York, 1970.

Evaluation and historic development of street furniture systems. Outlines a "systems approach" to integrated street furniture solutions.

54. U.S. Department of Transportation, Federal Highway Administration. *Manual on Uniform Traffic Control Devices for Streets and Highways*, U.S. Government Printing Office, Washington, D.C. 20402, (Stock No. 5001-0021), 1970.

The traffic signing standard. Provides all graphic and locational standards for traffic signing and markings.

Technical References.

55. Beazley, Elizabeth. *Design and Detail of the Space Between Buildings*, The Architectural Press, London, 1960.

Discusses alternative technical solutions and material selections for roads, pedestrian paths and other outdoor paved areas. Solutions to common site development components such as walls and fences; the planting in paved areas and edge treatments are detailed and illustrated with modern and historic European examples. Selection of materials and details based on functional requirements and appropriate sense of place are discussed.

56. Callender, John Hancock. *Time-Saver Standards for Architectural Design Data*, (Revised Fourth Edition), McGraw-Hill, New York, 1973.

Facilities discussed are residential, educational, cultural, health, religious, public, commercial, transportation, industrial, recreation and miscellaneous such as landscaping. Sections applicable to site designing include site planning, programming of large group facilities, parking, docks and terminals, warehouses, recreational facilities, and planting.

57. De Chiara, Joseph and Koppelman, Lee. *Planning Design Criteria (Second Edition)*, Van Nostrand Reinhold Co., New York, 1969.

An illustrated summary of basic reference material which presents a variety of data and established standards related to land planning and site design. Topics include master planning and land use principles, housing, vehicular circulation, recreation and industrial development.

58. Gage, Michael and Vendenberg, Martz. *Hard Landscape in Concrete*, John Wiley & Sons, Inc., New York, 1975.

Comprehensive guide to uses of concrete in the landscape for paving material, street furniture, play equipment, walls and screens. Technical details and specifications are included but standards of practice are British and dimensioning is metric.

59. Parker, Harry. *Simplified Site Engineering for Architects and Builders*, John Wiley & Sons, Inc., New York, 1954.

Simple, somewhat dated, but useful technical guide to grading, utilities, road design and other site development engineering concerns.

60. Ramsey, C. G. and Sleeper, H.R. *Architectural Graphic Standards (Sixth Edition)*, John Wiley & Sons, Inc., New York, 1970.

A general technical reference on architecture with an introductory chapter on planning and design principles. Addresses a variety of facilities found on military installations, such as truck docks, recreational playing fields, sun control, plot subdivision data, standard swimming pool dimensions, etc. Exterior construction and finish materials such as concrete, masonry, metal, wood, plaster and tile are also covered.

61. Robinette, Gary O. *Energy and Environment*, Kendall Hunt Publishing Co., Dubuque, Iowa, 1973.

One of the few comprehensive references to address the visual design issues associated with power generation plants, transmission lines and transformation facilities. Provides useful guidelines for site selection and illustrates various approaches to minimizing visual impacts.

62. Schultz, Theodore and McMahon, Nancy M. *Noise Assessment Guidelines*, U.S. Department of Housing and Urban Development (Stock No. 2300-1194), 1974.

Procedures for evaluating noise exposure of potential development sites. Created for use by persons without technical training. Sites are ranked from clearly acceptable to clearly unacceptable and levels of noise which require special abatement efforts are identified. Does not provide guidelines for designing noise abatement systems.

63. Stone, Edward H., II. *Visual Resource Management*, American Society of Landscape Architects, Washington, D.C., 1978.

Highlights a landscape inventory and analysis process used by the Forest Service and Bureau of Land Management in assessing the visual quality of specific lands areas. Application of the process is most suitable for predominantly natural undisturbed terrains.

Bibliographies.

The following *Council of Planning Librarians*, Exchange Bibliographies are available (copy can be obtained for fee from: Editor, Council of Planning Libraries, Post Office Box 229, Monticello, Illinois 61856) for those interested in a more comprehensive review of literature in the fields of urban design, planning and site design.

84. Montgomery, Roger. *A General Booklist on Urban Design*, 1969.
188. Stanley, Brock T. *Community Facilities Planning, A Selected Interdisciplinary Bibliography*, 1971.
476. Mills, Madolia Massey. *The Potential of Direct Solar Energy in Planning*, 1973.
906. Shilaber, Caroline. *Landscape Architecture/Environmental Planning, A Classified Bibliography*, 1975.
954. Unruh, David. *Space and Environment: An Annotated Bibliography*, 1976.
998. Gentile, Joseph Francis. *Landscape Planning and Design*, 1976.
1030. Kulp, Kenneth K. *Environmental Site Planning*, 1976.
-

Appendix C.

Model Scope of Work Statement and Design Consultant Selection Criteria for the Preparation of Installation Design Guides.

As stated in Chapter 1, the design guidelines provided in this manual are intended for general application on all military installations and, therefore, it is recommended that each installation develop its own design guide, tailored to its specific situation. These specific installation design guides should contain appropriate guidelines for all the component elements comprising the visual environment (as covered generically in Chapters 3 through 13 of this manual). However, the design guide would be responsive to such locationally specific conditions as climate, prevailing architectural character, and any other atypical installation policies or conditions.

This appendix is intended to: 1) serve as a guideline for individual installations in the development of a scope of work for the preparation of a design guide, and 2) provide criteria to aid in the selection of a well-qualified design consultant to prepare the design guide.

Section I:

Outline Scope of Work Statement.

I. Statement of Work.

A. Project Identification.

Description of the installation location, environs, boundaries; subareas within the installation that require differential treatment; and other specific information identifying the project.

B. Objective.

The objective of this contract is to develop a design guide for (name of installation). This design guide is to establish specific design criteria and an outline program to improve the visual environment of (name of installation). The design criteria should be developed in response to the general guidelines contained within the Installation Design Manual but should be tailored specifically to the unique characteristics of the installation. The outline program for improving the appearance of the installation is intended to be incorporated into the master plan of the installation.

C. General Requirements.

1. The contractor shall furnish the necessary professional and technical personnel, clerical services, materials, equipment and facilities and perform all travel in accordance with this document and with criteria and requirements furnished by the contracting officer.

2. The contractor shall correct all errors, inconsistencies or omissions in the design guide brought to his attention by the contracting officer, and make resubmittals, if required by the contracting officer, even if the period of service has expired.

II. Specific Requirements.

A. Task I - Orientation Conference.

Within fifteen calendar days after issue of a notice to proceed and before proceeding with the work, a conference will be held at the office of the contracting officer, at which time the contractor's representative(s) who will be in active charge of the work shall be present in order that all requirements may be thoroughly reviewed.

B. Task II Data Collection and Analysis.

1. Perform a visual survey of the installation using photographic and/or sketch techniques to document findings.

2. Identify existing visual assets and liabilities.

3. Evaluate major influences on the visual environment. The installation master plan is the primary source of information for mission statements; existing topography, structures, roads and other physical conditions; and future proposed land uses and circulation. Climatological information should also be evaluated to determine appropriate architectural, site planning and planting criteria related to the visual environment.

4. Prepare a report documenting existing visual conditions, assets, liabilities and major influences on the visual environment. Submit copies for review and approval by the contracting officer.

C. Task III Design Criteria.

1. Establish specific goals, objectives and priorities for improving the visual environment of the installation.

2. Develop design criteria responsive to these goals, objectives and priorities. These criteria should be developed for each of the following elements comprising the visual environment of the installation:

- Buildings
- Roads
- Parking
- Walkways
- Plazas and Courtyards
- Bikeways
- Planting
- Signing
- Lighting
- Site Furnishings
- Utilities

The design guide should establish overall guidelines including: a) a general architectural design vernacular including desired architectural character, massing, scale, materials and color palette; b) plant materials, prototypical applications and details that are appropriate to the installation and its climate; c) site planning and design guidelines for site systems including circulation (vehicular, pedestrian, bikeway), parking, signing, lighting and utilities; and d) a coordinated design system for site furnishings, signing and lighting.

3. Prepare, in outline form, the proposed contents and format of the design guide and submit for review and approval by the contracting officer.

D. Task IV Design Guide.

1. Upon completion of all the work under Tasks I, II and III above, prepare text, illustrations and photographs for the design guide for *(name of installation)*.

2. Submit ____ copies of a draft mock-up of the design guide for review and approval by the contracting officer.

3. Correct all errors, inconsistencies and omissions in the draft design guide as indicated by the contracting officer.

4. Submit to the contracting officer ____ copies of the final design guide, an audio-visual presentation of the design guide and a narrative keyed on the slides.

III. Submittals and Schedule.

A. Orientation Conference

Fifteen calendar days after notice to proceed

B. Data Collection and Analysis Report.

- Copies
- Calendar days after orientation conference
- Calendar day review period

C. Outline Contents and Format of Design Guide.

- Copies
- Calendar days following previous review
- Calendar day review period

D. Draft Mock-up of Design Guide.

- Copies
- Calendar days following previous review
- Calendar day review period

E. Final Design Guide.

- Copies
- Calendar days following previous review

F. Set of Reproducible Originals for the Complete Guide.

Unfolded mylar reproducible of fold out drawings, if any. Negatives for all black and white photographs and printed matter.

IV. Contract Period of Service.

All work under this contract will be completed within ____ calendar days after issue of notice to proceed.

V. Material to be Furnished by the Contracting Officer.

A. Copies of the Installation Design Manual and other related government regulations and technical manuals.

B. Installation master plan and topographic, building, utility and other appropriate base maps and aerial photographs as available.

C. Technical guidance and information through conferences and review of submittals.

D. Design guides prepared for other installations that may be helpful as models for preparing the design guide for this installation.

Section II:**Design Consultant Selection Criteria.**

When selecting a consultant to prepare a design guide for a military installation, the following factors should be considered.

I. Firm Type, Design Disciplines and Organization.

The consultant should be a design-oriented firm or group of firms. Either a single firm or an affiliated group of firms can successfully prepare a design guide as long as all the necessary design disciplines are represented on the team. These should include architecture; site planning; landscape architecture; graphic design; and illumination, civil and mechanical engineering.

If an affiliated group of firms is to provide these various disciplines, the organization of the team is critical. One firm should be the prime contractor, and a lead designer with that firm should be clearly identified as the project director. He must be given the authority required for such a position.

II. Personnel, Experience and Design Excellence.

It is critical that the personnel identified to work on the project be experienced design professionals from each of the necessary disciplines. It is the experience of the personnel assigned, rather than the firm's experience, that is most important.

The type of experience that is most desirable includes site planning and design. Completed projects will clearly demonstrate the designer's abilities at compatibly relating groups of buildings to each other and their natural setting and of sensitive attention to all aspects of site design. This project experience need not necessarily have been performed for the military; comparable civilian projects include institutional campuses, new communities, housing and commercial complexes and industrial parks.

In evaluating this experience, the design excellence of the completed projects is of critical importance. Site visits to representative projects by the selection board is desirable to best evaluate the skill of the design professionals. Minimally, site plans and photographs of completed projects should be carefully reviewed. Project experience in the vicinity of the installation or in a similar climate is an advantage but not a necessity.

III. Size and Workload.

Size and workload are interrelated. A small firm or group of small firms can successfully perform the required tasks as long as they are not overextended in their current workload. The project manager should be assigned between 80 percent and full time to the project and the design professionals between 30-60 percent. More people spending lesser percentages of their time reduces the efficiency and continuity of the consultant effort.

IV. Location.

While not a primary selection criteria, the location of the firm or group of firms should be considered as it relates to required travel to the installation, to the project officer, and between firms as necessary. A significant amount of time at the installation by the designers is necessary to develop a full understanding of all aspects involved in the preparation of the design guide for the installation.

The proponent agency of this publication is the Office of the Chief of Engineers, United States Army. Users are invited to send comments and suggested improvements on DA Form 2028 (Recommended Changes to Publications and Blank Forms) direct to HODA(DAEN-MPE-I) WASH DC 20314.

By Order of the Secretaries of the Army, the Air Force, and the Navy.

Official:

J. C. PENNINGTON
Major General, United States Army
The Adjutant General

E. C. MEYER
General, United States Army
Chief of Staff

Official:

VAN L. CRAWFORD
Colonel, United States Air Force
Director of Administration

LEW ALLEN, JR.
General, United States
Air Force
Chief of Staff

D. G. ISELIN
Rear Admiral, CEC, U. S. Navy
Commander, Naval Facilities
Engineering Command

Distribution:

To be distributed in accordance with DA Form 12-34B, requirements for TM 5-800 Series: Engineering and Design for Real Property Facilities.

* U.S. PRINTING OFFICE : 1993 0 - 342-421 (62204)

RECOMMENDED CHANGES TO EQUIPMENT TECHNICAL PUBLICATIONS



THEN... JOT DOWN THE DOPE ABOUT IT ON THIS FORM, CAREFULLY TEAR IT OUT, FOLD IT AND DROP IT IN THE MAIL!

SOMETHING WRONG WITH THIS PUBLICATION?

FROM: (PRINT YOUR UNIT'S COMPLETE ADDRESS)

DATE SENT

PUBLICATION NUMBER

PUBLICATION DATE

PUBLICATION TITLE

BE EXACT... PIN-POINT WHERE IT IS

PAGE NO.

PARA-GRAPH

FIGURE NO.

TABLE NO.

IN THIS SPACE TELL WHAT IS WRONG AND WHAT SHOULD BE DONE ABOUT IT:

TEAR ALONG PERFORATED LINE

PRINTED NAME, GRADE OR TITLE, AND TELEPHONE NUMBER

SIGN HERE:

DA FORM 2028-2
1 JUL 79

PREVIOUS EDITIONS ARE OBSOLETE.

P.S.—IF YOUR OUTFIT WANTS TO KNOW ABOUT YOUR RECOMMENDATION MAKE A CARBON COPY OF THIS AND GIVE IT TO YOUR HEADQUARTERS.

