

# Stay Healthy and Safe While Giving Manicures and Pedicures

A Guide for Nail Salon Workers



**California Healthy Nail  
Salon Collaborative**

818 Webster Street  
Oakland, CA 94607

*Julia Liou (510) 986-6830 x267*

*Jessica Huynh (661) 917-5634*

**Labor Occupational Health  
Program (LOHP)**

School of Public Health  
University of California

2223 Fulton St. 4th Floor

Berkeley, CA 94720-5120

*Helen Chen (510) 643-8119*

**Credits**

Asian Law Caucus

Boston Public Health Commission

California Department of Public Health, Occupational Health Branch

Environmental Protection Agency

INFORM

Mary Ann Zapalac (illustration)

John Minardi (graphic design)

StreetLevel (formerly UCSF Community Occupational Health Project)

Photos reprinted with permission

*This material was produced under grant number SH20864SH0 from the Occupational Safety and Health Administration, U.S. Department of Labor. It does not necessarily reflect the views or policies of the U.S. Department of Labor, nor does mention of trade names, commercial products, or organizations imply endorsement by the U.S. Government.*

# Stay Healthy and Safe While Giving Manicures and Pedicures

## A Guide for Nail Salon Workers

A joint project of the California Healthy Nail Salon Collaborative (CHNSC)  
and the Labor Occupational Health Program (LOHP)  
at the University of California at Berkeley



With this booklet, you will learn how to protect yourself from chemicals used at work, prevent aches and pains, and avoid contact with infected blood or bodily fluids. This booklet also explains your rights as a nail salon worker.

# Chemicals

**Tip:** Make sure your doctor or healthcare provider knows what kind of work you do and the chemicals you use. Tell your provider if you are pregnant or planning to become pregnant.



The chemicals used in nail salons can be harmful to your health. However, there are steps you can take to protect yourself.

## What are some chemicals that are commonly used in salons?

- Acetone (nail polish remover)
- Acetonitrile (fingernail glue remover)
- Ethyl methacrylate (artificial nails)
- Formaldehyde (nail hardener)
- Methacrylic Acid (acrylic primer)
- Methyl Methacrylate (artificial nails) (banned for use in nail salons)
- Ortho-phenylphenol (disinfectant)
- Phthalates (nail polish)
- Quaternary Ammonium Compounds (disinfectant)
- Toluene (nail polish, fingernail glue)

## How can chemicals get into your body?



*You can breathe them in, accidentally swallow them, or absorb them through your skin.*

Chemicals affect different people in different ways. Some chemicals used in nail salons can cause: skin rashes; eye, nose, and throat irritation; dizziness; and headaches. Other chemicals may cause more serious illnesses. If you use chemicals all day, every day, you are more likely to get sick than someone who uses the same chemicals once in a while.

# Chemicals continued

To learn about the chemicals you work with, refer to the Material Safety Data Sheet (MSDS). An MSDS provides detailed information about a chemical, such as health effects, how to protect yourself, how to safely store the chemical, and what to do in an emergency.

Your employer should have an MSDS for each chemical used in the salon. Ask for a copy. The MSDSs are usually in English and can be difficult to understand. You can contact the California Healthy Nail Salon Collaborative (CHNSC) or the Labor Occupational Health Project (LOHP) for assistance (see back page for contact information).

There are many things you can do to make your work safer from chemicals.

**1. Choose safer chemicals when possible.** There are safer nail polishes that do not contain dibutyl phthalate, formaldehyde, or toluene. For a list, see the Nail Polish Wallet Guide on the back page.

**2. Let in Fresh Air.**

- Open doors and windows when possible. If the salon has a ceiling vent, make sure it works.
- Some salons have ventilated tables. Change filters regularly. It is best if the tables are vented to the outside.
- Place fans near open doors or windows to let in more fresh air. Fans should pull air in on one end of the salon and push air out at the other end of the salon.

**3. Use good practices.**

- Always read labels and follow instructions when using products.
- Store chemicals in small bottles and label them. Close bottles when you are not using them.
- Put any trash soaked with chemicals (like cotton balls) in a sealed bag before you put it in the trash can. Keep the trash covered.
- Wash your hands before eating, drinking, or smoking. Also wash your hands before and after each client and after handling salon chemicals. Do not eat or drink near your work table.

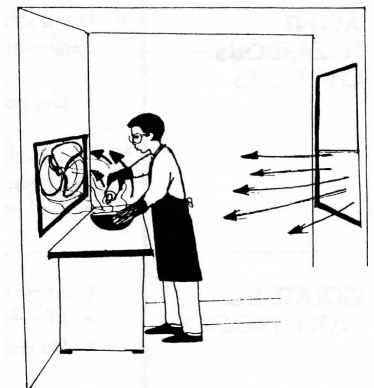
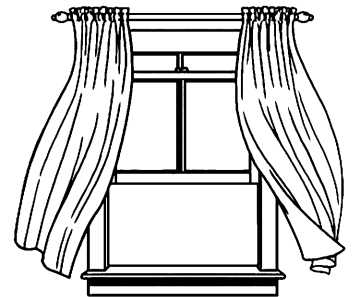

*good ventilation*

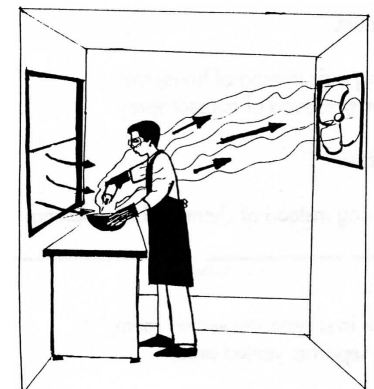

*bad ventilation*

# Chemicals continued



## 4. Use proper personal protective equipment.

- Use the right gloves. Nitrile gloves will protect you from chemicals. Avoid latex or vinyl gloves.
- Use a proper mask when transferring chemicals or when buffing or filing nails.
  - ♦ **Paper dust masks** protect you from some dusts (like nail filings) but not chemicals. The rectangular mask shown below does not provide a good fit. Also, stuffing tissues in your mask will not protect you from chemicals. It is best to use a round dust mask with a metal strip that you can adjust to fit the bridge of your nose.
  - ♦ **N95 dust masks** protect you against dust, viruses, and other germs but not chemicals. Some have filters that reduce chemical odors. Some have a valve to help you exhale more easily.
  - ♦ **Air-purifying respirators** can protect you from chemicals. But they can be uncomfortable and you must be fitted and trained to wear one that is right for you. And, you must use the correct type of cartridge to protect you from nail salon products. You must know how and when to change cartridges.

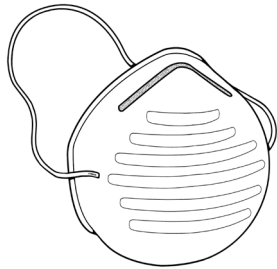

Paper dust mask

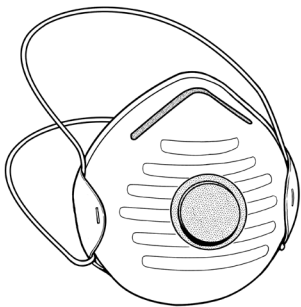

N95 dust mask

- When transferring chemicals to small bottles, open doors and windows. Wear goggles, gloves, and possibly an air-purifying respirator. If you are using an air-purifying respirator, follow the instructions in the previous bullet.
- Wear long-sleeved shirts and gloves. This prevents acrylic dust from touching your arms and hands. Wash your work clothes separately from other clothes. This prevents salon dust and chemicals from spreading to other clothes.



Air-purifying respirator

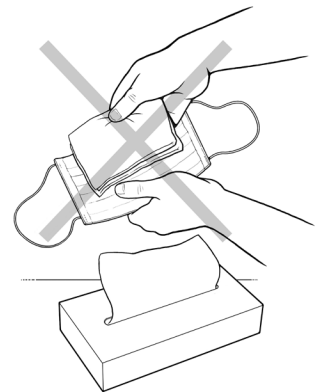
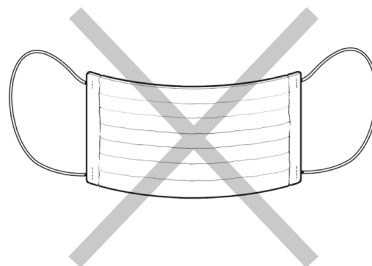

# Preventing Aches and Pains

Nail salon workers can get aches and pains from bending over or being in the same position... these are called “ergonomic hazards.”

Take a moment to think about whether there are any parts of your body that are hurting or uncomfortable. Where do you hurt?

## What can cause these injuries at work?

Aches and pains can be caused by holding the body in an awkward position. Aches and pains can also be caused by pressure on contact points... this can happen when your body touches a hard surface.

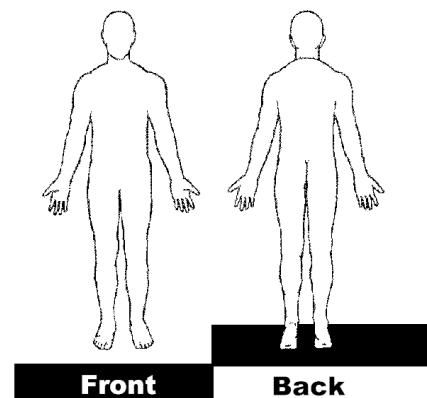

*What is wrong with this picture?*



*What improvements do you see?*



# Preventing Aches and Pains *continued*

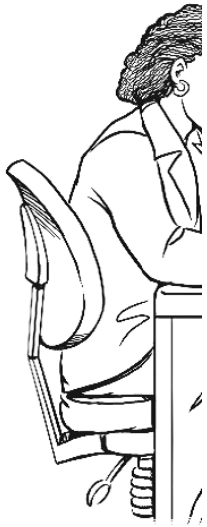

There are many things you can do to prevent aches and pains.

- **Adjust the lighting.** Good lighting can help you see without having to bend over.
- **Raise the client's hand or foot.** Use a cushion to raise the client's hand or foot so you do not have to bend over as far.
- **Use an adjustable chair.** Sit so that your feet are flat on the floor and your back is supported.
- **Put a towel or foam pad on the table edge** to soften it.
- **Put pads on tools.** This makes handles larger and easier to hold.
- **Take frequent breaks if possible.** Changing positions and doing a different task is also helpful.
- **Slow down when possible.** If you are working too fast, your body becomes tense and it is easier to get muscle pain.
- **Do gentle stretching exercises in between clients.** You may need to check with a doctor first!



*Neck*



*Shoulders and Upper Back*



*Neck*



*Neck*



*Arms and Shoulders*



*Fingers*



*Lower Back and Hips*



*Back of Thighs*



*Inner Thighs*



*Ankles*



# Infectious Diseases

Infectious diseases include the common cold, flu, HIV, and Hepatitis B (a liver infection). You can become infected if you come into contact with infected blood or bodily fluids.

There are many ways to protect yourself.

- **Avoid touching any blood or bodily fluids.**
- **Wear gloves.** This is especially important if a client has any cuts, open sores, or blisters. Throw away your gloves immediately after using them.
- **Always wash your hands with soap and water.**
- **Bandage and cover** all open cuts or bruises.
- **If a client bleeds, don't touch the blood.** Hand the client a cotton ball. Ask the client to throw the cotton ball in the trash.
- **Consider getting immunized against Hepatitis B.** Your doctor can help you decide whether this is needed.
- **Disinfect tools after each client:**
  1. Wash tools with soap and water. Use a scrub if needed.
  2. Rinse in clean water.
  3. Dry with a clean cloth or towel. It's important to dry.
  4. Immerse tools in an EPA-registered disinfectant. Soak the tools for 10-30 minutes, depending on manufacturer's directions. The disinfectant must be covered at all times.
  5. Dry with a clean cloth or towel.
  6. Store all disinfected items in a clean, covered place.
- **Disinfect foot basins and spas** after each client and at the end of the day. Follow the Board of Barbering & Cosmetology rules (Title 16, California Code of Regulations § 980.1-980.3) for how to clean basins. There are different rules for cleaning whirlpool footspas, pipe-less footspas, and non-whirlpool foot basins. Always use gloves. Always write down the time and date of each cleaning in a pedicure-cleaning log.

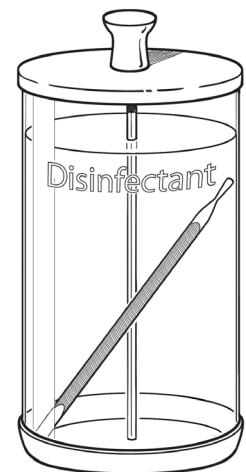

## Tip: Protect yourself when using disinfectant

- Try to avoid using disinfectants that contain quarternary ammonium compounds.
- Let in as much fresh air as possible.
- When disinfecting surfaces like worktables, disinfect only in areas where it is necessary.
- Try to clean surfaces before disinfecting. This can help reduce the amount of disinfectant you use.
- Follow manufacturer's directions for diluting disinfectant with water.

# Your Rights as a Worker



## What is the difference between an Employee and an Independent Contractor?

- There is no set definition of employee or independent contractor. Instead, courts and state agencies will look at a long list of factors to determine whether you are an employee or independent contractor.
- For example, if you: rent a station; purchase all your own supplies and tools; have your own customers and set your own appointments; set your own rate and are paid by customers directly; and have your own business license, you are more likely to be classified as an independent contractor.
- However, if: the owner sets the schedule; you are paid by the hour; the owner or receptionist makes the appointments for all workers; you do not rent the space; the owner sets the rates paid by customers; and you use the owner's tools and equipment, you are more likely to be classified as an employee.

## Why does it matter?

- Employees have the right to workplace health and safety, minimum wage, workers' compensation, and other benefits. Independent contractors do not.
- Just because a salon owner tells you that you are an independent contractor does not mean that you are. And, just because an owner gives you an IRS form 1099 instead of a W-2 does not mean that you are an independent contractor. Salons sometimes misclassify their workers. That is why it is important for you to know the difference between an employee and independent contractor. If you need help, you can contact the CHNSC, LOHP, or a legal services organization.

## What are my workplace health and safety rights?

- As an employee, you can report hazards to Cal/OSHA, a state agency responsible for ensuring the health and safety of workers. Cal/OSHA can come to a worksite if they believe the employer is violating worker health and safety standards. To file a complaint, you can call, fax, or go in person to your local Cal/OSHA office. To find your local office, call 1-866-924-9757 (enter your zip code to find the local office) or visit <http://www.dir.ca.gov/dosh/DistrictOffices.htm>
- As an employee, you also have the right to refuse to do work that would violate a worker health and safety standard and cause a real and apparent hazard to you or other employees. You may not be fired or punished in any way for reporting or making a complaint about unsafe work conditions. If you experience retaliation, you may file a complaint with the Division of Labor Standards Enforcement (also known as the State Labor Commissioner) within six months. For more information, visit <http://www.dir.ca.gov/dlse/dlseDiscrimination.html>
- If you are being paid less than the minimum wage, contact the Division of Labor Standards Enforcement at <http://www.dir.ca.gov/dlse/dlseWagesAndHours.html>.

# For More Information

## **Additional resources:**

- California Healthy Nail Salon Collaborative, “Toxic Trio” brochure, available at [www.cahealthynailsalons.org](http://www.cahealthynailsalons.org)
- California Healthy Nail Salon Collaborative, “Nail Polish Wallet Guide,” available at [www.cahealthynailsalons.org](http://www.cahealthynailsalons.org)
- Cal/OSHA workplace guidance document (forthcoming), available at <http://www.dir.ca.gov/dosh/>
- University of Connecticut Health Center, “I’m Pregnant . . . How Can I Protect Myself and My Pregnancy if I Keep My Job at the Nail Salon?,” available at <http://nailsalonalliance.org/nail-salon-reports/>
- U.S. Environmental Protection Agency, “Protecting the Health of Nail Salon Workers,” available at <http://www.epa.gov/dfeprojects/salon/nailsalonguide.pdf>

## **If you have questions, please contact us at:**

### **California Healthy Nail Salon Collaborative**

818 Webster Street

Oakland, CA 94607

*Julia Liou (510) 986-6830 x267*

*Jessica Huynh (661) 917-5634*

### **Labor Occupational Health Program (LOHP)**

School of Public Health

University of California

2223 Fulton St. 4th Floor

Berkeley, CA 94720-5120

*Helen Chen (510) 643-8119*



LABOR OCCUPATIONAL HEALTH PROGRAM  
UNIVERSITY OF CALIFORNIA, BERKELEY

CALIFORNIA  
*healthy*  
*nail salon*   
COLLABORATIVE