

FOCUS 4

CONSTRUCTION SAFETY & HEALTH

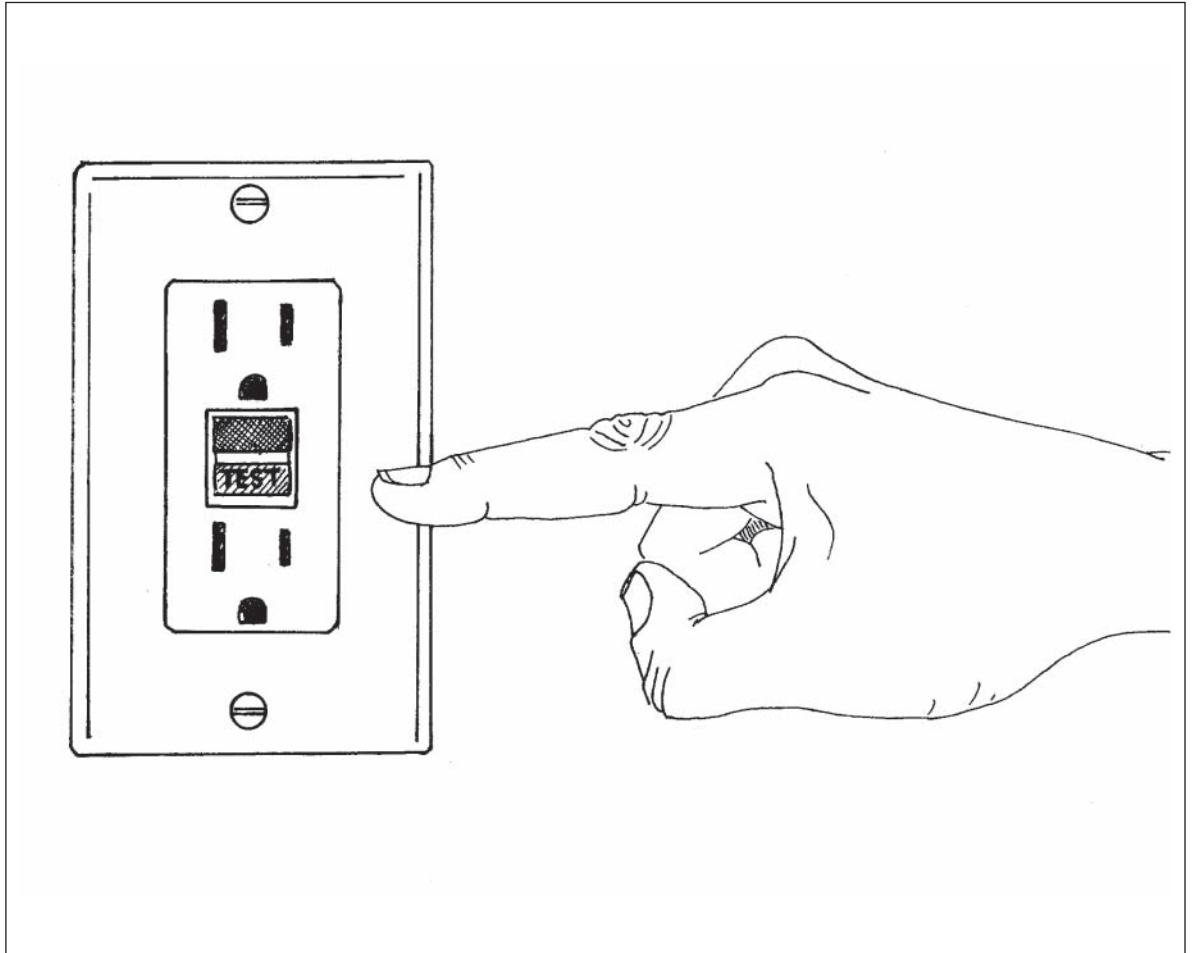

Electrical Safety

Trainer Guide

This material was produced under grant number SH-16586-07-06-F-36 from the Occupational Safety and Health Administration, U.S. Department of Labor. It does not necessarily reflect the views or policies of the U.S. Department of Labor, nor does mention of trade names, commercial products, or organizations imply endorsement by the U.S. Government.

Curriculum on Electrical Safety

GOAL

To provide a basic understanding of how electricity works and how to protect ourselves from common electrical hazards, both on and off the job.

INTRODUCTION

Electrocution is the fourth leading cause of work-related death for construction workers. On average, one worker is electrocuted on the job every day in the United States.

SCOPE AND LIMITATIONS

This training curriculum is primarily designed for workers without any formal training on electricity, although electricians may also benefit from a review. The document focuses on *some* of the fundamentals of electricity, electrical wiring, electric tools, protective methods and devices, and related work methods and safe practices in the construction industry.

The material is presented using an interactive training method.

The curriculum focuses on *common AC wiring*, as found in homes and on construction sites. It also includes information on power line safety.

This curriculum is not all-inclusive. It does not cover every electrical hazard nor does it describe every applicable OSHA electrical standard.

ACKNOWLEDGMENTS

We have drawn extensively from several sources in preparing this material. These include:

- *Electrical Safety for Non-Electricians*, by CSEA/Local 1,000 AFSCME
- *Electrical Safety: Safety and Health for Electrical Trades*, by NIOSH
- Thanks to the Construction Safety Council for permission to use their information on power line safety.
- Various training materials found on OSHA and NIOSH websites.

ELECTRICAL SAFETY

ACTIVITY 1 – GROUNDING

In your small group, read fact sheets A and B, and the following scenario. Then answer the questions below.

SCENARIO:

You encounter a co-worker on a residential remodeling job. She has an older drill with a steel housing and a 3-prong plug. The wiring in the building has only two-slot receptacles – with no “equipment ground” slot. She is just about to break off the grounding prong on the tool’s plug with a pair of pliers when you ask her to stop.

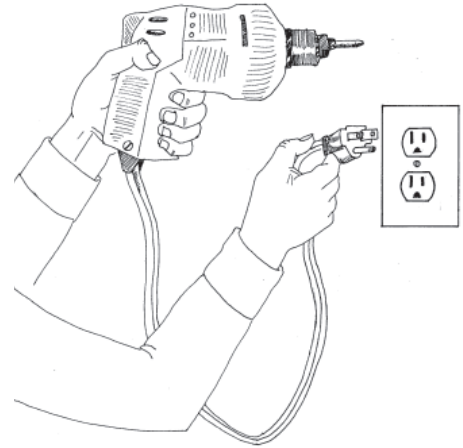

1. What do you say to your co-worker about this problem?

“NEVER break off a grounding prong from a 3-conductor plug. Your tools will still work, but you will have NO PROTECTION from a dangerous electrical shock in the event of an electrical defect in the tool! *Equipment grounding* only works when there is a *permanent and continuous* electrical connection between the metal shell of a tool and the earth.”

“Let’s see what we can do to get you a properly grounded outlet for that drill.”

Safe Work:
GROUNDED tool with
3-prong POLARIZED
plug, GROUNDED
receptacle.

2. What can you do to correct this problem?

You could use a 3-prong adaptor, but this isn’t a great idea unless you really know what you’re doing. Even if you use the adaptor correctly, do you really know if the receptacle and/or its box are properly grounded?

You could also use a grounded generator with a grounded *GFCI outlet*, running *outdoors*, with a *grounded extension cord*, to power your tools.

Finally, you could use low voltage, cordless, rechargeable battery tools.

3. What is the best way to deal with this?

Short term: use the *grounded generator*, as above, or use *cordless, rechargeable battery* operated tools, if you’re really in a hurry.

Longer term: Have an electrician install a grounded outlet.

ACTIVITY 1 – GROUNDING

Factsheet A – Two Ways to Wire an Electric Tool

OSHA CONSTRUCTION INDUSTRY STANDARDS SAY:

1926.302 (a)

Electric power-operated tools.

1926.302 (a) (1)

Electric power operated tools shall either be of the approved double-insulated type or grounded in accordance with Subpart K of this part.

WHAT DOES THAT MEAN?

There are two different ways of wiring an electrical tool: *double insulation* or the use of *equipment grounding*. First of all, the individual wires in the tool and cord are insulated and the cord itself is also insulated. These are the *first level* of insulation.

With the *double insulation* method, the manufacturer provides a *second level* of insulation inside the tool, to reduce the risk of a damaged “hot” wire within the tool (generally at 120 volts AC) from coming in contact with any exposed metal on the tool.

Double insulation protects you by providing another insulation barrier, preventing a wiring defect that could allow an energized conductor to touch any metal on the tool that you can touch. A double insulated tool will be marked on its handle or on a data label with the words “**Double Insulated**” or with a symbol: a square box within a box.

With the *equipment grounding* method, a third wire is added to the tool’s wiring and connected to a round pin on the tool’s plug. The other end of this grounding wire is connected to the metal frame of the tool. The 3-conductor plug on the tool must be plugged into a grounded outlet. The equipment ground connection on the outlet must be connected to a grounding connection at the electrical panel. The steel electrical panel is then connected to the earth. This is generally done via clamping a *system ground* wire to a **METAL** cold water pipe or to ground rods driven into the earth.

Equipment grounding only works when there is a *permanent and continuous* electrical connection between the metal shell of a tool and the earth. If a wiring defect in the tool allows an energized wire to touch the tool’s metal shell, grounding provides a *low resistance path to earth* for the resulting current. This will generally allow enough current to flow so that a fuse will blow or a circuit breaker is tripped, thus turning off the electricity in that circuit. **If this grounding path is broken at any point, the tool is NOT GROUNDED and the operator is at risk of shock or electrocution.**

All electrical tools and equipment must be maintained in safe condition and checked regularly for defects. They must be taken out of service if a defect is found.

ACTIVITY 1 – GROUNDING

Factsheet B – Install a Grounded Outlet

Occasionally you will encounter a building with older wiring, having receptacles with only two slots (called “hot” and “neutral”). These older receptacles don’t contain a round slot for the “equipment ground.” If you have a tool with a 3-prong plug, this is a problem.

The best solution is to have a licensed electrician install one or more *grounded outlets*. Of course, this will take some time and money. Is there anything else you can do instead? Here are three possibilities:

In the United States (but not in Canada) you can buy a *3-prong adaptor*. **This is not a good idea unless you’re sure of what you’re doing.** These adaptors generally come with either a small metal tab (to be attached to the screw securing a receptacle to its box cover) or with a short wire (often with green insulation and a thin, bare lug at the end of the wire). In theory, you can attach the metal tab or the grounding wire to a *grounded* screw in a *grounded* receptacle, thereby getting your *equipment ground* connection. *If you don’t know what you’re doing, such as, if there’s no proper ground at the receptacle, there is no equipment ground, therefore, no protection from electrical shock.*

Another possible alternative is to get your power from a *grounded generator* supplying a 120 volts AC *grounded outlet*. (Of course, your generator must be *outdoors* so hazardous engine exhaust can’t enter your work area, and you’ll need a grounded extension cord.)

Finally, you could do your work with *cordless tools*, operating at a relatively low DC voltage with re-chargeable batteries. This method would eliminate the 120 volts AC electrical hazard you’d otherwise encounter.

NEVER break off a grounding prong from a 3-conductor plug. Your tools will still work, but you will have NO PROTECTION from a dangerous electrical shock in the event of an electrical defect in the tool!

ELECTRICAL SAFETY

ACTIVITY 2 – IMPROPER WIRING / REVERSED POLARITY

In your small group, read fact sheets C and D, and the following scenario. Then answer the questions below.

SCENARIO:

You are a supervisor in a small construction company. A worker passing you in a hallway mentions that he thought he just felt a “tingle” after he plugged in an old floor lamp. He had touched a metal shell, the outside housing around a socket for the light bulb. You ask him to take you to the lamp. You unplug it and notice a two-prong plug, with both prongs the same size. You tell the worker, “I think I know what happened. We’ll get this fixed. Let me explain it to you.”

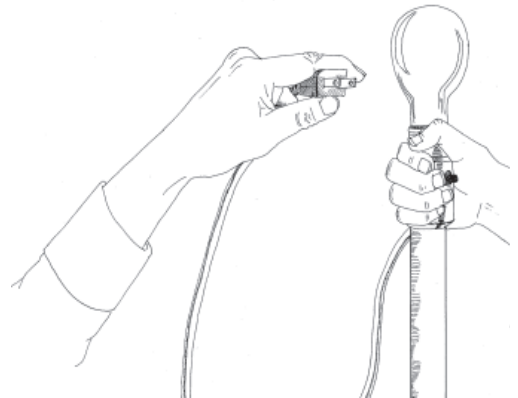

1. What is your explanation to the worker?

You tell the worker, “This plug is inserted “backwards,” that is, the *neutral* on the cord is connected to the *hot* in the receptacle. The hot side is supposed to go to the on/off switch on the lamp. When the switch is turned on, 120 volts should then be present at the center of the bulb’s base, with zero volts at its shell.”

“*With reversed polarity*, you’ll get 120 volts at the screw-in shell of the bulb and the switch will be on the *neutral side*. That’s not good, but it’s not necessarily an immediate problem for you if there’s *insulating material* between the bulb socket and the exterior metal shell of the lamp. However, if the insulation is damaged – or it’s entirely missing – you can get a condition where there’s 120 volts on the metal surface of the lamp as soon as you plug it in. When you touch the lamp, you can get a shock – or worse.”

Possibly Unsafe:

2-prong NON-POLARIZED plug
– could be plugged-in “backwards” and result in electric shock if lamp is defective (see text).

2. What are some steps to deal with this issue?

You can ask an electrician to find the *neutral* side of the lamp cord wire. Then plug it in the right way: hot to hot, neutral to neutral. This would control the immediate hazard. However, the electrician must ensure that there is intact insulation between the outside of the bulb socket and the metal exterior shell of the lamp.

3. What is the best way to correct the problem?

An electrician should install a *polarized* plug (which has a wider neutral blade) on the lamp cord, and fix any other electrical defects in the lamp.

ACTIVITY 2 – IMPROPER WIRING / REVERSED POLARITY

Factsheet C – Conductors, Connections and Polarity

It takes a minimum of two wires to have an electrical circuit. Electric *current* involves the flow of electrons. Current is measured in amperes (*amps* for short). It travels from a source, through the device it operates, called the *load*, and then back to the source.

In AC wiring, present in buildings, there is *voltage* present on the “hot” wire (generally at about 120 volts AC). Voltage provides the force that allows electrons to flow in a circuit. Switches on electrical devices are supposed to be wired only on the *hot* or *live* side of the circuit. The return conductor, known as the *neutral*, is at zero volts because it is deliberately *grounded* at the electrical panel. [See Activity 1 for more about electrical grounding.] The amount of current that flows in a circuit depends on its *electrical resistance*, or opposition to current flow, measured in *ohms*.

In an electrical shock, the amount of electrical **current**, in *amps*, that flows through your body **goes up when resistance** in ohms **goes down**.

The Current in **Amps** = Voltage in **Volts** DIVIDED BY Resistance in **Ohms**.

HIGHER VOLTAGE = *more current (if resistance remains the same)*.

LOWER RESISTANCE = *more current (if voltage remains the same)*.

Newer electric plugs have blades that are **polarized**, so the hot wire on the device is connected to the hot side of the electrical receptacle, and the neutral wire is connected to the neutral side. This is done by making the *neutral* blade on the plug *wider* than the hot blade. If you look at a grounded outlet, you’ll see that the hot slot is shorter than the neutral slot.

Older plugs may not be polarized, and both blades are the same size. It’s best to have an electrician re-wire the device using a polarized plug. The electrician should also ensure that the receptacle is properly wired.

Electricians install *grounded circuits*. They follow OSHA’s *Lockout/Tagout* standard when working on them. Circuits are de-energized and isolated. Stored energy is released and conductors are grounded. De-activated controls are then locked out, and tags are placed at their “off” position.

ACTIVITY 2 – IMPROPER WIRING / REVERSED POLARITY

Factsheet D – Reversed Polarity Can Kill!

What can happen if a *neutral* wire of a device is connected to the hot side of a circuit? This condition is known as *reversed polarity*. In a worst case scenario, the result can be death. However, your electrical device will still work! (It just wants voltage across its load, nothing more.)

There are inexpensive devices known as *circuit testers*, or *polarity testers*. Plug in this 3-prong device and you'll know at a glance if there's a wiring problem in the receptacle, just by looking at which lights are lit on the device. The two most dangerous conditions are: **hot and ground reversed**, and **hot and neutral reversed**.

In 1990, a Maryland worker was **killed by reversed polarity** on a defective toaster oven with a two-blade, non-polarized plug. His hand touched its *energized* (120 volts AC) metal shell, while his leg touched the grounded housing of an air conditioner.¹ See the following diagram.

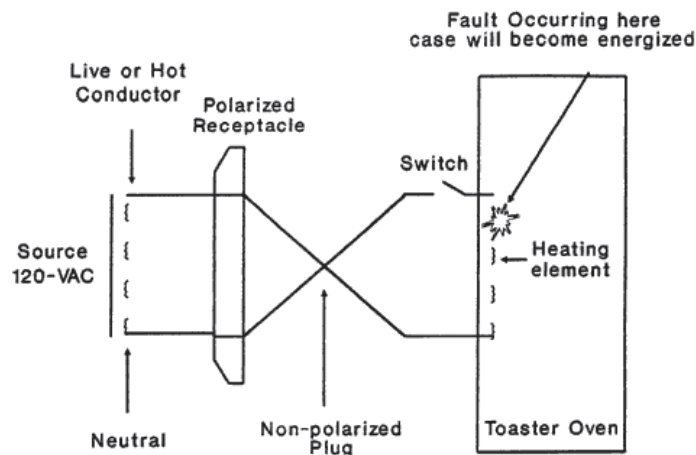

When the Live/hot conductor and Neutral wire are reversed, the current path is also reversed.

¹ NIOSH FACE Report 90-37, <http://www.cdc.gov/niosh/face/In-house/full9037.html>

ELECTRICAL SAFETY

ACTIVITY 3 – WET CONDITIONS / GROUND FAULT CIRCUIT INTERRUPTERS

In your small group, read fact sheets E and F, and the following scenario. Then answer the questions below.

SCENARIO:

You're an experienced worker in building maintenance, helping a new worker to learn the job. The task involves cleaning up a flooded basement. The new employee has started setting up electrical cords and tools for the job. You tell her, "Hold on a minute, let's check out the wiring first." Then you say, "No, we can't do this without GFCI protection. I'll tell you why."

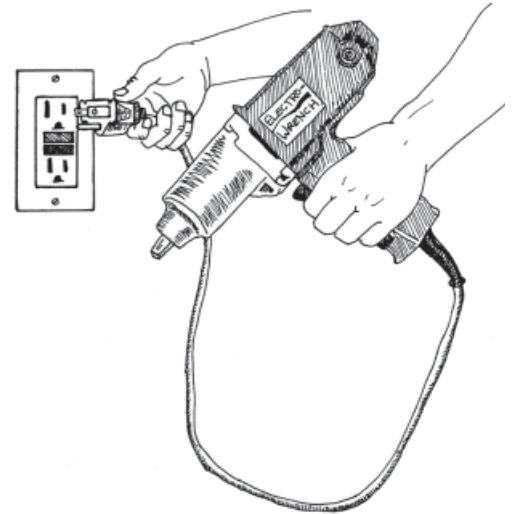

Safe Work:
GROUNDED tool, 3-prong POLARIZED plug, GFCI receptacle.

1. What would you tell the new employee?

"You need to take extra precautions any time you're using electrical equipment around water. If your skin is wet for ANY reason (flooding, raining, or sweating), your electrical resistance in ohms goes down. As your **resistance goes down**, any **current (amps)** that may flow through your body **will go up**. A *milliamp (mA)* = 1/1,000 of 1 Amp."

"It doesn't take a lot of current to kill you, especially if it flows through your heart. Currents above *75 milliamps (mA)* – quite common in wet conditions – can cause *ventricular fibrillation*, which can be fatal."

"GFCIs, which compare currents on the *hot* and *neutral* sides of a circuit, will trip and shut off electricity, within 1/40 of a second, if there is a difference between the two currents (*current leakage*) of about *5 mA* (such as current flowing in your body)."

2. What can you do to correct this problem for now?

Check to see if there are any permanently wired *GFCI receptacles*, or if there are *GFCI-protected receptacles*. If not, you should use a *plug-in GFCI* or a *GFCI extension cord*.

If you are working on a site with *temporary wiring*, and if the employer has not provided GFCI or GFCI-protected receptacles, you should bring your own plug-in GFCI outlet or GFCI extension cord. **Test your GFCI every time you use it. It must TRIP when you press "Test" and it must ENERGIZE when you press "Reset."**

3. What is the best way to deal with this in the future?

Get the employer or building owner to install GFCI outlets or GFCI-protected outlets in all wet or damp areas: bathrooms, kitchens, basements, outdoor circuits.

Factsheet E – Using Electrical Equipment in Wet Locations

Using electrical tools or equipment in wet areas can be a hazard. If your skin is dry, it has quite a lot of *resistance* (measured in *ohms* or Ω). However, if your skin is wet for any reason (rain, sweat, standing in a puddle of water), the skin's electrical resistance drops dramatically. The amount of electrical **current**, in *amps*, that flows through your body **goes up when resistance in ohms goes down. Amps = Volts/Ohms.**

The Current in **Amps** = Voltage in **Volts** DIVIDED BY Resistance in **Ohms**.

HIGHER VOLTAGE = *more current (if resistance remains the same).*

LOWER RESISTANCE = *more current (if voltage remains the same).*

HOW MUCH CURRENT DOES IT TAKE TO KILL ME?

It doesn't take much, especially if it passes through your heart. Currents above about *75 milliamps (mA)* can cause a condition called *ventricular fibrillation*. (A milliamp is 1/1,000 of 1 amp.) If your heart goes into fibrillation, it beats very rapidly – but it doesn't pump any blood – because it's not beating in its normal rhythm. If your blood can't carry oxygen to your brain, you'll experience brain death in 3 to 4 minutes. The way to get you back involves another electric shock, from a *defibrillator*.

If your skin is wet and you get your body across 120 volts of electricity, it's very likely that you'll have a current of 100 mA or more flowing through your heart. **Currents ABOVE 10 MA** can cause *muscle paralysis*. You may not be able to let go of energized tools or equipment. **Shocks that are longer in duration are more severe.**

Electrical systems must be wired with either *fuses* or *circuit breakers*. These devices are known as *overcurrent protection* and they are rated in amps. Most common household circuits are wired for 15 amps or 20 amps. **Overcurrent protection devices protect wiring and equipment from overheating and fires.** They may – or may not – protect you from electrical shock. If the current isn't high enough, the fuse won't blow or the circuit breaker won't trip. You could be shocked or killed without ever blowing a fuse or tripping a circuit breaker.

Factsheet F – GFCIs to the Rescue

A great breakthrough in electrical safety came with the invention of the *ground fault circuit interrupter (GFCI)*. A *ground fault* occurs when electrical current flows on a path where it's not supposed to be. Under normal conditions, current flows in a circuit, traveling from the source, through the device it operates, called the *load*, and then back to the source. [See Activity 2 for more about wiring of electrical circuits.]

Current (amps) flows out to the load from the “hot” side (which is generally at 120 volts AC) and returns on the “neutral” side (which is at zero volts). Under normal conditions, these two currents (hot and neutral) are equal. If they are not equal, because of *current leakage* (current returning on a different path than the neutral conductor), we get a ground fault. This can occur if current flows through your body and returns to the source through a path to ground. **Electricity will take ANY available path to return to its source.** We want it to return only on the neutral.

The ground fault circuit interrupter (GFCI) works by using the above principles. It measures total current on the hot side and total current on the neutral side of the circuit. They are supposed to be equal. If these two currents differ from each other by *more than 5 milliamps* (plus or minus 1 mA), the GFCI acts as a fast-acting circuit breaker and shuts off the electricity within 1/40 of 1 second. You can still feel this small amount of current, but it will quickly shut off.

GFCIs are manufactured in many forms. The most common one is the GFCI outlet. However, there are also GFCI circuit breakers, plug-in GFCI outlets and GFCI extension cords, as well as GFCIs hard-wired into devices such as hair dryers. All types have “Test” and “Reset” functions. **The GFCI must trip when you press the “Test” button. It must also energize the circuit when you press “Reset.” If either test fails, you must replace the GFCI in order to be protected!**

ELECTRICAL SAFETY

ACTIVITY 4 – EXTENSION CORDS, COPPER AND CURRENT

In your small group, read fact sheets G and H, and the following scenario. Then answer the questions below.

SCENARIO:

You're at work one day and a co-worker starts screaming: It looks like his saw is smoking, it smells like it's burning and his extension cord is getting hot enough to burn his hand. You walk over, take one look at the scene and start shaking your head. "Well, I know what your problem is, and I'll explain if you stop shouting," you tell him.

1. What is your explanation to the worker?

"The wires in your extension cord aren't heavy enough for the *electrical load* (in *amps*) from your saw. If there is too much current flowing through a wire that's not heavy enough, the wire will heat up and it could cause a fire."

"If the extension cord wire is too small, and ESPECIALLY if it's a long extension cord, you may also get a *voltage drop* across the extension cord. In such a case, the cord could act as a *series resistor*, resulting in lower voltage for your tools. This lower voltage could damage your equipment."

"You need to match the *rating* of the extension cord (either in *amps* or in *watts*), with the current which the tool uses. (**Watts DIVIDED BY volts = amps.**)"

2. What are some steps to deal with this issue?

All workers should get some basic training on electrical safety. They need to know about the problems and hazards which could result from *overloaded conductors*. Overloaded extension cords will heat up and *may cause a fire*, even if total circuit current isn't high enough to blow a fuse or trip a circuit breaker.

You should read operator's manuals for electric tools. They often have tables showing the wire size needed for extension cords of various lengths.

3. What is the best way to correct the problem?

Ideally, the employer should supply all necessary electrical devices, including UL approved, properly rated, *grounded* extension cords.

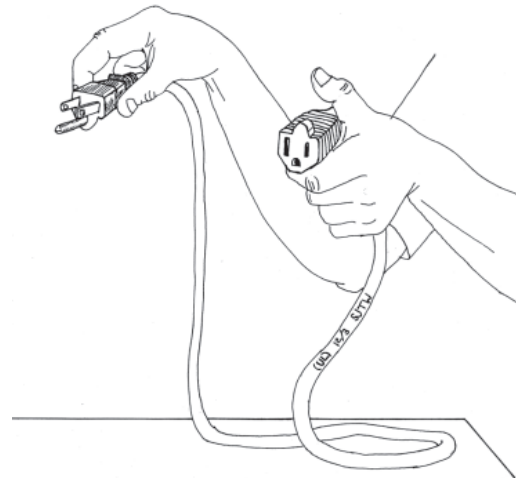

Safe Work: UL approved, 3-conductor, GROUND^{ED} extension cord, #12 wires.

ACTIVITY 4 – EXTENSION CORDS, COPPER AND CURRENT

Factsheet G – Wire Size and Ampacity

In terms of conducting electrical current, size matters: the size of the electrical conductor. Take a look at the following table regarding *ampacity*, the current carrying capacity of a conductor in amps. You'll notice two things: the **amount of current** a wire can safely carry **increases** as the **diameter** (and area) of the wire increases and as the number of the **wire size decreases**. Welcome to the American Wire Gauge (AWG).

AWG Copper Wire Table

Copper Wire size (AWG)	Diameter (mils)	Area (Circular mils)	Ampacity in free air	Ampacity as part of 3-conductor cable
14 AWG	64.1	4109	20 Amps	15 Amps
12 AWG	80.8	6529	25 Amps	20 Amps
10 AWG	101.9	10,384	40 Amps	30 Amps
8 AWG	128.5	16,512	70 Amps	50 Amps

BUT I DON'T WANT TO BE AN ENGINEER...

Hey, neither do I, but this stuff is important. Notice that a #8 wire is *twice the diameter*, but *four times the area* of a #14 wire. There are a couple of practical applications here. For one thing, the gauge of the wire determines the rating of a fuse or circuit breaker in amps. A circuit wired with #14 copper will get a 15 amp circuit breaker. A circuit with #12 copper can get a 20 amp breaker; #10 copper can be 30 amps, and so on.

The second thing to consider is that it's possible to create a fire hazard by *overloading an extension cord*. This occurs when too much current is flowing in a conductor that's not heavy enough for the electrical load in amps. The circuit can be properly wired and its circuit breaker correctly rated, but if too much current flows through an extension cord whose wires are too small, the cord will heat up. Sometimes there is also a *voltage drop* over a longer extension cord, which could damage your tools.

ACTIVITY 4 – EXTENSION CORDS, COPPER AND CURRENT

Factsheet H – Extension Cord Facts

With the wide use of power tools on construction sites, flexible extension cords often are necessary. Because they are exposed, flexible, and unsecured, they are more susceptible to damage than is fixed wiring. Hazards are created when cords, cord connectors, receptacles, and cord- and plug-connected equipment are improperly used and maintained. **Here are some factors on extension cord safety noted by OSHA.**

STRAIN RELIEF

- To reduce hazards, flexible cords must connect to devices and to fittings in ways that prevent tension at joints and terminal screws. Flexible cords are finely stranded for flexibility, so straining a cord can cause the strands of one conductor to loosen from under terminal screws and touch another conductor.



CORD DAMAGE

- A flexible cord may be damaged by door or window edges, by staples and fastenings, by abrasion from adjacent materials, or simply by aging. If the electrical conductors become exposed, there is a danger of shocks, burns, or fire. **Replace frayed or damaged cords. Avoid running cords over sharp corners and edges.**

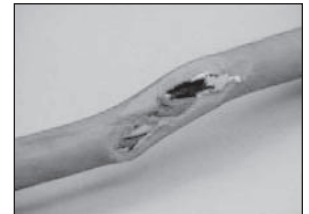

DURABILITY

- The OSHA construction standard requires flexible cords to be rated for hard or extra-hard usage. These ratings are derived from the National Electrical Code, and are required to be indelibly marked approximately every foot along the length of the cord. Examples of these codes are: S, ST, SO, and STO for hard service, and SJ, SJO, SJT, and SJTO for junior hard service.

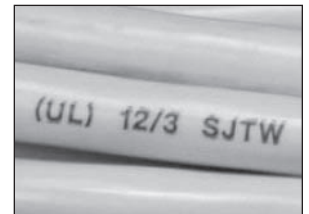

GROUNDING

- Extension cords must be 3-wire type so they may be grounded, and to permit grounding of any tools or equipment connected to them.

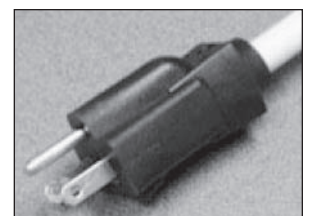

WET CONDITIONS

- When a cord connector is wet, electric current can leak to the equipment grounding conductor, and to humans who pick up that connector if they provide a path to ground. Such leakage can occur not just on the face of the connector, but at any wetted portion. Limit exposure of connectors and tools to excessive moisture by using watertight or sealable connectors.

NOTE: This page is adapted from OSHA eTool: Construction, Electrical Hazards, Flexible cords.

ELECTRICAL SAFETY

ACTIVITY 5 – “IT’S ONLY 120 VOLTS”

In your small group, read fact sheet I, and the following scenario. Then answer the questions below.

SCENARIO:

You are on a construction site in the morning after it rained all night, and there is some standing water on the ground. A co-worker is setting up his job, running an extension cord he built himself. He has used a 3-prong replacement plug, a length of 3-conductor Type NM non-metallic cable and a 3-conductor receptacle mounted in steel utility box. You see this and say, “Hey, you really need to be using a UL approved, factory made, grounded extension cord out here.” He replies, “I’ve used this set-up for years and never had any trouble. It’s not that dangerous, it’s only 120 volts. Anyway, it’s the current that kills you, not the voltage.”

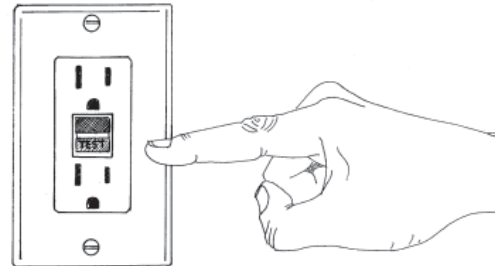

Safe Work: TEST A GFCI OUTLET – every time you use it – to be sure it works!

1. What would you say to this worker?

“Using electrical tools or equipment in wet areas can be a hazard. People have been killed by 120 volts of electricity while using homemade equipment, like your extension cord. If your skin is dry, it has quite a lot of *resistance* (measured in *ohms* or Ω). If your skin is wet (rain, sweat, standing in water), its electrical resistance drops dramatically. The electrical **current**, in *amps*, that flows in your body **goes up when resistance in ohms goes down**. **Amps = Volts/Ohms**. A *milliamp (mA)* = 1/1,000 of 1 Amp.”

“**Currents above 75 milliamps (mA) can lead to a condition called ventricular fibrillation, which can be fatal.** This level of current is common in wet conditions.”

“An electrical device called a *Ground Fault Circuit Interrupter (GFCI)* can save your life. It will trip and turn off the electricity when it detects *current leakage* as low as 5 mA, acting within 1/40 of a second. You should plug a UL approved extension cord into a GFCI outlet. **It’s important to test your GFCI every time you use it, so you know it will protect you. It must TRIP when you press “TEST.” It must also “Reset.”**”

2. What can you do to correct this problem for now?

Ask the worker how much his life is worth. Tell him that he can’t use his homemade cord. He needs a UL approved, correctly rated and *properly grounded* extension cord.

3. What is the best way to deal with this in the future?

You should get the employer to provide all needed electrical equipment, including GFCI receptacles and UL approved, correctly rated, and properly grounded extension cords.

ACTIVITY 5 – “IT’S ONLY 120 VOLTS”

Factsheet I – 120 Volts Can Kill!

Ordinary, household, 120 volts AC electricity is dangerous and it can kill. *Voltage* is the force that allows electricity to flow in a circuit. Electrical *current* involves the flow of electrons and it’s measured in *amps*. The third factor involved in current flow is *resistance*, the opposition to current flow, measured in *ohms*. We can use a simple formula to calculate the current: Current in **Amps** = Voltage in **Volts** DIVIDED BY Resistance in **Ohms**.

Using electrical tools or equipment in wet areas can be a hazard. If your skin is dry, it has quite a lot of *resistance* (measured in *ohms* or Ω). However, if your skin is wet for any reason (rain, sweat, standing in a puddle of water), the skin’s electrical resistance drops dramatically. The amount of electrical **current**, in *amps*, that flows through your body **goes up when resistance in ohms goes down. Amps = Volts/Ohms**.

If your skin is wet and you get your body across 120 volts of electricity – possibly from an electrical defect in a homemade extension cord – it’s very likely that you’ll have a current of *100 milliamps (mA)* or more flowing through your heart. (1 mA is 1/1,000 of 1 amp.) At 100 mA, you may not be able to let go of an energized tool or piece of equipment. **Currents above 75 milliamps (mA) can lead to a condition called *ventricular fibrillation*, which can be fatal.**

[See Activity 4 for more information on extension cord hazards.]

A major safety precaution when working under wet conditions is using an electrical device called a *Ground Fault Circuit Interrupter (GFCI)*. A properly wired and tested GFCI can save your life. It will trip and turn off the electricity when it detects *current leakage* as low as 5 mA. You should consider bringing and using your own plug-in GFCI receptacle or GFCI extension cord, especially if there is any question about the condition of electrical wiring at your site. **It’s important to test your GFCI every time you use it, so you know it will protect you.**

[See Activity 3, more about wet conditions, electrical hazards and GFCIs.]

ELECTRICAL SAFETY

ACTIVITY 6 – POWER LINE HAZARDS

In your small group, read fact sheet J (pages 17-20), and read the following scenario. Then answer the questions below.

SCENARIO:

You are the “competent person”² at a company that constructs and dismantles scaffolds, and you are reviewing an upcoming job with your crew. You mention that this job will require extra care because the scaffold will need to be close to a nearby power line and you will need to take necessary precautions. One of your crew says, “We shouldn’t even take on a job like that. There are lots of cases where people on scaffolds have been electrocuted. Why should we take chances with our lives?” You reply, “Yes, it can be dangerous, but there are ways to remove or control the hazard. I’ll explain it to you guys.”

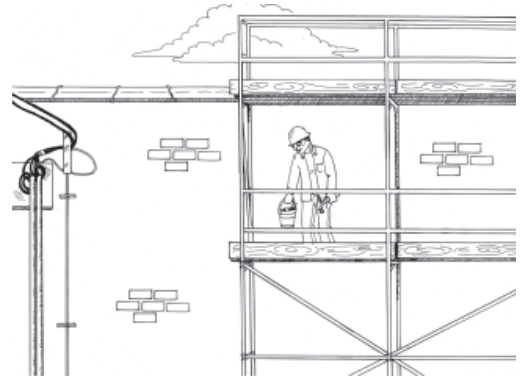

Safe Work: Scaffold must be AT LEAST 10 FEET from the power line.

1. What would you say to your crew?

“There are three major ways we can protect ourselves from power line hazards:

1. Maintaining a *safe distance* from the lines,
2. Having the power company *de-energize* and *ground* the lines,
3. Having the power company *install insulating sleeves* on the lines.

We will always consult the power company. If we have to go with options 2 or 3, we will have a power company rep on site and follow all instructions.”

2. What can you do to protect yourselves from power line hazards?

First of all, you can get all of your crew trained regarding power line hazards and about the available protective measures. Next, you can always keep your co-workers fully informed about what jobs may have electrical hazards, and the measure(s) you will take to control the hazards. Also, tell the workers that they should always ask questions if they have any doubts about maintaining safe working conditions.

3. In your opinion, what is the best way to deal with power line hazards, the second best, and so on?

In my own opinion: 1) Maintaining a safe distance, 2) De-energizing and grounding lines, and, 3) Installing insulating sleeves on lines. (See #1 about the power company.)

² A “competent person” (required by certain OSHA standards) must be able to recognize existing and predictable hazards, and must be authorized by the employer to take action to correct unsafe conditions.

ACTIVITY 6 – POWER LINE HAZARDS

Factsheet J – Power Lines Kill Workers

Most people know that power lines can kill, yet a surprising number of power line deaths occur on a regular basis. Electricity is generated and transmitted at high voltages for a good reason: it limits power loss as the electricity travels long distances from power plant to point of use. Power lines can be at tens of thousands of volts, even at hundreds of thousands of volts: the higher the voltage, the greater the potential danger.

Problems occur when people or equipment get too close to energized lines. Some of the most common situations that occur are:

- *Contacting lines* with cranes and other construction equipment
- *Hitting a line* when erecting or moving a scaffold
- *Getting too close* with a ladder or a tool, especially a *conductive* one, such as aluminum or wood.

There are three major ways to control power line hazards:

1. Maintaining a *safe distance* from lines.
2. Having the power company *de-energize and ground* the power line(s). **Have a power company rep at the site!**
3. Having the power company install *insulated sleeves* (also known as “eels”) over power lines. (See the above item.)

NOTE: Only the electric power utility can determine the clearance distance for this method of *insulating lines*.

Factsheet J continued...

NOTE: The information on pages 18 and 19 was adapted from material developed by the **Construction Safety Council.**

Staying away from power lines is the best option. The following illustration shows the safe power line clearance distance, as well as the working clearance distance. The table shows clearance distances from power lines for various line voltages.

NOTE: The term kV = 1,000 volts. For example, 50 kV = 50,000 volts.

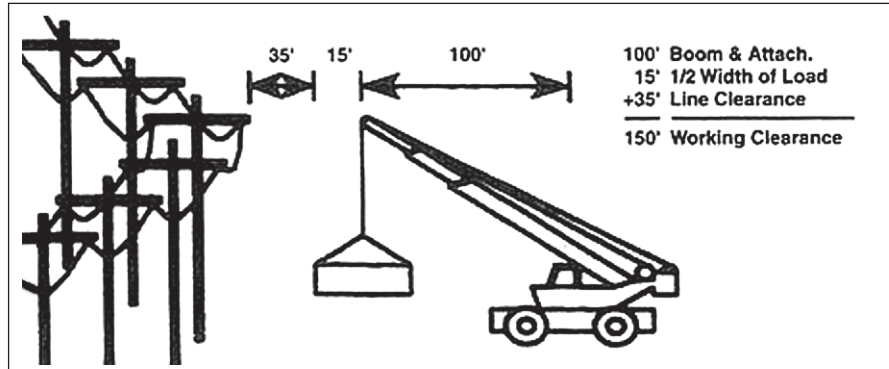

Power Line Clearance Distances

Voltages	Distances from Power Lines
≤ 50kV	10 feet
200 kV	15 feet
350 kV	20 feet
500 kV	25 feet
650 kV	30 feet
800 kV	35 feet

The best and easiest way, is to follow this rule:

- Up to 50 kV – Stay at least 10 feet away
- Over 50 kV – Stay at least 35 feet away

Factsheet J continued...

PREVENTIVE MEASURES

GENERAL

- Move equipment/activity to the safe working distance from power lines.
- Have utility de-energize and visibly ground power lines.
- Have utility move power lines to the safe working distance.
- Have utility install insulated sleeves on power lines.*
- Install flagged warning lines to mark horizontal and vertical power line clearance distances.
- Use nonconductive tools and materials.

CRANES AND OTHER HIGH REACHING EQUIPMENT

- Use an observer.*
- Use an insulated link, if applicable.*
- Use a boom cage guard, if applicable.*
- Use a proximity device, if applicable.*

MOBILE HEAVY EQUIPMENT

- Install rider posts or goal posts under power lines.
- Install warning signs at driver's eye level.

* *These options DO NOT allow the operator to work closer than the line clearance distance.*

LADDERS

- Use nonconductive ladders.
- Don't carry or move extension ladders fully extended. Retract before moving.
- Get help moving ladders to maintain control.

MATERIAL STORAGE

- Don't store any materials under power lines.
- Use caution tape and signs to cordon off area under power lines.

EXCAVATIONS

- Call 811 to contact your local one-call service several days before you dig to locate all *underground cables*.
- Hand dig within three feet of cable location.
- Be aware that more than one underground cable may be buried in area of locator markings.

**Remember: The Only safe power lines are the ones that don't exist.
CALL 811 BEFORE YOU DIG!**

Factsheet J continued...

POWER LINE PHOTOS: UNPROTECTED AND PROTECTED

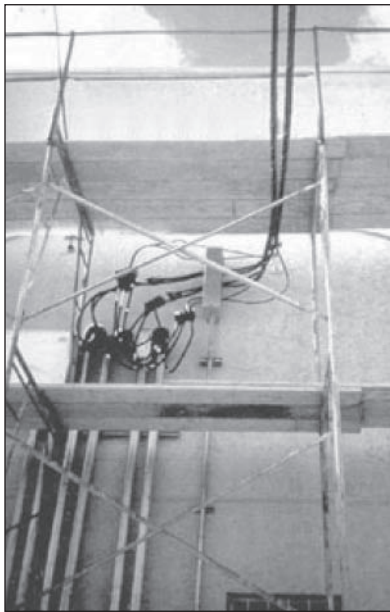

There is a hazard of shock or electrocution: scaffold and platform are less than 10 feet away from these power lines.



This scaffold has been protected from electrical hazards: three power lines at the top have been de-energized, jumpered together and then electrically grounded by the power company.



This power company worker is placing insulated sleeves ("eels") over the power line in this photo.

ELECTRICAL SAFETY SUMMARY

1. **CORD AND PLUG OPERATED** electric tools with exposed metal parts must have a *three-prong grounding plug* – **AND be grounded** – or else be *double-insulated*.
2. **EQUIPMENT GROUNDING** only works when there is a *permanent and continuous* electrical connection between the metal shell of a tool and the earth.
3. **PROPER POLARITY IN ELECTRICAL WIRING IS IMPORTANT:** hot to hot, neutral to neutral, equipment ground to equipment ground. *Polarized plugs* have a wider neutral blade to maintain correct polarity. **Reversed polarity can kill.**
4. **CIRCUITS MUST BE EQUIPPED WITH FUSES OR CIRCUIT BREAKERS** to protect against dangerous overloads. Fuses melt, while circuit breakers trip to turn off current like a switch. **Overcurrent protection devices protect wiring and equipment from overheating and fires.** They may, or may not, protect you.
5. **MOST 120 VOLT CIRCUITS** are wired to deliver up to 15 or 20 amps of current. Currents of **50-100 milliamperes** can kill you. (1 mA = 1/1,000 of 1 Amp.)
6. **WET CONDITIONS LOWER SKIN RESISTANCE**, allowing more current to flow through your body. Currents *above 75 milliamps* can cause *ventricular fibrillation*, which may be fatal. Severity of a shock depends on: *path* of current, *amount* of current, *duration* of current, *voltage* level, *moisture* and your *general health*.
7. **A GROUND FAULT CIRCUIT INTERRUPTER (GFCI)** protects from a *ground-fault*, the most common electrical hazard. GFCIs detect differences in current flow between hot and neutral. They trip when there is *current leakage* – such as through a person – of about **5 milliamperes** and they act within **1/40 of a second**. **Test a GFCI every time you use it. It must “Trip” and it must “Reset.”**
8. **EXTENSION CORD WIRES MUST BE HEAVY ENOUGH** for the amount of current they will carry. For construction, they must be UL approved, have strain relief and a 3-prong grounding plug, be durable, and be rated for hard or extra-hard usage.
9. **OVERHEAD POWER LINES CAN KILL.** The three major methods of protection are: maintaining a *safe distance*, *de-energizing AND grounding lines*, having the power company install *insulating sleeves*. **Have a power company rep on the site.**
10. **UNDERGROUND POWER LINES CAN KILL.** Call before you dig to locate all underground cables. Hand dig within three feet of cable location!

APPENDIX A

Condensed Electrical Glossary

AMPERE OR AMP: The unit of electrical *current* (flow of electrons).

- One *milliamp* (mA) = 1/1,000 of 1 Amp.

CONDUCTORS: Materials, such as metals, in which electrical current can flow.

ELECTRICAL HAZARDS can result in various effects on the body, including:

- **SHOCK** – The physical effects caused by electric current flowing in the body.
- **ELECTROCUTION** – Electrical shock or related electrical effects resulting in death.
- **BURNS** – Often occurring on the hands, thermal damage to tissue can be caused by the *flow of current* in the body, by *overheating* of improper or damaged *electrical components*, or by an *arc flash*.
- **FALLS** – A common effect, sometimes caused by the body’s reaction to an electrical current. A non-fatal shock may sometimes result in a fatal fall when a person is working on an elevated surface.

EXPOSED LIVE PARTS: Energized electrical components not properly enclosed in a box or otherwise isolated, such that workers can touch them and be shocked or killed. Some of the common hazards include: missing knockouts, unused openings in cabinets and missing covers. Covers must not be removed from wiring or breaker boxes. Any missing covers must be replaced with approved covers.

INSULATORS: Materials with high electrical resistance, so electrical current can’t flow.

LOCKOUT/TAGOUT: The common name for an OSHA standard, “*The control of hazardous energy (lockout /tagout)*.” **Lockout** is a means of controlling energy during repairs and maintenance of equipment, whereby energy sources are *de-energized*, *isolated*, and then *locked out* to prevent unsafe start-up of equipment which would endanger workers. *Lockout* includes – but is not limited to – the control of electrical energy. **Tagout** means the placing of warning tags to alert other workers to the presence of equipment that has been locked out. Tags alone **DO NOT LOCK OUT** equipment. **Tagout is most effective when done in addition to lockout.**

OHM or Ω : The unit of *electrical resistance* (opposition to current flow).

OHM’S LAW: A mathematical expression of the relationship among *voltage* (volts), *current* (amps) and *resistance* (ohms). This is often expressed as: $E = I \times R$. In this case, E = volts, I = amps and R = ohms. (The equation, Amps = Volts/Ohms, as used in this curriculum, is one form of Ohm’s Law.)

VOLT: The unit of *electromotive force (emf)* caused by a *difference in electrical charge or electrical potential* between one point and another point. **The presence of voltage is necessary before current can flow in a circuit** (in which *current* flows from a *source* to a *load* – the equipment using the electricity – and then back to its source).

WET CONDITIONS: Rain, sweat, standing in a puddle – all will decrease the skin’s electrical resistance and increase current flow through the body in the event of a shock. **Have a qualified electrician inspect any electrical equipment that has gotten wet before energizing it.**

APPENDIX B

General Rules for Construction Electrical Safety

MAJOR PROTECTIVE METHODS FROM ELECTRICAL HAZARDS

Protection from electrical hazards generally includes the following methods:

1. **DISTANCE:** Commonly used with regard to power lines.
2. **ISOLATION AND GUARDING:** Restricting access, commonly used with high voltage power distribution equipment.
3. **ENCLOSURE OF ELECTRICAL PARTS:** A major concept of electrical wiring in general, e.g., all connections are made in a box.
4. **GROUNDING:** Required for all non-current carrying exposed metal parts, unless isolated or guarded as above. (However, corded tools may be either *grounded* **OR** be *double-insulated*.) [See Activity 1 for more about electrical grounding.]
5. **INSULATION:** Intact insulation allows safe handling of everyday electrical equipment, including corded tools. Category also includes insulated mats and sleeves.
6. **DE-ENERGIZING AND GROUNDING:** Protective method used by electrical utilities and also in conjunction with electrical lockout/tagout.
7. **PERSONAL PROTECTIVE EQUIPMENT (PPE):** Using insulated gloves and other apparel to work on energized equipment, limited to qualified and trained personnel working under very limited circumstances.

GENERAL RULES FOR ELECTRICAL WORK

- *Non-conductive PPE is essential for electricians. NO METAL PPE!*

Class B hard hats provide the highest level of protection against electrical hazards, with high-voltage shock and burn protection (up to 20,000 volts). *Electrical hazard, safety-toe shoes* are nonconductive and will prevent the wearers' feet from completing an electrical circuit to the ground.

- *Be alert to electrical hazards*, especially when working with *ladders, scaffolds and other platforms*.
- *Never bypass electrical protective* systems or devices.
- *Disconnect cord tools* when not in use and when changing blades, bits or other accessories.
- *Inspect all tools* before use.
- *Use only grounded extension cords*.
- *Remove damaged* tools and damaged extension cords from use.
- *Keep working spaces and walkways clear* of electrical cords.

RULES FOR TEMPORARY WIRING AND LIGHTING

- *Use Ground Fault Circuit Interrupters (GFCIs)* on all 15-Amp and 20-Amp temporary wiring circuits.
- *Protect temporary lights* from contact and damage.
- *Don't suspend temporary lights by cords*, unless the temporary light is so designed.

NOTES

Training Evaluation – Focus 4 Construction Safety & Health

ELECTRICAL HAZARDS

Date:

Location:

Trainer:

1. Overall, how would you rate this training?

Excellent Good Fair Poor

2. Were the teaching methods (activities, exercises) effective?

Yes No Not sure

3. Were the handouts and materials useful?

Yes No Not sure

4. Will the information you received in this workshop be useful on your job?

Yes No Not sure

5. What did you like most about this training?

6. What did you like least about this training?

7. Please feel free to make additional comments or to suggest ways to improve the training.
