

Structural and Foundation Response Measured During the Site Specific Load Test on the London Avenue Outfall Canal I-Wall/Levee

Contract No. W912P9-05-D-0514, Task Order 6

Prepared for:

United States Army Corps of Engineers



Prepared by

URS

ARCHITECTS-ENGINEERS-PLANNERS

November 20, 2007

TABLE OF CONTENTS

EXECUTIVE SUMMARY	ES-1
SECTION 1 INTRODUCTION	1-1
1.1 Authorization	1-1
1.2 Project Objective.....	1-1
1.3 Purpose.....	1-1
SECTION 2 PRE-INSTALLATION ACTIVITIES	2-1
SECTION 3 ADAS EQUIPMENT INSTALLATION AND PRE-TEST SYSTEM TESTING.....	3-1
SECTION 4 INSTRUMENTATION MONITORING.....	4-1
4.1 Overview.....	4-1
4.2 Surface Water Levels.....	4-1
4.2.1 Staff Gages.....	4-1
4.2.2 Electronic Pressure Transducers	4-2
4.3 Piezometers	4-2
4.4 Crackmeters	4-4
4.4.1 Electronic Crackmeters	4-4
4.4.2 Manual Crackmeters	4-4
4.5 Inclinometers.....	4-4
4.6 Pressure Cells.....	4-5
4.7 Conventional and Robotic Survey	4-6
4.7.1 Survey Prisms	4-7
4.7.2 Survey Monuments with Prisms	4-7
4.8 Telltales.....	4-8
4.9 Tiltmeters	4-8
4.10 IP Video Cameras	4-9
SECTION 5 INTERIM AND FINAL DEMOBILIZATION.....	5-1
SECTION 6 CONCLUSIONS.....	6-1

List of Tables

Table 3.1 Instrumentation Schedule

Table 4.1 Sign Convention of Instrumentation

TABLE OF CONTENTS

List of Figures

Figure 1.1	General Site Location Plan
Figure 3.1	Instrumentation Plan View
Figure 3.2	Instrumentation Profile Drawing
Figure 3.3	I-Wall Instrumentation Elevation View
Figure 3.4	Site Photographs
Figure 3.5	Data Flow Diagram
Figure 3.6	Photographs of Inside of Instrumentation Trailer
Figure 3.7	Photographs of Dataloggers
Figure 3.8	Datalogger Wiring Diagram
Figure 3.9	Datalogger Wiring Diagram
Figure 3.10	Graphical Alarm Threshold Display
Figure 3.11	Photograph of Initial Computer Set-Up
Figure 4.1	Photograph of Cofferdam at Water Elevations 1.0 and 2.0 ft
Figure 4.2	Photograph of Cofferdam at Water Elevations 4.0 and 7.0 ft
Figure 4.3	Photograph of Surface Water Level Gages
Figure 4.4	Photographs of Piezometers
Figure 4.5	Photograph of Manual Crackmeter
Figure 4.6	Photographs of In-Place Inclinerometers
Figure 4.7	Photographs of Earth Pressure Cells
Figure 4.8	Photographs of Prisms and Survey Monuments with Prisms
Figure 4.9	Photograph of Robotic Survey Devices
Figure 4.10	Photographs of Telltale and Vibrating Wire Crackmeter
Figure 4.11	Photographs of Telltale Mounting
Figure 4.12	Photograph of Vibrating Wire Tiltmeter
Figure 4.13	Photograph of Camera
Figure 4.14	Surface Water Levels and Piezometric Time Series Plots
Figure 4.15	Phase I Phreatic Surface Profile
Figure 4.16	Phase II Phreatic Surface Profile
Figure 4.17	Surface Water Levels (SWLs), Tiltmeters, and Crackmeters
Figure 4.18	Canal Side Crackmeters with Tiltmeters
Figure 4.19	In-Place-Inclinerometers – Phase I
Figure 4.20	In-Place-Inclinerometers – Phase II
Figure 4.21	SWL's, Earth Pressure Cells and Base of Wall Prisms Time Series
Figure 4.22	Survey Prisms with SWL's
Figure 4.23	Surface Monuments with SWL's
Figure 4.24	Survey Prisms and Monuments – Phase I
Figure 4.25	Survey Prisms and Monuments – Phase II
Figure 4.26	Comparison of Survey Prisms and Tiltmeter (TM-3)
Figure 4.27	SWLs, Prisms and Tiltmeters

List of Appendices

Appendix A	Sensometrics Summary Report
Appendix B	Manual Inclinerometer Results

EXECUTIVE SUMMARY

The U.S. Army Corps of Engineers (USACE) conducted a site-specific hydrostatic load test on a 150-foot section of the existing I-Wall/Levee at the London Avenue Outfall Canal in New Orleans, LA at the location shown in Figure 1.1. Load increments applied for the testing was performed between August 18 and August 28, 2007. Structural and geotechnical instrumentation combined with an Automated Data Acquisition System (ADAS) were installed to monitor the behavior of the levee and I-Wall for the duration of the load test.

URS was retained by the USACE to design, install and operate an automated structural and geotechnical instrumentation monitoring system. During performance of the test, URS was to obtain and distribute instrumentation data to the USACE stakeholders and technical review team as needed. URS was not required to perform geotechnical or structural analyses or provide opinions on the evaluation of the performance of the levee/I-Wall. URS data analyses were performed solely to ensure the integrity of the instrumentation data.

Analyses of the levee and I-Wall by others indicated that the most likely cause of failure would be an increase in pore pressures in the underlying sand stratum. One cause of potential failure of the I-Wall was expected to be the formation of a gap between the wall and soil on the canal side of the I-Wall. As the water rises in the canal, more deflection of the wall occurs, increasing the width and depth of the gap. The gap provides a hydraulic conduit whereby water in the canal can flow into the sand stratum. An increase in pore pressures in this sand can cause heave, sand boils, and piping on the protected side of the I-Wall. Hydraulic pressure in the gap may also cause translation of the wall if the passive resistance of the soil is exceeded.

Both structural and geotechnical instruments were selected to monitor the potential failure modes. An ADAS system was installed to monitor the instruments in a near real-time mode. The intent was not only to measure pore pressure increases and deformations as they occur, but also to provide data for alerting the team conducting the test should target threshold levels of deformation be exceeded. During each load increment, graphical computer displays of key instruments were observed to monitor amber or red alert levels. No red level alerts were triggered during the testing period.

Over 150 instruments were monitored throughout the test period. During the test, the majority of instruments were read every 15 to 30 seconds, resulting in over 10,000,000 instrument readings. Approximately 175,000 readings were recorded and stored in the primary readings database. The instrumentation and ADAS system performed as intended with no downtime during the two week testing period. ADAS-recorded data was submitted in electronic format to the USACE.

1.1 AUTHORIZATION

The Hurricane Protection Office (HPO) in New Orleans performed a hydrostatic load test on a 150-foot section of the I-Wall and levee at the London Avenue Outfall Canal in New Orleans. This report provides a summary of the design and performance of the geotechnical and structural instrumentation, ADAS equipment, telemetry and data management systems that were used for monitoring the load test. This Report was prepared by URS for the USACE as authorized by Contract No. W912P9-05-D-0514, Task Order No. 6 dated July 9, 2007.

1.2 PROJECT OBJECTIVE

The primary objective of this task order was to procure, install, and operate instrumentation and an ADAS system to provide performance and safety monitoring for the load test performed on the existing I-Wall and levee.

In addition, an emerging measurement technology was evaluated. Products produced by SensaMetrics Inc. of Palo Alto, CA were included in the load test instrumentation to evaluate their potential for future use.

1.3 PURPOSE

The purpose of this document is as follows:

- a. Summarize the performance of the installed instruments.
- b. Summarize observations made during the test.
- c. Present key instrumentation plots of the final data.
- d. Summarize the database management and reporting system.

Pre-installation activities included the following items:

- 1.) Obtain and procure necessary instrumentation and electronic components for the load test monitoring system.
- 2.) Prepare and execute necessary subcontracts with Gotech, Inc. (conventional surveying), Leica Geosystems, Inc. (robotic total station surveying) and SensaMetrics (emerging technology company-MEMs tiltmeters).
- 3.) Prepare Work Safety Plan, Project Management Plan and Data Management Documents (wiring diagrams, data flow diagrams, etc.).
- 4.) Inventory and check out instrumentation and other electronic components at our electronics laboratory in St. Louis, Missouri.
- 5.) Configure and program dataloggers prior to shipping to the site for field installation.
- 6.) Conduct linearity checks of 26 existing 4-20 ma pressure transducers provided by the USACE St. Louis District for use during the test.
- 7.) Prepare manual data collection sheets for all manually read instruments.
- 8.) Configure WinIDP database application to store instrument readings during the test. Set up preliminary plot definitions for the associated instrument types.

A one-day site visit was made on July 5, 2007 to coordinate site activity plans and instrument and cabling locations/requirements with the cofferdam construction contractor and USACE personnel. Mr. Ken Berry (URS St. Louis) met with Mr. Patrick Conroy (USACE-St. Louis District) and contractor personnel.

A series of meetings and telephone conferences were held with key stakeholders to coordinate project requirements. During this time, conference calls were made with USACE and HPO personnel, Technical Review Board members, and subcontractors for planning and coordination.

SECTION THREE

URS personnel mobilized to the test site on July 30, 2007. System installation personnel coordinated instrument installations with contractor activities up to the start of the test on August 18. Excessive heat and early threats associated with Hurricane Dean were addressed by all personnel and stakeholders working at the test site.

The ADAS and related instrumentation were installed in accordance with the original system design contained in the report titled “Design of an Automated Data Acquisition System (ADAS) For a Site Specific Load Test on the London Avenue Outfall Canal I-Wall/Levee New Orleans, LA” dated May 2, 2007.

Both manual and electronic instruments were installed in general accordance with manufacturer’s requirements. The I-Wall instruments, which included crackmeters, tiltmeters, tell-tales, earth pressure cells, survey prisms and Avongard crack gages, were installed at the locations shown in Figures 3.1 through Figure 3.3 using either drilled-in mechanical anchors or epoxy. Surface monument prisms were mounted on manufactured brackets attached to the top of steel posts embedded in concrete. Installation of the protected side open-standpipe piezometers was performed by the USACE. The flood side piezometers and all three inclinometer casings were installed by a USACE subcontractor. Pressure transducer installations were performed by URS. Site photographs are included in Figure 3.4.

The ADAS was designed and installed to automate all of the electronic instruments used on the project (Refer to Table 3.1). A Data Flow Diagram is shown on Figure 3.5 and identifies the various instrumentation data sources, communication paths, computers and data reporting associated with the project. Twelve computers were operating within the site field trailer during the test. Throughout the testing period typically six individuals were monitoring the various computers, compiling data sets and transferring data to the review teams. (Figure 3.6) Manual backup measurements were made during each load increment.

The ADAS employed two Campbell Scientific dataloggers installed on a portable tripod adjacent to the field trailer (Figure 3.1) to collect and partially reduce raw instrument readings to engineering units. Photographs of the dataloggers are included in Figure 3.7. Main line electric power with solar recharged battery back-up was provided to the dataloggers. All instruments were connected to the datalogger using signal cable. Figures 3.8 and 3.9 show wiring diagrams for the two dataloggers. The dataloggers communicated with the primary control PC over

SECTION THREE

hardwire connections. Campbell Scientific's Logger Net and RTMC applications were used to program and communicate with the dataloggers during the load test.

Lightning protection methods included copper clad ground rods, air terminals, copper downloads and surge protection modules installed at appropriate locations. All equipment operated without fault throughout the test period. A lightning/thunderstorm during Phase II of the test did not impact the instrumentation or data acquisition equipment.

Amber and red thresholds were set to provide multiple levels of response. When an amber level was reached, more attention was to be paid to that instrument. A red alert level for an instrument was a "stop-the-test" level. Both amber and red alert levels were designated by the USACE technical review team. Amber level thresholds were exceeded during the test, but no red alert levels were ever exceeded. Alert levels used for the test are stated in Table 3-1. Instrument threshold values were displayed with actual readings in near real-time mode during the load test. Both audio and visual alarms were used to annunciate any alarm threshold exceedances. Figure 3.10 shows the primary data display in the site field trailer with an alert level indicated.

Manually read instruments were provided to allow backup readings for all electronic instruments with the exception of the earth pressure cells. The telltales were installed for a gross manual reading on gap formation. Table 3.1 provides the instrument reading frequency and the associated manual backup instrument for each sensor used on the project.

Two digital IP video cameras were installed at the locations shown on Figure 3.1. Camera images were stored every 15 minutes throughout the test period of August 18 through August 30, 2007.

Prior to beginning the load test, systems checks were made on all electronic instruments. Falling head tests were performed on Piezometers PZ-6, PZ-6A, PZ-7 and PZ-7A immediately prior to starting the test.

Installation of the instrumentation took longer than anticipated due to site logistics and weather. Construction operations, including jet grouting, pile driving and portadam installation, impacted instrument installation and duration of baseline measurement period. It was intended to have three days of baseline data prior to applying the first load increment. This was reduced to one

SECTION THREE

day. It was decided not to delay the start of testing due to the presence of Hurricane Dean in the Caribbean.

Data packets were compiled generally every fifteen minutes during testing. These data packets contained key instrumentation plots and supporting “*.csv” data files. The data packets were “zipped” and sent via a Verizon EV-DO broadband router to the Technical Review Teams that were using an off-site USACE office trailer approximately 1500 ft from the test site. URS installed a “point-to-point” WIFI network to the USACE trailer for use during the Phase II portion of the test.

Personnel located in the onsite computer trailer monitored the test in near real-time mode to observe any potential safety related threshold exceedances. Figure 3.11 contains a photograph showing the set up of one of the computer displays used for alarm monitoring.

The test of the I-Wall/levee system consisted of raising the water level in the cofferdam. Water was typically raised in 6-inch increments. These increments are described herein as load increments. Once a load increment was placed, then the water level was maintained until a decision was made to raise or lower the water level. Photographs of the cofferdam with various load increments are included as Figures 4.1 and 4.2.

The overall test was performed in two phases. Phase I was performed by raising the water level within the cofferdam while the bottom of the canal remained “undisturbed”. (Note: Bentonite pellets were added along the sheet pile wall to limit the hydraulic connection that might have been made during sheet pile installation.) After completion of Phase I, 6-inch diameter slotted PVC casings were installed to provide a hydraulic connection between the water in the cofferdam and the underlying sand stratum in the pockets of the sheet piling. These casings were identified as injection wells. Twenty-nine of these casings were installed along the western side of the cofferdam. Phase II then commenced using load increments of water similar to Phase I testing.

4.1 OVERVIEW

The instrumentation and associated ADAS system were designed to monitor deformation of the wall and berm for both engineering and safety purposes. Redundancy in measurements was provided by using multiple instrument types and comparing data from the various instruments. Manual readings were also obtained to verify readings made by electronic devices. A description of each instrument type is provided below. Manufacturers’ specifications for the instruments were included in the May 2007 instrumentation design report. Photographs of installed instruments are included in Figures 4.3 through 4.13.

4.2 SURFACE WATER LEVELS

4.2.1 Staff Gages

Manually read staff gages were affixed to the cofferdam (Figure 3.1). One gage was placed inside of the cofferdam to measure the water level within the cofferdam (test cell surface water level, SWL-2). A second gage was placed on the outside of the cofferdam to measure the surface water level in the canal (canal surface water level, SWL-1). These instruments were

mounted so that they were visible to the video cameras mounted on the I-Wall. Both gages were surveyed after installation to confirm elevations.

4.2.2 Electronic Pressure Transducers

Electronic 4-20ma pressure transducers were installed alongside the manually read staff gages. The transducers consisted of Geokon 4-20 ma pressure transducers. The pressure range of the transducers was 0 to 14.5 psi. The transducers were housed in slotted PVC pipe that was affixed to the side of the staff gage. A plot of the surface water levels measured during the test is shown in Figure 4.14.

During Phase II of the testing, the elevations measured by the transducer inside the cofferdam were questioned by the Resident Engineer. A manual water level device was lowered from the top of the I-Wall twice during the morning of August 28th. Both times, the elevation was measured manually and the manual measurements were within 0.1 to 0.2 ft of that indicated by the transducers.

An anomaly in the data of the canal surface water transducer was observed on August 28th. Upon visual inspection of the outside of the cofferdam, a stream of water was observed coming from one of the sheetpile interlocks and impinging on the PVC casing housing the transducer. The contractor installed a wooden pallet against the sheeting to deflect the stream of water leaking from the interlock to prevent it from flowing directly on the instrument.

Lastly, staining of the two transducers was observed when the devices were removed. The porous tips had the appearance of rust staining. The devices were made of stainless steel, so what was observed was not rust. There was also a brown coating along the cable and outside of the transducer. It is unknown what was in the canal water to cause this.

4.3 PIEZOMETERS

Open-standpipe piezometers were installed by the Corps of Engineers and their contractors. Falling head tests were performed by the USACE on all piezometers except PZ-13, PZ-14, and PZ-15 (the piezometers in the cofferdam). URS performed falling head tests on these three piezometers as well as Piezometers PZ-5, PZ-6, PZ-6A, PZ-7, and PZ-7A. URS installed 4-20 ma strain gage transducers in each piezometer. URS also installed riser pipes on selected piezometers so that piezometric heads above the ground surface could be monitored. The

extensions were approximately 3 feet 4 inches for piezometers at the mid-slope of the levee (PZ-16, PZ-17, and PZ-18.) The extensions for piezometers at the elevation of the level grade on the protected side of the levee were approximately 5 ft high (PZ-6, PZ-6A, PZ-7, PZ-7A, PZ-10, PZ-11, and PZ-12). The locations of the piezometers are shown in Figure 3.1. Data from all nineteen site piezometers are shown in Figure 4.14 for Phases I and II. Phreatic surface profiles of the site are shown in Figures 4.15 and 4.16.

There were several instances of operational canal water level raises whereby “waves” of water came down the canal. These waves and subsequent falls in the water level were observed in the piezometer data.

The open-standpipes on the protected side were also read manually for each load increment of water placement. (An exception to this was the first load increment of water for Phase I, when only 4 piezometers were read. Also, no manual readings were taken for the 5-foot cofferdam water level increment of Phase II during a thunderstorm.) Piezometer data from the test are shown in Figure 4.14. The manual readings were consistently in general agreement with the transducer readings. The only exception was Piezometer PZ-1.

Manual readings for Piezometer PZ-1 were consistent with the transducer readings during Phase I. At the beginning of Phase II, it was observed that there was a discrepancy of about 0.45 feet for the load increments up to a cofferdam water elevation of 4 feet. An increase in the discrepancy was observed in subsequent readings for the remainder of the test. The maximum discrepancy was 0.71 feet. Efforts were made to resolve the issue. Additional manual readings were obtained. A second manual reading device was used at Piezometer PZ-1 to check the values being obtained. The electronic transducer was pulled, but no signs of a problem were observed. Finally, marks on the cable that were made at the time of installation were checked to verify that the cable was not slipping. It is unknown why the instrument readings started to creep during Phase II.

The cable for PZ-10 was laid across a driveway and had to be removed to allow access for a trailer. The riser for PZ-12 was adjacent to another driveway, and was accidentally knocked over by a resident. Therefore, the instruments in these piezometers needed to be removed occasionally. Data from the instrumentation were still collected during these times, so the data contain spikes.

4.4 CRACKMETERS

4.4.1 Electronic Crackmeters

Vibrating wire crackmeters were installed at each joint in the I-Wall (Figure 3.1). Brackets for installation of the crackmeters were mounted to the top of the I-Wall so that differential movements across the panel joints could be measured. The crackmeters measure displacement in one direction.

In addition, three crackmeters were installed on the canal side of the I-Wall. Two were attached with one end on the sheet piles and one on the I-Wall. The third crackmeter was installed at the center of the test cell with one end of the crackmeter attached to a protective casing around Inclinometer IPI-1 and the other end attached to the I-Wall.

Time series plots of the crackmeters with tiltmeter measurements are included as Figures 4.17 and 4.18. No anomalies in the crackmeter data were observed. The crackmeters were stable and correlations with tiltmeter measurements were good.

4.4.2 Manual Crackmeters

Avongard Gages were installed as a manual backup to the vibrating wire crackmeters. The Avongard Gages had an added benefit of enabling measurement of movements in two dimensions. The manual gages were mounted across the I-Wall panel joints at each electronic crackmeter location. In addition, manual gauges were installed mid-height of the panel face on the protected side of the I-Wall on the joints. Manual gages were not installed with the canal side electronic crackmeters. The manual gages were usually read once per load increment.

4.5 INCLINOMETERS

Three in-place inclinometers were installed at the locations shown in Figure 3.1 and Figure 3.2. IPI-1 was on the canal side at the crest of the berm. Since the inclinometer was within the test cell, 10 feet of stick-up was provided for the inclinometer casing. A protective 8-inch diameter PVC casing was installed around the exposed inclinometer casing.

Another inclinometer (IPI-2) was installed on the protected side of the levee at the crest of the berm. The third inclinometer (IPI-3) was installed mid-slope on the protected side of the levee.

Each installation consisted of 6 uniaxial Geokon Model 6300 vibrating wire inclinometers. The elevations of the devices are shown in the cross section in Figure 3.2. Plots of the inclinometer data obtained at the end of each load increment during the test are shown in Figures 4.19 and 4.20.

One issue raised in the field was that there was an apparent anomaly in the data for the in-place inclinometer devices within IPI-1. The data trend fluctuated throughout the test. The maximum displacement of the IPI-1 was approximately 0.2 inches. The measurement in degrees of movement was a maximum of 0.06 degrees.

There was observed movement in the plots of the data for IPI-1. The instruments were being read at a fine resolution. Factors such as moon/earth tides, canal tides, wave action, vibrations from pumps, etc., likely influenced the readings. This inclinometer was subjected to more influencing factors (noise) than IPI-2 and IPI-3 since it was within the cofferdam. It is inconclusive as to the overall cause of the fluctuations in data. It is likely that had more movement occurred, then an actual trend in the data might have become apparent.

During the initial Phase I load increments, it was observed that there was an apparent discrepancy in the data being collected from sensors IPI-3-5 and IPI-3-6. It was determined that these sensors were misconnected at the multiplexer. The sensor wiring was corrected and the database was updated accordingly.

A manual inclinometer probe was used to profile the inclinometer casings. A manual profile was made prior to installation of the automated in-place devices. Once Phase II of the test had been completed, the in-place devices were removed and another round of manual inclinometer readings was made. Plots of the manual inclinometer data are included in Appendix B.

4.6 EARTH PRESSURE CELLS

Three earth pressure cells were installed to assist in monitoring potential gap formation. Excavations about 2 feet square by 2 feet deep were made adjacent to the I-Wall on the flood side. The pressure cells were then bolted to the wall. Two bolts were installed through tabs at the top of the device. A sheet of plastic was then placed over the cell, and the excavation was backfilled to within about 6 inches of grade using a sand/cement mixture. The sand/cement mixture was allowed to cure, and then the pressure cell was pressurized to approximately 5 psi.

Lastly, the remainder of the excavation was backfilled with clay and the cable from the pressure cell was wired to a datalogger.

The intent of the design was to detect a loss of contact between the soil and the I-Wall. The plastic sheet was installed to prevent the sand cement from bonding to the I-Wall. (The plastic sheet was inadvertently omitted from the PC-3 installation, but a loss in pressure was still observed in this device.) The increase in the water level would increase the pressure reading from the pressure cell. The formation of a gap should drop the pressure reading to the hydrostatic pressure.

Before the test, and after the installation of the pressure cells, the water level in the canal and the cofferdam was raised to approximately El. +2 feet. It was observed that one of the pressure cells (PC-3) was indicating a drop in pressure from 5 psi to 1.5 psi. The closest telltale (TT-5) also showed a drop of 2.5 feet.

The pressure cells behaved as anticipated. Readings from the pressure cells are shown in Figure 4.21.

4.7 CONVENTIONAL AND ROBOTIC SURVEYING

URS subcontracted with Gotech, Inc. of Baton Rouge, LA to provide conventional surveying of instrument locations and to make manual readings of the robotic survey prisms. In addition, coordinate location data for the various instruments as well as corners and injection wells for the test cell were surveyed. Gotech had to bring surveying control to the site using offsite benchmarks with data provided by the USACE. Conventional surveying was performed in three rounds. The first round was prior to initial loading of the cofferdam. The second round of conventional measurements was made between Phases I and II of the load test. The final round of measurements was obtained after the completion of Phase II.

URS subcontracted with Leica to automatically monitor the survey prisms and survey monuments with prisms using two robotic total station devices. A summary of the prism survey data is included in Figures 4.22 and 4.23. In addition, Figures 4.24 and 4.25 contain plots indicating wall and berm deflections at the end of each load increment for Phases I and II.

Three back sights for checking the location of the base stations were installed at Leica's request. If the pedestals of the base stations moved, data obtained from sighting the back sights would

indicate any movement. One back sight was installed at the eastern edge of the property at 5772 Warrington Drive. The other two back sights were adjacent to the I-Wall. One was approximately 400 feet north of the project site. The other was approximately 200 ft south of the project site. Initially, environmental corrections were being applied to the data. When the data was compared to the tiltmeter data, it became apparent that the environmental corrections were not necessary due to the close proximity of the prisms to the base stations. Figure 4.26 shows a correlation plot of the tiltmeter and survey data made in the instrumentation trailer by Leica.

4.7.1 Survey Prisms

Three dimensional survey prisms were installed at the top of the I-Wall near the center of each panel at the locations shown in Figure 3.1. Prisms were also attached to the I-Wall near the base of each panel. Initially one robotic total station device was planned. Once on site, the USACE review team requested to see the data more frequently than 30 to 40 minutes, so a second robotic device was installed. One instrument was set up to monitor primary prisms, while the other monitored secondary devices. The survey prisms provided displacement measurements in three dimensions; longitudinal (north/south), transverse (protected/unprotected side) and vertical changes in elevation. The cycle time required for reading all of the survey prisms using the two robotic devices was approximately 7 to 15 minutes. Photographs of the two robotic devices are included in Figure 4.9.

One anomaly was encountered during testing. Spikes in the data were occurring with one of the prisms (SP-6A). Leica determined that this was due to interference from one total station device partially blocking the line of sight for the other periodically. The spikes in the data were due to this partial instrument interference.

4.7.2 Survey Monuments with Prisms

Survey monuments with prisms were similar to prisms mounted on the I-Wall, except they were installed in the ground using concrete embedded steel posts. The locations of the survey monuments are shown in Figure 3.1. An auger was used to dig a 2-foot deep hole. A steel pipe was then installed and concreted in place. Brackets were attached to the top of the steel pipe, and prisms were then attached.

During the initial baseline testing, a one-inch displacement bolt was added to selected instruments. The purpose was to verify that the survey data collected by the robotic devices

would pick up the movement as well as verify the accuracy of measurements being made. The system did measure the correct displacement.

4.8 TELLTALES

Telltales were installed along the canal side of the I-Wall at the locations shown in Figure 3.1 to assist with the determination of gap formation. The telltales consisted of two 8-foot long grounding rods that were welded together to make a 16-foot long rod. The bottom of the rod was placed on the ground surface adjacent to the I-Wall. The rod was installed inside an outer casing so that it would remain nearly vertical, but be allowed to move vertically. The outer casing was secured to the I-Wall. The purpose of the instrument was to determine if a gap developed at the ground surface. If a gap formed, then the telltale would drop into the gap.

As stated in the pressure cell section of this report, Telltale TT-5 dropped 2.5 feet when water level in the canal first reached Elevation +2 after installation of the telltales. This was prior to the beginning of the test. The rod was temporarily removed so that mud could be used to fill the gap in the vicinity of TT-5. When the rod was reinstalled, it dropped back to 2.5 feet below grade where it was prior to placement of the mud backfill.

One anomaly to note is that there was some concern from the design team as to whether TT-3 was working properly. On August 21st, the rod for TT-3 was manually rotated and the rod was more or less pushed into the subgrade.

Another item of note is that the wet, soft soil conditions that existed after both Phases I and II extended only about ½ inch below the ground surface. Personnel were able to walk on the ground surface. (There was a concern at the site that the telltale rods may have been penetrating into the subgrade due to softening of the soil.)

4.9 TILTMETERS

Vibrating wire tiltmeters were attached to the I-Wall in the center of each panel at the locations shown in Figure 3.1. Initially during the test, alarm levels were being reached sporadically. After discussions with the manufacturer, the excitation voltage used to read the instruments was adjusted. This change eliminated the problem. The data for the tiltmeters was consistent with that obtained by the prisms and is shown in Figure 4.27. Tiltmeter data was also plotted with crackmeter and surface water levels in Figure 4.17.

Tiltmeter data shows a good correlation with the other deformation type instruments used on the project. The tiltmeters were the most sensitive instrument type used; and as such, they did show the effects of environmental conditions (sun light, tides and mechanical vibrations from pumps) more so than the other instrument types employed. The tiltmeters “saw” six inches of water being added to the test cell when raising the water level from about +1.0 Elevation to +1.5 ft Elevation. Note that test cell water was not above the levee at until approximately Elevation +2.5 ft.

4.10 IP VIDEO CAMERAS

IP Video cameras were installed on the I-Wall north and south of the cofferdam. Each camera contained two lenses and was powered using power over Ethernet direct burial cable. One lens was for wide angle images of the entire test cell. The other lens was for telephoto purposes and was directed on the manually read staff gages. Two LCD video monitors inside the URS field trailer were dedicated to the video cameras. Images were updated at the rate of one frame per second (1 fps). Electronic jpg files were saved every 15 minutes for each camera lens during the testing period.

Electronic data files of ADAS/Instrumentation data generated during testing are provided on a companion DVD to this report. IP Video images made during testing are also provided on the DVD.

The last load increment from the Phase II testing occurred on August 28, 2007. Post test readings were made until the morning of August 30th. An interim demobilization then occurred. All electronic instrumentation was removed and placed inside the storage container on site. The instruments were to be kept in storage while the USACE reviewed data from the test. If the USACE decided to perform any additional testing, then the instruments would be on-site and would be re-installed. No further testing was deemed necessary, so final demobilization was performed. Piezometer transducers were returned to the USACE St. Louis District. All other transducers and instruments purchased for the project were delivered to the New Orleans District. The site was restored, and URS was off of the site by the end of October 2007.

Based upon the acquired instrumentation data resulting from both phases of the load test and initial data plots we offer the following conclusions for your consideration.

- 1.) We believe that the instrumentation systems performed their designed function and produced high quality data. Generally there are high coefficients of determination (r^2) between various combinations of instrument correlations. (A coefficient of determination is a statistical term for measuring the variability within a data set. In this case, the high coefficients of determination indicate that multiple instruments are in agreement given different modes and methods of making measurements.)
- 2.) The use of automated threshold levels provided by the Technical Review Teams provided a reliable means to monitor and advance the test in a safe and controlled manner.
- 3.) There was a significant benefit in using multiple types of instruments to monitor the same behavior. This redundancy increased confidence in the instrumentation and assisted the team members in decision-making throughout the test.
- 4.) There are several possible combinations of instrument types used during the testing that could be considered for full-scale or permanent monitoring of the I-Wall/Levee in a cost effective manner. The results of this test can be used to optimize the design of either a full-scale or permanent monitoring system. An evaluation would be needed to further assess and identify the most cost effective number and compliment of instrument types required for a full-scale implementation. Based upon the results of this test it is likely that only every third or fourth I-Wall panel would need to be instrumented to provide sufficient coverage for long-term monitoring.

TABLES

Table 3.1
London Avenue Canal
Site Specific Load Test
Instrumentation Reading Schedule

Instrumentation Type	Instrument ID	Station	Offset from Canal Side I-Wall Face (ft)	Northing (ft)	Easting (ft)	Elev (ft)	Remote Monitoring Unit (RMU)	Scanning Frequency	Data Store Frequency (Minutes)	Threshold Values		Manual Back-up Instrument	Manual Reading Schedule	Comment
				Louisiana Lambert South Zone Grid System (NAD 83)		NAVD88 -2004.65				Amber	Red			
Surface water Levels (Auto)	SWL-1	-	-	554298.35	3680538.78	10.04	RMU-1	15 secs	15	-	-	SG-1	-	Canal Water Elevation
	SWL-2	-	-	554293.10	3680542.10	10.13	RMU-1	15 secs	0	-	-	SG-2	-	Test Cell Water Elevation
Staff Gage	SG-1	-	-	-	-	-	Manual	-	N/A	-	-	N/A	1x per load increment	
	SG-2	-	-	-	-	-	Manual	-	0	-	-	0	0	
Crackmeter	CM-1	108+20	0 *	-	-	-	RMU-2	60 secs	15	-	-	AG-1	1 per load increment	Field located at corner of cofferdam (South Side).
	CM-2	108+20	+1 *	-	-	-	RMU-2	60 secs	0	1.00 in	2.00 in	AG-2	0	Installed parallel to joint in between concrete I-Wall panels
	CM-3	108+50	+1 *	-	-	-	RMU-2	60 secs	0	1.00 in	2.00 in	AG-3	0	Installed parallel to joint in between concrete I-Wall panels
	CM-4	108+80	+1 *	-	-	-	RMU-2	60 secs	0	1.00 in	2.00 in	AG-4	0	Installed parallel to joint in between concrete I-Wall panels
	CM-5	109+10	+1 *	-	-	-	RMU-2	60 secs	0	1.00 in	2.00 in	AG-5	0	Installed parallel to joint in between concrete I-Wall panels
	CM-6	109+40	+1 *	-	-	-	RMU-2	60 secs	0	1.00 in	2.00 in	AG-6	0	Installed parallel to joint in between concrete I-Wall panels
	CM-7	109+70	+1 *	-	-	-	RMU-2	60 secs	0	1.00 in	2.00 in	AG-7	0	Installed parallel to joint in between concrete I-Wall panels
	CM-8	109+70	0 *	-	-	-	RMU-2	60 secs	0	-	-	AG-8	0	Field located at corner of cofferdam (North Side).
	CM-9	108+95	-1 *	-	-	-	RMU-2	60 secs	0	0.75 in	1.50 in	AG-9	0	Connected between top of IPI-1 and base of I-Wall.
Inclinometer	IPI-1-1	108+80	-16.74	554373.95	3680562.79	-57.70	RMU-2	60 secs	15 mins	-	-	Manual Profiling	Before and after testing	Six in-place Sensors Each.
	IPI-1-2	0	0	0	0	-42.77	RMU-2	60 secs	0	-	-	0	0	
	IPI-1-3	0	0	0	0	-27.70	RMU-2	60 secs	0	-	-	0	0	
	IPI-1-4	0	0	0	0	-22.77	RMU-2	60 secs	0	-	-	0	0	
	IPI-1-5	0	0	0	0	-17.70	RMU-2	60 secs	0	-	-	0	0	
	IPI-1-6	0	0	0	0	-7.70	RMU-2	60 secs	0	-	-	0	0	
	IPI-2-1	108+77	-6.66	554371.50	3680573.27	-57.96	RMU-2	60 secs	0	-	-	0	0	Six in-place Sensors Each
	IPI-2-2	0	0	0	0	-42.96	RMU-2	60 secs	0	-	-	0	0	
	IPI-2-3	0	0	0	0	-27.96	RMU-2	60 secs	0	-	-	0	0	
IPI-2-4	0	0	0	0	-22.96	RMU-2	60 secs	0	-	-	0	0		

* Denotes anticipated Station and Offset assuming centerline was along the I-Wall. When control was brought to the site, it became apparent that the centerline was east of the I-Wall and stationing was off by approximately 15 to 20 feet. These points were not surveyed. Therefore station and offset are old values and do not match rest of survey data.

Instrumentation Type	Instrument ID	Station	Offset from Canal Side I-Wall Face (ft)	Northing (ft)	Easting (ft)	Elev (ft)	Remote Monitoring Unit (RMU)	Scanning Frequency	Data Store Frequency (Minutes)	Threshold Values		Manual Back-up Instrument	Manual Reading Schedule	Comment
				Louisiana Lambert South Zone Grid System (NAD 83)		NAVD88 -2004.65				Amber	Red			
Inclinometer (Cont.)	IPI-2-5	0	0	0	0	-17.96	RMU-2	60 secs	15 mins	-	-	0	0	
	IPI-2-6	0	0	0	0	-7.96	RMU-2	60 secs	0	-	-	0	0	
	IPI-3-1	108+78	+9.42	554373.53	3680588.55	-53.40	RMU-2	60 secs	0	-	-	0	0	
	IPI-3-2	0	0	0	0	-37.41	RMU-2	60 secs	0	-	-	0	0	
	IPI-3-3	0	0	0	0	-22.41	RMU-2	60 secs	0	-	-	0	0	
	IPI-3-4	0	0	0	0	-17.41	RMU-2	60 secs	0	-	-	0	0	
	IPI-3-5	0	0	0	0	-12.41	RMU-2	60 secs	0	-	-	0	0	
	IPI-3-6	0	0	0	0	-7.41	RMU-2	60 secs	0	-	-	0	0	
							RMU-2	60 secs	0	-	-	0	0	
Piezometers	PZ-1	108+06	-6.44	554301.12	3680578.97	2.02	RMU 1	15 secs	15 mins	-	Varied	Open Standpipe	1 per load increment	Piezometer tips were to be just below tip of sheet piles. Note: tip of sheet pile -22 Elev.-ft (1994 Plans)
	PZ-2	108+26	-6.55	554321.35	3680577.21	1.8	RMU 1	15 secs	15 mins	-	Varied	0	0	
	PZ-3	108+71	-6.54	554366.00	3680573.83	2.08	RMU 1	15 secs	15 mins	-	Varied	0	0	
	PZ-3A	108+80	-6.56	554374.98	3680573.14	2.17	RMU 1	15 secs	15 mins	-	Varied	0	0	
	PZ-4	109+18	-6.11	554412.63	3680570.67	2.11	RMU 1	15 secs	15 mins	-	Varied	0	0	
	PZ-5	109+55	-6.06	554449.81	3680567.77	1.92	RMU 1	15 secs	15 mins	-	Varied	0	0	
	PZ-6	108+72	19.68	554368.50	3680599.59	-0.71	RMU 1	15 secs	15 mins	El 65.70	El 64.00	0	0	
	PZ-6A	108+81	21.38	554378.01	3680600.53	-1.11	RMU 1	15 secs	15 mins	El 65.70	El 64.00	0	0	
	PZ-7	108+71	38.15	554369.02	3680618.07	-0.83	RMU 1	15 secs	15 mins	El 65.70	El 64.00	0	0	
	PZ-7A	108+80	38.01	554378.37	3680617.21	-0.71	RMU 1	15 secs	15 mins	El 65.70	El 64.00	0	0	
	Reserved	-	-	-	-	-	-	-	-	-	-	0	0	
	Reserved	-	-	-	-	-	-	-	-	-	-	0	0	
	PZ-10	108+21	163.77	554328.88	3680747.20	-2.01	RMU 1	15 secs	15 mins	-	-	0	0	
	PZ-11	108+82	163.98	554389.56	3680742.68	-2.24	RMU 1	15 secs	15 mins	-	-	0	0	
	PZ-12	109+27	163.52	554434.58	3680738.72	-2.24	RMU 1	15 secs	15 mins	-	-	0	0	
	PZ-13	108+32	-16.77	554326.42	3680566.42	1.87	RMU 1	15 secs	15 mins	-	Varied	0	0	
	PZ-14	108+79	-16.78	554372.54	3680562.90	2.52	RMU 1	15 secs	15 mins	-	Varied	0	0	
	PZ-15	109+20	-17.45	554414.08	3680558.95	2.19	RMU 1	15 secs	15 mins	-	Varied	0	0	
	PZ-16	108+70	9.06	554365.79	3680589.10	1.05	RMU 1	15 secs	15 mins	-	-	0	0	
PZ-17	108+74	9.39	554370.09	3680589.12	0.76	RMU 1	15 secs	15 mins	-	-	0	0		
PZ-18	108+82	9.21	554378.15	3680588.25	1.29	RMU 1	15 secs	15 mins	-	-	0	0		
Pressure Cells	PC-1	108+47	0 *	554341.97	3680568.49	2.34	RMU 1	15 secs	15 mins	-	-	N/A	N/A	
	PC-2	108+92	0 *	554369.94	3680564.99	2.39	RMU 1	15 secs	15 mins	-	-	0	0	
	PC-3	109+37	0 *	554398.62	3680564.56	2.65	RMU 1	15 secs	15 mins	-	-	0	0	
Survey Prisms	SP-1	107+90	-17.1	554284.98	3680575.12	12.92	Leica 1	30 mins	15 mins	-	-	Surveying	Before and after Phase 1 and Phase 2	
	SP-1A	107+90	-10.49	554285.09	3680576.41	3.43	Leica 1	30 mins	0	0.75 in	1.50 in	0	0	

* Denotes anticipated Station and Offset assuming centerline was along the I-Wall. When control was brought to the site, it became apparent that the centerline was east of the I-Wall and stationing was off by approximately 15 to 20 feet. These points were not surveyed. Therefore station and offset are old values and do not match rest of survey data.

Instrumentation Type	Instrument ID	Station	Offset from Canal Side I-Wall Face (ft)	Northing (ft)	Eastings (ft)	Elev (ft)	Remote Monitoring Unit (RMU)	Scanning Frequency	Data Store Frequency (Minutes)	Threshold Values		Manual Back-up Instrument	Manual Reading Schedule	Comment
				Louisiana Lambert South Zone Grid System (NAD 83)		NAVD88 -2004.65				Amber	Red			
Survey Prisms (Cont.)	SP-2	108+19	-3.47	554313.50	3680573.21	12.94	Leica 1	30 mins	0			0	0	
	SP-2A	108+19	-10.38	554313.79	3680574.29	3.42	Leica 1	30 mins	30 mins	0.75 in	1.50 in	0	Before and after Phase 1 and Phase 2	
	SP-3	108+48	-3.51	554341.99	3680570.90	12.94	Leica 1	<15 mins	<15 mins	-	-	0	0	Primary
	SP-3A	108+48	-10.37	554342.35	3680572.10	3.48	Leica 1	<15 mins	<15 mins	0.75 in	1.50 in	0	0	Primary
	SP-4	108+77	-3.81	554370.62	3680568.41	12.98	Leica 1	<15 mins	<15 mins	-	-	0	0	Primary
	SP-4A	108+77	-10.55	554371.21	3680569.66	3.48	Leica 1	<15 mins	<15 mins	0.75 in	1.50 in	0	0	Primary
	SP-5	109+06	-17.14	554400.15	3680566.12	12.94	Leica 1	<15 mins	<15 mins	-	-	0	0	Primary
	SP-5A	109+05	-10.59	554399.80	3680567.40	3.51	Leica 1	<15 mins	<15 mins	0.75 in	1.50 in	0	0	Primary
	SP-6	109+34	-17.13	554428.65	3680563.88	12.91	Leica 1	30 mins	30 mins	-	-	0	0	
	SP-6A	109+34	-10.59	554428.53	3680565.15	3.47	Leica 1	30 mins	30 mins	0.75 in	1.50 in	0	0	
	SP-7	109+63	-17.17	554457.17	3680561.65	12.95	Leica 1	30 mins	30 mins	-	-	0	0	
	SP-7A	109+63	-10.64	554457.09	3680562.90	3.49	Leica 1	30 mins	30 mins	0.75 in	1.50 in	0	0	
Survey Monument	SM-1	107+90	-3.65	554285.52	3680583.22	1.95	Leica 2	30 mins	30 mins	0.50 in	1.00 in	Surveying	Before and after Phase 1 and Phase 2	
	SM-2	108+19	-3.47	554314.65	3680581.04	1.75	Leica 2	30 mins	30 mins	0.50 in	1.00 in	0	0	
	SM-3	108+48	-3.51	554342.94	3680578.80	1.75	Leica 2	<15 mins	<15 mins	0.50 in	1.00 in	0	0	Primary
	SM-4	108+77	-3.81	554371.79	3680576.33	1.97	Leica 2	<15 mins	<15 mins	0.50 in	1.00 in	0	0	Primary
	SM-5	109+06	-3.88	554400.53	3680574.05	2.03	Leica 2	<15 mins	<15 mins	0.50 in	1.00 in	0	0	Primary
	SM-6	109+34	-4.05	554429.01	3680571.68	2.11	Leica 2	30 mins	30 mins	0.50 in	1.00 in	0	0	
	SM-7	109+63	-4.13	554457.63	3680569.38	2.14	Leica 2	30 mins	30 mins	0.50 in	1.00 in	0	0	
	SM-8	107+90	8.62	554286.38	3680594.71	-1.79	Leica 2	30 mins	30 mins	0.25 in	0.50 in	0	0	
	SM-9	108+19	8.62	554315.41	3680592.33	-2.27	Leica 2	30 mins	30 mins	0.25 in	0.50 in	0	0	
	SM-10	108+48	8.56	554344.13	3680590.06	-2.17	Leica 2	30 mins	30 mins	0.25 in	0.50 in	0	0	
	SM-11	108+77	8.12	554373.01	3680587.47	-1.73	Leica 2	30 mins	30 mins	0.25 in	0.50 in	0	0	
	SM-12	109+06	7.93	554401.84	3680584.98	-1.91	Leica 2	30 mins	30 mins	0.25 in	0.50 in	0	0	
	SM-13	109+34	8.31	554430.15	3680583.20	-1.79	Leica 2	30 mins	30 mins	0.25 in	0.50 in	0	0	
	SM-14	109+63	7.94	554458.59	3680580.66	-1.52	Leica 2	30 mins	30 mins	0.25 in	0.50 in	0	0	
	SM-15	107+90	20.72	554287.17	3680606.19	-5.63	Leica 2	30 mins	30 mins	0.25 in	0.50 in	0	0	
	SM-16	108+19	20.56	554316.34	3680603.72	-5.74	Leica 2	30 mins	30 mins	0.25 in	0.50 in	0	0	
	SM-17	108+48	20.34	554345.10	3680601.21	-5.89	Leica 2	<15 mins	<15 mins	0.25 in	0.50 in	0	0	Primary
	SM-18	108+78	19.52	554374.25	3680598.24	-5.37	Leica 2	<15 mins	<15 mins	0.25 in	0.50 in	0	0	Primary
	SM-19	109+07	19.27	554403.48	3680595.61	-5.66	Leica 2	<15 mins	<15 mins	0.25 in	0.50 in	0	0	Primary
	SM-20	109+34	19.45	554430.84	3680593.67	-5.68	Leica 2	30 mins	30 mins	0.25 in	0.50 in	0	0	
	SM-21	109+63	19.87	554459.61	3680591.96	-5.34	Leica 2	30 mins	30 mins	0.25 in	0.50 in	0	0	
	SM-22	108+71	31.56	554369.05	3680610.70	-5.84	Leica 2	30 mins	30 mins	0.25 in	0.50 in	0	0	Field located
	SM-23	108+78	31.38	554375.25	3680610.14	-5.78	Leica 2	<15 mins	<15 mins	0.25 in	0.50 in	0	0	Primary, Field located
	SM-24	108+86	32.15	554384.42	3680610.13	-5.85	Leica 2	30 mins	30 mins	0.25 in	0.50 in	0	0	Field located
	SM-25	108+77	43.02	554375.30	3680622.11	-5.65	Leica 2	30 mins	30 mins	0.25 in	0.50 in	0	0	Field located, Installed too close for conventional surveying to measure installed coordinates
	SM-26	108+73	148.94	554379.40	3680728.26	-6.49	Leica 2	30 mins	30 mins	-	-	0	0	Field located

* Denotes anticipated Station and Offset assuming centerline was along the I-Wall. When control was brought to the site, it became apparent that the centerline was east of the I-Wall and stationing was off by approximately 15 to 20 feet. These points were not surveyed. Therefore station and offset are old values and do not match rest of survey data.

Instrumentation Type	Instrument ID	Station	Offset from Canal Side I-Wall Face (ft)	Northing (ft)	Easting (ft)	Elev (ft)	Remote Monitoring Unit (RMU)	Scanning Frequency	Data Store Frequency (Minutes)	Threshold Values		Manual Back-up Instrument	Manual Reading Schedule	Comment
				Louisiana Lambert South Zone Grid System (NAD 83)		NAVD88 -2004.65				Amber	Red			
Survey Monument	SM-27	108+81	148.29	554387.26	3680727.00	-6.35	Leica 2	30 mins	30 mins	-	-	0	0	Field located
	SM-28	108+79	95.72	554381.21	3680674.73	-5.35	Leica 2	30 mins	30 mins	-	-	0	0	Field located
TellTales	TT-1	108+53	0 *	-	-	-	Manual	-	Each Rdg..	-	-	N/A	1x per load increment	
	TT-2	108+80	0 *	-	-	-	0	-	Each Rdg.	-	-	0	0	
	TT-3	108+98	0 *	-	-	-	0	-	Each Rdg.	-	-	0	0	
	TT-4	109+10	0 *	-	-	-	Manual	-	Each Rdg	-	-	0	0	
	TT-5	109+43	0 *	-	-	-	0	-	Each Rdg	-	-	0	0	
Tiltmeters	TM-1	108+35	0 *	-	-	-	RMU-1	15 secs	15 secs	0.5 deg	1.0 deg	STM-1	N/A	
	TM-2	108+65	0 *	-	-	-	RMU-1	15 secs	15 secs	0.5 deg	1.0 deg	STM-2	N/A	
	TM-3	108+95	0 *	-	-	-	RMU-1	15 secs	15 secs	0.5 deg	1.0 deg	STM-3	N/A	
	TM-4	109+25	0 *	-	-	-	RMU-1	15 secs	15 secs	0.5 deg	1.0 deg	STM-4	N/A	
	TM-5	109+55	0 *	-	-	-	RMU-1	15 secs	15 secs	0.5 deg	1.0 deg	STM-5	N/A	

* Denotes anticipated Station and Offset assuming centerline was along the I-Wall. When control was brought to the site, it became apparent that the centerline was east of the I-Wall and stationing was off by approximately 15 to 20 feet. These points were not surveyed. Therefore station and offset are old values and do not match rest of survey data.

Table 4.1

London Avenue Canal

Sign Convention of Instrumentation

In-Place Inclinometers	+ = inclination towards canal side of levee - = inclination towards protected side of levee
Manual Inclinometers	- = inclination towards canal side of levee + = inclination towards protected side of levee
Tiltmeters	+ = tilt towards canal side of levee - = tilt towards protected side of levee
Crackmeters	+ = extension - = compression
Prisms ó Transverse Vector	+ = movement towards protected side of levee - = movement towards the canal side of levee
Longitudinal	+ = movement to the north - = movement to the south

FIGURES

DATE: 11/21/2007
 FILE: K:\System\New Orleans\Test Cell\ Load Test\Instrumentation Report_Figures\Submittal (11-21-07)\FIGURE 1.1.dgn

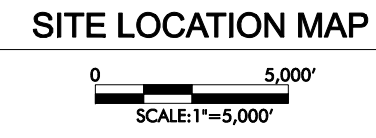
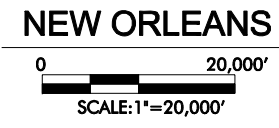
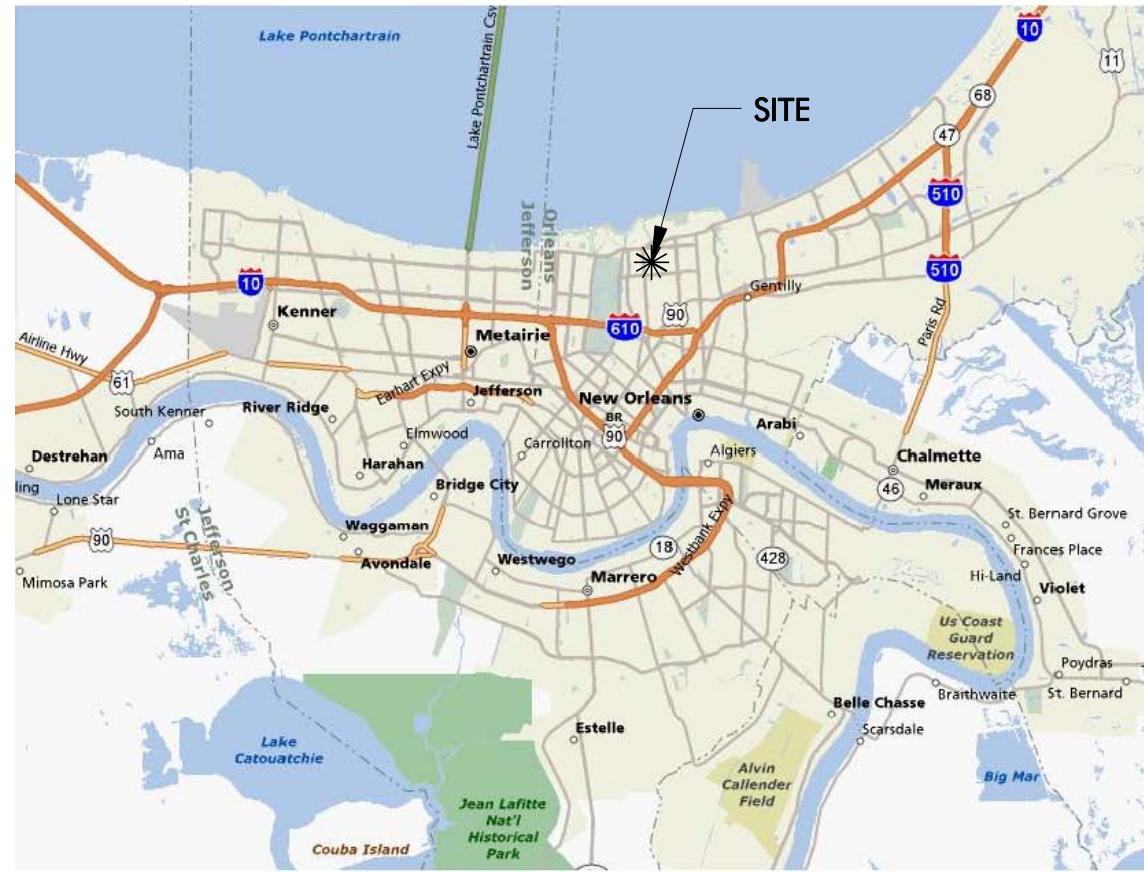

NOTE: SITE ADDRESS IS 5772 WARRINGTON DRIVE



MARK	DESCRIPTION	DATE	APPR.

DESIGNED BY: KGB	DATE: NOVEMBER 2007	SUBMITTED BY: KENNETH BERRY, P.E.	CONTRACT NO.:
DRAWN BY: DAB	SCALE: AS SHOWN	FILE NO.:	FILE NUMBER:
PROJECT NO.:	PROJECT SCALE:	PROJECT DATE:	PROJECT NUMBER:
PROJECT NO. 2186182.0007	PROJECT SCALE 1:1	PROJECT DATE 11/21/07	PROJECT NUMBER 11/21/07

U.S. ARMY ENGINEER DISTRICT
 CORPS OF ENGINEERS
 MISSISSIPPI VALLEY DIVISION
 NEW ORLEANS EAST
 ST. LOUIS DISTRICT OFFICE
 ORLEANS PARISH, LA.
 LONDON AVENUE CANAL
 SITE SPECIFIC LOAD TEST
 SITE LOCATION MAP

SHEET IDENTIFICATION NUMBER
FIGURE 1.1

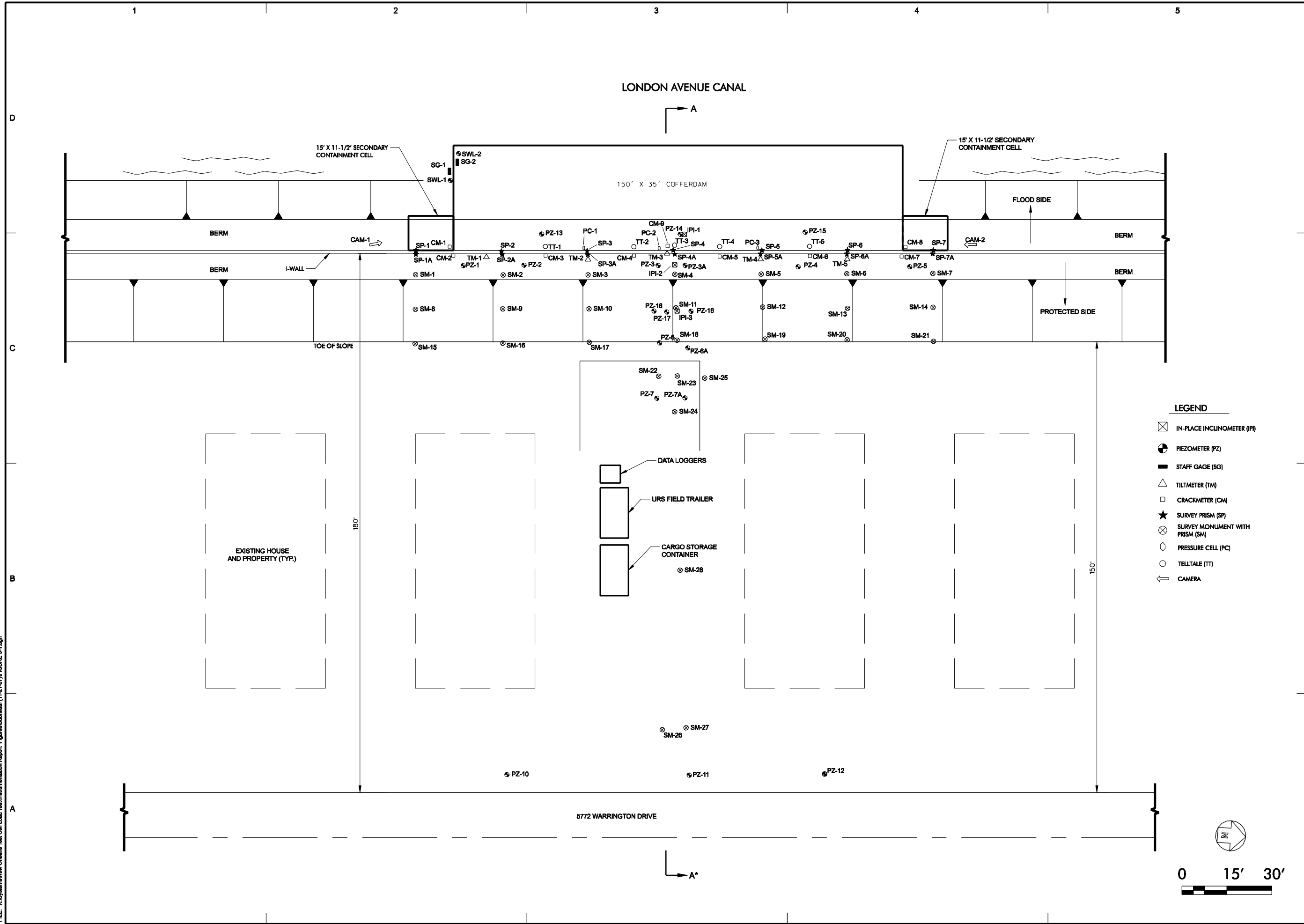

- LEGEND**
- ⊗ IN-PLACE INCLINOMETER (IPI)
 - PIEZOMETER (PZ)
 - STAFF GAGE (SG)
 - △ TILTMETER (TM)
 - CRACKMETER (CM)
 - ★ SURVEY PRISM (SP)
 - ⊗ SURVEY MONUMENT WITH PRISM (SM)
 - PRESSURE CELL (PC)
 - TELLTALE (TT)
 - ⇐ CAMERA

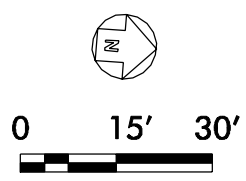

MARK	DESCRIPTION	DATE	APPR.

DESIGNED BY: KJMB
DRAWN BY: DAB
DATE: NOVEMBER 2007
SOLUTION NO.: KJMB

PROJECT NO.: 2189182L0001
DATE: 11/21/07

1001 Highroads Plaza
Baton Rouge, Louisiana 70803
(504) 282-9100
FAX: (504) 282-9101

U.S. ARMY ENGINEER DISTRICT
CORPS OF ENGINEERS
MISSISSIPPI VALLEY DIVISION
KENNETH BERRY, P.E.
FILE NUMBER: 11/21/07

NEW ORLEANS EAST
USACE - ST LOUIS DISTRICT OFFICE
ORLEANS PARISH, LA.
LONDON AVENUE CANAL
SITE SPECIFIC LOAD TEST

DATE: 11/21/2007
 FILE: K:\System\New Orleans\Test Cell\Load Test\Instrumentation Report_Figures\Submittal (11-21-07)\FIGURE 3-2.dgn

ELEVATION (FT, NAVD88)

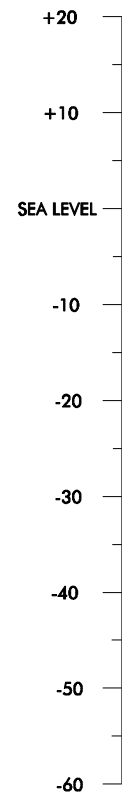

LEGEND

- INCLINOMETER
- PIEZOMETER
- SCREEN
- SURVEY MONUMENT / PRISM
- CRACKMETER
- TILTMETER

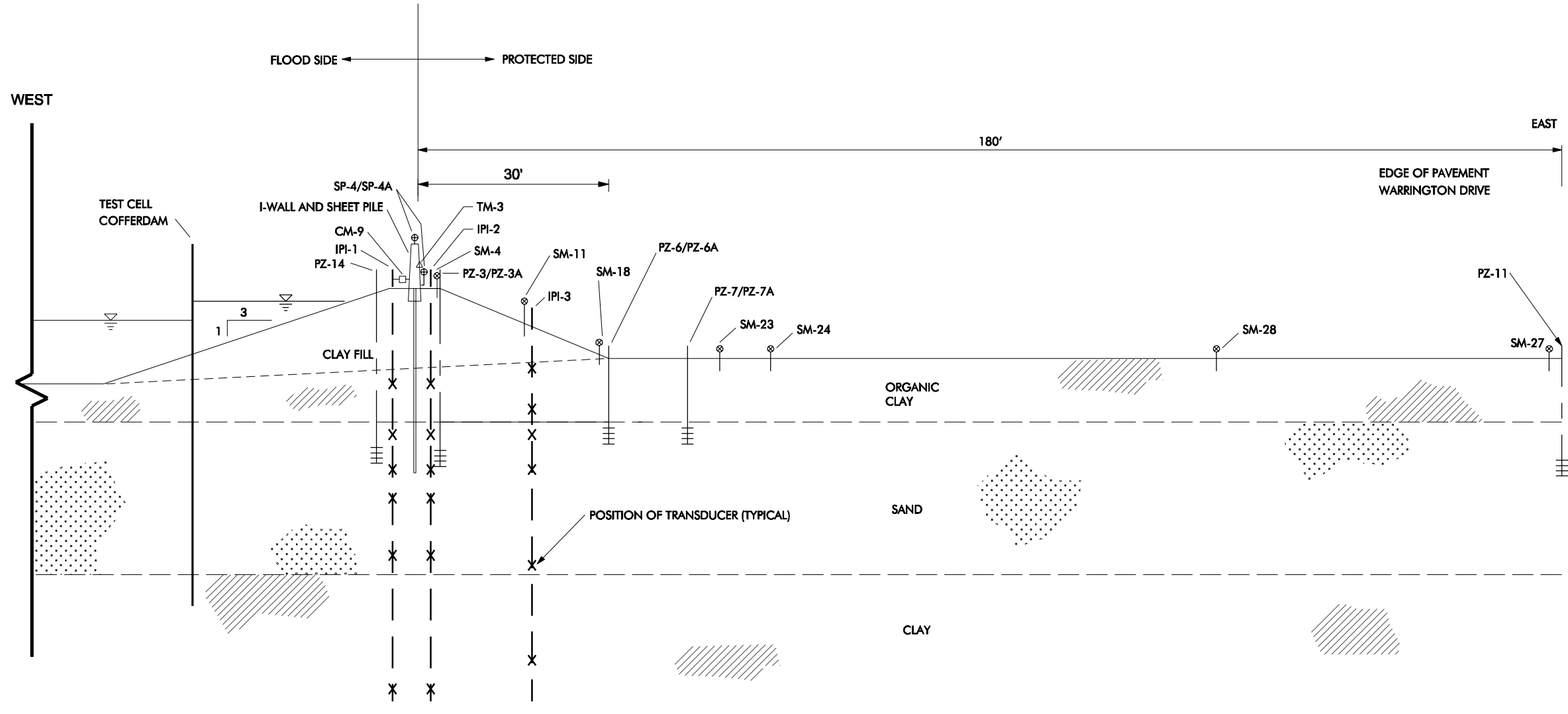

SECTION A-A*

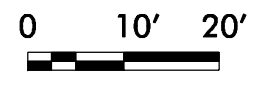

US ARMY CORPS OF ENGINEERS NEW ORLEANS DISTRICT	
DESIGNED BY: K9	DATE: NOVEMBER 2007
DWN BY: DAB	SOLUTION NO.:
SUBMITTED BY: KENNETH BERRY, P.E.	CONTRACT NO.:
FILE NO.:	FILE NUMBER:
PROJECT NO. 2186186L0001	PLAT DATE: 11/21/07
ANSI B 1:1	PLAT SCALE:
U.S. ARMY ENGINEER DISTRICT CORPS OF ENGINEERS MISSISSIPPI VALLEY DIVISION	1001 Highroads Plaza New Orleans, Louisiana 70119 (504) 688-0100
NEW ORLEANS EAST USACE - ST LOUIS DISTRICT OFFICE LEVEE UPGRADES ORLEANS PARISH, LA. LONDON AVENUE CANAL SITE SPECIFIC LOAD TEST	CROSS-SECTION A-A*
SHEET IDENTIFICATION NUMBER	FIGURE 3-2

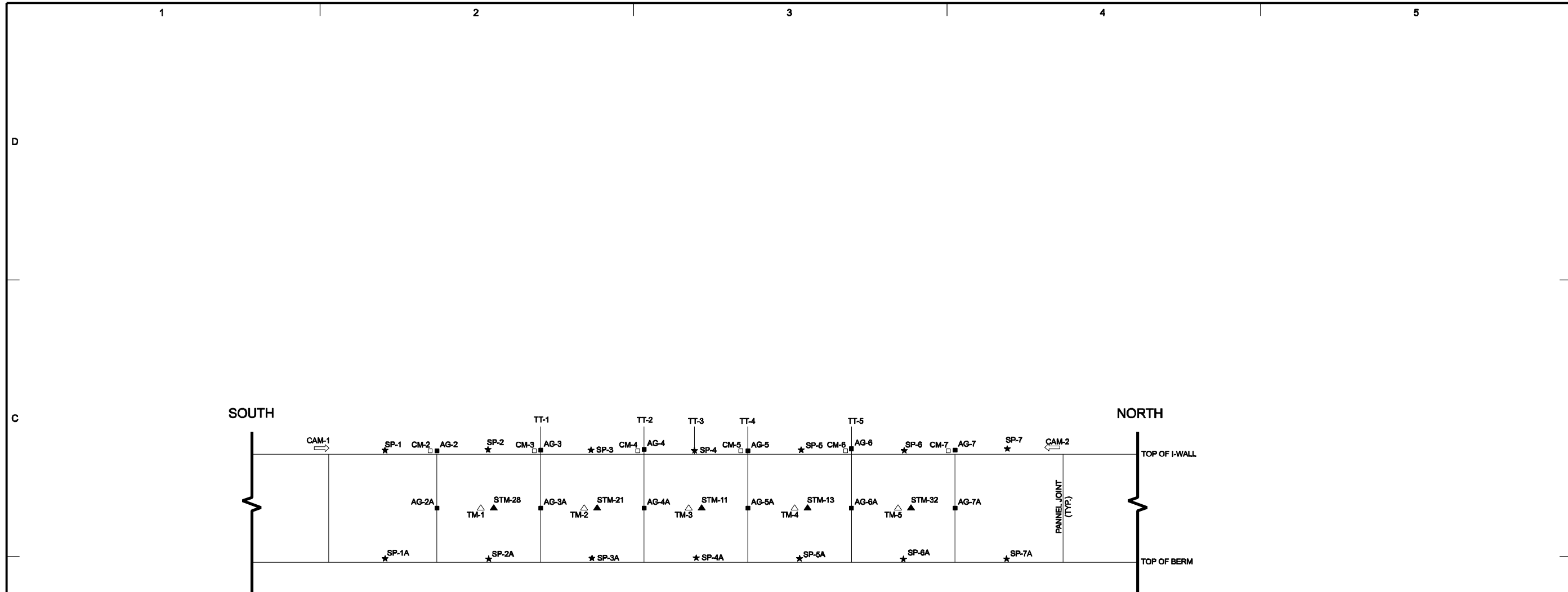

I-WALL ELEVATION (VIEW WEST)

LEGEND

- △ TILTMETER (TM)
- ▲ SENSAMETRICS TILTMETER (STM)
- CRACKMETER (CM)
- MANUAL CRACKMETER (AG)
- ★ SURVEY PRISM (SP)
- TELLTALE (TT)
- ← CAMERA

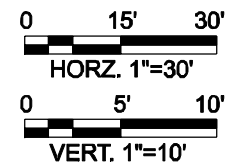

MARK	DESCRIPTION	DATE	APPR.

DESIGNED BY: KMB	DATE: NOVEMBER 2007
DWN BY: DAS	SOLUTION NO.:
COL BY: KMB	CONTRACT NO.:
PROJECT NO.:2186182.L0001	FILE NUMBER: 11/21/07
DATE: 11/21/07	DATE: 11/21/07

NEW ORLEANS EAST
USACE - ST LOUIS DISTRICT OFFICE LEVEE UPGRADES
ORLEANS PARISH, LA.
LONDON AVENUE CANAL
SITE SPECIFIC LOAD TEST
**ELEVATION OF INSTRUMENTS
ON I-WALL**

SHEET
IDENTIFICATION
NUMBER
FIGURE 3-3

Client Name:

USACE

Site Location:

London Avenue Canal Load Test

Project No.

21561880.00006

Photo No.

1

Date:

Description:

Site Photograph



Photo No.

2

Date:

Description:

Site Photograph



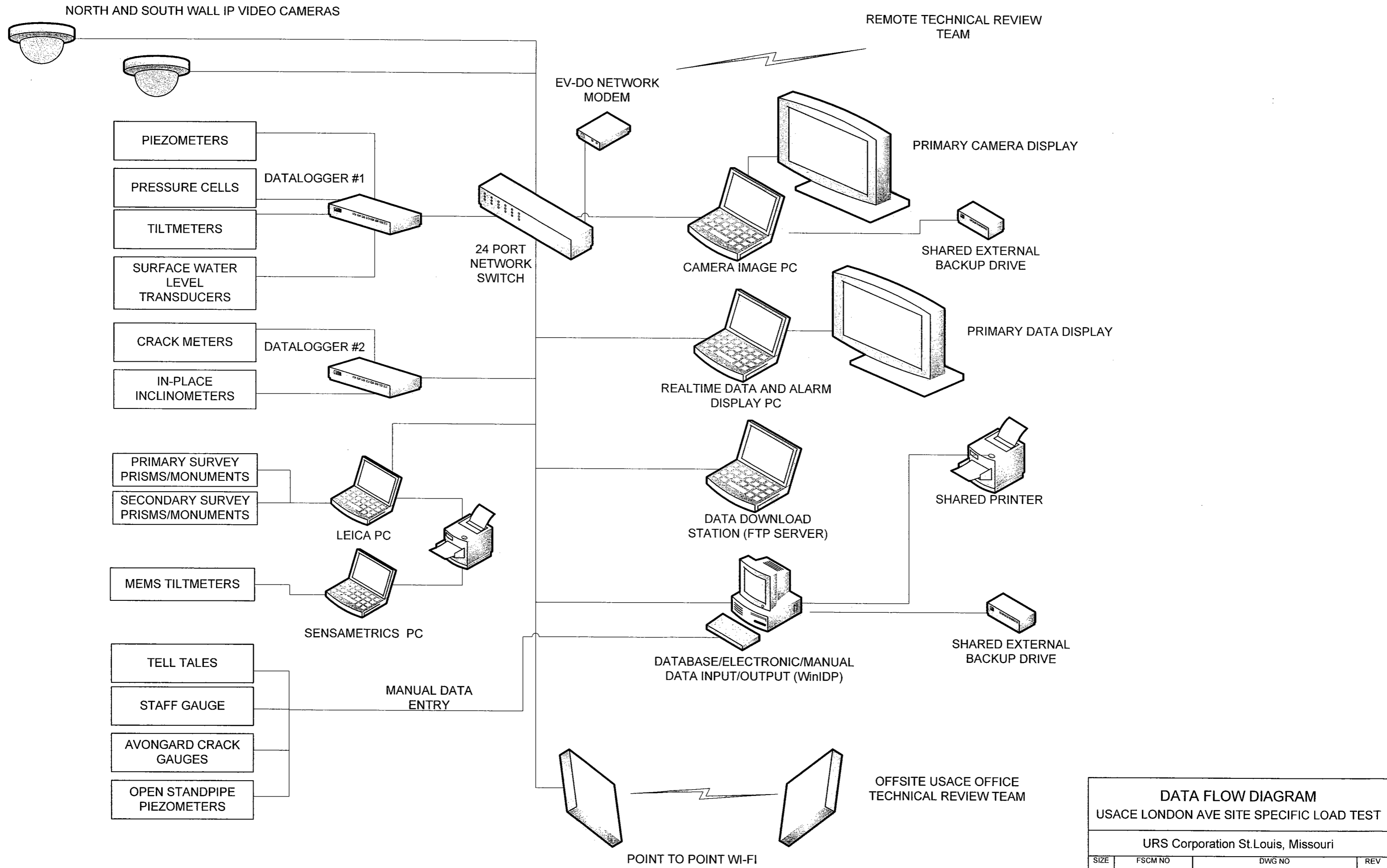

DATA FLOW DIAGRAM			
USACE LONDON AVE SITE SPECIFIC LOAD TEST			
URS Corporation St.Louis, Missouri			
SIZE	FSCM NO	DWG NO	REV
		FIGURE 3.5	
SCALE	NTS	10/08/07	SHEET 1 OF 1



Client Name: USACE		Site Location: London Avenue Canal Load Test	Project No. 21561880.00006
Photo No. 1	Date:		
Description: Inside of Instrumentation Trailer			

Photo No. 2	Date:		
Description: Inside of Instrumentation Trailer			

Client Name: USACE		Site Location: London Avenue Canal Load Test	Project No. 21561880.00006
Photo No. 1	Date:		
Description: Tripod supporting two enclosures with dataloggers.			

Photo No. 2	Date:	
Description: Datalogger, multiplexers and serial to IP Lantronics interfaces inside one of the enclosures.		

CHART 1

Piezometer ID	Input #	Wiring Type
PZ-1	1-1	2 wire
PZ-2	1-2	2 wire
PZ-3	2-1	2 wire
PZ-3A	2-2	2 wire
PZ-4	3-1	2 wire
PZ-5	3-2	2 wire
PZ-6	4-1	2 wire
PZ-6A	4-2	2 wire
PZ-7	5-1	2 wire
PZ-7A	5-2	2 wire
SWL-1	6-1	2 wire
SWL-2	6-2	2 wire
PZ-10	7-1	2 wire
PZ-11	7-2	2 wire
PZ-12	8-1	2 wire
PZ-13	8-2	2 wire
PZ-14	9-1	2 wire
PZ-15	9-2	2 wire
PZ-16	10-1	2 wire
PZ-17	10-2	2 wire
PZ18	11-1	2 wire

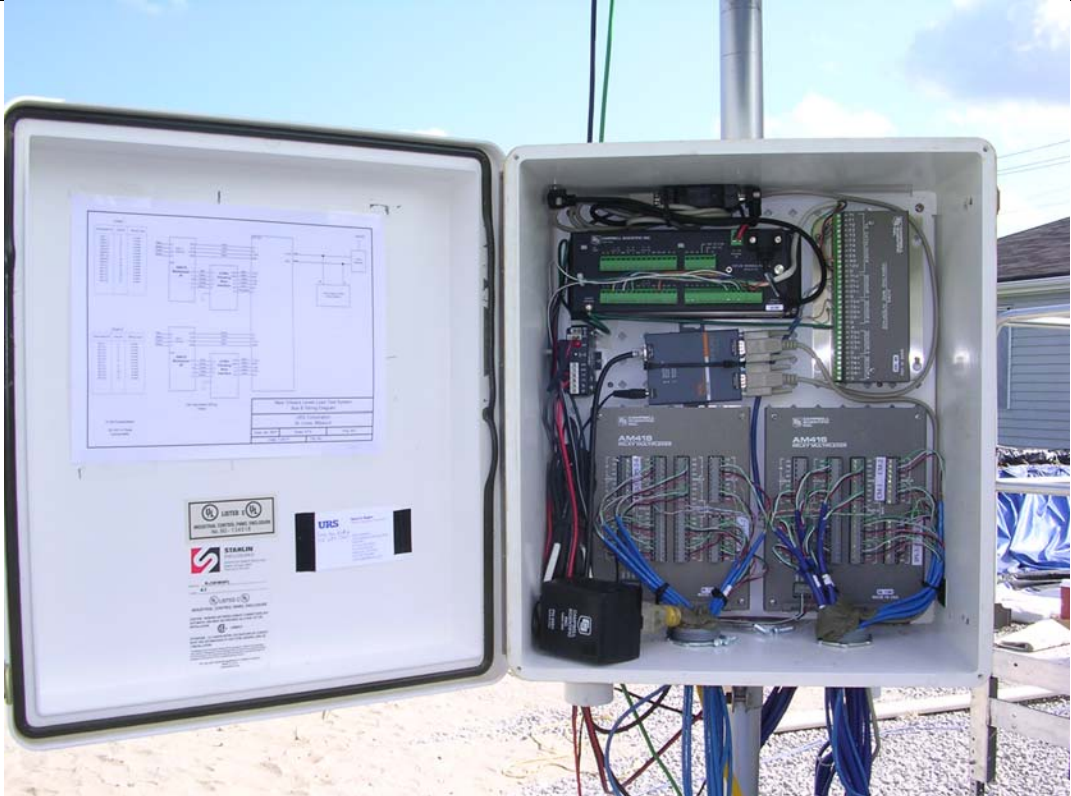
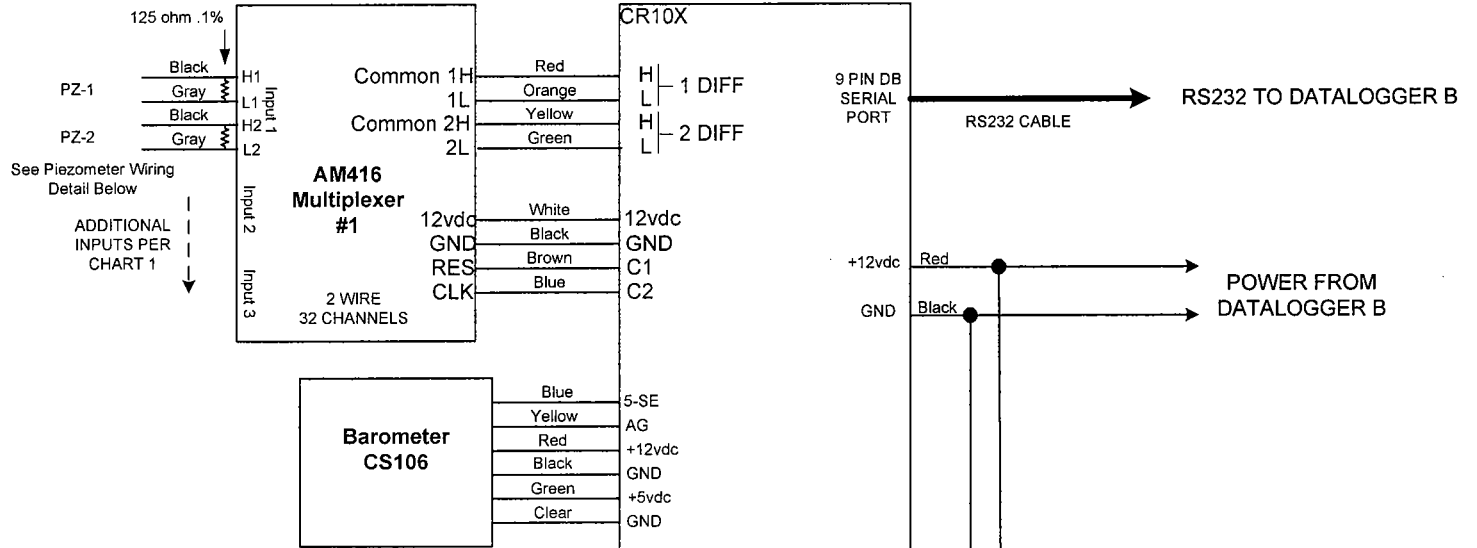
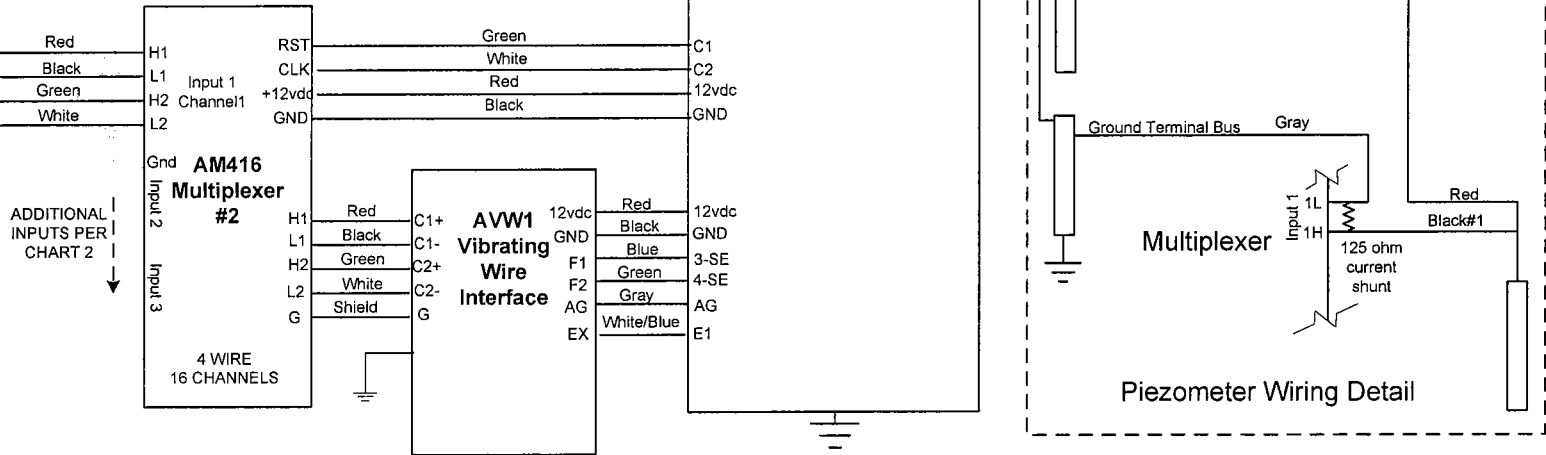

CHART 2

Piezometer ID	Input #	Wiring Type
PC-1	1	4 wire
PC-2	2	4 wire
PC-3	3	4 wire
TM-1	4	4 wire
TM-2	5	4 wire
TM-2	6	4 wire
TM-3	7	4 wire
TM-5	8	4 wire

3 VW Pressure Cells

5 VW Tiltmeters



VW instrument Wiring Detail

New Orleans Levee Load Test System
Box A Wiring Diagram

URS Corporation
St. Louis, Missouri

Drwn. By: BER

Scale: NTS

Proj. NO:

Date: 7-26-07

Fig. No. 3.8

CHART 1

Piezometer ID	Input #	Wiring Type
IPI-1-1	1	4 wire
IPI-1-2	2	4 wire
IPI-1-3	3	4 wire
IPI-1-4	4	4 wire
IPI-1-5	5	4 wire
IPI-1-6	6	4 wire
IPI-2-1	7	4 wire
IPI-2-2	8	4 wire
IPI-2-3	9	4 wire
IPI-2-4	10	4 wire
IPI-2-5	11	4 wire
IPI-2-6	12	4 wire

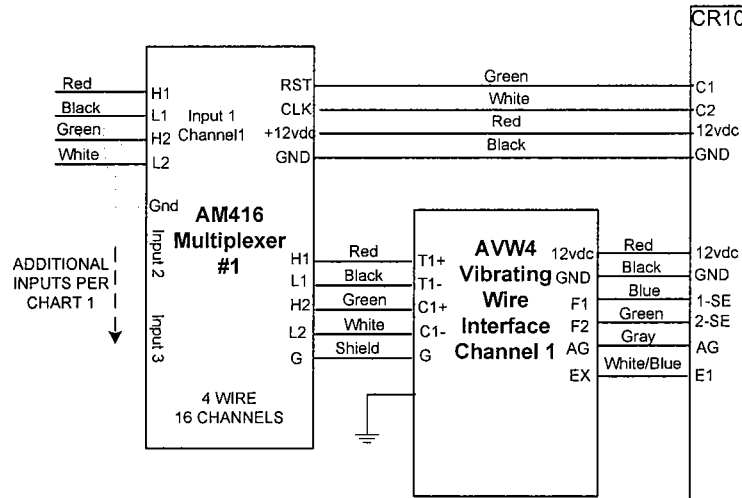
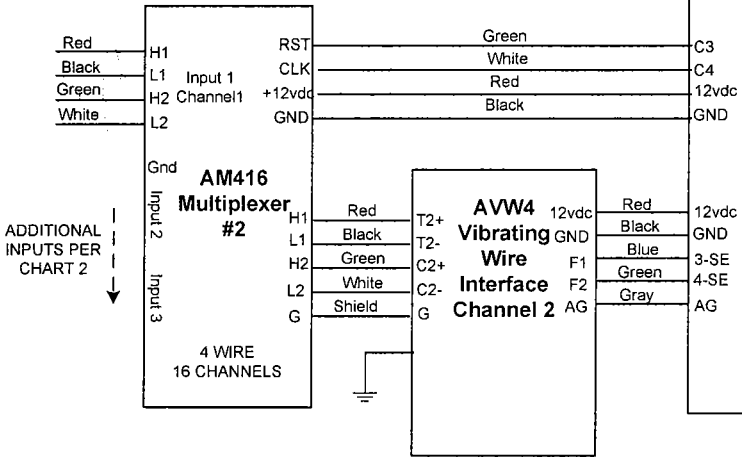

CHART 2

Piezometer ID	Input #	Wiring Type
IPI-3-1	1	4 wire
IPI-3-2	2	4 wire
IPI-3-3	3	4 wire
IPI-3-4	4	4 wire
IPI-3-5	5	4 wire
IPI-3-6	6	4 wire
CM-1-1	7	4 wire
CM-2-1	8	4 wire
CM-3-2	9	4 wire
CM-4-3	10	4 wire
CM-5-4	11	4 wire
CM-6-5	12	4 wire
CM-7-6	13	4 wire
CM-8-6	14	4 wire
CM-9-4	15	4 wire



VW instrument Wiring Detail

120VAC

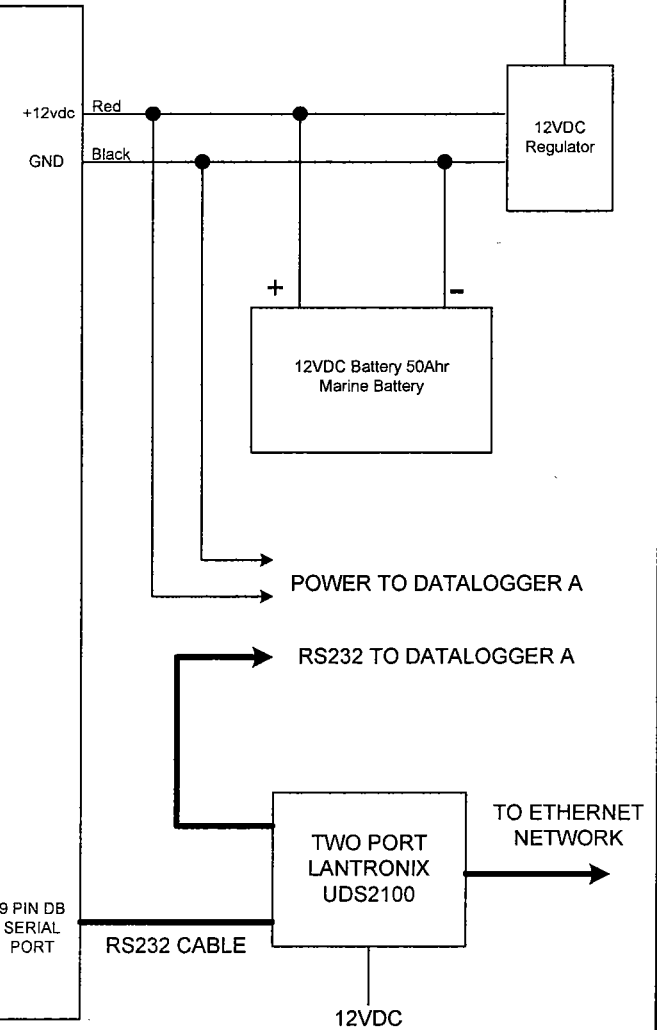

9 VW Crackmeters

18 VW In-Place
Inclinometer

New Orleans Levee Load Test System
Box B Wiring Diagram

URS Corporation
St. Louis, Missouri

Drwn. By: BER

Scale: NTS

Proj. NO:

Date: 7-26-07

Fig. No. 3.9

Client Name:

USACE

Site Location:

London Avenue Canal Load Test

Project No.

21561880.00006

Photo No.

1

Date:

Description:

Graphical Alarm
Threshold Display

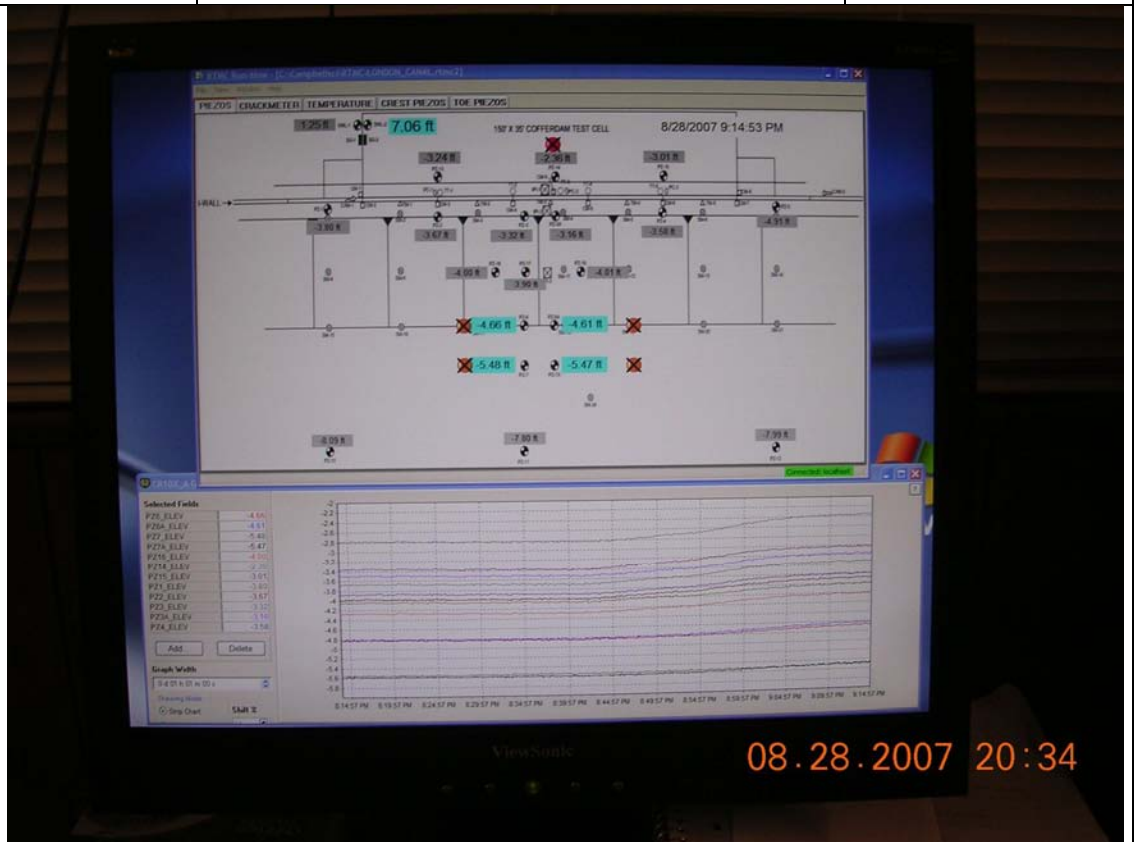

Client Name:

USACE

Site Location:

London Avenue Canal Load Test

Project No.

21561880.00006

Photo No.

1

Date:

Description:

Photograph of Initial Set-up of Computers Inside Instrumentation Trailer.



Client Name:

USACE

Site Location:

London Avenue Canal Load Test

Project No.

21561880.00006

Photo No.

1

Date:

Description:

Cofferdam With Water at Elevation 1.0 ft



Photo No.

2

Date:

Description:

Cofferdam With Water at Elevation 2.0 ft





Client Name: USACE		Site Location: London Avenue Canal Load Test	Project No. 21561880.00006
Photo No. 3	Date:		
Description: Cofferdam With Water at Elevation 4.0 ft			

Photo No. 4	Date:		
Description: Cofferdam With Water at Elevation 7.0 ft			

Client Name: USACE	Site Location: London Avenue Canal Load Test	Project No.: 21561880.00006
------------------------------	--	---------------------------------------

Photo No. 1	Date:
-----------------------	--------------

Description:
Photograph of Surface Water Level Gages (Staff Gage and Adjacent Casing for Transducer)



Client Name:

USACE

Site Location:

London Avenue Canal Load Test

Project No.

21561880.00006

Photo No.

1

Date:

Description:

Typical Piezometer Installation.



Photo No.

2

Date:

Description:

Piezometers with Riser Pipes Above Grade.



Client Name:

USACE

Site Location:

London Avenue Canal Load Test

Project No.

21561880.00006

Photo No.

1

Date:

Description:

Photograph of Manual Crackmeter





Client Name: USACE		Site Location: London Avenue Canal Load Test	Project No. 21561880.00006
Photo No. 1	Date:	 <p>08.25.2007 10:05</p>	
Description: Photograph of Incliner IPI-1. (Incliner is inside the cofferdam. The inclinometer is adjacent to Piezometer PZ-14.)			

Photo No. 2	Date:	
Description: Photograph of Incliner IPI-3.		

Client Name: USACE		Site Location: London Avenue Canal Load Test	Project No. 21561880.00006
Photo No. 1	Date:		
Description: Installation of PC-3 prior to completion of backfilling.			

Photo No. 2	Date:	
Description: Picture of a typical Earth Pressure Cell (from literature produced by the manufacturer Geokon).		

Client Name: USACE		Site Location: London Avenue Canal Load Test	Project No. 21561880.00006
Photo No. 1	Date:		
Description: Typical Prism Installation on I-Wall			

Photo No. 2	Date:	
Description: Typical Survey Monument with Prism		

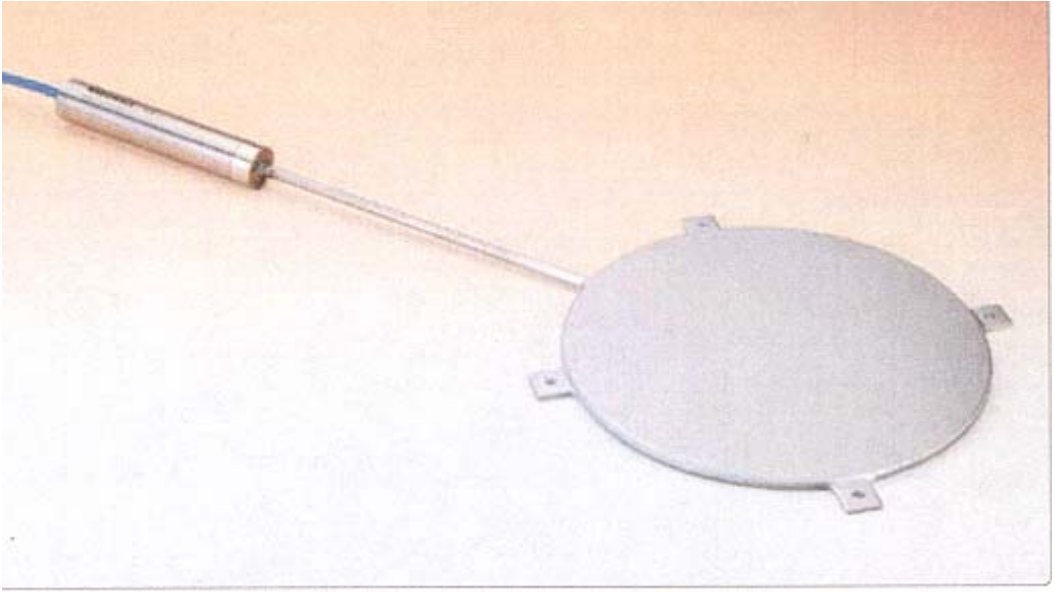

Client Name: USACE		Site Location: London Avenue Canal Load Test	Project No. 21561880.00006
Photo No. 1	Date:		
Description: Robotic Survey Devices			

Photo No. 2	Date:	
Description: Robotic Survey Device		

Client Name: USACE		Site Location: London Avenue Canal Load Test	Project No. 21561880.00006
Photo No. 1	Date:		
Description: Telltale and Vibrating Wire Crackmeter			

Photo No. 2	Date:	
Description: Telltale		

Client Name: USACE		Site Location: London Avenue Canal Load Test	Project No. 21561880.00006
Photo No. 3	Date:	 A photograph showing a vertical wall with two black L-shaped brackets mounted on it. A vertical pipe runs down the wall between the brackets. To the left of the wall is a wooden deck. In the background, there are some colorful flags and a white container.	
Description: Telltale Mounting on I-Wall			

Photo No. 4	Date:	 A close-up photograph of a vertical metal rod protruding from a concrete wall. The rod is surrounded by soil, twigs, and some green leaves. The rod appears to be part of a telltale installation.
Description: Bottom of Telltale Installation		

Client Name:

USACE

Site Location:

London Avenue Canal Load Test

Project No.

21561880.00006

Photo No.

1

Date:

Description:

Photograph of Vibrating Wire Tiltmeter



Client Name: USACE		Site Location: London Avenue Canal Load Test	Project No. 21561880.00006
Photo No. 1	Date:		
Description: Photograph of Video Camera			

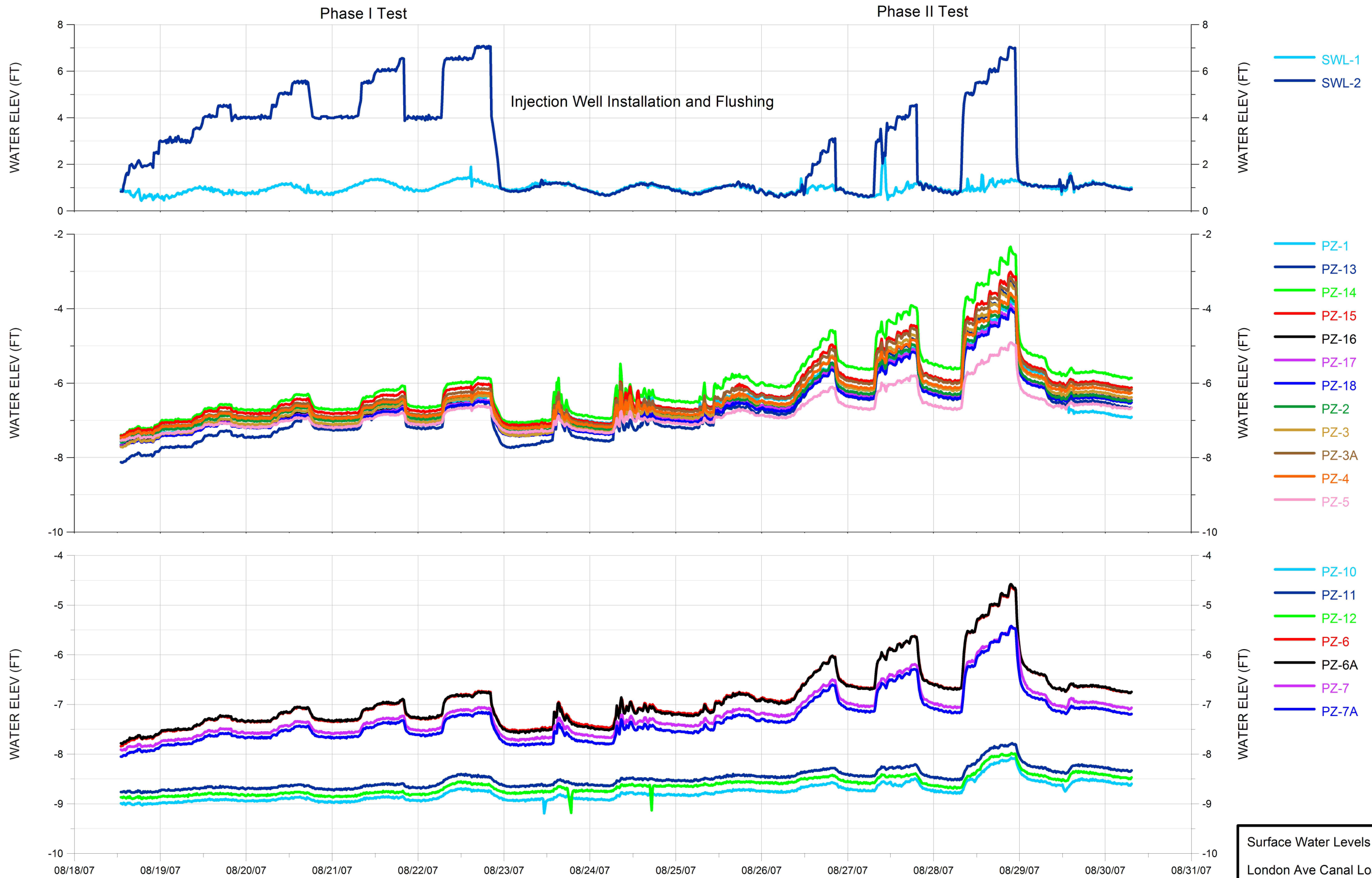

Surface Water Levels and PZs
 London Ave Canal Load Test
 FIGURE 4.14

PHASE I - PHREATIC SURFACE PROFILE CENTER LINE

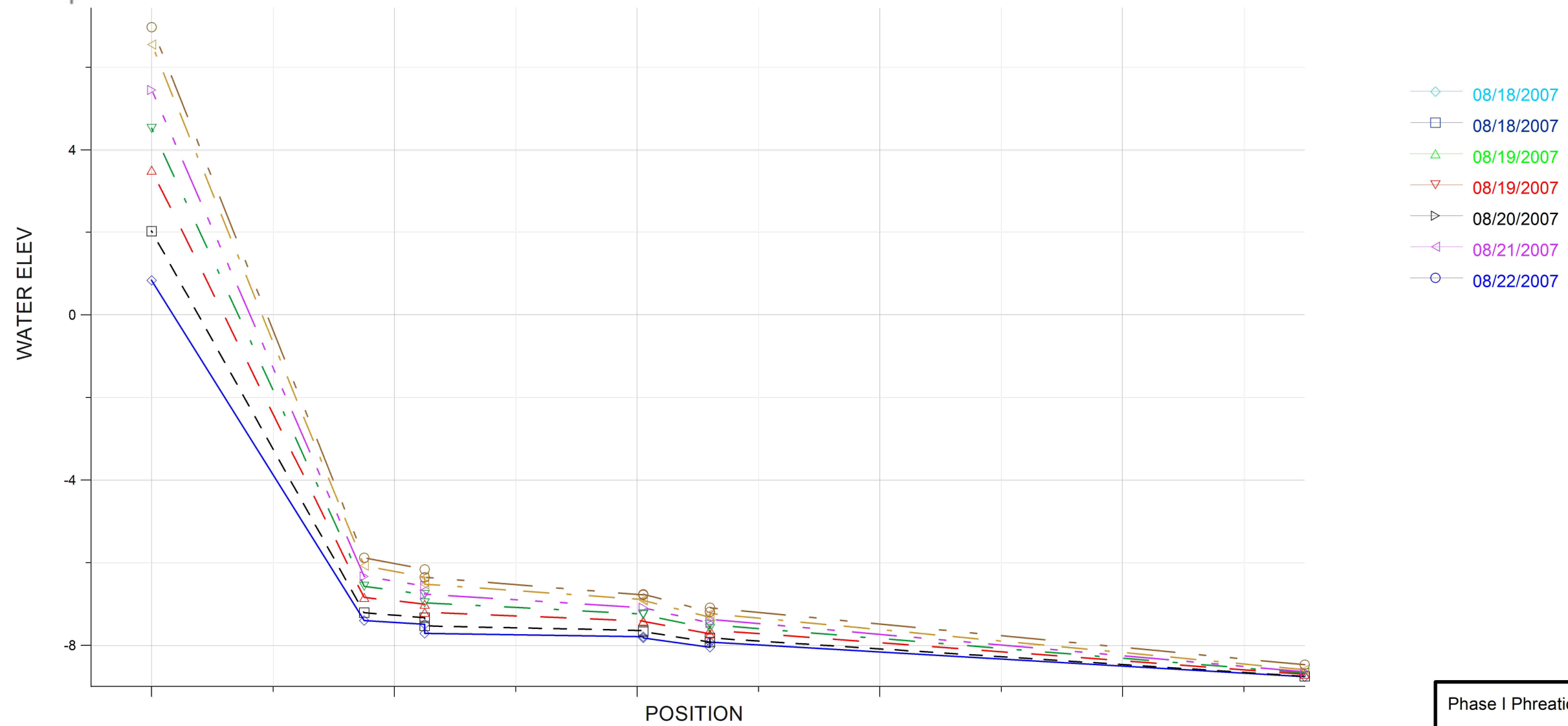
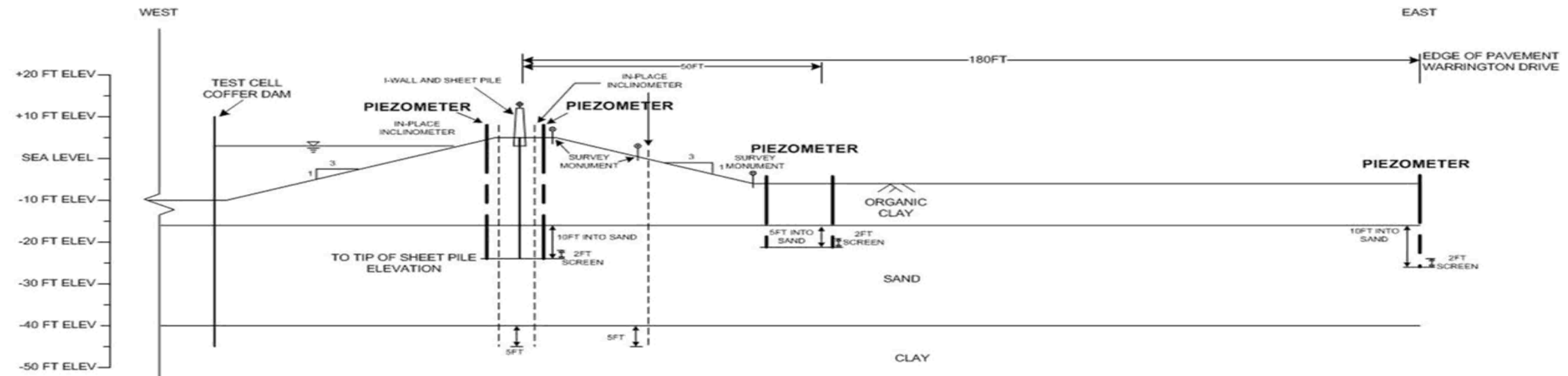

Phase I Phreatic Surface Profile
 London Canal Load Test
 FIGURE 4.15

PHASE II - PHREATIC SURFACE PROFILE CENTER LINE

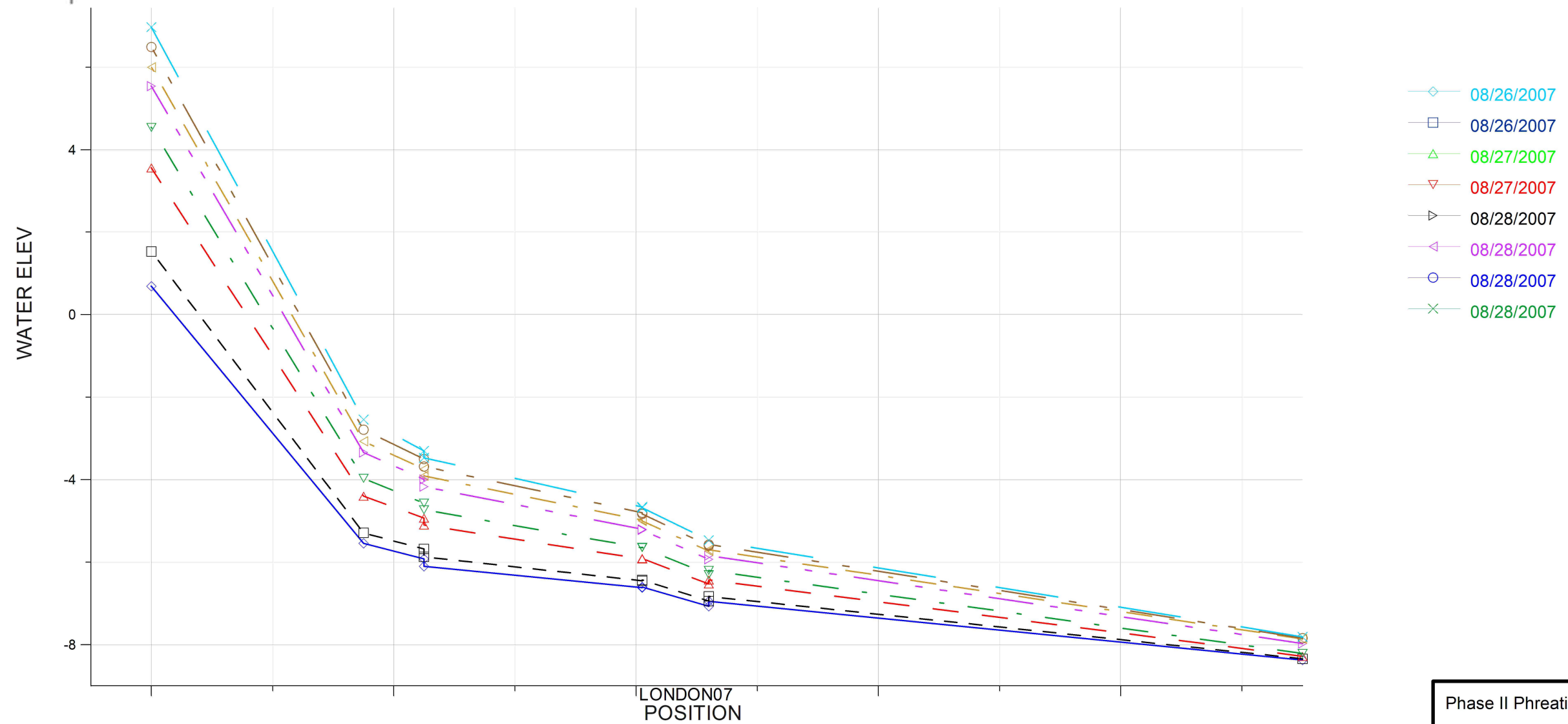
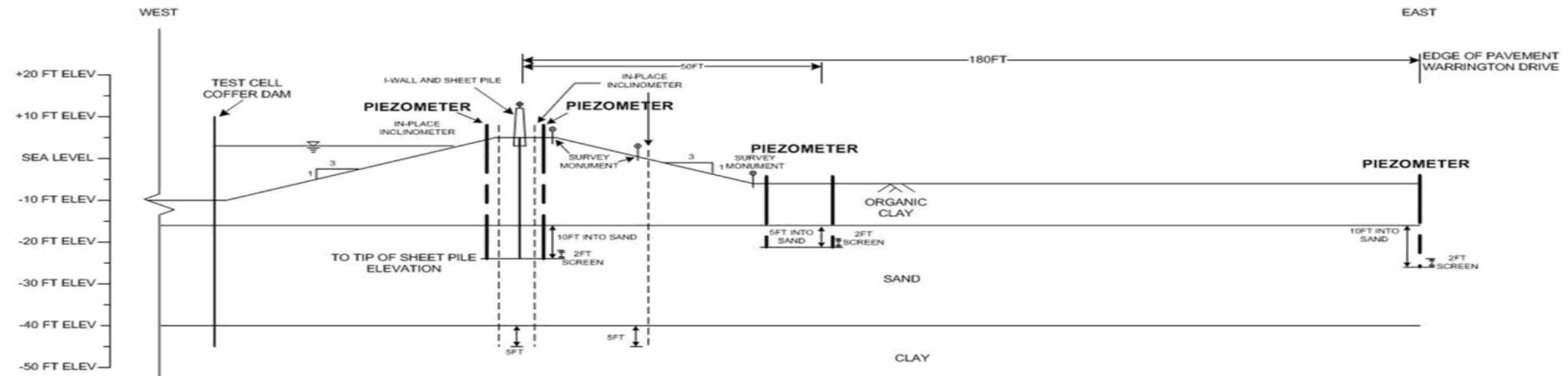

Phase II Phreatic Surface Profile
 London Canal Load Test
 FIGURE 4.16

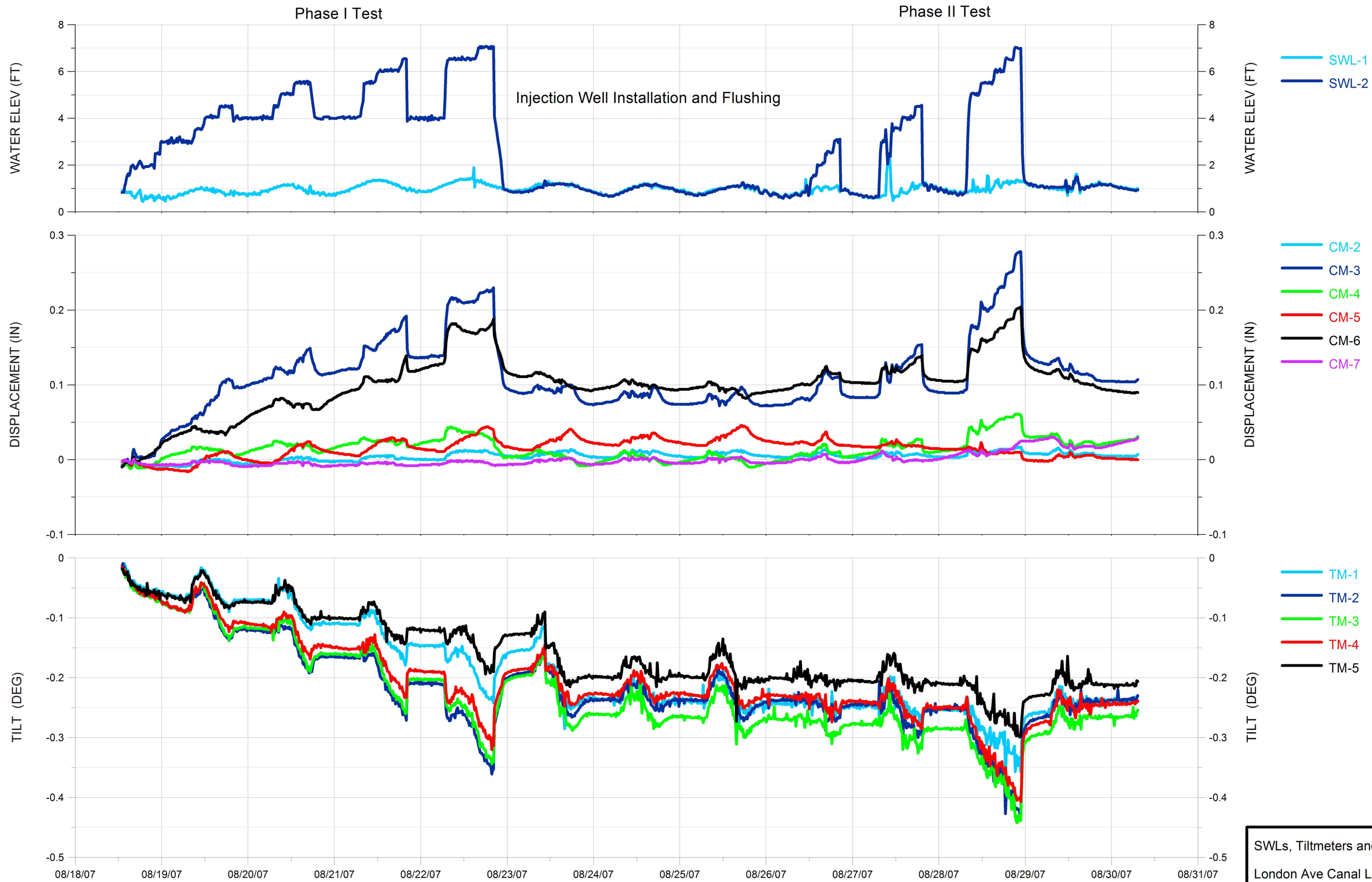

SWLs, Tiltmeters and Crack Meters
 London Ave Canal Load Test
 FIGURE 4.17

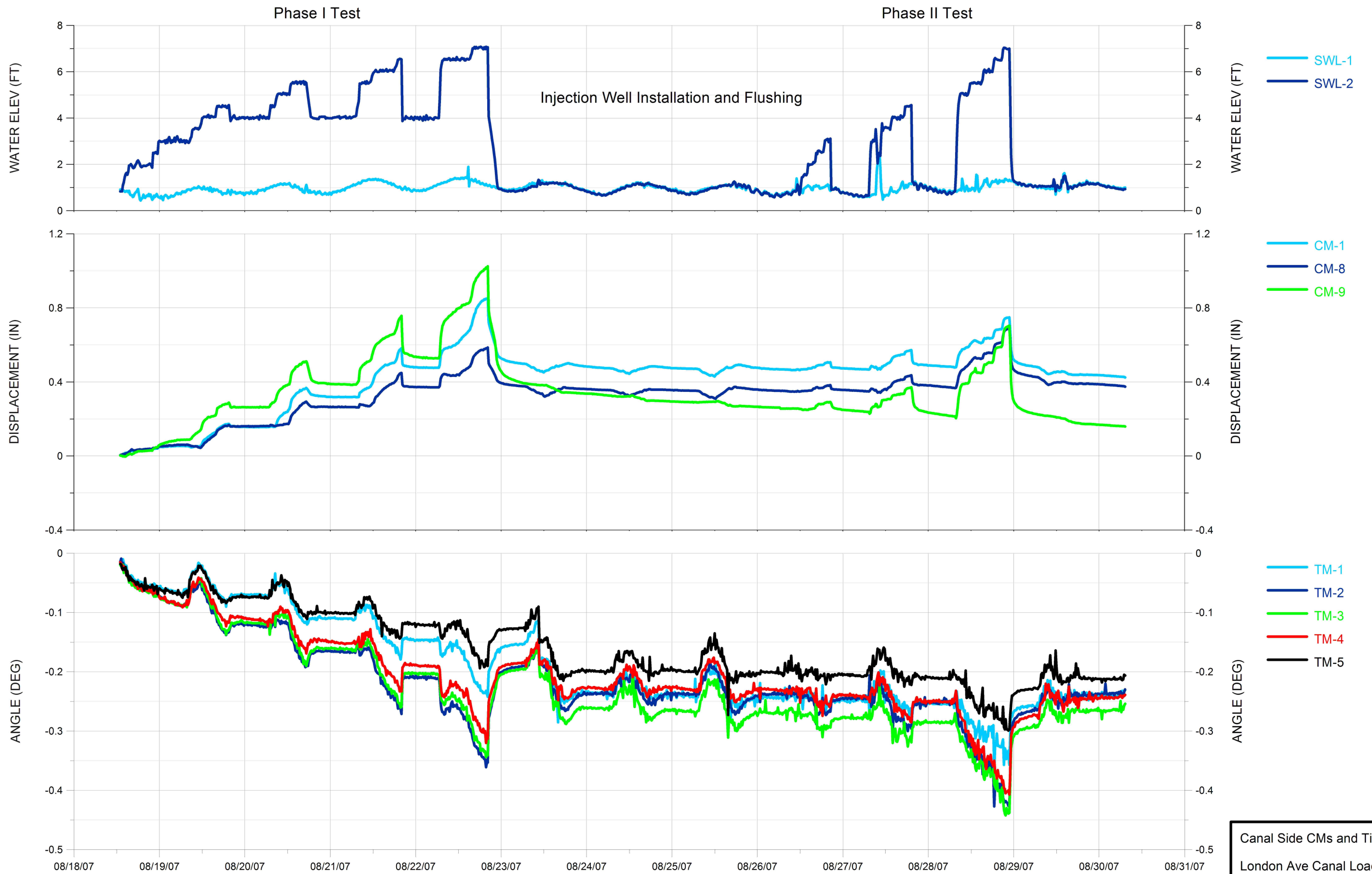

Canal Side CMs and Tiltmeters
 London Ave Canal Load Test
 FIGURE 4.18

IPI-1, IPI-2, and IPI-3 Phase I
Deflection (Inches) vs Elevation (Feet)

IPI 1 - Phase 1

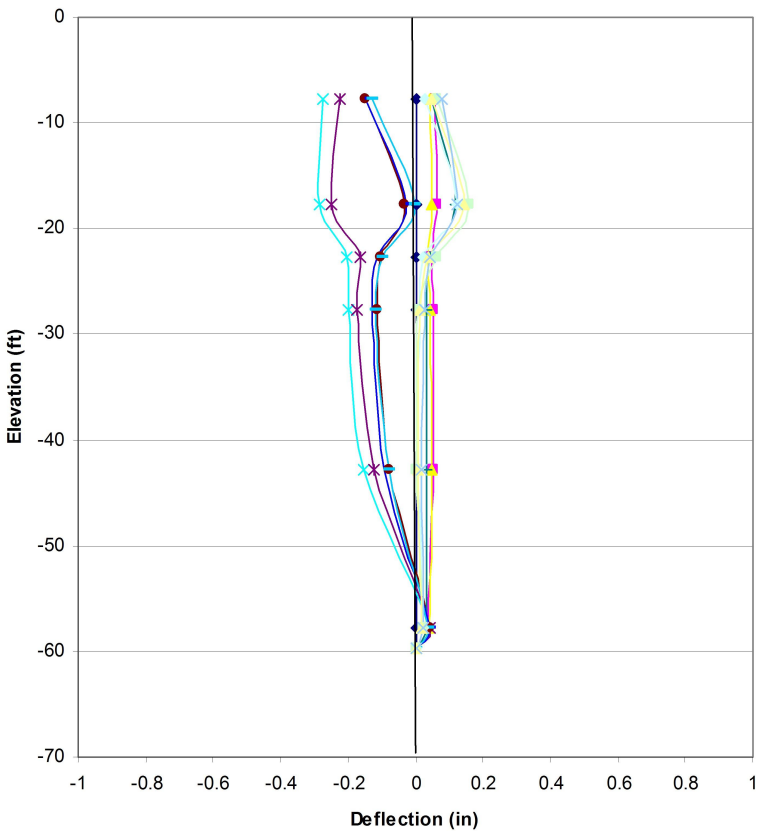

IPI 2 - Phase 1

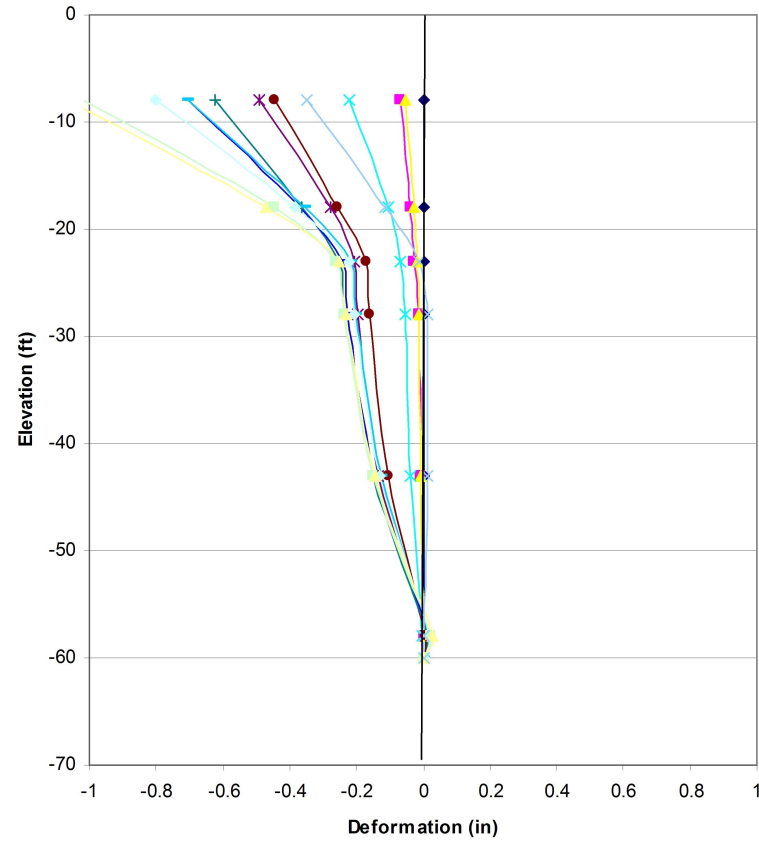

IPI 3 - Phase 1

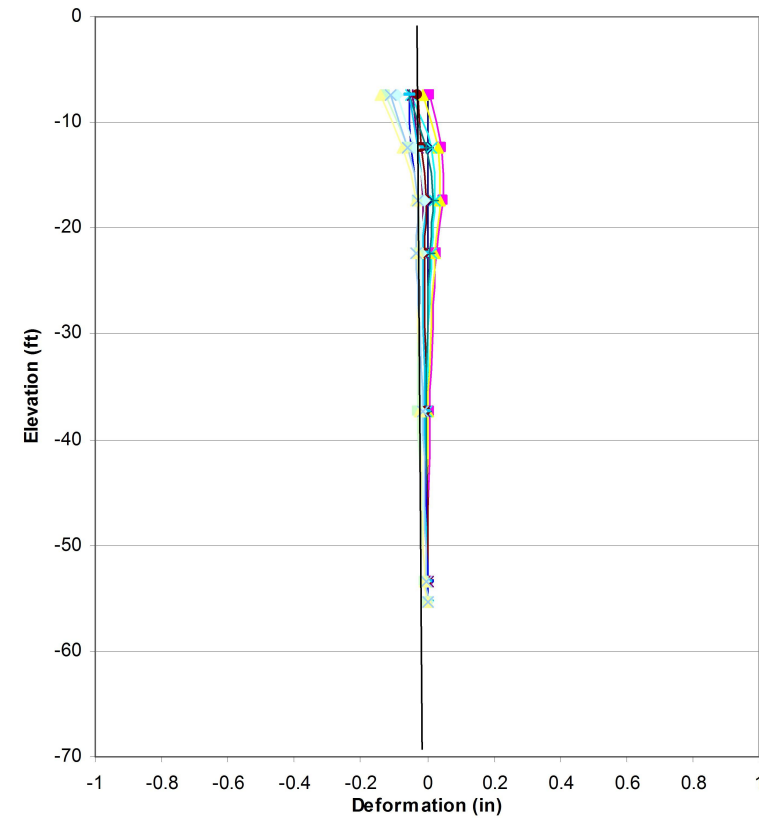

- ◆ Beginning of Phase 1
- Cell Water EI = 2 ft
- ▲ Cell Water EI = 2.5 ft
- ✕ Cell Water EI = 3 ft
- ✱ Cell Water EI = 3.5 ft
- Cell Water EI = 4 ft
- + Cell Water EI = 4.5 ft
- Cell Water EI = 5 ft
- Cell Water EI = 5.5 ft
- ◆ Cell Water EI = 6 ft
- Cell Water EI = 6.5 ft
- ▲ Cell Water EI = 7 ft
- ✕ End of Phase 1

IPIs Phase I
London Ave Canal Load Test
Figure 4.19

IPI-1, IPI-2, and IPI-3 Phase II
Deflection (Inches) vs Elevation (Feet)

IPI 1 - Phase 2

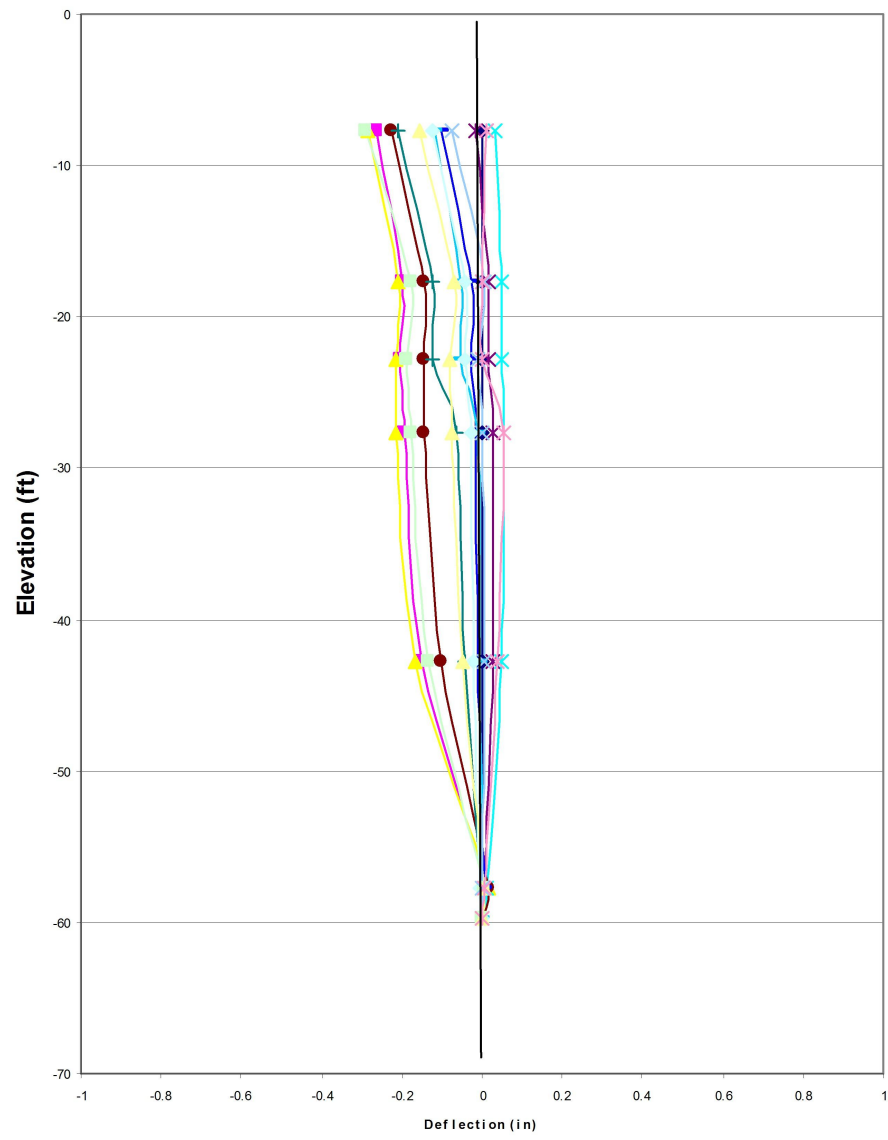

IPI 2 - Phase 2

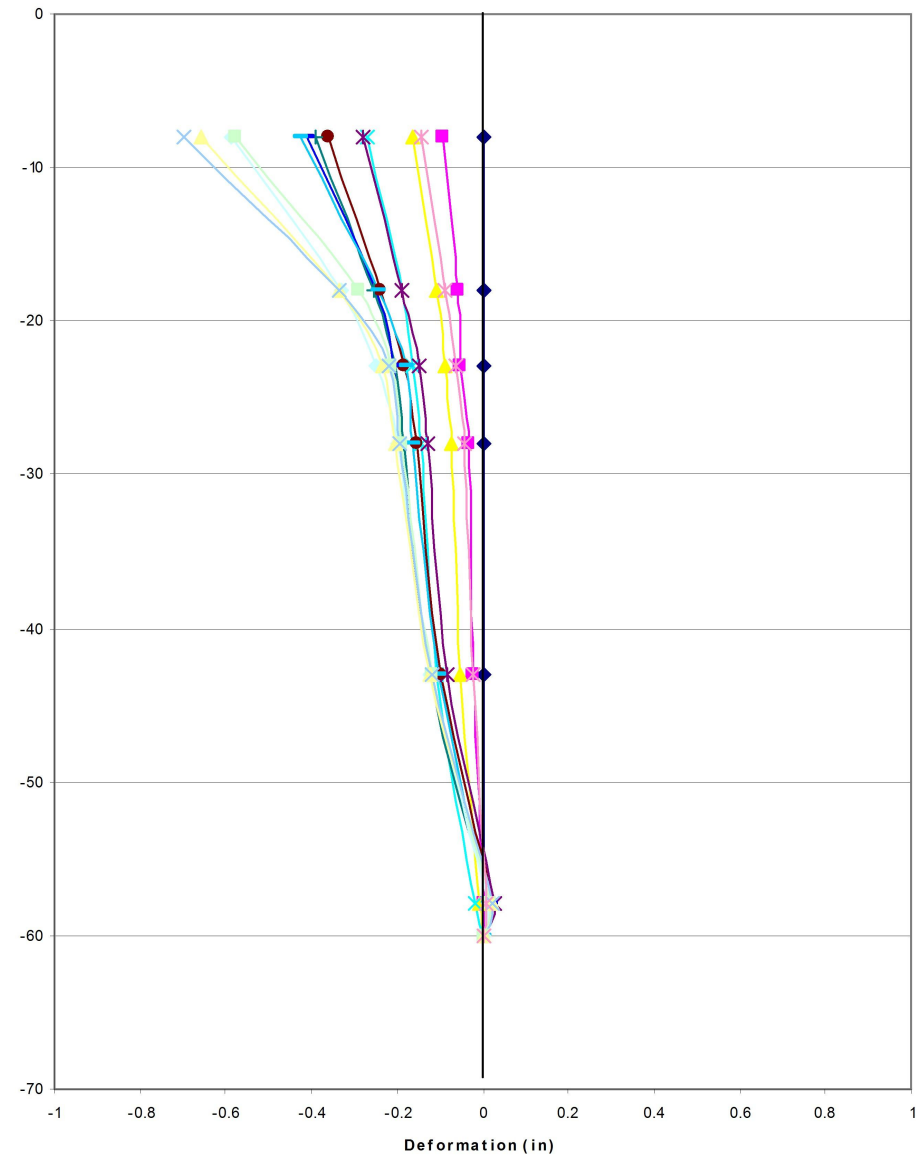

IPI 3 - Phase 2

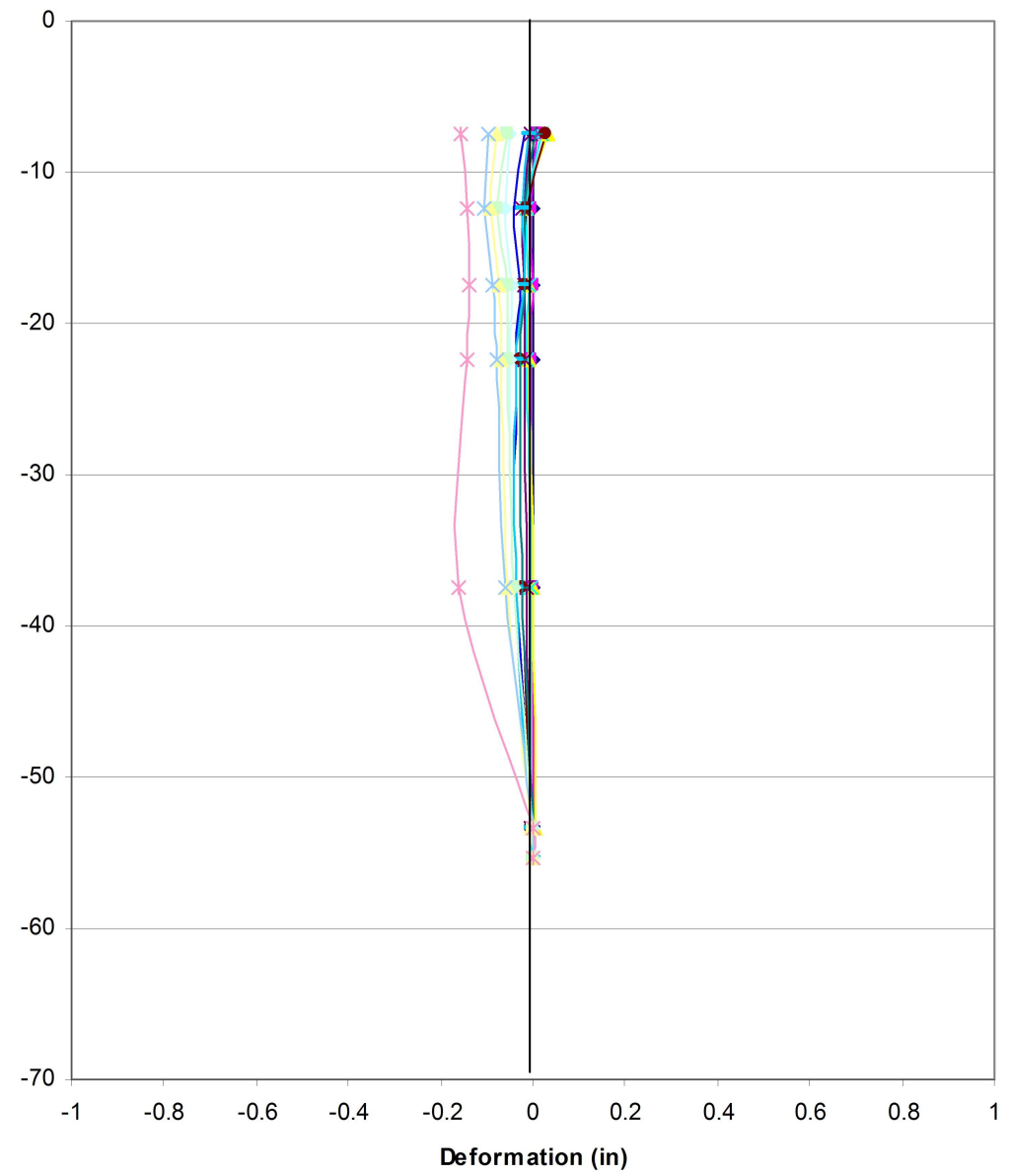

- ◆ Beginning of Phase 2
- Cell Water E = 1.5 ft
- ▲ Cell Water E = 2 ft
- ✕ Cell Water E = 2.5 ft
- ✖ Cell Water E = 3 ft
- Cell Water E = 3.5 ft
- + Cell Water E = 4 ft
- Cell Water E = 4.5 ft
- Cell Water E = 5 ft
- ◆ Cell Water E = 5.5 ft
- Cell Water E = 6 ft
- ▲ Cell Water E = 6.5 ft
- ✕ Cell Water E = 7 ft
- ✖ End of Phase 2

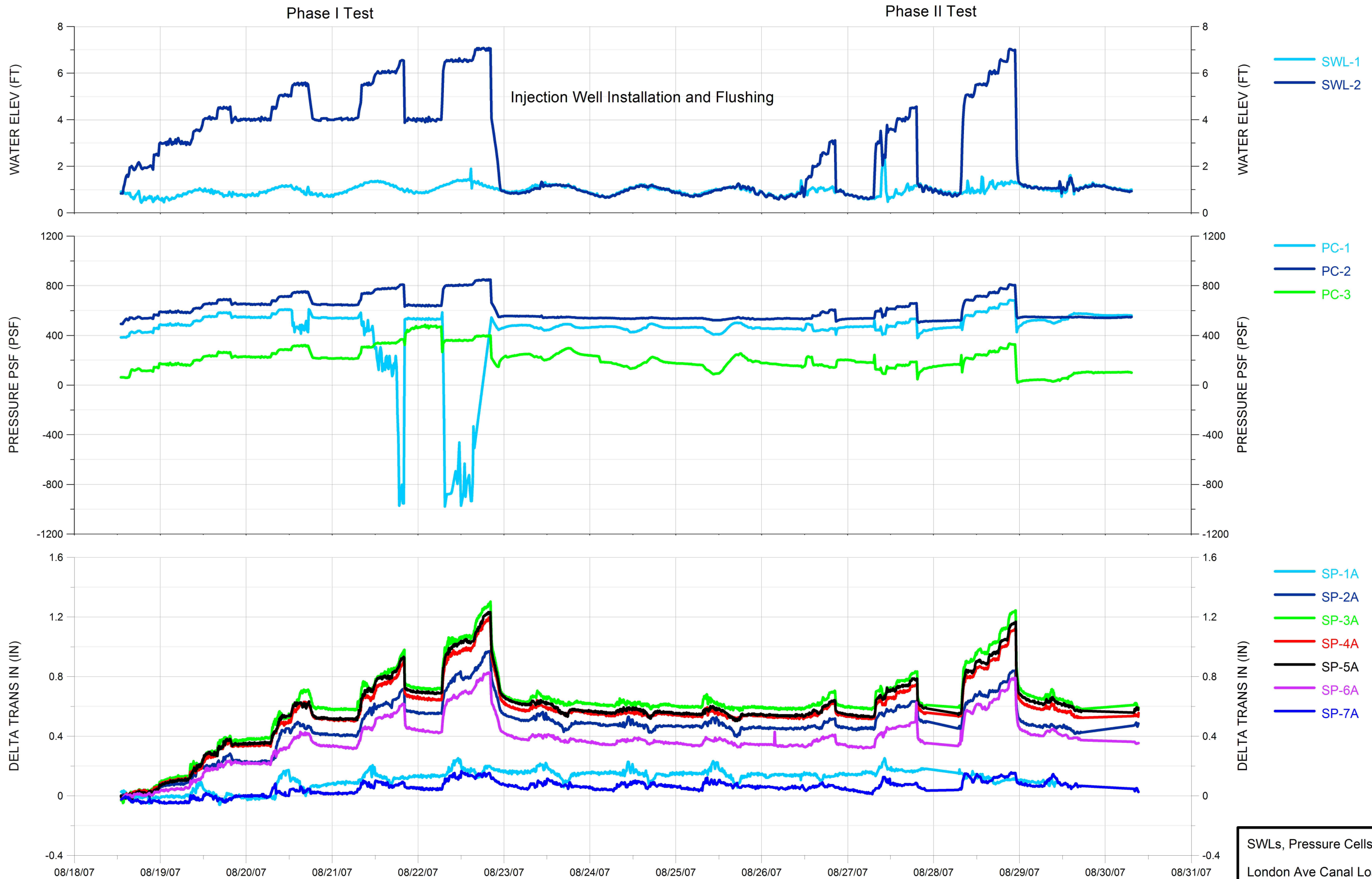

SWLs, Pressure Cells, Prisms
 London Ave Canal Load Test
 FIGURE 4.21

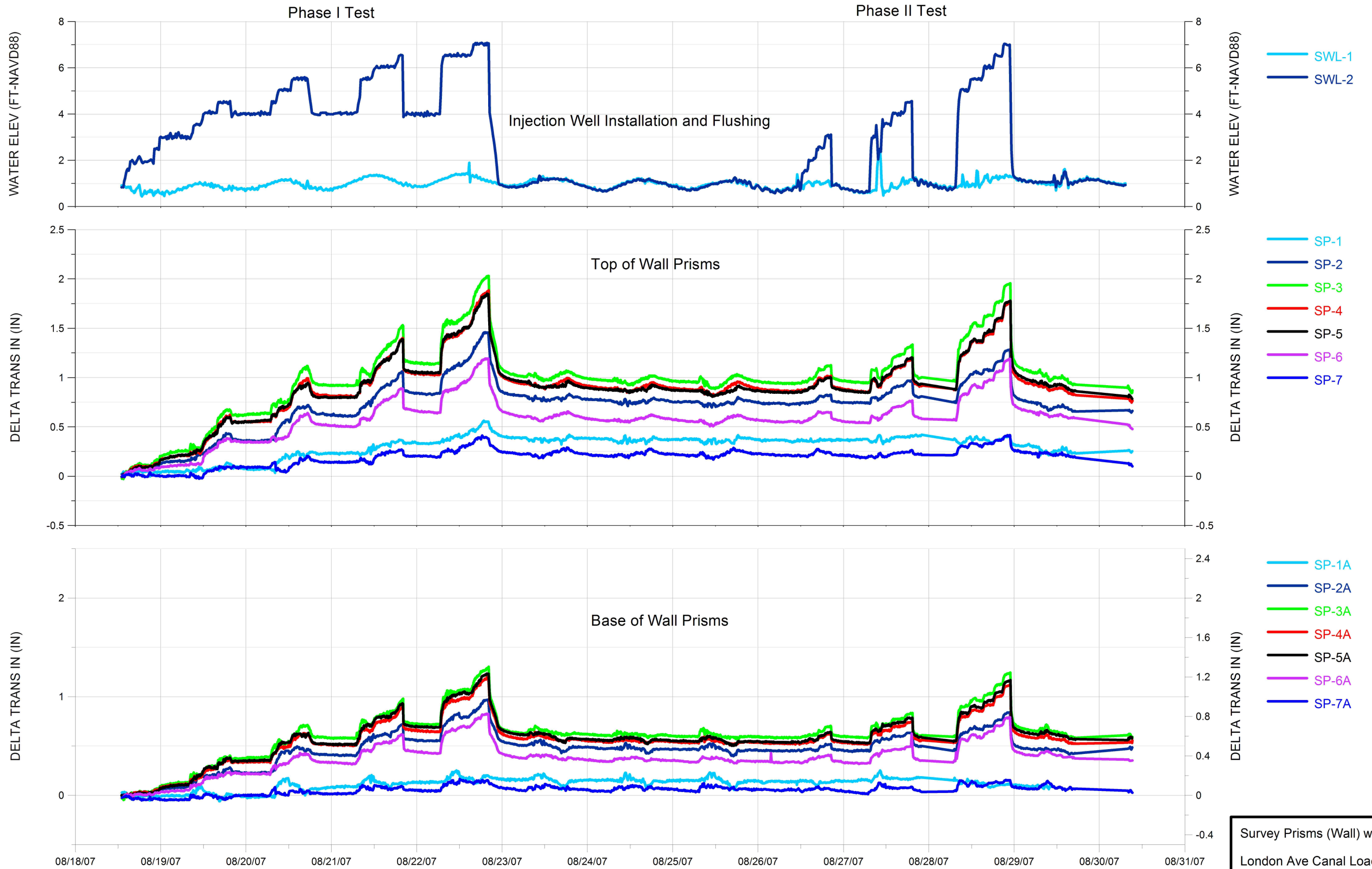

Survey Prisms (Wall) with SWLs
 London Ave Canal Load Test
 FIGURE 4.22

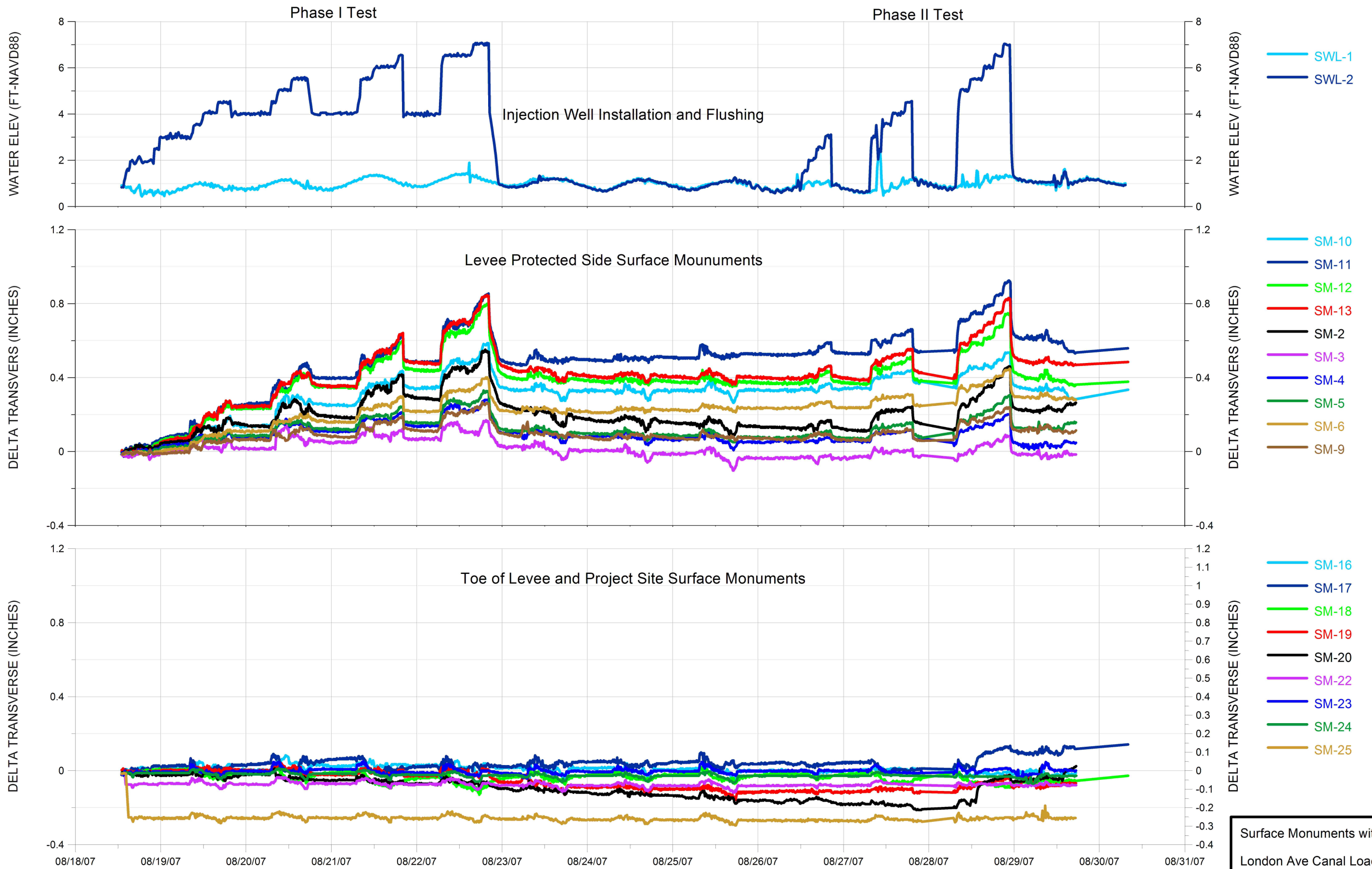

Surface Monuments with SWLs
 London Ave Canal Load Test
 FIGURE 4.23

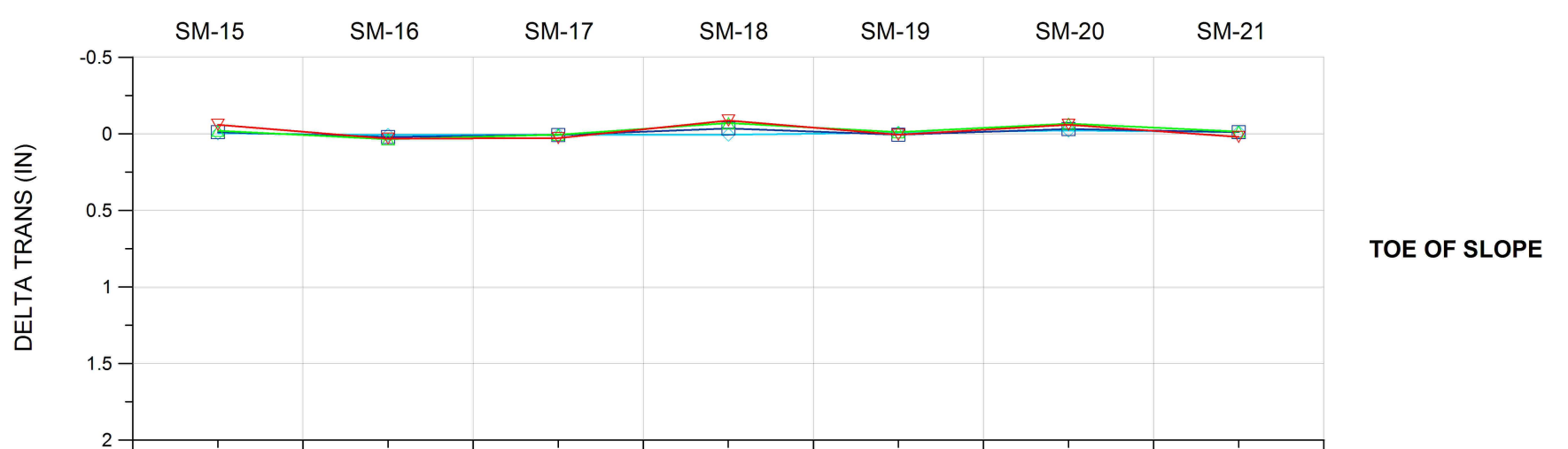
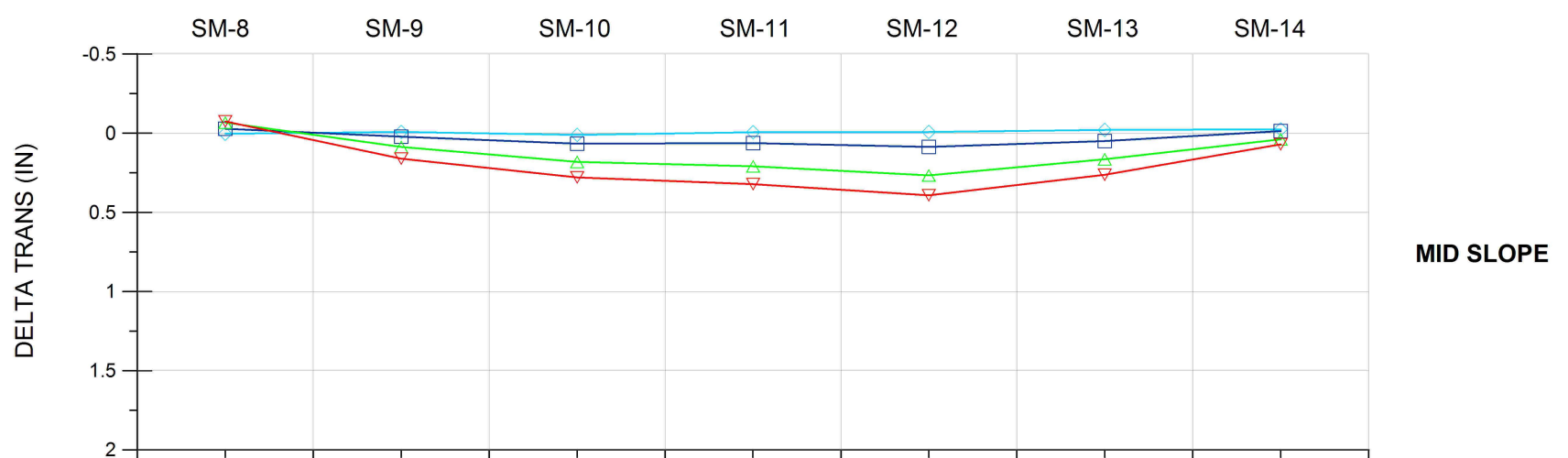
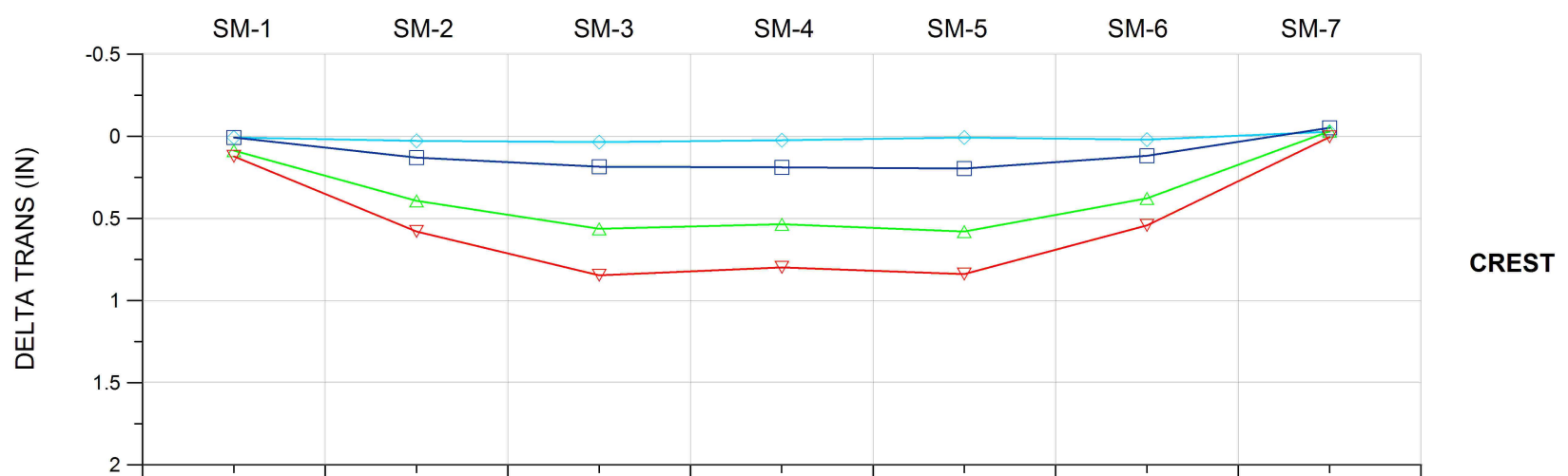
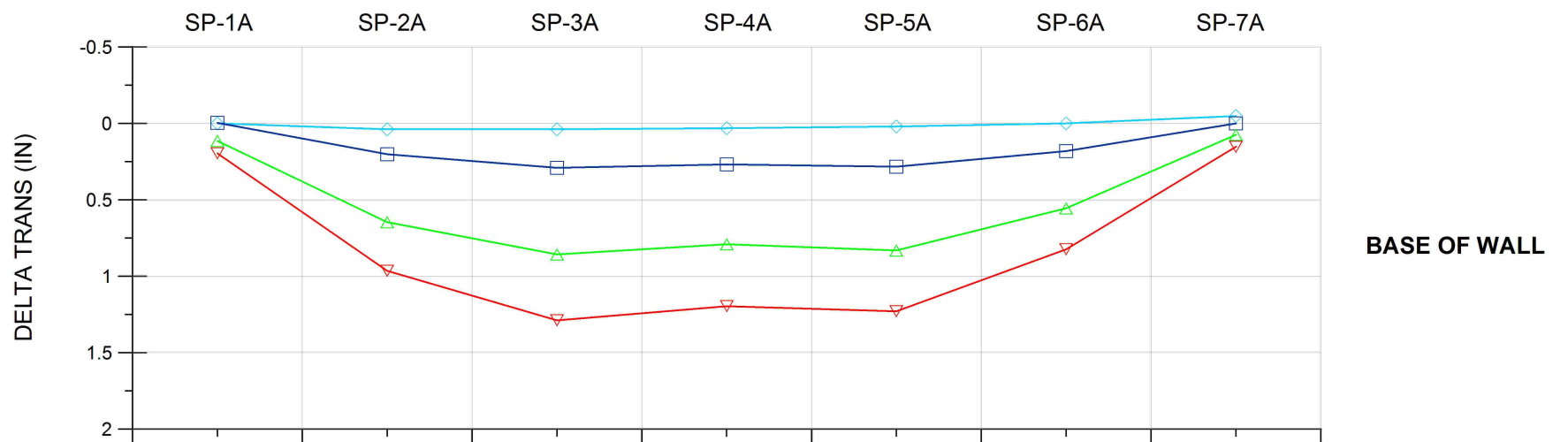
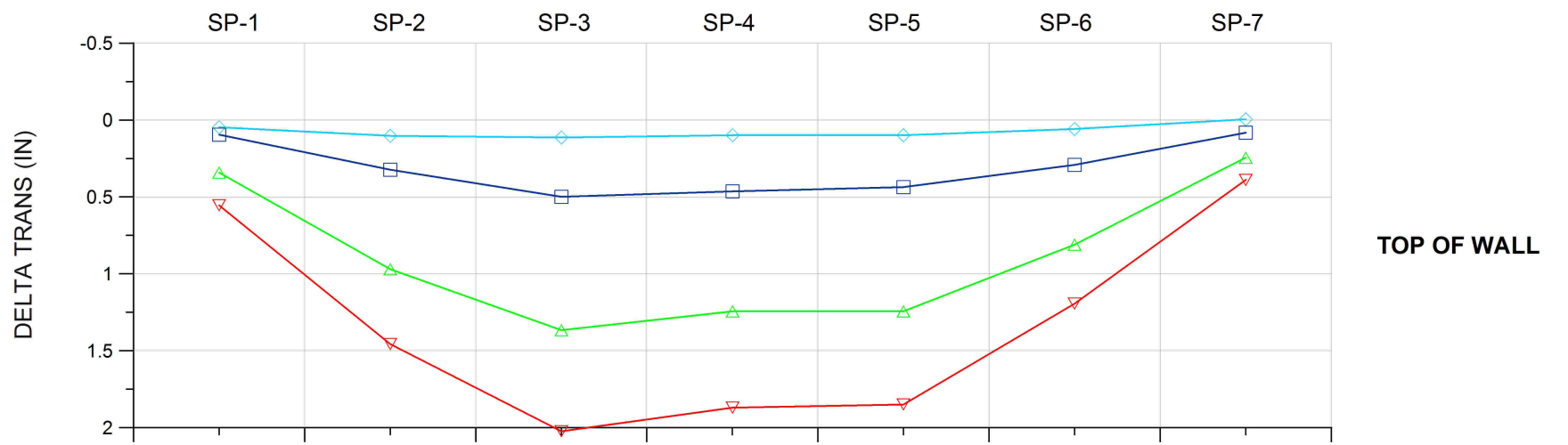

TEST CELL WATER ELEVATION

- ◇— 2 FT - 08/19/2007 19:50:00
- 4 FT - 08/19/2007 15:30:00
- △— 6 FT - 08/21/2007 17:45:00
- ▽— 7 FT - 08/22/2007 19:45:00

Survey Prisms and Monuments
 London Ave Canal Load Test
PHASE I TEST
 FIGURE 4.24

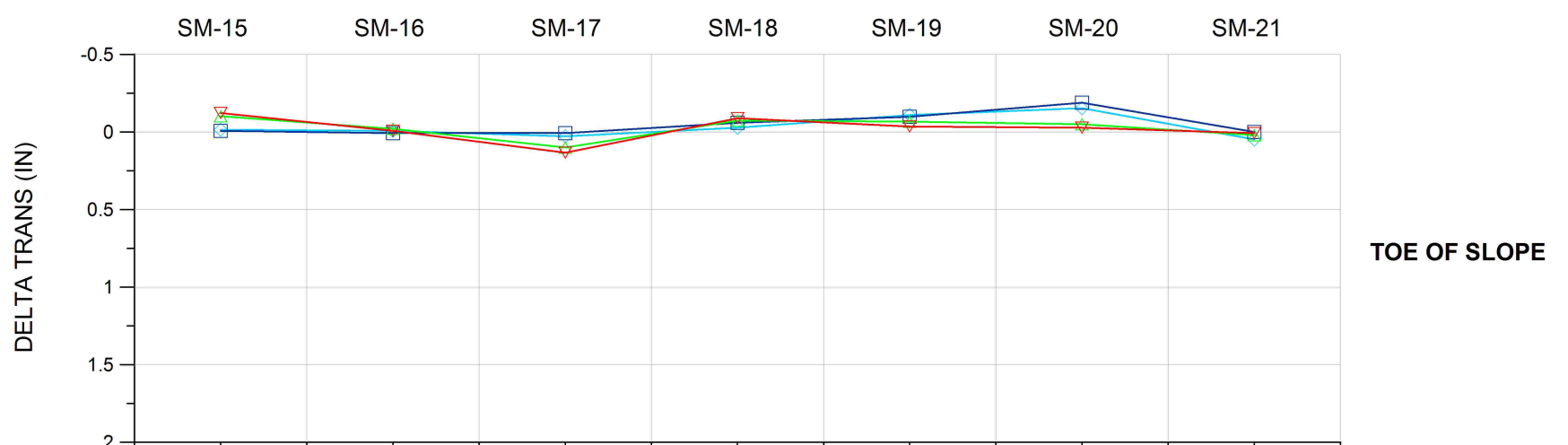
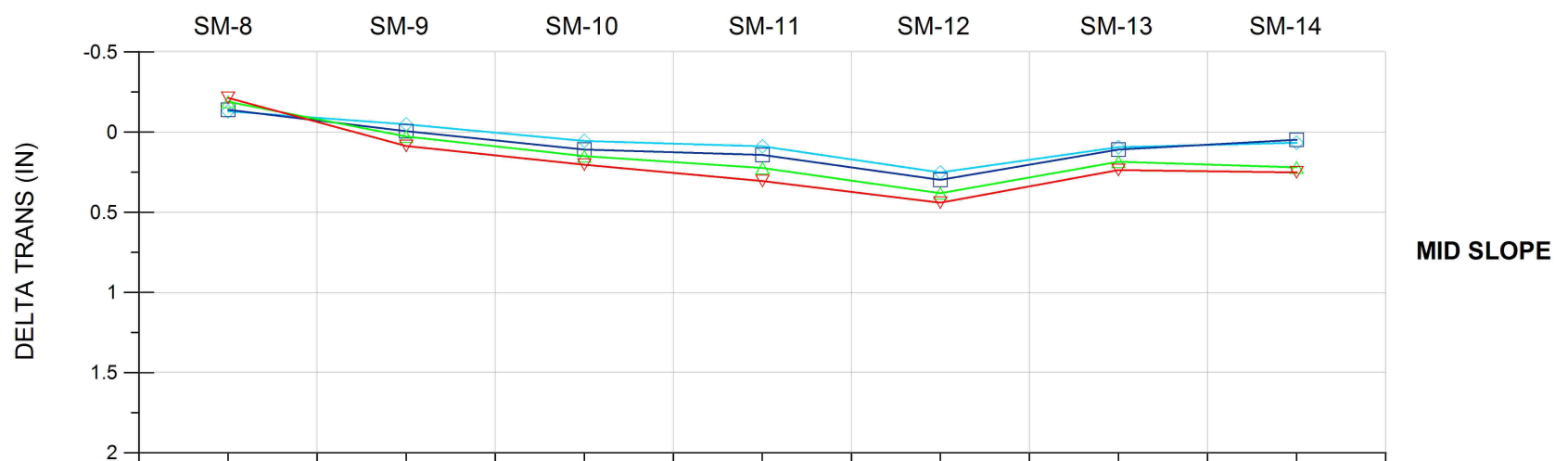
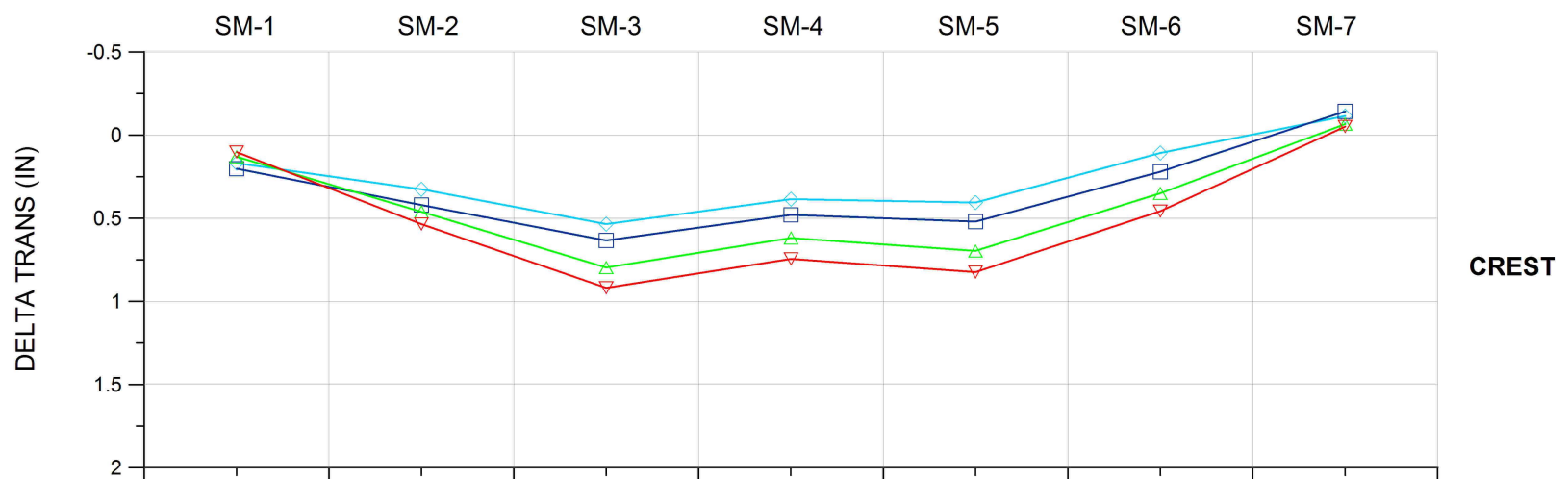
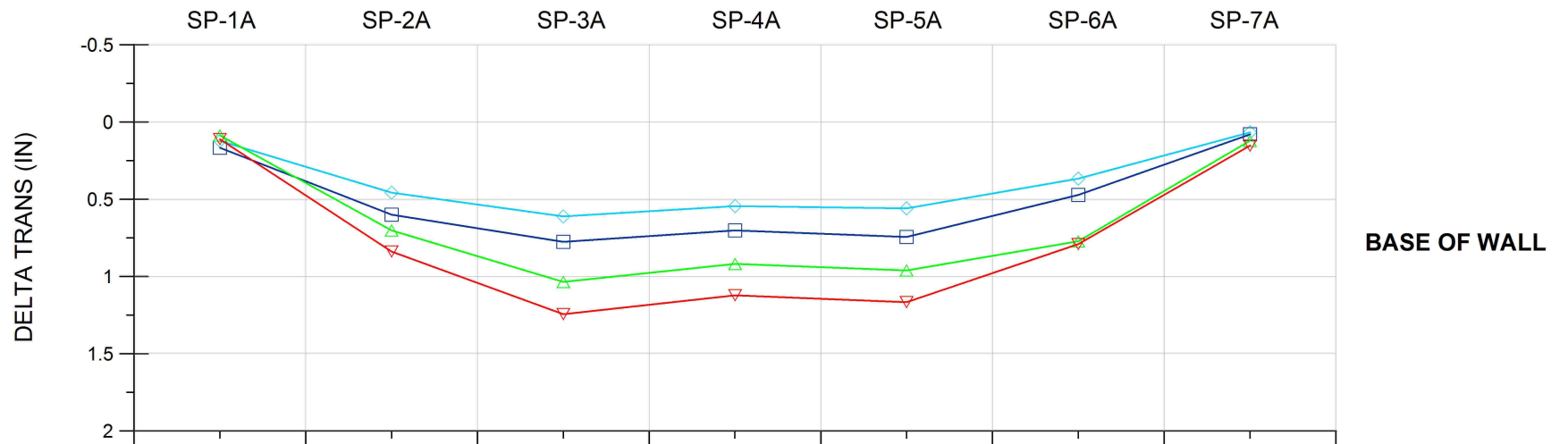
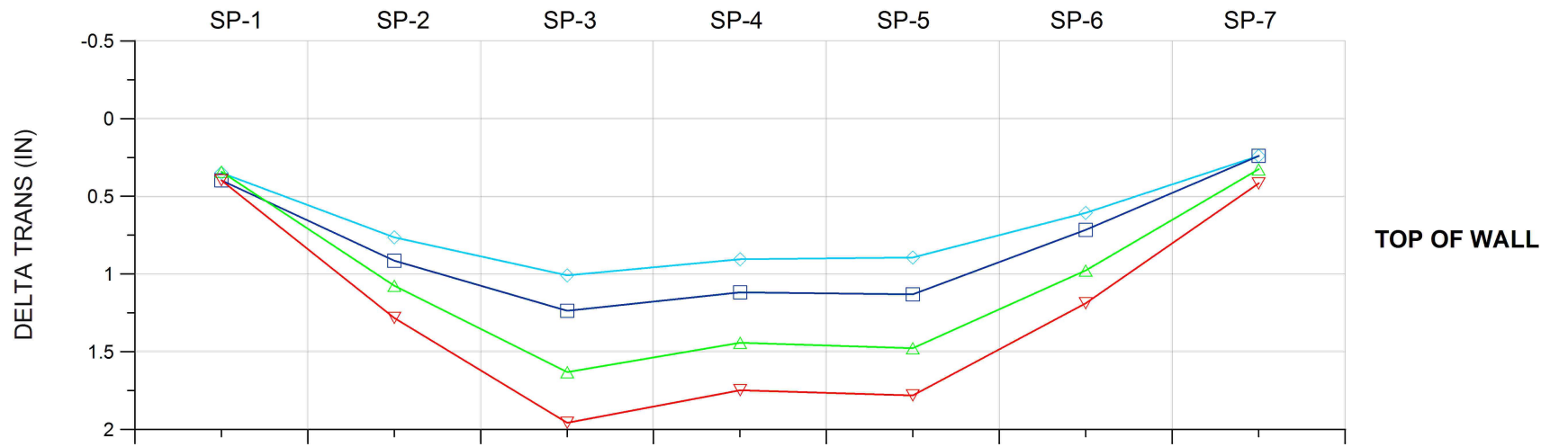

TEST CELL WATER ELEVATION

- ◇— 2 FT - 08/26/2007 15:45:00
- 4 FT - 08/27/2007 16:40:00
- △— 6 FT - 08/28/2007 17:45:00
- ▽— 7 FT - 08/28/2007 22:50:00

Survey Prisms and Monuments
 London Ave Canal Load Test
PHASE II TEST
 FIGURE 4.25

Tilt comparison (TPSvsTiltmeter)

Panel 3

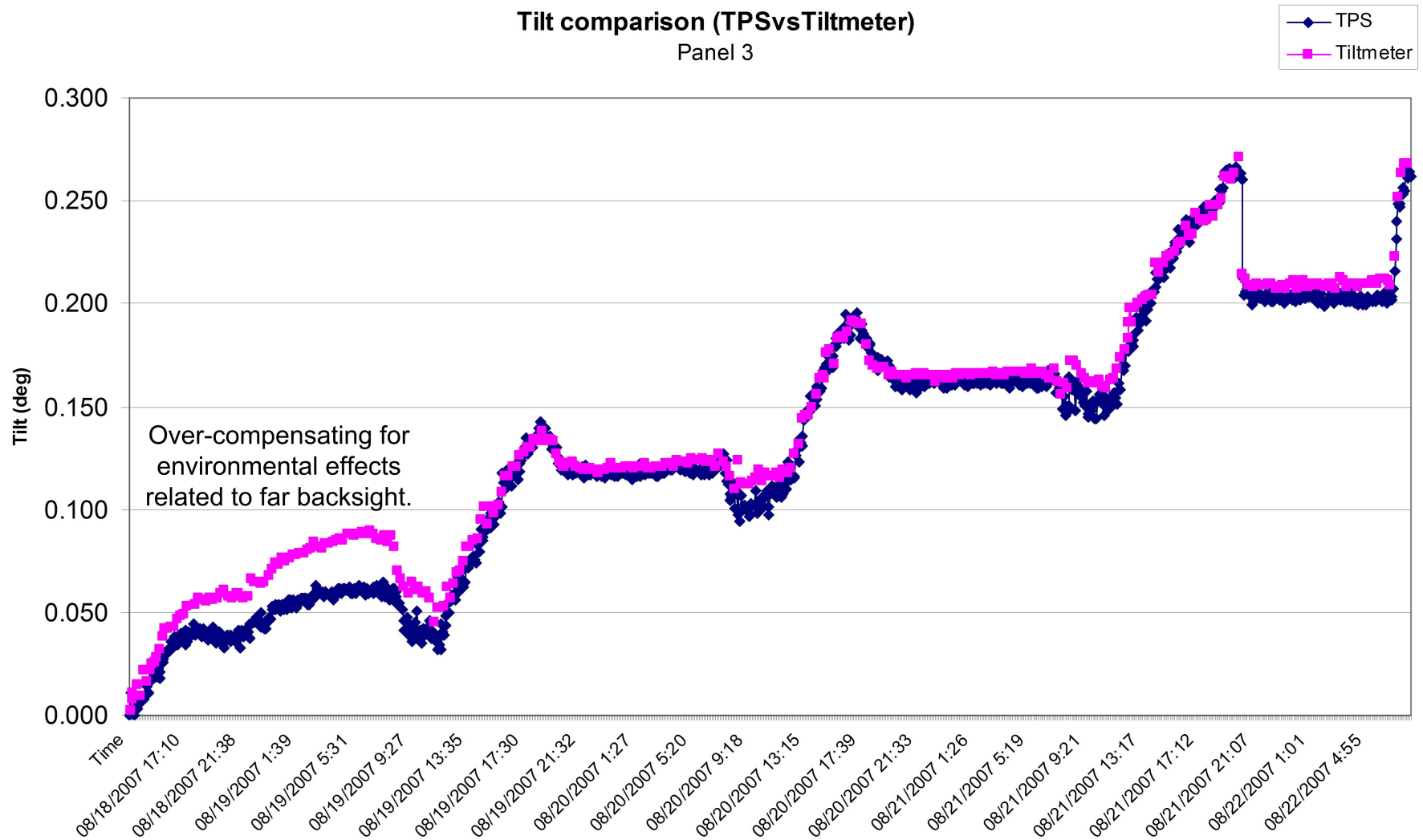

Example of comparison between tilt measured by the survey prisms on the I-Wall versus direct tilt measurements made by vibrating wire tiltmeter TM-3. This plot was generated about mid-way through the Phase I test.

Comparison of Survey Prisms and Tiltmeter (TM-3)
London Ave Canal Load Test
FIGURE 4.26

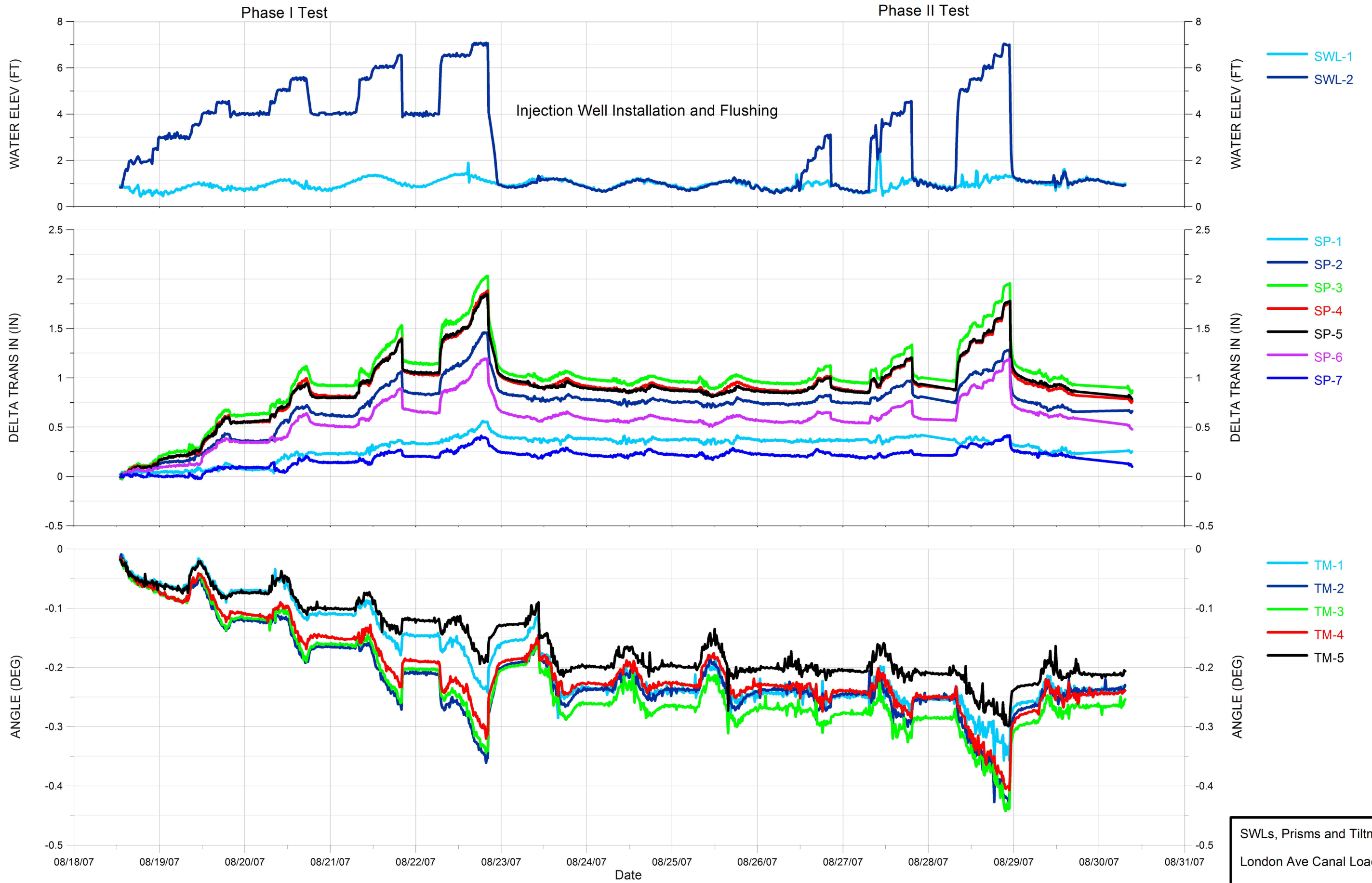

SWLs, Prisms and Tiltmeters
 London Ave Canal Load Test
 FIGURE 4.27

URS was tasked with subcontracting SensaMetrics Corporation to provide wall monitoring using wireless MEMs (micro-electro mechanical systems) type accelerometers. The intent was to evaluate the devices for possible future use. The SensaMetrics tiltmeters were installed 5 feet away from Geokon vibrating wire tiltmeters. The Geokon tiltmeters have a proven track record and could therefore be used to evaluate the SensaMetrics devices.

The final report submitted by SensaMetrics to URS is attached. The observations of the SensaMetrics tiltmeters are contained herein.

The devices installed by SensaMetrics were linked to an ADAS system independent of the rest of the instrumentation. Baseline data was limited. SensaMetrics waited until construction activities had decreased before turning the devices on. It was stated that there was a concern about construction-related vibrations. Once turned on, the data was routinely transferred to a laptop in the field trailer.

Readings from the instruments were transmitted wirelessly to the field trailer. However, electrical power had to be provided to the instruments. SensaMetrics explained that batteries could be used if monitored once or twice a day, but would be insufficient for the nearly constant monitoring required for this project. We understand that the devices can use two D-size batteries if they are programmed to read once or twice a day.

During baseline testing, it became evident that sunlight was affecting the instrument readings. This also occurred with the vibrating wire tiltmeters manufactured by Geokon. Metal shields were installed over the devices so that they would not be exposed to direct sunlight.

The SensaMetrics devices also had to have plastic placed around them to protect them from the rain. Figure 3 of the SensaMetrics Report is a picture of the installed devices prior to plastic covering the installation. It appears that some type of protective enclosure to protect the devices from the weather would be needed if the SensaMetrics devices were installed for long term monitoring.

Data provided from the SensaMetrics devices showed cyclical variations. Although the trends in the data can be followed, SensaMetrics did not provide a discussion of the results. The cyclical nature of the results is more frequent than expected considering normal daily temperature fluctuations.

The Geokon tiltmeters and prisms had excellent correlations when compared to each other. The SensaMetrics data did not have a reasonable correlation with the Geokon tiltmeter or the prisms.

It is a concern that the data obtained from SensaMetrics devices does not have close correlation to the other instruments. SensaMetrics does mention in their report that there are ways for them to obtain temperature corrections. Further development efforts would need to be made.

URS did not visit SensaMetrics facilities. Therefore a true evaluation of their manufacturing capability is not possible. It took several weeks for SensaMetrics to manufacture the 5 devices on site.

At this time we feel that the SensaMetrics devices are still in a developmental stage and as such may not be ready for possible full-scale implementation at this time. We concur that the approach being taken by SensaMetric is valid and that this type of monitoring device has a role in long-term infrastructure monitoring. There are other instrumentation manufacturers that have similar instruments and transmission protocols that would warrant further consideration in addition to SensaMetrics for possible future use in monitoring the I-Wall/levee system.



LONDON AVENUE CANAL
SITE-SPECIFIC LOAD TEST PROJECT
PROJECT No. 215618880
ENTERPRISE ONE No. 163763

SUMMARY SUBCONTRACT REPORT

September 12, 2007

1 Introduction

Sensometrics participated in the New Orleans London Avenue Site Specific Load Test Project as a subcontractor to the URS Corporation. This brief document represents a summary report of the company's project work and is organized as follows.

Section 2 outlines the pretest preparation efforts.

Section 3 presents the activities at the test site and collected tilt data over a nearly two week period.

Section 4 provides a brief summary with recommendations for future enhanced capabilities.

2 Pre-Test Development and Testing

Sensometrics has developed structural monitoring technology based on a wireless network of sensing devices designed to capture and process multi-sensor data. Figure 1 presents key features of the current prototype device.

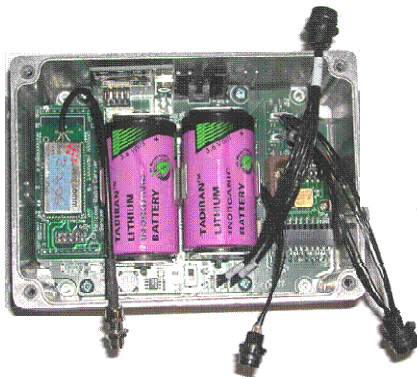

- 802.15.4 ZigBee mesh network radio system
- Instrumentation grade low noise three-axis accelerometer.
- Three-axis strong motion digital accelerometer for extreme event measurements with 2g or 10g upper limit options.
- Programmable strain bridge system containing three common strain resistor values. Accommodates two wire, three wire, half bridge and full-bridge configurations.
- 32 bit RISC CPU for data analysis through standard and custom algorithms. Currently there are two proprietary algorithms based on statistical pattern recognition techniques.
- Autonomous wireless operation for up to 5 years on two D size lithium batteries based on operations schedule consisting of 5 minute collection/analysis events per day and polling the trigger sensor for large event collection.
- Provision for external power to extend battery life or allow more frequent data collection and analysis.
- Up to 512 Mbytes of non-volatile memory to store data.

Figure 1. Key features of prototype device as a node of a wireless network

The pre-test engineering efforts consisted of implementing appropriate modifications and testing to enable Sensametrics' sensing device to perform and collect tilt measurements. The development activities can be described as follows:

- An algorithm was developed to convert vibration data captured by the low-noise accelerometer into tilt measurements. The algorithm was extensively tested in the Matlab environment by comparing algorithmic results with a wired vibration-based tilt meter.
- The provision for using external power was implemented to assure device operation during the site-specific test period.
- The tilt measurement algorithm was embedded in the device computational processor. Furthermore, device firmware changes were made to assure reliability of collection and to achieve as high measurement accuracy as possible.
- PC-based software was developed to serve as the tilt measurement decision support environment. It interacts with the wireless sensing devices through command and control messages. The principal output of this interaction is to accept at periodic time intervals tilt measurements collected by the sensing devices and process, if necessary, and display the data.
- Within the one month period (from the time of receiving a verbal approval to proceed with the subcontract until the actual site-specific test), extensive testing was performed in three areas. First, tilt measurements (this time provided by the devices themselves through the embedded tilt algorithm) continued to be compared with ones produced by a wired-based tiltmeters for correctness of results. Second, sensing devices operated for days to ascertain the reliability of tilt measurement collections and transmissions over extended periods of time. Distances between the devices and the laptop receiving measurement data were compatible with the ones expected at the actual test site. Third, the decision support functions were tested for intended command/control and display performance.
- At the end of the development period, the devices and supporting components were shipped to the London Avenue Canal test site.

It should be pointed out that initially Sensametrics proposed hardware changes to the current device (e.g., different accelerometer, different ADC filters, etc.) with the requisite firmware support to obtain significant tilt measurement accuracy. Because of cost constraints, the current hardware version of the sensing device was used for the tilt measurement system.

3 Site-Specific Load Test and Collection Results

The Sensametrics team at the test site consisted of four individuals – Garo Kiremidjian, Pooya Sarabandi, Allen Cheung and Carlos Cabrera. At any given time from 8/14/07 till 8/30/07 there was at least one person present. For most of this period there were two individuals present at any given time. The test site activities can be described as follows.

- Preparatory work was performed preceding actual installation. This included procuring material (power extension cords; duct tapes, tools, etc.) and waterproofing the devices and the connections between the device power cables and the extension cords.
- The devices were placed in brackets that were attached to the I-wall by URS Corp. field personnel before the arrival of members of the Sensametrics team. Sensametrics greatly appreciated this help. Figure 2 shows the devices with their identification numbers installed on the wall. Figure 3 presents a close-up of a tilt measurement device.

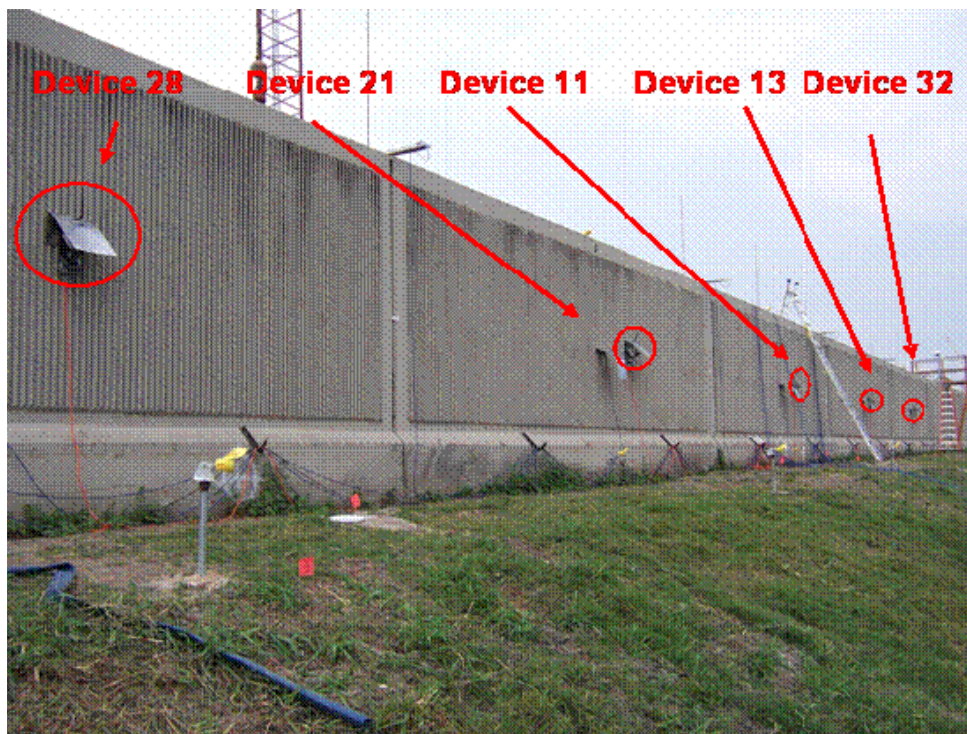

Figure 2. Installed devices



Figure 3. Close-up of an installed device

- The next step was to activate wireless communications. It was determined that having the coordinator antenna inside the trailer would not work. Under this configuration there was no communication between the laptop and the devices. Thus the coordinator antenna had to be placed outside the trailer and connected to the coordinator via a special cable. It turned out that the cable ordered prior to arrival at the test site was defective. Another cable had to be ordered by the manufacturer. Wireless communications between the devices and the laptop were activated by placing the coordinator antenna on the roof of the trailer with the replacement cable and positioning a coordinator next to it. This is presented in Figure 4.

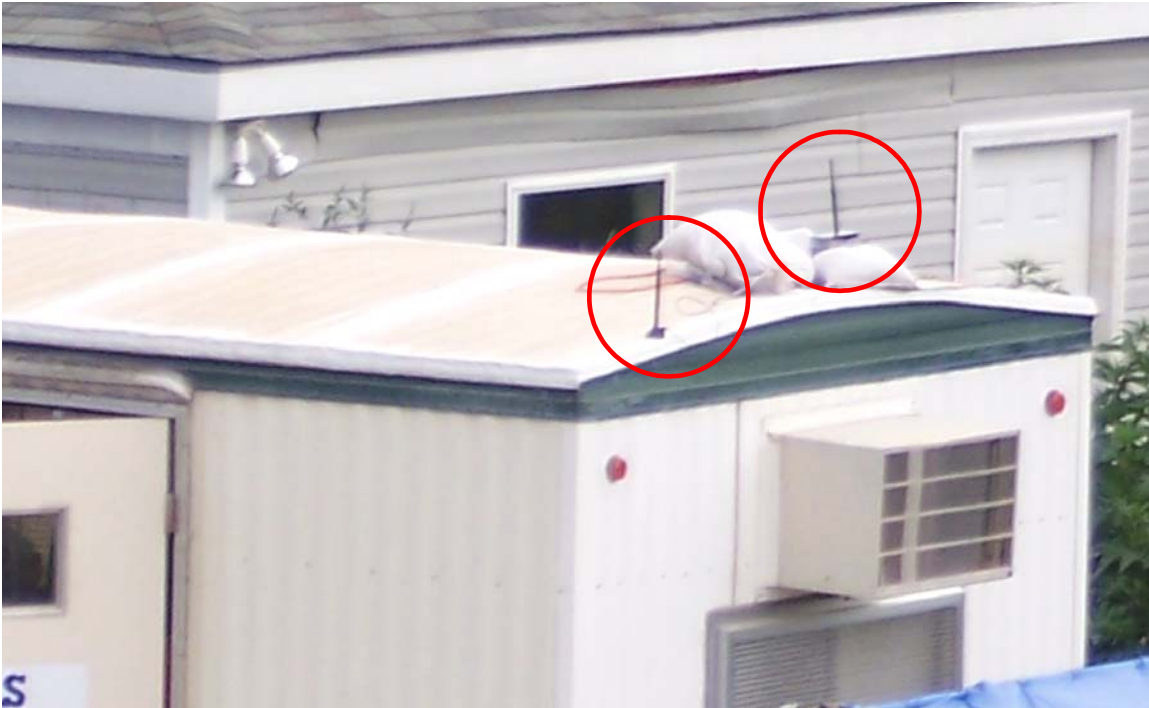

Figure 4. Antenna placement

- Data collection proceeded following the activation of wireless communications. Figure 5 presents the plots from each device for data collected from 8/17/07 till 8/29/07. The duration of each cycle of “vibration data collection”, “tilt processing” and “tilt measurement transmission” was about 5 min. The companion excel document contains the tilt measurement data used for generating the plots. The plots show a constant trend in the tilt measurement for all devices including gradual increase after the beginning of the test and noticeable decrease toward the end of the test period due to unloading the structure. Different device locations tend to provide different tilt measurements. Thus the middle panels have noticeable larger tilt measurements than the end panels. Occasional gaps in the data were due to unexpected laptop problems (registry problems) that necessitated several restarts. It should be pointed out that: (a) the devices themselves operated as intended during the entire collection period; and (b) any tilt measurement, in addition to being transmitted, was also stored on the SD card within the device.

Sensometrics Tilt Measurements

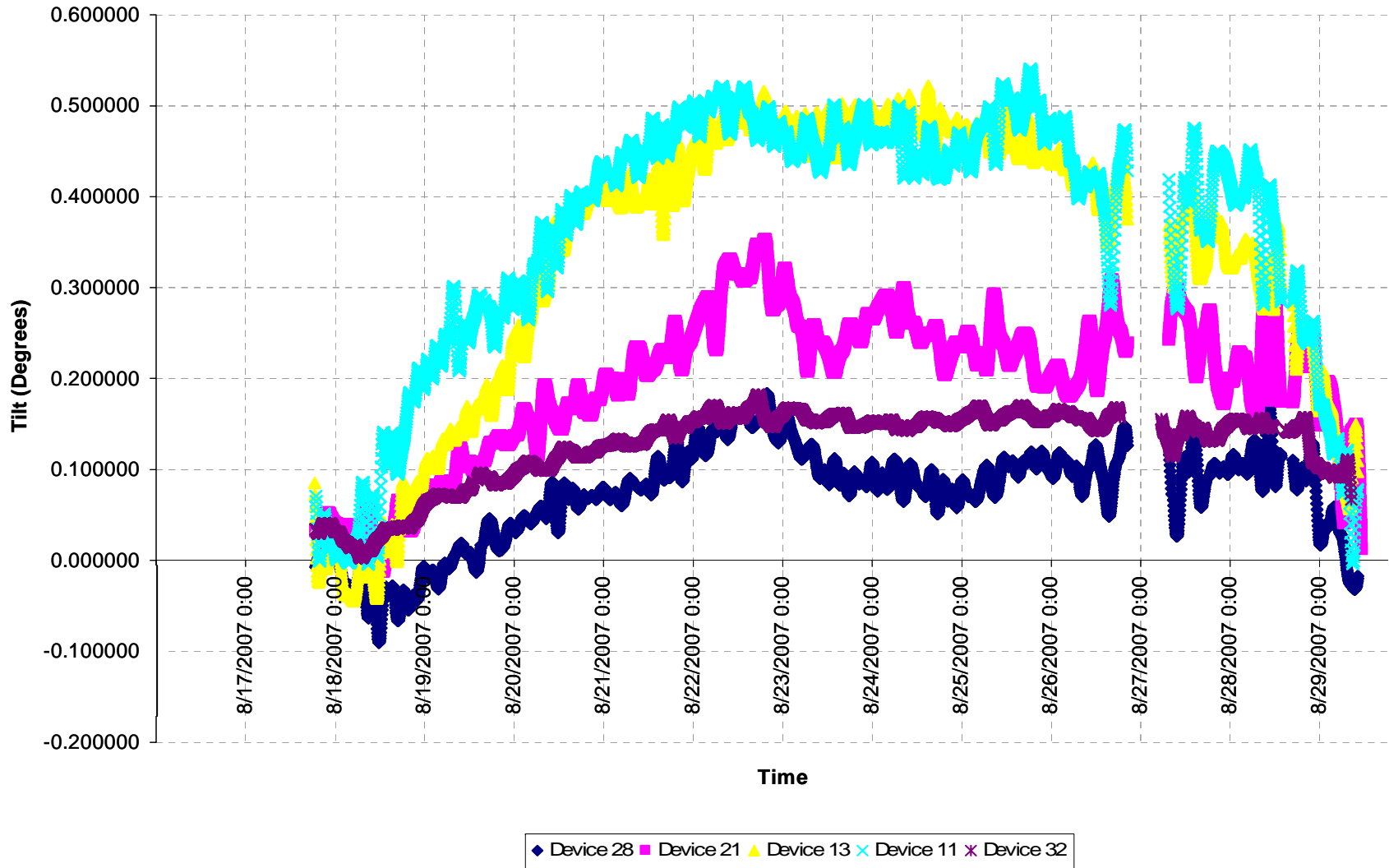

Figure 5. Tilt measurement plots

4 Conclusions

In spite of challenges associated with deploying relatively new technology in a new rather extreme environment, the tilt measurement system performed in accordance with its intended use. The prototype devices operated continuously over a two week period by collecting, processing, storing internally and transmitting tilt estimated based on vibration data without any snags or unexpected problems. The PC-based decision support environment successfully captured and structured the information received by the devices except at the few occasions when the laptop experienced registry-related problems.

Recommended capabilities that can significantly enhance the tilt measurement system as a comprehensive monitoring tool for structures such as levee flood walls are as follows.

- The installation of the wireless sensing devices is a relatively easy task because of elimination of cables. Power cords were the only cables required for the site specific test installation. Depending on required frequency of collection, these can be also eliminated through external battery packs or devices that utilize alternative power sources such as solar energy or thermal differential. The architecture of the devices and, in general, of the entire system would also eliminate the need for specialized data loggers.
- The current version of the Sensametrics device already has the capability to interface to sensors for capturing external temperature and humidity data. Tilt measurement algorithms embedded in the sensing device can be augmented with techniques that take into account possible environmental (e.g., temperature, humidity, etc.) effects on sensor data..
- The architecture of the Sensametrics sensing device allows interfaces to multiple sensors. Through algorithms embedded within the devices themselves, tilt measurements, other vibration-based measurements, strain data and information provided by other sensors can be correlated for effective and robust structural integrity assessments.

Prior to installation of the in-place inclinometer devices, a manual inclinometer probe was used to profile the inclinometer casing. Manual readings were obtained on a 2-foot depth interval. Once Phase II of the test had been completed, the in-place devices were removed and another round of manual inclinometer readings were made.

IPI-1 contained 10 feet of stick-up in order to prevent test water from flowing down the inside of the casing. In order to make manual readings, a ladder had to be used. No data was obtained in the upper 10 feet of casing since it was above the ground surface. IPI-2 and IPI-3 were installed with a surface well casing at the ground surface. It was not possible to properly mount the pulley for manual readings due to the casing constraints. For IPI-2, manual readings were obtained using the pulley frame but not the wheel. For IPI-3, manual readings were obtained with the pulley frame and wheel being on the downhill side of the A axis of the inclinometer casing instead of the uphill side of the casing.

The raw inclinometer data and cumulative displacement plots for each inclinometer are attached. One data set for IPI-2 baseline readings had some data missing. The plots attached have a deflection curve of the second baseline readings and the post-test readings. Since IPI-2 only has one useful set of baseline readings, the plots for IPI-2 only have a deflection curve for the post-test data.

I1 A-Axis

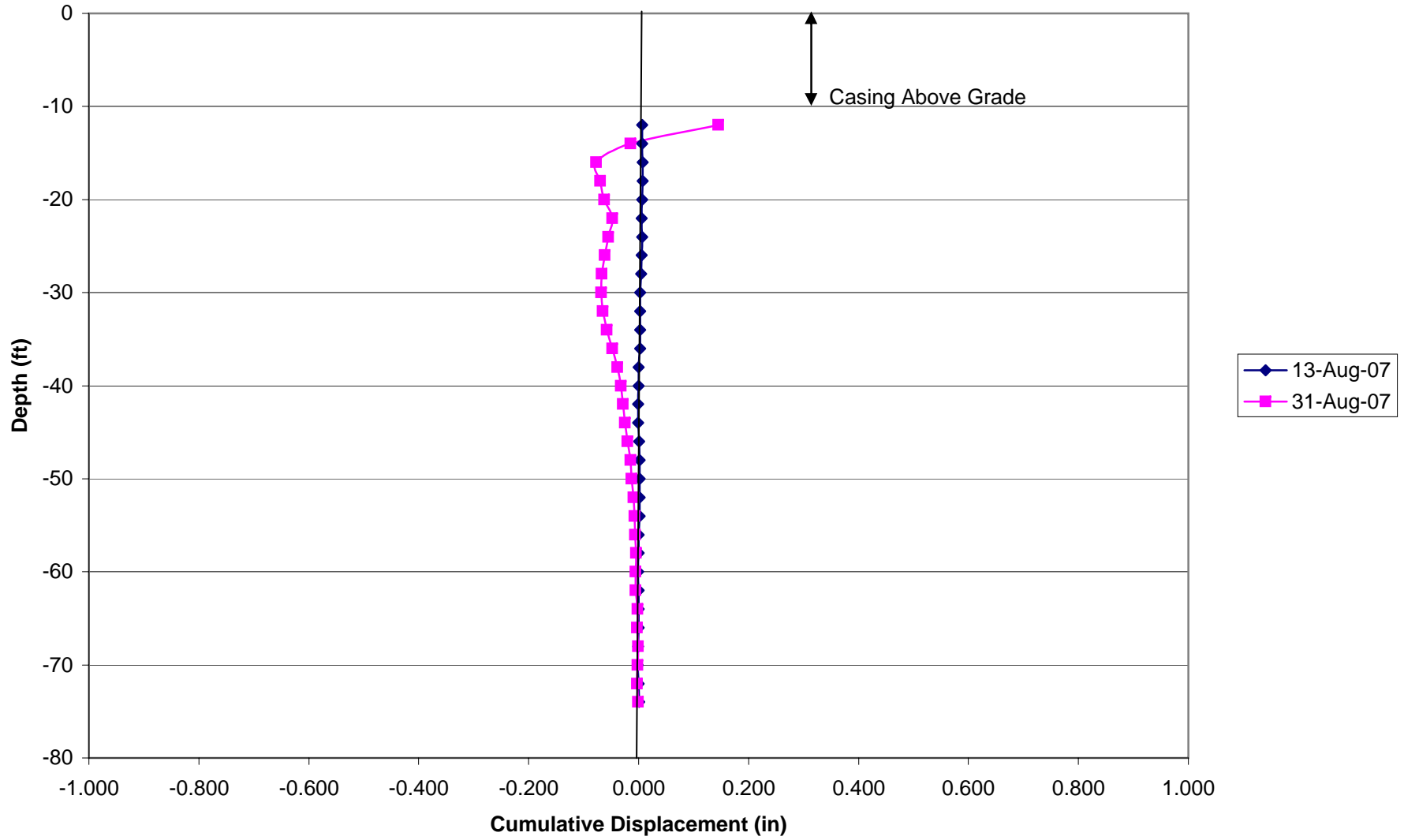

I1 B Axis

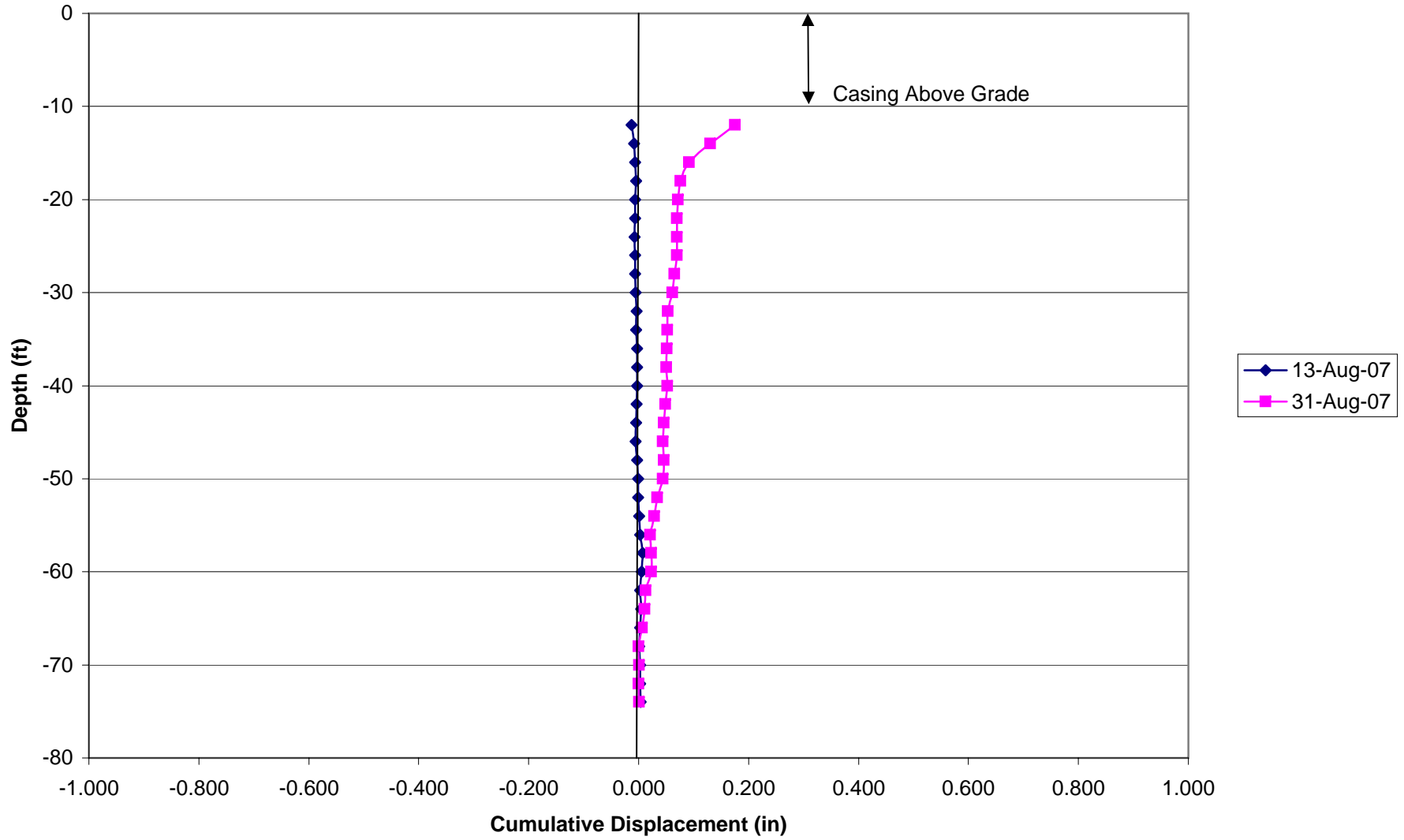

GK 603E(v 05/06);2.0;FORMAT II
PROJECT :LONDON
HOLE NO. :I1
DATE :08/13/07
TIME :10:06:11
PROBE NO.:10G1
FILE NAME:111
#READINGS:32

FLEVEL	A+	A-	B+	B-
74	-224	204	-480	469
72	-169	145	-479	467
70	-51	29	-485	473
68	5	-28	-503	493
66	47	-65	-511	505
64	73	-97	-531	530
62	97	-117	-538	531
60	-27	1	-504	503
58	-21	-4	-507	499
56	-16	-8	-500	492
54	-15	-15	-499	494
52	4	-22	-498	491
50	-38	12	-565	556
48	-31	7	-545	534
46	-25	6	-525	517
44	-26	2	-517	508
42	-50	27	-519	511
40	-49	25	-527	516
38	-94	72	-502	494
36	-140	114	-521	513
34	-186	167	-521	511
32	-212	190	-540	534
30	-91	69	-615	606
28	-119	96	-679	674
26	-162	140	-754	742
24	-139	119	-742	735
22	-144	125	-781	777
20	-140	114	-954	951
18	-91	64	-939	934
16	-86	60	-732	729
14	-156	130	-424	423
12	-198	178	-164	161

GK 603E(v 05/06);2.0;FORMAT II
PROJECT :LONDON
HOLE NO. :I1
DATE :08/13/07
TIME :10:41:07
PROBE NO.:10G1

FILE NAME:211
#READINGS:32

FLEVEL	A+	A-	B+	B-
74	-221	205	-470	473
72	-169	147	-479	469
70	-53	30	-485	473
68	7	-28	-506	493
66	50	-63	-512	500
64	73	-97	-536	523
62	97	-117	-542	530
60	-28	1	-507	495
58	-19	-3	-507	496
56	-15	-7	-506	493
54	-12	-15	-504	492
52	4	-22	-501	491
50	-38	12	-565	556
48	-30	8	-546	537
46	-25	7	-529	517
44	-26	5	-518	506
42	-49	28	-518	510
40	-49	24	-528	513
38	-94	72	-504	493
36	-137	113	-522	512
34	-186	166	-523	512
32	-213	189	-541	531
30	-90	70	-618	606
28	-115	98	-683	672
26	-160	140	-753	742
24	-138	118	-746	734
22	-145	126	-780	775
20	-138	114	-956	949
18	-90	64	-940	930
16	-86	59	-737	727
14	-159	129	-432	419
12	-201	176	-170	162

GK 603E(v 05/06);2.0;FORMAT II
PROJECT :LONDON
HOLE NO. :I1
DATE :08/31/07
TIME :12:41:37
PROBE NO.:10G1
FILE NAME:I1FINAL
#READINGS:33

FLEVEL	A+	A-	B+	B-
74	-223	207	-474	474
72	-169	148	-472	475
70	-48	30	-482	474
68	8	-26	-497	501

66	48	-62	-503	503
64	77	-94	-524	529
62	95	-113	-535	530
60	-26	2	-493	497
58	-17	-2	-503	504
56	-15	-4	-502	493
54	-12	-10	-489	492
52	5	-17	-488	492
50	-40	16	-551	552
48	-29	12	-540	536
46	-26	13	-524	521
44	-27	9	-515	507
42	-50	33	-517	509
40	-49	31	-522	514
38	-98	80	-500	500
36	-143	125	-520	513
34	-193	177	-517	513
32	-217	198	-539	533
30	-90	75	-603	605
28	-113	99	-674	672
26	-155	138	-746	742
24	-132	116	-740	737
22	-137	120	-777	781
20	-150	128	-953	949
18	-96	71	-937	929
16	-92	66	-718	717
14	-101	82	-391	392
12	-67	42	-125	125
10	207	0	474	0

I2 A Axis

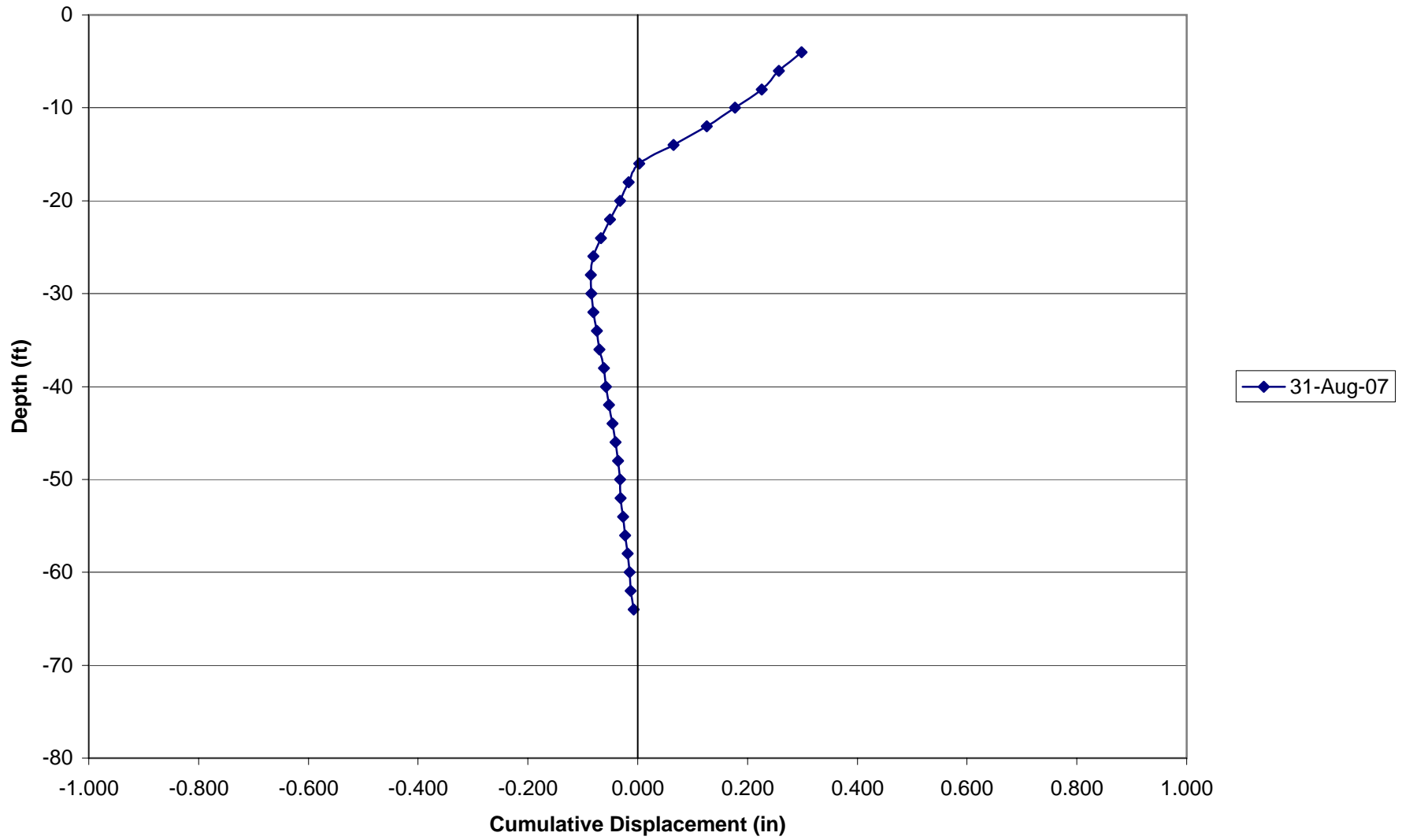

I2 B Axis

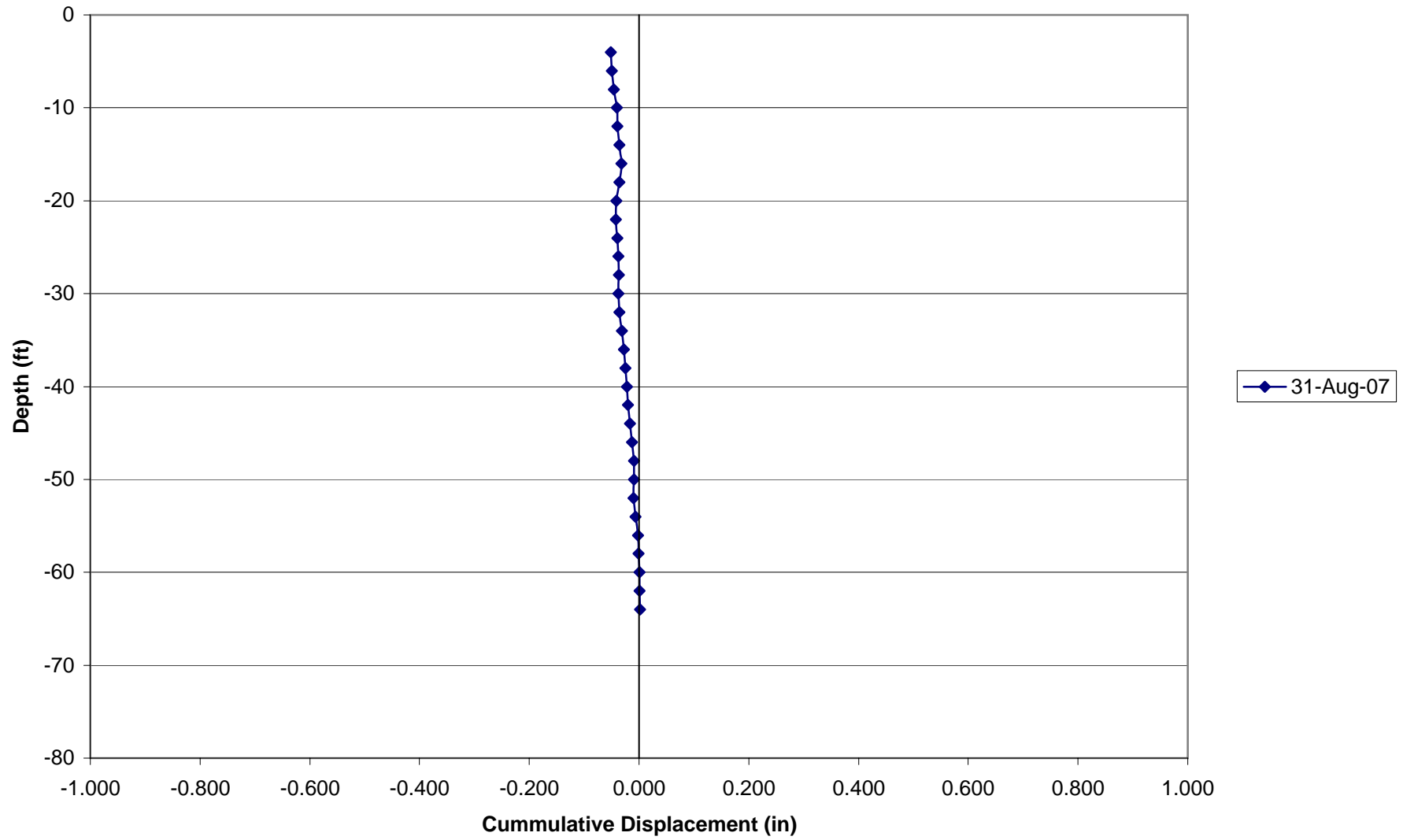

GK 603E(v 05/06);2.0;FORMAT II
PROJECT :LONDON
HOLE NO. :I2
DATE :08/10/07
TIME :19:09:38
PROBE NO.:10G1
FILE NAME:1
#READINGS:31

FLEVEL	A+	A-	B+	B-
64	306	0	151	0
62	318	0	190	0
60	494	0	280	0
58	462	0	286	0
56	431	0	293	0
54	379	380	293	293
52	-370	345	-280	278
50	-341	322	-276	271
48	-343	323	-263	256
46	-335	309	-231	228
44	-351	329	-210	204
42	-379	356	-197	197
40	-401	379	-137	140
38	-425	404	-149	153
36	-423	399	-173	176
34	-420	398	-208	201
32	-420	398	-247	248
30	-322	301	-278	270
28	-318	297	-310	301
26	-320	294	-297	293
24	-346	325	-295	287
22	-361	334	-294	292
20	-426	409	-271	263
18	-434	413	-289	282
16	-422	398	-300	295
14	-451	425	-285	278
12	-492	467	-286	280
10	-552	530	-198	198
8	-586	565	-183	174
6	-613	587	-204	198
4	-640	617	-230	227

GK 603E(v 05/06);2.0;FORMAT II
PROJECT :LONDON
HOLE NO. :I2
DATE :08/11/07
TIME :08:44:59
PROBE NO.:10G1

FILE NAME:2
#READINGS:31

FLEVEL	A+	A-	B+	B-
64	310	-336	151	-150
62	323	-336	192	-199
60	498	-516	282	-279
58	466	-484	286	-293
56	435	-452	292	-300
54	382	-402	298	-300
52	347	-372	279	-283
50	326	-339	272	-278
48	325	-346	256	-265
46	312	-335	227	-234
44	333	-352	208	-213
42	358	-382	194	-198
40	383	-398	134	-140
38	407	-425	147	-151
36	402	-425	171	-171
34	401	-420	205	-211
32	398	-424	248	-248
30	305	-320	271	-280
28	298	-318	305	-308
26	297	-320	293	-298
24	327	-347	287	-294
22	335	-361	294	-297
20	410	-424	268	-272
18	416	-434	283	-289
16	399	-421	299	-302
14	426	-448	280	-287
12	468	-492	280	-287
10	533	-551	201	-206
8	567	-585	177	-185
6	589	-613	201	-206
4	619	-641	233	-230

GK 603E(v05/06);2.0;FORMAT II
PROJECT :LONDON
HOLE NO. :I2
DATE :08/31/07
TIME :13:55:02
PROBE NO.:10G1
FILE NAME:I2FINAL
#READINGS:31

FLEVEL	A+	A-	B+	B-
64	305	-328	158	-146
62	316	-335	190	-199
60	494	-516	280	-281
58	462	-482	284	-293
56	430	-449	295	-295

54	379	-399	294	-297
52	343	-369	278	-277
50	322	-341	272	-279
48	322	-343	262	-260
46	309	-330	228	-227
44	328	-348	206	-209
42	354	-375	193	-193
40	378	-395	134	-137
38	403	-422	145	-147
36	395	-419	168	-170
34	397	-416	201	-209
32	394	-417	243	-245
30	303	-316	269	-280
28	298	-317	303	-311
26	302	-323	294	-295
24	339	-358	286	-292
22	350	-373	293	-294
20	427	-438	270	-271
18	429	-446	287	-294
16	415	-437	301	-306
14	479	-499	276	-285
12	519	-542	278	-283
10	579	-592	201	-204
8	607	-626	176	-177
6	616	-638	199	-203
4	654	-675	228	-231

I-3 A-axis

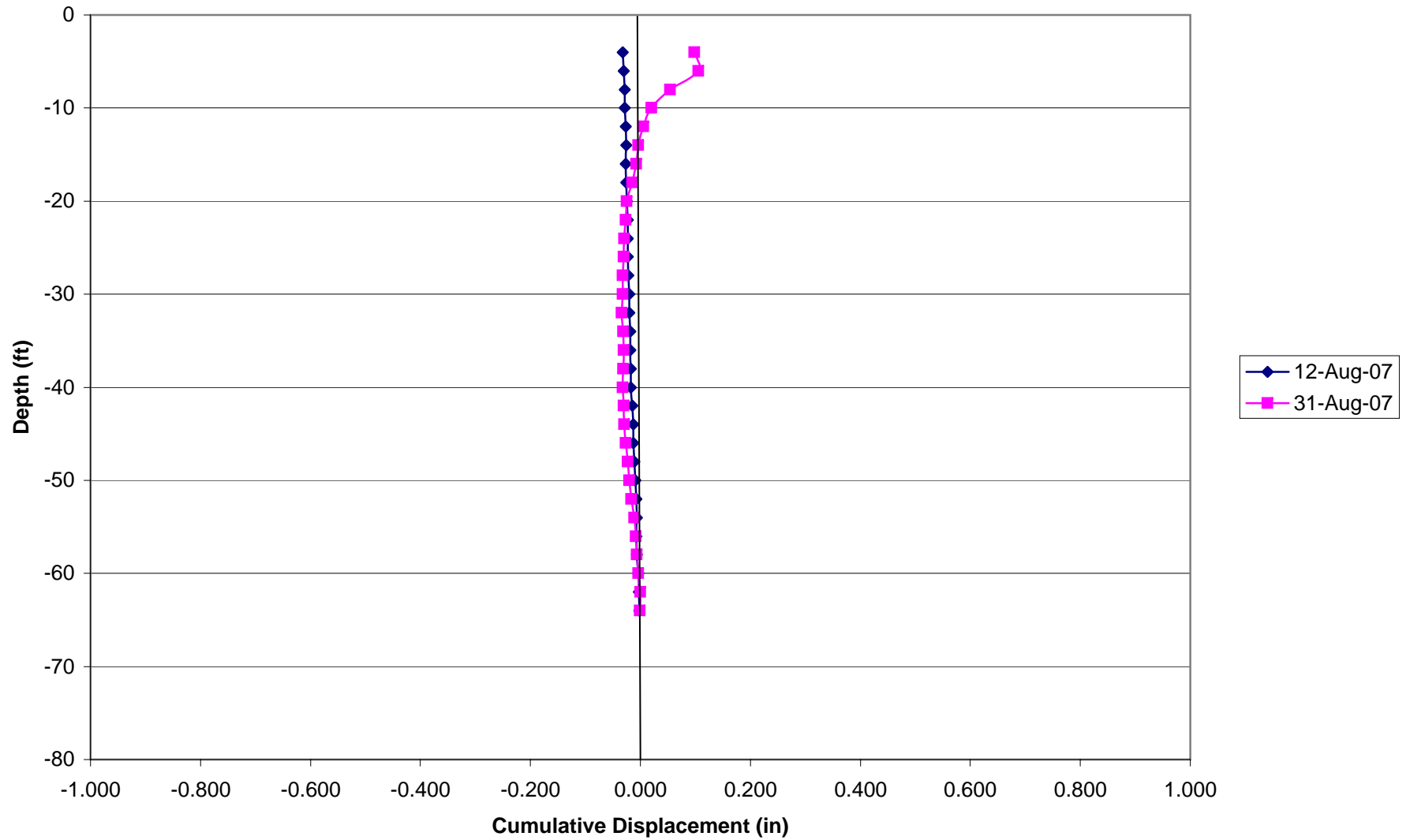

I-3 B Axis

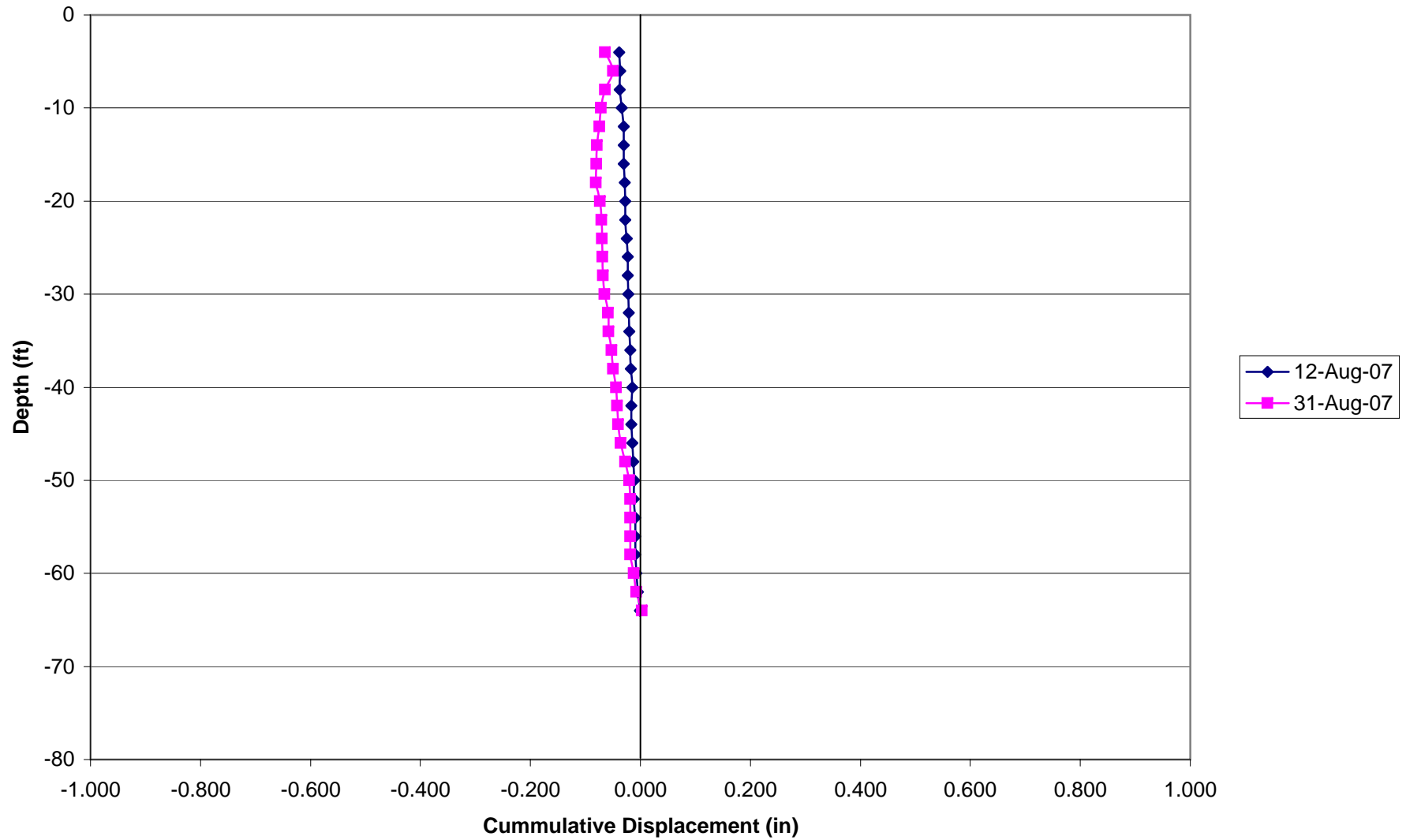

GK 603E(v 05/06);2.0;FORMAT II
PROJECT :LONDON
HOLE NO. :I3
DATE :08/12/07
TIME :09:41:30
PROBE NO.:10G1
FILE NAME:1I3
#READINGS:31

FLEVEL	A+	A-	B+	B-
64	375	-401	473	-478
62	332	-353	453	-458
60	267	-286	624	-633
58	289	-313	622	-631
56	293	-318	606	-614
54	318	-341	622	-627
52	362	-382	643	-651
50	406	-425	653	-661
48	407	-425	656	-666
46	414	-432	676	-683
44	393	-416	703	-712
42	398	-414	716	-728
40	334	-351	750	-760
38	294	-314	734	-744
36	282	-299	755	-764
34	233	-254	762	-772
32	229	-245	738	-745
30	254	-276	692	-699
28	230	-250	663	-669
26	209	-225	676	-686
24	181	-202	711	-718
22	181	-195	697	-704
20	216	-237	732	-736
18	221	-242	729	-736
16	237	-254	708	-714
14	241	-263	687	-695
12	232	-247	662	-671
10	194	-213	843	-850
8	240	-259	868	-872
6	270	-293	928	-937
4	319	-342	932	-935

GK 603E(v 05/06);2.0;FORMAT II
PROJECT :LONDON
HOLE NO. :I3
DATE :08/12/07
TIME :10:03:37
PROBE NO.:10G1
FILE NAME:2I3

#READINGS:31

FLEVEL	A+	A-	B+	B-
64	372	-401	470	-480
62	330	-353	448	-457
60	265	-287	620	-632
58	286	-312	619	-630
56	291	-318	605	-616
54	317	-343	620	-629
52	359	-383	639	-650
50	402	-426	654	-662
48	404	-426	653	-666
46	412	-431	674	-682
44	391	-417	700	-712
42	395	-414	716	-727
40	330	-351	752	-761
38	294	-314	731	-743
36	280	-300	754	-764
34	231	-256	760	-770
32	226	-245	736	-746
30	254	-276	690	-699
28	227	-250	660	-671
26	206	-225	675	-686
24	180	-203	708	-718
22	180	-196	694	-703
20	214	-237	729	-739
18	219	-242	727	-736
16	236	-254	706	-714
14	241	-264	686	-696
12	230	-247	662	-671
10	192	-212	838	-849
8	239	-261	862	-871
6	267	-293	929	-938
4	316	-342	929	-935

GK 603E(v05/06);2.0;FORMAT II

PROJECT :LONDON

HOLE NO. :I3

DATE :08/31/07

TIME :14:26:06

PROBE NO.:10G1

FILE NAME:I3FINAL

#READINGS:31

FLEVEL	A+	A-	B+	B-
64	378	-397	477	-478
62	335	-351	444	-451
60	266	-281	621	-628
58	288	-309	622	-620
56	293	-315	611	-610
54	318	-337	624	-624

52	358	-376	649	-646
50	404	-422	654	-657
48	405	-422	654	-655
46	413	-426	672	-673
44	394	-411	700	-707
42	399	-411	718	-724
40	332	-350	749	-757
38	297	-313	730	-739
36	284	-298	754	-761
34	234	-252	760	-765
32	229	-241	736	-745
30	257	-276	689	-691
28	232	-248	660	-667
26	211	-225	679	-682
24	184	-201	710	-717
22	185	-195	696	-704
20	219	-238	731	-732
18	231	-248	729	-725
16	244	-259	709	-714
14	247	-264	688	-695
12	241	-253	669	-672
10	209	-222	845	-853
8	270	-287	872	-880
6	312	-336	945	-945
4	314	-335	920	-922